



HAL
open science

Rôle de l'activation des cellules “ Natural Killer ” par le “ missing self ” dans la génération de lésions de rejet vasculaire chronique après transplantation d'organe

Alice Koenig

► To cite this version:

Alice Koenig. Rôle de l'activation des cellules “ Natural Killer ” par le “ missing self ” dans la génération de lésions de rejet vasculaire chronique après transplantation d'organe. Immunologie. Université de Lyon, 2018. Français. NNT: 2018LYSE1158 . tel-02176029

HAL Id: tel-02176029

<https://theses.hal.science/tel-02176029v1>

Submitted on 7 Jul 2019

HAL is a multi-disciplinary open access archive for the deposit and dissemination of scientific research documents, whether they are published or not. The documents may come from teaching and research institutions in France or abroad, or from public or private research centers.

L'archive ouverte pluridisciplinaire **HAL**, est destinée au dépôt et à la diffusion de documents scientifiques de niveau recherche, publiés ou non, émanant des établissements d'enseignement et de recherche français ou étrangers, des laboratoires publics ou privés.



N°d'ordre NNT :
2018LYSE1158

THESE de DOCTORAT DE L'UNIVERSITE DE LYON
opérée au sein de
l'Université Claude Bernard Lyon 1

Ecole Doctorale N° ED 340
Ecole Doctorale de Biologie Moléculaire, Intégrative et
Cellulaire

Spécialité de doctorat : Sciences

Discipline : Immunologie

Soutenue publiquement le 21/09/2018, par :

Alice Koenig

**Rôle de l'activation des cellules « Natural
Killer » par le « missing self » dans la
génération de lésions de rejet vasculaire
chronique après transplantation d'organe**

Devant le jury composé de :

Pr. Blancho Gilles, PU-PH, Université de Nantes, Nantes, Président

Dr. Mooney Nuala, Directrice de recherche, CNRS, Paris, Rapporteur
Dr. You Sylvaine, Chargée de Recherche, INSERM, Paris, Rapporteur

Pr. Belot Alexandre, PU-PH, Université Claude Bernard Lyon 1, Lyon, Examinateur
Dr. Charreau Béatrice, Biochimiste, Université de Nantes, Nantes, Examinatrice
Dr. Marçais Antoine, Chargé de Recherche, INSERM, Lyon, Examinateur

Pr. Thaunat Olivier, PU-PH, Université Claude Bernard Lyon 1, Lyon, Directeur de thèse

UNIVERSITE CLAUDE BERNARD - LYON 1

Président de l'Université

Président du Conseil Académique

Vice-président du Conseil d'Administration

Vice-président du Conseil Formation et Vie Universitaire

Vice-président de la Commission Recherche

Directrice Générale des Services

M. le Professeur F. FLEURY

M. le Professeur H. BEN HADID

M. le Professeur D. REVEL

M. le Professeur P. CHEVALIER

M. F. VALLÉE

Mme D. MARCHAND

COMPOSANTES SANTE

Faculté de Médecine Lyon Est – Claude Bernard

Directeur : M. le Professeur G. RODE

Faculté de Médecine et de Maïeutique Lyon Sud – Charles Mérieux

Directeur : Mme la Professeure C. BURILLON

Faculté d'Odontologie

Directeur : M. le Professeur D. BOURGEOIS

Institut des Sciences Pharmaceutiques et Biologiques

Directeur : Mme la Professeure C. VINCIGUERRA

Institut des Sciences et Techniques de la Réadaptation

Directeur : M. X. PERROT

Département de formation et Centre de Recherche en Biologie Humaine

Directeur : Mme la Professeure A-M. SCHOTT

COMPOSANTES ET DEPARTEMENTS DE SCIENCES ET TECHNOLOGIE

Faculté des Sciences et Technologies

Directeur : M. F. DE MARCHI

Département Biologie

Directeur : M. le Professeur F. THEVENARD

Département Chimie Biochimie

Directeur : Mme C. FELIX

Département GEP

Directeur : M. Hassan HAMMOURI

Département Informatique

Directeur : M. le Professeur S. AKKOUCHE

Département Mathématiques

Directeur : M. le Professeur G. TOMANOV

Département Mécanique

Directeur : M. le Professeur H. BEN HADID

Département Physique

Directeur : M. le Professeur J-C PLENET

UFR Sciences et Techniques des Activités Physiques et Sportives

Directeur : M. Y. VANPOULLE

Observatoire des Sciences de l'Univers de Lyon

Directeur : M. B. GUIDERDONI

Polytech Lyon

Directeur : M. le Professeur E. PERRIN

Ecole Supérieure de Chimie Physique Electronique

Directeur : M. G. PIGNAULT

Institut Universitaire de Technologie de Lyon 1

Directeur : M. le Professeur C. VITON

Ecole Supérieure du Professorat et de l'Education

Directeur : M. le Professeur A. MOUGNIOTTE

Institut de Science Financière et d'Assurances

Directeur : M. N. LEBOISNE

REMERCIEMENTS

Au Pr Olivier THAUNAT, mon directeur de thèse

Je te remercie de m'avoir fait confiance pour travailler sur ce sujet important. Je te remercie pour ton encadrement exigeant et toujours positif. Je me réjouis de poursuivre notre collaboration clinique et scientifique, j'espère qu'elle sera longue et fructueuse.

Au Dr Thierry DEFRANCE

Je suis très contente d'avoir fait partie de ton équipe. Je te remercie pour toute l'aide que tu as pu m'apporter au cours de ma thèse. Je te prie d'accepter l'expression de mon plus profond respect et le témoignage de ma sincère reconnaissance.

Au Pr Emmanuel MORELON,

Au cours de mes études, j'ai pu apprécier votre engagement en tant que chef du service de transplantation, ainsi que vos grandes qualités humaines envers les malades et vos collègues. Je suis heureuse de poursuivre notre collaboration clinique et espère toujours être digne de la confiance que vous m'accordez. Soyez assuré de mon plus grand respect.

Aux membres du jury,

Je suis honorée que vous ayez accepté de siéger dans mon jury. Je vous remercie du temps que vous allez consacrer à juger mon travail. Soyez assurés de ma reconnaissance et de mon respect.

Aux Dr Thierry WALZER et Antoine MARCAIS,

Je vous remercie pour toute l'aide que vous m'avez apporté au cours de ma thèse. J'ai apprécié que vous me fassiez profiter de vos grandes compétences dans le domaine des cellules NK. Soyez assurés de mon plus grand respect.

Merci à mes deux petits poulets de m'avoir soutenu et supporté au cours de cette nouvelle thèse.

Merci à toute ma famille,

A mes grands-parents.

A mon petit papa. Je suis triste que tu ne puisses plus être là pour assister à ma thèse.

Je me souviendrais toujours de ton amour de la vie et de ta profonde gentillesse.

A ma petite maman qui profite de la vie !!

A mes sœurs adorées !

A Perceval, mon beau-frère préféré et à Céleste, ma petite nièce chérie.

Merci à ma belle-famille : papi Jacques et mamie Nicole, mamie Cloclo et papi Daniel, Tedo, Miya.

Merci à tous mes amis : la bande des grognasses (Mélanie, Myriam, Marine), François, Thérance, les copines de Master (Caro, Charlotte et Hannah), Max, Carine et les zorzors, Didier et Anastasia,...

Merci à toutes les personnes qui ont participé à cette étude : Maud, Valérie, les techniciens du service d'anapath, les techniciens du labo HLA, les ARCs du service de transplant...

Merci à tous mes potes du labo :

A toi Chien-Chia, avec qui tout a commencé un beau jour de septembre 2012...

Sans toi toutes ces années au labo n'auraient pas été les mêmes ! Merci aussi pour toute l'aide que tu m'as apporté pour mon projet.

A toi Virginie. Merci pour ta bonne humeur permanente, les franches rigolades et bien sûr aussi ta technique hors pair !

A toutes les autres : Antoine, Arnaud, Barbizuth, Carole, David, Dimitri, Emilie, Eric, Guigui, Laurent, Loïc, Ludo, Mathilde, Morgan, Normaxus, Nathalie, Pascal, Paul, Rémy, Suzy...

Résumé

La transplantation d'organe est le meilleur traitement en cas de défaillance terminale d'un organe vital. Cependant, la survie sur le long terme est limitée par la perte inexorable de la fonction des greffons. Cette dernière est attribuée à l'inflammation microvasculaire (IMV) causée par la réponse anticorps contre les alloantigènes (rejet humoral chronique (RHC)).

En analysant une cohorte de 129 transplantés rénaux présentant de l'IMV sur une biopsie de greffon, nous avons trouvé que, dans la moitié des cas, les lésions n'étaient pas médiées par les anticorps. Chez ces patients, des études génétiques ont révélé une prévalence plus élevée de « mismatches » entre les molécules HLA de classe I (HLA-I) du donneur et les « Killer-cell immunoglobulin-receptors » (KIR) inhibiteurs des NK du receveur. Nous avons émis l'hypothèse que la nature allogénique de l'endothélium du greffon pouvait créer un « pseudo-missing-self ». De ce fait, les NK du receveur, exposés à des stimuli inflammatoires, ne reçoivent plus les signaux inhibiteurs transmis par le HLA-I de la part des cellules endothéliales du donneur. Dans un modèle de co-culture de cellules endothéliales et de NK humains, nous avons démontré que l'absence d'un ligand HLA-I du soi sur la cellule endothéliale peut activer les NK. Cette activation dépend de la voie mTOR dans les NK, qui peut être bloquée par la rapamycine, un inhibiteur de mTORC1 disponible en clinique. Enfin, nous avons confirmé l'existence de rejets NK induit par le « missing-self » et leur sensibilité à la rapamycine dans un modèle murin de transplantation cardiaque.

Notre travail identifie un nouveau type de rejet chronique, exclusivement médié par l'immunité innée, les NK, ayant le même impact délétère sur la survie des greffons que le RHC. Cependant, alors qu'il n'y a pas de traitement disponible pour le RHC, les inhibiteurs de mTOR préviennent efficacement le développement de lésions dans un modèle murin de rejet vasculaire chronique induit par le « missing-self ».

Mots-clés : transplantation, rejet chronique vasculaire, cellule NK, KIR inhibiteur, « missing-self », inhibiteurs de mTOR.

Abstract

Missing self triggers NK cell-mediated chronic vascular rejection of solid organ transplants

Organ transplantation is the best treatment for terminal organ failure. However, long-term outcome of organ transplantation remains limited by inexorable loss of graft function, which the prevalent dogma links to the microvascular inflammation (MVI) triggered by the recipient's antibody response against alloantigens (antibody-mediated chronic rejection, AMR).

Analysing a cohort of 129 renal transplant patients with MVI on graft biopsy, we found that, in half of the cases, histological lesions were not mediated by antibodies. In these patients, genetic studies revealed a higher prevalence of mismatches between donor HLA-I and inhibitory Killer-cell immunoglobulin-receptors (KIR) of recipient's NK cells. We hypothesized that the allogeneic nature of graft endothelium could create a "pseudo-missing self" situation, thereby the recipient's NK cells exposed to inflammatory stimuli would not receive HLA I-mediated inhibitory signals from donor endothelial cells. In co-culture experiments with human NK cells and endothelial cells, we demonstrated that the lack of self HLA-I on endothelial cells can activate NK. This activation triggers mTOR pathway in NK, which can be blocked by rapamycin, a commercially available inhibitor of mTORC1. Finally, we confirmed the existence of missing self-induced rejection and its sensitivity to mTOR inhibition in a murine heart transplantation model.

Our work identifies a new type of chronic rejection, exclusively mediated by innate NK cells, with the same detrimental impact on graft survival as AMR. However, while no therapy is available for AMR, mTOR inhibitors efficiently prevent the development of lesions in murine models of NK cell-mediated chronic vascular rejection.

Keywords: transplantation, chronic vascular rejection, NK cell, inhibitory KIR, missing self, mTOR inhibitors.

Table des matières

LISTE DES ABREVIATIONS	10
TABLE DES ILLUSTRATIONS (ARTICLES NON INCLUS)	12
PREAMBULE	13
I. INTRODUCTION	13
1. Immunopathologie du rejet d'allogreffe : une perspective historique	13
1.1. Vision centrée sur les lymphocytes T.....	13
1.1.1. Origine de la vision centrée sur les lymphocytes T.....	13
1.1.2. Alloreconnaissance lymphocytaire T.....	14
1.1.2.1. Cibles moléculaires de l'alloreconnaissance lymphocytaire T.....	14
1.1.2.2. Différentes voies de présentation des alloantigènes	15
1.1.2.2.1. Voie de présentation directe	15
1.1.2.2.2. Voie de présentation indirecte.....	18
1.1.3. Mécanismes effecteurs du rejet cellulaire	18
1.2. Emergence de la « théorie humorale » dans le rejet d'allogreffe.....	21
1.2.1. Identification des rejets humoraux après transplantation d'organe.....	21
1.2.2. Cibles moléculaires du rejet humoral	23
1.2.2.1. Les antigènes mineurs d'histocompatibilité	23
1.2.2.2. Les autoantigènes non polymorphes.....	23
1.2.3. Mécanismes moléculaires impliqués dans la génération des alloanticorps.....	25
1.2.4. Mécanismes effecteurs du rejet humoral	27
2. Les cellules NK	30
2.1. Caractéristiques générales des cellules NK.....	30
2.2. Origine et maturation des cellules NK.....	30
2.3. Le répertoire des récepteurs des cellules NK	32
2.3.1. Généralités.....	32
2.3.2. Cas particuliers des récepteurs KIR.....	34
2.3.2.1. Les gènes KIR	34
2.3.2.2. Les récepteurs KIR.....	35
2.4. Education des cellules NK	37
2.4.1. La théorie de l'éducation	37
2.4.2. L'éducation : un processus plastique	40
2.5. Activation des cellules NK.....	40

2.6.	Rôle de la voie mTOR dans l'éducation et l'activation des cellules NK	42
2.7.	Fonctions des cellules NK.....	44
2.7.1.	Cytotoxicité envers les cibles infectées et tumorales	44
2.7.1.1.	La voie perforine-granzymes	44
2.7.1.2.	La voie impliquant les récepteurs de mort.....	45
2.7.2.	Fonctions immunomodulatrices.....	46
II.	OBJECTIFS DU TRAVAIL DE THESE.....	49
III.	RESULTATS	51
IV.	DISCUSSION	124
1.	Synthèse.....	124
2.	Rôle de l'activation des cellules NK par le « missing self » dans l'initiation de rejets.....	124
3.	Mécanismes impliqués dans les rejets vasculaires chroniques des patients sans « missing self »	126
3.1.	Existence d'anticorps spécifiques du donneur non détectés	126
3.2.	Activation des cellules NK par la reconnaissance du « soi induit »	127
3.3.	Implication d'autres cellules de l'immunité innée : les monocytes	128
4.	Facteurs impliqués dans le développement de rejet NK/MS.....	130
V.	PERSPECTIVES	132
1.	Dépistage des patients transplantés rénaux à risque de présenter un rejet NK/MS.....	132
2.	Traitement des patients transplantés rénaux présentant un rejet NK/MS	134
VI.	CONCLUSIONS	138
VII.	REFERENCES BIBLIOGRAPHIQUES (ARTICLES NON INCLUS)	139
VIII.	ANNEXES	160
	Annexe 1 : Lymphoid neogenesis and tertiary lymphoid organs in transplanted organs.....	161
	Annexe 2 : CD4+ T cell help is mandatory for naive and memory donor-specific antibody responses: impact of therapeutic immunosuppression.....	171
	Annexe 3 : Recent advances in renal transplantation: antibody-mediated rejection takes center stage	186
	Annexe 4 : High mTOR activity is a hallmark of reactive natural killer cells and amplifies early signaling through activating receptors	197

Annexe 5 : brevet n° 17306154.0 déposé le 6 septembre 2017 « Method for predicting the risk of transplant rejection ».....	219
Annexe 6 : lettre d'intention du protocole STARR.....	261

LISTE DES ABREVIATIONS

ACT	« Activating »
ADCC	« Antibody-dependent cell-mediated cytotoxicity »
AMR	« Antibody-mediated rejection »
APAF-1	« Apoptotic-protease-activating-factor-1 »
APC	« Antigen presenting cell »
APE1	« Apurinic endonuclease 1 »
$\beta 2$ micro ^{-/-}	« $\beta 2$ microglobulin knock-out »
BAT3	« Human leukocyte antigen-B-associated transcript 3 »
BCR	« B cell receptor »
BID	« BH3-interacting domain death agonist »
CMH	Complexe majeur d'histocompatibilité
CMV	Cytomégalovirus
cNK	« Conventional NK cell »
CONV	« Convertase »
CPA	Cellule présentatrice de l'antigène
CPT	Capillarite péri-tubulaire
CRD	« Carbohydrate recognition domain »
CYT C	« Cytochrome c »
DC	« Dendritic cell »
DISC	« Death-inducing signaling complex »
DR	« Death receptor »
FADD	« Fas-associated death domain »
G	Glomérulite ou « glomerulitis »
GA	« Granzyme A »
GB	« Granzyme B »
GVHD	« Graft versus host disease »
GVL	« Graft versus leukemia »
H	« Human »
HLA	« Human leukocyte antigen »
iDC	« Immature dendritic cell »
IFNAR	« Interferon- α/β receptor »
Ig	Immunoglobuline
IL	Interleukine
ILC	« Innate lymphoid cell »
INF- γ	Interféron- γ
INH	« Inhibitory »
ITAM	« Immunoreceptor tyrosine-based activation motif »
ITIM	« Immunoreceptor tyrosine-based inhibitory motif »
KIR	« Killer-cell immunoglobulin-receptor »
L	« Long »
LAIR	« Leukocyte-associated inhibitory receptor »
LILR	« Leukocyte immunoglobulin-like receptor »
LRC	« Leukocyte receptor complex »
M	« Mouse »
mAb	« Monoclonal antibody »
MAC	« Membrane attack complex »
MALT	« Mucosal-associated lymphoid tissue »

mDC	« Mature dendritic cell »
MHC	« Major histocompatibility complex »
MICA/B	« MHC class I-related A/B »
MPA	« Mycophenolic acid »
mTOR	« Mammalian target of rapamycin »
MVI	« Microvascular inflammation »
NCR	« Natural cytotoxic receptor »
NK	« Natural killer »
pDC	« Plasmacytoid dendritic cell »
PTC	« Peritubular capillaritis »
RAG ^{-/-}	« Recombination activating gene knock-out »
S	« Short »
SCID	« Severe combined immunodeficiency »
SIRP α	« Signal regulatory protein α »
SNP	« Single nucleotide polymorphism »
T	« T cell »
TCR	« T cell receptor »
TLR	« Toll-like receptor »
TNF- α	« Tumor necrosis factor- α »
TRAIL	« TNF-related apoptosis-inducing ligand »
ULBP	« UL-16-binding-protein »

TABLE DES ILLUSTRATIONS (articles non inclus)

Figure 1. Voies de présentation des alloantigènes aux lymphocytes T	16
Figure 2. Mécanismes impliqués dans l'alloreconnaissance directe	17
Figure 3. Voie de présentation semi-directe.....	20
Figure 4. Modes d'action des principaux immunosuppresseurs ciblant les lymphocytes T	21
Figure 5. Physiopathologie du rejet humoral	29
Tableau 1. Les stades de développement des cellules NK humaines dans les organes lymphoïdes secondaires.....	32
Figure 6. Récepteurs des cellules NK	33
Figure 7. Représentation schématique des haplotypes A et B au locus KIR	35
Figure 8. Variégation des récepteurs KIR à la surface des cellules NK.....	36
Figure 9. Les récepteurs KIR et leurs ligands HLA	37
Figure 10. Théorie du désarmement	38
Figure 11. Modèle du rhéostat	39
Figure 12. Différents modes d'activation des cellules NK	41
Figure 13. La voie mTOR/Akt, rhéostat moléculaire de la réactivité de la cellule NK	43
Figure 14. Mécanismes impliqués dans la cytotoxicité des cellules NK.....	46
Figure 15. Modulation de la réponse lymphocytaire T par les cellules NK.....	48
Figure 16. Activation des cellules NK par la reconnaissance d'un « pseudo-missing self » après une transplantation d'organe	50
Figure 17. Activation des monocytes du receveur suite à la détection d'un polymorphisme de SIRP α	130
Figure 18. Cas d'un patient transplanté cardiaque présentant un rejet NK/MS	135
Figure 19. Cas d'un patient transplanté rénal présentant un rejet NK/MS	137

PREAMBULE

La transplantation d'organe est le seul recours pour les patients présentant une défaillance terminale du cœur, des poumons ou du foie. Elle est également la meilleure option thérapeutique en cas d'insuffisance rénale terminale. La transplantation d'un organe provenant d'un donneur de la même espèce mais génétiquement différent induit la reconnaissance par le système immunitaire du receveur des déterminants antigéniques spécifiques du donneur (alloantigènes). La réponse alloimmune qui se développe contre les alloantigènes est responsable de lésions tissulaires qui conduisent à la perte du greffon, un processus désigné par le terme de rejet d'allogreffe. Au XX^{ème} siècle, des progrès importants dans la compréhension des mécanismes immunologiques impliqués dans les rejets ont été réalisés : identification des rejets cellulaires puis des rejets humoraux. Parallèlement, des traitements immunosuppresseurs pour prévenir la survenue de ces rejets ont été développés. En contrôlant les rejets cellulaires, ces traitements ont permis d'améliorer la survie à court terme après la transplantation. En revanche, la perte des greffons sur le long terme qui est majoritairement attribuée aux rejets humoraux reste le principal obstacle à la transplantation. Outre l'efficacité limitée des traitements immunosuppresseurs pour traiter les rejets humoraux, ceci suggère aussi qu'il est possible que certains mécanismes immunologiques responsables de rejets chroniques nous échappent. Dans ce travail, il nous a donc paru intéressant d'essayer de mieux comprendre les mécanismes immunologiques du rejet chronique.

I. INTRODUCTION

1. Immunopathologie du rejet d'allogreffe : une perspective historique

1.1. Vision centrée sur les lymphocytes T

1.1.1. Origine de la vision centrée sur les lymphocytes T

Au début de XX^{ème} siècle, plusieurs équipes à travers le monde se sont essayées à la transplantation rénale mais se sont heurtées à des dysfonctions précoces des organes en raison de rejets. Il a fallu attendre la seconde guerre mondiale pour que Peter Medawar, jeune zoologiste anglais, établisse le caractère immunologique du rejet. Ce dernier a fait cette découverte en s'intéressant au devenir

des greffes de peau utilisées pour soigner les aviateurs victimes de brûlures. Il s'est rendu compte que chez l'homme une greffe de peau d'un donneur génétiquement différent était rejetée (contrairement à une autogreffe) et que ce rejet survenait plus rapidement si le receveur avait déjà reçu une première greffe de peau du même donneur (1). Afin de mieux comprendre ce phénomène, il a conduit des études extensives dans un modèle de greffe de peau allogénique chez le lapin et a mis en évidence la présence de leucocytes dans les greffons rejetés (2–4). Le Dr Mitchison a confirmé dans un modèle murin de greffe de tumeur allogénique que les cellules lymphoïdes étaient directement responsables du rejet d'allogreffe. Il a constaté que l'immunité envers une tumeur allogénique greffée pouvait être transférée à une autre souris d'une même lignée par l'injection des cellules du ganglion drainant (mais pas par le transfert du sérum contenant les anticorps) (5,6). L'année suivante, Billingham, Brent et Medawar ont confirmé les données de Mitchison dans un modèle murin de greffe de peau (7). Ils ont alors utilisé le terme « d'immunité adoptive ». Ces études ont démontré l'importance de l'alloimmunité cellulaire dans le rejet d'allogreffe, mais le rôle des lymphocytes comme cellule immunologiquement active était toujours incertain. En 1957, Gowans a ajouté une pierre à l'édifice en constatant que les lymphocytes étaient des cellules mobiles qui avaient la capacité de recirculer du sang à la lymphe et de la lymphe au sang. Ceci a confirmé qu'ils pouvaient ainsi migrer jusqu'au greffon pour y occasionner des lésions (8). Enfin, Miller a démontré que des souris thymectomisées, qui présentaient une déplétion profonde en lymphocytes T, n'étaient pas capables de rejeter une greffe de peau (9). A la même époque, chez l'homme, la première transplantation rénale allogénique à partir d'un donneur vivant HLA semi-identique a été réalisée par Jean Hamburger en 1952 (10). En l'absence d'immunosuppression, le greffon a été rejeté au bout de 21 jours et son analyse histologique a montré une infiltration massive par des lymphocytes T. Dans ce contexte, les lymphocytes T ont été unanimement reconnus comme les seuls effecteurs impliqués dans les rejets survenant après une transplantation d'organe.

1.1.2. Allorecognition lymphocytaire T

1.1.2.1. Cibles moléculaires de l'allorecognition lymphocytaire T

Les molécules du complexe majeur d'histocompatibilité (CMH) ou système HLA (pour « human leukocyte antigen ») chez l'homme qui diffèrent entre le donneur et le

receveur sont la cible de la réponse alloimmune cellulaire en raison de leur caractère hautement polymorphe et leur expression universelle à la surface des cellules. Les molécules du CMH de classe I (HLA-A, B, C chez l'homme) sont exprimées à la surface de la quasi-totalité des cellules nucléées de l'organisme. Les molécules du CMH de classe II (HLA-DR, DP, DQ chez l'homme) sont exprimées uniquement à la surface des cellules présentatrices de l'antigène (cellules dendritiques, macrophages, monocytes, lymphocytes B) et leur expression est modulée par l'inflammation. Certaines cellules, notamment les cellules endothéliales et les cellules parenchymateuses du greffon, peuvent exprimer les molécules du CMH de classe II dans un contexte inflammatoire (11,12).

1.1.2.2. Différentes voies de présentation des alloantigènes

Les lymphocytes T alloréactifs du receveur peuvent reconnaître les molécules du CMH spécifiques du donneur principalement de 2 manières : la voie directe et la voie indirecte (13).

1.1.2.2.1. Voie de présentation directe

Lorsqu'un organe est transplanté, des cellules présentatrices de l'antigène (CPA) « passagères » du donneur sont aussi amenées. Activées par les phénomènes d'ischémie-reperfusion, les CPA du donneur migrent vers les organes lymphoïdes secondaires du receveur (i.e. la rate et les ganglions lymphatiques) (14). Là, les molécules du CMH I et II allogéniques intactes présentes à la surface de ces cellules peuvent être reconnues respectivement par les lymphocytes T CD8⁺ et CD4⁺ du receveur (15,16). L'interaction entre un complexe CMH allogénique – peptide antigénique et un récepteur des lymphocytes T (« T cell receptor » : TCR) est appelé la voie de présentation directe (Figure 1A) (17). Cette voie de présentation diffère du principe qui dit qu'en théorie les lymphocytes T reconnaissent des fragments de protéines (peptides) qui ont été partiellement dégradés à l'intérieur des CPA de l'hôte puis exposés à leur surface en association aux molécules du CMH du soi. Ceci signifie que des lymphocytes T normalement spécifiques de complexes CMH du soi – peptide peuvent également reconnaître des complexes CMH allogénique – peptide (18).

Figure 1. Voies de présentation des alloantigènes aux lymphocytes T

(Boardman, *Biochem Soc Trans*, 2016)

APC, antigen presenting cell.

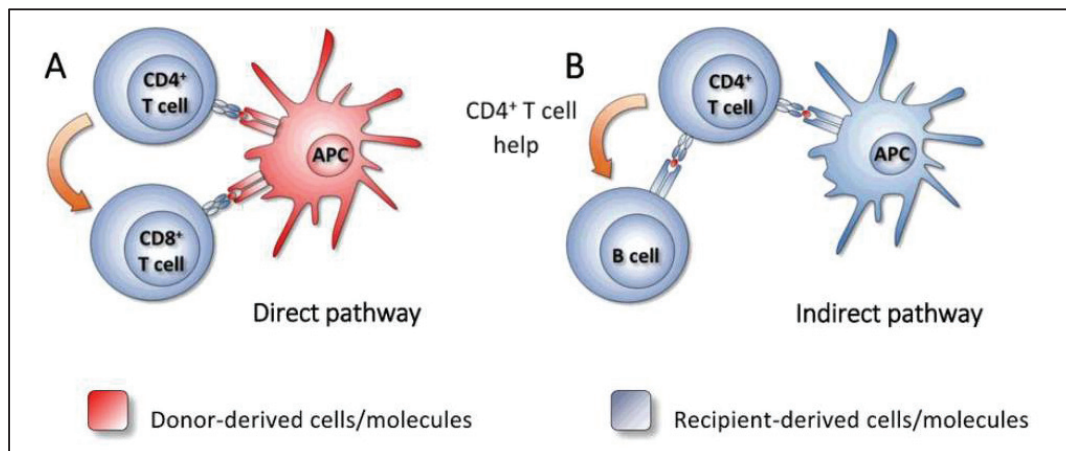

Cette voie de reconnaissance est rendue possible par le fait que lors de l'ontogénie des lymphocytes T, la sélection négative des lymphocytes T ne prend pas en compte les molécules du CMH allogéniques qui sont absentes du stroma thymique de l'individu. Certes les lymphocytes T alloréactifs de spécificité directe n'ont pas non plus subi de sélection positive mais un phénomène de reconnaissance croisée (ou immunité hétérologue) explique que des lymphocytes T spécifiques pour des complexes CMH du soi – peptide peuvent aussi reconnaître des complexes CMH allogénique – peptide (18). Ce concept explique également, qu'avant une première transplantation chez un individu non sensibilisé, il y ait déjà une proportion significative de lymphocytes T mémoires capables de répondre à des complexes CMH allogénique – peptide (19,20).

Le répertoire normal des lymphocytes T contient un grand nombre de lymphocytes T alloréactifs de spécificité directe (1 à 10 %) (21). Deux hypothèses complémentaires ont été proposées pour expliquer cela :

- Premièrement, le modèle de « la haute densité de déterminants » (Figure 2) (22), propose que le ligand du lymphocyte T alloréactif est la molécule du CMH allogénique elle-même, indépendamment du peptide qu'elle présente (23). De ce fait, chaque CPA du donneur possède un grand nombre de ligands potentiels à sa surface. Par conséquent, un large spectre de lymphocytes T alloréactifs de faible affinité ou d'affinité intermédiaire pour le ligand peut être stimulé.

- Deuxièmement, le modèle « des multiples complexes binaires » (Figure 2) (22), propose que les lymphocytes T alloréactifs reconnaissent des molécules du CMH allogéniques présentant des peptides du soi. Ce modèle suggère qu'une seule molécule du CMH allogénique peut se lier à différents peptides du soi donnant lieu à de multiples complexes binaires (24). Chaque combinaison agit ainsi comme un nouveau déterminant antigénique qui peut être reconnu par un clone lymphocytaire T donné. Ainsi, de nombreux clones lymphocytaires T peuvent être recrutés.

En raison de leur caractère mémoire et de leur grand nombre, les lymphocytes T alloréactifs de spécificité directe donnent naissance à une réponse immune intense. En revanche, elle s'atténue dans le temps avec la disparition des CPA « passagères » du donneur qui ne sont pas renouvelées (25,26).

Figure 2. Mécanismes impliqués dans l'alloréconnaissance directe (Lechler, *Nat Rev Immunol*, 2003)

APC, antigen presenting cell ; MHC, major histocompatibility complex.

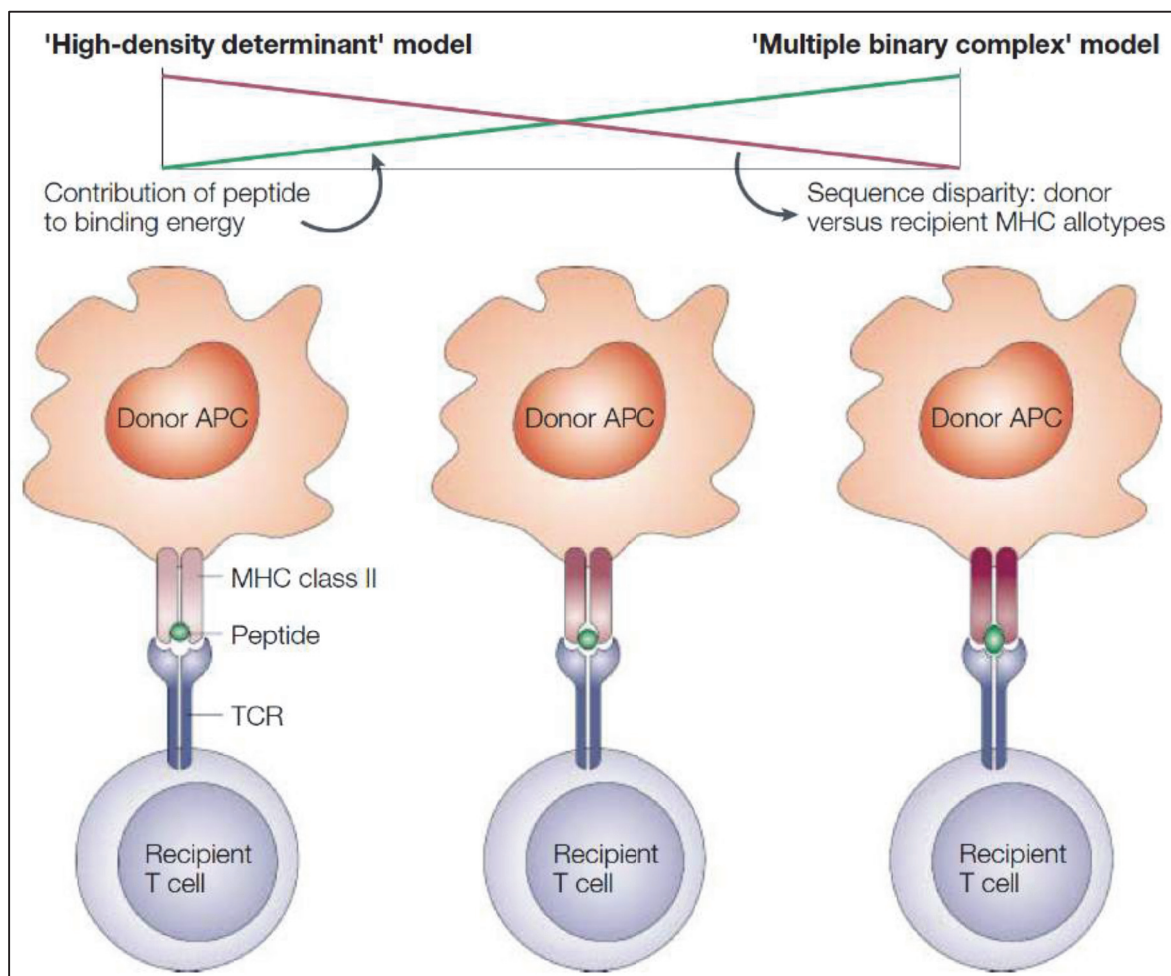

1.1.2.2.2. Voie de présentation indirecte

L'inflammation du greffon attire également les CPA du receveur qui internalisent les molécules du CMH allogéniques du donneur, les apprêtent puis présentent des peptides allogéniques à leur surface dans leurs molécules du CMH de classe II. Les CPA du receveur migrent ensuite vers les organes lymphoïdes secondaires et présentent le complexe CMH de classe II du soi – peptide allogénique aux clones lymphocytaires T CD4+ spécifiques (14). Cette voie de reconnaissance appelée voie indirecte dans le contexte de l'immunologie de la transplantation (25), est en fait la voie classique de reconnaissance des antigènes par le système immunitaire (Figure 1B) (17). Certes les lymphocytes T CD4+ activés par cette voie sont moins nombreux (1/10 000) (27), mais ils peuvent participer non seulement à la réponse alloimmune cellulaire mais également à la réponse alloimmune humorale (voir plus loin). Contrairement à la voie directe qui s'étiologie dans le temps, cette voie perdure tant que le greffon est présent (28).

1.1.3. Mécanismes effecteurs du rejet cellulaire

Après leur activation, les lymphocytes T alloréactifs quittent les organes lymphoïdes secondaires et migrent vers le greffon dans lequel ils s'infiltrèrent par diapédèse (29).

Les lymphocytes T CD8+ de spécificité directe reconnaissent les molécules du CMH allogéniques exprimées par les cellules épithéliales du greffon. Après avoir établi une synapse immunologique avec leurs cibles, les lymphocytes T CD8+ libèrent des granules cytotoxiques contenant de la perforine et des granzymes. La perforine facilite la décharge des granzymes dans le cytosol des cellules cibles. Les granzymes peuvent alors activer des caspases présentes dans le cytosol des cellules cibles dont la fonction principale est d'induire l'apoptose. Les lymphocytes T CD8+ activés expriment aussi la protéine Fas Ligand (CD95) qui se lie au récepteur inducteur de mort Fas présent sur les cellules épithéliales du greffon. Cette liaison induit également l'apoptose des cibles via les caspases (30). Enfin, les lymphocytes T CD8+ peuvent également produire des cytokines comme l'interféron- γ (INF- γ) , la lymphotoxine- α et

le « tumor necrosis factor- α » (TNF- α) et ainsi attirer et activer des cellules de l'immunité innée comme les macrophages.

Les lymphocytes T CD4⁺ de spécificité directe peuvent promouvoir la cytotoxicité des lymphocytes T CD8⁺ de spécificité directe par l'intermédiaire d'une CPA du donneur qu'ils activent afin qu'elle stimule à son tour les lymphocytes T CD8⁺ (31–34). Pour cela, il est nécessaire que les lymphocytes T CD4⁺ et CD8⁺ reconnaissent des déterminants antigéniques exprimés par la même CPA (31–33). Les lymphocytes T CD4⁺ de spécificité directe peuvent également faire preuve de cytotoxicité (35) lorsque l'expression des molécules du CMH de classe II allogéniques à la surface des cellules du parenchyme du greffon et des macrophages tissulaires est induite par l'inflammation (11,12).

Enfin, les lymphocytes T CD4⁺ de spécificité indirecte peuvent aussi être à l'origine du déclenchement d'une réaction d'hypersensibilité retardée (36). En effet, les lymphocytes T CD4⁺ de spécificité indirecte (qui sont les seuls à pouvoir interagir avec une CPA du receveur) sécrètent de l'INF- γ qui stimule les macrophages du receveur, créant ainsi de l'inflammation locale. Cette inflammation est responsable d'une dédifférenciation de l'épithélium adjacent et d'un phénomène de fibrogénèse (37).

Comme nous venons de le voir, les rejets cellulaires reposent majoritairement sur les lymphocytes T alloréactifs de spécificité directe. Les CPA du donneur disparaissant au cours du temps, la voie de présentation directe s'affaiblit dans le temps (25,26). Les rejets cellulaires surviennent donc surtout au cours de la première année après la transplantation (38). L'existence de quelques rejets cellulaires tardifs suggère que les lymphocytes T CD8⁺ de spécificité directe peuvent être activés à un moment où les CPA du donneur ont disparu. Depuis quelques années, plusieurs groupes ont suspecté qu'une troisième voie de présentation des molécules du CMH allogéniques, la voie semi-directe (Figure 3) (17), pouvait être impliquée dans ces rejets tardifs (39–41). L'existence de cette voie a été envisagée lorsqu'il a été constaté que les CPA du receveur pouvaient exprimer à leur surface des molécules du CMH de classe I du donneur intactes (40,41). Mais ce n'est que récemment que le « cross dressing » des CPA du receveur avec des molécules du CMH de classe I du donneur a été expliqué par des travaux qui ont démontré que les CPA du receveur pouvaient capter des exosomes issus de CPA du donneur contenant des molécules du CMH du donneur (42,43).

Figure 3. Voie de présentation semi-directe

(Boardman, Biocheml Soc Trans, 2016)

APC, antigen presenting cell.

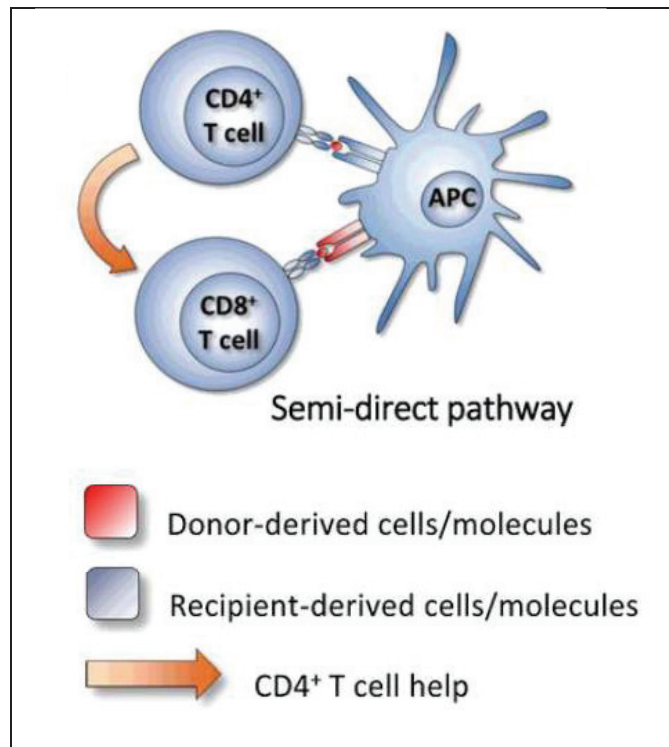

Jusque dans les années 2000, le rejet cellulaire était considéré comme le seul mécanisme immunologique pathogène pour le greffon. Dans ce contexte, la majorité des traitements immunosuppresseurs qui ont été développés en transplantation agissent en bloquant l'activation lymphocytaire T (Figure 4) (44). Ces traitements sont efficaces pour contrôler les rejets cellulaires et s'accompagnent d'une excellente survie des greffons à 1 an. Étonnamment cette efficacité sur le court terme ne s'est pas traduite par un effet sur la survie à long terme amenant la communauté scientifique à remettre en cause le dogme qui dit que seuls les lymphocytes T sont impliqués dans le développement de lésions de rejet après transplantation d'organe.

Figure 4. Modes d'action des principaux immunosuppresseurs ciblant les lymphocytes T (Halloran, N Eng J Med, 2004)

mAb : monoclonal antibody ; MHC, major histocompatibility complex ; MPA, mycophenolic acid.

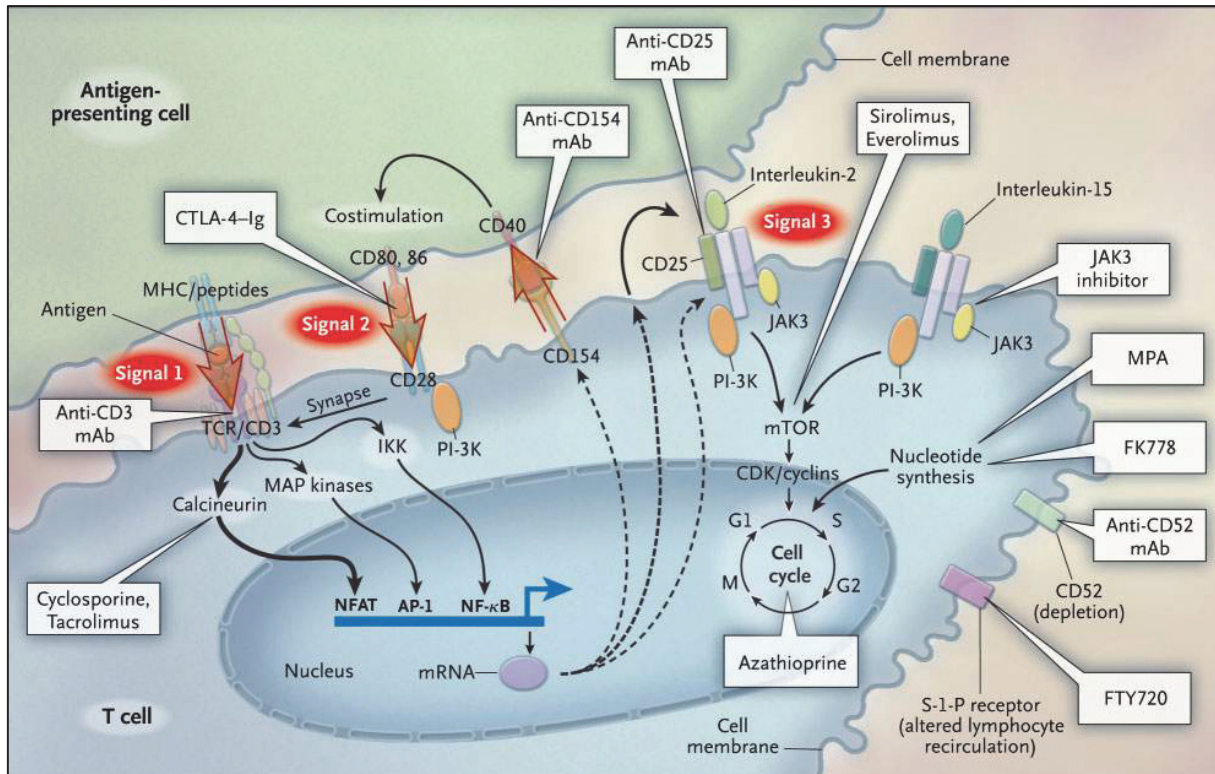

1.2. Emergence de la « théorie humorale » dans le rejet d'allogreffe

1.2.1. Identification des rejets humoraux après transplantation d'organe

Le rôle de la réponse alloimmune humorale dans la génération de lésions de rejet ne fait aucun doute aujourd'hui mais comment est-il possible qu'il ait été ignoré si longtemps ?

Toutes les expériences qui ont conclu que les lymphocytes T étaient les seules cellules impliquées dans l'initiation des rejets ont été menées dans des modèles de greffe de peau ou de tumeur. Par extension, la communauté scientifique a considéré que ce qui était vrai pour une greffe l'était aussi pour une transplantation d'organe. Mais une transplantation d'organe est-elle l'équivalent d'une greffe ? Dans le cas d'une greffe, la vascularisation des tissus greffés se développe à partir du receveur (l'endothélium exprime alors des molécules du CMH du soi) alors que dans le cas d'une transplantation, les vaisseaux du donneur sont anastomosés à ceux du receveur

mettant ainsi les cellules endothéliales allogéniques du donneur en contact direct avec la circulation du receveur. Cette distinction est essentielle car les anticorps étant d'imposantes molécules (150 kilodaltons), ils sont séquestrés dans le secteur vasculaire et ont du mal à diffuser dans les tissus (45). Ils se fixent donc essentiellement aux molécules du CMH allogéniques présentes à la surface des cellules endothéliales du greffon (45). En cas de greffe, les anticorps peuvent certes être synthétisés en réponse à la stimulation du système immunitaire du receveur par les alloantigènes mais n'ont pas la possibilité d'être pathogènes en l'absence de cible accessible. L'ensemble des conclusions des études expérimentales menées dans les modèles de greffe de peau et de tumeur ne sont donc pas transposables à la transplantation d'organe.

L'impact délétère des alloanticorps après transplantation d'organe a émergé dans les années 70 lorsque deux études cliniques ont mis en évidence une association entre la présence d'anticorps circulants dirigés contre les molécules HLA spécifiques du donneur au moment de la greffe et la perte de greffons précoce (46,47). Dans les années 90, l'équipe de Colvin a ensuite évalué la pathogénicité des alloanticorps dans un modèle murin de transplantation cardiaque hétérotopique. Le transfert régulier de sérum contenant des anticorps dirigés contre les cellules du donneur à des souris génétiquement déficientes en lymphocytes T et en lymphocytes B (« Severe combined immunodeficiency » : SCID) ayant reçu un transplant cardiaque allogénique était suffisant pour déclencher le développement de lésions de rejet vasculaire chronique (48). Cette étude a été la première à prouver avec certitude que l'alloimmunité humorale était un acteur majeur du rejet chronique après transplantation d'organe. Dans les années 2000, le développement de techniques en phase solide très sensibles pour détecter les anticorps (49,50) a permis que des études épidémiologiques à grande échelle soient conduites. Ces études ont confirmé l'implication des anticorps anti-HLA spécifiques du donneur dans certains rejets (51,52). Identifié tout d'abord dans le contexte de la transplantation rénale (51), l'existence de rejets humoraux a par la suite été démontré dans le contexte de la transplantation pancréatique (53,54), cardiaque (55), pulmonaire (56). Longtemps négligées, les conséquences délétères des alloanticorps anti-HLA sont aussi de plus en plus rapportées chez les transplantés hépatiques (57).

1.2.2. Cibles moléculaires du rejet humoral

Comme dans les rejets cellulaires, les principales cibles du rejet humoral sont les molécules du HLA allogéniques du greffon. Comme nous le verrons par la suite, ce sont les lymphocytes T CD4+ de spécificité indirecte qui apportent une aide aux lymphocytes B pour générer une réponse humorale contre le greffon. Ces derniers internalisent les antigènes, les apprêtent puis présentent des peptides antigéniques dans leurs molécules du CMH de classe II. De ce fait, ils sont susceptibles de présenter aux lymphocytes B des peptides issus des molécules du HLA du donneur mais également d'autres antigènes non-HLA présents dans les cellules du greffon. Des antigènes non-HLA sont donc également susceptibles d'être impliqués dans certains rejets humoraux.

1.2.2.1. Les antigènes mineurs d'histocompatibilité

Tout gène polymorphe différant entre le donneur et le receveur est susceptible de donner naissance à un alloantigène. Les antigènes mineurs d'histocompatibilité correspondent à des protéines pour lesquelles il existe un polymorphisme génétique, mais n'appartenant pas au HLA. Plusieurs études ont suggéré l'implication d'anticorps dirigés contre des antigènes mineurs d'histocompatibilité ou alloantigènes non-HLA dans les rejets humoraux (58,59). Par exemple, les femmes transplantées avec un greffon provenant d'un donneur masculin développent des anticorps contre l'antigène masculin H-Y dont la présence est associée à un risque accru de rejet et de perte de greffons (60,61). La molécule « MHC class I-related Chain A » (MICA) est également considéré comme une cible allogénique plausible de par sa nature polymorphe et son expression majorée à la surface des cellules endothéliales stressées (notamment par l'ischémie-reperfusion et les infections à cytomégalovirus (CMV)) (62–65). Plusieurs études ont trouvé une association entre la présence d'anticorps anti-MICA circulants et un risque accru de rejet et de perte des greffons (66–68).

1.2.2.2. Les autoantigènes non polymorphes

De manière plus inattendue, les patients ayant un rejet chronique présentent plus fréquemment des autoanticorps dirigés contre des antigènes non polymorphes

(69,70). Ces autoanticorps sont dirigés soit contre des cibles intracellulaires ubiquitaires (71–73) soit contre des cibles extracellulaires, souvent spécifiques de l'organe rejeté (69,74,75). Parmi les autoantigènes, ceux exprimés à la surface des cellules endothéliales revêtent une importance particulière car l'endothélium vasculaire est le premier lieu d'interaction entre le greffon et le système immunitaire du receveur (76–78,58). Jusqu'à récemment, les autoantigènes ciblés par les anticorps étaient inconnus car les anticorps anti-cellules endothéliales étaient principalement recherchés par des cross match endothéliaux (79). Désormais, plusieurs cibles des anticorps anti-cellules endothéliales sont identifiées (58,80).

Si l'augmentation de la prévalence des autoanticorps dans un contexte de rejet chronique est indéniable, leur pathogénicité reste plus incertaine. Pour qu'un autoanticorps puisse être délétère, le premier prérequis est qu'il puisse se fixer à sa cible. Ainsi, bien que certaines protéines intracellulaires puissent être exposées suite à l'apoptose des cellules du greffon, il paraît difficile d'attribuer un caractère pathogène à des autoanticorps dirigés contre des cibles intracellulaires. La réponse humorale autoimmune contre les autoantigènes intracellulaires est donc très certainement un marqueur de la détérioration des cellules du greffon par un autre mécanisme (notamment par des lésions d'ischémie-reperfusion, un processus infectieux, un rejet anti-HLA classique). En revanche, l'implication des autoanticorps dirigés contre des cibles extracellulaires dans des lésions de rejet paraît plus plausible. En réalisant des transferts de sérums de patients transplantés contenant des autoanticorps à des rats, plusieurs équipes ont clairement établi le rôle pathogène de certains autoanticorps dirigés contre des cibles extracellulaires (80,81). Comme les alloanticorps anti-HLA, les autoanticorps dirigés contre des cibles extracellulaires pourraient déclencher l'activation de la voie classique du complément et/ou recruter des cellules de l'immunité innée (voir plus loin). Mais ils pourraient aussi avoir une pathogénicité en rapport avec la fonction de leur cible. Par exemple, les autoanticorps dirigés contre le récepteur de type 1 de l'angiotensine II semblent avoir des effets propres liés à aux fonctions ce récepteur qui sont la régulation de la pression artérielle et de la balance sodée (80,82).

Quel que soit leur potentiel pathogène, la production d'anticorps contre des antigènes du « soi » nécessite une rupture de tolérance des lymphocytes B. Au cours du rejet chronique, l'infiltrat inflammatoire chronique peut s'organiser progressivement au sein du greffon rejeté pour constituer un tissu lymphoïde ectopique fonctionnel

(organe lymphoïde tertiaire) supportant la synthèse locale d'alloanticorps (83): un processus connu sous le nom de néogenèse lymphoïde (84,85) (*Une revue sur ce sujet figure en annexe 1*). Les organes lymphoïdes intra greffon diffèrent tout de même des organes lymphoïdes professionnels car : i) des cellules inflammatoires environnantes produisent de grandes quantités de cytokines inflammatoires et de facteurs de croissance, ii) des néoantigènes sont constamment libérés par les tissus lésés et iii) le défaut de drainage lymphatique emprisonne les néoantigènes et les cellules effectrices immunitaires dans le greffon rejeté. Ces particularités semblent interférer avec la délétion périphérique des clones B immatures autoréactifs qui, en retour, produisent des anticorps contre les autoantigènes intracellulaires (69).

1.2.3. Mécanismes moléculaires impliqués dans la génération des alloanticorps

La génération d'une réponse humorale contre un antigène protéique comme les molécules HLA requiert une activation thymo-dépendante du lymphocyte B (*Janeway's Immunobiology, Kenneth Murphy & Casey Weaver, 9th édition*). L'initiation de cette réponse a lieu dans les organes lymphoïdes secondaires (15). L'alloantigène est reconnu par l'immunoglobuline (Ig) de surface (« B cell receptor » : BCR) du lymphocyte B. L'alloantigène est ensuite internalisé dans le compartiment endosomal du lymphocyte B où il est apprêté sous forme de peptides. Les peptides sélectionnés sont chargés puis présentés dans les molécules du CMH de classe II à la surface du lymphocyte B activé. Les lymphocytes B ayant reçu le premier signal d'activation, migrent vers la frontière T-B pour interagir avec une sous population de lymphocytes T CD4⁺ : les lymphocytes T « follicular helper ». Ces derniers doivent être de spécificité indirecte (car ce sont les seuls dont les TCR reconnaissent les alloantigènes apprêtés et présentés par les molécules du CMH de classe II exprimées par les CPA du receveur) (86).

Lors de mon master 2, nous nous sommes interrogés sur le fait que certains patients développaient des anticorps anti-HLA spécifiques du greffon *de novo*, malgré une immunosuppression bloquant en théorie l'activation de leurs lymphocytes T CD4⁺ (87) (*Cette étude figure en annexe 2*). Nous avons émis l'hypothèse que l'aide des lymphocytes T CD4⁺ n'était peut-être pas indispensable pour que les lymphocytes B puissent générer une réponse anticorps anti-donneur après la transplantation. Des

travaux préalables de l'équipe de Zinkernagel avaient en effet apporté la preuve qu'une réponse thymo-indépendante contre un antigène protéique pouvait exister si deux conditions étaient respectées : l'antigène devait être administré à forte dose et par voie intraveineuse (88). Nous pensions que ces deux conditions étaient justement réunies en transplantation d'organe puisque les molécules HLA spécifiques du donneur sont fortement exprimées par les nombreuses cellules endothéliales du greffon et que ces dernières sont directement accessibles aux cellules immunitaires du receveur. En utilisant un modèle murin de transplantation cardiaque hétérotopique, nous avons démontré que ni les lymphocytes B naïfs ni les lymphocytes B mémoires ne pouvaient générer des anticorps anti-donneur sans l'aide des lymphocytes T CD4+. Ceci suggère que la réponse anticorps anti-donneur chez nos patients résulte plutôt d'un blocage insuffisant de leurs lymphocytes T CD4+ par les immunosuppresseurs. Cette hypothèse a été confirmée en analysant les lymphocytes T CD4+ « follicular helper » circulants (89) de 22 patients transplantés rénaux. Malgré l'immunosuppression, les lymphocytes T « follicular helper » des patients transplantés restaient capables de fournir aux lymphocytes B le second signal de « co-stimulation » via des médiateurs solubles (notamment l'interleukine (IL) 21) et des molécules de surface (en particulier CD40 ligand) (87).

Les lymphocytes B ayant reçu les 2 signaux d'activation prolifèrent et entrent dans le centre germinatif où se déroulent les réactions d'hypermutation somatique (qui améliorent l'affinité de l'Ig pour l'antigène) et de commutation de classe (qui changent l'isotype de l'Ig, ceci modifiant ses capacités effectrices). La réaction du centre germinatif aboutit à la sélection des clones lymphocytaires B les plus efficaces pour répondre à l'alloantigène. Ces derniers se différencient en lymphocytes B mémoires et en plasmocytes à longue durée de vie produisant des IgG de haute affinité. Alors que les lymphocytes B mémoires restent dans les organes lymphoïdes secondaires, les plasmocytes à longue durée de vie peuvent en théorie soit y rester également soit migrer vers la moelle osseuse. Après une transplantation, il semblerait que la rate soit la principale source des alloanticorps (90), les plasmocytes migrant peu vers la moelle osseuse en raison de la stimulation antigénique chronique (91).

1.2.4. Mécanismes effecteurs du rejet humoral

La fixation des anticorps aux alloantigènes exprimés par les cellules endothéliales du greffon peut promouvoir i) l'activation des cellules endothéliales, ii) l'activation du complément et iii) le recrutement de cellules de l'immunité innée par le biais de leur récepteur $Fc\gamma$ (45) (*Une revue sur ce sujet figure en annexe 3*).

Le « cross-linking » des molécules HLA de classe I déclenché par les alloanticorps engendre la transduction de signaux dans les cellules endothéliales menant à l'activation de voies de survie et prolifération (Figure 5) (92). L'activation directe des cellules endothéliales par les alloanticorps aboutie aussi à la production de cytokines pro inflammatoires (93), l'exocytose de vésicules contenant du facteur de Von Willebrand, et l'expression de molécules d'adhésion comme la P sélectine (94). En revanche, ce phénomène ne peut pas induire de véritables lésions de rejet du greffon (93).

La fixation des alloanticorps aux cellules endothéliales du greffon peut également déclencher l'activation de la voie classique du complément, un mécanisme prépondérant dans les rejets humoraux aigus (i.e. avec une dysfonction aiguë du transplant) (Figure 5) (95). Cette activation est initiée par la fixation du C1q aux complexes immuns formés par un hexamère d'IgG fixé aux molécules HLA du donneur (96). Le C1q est associé à deux serines estérases C1r et C1s, qui une fois activées clivent le composant C4 présent dans le plasma en C4a, libéré en phase fluide, et C4b, qui se fixe alors de façon covalente à la surface cible de l'activation. Le composant C2, circulant dans le plasma, peut alors s'associer au C4b et être clivé à son tour par C1s en C2a, qui reste associé à C4b, et C2b qui est libéré en phase fluide. Ainsi se trouve formé le complexe C4bC2a, appelé C3 convertase classique qui a la capacité de cliver le composant C3 en C3a et C3b. C3b s'associe au complexe C4bC2a pour former la C5 convertase qui va cliver C5 en C5b et C5a et permettre la formation du complexe d'attaque membranaire C5b-9. Ce dernier est responsable de l'activation des cellules endothéliales (97).

Les rejets humoraux chroniques peuvent survenir en dehors de toute activation de la voie classique du complément. La première preuve de ce concept a été apportée par l'équipe du Dr Colvin, qui a transplanté des souris génétiquement déficientes en lymphocytes T et en lymphocytes B (« Recombination activating gene knock-out » : $RAG^{-/-}$) avec des greffons cardiaques allogéniques. Ils ont observé que le transfert

passif d'anticorps spécifiques du greffon était suffisant pour induire le développement de lésions de rejet humoral chronique au niveau des vaisseaux du greffon. Le fait d'utiliser des anticorps, dont la chaîne lourde était incapable de fixer le complément (IgG1) (98) ou des souris RAG^{-/-} déficientes en C3 comme receveuses (99), ne modifiait pas la cinétique d'évolution de ces lésions (98,99). En effet, les cellules de l'immunité innée (neutrophiles, monocytes, cellules « Natural Killer » (NK)) peuvent se fixer au fragment Fc des anticorps et libérer des enzymes lytiques (perforine, granzyme) qui détruisent les cellules endothéliales : un mécanisme connu sous le nom de cytotoxicité dépendante des anticorps (« antibody-dependent cell-mediated cytotoxicity » : ADCC) (Figure 5) (95). En transplantation rénale, ce mécanisme est pourvoyeur de lésions d'inflammation microvasculaire associant une glomérulite (g) et/ou une capillarite péri-tubulaire (cpt). Ces lésions font partie des critères de diagnostic du rejet humoral en association avec la présence d'anticorps circulants spécifiques du donneur selon la classification de Banff (100). Parmi les cellules de l'immunité innée impliquées dans les lésions d'inflammation microvasculaire, les cellules NK semblent jouer un rôle clé. La déplétion de ces dernières est suffisante pour prévenir le développement des lésions vasculaires induites par les anticorps spécifiques du donneur dans un modèle de transplantation cardiaque hétérotopique (99). La validité de ces données expérimentales en clinique a été suggérée par des analyses transcriptomiques de biopsies de greffons rénaux de patients présentant un rejet humoral chronique (101).

Contrairement aux rejets cellulaires, les rejets humoraux peuvent survenir à tout moment de la transplantation, même tardivement car ils surviennent dans les suites de l'alloreconnaissance indirecte (38). En l'absence de traitement immunosuppresseur efficace pour cibler les cellules productrices des alloanticorps, le rejet humoral chronique est même devenu la principale cause de perte des greffons quel que soit l'organe transplanté (53,95,102–105).

Figure 5. Physiopathologie du rejet humoral (Pouliquen, F1000Prime Rep, 2015)

AMR, antibody-mediated rejection ; Conv, convertase ; MAC, membrane attack complex ; MHC, major histocompatibility complex.

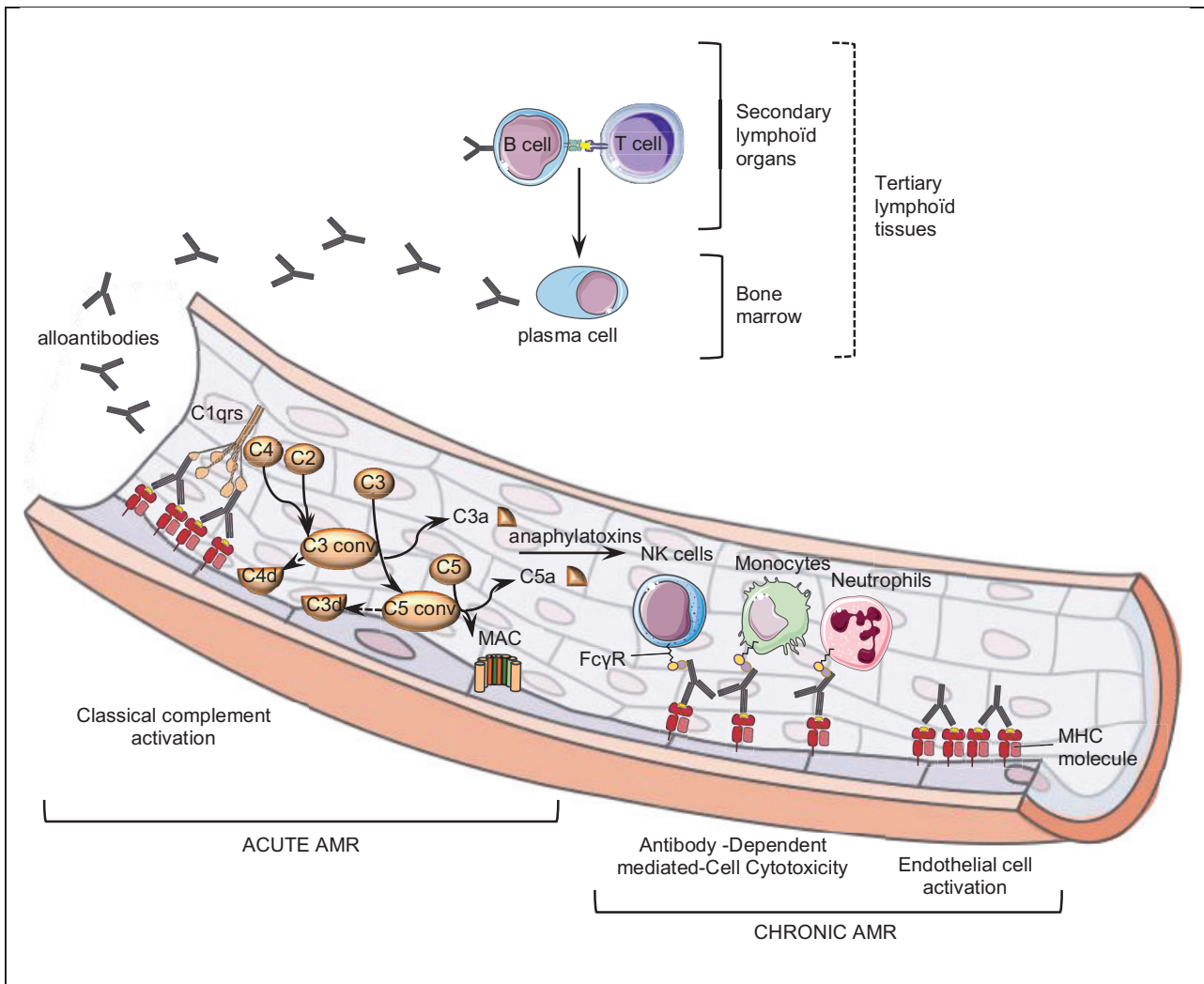

2. Les cellules NK

Comme nous venons de le voir, les cellules NK sont indispensables pour la destruction des greffons au cours du rejet chronique humoral. Il nous a donc paru intéressant d'étudier plus particulièrement la biologie de ces cellules.

2.1. Caractéristiques générales des cellules NK

Les cellules NK sont de grands lymphocytes granuleux appartenant à la famille des « innate lymphoid cells » (ILC) qui sont définies par 3 caractéristiques principales : i) l'absence de récepteur spécifique d'un antigène issu de réarrangements géniques ii) l'absence de marqueurs phénotypiques myéloïdes ou dendritiques et iii) une morphologie de type lymphoïde (106,107). Plus précisément, elles sont classées parmi les ILC1 qui sont définies par leur capacité à sécréter une cytokine : l'INF- γ même si elles se démarquent de l'ensemble des ILC par leur caractère cytotoxique (106,107). Les cellules NK représentent la troisième population lymphocytaire en termes de fréquence dans le sang (5 à 15 % des lymphocytes circulants) après les lymphocytes T et les lymphocytes B. Les cellules NK matures sont définies phénotypiquement par l'absence d'expression du CD3, la présence du CD56 et également Nkp46 (108,109). Les cellules NK constituent la première ligne de défense de l'organisme contre les infections intracellulaires et les cellules tumorales (110). Elles libèrent également des cytokines (majoritairement pro-inflammatoires : INF- γ , TNF- α , et parfois anti-inflammatoires : IL-10) et contribuent ainsi à la modulation de la réponse immune (110).

2.2. Origine et maturation des cellules NK

Les cellules NK humaines proviennent de progéniteurs hématopoïétiques CD34+CD45RA+ dérivés de la moelle osseuse. Jusqu'à peu, on pensait que la maturation des cellules NK avait lieu uniquement dans la moelle osseuse (111–115). Mais de plus en plus de preuves sont en faveur d'un développement des cellules NK également dans des sites extra médullaires. Les progéniteurs hématopoïétiques CD34+CD45RA+ quitteraient la moelle osseuse via le sang pour se rendre jusqu'aux organes lymphoïdes secondaires (116–119) mais également jusqu'aux thymus, tissus

lymphoïdes associés au tube digestif (« Mucosal-associated lymphoid tissue » : MALT), foie et utérus (118,120–122). Pour la suite, nous nous focaliserons surtout sur le développement des cellules NK conventionnelles qui a lieu principalement dans les organes lymphoïdes secondaires chez l'homme. Les progéniteurs hématopoïétiques CD34+CD45RA+ passent par différents stades de développement décrits dans le tableau 1 avant de devenir des cellules NK matures au stade 4b (109,123–125).

Au stade 4b, les cellules NK sont plus connues sous la dénomination de cellules NK CD56^{bright}CD16⁻ (Tableau 1). Elles expriment le récepteur inhibiteur CD94/NKG2A ainsi que le récepteur activateur Nkp46 mais n'expriment peu ou pas les « Killer-cell Immunoglobulin-like receptors » (KIR) et le récepteur activateur CD94/NKG2C. Concernant leur fonction, elles peuvent rapidement produire de grandes quantités de cytokines immunomodulatrices et de chimiokines en réponse à une stimulation par des cytokines (IL-2, IL-15, IL-12 et IL-18) produites par les monocytes activés, les cellules dendritiques et les lymphocytes T. Par contre, en raison de leur faible contenu en perforine et granzymes, ainsi que leur absence d'expression du CD16 et des KIR, les cellules NK CD56^{bright}CD16⁻ sont peu cytotoxiques. Etant donc principalement immunomodulatrices, les cellules NK CD56^{bright}CD16⁻ sont la population de cellules NK prédominante dans les organes lymphoïdes secondaires, et notamment dans les ganglions où elles résident dans la région parafolliculaire à proximité des cellules dendritiques et des lymphocytes T avec lesquels elles peuvent interagir pour moduler leur activité (voir plus loin).

Les cellules NK au stade 5 sont CD56^{dim}CD16⁺ (Tableau 1). Elles constituent la population majoritaire de cellules NK dans le sang périphérique. Elles expriment de manière variable Nkp46, CD94/NKG2A et CD94/NKG2C mais de manière quasi-constante le CD16 et les KIR. De ce fait, les cellules NK CD56^{dim}CD16⁺ sont hautement cytotoxiques (126). En revanche, elles produisent moins de cytokines que les cellules NK CD56^{bright}CD16⁻ en réponse à une stimulation cytokinique (IL-12, IL-15 et IL-18) (127). Toutefois, les cellules NK CD56^{dim}CD16⁺ restent capables d'en produire suite à une interaction avec une cellule cible stressée (127).

Tableau 1. Les stades de développement des cellules NK humaines dans les organes lymphoïdes secondaires (Freud, Immunity, 2017)

a.k.a, also known as ; cNK, conventional NK cell ; DC, dendritic cell ; lo, low ; T, T cell.

Stage	Surface Immunophenotype							Additional Features
	CD34	CD117	IL-1R1	CD94/NKG2A	NKp80	CD16	CD57	
1	+	-*	-	-	-	-	-	multipotent (DC, T, ILC, NK) CD45RA ⁺ CD10 ⁺
2a	+	+*	-*	-	-	-	-	multipotent (DC, T, ILC, NK)
2b	+*	+	+*	-	-	-	-	common ILC progenitor (ILC, NK)
3	-*	+	+	-*	-	-	-	overlap with ILC3s and ILC/NK restricted precursors
4a	-	+/lo	+/lo	+*	-*	-	-	ILC3-like profile (NKp44 ^{+/-} IL-22 ⁺) KIR ⁻ , IFN- γ ⁻ , non-cytolytic
4b	-	lo/-	lo/-	+	+*	-*	-	a.k.a. CD56 ^{bright} cNK; KIR ^{+/-} , IFN- γ ⁺ , weakly cytolytic
5	-	lo/-	lo/-	+/-	+	+*	-*	a.k.a. "early" CD56 ^{dim} cNK; KIR ^{+/-} , IFN- γ ⁺ , cytolytic
6	-	-	lo/-	+/-	+	+	+*	a.k.a. "late" CD56 ^{dim} cNK; KIR ^{+/-} , IFN- γ ⁺ , cytolytic

Asterisks (*) denote the immunophenotypic changes that define the stage transitions.

2.3. Le répertoire des récepteurs des cellules NK

2.3.1. Généralités

Les cellules NK présentent à leur surface de nombreux récepteurs activateurs et inhibiteurs qui leur permettent d'évaluer les cellules qui les entourent en permanence (110,128). Contrairement aux récepteurs spécifiques d'antigène comme le TCR des lymphocytes T et le BCR des lymphocytes B, les gènes des récepteurs des cellules NK sont en configuration germinale, et n'effectuent pas de réarrangements géniques. Les principaux récepteurs inhibiteurs sont : les KIR inhibiteurs et CD94/NKG2A (110,128). Ils reconnaissent respectivement des déterminants partagés par les molécules du CMH de classe I classiques et HLA-E qui sont présents à la surface de l'ensemble des cellules de l'organisme (Figure 6) (129–131). Les principaux récepteurs activateurs sont le CD16, les KIR activateurs, les « natural cytotoxic receptors » (NCR) (Nkp30, Nkp44 et Nkp46), CD94/NKG2C, NKG2D et les récepteurs de type Toll (« Toll-like receptor » : TLR) (Figure 6) (110,128–130,132–139). Ils détectent les changements dans le niveau d'expression membranaire de leurs ligands induits par le stress cellulaire (en dehors du CD16 qui

se lie aux fragments Fc des IgG et CD94/NKG2C qui interagit avec HLA-E). Ces ligands sont soit i) des ligands du « soi » qui sont généralement rares sur les cellules saines, et dont l'expression est augmentée à la surface des cellules en cas de transformation infectieuse ou tumorale, soit ii) des ligands infectieux, soit iii) des ligands des TLR.

Figure 6. Récepteurs des cellules NK (Vivier, Science, 2011)

Sauf mention contraire (h, human ; m, mouse), les récepteurs sont conservés entre les deux espèces.

Act, activating ; IFNAR, Interferon- α/β receptor ; Inh, inhibitory ; LAIR, Leukocyte-associated inhibitory receptor ; LILRB, Leukocyte immunoglobulin-like receptor B.

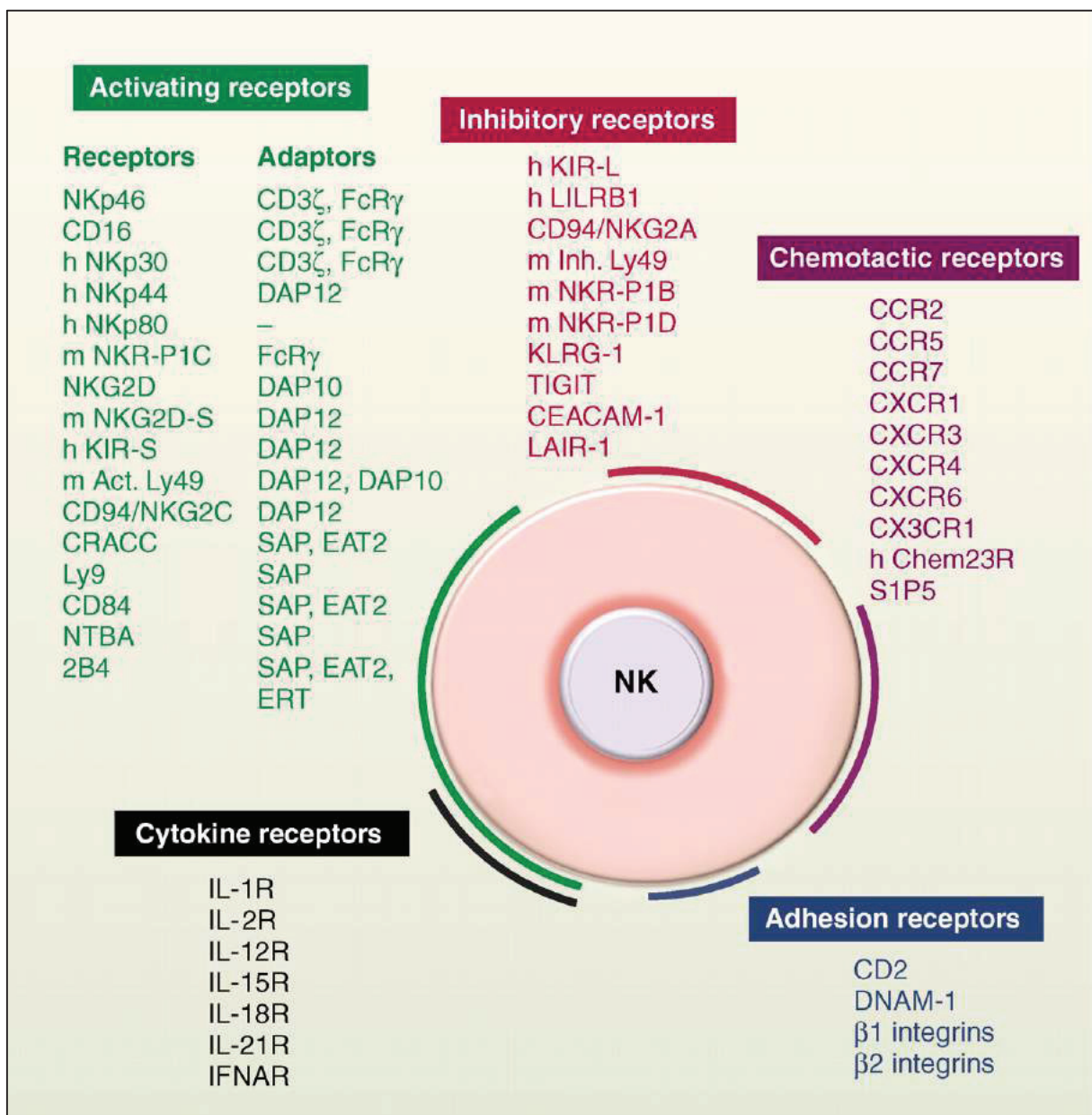

En plus de cette batterie de récepteurs activateurs et inhibiteurs, les cellules NK présentent également des récepteurs de cytokines et de chimiokines ainsi que des molécules d'adhésion impliqués respectivement dans leur maturation et activation, leur migration et leur adhésion aux cibles (Figure 6) (110).

Afin d'éviter un catalogue des nombreux récepteurs présents à la surface des cellules NK, j'ai fait le choix de me focaliser sur les KIR, qui seront l'objet de mon travail.

2.3.2. Cas particuliers des récepteurs KIR

2.3.2.1. Les gènes KIR

Les gènes KIR sont localisés dans la région du génome appelée « Leukocyte receptor complex » (LRC) située au niveau du bras long du chromosome 19 (19q13.4). La famille des gènes KIR est constituée de 15 gènes (KIR2DL-1 à 5, KIR2DS-1 à 5, KIR3DL-1 à 3, KIR3DS1) et de 2 pseudogènes (KIR2DP1 et KIR3DP1). Elle est hautement polymorphique, avec non seulement des polymorphismes des séquences de nucléotides mais également la présence/absence de chaque gène (140). Les gènes KIR sont organisés sous forme d'haplotypes (A ou B), qui diffèrent principalement par le nombre de KIR activateurs qu'ils contiennent. L'haplotype A présente un seul KIR activateur (KIR2DS4) alors que l'haplotype B en présente généralement plusieurs parmi KIR2DS1, KIR2DS2, KIR2DS3, KIR2DS5, KIR3DS1 (Figure 7) (129) (<https://www.ebi.ac.uk/ipd/kir/introduction.html>). Les haplotypes se combinent pour former de nombreux génotypes.

Figure 7. Représentation schématique des haplotypes A et B au locus KIR (Thielens, *Curr Opin Immunol*, 2012)

Deux exemples d'haplotypes A et B sont représentés. Les pseudogènes sont indiqués en gris, les KIR activateurs en vert et les KIR inhibiteurs en rouge. Les gènes conservés qui peuvent être des pseudogènes, des KIR activateurs ou inhibiteurs sont indiqués en violet.

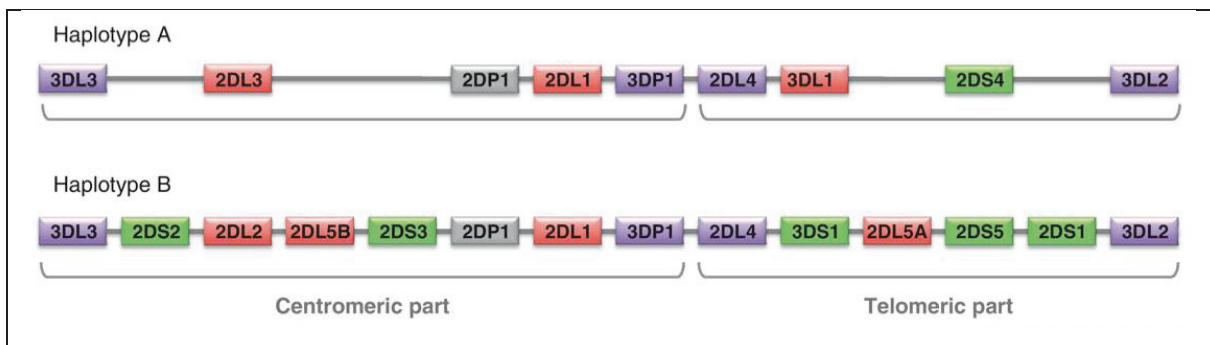

2.3.2.2. Les récepteurs KIR

Les KIR sont des récepteurs appartenant à la superfamille des immunoglobulines. Les récepteurs KIR possèdent tous 2 (KIR2D-) ou 3 (KIR3D-) domaines extracellulaires de type « immunoglobuline » (141), un domaine transmembranaire et un domaine cytoplasmique. Ils peuvent être inhibiteurs ou activateurs. Ils sont surtout présents à la surface des cellules NK $CD56^{dim}CD16^{+}$ (109). En raison d'une extinction mosaïque des gènes KIR selon les cellules, il existe une variabilité des récepteurs KIR à la surface des cellules NK (Figure 8) (142). Ce phénomène est stochastique et aboutit à la génération de multiples sous-populations de cellules NK exprimant des nombres et des combinaisons de KIR variables à leur surface (142). Comme nous le verrons par la suite, ceci impacte le processus d'éducation et la capacité des cellules NK à s'activer face à des cibles anormales.

Figure 8. Variéation des récepteurs KIR à la surface des cellules NK (Parham, *Nat Rev Immunol*, 2005)

Exemple de 4 sous-populations de cellules NK et de leur réactivité chez un individu ayant un génotype A/A et possédant les ligands de KIR inhibiteurs C1, C2 et Bw4.

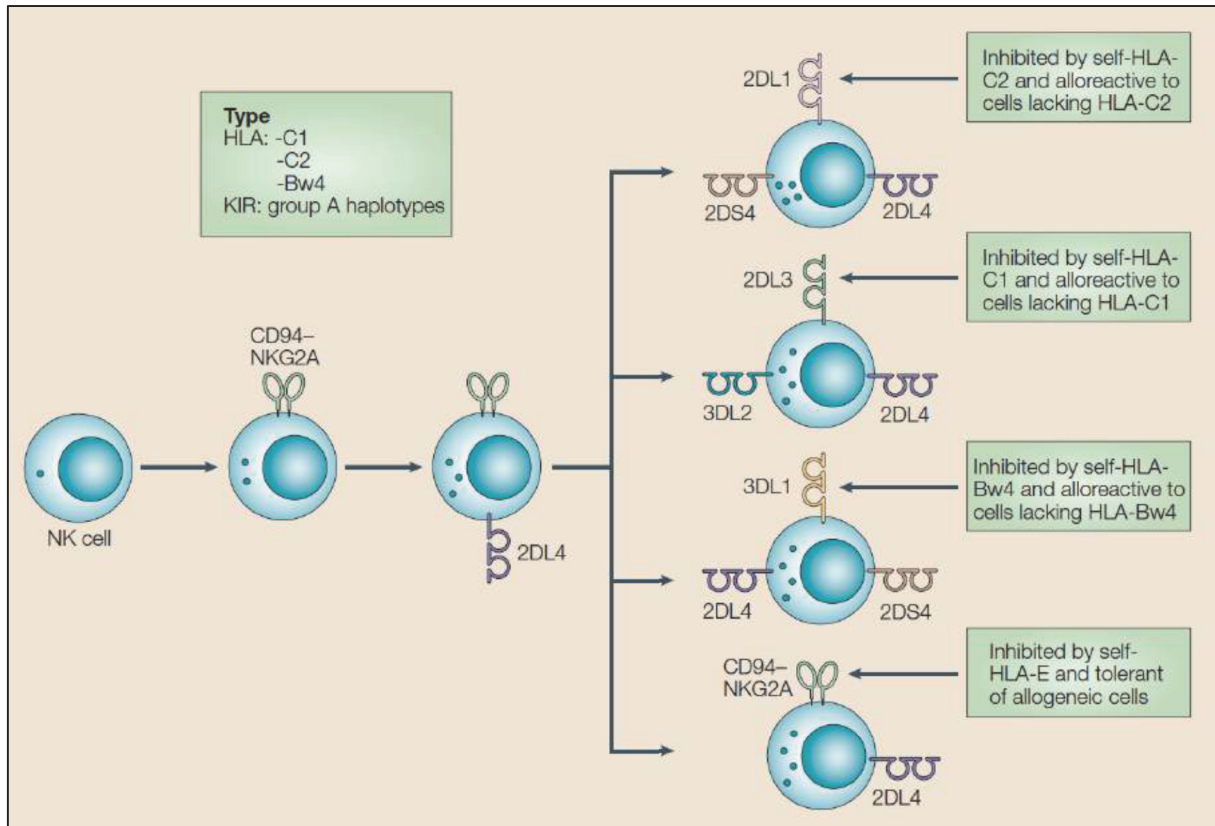

Les KIR inhibiteurs possèdent une longue queue cytoplasmique (KIR-L pour « long ») contenant 2 « immunoreceptor tyrosine-based inhibitory motifs » (ITIM) qui lorsqu'ils sont phosphorylés au niveau de leur tyrosine, recrutent des tyrosine phosphatases qui déphosphorylent les molécules adaptatrices activatrices et bloquent l'activation des cellules NK (143). Chaque KIR inhibiteur a pour ligands un sous-groupe d'allotypes HLA de classe I (Figure 9) (129). Le nombre de domaines extracellulaires (2 ou 3) leur confère une spécificité pour les allotypes HLA-C ou HLA-A/B respectivement. KIR2DL1 et KIR2DL2/3 reconnaissent des allotypes HLA-C distincts, basés sur les acides aminés en position 77 et 80 de l'hélice α du domaine α 1 de la molécule HLA-C. KIR2DL1 reconnaît les allotypes C avec une asparagine en position 77 et une lysine en position 80 (allotypes C2) alors que KIR2DL2 et KIR2DL3 reconnaissent ceux avec une sérine en position 77 et une asparagine en position 80 (allotypes C1) (129). Collectivement, les récepteurs inhibiteurs KIR2DL1, 2 et 3

reconnaissent tous les allotypes HLA-C. KIR3DL1 reconnaît les allotypes A et B avec le motif Bw4 et KIR3DL2 interagit avec les molécules HLA-A3 et A11. KIR2DL4, dont le rôle inhibiteur ou activateur est fonction des conditions (144,145), reconnaît la molécule du CMH de classe I non classique HLA-G (Figure 9).

Les KIR activateurs possèdent une courte queue cytoplasmique (KIR-S, pour « short »). Au niveau de leur domaine transmembranaire, un acide aminé chargé positivement leur permet de s'associer avec la protéine adaptatrice DAP12 qui est capable de générer un signal d'activation car elle possède des « immunoreceptor tyrosine-based activation motifs » (ITAM) dans sa portion intra cytoplasmique. Contrairement aux KIR inhibiteurs, leurs ligands sont moins bien connus. Il s'agit principalement de molécules induites par le stress cellulaire. Dans de rares cas, il peut aussi s'agir de molécules du CMH de classe I. C'est le cas pour KIR2DS1 qui a pour ligands les molécules HLA C d'allotype C2 (Figure 9).

Figure 9. Les récepteurs KIR et leurs ligands HLA (Thielens, *Curr Opin Immunol*, 2012)

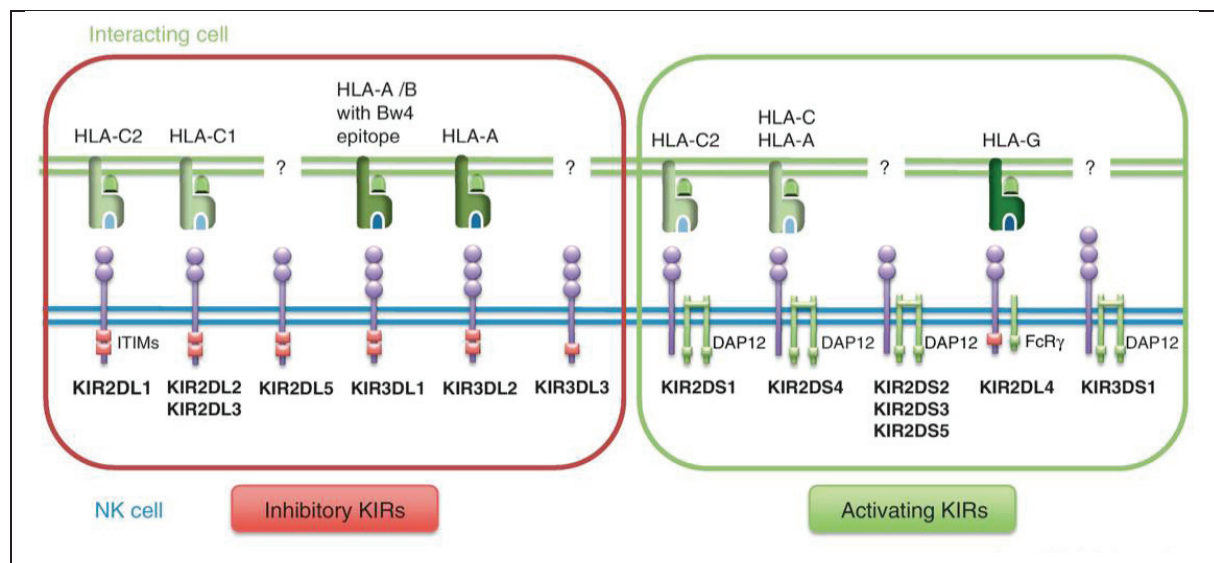

2.4. Education des cellules NK

2.4.1. La théorie de l'éducation

Les gènes des récepteurs inhibiteurs et leurs ligands appartenant aux molécules du CMH de classe I étant sur différents chromosomes, ils sont transmis indépendamment. Un processus d'éducation est donc nécessaire pour que les cellules

NK tolèrent le soi tout en étant capables de s'attaquer aux cellules infectées ou tumorales. Actuellement, la théorie qui paraît la plus crédible pour expliquer le processus d'éducation subit par les cellules NK est la théorie du « désarmement » (Figure 10) (146). Celle-ci postule que la réactivité des cellules NK est un état par défaut qui est perdu en cas de stimulation chronique des récepteurs activateurs sauf si cette stimulation est contrebalancée par un engagement concomitant des récepteurs inhibiteurs. Deux types de récepteurs inhibiteurs sont impliqués dans l'éducation des cellules NK : les KIR inhibiteurs et CD94/NKG2A. Ces récepteurs interagissent avec leurs ligands sur les cellules saines qui les entourent et transmettent des signaux qui s'opposent à ceux transmis par la stimulation chronique des récepteurs activateurs. Ceci permet de maintenir la réactivité des cellules NK. Les cellules NK n'exprimant pas de récepteurs inhibiteurs ou des récepteurs inhibiteurs dont les ligands ne sont pas présents chez l'individu présentent un état d'épuisement en rapport avec la stimulation chronique de leurs récepteurs activateurs. Elles sont donc hypo réactives.

Figure 10. Théorie du désarmement

(Höglund, *Nat Rev Immunol*, 2010)

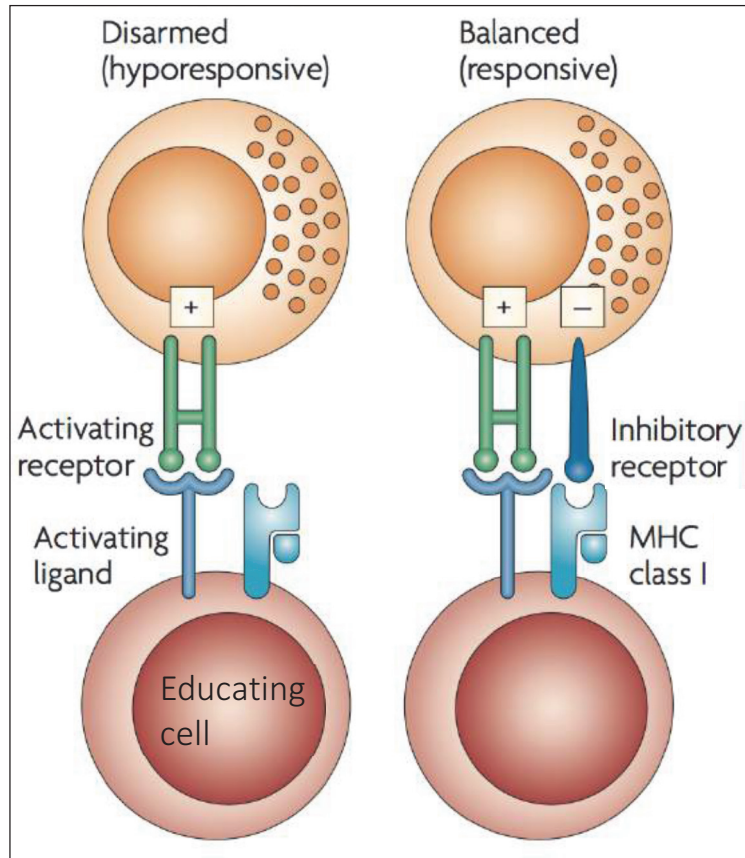

L'éducation n'est pas un processus binaire dont la résultante est l'émergence de cellules NK réactives ou pas. Il s'agit d'un processus permettant de régler finement la réactivité des cellules NK, à la manière d'un « rhéostat » (Figure 11). Le niveau de réactivité final des cellules NK dépend de la force des signaux inhibiteurs que la cellule NK a reçu pendant le processus d'éducation (147–149). Trois facteurs influencent donc la réactivité finale des cellules NK :

- Le niveau d'expression des ligands du CMH de classe I à la surface des cellules de l'individu pour un KIR inhibiteur donné. Par exemple, les cellules NK KIR2DL1+ seront plus réactives dans un individu C2/C2 que dans un individu C1/C2 (142).
- La force d'interaction entre un KIR inhibiteur et son ligand du CMH de classe I (142,147,150–153).
- Le nombre de KIR inhibiteurs (ayant leurs ligands parmi les molécules du CMH de classe I de l'individu) présents à la surface d'une cellule NK (127,147,148). Plus une cellule NK est porteuse de KIR inhibiteurs ayant leurs ligands parmi les molécules du CMH de classe I de l'individu, plus elle sera réactive (127).

Figure 11. Modèle du rhéostat (Sun, *Nat Rev Immunol*, 2011)

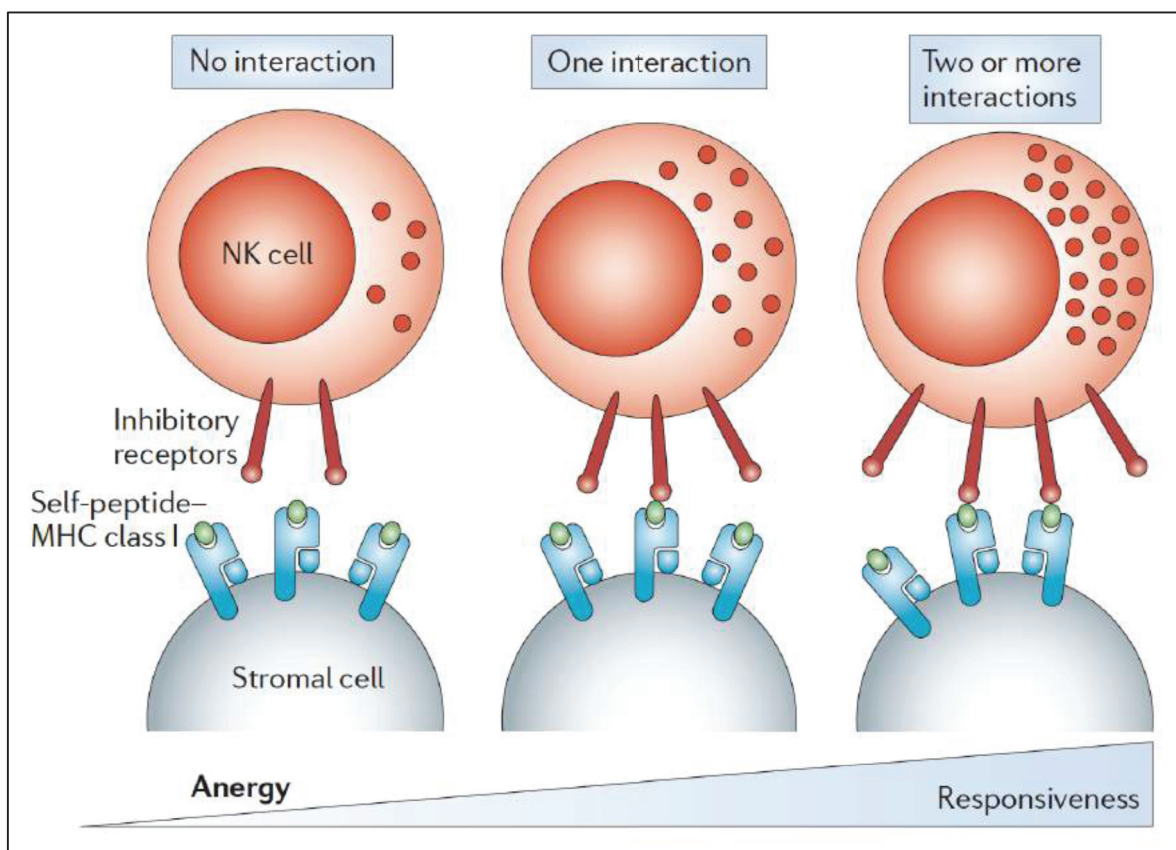

2.4.2. L'éducation : un processus plastique

La réactivité des cellules NK évolue dans le temps en fonction de la composition de l'environnement en molécules du CMH de classe I auquel les cellules NK sont confrontées. L'exemple le plus parlant vient d'études expérimentales réalisées chez la souris (154–156). Si des cellules NK réactives d'une souris C57BL/6 sauvage sont transférées à une souris C57BL/6 déficiente en molécules du CMH de classe I (« $\beta 2$ microglobulin knock-out » : $\beta 2\text{micro}^{-/-}$), elles deviennent hypo réactives (154). A l'inverse, si des cellules NK hypo réactives provenant d'une souris $\beta 2\text{micro}^{-/-}$ sont transférées à une souris C57BL/6 sauvage (préalablement déplétée de ces propres cellules NK pour éviter une lyse des cellules transférées), elles deviennent réactives, capables de sécréter de l'INF- γ et de dégranuler lors d'une stimulation *ex vivo* via leurs récepteurs activateurs (155). Ceci montre bien qu'une cellule NK s'adapte en continu à son environnement en molécules du CMH de classe I (156). Un changement de l'environnement en dehors de tout contexte inflammatoire modifie la réactivité de la cellule NK mais ne l'active pas.

2.5. Activation des cellules NK

Grâce au processus d'éducation, les cellules NK sont capables de distinguer les cellules stressées (infectées ou tumorales) des cellules saines. Face à une cible, les cellules NK vont pouvoir s'activer de plusieurs manières. Les cellules NK vont pouvoir être recrutées via leur récepteur activateur CD16 suite à l'opsonisation des cibles par des IgG. Le signal transmis par le CD16 est alors suffisant pour activer les cellules NK afin qu'elles tuent leur cible. C'est ce que l'on appelle la cytotoxicité dépendante des anticorps ou ADCC (Figure 12) (157). Dans ce cas-là, les cellules NK sont recrutées indirectement par le système immunitaire adaptatif (via les anticorps).

Figure 12. Différents modes d'activation des cellules NK (Morvan, *Nat Rev Cancer*, 2016)

MHC, major histocompatibility complex.

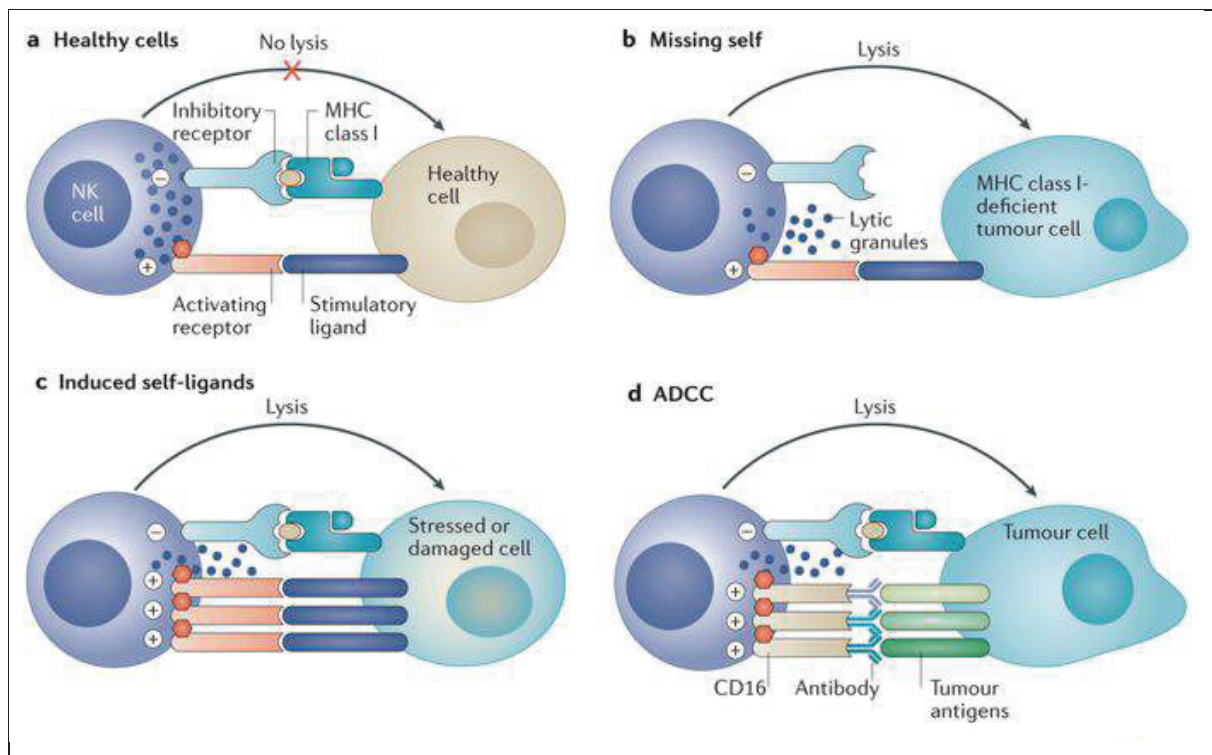

Grace à leur batterie de récepteurs activateurs et inhibiteurs, les cellules NK peuvent également évaluer directement les cellules cibles et faire preuve de cytotoxicité directe. Dans ce cas-là, la perception directe d'une cellule stressée par la cellule NK n'est pas suffisante pour qu'elle exerce pleinement ces fonctions effectrices. La cellule NK a besoin de recevoir un second signal d'activation de manière concomitante. Ce signal provient généralement d'autres cellules de l'immunité innée qui sont également recrutées sur le site de l'inflammation (macrophages, cellules dendritiques) et est de nature cytokinique : IL-12, IL-15, IL18 (110,158–161). Il apporte une sécurité supplémentaire pour que les cellules NK ne risquent pas de s'activer à tort contre des cellules saines. La cellule NK peut faire preuve de cytotoxicité directe dans deux situations :

- Les cellules infectées ou tumorales peuvent abaisser voire perdre totalement l'expression des molécules du CMH de classe I du soi afin d'échapper aux lymphocytes T CD8+ cytotoxiques. Dans ce contexte, les signaux activateurs transmis par les récepteurs activateurs reconnaissant leurs ligands sur les cellules cibles ne sont pas contrebalancés par les signaux inhibiteurs transmis

par les récepteurs inhibiteurs et les cellules NK peuvent alors s'activer. C'est ce que l'on appelle l'activation des cellules NK par la reconnaissance du « soi manquant » ou « missing self » (Figure 12).

- Les cellules infectées ou tumorales peuvent majorer fortement leur expression de ligands de stress pour les récepteurs activateurs. Dans ce contexte, même si l'expression des molécules du CMH de classe I du soi persiste sur les cibles, les signaux activateurs transmis par les récepteurs activateurs dépassent les signaux inhibiteurs transmis par les récepteurs inhibiteurs et les cellules NK peuvent s'activer. C'est ce que l'on appelle l'activation des cellules NK par la reconnaissance du « soi induit » ou « induced self » (Figure 12).

2.6. Rôle de la voie mTOR dans l'éducation et l'activation des cellules NK

Comme nous l'avons vu auparavant, l'éducation est un processus à la fois quantitatif et plastique. Ceci suggère qu'il existe lors de ce processus une intégration permanente de signaux activateurs et inhibiteurs de force variable modulant la réactivité des cellules NK lors de l'engagement de leurs récepteurs activateurs. Jusqu'à peu, les voies de transduction du signal impliquées dans le processus d'éducation des cellules NK étaient inconnues. Lors de ma thèse, j'ai collaboré à un travail mené par le Dr Marçais au sein de l'équipe du Dr Walzer au CIRI, qui démontre le rôle essentiel de la voie mTOR/Akt dans le processus d'éducation des cellules NK (162) (*Cette étude figure en annexe 4*). Ce travail montre que les cellules NK éduquées (et donc réactives) ont une activité basale de la voie mTOR/Akt plus élevée que les cellules non éduquées. Ce niveau basal d'activité est proportionnel au nombre de récepteurs inhibiteurs, présents à la surface de la cellule NK, ayant interagi avec leurs ligands lors du processus d'éducation. En l'absence d'engagement des récepteurs inhibiteurs lors de l'éducation, la stimulation chronique des récepteurs activateurs des cellules NK est associée à une perte de l'activité de la voie mTOR/Akt en parallèle de la perte de réactivité des cellules. Ceci démontre bien que lors de l'éducation, l'engagement des récepteurs inhibiteurs à la surface des cellules NK est nécessaire à la préservation de la réactivité des cellules NK via la voie mTOR/Akt. En l'absence d'engagement des récepteurs inhibiteurs, une stimulation cytokinique (IL-2, IL-15) peut restaurer la réactivité des cellules NK hypo répondeuses à travers la voie mTOR/Akt. Au final, l'éducation des cellules NK repose sur la modulation de l'activité

de la voie mTOR/Akt, véritable rhéostat de la cellule NK qui en conséquence contrôle la réactivité des cellules NK lors de la stimulation de ces récepteurs activateurs (Figure 13).

Figure 13. La voie mTOR/Akt, rhéostat moléculaire de la réactivité de la cellule NK

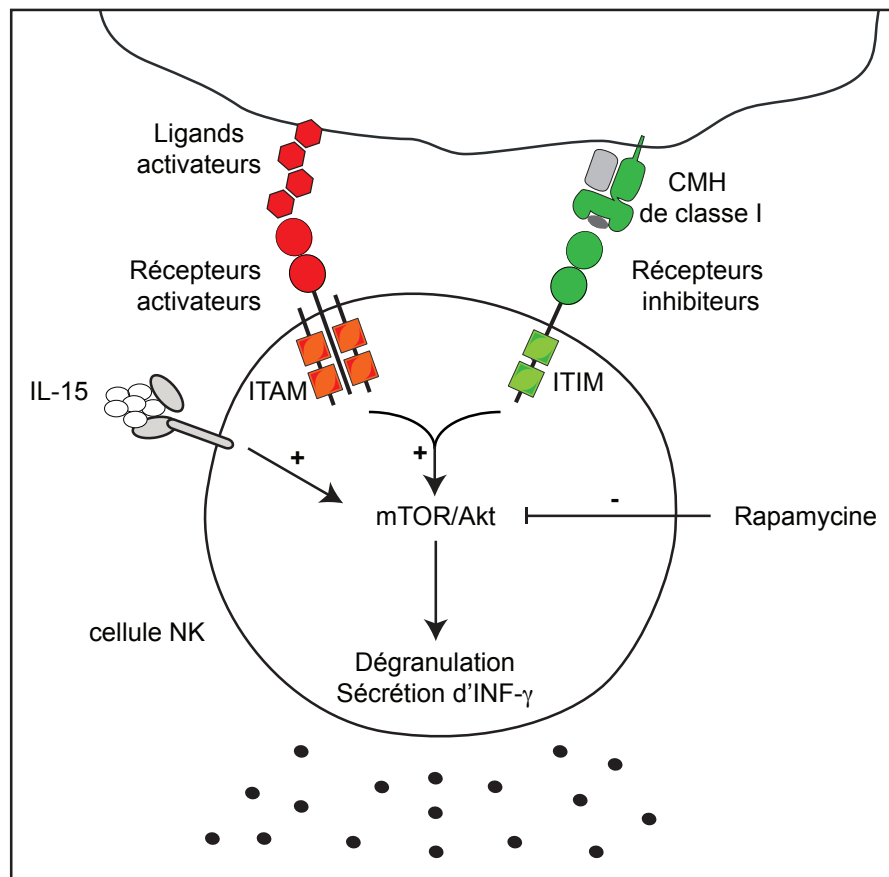

De ce fait, la voie mTOR/Akt n'est pas seulement impliquée dans l'éducation des cellules NK, mais également dans l'activation des cellules NK (162,163). En fonction de leur niveau basal de la voie mTOR/Akt, les cellules NK sont plus ou moins réactives lors de l'engagement de leurs récepteurs activateurs. En effet, plus les cellules NK sont réactives après l'éducation, plus elles sont capables de majorer l'activité de la voie mTOR/Akt en cas de stimulation aiguë de leurs récepteurs activateurs (Figure 13). Ceci se traduit par de meilleures fonctions effectrices en termes de cytotoxicité et sécrétion d'INF- γ face à une cible exprimant un « missing self ». Lors de l'activation des cellules NK, la voie mTOR/Akt est également impliquée dans les signaux d'activation cytokiniques reçus par les cellules NK (163). En réponse

à de fortes doses d'IL-15, sécrétée notamment par les cellules dendritiques en contexte inflammatoire, l'activité de la voie mTOR est fortement augmentée (Figure 13). Ceci se traduit par une capacité cytotoxique également majorée des cellules NK face à des cibles exprimant un « missing self ».

L'inhibition de mTORC1 par la rapamycine, un médicament disponible en clinique, induit une diminution de l'activité de la voie mTOR dans les cellules NK. Ceci est responsable d'une perte de la réactivité de la cellule NK (Figure 13). Dans un modèle murin *in vivo* de lyse cellulaire NK-dépendante, ceci se traduit par une forte diminution de la cytotoxicité des cellules NK face à des cellules cibles exprimant un « missing self » (162,163).

2.7. Fonctions des cellules NK

Les cellules NK sont surtout connues pour leur capacité à être cytotoxique. Mais elles sont également capables de sécréter des cytokines (pro-inflammatoires : TNF- α et INF- γ et anti-inflammatoires : IL-10) et des chimiokines (CCL-2 (MCP-1), CCL3 (MIP-1 α), CCL4 (MIP-1 β), CCL5 (RANTES)), qui leur permettent de moduler la réponse immune adaptative (128,164).

2.7.1. Cytotoxicité envers les cibles infectées et tumorales

Quel que soit le mode d'activation des cellules NK, les mécanismes cytotoxiques qui en découlent sont similaires. Il existe deux principaux mécanismes :

- La lyse dépendante de l'exocytose de granules lytiques
- La lyse dépendante des récepteurs de mort

2.7.1.1. La voie perforine-granzymes

Suite à la reconnaissance de la cellule cible, la cellule NK forme une synapse immunologique avec cette dernière (165). Cette étape est suivie de la migration des granules lytiques vers cette synapse. Ils fusionnent ensuite avec la membrane de la cellule NK et sont libérés (Figure 14) (166). Les granules lytiques contiennent de la perforine et des granzymes (A et B principalement) (166). La perforine libérée dans la fente synaptique se polymérise et forme des pores dans la membrane de la cellule

cible permettant l'entrée des granzymes dans cette dernière (166). Les granzymes sont des serines protéases qui induisent l'apoptose des cellules cibles. Le granzyme B induit l'apoptose des cibles tout d'abord en activant directement les caspases 3, 6, 7, 8, 9 et 10 (166). Le granzyme B permet également la transformation la protéine « BH3-interacting domain death agonist » (Bid) en sa forme active tronquée, tBid (167,168). tBid est alors transloqué dans la mitochondrie où il induit l'oligomérisation et l'activation des membres de la famille Bcl-2, Bax et Bak (169). Bax/Bak forment des mégacanaux dans la membrane externe des mitochondries permettant la libération de cytochrome c dans le cytosol (170). En association avec l'« apoptotic-protease-activating-factor-1 » (Apaf-1) et la pro caspase 9, le cytochrome c forme l'apoptosome où la pro caspase 9 est transformée en caspase 9 et est libérée (171). La caspase 9 activée peut alors avec les caspases 8 et 10 activer les caspases effectrices 3, 6 et 7 et induire ainsi l'apoptose de la cellule cible (172,173). Le granzyme A induit l'apoptose des cellules cibles de manière indépendante des caspases en induisant la fragmentation de l'ADN en clivant le « SET nuclear proto-oncogen », un inhibiteur de la desoxyribonucléase NME1 (174). Le granzyme A cible aussi l'endonucléase « apurinic endonuclease 1 » (APE1), et les lamines A, B et C bloquant ainsi la réparation de l'ADN et entraînant la rupture de l'enveloppe nucléaire. Ceci aboutit à la mort de la cellule (Figure 14) (175–177).

2.7.1.2. La voie impliquant les récepteurs de mort

Les cellules NK sont également capables d'induire l'apoptose des cellules cibles en interagissant avec les récepteurs de mort de la superfamille du TNF présents à la surface des cellules cibles (Figure 14) (177). Les interactions ont lieu principalement entre les récepteurs de mort suivants (FAS et les « death receptors » (DR)4 et DR5) et leurs ligands exprimés par les cellules NK (respectivement le ligand de Fas et « TNF-related apoptosis-inducing ligand » (TRAIL)) (178,179). L'engagement du récepteur de mort sur la cellule cible le stabilise et induit un changement conformationnel lui permettant de s'activer (180–182). Ceci permet le recrutement de la protéine adaptatrice « Fas-associated death domain » (FADD) et de la pro caspase 8, menant à la formation du « death-inducing signaling complex » (DISC), la plateforme d'activation pour la pro caspase 8 (182). La pro caspase 8 est convertie en sa forme active, la caspase 8 (183) qui clive les pro caspases effectrices

3, 6 et 7 en leurs formes actives, induisant ainsi l'apoptose de la cellule cible. La caspase 8 peut également transformer Bid en tBid et induire l'apoptose des cellules cibles via l'apoptosome (comme le granzyme B) (167,169–171).

Figure 14. Mécanismes impliqués dans la cytotoxicité des cellules NK (Reilly, *Front Immunol*, 2016)

Cyt c, cytochrome c ; GA, granzyme A ; GB granzyme B ;

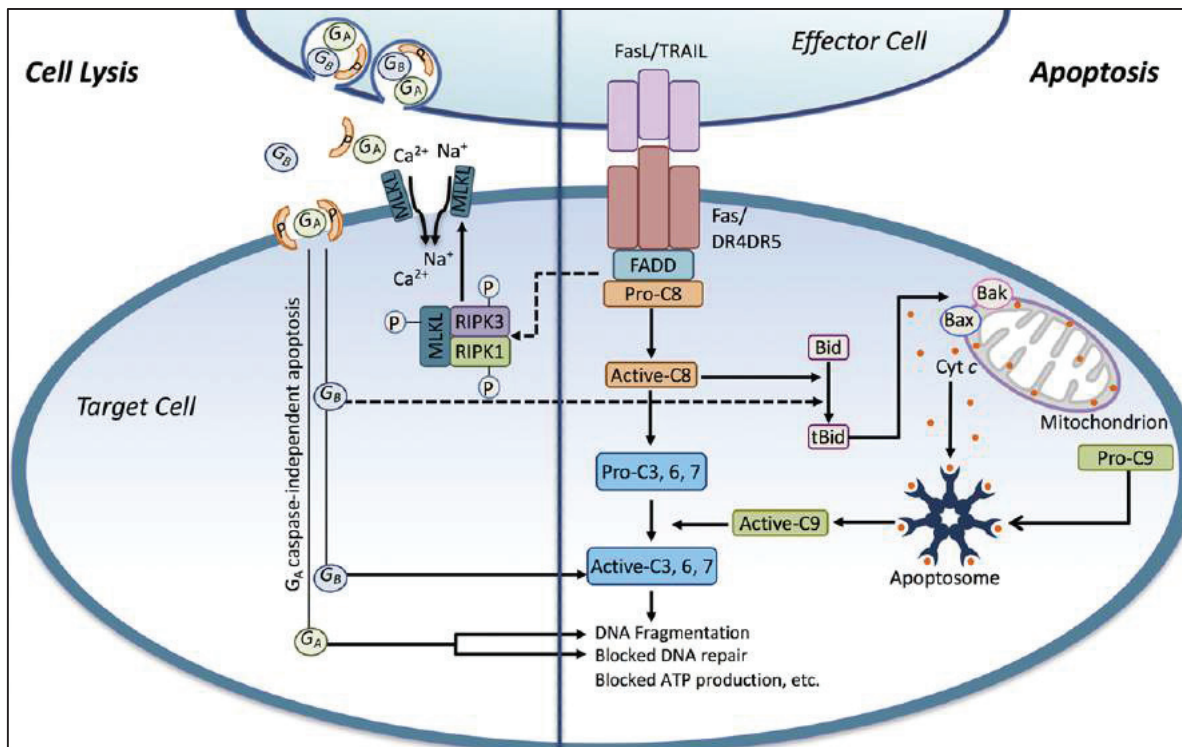

2.7.2. Fonctions immunomodulatrices

Les cellules NK façonnent la réponse immune adaptative en interagissant avec les cellules dendritiques et les lymphocytes T (Figure 15) (184).

Les cellules NK vont tout d'abord interagir avec les cellules dendritiques sur les sites inflammatoires. Les cellules dendritiques myéloïdes stimulées via leurs TLR sont la source de nombreuses cytokines : IL-12, IL-18 et IL-15. Ces cytokines vont favoriser la sécrétion d'INF- γ et la cytotoxicité des cellules NK ainsi que leur survie et prolifération (128,158,185,186). Les cellules dendritiques plasmacytoïdes, elles sécrètent des interférons de type 1 (INF- α/β) qui vont également contribuer à l'activité cytotoxique des cellules NK envers leurs cibles (128). En retour, les cellules NK sécrètent du TNF- α et de l'INF- γ qui favorisent la maturation des cellules dendritiques

(187). Les cellules dendritiques et des cellules NK dialoguent aussi à travers des contacts cellulaires directs (185,187–189). Enfin, les cellules NK peuvent aider les cellules dendritiques dans leur mission de présentation des antigènes aux lymphocytes T en tuant les cibles et en fournissant ainsi aux cellules dendritiques des antigènes à présenter aux lymphocytes T (190). Dans certaines situations, où l'inflammation est limitée, l'aide des cellules NK aux cellules dendritiques peut être critique pour permettre une activation optimale des cellules dendritiques et ainsi l'induction d'une réponse lymphocytaire T efficace (128,191,192). A l'inverse, les cellules NK peuvent également tuer les cellules dendritiques myéloïdes immatures (193,194). Cette sensibilité des cellules dendritiques myéloïdes immatures à la lyse NK-dépendante est très certainement due à leur faible niveau d'expression des molécules du CMH de classe I, et notamment HLA-E en comparaison aux cellules dendritiques matures. Même si l'importance de ce phénomène n'est pas formellement connue *in vivo*, il permettrait de maintenir une qualité/quantité de la réponse lymphocytaire T en découlant ainsi que de réguler l'homéostasie des cellules dendritiques pour maintenir une balance entre immunité et tolérance (192,195).

Les cellules NK vont également interagir avec les cellules dendritiques ainsi que les lymphocytes T dans les organes lymphoïdes secondaires. En interagissant avec les cellules dendritiques, les cellules NK vont continuer à favoriser la sécrétion d'IL-12 par ces dernières. La sécrétion d'IL-12 par les cellules dendritiques et d'INF- γ par les cellules NK vont influencer la polarisation des lymphocytes T CD4+ naïfs vers un phénotype Th1 (128,184,192,196). A l'inverse, les cellules NK vont à cet endroit aussi pouvoir limiter la réponse lymphocytaire T soit en tuant directement les lymphocytes T (197–199) soit en sécrétant des cytokines anti-inflammatoires comme l'IL-10 les inhibant (200).

Figure 15. Modulation de la réponse lymphocytaire T par les cellules NK

(Zhang, *Front Immunol*, 2017)

DC, dendritic cell, iDC, immature dendritic cell ; mDC, mature dendritic cell ; MHC, major histocompatibility complex ; pDC, plasmocytoid dendritic cell.

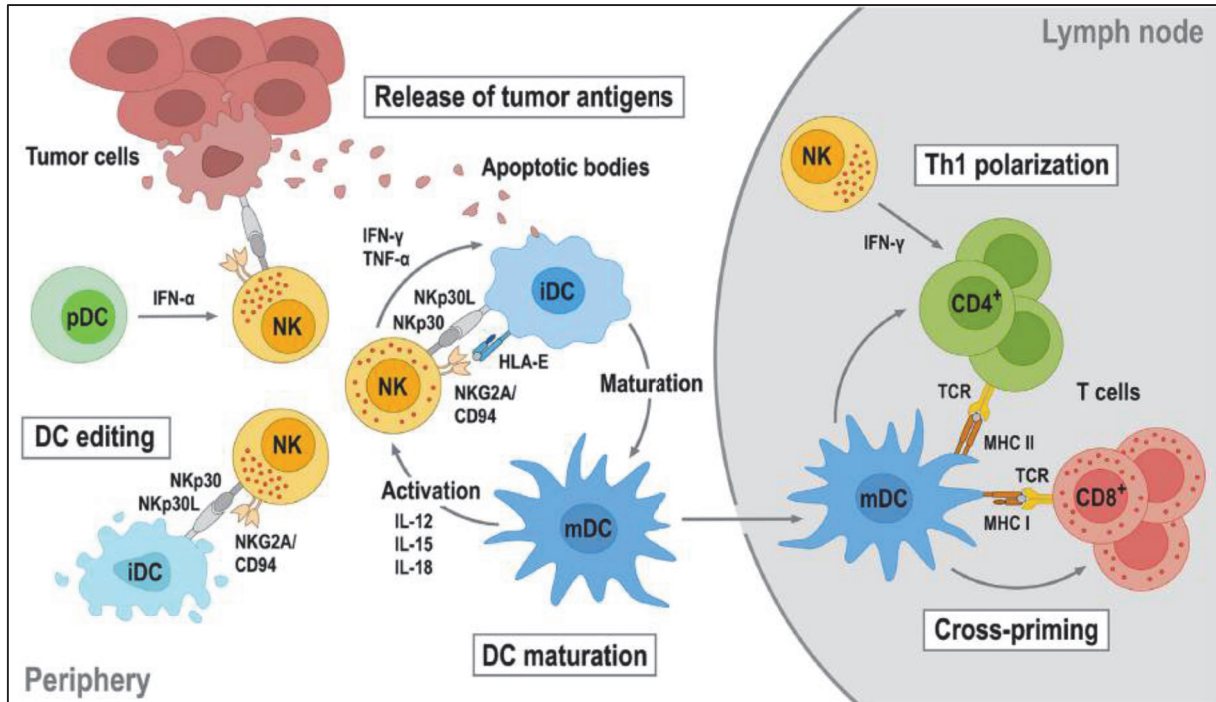

II. OBJECTIFS DU TRAVAIL DE THESE

Après une transplantation d'organe, la première cause de perte des greffons est le rejet d'allogreffe, un processus de destruction déclenché par la reconnaissance par le système immunitaire du receveur des antigènes spécifiques du donneur. Actuellement, le dogme immunologique considère que le rejet est médié par le système immunitaire adaptatif du receveur. Les lymphocytes T cytotoxiques sont responsables des rejets cellulaires. Les lymphocytes B produisant des anticorps anti-donneur sont impliqués dans les rejets humoraux. Les anticorps anti-donneur causent des lésions d'inflammation microvasculaire du greffon.

Pour une précédente étude (201), l'ensemble des biopsies de greffons rénaux réalisées entre 2004 et 2012 à Lyon a été revu. Parmi les 938 transplantés rénaux ayant eu une biopsie lors de cette période, 134 patients présentaient des lésions d'inflammation microvasculaire compatibles avec un rejet humoral. Une recherche d'anticorps spécifiques du donneur a été réalisée pour ces 129 patients. Etonnamment, seuls 75 patients présentaient des anticorps spécifiques du donneur (69 des anticorps anti-HLA et 6 des anticorps anti-cellules endothéliales) susceptibles d'expliquer leurs lésions. Nous avons voulu déterminer quel pouvait être le mécanisme immunologique impliqué dans la génération des lésions d'inflammation microvasculaire des 54 patients sans anticorps anti-donneur. Ceci nous a paru d'autant plus intéressant que ces patients sans anticorps spécifiques du donneur ont une survie du greffon réduite (60 % à 5 ans), similaire à des patients ayant un rejet humoral indépendant du complément. Parmi les acteurs susceptibles d'être impliqués dans cette nouvelle entité de rejet chronique, les cellules NK sont des candidates plausibles car i) elles sont capables de causer des lésions d'inflammation microvasculaire par un mécanisme d'ADCC au cours du rejet humoral et ii) elles sont aussi capables de s'activer de manière indépendante des anticorps lorsque leurs KIR inhibiteurs ne perçoivent pas leurs ligands HLA de classe I à la surface des cellules stressées. Ce phénomène est connu sous le nom de « missing self ». Après une transplantation d'organe allogénique, les molécules HLA de classe I du donneur diffèrent très souvent de celles du receveur, créant ainsi une situation de « pseudo-missing self ». Nous avons émis l'hypothèse, que dans ce contexte, les cellules NK du receveur pouvaient s'activer contre les cellules endothéliales du greffon et générer des lésions d'inflammation microvasculaire (Figure 16).

Les objectifs de ce travail de recherche translationnel ont été de :

- Démontrer le rôle de l'activation des cellules NK par le « missing self » dans la génération de lésions d'inflammation microvasculaire et de rejets chroniques après une transplantation d'organe.
- De confirmer l'implication de la voie mTOR dans l'activation des cellules NK en réponse au « missing self » et d'évaluer l'efficacité potentielle des inhibiteurs de mTOR pour traiter les patients présentant de tels rejets.

Figure 16. Activation des cellules NK par la reconnaissance d'un « pseudo-missing self » après une transplantation d'organe

Après une transplantation d'organe allogénique, généralement les molécules du CMH de classe I du donneur diffèrent de celles du receveur. Dans ce contexte, nous avons émis l'hypothèse que les cellules NK du receveur pouvaient percevoir l'absence de molécule du CMH de classe I du soi à la surface des cellules endothéliales du greffon, s'activer et générer des lésions d'inflammation microvasculaire du greffon.

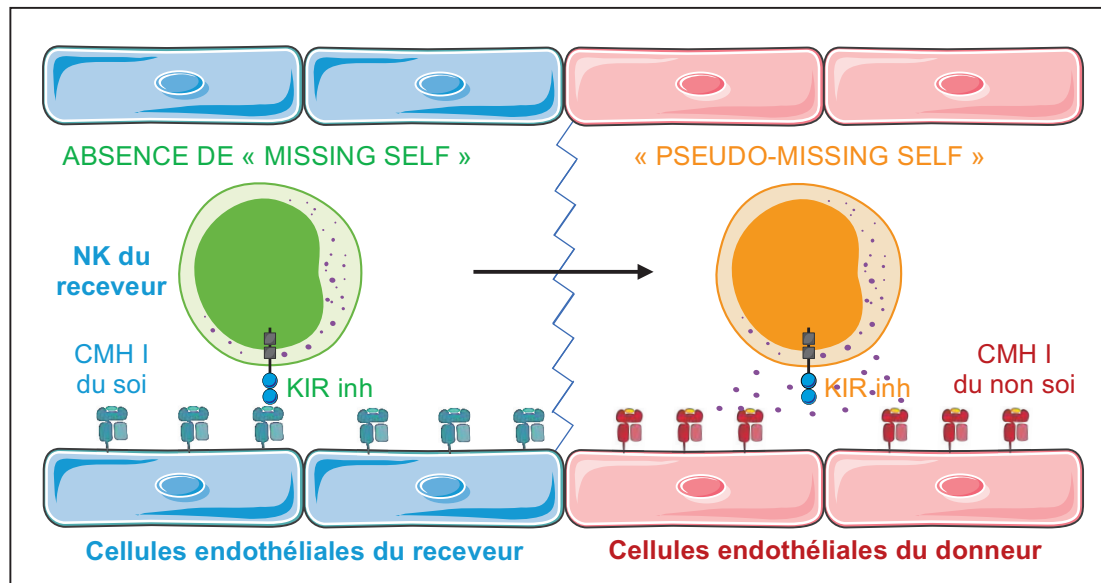

III. RESULTATS

Missing self triggers NK cell-mediated chronic vascular rejection of solid organ transplants

Alice Koenig^{1,2,3}, Chien-Chia Chen¹, Antoine Marçais¹, Virginie Mathias^{1,4}, Antoine Sicard^{1,2,3}, Maud Rabeyrin⁵, Maud Racapé⁶, Jean-Paul Duong-Van-Huyen⁶, Patrick Bruneval⁶, Alexandre Loupy⁶, Sebastien Dussurgey⁷, Stéphanie Ducreux^{1,4}, Helena Paidassi¹, Romain Guillemain⁸, Jean-Luc Taupin^{9,10,11}, Emmanuel Morelon^{1,2,3}, Antonino Nicoletti^{12,13}, Béatrice Charreau¹⁴, Valérie Dubois^{1,4}, Thierry Walzer^{1‡}, Thierry Defrance^{1‡}, Olivier Thaumat^{1,2,3,*}

‡ equal contribution

1. French National Institute of Health and Medical Research (Inserm) Unit 1111, Lyon, France;
2. Hospices Civils de Lyon, Edouard Herriot Hospital, Department of Transplantation, Nephrology and Clinical Immunology, Lyon, France;
3. Lyon-Est Medical Faculty, Claude Bernard University (Lyon 1), Lyon, France;
4. French National Blood Service (EFS), HLA Laboratory, Lyon, France;
5. Hospices Civils de Lyon, Department of Pathology, Bron, France;
6. Paris Translational Research Centre for Organ Transplantation, Paris Descartes University, Paris, France;
7. SFR Biosciences (UMS3444/CNRS, US8/Inserm, ENS de Lyon, UCBL), 69007 Lyon, France;
8. Assistance Publique - Hôpitaux de Paris, Georges Pompidou Hospital, Cardiology and Heart Transplant Department, Paris, France;

9. Assistance Publique - Hôpitaux de Paris, Immunology and HLA Laboratory, Saint-Louis Hospital, Paris, France;
10. French National Institute of Health and Medical Research (Inserm) Unit 1160, Paris, France;
11. Paris Diderot University, Paris, France.
12. French National Institute of Health and Medical Research (Inserm) Unit 1148, Laboratory of Vascular Translational Science, F-75018, Paris, France;
13. Paris Diderot University, F-75013, Paris, France;
14. French National Institute of Health and Medical Research (Inserm) UMR1064, Nantes, France;

* Correspondence to:

Olivier Thaunat MD, PhD

Phone: +33 4 7211 69 28

CIRI – INSERM U1111 - Université Lyon 1

21 Avenue Tony Garnier

69365 Lyon cedex 07, France

E-mail: olivier.thaunat@inserm.fr

Words: 6990; Figures: 8.

Supplementary online material: 2 Tables and 5 Figures

Abstract (197 words)

Long-term outcome of organ transplantation remains limited by inexorable loss of graft function, which the prevalent dogma links to the microvascular inflammation (MVI) triggered by the recipient's antibody response against alloantigens (antibody-mediated chronic rejection, AMR).

Analysing a cohort of 129 renal transplant patients with MVI on graft biopsy, we found that, in half of the cases, histological lesions were not mediated by antibodies. In these patients, genetic studies revealed a higher prevalence of mismatches between donor HLA-I and recipient inhibitory KIR receptors. We hypothesized that the allogeneic nature of graft endothelium could create a "pseudo-missing self" situation, thereby the recipient's NK cells exposed to inflammatory stimuli would not receive HLA I-mediated inhibitory signals from donor endothelial cells. Co-culture experiments and transplantation of $\beta 2$ -microglobulin^{-/-} hearts into WT mice validated this assumption and established that missing self-induced activation of NK cells depends on mTORC1.

Our work identifies a new type of chronic rejection, exclusively mediated by innate NK cells, with the same detrimental impact on graft survival as AMR. However, while no therapy is available for AMR, the commercially available inhibitor of mTORC1 rapamycin efficiently prevented the development of lesions in murine models of NK cell-mediated chronic vascular rejection.

Introduction

Recent lifestyle changes in developed countries and the increased incidence of chronic diseases have set the stage for the accelerated risk of vital organ failure, and its occurrence, which is currently recognised as the leading cause of premature death worldwide, with an estimated cost of ~25% of total health expenditures (www.who.int).

The best (often the only) therapeutic option for patients with end-stage vital organ failure is organ transplantation, which restores vital physiologic functions through the surgical substitution of the defective organ by a functioning graft retrieved from a donor. The antigenic determinants that differ between the donor and the recipient (alloantigens), in particular the highly polymorphic molecules from the major histocompatibility complex [MHC, i.e. human leucocyte antigen (HLA) in human], are inevitably recognised by the adaptive immune system of the recipient ¹, which leads to the failure of the transplanted organ, a process named “rejection”.

Until the end of the 1970s, the occurrence of acute cellular rejection episodes, i.e. the infiltration and the destruction of the graft by the recipient’s cytotoxic T lymphocytes, represented the main obstacle to the success of transplantation. Consequently, considerable efforts were made to develop potent immunosuppressive drugs blocking T cell activation. Introduction of calcineurin inhibitors in the early 1980s led to a dramatic reduction of the incidence of acute cellular rejection and doubled the percentage of functional renal grafts at 1 year post-transplantation ². However, this spectacular progress in the control of T cell alloimmune response barely impacted graft half-life ³ leading to the emergence of the “humoral theory” of chronic rejection ⁴. Seminal experimental studies have indeed demonstrated that repeated intravenous administration of alloantibodies were sufficient to trigger the development of typical

chronic rejection lesions in allogeneic cardiac grafts transplanted to T and B cell deficient mice ⁵. The theory was later validated in the clinical setting by a large-scale prospective trial showing that renal recipients with circulating alloantibodies directed against donor-specific HLA molecules (anti-HLA DSA) had twice the graft failure rate as those without ⁶. First identified in renal transplantation in the 2000s ⁷⁻⁹, antibody-mediated rejection (AMR) has since been recognised as the main cause of failure in heart ¹⁰, lung ¹¹, pancreas ¹², and vascularized composite ¹³ transplantations.

Graft endothelium represents the biological interface between donor alloantigens and host antibodies, which are retained in the recipient's circulation, due to their size ¹⁴. Binding of circulating anti-HLA DSA to directly accessible targets expressed by endothelial cells of graft microvasculature sometimes activates the classical complement pathway, which accelerates the rejection process ^{15,16}, but this is not mandatory for the development of chronic humoral rejection lesions ^{17,18}. Engagement of the surface Fc receptors of innate immune effectors by anti-HLA DSA bound to graft microvasculature is indeed sufficient to trigger the release of lytic enzymes that mediate endothelial cell damage. For this reason, the presence of microvascular inflammation in graft biopsy is widely considered as the histological hallmark of AMR ^{19,20}.

Our present translational study challenges this prevalent dogma. Analysing a cohort of 129 renal transplant patients we found that microvascular inflammation in graft biopsy was not mediated by antibodies in almost half of the cases. Instead, genetic analyses suggested that microvascular lesions were due to the direct activation of the recipient's NK cells by graft endothelial cells, which were unable to deliver the inhibitory signals due to the allogeneic nature of their HLA I molecules. The ability of

"missing self" to trigger NK cell activation and endothelial cell damage was confirmed *in vitro* and in murine experimental models *in vivo*.

Material and methods

Human study

The study was carried out in accordance with French legislation on biomedical research and the Declaration of Helsinki.

The computer database (DIAMIC) of the Lyon University Hospital pathology department was used to screen all kidney-allograft biopsies (2024 biopsies in 938 patients) performed between September 1st 2004 and September 1st 2012, for microvascular inflammation (MVI+). The biopsies of the 143 patients were systematically reviewed by the same trained pathologist (M. Rabeyrin), who graded the lesions according to Banff classification ²¹. Fourteen patients, whose biopsy analysis did not confirm the presence of MVI lesions (Banff g+ptc score<2) were excluded. Computer-assisted analyses were conducted as described in reference ²² to quantify NK cells in the patient biopsies. (see **Supplementary material & methods** section for details).

Clinical data of the 129 patients enrolled in the study was obtained from two independent national registries [Cristal: <http://www.sipg.sante.fr/portail/>, and Données Informatiques Validées en Transplantation (DIVAT); <http://www.divat.fr/>] and crosschecked. The patient characteristics are summarized in the **Supplementary Table 1**.

Serum samples banked at the time of biopsy (N° of biocollection: AC- 2011-1375 and #AC-2016-2706) were screened for the presence of anti-HLA donor-specific antibodies (DSA), and, if positive, for the ability of these anti-HLA DSA to bind the complement fraction C3d. These centralized analyses were performed in a blinded fashion with single-antigen flow bead assays according to the manufacturer's instructions (Immucor, Norcross, GA, USA). To rule out the presence of non-HLA

donor-specific antibodies, negative sera were tested in endothelial flow cross match assay as described in reference ²³ (see **Supplementary material & methods** section for details).

The steps leading to the distribution of patients into the first 3 groups of patients (MVI+DSA+C3d+, n=40; MVI+DSA+C3d-, n=29; and MVI+DSA-, n=54) are summarized **Figure 1A**.

A control cohort, without MVI on graft biopsy, nor circulating DSA (MVI-DSA-, n=75), but matched for the main clinical characteristics of the MVI+DSA- patients, was established from the pool of 938 patients.

Identification of genetically-predicted missing self

Donor and recipient HLA typing were performed by PCR-SSO reverse (One Lambda, Canoga Park, CA, USA). Recipients were genotyped for the 14 KIR genes (2DL1, 2DL2, 2DL3, 2DL4, 2DL5, 2DS1, 2DS2, 2DS3, 2DS4, 2DS5, 3DL1, 3DL2, 3DL3, 3DS1) and 2 pseudogenes (2DP1, 3DP1) by PCR-SSO reverse (KIR SSO Genotyping Test, One Lambda and Lifecodes KIR Genotyping, Immucor).

2DL1, 2DL2, 2DL3, 3DL1, 3DL2 inhibitory KIR receptors educated NK cells only when the recipient expressed their respective HLA ligand: KIR2DL1/C2; KIR2DL2/C1; KIR2DL3/C1; KIR3DL1/Bw4 and KIR3DL2/A*03, *11.

Genetic prediction of missing self was defined as the lack of expression by the graft of the type of HLA molecule able to bind to an educating KIR of the recipient (**Figure 2A** and **Supplementary material & methods** section for details)

Cell preparation and cultures

The human erythroleukemia cell line K562, which lacks expression of any MHC molecules, was cultured in RPMI-1640 (ThermoFisher Scientific, Courtaboeuf, France) complemented with fetal Bovine serum (FBS) 10 % (Dutscher, Brumath,

France), L-Glutamine 2 mM (ThermoFisher Scientific), Penicillin 100 U/mL, Streptomycin 100 µM and HEPES 25 mM (ThermoFisher Scientific) (hereafter referred to as "complete RPMI").

Primary human arterial endothelial cells were isolated from organ donors (agreement PFS08-017 from the Agence de la Biomédecine, <https://www.agence-biomedecine.fr>) and prospectively stored in the DIVAT biobank (N° of biocollection #02G55). They were cultured in endothelial cell growth medium 2 (Promocell, Heidelberg, Germany) in flasks coated with fibronectin (Promocell) or gelatin 1 % (Sigma, Saint Quentin-Fallavier, France) and used between passages 2 and 7.

Peripheral blood mononuclear cells (PBMC) were isolated from the blood of healthy volunteers by Ficoll gradient centrifugation (Eurobio, Courtaboeuf, France). PBMCs were cultured overnight at 37°C in 5% CO² in complete RPMI supplemented with recombinant human IL-2 (R&Dsystems, Minneapolis, MN, USA) or were maintained at 4°C in complete RPMI. NK cells were purified (> 90%) from PBMCs by negative selection with magnetic enrichment kits (Stemcell, Grenoble, France).

Flow cytometry

NK cell count

Two hundred microliters of blood were incubated with anti-CD45 (clone 30-F11, 1/400, BioLegend, London, UK), -CD3 (clone SK7, 1/10, BD biosciences, Le Pont de Claix, France) and -CD56 (clone NCAM16.2, 1/10, BD biosciences) antibodies. The samples were then incubated with a Lysing Solution (BD biosciences) to eliminate the red blood cells.

Lymphocyte count was performed with ABX Pentra 60C+ (Horiba, Irvine, CA, USA).

KIR phenotyping

Single cell suspensions of human PBMCs were incubated with a fixable viability dye (ThermoFisher Scientific) for 20 minutes at 4°C. After washing, the cells were incubated first with anti-CD19 (clone HIB19, 1/10, BD biosciences), -CD14 (clone M5E2, 1/10, BD biosciences), -CD3 (clone SK7, 1/10, BD biosciences), -CD56 (clone NCAM16.2, 1/10, BD biosciences), -KIR3DL1 (clone DX9, 1/25, BD biosciences), -KIR2DL1/S5 (clone 143211, 1/10, R&Dsystems), and -KIR2DL3 (clone 180701, 1/10, R&Dsystems) antibodies for 15 minutes at room temperature and then with anti-KIR2DL1/S1 (clone EB6B, 1/25, Beckman Coulter, Villepinte, France), -KIR2DL2-3/S2 (clone GL183, 1/25, Beckman Coulter), and -KIR3DL1-2 (clone REA168, 1/10, Miltenyi Biotec, Bergisch Gladbach, Germany) antibodies for an additional 15 minutes. The cells were then fixed with paraformaldehyde 2 % (ThermoFisher Scientific) and the sample was stored at 4°C until analysis.

Data collection

Sample acquisitions were made on a LSR FORTRESSA or a FACScanto II® flow cytometer (BD biosciences) and analyses were performed with FlowJo software version 10.0.8r1 (Tree Star Inc, Ashland, OR, USA).

Imaging Flow cytometry

Purified human NK cells (10^5) were mixed with K562 cells at a ratio of 1:1 in V-bottomed 96-well plates, centrifuged at 100 g for 1 minutes, and incubated 30 min, 1 hour, 2 hours or 3 hours at 37°C at 5% CO². Negative controls were NK cells cultured alone and positive controls were NK cells cultured with IL-15 (100 ng/ml, Peprotech).

At indicated time points, the cells were harvested, stained with a fixable viability dye (ThermoFisher Scientific) and then surface stained with anti-CD3 (clone SK7, 1/10, BD biosciences), and -CD56 (clone NCAM16.2, 1/10, BD biosciences) antibodies.

The cells were subsequently fixed, permeabilized (Lysefix/PermIII® fixation/permeabilization kit, BD Biosciences) and stained with anti-Phospho-S6 Ribosomal Protein Ser 235/236 (clone D57.2.2E, 1/50, Cell Signaling Technology, Leiden, The Netherlands) or anti-PAkt S473 (clone M89-61, 1/40, BD biosciences) antibodies.

Sample acquisitions were made on an ImageStream X Mark II (Amnis-EMD Millipore, Darmstadt, Germany) with 40X magnification and analysed with IDEAS software (v6.0).

NK cell activation *in vitro*

PBMCs were cultured overnight in RPMI supplemented with 500 UI/ml of recombinant human IL-2 (R&Dsystems). Purified NK cells (10^5 cells) were then mixed with endothelial cells at a ratio of 1:1 in flat-bottomed 96-well plates, centrifuged at 100 g for 1 minutes, and incubated at 37°C at 5% CO₂. Anti-CD107a-FITC (clone H4A3, 5 µl, ThermoFisher Scientific) was added prior the start of the assay. One hour after the beginning of the co-culture, Golgi Stop (BD biosciences) was added to each well.

After 4 hours of co-culture, the cells were harvested and surface stained with appropriate antibody combinations to identify KIR subsets. The cells were subsequently fixed and permeabilized (Cytofix/Cytoperm fixation/permeabilization kit, BD Biosciences), stained with anti-MIP1β-V450 (clone D21-1351, 1/40, BD biosciences) antibodies and analysed by flow cytometry.

Endothelial cell viability *in vitro*

PBMCs were cultured overnight in RPMI supplemented with 60 UI/ml of recombinant human IL-2 (R&Dsystems). In each culture well, 10^4 human primary endothelial cells (either Bw4⁻ or Bw4⁺) were seeded. After 24h, 10^5 purified NK cells from KIR3DL1⁺ or

KIR3DL1⁻ donors were added to the culture. When indicated, 0.5 µg of anti-KIR3DL1 blocking monoclonal antibody (clone DX9, BD biosciences) or an isotype control was added to the cultures.

Endothelial cell viability was monitored every 5 min for 10 h by electrical impedance measurement with an xCELLigence RTCA SP instrument (ACEA Biosciences, San Diego, CA, USA). The cell indexes (CI) were normalized to the reference value (measured just prior to adding NK cells to the culture). Endothelial cell viability in the experimental well was normalized over the control well.

Mice

Wild type C57BL/6 (H-2^b) mice aged 8-15 weeks were purchased from Charles River Laboratories (Saint Germain sur l'Arbresle, France).

C57BL/6 mice in which β 2 microglobulin gene has been deleted (hereafter referred as β 2 microglobulin KO) lack MHC class I protein expression on the cell surface.

All mice were maintained under exemption of specific pathogenic organisms condition in our animal facility: Plateau de Biologie Expérimentale de la Souris (<http://www.sfr-biosciences.fr/plateformes/animal-sciences/AniRA-PBES>; Lyon, France).

All animal studies were approved by the local ethical committee for animal research (CECCAPP, <http://www.sfr-biosciences.fr/ethique/experimentation-animale/ceccapp>).

Missing-self-induced NK cell-mediated rejection models

Cell transfer model

These experiments were conducted as in reference ²⁴. Briefly, splenocytes from wild type C57BL/6 or β 2-microglobulin KO mice were labelled respectively with carboxyfluorescein diacetate succinimidyl ester (CFSE, 2 µM, ThermoFisher Scientific) and CellTraceViolet (CTV, 2 µM; ThermoFisher Scientific). Five million

cells of each genotype were IV transferred into wild type C57BL/6 recipient mice. Sixty hours after transfer, splenocytes were isolated and analysed by flow cytometry. The percentage of remaining β 2-microglobulin KO cells was calculated using the following formula: % remaining cells = $100 \times (\beta$ 2-microglobulin KO cells/wild-type cells) at 60 h (β 2-microglobulin KO cells/wild-type cells) in input mix. (see **Supplementary material & methods** section for details)

Heart transplantation model

Cervical heterotopic heart transplantations were performed as described in reference ¹⁴ (see **Supplementary material & methods** section for details).

When indicated, the heart graft was kept at 4°C for 3 hours before transplantation to induce ischemia/reperfusion injuries.

Heart transplants were harvested 60 days after transplantation, fixed in 4% buffered formalin for 24h and embedded in paraffin for hematoxylin and eosin stain and immunohistochemistry. The following primary antibodies were used: anti-mouse CD31 (clone SZ31; 1/50; Dianova, Hamburg, Germany), anti-mouse CD45 (clone 30-F11; 1/40, BD biosciences), and anti-Nkp46 (kind gift from Innate Pharma, Marseille, France) to stain, respectively, the endothelial cells, the hematopoietic cells and the NK cells. The sections were revealed by Vectastain ABC HRP Kit (Vector, Peterborough, UK). The amount of labeled cells was semiquantitatively assessed as follows: 0 normal; 1+ minimal or rare foci; 2+ moderate or several foci; 3+ marked or multifocal or diffuse.

Treatment of recipients

When indicated, mice were given intraperitoneal injections of cyclosporine (Sandimmun, Novartis, Rueil-Malmaison, France) 20mg/kg/day or rapamycin (Bio basic, Amherst, NY, USA) 3 mg/kg/day from day-7 to the end of the experiment.

Statistical analyses

For each data set, mean \pm standard deviation was calculated. For graphical presentation of the same data sets, box plots were generated using Prism software (Version 6.01; GraphPad Software Inc., La Jolla, CA), which present the entire data set distribution. The centre line in the boxes shows the medians; the box limits indicate the 25th and 75th percentiles, the whiskers indicate the 10th and 90th percentiles.

Differences between the groups were evaluated by: Mann-Whitney test, unpaired *t*-test, one-way ANOVA followed by a Tukey's *post hoc* test, or by two-way ANOVA followed by a Sidak's *post hoc* test, according to the size of the groups and the distribution of the variable. The test used for comparison is indicated in the figure legends.

Renal graft survivals were compared using the log-rank test.

The differences between the groups were considered statistically significant for $p < 0.05$ and were reported with asterisk symbols (*: $p < 0.05$; **: $p < 0.01$; ***: $p < 0.001$; ****: $p < 0.0001$).

Results

Antibodies are not the sole trigger for graft microvascular inflammation

In kidney transplantation, microvascular inflammation (MVI) is defined as the presence of innate immune effectors in the lumen of peritubular capillaries (peritubular capillaritis, ptc) and/or glomeruli (glomerulitis, g) ²¹. We retrospectively reviewed all kidney graft biopsies performed at our University Hospital between September 2004 and September 2012 (n= 2024 in 938 patients) and identified 129 renal recipients with typical graft microvascular inflammation (g+ptc \geq 2). The clinical characteristics of these patients are presented in **Supplementary Table 1**.

While 69 of these patients had detectable circulating anti-donor HLA antibodies (i.e. "typical AMR"), the remaining ones (60/129, 46,5%) had no detectable circulating anti-donor HLA antibodies (anti-HLA DSA) in highly sensitive solid phase assays (**Figure 1A**).

Previous studies have shown that *bona fide* humoral rejections can be triggered by non-HLA antibodies directed against either minor histocompatibility alloantigens or autoantigens ^{1,25-28}. Flow cytometric crossmatch with activated HLA-matched endothelial cells ²³ indeed identified 6 patients (6/129, 4,6%) with non-HLA anti-endothelial cells antibodies that could account for graft microvascular inflammation (**Supplementary Figure 1 & Figure 1A**). Based on these results we concluded that in almost half of the cases (54/129, 41,9%; group MVI+DSA-), graft microvascular inflammation is not caused by host humoral response.

Antibody-independent microvascular inflammation impacts graft survival

The binding of high amounts of antibodies to graft endothelium triggers the classical complement pathway ²⁹ that is responsible for acute tissue injuries, which dramatically shorten graft survival ^{15,16}. However, even in the absence of complement

activation, donor-specific antibodies can still recruit innate immune effectors and this microvascular inflammation has a detrimental impact on graft survival ¹⁷.

In line with this data, we observed that among the 69 renal recipients with typical AMR (i.e. circulating anti-HLA DSA and microvascular inflammation on graft biopsy), the 40 patients whose DSA were able to activate the complement cascade *in vitro* (group MVI+DSA+C3d+, **Figure 1A**), had the highest score for C4d deposition in graft biopsy (**Figure 1B**) and the worst graft survival (**Figure 1C**).

Interestingly, the 54 patients with antibody-independent microvascular inflammation (group MVI+DSA-, **Figure 1A**) had the same graft survival as the 29 patients with AMR, due to non-complement activating DSA (group MVI+DSA+C3d-, **Figure 1A**) (**Figure 1C**). Graft survivals of these two groups were better than that of MVI+DSA+C3d+ patients but significantly worse than the graft survival of a matched control cohort (group MVI-DNA-, **Figure 1A**) as shown **Figure 1C**.

This data therefore demonstrates that, regardless of whether it is DSA-dependent or antibody-independent, microvascular inflammation has the same detrimental impact on graft survival.

NK cells are present in both types of microvascular inflammation

Antibodies which are unable to activate the complement cascade can still recruit innate immune effectors that can be responsible for antibody-dependent cell mediated cytotoxicity (ADCC), thus leading to chronic humoral rejection ⁷. Seminal experimental studies ¹⁸, confirmed by subsequent clinical observations ³⁰, have demonstrated that among the various subsets of FcY receptor-expressing innate immune effectors, NK cells are crucial for the development of chronic humoral rejection lesions.

In line with this data, we observed the presence of NK cells in the graft microcirculation of MVI+DSA+C3d- patients (**Figure 1D** and **1E**). Interestingly, NK cell infiltration was similar in MVI+DSA- patients, whose microvascular inflammation was not triggered by antibody deposition on the graft endothelium (**Figure 1D** and **1E**). This data suggests that in chronic rejection, a final common pathway involving NK cells can be triggered either by the humoral arm of the adaptive immune system of the recipients (as widely accepted) or by direct (antibody-independent) activation of innate effectors.

Genetically predicted missing self increases the risk for antibody-independent microvascular inflammation

What could be the stimulus responsible for NK cell recruitment to graft endothelium in the absence of DSA?

NK cell activation is governed by the integration of activating and inhibitory signals. A major class of NK cell receptors involved in this process is killer Ig-like receptors (KIRs). Activating KIRs have a short cytoplasmic tail (KIR-S) and signal through the DAP12 adaptor but their ligands remain poorly defined³¹. Inhibitory KIRs have long cytoplasmic tails (KIR-L) containing two ITIMs. Each inhibitory KIR displays two (KIR2DL) or three (KIR3DL) extracellular Ig-domains that confer specificity for HLA-C or HLA-A/B allotypes, respectively (a graph summarising this information is presented in **Supplementary Figure 2A**)^{31,32}.

KIR locus is highly polymorphic for allele and gene content³¹. At the population level, 2 major KIR haplotypes can be defined. Haplotypes A and B share most of their inhibitory KIR-L content but differ strongly in their activating KIR-S content. Haplotype A patients have only one activating KIR (KIR2DS4) whereas those of haplotype B have multiple activating KIRs³³. We analysed the KIR genotype and KIR haplotype

of recipients for whom DNA was available and compared patients from MVI-DSA- (control group, n=55) and MVI+DSA- (n= 44) groups. No difference was found between the recipients with antibody-independent microvascular inflammation and the controls (**Supplementary Table 2**).

Because the HLA locus is located on chromosome region 6p21 whereas the KIR locus is on 19q13.4, HLA and KIR are inherited independently. Consequently, NK cells need to undergo a process of education (**Figure 2A**), in which auto-reactive NK cells (due to the lack of expression of HLA I ligands for inhibitory KIR receptors) are rendered anergic³⁴. The HLA I genotype of recipients was therefore analysed and integrated in the previous analysis. However, even when only educating inhibitory KIRs were considered, no difference was found between recipients of the MVI+DSA- and MVI-DSA groups (**Supplementary Table 2**).

The "missing self" theory predicts that the role of educated inhibitory KIR-expressing NK cells is to eliminate HLA-deficient cells that arise during tumoral transformation³⁵ or as a result of MHC I down-regulation that occurs in certain viral infections³⁶. Although graft endothelial cells express a normal level of HLA I molecules (**Figure 2B**), their allogeneic nature could theoretically induce a situation in which donor endothelial cells express an HLA I allotype that is unable to interact with an educating inhibitory KIR receptor expressed by recipient NK cells. This situation could trigger a "pseudo-missing self" response by recipient's NK cells (**Figure 2A**). To test whether this hypothesis could explain antibody-independent graft microvascular inflammation, we integrated, for each donor/recipient pair, the genetic analyses of i) recipient KIRs and ii) recipient HLA-class I (in order to identify educating KIRs). Recipient data was then combined with the donor HLA-class I genotype to identify situations of missing self. In line with our hypothesis, recipients with antibody-independent microvascular

inflammation had statistically more genetically predicted missing self (MS) than matched controls (**Figure 2C**).

Of note, ~1/3 (15/44; 34.1%) of MVI+DSA- patients had no genetically predicted missing self, indicating that other molecular mechanisms can also induce antibody-independent microvascular inflammation (**Figure 2C**).

Priming and heterogeneity of the NK cell population influence clinical expression of genetically predicted missing self

Genetic analyses of the donor/recipient pairs also revealed that ~1/3 (21/55; 38.2%) of MVI-DSA- recipients had predicted missing self, which suggested that this condition alone is not sufficient to trigger graft microvascular inflammation (**Figure 2C**).

In contrast to long-held dogma, NK cells are not naturally active killers. Instead, recent experimental evidence has demonstrated that educated NK cells need to undergo priming in order to acquire their full effector functions³⁷. In clinical transplantation, two frequent complications can promote the priming of recipient NK cells: i) ischemia/reperfusion injuries, and ii) viral infections. Cold ischemia time was longer in MVI+DSA- than in MVI-DSA- patients (**Figure 3A**) and the incidence of viral infections (in particular CMV infection) was higher in MVI+DSA- patients (**Figure 3B**). This data suggests that the absence of graft microvascular inflammation, in some patients with genetically predicted missing self, can be explained by the absence of sufficient priming of NK cells.

Another possible non-exclusive explanation for the absence of graft microvascular inflammation in patients with genetically predicted missing self could be the inter-individual heterogeneity of the NK cell population. Because of the retrospective nature of our study and the lack of frozen PBMCs for these patients, we were unable

to directly test the hypothesis in the cohort. Instead, we performed a flow cytometry phenotypic analysis of the circulating NK cells of 6 healthy volunteers with identical inhibitory KIR genotypes (**Supplementary Figure 2B**). The absolute count of NK cells among circulating lymphocytes showed huge inter-individual differences (**Figure 3C**). Beyond these quantitative disparities, variegated expression of KIR genes resulted in major inter-individual qualitative differences in the repertoire of inhibitory KIR receptors expressed by circulating NK cells (**Figure 3D**). This had two main consequences: i) a high proportion (38.5%) of circulating NK cells did not express any inhibitory KIR (**Supplementary Figure 2C**), ii) even for inhibitory KIR-expressing NK cells, the proportion of NK cells that was able to specifically detect alteration of a particular HLA I molecule was highly different between the individuals (**Figure 3D**). Therefore, it is conceivable that for some recipients with genetically predicted missing self, the lack of graft microvascular inflammation was due to the fact that the NK cell population that was able to sense the missing self (i.e. expressing the appropriate inhibitory KIR) was too small.

The complexity of the clinical setting, in which each donor/recipient pair is different, at best allows for establishing correlations. To confirm the causality of missing self in the occurrence of NK-mediated chronic vascular rejection of solid organ transplants we moved to experimental approaches.

Allogeneic endothelial cells trigger missing self-induced activation of NK cells *in vitro*

Upon activation, NK cells kill target cells by directed exocytosis of cytotoxic granules, which can be quantified by the induced cell surface expression of CD107a (LAMP-1), a trans-membrane protein that usually resides in secretory lysosomes. In addition to

their cytolytic function, activated NK cells also secrete a variety of soluble factors, including MIP-1 β .

In order to test whether endothelial missing self could trigger activation of NK cells, primary allogeneic human endothelial cells were co-cultured with NK cells purified from the PBMCs of healthy volunteers. After 4 hours of culture, NK cells were recovered and their inhibitory KIR phenotype and activation status (i.e. expression of CD107a and MIP-1 β) was assessed at the single cell level by flow cytometry.

Our first analysis focused on the 5 NK cell populations that expressed only one inhibitory KIR (**Supplementary Figure 2B**). According to the HLA-class I genotypes of the endothelial cells and NK cell donors, 3 distinct situations were identified for each of these NK cell populations (**Figure 2A**): i) absence of missing self (no MS), ii) presence of a missing self for a ligand not expressed by the NK cell donor (uneducated missing self, uneduc MS), or iii) missing self (MS). In line with the clinical data presented above, the 3 groups of NK cells behaved uniformly and did not show any sign of activation after co-culture with the endothelial cells in absence of prior priming (**Supplementary Figure 3A**). After priming with low dose IL-2, NK cells that could specifically detect the absence of expression of a particular HLA class I molecule (MS group) expressed significantly higher levels of both CD107a (**Figure 4A**) and MIP-1 β (**Figure 4B**) as compared to NK cells that did not express the specific inhibitory KIR (no MS) or that expressed the appropriate inhibitory KIR but were not educated (uneduc MS). This result validates our hypothesis that allogeneic endothelial cells can trigger missing self-induced activation of primed and educated NK cells.

To determine whether some molecular combinations were more prone than others to promote missing self-induced NK cell activation, the previous dataset was re-

analysed considering each inhibitory KIR separately. All inhibitory KIRs were equally able to promote activation of primed and educated NK cells in the absence of their specific HLA class I molecule on the endothelial cells, except for KIR3DL2 (**Supplementary Figure 3B**). This result fits with the conclusion of recent independent reports ^{38,39}, and suggests that KIR3DL2 might not be an educating inhibitory KIR. Taking this notion into account, we re-analysed the clinical data presented in **Figure 2C** removing KIR3DL2 from the definition of genetically predicted missing self. Although this simple change did not correct the other limitations of this method (details discussed in the section "Priming and heterogeneity of the NK cell population influence clinical expression of genetically predicted missing self"), it was sufficient to reduce the proportion of recipients with genetically predicted missing self in the group without graft microvascular inflammation [proportion of recipients with genetically predicted missing self in MVI-DSA- group with vs without KIR3DL2: 21/55 (38.2%) vs 15/55 (27.3%)].

A significant proportion of NK cells (25.4 %, **Supplementary Figure 2C**) express more than one inhibitory KIR on their surface. To determine how these distinct signals contribute to cell activation, we focused the analysis on NK cells that expressed two inhibitory KIRs, one of them being responsible for missing self-induced activation. Depending on the type of the second inhibitory KIR and the HLA I genotypes of the endothelial cells and the NK cell donor, 3 situations were identified: i) missing self + matched (MS+M), ii) missing self + uneducated missing self (MS+uneduc MS), or iii) missing self + missing self (2MS). Activation status of the NK cells of these 3 groups after co-culture with allogeneic endothelial cells was compared to that of NK cells that express only one educating inhibitory KIR. The level of expression of both CD107a and MIP-1 β was increased in 2MS, and

decreased in MS+uneduc MS and the MS+M group (**Figure 4C** and **4D**). These results demonstrate that the signals generated by each educating inhibitory KIR expressed on the surface are integrated by NK cells and modulate missing self-induced activation.

Missing-self-induced activation of NK cells has a deleterious impact on endothelial cells

Having demonstrated that allogeneic endothelial cells could trigger missing self-induced activation of NK cells, we aimed at determining its impact on endothelial cells. To address this issue, the integrity of adherent endothelial cells was monitored by real time impedance measurement in the co-culture model described above.

In a first set of experiments (model #1, presented **Figure 5A**), we compared the survival of the same primary allogeneic endothelial cells exposed to NK cells from two distinct donors: one donor with missing self and the other without (negative control). The experiment, reproduced with 6 different pairs, demonstrated that endothelial cell survival was consistently reduced when co-cultured with NK cells expressing one inhibitory KIR unable to interact with the appropriate HLA I molecules on endothelial cells (**Figure 5B**).

To rule out the possibility that the differences observed in the first model were influenced by inter-individual heterogeneity of NK cell populations between donors, we developed a second model (model #2, presented **Figure 5A**), in which the allogeneic endothelial cells were co-cultured with NK cells from the same matched donor with anti-KIR3DL1 blocking mAb or an isotype control mAb. In line with previous results, co-cultures with anti-KIR3DL1 blocking mAb induced an "artificial" missing self, which significantly lowered endothelial cell survival (**Figure 5C**).

Collectively, this *in vitro* data supports the notion that missing self-induced activation of NK cells has a deleterious impact on graft vasculature.

Missing self triggers NK cell-mediated rejection *in vivo*

We next investigated the impact of missing self-induced activation of NK cells in two *in vivo* models.

In the first model (model #1, presented **Figure 6A**), fluorescently labelled splenocytes purified from wild type C57B/L6 (controls) and β 2-microglobulin KO mice (lacking MHC I) from the same genetic background were IV co-injected to wild type C57B/L6 mice (**Supplementary Figure 4A**). After 2.5 days, both types of splenocytes were enumerated in the spleen of recipient mice by flow cytometry (**Supplementary Figure 4B**). In line with *in vitro* data, missing self triggered the specific destruction of the cellular targets that lacked MHC I expression (**Figure 6B and supplementary Figure 4B**). The role of NK cells in missing self-induced cellular destruction was demonstrated by the persistence of β 2-microglobulin KO splenocytes in recipients, whose NK cells were depleted by anti-NK1.1 mAb before splenocytes transfer. (**Figure 6B and Supplementary Figure 4 B and 4C**).

To validate the existence of missing self-induced NK-mediated rejection in the context of transplantation, we adapted the heterotopic heart transplantation model as shown **Figure 6A** (model #2). Heart grafts, harvested in wild type C57B/L6 (controls) or β 2-microglobulin KO mice, were transplanted to wild type C57B/L6 mice. As observed in the clinic, the mere absence of MHC I molecules on the graft endothelium was insufficient to promote the development of histological lesions (group β 2-microglobulin KO into C57B/L6, β 2 \rightarrow B6; **Figure 6C**, and **6E**). However, priming of the recipients' NK cells induced by mild ischemia/reperfusion injuries resulted in the appearance of microvascular inflammation, specifically in β 2-

microglobulin KO heart transplants (groups β 2-microglobulin KO into C57B/L6 + ischemia, β 2 \rightarrow B6 + isch *versus* C57B/L6 into C57B/L6 + ischemia, B6 \rightarrow B6 + isch; **Figure 6C**, and **6E**). Similar results were obtained when priming of NK cells was performed with Poly (I:C), used as a surrogate for viral infection (**Supplementary Figure 4D and 4E**). Graft microvascular inflammation in this model was very similar to that observed in MVI+DSA- patients: circulating CD45+ immune cells, including Nkp46+ NK cells were found to adhere to CD31+ turgid capillary endothelial cells (**Figure 6D**, and **6E**). The central role of NK cells in this type of rejection was demonstrated by the complete disappearance of lesions in β 2-microglobulin KO heart grafts transplanted to recipients, whose NK cells were depleted by anti-NK1.1 mAb (group β 2-microglobulin KO into C57B/L6 + ischemia + anti-NK1.1, β 2 \rightarrow B6 + isch + α NK1.1; **Supplementary Figure 4C**, **Figure 6C**, **6D**, and **6E**).

Missing self triggers mTORC1 pathway in NK cells

To gain insights into the molecular mechanisms involved in missing self-induced NK cell activation, human NK cells were purified from PBMCs of healthy volunteers and co-cultured with K562 cells, an MHC class I-deficient human cell line.

Based on previous works from our group, which have reported the critical importance of this pathway for NK cell activation^{24,40}, the analysis was focused on mTOR pathway. The phosphorylation status of S6 Ribosomal Protein (S6RP) and protein kinase B (AKT), located downstream from mTORC1 and mTORC2 complexes respectively, was longitudinally assessed in NK cells using imaging flow cytometry (**Supplementary Figure 5** and **Figure 7A**). While isolated NK cells showed only a modest increase of pS6RP, the mTORC1 pathway was strongly activated in NK cells that had formed doublets with K562 targets (**Figure 7A** and **7B**). In contrast, no significant change was observed regarding the phosphorylation status of AKT in NK

cells, which suggests that mTORC2 does not play a role in missing self-induced NK cell activation (**Figure 7A** and **7C**).

Rapamycin blocks mTORC1 *in vivo* and prevents missing self-induced NK-mediated rejection

Calcineurin inhibitors are currently the cornerstone of therapeutic immunosuppression in solid organ transplantation^{41,42}. Rapamycin, an allosteric inhibitor of the mTORC1 complex, was approved for immunosuppression as an alternative to calcineurin inhibitors in the early 2000s⁴³. Based on the molecular data presented above, we hypothesised that rapamycin might have potent therapeutic effects against missing self-induced NK-mediated rejection. To test this theory we compared the effects of rapamycin and cyclosporin in the two *in vivo* models presented above (**Figure 8A**).

As expected, rapamycin, but not cyclosporin, reduced the activation of the mTORC1 pathway in NK cells exposed to missing self *in vivo* (**Figure 8B**). The blockade of mTORC1 with rapamycin correlated with significantly improved survival of β 2-microglobulin KO cellular targets as compared with controls and cyclosporin treated animals (**Figure 8C**).

The beneficial effect of rapamycin was also observed in the heterotopic heart transplantation model (**Figure 8A**). Indeed, while cyclosporin A-treated animals developed the same microvascular inflammation as untreated controls, recipient mice treated with rapamycin showed significantly less endothelial turgidity and inflammatory effectors in heart graft capillaries (**Figure 8D, 8E** and **8F**).

Our data therefore validate the idea that rapamycin may protect transplant recipients against missing self-induced NK-mediated rejection.

Discussion

In the present study, we demonstrated that the allogeneic nature of graft endothelial cells sometimes creates missing self, a situation that can be sensed by primed NK cells in the recipient's circulation. Missing self-induced NK cell activation promotes the development of graft microvascular inflammation that has the exact same detrimental impact on organ survival as non-complement activating anti-HLA DSA, the primary cause of late transplant loss ⁷⁻⁹. However, while there is currently no efficient therapy against antibody-mediated chronic vascular rejection, our study established that missing self-induced activation of NK cells is dependent upon the mTORC1 pathway that can be blocked by rapamycin. Preclinical studies using experimental murine models confirmed the efficiency of rapamycin to prevent the development of histological lesions.

We believe that this data can have several levels of significance. Firstly, clinicians in charge of transplant patients are frequently confronted with microvascular inflammation lesions on graft biopsy. As an illustration, the prevalence of Banff score g+cpt \geq 2 lesions was estimated to be as high as 13.8% in our cohort of renal transplant patients, albeit we do not perform HLA incompatible transplantations (i.e. transplantation in the presence of preformed anti-HLA DSA) in our centre. Until now, microvascular inflammation lesions have been considered as the hallmark of antibody-mediated rejection (AMR). Induced by the growing importance of AMR, now recognised as the primary cause of transplant failure ⁷⁻⁹, the consensus, established in 2013 by the Banff group, stated that patients with MVI should be diagnosed with AMR, despite the possible absence of circulating anti-HLA DSA and of positive C4d staining on the graft biopsy ²¹. The rationale for this decision was based on the fact that available assays only detect anti-HLA antibodies, whereas graft endothelial cells

express other minor histocompatibility antigens or autoantigens ^{1,23,25,26,44} that can be targeted by the recipient's humoral immune response. Our data suggest that such anti-endothelial cell antibodies exist but account for <10% of isolated MVI cases. Instead, we propose that most isolated (DSA-) MVI are the result of a previously unrecognized type of rejection, due to the "direct" activation of the recipient's NK cells by missing self.

An intriguing question is why previous large clinical studies have failed to detect the detrimental impact of genetically predicted KIR-ligand incompatibility on renal allograft survival ^{45,46}? Our results have clearly shown that genetically predicted missing self is not a sufficient condition to develop NK cell-mediated rejection. Firstly, patients with similar genetic profiles exhibit high inter-individual heterogeneity in the size of the NK cell population able to sense the missing self. Secondly, even among patients (and mice) with sufficient NK cells able to sense the missing self, only those whose NK cells were previously primed (by ischemia/reperfusion injuries or a viral infection) did develop MVI lesions. Finally, another layer of complexity may arise from the fact that NK cells have also been shown to regulate the alloimmune response through the killing of donor antigen-presenting cells ⁴⁷⁻⁴⁹.

Although missing self-induced and non-complement-activating anti-HLA antibody-mediated rejections have the same detrimental impact on graft survival, it is crucially important to differentiate these two conditions. Patients with missing self-induced rejection will indeed not respond to the costly and tedious treatment of AMR, which associates plasmapheresis with high dose intravenous immunoglobulins ⁷. The mixture of authentic cases of AMR with previously unrecognized cases of missing self-induced rejection might explain the high heterogeneity in response to treatment ^{7,16}. Furthermore, our results demonstrated that rapamycin efficiently prevents the

development of histological lesions due to missing self-induced NK cell activation in a murine experimental model of transplantation. Of note, on the basis of conflicting clinical reports suggesting that mTOR inhibitors might be less potent to prevent DSA generation^{42,50-52}, transplanted patients with graft microvascular inflammation (and wrongly diagnosed with AMR) are often switched from an mTOR inhibitor-based to calcineurin-inhibitor (CNI) based maintenance regimen. This is likely detrimental to graft survival because our data shows that CNI have no impact on missing self-induced rejections.

Beyond its clinical impact, our work is also of interest for basic immunologists. Until very recently, rejection of allografts was thought to be strictly dependent on the recipient's adaptive immune system. The consensus sequence described in textbooks starts with the recognition of donor-specific HLA molecules by the recipient's T lymphocytes through direct or indirect pathways^{53,54}. Direct allorecognition of donor-specific HLA molecules as intact complexes on the surface of passenger leukocytes activates up to 10% of a recipient's T cells, which triggers acute cellular rejection. Disappearance of passenger leukocytes explains the decay of acute cellular rejection incidence with time after transplantation⁵⁵. In contrast, the "indirect" recognition of allogeneic peptides, presented within MHC-II molecules on the surface of the recipient's APC, activates much fewer CD4+ T cells, but is critically important for the generation of alloantibodies⁵⁶. Because the indirect pathway does not fade with time, AMR represents the main cause of late transplant failure⁷⁻⁹. In this prevalent model, innate immune cells in general (and NK cells in particular) are merely considered as downstream effectors which participate in the destruction of the graft only upon recruitment by the adaptive immune system^{7,57,58}.

Our present work challenges this vision and coincides with the concept of innate allorecognition⁵⁹, which proposes that the innate immune system alone can promote rejection of transplanted organs. The first experimental evidence supporting this notion came in the 1960s from the observation that bone marrow grafted from parental strains of mice to F1 hybrids between the parental strain and a second strain was rejected, a process referred to as "hybrid resistance"⁶⁰. Hybrid resistance was later linked to the ability of NK cells to react to missing self⁶¹ but for years this process was not thought to be involved in solid tissue rejection because i) the Snell's 3rd "Laws of Transplantation" stated that "skin grafts from either inbred parent strain to the F₁ hybrid succeed"⁶², and ii) MHC homozygous embryonic stem (ES) cell-derived teratomas form and persist in MHC heterozygous mice⁶³. We believe that the lack of impact of missing self-induced NK cell activation in these 2 models is due to the fact that in both cases the graft vasculature comes from the recipient¹⁴ and therefore has a "normal" expression of self-MHC. Our hypothesis is consistent with i) the seminal work by Uehara et al., who reported that missing self-induced NK cell activation leads to the development of chronic allograft vasculopathy with no accompanying interstitial inflammation in parental cardiac grafts transplanted to F1 hybrid recipients⁶⁴, and ii) histological lesions were limited to the graft vasculature in both the patient biopsies and the murine experimental model in our own study.

Importantly, NK cells might not be the only innate immune effectors capable of innate allorecognition. Indeed, ~1/3 of MVI+DSA- patients in our cohort had no genetically predicted missing self, suggesting that other innate immune effectors are able to induce antibody-independent graft microvascular inflammation. Recent data from Fadi Lakkis's group identifies the recipient's monocytes as probable culprits. Monocytes are indeed able to distinguish between self and allogeneic non-self

through the expression of CD47, a surface receptor able to sense SIRP α polymorphism in the donor ⁶⁵. In accordance with this theory, it has been reported that depleting macrophages from recipients of parental to F1 cardiac transplants did reduce the formation of chronic allograft vasculopathy in an murine experimental model ⁶⁶.

In conclusion, this study identifies a new type of chronic rejection, whose pathophysiology is independent of recipient's adaptive immune system. Missing self-induced NK cell-mediated chronic vascular rejection is as prevalent as AMR and has the same detrimental impact on organ survival. However, while there is currently no efficient therapy against chronic AMR, rapamycin, a commercially available mTOR inhibitor, has shown promising efficiency to prevent the development of histological lesions in a preclinical murine model of missing self-induced NK cell-mediated chronic vascular rejection.

Acknowledgements

We wish to thank: Mme Christelle Forcet and Violaine Tribollet for their help with Xcelligence experiments, Dr Marie-Claude Gagnieu for dosage of immunosuppressive drugs, and Laurent Genestier for fruitful scientific discussions.

OT is supported by the Agence Nationale Pour la Recherche (ANR-16-CE17-0007-01), and the Etablissement Français du Sang. CCC, EM and OT are supported by the Institut Hospitalo-Universitaire–Organ Protection and Replacement (IHU-OPeRa; ANR-10-IBHU-004). AK is supported by INSERM (poste accueil 2015/1239/BT), the Hospices Civils de Lyon and the Fondation du Rein. SFR Biosciences is supported by the Agence Nationale pour la Recherche (ANR -11-EQPX-0035 PHENOCAN).

EM and OT are members of the CENTAURE Transplantation Research Network.

Author contributions

AK and OT conceived and designed the experiments. AK, CCC, VM, AS, MR, SD performed the experiments. AK, CCC, VM, MR, PB, JPDVHV, VD, SD and OT analyzed the data. AK and OT wrote the paper; AM, AS, AL, HP, RG, JLT, EM, AN, BC, TW and TD contributed to the discussion.

Competing Interests Statements

The authors have no conflict of interest to disclose.

References

1. Reindl-Schwaighofer R, Heinzl A, Signorini L, Thauinat O, Oberbauer R. Mechanisms underlying human genetic diversity: consequence for antigraft antibody responses. *Transplant international* 2017.
2. Calne RY, White DJ, Thiru S, et al. Cyclosporin A in patients receiving renal allografts from cadaver donors. *Lancet* 1978;2:1323-7.
3. Lamb KE, Lodhi S, Meier-Kriesche HU. Long-term renal allograft survival in the United States: a critical reappraisal. *American journal of transplantation* 2011;11:450-62.
4. Terasaki PI, Cai J. Humoral theory of transplantation: further evidence. *Current opinion in immunology* 2005;17:541-5.
5. Russell PS, Chase CM, Winn HJ, Colvin RB. Coronary atherosclerosis in transplanted mouse hearts. II. Importance of humoral immunity. *Journal of immunology* 1994;152:5135-41.
6. Terasaki PI, Ozawa M. Predicting kidney graft failure by HLA antibodies: a prospective trial. *American journal of transplantation* 2004;4:438-43.
7. Pouliquen E, Koenig A, Chen CC, et al. Recent advances in renal transplantation: antibody-mediated rejection takes center stage. *F1000prime reports* 2015;7:51.
8. Sellares J, de Freitas DG, Mengel M, et al. Understanding the causes of kidney transplant failure: the dominant role of antibody-mediated rejection and nonadherence. *American journal of transplantation* 2012;12:388-99.
9. Wiebe C, Gibson IW, Blydt-Hansen TD, et al. Evolution and clinical pathologic correlations of de novo donor-specific HLA antibody post kidney transplant. *American journal of transplantation* 2012;12:1157-67.

10. Loupy A, Toquet C, Rouvier P, et al. Late Failing Heart Allografts: Pathology of Cardiac Allograft Vasculopathy and Association With Antibody-Mediated Rejection. *American journal of transplantation* 2016;16:111-20.
11. Roux A, Bendib Le Lan I, Holifanjaniaina S, et al. Antibody-Mediated Rejection in Lung Transplantation: Clinical Outcomes and Donor-Specific Antibody Characteristics. *American journal of transplantation* 2016;16:1216-28.
12. Cantarovich D, De Amicis S, Akl A, et al. Posttransplant donor-specific anti-HLA antibodies negatively impact pancreas transplantation outcome. *American journal of transplantation* 2011;11:2737-46.
13. Thaunat O, Badet L, Dubois V, Kanitakis J, Petruzzo P, Morelon E. Immunopathology of rejection: do the rules of solid organ apply to vascularized composite allotransplantation? *Current opinion in organ transplantation* 2015;20:596-601.
14. Chen CC, Pouliquen E, Broisat A, et al. Endothelial chimerism and vascular sequestration protect pancreatic islet grafts from antibody-mediated rejection. *The Journal of clinical investigation* 2018;128:219-32.
15. Loupy A, Lefaucheur C, Vernerey D, et al. Complement-binding anti-HLA antibodies and kidney-allograft survival. *The New England journal of medicine* 2013;369:1215-26.
16. Sicard A, Ducreux S, Rabeyrin M, et al. Detection of C3d-binding donor-specific anti-HLA antibodies at diagnosis of humoral rejection predicts renal graft loss. *Journal of the American Society of Nephrology* 2015;26:457-67.

17. Guidicelli G, Guerville F, Lepreux S, et al. Non-Complement-Binding De Novo Donor-Specific Anti-HLA Antibodies and Kidney Allograft Survival. *Journal of the American Society of Nephrology* 2016;27:615-25.
18. Hirohashi T, Uehara S, Chase CM, et al. Complement independent antibody-mediated endarteritis and transplant arteriopathy in mice. *American journal of transplantation* 2010;10:510-7.
19. Fishbein GA, Fishbein MC. Morphologic and immunohistochemical findings in antibody-mediated rejection of the cardiac allograft. *Human immunology* 2012;73:1213-7.
20. Gupta A, Broin PO, Bao Y, et al. Clinical and molecular significance of microvascular inflammation in transplant kidney biopsies. *Kidney international* 2016;89:217-25.
21. Haas M, Loupy A, Lefaucheur C, et al. The Banff 2017 Kidney Meeting Report: Revised diagnostic criteria for chronic active T cell-mediated rejection, antibody-mediated rejection, and prospects for integrative endpoints for next-generation clinical trials. *American journal of transplantation* 2018;18:293-307.
22. Sicard A, Meas-Yedid V, Rabeyrin M, et al. Computer-assisted topological analysis of renal allograft inflammation adds to risk evaluation at diagnosis of humoral rejection. *Kidney international* 2017;92:214-26.
23. Le Bas-Bernardet S, Hourmant M, Coupel S, Bignon JD, Souillou JP, Charreau B. Non-HLA-type endothelial cell reactive alloantibodies in pre-transplant sera of kidney recipients trigger apoptosis. *American journal of transplantation* 2003;3:167-77.

24. Marcais A, Marotel M, Degouve S, et al. High mTOR activity is a hallmark of reactive natural killer cells and amplifies early signaling through activating receptors. *eLife* 2017;6.
25. Dragun D, Catar R, Philippe A. Non-HLA antibodies against endothelial targets bridging allo- and autoimmunity. *Kidney international* 2016;90:280-8.
26. Jackson AM, Sigdel TK, Delville M, et al. Endothelial cell antibodies associated with novel targets and increased rejection. *Journal of the American Society of Nephrology* 2015;26:1161-71.
27. Sicard A, Chen CC, Morelon E, Thaunat O. Alloimmune-induced intragraft lymphoid neogenesis promotes B-cell tolerance breakdown that accelerates chronic rejection. *Current opinion in organ transplantation* 2016;21:368-74.
28. Thaunat O, Graff-Dubois S, Fabien N, et al. A stepwise breakdown of B-cell tolerance occurs within renal allografts during chronic rejection. *Kidney international* 2012;81:207-19.
29. Smith RN, Kawai T, Boskovic S, et al. Four stages and lack of stable accommodation in chronic alloantibody-mediated renal allograft rejection in *Cynomolgus* monkeys. *American journal of transplantation* 2008;8:1662-72.
30. Hidalgo LG, Sis B, Sellares J, et al. NK cell transcripts and NK cells in kidney biopsies from patients with donor-specific antibodies: evidence for NK cell involvement in antibody-mediated rejection. *American journal of transplantation* 2010;10:1812-22.
31. Thielens A, Vivier E, Romagne F. NK cell MHC class I specific receptors (KIR): from biology to clinical intervention. *Current opinion in immunology* 2012;24:239-45.

32. Campbell KS, Purdy AK. Structure/function of human killer cell immunoglobulin-like receptors: lessons from polymorphisms, evolution, crystal structures and mutations. *Immunology* 2011;132:315-25.
33. Parham P. The genetic and evolutionary balances in human NK cell receptor diversity. *Seminars in immunology* 2008;20:311-6.
34. Shifrin N, Raulet DH, Ardolino M. NK cell self tolerance, responsiveness and missing self recognition. *Seminars in immunology* 2014;26:138-44.
35. Kusunoki Y, Kyoizumi S, Honma M, et al. NK-mediated elimination of mutant lymphocytes that have lost expression of MHC class I molecules. *Journal of immunology* 2000;165:3555-63.
36. Wiertz EJ, Jones TR, Sun L, Bogoy M, Geuze HJ, Ploegh HL. The human cytomegalovirus US11 gene product dislocates MHC class I heavy chains from the endoplasmic reticulum to the cytosol. *Cell* 1996;84:769-79.
37. Wagner JA, Rosario M, Romee R, et al. CD56bright NK cells exhibit potent antitumor responses following IL-15 priming. *The Journal of clinical investigation* 2017;127:4042-58.
38. Shaw J, Kollnberger S. New perspectives on the ligands and function of the killer cell immunoglobulin-like receptor KIR3DL2 in health and disease. *Frontiers in immunology* 2012;3:339.
39. Yawata M, Yawata N, Draghi M, Partheniou F, Little AM, Parham P. MHC class I-specific inhibitory receptors and their ligands structure diverse human NK-cell repertoires toward a balance of missing self-response. *Blood* 2008;112:2369-80.

40. Marcais A, Cherfils-Vicini J, Viant C, et al. The metabolic checkpoint kinase mTOR is essential for IL-15 signaling during the development and activation of NK cells. *Nature immunology* 2014;15:749-57.
41. Ekberg H, Tedesco-Silva H, Demirbas A, et al. Reduced exposure to calcineurin inhibitors in renal transplantation. *The New England journal of medicine* 2007;357:2562-75.
42. Thauinat O, Koenig A, Leibler C, Grimbert P. Effect of Immunosuppressive Drugs on Humoral Allosensitization after Kidney Transplant. *Journal of the American Society of Nephrology* 2016;27:1890-900.
43. Li J, Kim SG, Blenis J. Rapamycin: one drug, many effects. *Cell metabolism* 2014;19:373-9.
44. Joosten SA, van Dixhoorn MG, Borrias MC, et al. Antibody response against perlecan and collagen types IV and VI in chronic renal allograft rejection in the rat. *The American journal of pathology* 2002;160:1301-10.
45. Kreijveld E, van der Meer A, Tijssen HJ, Hilbrands LB, Joosten I. KIR gene and KIR ligand analysis to predict graft rejection after renal transplantation. *Transplantation* 2007;84:1045-51.
46. Tran TH, Mytilineos J, Scherer S, Laux G, Middleton D, Opelz G. Analysis of KIR ligand incompatibility in human renal transplantation. *Transplantation* 2005;80:1121-3.
47. Laffont S, Seillet C, Ortaldo J, Coudert JD, Guery JC. Natural killer cells recruited into lymph nodes inhibit alloreactive T-cell activation through perforin-mediated killing of donor allogeneic dendritic cells. *Blood* 2008;112:661-71.

48. Martinez-Llordella M, Lozano JJ, Puig-Pey I, et al. Using transcriptional profiling to develop a diagnostic test of operational tolerance in liver transplant recipients. *The Journal of clinical investigation* 2008;118:2845-57.
49. Yu G, Xu X, Vu MD, Kilpatrick ED, Li XC. NK cells promote transplant tolerance by killing donor antigen-presenting cells. *The Journal of experimental medicine* 2006;203:1851-8.
50. Grimbert P, Thauvat O. mTOR inhibitors and risk of chronic antibody-mediated rejection after kidney transplantation: where are we now? *Transplant international : official journal of the European Society for Organ Transplantation* 2017;30:647-57.
51. Kamar N, Del Bello A, Congy-Jolivet N, et al. Incidence of donor-specific antibodies in kidney transplant patients following conversion to an everolimus-based calcineurin inhibitor-free regimen. *Clinical transplantation* 2013;27:455-62.
52. Liefeldt L, Brakemeier S, Glander P, et al. Donor-specific HLA antibodies in a cohort comparing everolimus with cyclosporine after kidney transplantation. *American journal of transplantation* 2012;12:1192-8.
53. Afzali B, Lombardi G, Lechler RI. Pathways of major histocompatibility complex allorecognition. *Current opinion in organ transplantation* 2008;13:438-44.
54. Marino J, Paster J, Benichou G. Allorecognition by T Lymphocytes and Allograft Rejection. *Frontiers in immunology* 2016;7:582.
55. Halloran PF, Chang J, Famulski K, et al. Disappearance of T Cell-Mediated Rejection Despite Continued Antibody-Mediated Rejection in Late Kidney Transplant Recipients. *Journal of the American Society of Nephrology* 2015;26:1711-20.

56. Chen CC, Koenig A, Saison C, et al. CD4+ T Cell Help Is Mandatory for Naive and Memory Donor-Specific Antibody Responses: Impact of Therapeutic Immunosuppression. *Frontiers in immunology* 2018;9:275.
57. Hirohashi T, Chase CM, Della Pelle P, et al. A novel pathway of chronic allograft rejection mediated by NK cells and alloantibody. *American journal of transplantation* 2012;12:313-21.
58. Qi F, Adair A, Ferenbach D, et al. Depletion of cells of monocyte lineage prevents loss of renal microvasculature in murine kidney transplantation. *Transplantation* 2008;86:1267-74.
59. Oberbarnscheidt MH, Lakkis FG. Innate allorecognition. *Immunological reviews* 2014;258:145-9.
60. Cudkowicz G, Stimpfling JH. Deficient Growth of C57bl Marrow Cells Transplanted in F1 Hybrid Mice. Association with the Histocompatibility-2 Locus. *Immunology* 1964;7:291-306.
61. Karre K, Ljunggren HG, Piontek G, Kiessling R. Selective rejection of H-2-deficient lymphoma variants suggests alternative immune defence strategy. *Nature* 1986;319:675-8.
62. Snell G. The immunology of tissue transplantation. 16th Annu Symp Fundamental Cancer Res; 1963; Univ. Texas, Houston: Hoeber-Harper. p. 323-52.
63. Kim K, Lerou P, Yabuuchi A, et al. Histocompatible embryonic stem cells by parthenogenesis. *Science* 2007;315:482-6.
64. Uehara S, Chase CM, Kitchens WH, et al. NK cells can trigger allograft vasculopathy: the role of hybrid resistance in solid organ allografts. *Journal of immunology* 2005;175:3424-30.

65. Dai H, Friday AJ, Abou-Daya KI, et al. Donor SIRPalpha polymorphism modulates the innate immune response to allogeneic grafts. *Science immunology* 2017;2.
66. Kitchens WH, Chase CM, Uehara S, et al. Macrophage depletion suppresses cardiac allograft vasculopathy in mice. *American journal of transplantation* 2007;7:2675-82.

Figure Legends

Figure 1: Antibody-independent graft microvascular inflammation

Kidney allograft biopsies of 938 patients were screened for microvascular inflammation (MVI) lesions. Presence of circulating anti-HLA donor-specific antibodies (anti-HLA DSA) and their ability to activate the complement cascade was assessed in synchronous serum using solid phase assays. Negative sera were additionally screened for anti-endothelial cell antibodies (anti-EC Abs) by flow cross match (see Supplementary Figure 1).

Three groups of patients were defined: i) group MVI+DSA+C3d+ (n=40; solid black line), group MVI+DSA+C3d- (n=29; dashed black line), and iii) MVI+DSA- (n=54; red line). A 4th group (MVI-DSA-; n=75; solid grey line), devoid of MVI lesions in graft biopsy and circulating donor-specific antibody, but matched for clinical characteristics with MVI+DSA- patients, was established.

A. Flow chart showing the distribution of the patients in the different groups.

B. C4d staining was quantified (0-3) in graft biopsy according to Banff classification. Distribution of this parameter is shown for the 4 groups. ns: $p \geq 0.05$; *: $p < 0.05$, ****: $p < 0.0001$; One-way Anova.

C. Renal graft survival curves were compared in the 4 groups. ns: $p \geq 0.05$, ***: $p < 0.001$, ****: $p < 0.0001$; Log Rank test.

D-E. Paraffin-embedded sections of graft biopsies of patients from MVI+DSA+C3d- and MVI+DSA- groups were stained for endothelial cells (anti-CD34) and NK cells (anti-CD56). **D.** Representative images of microvascular inflammation lesions found in the glomeruli (upper row) and the peritubular capillaries (lower row) are shown. Scale bar=100 μ m. **E.** NK cells were quantified in graft biopsy of patients from MVI+DSA+C3d- and MVI+DSA- groups. ns: $p \geq 0.05$; Mann Whitney test.

Figure 2: Genetically predicted missing self and antibody-independent microvascular inflammation

A. Schematic representation of the education process of NK cells in the bone marrow (upper row) and the 3 distinct situations that can be encountered by circulating NK cells when contacting the vasculature of an allogeneic organ (lower row): i) absence of missing self (no MS), ii) presence of a missing self for a ligand not expressed by the NK cell donor (uneducated missing self, uneduc MS), or iii) missing self (MS).

B. Left panel: representative images showing the expression of HLA I molecules on glomeruli (upper row) and peritubular capillaries (middle row) of renal graft biopsies of 2 distinct patients. Scale bar = 100 μ m. Right panel: the expression of HLA I molecules was quantified on the surface of primary human endothelial cells from 3 different donors. K562 cells, which lack the expression of HLA molecules, were used as negative control (grey). Representative flow cytometry profiles are shown.

C. Genetic analyses were conducted for each donor/recipient pair from MVI+DSA- group (left panel) and MVI-DSA- (right panel, control), in order to identify situations of missing self (MS), in which allogeneic graft endothelial cells are unable to deliver the inhibitory signal to an educating inhibitory KIR of the donor. **: $p < 0.01$; Fisher's exact test.

Figure 3: Priming and heterogeneity of the NK cell population influence clinical expression of genetically predicted missing self

A. Cold ischemia time was compared for patients from MVI-DSA- and MVI+DSA- group. Median and 10-90 percentiles. *: $p < 0.05$; Mann Whitney test.

B. The prevalence of viral (all viruses, upper row) and cytomegalovirus (CMV, lower row) infections were compared for patients from MVI-DSA- (left column) and MVI+DSA- (right column) groups. **: $p < 0.01$; Fisher's exact test.

C-D Phenotypic analyses of circulating NK cells from 6 healthy volunteers (HV #1 to #6) with identical inhibitory KIR genotypes. **C.** Left panel: individual values for absolute count of circulating NK cells are plotted. Right panel: the dispersion of the size of NK and T lymphocyte populations in the circulation of the 6 HV is shown. **D.** Expression of the 5 inhibitory KIR receptors was assessed at the single cell level. The differences in distribution of the 23 NK cell subsets are shown for the 6 healthy volunteers. Each axis of the radar plot represents a given combination of inhibitory KIR as indicated by the colour code on the left. The scale of each axis is adjusted to optimise the display of every population of NK cells.

Figure 4: Allogeneic endothelial cells trigger missing self-induced activation of NK cells in vitro

Primary allogeneic human endothelial cells were co-cultured with purified NK cells from 30 healthy volunteers primed with low dose IL-2. After 4 hours of culture the activation status of the NK cells was assessed at the single cell level by flow cytometry.

A-B. Analyses were focused on the 5 NK cell populations that expressed a single inhibitory KIR. **A.** Expression of CD107a (LAMP-1) on NK cell surface after 4-hour co-culture. Left panel: representative flow cytometry profiles. Middle panel: individual values of NK cell populations according to their status against primary allogeneic human endothelial cells. **B.** Intracellular staining for MIP-1 β in NK cells after 4-hour co-culture. Left panel: representative flow cytometry profiles. Middle panel: individual

values of NK cell populations according to their status against primary allogeneic human endothelial cells.

C-D. Analyses were focused on the NK cell populations that expressed two inhibitory KIRs, one of them lacking its ligand on endothelial cells (missing self, MS). According to the nature of the second inhibitory KIR, 3 situations were distinguished: i) 1MS+1M, if endothelial cells expressed the ligand for the second inhibitory KIR, ii) 1MS+uneduc MS, if neither endothelial cells nor NK cell donor expressed the ligand for the second inhibitory KIR, and iii) 2MS, if endothelial cells did not express the ligands of both inhibitory KIRs. Results are normalised over the value observed for the NK cell population that expressed the single mismatched inhibitory KIR. **C.** Expression of CD107a (LAMP-1) on NK cell surface after 4-hour co-culture. **D.** Intracellular staining for MIP-1 β in NK cells after 4 hour co-culture.

ns: $p \geq 0.05$, *: $p < 0.05$, **: $p < 0.01$, ***: $p < 0.001$, ****: $p < 0.0001$; One-way Anova.

Figure 5: Missing self-induced activation of NK cells is harmful for endothelial cells

A. Schematic representation of the 2 experimental models. Purified NK cells from healthy volunteers were co-cultured with adherent primary allogeneic human endothelial cells, the viability of which was assessed by real-time impedance measurement. Real time impedance data of the experimental co-culture was normalized over control.

B. Model #1: The same primary human endothelial cells were co-cultured with NK cells purified from 2 distinct donors: the first without missing self (control co-culture) and the second with missing self (experimental co-culture). Individual impedance

profiles (mean \pm standard error; upper panel) and the area under the curves (lower panel) from 6 independent experiments are shown.

C. Model #2: The same primary human endothelial cells were co-cultured with NK cells purified from a donor without missing self, in presence of a blocking anti-inhibitory KIR mAb (experimental co-culture) or an isotype control mAb (control co-culture). Individual impedance profiles (mean \pm standard error; upper panel) and area under the curves (lower panel) from 6 independent experiments are shown.

*: $p < 0.05$; Wilcoxon Signed Rank test.

Figure 6: Missing self triggers NK cell-mediated rejection in vivo

A. Schematic representation of the two murine experimental models.

B. Model #1: proportion of $\beta 2$ microglobulin KO target cells still alive 2.5 days after transfer to wild type C57BL/6 recipients treated or not with anti-NK depleting mAb (α NK1.1). Individual data of 10 mice from 2 independent experiments (grey and black dots respectively) are shown. Bars indicate mean \pm standard deviation. ****: $p < 0.0001$; One-way Anova.

C-E. Model #2: Wild type C57BL/6 mice were transplanted with either a C57BL/6 or a $\beta 2$ microglobulin KO heart. In some cases, the heart was subjected to 3 hours of cold ischemia before transplantation (+ Isch). Some recipients were treated with anti-NK depleting mAb (+ α NK1.1). Heart grafts were harvested 60 days after transplantation for histological analysis. Two independent experiments. **C.** Representative findings of H&E stain are shown for the 4 experimental groups: from top to bottom (i) $\beta 2 \rightarrow B6$ (n=4); (ii) $\beta 2 \rightarrow B6$ + Isch (n=8); (iii) $\beta 2 \rightarrow B6$ + Isch + α NK1.1 (n=5); and (iv) $B6 \rightarrow B6$ + Isch (n=8). Scale bars: 100 μ m. **D.** Immunohistochemistry was performed to evaluate the morphology of the microvasculature (CD31), the immune cell infiltration (CD45),

and the NK cell infiltration (Nkp46). Representative findings are shown for the 4 experimental groups. Scale bars: 100 μ m. **E.** A trained pathologist graded intensity of each elementary lesion on a semi-quantitative scale (score 0–3). Mean \pm standard deviation. *: p<0.05; **: p<0.01; One-way Anova.

Figure 7: Missing self triggers an mTORC1 pathway in NK cells

Purified NK cells from a healthy donor were co-cultured with HLA-deficient K562 cells. Imaging flow cytometer was used at indicated time points to detect the phosphorylated form of S6 Ribosomal Protein (p-S6RP, downstream mTORC1) and of protein kinase B (Akt, downstream mTORC2), in isolated NK and NK that form doublets with K562 target cells.

A. Representative images of NK cells, cultured alone (negative control), in presence of IL-15 (positive control), and from co-cultures with K562 cells are shown.

B The intensity of the signal corresponding to the phosphorylated form of S6RP was measured at various time points in NK cells (CD56 mask), isolated (grey curve) or in doublet with K562 cells (black curve). Data was normalized over baseline; mean \pm standard deviation.

C. The intensity of the signal corresponding to the phosphorylated form of Akt was measured at various time points in NK cells (CD56 mask), isolated (grey curve) or in doublet with K562 cells (black curve). Data was normalized over baseline; mean \pm standard deviation.

Figure 8: Rapamycin prevents missing self-induced NK cell-mediated rejection in vivo

A. Schematic representation of the 2 experimental models.

B-C. Model #1: Labelled wild type C57BL/6 and $\beta 2$ microglobulin KO splenocytes were cotransferred to wild type C57BL/6 mice. Recipient mice were treated with i) vehicle (control, Ctrl), ii) cyclosporin A (CsA), or iii) or rapamycin (Rapa). **B.** Intensity of the signal that corresponds to the phosphorylated form of S6 Ribosomal Protein (p-S6RP) in circulating NK cells. Individual data of 10 mice from 2 independent experiments (grey and black dots respectively) are shown. Bars indicate mean \pm standard deviation. **C.** Proportion of $\beta 2$ microglobulin KO target cells still alive 2.5 days after transfer to wild type C57BL/6 recipients. Individual data of 15 to 20 mice from 4 independent experiments (shade of grey dots) are shown. Bars indicate mean \pm standard deviation.

D-F. Model #2: Wild type C57BL/6 mice were transplanted with $\beta 2$ microglobulin KO heart subjected to 3 hours of cold ischemia. Recipient mice were treated with i) vehicle (control, Ctrl), ii) cyclosporin A (CsA), iii) or rapamycin (Rapa). Heart grafts were harvested 60 days after transplantation for histological analysis. Two independent experiments. **D.** Representative findings of H&E stain are shown for the 3 experimental groups: from top to bottom (i) Ctrl (n=8); (ii) CsA (n=5); (iii) Rapa (n=7). Scale bars: 100 μ m. **E.** Immunohistochemistry was performed to evaluate the morphology of the microvasculature (CD31), the immune cell infiltration (CD45), and the NK cell infiltration (Nkp46). Representative findings are shown for the 3 experimental groups. Scale bars: 100 μ m. **F.** A trained pathologist graded the intensity of each elementary lesion on a semi-quantitative scale (score 0–3). Mean \pm standard deviation.

ns: $p \geq 0.05$; *: $p < 0.05$; **: $p < 0.01$; ****: $p < 0.0001$; One-way Anova.

Figure 1

A

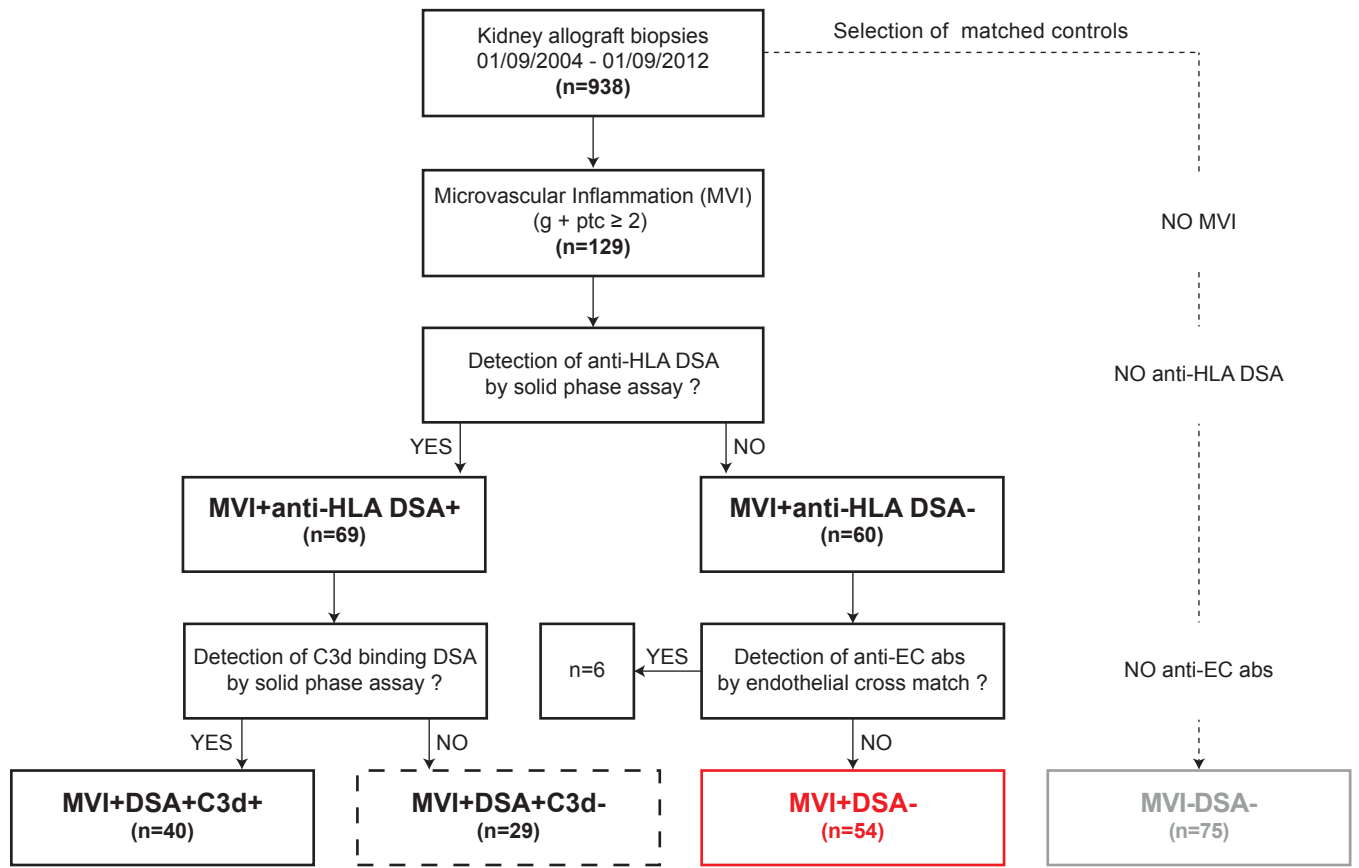

B

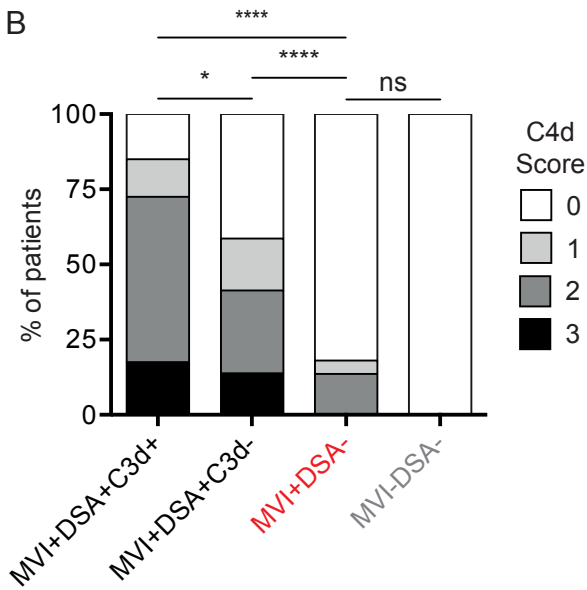

C

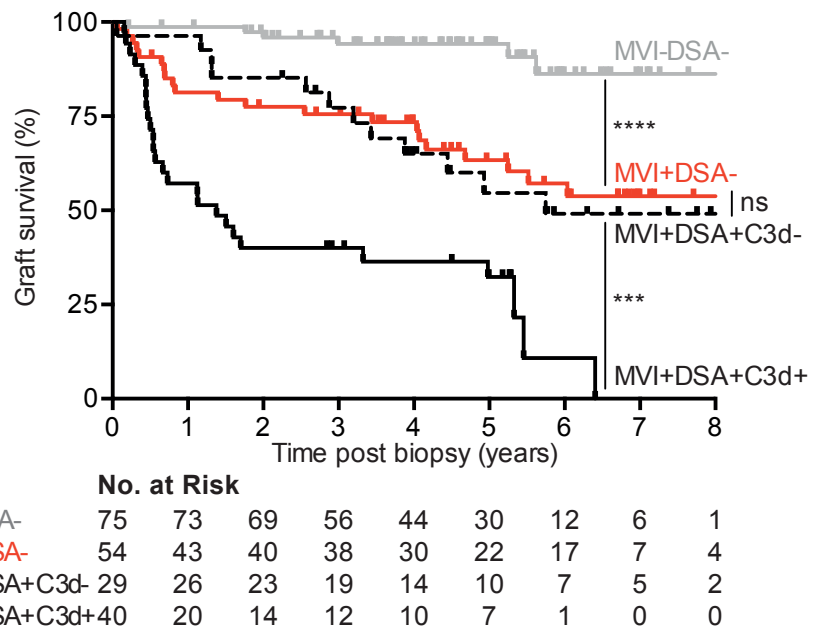

D

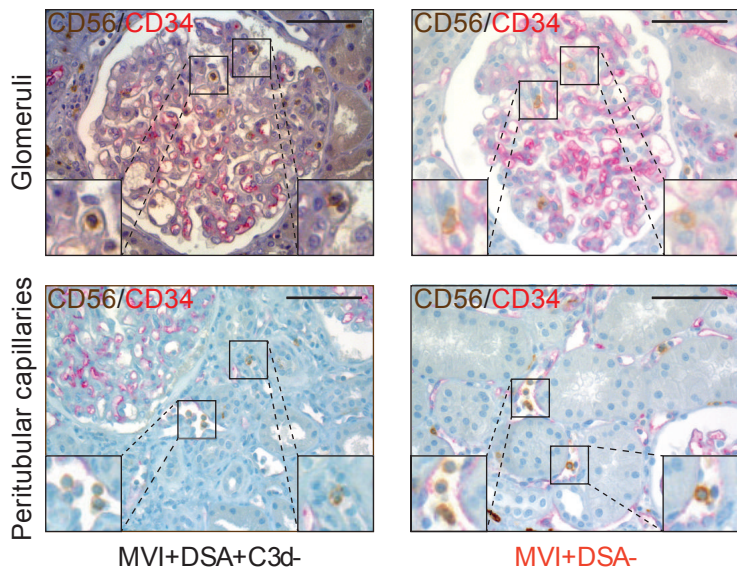

E

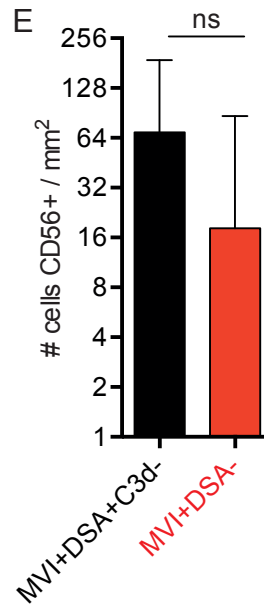

Figure 2

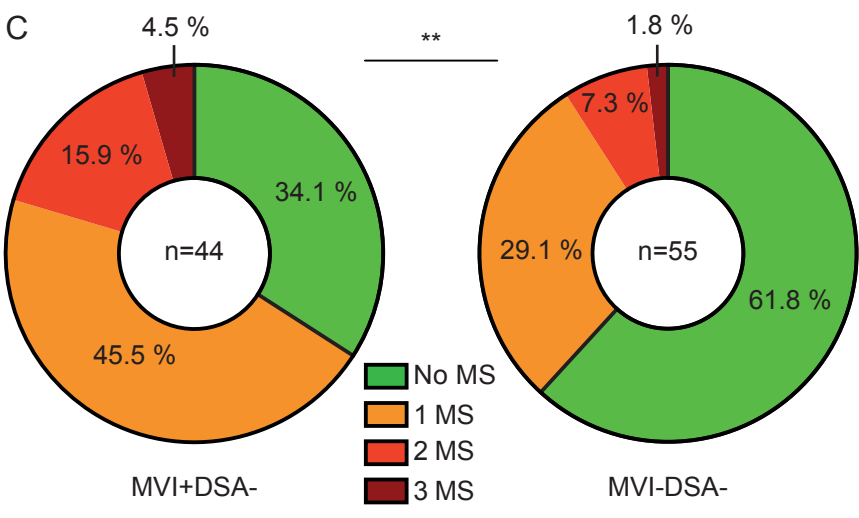
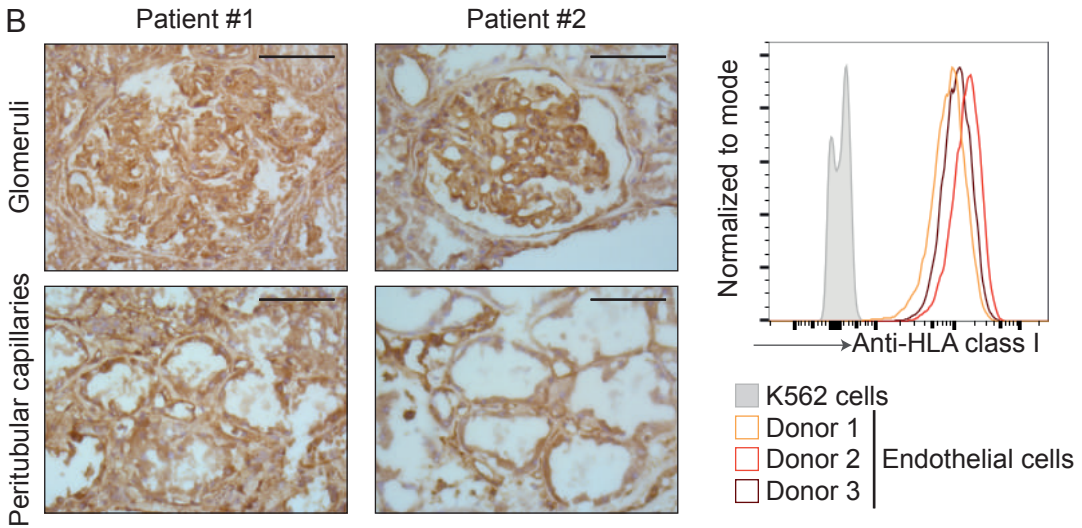
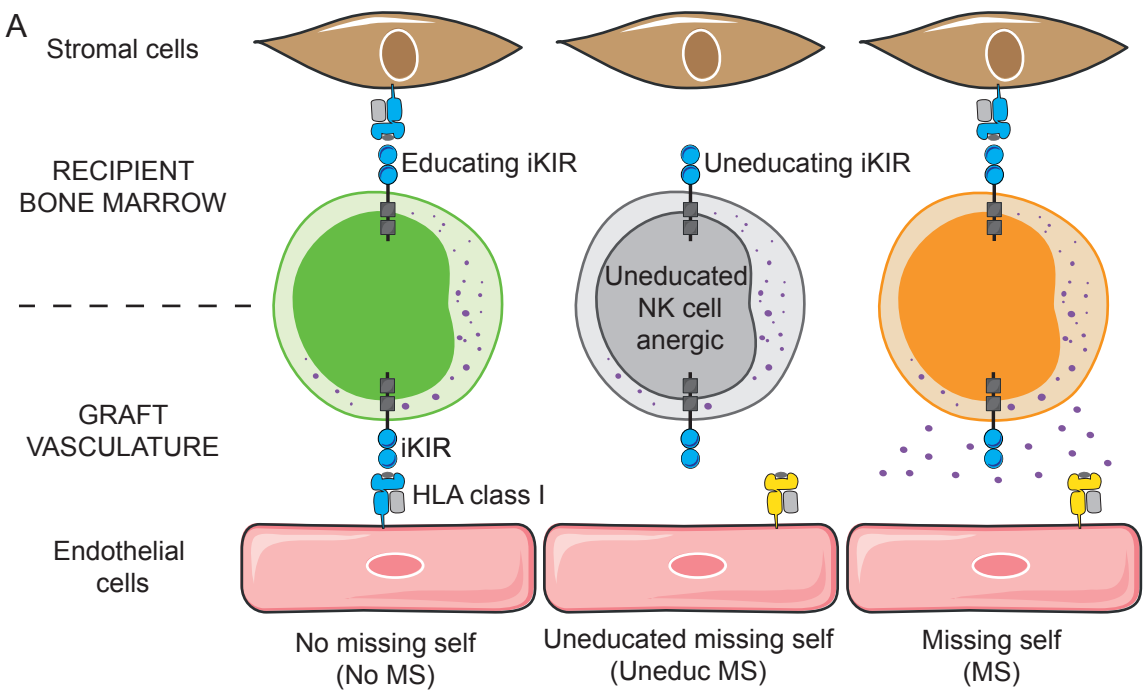

Figure 3

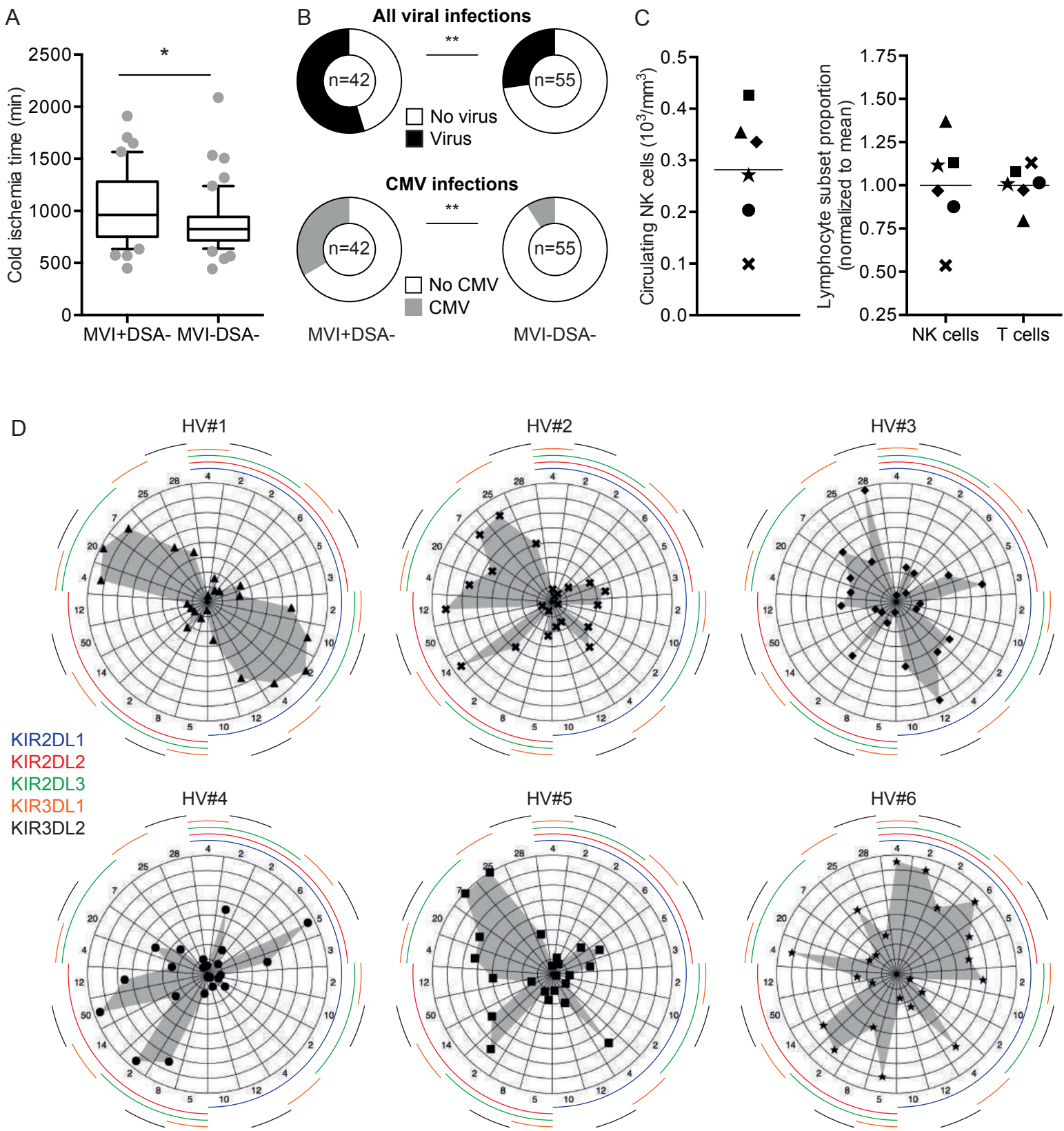
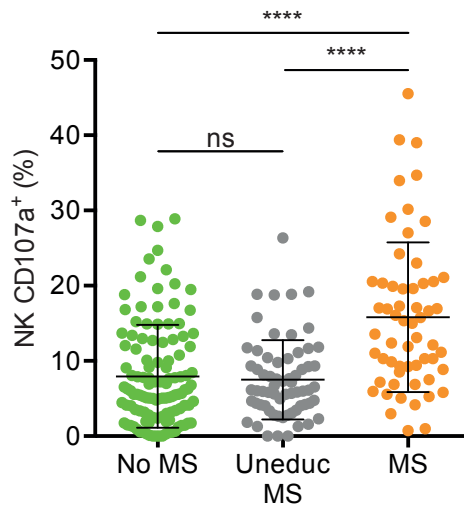
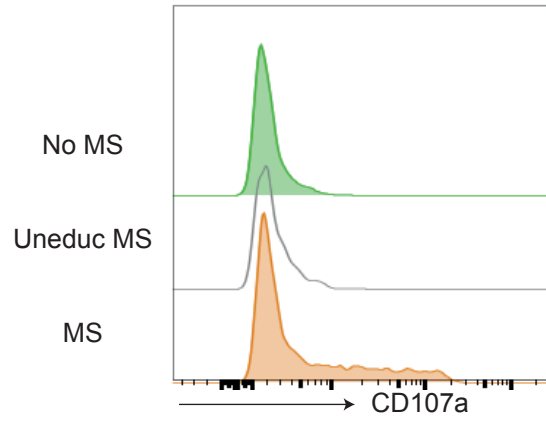
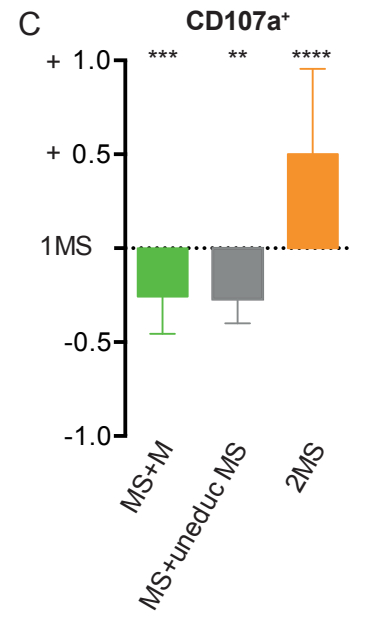

Figure 4

A



C



B

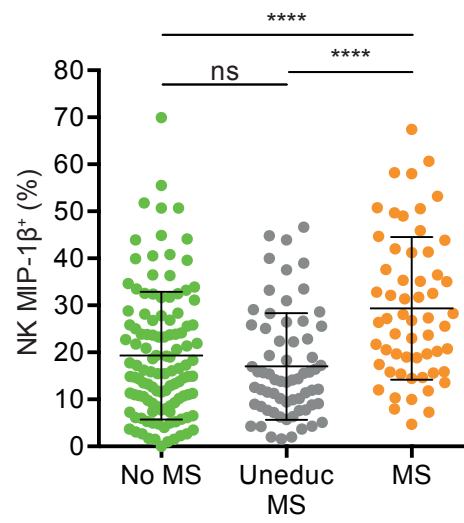
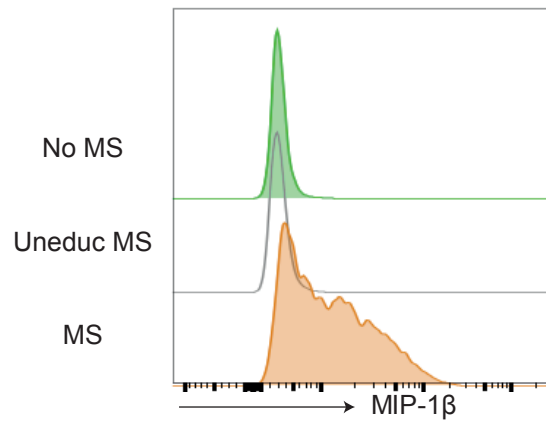

D

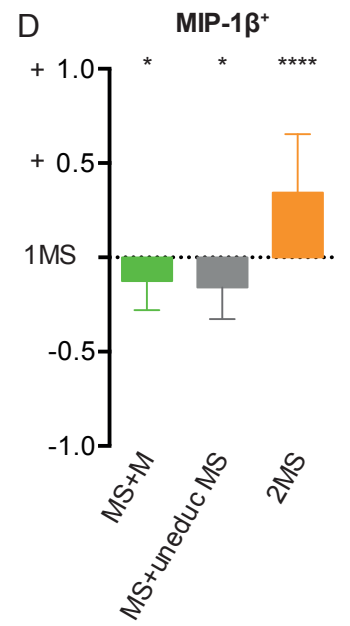

Figure 5

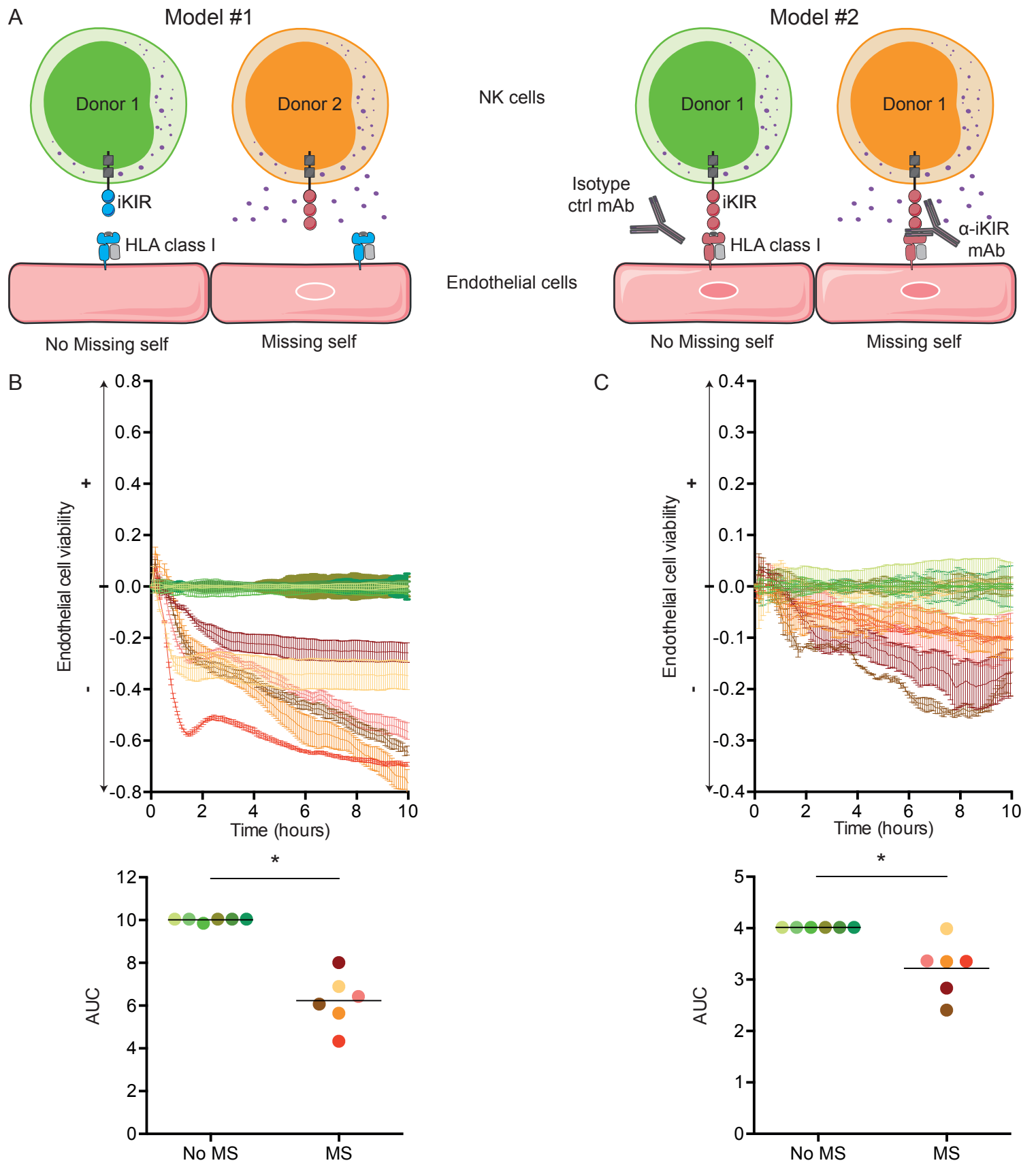

Figure 6

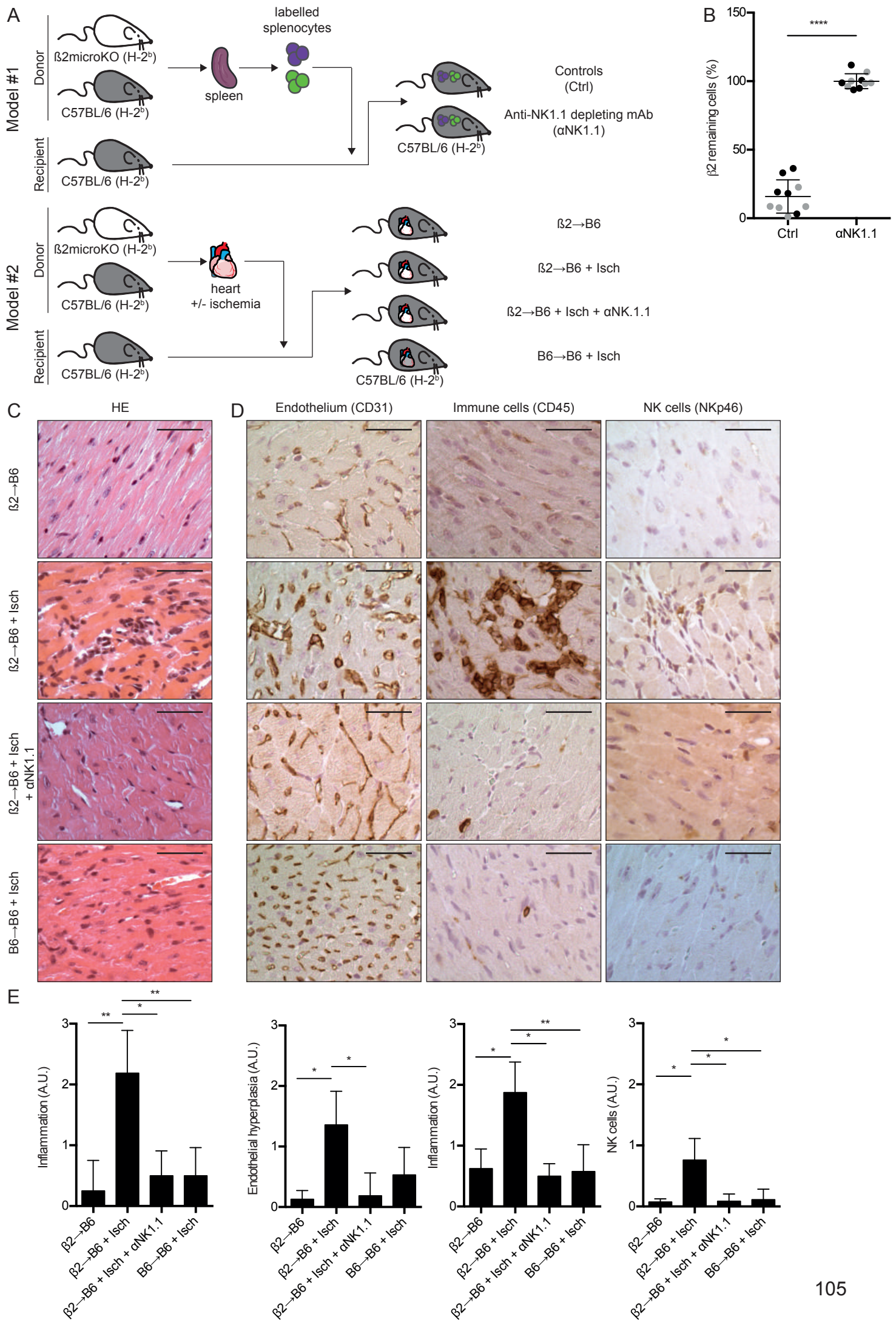

Figure 7

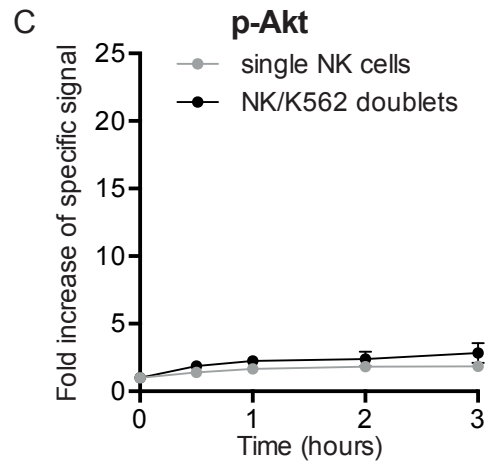
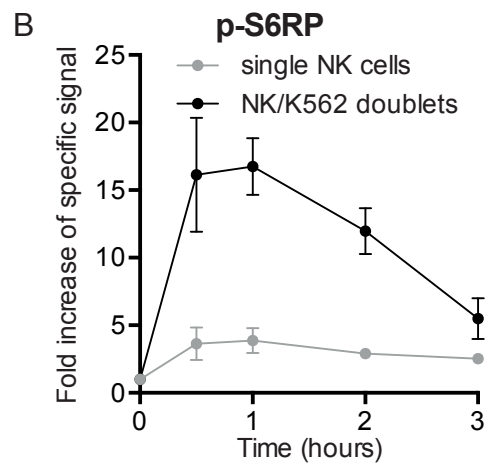
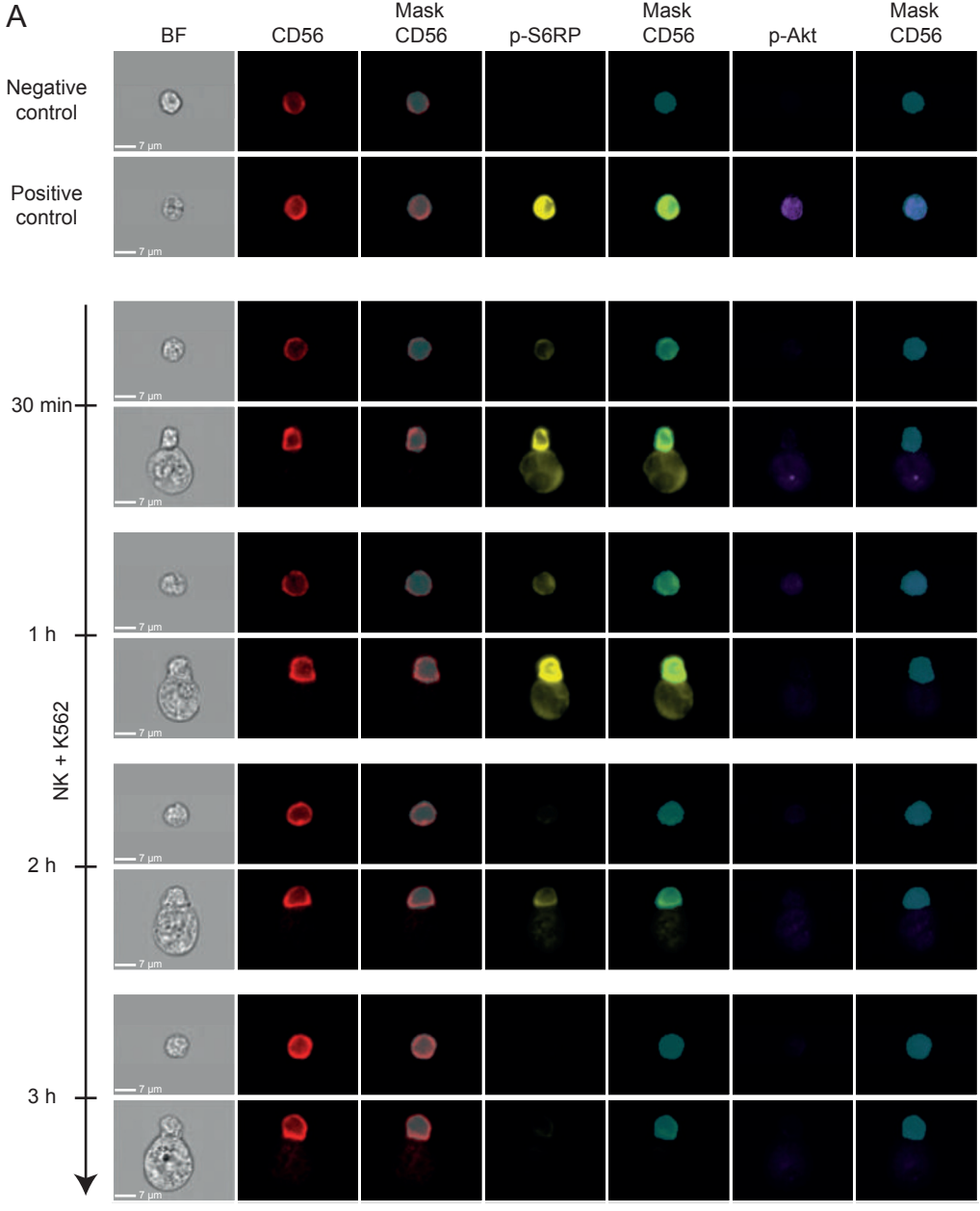
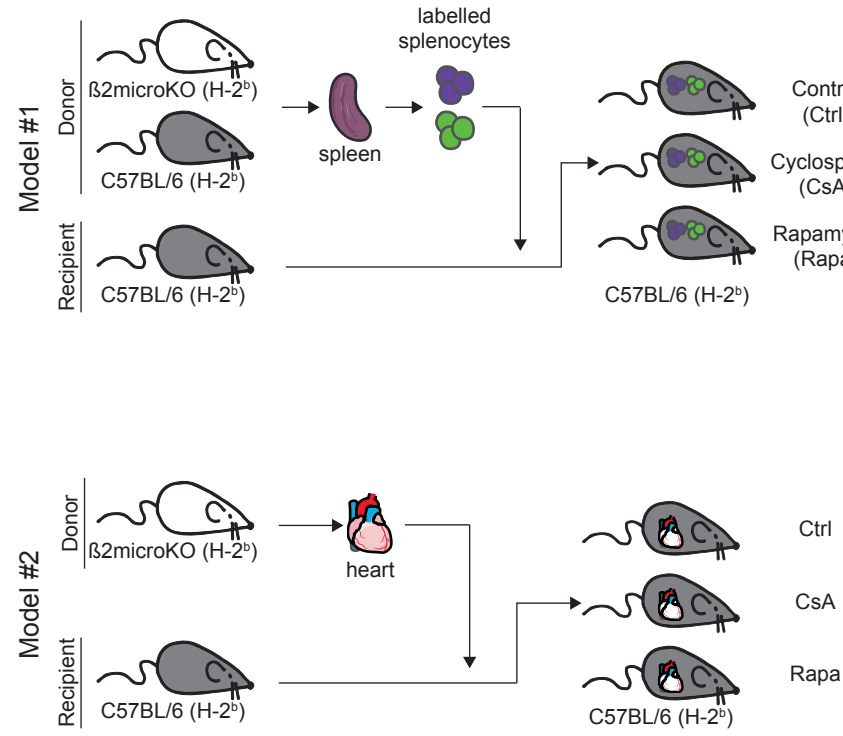
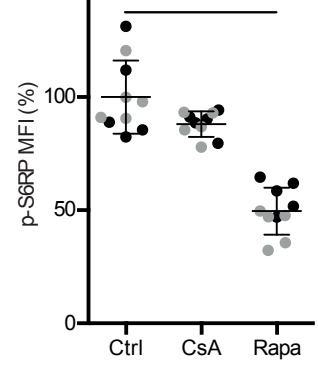

Figure 8

A



B



C

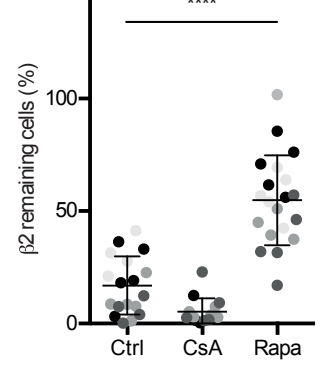

D

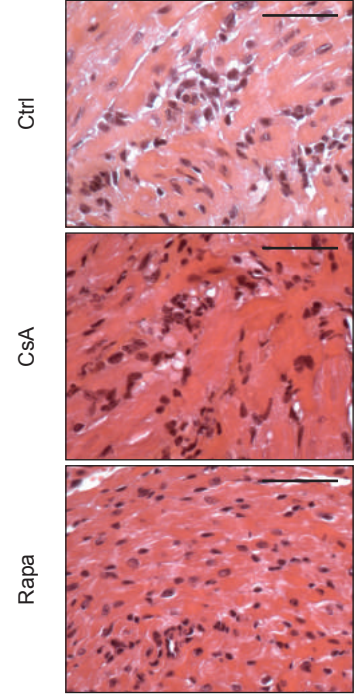

E

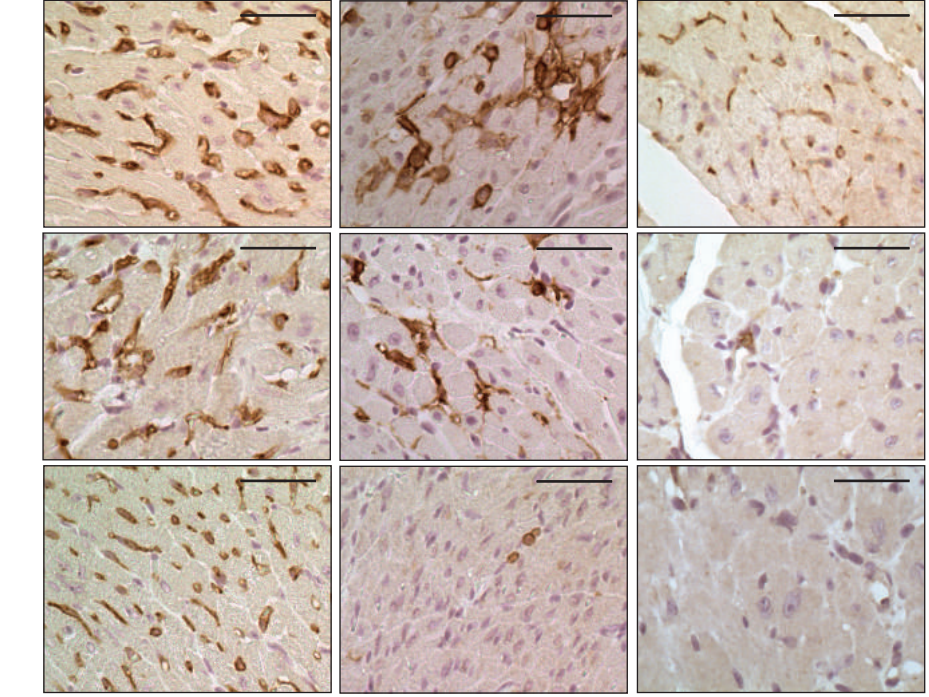

F

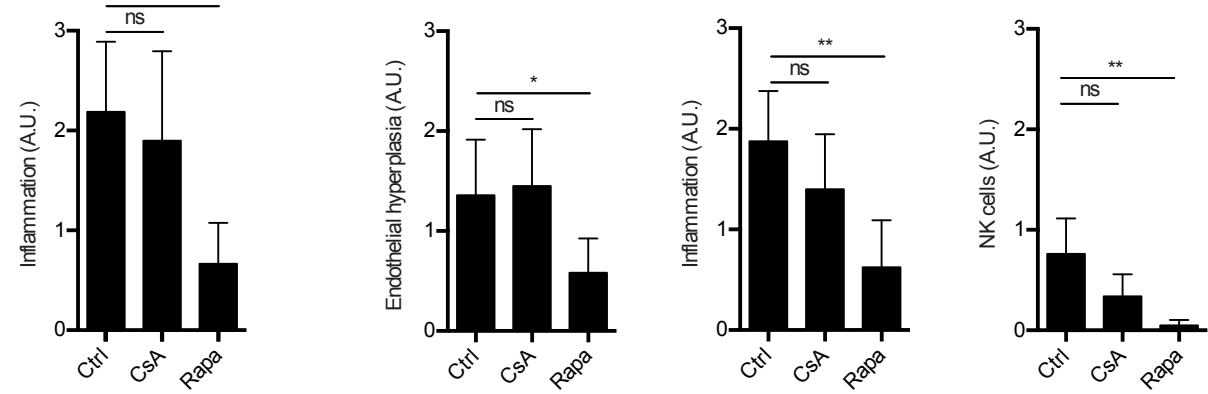

Supplementary material

Supplementary material & methods

Clinical pathology

Kidney graft biopsies were performed systematically as part of the routine follow-up procedure at 3 months and 1-year post transplantation, or in case of rejection suspicion at the other time points.

Renal specimens were fixed in acetic acid-formol-absolute alcohol and paraffin embedded sections were stained by routine methods. C4d staining was performed by indirect immunofluorescence on frozen sections using an anti-human C4d complement-rabbit clonal antibody (clone A24-T, produced by DB Biotech, Kosice, Slovak Republic).

The renal pathologist (M. Rabeyrin) who reviewed the biopsies specimens was blinded to clinical and immunological data.

Double stainings with anti-CD34 (endothelial cells) and anti-CD56 (NK cells) was performed by immunochemistry on paraffin embedded sections using anti-human CD34 (clone QBEnd10, Dako, Les Ulis, France) and anti-human CD56 (clone CD564 antibodies, produced by Novocastra and distributed by Leica Microsystems SAS, Nanterre, France).

Detection of donor-specific antibodies

Detection of anti-HLA antibodies

Serum samples banked at the time of biopsy from patients with significant microvascular inflammation were tested for the presence of donor specific anti-HLA antibodies using Screening Flow Beads (LifeScreen, Class I and Class II ID ®, Lifecodes, Immucor) and Single Antigen Flow Beads (LSA class I and class II®, Lifecodes, Immucor) in case of positivity or questionable result of the screening test.

All the sera of MVI+DSA- and MVI-DNA- patients collected before the biopsy were also checked and patients with circulating donor specific anti-HLA antibodies detected at any time point were excluded.

All the analyses were performed in a blinded fashion by the same trained immunobiologist (V. Dubois) at the Etablissement Français du Sang, Lyon, France.

Detection of anti-endothelial cell antibodies

Target endothelial cells were HLA-matched to avoid false positive tests due to HLA binding (for sera containing anti-HLA antibodies that were not specific of kidney donor).

Briefly, confluent endothelial cell monolayers were starved overnight in endothelial cell basal medium supplemented with 2% FBS without growth factors and incubated with recombinant human TNF α (100 U/mL, Peprotech) for 48 hours. Endothelial cells were then dissociated with trypsin and 1 to $2 \cdot 10^5$ endothelial cells were incubated for 30 minutes at room temperature with 25 μ l of serum diluted at $\frac{1}{4}$ in PBS 1x FBS 1%. Reactivity of patient's sera for endothelial cells was revealed by incubation with a FITC-conjugated F(ab')₂ anti-human IgG (clone 30242, Bio rad, Hercule, CA, USA) for 20 minutes at 4 °C. The fluorescence level was expressed as Mean Fluorescence Intensity.

A serum containing an anti-HLA class I antibody directed against HLA typing of the endothelial cell lines was used as positive control. Negative controls were performed using a pool of human AB sera from healthy male donors (EFS).

Results are expressed as a ratio of the MFI obtained with patients' sera on the one obtained with the negative control. A value of the ratio superior to 1.5 was considered as positive.

HLA and KIR genotyping

HLA-C1 and C2 groups were determined for the donors and recipients considering the HLA C typing obtained by PCR-SSO reverse (One Lambda). The presence or not of Bw4 motif was determined for the donors and recipients considering the HLA A and B typing obtained by PCR-SSO reverse (One Lambda).

Number of inhibitory KIRs was determined considering 7 inhibitory KIRs: 2DL1, 2DL2, 2DL3, 2DL5, 3DL1, 3DL2 and 3DL3. KIR2DL4 was not considered as an inhibitory KIR because it has been reported as having both activating and inhibitory functions. Number of activating KIRs was determined considering 6 activating KIRs: 2DS1, 2DS2, 2DS3, 2DS4, 2DS5 and 3DS1.

AA, BB and AB haplotypes were assigned as follow: AA haplotype if none of the following KIR gene was present: 2DL2, 2DL5, 2DS1, 2DS2, 2DS3, KIR2DS5, 3DS1; BB haplotype if 2DL1, 2DL3, 3DL1, 2DS4 and 2DP1 were absent; Remaining patients were assigned to AB haplotype (according to <https://www.ebi.uk/ipd/kir/introduction.html>).

NK cell depletion in vivo

Where indicated, mice were given intraperitoneal injections of anti-NK1.1 monoclonal antibody (clone PB136, BioXcell, West Lebanon, NH, USA). NK cell depletion was verified by flow cytometry by quantifying the number of circulating Nkp46+ cells.

In cell transfer model model, 200 µg of anti-NK1.1 monoclonal antibody were given at day -7 and day -1, whereas in heart transplantation model, 100 µg of anti-NK1.1 monoclonal antibody were administered to recipient mice twice a week from day -7 to the end of the experiment.

Heart transplantation model

Cardiac allografts were transplanted into subcutaneous space of right neck. Anastomoses were performed by connecting end-to-end the ascending aorta of the

graft with the recipient's common carotid artery and by pulling the main pulmonary artery with the external jugular vein.

Where indicated, mice were injected intraperitoneally with 100 µg of poly(I:C) (polyinosinic-polycytidylic acid; Invivogen, Toulouse, France) at day 4.

Supplementary figure legends

Supplementary Figure 1: Endothelial flow cross match

A. Schematic representation of the flow cross match technique used to detect anti-endothelial antibodies (AECA) in the circulation of renal transplant patients.

B. Overlay of representative flow cytometry profiles. Shaded profiles are respectively for endothelial cells incubated in AB serum (negative control, light grey) or in serum of patients with anti-HLA antibodies (positive control, dark grey). Open profiles are representative of a negative (patient #1, black) and a positive (patient #2, red) test, respectively.

C. Histograms showing the individual data from patients of MVI+ anti-HLA DSA- (left, n=59) and MVI-DSA- (right, n=74) group. AECA titre is the ratio of mean fluorescence intensities of endothelial cells incubated in patient's serum and AB serum (negative control). Grey dashed line indicates the threshold of positivity of the assay (AECA titre > 1.5).

Supplementary Figure 2: Inhibitory KIR repertoire

A. Schematic representation of the interactions between inhibitory KIR receptors on human NK cells and their ligands. KIR2DL1 and KIR2DL2/3 recognise distinct HLA-C allotypes, called C2 or C1 based on polymorphisms at positions 77 and 80 in the $\alpha 1$ -domain of the HLA heavy chain. KIR3DL1 ligands are HLA A and B molecules that share the Bw4 epitope, and KIR3DL2 binds HLA-A3 and HLA-A11.

B-C Flow cytometry was used to analyse the expression of the 5 inhibitory KIRs (2DL1, 2DL2, 2DL3, 3DL1, 3DL2) on circulating NK cells of 6 healthy volunteers with identical genotypes. **B.** A combination of 6 fluorescent mAb specific for respectively i)

KIR2DL1 and KIR2DS5, ii) KIR2DL1, iii) KIR2DL2 and KIR2DL3 and KIR2DS2, iv) KIR2DL3, v) KIR3DL1 and KIR3DL2, and vi) KIR3DL1 were used. The gating strategy used to identify NK cell populations that express a single inhibitory KIR is shown. **C.** According to the combination of inhibitory KIRs expressed on the cell surface, 23 subsets of NK cells could be defined. The histogram shows the relative proportion of each NK cell subset: i.e. inhibitory KIR repertoire. The open circle indicates the mean of each NK cell subset. Bars indicate the mean of each category, which were defined according to the number of inhibitory KIR expressed on the NK cell surface (0 to 5). Standard deviation is indicated for each mean value.

Supplementary Figure 3: Allogeneic endothelial cells trigger missing self-induced activation of NK cells in vitro

Primary allogeneic human endothelial cells were co-cultured with purified NK cells from 30 healthy volunteers. After 4 hours of culture, the activation status of the NK cells was assessed at the single cell level by flow cytometry focusing on the 5 NK cell populations that expressed a single inhibitory KIR. Three distinct situations were defined: i) endothelial cells expressed the ligand for the inhibitory KIR (No MS), ii) neither endothelial cells nor NK cell donor expressed the ligand for the inhibitory KIR (Uneduc MS), or iii) endothelial cells did not express the ligand of inhibitory KIR (missing self, MS).

A. Experiments were performed with unprimed purified NK cells. Left: Expression of CD107a (LAMP-1) on NK cells surface. Right: Intracellular staining for MIP-1 β in NK cells.

B. Experiments were performed after priming of purified NK cells with low dose IL2. Each graph shows the ability of a given missing self situation to activate NK cells.

KIR2DL2 (red or dark green) and KR2DL3 (orange or light green) were plotted together because they bind to the same ligand on endothelial cells. Upper row: Expression of CD107a (LAMP-1) on NK cells surface. Lower row: Intracellular staining for MIP-1 β in NK cells.

ns: $p \geq 0.05$; *: $p < 0.05$; **: $p < 0.01$; ****: $p < 0.0001$; One-way Anova.

Supplementary Figure 4: Missing self triggers NK cell-mediated rejection in vivo

A-B A cell transfer model was used to explore the ability of NK cells to destroy cellular targets lacking MHC I in vivo. **A.** Representative flow profile of the cell suspension prior transfer: Violet: $\beta 2$ microglobulin KO cells (targets); Green: wild type C57BL/6 cells (control). **B.** Representative flow profiles obtained during analyses of the spleen of wild type C57BL/6 recipients 2.5 days after cell transfer. Upper row: control animal; lower row: after NK cell depletion with anti-NK1.1 mAb.

C. The efficiency of the NK cell depletion was assessed in recipient mice by flow cytometry. Left: The proportion of Nkp46 $^{+}$ cells was assessed in the circulation of 4 mice before and seven days after IP injection of 200 μ g of anti-NK1.1 mAb (mean \pm standard deviation). Middle and right: Mice transplanted with a $\beta 2$ microglobulin KO heart allograft were depleted for NK cells by IP injection of 100 μ g anti-NK1.1 mAb twice a week from day -7 to day 60 post transplantation. Middle: the proportion of Nkp46 $^{+}$ cells was assessed in the circulation of 5 recipient mice before (0) depletion and every 7 days post-transplantation. Mean \pm standard deviation. Right: at day 60 post-transplantation, heart graft was harvested for pathological analyses and NK cell depletion was assessed in secondary lymphoid organs (LN: lymph nodes, and spleen) of recipient mouse. Individual data of 6 mice are shown.

D-E. Wild type C57BL/6 mice were transplanted with either a C57BL/6 or a $\beta 2$ microglobulin KO heart. In some cases the heart was subjected to 3 hours of cold ischemia before transplantation (+ Isch). Some recipients received 100 μ g of polyinosinic-polycytidylic acid IP 4 days post-transplantation (+ Poly(I:C)). Heart grafts were harvested 60 days after transplantation for histological analysis. **D.** Representative findings of H&E stain are shown for the 4 experimental groups. Scale bars: 100 μ m. **E.** A trained pathologist graded the intensity of the microvascular inflammation (MVI) on a semi-quantitative scale (score 0–3). Mean \pm standard deviation.

ns: $p \geq 0.05$; *: $p < 0.05$; One-way Anova.

Supplementary Figure 5: Gating strategy for imaging flow cytometry analysis of activated NK cells

Purified NK cells from a healthy donor were co-cultured with HLA-deficient K562 cells. Imaging flow cytometer was used to detect the phosphorylated form of S6 Ribosomal Protein (S6RP, downstream mTORC1) and protein kinase B (Akt, downstream mTORC2) in isolated NK cells and NK cells forming doublets with K562 target cells.

A. The following populations were gated: (0) single NK cells (S) and doublets formed by an NK cell and a K562 cell (D) by BF Area (x-axis) and Aspect Ratio (y axis).

Selection of doublets: (D1) elimination of out of focus cells. (D2 to D4) Elimination of CD3+ T cells and dead cells and identification of doublets of NK (CD3-CD56+) and K562 cells. (D5) CD56 mask. (D6) Upper row: representative example of p-S6RP signal in NK/K562 doublets (left) and overlay between CD56 mask (area where the signal intensity was measured) and p-S6RP signal. Lower row: representative

example of p-Akt signal in NK/K562 doublets (left) and overlay between CD56 mask and p-Akt signal.

Selection of single NK cells: (S1) elimination of out of focus cells. (S2) Elimination of CD3+ T cells and dead cells and identification of single NK cells (CD3-CD56+). (S3) CD56 mask. (S4) Upper row: representative example of p-S6RP signal in single NK cells (left) and overlay between CD56 mask and p-S6RP signal. Lower row: representative example of p-Akt signal in in single NK cells (left) and overlay between CD56 mask and p-Akt signal.

A

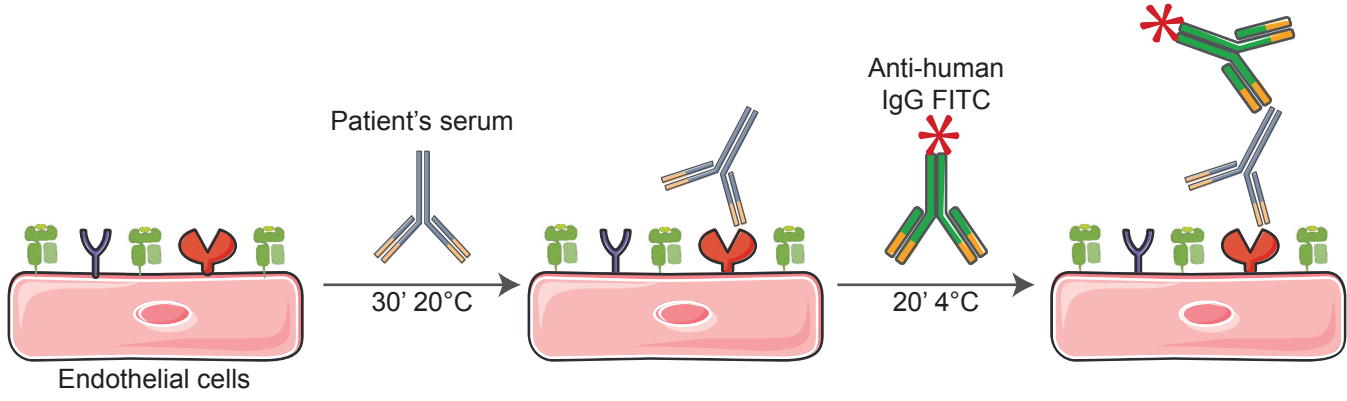

B

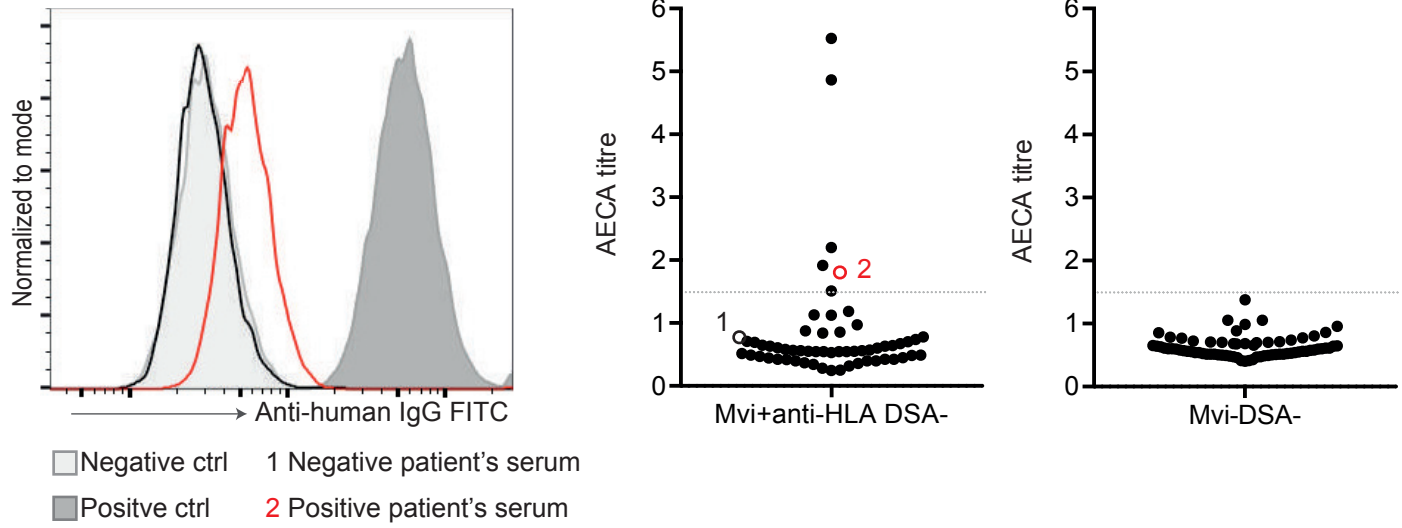

A

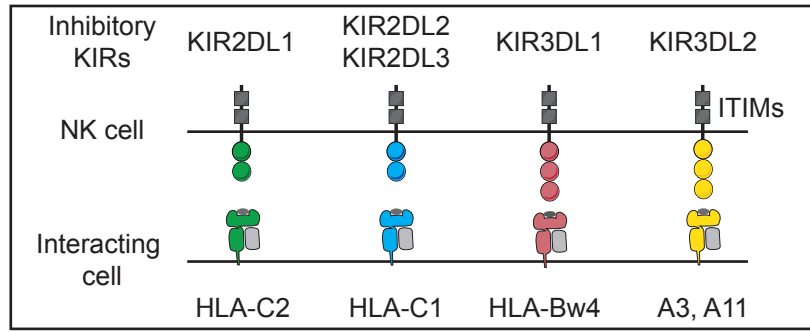

B

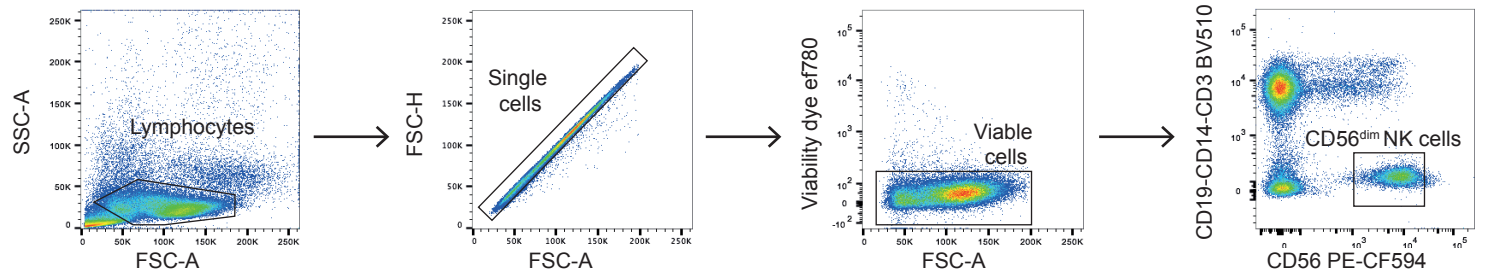

Gated on CD56^{dim} NK cells

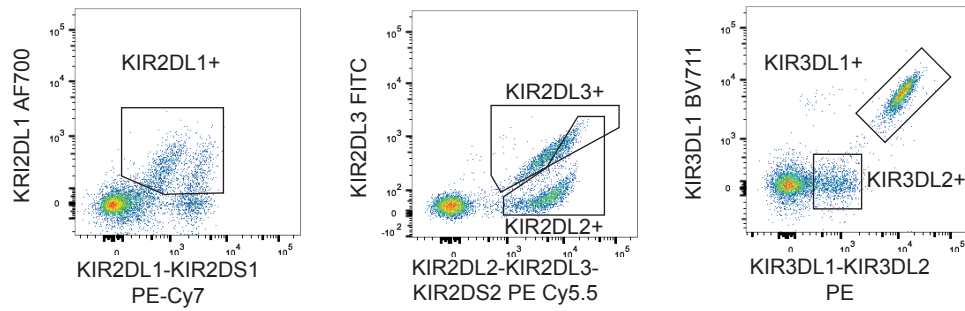

C

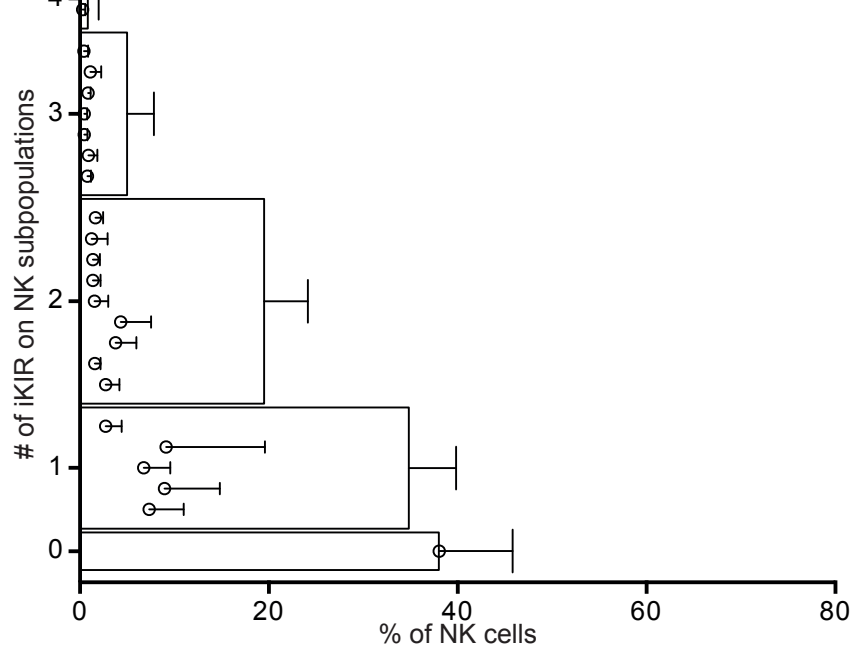

Supplementary figure 3

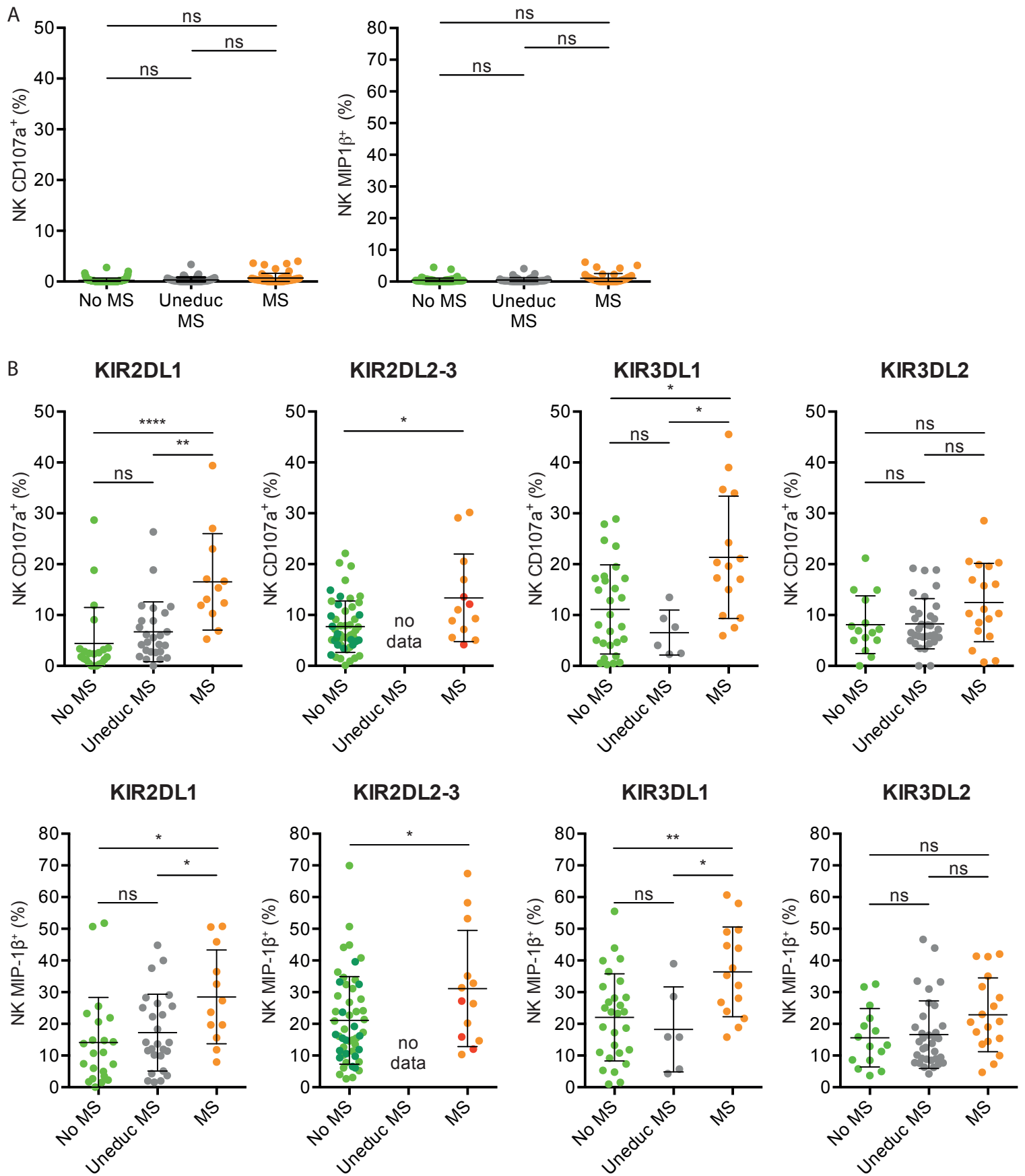

Supplementary figure 4

A

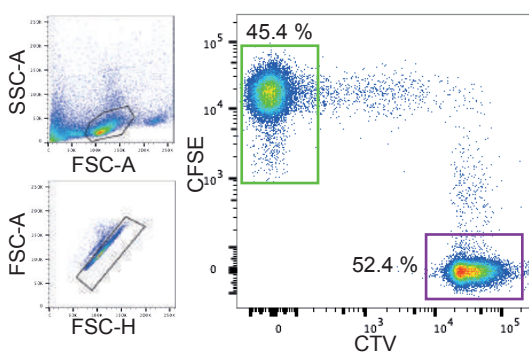

B

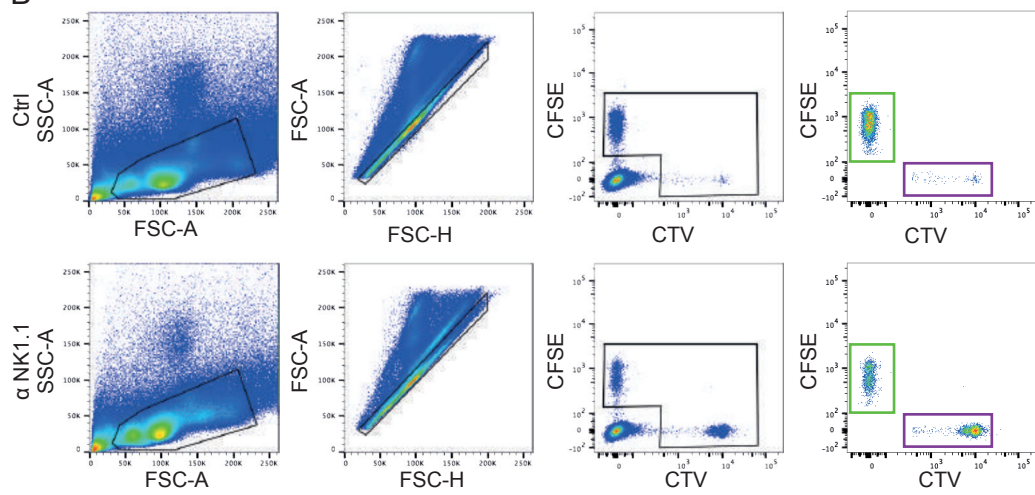

C

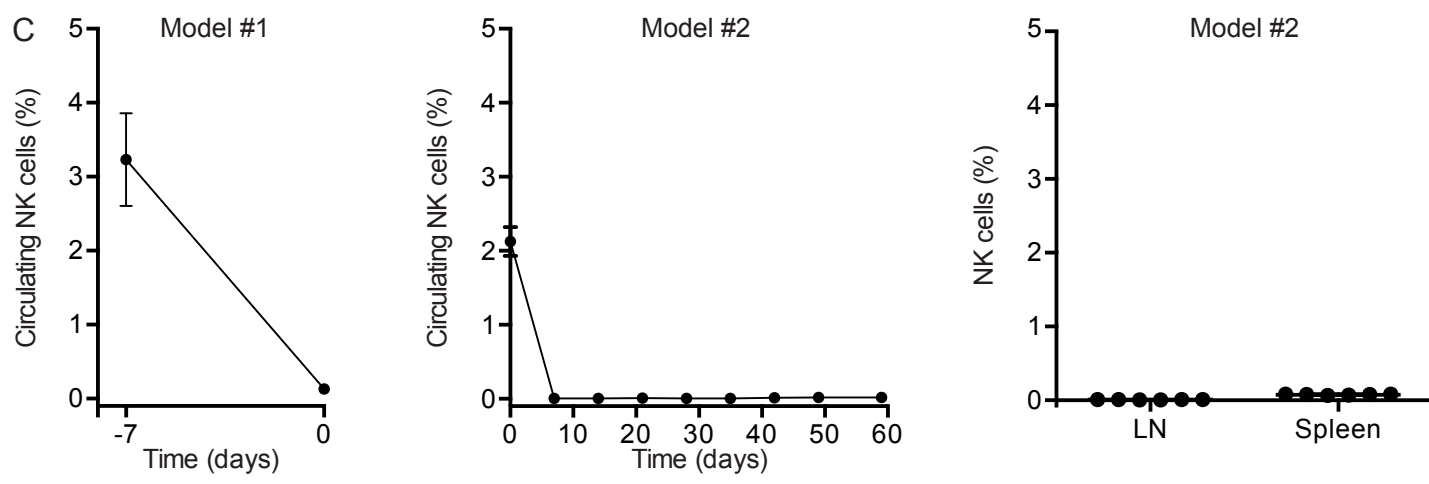

D

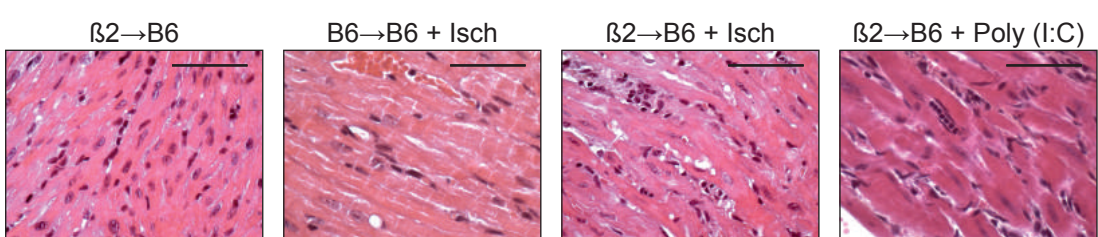

E

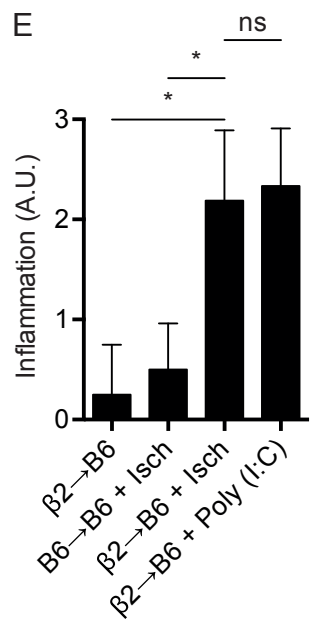

Supplementary figure 5

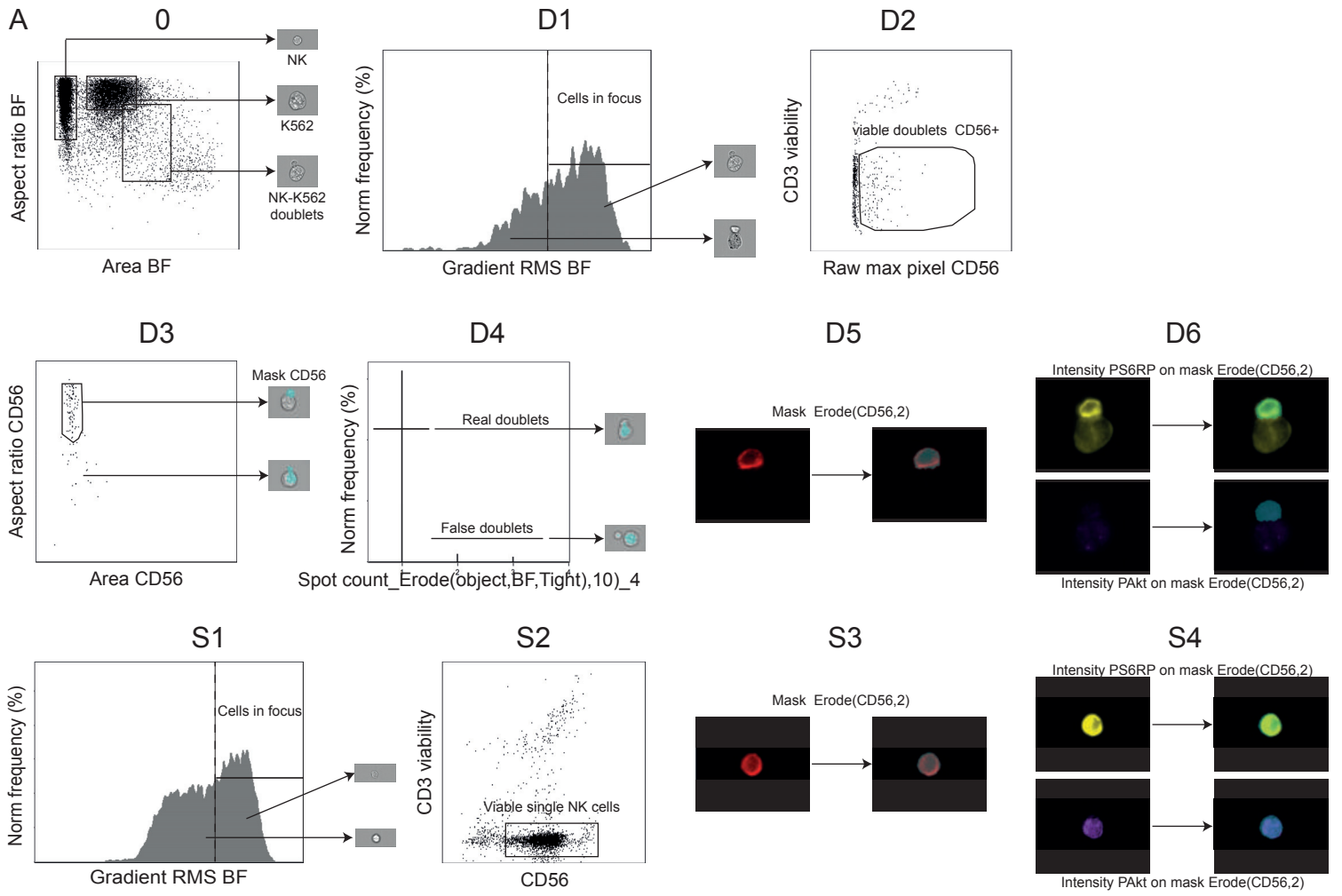

Supplementary Tables

Supplementary Table 1: Clinical characteristics of renal transplant patients

Variable	MVI+DSA+C3d+ (n=40)	MVI+DSA+C3d- (n=29)	MVI+DSA- (n=44)	MVI-DSA- (n=55)	P value 2 vs 3	P value 3 vs 4
Characteristics at the time of transplantation						
Recipient						
Age (yr)	36.7 ± 12.4	43.5 ± 15.8	42.5 ± 13.6	45.4 ± 14.0	0.8	0.3
Men, n (%)	26 (65.0)	16 (61.5)	31 (71.5)	42 (76.4)	0.2	0.6
Retransplantation, n (%)	14 (35)	10 (34)	10 (22.7)	5 (9.1)	0.3	0.1
Time since dialysis (mo)	50.2 ± 65.1	65.4 ± 65	24.7 ± 29.1	29.4 ± 34.6	0.001	0.5
Blood group, n (%)						
Type A	24 (60.0)	14 (48.0)	24 (54.5)	25 (45.5)	0.1	0.02
Type B	2 (5.0)	4 (14.0)	6 (13.6)	8 (14.5)		
Type O	13 (32.5)	11 (38.0)	9 (20.5)	22 (40.0)		
Type AB	1 (2.5)	0 (0.0)	5 (11.4)	0 (0.0)		
Donor						
Deceased, n (%)	37 (92.5)	27 (93.1)	41 (93.2)	49 (89.1)	1.0	0.7
Age (yr)	38.1 ± 17.9	40.4 ± 16.1	43.1 ± 14.4	45.5 ± 16.2	0.5	0.5
Transplantation						
Cold ischemia time (min)	902 ± 396	1013 ± 289	986 ± 342	876 ± 307	0.9	0.03
No. of HLA A/B/DR mismatch	3.6 ± 1.5	4.0 ± 1.3	4.0 ± 1.3	3.9 ± 1.4	1.0	0.8
Combined transplantation, n (%) ^a	5 (12.5)	3 (10.0)	6 (13.6)	15 (27.3)	1.0	0.1
Delayed graft function, n (%)	10 (25.0)	4 (14.0)	7 (16.3)	9 (16.4)	1.0	1.0
Immunosuppression						
Induction therapy						
Antithymocyte globulins	30 (75.0)	22 (75.9)	29 (65.9)	47 (85.5)	0.6	0.05
Anti-IL2 receptor	6 (15.0)	4 (13.8)	14 (31.8)	14 (25.5)	0.1	0.5
Maintenance therapy						
Cyclosporine	23 (57.5)	18 (62.1)	17 (38.6)	16 (29.1)	0.06	0.4
Tacrolimus	15 (37.5)	11 (37.9)	25 (56.8)	40 (72.7)	0.2	0.1
Azathioprine	4 (10.0)	1 (3.5)	1 (2.3)	0 (0.0)	1.0	0.4
Mycophenolate mofetil	33 (82.5)	26 (89.7)	42 (95.5)	55 (100.0)	0.4	0.2
Steroids	38 (95)	28 (96.6)	43 (97.7)	54 (98.2)	1.0	1.0
Characteristics at the time of biopsy						
Clinicobiologic characteristics						
Time post-transplantation (mo)	55 ± 60	39 ± 42	25 ± 39	9 ± 6	0.1	0.003
Proteinuria (g/d)	2.3 ± 5.8	0.7 ± 1.0	0.7 ± 1.5	0.1 ± 0.2	1.0	0.01
Creatininemia (μmol/L)	362 ± 382	201 ± 136	190 ± 90	137 ± 57	0.7	< 0.0001
eGFR ^b (ml/min per 1.73 m ²)	29.5 ± 20.9	39.2 ± 18.5	42.4 ± 21.5	56.6 ± 20.6	0.5	0.001
Histologic characteristics (Banff scores ^c)						
Microvascular inflammation ^d	3.5 ± 1.2	3.4 ± 1.0	3.1 ± 1.3	0.2 ± 0.4	0.2	< 0.0001
Transplant glomerulopathy	1.1 ± 1.2	1.0 ± 1.2	1.0 ± 1.3	0.02 ± 0.1	0.8	< 0.0001
Interstitial inflammation and tubulitis	2.9 ± 2.1	2.2 ± 1.8	2.4 ± 1.7	1.5 ± 1.9	0.7	0.02
Interstitial fibrosis and tubular atrophy	1.7 ± 0.8	1.5 ± 0.7	1.7 ± 1.0	1.4 ± 0.7	0.3	0.05
Arteriosclerosis	0.9 ± 1.0	1.1 ± 1.1	1.2 ± 1.1	0.7 ± 0.8	0.8	0.01
Enderteritis (vasculitis)	0.25 ± 0.5	0.24 ± 0.5	0.3 ± 0.7	0	0.6	n/a
C4d deposition	1.75 ± 0.9	1.2 ± 1.1	0.3 ± 0.7	0	0.0001	n/a

Abbreviations: DSA: Donor specific antibodies, MVI: microvascular inflammation

a Simultaneous pancreas and kidney transplantations.

b Calculated with the Modification of Diet in Renal Disease formula.

c Banff scores (0: no significant lesion, 1: mild, 2: moderate, 3: severe).

d Sum of the Banff scores for glomerulitis and capillaritis.

Supplementary Table 2: HLA and KIR genotypes of donors & recipients

	MVI-DSA- (n=55)	MVI+DSA- (n=44)	P value
RECIPIENTS			
KIR genes			
Inhibitory KIRs, n (%)			
KIR2DL1	53 (96.4)	42 (95.5)	1
KIR2DL2	31 (56.4)	21 (47.7)	0.4
KIR2DL3	49 (89.1)	41 (93.2)	0.7
KIR2DL5	32 (58.2)	20 (45.5)	0.2
KIR3DL1	52 (94.5)	44 (100)	0.3
KIR3DL2	55 (100.0)	44 (100.0)	1
KIR3DL3	55 (100.0)	44 (100.0)	1
Activating KIRs, n (%)			
KIR2DS1	17 (30.9)	12 (27.3)	0.8
KIR2DS2	31 (56.4)	21 (47.7)	0.4
KIR2DS3	21 (38.0)	8 (18.2)	0.04
KIR2DS4	52 (94.5)	44 (100)	0.3
KIR2DS5	18 (32.7)	13 (29.5)	0.8
KIR3DS1	15 (27.3)	12 (27.3)	1
Unknown, n (%)			
KIR2DL4	55 (100.0)	44 (100.0)	1
Numbers of KIRs			
Inhibitory KIRs, n (%)			
5	16 (29.1)	17 (38.6)	0.5
6	21 (38.2)	17 (38.6)	
7	17 (30.9)	10 (22.7)	
Activating KIRs, n (%)			
1-2	22 (40.0)	24 (54.5)	0.4
3-4	23 (41.8)	17 (38.6)	
5-6	8 (14.5)	3 (6.8)	
Haplotypes, n (%)			
A/A	14 (25.5)	14 (31.8)	0.3
B/B	3 (5.4)	0 (0.0)	
A/B	38 (69.1)	30 (68.2)	
Inhibitory KIR ligands, n (%)			
C1/C1	21 (38.2)	16 (36.4)	1
C1/C2	25 (45.5)	20 (45.5)	
C2/C2	9 (16.3)	8 (18.2)	
Bw4	41 (74.5)	36 (81.8)	0.5
A3, A11	17 (30.9)	10 (22.7)	0.5
Educating KIRs			
Activating KIRs, n (%)			
KIR2DS1+/C2-	5 (9.1)	3 (6.8)	0.7
Inhibitory KIRs, n (%)			
KIR2DL1+/C2+	32 (58.2)	27 (61.4)	0.8
KIR2DL2+/C1+	24 (43.6)	17 (38.6)	0.7
KIR2DL3+/C1+	42 (76.4)	33 (75.0)	1
KIR3DL1+/Bw4+	38 (69.1)	35 (79.5)	0.3
KIR3DL2+/A 3, 11+	15 (27.3)	10 (22.7)	0.6
DONORS			
Inhibitory KIR ligands, n (%)			
C1/C1	18 (32.7)	18 (40.9)	0.2
C1/C2	32 (58.2)	18 (40.9)	
C2/C2	5 (9.1)	8 (18.2)	
Bw4	45 (81.8)	28 (63.6)	0.06
A3, A11	26 (47.3)	11 (25.0)	0.04

Abbreviations: DSA: Donor specific antibodies, MVI: microvascular inflammation

IV. DISCUSSION

1. Synthèse

Après une transplantation d'organe, le rejet chronique est responsable de la majorité des pertes de greffons sur le long terme (53,95,102–105). Il oblige à réinscrire les patients sur liste d'attente de transplantation et aggrave ainsi le déséquilibre déjà existant entre l'offre et la demande d'organes. Pour ces raisons, le rejet chronique constitue une des problématiques majeures de la transplantation. Jusqu'à notre étude, le rejet chronique était principalement attribué à la réponse alloimmune humorale qui se développe contre le greffon (53,95,102–105). Mais notre travail apporte la preuve que, qu'après une transplantation rénale :

- La moitié des rejets vasculaires chroniques surviennent de manière indépendante des anticorps.
- Ces rejets sont secondaires à l'activation des cellules NK du receveur suite à la perception du « missing self » au niveau de l'endothélium du greffon.
- Ces rejets sont responsables d'autant de pertes de greffons que les rejets humoraux secondaires à des anticorps n'activant pas le complément.
- L'activation des cellules NK par le « missing self » est dépendante de la voie mTORC1 qui peut être efficacement bloquée par un inhibiteur de mTOR : la rapamycine.
- La rapamycine est efficace pour prévenir la survenue de lésions de rejet induites par les cellules NK dans un modèle murin préclinique de transplantation cardiaque.

2. Rôle de l'activation des cellules NK par le « missing self » dans l'initiation de rejets

Nos données vont à l'encontre du dogme immunologique prévalent qui dit que l'immunité innée peut participer au rejet seulement si elle est recrutée par le système immunitaire adaptatif. Elles démontrent que les cellules NK « directement » activées par le « missing self » peuvent être à l'origine de rejets vasculaires chroniques (par la suite dénommés rejets NK/MS).

Cudkowicz et al. sont les premiers à avoir montré l'implication de l'activation des cellules NK par le « missing self » dans des rejets après une greffe de moelle (202). Ils ont observé qu'une greffe de moelle provenant d'une lignée parentale à une

lignée hybride F1 (entre la lignée parentale et une seconde lignée) était rejetée (202). Ils ont appelé ce phénomène « la résistance hybride » (202). Ce rejet de greffe avait lieu en dehors de toute allogénicité liée au CMH puisque les molécules du CMH du donneur étaient présentes chez le receveur. Il a fallu attendre les années 80 que ce rejet soit attribué à l'activation des cellules NK suite à la reconnaissance du « missing self » sur les cellules greffées (203). Chez l'homme, l'impact du « missing self » a été étudié pour la première fois à la fin des années 90 dans le contexte de la greffe de moelle osseuse haploidentique (1 haplotype HLA sur 2 du donneur présent chez le receveur). Ruggieri et al. ont mis en évidence que les cellules NK du donneur pouvaient s'activer suite à la reconnaissance d'un « missing self » sur les cellules du receveur (204,205). Elles étaient alors responsables d'un effet « graft versus leukemia » (GVL) en tuant les cellules leucémiques restantes. Elles prévenaient également la survenue d'une « graft versus host disease » (GVHD) en tuant les cellules dendritiques du receveur (et en les empêchant ainsi de présenter les molécules du CMH du receveur aux lymphocytes T du donneur) (204,205). En revanche, les cellules NK du donneur, elles-mêmes, n'étaient pas responsables d'un effet GVHD car l'alloréactivité NK disparaissait rapidement en raison d'une rééducation des cellules NK du donneur soumises à un nouvel environnement en molécules du CMH de classe I (155).

Pendant longtemps, l'implication du « missing self » en transplantation d'organe a été ignoré car Snell avait constaté qu'une greffe de peau provenant d'une lignée parentale à une lignée hybride F1 n'était pas rejetée (206). Le manque d'impact du « missing self » dans ce modèle est certainement dû au fait que les vaisseaux irriguant une greffe proviennent du receveur et de ce fait, expriment les molécules du CMH de classe I du receveur (45). Cette hypothèse est cohérente avec nos données qui démontrent que les lésions de rejet induites par le « missing self » sont limitées aux vaisseaux du greffon aussi bien chez les patients que dans le modèle expérimental murin. Comme nous, l'équipe du Dr Colvin avait également déjà constaté par le passé que lorsqu'un greffon cardiaque provenant d'une lignée parentale était transplanté à une lignée hybride F1, le greffon présentait uniquement des lésions de rejet vasculaire chronique (207). Mais en dehors de ces données expérimentales, jusqu'à notre étude, aucune équipe n'avait réussi à montrer clairement l'implication du « missing self » dans l'induction de rejet chez l'homme en transplantation d'organe. De nombreuses études se sont intéressées à cette problématique sans déterminer le caractère

éduquant des différents KIR inhibiteurs (208,209), voire sans déterminer les KIR inhibiteurs présents chez les receveurs (210–212). Dans ce contexte, l'analyse de l'existence d'une situation de « missing self » entre les cellules NK du receveur et les cellules du greffon était tout simplement impossible. Ensuite, certaines études ont choisi d'analyser des cohortes de patients présentant un rejet cellulaire aigu (et donc interstitiel) (209). Ce critère de jugement ne semble pas adapté puisque dans notre étude, les patients ayant un rejet induit par le « missing self » présentent des lésions vasculaires de leurs greffons. Enfin, contrairement à nous, certains auteurs ont cherché à analyser l'impact du « missing self » sur la survie des greffons sans éliminer la présence d'anticorps anti-donneur chez leurs patients, un facteur confondant évident (213–215). Au final, notre étude est la première à démontrer avec certitude l'implication de l'activation des cellules NK par le « missing self » dans la survenue de rejets vasculaires chroniques après transplantation d'organe chez l'homme.

3. Mécanismes impliqués dans les rejets vasculaires chroniques des patients sans « missing self »

Dans notre cohorte, un tiers des patients présentent des lésions d'inflammation microvasculaire sans « missing self ». Plusieurs hypothèses peuvent être émises pour expliquer ce fait.

3.1. Existence d'anticorps spécifiques du donneur non détectés

Même si nous les avons cherchés extensivement, il est possible que ces patients présentent tout de même des anticorps dirigés contre leurs greffons. Tous les patients ayant des lésions d'inflammation microvasculaire ont eu une recherche d'anticorps anti-HLA spécifiques du donneur dans leur sérum par une technique très sensible (Luminex). Les patients chez qui un anticorps a été retrouvé même de manière transitoire ont été éliminés. Nous avons ensuite recherché la présence d'anticorps anti-cellules endothéliales chez les patients présentant des lésions d'inflammation microvasculaire sans anticorps anti-HLA spécifiques du greffon. Ces anticorps revêtent en effet une importance particulière car l'endothélium vasculaire est le premier lieu d'interaction entre le greffon et le système immunitaire du receveur. La plupart des antigènes non-HLA présents à la surface des cellules endothéliales étant

inconnus, nous avons pris le parti de réaliser un cross match endothélial par cytométrie en flux afin de tester le plus grand nombre d'antigènes en utilisant une technique par ailleurs sensible. Même si ce cross match a pu être réalisé pour l'ensemble des patients, nous ne pouvons exclure que certains patients présentent des anticorps non-HLA contre des antigènes non présents sur les cellules endothéliales utilisées. En effet pour les cross matches, nous avons utilisé comme cible des lignées primaires de cellules endothéliales humaines d'origines coronarienne et aortique qui sont des cellules endothéliales macrovasculaires et non microvasculaires comme au niveau des glomérules et des capillaires péri-tubulaires rénaux. Ceci pourrait être un facteur limitant pour la détection de certains anticorps non-HLA même si la majorité des études réalisant des cross matches endothéliaux chez les transplantés rénaux utilisent également des cellules endothéliales macrovasculaires d'origines diverses (216,217). Une autre source intéressante de cellules endothéliales aurait pu être des cellules endothéliales microvasculaires glomérulaires immortalisées (218). Mais le problème est qu'une seule lignée de ce type est disponible actuellement. Il aurait donc été impossible de réaliser le cross match pour certains patients présentant des anticorps circulants anti-HLA non spécifiques de leur greffon. Pour utiliser cette lignée, il aurait fallu inactiver les gènes des molécules du CMH de classe I et II afin qu'elle soit compatible avec l'ensemble des patients. Enfin, nous aurions pu utiliser des précurseurs sanguins des cellules endothéliales du donneur qui sont utilisés par le seul kit de cross match endothélial commercial XM-ONE (219). Mais d'une part, ces cellules sont immatures, ceci interférant également avec les antigènes présents à leur surface et d'autre part, étant à distance de la greffe, nous ne disposons pas de matériel cellulaire sanguin disponible pour le donneur.

3.2. Activation des cellules NK par la reconnaissance du « soi induit »

Il est tout à fait possible que les cellules NK du receveur soient impliquées dans les lésions d'inflammation microvasculaire de ces patients malgré l'absence de « missing self ». L'activation des cellules NK face à une cellule cible survient suite à la modification de l'équilibre des signaux activateurs/inhibiteurs en faveur des signaux activateurs. La forte expression de ligands de stress à la surface des cellules cibles interagissant avec les récepteurs activateurs peut aussi conduire à l'activation des cellules NK même en l'absence de perte de l'expression des molécules du CMH de

classe I du soi : c'est ce que l'on appelle l'activation par le « soi induit » ou « induced self ».

Parmi les récepteurs activateurs susceptibles d'être impliqués, NKG2D est une piste intéressante. A l'état basal, plusieurs de ses ligands sont exprimés sur les cellules endothéliales, notamment microvasculaires rénales : MICA, MICB, « UL-16-binding-protein » (ULBP)-2 et -3 (64,220,221). L'expression de MICA à la surface des cellules endothéliales du greffon peut être majorée par l'existence d'un polymorphisme génétique chez le donneur (présence du variant génétique MICA A5.1) (220,222) et certaines situations de stress après la transplantation (lésions d'ischémie/reperfusion, infection par le CMV,...) (62–65). *In vitro*, cette surexpression de MICA est associée à une plus grande sensibilité des cellules endothéliales à la lyse NK-dépendante (64,220).

Un autre récepteur activateur susceptible d'être impliqué est CD94/NKG2C, notamment dans un contexte infectieux. Ce récepteur a pour ligand la molécule du HLA non classique, HLA-E. HLA-E est exprimé de manière constitutive à la surface de toutes les cellules nucléées. Son expression dépend directement de l'expression des molécules du CMH de classe I car le peptide présenté par HLA-E est issu de la séquence signal de ces molécules. En cas d'infection à CMV, les cellules endothéliales du greffon peuvent représenter un site de latence du virus (223,224). Dans ce cas-là, l'expression des molécules du CMH de classe I à la surface des cellules endothéliales infectées est diminuée mais l'expression de HLA-E est tout de même maintenue car la protéine virale UL40 produit un peptide de remplacement (224,225). Parallèlement, l'infection à CMV entraîne également l'expansion de cellules NK exprimant les marqueurs CD94/NKG2C et CD57 (226,227) qui sont considérées comme des cellules « mémoires ». Ce changement de phénotype est donc durable dans le temps et s'accompagne de meilleures capacités cytotoxique et de sécrétion d'INF- γ . Dans ce contexte, il est possible que cette majoration importante du nombre de cellules NK susceptibles de cibler les cellules endothéliales infectées du greffon puissent être à l'origine de lésions de l'endothélium du greffon.

3.3. Implication d'autres cellules de l'immunité innée : les monocytes

Plusieurs équipes ont montré que les monocytes pouvaient, comme les cellules NK, reconnaître la nature allogénique des cellules d'un greffon, autrement dit

reconnaître le non soi sans signal danger (228–232). Jusqu'à peu, on considérait que la maturation des CPA du receveur (cellules dendritiques/monocytes) avait lieu suite à la libération de molécules « danger » par les cellules stressées ou mourantes du greffon pendant la période du post-greffe immédiat. La première preuve que des alloantigènes pouvaient être reconnus directement par les monocytes du receveur a été apportée par Zecher et al. (228). Ils ont démontré que l'injection sous cutanée de splénocytes allogéniques à des souris $RAG^{-/-}$ déclenchait une réaction d'hypersensibilité (contrairement à une injection de cellules syngéniques) (228). Des expériences de déplétion et de transfert de cellules leur ont permis de démontrer que cette réaction était causée par les monocytes (228). Une autre étude a constaté qu'après une première immunisation, les macrophages pouvaient identifier et tuer les cellules allogéniques, en l'absence de lymphocytes T et B (229). Enfin, Oberbarnscheidt et al. ont mis en évidence que la transplantation d'un greffon allogénique dans une souris $RAG^{-/-}\gamma c^{-/-}$ (souris déficientes en lymphocytes T, B et NK) entraînait une différenciation persistante des monocytes du receveur en cellules dendritiques matures, capables de stimuler les lymphocytes T du receveur. A l'inverse, la transplantation d'un greffon syngénique s'accompagnait d'une différenciation limitée des monocytes en cellules dendritiques, incapables de stimuler efficacement les lymphocytes T (230). Ces données ont également été confirmées dans un modèle d'immunisation avec des leucocytes allogéniques injectés par voie intraveineuse (231). Enfin, jusqu'à peu, les alloantigènes du non soi reconnus par les monocytes étaient inconnus. Récemment, il a été montré que les monocytes du receveur pouvaient s'activer suite à la détection d'un polymorphisme de la protéine « Signal regulatory protein α » ($SIRP\alpha$) sur les cellules du greffon (232) (Figure 17).

Figure 17. Activation des monocytes du receveur suite à la détection d'un polymorphisme de SIRP α (Dai, *Sci Immunol*, 2017)

A. Balance équilibrée entre les signaux activateurs transmis par CD47 et les signaux inhibiteurs transmis par SIRP α dans les monocytes du receveur en cas de transplantation syngénique.

B. Balance déséquilibrée dans le cas d'une transplantation allogénique lorsque la protéine SIRP α du donneur (en rouge) a une affinité plus forte pour CD47 que celle du receveur (en vert). Ceci entraîne la différenciation des monocytes du receveur en cellules dendritiques.

DC, dendritic cell.

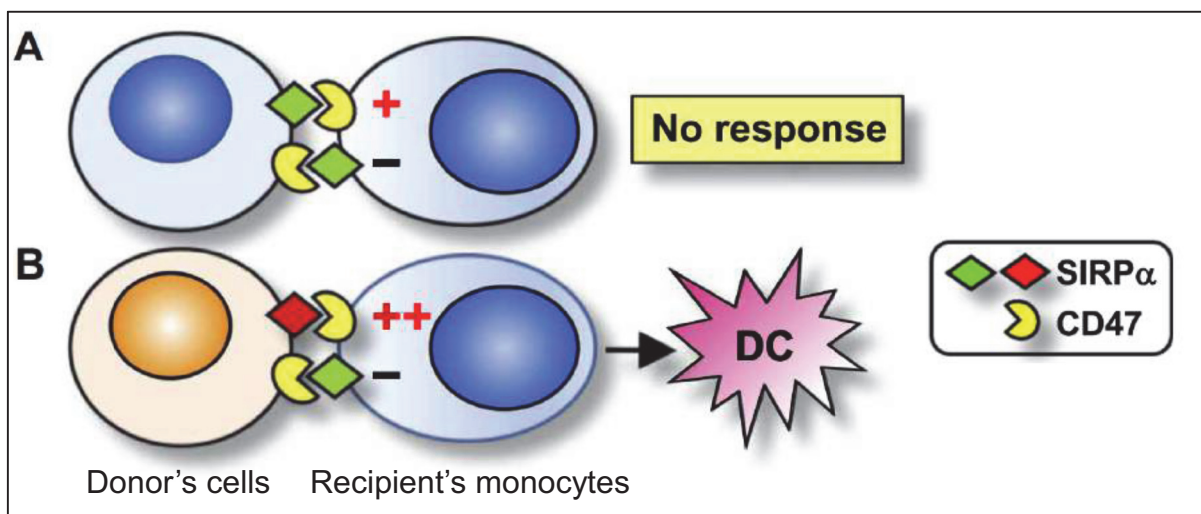

4. Facteurs impliqués dans le développement de rejet NK/MS

Dans notre cohorte, un tiers des patients ne présentent pas de lésions d'inflammation microvasculaire malgré la présence d'un « missing self » prédit génétiquement. Comme nous l'avons déjà expliqué dans notre étude, un nombre insuffisant de cellules NK susceptibles de répondre au « missing self » et/ou une absence de pré activation des cellules NK du receveur peuvent expliquer cette apparente discordance. Il est aussi possible qu'une activation insuffisante des cellules cibles des cellules NK, les cellules endothéliales du greffon soit aussi impliquée chez ces patients sans lésions. Dans nos expériences de co-cultures entre des cellules NK humaines et des cellules endothéliales primaires, l'activation des cellules endothéliales par du TNF- α n'avait pas d'impact sur l'activation des cellules NK, ni leur capacité à tuer les cellules endothéliales. Toutefois, ces données ne permettent pas

d'éliminer le fait que l'activation des cellules endothéliales soit nécessaire pour le recrutement des cellules NK dans des conditions physiologiques. Nous avons conduit des expériences préliminaires pour monitorer l'adhésion de cellules NK humaines à des tapis de cellules endothéliales en présence d'un flux. Dans ce système, les cellules endothéliales étaientensemencées dans des micro canaux puis soumises à un flux pour mimer au mieux leur environnement naturel. Le lendemain, les cellules NK étaient injectées dans les canaux tapissés de cellules endothéliales en présence d'un flux dont la vitesse était similaire au flux présent dans les micro vaisseaux des greffons. L'adhésion des cellules NK n'était possible que si les cellules NK et les cellules endothéliales étaient activées respectivement par de l'IL-2 et du TNF- α . Ces données sont cohérentes avec plusieurs publications qui mettent en évidence que suite à une stimulation par du TNF- α et/ou de l'INF- γ , les cellules endothéliales expriment plus de molécules d'adhésion ICAM-1 et VCAM-1 et sécrètent des cytokines (IL-6, IL-8) et des chimiokines (CCL2, CX3CL1 (fractalkine)) (221,233). Parmi ces facteurs, la fractalkine, qui est présente à la surface uniquement des cellules endothéliales activées joue un rôle majeur pour l'adhésion des cellules NK ainsi que pour la lyse des cellules endothéliales NK-dépendante (234). De même, l'IL-6 semble particulièrement importante. Dans un modèle murin de transplantation cardiaque (C57BL/6→BALB/c RAG^{-/-}), les cellules NK étaient à l'origine de lésions de rejet vasculaire chronique seulement lorsque les greffons étaient soumis à une période d'ischémie froide avant la transplantation (235). Dans les greffons, plusieurs transcrits de cytokines inflammatoires étaient augmentés initialement (IL-6, INF- γ , INF- α). Mais seuls ceux de l'IL-6 persistaient de manière durable. La transplantation de greffons de donneurs IL-6^{-/-} abrogeait complètement le développement des lésions. Le rôle des lésions d'ischémie reperfusion pour favoriser l'adhésion des cellules NK aux cellules endothéliales a également été mis en évidence par Maurus et al. (233). Ainsi, dans notre modèle murin *in vivo* de transplantation cardiaque, il est donc tout à fait possible que l'ischémie froide ait joué un rôle pour pré activer aussi bien les cellules NK des souris receveuses que les cellules endothéliales du greffon.

V. PERSPECTIVES

La découverte d'un nouveau type de rejet initié par les cellules NK ainsi que d'une thérapeutique potentiellement efficace pour le traiter suggère que nous développons une nouvelle stratégie de prise en charge des patients transplantés rénaux.

- Pour les transplantés rénaux en attente de transplantation, la stratégie pourrait consister à dépister les patients à risque de rejet NK/MS. Ceci nous permettrait de les suivre de manière rapprochée et de les traiter de manière précoce voir préventive.
- Pour les patients déjà transplantés, la stratégie consisterait à diagnostiquer les patients présentant un rejet NK/MS afin de pouvoir les traiter avant l'émergence de lésions chroniques irréversibles.

1. Dépistage des patients transplantés rénaux à risque de présenter un rejet NK/MS

Pour savoir quels patients sont à risque de présenter un rejet NK/MS, nous aurons besoin de déterminer l'ensemble des KIR inhibiteurs éduquant présents à la surface des cellules NK des transplantés rénaux en attente de greffe. Comme nous l'avons montré dans notre étude, il est possible de déterminer la présence des KIR inhibiteurs au niveau génétique et phénotypique. Le génotypage ne permettant pas de prédire l'expression des KIR inhibiteurs à la surface des cellules NK, nous réaliserons directement un phénotypage des KIR inhibiteurs des patients. Nous pourrons ainsi savoir pour chaque KIR inhibiteur : 1) s'il est exprimé à la surface des cellules NK 2) dans quelles proportions 3) de manière isolée ou en association avec d'autres KIR inhibiteurs. Ce phénotypage sera confronté au typage HLA de classe I (A, B et C) des patients afin de déterminer les KIR inhibiteurs éduquant. Le jour de la transplantation, la réalisation du typage HLA de classe I du donneur permettra de déterminer quels ligands de KIR inhibiteurs sont présents sur le greffon. Avec toutes ces informations, nous pourrons ainsi savoir s'il existe un « missing self » sur le greffon susceptible d'activer les cellules NK du receveur.

Comme nous l'avons démontré dans notre travail, l'existence d'un « missing self » seul n'est pas suffisant pour déclencher la génération de lésions de rejet NK/MS.

Chez les patients dont le greffon présente un « missing self », nous organiserons donc un suivi rapproché :

- Des événements susceptibles de pré activer leurs cellules NK et/ou les cellules endothéliales du greffon : durée ischémie froide, infections virales (CMV, BK virus, ...), ...
- Du phénotype de leurs cellules NK circulantes : nombre de cellules NK circulantes, expression des récepteurs inhibiteurs (KIR inhibiteurs, NKG2A), des récepteurs activateurs (KIR activateurs, NKG2C, NKG2D), du marqueur « mémoire » CD57.
- De l'état d'activation de leurs cellules NK circulantes : à l'état basal et suite à une stimulation par des cellules endothéliales exprimant le même « missing self » que le greffon. Ce test sera réalisé globalement selon le même protocole que les co-cultures entre les cellules NK humaines et les cellules endothéliales de notre étude. En revanche, si nous souhaitons réaliser ce test à plus grande échelle, il sera difficile d'utiliser comme cibles des lignées primaires de cellules endothéliales en raison de leur durée de vie limitée et donc de la nécessité d'avoir accès à une banque de lignées de cellules endothéliales. Nous souhaiterions donc utiliser de préférence des cellules endothéliales microvasculaires glomérulaires immortalisées (218) qui ont aussi l'avantage d'être phénotypiquement plus proches des cibles des cellules NK chez nos patients. L'idée serait d'avoir une lignée exprimant tous les ligands HLA de classe I des KIR inhibiteurs (C1/C2, Bw4). A partir de cette lignée, les gènes des différents ligands seraient inactivés par la technique du CRISPR Cas9 afin d'obtenir des lignées présentant les mêmes « missing self » que les patients.

Pour savoir quels patients sont à risque de développer un rejet NK/MS, nous aurons besoin de déterminer parmi les paramètres suivis lesquels sont les plus à risque. Pour le moment, nous n'avons pas la réponse à cette question, l'ensemble des tests de l'étude ayant été réalisés avec des cellules NK de donneurs sains. Pour nous aider dans cette démarche, nous allons mesurer ses paramètres chez des transplantés rénaux ayant un rejet NK/MS authentifié (présence de lésions d'inflammation microvasculaire sur une biopsie de leur greffon + d'un « missing self » au niveau phénotypique (en l'absence d'anticorps anti-donneur bien sûr)). Nous comparerons les paramètres de ces patients à ceux des patients à risque de présenter un rejet NK/MS afin d'essayer de déterminer les patients particulièrement à risque.

Chez ces patients, une ponction biopsie rénale recherchant la présence d'inflammation microvasculaire sera réalisée. Si de telles lésions sont retrouvées, un inhibiteur de mTOR sera introduit. En l'absence de lésion, se pose tout de même la question de modifier en préventif le traitement immunosuppresseur des patients à risque élevé de rejet NK/MS. Cette stratégie préventive pourrait en effet permettre de prévenir la survenue de certains rejets NK/MS dont le pronostic est aussi péjoratif que celui des rejets humoraux indépendant du complément.

Les différents éléments de cette nouvelle stratégie diagnostique font l'objet d'un brevet déposé le 6 septembre 2017 (*Brevet en annexe 5*).

2. Traitement des patients transplantés rénaux présentant un rejet NK/MS

Les données obtenues dans notre modèle murin préclinique de transplantation cardiaque sont en faveur d'un effet bénéfique des inhibiteurs de mTOR pour prévenir les lésions d'inflammation microvasculaire secondaires à l'activation des cellules NK par le « missing self ». Chez l'homme, nous avons entrepris de rechercher des cas en faveur de l'efficacité des inhibiteurs de mTOR pour traiter les rejets NK/MS.

Le premier cas rétrospectif est celui d'un patient transplanté cardiaque (Figure 18). Pendant plusieurs mois, ce patient a présenté des lésions d'inflammation microvasculaire stables sur 10 biopsies consécutives. Aucun anticorps anti-donneur circulant susceptible d'expliquer ses lésions n'a jamais été détecté. En revanche, ce patient présente un « missing self » au niveau de son greffon pour le KIR2DL3. Un inhibiteur de mTOR (évérolimus) a été introduit chez ce patient (pour une raison autre) et a permis de réduire significativement et durablement les lésions d'inflammation microvasculaire présentes sur son greffon.

Figure 18. Cas d'un patient transplanté cardiaque présentant un rejet NK/MS

- A. Représentation schématique de l'appariement entre les récepteurs KIR inhibiteurs des cellules NK du patient et leurs ligands sur le greffon.
- B. Gradation de l'intensité des lésions d'inflammation microvasculaire (MVI) selon une échelle semi-quantitative (score 0-3) sur 10 biopsies consécutives avant la mise sous inhibiteur de mTOR (mTOR inh) et 15 biopsies consécutives après. Moyenne \pm déviation standard. *** : $p < 0.001$; Test de Mann-Whitney.
- C. Images représentatives de biopsies du greffon après une coloration de type HES avant et après la mise sous inhibiteur de mTOR. Echelle : 200 μ m.

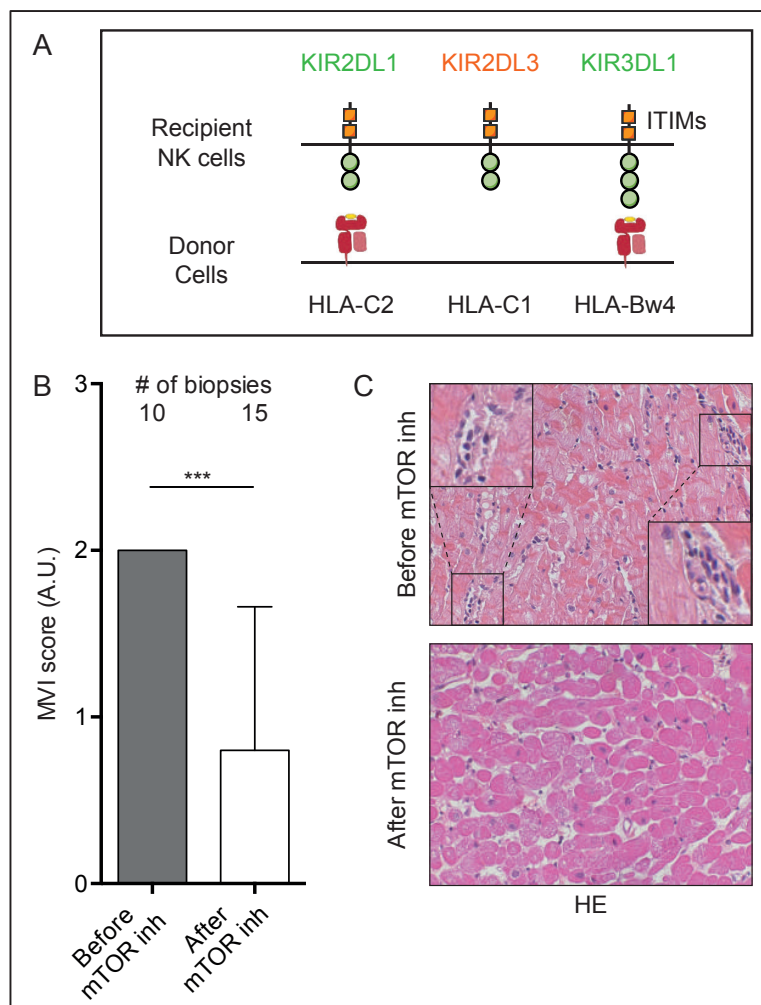

Nous avons également recueilli le cas prospectif d'un patient transplanté rénal (Figure 19). Ce patient a bénéficié d'une biopsie de dépistage (i.e. en l'absence de dysfonction de son greffon) à 3 mois de la transplantation. Des lésions d'inflammation microvasculaire (présence de glomérulite et de capillarite péri-tubulaire) ont été mise en évidence en l'absence d'anticorps anti-donneur circulants mais en présence de 2

« missing self ». Le patient recevait alors une trithérapie immunosuppressive classique (corticoïdes + anticalcineurine (tacrolimus) + antimétabolite (acide mycophénolique)). Un inhibiteur de mTOR (évérolimus) a été introduit en remplacement de l'antimétabolite et le patient a été rebiopsié 6 mois après. Cette modification de traitement a permis de faire disparaître totalement les lésions d'inflammation microvasculaire du patient. Ces cas sont encourageants mais ils nécessitent bien sûr d'être confirmés dans une étude prospective bien conduite avant l'utilisation des inhibiteurs de mTOR à plus grande échelle chez nos patients.

Dans cette optique, nous avons entrepris une étude clinique pilote chez les transplantés rénaux présentant un rejet NK/MS (Etude STARR : Efficacité de l'évérolimus pour le traitement des **Tr**Ansplantés **R**énaux présentant un **R**ejet secondaire à l'activation des NK par le « missing self »). J'ai obtenu un financement pour la réaliser lors de l'appel d'offre jeune chercheur des Hospices Civils de Lyon en 2017 (*Lettre d'intention soumise lors de l'appel d'offre en annexe 6*). Cette étude est actuellement en cours de soumission auprès de l'ANSM et du CPP et nous devrions avoir les autorisations nécessaires pour la débiter au deuxième semestre 2018. Nous avons prévu d'inclure dans cette étude 20 transplantés rénaux de notre centre présentant un rejet NK/MS, c'est-à-dire :

- Dont une biopsie du greffon montre pour la première fois des lésions d'inflammation.
- En l'absence d'anticorps spécifiques du donneur (anticorps anti-HLA et anticorps anti-cellules endothéliales).
- En présence d'au moins 1 « missing self » présent phénotypiquement entre un KIR inhibiteur éduquant du receveur et les molécules HLA de classe I du donneur.

La majorité des patients transplantés rénaux que nous suivons reçoivent une trithérapie immunosuppressive associant un corticoïde + un anticalcineurine (tacrolimus ou ciclosporine) + un antimétabolite (acide mycophénolique ou azathioprine). A J0, leur antimétabolite sera arrêté et remplacé par un inhibiteur de mTOR (évérolimus). Les corticoïdes et l'anticalcineurine seront poursuivis. Cette étude aura pour objectif principal d'évaluer l'efficacité de l'évérolimus pour prévenir la dégradation de la fonction du greffon de patients présentant un rejet NK/MS. Elle aura également pour objectifs secondaires d'évaluer l'impact de l'évérolimus sur i) la sévérité des lésions histologiques et ii) le degré d'activation des cellules NK des

patients. Ce travail devrait nous permettre d'acquérir des données préliminaires sur l'efficacité thérapeutique de l'évérolimus dans ce nouveau type de rejet. Les résultats de cette étude pilote serviront de base pour la mise en place d'un essai randomisé prospectif de plus grande envergure dans le cadre d'un PHRC.

Figure 19. Cas d'un patient transplanté rénal présentant un rejet NK/MS

- A. Représentation schématique de l'appariement entre les récepteurs KIR inhibiteurs des cellules NK du patient et leurs ligands sur le greffon.
- B. Gradation de l'intensité des lésions d'inflammation microvasculaire (MVI) (glomérulite (g) + capillarite péri-tubulaire (ptc)) selon une échelle semi-quantitative (score 0-3 pour le g et le ptc) sur 1 biopsie avant et 1 biopsie 6 mois après la mise sous inhibiteur de mTOR (mTOR inh).
- C. Images représentatives de biopsies du greffon après une coloration de type Trichome de Masson ou PAS avant et après la mise sous inhibiteur de mTOR. Echelle : 100 µm.

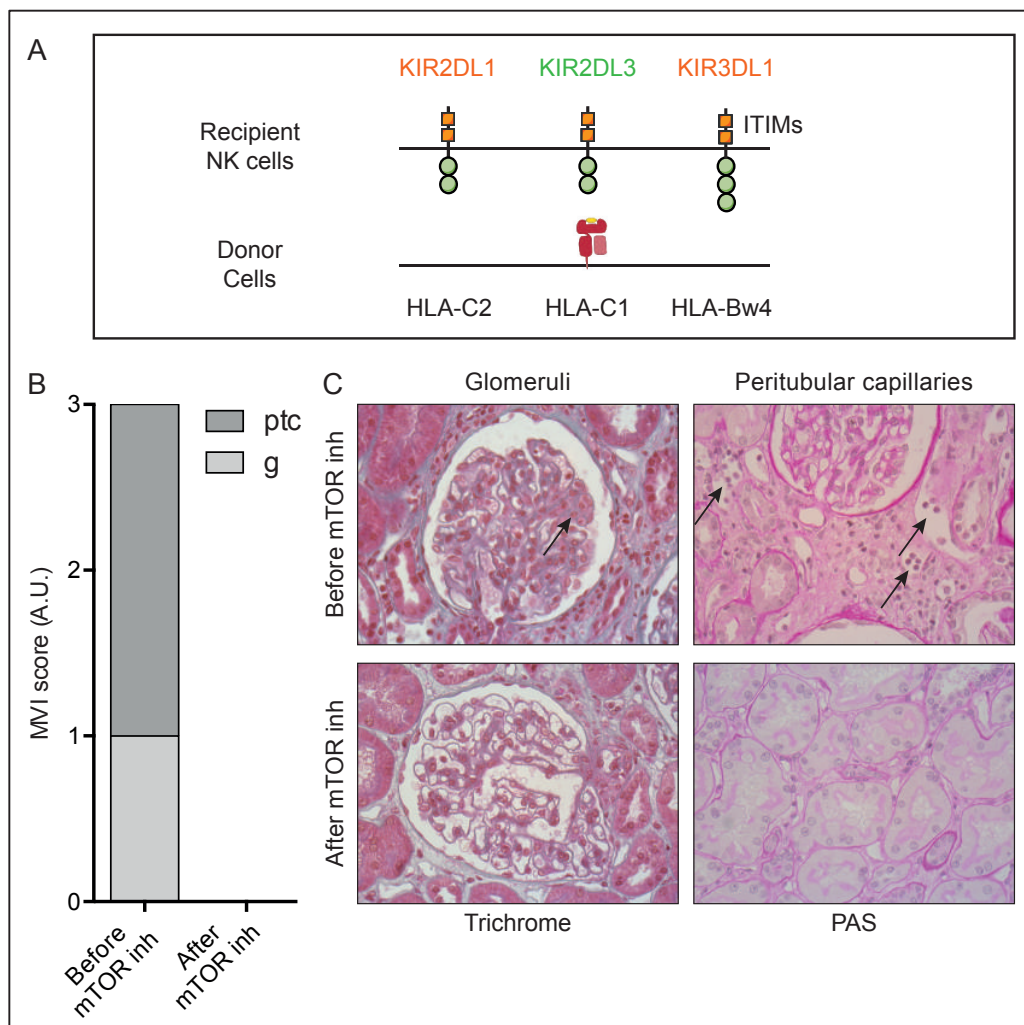

VI. CONCLUSIONS

Notre travail nous a permis de démontrer que certains rejets vasculaires chroniques après transplantation d'organe surviennent de manière indépendante des anticorps. Ces rejets sont secondaires à l'activation des cellules NK par le « missing self ». En ce sens, nos données vont à l'encontre du dogme immunologique qui prédit que le rejet d'allogreffe est exclusivement médié par le système immunitaire adaptatif. A l'avenir, il sera important de prendre en compte ces rejets car i) ils sont aussi fréquents que les rejets humoraux qui sont considérés comme la première cause de perte des greffons et ii) ils présentent un pronostic aussi médiocre que les rejets humoraux indépendant du complément. Pour notre pratique clinique future, il est donc particulièrement important de mieux diagnostiquer ces rejets qui jusque-là étaient considérés à tort comme des rejets humoraux. Car contrairement aux rejets humoraux pour lesquels nous ne disposons pas de traitement efficace, les rejets NK/MS sont susceptibles de répondre à un traitement par inhibiteurs de mTOR. Si tel est le cas, ceci pourrait nous permettre de prévenir certains rejets chroniques et ainsi d'améliorer la durée de vie de greffons sur le long terme et donc la problématique de la pénurie d'organes.

VII. REFERENCES BIBLIOGRAPHIQUES (articles non inclus)

1. Gibson T, Medawar PB. The fate of skin homografts in man. *J Anat.* 1943 Jul;77(Pt 4):299-310.4.
2. Medawar PB. The behaviour and fate of skin autografts and skin homografts in rabbits: A report to the War Wounds Committee of the Medical Research Council. *J Anat.* 1944 Oct;78(Pt 5):176-99.
3. Medawar PB. Immunity to homologous grafted skin; the relationship between the antigens of blood and skin. *Br J Exp Pathol.* 1946 Feb;27:15-24.
4. Medawar PB. Immunity to homologous grafted skin; the suppression of cell division in grafts transplanted to immunized animals. *Br J Exp Pathol.* 1946 Feb;27:9-14.
5. Mitchison NA. Passive transfer of transplantation immunity. *Nature.* 1953 Feb 7;171(4345):267-8.
6. Mitchison NA. Studies on the immunological response to foreign tumor transplants in the mouse. I. The role of lymph node cells in conferring immunity by adoptive transfer. *J Exp Med.* 1955 Aug 1;102(2):157-77.
7. Billingham RE, Brent L, Medawar PB. Quantitative studies on tissue transplantation immunity. II. The origin, strength and duration of actively and adoptively acquired immunity. *Proc R Soc Lond B Biol Sci.* 1954 Dec 15;143(910):58-80.
8. Gowans JL. The effect of the continuous re-infusion of lymph and lymphocytes on the output of lymphocytes from the thoracic duct of unanaesthetized rats. *Br J Exp Pathol.* 1957 Feb;38(1):67-78.
9. Miller JF. Role of the thymus in immunity. *Br Med J.* 1963 Aug 24;2(5355):459-64.
10. Oeconomos N, Hamburger J, Delinotte P, Vaysse J, Richet G, Antoine B, et al. [Attempt at renal homograft (maternal kidney) after nephrectomy for traumatism of a lone kidney]. *Memoires Acad Chir Fr.* 1953 Oct 14;79(25-66):642-52.
11. Grazia TJ, Pietra BA, Johnson ZA, Kelly BP, Plenter RJ, Gill RG. A two-step model of acute CD4 T-cell mediated cardiac allograft rejection. *J Immunol.* 2004 Jun 15;172(12):7451-8.
12. Kreisel D, Krasinskas AM, Krupnick AS, Gelman AE, Balsara KR, Popma SH, et al. Vascular endothelium does not activate CD4+ direct allorecognition in graft rejection. *J Immunol.* 2004 Sep 1;173(5):3027-34.
13. Rogers NJ, Lechler RI. Allorecognition. *Am J Transplant.* 2001 Jul;1(2):97-102.

14. Celli S, Albert ML, Bousso P. Visualizing the innate and adaptive immune responses underlying allograft rejection by two-photon microscopy. *Nat Med*. 2011 Jun;17(6):744–9.
15. Lakkis FG, Arakelov A, Konieczny BT, Inoue Y. Immunologic ‘ignorance’ of vascularized organ transplants in the absence of secondary lymphoid tissue. *Nat Med*. 2000 Jun;6(6):686–8.
16. Benichou G. Direct and indirect antigen recognition: the pathways to allograft immune rejection. *Front Biosci J Virtual Libr*. 1999 May 15;4:D476-480.
17. Boardman D, Maher J, Lechler R, Smyth L, Lombardi G. Antigen-specificity using chimeric antigen receptors: the future of regulatory T-cell therapy? *Biochem Soc Trans*. 2016 Apr 15;44(2):342–8.
18. Daniel C, Horvath S, Allen PM. A Basis for Alloreactivity: MHC Helical Residues Broaden Peptide Recognition by the TCR. *Immunity*. 1998 May 1;8(5):543–52.
19. Lombardi G, Sidhu S, Daly M, Batchelor JR, Makgoba W, Lechler RI. Are primary alloresponses truly primary? *Int Immunol*. 1990;2(1):9–13.
20. Merckenschlager M, Ikeda H, Wilkinson D, Beverley PCL, Trowsdale J, Fisher AG, et al. Allorecognition of HLA-DR and -DQ transfectants by human CD45RA and CD45RO CD4 T cells: Repertoire analysis and activation requirements. *Eur J Immunol*. 1991 Jan 1;21(1):79–88.
21. Suchin EJ, Langmuir PB, Palmer E, Sayegh MH, Wells AD, Turka LA. Quantifying the frequency of alloreactive T cells in vivo: new answers to an old question. *J Immunol*. 2001 Jan 15;166(2):973–81.
22. Lechler RI, Garden OA, Turka LA. The complementary roles of deletion and regulation in transplantation tolerance. *Nat Rev Immunol*. 2003 Feb;3(2):147–58.
23. Bevan MJ. High determinant density may explain the phenomenon of alloreactivity. *Immunol Today*. 1984 May;5(5):128–30.
24. Matzinger P, Bevan MJ. Why do so many lymphocytes respond to major histocompatibility antigens? *Cell Immunol*. 1977 Mar 1;29(1):1–5.
25. Ali JM, Bolton EM, Bradley JA, Pettigrew GJ. Allorecognition Pathways in Transplant Rejection and Tolerance. *Transplantation*. 2013 Oct;96(8):681.
26. Ali JM, Negus MC, Conlon TM, Harper IG, Qureshi MS, Motallebzadeh R, et al. Diversity of the CD4 T Cell Alloresponse: The Short and the Long of It. *Cell Rep*. 2016 Feb 9;14(5):1232.

27. Valujskikh A, Hartig C, Heeger PS. Indirectly primed CD8⁺ T cells are a prominent component of the allogeneic rejection in mice. *Transplantation*. 2001 Feb;71(3):418.
28. Baker RJ, Hernandez-Fuentes MP, Brookes PA, Chaudhry AN, Cook HT, Lechler RI. Loss of Direct and Maintenance of Indirect Alloresponses in Renal Allograft Recipients: Implications for the Pathogenesis of Chronic Allograft Nephropathy. *J Immunol*. 2001 Dec 15;167(12):7199–206.
29. Wood KJ, Goto R. Mechanisms of rejection: current perspectives. *Transplantation*. 2012 Jan 15;93(1):1–10.
30. Valujskikh A, Zhang Q, Heeger PS. CD8 T Cells Specific for a Donor-Derived, Self-Restricted Transplant Antigen Are Nonpathogenic Bystanders after Vascularized Heart Transplantation in Mice. *J Immunol*. 2006 Feb 15;176(4):2190–6.
31. Ridge JP, Di Rosa F, Matzinger P. A conditioned dendritic cell can be a temporal bridge between a CD4⁺ T-helper and a T-killer cell. *Nature*. 1998 Jun 4;393(6684):474–8.
32. Bennett SRM, Carbone FR, Karamalis F, Flavell RA, Miller JFAP, Heath WR. Help for cytotoxic-T-cell responses is mediated by CD40 signalling. *Nature*. 1998 Jun 4;393(6684):478–80.
33. Schoenberger SP, Toes REM, van der Voort EIH, Offringa R, Melief CJM. T-cell help for cytotoxic T lymphocytes is mediated by CD40–CD40L interactions. *Nature*. 1998 Jun 4;393(6684):480–3.
34. Taylor AL, Negus SL, Negus M, Bolton EM, Bradley JA, Pettigrew GJ. Pathways of Helper CD4 T Cell Allorecognition in Generating Alloantibody and CD8 T Cell Alloimmunity: *Transplantation*. 2007 Apr;83(7):931–7.
35. Pietra BA, Wiseman A, Bolwerk A, Rizeq M, Gill RG. CD4 T cell-mediated cardiac allograft rejection requires donor but not host MHC class II. *J Clin Invest*. 2000 Oct 15;106(8):1003–10.
36. Vella JP, Vos L, Carpenter CB, Sayegh MH. Role of indirect allorecognition in experimental late acute rejection. *Transplantation*. 1997 Dec 27;64(12):1823–8.
37. Halloran PF. T Cell-mediated Rejection of Kidney Transplants: A Personal Viewpoint. *Am J Transplant*. 2010 May 1;10(5):1126–34.
38. Halloran PF, Chang J, Famulski K, Hidalgo LG, Salazar IDR, Lopez MM, et al. Disappearance of T Cell-Mediated Rejection Despite Continued Antibody-Mediated Rejection in Late Kidney Transplant Recipients. *J Am Soc Nephrol*. 2015 Jan 7;26(7):1711–20.

39. Herrera OB, Golshayan D, Tibbott R, Ochoa FS, James MJ, Marelli-Berg FM, et al. A Novel Pathway of Alloantigen Presentation by Dendritic Cells. *J Immunol*. 2004 Oct 15;173(8):4828–37.
40. Smyth LA, Herrera OB, Golshayan D, Lombardi G, Lechler RI. A Novel Pathway of Antigen Presentation by Dendritic and Endothelial Cells: Implications for Allorecognition and Infectious Diseases. *Transplantation*. 2006 Jul;82:S15.
41. Smyth LA, Afzali B, Tsang J, Lombardi G, Lechler RI. Intercellular transfer of MHC and immunological molecules: molecular mechanisms and biological significance. *Am J Transplant*. 2007 Jun;7(6):1442–9.
42. Liu Q, Rojas-Canales DM, Divito SJ, Shufesky WJ, Stolz DB, Erdos G, et al. Donor dendritic cell–derived exosomes promote allograft-targeting immune response. *J Clin Invest*. 2016 Aug 1;126(8):2805.
43. Marino J, Babiker-Mohamed MH, Crosby-Bertorini P, Paster JT, LeGuern C, Germana S, et al. Donor exosomes rather than passenger leukocytes initiate alloreactive T cell responses after transplantation. *Sci Immunol*. 2016 Jul 14;1(1):aaf8759–aaf8759.
44. Halloran PF. Immunosuppressive drugs for kidney transplantation. *N Engl J Med*. 2004 Dec 23;351(26):2715–29.
45. Chen C-C, Pouliquen E, Broisat A, Andreatta F, Racapé M, Bruneval P, et al. Endothelial chimerism and vascular sequestration protect pancreatic islet grafts from antibody-mediated rejection. *J Clin Invest*. 2018 Jan 2;128(1):219–32.
46. Patel R, Terasaki PI. Significance of the positive crossmatch test in kidney transplantation. *N Engl J Med*. 1969 Apr 3;280(14):735–9.
47. Jeannet M, Pinn VW, Flax MH, Winn HJ, Russell PS. Humoral antibodies in renal allotransplantation in man. *N Engl J Med*. 1970 Jan 15;282(3):111–7.
48. Russell PS, Chase CM, Winn HJ, Colvin RB. Coronary atherosclerosis in transplanted mouse hearts. II. Importance of humoral immunity. *J Immunol*. 1994 May 15;152(10):5135–41.
49. Pei R, Lee J-H, Shih N-J, Chen M, Terasaki PI. Single human leukocyte antigen flow cytometry beads for accurate identification of human leukocyte antigen antibody specificities. *Transplantation*. 2003 Jan 15;75(1):43–9.
50. Gebel HM, Liwski RS, Bray RA. Technical aspects of HLA antibody testing. *Curr Opin Organ Transplant*. 2013 Aug;18(4):455–62.

51. Terasaki PI, Ozawa M. Predicting kidney graft failure by HLA antibodies: a prospective trial. *Am J Transplant*. 2004 Mar;4(3):438–43.
52. Lefaucheur C, Loupy A, Hill GS, Andrade J, Nochy D, Antoine C, et al. Preexisting Donor-Specific HLA Antibodies Predict Outcome in Kidney Transplantation. *J Am Soc Nephrol*. 2010 Jan 8;21(8):1398–406.
53. Cantarovich D, De Amicis S, Akl A, Devys A, Vistoli F, Karam G, et al. Posttransplant Donor-Specific Anti-HLA Antibodies Negatively Impact Pancreas Transplantation Outcome. *Am J Transplant*. 2011 Dec 1;11(12):2737–46.
54. Mittal S, Page SL, Friend PJ, Sharples EJ, Fuggle SV. De novo donor-specific HLA antibodies: biomarkers of pancreas transplant failure. *Am J Transplant*. 2014 Jul;14(7):1664–71.
55. Kobashigawa J, Crespo-Leiro MG, Ensminger SM, Reichenspurner H, Angelini A, Berry G, et al. Report from a consensus conference on antibody-mediated rejection in heart transplantation. *J Heart Lung Transplant*. 2011 Mar;30(3):252–69.
56. Wallace WD, Weigt SS, Farver CF. Update on pathology of antibody-mediated rejection in the lung allograft. *Curr Opin Organ Transplant*. 2014 Jun;19(3):303–8.
57. O’Leary JG, Demetris AJ, Friedman LS, Gebel HM, Halloran PF, Kirk AD, et al. The Role of Donor-Specific HLA Alloantibodies in Liver Transplantation. *Am J Transplant*. 2014 Apr;14(4):779.
58. Jackson AM, Sigdel TK, Delville M, Hsieh S-C, Dai H, Bagnasco S, et al. Endothelial cell antibodies associated with novel targets and increased rejection. *J Am Soc Nephrol*. 2015 May;26(5):1161–71.
59. Dragun D, Catar R, Philippe A. Non-HLA antibodies against endothelial targets bridging allo- and autoimmunity. *Kidney Int*. 2016;90(2):280–8.
60. Gratwohl A, Döhler B, Stern M, Opelz G. H-Y as a minor histocompatibility antigen in kidney transplantation: a retrospective cohort study. *The Lancet*. 2008 Jul 11;372(9632):49–53.
61. Tan JC, Wadia PP, Coram M, Grumet FC, Kambham N, Miller K, et al. H-Y antibody development associates with acute rejection in female patients with male kidney transplants. *Transplantation*. 2008 Jul 15;86(1):75–81.
62. Kim J, Chang CK, Hayden T, Liu F-C, Benjamin J, Hamerman JA, et al. The Activating Immunoreceptor NKG2D and Its Ligands Are Involved in Allograft Transplant Rejection. *J Immunol*. 2007 Nov 15;179(10):6416–20.

63. Luo L, Lu J, Wei L, Long D, Guo JY, Shan J, et al. The role of HIF-1 in up-regulating MICA expression on human renal proximal tubular epithelial cells during hypoxia/reoxygenation. *BMC Cell Biol.* 2010;11:91.
64. Chauveau A, Tonnerre P, Pabois A, Gavlovsky P-J, Chatelais M, Coupel S, et al. Endothelial cell activation and proliferation modulate NKG2D activity by regulating MICA expression and shedding. *J Innate Immun.* 2014;6(1):89–104.
65. Groh V, Rhinehart R, Randolph-Habecker J, Topp MS, Riddell SR, Spies T. Costimulation of CD8 $\alpha\beta$ T cells by NKG2D *via* engagement by MIC induced on virus-infected cells. *Nat Immunol.* 2001 Mar;2(3):255–60.
66. Zou Y, Stastny P, Süsal C, Döhler B, Opelz G. Antibodies against MICA antigens and kidney-transplant rejection. *N Engl J Med.* 2007 Sep 27;357(13):1293–300.
67. Terasaki PI, Ozawa M, Castro R. Four-year Follow-up of a Prospective Trial of HLA and MICA Antibodies on Kidney Graft Survival. *Am J Transplant.* 2007 Feb 1;7(2):408–15.
68. Chaudhuri A, Ozawa M, Everly MJ, Ettenger R, Dharnidharka V, Benfield M, et al. The Clinical Impact of Humoral Immunity in Pediatric Renal Transplantation. *J Am Soc Nephrol.* 2013 Jan 4;24(4):655–64.
69. Thaunat O, Graff-Dubois S, Fabien N, Duthey A, Attuil-Audenis V, Nicoletti A, et al. A stepwise breakdown of B-cell tolerance occurs within renal allografts during chronic rejection. *Kidney Int.* 2012 Jan;81(2):207–19.
70. Angaswamy N, Tiriveedhi V, Sarma NJ, Subramanian V, Klein C, Wellen J, et al. Interplay between immune responses to HLA and non-HLA self-antigens in allograft rejection. *Hum Immunol.* 2013 Nov;74(11):1478–85.
71. Li L, Wadia P, Chen R, Kambham N, Naesens M, Sigdel TK, et al. Identifying compartment-specific non-HLA targets after renal transplantation by integrating transcriptome and “antibodyome” measures. *Proc Natl Acad Sci U S A.* 2009 Mar 17;106(11):4148–53.
72. Sutherland SM, Li L, Sigdel TK, Wadia PP, Miklos DB, Butte AJ, et al. Protein microarrays identify antibodies to protein kinase C ζ that are associated with a greater risk of allograft loss in pediatric renal transplant recipients. *Kidney Int.* 2009 Dec;76(12):1277–83.
73. Besarani D, Cerundolo L, Smith JD, Procter J, Barnardo MCN, Roberts ISD, et al. Role of Anti-Vimentin Antibodies in Renal Transplantation. *Transplantation.* 2014 Jul;98(1):72.

74. Joosten SA, Sijpkens YWJ, Van Ham V, Trouw LA, Van Der Vlag J, Van Den Heuvel B, et al. Antibody Response Against the Glomerular Basement Membrane Protein Agrin in Patients with Transplant Glomerulopathy. *Am J Transplant*. 2005 Feb 1;5(2):383–93.
75. Hachem RR, Tiriveedhi V, Patterson GA, Aloush A, Trulock EP, Mohanakumar T. Antibodies to K- α 1 tubulin and collagen V are associated with chronic rejection after lung transplantation. *Am J Transplant*. 2012 Aug;12(8):2164.
76. Sun Q, Liu Z, Chen J, Chen H, Wen J, Cheng D, et al. Circulating Anti-endothelial Cell Antibodies Are Associated with Poor Outcome in Renal Allograft Recipients with Acute Rejection. *Clin J Am Soc Nephrol*. 2008 Jan 9;3(5):1479–86.
77. Sun Q, Cheng Z, Cheng D, Chen J, Ji S, Wen J, et al. De novo development of circulating anti-endothelial cell antibodies rather than pre-existing antibodies is associated with post-transplant allograft rejection. *Kidney Int*. 2011 Mar;79(6):655–62.
78. Jackson AM, Kuperman MB, Montgomery RA. Multiple Hyperacute Rejections in the Absence of Detectable Complement Activation in a Patient With Endothelial Cell Reactive Antibody. *Am J Transplant*. 2012 Jun 1;12(6):1643–9.
79. Lucchiari N, Panajotopoulos N, Xu C, Rodrigues H, Ianhez LE, Kalil J, et al. Antibodies eluted from acutely rejected renal allografts bind to and activate human endothelial cells. *Hum Immunol*. 2000 May;61(5):518–27.
80. Dragun D, Müller DN, Bräsen JH, Fritsche L, Nieminen-Kelhä M, Dechend R, et al. Angiotensin II type 1-receptor activating antibodies in renal-allograft rejection. *N Engl J Med*. 2005 Feb 10;352(6):558–69.
81. Iwata T, Philipovskiy A, Fisher AJ, Presson RG, Jr, Chiyo M, et al. Anti-Type V Collagen Humoral Immunity in Lung Transplant Primary Graft Dysfunction. *J Immunol*. 2008 Oct 15;181(8):5738.
82. Taniguchi M, Rebellato LM, Cai J, Hopfield J, Briley KP, Haisch CE, et al. Higher Risk of Kidney Graft Failure in the Presence of Anti-Angiotensin II Type-1 Receptor Antibodies. *Am J Transplant*. 2013 Oct 1;13(10):2577–89.
83. Thauvat O, Field A-C, Dai J, Louedec L, Patey N, Bloch M-F, et al. Lymphoid neogenesis in chronic rejection: evidence for a local humoral alloimmune response. *Proc Natl Acad Sci U S A*. 2005 Oct 11;102(41):14723–8.
84. Kratz A, Campos-Neto A, Hanson MS, Ruddle NH. Chronic inflammation caused by lymphotoxin is lymphoid neogenesis. *J Exp Med*. 1996 Jan 4;183(4):1461–72.

85. Koenig A, Thaunat O. Lymphoid Neogenesis and Tertiary Lymphoid Organs in Transplanted Organs. *Front Immunol.* 2016;7:646.
86. Conlon TM, Saeb-Parsy K, Cole JL, Motallebzadeh R, Qureshi MS, Rehakova S, et al. Germinal Center Alloantibody Responses Are Mediated Exclusively by Indirect-Pathway CD4 T Follicular Helper Cells. *J Immunol.* 2012 Mar 15;188(6):2643–52.
87. Chen C-C, Koenig A, Saison C, Dahdal S, Rigault G, Barba T, et al. CD4+ T Cell Help Is Mandatory for Naive and Memory Donor-Specific Antibody Responses: Impact of Therapeutic Immunosuppression. *Front Immunol.* 2018;9:275.
88. Ochsenbein AF, Pinschewer DD, Odermatt B, Ciurea A, Hengartner H, Zinkernagel RM. Correlation of T Cell Independence of Antibody Responses with Antigen Dose Reaching Secondary Lymphoid Organs: Implications for Splenectomized Patients and Vaccine Design. *J Immunol.* 2000 Jun 15;164(12):6296–302.
89. Morita R, Schmitt N, Bentebibel S-E, Ranganathan R, Bourdery L, Zurawski G, et al. Human blood CXCR5(+)CD4(+) T cells are counterparts of T follicular cells and contain specific subsets that differentially support antibody secretion. *Immunity.* 2011 Jan 28;34(1):108–21.
90. Sicard A, Phares TW, Yu H, Fan R, Baldwin WM, Fairchild RL, et al. The spleen is the major source of antidonor antibody-secreting cells in murine heart allograft recipients. *Am J Transplant.* 2012 Jul;12(7):1708–19.
91. Slocombe T, Brown S, Miles K, Gray M, Barr TA, Gray D. Plasma Cell Homeostasis: The Effects of Chronic Antigen Stimulation and Inflammation. *J Immunol.* 2013 Sep 15;191(6):3128–38.
92. Valenzuela NM, McNamara JT, Reed EF. Antibody-mediated graft injury: complement-dependent and complement-independent mechanisms. *Curr Opin Organ Transplant.* 2014 Feb;19(1):33–40.
93. Bian H, Reed EF. Alloantibody-mediated class I signal transduction in endothelial cells and smooth muscle cells: enhancement by IFN-gamma and TNF-alpha. *J Immunol.* 1999 Jul 15;163(2):1010–8.
94. Yamakuchi M, Kirkiles-Smith NC, Ferlito M, Cameron SJ, Bao C, Fox-Talbot K, et al. Antibody to human leukocyte antigen triggers endothelial exocytosis. *Proc Natl Acad Sci.* 2007 Jan 23;104(4):1301–6.
95. Pouliquen E, Koenig A, Chen CC, Sicard A, Rabeyrin M, Morelon E, et al. Recent advances in renal transplantation: antibody-mediated rejection takes center stage. *F1000prime Rep.* 2015;7:51.

96. Diebold CA, Beurskens FJ, de Jong RN, Koning RI, Strumane K, Lindorfer MA, et al. Complement is activated by IgG hexamers assembled at the cell surface. *Science*. 2014 Mar 14;343(6176):1260–3.
97. Roumenina LT, Zuber J, Frémeaux-Bacchi V. Physiological and therapeutic complement regulators in kidney transplantation. *Curr Opin Organ Transplant*. 2013 Aug;18(4):421–9.
98. Hirohashi T, Uehara S, Chase CM, DellaPelle P, Madsen JC, Russell PS, et al. Complement Independent Antibody-Mediated Endarteritis and Transplant Arteriopathy in Mice. *Am J Transplant*. 2010 Mar 1;10(3):510–7.
99. Hirohashi T, Chase CM, Della Pelle P, Sebastian D, Alessandrini A, Madsen JC, et al. A Novel Pathway of Chronic Allograft Rejection Mediated by NK Cells and Alloantibody. *Am J Transplant*. 2012 Feb 1;12(2):313–21.
100. Haas M, Loupy A, Lefaucheur C, Roufosse C, Glotz D, Seron D, et al. The Banff 2017 Kidney Meeting Report: Revised diagnostic criteria for chronic active T cell-mediated rejection, antibody-mediated rejection, and prospects for integrative endpoints for next-generation clinical trials. *Am J Transplant*. 2018 Feb;18(2):293–307.
101. Hidalgo LG, Sis B, Sellares J, Campbell PM, Mengel M, Einecke G, et al. NK Cell Transcripts and NK Cells in Kidney Biopsies from Patients with Donor-Specific Antibodies: Evidence for NK Cell Involvement in Antibody-Mediated Rejection. *Am J Transplant*. 2010 Aug 1;10(8):1812–22.
102. Sellarés J, de Freitas DG, Mengel M, Reeve J, Einecke G, Sis B, et al. Understanding the causes of kidney transplant failure: the dominant role of antibody-mediated rejection and nonadherence. *Am J Transplant*. 2012 Feb;12(2):388–99.
103. Wiebe C., Gibson I. W., Blydt-Hansen T. D., Karpinski M., Ho J., Storsley L. J., et al. Evolution and Clinical Pathologic Correlations of De Novo Donor-Specific HLA Antibody Post Kidney Transplant. *Am J Transplant*. 2012 Mar 19;12(5):1157–67.
104. Loupy A, Toquet C, Rouvier P, Beuscart T, Bories MC, Varnous S, et al. Late Failing Heart Allografts: Pathology of Cardiac Allograft Vasculopathy and Association With Antibody-Mediated Rejection. *Am J Transplant*. 2016 Jan;16(1):111–20.
105. Roux A, Bendib Le Lan I, Holifanjaniaina S, Thomas KA, Hamid AM, Picard C, et al. Antibody-Mediated Rejection in Lung Transplantation: Clinical Outcomes and Donor-Specific Antibody Characteristics. *Am J Transplant*. 2016 Apr;16(4):1216–28.
106. Spits H, Artis D, Colonna M, Diefenbach A, Di Santo JP, Eberl G, et al. Innate lymphoid cells—a proposal for uniform nomenclature. *Nat Rev Immunol*. 2013

Feb;13(2):145–9.

107. Artis D, Spits H. The biology of innate lymphoid cells. *Nature*. 2015 Jan 15;517(7534):293–301.

108. Freud AG, Zhao S, Wei S, Gitana GM, Molina-Kirsch HF, Atwater SK, et al. Expression of the Activating Receptor, NKp46 (CD335), in Human Natural Killer and T-Cell Neoplasia. *Am J Clin Pathol*. 2013 Dec 1;140(6):853–66.

109. Freud AG, Mundy-Bosse BL, Yu J, Caligiuri MA. The Broad Spectrum of Human Natural Killer Cell Diversity. *Immunity*. 2017 21;47(5):820–33.

110. Vivier E, Raulet DH, Moretta A, Caligiuri MA, Zitvogel L, Lanier LL, et al. Innate or Adaptive Immunity? The Example of Natural Killer Cells. *Science*. 2011 Jul 1;331(6013):44–9.

111. Lotzová E, Savary CA, Champlin RE. Genesis of human oncolytic natural killer cells from primitive CD34+CD33- bone marrow progenitors. *J Immunol*. 1993 Jun 15;150(12):5263–9.

112. Miller JS, Alley KA, McGlave P. Differentiation of natural killer (NK) cells from human primitive marrow progenitors in a stroma-based long-term culture system: identification of a CD34+7+ NK progenitor. *Blood*. 1994 May 1;83(9):2594–601.

113. Kim S, Iizuka K, Kang H-SP, Dokun A, French AR, Greco S, et al. In vivo developmental stages in murine natural killer cell maturation. *Nat Immunol*. 2002 Jun;3(6):523–8.

114. Fathman JW, Bhattacharya D, Inlay MA, Seita J, Karsunky H, Weissman IL. Identification of the earliest natural killer cell-committed progenitor in murine bone marrow. *Blood*. 2011 Nov 17;118(20):5439–47.

115. Carotta S, Pang SHM, Nutt SL, Belz GT. Identification of the earliest NK-cell precursor in the mouse BM. *Blood*. 2011 May 19;117(20):5449–52.

116. Freud AG, Yokohama A, Becknell B, Lee MT, Mao HC, Ferketich AK, et al. Evidence for discrete stages of human natural killer cell differentiation in vivo. *J Exp Med*. 2006 Apr 17;203(4):1033–43.

117. Freud AG, Becknell B, Roychowdhury S, Mao HC, Ferketich AK, Nuovo GJ, et al. A human CD34(+) subset resides in lymph nodes and differentiates into CD56bright natural killer cells. *Immunity*. 2005 Mar;22(3):295–304.

118. Luther C, Warner K, Takei F. Unique progenitors in mouse lymph node develop into CD127+ NK cells: thymus-dependent and thymus-independent pathways. *Blood*. 2011 Apr 14;117(15):4012–21.

119. Warner K, Luther C, Takei F. Lymphoid progenitors in normal mouse lymph nodes develop into NK cells and T cells in vitro and in vivo. *Exp Hematol*. 2012 May 1;40(5):401–6.
120. Chinen H, Matsuoka K, Sato T, Kamada N, Okamoto S, Hisamatsu T, et al. Lamina Propria c-kit+ Immune Precursors Reside in Human Adult Intestine and Differentiate Into Natural Killer Cells. *Gastroenterology*. 2007 Aug 1;133(2):559–73.
121. Moroso V, Famili F, Papazian N, Cupedo T, Laan LJW van der, Kazemier G, et al. NK cells can generate from precursors in the adult human liver. *Eur J Immunol*. 41(11):3340–50.
122. Vacca P, Vitale C, Montaldo E, Conte R, Cantoni C, Fulcheri E, et al. CD34+ hematopoietic precursors are present in human decidua and differentiate into natural killer cells upon interaction with stromal cells. *Proc Natl Acad Sci*. 2011 Feb 8;108(6):2402–7.
123. Scoville SD, Mundy-Bosse BL, Zhang MH, Chen L, Zhang X, Keller KA, et al. A Progenitor Cell Expressing Transcription Factor ROR γ t Generates All Human Innate Lymphoid Cell Subsets. *Immunity*. 2016 May 17;44(5):1140–50.
124. Lim AI, Li Y, Lopez-Lastra S, Stadhouders R, Paul F, Casrouge A, et al. Systemic Human ILC Precursors Provide a Substrate for Tissue ILC Differentiation. *Cell*. 2017 Mar 9;168(6):1086-1100.e10.
125. Freud AG, Keller KA, Scoville SD, Mundy-Bosse BL, Cheng S, Youssef Y, et al. NKp80 Defines a Critical Step during Human Natural Killer Cell Development. *Cell Rep*. 2016 12;16(2):379–91.
126. Lanier LL, Le AM, Civin CI, Loken MR, Phillips JH. The relationship of CD16 (Leu-11) and Leu-19 (NKH-1) antigen expression on human peripheral blood NK cells and cytotoxic T lymphocytes. *J Immunol*. 1986 Jun 15;136(12):4480–6.
127. Anfossi N, André P, Guia S, Falk CS, Roetynck S, Stewart CA, et al. Human NK Cell Education by Inhibitory Receptors for MHC Class I. *Immunity*. 2006 Aug;25(2):331–42.
128. Vivier E, Tomasello E, Baratin M, Walzer T, Ugolini S. Functions of natural killer cells. *Nat Immunol*. 2008 May;9(5):503–10.
129. Thielens A, Vivier E, Romagné F. NK cell MHC class I specific receptors (KIR): from biology to clinical intervention. *Curr Opin Immunol*. 2012 Apr;24(2):239–45.
130. Braud VM, Allan DS, O’Callaghan CA, Söderström K, D’Andrea A, Ogg GS, et al. HLA-E binds to natural killer cell receptors CD94/NKG2A, B and C. *Nature*. 1998 Feb

19;391(6669):795–9.

131. Lee N, Llano M, Carretero M, Ishitani A, Navarro F, López-Botet M, et al. HLA-E is a major ligand for the natural killer inhibitory receptor CD94/NKG2A. *Proc Natl Acad Sci*. 1998 Apr 28;95(9):5199–204.

132. Zingoni A, Molfetta R, Fionda C, Soriani A, Paolini R, Cippitelli M, et al. NKG2D and Its Ligands: “One for All, All for One.” *Front Immunol* [Internet]. 2018 [cited 2018 Jun 17];9. Available from: <https://www.frontiersin-org.gate2.inist.fr/articles/10.3389/fimmu.2018.00476/full>

133. Sivori S, Vitale M, Morelli L, Sanseverino L, Augugliaro R, Bottino C, et al. p46, a novel natural killer cell-specific surface molecule that mediates cell activation. *J Exp Med*. 1997 Oct 6;186(7):1129–36.

134. Vitale M, Bottino C, Sivori S, Sanseverino L, Castriconi R, Marcenaro E, et al. NKp44, a novel triggering surface molecule specifically expressed by activated natural killer cells, is involved in non-major histocompatibility complex-restricted tumor cell lysis. *J Exp Med*. 1998 Jun 15;187(12):2065–72.

135. Pende D, Parolini S, Pessino A, Sivori S, Augugliaro R, Morelli L, et al. Identification and molecular characterization of NKp30, a novel triggering receptor involved in natural cytotoxicity mediated by human natural killer cells. *J Exp Med*. 1999 Nov 15;190(10):1505–16.

136. Bauer S, Groh V, Wu J, Steinle A, Phillips JH, Lanier LL, et al. Activation of NK Cells and T Cells by NKG2D, a Receptor for Stress-Inducible MICA. *Science*. 1999 Jul 30;285(5428):727–9.

137. Cosman D, Müllberg J, Sutherland CL, Chin W, Armitage R, Fanslow W, et al. ULBPs, Novel MHC Class I–Related Molecules, Bind to CMV Glycoprotein UL16 and Stimulate NK Cytotoxicity through the NKG2D Receptor. *Immunity*. 2001 Feb 1;14(2):123–33.

138. Sivori S, Falco M, Chiesa MD, Carlomagno S, Vitale M, Moretta L, et al. CpG and double-stranded RNA trigger human NK cells by Toll-like receptors: Induction of cytokine release and cytotoxicity against tumors and dendritic cells. *Proc Natl Acad Sci U S A*. 2004 Jun 7;101(27):10116–21.

139. Adib-Conquy M, Scott-Algara D, Cavaillon J-M, Souza-Fonseca-Guimaraes F. TLR-mediated activation of NK cells and their role in bacterial/viral immune responses in mammals. *Immunol Cell Biol*. 2014 Mar;92(3):256–62.

140. Uhrberg M, Valiante NM, Shum BP, Shilling HG, Lienert-Weidenbach K, Corliss

- B, et al. Human diversity in killer cell inhibitory receptor genes. *Immunity*. 1997 Dec;7(6):753–63.
141. Colonna M, Samaridis J. Cloning of immunoglobulin-superfamily members associated with HLA-C and HLA-B recognition by human natural killer cells. *Science*. 1995 Apr 21;268(5209):405–8.
142. Parham P. MHC class I molecules and kirs in human history, health and survival. *Nat Rev Immunol*. 2005 Mar;5(3):201–14.
143. Vivier E, Nunès JA, Vély F. Natural killer cell signaling pathways. *Science*. 2004 Nov 26;306(5701):1517–9.
144. Campbell KS, Purdy AK. Structure/function of human killer cell immunoglobulin-like receptors: lessons from polymorphisms, evolution, crystal structures and mutations. *Immunology*. 2011 Mar 1;132(3):315–25.
145. Kikuchi-Maki A, Yusa S, Catina TL, Campbell KS. KIR2DL4 Is an IL-2-Regulated NK Cell Receptor That Exhibits Limited Expression in Humans but Triggers Strong IFN- γ Production. *J Immunol*. 2003 Jan 10;171(7):3415–25.
146. Höglund P, Brodin P. Current perspectives of natural killer cell education by MHC class I molecules. *Nat Rev Immunol*. 2010 Oct;10(10):724–34.
147. Brodin P, Lakshmikanth T, Johansson S, Kärre K, Höglund P. The strength of inhibitory input during education quantitatively tunes the functional responsiveness of individual natural killer cells. *Blood*. 2009 Mar 12;113(11):2434–41.
148. Joncker NT, Fernandez NC, Treiner E, Vivier E, Raulet DH. NK Cell Responsiveness Is Tuned Commensurate with the Number of Inhibitory Receptors for Self-MHC Class I: The Rheostat Model. *J Immunol*. 2009 Apr 15;182(8):4572–80.
149. Sun JC, Lanier LL. NK cell development, homeostasis and function: parallels with CD8⁺ T cells. *Nat Rev Immunol*. 2011 Aug 26;11(10):645–57.
150. Boyington JC, Sun PD. A structural perspective on MHC class I recognition by killer cell immunoglobulin-like receptors. *Mol Immunol*. 2002 May;38(14):1007–21.
151. Winter CC, Gumperz JE, Parham P, Long EO, Wagtmann N. Direct binding and functional transfer of NK cell inhibitory receptors reveal novel patterns of HLA-C allotype recognition. *J Immunol*. 1998 Jul 15;161(2):571–7.
152. Johansson S, Johansson M, Rosmaraki E, Vahlne G, Mehr R, Salmon-Divon M, et al. Natural killer cell education in mice with single or multiple major histocompatibility complex class I molecules. *J Exp Med*. 2005 Apr 4;201(7):1145–55.

153. Kim S, Sunwoo JB, Yang L, Choi T, Song Y-J, French AR, et al. HLA alleles determine differences in human natural killer cell responsiveness and potency. *Proc Natl Acad Sci*. 2008 Feb 26;105(8):3053–8.
154. Elliott JM, Wahle JA, Yokoyama WM. MHC class I–deficient natural killer cells acquire a licensed phenotype after transfer into an MHC class I–sufficient environment. *J Exp Med*. 2010 Sep 27;207(10):2073–9.
155. Joncker NT, Shifrin N, Delebecque F, Raulet DH. Mature natural killer cells reset their responsiveness when exposed to an altered MHC environment. *J Exp Med*. 2010 Sep 27;207(10):2065–72.
156. Ebihara T, Jonsson AH, Yokoyama WM. Natural killer cell licensing in mice with inducible expression of MHC class I. *Proc Natl Acad Sci*. 2013 Nov 5;110(45):E4232–7.
157. Morvan MG, Lanier LL. NK cells and cancer: you can teach innate cells new tricks. *Nat Rev Cancer*. 2016 Jan;16(1):7–19.
158. Lucas M, Schachterle W, Oberle K, Aichele P, Diefenbach A. Dendritic Cells Prime Natural Killer Cells by trans-Presenting Interleukin 15. *Immunity*. 2007 Apr 27;26(4):503–17.
159. Mortier E, Advincula R, Kim L, Chmura S, Barrera J, Reizis B, et al. Macrophage- and Dendritic-Cell-Derived Interleukin-15 Receptor Alpha Supports Homeostasis of Distinct CD8+ T Cell Subsets. *Immunity*. 2009 Nov 20;31(5):811–22.
160. Guia S, Cognet C, Beaucoudrey L de, Tessmer MS, Jouanguy E, Berger C, et al. A role for interleukin-12/23 in the maturation of human natural killer and CD56+ T cells in vivo. *Blood*. 2008 May 15;111(10):5008–16.
161. Chaix J, Tessmer MS, Hoebe K, Fuséri N, Ryffel B, Dalod M, et al. Cutting Edge: Priming of NK Cells by IL-18. *J Immunol*. 2008 Aug 1;181(3):1627–31.
162. Marçais A, Marotel M, Degouve S, Koenig A, Fauteux-Daniel S, Drouillard A, et al. High mTOR activity is a hallmark of reactive natural killer cells and amplifies early signaling through activating receptors. *eLife*. 2017 06;6.
163. Marçais A, Cherfils-Vicini J, Viant C, Degouve S, Viel S, Fenis A, et al. The metabolic checkpoint kinase mTOR is essential for IL-15 signaling during the development and activation of NK cells. *Nat Immunol*. 2014 Aug;15(8):749–57.
164. Fauriat C, Long EO, Ljunggren H-G, Bryceson YT. Regulation of human NK-cell cytokine and chemokine production by target cell recognition. *Blood*. 2010 Mar 18;115(11):2167–76.

165. Deguine J, Breart B, Lemaître F, Santo JPD, Bouso P. Intravital Imaging Reveals Distinct Dynamics for Natural Killer and CD8⁺ T Cells during Tumor Regression. *Immunity*. 2010 Oct 29;33(4):632–44.
166. Cullen SP, Martin SJ. Mechanisms of granule-dependent killing. *Cell Death Differ*. 2008 Feb;15(2):251–62.
167. Schug ZT, Gonzalez F, Houtkooper RH, Vaz FM, Gottlieb E. BID is cleaved by caspase-8 within a native complex on the mitochondrial membrane. *Cell Death Differ*. 2011 Mar;18(3):538–48.
168. Sutton VR, Davis JE, Cancilla M, Johnstone RW, Ruefli AA, Sedelies K, et al. Initiation of apoptosis by granzyme B requires direct cleavage of bid, but not direct granzyme B-mediated caspase activation. *J Exp Med*. 2000 Nov 20;192(10):1403–14.
169. Dewson G, Kluck RM. Mechanisms by which Bak and Bax permeabilise mitochondria during apoptosis. *J Cell Sci*. 2009 Aug 15;122(Pt 16):2801–8.
170. Westphal D, Kluck RM, Dewson G. Building blocks of the apoptotic pore: how Bax and Bak are activated and oligomerize during apoptosis. *Cell Death Differ*. 2014 Feb;21(2):196–205.
171. Riedl SJ, Li W, Chao Y, Schwarzenbacher R, Shi Y. Structure of the apoptotic protease-activating factor 1 bound to ADP. *Nature*. 2005 Apr 14;434(7035):926–33.
172. Bratton SB, Cohen GM. Apoptotic death sensor: an organelle's alter ego? *Trends Pharmacol Sci*. 2001 Jun;22(6):306–15.
173. Cullen SP, Adrain C, Lüthi AU, Duriez PJ, Martin SJ. Human and murine granzyme B exhibit divergent substrate preferences. *J Cell Biol*. 2007 Feb 12;176(4):435–44.
174. Fan Z, Beresford PJ, Oh DY, Zhang D, Lieberman J. Tumor suppressor NM23-H1 is a granzyme A-activated DNase during CTL-mediated apoptosis, and the nucleosome assembly protein SET is its inhibitor. *Cell*. 2003 Mar 7;112(5):659–72.
175. Lieberman J. Granzyme A activates another way to die. *Immunol Rev*. 2010 May;235(1):93–104.
176. Beresford PJ, Zhang D, Oh DY, Fan Z, Greer EL, Russo ML, et al. Granzyme A activates an endoplasmic reticulum-associated caspase-independent nuclease to induce single-stranded DNA nicks. *J Biol Chem*. 2001 Nov 16;276(46):43285–93.
177. O' Reilly E, Tirincci A, Logue SE, Szegezdi E. The Janus Face of Death Receptor Signaling during Tumor Immunoediting. *Front Immunol [Internet]*. 2016 [cited 2018 Jun 18];7. Available from: <https://www.frontiersin.org/articles/10.3389/fimmu.2016.00446/>

full

178. Takeda K, Smyth MJ, Cretney E, Hayakawa Y, Kayagaki N, Yagita H, et al. Critical Role for Tumor Necrosis Factor–related Apoptosis-inducing Ligand in Immune Surveillance Against Tumor Development. *J Exp Med*. 2002 Jan 21;195(2):161–9.
179. Guicciardi ME, Gores GJ. Life and death by death receptors. *FASEB J*. 2009 Jun;23(6):1625–37.
180. Chan FK, Chun HJ, Zheng L, Siegel RM, Bui KL, Lenardo MJ. A domain in TNF receptors that mediates ligand-independent receptor assembly and signaling. *Science*. 2000 Jun 30;288(5475):2351–4.
181. Siegel RM, Frederiksen JK, Zacharias DA, Chan FK, Johnson M, Lynch D, et al. Fas preassociation required for apoptosis signaling and dominant inhibition by pathogenic mutations. *Science*. 2000 Jun 30;288(5475):2354–7.
182. Sessler T, Healy S, Samali A, Szegezdi E. Structural determinants of DISC function: new insights into death receptor-mediated apoptosis signalling. *Pharmacol Ther*. 2013 Nov;140(2):186–99.
183. Riley JS, Malik A, Holohan C, Longley DB. DED or alive: assembly and regulation of the death effector domain complexes. *Cell Death Dis*. 2015 Aug 27;6:e1866.
184. Zhang C, Oberoi P, Oelsner S, Waldmann A, Lindner A, Tonn T, et al. Chimeric Antigen Receptor-Engineered NK-92 Cells: An Off-the-Shelf Cellular Therapeutic for Targeted Elimination of Cancer Cells and Induction of Protective Antitumor Immunity. *Front Immunol* [Internet]. 2017 [cited 2018 Jul 17];8. Available from: <https://www.frontiersin.org/articles/10.3389/fimmu.2017.00533/full>
185. Andrews DM, Scalzo AA, Yokoyama WM, Smyth MJ, Degli-Esposti MA. Functional interactions between dendritic cells and NK cells during viral infection. *Nat Immunol*. 2003 Feb;4(2):175–81.
186. Walzer T, Dalod M, Robbins SH, Zitvogel L, Vivier E. Natural-killer cells and dendritic cells: “l’union fait la force.” *Blood*. 2005 Oct 1;106(7):2252–8.
187. Vitale M, Della Chiesa M, Carlomagno S, Pende D, Aricò M, Moretta L, et al. NK-dependent DC maturation is mediated by TNFalpha and IFNgamma released upon engagement of the NKp30 triggering receptor. *Blood*. 2005 Jul 15;106(2):566–71.
188. Borg C, Jalil A, Laderach D, Maruyama K, Wakasugi H, Charrier S, et al. NK cell activation by dendritic cells (DCs) requires the formation of a synapse leading to IL-12 polarization in DCs. *Blood*. 2004 Nov 15;104(10):3267–75.
189. Pallandre JR, Krzewski K, Bedel R, Ryffel B, Caignard A, Rohrlich PS, et al.

- Dendritic cell and natural killer cell cross-talk: a pivotal role of CX3CL1 in NK cytoskeleton organization and activation. *Blood*. 2008 Dec 1;112(12):4420–4.
190. Krebs P, Barnes MJ, Lampe K, Whitley K, Bahjat KS, Beutler B, et al. NK cell-mediated killing of target cells triggers robust antigen-specific T cell-mediated and humoral responses. *Blood*. 2009 Jun 25;113(26):6593–602.
191. Dao T, Gomez-Nunez M, Antczak C, Kappel B, Jaggi JS, Korontsvit T, et al. Natural killer cells license dendritic cell cross-presentation of B lymphoma cell-associated antigens. *Clin Cancer Res*. 2005 Dec 15;11(24 Pt 1):8763–72.
192. Ferlazzo G, Morandi B. Cross-Talks between Natural Killer Cells and Distinct Subsets of Dendritic Cells. *Front Immunol* [Internet]. 2014 [cited 2018 Jun 18];5. Available from: [https://www-frontiersin-org.gate2.inist.fr/articles/10.3389/fimmu.2014.00159/full](https://www.frontiersin-org.gate2.inist.fr/articles/10.3389/fimmu.2014.00159/full)
193. Ferlazzo G, Tsang ML, Moretta L, Melioli G, Steinman RM, Münz C. Human dendritic cells activate resting natural killer (NK) cells and are recognized via the NKp30 receptor by activated NK cells. *J Exp Med*. 2002 Feb 4;195(3):343–51.
194. Piccioli D, Sbrana S, Melandri E, Valiante NM. Contact-dependent stimulation and inhibition of dendritic cells by natural killer cells. *J Exp Med*. 2002 Feb 4;195(3):335–41.
195. Andrews DM, Estcourt MJ, Andoniou CE, Wikstrom ME, Khong A, Voigt V, et al. Innate immunity defines the capacity of antiviral T cells to limit persistent infection. *J Exp Med*. 2010 Jun 7;207(6):1333–43.
196. Martín-Fontecha A, Thomsen LL, Brett S, Gerard C, Lipp M, Lanzavecchia A, et al. Induced recruitment of NK cells to lymph nodes provides IFN- γ for TH1 priming. *Nat Immunol*. 2004 Dec;5(12):1260–5.
197. Cerboni C, Zingoni A, Cippitelli M, Piccoli M, Frati L, Santoni A. Antigen-activated human T lymphocytes express cell-surface NKG2D ligands via an ATM/ATR-dependent mechanism and become susceptible to autologous NK-cell lysis. *Blood*. 2007 Jul 15;110(2):606–15.
198. Waggoner SN, Cornberg M, Selin LK, Welsh RM. Natural killer cells act as rheostats modulating antiviral T cells. *Nature*. 2011 Nov 20;481(7381):394–8.
199. Rabinovich BA, Li J, Shannon J, Hurren R, Chalupny J, Cosman D, et al. Activated, but not resting, T cells can be recognized and killed by syngeneic NK cells. *J Immunol*. 2003 Apr 1;170(7):3572–6.

200. Deniz G, Erten G, Küçüksezer UC, Kocacik D, Karagiannidis C, Aktas E, et al. Regulatory NK cells suppress antigen-specific T cell responses. *J Immunol*. 2008 Jan 15;180(2):850–7.
201. Sicard A, Ducreux S, Rabeyrin M, Couzi L, McGregor B, Badet L, et al. Detection of C3d-binding donor-specific anti-HLA antibodies at diagnosis of humoral rejection predicts renal graft loss. *J Am Soc Nephrol*. 2015 Feb;26(2):457–67.
202. Cudkowicz G, Stimpfling JH. Deficient growth of C57BL marrow cells transplanted in F1 hybrid mice. Association with the histocompatibility-2 locus. *Immunology*. 1964 May;7:291–306.
203. Kärre K, Ljunggren HG, Piontek G, Kiessling R. Selective rejection of H-2-deficient lymphoma variants suggests alternative immune defence strategy. *Nature*. 1986 Feb 20;319(6055):675–8.
204. Ruggeri L, Capanni M, Casucci M, Volpi I, Tosti A, Perruccio K, et al. Role of natural killer cell alloreactivity in HLA-mismatched hematopoietic stem cell transplantation. *Blood*. 1999 Jul 1;94(1):333–9.
205. Ruggeri L, Capanni M, Urbani E, Perruccio K, Shlomchik WD, Tosti A, et al. Effectiveness of donor natural killer cell alloreactivity in mismatched hematopoietic transplants. *Science*. 2002 Mar 15;295(5562):2097–100.
206. Snell GD. The genetics of transplantation. *J Natl Cancer Inst*. 1953 Dec;14(3):691–700; discussion, 701–4.
207. Uehara S, Chase CM, Kitchens WH, Rose HS, Colvin RB, Russell PS, et al. NK Cells Can Trigger Allograft Vasculopathy: The Role of Hybrid Resistance in Solid Organ Allografts. *J Immunol*. 2005 Jan 9;175(5):3424–30.
208. Kreijveld E, van der Meer A, Tijssen HJ, Hilbrands LB, Joosten I. KIR gene and KIR ligand analysis to predict graft rejection after renal transplantation. *Transplantation*. 2007 Oct 27;84(8):1045–51.
209. Kunert K, Seiler M, Mashreghi MF, Klippert K, Schönemann C, Neumann K, et al. KIR/HLA ligand incompatibility in kidney transplantation. *Transplantation*. 2007 Dec 15;84(11):1527–33.
210. Tran TH, Mytilineos J, Scherer S, Laux G, Middleton D, Opelz G. Analysis of KIR ligand incompatibility in human renal transplantation. *Transplantation*. 2005 Oct 27;80(8):1121–3.
211. Hanvesakul R, Kubal C, Moore J, Neil D, Cook M, Ball S, et al. KIR and HLA-C interactions promote differential dendritic cell maturation and is a major determinant of

- graft failure following kidney transplantation. *PLoS One*. 2011;6(8):e23631.
212. Tran TH, Middleton D, Döhler B, Scherer S, Meenagh A, Sleator C, et al. Reassessing the impact of donor HLA-C genotype on long-term liver transplant survival. *Am J Transplant*. 2009 Jul;9(7):1674–8.
213. van Bergen J, Thompson A, Haasnoot GW, Roodnat JJ, de Fijter JW, Claas FHJ, et al. KIR-ligand mismatches are associated with reduced long-term graft survival in HLA-compatible kidney transplantation. *Am J Transplant*. 2011 Sep;11(9):1959–64.
214. Tran TH, Unterrainer C, Fiedler G, Döhler B, Scherer S, Ruhlenstroth A, et al. No impact of KIR-ligand mismatch on allograft outcome in HLA-compatible kidney transplantation. *Am J Transplant*. 2013 Apr;13(4):1063–8.
215. Littera R, Piredda G, Argiolas D, Lai S, Congeddu E, Ragatzu P, et al. KIR and their HLA Class I ligands: Two more pieces towards completing the puzzle of chronic rejection and graft loss in kidney transplantation. *PLoS One*. 2017;12(7):e0180831.
216. Le Bas-Bernardet S, Hourmant M, Coupel S, Bignon J-D, Souillou J-P, Charreau B. Non-HLA-Type Endothelial Cell Reactive Alloantibodies in Pre-Transplant Sera of Kidney Recipients Trigger Apoptosis. *Am J Transplant*. 2003 Feb 1;3(2):167–77.
217. Canet E, Devallière J, Gérard N, Karam G, Giral M, Charreau B, et al. Profiling posttransplant circulating antibodies in kidney transplantation using donor endothelial cells. *Transplantation*. 2012 Feb 15;93(3):257–64.
218. Satchell SC, Tasman CH, Singh A, Ni L, Geelen J, Ruhland CJ von, et al. Conditionally immortalized human glomerular endothelial cells expressing fenestrations in response to VEGF. *Kidney Int*. 2006 May 1;69(9):1633–40.
219. Breimer ME, Rydberg L, Jackson AM, Lucas DP, Zachary AA, Melancon JK, et al. Multicenter evaluation of a novel endothelial cell crossmatch test in kidney transplantation. *Transplantation*. 2009 Feb 27;87(4):549–56.
220. Tonnerre P, Gérard N, Chatelais M, Poli C, Allard S, Cury S, et al. MICA Variant Promotes Allosensitization after Kidney Transplantation. *J Am Soc Nephrol*. 2013 Jan 6;24(6):954–66.
221. Tognarelli S, Gayet J, Lambert M, Dupuy S, Karras A, Cohen P, et al. Tissue-specific microvascular endothelial cells show distinct capacity to activate NK cells: implications for the pathophysiology of granulomatosis with polyangiitis. *J Immunol*. 2014 Apr 1;192(7):3399–408.
222. Tonnerre P, Gérard N, Gavlovsky P-J, Mazalrey S, Hourmant M, Cheneau M-L, et al. MICA Mutant A5.1 Influences BK Polyomavirus Reactivation and Associated

Nephropathy After Kidney Transplantation. *J Infect Dis*. 2016 Sep 1;214(5):807–16.

223. Ricotta D, Alessandri G, Pollara C, Fiorentini S, Favilli F, Tosetti M, et al. Adult human heart microvascular endothelial cells are permissive for non-lytic infection by human cytomegalovirus. *Cardiovasc Res*. 2001 Feb 1;49(2):440–8.

224. Djaoud Z, Riou R, Gavlovsky P-J, Mehlal S, Bressollette C, Gérard N, et al. Cytomegalovirus-Infected Primary Endothelial Cells Trigger NKG2C⁺ Natural Killer Cells. *J Innate Immun*. 2016;8(4):374–85.

225. Kaminski H, Fishman JA. The Cell Biology of Cytomegalovirus: Implications for Transplantation. *Am J Transplant*. 2016;16(8):2254–69.

226. Gumá M, Budt M, Sáez A, Brckalo T, Hengel H, Angulo A, et al. Expansion of CD94/NKG2C⁺ NK cells in response to human cytomegalovirus-infected fibroblasts. *Blood*. 2006 May 1;107(9):3624–31.

227. Béziat V, Traherne JA, Liu LL, Jayaraman J, Enqvist M, Larsson S, et al. Influence of KIR gene copy number on natural killer cell education. *Blood*. 2013 Jun 6;121(23):4703–7.

228. Zecher D, Rooijen N van, Rothstein DM, Shlomchik WD, Lakkis FG. An Innate Response to Allogeneic Nonself Mediated by Monocytes. *J Immunol*. 2009 Dec 15;183(12):7810–6.

229. Liu W, Xiao X, Demirci G, Madsen J, Li XC. Innate NK cells and macrophages recognize and reject allogeneic nonself in vivo via different mechanisms. *J Immunol*. 2012 Mar 15;188(6):2703–11.

230. Oberbarnscheidt MH, Zeng Q, Li Q, Dai H, Williams AL, Shlomchik WD, et al. Non-self recognition by monocytes initiates allograft rejection. *J Clin Invest*. 2014 Aug;124(8):3579–89.

231. Chow KV, Delconte RB, Huntington ND, Tarlinton DM, Sutherland RM, Zhan Y, et al. Innate Allorecognition Results in Rapid Accumulation of Monocyte-Derived Dendritic Cells. *J Immunol*. 2016 01;197(5):2000–8.

232. Dai H, Friday AJ, Abou-Daya KI, Williams AL, Mortin-Toth S, Nicotra ML, et al. Donor SIRP α polymorphism modulates the innate immune response to allogeneic grafts. *Sci Immunol*. 2017 Jun 23;2(12):eaam6202.

233. Maurus CF, Schneider MKJ, Schmidt D, Zünd G, Seebach JD. Activation of Human Microvascular Endothelial Cells with TNF-Alpha and Hypoxia/Reoxygenation Enhances NK-cell Adhesion, but not NK-Cytotoxicity. *Transplantation*. 2006 Apr;81(8):1204.

234. Yoneda O, Imai T, Goda S, Inoue H, Yamauchi A, Okazaki T, et al. Fractalkine-Mediated Endothelial Cell Injury by NK Cells. *J Immunol*. 2000 Apr 15;164(8):4055–62.
235. Zhang Z-X, Huang X, Jiang J, Lian D, Min W-P, Liu W, et al. Natural killer cells play a critical role in cardiac allograft vasculopathy in an interleukin-6--dependent manner. *Transplantation*. 2014 Nov 27;98(10):1029–39.

VIII. ANNEXES

Annexe 1 : Lymphoid neogenesis and tertiary lymphoid organs in transplanted organs



Lymphoid Neogenesis and Tertiary Lymphoid Organs in Transplanted Organs

Alice Koenig^{1,2,3} and Olivier Thauinat^{1,2,3*}

¹Service de Transplantation, Néphrologie et Immunologie Clinique, Hôpital Edouard Herriot, Hospices Civils de Lyon, Lyon, France, ²INSERM UMR1111, Lyon, France, ³Université de Lyon, Lyon, France

The progressive organization of immune effectors into functional ectopic lymphoid structures, named tertiary lymphoid organs (TLO), has been observed in many conditions in which target antigens fail to be eliminated by the immune system. Not surprisingly, TLO have been recurrently identified in chronically rejected allografts. Although significant progress has been made over the last decades in understanding the molecular mechanisms involved in TLO development (a process named lymphoid neogenesis), the role of intragraft TLO (if any) in chronic rejection remains elusive. The prevailing dogma is that TLO contribute to graft rejection by generating and propagating local humoral and cellular alloimmune responses. However, TLO have been recently observed in long-term accepting allografts, suggesting that they might also be able to regulate alloimmune responses. In this review, we discuss our current understanding of how TLO are induced and propose a unified model in which TLO can play deleterious or regulatory roles and therefore actively modulate the kinetics of chronic rejection.

Keywords: transplantation, lymphoid neogenesis, tertiary lymphoid organs, chronic rejection, tolerance

OPEN ACCESS

Edited by:

Andreas Habenicht,
Ludwig Maximilian University of
Munich, Germany

Reviewed by:

Matthias Lochner,
Center for Experimental and Clinical
Infection Research, Germany
Megan K. L. MacLeod,
University of Glasgow, UK

*Correspondence:

Olivier Thauinat
olivier.thauinat@chu-lyon.fr

Specialty section:

This article was submitted to
Inflammation, a section of the journal
Frontiers in Immunology

Received: 03 October 2016

Accepted: 13 December 2016

Published: 27 December 2016

Citation:

Koenig A and Thauinat O (2016)
Lymphoid Neogenesis and
Tertiary Lymphoid Organs in
Transplanted Organs.
Front. Immunol. 7:646.
doi: 10.3389/fimmu.2016.00646

INTRODUCTION: THE CHALLENGE OF CHRONIC REJECTION IN TRANSPLANTATION

Vital organ failure is a life-threatening condition where a vital organ (i.e., kidney, heart, liver, or lung...) does not perform its expected function. Recent lifestyle changes in developed countries, and the increased incidence of chronic diseases such as hypertension, obesity, and diabetes, have set the stage for accelerated risk for, and the occurrence of, vital organ failure. As a result, vital organ failure is currently recognized as the leading cause of debility and premature death worldwide (www.who.int). In France alone, the personal, societal, and economic consequences of vital organ failure have a cost of more than €70 billion a year (25% of total health expenditures).

Transplantation consists in the restoration of vital physiologic functions through the surgical substitution of a defective organ by a functioning graft retrieved from a donor. Patients with end-stage vital organ failure depend on solid organ transplantation, which is their best (often their only) therapeutic option.

In clinical transplantation, the donor is from the same species but genetically different. Consequently, the immune system of the recipient inevitably recognizes the antigenic determinants (alloantigens) that differ between the recipient and the donor, particularly the highly polymorphic molecules from the major histocompatibility complex [i.e., human leukocyte antigen (HLA)] in humans. The alloimmune response that develops against the donor-specific HLA molecules is

responsible for tissue damage, which leads to the failure of the transplanted organ, a process named “rejection.”

In the absence of a clinically applicable protocol able to induce the specific tolerance of the allogenic transplant by the recipient’s immune system (1, 2), the prevention of rejection is currently dependent upon immunosuppressive drugs (3). These drugs produce generalized immunosuppression, which means that any reduction in immune responsiveness to the allograft is accompanied by reduced immunity to infections and malignant diseases. Chronic immune injuries that result from the incomplete blockade of the recipient’s alloimmune response (i.e., chronic rejection) are currently the main factor limiting graft function duration (4). No significant progress has been made on this issue over the last decades as highlighted by the stagnation of graft half-life (5). A better understanding of the pathophysiology of chronic rejection is therefore a mandatory step in identifying innovative approaches that would prolong graft function duration.

INTRAGRAFT TERTIARY LYMPHOID ORGANS (TLO)

Rejected grafts are characterized by interstitial infiltration of cellular effectors, mainly T cells and macrophages, but also dendritic cells, NK cells, B cells, and plasma cells.

In contrast with acute rejection, where infiltrates exhibit no particular spatial organization, during chronic rejection immune cells tend to organize themselves in structures that morphologically resemble the secondary lymphoid organs.

Analyzing all sorts of human kidney grafts removed for terminal chronic rejection, we and others showed that in the majority of chronically rejected grafts the immune cells were grouped, conferring a nodular organization to the infiltrate (6, 7). These nodules exhibited a highly organized microarchitecture with clear cell subset segregation: the core, made of the B cells intermingled with a network of follicular dendritic cells, was surrounded by T cells and mature dendritic cells. CD138-expressing plasma cells were found within or in close vicinity to TLO, suggesting that part of these cells differentiated locally. As in canonical secondary lymphoid organs the compartmentalization of the different cell subsets appeared to be mediated by gradients of homeostatic chemokines CCL21 (in the T cell area) and CXCL13 (in the B cell area). Furthermore, neolymphatic vessels and PNAd-expressing high endothelial venules (HEVs) were observed in the periphery of the nodules (8).

The structural organization of immune effectors observed in chronically rejected renal grafts (**Figure 1**) does not seem specific of this type of transplant since similar lymphoid structures have been observed in chronically rejected pancreas, livers, hearts (7, 9–11), lungs (12), and even composite transplants (13–15). This phenomenon is not specific of the alloimmune setting either, since the very same lymphoid structures have previously been observed in various inflammatory conditions, including chronic infections, autoimmune diseases, and cancers (16, 17). Structural organization of immune effectors therefore appears as a generic response of the chronically stimulated immune system that cannot eradicate targeted antigens.

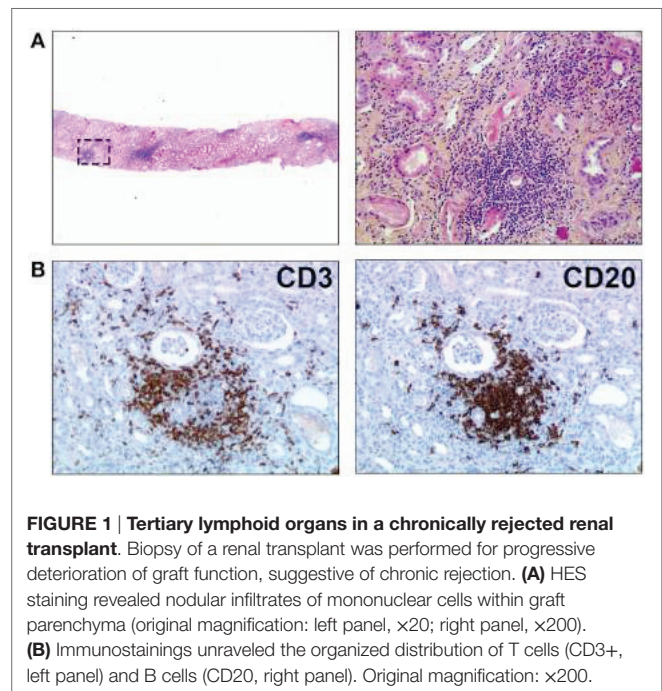

FIGURE 1 | Tertiary lymphoid organs in a chronically rejected renal transplant. Biopsy of a renal transplant was performed for progressive deterioration of graft function, suggestive of chronic rejection. **(A)** HES staining revealed nodular infiltrates of mononuclear cells within graft parenchyma (original magnification: left panel, $\times 20$; right panel, $\times 200$). **(B)** Immunostainings unraveled the organized distribution of T cells (CD3+, left panel) and B cells (CD20, right panel). Original magnification: $\times 200$.

Because the microarchitecture of organized immune infiltrates is highly reminiscent of that of secondary lymphoid organs, these lymphoid structures have been named TLO.

MOLECULAR MECHANISMS INVOLVED IN THE DEVELOPMENT OF SECONDARY LYMPHOID ORGANS

Primary immune responses are initiated in secondary lymphoid organs, which are located at strategic sites where antigens are most likely to be encountered.

The development of secondary lymphoid organs, a process named lymphoid organogenesis, is initiated during embryogenesis independently of antigen recognition at predetermined sites as a result of complex interactions between hematopoietic, mesenchymal, and endothelial cells (18, 19). Lymphoid organogenesis can be schematically divided into two consecutive steps: first the induction, then the organization phase.

The induction phase depends on lymphoid-tissue inducer cells, which arise in the fetal liver. Under the influence of TRANCE (at sites of peripheral lymph node development) or IL-7 (at mucosal sites) lymphoid-tissue inducer cells express membrane-bound lymphotoxin: a heterotrimer containing lymphotoxin α and lymphotoxin β that allow lymphoid-tissue inducer cells to interact with the lymphotoxin β receptor (LT β R) of stromal cells. Signaling through the LT β R initiates NF κ B signaling in stromal cells, which promotes the production of homeostatic chemokines (18, 19).

Homeostatic chemokines are crucial for the organization phase. CXCL13 recruits circulating B cells to what becomes the B cell area of lymphoid tissues, and the T zone chemokines (CCL19 and CCL21) attract T and dendritic cells to shape the T cell area

(18, 19). The lymphotoxin signaling pathway is also crucial in promoting the differentiation of HEVs, which are postcapillary venules expressing specific adhesion molecules (known as addressins) that have a crucial role in lymphocyte trafficking to secondary lymphoid organs (18, 19).

MOLECULAR MECHANISMS OF LYMPHOID NEOGENESIS IN TRANSPLANTATION

Chronic rejection provides optimal conditions for studying the molecular mechanisms involved in the development of TLO (Figure 2). Indeed, (i) TLO have systematically been detected in chronically rejected grafts; (ii) the antigens targeted by the immune system are known (recipient-mismatched HLA antigens

of the transplanted tissues); and (iii) chronically rejected grafts are sometimes removed, providing a large amount of diseased tissue, which can be comprehensively analyzed.

In-depth analysis of a series of detransplanted human renal grafts revealed the heterogenous nature of the cellular composition of TLO (8). Two types of B cell nodules could be identified: nodules composed of a uniform CD20^{pos} B cell population expressing IgD and Bcl-2 were similar to primary follicles, while nodules with a core of CD20^{pos}IgD^{neg}Bcl-2^{neg} B cells, highly expressing Bcl-6 that had pushed aside the CD20^{pos}IgD^{pos}Bcl-2^{pos} B cells, resembled secondary follicles, i.e., germinal centers (8). The ratio between these two types of structures differed between samples, and the number of ectopic germinal centers did not increase with the quantity of primary nodules. The phenotypic heterogeneity of TLO correlated more with the expression profile of a set of genes (*CCL19*, *CCL21*, *CXCL12*, *CXCL13*, *CCR7*, *CXCR4*, and *CXCR5*)

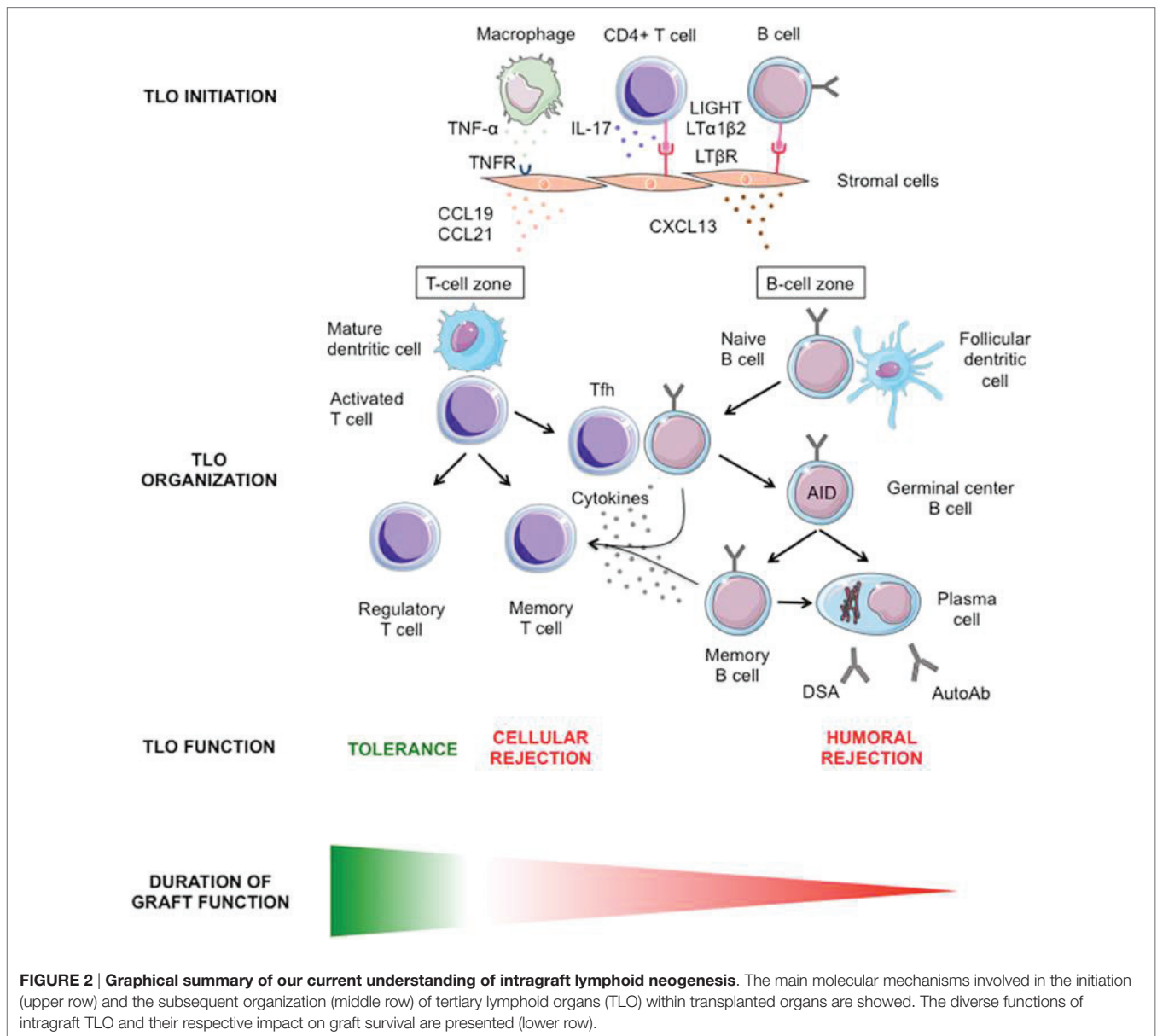

FIGURE 2 | Graphical summary of our current understanding of intra-graft lymphoid neogenesis. The main molecular mechanisms involved in the initiation (upper row) and the subsequent organization (middle row) of tertiary lymphoid organs (TLO) within transplanted organs are shown. The diverse functions of intra-graft TLO and their respective impact on graft survival are presented (lower row).

involved in the formation and the maintenance of canonical secondary lymphoid organs (i.e., the lymphoid organogenesis described in the previous section) (18, 19). The complete recapitulation of this genetic program in chronically rejected grafts resulted in the generation of fully functional ectopic germinal centers that allowed for the efficient maturation of B cells into memory B cells and plasma cells (**Figure 2**). In contrast, when this recapitulation was incomplete, local B cell maturation was impeded (8). These results highlighted the similarity between the molecular processes involved in the development of canonical secondary lymphoid organs and those involved in the organization of immune effectors during chronic inflammation, a process named lymphoid neogenesis.

If the molecular mechanisms responsible for the organization and maintenance of secondary lymphoid organs and TLO appear similar, the initiation of the cascade is likely to be different (**Figure 2**). The formation of secondary lymphoid organs in the embryo is developmentally programmed and results from the interaction between lymphotoxin- $\alpha_1\beta_2$ -expressing lymphoid-tissue inducer cells and lymphotoxin- β receptor-expressing stromal organizer cells (18, 19). In contrast, TLO development seems independent of lymphoid-tissue inducer cells (20, 21). Yet, several studies have documented the importance of the lymphotoxin pathway in lymphoid neogenesis (21, 22), including in a transplantation setting (23), by demonstrating that the development of TLO was abolished by treatment with inhibitory LT β R-Ig fusion protein. We must then ask who provides lymphotoxin signaling in the chronic rejection setting. Beyond lymphoid-tissue inducer cells, lymphotoxin- α and lymphotoxin- β are also expressed by activated lymphocytes (24). It is therefore conceivable that activated T and/or B cells replace lymphoid-tissue inducer cells to initiate lymphoid neogenesis in rejected grafts (**Figure 2**) as already demonstrated for the induction of TLO in the gut (21). Another possibility is that lymphotoxin is dispensable for the formation of TLO. Lymphotoxin- α and lymphotoxin- β are two related members of the large TNF ligand family (25). Since homologous genes and gene products often have redundant physiological functions, it seems reasonable to propose that other ligands and/or receptors of the TNF superfamily could act as alternative pathways for TLO induction (**Figure 2**). In line with this hypothesis, the provision of the alternative LT β R ligand LIGHT (aka tumor necrosis factor superfamily member 14) by activated T cells infiltrating inflamed pancreas have been shown to be crucial for the formation of TLO (26). Furthermore, TNF- α , which is produced within rejected grafts (27), has been shown to be critical for the development of TLO in a murine model of atherosclerosis (20). TNF- α does not bind to LT β R but to distinct TNF receptors (25). Using apolipoprotein E-deficient mice, which spontaneously develop atherosclerotic lesions in their aorta, the Antonino Nicoletti's group recently demonstrated that the blockade of LT β R signaling had no effect, whereas that of TNFR1/2 signaling reduced the expression of homeostatic chemokines and the subsequent development of TLO (20). Finally, it has recently been reported that IL-17 produced by CD4+ T cells (i.e., Th17 cells) was essential for the formation of both (i) TLO in the central nervous system of mice during experimental autoimmune encephalomyelitis (the animal model

of multiple sclerosis) (28) and (ii) the development of inducible bronchus-associated lymphoid tissue, an ectopic lymphoid tissue that forms in the lungs after pulmonary inflammation (29, 30). In the latter setting, IL-17 acted by triggering the expression of homeostatic chemokines independently of lymphotoxin signaling (**Figure 2**). If this hypothesis was proven true in transplantation, initiation of lymphoid neogenesis in chronically rejected grafts could therefore be totally independent of both lymphoid-tissue inducer cells and the lymphotoxin/TNF pathway. Interestingly, we have recently reported that a Th17 polarization of CD4+ T cells infiltrating the graft was associated with increased TLO development during clinical chronic rejection (31).

It is conceivable that instead of conflicting with each other, these different works reveal the fact that several pathways can promote the initiation of TLO depending on the initiating events. This hypothesis was recently substantiated by the demonstration that the development of bronchus-associated lymphoid tissue was triggered by different pathways according to the pathogen responsible for lung inflammation (29).

While significant progress has been made in the identification of the molecular mechanisms that participate to the development of TLO, the endogenous signals capable of inhibiting the lymphoid neogenesis are far more elusive. Through evaluation of synovial tissues from rheumatoid arthritis patients it has been recently reported that low interleukin-27 (IL-27) expression corresponds with an increased incidence of TLO and gene signatures associated with their development and activity. The presence of synovial TLO was also noted in mice deficient in the IL-27 receptor after the onset of inflammatory arthritis (32). IL-27 might therefore represent a negative regulator of TLO development. Whether this is also true for chronic rejection remains to be demonstrated.

DO INTRAGRAFT TLO PROMOTE CHRONIC REJECTION?

Tertiary lymphoid organs differ from canonical secondary lymphoid organs inasmuch as they develop in an inflammatory milieu (31, 33), enriched in neoantigens released from injured tissue and trapped by defective lymphatic drainage (34). Comparing the cellular composition of TLO of chronically rejected grafts with one of the secondary lymphoid organs, we observed a drastic increase in the percentage of activated and memory CD4+ T cell in intragraft TLO and a symmetric decrease in T regulatory subsets (IL-10-producing Tr1 cells and Foxp3^{pos} Tregs) in both a murine experimental model and human samples (33, 35).

These peculiarities suggest that the local immune response that develops in intragraft TLO might be less tightly regulated than in secondary lymphoid organs and are therefore more aggressive. In line with this hypothesis, we (33) and others (23) have shown that intragraft TLO are a major site where B cell tolerance breakdown occurs during chronic rejection (**Figure 2**). Interestingly, the generation of autoantibodies following solid organ transplantation has long been reported to correlate with chronic rejection, and the deleterious impact of some autoantibodies on graft survival has been demonstrated (36, 37). Furthermore, comparing the alloimmune responses elicited in intragraft TLO, spleen, and draining lymph nodes in a rat model of chronic rejection, our

group observed increased production of anti-HLA antibodies in TLO as compared with canonical secondary lymphoid organs (35). Not only were the humoral alloimmune responses elicited in TLO quantitatively enhanced but they also displayed a more diverse repertoire, a finding that we confirmed in the clinical setting by the analysis of chronically rejected human kidney allografts (8).

Tertiary lymphoid organs could also contribute to chronic destruction of the graft through antibody-independent functions of B cells. B cells are indeed unique antigen-presenting cells because (i) they have an antigen-specific receptor (B cell receptor), which when engaged by surface-tethered antigens leads to the formation of an immunological synapse that coordinates cell signaling events and promotes antigen uptake for presentation on MHC class II molecules (38), even when the antigen is membrane-tethered or is present in limiting quantities and (ii) B cells have the capacity to clonally expand, thereby becoming the numerically dominant antigen-presenting cells. Interestingly, it has been reported that the presence of B cell clusters within the graft during rejection was associated with reduced graft survival and resistance to steroid therapy, independently of C4d (a breakdown product generated during classical complement pathway activation) deposition or alloantibody detection (39). Some authors have proposed that this could be due to the local presentation of antigen to effector T cells by intragraft B cells (40). This hypothesis is supported by experimental data from the group of Fadi Lakkis, who showed that in a murine skin graft model, TLO perpetuate the rejection process by supporting naïve T cell activation within the graft (41). Strikingly, the same authors also demonstrated that TLO generate T cell memory immune responses (41).

In addition to presenting antigen, B cells can also enhance T cell-mediated immune responses through the secretion of cytokines and chemokines. Studies from the group of Frances Lund (42) have shown that B cells can be functionally subdivided based on their cytokine profile. B cells activated in the presence of TH1-type cytokines (referred to as Be-1 cells) secrete IFN γ and IL-12 but not IL-4, IL-13, or IL-2. By contrast, B cells activated in the presence of TH2-type cytokines (Be-2 cells) secrete IL-2, lymphotoxin, IL-4, and IL-13 but make minimal amounts of IFN γ and IL-12. Both Be-1 and Be-2 cells seem able to produce IL-10, TNF α , and IL-6. The importance of B cell cytokines in promoting T cell responses has been illustrated in several models. For example, *in vitro* generated effector B cells that produced either TH1- or TH2-type cytokines were shown to promote the activation and differentiation of naïve T cells into effector TH1 and TH2 cells, respectively (43). The importance of B cell cytokines in promoting T cell responses has been confirmed *in vivo*. In a murine model of *Toxoplasma gondii* infection, TNF production by B cells was shown to be required for the generation of an optimal TH1 cell protective response (44). In another set of experiments, the generation of a protective TH2 memory response to *H. polygyrus* was shown to depend on IL-2-producing B cells (45). The exact role of cytokine-producing B cells in enhancing intra-TLO T cell responses remains to be evaluated.

Since grafts in which TLO were harboring germinal center reactions had a shorter life expectancy (Figure 2), we have proposed that lymphoid neogenesis could play a detrimental role

during chronic rejection (8). However, the validity of this conclusion is limited by the fact that only explanted grafts have been analyzed, i.e., organs displaying extreme rejection damage that are sometimes (notably in the case of renal grafts) removed after immunosuppressive therapy withdrawal. The definitive demonstration that TLO are involved in the pathophysiology of chronic rejection would require selectively impairing the development of intragraft TLO while leaving the rest of the recipient's immune system unaffected. Addressing this issue is not trivial because, as discussed above, TLO share many biological pathways with canonical lymphoid tissue, and hence an adequate experimental model is not currently available. Therefore, most of the attempts to validate the data obtained in murine experimental models and in human detransplanted grafts have relied on graft biopsies. The identification of TLO within the grafts before the development of the lesions indeed appears as a prerequisite for confirming the role of lymphoid neogenesis in chronic rejection. This implies a study of protocol biopsies, which has long been introduced as standard follow up in transplantation (46). Unfortunately, the numerous studies aiming at evaluating the correlation between the presence of TLO in protocol biopsies and the later development of chronic rejection have reached conflicting conclusions (Table 1).

The absence of an unequivocal deleterious role for B cell clusters has led to the conclusion that these structures could be like “fish in a sunken ship,” i.e., although fish are frequently seen in a sunken boat, they play no role in the process responsible for the shipwreck.

INTRAGRAFT TLO: FRIENDS AND FOES?

An alternative explanation could reconcile these apparently conflicting results. As discussed above, the proportion of B cells that infiltrate chronically rejected kidney grafts does not correlate with the functionality of intragraft TLO (8). The attraction of B cells within inflamed tissue appears therefore to be a generic phenomenon with no intrinsic deleterious consequences on the graft. However, when intragraft B cells meet the appropriate microenvironment, and upon the complete recapitulation of the lymphoid organogenesis program, B cell nodules organize themselves into functional ectopic germinal centers, which harbor the development of a local aggressive immune response. Because graft biopsies provide only a very limited amount of tissue (which is already an important limitation for evaluation in a patchy process such as lymphoid neogenesis), they do not allow for functional analysis of the ectopic lymphoid organs and are therefore inappropriate for analyzing the role of B cell clusters in rejected grafts.

Another layer of complexity has recently been brought into the picture by experimental evidence that certain B cell subsets are endowed with an immune regulatory role (47). For instance, IL-10-producing B cells have been shown to efficiently prevent the induction of autoimmune disease in several mouse models (48–50). Tolerance in transplantation is defined as the maintenance of graft function in the absence of therapeutic immunosuppression for at least 12 months. About 100 tolerant patients have been identified among renal transplant recipients over the last decade (51). These patients, defined as “operationally tolerant,”

TABLE 1 | Summary of biopsy-based studies evaluating the role of graft-infiltrating B cells.

Reference	Population	Biopsy indication	Histologic criteria	Key findings
KIDNEY RECIPIENTS				
Sarwal et al. (39)	51 patients	Biopsy with acute graft rejection	CD20+ cell count >275/HPF	B cell clusters associated with glucocorticoid resistance and graft loss
Hippen et al. (58)	27 patients	Biopsy with Banff 1A or 1B acute rejection	CD20+ if “strong and diffuse staining”	CD20+ correlated with steroid-resistance rejection and reduced graft survival
Kayler et al. (59)	120 patients	Biopsy with first episode of acute cellular rejection	Cluster of ≥ 15 CD20+ cells in the tubulo-interstitial compartment	CD20+ clusters are not prognostic factors for glucocorticoid resistance and graft loss
Bagnasco et al. (60)	58 patients (74 biopsies)	Biopsy with type 1 and type 2 acute cellular rejection during the first year post-Tx	B cell-rich when ≥ 1 cluster containing 100 CD20+ cells/HPF	No correlation between B cell-rich biopsies and worst graft outcome
Scheepstra et al. (61)	50 patients (54 biopsies)	Biopsy with clinically suspect and histologically confirmed acute rejection	B cell (CD20+) count >275/HPF CD20+ cluster if >30 cells CD20+ without the interposition of tubules	Presence of B cells does not correlate with response to conventional therapy or graft outcome
Hwang et al. (62)	54 patients (67 biopsies)	Biopsy with acute cellular rejection	CD20+ count >275/HPF CD38+ if >30% infiltration	CD38+ B cells \pm CD20+ B cells correlated with poor clinical outcomes
Martin et al. (63)	18 patients	Serial biopsies for 10 recipients with chronic dysfunction and 8 with long-term normal graft function	Plasma cells count Cd4 deposits DSA elution from biopsy	Patients developing chronic rejection present plasma cells, DSA, and C4d depositions more often than control group on their biopsy
Abbas et al. (64)	50 patients	Biopsy for cause	Plasma cell-rich acute rejection if >10% plasma cells	Plasma cell-rich acute rejection correlated with a poor graft outcome when associated with DSA
HEART RECIPIENTS				
Yamani et al. (65)	140 patients	Systematic biopsy	Nodular endocardial infiltrates (quilty lesions)	Quilty lesions are associated with increased development of coronary vasculopathy at 1 year
Chu et al. (66)	285 patients	Systematic biopsy	Quilty lesions	Patients with quilty lesions and no anti-HLA class II DSA are more likely to develop graft arteriosclerosis at 5 years
Hiemann et al. (67)	873 patients (9,713 biopsies)	Systematic biopsy	Quilty lesions	Quilty lesions are associated with an increased risk for stenotic microvasculopathy and a poor graft outcome
Zakliczynski et al. (68)	344 patients	Systematic biopsy	Quilty lesions	Positive correlation between quilty lesions and an increased risk of acute rejection but not with the occurrence of coronary artery vasculopathy
Frank et al. (69)	79 patients (37 with DSA)	Biopsy with or without graft dysfunction	Ratios of T:B cells and CD4:CD8 T cells	Patients with DSA have lower CD4:CD8 T cell ratio than controls T:B cell ratio was similar in patients with and without DSA
COMPOSITE TISSUE RECIPIENTS				
Hautz et al. (14)	6 human hand recipients (187 biopsies)	Systematic and for cause biopsies	CD3, CD4, CD8, CD20 PNA _d stainings	PNA _d expression in graft vessels correlated with rejection and T- and B-cell infiltration

DSA, donor-specific antibodies; HLA, human leukocyte antigen; HPF, high power field; PNA_d, peripheral lymph node addressin; Tx, transplantation.

are healthy, do not exhibit more infections or malignancies than healthy volunteers, and do not display clinical evidence of immune incompetence (51). When compared with transplanted patients with stable graft function under pharmacologic immunosuppression, operationally tolerant patients exhibited an increase in both absolute number and frequency of total B cells (52). Furthermore, two independent microarray analyses of PBMC revealed a higher expression of B cell-related genes and their associated molecular

pathways in tolerant recipients (53, 54). It is therefore conceivable that in certain conditions intragraft B cell infiltrate, instead of being neutral or deleterious, could actually promote graft survival (Figure 2). This theory has been nicely illustrated by murine experimental studies that recently reported the formation of TLO within tolerated allografts (55–57). If such a local protective response can prevent terminal failure of grafts, then not only would such samples having “tolerogenic” TLO be absent from

the studies based on the analysis of detransplanted grafts but it could also explain the difficulty of biopsy-based studies to reach an unequivocal conclusion.

CONCLUSION

Transplanted organ expresses donor-specific alloantigens, which stimulate a recipient's immune system. Prevention of acute rejection of the graft is achieved using a combination of non-specific immunosuppressive drugs that can only partially block the allo-immune effectors. The residual enduring alloimmune response promotes immune injuries known as chronic rejection, the main cause of late allograft loss. As in other chronic immune diseases, immune effectors within chronically rejected allografts progressively organize into functional TLO that display the same micro-architecture as secondary lymphoid organs, a process known as lymphoid neogenesis. Because biopsy-based studies have reached conflicting conclusions regarding the pathological significance of these TLO, it has been proposed that the presence of TLO in rejected grafts is a non-specific response to local inflammation-induced production of chemokines. While that can indeed sometimes be the case, it should not be excluded that under appropriate conditions, lymphoid neogenesis turns non-functional TLO into ectopic germinal centers, in which a local aggressive humoral immune response can be elicited. Alternatively, functional TLO can also regulate immune responses and slow down the destruction process.

REFERENCES

- Leventhal J, Abecassis M, Miller J, Gallon L, Ravindra K, Tollerud DJ, et al. Chimerism and tolerance without GVHD or engraftment syndrome in HLA-mismatched combined kidney and hematopoietic stem cell transplantation. *Sci Transl Med* (2012) 4:124ra28. doi:10.1126/scitranslmed.3003509
- Cetrulo CL, Drijkoningen T, Sachs DH. Tolerance induction via mixed chimerism in vascularized composite allotransplantation: is it time for clinical application? *Curr Opin Organ Transplant* (2015) 20:602–7. doi:10.1097/MOT.0000000000000248
- Halloran PF. Immunosuppressive drugs for kidney transplantation. *N Engl J Med* (2004) 351:2715–29. doi:10.1056/NEJMra033540
- Sellarés J, de Freitas DG, Mengel M, Reeve J, Einecke G, Sis B, et al. Understanding the causes of kidney transplant failure: the dominant role of antibody-mediated rejection and nonadherence. *Am J Transplant* (2012) 12:388–99. doi:10.1111/j.1600-6143.2011.03840.x
- Lodhi SA, Lamb KE, Meier-Kriesche HU. Solid organ allograft survival improvement in the United States: the long-term does not mirror the dramatic short-term success. *Am J Transplant* (2011) 11:1226–35. doi:10.1111/j.1600-6143.2011.03539.x
- Kerjaschki D, Regele HM, Moosberger I, Nagy-Bojarski K, Watschinger B, Soleiman A, et al. Lymphatic neoangiogenesis in human kidney transplants is associated with immunologically active lymphocytic infiltrates. *J Am Soc Nephrol* (2004) 15:603–12. doi:10.1097/01.ASN.0000113316.52371.2E
- Thauinat O, Field A-C, Dai J, Louedec L, Patey N, Bloch M-F, et al. Lymphoid neogenesis in chronic rejection: evidence for a local humoral alloimmune response. *Proc Natl Acad Sci U S A* (2005) 102:14723–8. doi:10.1073/pnas.0507223102
- Thauinat O, Patey N, Caligiuri G, Gautreau C, Mamani-Matsuda M, Mekki Y, et al. Chronic rejection triggers the development of an aggressive intra-graft immune response through recapitulation of lymphoid organogenesis. *J Immunol* (2010) 185:717–28. doi:10.4049/jimmunol.0903589
- Thauinat O, Patey N, Morelon E, Michel J-B, Nicoletti A. Lymphoid neogenesis in chronic rejection: the murderer is in the house. *Curr Opin Immunol* (2006) 18:576–9. doi:10.1016/j.coi.2006.07.006
- Thauinat O, Nicoletti A. Lymphoid neogenesis in chronic rejection. *Curr Opin Organ Transplant* (2008) 13:16–9. doi:10.1097/MOT.0b013e3282f3df15
- Wehner JR, Fox-Talbot K, Halushka MK, Ellis C, Zachary AA, Baldwin WM. B cells and plasma cells in coronaries of chronically rejected cardiac transplants. *Transplantation* (2010) 89:1141–8. doi:10.1097/TP.0b013e3181d3f271
- Sato M, Hirayama S, Hwang DM, Lara-Guerra H, Wagnetz D, Waddell TK, et al. The role of intrapulmonary de novo lymphoid tissue in obliterative bronchiolitis after lung transplantation. *J Immunol* (2009) 182:7307–16. doi:10.4049/jimmunol.0803606
- Kanidakis J, Karayannopoulou G, Lanzetta M, Petruzzo P. Graft vasculopathy in the skin of a human hand allograft: implications for diagnosis of rejection of vascularized composite allografts. *Transpl Int* (2014) 27:e118–23. doi:10.1111/tri.12399
- Hautz T, Zelger BG, Nasr IW, Mundinger GS, Barth RN, Rodriguez ED, et al. Lymphoid neogenesis in skin of human hand, nonhuman primate, and rat vascularized composite allografts. *Transpl Int* (2014) 27:966–76. doi:10.1111/tri.12358
- Thauinat O, Badet L, Dubois V, Kanidakis J, Petruzzo P, Morelon E. Immunopathology of rejection: do the rules of solid organ apply to vascularized composite allotransplantation? *Curr Opin Organ Transplant* (2015) 20:596–601. doi:10.1097/MOT.0000000000000242
- Dieu-Nosjean M-C, Giraldo NA, Kaplon H, Germain C, Fridman WH, Sautès-Fridman C. Tertiary lymphoid structures, drivers of the anti-tumor responses in human cancers. *Immunol Rev* (2016) 271:260–75. doi:10.1111/imr.12405
- Pitzalis C, Jones GW, Bombardieri M, Jones SA. Ectopic lymphoid-like structures in infection, cancer and autoimmunity. *Nat Rev Immunol* (2014) 14:447–62. doi:10.1038/nri3700

AUTHOR CONTRIBUTIONS

All the authors listed have made substantial, direct, and intellectual contribution to the work and approved it for publication.

ACKNOWLEDGMENTS

The authors wish to thank the Drs. Maud Rabeyrin and Brigitte McGregor, from the Pathology Department of Edouard Herriot Hospital (Lyon University Hospital), for their help in collecting the pathological samples. The authors wish to thank Mathilde Koenig and Servier Medical Art (creativecommons.org/licenses/by/3.0/fr/) for their contribution to the design of the figure.

FUNDING

OT is supported by the Agence Nationale pour la Recherche (ANR-12-PDOC-0019), the Agence de la Biomédecine (AOR-2013), the Société Francophone de Transplantation, and the Etablissement Français du Sang.

18. Randall TD, Carragher DM, Rangel-Moreno J. Development of secondary lymphoid organs. *Annu Rev Immunol* (2008) 26:627–50. doi:10.1146/annurev.immunol.26.021607.090257
19. Van de Pavert SA, Mebius RE. New insights into the development of lymphoid tissues. *Nat Rev Immunol* (2010) 10:664–74. doi:10.1038/nri2832
20. Guedj K, Khallouf-Laschet J, Clement M, Morvan M, Gaston A-T, Fornasa G, et al. M1 macrophages act as LTβR-independent lymphoid tissue inducer cells during atherosclerosis-related lymphoid neogenesis. *Cardiovasc Res* (2014) 101:434–43. doi:10.1093/cvr/cvt263
21. Lochner M, Ohnmacht C, Presley L, Bruhns P, Si-Tahar M, Sawa S, et al. Microbiota-induced tertiary lymphoid tissues aggravate inflammatory disease in the absence of RORγt and LTi cells. *J Exp Med* (2011) 208:125–34. doi:10.1084/jem.20100052
22. Columba-Cabezas S, Griguoli M, Rosicarelli B, Magliozzi R, Ria F, Serafini B, et al. Suppression of established experimental autoimmune encephalomyelitis and formation of meningeal lymphoid follicles by lymphotoxin beta receptor-Ig fusion protein. *J Neuroimmunol* (2006) 179:76–86. doi:10.1016/j.jneuroim.2006.06.015
23. Motallebzadeh R, Rehakova S, Conlon TM, Win TS, Callaghan CJ, Goddard M, et al. Blocking lymphotoxin signaling abrogates the development of ectopic lymphoid tissue within cardiac allografts and inhibits effector antibody responses. *FASEB J* (2012) 26:51–62. doi:10.1096/fj.11-186973
24. Ware CF, Crowe PD, Grayson MH, Androlewicz MJ, Browning JL. Expression of surface lymphotoxin and tumor necrosis factor on activated T, B, and natural killer cells. *J Immunol* (1992) 149:3881–8.
25. Locksley RM, Killeen N, Lenardo MJ. The TNF and TNF receptor superfamilies: integrating mammalian biology. *Cell* (2001) 104:487–501. doi:10.1016/S0092-8674(01)00237-9
26. Lee Y, Chin RK, Christiansen P, Sun Y, Tumanov AV, Wang J, et al. Recruitment and activation of naive T cells in the islets by lymphotoxin beta receptor-dependent tertiary lymphoid structure. *Immunity* (2006) 25:499–509. doi:10.1016/j.immuni.2006.06.016
27. Krams SM, Falco DA, Villanueva JC, Rabkin J, Tomlanovich SJ, Vincenti F, et al. Cytokine and T cell receptor gene expression at the site of allograft rejection. *Transplantation* (1992) 53:151–6. doi:10.1097/00007890-199201000-00031
28. Peters A, Pitcher LA, Sullivan JM, Mitsdoerffer M, Acton SE, Franz B, et al. Th17 cells induce ectopic lymphoid follicles in central nervous system tissue inflammation. *Immunity* (2011) 35:986–96. doi:10.1016/j.immuni.2011.10.015
29. Fleige H, Ravens S, Moschovakis GL, Bölter J, Willenzon S, Sutter G, et al. IL-17-induced CXCL12 recruits B cells and induces follicle formation in BALT in the absence of differentiated FDCs. *J Exp Med* (2014) 211:643–51. doi:10.1084/jem.20131737
30. Rangel-Moreno J, Carragher DM, de la Luz Garcia-Hernandez M, Hwang JY, Kusser K, Hartson L, et al. The development of inducible bronchus-associated lymphoid tissue depends on IL-17. *Nat Immunol* (2011) 12:639–46. doi:10.1038/ni.2053
31. Deteix C, Attauil-Audenis V, Duthey A, Patey N, McGregor B, Dubois V, et al. Intra-graft Th17 infiltrate promotes lymphoid neogenesis and hastens clinical chronic rejection. *J Immunol* (2010) 184:5344–51. doi:10.4049/jimmunol.0902999
32. Jones GW, Bombardieri M, Greenhill CJ, McLeod L, Nerviani A, Rocher-Ros V, et al. Interleukin-27 inhibits ectopic lymphoid-like structure development in early inflammatory arthritis. *J Exp Med* (2015) 212:1793–802. doi:10.1084/jem.20132307
33. Thauinat O, Graff-Dubois S, Fabien N, Duthey A, Attauil-Audenis V, Nicoletti A, et al. A stepwise breakdown of B-cell tolerance occurs within renal allografts during chronic rejection. *Kidney Int* (2012) 81:207–19. doi:10.1038/ki.2011.317
34. Thauinat O, Kerjaschki D, Nicoletti A. Is defective lymphatic drainage a trigger for lymphoid neogenesis? *Trends Immunol* (2006) 27:441–5. doi:10.1016/j.it.2006.08.003
35. Thauinat O, Graff-Dubois S, Brouard S, Gautreau C, Varthaman A, Fabien N, et al. Immune responses elicited in tertiary lymphoid tissues display distinctive features. *PLoS One* (2010) 5:e11398. doi:10.1371/journal.pone.0011398
36. Dragun D, Müller DN, Bräsen JH, Fritsche L, Nieminen-Kelhä M, Dechend R, et al. Angiotensin II type 1-receptor activating antibodies in renal-allograft rejection. *N Engl J Med* (2005) 352:558–69. doi:10.1056/NEJMoa035717
37. Sicard A, Chen C-C, Morelon E, Thauinat O. Alloimmune-induced intra-graft lymphoid neogenesis promotes B-cell tolerance breakdown that accelerates chronic rejection. *Curr Opin Organ Transplant* (2016) 21:368–74. doi:10.1097/MOT.0000000000000329
38. Carrasco YR, Batista FD. B cell recognition of membrane-bound antigen: an exquisite way of sensing ligands. *Curr Opin Immunol* (2006) 18:286–91. doi:10.1016/j.coi.2006.03.013
39. Sarwal M, Chua M-S, Kambham N, Hsieh S-C, Satterwhite T, Masek M, et al. Molecular heterogeneity in acute renal allograft rejection identified by DNA microarray profiling. *N Engl J Med* (2003) 349:125–38. doi:10.1056/NEJMoa035588
40. Zarkhin V, Kambham N, Li L, Kwok S, Hsieh S-C, Salvatierra O, et al. Characterization of intra-graft B cells during renal allograft rejection. *Kidney Int* (2008) 74:664–73. doi:10.1038/ki.2008.249
41. Nasr IW, Reel M, Oberbarnscheidt MH, Mounzer RH, Baddoura FK, Ruddle NH, et al. Tertiary lymphoid tissues generate effector and memory T cells that lead to allograft rejection. *Am J Transplant* (2007) 7:1071–9. doi:10.1111/j.1600-6143.2007.01756.x
42. Lund FE, Randall TD. Effector and regulatory B cells: modulators of CD4+ T cell immunity. *Nat Rev Immunol* (2010) 10:236–47. doi:10.1038/nri2729
43. Harris DP, Haynes L, Sayles PC, Duso DK, Eaton SM, Lepak NM, et al. Reciprocal regulation of polarized cytokine production by effector B and T cells. *Nat Immunol* (2000) 1:475–82. doi:10.1038/82717
44. Menard LC, Minns LA, Darce S, Mielcarz DW, Foureau DM, Roos D, et al. B cells amplify IFN-γ production by T cells via a TNF-α-mediated mechanism. *J Immunol* (2007) 179:4857–66. doi:10.4049/jimmunol.179.7.4857
45. Wojciechowski W, Harris DP, Sprague F, Mousseau B, Makris M, Kusser K, et al. Cytokine-producing effector B cells regulate type 2 immunity to *H. polygyrus*. *Immunity* (2009) 30:421–33. doi:10.1016/j.immuni.2009.01.006
46. Thauinat O, Legendre C, Morelon E, Kreis H, Mamzer-Bruneel M-F. To biopsy or not to biopsy? Should we screen the histology of stable renal grafts? *Transplantation* (2007) 84:671–6. doi:10.1097/01.tp.0000282870.71282.ed
47. Rosser EC, Mauri C. Regulatory B cells: origin, phenotype, and function. *Immunity* (2015) 42:607–12. doi:10.1016/j.immuni.2015.04.005
48. Fillatreau S, Gray D, Anderton SM. Not always the bad guys: B cells as regulators of autoimmune pathology. *Nat Rev Immunol* (2008) 8:391–7. doi:10.1038/nri2315
49. Bouaziz J-D, Yanaba K, Tedder TF. Regulatory B cells as inhibitors of immune responses and inflammation. *Immunol Rev* (2008) 224:201–14. doi:10.1111/j.1600-065X.2008.00661.x
50. Thauinat O, Morelon E, Defrance T. Am^Bvalent: anti-CD20 antibodies unravel the dual role of B cells in immunopathogenesis. *Blood* (2010) 116:515–21. doi:10.1182/blood-2010-01-266668
51. Brouard S, Pallier A, Renaudin K, Foucher Y, Danger R, Devys A, et al. The natural history of clinical operational tolerance after kidney transplantation through twenty-seven cases. *Am J Transplant* (2012) 12:3296–307. doi:10.1111/j.1600-6143.2012.04249.x
52. Pallier A, Hillion S, Danger R, Giral M, Racapé M, Degauque N, et al. Patients with drug-free long-term graft function display increased numbers of peripheral B cells with a memory and inhibitory phenotype. *Kidney Int* (2010) 78:503–13. doi:10.1038/ki.2010.162
53. Newell KA, Asare A, Kirk AD, Gisler TD, Bourcier K, Suthanthiran M, et al. Identification of a B cell signature associated with renal transplant tolerance in humans. *J Clin Invest* (2010) 120:1836–47. doi:10.1172/JCI39933
54. Sagoo P, Perucha E, Sawitzki B, Tomiuk S, Stephens DA, Miquieu P, et al. Development of a cross-platform biomarker signature to detect renal transplant tolerance in humans. *J Clin Invest* (2010) 120:1848–61. doi:10.1172/JCI39922

55. Brown K, Sacks SH, Wong W. Tertiary lymphoid organs in renal allografts can be associated with donor-specific tolerance rather than rejection. *Eur J Immunol* (2011) 41:89–96. doi:10.1002/eji.201040759
56. Le Texier L, Thebault P, Lavault A, Usal C, Merieau E, Quillard T, et al. Long-term allograft tolerance is characterized by the accumulation of B cells exhibiting an inhibited profile. *Am J Transplant* (2011) 11:429–38. doi:10.1111/j.1600-6143.2010.03336.x
57. Li W, Bribriescio AC, Nava RG, Brescia AA, Ibricevic A, Spahn JH, et al. Lung transplant acceptance is facilitated by early events in the graft and is associated with lymphoid neogenesis. *Mucosal Immunol* (2012) 5:544–54. doi:10.1038/mi.2012.30
58. Hippen BE, DeMattos A, Cook WJ, Kew CE, Gaston RS. Association of CD20+ infiltrates with poorer clinical outcomes in acute cellular rejection of renal allografts. *Am J Transplant* (2005) 5:2248–52. doi:10.1111/j.1600-6143.2005.01009.x
59. Kayler LK, Lakkis FG, Morgan C, Basu A, Blisard D, Tan HP, et al. Acute cellular rejection with CD20-positive lymphoid clusters in kidney transplant patients following lymphocyte depletion. *Am J Transplant* (2007) 7:949–54. doi:10.1111/j.1600-6143.2007.01737.x
60. Bagnasco SM, Tsai W, Rahman MH, Kraus ES, Barisoni L, Vega R, et al. CD20-positive infiltrates in renal allograft biopsies with acute cellular rejection are not associated with worse graft survival. *Am J Transplant* (2007) 7:1968–73. doi:10.1111/j.1600-6143.2007.01885.x
61. Scheepstra C, Bemelman FJ, van der Loos C, Rowshani AT, van Donselaar-Van der Pant KAMI, Idu MM, et al. B cells in cluster or in a scattered pattern do not correlate with clinical outcome of renal allograft rejection. *Transplantation* (2008) 86:772–8. doi:10.1097/TP.0b013e3181860a74
62. Hwang HS, Song JH, Hyoung BJ, Lee SY, Jeon YJ, Kang SH, et al. Clinical impacts of CD38+ B cells on acute cellular rejection with CD20+ B cells in renal allograft. *Transplantation* (2010) 89:1489–95. doi:10.1097/TP.0b013e3181dd35b8
63. Martin L, Charon-Barra C, Bocré O, Guignier F, D'Atis P, Dautin G, et al. Detection of plasma cells, C4d deposits and donor-specific antibodies on sequential graft biopsies of renal transplant recipients with chronic dysfunction. *Transpl Immunol* (2010) 22:110–4. doi:10.1016/j.trim.2009.11.001
64. Abbas K, Mubarak M, Zafar MN, Aziz T, Abbas H, Muzaffar R, et al. Plasma cell-rich acute rejections in living-related kidney transplantation: a clinicopathological study of 50 cases. *Clin Transplant* (2015) 29:835–41. doi:10.1111/ctr.12589
65. Yamani MH, Ratliff NB, Starling RC, Tuzcu EM, Yu Y, Cook DJ, et al. Quilty lesions are associated with increased expression of vitronectin receptor (alpha v beta 3) and subsequent development of coronary vasculopathy. *J Heart Lung Transplant* (2003) 22:687–90. doi:10.1016/S1053-2498(02)01181-6
66. Chu KE, Ho EK, de la Torre L, Vasilescu ER, Marboe CC. The relationship of nodular endocardial infiltrates (Quilty lesions) to survival, patient age, anti-HLA antibodies, and coronary artery disease following heart transplantation. *Cardiovasc Pathol* (2005) 14:219–24. doi:10.1016/j.carpath.2005.03.009
67. Hiemann NE, Knosalla C, Wellnhofer E, Lehmkühl HB, Hetzer R, Meyer R. Quilty indicates increased risk for microvasculopathy and poor survival after heart transplantation. *J Heart Lung Transplant* (2008) 27:289–96. doi:10.1016/j.healun.2007.11.573
68. Zakliczynski M, Nozynski J, Konecka-Mrowka D, Pyka L, Trybunia D, Swierad M, et al. Quilty effect correlates with biopsy-proven acute cellular rejection but does not predict transplanted heart coronary artery vasculopathy. *J Heart Lung Transplant* (2009) 28:255–9. doi:10.1016/j.healun.2008.12.011
69. Frank R, Dean SA, Molina MR, Kamoun M, Lal P. Correlations of lymphocyte subset infiltrates with donor-specific antibodies and acute antibody-mediated rejection in endomyocardial biopsies. *Cardiovasc Pathol* (2015) 24:168–72. doi:10.1016/j.carpath.2014.11.001

Conflict of Interest Statement: The authors declare that the research was conducted in the absence of any commercial or financial relationships that could be construed as a potential conflict of interest.

Copyright © 2016 Koenig and Thauinat. This is an open-access article distributed under the terms of the Creative Commons Attribution License (CC BY). The use, distribution or reproduction in other forums is permitted, provided the original author(s) or licensor are credited and that the original publication in this journal is cited, in accordance with accepted academic practice. No use, distribution or reproduction is permitted which does not comply with these terms.

Annexe 2 : CD4+ T cell help is mandatory for naive and memory donor-specific antibody responses: impact of therapeutic immunosuppression



CD4+ T Cell Help Is Mandatory for Naive and Memory Donor-Specific Antibody Responses: Impact of Therapeutic Immunosuppression

Chien-Chia Chen^{1,2}, Alice Koenig¹, Carole Saison^{1,3}, Suzan Dahdal^{1,3}, Guillaume Rigault¹, Thomas Barba¹, Morgan Taillardet¹, Dimitri Chartoire¹, Michel Ovize^{2,4}, Emmanuel Morelon^{1,2,3,4}, Thierry Defrance¹ and Olivier Thaunat^{1,2,3,4*}

¹ French National Institute of Health and Medical Research (INSERM) Unit 1111, Lyon, France, ² IHU OPERA, Cardioprotection Laboratory, Hospices Civils de Lyon, CIC, Bron, France, ³ Edouard Herriot University Hospital, Department of Transplantation, Nephrology and Clinical Immunology, Lyon, France, ⁴ Lyon-Est Medical Faculty, Claude Bernard University Lyon 1, Lyon, France

OPEN ACCESS

Edited by:

Zhenhua Dai,
Guangdong Province Traditional
Chinese Medical Hospital, China

Reviewed by:

Lloyd Joseph Andrew D'Orsogna,
Fiona Stanley Hospital, Australia
Federica Casiraghi,
Istituto Di Ricerche Farmacologiche
Mario Negri, Italy

*Correspondence:

Olivier Thaunat
olivier.thaunat@inserm.fr

Specialty section:

This article was submitted to
Alloimmunity and Transplantation,
a section of the journal
Frontiers in Immunology

Received: 28 August 2017

Accepted: 30 January 2018

Published: 19 February 2018

Citation:

Chen C-C, Koenig A, Saison C,
Dahdal S, Rigault G, Barba T,
Taillardet M, Chartoire D, Ovize M,
Morelon E, Defrance T and
Thaunat O (2018) CD4+ T Cell Help
Is Mandatory for Naive and Memory
Donor-Specific Antibody Responses:
Impact of Therapeutic
Immunosuppression.
Front. Immunol. 9:275.
doi: 10.3389/fimmu.2018.00275

Antibody-mediated rejection is currently the leading cause of transplant failure. Prevailing dogma predicts that B cells differentiate into anti-donor-specific antibody (DSA)-producing plasma cells only with the help of CD4+ T cells. Yet, previous studies have shown that dependence on helper T cells decreases when high amounts of protein antigen are recruited to the spleen, two conditions potentially met by organ transplantation. This could explain why a significant proportion of transplant recipients develop DSA despite therapeutic immunosuppression. Using murine models, we confirmed that heart transplantation, but not skin grafting, is associated with accumulation of a high quantity of alloantigens in recipients' spleen. Nevertheless, neither naive nor memory DSA responses could be observed after transplantation of an allogeneic heart into recipients genetically deficient for CD4+ T cells. These findings suggest that DSA generation rather result from insufficient blockade of the helper function of CD4+ T cells by therapeutic immunosuppression. To test this second theory, different subsets of circulating T cells: CD8+, CD4+, and T follicular helper [CD4+CXCR5+, T follicular helper cells (Tfh)], were analyzed in 9 healthy controls and 22 renal recipients. In line with our hypothesis, we observed that triple maintenance immunosuppression (CNI + MMF + steroids) efficiently blocked activation-induced upregulation of CD25 on CD8+, but not on CD4+ T cells. Although the level of expression of CD40L and ICOS was lower on activated Tfh of immunosuppressed patients, the percentage of CD40L-expressing Tfh was the same than control patients, as was Tfh production of IL21. Induction therapy with antithymocyte globulin (ATG) resulted in prolonged depletion of Tfh and reduction of CD4+ T cells number with depleting monoclonal antibody in murine model resulted in exponential decrease in DSA titers. Furthermore, induction with ATG also had long-term beneficial influence on Tfh function after immune reconstitution. We conclude that CD4+ T cell help is mandatory for naive and memory DSA responses, making Tfh cells attractive targets for improving the prevention of DSA generation and to prolong allograft survival. Waiting for innovative treatments to be translated into the clinical field ATG induction seems to currently offer the best clinical prospect to achieve this goal.

Keywords: transplantation, transplant immunology, alloimmune response, antibody-mediated rejection, donor-specific antibody, immunosuppression

INTRODUCTION

Progress in therapeutic immunosuppression achieved over the last decades has dramatically reduced the incidence of T cell-mediated rejection, which is no longer considered as a significant cause of transplant loss (1).

Unexpectedly, this progress has barely impacted the half-life of transplanted organs that has stagnated over the same period (2). These disappointing results are due to the lack of impact of modern immunosuppressive drugs on the humoral arm of recipient's alloimmune response (3). Indeed, while under modern immunosuppression regimen, less than 10% of kidney recipients experience an acute cellular rejection episode, the prevalence of *de novo* anti-donor antibodies [donor specific antibody (DSA)] is estimated 10–20% 5 years posttransplantation (4, 5). Consequently, antibody-mediated rejection (AMR) is now widely recognized as the first cause of transplant failure (6–10).

Immunosuppressive drugs used in maintenance therapy mainly act on T cells (3, 11). However, from an immunological point of view, it is surprising that the strict control of cellular (i.e., T cell) immune response obtained with modern immunosuppressive armamentarium did not translate into a more profound impairment of the generation of DSA. Because of their protein nature, HLA molecules are indeed expected to behave as typical T-cell-dependent antigens, which means that donor-HLA specific B cells should be critically dependent upon the help of CD4+ T cells to differentiate into DSA-producing plasma cells (12). This apparent paradox suggests that, in transplantation, some DSA responses might be elicited without the help of CD4+ T cells.

This iconoclastic hypothesis is supported by experimental findings from the group of Zinkernagel that reported the generation of neutralizing antibody against vesicular stomatitis virus in CD4+ T cell-depleted mice (13). Interestingly, dependence on T cell help in this model went decreasing when increasing amounts of protein antigens were recruited to the spleen, leading the authors to conclude that both antigen dose and localization in secondary lymphoid organs are key to circumvent T cell help for induction of B cell responses (13).

It is noteworthy that organ transplantation could meet these two conditions since donor specific HLA molecules are highly expressed by the endothelial cells of graft vasculature, which is directly connected to recipient's vessels.

We, therefore, undertook this study to test whether transplant recipients could generate DSA in the absence of CD4+ T cell help.

MATERIALS AND METHODS

Human Study

To determine the capacity of T cells to get activated under immunosuppression, we prospectively enrolled 22 patients who underwent kidney transplantation at the Lyon University Hospital between 2015 and 2016. Inclusion criteria were (i) first transplantation (kidney or kidney–pancreas), (ii) no anti-HLA antibody at the time of the transplantation. These 22 patients were compared to 9 healthy controls.

Whole blood samples were collected by venepuncture into heparin-containing vials, once in controls and before

transplantation and at 3 months and 1 year after transplantation for transplanted patients.

Peripheral blood mononuclear cells (PBMCs) and plasma were isolated by Ficoll gradient centrifugation. Plasma was then centrifuged at 4,000 g for 10 min to remove platelets. PBMCs were plated 1 h in petri dishes to discard adherent cells (monocytes) and then 1×10^6 non-adherent cells were cultured 24 h at 37°C in 5% CO₂ in 1 mL of patient's own plasma (containing or not immunosuppressive drugs) in the presence or absence of human T-activator CD3/CD28 beads (Gibco Dynabeads®). For IL21 staining, 1 µL of Brefeldin A (BD Bioscience) was added for the last 5 h of the culture. After 24 h of culture, Dynabeads were removed with a magnet and PBMCs were analyzed by flow cytometry as detailed below.

This study was carried out in accordance with French legislation on biomedical research. All subjects gave written informed consent in accordance with the Declaration of Helsinki. The protocol and the biocollection were authorized by the Ministry of Research and the Rhône-Alpes Regional Health Agency (#AC-2011-1375 and #AC-2016-2706).

Mice

Wild-type C57BL/6 (H-2^b) and BALB/c (H-2^d) mice were purchased from Charles River Laboratories (Saint Germain sur l'Arbresle, France).

C57BL/6-Tg(CAG-EGFP)10sb/j (GFP) mice were purchased from The Jackson Laboratory (Bar Harbor, ME, USA).

MHC II knock out (A β KO) mice on C57BL/6 genetic background were provided by Dr. Benoist and Mathis (Boston, MA, USA) (14).

HLA A2 transgenic mice on C57BL/6 genetic background (15) were kindly provided by Dr Lemonnier (Paris, France).

RAG2 Knock Out (RAG2 KO) mice on C57BL/6 background came from CDTA (Cryopreservation Distribution Typage et Archivage animal, Orléans, France). Mice 8–15 weeks of age were used and maintained under specific pathogen-free conditions in our animal facility: Plateau de Biologie Expérimentale de la Souris (PBES, ENS Lyon, France).

This study was carried out in accordance with the French legislation on live animal experimentation. The protocol was approved both by local "CECCAPP" (<http://www.sfr-biosciences.fr/ethique/experimentation-animale/ceccapp>) and national AFiS ethical committees (#02870.01).

Models of Allosensitization

Skin Grafting

Skin grafting was performed using the method described by Billingham et al. (16). Briefly, a piece of skin graft about 1 cm \times 1 cm in size was harvested from the trunk of donor and it was then implanted on the back of the recipient, fixed by silk sutures, and protected for 7 days with bandage.

Heterotopic Heart Transplantation

Cervical heterotopic heart transplantations were performed as in Chen (17). Briefly, cardiac allografts were transplanted into subcutaneous space of right neck. Anastomoses were performed by connecting end-to-end the ascending aorta of the graft with

the recipient's common carotid artery and by pulling the main pulmonary artery with the external jugular vein.

Intravenous Allogeneic Cell Injection

To mimic the allosensitization that results from solid organ transplantation, 10×10^6 splenocytes from HLA A2 mice were injected intravenously to wild-type C57BL/6. In contrast with subcutaneous injection, IV injection of allogeneic splenocytes indeed allows delivering a high quantity of alloantigen to the spleen of recipient (Figure S1A in Supplementary Material) and triggered DSA generation (Figure S1B in Supplementary Material).

CD4+ T Cell Depletion *In Vivo*

Seminal experimental studies addressing the role of helper T cells in rejection *in vivo* have relied on the treatment of wild-type (WT) mice with depleting anti-CD4 monoclonal antibodies (mAbs) (18, 19).

In the present study, we used IP administration of GK1.5, a rat IgG2b anti-murine CD4 mAb (20), commonly used to induce CD4+ T cell depletion in mice (21).

Cell Lines

The human erythroleukemia cell line K562 (22) lacking expression of all MHC I and II molecules and the single antigen expressing cell line (SAL) A2, a K562 cell line transfected with plasmid coding for HLA A2 and selection genes for the resistance to neomycin and ampicillin (23) were kindly provided by Dr. Doxiadis (Leiden, The Netherlands).

K562 cells were cultured in RPMI-1640 (Invitrogen) complemented with fetal calf serum 10% (Dutscher), L-Glutamine 2 mM (Invitrogen), penicillin 100 U/mL, streptomycin 100 μ M, and HEPES 25 mM (Invitrogen).

Single antigen expressing cell line A2 cells were cultured in the same medium as K562 complemented with G418, a neomycin derivative (Invitrogen) at the concentration of 1.75 mg/mL.

Flow Cytometry

After a 24 h culture, human PBMCs were stained 30 min at room temperature in the dark with the relevant fluorescent antibodies directed against CD3 (UCHT1), CD4 (SK3), CD8 (SK1), CD25 (2 A3), CXCR5 (RF8B2), CD40L (TRAP1), IL21 (3A3-N2.1), ICOS (ISA-3); all from BD Biosciences except ISA-3 from ebioscience. Cells were then stained with and a viability dye LIVE/DEAD Aqua (Invitrogen) according to the manufacturer's instructions and fixed with Cytotfix/Cytoperm[®] fixation/permeabilization kit (BD Biosciences) before analysis.

A FACS ARIA II flow cytometer was used for flow cytometry. Data were analysed with BD FACS Diva software (BD Biosciences).

Murine single-cell suspensions from spleen, lymph nodes, thymus, or blood were incubated with a blocking anti-mouse Fc receptor antibody (2.4G2, home-made hybridoma). Cells were then incubated at 4°C with relevant fluorescent antibodies: CD3 (145-2C11), CD4 (RM4-4), CD8 (53-6.7) and CD19 (1D3) (all from BD Biosciences). Before analysis by flow cytometry, DAPI (4',6-diamidino-2-phenylindole dihydrochloride, Sigma-Aldrich) was added to the cell suspension to exclude dead cells. Samples acquisitions were made on a BD LSR II flow cytometer

(BD Biosciences). Data were analyzed with FlowJo software (Tree Star).

Cell Sorting and Adoptive Transfer of B Lymphocytes

For isolation of B lymphocytes, splenocytes from immunized mice were stained with phycoerythrin (PE)-conjugated antibodies against CD3 ϵ (145-2C11), CD4 (RM4-5), CD8 (53-6.7), CD11b (M1/70), CD11c (HL3), NK-1.1 (PK136), Ter119/Erythroid cells (TER-119), CD117 (2B8), and PerCP-Cy5.5 conjugated antibody against B220 (RA3-6B2) (all from BD Biosciences). After staining, cells were negatively separated by LD magnetic columns with anti-PE Microbeads labeling (Miltenyi Biotec). The separated cell suspensions underwent cell sorting by using a BD FACS Aria cell sorter (BD Biosciences) to collect PE negative and PerCP-Cy5.5 positive cells. 5×10^6 purified B lymphocytes were transferred to RAG2 KO mice by intravenous injection.

Detection of Anti-HLA A2 Antibodies

1×10^5 SAL A2 or K562 (negative control) cells were incubated with mice sera diluted at 1/1,000 for 30 min at 4°C. After washing, cells were stained with PE-conjugated anti-light chain antibody (187.1) (BD Biosciences) and analyzed by flow cytometry. To rule out the possibility to miss a low titer of anti-HLA A2 antibodies, all negative sera were systematically screened again at a 1/100 dilution. The titer of anti-HLA A2 antibodies at each time point (dx) was calculated with the following formula:

$$\text{normalised DSA titer} = \frac{MFI_{SAL}(dx) / MFI_{K562}(dx)}{MFI_{SAL}(d0) / MFI_{K562}(d0)}$$

The normalized DSA titer, therefore, reflects the fold increases of specific signal over the baseline (measured before transplantation).

Detection of Anti-HLA A2 Specific B Cells by ELISpot Assay

Single-cell suspensions were stained with PE-conjugated anti-B220 (RA3-6B2) (BD Biosciences). B cells were positively separated by passing through LS magnetic column with anti-PE microbeads labeling. After separation, cells underwent *in vitro* activation with a mixture of the TLR7/8 ligand R848 at 1 μ g/mL and recombinant mouse IL-2 at 10 ng/mL (Mabtech) for 72 h. Then, cells were cultured for 24 h in the 96-well plates pre-coated with capture anti-IgG antibody (ELISpot^{PLUS} mouse IgG kit, Mabtech). Detection of spots was performed by adding either anti-IgG biotinylated detection antibody (Mabtech) or biotin-labeled HLA-A*02:01 Pentamer (ProImmune) for 2 h, followed by incubation with streptavidin-ALP (Mabtech) for 1 h and development by BCIP/NBT-plus substrate (Mabtech).

Detection of Anti-NP Antibodies by ELISA

For some experiments, mice were immunized intraperitoneally with 75 μ g NP-KLH mixed with 100 μ L Inject Alum Adjuvant (Thermo Scientific, Courtaboeuf, France) or 200 μ g NP-Dextran. Preimmune sera and sera obtained once a week after immunization

were tested for IgM and IgG anti-NP antibodies. Maxisorp plates (Nunc) were coated with NP 23-conjugated BSA. Serially diluted serum samples were added for 1 h 30 at room temperature. Anti-NP IgM and IgG Abs were detected using alkaline phosphatase conjugated goat anti-mouse IgM or IgG Abs (1/2,000 dilution) followed by phosphatase substrate (Sigma-Aldrich). The plates were then read at 405 nm/490 nm with an automatic reader (Zeiss VERSAmax). OD was converted to concentration based on standard curves with sera from C57BL/6 mice immunized with NP-KLH using a four-parameter logistic equation (Softmax Pro 5.3 software; Molecular Devices).

Statistical Analyses

Statistical significance of differences was tested with chi-square test for proportions and non-parametric tests for continuous variables: Mann-Whitney or Kruskal-Wallis with Dunn's multiple comparisons for unpaired dataset and Friedman with Dunn's multiple comparisons for paired dataset.

Skin graft survivals were compared using the log-rank test.

The differences between the groups were considered statistically significant for $p < 0.05$ and were reported as asterisk symbols (* $p < 0.05$; ** $p < 0.01$; *** $p < 0.001$; **** $p < 0.0001$).

RESULTS

Presentation of the Experimental Model

$\text{A}\beta\text{KO}$ mice, which are genetically modified C57BL/6 mice devoid of CD4+ T cells were used as recipients. $\text{A}\beta\text{KO}$ mice lack major histocompatibility complex class II (MHCII) molecules (14). As a result, positive selection of CD4+ T cells can not occur in the thymus and $\text{A}\beta\text{KO}$ mice show near-complete elimination of CD4+ T lymphocytes in the periphery, the lymph nodes, and the spleen (Figure 1A). The few remaining detectable CD4+ T cells are anyhow unable to provide efficient help to B cells because the latter do not express MHCII. This was demonstrated by the complete abrogation of the IgG response to a NP-KLH, a model of thymo-dependent antigen (24) (Figure 1B). Importantly, this lack of IgG response in $\text{A}\beta\text{KO}$ mice was not due to an abnormal

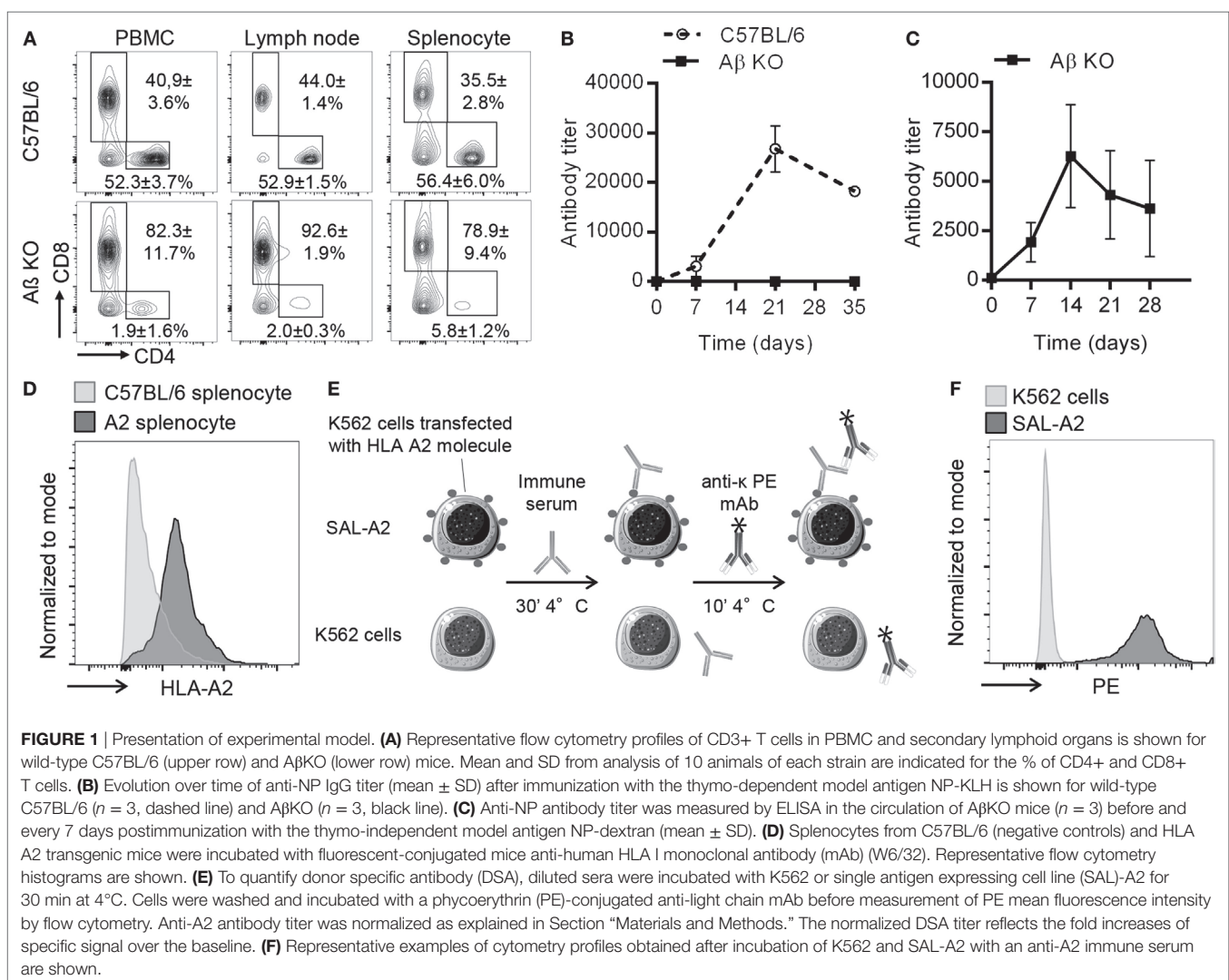

B cell compartment since (i) B-lymphocytes occur in normal numbers and are capable of terminal differentiation to plasma cells in these animals (14), and (ii) we showed that $A\beta$ KO mice indeed generated NP-specific IgM in response to vaccination with NP-dextran (**Figure 1C**), a model of thymo-independent antigen (25).

To simplify the monitoring of donor-specific antibody (DSA) response in recipient mice we used donors with the same genetic background (C57BL/6, H2^b) except for the transgenic expression of the human MHC I molecule HLA-A2 [kind gift from Dr Lemonnier (15); **Figure 1D**].

In this model, the DSA response, which is exclusively directed against the HLA-A2 molecule was easily monitored using single antigen-expressing (SAL-A2) cell line [kind gift from Doxiadis (23)] and the sensitive and specific flow cross match assay (**Figures 1E,F**), a technique routinely used for the follow-up of transplant recipients in the clinic (26).

CD4+ T Cell Help Is Mandatory for Naive DSA Response

Because $A\beta$ KO mice have a normal CD8+ T cell compartment (**Figure 1A**), they efficiently rejected an allogeneic A2 skin graft

with only a slight delay as compared with C57BL/6 WT controls (respective mean survival 14.75 ± 1.5 vs 8.75 ± 1.5 days, Log Rank: $p = 0.0058$; **Figure 2A**).

Donor-specific antibody response was monitored in naive recipients grafted with an A2 skin. Anti HLA-A2 alloantibodies appeared in the serum of WT recipients between day 7 and 14 post-transplantation, peaked at day 21, and decreased slowly thereafter with the elimination of alloantigens due to the rejection process (**Figure 2B**). No DSA could be detected in the serum of $A\beta$ KO.

These results confirm the conclusion of Steele et al. (27) who reported that CD4+ T cells are essential helper cells for B cell alloantibody production in a similar murine model of MHC-disparate skin graft rejection. However, in the study by Ochsenbein et al., dependence on T cell help went decreasing when increasing amounts of antigen were recruited to the spleen (13). One possibility to explain the lack of DSA response in $A\beta$ KO recipients grafted with A2 skin could be that this procedure provides too few alloantigens drained to the spleen of recipients (in contrast with transplantation, no vascular anastomosis is performed between the circulations of donor and recipient during grafting). To test this hypothesis, C57BL/6 donor mice transgenic for the green fluorescent protein (GFP+) were used as donor

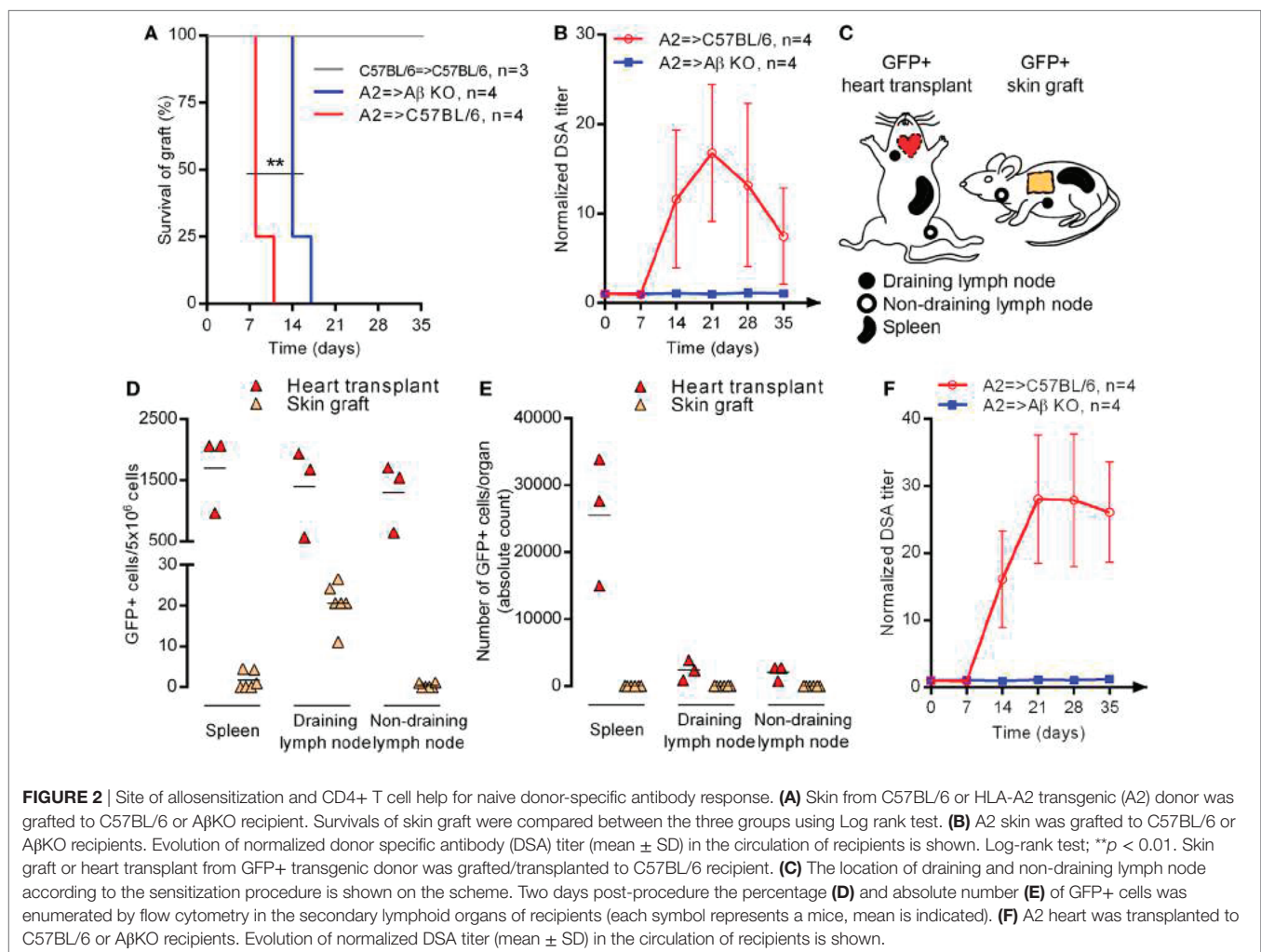

of skin graft or heart transplant (**Figure 2C**). The proportion (**Figure 2D**) and absolute number (**Figure 2E**) of GFP positive cells were quantified by flow cytometry at day 2 post-procedure in the draining lymph node, a distant non-draining lymph node, and the spleen of recipients. After skin grafting, only few GFP+ cells were detected, exclusively in the draining lymph node of recipient (**Figures 2D,E**). About 100 times more GFP+ cells were found in the draining lymph node of heart recipients. In addition, GFP+ cells were also detected in the spleen and the non-draining lymph node after heart transplantation (**Figure 2D**), demonstrating that alloantigens are drained through recipient's circulation after transplantation but not after grafting. In fact, when absolute numbers were considered, spleen appeared as the main site of allosensitization after transplantation (**Figure 2E**).

Despite these differences in alloantigen dose and localization in secondary lymphoid organs of recipients, we could not detect any DSA generation after A2 heart transplantation in A β KO recipients (**Figure 2F**). We conclude from this set of experiments that DSA generation in naive recipients requires CD4+ T cell help.

CD4+ T Cell Help Is Mandatory for Memory DSA Response

In contrast with laboratory mice, the immune system of which is largely naive (28), transplanted patients have an immune memory, including memory B cells (29). Interestingly, some studies have reported that ability of virus-specific memory B cells to secrete IgG is independent of cognate or bystander T cell help (30).

Transplantation with an A2 but not a BALB/c heart leads to the generation of anti-A2 specific memory B cells that could be readily quantified in recipients' spleen with ELISpot assay (**Figure 3A**). To determine whether the rechallenge of allospecific memory B cells can lead to the generation of DSA in the absence of CD4+ T cells, we passively transferred A2- or BALB/c-specific memory B cells to C57BL/6 RAG2 KO recipients (**Figure 3B**). C57BL/6 RAG2 KO mice lack the recombinase necessary for TCR and BCR rearrangements and are, therefore, devoid of T and B cells (**Figure 3C**). In addition to the high degree of purity achieved when isolating B cells ($99.83 \pm 0.21\%$, **Figure 3D**), we ensured that no CD4+ T cell remained in C57BL/6 RAG2 KO post-cell transfer by administering anti-CD4 mAb (**Figure 3B**). As expected, B cells (but neither CD4+ nor CD8+ T cells) could be detected in the circulation of transferred C57BL/6 RAG2 KO animals up to the end of the follow-up period (**Figure 3C**). Not only were B cells detectable in transferred C57BL/6 RAG2 KO mice, but A2-specific memory B cells were able to differentiate into DSA-producing plasma cells, as demonstrated by ELISpot assays conducted with splenocytes harvested 100 days post-transfer (**Figure 3E**).

However, and in striking contradiction with our hypothesis, the rechallenge of allospecific memory B cells with A2 heart did not lead to the generation of DSA in the absence of CD4+ T cells (**Figure 3F**). The mandatory nature of CD4+ T cell help for DSA generation in sensitized recipients was further confirmed by demonstrating that co-transfer of purified CD4+ T cells with memory B cells in C57BL/6 RAG2 KO mice was sufficient to restore alloantibody response after rechallenge (Figures S1C,D in Supplementary Material).

Impact of Maintenance Immunosuppression on T Follicular Helper Functions in the Clinic

Based on our previous results, it seems clear that DSA generation, both in naive and sensitized recipients, requires help from CD4+ T cells. The fact that, despite therapeutic immunosuppression, 10–20% of transplant recipients develop *de novo* DSA within 5 years posttransplantation (3–5), suggests that immunosuppressive drugs do not efficiently block CD4+ T cell help to B cells.

To test this hypothesis, we prospectively monitored circulating T cells in 22 immunosuppressed renal recipients, 3 months (3 M) and 12 months (12 M) posttransplantation (**Figure 4A**). Clinical characteristics of the cohort are presented **Table 1** and the trough levels of maintenance immunosuppressive drugs are shown **Figure 4B**. Immunosuppressed patients were compared to 9 age- and sex-matched healthy controls. Indeed, comparing the evolution of T cell parameters before *versus* after transplantation for the same patients would not have allowed to disentangle the impact of immunosuppressive drugs from that of the correction of end stage renal failure, which has a major impact on the immune system (31).

To test whether maintenance immunosuppressive regimen is able to block T cells activation, PBMCs of patients were cultured with anti-CD3/CD28 microbeads in the presence of patient's own plasma (**Figure 4A**). Surface expression of the α chain of IL-2 receptor (CD25) was used to monitor activation of CD8+ and CD4+ T cells (32). As expected, *in vitro* stimulation of T cells from healthy controls led to significant upregulation of CD25 expression on both CD4+ and CD8+ subsets (**Figure 4C**). Interestingly, while the presence of plasma containing immunosuppressive drugs significantly reduced activation-induced upregulation of CD25 on CD8+ T cells, it had no significant impact on CD4+ T cells (**Figure 4C**).

To further document the lack of impact of maintenance immunosuppression on thymo-dependent humoral immune response, we focused our analysis on T follicular helper cells (Tfh), a CD4+ T cell subset specialized for providing help to B cells (33, 34). Recent studies have indeed demonstrated that CD4+CXCR5+ human blood T cells represent the circulating compartment of Tfh (35), and we confirmed that CD3+CD4+CXCR5+Tfh could be detected in the circulation of both controls and transplanted patients (**Figure 4A**).

T follicular helper cells provide help to B cells through a variety of molecules that are either expressed on their surface: CD40L (36) and ICOS (37), or are secreted: IL-21, a type I cytokine recognized as the most potent driver of B cell terminal differentiation (38, 39). *In vitro* activation with anti-CD3/CD28 microbeads promoted the expression of CD40L (**Figure 4D**) and ICOS (**Figure 4E**) by the Tfh. As expected, triple maintenance immunosuppression significantly decreased the level of expression of both CD40L and ICOS on activated Tfh (**Figures 4D,E**). However, the impact of triple maintenance immunosuppression was incomplete because the drug combination failed to reduce the percentage of Tfh that expressed CD40L after stimulation (**Figure 4D**) or the production of IL21 by Tfh (**Figure 4F**).

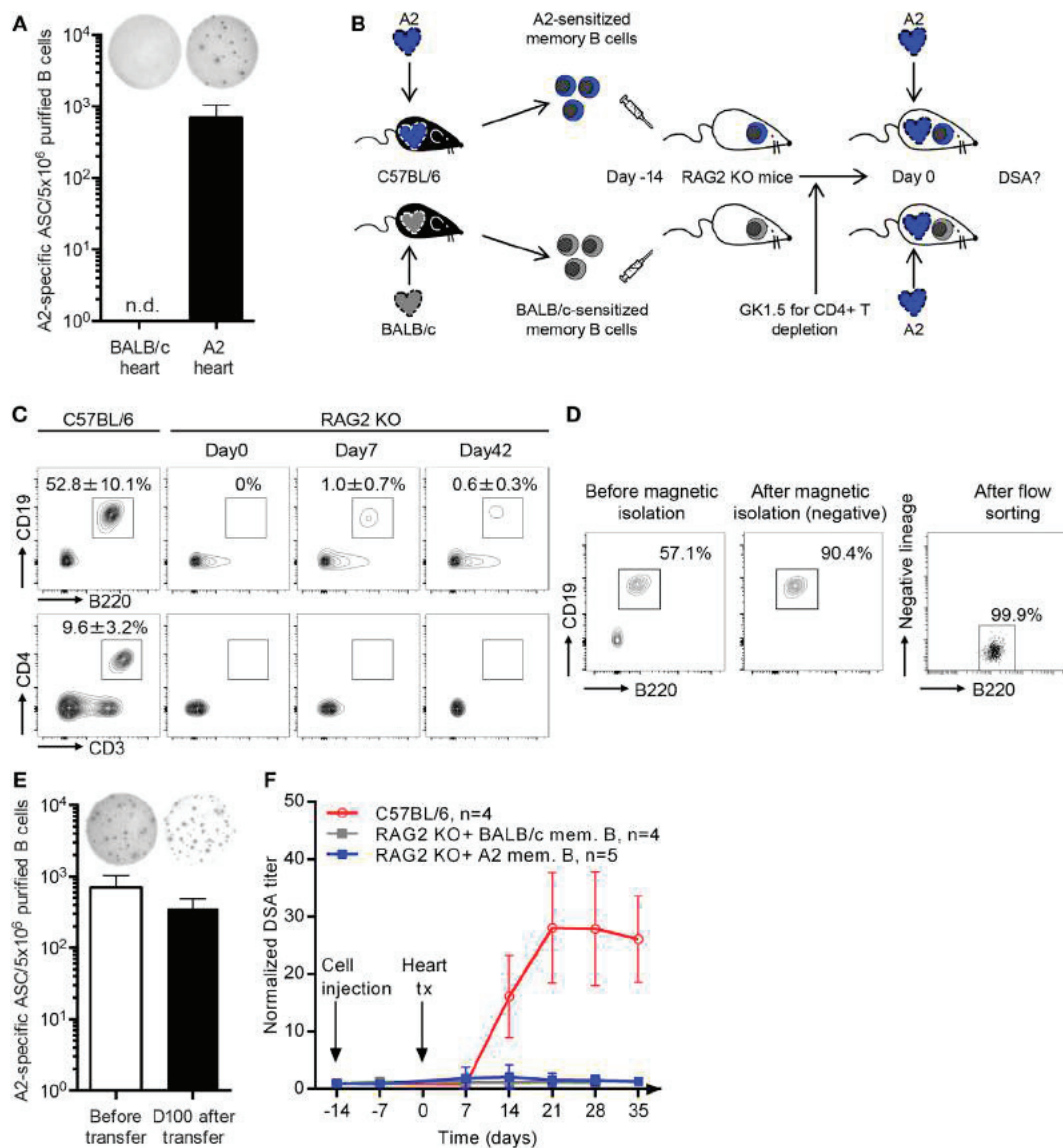

FIGURE 3 | CD4+ T cell help is mandatory for memory donor-specific antibody (DSA) response. **(A)** Allogeneic heart from HLA A2 transgenic (A2) or BALB/c donor was transplanted to C57BL/6 recipient. Fifty days posttransplantation HLA A2-specific memory B cells were enumerated in the spleen of recipients by ELISpot. Representative wells are shown and the number of A2-specific memory B cells (mean \pm SD) is plotted for the two groups ($n = 4$). **(B)** Graphical representation of the experimental setting used to evaluate the importance of CD4+ T cell help in memory DSA response. **(C)** Flow cytometry was used to quantify the proportion (mean \pm SD) of B cells (B220+CD19+) and helper T cells (CD3+CD4+) in controls (C57BL/6; left column) and RAG2 KO recipients before memory B cell transfer (day 0, second column from the left), just prior heart transplantation (day 7, third column from the left), and 42 days after A2 heart transplantation (right column). **(D)** The purity of B cell suspension, obtained from the spleen of C57BL/6 mice sensitized with a A2 or a BALB/c heart transplantation, was evaluated by flow cytometry: before magnetic isolation (left panel), after magnetic isolation (middle panel) and after flow sorting (just prior transfer to RAG2KO mice, left panel). **(E)** HLA A2-specific memory B cells were enumerated by ELISpot in B cell suspensions before transfer (left histogram) and in the spleen of RAG2 KO animals transplanted with an A2 heart 100 days after transfer (right histogram). **(F)** Evolution of normalized donor-specific antibody titer (mean \pm SD) was monitored in the circulation of 3 groups of recipients transplanted with an A2 heart: wild-type C57BL/6 (positive controls, dotted line), RAG2 KO transferred with anti-BALB/c memory B cells (negative controls, dashed line), and RAG2 KO transferred with anti-A2 memory B cells (experimental group, black line).

Reduction of CD4+ T Cells Number Dampens Naive and Memory DSA Responses

Transplanted patients often receive induction therapy at the time of transplantation to prevent acute rejection during the early posttransplantation period. Induction immunosuppressive

agents used in our center are either the lymphocyte-depleting agent rabbit antithymocyte globulin (ATG) or the anti-IL2 receptor mAb basiliximab, which is non-depleting.

Induction with ATG induced a 90% drop in the number of cTfh at 3 months (**Figure 5A**). Beyond this time point, the number of cTfh started to increase slowly and was no longer

significantly different from baseline at 1 year posttransplantation (Figure 5A). As expected, induction with the non-depleting agent, basiliximab was not followed by any reduction in cTfh

number. At the contrary, cTfh number was significantly increased (+36%) at 1 year posttransplantation in patients that received basiliximab (Figure 5A).

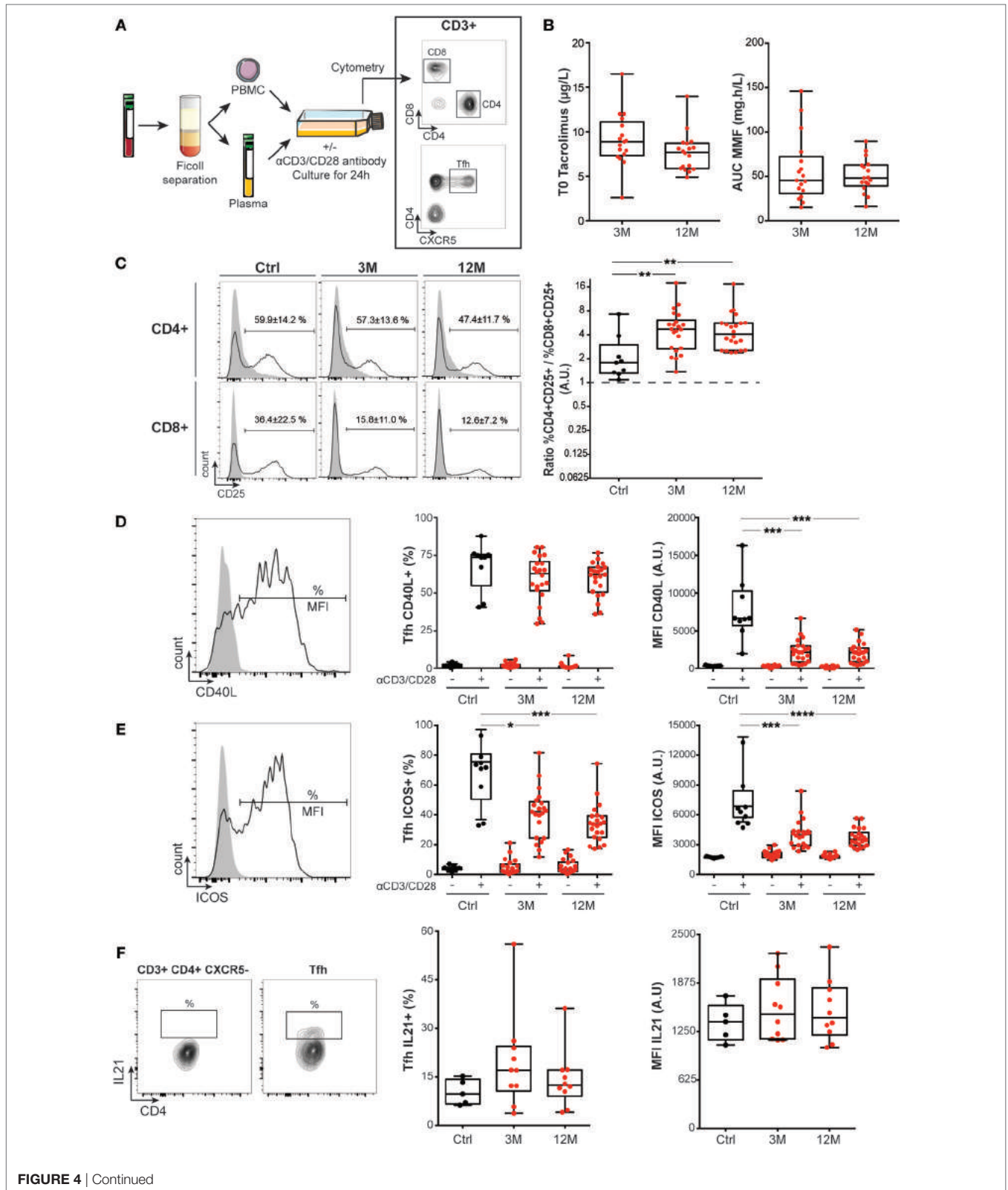

FIGURE 4 | Continued

FIGURE 4 | Impact of maintenance immunosuppression on CD4+ T cell activation in the clinic. **(A)** T cells were prospectively monitored in the circulation of 9 healthy controls and 22 patients after renal transplantation (3 months, 3M; and 12 months, 12M). Peripheral blood mononuclear cell (PBMC) and plasma (containing or not immunosuppressive drugs) were separated by Ficoll. **(B)** Tacrolimus trough levels (TO) and areas under the curve (AUC) of mycophenolate mofetil measured in the plasma of renal transplanted patients at 3 and 12M are plotted (each symbol is a patient). **(C)** Left panel: representative FACS profile of controls (Ctrl; left column) and renal recipients (3 M, middle column; 12 M, left column). The expression of the activation marker CD25 was measured by flow cytometry on the surface of CD4+ (top) and CD8+ (bottom) T cells. The analysis was performed after 24H culture in patient's own plasma without (gray area) or with (black line) stimulation with CD3/CD28 microbeads. The percentage of CD25-expressing T cells after stimulation is indicated (mean \pm SD). Right panel: the ratio of the percentage of CD4+ T cells expressing CD25 over the percentage of CD8+ T cells expressing CD25 after stimulation is plotted for the 9 controls (Ctrl, black symbols) and the 22 renal recipients at 3 and 12M (red symbols). Ratios were compared between Ctrl and renal recipients at M3 and M12: Kruskal–Wallis with Dunn's multiple comparisons. ** $p < 0.01$. **(D,E)** Flow cytometry was used to analyze the expression of helper molecules CD40L **(D)** or ICOS **(E)** on T follicular helper cells (Tfh) surface after 24H culture in control's patient's own plasma without (gray area) or with (black line) stimulation with CD3/CD28 microbeads. Left panel: representative FACS profile. Middle panel: percentage of Tfh that express the helper molecule. Right panel: level of expression of the helper molecule [mean fluorescence intensity (MFI)]. Each control (Ctrl, black) and renal recipient at 3 and 12M (red) is a symbol. **(F)** Flow cytometry was used to analyze the production of IL21 by Tfh in controls (Ctrl, black symbols) and renal recipients at 3 and 12M posttransplantation (red symbols) for whom frozen PBMCs were available. Left panel: representative FACS profile. Middle: percentage of IL21-expressing Tfh. Right: level of expression of IL21 (MFI). Percentage of positive Tfh and MFI were compared between Ctrl and renal recipients at M3 and M12: Kruskal–Wallis with Dunn's multiple comparisons. * $p < 0.05$; ** $p < 0.001$; *** $p < 0.0001$.

TABLE 1 | Characteristics of study population.

Recipients <i>n</i> (%) or mean \pm SD	All pts	ATG	Basilix	<i>p</i> -Value*
	22 (100)	11 (50)	11 (50)	
Age at transplantation (years)	47 \pm 13	47 \pm 16	47 \pm 9	0.99
Men	14 (64)	6 (55)	8 (73)	0.66
Cause of ESRD				0.09
Glomerulonephritis	7 (31)	3 (27)	4 (36)	
Diabetes mellitus	8 (36)	6 (55)	2 (18)	
ADPKD	3 (14)	2 (18)	1 (9)	
Other	4 (18)	0 (0)	4 (36)	
Duration of dialysis before Tx (months)	22 \pm 14	23 \pm 12	21 \pm 16	0.38
Donors				
Donor age (years)	47 (13)	43 \pm 14	47 \pm 9	0.43
Men	13 (50)	6 (55)	4 (36)	0.67
Deceased donor	21 (81)	10 (91)	8 (73)	0.47
Expanded criteria donor	11 (42)	5 (45)	4 (36)	1
Transplantation				
Number of HLA MisMX (A, B, DR)	3.7 \pm 1.6	4.3 \pm 1.5	3.2 \pm 1.6	0.10
Cold ischemia time (hours)	11 \pm 6	12 \pm 4	11 \pm 6	0.47
Induction therapy				Not tested
Antithymocyte globulin (rabbit)	11 (50)	11 (100)	0 (0)	
Basiliximab	11 (50)	0 (0)	11 (100)	
Maintenance immunosuppression				0.54
Tacrolimus	16 (73)	9 (82)	7 (66)	
Cyclosporin	6 (27)	2 (18)	4 (36)	
Everolimus	2 (9)	0 (0)	2 (18)	
Mycophenolate Mofetil	20 (91)	11 (100)	9 (82)	
Corticosteroids	22 (100)	11 (100)	11 (100)	

ADPKD, autosomal dominant polycystic kidney disease; ATG, antithymocyte globulin; Basilix, basiliximab; ESRD, end-stage renal disease; MisMX, mismatches.

*Comparison between patients induced with ATG and basiliximab: chi-square test for comparison of proportions and Mann–Whitney test for comparison of continuous variables.

Our previous results indicate that while maintenance immunosuppression does not completely block Tfh functions, a prolonged depletion of cTfh can be achieved following induction with a depleting agent. We, therefore, analyzed the impact of such prolonged depletion in CD4+ T cells on naive and memory experimental DSA responses.

GK1.5 (20) is a rat IgG2b anti-murine CD4 mAb commonly used to induce CD4+ T cell depletion in mice (21). Using

repeated IV administrations of different doses of GK1.5, we were able to obtain various levels of CD4+ T cell depletion (Figure 5B). Due to (i) the large number of animals to be analyzed and (ii) the complexity of microsurgical models of transplantation (sequential transplantation of two hearts in the cervical area of the same mice is unfeasible, making analysis of memory response impossible), we used a simplified model of allosensitisation (presented in Figure S1 in Supplementary Material). DSA responses of C57BL/6 WT mice were induced by IV injection of purified splenocytes from HLA-A2 transgenic mice (Figure 5C). CD4+ T cell depletion did not change the kinetic of DSA generation but resulted in significant reduction of DSA titers both in naive and memory responses (Figure 5D). Importantly, DSA titers strongly correlated with the number of remaining CD4+ T cells of recipient mice in an exponential regression model (r^2 for naive and memory responses, respectively, 0.86 and 0.84, Figure 5E).

Long-term Effect of ATG Induction on Tfh Functionality

Recovery of peripheral T-cell counts, including cTfh occurred gradually after cessation of ATG treatment (Figure 5A). However, beyond the quantitative impact of ATG, several studies have documented a long-term qualitative influence of the drug on T cell compartment (40). To determine if ATG induction could have long-term effects on Tfh function, we compared the profile of cTfh of renal recipients that received ATG or basiliximab as induction. The two groups did not differ regarding their clinical characteristics (Table 1) or maintenance regimen (Table 1; Figure 6A). Although cTfh functions of the two groups were similar before transplantation (Figures 6B,C), cTfh of renal recipients that received ATG exhibited a significantly reduced activation-induced upregulation of CD40L (Figure 6B) and a similar trend was observed for ICOS (Figure 6C).

These results suggest that ATG induction could reduce the incidence of *de novo* DSA after renal transplantation. We were, however, unable to test this hypothesis in this study because only three patients of the 22 enrolled, have developed *de novo* DSA over the follow-up period (2 in the group ATG induction, 1 in the group basiliximab induction).

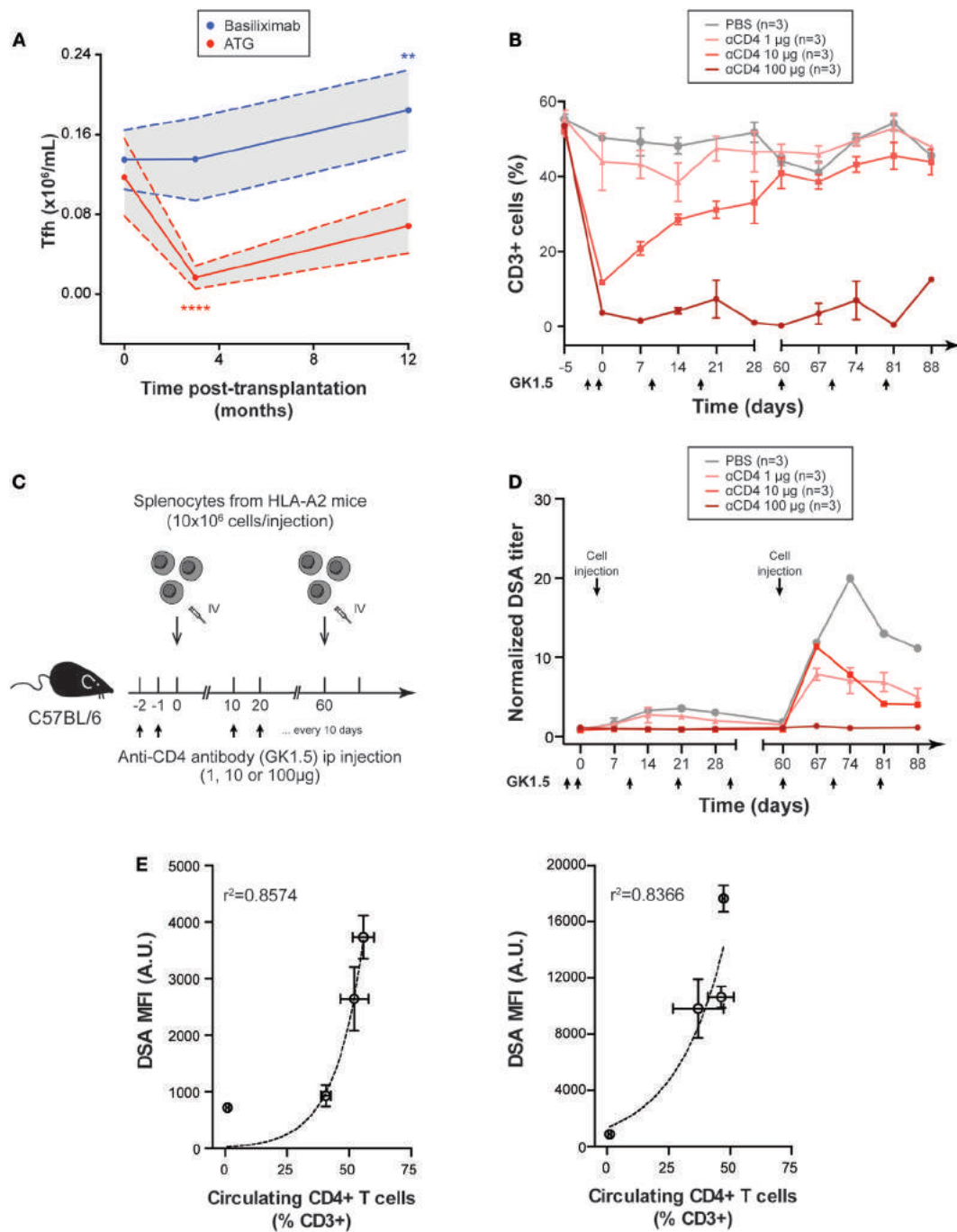
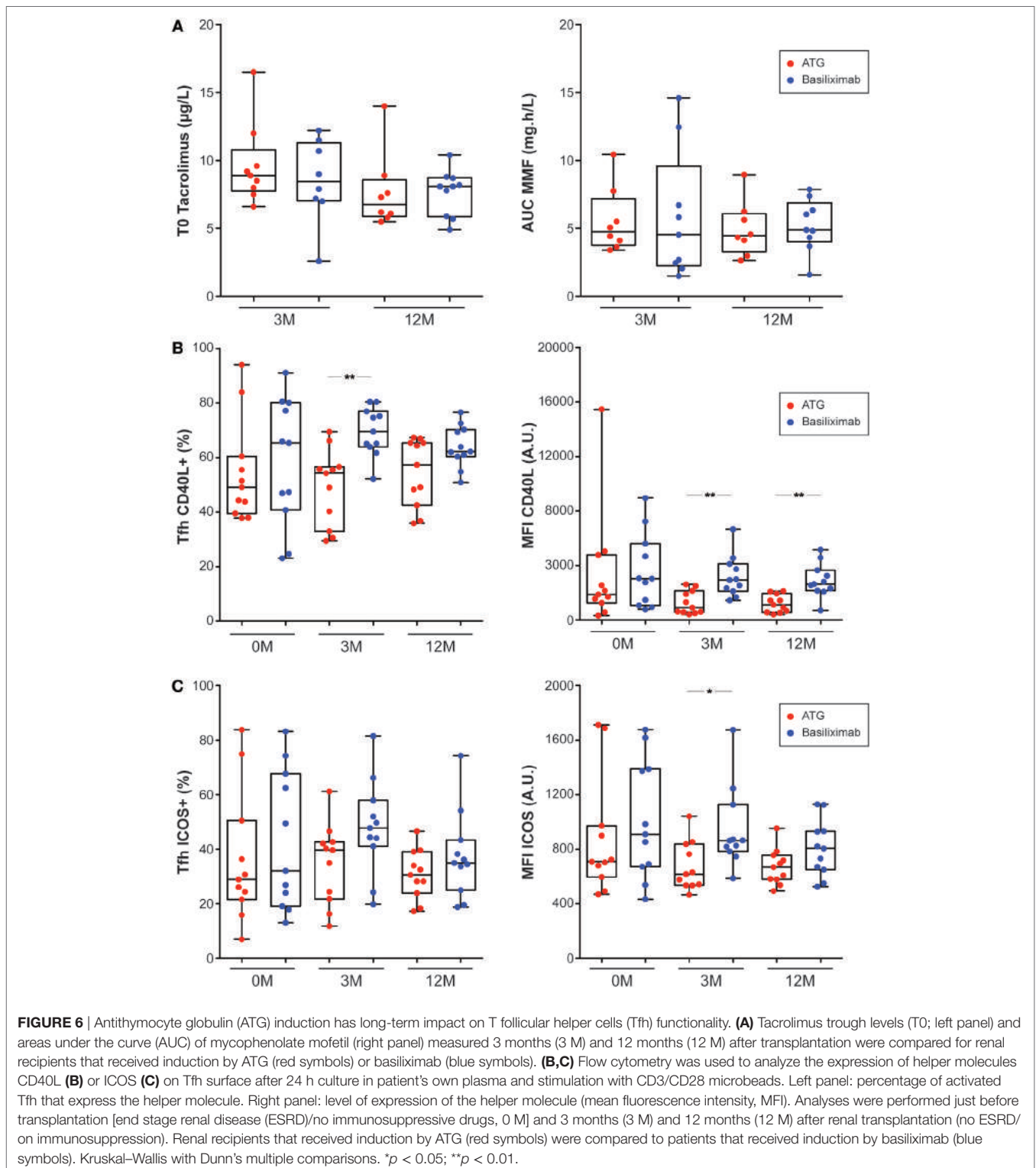

FIGURE 5 | Reduction of CD4+ T cells number dampens donor specific antibody (DSA) responses. **(A)** The number of circulating T follicular helper cells was evaluated in the cohort of 22 renal transplanted patients by flow cytometry and compared according to the nature of immunosuppressive drug used for induction: rabbit anti-thymoglobulin (anti-thymocyte globulin, red line; $n = 11$) or basiliximab (blue line; $n = 11$). Gray areas indicate 95 confidence intervals. Friedman paired test with Dunn's multiple comparisons. $**p < 0.01$; $****p < 0.0001$. **(B)** Various doses of anti-CD4 mAb GK1.5 were sequentially administered IP to wild-type C57BL/6 mice to obtain various level of CD4+ T cell depletion ($n = 3$ mice per group). Black arrows indicate the timing of mAb administrations. Evolution of the % of CD3+ cells in peripheral blood mononuclear cell (PBMC) (mean \pm SD) over time is shown in the control (PBS) and the three experimental groups. **(C)** Graphical representation of the experimental setting used to evaluate the impact of the reduction of circulating CD4+ T cells number on naive and memory DSA responses. C57BL/6 mice were depleted with various dose of anti-CD4 mAb GK1.5 and sensitized at day 0 (naive response) and day 60 (memory response) by IV injection of 10×10^6 PBMC from A2 transgenic donors. **(D)** Evolution of normalized DSA titer (mean \pm SD) in the circulation of the control (PBS) and the three experimental groups with various level of CD4 + T cell depletion is shown. **(E)** The relation between the number of circulating CD4+ T cells and DSA titer is shown for naive (left panel) and memory (right panel) responses (mean \pm SD). Exponential regression models are plotted (dashed line).



DISCUSSION

In this translational study, we confirmed that CD4+ T cells are essential for DSA generation in a murine model of MHC-disparate skin graft rejection (27). In contrast with grafting procedure (in which allosensitisation of recipient's immune system takes place

in the nearby draining lymph node), organ transplantation leads to the accumulation of donor-derived alloantigens in the spleen of recipients. While this condition was previously reported to abolish the dependence on T cell help for the generation of antibody against viral protein antigens (13, 30), neither naive nor sensitized mice developed DSA after heart transplantation in the absence of

CD4+ T cells. These data along with other recent experimental studies (41, 42) demonstrate that CD4+ T cell help is mandatory for both naive and memory DSA responses after transplantation.

It implies that transplanted patients that develop DSA must have maintained a certain level of CD4+ T cell functionality despite immunosuppressive drugs. To test this theory, we analyzed the impact of therapeutic immunosuppression on circulating CD4+ T cells in a cohort of 22 renal transplanted patients. In contrast with CD8+ T cells, exposure to the cocktail of drugs used for maintenance immunosuppression did not change significantly the ability of CD4+ T cells to upregulate the activation marker CD25 upon CD3/CD28 stimulation. Further analyses, focused on Tfh, the subset specialized for providing help to B cells (33, 34), confirmed that maintenance immunosuppression only partially reduced CD40L and ICOS expression on activated Tfh surface and had no effect on their secretion of IL-21. These findings provide molecular explanations as to why cTfh isolated from renal transplanted patients retain the capacity to induce B cell differentiation into immunoglobulin-producing plasmablasts *in vitro*, as recently reported by an independent group (43).

Altogether our data suggest that, beyond non-adherence to immunosuppressive drugs, which has been identified in ~50% of patients that develop AMR (5, 8), the inability of maintenance immunosuppression to adequately block Tfh helper function is also a major cause for DSA generation posttransplantation.

While maintenance immunosuppressive drugs cocktail does not block Tfh function, our data indicate that it is possible to achieve prolonged Tfh depletion in patients if ATG is used as induction therapy. Interestingly, murine experimental model revealed an exponential positive correlation between the number of CD4+ T cells and DSA titers generated both in primary and memory alloimmune responses. Furthermore, beyond its quantitative impact, ATG might also have a beneficial long-term influence on Tfh functionality after reconstitution. Indeed, cTfh of renal transplanted patients induced with ATG exhibited significantly reduced activation-induced upregulation of CD40L and ICOS as compared with cTfh of patients induced with basiliximab. These experimental findings are consistent with the clinical observation by Brokhof et al., which, as compared to basiliximab, induction with ATG is associated with a reduction in the occurrence of *de novo* DSA and AMR in a cohort of 114 renal transplant recipients (3, 44).

We conclude that CD4+ T cell help is mandatory for both naive and memory DSA responses after transplantation and is not adequately blocked by current maintenance immunosuppressive drugs. Why these drugs, which are so effective in blocking CD8+ T cell-mediated cellular rejection, do not show similar efficiency on CD4+ T cell helper function is an important issue that future molecular studies will have to elucidate. Specific pathways involved in helper functions of Tfh indeed represent attractive targets for improving the prevention of DSA generation, and thereby to prolong allograft survival. In this regard, positive preliminary results reported with strategies aiming at blocking costimulation (45) or IL21 pathway (43) represent promising attempts. Waiting for these innovative treatments to be translated into the clinical field, it is important to keep in mind that ATG induction could be effective to limit DSA response after transplantation through both quantitative and qualitative impacts on Tfh subset.

ETHICS STATEMENT

This study was carried out in accordance with French legislation on biomedical research. All subjects gave written informed consent in accordance with the Declaration of Helsinki. The protocol and the biocollection were authorized by the Ministry of Research and the Rhône-Alpes Regional Health Agency (#AC-2011-1375 and #AC-2016-2706). This study was carried out in accordance with the French legislation on live animal experimentation. The protocol was approved both by local "CECCAPP" (<http://www.sfr-biosciences.fr/ethique/experimentation-animale/ceccapp>) and national AFiS ethical committees (#02870.01).

AUTHOR CONTRIBUTIONS

Conception and design of the experiments: C-CC, AK, OT. Acquisition, analysis, and interpretation of data: C-CC, AK, CS, SD, GR, TB, MT, DC, OT. Drafting the MS: C-CC, MO, EM, TD, and OT.

ACKNOWLEDGMENTS

We are thankful to Laurent Genestier for fruitful scientific discussions. We are indebted to Drs François Lemonnier and Ilias Doxiadis for providing us with, respectively, the HLA A2 transgenic mice and the SAL A2 cell line.

FUNDING

OT is supported by the Agence Nationale pour la Recherche (ANR-12-PDOC-001), the Agence de la Biomédecine (AOR-2015), the Société Francophone de Transplantation. GR received a research grant from the university hospital of Grenoble, France. C-CC, MO, EM, and OT are supported by the IHU OPERA (ANR-10-IBHU-004). EM and OT are members of the CENTAURE Transplantation Research Network.

SUPPLEMENTARY MATERIAL

The Supplementary Material for this article can be found online at <http://www.frontiersin.org/articles/10.3389/fimmu.2018.00275/full#supplementary-material>.

FIGURE S1 | Intravenous allogeneic cell injection model. **(A)** Upper panel: cell suspension was prepared from the spleen of a GFP transgenic mice and 10×10^6 GFP+ splenocytes were injected intravenously (i.v. red) or subcutaneously (s.c. blue) to wild-type C57BL/6 mice. Lower panel: 2 days post-procedure the percentage GFP+ cells was enumerated by flow cytometry in the secondary lymphoid organs of recipients (each symbol represents a mice; mean \pm SD is indicated). **(B)** Upper panel: cell suspension was prepared from the spleen of an HLA A2 mice and 10×10^6 splenocytes were injected intravenously (red, $n = 3$) or subcutaneously (blue, $n = 3$) to wild-type C57BL/6 mice. Lower panel: evolution of normalized donor specific antibody (DSA) titer (mean \pm SD) in the circulation of recipients is shown. **(C)** Graphical representation of the experimental setting used to evaluate the importance of CD4+ T cell help in memory donor-specific antibody response. **(D)** Evolution of normalized DSA titer (mean \pm SD) was monitored in the circulation of three groups of recipients sensitized by IV injection of A2 splenocytes: RAG2 KO transferred with anti-A2 memory B and CD4+ T cells (red line; $n = 3$), RAG2 KO transferred with anti-A2 memory B cells alone (red dashed line; $n = 3$) and untransferred RAG2 KO (gray line; $n = 3$).

REFERENCES

- Halloran PF, Chang J, Famulski K, Hidalgo LG, Salazar ID, Merino Lopez M, et al. Disappearance of T cell-mediated rejection despite continued antibody-mediated rejection in late kidney transplant recipients. *J Am Soc Nephrol* (2015) 26(7):1711–20. doi:10.1681/ASN.2014060588
- Lodhi SA, Lamb KE, Meier-Kriesche HU. Improving long-term outcomes for transplant patients: making the case for long-term disease-specific and multidisciplinary research. *Am J Transplant* (2011) 11(10):2264–5. doi:10.1111/j.1600-6143.2011.03713.x
- Thaunat O, Koenig A, Leibler C, Grimbert P. Effect of immunosuppressive drugs on humoral allosensitization after kidney transplant. *J Am Soc Nephrol* (2016) 27(7):1890–900. doi:10.1681/ASN.2015070781
- Everly MJ, Rebellato LM, Haisch CE, Ozawa M, Parker K, Briley KP, et al. Incidence and impact of de novo donor-specific alloantibody in primary renal allografts. *Transplantation* (2013) 95(3):410–7. doi:10.1097/TP.0b013e31827d62e3
- Wiebe C, Gibson IW, Blydt-Hansen TD, Pochinco D, Birk PE, Ho J, et al. Rates and determinants of progression to graft failure in kidney allograft recipients with de novo donor-specific antibody. *Am J Transplant* (2015) 15(11):2921–30. doi:10.1111/ajt.13347
- Einecke G, Sis B, Reeve J, Mengel M, Campbell PM, Hidalgo LG, et al. Antibody-mediated microcirculation injury is the major cause of late kidney transplant failure. *Am J Transplant* (2009) 9(11):2520–31. doi:10.1111/j.1600-6143.2009.02799.x
- Gaston RS, Cecka JM, Kasiske BL, Fieberg AM, Leduc R, Cosio FC, et al. Evidence for antibody-mediated injury as a major determinant of late kidney allograft failure. *Transplantation* (2010) 90(1):68–74. doi:10.1097/TP.0b013e3181e065de
- Sellares J, de Freitas DG, Mengel M, Reeve J, Einecke G, Sis B, et al. Understanding the causes of kidney transplant failure: the dominant role of antibody-mediated rejection and nonadherence. *Am J Transplant* (2012) 12(2):388–99. doi:10.1111/j.1600-6143.2011.03840.x
- Thaunat O. Humoral immunity in chronic allograft rejection: puzzle pieces come together. *Transpl Immunol* (2012) 26(2–3):101–6. doi:10.1016/j.trim.2011.11.003
- Pouliquen E, Koenig A, Chen CC, Sicard A, Rabeyrin M, Morelon E, et al. Recent advances in renal transplantation: antibody-mediated rejection takes center stage. *F1000Prime Rep* (2015) 7:51. doi:10.12703/P7-51
- Heidt S, Roelen DL, Eijnsink C, Eikmans M, van Kooten C, Claas FH, et al. Calcineurin inhibitors affect B cell antibody responses indirectly by interfering with T cell help. *Clin Exp Immunol* (2010) 159(2):199–207. doi:10.1111/j.1365-2249.2009.04051.x
- Lanzavecchia A. Antigen-specific interaction between T and B cells. *Nature* (1985) 314(6011):537–9. doi:10.1038/314537a0
- Ochsenbein AF, Pinschewer DD, Odermatt B, Ciurea A, Hengartner H, Zinkernagel RM. Correlation of T cell independence of antibody responses with antigen dose reaching secondary lymphoid organs: implications for splenectomized patients and vaccine design. *J Immunol* (2000) 164(12):6296–302. doi:10.4049/jimmunol.164.12.6296
- Cosgrove D, Gray D, Dierich A, Kaufman J, Lemeur M, Benoist C, et al. Mice lacking MHC class II molecules. *Cell* (1991) 66(5):1051–66. doi:10.1016/0092-8674(91)90448-8
- Pascolo S, Bervas N, Ure JM, Smith AG, Lemonnier FA, Perarnau B. HLA-A2.1-restricted education and cytolytic activity of CD8(+) T lymphocytes from beta2 microglobulin (beta2m) HLA-A2.1 monochain transgenic H-2Db beta2m double knockout mice. *J Exp Med* (1997) 185(12):2043–51. doi:10.1084/jem.185.12.2043
- Billingham RE, Brent L, Medawar PB, Sparrow EM. Quantitative studies on tissue transplantation immunity. I. The survival times of skin homografts exchanged between members of different inbred strains of mice. *Proc R Soc Lond B Biol Sci* (1954) 143(910):43–58. doi:10.1098/rspb.1954.0053
- Chen ZH. A technique of cervical heterotopic heart transplantation in mice. *Transplantation* (1991) 52(6):1099–101. doi:10.1097/00007890-199112000-00035
- Cobbold S, Waldmann H. Skin allograft rejection by L3/T4+ and Lyt-2+ T cell subsets. *Transplantation* (1986) 41(5):634–9. doi:10.1097/00007890-198605000-00016
- Madsen JC, Peugh WN, Wood KJ, Morris PJ. The effect of anti-L3T4 monoclonal antibody treatment on first-set rejection of murine cardiac allografts. *Transplantation* (1987) 44(6):849–52. doi:10.1097/00007890-198712000-00029
- Dialynas DP, Quan ZS, Wall KA, Pierres A, Quintans J, Loken MR, et al. Characterization of the murine T cell surface molecule, designated L3T4, identified by monoclonal antibody GK1.5: similarity of L3T4 to the human Leu-3/T4 molecule. *J Immunol* (1983) 131(5):2445–51.
- Cobbold SP, Jayasuriya A, Nash A, Prospero TD, Waldmann H. Therapy with monoclonal antibodies by elimination of T-cell subsets in vivo. *Nature* (1984) 312(5994):548–51. doi:10.1038/312548a0
- Lozzio CB, Lozzio BB. Human chronic myelogenous leukemia cell-line with positive Philadelphia chromosome. *Blood* (1975) 45(3):321–34.
- Zoet YM, Eijnsink C, Kardol MJ, Franke-van Dijk ME, Wilson GL, de Paus R, et al. The single antigen expressing lines (SALs) concept: an excellent tool for screening for HLA-specific antibodies. *Hum Immunol* (2005) 66(5):519–25. doi:10.1016/j.humimm.2005.01.007
- Smith FI, Tesch H, Rajewsky K. Heterogeneous and monoclonal helper T cells induce similar anti-(4-hydroxy-3-nitrophenyl)acetyl (NP) antibody populations in the primary adoptive response. II. Lambda light chain dominance and idiotope expression. *Eur J Immunol* (1984) 14(2):195–200. doi:10.1002/eji.1830140216
- Sverremark E, Fernandez C. Unresponsiveness following immunization with the T-cell-independent antigen dextran B512. Can it be abrogated? *Immunology* (1998) 95(3):402–8.
- Bachelet T, Visentin J, Guidicelli G, Merville P, Couzi L, Taupin JL. Anti-HLA donor-specific antibodies are not created equally. Don't forget the flow. *Transpl Int* (2016) 29(4):508–10. doi:10.1111/tri.12745
- Steele DJ, Laufer TM, Smiley ST, Ando Y, Grusby MJ, Glimcher LH, et al. Two levels of help for B cell alloantibody production. *J Exp Med* (1996) 183(2):699–703. doi:10.1084/jem.183.2.699
- Beura LK, Hamilton SE, Bi K, Schenkel JM, Odumade OA, Casey KA, et al. Normalizing the environment recapitulates adult human immune traits in laboratory mice. *Nature* (2016) 532(7600):512–6. doi:10.1038/nature17655
- Lucia M, Luque S, Crespo E, Melilli E, Cruzado JM, Martorell J, et al. Preformed circulating HLA-specific memory B cells predict high risk of humoral rejection in kidney transplantation. *Kidney Int* (2015) 88(4):874–87. doi:10.1038/ki.2015.205
- Hebeis BJ, Klenovsek K, Rohwer P, Ritter U, Schneider A, Mach M, et al. Activation of virus-specific memory B cells in the absence of T cell help. *J Exp Med* (2004) 199(4):593–602. doi:10.1084/jem.20030091
- Betjes MG. Immune cell dysfunction and inflammation in end-stage renal disease. *Nat Rev Nephrol* (2013) 9(5):255–65. doi:10.1038/nrneph.2013.44
- Caruso A, Licenziati S, Corulli M, Canaris AD, De Francesco MA, Fiorentini S, et al. Flow cytometric analysis of activation markers on stimulated T cells and their correlation with cell proliferation. *Cytometry* (1997) 27(1):71–6. doi:10.1002/(SICI)1097-0320(19970101)27:1<71::AID-CYTO9>3.0.CO;2-O
- King C, Tangye SG, Mackay CR. T follicular helper (TFH) cells in normal and dysregulated immune responses. *Annu Rev Immunol* (2008) 26:741–66. doi:10.1146/annurev.immunol.26.021607.090344
- Fazilleau N, Mark L, McHeyzer-Williams LJ, McHeyzer-Williams MG. Follicular helper T cells: lineage and location. *Immunity* (2009) 30(3):324–35. doi:10.1016/j.immuni.2009.03.003
- Morita R, Schmitt N, Bentebibel SE, Ranganathan R, Bourdery L, Zurawski G, et al. Human blood CXCR5(+)CD4(+) T cells are counterparts of T follicular cells and contain specific subsets that differentially support antibody secretion. *Immunity* (2011) 34(1):108–21. doi:10.1016/j.immuni.2010.12.012
- Banchereau J, Bazan F, Blanchard D, Briere F, Galizzi JP, van Kooten C, et al. The CD40 antigen and its ligand. *Annu Rev Immunol* (1994) 12:881–922. doi:10.1146/annurev.iy.12.040194.004313
- Crotty S. Follicular helper CD4 T cells (TFH). *Annu Rev Immunol* (2011) 29:621–63. doi:10.1146/annurev-immunol-031210-101400
- Linterman MA, Beaton L, Yu D, Ramiscal RR, Srivastava M, Hogan JJ, et al. IL-21 acts directly on B cells to regulate Bcl-6 expression and germinal center responses. *J Exp Med* (2010) 207(2):353–63. doi:10.1084/jem.20091738
- Zotos D, Coquet JM, Zhang Y, Light A, D'Costa K, Kallies A, et al. IL-21 regulates germinal center B cell differentiation and proliferation through a B cell-intrinsic mechanism. *J Exp Med* (2010) 207(2):365–78. doi:10.1084/jem.20091777

40. Tang Q, Leung J, Melli K, Lay K, Chuu EL, Liu W, et al. Altered balance between effector T cells and FOXP3+ HELIOS+ regulatory T cells after thymoglobulin induction in kidney transplant recipients. *Transpl Int* (2012) 25(12):1257–67. doi:10.1111/j.1432-2277.2012.01565.x
41. Taylor AL, Negus SL, Negus M, Bolton EM, Bradley JA, Pettigrew GJ. Pathways of helper CD4 T cell allorecognition in generating alloantibody and CD8 T cell alloimmunity. *Transplantation* (2007) 83(7):931–7. doi:10.1097/01.tp.0000257960.07783.e3
42. Conlon TM, Saeb-Parsy K, Cole JL, Motallebzadeh R, Qureshi MS, Rehakova S, et al. Germinal center alloantibody responses are mediated exclusively by indirect-pathway CD4 T follicular helper cells. *J Immunol* (2012) 188(6):2643–52. doi:10.4049/jimmunol.1102830
43. de Graav GN, Dieterich M, Hesselink DA, Boer K, Clahsen-van Groningen MC, Kraaijeveld R, et al. Follicular T helper cells and humoral reactivity in kidney transplant patients. *Clin Exp Immunol* (2015) 180(2):329–40. doi:10.1111/cei.12576
44. Brokhof MM, Sollinger HW, Hager DR, Muth BL, Pirsch JD, Fernandez LA, et al. Antithymocyte globulin is associated with a lower incidence of de novo donor-specific antibodies in moderately sensitized renal transplant recipients. *Transplantation* (2014) 97(6):612–7. doi:10.1097/TP.0000000000000031
45. Kim EJ, Kwun J, Gibby AC, Hong JJ, Farris AB III, Iwakoshi NN, et al. Costimulation blockade alters germinal center responses and prevents antibody-mediated rejection. *Am J Transplant* (2014) 14(1):59–69. doi:10.1111/ajt.12526

Conflict of Interest Statement: The authors declare that the research was conducted in the absence of any commercial or financial relationships that could be construed as a potential conflict of interest.

Copyright © 2018 Chen, Koenig, Saison, Dahdal, Rigault, Barba, Taillardet, Chartoire, Ovize, Morelon, Defrance and Thaunat. This is an open-access article distributed under the terms of the Creative Commons Attribution License (CC BY). The use, distribution or reproduction in other forums is permitted, provided the original author(s) and the copyright owner are credited and that the original publication in this journal is cited, in accordance with accepted academic practice. No use, distribution or reproduction is permitted which does not comply with these terms.

Annexe 3 : Recent advances in renal transplantation: antibody-mediated rejection takes center stage

Recent advances in renal transplantation: antibody-mediated rejection takes center stage

Eric Pouliquen^{1-3#}, Alice Koenig^{1-3#}, Chien Chia Chen¹⁻³, Antoine Sicard¹⁻³, Maud Rabeyrin⁴, Emmanuel Morelon¹⁻³, Valérie Dubois⁵ and Olivier Thauinat*¹⁻³

Addresses: ¹Hospices Civils de Lyon, Hôpital Edouard Herriot, Service de Transplantation, Néphrologie et Immunologie Clinique, Lyon, France; ²Institut National de la Santé et de la Recherche Médicale U1111, Lyon, France; ³Unité de Formation et de Recherche Lyon Est, Université de Lyon, Lyon, France; ⁴Laboratoire d'anatomopathologie, Hospices Civils de Lyon, Hôpital Edouard Herriot, Lyon, France; ⁵Laboratoire d'Histocompatibilité, Etablissement Français du Sang, Lyon, France

These authors contributed equally to this work.

* Corresponding author: Olivier Thauinat (olivier.thauinat@chu-lyon.fr)

F1000Prime Reports 2015, 7:51 (doi:10.12703/P7-51)

All F1000Prime Reports articles are distributed under the terms of the Creative Commons Attribution-Non Commercial License (<http://creativecommons.org/licenses/by-nc/3.0/legalcode>), which permits non-commercial use, distribution, and reproduction in any medium, provided the original work is properly cited.

The electronic version of this article is the complete one and can be found at: <http://f1000.com/prime/reports/m/7/51>

Abstract

Overlooked for decades, antibodies have taken center stage in renal transplantation and are now widely recognized as the first cause of allograft failure. Diagnosis of antibody-mediated rejection has considerably improved with identification of antibody-mediated lesions in graft biopsies and advances made in the detection of circulating donor-specific antibodies. Unfortunately, this progress has not yet translated into better outcomes for patients. Indeed, in the absence of a drug able to suppress antibody generation by plasma cells, available therapies can only slow down graft destruction. This review provides an overview of the current knowledge of antibody-mediated rejection and discusses future interesting research directions.

The original sin of transplant immunologists

Since the first successful attempt performed in 1954, kidney transplantation has emerged as the best option for end-stage renal failure, providing both a better quality of life and better survival to patients, for a third of the cost of hemodialysis [1]. However, because in clinical transplantation the donor is from the same species but genetically different, the adaptive immune system of the recipient recognizes alloantigens expressed by the graft: that is, proteins present in different allelic forms encoded at the same gene locus in different individuals, such as major histocompatibility complex (MHC) molecules. An immune response that develops against alloantigens leads to the destruction of the transplanted organ, a process termed "rejection", which remains the first cause of renal allograft failure.

The adaptive immune system comprises two distinct effector mechanisms—cytotoxic T cells and antibodies—and the question of which of these mechanisms contribute to graft rejection has been central from the very beginning of transplant immunology. Gorer [2] was the first to report the development of antibodies against alloantigens. In this early era, however, most of the knowledge pertaining to the immunological mechanisms involved in rejection was derived from the skin graft model popularized by Billingham and Medawar [3]. The observations made in this model that (i) skin allografts were not rejected in animals lacking T cells and that (ii) adoptive transfer of purified T cells, but not alloantibodies, was sufficient to restore the rejection of skin allografts in immunodeficient rodents [4] stemmed from the concept that T cells were "the" cell subset

responsible for rejection of allogeneic transplants, a vision that prevailed until the 2000s.

During the last decade, however, experimental and clinical studies have challenged this "T cell-centric" vision and brought antibodies back to the center stage of transplant immunology [5].

Transplantation versus grafting: vessels' origin matters

The first evidence that humoral immunity can be deleterious in the setting of clinical transplantation came in the early 1970s from seminal clinical observations that (i) the presence of preformed circulating donor-specific antibodies (DSAs) was associated with a high risk for "hyperacute rejection" (that is, immediate graft failure due to widespread capillary thrombosis and necrosis [6]) and that (ii) *de novo* generation of DSAs after transplantation correlated with poor outcomes and histologic evidence of vascular obliterative lesions, named "allograft vasculopathy" [7].

These clinical findings were in apparent contradiction with the resistance of skin grafts to passive transfer of alloantibodies [4]. The origin of this discrepancy lies in the fact that, in contrast with grafted tissue, whose vascularization develops from the recipient, the vessels of renal allografts are anastomosed to those of the recipient, placing donor allogeneic endothelial cells in direct contact with the recipient's circulation. This makes a crucial difference in the sensitivity of renal transplants to the humoral arm of the recipient's alloimmune response. Antibodies are indeed massive proteins (150 kDa) largely sequestered in blood circulation [8]. Accordingly, when Russell and colleagues [9] performed passive transfer of alloantibodies to immunodeficient mice transplanted with allogeneic hearts in the late 1990s, they observed that continuing injections of antiserum were sufficient to drive the development of obstructive coronary lesions. This first experimental demonstration that humoral immunity is the prime instigator of allograft vasculopathy [9] has since been confirmed in other models [10] and in the clinical setting [11].

Pathophysiology of antibody-mediated rejection

Humoral response to allogeneic transplant

Recent experimental studies have shed light on the natural history of antibody-mediated rejection (AMR) (Figure 1) [12,13]. The sequence starts with the generation of antibodies directed against the graft (DSAs). Although highly polymorphic mismatched HLA molecules represent the most documented targets for DSAs, it is clear that DSAs can also be directed against other kinds of molecular targets, including polymorphic minor

histocompatibility antigens [14] and, following a breakdown of B-cell tolerance [15], non-polymorphic autoantigens [16]. Although some studies suggest that "non-HLA" antibodies could participate in the development of rejection [17], particularly those expressed on the endothelial cell surface [18], such as anti-angiotensin II type-1 receptor antibodies [19,20], their exact pathological potential remains a matter of debate, and hereafter, we will focus on anti-donor HLA antibodies (abbreviated DSAs).

The generation of such high-affinity, class-switched alloantibodies directed against a protein antigen requires the development of a germinal center reaction, which implies the expansion of CD4⁺ T cells with indirect allospecificity (that is, CD4⁺ T cells whose T cell receptors recognize alloantigens processed and presented in the context of MHC class II molecules expressed by recipient antigen-presenting cells) (Figure 1) [21].

The initiation of a T cell-dependent humoral immune response takes place within the recipient's canonical secondary lymphoid organs: spleen and draining lymph nodes (Figure 1) [22]. However, recent evidence suggests that, with time, immune effectors infiltrating the graft sometimes organize into ectopic lymphoid tissue (Figure 1) [23,24], which harbors the maturation of a local humoral immune response [25] that can also participate in the rejection process [26].

Implication of the classical complement pathway in acute antibody-mediated rejection

Binding of circulating DSAs to directly accessible graft endothelial cells can trigger the activation of the classical complement pathway, a central process in the pathophysiology of acute AMR (that is, AMR with acute graft dysfunction). Briefly, C1q binding to DSAs complexed with antigen activates the serine esterases C1s and C1r, which allow the cleavage of C4. This results in the deposition of C4d in tissue and the assembly of the classical pathway C3 convertase. The latter cleaves C3 into C3a and C3b. C3a is a potent proinflammatory mediator that causes leukocyte recruitment, whereas C3b propagates the complement cascade, leading to the formation of sublytic membrane attack complexes responsible for the activation of endothelial cells (Figure 1) [27].

Complement is dispensable for chronic/subclinical antibody-mediated rejection

In contrast with acute AMR, activation of the classical complement pathway appears to be dispensable for the development of chronic/subclinical AMR lesions. The first evidence supporting this concept came from Colvin and colleagues, who transplanted RAG KO immunodeficient

Figure 1. Schematic representation of antibody-mediated rejection pathophysiology

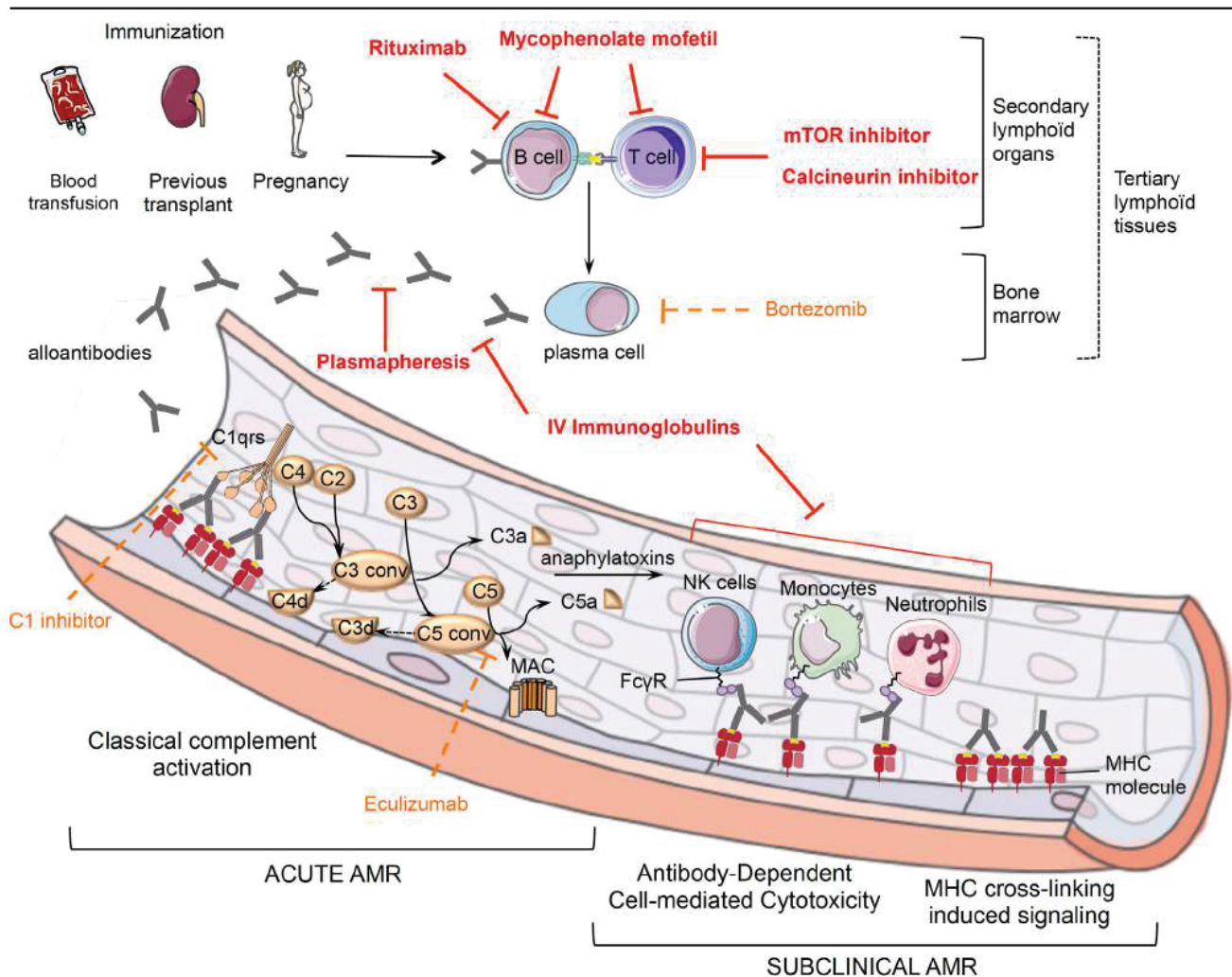

Mechanisms of action of therapies are indicated. Therapies currently used are in bold red; drugs under evaluation are in dashed orange. AMR, antibody-mediated rejection; Conv, convertase; IV, intravenous; MAC, membrane attack complex; MHC, major histocompatibility complex; mTOR, mammalian target of rapamycin; NK, natural killer.

mice with allogeneic hearts and observed that the passive transfer of non-complement-fixing DSAs was sufficient to promote allograft vasculopathy [28]. Innate immune cells can indeed bind to the fragment crystallizable (Fc) region of antibodies and release lytic enzymes (a mechanism called antibody-dependent cell-mediated cytotoxicity, or ADCC) (Figure 1), which mediate smoldering endothelial cell damage. The recognition of this pathological mechanism in the clinic led to the recognition of C4d-negative forms of AMR, often diagnosed on screening biopsy (that is, subclinical AMR) [29]. Chronic vascular inflammation in turn promotes the progressive development of typical vascular lesions (that is, transplant glomerulopathy, allograft vasculopathy, and lamination of the peritubular

capillary basement membrane). Finally, progressive tissue destruction leads to irreversible loss of graft function, proteinuria, and hypertension (that is, chronic AMR).

The question of which type of innate immune effectors plays the key role in AMR is still a matter of debate. Hirohashi and colleagues [30] showed that depletion of natural killer cells was sufficient to abrogate DSA-induced arterial lesions. The validity of these experimental data in the clinic is supported by transcriptomic analysis of renal graft biopsies from patients with chronic AMR [31]. However, it is likely that other cell types, including neutrophils and monocytes, are also involved (Figure 1). Recent data from the clinic even suggest that

expanded circulating cytomegalovirus-responsive $\gamma\delta$ T cells could participate in allograft lesions mediated by DSAs through ADCC, offering a new pathophysiological link between cytomegalovirus infection and allograft dysfunction [32].

Finally, some experimental studies demonstrated that DSAs can directly trigger activating signals in endothelial cells through MHC molecule cross-linking (Figure 1), which promotes exocytosis of Weibel-Palade bodies, activates the coagulation cascade, and increases the expression of adhesion molecules and growth factors [33]. This mechanism could also participate in the development of complement-independent AMR lesions.

One pathophysiology, several clinical courses

If clinical studies have largely validated the sequence of molecular events established in experimental models of AMR [34,35], the progression along the successive stages of the pathology can, however, follow different clinical courses [36]. For some patients, AMR is made clinically patent by the occurrence of one or more episodes of graft dysfunction. In contrast, other kidney graft recipients with DSAs experience smoldering forms of AMR (that is, subclinical AMR), characterized by persistent microvascular abnormalities without acute graft dysfunction [29].

The quantity (titer) of circulating DSAs is an obvious factor influencing the clinical expression of the disease [37,38]. Qualitative factors, linked to antibody structure, are also important sources of clinical heterogeneity. The immunoglobulin (Ig) molecule is shaped like a Y, with two identical halves, each made up of a heavy chain and a light chain. The two arms of the Y, each formed by the amino terminal extremity of a heavy chain and a light chain, contain the antigen-binding site. Higher avidity could explain why some patients develop clinically patent AMR with low DSA titer. At the base of the Y, composed of the carboxy terminal extremity of the constant region of the two heavy chains, is the Fc region. During a T cell-dependent humoral response, class-switch recombination occurs in the germinal center, leading to the replacement of the constant region of the Ig heavy chain. Accordingly, anti-HLA alloantibodies of a wide range of isotypes (IgG1, G2, G3, G4, Ig A1, A2, IgM) can be eluted from explanted renal allografts [39]. Through their Fc portion, each heavy-chain isotype displays a different capability to bind C1q (and therefore to trigger the classical complement pathway) and to recruit immune effectors through their Fc receptors. Interestingly, it has been reported that patients with exclusively weak complement-activating DSAs (that is, IgG1 and IgG4) tend to experience less acute AMR and better outcome [40-42]. Another possible source of heterogeneity comes from the carbohydrate chains that are attached to Fc [43]. Age,

gender, and disease status are all factors influencing Ig Fc glycosylation [43]. In the case of IgG, terminal sugars affect the binding to the Fc γ RIIIa receptor and thereby influence ADCC, whereas terminal galactose residues affect antibody binding to C1q and thereby modulate IgG complement-dependent activity [44].

Challenges in antibody-mediated rejection diagnosis

The recognition of subclinical forms of the disease implies that, upon detection of circulating DSAs, a renal biopsy should be performed, even in the absence of clinically patent graft dysfunction (that is, "screening biopsies") [45]. In 2005, the Banff Conference on Allograft Pathology defined criteria for diagnosing AMR [46], which include the three following cardinal features: (a) presence of circulating DSAs, (b) morphologic evidence of antibody-mediated tissue injury (glomerular or peritubular capillaries inflammation score > 0), and (c) positive staining for C4d in peritubular capillaries (used as a surrogate marker for local classical complement pathway activation) [47]. Since then, however, the value of C4d for the diagnosis of AMR has been questioned. Although there is little doubt that complement activation is important for DSAs to trigger clinically patent "acute" AMR [48], a high percentage of graft biopsies with morphologic evidence of antibody-mediated tissue injury are C4d-negative [49]. This notion has been strengthened by transcriptomic analyses, which demonstrate a similar increased level of expression for endothelial genes in C4d-negative and C4d-positive AMR biopsies [50]. Finally, the direct demonstration that DSAs can trigger chronic arterial lesions in murine experimental models without complement participation [28] led to the recognition of C4d-negative AMR in the most recent Banff classification [51].

(R)evolution in anti-HLA antibody monitoring

In line with the growing clinical interest in AMR, tools available for DSA detection have considerably improved over the last few decades [52]. Historically, the first test to detect circulating DSAs was the complement-dependent cytotoxicity (CDC) assay performed between recipient sera and donor lymphocytes.

In the early 1980s, flow cytometry cross-match (FCXM) emerged as an alternative to CDC assays [53]. Although the FCXM was 10- to 100-fold more sensitive to detect DSAs, it rapidly appeared that T cell or (especially) B-cell FCXM (or both) lacked specificity because of (i) auto-antibodies binding to donor lymphocytes and (ii) binding of Ig to lymphocyte Fc receptors (independently of their antigen specificity). These limitations explained the

discrepancies among centers in outcomes of patients with positive FCXM and led to confusion regarding the clinical utility of the FCXM.

The revolutionary development in DSA screening was the introduction of solid-phase membrane-independent assays. The enzyme-linked immunosorbent assay was the first assay to use purified HLA proteins [54] and was soon followed by flow cytometric and multiplex assays. All of these approaches coupled purified HLA antigens to inert plastic or latex. Currently, genetic engineering is being used to produce microparticles coated with single HLA alleles, offering the possibility not only to detect circulating DSAs with exquisite sensitivity but also to readily identify their specificities [55].

Solid-phase antibody detection assays are not devoid of limitations [56]. Technical issues include the following: (i) the different nature (natural versus recombinant) of antigens on screening and specificity products; (ii) the definition of the threshold level (mean fluorescent intensity, or MFI) to consider an antibody as being "present"; (iii) the conformation of HLA antigens (intact or denatured) upon adherence to the beads; (iv) the density of antigen on the beads; and (v) interfering factors that mask the detection of DSAs (sometimes named the "prozone phenomenon") [57].

Although the solid-phase antibody detection assays have permitted the detection of DSAs not detectable by CDC assay, the clinical significance of these antibodies is incompletely understood. Recent studies have indeed shown that not all DSAs identified by solid-phase antibody detection assays predict a poor outcome [58], underlying the need for tools allowing better stratification of the risk.

Risk stratification in antibody-mediated rejection

Some approaches to stratifying the risk of graft loss in AMR rely on graft biopsy. Bachelet and colleagues [59] have shown, for instance, that the presence of DSAs bound to the graft (as assessed by solid-phase antibody detection assays on eluate from needle core graft biopsies) was predictive of unfavorable short-term transplant outcome. Coupling analysis of histological features with transcriptomic profiling of graft biopsy with the "molecular microscope" system seems to be another interesting way to improve risk stratification in AMR [60].

As discussed above, complement activation is not necessary for DSAs to drive vascular lesions. However, because the combination of complement-dependent and -independent mechanisms is synergistically

deleterious for the graft, complement activation is a good candidate for risk stratification in AMR. C4d staining in renal capillaries showed poor performance in predicting AMR outcome in several independent studies [49,50,61,62].

Recently, several manufacturers have modified their solid-phase antibody detection assays to directly assess the capacity of circulating DSAs to bind the complement components of the classical pathway (that is, C1q [63], C4d [64], or C3d [62]). A recent study has demonstrated the value of these assays in predicting allograft loss in AMR [62]. However, the direct correlation observed between DSA titer (MFI value measured with classic solid-phase antibody detection assays) and DSA ability to trigger complement activation (which was predicted by basic molecular immunology [65]) questions the clinical utility of these tests. One possibility could be to spare them for AMR patients with low DSA titer, for which a C3d-binding assay has shown promise in predicting graft loss [62].

Therapeutic challenges

It is widely accepted that a significant proportion of what were once called "cortico-resistant rejections" were, in fact, AMR. Although anti-thymocyte globulin (ATG), which contains activity against numerous cell surface proteins, can induce complement-independent apoptosis of naive, activated B cells, and plasma cells [66], ATG alone is ineffective in AMR.

Historically, the first attempt to reduce DSAs' deleterious effects on graft endothelium relied on the use of high-dose intravenous immunoglobulin (IVIg), a therapy with incompletely understood mechanisms, which could accelerate DSA catabolism, act as scavenger of activated complement, and down-modulate the activation of innate immune effectors [67].

Although IVIg remains an essential component of AMR treatment, several studies have shown that better outcomes were achieved when it was combined with a rapid depletion of circulating DSAs (with plasmapheresis [68] or immunoabsorption [69]). As expected from its mechanism of action, this costly and tedious therapeutic approach is not curative (DSA-producing plasma cells are not affected) and therefore has only a suspensive effect on antibody-mediated graft destruction [70]. In short, it is realistic to consider that, in most cases, IVIg and plasmapheresis will (at best) turn an acute form of AMR into a subclinical disease.

In an attempt to provide a sustained therapeutic effect, anti-CD20 monoclonal depleting antibody (rituximab), a widely established treatment of B cell lymphoma, has

been tested in AMR. Although the rationale of this approach can be questioned (since CD20 is not expressed on plasma cells), several small retrospective series reported promising results [71,72] and a recent meta-analysis of 10 of these studies concluded that rituximab was a reasonable therapeutic option in the treatment of AMR. The first controlled trial, published in 2009 [68], indeed concluded that a plasmapheresis/IVIg/anti-CD20 regimen was associated with better graft outcome in comparison with IVIg alone. However, the benefit reported could be due to either DSA removal or B cell depletion. In fact, the only multicenter randomized study—Impact of Treatment With Rituximab on the Progression of Humoral Acute Rejection After Renal Transplantation (RITUX-ERAH) (ClinicalTrials.gov Identifier: NCT01350882 <http://clinicaltrials.gov/ct2/show/NCT01350882>)—performed to investigate the effect of rituximab on AMR, found no difference at 12 months on graft loss, epidermal growth factor receptor (eGFR), proteinuria, and glomerulitis score between placebo and rituximab groups [73]. Therefore, the benefits reported in small retrospective series should be carefully considered since methodological and positive publication bias seems likely. Furthermore, the use of rituximab in this context may be associated with a higher risk of infection [74,75].

We have already seen above that intragraft complement activation was associated with worse outcomes in AMR. Thus, blocking complement cascade seems to be an attractive therapeutic option, especially for patients with DSAs able to bind complement components in solid-phase assays [62]. Experimentally, C1 blockade prevented acute AMR of kidney allografts in allosensitized baboons [76]. Although C1 inhibition has not been tested in clinical AMR yet, a C1 inhibitor for treatment of patients with hereditary angioedema is already available [77]. Eculizumab is a humanized monoclonal antibody that targets complement protein C5 initially developed to treat paroxysmal nocturnal hemoglobinuria [78]. Eculizumab appears to be effective in protecting renal allografts from post-transplant recurrence of atypical hemolytic uremic syndrome [79]. Only a few case reports with short follow-ups are currently available in the literature regarding eculizumab efficiency in AMR [80]. Although eculizumab in prophylaxis appears to be effective at preventing acute AMR in sensitized patients [81], it is unclear whether eculizumab contributes to the development of accommodation and therefore how long treatment should continue (a particularly important issue given the expense of the drug). Another important limitation of complement blockades is the fact that these approaches are unlikely to prevent the development of chronic antibody-mediated lesions, which also result from complement-independent mechanisms.

In fact, only the disappearance of DSAs from the recipient's circulation could stop graft destruction in AMR (and achieve efficient desensitization). In the absence of therapy able to deplete selectively DSA-producing plasma cells, bortezomib—a selective inhibitor of the 26S proteasome widely used for the treatment of multiple myeloma—has been proposed. Bortezomib induces apoptosis among plasma cells in whole bone marrow cell cultures, thereby reducing the secretion of alloantibodies (but also vaccinal antibodies) *in vitro* [82]. Clinical experience with this drug in the context of AMR is still limited [83], but, based on these promising preliminary results, prospective studies have been launched to evaluate bortezomib efficiency and tolerance profile in this indication (ClinicalTrials.gov Identifier: NCT02201576 <http://clinicaltrials.gov/ct2/show/NCT02201576>, ClinicalTrials.gov Identifier: NCT01873157 <http://clinicaltrials.gov/ct2/show/NCT01873157>).

In the absence of efficient curative treatment for AMR, emphasis should be placed on “primary” prevention of *de novo* DSAs. This objective requires (i) avoiding futile transfusions in candidates for transplantation, (ii) maximizing HLA compatibility between donor and recipient, (iii) improving adherence to immunosuppressive treatments [5], and (iv) optimizing maintenance of immunosuppression. Particular attention should be paid to this issue when immunosuppression is reduced [70]. In this regard, strategies aiming at suppressing anti-calcineurin appear to be particularly at risk of *de novo* DSA generation [84,85].

Conclusions

In the shadows since the early era of transplantation, DSAs have recently been recognized as the first cause of allograft failure. Although important advances have been made in AMR diagnosis in this last decade, a curative therapy is still lacking. Since current therapeutic strategies can only slow down antibody-mediated destruction of the graft, special emphasis should be placed on the prevention of DSA generation. Finally, it should be kept in mind that B cells are much more than plasma cell precursors. B cells are endowed with important antibody-independent functions, including immunoregulation [86] and antigen presentation to T cells [87], which are increasingly recognized as key in the balance between rejection/tolerance of solid organ transplants.

Abbreviations

ADCC, antibody-dependent cell-mediated cytotoxicity; AMR, antibody-mediated rejection; ATG, antithymocyte globulin; CDC, complement-dependent cytotoxicity; DSA, donor-specific antibody; Fc, fragment crystallizable; FCXM, flow cytometry cross-match; Ig, immunoglobulin;

IVIg, intravenous immunoglobulin; MFI, mean fluorescent intensity; MHC, major histocompatibility complex.

Disclosures

The authors declare that they have no disclosures.

Acknowledgments

The authors are supported by the CENTAURE Transplantation Research Network, the Agence Nationale de la Recherche (ANR-12-PDOC-0019.01), the Hospices Civils de Lyon, and the Fondation pour la Recherche Medicale. The authors wish to thank Mathilde Koenig and Servier Medical Art (creativecommons.org/licenses/by/3.0/fr/) for their contribution to the design of the figure.

References

- Schieppati A, Remuzzi G: **Chronic renal diseases as a public health problem: epidemiology, social, and economic implications.** *Kidney international. Supplement* 2005:57-S10.
- Gorer PA: **The antigenic basis of tumour transplantation.** *J Pathol* 1938, **47**:231-52.
- Billingham RE, Medawar PB: **The Technique of Free Skin Grafting in Mammals.** *Journal of Experimental Biology* 1951, **28**:385-402.
- Benichou G, Yamada Y, Yun S, Lin C, Fray M, Tocco G: **Immune recognition and rejection of allogeneic skin grafts.** *Immunotherapy* 2011, **3**:757-70.
- Sellarés J, de Freitas DG, Mengel M, Reeve J, Einecke G, Sis B, Hidalgo LG, Famulski K, Matas A, Halloran PF: **Understanding the causes of kidney transplant failure: the dominant role of antibody-mediated rejection and nonadherence.** *American journal of transplantation: official journal of the American Society of Transplantation and the American Society of Transplant Surgeons* 2012, **12**:388-99.
- Patel R, Terasaki PI: **Significance of the positive crossmatch test in kidney transplantation.** *The New England journal of medicine* 1969, **280**:735-9.
- Jeannot M, Pinn VW, Flax MH, Winn HJ, Russell PS: **Humoral antibodies in renal allotransplantation in man.** *The New England journal of medicine* 1970, **282**:111-7.
- Hall JG, Smith ME, Edwards PA, Shooter KV: **The low concentration of macroglobulin antibodies in peripheral lymph.** *Immunology* 1969, **16**:773-8.
- Russell PS, Chase CM, Winn HJ, Colvin RB: **Coronary atherosclerosis in transplanted mouse hearts. II. Importance of humoral immunity.** *Journal of immunology (Baltimore, Md.: 1950)* 1994, **152**:5135-41.
- Thaunat O, Louedec L, Dai J, Bellier F, Groyer E, Delignat S, Gaston A, Caligiuri G, Joly E, Plissonnier D, Michel J, Nicoletti A: **Direct and indirect effects of alloantibodies link neointimal and medial remodeling in graft arteriosclerosis.** *Arteriosclerosis, thrombosis, and vascular biology* 2006, **26**:2359-65.
- Hill GS, Nochy D, Bruneval P, Duong van Huyen JP, Glotz D, Suberbielle C, Zuber J, Anglicheau D, Empana J, Legendre C, Loupy A: **Donor-specific antibodies accelerate arteriosclerosis after kidney transplantation.** *Journal of the American Society of Nephrology: JASN* 2011, **22**:975-83.
- Smith RN, Kawai T, Boskovic S, Nadazdin O, Sachs DH, Cosimi AB, Colvin RB: **Chronic antibody mediated rejection of renal allografts: pathological, serological and immunologic features in nonhuman primates.** *American journal of transplantation: official journal of the American Society of Transplantation and the American Society of Transplant Surgeons* 2006, **6**:1790-8.
- Thaunat O: **Humoral immunity in chronic allograft rejection: puzzle pieces come together.** *Transplant immunology* 2012, **26**:101-6.
- Tan JC, Wadia PP, Coram M, Grumet FC, Kambham N, Miller K, Pereira S, Vayntrub T, Miklos DB: **H-Y antibody development associates with acute rejection in female patients with male kidney transplants.** *Transplantation* 2008, **86**:75-81.
- Thaunat O, Graff-Dubois S, Fabien N, Duthey A, Attui-Audenis V, Nicoletti A, Patey N, Morelon E: **A stepwise breakdown of B-cell tolerance occurs within renal allografts during chronic rejection.** *Kidney international* 2012, **81**:207-19.
- Li L, Wadia P, Chen R, Kambham N, Naesens M, Sigdel TK, Miklos DB, Sarwal MM, Butte AJ: **Identifying compartment-specific non-HLA targets after renal transplantation by integrating transcriptome and "antibodyome" measures.** *Proceedings of the National Academy of Sciences of the United States of America* 2009, **106**:4148-53.
- Dragun D, Catar R, Philippe A: **Non-HLA antibodies in solid organ transplantation: recent concepts and clinical relevance.** *Current opinion in organ transplantation* 2013, **18**:430-5.
- Jackson AM, Sigdel TK, Delville M, Hsieh S, Dai H, Bagnasco S, Montgomery RA, Sarwal MM: **Endothelial Cell Antibodies Associated with Novel Targets and Increased Rejection.** *Journal of the American Society of Nephrology: JASN* 2014.
- Dragun D, Müller DN, Bräsen JH, Fritsche L, Nieminen-Kelhä M, Dechend R, Kintscher U, Rudolph B, Hoebcke J, Eckert D, Mazak I, Plehm R, Schönemann C, Unger T, Budde K, Neumayer H, Luft FC, Wallukat G: **Angiotensin II type I-receptor activating antibodies in renal-allograft rejection.** *The New England journal of medicine* 2005, **352**:558-69.
- Taniguchi M, Rebello LM, Cai J, Hopfield J, Briley KP, Haisch CE, Catrou PG, Bolin P, Parker K, Kendrick WT, Kendrick SA, Harland RC, Terasaki PI: **Higher risk of kidney graft failure in the presence of anti-angiotensin II type-I receptor antibodies.** *American journal of transplantation: official journal of the American Society of Transplantation and the American Society of Transplant Surgeons* 2013, **13**:2577-89.
- Conlon TM, Saeb-Parsy K, Cole JL, Motallebzadeh R, Qureshi MS, Rehakova S, Negus MC, Callaghan CJ, Bolton EM, Bradley JA, Pettigrew GJ: **Germinal center alloantibody responses are mediated exclusively by indirect-pathway CD4 T follicular helper cells.** *Journal of immunology (Baltimore, Md.: 1950)* 2012, **188**:2643-52.
- Lakkis FG, Arakelov A, Konieczny BT, Inoue Y: **Immunologic 'ignorance' of vascularized organ transplants in the absence of secondary lymphoid tissue.** *Nature medicine* 2000, **6**:686-8.
- Thaunat O, Patey N, Caligiuri G, Gautreau C, Mamani-Matsuda M, Mekki Y, Dieu-Nosjean M, Eberl G, Ecochard R, Michel J, Graff-Dubois S, Nicoletti A: **Chronic rejection triggers the development of an aggressive intragraft immune response through recapitulation of lymphoid organogenesis.** *Journal of immunology (Baltimore, Md.: 1950)* 2010, **185**:717-28.
- Thaunat O, Nicoletti A: **Lymphoid neogenesis in chronic rejection.** *Current opinion in organ transplantation* 2008, **13**:16-9.
- Thaunat O, Graff-Dubois S, Brouard S, Gautreau C, Varthaman A, Fabien N, Field A, Louedec L, Dai J, Joly E, Morelon E, Souillou J, Michel J, Nicoletti A: **Immune responses elicited in tertiary lymphoid tissues display distinctive features.** *PLoS one* 2010, **5**:e11398.
- Thaunat O: **Pathophysiologic significance of B-cell clusters in chronically rejected grafts.** *Transplantation* 2011, **92**:121-6.
- Roumenina LT, Zuber J, Frémeaux-Bacchi V: **Physiological and therapeutic complement regulators in kidney transplantation.** *Current opinion in organ transplantation* 2013, **18**:421-9.



28. Hirohashi T, Uehara S, Chase CM, DellaPelle P, Madsen JC, Russell PS, Colvin RB: **Complement independent antibody-mediated endarteritis and transplant arteriopathy in mice.** *American journal of transplantation: official journal of the American Society of Transplantation and the American Society of Transplant Surgeons* 2010, **10**:510-7.
- F1000Prime RECOMMENDED**
29. Loupy A, Suberbielle-Boissel C, Hill GS, Lefaucheur C, Anglicheau D, Zuber J, Martinez F, Thervet E, Méjean A, Charron D, Duong van Huyen JP, Bruneval P, Legendre C, Nochy D: **Outcome of subclinical antibody-mediated rejection in kidney transplant recipients with preformed donor-specific antibodies.** *American journal of transplantation: official journal of the American Society of Transplantation and the American Society of Transplant Surgeons* 2009, **9**:2561-70.
30. Hirohashi T, Chase CM, Della Pelle P, Sebastian D, Alessandrini A, Madsen JC, Russell PS, Colvin RB: **A novel pathway of chronic allograft rejection mediated by NK cells and alloantibody.** *American journal of transplantation: official journal of the American Society of Transplantation and the American Society of Transplant Surgeons* 2012, **12**:313-21.
- F1000Prime RECOMMENDED**
31. Hidalgo LG, Sis B, Sellares J, Campbell PM, Mengel M, Einecke G, Chang J, Halloran PF: **NK cell transcripts and NK cells in kidney biopsies from patients with donor-specific antibodies: evidence for NK cell involvement in antibody-mediated rejection.** *American journal of transplantation: official journal of the American Society of Transplantation and the American Society of Transplant Surgeons* 2010, **10**:1812-22.
- F1000Prime RECOMMENDED**
32. Bachelet T, Couzi L, Pitard V, Sicard X, Rigotherier C, Lepreux S, Moreau J, Taupin J, Merville P, Déchanet-Merville J: **Cytomegalovirus-responsive $\gamma\delta$ T cells: novel effector cells in antibody-mediated kidney allograft microcirculation lesions.** *Journal of the American Society of Nephrology: JASN* 2014, **25**:2471-82.
- F1000Prime RECOMMENDED**
33. Zhang X, Reed EF: **Effect of antibodies on endothelium.** *American journal of transplantation: official journal of the American Society of Transplantation and the American Society of Transplant Surgeons* 2009, **9**:2459-65.
34. Mauyyedi S, Pelle PD, Saidman S, Collins AB, Pascual M, Tolkoff-Rubin NE, Williams WW, Cosimi AA, Schneeberger EE, Colvin RB: **Chronic humoral rejection: identification of antibody-mediated chronic renal allograft rejection by C4d deposits in peritubular capillaries.** *Journal of the American Society of Nephrology: JASN* 2001, **12**:574-82.
35. Regele H, Böhmig GA, Habicht A, Gollowitzer D, Schillinger M, Rockenschaub S, Watschinger B, Kerjaschki D, Exner M: **Capillary deposition of complement split product C4d in renal allografts is associated with basement membrane injury in peritubular and glomerular capillaries: a contribution of humoral immunity to chronic allograft rejection.** *Journal of the American Society of Nephrology: JASN* 2002, **13**:2371-80.
36. Loupy A, Jordan SC: **Transplantation: Donor-specific HLA antibodies and renal allograft failure.** *Nature reviews. Nephrology* 2013, **9**:130-1.
37. Heilman RL, Nijim A, Desmarteau YM, Khamash H, Pando MJ, Smith ML, Chakkera HA, Huskey J, Valdez R, Reddy KS: **De Novo Donor-Specific Human Leukocyte Antigen Antibodies Early After Kidney Transplantation.** *Transplantation* 2014.
38. Lefaucheur C, Loupy A, Hill GS, Andrade J, Nochy D, Antoine C, Gautreau C, Charron D, Glotz D, Suberbielle-Boissel C: **Preexisting donor-specific HLA antibodies predict outcome in kidney transplantation.** *Journal of the American Society of Nephrology: JASN* 2010, **21**:1398-406.
39. Heinemann FM, Roth I, Rebmann V, Arnold M, Witzke O, Wilde B, Spriewald BM, Grosse-Wilde H: **Immunoglobulin isotype-specific characterization of anti-human leukocyte antigen antibodies eluted from explanted renal allografts.** *Human immunology* 2007, **68**:500-6.
40. Hönger G, Hoyer H, Arnold M, Spriewald BM, Schaub S, Amico P: **Pretransplant IgG subclasses of donor-specific human leukocyte antigen antibodies and development of antibody-mediated rejection.** *Transplantation* 2011, **92**:41-7.
- F1000Prime RECOMMENDED**
41. Wahrmann M, Exner M, Schillinger M, Haidbauer B, Regele H, Körmöczy GF, Hörl WH, Böhmig GA: **Pivotal role of complement-fixing HLA alloantibodies in presensitized kidney allograft recipients.** *American journal of transplantation: official journal of the American Society of Transplantation and the American Society of Transplant Surgeons* 2006, **6**:1033-41.
- F1000Prime RECOMMENDED**
42. Ciciarelli JC, Kasahara N, Lemp NA, Adamson R, Dembitsky W, Browne B, Steinberg S: **Immunoglobulin G subclass analysis of HLA donor specific antibodies in heart and renal transplant recipients.** *Clinical transplants* 2013:413-22.
- F1000Prime RECOMMENDED**
43. Arnold JN, Wormald MR, Sim RB, Rudd PM, Dwek RA: **The impact of glycosylation on the biological function and structure of human immunoglobulins.** *Annual review of immunology* 2007, **25**:21-50.
44. Raju TS: **Terminal sugars of Fc glycans influence antibody effector functions of IgGs.** *Current opinion in immunology* 2008, **20**:471-8.
- F1000Prime RECOMMENDED**
45. Thanaat O, Legendre C, Morelon E, Kreis H, Mamzer-Bruneel M: **To biopsy or not to biopsy? Should we screen the histology of stable renal grafts?** *Transplantation* 2007, **84**:671-6.
46. Solez K, Colvin RB, Racusen LC, Sis B, Halloran PF, Birk PE, Campbell PM, Cascalho M, Collins AB, Demetris AJ, Drachenberg CB, Gibson IW, Grimm PC, Haas M, Lerut E, Liapis H, Mannon RB, Marcus PB, Mengel M, Mihatsch MJ, Nankivell BJ, Nickleleit V, Papadimitriou JC, Platt JL, Randhawa P, Roberts I, Salinas-Madruga L, Salomon DR, Seron D, Sheaff M et al.: **Banff '05 Meeting Report: differential diagnosis of chronic allograft injury and elimination of chronic allograft nephropathy ('CAN').** *American journal of transplantation: official journal of the American Society of Transplantation and the American Society of Transplant Surgeons* 2007, **7**:S18-26.
47. Feucht HE, Schneeberger H, Hillebrand G, Burkhardt K, Weiss M, Riethmüller G, Land W, Albert E: **Capillary deposition of C4d complement fragment and early renal graft loss.** *Kidney international* 1993, **43**:1333-8.
48. Rahimi S, Qian Z, Layton J, Fox-Talbot K, Baldwin WM, Wasowska BA: **Non-complement- and complement-activating antibodies synergize to cause rejection of cardiac allografts.** *American journal of transplantation: official journal of the American Society of Transplantation and the American Society of Transplant Surgeons* 2004, **4**:326-34.
49. Loupy A, Hill GS, Suberbielle C, Charron D, Anglicheau D, Zuber J, Timsit MO, Duong JP, Bruneval P, Vernerey D, Empana JP, Jouven X, Nochy D, Legendre CH: **Significance of C4d Banff scores in early protocol biopsies of kidney transplant recipients with preformed donor-specific antibodies (DSA).** *American journal of transplantation: official journal of the American Society of Transplantation and the American Society of Transplant Surgeons* 2011, **11**:56-65.
- F1000Prime RECOMMENDED**
50. Sis B, Jhangri GS, Bunnag S, Allanach K, Kaplan B, Halloran PF: **Endothelial gene expression in kidney transplants with alloantibody indicates antibody-mediated damage despite**

lack of C4d staining. *American journal of transplantation: official journal of the American Society of Transplantation and the American Society of Transplant Surgeons* 2009, **9**:2312-23.



51. Haas M, Sis B, Racusen LC, Solez K, Glotz D, Colvin RB, Castro MCR, David, DSR, David-Neto E, Bagnasco SM, Cendales LC, Cornell LD, Demetris AJ, Drachenberg CB, Farver CF, Farris AB, Gibson IW, Kraus E, Liapis H, Loupy A, Nickleleit V, Randhawa P, Rodriguez ER, Rush D, Smith RN, Tan CD, Wallace WD, Mengel M: **Banff 2013 meeting report: inclusion of c4d-negative antibody-mediated rejection and antibody-associated arterial lesions.** *American journal of transplantation: official journal of the American Society of Transplantation and the American Society of Transplant Surgeons* 2014, **14**:272-83.
52. Gebel HM, Bray RA: **Laboratory assessment of HLA antibodies circa 2006: making sense of sensitivity.** *Transplantation Reviews* 2006, **20**:189-94.
53. Garovoy MR, Rheinschmidt MA: **Flow cytometry analysis: a high technology crossmatch technique facilitating transplantation.** *Transplant Proc* 1983, **15**:1939-44.
54. Kao KJ, Scornik JC, Small SJ: **Enzyme-linked immunoassay for anti-HLA antibodies—an alternative to panel studies by lymphocytotoxicity.** *Transplantation* 1993, **55**:192-6.
55. Pei R, Lee J, Shih N, Chen M, Terasaki PI: **Single human leukocyte antigen flow cytometry beads for accurate identification of human leukocyte antigen antibody specificities.** *Transplantation* 2003, **75**:43-9.
56. Gebel HM, Bray RA: **HLA antibody detection with solid phase assays: great expectations or expectations too great?** *American journal of transplantation: official journal of the American Society of Transplantation and the American Society of Transplant Surgeons* 2014, **14**:1964-75.
57. Guidicelli G, Anies G, Bachelet T, Dubois V, Moreau J, Merville P, Couzi L, Taupin J: **The complement interference phenomenon as a cause for sharp fluctuations of serum anti-HLA antibody strength in kidney transplant patients.** *Transplant immunology* 2013, **29**:17-21.
58. Süsal C, Ovens J, Mahmoud K, Döhler B, Scherer S, Ruhenstroth A, Tran TH, Heinold A, Opelz G: **No association of kidney graft loss with human leukocyte antigen antibodies detected exclusively by sensitive Luminex single-antigen testing: a Collaborative Transplant Study report.** *Transplantation* 2011, **91**:883-7.
-
59. Bachelet T, Couzi L, Lepreux S, Legeret M, Pariscoat G, Guidicelli G, Merville P, Taupin J: **Kidney intra-graft donor-specific antibodies as determinant of antibody-mediated lesions and poor graft outcome.** *American journal of transplantation: official journal of the American Society of Transplantation and the American Society of Transplant Surgeons* 2013, **13**:2855-64.
-
60. Loupy A, Lefaucheur C, Vernerey D, Chang J, Hidalgo LG, Beuscart T, Verine J, Aubert O, Dubleumortier S, Duong van Huyen, Jean-Paul, Jouven X, Glotz D, Legendre C, Halloran PF: **Molecular microscope strategy to improve risk stratification in early antibody-mediated kidney allograft rejection.** *Journal of the American Society of Nephrology: JASN* 2014, **25**:2267-77.
-
61. Lefaucheur C, Nochy D, Hill GS, Suberbielle-Boissel C, Antoine C, Charron D, Glotz D: **Determinants of poor graft outcome in patients with antibody-mediated acute rejection.** *American journal of transplantation: official journal of the American Society of Transplantation and the American Society of Transplant Surgeons* 2007, **7**:832-41.
62. Sicard A, Ducreux S, Rabeyrin M, Couzi L, McGregor B, Badet L, Scoazec JY, Bachelet T, Lepreux S, Visentin J, Merville P, Fremeaux-Bacchi V, Morelon E, Taupin J, Dubois V, Thauinat O: **Detection of C3d-binding donor-specific anti-HLA antibodies at diagnosis of humoral rejection predicts renal graft loss.** *Journal of the American Society of Nephrology: JASN* 2015, **26**:457-67.
63. Loupy A, Lefaucheur C, Vernerey D, Prugger C, Duong van Huyen, Jean-Paul, Mooney N, Suberbielle C, Frémeaux-Bacchi V, Méjean A, Desgrandchamps F, Anglicheau D, Nochy D, Charron D, Empana J, Delahousse M, Legendre C, Glotz D, Hill GS, Zeevi A, Jouven X: **Complement-binding anti-HLA antibodies and kidney-allograft survival.** *The New England journal of medicine* 2013, **369**:1215-26.
-
64. Bartel G, Wahrmann M, Schwaiger E, Kikić Ž, Winzer C, Hörl WH, Mühlbacher F, Hoke M, Zlabinger GJ, Regele H, Böhmig GA: **Solid phase detection of C4d-fixing HLA antibodies to predict rejection in high immunological risk kidney transplant recipients.** *Transplant international: official journal of the European Society for Organ Transplantation* 2013, **26**:121-30.
65. Diebolder CA, Beurskens FJ, de Jong, Rob N, Koning RI, Strumane K, Lindorfer MA, Voorhorst M, Ugurlar D, Rosati S, Heck Albert JR, van de Winkel, Jan GJ, Wilson IA, Koster AJ, Taylor RP, Saphire EO, Burton DR, Schuurman J, Gros P, Parren, Paul WHI: **Complement is activated by IgG hexamers assembled at the cell surface.** *Science (New York, NY)* 2014, **343**:1260-3.
66. Zand MS, Vo T, Huggins J, Felgar R, Liesveld J, Pellegrin T, Bozorgzadeh A, Sanz I, Briggs BJ: **Polyclonal rabbit antithymocyte globulin triggers B-cell and plasma cell apoptosis by multiple pathways.** *Transplantation* 2005, **79**:1507-15.
67. Kazatchkine MD, Kaveri SV: **Immunomodulation of autoimmune and inflammatory diseases with intravenous immune globulin.** *The New England journal of medicine* 2001, **345**:747-55.
68. Lefaucheur C, Nochy D, Andrade J, Verine J, Gautreau C, Charron D, Hill GS, Glotz D, Suberbielle-Boissel C: **Comparison of combination Plasmapheresis/IVIg/anti-CD20 versus high-dose IVIg in the treatment of antibody-mediated rejection.** *American journal of transplantation: official journal of the American Society of Transplantation and the American Society of Transplant Surgeons* 2009, **9**:1099-107.
-
69. Böhmig GA, Wahrmann M, Regele H, Exner M, Robl B, Derfler K, Soliman T, Bauer P, Müllner M, Druml W: **Immunoabsorption in severe C4d-positive acute kidney allograft rejection: a randomized controlled trial.** *American journal of transplantation: official journal of the American Society of Transplantation and the American Society of Transplant Surgeons* 2007, **7**:117-21.
70. Gupta G, Abu Jawdeh, Bassam G, Racusen LC, Bhasin B, Arend LJ, Trollinger B, Kraus E, Rabb H, Zachary AA, Montgomery RA, Alachkar N: **Late antibody-mediated rejection in renal allografts: outcome after conventional and novel therapies.** *Transplantation* 2014, **97**:1240-6.
71. Faguer S, Kamar N, Guilbeaud-Frugier C, Fort M, Modesto A, Mari A, Ribes D, Cointault O, Lavyssièrre L, Guitard J, Durand D, Rostaing L: **Rituximab therapy for acute humoral rejection after kidney transplantation.** *Transplantation* 2007, **83**:1277-80.
72. An GH, Yun J, Hong YA, Khvan M, Chung BH, Choi BS, Park CW, Choi YJ, Kim Y, Yang CW: **The effect of combination therapy with rituximab and intravenous immunoglobulin on the progression of chronic antibody mediated rejection in renal transplant recipients.** *Journal of immunology research* 2014, **2014**:828732.
73. Sautenet B, Blancho G, Buchler M, Morelon E, Toupance O, Barrou B, Ducloux D, Hurault de Ligny B, Moulin B, Le Gouge A, Lebranchu Y: **One Year Results of the Effects of Rituximab on Acute Humoral Rejection in Renal Transplantation: RITUX ERAH, a Multicenter Randomized Placebo Controlled Trial [abstract].** Presented at 2013 American Transplant Congress: 18-22 May 2013, Seattle, WA.

74. Kamar N, Milioto O, Puissant-Lubrano B, Esposito L, Pierre MC, Mohamed AO, Lavayssière L, Cointault O, Ribes D, Cardeau I, Nogier MB, Durand D, Abbal M, Blancher A, Rostaing L: **Incidence and predictive factors for infectious disease after rituximab therapy in kidney-transplant patients.** *American journal of transplantation: official journal of the American Society of Transplantation and the American Society of Transplant Surgeons* 2010, **10**:89-98.
- 
75. Hychko G, Mirhosseini A, Parhizgar A, Ghahramani N: **A Systematic Review and Meta-Analysis of Rituximab in Antibody-mediated Renal Allograft Rejection.** *International journal of organ transplantation medicine* 2011, **2**:51-6.
76. Tillou X, Poirier N, Le Bas-Bernardet S, Hervouet J, Minault D, Renaudin K, Vistoli F, Karam G, Doha M, Soullillou JP, Blancho G: **Recombinant human C1-inhibitor prevents acute antibody-mediated rejection in alloimmunized baboons.** *Kidney international* 2010, **78**:152-9.
77. Zuraw BL, Busse PJ, White M, Jacobs J, Lumry W, Baker J, Craig T, Grant JA, Hurewitz D, Bielory L, Cartwright WE, Koleilat M, Ryan W, Schaefer O, Manning M, Patel P, Bernstein JA, Friedman RA, Wilkinson R, Tanner D, Kohler G, Gunther G, Levy R, McClellan J, Redhead J, Guss D, Heyman E, Blumenstein BA, Kalfus I, Frank MM: **Nanofiltered C1 inhibitor concentrate for treatment of hereditary angioedema.** *The New England journal of medicine* 2010, **363**:513-22.
78. Hillmen P, Young NS, Schubert J, Brodsky RA, Socié G, Muus P, Röth A, Szer J, Elebute MO, Nakamura R, Browne P, Risitano AM, Hill A, Schrezenmeier H, Fu C, Maciejewski J, Rollins SA, Mojcik CF, Rother RP, Luzzatto L: **The complement inhibitor eculizumab in paroxysmal nocturnal hemoglobinuria.** *The New England journal of medicine* 2006, **355**:1233-43.
79. Zuber J, Le Quintrec M, Krid S, Bertoye C, Gueutin V, Lahoche A, Heyne N, Ardissino G, Chatelet V, Noël L, Hourmant M, Niaudet P, Frémeaux-Bacchi V, Rondeau E, Legendre C, Loirat C: **Eculizumab for atypical hemolytic uremic syndrome recurrence in renal transplantation.** *American journal of transplantation: official journal of the American Society of Transplantation and the American Society of Transplant Surgeons* 2012, **12**:3337-54.
80. Barnett A, Nicholas R, Asgari E, Chowdhury P, Sacks SH, Dorling A, Mamode N: **The use of eculizumab in renal transplantation.** *Clinical transplantation* 2013, **27**:E216-29.
81. Stegall MD, Diwan T, Raghavaiah S, Cornell LD, Burns J, Dean PG, Cosio FG, Gandhi MJ, Kremers W, Gloor JM: **Terminal complement inhibition decreases antibody-mediated rejection in sensitized renal transplant recipients.** *American journal of transplantation: official journal of the American Society of Transplantation and the American Society of Transplant Surgeons* 2011, **11**:2405-13.
82. Perry DK, Burns JM, Pollinger HS, Amiot BP, Gloor JM, Gores GJ, Stegall MD: **Proteasome inhibition causes apoptosis of normal human plasma cells preventing alloantibody production.** *American journal of transplantation: official journal of the American Society of Transplantation and the American Society of Transplant Surgeons* 2009, **9**:201-9.
83. Everly MJ, Everly JJ, Susskind B, Brailey P, Arend LJ, Alloway RR, Roy-Chaudhury P, Govil A, Mogilishetty G, Rike AH, Cardi M, Wadhi G, Tevar A, Woodle ES: **Bortezomib provides effective therapy for antibody- and cell-mediated acute rejection.** *Transplantation* 2008, **86**:1754-61.
84. Liefeldt L, Brakemeier S, Glander P, Waiser J, Lachmann N, Schönemann C, Zukunft B, Illigens P, Schmidt D, Wu K, Rudolph B, Neumayer H, Budde K: **Donor-specific HLA antibodies in a cohort comparing everolimus with cyclosporine after kidney transplantation.** *American journal of transplantation: official journal of the American Society of Transplantation and the American Society of Transplant Surgeons* 2012, **12**:1192-8.
85. Serre J, Michonneau D, Bachy E, Noël L, Dubois V, Suberbielle C, Kreis H, Legendre C, Mamzer-Bruneel M, Morelon E, Thauinat O: **Maintaining calcineurin inhibition after the diagnosis of post-transplant lymphoproliferative disorder improves renal graft survival.** *Kidney international* 2014, **85**:182-90.
86. Chesneau M, Michel L, Degauque N, Brouard S: **Regulatory B cells and tolerance in transplantation: from animal models to human.** *Frontiers in immunology* 2013, **4**:497.
87. Zeng Q, Ng Y, Singh T, Jiang K, Sheriff KA, Ippolito R, Zahalka S, Li Q, Randhawa P, Hoffman RA, Ramaswami B, Lund FE, Chalasani G: **B cells mediate chronic allograft rejection independently of antibody production.** *The Journal of clinical investigation* 2014, **124**:1052-6.

Annexe 4 : High mTOR activity is a hallmark of reactive natural killer cells and amplifies early signaling through activating receptors

High mTOR activity is a hallmark of reactive natural killer cells and amplifies early signaling through activating receptors

Antoine Marçais^{1,2,3,4,5*}, Marie Marotel^{1,2,3,4,5}, Sophie Degouve^{1,2,3,4,5}, Alice Koenig^{1,2,3,4,5}, Sébastien Fauteux-Daniel^{1,2,3,4,5}, Annabelle Drouillard^{1,2,3,4,5}, Heinrich Schlums⁶, Sébastien Viel^{1,2,3,4,5,7}, Laurie Besson^{1,2,3,4,5}, Omran Allatif^{1,2,3,4,5}, Mathieu Bléry⁸, Eric Vivier^{9,10}, Yenan Bryceson^{6,11}, Olivier Thaunat^{1,2,3,4,5}, Thierry Walzer^{1,2,3,4,5*}

¹CIRI, Centre International de Recherche en Infectiologie - International Center for Infectiology Research, Lyon, France; ²Inserm, U1111, Lyon, France; ³Ecole Normale Supérieure de Lyon, Lyon, France; ⁴Université Lyon 1, Lyon, France; ⁵CNRS, UMR5308, Lyon, France; ⁶Centre for Hematology and Regenerative Medicine, Department of Medicine, Karolinska Institutet, Karolinska University Hospital Huddinge, Stockholm, Sweden; ⁷Laboratoire d'Immunologie, Hospices Civils de Lyon, Centre Hospitalier Lyon Sud, Lyon, France; ⁸Innate-Pharma, Marseille, France; ⁹Aix-Marseille Université, CNRS, INSERM, CIML, Marseille, France; ¹⁰APHM, Hôpital de la Timone, Service d'Immunologie, Marseille, France; ¹¹Broegelmann Research Laboratory, The Gades Institute, University of Bergen, Bergen, Norway

*For correspondence: antoine.marcais@inserm.fr (AM); thierry.walzer@inserm.fr (TW)

Competing interest: See page 18

Funding: See page 18

Received: 28 February 2017

Accepted: 29 August 2017

Published: 06 September 2017

Reviewing editor: Wayne M Yokoyama, Howard Hughes Medical Institute, Washington University School of Medicine, United States

© Copyright Marçais et al. This article is distributed under the terms of the [Creative Commons Attribution License](#), which permits unrestricted use and redistribution provided that the original author and source are credited.

Abstract NK cell education is the process through which chronic engagement of inhibitory NK cell receptors by self MHC-I molecules preserves cellular responsiveness. The molecular mechanisms responsible for NK cell education remain unclear. Here, we show that mouse NK cell education is associated with a higher basal activity of the mTOR/Akt pathway, commensurate to the number of educating receptors. This higher activity was dependent on the SHP-1 phosphatase and essential for the improved responsiveness of reactive NK cells. Upon stimulation, the mTOR/Akt pathway amplified signaling through activating NK cell receptors by enhancing calcium flux and LFA-1 integrin activation. Pharmacological inhibition of mTOR resulted in a proportional decrease in NK cell reactivity. Reciprocally, acute cytokine stimulation restored reactivity of hyporesponsive NK cells through mTOR activation. These results demonstrate that mTOR acts as a molecular rheostat of NK cell reactivity controlled by educating receptors and uncover how cytokine stimulation overcomes NK cell education.

DOI: <https://doi.org/10.7554/eLife.26423.001>

Introduction

Natural killer (NK) cells are group 1 innate lymphoid cells characterized by their ability to kill target cells and to secrete cytokines such as IFN- γ (*Spits et al., 2013*). Thereby, they take part in the early response against infected and neoplastic cells. Target cell recognition and NK cell activation are controlled by the balance between positive and negative signals arising from the engagement of an array of NK activating receptors (NKar) and NK inhibitory receptors (NKir). While normal cells express an excess of NKir ligands, stressed cells, such as tumor and infected cells, may lose

eLife digest The cells of the immune system patrol the body to detect and destroy harmful microbes and diseased cells. Natural killer cells are immune cells with a natural capacity to kill infected or cancerous cells, as their name suggests. Importantly, they do so while sparing the surrounding healthy cells.

As natural killer cells mature they go through an “education” process to learn to distinguish between normal and abnormal cells. During education, the natural killer cells interact continuously with nearby healthy cells. However, it remains unknown how these interactions change the natural killer cells, or how these changes control their killing activity.

Marçais et al. now show that a protein called mTOR is essential to the education of natural killer cells. Comparing natural killer cells that had or had not completed the education process revealed that mTOR is more active in the educated cells. Moreover, inhibiting the activity of mTOR caused educated natural killer cells to lose their ability to identify diseased cells, while stimulating mTOR activity in uneducated natural killer cells mimicked the education process, allowing them to recognize and eliminate diseased host cells.

Certain nutrients are known to control the activity of mTOR, which suggests these nutrients could also affect how natural killer cells develop. In addition, manipulating the activity of mTOR could be used to control the response of natural killer cells to diseased host cells, and so could form part of treatments for cancer and infectious diseases. However, given that mTOR plays numerous roles within different body cells, any potential therapies that are developed would need to be able to manipulate mTOR specifically in natural killer cells.

DOI: <https://doi.org/10.7554/eLife.26423.002>

expression of NKir ligands (‘missing-self’) or acquire expression of NKar ligands (‘modified-self’), thus tilting the balance towards activation. NKirs, which mostly recognize classical or non-classical MHC-I molecules, are stochastically expressed, resulting in a variegated expression pattern. Depending on the species, three types of NKir interact with MHC-I: Killer Immunoglobulin-like Receptors (KIR) in primates, Ly49 receptors of the lectin-like family in rodents and the heterodimer formed by CD94 and NKG2A in these species (**Vivier et al., 2008**).

In addition, considerable functional heterogeneity is observed in the NK cell population. Such cell intrinsic differences led to the proposition that NK cell reactivity and consequently their ability to discriminate self from non-self is the result of an education process (**Anfossi et al., 2006; Fernandez et al., 2005; Kim et al., 2005**). There was however considerable debate over the molecular process leading to education. Two theories were crafted to account for these observations: the first one proposing that a priming (or arming) signal was required to confer reactivity to otherwise hyporesponsive cells, the second positing that responsiveness is a default state that is lost upon unopposed chronic stimulation of NKar (disarming) (**Höglund and Brodin, 2010**). The data accumulated so far are in favor of the latter model, suggesting that intrinsic reactivity is lost upon chronic engagement of NKar unless this is opposed by concomitant engagement of NKir. Indeed, there is no evidence so far that priming signals are a prerequisite for acquisition of responsiveness. In contrast, disarming is the simplest explanation to account for the tolerance to self of NK cells raised in a mosaic or chimeric environment (**Johansson et al., 1997; Wu and Raulet, 1997**). Moreover, the loss of reactivity consequent to exposure of NK cells to activating ligands functionally demonstrates the possibility to disarm reactive NK cells (**Oppenheim et al., 2005; Tripathy et al., 2008**).

At the molecular level, physical interaction between NKirs and their ligands is required to maintain responsiveness as (1) only NK cells expressing NKir engaged by MHC-I at the surface of surrounding cells are reactive and as (2) NK cells expressing NKirs but developing in MHC-I deficient humans or animals are functionally impaired (**Fernandez et al., 2005; Kim et al., 2005; Zimmer et al., 1998**). In addition, the inhibitory signaling module acting downstream of NKirs is required to maintain reactivity. Indeed, mutation of the immunoreceptor tyrosine-based motifs (ITIM) of inhibitory Ly49 molecules or deficiency in the phosphatase SHP-1, recruited to NKirs upon ligation, decreases responsiveness (**Kim et al., 2005; Viant et al., 2014**). Inhibition of the activating signal by NKir thus serves two-distinct but related purposes: it counters inappropriate NK cell

activation and it prevents the desensitization induced by chronic stimulation thereby preserving NK cell reactivity. In inbred C57BL/6 mice, Ly49C (specific for H2-K^b), Ly49I (specific for H2-K^b) and the CD94/NKG2A receptor (specific for a D^b peptide presented by Qa-1) have been shown to interact with substantial affinity with self-MHC class I molecules, while other receptors show no or marginal affinity (Hanke et al., 1999; Michaëlsson et al., 2000; Vance et al., 1998). Consequently, NK cell populations expressing these receptors are educated in C57BL/6 mice, that is, they are more reactive than their non-educated counterparts (Fernandez et al., 2005; Joncker et al., 2009; Kim et al., 2005). Education is a dynamic process tuned by the number of engaged NKirs and the strength of each interaction in a rheostat-like manner (Brodin et al., 2009a; Johansson et al., 2005; Joncker et al., 2009). It is also reversible in as little as one or two days as shown in different experimental set-ups (Ebihara et al., 2013; Elliott et al., 2010; Joncker et al., 2010). This suggests the existence of a potent cellular process integrating activating and inhibitory educating signals of variable strength (i.e. the strength of the NKar or NKir-ligand interaction and number of different interactions over time) and controlling the display of effector functions in response to NKar stimulation.

Previous studies have shown that reactive NK cells are characterized by stronger calcium flux and LFA-1 integrin activation upon NKar stimulation (Guia et al., 2011; Thomas et al., 2013). However, the nature of the molecular process conditioning NK cell reactivity and negatively affected by chronic engagement of NKar is unknown. To address this question, we systematically compared phosphorylation levels of key molecules involved in immunoreceptor tyrosine-based activating motif (ITAM) signaling in reactive vs. hyporesponsive NK cells at steady-state and following NKar stimulation. We discovered that NK cell reactivity is associated with a higher basal activity of the mammalian target of rapamycin (mTOR) pathway. Our genetic and pharmacological approaches collectively demonstrate a prominent role of mTOR signaling in controlling steady-state NK cell responsiveness.

Results

Reactive NK cells display higher activity of the Akt/mTOR pathway at steady-state and following acute NKar engagement

Seeking to identify molecular pathways involved in NK cell education, we systematically screened the basal levels of 20 phosphorylations on 16 proteins involved in ITAM signaling between reactive and hyporesponsive NK cells by flow cytometry (complete list in Table 1). This flow-cytometry based approach allowed us to combine the advantages of single-cell analysis and comparison of equivalent cell subset thanks to electronic gating. In C57BL/6 mice, the main educating NKirs are NKG2A and Ly49C, defining four subsets of which the double-negative display the lowest, the double-positive the highest and the single positives an intermediate responsiveness (Joncker et al., 2009). We also analyzed *B2m*^{-/-} NK cells that are uniformly unreactive. Most of these phosphorylations are developmentally regulated (Figure 1—figure supplement 1), thus, to exclude any developmental bias, we compared similar developmental stages defined by CD11b and CD27 (Figure 1—figure supplement 2). Strikingly, all analyzed phosphorylations in the Akt/mTOR pathway correlated positively with the level of NK cell reactivity (Figure 1A). This was true when comparing C57BL/6 and *B2m*^{-/-} NK cells as well as reactive and unreactive populations in C57BL/6 mice, regardless of the maturation stage. In C57BL/6 populations, absence of either NKG2A or Ly49C had a measurable negative effect, the absence of both leading to further decrease in the phosphorylation level. We also noted a significant correlation between education status and the level of pNFκB S529 and S468 as well as pLck Y505 and pItk Y180 (Figure 1A). However, as the most consistent differences lied in the Akt/mTOR pathway, we decided to focus our analysis on this pathway.

The phosphatase SHP-1 is required to maintain an optimal NK cell reactivity (Viant et al., 2014). To test its involvement in the maintenance of the basal activity of the Akt/mTOR pathway, we measured the phosphorylation levels of the ribosomal S6 protein and Akt in NK cells deficient in *Ptpn6*, the gene encoding SHP-1. As a control, we also measured the level of phosphorylation of STAT5 in these cells. The basal activity of the Akt/mTOR pathway was specifically decreased in NK cells from *Ncr1*^{Cre/+} *Ptpn6*^{lox/lox} mice compared to control NK cells while pSTAT5 levels were unchanged (Figure 1B). Thus, basal activation of the Akt/mTOR pathway is correlated with NK cell reactivity and controlled by SHP-1-dependent signaling downstream of NKirs.

Table 1. List of the antibodies used in this study and the phosphoepitopes they recognize.

Phosphoepitope	Clone (Supplier)
pCD3 ζ (Y142)	K25-407.69 (BD)
pLck (Y505)	4/LCK-Y505 (BD)
pSyk (Y342)	I120-722 (BD)
pSLP76 (Y128)	J141-668.36.58 (BD)
pIrk (Y180)	N35-86 (BD)
pPLC γ 2 (Y759)	K86-689.37 (BD)
pWIP (S478)	K32-824 (BD)
p-p38 (T180/Y182)	36/p38 (pT180/pY182) (BD)
pERK1/2 (T203/Y205)	20A (BD)
p-c-Cbl (Y698)	47/c-Cbl (BD)
pJNK (T183/Y185)	N9-66 (BD)
pNFkB p65 (S468)	#3039 (CST)
pNFkB p65 (S529)	K10-895.12.50 (CST)
pNFkB p65 (S536)	93H1 (CST)
pAkt (T308)	C31E5E (CST)
pAkt (S473)	M89-61 (BD)
pS6 (S235/236)	D57.2.2E (CST)
p4EBP1 (T36/45)	236B4 (CST)
p-mTOR (S2448)	D9C2 (CST)
p-mTOR (S2481)	#2974 (CST)

DOI: <https://doi.org/10.7554/eLife.26423.007>

We next compared mTOR-related signaling events arising from NKar stimulation in reactive versus hyporesponsive NK cells. To this end, we stimulated splenocytes from C57BL/6 (around 85% of NK cells are reactive in these mice) and $B2m^{-/-}$ mice by crosslinking NK1.1 and we measured phosphorylation events over time. Phosphorylation of Akt on T308 and S473 and phosphorylation of the ribosomal protein S6 were induced at higher levels in reactive NK cells compared to hyporesponsive NK cells (**Figure 1C,D**). By contrast, other signaling events not linked to the mTOR pathway were induced at similar levels (**Figure 1C,D** and **Figure 1—figure supplement 3**).

In summary, high activity of the Akt/mTOR pathway is a hallmark of reactive NK cells both at steady-state and following stimulation through NKars. Importantly, considering that education is not a discrete but rather a continuous process, absence of one or two of the educating NKir in C57BL/6 resulted in a commensurate loss in mTOR activity.

Chronic NK cell stimulation results in decreased phosphorylation of the Akt/mTOR pathway which parallels the loss of reactivity

Education is rapidly reverted by unopposed chronic stimulation. Indeed, transfer of reactive NK cells into a host devoid of MHC-I leads to their rapid loss of reactivity and to their tolerance to MHC-I negative cells (**Joncker et al., 2010**). We thus sought to test whether chronic NKar stimulation decreased the activity of the Akt/mTOR pathway in parallel with the decrease of reactivity. To this purpose, we transferred reactive C57BL/6 NK cells into control C57BL/6 or $B2m^{-/-}$ mice and measured basal Akt/mTOR phosphorylation levels and their reactivity 3 days after transfer. To quantify the intensity of NKar signaling, we took advantage of a transcriptional reporter of the TCR signaling (**Moran et al., 2011**). This reporter consists of a GFP under the control of the promoter sequence of *Nur77*, an orphan nuclear receptor strongly induced in response to TCR stimulation. The signaling pathways triggered by TCR or NKar engagement mobilizing the same signaling adaptors, we reasoned that the *Nur77*^{GFP} construct might also report NKar triggering. Indeed, in vitro stimulation with an NK1.1 agonist antibody or YAC-1 cells, a lymphoblastic cell line detected as foreign by C57BL/6 NK cells, resulted in an increase in the GFP fluorescence (**Figure 2—figure supplement 1**).

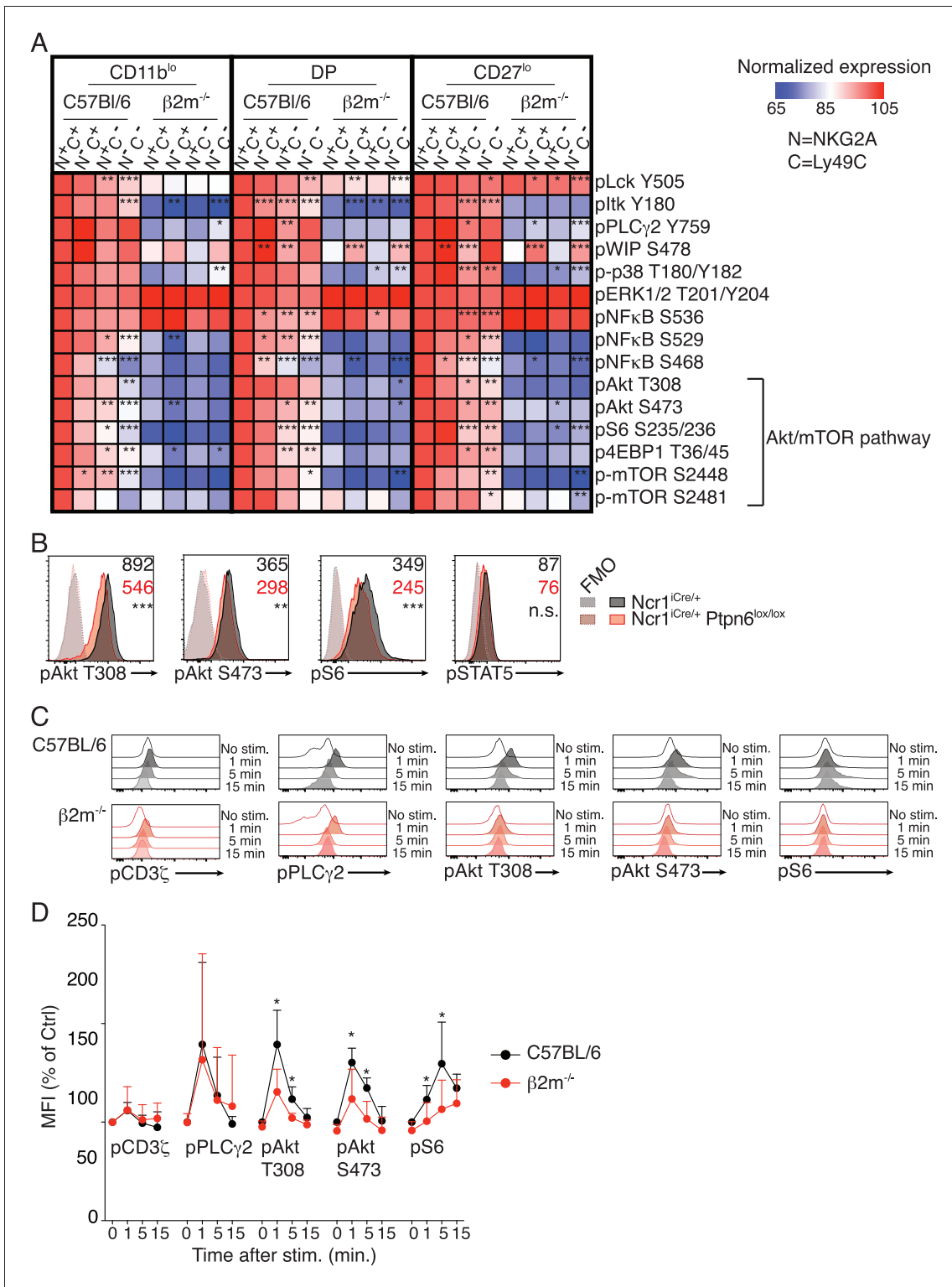

Figure 1. Basal activity of the mTOR pathway is proportional to the level of NK cell reactivity, and dependent on SHP1. (A) Heatmap representing the phosphorylation level of the phosphoepitopes indicated on the right in the different subsets of splenic resting NK cells indicated on top and gated as defined in **Figure 1—figure supplement 2**. Mean Fluorescence Intensity was recorded for each phosphoepitope in each subset. Normalized expression was calculated using the N⁺C⁺ subset of C57BL/6 mice as reference, as described in the Materials and Methods. The mean values are shown (n = 6 mice of each genotype in three independent experiments, adjusted p-values were calculated as described in the Materials and methods **Figure 1 continued on next page**

Figure 1 continued

and compare the N^+C^+ subset to the indicated subset, * $p < 0.05$, ** $p < 0.01$, *** $p < 0.001$). (B) Histograms representing the phosphorylation level of the indicated proteins in splenic resting NK cells from $Ncr1^{Cre/+}$ or $Ncr1^{Cre/+} Ptpn6^{lox/lox}$ mice (representative of 5 mice of each genotype in three independent experiments, t-test, ** $p < 0.01$; *** $p < 0.001$, n.s. non significant). The MFI are indicated, in black for the $Ncr1^{Cre/+}$ NK cells and in red for the $Ncr1^{Cre/+} Ptpn6^{lox/lox}$ NK cells. (C–D) Phosphorylation level of the indicated phospho-epitope in splenic NK cells from C57BL/6 or $B2m^{-/-}$ mice following NK1.1 stimulation for the indicated time. (C) Histogram overlays from one representative experiment. (D) MFI of the indicated phospho-epitope (mean +SD) of 5 mice of each genotype in five independent experiments (t-test, * $p < 0.05$).

DOI: <https://doi.org/10.7554/eLife.26423.003>

The following figure supplements are available for figure 1:

Figure supplement 1. Bar graph showing the phosphorylation level of the indicated phosphoepitopes in the different subsets of splenic resting C57BL/6 NK cells defined by their expression of CD27 and CD11b.

DOI: <https://doi.org/10.7554/eLife.26423.004>

Figure supplement 2. Flow cytometry density plots presenting the analysis strategy to compare educated versus uneducated NK cells in C57BL/6 mice and the phenotypically equivalent subsets in $B2m^{-/-}$ mice.

DOI: <https://doi.org/10.7554/eLife.26423.005>

Figure supplement 3. Phosphorylation level of phospho-epitopes defined in **Table 1** was measured by flow-cytometry in splenic NK cells from C57BL/6 or $B2m^{-/-}$ mice following NK1.1 stimulation for the indicated time.

DOI: <https://doi.org/10.7554/eLife.26423.006>

Moreover, this increase was commensurate with reactivity so that higher GFP levels were reached in reactive $NKG2A^+Ly49C^+$ NK cells, thus validating the expression of GFP as a reporter of NK cell stimulation. Transfer of $Nur77^{GFP}$ cells into $B2m^{-/-}$ mice resulted in a transient increase in the GFP level in the reactive subsets one day after transfer indicative of ongoing NK cell signaling (**Figure 2A**). Interestingly, this was followed, 3 days after transfer, by a significant decrease in steady-state GFP level indicative of a loss of the cell capacity to signal following NK cell stimulation. As previously reported, NK cells transferred into $B2m^{-/-}$ mice lost their reactivity while reactivity was maintained upon transfer into C57BL/6 host (**Figure 2B**, anti-NK1.1 stimulation and **Figure 2—figure supplement 2**, anti-NKp46 or YAC1 stimulation). Importantly, this was paralleled by a decrease in the phosphorylation of S6 and Akt S473 and a loss of the gradient observed between the different subsets expressing $Ly49C$ and $NKG2A$ (**Figure 2C**).

Collectively, these results demonstrate that the basal activity of the Akt/mTOR pathway is negatively affected by persistent and unopposed NK cell stimulation. This suggests that engagement of $Ly49C$ and $NKG2A$ in C57BL/6 mice preserves Akt/mTOR basal activity resulting in higher basal phosphorylation in the NK cell population expressing these NK cells.

mTOR is essential for NK cell reactivity

To test if high mTOR activity was required for NK cell reactivity, we stimulated NK cells from $Ncr1^{Cre/+} Mtor^{lox/lox}$ or control mice with plate-bound anti-NK1.1 antibody or YAC-1 cells and measured NK cell degranulation relative to the expression of the major educating receptors $Ly49C$ and $NKG2A$. Control NK cells responded significantly better than mTOR-deficient NK cells, irrespective of the subset analyzed (**Figure 3A**). Moreover, within control NK cells, reactive $Ly49C^+NKG2A^+$ degranulated more than the other subsets, while mTOR deficiency resulted in equally hyporesponsive subsets.

These results suggested a major role of mTOR in NK cell reactivity. However, mTOR deficiency leads to a severe NK cell developmental block that may confound the interpretation of the results (**Marçais et al., 2014**). To address this issue we took advantage of Torin2, a highly selective ATP-competitive mTOR inhibitor targeting both mTORC1 and mTORC2 (**Liu et al., 2011**). We stimulated mature NK cells from C57BL/6 and $B2m^{-/-}$ mice with plate-bound anti-NK1.1 in the presence or absence of the inhibitor. Torin2 significantly decreased the capacity of C57BL/6 NK cells to produce IFN- γ and to degranulate upon stimulation, regardless of the subset analyzed (**Figure 3B**). Moreover, treatment of C57BL/6 NK cells with Torin2 abrogated the differences between highly reactive ($Ly49C^+NKG2A^+$) and hyporesponsive ($Ly49C^-NKG2A^-$) cells. Treatment of hyporesponsive $B2m^{-/-}$ NK cells led to a further decrease in their capacity to degranulate while their production of IFN- γ was unaffected. Similar results were obtained upon NKp46 stimulation (**Figure 3—figure supplement 1**). Torin2 treated C57BL/6 NK cells thus functionally behaved like $B2m^{-/-}$ hyporesponsive NK

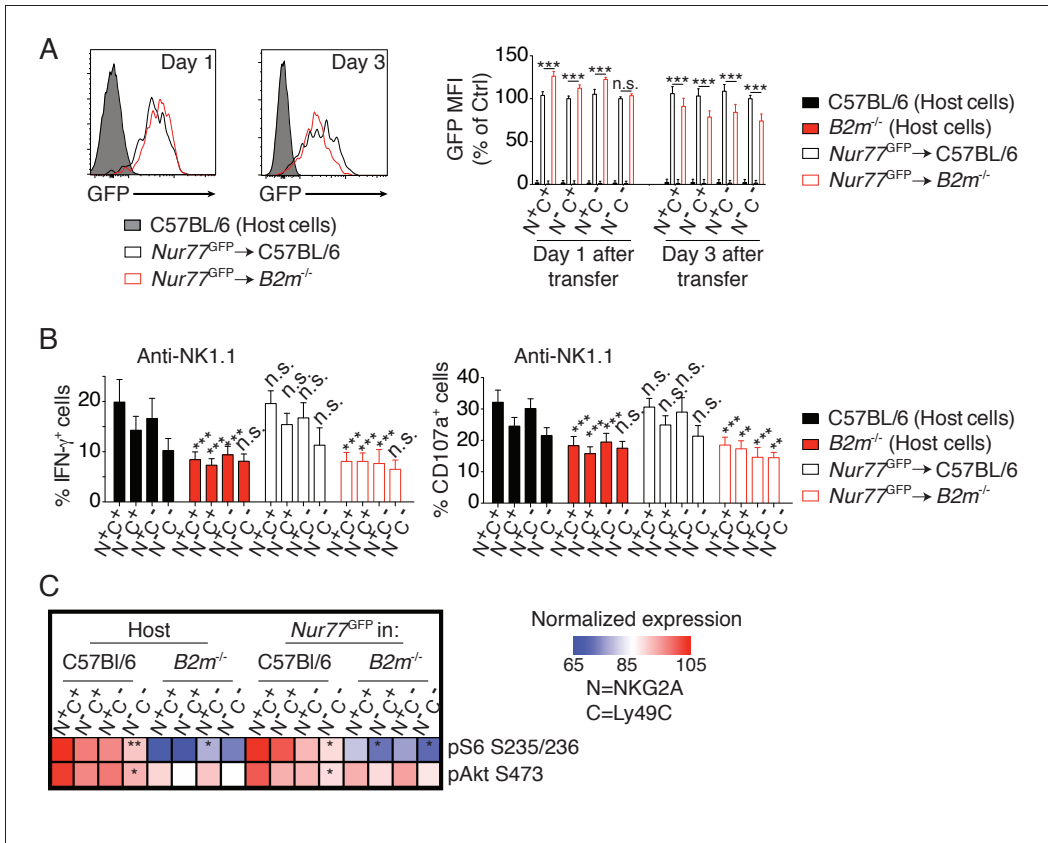

Figure 2. Reversion of education is accompanied by loss of the basal activity of the mTOR pathway. (A) Left: Representative histograms showing the GFP fluorescence levels of *Nur77^{GFP}* NK cells transferred into C57BL/6 or *B2m^{-/-}* mice and harvested 1 or 3 days after transfer. Non-transgenic host cells are shown. Right: Bar graph showing the GFP levels of the indicated splenic NK cell subsets normalized to the N⁺C⁺ population of *Nur77^{GFP}* NK cells transferred into C57BL/6 control mice (mean +SD, n = 6 mice of each genotype per time point in two independent experiments, two-way ANOVA; ***p<0.001, n.s. non significant). (B) Percentage (mean + SD) of IFN- γ ⁺ or CD107a⁺ cells among splenic host or transferred NK cells of the indicated subset following a 4 hr stimulation with coated anti-NK1.1. The experiment was done 3 days after transfer (n = 6 mice of each genotype in two independent experiments, two-way ANOVA comparing each subset to its counterpart in C57BL/6 mice, **p<0.01, ***p<0.001, n.s. non significant). (C) Heatmap representing the phosphorylation level of the phosphoepitopes indicated on the right in the different subsets of splenic resting NK cells indicated on top. Mean Fluorescence Intensity was recorded for each phosphoepitope in each subset. Normalized expression was calculated using the N⁺C⁺ subset of C57BL/6 host NK cells as reference. The mean values are shown (n = 6 mice of each genotype in two independent experiments, t-tests comparing the N⁺C⁺ subset to the indicated subset, *p<0.05, **p<0.01).

DOI: <https://doi.org/10.7554/eLife.26423.008>

The following figure supplements are available for figure 2:

Figure supplement 1. Left: Representative histograms showing the GFP fluorescence levels of *Nur77^{GFP}* NK cells before or after a 4 hr stimulation with anti-NK1.1 or YAC-1 cells.

DOI: <https://doi.org/10.7554/eLife.26423.009>

Figure supplement 2. Percentage (mean +SD) of IFN- γ ⁺ or CD107a⁺ cells among splenic host or transferred NK cells of the indicated subset following 4 hr stimulation with (A) coated anti-NKp46 or (B) YAC-1 cells.

DOI: <https://doi.org/10.7554/eLife.26423.010>

cells. Similarly, Torin2 inhibited C57BL/6 NK cells from triggering YAC-1 lysis at a similar level seen in hyporesponsive *B2m^{-/-}* NK cells (Figure 3C). Torin2 treatment had no effect on the lytic capacity of *B2m^{-/-}* NK cells.

Education conditions the phenomenon of missing-self recognition. A classical readout to highlight this property is to measure the rate of rejection of MHC-I negative target cells in vivo. To test whether basal activity of the Akt/mTOR pathway was involved in this process, we transferred a mix of C57BL/6 and NK-sensitive MHC-I negative (*B2m^{-/-}*) target cells into C57BL/6 mice, previously

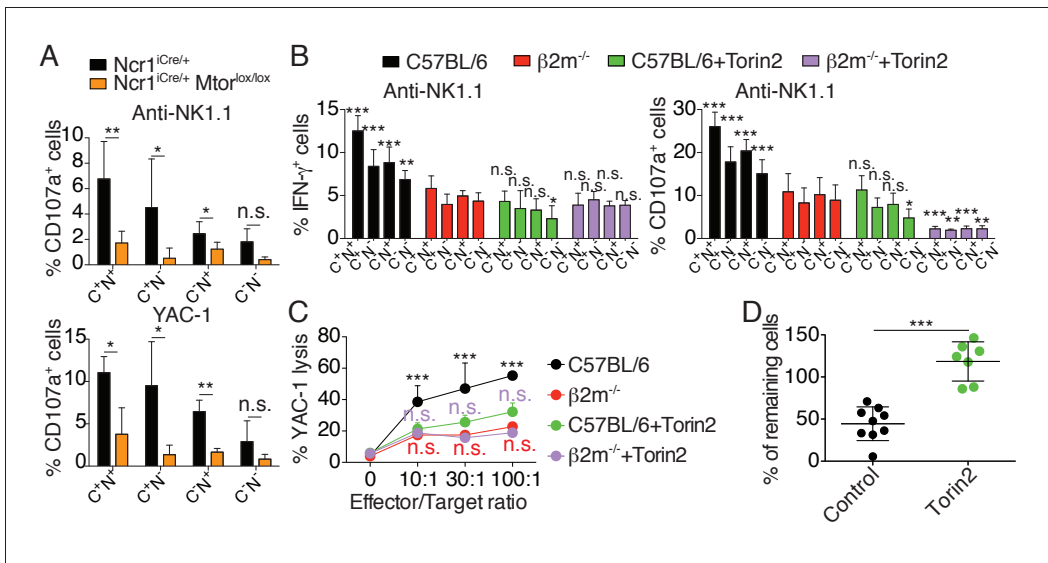

Figure 3. mTOR is essential for NK cell reactivity. (A) Percentage (mean \pm SD) of CD107a⁺ cells among splenic CD11b^{lo} NK cells of the indicated subset from *Ncr1^{iCre/+}* or *Ncr1^{iCre/+} Mtor^{lox/lox}* mice following 4 hr stimulation with coated anti-NK1.1 or YAC-1 cells ($n = 5$ mice of each genotype in three independent experiments, t-tests comparing each subset in both genotype, * $p < 0.05$, ** $p < 0.01$, n.s. non significant). (B) Percentage (mean \pm SD) of IFN- γ ⁺ or CD107a⁺ cells among splenic NK cells of the indicated subset from C57BL/6 or *B2m^{-/-}* mice following 4 hr stimulation with coated anti-NK1.1 in the presence or absence of 250 nM Torin2 ($n = 9$ –10 mice of each genotype in five independent experiments, two-way ANOVA comparing each subset to its counterpart in *B2m^{-/-}* mice, * $p < 0.05$, ** $p < 0.01$, *** $p < 0.001$, n.s. non significant). (C) Percentage (mean \pm SD) of dead YAC-1 cells after a 4 hr co-culture with purified NK cells of the indicated genotype at the indicated Effector/Target ratio in the presence or absence of 250 nM Torin2 ($n = 9$ C57BL/6 and 7 *B2m^{-/-}* mice in four independent experiments, two-way ANOVA comparing each E/T ratio of C57BL/6 + Torin2 to C57BL/6, *B2m^{-/-}* or *B2m^{-/-} + Torin2* as indicated by the color, *** $p < 0.001$, n.s. non significant). (D) Percentage of remaining *B2m^{-/-}* target cells following in vivo cytotoxicity experiment as described in the Materials and methods. Each dot represents a single mouse, bars indicate mean and SD ($n = 9$ control treated mice and 7 Torin2 treated mice in two independent experiments, t-test, *** $p < 0.001$).

DOI: <https://doi.org/10.7554/eLife.26423.011>

The following figure supplement is available for figure 3:

Figure supplement 1. Percentage (mean \pm SD) of IFN- γ ⁺ or CD107a⁺ cells among splenic NK cells of the indicated subset from C57BL/6 or *B2m^{-/-}* mice following 4 hr stimulation with coated anti-NKp46 in the presence or absence of 250 nM Torin2 ($n = 9$ –10 mice of each genotype in five independent experiments, 2-way ANOVA comparing each subset to its counterpart in *B2m^{-/-}* mice, * $p < 0.05$, ** $p < 0.01$, *** $p < 0.001$, n.s. non significant).

DOI: <https://doi.org/10.7554/eLife.26423.012>

treated or not with Torin2. While injection into control mice led to the disappearance of 50% of the target cells, this rejection was abrogated in Torin2 treated animals, underlining the importance of mTOR activity in NK cell recognition of missing-self under steady-state conditions (**Figure 3D**).

Altogether, these results demonstrate that mTOR is required for NK cell reactivity.

mTOR is a rheostat of NK cell reactivity through NKAr

The ‘rheostat’ model of education proposes that the strength of the MHC-I input translates into a quantitative modification of NK cell responsiveness (**Brodin et al., 2009b**). Indeed, several studies reported that the higher the number of self-MHC-I receptors expressed by NK cells interacting with their ligands, the stronger their responsiveness (**Brodin et al., 2009a; Johansson et al., 2005; Joncker et al., 2009**). As shown in **Figure 1**, the level of mTOR activity was tightly correlated with the number of educating NKirs in NK cells, suggesting that mTOR could serve as the molecular rheostat translating the MHC-I input into quantitative tuning of the responsiveness. To directly test this point, we analyzed how the ex vivo modulation of mTOR activity by pharmacologic mTOR inhibitors changed NK cell responsiveness. We took advantage of four different inhibitors of graded mTOR inhibitory potential: the macrolide Rapamycin that primarily inhibits mTORC1 and three ATP-competitive inhibitors targeting both mTORC1 and mTORC2 to a varying extent: AZD2014, KU-0063794 (KU) and Torin2 (**García-Martínez et al., 2009; Guichard et al., 2015; Liu et al., 2011;**

Sabatini et al., 1994; Yang et al., 2013). The use of different concentrations of those compounds allowed us to modulate mTOR activity in NK cells over a dynamic range of 10-fold for mTORC1 or 2-fold for mTORC2 as measured by phosphorylation of S6 and Akt S473 respectively (**Figure 4A**). Of note, we confirmed that Rapamycin acted specifically on mTORC1 while AZD, KU and Torin2 inhibited both complexes. Importantly, at these concentrations no significant changes in STAT5 phosphorylation or specific toxicity over a 24 hr incubation period were noted (**Figure 4—figure supplement 1A and B**). We then correlated the S6 and Akt phosphorylation levels to the IFN- γ production and degranulation induced by NK1.1 crosslinking. S6 phosphorylation was positively correlated with the effector functions in all conditions tested (**Figure 4B**). Similar correlations were found between Akt phosphorylation and effector function upon AZD, KU or Torin2 treatment (**Figure 4C**). However, this correlation was lost upon Rapamycin treatment, suggesting that mTORC2 activity alone is not sufficient to sustain effector functions (**Figure 4B,C**). In addition, effector functions were not correlated to STAT5 phosphorylation levels (**Figure 4—figure supplement 1B,C**). Similar results were obtained upon stimulation of NK cells from *Ncr1^{iCre}* and *Ncr1^{iCre} Mtor^{lox/lox}* mice and measure of the phosphorylation levels of the S6 and Akt proteins in parallel thus genetically confirming the results (**Figure 4—figure supplement 1D**).

Overall, these results demonstrate that mTOR acts as a molecular rheostat of NK cell responsiveness. Together with results in **Figures 1 and 2**, they demonstrate that NK cell education relies on the modulation of mTOR activity that in turn controls NK cell responsiveness through NKars.

mTOR is essential for calcium response and integrin activation in NK cells following NKar engagement

Next, we asked whether mTOR activity could regulate signaling via NKar. Previous studies established that reactive NK cells display higher calcium flux (*Guia et al., 2011*) and higher integrin activation than hyporesponsive NK cells (*Thomas et al., 2013*). Hence we sought to test the impact of mTOR activity on these cardinal events in lymphocyte activation. We first measured the calcium flux in real time by flow cytometry following NK1.1 stimulation using fluorescent calcium probes and we quantified the intensity of the fluorescence peak. When we challenged *Ncr1^{iCre/+}* (control) and *Ncr1^{iCre/+} Mtor^{lox/lox}* NK cells, NK1.1 cross-linking resulted in a detectable calcium flux in NK cells of both genotypes (**Figure 5A**). However, the peak was lowered (15–20%) in the absence of mTOR. We next applied the same protocol to control C57BL/6 NK cells in the presence or absence of Torin2 to acutely inhibit mTOR. As shown in **Figure 5B**, mTOR inhibition resulted in a decreased calcium flux characterized by a 20%-decrease in the peak intensity, thus phenocopying the impact of mTOR deficiency.

Next, we assessed the effect of mTOR deficiency on LFA-1 integrin activation following NKar triggering of inside-out signaling. For this purpose, we incubated NK cells from *Ncr1^{iCre/+}* and *Ncr1^{iCre/+} Mtor^{lox/lox}* mice with beads coated with ICAM-1, the ligand of LFA-1, in the presence or absence of NK1.1 cross-linking. At different times, we measured by flow-cytometry the percentage of beads-associated NK cells as an indicator of LFA-1 activation in NK cells. As shown in **Figure 5C**, NK1.1 cross-linking failed to induce LFA-1 activation in mTOR-deficient NK cells contrary to control NK cells. In parallel, we also tested the effect of acute mTOR inhibition on LFA-1 activation in mature educated NK cells. As shown in **Figure 5D**, addition of Torin2 resulted in significant inhibition of LFA-1 activation induced by NK1.1 stimulation.

Thus, using genetic and pharmacological tools, we showed that the mTOR pathway lies upstream of two signaling events, calcium flux and LFA-1 integrin activation, which are elevated in reactive NK cells.

Metabolic parameters of reactive and hyporesponsive NK cells

mTOR is a well-known regulator of the cell metabolism. We thus asked whether the higher activity of mTOR measured in reactive NK cells resulted in detectable changes in metabolic activity. We first measured cell size and granularity using the FSC and SSC flow-cytometry parameters. Reactive NK cells from C57BL/6 control mice presented a slight but significant increase of both morphological indicators when compared to hyporesponsive NK cells of *B2m^{-/-}* mice (**Figure 6A**). Similarly, their mitochondrial content as well as glucose and fatty-acid uptake capacities estimated by measure of the uptake of the glucose fluorescent analog 2-NBDG or the fatty-acid fluorescent analog Bodipy

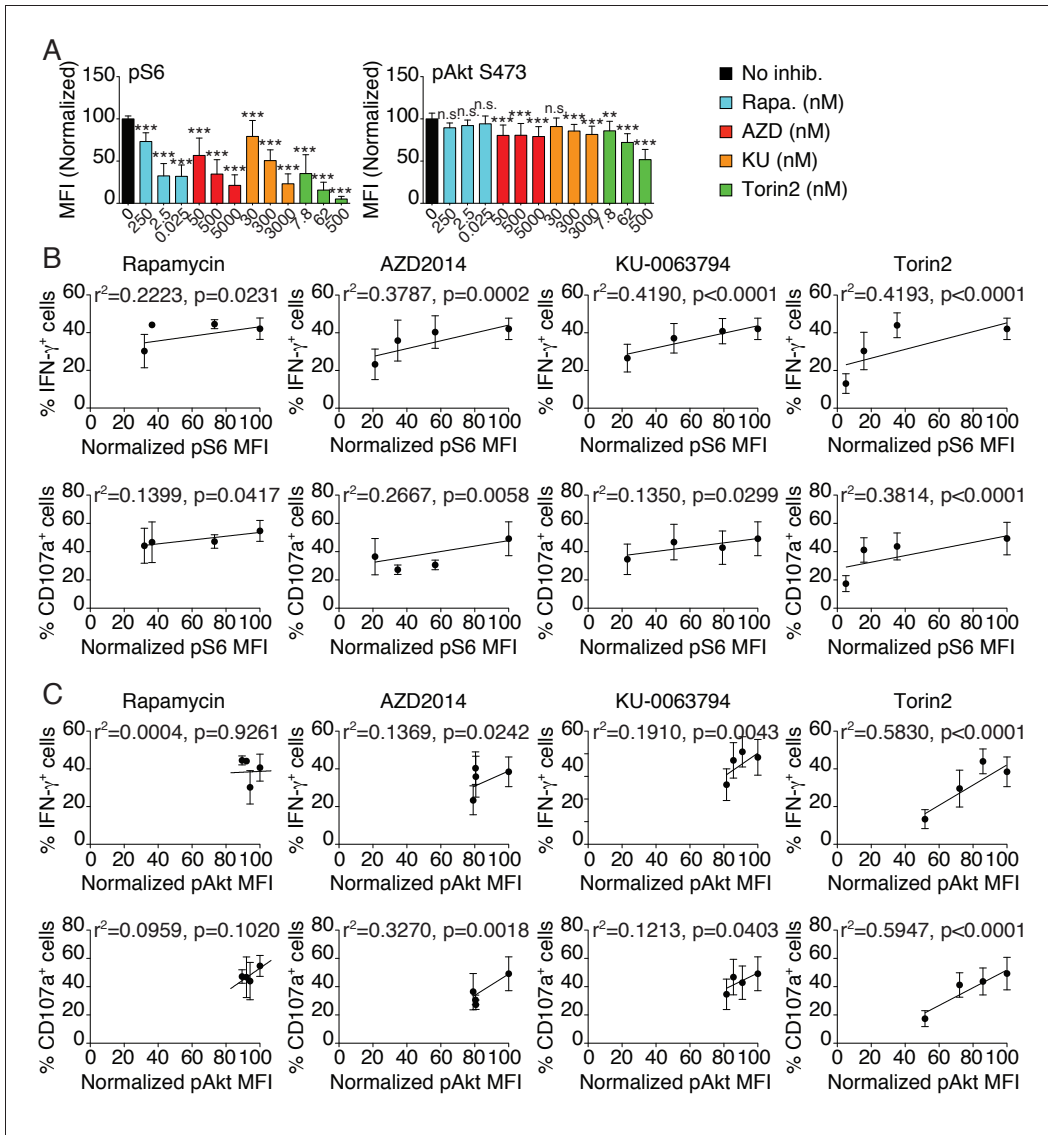

Figure 4. mTOR is a rheostat of NK cell reactivity through NKAr. (A) Bar graph showing the phosphorylation level of S6 (left) and Akt S473 (right) in splenic NK cells following 1 hr treatment with 100 ng/ml IL-15 in the presence or absence of the indicated mTOR inhibitors at the indicated concentration (mean of the MFI normalized to the No inhibitor condition +SD, n = 9 mice in three independent experiments, one-way ANOVA comparing the No inhibitor condition with the indicated condition, **p<0.01; ***p<0.001, n.s. non significant). (B–C) Linear regression plots showing the correlation between (B) pS6 or (C) pAkt S473 as indicated and the percentage of IFN- γ ⁺ or CD107a⁺ NK cells following 4 hr stimulation with coated anti-NK1.1 in the presence of 100 ng/ml IL-15 and mTOR inhibitors (mean \pm SD, n = 9 mice in three independent experiments, the r^2 and p-value calculated by linear regression are indicated).

DOI: <https://doi.org/10.7554/eLife.26423.013>

The following figure supplement is available for figure 4:

Figure supplement 1. Bar graphs showing (A) the phosphorylation level of STAT5 in splenic NK cells following 1 hr treatment with 100 ng/ml IL-15 or (B) the percentage of live NK cells following a 24 hr culture in the presence or absence of the indicated mTOR inhibitors at the indicated concentration (A) mean of the MFI normalized to the No inhibitor condition or (B) percentage of live cells + SD, n = 9 mice in three independent experiments for pSTAT5 and 4 mice in two independent experiments for Viability, one-way ANOVA comparing the No inhibitor condition with the indicated condition, n.s. non significant).

DOI: <https://doi.org/10.7554/eLife.26423.014>

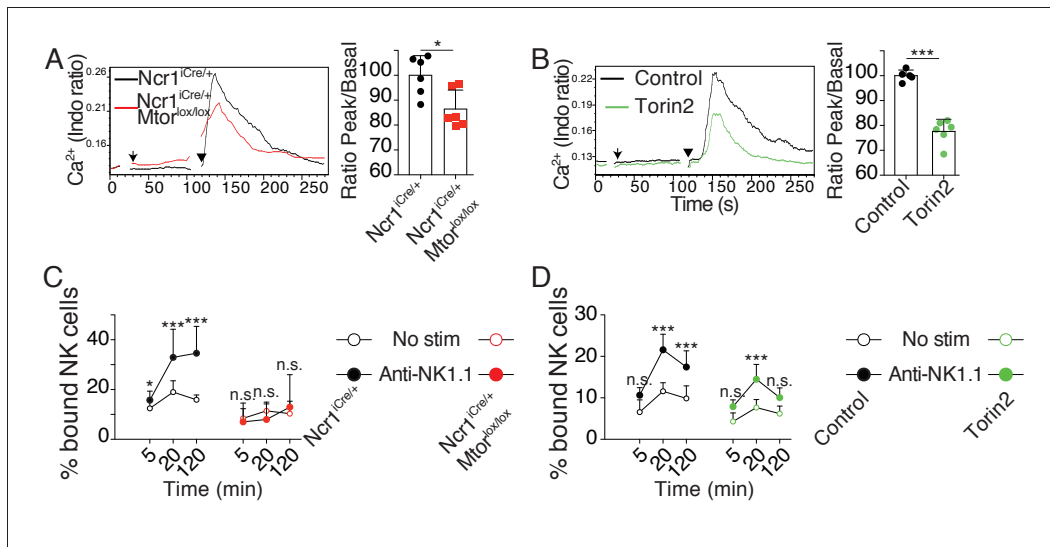

Figure 5. mTOR is essential for calcium response and integrin activation following NK cell engagement. (A) *Left:* Representative histogram overlay showing the Ca^{2+} flux intensity in splenic CD11b^{lo} NK cells from $\text{Ncr1}^{\text{Cre/+}}$ or $\text{Ncr1}^{\text{Cre/+}} \text{Mtor}^{\text{lox/lox}}$ mice. NK cells were activated following incubation with biotinylated anti-NK1.1 (Arrow) followed by cross-linking with streptavidin (Arrowhead). *Right:* Bar graph showing the Ratio Peak/basal normalized to the ratio of control NK cells (mean \pm SD, t-test $^*p < 0.05$). (B) *Left:* Representative histogram overlay showing the Ca^{2+} flux intensity in splenic NK cells from C57BL/6 mice in the presence or absence of 500 nM Torin2. *Right:* Bar graph showing the Ratio Peak/basal normalized to the ratio of control NK cells (mean \pm SD, t-test $^{***}p < 0.001$). (C) Percentage of splenic CD11b^{lo} NK cells from $\text{Ncr1}^{\text{Cre/+}}$ or $\text{Ncr1}^{\text{Cre/+}} \text{Mtor}^{\text{lox/lox}}$ mice bound to beads coated with ICAM-1 after the indicated incubation time with or without NK1.1 stimulation (mean \pm SD, $n = 6$ mice of each genotype in four independent experiments, two-way ANOVA comparing the conditions with or without NK1.1 stimulation, n.s. non significant, $^{**}p < 0.01$, $^{***}p < 0.001$). (D) Percentage of splenic C57BL/6 NK cells bound to beads coated with ICAM-1 after the indicated incubation time with or without NK1.1 stimulation, in the presence or absence of 250 nM Torin2 (mean \pm SD, $n = 6$ mice in four independent experiments, two-way ANOVA comparing the conditions with or without NK1.1 stimulation, n.s. non significant, $^{***}p < 0.001$).

DOI: <https://doi.org/10.7554/eLife.26423.015>

FL-C16 were significantly higher (**Figure 6B**). In contrast, mitochondrial ROS production, lipid droplet content or lipid peroxidation were comparable in both cell types (data not shown). Differences were also detectable for FSC and SSC values as well as fatty-acid uptake when comparing reactive and hyporesponsive NK cell subsets present in the most mature CD27^{low} population of C57BL/6 mice (**Figure 6C**).

In summary, the higher activity of the Akt/mTOR pathway observed in reactive cells increased their metabolic activity compared to hyporesponsive NK cells, which may also contribute to their enhanced responsiveness.

Cytokine stimulation overcomes NK cell education by inducing high mTOR activity that restores NK cell signaling

Several studies have demonstrated that hyporesponsive NK cells can be rendered reactive (**Ebihara et al., 2013; Elliott et al., 2010; Joncker et al., 2010; Sun and Lanier, 2008**). The underlying molecular mechanism has however remained elusive. We reasoned that if the mTOR pathway was really a key determinant of NK cell reactivity, acute activation of this pathway should immediately restore reactivity of hyporesponsive cells. To test this hypothesis, we stimulated NK cells from C57BL/6 or $\text{B2m}^{-/-}$ mice with plate-bound antibodies stimulating NK1.1 or NKp46 and we simultaneously added IL-2, a cytokine known to potently activate mTOR (**Marçais et al., 2014**). To test the requirement for the mTOR pathway in this process, cells were also treated or not with Torin2. IL-2 resulted in an increase of the cell capacity to produce IFN- γ and to degranulate as measured by CD107a exposure (**Figure 7A**). This acute treatment was sufficient for hyporesponsive cells to acquire a level of reactivity equal or even higher than that of reactive NK cells from C57BL/6, regardless of the stimulating antibody. mTOR activity was required for this effect since the increase in reactivity was suppressed by mTOR inhibition (**Figure 7A**). Similar results were obtained when using IL-

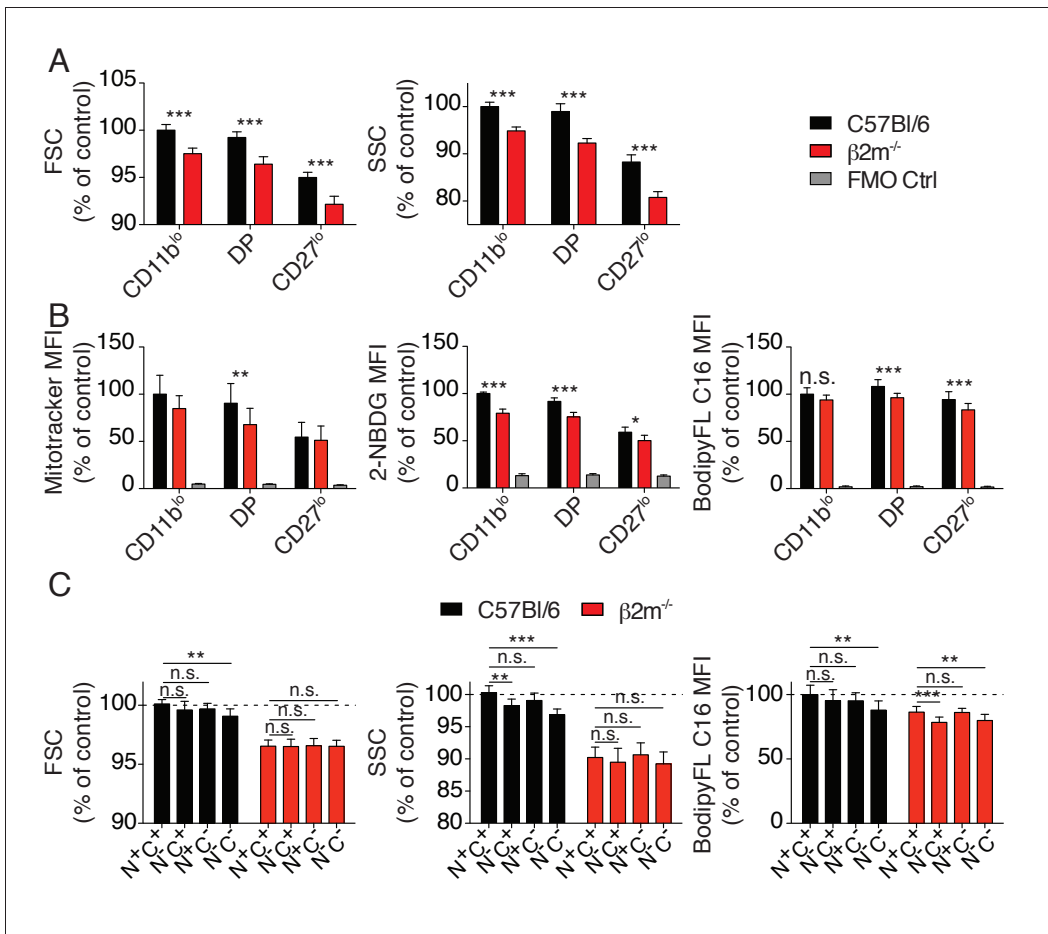

Figure 6. Metabolic parameters of reactive and hyporesponsive NK cells. (A) Bar graphs showing FSC and SSC values of splenic NK cell subsets from C57BL/6 or $B2m^{-/-}$ mice (mean +SD, $n = 6$ mice of each genotype in three independent experiments, t-test, *** $p < 0.001$). MFI were normalized to the CD11b^{lo} subset of C57BL/6 mice. (B) Bar graphs showing MFI of mitotracker staining, 2-NBDG or BodipyFL C16 incorporation of splenic NK cell subsets from C57BL/6 or $B2m^{-/-}$ mice (mean +SD, $n = 6-10$ mice of each genotype in three independent experiments, t-test, * $p < 0.05$, ** $p < 0.01$, *** $p < 0.001$, n.s. non significant). MFI were normalized to the CD11b^{lo} subset of C57BL/6 mice. (C) Bar graphs showing FSC and SSC values or BodipyFL C16 incorporation of splenic NK cell subsets (gated on CD27^{low}) from C57BL/6 or $B2m^{-/-}$ mice (mean +SD, $n = 6-10$ mice of each genotype in three independent experiments, t-test, n.s. non significant, * $p < 0.05$, *** $p < 0.001$). MFI were normalized to the N⁺C⁺ subset of C57BL/6 mice.

DOI: <https://doi.org/10.7554/eLife.26423.016>

15 instead of IL-2 (**Figure 7—figure supplement 1**). Acute IL-15 stimulation also restored the cytotoxic activity of hyporesponsive NK cells against YAC-1 cells while further enhancing cytotoxicity of C57BL/6 cells (**Figure 7B**). Again, this effect was completely reversed upon concomitant Torin2 treatment. Taken together, these results show that induction of responsiveness in NK cells upon cytokine exposure is a rapid phenomenon acting via mTOR activation.

In order to decipher the mechanism required for NK cell re-education, we next tested whether acute IL-15 treatment restored early signaling in hyporesponsive cells. We first investigated the impact of IL-15 treatment on the calcium flux triggered by NK1.1 stimulation in control or hyporesponsive NK cells. As expected, NK1.1 stimulation of hyporesponsive NK cells resulted in a very poor calcium flux compared to reactive NK cells (**Figure 7C**). Strikingly, treatment with IL-15 increased the calcium flux ability of reactive and hyporesponsive NK cells in an mTOR-dependent way (**Figure 7C** and **Figure 7—figure supplement 2**). We then measured the impact of IL-15 treatment on LFA-1 activation following NK1.1 stimulation. The presence of IL-15 in the assay rendered hyporesponsive NK cells able to activate LFA-1 upon NK1.1 stimulation and bind ICAM-1 coated beads (**Figure 7D**).

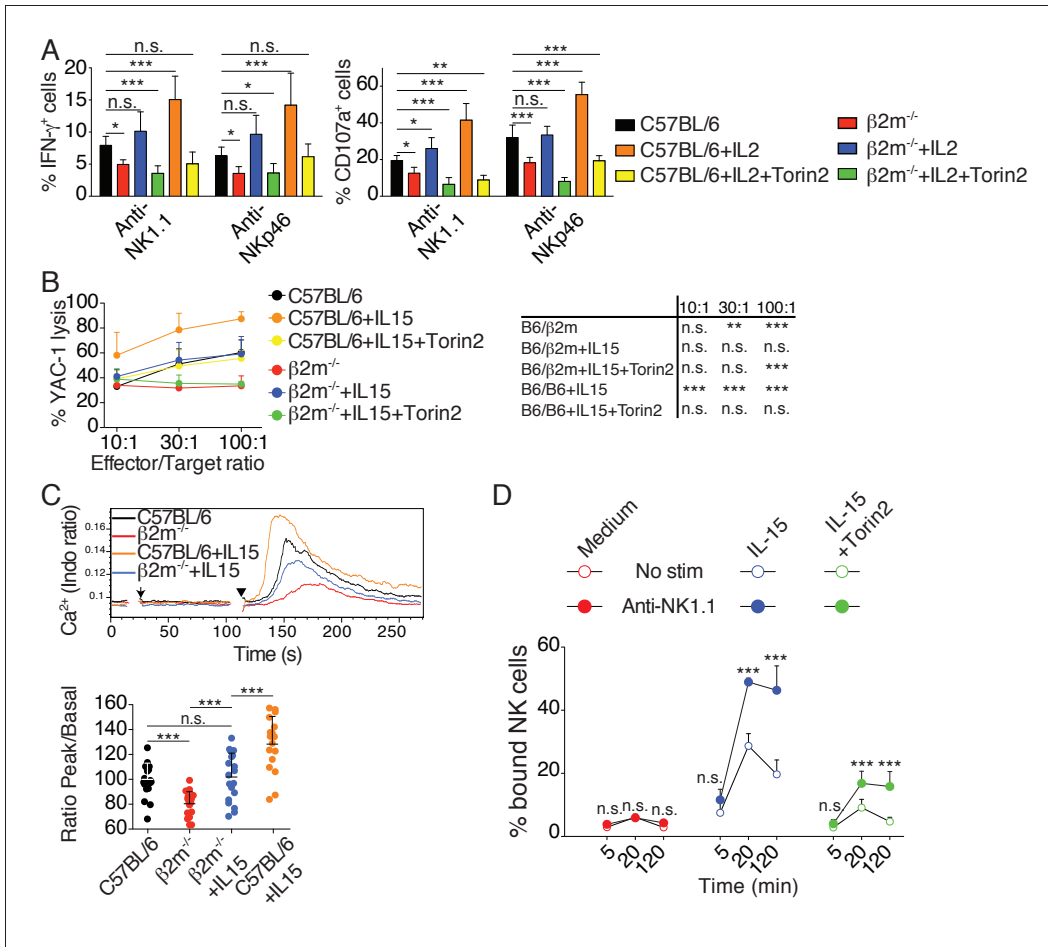

Figure 7. Cytokine stimulation overcomes NK cell education by inducing high mTOR activity that restores NKAR signaling. (A) Percentage (mean +SD) of IFN- γ or CD107a positive cells among splenic NK cells from C57BL/6 or $B2m^{-/-}$ mice following 4 hr stimulation with coated anti-NK1.1 or anti-NKp46 in the presence or absence of 200U/ml IL-2 and 250 nM Torin2 as indicated (n = 9–10 mice of each genotype in five independent experiments, one-way ANOVA comparing each condition to the C57BL/6 condition, * $p < 0.05$, ** $p < 0.01$, *** $p < 0.001$, n.s. non significant). (B) Percentage (mean +SD) of dead YAC-1 cells after a 4 hr co-culture with purified NK cells from C57BL/6 or $B2m^{-/-}$ mice at the indicated Effector/Target ratio in the presence or absence of 10 ng/ml IL-15 and 250 nM Torin2 as indicated (n = 7 mice of each genotype in three independent experiments, the table on the right presents the results of a two-way ANOVA comparing C57BL/6 with the other experimental conditions for the indicated Effector/Target ratio, ** $p < 0.01$, *** $p < 0.001$, n.s. non significant). (C) *Top*: Representative histogram overlay showing the Ca^{2+} flux intensity in splenic NK cells from C57BL/6 or $B2m^{-/-}$ mice with or without IL-15 (100 ng/ml). NK cells were activated following incubation with biotinylated anti-NK1.1 (Arrow) followed by cross-linking with streptavidin (Arrowhead). *Down*: Bar graph showing the Ratio Peak/basal normalized to the ratio of control NK cells (mean +SD of n = 17–20 replicates from 6 mice in six independent experiments, one-way ANOVA comparing the indicated conditions, ** $p < 0.01$, *** $p < 0.001$). (D) Percentage of splenic NK cells from $B2m^{-/-}$ mice bound to beads coated with ICAM-1 after the indicated incubation time with or without NK1.1 stimulation, in the presence or absence of 100 ng/ml IL-15 and 250 nM Torin2 (n = 6 mice in four independent experiments, two-way ANOVA comparing stimulated to non-stimulated conditions, n.s. non significant, *** $p < 0.001$).

DOI: <https://doi.org/10.7554/eLife.26423.017>

The following figure supplements are available for figure 7:

Figure supplement 1. Percentage (mean +SD) of IFN- γ or CD107a positive cells among splenic NK cells from C57BL/6 or $B2m^{-/-}$ mice following 4 hr stimulation with coated anti-NK1.1 or anti-NKp46 in the presence or absence of 10 ng/ml IL-15 and 250 nM Torin2 as indicated (n = 4 mice of each genotype in two independent experiments, one-way ANOVA comparing each condition to the C57BL/6 condition, * $p < 0.05$, ** $p < 0.01$, *** $p < 0.001$, n.s. non significant).

DOI: <https://doi.org/10.7554/eLife.26423.018>

Figure supplement 2. *Left*: Representative histogram overlay showing the Ca^{2+} flux intensity in splenic NK cells from C57BL/6 or $B2m^{-/-}$ mice with or without IL-15 (100 ng/ml) and Torin2 (500 nM).

DOI: <https://doi.org/10.7554/eLife.26423.019>

This effect was strongly decreased upon Torin2 treatment, underlying the non-redundant role of mTOR in this process.

Altogether, these results show that acute stimulation of the mTOR pathway can restore the ability of hyporesponsive NK cells to induce calcium flux and activate LFA-1 upon NKAr engagement, thereby re-establishing their reactivity.

Discussion

Here, to gain mechanistic insight into the phenomenon of NK cell education, we explored signal transduction pathways downstream NKAr in reactive and hyporesponsive NK cells. We found that the activity of the Akt/mTOR pathway was selectively higher in reactive NK cells. This was characterized by higher basal phosphorylation of direct and indirect targets of both mTOR complexes (mTORC1 and 2) in strict correlation with the reactivity level. In addition, this pattern was lost concomitantly with the loss of reactivity observed upon transfer of reactive cells in *B2m*^{-/-} hosts. Our screen also revealed that two out of the three NFκB p65 phosphorylations investigated (S468 and S529) correlated with reactivity. This could be the result of the heightened Akt/mTOR pathway activity, as mTORC2 has been involved in NFκB activation during CD4 T cell stimulation (Lee et al., 2010). Alternatively, this could reveal the involvement of other pathways in the control of NK cell reactivity.

What is the extracellular signal and the signaling pathway responsible for the maintenance of mTOR basal activity in reactive NK cells specifically? An obvious candidate would be IL-15 as this cytokine is a privileged activator of this pathway (Marçais et al., 2014). However, pSTAT5 levels were identical between reactive and hyporesponsive NK cells (data not shown). Moreover, in vivo treatment with antibodies blocking IL-15 signaling did not alter NK cell education (data not shown). Finally, it is difficult to envisage how reactive cells would get preferential access to IL-15. Instead, in line with the disarming hypothesis, we would favor a model in which basal mTOR activity is set independently of education signals. This initial activity would then be decreased by disarming signals. How mTOR activity is decreased by chronic NKAr stimulation is still an open question. We hypothesize that in the absence of surrounding MHC-I or in NK cells lacking functional NKirs, unopposed NKAr signaling could lead to shut-down of the Akt/mTOR pathway due to depletion of necessary intermediates or establishment of negative feedbacks as it has been demonstrated in the case of induction of resistance to insulin (Um et al., 2006). Engagement of NKirs would prevent this desensitization and maintain an optimal activity of the pathway. In favor of this hypothesis, we show that SHP-1, the phosphatase triggered by NKir ligation and necessary to maintain NK cell reactivity (Viant et al., 2014), was required to maintain an optimal activity of the mTOR pathway. Furthermore, transfer of *Nur77*^{GFP} cells into *B2m*^{-/-} hosts was accompanied by an increase in the GFP level, evidence of active NKAr signaling, and followed by the loss of mTOR basal activity concomitant with the loss of reactivity of NKG2A⁺Ly49C⁺ NK cells.

Previous studies have conclusively shown that NK cell education is not an on-off switch but rather a variation on a continuous axis (Brodin et al., 2009a; Joncker et al., 2009). We propose that the mTOR pathway is the long-sought molecular rheostat able to both respond to educating signals and control effector functions in return. Indeed, we showed that activity of the Akt/mTOR pathway is regulated commensurate with the level of NKir engagement by MHC-I molecules. Furthermore, we demonstrated that modulation of mTOR activity by exogenous cytokine or pharmacologic treatments was directly correlated with NK cell responsiveness. Furthermore, mTOR could also regulate NK cell responsiveness by integrating signals beyond NKir ligands. Considering the concept of the extended rheostat model as described initially by Höglund and colleagues (Brodin et al., 2009b), we envision extracellular inputs in an extended sense, including immunological as well as purely metabolic inputs. Interestingly, a number of environmental conditions, such as the presence of inflammatory (Sun and Lanier, 2008) or anti-inflammatory cytokines (Sungur et al., 2013), but also the presence of nutrients (Keppel et al., 2015), impact on NK cell responsiveness. All these stimuli positively or negatively affect mTOR activity (Efeyan et al., 2015; Marçais et al., 2014; Sinclair et al., 2013; Viel et al., 2016). mTOR activity could thus be the nexus targeted by these different stimuli which would explain their impact on NK cell responsiveness. Thus, considering mTOR as the rheostat of NK cell responsiveness would help to build a common conceptual framework in which these observations could be ordered.

Finally, we also present evidence on how mTOR activity affects NK cell effector functions. We demonstrated that mTOR activity controls two distinct events characterizing reactive NK cells and required for the triggering of effector functions: Ca^{2+} flux and integrin activation. How could mTOR activity control such apparently unrelated signaling events? Depending on the relative involvement of mTORC1 or mTORC2, several possibilities can be considered. First, the fact that Rapamycin which specifically inhibits mTORC1 is sufficient to decrease responsiveness unmasks the non-redundant role of this complex. In line with the role of mTORC1 in the control of cellular metabolism, we described that higher basal mTOR activity in educated cells translated into higher basal metabolism as measured by morphological parameters as well as glucose and fatty-acid uptake and mitochondrial content. We and others have described the necessary role of the mTORC1-dependent metabolism in the development of NK cell effector functions ([Donnelly et al., 2014](#); [Marçais et al., 2014](#)). In addition to improving the cellular fitness, metabolism could directly modulate signaling by controlling the availability of key intermediates as recently described for Th17/Treg differentiation ([Araujo et al., 2017](#)). Another possibility would be through the regulation of the actin cytoskeleton. Indeed, an emerging mode of lymphocyte signaling regulation is through cytoskeleton-dependent regulation of membrane receptors compartmentalization ([Mattila et al., 2016](#)), a process that has been proposed to explain the reactivity of educated NK cells ([Guia et al., 2011](#)). mTORC2 has been shown to regulate the cytoskeletal organization ([Huang et al., 2013](#); [Sarbasov et al., 2004](#)) and could therefore prime reactive NK cells by cytoskeletal modifications. An interesting parallel can also be drawn with T cell anergy. Indeed, TCR stimulation in the absence of CD28 co-stimulation results in T cell hyporesponsiveness to further re-stimulation. Numerous studies have shown that the precise control of mTOR activity is at the heart of this phenomenon ([Chappert and Schwartz, 2010](#); [Marçais et al., 2014](#); [Zheng et al., 2007](#); [2009](#)). Interestingly, this state is characterized by defective Ca^{2+} flux ([Dubois et al., 1998](#)). Further resembling hyporesponsive NK cells, treatment of anergic T cells with IL-2 restores their responsiveness, an event that relies on mTOR activation ([Dubois et al., 1998](#); [Zheng et al., 2007](#)). Ca^{2+} flux is classically triggered by IP_3 -induced release of endoplasmic reticulum stores which, upon detection by the STIM1/2 sensors, leads to opening of the ORAI channels present on the plasma membrane and extracellular Ca^{2+} entry ([Hogan and Rao, 2015](#)). In addition, an underestimated Ca^{2+} store is the endo-lysosomal compartment ([Morgan et al., 2011](#)), which constitutes a further link with mTOR since mTORC1 is activated on the lysosomal surface and positively regulated by lysosomal nutrients ([Efeyan et al., 2015](#)) as well as by calcium release from lysosomal stores ([Li et al., 2016](#)). Concerning regulation of integrin activation, a putative link would be through the inhibition of GSK3 β . Indeed, this kinase is inhibited by Akt following mTORC2 activation ([Hagiwara et al., 2012](#)), and a recent study showed that its inhibition leads to better ability of NK cells to form conjugate via integrin activation ([Parameswaran et al., 2016](#)). In addition, PKC θ , a target of mTORC2 ([Lee et al., 2010](#)), activates WIP via S488 phosphorylation in lymphocytes ([Fried et al., 2014](#)). Since a macro-complex involving WIP, WASp, actin and myosin IIa has been defined in NK cells ([Krzewski et al., 2006](#)), WIP activation could explain better interaction with ICAM-1-coated beads in our assay and ultimately better docking to target cell.

In summary, these findings identify the activity of the mTOR pathway as the molecular rheostat responsible for the control of basal NK cell reactivity in response to NK cell ligation. In addition, this provides a molecular basis for a number of previous experiments showing that NK cell education can be overcome by cytokine treatment. Finally, our data underline the extreme versatility of the regulation of NK cell responsiveness and further point to mTOR as a valid target for the manipulation of NK cells for therapeutic purposes.

Materials and methods

Mice and adoptive transfers

Wild-type C57BL/6 mice were purchased from Charles River Laboratories (L'Arbresle). $B2m^{-/-}$ ([Koller et al., 1990](#)), $Ncr1^{iCre/+}$ $Mtor^{lox/lox}$ ([Marçais et al., 2014](#)) and $Ncr1^{iCre/+}$ $Ptpn6^{lox/lox}$ mice ([Viant et al., 2014](#)) were previously described, littermate control mice were used as controls. $Nur77^{GFP}$ mice were previously described ([Moran et al., 2011](#)). Female mice 8 to 24 week-old were used. $Nur77^{GFP}$ splenocytes were injected i.v. in C57BL/6 or $B2m^{-/-}$ host. Each host received 25×10^6 splenocytes labeled with CTV (1 μM , Molecular Probes) to allow subsequent identification. Host

mice were sacrificed one or 3 days after for analysis of the spleen. This study was carried out in accordance with the French recommendations in the Guide for the ethical evaluation of experiments using laboratory animals and the European guidelines 86/609/CEE. All experimental studies were approved by the bioethic local committee CECCAPP. Mice were bred in the Plateau de Biologie Expérimentale de la Souris, our animal facility.

Flow cytometry

Single cell suspensions of spleens were obtained and stained. Intracellular stainings for phosphorylated proteins were done using Lyse/Fix and PermlII buffers (BD Bioscience). Measurement of glucose uptake was performed as described (Marçais *et al.*, 2014). Mitochondrial content was measured using Mitotracker Green (Molecular Probes, 1 μ M) incubated for 10 min at 37°C in PBS. Lipid uptake was measured using BodipyFL C16 (Molecular Probes, 1 μ M) incubated for 30 min at 37°C in complete medium. Surface staining were then performed to identify the different populations. Flow cytometry was carried out on a FACS LSR II or on a FACS Fortessa (Becton-Dickinson). Data were analysed using FlowJo (Treestar). The following mAbs from eBioscience, BD Biosciences or Biolegend were used: anti-CD19 (ebio1D3), anti-CD3 (145–2 C11), anti-NK1.1 (PK136), anti-NKp46 (29A1.4), anti-CD49b (DX5), anti-CD11b (M1/70), anti-CD27 (LG.7F9), anti-Ly49I (YLI90), anti-NKG2A/C/E (20d5), anti-IFN- γ (XMG1.2), anti-CD107a (1D4B). The mAb 4LO3311 recognizing Ly49C was purified on protein A column from supernatant of the 4LO3311 hybridoma generously provided by Pr. Suzanne Lemieux (Institut Armand Frappier, Québec). NKG2A positive cells were identified using the 20d5 clone which also recognizes NKG2C and NKG2E, however, since mouse resting NK cells only express NKG2A, we considered 20d5 reactive cells as NKG2A positive (Vance *et al.*, 1998).

Cell culture and stimulation

1.5×10^6 splenocytes were cultured on antibody coated plates (anti-NKp46 (Goat polyclonal, R&D), anti-NK1.1 (PK136, BioXCell) at 10 μ g/ml on Immulon 2HB or Nunclon plates) with Golgi-stop (BD Biosciences) in the presence of anti-CD107a for 4 hr. Cytokines and mTOR inhibitors were used at the following concentrations unless otherwise stated: rmlL-15 (Peprotech; 100 ng/ml), IL-2 (mull-2 supernatant; 200 U/ml), Rapamycin (Calbiochem; 25 nM), KU-0063794 (Stemgent; 3 μ M), AZD2014 (Selleckchem; 5 μ M) and Torin2 (Tocris; 250 nM). Surface and intracellular stainings were then performed and IFN- γ production as well as CD107a exposure was measured by flow cytometry. In some experiments, cell viability was determined using 7AAD (Invitrogen, 250 nM).

For phospho-flow stainings following short-term NK1.1 stimulation, 3×10^6 splenocytes were stimulated using biotinylated NK1.1 (PK136, 5 μ g/ml) followed 1 min 30 s later by streptavidin (Life Technologies, 10 μ g/ml) and fixed by addition of 10 volumes of Lyse/Fix at the indicated time point.

In vivo cytotoxicity assay

Recipient mice were treated by daily i.p. injection of Torin2 (10 mg/kg, vehicle: 40% H₂O, 40% PEG400 (Sigma), 20 % N methyl two pyrrolidone (Sigma)) for 6 days prior to target transfer. Splenocytes from C57BL/6 or *B2m*^{-/-} mice were labeled respectively with CellTraceViolet (1 μ M) or CFSE (5 μ M) (both from Life Technologies), and 10×10^6 cells (5×10^6 of each genotype) were transferred by i.v. injection. 60 hr after transfer, splenocytes were isolated and analyzed by FACS. Percentage of remaining *B2m*^{-/-} cells was calculated using the following formula: % remaining cells = 100 x (number *B2m*^{-/-} cells/number C57BL/6 cells) at 60 h / (number *B2m*^{-/-} cells/number C57BL/6 cells) in input mix.

In vitro cytotoxicity assay

NK cells were first enriched by negative depletion prior to killing assay. Briefly, splenocytes suspension were incubated with biotinylated mAb against: CD3 (14–2 C11), TCR β (H57-597), TCR $\gamma\delta$ (GL3), CD19 (ebio1D3), TER-119 (ter119) (eBioscience), followed by incubation with anti-biotin microbeads (Miltenyi), and enrichment by magnetic separation on an AutoMACS. Enriched NK cells were co-cultured for 4 hr with YAC-1 cells labeled with CFSE (Life Technologies) at different Effector to target (E/T) ratios calculated based on the cell number and the percentage of NK cells after purification.

The percentage of dead cells within CFSE positive YAC-1 cells was measured by flow cytometry after staining with 7AAD.

Calcium flux

Calcium flux was measured essentially as described (Guia *et al.*, 2011). Briefly, RBC-lysed splenocytes suspension in RPMI/0.2% BSA/25 mM HEPES were stained at RT with the following mAb: anti-CD3/CD19 PEeFluor610, anti-CD49b APC, anti-CD11b APCCy7, anti-CD27 PE. They were then stained at 1×10^7 cells/ml with Indo-1 (1 μ M, Life Technologies) for 30 min at 37°C and washed two times at 4°C. They were resuspended in the above medium and placed at 37°C for 30 min prior acquisition in the presence or absence of rmlL-15 (100 ng/ml) or Torin2 (250 nM). Samples were acquired on a LSRII (BD) as follow: 15 s baseline acquisition, addition of anti-NK1.1 biotin (PK136, 5 μ g/ml), acquisition for 1 min 30 s, addition of Streptavidin (Life Technologies, 10 μ g/ml) and, acquisition for another 3–5 min.

ICAM1 coated beads assay

One mg Protein G-coated 4–4.9 μ m beads (Spherotec) was incubated for 30 min with 3.5 μ g ICAM1-hlgG1Fc (R&D) on a rotating wheel at RT in PBS. Beads were then pelleted by centrifugation and washed two times with complete medium, counted on a FACS Accuri (BD) and resuspended at 1×10^7 beads/ml. In parallel, NK cells were purified (80–90% purity) using biotinylated antibodies directed against CD3, CD19, CD5, CD24, F4/80 and Ly6G and anti-biotin beads. They were then incubated with anti-NKp46-PE (29A1.4, BD) and purified anti-NK1.1 (PK136, BioXCell). 100,000 purified NK cells in 10 μ l were placed in a U-bottom well and 100,000 ICAM-1 coated beads were added. To cross-link NK1.1 and measure the effect of inside-out signaling, a Goat F(ab)₂ anti-mouse IgG (10 μ g/ml, Life Technologies) was added to the wells. Interaction was fixed at the indicated time-point by addition of 100 μ l Cytotfix/Cytoperm (BD). The percentage of interaction (i.e. percentage of NKp46 positive cells attached to beads) was measured by flow cytometry.

Statistical analysis

Statistical analyses were performed using Prism 5 (Graph-Pad Software). Two tailed unpaired t-test, and ANOVA tests with Bonferroni correction were used as indicated in the figure legends. Significance is indicated as follows: * $p < 0.05$; ** $p < 0.01$; *** $p < 0.001$. The heatmap presented in **Figure 1A** was established as follow: we first selected the phosphoepitopes for which the MFI (Mean Fluorescence Intensity) was significantly above the one of the FMO control (Student T-test). The MFI of the 15 selected phosphoepitopes for the 4 NC sub-populations defined in **Figure 1—figure supplement 2** was then normalized to the MFI value of the NKG2A⁺Ly49C⁺ populations in the C57BL/6 mice and the values obtained were averaged to calculate the means for each populations. These values were used to establish the Heatmap using the Multiple Experiment Viewer application. We used the R statistical language to manage our database and carry out the statistical analysis (R version 3.3.2). We splitted the database into six datasets (2 Mouse strains * Differentiation subsets), each containing the 15 phospho-epitopes. We performed an ANOVA for each phospho-epitope to test for the phosphorylation difference between the 4 NC sub-populations. The parameters of the ANOVA Type I SS were adapted to control for the experiment effect. The Bartlett Homogeneity of Variances Test was applied first, when it failed to reject its H₀, then the phospho-epitope was retained for the ANOVA test. The normality of the residuals of the ANOVA model was checked graphically and numerically with the Shapiro-Wilk Normality Test. When this test failed to reject its H₀ then the adjusted P values for multiple comparisons were extracted with the Tukey's 'Honest Significant Difference' method.

Acknowledgements

The authors acknowledge the contribution of SFR Biosciences (UMS3444/CNRS, ENSL, UCBL, US8/INSERM) facilities, in particular the Plateau de Biologie Expérimentale de la Souris, and the flow cytometry facility. We would like to thank Pr. Suzanne Lemieux (INRS, Institut Armand-Frappier, Laval, Québec, Canada) for providing us with the 4LO3311 hybridoma and Pr. David Raulet for advice on its purification. We would like to thank Pr. Kristin Hogquist for the Nur77^{GFP} mice. The TW lab is supported by the Agence Nationale de la Recherche (ANR JC SPHINKS to TW and ANR JC BaNK to AM), the ARC foundation (équipe labellisée), the European Research council (ERC-Stg

281025), and receives institutional grants from the Institut National de la Santé et de la Recherche Médicale (INSERM), Centre National de la Recherche Scientifique (CNRS), Université Claude Bernard Lyon1 and ENS de Lyon. MM is the recipient of a fellowship from La Ligue Nationale contre le Cancer.

Additional information

Competing interests

Mathieu Bléry: MB is employee of Innate-Pharma. Eric Vivier: EV is shareholder of Innate-Pharma. The other authors declare that no competing interests exist.

Funding

Funder	Grant reference number	Author
Agence Nationale de la Recherche	ANR-16-CE15-0005-01 Bank	Antoine Marçais
H2020 European Research Council	281025 Dironaki	Thierry Walzer

The funders had no role in study design, data collection and interpretation, or the decision to submit the work for publication.

Author contributions

Antoine Marçais, Conceptualization, Formal analysis, Supervision, Funding acquisition, Validation, Investigation, Methodology, Writing—original draft, Writing—review and editing; Marie Marotel, Alice Koenig, Sébastien Viel, Formal analysis, Investigation, Writing—review and editing; Sophie Degouve, Formal analysis, Investigation, Methodology, Writing—review and editing; Sébastien Fauteux-Daniel, Annabelle Drouillard, Laurie Besson, Formal analysis, Investigation; Heinrich Schlums, Investigation, Methodology, Writing—review and editing; Omran Allatif, Formal analysis, Validation, Methodology; Mathieu Bléry, Eric Vivier, Resources, Writing—review and editing; Yenan Bryceson, Supervision, Validation, Writing—review and editing; Olivier Thauvat, Supervision, Validation, Methodology, Writing—review and editing; Thierry Walzer, Conceptualization, Supervision, Funding acquisition, Project administration, Writing—review and editing

Author ORCIDs

Antoine Marçais,  <https://orcid.org/0000-0002-3591-6268>

Thierry Walzer,  <http://orcid.org/0000-0002-0857-8179>

Ethics

Animal experimentation: This study was carried out in accordance with the French recommendations in the Guide for the ethical evaluation of experiments using laboratory animals and the European guidelines 86/609/CEE. All experimental studies were approved by the bioethical local committee CECCAPP (Permit number: CECCAPP_ENS_2014_018).

Decision letter and Author response

Decision letter <https://doi.org/10.7554/eLife.26423.021>

Author response <https://doi.org/10.7554/eLife.26423.022>

Additional files

Supplementary files

- Transparent reporting form

DOI: <https://doi.org/10.7554/eLife.26423.020>

References

- Anfossi N**, André P, Guia S, Falk CS, Roetyncck S, Stewart CA, Bresó V, Frassati C, Reviron D, Middleton D, Romagné F, Ugolini S, Vivier E. 2006. Human NK cell education by inhibitory receptors for MHC class I. *Immunity* **25**:331–342. DOI: <https://doi.org/10.1016/j.immuni.2006.06.013>, PMID: 16901727
- Araujo L**, Khim P, Mkhikian H, Mortales CL, Demetriou M. 2017. Glycolysis and glutaminolysis cooperatively control T cell function by limiting metabolite supply to N-glycosylation. *eLife* **6**:e21330. DOI: <https://doi.org/10.7554/eLife.21330>, PMID: 28059703
- Brodin P**, Lakshmikanth T, Johansson S, Kärre K, Höglund P. 2009a. The strength of inhibitory input during education quantitatively tunes the functional responsiveness of individual natural killer cells. *Blood* **113**:2434–2441. DOI: <https://doi.org/10.1182/blood-2008-05-156836>, PMID: 18974374
- Brodin P**, Kärre K, Höglund P. 2009b. NK cell education: not an on-off switch but a tunable rheostat. *Trends in Immunology* **30**:143–149. DOI: <https://doi.org/10.1016/j.it.2009.01.006>, PMID: 19282243
- Chappert P**, Schwartz RH. 2010. Induction of T cell anergy: integration of environmental cues and infectious tolerance. *Current Opinion in Immunology* **22**:552–559. DOI: <https://doi.org/10.1016/j.coi.2010.08.005>, PMID: 20869863
- Donnelly RP**, Loftus RM, Keating SE, Liou KT, Biron CA, Gardiner CM, Finlay DK. 2014. mTORC1-dependent metabolic reprogramming is a prerequisite for NK cell effector function. *The Journal of Immunology* **193**:4477–4484. DOI: <https://doi.org/10.4049/jimmunol.1401558>, PMID: 25261477
- Dubois PM**, Pihlgren M, Tomkowiak M, Van Mechelen M, Marvel J. 1998. Tolerant CD8 T cells induced by multiple injections of peptide antigen show impaired TCR signaling and altered proliferative responses in vitro and in vivo. *Journal of Immunology* **161**:5260–5267. PMID: 9820498
- Ebihara T**, Jonsson AH, Yokoyama WM. 2013. Natural killer cell licensing in mice with inducible expression of MHC class I. *PNAS* **110**:E4232–E4237. DOI: <https://doi.org/10.1073/pnas.1318255110>, PMID: 24145414
- Efeyan A**, Comb WC, Sabatini DM. 2015. Nutrient-sensing mechanisms and pathways. *Nature* **517**:302–310. DOI: <https://doi.org/10.1038/nature14190>, PMID: 25592535
- Elliott JM**, Wahle JA, Yokoyama WM. 2010. MHC class I-deficient natural killer cells acquire a licensed phenotype after transfer into an MHC class I-sufficient environment. *The Journal of Experimental Medicine* **207**:2073–2079. DOI: <https://doi.org/10.1084/jem.20100986>, PMID: 20819924
- Fernandez NC**, Treiner E, Vance RE, Jamieson AM, Lemieux S, Raulet DH. 2005. A subset of natural killer cells achieves self-tolerance without expressing inhibitory receptors specific for self-MHC molecules. *Blood* **105**:4416–4423. DOI: <https://doi.org/10.1182/blood-2004-08-3156>, PMID: 15728129
- Fried S**, Reicher B, Pauker MH, Eliyahu S, Matalon O, Noy E, Chill J, Barda-Saad M. 2014. Triple-color FRET analysis reveals conformational changes in the WIP-WASp actin-regulating complex. *Science Signaling* **7**:ra60. DOI: <https://doi.org/10.1126/scisignal.2005198>, PMID: 24962707
- García-Martínez JM**, Moran J, Clarke RG, Gray A, Cosulich SC, Chresta CM, Alessi DR. 2009. Ku-0063794 is a specific inhibitor of the mammalian target of rapamycin (mTOR). *Biochemical Journal* **421**:29–42. DOI: <https://doi.org/10.1042/BJ20090489>, PMID: 19402821
- Guia S**, Jaeger BN, Piatek S, Mailfert S, Trombik T, Fenis A, Chevrier N, Walzer T, Kerdiles YM, Marguet D, Vivier E, Ugolini S. 2011. Confinement of activating receptors at the plasma membrane controls natural killer cell tolerance. *Science Signaling* **4**:ra21. DOI: <https://doi.org/10.1126/scisignal.2001608>, PMID: 21467299
- Guichard SM**, Curwen J, Bihani T, D’Cruz CM, Yates JW, Grondine M, Howard Z, Davies BR, Bigley G, Klinowska T, Pike KG, Pass M, Chresta CM, Polanska UM, McEwen R, Delpuech O, Green S, Cosulich SC. 2015. AZD2014, an inhibitor of mTORC1 and mTORC2, is highly effective in ER+ breast cancer when administered using intermittent or continuous schedules. *Molecular Cancer Therapeutics* **14**:2508–2518. DOI: <https://doi.org/10.1158/1535-7163.MCT-15-0365>, PMID: 26358751
- Hagiwara A**, Cornu M, Cybulski N, Polak P, Betz C, Trapani F, Terracciano L, Heim MH, Rüegg MA, Hall MN. 2012. Hepatic mTORC2 activates glycolysis and lipogenesis through Akt, glucokinase, and SREBP1c. *Cell Metabolism* **15**:725–738. DOI: <https://doi.org/10.1016/j.cmet.2012.03.015>, PMID: 22521878
- Hanke T**, Takizawa H, McMahon CW, Busch DH, Pamer EG, Miller JD, Altman JD, Liu Y, Cado D, Lemonnier FA, Bjorkman PJ, Raulet DH. 1999. Direct assessment of MHC class I binding by seven Ly49 inhibitory NK cell receptors. *Immunity* **11**:67–77. DOI: [https://doi.org/10.1016/S1074-7613\(00\)80082-5](https://doi.org/10.1016/S1074-7613(00)80082-5), PMID: 10435580
- Hogan PG**, Rao A. 2015. Store-operated calcium entry: Mechanisms and modulation. *Biochemical and Biophysical Research Communications* **460**:40–49. DOI: <https://doi.org/10.1016/j.bbrc.2015.02.110>, PMID: 25998732
- Huang W**, Zhu PJ, Zhang S, Zhou H, Stoica L, Galiano M, Krnjević K, Roman G, Costa-Mattioli M. 2013. mTORC2 controls actin polymerization required for consolidation of long-term memory. *Nature Neuroscience* **16**:441–448. DOI: <https://doi.org/10.1038/nn.3351>, PMID: 23455608
- Höglund P**, Brodin P. 2010. Current perspectives of natural killer cell education by MHC class I molecules. *Nature Reviews Immunology* **10**:724–734. DOI: <https://doi.org/10.1038/nri2835>, PMID: 20818413
- Johansson MH**, Bieberich C, Jay G, Kärre K, Höglund P. 1997. Natural killer cell tolerance in mice with mosaic expression of major histocompatibility complex class I transgene. *The Journal of Experimental Medicine* **186**:353–364. DOI: <https://doi.org/10.1084/jem.186.3.353>, PMID: 9236187
- Johansson S**, Johansson M, Rosmaraki E, Vahlne G, Mehr R, Salmon-Divon M, Lemonnier F, Kärre K, Höglund P. 2005. Natural killer cell education in mice with single or multiple major histocompatibility complex class I

- molecules. *The Journal of Experimental Medicine* **201**:1145–1155. DOI: <https://doi.org/10.1084/jem.20050167>, PMID: 15809355
- Joncker NT**, Fernandez NC, Treiner E, Vivier E, Raulet DH. 2009. NK cell responsiveness is tuned commensurate with the number of inhibitory receptors for self-MHC class I: the rheostat model. *The Journal of Immunology* **182**:4572–4580. DOI: <https://doi.org/10.4049/jimmunol.0803900>, PMID: 19342631
- Joncker NT**, Shifrin N, Delebecque F, Raulet DH. 2010. Mature natural killer cells reset their responsiveness when exposed to an altered MHC environment. *The Journal of Experimental Medicine* **207**:2065–2072. DOI: <https://doi.org/10.1084/jem.20100570>, PMID: 20819928
- Keppel MP**, Saucier N, Mah AY, Vogel TP, Cooper MA. 2015. Activation-specific metabolic requirements for NK Cell IFN- γ production. *The Journal of Immunology* **194**:1954–1962. DOI: <https://doi.org/10.4049/jimmunol.1402099>, PMID: 25595780
- Kim S**, Poursine-Laurent J, Truscott SM, Lybarger L, Song YJ, Yang L, French AR, Sunwoo JB, Lemieux S, Hansen TH, Yokoyama WM. 2005. Licensing of natural killer cells by host major histocompatibility complex class I molecules. *Nature* **436**:709–713. DOI: <https://doi.org/10.1038/nature03847>, PMID: 16079848
- Koller BH**, Marrack P, Kappler JW, Smithies O. 1990. Normal development of mice deficient in beta 2M, MHC class I proteins, and CD8+ T cells. *Science* **248**:1227–1230. DOI: <https://doi.org/10.1126/science.2112266>, PMID: 2112266
- Krzewski K**, Chen X, Orange JS, Strominger JL. 2006. Formation of a WIP-, WASp-, actin-, and myosin IIA-containing multiprotein complex in activated NK cells and its alteration by KIR inhibitory signaling. *The Journal of Cell Biology* **173**:121–132. DOI: <https://doi.org/10.1083/jcb.200509076>, PMID: 16606694
- Lee K**, Gudapati P, Dragovic S, Spencer C, Joyce S, Killeen N, Magnuson MA, Boothby M. 2010. Mammalian target of rapamycin protein complex 2 regulates differentiation of Th1 and Th2 cell subsets via distinct signaling pathways. *Immunity* **32**:743–753. DOI: <https://doi.org/10.1016/j.immuni.2010.06.002>, PMID: 20620941
- Li RJ**, Xu J, Fu C, Zhang J, Zheng YG, Jia H, Liu JO. 2016. Regulation of mTORC1 by lysosomal calcium and calmodulin. *eLife* **5**:e19360. DOI: <https://doi.org/10.7554/eLife.19360>, PMID: 27787197
- Liu Q**, Wang J, Kang SA, Thoreen CC, Hur W, Ahmed T, Sabatini DM, Gray NS. 2011. Discovery of 9-(6-aminopyridin-3-yl)-1-(3-(trifluoromethyl)phenyl)benzo[h][1,6]naphthyridin-2(1H)-one (Torin2) as a potent, selective, and orally available mammalian target of rapamycin (mTOR) inhibitor for treatment of cancer. *Journal of Medicinal Chemistry* **54**:1473–1480. DOI: <https://doi.org/10.1021/jm101520v>, PMID: 21322566
- Marçais A**, Blevins R, Graumann J, Feytout A, Dharmalingam G, Carroll T, Amado IF, Bruno L, Lee K, Walzer T, Mann M, Freitas AA, Boothby M, Fisher AG, Merkenschlager M. 2014. microRNA-mediated regulation of mTOR complex components facilitates discrimination between activation and anergy in CD4 T cells. *The Journal of Experimental Medicine* **211**:2281–2295. DOI: <https://doi.org/10.1084/jem.20132059>, PMID: 25311506
- Marçais A**, Cherfils-Vicini J, Viant C, Degouve S, Viel S, Fenis A, Rabilloud J, Mayol K, Tavares A, Biennu J, Gangloff YG, Gilson E, Vivier E, Walzer T. 2014. The metabolic checkpoint kinase mTOR is essential for IL-15 signaling during the development and activation of NK cells. *Nature Immunology* **15**:749–757. DOI: <https://doi.org/10.1038/ni.2936>, PMID: 24973821
- Mattila PK**, Batista FD, Treanor B. 2016. Dynamics of the actin cytoskeleton mediates receptor cross talk: An emerging concept in tuning receptor signaling. *The Journal of Cell Biology* **212**:267–280. DOI: <https://doi.org/10.1083/jcb.201504137>, PMID: 26833785
- Michaëlsson J**, Achour A, Salcedo M, Kåse-Sjöström A, Sundbäck J, Harris RA, Kärre K. 2000. Visualization of inhibitory Ly49 receptor specificity with soluble major histocompatibility complex class I tetramers. *European Journal of Immunology* **30**:300–307. DOI: [https://doi.org/10.1002/1521-4141\(200001\)30:1<300::AID-IMMU300>3.0.CO;2-S](https://doi.org/10.1002/1521-4141(200001)30:1<300::AID-IMMU300>3.0.CO;2-S), PMID: 10602053
- Moran AE**, Holzapfel KL, Xing Y, Cunningham NR, Maltzman JS, Punt J, Hogquist KA. 2011. T cell receptor signal strength in Treg and iNKT cell development demonstrated by a novel fluorescent reporter mouse. *The Journal of Experimental Medicine* **208**:1279–1289. DOI: <https://doi.org/10.1084/jem.20110308>, PMID: 21606508
- Morgan AJ**, Platt FM, Lloyd-Evans E, Galione A. 2011. Molecular mechanisms of endolysosomal Ca²⁺ signalling in health and disease. *Biochemical Journal* **439**:349–378. DOI: <https://doi.org/10.1042/BJ20110949>, PMID: 21992097
- Oppenheim DE**, Roberts SJ, Clarke SL, Filler R, Lewis JM, Tigelaar RE, Girardi M, Hayday AC. 2005. Sustained localized expression of ligand for the activating NKG2D receptor impairs natural cytotoxicity in vivo and reduces tumor immunosurveillance. *Nature Immunology* **6**:928–937. DOI: <https://doi.org/10.1038/ni1239>, PMID: 16116470
- Parameswaran R**, Ramakrishnan P, Moreton SA, Xia Z, Hou Y, Lee DA, Gupta K, deLima M, Beck RC, Wald DN. 2016. Repression of GSK3 restores NK cell cytotoxicity in AML patients. *Nature Communications* **7**:11154. DOI: <https://doi.org/10.1038/ncomms11154>, PMID: 27040177
- Sabatini DM**, Erdjument-Bromage H, Lui M, Tempst P, Snyder SH. 1994. RAFT1: a mammalian protein that binds to FKBP12 in a rapamycin-dependent fashion and is homologous to yeast TORs. *Cell* **78**:35–43. DOI: [https://doi.org/10.1016/0092-8674\(94\)90570-3](https://doi.org/10.1016/0092-8674(94)90570-3), PMID: 7518356
- Sarbassov DD**, Ali SM, Kim DH, Guertin DA, Latek RR, Erdjument-Bromage H, Tempst P, Sabatini DM. 2004. Rictor, a novel binding partner of mTOR, defines a rapamycin-insensitive and raptor-independent pathway that regulates the cytoskeleton. *Current Biology* **14**:1296–1302. DOI: <https://doi.org/10.1016/j.cub.2004.06.054>, PMID: 15268862

- Sinclair LV**, Rolf J, Emslie E, Shi YB, Taylor PM, Cantrell DA. 2013. Control of amino-acid transport by antigen receptors coordinates the metabolic reprogramming essential for T cell differentiation. *Nature Immunology* **14**: 500–508. DOI: <https://doi.org/10.1038/ni.2556>, PMID: 23525088
- Spits H**, Artis D, Colonna M, Diefenbach A, Di Santo JP, Eberl G, Koyasu S, Locksley RM, McKenzie AN, Mebius RE, Powrie F, Vivier E. 2013. Innate lymphoid cells—a proposal for uniform nomenclature. *Nature Reviews Immunology* **13**:145–149. DOI: <https://doi.org/10.1038/nri3365>, PMID: 23348417
- Sun JC**, Lanier LL. 2008. Cutting edge: viral infection breaks NK cell tolerance to "missing self". *The Journal of Immunology* **181**:7453–7457. DOI: <https://doi.org/10.4049/jimmunol.181.11.7453>, PMID: 19017932
- Sungur CM**, Tang-Feldman YJ, Ames E, Alvarez M, Chen M, Longo DL, Pomeroy C, Murphy WJ. 2013. Murine natural killer cell licensing and regulation by T regulatory cells in viral responses. *PNAS* **110**:7401–7406. DOI: <https://doi.org/10.1073/pnas.1218767110>, PMID: 23589894
- Thomas LM**, Peterson ME, Long EO. 2013. Cutting edge: NK cell licensing modulates adhesion to target cells. *The Journal of Immunology* **191**:3981–3985. DOI: <https://doi.org/10.4049/jimmunol.1301159>, PMID: 24038086
- Tripathy SK**, Keyel PA, Yang L, Pingel JT, Cheng TP, Schneeberger A, Yokoyama WM. 2008. Continuous engagement of a self-specific activation receptor induces NK cell tolerance. *The Journal of Experimental Medicine* **205**:1829–1841. DOI: <https://doi.org/10.1084/jem.20072446>, PMID: 18606857
- Um SH**, D'Alessio D, Thomas G. 2006. Nutrient overload, insulin resistance, and ribosomal protein S6 kinase 1, S6K1. *Cell Metabolism* **3**:393–402. DOI: <https://doi.org/10.1016/j.cmet.2006.05.003>, PMID: 16753575
- Vance RE**, Kraft JR, Altman JD, Jensen PE, Raulet DH. 1998. Mouse CD94/NKG2A is a natural killer cell receptor for the nonclassical major histocompatibility complex (MHC) class I molecule Qa-1(b). *The Journal of Experimental Medicine* **188**:1841–1848. DOI: <https://doi.org/10.1084/jem.188.10.1841>, PMID: 9815261
- Viant C**, Fenis A, Chicanne G, Payrastre B, Ugolini S, Vivier E. 2014. SHP-1-mediated inhibitory signals promote responsiveness and anti-tumour functions of natural killer cells. *Nature Communications* **5**:5108. DOI: <https://doi.org/10.1038/ncomms6108>, PMID: 25355530
- Viel S**, Marçais A, Guimaraes FS, Loftus R, Rabilloud J, Grau M, Degouve S, Djebali S, Sanlaville A, Charrier E, Bienvenu J, Marie JC, Caux C, Marvel J, Town L, Huntington ND, Bartholin L, Finlay D, Smyth MJ, Walzer T. 2016. TGF- β inhibits the activation and functions of NK cells by repressing the mTOR pathway. *Science Signaling* **9**:ra19. DOI: <https://doi.org/10.1126/scisignal.aad1884>, PMID: 26884601
- Vivier E**, Tomasello E, Baratin M, Walzer T, Ugolini S. 2008. Functions of natural killer cells. *Nature Immunology* **9**:503–510. DOI: <https://doi.org/10.1038/ni1582>, PMID: 18425107
- Wu MF**, Raulet DH. 1997. Class I-deficient hemopoietic cells and nonhemopoietic cells dominantly induce unresponsiveness of natural killer cells to class I-deficient bone marrow cell grafts. *Journal of Immunology* **158**: 1628–1633. PMID: 9029098
- Yang H**, Rudge DG, Koos JD, Vaidialingam B, Yang HJ, Pavletich NP. 2013. mTOR kinase structure, mechanism and regulation. *Nature* **497**:217–223. DOI: <https://doi.org/10.1038/nature12122>, PMID: 23636326
- Zheng Y**, Collins SL, Lutz MA, Allen AN, Kole TP, Zarek PE, Powell JD. 2007. A role for mammalian target of rapamycin in regulating T cell activation versus anergy. *The Journal of Immunology* **178**:2163–2170. DOI: <https://doi.org/10.4049/jimmunol.178.4.2163>, PMID: 17277121
- Zheng Y**, Delgoffe GM, Meyer CF, Chan W, Powell JD. 2009. Anergic T cells are metabolically anergic. *The Journal of Immunology* **183**:6095–6101. DOI: <https://doi.org/10.4049/jimmunol.0803510>, PMID: 19841171
- Zimmer J**, Donato L, Hanau D, Cazenave JP, Tongio MM, Moretta A, de la Salle H, Salle Hdela. 1998. Activity and phenotype of natural killer cells in peptide transporter (TAP)-deficient patients (type I bare lymphocyte syndrome). *The Journal of Experimental Medicine* **187**:117–122. DOI: <https://doi.org/10.1084/jem.187.1.117>, PMID: 9419217

**Annexe 5 : brevet n° 17306154.0 déposé le 6 septembre 2017
« Method for predicting the risk of transplant rejection »**

Method for predicting the risk of transplant rejection

FIELD OF THE INVENTION:

The present invention relates to a method for predicting the risk of transplant rejection in recipient subject. The present invention also relates to a method for treating or preventing transplant rejection.

BACKGROUND OF THE INVENTION:

Rejection represents the main cause of solid organ transplants loss and therefore an important unmet medical need in the current context of severe organ shortage.

The current immunological paradigm is that rejection is due to the recognition of alloantigens (mainly the highly polymorphic donor-specific HLA molecules) by recipient's adaptive immune system. Allorecognition, results in the generation of cytotoxic cellular effectors and/or donor specific antibodies (DSA), which drive graft destruction. While the cellular arm of the alloimmune response has progressively come under pharmacological control, current immunosuppressive armamentarium does not completely prevent the generation of DSA (Thaunat et al., 2016). As a result, antibody-mediated rejection (AMR) is now widely recognized as the first cause of allograft loss (Sellarés et al., 2012).

A few years ago, it has been demonstrated in a murine experimental model of heart transplantation that parental grafts transplanted in F1 recipients developed chronic rejection with graft arteriosclerosis (Uehara et al., 2005). This process was unlikely to be due to adaptive immune system, because in parental => F1 combination the graft do not express any alloantigen). Instead, this experimental model suggested that other type of rejection could lead to vascular lesions and therefore limit the duration of graft function. Thus it is therefore needed to be able to predict the risk of transplant rejection in this case, in particular in transplanted patients with no detectable humoral response against the transplant (and notably the transplant endothelial cells) more particularly in transplanted patient who does not present donor specific antibodies. Considering the high morbidity associated with transplant rejection, it also remains highly clinically relevant to propose new adapted treatments for this previously unrecognized condition.

SUMMARY OF THE INVENTION:

As mentioned above, the current paradigm is that allograft rejection is driven exclusively by recipient's adaptive immune system. In the present context where cellular immunity, involving mostly CD8 T cells, is controlled by current immunosuppressive drugs, rejection is mostly due to humoral immunity, involving anti donor specific antibodies directed mostly against mismatch donor HLA molecules and leading to microvascular inflammation and to the graft (or transplant) rejection.

The inventors have found that some transplanted patient has microvascular inflammation while having no donor specific antibodies. Surprisingly they discovered that the innate immune effectors NK cells could trigger microvascular inflammation and chronic rejection. NK-mediated rejection was due to the lack of expression by the graft of (at least) one type of HLA-I ligand for an inhibitory KIR expressed by recipient NK cells (a situation known as "missing self"). Missing self on graft endothelial cells was sufficient to induce the activation of NK cells in the recipient subject, which in turn trigger microvascular inflammation and ultimately lead to transplant rejection (typically chronic transplant rejection).

Therefore the present invention relates to an *in vitro* method for predicting the risk of transplant rejection in a subject who is the recipient of a transplant from a transplant donor, said method comprising the detection of missing-self activation of NK (natural killer) cells, wherein the detection of missing-self activation of NK cells is indicative of a risk for transplant rejection.

The invention also comprises a method of selecting a HLA compatible donor transplant for a candidate recipient subject comprising:

- obtaining the inhibitory KIR genotype of the candidate recipient subject and the HLA-I genotype of the transplant donor and the candidate recipient subject;
- comparing the HLA-I genotype and the KIR genotype of the candidate recipient subject et determining the functional KIRs; and
- comparing the genotype of the recipient inhibitory functional KIRs of the candidate recipient subject with the donor HLA-I genotype, and
- identifying whether or not a ligand of a functional inhibitory KIR (Killer-cell Immunoglobulin-like Receptor) of the recipient subject is absent in the transplant donor.

The present invention also relates to an inhibitor of mTOR (mammalian target of rapamycin) for use in the prevention of transplant rejection in a subject who is the recipient of

a transplant and selected as having at least one recipient inhibitory functional KIR directed against a corresponding HLA-I ligand missing in the donor HLA-I genotype.

DETAILED DESCRIPTION OF THE INVENTION:

1. Definitions:

As used herein “transplant rejection” (or graft rejection) encompasses acute transplant rejection and chronic transplant rejection. Preferably the transplant rejection is chronic transplant rejection. Preferably also the transplant rejection is NK cell-mediated rejection, notably missing-self-induced NK-mediated rejection.

Natural killer cells are the third population of lymphocytes defined by the CD3-CD56+ cell surface phenotype and share several features with CD8+ cytolytic T-lymphocytes in their development, morphology, cell surface phenotypes, killing mechanism, and cytokine production. NK cells express both activating and inhibitory receptors that are calibrated to ensure self-tolerance, while exerting early assaults against virus infection and tumor transformation. Having properties of both innate and adaptive immunity, NK cells spontaneously lyse target cells, as well as function as regulatory cells influencing subsequent antigen-specific T-cell and B-cell responses.

The recipient NK cells can recognize and respond against an allograft by three possible mechanisms: missing-self recognition, induced-self recognition, and ADCC (Rajalingam R. Variable interactions of recipient killer cell immunoglobulin-like receptors with self and allogeneic human leukocyte antigen class I ligands may influence the outcome of solid organ transplants. *Curr Opin Organ Transplant* (2008) 13:430–7). Because NK cells circulate in a state that can spontaneously deliver effector function, it is critical that they do not attack surrounding healthy cells. To prevent such detrimental autoreactivity, NK cells express an array of inhibitory receptors recognizing self-HLA class I molecules.

Expression of four distinct HLA class I molecules (HLA-A, -B, -C, and -E) on normal healthy cells provides ligands for the inhibitory receptors of NK cells and, consequently, are resistant to NK cell attack. Down-regulation of HLA class I (HLA-I) expression due to certain viral infections, neoplastic transformations, or absence of relevant HLA class I ligands on the allograft at the setting of allogeneic transplantation, alleviates inhibitory signals, permitting NK cells to eliminate these unhealthy or allogeneic target cells, a phenomenon originally described as the “missing-self” hypothesis (see notably Ljunggren HG, Karre K. In search of the “missing self”: MHC molecules and NK cell recognition. *Immunol Today* (1990) 11:237–

44). In addition to the “missing-self” mechanism, the expression of ligands for activating receptors on stressed target cell surface might also contribute to NK cell attack, known as “induced-self” recognition. The activation receptors can directly recognize stress-induced ligands associated with certain physiological conditions, such as infection, tumor transformation, and transplanted allograft (Raulet DH, Vance RE, McMahon CW. Regulation of the natural killer cell receptor repertoire. *Annu Rev Immunol* (2001) 19:291–330).

Thus, as used herein, “missing-self-induced NK-mediated rejection” means that transplant rejection is mediated by NK cells which activation is triggered by “missing self”.

By “missing self” it is herein intended that the inhibitory receptors of NK cells missed their corresponding HLA-I ligand in the target cell, in particular on the transplant cells (and typically endothelial donor cells).

Fourteen distinct KIRs (Killer-cell Immunoglobulin-like Receptors) have been characterized in humans that comprise either 2 or 3 (2D or 3D) Ig-like domains and either a long (L) or short (S) cytoplasmic tail (see table 1 below) (for review see also Rajalingam R. The Impact of HLA Class I-Specific Killer Cell Immunoglobulin-Like Receptors on Antibody-Dependent Natural Killer Cell-Mediated Cytotoxicity and Organ Allograft Rejection. *Frontiers in Immunology*. 2016;7:585 and Thielens A, Vivier E, Romagné F. NK cell MHC class I specific receptors (KIR): from biology to clinical intervention. *Curr Opin Immunol*. 2012 Apr;24(2):239–45. Parham P., MHC class I molecules and KIRs in human history, health and survival. *Nat Rev Immunol*. 2005 Mar;5(3):201-14). Six KIRs are activating types and the remaining KIRs are inhibitory types. Inhibitory KIRs notably comprise KIR2DL1, KIR2DL2, KIR2DL3, KIR3DL1, KIR3DL2, KIR2DL4, KIR2DL5, KIR3DL3. The cytoplasmic tails of the inhibitory KIRs carry an ITIM motif that trigger inhibitory signals upon binding to distinct HLA class I ligands (as detailed in table 1 below). The short-tailed activating KIRs lack ITIM, but carry a positively charged amino acid residue in the transmembrane region that allows the interaction with an adaptor chain DAP-12

KIRs that are expressed on the surface of NK cells recognize allotypic determinants (“KIR ligands”) shared by certain HLA class I allele groups. KIR2DL1 recognizes HLA-C alleles with a Lys80 residue (HLA-C2 (Cw2, Cw4, Cw5, Cw6, Cw15, Cw17, Cw18; “group 2’ alleles”), KIR2DL2 and KIR2DL3 recognize HLA-C with an Asn80 residue (HLA-Cw3 and related, “group 1” alleles); KIR3DL1 is the receptor for HLA-B alleles sharing the Bw4 supertypic specificity (HLA-Bw4 (B13, B27, B37, B44, B47, B38, B49, B51, B52, B53, B57,

B58, B59, B63, B77, B23, B24, B38)). Finally, KIR3DL2 was shown to function as a receptor for HLA-A3/-A11 alleles when bound to Epstein-Barr virus (EBV) peptides (see also below table 1).

On the basis of gene content, KIR haplotypes are broadly classified into two groups. Group A haplotypes have a fixed gene content (KIR3DL3-2DL3-2DP1-2DL1-3DP1-2DL4-3DL1-2DS4-3DL2) that encode four inhibitory KIRs, 2DL1, 2DL3, 3DL1, and 3DL2, specific for four major HLA class I ligands, C2, C1, Bw4, and A3/A11, respectively, and an activating KIR 2DS4, which is weakly specific for some HLA-C allotypes (C1 or C2 epitope), as well as the HLA-A3/11 epitope. In contrast, group B haplotypes are variable both in numbers and combinations of KIR genes, and comprising several genes (2DL2, 2DL5, 2DS1, 2DS2, 2DS3, 2DS5, and 3DS1) that are not part of the A haplotype. Moreover, B haplotypes possess KIRs that have no binding to HLA class I ligands, such as KIR2DL5, 2DS2, 2DS3, and 2DS5. While group A haplotypes contain only KIR2DS4 as an activating gene, group B haplotypes contain up to five activating KIRs – KIR2DS1, 2DS2, 2DS3, 2DS5, and 3DS1. Inheritance of paternal and maternal haplotypes comprising different KIR gene contents generates human diversity in KIR genotypes. For example, homozygotes for group A haplotypes have only seven functional KIR genes, while the heterozygotes for group A and certain group B haplotypes may have all 14 functional KIR genes. All human populations have both group A and B KIR haplotypes, but their incidences vary substantially among populations.

According to the present invention, a recipient inhibitory KIR is considered “functional” (the terms “successfully educated”, or “licensed” may also be used interchangeably), if the said recipient expresses its corresponding HLA-I ligand.

The terms “subject” and “patient” are used interchangeably in the present application. A subject of the present invention is a mammal, preferably a human.

In the present application, the terms “recipient”, “transplant recipient”, “transplanted recipient”, “transplanted patient”, or “subject recipient” are used interchangeably. In some embodiments a recipient according to the invention is a candidate recipient.

The donor HLA-I corresponds to the HLA-I of the transplant donor. The term “donor” or “transplant donor” are also used interchangeably. The donor or the transplant donor may also be a putative transplant donor.

1. Method for the prognosis or for the diagnosis of transplant rejection and method for selecting a HLA compatible donor transplant for a candidate recipient subject

The method of the invention may be performed before or after transplantation in the subject recipient. Thus, a subject according to the invention may have already received a transplant (transplanted subject) or may be a candidate for transplantation..

In some embodiment, the recipient subject may have or not detectable microvascular inflammation (mvi) associated with the transplant. In some embodiments also, the subject who has received a transplant may also have or not detectable donor specific antibodies (DSA). In one embodiment, a subject who has received a transplant presents microvascular inflammation and does not have detectable DSA. In one other embodiment, a subject who has received a transplant does not present detectable microvascular inflammation and does not have detectable DSA.

The present invention relates to an in vitro method for predicting the risk of transplant rejection in a subject who is the recipient of a transplant from a transplant donor by the detection of missing-self activation of NK (natural killer) cells.

According to the invention a situation of "missing self" can be identified by comparison of the genotype of functional inhibitory KIR of the recipient with the HLA-I genotype of the donor.

Indeed, according to the present invention, the identification of the absence in the transplant donor of a ligand for a functional inhibitory Killer-cell Immunoglobulin-like Receptor (KIR) of the recipient subject. In other words identification in the recipient subject of a functional inhibitory KIR missing his corresponding HLA-I ligand in the transplant (or in the putative transplant) is indicative of a risk for transplant rejection in the said recipient subject.

Thus, for a given subject recipient / transplant donor couple, the lack of expression by the graft of at least one type of HLA-I ligand for a functional inhibitory KIR expressed by recipient NK cells is indicative of a risk for transplant rejection in the recipient.

The presence of at least one inhibitory functional KIR in the recipient missing its corresponding HLA-I ligands in the transplant donor leads to the activation of NK cells. Thus, according to the invention, the presence of at least one recipient inhibitory KIR vs transplant donor HLA-I ligand mismatch is indicative of a higher risk (or an increase susceptibility) for

transplant rejection as compared to a patient wherein no recipient inhibitory KIR vs transplant donor HLA-I ligand mismatch is identified.

Estimation of the risk for transplant rejection may be achieved based on statistical analysis performed on a statistically significant population of transplanted subjects with no recipient inhibitory KIR/ inhibitory KIR Ligand mismatch vs a statistically significant population of transplanted subjects having at least one recipient inhibitory KIR/ inhibitory KIR ligand mismatch.

The risk of presenting a transplant rejection may be further improved in various clinical situations comprising the presence of microvascular inflammation, the pathological history of the patient (notably the ischemia/reperfusion and infectious histories of the patient).

The invention also comprises a method of selecting a HLA compatible donor transplant for a candidate recipient subject, the method comprising:

- comparing the genotype of the recipient inhibitory functional KIRs of the candidate recipient subject with the donor HLA-I genotype, and
- identifying whether or not a ligand of a functional inhibitory KIR (Killer-cell Immunoglobulin-like Receptor) of the recipient subject is absent in the transplant donor.

Preferably according to the method of selection of the invention, a transplant donor is selected such that no missing self would be created in the recipient subject. In other words, the transplant donor expresses the HLA-I ligands of the inhibitory functional KIRs of the candidate recipient subject.

Typically, the method for predicting the risk of transplant rejection as well as the method for selecting a HLA compatible donor transplant for a candidate recipient subject of the invention comprises beforehand the steps of:

- obtaining the inhibitory KIR genotype of the candidate recipient subject and the HLA-I genotype of the transplant donor and of the candidate recipient subject;
- comparing the HLA-I genotype and the KIR genotype of the candidate recipient subject and determining the functional KIRs.

Inhibitory KIRs according to the invention are notably as listed above. Preferentially inhibitory KIRs according to the invention are selected from the group comprising KIR2DL1, KIR2DL2, KIR2DL3, KIR2DL5, KIR3DL1, KIR3DL2 and KIR3DL3. Typically, KIR2DL4

is not considered as an inhibitory KIR because it has been reported as having both activating and inhibitory functions (Campbell and Purdy, 2011; Kikuchi-Maki et al., 2003). Most preferably, inhibitory KIRs according to the invention are selected from inhibitory KIRs for which the corresponding ligand is identified. Thus KIRs according to the invention typically comprise KIR2DL1, KIR2DL2, KIR2DL3, KIR3DL1, and KIR3DL2.

In some embodiments, the inhibitory KIR genotype of the candidate recipient subject and the recipient and transplant donor HLA-I genotypes can be obtained by typing the subject recipient HLA-A, HLA-B and HLA-C alleles.

The transplant donor may be categorized in the following inhibitory KIR-ligand groups: HLA-C group 1 alleles (HLA-C1), HLA-C group 2 alleles (HLA-C2), HLA-Bw4 group alleles and HLA-A3/-A11 alleles.

Comparison of the data on HLA-A, HLA-B, HLA-C1 and HLA-C2 of donors and recipients allows to determine whether HLA-I ligand of KIRs of the recipient are missing. Depending on the embodiment, seven inhibitory KIR/ inhibitory KIR-ligand pairs as defined above, and more preferably five inhibitory KIR/ inhibitory KIR-ligand pairs are analyzed.

In one embodiment of the invention the presence of the HLA-1 Bw4 ligand of KIR3DL1 is assessed in transplant donor. Typically the functionality of KIR3DL1 in the recipient subject is also determined.

The absence of at least HLA-1 Bw4 in a transplant donor is associated with a risk of transplant rejection in particular in recipient subject expressing functional KIR3DL1.

In another embodiment, a putative transplant donor expressing HLA-1 Bw4 is selected for a given candidate recipient expressing KIR3DL1.

Obtaining inhibitory KIR genotype of the candidate recipient subject and the recipient and transplant donor HLA-I genotypes is typically achieved using high resolution typing, such as by PCR-SSO reverse (One Lambda).

Inhibitory KIRs and / or HLA-I typing may be performed on a biological sample from the recipient or the donor. A sample according to the invention can be a body fluid such as for example blood, serum, lymph, or any biological tissue. The biological sample may also be pretreated, for example, by homogenization, extraction, enzymatic and/or chemical treatments as commonly used in the field.

Optionally, the method for predicting the risk of transplant rejection in a subject, or the method for selecting a HLA compatible donor transplant for a candidate recipient subject further comprises a step of determining the proportion of NK cells bearing inhibitory functional KIRs directed against HLA-I ligand missing in donor HLA-I genotype.

The size of the population of NK cells bearing inhibitory functional KIRs directed against HLA-I ligand missing in donor HLA-I genotype allows to quantify the strength of the "missing self". The risk of transplant rejection indeed vary as a function or the proportion of NK cells bearing inhibitory KIRs, directed against HLA-I ligand missing in the donor HLA-I genotype.

Typically, a recipient subject having a high proportion of NK cells bearing inhibitory KIRs, notably functional inhibitory KIRs, directed against HLA-I ligand missing in the donor HLA-I genotype have a higher risk of transplant rejection as compared to a subject having a high proportion of NK cells bearing inhibitory functional KIRs directed against HLA-I ligand missing in the donor HLA-I genotype.

A threshold, below which the risk may be considered as clinically acceptable, may be established based on statistical analysis of the clinical outcome (in terms of transplant rejection) of a population of transplanted patients having various proportion of NK cells bearing inhibitory functional KIRs directed against HLA-I ligands missing in the donor HLA-I genotype.

In one embodiment of a method of selecting a HLA compatible donor transplant for a candidate recipient subject, a transplant donor is selected whose, HLA-I ligands present at least one mismatch with the inhibitory functional KIRs of the candidate recipient, if the proportion of NK cells bearing inhibitory functional KIRs directed against HLA-I ligand missing in donor HLA-I genotype is below a threshold considered as statistically acceptable in terms of clinical outcome.

As a matter of example, determination of the proportion of NK cells bearing inhibitory functional KIRs directed against HLA-I ligand missing in donor HLA-I genotype may be performed as illustrated in the results detailed in the experimental section (see example 2).

Alternatively, in a method for predicting the risk of transplant rejection in a subject, the detection of missing-self activation of NK cells may be assessed by

- co-cultivating stimulated NK cells from the recipient subject with endothelial cells, preferably primary endothelial cells typically from the transplant donor or with endothelial cells (typically endothelial cell lines) expressing various combination of inhibitory KIR ligands ; and

- detecting the presence of degranulation (using CD107a as a marker) or expression of chemokines (such as MIP1), as shown in the results.

Optionally, the method for predicting the risk of transplant rejection in a subject, or the method for selecting a HLA compatible donor transplant for a candidate recipient subject further comprises the in vitro detection of NK cell-mediated rejection.

The detection of NK cell mediated rejection may be achieved as illustrated in the examples. Typically, stimulated NK cells from the recipient subject are co-cultivated with donor endothelial cells (notably primary endothelial cells) expressing or not the inhibitory HLA-I ligands. NK cells are typically stimulated according to the current practice in the field such as with interleukin 2. Detection of the activation of NK cell may be achieved by detection of degranulation (using CD107a as a marker) or expression of chemokines (such as MIP1), as shown in the results.

Detection of NK cell activation is indicative of a high risk for transplant rejection or for a diagnosis of transplant rejection.

Detection of NK cell mediated rejection as described above may be performed routinely, for the monitoring of patient diagnosed with a high risk for transplant rejection, or to whom a prognostic of a risk of transplant rejection was set according to the method as previously defined. In particular, detection of NK cell mediated rejection in patients may be performed in patients, wherein the proportion of NK cells bearing inhibitory KIRs directed against HLA-I ligand missing in donor HLA-I genotype, is elevated (i.e.: typically above a statistically significant threshold).

Taken together the method according to the invention allows the close monitoring of the risk of transplant rejection in a recipient patient such that invasive detection techniques such as biopsy may be avoided or delayed and an adapted curative or preventive treatment may be propose before transplant rejection.

Preferably, according to the invention, the transplant is an organ or a tissue. According to the invention, transplant organ is preferably a solid transplant organ, notably selected from heart transplant, lung transplant, kidney transplant, liver transplant, pancreas transplant,

intestine transplant, thymus transplant. A tissue transplant encompasses, composite tissue transplant, bones transplant and tendons transplant (both referred to as musculoskeletal grafts), corneae transplant, skin transplant, heart valves transplant, nerves transplant and veins transplant. Most preferably the transplant is a solid organ transplant such as heart, kidney, liver or lung transplant.

Transplant rejection according to the invention encompasses acute and chronic transplant rejection. Preferably, transplant rejection is chronic transplant rejection.

2. Methods of prevention and/or treatment of transplant rejection

The present invention also relates to a method of preventing or treating transplant rejection, notably NK cell transplant rejection in a transplanted subject in need thereof wherein:

the subject is identified as having missing-self activation of NK, and wherein an effective amount of an inhibitor of the mammalian target of rapamycin (mTor) is administered to said subject.

Preferably the subject is identified as having at least one inhibitory functional KIR directed against a HLA-I ligand missing in donor HLA-I genotype. In other words according to the invention, a subject is selected such that his graft lacks the expression of at least one HLA-I ligand for a functional inhibitory KIR expressed by his NK cells.

Preferably the subject is identified as having a risk for transplant rejection, notably transplant rejection mediated by missing self NK activation, by performing the method for predicting the risk of transplant rejection, as previously described.

Preferably the transplant rejection is transplant rejection mediated by missing self NK activation. In a preferred embodiment of the method, the recipient subject has no donor specific antibody (DSA).

Definitions and optional steps of the method for predicting a risk of transplant rejection according to the invention have been described previously and apply to the present methods of treatment and prevention.

mTOR, also known as the mechanistic target of rapamycin and FK506-binding protein 12-rapamycin-associated protein 1 (FRAP1), is a kinase that in humans is encoded by the

MTOR gene. mTOR belongs to the family of phosphatidylinositol-3-kinase-related kinases (PIKKs). Members in this family are large in size (>2,500 amino acids) and harbor a kinase domain at their C-terminals that shares sequence similarity to phosphatidylinositol-3-kinase (PI3K). Despite having the sequence signature of a lipid kinase, mTOR is a protein kinase that phosphorylates threonine and serine residues in its substrates. In cells mTOR serves as the catalytic subunits of two multi-protein complexes termed as the mTOR complex 1 (mTORC1) and complex 2 (mTORC2).

mTORC1 is a major downstream component of the PI3K/AKT pathway that relays the signals from tumor suppressors PTEN, LKB1 and TSC1/2, and oncoproteins PI3K and AKT. Downstream mTORC1 controls cellular biogenesis through regulation of protein synthesis and turnover. It phosphorylates eIF4E binding protein 1 (4EBP1) and ribosomal protein S6 kinase (S6K), two factors involved in translation initiation. Its activity controls protein turnover through repressing autophagy.

mTORC2 is also involved in the PI3K/AKT pathway but its function is independent of mTORC1. It phosphorylates and stimulates AKT activation, and hence plays a critical role in AKT mediated cell survival

Preferably the mTor inhibitor according to the invention is preferably an inhibitor of mTor C1.

Inhibitors of mTor suitable for the invention are notably described in Zheng Y, Jiang Y. mTOR Inhibitors at a Glance. *Molecular and cellular pharmacology*. 2015;7(2):15-20.

In particular, an mTor inhibitor according to the invention can be selected from rapamycin or one of its analogs termed as rapalogs (such as Temsirolimus (CCI-779), Everolimus (RAD001), or Ridaforolimus (AP23573)), ATP competitive inhibitors, pyrimidine derivatives (such as PP242 and PP30, the morpholino-linked pyrimidine derivatives (such as WAY-600, WYE-687 and WYE354 (37), KU0063794, the triazine derivative OSI-027, AZD8055, AZD2014 or Pink 128).

Typically the mTor inhibitor inhibits mTorC1. Preferably, the inhibitor of mTor is selected from rapamycin and its analogs termed rapalogs. Most preferably, the mTor inhibitor is rapamycin.

The terms “treatment”, “treating” or “treat” and the like refer to obtaining a desired pharmacological and/or physiological effect. This effect is preferentially therapeutic in terms of partial or complete stabilization or cure of transplant rejection and/or adverse effects attributable to transplant rejection (notably chronic transplant rejection). Treatment covers

any treatment of transplant rejection in a mammal, particularly a human, aimed at inhibiting the transplant rejection symptom(s), (i.e., arresting its development) or relieving the transplant rejection symptoms (i.e., causing regression of the transplant regression or symptoms).

The terms “prevention”, “preventing” or “prevent” and the like also refer to obtaining a desired pharmacological and/or physiological prophylactic effect in terms or completely or partially preventing the transplant or a symptom thereof. It covers therefore any preventive treatment of transplant in a mammal, particularly a human, aimed at preventing the transplant rejection or symptom from occurring in a subject, who may be at risk, or predisposed to transplant rejection but has not yet been diagnosed as having it.

The inhibitor of the can be administered by any suitable route, for example, intravenously, intranasally, peritoneally, intramuscularly, orally and other conventional methods.

Said inhibitor according to the invention can be included in a composition. It can be mixed and/or carried with one or more liquid and/or solid pharmaceutically acceptable carriers, ingredients and/or excipients. As used herein, "pharmaceutically acceptable carrier" is intended to include any and all solvents, dispersion media, coatings, antibacterial and antifungal agents, isotonic and absorption delaying agents, and the like, compatible with pharmaceutical administration. The use of such media and agents for pharmaceutically active substances is well known in the art. Supplementary active compounds can also be incorporated into the composition.

The present invention also provides an inhibitor of mTor as defined above, for use in the treatment or the prevention of transplant rejection, notably chronic transplant rejection (in particular NK cell mediated rejection) in a subject who is the recipient of a transplant and who has been selected as having at least one functional recipient KIR directed against HLA-I ligand missing in donor HLA-I genotype.

Preferably the subject has no DSA.

Typically, the subject is identified as having transplant rejection or being at risk of having transplant rejection according to one of the methods as previously described.

In one embodiment, the recipient subject presents at least one functional recipient inhibitory KIR directed against HLA-I ligand missing in donor HLA-I genotype and has a

high proportion of NK cells bearing mismatching functional KIRs directed against HLA-I ligands missing in the donor HLA-I genotype.

The present invention also relates to the use of an inhibitor of as defined above for the preparation of a medicament for treating or for prevention transplant rejection in a subject who is the recipient of a transplant and selected as having at least one functional recipient inhibitory KIR directed against HLA-I ligand missing in donor HLA-I genotype.

FIGURES:

Figure 1: Microvascular inflammation (mvi) in the absence of any donor specific antibodies (DSA) is associated with a kidney graft survival as worst as mvi due to non-complement activating DSA. Kaplan meier curves for kidney graft survival are shown for patients diagnosed with mvi and no DSA (mvi+DSA-), patient diagnosed with complement-independent humoral rejection (mvi+DSA+C3d-) and for control (mvi-DSA-).

Figure 2: Quantification of different inflammatory cells infiltrating the allograft biopsies. Comparison between mvi+DSA- and mvi+DSA+C3d- were done using unpaired t test.

Figure 3: Percentage of NK cells bearing only one functional inhibitory KIR (KIR2DL1 or LIR2DL2 and/or 3, KIR3DL1).

Figure 4: 4A. Percentage of CD107a+ cells in the different subpopulations of IL2+ NK cells bearing only one inhibitory KIR (KIR2DL1 or LIR2DL2 and/or 3, KIR3DL1, KIR3DL2). Mismatched licensed cells show significantly more activation as compared to mathed NK cells or mismatched non licensed NK cells. **4B. Percentage of CD107a+ cells in the different subpopulations of IL2+ NK cells bearing a define inhibitory KIR (KIR2DL1 or LIR2DL2 and/or 3, KIR3DL1, KIR3DL2).**

Figure: 5A. Percentage of MIP1 β + cells in the different subpopulations of IL2+ NK cells bearing only one inhibitory KIR (KIR2DL1 or LIR2DL2 and/or 3, KIR3DL1, KIR3DL2). **5B. Percentage of MIP1 β + cells in the different subpopulations of IL2+ NK cells bearing a define inhibitory KIR (KIR2DL1 or LIR2DL2 and/or 3, KIR3DL1, KIR3DL2).**

Figure 6: Impact of immunosuppressants on missing-self-mediated killing. 6A: Graph showing the remaining percentage of B 2 micro KO cells in C57BL/6 mice as function of time. 6B. Graph showing the remaining percentage of B 2 micro KO cells in C57BL/6 mice in the presence of rapamycine

EXAMPLES:

Example 1: Missing self triggers NK-mediated microvascular injuries and chronic rejection of allogeneic kidney transplants

Introduction

Rejection represents the main cause of solid organ transplants loss and therefore an important unmet medical need in the current context of severe organ shortage (www.who.int).

The current immunological paradigm is that rejection is due to the recognition of alloantigens (mainly the highly polymorphic donor-specific HLA molecules) by recipient's adaptive immune system. Allorecognition, results in the generation of cytotoxic cellular effectors and/or donor specific antibodies (DSA), which drive graft destruction. While the cellular arm of the alloimmune response has progressively come under pharmacological control, current immunosuppressive armamentarium does not completely prevent the generation of DSA (Everly et al., 2013). As a result, antibody-mediated rejection (AMR) is now widely recognized as the first cause of allograft loss (Sellarés et al., 2012).

DSA are massive protein largely sequestered in the circulation (Hall et al., 1969). They bind to directly accessible allogeneic targets expressed by graft endothelium, where they activate classical complement pathway and/or recruit innate immune effectors, in particular NK cells, which drive antibody-dependent cell-mediated cytotoxicity (ADCC) (Pouliquen et al., 2015). While activation of classical complement pathway seems necessary to trigger acute (i.e. clinically patent AMR), DSA-mediated microvascular inflammation alone is sufficient to promote the development of chronic AMR (Hirohashi et al., 2012). Experimental studies have indeed shown that the passive transfer of DSA that were unable to activate complement (IgG1), or DSA transferred in RAG1^{-/-}C3^{-/-} mice, were equally good in promoting the development of graft arteriosclerosis (Hirohashi et al., 2010, 2012), an effect that was completely lost if NK cells were depleted prior the passive transfer of DSA (Hirohashi et al., 2012). The central role of NK in promoting chronic AMR in the clinical setting is supported by transcriptomic analyses of renal graft biopsies showing that 6 among the 23 most expressed transcripts in renal allograft with chronic AMR lesions were from NK origin (Hidalgo et al., 2010).

In addition to their ability to collaborate with the humoral arm of adaptive immune system to promote target destruction, NK cells are also endowed with autonomous (or “natural”) cytotoxic functions. These large lymphocytes constitute indeed the first line of defense against intracellular infections and tumor cells. The regulation of this natural cytotoxicity

depends on the balance between inhibitory and activating signals that NK sense with their battery of cell surface receptors. Among them are the killer-cell immunoglobulin-like receptors (KIR). Inhibitory KIR receptors interact with self-MHC class I molecules, thus preventing NK-cell mediated killing against healthy cells. In case of infectious or tumoral transformation, cells down regulate the expression of MHC class I molecules and become susceptible to NK-mediated killing, a process known as “missing self”.

A few years ago, it has been demonstrated in a murine experimental model of heart transplantation that parental grafts transplanted in F1 recipients developed chronic rejection with graft arteriosclerosis (Uehara et al., 2005). This process was unlikely to be due to antibody-mediated rejection as it happened also in B cell depleted recipients (Uehara et al., 2005). We undertook the present study to determine whether “missing self” could also participate to promote a NK-mediated form of chronic vascular rejection in the setting of clinical kidney allotransplantation.

Material and Methods

Principal cohort

The reports of all kidney-allograft biopsies performed between September 1st 2004 and september 1st 2012 in either Edouard Herriot Hospital or Lyon Sud Hospital, the 2 university hospitals of Lyon (France), were screened (2024 biopsies in 938 patients) by means of the pathology department’s computer database (DIAMIC). One hundred and forty three patients with microvascular inflammation (mvi+) were identified. A renal pathologist and a nephrologist reviewed all biopsy specimens, and 9 patients whose biopsy specimens did not show significant microvascular inflammation were excluded. Among the 134 patients, 65 who displayed no anti-HLA DSA during the same period were identified through the immunology department’s computer database. An endothelial flow cross match was performed for these patients and one patient who displayed anti-endothelial cell antibodies was excluded. Finally, 41 patients having DNA samples available for the donor and the recipient were enrolled in the study (hereafter called mvi+DSA- group).

The steps of selection are summarized in figure 1.

Control groups

Mvi+DSA+C3d- group :

Following the same process as the principal cohort, 69 patients with microvascular inflammation lesions and anti-HLA DSA were identified. Serum samples banked at the time

of biopsy were analysed in a blinded fashion for the presence of C3d-binding donor-specific anti-HLA antibodies (V.D. at the Etablissement Français du Sang, Lyon, France) with the use of single-antigen flow bead assays according to the manufacturer's protocol (C3d-binding antibody assay; Lifecodes). Twenty-nine patients with significant microvascular inflammation in the context of complement-independent antibody-mediated rejection (DSA unable to bind C3d, mvi+DSA+C3d-) were enrolled in the study.

The steps of selection are summarized in figure 1.

Mvi-DSA- group :

The histopathological, immunological and clinical data of patients who received kidney transplantation at Edouard Herriot Hospital were screened by means of the departments' computer databases. Information from the three databases were integrated in order to identify 100 patients without any microvascular inflammation ($g+cpt \leq 1$) on biopsy and without any anti-HLA DSA and matched with patients of the principal cohort regarding main baseline characteristics. A renal pathologist and a nephrologist reviewed the 100 specimens and 14 patients whose biopsies showed microvascular inflammation or were not adequate were excluded. All the serum samples for these patients were screened and nine patients with anti-HLA DSA were excluded. Finally, 56 patients having DNA samples available for the donor and the recipient were enrolled in the study (hereafter called mvi-DSA- group). The steps of selection are summarized in the table 1 below.

All patients received an ABO compatible transplantation with negatives historical and current complement-dependent cytotoxicity crossmatches. Clinical data were obtained from two independent national registries (Cristal: <http://www.sipg.sante.fr/portail/>, and Données Informatiques Validées en Transplantation: <http://www.divat.fr/>) and crosschecked. The characteristics of the patients are summarized in table 1.

The end of follow-up was set as January 31th, 2015 (mean follow up duration for the cohort \pm SD: 69.2 ± 40 months for mvi+DSA- patients; 82.7 ± 48.7 months for mvi+DSA+C3d- patients and 57.9 ± 19.9 months for mvi-DSA- patients). Allograft survival in the principal cohort (mvi+DSA-) was compared with allograft survival of mvi+DSA+C3d- and mvi-DSA- patients.

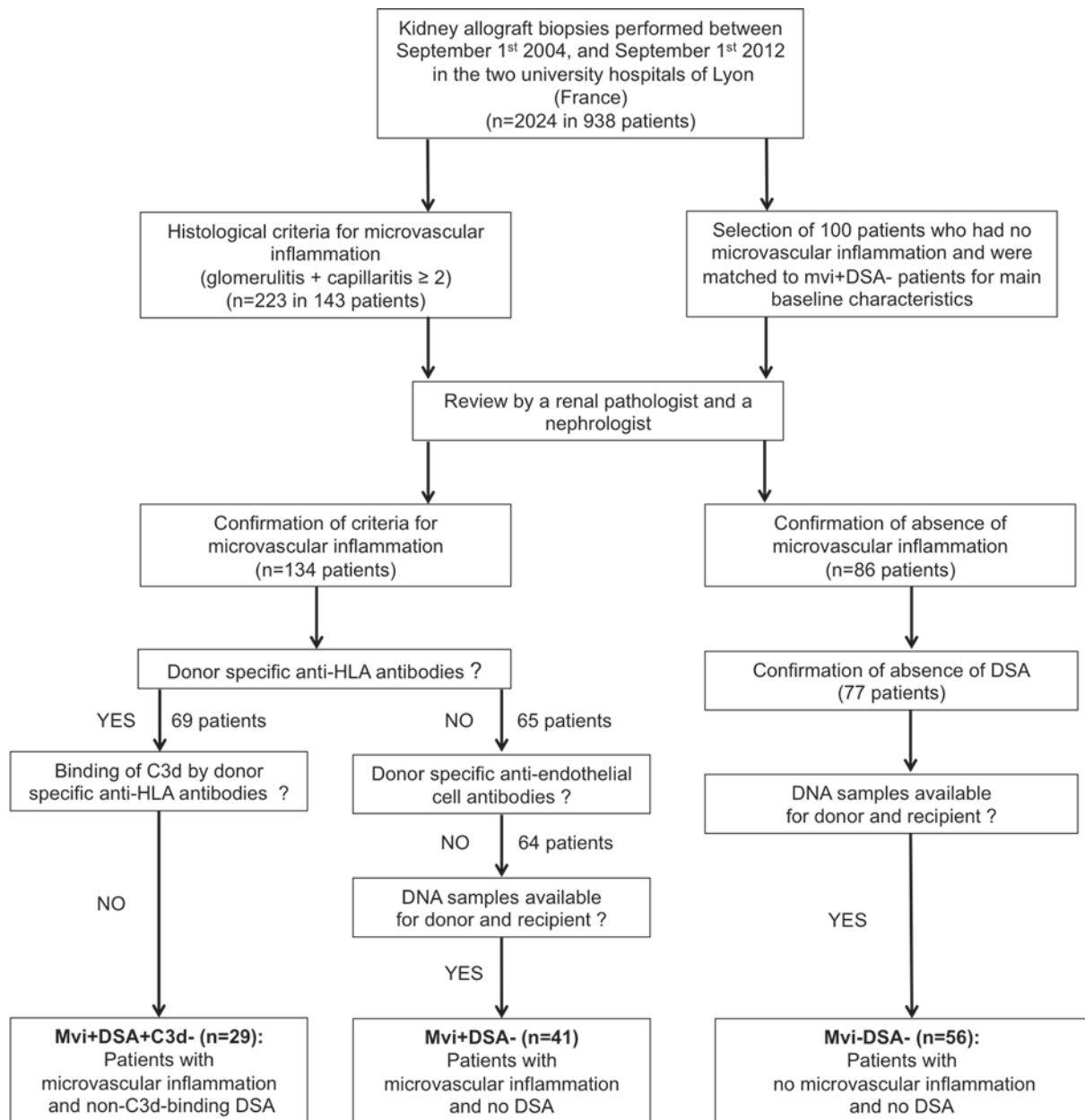

Table 1: flow chart of the study.

Allograft pathology

Kidney graft biopsies were performed systematically as part of the routine follow-up procedure at 3 months and 1-year post transplantation, or in case of rejection suspicion at the other time points.

Renal specimens were fixed in acetic acid-formol-absolute alcohol and paraffin embedded sections were stained by routine methods. C4d staining was performed by indirect immunofluorescence on frozen sections using an anti-human C4d complement-rabbit clonal antibody (clone A24-T, produced by DB Biotech, Kosice, Slovak Republic). The renal

pathologist (M.R.) and the nephrologist (A.S.) who reviewed the biopsies specimens were blinded to clinical and immunological information.

Renal allograft lesions were graded according to the Banff classification updated in 2011. Histological criteria for significant microvascular inflammation were defined by a sum of the scores for glomerulitis and peritubular capillaritis ≥ 2 , with or without concurrent positive C4d staining.

Double stainings with anti-CD34 (endothelial cells) and respectively one antibody among anti-CD56 (NK cells), anti-CD3 (T cells), anti-CD68 (macrophages) and anti-66b (granulocytes) were performed by immunohistochemistry on paraffin embedded sections using an anti-human CD34 (clone QBEnd10, Dako, Les Ulis, France) and respectively anti-human CD56 (clone CD564, produced by Novocastra and distributed by Leica Microsystems SAS, Nanterre, France), anti-human CD3 (clone SK7, Becton Dickinson, Le Pont de Claix, France), anti-human CD68 (clone PGM1, Dako, Les Ulis, France) and anti-66b (clone G10F5, Becton Dickinson). Computerized quantitative analyses were conducted in collaboration with Pasteur Institute. The algorithm allows for precise quantification of inflammatory cells in the renal allograft. The quantification of inflammatory cells in mvi+DSA- patients' biopsies was compared to the one of mvi+DSA+C3d- patients' biopsies (positive control).

Detection of anti-HLA antibodies

Donor-recipient HLA typing were performed by PCR-SSO reverse (One Lambda, Canoga Park, CA, USA).

Serum samples banked at the time of biopsy from patients with significant microvascular inflammation were tested for the presence of donor specific anti-HLA antibodies using Screening Flow Beads (LifeScreen, Class I and Class II ID ®, Lifecodes, Immucor, Norcross, GA, USA) and Single Antigen Flow Beads (LSA class I and class II®, Lifecodes, Immucor) in case of positivity or questionable result of the screening test. All the sera of each patient after transplantation were also reviewed and patients with circulating donor specific anti-HLA antibodies detected at any time point were excluded from the mvi+DSA- group.

All the analyses were performed in a blinded fashion by a single trained immunobiologist (V.D.) at the Etablissement Français du Sang (Lyon, France).

Detection of anti-endothelial cell antibodies

An endothelial flow cross match was performed as reported previously in the literature (Canet et al., 2012). Two primary cell lines of coronary endothelial cells (#407 and 408) (Promocell,

Heidelberg, Germany) were used for this test. For sera containing anti-HLA non-DSA, target endothelial cells were HLA-matched to avoid anti-HLA binding. Briefly, $1 \text{ or } 2 * 10^5$ endothelial cells were incubated for 30 minutes at room temperature with 25 μl of serum diluted at $\frac{1}{4}$ in PBS 1x FBS 1%. Reactivity of patient's sera for endothelial cells was revealed by incubation with a FITC conjugate F(ab')₂ anti-human IgG (30242, Bio rad, Hercule, CA, USA) for 20 minutes at 4 °C. After 3 washes with PBS 1x FBS 1%, the cells were resuspended in 200 μl of PBS 1x FBS 1% and analysed by flow cytometry (FACScanto II® analyser, Becton Dickinson, Montain View, CA, USA). The fluorescence level was expressed as Mean Fluorescence Intensity. A serum containing an anti-HLA class I antibody directed against HLA typing of the endothelial cell lines was used as positive control. Negative controls were performed using a pool of normal human AB sera from healthy male donors (EFS; Lyon, France).

Determination of KIR ligand and KIR receptor genotyping

These analyses were performed for the principal cohort: mvi+DSA- patients and a control group: mvi-DSA- patients.

Donors' and recipients' KIR ligands were determined as following. HLA-C1 and C2 groups were determined for the donors and recipients taking into account the HLA C typing obtained by PCR-SSO reverse (One Lambda). The presence or not of Bw4 motif was determined for the donors and recipients taking into account the HLA A and B typing obtained by PCR-SSO reverse (One Lambda).

Genotyping of 14 KIR genes (2DL1, 2DL2, 2DL3, 2DL4, 2DL5, 2DS1, 2DS2, 2DS3, 2DS4, 2DS5, 3DL1, 3DL2, 3DL3, 3DS1) and 2 pseudogenes (2DP1, 3DP1) was realized for the recipients by PCR-SSO reverse (KIR SSO Genotyping Test, One Lambda) according to the manufacturer's instructions. Number of inhibitory KIRs was determined considering 7 inhibitory KIRs: 2DL1, 2DL2, 2DL3, 2DL5, 3DL1, 3DL2 and 3DL3. KIR2DL4 was not considered as an inhibitory KIR because it has been reported as having both activating and inhibitory functions (Campbell and Purdy, 2011; Kikuchi-Maki et al., 2003). Number of activating KIRs was determined considering 6 activating KIRs: 2DS1, 2DS2, 2DS3, 2DS4, 2DS5 and 3DS1.

AA, BB and AB haplotypes were assigned as following: AA haplotype if none of the following KIR gene was present: 2DL2, 2DL5, 2DS1, 2DS2, 2DS3, KIR2DS5, 3DS1; BB haplotype if 2DL1, 2DL3, 3DL1, 2DS4 and 2DP1 were absent; Remaining KIR combinations were assigned with AB haplotype (according to <https://www.ebi.uk/ipd/kir/introduction.html>).

The functionality of inhibitory KIR receptors was assessed for the one with known MHC class I ligands (2DL1, 2DL2, 2DL3, 3DL1, 3DL2). They were considered as functional only if the recipient possessed their respective HLA ligand (KIR2DL1/C2; KIR2DL2/C1; KIR2DL3/C1; KIR3DL1/Bw4 and KIR3DL2/A*03,*11). The functionality of the only activating KIR (KIR2DS1) known to undergo a licensing was also assessed (Fauriat et al., 2010). It was considered to be functional only if the recipient didn't possess its ligand.

Statistical analysis

Categorical variables were expressed as percentages and compared with the chi-squared test. Continuous variables were expressed as mean \pm standard deviation and compared using unpaired *t* test.

Graft survival was calculated from the date of biopsy until the beginning of hemodialysis. Survival curves were constructed with the Kaplan–Meier method and compared with the log-rank test.

All tests were two sided, and *P* values <0.05 were considered to represent statistically significant differences. Statistical analyses were realized using GraphpadPrism® 6.0a for Mac OS X.

Results

Study population

Of 938 kidney transplant recipients followed over the study period in the 2 institutions participating to the study, 65 donor/recipient pairs fulfilled the pre-screening criteria:

i) significant microvascular inflammation on graft biopsy ($g+ptc \geq 2$), ii) no circulating donor specific anti-HLA antibodies in solid phase assay.

Endothelial flow cross match was performed for 27 out of the 65 sera (41.5 %) to rule out the presence of non-HLA antibodies directed against graft endothelium. The others patients couldn't be tested because they had non-donor specific anti-HLA antibodies directed against the HLA of the two primary endothelial cell lines available. One patient with positive endothelial flow cross match was discarded.

Finally, the 41 patients fulfilling the inclusion criteria and having DNA available for the donor and recipient were enrolled in the study (mvi+DSA-).

Interestingly, even though mvi+DSA- patients didn't have anti-graft antibodies they had significant microvascular inflammation on their biopsy and a graft survival, which was significantly worse than matched control recipients with neither mvi nor DSA (mvi-DSA-). In

fact mvi+DSA- graft survival was similar to the one of patients diagnosed with conventional antibody-mediated rejection due to non-complement binding DSA (mvi+DSA+C3d-) (Figure 1).

As expected, Mvi+DSA- patients and mvi-DSA- patients displayed similar characteristics (Table 2), especially regarding the number of HLA mismatches, except for microvascular inflammation ($p < 0.0001$).

Mvi+DSA- patients and mvi+DSA+C3d- had also similar baseline characteristics, including regarding the severity of histological lesions (Table 2 below).

Variable	MVI-DSA- (n=56)	MVI+DSA- (n=41)	Mvi+DSA+C3d- (n=29)	P value 1 vs 2	P value 2 vs 3
Characteristics at the time of transplantation					
Recipient					
Age, years	45.7 ± 14	43.6 ± 13.1	43.4 ± 15.7	0.5	0.9
Gender, male, n (%)	42 (75)	25 (61)	16 (55.2)	0.2	0.5
Retransplantation, n (%)	6 (10.7)	7 (17.1)	10 (34.5)	0.4	0.2
Time since dialysis (mo)	28.5 ± 34.3	25.2 ± 27.9	65.4 ± 65	0.6	0.004
Blood group, n (%)					
Type A	25 (44.6)	20 (48.8)	14 (48.3)	0.04	0.2
Type B	8 (14.3)	5 (12.2)	4 (13.8)		
Type O	23 (41.1)	11 (26.8)	11 (37.9)		
Type AB	0 (0)	5 (12.2)	0 (0)		
Donor					
Deceased, n (%)	50 (89.3)	39 (95.1)	27 (93.1)	0.5	1
Age, years	45.5 ± 16.1	42.3 ± 14.0	40.4 (16.1)	0.3	0.6
Transplantation					
Cold ischemia time, minutes	784 ± 372	947 ± 395	978 ± 341	0.04	0.7
Number of HLA A/B/DR mismatch	4 ± 1.4	3.9 ± 1.3	4 ± 1.4	0.9	0.8
Combined transplantation, n (%)	15 (26.8)	6 (14.6)	3 (10.3)	0.2	0.7
Delayed graft function, n (%)	21 (37.5)	16 (39)	8 (27.6)	1	0.5
Immunosuppression					
Cyclosporine, n (%)	16 (28.6)	14 (34.1)	18 (62.1)	0.7	0.01
Tacrolimus, n (%)	41 (73.2)	25 (61)	11 (37.9)	0.2	0.1
Azathioprine, n (%)	0 (0)	0 (0)	1 (3.4)	1	0.4
Mycophenolate mofetil, n (%)	56 (100)	40 (97.6)	26 (89.7)	0.4	0.6
Steroids, n (%)	56 (100)	40 (97.6)	28 (96.6)	0.4	1
Induction therapy					
antithymocyte globulins, n (%)	42 (75)	28 (68.3)	22 (75.9)	0.5	0.4
anti-IL2 receptor, n (%)	14 (25)	13 (31.7)	4 (13.8)	0.5	0.2
Characteristics at the time of biopsy					
Follow-up post biopsy (mo)	49.2 ± 20.2	50.2 ± 28.6	48.1 ± 29.6	0.8	0.8
Banff scores*					
Microvascular inflammation**	0.21 ± 0.4	3.1 ± 1.2	3.4 ± 1	< 0.0001	0.3
Transplant glomerulopathy	0.02 ± 0.1	0.8 ± 1.2	1 ± 1.2	< 0.0001	0.4
Interstitial Inflammation and Tubulitis	1.5 ± 1.9	2.5 ± 1.9	2.2 ± 1.8	0.01	0.5
Interstitial Fibrosis and Tubular Atrophy	1.4 ± 0.7	1.8 ± 0.9	1.5 ± 0.7	0.04	0.2
Arteriosclerosis	0.7 ± 0.8	1.1 ± 1.1	1.1 ± 1.1	0.04	0.9
Endarteritis	0	0.3 ± 0.7	0.2 ± 0.5	n/a	0.5
C4d deposition	0	0.3 ± 0.7	1.2 ± 1.1	n/a	< 0.0001

Abbreviations: DSA: Donor specific antibodies, Mvi: microvascular inflammation

*Banff scores: (0: no significant lesion, 1: mild, 2: moderate, 3: severe)

** Sum of the Banff scores for glomerulitis and capillaritis

Unless noted otherwise results are expressed as mean ± standard deviation. n/a, not adapted

Comparison between mvi-DSA- and mvi+DSA- patients (1 vs 2); and between mvi+DSA- and mvi+DSA+C3d- patients (2 vs 3)

(Chi-squared tests for comparison of proportions and unpaired t test for comparison of continuous variables).

Data concerning time since dialysis and immunosuppression are missing for one patient

Data concerning cold ischemia time, delayed graft function, donor age and induction therapy are missing for 2 patients

Table 2: baseline characteristics**Recipients' KIR genotypes in mvi+DSA- and mvi-DSA- groups**

First, we analysed whether recipients' KIR genotype might impact the occurrence of microvascular injuries. KIR genotype frequencies were similar in mvi+DSA- and mvi-DSA- patients for all the KIR genes (Table 3).

The numbers of inhibitory and activating KIR genes were also similar between the 2 groups (Table 4).

Recipients could be distributed in 2 haplotypes (A or B) according to the number of activating KIR genes: only one activating KIR (KIR2DS4) for A haplotype, in contrast with > 1 activating KIR for B haplotype. There was no statistical difference in the distribution of recipients KIR haplotypes between the two groups (Table 4).

Gene	MVI-DSA- (n=56)	MVI+DSA- (n=41)	P value
Inhibitory KIRs, n (%)			
KIR2DL1	54 (96.4)	39 (95.1)	1
KIR2DL2	31 (55.3)	19 (46.3)	0.4
KIR2DL3	50 (89.3)	37 (90.2)	1
KIR2DL5	32 (57.1)	19 (46.3)	0.3
KIR3DL1	55 (94.8)	41 (100)	0.3
KIR3DL2	56 (100)	41 (100)	1
KIR3DL3	56 (100)	41 (100)	1
Activating KIRs, n (%)			
KIR2DS1	17 (30.3)	11 (26.8)	0.8
KIR2DS2	31 (55.4)	19 (46.3)	0.4
KIR2DS3	21 (37.5)	8 (19.5)	0.07
KIR2DS4	53 (94.6)	41 (100)	0.3
KIR2DS5	18 (32.1)	12 (29.2)	0.8
KIR3DS1	15 (26.8)	11 (26.8)	1
Unknown, n (%)			
KIR2DL4	56 (100)	41 (100)	1

Abbreviations: DSA: Donor specific antibodies, Mvi: microvascular inflammation

Table 3 : KIR gene frequencies

	MVI-DSA- (n=56)	MVI+DSA- (n=41)	P value
Numbers of inhibitory KIRs, n (%)			
5	18 (31)	17 (41.4)	0.4
6	21 (36.2)	16 (39)	
7	17 (29.3)	8 (19.5)	
Numbers of activating KIRs, n (%)			
1-2	26 (44.8)	22 (53.7)	0.5
3-4	24 (41.4)	16 (39)	
5-6	8 (13.8)	3 (7.3)	
Haplotypes, n (%)			
A/A	16 (27.6)	14 (34.1)	0.3
B/B	3 (5.2)	0 (0)	
A/B	39 (67.2)	27 (65.9)	

Abbreviations: DSA: Donor specific antibodies, Mvi: microvascular inflammation

Table 4: Number of inhibitory and activating KIR genes, KIR haplotype frequencies

Donors' and recipients' KIR ligands in mvi+DSA- and mvi-DSA- groups

We investigated the donors' and recipients' HLA-C1, HLA-C2, HLA-Bw4, and HLA-A3, A11 genotype frequencies in mvi+DSA- and mvi-DSA- patients.

The distribution of recipients' HLA-C1/2, HLA-Bw4 and HLA-A genotype frequencies were similar between both groups (Table 5).

Looking at donors' KIR ligands, donors of the mvi+DSA- group tended to be more often C1/C1 than donors of the mvi-DSA- group (46.3 % and 33.9 % respectively, $p=0.06$). We observed also a tendency to have less donors which were A3 and/or A11 in mvi+DSA- patients than in mvi-DSA- patients (26.8 % and 44.6 % respectively, $p=0.09$). The frequency of HLA-Bw4 positive donors was not different between the 2 groups ($p=0.2$) (Table 5).

	MVI-DSA- (n=56)	MVI+DSA- (n=41)	P value
Recipients' KIR ligands, n (%)			
C1/C1	21 (37.5)	16 (39)	1
C1/C2	26 (46.4)	19 (46.3)	
C2/C2	9 (16.1)	6 (14.6)	
Bw4	42 (75)	34 (82.9)	0.2
A3, A11	16 (28.6)	9 (22)	0.5
Donors' KIR ligands, n (%)			
C1/C1	19 (33.9)	19 (46.3)	0.06
C1/C2	32 (57.1)	14 (34.1)	
C2/C2	5 (8.9)	8 (19.5)	
Bw4	45 (80.4)	28 (68.3)	0.2
A3, A11	25 (44.6)	11 (26.8)	0.09

Abbreviations: DSA: Donor specific antibodies, Mvi: microvascular inflammation

Table 5: Distribution of recipient's and donor's HLA-C1/2, HLA-A and HLA-Bw4 genotype frequencies

Functionality of recipients' KIR receptors in mvi+DSA- and mvi-DSA- groups.

Only NK cells carrying inhibitory KIR receptors for which the recipients possess corresponding HLA ligands are functional and thus susceptible to be activated by “missing self” when they sense the absence of MHC class I on donors' allogenic cells. Functional inhibitory KIR gene frequencies were similar between both groups (Table 6).

Even if the licensing mechanism of activating KIR receptors remains more elusive, it was shown to exist for KIR2DS1 (Fauriat et al., 2010). NK cells KIR2DS1+ of C2+ patients are hypo responsive, which is a supplementary mechanism to ensure self-tolerance. In our cohort, the proportion of recipients having a functional KIR2DS1 was low and similar between mvi+DSA- and mvi-DSA- groups (Table 6).

	MVI-DSA- (n=56)	MVI+DSA- (n=41)	P value
Functional activating KIRs, n (%)			
KIR2DS1+/C2-	5 (8.9)	3 (7.3)	1
Functional inhibitory KIRs, n (%)			
KIR2DL1+/C2+	33 (58.9)	24 (58.5)	1
KIR2DL2+/C1+	24 (42.9)	16 (39)	0.7
KIR2DL3+/C1+	43 (76.8)	31 (75.6)	1
KIR3DL1+/Bw4+	39 (69.6)	33 (80.5)	0.2
KIR3DL2+/A 3, 11+	16 (28.6)	9 (22)	0.6

Abbreviations: DSA: Donor specific antibodies, Mvi: microvascular inflammation

Table 6: Functional KIR gene frequencies

Worst recipients' functional inhibitory KIR/donors' HLA ligands matching in mvi+DSA- patients

Considering that the NK clones of an individual expressed heterogeneously all the inhibitory KIRs present in the genome and that one KIR/ligand mismatching is enough to activate part of the NK cell population, we calculated the total number of mismatches for each individual donor/recipient pairs for functional inhibitory KIRs (KIR2DL1, KIR2DL2, KIR2DL3, KIR3DL1, KIR3DL2) and their respective donors' HLA ligands. The proportion of patients with at least one mismatch was higher for mvi+DSA- group compared to mvi-DSA- group (63.4% versus 37.5 %, p=0.03).

Then, we analysed the effect of each individual KIR/ligand mismatching to see which KIR/ligand combinations were overrepresented in mvi+DSA- group as compared with controls. More patients were mismatched for KIR3DL1/Bw4 in the mvi+DSA- group compared to the mvi-DSA- group (36.4 % versus 10.3 %, p=0.01) (Table 7). For the other inhibitory KIRs, no significant difference was found between the 2 groups (Table 7).

Recipients' functional KIR receptor	MVI-DSA- (n=56)		MVI+DSA- (n=41)		P value
	MisMatch	Match	MisMatch	Match	
<i>Activating KIRs, n (%)</i>	3 (60)	2 (40)	1 (33.3)	2 (66.7)	1
KIR2DS1					
<i>Inhibitory KIRs, n (%)</i>					
KIR2DL1	11 (33.3)	22 (66.6)	11 (45.8)	13 (54.2)	0.4
KIR2DL2	3 (12.5)	21 (87.5)	2 (12.5)	14 (87.5)	1
KIR2DL3	4 (9.3)	39 (90.7)	6 (19.4)	25 (80.6)	0.3
KIR3DL1	4 (10.3)	35 (89.7)	12 (36.4)	21 (63.6)	0.01
KIR3DL2	7 (43.7)	9 (56.3)	4 (44.4)	5 (55.5)	0.7

Abbreviations: DSA: Donor specific antibodies, Mvi: microvascular inflammation

Table 7: Matching and mismatching between functional recipient's KIRs and their respective HLA ligands present in the donors.

Mvi+DSA- patients presented as much CD56+ cells on allograft biopsies as mvi+DSA+C3d- patients

We reasoned that if mvi+DSA- patients develop graft microvascular inflammation due to activation of NK by “missing self” on graft endothelium, we should observed activated NK cells in their biopsies. We therefore performed a computer-assisted quantification of CD56+ cells infiltrating the graft. As positive controls, we used the graft biopsies of patients diagnosed with antibody-mediated rejection due to non-complement binding DSA (mvi+DSA+C3d-), a condition known to be driven by NK-mediated ADCC.

In line with our hypothesis, CD56+ cells were present in the allograft biopsy specimens of mvi+DSA- patients. Despite the lack of anti-graft antibodies, mvi+DSA- patients had the same number of CD56+ cells on their allograft biopsies as mvi+DSA+C3d- patients (Figure 2).

We also identified and quantified the other inflammatory cells infiltrating the grafts of mvi+DSA- patients. Two other cell lines were particularly represented in the infiltrates: CD3 cells (T cells) and CD68 cells (macrophages) (Figure 2). On the contrary, CD66b cells (granulocytes) were rare in most patients (Figure 2). These results were similar to the one obtained in mvi+DSA+C3d- patients.

Discussion

To the best of our knowledge, our study is the first to show that NK cells activated by “missing self” can trigger microvascular inflammation leading to chronic rejection after solid organ transplantation.

The previous studies evaluating the role of NK in renal transplantation reached conflicting results. In a large multicentric study, Tran et al. reported that NK didn't impact long-term allograft survival but they only looked at the matching between HLA ligands of KIRs between the recipients and the donors, not performing KIR genotyping (Tran et al., 2005). Two other teams evaluated the role of NK cells in renal transplantation (Kreijveld et al., 2007; Kunert et al., 2007). Whereas the first study didn't find any impact of KIR/ligand matching on the prediction of the risk of acute rejection, the second one showed that KIR2DL1+ or KIR2DL2/2DS2 recipients receiving a graft from donors possessing their ligands were less at risk of acute cellular rejection. As for the study by Tran et al, these 2 studies didn't take into account the functionality of recipients' KIR receptors, thus considering some patients as being mismatched for KIR/ligand combinations while their NK cells were in fact bearing unlicensed inhibitory KIRs (and were therefore unable to respond to the mismatch). On top of that, these 2 studies used acute rejection as endpoint (Kreijveld et al., 2007; Kunert et al., 2007). Although a convenient clinical endpoint (easy to diagnose, occurrence in the first 12 months), this might not be relevant to evaluate the impact of NK response against the graft since most murine experimental studies have shown that NK cell activation by “missing self” rather induce smoldering allograft injuries leading to late allograft failure (Uehara et al., 2005; Zhang et al., 2015). The strength of our study lays in the fact that we investigated the role of NK cell activation by “missing self” in the particular setting of microvascular injuries and chronic rejection after renal transplantation.

We included in our study only patients in whom a humoral response against graft endothelium has been excluded, as it is the first cause of microvascular injuries and chronic rejection after renal transplantation (Pouliquen et al., 2015; Sellarés et al., 2012; Thauinat, 2012). Not only patients with donor specific anti-HLA antibodies were excluded, but also patients with anti-endothelial cells as these antibodies take on great importance, as the endothelium is the site of interaction between the graft and the recipient's immune system (Breimer et al., 2009; Jackson et al., 2015; Sun et al., 2008, 2011).

On top of that, our clinico-biological and genetic data were strengthened by histological analyses of grafts using computer-assisted inflammation quantification which allowed us to precisely numbered inflammatory cells within the graft. Even though mvi+DSA- patients

have no antibodies, the number of NK cells (CD56+) infiltrating their allograft was the same as for mvi+DSA+C3d- patients in whom antibodies bind to graft endothelium and recruit NK cells, which drive ADCC. Our histological analyses also highlighted the presence of macrophages and T cells on allograft biopsies of mvi+DSA- and mvi+DSA+C3d- patients, advocating for a final common pathway whatever the mode of NK cell activation.

We considered only the mismatches between donors' HLA ligands and recipients' functional KIRs. The patients having at least one KIR/ligand mismatch were more at risk to present microvascular injuries. Moreover, the mismatching for KIR3DL1/Bw4 association was overrepresented in mvi+DSA- patients. This mismatch was sufficient to trigger NK cell activation, which could initiate the recapitulation of lesional mechanism of complement-independent antibody-mediated rejection: microvascular injuries leading to chronic rejection and finally allograft loss.

Our data challenge the current paradigm that innate immune system can participate to rejection only if recruited by adaptive immune system. Here “missing-self” directly activate NK cells. In other terms, NK cells have the ability to recognize non-self in the absence of danger signal. Our data are in the same line as the results of the team of Lakkis, which have shown that monocytes were also able to discriminate self and non-self (Oberbarnscheidt et al., 2014).

Currently, efforts are made to allocate HLA compatible transplant (define as an absence of pre formed DSA) to recipients. As KIR3DL1 is functional in 65 % of recipients and since its matching with Bw4 is not part of allocation criteria, current rules of allocations result in the fact that 25 % of the recipients receive a graft that will develop chronic rejection lesions exactly as if the recipient has a non-C3d-binding DSA.

We conclude that “missing self” is sufficient to activate NK cells, which can cause a novel kind of innate-driven chronic rejection after renal transplantation. Studies are needed to better understand the impact of the different immunosuppressive drugs on NK cells. Meanwhile, integration of KIR3DL1/Bw4 matching to current strategies of organ allocation could improve long-term outcomes.

Example 2: In vitro modelisation of missing-self mediated NK activation

Material and Methods

At day 0, whole blood samples were collected from healthy donors by venipuncture into Acide Citrate Dextrose-containing vials. Peripheral blood mononuclear cells (PBMC)

were isolated by Ficoll gradient centrifugation (Eurobio). PBMCs were cultured overnight at 37°C in 5% CO₂ in complete culture medium (RPMI 1640 containing glutamine and supplemented with 10 % FBS, hepes and penicillin-streptomycin) supplemented with 500 UI/ml recombinant human IL-2 (R&Dsystems) or were maintained at 4°C in complete culture medium.

Simultaneously, endothelial cells were seeded (100 000 in each well) in wells of a flat bottom 96-well plate coated with gelatin 1% (Sigma). Endothelial cells were cultured overnight at 37°C in 5% CO₂ in endothelial cell growth culture 2 medium (Promocell).

A day 1, NK cells were isolated using stem cell magnetic kit according to the manufacturer's instructions. Then, purified NK cells were resuspended at 0.5 millions/ml in complete RPMI.

One hundred thousand NK cells were added in each well containing endothelial cells after removing endothelial cell culture medium. Five microliter of anti-human CD 107a FITC (eBIOH4A3, ebioscience) was added in each well at the beginning of the co-culture. One hour after the beginning of the co-culture, golgi stop (DB biosciences) was added in each well. Then cells were co-cultured for 3 hours.

After the co-culture, cells were detached with trypsin and recovered in V bottom- 96-well plates.

Then cells were stained 20 min at room temperature in 50 µl of the following antibodies diluted in PBS1x:

CD3 APC-H7 (SK7) *BD biosciences 1/25e*
CD56 PE CF594 (NCAM16.2) *BD biosciences 1/25e*
KIR2DL1/S5 AF 700 (143211) *R&Dsystems 1/10e*
KIR2DL3 APC (180701) *R&Dsystems 1/10e*
KIR3DL1 BV 711 (DX9) *BD biosciences 1/25e*
CD 107a FITC (eBIOH4A3) *ebiosciences 1/50e*
Fixable viability dye eFluor 506 *ebiosciences 1/1000e*

Without washing, the following antibodies were added in 50 µl in PBS1x for an incubation of 15 minutes at room temperature:

KIR2DL1/S1 PE CY7 (EB6B) *Beckman Coulter 1/25e*
KIR2DL2-3/S2 PE CY5.5 (GL183) *Beckman Coulter 1/25e*

KIR3DL1-2 PE (REA168) *Miltenyi Biotec 1/10e*

Then cells were washed twice with PBS1x. After this, cells were fixed with 75 µl of Cytotfix/Cytoperm® fixation/permeabilization kit (BD Biosciences) 20 min at 4°C. After two washing with Permwash, cells were stained 30 min at 4°C in 100 µl of the following antibody diluted in Permwash:

MIP1B V450 (D21-1351) *BD biosciences 1/40e*

After one washing with PBS1x, cells were resuspended in PBS1x. Then samples acquisitions were made on a BD FORTESSA IV flow cytometer (BD Biosciences). Data were analysed with FlowJo software (Tree Star).

Results:

NK cells from healthy donors previously stimulated (IL2+) or not (IL2-) with IL2 were co-cultured 4 hours with different primary endothelial cell lines bearing different HLA class I ligands of inhibitory KIRs.

NK cell activation is assessed by the expression of the degranulation marker CD107a or the chemokine MIP1β.

The percentage of NK cells bearing only one inhibitory KIR expressing the degranulation marker CD107a or the chemokine MIP1β was assessed by flow cytometry in the following subpopulations :

- NK cells with an iKIR having its ligand present on endothelial cells (Matched iKIR (M)),
- non licensed NK cells with a iKIR not having its ligand on endothelial cells (Mismatched non licensed iKIR (MM L-)), and
- licensed NK cells with an iKIR not having its ligand on endothelial cells (Mismatched licensed iKIR (MM L+)).

After 4 hours of co culture the percentage of NK cells expressing CD107a or MIP1B was calculated for the following NK cells populations (KIR repertoire staining and analysis in NK cell was performed as described in Béziat V, Liu LL, Malmberg J-A, et al. NK cell responses to cytomegalovirus infection lead to stable imprints in the human KIR repertoire and involve activating KIRs. *Blood*. 2013;121(14):2678-2688).:

- NK cells bearing one inhibitory KIR which had its ligands on the endothelial cell line (matched NK cells);

- NK cells bearing one non-functional inhibitory KIR which doesn't have its ligand on endothelial cells (mismatched non licensed NK cells); and
- NK cells with one functional inhibitory KIR which doesn't have its ligand on endothelial cells (mismatched licensed NK cells).

In the absence of NK cell stimulation with IL2 before the co-culture, none of the 3 subpopulations of NK cells expressed either CD107A or MIP1B. However, when they were stimulated with IL2 before the co-culture, the percentage of mismatched licensed NK cells positive for the degranulation marker CD107a and the chemokine MIP1B was significantly higher than for matched NK cells and mismatched non licensed NK cells. These results were found for the 3 inhibitory KIRs which can be licensed: KIR2DL1, KIR2DL2-3, KIR3DL1. The results confirm that NK cells can sense missing-self on primary endothelial cells.

These results also suggest that NK cells need to be primed to sense missing-self on endothelial cells, as without IL2 nothing occurs.

Figure 3 shows the percentage of NK cells bearing only one functional inhibitory KIR (KIR2DL1 or KIR2DL2 and/or 3, KIR3DL1).

Figure 4A shows the percentage of CD107a+ cells in the different subpopulations of IL2+ NK cells bearing only one inhibitory KIR (KIR2DL1 or KIR2DL2 and/or 3, KIR3DL1, KIR3DL2). Mismatched licensed cells show significantly more activation as compared to matched NK cells or mismatched non licensed NK cells.

Figure 4B shows the percentage of CD107a+ cells in the different subpopulations of IL2+ NK cells bearing a defined inhibitory KIR (KIR2DL1 or KIR2DL2 and/or 3, KIR3DL1, KIR3DL2).

Figure 5A shows the percentage of MIP1 β + cells in the different subpopulations of IL2+ NK cells bearing only one inhibitory KIR (KIR2DL1 or KIR2DL2 and/or 3, KIR3DL1, KIR3DL2). Figure 5B shows the percentage of MIP1 β + cells in the different subpopulations of IL2+ NK cells bearing a defined inhibitory KIR (KIR2DL1 or KIR2DL2 and/or 3, KIR3DL1, KIR3DL2).

Example 3: Identification of immunosuppressant to be used for transplant rejection mediated by missing-self activated NK cells

a) In vitro model:

mTOR pathway was selected as a target of interest as mTOR was known to be involved in NK cell activation. Furthermore inhibitors of mTOR, such as rapamycin, are

already available in clinic. The same experimental setting as previously described (see example 2) was used.

The results show that mTOR efficiently prevents NK cell mediated transplant rejection.

b) In vivo cellular model of missing self

Wild type B6 mice were, injecting with splenocytes coming from a B2 micro KO mouse (lacking class I molecules on their surface) and therefore sensitive to the NK dependent lysis by missing self.

To control that the lysis of the cells is not due to another phenomenon, splenocytes from a wild-type B6 mouse were injected at the same time.

After the injection, the recipient mice were killed at different time points and their spleen were recovered. The splenocytes were analyzed by flow cytometry and the % of remaining B2 micro KO cells compared to that injected at day 0 was calculated.

With the time, B 2 micro KO cells are progressively killed and disappear around day 7 (see figure 6A).

In mice treated with an inhibitor of mTOR, such as rapamycine, survival of B2 micro KO cells is drastically increased which confirm the potential efficacy of this drug in the treatment of transplant rejection mediated by missing-self-activated NK cells.

References

Throughout this application, various references describe the state of the art to which this invention pertains. The disclosures of these references are hereby incorporated by reference into the present disclosure.

Van Bergen, J., Thompson, A., Haasnoot, G.W., Roodnat, J.I., de Fijter, J.W., Claas, F.H.J., Koning, F., and Doxiadis, I.I.N. (2011). KIR-ligand mismatches are associated with reduced long-term graft survival in HLA-compatible kidney transplantation. *Am. J. Transplant.* *11*, 1959–1964.

Breimer, M.E., Rydberg, L., Jackson, A.M., Lucas, D.P., Zachary, A.A., Melancon, J.K., Von Visger, J., Pelletier, R., Saidman, S.L., Williams, W.W., et al. (2009). Multicenter evaluation of a novel endothelial cell crossmatch test in kidney transplantation. *Transplantation* *87*, 549–556.

Campbell, K.S., and Purdy, A.K. (2011). Structure/function of human killer cell immunoglobulin-like receptors: lessons from polymorphisms, evolution, crystal structures and mutations. *Immunology* *132*, 315–325.

Canet, E., Devallière, J., Gérard, N., Karam, G., Giral, M., Charreau, B., and Coupel, S. (2012). Profiling posttransplant circulating antibodies in kidney transplantation using donor endothelial cells. *Transplantation* *93*, 257–264.

Everly, M.J., Rebellato, L.M., Haisch, C.E., Ozawa, M., Parker, K., Briley, K.P., Catrou, P.G., Bolin, P., Kendrick, W.T., Kendrick, S.A., et al. (2013). Incidence and impact of de novo donor-specific alloantibody in primary renal allografts. *Transplantation* *95*, 410–417.

Fauriat, C., Ivarsson, M.A., Ljunggren, H.-G., Malmberg, K.-J., and Michaëlsson, J. (2010). Education of human natural killer cells by activating killer cell immunoglobulin-like receptors. *Blood* *115*, 1166–1174.

Hall, J.G., Smith, M.E., Edwards, P.A., and Shooter, K.V. (1969). The low concentration of macroglobulin antibodies in peripheral lymph. *Immunology* *16*, 773–778.

Hidalgo, L.G., Sis, B., Sellares, J., Campbell, P.M., Mengel, M., Einecke, G., Chang, J., and Halloran, P.F. (2010). NK cell transcripts and NK cells in kidney biopsies from patients with donor-specific antibodies: evidence for NK cell involvement in antibody-mediated rejection. *Am. J. Transplant.* *10*, 1812–1822.

Hirohashi, T., Uehara, S., Chase, C.M., DellaPelle, P., Madsen, J.C., Russell, P.S., and Colvin, R.B. (2010). Complement Independent Antibody-Mediated Endarteritis and Transplant Arteriopathy in Mice. *Am. J. Transplant.* *10*, 510–517.

Hirohashi, T., Chase, C.M., Della Pelle, P., Sebastian, D., Alessandrini, A., Madsen, J.C., Russell, P.S., and Colvin, R.B. (2012). A Novel Pathway of Chronic Allograft Rejection Mediated by NK Cells and Alloantibody. *Am. J. Transplant.* *12*, 313–321.

Jackson, A.M., Sigdel, T.K., Delville, M., Hsieh, S.-C., Dai, H., Bagnasco, S., Montgomery, R.A., and Sarwal, M.M. (2015). Endothelial cell antibodies associated with novel targets and increased rejection. *J. Am. Soc. Nephrol.* *26*, 1161–1171.

Kikuchi-Maki, A., Yusa, S., Catina, T.L., and Campbell, K.S. (2003). KIR2DL4 Is an IL-2-Regulated NK Cell Receptor That Exhibits Limited Expression in Humans but Triggers Strong IFN- γ Production. *J. Immunol.* *171*, 3415–3425.

Kreijveld, E., van der Meer, A., Tijssen, H.J., Hilbrands, L.B., and Joosten, I. (2007). KIR gene and KIR ligand analysis to predict graft rejection after renal transplantation. *Transplantation* *84*, 1045–1051.

Kunert, K., Seiler, M., Mashreghi, M.F., Klippert, K., Schönemann, C., Neumann, K., Pratschke, J., Reinke, P., Volk, H.-D., and Kotsch, K. (2007). KIR/HLA ligand incompatibility in kidney transplantation. *Transplantation* *84*, 1527–1533.

Oberbarnscheidt, M.H., Zeng, Q., Li, Q., Dai, H., Williams, A.L., Shlomchik, W.D., Rothstein, D.M., and Lakkis, F.G. (2014). Non-self recognition by monocytes initiates allograft rejection. *J. Clin. Invest.* *124*, 3579–3589.

Pouliquen, E., Koenig, A., Chen, C.C., Sicard, A., Rabeyrin, M., Morelon, E., Dubois, V., and

Thaunat, O. (2015). Recent advances in renal transplantation: antibody-mediated rejection takes center stage. *F1000prime Rep.* 7, 51.

Ruggeri, L., Capanni, M., Urbani, E., Perruccio, K., Shlomchik, W.D., Tosti, A., Posati, S., Rogaia, D., Frassoni, F., Aversa, F., et al. (2002). Effectiveness of donor natural killer cell alloreactivity in mismatched hematopoietic transplants. *Science* 295, 2097–2100.

Sellarés, J., de Freitas, D.G., Mengel, M., Reeve, J., Einecke, G., Sis, B., Hidalgo, L.G., Famulski, K., Matas, A., and Halloran, P.F. (2012). Understanding the Causes of Kidney Transplant Failure: The Dominant Role of Antibody-Mediated Rejection and Nonadherence. *Am. J. Transplant.* 12, 388–399.

Sun, Q., Liu, Z., Chen, J., Chen, H., Wen, J., Cheng, D., and Li, L. (2008). Circulating Anti-endothelial Cell Antibodies Are Associated with Poor Outcome in Renal Allograft Recipients with Acute Rejection. *Clin. J. Am. Soc. Nephrol.* 3, 1479–1486.

Sun, Q., Cheng, Z., Cheng, D., Chen, J., Ji, S., Wen, J., Zheng, C., and Liu, Z. (2011). De novo development of circulating anti-endothelial cell antibodies rather than pre-existing antibodies is associated with post-transplant allograft rejection. *Kidney Int.* 79, 655–662.

Thaunat, O. (2012). Humoral immunity in chronic allograft rejection: puzzle pieces come together. *Transpl. Immunol.* 26, 101–106.

Tran, T.H., Mytilineos, J., Scherer, S., Laux, G., Middleton, D., and Opelz, G. (2005). Analysis of KIR ligand incompatibility in human renal transplantation. *Transplantation* 80, 1121–1123.

Tran, T.H., Unterrainer, C., Fiedler, G., Döhler, B., Scherer, S., Ruhstroth, A., Adamek, M., Middleton, D., and Opelz, G. (2013). No impact of KIR-ligand mismatch on allograft outcome in HLA-compatible kidney transplantation. *Am. J. Transplant.* 13, 1063–1068.

Uehara, S., Chase, C.M., Kitchens, W.H., Rose, H.S., Colvin, R.B., Russell, P.S., and Madsen, J.C. (2005). NK Cells Can Trigger Allograft Vasculopathy: The Role of Hybrid Resistance in Solid Organ Allografts. *J. Immunol.* 175, 3424–3430.

Zhang, Z.-X., Huang, X., Jiang, J., Lau, A., Yin, Z., Liu, W., Haig, A., and Jevnikar, A.M. (2015). Natural Killer Cells Mediate Long-term Kidney Allograft Injury. *Transplantation* 99, 916–924.

CLAIMS:

1. An *in vitro* method for predicting the risk of transplant rejection in a subject who is the recipient of a transplant from a transplant donor, said method comprising:
the detection of missing-self activation of Natural Killer (NK) cells, wherein the detection of missing-self activation of NK cells is indicative of a risk for transplant rejection.

2. The method of claim 1, wherein the detection of missing-self activation of NK cells is achieved by the identification of the absence in the transplant donor of a ligand for a functional inhibitory Killer-cell Immunoglobulin-like Receptor (KIR) of the recipient subject.

3. The method of claim 1 or 2, wherein the identification of the absence in the transplant donor of a ligand of a functional inhibitory KIR of the recipient subject comprises:

- obtaining the KIR genotype of the recipient subject and the transplant donor HLA-I genotype, and
- comparing the genotype of the recipient functional KIRs with the genotype of the transplant donor HLA-I.

4. The method of any one of claims 1-3, further comprising obtaining the HLA-I genotype of the recipient subject,

wherein KIRs are considered functional if the recipient subject expresses their corresponding HLA-I ligands.

5. The method of claim 1 or 2, wherein the detection of missing-self activation of NK cells comprises

- co-cultivating stimulated NK cells from the recipient subject with endothelial cells, preferably primary endothelial cells; and
- detecting the presence of a degranulation compound, preferably CD107a.

6. The method of any one of claims 1-5, wherein the recipient subject is a candidate recipient subject.

7. A method of selecting a HLA compatible donor transplant for a candidate recipient subject comprising:

- obtaining the inhibitory KIR genotype of the candidate recipient subject and the HLA-I genotype of the transplant donor and the candidate recipient subject;
- comparing the HLA-I genotype and the KIR genotype of the candidate recipient subject et determining the functional KIRs; and
- comparing the genotype of the recipient inhibitory functional KIRs of the candidate recipient subject with the donor HLA-I genotype, and
- identifying whether or not a ligand of a functional inhibitory KIR (Killer-cell Immunoglobulin-like Receptor) of the recipient subject is absent in the transplant donor.

8. The method of any one of claims 1-7, further comprising determining the proportion of NK cells in the recipient subject bearing inhibitory functional KIRs directed against HLA-I ligand missing in the donor HLA-I genotype.

9. The method of any one of claims 1-8, wherein the inhibitory KIRs comprise KIR2DL1, KIR2DL3, KIR2DL5, KIR3DL1, KIR3DL2 and KIR3DL3.

10. The method of any one of claims 1-9, wherein the transplant is a solid transplant organ, notably selected from heart transplant, lung transplant, kidney transplant, liver transplant, pancreas transplant, intestine transplant, thymus transplant and is preferably kidney transplant.

11- An mTor inhibitor, for use in the prevention or the treatment of transplant rejection in a subject who is the recipient of a transplant and selected as having at least one recipient functional KIR directed against HLA-I ligand missing in donor HLA-I genotype.

12. An mTor inhibitor for use according to claim 11, wherein the inhibitor is an inhibitor of mTorC1, notably wherein the inhibitor is rapamycin or one of its rapalog analog.

13 The method according to any one of claims 1-10 or the m Tor inhibitor for use according to claim 11 or 12, wherein the transplant rejection is chronic rejection.

ABSTRACT

The invention relates to an in vitro method for predicting the risk for transplant rejection in a transplanted subject. The inventors have shown that innate immune effectors NK cells could trigger microvascular inflammation and chronic transplant rejection. NK-mediated rejection was due to the lack of expression by the graft of at least one type of HLA-I ligand for an inhibitory KIR expressed by recipient NK cells. Thus the invention relates to an in vitro method for predicting the risk of transplant rejection in a transplanted subject comprising the detection of missing-self activation of NK cells. The inventors also showed that mTOR inhibitors are efficient to prevent missing-self mediated transplant rejection. The invention thus relates to an mTor inhibitor for use in the prevention or treatment of a transplanted recipient subject at risk of missing-self mediated transplant rejection.

Annexe 6 : lettre d'intention du protocole STARR

Lettre d'intention

Appel d'offres HCL Jeunes Chercheurs 2017

1- Investigateurs, équipes et structures associées

Investigateur Coordonnateur	
Investigateur Coordonnateur ¹	Alice KOENIG
Service	Néphrologie, immunologie et transplantation
Coordonnées de l'investigateur	Téléphone : 06 38 66 69 52 E-mail : koenig.alice@gmail.com Adresse : INSERM U1111, 21, avenue Tony Garnier, 69007 LYON
Statut (CCA, AHU, AS, PH, MCU-PH, PHU, Pat Associé)	CCA (au 01/11/17)
Age ²	32
Mobilité à l'étranger :	<input type="checkbox"/> OUI, si oui préciser : <input checked="" type="checkbox"/> NON
Nom et coordonnées du (ou des) méthodologiste(s) :	Nom / prénom : GUITTARD Laure / SUBTIL Fabien Téléphone : 04 72 11 28 01 / 04 72 11 52 38 E-mail : laure.guittard@chu-lyon.fr fabien.subtil@chu-lyon.fr Adresse : Unité d'appui à la recherche clinique ; Pôle IMER – Groupement HEH ; Hôpital Edouard Herriot : B12 - 5, Place d'Arsonval ; 69 437 Lyon Cedex 03 Service de Biostatistiques des HCL ; 162, av. Lacassagne – Bat A, 5ème étage – 69003 Lyon

¹ Fournir le CV abrégé de l'investigateur coordonnateur

² Le porteur doit être âgé de moins de 40 ans à au 31/12/2016

Structures et unités associés		
Implication d'une structure support à la recherche	<input checked="" type="checkbox"/> OUI <input type="checkbox"/> NON	Si OUI, précisez <input type="checkbox"/> CIC <input type="checkbox"/> CRC <input checked="" type="checkbox"/> Autres, précisez : Laboratoire de recherche translationnelle en transplantation et médecine régénérative ; Pôle IMER ; Service de biostatistiques des HCL
Implication d'une unité de recherche	<input checked="" type="checkbox"/> OUI <input type="checkbox"/> NON	Si OUI, précisez : INSERMU 1111, Lyon

2- Le projet :

Acronyme : STARR

Titre du Projet : Efficacité de l'évérolimuS pour le traitement des TrAnsplantés Rénaux présentant un Rejet secondaire à l'activation des NK par le « missing-self »

Durée du projet : 24 mois

Nombre de patients : 20

Mots clés		
Merci de préciser trois mots clés pour la recherche d'experts		
Thématique principale	Thématique secondaire	Maladie concernée
Transplantation rénale	Immunosuppression	Rejet

Type de projet :

- Recherche thérapeutique
- Epidémiologie
- Imagerie
- Analyse de bases de données
- Recherche biologique

Diagnostic / dépistage

Facteurs pronostiques

Autres : _____

Document scientifique

*Il est demandé que ce document soit structuré et ne dépasse pas 1000 mots. **Un document excédant le nombre de mots autorisés ne sera pas examiné par la commission scientifique. Aucune Annexe ne sera acceptée +++***

1- Contexte scientifique

Après transplantation rénale, la première cause de perte des greffons est le rejet d'allogreffe, un processus de destruction déclenché par la reconnaissance par le système immunitaire du receveur des antigènes (HLA) spécifiques du donneur. Actuellement, le dogme considère que le rejet est médié par le système immunitaire adaptatif du receveur : i) lymphocytes T cytotoxiques responsables des rejets cellulaires et lymphocytes B produisant des anticorps anti-donneur responsables des rejets humoraux¹. Malgré l'utilisation d'immunosuppresseurs de plus en plus puissants, ciblant le système immunitaire adaptatif, la demi-vie des greffons stagne, suggérant que d'autres mécanismes immunologiques pourraient être impliqués dans les rejets.

Les lymphocytes Natural Killer (NK) sont des effecteurs cytotoxiques du système immunitaire inné. Ils possèdent à leur surface des récepteurs KIR inhibiteurs qui sont capables de se lier aux molécules HLA de classe I portées par la quasi-totalité des cellules de l'organisme. En cas de transformation tumorale ou infectieuse, les cellules perdent l'expression des molécules HLA de classe I et deviennent sensibles à la lyse NK-dépendante, un phénomène connu sous le nom de « missing-self »².

Lors de ma thèse de science, j'ai démontré qu'après une transplantation rénale les NK du receveur pouvaient s'activer contre les cellules du greffon lorsque leurs KIRs inhibiteurs ne reconnaissaient pas les molécules HLA de classe I mismatchées du donneur. Cette forme particulière de « missing-self » est à l'origine d'une nouvelle entité de rejets médiés par l'immunité innée. Dans un modèle *in vivo* murin de transplantation cardiaque, j'ai montré qu'une classe d'immunosuppresseur peu utilisée mais qui a déjà l'AMM dans la prévention du rejet : les inhibiteurs de mTOR (sirolimus) pouvaient bloquer l'activation des NK et ralentir la destruction des greffons.

Dans ce projet, je propose de valider cette hypothèse dans une cohorte clinique de transplantés rénaux présentant un rejet NK médié.

2- Originalité et caractère innovant

La force de ce projet réside dans son caractère translationnel. Il repose sur des études expérimentales humaines et murines qui m'ont permis de démontrer avec certitude i) l'existence de rejets NK médiés pour le moment méconnu, ii) l'efficacité thérapeutique du sirolimus dans un modèle murin.

Notre équipe qui a la première identifié ces rejets et qui dispose d'une importante expertise dans l'immunologie des greffes est la mieux placée pour mener à bien ce projet innovant aux importantes retombées dans le domaine de la transplantation d'organe.

3- Objectifs principal et secondaires

- Objectif principal :
- Evaluer l'efficacité de l'évérolimus pour prévenir la dégradation de la fonction du greffon de patients présentant un rejet NK médié.

- Objectifs secondaires :
- Evaluer l'impact de l'évérolimus sur i) la sévérité des lésions histologiques et ii) le degré d'activation des NK des patients.

- Critère de jugement principal :
- Clinique : variation relative du Débit de Filtration Glomérulaire (DFG) estimé entre J-15 et M6

après la mise sous évérolimus

- Critères de jugement secondaires :
 - Cliniques : variation relative du rapport protéinurie/créatininurie entre J-15 et M6
 - Histologiques : diminution de l'inflammation microvasculaire (g+cpt) et stabilisation des lésions chroniques glomérulaires (cg) et vasculaires (cv) entre J-15 et M6
 - Biologiques : baisse du degré d'activation des NK entre J0 et M6

4- Plan expérimental et choix méthodologique

Nous souhaitons réaliser une étude prospective monocentrique pilote dans le service de transplantation rénale de l'hôpital Edouard Herriot.

➤ **Population de l'étude**

Transplantés rénaux

- Dont une biopsie du greffon réalisée dans le cadre du suivi habituel (J-15) montre pour la première fois des lésions d'inflammation microvasculaire (glomérulite (g) + capillarite péritubulaire (cpt) ≥ 2) et des lésions chroniques limitées (cg <3 et cv <3) selon la classification de Banff³.
- En l'absence d'anticorps spécifiques du donneur.
- Avec au moins 1 mismatch entre un KIR inhibiteur du receveur et les molécules HLA de classe I du donneur.

En considérant que l'écart-type de la variation relative de DFG entre J-15 et M6 est de 0,2 (cohorte antérieure), l'inclusion de 20 patients devrait permettre d'avoir une précision de ± 0.09 dans l'estimation de la moyenne de variation relative. En tenant compte du nombre de patients ayant eu ce type de rejet entre 2013 et 2014 (30 en 2 ans), l'inclusion de 20 patients en 1.5 an est réaliste. Tous les patients signeront un consentement pour participer à l'étude. La durée de participation des patients sera de 6 mois après l'introduction de l'évérolimus (J0).

➤ **Protocole**

Les patients inclus recevront une immunosuppression comprenant de l'évérolimus, un anticalcineurine et des corticoïdes.

Les critères de jugement seront monitorés comme suit :

- Critères cliniques :
 - Fonction du greffon (J-15, M6) : DFG estimé, rapport protéinurie/créatininurie
 - Tolérance de l'évérolimus (M3, M6) : Tension artérielle, apparition d'œdèmes des membres inférieurs, aphtes.
- Critères histologiques sur biopsies du greffon (J-15, M6)
 - Evaluation semi-quantitative de l'inflammation microvasculaire (g+cpt) et des lésions chroniques (cg et cv) par un unique pathologiste (Dr Rabeyrin).
 - Quantification des différents types de cellules inflammatoires (dont NK) présentes dans la biopsie à l'aide d'un outil de quantification assistée par ordinateur que nous avons récemment breveté⁴.
- Critères biologiques :
 - Degré d'activation des NK (J0, M6) : Analyse par cytométrie en flux du nombre de NK exprimant un marqueur de dégranulation (CD107a) et une chemokine intracellulaire (MIP1 β).
 - Tolérance de l'évérolimus (M3, M6) : hémogramme, bilan lipidique, glycémie.

5- Résultats attendus et perspectives

Au total, ce travail devrait nous permettre :

- i) de confirmer dans une cohorte clinique indépendante l'existence de rejets NK médiés
- ii) d'acquérir des données préliminaires sur l'efficacité thérapeutique de l'évérolimus dans ce type de rejet.

Les résultats de cette étude pilote serviront de base pour la mise en place d'un essai de plus grande envergure dans le cadre d'un PHRC. Cet essai clinique randomisé comparera une

immunosuppression à base d'évérolimus à la poursuite d'un traitement classique (anticalcineurine + antimétabolique + corticoïdes) chez les transplantés rénaux présentant un rejet NK médié.

6- Références bibliographiques

1. Wood K. *Transplantation* **93**,1–10(2012).
2. Thielens A. *Curr. Opin. Immunol.* **24**,239–245(2012).
3. Loupy A. *Am. J. Transplant.* **17**,28–41(2017).
4. Sicard A. *Kidney Int.* doi:10.1016/j.kint.2017.01.011

3- Financement

Sont autorisés les **frais liés à l'investigation** (*personnels médicaux, non médicaux, titulaires ou non, dépenses médicales en petit matériels, hôtelières et générales, les frais de promotion : arc moniteur, assurance, vigilance, sont également à budgéter.*

Coût global du projet :	29 948,41 euros	
Soutiens hors HCL	OUI <input type="checkbox"/> NON <input checked="" type="checkbox"/>	Si oui, précisez :
Financement obtenu	OUI <input type="checkbox"/> NON <input checked="" type="checkbox"/>	Si oui, précisez :
Montant demandé à l'appel d'offres Jeune Chercheur Dans la limite de 30 000 €		Montant : 29 948,41 euros