



HAL
open science

Experimental and Theoretical Study of Two Non-linear Processes Induced by Ultra-narrow Resonances in Atoms

Chitram Banerjee

► **To cite this version:**

Chitram Banerjee. Experimental and Theoretical Study of Two Non-linear Processes Induced by Ultra-narrow Resonances in Atoms. Optics [physics.optics]. Université Paris Saclay (COMUE), 2019. English. NNT : 2019SACLS139 . tel-02185535

HAL Id: tel-02185535

<https://theses.hal.science/tel-02185535>

Submitted on 16 Jul 2019

HAL is a multi-disciplinary open access archive for the deposit and dissemination of scientific research documents, whether they are published or not. The documents may come from teaching and research institutions in France or abroad, or from public or private research centers.

L'archive ouverte pluridisciplinaire **HAL**, est destinée au dépôt et à la diffusion de documents scientifiques de niveau recherche, publiés ou non, émanant des établissements d'enseignement et de recherche français ou étrangers, des laboratoires publics ou privés.

Experimental and Theoretical Study of Two Non-linear Processes Induced by Ultra-narrow Resonances in Atoms

Thèse de doctorat de l'Université Paris-Saclay
préparée à Université Paris-Sud

École doctorale n°572 Ondes et Matières
Spécialité de doctorat: Physique Quantique

Thèse présentée et soutenue à Orsay, le 14/06/2019, par

Chitram BANERJEE

Composition du Jury :

Rosa Tualle-Brouri Professor, Institut d'Optique, LCF	Président
Daniel Bloch Research Director, Université Paris 13, LPL	Rapporteur
Mohamed Aziz Bouchene Professor, Paul Sabatier Université, LCAR	Rapporteur
Nirmalya Ghosh Associate Professor, IISER-Kolkata, BioNAP	Examineur
Jasleen Lugani Researcher, University Jena, Abbe Center of Photonics	Examineur
Fabienne Goldfarb Associate Professor, Université Paris-sud, LAC	Directeur de thèse

Abstract

In this PhD work, two distinct phenomena are considered, which are both related to non-linear interactions between light and atoms. The first part of the thesis is dedicated to four wave mixing based on the internal degrees of freedom of room temperature helium atoms and uses it for amplification processes and generation of squeezed light. The second studied process is based on external degrees of freedom of cold cesium atoms and used for light storage and phase conjugate field generation through multi-wave mixing.

I experimentally observed and characterized phase sensitive amplification via four-wave mixing in metastable helium at room temperature. I have obtained about 9 dB of maximum gain with a bandwidth of about 300 kHz. The obtained phase transfer functions showed a strong phase squeezing, indicating that the phenomenon was almost free of unwanted processes.

In the second part, I explain how recoil induced resonances, which are due to the transfer of momentum between a photon and an atom, can be used to store light. I also explain how this phenomenon can lead to generation of a phase conjugate field, and why the existing theory fails to model the dip, which appears in the phase conjugate generation spectrum when the field power is increased. I extend the model to the fifth order so that it can reproduce this new feature and demonstrate that it depends on the decay rate of the coherence, which is excited between atomic levels of different momenta.

I then show that a simpler model, which is based on three levels defined by internal and external degrees of freedom of the atom, can explain the observed phenomenon.

Sythese en français

Dans ce travail de thèse, je considère deux phénomènes distincts, tous deux liés aux interactions non-linéaires entre la lumière et des atomes. La première partie est dédiée à du mélange à 4 ondes basé sur des degrés de liberté internes d'atomes d'hélium à température ambiante, et l'utilise pour des processus d'amplification et de la génération d'états comprimés. Le second phénomène étudié est basé sur des degrés de liberté externes d'atomes de césium froids et est utilisé pour du stockage de lumière et la génération d'un champ conjugué en phase par mélange d'ondes.

J'ai expérimentalement observé et caractérisé de l'amplification sensible à la phase par mélange à quatre ondes dans de l'hélium métastable à température ambiante. J'ai obtenu un gain maximum d'environ 9 dB avec une bande passante d'environ 300 kHz. Les fonctions de transfert phase/phase obtenues ont montré une forte compression de phase, indiquant que le phénomène était presque exempt de processus indésirables.

Dans la seconde partie, j'explique comment les résonances de recul, dues à un transfert de quantité de mouvement entre un photon et un atome, peuvent être utilisées pour du stockage de lumière. J'explique également comment ce phénomène peut conduire à la génération d'un champ conjugué, et pourquoi la théorie existante ne permet pas de modéliser le creux qui apparaît dans le spectre de génération du champ conjugué lorsqu'on augmente la puissance optique. Pour reproduire ce nouvel élément, j'ai effectué un développement jusqu'au 5e ordre, qui démontre qu'il dépend de la cohérence qui est excitée entre des niveaux de moments atomiques différents.

Je montre ensuite qu'un modèle plus simple, basé sur trois niveaux atomiques définis par des degrés de liberté interne et externe de l'atome, peut expliquer le phénomène observé.

Acknowledgements

Four years ago I landed in Paris on a breezy autumn day, somewhat awestruck and confused in this new country. And these last years has been one of the most extraordinary times of my life. Just like a thirsty boy, I gulped new experiences: scientifically, socially and culturally. It is impossible to list here everyone who have inspired me and pushed me forward. Yet, I would like to oblige myself making an imperfect attempt.

Foremost of all, it would be great to take this opportunity to thank Fabienne Goldfarb, who has not only guided and driven me in my thesis, I have gained significant insights and the broader aspects of scientific thinking. In addition, she had to put up with all my immaturities. I am also grateful to Fabien Bretenaker for catering to all my queries and showing me the right direction whenever I was stuck. I am indebted to Etienne Brion for those long discussions, without which I could not move forward.

Memories of a place are also intimately connected to the people. I have been fortunate enough to have the company of many wonderful friends here. I was a complete stranger in a foreign land. When I met Jasleen, I found a sister far from home. I was welcomed heartily into the group by Marie-Aude, to fill-up the bengali quota in the group after Syamsundarda. In free times, I found myself discussing and debating over everything but (more often than not) physics with professor Aliou, Tarek, not to mention sharing many of my interests with Weilin. Soon the group was filled with warm presence of Hui, Pascal, Paul and Gregory. We continued the tradition of idle (often silly and ridiculous) discussions. In Denabuj and Ivan I found brothers from different mothers. Thanks to them, the time of writing theses was less unbearable.

Denabuj was a bridge between the lab and the friends outside, without whom my stay would have been a secluded lonely one. Our IISER-K-‘Paris branch’ was initiated by Harsh bhaiya and Shibuda and I think I could successfully bear the torch to Trinish, Abhyuday, Denabuj, Voushik and Debmalyada. I would miss our ‘Shonibarar Adda’s. Thank you Soumitrada and Bradrajda for listening patiently to all my frustrations. Pabitrada and Rajeshda, thank you for taking care of me and helping me always. I am grateful to you all.

At the end, I thank and dedicate this thesis to my family, to whom I owe more than my existence, for your constant support and guidance. Thuje, I know you are there watching me, blessing me. I cannot thank you as I am me due to you.

Contents

Abstract	iii
Synthese en francais	v
Acknowledgements	vii
General Introduction	1
1 Quantum Noise and Amplification of Light	5
1.1 Quantum Noise	7
1.1.1 Definitions	8
1.1.2 Coherent States	9
1.1.3 Squeezed States	11
1.1.4 Homodyne Detection	15
1.2 Light Amplification	18
1.2.1 Propagation of light in a dielectric medium	18
1.2.2 Some non-linear phenomena	20
1.3 Phase insensitive and phase sensitive amplification	22
1.3.1 Classical FWM	23
1.3.2 Phase Insensitive Amplification gain	25
1.3.3 Phase Sensitive Amplification gain	26
1.4 Noise properties of PIA and PSA	27
1.4.1 Input and Output field operators	28
1.4.1.1 Input fields	28
1.4.1.2 Output fields	28
1.4.2 Noise for PIA	29
1.4.3 Noise for PSA	30
1.4.4 Quadrature noises after PSA	31
1.4.5 Two mode squeezing	33
2 Ultra-narrow Atomic Resonances	37
2.1 Coherent Population Trapping	38
2.2 Electromagnetically Induced Transparency	40

2.3	Recoil Induced Resonances (RIR)	44
2.3.1	RIR with one pump beam	45
2.3.2	RIR with counterpropagating pump beams	49
3	PSA in metastable Helium	53
3.1	Experimental Set-up	53
3.1.1	Metastable Helium setup	53
3.1.2	Polarization selection of Lambda scheme	56
3.1.3	Set-up	57
3.2	Observations and Data-processing	59
3.2.1	Phase Sensitive Amplification	59
3.2.2	Input Phase measurement	60
3.2.3	Output phase and Gain	62
3.2.4	PSA Characterization	65
3.2.5	Comparison with Phase Insensitive Amplification	65
3.3	Theoretical Formulation	67
3.4	Noise Properties	71
3.4.1	Setup	73
3.4.2	Experimental results	73
3.4.3	Heterodyne detection	75
4	Recoil Induced Resonances	79
4.1	Experiments and Observations	79
4.1.1	signal transmission Spectroscopy	79
4.1.2	RIR memory effect	80
4.1.3	Phase conjugate generation Spectroscopy	83
4.2	Theoretical Explanation	85
4.2.1	Two level system	85
4.2.1.1	Results at third order of expansion	88
4.2.1.2	Results at fifth order	91
4.2.2	A simpler three level model	94
	General Conclusion	101
A	Quantum Noise of a light field	103
A.1	Field quantization	103
A.2	Coherent states	105
A.3	Noise calculation for PSA	107
A.3.1	Noise figures	107
A.3.2	Quadrature noises after PSA	113

A.3.3	Two mode squeezing	115
A.4	Effect of losses on squeezed state detection	116
B	Data Analysis	119
B.1	Input Phase Extraction	119
B.2	Phase Sensitive Amplification analysis	121
B.2.1	Gain and Output phase	121
B.3	Phase Insensitive Amplification analysis	123
C	Detailed calculations for RIR	127
C.1	Perturbative development	127
C.1.1	Bloch equations	127
C.1.2	Zeroth order: No fields	128
C.1.3	First order	129
C.1.4	Second order	129
C.1.5	Third order	131
C.1.6	Fourth order	133
C.1.7	Fifth order	151
C.1.7.1	Selection of terms	179

List of Abbreviations

AWG	A rbitrary W ave G enerator
BPSK	B inary P hase S hift K eying
CPT	C oherent P opulation T rapping
EDFA	E rbium D oped F iber A mplifier
EIT	E lectromagnetically I nduced T ransparency
ESA	E lectronic S ignal A nalyzer
FWM	F our W ave M ixing
HWP	H alf W ave P late
LO	L ocal O scillator
NF	N oise F igure
PBS	P olarizing B eam S plitter
p.c.	p hase c onjugate
PIA	P hase I nsensitive A mplification
PSA	P hase I nsensitive A mplification
PSD	P ower S pectral D ensity
PSK	P hase S hift K eying
QPSK	Q uadrature P hase S hift K eying
RIR	R ecoil I nduced R esonances
SNR	S ignal to N oise R atio
SQL	S tandard Q uantum L imit

Dedicated to my Family

General Introduction

This PhD work is divided into two parts, which consider two distinct phenomena, but are both related to non-linear interactions between light and atoms. The first part of the thesis studied four wave mixing using the internal degrees of freedom of room temperature helium atoms and uses it for amplification processes and generation of squeezed light. The second process that I explain, uses external degrees of freedom of cold cesium atoms to store light and generate a phase conjugate field through multi-wave mixing.

Conventional electronic information communications and data processing are recently being overtaken with the recent upsurge of photonics with lasers and fiber-optic communications. Compared to traditional electrical communication, optical ones are advantageous due to their higher bandwidth, lower loss, security and cost efficiency. The other important aspect is that many different properties of light can be used to encode binary bits (1 and 0) of information e.g. the intensity, phase or polarization etc.

The on-off keying based on intensity modulation is still the most widely used protocol for fiber-optic transmissions, where a train of consecutive high and low intensities carry 0's and 1's of the binary information. In comparison, phase shift keying (PSK) protocols are mostly used for wireless (LAN or bluetooth) communications. For binary PSK (BPSK), the phase of the signal is flipped between 0 and π , which denotes the 0's and 1's. It is possible to encode four bits via quadrature PSK (QPSK) or even higher amount of bits via higher order PSK protocols.

Although one of the main advantages of using fiber-optic telecommunication is its low loss (attenuation coefficient is often of the order 10^{-1} dB/Km), the long submarine communications cannot be loss-less. After every few hundreds of kilometers, we need to reamplify the optical signal. But traditional amplifiers such as erbium doped fiber amplifier (EDFA) degrade the signal by introducing noises. This is a problem for both intensity modulation or phase-shift keying protocols.

Phase sensitive amplification (PSA) is a coherent amplification process, which

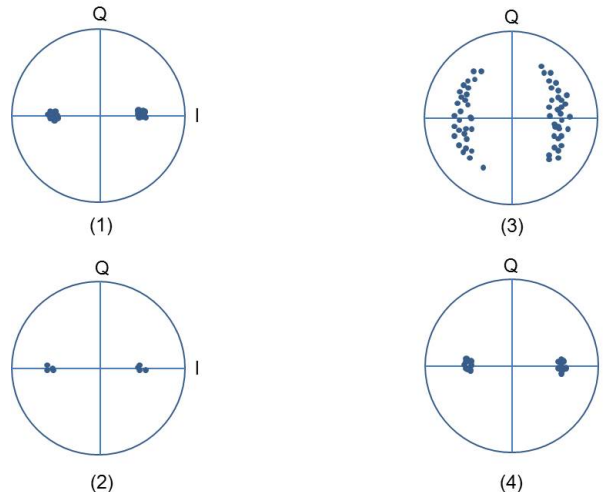

FIGURE 1: Constellation diagrams of a BPSK signal: I and Q are the in-phase and quadrature components of a signal. (1) An initial ensemble of BPSK signal with 0 and π phases. (2) A lossy medium dissipates some of the signal photons. (3) A traditional amplifier introduces noises (phase noise here). (4) A phase regenerator operating via phase sensitive amplification (PSA) is able to compress the noisy signal into 0 and π phases again, which resembles the initial signal (1).

has been shown to be able to amplify a signal without introducing noise [Caves, 1982, Imajuku and Takada, 2003]. This property is of interest not only for intensity-modulation protocols due to its direct influence on the repeater noise performance, but also for phase-shift keying protocols where the phase-squeezing property of PSA has been shown to be able to regenerate the original signal [Slavík et al., 2010]. A phase regeneration process via PSA is shown in fig. 1. In the following thesis I have studied experimentally and theoretically PSA in metastable helium in a vapor cell at room temperature and I could directly measure phase squeezing transfer curves, such as the ones studied for phase regeneration purpose.

Along with information exchanges, information storage is an integral part of any computation scheme. Storage of optical signal has been a challenge towards an all-optical computation. Electromagnetically Induced Transparency (EIT) has been shown to be able to efficiently store quantum states of light [Fleischhauer and Lukin, 2002]. In our group, we have previously reported efficient storage of classical light in Raman coherences of atomic states in EIT conditions and via another phenomenon, coherent population oscillations (CPO) [Maynard, 2016]. Jose Tabosa's group from the University of Pernambuco, Brazil have demonstrated the possibility to store light in the momentum-coherences of cold cesium atoms [Almeida et al., 2016].

When an atom absorbs or emits a photon, the atom recoils due to a transfer of momentum with the photon. Atomic recoil has since long been predicted and verified to give rise to non-linear interactions between light and atomic media [Guo, Berman, Dubetsky, and Grynberg, 1992, Lounis, Verkerk, Courtois, Salomon, and Grynberg, 1993]. This atomic recoil gives rise to coherences between atoms with different momenta, which induce resonance features in atom-light interactions, namely recoil induced resonances (RIR). I have developed a higher order perturbation model and an equivalent three level model that can explain RIR features, which had been recorded by Jose Tabosa's group.

In the first chapter of my thesis, I introduce the definitions needed to characterise a quantum electromagnetic field. I more specifically define what are the non-classical squeezed states of light and show their noise properties. Then, I introduce the phase sensitive and insensitive amplification (PSA and PIA) processes, compare their noise properties and theoretically explain how PSA leads to squeezing.

In the second chapter, I briefly introduce the different atomic resonances which are of interest in the thesis namely coherent population trapping (CPT), electromagnetically induced transparency (EIT) and recoil induced resonances (RIR), which I have used during my PhD work.

In the third chapter, I describe the experimental set-up and relevant atomic level schemes of metastable helium and the observation and characterization of PSA gains. PSA is usually associated to generation of squeezing which noise below the standard quantum limit. I explain the experimental set-up used for squeezing detection and why I could finally not detect it.

In the fourth chapter, I present the experimental observation of RIR by the group of Jose Tabosa in the university of Pernambuco, Brazil and the third order theory which explains the transmission, phase conjugate (p.c.) generation and storage effects of RIR. I explain the fifth order expansion that I developed to explain the emergence of new features in the p.c. generation spectra, when the pump field powers are high enough. I also propose a simpler three level atom model.

Chapter 1

Quantum Noise and Amplification of Light

Contents

1.1	Quantum Noise	7
1.1.1	Definitions	8
1.1.2	Coherent States	9
1.1.3	Squeezed States	11
1.1.4	Homodyne Detection	15
1.2	Light Amplification	18
1.2.1	Propagation of light in a dielectric medium	18
1.2.2	Some non-linear phenomena	20
1.3	Phase insensitive and phase sensitive amplification	22
1.3.1	Classical FWM	23
1.3.2	Phase Insensitive Amplification gain	25
1.3.3	Phase Sensitive Amplification gain	26
1.4	Noise properties of PIA and PSA	27
1.4.1	Input and Output field operators	28
1.4.2	Noise for PIA	29
1.4.3	Noise for PSA	30
1.4.4	Quadrature noises after PSA	31
1.4.5	Two mode squeezing	33

Light is classically described as an electromagnetic (EM) field wave, which can be written as a superposition of traveling monochromatic waves:

$$\vec{E}(t, \vec{r}) = \vec{\epsilon}(Ae^{-i(\omega t - \vec{k} \cdot \vec{r})} + A^*e^{i(\omega t - \vec{k} \cdot \vec{r})}) \quad (1.1)$$

where $\vec{E}(t, \vec{r})$ denotes the instantaneous electric field polarized along $\vec{\epsilon}$ at a time t and a position \vec{r} . $A = |A|e^{i\phi}$ is the complex amplitude of the electric component, which is oscillating at a frequency ω with a wave-vector \vec{k} . This description in eq. (1.1) can also be broken down in a time-dependent form as (at $\vec{r} = 0$):

$$\vec{E}(t) = \vec{\epsilon}(2|A|\cos(\phi)\cos(\omega t) - 2|A|\sin(\phi)\sin(\omega t)) \quad (1.2)$$

This expression divides the field into two parts oscillating in quadrature, with amplitudes $|A|\cos(\phi)$ and $|A|\sin(\phi)$. They are known as the quadratures of the field.

Models, which quantize atomic levels but consider only classical light, cannot explain effects such as the spontaneous emission. This is why Weisskopf and his mentor Wigner developed the quantized light formalism through a quantized weakly coupled atom-light system [Weisskopf and Wigner, 1930].

In comparison to the classical form shown in eq. 1.1, the quantum mechanical representation of light uses creation and annihilation operators, so that the quantized E.M. field can be written as [Scully and Zubairy, 1997] (more details are given in appendix A):

$$\hat{E}(\vec{r}, t) = \vec{\epsilon}\mathcal{E}(\hat{a}e^{-i(\omega t - \vec{k} \cdot \vec{r})} + \hat{a}^\dagger e^{i(\omega t - \vec{k} \cdot \vec{r})}) \quad (1.3)$$

where \hat{E} is now the field operator and \hat{a} and \hat{a}^\dagger are respectively the annihilation and creation operators of a photon, with a frequency ω and wavevector \vec{k} . More generally, an EM field is a sum over all the modes, which compose the radiation. $\mathcal{E} = \left(\frac{\hbar\omega}{2\epsilon_0 V}\right)^{\frac{1}{2}}$, is the single photon amplitude, where V is the quantization volume and $\vec{\epsilon}$ the polarization vector. When one considers the coupling of the quantized EM field with an excited atom, spontaneous emission then arises from the fact that the annihilation and creation operators do not commute : $[a, a^\dagger] = 1$.

The eq. (1.3) can be compared directly to the classical representation (shown

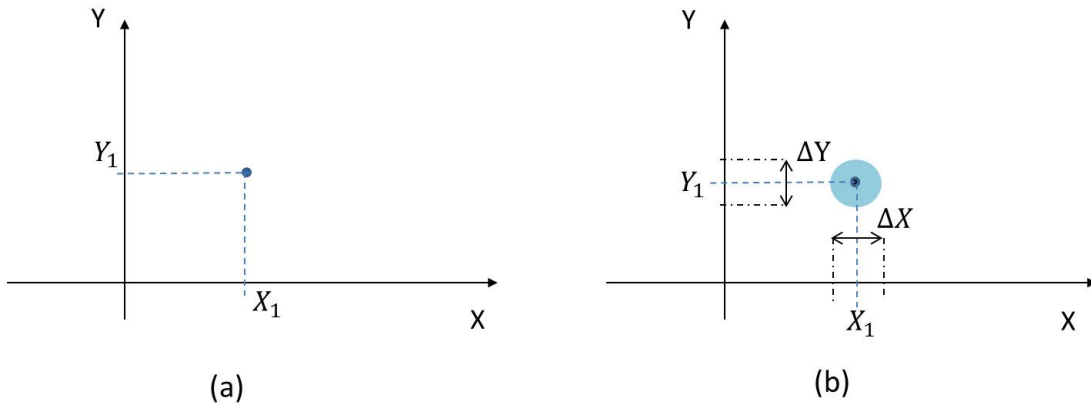

FIGURE 1.1: Comparison of the classical and quantum representations of a field in the quadrature space: (a) the classical picture: where the quadratures have values X_1 and Y_1 and the EM field is just the point given by the coordinates. (b) the quantum picture: the mean field values of the quadratures are still X_1 and Y_1 (centre of the circle) but the point is surrounded fluctuation, denoted as ΔX and ΔY respectively.

in eq. (1.1)), with the equivalence of $A \Leftrightarrow \hat{a}$. In the same way, the quadrature operators \hat{X} and \hat{Y} can be defined for the quantized field as:

$$\begin{aligned}\hat{X} &= \frac{1}{2}(\hat{a} + \hat{a}^\dagger) \\ \hat{Y} &= \frac{1}{2i}(\hat{a} - \hat{a}^\dagger)\end{aligned}\tag{1.4}$$

The two quadratures can be recognized as equivalents of the position \hat{x} and momentum \hat{p} operators of a simple harmonic oscillator system. Hence, the quadratures are canonically conjugate one with each other and verify $[X, Y] = \frac{i}{2}$ and the uncertainty relation $\langle \Delta X \rangle \langle \Delta Y \rangle \geq \frac{1}{4}$, where the standard deviation $\langle \Delta \mathcal{O} \rangle$ of an operator \mathcal{O} is defined as:

$$\langle \Delta \mathcal{O} \rangle = \sqrt{\langle \mathcal{O}^2 \rangle - \langle \mathcal{O} \rangle^2}\tag{1.5}$$

1.1 Quantum Noise

Since Heisenberg derived the relation between the uncertainties of the momentum and position operators, it has been clear that quantum mechanical operators will always contain inherent fluctuations around a mean value. The description of a system thus always includes these two quantities.

The description of a field in the quadrature space thus differs fundamentally from the classical case to the quantum one. The quadratures X and Y , will classically have two fixed values. The quantum mechanical description of the

field must include the mean values of the quadratures, which are equal to the classical ones, together with their corresponding uncertainties (see fig. 1.1).

1.1.1 Definitions

In the following, the quadratures are taken to be the dimensionless Hermitian operators \hat{X} and \hat{Y} , defined in eq. (1.4).

A quantized monomode electro-magnetic field (given as, $\vec{E}(t) = \vec{\mathcal{E}} (\hat{a}e^{-i\omega t} + \hat{a}^\dagger e^{i\omega t})$) can then be rewritten as:

$$E(t) = 2\mathcal{E} (X \cos(\omega t) + Y \sin(\omega t)) \quad (1.6)$$

Mean field

Classically, the energy flow per unit area per unit time for a monochromatic plane wave is proportional to the field square of the absolute amplitude $|E|^2$. Quantum mechanically, when the field is quantized in a monochromatic and plane wave basis, the energy carried by each photon is $\hbar\omega$. The average energy flow per unit area is linked to the number of photons per unit area, per unit time, which is given as:

$$\hat{N} = \hat{a}^\dagger \hat{a} \quad (1.7)$$

where \hat{a}^\dagger and \hat{a} are respectively the creation and annihilation operators. The measure of the intensity, which is proportional to the square of the modulus of the classical field amplitude $|E|^2$, is thus a measure of the expectation value of the number operator $\langle \hat{N} \rangle$.

Noise

Due to quantum uncertainties, the measurement of the number operator will have several outcomes. The standard deviation of these outcomes, for a given initial state, is the quantum noise associated to the considered state. By definition, the variance of the photon number of an EM field in a state $|\psi\rangle$ is:

$$\langle \Delta N \rangle^2 = \langle \psi | \hat{N}^2 | \psi \rangle - (\langle \psi | \hat{N} | \psi \rangle)^2 \quad (1.8)$$

or equivalently, the standard deviation is written as:

$$\langle \Delta N \rangle = \sqrt{\langle \psi | \hat{N}^2 | \psi \rangle - (\langle \psi | \hat{N} | \psi \rangle)^2} \quad (1.9)$$

In terms of the number operator \hat{N} and the standard deviation $\langle \Delta N \rangle$, the signal-to-noise-ratio (**SNR**), is defined as:

$$SNR = \frac{\langle \hat{N} \rangle^2}{\langle \Delta N \rangle^2} \quad (1.10)$$

To characterize how the noise properties are modified during an optical interaction, we define the **Noise Figure** (NF) as the ratio of the SNR at the input to the SNR at the output:

$$NF = \frac{SNR_{in}}{SNR_{out}} \quad (1.11)$$

An ideal interaction does not change the SNR, so that $NF=1$, while a degradation of the SNR gives $NF > 1$.

In the following sections, I show how it is possible to get a better NF than the ones obtained with standard amplification protocols, which are known to give $NF \approx 2$, as explained in the sec. [1.4.2](#).

1.1.2 Coherent States

Coherent states are defined to be the eigenstate of the annihilation operator \hat{a} . We usually call $|\alpha\rangle$ the coherent state with the eigenvalue α i.e. :

$$\hat{a} |\alpha\rangle = \alpha |\alpha\rangle \quad (1.12)$$

The eigenvalue α is a complex number, which can be written as $\alpha = |\alpha| e^{i\theta}$.

It can be easily shown that the average number of photons in a coherent state $|\alpha\rangle$ is $|\alpha|^2$:

$$\begin{aligned} \langle \alpha | \hat{N} | \alpha \rangle &= \langle \alpha | (\hat{a}^\dagger \hat{a}) | \alpha \rangle \\ &= |\alpha|^2 \end{aligned} \quad (1.13)$$

Intensity noise

It is possible to express the state $|\alpha\rangle$ as a superposition of Fock states $\{|n\rangle\}$ (see appendix [A](#)):

$$|\alpha\rangle = e^{-\frac{1}{2}|\alpha|^2} \sum_{n=0}^{\infty} \frac{\alpha^n}{\sqrt{n!}} |n\rangle \quad (1.14)$$

A coherent laser output will thus exhibit a Poissonian statistics, as demonstrated experimentally by Arechhi et al. [Arechhi, [1965](#)].

Indeed, the standard deviation in the number operator $\Delta\hat{N}$, for a coherent state can be calculated using eq. (1.10).

$$\begin{aligned}\langle\alpha|\hat{N}^2|\alpha\rangle &= \langle\alpha|\hat{a}^\dagger\hat{a}\hat{a}^\dagger\hat{a}|\alpha\rangle \\ &= \langle\alpha|\hat{a}^\dagger(1+\hat{a}^\dagger\hat{a})\hat{a}|\alpha\rangle \\ &= |\alpha|^2 + |\alpha|^4\end{aligned}\tag{1.15}$$

So that, the standard deviation ΔN is :

$$\begin{aligned}\langle\alpha|\Delta N|\alpha\rangle &= \sqrt{\langle\alpha|\hat{N}^2|\alpha\rangle - \langle\alpha|\hat{N}|\alpha\rangle^2} \\ &= |\alpha| = \sqrt{\langle\hat{N}\rangle}\end{aligned}\tag{1.16}$$

which is a well-known property of the Poissonian distribution.

Assuming a perfect quantum efficiency, a photodetector converts every photon into electrons of charge q . Thus a detection of a coherent state will give rise to a photocurrent $q\langle\hat{N}\rangle$ with a noise $q\langle\Delta N\rangle = q\sqrt{\langle\hat{N}\rangle}$, which is the shot noise and often called the standard quantum limit (SQL).

Quadrature noise

Recalling the definition of the quadrature operators \hat{X} and \hat{Y} in terms of the annihilation and creation operators, one can show that the averaged values for a coherent state $|\alpha\rangle$ are :

$$\begin{aligned}\langle\alpha|X|\alpha\rangle &= \frac{1}{2}(\alpha + \alpha^*) \\ \langle\alpha|X^2|\alpha\rangle &= \frac{1}{4}(\alpha + \alpha^*)^2 + 1/4 \\ \langle\alpha|Y|\alpha\rangle &= \frac{1}{2i}(\alpha - \alpha^*) \\ \langle\alpha|Y^2|\alpha\rangle &= \frac{-1}{4}(\alpha - \alpha^*)^2 + 1/4\end{aligned}\tag{1.17}$$

From which, it can be easily deduced that :

$$\langle\Delta X\rangle^2 = \frac{1}{4} = \langle\Delta Y\rangle^2\tag{1.18}$$

The state $|\alpha\rangle$ thus satisfies the minimum uncertainty relation :

$$\langle\Delta X\rangle \langle\Delta Y\rangle = \frac{1}{4}\tag{1.19}$$

This equality demonstrates that the total uncertainty remains the same whatever the mean photon number $|\alpha|$, in contrast to the well-known number states $|n\rangle$. Indeed, for such Fock states the total uncertainty increases with the number of photons n (see Appendix A):

$$\langle \Delta X \rangle_n \langle \Delta Y \rangle_n = \frac{1}{4}(2n + 1) \quad (1.20)$$

A study of multi-photon Fock states and their quadrature noises has been done by Cooper et al [Cooper, Wright, Söller, and Smith, 2013], which experimentally demonstrated this property for $n = 1$ and 2 .

Measuring the noise of the quadratures of a field is not as direct as measuring the field mean values and the shot noise. In the section 1.1.4 I describe the homodyne detection scheme usually used for this purpose.

1.1.3 Squeezed States

Definition

In terms of the quadrature operators [eq. (1.6)], the field $\vec{E}(t)$ is expressed as $\vec{E}(t) = 2\vec{\mathcal{E}}(X \cos(\omega t) + Y \sin(\omega t))$.

Due to the commutation relation $[X, Y] = i/2$, the total noise $\langle \Delta X \rangle \langle \Delta Y \rangle$ is limited by the uncertainty relation:

$$\langle \Delta X \rangle \langle \Delta Y \rangle \geq \frac{1}{4}$$

As shown previously, the coherent state saturates this inequality with equal noise on both quadratures i.e. $\langle \Delta X \rangle = \langle \Delta Y \rangle = \frac{1}{2}$. The only way to decrease the noise on one quadrature is thus to increase it on the other, keeping $\langle \Delta X \rangle \langle \Delta Y \rangle = \frac{1}{4}$. Such a state, is called a squeezed state of light [Scully and Zubairy, 1997].

If we use the same representation as in fig. 1.1, a coherent state is given by a circle, while the squeezed state will give an ellipse (see fig. 1.2). [Caves, 1982]. The center of the ellipse (or, circle for a coherent state) is at the expectation value $\langle X + iY \rangle$ in the complex plane, and the area is given by $\langle \Delta X \rangle \langle \Delta Y \rangle$.

Fig. 1.2 gives the phase-space representation of a coherent state, a squeezed state along X and a squeezed state along Y , when the mode is in a state with $\langle Y \rangle = 0$. The uncertainty in X corresponds to an amplitude fluctuation and

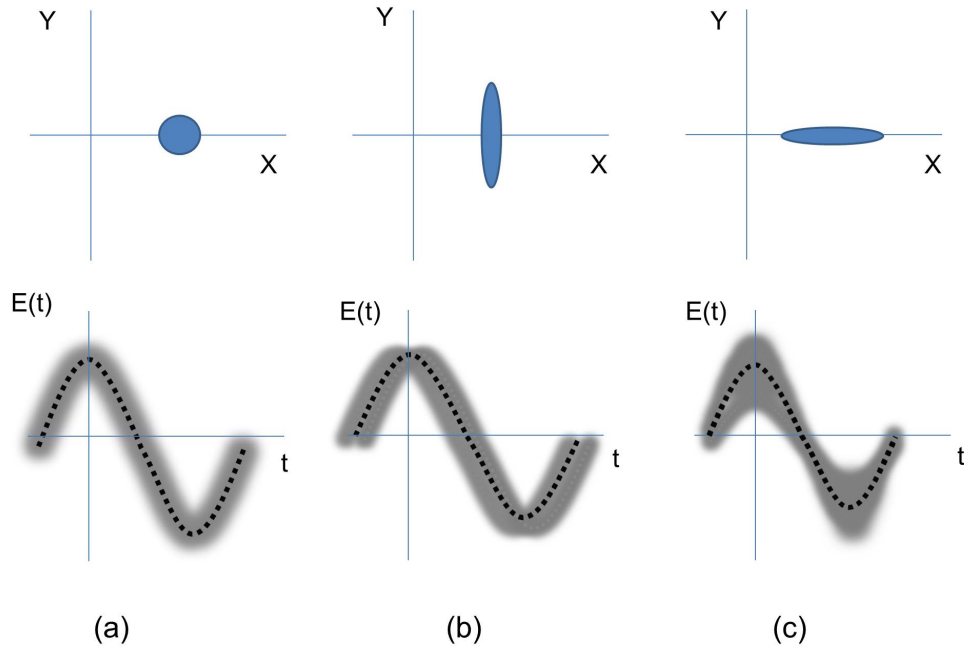

FIGURE 1.2: Representation of (a) a coherent state, (b) a phase-squeezed state and (c) an amplitude-squeezed state in the case of $\langle Y \rangle = 0$. In the top row, the phase space representation for each corresponding case. The centers of the circle (case (a)) or the ellipses (cases (b) & c)) are the mean electric field amplitudes. Their area are the quantum noise. In the bottom row, the mean electric field as a function of time (dotted line), and its fluctuations (gray shadow). The state is squeezed in one quadrature when the noise in that quadrature is less than the standard quantum limit given by a coherent state (c.f. (a)).

the uncertainty in Y can be seen as a phase fluctuation [Caves, 1982]. The three cases described in fig. 1.2 are :

- (a) A **coherent state** : the noise is the same for both quadratures, as shown in eq. (1.18).
- (b) An **X-squeezed state** : $\langle \Delta X \rangle < \langle \Delta Y \rangle$. The total noise is thus minimum when $\sin(\omega t) = 0$, and maximum when $\cos(\omega t) = 0$.
- (c) A **Y-squeezed state** : $\langle \Delta Y \rangle < \langle \Delta X \rangle$. The total noise is thus minimum when $\cos(\omega t) = 0$, and maximum when $\sin(\omega t) = 0$.

These states have been used very recently to successfully detect the gravitational waves for the first time [Abbott et al., 2016]. They have also found other applications including detection of weak spectroscopic signals [Polzik, Carri, and Kimble, 1992], new imaging techniques in biology [Taylor et al., 2013] and magnetometry [Otterstrom, Pooser, and Lawrie, 2014]. They are also interesting for quantum information protocols with continuous variables [Yonezawa and

Furusawa, 2010].

Squeezing parameter

It is possible to define a unitary squeezing operator \hat{S} [Gerry and Knight, 2004], as:

$$\hat{S}(\zeta) = \exp\left(\frac{1}{2}\zeta^*\hat{a}^2 - \frac{1}{2}\zeta\hat{a}^{\dagger 2}\right) \quad (1.21)$$

where a and a^\dagger are the annihilation and creation operators, and $\zeta = re^{i\theta}$ is any arbitrary complex number. The factor r is called the squeezing parameter. A squeezed state is produced when this squeezing operator acts on a coherent state:

$$|\alpha\rangle \rightarrow |\alpha, \zeta\rangle = S(\zeta)|\alpha\rangle$$

In the Heisenberg picture, the annihilation operator changes under this unitary transformation as:

$$\hat{a} \rightarrow \hat{S}^\dagger(\zeta)\hat{a}\hat{S}(\zeta) = \hat{a} \cosh r - \hat{a}^\dagger e^{i\theta} \sinh r \quad (1.22)$$

For $\theta = 0$, the quadratures are modified by the application of the squeezing operator, so that:

$$\begin{aligned} \langle \Delta X \rangle &= \frac{1}{2} \rightarrow \langle \Delta X \rangle = \frac{e^{-r}}{2} \\ \langle \Delta Y \rangle &= \frac{1}{2} \rightarrow \langle \Delta Y \rangle = \frac{e^r}{2} \end{aligned}$$

The noise is thus smaller in one quadrature than in the other and the minimum is less than $\frac{1}{2}$, which is lower than the SQL defined by coherent states. The ratio of this decrease in noise, to the noise of one quadrature of a coherent state is $(1 - e^{-r})$, which is often expressed in dBs to describe the level of squeezing. For $r \ll 1$, the relative decrease in noise is simply $(1 - e^{-r}) \approx r$.

Experimentally, a squeezed state of 0.3 dB below the vacuum noise, was first detected via four wave mixing in a sodium vapor [Slusher, Hollberg, Yurke, Mertz, and Valley, 1985]. Soon afterwards, a 3.5 dB vacuum squeezing was observed using non-linear phenomena in optical fibers [Wu, Kimble, Hall, and Wu, 1986]. In Rubidium vapor cells, more than 8 dB of squeezing has been detected [McCormick, Marino, Boyer, and Lett, 2008]. And a 9 dB squeezing has been measured in an optical parametric oscillator, operating below threshold [Takeno, Yukawa, Yonezawa, and Furusawa, 2007]. A squeezing of 12.7 dB,

generated with nonlinear crystals in monolithic cavity, is used in the gravitation wave detection [Eberle et al., 2010]. The state of the art squeezing of 15 dB was achieved in an optical parametric amplifier operating under threshold, for calibration of photoelectric efficiency [Vahlbruch, Mehmet, Danzmann, and Schnabel, 2016].

Two-mode squeezing

For two correlated fields, whose annihilation and creation operators are $\{\hat{a}, \hat{a}^\dagger\}$ and $\{\hat{b}, \hat{b}^\dagger\}$, we can introduce the two-mode squeezing operator $S_2(\zeta)$ [Scully and Zubairy, 1997]:

$$\hat{S}_2(\zeta) = \exp\left(\frac{1}{2}\zeta^*ab - \frac{1}{2}\zeta a^\dagger b^\dagger\right) \quad (1.23)$$

which cannot be factorized into two single-mode squeezing operators for the individual fields of the form eq. (1.21). Under the action of the operator $S_2(\zeta)$, the individual field annihilation operators modify as:

$$\begin{aligned} a &\rightarrow S_2^\dagger(\zeta)aS_2(\zeta) = a \cosh r - b^\dagger e^{i\theta} \sinh r \\ b &\rightarrow S_2^\dagger(\zeta)bS_2(\zeta) = b \cosh r - a^\dagger e^{i\theta} \sinh r \end{aligned} \quad (1.24)$$

The two mode squeezing operator models the correlations between the two fields induced by the joint creation or annihilation of the fields. The joint annihilation and creation operators a_\pm, a_\pm^\dagger can be defined as:

$$\begin{aligned} a_\pm &= \frac{1}{\sqrt{2}}(a \pm e^{i\phi}b) \\ a_\pm^\dagger &= \frac{1}{\sqrt{2}}(a^\dagger \pm e^{-i\phi}b^\dagger) \end{aligned} \quad (1.25)$$

where ϕ is an arbitrary phase factor. The joint in-phase and out-of-phase quadratures are then given as:

$$\begin{aligned} x_\pm &= \frac{1}{\sqrt{2}}(a_\pm + a_\pm^\dagger) \\ y_\pm &= \frac{1}{\sqrt{2}i}(a_\pm - a_\pm^\dagger) \end{aligned} \quad (1.26)$$

When both modes are coherent states, the uncertainty relation for the pair of joint quadratures reads $\langle \Delta x_+ \rangle \langle \Delta y_+ \rangle = \frac{1}{4}$. The action of the squeezing operator of eq. (1.23) gives the following standard deviations :

$$\begin{aligned} \langle \Delta x_+(\phi = \theta) \rangle &= \frac{e^{-r}}{2} & \langle \Delta y_+(\phi = \theta + \pi) \rangle &= \frac{e^r}{2} \\ \langle \Delta x_-(\phi = \theta) \rangle &= \frac{e^r}{2} & \langle \Delta y_-(\phi = \theta + \pi) \rangle &= \frac{e^{-r}}{2} \end{aligned}$$

which are similar to the one-mode squeezed quadrature noises in eq. (1.23). Physically it means that we are looking at the noise correlations in the quadratures of the sum and difference of both fields. While individually, each field remains in a coherent state.

Such a two-mode squeezing has been detected via optical parametric amplifiers [Vasilyev, Choi, Kumar, and D'Ariano, 2000] and in hot Rubidium atomic vapors [Corzo, Marino, Jones, and Lett, 2011]. Boyer et al. achieved a two mode squeezed 2D entangled image [Boyer, Marino, Pooser, and Lett, 2008]. These two-mode correlations have been an experimental way to realize Einstein Podolsky Rosen paradoxes [Reid and Drummond, 1988, Babichev, Appel, and Lvovsky, 2004]. It has also been suggested to be utilized to handle classical disturbances in in detection schemes [Steinlechner et al., 2013].

1.1.4 Homodyne Detection

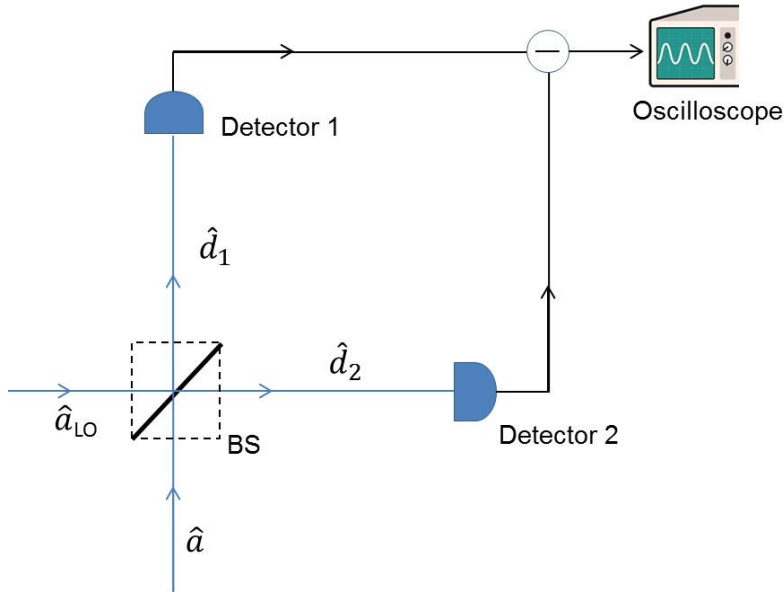

FIGURE 1.3: Balanced homodyne detection scheme. The signal \hat{a} is mixed with a strong local oscillator beam with the same frequency \hat{a}_{LO} using a 50/50 beam splitter. The outputs \hat{d}_1 and \hat{d}_2 are detected with identical photodiodes (Detectors 1 and 2). The photocurrents are then electronically subtracted, allowing to remove the technical noises.

Squeezing of the field quadratures cannot be directly measured through the intensity fluctuations of the considered field because quadrature noises are then added. Indeed, squeezing measurements require to be able to detect separately

the quadratures, which can be done using a balanced homodyne detection. The experimental scheme is shown in fig. 1.3: the signal, which has to be analyzed, is mixed with a strong local oscillator (LO) of the same frequency, usually a coherent state. The use of a 50/50 beamsplitter gives two beams, which are detected by two identical photodiodes: the photocurrents are subtracted, so that technical noises can be suppressed.

The following quantum analysis of the homodyne scheme was developed by Yuen and Shapiro [Yuen and Shapiro, 1978]. The action of a lossless beamsplitter on the annihilation operators of the input signal and local oscillator can be modeled as:

$$\begin{pmatrix} \hat{d}_1 \\ \hat{d}_2 \end{pmatrix} = \begin{pmatrix} r & t \\ t & r \end{pmatrix} \begin{pmatrix} \hat{a}_L \\ \hat{a} \end{pmatrix} \quad (1.27)$$

where reflection and transmission coefficients of the beamsplitter, r and t respectively, verify:

$$|r|^2 + |t|^2 = 1 \quad \text{and} \quad t^*r + r^*t = 0 \quad (1.28)$$

For a 50/50 beamsplitter, we get:

$$|r| = |t| = \frac{1}{\sqrt{2}}$$

so that, up to an overall phase factor,

$$\hat{d}_1 = \frac{1}{\sqrt{2}}(\hat{a}_L + i\hat{a}) \quad \hat{d}_2 = \frac{1}{\sqrt{2}}(i\hat{a}_L + \hat{a})$$

The measurement of the difference of the detected photon fluxes is then:

$$\begin{aligned} \hat{D} = (\hat{d}_1^\dagger \hat{d}_1 - \hat{d}_2^\dagger \hat{d}_2) &= \frac{1}{2} \left((\hat{a}_L^\dagger - i\hat{a}^\dagger)(\hat{a}_L + i\hat{a}) - (-i\hat{a}_L^\dagger + \hat{a}^\dagger)(i\hat{a}_L + \hat{a}) \right) \\ &= \frac{1}{2} \left((a_L^\dagger a_L - ia^\dagger a_L + ia_L^\dagger a + a^\dagger a) - (a_L^\dagger a_L - ia_L^\dagger a + ia^\dagger a_L + a^\dagger a) \right) \\ &= i \left(a_L^\dagger a - a^\dagger a_L \right) \end{aligned} \quad (1.29)$$

If we assume that the local oscillator is a coherent state $|\alpha_L\rangle$ with $\alpha_L = |\alpha_L| \exp(i\phi_L)$, the above expression gives:

$$\langle \alpha_L | \hat{D} | \alpha_L \rangle = i |\alpha_L| (e^{-i\phi_L} a - e^{i\phi_L} a^\dagger) \quad (1.30)$$

So that,

$$\langle \alpha_L | \hat{D} | \alpha_L \rangle (\phi_L = 0) = i|\alpha_L|(a - a^\dagger) = -2|\alpha| \hat{Y} \quad (1.31)$$

$$\langle \alpha_L | \hat{D} | \alpha_L \rangle (\phi_L = \frac{\pi}{2}) = |\alpha_L|(a + a^\dagger) = 2|\alpha| \hat{X} \quad (1.32)$$

When we scan the local oscillator phase, we can have a direct measurement of the quadratures X and Y defined in the eq.s (1.4).

- When the input field \hat{a} is a coherent state, independent of the local oscillator phase ϕ_L , the fluctuations in the measurement are $\langle \Delta \hat{D} \rangle^2 = |\alpha_L|^2$, which is thus the SQL to which the measurements should be compared.
- When the input field is a squeezed state $S^\dagger(\zeta)\hat{a}S(\zeta)$, the standard deviation $\langle \Delta \hat{D} \rangle$ scans different quadratures, when one varies the LO phase. In the case of real ζ parameter:

- For an amplitude squeezed state, $\langle \Delta \hat{D}(\phi_L = 0) \rangle^2 > |\alpha_L|^2$ and $\langle \Delta \hat{D}(\phi_L = \frac{\pi}{2}) \rangle^2 < |\alpha_L|^2$.
- For a phase squeezed state, $\langle \Delta \hat{D}(\phi_L = 0) \rangle^2 < |\alpha_L|^2$ and $\langle \Delta \hat{D}(\phi_L = \frac{\pi}{2}) \rangle^2 > |\alpha_L|^2$.

However, real beamsplitters have losses, which can be modeled by adding phantom beamsplitters in front of the detectors, where the incident field is mixed with a vacuum mode (\hat{b}) from the other side [Leonhardt, 1997] (c.f. fig 1.4).

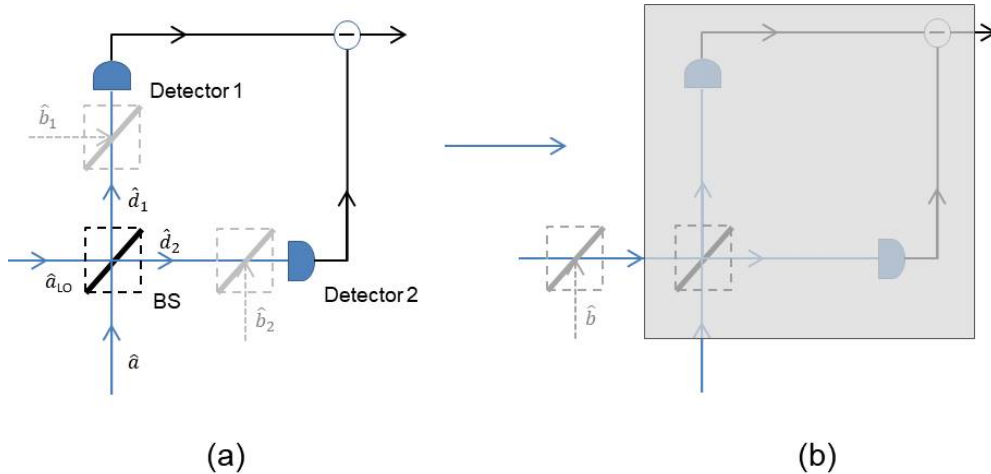

FIGURE 1.4: Modeling losses in homodyne detection with phantom beam-splitters (shown in gray): (a) two vacuums \hat{b}_1 and \hat{b}_2 are mixed with the two output ports (\hat{d}_1 and \hat{d}_2 respectively) of the homodyne-mixing 50/50 beam splitter. and (b) an effective vacuum input in front of an ideal homodyne detection scheme. The two representations (a) and (b) are equivalent [Leonhardt, 1997].

If we assume an overall beamsplitter of a transmission coefficient η and that the local oscillator power is much more than the signal one, then the variance of difference of the photocurrents $\langle \Delta D \rangle^2$ can be shown to be (see appendix A.4) :

$$\langle \Delta D \rangle^2 = \eta |\alpha_L|^2 \{1 + \eta [4 \langle \Delta E \rangle^2 - 1]\} \quad (1.33)$$

where we assumed that the \hat{b} field (see fig. 1.4(b)) is a coherent vacuum state, and the operator $\hat{E} = \frac{1}{2}[e^{i\phi_L} \hat{a}^\dagger + e^{-i\phi_L} \hat{a}]$. The LO shot noise $\eta |\alpha_{LO}|^2$ is the standard quantum limit (SQL).

- When the input signal is in a coherent state, then $\langle \Delta E \rangle^2 = \frac{1}{4}$. So that, when this difference is measured via an Electric Spectrum Analyzer (ESA), we observe the shot noise of the LO i.e. the SQL.
- When the input signal is in a squeezed state, $\langle \Delta E \rangle^2 < \frac{1}{4}$ or $\langle \Delta E \rangle^2 > \frac{1}{4}$, depending on the values of ϕ_L . When the difference of the photocurrents is measured via an ESA while the LO phase is scanned, we can see noise decreasing below the LO shot noise for some values, while it increases above for others.

In fig. 1.5, I have plotted the observed squeezing and the SQL levels as a function of the transmission coefficient η of the fictitious beamsplitter. A 2 dB initial squeezing will not be visible when losses are more than 76%, while for a 9 dB of squeezing, it is visible up to nearly 53% of losses.

For a two mode squeezing (c.f. sec. 1.4.5), we should use a ‘‘Heterodyne detection’’ scheme, which will be detailed in the next chapter, in section 3.4.

1.2 Light Amplification

1.2.1 Propagation of light in a dielectric medium

‘‘Non-linear optical phenomena are the various response of a material system to an applied optical field that depends in a ‘nonlinear’ manner on the strength of the optical field’’ [Boyd, 2003]. Such phenomena can be modeled using the Maxwell’s equations, which describe the propagation of an electromagnetic field in different media. In this thesis, I am interested only in dielectric media without

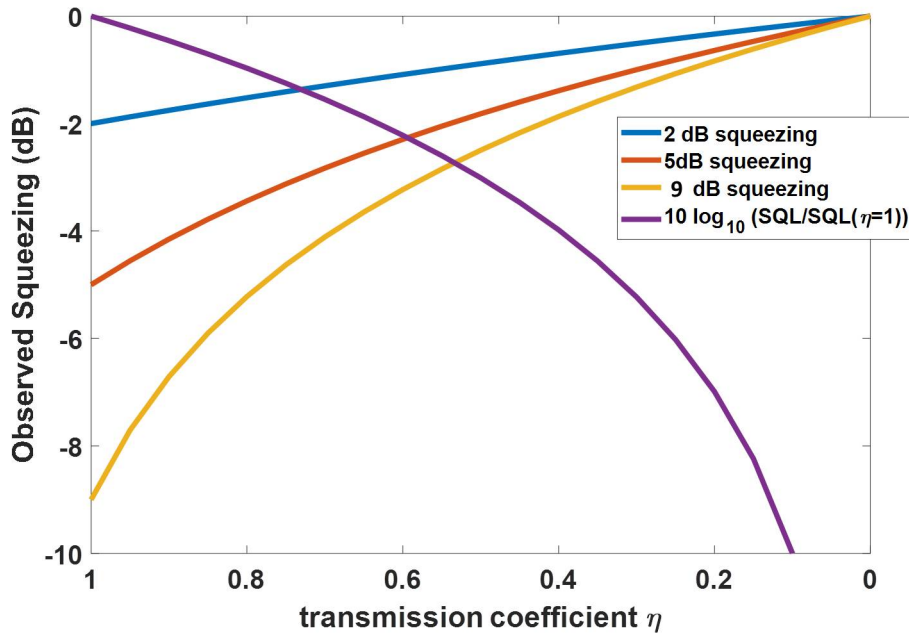

FIGURE 1.5: Detected squeezing as a function of the transmission efficiency of the fictitious noise-beamsplitter for three different input squeezing levels: (a) 2 dB (blue), (b) 5 dB (orange) and (c) 9 dB (yellow). In magenta, the standard quantum limit is shown as a function of transmission coefficient, relative to the SQL for full transmission expressed in dBs.

any free current and charges, so that in SI units the Maxwell's equations are stated as (in SI units):

$$\begin{aligned} \nabla \cdot \vec{D} &= 0 & \nabla \times \vec{E} &= -\partial_t \vec{B} \\ \nabla \cdot \vec{B} &= 0 & \nabla \times \vec{H} &= \partial_t \vec{D} \end{aligned} \quad (1.34)$$

where, \vec{E} is the electric field, \vec{B} , the magnetic field, \vec{D} , the displacement field, and \vec{H} , the magnetizing field. The displacement field \vec{D} is obtained by summing up the free space flux density and the one due to the locally induced polarization \vec{P} :

$$\vec{D} = \epsilon_0 \vec{E} + \vec{P} \quad (1.35)$$

where ϵ_0 is the free space permittivity. Assuming that the medium is nonmagnetic (i.e. $\vec{H} = \vec{B}/\mu_0$) and using the fact that $c = 1/\sqrt{\mu_0\epsilon_0}$, the insertion of eq. (1.35) in eq. (1.34), gives the relation between \vec{P} and \vec{E} :

$$-\frac{1}{\epsilon_0 c^2} \partial_t^2 \vec{P} = \nabla \times \nabla \times \vec{E} + \frac{1}{c^2} \partial_t^2 \vec{E} \quad (1.36)$$

The polarization vector, can be conveniently split into its linear and nonlinear response parts, as:

$$P = \epsilon_0 \chi^{(1)} \vec{E} + \vec{P}^{NL} \quad (1.37)$$

Using this expression for \vec{P} in eq. 1.36 and that $\nabla \cdot \vec{E} = 0$, we obtain the relation:

$$\frac{1}{\epsilon_0 c^2} \partial_t^2 \vec{P}_{NL} = \nabla^2 \vec{E} - \frac{1 + \chi^{(1)}}{c^2} \partial_t^2 \vec{E} \quad (1.38)$$

The above equation governs how a non-linear medium responds to any incident electric field. The nonlinear part of the polarization field can be expanded as an infinite series of electric field as:

$$\vec{P}_{NL} = \epsilon_0 \left[\chi^{(2)} \vec{E}^2 + \chi^{(3)} \vec{E}^3 + \chi^{(4)} \vec{E}^4 \dots \right] \quad (1.39)$$

Here, the powers of the field vectors imply the tensorial nature of the non-linear susceptibilities. In eq. 1.39, the $\chi^{(2,3,\dots)}$ are the second, third etc order non-linear coefficients respectively. In general, a process corresponding to a term involving E^n is called (n+1)-wave mixing process as it involves (n+1) waves, including P_{NL} . In this thesis, the scalar interpretation of the equation is sufficient, so that we write:

$$P_{NL} = \epsilon_0 \left[\chi^{(2)} E^2 + \chi^{(3)} E^3 + \chi^{(4)} E^4 \dots \right] \quad (1.40)$$

1.2.2 Some non-linear phenomena

I consider now the sum of n electric fields with different amplitudes E_n and frequencies ω_n :

$$E = \sum_n [E_n e^{i\omega_n t} + c.c.] \quad (1.41)$$

Putting this expression into eq. 1.40, one can observe that a second order non-linear phenomenon is given by $(E_1 e^{i\omega_1 t} + E_1^* e^{-i\omega_1 t} + E_2 e^{i\omega_2 t} + E_2^* e^{-i\omega_2 t} + \dots)^2$, which can be expanded and shows terms:

- with frequencies $(\omega_i + \omega_j)$ where $\{i, j : 1 \rightarrow n\}$: the process is called sum-frequency generation.
- with frequencies $(\omega_i - \omega_j)$: the process is called difference frequency generation.

Similarly, a third order non-linear process gives rise to polarization components that oscillate with frequencies $(\omega_i \pm \omega_j \pm \omega_k)$ with $\{i, j, k : 1 \rightarrow n\}$. The

non-linear polarizations radiate electric fields oscillating at these frequencies.

Because, these processes generate frequencies different from the original fields, it has found interest in many ways :

- (a) The Second Harmonic Generation (SHG) is a sum frequency generation by a second order non-linear process where a sum frequency field is generated using degenerate input fields (fig. 1.6(a)). This gives rise to an electric field with twice the original frequency. Using this phenomenon, second harmonic imaging is an efficient tool for studying nonlinear biological systems [Freund and Deutsch, 1986]. It also is extensively used in industry to generate green 532 nm laser from 1064 nm infrared laser, with non-linear crystals such as potassium titanyl phosphate (KTP).

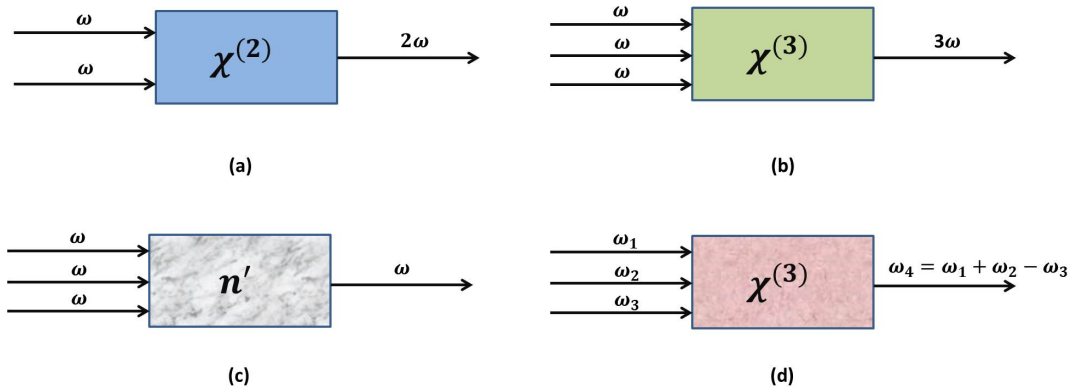

FIGURE 1.6: Schematic diagram of (a) second harmonic generation through a second order non-linear $\chi^{(2)}$ crystal, (b) third harmonic generation through a third order non-linear $\chi^{(3)}$ crystal, (c) Kerr effect through a third order non-linear crystal where the refractive index is modified, but the frequency of the exiting field remains the same (d) Four wave mixing through a third order non-linear $\chi^{(3)}$ medium.

- (b) The Third Harmonic Generation (THG) is a sum frequency generation by a third order non-linear process with three degenerate input fields. The new electric field oscillates with a frequency, which is thrice the original one (fig. 1.6(b)). THG has found interests from labeling nanoparticles by size [Lippitz, Dijk, and Orrit, 2005] to advanced imaging schemes in biological tissues [Kuzmin et al., 2016].
- (c) The Kerr effect, is a third order nonlinear process, with three degenerate input fields. Here, the term of interest is E^*EE (fig. 1.6(c)), so that the effective refractive index of the medium can be shown to be [Boyd, 2003]:

$$n' = n + \frac{3\chi^{(3)}}{8n}|E|^2$$

Because of this intensity dependent refractive index change, a Gaussian beam will create a Gaussian refractive index spatial variation even in an isotropic medium, which mimics a lens, and induces self-focusing [Kelley, 1965]. Optical Kerr effect has found applications in silicon wave-guides [Stolen and Ashkin, 1973], or in spectroscopy of liquid materials [Zhong and Fourkas, 2008].

- (d) The Four Wave Mixing (FWM) is a third order non-linear process where three electric fields with different frequencies ω_1, ω_2 and ω_3 gives birth to another field with a frequency $\omega_4 = \omega_1 + \omega_2 - \omega_3$ (fig. 1.6(d)). This process has been used to observe phenomena like intensity and noise correlations [Qin et al., 2014] or squeezing [Agarwal, 1986]. In terms of applications, FWM is used as a tool for real-time holographic imaging [Yariv, 1978], real-time image processing [Pepper, AuYeung, Fekete, and Yariv, 1978] and is the fundamental principle of spectroscopic processes like Coherent Anti-Stokes Raman Spectroscopy (CARS), Coherent Stokes Raman Spectroscopy (CSRS) or Stimulated Raman Gain Spectroscopy (SRS) [Shen, 1984].

Although useful, the first two processes discussed above create frequencies much further from the original interacting fields. FWM process has the advantage of creating frequencies which are similar to the input fields. Usually, the higher the order, the smaller the amplitude of the phenomena. But, centro-symmetric media have a $\chi^{(2)}$ equal to 0, so that the third order processes are easier to detect. This is the case with a gas cell.

1.3 Phase insensitive and phase sensitive amplification

One of the main advantages of using optical fiber for transmission of information is its low loss (attenuation coefficient can be of the order 10^{-1} dB/Km). Still, even with this low attenuation rate, for very long communication channels, we need to reamplify the optical signal. Traditional amplifiers such as Erbium Doped Fiber Amplifier (EDFA) or Semiconductor Optical Amplifiers (SOA) are open systems : because they interact with the environment, the signal to noise ratio is degraded by about 3 dB for high gains [Caves, 1982].

Contrary to these phase insensitive amplifiers, the Phase Sensitive Amplification (PSA) phenomenon, discussed in this section, can show an ideal Noise Factor $NF = 1$. It is possible because PSA happens in a closed Hamiltonian system

which uses non-linear interactions to transfer photons from a pump channel to a signal one.

Here we are interested in FWM processes involving a degenerate pump of frequency ω_P . Two such pump photons are annihilated to amplify a signal field of frequency ω_s and an idler field of frequency ω_i , which are symmetrically detuned from ω_P by a frequency difference δ (see in fig. 1.7).

1.3.1 Classical FWM

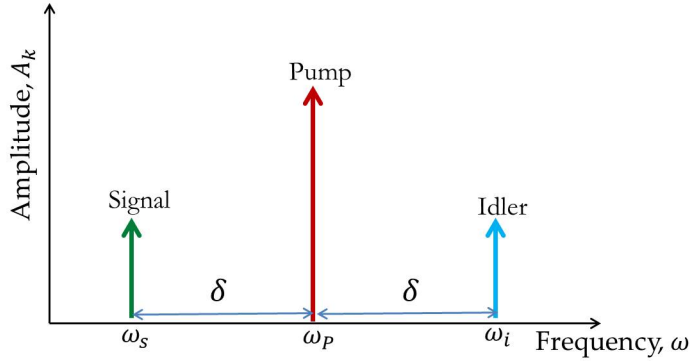

FIGURE 1.7: Schematic diagram of the frequencies of the involved fields. A strong pump (or coupling, in red) with a frequency ω_P and two weaker fields: a signal (in green, frequency $\omega_s = \omega_P - \delta$) and an idler (in blue, frequency $\omega_i = \omega_P + \delta$)

We consider three copropagating monochromatic fields:

$$E_{P,i,s} = A_{P,i,s}(z)e^{i(k_{P,i,s}z - \omega_{P,i,s}t)} + c.c. \quad (1.42)$$

where P,i,s are the labels for the pump, idler and signal beams respectively. The frequencies satisfy the relation: $2\omega_P = \omega_i + \omega_s$ (see fig.1.7). $A_{P,i,s}(z)$ are the amplitudes, which vary along the direction of propagation \vec{z} . We consider the nonlinear FWM components of the polarization with frequencies ω_P , ω_s and ω_i [Boyd, 2003] (other frequency components are also produced, but they are very far from the incident frequencies):

$$\begin{aligned} P_{NL}^{FWM} &= \epsilon_0 \chi^{(3)} (E_P + E_i + E_s)^3 \\ \Rightarrow P_{NL}^{FWM} \Big|_{\omega_P} &= \epsilon_0 \chi^{(3)} [(3A_P A_P^* + 6A_s A_s^* + 6A_i A_i^*) A_P e^{ik_P z} + 6A_i A_s A_P^* e^{i(k_i + k_s - k_P)z}]; \\ \Rightarrow P_{NL}^{FWM} \Big|_{\omega_s} &= \epsilon_0 \chi^{(3)} [(6A_P A_P^* + 3A_s A_s^* + 6A_i A_i^*) A_s e^{ik_s z} + 3A_P^2 A_i^* e^{i(2k_P - k_i)z}]; \\ \Rightarrow P_{NL}^{FWM} \Big|_{\omega_i} &= \epsilon_0 \chi^{(3)} [(6A_P A_P^* + 6A_s A_s^* + 3A_i A_i^*) A_i e^{ik_i z} + 3A_P^2 A_s^* e^{i(2k_P - k_s)z}]; \end{aligned} \quad (1.43)$$

The non-linear wave-equation eq. 1.38 gives, for each frequency components $\omega_{P,i,s}$:

$$\partial_z^2 (A_{P,i,s} e^{ik_{P,i,s}z}) + \frac{1 + \chi^{(1)}}{c^2} \omega_{P,i,s}^2 (A_{P,i,s} e^{ik_{P,i,s}z}) = \frac{-\omega_{P,i,s}^2}{\epsilon_0 c^2} P_{NL}^{FWM} \Big|_{\omega_{P,i,s}} \quad (1.44)$$

where ∇^2 is replaced by ∂_z^2 because the field depends only on z (eq. (1.42)). Using

$$\partial_z^2 (A_{P,i,s} e^{ik_{P,i,s}z}) = \partial_z^2 A_{P,i,s} + 2ik_{P,i,s} \partial_z A_{P,i,s} - k_{P,i,s}^2 A_{P,i,s} \quad (1.45)$$

with the slowly varying wave approximation $|\partial_z^2 A| \ll k|\partial_z A|$ and $k_{P,i,s}^2 = \epsilon^{(1)} \omega_{P,i,s}^2 / c^2$, eq. (1.44) gives the coupled equations :

$$\begin{aligned} \partial_z A_s &= i\gamma (|A_s|^2 + 2|A_P|^2 + 2|A_i|^2) A_s + i\gamma A_P^2 A_i^* \exp\{-i\Delta\beta z\} \\ \partial_z A_P &= i\gamma (2|A_s|^2 + |A_P|^2 + 2|A_i|^2) A_P + 2i\gamma A_s A_i A_P^* \exp\{i\Delta\beta z\} \\ \partial_z A_i &= i\gamma (2|A_s|^2 + 2|A_P|^2 + |A_i|^2) A_i + i\gamma A_P^2 A_s^* \exp\{-i\Delta\beta z\} \end{aligned} \quad (1.46)$$

where $\Delta\beta = 2k_P - k_s - k_i$ is the linear wave-vector mismatch and $\gamma = \frac{|k_P| \chi^{(3)}}{\chi^{(1)}(\Omega_P)}$ is the non-linear parameter. In the undepleted pump approximation (i.e. the amplitude of the pump field is high enough to consider that its intensity, which is proportional to $|A_P|^2 = P_P$, is constant), if $|A_s|^2 = |A_i|^2 \ll |A_P|^2$, the above equations give:

$$\begin{aligned} \partial_z A_P &= i\gamma P_P A_P \\ \Rightarrow A_P &= A_P(0) \exp\{i\gamma P_P z\} \\ \partial_z A_s &= i\gamma 2P_P A_s + i\gamma P_P A_i^* \exp\{(2i\gamma P_P - i\Delta\beta)z\} \\ \partial_z A_i &= i\gamma 2P_P A_i + i\gamma P_P A_s^* \exp\{(i\gamma P_P - i\Delta\beta)z\} \end{aligned} \quad (1.47)$$

The last two equations are the coupled differential equations for the signal and idler amplitudes, the solutions to which are given by:

$$\begin{aligned} A_s &= \mu A_s(0) + \nu A_i^*(0) \\ A_i &= \nu A_s^*(0) + \mu A_i(0) \end{aligned} \quad (1.48)$$

with

$$\begin{aligned} \mu &= \left(\cosh(gz) + i \frac{\kappa}{2g} \sinh(gz) \right) \exp\{(i\Delta\beta z/2)\} \\ \nu &= \frac{i\gamma}{g} A_P^2(0) \sinh(gz) \exp\{(i\Delta\beta z/2)\} \end{aligned} \quad (1.49)$$

where

$$\begin{aligned} \kappa &= 2\gamma P_P - \Delta\beta \text{ is the nonlinear phase mismatch.} \\ g &= \sqrt{\gamma^2 P_P^2 - \left(\frac{\kappa}{2}\right)^2} \text{ is the parametric gain coefficient.} \end{aligned} \quad (1.50)$$

From the definitions of μ and ν , it can be seen that,

$$|\mu|^2 - |\nu|^2 = 1 \quad (1.51)$$

1.3.2 Phase Insensitive Amplification gain

In the case of Phase Insensitive Amplification (PIA), we just fix the initial idler amplitude to be zero, i.e. $A_i^*(0) = 0$, so that, the eq.s 1.48, are redefined to be:

$$\begin{aligned} A_s &= \mu A_s(0) \\ A_i &= \nu A_s^*(0) \end{aligned} \quad (1.52)$$

The gain for the signal field is given by:

$$\begin{aligned} G_{PIA} &= \frac{|A_s|^2}{|A_s(0)|^2} \\ &= |\mu|^2 \\ &= \cosh^2(gz) + \left(\frac{\kappa}{2g}\right)^2 \sinh^2(gz) \end{aligned} \quad (1.53)$$

There is no phase dependence in this expression. Indeed, an idler $A_i = \nu A_s^*(0)$ is created, which depends on the gain parameter, so that it adapts its phase to get the above gain for the signal.

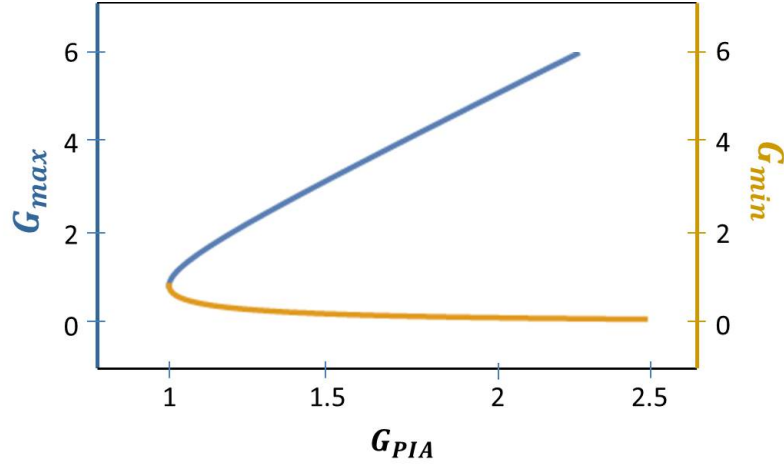

FIGURE 1.8: Dependence of the maximum (in blue) and minimum (in yellow) PSA gains on the PIA gain.

1.3.3 Phase Sensitive Amplification gain

We now assume identical powers for the idler and signal fields : $A_s(0) = A_i(0) = P_s$, so that :

$$\begin{aligned}
 G_{PSA} &= \frac{|A_s|^2}{|A_s(0)|^2} \\
 &= \frac{|\mu A_s(0) + \nu A_i^*(0)|^2}{|A_s(0)|^2} \\
 &= |\mu|^2 + |\nu|^2 + 2|\mu||\nu| \cos(\theta_\mu - \theta_\nu + \theta_s + \theta_i) \\
 &= 1 + \left[1 + \frac{\kappa^2 + 4\gamma^2 P_P^2 + 4\kappa\gamma P_P \cos(\theta_{rel})}{4g^2} \right] \sinh^2(gz) \\
 &\quad + \frac{\gamma}{g} P_P \sin(\theta_{rel}) \sinh(2gz)
 \end{aligned} \tag{1.54}$$

where, $\mu = |\mu| \exp(i\theta_\mu)$, $\nu = |\nu| \exp(i\theta_\nu)$ and $\theta_{rel} = \theta_s + \theta_i - 2\theta_p$. θ_{rel} is the initial phase difference between the coupling, signal and idler beams.

From the above expression for the gain, we deduce the maximum and minimum achievable gain values, $G_{max} = (|\mu| + |\nu|)^2$ and $G_{min} = (|\mu| - |\nu|)^2$. From the definitions of μ and ν it can easily be verified that,

$$G_{min} = \frac{1}{G_{max}} \tag{1.55}$$

which is a characteristic of PSA.

From the relation between μ and ν (c.f. eq. 1.51), the maximum and minimum PSA gains can be written in terms of the PIA gain g :

$$G_{max} = 2g - 1 + 2\sqrt{g(g-1)} \quad (1.56)$$

$$G_{min} = 2g - 1 - 2\sqrt{g(g-1)} \quad (1.57)$$

Fig. 1.8 shows the maximum and minimum PSA gains as a function of the PIA gain g . As the idler is here sent into the medium together with the signal, its relative phase with respect to the pump is fixed : contrary to *PIA*, the gain thus adapts itself to the relative phase between the pump, signal and idler : $\theta_{rel} = \theta_s + \theta_i - 2\theta_P$ and goes from values higher than 1 (amplification) to values lower than 1 (deamplification).

1.4 Noise properties of PIA and PSA

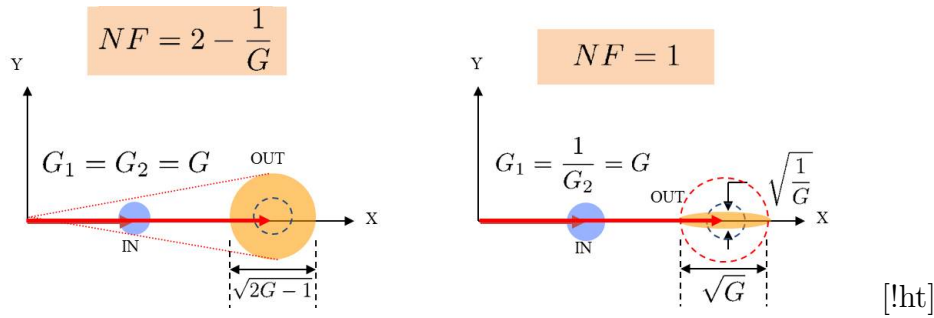

FIGURE 1.9: Quadrature noises for $\langle Y \rangle = 0$: evolution by a PIA process (left), and by a PSA process (right). The total noise area is increased during PIA, but remains the same during a PSA process. The noise along both quadratures are increased by the gain factor G for PIA. For PSA, the gain is increased along one quadrature and decreased along the other, keeping the total noise area constant. The corresponding Noise Factors (NF) are mentioned.

We are interested in the noise properties of the signal and idler fields. Starting from the eq.s 1.48, we replace the field amplitudes by the corresponding operators [see Appendix A.1] as:

$$\begin{aligned} \hat{A} &= \mu \hat{a} + \nu \hat{b}^\dagger \\ \hat{B} &= \nu \hat{a}^\dagger + \mu \hat{b} \end{aligned} \quad (1.58)$$

where \hat{A} and \hat{B} are the annihilation operators for the output signal and idler, and \hat{a} and \hat{b} are the input signal and idler annihilation operators respectively. The parameters μ and ν are defined in the eq. (1.49), which depends on the

pump power and the phase mismatch. To calculate the NF, we need to compute the signal to noise ratio for the input and output fields.

1.4.1 Input and Output field operators

1.4.1.1 Input fields

The number operator for the sum of the signal and idler fields is defined as:

$$\hat{N}_{in} = \hat{a}^\dagger \hat{a} + \hat{b}^\dagger \hat{b} \quad (1.59)$$

So that,

$$\Rightarrow \hat{N}_{in}^2 = \hat{a}^\dagger \hat{a} \hat{a}^\dagger \hat{a} + \hat{b}^\dagger \hat{b} \hat{b}^\dagger \hat{b} + \hat{a}^\dagger \hat{a} \hat{b}^\dagger \hat{b} + \hat{b}^\dagger \hat{b} \hat{a}^\dagger \hat{a} \quad (1.60)$$

Let us consider the case where both the signal and idler are coherent states, so that the input state is $|\alpha, \beta\rangle$ where $\hat{a}|\alpha, \beta\rangle = \alpha|\alpha, \beta\rangle$ and $\hat{b}|\alpha, \beta\rangle = \beta|\alpha, \beta\rangle$. $|\alpha|^2$ ($|\beta|^2$) is the average photon number in the coherent signal (idler) state. We can then compute the expectation values for the different required operators:

$$\begin{aligned} \langle \hat{N}_{in} \rangle &= \langle \alpha, \beta | \hat{a}^\dagger \hat{a} + \hat{b}^\dagger \hat{b} | \alpha, \beta \rangle \\ &= |\alpha|^2 + |\beta|^2 \end{aligned} \quad (1.61)$$

and,

$$\begin{aligned} \langle \hat{N}_{in}^2 \rangle &= \langle \alpha, \beta | \hat{a}^\dagger \hat{a} \hat{a}^\dagger \hat{a} + \hat{b}^\dagger \hat{b} \hat{b}^\dagger \hat{b} + \hat{a}^\dagger \hat{a} \hat{b}^\dagger \hat{b} + \hat{b}^\dagger \hat{b} \hat{a}^\dagger \hat{a} | \alpha, \beta \rangle \\ &= (|\alpha|^2 + |\beta|^2)^2 + |\alpha|^2 + |\beta|^2 \end{aligned} \quad (1.62)$$

which gives:

$$\langle \Delta N \rangle^2 = |\alpha|^2 + |\beta|^2 \quad (1.63)$$

So that :

$$\text{SNR}_{in} = \frac{(|\alpha|^2 + |\beta|^2)^2}{|\alpha|^2 + |\beta|^2} = |\alpha|^2 + |\beta|^2 \quad (1.64)$$

1.4.1.2 Output fields

For the output field, the total photon number operator is now :

$$\hat{N}_{out} = \hat{A}^\dagger \hat{A} + \hat{B}^\dagger \hat{B} \quad (1.65)$$

$$\begin{aligned} &= (\mu \hat{a} + \nu \hat{b}^\dagger)^\dagger (\mu \hat{a} + \nu \hat{b}^\dagger) + (\nu \hat{a}^\dagger + \mu \hat{b})^\dagger (\nu \hat{a}^\dagger + \mu \hat{b}) \\ &= (|\mu|^2 + |\nu|^2) + (|\mu|^2 + |\nu|^2) N_{in} + 2\nu^* \mu a b + 2\mu^* \nu a^\dagger b^\dagger \end{aligned} \quad (1.66)$$

and,

$$\hat{N}_{out}^2 = ((|\mu|^2 + |\nu|^2) + (|\mu|^2 + |\nu|^2)N_{in} + 2\nu^*\mu ab + 2\mu^*\nu a^\dagger b^\dagger)^2 \quad (1.67)$$

The expectation values for these operators are thus:

$$\begin{aligned} \langle \hat{N}_{out} \rangle &= \langle \alpha, \beta | N_{out} | \alpha, \beta \rangle \\ &= (|\mu|^2 + |\nu|^2) + (|\mu|^2 + |\nu|^2)(|\alpha|^2 + |\beta|^2) + 2\nu^*\mu\alpha\beta + 2\mu^*\nu\alpha^*\beta^* \end{aligned} \quad (1.68)$$

and,

$$\begin{aligned} \langle N_{out}^2 \rangle &= \langle \alpha, \beta | N_{out}^2 | \alpha, \beta \rangle \\ &= (|\mu|^2 + |\nu|^2)^2 + (|\mu|^2 + |\nu|^2)^2 \left((|\alpha|^2 + |\beta|^2)^2 + |\alpha|^2 + |\beta|^2 \right) + \\ &2(|\mu|^2 + |\nu|^2)^2 (|\alpha|^2 + |\beta|^2) + 4(|\mu|^2 + |\nu|^2) (\nu^*\mu\alpha\beta + \mu^*\nu\alpha^*\beta^*) + \\ &4(|\mu|^2 + |\nu|^2)(1 + |\alpha|^2 + |\beta|^2) (\nu^*\mu\alpha\beta + \mu^*\nu\alpha^*\beta^*) + \\ &4\nu^{*2}\mu^2\alpha^2\beta^2 + 4|\nu|^2|\mu|^2(1 + |\alpha|^2)(1 + |\beta|^2) + 4|\nu|^2|\mu|^2|\alpha|^2|\beta|^2 + \\ &4\mu^{*2}\nu^2\alpha^{*2}\beta^{*2} \end{aligned} \quad (1.69)$$

Except if α or $\beta = 0$, which are PIA cases, the noise depends on the relative phase, $\theta_{rel} = \pm(\theta_\mu - \theta_\nu + \theta_s + \theta_i)$. From the eq. 1.49, it can be shown that $\theta_{rel} = \mp(2\theta_p - \theta_s - \theta_i)$.

1.4.2 Noise for PIA

Let us first consider the PIA scenario with the input state $|\alpha, 0\rangle$. Using the eq.s (1.68) and (1.69), with $\beta = 0$, one gets :

$$\begin{aligned} \langle \Delta N_{PIA} \rangle^2 &= (|\mu|^2 + |\nu|^2)^2 + (|\mu|^2 + |\nu|^2)^2 (|\alpha|^4 + 3|\alpha|^2) + \\ &4|\nu|^2|\mu|^2(1 + |\alpha|^2) - \\ &((|\mu|^2 + |\nu|^2) + |\alpha|^2(|\mu|^2 + |\nu|^2))^2 \\ &= |\alpha|^2(|\mu|^2 + |\nu|^2)^2 + 4|\nu|^2|\mu|^2(1 + |\alpha|^2) \end{aligned} \quad (1.70)$$

The gain then can be expressed as:

$$G_{PIA} = \frac{\langle N_{PIA} \rangle}{\langle N_{in} \rangle}$$

$$= \frac{(|\mu|^2 + |\nu|^2) + |\alpha|^2(|\mu|^2 + |\nu|^2)}{|\alpha|^2}$$

If $|\alpha|^2 \gg 1$, the gain is then given by $G_{PIA} \approx (|\mu|^2 + |\nu|^2)$ so that :

$$\begin{aligned} \text{SNR}_{out} &= \frac{\langle N_{PIA} \rangle^2}{\langle \Delta N_{PIA} \rangle^2} \\ &= \frac{((|\mu|^2 + |\nu|^2) + |\alpha|^2(|\mu|^2 + |\nu|^2))^2}{|\alpha|^2(|\mu|^2 + |\nu|^2)^2 + 4|\nu|^2|\mu|^2(1 + |\alpha|^2)} \\ &\approx \frac{(|\mu|^2 + |\nu|^2)^2|\alpha|^2}{(|\mu|^2 + |\nu|^2)^2 + 4|\nu|^2|\mu|^2} \quad (\text{as } |\alpha|^2 \gg 1) \end{aligned} \quad (1.71)$$

As $\text{SNR}_{in} = |\alpha|^2$, the NF is given by :

$$\begin{aligned} \text{NF}_{PIA} &= \frac{\text{SNR}_{in}}{\text{SNR}_{out}} \\ &= \frac{(|\mu|^2 + |\nu|^2)^2 + 4|\nu|^2|\mu|^2}{(|\mu|^2 + |\nu|^2)^2} \\ &= \frac{(|\mu|^2 + |\nu|^2)^2 + (|\mu|^2 + |\nu|^2)^2 - (|\mu|^2 - |\nu|^2)^2}{(|\mu|^2 + |\nu|^2)^2} \\ &= 2 - \frac{1}{G_{PIA}} \end{aligned} \quad (1.72)$$

For large gains, the PIA process worsens the SNR by about 3 dB [Caves, 1982]. It is here visible that it is coming from the vacuum state entering by the idler mode: the fact that the amplifier is an open system coupled to the environment is the reason for this noise degradation.

1.4.3 Noise for PSA

For the PSA process, we now take $|\beta| = |\alpha|$, to calculate the noise figure (for more detailed calculations c.f. Appendix A.3). From eq.s (1.68) and (1.69) :

$$\begin{aligned} \langle N_{PSA} \rangle &= (|\mu|^2 + |\nu|^2)(1 + 2|\alpha|^2) + 4|\mu||\nu||\alpha|^2 \cos(\theta_{rel}) \quad (1.73) \\ \langle N_{PSA}^2 \rangle &= (|\mu|^2 + |\nu|^2)^2 + (|\mu|^2 + |\nu|^2)^2 \left((|\alpha|^2 + |\beta|^2)^2 + |\alpha|^2 + |\beta|^2 \right) + \\ &\quad 2(|\mu|^2 + |\nu|^2)^2 (|\alpha|^2 + |\beta|^2) + 8(|\mu|^2 + |\nu|^2)|\mu||\nu||\alpha||\beta| \cos(\theta_{rel}) + \\ &\quad 8(|\mu|^2 + |\nu|^2)(1 + |\alpha|^2 + |\beta|^2)|\mu||\nu||\alpha||\beta| \cos(\theta_{rel}) + \\ &\quad 8|\mu|^2|\nu|^2|\alpha|^2|\beta|^2 \cos(2\theta_{rel}) + 4|\nu|^2|\mu|^2(1 + |\alpha|^2)(1 + |\beta|^2) + 4|\nu|^2|\mu|^2|\alpha|^2|\beta|^2 \end{aligned}$$

$$\begin{aligned}
\langle \Delta N_{PSA} \rangle^2 &= \langle N_{PSA}^2 \rangle - \langle N_{PSA} \rangle^2 \\
&= 2|\alpha|^2(|\mu|^2 + |\nu|^2)^2 + 8|\mu||\nu||\alpha|^2(|\mu|^2 + |\nu|^2)\cos(\theta_{rel}) + \\
&\quad 8|\mu|^2|\nu|^2|\alpha|^2 + 4|\mu|^2|\nu|^2
\end{aligned} \tag{1.74}$$

The gain can then be shown to be:

$$\begin{aligned}
G_{PSA} &= \frac{\langle N_{PSA} \rangle}{\langle N_{in} \rangle} \\
&= \frac{(|\mu|^2 + |\nu|^2)(1 + 2|\alpha|^2) + 4|\mu||\nu||\alpha|^2\cos(\theta_{rel})}{2|\alpha|^2}
\end{aligned}$$

If $|\alpha| \gg 1$, $G_{PSA} \approx |\mu|^2 + |\nu|^2 + 2|\mu||\nu|\cos(\theta_{rel})$. As expected, this is similar to the classical result in eq. 1.54: while the relative phase θ_{rel} is scanned, the PSA gain varies from a maximum gain $G(\theta_{rel} = 0) = (|\mu| + |\nu|)^2 = G_{max}$ to a minimum gain $G(\theta_{rel} = \pi) = (|\mu| - |\nu|)^2 = G_{min}$.

The SNR after the PSA output is:

$$\begin{aligned}
\text{SNR}_{PSA} &= \frac{\langle N_{PSA} \rangle^2}{\langle \Delta N_{PSA} \rangle^2} \\
&\approx \frac{2|\alpha|^2((|\mu|^2 + |\nu|^2) + 2|\mu||\nu|\cos(\theta_{rel}))^2}{(|\mu|^2 + |\nu|^2)^2 + 4|\mu||\nu|(|\mu|^2 + |\nu|^2)\cos(\theta_{rel}) + 4|\mu|^2|\nu|^2} \quad (\text{as } |\alpha|^2 \gg 1)
\end{aligned}$$

At the input, $\text{SNR}_{in} = 2|\alpha|^2$, so that the N.F. is given by:

$$\begin{aligned}
\text{N.F.}_{PSA} &= \frac{\text{SNR}_{in}}{\text{SNR}_{out}} \\
&= \frac{(|\mu|^2 + |\nu|^2)^2 + 4|\mu||\nu|(|\mu|^2 + |\nu|^2)\cos(\theta_{rel}) + 4|\mu|^2|\nu|^2}{((|\mu|^2 + |\nu|^2) + 2|\mu||\nu|\cos(\theta_{rel}))^2} \\
&= \frac{2(2G_{PIA} - 1)}{G_{PSA}} - \frac{1}{G_{PSA}^2}
\end{aligned} \tag{1.75}$$

The calculations to express the N.F. in terms of the PSA and PIA gains is more detailed in Appendix A.3. At $\theta_{rel} = 0$, the gain is maximum and $\text{SNR}_{out} = 2|\alpha|^2$, so that N.F. = 1 : the PSA does not deteriorate the SNR of the initial input.

1.4.4 Quadrature noises after PSA

For the two fields, we can define the individual quadratures as (see eq. (1.4)):

input	output
$x_a = \frac{1}{2}(a + a^\dagger)$	$X_A = \frac{1}{2}(A + A^\dagger)$
$y_a = \frac{1}{2i}(a - a^\dagger)$	$Y_A = \frac{1}{2i}(A - A^\dagger)$
$x_b = \frac{1}{2}(b + b^\dagger)$	$X_B = \frac{1}{2}(B + B^\dagger)$
$y_b = \frac{1}{2i}(b - b^\dagger)$	$Y_B = \frac{1}{2i}(B - B^\dagger)$

As the input signal and idler fields are coherent states, $\langle \Delta x_{a,b} \rangle = \frac{1}{2} = \langle \Delta y_{a,b} \rangle$. Following the evolution of the fields through the PSA process given by eq. (1.58), the output field quadratures are:

$$\begin{aligned} X_A &= \frac{1}{2}(A + A^\dagger) \\ &= \frac{1}{2}(\mu a + \mu^* a^\dagger + \nu b^\dagger + \nu^* b) \end{aligned} \quad (1.76)$$

$$\begin{aligned} Y_A &= \frac{1}{2i}(A - A^\dagger) \\ &= \frac{1}{2i}(\mu a - \mu^* a^\dagger + \nu b^\dagger - \nu^* b) \end{aligned} \quad (1.77)$$

$$\begin{aligned} X_B &= \frac{1}{2}(B + B^\dagger) \\ &= \frac{1}{2}(\nu a^\dagger + \nu^* a + \mu b + \mu^* b^\dagger) \end{aligned} \quad (1.78)$$

$$\begin{aligned} Y_B &= \frac{1}{2i}(B - B^\dagger) \\ &= \frac{1}{2}(\nu a^\dagger - \nu^* a + \mu b - \mu^* b^\dagger) \end{aligned} \quad (1.79)$$

As the input state $|\alpha, \beta\rangle$ is the product of two independent coherent states one gets:

$$\begin{aligned} \langle X_A \rangle &= \langle \alpha, \beta | X_A | \alpha, \beta \rangle \\ &= \frac{1}{2}(\mu \alpha + \mu^* \alpha^* + \nu \beta^* + \nu^* \beta) \end{aligned} \quad (1.80)$$

$$\begin{aligned} \langle X_A^2 \rangle &= \langle \alpha, \beta | X_A^2 | \alpha, \beta \rangle \\ &= \frac{1}{4}(\mu^2 \alpha^2 + \mu^{*2} \alpha^{*2} + \nu^2 \beta^{*2} + \nu^{*2} \beta^2 + \\ &\quad |\mu|^2(|\alpha|^2 + 1) + \mu \nu \alpha \beta^* + \mu \nu^* \alpha^* \beta + |\mu|^2 |\alpha|^2 + \mu^* \nu \alpha^* \beta^* + \mu^* \nu^* \alpha^* \beta + \\ &\quad \nu \mu \beta^* \alpha + \nu \mu^* \alpha^* \beta^* + |\nu|^2 |\beta|^2 + \nu^* \mu \beta \alpha + \nu^* \mu^* \beta \alpha^* + |\nu|^2 (|\beta|^2 + 1)) \end{aligned} \quad (1.81)$$

$$\begin{aligned} \Rightarrow \langle \Delta X_A \rangle^2 &= \frac{1}{4}(|\mu|^2 + |\nu|^2) \\ \langle \Delta X_A \rangle &= \frac{1}{2} \sqrt{G_{PIA}} \end{aligned} \quad (1.82)$$

For all the other quadratures as well, it can be shown that $\langle \Delta Y_A \rangle = \langle \Delta X_B \rangle = \langle \Delta Y_B \rangle = \frac{1}{2} \sqrt{G_{PIA}}$ (for detailed calculations, see Appendix A). Individually, none of the fields are squeezed : indeed the sum and difference of the signal fields are squeezed, as shown in the next section. It can also be noticed that although the noise is the same on both quadratures, the states are not coherent anymore: their fluctuations are larger than $\frac{1}{2}$.

1.4.5 Two mode squeezing

Following [Ferrini et al., 2014] we perform a transformation of operators :

$$a_+ = \frac{a+b}{\sqrt{2}} \quad A_+ = \frac{A+B}{\sqrt{2}} \quad (1.83)$$

$$a_- = \frac{a-b}{\sqrt{2}} \quad A_- = \frac{A-B}{\sqrt{2}} \quad (1.84)$$

The definition of A_+ and A_- (see eq. 1.58) is now given by:

$$A_{\pm} = \mu a_{\pm} \pm \nu a_{\pm}^{\dagger}$$

the form of which is the one of a squeezed annihilation operator, as in eq. 1.22. Quadratures are then defined by:

$$a_{\pm} = x_{\pm} + iy_{\pm} \quad A_{\pm} = X_{\pm} + iY_{\pm}$$

The transformation shown here, from the input quadratures to the output quadratures, can be described by the following matrices [McKinstrie and Karlsson, 2013]:

$$\begin{pmatrix} X_{\pm} \\ Y_{\pm} \end{pmatrix} = \begin{pmatrix} \cos \theta & -\sin \theta \\ \sin \theta & \cos \theta \end{pmatrix} \begin{pmatrix} |\mu| \pm |\nu| & 0 \\ 0 & |\mu| \mp |\nu| \end{pmatrix} \begin{pmatrix} \cos \phi & \sin \phi \\ -\sin \phi & \cos \phi \end{pmatrix} \begin{pmatrix} x_{\pm} \\ y_{\pm} \end{pmatrix} \quad (1.85)$$

We can write more conveniently,

$$Q_{\pm} = R(\theta) M_{\pm} R(-\phi) q_{\pm} \quad (1.86)$$

where $Q_{\pm} = \begin{pmatrix} X_{\pm} \\ Y_{\pm} \end{pmatrix}$, $q_{\pm} = \begin{pmatrix} x_{\pm} \\ y_{\pm} \end{pmatrix}$ are the input and output quadrature vectors. The matrix $R(\theta)$ is a unitary rotation by an angle θ in the phase space.

This description is in the Heisenberg picture, and shows the transformation of the operator:

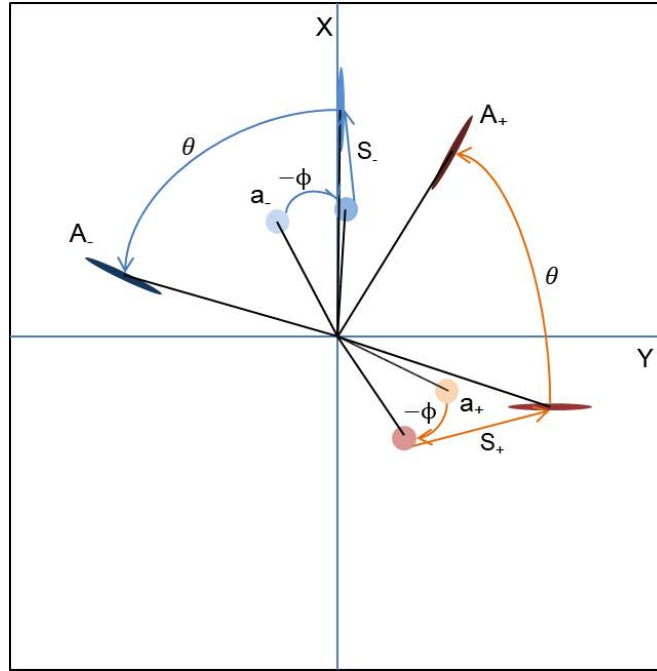

FIGURE 1.10: Evolution of the input error ellipse for the fields a_{\pm} into the output error ellipses for the fields A_{\pm} in the complex quadrature plane. The red color corresponds to the fields with a minus-subscript, and the blue color is for the fields with a plus-subscript. At the input, the fields a_{\pm} are in a coherent state, hence the circle. They undergo the unitary rotations and the squeezing operation (one quadrature is amplified, and the other is de-amplified) as shown in eq. 1.85.

- (1) $R(-\phi)$ denotes a clockwise rotation by an angle $\phi = \frac{1}{2}(\theta_{\nu} - \theta_{\mu})$.
- (2) M_{+} (M_{-}) transforms the quadratures q_{+} (q_{-}). The quadrature x_{+} (y_{+}) is multiplied by a factor $|\mu| + |\nu|$ ($|\mu| - |\nu|$). As $|\mu|^2 - |\nu|^2 = 1$, the factors $|\mu| + |\nu|$ and $|\mu| - |\nu|$ are reciprocals and when the quadrature x_{+} is amplified, y_{+} is deamplified and vice-versa. Similar argument holds for x_{-} and y_{-} as well.
- (3) Finally, the fields experience another rotation $R(\theta)$ in the phase space, by an angle $\theta = \frac{1}{2}(\theta_{\nu} + \theta_{\mu})$.

Fig. 1.10 shows the transformation described above in the phase space. The output quadratures can be expanded in terms of the output field annihilation and creation operators:

$$\begin{aligned}
 X_{+} &= \frac{1}{2\sqrt{2}} ((A + B) + (A^{\dagger} + B^{\dagger})) \\
 Y_{+} &= \frac{1}{2\sqrt{2}i} ((A + B) - (A^{\dagger} + B^{\dagger}))
 \end{aligned}$$

$$\begin{aligned}
X_- &= \frac{1}{2\sqrt{2}} ((A - B) + (A^\dagger - B^\dagger)) \\
Y_- &= \frac{1}{2\sqrt{2}i} ((A - B) - (A^\dagger - B^\dagger))
\end{aligned} \tag{1.87}$$

Lets now calculate the fluctuations of the quadrature X_+ (c.f. Appendix A.3.3) for an input state $|\alpha, \alpha\rangle$:

$$\begin{aligned}
\langle X_+ \rangle &= \frac{1}{2\sqrt{2}} (\langle A + A^\dagger \rangle + \langle B + B^\dagger \rangle) \\
&= \frac{1}{\sqrt{2}} ((\mu^* + \nu)\alpha^* + (\mu + \nu^*)\alpha)
\end{aligned} \tag{1.88}$$

The variance in this quadrature is given by :

$$\langle \Delta X_+ \rangle^2 = \frac{1}{4} (|\mu|^2 + |\nu|^2 + 2|\mu||\nu| \cos 2(\theta_\mu + \theta_\nu)) \tag{1.89}$$

- When $\theta_\mu + \theta_\nu = 0$, we have $\langle \Delta X_+ \rangle = \frac{1}{2}(|\mu| + |\nu|)$.
- When $\theta_\mu + \theta_\nu = \frac{\pi}{2}$, we have $\langle \Delta X_+ \rangle = \frac{1}{2}(|\mu| - |\nu|)$.

As $(|\mu| + |\nu|) \cdot (|\mu| - |\nu|) = 1$, $(|\mu| + |\nu|) > 0$ and $(|\mu| - |\nu|) > 0$, we deduce that $(|\mu| + |\nu|) > 1 > (|\mu| - |\nu|)$.

We thus see that $\langle \Delta X_+(\theta_\mu + \theta_\nu = \frac{\pi}{2}) \rangle < \frac{1}{2}$: the state is squeezed along the X_+ quadrature. For $\theta_\mu + \theta_\nu = 0$, it is squeezed along Y_+ . The calculations for all quadratures are detailed in Appendix A.3.3. We observe that X_+ and Y_- quadratures are squeezed simultaneously when the X_- and Y_+ quadratures are anti-squeezed. Similarly, X_- and Y_+ quadratures are squeezed when X_+ and Y_- are anti-squeezed.

Fig. 1.10 shows how the sum or difference of fields are being squeezed together, while the isolated fields are not. The squeezing is due to the quantum correlations between the fields because the signal and idler photons are created pairwise.

Chapter 2

Ultra-narrow Atomic Resonances

Contents

2.1	Coherent Population Trapping	38
2.2	Electromagnetically Induced Transparency	40
2.3	Recoil Induced Resonances (RIR)	44
2.3.1	RIR with one pump beam	45
2.3.2	RIR with counterpropagating pump beams	49

The real part (dispersion) and imaginary part (absorption) of the susceptibility (χ) of a system are linked through the Kramers-Kronig relation [Boyd, 2003]:

$$\begin{aligned}\mathcal{R}e(\chi(\omega)) &= \frac{1}{\pi} \int_{-\infty}^{\infty} \frac{\mathcal{I}m(\chi(\omega'))d\omega'}{\omega' - \omega} \\ \mathcal{I}m(\chi(\omega)) &= -\frac{1}{\pi} \int_{-\infty}^{\infty} \frac{\mathcal{R}e(\chi(\omega'))d\omega'}{\omega' - \omega}\end{aligned}\tag{2.1}$$

Nonlinear optics require steep dispersions, which are thus associated to sudden changes of the transmission of the medium. Here I discuss some atomic processes, which give rise to ultra-narrow resonances i.e., which have a bandwidth less than the optical coherences decay rates.

Two of them, Coherent Population Trapping (CPT) and Electromagnetically Induced Transparency (EIT) involve atomic internal degrees of freedom. The third one, known as Recoil Induced Resonances (RIR), requires to consider atomic external degrees of freedom.

2.1 Coherent Population Trapping

Let us consider a three-level atomic system in a Λ configuration (see fig. 2.1(a)), where two ground states $|g_1\rangle$ and $|g_2\rangle$ are optically coupled to the same excited state $|e\rangle$. The ground states energy difference is $2\hbar\Delta$.

Two fields couple the two legs of the Λ system : the transition $|g_1\rangle \rightarrow |e\rangle$ is coupled by the coupling field E_c and the transition $|g_2\rangle \rightarrow |e\rangle$ is coupled by the signal field E_s . The corresponding Rabi frequencies are given as:

$$\Omega_{c,p} = \frac{dE_{c,s}}{\hbar} \quad (2.2)$$

where, d is the dipole moment of the transition, and $E_{c,p}$ are the complex amplitudes of coupling and signal fields respectively. Their frequencies $\omega_{c,s}$ are detuned from the corresponding transitions by $\Delta_{c,s} = \omega_{c,s} - (\omega_0 \pm \Delta)$.

The state of the system is described through the density matrix ρ , which evolves following the Von-Neumann equation:

$$\frac{d}{dt}\rho = \frac{1}{i\hbar} [\mathcal{H}, \rho] + \frac{\partial}{\partial t}\rho|_{relax} \quad (2.3)$$

Where, \mathcal{H} is the interaction Hamiltonian and the term $\frac{\partial}{\partial t}\rho|_{relax}$ describes the non-unitary relaxation processes. The relevant decay rates are:

- Γ_0 : spontaneous decay rate from the excited state to the ground states.
- γ : optical coherences decay rate of the transitions $|e\rangle \leftrightarrow |g_1\rangle$ and $|e\rangle \leftrightarrow |g_2\rangle$, which are assumed to be equal.
- γ_{12} : decay rate of the Raman coherence between the ground states $|g_1\rangle$ and $|g_2\rangle$.
- γ_t : transit rate through the laser beam, which can be added for moving atoms.

The total Hamiltonian of the system, in the $\{|e\rangle, |g_1\rangle, |g_2\rangle\}$ basis and in the rotating wave approximation, is given as:

$$\mathcal{H} = \begin{pmatrix} 0 & \Omega_s e^{-i\omega_s t} & \Omega_c e^{-i\omega_c t} \\ \Omega_s^* e^{i\omega_s t} & \omega_0 - \Delta & 0 \\ \Omega_c^* e^{i\omega_c t} & 0 & \omega_0 + \Delta \end{pmatrix} \quad (2.4)$$

where $\Omega_{c,s}$ are the Rabi frequencies of the coupling and signal fields respectively.

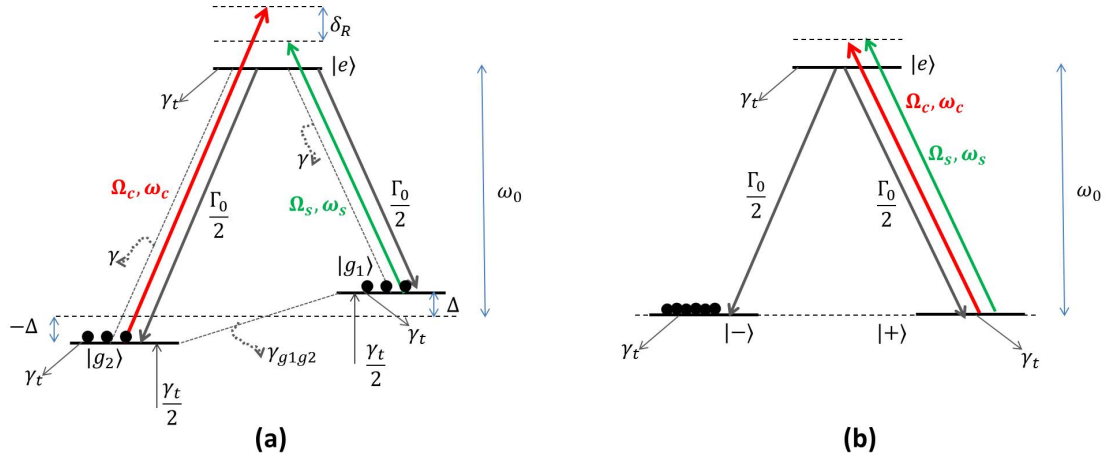

FIGURE 2.1: (a) Three atomic energy levels in a Λ scheme : two ground states $|g_1\rangle$ and $|g_2\rangle$ are optically coupled to the excited state $|e\rangle$ by a coupling field (shown in red) and a signal field (shown in green) of Rabi frequencies Ω_c , and Ω_s , and optical frequencies ω_c and ω_s respectively. 2Δ is the energy splitting between the two ground states. $\omega_0 \pm \Delta$ are the optical transition frequencies. The spontaneous decay rate of the excited state is Γ_0 . The atoms have a transit rate γ_t into the laser beam, the optical coherences and the ground-state Raman coherence decay rates are γ and γ_{12} respectively. (b) Atomic system in the $\{|+\rangle, |-\rangle\}$ basis, when the fields are at Raman resonance. The $|-\rangle \rightarrow |e\rangle$ transition is not coupled to the light and after a few pumping cycles, all the atoms end up in the $|-\rangle$ dark state.

The evolution of the density matrix elements (eq. 2.3) is then given by the Bloch equations (the indices 1 and 2 labels the states $|g_1\rangle$ and $|g_2\rangle$ respectively):

$$\begin{aligned}
\frac{d}{dt}\tilde{\rho}_{ee} &= -i[(\tilde{\rho}_{e1}\Omega_s^* - \tilde{\rho}_{1e}\Omega_s) + (\tilde{\rho}_{e2}\Omega_c^* - \tilde{\rho}_{2e}\Omega_c)] - (\Gamma_0 + \gamma_t)\tilde{\rho}_{ee}, \\
\frac{d}{dt}\tilde{\rho}_{11} &= i(\tilde{\rho}_{e1}\Omega_s^* - \tilde{\rho}_{1e}\Omega_s) + \frac{\Gamma_0}{2}\tilde{\rho}_{ee} + \frac{\gamma_t}{2} - \gamma_t\tilde{\rho}_{11}, \\
\frac{d}{dt}\tilde{\rho}_{22} &= i(\tilde{\rho}_{e2}\Omega_c^* - \tilde{\rho}_{2e}\Omega_c) + \frac{\Gamma_0}{2}\tilde{\rho}_{ee} + \frac{\gamma_t}{2} - \gamma_t\tilde{\rho}_{22}, \\
\frac{d}{dt}\tilde{\rho}_{e1} &= [i\Delta_s - \gamma]\tilde{\rho}_{e1} + i(\tilde{\rho}_{11} - \tilde{\rho}_{ee})\Omega_s + i\tilde{\rho}_{21}\Omega_c, \\
\frac{d}{dt}\tilde{\rho}_{e2} &= [i\Delta_c - \gamma]\tilde{\rho}_{e2} + i(\tilde{\rho}_{22} - \tilde{\rho}_{ee})\Omega_c + i\tilde{\rho}_{12}\Omega_s, \\
\frac{d}{dt}\tilde{\rho}_{12} &= -\tilde{\rho}_{12}(\gamma_{12} + i\delta_R) - i\tilde{\rho}_{1e}\Omega_c + i\tilde{\rho}_{e2}\Omega_s^*.
\end{aligned} \tag{2.5}$$

where we have taken, $\rho_{e1} = \tilde{\rho}_{e1}e^{-i\omega_s t}$, $\rho_{e2} = \tilde{\rho}_{e2}e^{-i\omega_c t}$, $\rho_{12} = \tilde{\rho}_{12}e^{-i(\omega_c - \omega_s)t}$ and $\rho_{ii} = \tilde{\rho}_{ii}$ for $i \in \{e, 1, 2\}$. $\delta_R = \Delta_s - \Delta_c$ is the Raman detuning from the two photon transition.

When $\Delta_s = \Delta_c$, the two photon transition is at resonance ($\delta_R = 0$), and excites the ground state Raman coherence : the condition is thus known as Raman resonance. In this case, it is instructive to apply a unitary transform on the

ground states $|g_1\rangle$ and $|g_2\rangle$ to define the states :

$$\begin{aligned} |+\rangle &= \frac{\Omega_s}{\sqrt{\Omega_s^2 + \Omega_c^2}} |g_1\rangle + \frac{\Omega_c}{\sqrt{\Omega_s^2 + \Omega_c^2}} |g_2\rangle; \\ |-\rangle &= \frac{\Omega_c}{\sqrt{\Omega_s^2 + \Omega_c^2}} |g_1\rangle - \frac{\Omega_s}{\sqrt{\Omega_s^2 + \Omega_c^2}} |g_2\rangle. \end{aligned} \quad (2.6)$$

The $|-\rangle$ state is an eigenvector of \mathcal{H} with the eigenvalue 0. The state $|+\rangle$ is orthogonal to $|-\rangle$. The probability of the transition $|e\rangle \leftrightarrow |-\rangle$ under the Hamiltonian \mathcal{H} (c.f. eq 2.4) is $|\langle e|\mathcal{H}|-\rangle|^2 = 0$. The probability of the other transition $|e\rangle \leftrightarrow |+\rangle$ is non-zero (see fig. 2.1(b)).

After some cycles of optical pumping, all the population is trapped in the $|-\rangle$ dark state [Arimondo, 1996]. This process is known as coherent population trapping .

Coherent population trapping has been used as a tool to cool down atoms below recoil energy [Aspect, Arimondo, Kaiser, Vansteenkiste, and Cohen-Tannoudji, 1988], for phase-conjugate generation via non-linear interactions in sodium [Hemmer et al., 1995], for precision atomic clocks [Zanon et al., 2005] or to achieve slow group velocity of light [Schmidt, Wynands, Hussein, and Meschede, 1996]. In the case of metastable helium, as described in the next chapter, the ground states are Zeeman sublevels, so that their splitting Δ can be varied using a magnetic field.

2.2 Electromagnetically Induced Transparency

A limiting case of CPT is when the coupling Rabi frequency is much higher than the signal one i.e. $\Omega_c \gg \Omega_s$. The ground state $|g_1\rangle$ (see fig. 2.1(a)) is effectively the dark state ($|+\rangle \approx |g_1\rangle$). The signal field, which should be absorbed when resonant, is transmitted: this phenomenon is known as electromagnetically induced transparency (EIT) [Harris, Field, and Imamoglu, 1990].

The absorption of the signal field is given as the imaginary part of the linear susceptibility χ , which can be shown to be [Lauprêtre, 2012]:

$$\chi = \frac{n_{at}|d_{e1}|^2}{\Omega_s \epsilon_0 h} \tilde{\rho}_{e1} \quad (2.7)$$

where, n_{at} is the density of atoms in the medium, d_{e1} is the dipole moment of the $|e\rangle \leftrightarrow |1\rangle$ transition and ϵ_0 is the vacuum permittivity.

The optical coherence $\tilde{\rho}_{e1}$ can be deduced from the Bloch equations (eq.s 2.5). In the stationary regime the coherence $\tilde{\rho}_{e1}$, at first order in the signal, is given

by [Lauprêtre, 2012]:

$$\tilde{\rho}_{e1}^{(1)} = \frac{i\Omega_s(\gamma_{12} - i\delta_R)}{[\gamma - i(\Delta_c + \delta_R)](\gamma_{12} - i\delta_R) + |\Omega_c|^2} \quad (2.8)$$

where, the quantity δ_R is the two photon detuning, in the presence of a ground state splitting 2Δ . Using eq. 2.8 in eq. 2.7, the linear susceptibility χ is:

$$\chi = \frac{n_{at}|d_{e1}|^2}{\epsilon_0 h} \frac{i(\gamma_{1-1} - i\delta_R)}{[\gamma - i(\Delta_c + \delta_R)](\gamma_{1-1} - i\delta_R) + |\Omega_c|^2} \quad (2.9)$$

The transmission T of a medium with linear susceptibility χ and length L is:

$$T = e^{-\frac{\omega_0}{c} \text{Im}(\chi)L} \quad (2.10)$$

Fig. 2.2 shows the shape of the transmission as a function of the pump-signal detuning for different parameters:

- $\gamma = 22.3$ MHz, the natural linewidth of helium at 1 Torr.
- $\gamma_{12} = 5$ kHz, a usual value when it is limited by the transit rate in the laser beam of 3 mm diameter.

It can be seen that:

- An increase of the ground state Raman coherence decay rate, decreases the contrast and increases the width of the resonance (fig. 2.2(a)).
- When the pump power is increased, the saturation increases the width of the resonance (fig. 2.2(b)). In fig. 2.2(b) I have plotted the transmission for $\gamma/2\pi = 0.86$ GHz which is the Doppler width, which is reasonable as velocity changing collisions distribute the atoms throughout the Doppler classes.
- A change in the ground state splitting Δ modifies the two-photon resonance condition, and shifts the resonance (fig. 2.2(c)).
- When the optical detuning Δ_c is not zero, the two-photon resonance becomes asymmetric (fig. 2.2(d)).

While the transmission of the probe is given by the imaginary part of χ , the real part is linked to the dispersion. Indeed, the phase velocity is given by $v_\phi = \frac{c}{\text{Re}(n(\omega))}$ with $n^2(\omega) = 1 + \chi(\omega)$. So that at first order :

$$n(\omega) = n(\omega_0) + (\omega - \omega_0) \left. \frac{dn}{d\omega} \right|_{\omega_0} \quad (2.11)$$

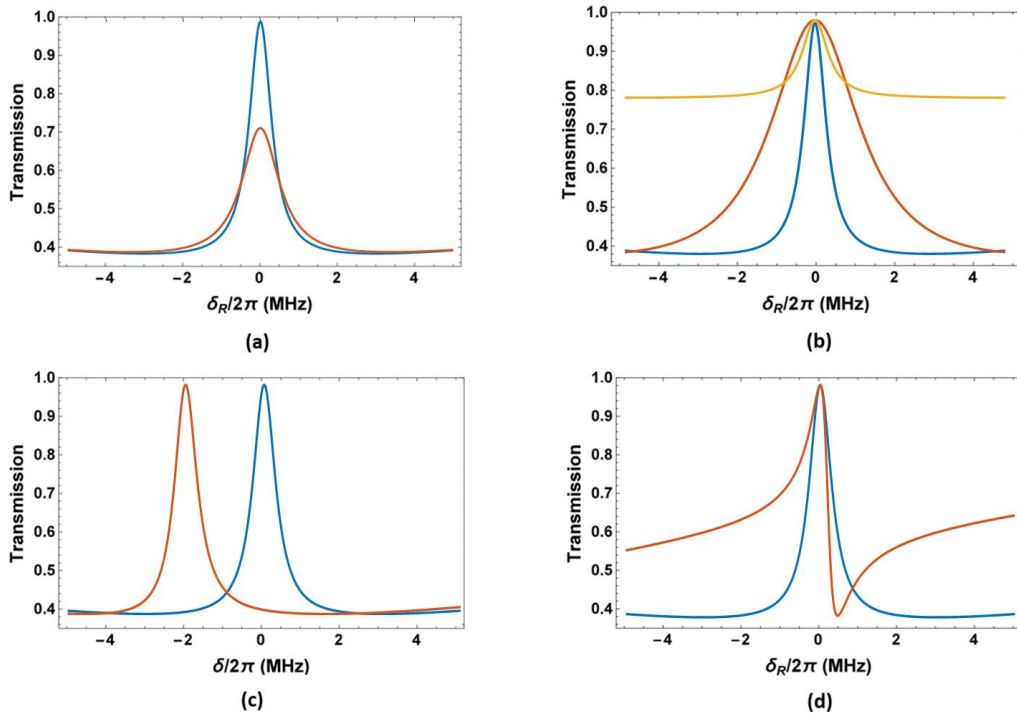

FIGURE 2.2: Transmission of the signal field as a function of the detuning δ . The blue spectrum parameters are : $\gamma_{12}/2\pi = 5kHz$, $\gamma/2\pi = 22.3MHz$, $\Delta_c/2\pi = 0MHz$ (so that $\delta = \delta_R$), $\Delta/2\pi = 0MHz$, and $\Omega_c/2\pi = 3MHz$. The orange curves show the spectrum when (a) $\gamma_{12}/2\pi = 250kHz$, (b) $\Omega_c/2\pi = 6MHz$, the yellow curve is for $\gamma/2\pi = 0.86GHz$ which is the Doppler width, (c) $\Delta/2\pi = 1MHz$ and (d) $\Delta_c/2\pi = 20MHz$ while keeping the other parameters equal to the blue ones.

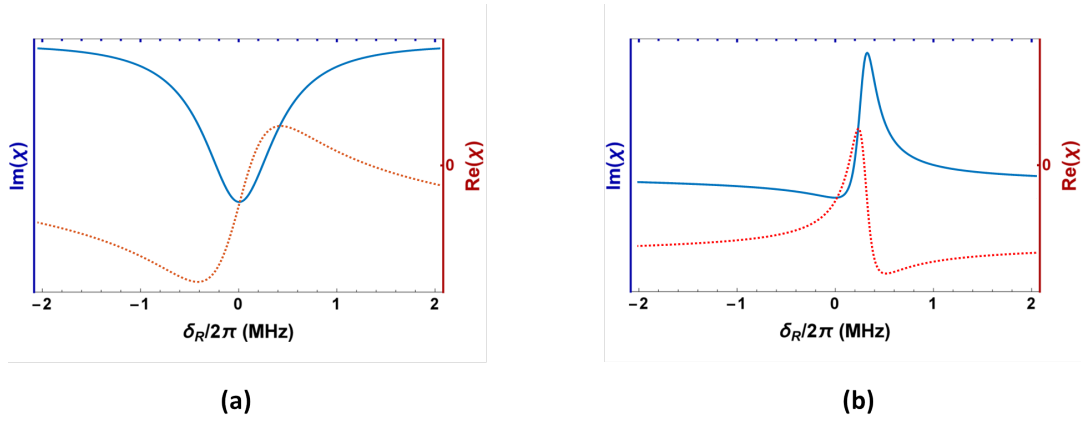

FIGURE 2.3: (a) Plot of the imaginary (in solid blue) and real (in dotted red) parts of the linear susceptibility χ as a function of two-photon-detuning $\delta_R/2\pi$ when $\gamma_{1-1}/2\pi = 5kHz$, $\gamma/2\pi = 22.3MHz$, $\Delta_c/2\pi = 0MHz$, $\Delta/2\pi = 0MHz$, and $\Omega_c/2\pi = 3MHz$. A high positive derivative of the $\mathcal{R}e(\chi)$ at the center causes slow light. (b) Plot of the same, for $\Delta_c/2\pi = 20MHz$, keeping the other parameters the same. A high negative derivative of the $\mathcal{R}e(\chi)$ gives rise to of fast light.

The group velocity of light in a medium of linear susceptibility χ is then given as:

$$v_g(\omega_0) = \frac{c}{n_R(\omega_0) + \omega_0 \left. \frac{dn_R}{d\omega} \right|_{\omega_0}} \approx \frac{c}{\left(1 + \frac{\omega_0}{2} \left. \frac{d\mathcal{R}e(\chi(\omega))}{d\omega} \right|_{\omega_0}\right)} \quad (2.12)$$

where I have used that the real part of refractive index is close to 1 : $n_R(\omega_0) \approx 1$.

Fig 2.3 shows the imaginary and real parts of χ for the parameters of fig. 2.2(d).

- When $\Delta_c = 0$, $\text{Im}\{\chi\}$ is symmetric around $\delta_R = 0$ and $\text{Re}\{\chi\}$ have a positive slope which induces slow light : for $\delta_R = 0$, the parameters used here give $v_g \approx 0.3c$. Similar group velocity has been observed in metastable He^* [Goldfarb et al., 2008].
- For, $\Delta_c = 20MHz$, $\text{Im}\{\chi\}$ is asymmetric and around $\delta_R/2\pi = 0.3MHz$, the slope of $\text{Re}\{\chi\}$ is negative inducing a fast light propagation at $v_g = 1.2c$.

Slow light can be achieved not only via EIT, but also via other atomic resonances such as Zeeman coherence oscillations [Hashmi and Bouchene, 2008], resonator waveguides [Lee, Gehm, and Neifeld, 2010], metamaterials [Lu, Savo, Casse, and Sridhar, 2009] etc. It was proposed to be used to enhance nonlinear effects [Harris, Field, and Imamoglu, 1990].

It has been shown that a fast light does not violate causality, due to the limited bandwidth associated to the resonance [Boyd, Gauthier, and Wolf, 2002] : in fact the phase velocity is not changed, the light pulses are stretched in the

medium and compressed at the medium edges to show a high group velocity [Crouzil and Bouchene, 2009].

EIT has also been used to stop and store of light in atomic systems. First observed by Hau et al. [Hau, Harris, Dutton, and Behroozi, 1999] for about 17 seconds, the storage time has been increased to about 1 minute [Heinze, Hubrich, and Halfmann, 2013].

2.3 Recoil Induced Resonances (RIR)

Einstein's discovery of atomic recoil from photon absorption and emission [Einstein, 1917] was first taken into account for atomic transitions coupled by electromagnetic fields by Kol'chenko et al. [Kolchenko, Rautian, and Sokolovskii, 1969]. Experimentally this recoil effect was first observed in saturation spectroscopy of Methane by Hall et al. [Hall, Bordé, and Uehara, 1976]. At the same time, Hänsch et al. proposed recoil as a mechanism to cool atomic gases by distribution of kinetic energy to scattered photons [Hänsch and Schawlow, 1975].

Recoil induced resonances, first introduced theoretically by Guo *et. al.* [Guo, Berman, Dubetsky, and Grynberg, 1992], are a kind of atomic resonances mediated by the transfer of kinetic energy of atoms to photons or vice versa via recoil, which results into narrow features in the probe-transmission and phase conjugate generation spectra. The theoretical prediction of RIR was soon experimentally validated by Lounis et al. [Lounis, Verkerk, Courtois, Salomon, and Grynberg, 1993] and Courtois et al. [Courtois, Grynberg, Lounis, and Verkerk, 1994]. Meacher et al. proposed and showed RIR to be an excellent probe for temperature measurement of cold atoms [Meacher, Boiron, Metcalf, Salomon, and Grynberg, 1994].

A specificity of RIR is that it gives rise to Gaussian derivative resonance shapes because it results from difference in atomic populations of different momenta classes, which generally follows a Maxwell-Boltzmann distribution. Here I discuss the experiments, which are done typically in two configurations:

- Case (a) With **one pump** and **one signal** beams (see fig. 2.4(a)): the pump beam has an wave-vector $\vec{k}_P = k\vec{x}$ and a frequency ω_P which is detuned from the natural transition frequency ω by an amount $\Delta = \omega_P - \omega$. The signal beam makes a small angle θ with the pump beam, and has a wave-vector $\vec{k}_s = k\vec{x} + k\theta\vec{y}$ and a frequency $\omega_s = \omega_P + \delta$. When the intensity of

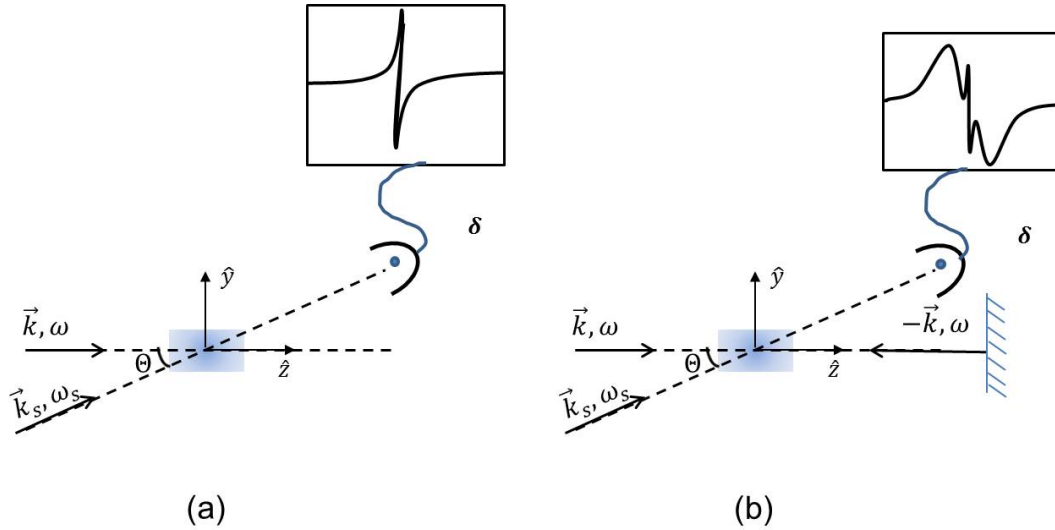

FIGURE 2.4: Geometry of the wave-vectors and frequencies of the pump and signal fields (signal, denoted with a s-subscript) for (a) one pump and one signal beams and (b) two retroreflected counterpropagating pump beams with one signal beam. In little windows, the corresponding characteristic probe transmissions are shown as a function of pump-signal detuning : (a) shows single sharp feature and (b) shows a broad and a sharp one.

the transmitted signal is plotted as a function of δ , we observe a sharp Gaussian derivative shape as plotted in fig. 2.6.

Case (b) With **two retro-reflected pump beams** and **one signal** beam (see fig. 2.4(b)): compared to the previous case, the pump is reflected on a mirror to create a second counter-propagating pump. In this case, the intensity of transmitted signal as a function δ shows two Gaussian derivative features of unequal width.

The signal transmission spectroscopy examines signal-attenuation or gain as a function of the pump-signal detuning δ . In the next sections, I explain the processes, which lead to these particular shapes.

2.3.1 RIR with one pump beam

RIR can be interpreted, either in terms of stimulated Raman scattering between differently populated atomic velocity groups, or in terms of stimulated Rayleigh scattering from a bunched atomic density [Courtois and Grynberg, 1996]. In this section we discuss only the Raman scattering interpretation. The Rayleigh scattering is discussed in section 4.1.2.

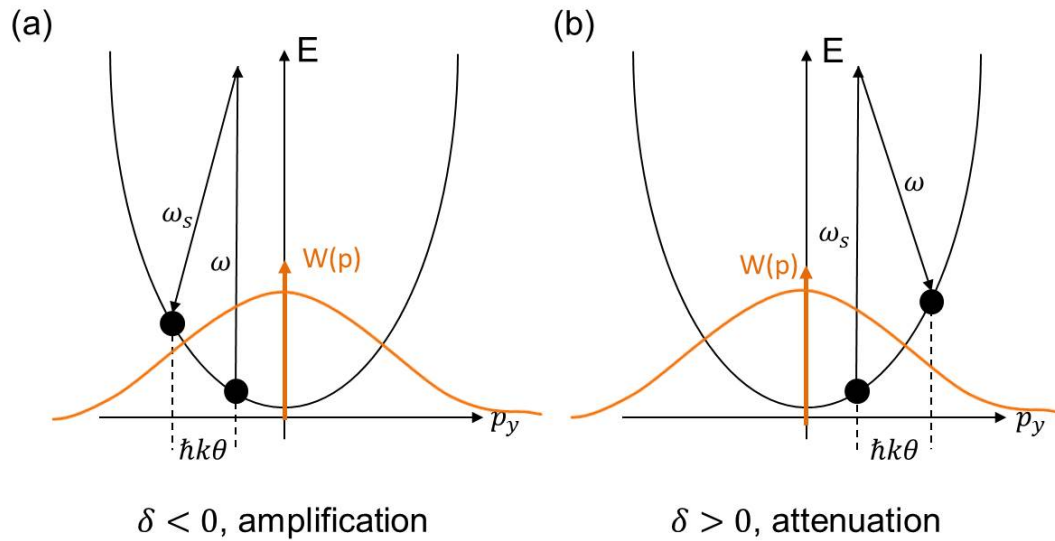

FIGURE 2.5: Stimulated Raman transitions between atomic free external states with kinetic energy $E = p_y^2/2M$, where M is the mass of a single atom. The population difference between different initial and final momentum states induces (a) signal gain when $\delta = \omega_s - \omega_P < 0$ as more photons are transferred from the pump channel to the signal one than the opposite, and (b) signal attenuation when $\delta = \omega_s - \omega_P > 0$ as more photons are transferred from the signal channel to the pump one than the opposite.

To understand the effect of atomic recoil on the signal transmission, we consider an ensemble of two level atoms which are interacting with two beams: one pump beam with a wave-vector $\vec{k} = k\vec{x}$ and a frequency ω , and one signal beam with a wave-vector $\vec{k}_s = k_s \cos \theta \vec{x} + k_s \sin \theta \vec{y}$, and a frequency $\omega_s = \omega + \delta$. As we are looking for changes in the signal transmission, we consider the 2 following cases:

- the atom absorbs one photon from the pump channel and emits one photon in the signal channel. Thus, the initial momentum of the atom \vec{p} is modified to $\vec{p} + \hbar(\vec{k} - \vec{k}_s)$.
- the atom absorbs one photon from the signal and gives off one in the pump channel. This produces an atom with a final momentum p from an initial momentum of $\vec{p} + \hbar(\vec{k} - \vec{k}_s)$.

Here we have not considered the processes that involve absorption and emission of the same fields, which do not change the signal transmission. We have also neglected higher order interactions of pump and signal fields. If the angle θ is small enough, we can consider $\vec{k}_s \approx k\vec{x} + k\theta\vec{y}$. With this approximation, for an absorption from the pump channel and an emission in the signal one, the

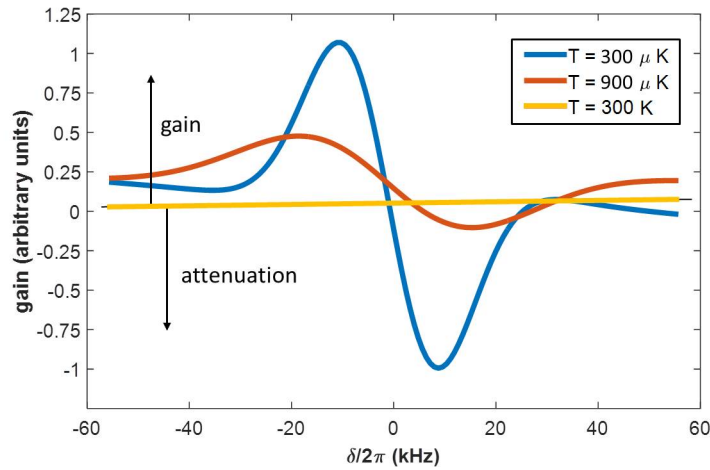

FIGURE 2.6: Typical RIR transmission spectra, as a function of pump-signal detuning. When the detuning is negative we see a gain, and vice versa. In blue, the gain spectrum is shown for $\Delta/2\pi = 30\text{MHz}$, $\theta = 2\text{deg}$ and $T = 300\mu\text{K}$. In red and yellow the temperature is increased to $T = 900\mu\text{K}$ and $T = 300\text{K}$ respectively.

momentum and energy conservation relations give:

$$\hbar\omega + \frac{p^2}{2m} = \hbar\omega_s + \frac{(p + \hbar(\vec{k} - \vec{k}_s))^2}{2m} \quad (2.13)$$

$$\Rightarrow \delta = \frac{k\theta p_y}{m} \quad (2.14)$$

where m is the atomic mass and p_y is the y -component of initial momentum \vec{p} .

The population of atoms with a momentum \vec{p} can be considered to follow a Maxwell Boltzmann distribution $\pi(\vec{p})$. As generally, $\pi(\vec{p})$ is different from $\pi(\vec{p} + \hbar(\vec{k} - \vec{k}_p))$ and the two processes compete and give rise to signal gain or signal-loss:

- (1) When $\delta < 0$, $p_y < 0$ (fig. 2.5(a)), an absorption from the pump channel and an emission in the signal one, takes an atom with an initial momentum with a y -component $p_y = -|p|$ to $p_y = -|p + \hbar k\theta|$. The reverse process takes one atom from $p_y = -|p + \hbar k\theta|$ to $p_y = -|p|$. As, $\pi(-|p|) > \pi(-|p + \hbar k\theta|)$. These processes lead to an amplification of the signal field.
- (2) When $\delta > 0$, $p_y > 0$ (fig. 2.5(b)), an absorption from the signal channel and an emission in the pump one takes an atom with an initial momentum with a y -component $p_y = |p|$ to $p_y = |p + \hbar k\theta|$. The reverse process takes

one atom from $p_y = |p + \hbar k\theta|$ to $p_y = |p|$. As $\pi(|p|) > \pi(|p + \hbar k\theta|)$: the result is a loss for the signal field.

This physical picture qualitatively describes the characteristic signal transmission spectrum for RIR, as a function of the pump-signal detuning. In the case of a simple two level atom, the gain of a signal is given by [Shen, 1984]:

$$g(\delta) = \frac{\Omega^2 \Omega_p}{\Delta^2} \frac{\gamma(\pi[g] - \pi[e])}{\gamma^2 + \delta^2} \quad (2.15)$$

where $\pi[e]$ and $\pi[g]$ are the initial populations of the excited level (e) and ground level (g), Ω and Ω_p are the Rabi frequencies for the pump and signal fields respectively Δ is the optical detuning, and γ is decay rate of the population relaxation rate.

Considering the contribution of several atoms with a momentum p_y for the ground state and $(p_y - \hbar k\theta)$ for the excited state, we have a Lorentzian gain around $\delta = k\theta p_y/m$ (eq. (2.14)). For a group of atoms, the total gain can then be integrated over all the momentum classes [Courtois, Grynberg, Lounis, and Verkerk, 1994]:

$$g(\delta) = \frac{\Omega^2 \Omega_p}{\Delta^2} \int dp_y \frac{\gamma\{\pi[p_y] - \pi[p_y - \hbar k\theta]\}}{\gamma^2 + (\delta - k\theta p_y/m)^2} \quad (2.16)$$

The integral shown in the above equation (2.16) is dependent on the momentum distribution of the atoms in the medium. We can simplify further, by considering that at any temperature T , the atomic momenta follow a Maxwell-Boltzmann distribution with a mean velocity \bar{v} . Assuming $\gamma \ll k\theta\bar{v}$, the gain in eq. (2.16) can then be simply written as:

$$g(\delta) = -\sqrt{\frac{\pi}{2}} \frac{\hbar \Omega^2 \Omega_p}{\Delta^2 k_B T} \frac{\delta}{k\theta\bar{v}} \exp\left(-\frac{\delta^2}{2(k\theta\bar{v})^2}\right) \quad (2.17)$$

The gain, as a function of the pump-signal detuning δ , has a Gaussian derivative shape, which is characteristic of RIR. Its width is linked to the mean velocity of the atomic system which is a signature of the medium's temperature and the distance between the peaks is $2k\theta\bar{v}$. In fig. 2.6 I show typical RIR gain spectra for three different temperatures. The flat line corresponds to room temperature spectrum, thus showing impossibility of RIR detection with hot atoms.

The signal transmission spectra predicted by Guo [Guo, Berman, Dubetsky, and Grynberg, 1992], were soon experimentally verified by Courtois et al. [Courtois, Grynberg, Lounis, and Verkerk, 1994] in the one pump configuration.

The signal transmission spectrum, as a function of the pump-signal detuning δ , was observed to fit better to a Gaussian derivative shape (characteristic of RIR, c.f. eq. 2.17) than to a dispersion shape (i.e. Lorentzian derivative). Courtois et al. also proposed this spectrum as an in-situ nondestructive temperature measurement of a cold atomic cloud, soon experimentally realized by Meacher et al. for cesium atoms [Meacher, Boiron, Metcalf, Salomon, and Grynberg, 1994]. Recently Wang et al. has implemented the same for cold Rubidium [Wang, Deng, and Wang, 2015].

2.3.2 RIR with counterpropagating pump beams

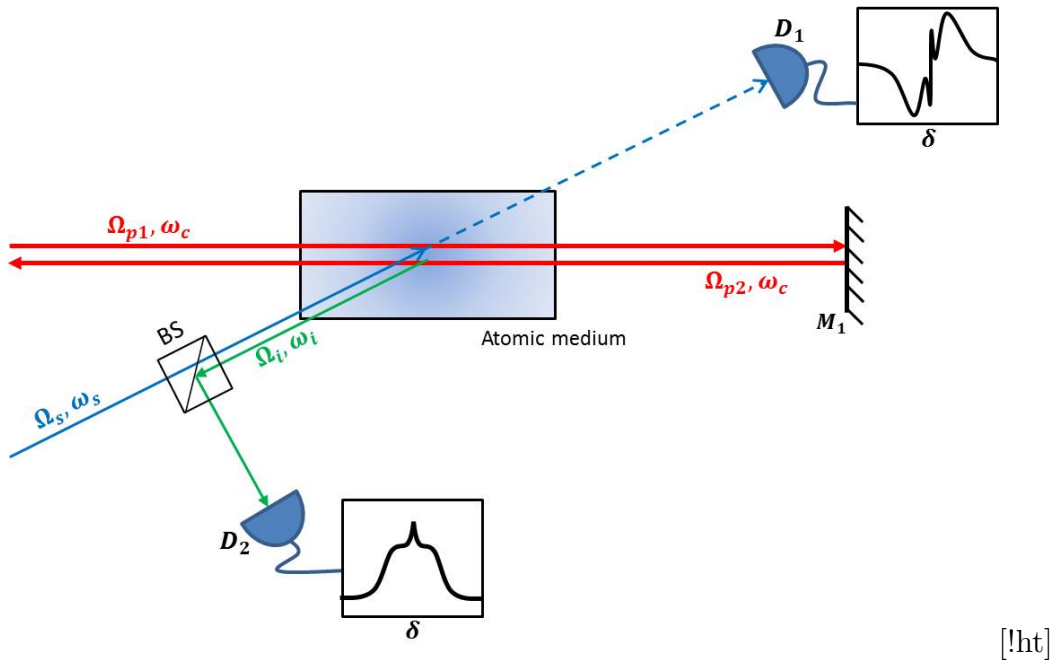

FIGURE 2.7: Three optical fields interact with an atomic cloud : in thick red, the coupling beam, of Rabi frequency Ω_{p1} is retro-reflected from the mirror M_1 to create the coupling beam 2, of Rabi frequency Ω_{p2} . In thin blue line, the incident signal beam of Rabi frequency Ω_s have an angle θ with the first pump beam. The exiting signal beam (in dotted blue line) is detected by the photo-diode D_1 . The idler beam (in thin green line) created through the four wave mixing process, is detected, after reflection from the beam-splitter BS , by the photodiode D_2 .

We consider the case of two counterpropagating pump beams, described in fig. 2.7. In such a set-up, a four wave mixing process allow the generation of a phase-conjugate (p.c.) field counterpropagating to the signal with a frequency $\omega_p - \delta$. Generation of such a backward p.c. field is well studied theoretically [Ducloy, Oliveira, and Bloch, 1985] and experimentally [Oria, Bloch, Fichet, and Ducloy, 1989]. Here, we want to observe a p.c. generation due to the recoil induced nonlinear interaction between the light and atoms.

The photodiode D_2 in fig. 2.7 detects the phase-conjugate (p.c.) beam intensity, after reflection from the beamsplitter BS . We are interested in the intensity of the generated p.c. field as a function of the pump-signal detuning δ , which will be called phase conjugate generation spectrum.

For the transmission, this scenario can be thought of a superposition of two “one pump” cases:

- (1) RIR between the forward pump beam with a wave-vector \vec{k}_P and the signal beam with a wave-vector \vec{k}_s .
- (2) RIR between the retroreflected pump beam with a wave-vector $-\vec{k}_P$ and the signal beam with a wave-vector \vec{k}_s .

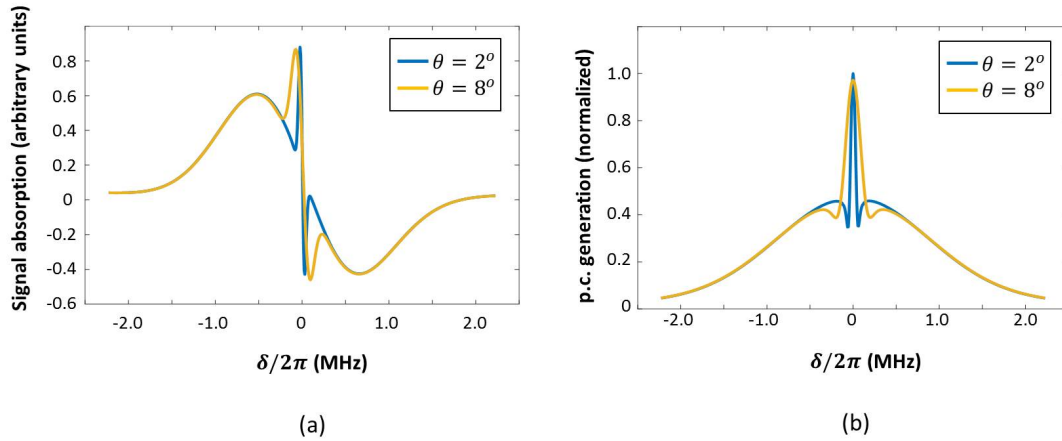

FIGURE 2.8: Theoretically obtained (a) transmitted signal intensity and (b) generated phase conjugate field intensity as a function of pump-signal detuning δ for a temperature $T = 300\mu K$, $\Gamma/2\pi = 6MHz$, $\Delta/2\pi = 30MHz$, $\gamma_t = 1kHz$. The blue line corresponds to an angle $\theta = 2^\circ$ and the yellow line to an angle $\theta = 8^\circ$.

It can be deduced from the scheme with one pump that these two cases will contribute to the signal transmission spectrum in the two pump configuration : the case (1) gives a sharp feature with a width $(2|\vec{k}_P - \vec{k}_s|v)$ and the case (2) gives a wide feature with a width $(2|-\vec{k}_P - \vec{k}_s|v)$.

As mentioned above, a phase conjugate field is also generated. It arises from the third order non-linear interaction between the two counterpropagating pump and signal fields in the atomic medium. A similar combination of sharp and wide features is also seen for the phase conjugate generation spectrum arising from similar considerations. Fig. 2.8 shows these two features for both the signal transmission and phase conjugate generation for two different angles : increasing the angle increases the width of the central sharp feature, whose width is given

by $2k\bar{v}\theta$, but the broad one, whose width is given by $2k\bar{v}$, remains the same. Experimentally, the two features have been well observed in one dimensional optical lattice [Brzowska, Brzowski, Zachorowski, and Gawlik, 2006] and in a magneto optical trap [Brzowski, Brzowska, Zachorowski, Zawada, and Gawlik, 2005].

A more rigorous development to show the effect of atomic recoil on light-atom interaction is presented in chapter 4, together with an extension and a discussion in the frame of the experiments performed in Jose Tabosa's group.

Chapter 3

PSA in metastable Helium

Contents

3.1	Experimental Set-up	53
3.1.1	Metastable Helium setup	53
3.1.2	Polarization selection of Lambda scheme	56
3.1.3	Set-up	57
3.2	Observations and Data-processing	59
3.2.1	Phase Sensitive Amplification	59
3.2.2	Input Phase measurement	60
3.2.3	Output phase and Gain	62
3.2.4	PSA Characterization	65
3.2.5	Comparison with Phase Insensitive Amplification	65
3.3	Theoretical Formulation	67
3.4	Noise Properties	71
3.4.1	Setup	73
3.4.2	Experimental results	73
3.4.3	Heterodyne detection	75

In this chapter I present the atomic system, the experimental set-up and observations, and I explain the algorithms and methods employed to analyse the obtained data.

3.1 Experimental Set-up

3.1.1 Metastable Helium setup

Helium is the second element in the periodic table and second most abundant atom in the universe. Due to its simple electronic level structure, helium has

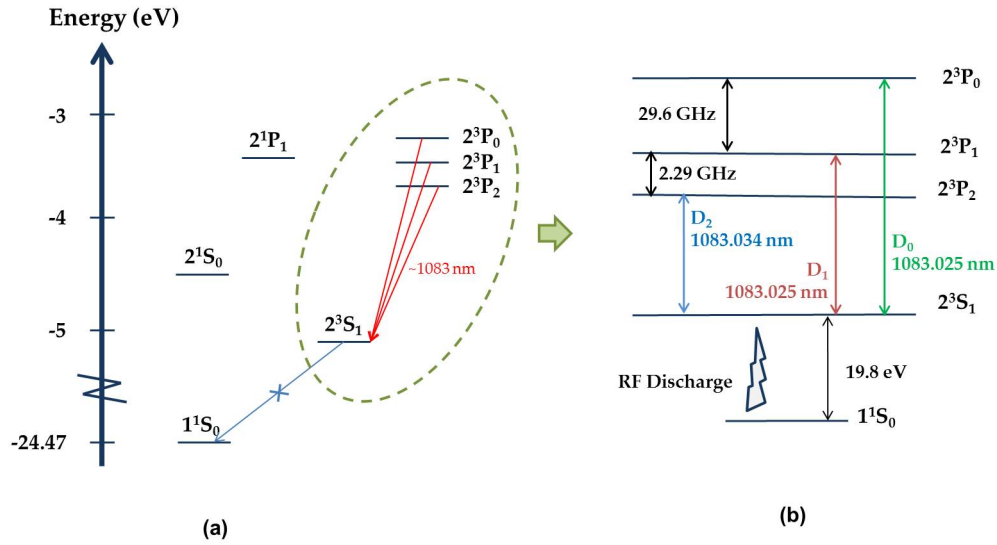

FIGURE 3.1: First energy levels in Helium. The 2^3S_1 state is the metastable state, which does not decay to the ground state 1^1S_0 due to spin-flip. This metastable state, which is 19.8 eV away from the 1^1S_0 ground state, is populated by an RF discharge: the optical transitions from 2^3S_1 to 2^3P_0 , 2^3P_1 and 2^3P_2 are called D_0 , D_1 and D_2 respectively.

been studied and used for its non-linear optical properties [Bishop and Lam, 1988], in cooling via photoassociation [Leduc and Cohen-Tannoudji, 2010] or as Rydberg systems [Schulz et al., 1996]. In our group, a room temperature helium gas cell is used to study coherent atom-photon interactions.

We use the metastable 2^3S_1 state of helium, which is nearly 20 eV away from the 1^1S_0 ground state (see fig. 3.1). Because the transition $1^1S_0 \leftrightarrow 2^3S_1$, require a spin change, which is not optically allowed, atoms in the 2^3S_1 state can not decay by spontaneous emission : it has a very long lifetime (~ 8000 s [Hodgman et al., 2009]), and is said to be metastable (He^*).

Important parameters for 2^3P Level	
2^3S_1 to 2^3P Saturation Intensity	0.16 mW/cm ²
Doppler half width half maxima (at T=300K) W_D	$2\pi \times 0.85$ GHz
Optical Coherence Decay rate (at 1 Torr, 300K) Γ	1.4×10^8 s ⁻¹
Population relaxation rate (Γ_0)	$2\pi \times 1.63$ MHz
Zeeman splitting in 2^3S_1 state	349 kHz/G

The helium gas is stored in a 2 cm \times 6 cm cylindrical glass-cell, at a pressure of 1 Torr, surrounded by two electrodes so that it is possible to switch on an RF discharge of frequency 27 MHz across the cell. The discharge creates a plasma and collisions of the helium atoms with the electrons and ions of the

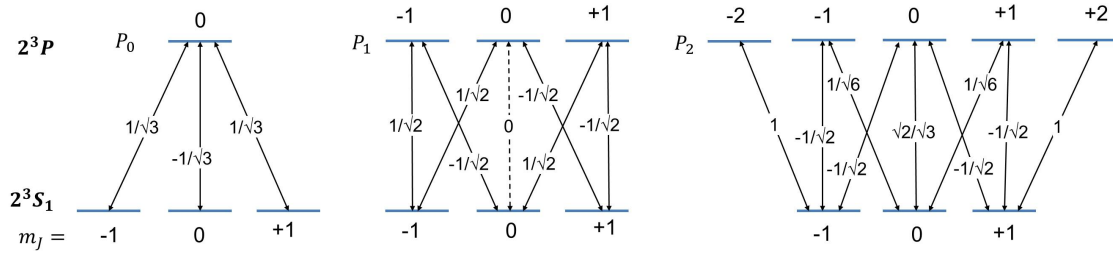

FIGURE 3.2: Clebsch Gordon coefficients of the D_0 , D_1 , D_2 transition lines. The dotted line is a forbidden transitions.

plasma then excite a fraction of them in the metastable state. We could create a density of $\sim 10^{11}\text{cm}^{-3}$ of metastable helium atoms, which is the expected order of magnitude, compared to density of $\sim 10^{17}\text{cm}^{-3}$ ground state He atoms in the cell which act as a buffer gas [Nersisyan, Morrow, and Graham, 2004].

We are interested in the transition from the metastable 2^3S_1 state to the 2^3P excited states. The state 2^3P , with $S=1$ and $L=1$, has a fine structure due to LS coupling : the total angular momentum can take three values $J = 0, 1$ or 2 and the three states are denoted as 2^3P_0 , 2^3P_1 and 2^3P_2 (see fig. 3.1). The corresponding transitions from the 2^3S_1 state are called D_0 , D_1 , and D_2 lines, which are separated by 29.6 GHz and 2.29 GHz respectively (see fig. 2.7(b)).

We work with a metastable helium cell at room temperature ($T = 300$ K). The Doppler broadening in these conditions is about 0.9 GHz, which is smaller than the $D_0 \leftrightarrow D_1$ and $D_1 \leftrightarrow D_2$ energy differences : contrary to the alkali atoms, which exhibit hyperfine structures, it is possible to select specific transitions even at room temperatures.

Moreover, atomic collisions do not pose any particular problem because they do not destroy the metastable atoms He^* . Indeed the collisions between a ground-state He atom and a metastable He^* are not depolarizing [Pinard and Laloë, 1980]. In addition, in the presence of optical pumping, the collisions between two metastable atoms He^* do not generate Penning ionization [Shlyapnikov, Walraven, Rahmanov, and Reynolds, 1994]. In fact, the ground state helium atoms behave like a buffer gas, which makes it possible to confine the atoms longer in the beam and thus to lengthen the lifetime of the observed phenomena.

Another effect of collisions is their ability to move one atom from one speed class to another : these are Velocity Changing Collisions (VCC). Due to VCC,

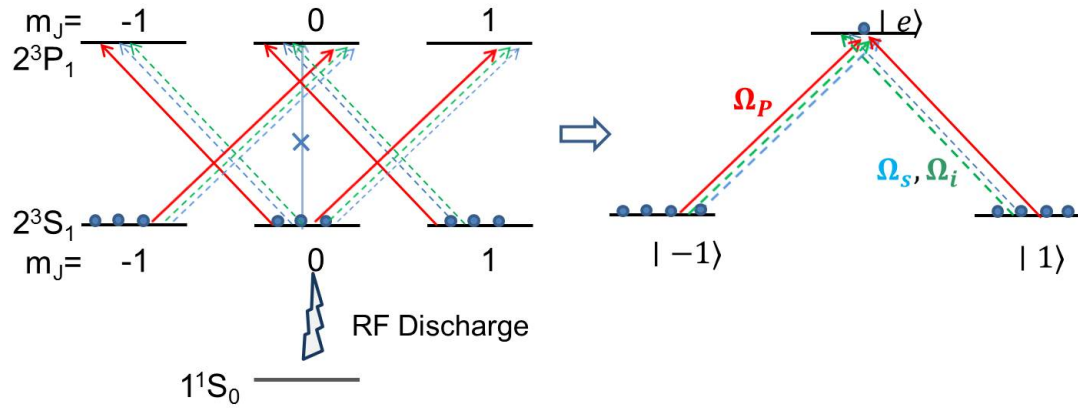

FIGURE 3.3: At left, excited transitions of the D_1 line for linear and orthogonally polarized coupling (strong, thick red solid lines) and signal and idler (weak, thin dashed blue and green lines) fields. As the $m = 0 \rightarrow m = 0$ transition is forbidden, after a few cycles of optical pumping, the effective population is distributed between the $m = \pm 1$ ground states as shown on the right.

the optical pumping applied on a spectral range limited to some MHz can be distributed over all the Doppler range of GHz [Goldfarb et al., 2008]. It has to be noticed that we always work with copropagating laser beams, so that two-photon-resonances can be achieved for all velocity classes for the same laser detunings.

3.1.2 Polarization selection of Lambda scheme

The Zeeman sublevels for the D_0 , D_1 and D_2 , along with their corresponding Clebsch-Gordon coefficients are shown in fig. 3.2 [Zelevinsky, 2004].

For most of our experiments we concentrate on the D_1 transition. Both the ground state (2^3S_1) and the excited state (2^3P_1) are triplet states, hence they both have three Zeeman substates corresponding to $m_J = -1, 0, +1$ (see fig. 3.3).

For a field propagating in the z-direction, the linear polarization unit vectors \vec{x} and \vec{y} can be decomposed into a right-circularly polarized ($\vec{\sigma}_+$) and a left circularly polarized ($\vec{\sigma}_-$) components (or vice-versa):

$$\begin{cases} \vec{\sigma}_+ = \frac{\vec{x} - i\vec{y}}{\sqrt{2}} \\ \vec{\sigma}_- = \frac{\vec{x} + i\vec{y}}{\sqrt{2}} \end{cases} \quad \begin{cases} \vec{x} = \frac{\vec{\sigma}_+ + \vec{\sigma}_-}{\sqrt{2}} \\ \vec{y} = \frac{\vec{\sigma}_- - \vec{\sigma}_+}{i\sqrt{2}} \end{cases} \quad (3.1)$$

One linearly polarized (\vec{x} or \vec{y}) field will thus excite both the σ_+ and σ_- transitions. As the $m_s = 0$ to $m_s = 0$ transition is forbidden for levels with the same total angular momentum, the $m_s = 0$ ground state is empty after a few pumping cycles. The $m = \pm 1$ excited levels can then be neglected. We thus end up with the Λ system shown in fig. 3.3, where both transitions are excited simultaneously by the linearly polarized pump, signal and idler fields.

3.1.3 Set-up

The experimental set-up is shown in fig. 3.4. Using a polarizing beamsplitter, the laser beam is divided into two arms: one for the pump beam, and the other for the signal and idler ones, which are thus orthogonally polarized to the pump field polarization.

The frequencies and amplitudes of the coupling and signal-idler fields are controlled by two acousto-optic modulators ($AO_{s,i}$ and AO_c) driven by an RF arbitrary waveform generator (AWG). As it is important to have beams with identical spatial modes, we have used successively pin-holes and single mode fibers as spatial filters. We have finally chosen the latter one, which was more robust. Throughout the experiment, the power of the incident signal-idler beam was kept around $30 \mu W$ with a beam diameter of 3 mm giving rise to an average intensity of about $0.4 mW/cm^2$. Though this is more than the saturation intensity, we must consider reflectivity of the walls of the glass cell which is measured to be $\sim 85\%$ and also the fact that the beam modes are not perfectly Gaussian, so that we underestimate the effective beam diameter. Indeed, we have checked that no saturation could be observed. A tapered amplifier was used on the other path so that the power of the coupling beam could be varied from 10 mW to 70 mW. The input phase difference could be scanned with a piezo-electric actuator on the pump path. A three layer mu-metal shielding around the gas-cell protects the helium atoms from stray magnetic fields.

For phase sensitive amplification, the AWG is used to feed the $AO_{s,i}$ with an RF signal containing two frequencies separated by $\pm\delta$, so that both the signal and idler fields are simultaneously created. The value of δ could be varied from 1 to 500 kHz. In the case of phase insensitive amplification, the $AO_{s,i}$ was fed by only one frequency, detuned from the coupling beam by δ . In the next paragraph, I present the data obtained in typical PSA and PIA conditions, and

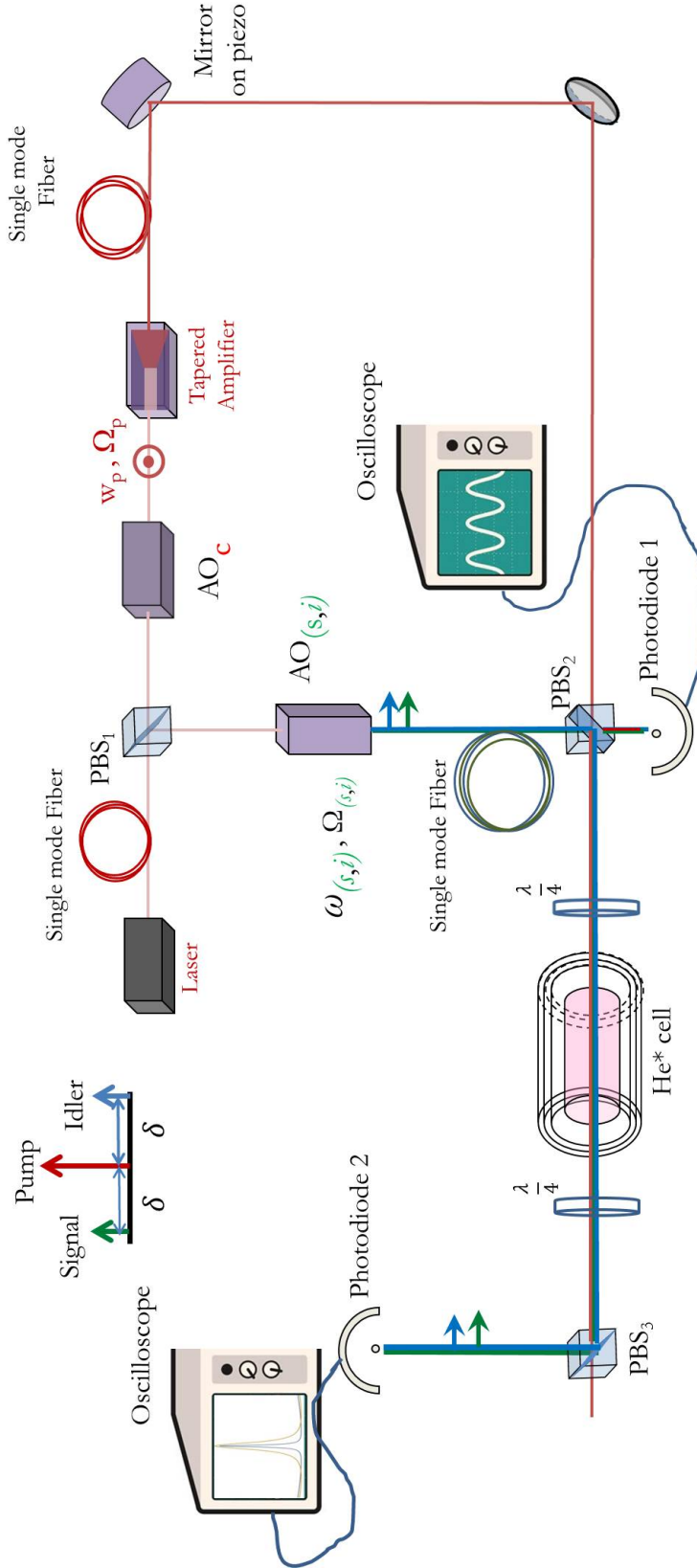

FIGURE 3.4: Set-up used for PSA and PIA experiments: The coupling (in red), signal (in blue) and idler (in green) fields, of optical frequencies $\omega_{c,s,i}$ and Rabi frequencies $\Omega_{c,s,i}$, are produced from the same laser. A polarizing beam-splitter (PBS_1) separates the beam into two linearly and orthogonally polarized beams, that can be controlled using two acousto-optic modulators (AO_c for the coupling and $AO_{s,i}$ for the signal and idler). A tapered amplifier is needed to get coupling powers higher than 20 mW. The signal and idler frequencies are equally spaced from the coupling frequency, as shown in the inset. Single mode fibers are used to select the TEM_{00} mode, before recombination thanks to the PBS_2 . The cell is protected from stray magnetic fields by a 3-layer mu metal shielding. The PBS_3 removes the pump beam before detection by the Photodiode 2. The Photodiode 1 is used to monitor and record the input phase difference between the coupling and signal-idler, which can be scanned using the piezo-electric actuator placed on the coupling arm.

discuss how to analyze and interpret the data.

3.2 Observations and Data-processing

3.2.1 Phase Sensitive Amplification

The figure 3.5 shows an example of the gain and the relative output phase $\Delta\phi_{out} = 2\phi_c - \phi_i - \phi_s$, as a function of the relative input phase $\Delta\phi_{in} = 2\phi_c - \phi_i - \phi_s$, where $\phi_{c,i,s}$ are the phases of the coupling, idler and signal beams respectively. The detuning δ between the coupling and probe beams was set to 2 kHz, and the powers were 30 mW and 30 μ W respectively. The coupling field was at the center of the D_1 Doppler broadened transition. This configuration allowed to optimize the amplification process.

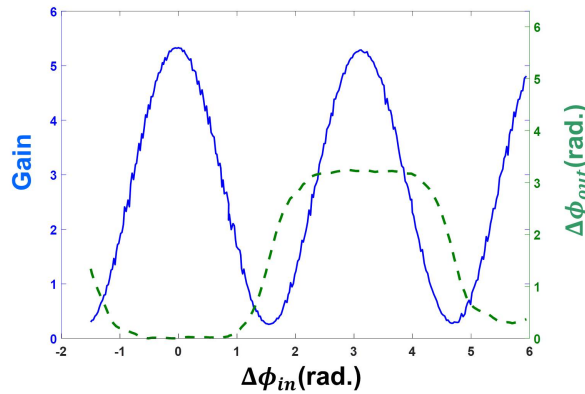

FIGURE 3.5: In blue, variation of the signal-gain as a function of the input relative phase $\Delta\phi_{in}$ between the signal-idler and coupling beams. In green, the phase transfer function, $\Delta\phi_{out}$ vs $\Delta\phi_{in}$ exhibits a distinctive square wave form. The detuning between the probe beams and the coupling was set to be 2 kHz, and their powers were 30 mW and 30 μ W respectively.

The input field intensities and relative input phases $\Delta\phi_{in}$ could be obtained from the data recorded by the photodiode 1 before the cell, and the gains and relative output phases $\Delta\phi_{out}$ from the data recorded from the photodiode 2 after the cell (c.f. fig. 3.4). We obtain here a maximum gain $G_{max} \simeq 5.4$ and a minimum gain $G_{min} \simeq 0.3$ which is close to $\frac{1}{G_{max}} \simeq 0.2$. The gain is maximum for $\Delta\phi_{in} = 0.12[\pi]$ rad. The output phase varies by steps : it is either 0 or π except when the gain is minimum. We could later achieve higher gains, close to 8.

In the following sections, I explain the data-analysis process that allowed us to extract these informations from the raw data.

3.2.2 Input Phase measurement

The input relative phase at the entrance of the cell is deduced from the intensity beats of the coupling, signal and idler beams recorded through the other port of the polarizing beam splitter PBS₂, which goes to the photodiode 1 (see fig. 3.4). The fig. 3.6(a) shows a typical signal that can be observed on the oscilloscope. The relative phase is slowly varied with the piezo-actuator: a 2π radian scan takes typically 2.5 s, so that the blue and orange signals plotted here on a scale of some ms can be considered to correspond to given and constant phases.

If the detuning between the coupling and the signal (idler) beams is +δ (−δ) and if the signal and idler beams have the same phase (which can be taken to be the phase reference, equal to 0), the intensity recorded by the photodiode 1 can be written as:

$$I_1(t) = I_c + I_s + I_i + \alpha\sqrt{I_c I_s}\cos(\delta t + \phi_t^{in}) + \alpha\sqrt{I_c I_i}\cos(\delta t - \phi_t^{in}) + 2\sqrt{I_s I_i}\cos(2\delta t) \quad (3.2)$$

where $I_{c,s,i}$ are respectively coupling, signal and idler intensities and ϕ_t^{in} is the phase of the coupling beam at the input, which is constant for one frame. α is the contrast factor, which depends on the alignment. Ideally, if the modes were exactly matched, the value of α could be 2. For one experiment, the α factor can be extracted from the difference of the maximum and minimum values of $I_1(t)$, which correspond to $I_c + I_s + I_i \pm \alpha(\sqrt{I_c I_s} + \sqrt{I_c I_i})$, which correspond to $\phi_t^{in} = 0$ and the $\phi_t^{in} = \pi$, so that [Maynard, 2016]:

$$I_{max} - I_{min} = 2\alpha(\sqrt{I_c I_s} + \sqrt{I_c I_i}) \quad (3.3)$$

Experimentally, we could get $\alpha \approx 1.8$.

When the signal and idler have equal intensities, the equation (3.2) is reduced to:

$$I_1(t) = I_c + 2I_s + 2\alpha\sqrt{I_c I_s}\cos(\delta t)\cos(\phi_t^{in}) + 2I_s\cos(2\delta t) \quad (3.4)$$

As we can record the coupling level and the signal-idler beating separately, it is possible to extract the factor $\alpha\cos(\phi)$ from a series of datasets recorded as

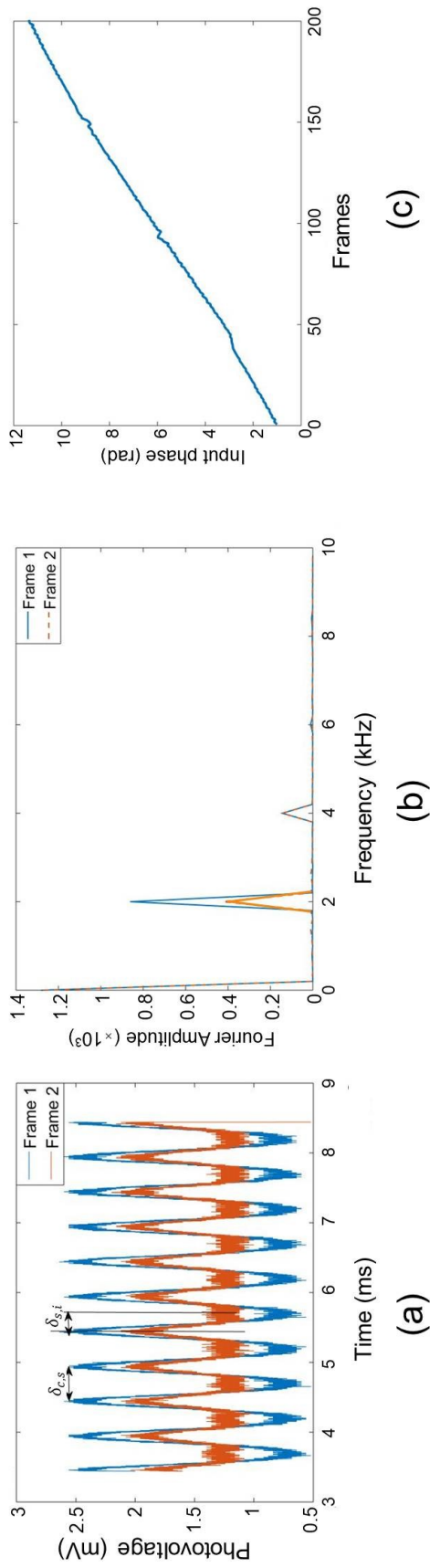

FIGURE 3.6: (a) two different frames recorded at two different times. For each frame, the phase ϕ_{in} is considered constant, as the piezo actuator scans about 1.2×10^{-5} rad in 5ms. (b) Fourier components of both frame of the figure (a): the component at $\delta = 2kHz$ varies, while the component at 2δ , which corresponds to the beats between the signal and the idler, remains constant, as expected. (c) extracted and unwrapped input phase as a function of the recorded frames. These frames are recorded simultaneously with the data obtained by the photodiode 2 at the output of the cell, so that the input phase can be used as the x-axis for the fig. 3.5. The unwrapping process is detailed in the appendix B.1.

movie frames (see Appendix B).

We analyze the Fourier transform of the data, and compare the different frequency components as shown in fig. 3.6(b). The δ frequency part varies much faster than ϕ_t^{in} . When ϕ_t^{in} varies, the height of the peak at frequency δ ($= 2$ kHz here) varies, while the height of the one at frequency 2δ is constant, as expected from the eq. 3.4.

It is then possible to measure ϕ_t^{in} in a range from 0 to π radians: an unwrapping process, detailed in the appendix B.1, then makes it possible to extract the linear scan shown in the fig. 3.6(c).

3.2.3 Output phase and Gain

The output phase and gain are deduced from the data recorded by the photodiode 2, placed after the cell (see fig. 3.4). The beamsplitter PBS₃ allows to efficiently get rid of the strong coupling. For data processing, one dataset of one frame is recorded without any coupling (a typical data is shown in fig. 3.7(a)) and one dataset as movie frames : in this second case, while the input phase ϕ_t^{in} is slowly varied : the amplitude of the beating thus changes from one frame to the other (c.f. fig. 3.7(b)&(c)).

The output intensities of the coupling, signal, and idler beams are denoted respectively as I_c^{out} , I_s^{out} and I_i^{out} . As initially the signal and idler fields are both detuned by δ from the coupling frequency and have the same input intensities $I_s = I_i$, the gain on both channels are the same: $I_s^{out} = I_i^{out} = G.I_s$ where the factor G is the intensity gain.

Let us assume the output coupling phase to be ϕ_t^{out} with respect to the signal and idler phase (which are the same). Following eq. (3.4), the output intensity I_2 detected by the photodiode 2 at a time t is given as:

$$I_2(t) = I_c^{out} + 2I_s^{out} + 2\alpha\sqrt{I_c^{out}I_s^{out}}\cos(\delta t)\cos(\phi_t^{out}) + 2I_s^{out}\cos(2\delta t) \quad (3.5)$$

The output phase variation, i.e. ϕ_t^{out} as a function of the frame count, is then extracted following the same procedure as the one used for the input phase ϕ_t^{in} .

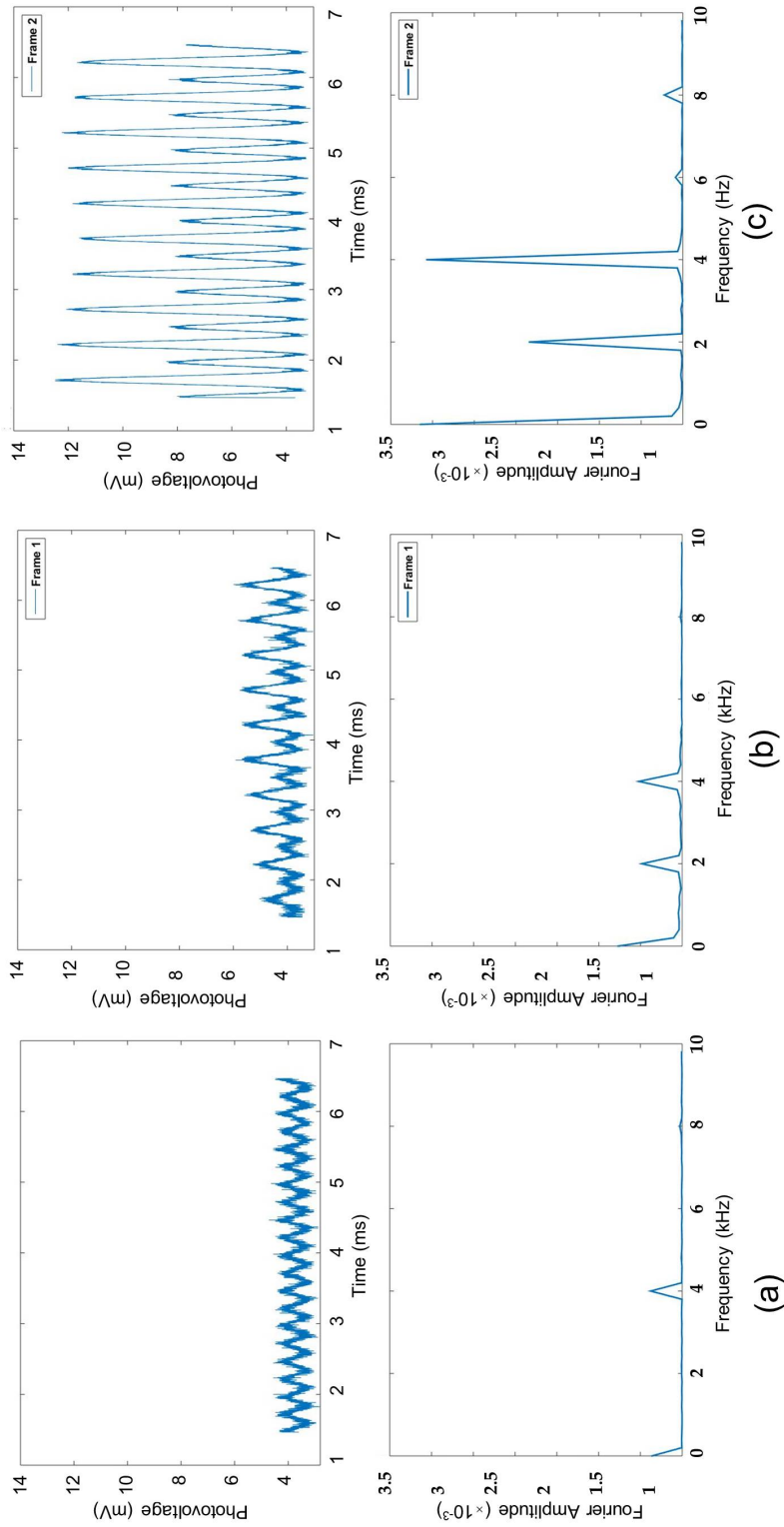

FIGURE 3.7: the three columns show three data-frames (above) and their corresponding Fourier transforms (below): (a) for the probe-alone, cell-off case, (b) for a small gain ($G=1.2$) and (c) for a high gain ($G=6.5$). In the case (a), the Fourier transform exhibit a single peak at $2\delta = 4\text{kHz}$. In the case (b), the Fourier components at $\delta = 2\text{kHz}$ and $2\delta = 4\text{kHz}$ are visible. In the case (c), higher frequencies are also generated.

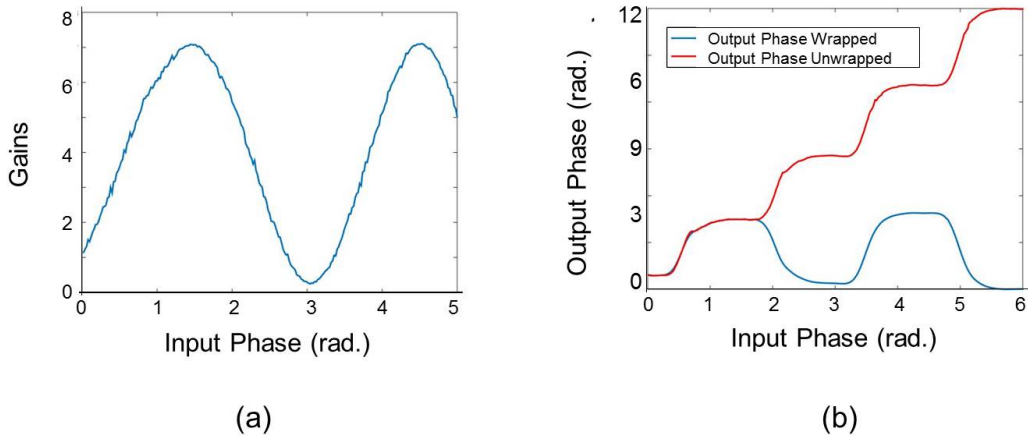

FIGURE 3.8: (a) gain observed as a function of relative input phase ϕ_t^{in} : a maximum gain of 7.1 and minimum gain of 0.22 is achieved, for a coupling power of 45mw and pump-probe detuning $\delta = 2\text{kHz}$. (b) Output phase as a function of ϕ_t^{in} (in blue), and unwrapped (in red).

The signal intensity is recorded at the photodiode 2 without the PSA. We can obtain the gain by comparing the 2δ component of the Fourier transform of a frame recorded with just the probe and cell off, with each PSA frames (see fig. 3.7).

The gain and the output phases can then be plotted as a function of the input phase, which is recorded simultaneously. The fig. 3.8 give an example of such plots, obtained with probe and coupling input powers of $30 \mu\text{W}$ and 45mW respectively, and $\delta = 2\text{kHz}$. The gain has then a maximum value of $G_{max} \approx 7.1$ and a minimum value of $G_{min} \approx 0.22$ which is close to $1/G_{max} \approx 0.14$. When unwrapped (detail in Appendix A), the output phase shows a very well-defined stair-case behavior, which indicates phase-squeezing [Lundström, Tong, Karlsson, and Andrekson, 2011]. It should be noticed that such a vocabulary, coming from the telecommunication community, does not indicate that quantum squeezing is achieved. Phase squeezing is interesting for telecommunication applications because it can be used for signal regeneration. Indeed, with encoding protocols such as phase-shift keying (PSK), fiber-optic transmission deteriorates the signal quality, which can be regenerated with the help of phase-squeezing.

3.2.4 PSA Characterization

The fig. 3.9(a) shows the dependence of the PSA gain on the pump power with $\delta = 2kHz$. The maximum gain of about 6 is obtained for a coupling power of about 30 mw with a beam diameter of 3 mm, which corresponds to an averaged intensity of $\sim 0.4W/cm^2$. We observe a saturation in the gain, which is probably due to the limited number of He^* atoms interacting with the beam, which is about $10^{11}atoms/cm^3$. After 45 mW, there is a decrease of G_{max} which might be due to higher order nonlinear processes or residual absorption by the D_2 line. We have later been able to observe $G_{max} \approx 8$, thanks to a more optimized beam shape and power.

In fig. 3.9(b) the maximum and minimum gains are plotted as functions of the pump-probe detuning δ for a pump power of 40mW. The gain is observed to be maximum closer to the degenerate condition, i.e. when the signal and idler fields have the same frequency as the coupling, which is resonant on the D_1 transition. The fact that $G_{min} \sim 1/G_{max}$ is the signature of a very good PSA, without extra unwanted processes, which would compete with the FWM phenomenon. The mismatch in the experimental outcomes is attributed to slight misalignments and absorption effects when δ is increased.

3.2.5 Comparison with Phase Insensitive Amplification

It is interesting to compare these results to PIA, when the signal is sent without any input idler. As the PIA gain does not vary with the pump-probe phase difference ϕ_{in} (see eq. 3.6), the signal processing is much easier. The details are given in Appendix A.

For a PIA experiment, performed with the same experimental parameters as the corresponding PSA experiment, the PIA gain g is theoretically related to the PSA gain G as (sec.1.3):

$$\begin{aligned} G(\Phi) &= 2g - 1 + 2\sqrt{g(g-1)}\cos(\Phi) \\ \Rightarrow g &= \frac{1}{4}(2 + G_{max} + G_{min}) \end{aligned} \quad (3.6)$$

The second row in fig. 3.9 shows experimental PIA gains (g_{exp}) together with experimental PSA maximum and minimum gains (G_{max} and G_{min}) and the value of g , which can be calculated from them. Fig. 3.9(c) compares the theoretical and experimental PIA gains as a function of pump powers at $\delta =$

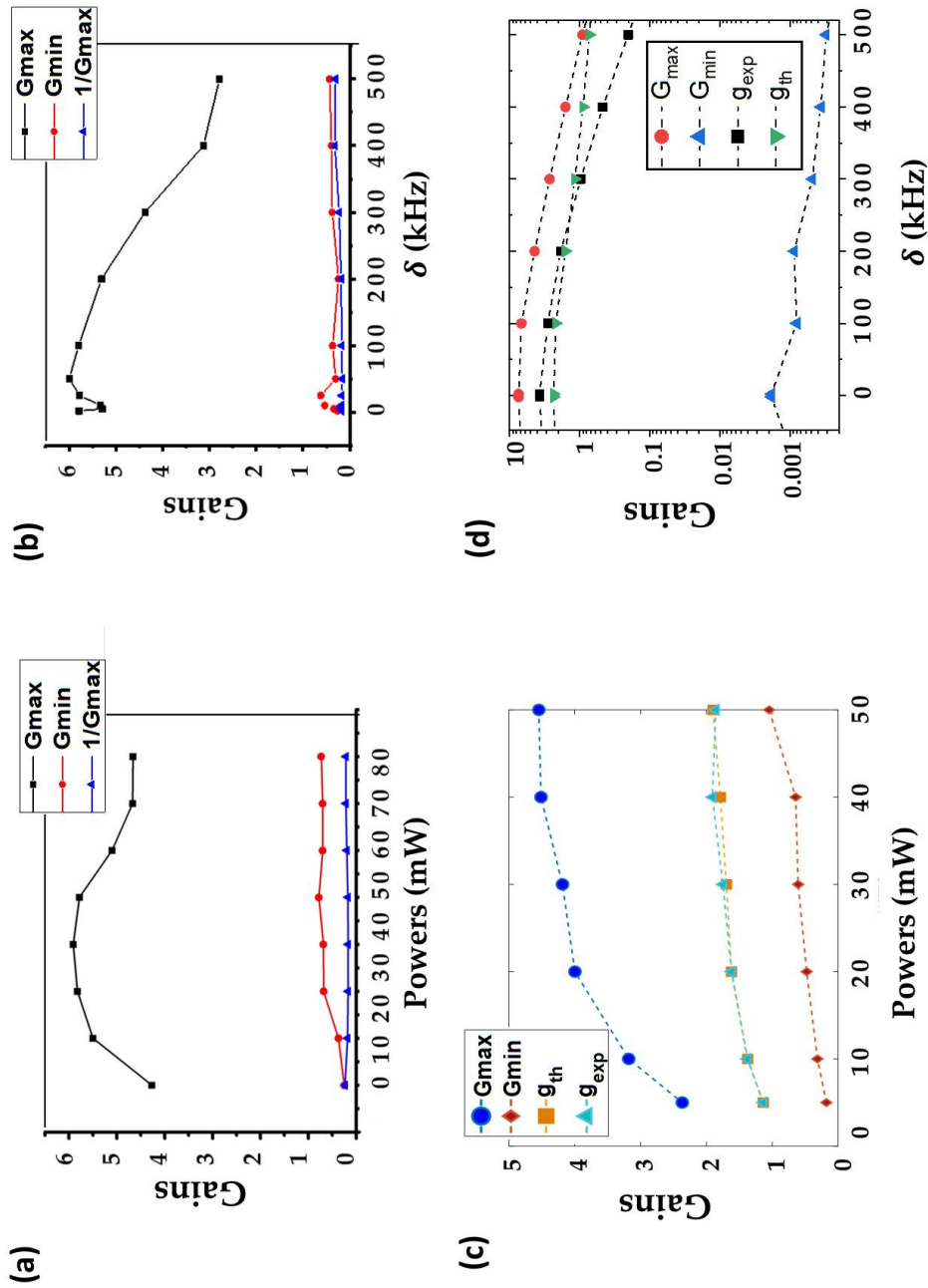

FIGURE 3.9: (a) Dependence of the PSA gain on the pump-power for $\delta = 2\text{kHz}$. (b) Dependence of the PSA gain on the pump-probe detuning δ for a pump power of 40mW. (c) PSA maximum and minimum gains G_{max} and G_{min} compared to the experimentally observed PIA gain (g_{exp}) and the calculated one from the PSA data (g_{th}) as a function of varying powers and fixed pump-probe detuning $\delta = 2\text{kHz}$, and (d) as a function pump-probe detuning δ for a pump power of 50 mW. The g_{th} is the expected PIA gain, obtained from the corresponding G_{max} and G_{min} PSA values (eq. 3.6). For all the data points shown here, we have used a non-degenerated signal-idler scheme, where the frequencies of the signal and idler beams are respectively $\omega + \delta$ and $\omega - \delta$ and the coupling frequency ω is resonant with the D_1 transition.

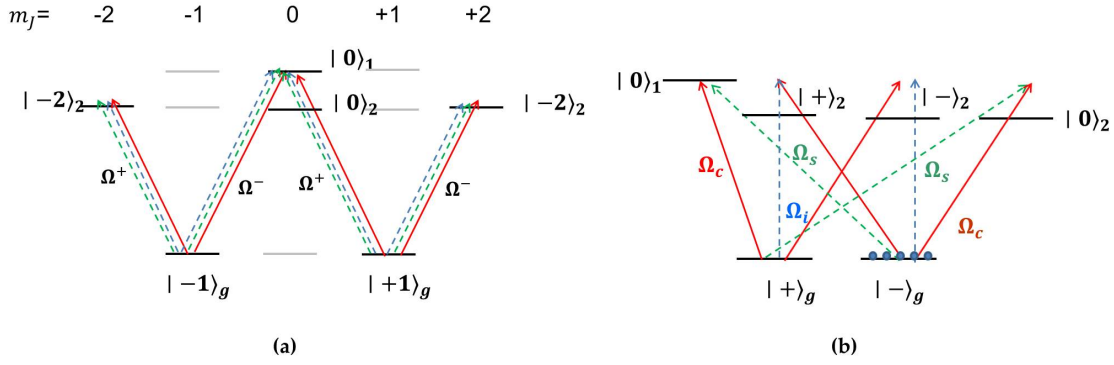

FIGURE 3.10: Relevant states necessary for PSA modelization in He^* . The thick red line shows the transitions coupled by the pump field, and the thin dashed lines denote the same for the signal and idler fields respectively. The relevant Zeeman states are shown in prominent black lines, and are labeled using their m number. The 2^3S_1 , 2^3P_1 and 2^3P_2 are denoted with subscripts $g,1$ and 2 respectively.

$2kH z$. They almost overlap perfectly, which confirms the absence of processes competing with the PSA. On right, fig. 3.9(d) shows these gains as a function of δ . It is clearly visible that beyond $\delta = 300kH z$, they do not match. This can be understood by the fact that there is more absorption when δ is increased, so that G_{min} is less than $\frac{1}{G_{max}}$.

3.3 Theoretical Formulation

In this section, I briefly discuss the theoretical basis of the phase sensitive amplification in the metastable helium system. I explain how CPT can lead to such a good PSA process, almost free from extra non-linear phenomena. This part of the project has been mainly carried out by Pascal Neveu [Neveu et al., 2018], and will thus be covered in detail in his thesis.

In the section 3.1.2, I have explained how a Λ -system could be selected by polarization from the D_1 transition. Nevertheless, it was assumed that the D_1 and D_2 lines are far enough so that the influence of the 2^3P_2 levels can be neglected. But in reality, the Doppler width is about 0.9 GHz, whereas the optical detuning between the transitions is about 2.29 GHz. Indeed combined with the CPT effect occurring on the D_1 , which suppresses its linear absorption, the D_2 transition can give rise to efficient multiphoton four wave mixing channels.

For the Λ -system, the relevant ground states are $| \pm 1 \rangle_g = | 2^3S_1, m = \pm 1 \rangle$ and the excited state is $| 0 \rangle_1 = | 2^3P_1, m = 0 \rangle$. If we consider the D_2 transition,

due to selection rules and the fact that only $|2^3S_1, m = \pm 1\rangle$ are populated, the relevant Zeeman sublevels of the 2^3P_2 state are $|\pm 2\rangle_2 = |2^3P_2, m = \pm 2\rangle$ and $|0\rangle_2 = |2^3P_2, m = \pm 0\rangle$ (c.f. fig. 3.10). As the laser is detuned by more than 2 GHz from the D_2 transition, the $|2^3S_1, m = 0\rangle$ ground state can still be neglected, together with the $|2^3P_2, m = \pm 1\rangle$ states.

In the atomic basis $\{|0\rangle_1, |-1\rangle_g, |+1\rangle_g, |0\rangle_2, |-2\rangle_2, |+2\rangle_2\}$, the interaction Hamiltonian H , for fields at resonance with the D_1 transition, is given by:

$$H = \begin{bmatrix} 0 & \Omega^+ & \Omega^- & 0 & 0 & 0 \\ \Omega^{+*} & 0 & 0 & -\frac{\Omega^{+*}}{\sqrt{3}} & \sqrt{2}\Omega^{-*} & 0 \\ \Omega^{-*} & 0 & 0 & \frac{\Omega^{-*}}{\sqrt{3}} & 0 & \sqrt{2}\Omega^{+*} \\ 0 & -\frac{\Omega^+}{\sqrt{3}} & \frac{\Omega^-}{\sqrt{3}} & \Delta & 0 & 0 \\ 0 & \sqrt{2}\Omega^- & 0 & 0 & \Delta & 0 \\ 0 & 0 & \sqrt{2}\Omega^+ & 0 & 0 & \Delta \end{bmatrix} \quad (3.7)$$

where the numerical factors originate from the Clebsch-Gordan coefficients (see fig. 3.2), and Δ is the frequency difference between the D_1 and D_2 lines, and the Rabi frequencies Ω^\pm are expressed in the circular polarization basis. As the coupling and probe fields are linearly and orthogonally polarized, with respective Rabi frequencies Ω_p and Ω_c , the Ω^\pm can be written as:

$$\Omega^\pm = \frac{1}{\sqrt{2}}(\Omega_p \pm i\Omega_c) \quad (3.8)$$

Using the Hamiltonian, described in eq. 3.7, the evolution of the density matrix ρ is given via the optical Bloch equations (OBE):

$$i\hbar\partial_t\rho = [H, \rho] + \mathcal{L}(\rho) \quad (3.9)$$

where \mathcal{L} stands for the non-Hermitian evolution of ρ due to dissipative processes like spontaneous emission (rate Γ_0) or optical coherence decay (rate Γ). The OBE's are solved and used in the Maxwell's equations, to propagate the fields in the medium along z :

$$(c\partial_z + \partial_t)\Omega^\pm = ic\eta \pm \frac{1}{\sqrt{3}} \left(\rho_{0_2\mp 1_g} \pm \sqrt{2}\rho_{\pm 2_2\pm 1_g} - \rho_{0_1\mp 1_g} \right) \quad (3.10)$$

where η is the atom-field coupling coefficient, $\rho_{ij} = \text{Tr}[\rho |i\rangle\langle j|]$, and the numerical factors are given by the Clebsch-Gordan coefficients.

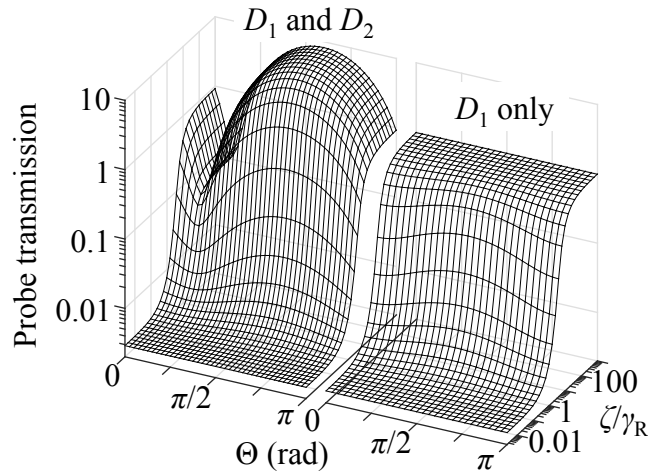

FIGURE 3.11: Simulated probe transmission with (left) D_2 transition and without (right) D_2 transition, for degenerate signal, idler and coupling fields for an optical depth of 2.7. The plotting parameters are Θ (initial relative phase between pump and probe) and the coupling field strength ζ/γ_R . A transmission of 1 is achieved with the D_1 transition only, but it is necessary to take the D_2 into account to observe a probe gain. PSA occurs via the D_2 sublevels as soon as power-broadening factor of the coupling field ζ is larger than Raman coherence decay rate γ_R : CPT can then overpower the absorption. (thanks to P. Neveu)

Figure 3.11 shows the result of the numerical simulations of the probe transmission for the degenerate signal, idler and coupling case, i.e. when the detuning δ is equal to 0. The optical depth is equal to 2.7, which is the experimentally measured value. The coupling strength is represented through the power broadening factor $\zeta = \Omega_c^2/\Gamma$ and Θ is the input relative phase. When the Λ scheme through the D_1 transition is considered alone, we have a maximum gain of 1, and very little input phase dependence is observed. When both the D_1 and D_2 transitions are considered, amplification (gain > 1) is seen and the experimentally observed phase-dependence is reproduced. In both cases, the probe gain increases when the pump power is increased. The CPT phenomenon is efficient when the coupling field strength ζ overcomes the Raman coherence decay rate γ_R between the ground states $|\pm 1\rangle_g$. For $\zeta \ll \gamma_R$, the resonant absorption of coupling forbids any significant multiwave processes. When, $\zeta \gg \gamma_R$, the transparency due to CPT, allows significant four-wave mixing, thus allowing high PSA gain to be observed and a plateau is reached with a gain of about 10.

Lets consider the condition of strong CPT, i.e. $\zeta \gg \gamma_R$. Then, eq. 3.9 and eq. 3.10, under the assumption that the atoms are in steady-state, leads to:

$$\partial_z \Omega_c = \frac{4i\eta}{3\Delta} \Omega_c + \mathcal{O}\left(\frac{\Gamma, \zeta}{\Delta}\right) \quad (3.11)$$

$$\partial_z \Omega_p = \frac{4i\eta}{3\Delta} \frac{2\Omega_p \Omega_c^* - \Omega_c \Omega_p^*}{\Omega_c^*} + \mathcal{O}\left(\frac{\Gamma, \zeta}{\Delta}\right) \quad (3.12)$$

where we will neglect the $\mathcal{O}\left(\frac{\Gamma, \zeta}{\Delta}\right)$. From eq. 3.12, we obtain the following set of solutions:

$$\begin{pmatrix} \Omega_c(L) \\ \Omega_p(L) \\ \Omega_p^*(L) \end{pmatrix} = \begin{pmatrix} e^{i\mu} & 0 & 0 \\ 0 & (1+i\mu)e^{i\mu} & -i\mu e^{i\mu} \\ 0 & +i\mu e^{-i\mu} & (1-i\mu)e^{-i\mu} \end{pmatrix} \begin{pmatrix} \Omega_c(0) \\ \Omega_p(0) \\ \Omega_p^*(0) \end{pmatrix} \quad (3.13)$$

where $\mu = \frac{4\eta}{3\Delta} L$, L being the length of the atomic medium along z direction. It is clearly a PSA transfer matrix of symplectic type [Ferrini et al., 2014]. We can calculate the gain, $G(\Theta) = |\Omega_p(L, \theta)/\Omega_p(0)|^2$. Eq. 3.13 shows that $G(\Theta)$ oscillates between two values G_{max} and G_{min} , given by:

$$G_{max} = 1 + 2\mu(\mu + \sqrt{1 + \mu^2}) = 1/G_{min} \quad (3.14)$$

$$\Theta_{max} = \frac{1}{2} \tan^{-1}\left(\frac{1}{\mu}\right) = \frac{\pi}{2} + \Theta_{min} \quad (3.15)$$

We have neglected $\mathcal{O}\left(\frac{\Gamma, \zeta}{\Delta}\right)$ or higher order terms : indeed their contribution is negligible because they involve multiphoton channels through the D_2 line, which is far detuned. We consider now only channels involving some efficient D_1 transitions due to CPT. To understand the mechanism behind this FWM, it is easier to consider the system in the bright state- dark state basis of the CPT, which are defined as:

$$|\pm\rangle_g = \frac{|+1\rangle_g \pm |-1\rangle_g}{\sqrt{2}} \quad (3.16)$$

Each transition is then coupled by only one field (see fig. 3.10) : the coupling and probe beams excites the transitions $|+\rangle \leftrightarrow |e\rangle$ and $|-\rangle \leftrightarrow |e\rangle$ respectively. We can similarly decouple the D_2 transitions by defining the following two superpositions of states:

$$|\pm\rangle_2 = \frac{|+2\rangle_2 \pm |-2\rangle_2}{\sqrt{2}} \quad (3.17)$$

So that, we have a modified basis set $\{|0\rangle_1, |-\rangle_g, |+\rangle_g, |0\rangle_2, |-\rangle_2, |+\rangle_2\}$. The transitions in this basis are shown in fig. 3.10. Because of the strong CPT, the population is trapped in the dark state $|-\rangle_g$ and the four-wave mixing processes

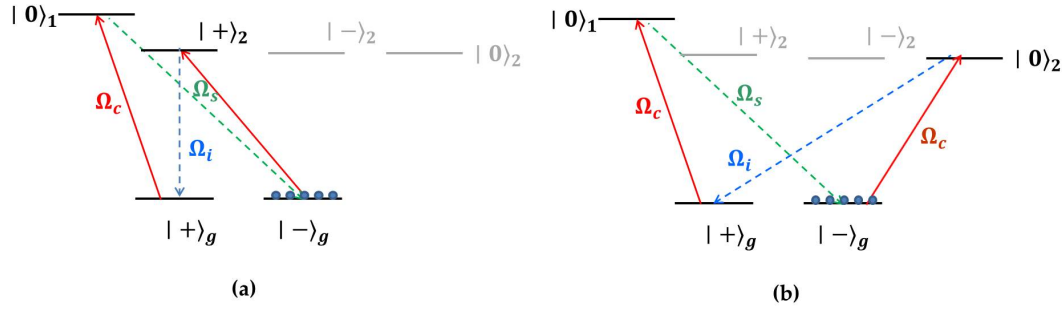

FIGURE 3.12: The two main FWM channels involving D_2 sublevels : (a) via the $|\pm\rangle_2$ and (b) via the $|0\rangle_2$ level. The theoretical model neglects processes involving D_2 sublevels twice.

starting at $|-\rangle_g$ are dominant. Processes involving the D_2 transition more than once can also be neglected, so that the two main FWM channels are (see fig. 3.12):

$$\text{FWM via } |\pm\rangle_2 : |-\rangle_g \xrightarrow{\Omega_c} |+\rangle_2 \xrightarrow{\Omega_p^*} |+\rangle_g \xrightarrow{\Omega_c} |0\rangle_1 \xrightarrow{\Omega_p^*} |-\rangle_g \quad (3.18)$$

$$\text{FWM via } |0\rangle_2 : |-\rangle_g \xrightarrow{\Omega_c} |0\rangle_2 \xrightarrow{\Omega_p^*} |+\rangle_g \xrightarrow{\Omega_c} |0\rangle_1 \xrightarrow{\Omega_p^*} |-\rangle_g \quad (3.19)$$

These two processes, enabled by CPT, correspond to the above transfer matrix, and lead to the high phase dependent amplification that is experimentally observed. In agreement with the plot in fig. 3.9, the fact that the dominant FWM processes start from the dark state $|-\rangle_g$ of CPT implies that when the coupling field amplitude is too weak for CPT to occur, the population is incoherently shared between the ground states and the D_1 line absorption destroys any multiphoton process.

It has to be noted, that there is a remnant absorption from the D_2 , which explains that the transmission is not 100% and the experimentally observed gains are not exactly reciprocals of each other.

3.4 Noise Properties

In section 1.1.4, I have discussed the general scheme for the characterization of the noise properties of a squeezed state of light, with a homodyne detection. In the case of a two mode squeezing with different frequencies a heterodyne detection is needed. I first describe the monomode set-up, usable for degenerate signal/idler vacuum squeezed states. I then explain the heterodyne detection

scheme which can be used for two mode squeezing detection.

3.4.1 Setup

The figure 3.13 shows the experimental set-up schematically.

We use some part of the input pump beam as the local oscillator (LO). The power distribution between the local oscillator and the coupling beam for the PSA experiment is controlled by the half-wave-plate HWP5 in front of the polarizing beamsplitter PBS3. The coupling beam is then mixed with the co-propagating signal and idler beams (probe) via the beamsplitter PBS4, before entering the helium cell. When the discharge is switched on, entangled pairs of signal and idler photons are created from the pump ones through four wave mixing. The output states of the sum and difference of the signal and idler states are squeezed (see sec. 1.4.5). The combination of the half wave plate HWP4 and the polarizer P1 separates the coupling beam and allows only the probe beam to transmit. The beamsplitter PBS2 mixes the probe and the LO. The half-wave plate HWP2 (HWP3) helps to fully transmit (reflect) the probe (LO) beam. the half-wave plate HWP1 is carefully rotated so as to transmit and reflect equal powers from the two output ports of the beamsplitter PBS1, which are then detected by the photodiodes D1 and D2. The photocurrents are electronically subtracted. When the two output ports of PBS1 have the same powers, balanced detection is achieved.

3.4.2 Experimental results

For a homodyne detection, the frequencies of the signal (ω_s), idler (ω_i), coupling (ω_c) and local oscillator (ω_L) are the same. In fig. 3.14, I show experimentally obtained noise power spectral densities observed with an electrical signal analyser (ESA). As the cell is switched off, both the signal and LO fields are assumed to be in a coherent state. We should thus expect a flat line for frequencies above the technical noise frequencies. Unfortunately, it exhibits an increase of noise around 200 MHz, with a width of about 50 MHz, limited by the detector bandwidth.

The laser used for the experiment was a GaAs Bragg reflector laser from Eagleyard which has a bandwidth of 2 MHz, which correspond to a coherence length of about 150 meters. Whereas the path difference of the homodyne experiment is less than some tens of centimeters. The relative coherence time

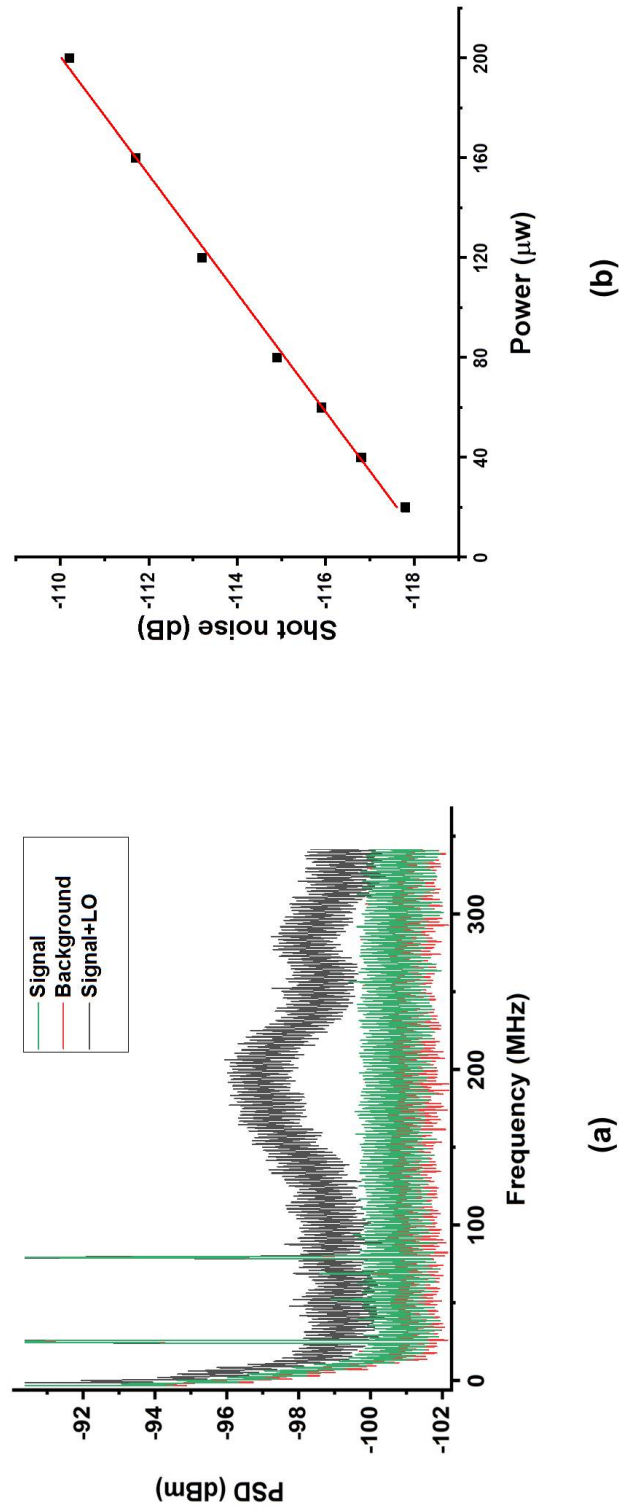

FIGURE 3.14: (a) Experimental noise power spectral densities (PSD) obtained from the balanced detection, in cell off condition: the background PSD with no light (in red), the signal only (in green) and the signal mixed with the LO (in black). As this is for homodyne detection, both the signal and the LO have the same frequency. The black plot shows an increase of noise after 100 MHz. (b) experimental shot-noise for the LO with varying powers. The noise linearly increases with power as expected.

between the LO and signal should be larger than the time-difference needed to follow their beam paths. The high phase noise observed around 200 MHz (fig. 3.14(a)) can be attributed to the fact that the semi-conductor diode laser does not emit a Lorentzian line. We have recently replaced the laser with a new and better Ytterbium based fiber laser from Keopsys. It had arrived in october 2018, so I could not work much with it : new results should be available in the P. Neveu thesis.

3.4.3 Heterodyne detection

I could not realize the heterodyne detection with the previous laser, but I had considered how it could detect the expected two mode squeezing [DeLange, 1968].

For heterodyne detection, we consider a two mode squeezed state, with frequencies $\omega_s = \omega_c - \delta$ and $\omega_i = \omega_c + \delta$ and a local oscillator of frequency ω_L :

$$\omega_L = \frac{\omega_i + \omega_s}{2} = \omega_c$$

where ω_c is the coupling frequency. We thus consider the annihilation operators \hat{A} and \hat{B} of the signal and idler respectively. We then write the total probe (=signal+idler) annihilation operator \hat{a} as:

$$\hat{a} = \hat{A}e^{-i\delta t} + \hat{B}e^{i\delta t} \quad (3.20)$$

The annihilation operator of the total field \hat{a}_{tot} , is given as:

$$\hat{a}_{tot} = \hat{a}_L^{\leftrightarrow} + i\hat{a}^{\uparrow}$$

where \hat{a}_L , as defined in sec. 1.1.4, is the annihilation operator of the local oscillator field, and the \leftrightarrow or \uparrow shows the polarization direction of the corresponding fields. The action of the half wave plate HWP1 then rotates the polarization directions by 45° so that the total annihilation operator is now modified to :

$$\hat{a}_{tot} = \hat{a}_L^{\nearrow} + i\hat{a}^{\nearrow}$$

The action of the PBS1 (c.f. fig. 3.13) creates two outputs, which are denoted as \hat{d}_1 and \hat{d}_2 (c.f. sec. 1.1.4) :

$$\hat{d}_1 = \frac{1}{\sqrt{2}} (\hat{a}_L + i\hat{a})$$

$$= \frac{1}{\sqrt{2}} \left(\hat{a}_L + i\hat{A}e^{-i\delta t} + i\hat{B}e^{i\delta t} \right) \quad (3.21)$$

$$\begin{aligned} \hat{d}_2 &= -\frac{1}{\sqrt{2}} (i\hat{a}_L + \hat{a}) \\ &= -\frac{1}{\sqrt{2}} \left(i\hat{a}_L + \hat{A}e^{-i\delta t} + \hat{B}e^{i\delta t} \right) \end{aligned} \quad (3.22)$$

The photon-flux difference operator \hat{D} can be computed as:

$$\begin{aligned} \hat{D} &= \left(\hat{d}_1^\dagger \hat{d}_1 - \hat{d}_2^\dagger \hat{d}_2 \right) \\ &= \frac{1}{2} \left(\hat{a}_L + i\hat{A}e^{-i\delta t} + i\hat{B}e^{i\delta t} \right) \left(\hat{a}_L^\dagger - i\hat{A}^\dagger e^{i\delta t} - i\hat{B}^\dagger e^{-i\delta t} \right) \\ &\quad - \frac{1}{2} \left(i\hat{a}_L + \hat{A}e^{-i\delta t} + \hat{B}e^{i\delta t} \right) \left(-i\hat{a}_L^\dagger + \hat{A}^\dagger e^{i\delta t} + \hat{B}^\dagger e^{-i\delta t} \right) \\ &= i \left\{ \left(\hat{A}e^{-i\delta t} + \hat{B}e^{i\delta t} \right) \hat{a}_L^\dagger - \left(\hat{A}e^{-i\delta t} + \hat{B}e^{i\delta t} \right)^\dagger \hat{a}_L \right\} \end{aligned} \quad (3.23)$$

$$= i(\hat{a}\hat{a}_L^\dagger - \hat{a}^\dagger\hat{a}_L) \quad (3.24)$$

We can consider the local oscillator to be a coherent state with a mean photon number $|\alpha_L|^2$ and a phase ϕ_L . The fluctuations in \hat{D} can then be calculated from :

$$\begin{aligned} \langle \hat{D} \rangle &= i|\alpha_L| \langle (\hat{a}e^{-i\phi_L} - \hat{a}^\dagger e^{i\phi_L}) \rangle \\ &= |\alpha_L| \langle \hat{P}_{\phi_L} \rangle \\ \langle \hat{D}^2 \rangle &= -\langle (\hat{a}\hat{a}_L^\dagger - \hat{a}^\dagger\hat{a}_L)(\hat{a}\hat{a}_L^\dagger - \hat{a}^\dagger\hat{a}_L) \rangle \\ &= -\langle \hat{a}\hat{a}\hat{a}_L^\dagger\hat{a}_L^\dagger - \hat{a}^\dagger\hat{a}\hat{a}_L\hat{a}_L^\dagger - \hat{a}\hat{a}^\dagger\hat{a}_L^\dagger\hat{a}_L + \hat{a}^\dagger\hat{a}^\dagger\hat{a}_L\hat{a}_L \rangle \\ &= -\langle \hat{a}\hat{a}\hat{a}_L^\dagger\hat{a}_L^\dagger - \hat{a}^\dagger\hat{a}(1 + \hat{a}_L^\dagger\hat{a}_L) - (1 + \hat{a}^\dagger\hat{a})\hat{a}_L^\dagger\hat{a}_L + \hat{a}^\dagger\hat{a}^\dagger\hat{a}_L\hat{a}_L \rangle \\ &= -|\alpha_L|^2 \langle \hat{a}^2 e^{-2i\phi_L} + \hat{a}^{\dagger 2} e^{2i\phi_L} - 2\hat{a}^\dagger\hat{a} - 1 \rangle + \langle \hat{a}^\dagger\hat{a} \rangle \\ &= |\alpha_L|^2 \langle \hat{P}_{\phi_L}^2 \rangle + \langle \hat{a}^\dagger\hat{a} \rangle \end{aligned} \quad (3.26)$$

So that we get the variance :

$$\Rightarrow \Delta\hat{D}^2 = |\alpha_L|^2 \Delta\hat{P}_{\phi_L}^2 + \langle \hat{a}^\dagger\hat{a} \rangle \quad (3.27)$$

where we have defined the probe quadrature operator $\hat{P}_{\phi_L} = i(\hat{a}e^{-i\phi_L} - \hat{a}^\dagger e^{i\phi_L})$, which is scanned with respect to the local oscillator phase ϕ_L .

When the signal and idler fields are coherent and contains the same mean photon number $|\alpha|^2$:

$$\begin{aligned}
\langle \hat{P}_{\phi_L} \rangle &= i|\alpha|(e^{-i\delta t - \phi_L} + e^{i\delta t - \phi_L} - e^{-i\delta t + \phi_L} - e^{i\delta t + \phi_L}) \\
&= 2i|\alpha|(-i \sin(\delta t + \phi_L) + i \sin(\delta t - \phi_L)) \\
&= 4|\alpha| \cos(\delta t) \sin(\phi_L) \\
\langle \hat{P}_{\phi_L}^2 \rangle &= -\langle \hat{a}^2 e^{-2i\phi_L} + \hat{a}^{\dagger 2} e^{2i\phi_L} - 2\hat{a}^\dagger \hat{a} - 1 \rangle \\
&= -|\alpha|^2(8 \cos^2(\delta t) \cos(2\phi_L) - 8 \cos^2(\delta t)) + 1 \\
&= 16|\alpha|^2 \cos^2(\delta t) \sin^2(\phi_L) + 1
\end{aligned}$$

So that the quadrature variance is:

$$\langle \Delta \hat{P}_{\phi_L}^2 \rangle = 1$$

which is the same result as a monomode coherent state. The fluctuations are thus given by:

$$\begin{aligned}
\Delta \hat{D}^2 &= |\alpha_L|^2 \Delta \hat{P}_{\phi_L}^2 + \langle \hat{a}^\dagger \hat{a} \rangle \\
&= |\alpha_L|^2 + 4|\alpha|^2 \cos^2(\delta t)
\end{aligned} \tag{3.28}$$

which is independent of the LO phase as expected for the coherent state. This is the noise floor for coherent state input into the balanced heterodyne detection scheme.

When, the signal and idler are two-mode squeezed, P_{ϕ_L} is squeezed : the fluctuation $\Delta \hat{P}_{\phi_L}^2$ is more than 1 for $\phi_L = 0$, and less than 1 when $\phi_L = \pi$. The fluctuations in the measurement \hat{D} then go above and below the standard quantum limit. We can see, as the phases δt and ϕ_L are varied, the flux difference operator \hat{D} can scan the quadratures \hat{X}_\pm or \hat{Y}_\pm as shown in the set of equations 1.87, as:

δt phase	ϕ_L phase	\hat{D}
0	0	$-2\sqrt{2} \alpha_L Y_+$
0	$-\frac{\pi}{2}$	$-2\sqrt{2} \alpha_L X_+$
$-\frac{\pi}{2}$	0	$-2\sqrt{2} \alpha_L Y_-$
$-\frac{\pi}{2}$	$-\frac{\pi}{2}$	$-2\sqrt{2} \alpha_L X_-$

TABLE 3.1: Quadratures measured for specific δt and ϕ_L phase combinations.

Hence, observing the variance of the photon flux difference, implies direct measurement of the various quadratures, at specific instances, when the phases (including both the local oscillator phase, and the pump-probe beating phase) are varied.

Chapter 4

Recoil Induced Resonances

Contents

4.1 Experiments and Observations	79
4.1.1 signal transmission Spectroscopy	79
4.1.2 RIR memory effect	80
4.1.3 Phase conjugate generation Spectroscopy	83
4.2 Theoretical Explanation	85
4.2.1 Two level system	85
4.2.2 A simpler three level model	94

I have introduced recoil induced resonances in sec. 2.3 and briefly discussed some physical interpretations. In this chapter, I describe storage experiments based on RIR and examine the case when the counterpropagating laser pumps are stronger, so that experimental observations in the phase conjugate generation spectrum cannot be reproduced with the third order perturbative calculations performed by Guo et al. [Guo, Berman, Dubetsky, and Grynberg, 1992]. The experimental results were obtained by Jose Tabosa's group in Recife, Brazil.

4.1 Experiments and Observations

4.1.1 signal transmission Spectroscopy

In fig. 4.1, I present an experimental signal transmission spectrum as a function of the pump-signal detuning. The experiment was done on a cold Cesium cloud, by the group of Jose Tabosa in the Federal University of Pernambuco, Brazil. The experiment is done with one pump and one signal beams, and the transmitted intensity of the signal is measured as a function of pump-signal detuning (see fig. 4.2(a)). The Gaussian derivative form of the eq. (2.17) fits the spectrum much better ($R^2 = 0.95$) compared to a Lorentzian derivative

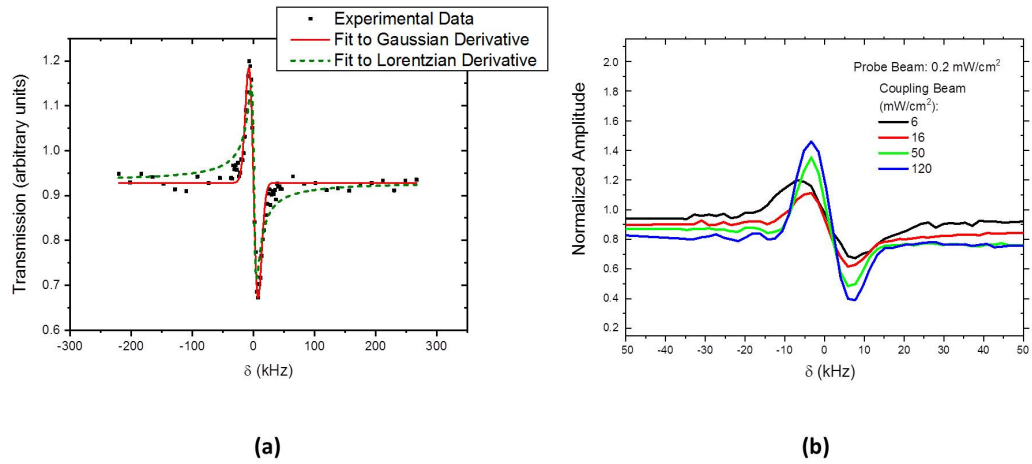

FIGURE 4.1: Experimental transmission spectrum as a function of pump-signal detuning with Gaussian and Lorentzian derivative fits, courtesy: Jose Tabosa et al. (a) Transmission spectra for different pump intensities. The black squares in (a) are experimentally obtained by the group of Jose Tabosa, in the two retro-reflected pumps and one signal configuration (case 2 in sec. 4.1) with a cold Cesium cloud. The pump and signal intensities were respectively 6 mW/cm^2 and 0.2 mW/cm^2 . The angle between the pump and signal beams was 2 deg and the temperature of the atomic cloud was $\sim 300 \mu\text{K}$. In red, the theoretical fit to the eq. 2.17 is shown. The fit has an R^2 value of 0.95. In dashed green, the fit with a Lorentzian derivative dispersion shape has $R^2 = 0.81$. (b) the width of this transmission spectrum does not change as the pump intensity is increased : no power broadening is visible

dispersion shape ($R^2 = 0.81$). The extrema of this function are obtained from:

$$g'(\delta) = 0 \Rightarrow \frac{\delta^2}{(k\theta\bar{v})^2} = 1$$

which describes a peak to peak distance of $2k\theta\bar{v}$.

It could be used to estimate the temperature of the atomic cloud $T \approx 300 \mu\text{K}$ [Almeida et al., 2016]. A particularity of the RIR transmission spectra is that it does not broaden with increasing field intensities (see fig. 4.1), which had also been observed by the same group. The dependence of the width of the above mentioned spectra on various physical parameters, are discussed and shown through the theoretical development in sec. 4.2.1.1.

4.1.2 RIR memory effect

Recoil induced resonances can also be used to store light in atomic media [Almeida et al., 2016] : the information is stored in the momentum-coherence of the system. Alternatively, it can equivalently be described as storage through the spatial bunching of atoms, induced by recoil.

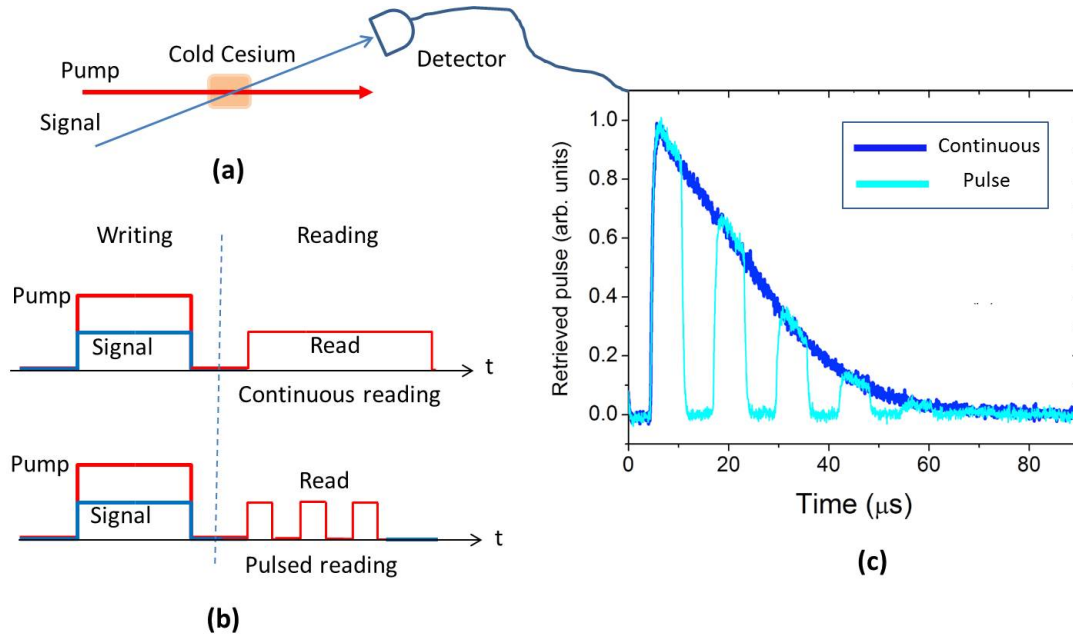

FIGURE 4.2: RIR based light storage (a) experimental set-up, (b) sequences of the field pulses in the writing and reading processes for continuous and pulsed reading cases. (c) Experimental data obtained for the retrieval for continuous (dark blue) and pulsed (sky blue) read beams, courtesy: Jose Tabosa et al. The read beam intensity is $140\text{mW}/\text{cm}^2$. The decay is Gaussian with width $\sim 30\mu\text{s}$.

The experimental set-up for storage remains the same as the case shown in fig. 4.2(a), operating with one pump and one signal beams, and the sequence is described below, fig. 4.2(b). In the writing step, the pump and the signal fields interfere: it gives rise to an intensity modulation, which creates an atomic grating in the atomic cloud (more details below). Then both beams are switched off and after a certain period of time, the pump is switched on again (read beam). It is diffracted by the atomic grating and the diffracted beam (retrieved pulse) propagates along the signal direction.

Fig. 4.2(c) shows the experimentally obtained retrieved field intensity as a function of time. It should be noted that the temporal width of the retrieved pulse is solely given by the lifetime of the atomic gratings, and does not depend on the reading beam intensity (c.f. fig. 4.2(a)). As shown by the data taken in a pulsed reading configuration, the reading process does not deteriorate the stored information (c.f. fig. 4.2(b)). This is different from the EIT based storage scheme [Phillips, Fleischhauer, Mair, Walsworth, and Lukin, 2001] where the reading beam destroys the stored information.

The lifetime is then given by a Gaussian decay due to the atomic motion, the contrast of the grating is thus assumed to be given by $c = c_0 e^{-(t/\tau_g)^2}$. The

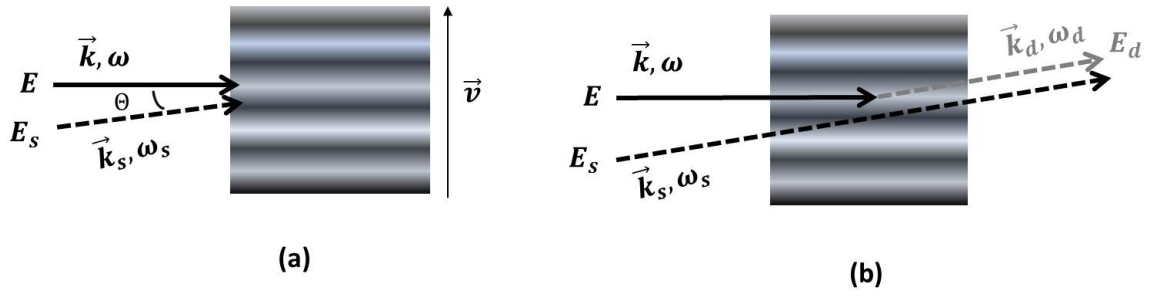

FIGURE 4.3: Explanation of the Recoil Induced Resonance as a diffraction from material grating. In (a), creation of a moving material grating due to interference of the two fields. In (b) diffraction of pump creating diffracted field E_d which interferes with the initial signal beam.

characteristic time is $\tau_g = \frac{\Lambda}{\sqrt{2\pi\bar{v}}}$, where $\Lambda = \lambda/2(\sin(\theta/2))$ is the period of the atomic grating obtained with the optical wavelength λ , and $\bar{v} = \sqrt{\frac{2k_B T}{M}}$ is the r.m.s. velocity of the atomic medium, proportional to the temperature T . The figure fig. 4.2(c) shows a life time of about $30\mu s$, which provides a measurement of the atomic temperature $T \approx 300\mu K$.

In sec. 2.3, the physical origin of RIR is explained in terms of Raman scattering from simple two level atoms in momentum states. The storage phenomenon described here could be better understood using an explanation of RIR in terms of Rayleigh scattering in the position space [Courtois and Grynberg, 1996]. Let us consider the case when both pump and signal fields are propagating with wave vectors \vec{k} and \vec{k}_s respectively. The corresponding field amplitudes are E and E_s . In such a case, the polarization vector \vec{P} of the medium is proportional to the superposition of the two fields:

$$\vec{P}(r, t) = \epsilon_0 \chi \{ \vec{E} e^{-i(\omega t - \vec{k} \cdot \vec{r})} + \vec{E}_s e^{-i(\omega_s t - \vec{k}_s \cdot \vec{r})} \} \quad (4.1)$$

where ϵ_0 is the vacuum permittivity and χ is the susceptibility of the medium. In general, the susceptibility χ is a function of several atomic properties that depend on the electric field intensity. As can be seen from eq. 4.1, the two fields interfere in the medium creating a interference pattern that moves (see fig. 4.3(a)) with a phase velocity $\vec{v} = \frac{\delta(\vec{k} - \vec{k}_s)}{|\vec{k} - \vec{k}_s|^2}$ [Courtois and Grynberg, 1996].

Such an intensity modulation induces an atomic periodic grating which also moves with the same velocity \vec{v} so that two components of the field propagates in the signal direction (c.f. fig. 4.3(b)):

- the transmitted signal beam;
- a part of the pump beam that is diffracted by the moving grating, which has the same frequency as the signal (i.e. ω_s), because of the induced Doppler shift.

Due to their phase-difference, both components interfere and give rise to the RIR effect. When the two fields interfere constructively, the signal experiences gain, and when they interfere destructively, it experiences losses. The formation and destruction characteristic times of such a grating depends on the finite response and decay times of the medium. The lifetime of this memory effect is thus directly linked to the atomic movement, which erase progressively the pattern.

4.1.3 Phase conjugate generation Spectroscopy

In sec. 2.3, I have briefly introduced the case of two counterpropagating pumps where a phase-conjugate beam is created due to the non-linear interaction among the optical fields via RIR. The dependence of the phase conjugate (p.c.) generation spectrum on the pump-signal detuning was predicted by Guo & al. [Guo, Berman, Dubetsky, and Grynberg, 1992]. Experimentally it was observed first by Lounis et al. in cold cesium atoms [Lounis, Verkerk, Courtois, Salomon, and Grynberg, 1993] and very recently by Ji et al. [Ji et al., 2018] with better precision.

Such experiments were also performed by J. Tabosa's group. As the pump intensity is increased, they have observed the emergence of a dip in the p.c. generation spectrum (see fig. 4.4(a)). The splittings between the two peaks as a function of increasing pump intensities have been plotted in fig. 4.4(b) for two different optical detunings as the minimum intensity required for the dip to emerge depends on the optical detuning Δ . At $\Delta/2\pi = 30\text{MHz}$, the splitting appears for a pump intensity of about 140 mW/cm^2 , while at 25 MHz it is already visible for 100 mW/cm^2 . In both cases, the splitting saturates between 20 and 25 kHz.

I show in section 4.2.1.2 that this feature cannot be explained under the 3rd order perturbation approximation of RIR. It is also not explained by the dynamic Stark splitting [Klein, Oria, Bloch, and Ducloy, 1989] as this splitting is much narrower and saturates at a constant value. I show below that as more pump intensity is involved, the six wave mixing processes which are also mediated by

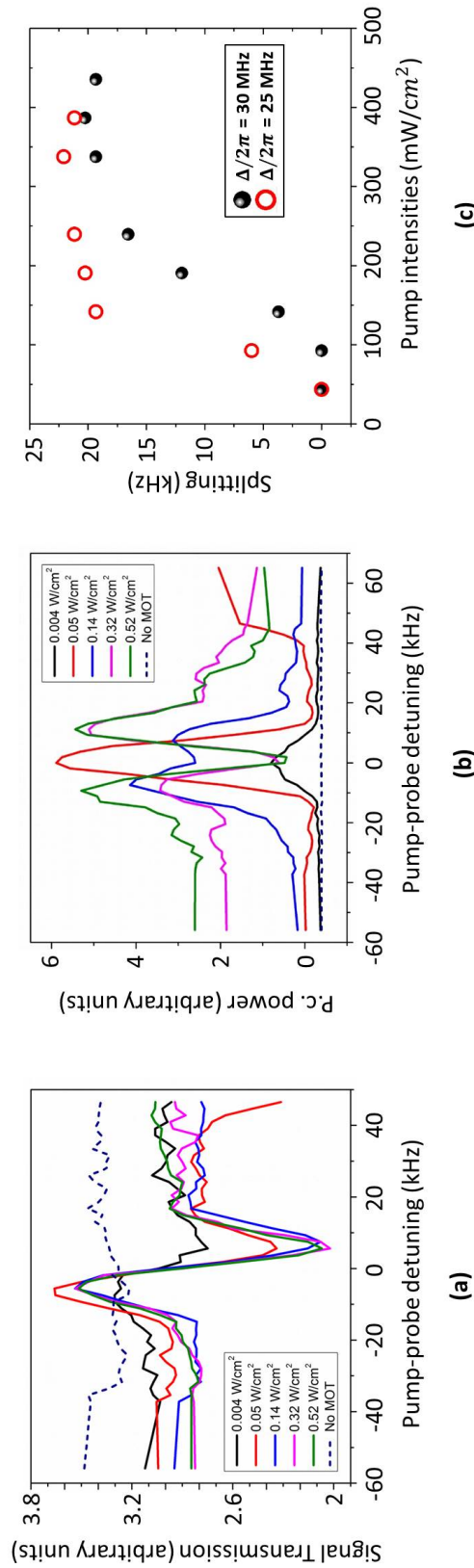

FIGURE 4.4: (a) Experimental probe transmission spectra and (b) phase conjugate generation spectra as a function of pump-signal detuning for different pump intensities (indicated in the legend box). The experiment was done on cold cesium atoms, by the group of Jose Tabosa in University of Pernambuco, Brazil, with a temperature $T = 300\mu K$, $\Gamma/2\pi = 6MHz$, and $\Delta/2\pi = 30MHz$. The angle between pump and signal beams is $\theta = 2$ deg and the signal intensity is 0.02 mW/cm². A dip at the centre of the spectra is visible when the pump intensity is more than 0.14 W/cm². (c) splitting distance as a function of increasing pump intensities for two optical detunings $\Delta = 30MHz$ and $\Delta = 25MHz$. The threshold pump intensity for the splitting to appear increases, with the detuning. In both cases, the splitting saturates at about 22 kHz.

atomic recoil can indeed not be neglected anymore. These higher order processes interfere coherently with the primary four wave mixing process, resulting in the dip in the idler generation spectrum.

4.2 Theoretical Explanation

4.2.1 Two level system

We consider here a two level system $\{|1\rangle, |2\rangle\}$ where $|1\rangle$ is the ground state and $|2\rangle$ the excited one. The spontaneous decay rate is Γ and the atom can absorb or emit a photon, which changes its momentum from a value p to a value p' , so that $\hbar(p' - p)$ is the photon momentum. The standard two level density matrix ρ of a two level system, which is defined as:

$$\rho = \sum_{\alpha, \beta \in \{1, 2\}} \rho_{\alpha\beta} |\alpha\rangle \langle \beta|$$

is expanded in the momentum-space as :

$$\rho(p, p') = \sum_{\alpha, \beta \in \{1, 2\}} \rho_{\alpha\beta}(p, p') |\alpha, p\rangle \langle \beta, p'| \quad (4.2)$$

The states are now written with reference to their corresponding initial and final momenta p and p' . The terms $\rho_{11}(p, p')$ or $\rho_{22}(p, p')$, are not population anymore but coherences between states of different momenta (c.f. eq. 4.2).

We consider the interaction of such a two level system with n electric fields:

$$E = \sum_{\mu=1}^n E_{\mu} e^{-i(\omega_{\mu}t - k_{\mu} \cdot r)} + c.c. \quad (4.3)$$

where E_{μ} , ω_{μ} and k_{μ} are the amplitude, frequency and wave-vector of the μ -th field. We also introduce the variables $\tilde{\rho}_{\alpha\beta}$:

$$\begin{aligned} \rho_{\alpha\alpha} &= \tilde{\rho}_{\alpha\alpha}(p, p') e^{-i\frac{(p^2 - p'^2)}{2m}t} \\ \rho_{\alpha\beta} &= \tilde{\rho}_{\alpha\beta}(p, p') e^{i\omega t} e^{-i\frac{(p^2 - p'^2)}{2m}t} \end{aligned} \quad (4.4)$$

where ω is the frequency of the transition, and m is the mass of an individual atom. The transformations shown in eq.(4.4) are equivalent to the standard rotating wave transformation, but includes the momenta. In terms of these variables, the Maxwell-Bloch equations for the system, can be written down

[Guo, Berman, Dubetsky, and Grynberg, 1992] as:

$$\begin{aligned} \left(\frac{\partial}{\partial t} + \gamma\right)\tilde{\rho}_{12}(p, p') &= \sum_{\mu} i(\Omega_{\mu}^* e^{(i\Delta_{\mu} - i\frac{k_{\mu}\cdot p'}{m} + i\omega_k)t})\tilde{\rho}_{11}(p, p' - \hbar k_{\mu}) \\ &\quad - i(\Omega_{\mu}^* e^{(i\Delta_{\mu} - i\frac{k_{\mu}\cdot p}{m} - i\omega_k)t})\tilde{\rho}_{22}(p + \hbar k_{\mu}, p') \end{aligned} \quad (4.5)$$

$$\begin{aligned} \left(\frac{\partial}{\partial t} + \gamma_2\right)\tilde{\rho}_{22}(p, p') &= \sum_{\mu} i(\Omega_{\mu}^* e^{(i\Delta_{\mu} - i\frac{k_{\mu}\cdot p'}{m} + i\omega_k)t})\tilde{\rho}_{21}(p, p' - \hbar k_{\mu}) \\ &\quad - i(\Omega_{\mu} e^{(-i\Delta_{\mu} + i\frac{k_{\mu}\cdot p}{m} - i\omega_k)t})\tilde{\rho}_{12}(p - \hbar k_{\mu}, p') \end{aligned} \quad (4.6)$$

$$\begin{aligned} \left(\frac{\partial}{\partial t} + \gamma_1\right)\tilde{\rho}_{11}(p, p') &= \sum_{\mu} i(\Omega_{\mu} e^{(-i\Delta_{\mu} + i\frac{k_{\mu}\cdot p'}{m} + i\omega_k)t})\tilde{\rho}_{12}(p, p' + \hbar k_{\mu}) \\ &\quad - i(\Omega_{\mu}^* e^{(i\Delta_{\mu} - i\frac{k_{\mu}\cdot p}{m} - i\omega_k)t})\tilde{\rho}_{21}(p + \hbar k_{\mu}, p') \\ &\quad + \int \Gamma N(q) dq \tilde{\rho}_{22}(p + \hbar q, p' + \hbar q) e^{i(-\frac{p\cdot q}{m} + \frac{p'\cdot q}{m})t} \\ &\quad + \gamma_t W(p, p') \end{aligned} \quad (4.7)$$

$$\tilde{\rho}_{21}(p, p') = [\tilde{\rho}_{12}(p', p)]^* \quad (4.8)$$

Ω_{μ} are the Rabi frequencies for the individual fields E_{μ} :

$$\Omega_{\mu} = \frac{-\langle 2|D|1\rangle E_{\mu}}{\hbar} \quad (4.9)$$

where \hat{D} is the dipole moment operator. The individual fields are detuned from the resonance frequency ω of the two level system by $\Delta_{\mu} = \omega_{\mu} - \omega$. The recoil frequency ω_k of the atom is defined as $\omega_k = \frac{\hbar k^2}{2m}$, where we have assumed, that for all the fields, $|k_{\mu}| \cong k$.

The various decay rates in eq.s(4.5)-(4.8) are :

- (1) Γ : spontaneous decay rate from the excited state to the ground state.
- (2) γ_t : lifetime of the atoms in the interaction region. The value given by the experimentalist team was $\gamma_t/2\pi \sim 1$ kHz.
- (3) γ_1 : total decay rate of the lower level population and coherences. It can be written as $\gamma_1 = \gamma_t + \gamma'_1(1 - \delta_{pp'})$, where γ'_1 is a possible extra decay for the coherences between states of different momenta.
- (4) γ_2 : decay rate of the excited state populations and coherences between upper levels of different momenta: $\gamma_2 = \Gamma + \gamma_t$.

(5) γ : optical coherence decay rate : $\gamma = \gamma_t + \frac{\Gamma}{2}$.

We assume that new atoms add up to the ground state momentum coherence following a distribution $W(p, p')$ so that the ground state is pumped at a rate $\Lambda = \gamma_t W(p, p')$. When $p = p'$, $\rho_{11}(p, p)$ is the ground state population with a momentum p . In this case, the distribution should be the Maxwell-Boltzmann distribution:

$$W(p, p') = \frac{N}{V} (2\pi\hbar)^3 \frac{1}{(\sqrt{\pi}p_0)^3} e^{-\frac{p_x^2 + p_y^2 + p_z^2}{p_0^2}} \delta(p - p') \quad (4.10)$$

where $\delta(x)$ denotes the Dirac delta function.

In the eq.(4.7), the third term represents the ground state feeding, by spontaneous emission from the excited state. The term describes a process where an atom with a coherence $\rho_{22}(p + \hbar q, p' + \hbar q)$ emits a photon in a random direction with a wavevector $\vec{q} = |k|(\sin\theta \cos\phi \vec{x} + \sin\theta \sin\phi \vec{y} + \cos\theta \vec{z})$. θ and ϕ are the inclination and azimuthal angles respectively when the dipole direction is along \hat{z} and $N(\vec{q})$ is the probability that the emission occurs in the direction θ [Grynberg, Aspect, and Fabre, 2010]:

$$N(\vec{q}) \rightarrow N(\theta) = \frac{3}{8\pi} \sin^2\theta \quad (4.11)$$

To find the total effect of the spontaneous emission, it is necessary to integrate over all such possible directions, with $dq = |k| \sin\theta d\theta d\phi$, $0 \leq \theta \leq \pi$, $0 \leq \phi \leq 2\pi$.

The optical coherence can then be written in the laboratory frame, from the quantity $\tilde{\rho}_{12}(p, p')$ in the Bloch equations (4.5)-(4.8), as:

$$\rho_{12}(r, t) = \frac{1}{2\pi\hbar^3} \int \int dp dp' \tilde{\rho}_{12}(p, p') \exp\left(i \frac{(p - p') \cdot \vec{r}}{\hbar} - i \frac{p^2 - p'^2}{2m\hbar} t + i\omega t\right) \quad (4.12)$$

The macroscopic polarization $P(r, t)$ of the atomic ensemble, is then linked to the atomic optical coherence $\rho_{12}(r, t)$ as:

$$P(r, t) = \langle 2|D|1 \rangle \tilde{\rho}_{12}(r, t) + c.c. \quad (4.13)$$

The set of differential equations (4.5)-(4.8) is not analytically solvable exactly. A perturbative treatment is thus required. I present the detailed calculations in Appendix C, and only the relevant observations and plots are described in the following parts.

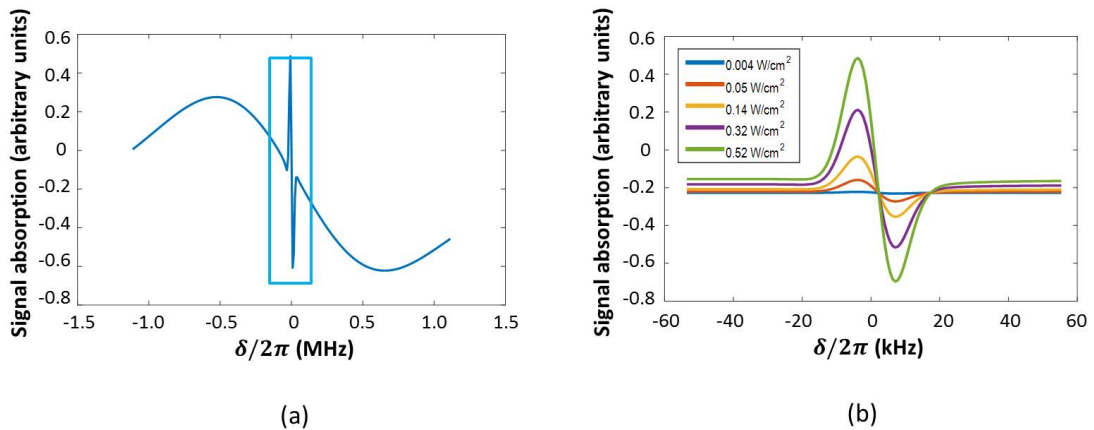

FIGURE 4.5: (a) Signal transmission spectrum as a function of the pump-signal detuning δ from a 3rd order coherence calculation for a temperature $T = 300\mu K$, $\Gamma/2\pi = 6MHz$, $\Delta/2\pi = 30MHz$, $\gamma_t/2\pi = 1kHz$ and $\theta = 2^\circ$ (b) zoom on the central sharp feature, which has a width $2k\bar{v}\theta$ for different pump intensities.

4.2.1.1 Results at third order of expansion

The third order contribution to the coherence ρ_{12} comes as a four-wave mixing process with two relevant pathways:

$$\tilde{\rho}_{11}^{(0)} \xrightarrow{\Omega_\mu^*} \tilde{\rho}_{12}^{(1)} \xrightarrow{\Omega_\nu} \tilde{\rho}_{22}^{(2)} \xrightarrow{\Omega_\sigma^*} \tilde{\rho}_{12}^{(3)} \quad (4.14)$$

$$\tilde{\rho}_{11}^{(0)} \xrightarrow{\Omega_\mu} \tilde{\rho}_{12}^{(1)} \xrightarrow{\Omega_\nu^*} \tilde{\rho}_{22}^{(2)} \xrightarrow{\Omega_\sigma^*} \tilde{\rho}_{12}^{(3)} \quad (4.15)$$

where the indices (μ, ν and σ) denote the fields (pump, counter-propagating pump or signal) and $\Omega_{\mu, \nu, \sigma}$ etc. denote the corresponding Rabi frequencies (for details, see appendix C). Ω_μ is the first order of perturbation ν the second order and σ the third.

The third order component of the polarization, which is proportional to the third order coherence $\rho_{12}^{(3)}$, (see eq. 4.13), can be shown to be proportional to $\Omega_\mu^* \Omega_\nu \Omega_\sigma^*$ (for pathway 1, eq. 4.14), or to $\Omega_\mu \Omega_\nu^* \Omega_\sigma^*$ (for pathway 2, eq. 4.15).

If we look at changes in the transmission spectrum of the probe, conservation of energy and momentum imply that each path will involve one absorption and one emission by the same pump (either propagating or counterpropagating) so that the result is the addition of two RIR provided by each pump as described in the next paragraph. When both pumps are involved, it leads to the generation of a phase conjugate field in the direction opposite to the signal.

Signal transmission

Experimentally, the signal transmission corresponds to the field, which is detected by the photodiode D_1 (see fig. 2.7). It is given by the components with a wave vector \vec{k}_s and a frequency $\omega_P + \delta$. This can be achieved by four different combinations of μ, ν and σ , showing two distinct features :

- (1) μ is the signal field and ν and σ are the forward pump beam in the pathway 1 (eq. 4.14), or,
 ν is the signal field and μ and σ are the forward pump beam in pathway 2 (eq. 4.15).
- (2) μ is the signal field and ν and σ are the counter-propagating (or backward) pump beams in pathway 1 (eq. 4.14), or
 ν is the signal field and μ and σ are the backward pump beam in pathway 2 (4.15).

In the case (1) the calculations give a sharp feature in the signal transmission spectrum (see appendix C). Indeed, with the assumption that $\gamma_t \ll k\bar{v}\theta$, the width of the induced resonance is $2k\bar{v}\theta$, where k is modulus of the wave-vector of the pump/signal fields, u is the r.m.s velocity of the atoms in the medium and θ is the angle between the signal and the forward pump beams. The transmission g as a function of pump-signal detuning δ is (see sec. 2.3):

$$g(\delta) = -\sqrt{\frac{\pi}{2}} \frac{\hbar\Omega^2\Omega_s}{\Delta^2k_B T} \frac{\delta}{k\theta u} \exp\left(-\frac{\delta^2}{2(k\theta u)^2}\right) \quad (4.16)$$

where Ω is the Rabi frequency and T is the temperature.

In the case (2) the calculations give a broad feature in the signal transmission spectrum. The width of this feature is $4k\bar{v}$ when $\gamma_t \ll ku$ and $\theta \ll 1$.

$$g(\delta) = -\sqrt{\frac{\pi}{2}} \frac{\hbar\Omega^2\Omega_s}{\Delta^2k_B T} \frac{\delta}{2ku} \exp\left(-\frac{\delta^2}{2(2ku)^2}\right) \quad (4.17)$$

The two counter-propagating pumps and one signal configuration is a coherent addition of two single pump - single signal interactions. The fig. 4.5(a) shows the result of the calculations for $T = 300\mu K$, $\Gamma/2\pi = 6 MHz$, $\Delta/2\pi = 30 MHz$, $\gamma_t = 1 kHz$ and $\theta = 2^\circ$: both features appear and fig. 4.5(b) is a zoom on the sharp one. It reproduces quite well the experimentally obtained transmission spectrum (shown in fig. 4.4(a)) : the Gaussian derivative shape with about 15

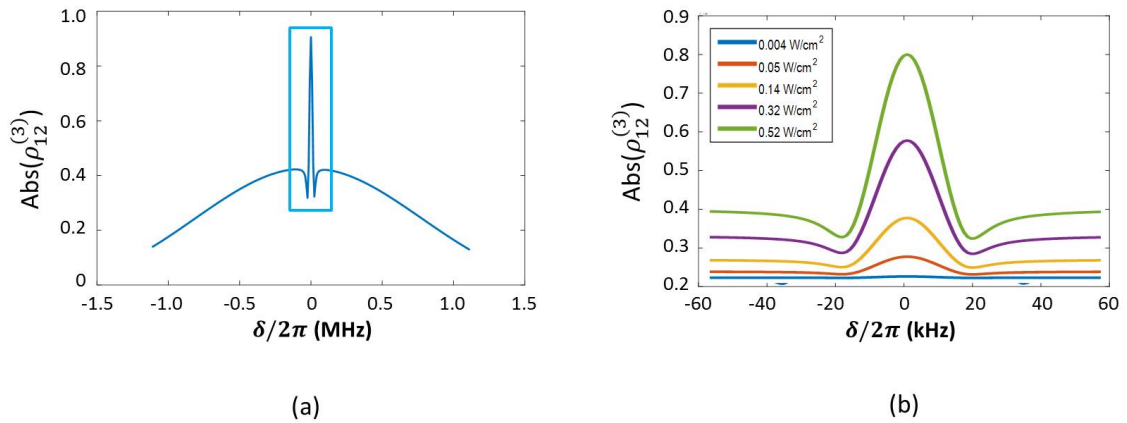

FIGURE 4.6: (a) Phase conjugate (p.c.) generation spectrum as a function of the pump-signal detuning δ from a 3rd order coherence calculation for $T = 300\mu K$, $\Gamma/2\pi = 6MHz$, $\Delta/2\pi = 30MHz$, $\gamma_i/2\pi = 1kHz$ and $\theta = 2$ deg. The intensity of the generated p.c. field is proportional to $|\rho_{12}|^2$. (b) zoom on the central sharp feature of width $2k\bar{v}\theta$ for different pump intensities.

kHz separation between the peaks in the sharp feature. The other combinations of μ, ν and σ either lead to zero contribution, or just adds a background offset so that it can be neglected.

Phase conjugate generation

The components of the field in the direction $-\vec{k}_s$ with a frequency $\omega_P - \delta$, correspond to a phase conjugate (p.c.) field, generated through the four-wave mixing process of the two pumps and the signal. Experimentally, when the signal frequency is scanned, the photodiode D_2 allows to record the phase conjugate generation spectrum, which is the intensity of the p.c. field as a function of the input signal frequency (see fig. 2.7). This spectrum can be calculated as the absolute amplitude of the corresponding component of the coherence as a function of the pump-signal detuning δ . Using a third order perturbative expansion, we can sort the following combinations of fields that are responsible for the generation of the phase conjugate beam for both paths:

- (1) When μ is the forward pump field, ν the signal field and σ the counter-propagating or backward pump beam, it describes a process of backward pump scattering in the phase-conjugate direction from an atomic grating created by the forward pump and the signal fields.

- (2) When μ is the backward pump field, ν the signal field and σ the forward pump beam, it describes a process of forward pump scattering from an atomic grating created by the backward pump and the signal fields.

The first gives rise to a broad feature having a width $4ku$, while the second gives a sharp one with a width $2ku\theta$. I show the theoretical spectra in fig. 4.6. We are interested in the sharper feature only (fig. 4.6(b)), which matches with the experimental observation for small pump intensities (shown in fig. 4.4), but fails to reproduce the dip, which appears at higher intensities (fig. 4.6) .

4.2.1.2 Results at fifth order

To account for the effect of higher pump intensities, it is necessary to go to higher order of perturbation. When other parameters (the decay rates and Doppler width) are small compared to the optical detuning Δ and the Rabi frequencies of the fields, the ratio of the 3rd order to the 5th order contribution into the coherence ρ_{12} is proportional to $|\Omega|^2/(\Gamma)\Delta$, where Ω is the pumps Rabi frequency. Thus, for sufficient intensities, the 3rd and 5th order coherences i.e. $\rho_{12}^{(3)}$ and $\rho_{12}^{(5)}$ are comparable and can interfere. Indeed, a pump intensity of 140 mW/cm^2 corresponds to $\Omega = 4.8 \text{ MHz}$, so that $\Omega/\Delta \approx 0.1$ for $\Delta/2\pi = 30 \text{ MHz}$. Similarly, a pump intensity of 100 mW/cm^2 corresponds to $\Omega = 4 \text{ MHz}$, so that $\Omega/\Delta \approx 0.1$ for $\Delta/2\pi = 25 \text{ MHz}$. These values are consistent with the experimental ones, for which the dip appears (see fig. 4.4).

The following four pathways, address the relevant six-wave mixing process:

$$\tilde{\rho}_{11}^{(0)} \xrightarrow{\Omega_\mu^*} \tilde{\rho}_{12}^{(1)} \xrightarrow{\Omega_\nu} \tilde{\rho}_{22}^{(2)} \xrightarrow{\Omega_\sigma^*} \tilde{\rho}_{12}^{(3)} \xrightarrow{\Omega_\alpha} \tilde{\rho}_{22}^{(4)} \xrightarrow{\Omega_\beta^*} \tilde{\rho}_{12}^{(5)} \quad (4.18)$$

$$\tilde{\rho}_{11}^{(0)} \xrightarrow{\Omega_\mu} \tilde{\rho}_{12}^{(1)} \xrightarrow{\Omega_\nu^*} \tilde{\rho}_{22}^{(2)} \xrightarrow{\Omega_\sigma^*} \tilde{\rho}_{12}^{(3)} \xrightarrow{\Omega_\alpha} \tilde{\rho}_{22}^{(4)} \xrightarrow{\Omega_\beta^*} \tilde{\rho}_{12}^{(5)} \quad (4.19)$$

$$\tilde{\rho}_{11}^{(0)} \xrightarrow{\Omega_\mu^*} \tilde{\rho}_{12}^{(1)} \xrightarrow{\Omega_\nu} \tilde{\rho}_{22}^{(2)} \xrightarrow{\Omega_\sigma} \tilde{\rho}_{21}^{(3)} \xrightarrow{\Omega_\alpha^*} \tilde{\rho}_{22}^{(4)} \xrightarrow{\Omega_\beta^*} \tilde{\rho}_{12}^{(5)} \quad (4.20)$$

$$\tilde{\rho}_{11}^{(0)} \xrightarrow{\Omega_\mu} \tilde{\rho}_{12}^{(1)} \xrightarrow{\Omega_\nu^*} \tilde{\rho}_{22}^{(2)} \xrightarrow{\Omega_\sigma} \tilde{\rho}_{21}^{(3)} \xrightarrow{\Omega_\alpha^*} \tilde{\rho}_{22}^{(4)} \xrightarrow{\Omega_\beta^*} \tilde{\rho}_{12}^{(5)} \quad (4.21)$$

where the fields corresponding to the indices μ, ν, σ, α and β can be any of the two pump or signal fields. The corresponding 46 different combinations of fields giving rise to phase conjugate generation are listed in the appendix (C). Nevertheless, I have only considered the contributions when the signal field appears once: due to its small intensity compared to the pumps ($\Omega_s \ll \Omega_P$), the cases when it interacts several times with the atom can be neglected.

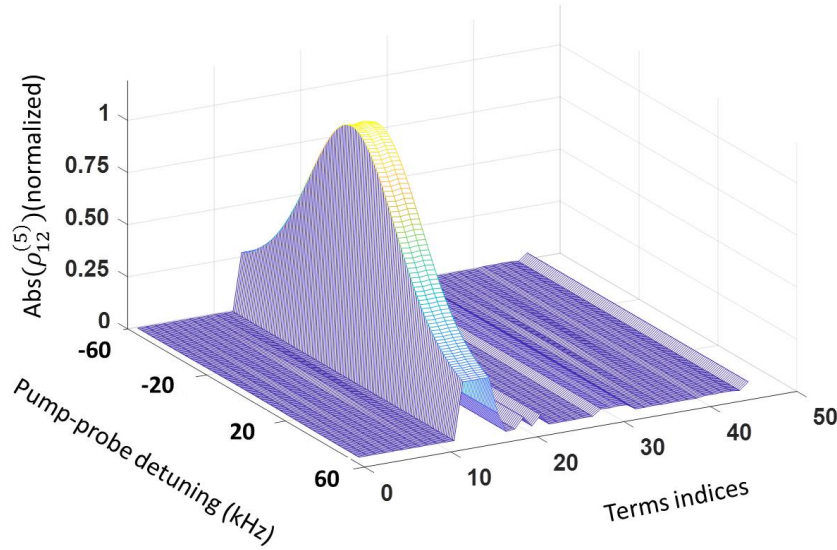

FIGURE 4.7: Comparison of all the 46 fifth order terms as a function of pump-signal detuning : for a temperature $T = 300\mu K$, $\Gamma/2\pi = 6MHz$, $\Delta/2\pi = 30MHz$, $\gamma_t/2\pi = 1kHz$ and $\theta = 2$ deg. Four terms give the major contribution.

All the 46 combinations are plotted in fig. 4.7, for parameters corresponding to the experimental conditions. It is visible that only a few of them contribute to the phase conjugate beam. They correspond to the following pathways :

$$\begin{aligned}
 & \tilde{\rho}_{11}^{(0)} \xrightarrow{\Omega_{+P}^*} \tilde{\rho}_{12}^{(1)} \xrightarrow{\Omega_{+P}} \tilde{\rho}_{22}^{(2)} \xrightarrow{\Omega_s} \tilde{\rho}_{21}^{(3)} \xrightarrow{\Omega_{-P}^*} \tilde{\rho}_{22}^{(4)} \xrightarrow{\Omega_{+P}^*} \tilde{\rho}_{12}^{(5)} \\
 & \tilde{\rho}_{11}^{(0)} \xrightarrow{\Omega_{+P}} \tilde{\rho}_{12}^{(1)} \xrightarrow{\Omega_{+P}^*} \tilde{\rho}_{22}^{(2)} \xrightarrow{\Omega_s} \tilde{\rho}_{21}^{(3)} \xrightarrow{\Omega_{-P}^*} \tilde{\rho}_{22}^{(4)} \xrightarrow{\Omega_{+P}^*} \tilde{\rho}_{12}^{(5)} \\
 & \tilde{\rho}_{11}^{(0)} \xrightarrow{\Omega_{-P}^*} \tilde{\rho}_{12}^{(1)} \xrightarrow{\Omega_{-P}} \tilde{\rho}_{22}^{(2)} \xrightarrow{\Omega_s} \tilde{\rho}_{21}^{(3)} \xrightarrow{\Omega_{-P}^*} \tilde{\rho}_{22}^{(4)} \xrightarrow{\Omega_{+P}^*} \tilde{\rho}_{12}^{(5)} \\
 & \tilde{\rho}_{11}^{(0)} \xrightarrow{\Omega_{-P}} \tilde{\rho}_{12}^{(1)} \xrightarrow{\Omega_{-P}^*} \tilde{\rho}_{22}^{(2)} \xrightarrow{\Omega_s} \tilde{\rho}_{21}^{(3)} \xrightarrow{\Omega_{-P}^*} \tilde{\rho}_{22}^{(4)} \xrightarrow{\Omega_{+P}^*} \tilde{\rho}_{12}^{(5)}
 \end{aligned}$$

where the subscripts Ω_{+P}, Ω_{-P} , and Ω_s denote the forward pump, the backward pump and the signal fields respectively. .

Fig. 4.8 shows the theoretical prediction for such a model. On the left, fig. 4.8(a) gives the p.c. generation spectra for different pump intensities corresponding to the experimental values and $\Delta/2\pi = 30$ MHz. The emergence of a dip is reproduced. It emerges progressively by a shoulder visible at 0.14 W/cm^2 . On the top, center, the fig. 4.8(b) gives the splitting distance between the peaks as a function of the pump intensity for $\gamma_t/2\pi = 1$ kHz and no extra decoherence for the coherence between levels of different momenta ($\gamma_1' = 0$ kHz). The splitting seems to saturate at about 22 kHz, which is very similar

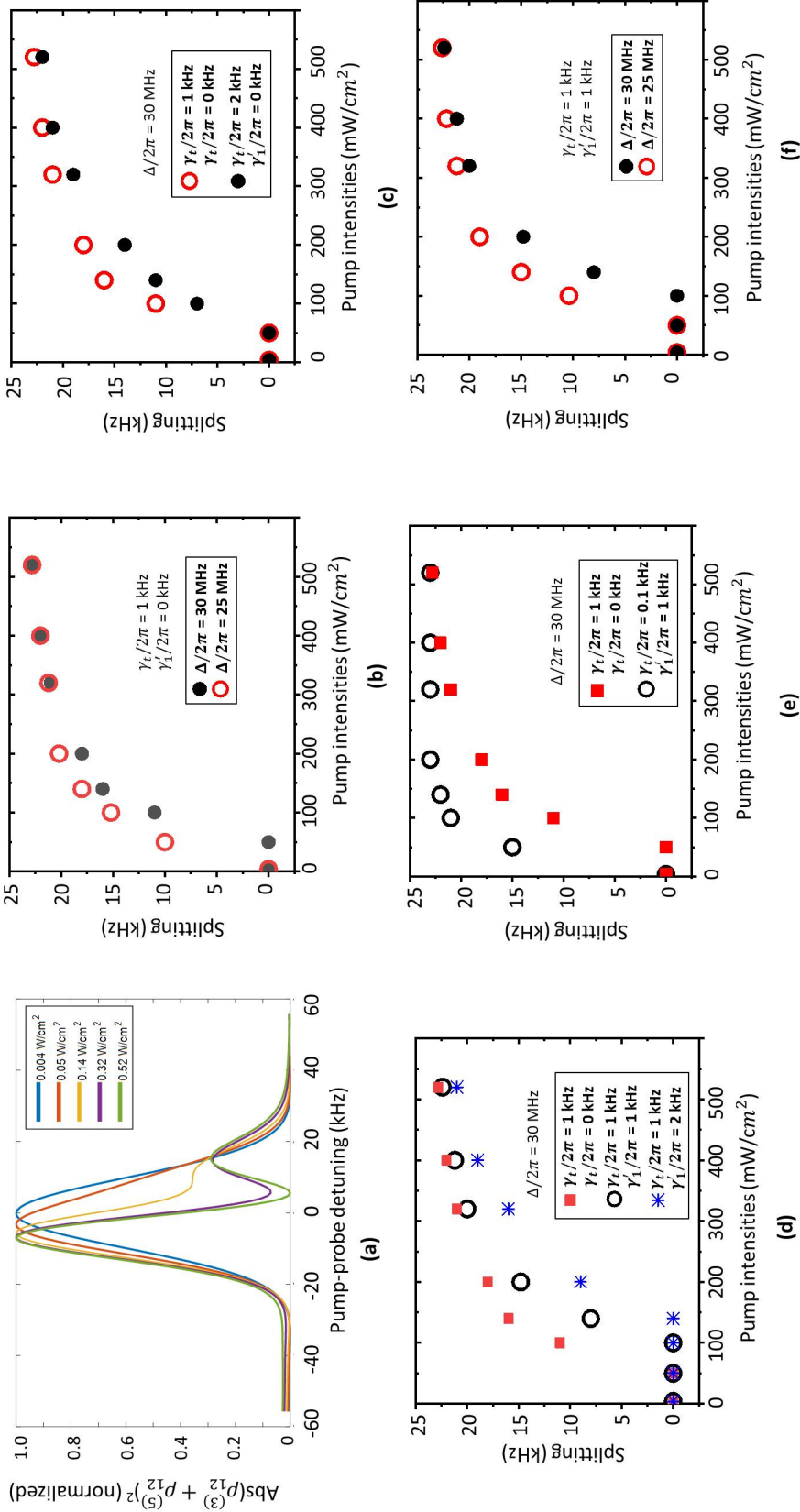

FIGURE 4.8: Results obtained with a 5th order perturbation expansion. (a) Theoretically obtained phase conjugate generation spectra as a function of the pump-signal detuning, for different pump intensities (indicated in the legend box). The calculations are done for cesium atoms with $T = 300 \mu K$, $\Gamma/2\pi = 6 \text{ MHz}$, $\gamma_t/2\pi = 1 \text{ kHz}$, $\theta = 2^\circ$, $\Delta/2\pi = 30 \text{ MHz}$ and a signal intensity equal to 0.02 mW/cm^2 . The spectra are normalized independently. A dip is visible for pump intensity higher than 0.14 W/cm^2 . (b) Splitting values as a function of pump intensities for optical detuning $\Delta/2\pi = 30 \text{ MHz}$ and $\Delta/2\pi = 25 \text{ MHz}$ with $\gamma_t/2\pi = 1 \text{ kHz}$ and $\gamma'_1 = 0$. (c) and (d) Comparison of the effect of γ_t and γ'_1 . (e) Comparison of the effect of γ_t and γ'_1 . (f) Splitting values for $\Delta/2\pi = 30 \text{ MHz}$ and $\Delta/2\pi = 25 \text{ MHz}$, when $\gamma_t/2\pi = 1 \text{ kHz}$ and $\gamma'_1/2\pi = 1 \text{ kHz}$.

to the experimentally observed value of 23 kHz. At $\Delta/2\pi = 30$ MHz, the dip suddenly appears around a intensity of 100 mW/cm^2 and at $\Delta/2\pi = 25$ MHz, it emerges at a smaller pump intensity of 50 mW/cm^2 . Both values are smaller than the experimental ones which are close to 150 mW/cm^2 and 100 mW/cm^2 respectively. The fig.s (c) and (d) shows the effect of an increase of γ_t and γ'_1 for $\Delta/2\pi = 30$ MHz. In the first case, the threshold remains the same, while it increases in the second. Indeed, for $\gamma_t/2\pi = \gamma'_1/2\pi = 1$ kHz, the experimental behaviour is quite well reproduced. The fig. 4.8(e) compares the effect of the transit and coherence decay rate. Indeed, a lower γ_t and $\gamma'_1 = 1$ kHz gives a sharper step and a lower threshold, which does not fit with the experimental observation. The fig. 4.8(f) gives the simulation results for $\Delta/2\pi = 30$ MHz and $\Delta/2\pi = 25$ MHz, using the best parameters found with the fig. 4.8(d): $\gamma_t/2\pi = 1$ kHz and $\gamma'_1/2\pi = 1$ kHz. The split emerges for a pump power 150 mW/cm^2 when $\Delta/2\pi = 30$ MHz and for a pump power 100 mW/cm^2 when $\Delta/2\pi = 25$ MHz. The splitting values saturate at about 22 MHz, which is close to the experimental observations.

The relative heights of the peaks do not quantitatively match with the experimental ones, which might be a result of even higher order processes which are not taken into account here. But it is nevertheless clear that the threshold behaviour of the splitting can be reproduced by taking into account an extra decoherence rate between levels of different momenta.

4.2.2 A simpler three level model

In the previous description of the recoil induced resonance, we have considered all possible momenta of the atoms and the density matrix elements could be a function of any momenta p and p' . Nevertheless there is a specific four wave mixing process that is closed, meaning that the initial and final momenta of the atom before and after the interaction, are the same. Such a process contributes maximally to the RIR phenomenon.

In fig. 4.9(b), we describe such a closed process:

- (1) An atom in the ground state ($|a\rangle$) with an initial momentum p absorbs a forward pump photon of wavevector \vec{k}_P so that its momentum is changed to $\vec{p} + \hbar\vec{k}_P$.
- (2) The atom then releases a signal photon of wavevector \vec{k}_s , which changes its momentum to $\vec{p} + \hbar(\vec{k}_P - \vec{k}_s)$.

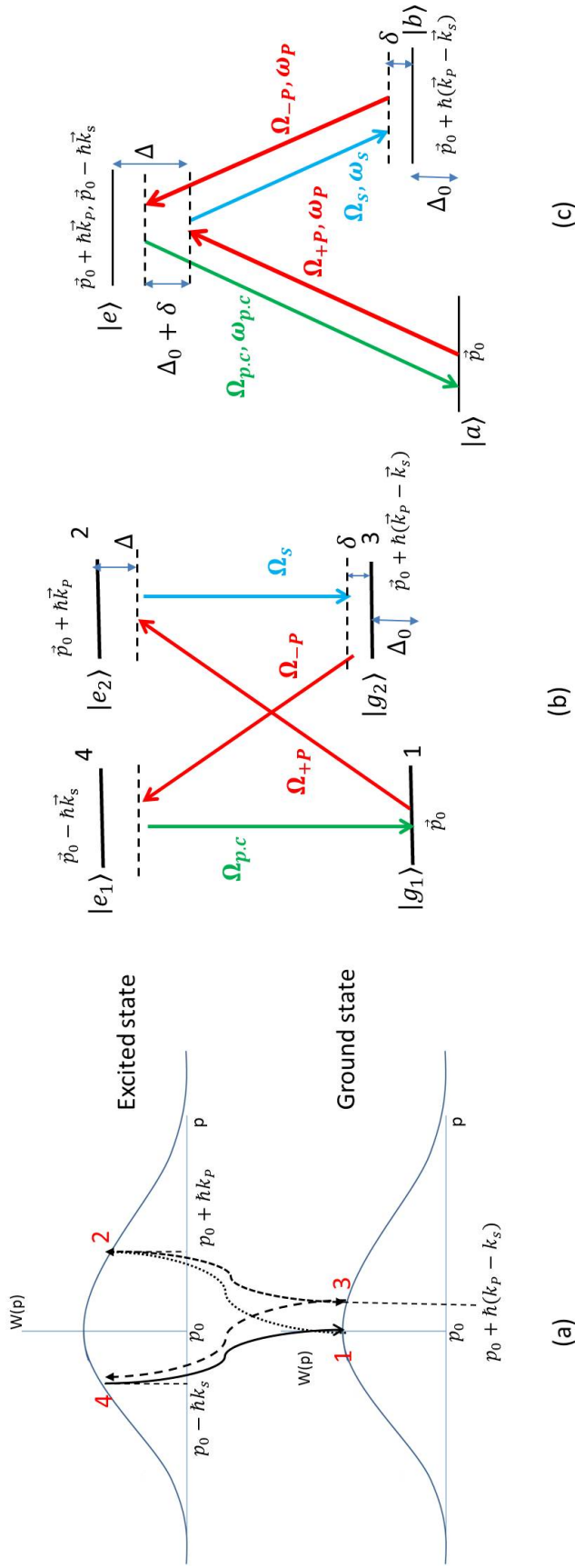

FIGURE 4.9: (a) evolution of the momentum of the atom in the distribution function of momenta W_p (commonly Maxwell-Boltzmann). Starting with an initial momentum p_0 (r.m.s. momentum) the atom ends up in the same state after absorbing a photon from the forward pump (2), emitting a stimulated photon (3) absorbing a backward pump photon (4) and emitting a phase conjugate (p.c.) photon. (b) Four level closed system with two ground states $|a\rangle$ and $|b\rangle$ and two excited states $|e_1\rangle$ and $|e_2\rangle$, which are coupled by the two counter propagating pump beams with Rabi frequencies $\Omega_{+P,-P}$ and the signal beam with a Rabi frequency Ω_s . The four wave mixing process creates the p.c. beam with a Rabi frequency $\Omega_{p.c.}$. (c) Equivalent three level system : two ground states $|a\rangle$ and $|b\rangle$ are coupled by the forward pump (+P) and backward pump (-P) fields (in red) and the signal (p) field (in green). The green phase conjugate (p.c.) field is created by a four wave mixing process. $\omega_{+P,-P,s,p.c.}$ denote the corresponding optical frequencies of the fields. The pump fields are detuned from the transition frequency by Δ . $\hbar\Delta_0$ is the energy difference between the two ground states. δ is the frequency detuning between the pump and the probe beams.⁷

- (3) The atom absorbs another pump photon from the counter-propagating beam of wavevector $-\vec{k}_P$ so that the atom's momentum becomes $\vec{p} - \hbar\vec{k}_s$.
- (3) Finally, the emission of a phase conjugate photon counter-propagating to the signal with a wavevector $-\vec{k}_s$ gives an atom with a final momentum \vec{p} .

This interaction can be modeled as a four level atom in an X-scheme (fig. 4.9(b)). We will consider that $|e_1\rangle$ and $|e_2\rangle$ correspond to one single level, which is just used to excite the coherence between both ground states through multi-photon processes because the fields are far enough detuned so that $\Delta \gg \omega_k$. This then generates a phase conjugate field by undergoing a writing and reading mechanism [Triche, 1997] similar to what is described in sec. 4.1.2. The generation of a phase conjugate beam then involves a writing process involving the forward pump beam and the signal beam, followed by a reading process with the backward pump beam. This model corresponds to a truncated version of the previous two-level model.

Four-wave mixing from a three-level model is well studied [Agarwal, 1986, Du, Oh, Wen, and Rubin, 2007]. Yet, the particularity of the system studied here, is that the two ground states $|a\rangle$ and $|b\rangle$ are not different internal atomic states : in this model, both of them correspond to the same atomic state, but with different linear momenta *viz.* \vec{p} and $\vec{p} + \hbar(\vec{k}_P - \vec{k}_s)$ (see fig. 4.9(a)). Thus, the ground state coherence, is the momentum coherence $\rho_{11}(\vec{p}, \vec{p} + \hbar(\vec{k}_P - \vec{k}_s))$ described in the previous model (eq. 4.2).

The notations are summarized in fig. 4.9(b) : the two ground states are named $|a\rangle$ and $|b\rangle$, and the excited state is $|e\rangle$. The transition frequency is ω . The energy difference between the two ground states is $E_b - E_a = -\hbar\Delta_0 = \frac{(\vec{p} + \hbar(\vec{k}_P - \vec{k}_s))^2}{2m} - \frac{p^2}{2m}$. The three fields incident on this system are the forward pump beam, the counter-propagating or backward pump beam and the signal beam. Both pump beams have the same frequency ω_P , which is detuned from the transition by $\Delta = \omega - \omega_P$. The signal frequency ω_s is detuned from the pump one by $\delta = \omega_s - \omega_P$. The Rabi frequencies of the forward pump, the backward pump and the signal fields are $\Omega_{+P,-P,s}$.

In a Λ - system, when the legs are coupled with the pump and signal fields with Rabi frequencies Ω_p and Ω_s , the ground state coherence is written as

[Triche, 1997] :

$$\rho_{ab}(r, t) = \frac{\Delta_R + i\gamma}{\Delta_R^2 + \gamma^2 + |\Omega_{eff}|^2/2} \frac{\Omega_{eff}}{2} e^{i(\Delta\vec{k}\cdot\vec{r}-\delta t)} \quad (4.22)$$

where, $\Delta_R = -\delta - \Delta_0$ is the Raman detuning between the ground states $|a\rangle$ and $|b\rangle$ and γ is the ground-state coherence decay rate. $\Delta\vec{k} = \text{veck}_s - \text{veck}_P$ is the wave-vector mismatch between the forward pump and signal. The quantity $\Omega_{eff} = \frac{\Omega_P^* \Omega_s}{2\Delta}$ is the effective Rabi frequency of the Raman transition between the two ground states $a \leftrightarrow b$. The phase conjugate beam is then generated by the diffraction of the backward pump from the coherence:

$$\frac{d}{dt}\rho_{ea} + i\omega\rho_{ea} = -\frac{D_{eb}}{2i\hbar} E e^{i(-\vec{k}_P\cdot\vec{r}-\omega_P t)} \rho_{ba}(t) \quad (4.23)$$

Using eq. 4.22 in eq. 4.23, we have:

$$\frac{d}{dt}\rho_{ea} + i\omega\rho_{ea} = -\frac{D_{eb}}{2i\hbar} E_{-P} \frac{\Delta_R + i\gamma}{\Delta_R^2 + \gamma^2 + |\Omega_{eff}|^2/2} \frac{\Omega_{eff}}{2} e^{i((- \vec{k}_s\cdot\vec{r} - (\omega_P - \delta)t)} \quad (4.24)$$

where we have neglected the optical coherence decay rate $\gamma/2$ in front of the transition frequency $(\omega_e - \omega_a)$. Eq. 4.24 confirms the generation of the phase conjugate beam that propagates opposite to the signal with a frequency $(\omega_P - \delta)$. The solution to the eq. 4.24 can be calculated as:

$$\begin{aligned} \rho_{ea}(p, t) &= -\frac{D_{eb}}{2i\hbar} E_{-P} \frac{\Delta_R + i\gamma}{\Delta_R^2 + \gamma^2 + |\Omega_{eff}|^2/2} \frac{\Omega_{eff}}{2} \frac{1}{e^{\int i(\omega_e - \omega_a) dt}} \int e^{\int i(\omega_e - \omega_a) dt} e^{i((- \vec{k}_s\cdot\vec{r} - (\omega_P - \delta)t)} dt \\ &= -\frac{D_{eb}}{2i\hbar} E_{-P} \frac{\Delta_R + i\gamma}{\Delta_R^2 + \gamma^2 + |\Omega_{eff}|^2/2} \frac{\Omega_{eff}}{2} \frac{(\omega_e - \omega_b)}{(\Delta - \delta)} e^{i((- \vec{k}_s\cdot\vec{r} - (\omega_P - \delta)t)} \end{aligned} \quad (4.25)$$

The coherence $\rho_{ea}(p, t)$ depends on the initial momentum p of the atom through Δ_R . We assume a Maxwell-Boltzmann distribution of the momenta, which is written as:

$$W(p) = \frac{1}{\sqrt{(\pi p_0)^3}} e^{-p^2/p_0^2} \quad (4.26)$$

The total coherence coming from all the momentum classes can then finally be computed by:

$$\rho_{ea}(t) = \int \rho_{ea}(p, t) W(p) dp \quad (4.27)$$

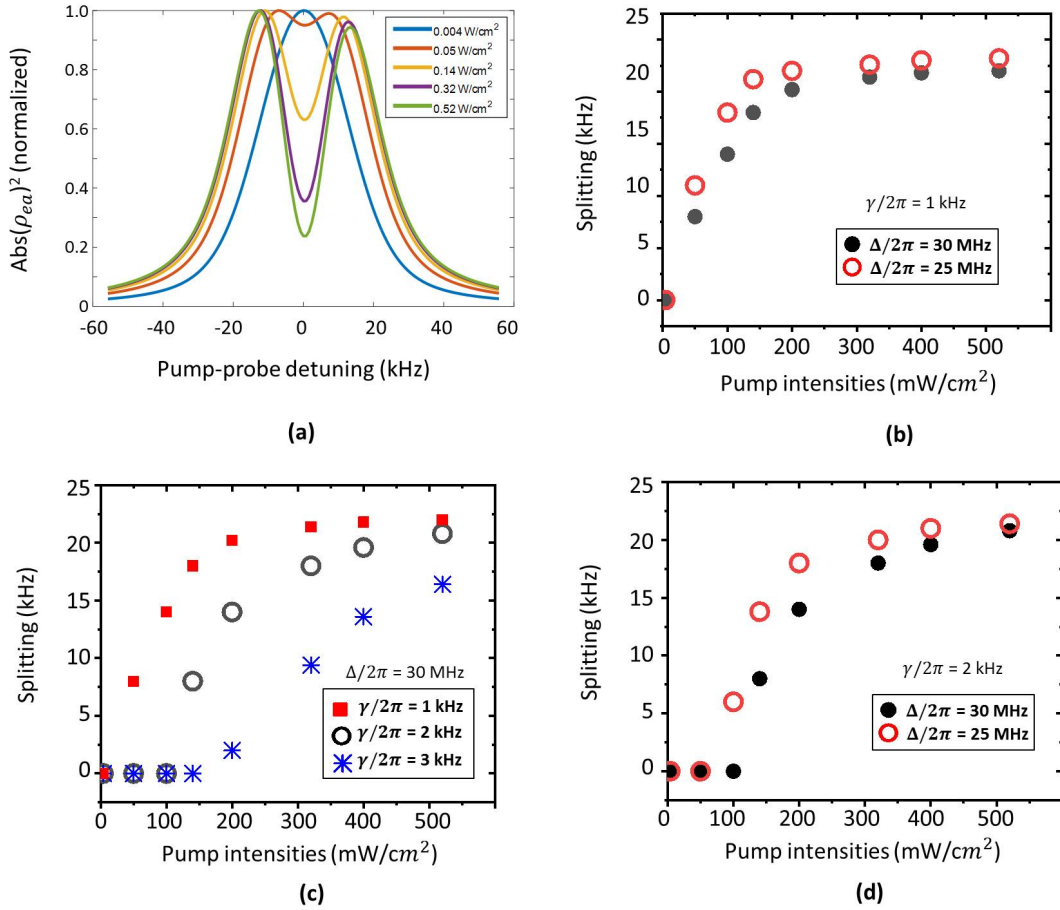

FIGURE 4.10: Results of the theoretical simulation with the three level model. (a) phase conjugate generation spectra as a function of pump-signal detuning δ for different pump intensities and $T = 300\mu\text{K}$, $\Delta/2\pi = 30$ MHz, $\lambda = 852$ nm, $\gamma = 1$ kHz. The signal intensity is 0.2 mW/cm^2 . For any pump-intensities higher than 0.004 W/cm^2 , a characteristic dip appears. (b) splitting distance as a function of pump intensities, for optical detuning $\Delta/2\pi = 30$ MHz and $\Delta/2\pi = 25$ MHz, with $\gamma/2\pi = 1$ kHz. (c) comparison of the effect of three different ground state coherence decay rates γ with $\Delta/2\pi = 30$ MHz. The threshold pump intensity increases for increasing γ . (d) Splitting values for $\Delta/2\pi = 30$ MHz and $\Delta/2\pi = 25$ MHz when $\gamma/2\pi = 2$ kHz.

The absolute value of the amplitude of this coherence $\rho_{ea}(t)$, gives the generated phase conjugate field. The p.c. generation spectra as a function of pump signal detuning is shown in fig. 4.10(a) for different pump intensities. We can observe the emergence of the dip when increasing the pump intensity. Contrary to the experimental data and the fifth order simulations, the two peak relative heights remain the same throughout. Fig. 4.10(b) presents the splitting values as a function of increasing pump intensities for $\gamma/2\pi = 1$ kHz, which shows that for both $\Delta/2\pi = 30$ MHz and $\Delta/2\pi = 25$ MHz, the splitting emerges even for very small pump intensities which is different from the experimental observation (fig. 4.4). The decay rate of the ground state coherence γ affects the threshold intensity for which the dip emerges (see fig. 4.10(c)). For $\gamma/2\pi = 2$ kHz (fig. 4.10(d)), the splitting emerges for a pump intensity of about 150 mW/cm² when $\Delta/2\pi = 30$ MHz, and for about 100 mW/cm² when $\Delta/2\pi = 25$ MHz, which is the experimental observation. In this simpler model, the ground state population decay rate is not considered, but the coherence decay rate $\gamma/2\pi = 2$ kHz is consistent with $\gamma_1 = \gamma_t + \gamma'_1$ kHz for coherences between different momenta in the fifth order perturbation model. Thus, a study of this threshold intensity can be used as a signal for decoherence processes in the atomic system.

General Conclusion

In my thesis, I have presented two very different non-linear phenomena. Both rely on multiwave mixing but as the phase sensitive and in He* uses superpositions of internal atomic states, the phase conjugate generation through RIR uses external degrees of freedom of the atom

The PSA experiments were performed in metastable He* which was chosen for its simple level structure with no hyperfine splitting. This helps to understand the non-linear four wave mixing (FWM) process that results into phase sensitive amplification (PSA). Contrary to alkali metal atoms [Corzo, Marino, Jones, and Lett, 2012, Ma, Liu, Qin, Jia, and Gao, 2017], free from unwanted processes, which would degrade the phenomenon. This has lead us to theoretically understand how coherent population trapping (CPT) could enable PSA and give rise to gains upto nearly 9 dB for a relatively low optical depth, below 3 [Neveu et al., 2018]. I thus designed an experimental setup to detect the two-mode squeezing which should be associated to such a good PSA process. Unfortunately, the high phase noise of the laser diode that we used prevented me from realizing a characterization of these nonclassical states of light. We have installed a new and better laser source and the squeezing detection experiment should now give good results. A possible outlook is to store and retrieve these squeezed states and check that their evolution through CPO follows the expected behaviour predicted by P. Neveu [Neveu, Bretenaker, Goldfarb, and Brion, 2019].

The other phenomenon, which I had theoretically studied, is a four wave mixing phenomenon based on states involving external degrees of freedom of the atom. Indeed, RIR occurs due to the recoil induced by the absorption or emission of photons by the atom. It was already known that such a quantized recoil could lead to Gaussian derivative resonances in the transmission spectrum of a probe going through a cold atom cloud with a small angle with respect to a large coupling beam. In the case of two counterpropagating coupling beams, the generation of a phase conjugate beam was predicted and experimentally demonstrated in the 1990's. Nevertheless, the theory failed to explain a feature

that was visible for pump powers higher than 100 mW/cm^2 in the group of J. Tabosa.

I derived higher order calculation and proved that it can be attributed to destructive interference between the phase conjugate beams produced by four wave mixing and six wave mixing. The power needed for this dip to emerge depends on the coherence rate between levels of different momenta. I could also propose a much simpler model, based on atomic levels with different external degrees of freedom. The calculations give results, which are consistent with the fifth order expansion: the dip behaviour is well reproduced for the coherence decay rate between levels of different momenta. Such a phenomenon could thus be used as a probe of this coherence decay rate.

Appendix A

Quantum Noise of a light field

Contents

A.1	Field quantization	103
A.2	Coherent states	105
A.3	Noise calculation for PSA	107
	A.3.1 Noise figures	107
	A.3.2 Quadrature noises after PSA	113
	A.3.3 Two mode squeezing	115
A.4	Effect of losses on squeezed state detection	116

A.1 Field quantization

To quantize the electro-magnetic field, we can start from the elementary equations in electromagnetism, i.e. the Maxwell's equations (in free space, eq.s [1.34](#)):

$$\begin{aligned} \nabla \cdot \vec{D} &= 0 & \nabla \times \vec{E} &= \partial_t \vec{B} \\ \nabla \cdot \vec{B} &= 0 & \nabla \times \vec{B} &= \frac{1}{c^2} \partial_t \vec{E} \end{aligned} \quad (\text{A.1})$$

As discussed in [1.2](#), we can derive the wave equation for electric field \vec{E} as:

$$\nabla^2 \vec{E} - \frac{1}{c^2} \partial_t^2 \vec{E} = 0 \quad (\text{A.2})$$

If we consider a monochromatic plane wave electric field in a space of volume V and polarized along $\vec{\epsilon}$, then, a solution to the wave eq. [\(A.2\)](#), is written as [Scully and Zubairy, [1997](#)]:

$$\vec{E}(\vec{r}, t) = \vec{\epsilon} \mathcal{E}(q e^{-i(\omega t - \vec{k} \cdot \vec{r})} + q^* e^{i(\omega t - \vec{k} \cdot \vec{r})}) \quad (\text{A.3})$$

where $A = \mathcal{E}\alpha$ is the field amplitude with $\mathcal{E} = \left(\frac{\hbar\omega}{2\epsilon_0 V}\right)^{\frac{1}{2}}$ and q a complex amplitude, \vec{k} is the wave-vector, $\omega = kc$ is the corresponding allowed frequency. Combining eq. (A.3) with the Maxwell's equations, gives the magnetic field $\vec{H}(\vec{r}, t)$:

$$\vec{H}(\vec{r}, t) = \frac{i\vec{k} \times \hat{\epsilon}}{\mu_0\omega} \mathcal{E} \dot{q} e^{-i(\omega t - \vec{k} \cdot \vec{r})} + c.c. \quad (\text{A.4})$$

where c.c. is the complex conjugate. The total field energy in the cavity is thus given by:

$$\begin{aligned} \mathcal{H} &= \int dV (\epsilon_0 E^2 + \mu_0 H^2) \\ &= \frac{1}{2} (\omega^2 q^2 + \dot{q}^2) \end{aligned} \quad (\text{A.5})$$

We can identify q and \dot{q} as the canonical pair variables equivalent to the position and momentum operators for a simple harmonic oscillator case. The canonical annihilation and creation operators \hat{a} and \hat{a}^\dagger can be defined as:

$$\begin{aligned} \hat{a} e^{-i(\omega t - \vec{k} \cdot \vec{r})} &= \frac{1}{\sqrt{2\hbar\omega}} (\omega q + i\dot{q}) \\ \hat{a}^\dagger e^{i(\omega t - \vec{k} \cdot \vec{r})} &= \frac{1}{\sqrt{2\hbar\omega}} (\omega q - i\dot{q}) \end{aligned} \quad (\text{A.6})$$

which follow the canonical commutation relation $[\hat{a}, \hat{a}^\dagger] = 1$. In terms of these operators, the Hamiltonian of eq. (A.5) is:

$$\hat{\mathcal{H}} = \hbar\omega \left(\hat{a}^\dagger \hat{a} + \frac{1}{2} \right) \quad (\text{A.7})$$

and the electric field of eq. (A.3) is given by:

$$\hat{\vec{E}}(\vec{r}, t) = \vec{\epsilon} \mathcal{E} (\hat{a} e^{-i\omega t} + \hat{a}^\dagger e^{i\omega t}) \sin(kz) \quad (\text{A.8})$$

We can define two hermitian operators similar to the classical quadratures of a light wave, and hence called quadrature operators:

$$\hat{X} = \frac{1}{2} (a + a^\dagger) \quad (\text{A.9})$$

$$\hat{Y} = \frac{1}{2i} (a - a^\dagger) \quad (\text{A.10})$$

In terms of which, the field can now be written as:

$$\hat{\vec{E}}(t) = \vec{\epsilon} \mathcal{E} \left(\hat{X} \cos(\omega t) + \hat{Y} \sin(\omega t) \right)$$

Contrary to their classical counterparts, these quadrature operators do not commute and they verify the Heisenberg uncertainty principle. Indeed, using $[a, a^\dagger] = 1$, we can show that:

$$\begin{aligned}
[X, Y] &= \frac{1}{4i}((a + a^\dagger)(a - a^\dagger) - (a - a^\dagger)(a + a^\dagger)) \\
&= \frac{1}{4i}(aa - aa^\dagger + a^\dagger a - a^\dagger a^\dagger - aa - aa^\dagger + a^\dagger a + a^\dagger a^\dagger) \\
&= \frac{1}{2i}(-aa^\dagger + a^\dagger a) \\
&= \frac{i}{2}
\end{aligned} \tag{A.11}$$

The uncertainty principle, then arise from the Cauchy-Schwartz inequality:

$$\boxed{\Rightarrow \langle \Delta X \rangle^2 \langle \Delta Y \rangle^2 \geq \frac{1}{16}} \tag{A.12}$$

A.2 Coherent states

As defined in chapter 1, a coherent state is the unique eigenstate of the annihilation operator. As such, it is written as:

$$\hat{a} | \alpha \rangle = \alpha | \alpha \rangle \tag{A.13}$$

So that, $\langle \alpha | a^\dagger a | \alpha \rangle = |\alpha|^2$. To get the variances of each of the quadratures, we have to calculate:

$$\begin{aligned}
\langle \alpha | X | \alpha \rangle &= \frac{1}{2}(\alpha + \alpha^*) \\
\langle \alpha | X^2 | \alpha \rangle &= \frac{1}{4}(\alpha + \alpha^*)^2 + 1/4 \\
\langle \alpha | Y | \alpha \rangle &= \frac{1}{2i}(\alpha - \alpha^*) \\
\langle \alpha | Y^2 | \alpha \rangle &= \frac{-1}{4}(\alpha - \alpha^*)^2 + 1/4
\end{aligned} \tag{A.14}$$

It is then straightforward to deduce that for a coherent state, the variances of the two quadrature operators are minimum and equal:

$$\boxed{\langle \Delta X \rangle^2 = \frac{1}{4} = \langle \Delta Y \rangle^2} \quad \boxed{\langle \Delta X \rangle^2 \langle \Delta Y \rangle^2 = \frac{1}{16}} \tag{A.15}$$

To write such a state $|\alpha\rangle$ in the basis of number states, or Fock states $\{|n\rangle\}$, we write as:

$$|\alpha\rangle = \sum_n |n\rangle \langle n|\alpha\rangle \quad (\text{A.16})$$

We can calculate the projection(s) $\langle n|\alpha\rangle$ from eq. A.13, by replacing $(n-1)$ in place of n , and iterating the process:

$$\hat{a}|\alpha\rangle = \alpha|\alpha\rangle \quad (\text{A.17})$$

$$\Rightarrow \langle n-1|\hat{a}|\alpha\rangle = \alpha\langle n-1|\alpha\rangle \quad (\text{A.18})$$

$$\sqrt{n}\langle n|\alpha\rangle = \alpha\langle n-1|\alpha\rangle \quad (\text{A.19})$$

$$\langle n|\alpha\rangle = \frac{\alpha}{\sqrt{n}}\langle n-1|\alpha\rangle \quad (\text{A.20})$$

$$= \frac{\alpha}{\sqrt{n}} \frac{\alpha}{\sqrt{n-1}} \langle n-2|\alpha\rangle$$

$$\vdots$$

$$= \frac{\alpha^n}{\sqrt{n!}} \langle 0|\alpha\rangle \quad (\text{A.21})$$

Hence we can write a coherent state as a superposition of all the number states:

$$|\alpha\rangle = \sum_{n=0}^{\infty} c_0 \frac{\alpha^n}{\sqrt{n!}} |n\rangle \quad (\text{A.22})$$

where $c_0 = \langle 0|\alpha\rangle$. The value of c_0 can be found from the normalization condition:

$$\begin{aligned} \sum_{n=0}^{\infty} |c_0 \frac{\alpha^n}{\sqrt{n!}}|^2 &= 1 \\ \Rightarrow |c_0|^2 \sum_{n=0}^{\infty} \frac{|\alpha|^{2n}}{n!} &= 1 \\ \Rightarrow |c_0|^2 e^{|\alpha|^2} &= 1 \\ \Rightarrow c_0 &= e^{-\frac{|\alpha|^2}{2}} \end{aligned} \quad (\text{A.23})$$

This concludes the expression of coherent states in terms of number states.

A.3 Noise calculation for PSA

Phase relation

From equations 1.49, if we write $\mu = |\mu|e^{i\theta_\mu}$ and $\nu = |\nu|e^{i\theta_\nu}$, we can write :

$$\frac{\mu}{\nu} = \frac{\left(\cosh(gz) + i\frac{\kappa}{2g}\sinh(gz)\right)}{\frac{i\gamma}{g}A_P^2(0)\sinh(gz)} \quad (\text{A.24})$$

From the definitions of κ and g , it follows that the phase of this fraction, $(\theta_\mu - \theta_\nu) = -2\theta_p$, where θ_p is the pump phase at the input: $A_p^2(0) = P_p e^{2i\theta_p}$.

We consider the case described by the fig. 1.7 in page 23, when a signal and idler fields of equal power are symmetrically detuned from a pump with large power. Starting from the eq.s 1.48, we replace the field amplitudes with the corresponding operators as:

$$\hat{A} = \mu\hat{a} + \nu\hat{b}^\dagger \quad (\text{A.25})$$

$$\hat{B} = \nu\hat{a}^\dagger + \mu\hat{b} \quad (\text{A.26})$$

where \hat{A} and \hat{B} denote the annihilation operators for output signal and idler; and \hat{a} and \hat{b} denote the input signal and idler annihilation operators respectively. μ and ν are coefficients due to the propagation in the medium (eq. (1.58)).

A.3.1 Noise figures

Input fields

The number operator for the signal and idler together is defined as:

$$N_{in} = a^\dagger a + b^\dagger b \quad (\text{A.27})$$

$$\Rightarrow N_{in}^2 = a^\dagger a a^\dagger a + b^\dagger b a^\dagger a + a^\dagger a b^\dagger b + b^\dagger b b^\dagger b \quad (\text{A.28})$$

We consider the case where both the signal and idler are coherent states, and denote the input state with the vector $|\alpha, \beta\rangle$ where $a|\alpha, \beta\rangle = \alpha|\alpha, \beta\rangle$, and $b|\alpha, \beta\rangle = \beta|\alpha, \beta\rangle$. $|\alpha|^2$ and $|\beta|^2$ are the average number of photons in the signal and idler fields respectively. The expectation values for the different required operators are :

$$\begin{aligned}
\langle N_{in} \rangle &= \langle \alpha, \beta | a^\dagger a + b^\dagger b | \alpha, \beta \rangle \\
&= |\alpha|^2 + |\beta|^2
\end{aligned} \tag{A.29}$$

$$\begin{aligned}
\langle N_{in}^2 \rangle &= \langle \alpha, \beta | a^\dagger a a^\dagger a + b^\dagger b a^\dagger a + a^\dagger a b^\dagger b + b^\dagger b b^\dagger b | \alpha, \beta \rangle \\
&= |\alpha|^2 \langle \alpha, \beta | a a^\dagger | \alpha, \beta \rangle + |\beta|^2 |\alpha|^2 + |\alpha|^2 |\beta|^2 + |\beta|^2 \langle \alpha, \beta | b b^\dagger | \alpha, \beta \rangle \\
&= |\alpha|^2 (1 + |\alpha|^2) + |\beta|^2 |\alpha|^2 + |\alpha|^2 |\beta|^2 + |\beta|^2 (1 + |\beta|^2) \\
&= (|\alpha|^2 + |\beta|^2)^2 + |\alpha|^2 + |\beta|^2
\end{aligned} \tag{A.30}$$

So, SNR_{in} is calculated to be:

$$\text{SNR}_{in} = \frac{(|\alpha|^2 + |\beta|^2)^2}{(|\alpha|^2 + |\beta|^2)^2 + |\alpha|^2 + |\beta|^2 - (|\alpha|^2 + |\beta|^2)^2} = |\alpha|^2 + |\beta|^2 \tag{A.31}$$

Detection of both signal and idler fields

The number operator for the signal and idler fields together:

$$N_{out} = A^\dagger A + B^\dagger B \tag{A.32}$$

$$\begin{aligned}
&= (\mu a + \nu b^\dagger)^\dagger (\mu a + \nu b^\dagger) + (\nu a^\dagger + \mu b)^\dagger (\nu a^\dagger + \mu b) \\
&= (\mu^* a^\dagger + \nu^* b) (\mu a + \nu b^\dagger) + (\nu^* a + \mu^* b^\dagger) (\nu a^\dagger + \mu b) \\
&= |\mu|^2 a^\dagger a + \nu^* \mu b a + \mu^* \nu a^\dagger b^\dagger + |\nu|^2 b b^\dagger + \\
&\quad |\nu|^2 a a^\dagger + \nu^* \mu a b + \mu^* \nu b^\dagger a^\dagger + |\mu|^2 b^\dagger b
\end{aligned} \tag{A.33}$$

$$\begin{aligned}
&= (|\mu|^2 + |\nu|^2) + (|\mu|^2 + |\nu|^2) (a^\dagger a + b^\dagger b) + \\
&\quad \nu^* \mu (b a + a b) + \mu^* \nu (a^\dagger b^\dagger + b^\dagger a^\dagger) \\
&= (|\mu|^2 + |\nu|^2) + (|\mu|^2 + |\nu|^2) N_{in} + 2\nu^* \mu a b + 2\mu^* \nu a^\dagger b^\dagger
\end{aligned} \tag{A.34}$$

So that we have:

$$\begin{aligned}
\Rightarrow N_{out}^2 &= \left((|\mu|^2 + |\nu|^2) + (|\mu|^2 + |\nu|^2) N_{in} + 2\nu^* \mu a b + 2\mu^* \nu a^\dagger b^\dagger \right)^2 \\
&= (|\mu|^2 + |\nu|^2)^2 + (|\mu|^2 + |\nu|^2)^2 N_{in}^2 + (2\nu^* \mu a b + 2\mu^* \nu a^\dagger b^\dagger)^2 + \\
&\quad 2(|\mu|^2 + |\nu|^2)^2 N_{in} + 2(|\mu|^2 + |\nu|^2) (2\nu^* \mu a b + 2\mu^* \nu a^\dagger b^\dagger) + \\
&\quad (|\mu|^2 + |\nu|^2) N_{in} (2\nu^* \mu a b + 2\mu^* \nu a^\dagger b^\dagger) + (|\mu|^2 + |\nu|^2) (2\nu^* \mu a b + 2\mu^* \nu a^\dagger b^\dagger) N_{in}
\end{aligned} \tag{A.35}$$

$$\begin{aligned}
&= (|\mu|^2 + |\nu|^2)^2 + (|\mu|^2 + |\nu|^2)^2 N_{in}^2 + 2(|\mu|^2 + |\nu|^2)^2 N_{in} + \\
&\quad 2(|\mu|^2 + |\nu|^2) (2\nu^* \mu ab + 2\mu^* \nu a^\dagger b^\dagger) + \\
&\quad 2\nu^* \mu (|\mu|^2 + |\nu|^2) (a^\dagger a ab + ab^\dagger bb + aa^\dagger ab + abb^\dagger b) + \\
&\quad 2\mu^* \nu (|\mu|^2 + |\nu|^2) (a^\dagger aa^\dagger b^\dagger + a^\dagger b^\dagger bb^\dagger + a^\dagger a^\dagger ab^\dagger + a^\dagger b^\dagger b^\dagger b) + \\
&\quad 4\nu^{*2} \mu^2 aabb + 4|\nu|^2 |\mu|^2 aa^\dagger bb^\dagger + 4|\nu|^2 |\mu|^2 a^\dagger ab^\dagger b + 4\mu^{*2} \nu^2 a^\dagger a^\dagger b^\dagger b^\dagger \quad (A.36)
\end{aligned}$$

The expectation values for these operators are thus given by :

$$\begin{aligned}
\langle N_{out} \rangle &= \langle \alpha, \beta | N_{out} | \alpha, \beta \rangle \\
&= (|\mu|^2 + |\nu|^2) + (|\mu|^2 + |\nu|^2) \langle N_{in} \rangle + 2\nu^* \mu \langle \alpha, \beta | ab | \alpha, \beta \rangle + 2\mu^* \nu \langle \alpha, \beta | a^\dagger b^\dagger | \alpha, \beta \rangle \\
&= (|\mu|^2 + |\nu|^2) + (|\mu|^2 + |\nu|^2) (|\alpha|^2 + |\beta|^2) + 2\nu^* \mu \alpha \beta + 2\mu^* \nu \alpha^* \beta^* \quad (A.37)
\end{aligned}$$

$$\begin{aligned}
\langle N_{out}^2 \rangle &= \langle \alpha, \beta | N_{out}^2 | \alpha, \beta \rangle \\
&= (|\mu|^2 + |\nu|^2)^2 + (|\mu|^2 + |\nu|^2)^2 \left((|\alpha|^2 + |\beta|^2)^2 + |\alpha|^2 + |\beta|^2 \right) + \\
&\quad 2(|\mu|^2 + |\nu|^2)^2 (|\alpha|^2 + |\beta|^2) + 2(|\mu|^2 + |\nu|^2) (2\nu^* \mu \alpha \beta + 2\mu^* \nu \alpha^* \beta^*) + \\
&\quad 2\nu^* \mu (|\mu|^2 + |\nu|^2) (|\alpha|^2 \alpha \beta + \alpha |\beta|^2 \beta + 2\alpha \beta + |\alpha|^2 \alpha \beta + \alpha |\beta|^2 \beta) + \\
&\quad 2\mu^* \nu (|\mu|^2 + |\nu|^2) (\alpha^* (1 + 2|\alpha|^2) \beta^* + \alpha^* \beta^* (1 + 2|\beta|^2)) + \\
&\quad 4\nu^{*2} \mu^2 \alpha^2 \beta^2 + 4|\nu|^2 |\mu|^2 (1 + |\alpha|^2) (1 + |\beta|^2) + 4|\nu|^2 |\mu|^2 |\alpha|^2 |\beta|^2 + \\
&\quad 4\mu^{*2} \nu^2 \alpha^{*2} \beta^{*2} \\
&= (|\mu|^2 + |\nu|^2)^2 + (|\mu|^2 + |\nu|^2)^2 \left((|\alpha|^2 + |\beta|^2)^2 + |\alpha|^2 + |\beta|^2 \right) + \\
&\quad 2(|\mu|^2 + |\nu|^2)^2 (|\alpha|^2 + |\beta|^2) + 4(|\mu|^2 + |\nu|^2) (\nu^* \mu \alpha \beta + \mu^* \nu \alpha^* \beta^*) + \\
&\quad 4(|\mu|^2 + |\nu|^2) (1 + |\alpha|^2 + |\beta|^2) (\nu^* \mu \alpha \beta + \mu^* \nu \alpha^* \beta^*) + \\
&\quad 4\nu^{*2} \mu^2 \alpha^2 \beta^2 + 4|\nu|^2 |\mu|^2 (1 + |\alpha|^2) (1 + |\beta|^2) + 4|\nu|^2 |\mu|^2 |\alpha|^2 |\beta|^2 + \\
&\quad 4\mu^{*2} \nu^2 \alpha^{*2} \beta^{*2} \quad (A.38)
\end{aligned}$$

It is important to notice that for the output case, the terms are complex numbers, so that, the noise depends on the relative phase $\pm(\theta_\mu - \theta_\nu + \theta_s + \theta_i)$ which, from the eq. 1.49, can be shown to be equal to $\theta_{rel} = \mp(2\theta_p - \theta_s - \theta_i)$.

The general expressions, in terms of the relative phase θ_{rel} are:

$$\langle N_{out} \rangle = (|\mu|^2 + |\nu|^2) + (|\mu|^2 + |\nu|^2) (|\alpha|^2 + |\beta|^2) + 2\nu^* \mu \alpha \beta + 2\mu^* \nu \alpha^* \beta^*$$

$$= (|\mu|^2 + |\nu|^2) + (|\mu|^2 + |\nu|^2)(|\alpha|^2 + |\beta|^2) + 4|\mu||\nu||\alpha||\beta|\cos(\theta_{rel}) \quad (\text{A.39})$$

$$\begin{aligned} \langle N_{out}^2 \rangle &= (|\mu|^2 + |\nu|^2)^2 + (|\mu|^2 + |\nu|^2)^2 \left((|\alpha|^2 + |\beta|^2)^2 + |\alpha|^2 + |\beta|^2 \right) + \\ & 2(|\mu|^2 + |\nu|^2)^2 (|\alpha|^2 + |\beta|^2) + 4(|\mu|^2 + |\nu|^2) (\nu^* \mu \alpha \beta + \mu^* \nu \alpha^* \beta^*) + \\ & 4(|\mu|^2 + |\nu|^2)(1 + |\alpha|^2 + |\beta|^2) (\nu^* \mu \alpha \beta + \mu^* \nu \alpha^* \beta^*) + \\ & 4\nu^* \mu^2 \alpha^2 \beta^2 + 4|\nu|^2 |\mu|^2 (1 + |\alpha|^2)(1 + |\beta|^2) + 4|\nu|^2 |\mu|^2 |\alpha|^2 |\beta|^2 + \\ & 4\mu^* \nu^2 \alpha^* \beta^{*2} \\ &= (|\mu|^2 + |\nu|^2)^2 + (|\mu|^2 + |\nu|^2)^2 \left((|\alpha|^2 + |\beta|^2)^2 + |\alpha|^2 + |\beta|^2 \right) + \\ & 2(|\mu|^2 + |\nu|^2)^2 (|\alpha|^2 + |\beta|^2) + 8(|\mu|^2 + |\nu|^2) |\mu||\nu||\alpha||\beta|\cos(\theta_{rel}) + \\ & 8(|\mu|^2 + |\nu|^2)(1 + |\alpha|^2 + |\beta|^2) |\mu||\nu||\alpha||\beta|\cos(\theta_{rel}) + \\ & 8|\mu|^2 |\nu|^2 |\alpha|^2 |\beta|^2 \cos(2\theta_{rel}) + 4|\nu|^2 |\mu|^2 (1 + |\alpha|^2)(1 + |\beta|^2) + 4|\nu|^2 |\mu|^2 |\alpha|^2 |\beta|^2 \end{aligned} \quad (\text{A.40})$$

The variance can then be shown to be given by :

$$\begin{aligned} \langle \Delta N_{PSA} \rangle^2 &= \langle N_{PSA}^2 \rangle - \langle N_{PSA} \rangle^2 \\ &= (|\mu|^2 + |\nu|^2)^2 + (|\mu|^2 + |\nu|^2)^2 \left((|\alpha|^2 + |\beta|^2)^2 + |\alpha|^2 + |\beta|^2 \right) + \\ & 2(|\mu|^2 + |\nu|^2)^2 (|\alpha|^2 + |\beta|^2) + 8(|\mu|^2 + |\nu|^2) |\mu||\nu||\alpha||\beta|\cos(\theta_{rel}) + \\ & 8(|\mu|^2 + |\nu|^2)(1 + |\alpha|^2 + |\beta|^2) |\mu||\nu||\alpha||\beta|\cos(\theta_{rel}) + \\ & 8|\mu|^2 |\nu|^2 |\alpha|^2 |\beta|^2 \cos(2\theta_{rel}) + 4|\nu|^2 |\mu|^2 (1 + |\alpha|^2)(1 + |\beta|^2) + 4|\nu|^2 |\mu|^2 |\alpha|^2 |\beta|^2 \\ & - \{ (|\mu|^2 + |\nu|^2) + (|\mu|^2 + |\nu|^2)(|\alpha|^2 + |\beta|^2) + 4|\mu||\nu||\alpha||\beta|\cos(\theta_{rel}) \}^2 \\ &= (|\mu|^2 + |\nu|^2)^2 (|\alpha|^2 + |\beta|^2) + 8|\mu||\nu||\alpha||\beta| (|\mu|^2 + |\nu|^2) \cos(\theta_{rel}) + \\ & 4|\mu|^2 |\nu|^2 (1 + |\alpha|^2 + |\beta|^2) \end{aligned} \quad (\text{A.41})$$

The SNR at the output of the PSA is thus:

$$\begin{aligned} \text{SNR}_{PSA} &= \frac{\langle N_{PSA} \rangle^2}{\langle \Delta N_{PSA} \rangle^2} \\ &= \frac{((|\mu|^2 + |\nu|^2)(1 + 2|\alpha|^2) + 4|\mu||\nu||\alpha|^2 \cos(\theta_{rel}))^2}{2|\alpha|^2 (|\mu|^2 + |\nu|^2)^2 + 8|\mu||\nu||\alpha|^2 (|\mu|^2 + |\nu|^2) \cos(\theta_{rel}) + 4|\mu|^2 |\nu|^2 (1 + 2|\alpha|^2)} \\ &\approx \frac{2|\alpha|^2 ((|\mu|^2 + |\nu|^2) + 2|\mu||\nu| \cos(\theta_{rel}))^2}{(|\mu|^2 + |\nu|^2)^2 + 4|\mu||\nu| (|\mu|^2 + |\nu|^2) \cos(\theta_{rel}) + 4|\mu|^2 |\nu|^2} \quad (\text{as } |\alpha|^2 \gg 1) \end{aligned}$$

At the input, we had $\text{SNR}_{in} = 2|\alpha|^2$, so that, using $|\mu|^2 - |\nu|^2 = 1$:

$$\begin{aligned}
\text{N.F.}_{PSA} &= \frac{\text{SNR}_{in}}{\text{SNR}_{out}} \\
&= \frac{(|\mu|^2 + |\nu|^2)^2 + 4|\mu||\nu|(|\mu|^2 + |\nu|^2)\cos(\theta_{rel}) + 4|\mu|^2|\nu|^2}{((|\mu|^2 + |\nu|^2) + 2|\mu||\nu|\cos(\theta_{rel}))^2} \\
&= \frac{2(|\mu|^2 + |\nu|^2)^2 + 4|\mu||\nu|(|\mu|^2 + |\nu|^2)\cos(\theta_{rel}) - ((|\mu|^2 + |\nu|^2)^2 - 4|\mu|^2|\nu|^2)}{((|\mu|^2 + |\nu|^2) + 2|\mu||\nu|\cos(\theta_{rel}))^2} \\
&= \frac{2(|\mu|^2 + |\nu|^2)}{((|\mu|^2 + |\nu|^2) + 2|\mu||\nu|\cos(\theta_{rel}))} - \frac{1}{((|\mu|^2 + |\nu|^2) + 2|\mu||\nu|\cos(\theta_{rel}))^2}
\end{aligned} \tag{A.42}$$

The noise figure is more easily expressed injecting the expressions for PSA and PIA gains : $G_{PSA} = (|\mu|^2 + |\nu|^2) + 2|\mu||\nu|\cos(\theta_{rel})$, and, $G_{PIA} = |\mu|^2 = 1 + |\nu|^2$:

$$\text{N.F.}_{PSA} = \frac{2(2G_{PIA} - 1)}{G_{PSA}} - \frac{1}{G_{PSA}^2} \tag{A.43}$$

Detection of the signal alone

When we consider only the signal channel, the number operators \hat{N} are defined as:

$$\begin{aligned}
N_{in} &= \hat{a}^\dagger \hat{a} \\
N_{out} &= \hat{A}^\dagger \hat{A}
\end{aligned} \tag{A.44}$$

While the input state is still given as $|\psi\rangle_{in} = |\alpha, \beta\rangle$. Thus for $\alpha = \beta$:

$$\begin{aligned}
\langle N_{in} \rangle &= \langle \alpha, \beta | a^\dagger a | \alpha, \beta \rangle \\
&= |\alpha|^2
\end{aligned} \tag{A.45}$$

$$\langle N_{in}^2 \rangle = \langle \alpha, \beta | a^\dagger a a^\dagger a | \alpha, \beta \rangle \tag{A.46}$$

$$= |\alpha|^2(1 + |\alpha|^2) \tag{A.47}$$

The input signal-to-noise ratio is then:

$$\text{SNR}_{in} = \frac{|\alpha|^4}{|\alpha|^2(1 + |\alpha|^2) - |\alpha|^4} = |\alpha|^2 \tag{A.48}$$

At the output, for $\alpha = \beta$

$$\begin{aligned}
\langle N_{out} \rangle &= \langle \alpha, \beta | A^\dagger A | \alpha, \beta \rangle \\
&= \langle \alpha, \beta | (\mu^* a^\dagger + \nu^* b) (\mu a + \nu b^\dagger) | \alpha, \beta \rangle \\
&= \langle \alpha, \alpha | (|\mu|^2 a^\dagger a + \mu^* \nu a^\dagger b^\dagger + \nu^* \mu b a + |\nu|^2 b b^\dagger) | \alpha, \beta \rangle \\
&= |\mu|^2 |\alpha|^2 + |\nu|^2 (1 + |\alpha|^2) + 2|\mu||\nu||\alpha|^2 \cos(\theta_{rel}) \tag{A.49}
\end{aligned}$$

$$\begin{aligned}
\langle N_{out}^2 \rangle &= \langle \alpha, \beta | A^\dagger A A^\dagger A | \alpha, \beta \rangle \\
&= \langle \alpha, \beta | (\mu^* a^\dagger + \nu^* b) (\mu a + \nu b^\dagger) (\mu^* a^\dagger + \nu^* b) (\mu a + \nu b^\dagger) | \alpha, \beta \rangle \\
&= \langle \alpha, \beta | (|\mu|^4 a^\dagger a a^\dagger a + |\mu|^2 \mu^* \nu a^\dagger a a^\dagger b^\dagger + |\mu|^2 \nu^* \mu a^\dagger a b a + |\mu|^2 |\nu|^2 a^\dagger a b b^\dagger + \\
&\quad |\mu|^2 \mu^* \nu a^\dagger b^\dagger a^\dagger a + \mu^{*2} \nu^2 a^\dagger b^\dagger a^\dagger b^\dagger + |\mu|^2 |\nu|^2 a^\dagger b^\dagger b a + \mu^* \nu |\nu|^2 a^\dagger b^\dagger b b^\dagger + \\
&\quad |\mu|^2 \nu^* \mu b a a^\dagger a + |\mu|^2 |\nu|^2 b a a^\dagger b^\dagger + \nu^{*2} \mu^2 b a b a + \mu |\nu|^2 \nu^* b a b b^\dagger + \\
&\quad |\mu|^2 |\nu|^2 b b^\dagger a^\dagger a + \mu^* \nu |\nu|^2 b b^\dagger a^\dagger b^\dagger + \mu \nu^* |\nu|^2 b b^\dagger b a + |\nu|^4 b b^\dagger b b^\dagger) | \alpha, \beta \rangle \\
&= |\mu|^4 |\alpha|^2 (1 + |\alpha|^2) + |\mu|^2 |\nu|^2 (1 + 2|\alpha|^2)^2 + |\nu|^4 (1 + 3|\alpha|^2 + |\alpha|^4) + \\
&\quad 2|\mu||\nu||\alpha|^2 \{ |\mu|^2 (1 + 2|\alpha|^2) + |\nu|^2 (3 + 2|\alpha|^2) \} \cos(\theta_{rel}) + \\
&\quad 2|\mu|^2 |\nu|^2 |\alpha|^4 \cos(2\theta_{rel}) \quad \text{with } \alpha = \beta \tag{A.50}
\end{aligned}$$

$$\begin{aligned}
\langle \Delta N_{out} \rangle^2 &= \langle N_{out}^2 \rangle - \langle N_{out} \rangle^2 \\
&= |\mu|^4 |\alpha|^2 (1 + |\alpha|^2) + |\mu|^2 |\nu|^2 (1 + 2|\alpha|^2)^2 + |\nu|^4 (1 + 3|\alpha|^2 + |\alpha|^4) + \\
&\quad 2|\mu||\nu||\alpha|^2 \{ |\mu|^2 (1 + 2|\alpha|^2) + |\nu|^2 (3 + 2|\alpha|^2) \} \cos(\theta_{rel}) + \\
&\quad 2|\mu|^2 |\nu|^2 |\alpha|^4 \cos(2\theta_{rel}) - (|\mu|^2 |\alpha|^2 + |\nu|^2 (1 + |\alpha|^2) + 2|\mu||\nu||\alpha|^2 \cos(\theta_{rel}))^2 \\
&= |\mu|^4 |\alpha|^2 + |\nu|^4 |\alpha|^2 + |\mu|^2 |\nu|^2 (1 + 2|\alpha|^2) + 2|\mu||\nu||\alpha|^2 (|\mu|^2 + |\nu|^2) \cos(\theta_{rel}) \tag{A.51}
\end{aligned}$$

So that, SNR_{out} can be calculated as:

$$\begin{aligned}
\text{SNR}_{out} &= \frac{\langle N_{out} \rangle^2}{\langle \Delta N_{out} \rangle^2} \\
&= \frac{(|\mu|^2 |\alpha|^2 + |\nu|^2 (1 + |\alpha|^2) + 2|\mu||\nu||\alpha|^2 \cos(\theta_{rel}))^2}{|\mu|^4 |\alpha|^2 + |\nu|^4 |\alpha|^2 + |\mu|^2 |\nu|^2 (1 + 2|\alpha|^2) + 2|\mu||\nu||\alpha|^2 (|\mu|^2 + |\nu|^2) \cos(\theta_{rel})} \\
&\approx \frac{|\alpha|^2 (|\mu|^2 + |\nu|^2 + 2|\mu||\nu| \cos(\theta_{rel}))^2}{|\mu|^4 + |\nu|^4 + 2|\mu|^2 |\nu|^2 + 2|\mu||\nu| (|\mu|^2 + |\nu|^2) \cos(\theta_{rel})}
\end{aligned}$$

The noise figure is then given by:

$$\begin{aligned}
\text{N.F.} &= \frac{|\mu|^4 + |\nu|^4 + 2|\mu|^2|\nu|^2 + 2|\mu||\nu|(|\mu|^2 + |\nu|^2) \cos(\theta_{rel})}{(|\mu|^2 + |\nu|^2 + 2|\mu||\nu| \cos(\theta_{rel}))^2} \\
&= \frac{(|\mu|^2 + |\nu|^2)}{(|\mu|^2 + |\nu|^2 + 2|\mu||\nu| \cos(\theta_{rel}))} \\
&= \frac{2G_{PIA} - 1}{G_{PSA}} \tag{A.52}
\end{aligned}$$

The NF thus depends on the detection scheme, whether both the signal and idler are detected or only one.

A.3.2 Quadrature noises after PSA

For the two fields, we can define the individual quadratures as (see eq. (1.4)):

at input	at output
$x_a = \frac{1}{2}(a + a^\dagger)$	$X_A = \frac{1}{2}(A + A^\dagger)$
$y_a = \frac{1}{2i}(a - a^\dagger)$	$Y_A = \frac{1}{2i}(A - A^\dagger)$
$x_b = \frac{1}{2}(b + b^\dagger)$	$X_B = \frac{1}{2}(B + B^\dagger)$
$y_b = \frac{1}{2i}(b - b^\dagger)$	$Y_B = \frac{1}{2i}(B - B^\dagger)$

At the input, the signal and idler fields are coherent, so that we have $\langle \Delta x_{a,b} \rangle = \frac{1}{2} = \langle \Delta y_{a,b} \rangle$. Following the evolution of the fields by PSA process, given by eq. (1.58), the output field quadratures are:

$$\begin{aligned}
X_A &= \frac{1}{2}(A + A^\dagger) \\
&= \frac{1}{2}(\mu a + \mu^* a^\dagger + \nu b^\dagger + \nu^* b) \tag{A.53}
\end{aligned}$$

$$\begin{aligned}
Y_A &= \frac{1}{2i}(A - A^\dagger) \\
&= \frac{1}{2i}(\mu a - \mu^* a^\dagger + \nu b^\dagger - \nu^* b) \tag{A.54}
\end{aligned}$$

$$\begin{aligned}
X_B &= \frac{1}{2}(B + B^\dagger) \\
&= \frac{1}{2}(\nu a^\dagger + \nu^* a + \mu b + \mu^* b^\dagger) \tag{A.55}
\end{aligned}$$

$$\begin{aligned}
Y_B &= \frac{1}{2i}(B - B^\dagger) \\
&= \frac{1}{2i}(\nu a^\dagger - \nu^* a + \mu b - \mu^* b^\dagger) \tag{A.56}
\end{aligned}$$

From these we can calculate fluctuations in each of the quadratures.

We use the same input state $|\alpha, \beta\rangle$ as in the section A.3.1, so that:

$$\begin{aligned}\langle X_A \rangle &= \langle \alpha, \beta | X_A | \alpha, \beta \rangle \\ &= \frac{1}{2}(\mu\alpha + \mu^* \alpha^* + \nu\beta^* + \nu^* \beta)\end{aligned}\quad (\text{A.57})$$

$$\begin{aligned}X_A^2 &= \frac{1}{4}(\mu a + \mu^* a^\dagger + \nu b^\dagger + \nu^* b)^2 \\ &= \frac{1}{4}(\mu^2 a a + \mu^{*2} a^\dagger a^\dagger + \nu^2 b^\dagger b^\dagger + \nu^{*2} b b + \\ &\quad \mu\mu^* a a^\dagger + \mu\nu a b^\dagger + \mu\nu^* a b + \mu^* \mu a^\dagger a + \mu^* \nu a^\dagger b^\dagger + \mu^* \nu^* a^\dagger b + \\ &\quad \nu\mu b^\dagger a + \nu\mu^* b^\dagger a^\dagger + \nu\nu^* b^\dagger b + \nu^* \mu b a + \nu^* \mu^* b a^\dagger + \nu^* \nu b b^\dagger)\end{aligned}\quad (\text{A.58})$$

$$\begin{aligned}\langle X_A^2 \rangle &= \langle \alpha, \beta | X_A^2 | \alpha, \beta \rangle \\ &= \frac{1}{4}(\mu^2 \alpha^2 + \mu^{*2} \alpha^{*2} + \nu^2 \beta^{*2} + \nu^{*2} \beta^2 + \\ &\quad |\mu|^2(|\alpha|^2 + 1) + \mu\nu\alpha\beta^* + \mu\nu^* \alpha\beta + |\mu|^2|\alpha|^2 + \mu^* \nu \alpha^* \beta^* + \mu^* \nu^* \alpha^* \beta + \\ &\quad \nu\mu\beta^* \alpha + \nu\mu^* \alpha^* \beta^* + |\nu|^2|\beta|^2 + \nu^* \mu\beta\alpha + \nu^* \mu^* \beta\alpha^* + |\nu|^2(|\beta|^2 + 1))\end{aligned}\quad (\text{A.59})$$

$$\begin{aligned}\Rightarrow \langle \Delta X_A \rangle^2 &= \frac{1}{4}(|\mu|^2 + |\nu|^2) \\ \langle \Delta X_A \rangle &= \frac{1}{2}\sqrt{G_{PIA}}\end{aligned}\quad (\text{A.60})$$

For the other quadrature:

$$\begin{aligned}\langle Y_A \rangle &= \langle \alpha, \beta | Y_A | \alpha, \beta \rangle \\ &= \frac{1}{2i}(\mu\alpha - \mu^* \alpha^* + \nu\beta^* - \nu^* \beta)\end{aligned}\quad (\text{A.61})$$

$$\begin{aligned}Y_A^2 &= -\frac{1}{4}(\mu a - \mu^* a^\dagger + \nu b^\dagger - \nu^* b)^2 \\ &= -\frac{1}{4}(\mu^2 a a + \mu^{*2} a^\dagger a^\dagger + \nu^2 b^\dagger b^\dagger + \nu^{*2} b b \\ &\quad - \mu\mu^* a a^\dagger + \mu\nu a b^\dagger - \mu\nu^* a b - \mu^* \mu a^\dagger a - \mu^* \nu a^\dagger b^\dagger + \mu^* \nu^* a^\dagger b \\ &\quad + \nu\mu b^\dagger a - \nu\mu^* b^\dagger a^\dagger - \nu\nu^* b^\dagger b - \nu^* \mu b a + \nu^* \mu^* b a^\dagger - \nu^* \nu b b^\dagger)\end{aligned}\quad (\text{A.62})$$

$$\begin{aligned}\langle Y_A^2 \rangle &= \langle \alpha, \beta | Y_A^2 | \alpha, \beta \rangle \\ &= -\frac{1}{4}(\mu^2 \alpha^2 + \mu^{*2} \alpha^{*2} + \nu^2 \beta^{*2} + \nu^{*2} \beta^2 \\ &\quad - |\mu|^2(|\alpha|^2 + 1) + \mu\nu\alpha\beta^* - \mu\nu^* \alpha\beta - |\mu|^2|\alpha|^2 - \mu^* \nu \alpha^* \beta^* + \mu^* \nu^* \alpha^* \beta \\ &\quad + \nu\mu\beta^* \alpha - \nu\mu^* \alpha^* \beta^* - |\nu|^2|\beta|^2 - \nu^* \mu\beta\alpha + \nu^* \mu^* \beta\alpha^* - |\nu|^2(|\beta|^2 + 1))\end{aligned}\quad (\text{A.63})$$

$$\Rightarrow \langle \Delta Y_A \rangle^2 = \frac{1}{4}(|\mu|^2 + |\nu|^2)$$

$$\langle \Delta Y_A \rangle = \frac{1}{2} \sqrt{G_{PIA}} \quad (\text{A.64})$$

The quadrature noises of the idler field, namely $\langle \Delta X_B \rangle$ and $\langle \Delta Y_B \rangle$ can be found similarly. Using the symmetry of signal and idler quadratures, a substitution $\mu \rightarrow \nu^*$ gives directly $\langle \Delta X_B \rangle = \langle \Delta Y_B \rangle = \frac{1}{2} \sqrt{G_{PIA}}$.

A.3.3 Two mode squeezing

As explained in section 1.4.5, the output quadratures are given as:

$$\begin{aligned} X_+ &= \frac{1}{2\sqrt{2}} ((A + B) + (A^\dagger + B^\dagger)) \\ Y_+ &= \frac{1}{i2\sqrt{2}} ((A + B) - (A^\dagger + B^\dagger)) \\ X_- &= \frac{1}{2\sqrt{2}} ((A - B) + (A^\dagger - B^\dagger)) \\ Y_- &= \frac{1}{i2\sqrt{2}} ((A - B) - (A^\dagger - B^\dagger)) \end{aligned} \quad (\text{A.65})$$

Lets calculate the fluctuations of the quadrature X_+ with respect to an input state $|\alpha, \beta\rangle$ with $\alpha = \beta$:

$$\begin{aligned} \langle X_+ \rangle &= \langle \text{Re}(A_+) \rangle \\ &= \frac{1}{2\sqrt{2}} (\langle A + A^\dagger \rangle + \langle B + B^\dagger \rangle) \\ &= \frac{1}{2\sqrt{2}} \langle (\mu^* a^\dagger + \nu^* b + \mu a + \nu b^\dagger + \nu^* a + \mu^* b^\dagger + \nu a^\dagger + \mu b) \rangle \\ &= \frac{1}{\sqrt{2}} ((\mu^* + \nu) \alpha^* + (\mu + \nu^*) \alpha) \end{aligned} \quad (\text{A.66})$$

$$\begin{aligned} \langle X_+^2 \rangle &= \frac{1}{8} \langle (\mu^* a^\dagger + \nu^* b + \mu a + \nu b^\dagger + \nu^* a + \mu^* b^\dagger + \nu a^\dagger + \mu b)^2 \rangle \\ &= \frac{1}{8} (2\mu^{*2} \alpha^{*2} + 2\nu^{*2} \alpha^2 + 2\mu^2 \alpha^2 + 2\nu^2 \alpha^{*2} + \\ &\quad 2\mu^* \nu^* |\alpha|^2 + |\mu|^2 (1 + 2|\alpha|^2) + 2\mu^* \nu \alpha^{*2} + \mu^* \nu^* (1 + 2|\alpha|^2) + \\ &\quad 2\mu^{*2} \alpha^{*2} + 2\mu^* \nu \alpha^{*2} + 2|\mu|^2 |\alpha|^2 + 2\nu^* \mu \alpha^2 + \\ &\quad |\nu|^2 (1 + 2|\alpha|^2) + 2\nu^{*2} \alpha^2 + \nu^* \mu^* (1 + 2|\alpha|^2) + 2|\nu|^2 |\alpha|^2 + \\ &\quad 2\nu^* \mu \alpha^2 + 2\mu \nu |\alpha|^2 + 2\mu \nu^* \alpha^2 + 2|\mu|^2 |\alpha|^2 + \\ &\quad \mu \nu (1 + 2|\alpha|^2) + 2\mu^2 \alpha^2 + 2|\nu|^2 |\alpha|^2 + 2\nu \mu^* \alpha^{*2} + \\ &\quad 2\nu^2 \alpha^{*2} + \mu \nu (1 + 2|\alpha|^2) + 2\nu^* \mu^* |\alpha|^2 + |\nu|^2 (1 + 2|\alpha|^2) + \end{aligned}$$

$$2\nu^*\mu\alpha^2 + 2\mu^*\nu\alpha^{*2} + |\mu|^2(1 + 2|\alpha|^2) + 2\nu\mu|\alpha|^2$$

From these two expectation values, the variance in this quadrature is given by :

$$\langle \Delta X_+ \rangle^2 = \frac{1}{4}(|\mu|^2 + |\nu|^2 + 2|\mu||\nu| \cos 2(\theta_\mu + \theta_\nu))$$

As $|\mu|^2 - |\nu|^2 = 1$, $\langle \Delta X_+ \rangle$ can be less than $\frac{1}{2}$, the standard deviation of a coherent state, when $\cos(2(\theta_\mu + \theta_\nu)) < 0$, which is characteristic of squeezed states of light.

For the other quadratures, it can similarly be shown that :

$$\begin{aligned} \langle \Delta Y_+ \rangle^2 &= \langle Y_+^2 \rangle - \langle Y_+ \rangle^2 \\ &= -\frac{1}{4}(\mu - \nu^*)(\nu - \mu^*) \\ &= \frac{1}{4}(|\mu|^2 + |\nu|^2 - 2|\mu||\nu| \cos(2(\theta_\mu + \theta_\nu))) \end{aligned} \quad (\text{A.67})$$

$$\begin{aligned} \langle \Delta X_- \rangle^2 &= \langle X_-^2 \rangle - \langle X_- \rangle^2 \\ &= \frac{1}{4}(\mu - \nu^*)(\mu^* - \nu) \\ &= \frac{1}{4}(|\mu|^2 + |\nu|^2 - 2|\mu||\nu| \cos(2(\theta_\mu + \theta_\nu))) \end{aligned} \quad (\text{A.68})$$

$$\begin{aligned} \langle \Delta Y_- \rangle^2 &= \langle Y_-^2 \rangle - \langle Y_- \rangle^2 \\ &= \frac{1}{4}(\mu + \nu^*)(\mu^* + \nu) \\ &= \frac{1}{4}(|\mu|^2 + |\nu|^2 + 2|\mu||\nu| \cos(2(\theta_\mu + \theta_\nu))) \end{aligned} \quad (\text{A.69})$$

Thus, The quadratures X_+ and Y_- are squeezed for the the same $\theta_{rel} = \pi[2\pi]$ and the quadratures X_- and Y_+ are squeezed for the same $\theta_{rel} = 0[2\pi]$.

A.4 Effect of losses on squeezed state detection

To account for losses in balanced homodyne scheme (sec. 1.1.4), we introduce two fictitious beamsplitters with transmission coefficient η (see fig. 1.4 in page 17). The annihilation operators for the detected fields are :

$$\hat{d}'_1 = \eta^{1/2}\hat{d}_1 + (1 - \eta)^{1/2}\hat{b}_1; \quad \hat{d}'_2 = \eta^{1/2}\hat{d}_2 + (1 - \eta)^{1/2}\hat{b}_2 \quad (\text{A.70})$$

where the operators \hat{b}_1 and \hat{b}_2 are the annihilation operators for the two vacuum fields being mixed with the two channels. With this, now the photon

number difference is obtained to be:

$$\begin{aligned}
\hat{D} &= \hat{d}_1^\dagger \hat{d}_1 - \hat{d}_2^\dagger \hat{d}_2 \\
&= \left(\eta^{1/2} \hat{d}_1^\dagger + (1-\eta)^{1/2} \hat{b}_1^\dagger \right) \left(\eta^{1/2} \hat{d}_1 + (1-\eta)^{1/2} \hat{b}_1 \right) - \\
&\quad \left(\eta^{1/2} \hat{d}_2^\dagger + (1-\eta)^{1/2} \hat{b}_2^\dagger \right) \left(\eta^{1/2} \hat{d}_2 + (1-\eta)^{1/2} \hat{b}_2 \right) \\
&= \eta \left(\hat{d}_1^\dagger \hat{d}_1 - \hat{d}_2^\dagger \hat{d}_2 \right) \\
&\quad + [\eta(1-\eta)]^{1/2} \left(\hat{d}_1^\dagger \hat{b}_1 + \hat{b}_1^\dagger \hat{d}_1 - \hat{d}_2^\dagger \hat{b}_2 - \hat{b}_2^\dagger \hat{d}_2 \right) \\
&\quad + (1-\eta) \left(\hat{b}_1^\dagger \hat{b}_1 - \hat{b}_2^\dagger \hat{b}_2 \right)
\end{aligned} \tag{A.71}$$

We can assume that the local oscillator field is a classical field, and replace the corresponding annihilation operator with the complex field amplitude α_L . Moreover, as we consider only vacuum input fields through the fictitious beam-splitters, $\langle \hat{b}_1^\dagger \hat{b}_1 \rangle = \langle \hat{b}_2^\dagger \hat{b}_2 \rangle = 0$, so that we can express the photon number difference as:

$$D = \eta^{1/2} \alpha_L^* \left(\eta^{1/2} \hat{a} + (1-\eta)^{1/2} \hat{b} \right) + H.c. \tag{A.72}$$

where the operator \hat{b} is defined as:

$$\hat{b} \equiv \frac{1}{\sqrt{2}} (\hat{b}_1 - \hat{b}_2)$$

with $\langle \hat{b}^\dagger \hat{b} \rangle = \langle \hat{b}_1^\dagger \hat{b}_1 \rangle = \langle \hat{b}_2^\dagger \hat{b}_2 \rangle = 0$. Instead of introducing losses on each output ports of the homodyne beam-splitter, we can thus equivalently consider one beam-splitter in front of the whole ideally operating homodyne detection scheme (see fig. 1.4).

To see the effect of this losses, we define two operators as:

$$\hat{E} = \frac{1}{2} [e^{i\phi_L} \hat{a}^\dagger + e^{-i\phi_L} \hat{a}] \tag{A.73}$$

$$\hat{E}_b = \frac{1}{2} [e^{i\phi_L} \hat{b}^\dagger + e^{-i\phi_L} \hat{b}] \tag{A.74}$$

The photon number difference can be written as:

$$\hat{D} = 2\eta |\alpha_L| \hat{E} + 2\sqrt{\eta(1-\eta)} |\alpha_L| \hat{E}_b$$

From this we can show that the detected variance of the photocurrent is given by :

$$\begin{aligned}
 \langle \Delta D \rangle^2 &= \langle D^2 \rangle - \langle D \rangle^2 \\
 &= 4 \left(\eta^2 |\alpha_L|^2 \langle E^2 \rangle + \eta(1-\eta) |\alpha_L|^2 \langle E_b^2 \rangle \right) - 4\eta^2 |\alpha_L|^2 \langle E \rangle^2 \\
 &= \eta |\alpha_L|^2 \left\{ 1 + \eta [4 \langle \Delta E \rangle^2 - 1] \right\}
 \end{aligned} \tag{A.75}$$

where we assumed the fact that the fictitious \hat{b} field is a coherent vacuum state, so that, $\langle \Delta E_b \rangle^2 = 1/4$.

It can be noticed that in the above expression, for a coherent input signal state, $4 \langle \Delta E \rangle^2 - 1 = 0$, so that we end up with the shot noise of the local oscillator.

For a squeezed state input, depending on the value of ϕ_L , we can have $\langle \Delta E \rangle^2 < 1/4$, and hence a total noise that is below the shot noise.

Appendix B

Data Analysis

Contents

B.1	Input Phase Extraction	119
B.2	Phase Sensitive Amplification analysis	121
	B.2.1 Gain and Output phase	121
B.3	Phase Insensitive Amplification analysis	123

B.1 Input Phase Extraction

The input phase is extracted from the data frames recorded with the photodiode 1 (see fig. 3.4 in page 58). The input intensity is given by the eq. (3.4), which reads:

$$I^{in}(t) = I_c + 2I_s + 2\alpha\sqrt{I_c I_s}\cos(\delta t)\cos(\phi_t^{in}) + 2I_s\cos(2\delta t) \quad (\text{B.1})$$

The Fourier transform of such a function will have three peaks: one at DC, one at δ frequency with a height $2\alpha\cos(\phi_t^{in})$ and the other at 2δ frequency with a height $2I_s$.

We apply a saw-tooth voltage on the piezo so that the phase variation of the coupling is linear modulo π radians. So the phase $\phi_t^{in} = R.t$ where the scan velocity R is very slow : it was experimentally measured to be about 500 mHz. The phase ϕ_t^{in} could thus be considered to be constant for each data set taken on a time scale of less than 10 ms.

At a time $t = t_1$, we obtain $2\alpha\cos(\phi_{t_1}^{in})$ using the three Fourier transform peaks as:

$$\alpha \cos(\phi) = \frac{\text{amplitude of peak at } \delta}{\sqrt{(\text{amplitude of peak at DC} - \text{amplitude of peak at } 2\delta) \times \frac{\text{amplitude of peak at } 2\delta}{2}}} \quad (\text{B.2})$$

In the experiment, we record a movie made of several frames separated by few tens of milliseconds. Each frame corresponds to a value of $h_t = 2\alpha \cos(\phi_t^{in})$. As $R \ll \delta$, the plot of h_t follow a sinusoidal variation. We can then estimate α as:

$$\alpha_{estimate} = \frac{1}{2} ((\alpha \cos \phi)_{max} - (\alpha \cos \phi)_{min}) \quad (\text{B.3})$$

Lets take the example of a data recorded at the photodiode 1: two such frames are shown in fig. B.1(a).

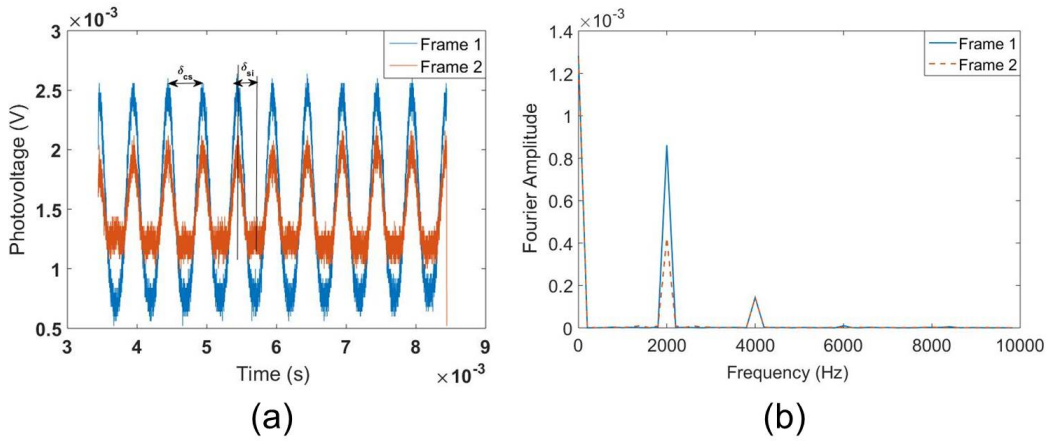

FIGURE B.1: (a) Data recorded from the photodiode 1. This particular data has 6400 data point for a time span of 5 ms.(b) Fourier transform of the two frames.

The fig. B.1(b) shows three distinct peaks: one DC component, one peak at $\delta = 2$ kHz and one at $2\delta = 4$ kHz, as expected from eq. (3.4). Using 200 of such frames consecutively, each about 10ms apart, we could calculate the corresponding $\alpha \cos(\phi_t^{in})$ and plot it as shown in fig. B.2.

For an ideal alignment of perfectly identical beams, $\alpha = 2$ and the variation of $\alpha \cos(\phi(t))$ in the fig. B.2 would have ranged from +2 to -2. But we observe, the plot ranges from +1.73 to -1.91, so that we estimate $\alpha \approx 1.82$. We can then deduce ϕ_t^{in} for each frame as shown in the fig. B.3(a).

The phase obtained from this data analysis (figure B.3(a)) is always modulo π radians. This can be “unwrapped” from the extremities to obtain the linear scan of input phase via piezo, as shown in fig. B.3(b). When the piezoactuator goes back, it is visible through a change of velocity of the scan.

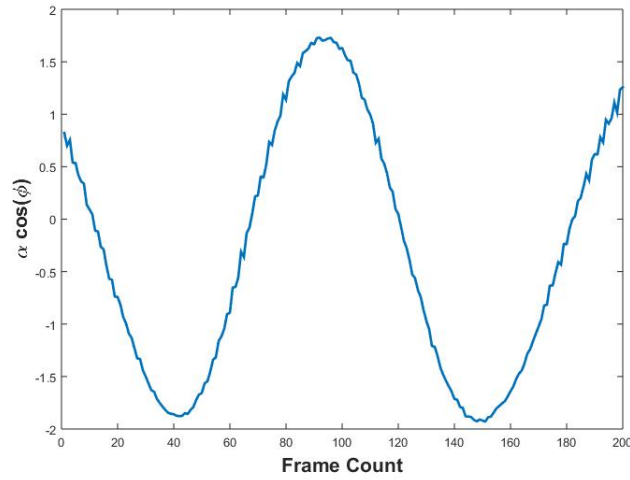

FIGURE B.2: $\alpha \cos(\phi)$ as a function of frame count, extracted from the fig. B.1.

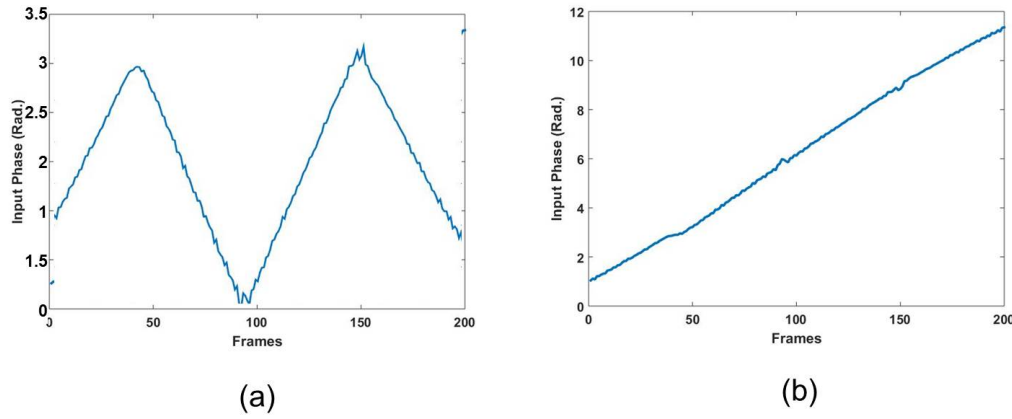

FIGURE B.3: Input phase variation, as a function of frame count, (a) extracted directly from the Fig. B.2 modulo π radians. (b) unwrapped input phase shows the linear scan of the piezo.

B.2 Phase Sensitive Amplification analysis

B.2.1 Gain and Output phase

The photodiode 2 detects the intensities of the coupling, signal, and the idler, which are respectively labeled as I_c^{out} , I_s^{out} and I_i^{out} . As initially $I_s = I_i$ the gain on both these channels are the same, i.e. $I_s^{out} = I_i^{out} = G.I_s$, where the factor G is the intensity gain. Let us call the output coupling phase ϕ_t^{out} with respect to the signal and idler phase. Following the eq. (3.4), the output intensity I^{out} detected by the photodiode 2 (in fig. 3.4) is given by:

$$I^{out}(t) = I_c^{out} + I_s^{out} + I_i^{out} + \alpha \sqrt{I_c^{out} I_s^{out}} \cos(\delta t + \phi_t^{out})$$

$$\begin{aligned}
& + \alpha \sqrt{I_c^{out} I_i^{out}} \cos(\delta t - \phi_t^{out}) + 2\sqrt{I_s^{out} I_i^{out}} \cos(2\delta t) \\
& = I_c^{out} + 2I_s^{out} + 2\alpha \sqrt{I_c^{out} I_s^{out}} \cos(\delta t) \cos(\phi_t^{out}) + 2I_s^{out} \cos(2\delta t) \quad (\text{B.4})
\end{aligned}$$

To extract the output phase ϕ_t^{out} as a function of the frame count, we follow an analysis similar to the input phase.

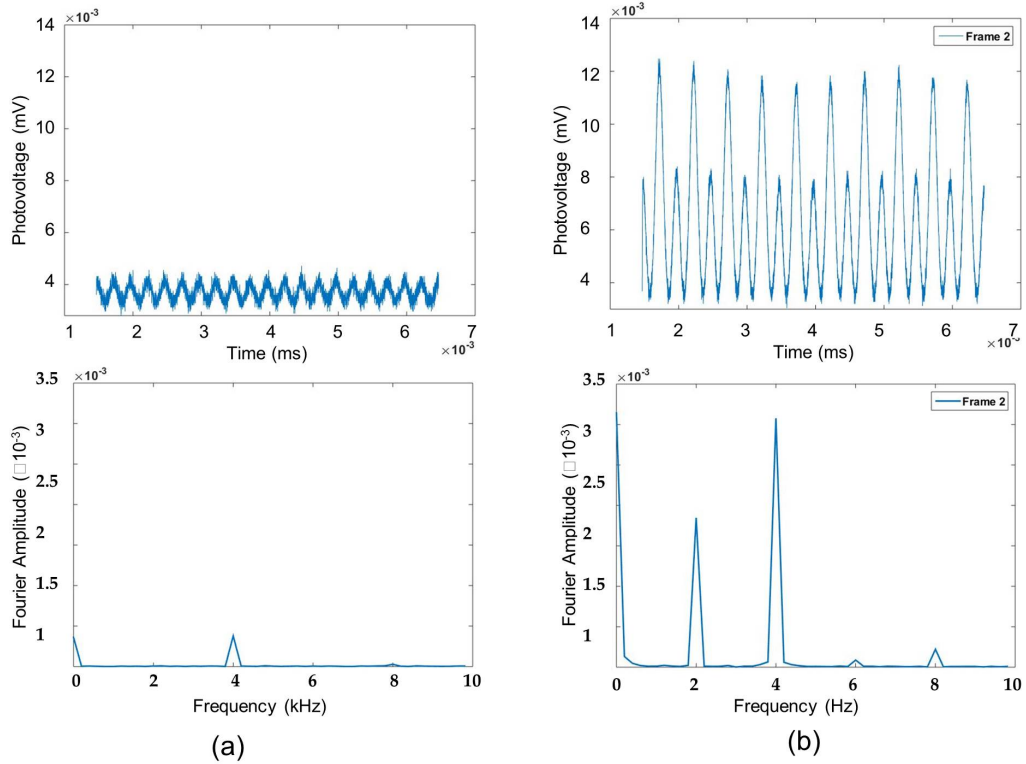

FIGURE B.4: Data obtained from output photodiode (a) without the PSA (i.e. discharge to the Helium cell switched off), while coupling is being blocked. and (b) a PSA frame with amplified probe and some remaining coupling. In the top row, the data frames as recorded in the oscilloscope, and the bottom row, their Fourier transforms. In case (a) only the DC and $2\delta = 4$ kHz components are seen. In case (b) DC, $\delta = 2$ kHz, and $2\delta = 4$ kHz components are visible. The 4 kHz peak is higher in (b) than (a), due to PSA.

The PSA gain G is extracted using the Fourier transform of the above signal and the Fourier transform of the intensity recorded without the coupling beam and metastable helium atoms:

$$I_{probe\ alone} = 2I_s + 2I_s \cos(2\delta t) \quad (\text{B.5})$$

The gain G is then given by:

$$G = \frac{2\delta \text{ peak height of PSA frame}}{2\delta \text{ peak height of the probe alone frame}} \quad (\text{B.6})$$

The fig. B.4 gives an example of data recorded with the probe alone (B.4(a)) and with PSA (B.4(b)). For this case the pump power was ~ 45 mW and the signal-coupling detuning $\delta = 2$ kHz. So, we have three peaks: DC, 2 kHz, and 4kHz. The gain for the frame can thus be calculated to be : $G \approx 6.8$.

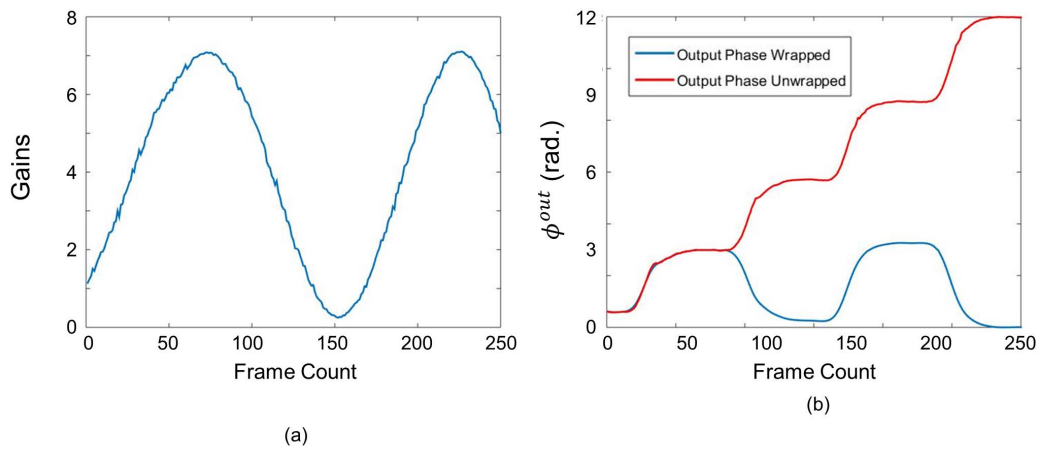

FIGURE B.5: (a) Gain plotted as a function of frame count: a maximum gain of 7.1 and a minimum gain of 0.23 are achieved, for a coupling power of 45mw and pump-probe detuning $\delta = 2$ kHz. (b) Output phase variation as a function of the frame-count: unwrapped (in red) and wrapped (in blue).

We can thus plot the gain G for each frame and extract the corresponding output phase as shown in fig. B.5. The output-phase shows a very well-defined stair-case behavior when unwrapped from the flat extreme points (see fig. B.5(b)). As we have simultaneously recorded the frames corresponding to the input phase, it is possible to plot the figures 3.7 in page 63), which gives the gain as a function of ϕ^{in} and the phase transfer function ϕ^{out} as a function of ϕ^{in} .

B.3 Phase Insensitive Amplification analysis

In the case of PIA, the probe contains only one frequency $\delta + \omega_c$, where ω_c is the coupling frequency. At the output, the PIA process generates an idler at frequency $\omega_c - \delta$. The intensity recorded by the photodiode 2 is thus:

$$I_{PIA} = I_s + I_c + I_i + 2\sqrt{I_s I_i} \cos(2\delta t) + \alpha(\sqrt{I_c I_s} + \sqrt{I_c I_i}) \cos(\delta t) \quad (\text{B.7})$$

where $I_{c,s,i}$ are the intensities of the coupling, signal and idler fields after PIA. The factor α is the contrast factor which is the same as that for the PSA case (see Appendix B.2). To compute the gain, we compare the PIA signal intensity (I_s) to the cell-off signal power (I'_s) using three different datasets:

- (A) **Probe only** and cell off (see fig. B.6(a)): the peak height at 0 frequency is $A_0 = I'_s$.
- (B) **PIA data** (see fig. B.6(b)): The peak height at 0 frequency is $B_0 = (I_s + I_c + I_i)$, the one at δ frequency is $B_1 = \alpha(\sqrt{I_c I_s} + \sqrt{I_c I_i})$ and the one at 2δ , is $B_2 = 2\sqrt{I_s I_i}$.
- (C) **Coupling field only** (see fig. B.6(c)): the 0 frequency height of its Fourier transform is $C_0 = I_c$.

As the signal intensity I_S after PIA is given by:

$$\begin{aligned} I_s &= \frac{1}{4} \{(\sqrt{I_s} + \sqrt{I_i}) + (\sqrt{I_s} - \sqrt{I_i})\}^2 \\ &= \frac{1}{4} \left\{ \frac{\alpha\sqrt{I_c}(\sqrt{I_s} + \sqrt{I_i})}{\alpha\sqrt{I_c}} + (\sqrt{I_s + I_i - 2\sqrt{I_s I_i}}) \right\}^2 \\ &= \frac{1}{4} \left\{ \frac{B_1}{\alpha\sqrt{C_0}} + \sqrt{(B_0 - C_0 - B_2)} \right\}^2 \end{aligned} \quad (\text{B.8})$$

the PIA gain G_{PIA} can then be calculated from:

$$G_{PIA} = \frac{I_s}{I'_s} = \frac{I_s}{A_0} \quad (\text{B.9})$$

which does not depend on the pump-probe relative phase difference. Fig. B.6 shows the three data taken, and their Fourier transforms, for a signal power $\approx 30\mu W$, and a pump power of $\approx 20mW$, and a signal to pump frequency difference $\delta = 2$ kHz. The different components from this figure are: $A_0 = 1.1$, $B_0 = 8.3$, $B_1 = 5.2$, $B_2 = 2.8$ and $C_0 = 4.8$. So that we get $I_s \approx 1.9$, and the gain is $G_{PIA} \approx 1.7$.

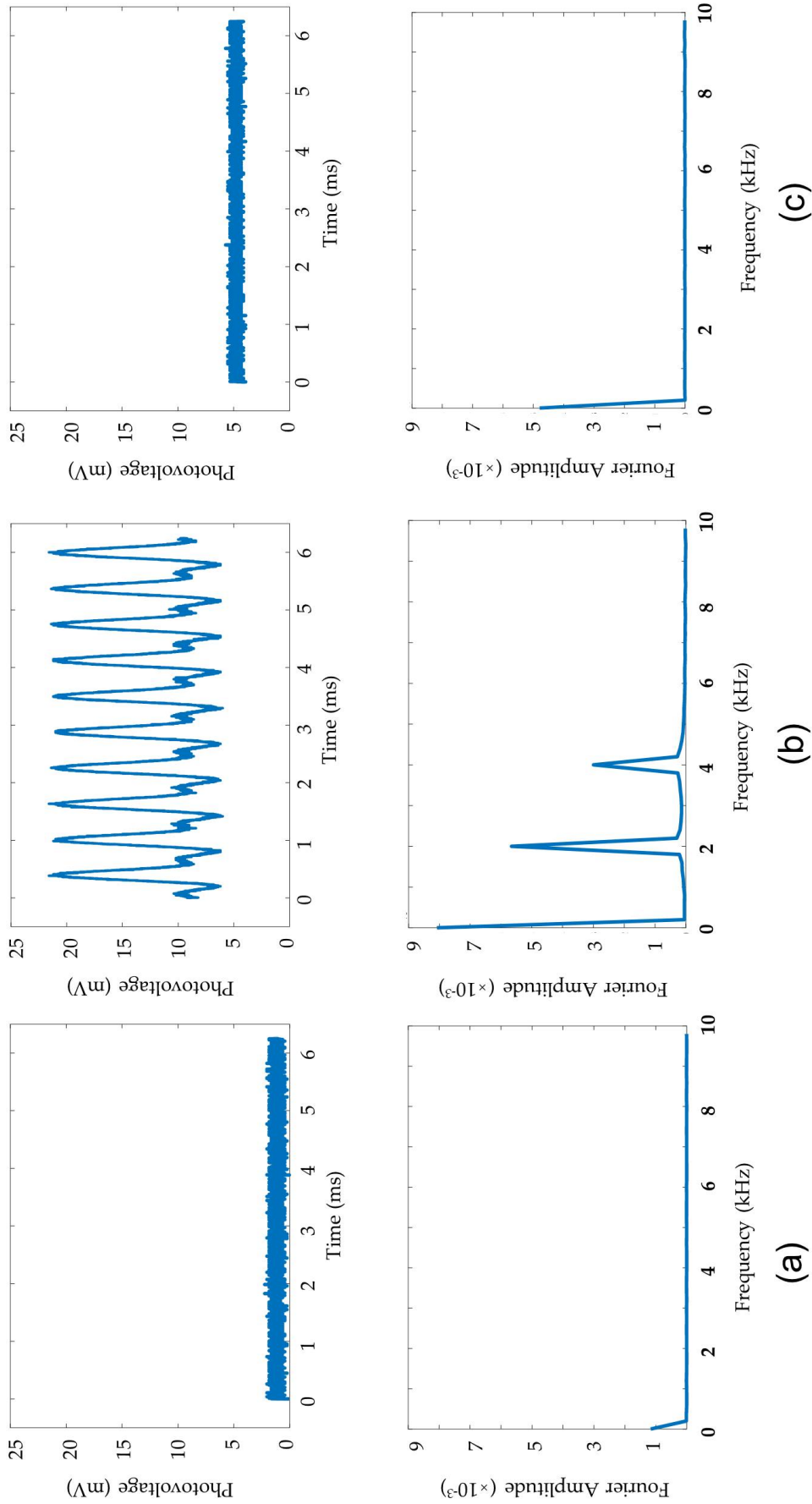

FIGURE B.6: Three datasets required for PIA gain analysis: (a) Probe only data set from oscilloscope (up), where cell is switched off, and coupling is blocked. The Fourier transform (bottom) shows the DC part is $A_0 \approx 1.1$. (b) PIA gain data from oscilloscope (up), where the cell is on, and the signal and coupling beams undergo PIA. The Fourier transform (bottom) shows the coupling-signal and coupling-idler beating components at $\delta = 2\text{kHz}$, and the signal-idler beating component at $2\delta = 4\text{kHz}$. The DC, δ and 2δ components are respectively $B_0 = 8.3$, $B_1 = 5.2$, $B_2 = 2.8$. (c) Coupling only data from oscilloscope (up), where the cell is switched on and the signal is blocked. The Fourier transform of the data (bottom) shows a DC component $C_0 \approx 4.8$.

Appendix C

Detailed calculations for RIR

Contents

C.1 Perturbative development	127
C.1.1 Bloch equations	127
C.1.2 Zeroth order: No fields	128
C.1.3 First order	129
C.1.4 Second order	129
C.1.5 Third order	131
C.1.6 Fourth order	133
C.1.7 Fifth order	151

C.1 Perturbative development

We consider the two level system of the section 4.2.1.1. Starting from the equations (4.5)-(4.8), I expand the fields order by order, and extract the combinations of interest, which give rise to the observed phenomena.

C.1.1 Bloch equations

When some fields E_μ detuned from the atomic transition frequency by Δ_μ , excite the transition, one gets (section 4.2):

$$\begin{aligned} \left(\frac{\partial}{\partial t} + \gamma\right)\tilde{\rho}_{12}(p, p') &= \sum_{\mu} i(\Omega_{\mu}^* e^{(i\Delta_{\mu} - i\frac{k_{\mu}\cdot p'}{m} + i\omega_k)t})\tilde{\rho}_{11}(p, p' - \hbar k_{\mu}) \\ &\quad - i(\Omega_{\mu}^* e^{(i\Delta_{\mu} - i\frac{k_{\mu}\cdot p}{m} - i\omega_k)t})\tilde{\rho}_{22}(p + \hbar k_{\mu}, p') \end{aligned} \quad (4.5)$$

$$\left(\frac{\partial}{\partial t} + \gamma_2\right)\tilde{\rho}_{22}(p, p') = \sum_{\mu} i(\Omega_{\mu}^* e^{(i\Delta_{\mu} - i\frac{k_{\mu}\cdot p'}{m} + i\omega_k)t})\tilde{\rho}_{21}(p, p' - \hbar k_{\mu})$$

$$-i(\Omega_\mu e^{(-i\Delta_\mu + i\frac{k_\mu \cdot p}{m} - i\omega_k)t})\tilde{\rho}_{12}(p - \hbar k_\mu, p') \quad (4.6)$$

$$\begin{aligned} \left(\frac{\partial}{\partial t} + \gamma_1\right)\tilde{\rho}_{11}(p, p') &= \sum_\mu i(\Omega_\mu e^{(-i\Delta_\mu + i\frac{k_\mu \cdot p'}{m} + i\omega_k)t})\tilde{\rho}_{12}(p, p' + \hbar k_\mu) \\ &\quad - i(\Omega_\mu^* e^{(i\Delta_\mu - i\frac{k_\mu \cdot p}{m} - i\omega_k)t})\tilde{\rho}_{21}(p + \hbar k_\mu, p') \\ &\quad + \int \Gamma N(q) dq \tilde{\rho}_{22}(p + \hbar q, p' + \hbar q) e^{i(-\frac{p \cdot q}{m} + \frac{p' \cdot q}{m})t} \\ &\quad + \gamma_1 W(p, p') \end{aligned} \quad (4.7)$$

$$\tilde{\rho}_{21}(p, p') = [\tilde{\rho}_{12}(p', p)]^* \quad (4.8)$$

where

- Ω_μ are the corresponding field Rabi frequencies, $\Omega_\mu = \frac{-\langle 2|D|1\rangle E_\mu}{\hbar}$.
- ω_k is the single photon recoil energy of an atom $\omega_k = \frac{\hbar k^2}{2m}$.
- k_μ is the wave-number of the E_μ field.

The various decay rates are defined in page 86.

C.1.2 Zeroth order: No fields

At, zeroth order, the system is not interacting with any fields. Following eqⁿs (4.5)-(4.8), the density matrix elements are then:

$$\begin{aligned} \tilde{\rho}_{12}^{(0)}(p, p') &= 0 \\ \tilde{\rho}_{22}^{(0)}(p, p') &= 0 \\ \tilde{\rho}_{11}^{(0)}(p, p') &= W(p, p') \end{aligned} \quad (C.1)$$

The momentum distribution function $W(p, p')$ is thus the ground state momentum distribution of this two level atom, while no field interacts with it. The function is then taken to be the standard Maxwell-Boltzmann momentum distribution. We would also neglect possible ground state momentum coherence in the medium per se, without any fields interacting with it : the distribution function is zero whenever $p \neq p'$. Thus, we have taken,

$$W(p, p') = \frac{N}{V} (2\pi\hbar)^3 W(p) \delta(p - p') \quad (C.2)$$

where $\delta(x)$ denotes the dirac delta function, N is the number of atoms in the volume V of the atomic medium and $W(p)$ is the normalized Gaussian distribution function:

$$W(\mathbf{p}) = \frac{1}{(\sqrt{\pi}p_0)^3} e^{-\frac{p_x^2 + p_y^2 + p_z^2}{p_0^2}}$$

where $\mathbf{p} = (p_x, p_y, p_z)$ and p_0 is the r.m.s momentum in each direction.

C.1.3 First order

I now consider a field E_μ , which couples the atomic transition. At the first order, we look at the linear dependence of the density matrix elements on the fields, which can be considered independently. From the equations (C.1), the first order coherences between levels with the same internal state but different momenta can be seen to be zero because they depend on the zeroth order coherence $\tilde{\rho}_{12}^{(0)}$. The first order coherence, however, can be calculated as:

$$\left(\frac{\partial}{\partial t} + \gamma\right)\tilde{\rho}_{12}^{(1)}(p, p') = i(\Omega_\mu^* e^{(i\Delta_\mu - i\frac{k_\mu \cdot p'}{m} + i\omega_k)t})W(p, p' - \hbar k_\mu) \quad (\text{C.3})$$

$$\begin{aligned} \Rightarrow \tilde{\rho}_{12}^{(1)}(p, p') &= i \frac{(\Omega_\mu^* e^{(i\Delta_\mu - i\frac{k_\mu \cdot p'}{m} + i\omega_k)t})}{\gamma + i\Delta_\mu - i\frac{k_\mu \cdot p'}{m} + i\omega_k} W(p, p' - \hbar k_\mu) \\ &= i \frac{(\Omega_\mu^* e^{(i\Delta_\mu - i\frac{k_\mu \cdot p}{m} - i\omega_k)t})}{\gamma + i\Delta_\mu - i\frac{k_\mu \cdot p}{m} - i\omega_k} W(p, p' - \hbar k_\mu) \end{aligned} \quad (\text{C.4})$$

and,

$$\tilde{\rho}_{22}^{(0)}(p, p') = 0 \quad (\text{C.5})$$

$$\tilde{\rho}_{11}^{(0)}(p, p') = W(p, p') \quad (\text{C.6})$$

These equations describe the recoil the excitation of the optical coherence, including the recoil $\hbar k_\mu$ experienced by the atom due to the photons of the electric field. When this field is weak, the excited population can still be neglected and the population remain unchanged.

C.1.4 Second order

From eqⁿs (C.4)-(C.6), the second order density matrix elements (i.e. quadratic dependence on fields) can be calculated, when a second field E_ν is introduced.

$$\begin{aligned} \left(\frac{\partial}{\partial t} + \gamma_2\right)\tilde{\rho}_{22}^{(2)}(p, p') &= i(\Omega_\nu^* e^{(i\Delta_\nu - i\frac{k_\nu \cdot p'}{m} + i\omega_k)t})[\tilde{\rho}_{12}^{(1)}(p' - \hbar k_\nu, p)]^* \\ &\quad - i(\Omega_\nu e^{(-i\Delta_\nu + i\frac{k_\nu \cdot p}{m} - i\omega_k)t})\tilde{\rho}_{12}^{(1)}(p - \hbar k_\nu, p') \end{aligned}$$

$$\begin{aligned}
&= i(\Omega_\nu^* e^{(i\Delta_\nu - i\frac{k_\nu \cdot p'}{m} + i\omega_k)t}) \left[i \frac{(\Omega_\mu^* e^{(i\Delta_\mu - i\frac{k_\mu \cdot (p' - \hbar k_\nu)}{m} - i\omega_k)t})}{\gamma + i\Delta_\mu - i\frac{k_\mu \cdot (p' - \hbar k_\nu)}{m} - i\omega_k} W(p' - \hbar k_\nu, p - \hbar k_\mu) \right]^* \\
&\quad - i(\Omega_\nu e^{(-i\Delta_\nu + i\frac{k_\nu \cdot p}{m} - i\omega_k)t}) i \frac{(\Omega_\mu^* e^{(i\Delta_\mu - i\frac{k_\mu \cdot (p - \hbar k_\nu)}{m} - i\omega_k)t})}{\gamma + i\Delta_\mu - i\frac{k_\mu \cdot (p - \hbar k_\nu)}{m} - i\omega_k} W(p - \hbar k_\nu, p' - \hbar k_\mu) \\
&= i(\Omega_\nu^* e^{(i\Delta_\nu - i\frac{k_\nu \cdot p'}{m} + i\omega_k)t}) (-i) \frac{(\Omega_\mu e^{(-i\Delta_\mu + i\frac{k_\mu \cdot (p' - \hbar k_\nu)}{m} + i\omega_k)t})}{\gamma - i\Delta_\mu + i\frac{k_\mu \cdot (p' - \hbar k_\nu)}{m} + i\omega_k} W(p' - \hbar k_\nu, p - \hbar k_\mu) \\
&\quad - i(\Omega_\nu e^{(-i\Delta_\nu + i\frac{k_\nu \cdot p}{m} - i\omega_k)t}) i \frac{(\Omega_\mu^* e^{(i\Delta_\mu - i\frac{k_\mu \cdot (p - \hbar k_\nu)}{m} - i\omega_k)t})}{\gamma + i\Delta_\mu - i\frac{k_\mu \cdot (p - \hbar k_\nu)}{m} - i\omega_k} W(p - \hbar k_\nu, p' - \hbar k_\mu) \\
&= \frac{(\Omega_\nu^* \Omega_\mu e^{(i(\Delta_\nu - \Delta_\mu) - i\frac{(k_\nu - k_\mu) \cdot p'}{m} - i\frac{\hbar k_\mu \cdot k_\nu}{m} + 2i\omega_k)t})}{(\gamma - i\Delta_\mu + i\frac{k_\mu \cdot p}{m} - i\omega_k)} W(p' - \hbar k_\nu, p - \hbar k_\mu) \\
&\quad + \frac{(\Omega_\nu \Omega_\mu^* e^{(-i(\Delta_\nu - \Delta_\mu) + i\frac{(k_\nu - k_\mu) \cdot p}{m} - i\frac{\hbar k_\mu \cdot k_\nu}{m} - 2i\omega_k)t})}{(\gamma + i\Delta_\mu - i\frac{k_\mu \cdot p'}{m} + i\omega_k)} W(p - \hbar k_\nu, p' - \hbar k_\mu)
\end{aligned}$$

So that we can get the steady state solution:

$$\begin{aligned}
\Rightarrow \tilde{\rho}_{22}^{(2)}(p, p') &= \frac{(\Omega_\nu^* \Omega_\mu e^{(i(\Delta_\nu - \Delta_\mu) - i\frac{(k_\nu - k_\mu) \cdot p'}{m} - i\frac{\hbar k_\mu \cdot k_\nu}{m} + 2i\omega_k)t})}{(\gamma_2 + i(\Delta_\nu - \Delta_\mu) - i\frac{(k_\nu - k_\mu) \cdot p'}{m} - i\frac{\hbar k_\mu \cdot k_\nu}{m} + 2i\omega_k)(\gamma - i\Delta_\mu + i\frac{k_\mu \cdot p}{m} - i\omega_k)} W(p' - \hbar k_\nu, p - \hbar k_\mu) \\
&\quad + \frac{(\Omega_\nu \Omega_\mu^* e^{(-i(\Delta_\nu - \Delta_\mu) + i\frac{(k_\nu - k_\mu) \cdot p}{m} - i\frac{\hbar k_\mu \cdot k_\nu}{m} - 2i\omega_k)t})}{(\gamma_2 - i(\Delta_\nu - \Delta_\mu) + i\frac{(k_\nu - k_\mu) \cdot p}{m} - i\frac{\hbar k_\mu \cdot k_\nu}{m} - 2i\omega_k)(\gamma + i\Delta_\mu - i\frac{k_\mu \cdot p'}{m} + i\omega_k)} W(p - \hbar k_\nu, p' - \hbar k_\mu)
\end{aligned} \tag{C.7}$$

$\rho_{22}(p, p')$ is the coherence between two excited levels of different momenta. This can be used to derive the density matrix elements for the ground state:

$$\begin{aligned}
\left(\frac{\partial}{\partial t} + \gamma_1\right) \tilde{\rho}_{11}^{(2)}(p, p') &= i(\Omega_\nu e^{(-i\Delta_\nu + i\frac{k_\nu \cdot p'}{m} + i\omega_k)t}) \tilde{\rho}_{12}^{(1)}(p, p' + \hbar k_\nu) \\
&\quad - i(\Omega_\nu^* e^{(i\Delta_\nu - i\frac{k_\nu \cdot p}{m} - i\omega_k)t}) \tilde{\rho}_{21}^{(1)}(p + \hbar k_\nu, p') \\
&\quad + \int \Gamma N(q) dq \tilde{\rho}_{22}^{(2)}(p + \hbar q, p' + \hbar q) e^{i(-\frac{p \cdot q}{m} + \frac{p' \cdot q}{m})t}
\end{aligned}$$

So that the ground state coherences between levels of different atomic momenta are given by:

$$\begin{aligned}
\Rightarrow \tilde{\rho}_{11}^{(2)}(p, p') &= \\
&- \frac{(\Omega_\nu \Omega_\mu^* e^{(-i(\Delta_\nu - \Delta_\mu) + i\frac{(k_\nu - k_\mu) \cdot p'}{m} - i\frac{\hbar k_\mu \cdot k_\nu}{m} + 2i\omega_k)t})}{(\gamma_1 - i(\Delta_\nu - \Delta_\mu) + i\frac{(k_\nu - k_\mu) \cdot p'}{m} - i\frac{\hbar k_\mu \cdot k_\nu}{m} + 2i\omega_k)} W(p, p' + \hbar k_\nu - \hbar k_\mu) \\
&\quad \times (\gamma + i\Delta_\mu - i\frac{k_\mu \cdot p}{m} - i\omega_k) \\
&- \frac{(\Omega_\nu^* \Omega_\mu e^{(i(\Delta_\nu - \Delta_\mu) - i\frac{(k_\nu - k_\mu) \cdot p}{m} + i\frac{\hbar k_\mu \cdot k_\nu}{m} - 2i\omega_k)t})}{(\gamma_1 + i(\Delta_\nu - \Delta_\mu) - i\frac{(k_\nu - k_\mu) \cdot p}{m} + i\frac{\hbar k_\mu \cdot k_\nu}{m} - 2i\omega_k)} W(p', p + \hbar k_\nu - \hbar k_\mu) \\
&\quad \times (\gamma - i\Delta_\mu + i\frac{k_\mu \cdot (p + \hbar k_\nu - \hbar k_\mu)}{m} + i\omega_k) \\
&+ \int \Gamma N(q) dq e^{i(-\frac{p \cdot q}{m} + \frac{p' \cdot q}{m})t}
\end{aligned}$$

$$\begin{aligned}
& \times \left\{ \frac{(\Omega_\nu^* \Omega_\mu e^{(i(\Delta_\nu - \Delta_\mu) - i \frac{(k_\nu - k_\mu) \cdot (p' + \hbar q) - i \frac{\hbar k_\mu \cdot k_\nu}{m} + 2i\omega_k)t}) W(p' + \hbar q - \hbar k_\nu, p + \hbar q - \hbar k_\mu)}{(\gamma_1 + i(\Delta_\nu - \Delta_\mu) - i \frac{(k_\nu - k_\mu) \cdot (p' + \hbar q) - i \frac{\hbar k_\mu \cdot k_\nu}{m} + 2i\omega_k - i \frac{p \cdot q}{m} + i \frac{p' \cdot q}{m})} \right. \\
& \quad \times (\gamma_2 + i(\Delta_\nu - \Delta_\mu) - i \frac{(k_\nu - k_\mu) \cdot (p' + \hbar q) - i \frac{\hbar k_\mu \cdot k_\nu}{m} + 2i\omega_k)}{m} \\
& \quad \left. \times (\gamma - i\Delta_\mu + i \frac{k_\mu \cdot (p + \hbar q)}{m} - i\omega_k) \right. \\
& + \left. \frac{(\Omega_\nu \Omega_\mu^* e^{(-i(\Delta_\nu - \Delta_\mu) + i \frac{(k_\nu - k_\mu) \cdot (p + \hbar q) - i \frac{\hbar k_\mu \cdot k_\nu}{m} - 2i\omega_k)t}) W(p + \hbar q - \hbar k_\nu, p' + \hbar q - \hbar k_\mu)}{(\gamma_1 - i(\Delta_\nu - \Delta_\mu) + i \frac{(k_\nu - k_\mu) \cdot (p + \hbar q) - i \frac{\hbar k_\mu \cdot k_\nu}{m} - 2i\omega_k - i \frac{p \cdot q}{m} + i \frac{p' \cdot q}{m})} \right\} \\
& \quad \times (\gamma_2 - i(\Delta_\nu - \Delta_\mu) + i \frac{(k_\nu - k_\mu) \cdot (p + \hbar q) - i \frac{\hbar k_\mu \cdot k_\nu}{m} - 2i\omega_k)}{m} \\
& \quad \times (\gamma + i\Delta_\mu - i \frac{k_\mu \cdot (p' + \hbar q)}{m} + i\omega_k)
\end{aligned}$$

Compared to the excited level, a term is added, which relates to the transfer of coherence from the excited level to the ground level by spontaneous emission.

C.1.5 Third order

We can now replace the obtained second order populations in the following equation to calculate the third order coherence, when a third field E_σ is added.

$$\begin{aligned}
& \left(\frac{\partial}{\partial t} + \gamma \right) \tilde{\rho}_{12}^{(3)}(p, p') = i(\Omega_\sigma^* e^{(i\Delta_\sigma - i \frac{k_\sigma \cdot p'}{m} + i\omega_k)t}) \tilde{\rho}_{11}^{(2)}(p, p' - \hbar k_\sigma) \\
& - i(\Omega_\sigma^* e^{(i\Delta_\sigma - i \frac{k_\sigma \cdot p}{m} - i\omega_k)t}) \tilde{\rho}_{22}^{(2)}(p + \hbar k_\sigma, p') \\
& = i \left[- \frac{(\Omega_\sigma^* \Omega_\nu \Omega_\mu^* e^{(-i(-\Delta_\sigma + \Delta_\nu - \Delta_\mu) + i \frac{(k_\nu - k_\mu) \cdot (p' - \hbar k_\sigma) - i \frac{k_\sigma \cdot p'}{m} - i \frac{\hbar k_\mu \cdot k_\nu}{m} + 3i\omega_k)t})}{(\gamma_1 - i(\Delta_\nu - \Delta_\mu) + i \frac{(k_\nu - k_\mu) \cdot (p' - \hbar k_\sigma) - i \frac{\hbar k_\mu \cdot k_\nu}{m} + 2i\omega_k)} \right. \\
& \quad \left. \times (\gamma + i\Delta_\mu - i \frac{k_\mu \cdot p}{m} - i\omega_k) \right. \\
& - \frac{(\Omega_\sigma^* \Omega_\nu^* \Omega_\mu e^{(i(\Delta_\sigma + \Delta_\nu - \Delta_\mu) - i \frac{(k_\nu - k_\mu) \cdot p - i \frac{k_\sigma \cdot p'}{m} + i \frac{\hbar k_\mu \cdot k_\nu}{m} - i\omega_k)t})}{(\gamma_1 + i(\Delta_\nu - \Delta_\mu) - i \frac{(k_\nu - k_\mu) \cdot p - i \frac{\hbar k_\mu \cdot k_\nu}{m} - 2i\omega_k)} W(p' - \hbar k_\sigma, p + \hbar k_\nu - \hbar k_\mu) \\
& \quad \left. \times (\gamma - i\Delta_\mu + i \frac{k_\mu \cdot (p + \hbar k_\nu - \hbar k_\mu)}{m} + i\omega_k) \right. \\
& + \int \Gamma N(q) dq e^{i(-\frac{p \cdot q}{m} + \frac{(p' - \hbar k_\sigma) \cdot q}{m})t} \times \\
& \left\{ \frac{(\Omega_\sigma^* \Omega_\nu^* \Omega_\mu e^{(i(\Delta_\sigma + \Delta_\nu - \Delta_\mu) - i \frac{(k_\nu - k_\mu) \cdot (p' + \hbar q) - i \frac{k_\sigma \cdot p'}{m} - i \frac{\hbar k_\mu \cdot k_\nu}{m} + 3i\omega_k)t})}{(\gamma_1 + i(\Delta_\nu - \Delta_\mu) - i \frac{(k_\nu - k_\mu) \cdot (p' - \hbar k_\sigma + \hbar q) - i \frac{\hbar k_\mu \cdot k_\nu}{m} + 2i\omega_k - i \frac{(p + \hbar q) \cdot q}{m} + i \frac{(p' - \hbar k_\sigma) \cdot q}{m})} \right. \\
& \quad \times (\gamma_2 + i(\Delta_\nu - \Delta_\mu) - i \frac{(k_\nu - k_\mu) \cdot (p' - \hbar k_\sigma + \hbar q) - i \frac{\hbar k_\mu \cdot k_\nu}{m} + 2i\omega_k)}{m} \\
& \quad \left. \times (\gamma - i\Delta_\mu + i \frac{k_\mu \cdot (p + \hbar q)}{m} - i\omega_k) \right\} \\
& \times W(p' - \hbar k_\sigma + \hbar q - \hbar k_\nu, p + \hbar q - \hbar k_\mu)
\end{aligned}$$

$$\begin{aligned}
& + \frac{(\Omega_\sigma^* \Omega_\nu \Omega_\mu^* e^{(-i(-\Delta_\sigma + \Delta_\nu - \Delta_\mu) + i \frac{(k_\nu - k_\mu) \cdot (p + \hbar q)}{m} - i \frac{k_\sigma \cdot p'}{m} - i \frac{\hbar k_\mu \cdot k_\nu}{m} - i \omega_k)t})}{(\gamma_1 - i(\Delta_\nu - \Delta_\mu) + i \frac{(k_\nu - k_\mu) \cdot (p + \hbar q)}{m} - i \frac{\hbar k_\mu \cdot k_\nu}{m} - 2i\omega_k - i \frac{(p + \hbar q) \cdot q}{m} + i \frac{(p' - \hbar k_\sigma) \cdot q}{m})} \\
& \quad (\gamma_2 - i(\Delta_\nu - \Delta_\mu) + i \frac{(k_\nu - k_\mu) \cdot (p + \hbar q)}{m} - i \frac{\hbar k_\mu \cdot k_\nu}{m} - 2i\omega_k) \\
& \quad (\gamma + i\Delta_\mu - i \frac{k_\mu \cdot (p' - \hbar k_\sigma + \hbar q)}{m} + i\omega_k) \\
& \times W(p + \hbar q - \hbar k_\nu, p' - \hbar k_\sigma + \hbar q - \hbar k_\mu) \} \\
& - i \left\{ \frac{(\Omega_\sigma^* \Omega_\nu^* \Omega_\mu e^{(i(\Delta_\sigma + \Delta_\nu - \Delta_\mu) - i \frac{(k_\nu - k_\mu) \cdot p'}{m} - i \frac{k_\sigma \cdot p}{m} - i \frac{\hbar k_\mu \cdot k_\nu}{m} + i \omega_k)t}) W(p' - \hbar k_\nu, p + \hbar k_\sigma - \hbar k_\mu)}{(\gamma_2 + i(\Delta_\nu - \Delta_\mu) - i \frac{(k_\nu - k_\mu) \cdot p'}{m} - i \frac{\hbar k_\mu \cdot k_\nu}{m} + 2i\omega_k)(\gamma - i\Delta_\mu + i \frac{k_\mu \cdot (p + \hbar k_\sigma)}{m} - i\omega_k)} \right. \\
& \left. + \frac{(\Omega_\sigma^* \Omega_\nu \Omega_\mu^* e^{(-i(-\Delta_\sigma + \Delta_\nu - \Delta_\mu) + i \frac{(k_\nu - k_\mu) \cdot (p + \hbar k_\sigma)}{m} - i \frac{k_\sigma \cdot p}{m} - i \frac{\hbar k_\mu \cdot k_\nu}{m} - 3i\omega_k)t}) W(p + \hbar k_\sigma - \hbar k_\nu, p' - \hbar k_\mu)}{(\gamma_2 - i(\Delta_\nu - \Delta_\mu) + i \frac{(k_\nu - k_\mu) \cdot (p + \hbar k_\sigma)}{m} - i \frac{\hbar k_\mu \cdot k_\nu}{m} - 2i\omega_k)(\gamma + i\Delta_\mu - i \frac{k_\mu \cdot p'}{m} + i\omega_k)} \right\}
\end{aligned}$$

The third order optical coherence terms can then be obtained:

$$\begin{aligned}
& \tilde{\rho}_{12}^{(3)}(p, p') = \\
& i \left[- \frac{(\Omega_\sigma^* \Omega_\nu \Omega_\mu^* e^{(-i(-\Delta_\sigma + \Delta_\nu - \Delta_\mu) + i \frac{(k_\nu - k_\mu) \cdot (p - \hbar k_\nu + \hbar k_\mu)}{m} - i \frac{k_\sigma \cdot (p + \hbar k_\sigma - \hbar k_\nu + \hbar k_\mu)}{m} - i \frac{\hbar k_\mu \cdot k_\nu}{m} + 3i\omega_k)t}) W(p, p')}{(\gamma - i(-\Delta_\sigma + \Delta_\nu - \Delta_\mu) + i \frac{(k_\nu - k_\mu) \cdot (p - \hbar k_\nu + \hbar k_\mu)}{m} - i \frac{k_\sigma \cdot (p + \hbar k_\sigma - \hbar k_\nu + \hbar k_\mu)}{m} - i \frac{\hbar k_\mu \cdot k_\nu}{m} + 3i\omega_k)} \right. \\
& \quad (\gamma_1 + -i(\Delta_\nu - \Delta_\mu) + i \frac{(k_\nu - k_\mu) \cdot (p - \hbar k_\nu + \hbar k_\mu)}{m} - i \frac{\hbar k_\mu \cdot k_\nu}{m} + 2i\omega_k) \\
& \quad (\gamma + i\Delta_\mu - i \frac{k_\mu \cdot p}{m} - i\omega_k) \\
& - \frac{(\Omega_\sigma^* \Omega_\nu^* \Omega_\mu e^{(i(\Delta_\sigma + \Delta_\nu - \Delta_\mu) - i \frac{(k_\nu - k_\mu) \cdot p}{m} - i \frac{k_\sigma \cdot (p + \hbar k_\sigma + \hbar k_\nu - \hbar k_\mu)}{m} + i \frac{\hbar k_\mu \cdot k_\nu}{m} - i\omega_k)t}) W(p', p)}{(\gamma + i(\Delta_\sigma + \Delta_\nu - \Delta_\mu) - i \frac{(k_\nu - k_\mu) \cdot p}{m} - i \frac{k_\sigma \cdot (p + \hbar k_\sigma + \hbar k_\nu - \hbar k_\mu)}{m} + i \frac{\hbar k_\mu \cdot k_\nu}{m} - i\omega_k)} \\
& \quad (\gamma_1 + i(\Delta_\nu - \Delta_\mu) - i \frac{(k_\nu - k_\mu) \cdot p}{m} + i \frac{\hbar k_\mu \cdot k_\nu}{m} - 2i\omega_k) \\
& \quad (\gamma - i\Delta_\mu + i \frac{k_\mu \cdot (p + \hbar k_\nu - \hbar k_\mu)}{m} + i\omega_k) \\
& + \int \Gamma N(q) dq \times \\
& \left\{ \frac{(\Omega_\sigma^* \Omega_\nu^* \Omega_\mu e^{(i(\Delta_\sigma + \Delta_\nu - \Delta_\mu) - i \frac{(k_\nu - k_\mu) \cdot (p' + \hbar q)}{m} - i \frac{k_\sigma \cdot p'}{m} - i \frac{\hbar k_\mu \cdot k_\nu}{m} + 3i\omega_k - \frac{p \cdot q}{m} + \frac{(p' - \hbar k_\sigma) \cdot q}{m})t})}{(\gamma + i(\Delta_\sigma + \Delta_\nu - \Delta_\mu) - i \frac{(k_\nu - k_\mu) \cdot (p' + \hbar q)}{m} - i \frac{k_\sigma \cdot p'}{m} - i \frac{\hbar k_\mu \cdot k_\nu}{m} + 3i\omega_k - \frac{p \cdot q}{m} + \frac{(p' - \hbar k_\sigma) \cdot q}{m})} \right. \\
& \quad (\gamma_1 + i(\Delta_\nu - \Delta_\mu) - i \frac{(k_\nu - k_\mu) \cdot (p' - \hbar k_\sigma + \hbar q)}{m} - i \frac{\hbar k_\mu \cdot k_\nu}{m} + 2i\omega_k - \frac{(p + \hbar q) \cdot q}{m} + \frac{(p' - \hbar k_\sigma) \cdot q}{m}) \\
& \quad (\gamma_2 + i(\Delta_\nu - \Delta_\mu) - i \frac{(k_\nu - k_\mu) \cdot (p' - \hbar k_\sigma + \hbar q)}{m} - i \frac{\hbar k_\mu \cdot k_\nu}{m} + 2i\omega_k) \\
& \quad (\gamma - i\Delta_\mu + i \frac{k_\mu \cdot (p + \hbar q)}{m} - i\omega_k) \\
& \times W(p' - \hbar k_\sigma + \hbar q - \hbar k_\nu, p + \hbar q - \hbar k_\mu) \\
& + \frac{(\Omega_\sigma^* \Omega_\nu \Omega_\mu^* e^{(-i(-\Delta_\sigma + \Delta_\nu - \Delta_\mu) + i \frac{(k_\nu - k_\mu) \cdot (p + \hbar q)}{m} - i \frac{k_\sigma \cdot p'}{m} - i \frac{\hbar k_\mu \cdot k_\nu}{m} - i\omega_k - \frac{p \cdot q}{m} + \frac{(p' - \hbar k_\sigma) \cdot q}{m})t})}{(\gamma - i(-\Delta_\sigma + \Delta_\nu - \Delta_\mu) + i \frac{(k_\nu - k_\mu) \cdot (p + \hbar q)}{m} - i \frac{k_\sigma \cdot p'}{m} - i \frac{\hbar k_\mu \cdot k_\nu}{m} - i\omega_k - \frac{p \cdot q}{m} + \frac{(p' - \hbar k_\sigma) \cdot q}{m})} \\
& \quad (\gamma_1 - i(\Delta_\nu - \Delta_\mu) + i \frac{(k_\nu - k_\mu) \cdot (p + \hbar q)}{m} - i \frac{\hbar k_\mu \cdot k_\nu}{m} - 2i\omega_k - \frac{(p + \hbar q) \cdot q}{m} + \frac{(p' - \hbar k_\sigma) \cdot q}{m}) \\
& \quad (\gamma_2 - i(\Delta_\nu - \Delta_\mu) + i \frac{(k_\nu - k_\mu) \cdot (p + \hbar q)}{m} - i \frac{\hbar k_\mu \cdot k_\nu}{m} - 2i\omega_k) \\
& \quad (\gamma + i\Delta_\mu - i \frac{k_\mu \cdot (p' - \hbar k_\sigma + \hbar q)}{m} + i\omega_k)
\end{aligned}$$

$$\begin{aligned}
& \times W(p + \hbar q - \hbar k_\nu, p' - \hbar k_\sigma + \hbar q - \hbar k_\mu) \} \\
& - i \left\{ \frac{(\Omega_\sigma^* \Omega_\nu^* \Omega_\mu e^{i(\Delta_\sigma + \Delta_\nu - \Delta_\mu) - i \frac{(k_\nu - k_\mu) \cdot (p + \hbar k_\sigma + \hbar k_\nu - \hbar k_\mu)}{m} - i \frac{k_\sigma \cdot p}{m} - i \frac{\hbar k_\mu \cdot k_\nu}{m} + i \omega_k) t})}{(\gamma + i(\Delta_\sigma + \Delta_\nu - \Delta_\mu) - i \frac{(k_\nu - k_\mu) \cdot p'}{m} - i \frac{k_\sigma \cdot p}{m} - i \frac{\hbar k_\mu \cdot k_\nu}{m} + i \omega_k)} \right. \\
& \quad (\gamma_2 + i(\Delta_\nu - \Delta_\mu) - i \frac{(k_\nu - k_\mu) \cdot p'}{m} - i \frac{\hbar k_\mu \cdot k_\nu}{m} + 2i \omega_k) \\
& \quad \left. (\gamma - i \Delta_\mu + i \frac{k_\mu \cdot (p + \hbar k_\sigma)}{m} - i \omega_k) \right\} \\
& \times W(p' - \hbar k_\nu, p + \hbar k_\sigma - \hbar k_\mu) \\
& + \frac{(\Omega_\sigma^* \Omega_\nu \Omega_\mu^* e^{-i(-\Delta_\sigma + \Delta_\nu - \Delta_\mu) + i \frac{(k_\nu - k_\mu) \cdot (p + \hbar k_\sigma)}{m} - i \frac{k_\sigma \cdot p}{m} - i \frac{\hbar k_\mu \cdot k_\nu}{m} - 3i \omega_k) t})}{(\gamma - i(-\Delta_\sigma + \Delta_\nu - \Delta_\mu) + i \frac{(k_\nu - k_\mu) \cdot (p + \hbar k_\sigma)}{m} - i \frac{k_\sigma \cdot p}{m} - i \frac{\hbar k_\mu \cdot k_\nu}{m} - 3i \omega_k)} \\
& \quad (\gamma_2 - i(\Delta_\nu - \Delta_\mu) + i \frac{(k_\nu - k_\mu) \cdot (p + \hbar k_\sigma)}{m} - i \frac{\hbar k_\mu \cdot k_\nu}{m} - 2i \omega_k) \\
& \quad \left. (\gamma + i \Delta_\mu - i \frac{k_\mu \cdot p'}{m} + i \omega_k) \right\} \\
& \times W(p + \hbar k_\sigma - \hbar k_\nu, p' - \hbar k_\mu) \}
\end{aligned}$$

I write here, in red, the final result for the coherence due to four wave mixing processes. This was used to get the fig. 4.6 in page 90 but failed to reproduce the dips which could be observed for pump powers higher than 100 mW/cm² and visible in fig. 4.4.

C.1.6 Fourth order

The populations in the fourth order are computed from the third order coherences, considering a new field E_α :

$$\begin{aligned}
& \left(\frac{\partial}{\partial t} + \gamma_2 \right) \tilde{\rho}_{22}^{(4)}(p, p') = i(\Omega_\alpha^* e^{i(\Delta_\alpha - i \frac{k_\alpha \cdot p'}{m} + i \omega_k) t}) [\tilde{\rho}_{12}^{(3)}(p' - \hbar k_\alpha, p)]^* \\
& \quad - i(\Omega_\alpha e^{-i(\Delta_\alpha + i \frac{k_\alpha \cdot p}{m} - i \omega_k) t}) \tilde{\rho}_{12}^{(3)}(p - \hbar k_\alpha, p') \\
& = \left[\frac{-(\Omega_\alpha^* \Omega_\sigma \Omega_\nu^* \Omega_\mu e^{i(+\Delta_\alpha - \Delta_\sigma + \Delta_\nu - \Delta_\mu) - i \frac{(k_\nu - k_\mu) \cdot (p - \hbar k_\sigma)}{m} + i \frac{k_\sigma \cdot p}{m} - i \frac{k_\alpha \cdot p'}{m} + i \frac{\hbar k_\mu \cdot k_\nu}{m} - 2i \omega_k) t})}{(\gamma + i(-\Delta_\sigma + \Delta_\nu - \Delta_\mu) - i \frac{(k_\nu - k_\mu) \cdot (p - \hbar k_\sigma)}{m} + i \frac{k_\sigma \cdot p}{m} + i \frac{\hbar k_\mu \cdot k_\nu}{m} - 3i \omega_k)} \right. \\
& \quad (\gamma_1 + i(\Delta_\nu - \Delta_\mu) - i \frac{(k_\nu - k_\mu) \cdot (p - \hbar k_\sigma)}{m} + i \frac{\hbar k_\mu \cdot k_\nu}{m} - 2i \omega_k) \\
& \quad \left. (\gamma - i \Delta_\mu + i \frac{k_\mu \cdot (p' - \hbar k_\alpha)}{m} + i \omega_k) \right] \\
& \times W(p' - \hbar k_\alpha, p - \hbar k_\sigma + \hbar k_\nu - \hbar k_\mu) \\
& - \frac{(\Omega_\alpha^* \Omega_\sigma \Omega_\nu \Omega_\mu^* e^{-i(-\Delta_\alpha + \Delta_\sigma + \Delta_\nu - \Delta_\mu) + i \frac{(k_\nu - k_\mu) \cdot (p' - \hbar k_\alpha)}{m} + i \frac{k_\sigma \cdot p}{m} - i \frac{k_\alpha \cdot p'}{m} - i \frac{\hbar k_\mu \cdot k_\nu}{m} + 2i \omega_k) t})}{(\gamma - i(\Delta_\sigma + \Delta_\nu - \Delta_\mu) + i \frac{(k_\nu - k_\mu) \cdot (p' - \hbar k_\alpha)}{m} + i \frac{k_\sigma \cdot p}{m} - i \frac{\hbar k_\mu \cdot k_\nu}{m} + i \omega_k)} \\
& \quad (\gamma_1 - i(\Delta_\nu - \Delta_\mu) + i \frac{(k_\nu - k_\mu) \cdot (p' - \hbar k_\alpha)}{m} - i \frac{\hbar k_\mu \cdot k_\nu}{m} + 2i \omega_k) \\
& \quad \left. (\gamma + i \Delta_\mu - i \frac{k_\mu \cdot (p' - \hbar k_\alpha + \hbar k_\nu - \hbar k_\mu)}{m} - i \omega_k) \right] \\
& \times W(p - \hbar k_\sigma, p' - \hbar k_\alpha + \hbar k_\nu - \hbar k_\mu)
\end{aligned}$$

$$\begin{aligned}
& + \int \Gamma N(q) dq e^{(+i\frac{(p'-\hbar k_\alpha)\cdot q}{m} - i\frac{(p-\hbar k_\sigma)\cdot q}{m})t} \times \\
& \left\{ \frac{(\Omega_\alpha^* \Omega_\sigma \Omega_\nu \Omega_\mu^* e^{(-i(-\Delta_\alpha + \Delta_\sigma + \Delta_\nu - \Delta_\mu) + i\frac{(k_\nu - k_\mu)\cdot(p+\hbar q)}{m} + i\frac{k_\sigma\cdot p}{m} - i\frac{k_\alpha\cdot p'}{m} + i\frac{\hbar k_\mu\cdot k_\nu}{m} - 2i\omega_k)t})}{(\gamma - i(\Delta_\sigma + \Delta_\nu - \Delta_\mu) + i\frac{(k_\nu - k_\mu)\cdot(p+\hbar q)}{m} + i\frac{k_\sigma\cdot p}{m} + i\frac{\hbar k_\mu\cdot k_\nu}{m} - 3i\omega_k + i\frac{(p'-\hbar k_\alpha)\cdot q}{m} - i\frac{(p-\hbar k_\sigma)\cdot q}{m})} \right. \\
& \quad \frac{(\gamma_1 - i(\Delta_\nu - \Delta_\mu) + i\frac{(k_\nu - k_\mu)\cdot(p-\hbar k_\sigma + \hbar q)}{m} + i\frac{\hbar k_\mu\cdot k_\nu}{m} - 2i\omega_k + i\frac{(p'-\hbar k_\alpha + \hbar q)\cdot q}{m} - i\frac{(p-\hbar k_\sigma)\cdot q}{m})}{(\gamma_2 - i(\Delta_\nu - \Delta_\mu) + i\frac{(k_\nu - k_\mu)\cdot(p-\hbar k_\sigma + \hbar q)}{m} + i\frac{\hbar k_\mu\cdot k_\nu}{m} - 2i\omega_k)} \\
& \quad \left. (\gamma + i\Delta_\mu - i\frac{k_\mu\cdot(p'-\hbar k_\alpha + \hbar q)}{m} + i\omega_k) \right\} \\
& \times W(p - \hbar k_\sigma + \hbar q - \hbar k_\nu, p' - \hbar k_\alpha + \hbar q - \hbar k_\mu) \\
& + \frac{(\Omega_\alpha^* \Omega_\sigma \Omega_\nu \Omega_\mu^* e^{(i(\Delta_\alpha - \Delta_\sigma + \Delta_\nu - \Delta_\mu) - i\frac{(k_\nu - k_\mu)\cdot(p'-\hbar k_\alpha + \hbar q)}{m} + i\frac{k_\sigma\cdot p}{m} - i\frac{k_\alpha\cdot p'}{m} + i\frac{\hbar k_\mu\cdot k_\nu}{m} + 2i\omega_k)t})}{(\gamma + i(-\Delta_\sigma + \Delta_\nu - \Delta_\mu) - i\frac{(k_\nu - k_\mu)\cdot(p'-\hbar k_\alpha + \hbar q)}{m} + i\frac{k_\sigma\cdot p}{m} + i\frac{\hbar k_\mu\cdot k_\nu}{m} + i\omega_k + i\frac{(p'-\hbar k_\alpha)\cdot q}{m} - i\frac{(p-\hbar k_\sigma)\cdot q}{m})} \\
& \quad \frac{(\gamma_1 + i(\Delta_\nu - \Delta_\mu) - i\frac{(k_\nu - k_\mu)\cdot(p'-\hbar k_\alpha + \hbar q)}{m} + i\frac{\hbar k_\mu\cdot k_\nu}{m} + 2i\omega_k + \frac{(p'-\hbar k_\alpha + \hbar q)\cdot q}{m} - \frac{(p-\hbar k_\sigma)\cdot q}{m})}{(\gamma_2 + i(\Delta_\nu - \Delta_\mu) - i\frac{(k_\nu - k_\mu)\cdot(p'-\hbar k_\alpha + \hbar q)}{m} + i\frac{\hbar k_\mu\cdot k_\nu}{m} + 2i\omega_k)} \\
& \quad \left. (\gamma - i\Delta_\mu + i\frac{k_\mu\cdot(p-\hbar k_\sigma + \hbar q)}{m} - i\omega_k) \right\} \\
& \times W(p' - \hbar k_\alpha + \hbar q - \hbar k_\nu, p - \hbar k_\sigma + \hbar q - \hbar k_\mu) \} \\
& + \left\{ \frac{(\Omega_\alpha^* \Omega_\sigma \Omega_\nu \Omega_\mu^* e^{(-i(-\Delta_\alpha + \Delta_\sigma + \Delta_\nu - \Delta_\mu) + i\frac{(k_\nu - k_\mu)\cdot p}{m} + i\frac{k_\sigma\cdot(p'-\hbar k_\alpha)}{m} - i\frac{k_\alpha\cdot p'}{m} + i\frac{\hbar k_\mu\cdot k_\nu}{m} - 2i\omega_k)t})}{(\gamma - i(\Delta_\sigma + \Delta_\nu - \Delta_\mu) + i\frac{(k_\nu - k_\mu)\cdot p}{m} + i\frac{k_\sigma\cdot(p'-\hbar k_\alpha)}{m} + i\frac{\hbar k_\mu\cdot k_\nu}{m} - i\omega_k)} \right. \\
& \quad \frac{(\gamma_2 - i(\Delta_\nu - \Delta_\mu) + i\frac{(k_\nu - k_\mu)\cdot p}{m} + i\frac{\hbar k_\mu\cdot k_\nu}{m} - 2i\omega_k)}{(\gamma + i\Delta_\mu - i\frac{k_\mu\cdot(p'-\hbar k_\alpha + \hbar k_\sigma)}{m} + i\omega_k)} \\
& \left. \times W(p - \hbar k_\nu, p' - \hbar k_\alpha + \hbar k_\sigma - \hbar k_\mu) \right\} \\
& + \frac{(\Omega_\alpha^* \Omega_\sigma \Omega_\nu \Omega_\mu^* e^{(i(\Delta_\alpha - \Delta_\sigma + \Delta_\nu - \Delta_\mu) - i\frac{(k_\nu - k_\mu)\cdot(p'-\hbar k_\alpha + \hbar k_\sigma)}{m} + i\frac{k_\sigma\cdot(p'-\hbar k_\alpha)}{m} - i\frac{k_\alpha\cdot p'}{m} + i\frac{\hbar k_\mu\cdot k_\nu}{m} + 4i\omega_k)t})}{(\gamma + i(-\Delta_\sigma + \Delta_\nu - \Delta_\mu) - i\frac{(k_\nu - k_\mu)\cdot(p'-\hbar k_\alpha + \hbar k_\sigma)}{m} + i\frac{k_\sigma\cdot(p'-\hbar k_\alpha)}{m} + i\frac{\hbar k_\mu\cdot k_\nu}{m} + 3i\omega_k)} \\
& \quad \frac{(\gamma_2 + i(\Delta_\nu - \Delta_\mu) - i\frac{(k_\nu - k_\mu)\cdot(p'-\hbar k_\alpha + \hbar k_\sigma)}{m} + i\frac{\hbar k_\mu\cdot k_\nu}{m} + 2i\omega_k)}{(\gamma - i\Delta_\mu + i\frac{k_\mu\cdot p}{m} - i\omega_k)} \\
& \times W(p' - \hbar k_\alpha + \hbar k_\sigma - \hbar k_\nu, p - \hbar k_\mu) \} \\
& + \left[\frac{(\Omega_\alpha \Omega_\sigma^* \Omega_\nu \Omega_\mu^* e^{(-i(-\Delta_\alpha - \Delta_\sigma + \Delta_\nu - \Delta_\mu) + i\frac{(k_\nu - k_\mu)\cdot(p'-\hbar k_\sigma)}{m} - i\frac{k_\sigma\cdot p'}{m} + i\frac{k_\alpha\cdot p}{m} - i\frac{\hbar k_\mu\cdot k_\nu}{m} + 2i\omega_k)t})}{(\gamma - i(-\Delta_\sigma + \Delta_\nu - \Delta_\mu) + i\frac{(k_\nu - k_\mu)\cdot(p'-\hbar k_\sigma)}{m} - i\frac{k_\sigma\cdot p'}{m} - i\frac{\hbar k_\mu\cdot k_\nu}{m} + 3i\omega_k)} \right. \\
& \quad \frac{(\gamma_1 - i(\Delta_\nu - \Delta_\mu) + i\frac{(k_\nu - k_\mu)\cdot(p'-\hbar k_\sigma)}{m} - i\frac{\hbar k_\mu\cdot k_\nu}{m} + 2i\omega_k)}{(\gamma + i\Delta_\mu - i\frac{k_\mu\cdot(p-\hbar k_\alpha)}{m} - i\omega_k)} \\
& \left. \times W(p - \hbar k_\alpha, p' - \hbar k_\sigma + \hbar k_\nu - \hbar k_\mu) \right] \\
& \frac{(\Omega_\alpha \Omega_\sigma^* \Omega_\nu \Omega_\mu^* e^{(i(-\Delta_\alpha + \Delta_\sigma + \Delta_\nu - \Delta_\mu) - i\frac{(k_\nu - k_\mu)\cdot(p-\hbar k_\alpha)}{m} - i\frac{k_\sigma\cdot p'}{m} + i\frac{k_\alpha\cdot p}{m} + i\frac{\hbar k_\mu\cdot k_\nu}{m} - 2i\omega_k)t})}{(\gamma + i(\Delta_\sigma + \Delta_\nu - \Delta_\mu) - i\frac{(k_\nu - k_\mu)\cdot(p-\hbar k_\alpha)}{m} - i\frac{k_\sigma\cdot p'}{m} + i\frac{\hbar k_\mu\cdot k_\nu}{m} - i\omega_k)} \\
& \quad \frac{(\gamma_1 + i(\Delta_\nu - \Delta_\mu) - i\frac{(k_\nu - k_\mu)\cdot(p-\hbar k_\alpha)}{m} + i\frac{\hbar k_\mu\cdot k_\nu}{m} - 2i\omega_k)}{(\gamma - i\Delta_\mu + i\frac{k_\mu\cdot(p-\hbar k_\alpha + \hbar k_\nu - \hbar k_\mu)}{m} + i\omega_k)} \\
& \quad \left. (\gamma - i\Delta_\mu + i\frac{k_\mu\cdot(p-\hbar k_\alpha + \hbar k_\nu - \hbar k_\mu)}{m} + i\omega_k) \right\}
\end{aligned}$$

$$\begin{aligned}
& \times W(p' - \hbar k_\sigma, p - \hbar k_\alpha + \hbar k_\nu - \hbar k_\mu) \\
& + \int \Gamma N(q) dq e^{i\left(-\frac{(p-\hbar k_\alpha)\cdot q}{m} + \frac{(p'-\hbar k_\sigma)\cdot q}{m}\right)t} \times \\
& \left\{ \frac{(\Omega_\alpha \Omega_\sigma^* \Omega_\nu^* \Omega_\mu^* e^{(i(-\Delta_\alpha + \Delta_\sigma + \Delta_\nu - \Delta_\mu) - i\frac{(k_\nu - k_\mu)\cdot(p'+\hbar q)}{m} - i\frac{k_\sigma\cdot p'}{m} + i\frac{k_\alpha\cdot p}{m} - i\frac{\hbar k_\mu\cdot k_\nu}{m} + 2i\omega_k)t})}{(\gamma + i(\Delta_\sigma + \Delta_\nu - \Delta_\mu) - i\frac{(k_\nu - k_\mu)\cdot(p'+\hbar q)}{m} - i\frac{k_\sigma\cdot p'}{m} - i\frac{\hbar k_\mu\cdot k_\nu}{m} + 3i\omega_k \dots} \right. \\
& \quad \left. - i\frac{(p-\hbar k_\alpha)\cdot q}{m} + i\frac{(p'-\hbar k_\sigma)\cdot q}{m}\right) \\
& \quad (\gamma_1 + i(\Delta_\nu - \Delta_\mu) - i\frac{(k_\nu - k_\mu)\cdot(p'-\hbar k_\sigma + \hbar q)}{m} - i\frac{\hbar k_\mu\cdot k_\nu}{m} + 2i\omega_k - i\frac{(p-\hbar k_\alpha + \hbar q)\cdot q}{m} + i\frac{(p'-\hbar k_\sigma)\cdot q}{m}) \\
& \quad (\gamma_2 + i(\Delta_\nu - \Delta_\mu) - i\frac{(k_\nu - k_\mu)\cdot(p'-\hbar k_\sigma + \hbar q)}{m} - i\frac{\hbar k_\mu\cdot k_\nu}{m} + 2i\omega_k) \\
& \quad (\gamma - i\Delta_\mu + i\frac{k_\mu\cdot(p-\hbar k_\alpha + \hbar q)}{m} - i\omega_k) \\
& \times W(p' - \hbar k_\sigma + \hbar q - \hbar k_\nu, p - \hbar k_\alpha + \hbar q - \hbar k_\mu) \\
& + \frac{(\Omega_\alpha \Omega_\sigma^* \Omega_\nu \Omega_\mu^* e^{(-i(\Delta_\alpha - \Delta_\sigma + \Delta_\nu - \Delta_\mu) + i\frac{(k_\nu - k_\mu)\cdot(p-\hbar k_\alpha + \hbar q)}{m} - i\frac{k_\sigma\cdot p'}{m} + i\frac{k_\alpha\cdot p}{m} - i\frac{\hbar k_\mu\cdot k_\nu}{m} - 2i\omega_k)t})}{(\gamma - i(-\Delta_\sigma + \Delta_\nu - \Delta_\mu) + i\frac{(k_\nu - k_\mu)\cdot(p-\hbar k_\alpha + \hbar q)}{m} - i\frac{k_\sigma\cdot p'}{m} - i\frac{\hbar k_\mu\cdot k_\nu}{m} - i\omega_k \dots} \\
& \quad \left. - i\frac{(p-\hbar k_\alpha)\cdot q}{m} + i\frac{(p'-\hbar k_\sigma)\cdot q}{m}\right) \\
& \quad (\gamma_1 - i(\Delta_\nu - \Delta_\mu) + i\frac{(k_\nu - k_\mu)\cdot(p-\hbar k_\alpha + \hbar q)}{m} - i\frac{\hbar k_\mu\cdot k_\nu}{m} - 2i\omega_k - i\frac{(p-\hbar k_\alpha + \hbar q)\cdot q}{m} + i\frac{(p'-\hbar k_\sigma)\cdot q}{m}) \\
& \quad (\gamma_2 - i(\Delta_\nu - \Delta_\mu) + i\frac{(k_\nu - k_\mu)\cdot(p-\hbar k_\alpha + \hbar q)}{m} - i\frac{\hbar k_\mu\cdot k_\nu}{m} - 2i\omega_k) \\
& \quad (\gamma + i\Delta_\mu - i\frac{k_\mu\cdot(p'-\hbar k_\sigma + \hbar q)}{m} + i\omega_k) \\
& \times W(p - \hbar k_\alpha + \hbar q - \hbar k_\nu, p' - \hbar k_\sigma + \hbar q - \hbar k_\mu) \} \\
& - \left\{ \frac{(\Omega_\alpha \Omega_\sigma^* \Omega_\nu^* \Omega_\mu^* e^{(i(-\Delta_\alpha + \Delta_\sigma + \Delta_\nu - \Delta_\mu) - i\frac{(k_\nu - k_\mu)\cdot p'}{m} - i\frac{k_\sigma\cdot(p-\hbar k_\alpha)}{m} + i\frac{k_\alpha\cdot p}{m} - i\frac{\hbar k_\mu\cdot k_\nu}{m})t)}{(\gamma + i(\Delta_\sigma + \Delta_\nu - \Delta_\mu) - i\frac{(k_\nu - k_\mu)\cdot p'}{m} - i\frac{k_\sigma\cdot(p-\hbar k_\alpha)}{m} - i\frac{\hbar k_\mu\cdot k_\nu}{m} + i\omega_k)} \right. \\
& \quad \left. (\gamma_2 + i(\Delta_\nu - \Delta_\mu) - i\frac{(k_\nu - k_\mu)\cdot p'}{m} - i\frac{\hbar k_\mu\cdot k_\nu}{m} + 2i\omega_k) \right. \\
& \quad \left. (\gamma - i\Delta_\mu + i\frac{k_\mu\cdot(p-\hbar k_\alpha + \hbar k_\sigma)}{m} - i\omega_k) \right. \\
& \times W(p' - \hbar k_\nu, p - \hbar k_\alpha + \hbar k_\sigma - \hbar k_\mu) \\
& + \frac{(\Omega_\alpha \Omega_\sigma^* \Omega_\nu \Omega_\mu^* e^{(-i(\Delta_\alpha - \Delta_\sigma + \Delta_\nu - \Delta_\mu) + i\frac{(k_\nu - k_\mu)\cdot(p-\hbar k_\alpha + \hbar k_\sigma)}{m} - i\frac{k_\sigma\cdot(p-\hbar k_\alpha)}{m} + i\frac{k_\alpha\cdot p}{m} - i\frac{\hbar k_\mu\cdot k_\nu}{m} - 4i\omega_k)t)}{(\gamma - i(-\Delta_\sigma + \Delta_\nu - \Delta_\mu) + i\frac{(k_\nu - k_\mu)\cdot(p-\hbar k_\alpha + \hbar k_\sigma)}{m} - i\frac{k_\sigma\cdot(p-\hbar k_\alpha)}{m} - i\frac{\hbar k_\mu\cdot k_\nu}{m} - 3i\omega_k)} \\
& \quad (\gamma_2 - i(\Delta_\nu - \Delta_\mu) + i\frac{(k_\nu - k_\mu)\cdot(p-\hbar k_\alpha + \hbar k_\sigma)}{m} - i\frac{\hbar k_\mu\cdot k_\nu}{m} - 2i\omega_k) \\
& \quad (\gamma + i\Delta_\mu - i\frac{k_\mu\cdot p'}{m} + i\omega_k) \\
& \times W(p - \hbar k_\alpha + \hbar k_\sigma - \hbar k_\nu, p' - \hbar k_\mu) \} \\
\end{aligned}$$

The fourth order density matrix terms are then :

$$\tilde{\rho}_{22}^{(4)}(p, p') =$$

$$\left[- \frac{(\Omega_\alpha^* \Omega_\sigma \Omega_\nu^* \Omega_\mu^* e^{(i(+\Delta_\alpha - \Delta_\sigma + \Delta_\nu - \Delta_\mu) - i\frac{(k_\nu - k_\mu)\cdot(p-\hbar k_\sigma)}{m} + i\frac{k_\sigma\cdot p}{m} - i\frac{k_\alpha\cdot p'}{m} + i\frac{\hbar k_\mu\cdot k_\nu}{m} - 2i\omega_k)t)}{(\gamma_2 + i(+\Delta_\alpha - \Delta_\sigma + \Delta_\nu - \Delta_\mu) - i\frac{(k_\nu - k_\mu)\cdot(p-\hbar k_\sigma)}{m} + i\frac{k_\sigma\cdot p}{m} - i\frac{k_\alpha\cdot p'}{m} + i\frac{\hbar k_\mu\cdot k_\nu}{m} - 2i\omega_k)} \right. \\
\left. (\gamma + i(-\Delta_\sigma + \Delta_\nu - \Delta_\mu) - i\frac{(k_\nu - k_\mu)\cdot(p-\hbar k_\sigma)}{m} + i\frac{k_\sigma\cdot p}{m} + i\frac{\hbar k_\mu\cdot k_\nu}{m} - 3i\omega_k) \right. \\
\left. (\gamma_1 + i(\Delta_\nu - \Delta_\mu) - i\frac{(k_\nu - k_\mu)\cdot(p-\hbar k_\sigma)}{m} + i\frac{\hbar k_\mu\cdot k_\nu}{m} - 2i\omega_k) \right. \\
\left. (\gamma - i\Delta_\mu + i\frac{k_\mu\cdot(p'-\hbar k_\alpha)}{m} + i\omega_k) \right]$$

$$\begin{aligned}
& \times W(p' - \hbar k_\alpha, p - \hbar k_\sigma + \hbar k_\nu - \hbar k_\mu) \\
& - \frac{-(\Omega_\alpha^* \Omega_\sigma \Omega_\nu \Omega_\mu^* e^{(-i(-\Delta_\alpha + \Delta_\sigma + \Delta_\nu - \Delta_\mu) + i \frac{(k_\nu - k_\mu) \cdot (p' - \hbar k_\alpha)}{m} + i \frac{k_\sigma \cdot p}{m} - i \frac{k_\alpha \cdot p'}{m} - i \frac{\hbar k_\mu \cdot k_\nu}{m} + 2i\omega_k)t})}{(\gamma_2 - i(\Delta_\alpha + \Delta_\sigma + \Delta_\nu - \Delta_\mu) + i \frac{(k_\nu - k_\mu) \cdot (p' - \hbar k_\alpha)}{m} + i \frac{k_\sigma \cdot p}{m} - i \frac{k_\alpha \cdot p'}{m} - i \frac{\hbar k_\mu \cdot k_\nu}{m} + 2i\omega_k) \\
& \quad (\gamma - i(\Delta_\sigma + \Delta_\nu - \Delta_\mu) + i \frac{(k_\nu - k_\mu) \cdot (p' - \hbar k_\alpha)}{m} + i \frac{k_\sigma \cdot p}{m} - i \frac{\hbar k_\mu \cdot k_\nu}{m} + i\omega_k) \\
& \quad (\gamma_1 - i(\Delta_\nu - \Delta_\mu) + i \frac{(k_\nu - k_\mu) \cdot (p' - \hbar k_\alpha)}{m} - i \frac{\hbar k_\mu \cdot k_\nu}{m} + 2i\omega_k) \\
& \quad (\gamma + i\Delta_\mu - i \frac{k_\mu \cdot (p' - \hbar k_\alpha + \hbar k_\nu - \hbar k_\mu)}{m} - i\omega_k)} \\
& \times W(p - \hbar k_\sigma, p' - \hbar k_\alpha + \hbar k_\nu - \hbar k_\mu) \\
& + \int \Gamma N(q) dq e^{(+i \frac{(p' - \hbar k_\alpha) \cdot q}{m} - i \frac{(p - \hbar k_\sigma) \cdot q}{m})t} \times \\
& \left\{ \frac{(\Omega_\alpha^* \Omega_\sigma \Omega_\nu \Omega_\mu^* e^{(-i(-\Delta_\alpha + \Delta_\sigma + \Delta_\nu - \Delta_\mu) + i \frac{(k_\nu - k_\mu) \cdot (p + \hbar q)}{m} + i \frac{k_\sigma \cdot p}{m} - i \frac{k_\alpha \cdot p'}{m} + i \frac{\hbar k_\mu \cdot k_\nu}{m} - 2i\omega_k)t})}{(\gamma_2 - i(-\Delta_\alpha + \Delta_\sigma + \Delta_\nu - \Delta_\mu) + i \frac{(k_\nu - k_\mu) \cdot (p + \hbar q)}{m} + i \frac{k_\sigma \cdot p}{m} - i \frac{k_\alpha \cdot p'}{m} + i \frac{\hbar k_\mu \cdot k_\nu}{m} - 2i\omega_k \dots} \right. \\
& \quad + i \frac{(p' - \hbar k_\alpha) \cdot q}{m} - i \frac{(p - \hbar k_\sigma) \cdot q}{m}) \\
& \quad (\gamma - i(\Delta_\sigma + \Delta_\nu - \Delta_\mu) + i \frac{(k_\nu - k_\mu) \cdot (p + \hbar q)}{m} + i \frac{k_\sigma \cdot p}{m} + i \frac{\hbar k_\mu \cdot k_\nu}{m} - 3i\omega_k + i \frac{(p' - \hbar k_\alpha) \cdot q}{m} - i \frac{(p - \hbar k_\sigma) \cdot q}{m}) \\
& \quad (\gamma_1 - i(\Delta_\nu - \Delta_\mu) + i \frac{(k_\nu - k_\mu) \cdot (p - \hbar k_\sigma + \hbar q)}{m} + i \frac{\hbar k_\mu \cdot k_\nu}{m} - 2i\omega_k + i \frac{(p' - \hbar k_\alpha + \hbar q) \cdot q}{m} - i \frac{(p - \hbar k_\sigma) \cdot q}{m}) \\
& \quad (\gamma_2 - i(\Delta_\nu - \Delta_\mu) + i \frac{(k_\nu - k_\mu) \cdot (p - \hbar k_\sigma + \hbar q)}{m} + i \frac{\hbar k_\mu \cdot k_\nu}{m} - 2i\omega_k) \\
& \quad \left. (\gamma + i\Delta_\mu - i \frac{k_\mu \cdot (p' - \hbar k_\alpha + \hbar q)}{m} + i\omega_k) \right\} \\
& \times W(p - \hbar k_\sigma + \hbar q - \hbar k_\nu, p' - \hbar k_\alpha + \hbar q - \hbar k_\mu) \\
& + \frac{(\Omega_\alpha^* \Omega_\sigma \Omega_\nu \Omega_\mu^* e^{(i(\Delta_\alpha - \Delta_\sigma + \Delta_\nu - \Delta_\mu) - i \frac{(k_\nu - k_\mu) \cdot (p' - \hbar k_\alpha + \hbar q)}{m} + i \frac{k_\sigma \cdot p}{m} - i \frac{k_\alpha \cdot p'}{m} + i \frac{\hbar k_\mu \cdot k_\nu}{m} + 2i\omega_k)t})}{(\gamma_2 + i(\Delta_\alpha - \Delta_\sigma + \Delta_\nu - \Delta_\mu) - i \frac{(k_\nu - k_\mu) \cdot (p' - \hbar k_\alpha + \hbar q)}{m} + i \frac{k_\sigma \cdot p}{m} - i \frac{k_\alpha \cdot p'}{m} + i \frac{\hbar k_\mu \cdot k_\nu}{m} + 2i\omega_k \dots} \\
& \quad + i \frac{(p' - \hbar k_\alpha) \cdot q}{m} - i \frac{(p - \hbar k_\sigma) \cdot q}{m}) \\
& \quad (\gamma + i(-\Delta_\sigma + \Delta_\nu - \Delta_\mu) - i \frac{(k_\nu - k_\mu) \cdot (p' - \hbar k_\alpha + \hbar q)}{m} + i \frac{k_\sigma \cdot p}{m} + i \frac{\hbar k_\mu \cdot k_\nu}{m} + i\omega_k \dots} \\
& \quad + i \frac{(p' - \hbar k_\alpha) \cdot q}{m} - i \frac{(p - \hbar k_\sigma) \cdot q}{m}) \\
& \quad (\gamma_1 + i(\Delta_\nu - \Delta_\mu) - i \frac{(k_\nu - k_\mu) \cdot (p' - \hbar k_\alpha + \hbar q)}{m} + i \frac{\hbar k_\mu \cdot k_\nu}{m} + 2i\omega_k + \frac{(p' - \hbar k_\alpha + \hbar q) \cdot q}{m} - \frac{(p - \hbar k_\sigma) \cdot q}{m}) \\
& \quad (\gamma_2 + i(\Delta_\nu - \Delta_\mu) - i \frac{(k_\nu - k_\mu) \cdot (p' - \hbar k_\alpha + \hbar q)}{m} + i \frac{\hbar k_\mu \cdot k_\nu}{m} + 2i\omega_k) \\
& \quad \left. (\gamma - i\Delta_\mu + i \frac{k_\mu \cdot (p - \hbar k_\sigma + \hbar q)}{m} - i\omega_k) \right\} \\
& \times W(p' - \hbar k_\alpha + \hbar q - \hbar k_\nu, p - \hbar k_\sigma + \hbar q - \hbar k_\mu) \\
& + \left\{ \frac{(\Omega_\alpha^* \Omega_\sigma \Omega_\nu \Omega_\mu^* e^{(-i(\Delta_\alpha + \Delta_\sigma + \Delta_\nu - \Delta_\mu) + i \frac{(k_\nu - k_\mu) \cdot p}{m} + i \frac{k_\sigma \cdot (p' - \hbar k_\alpha)}{m} - i \frac{k_\alpha \cdot p'}{m} + i \frac{\hbar k_\mu \cdot k_\nu}{m} - 2i\omega_k)t})}{(\gamma_2 - i(-\Delta_\alpha + \Delta_\sigma + \Delta_\nu - \Delta_\mu) + i \frac{(k_\nu - k_\mu) \cdot p}{m} + i \frac{k_\sigma \cdot (p' - \hbar k_\alpha)}{m} - i \frac{k_\alpha \cdot p'}{m} + i \frac{\hbar k_\mu \cdot k_\nu}{m} - 2i\omega_k) \right. \\
& \quad (\gamma - i(\Delta_\sigma + \Delta_\nu - \Delta_\mu) + i \frac{(k_\nu - k_\mu) \cdot p}{m} + i \frac{k_\sigma \cdot (p' - \hbar k_\alpha)}{m} + i \frac{\hbar k_\mu \cdot k_\nu}{m} - i\omega_k) \\
& \quad (\gamma_2 - i(\Delta_\nu - \Delta_\mu) + i \frac{(k_\nu - k_\mu) \cdot p}{m} + i \frac{\hbar k_\mu \cdot k_\nu}{m} - 2i\omega_k) \\
& \quad \left. (\gamma + i\Delta_\mu - i \frac{k_\mu \cdot (p' - \hbar k_\alpha + \hbar k_\sigma)}{m} + i\omega_k) \right\} \\
& \times W(p - \hbar k_\nu, p' - \hbar k_\alpha + \hbar k_\sigma - \hbar k_\mu)
\end{aligned}$$

$$\begin{aligned}
& + \frac{(\Omega_\alpha^* \Omega_\sigma \Omega_\nu^* \Omega_\mu e^{i(+\Delta_\alpha - \Delta_\sigma + \Delta_\nu - \Delta_\mu) - i \frac{(k_\nu - k_\mu) \cdot (p' - \hbar k_\alpha + \hbar k_\sigma)}{m} + i \frac{k_\sigma \cdot (p' - \hbar k_\alpha)}{m} - i \frac{k_\alpha \cdot p'}{m} + i \frac{\hbar k_\mu \cdot k_\nu}{m} + 4i\omega_k)t}}{(\gamma_2 + i(+\Delta_\alpha - \Delta_\sigma + \Delta_\nu - \Delta_\mu) - i \frac{(k_\nu - k_\mu) \cdot (p' - \hbar k_\alpha + \hbar k_\sigma)}{m} + i \frac{k_\sigma \cdot (p' - \hbar k_\alpha)}{m} - i \frac{k_\alpha \cdot p'}{m} + i \frac{\hbar k_\mu \cdot k_\nu}{m} + 4i\omega_k)} \\
& \quad (\gamma + i(-\Delta_\sigma + \Delta_\nu - \Delta_\mu) - i \frac{(k_\nu - k_\mu) \cdot (p' - \hbar k_\alpha + \hbar k_\sigma)}{m} + i \frac{k_\sigma \cdot (p' - \hbar k_\alpha)}{m} + i \frac{\hbar k_\mu \cdot k_\nu}{m} + 3i\omega_k) \\
& \quad (\gamma_2 + i(\Delta_\nu - \Delta_\mu) - i \frac{(k_\nu - k_\mu) \cdot (p' - \hbar k_\alpha + \hbar k_\sigma)}{m} + i \frac{\hbar k_\mu \cdot k_\nu}{m} + 2i\omega_k) \\
& \quad (\gamma - i\Delta_\mu + i \frac{k_\mu \cdot p}{m} - i\omega_k) \\
& \times W(p' - \hbar k_\alpha + \hbar k_\sigma - \hbar k_\nu, p - \hbar k_\mu) \} \\
& + \left[\left[- \frac{(\Omega_\alpha \Omega_\sigma^* \Omega_\nu \Omega_\mu^* e^{-i(\Delta_\alpha - \Delta_\sigma + \Delta_\nu - \Delta_\mu) + i \frac{(k_\nu - k_\mu) \cdot (p' - \hbar k_\sigma)}{m} - i \frac{k_\sigma \cdot p'}{m} + i \frac{k_\alpha \cdot p}{m} - i \frac{\hbar k_\mu \cdot k_\nu}{m} + 2i\omega_k)t}}{(\gamma_2 - i(\Delta_\alpha - \Delta_\sigma + \Delta_\nu - \Delta_\mu) + i \frac{(k_\nu - k_\mu) \cdot (p' - \hbar k_\sigma)}{m} - i \frac{k_\sigma \cdot p'}{m} + i \frac{k_\alpha \cdot p}{m} - i \frac{\hbar k_\mu \cdot k_\nu}{m} + 2i\omega_k)} \right. \right. \\
& \quad (\gamma - i(-\Delta_\sigma + \Delta_\nu - \Delta_\mu) + i \frac{(k_\nu - k_\mu) \cdot (p' - \hbar k_\sigma)}{m} - i \frac{k_\sigma \cdot p'}{m} - i \frac{\hbar k_\mu \cdot k_\nu}{m} + 3i\omega_k) \\
& \quad (\gamma_1 - i(\Delta_\nu - \Delta_\mu) + i \frac{(k_\nu - k_\mu) \cdot (p' - \hbar k_\sigma)}{m} - i \frac{\hbar k_\mu \cdot k_\nu}{m} + 2i\omega_k) \\
& \quad \left. \left. (\gamma + i\Delta_\mu - i \frac{k_\mu \cdot (p - \hbar k_\alpha)}{m} - i\omega_k) \right] \right] \\
& \times W(p - \hbar k_\alpha, p' - \hbar k_\sigma + \hbar k_\nu - \hbar k_\mu) \\
& - \frac{(\Omega_\alpha \Omega_\sigma^* \Omega_\nu^* \Omega_\mu e^{i(-\Delta_\alpha + \Delta_\sigma + \Delta_\nu - \Delta_\mu) - i \frac{(k_\nu - k_\mu) \cdot (p - \hbar k_\alpha)}{m} - i \frac{k_\sigma \cdot p'}{m} + i \frac{k_\alpha \cdot p}{m} + i \frac{\hbar k_\mu \cdot k_\nu}{m} - 2i\omega_k)t}}{(\gamma_2 + i(-\Delta_\alpha + \Delta_\sigma + \Delta_\nu - \Delta_\mu) - i \frac{(k_\nu - k_\mu) \cdot (p - \hbar k_\alpha)}{m} - i \frac{k_\sigma \cdot p'}{m} + i \frac{k_\alpha \cdot p}{m} + i \frac{\hbar k_\mu \cdot k_\nu}{m} - 2i\omega_k)} \\
& \quad (\gamma + i(\Delta_\sigma + \Delta_\nu - \Delta_\mu) - i \frac{(k_\nu - k_\mu) \cdot (p - \hbar k_\alpha)}{m} - i \frac{k_\sigma \cdot p'}{m} + i \frac{\hbar k_\mu \cdot k_\nu}{m} - i\omega_k) \\
& \quad (\gamma_1 + i(\Delta_\nu - \Delta_\mu) - i \frac{(k_\nu - k_\mu) \cdot (p - \hbar k_\alpha)}{m} + i \frac{\hbar k_\mu \cdot k_\nu}{m} - 2i\omega_k) \\
& \quad (\gamma - i\Delta_\mu + i \frac{k_\mu \cdot (p - \hbar k_\alpha + \hbar k_\nu - \hbar k_\mu)}{m} + i\omega_k) \\
& \times W(p' - \hbar k_\sigma, p - \hbar k_\alpha + \hbar k_\nu - \hbar k_\mu) \\
& + \int \Gamma N(q) dq e^{(-i \frac{(p - \hbar k_\alpha) \cdot q}{m} + i \frac{(p' - \hbar k_\sigma) \cdot q}{m})t} \times \\
& \left\{ \frac{(\Omega_\alpha \Omega_\sigma^* \Omega_\nu^* \Omega_\mu e^{i(-\Delta_\alpha + \Delta_\sigma + \Delta_\nu - \Delta_\mu) - i \frac{(k_\nu - k_\mu) \cdot (p' + \hbar q)}{m} - i \frac{k_\sigma \cdot p'}{m} + i \frac{k_\alpha \cdot p}{m} - i \frac{\hbar k_\mu \cdot k_\nu}{m} + 2i\omega_k)t}}{(\gamma_2 + i(-\Delta_\alpha + \Delta_\sigma + \Delta_\nu - \Delta_\mu) - i \frac{(k_\nu - k_\mu) \cdot (p' + \hbar q)}{m} - i \frac{k_\sigma \cdot p'}{m} + i \frac{k_\alpha \cdot p}{m} - i \frac{\hbar k_\mu \cdot k_\nu}{m} + 2i\omega_k \dots} \right. \\
& \quad - i \frac{(p - \hbar k_\alpha) \cdot q}{m} + i \frac{(p' - \hbar k_\sigma) \cdot q}{m}) \\
& \quad (\gamma + i(\Delta_\sigma + \Delta_\nu - \Delta_\mu) - i \frac{(k_\nu - k_\mu) \cdot (p' + \hbar q)}{m} - i \frac{k_\sigma \cdot p'}{m} - i \frac{\hbar k_\mu \cdot k_\nu}{m} + 3i\omega_k \dots} \\
& \quad - i \frac{(p - \hbar k_\alpha) \cdot q}{m} + i \frac{(p' - \hbar k_\sigma) \cdot q}{m}) \\
& \quad (\gamma_1 + i(\Delta_\nu - \Delta_\mu) - i \frac{(k_\nu - k_\mu) \cdot (p' - \hbar k_\sigma + \hbar q)}{m} - i \frac{\hbar k_\mu \cdot k_\nu}{m} + 2i\omega_k \dots} \\
& \quad - i \frac{(p - \hbar k_\alpha + \hbar q) \cdot q}{m} + i \frac{(p' - \hbar k_\sigma) \cdot q}{m}) \\
& \quad (\gamma_2 + i(\Delta_\nu - \Delta_\mu) - i \frac{(k_\nu - k_\mu) \cdot (p' - \hbar k_\sigma + \hbar q)}{m} - i \frac{\hbar k_\mu \cdot k_\nu}{m} + 2i\omega_k) \\
& \quad \left. (\gamma - i\Delta_\mu + i \frac{k_\mu \cdot (p - \hbar k_\alpha + \hbar q)}{m} - i\omega_k) \right\} \\
& \times W(p' - \hbar k_\sigma + \hbar q - \hbar k_\nu, p - \hbar k_\alpha + \hbar q - \hbar k_\mu)
\end{aligned}$$

$$\begin{aligned}
& + \frac{(\Omega_\alpha \Omega_\sigma^* \Omega_\nu \Omega_\mu^* e^{(-i(\Delta_\alpha - \Delta_\sigma + \Delta_\nu - \Delta_\mu) + i \frac{(k_\nu - k_\mu) \cdot (p - \hbar k_\alpha + \hbar q)}{m} - i \frac{k_\sigma \cdot p'}{m} + i \frac{k_\alpha \cdot p}{m} - i \frac{\hbar k_\mu \cdot k_\nu}{m} - 2i\omega_k)t)}}{(\gamma_2 - i(\Delta_\alpha - \Delta_\sigma + \Delta_\nu - \Delta_\mu) + i \frac{(k_\nu - k_\mu) \cdot (p - \hbar k_\alpha + \hbar q)}{m} - i \frac{k_\sigma \cdot p'}{m} + i \frac{k_\alpha \cdot p}{m} - i \frac{\hbar k_\mu \cdot k_\nu}{m} - 2i\omega_k \dots} \\
& \quad - i \frac{(p - \hbar k_\alpha) \cdot q}{m} + i \frac{(p' - \hbar k_\sigma) \cdot q}{m})} \\
& \quad (\gamma - i(-\Delta_\sigma + \Delta_\nu - \Delta_\mu) + i \frac{(k_\nu - k_\mu) \cdot (p - \hbar k_\alpha + \hbar q)}{m} - i \frac{k_\sigma \cdot p'}{m} - i \frac{\hbar k_\mu \cdot k_\nu}{m} - i\omega_k - i \frac{(p - \hbar k_\alpha) \cdot q}{m} \dots \\
& \quad \quad \quad + i \frac{(p' - \hbar k_\sigma) \cdot q}{m})} \\
& \quad (\gamma_1 - i(\Delta_\nu - \Delta_\mu) + i \frac{(k_\nu - k_\mu) \cdot (p - \hbar k_\alpha + \hbar q)}{m} - i \frac{\hbar k_\mu \cdot k_\nu}{m} - 2i\omega_k - i \frac{(p - \hbar k_\alpha + \hbar q) \cdot q}{m} + i \frac{(p' - \hbar k_\sigma) \cdot q}{m})} \\
& \quad \quad (\gamma_2 - i(\Delta_\nu - \Delta_\mu) + i \frac{(k_\nu - k_\mu) \cdot (p - \hbar k_\alpha + \hbar q)}{m} - i \frac{\hbar k_\mu \cdot k_\nu}{m} - 2i\omega_k) \\
& \quad \quad \quad (\gamma + i\Delta_\mu - i \frac{k_\mu \cdot (p' - \hbar k_\sigma + \hbar q)}{m} + i\omega_k) \\
& \times W(p - \hbar k_\alpha + \hbar q - \hbar k_\nu, p' - \hbar k_\sigma + \hbar q - \hbar k_\mu) \} \\
& - \left\{ \frac{(\Omega_\alpha \Omega_\sigma^* \Omega_\nu \Omega_\mu^* e^{(i(-\Delta_\alpha + \Delta_\sigma + \Delta_\nu - \Delta_\mu) - i \frac{(k_\nu - k_\mu) \cdot p'}{m} - i \frac{k_\sigma \cdot (p - \hbar k_\alpha)}{m} + i \frac{k_\alpha \cdot p}{m} - i \frac{\hbar k_\mu \cdot k_\nu}{m})t)}}{(\gamma_2 + i(-\Delta_\alpha + \Delta_\sigma + \Delta_\nu - \Delta_\mu) - i \frac{(k_\nu - k_\mu) \cdot p'}{m} - i \frac{k_\sigma \cdot (p - \hbar k_\alpha)}{m} + i \frac{k_\alpha \cdot p}{m} - i \frac{\hbar k_\mu \cdot k_\nu}{m})} \right. \\
& \quad (\gamma + i(\Delta_\sigma + \Delta_\nu - \Delta_\mu) - i \frac{(k_\nu - k_\mu) \cdot p'}{m} - i \frac{k_\sigma \cdot (p - \hbar k_\alpha)}{m} - i \frac{\hbar k_\mu \cdot k_\nu}{m} + i\omega_k) \\
& \quad \quad (\gamma_2 + i(\Delta_\nu - \Delta_\mu) - i \frac{(k_\nu - k_\mu) \cdot p'}{m} - i \frac{\hbar k_\mu \cdot k_\nu}{m} + 2i\omega_k) \\
& \quad \quad \quad (\gamma - i\Delta_\mu + i \frac{k_\mu \cdot (p - \hbar k_\alpha + \hbar k_\sigma)}{m} - i\omega_k) \\
& \times W(p' - \hbar k_\nu, p - \hbar k_\alpha + \hbar k_\sigma - \hbar k_\mu) \\
& + \frac{(\Omega_\alpha \Omega_\sigma^* \Omega_\nu \Omega_\mu^* e^{(-i(\Delta_\alpha - \Delta_\sigma + \Delta_\nu - \Delta_\mu) + i \frac{(k_\nu - k_\mu) \cdot (p - \hbar k_\alpha + \hbar k_\sigma)}{m} - i \frac{k_\sigma \cdot (p - \hbar k_\alpha)}{m} + i \frac{k_\alpha \cdot p}{m} - i \frac{\hbar k_\mu \cdot k_\nu}{m} - 4i\omega_k)t)}}{(\gamma_2 - i(\Delta_\alpha - \Delta_\sigma + \Delta_\nu - \Delta_\mu) + i \frac{(k_\nu - k_\mu) \cdot (p - \hbar k_\alpha + \hbar k_\sigma)}{m} - i \frac{k_\sigma \cdot (p - \hbar k_\alpha)}{m} + i \frac{k_\alpha \cdot p}{m} - i \frac{\hbar k_\mu \cdot k_\nu}{m} - 4i\omega_k) \\
& \quad (\gamma - i(-\Delta_\sigma + \Delta_\nu - \Delta_\mu) + i \frac{(k_\nu - k_\mu) \cdot (p - \hbar k_\alpha + \hbar k_\sigma)}{m} - i \frac{k_\sigma \cdot (p - \hbar k_\alpha)}{m} - i \frac{\hbar k_\mu \cdot k_\nu}{m} - 3i\omega_k) \\
& \quad \quad (\gamma_2 - i(\Delta_\nu - \Delta_\mu) + i \frac{(k_\nu - k_\mu) \cdot (p - \hbar k_\alpha + \hbar k_\sigma)}{m} - i \frac{\hbar k_\mu \cdot k_\nu}{m} - 2i\omega_k) \\
& \quad \quad \quad (\gamma + i\Delta_\mu - i \frac{k_\mu \cdot p'}{m} + i\omega_k) \\
& \times W(p - \hbar k_\alpha + \hbar k_\sigma - \hbar k_\nu, p' - \hbar k_\mu) \} \\
\end{aligned}$$

We can do the same process for the ground stated density matrix terms:

$$\begin{aligned}
\left(\frac{\partial}{\partial t} + \gamma_1\right) \tilde{\rho}_{11}^{(4)}(p, p') &= i(\Omega_\alpha e^{(-i\Delta_\alpha + i \frac{k_\alpha \cdot p'}{m} + i\omega_k)t}) \tilde{\rho}_{12}^{(3)}(p, p' + \hbar k_\alpha) \\
&\quad - i(\Omega_\alpha^* e^{(i\Delta_\alpha - i \frac{k_\alpha \cdot p}{m} - i\omega_k)t}) \tilde{\rho}_{21}^{(3)}(p + \hbar k_\alpha, p') \\
&\quad + \int \Gamma N(q) dq \tilde{\rho}_{22}^{(4)}(p + \hbar q, p' + \hbar q) e^{i(-\frac{p \cdot q}{m} + \frac{p' \cdot q}{m})t} \\
&= i(\Omega_\alpha e^{(-i\Delta_\alpha + i \frac{k_\alpha \cdot p'}{m} + i\omega_k)t}) \tilde{\rho}_{12}^{(3)}(p, p' + \hbar k_\alpha) \\
&\quad - i(\Omega_\alpha^* e^{(i\Delta_\alpha - i \frac{k_\alpha \cdot p}{m} - i\omega_k)t}) [\tilde{\rho}_{12}^{(3)}(p', p + \hbar k_\alpha)]^* \\
&\quad + \int \Gamma N(q) dq \tilde{\rho}_{22}^{(4)}(p + \hbar q, p' + \hbar q) e^{i(-\frac{p \cdot q}{m} + \frac{p' \cdot q}{m})t}
\end{aligned}$$

$$\begin{aligned}
&= \left[\left[+ \frac{(\Omega_\alpha \Omega_\sigma^* \Omega_\nu \Omega_\mu^* e^{(-i(\Delta_\alpha - \Delta_\sigma + \Delta_\nu - \Delta_\mu) + i \frac{(k_\nu - k_\mu) \cdot (p' + \hbar k_\alpha - \hbar k_\sigma)}{m} - i \frac{k_\sigma \cdot (p' + \hbar k_\alpha)}{m} + i \frac{k_\alpha \cdot p'}{m} - i \frac{\hbar k_\mu \cdot k_\nu}{m} + 4i\omega_k)t})}{(\gamma - i(-\Delta_\sigma + \Delta_\nu - \Delta_\mu) + i \frac{(k_\nu - k_\mu) \cdot (p' + \hbar k_\alpha - \hbar k_\sigma)}{m} - i \frac{k_\sigma \cdot (p' + \hbar k_\alpha)}{m} - i \frac{\hbar k_\mu \cdot k_\nu}{m} + 3i\omega_k)} \right. \right. \\
&\quad \left. \left. (\gamma_1 - i(\Delta_\nu - \Delta_\mu) + i \frac{(k_\nu - k_\mu) \cdot (p' + \hbar k_\alpha - \hbar k_\sigma)}{m} - i \frac{\hbar k_\mu \cdot k_\nu}{m} + 2i\omega_k) \right. \right. \\
&\quad \left. \left. (\gamma + i\Delta_\mu - i \frac{k_\mu \cdot p}{m} - i\omega_k) \right. \right. \\
&\times W(p, p' + \hbar k_\alpha - \hbar k_\sigma + \hbar k_\nu - \hbar k_\mu) \\
&+ \frac{(\Omega_\alpha \Omega_\sigma^* \Omega_\nu \Omega_\mu^* e^{(i(-\Delta_\alpha + \Delta_\sigma + \Delta_\nu - \Delta_\mu) - i \frac{(k_\nu - k_\mu) \cdot p}{m} - i \frac{k_\sigma \cdot (p' + \hbar k_\alpha)}{m} + i \frac{k_\alpha \cdot p'}{m} + i \frac{\hbar k_\mu \cdot k_\nu}{m})t})}{(\gamma + i(\Delta_\sigma + \Delta_\nu - \Delta_\mu) - i \frac{(k_\nu - k_\mu) \cdot p}{m} - i \frac{k_\sigma \cdot (p' + \hbar k_\alpha)}{m} + i \frac{\hbar k_\mu \cdot k_\nu}{m} - i\omega_k)} \\
&\quad (\gamma_1 + i(\Delta_\nu - \Delta_\mu) - i \frac{(k_\nu - k_\mu) \cdot p}{m} + i \frac{\hbar k_\mu \cdot k_\nu}{m} - 2i\omega_k) \\
&\quad (\gamma - i\Delta_\mu + i \frac{k_\mu \cdot (p + \hbar k_\nu - \hbar k_\mu)}{m} + i\omega_k) \\
&\times W(p' + \hbar k_\alpha - \hbar k_\sigma, p + \hbar k_\nu - \hbar k_\mu) \\
&- \int \Gamma N(q) dq e^{(-i \frac{p \cdot q}{m} + i \frac{(p' + \hbar k_\alpha - \hbar k_\sigma) \cdot q}{m})t} \times \\
&\left\{ \frac{(\Omega_\alpha \Omega_\sigma^* \Omega_\nu \Omega_\mu^* e^{(i(-\Delta_\alpha + \Delta_\sigma + \Delta_\nu - \Delta_\mu) - i \frac{(k_\nu - k_\mu) \cdot (p' + \hbar k_\alpha + \hbar q)}{m} - i \frac{k_\sigma \cdot (p' + \hbar k_\alpha)}{m} + i \frac{k_\alpha \cdot p'}{m} - i \frac{\hbar k_\mu \cdot k_\nu}{m} + 4i\omega_k)t})}{(\gamma + i(\Delta_\sigma + \Delta_\nu - \Delta_\mu) - i \frac{(k_\nu - k_\mu) \cdot (p' + \hbar k_\alpha + \hbar q)}{m} - i \frac{k_\sigma \cdot (p' + \hbar k_\alpha)}{m} - i \frac{\hbar k_\mu \cdot k_\nu}{m} + 3i\omega_k - i \frac{p \cdot q}{m} \dots} \right. \\
&\quad \left. + i \frac{(p' + \hbar k_\alpha - \hbar k_\sigma) \cdot q}{m} \right. \\
&\quad (\gamma_1 + i(\Delta_\nu - \Delta_\mu) - i \frac{(k_\nu - k_\mu) \cdot (p' + \hbar k_\alpha - \hbar k_\sigma + \hbar q)}{m} - i \frac{\hbar k_\mu \cdot k_\nu}{m} + 2i\omega_k - i \frac{(p + \hbar q) \cdot q}{m} \dots \\
&\quad \left. + i \frac{(p' + \hbar k_\alpha - \hbar k_\sigma) \cdot q}{m} \right. \\
&\quad (\gamma_2 + i(\Delta_\nu - \Delta_\mu) - i \frac{(k_\nu - k_\mu) \cdot (p' + \hbar k_\alpha - \hbar k_\sigma + \hbar q)}{m} - i \frac{\hbar k_\mu \cdot k_\nu}{m} + 2i\omega_k) \\
&\quad \left. (\gamma - i\Delta_\mu + i \frac{k_\mu \cdot (p + \hbar q)}{m} - i\omega_k) \right. \\
&\times W(p' + \hbar k_\alpha - \hbar k_\sigma + \hbar q - \hbar k_\nu, p + \hbar q - \hbar k_\mu) \\
&+ \frac{(\Omega_\alpha \Omega_\sigma^* \Omega_\nu \Omega_\mu^* e^{(-i(\Delta_\alpha - \Delta_\sigma + \Delta_\nu - \Delta_\mu) + i \frac{(k_\nu - k_\mu) \cdot (p + \hbar q)}{m} - i \frac{k_\sigma \cdot (p' + \hbar k_\alpha)}{m} + i \frac{k_\alpha \cdot p'}{m} - i \frac{\hbar k_\mu \cdot k_\nu}{m})t})}{(\gamma - i(-\Delta_\sigma + \Delta_\nu - \Delta_\mu) + i \frac{(k_\nu - k_\mu) \cdot (p + \hbar q)}{m} - i \frac{k_\sigma \cdot (p' + \hbar k_\alpha)}{m} - i \frac{\hbar k_\mu \cdot k_\nu}{m} - i\omega_k - i \frac{p \cdot q}{m} \dots} \\
&\quad + i \frac{(p' + \hbar k_\alpha - \hbar k_\sigma) \cdot q}{m} \\
&\quad (\gamma_1 - i(\Delta_\nu - \Delta_\mu) + i \frac{(k_\nu - k_\mu) \cdot (p + \hbar q)}{m} - i \frac{\hbar k_\mu \cdot k_\nu}{m} - 2i\omega_k - i \frac{(p + \hbar q) \cdot q}{m} \dots \\
&\quad + i \frac{(p' + \hbar k_\alpha - \hbar k_\sigma) \cdot q}{m} \\
&\quad (\gamma_2 - i(\Delta_\nu - \Delta_\mu) + i \frac{(k_\nu - k_\mu) \cdot (p + \hbar q)}{m} - i \frac{\hbar k_\mu \cdot k_\nu}{m} - 2i\omega_k) \\
&\quad (\gamma + i\Delta_\mu - i \frac{k_\mu \cdot (p' + \hbar k_\alpha - \hbar k_\sigma + \hbar q)}{m} + i\omega_k) \\
&\times W(p + \hbar q - \hbar k_\nu, p' + \hbar k_\alpha - \hbar k_\sigma + \hbar q - \hbar k_\mu) \left. \right\} \\
&+ \left\{ \frac{(\Omega_\alpha \Omega_\sigma^* \Omega_\nu \Omega_\mu^* e^{(i(-\Delta_\alpha + \Delta_\sigma + \Delta_\nu - \Delta_\mu) - i \frac{(k_\nu - k_\mu) \cdot (p' + \hbar k_\alpha)}{m} - i \frac{k_\sigma \cdot p}{m} + i \frac{k_\alpha \cdot p'}{m} - i \frac{\hbar k_\mu \cdot k_\nu}{m} + 2i\omega_k)t})}{(\gamma + i(\Delta_\sigma + \Delta_\nu - \Delta_\mu) - i \frac{(k_\nu - k_\mu) \cdot (p' + \hbar k_\alpha)}{m} - i \frac{k_\sigma \cdot p}{m} - i \frac{\hbar k_\mu \cdot k_\nu}{m} + i\omega_k)} \right. \\
&\quad (\gamma_2 + i(\Delta_\nu - \Delta_\mu) - i \frac{(k_\nu - k_\mu) \cdot (p' + \hbar k_\alpha)}{m} - i \frac{\hbar k_\mu \cdot k_\nu}{m} + 2i\omega_k) \\
&\quad \left. (\gamma - i\Delta_\mu + i \frac{k_\mu \cdot (p + \hbar k_\sigma)}{m} - i\omega_k) \right. \\
&\times W(p' + \hbar k_\alpha - \hbar k_\nu, p + \hbar k_\sigma - \hbar k_\mu)
\end{aligned}$$

$$\begin{aligned}
& + \frac{(\Omega_\alpha \Omega_\sigma^* \Omega_\nu \Omega_\mu^* e^{(-i(\Delta_\alpha - \Delta_\sigma + \Delta_\nu - \Delta_\mu) + i \frac{(k_\nu - k_\mu) \cdot (p + \hbar k_\sigma)}{m} - i \frac{k_\sigma \cdot p}{m} + i \frac{k_\alpha \cdot p'}{m} - i \frac{\hbar k_\mu \cdot k_\nu}{m} - 2i\omega_k)t)}}{(\gamma - i(-\Delta_\sigma + \Delta_\nu - \Delta_\mu) + i \frac{(k_\nu - k_\mu) \cdot (p + \hbar k_\sigma)}{m} - i \frac{k_\sigma \cdot p}{m} - i \frac{\hbar k_\mu \cdot k_\nu}{m} - 3i\omega_k)} \\
& \quad (\gamma_2 - i(\Delta_\nu - \Delta_\mu) + i \frac{(k_\nu - k_\mu) \cdot (p + \hbar k_\sigma)}{m} - i \frac{\hbar k_\mu \cdot k_\nu}{m} - 2i\omega_k) \\
& \quad (\gamma + i\Delta_\mu - i \frac{k_\mu \cdot (p' + \hbar k_\alpha)}{m} + i\omega_k) \\
& \times W(p + \hbar k_\sigma - \hbar k_\nu, p' + \hbar k_\alpha - \hbar k_\mu) \} \\
& - \left[\frac{(\Omega_\alpha^* \Omega_\sigma \Omega_\nu^* \Omega_\mu e^{(i(\Delta_\alpha - \Delta_\sigma + \Delta_\nu - \Delta_\mu) - i \frac{(k_\nu - k_\mu) \cdot (p + \hbar k_\alpha - \hbar k_\sigma)}{m} + i \frac{k_\sigma \cdot (p + \hbar k_\alpha)}{m} - i \frac{k_\alpha \cdot p}{m} + i \frac{\hbar k_\mu \cdot k_\nu}{m} - 4i\omega_k)t)}}{(\gamma + i(-\Delta_\sigma + \Delta_\nu - \Delta_\mu) - i \frac{(k_\nu - k_\mu) \cdot (p + \hbar k_\alpha - \hbar k_\sigma)}{m} + i \frac{k_\sigma \cdot (p + \hbar k_\alpha)}{m} + i \frac{\hbar k_\mu \cdot k_\nu}{m} - 3i\omega_k)} \right. \\
& \quad (\gamma_1 + i(\Delta_\nu - \Delta_\mu) - i \frac{(k_\nu - k_\mu) \cdot (p + \hbar k_\alpha - \hbar k_\sigma)}{m} + i \frac{\hbar k_\mu \cdot k_\nu}{m} - 2i\omega_k) \\
& \quad \left. (\gamma - i\Delta_\mu + i \frac{k_\mu \cdot p'}{m} + i\omega_k) \right] \\
& \times W(p', p + \hbar k_\alpha - \hbar k_\sigma + \hbar k_\nu - \hbar k_\mu) \\
& - \frac{(\Omega_\alpha^* \Omega_\sigma \Omega_\nu \Omega_\mu^* e^{(-i(-\Delta_\alpha + \Delta_\sigma + \Delta_\nu - \Delta_\mu) + i \frac{(k_\nu - k_\mu) \cdot p'}{m} + i \frac{k_\sigma \cdot (p + \hbar k_\alpha)}{m} - i \frac{k_\alpha \cdot p}{m} - i \frac{\hbar k_\mu \cdot k_\nu}{m})t)}}{(\gamma - i(\Delta_\sigma + \Delta_\nu - \Delta_\mu) + i \frac{(k_\nu - k_\mu) \cdot p'}{m} + i \frac{k_\sigma \cdot (p' + \hbar k_\alpha)}{m} - i \frac{\hbar k_\mu \cdot k_\nu}{m} + i\omega_k)} \\
& \quad (\gamma_1 - i(\Delta_\nu - \Delta_\mu) + i \frac{(k_\nu - k_\mu) \cdot p'}{m} - i \frac{\hbar k_\mu \cdot k_\nu}{m} + 2i\omega_k) \\
& \quad (\gamma + i\Delta_\mu - i \frac{k_\mu \cdot (p' + \hbar k_\nu - \hbar k_\mu)}{m} - i\omega_k) \\
& \times W(p + \hbar k_\alpha - \hbar k_\sigma, p' + \hbar k_\nu - \hbar k_\mu) \\
& + \int \Gamma N(q) dq e^{(+i \frac{p' \cdot q}{m} - i \frac{(p + \hbar k_\alpha - \hbar k_\sigma) \cdot q}{m})t} \times \\
& \left\{ \frac{(\Omega_\alpha^* \Omega_\sigma \Omega_\nu \Omega_\mu^* e^{(-i(-\Delta_\alpha + \Delta_\sigma + \Delta_\nu - \Delta_\mu) + i \frac{(k_\nu - k_\mu) \cdot (p' + \hbar q)}{m} + i \frac{k_\sigma \cdot (p + \hbar k_\alpha)}{m} - i \frac{k_\alpha \cdot p}{m} + i \frac{\hbar k_\mu \cdot k_\nu}{m} - 4i\omega_k)t)}}{(\gamma - i(\Delta_\sigma + \Delta_\nu - \Delta_\mu) + i \frac{(k_\nu - k_\mu) \cdot (p + \hbar k_\alpha + \hbar q)}{m} + i \frac{k_\sigma \cdot (p + \hbar k_\alpha)}{m} + i \frac{\hbar k_\mu \cdot k_\nu}{m} - 3i\omega_k \dots} \right. \\
& \quad + i \frac{p' \cdot q}{m} - i \frac{(p + \hbar k_\alpha - \hbar k_\sigma) \cdot q}{m}) \\
& \quad (\gamma_1 - i(\Delta_\nu - \Delta_\mu) + i \frac{(k_\nu - k_\mu) \cdot (p + \hbar k_\alpha - \hbar k_\sigma + \hbar q)}{m} + i \frac{\hbar k_\mu \cdot k_\nu}{m} - 2i\omega_k \dots} \\
& \quad + i \frac{(p' + \hbar q) \cdot q}{m} - i \frac{(p + \hbar k_\alpha - \hbar k_\sigma) \cdot q}{m}) \\
& \quad (\gamma_2 - i(\Delta_\nu - \Delta_\mu) + i \frac{(k_\nu - k_\mu) \cdot (p + \hbar k_\alpha - \hbar k_\sigma + \hbar q)}{m} + i \frac{\hbar k_\mu \cdot k_\nu}{m} - 2i\omega_k) \\
& \quad \left. (\gamma + i\Delta_\mu - i \frac{k_\mu \cdot (p' + \hbar q)}{m} + i\omega_k) \right\} \\
& \times W(p + \hbar k_\alpha - \hbar k_\sigma + \hbar q - \hbar k_\nu, p' + \hbar q - \hbar k_\mu) \\
& + \frac{(\Omega_\alpha^* \Omega_\sigma \Omega_\nu^* \Omega_\mu e^{(i(\Delta_\alpha - \Delta_\sigma + \Delta_\nu - \Delta_\mu) - i \frac{(k_\nu - k_\mu) \cdot (p' + \hbar q)}{m} + i \frac{k_\sigma \cdot (p + \hbar k_\alpha)}{m} - i \frac{k_\alpha \cdot p}{m} + i \frac{\hbar k_\mu \cdot k_\nu}{m})t)}}{(\gamma + i(-\Delta_\sigma + \Delta_\nu - \Delta_\mu) - i \frac{(k_\nu - k_\mu) \cdot (p' + \hbar q)}{m} + i \frac{k_\sigma \cdot (p + \hbar k_\alpha)}{m} + i \frac{\hbar k_\mu \cdot k_\nu}{m} + i\omega_k \dots} \\
& \quad + i \frac{p \cdot q}{m} - i \frac{(p + \hbar k_\alpha - \hbar k_\sigma) \cdot q}{m}) \\
& \quad (\gamma_1 + i(\Delta_\nu - \Delta_\mu) - i \frac{(k_\nu - k_\mu) \cdot (p' + \hbar q)}{m} + i \frac{\hbar k_\mu \cdot k_\nu}{m} + 2i\omega_k \dots} \\
& \quad + i \frac{(p' + \hbar q) \cdot q}{m} - i \frac{(p + \hbar k_\alpha - \hbar k_\sigma) \cdot q}{m}) \\
& \quad (\gamma_2 + i(\Delta_\nu - \Delta_\mu) - i \frac{(k_\nu - k_\mu) \cdot (p' + \hbar q)}{m} + i \frac{\hbar k_\mu \cdot k_\nu}{m} + 2i\omega_k) \\
& \quad \left. (\gamma - i\Delta_\mu + i \frac{k_\mu \cdot (p + \hbar k_\alpha - \hbar k_\sigma + \hbar q)}{m} - i\omega_k) \right\} \\
& \times W(p' + \hbar q - \hbar k_\nu, p + \hbar k_\alpha - \hbar k_\sigma + \hbar q - \hbar k_\mu) \}
\end{aligned}$$

$$\begin{aligned}
& - \left\{ \frac{(\Omega_\alpha^* \Omega_\sigma \Omega_\nu \Omega_\mu^* e^{(-i(-\Delta_\alpha + \Delta_\sigma + \Delta_\nu - \Delta_\mu) + i \frac{(k_\nu - k_\mu) \cdot (p + \hbar k_\alpha)}{m} + i \frac{k_\sigma \cdot p'}{m} - i \frac{k_\alpha \cdot p}{m} + i \frac{\hbar k_\mu \cdot k_\nu}{m} - 2i\omega_k)t})}{(\gamma - i(\Delta_\sigma + \Delta_\nu - \Delta_\mu) + i \frac{(k_\nu - k_\mu) \cdot (p + \hbar k_\alpha)}{m} + i \frac{k_\sigma \cdot p'}{m} + i \frac{\hbar k_\mu \cdot k_\nu}{m} - i\omega_k)} \right. \\
& \quad (\gamma_2 - i(\Delta_\nu - \Delta_\mu) + i \frac{(k_\nu - k_\mu) \cdot (p + \hbar k_\alpha)}{m} + i \frac{\hbar k_\mu \cdot k_\nu}{m} - 2i\omega_k) \\
& \quad \left. (\gamma + i\Delta_\mu - i \frac{k_\mu \cdot (p + \hbar k_\sigma)}{m} + i\omega_k) \right\} \\
& \times W(p + \hbar k_\alpha - \hbar k_\nu, p' + \hbar k_\sigma - \hbar k_\mu) \\
& + \frac{(\Omega_\alpha^* \Omega_\sigma \Omega_\nu \Omega_\mu^* e^{(+i(\Delta_\alpha - \Delta_\sigma + \Delta_\nu - \Delta_\mu) - i \frac{(k_\nu - k_\mu) \cdot (p' + \hbar k_\sigma)}{m} + i \frac{k_\sigma \cdot p}{m} - i \frac{k_\alpha \cdot p}{m} + i \frac{\hbar k_\mu \cdot k_\nu}{m} + 2i\omega_k)t})}{(\gamma + i(-\Delta_\sigma + \Delta_\nu - \Delta_\mu) - i \frac{(k_\nu - k_\mu) \cdot (p' + \hbar k_\sigma)}{m} + i \frac{k_\sigma \cdot p}{m} + i \frac{\hbar k_\mu \cdot k_\nu}{m} + 3i\omega_k)} \\
& \quad (\gamma_2 + i(\Delta_\nu - \Delta_\mu) - i \frac{(k_\nu - k_\mu) \cdot (p' + \hbar k_\sigma)}{m} + i \frac{\hbar k_\mu \cdot k_\nu}{m} + 2i\omega_k) \\
& \quad (\gamma - i\Delta_\mu + i \frac{k_\mu \cdot (p + \hbar k_\alpha)}{m} - i\omega_k) \\
& \times W(p' + \hbar k_\sigma - \hbar k_\nu, p + \hbar k_\alpha - \hbar k_\mu) \Big\} \\
& + \int \Gamma N(q) dq e^{i(-\frac{p \cdot q}{m} + \frac{p' \cdot q}{m})t} \times \\
& \left[- \frac{(\Omega_\alpha^* \Omega_\sigma \Omega_\nu \Omega_\mu^* e^{(i(+\Delta_\alpha - \Delta_\sigma + \Delta_\nu - \Delta_\mu) - i \frac{(k_\nu - k_\mu) \cdot (p + \hbar q - \hbar k_\sigma)}{m} + i \frac{k_\sigma \cdot (p + \hbar q)}{m} - i \frac{k_\alpha \cdot (p' + \hbar q)}{m} + i \frac{\hbar k_\mu \cdot k_\nu}{m} - 2i\omega_k)t})}{(\gamma_2 + i(+\Delta_\alpha - \Delta_\sigma + \Delta_\nu - \Delta_\mu) - i \frac{(k_\nu - k_\mu) \cdot (p + \hbar q - \hbar k_\sigma)}{m} + i \frac{k_\sigma \cdot (p + \hbar q)}{m} \dots} \right. \\
& \quad - i \frac{k_\alpha \cdot (p' + \hbar q)}{m} + i \frac{\hbar k_\mu \cdot k_\nu}{m} - 2i\omega_k) \\
& \quad (\gamma + i(-\Delta_\sigma + \Delta_\nu - \Delta_\mu) - i \frac{(k_\nu - k_\mu) \cdot (p + \hbar q - \hbar k_\sigma)}{m} + i \frac{k_\sigma \cdot (p + \hbar q)}{m} \dots \\
& \quad \left. + i \frac{\hbar k_\mu \cdot k_\nu}{m} - 3i\omega_k) \right. \\
& \quad (\gamma_1 + i(\Delta_\nu - \Delta_\mu) - i \frac{(k_\nu - k_\mu) \cdot (p + \hbar q - \hbar k_\sigma)}{m} + i \frac{\hbar k_\mu \cdot k_\nu}{m} - 2i\omega_k) \\
& \quad \left. (\gamma - i\Delta_\mu + i \frac{k_\mu \cdot (p' + \hbar q - \hbar k_\alpha)}{m} + i\omega_k) \right\} \\
& \times W(p' + \hbar q - \hbar k_\alpha, p + \hbar q - \hbar k_\sigma + \hbar k_\nu - \hbar k_\mu) \\
& - \frac{(\Omega_\alpha^* \Omega_\sigma \Omega_\nu \Omega_\mu^* e^{(-i(-\Delta_\alpha + \Delta_\sigma + \Delta_\nu - \Delta_\mu) + i \frac{(k_\nu - k_\mu) \cdot (p' + \hbar q - \hbar k_\alpha)}{m} + i \frac{k_\sigma \cdot (p + \hbar q)}{m} - i \frac{k_\alpha \cdot (p' + \hbar q)}{m} - i \frac{\hbar k_\mu \cdot k_\nu}{m} + 2i\omega_k)t})}{(\gamma_2 - i(+\Delta_\alpha + \Delta_\sigma + \Delta_\nu - \Delta_\mu) + i \frac{(k_\nu - k_\mu) \cdot (p' + \hbar q - \hbar k_\alpha)}{m} + i \frac{k_\sigma \cdot (p + \hbar q)}{m} \dots} \\
& \quad - i \frac{k_\alpha \cdot (p' + \hbar q)}{m} - i \frac{\hbar k_\mu \cdot k_\nu}{m} + 2i\omega_k) \\
& \quad (\gamma - i(\Delta_\sigma + \Delta_\nu - \Delta_\mu) + i \frac{(k_\nu - k_\mu) \cdot (p' + \hbar q - \hbar k_\alpha)}{m} + i \frac{k_\sigma \cdot (p + \hbar q)}{m} \dots \\
& \quad \left. - i \frac{\hbar k_\mu \cdot k_\nu}{m} + i\omega_k) \right. \\
& \quad (\gamma_1 - i(\Delta_\nu - \Delta_\mu) + i \frac{(k_\nu - k_\mu) \cdot (p' + \hbar q - \hbar k_\alpha)}{m} - i \frac{\hbar k_\mu \cdot k_\nu}{m} + 2i\omega_k) \\
& \quad \left. (\gamma + i\Delta_\mu - i \frac{k_\mu \cdot (p' + \hbar q - \hbar k_\alpha + \hbar k_\nu - \hbar k_\mu)}{m} - i\omega_k) \right\} \\
& \times W(p + \hbar q - \hbar k_\sigma, p' + \hbar q - \hbar k_\alpha + \hbar k_\nu - \hbar k_\mu) \\
& + \int \Gamma N(q') dq' e^{(+i \frac{(p' + \hbar q - \hbar k_\alpha) \cdot q'}{m} - i \frac{(p + \hbar q - \hbar k_\sigma) \cdot q'}{m})t} \times
\end{aligned}$$

$$\begin{aligned}
& + \left[\frac{(\Omega_\alpha \Omega_\sigma^* \Omega_\nu \Omega_\mu^* e^{(-i(\Delta_\alpha - \Delta_\sigma + \Delta_\nu - \Delta_\mu) + i \frac{(k_\nu - k_\mu) \cdot (p' + \hbar q - \hbar k_\sigma)}{m} - i \frac{k_\sigma \cdot (p' + \hbar q)}{m} + i \frac{k_\alpha \cdot (p + \hbar q)}{m} - i \frac{\hbar k_\mu \cdot k_\nu}{m} + 2i\omega_k)t)}}{(\gamma_2 - i(-\Delta_\alpha - \Delta_\sigma + \Delta_\nu - \Delta_\mu) + i \frac{(k_\nu - k_\mu) \cdot (p' + \hbar q - \hbar k_\sigma)}{m} - i \frac{k_\sigma \cdot (p' + \hbar q)}{m} + i \frac{k_\alpha \cdot (p + \hbar q)}{m} \dots} \right. \\
& \quad \left. - i \frac{\hbar k_\mu \cdot k_\nu}{m} + 2i\omega_k) \right. \\
& \quad (\gamma - i(-\Delta_\sigma + \Delta_\nu - \Delta_\mu) + i \frac{(k_\nu - k_\mu) \cdot (p' + \hbar q - \hbar k_\sigma)}{m} - i \frac{k_\sigma \cdot (p' + \hbar q)}{m} - i \frac{\hbar k_\mu \cdot k_\nu}{m} + 3i\omega_k) \\
& \quad (\gamma_1 - i(\Delta_\nu - \Delta_\mu) + i \frac{(k_\nu - k_\mu) \cdot (p' + \hbar q - \hbar k_\sigma)}{m} - i \frac{\hbar k_\mu \cdot k_\nu}{m} + 2i\omega_k) \\
& \quad \left. (\gamma + i\Delta_\mu - i \frac{k_\mu \cdot (p + \hbar q - \hbar k_\alpha)}{m} - i\omega_k) \right) \\
& \times W(p + \hbar q - \hbar k_\alpha, p' + \hbar q - \hbar k_\sigma + \hbar k_\nu - \hbar k_\mu) \\
& - \frac{(\Omega_\alpha \Omega_\sigma^* \Omega_\nu \Omega_\mu^* e^{(i(-\Delta_\alpha + \Delta_\sigma + \Delta_\nu - \Delta_\mu) - i \frac{(k_\nu - k_\mu) \cdot (p + \hbar q - \hbar k_\alpha)}{m} - i \frac{k_\sigma \cdot (p' + \hbar q)}{m} + i \frac{k_\alpha \cdot (p + \hbar q)}{m} + i \frac{\hbar k_\mu \cdot k_\nu}{m} - 2i\omega_k)t)}}{(\gamma_2 + i(-\Delta_\alpha + \Delta_\sigma + \Delta_\nu - \Delta_\mu) - i \frac{(k_\nu - k_\mu) \cdot (p + \hbar q - \hbar k_\alpha)}{m} - i \frac{k_\sigma \cdot (p' + \hbar q)}{m} + i \frac{k_\alpha \cdot (p + \hbar q)}{m} \dots} \\
& \quad + i \frac{\hbar k_\mu \cdot k_\nu}{m} - 2i\omega_k) \\
& \quad (\gamma + i(\Delta_\sigma + \Delta_\nu - \Delta_\mu) - i \frac{(k_\nu - k_\mu) \cdot (p + \hbar q - \hbar k_\alpha)}{m} - i \frac{k_\sigma \cdot (p' + \hbar q)}{m} + i \frac{\hbar k_\mu \cdot k_\nu}{m} - i\omega_k) \\
& \quad (\gamma_1 + i(\Delta_\nu - \Delta_\mu) - i \frac{(k_\nu - k_\mu) \cdot (p + \hbar q - \hbar k_\alpha)}{m} + i \frac{\hbar k_\mu \cdot k_\nu}{m} - 2i\omega_k) \\
& \quad \left. (\gamma - i\Delta_\mu + i \frac{k_\mu \cdot (p + \hbar q - \hbar k_\alpha + \hbar k_\nu - \hbar k_\mu)}{m} + i\omega_k) \right) \\
& \times W(p' + \hbar q - \hbar k_\sigma, p + \hbar q - \hbar k_\alpha + \hbar k_\nu - \hbar k_\mu) \\
& + \int \Gamma N(q') dq' e^{(-i \frac{(p + \hbar q - \hbar k_\alpha) \cdot q'}{m} + i \frac{(p' + \hbar q - \hbar k_\sigma) \cdot q'}{m})t} \times \\
& \left\{ \frac{(\Omega_\alpha \Omega_\sigma^* \Omega_\nu \Omega_\mu^* e^{(i(-\Delta_\alpha + \Delta_\sigma + \Delta_\nu - \Delta_\mu) - i \frac{(k_\nu - k_\mu) \cdot (p' + \hbar q + \hbar q')}{m} - i \frac{k_\sigma \cdot (p' + \hbar q)}{m} + i \frac{k_\alpha \cdot (p + \hbar q)}{m} - i \frac{\hbar k_\mu \cdot k_\nu}{m} + 2i\omega_k)t)}}{(\gamma_2 + i(-\Delta_\alpha + \Delta_\sigma + \Delta_\nu - \Delta_\mu) - i \frac{(k_\nu - k_\mu) \cdot (p' + \hbar q + \hbar q')}{m} - i \frac{k_\sigma \cdot (p' + \hbar q)}{m} + i \frac{k_\alpha \cdot (p + \hbar q)}{m} \dots} \right. \\
& \quad - i \frac{\hbar k_\mu \cdot k_\nu}{m} + 2i\omega_k - i \frac{(p + \hbar q - \hbar k_\alpha) \cdot q'}{m} + i \frac{(p' + \hbar q - \hbar k_\sigma) \cdot q'}{m}) \\
& \quad (\gamma + i(\Delta_\sigma + \Delta_\nu - \Delta_\mu) - i \frac{(k_\nu - k_\mu) \cdot (p' + \hbar q + \hbar q')}{m} - i \frac{k_\sigma \cdot p'}{m} - i \frac{\hbar k_\mu \cdot k_\nu}{m} + 3i\omega_k \dots \\
& \quad \left. - i \frac{(p + \hbar q - \hbar k_\alpha) \cdot q'}{m} + i \frac{(p' + \hbar q - \hbar k_\sigma) \cdot q'}{m}) \right. \\
& \quad (\gamma_1 + i(\Delta_\nu - \Delta_\mu) - i \frac{(k_\nu - k_\mu) \cdot (p' + \hbar q - \hbar k_\sigma + \hbar q')}{m} - i \frac{\hbar k_\mu \cdot k_\nu}{m} + 2i\omega_k \dots \\
& \quad \left. - i \frac{(p + \hbar q - \hbar k_\alpha + \hbar q') \cdot q'}{m} + i \frac{(p' + \hbar q - \hbar k_\sigma) \cdot q'}{m}) \right. \\
& \quad (\gamma_2 + i(\Delta_\nu - \Delta_\mu) - i \frac{(k_\nu - k_\mu) \cdot (p' + \hbar q - \hbar k_\sigma + \hbar q')}{m} - i \frac{\hbar k_\mu \cdot k_\nu}{m} + 2i\omega_k) \\
& \quad \left. (\gamma - i\Delta_\mu + i \frac{k_\mu \cdot (p + \hbar q - \hbar k_\alpha + \hbar q')}{m} - i\omega_k) \right) \\
& \times W(p' + \hbar q - \hbar k_\sigma + \hbar q' - \hbar k_\nu, p + \hbar q - \hbar k_\alpha + \hbar q' - \hbar k_\mu) \\
& + \frac{(\Omega_\alpha \Omega_\sigma^* \Omega_\nu \Omega_\mu^* e^{(-i(\Delta_\alpha - \Delta_\sigma + \Delta_\nu - \Delta_\mu) + i \frac{(k_\nu - k_\mu) \cdot (p + \hbar q - \hbar k_\alpha + \hbar q)}{m} - i \frac{k_\sigma \cdot (p' + \hbar q)}{m} + i \frac{k_\alpha \cdot (p + \hbar q)}{m} - i \frac{\hbar k_\mu \cdot k_\nu}{m} - 2i\omega_k)t)}}{(\gamma_2 - i(\Delta_\alpha - \Delta_\sigma + \Delta_\nu - \Delta_\mu) + i \frac{(k_\nu - k_\mu) \cdot (p + \hbar q - \hbar k_\alpha + \hbar q)}{m} - i \frac{k_\sigma \cdot (p' + \hbar q)}{m} + i \frac{k_\alpha \cdot (p + \hbar q)}{m} \dots} \\
& \quad - i \frac{\hbar k_\mu \cdot k_\nu}{m} - 2i\omega_k - i \frac{(p + \hbar q - \hbar k_\alpha) \cdot q'}{m} + i \frac{(p' + \hbar q - \hbar k_\sigma) \cdot q'}{m}) \\
& \quad (\gamma - i(-\Delta_\sigma + \Delta_\nu - \Delta_\mu) + i \frac{(k_\nu - k_\mu) \cdot (p + \hbar q - \hbar k_\alpha + \hbar q)}{m} - i \frac{k_\sigma \cdot (p' + \hbar q)}{m} \dots \\
& \quad - i \frac{\hbar k_\mu \cdot k_\nu}{m} - i\omega_k - i \frac{(p + \hbar q - \hbar k_\alpha) \cdot q'}{m} + i \frac{(p' + \hbar q - \hbar k_\sigma) \cdot q'}{m}) \\
& \quad (\gamma_1 - i(\Delta_\nu - \Delta_\mu) + i \frac{(k_\nu - k_\mu) \cdot (p + \hbar q - \hbar k_\alpha + \hbar q')}{m} - i \frac{\hbar k_\mu \cdot k_\nu}{m} - 2i\omega_k \dots \\
& \quad \left. - i \frac{(p + \hbar q - \hbar k_\alpha + \hbar q') \cdot q'}{m} + i \frac{(p' + \hbar q - \hbar k_\sigma) \cdot q'}{m}) \right. \\
& \quad (\gamma_2 - i(\Delta_\nu - \Delta_\mu) + i \frac{(k_\nu - k_\mu) \cdot (p + \hbar q - \hbar k_\alpha + \hbar q')}{m} - i \frac{\hbar k_\mu \cdot k_\nu}{m} - 2i\omega_k) \\
& \quad \left. (\gamma + i\Delta_\mu - i \frac{k_\mu \cdot (p' + \hbar q - \hbar k_\sigma + \hbar q')}{m} + i\omega_k) \right)
\end{aligned}$$

$$\begin{aligned}
& \times W(p + \hbar q - \hbar k_\alpha + \hbar q' - \hbar k_\nu, p' + \hbar q - \hbar k_\sigma + \hbar q' - \hbar k_\mu) \} \\
& - \left\{ \frac{(\Omega_\alpha \Omega_\sigma^* \Omega_\nu^* \Omega_\mu e^{i(-\Delta_\alpha + \Delta_\sigma + \Delta_\nu - \Delta_\mu) - i \frac{(k_\nu - k_\mu) \cdot (p' + \hbar q)}{m} - i \frac{k_\sigma \cdot (p + \hbar q - \hbar k_\alpha)}{m} + i \frac{k_\alpha \cdot (p + \hbar q)}{m} - i \frac{\hbar k_\mu \cdot k_\nu}{m}) t)}{(\gamma_2 + i(-\Delta_\alpha + \Delta_\sigma + \Delta_\nu - \Delta_\mu) - i \frac{(k_\nu - k_\mu) \cdot (p' + \hbar q)}{m} - i \frac{k_\sigma \cdot (p + \hbar q - \hbar k_\alpha)}{m} + i \frac{k_\alpha \cdot (p + \hbar q)}{m} - i \frac{\hbar k_\mu \cdot k_\nu}{m})} \right. \\
& \quad (\gamma + i(\Delta_\sigma + \Delta_\nu - \Delta_\mu) - i \frac{(k_\nu - k_\mu) \cdot (p' + \hbar q)}{m} - i \frac{k_\sigma \cdot (p + \hbar q - \hbar k_\alpha)}{m} - i \frac{\hbar k_\mu \cdot k_\nu}{m} + i \omega_k) \\
& \quad \quad (\gamma_2 + i(\Delta_\nu - \Delta_\mu) - i \frac{(k_\nu - k_\mu) \cdot (p' + \hbar q)}{m} - i \frac{\hbar k_\mu \cdot k_\nu}{m} + 2i \omega_k) \\
& \quad \quad \quad (\gamma - i \Delta_\mu + i \frac{k_\mu \cdot (p + \hbar q - \hbar k_\alpha + \hbar k_\sigma)}{m} - i \omega_k) \\
& \times W(p' + \hbar q - \hbar k_\nu, p + \hbar q - \hbar k_\alpha + \hbar k_\sigma - \hbar k_\mu) \\
& + \frac{(\Omega_\alpha \Omega_\sigma^* \Omega_\nu \Omega_\mu^* e^{-i(\Delta_\alpha - \Delta_\sigma + \Delta_\nu - \Delta_\mu) + i \frac{(k_\nu - k_\mu) \cdot (p + \hbar q - \hbar k_\alpha + \hbar k_\sigma)}{m} - i \frac{k_\sigma \cdot (p + \hbar q - \hbar k_\alpha)}{m} + i \frac{k_\alpha \cdot (p + \hbar q)}{m} - i \frac{\hbar k_\mu \cdot k_\nu}{m} - 4i \omega_k) t)}{(\gamma_2 - i(-\Delta_\alpha - \Delta_\sigma + \Delta_\nu - \Delta_\mu) + i \frac{(k_\nu - k_\mu) \cdot (p + \hbar q - \hbar k_\alpha + \hbar k_\sigma)}{m} - i \frac{k_\sigma \cdot (p + \hbar q - \hbar k_\alpha)}{m} + i \frac{k_\alpha \cdot (p + \hbar q)}{m} \dots} \\
& \quad \quad \quad - i \frac{\hbar k_\mu \cdot k_\nu}{m} - 4i \omega_k) \\
& \quad (\gamma - i(-\Delta_\sigma + \Delta_\nu - \Delta_\mu) + i \frac{(k_\nu - k_\mu) \cdot (p + \hbar q - \hbar k_\alpha + \hbar k_\sigma)}{m} - i \frac{k_\sigma \cdot (p + \hbar q - \hbar k_\alpha)}{m} \dots \\
& \quad \quad \quad - i \frac{\hbar k_\mu \cdot k_\nu}{m} - 3i \omega_k) \\
& \quad (\gamma_2 - i(\Delta_\nu - \Delta_\mu) + i \frac{(k_\nu - k_\mu) \cdot (p + \hbar q - \hbar k_\alpha + \hbar k_\sigma)}{m} - i \frac{\hbar k_\mu \cdot k_\nu}{m} - 2i \omega_k) \\
& \quad \quad (\gamma + i \Delta_\mu - i \frac{k_\mu \cdot (p' + \hbar q)}{m} + i \omega_k) \\
& \times W(p + \hbar q - \hbar k_\alpha + \hbar k_\sigma - \hbar k_\nu, p' + \hbar q - \hbar k_\mu) \}
\end{aligned}$$

Which leads to the following result:

$$\begin{aligned}
& \tilde{\rho}_{11}^{(4)}(p, p') \\
& = \left[\frac{(\Omega_\alpha \Omega_\sigma^* \Omega_\nu \Omega_\mu^* e^{-i(+\Delta_\alpha - \Delta_\sigma + \Delta_\nu - \Delta_\mu) + i \frac{(k_\nu - k_\mu) \cdot (p' + \hbar k_\alpha - \hbar k_\sigma)}{m} - i \frac{k_\sigma \cdot (p' + \hbar k_\alpha)}{m} + i \frac{k_\alpha \cdot p'}{m} - i \frac{\hbar k_\mu \cdot k_\nu}{m} + 4i \omega_k) t)}{(\gamma_1 - i(+\Delta_\alpha - \Delta_\sigma + \Delta_\nu - \Delta_\mu) + i \frac{(k_\nu - k_\mu) \cdot (p' + \hbar k_\alpha - \hbar k_\sigma)}{m} - i \frac{k_\sigma \cdot (p' + \hbar k_\alpha)}{m} + i \frac{k_\alpha \cdot p'}{m} \dots} \right. \\
& \quad \quad \quad - i \frac{\hbar k_\mu \cdot k_\nu}{m} + 4i \omega_k) \\
& \quad (\gamma - i(-\Delta_\sigma + \Delta_\nu - \Delta_\mu) + i \frac{(k_\nu - k_\mu) \cdot (p' + \hbar k_\alpha - \hbar k_\sigma)}{m} - i \frac{k_\sigma \cdot (p' + \hbar k_\alpha)}{m} \dots \\
& \quad \quad \quad - i \frac{\hbar k_\mu \cdot k_\nu}{m} + 3i \omega_k) \\
& \quad (\gamma_1 - i(\Delta_\nu - \Delta_\mu) + i \frac{(k_\nu - k_\mu) \cdot (p' + \hbar k_\alpha - \hbar k_\sigma)}{m} - i \frac{\hbar k_\mu \cdot k_\nu}{m} + 2i \omega_k) \\
& \quad \quad (\gamma + i \Delta_\mu - i \frac{k_\mu \cdot p}{m} - i \omega_k) \\
& \times W(p, p' + \hbar k_\alpha - \hbar k_\sigma + \hbar k_\nu - \hbar k_\mu) \\
& + \frac{(\Omega_\alpha \Omega_\sigma^* \Omega_\nu^* \Omega_\mu e^{i(-\Delta_\alpha + \Delta_\sigma + \Delta_\nu - \Delta_\mu) - i \frac{(k_\nu - k_\mu) \cdot p}{m} - i \frac{k_\sigma \cdot (p' + \hbar k_\alpha)}{m} + i \frac{k_\alpha \cdot p'}{m} + i \frac{\hbar k_\mu \cdot k_\nu}{m}) t)}{(\gamma_1 + i(-\Delta_\alpha + \Delta_\sigma + \Delta_\nu - \Delta_\mu) - i \frac{(k_\nu - k_\mu) \cdot p}{m} - i \frac{k_\sigma \cdot (p' + \hbar k_\alpha)}{m} + i \frac{k_\alpha \cdot p'}{m} + i \frac{\hbar k_\mu \cdot k_\nu}{m})} \\
& \quad (\gamma + i(\Delta_\sigma + \Delta_\nu - \Delta_\mu) - i \frac{(k_\nu - k_\mu) \cdot p}{m} - i \frac{k_\sigma \cdot (p' + \hbar k_\alpha)}{m} + i \frac{\hbar k_\mu \cdot k_\nu}{m} - i \omega_k) \\
& \quad (\gamma_1 + i(\Delta_\nu - \Delta_\mu) - i \frac{(k_\nu - k_\mu) \cdot p}{m} + i \frac{\hbar k_\mu \cdot k_\nu}{m} - 2i \omega_k) \\
& \quad \quad (\gamma - i \Delta_\mu + i \frac{k_\mu \cdot (p + \hbar k_\nu - \hbar k_\mu)}{m} + i \omega_k) \\
& \times W(p' + \hbar k_\alpha - \hbar k_\sigma, p + \hbar k_\nu - \hbar k_\mu) \\
& - \int \Gamma N(q) dq e^{(-i \frac{p \cdot q}{m} + i \frac{(p' + \hbar k_\alpha - \hbar k_\sigma) \cdot q}{m}) t} \times
\end{aligned}$$

$$\begin{aligned}
& \left\{ \frac{(\Omega_\alpha \Omega_\sigma^* \Omega_\nu^* \Omega_\mu^* e^{(i(-\Delta_\alpha + \Delta_\sigma + \Delta_\nu - \Delta_\mu) - i \frac{(k_\nu - k_\mu) \cdot (p' + \hbar k_\alpha + \hbar q)}{m} - i \frac{k_\sigma \cdot (p' + \hbar k_\alpha)}{m} + i \frac{k_\alpha \cdot p'}{m} - i \frac{\hbar k_\mu \cdot k_\nu}{m} + 4i\omega_k)t)}}{(\gamma_1 + i(-\Delta_\alpha + \Delta_\sigma + \Delta_\nu - \Delta_\mu) - i \frac{(k_\nu - k_\mu) \cdot (p' + \hbar k_\alpha + \hbar q)}{m} - i \frac{k_\sigma \cdot (p' + \hbar k_\alpha)}{m} + i \frac{k_\alpha \cdot p'}{m} - i \frac{p \cdot q}{m} \dots} \right. \\
& \quad \left. + i \frac{(p' + \hbar k_\alpha - \hbar k_\sigma) \cdot q}{m} - i \frac{\hbar k_\mu \cdot k_\nu}{m} + 4i\omega_k) \right. \\
& \quad (\gamma + i(\Delta_\sigma + \Delta_\nu - \Delta_\mu) - i \frac{(k_\nu - k_\mu) \cdot (p' + \hbar k_\alpha + \hbar q)}{m} - i \frac{k_\sigma \cdot (p' + \hbar k_\alpha)}{m} - i \frac{\hbar k_\mu \cdot k_\nu}{m} + 3i\omega_k \dots \\
& \quad \quad \left. - i \frac{p \cdot q}{m} + i \frac{(p' + \hbar k_\alpha - \hbar k_\sigma) \cdot q}{m} \right. \\
& \quad (\gamma_1 + i(\Delta_\nu - \Delta_\mu) - i \frac{(k_\nu - k_\mu) \cdot (p' + \hbar k_\alpha - \hbar k_\sigma + \hbar q)}{m} - i \frac{\hbar k_\mu \cdot k_\nu}{m} + 2i\omega_k \dots \\
& \quad \quad \left. - i \frac{(p + \hbar q) \cdot q}{m} + i \frac{(p' + \hbar k_\alpha - \hbar k_\sigma) \cdot q}{m} \right. \\
& \quad (\gamma_2 + i(\Delta_\nu - \Delta_\mu) - i \frac{(k_\nu - k_\mu) \cdot (p' + \hbar k_\alpha - \hbar k_\sigma + \hbar q)}{m} - i \frac{\hbar k_\mu \cdot k_\nu}{m} + 2i\omega_k) \\
& \quad \quad \left. (\gamma - i\Delta_\mu + i \frac{k_\mu \cdot (p + \hbar q)}{m} - i\omega_k) \right\} \\
& \times W(p' + \hbar k_\alpha - \hbar k_\sigma + \hbar q - \hbar k_\nu, p + \hbar q - \hbar k_\mu) \\
& + \frac{(\Omega_\alpha \Omega_\sigma^* \Omega_\nu^* \Omega_\mu^* e^{(-i(\Delta_\alpha - \Delta_\sigma + \Delta_\nu - \Delta_\mu) + i \frac{(k_\nu - k_\mu) \cdot (p + \hbar q)}{m} - i \frac{k_\sigma \cdot (p' + \hbar k_\alpha)}{m} + i \frac{k_\alpha \cdot p'}{m} - i \frac{\hbar k_\mu \cdot k_\nu}{m})t)}}{(\gamma_1 - i(\Delta_\alpha - \Delta_\sigma + \Delta_\nu - \Delta_\mu) + i \frac{(k_\nu - k_\mu) \cdot (p + \hbar q)}{m} - i \frac{k_\sigma \cdot (p' + \hbar k_\alpha)}{m} + i \frac{k_\alpha \cdot p'}{m} - i \frac{p \cdot q}{m} \dots} \\
& \quad \left. + i \frac{(p' + \hbar k_\alpha - \hbar k_\sigma) \cdot q}{m} - i \frac{\hbar k_\mu \cdot k_\nu}{m} \right. \\
& \quad (\gamma - i(-\Delta_\sigma + \Delta_\nu - \Delta_\mu) + i \frac{(k_\nu - k_\mu) \cdot (p + \hbar q)}{m} - i \frac{k_\sigma \cdot (p' + \hbar k_\alpha)}{m} - i \frac{\hbar k_\mu \cdot k_\nu}{m} - i\omega_k - i \frac{p \cdot q}{m} \dots \\
& \quad \quad \left. + i \frac{(p' + \hbar k_\alpha - \hbar k_\sigma) \cdot q}{m} \right. \\
& \quad (\gamma_1 - i(\Delta_\nu - \Delta_\mu) + i \frac{(k_\nu - k_\mu) \cdot (p + \hbar q)}{m} - i \frac{\hbar k_\mu \cdot k_\nu}{m} - 2i\omega_k - i \frac{(p + \hbar q) \cdot q}{m} \dots \\
& \quad \quad \left. + i \frac{(p' + \hbar k_\alpha - \hbar k_\sigma) \cdot q}{m} \right. \\
& \quad (\gamma_2 - i(\Delta_\nu - \Delta_\mu) + i \frac{(k_\nu - k_\mu) \cdot (p + \hbar q)}{m} - i \frac{\hbar k_\mu \cdot k_\nu}{m} - 2i\omega_k) \\
& \quad \quad \left. (\gamma + i\Delta_\mu - i \frac{k_\mu \cdot (p' + \hbar k_\alpha - \hbar k_\sigma + \hbar q)}{m} + i\omega_k) \right\} \\
& \times W(p + \hbar q - \hbar k_\nu, p' + \hbar k_\alpha - \hbar k_\sigma + \hbar q - \hbar k_\mu) \} \\
& + \left\{ \frac{(\Omega_\alpha \Omega_\sigma^* \Omega_\nu^* \Omega_\mu^* e^{(i(-\Delta_\alpha + \Delta_\sigma + \Delta_\nu - \Delta_\mu) - i \frac{(k_\nu - k_\mu) \cdot (p' + \hbar k_\alpha)}{m} - i \frac{k_\sigma \cdot p}{m} + i \frac{k_\alpha \cdot p'}{m} - i \frac{\hbar k_\mu \cdot k_\nu}{m} + 2i\omega_k)t)}}{(\gamma_1 + i(-\Delta_\alpha + \Delta_\sigma + \Delta_\nu - \Delta_\mu) - i \frac{(k_\nu - k_\mu) \cdot (p' + \hbar k_\alpha)}{m} - i \frac{k_\sigma \cdot p}{m} + i \frac{k_\alpha \cdot p'}{m} - i \frac{\hbar k_\mu \cdot k_\nu}{m} + 2i\omega_k) \right. \\
& \quad (\gamma + i(\Delta_\sigma + \Delta_\nu - \Delta_\mu) - i \frac{(k_\nu - k_\mu) \cdot (p' + \hbar k_\alpha)}{m} - i \frac{k_\sigma \cdot p}{m} - i \frac{\hbar k_\mu \cdot k_\nu}{m} + i\omega_k) \\
& \quad (\gamma_2 + i(\Delta_\nu - \Delta_\mu) - i \frac{(k_\nu - k_\mu) \cdot (p' + \hbar k_\alpha)}{m} - i \frac{\hbar k_\mu \cdot k_\nu}{m} + 2i\omega_k) \\
& \quad \quad \left. (\gamma - i\Delta_\mu + i \frac{k_\mu \cdot (p + \hbar k_\sigma)}{m} - i\omega_k) \right\} \\
& \times W(p' + \hbar k_\alpha - \hbar k_\nu, p + \hbar k_\sigma - \hbar k_\mu) \\
& + \frac{(\Omega_\alpha \Omega_\sigma^* \Omega_\nu^* \Omega_\mu^* e^{(-i(\Delta_\alpha - \Delta_\sigma + \Delta_\nu - \Delta_\mu) + i \frac{(k_\nu - k_\mu) \cdot (p + \hbar k_\sigma)}{m} - i \frac{k_\sigma \cdot p}{m} + i \frac{k_\alpha \cdot p'}{m} - i \frac{\hbar k_\mu \cdot k_\nu}{m} - 2i\omega_k)t)}}{(\gamma_1 - i(\Delta_\alpha - \Delta_\sigma + \Delta_\nu - \Delta_\mu) + i \frac{(k_\nu - k_\mu) \cdot (p + \hbar k_\sigma)}{m} - i \frac{k_\sigma \cdot p}{m} + i \frac{k_\alpha \cdot p'}{m} - i \frac{\hbar k_\mu \cdot k_\nu}{m} - 2i\omega_k) \\
& \quad (\gamma - i(-\Delta_\sigma + \Delta_\nu - \Delta_\mu) + i \frac{(k_\nu - k_\mu) \cdot (p + \hbar k_\sigma)}{m} - i \frac{k_\sigma \cdot p}{m} - i \frac{\hbar k_\mu \cdot k_\nu}{m} - 3i\omega_k) \\
& \quad (\gamma_2 - i(\Delta_\nu - \Delta_\mu) + i \frac{(k_\nu - k_\mu) \cdot (p + \hbar k_\sigma)}{m} - i \frac{\hbar k_\mu \cdot k_\nu}{m} - 2i\omega_k) \\
& \quad \quad \left. (\gamma + i\Delta_\mu - i \frac{k_\mu \cdot (p' + \hbar k_\alpha)}{m} + i\omega_k) \right\} \\
& \times W(p + \hbar k_\sigma - \hbar k_\nu, p' + \hbar k_\alpha - \hbar k_\mu) \}
\end{aligned}$$

$$\begin{aligned}
& - \left[\frac{(\Omega_\alpha^* \Omega_\sigma \Omega_\nu^* \Omega_\mu e^{(i(\Delta_\alpha - \Delta_\sigma + \Delta_\nu - \Delta_\mu) - i \frac{(k_\nu - k_\mu) \cdot (p + \hbar k_\alpha - \hbar k_\sigma)}{m} + i \frac{k_\sigma \cdot (p + \hbar k_\alpha)}{m} - i \frac{k_\alpha \cdot p}{m} + i \frac{\hbar k_\mu \cdot k_\nu}{m} - 4i\omega_k)t)}}{(\gamma_1 + i(\Delta_\alpha - \Delta_\sigma + \Delta_\nu - \Delta_\mu) - i \frac{(k_\nu - k_\mu) \cdot (p + \hbar k_\alpha - \hbar k_\sigma)}{m} + i \frac{k_\sigma \cdot (p + \hbar k_\alpha)}{m} - i \frac{k_\alpha \cdot p}{m} + i \frac{\hbar k_\mu \cdot k_\nu}{m} - 4i\omega_k)} \right. \\
& \quad \frac{(\gamma + i(-\Delta_\sigma + \Delta_\nu - \Delta_\mu) - i \frac{(k_\nu - k_\mu) \cdot (p + \hbar k_\alpha - \hbar k_\sigma)}{m} + i \frac{k_\sigma \cdot (p + \hbar k_\alpha)}{m} + i \frac{\hbar k_\mu \cdot k_\nu}{m} - 3i\omega_k)}{(\gamma_1 + i(\Delta_\nu - \Delta_\mu) - i \frac{(k_\nu - k_\mu) \cdot (p + \hbar k_\alpha - \hbar k_\sigma)}{m} + i \frac{\hbar k_\mu \cdot k_\nu}{m} - 2i\omega_k)} \\
& \quad \left. (\gamma - i\Delta_\mu + i \frac{k_\mu \cdot p'}{m} + i\omega_k) \right] \\
& \times W(p', p + \hbar k_\alpha - \hbar k_\sigma + \hbar k_\nu - \hbar k_\mu) \\
& - \frac{(\Omega_\alpha^* \Omega_\sigma \Omega_\nu \Omega_\mu^* e^{(-i(-\Delta_\alpha + \Delta_\sigma + \Delta_\nu - \Delta_\mu) + i \frac{(k_\nu - k_\mu) \cdot p'}{m} + i \frac{k_\sigma \cdot (p + \hbar k_\alpha)}{m} - i \frac{k_\alpha \cdot p}{m} - i \frac{\hbar k_\mu \cdot k_\nu}{m})t)}}{(\gamma_1 - i(-\Delta_\alpha + \Delta_\sigma + \Delta_\nu - \Delta_\mu) + i \frac{(k_\nu - k_\mu) \cdot p'}{m} + i \frac{k_\sigma \cdot (p + \hbar k_\alpha)}{m} - i \frac{k_\alpha \cdot p}{m} - i \frac{\hbar k_\mu \cdot k_\nu}{m})} \\
& \quad (\gamma - i(\Delta_\sigma + \Delta_\nu - \Delta_\mu) + i \frac{(k_\nu - k_\mu) \cdot p'}{m} + i \frac{k_\sigma \cdot (p + \hbar k_\alpha)}{m} - i \frac{\hbar k_\mu \cdot k_\nu}{m} + i\omega_k) \\
& \quad (\gamma_1 - i(\Delta_\nu - \Delta_\mu) + i \frac{(k_\nu - k_\mu) \cdot p'}{m} - i \frac{\hbar k_\mu \cdot k_\nu}{m} + 2i\omega_k) \\
& \quad (\gamma + i\Delta_\mu - i \frac{k_\mu \cdot (p' + \hbar k_\nu - \hbar k_\mu)}{m} - i\omega_k) \\
& \times W(p + \hbar k_\alpha - \hbar k_\sigma, p' + \hbar k_\nu - \hbar k_\mu) \\
& + \int \Gamma N(q) dq e^{(+i \frac{p' \cdot q}{m} - i \frac{(p + \hbar k_\alpha - \hbar k_\sigma) \cdot q}{m})t} \times \\
& \left\{ \frac{(\Omega_\alpha^* \Omega_\sigma \Omega_\nu \Omega_\mu^* e^{(-i(-\Delta_\alpha + \Delta_\sigma + \Delta_\nu - \Delta_\mu) + i \frac{(k_\nu - k_\mu) \cdot (p' + \hbar q)}{m} + i \frac{k_\sigma \cdot (p + \hbar k_\alpha)}{m} - i \frac{k_\alpha \cdot p}{m} + i \frac{\hbar k_\mu \cdot k_\nu}{m} - 4i\omega_k)t)}}{(\gamma_1 - i(-\Delta_\alpha + \Delta_\sigma + \Delta_\nu - \Delta_\mu) + i \frac{(k_\nu - k_\mu) \cdot (p' + \hbar q)}{m} + i \frac{k_\sigma \cdot (p + \hbar k_\alpha)}{m} - i \frac{k_\alpha \cdot p}{m} + i \frac{p' \cdot q}{m} \dots} \right. \\
& \quad - i \frac{(p + \hbar k_\alpha - \hbar k_\sigma) \cdot q}{m} + i \frac{\hbar k_\mu \cdot k_\nu}{m} - 4i\omega_k) \\
& \quad (\gamma - i(\Delta_\sigma + \Delta_\nu - \Delta_\mu) + i \frac{(k_\nu - k_\mu) \cdot (p + \hbar k_\alpha + \hbar q)}{m} + i \frac{k_\sigma \cdot (p + \hbar k_\alpha)}{m} + i \frac{\hbar k_\mu \cdot k_\nu}{m} - 3i\omega_k + i \frac{p' \cdot q}{m} \dots \\
& \quad \left. - i \frac{(p + \hbar k_\alpha - \hbar k_\sigma) \cdot q}{m} \right) \\
& \quad (\gamma_1 - i(\Delta_\nu - \Delta_\mu) + i \frac{(k_\nu - k_\mu) \cdot (p + \hbar k_\alpha - \hbar k_\sigma + \hbar q)}{m} + i \frac{\hbar k_\mu \cdot k_\nu}{m} - 2i\omega_k + i \frac{(p' + \hbar q) \cdot q}{m} - i \frac{(p + \hbar k_\alpha - \hbar k_\sigma) \cdot q}{m}) \\
& \quad (\gamma_2 - i(\Delta_\nu - \Delta_\mu) + i \frac{(k_\nu - k_\mu) \cdot (p + \hbar k_\alpha - \hbar k_\sigma + \hbar q)}{m} + i \frac{\hbar k_\mu \cdot k_\nu}{m} - 2i\omega_k) \\
& \quad \left. (\gamma + i\Delta_\mu - i \frac{k_\mu \cdot (p' + \hbar q)}{m} + i\omega_k) \right\} \\
& \times W(p + \hbar k_\alpha - \hbar k_\sigma + \hbar q - \hbar k_\nu, p' + \hbar q - \hbar k_\mu) \\
& + \frac{(\Omega_\alpha^* \Omega_\sigma \Omega_\nu^* \Omega_\mu e^{(i(\Delta_\alpha - \Delta_\sigma + \Delta_\nu - \Delta_\mu) - i \frac{(k_\nu - k_\mu) \cdot (p' + \hbar q)}{m} + i \frac{k_\sigma \cdot (p + \hbar k_\alpha)}{m} - i \frac{k_\alpha \cdot p}{m} + i \frac{\hbar k_\mu \cdot k_\nu}{m})t)}}{(\gamma_1 + i(\Delta_\alpha - \Delta_\sigma + \Delta_\nu - \Delta_\mu) - i \frac{(k_\nu - k_\mu) \cdot (p' + \hbar q)}{m} + i \frac{k_\sigma \cdot (p + \hbar k_\alpha)}{m} - i \frac{k_\alpha \cdot p}{m} + i \frac{p' \cdot q}{m} \dots} \\
& \quad - i \frac{(p + \hbar k_\alpha - \hbar k_\sigma) \cdot q}{m} + i \frac{\hbar k_\mu \cdot k_\nu}{m}) \\
& \quad (\gamma + i(-\Delta_\sigma + \Delta_\nu - \Delta_\mu) - i \frac{(k_\nu - k_\mu) \cdot (p' + \hbar q)}{m} + i \frac{k_\sigma \cdot (p + \hbar k_\alpha)}{m} + i \frac{\hbar k_\mu \cdot k_\nu}{m} + i\omega_k + i \frac{p \cdot q}{m} \dots \\
& \quad \left. - i \frac{(p + \hbar k_\alpha - \hbar k_\sigma) \cdot q}{m} \right) \\
& \quad (\gamma_1 + i(\Delta_\nu - \Delta_\mu) - i \frac{(k_\nu - k_\mu) \cdot (p' + \hbar q)}{m} + i \frac{\hbar k_\mu \cdot k_\nu}{m} + 2i\omega_k + i \frac{(p' + \hbar q) \cdot q}{m} \dots \\
& \quad \left. - i \frac{(p + \hbar k_\alpha - \hbar k_\sigma) \cdot q}{m} \right) \\
& \quad (\gamma_2 + i(\Delta_\nu - \Delta_\mu) - i \frac{(k_\nu - k_\mu) \cdot (p' + \hbar q)}{m} + i \frac{\hbar k_\mu \cdot k_\nu}{m} + 2i\omega_k) \\
& \quad (\gamma - i\Delta_\mu + i \frac{k_\mu \cdot (p + \hbar k_\alpha - \hbar k_\sigma + \hbar q)}{m} - i\omega_k) \\
& \times W(p' + \hbar q - \hbar k_\nu, p + \hbar k_\alpha - \hbar k_\sigma + \hbar q - \hbar k_\mu) \} \\
\end{aligned}$$

$$\begin{aligned}
& - \left\{ \frac{(\Omega_\alpha^* \Omega_\sigma \Omega_\nu \Omega_\mu^* e^{(-i(-\Delta_\alpha + \Delta_\sigma + \Delta_\nu - \Delta_\mu) + i \frac{(k_\nu - k_\mu) \cdot (p + \hbar k_\alpha)}{m} + i \frac{k_\sigma \cdot p'}{m} - i \frac{k_\alpha \cdot p}{m} + i \frac{\hbar k_\mu \cdot k_\nu}{m} - 2i\omega_k)t})}{(\gamma_1 - i(-\Delta_\alpha + \Delta_\sigma + \Delta_\nu - \Delta_\mu) + i \frac{(k_\nu - k_\mu) \cdot (p + \hbar k_\alpha)}{m} + i \frac{k_\sigma \cdot p'}{m} - i \frac{k_\alpha \cdot p}{m} + i \frac{\hbar k_\mu \cdot k_\nu}{m} - 2i\omega_k)} \right. \\
& \quad (\gamma - i(\Delta_\sigma + \Delta_\nu - \Delta_\mu) + i \frac{(k_\nu - k_\mu) \cdot (p + \hbar k_\alpha)}{m} + i \frac{k_\sigma \cdot p'}{m} + i \frac{\hbar k_\mu \cdot k_\nu}{m} - i\omega_k) \\
& \quad \left. (\gamma_2 - i(\Delta_\nu - \Delta_\mu) + i \frac{(k_\nu - k_\mu) \cdot (p + \hbar k_\alpha)}{m} + i \frac{\hbar k_\mu \cdot k_\nu}{m} - 2i\omega_k) \right. \\
& \quad \left. (\gamma + i\Delta_\mu - i \frac{k_\mu \cdot (p' + \hbar k_\sigma)}{m} + i\omega_k) \right) \\
& \times W(p + \hbar k_\alpha - \hbar k_\nu, p' + \hbar k_\sigma - \hbar k_\mu) \\
& + \frac{(\Omega_\alpha^* \Omega_\sigma \Omega_\nu \Omega_\mu^* e^{(+i(\Delta_\alpha - \Delta_\sigma + \Delta_\nu - \Delta_\mu) - i \frac{(k_\nu - k_\mu) \cdot (p' + \hbar k_\sigma)}{m} + i \frac{k_\sigma \cdot p}{m} - i \frac{k_\alpha \cdot p}{m} + i \frac{\hbar k_\mu \cdot k_\nu}{m} + 2i\omega_k)t})}{(\gamma_1 + i(\Delta_\alpha - \Delta_\sigma + \Delta_\nu - \Delta_\mu) - i \frac{(k_\nu - k_\mu) \cdot (p' + \hbar k_\sigma)}{m} + i \frac{k_\sigma \cdot p}{m} - i \frac{k_\alpha \cdot p}{m} + i \frac{\hbar k_\mu \cdot k_\nu}{m} + 2i\omega_k)} \\
& \quad (\gamma + i(-\Delta_\sigma + \Delta_\nu - \Delta_\mu) - i \frac{(k_\nu - k_\mu) \cdot (p' + \hbar k_\sigma)}{m} + i \frac{k_\sigma \cdot p}{m} + i \frac{\hbar k_\mu \cdot k_\nu}{m} + 3i\omega_k) \\
& \quad (\gamma_2 + i(\Delta_\nu - \Delta_\mu) - i \frac{(k_\nu - k_\mu) \cdot (p' + \hbar k_\sigma)}{m} + i \frac{\hbar k_\mu \cdot k_\nu}{m} + 2i\omega_k) \\
& \quad (\gamma - i\Delta_\mu + i \frac{k_\mu \cdot (p + \hbar k_\alpha)}{m} - i\omega_k) \\
& \times W(p' + \hbar k_\sigma - \hbar k_\nu, p + \hbar k_\alpha - \hbar k_\mu) \Big\} \\
& + \int \Gamma N(q) dq e^{i(-\frac{p \cdot q}{m} + \frac{p' \cdot q}{m})t} \times \\
& \left[- \frac{(\Omega_\alpha^* \Omega_\sigma \Omega_\nu \Omega_\mu^* e^{(i(+\Delta_\alpha - \Delta_\sigma + \Delta_\nu - \Delta_\mu) - i \frac{(k_\nu - k_\mu) \cdot (p + \hbar q - \hbar k_\sigma)}{m} + i \frac{k_\sigma \cdot (p + \hbar q)}{m} - i \frac{k_\alpha \cdot (p' + \hbar q)}{m} + i \frac{\hbar k_\mu \cdot k_\nu}{m} - 2i\omega_k)t})}{(\gamma_1 + i(+\Delta_\alpha - \Delta_\sigma + \Delta_\nu - \Delta_\mu) - i \frac{(k_\nu - k_\mu) \cdot (p + \hbar q - \hbar k_\sigma)}{m} + i \frac{k_\sigma \cdot (p + \hbar q)}{m} - i \frac{k_\alpha \cdot (p' + \hbar q)}{m} \dots} \right. \\
& \quad \left. - \frac{p \cdot q}{m} + \frac{p' \cdot q}{m} + i \frac{\hbar k_\mu \cdot k_\nu}{m} - 2i\omega_k) \right. \\
& \quad (\gamma_2 + i(+\Delta_\alpha - \Delta_\sigma + \Delta_\nu - \Delta_\mu) - i \frac{(k_\nu - k_\mu) \cdot (p + \hbar q - \hbar k_\sigma)}{m} + i \frac{k_\sigma \cdot (p + \hbar q)}{m} \dots \\
& \quad \left. - i \frac{k_\alpha \cdot (p' + \hbar q)}{m} + i \frac{\hbar k_\mu \cdot k_\nu}{m} - 2i\omega_k) \right. \\
& \quad (\gamma + i(-\Delta_\sigma + \Delta_\nu - \Delta_\mu) - i \frac{(k_\nu - k_\mu) \cdot (p + \hbar q - \hbar k_\sigma)}{m} + i \frac{k_\sigma \cdot (p + \hbar q)}{m} \dots \\
& \quad \left. + i \frac{\hbar k_\mu \cdot k_\nu}{m} - 3i\omega_k) \right. \\
& \quad (\gamma_1 + i(\Delta_\nu - \Delta_\mu) - i \frac{(k_\nu - k_\mu) \cdot (p + \hbar q - \hbar k_\sigma)}{m} + i \frac{\hbar k_\mu \cdot k_\nu}{m} - 2i\omega_k) \\
& \quad \left. (\gamma - i\Delta_\mu + i \frac{k_\mu \cdot (p' + \hbar q - \hbar k_\alpha)}{m} + i\omega_k) \right) \\
& \times W(p' + \hbar q - \hbar k_\alpha, p + \hbar q - \hbar k_\sigma + \hbar k_\nu - \hbar k_\mu) \\
& - \frac{(\Omega_\alpha^* \Omega_\sigma \Omega_\nu \Omega_\mu^* e^{(-i(-\Delta_\alpha + \Delta_\sigma + \Delta_\nu - \Delta_\mu) + i \frac{(k_\nu - k_\mu) \cdot (p' + \hbar q - \hbar k_\alpha)}{m} + i \frac{k_\sigma \cdot (p + \hbar q)}{m} - i \frac{k_\alpha \cdot (p' + \hbar q)}{m} - i \frac{\hbar k_\mu \cdot k_\nu}{m} + 2i\omega_k)t})}{(\gamma_1 - i(-\Delta_\alpha + \Delta_\sigma + \Delta_\nu - \Delta_\mu) + i \frac{(k_\nu - k_\mu) \cdot (p' + \hbar q - \hbar k_\alpha)}{m} + i \frac{k_\sigma \cdot (p + \hbar q)}{m} - i \frac{k_\alpha \cdot (p' + \hbar q)}{m} - \frac{p \cdot q}{m} \dots} \\
& \quad \left. + \frac{p' \cdot q}{m} - i \frac{\hbar k_\mu \cdot k_\nu}{m} + 2i\omega_k) \right. \\
& \quad (\gamma_2 - i(+\Delta_\alpha + \Delta_\sigma + \Delta_\nu - \Delta_\mu) + i \frac{(k_\nu - k_\mu) \cdot (p' + \hbar q - \hbar k_\alpha)}{m} + i \frac{k_\sigma \cdot (p + \hbar q)}{m} - i \frac{k_\alpha \cdot (p' + \hbar q)}{m} \dots \\
& \quad \left. - i \frac{\hbar k_\mu \cdot k_\nu}{m} + 2i\omega_k) \right. \\
& \quad (\gamma - i(\Delta_\sigma + \Delta_\nu - \Delta_\mu) + i \frac{(k_\nu - k_\mu) \cdot (p' + \hbar q - \hbar k_\alpha)}{m} + i \frac{k_\sigma \cdot (p + \hbar q)}{m} - i \frac{\hbar k_\mu \cdot k_\nu}{m} + i\omega_k) \\
& \quad (\gamma_1 - i(\Delta_\nu - \Delta_\mu) + i \frac{(k_\nu - k_\mu) \cdot (p' + \hbar q - \hbar k_\alpha)}{m} - i \frac{\hbar k_\mu \cdot k_\nu}{m} + 2i\omega_k) \\
& \quad \left. (\gamma + i\Delta_\mu - i \frac{k_\mu \cdot (p' + \hbar q - \hbar k_\alpha + \hbar k_\nu - \hbar k_\mu)}{m} - i\omega_k) \right) \\
& \times W(p + \hbar q - \hbar k_\sigma, p' + \hbar q - \hbar k_\alpha + \hbar k_\nu - \hbar k_\mu) \\
& + \int \Gamma N(q') dq' e^{(+i \frac{(p' + \hbar q - \hbar k_\alpha) \cdot q'}{m} - i \frac{(p + \hbar q - \hbar k_\sigma) \cdot q'}{m})t} \times
\end{aligned}$$

$$\begin{aligned}
& + \frac{(\Omega_\alpha^* \Omega_\sigma \Omega_\nu^* \Omega_\mu e^{(i(+\Delta_\alpha - \Delta_\sigma + \Delta_\nu - \Delta_\mu) - i \frac{(k_\nu - k_\mu) \cdot (p' + \hbar q - \hbar k_\alpha + \hbar k_\sigma)}{m} + i \frac{k_\sigma \cdot (p' + \hbar q - \hbar k_\alpha)}{m} - i \frac{k_\alpha \cdot (p' + \hbar q)}{m} + i \frac{\hbar k_\mu \cdot k_\nu}{m} + 4i\omega_k)t)}}{(\gamma_1 + i(+\Delta_\alpha - \Delta_\sigma + \Delta_\nu - \Delta_\mu) - i \frac{(k_\nu - k_\mu) \cdot (p' + \hbar q - \hbar k_\alpha + \hbar k_\sigma)}{m} + i \frac{k_\sigma \cdot (p' + \hbar q - \hbar k_\alpha)}{m} - i \frac{k_\alpha \cdot (p' + \hbar q)}{m} \dots} \\
& \quad - i \frac{p \cdot q}{m} + i \frac{p' \cdot q}{m} + i \frac{\hbar k_\mu \cdot k_\nu}{m} + 4i\omega_k) \\
& \quad (\gamma_2 + i(+\Delta_\alpha - \Delta_\sigma + \Delta_\nu - \Delta_\mu) - i \frac{(k_\nu - k_\mu) \cdot (p' + \hbar q - \hbar k_\alpha + \hbar k_\sigma)}{m} + i \frac{k_\sigma \cdot (p' + \hbar q - \hbar k_\alpha)}{m} \dots \\
& \quad - i \frac{k_\alpha \cdot (p' + \hbar q)}{m} + i \frac{\hbar k_\mu \cdot k_\nu}{m} + 4i\omega_k) \\
& \quad (\gamma + i(-\Delta_\sigma + \Delta_\nu - \Delta_\mu) - i \frac{(k_\nu - k_\mu) \cdot (p' + \hbar q - \hbar k_\alpha + \hbar k_\sigma)}{m} + i \frac{k_\sigma \cdot (p' + \hbar q - \hbar k_\alpha)}{m} \dots \\
& \quad + i \frac{\hbar k_\mu \cdot k_\nu}{m} + 3i\omega_k) \\
& \quad (\gamma_2 + i(\Delta_\nu - \Delta_\mu) - i \frac{(k_\nu - k_\mu) \cdot (p' + \hbar q - \hbar k_\alpha + \hbar k_\sigma)}{m} + i \frac{\hbar k_\mu \cdot k_\nu}{m} + 2i\omega_k) \\
& \quad (\gamma - i\Delta_\mu + i \frac{k_\mu \cdot (p + \hbar q)}{m} - i\omega_k) \\
& \times W(p' + \hbar q - \hbar k_\alpha + \hbar k_\sigma - \hbar k_\nu, p + \hbar q - \hbar k_\mu) \} \\
& + \left[- \frac{(\Omega_\alpha \Omega_\sigma^* \Omega_\nu \Omega_\mu^* e^{(-i(+\Delta_\alpha - \Delta_\sigma + \Delta_\nu - \Delta_\mu) + i \frac{(k_\nu - k_\mu) \cdot (p' + \hbar q - \hbar k_\sigma)}{m} - i \frac{k_\sigma \cdot (p' + \hbar q)}{m} + i \frac{k_\alpha \cdot (p + \hbar q)}{m} - i \frac{\hbar k_\mu \cdot k_\nu}{m} + 2i\omega_k)t)}}{(\gamma_1 - i(+\Delta_\alpha - \Delta_\sigma + \Delta_\nu - \Delta_\mu) + i \frac{(k_\nu - k_\mu) \cdot (p' + \hbar q - \hbar k_\sigma)}{m} - i \frac{k_\sigma \cdot (p' + \hbar q)}{m} + i \frac{k_\alpha \cdot (p + \hbar q)}{m} \dots} \right. \\
& \quad - \frac{p \cdot q}{m} + \frac{p' \cdot q}{m} - i \frac{\hbar k_\mu \cdot k_\nu}{m} + 2i\omega_k) \\
& \quad (\gamma_2 - i(-\Delta_\alpha - \Delta_\sigma + \Delta_\nu - \Delta_\mu) + i \frac{(k_\nu - k_\mu) \cdot (p' + \hbar q - \hbar k_\sigma)}{m} - i \frac{k_\sigma \cdot (p' + \hbar q)}{m} + i \frac{k_\alpha \cdot (p + \hbar q)}{m} \dots \\
& \quad - i \frac{\hbar k_\mu \cdot k_\nu}{m} + 2i\omega_k) \\
& \quad (\gamma - i(-\Delta_\sigma + \Delta_\nu - \Delta_\mu) + i \frac{(k_\nu - k_\mu) \cdot (p' + \hbar q - \hbar k_\sigma)}{m} - i \frac{k_\sigma \cdot (p' + \hbar q)}{m} - i \frac{\hbar k_\mu \cdot k_\nu}{m} + 3i\omega_k) \\
& \quad (\gamma_1 - i(\Delta_\nu - \Delta_\mu) + i \frac{(k_\nu - k_\mu) \cdot (p' + \hbar q - \hbar k_\sigma)}{m} - i \frac{\hbar k_\mu \cdot k_\nu}{m} + 2i\omega_k) \\
& \quad \left. (\gamma + i\Delta_\mu - i \frac{k_\mu \cdot (p + \hbar q - \hbar k_\alpha)}{m} - i\omega_k) \right] \\
& \times W(p + \hbar q - \hbar k_\alpha, p' + \hbar q - \hbar k_\sigma + \hbar k_\nu - \hbar k_\mu) \\
& - \frac{(\Omega_\alpha \Omega_\sigma^* \Omega_\nu \Omega_\mu^* e^{(i(-\Delta_\alpha + \Delta_\sigma + \Delta_\nu - \Delta_\mu) - i \frac{(k_\nu - k_\mu) \cdot (p + \hbar q - \hbar k_\alpha)}{m} - i \frac{k_\sigma \cdot (p' + \hbar q)}{m} + i \frac{k_\alpha \cdot (p + \hbar q)}{m} + i \frac{\hbar k_\mu \cdot k_\nu}{m} - 2i\omega_k)t)}}{(\gamma_1 + i(-\Delta_\alpha + \Delta_\sigma + \Delta_\nu - \Delta_\mu) - i \frac{(k_\nu - k_\mu) \cdot (p + \hbar q - \hbar k_\alpha)}{m} - i \frac{k_\sigma \cdot (p' + \hbar q)}{m} + i \frac{k_\alpha \cdot (p + \hbar q)}{m} \dots} \\
& \quad - \frac{p \cdot q}{m} + \frac{p' \cdot q}{m} + i \frac{\hbar k_\mu \cdot k_\nu}{m} - 2i\omega_k) \\
& \quad (\gamma_2 + i(-\Delta_\alpha + \Delta_\sigma + \Delta_\nu - \Delta_\mu) - i \frac{(k_\nu - k_\mu) \cdot (p + \hbar q - \hbar k_\alpha)}{m} - i \frac{k_\sigma \cdot (p' + \hbar q)}{m} + i \frac{k_\alpha \cdot (p + \hbar q)}{m} \dots \\
& \quad + i \frac{\hbar k_\mu \cdot k_\nu}{m} - 2i\omega_k) \\
& \quad (\gamma + i(\Delta_\sigma + \Delta_\nu - \Delta_\mu) - i \frac{(k_\nu - k_\mu) \cdot (p + \hbar q - \hbar k_\alpha)}{m} - i \frac{k_\sigma \cdot (p' + \hbar q)}{m} + i \frac{\hbar k_\mu \cdot k_\nu}{m} - i\omega_k) \\
& \quad (\gamma_1 + i(\Delta_\nu - \Delta_\mu) - i \frac{(k_\nu - k_\mu) \cdot (p + \hbar q - \hbar k_\alpha)}{m} + i \frac{\hbar k_\mu \cdot k_\nu}{m} - 2i\omega_k) \\
& \quad \left. (\gamma - i\Delta_\mu + i \frac{k_\mu \cdot (p + \hbar q - \hbar k_\alpha + \hbar k_\nu - \hbar k_\mu)}{m} + i\omega_k) \right] \\
& \times W(p' + \hbar q - \hbar k_\sigma, p + \hbar q - \hbar k_\alpha + \hbar k_\nu - \hbar k_\mu) \\
& + \int \Gamma N(q') dq' e^{(-i \frac{(p + \hbar q - \hbar k_\alpha) \cdot q'}{m} + i \frac{(p' + \hbar q - \hbar k_\sigma) \cdot q'}{m})t} \times
\end{aligned}$$

$$\begin{aligned}
& \left\{ \frac{(\Omega_\alpha \Omega_\sigma^* \Omega_\nu^* \Omega_\mu e^{(i(-\Delta_\alpha + \Delta_\sigma + \Delta_\nu - \Delta_\mu) - i \frac{(k_\nu - k_\mu) \cdot (p' + \hbar q + \hbar q')}{m} - i \frac{k_\sigma \cdot (p' + \hbar q)}{m} + i \frac{k_\alpha \cdot (p + \hbar q)}{m} - i \frac{\hbar k_\mu \cdot k_\nu}{m} + 2i\omega_k)t)}}{(\gamma_1 + i(-\Delta_\alpha + \Delta_\sigma + \Delta_\nu - \Delta_\mu) - i \frac{(k_\nu - k_\mu) \cdot (p' + \hbar q + \hbar q')}{m} - i \frac{k_\sigma \cdot (p' + \hbar q)}{m} + i \frac{k_\alpha \cdot (p + \hbar q)}{m} - i \frac{(p + \hbar q - \hbar k_\alpha) \cdot q'}{m} \dots} \right. \\
& \quad + i \frac{(p' + \hbar q - \hbar k_\sigma) \cdot q'}{m} - \frac{p \cdot q}{m} + \frac{p' \cdot q}{m} - i \frac{\hbar k_\mu \cdot k_\nu}{m} + 2i\omega_k) \\
& \quad (\gamma_2 + i(-\Delta_\alpha + \Delta_\sigma + \Delta_\nu - \Delta_\mu) - i \frac{(k_\nu - k_\mu) \cdot (p' + \hbar q + \hbar q')}{m} - i \frac{k_\sigma \cdot (p' + \hbar q)}{m} + i \frac{k_\alpha \cdot (p + \hbar q)}{m} \dots \\
& \quad - i \frac{\hbar k_\mu \cdot k_\nu}{m} + 2i\omega_k - i \frac{(p + \hbar q - \hbar k_\alpha) \cdot q'}{m} + i \frac{(p' + \hbar q - \hbar k_\sigma) \cdot q'}{m}) \\
& \quad (\gamma + i(\Delta_\sigma + \Delta_\nu - \Delta_\mu) - i \frac{(k_\nu - k_\mu) \cdot (p' + \hbar q + \hbar q')}{m} - i \frac{k_\sigma \cdot p'}{m} - i \frac{\hbar k_\mu \cdot k_\nu}{m} + 3i\omega_k \dots \\
& \quad - i \frac{(p + \hbar q - \hbar k_\alpha) \cdot q'}{m} + i \frac{(p' + \hbar q - \hbar k_\sigma) \cdot q'}{m}) \\
& \quad (\gamma_1 + i(\Delta_\nu - \Delta_\mu) - i \frac{(k_\nu - k_\mu) \cdot (p' + \hbar q - \hbar k_\sigma + \hbar q')}{m} - i \frac{\hbar k_\mu \cdot k_\nu}{m} + 2i\omega_k - i \frac{(p + \hbar q - \hbar k_\alpha + \hbar q') \cdot q'}{m} + i \frac{(p' + \hbar q - \hbar k_\sigma) \cdot q'}{m}) \\
& \quad (\gamma_2 + i(\Delta_\nu - \Delta_\mu) - i \frac{(k_\nu - k_\mu) \cdot (p' + \hbar q - \hbar k_\sigma + \hbar q')}{m} - i \frac{\hbar k_\mu \cdot k_\nu}{m} + 2i\omega_k) \\
& \quad \left. (\gamma - i\Delta_\mu + i \frac{k_\mu \cdot (p + \hbar q - \hbar k_\alpha + \hbar q')}{m} - i\omega_k) \right\} \\
& \times W(p' + \hbar q - \hbar k_\sigma + \hbar q' - \hbar k_\nu, p + \hbar q - \hbar k_\alpha + \hbar q' - \hbar k_\mu) \\
& + \frac{(\Omega_\alpha \Omega_\sigma^* \Omega_\nu \Omega_\mu^* e^{(-i(\Delta_\alpha - \Delta_\sigma + \Delta_\nu - \Delta_\mu) + i \frac{(k_\nu - k_\mu) \cdot (p + \hbar q - \hbar k_\alpha + \hbar q)}{m} - i \frac{k_\sigma \cdot (p' + \hbar q)}{m} + i \frac{k_\alpha \cdot (p + \hbar q)}{m} - i \frac{\hbar k_\mu \cdot k_\nu}{m} - 2i\omega_k)t)}}{(\gamma_1 - i(\Delta_\alpha - \Delta_\sigma + \Delta_\nu - \Delta_\mu) + i \frac{(k_\nu - k_\mu) \cdot (p + \hbar q - \hbar k_\alpha + \hbar q)}{m} - i \frac{k_\sigma \cdot (p' + \hbar q)}{m} + i \frac{k_\alpha \cdot (p + \hbar q)}{m} \dots} \\
& \quad - i \frac{(p + \hbar q - \hbar k_\alpha) \cdot q'}{m} + i \frac{(p' + \hbar q - \hbar k_\sigma) \cdot q'}{m} - \frac{p \cdot q}{m} + \frac{p' \cdot q}{m} - i \frac{\hbar k_\mu \cdot k_\nu}{m} - 2i\omega_k) \\
& \quad (\gamma_2 - i(\Delta_\alpha - \Delta_\sigma + \Delta_\nu - \Delta_\mu) + i \frac{(k_\nu - k_\mu) \cdot (p + \hbar q - \hbar k_\alpha + \hbar q')}{m} - i \frac{k_\sigma \cdot (p' + \hbar q)}{m} \dots \\
& \quad + i \frac{k_\alpha \cdot (p + \hbar q)}{m} - i \frac{\hbar k_\mu \cdot k_\nu}{m} - 2i\omega_k - i \frac{(p + \hbar q - \hbar k_\alpha) \cdot q'}{m} + i \frac{(p' + \hbar q - \hbar k_\sigma) \cdot q'}{m}) \\
& \quad (\gamma - i(-\Delta_\sigma + \Delta_\nu - \Delta_\mu) + i \frac{(k_\nu - k_\mu) \cdot (p + \hbar q - \hbar k_\alpha + \hbar q')}{m} - i \frac{k_\sigma \cdot (p' + \hbar q)}{m} - i \frac{\hbar k_\mu \cdot k_\nu}{m} - i\omega_k \dots \\
& \quad - i \frac{(p + \hbar q - \hbar k_\alpha) \cdot q'}{m} + i \frac{(p' + \hbar q - \hbar k_\sigma) \cdot q'}{m}) \\
& \quad (\gamma_1 - i(\Delta_\nu - \Delta_\mu) + i \frac{(k_\nu - k_\mu) \cdot (p + \hbar q - \hbar k_\alpha + \hbar q')}{m} - i \frac{\hbar k_\mu \cdot k_\nu}{m} - 2i\omega_k \dots \\
& \quad - i \frac{(p + \hbar q - \hbar k_\alpha + \hbar q') \cdot q'}{m} + i \frac{(p' + \hbar q - \hbar k_\sigma) \cdot q'}{m}) \\
& \quad (\gamma_2 - i(\Delta_\nu - \Delta_\mu) + i \frac{(k_\nu - k_\mu) \cdot (p + \hbar q - \hbar k_\alpha + \hbar q')}{m} - i \frac{\hbar k_\mu \cdot k_\nu}{m} - 2i\omega_k) \\
& \quad \left. (\gamma + i\Delta_\mu - i \frac{k_\mu \cdot (p' + \hbar q - \hbar k_\sigma + \hbar q')}{m} + i\omega_k) \right\} \\
& \times W(p + \hbar q - \hbar k_\alpha + \hbar q' - \hbar k_\nu, p' + \hbar q - \hbar k_\sigma + \hbar q' - \hbar k_\mu) \} \\
& - \left\{ \frac{(\Omega_\alpha \Omega_\sigma^* \Omega_\nu^* \Omega_\mu e^{(i(-\Delta_\alpha + \Delta_\sigma + \Delta_\nu - \Delta_\mu) - i \frac{(k_\nu - k_\mu) \cdot (p' + \hbar q)}{m} - i \frac{k_\sigma \cdot (p + \hbar q - \hbar k_\alpha)}{m} + i \frac{k_\alpha \cdot (p + \hbar q)}{m} - i \frac{\hbar k_\mu \cdot k_\nu}{m})t)}}{(\gamma_1 + i(-\Delta_\alpha + \Delta_\sigma + \Delta_\nu - \Delta_\mu) - i \frac{(k_\nu - k_\mu) \cdot (p' + \hbar q)}{m} - i \frac{k_\sigma \cdot (p + \hbar q - \hbar k_\alpha)}{m} + i \frac{k_\alpha \cdot (p + \hbar q)}{m} \dots} \right. \\
& \quad - i \frac{p \cdot q}{m} + i \frac{p' \cdot q}{m} - i \frac{\hbar k_\mu \cdot k_\nu}{m}) \\
& \quad (\gamma_2 + i(-\Delta_\alpha + \Delta_\sigma + \Delta_\nu - \Delta_\mu) - i \frac{(k_\nu - k_\mu) \cdot (p' + \hbar q)}{m} - i \frac{k_\sigma \cdot (p + \hbar q - \hbar k_\alpha)}{m} \dots \\
& \quad + i \frac{k_\alpha \cdot (p + \hbar q)}{m} - i \frac{\hbar k_\mu \cdot k_\nu}{m}) \\
& \quad (\gamma + i(\Delta_\sigma + \Delta_\nu - \Delta_\mu) - i \frac{(k_\nu - k_\mu) \cdot (p' + \hbar q)}{m} - i \frac{k_\sigma \cdot (p + \hbar q - \hbar k_\alpha)}{m} - i \frac{\hbar k_\mu \cdot k_\nu}{m} + i\omega_k) \\
& \quad (\gamma_2 + i(\Delta_\nu - \Delta_\mu) - i \frac{(k_\nu - k_\mu) \cdot (p' + \hbar q)}{m} - i \frac{\hbar k_\mu \cdot k_\nu}{m} + 2i\omega_k) \\
& \quad \left. (\gamma - i\Delta_\mu + i \frac{k_\mu \cdot (p + \hbar q - \hbar k_\alpha + \hbar k_\sigma)}{m} - i\omega_k) \right\} \\
& \times W(p' + \hbar q - \hbar k_\nu, p + \hbar q - \hbar k_\alpha + \hbar k_\sigma - \hbar k_\mu)
\end{aligned}$$

$$\begin{aligned}
& + \frac{(\Omega_\alpha \Omega_\sigma^* \Omega_\nu \Omega_\mu^* e^{(-i(-\Delta_\alpha + \Delta_\sigma + \Delta_\nu - \Delta_\mu) + i \frac{(k_\nu - k_\mu) \cdot (p + \hbar q - \hbar k_\alpha + \hbar k_\sigma)}{m} - i \frac{k_\sigma \cdot (p + \hbar q - \hbar k_\alpha)}{m} + i \frac{k_\alpha \cdot (p + \hbar q)}{m} - i \frac{\hbar k_\mu \cdot k_\nu}{m} - 4i\omega_k)t)}}{(\gamma_1 - i(-\Delta_\alpha + \Delta_\sigma + \Delta_\nu - \Delta_\mu) + i \frac{(k_\nu - k_\mu) \cdot (p + \hbar q - \hbar k_\alpha + \hbar k_\sigma)}{m} - i \frac{k_\sigma \cdot (p + \hbar q - \hbar k_\alpha)}{m} \dots} \\
& \quad + i \frac{k_\alpha \cdot (p + \hbar q)}{m} - i \frac{p \cdot q}{m} + i \frac{p' \cdot q}{m} - i \frac{\hbar k_\mu \cdot k_\nu}{m} - 4i\omega_k) \\
& \quad (\gamma_2 - i(-\Delta_\alpha - \Delta_\sigma + \Delta_\nu - \Delta_\mu) + i \frac{(k_\nu - k_\mu) \cdot (p + \hbar q - \hbar k_\alpha + \hbar k_\sigma)}{m} - i \frac{k_\sigma \cdot (p + \hbar q - \hbar k_\alpha)}{m} \dots) \\
& \quad + i \frac{k_\alpha \cdot (p + \hbar q)}{m} - i \frac{\hbar k_\mu \cdot k_\nu}{m} - 4i\omega_k) \\
& \quad (\gamma - i(-\Delta_\sigma + \Delta_\nu - \Delta_\mu) + i \frac{(k_\nu - k_\mu) \cdot (p + \hbar q - \hbar k_\alpha + \hbar k_\sigma)}{m} - i \frac{k_\sigma \cdot (p + \hbar q - \hbar k_\alpha)}{m} - i \frac{\hbar k_\mu \cdot k_\nu}{m} - 3i\omega_k) \\
& \quad (\gamma_2 - i(\Delta_\nu - \Delta_\mu) + i \frac{(k_\nu - k_\mu) \cdot (p + \hbar q - \hbar k_\alpha + \hbar k_\sigma)}{m} - i \frac{\hbar k_\mu \cdot k_\nu}{m} - 2i\omega_k) \\
& \quad (\gamma + i\Delta_\mu - i \frac{k_\mu \cdot (p' + \hbar q)}{m} + i\omega_k) \\
& \times W(p + \hbar q - \hbar k_\alpha + \hbar k_\sigma - \hbar k_\nu, p' + \hbar q - \hbar k_\mu) \}
\end{aligned}$$

C.1.7 Fifth order

When we add a fifth field E_β , we can now obtain the fifth order optical coherence density matrix terms:

$$\begin{aligned}
\left(\frac{\partial}{\partial t} + \gamma\right) \tilde{\rho}_{12}^{(5)}(p, p') &= i(\Omega_\beta^* e^{(i\Delta_\beta - i \frac{k_\sigma \cdot p'}{m} + i\omega_k)t}) \tilde{\rho}_{11}^{(4)}(p, p' - \hbar k_\beta) \\
&\quad - i(\Omega_\beta^* e^{(i\Delta_\beta - i \frac{k_\beta \cdot p}{m} - i\omega_k)t}) \tilde{\rho}_{22}^{(4)}(p + \hbar k_\beta, p')
\end{aligned}$$

We replace the fourth order population terms to get:

$$\begin{aligned}
& \left(\frac{\partial}{\partial t} + \gamma\right) \tilde{\rho}_{12}^{(5)}(p, p') = \\
& [\\
& \quad i(\Omega_\beta^* \Omega_\alpha \Omega_\sigma^* \Omega_\nu \Omega_\mu^* \times \dots \\
& \quad e^{(-i(-\Delta_\beta + \Delta_\alpha - \Delta_\sigma + \Delta_\nu - \Delta_\mu) + i \frac{(k_\nu - k_\mu) \cdot (p' - \hbar k_\beta + \hbar k_\alpha - \hbar k_\sigma)}{m} - i \frac{k_\sigma \cdot (p' - \hbar k_\beta + \hbar k_\alpha)}{m} + i \frac{k_\alpha \cdot (p' - \hbar k_\beta)}{m} - i \frac{k_\beta \cdot p'}{m} - i \frac{\hbar k_\mu \cdot k_\nu}{m} + 5i\omega_k)t)} \\
& \quad \left[+ \frac{(\gamma_1 - i(+\Delta_\alpha - \Delta_\sigma + \Delta_\nu - \Delta_\mu) + i \frac{(k_\nu - k_\mu) \cdot (p' - \hbar k_\beta + \hbar k_\alpha - \hbar k_\sigma)}{m} - i \frac{k_\sigma \cdot (p' - \hbar k_\beta + \hbar k_\alpha)}{m} \dots} \right. \\
& \quad \quad + i \frac{k_\alpha \cdot (p' - \hbar k_\beta)}{m} - i \frac{\hbar k_\mu \cdot k_\nu}{m} + 4i\omega_k) \\
& \quad \quad (\gamma - i(-\Delta_\sigma + \Delta_\nu - \Delta_\mu) + i \frac{(k_\nu - k_\mu) \cdot (p' - \hbar k_\beta + \hbar k_\alpha - \hbar k_\sigma)}{m} - i \frac{k_\sigma \cdot (p' - \hbar k_\beta + \hbar k_\alpha)}{m} \dots) \\
& \quad \quad \quad - i \frac{\hbar k_\mu \cdot k_\nu}{m} + 3i\omega_k) \\
& \quad \quad (\gamma_1 - i(\Delta_\nu - \Delta_\mu) + i \frac{(k_\nu - k_\mu) \cdot (p' - \hbar k_\beta + \hbar k_\alpha - \hbar k_\sigma)}{m} - i \frac{\hbar k_\mu \cdot k_\nu}{m} + 2i\omega_k) \\
& \quad \quad \quad (\gamma + i\Delta_\mu - i \frac{k_\mu \cdot p}{m} - i\omega_k) \\
& \quad \times W(p, p' - \hbar k_\beta + \hbar k_\alpha - \hbar k_\sigma + \hbar k_\nu - \hbar k_\mu)
\end{aligned}$$

$$\begin{aligned}
& \times W(p' - \hbar k_\beta + \hbar k_\alpha - \hbar k_\nu, p + \hbar k_\sigma - \hbar k_\mu) \\
& \quad \frac{i(\Omega_\beta^* \Omega_\alpha \Omega_\sigma^* \Omega_\nu \Omega_\mu^* \times \dots}{e^{(-i(-\Delta_\beta + \Delta_\alpha - \Delta_\sigma + \Delta_\nu - \Delta_\mu) + i \frac{(k_\nu - k_\mu) \cdot (p + \hbar k_\sigma)}{m} - i \frac{k_\sigma \cdot p}{m} + i \frac{k_\alpha \cdot (p' - \hbar k_\beta)}{m} - i \frac{k_\beta \cdot p'}{m} - i \frac{\hbar k_\mu \cdot k_\nu}{m} - i \omega_k)t}} \\
& + \frac{(\gamma_1 - i(\Delta_\alpha - \Delta_\sigma + \Delta_\nu - \Delta_\mu) + i \frac{(k_\nu - k_\mu) \cdot (p + \hbar k_\sigma)}{m} - i \frac{k_\sigma \cdot p}{m} + i \frac{k_\alpha \cdot (p' - \hbar k_\beta)}{m} - i \frac{\hbar k_\mu \cdot k_\nu}{m} - 2i\omega_k)}{(\gamma - i(-\Delta_\sigma + \Delta_\nu - \Delta_\mu) + i \frac{(k_\nu - k_\mu) \cdot (p + \hbar k_\sigma)}{m} - i \frac{k_\sigma \cdot p}{m} - i \frac{\hbar k_\mu \cdot k_\nu}{m} - 3i\omega_k)} \\
& \quad (\gamma_2 - i(\Delta_\nu - \Delta_\mu) + i \frac{(k_\nu - k_\mu) \cdot (p + \hbar k_\sigma)}{m} - i \frac{\hbar k_\mu \cdot k_\nu}{m} - 2i\omega_k)}{(\gamma + i\Delta_\mu - i \frac{k_\mu \cdot (p' - \hbar k_\beta + \hbar k_\alpha)}{m} + i\omega_k)} \\
& \times W(p + \hbar k_\sigma - \hbar k_\nu, p' - \hbar k_\beta + \hbar k_\alpha - \hbar k_\mu) \} \\
& - \left[\frac{i(\Omega_\beta^* \Omega_\alpha \Omega_\sigma \Omega_\nu^* \Omega_\mu \times \dots}{e^{(i(\Delta_\beta + \Delta_\alpha - \Delta_\sigma + \Delta_\nu - \Delta_\mu) - i \frac{(k_\nu - k_\mu) \cdot (p + \hbar k_\alpha - \hbar k_\sigma)}{m} + i \frac{k_\sigma \cdot (p + \hbar k_\alpha)}{m} - i \frac{k_\alpha \cdot p}{m} - i \frac{k_\beta \cdot p'}{m} + i \frac{\hbar k_\mu \cdot k_\nu}{m} - 3i\omega_k)t}} \right. \\
& \quad \frac{(\gamma_1 + i(\Delta_\alpha - \Delta_\sigma + \Delta_\nu - \Delta_\mu) - i \frac{(k_\nu - k_\mu) \cdot (p + \hbar k_\alpha - \hbar k_\sigma)}{m} + i \frac{k_\sigma \cdot (p + \hbar k_\alpha)}{m} - i \frac{k_\alpha \cdot p}{m} + i \frac{\hbar k_\mu \cdot k_\nu}{m} - 4i\omega_k)}{(\gamma + i(-\Delta_\sigma + \Delta_\nu - \Delta_\mu) - i \frac{(k_\nu - k_\mu) \cdot (p + \hbar k_\alpha - \hbar k_\sigma)}{m} + i \frac{k_\sigma \cdot (p + \hbar k_\alpha)}{m} + i \frac{\hbar k_\mu \cdot k_\nu}{m} - 3i\omega_k)} \\
& \quad \left. \frac{(\gamma_1 + i(\Delta_\nu - \Delta_\mu) - i \frac{(k_\nu - k_\mu) \cdot (p + \hbar k_\alpha - \hbar k_\sigma)}{m} + i \frac{\hbar k_\mu \cdot k_\nu}{m} - 2i\omega_k)}{(\gamma - i\Delta_\mu + i \frac{k_\mu \cdot (p' - \hbar k_\beta)}{m} + i\omega_k)} \right] \\
& \times W(p' - \hbar k_\beta, p + \hbar k_\alpha - \hbar k_\sigma + \hbar k_\nu - \hbar k_\mu) \\
& \quad \frac{i(\Omega_\beta^* \Omega_\alpha \Omega_\sigma \Omega_\nu \Omega_\mu^* \times \dots}{e^{(-i(-\Delta_\beta - \Delta_\sigma - \Delta_\alpha + \Delta_\sigma + \Delta_\nu - \Delta_\mu) + i \frac{(k_\nu - k_\mu) \cdot (p' - \hbar k_\beta)}{m} + i \frac{k_\sigma \cdot (p + \hbar k_\alpha)}{m} - i \frac{k_\alpha \cdot p}{m} - i \frac{k_\beta \cdot p'}{m} - i \frac{\hbar k_\mu \cdot k_\nu}{m} + i\omega_k)t}} \\
& \quad \frac{(\gamma_1 - i(-\Delta_\alpha + \Delta_\sigma + \Delta_\nu - \Delta_\mu) + i \frac{(k_\nu - k_\mu) \cdot (p' - \hbar k_\beta)}{m} + i \frac{k_\sigma \cdot (p + \hbar k_\alpha)}{m} - i \frac{k_\alpha \cdot p}{m} - i \frac{\hbar k_\mu \cdot k_\nu}{m})}{(\gamma - i(\Delta_\sigma + \Delta_\nu - \Delta_\mu) + i \frac{(k_\nu - k_\mu) \cdot (p' - \hbar k_\beta)}{m} + i \frac{k_\sigma \cdot (p' - \hbar k_\beta + \hbar k_\alpha)}{m} - i \frac{\hbar k_\mu \cdot k_\nu}{m} + i\omega_k)} \\
& \quad \frac{(\gamma_1 - i(\Delta_\nu - \Delta_\mu) + i \frac{(k_\nu - k_\mu) \cdot (p' - \hbar k_\beta)}{m} - i \frac{\hbar k_\mu \cdot k_\nu}{m} + 2i\omega_k)}{(\gamma + i\Delta_\mu - i \frac{k_\mu \cdot (p' - \hbar k_\beta + \hbar k_\nu - \hbar k_\mu)}{m} - i\omega_k)} \\
& \times W(p + \hbar k_\alpha - \hbar k_\sigma, p' - \hbar k_\beta + \hbar k_\nu - \hbar k_\mu) \\
& + \int \Gamma N(q) dq e^{(+i \frac{(p' - \hbar k_\beta) \cdot q}{m} - i \frac{(p + \hbar k_\alpha - \hbar k_\sigma) \cdot q}{m})t} \times \\
& \left\{ \frac{i(\Omega_\beta^* \Omega_\alpha \Omega_\sigma \Omega_\nu \Omega_\mu^* \times \dots}{e^{(-i(-\Delta_\beta - \Delta_\alpha + \Delta_\sigma + \Delta_\nu - \Delta_\mu) + i \frac{(k_\nu - k_\mu) \cdot (p' - \hbar k_\beta + \hbar q)}{m} + i \frac{k_\sigma \cdot (p + \hbar k_\alpha)}{m} - i \frac{k_\alpha \cdot p}{m} - i \frac{k_\beta \cdot p'}{m} + i \frac{\hbar k_\mu \cdot k_\nu}{m} - 5i\omega_k)t}} \right. \\
& \quad \frac{(\gamma_1 - i(-\Delta_\alpha + \Delta_\sigma + \Delta_\nu - \Delta_\mu) + i \frac{(k_\nu - k_\mu) \cdot (p' - \hbar k_\beta + \hbar q)}{m} + i \frac{k_\sigma \cdot (p + \hbar k_\alpha)}{m} - i \frac{k_\alpha \cdot p}{m} \dots}{+ i \frac{(p' - \hbar k_\beta) \cdot q}{m} - i \frac{(p + \hbar k_\alpha - \hbar k_\sigma) \cdot q}{m} + i \frac{\hbar k_\mu \cdot k_\nu}{m} - 4i\omega_k)}{(\gamma - i(\Delta_\sigma + \Delta_\nu - \Delta_\mu) + i \frac{(k_\nu - k_\mu) \cdot (p + \hbar k_\alpha + \hbar q)}{m} + i \frac{k_\sigma \cdot (p + \hbar k_\alpha)}{m} + i \frac{\hbar k_\mu \cdot k_\nu}{m} \dots} \\
& \quad \frac{-3i\omega_k + i \frac{(p' - \hbar k_\beta) \cdot q}{m} - i \frac{(p + \hbar k_\alpha - \hbar k_\sigma) \cdot q}{m}}{(\gamma_1 - i(\Delta_\nu - \Delta_\mu) + i \frac{(k_\nu - k_\mu) \cdot (p + \hbar k_\alpha - \hbar k_\sigma + \hbar q)}{m} + i \frac{\hbar k_\mu \cdot k_\nu}{m} - 2i\omega_k \dots} \\
& \quad \frac{+ i \frac{(p' - \hbar k_\beta + \hbar q) \cdot q}{m} - i \frac{(p + \hbar k_\alpha - \hbar k_\sigma) \cdot q}{m}}{(\gamma_2 - i(\Delta_\nu - \Delta_\mu) + i \frac{(k_\nu - k_\mu) \cdot (p + \hbar k_\alpha - \hbar k_\sigma + \hbar q)}{m} + i \frac{\hbar k_\mu \cdot k_\nu}{m} - 2i\omega_k)} \\
& \quad \left. \frac{(\gamma + i\Delta_\mu - i \frac{k_\mu \cdot (p' - \hbar k_\beta + \hbar q)}{m} + i\omega_k)}{\right\} \\
& \times W(p + \hbar k_\alpha - \hbar k_\sigma + \hbar q - \hbar k_\nu, p' - \hbar k_\beta + \hbar q - \hbar k_\mu)
\end{aligned}$$

$$\begin{aligned}
& i(\Omega_\beta^* \Omega_\alpha^* \Omega_\sigma \Omega_\nu^* \Omega_\mu \times \dots \\
& e^{i(\Delta_\beta + \Delta_\alpha - \Delta_\sigma + \Delta_\nu - \Delta_\mu) - i \frac{(k_\nu - k_\mu) \cdot (p' - \hbar k_\beta + \hbar q)}{m} + i \frac{k_\sigma \cdot (p + \hbar k_\alpha)}{m} - i \frac{k_\alpha \cdot p}{m} - i \frac{k_\beta \cdot p'}{m} + i \frac{\hbar k_\mu \cdot k_\nu}{m} + i \omega_k t) \\
& + \frac{(\gamma_1 + i(\Delta_\alpha - \Delta_\sigma + \Delta_\nu - \Delta_\mu) - i \frac{(k_\nu - k_\mu) \cdot (p' - \hbar k_\beta + \hbar q)}{m} + i \frac{k_\sigma \cdot (p + \hbar k_\alpha)}{m} \dots}{(\gamma_1 + i(-\Delta_\sigma + \Delta_\nu - \Delta_\mu) - i \frac{(k_\nu - k_\mu) \cdot (p' - \hbar k_\beta + \hbar q)}{m} + i \frac{k_\sigma \cdot (p + \hbar k_\alpha)}{m} \dots} \\
& \quad - i \frac{k_\alpha \cdot p}{m} + i \frac{(p' - \hbar k_\beta) \cdot q}{m} - i \frac{(p + \hbar k_\alpha - \hbar k_\sigma) \cdot q}{m} + i \frac{\hbar k_\mu \cdot k_\nu}{m})}{(\gamma_1 + i(\Delta_\nu - \Delta_\mu) - i \frac{(k_\nu - k_\mu) \cdot (p' - \hbar k_\beta + \hbar q)}{m} + i \frac{\hbar k_\mu \cdot k_\nu}{m} + 2i\omega_k + i \frac{(p' - \hbar k_\beta + \hbar q) \cdot q}{m} \dots} \\
& \quad - i \frac{(p + \hbar k_\alpha - \hbar k_\sigma) \cdot q}{m})}{(\gamma_2 + i(\Delta_\nu - \Delta_\mu) - i \frac{(k_\nu - k_\mu) \cdot (p' - \hbar k_\beta + \hbar q)}{m} + i \frac{\hbar k_\mu \cdot k_\nu}{m} + 2i\omega_k)} \\
& \quad (\gamma - i\Delta_\mu + i \frac{k_\mu \cdot (p + \hbar k_\alpha - \hbar k_\sigma + \hbar q)}{m} - i\omega_k) \\
& \times W(p' - \hbar k_\beta + \hbar q - \hbar k_\nu, p + \hbar k_\alpha - \hbar k_\sigma + \hbar q - \hbar k_\mu) \} \\
& i(\Omega_\beta^* \Omega_\alpha^* \Omega_\sigma \Omega_\nu^* \Omega_\mu \times \dots \\
& e^{i(-\Delta_\beta - \Delta_\alpha + \Delta_\sigma + \Delta_\nu - \Delta_\mu) + i \frac{(k_\nu - k_\mu) \cdot (p + \hbar k_\alpha)}{m} + i \frac{k_\sigma \cdot (p' - \hbar k_\beta)}{m} - i \frac{k_\alpha \cdot p}{m} - i \frac{k_\beta \cdot p'}{m} + i \frac{\hbar k_\mu \cdot k_\nu}{m} - i \omega_k t) \\
& - \left\{ \frac{(\gamma_1 - i(-\Delta_\alpha + \Delta_\sigma + \Delta_\nu - \Delta_\mu) + i \frac{(k_\nu - k_\mu) \cdot (p + \hbar k_\alpha)}{m} + i \frac{k_\sigma \cdot (p' - \hbar k_\beta)}{m} \dots}{(\gamma_1 - i(\Delta_\sigma + \Delta_\nu - \Delta_\mu) + i \frac{(k_\nu - k_\mu) \cdot (p + \hbar k_\alpha)}{m} + i \frac{k_\sigma \cdot (p' - \hbar k_\beta)}{m} + i \frac{\hbar k_\mu \cdot k_\nu}{m} - i\omega_k)} \right. \\
& \quad - i \frac{k_\alpha \cdot p}{m} + i \frac{\hbar k_\mu \cdot k_\nu}{m} - 2i\omega_k) \\
& \quad (\gamma_2 - i(\Delta_\nu - \Delta_\mu) + i \frac{(k_\nu - k_\mu) \cdot (p + \hbar k_\alpha)}{m} + i \frac{k_\sigma \cdot (p' - \hbar k_\beta)}{m} + i \frac{\hbar k_\mu \cdot k_\nu}{m} - 2i\omega_k) \\
& \quad (\gamma + i\Delta_\mu - i \frac{k_\mu \cdot (p' - \hbar k_\beta + \hbar k_\sigma)}{m} + i\omega_k) \\
& \times W(p + \hbar k_\alpha - \hbar k_\nu, p' - \hbar k_\beta + \hbar k_\sigma - \hbar k_\mu) \\
& i(\Omega_\beta^* \Omega_\alpha^* \Omega_\sigma \Omega_\nu^* \Omega_\mu \times \dots \\
& e^{i(\Delta_\beta + \Delta_\alpha - \Delta_\sigma + \Delta_\nu - \Delta_\mu) - i \frac{(k_\nu - k_\mu) \cdot (p' - \hbar k_\beta + \hbar k_\sigma)}{m} + i \frac{k_\sigma \cdot p}{m} - i \frac{k_\alpha \cdot p}{m} - i \frac{k_\beta \cdot p'}{m} + i \frac{\hbar k_\mu \cdot k_\nu}{m} + 3i\omega_k t) \\
& + \frac{(\gamma_1 + i(\Delta_\alpha - \Delta_\sigma + \Delta_\nu - \Delta_\mu) - i \frac{(k_\nu - k_\mu) \cdot (p' - \hbar k_\beta + \hbar k_\sigma)}{m} + i \frac{k_\sigma \cdot p}{m} - i \frac{k_\alpha \cdot p}{m} + i \frac{\hbar k_\mu \cdot k_\nu}{m} + 2i\omega_k)}{(\gamma_1 + i(-\Delta_\sigma + \Delta_\nu - \Delta_\mu) - i \frac{(k_\nu - k_\mu) \cdot (p' - \hbar k_\beta + \hbar k_\sigma)}{m} + i \frac{k_\sigma \cdot p}{m} + i \frac{\hbar k_\mu \cdot k_\nu}{m} + 3i\omega_k)} \\
& \quad (\gamma_2 + i(\Delta_\nu - \Delta_\mu) - i \frac{(k_\nu - k_\mu) \cdot (p' - \hbar k_\beta + \hbar k_\sigma)}{m} + i \frac{\hbar k_\mu \cdot k_\nu}{m} + 2i\omega_k) \\
& \quad (\gamma - i\Delta_\mu + i \frac{k_\mu \cdot (p + \hbar k_\alpha)}{m} - i\omega_k) \\
& \times W(p' - \hbar k_\beta + \hbar k_\sigma - \hbar k_\nu, p + \hbar k_\alpha - \hbar k_\mu) \} \\
& + \int \Gamma N(q) dq e^{i(-\frac{p \cdot q}{m} + \frac{(p' - \hbar k_\beta) \cdot q}{m}) t} \times \\
& - i(\Omega_\beta^* \Omega_\alpha^* \Omega_\sigma \Omega_\nu^* \Omega_\mu \times \dots \\
& e^{i(\Delta_\beta + \Delta_\alpha - \Delta_\sigma + \Delta_\nu - \Delta_\mu) - i \frac{(k_\nu - k_\mu) \cdot (p + \hbar q - \hbar k_\sigma)}{m} + i \frac{k_\sigma \cdot (p + \hbar q)}{m} - i \frac{k_\alpha \cdot (p' - \hbar k_\beta + \hbar q)}{m} - i \frac{k_\beta \cdot p'}{m} + i \frac{\hbar k_\mu \cdot k_\nu}{m} - i \omega_k t) \\
& \left[- \frac{(\gamma_1 + i(+\Delta_\alpha - \Delta_\sigma + \Delta_\nu - \Delta_\mu) - i \frac{(k_\nu - k_\mu) \cdot (p + \hbar q - \hbar k_\sigma)}{m} + i \frac{k_\sigma \cdot (p + \hbar q)}{m} - i \frac{k_\alpha \cdot (p' - \hbar k_\beta + \hbar q)}{m} \dots}{(\gamma_1 + i(+\Delta_\alpha - \Delta_\sigma + \Delta_\nu - \Delta_\mu) - i \frac{(k_\nu - k_\mu) \cdot (p + \hbar q - \hbar k_\sigma)}{m} + i \frac{k_\sigma \cdot (p + \hbar q)}{m} - i \frac{k_\alpha \cdot (p' - \hbar k_\beta + \hbar q)}{m} \dots} \right. \\
& \quad - \frac{p \cdot q}{m} + \frac{(p' - \hbar k_\beta) \cdot q}{m} + i \frac{\hbar k_\mu \cdot k_\nu}{m} - 2i\omega_k) \\
& \quad (\gamma_2 + i(+\Delta_\alpha - \Delta_\sigma + \Delta_\nu - \Delta_\mu) - i \frac{(k_\nu - k_\mu) \cdot (p + \hbar q - \hbar k_\sigma)}{m} + i \frac{k_\sigma \cdot (p + \hbar q)}{m} \dots}{(\gamma_2 + i(+\Delta_\alpha - \Delta_\sigma + \Delta_\nu - \Delta_\mu) - i \frac{(k_\nu - k_\mu) \cdot (p + \hbar q - \hbar k_\sigma)}{m} + i \frac{k_\sigma \cdot (p + \hbar q)}{m} \dots} \\
& \quad - i \frac{k_\alpha \cdot (p' - \hbar k_\beta + \hbar q)}{m} + i \frac{\hbar k_\mu \cdot k_\nu}{m} - 2i\omega_k) \\
& \quad (\gamma + i(-\Delta_\sigma + \Delta_\nu - \Delta_\mu) - i \frac{(k_\nu - k_\mu) \cdot (p + \hbar q - \hbar k_\sigma)}{m} + i \frac{k_\sigma \cdot (p + \hbar q)}{m} + i \frac{\hbar k_\mu \cdot k_\nu}{m} - 3i\omega_k) \\
& \quad (\gamma_1 + i(\Delta_\nu - \Delta_\mu) - i \frac{(k_\nu - k_\mu) \cdot (p + \hbar q - \hbar k_\sigma)}{m} + i \frac{\hbar k_\mu \cdot k_\nu}{m} - 2i\omega_k) \\
& \quad (\gamma - i\Delta_\mu + i \frac{k_\mu \cdot (p' - \hbar k_\beta + \hbar q - \hbar k_\alpha)}{m} + i\omega_k) \\
\end{aligned}$$

$$\begin{aligned}
& \times W(p' - \hbar k_\beta + \hbar q - \hbar k_\alpha + \hbar q' - \hbar k_\nu, p + \hbar q - \hbar k_\sigma + \hbar q' - \hbar k_\mu) \} \\
& \quad i(\Omega_\beta^* \Omega_\alpha^* \Omega_\sigma \Omega_\nu \Omega_\mu^* \times \dots \\
& \quad e^{(-i(-\Delta_\beta - \Delta_\alpha + \Delta_\sigma + \Delta_\nu - \Delta_\mu) + i \frac{(k_\nu - k_\mu) \cdot (p + \hbar q)}{m} + i \frac{k_\sigma \cdot (p' - \hbar k_\beta + \hbar q - \hbar k_\alpha)}{m} - i \frac{k_\alpha \cdot (p' - \hbar k_\beta + \hbar q)}{m} - i \frac{k_\beta \cdot p'}{m} + i \frac{\hbar k_\mu \cdot k_\nu}{m} - i \omega_k)t)} \\
& \quad + \left\{ \frac{(\gamma_1 - i(-\Delta_\alpha + \Delta_\sigma + \Delta_\nu - \Delta_\mu) + i \frac{(k_\nu - k_\mu) \cdot (p + \hbar q)}{m} + i \frac{k_\sigma \cdot (p' - \hbar k_\beta + \hbar q - \hbar k_\alpha)}{m} \dots}{\dots} \right. \\
& \quad \quad \quad - i \frac{k_\alpha \cdot (p' - \hbar k_\beta + \hbar q)}{m} - \frac{p \cdot q}{m} + \frac{(p' - \hbar k_\beta) \cdot q}{m} + i \frac{\hbar k_\mu \cdot k_\nu}{m} - 2i\omega_k) \\
& \quad \quad \quad (\gamma_2 - i(-\Delta_\alpha + \Delta_\sigma + \Delta_\nu - \Delta_\mu) + i \frac{(k_\nu - k_\mu) \cdot (p + \hbar q)}{m} + i \frac{k_\sigma \cdot (p' - \hbar k_\beta + \hbar q - \hbar k_\alpha)}{m} \dots}{\dots} \\
& \quad \quad \quad - i \frac{k_\alpha \cdot (p' - \hbar k_\beta + \hbar q)}{m} + i \frac{\hbar k_\mu \cdot k_\nu}{m} - 2i\omega_k) \\
& \quad \quad \quad (\gamma - i(\Delta_\sigma + \Delta_\nu - \Delta_\mu) + i \frac{(k_\nu - k_\mu) \cdot (p + \hbar q)}{m} + i \frac{k_\sigma \cdot (p' - \hbar k_\beta + \hbar q - \hbar k_\alpha)}{m} \dots}{\dots} \\
& \quad \quad \quad \quad \quad \quad + i \frac{\hbar k_\mu \cdot k_\nu}{m} - i\omega_k) \\
& \quad \quad \quad (\gamma_2 - i(\Delta_\nu - \Delta_\mu) + i \frac{(k_\nu - k_\mu) \cdot (p + \hbar q)}{m} + i \frac{\hbar k_\mu \cdot k_\nu}{m} - 2i\omega_k) \\
& \quad \quad \quad (\gamma + i\Delta_\mu - i \frac{k_\mu \cdot (p' - \hbar k_\beta + \hbar q - \hbar k_\alpha + \hbar k_\sigma)}{m} + i\omega_k) \\
& \times W(p + \hbar q - \hbar k_\nu, p' - \hbar k_\beta + \hbar q - \hbar k_\alpha + \hbar k_\sigma - \hbar k_\mu) \\
& \quad i(\Omega_\beta^* \Omega_\alpha^* \Omega_\sigma \Omega_\nu \Omega_\mu^* e^{(i(\Delta_\beta + \Delta_\alpha - \Delta_\sigma + \Delta_\nu - \Delta_\mu))t} \times \dots \\
& \quad e^{(-i \frac{(k_\nu - k_\mu) \cdot (p' - \hbar k_\beta + \hbar q - \hbar k_\alpha + \hbar k_\sigma)}{m} + i \frac{k_\sigma \cdot (p' - \hbar k_\beta + \hbar q - \hbar k_\alpha)}{m} - i \frac{k_\alpha \cdot (p' - \hbar k_\beta + \hbar q)}{m} - i \frac{k_\beta \cdot p'}{m} + i \frac{\hbar k_\mu \cdot k_\nu}{m} + 5i\omega_k)t)} \\
& \quad + \frac{(\gamma_1 + i(+\Delta_\alpha - \Delta_\sigma + \Delta_\nu - \Delta_\mu) - i \frac{(k_\nu - k_\mu) \cdot (p' - \hbar k_\beta + \hbar q - \hbar k_\alpha + \hbar k_\sigma)}{m} + i \frac{k_\sigma \cdot (p' - \hbar k_\beta + \hbar q - \hbar k_\alpha)}{m} \dots}{\dots} \\
& \quad \quad \quad - i \frac{k_\alpha \cdot (p' - \hbar k_\beta + \hbar q)}{m} - \frac{p \cdot q}{m} + \frac{(p' - \hbar k_\beta) \cdot q}{m} + i \frac{\hbar k_\mu \cdot k_\nu}{m} + 4i\omega_k) \\
& \quad \quad \quad (\gamma_2 + i(+\Delta_\alpha - \Delta_\sigma + \Delta_\nu - \Delta_\mu) - i \frac{(k_\nu - k_\mu) \cdot (p' - \hbar k_\beta + \hbar q - \hbar k_\alpha + \hbar k_\sigma)}{m} \dots}{\dots} \\
& \quad \quad \quad + i \frac{k_\sigma \cdot (p' - \hbar k_\beta + \hbar q - \hbar k_\alpha)}{m} - i \frac{k_\alpha \cdot (p' - \hbar k_\beta + \hbar q)}{m} + i \frac{\hbar k_\mu \cdot k_\nu}{m} + 4i\omega_k) \\
& \quad \quad \quad (\gamma + i(-\Delta_\sigma + \Delta_\nu - \Delta_\mu) - i \frac{(k_\nu - k_\mu) \cdot (p' - \hbar k_\beta + \hbar q - \hbar k_\alpha + \hbar k_\sigma)}{m} \dots}{\dots} \\
& \quad \quad \quad \quad \quad \quad + i \frac{k_\sigma \cdot (p' - \hbar k_\beta + \hbar q - \hbar k_\alpha)}{m} + i \frac{\hbar k_\mu \cdot k_\nu}{m} + 3i\omega_k) \\
& \quad \quad \quad (\gamma_2 + i(\Delta_\nu - \Delta_\mu) - i \frac{(k_\nu - k_\mu) \cdot (p' - \hbar k_\beta + \hbar q - \hbar k_\alpha + \hbar k_\sigma)}{m} \dots}{\dots} \\
& \quad \quad \quad \quad \quad \quad + i \frac{\hbar k_\mu \cdot k_\nu}{m} + 2i\omega_k) \\
& \quad \quad \quad (\gamma - i\Delta_\mu + i \frac{k_\mu \cdot (p + \hbar q)}{m} - i\omega_k) \\
& \times W(p' - \hbar k_\beta + \hbar q - \hbar k_\alpha + \hbar k_\sigma - \hbar k_\nu, p + \hbar q - \hbar k_\mu) \} \\
& \quad i(\Omega_\beta^* \Omega_\alpha^* \Omega_\sigma \Omega_\nu \Omega_\mu^* \times \dots \\
& \quad e^{(-i(-\Delta_\beta + \Delta_\alpha - \Delta_\sigma + \Delta_\nu - \Delta_\mu) + i \frac{(k_\nu - k_\mu) \cdot (p' - \hbar k_\beta + \hbar q - \hbar k_\sigma)}{m} - i \frac{k_\sigma \cdot (p' - \hbar k_\beta + \hbar q)}{m} + i \frac{k_\alpha \cdot (p + \hbar q)}{m} - i \frac{k_\beta \cdot p'}{m} - i \frac{\hbar k_\mu \cdot k_\nu}{m} + 3i\omega_k)t)} \\
& \quad + \left[\frac{(\gamma_1 - i(+\Delta_\alpha - \Delta_\sigma + \Delta_\nu - \Delta_\mu) + i \frac{(k_\nu - k_\mu) \cdot (p' - \hbar k_\beta + \hbar q - \hbar k_\sigma)}{m} - i \frac{k_\sigma \cdot (p' - \hbar k_\beta + \hbar q)}{m} \dots}{\dots} \right. \\
& \quad \quad \quad + i \frac{k_\alpha \cdot (p + \hbar q)}{m} - \frac{p \cdot q}{m} + i \frac{(p' - \hbar k_\beta) \cdot q}{m} - i \frac{\hbar k_\mu \cdot k_\nu}{m} + 2i\omega_k) \\
& \quad \quad \quad (\gamma_2 - i(+\Delta_\alpha - \Delta_\sigma + \Delta_\nu - \Delta_\mu) + i \frac{(k_\nu - k_\mu) \cdot (p' - \hbar k_\beta + \hbar q - \hbar k_\sigma)}{m} \dots}{\dots} \\
& \quad \quad \quad - i \frac{k_\sigma \cdot (p' - \hbar k_\beta + \hbar q)}{m} + i \frac{k_\alpha \cdot (p + \hbar q)}{m} - i \frac{\hbar k_\mu \cdot k_\nu}{m} + 2i\omega_k) \\
& \quad \quad \quad (\gamma - i(-\Delta_\sigma + \Delta_\nu - \Delta_\mu) + i \frac{(k_\nu - k_\mu) \cdot (p' - \hbar k_\beta + \hbar q - \hbar k_\sigma)}{m} \dots}{\dots} \\
& \quad \quad \quad \quad \quad \quad - i \frac{k_\sigma \cdot (p' - \hbar k_\beta + \hbar q)}{m} - i \frac{\hbar k_\mu \cdot k_\nu}{m} + 3i\omega_k) \\
& \quad \quad \quad (\gamma_1 - i(\Delta_\nu - \Delta_\mu) + i \frac{(k_\nu - k_\mu) \cdot (p' - \hbar k_\beta + \hbar q - \hbar k_\sigma)}{m} - i \frac{\hbar k_\mu \cdot k_\nu}{m} + 2i\omega_k) \\
& \quad \quad \quad (\gamma + i\Delta_\mu - i \frac{k_\mu \cdot (p + \hbar q - \hbar k_\alpha)}{m} - i\omega_k) \\
& \times W(p + \hbar q - \hbar k_\alpha, p' - \hbar k_\beta + \hbar q - \hbar k_\sigma + \hbar k_\nu - \hbar k_\mu)
\end{aligned}$$

$$\begin{aligned}
& i(\Omega_\beta^* \Omega_\alpha \Omega_\sigma^* \Omega_\nu^* \Omega_\mu \times \dots \\
& e^{i(\Delta_\beta - \Delta_\alpha + \Delta_\sigma + \Delta_\nu - \Delta_\mu) - i \frac{(k_\nu - k_\mu) \cdot (p + \hbar q - \hbar k_\alpha)}{m} - i \frac{k_\sigma \cdot (p' - \hbar k_\beta + \hbar q)}{m} + i \frac{k_\alpha \cdot (p + \hbar q)}{m} - i \frac{k_\beta \cdot p'}{m} + i \frac{\hbar k_\mu \cdot k_\nu}{m} - i \omega_k) t} \\
& \frac{(\gamma_1 + i(-\Delta_\alpha + \Delta_\sigma + \Delta_\nu - \Delta_\mu) - i \frac{(k_\nu - k_\mu) \cdot (p + \hbar q - \hbar k_\alpha)}{m} - i \frac{k_\sigma \cdot (p' + \hbar q)}{m} \dots}{+ i \frac{k_\alpha \cdot (p + \hbar q)}{m} - \frac{p \cdot q}{m} + i \frac{(p' - \hbar k_\beta) \cdot q}{m} + i \frac{\hbar k_\mu \cdot k_\nu}{m} - 2i\omega_k)}{(\gamma_2 + i(-\Delta_\alpha + \Delta_\sigma + \Delta_\nu - \Delta_\mu) - i \frac{(k_\nu - k_\mu) \cdot (p + \hbar q - \hbar k_\alpha)}{m} - i \frac{k_\sigma \cdot (p' - \hbar k_\beta + \hbar q)}{m} \dots}{+ i \frac{k_\alpha \cdot (p + \hbar q)}{m} + i \frac{\hbar k_\mu \cdot k_\nu}{m} - 2i\omega_k)} \\
& (\gamma + i(\Delta_\sigma + \Delta_\nu - \Delta_\mu) - i \frac{(k_\nu - k_\mu) \cdot (p + \hbar q - \hbar k_\alpha)}{m} \dots}{- i \frac{k_\sigma \cdot (p' - \hbar k_\beta + \hbar q)}{m} + i \frac{\hbar k_\mu \cdot k_\nu}{m} - i\omega_k)} \\
& (\gamma_1 + i(\Delta_\nu - \Delta_\mu) - i \frac{(k_\nu - k_\mu) \cdot (p + \hbar q - \hbar k_\alpha)}{m} + i \frac{\hbar k_\mu \cdot k_\nu}{m} - 2i\omega_k)} \\
& (\gamma - i\Delta_\mu + i \frac{k_\mu \cdot (p + \hbar q - \hbar k_\alpha + \hbar k_\nu - \hbar k_\mu)}{m} + i\omega_k)} \\
& \times W(p' - \hbar k_\beta + \hbar q - \hbar k_\sigma, p + \hbar q - \hbar k_\alpha + \hbar k_\nu - \hbar k_\mu) \\
& + \int \Gamma N(q') dq' e^{(-i \frac{(p + \hbar q - \hbar k_\alpha) \cdot q'}{m} + i \frac{(p' - \hbar k_\beta + \hbar q - \hbar k_\sigma) \cdot q'}{m}) t} \times \\
& i(\Omega_\beta^* \Omega_\alpha \Omega_\sigma^* \Omega_\nu^* \Omega_\mu \times \dots \\
& e^{i(\Delta_\beta - \Delta_\alpha + \Delta_\sigma + \Delta_\nu - \Delta_\mu) - i \frac{(k_\nu - k_\mu) \cdot (p' - \hbar k_\beta + \hbar q + \hbar q')}{m} - i \frac{k_\sigma \cdot (p' - \hbar k_\beta + \hbar q)}{m} + i \frac{k_\alpha \cdot (p + \hbar q)}{m} - i \frac{k_\beta \cdot p'}{m} - i \frac{\hbar k_\mu \cdot k_\nu}{m} + 3i\omega_k) t} \\
& \left\{ \frac{(\gamma_1 + i(-\Delta_\alpha + \Delta_\sigma + \Delta_\nu - \Delta_\mu) - i \frac{(k_\nu - k_\mu) \cdot (p' - \hbar k_\beta + \hbar q + \hbar q')}{m} - i \frac{k_\sigma \cdot (p' - \hbar k_\beta + \hbar q)}{m} + i \frac{k_\alpha \cdot (p + \hbar q)}{m} \dots}{- i \frac{(p + \hbar q - \hbar k_\alpha) \cdot q'}{m} + i \frac{(p' - \hbar k_\beta + \hbar q - \hbar k_\sigma) \cdot q'}{m} - i \frac{p \cdot q}{m} + i \frac{(p' - \hbar k_\beta) \cdot q}{m} - i \frac{\hbar k_\mu \cdot k_\nu}{m} + 2i\omega_k)}{(\gamma_2 + i(-\Delta_\alpha + \Delta_\sigma + \Delta_\nu - \Delta_\mu) - i \frac{(k_\nu - k_\mu) \cdot (p' - \hbar k_\beta + \hbar q + \hbar q')}{m} - i \frac{k_\sigma \cdot (p' - \hbar k_\beta + \hbar q)}{m} + i \frac{k_\alpha \cdot (p + \hbar q)}{m} \dots}{- i \frac{\hbar k_\mu \cdot k_\nu}{m} + 2i\omega_k - i \frac{(p + \hbar q - \hbar k_\alpha) \cdot q'}{m} + i \frac{(p' - \hbar k_\beta + \hbar q - \hbar k_\sigma) \cdot q'}{m}})} \right. \\
& (\gamma + i(\Delta_\sigma + \Delta_\nu - \Delta_\mu) - i \frac{(k_\nu - k_\mu) \cdot (p' - \hbar k_\beta + \hbar q + \hbar q')}{m} - i \frac{k_\sigma \cdot (p' - \hbar k_\beta)}{m} \dots}{- i \frac{\hbar k_\mu \cdot k_\nu}{m} + 3i\omega_k - i \frac{(p + \hbar q - \hbar k_\alpha) \cdot q'}{m} + i \frac{(p' - \hbar k_\beta + \hbar q - \hbar k_\sigma) \cdot q'}{m}})} \\
& (\gamma_1 + i(\Delta_\nu - \Delta_\mu) - i \frac{(k_\nu - k_\mu) \cdot (p' - \hbar k_\beta + \hbar q - \hbar k_\sigma + \hbar q')}{m} - i \frac{\hbar k_\mu \cdot k_\nu}{m} \dots}{+ 2i\omega_k - i \frac{(p + \hbar q - \hbar k_\alpha + \hbar q') \cdot q'}{m} + i \frac{(p' - \hbar k_\beta + \hbar q - \hbar k_\sigma) \cdot q'}{m}})} \\
& (\gamma_2 + i(\Delta_\nu - \Delta_\mu) - i \frac{(k_\nu - k_\mu) \cdot (p' - \hbar k_\beta + \hbar q - \hbar k_\sigma + \hbar q')}{m} \dots}{- i \frac{\hbar k_\mu \cdot k_\nu}{m} + 2i\omega_k)} \\
& (\gamma - i\Delta_\mu + i \frac{k_\mu \cdot (p + \hbar q - \hbar k_\alpha + \hbar q')}{m} - i\omega_k) \\
& \times W(p' - \hbar k_\beta + \hbar q - \hbar k_\sigma + \hbar q' - \hbar k_\nu, p + \hbar q - \hbar k_\alpha + \hbar q' - \hbar k_\mu)
\end{aligned}$$

$$\begin{aligned}
& i(\Omega_\beta^* \Omega_\alpha \Omega_\sigma^* \Omega_\nu \Omega_\mu^* \times \dots \\
& e^{(-i(-\Delta_\beta + \Delta_\alpha - \Delta_\sigma + \Delta_\nu - \Delta_\mu) + i \frac{(k_\nu - k_\mu) \cdot (p + \hbar q - \hbar k_\alpha + \hbar q)}{m} - i \frac{k_\sigma \cdot (p' - \hbar k_\beta + \hbar q)}{m} + i \frac{k_\alpha \cdot (p + \hbar q)}{m} - i \frac{k_\beta \cdot p'}{m} - i \frac{\hbar k_\mu \cdot k_\nu}{m} - i \omega_k) t)} \\
& + \frac{(\gamma_1 - i(\Delta_\alpha - \Delta_\sigma + \Delta_\nu - \Delta_\mu) + i \frac{(k_\nu - k_\mu) \cdot (p + \hbar q - \hbar k_\alpha + \hbar q)}{m} - i \frac{k_\sigma \cdot (p' - \hbar k_\beta + \hbar q)}{m} + i \frac{k_\alpha \cdot (p + \hbar q)}{m} \dots \\
& \quad - i \frac{(p + \hbar q - \hbar k_\alpha) \cdot q'}{m} + i \frac{(p' - \hbar k_\beta + \hbar q - \hbar k_\sigma) \cdot q'}{m} - \frac{p \cdot q}{m} + \frac{(p' - \hbar k_\beta) \cdot q}{m} - i \frac{\hbar k_\mu \cdot k_\nu}{m} - 2i\omega_k)}{(\gamma_2 - i(\Delta_\alpha - \Delta_\sigma + \Delta_\nu - \Delta_\mu) + i \frac{(k_\nu - k_\mu) \cdot (p + \hbar q - \hbar k_\alpha + \hbar q)}{m} - i \frac{k_\sigma \cdot (p' - \hbar k_\beta + \hbar q)}{m} + i \frac{k_\alpha \cdot (p + \hbar q)}{m} \dots \\
& \quad - i \frac{\hbar k_\mu \cdot k_\nu}{m} - 2i\omega_k - i \frac{(p + \hbar q - \hbar k_\alpha) \cdot q'}{m} + i \frac{(p' - \hbar k_\beta + \hbar q - \hbar k_\sigma) \cdot q'}{m})} \\
& \quad (\gamma - i(-\Delta_\sigma + \Delta_\nu - \Delta_\mu) + i \frac{(k_\nu - k_\mu) \cdot (p + \hbar q - \hbar k_\alpha + \hbar q)}{m} - i \frac{k_\sigma \cdot (p' - \hbar k_\beta + \hbar q)}{m} \dots \\
& \quad - i \frac{\hbar k_\mu \cdot k_\nu}{m} - i\omega_k - i \frac{(p + \hbar q - \hbar k_\alpha) \cdot q'}{m} + i \frac{(p' - \hbar k_\beta + \hbar q - \hbar k_\sigma) \cdot q'}{m})} \\
& \quad (\gamma_1 - i(\Delta_\nu - \Delta_\mu) + i \frac{(k_\nu - k_\mu) \cdot (p + \hbar q - \hbar k_\alpha + \hbar q)}{m} - i \frac{\hbar k_\mu \cdot k_\nu}{m} \dots \\
& \quad - 2i\omega_k - i \frac{(p + \hbar q - \hbar k_\alpha + \hbar q') \cdot q'}{m} + i \frac{(p' - \hbar k_\beta + \hbar q - \hbar k_\sigma) \cdot q'}{m})} \\
& \quad (\gamma_2 - i(\Delta_\nu - \Delta_\mu) + i \frac{(k_\nu - k_\mu) \cdot (p + \hbar q - \hbar k_\alpha + \hbar q)}{m} - i \frac{\hbar k_\mu \cdot k_\nu}{m} - 2i\omega_k) \\
& \quad (\gamma + i\Delta_\mu - i \frac{k_\mu \cdot (p' - \hbar k_\beta + \hbar q - \hbar k_\sigma + \hbar q')}{m} + i\omega_k) \\
& \times W(p + \hbar q - \hbar k_\alpha + \hbar q' - \hbar k_\nu, p' - \hbar k_\beta - \hbar k_\sigma + \hbar q - \hbar k_\sigma + \hbar q' - \hbar k_\mu) \} \\
& i(\Omega_\beta^* \Omega_\alpha \Omega_\sigma^* \Omega_\nu \Omega_\mu^* \times \dots \\
& - \left\{ e^{(i(\Delta_\beta - \Delta_\alpha + \Delta_\sigma + \Delta_\nu - \Delta_\mu) - i \frac{(k_\nu - k_\mu) \cdot (p' - \hbar k_\beta + \hbar q)}{m} - i \frac{k_\sigma \cdot (p + \hbar q - \hbar k_\alpha)}{m} + i \frac{k_\alpha \cdot (p + \hbar q)}{m} - i \frac{k_\beta \cdot p'}{m} - i \frac{\hbar k_\mu \cdot k_\nu}{m} + i \omega_k) t)} \right. \\
& \quad (\gamma_1 + i(-\Delta_\alpha + \Delta_\sigma + \Delta_\nu - \Delta_\mu) - i \frac{(k_\nu - k_\mu) \cdot (p' - \hbar k_\beta + \hbar q)}{m} - i \frac{k_\sigma \cdot (p + \hbar q - \hbar k_\alpha)}{m} \dots \\
& \quad \quad + i \frac{k_\alpha \cdot (p + \hbar q)}{m} - \frac{p \cdot q}{m} + \frac{(p' - \hbar k_\beta) \cdot q}{m} - i \frac{\hbar k_\mu \cdot k_\nu}{m}) \\
& \quad (\gamma_2 + i(-\Delta_\alpha + \Delta_\sigma + \Delta_\nu - \Delta_\mu) - i \frac{(k_\nu - k_\mu) \cdot (p' - \hbar k_\beta + \hbar q)}{m} - i \frac{k_\sigma \cdot (p + \hbar q - \hbar k_\alpha)}{m} \dots \\
& \quad \quad + i \frac{k_\alpha \cdot (p + \hbar q)}{m} - i \frac{\hbar k_\mu \cdot k_\nu}{m}) \\
& \quad (\gamma + i(\Delta_\sigma + \Delta_\nu - \Delta_\mu) - i \frac{(k_\nu - k_\mu) \cdot (p' - \hbar k_\beta + \hbar q)}{m} \dots \\
& \quad \quad - i \frac{k_\sigma \cdot (p + \hbar q - \hbar k_\alpha)}{m} - i \frac{\hbar k_\mu \cdot k_\nu}{m} + i\omega_k) \\
& \quad (\gamma_2 + i(\Delta_\nu - \Delta_\mu) - i \frac{(k_\nu - k_\mu) \cdot (p' - \hbar k_\beta + \hbar q)}{m} \dots \\
& \quad \quad - i \frac{\hbar k_\mu \cdot k_\nu}{m} + 2i\omega_k) \\
& \quad (\gamma - i\Delta_\mu + i \frac{k_\mu \cdot (p + \hbar q - \hbar k_\alpha + \hbar k_\sigma)}{m} - i\omega_k) \\
& \times W(p' - \hbar k_\beta + \hbar q - \hbar k_\nu, p + \hbar q - \hbar k_\alpha + \hbar k_\sigma - \hbar k_\mu) \\
& i(\Omega_\beta^* \Omega_\alpha \Omega_\sigma^* \Omega_\nu \Omega_\mu^* \times \dots \\
& e^{(-i(-\Delta_\beta - \Delta_\alpha + \Delta_\sigma + \Delta_\nu - \Delta_\mu) + i \frac{(k_\nu - k_\mu) \cdot (p + \hbar q - \hbar k_\alpha + \hbar k_\sigma)}{m} - i \frac{k_\sigma \cdot (p + \hbar q - \hbar k_\alpha)}{m} + i \frac{k_\alpha \cdot (p + \hbar q)}{m} - i \frac{k_\beta \cdot p'}{m} - i \frac{\hbar k_\mu \cdot k_\nu}{m} - 3i\omega_k) t)} \\
& + \frac{(\gamma_1 - i(-\Delta_\alpha + \Delta_\sigma + \Delta_\nu - \Delta_\mu) + i \frac{(k_\nu - k_\mu) \cdot (p + \hbar q - \hbar k_\alpha + \hbar k_\sigma)}{m} \dots \\
& \quad - i \frac{k_\sigma \cdot (p + \hbar q - \hbar k_\alpha)}{m} + i \frac{k_\alpha \cdot (p + \hbar q)}{m} - \frac{p \cdot q}{m} + \frac{(p' - \hbar k_\beta) \cdot q}{m} - i \frac{\hbar k_\mu \cdot k_\nu}{m} - 4i\omega_k)}{(\gamma_2 - i(-\Delta_\alpha - \Delta_\sigma + \Delta_\nu - \Delta_\mu) + i \frac{(k_\nu - k_\mu) \cdot (p + \hbar q - \hbar k_\alpha + \hbar k_\sigma)}{m} \dots \\
& \quad - i \frac{k_\sigma \cdot (p + \hbar q - \hbar k_\alpha)}{m} + i \frac{k_\alpha \cdot (p + \hbar q)}{m} - i \frac{\hbar k_\mu \cdot k_\nu}{m} - 4i\omega_k)} \\
& \quad (\gamma - i(-\Delta_\sigma + \Delta_\nu - \Delta_\mu) + i \frac{(k_\nu - k_\mu) \cdot (p + \hbar q - \hbar k_\alpha + \hbar k_\sigma)}{m} \dots \\
& \quad \quad - i \frac{k_\sigma \cdot (p + \hbar q - \hbar k_\alpha)}{m} - i \frac{\hbar k_\mu \cdot k_\nu}{m} - 3i\omega_k) \\
& \quad (\gamma_2 - i(\Delta_\nu - \Delta_\mu) + i \frac{(k_\nu - k_\mu) \cdot (p + \hbar q - \hbar k_\alpha + \hbar k_\sigma)}{m} \dots \\
& \quad \quad - i \frac{\hbar k_\mu \cdot k_\nu}{m} - 2i\omega_k) \\
& \quad (\gamma + i\Delta_\mu - i \frac{k_\mu \cdot (p' - \hbar k_\beta + \hbar q)}{m} + i\omega_k) \\
& \times W(p + \hbar q - \hbar k_\alpha + \hbar k_\sigma - \hbar k_\nu, p' - \hbar k_\beta + \hbar q - \hbar k_\mu) \} \\
\end{aligned}$$

$$\begin{aligned}
&] \\
& - \\
& [\\
& -i(\Omega_\beta^* \Omega_\alpha^* \Omega_\sigma \Omega_\nu^* \Omega_\mu \times \dots \\
& e^{(i(\Delta_\beta + \Delta_\alpha - \Delta_\sigma + \Delta_\nu - \Delta_\mu) - i \frac{(k_\nu - k_\mu) \cdot (p + \hbar k_\beta - \hbar k_\sigma)}{m} + i \frac{k_\sigma \cdot (p + \hbar k_\beta)}{m} - i \frac{k_\alpha \cdot p'}{m} - i \frac{k_\beta \cdot p}{m} + i \frac{\hbar k_\mu \cdot k_\nu}{m} - 3i\omega_k)t)} \\
& \left[- \frac{(\gamma_2 + i(+\Delta_\alpha - \Delta_\sigma + \Delta_\nu - \Delta_\mu) - i \frac{(k_\nu - k_\mu) \cdot (p + \hbar k_\beta - \hbar k_\sigma)}{m} \dots}{+ i \frac{k_\sigma \cdot (p + \hbar k_\beta)}{m} - i \frac{k_\alpha \cdot p'}{m} + i \frac{\hbar k_\mu \cdot k_\nu}{m} - 2i\omega_k)}{(\gamma + i(-\Delta_\sigma + \Delta_\nu - \Delta_\mu) - i \frac{(k_\nu - k_\mu) \cdot (p + \hbar k_\beta - \hbar k_\sigma)}{m} \dots}{+ i \frac{k_\sigma \cdot p}{m} + i \frac{\hbar k_\mu \cdot k_\nu}{m} - 3i\omega_k)} \right. \\
& \left. (\gamma_1 + i(\Delta_\nu - \Delta_\mu) - i \frac{(k_\nu - k_\mu) \cdot (p + \hbar k_\beta - \hbar k_\sigma)}{m} + i \frac{\hbar k_\mu \cdot k_\nu}{m} - 2i\omega_k) \right. \\
& \left. (\gamma - i\Delta_\mu + i \frac{k_\mu \cdot (p' - \hbar k_\alpha)}{m} + i\omega_k) \right) \\
& \times W(p' - \hbar k_\alpha, p + \hbar k_\beta - \hbar k_\sigma + \hbar k_\nu - \hbar k_\mu) \\
& -i(\Omega_\beta^* \Omega_\alpha^* \Omega_\sigma \Omega_\nu^* \Omega_\mu \times \dots \\
& e^{(-i(-\Delta_\beta - \Delta_\alpha + \Delta_\sigma + \Delta_\nu - \Delta_\mu) + i \frac{(k_\nu - k_\mu) \cdot (p' - \hbar k_\alpha)}{m} + i \frac{k_\sigma \cdot (p + \hbar k_\beta)}{m} - i \frac{k_\alpha \cdot p'}{m} - i \frac{k_\beta \cdot p}{m} - i \frac{\hbar k_\mu \cdot k_\nu}{m} + i\omega_k)t)} \\
& \left[- \frac{(\gamma_2 - i(+\Delta_\alpha + \Delta_\sigma + \Delta_\nu - \Delta_\mu) + i \frac{(k_\nu - k_\mu) \cdot (p' - \hbar k_\alpha)}{m} \dots}{+ i \frac{k_\sigma \cdot (p + \hbar k_\beta)}{m} - i \frac{k_\alpha \cdot p'}{m} - i \frac{\hbar k_\mu \cdot k_\nu}{m} + 2i\omega_k)}{(\gamma - i(\Delta_\sigma + \Delta_\nu - \Delta_\mu) + i \frac{(k_\nu - k_\mu) \cdot (p' - \hbar k_\alpha)}{m} + i \frac{k_\sigma \cdot (p + \hbar k_\beta)}{m} \dots}{- i \frac{\hbar k_\mu \cdot k_\nu}{m} + i\omega_k)} \right. \\
& \left. (\gamma_1 - i(\Delta_\nu - \Delta_\mu) + i \frac{(k_\nu - k_\mu) \cdot (p' - \hbar k_\alpha)}{m} \dots}{- i \frac{\hbar k_\mu \cdot k_\nu}{m} + 2i\omega_k)} \right. \\
& \left. (\gamma + i\Delta_\mu - i \frac{k_\mu \cdot (p' - \hbar k_\alpha + \hbar k_\nu - \hbar k_\mu)}{m} - i\omega_k) \right) \\
& \times W(p + \hbar k_\beta - \hbar k_\sigma, p' - \hbar k_\alpha + \hbar k_\nu - \hbar k_\mu) \\
& + \int \Gamma N(q) dq e^{(+i \frac{(p' - \hbar k_\alpha) \cdot q}{m} - i \frac{(p + \hbar k_\beta - \hbar k_\sigma) \cdot q}{m})t} \times \\
& i(\Omega_\beta^* \Omega_\alpha^* \Omega_\sigma \Omega_\nu^* \Omega_\mu \times \dots \\
& \left\{ e^{(-i(-\Delta_\beta - \Delta_\alpha + \Delta_\sigma + \Delta_\nu - \Delta_\mu) + i \frac{(k_\nu - k_\mu) \cdot (p + \hbar k_\beta + \hbar q)}{m} + i \frac{k_\sigma \cdot (p + \hbar k_\beta)}{m} - i \frac{k_\alpha \cdot p'}{m} - i \frac{k_\beta \cdot p}{m} + i \frac{\hbar k_\mu \cdot k_\nu}{m} - i\omega_k)t)} \right. \\
& \left. (\gamma_2 - i(-\Delta_\alpha + \Delta_\sigma + \Delta_\nu - \Delta_\mu) + i \frac{(k_\nu - k_\mu) \cdot (p + \hbar k_\beta + \hbar q)}{m} + i \frac{k_\sigma \cdot (p + \hbar k_\beta)}{m} \dots}{- i \frac{k_\alpha \cdot p'}{m} + i \frac{\hbar k_\mu \cdot k_\nu}{m} - 2i\omega_k + i \frac{(p' - \hbar k_\alpha) \cdot q}{m} - i \frac{(p + \hbar k_\beta - \hbar k_\sigma) \cdot q}{m}} \right. \\
& \left. (\gamma - i(\Delta_\sigma + \Delta_\nu - \Delta_\mu) + i \frac{(k_\nu - k_\mu) \cdot (p + \hbar k_\beta + \hbar q)}{m} + i \frac{k_\sigma \cdot (p + \hbar k_\beta)}{m} \dots}{+ i \frac{\hbar k_\mu \cdot k_\nu}{m} - 3i\omega_k + i \frac{(p' - \hbar k_\alpha) \cdot q}{m} - i \frac{(p + \hbar k_\beta - \hbar k_\sigma) \cdot q}{m}} \right. \\
& \left. (\gamma_1 - i(\Delta_\nu - \Delta_\mu) + i \frac{(k_\nu - k_\mu) \cdot (p + \hbar k_\beta - \hbar k_\sigma + \hbar q)}{m} \dots}{+ i \frac{\hbar k_\mu \cdot k_\nu}{m} - 2i\omega_k + i \frac{(p' - \hbar k_\alpha + \hbar q) \cdot q}{m} - i \frac{(p + \hbar k_\beta - \hbar k_\sigma) \cdot q}{m}} \right. \\
& \left. (\gamma_2 - i(\Delta_\nu - \Delta_\mu) + i \frac{(k_\nu - k_\mu) \cdot (p + \hbar k_\beta - \hbar k_\sigma + \hbar q)}{m} \dots}{+ i \frac{\hbar k_\mu \cdot k_\nu}{m} - 2i\omega_k)} \right. \\
& \left. (\gamma + i\Delta_\mu - i \frac{k_\mu \cdot (p' - \hbar k_\alpha + \hbar q)}{m} + i\omega_k) \right) \\
& \times W(p + \hbar k_\beta - \hbar k_\sigma + \hbar q - \hbar k_\nu, p' - \hbar k_\alpha + \hbar q - \hbar k_\mu)
\end{aligned}$$

$$\begin{aligned}
& (\Omega_\beta^* \Omega_\alpha^* \Omega_\sigma \Omega_\nu^* \Omega_\mu \times \dots \\
& e^{i(\Delta_\beta + \Delta_\alpha - \Delta_\sigma + \Delta_\nu - \Delta_\mu) - i \frac{(k_\nu - k_\mu) \cdot (p' - \hbar k_\alpha + \hbar q)}{m} + i \frac{k_\sigma \cdot (p + \hbar k_\beta)}{m} - i \frac{k_\alpha \cdot p'}{m} - i \frac{k_\beta \cdot p}{m} + i \frac{\hbar k_\mu \cdot k_\nu}{m} + i \omega_k) t) \\
& + \frac{(\gamma_2 + i(+\Delta_\alpha - \Delta_\sigma + \Delta_\nu - \Delta_\mu) - i \frac{(k_\nu - k_\mu) \cdot (p' - \hbar k_\alpha + \hbar q)}{m} + i \frac{k_\sigma \cdot (p + \hbar k_\beta)}{m} \dots \\
& \quad - i \frac{k_\alpha \cdot p'}{m} + i \frac{\hbar k_\mu \cdot k_\nu}{m} + 2i\omega_k + i \frac{(p' - \hbar k_\alpha) \cdot q}{m} - i \frac{(p + \hbar k_\beta - \hbar k_\sigma) \cdot q}{m})}{(\gamma + i(-\Delta_\sigma + \Delta_\nu - \Delta_\mu) - i \frac{(k_\nu - k_\mu) \cdot (p' - \hbar k_\alpha + \hbar q)}{m} + i \frac{k_\sigma \cdot (p + \hbar k_\beta)}{m} \dots \\
& \quad + i \frac{\hbar k_\mu \cdot k_\nu}{m} + i\omega_k + i \frac{(p' - \hbar k_\alpha) \cdot q}{m} - i \frac{(p + \hbar k_\beta - \hbar k_\sigma) \cdot q}{m})} \\
& \quad (\gamma_1 + i(\Delta_\nu - \Delta_\mu) - i \frac{(k_\nu - k_\mu) \cdot (p' - \hbar k_\alpha + \hbar q)}{m} + i \frac{\hbar k_\mu \cdot k_\nu}{m} \dots \\
& \quad + 2i\omega_k + \frac{(p' - \hbar k_\alpha + \hbar q) \cdot q}{m} - \frac{(p + \hbar k_\beta - \hbar k_\sigma) \cdot q}{m})} \\
& \quad (\gamma_2 + i(\Delta_\nu - \Delta_\mu) - i \frac{(k_\nu - k_\mu) \cdot (p' - \hbar k_\alpha + \hbar q)}{m} \dots \\
& \quad + i \frac{\hbar k_\mu \cdot k_\nu}{m} + 2i\omega_k) \\
& \quad (\gamma - i\Delta_\mu + i \frac{k_\mu \cdot (p + \hbar k_\beta - \hbar k_\sigma + \hbar q)}{m} - i\omega_k) \\
& \times W(p' - \hbar k_\alpha + \hbar q - \hbar k_\nu, p + \hbar k_\beta - \hbar k_\sigma + \hbar q - \hbar k_\mu) \} \\
& i(\Omega_\beta^* \Omega_\alpha^* \Omega_\sigma \Omega_\nu \Omega_\mu^* \times \dots \\
& + \{ e^{(-i(-\Delta_\beta + \Delta_\alpha + \Delta_\sigma + \Delta_\nu - \Delta_\mu) + i \frac{(k_\nu - k_\mu) \cdot (p + \hbar k_\beta)}{m} + i \frac{k_\sigma \cdot (p' - \hbar k_\alpha)}{m} - i \frac{k_\alpha \cdot p'}{m} - i \frac{k_\beta \cdot p}{m} + i \frac{\hbar k_\mu \cdot k_\nu}{m} - 3i\omega_k) t) \\
& \quad (\gamma_2 - i(-\Delta_\alpha + \Delta_\sigma + \Delta_\nu - \Delta_\mu) + i \frac{(k_\nu - k_\mu) \cdot (p + \hbar k_\beta)}{m} \dots \\
& \quad + i \frac{k_\sigma \cdot (p' - \hbar k_\alpha)}{m} - i \frac{k_\alpha \cdot p'}{m} + i \frac{\hbar k_\mu \cdot k_\nu}{m} - 2i\omega_k) \\
& \quad (\gamma - i(\Delta_\sigma + \Delta_\nu - \Delta_\mu) + i \frac{(k_\nu - k_\mu) \cdot (p + \hbar k_\beta)}{m} + i \frac{k_\sigma \cdot (p' - \hbar k_\alpha)}{m} \dots \\
& \quad + i \frac{\hbar k_\mu \cdot k_\nu}{m} - i\omega_k) \\
& \quad (\gamma_2 - i(\Delta_\nu - \Delta_\mu) + i \frac{(k_\nu - k_\mu) \cdot (p + \hbar k_\beta)}{m} \dots \\
& \quad + i \frac{\hbar k_\mu \cdot k_\nu}{m} - 2i\omega_k) \\
& \quad (\gamma + i\Delta_\mu - i \frac{k_\mu \cdot (p' - \hbar k_\alpha + \hbar k_\sigma)}{m} + i\omega_k) \\
& \times W(p + \hbar k_\beta - \hbar k_\nu, p' - \hbar k_\alpha + \hbar k_\sigma - \hbar k_\mu) \\
& i(\Omega_\beta^* \Omega_\alpha^* \Omega_\sigma \Omega_\nu^* \Omega_\mu \times \dots \\
& + \frac{e^{i(\Delta_\beta + \Delta_\alpha - \Delta_\sigma + \Delta_\nu - \Delta_\mu) - i \frac{(k_\nu - k_\mu) \cdot (p' - \hbar k_\alpha + \hbar k_\sigma)}{m} + i \frac{k_\sigma \cdot (p' - \hbar k_\alpha)}{m} - i \frac{k_\alpha \cdot p'}{m} - i \frac{k_\beta \cdot p}{m} + i \frac{\hbar k_\mu \cdot k_\nu}{m} + 3i\omega_k) t) \\
& \quad (\gamma_2 + i(+\Delta_\alpha - \Delta_\sigma + \Delta_\nu - \Delta_\mu) - i \frac{(k_\nu - k_\mu) \cdot (p' - \hbar k_\alpha + \hbar k_\sigma)}{m} + i \frac{k_\sigma \cdot (p' - \hbar k_\alpha)}{m} \dots \\
& \quad - i \frac{k_\alpha \cdot p'}{m} + i \frac{\hbar k_\mu \cdot k_\nu}{m} + 4i\omega_k) \\
& \quad (\gamma + i(-\Delta_\sigma + \Delta_\nu - \Delta_\mu) - i \frac{(k_\nu - k_\mu) \cdot (p' - \hbar k_\alpha + \hbar k_\sigma)}{m} \dots \\
& \quad + i \frac{k_\sigma \cdot (p' - \hbar k_\alpha)}{m} + i \frac{\hbar k_\mu \cdot k_\nu}{m} + 3i\omega_k) \\
& \quad (\gamma_2 + i(\Delta_\nu - \Delta_\mu) - i \frac{(k_\nu - k_\mu) \cdot (p' - \hbar k_\alpha + \hbar k_\sigma)}{m} \dots \\
& \quad + i \frac{\hbar k_\mu \cdot k_\nu}{m} + 2i\omega_k) \\
& \quad (\gamma - i\Delta_\mu + i \frac{k_\mu \cdot (p + \hbar k_\beta)}{m} - i\omega_k) \\
& \times W(p' - \hbar k_\alpha + \hbar k_\sigma - \hbar k_\nu, p + \hbar k_\beta - \hbar k_\mu) \} \\
\end{aligned}$$

$$\begin{aligned}
& i(\Omega_\beta^* \Omega_\alpha \Omega_\sigma^* \Omega_\nu \Omega_\mu^* \times \dots \\
& e^{(-i(-\Delta_\beta + \Delta_\alpha - \Delta_\sigma + \Delta_\nu - \Delta_\mu) + i \frac{(k_\nu - k_\mu) \cdot (p' - \hbar k_\sigma)}{m} - i \frac{k_\sigma \cdot p'}{m} + i \frac{k_\alpha \cdot (p + \hbar k_\beta)}{m} - i \frac{k_\beta \cdot p}{m} - i \frac{\hbar k_\mu \cdot k_\nu}{m} + i \omega_k)t}) \\
& + \left[\frac{(\gamma_2 - i(\Delta_\alpha - \Delta_\sigma + \Delta_\nu - \Delta_\mu) + i \frac{(k_\nu - k_\mu) \cdot (p' - \hbar k_\sigma)}{m} - i \frac{k_\sigma \cdot p'}{m} \dots}{(\gamma_2 - i(\Delta_\alpha - \Delta_\sigma + \Delta_\nu - \Delta_\mu) + i \frac{(k_\nu - k_\mu) \cdot (p' - \hbar k_\sigma)}{m} - i \frac{k_\sigma \cdot p'}{m} \dots} \right. \\
& \quad \left. + i \frac{k_\alpha \cdot (p + \hbar k_\beta)}{m} - i \frac{\hbar k_\mu \cdot k_\nu}{m} + 2i\omega_k) \right. \\
& \quad (\gamma - i(-\Delta_\sigma + \Delta_\nu - \Delta_\mu) + i \frac{(k_\nu - k_\mu) \cdot (p' - \hbar k_\sigma)}{m} - i \frac{k_\sigma \cdot p'}{m} \dots \\
& \quad \quad \left. - i \frac{\hbar k_\mu \cdot k_\nu}{m} + 3i\omega_k) \right. \\
& \quad (\gamma_1 - i(\Delta_\nu - \Delta_\mu) + i \frac{(k_\nu - k_\mu) \cdot (p' - \hbar k_\sigma)}{m} \dots \\
& \quad \quad \left. - i \frac{\hbar k_\mu \cdot k_\nu}{m} + 2i\omega_k) \right. \\
& \quad \left. (\gamma + i\Delta_\mu - i \frac{k_\mu \cdot (p + \hbar k_\beta - \hbar k_\alpha)}{m} - i\omega_k) \right] \\
& \times W(p + \hbar k_\beta - \hbar k_\alpha, p' - \hbar k_\sigma + \hbar k_\nu - \hbar k_\mu) \\
& i(\Omega_\beta^* \Omega_\alpha \Omega_\sigma^* \Omega_\nu \Omega_\mu^* \times \dots \\
& e^{(i(\Delta_\beta - \Delta_\alpha + \Delta_\sigma + \Delta_\nu - \Delta_\mu) - i \frac{(k_\nu - k_\mu) \cdot (p + \hbar k_\beta - \hbar k_\alpha)}{m} - i \frac{k_\sigma \cdot p'}{m} + i \frac{k_\alpha \cdot (p + \hbar k_\beta)}{m} - i \frac{k_\beta \cdot p}{m} + i \frac{\hbar k_\mu \cdot k_\nu}{m} - 3i\omega_k)t}) \\
& - \frac{(\gamma_2 + i(-\Delta_\alpha + \Delta_\sigma + \Delta_\nu - \Delta_\mu) - i \frac{(k_\nu - k_\mu) \cdot (p + \hbar k_\beta - \hbar k_\alpha)}{m} \dots}{(\gamma_2 + i(-\Delta_\alpha + \Delta_\sigma + \Delta_\nu - \Delta_\mu) - i \frac{(k_\nu - k_\mu) \cdot (p + \hbar k_\beta - \hbar k_\alpha)}{m} \dots} \dots \\
& \quad - i \frac{k_\sigma \cdot p'}{m} + i \frac{k_\alpha \cdot (p + \hbar k_\beta)}{m} + i \frac{\hbar k_\mu \cdot k_\nu}{m} - 2i\omega_k) \dots \\
& \quad (\gamma + i(\Delta_\sigma + \Delta_\nu - \Delta_\mu) - i \frac{(k_\nu - k_\mu) \cdot (p + \hbar k_\beta - \hbar k_\alpha)}{m} \dots \\
& \quad \quad - i \frac{k_\sigma \cdot p'}{m} + i \frac{\hbar k_\mu \cdot k_\nu}{m} - i\omega_k) \dots \\
& \quad (\gamma_1 + i(\Delta_\nu - \Delta_\mu) - i \frac{(k_\nu - k_\mu) \cdot (p + \hbar k_\beta - \hbar k_\alpha)}{m} \dots \\
& \quad \quad + i \frac{\hbar k_\mu \cdot k_\nu}{m} - 2i\omega_k) \dots \\
& \quad (\gamma - i\Delta_\mu \dots \\
& \quad + i \frac{k_\mu \cdot (p + \hbar k_\beta - \hbar k_\alpha + \hbar k_\nu - \hbar k_\mu)}{m} + i\omega_k) \dots \\
& \times W(p' - \hbar k_\sigma, p + \hbar k_\beta - \hbar k_\alpha + \hbar k_\nu - \hbar k_\mu) \\
& + \int \Gamma N(q) dq e^{(-i \frac{(p + \hbar k_\beta - \hbar k_\alpha) \cdot q}{m} + i \frac{(p' - \hbar k_\sigma) \cdot q}{m})t} \times
\end{aligned}$$

$$\begin{aligned}
& i(\Omega_\beta^* \Omega_\alpha \Omega_\sigma^* \Omega_\nu \Omega_\mu^* \times \dots \\
& e^{(i(\Delta_\beta - \Delta_\alpha + \Delta_\sigma + \Delta_\nu - \Delta_\mu) - i \frac{(k_\nu - k_\mu) \cdot (p' + \hbar q)}{m} - i \frac{k_\sigma \cdot p'}{m} + i \frac{k_\alpha \cdot (p + \hbar k_\beta)}{m} - i \frac{k_\beta \cdot p}{m} - i \frac{\hbar k_\mu \cdot k_\nu}{m} + i \omega_k)t}) \\
& \left\{ \frac{(\gamma_2 + i(-\Delta_\alpha + \Delta_\sigma + \Delta_\nu - \Delta_\mu) - i \frac{(k_\nu - k_\mu) \cdot (p' + \hbar q)}{m} - i \frac{k_\sigma \cdot p'}{m} + i \frac{k_\alpha \cdot (p + \hbar k_\beta)}{m} \dots}{(\gamma_2 + i(-\Delta_\alpha + \Delta_\sigma + \Delta_\nu - \Delta_\mu) - i \frac{(k_\nu - k_\mu) \cdot (p' + \hbar q)}{m} - i \frac{k_\sigma \cdot p'}{m} + i \frac{k_\alpha \cdot (p + \hbar k_\beta)}{m} \dots} \dots} \right. \\
& \quad \left. - i \frac{\hbar k_\mu \cdot k_\nu}{m} + 2i\omega_k - i \frac{(p + \hbar k_\beta - \hbar k_\alpha) \cdot q}{m} + i \frac{(p' - \hbar k_\sigma) \cdot q}{m} \right. \\
& \quad (\gamma + i(\Delta_\sigma + \Delta_\nu - \Delta_\mu) - i \frac{(k_\nu - k_\mu) \cdot (p' + \hbar q)}{m} - i \frac{k_\sigma \cdot p'}{m} - i \frac{\hbar k_\mu \cdot k_\nu}{m} \dots \\
& \quad \quad + 3i\omega_k - i \frac{(p + \hbar k_\beta - \hbar k_\alpha) \cdot q}{m} + i \frac{(p' - \hbar k_\sigma) \cdot q}{m} \right. \\
& \quad (\gamma_1 + i(\Delta_\nu - \Delta_\mu) - i \frac{(k_\nu - k_\mu) \cdot (p' - \hbar k_\sigma + \hbar q)}{m} - i \frac{\hbar k_\mu \cdot k_\nu}{m} \dots \\
& \quad \quad + 2i\omega_k - i \frac{(p + \hbar k_\beta - \hbar k_\alpha + \hbar q) \cdot q}{m} + i \frac{(p' - \hbar k_\sigma) \cdot q}{m} \right. \\
& \quad (\gamma_2 + i(\Delta_\nu - \Delta_\mu) - i \frac{(k_\nu - k_\mu) \cdot (p' - \hbar k_\sigma + \hbar q)}{m} \dots \\
& \quad \quad \left. - i \frac{\hbar k_\mu \cdot k_\nu}{m} + 2i\omega_k) \right. \\
& \quad \left. (\gamma - i\Delta_\mu + i \frac{k_\mu \cdot (p + \hbar k_\beta - \hbar k_\alpha + \hbar q)}{m} - i\omega_k) \right\} \\
& \times W(p' - \hbar k_\sigma + \hbar q - \hbar k_\nu, p + \hbar k_\beta - \hbar k_\alpha + \hbar q - \hbar k_\mu)
\end{aligned}$$

$$\begin{aligned}
& i(\Omega_\beta^* \Omega_\alpha \Omega_\sigma^* \Omega_\nu \Omega_\mu^* \times \dots \\
& e^{(-i(-\Delta_\beta + \Delta_\alpha - \Delta_\sigma + \Delta_\nu - \Delta_\mu) + i \frac{(k_\nu - k_\mu) \cdot (p + \hbar k_\beta - \hbar k_\alpha + \hbar q)}{m} - i \frac{k_\sigma \cdot p'}{m} + i \frac{k_\alpha \cdot p}{m} - i \frac{k_\beta \cdot p}{m} - i \frac{\hbar k_\mu \cdot k_\nu}{m} - 3i\omega_k)t}) \\
& + \frac{(\gamma_2 - i(\Delta_\alpha - \Delta_\sigma + \Delta_\nu - \Delta_\mu) + i \frac{(k_\nu - k_\mu) \cdot (p + \hbar k_\beta - \hbar k_\alpha + \hbar q)}{m} - i \frac{k_\sigma \cdot p'}{m} \dots \\
& \quad + i \frac{k_\alpha \cdot (p + \hbar k_\beta)}{m} - i \frac{\hbar k_\mu \cdot k_\nu}{m} - 2i\omega_k - i \frac{(p + \hbar k_\beta - \hbar k_\alpha) \cdot q}{m} + i \frac{(p' - \hbar k_\sigma) \cdot q}{m}) \\
& \quad (\gamma - i(-\Delta_\sigma + \Delta_\nu - \Delta_\mu) + i \frac{(k_\nu - k_\mu) \cdot (p + \hbar k_\beta - \hbar k_\alpha + \hbar q)}{m} - i \frac{k_\sigma \cdot p'}{m} \dots \\
& \quad \quad - i \frac{\hbar k_\mu \cdot k_\nu}{m} - i\omega_k - i \frac{(p + \hbar k_\beta - \hbar k_\alpha) \cdot q}{m} + i \frac{(p' - \hbar k_\sigma) \cdot q}{m}) \\
& \quad \quad (\gamma_1 - i(\Delta_\nu - \Delta_\mu) + i \frac{(k_\nu - k_\mu) \cdot (p + \hbar k_\beta - \hbar k_\alpha + \hbar q)}{m} \dots \\
& \quad \quad - i \frac{\hbar k_\mu \cdot k_\nu}{m} - 2i\omega_k - i \frac{(p + \hbar k_\beta - \hbar k_\alpha + \hbar q) \cdot q}{m} + i \frac{(p' - \hbar k_\sigma) \cdot q}{m}) \\
& \quad \quad (\gamma_2 - i(\Delta_\nu - \Delta_\mu) + i \frac{(k_\nu - k_\mu) \cdot (p + \hbar k_\beta - \hbar k_\alpha + \hbar q)}{m} \dots \\
& \quad \quad \quad - i \frac{\hbar k_\mu \cdot k_\nu}{m} - 2i\omega_k) \\
& \quad \quad (\gamma + i\Delta_\mu - i \frac{k_\mu \cdot (p' - \hbar k_\sigma + \hbar q)}{m} + i\omega_k)}{(\gamma_2 + i(-\Delta_\alpha + \Delta_\sigma + \Delta_\nu - \Delta_\mu) - i \frac{(k_\nu - k_\mu) \cdot p'}{m} - i \frac{k_\sigma \cdot (p + \hbar k_\beta - \hbar k_\alpha)}{m} \dots \\
& \quad \quad \quad + i \frac{k_\alpha \cdot p}{m} - i \frac{\hbar k_\mu \cdot k_\nu}{m})} \\
& \quad \quad (\gamma + i(\Delta_\sigma + \Delta_\nu - \Delta_\mu) - i \frac{(k_\nu - k_\mu) \cdot p'}{m} - i \frac{k_\sigma \cdot (p + \hbar k_\beta - \hbar k_\alpha)}{m} \dots \\
& \quad \quad \quad - i \frac{\hbar k_\mu \cdot k_\nu}{m} + i\omega_k) \\
& \quad \quad (\gamma_2 + i(\Delta_\nu - \Delta_\mu) - i \frac{(k_\nu - k_\mu) \cdot p'}{m} - i \frac{\hbar k_\mu \cdot k_\nu}{m} + 2i\omega_k) \\
& \quad \quad (\gamma - i\Delta_\mu + i \frac{k_\mu \cdot (p + \hbar k_\beta - \hbar k_\alpha + \hbar k_\sigma)}{m} - i\omega_k)} \\
& \times W(p + \hbar k_\beta - \hbar k_\alpha + \hbar q - \hbar k_\nu, p' - \hbar k_\sigma + \hbar q - \hbar k_\mu) \} \\
& i(\Omega_\beta^* \Omega_\alpha \Omega_\sigma^* \Omega_\nu \Omega_\mu^* \times \dots \\
& e^{(i(\Delta_\beta - \Delta_\alpha + \Delta_\sigma + \Delta_\nu - \Delta_\mu) - i \frac{(k_\nu - k_\mu) \cdot p'}{m} - i \frac{k_\sigma \cdot (p + \hbar k_\beta - \hbar k_\alpha)}{m} + i \frac{k_\alpha \cdot (p + \hbar k_\beta)}{m} - i \frac{k_\beta \cdot p}{m} - i \frac{\hbar k_\mu \cdot k_\nu}{m} + i\omega_k)t}) \\
& - \left\{ \frac{(\gamma_2 + i(-\Delta_\alpha + \Delta_\sigma + \Delta_\nu - \Delta_\mu) - i \frac{(k_\nu - k_\mu) \cdot p'}{m} - i \frac{k_\sigma \cdot (p + \hbar k_\beta - \hbar k_\alpha)}{m} \dots \\
& \quad \quad \quad + i \frac{k_\alpha \cdot p}{m} - i \frac{\hbar k_\mu \cdot k_\nu}{m}) \\
& \quad \quad (\gamma + i(\Delta_\sigma + \Delta_\nu - \Delta_\mu) - i \frac{(k_\nu - k_\mu) \cdot p'}{m} - i \frac{k_\sigma \cdot (p + \hbar k_\beta - \hbar k_\alpha)}{m} \dots \\
& \quad \quad \quad - i \frac{\hbar k_\mu \cdot k_\nu}{m} + i\omega_k) \\
& \quad \quad (\gamma_2 + i(\Delta_\nu - \Delta_\mu) - i \frac{(k_\nu - k_\mu) \cdot p'}{m} - i \frac{\hbar k_\mu \cdot k_\nu}{m} + 2i\omega_k) \\
& \quad \quad (\gamma - i\Delta_\mu + i \frac{k_\mu \cdot (p + \hbar k_\beta - \hbar k_\alpha + \hbar k_\sigma)}{m} - i\omega_k)} \right. \\
& \times W(p' - \hbar k_\nu, p + \hbar k_\beta - \hbar k_\alpha + \hbar k_\sigma - \hbar k_\mu) \\
& i(\Omega_\beta^* \Omega_\alpha \Omega_\sigma^* \Omega_\nu \Omega_\mu^* \times \dots \\
& e^{(-i(-\Delta_\beta + \Delta_\alpha - \Delta_\sigma + \Delta_\nu - \Delta_\mu) + i \frac{(k_\nu - k_\mu) \cdot (p + \hbar k_\beta - \hbar k_\alpha + \hbar k_\sigma)}{m} - i \frac{k_\sigma \cdot (p + \hbar k_\beta - \hbar k_\alpha)}{m} + i \frac{k_\alpha \cdot (p + \hbar k_\beta)}{m} - i \frac{k_\beta \cdot p}{m} - i \frac{\hbar k_\mu \cdot k_\nu}{m} - 3i\omega_k)t}) \\
& + \frac{(\gamma_2 - i(\Delta_\alpha - \Delta_\sigma + \Delta_\nu - \Delta_\mu) + i \frac{(k_\nu - k_\mu) \cdot (p + \hbar k_\beta - \hbar k_\alpha + \hbar k_\sigma)}{m} \\
& \quad \quad - i \frac{k_\sigma \cdot (p + \hbar k_\beta - \hbar k_\alpha)}{m} + i \frac{k_\alpha \cdot (p + \hbar k_\beta)}{m} \\
& \quad \quad \quad - i \frac{\hbar k_\mu \cdot k_\nu}{m} - 4i\omega_k) \\
& \quad \quad (\gamma - i(-\Delta_\sigma + \Delta_\nu - \Delta_\mu) + i \frac{(k_\nu - k_\mu) \cdot (p + \hbar k_\beta - \hbar k_\alpha + \hbar k_\sigma)}{m} \dots \\
& \quad \quad \quad - i \frac{k_\sigma \cdot (p + \hbar k_\beta - \hbar k_\alpha)}{m} - i \frac{\hbar k_\mu \cdot k_\nu}{m} - 3i\omega_k) \\
& \quad \quad (\gamma_2 - i(\Delta_\nu - \Delta_\mu) + i \frac{(k_\nu - k_\mu) \cdot (p + \hbar k_\beta - \hbar k_\alpha + \hbar k_\sigma)}{m} \dots \\
& \quad \quad \quad - i \frac{\hbar k_\mu \cdot k_\nu}{m} - 2i\omega_k) \\
& \quad \quad (\gamma + i\Delta_\mu - i \frac{k_\mu \cdot p'}{m} + i\omega_k)} \\
& \times W(p + \hbar k_\beta - \hbar k_\alpha + \hbar k_\sigma - \hbar k_\nu, p' - \hbar k_\mu) \} \\
&]
\end{aligned}$$

The final solution can be written in the following way, where different colours are used for different kind of processes as explained afterwards:

$$\begin{aligned}
& \tilde{\rho}_{12}^{(5)}(p, p') = \\
& [\\
& \quad i(\Omega_\beta^* \Omega_\alpha \Omega_\sigma^* \Omega_\nu \Omega_\mu^* e^{-i(-\Delta_\beta + \Delta_\alpha - \Delta_\sigma + \Delta_\nu - \Delta_\mu)t} \times \dots \\
& \quad e^{(+i \frac{(k_\nu - k_\mu) \cdot (p' - \hbar k_\beta + \hbar k_\alpha - \hbar k_\sigma)}{m} - i \frac{k_\sigma \cdot (p' - \hbar k_\beta + \hbar k_\alpha)}{m} + i \frac{k_\alpha \cdot (p' - \hbar k_\beta)}{m} - i \frac{k_\beta \cdot p'}{m} - i \frac{\hbar k_\mu \cdot k_\nu}{m} + 5i\omega_k)t}) \\
& \quad \left[\left(\gamma - i(-\Delta_\beta + \Delta_\alpha - \Delta_\sigma + \Delta_\nu - \Delta_\mu) + i \frac{(k_\nu - k_\mu) \cdot (p' - \hbar k_\beta + \hbar k_\alpha - \hbar k_\sigma)}{m} \dots \right. \right. \\
& \quad \quad \left. \left. - i \frac{k_\sigma \cdot (p' - \hbar k_\beta + \hbar k_\alpha)}{m} + i \frac{k_\alpha \cdot (p' - \hbar k_\beta)}{m} - i \frac{k_\beta \cdot p'}{m} - i \frac{\hbar k_\mu \cdot k_\nu}{m} + 5i\omega_k \right) \right. \\
& \quad \quad \left(\gamma_1 - i(+\Delta_\alpha - \Delta_\sigma + \Delta_\nu - \Delta_\mu) + i \frac{(k_\nu - k_\mu) \cdot (p' - \hbar k_\beta + \hbar k_\alpha - \hbar k_\sigma)}{m} \dots \right. \\
& \quad \quad \quad \left. - i \frac{k_\sigma \cdot (p' - \hbar k_\beta + \hbar k_\alpha)}{m} + i \frac{k_\alpha \cdot (p' - \hbar k_\beta)}{m} - i \frac{\hbar k_\mu \cdot k_\nu}{m} + 4i\omega_k \right) \\
& \quad \quad \left(\gamma - i(-\Delta_\sigma + \Delta_\nu - \Delta_\mu) + i \frac{(k_\nu - k_\mu) \cdot (p' - \hbar k_\beta + \hbar k_\alpha - \hbar k_\sigma)}{m} \dots \right. \\
& \quad \quad \quad \left. - i \frac{k_\sigma \cdot (p' - \hbar k_\beta + \hbar k_\alpha)}{m} - i \frac{\hbar k_\mu \cdot k_\nu}{m} + 3i\omega_k \right) \\
& \quad \quad \left(\gamma_1 - i(\Delta_\nu - \Delta_\mu) + i \frac{(k_\nu - k_\mu) \cdot (p' - \hbar k_\beta + \hbar k_\alpha - \hbar k_\sigma)}{m} \dots \right. \\
& \quad \quad \quad \left. - i \frac{\hbar k_\mu \cdot k_\nu}{m} + 2i\omega_k \right) \\
& \quad \quad \left. \left. (\gamma + i\Delta_\mu - i \frac{k_\mu \cdot p}{m} - i\omega_k) \right) \right. \\
& \quad \times W(p, p' - \hbar k_\beta + \hbar k_\alpha - \hbar k_\sigma + \hbar k_\nu - \hbar k_\mu) \tag{1.a} \\
& \quad i(\Omega_\beta^* \Omega_\alpha \Omega_\sigma^* \Omega_\nu \Omega_\mu \times \dots \\
& \quad e^{(i(\Delta_\beta - \Delta_\alpha + \Delta_\sigma + \Delta_\nu - \Delta_\mu) - i \frac{(k_\nu - k_\mu) \cdot p}{m} - i \frac{k_\sigma \cdot (p' - \hbar k_\beta + \hbar k_\alpha)}{m} + i \frac{k_\alpha \cdot (p' - \hbar k_\beta)}{m} - i \frac{k_\beta \cdot p'}{m} + i \frac{\hbar k_\mu \cdot k_\nu}{m} + i\omega_k)t}) \\
& \quad + \frac{(\gamma + i(\Delta_\beta - \Delta_\alpha + \Delta_\sigma + \Delta_\nu - \Delta_\mu) - i \frac{(k_\nu - k_\mu) \cdot p}{m} \dots}{- i \frac{k_\sigma \cdot (p' - \hbar k_\beta + \hbar k_\alpha)}{m} + i \frac{k_\alpha \cdot (p' - \hbar k_\beta)}{m} - i \frac{k_\beta \cdot p'}{m} + i \frac{\hbar k_\mu \cdot k_\nu}{m} + i\omega_k)} \\
& \quad \quad \left(\gamma_1 + i(-\Delta_\alpha + \Delta_\sigma + \Delta_\nu - \Delta_\mu) - i \frac{(k_\nu - k_\mu) \cdot p}{m} - i \frac{k_\sigma \cdot (p' - \hbar k_\beta + \hbar k_\alpha)}{m} \dots \right. \\
& \quad \quad \quad \left. + i \frac{k_\alpha \cdot (p' - \hbar k_\beta)}{m} + i \frac{\hbar k_\mu \cdot k_\nu}{m} \right) \\
& \quad \quad \left(\gamma + i(\Delta_\sigma + \Delta_\nu - \Delta_\mu) - i \frac{(k_\nu - k_\mu) \cdot p}{m} - i \frac{k_\sigma \cdot (p' - \hbar k_\beta + \hbar k_\alpha)}{m} \dots \right. \\
& \quad \quad \quad \left. + i \frac{\hbar k_\mu \cdot k_\nu}{m} - i\omega_k \right) \\
& \quad \quad \left(\gamma_1 + i(\Delta_\nu - \Delta_\mu) - i \frac{(k_\nu - k_\mu) \cdot p}{m} + i \frac{\hbar k_\mu \cdot k_\nu}{m} - 2i\omega_k \right) \\
& \quad \quad \left. \left. (\gamma - i\Delta_\mu + i \frac{k_\mu \cdot (p + \hbar k_\nu - \hbar k_\mu)}{m} + i\omega_k) \right) \right. \\
& \quad \times W(p' - \hbar k_\beta + \hbar k_\alpha - \hbar k_\sigma, p + \hbar k_\nu - \hbar k_\mu) \tag{2.a} \\
& \quad - \int \Gamma N(q) dq e^{(-i \frac{p \cdot q}{m} + i \frac{(p' - \hbar k_\beta + \hbar k_\alpha - \hbar k_\sigma) \cdot q}{m})t} \times
\end{aligned}$$

$$\times W(p' - \hbar k_\beta + \hbar k_\alpha - \hbar k_\nu, p + \hbar k_\sigma - \hbar k_\mu) \quad (2.c)$$

$$\begin{aligned} & i(\Omega_\beta^* \Omega_\alpha \Omega_\sigma^* \Omega_\nu \Omega_\mu^* \times \dots \\ & e^{(-i(-\Delta_\beta + \Delta_\alpha - \Delta_\sigma + \Delta_\nu - \Delta_\mu) + i \frac{(k_\nu - k_\mu) \cdot (p + \hbar k_\sigma)}{m} - i \frac{k_\sigma \cdot p}{m} + i \frac{k_\alpha \cdot (p' - \hbar k_\beta)}{m} - i \frac{k_\beta \cdot p'}{m} - i \frac{\hbar k_\mu \cdot k_\nu}{m} - i \omega_k)t} \\ & + \frac{(\gamma - i(-\Delta_\beta + \Delta_\alpha - \Delta_\sigma + \Delta_\nu - \Delta_\mu) + i \frac{(k_\nu - k_\mu) \cdot (p + \hbar k_\sigma)}{m} - i \frac{k_\sigma \cdot p}{m} \dots \\ & \quad + i \frac{k_\alpha \cdot (p' - \hbar k_\beta)}{m} - i \frac{k_\beta \cdot p'}{m} - i \frac{\hbar k_\mu \cdot k_\nu}{m} - i \omega_k)}{(\gamma_1 - i(\Delta_\alpha - \Delta_\sigma + \Delta_\nu - \Delta_\mu) + i \frac{(k_\nu - k_\mu) \cdot (p + \hbar k_\sigma)}{m} - i \frac{k_\sigma \cdot p}{m} \dots \\ & \quad + i \frac{k_\alpha \cdot (p' - \hbar k_\beta)}{m} - i \frac{\hbar k_\mu \cdot k_\nu}{m} - 2i\omega_k)} \\ & \quad (\gamma - i(-\Delta_\sigma + \Delta_\nu - \Delta_\mu) + i \frac{(k_\nu - k_\mu) \cdot (p + \hbar k_\sigma)}{m} - i \frac{k_\sigma \cdot p}{m} \dots \\ & \quad \quad - i \frac{\hbar k_\mu \cdot k_\nu}{m} - 3i\omega_k)} \\ & \quad (\gamma_2 - i(\Delta_\nu - \Delta_\mu) + i \frac{(k_\nu - k_\mu) \cdot (p + \hbar k_\sigma)}{m} \dots \\ & \quad \quad - i \frac{\hbar k_\mu \cdot k_\nu}{m} - 2i\omega_k)} \\ & \quad (\gamma + i\Delta_\mu - i \frac{k_\mu \cdot (p' - \hbar k_\beta + \hbar k_\alpha)}{m} + i\omega_k) \\ & \times W(p + \hbar k_\sigma - \hbar k_\nu, p' - \hbar k_\beta + \hbar k_\alpha - \hbar k_\mu) \} \end{aligned} \quad (1.c)$$

$$\begin{aligned} & i(\Omega_\beta^* \Omega_\alpha^* \Omega_\sigma \Omega_\nu^* \times \dots \\ & e^{(i(\Delta_\beta + \Delta_\alpha - \Delta_\sigma + \Delta_\nu - \Delta_\mu) - i \frac{(k_\nu - k_\mu) \cdot (p + \hbar k_\alpha - \hbar k_\sigma)}{m} + i \frac{k_\sigma \cdot (p + \hbar k_\alpha)}{m} - i \frac{k_\alpha \cdot p}{m} - i \frac{k_\beta \cdot p'}{m} + i \frac{\hbar k_\mu \cdot k_\nu}{m} - 3i\omega_k)t} \\ & - \left[\frac{(\gamma + i(\Delta_\beta + \Delta_\alpha - \Delta_\sigma + \Delta_\nu - \Delta_\mu) - i \frac{(k_\nu - k_\mu) \cdot (p + \hbar k_\alpha - \hbar k_\sigma)}{m} \dots \\ & \quad + i \frac{k_\sigma \cdot (p + \hbar k_\alpha)}{m} - i \frac{k_\alpha \cdot p}{m} - i \frac{k_\beta \cdot p'}{m} + i \frac{\hbar k_\mu \cdot k_\nu}{m} - 3i\omega_k)}{(\gamma_1 + i(\Delta_\alpha - \Delta_\sigma + \Delta_\nu - \Delta_\mu) - i \frac{(k_\nu - k_\mu) \cdot (p + \hbar k_\alpha - \hbar k_\sigma)}{m} \dots \\ & \quad + i \frac{k_\sigma \cdot (p + \hbar k_\alpha)}{m} - i \frac{k_\alpha \cdot p}{m} + i \frac{\hbar k_\mu \cdot k_\nu}{m} - 4i\omega_k)} \\ & \quad (\gamma + i(-\Delta_\sigma + \Delta_\nu - \Delta_\mu) - i \frac{(k_\nu - k_\mu) \cdot (p + \hbar k_\alpha - \hbar k_\sigma)}{m} \dots \\ & \quad \quad + i \frac{k_\sigma \cdot (p + \hbar k_\alpha)}{m} + i \frac{\hbar k_\mu \cdot k_\nu}{m} - 3i\omega_k)} \\ & \quad (\gamma_1 + i(\Delta_\nu - \Delta_\mu) - i \frac{(k_\nu - k_\mu) \cdot (p + \hbar k_\alpha - \hbar k_\sigma)}{m} \dots \\ & \quad \quad + i \frac{\hbar k_\mu \cdot k_\nu}{m} - 2i\omega_k)} \\ & \quad (\gamma - i\Delta_\mu + i \frac{k_\mu \cdot (p' - \hbar k_\beta)}{m} + i\omega_k) \end{aligned} \quad (3.a)$$

$$\times W(p' - \hbar k_\beta, p + \hbar k_\alpha - \hbar k_\sigma + \hbar k_\nu - \hbar k_\mu) \quad (3.a)$$

$$\begin{aligned} & i(\Omega_\beta^* \Omega_\alpha^* \Omega_\sigma \Omega_\nu \Omega_\mu^* \times \dots \\ & e^{(-i(-\Delta_\beta - \Delta_\alpha + \Delta_\sigma + \Delta_\nu - \Delta_\mu) + i \frac{(k_\nu - k_\mu) \cdot (p' - \hbar k_\beta)}{m} + i \frac{k_\sigma \cdot (p + \hbar k_\alpha)}{m} - i \frac{k_\alpha \cdot p}{m} - i \frac{k_\beta \cdot p'}{m} - i \frac{\hbar k_\mu \cdot k_\nu}{m} + i\omega_k)t} \\ & \frac{(\gamma - i(-\Delta_\beta - \Delta_\alpha + \Delta_\sigma + \Delta_\nu - \Delta_\mu) + i \frac{(k_\nu - k_\mu) \cdot (p' - \hbar k_\beta)}{m} + i \frac{k_\sigma \cdot (p + \hbar k_\alpha)}{m} \dots \\ & \quad - i \frac{k_\alpha \cdot p}{m} - i \frac{k_\beta \cdot p'}{m} - i \frac{\hbar k_\mu \cdot k_\nu}{m} + i\omega_k)}{(\gamma_1 - i(-\Delta_\alpha + \Delta_\sigma + \Delta_\nu - \Delta_\mu) + i \frac{(k_\nu - k_\mu) \cdot (p' - \hbar k_\beta)}{m} \dots \\ & \quad + i \frac{k_\sigma \cdot (p + \hbar k_\alpha)}{m} - i \frac{k_\alpha \cdot p}{m} - i \frac{\hbar k_\mu \cdot k_\nu}{m})} \\ & \quad (\gamma - i(\Delta_\sigma + \Delta_\nu - \Delta_\mu) + i \frac{(k_\nu - k_\mu) \cdot (p' - \hbar k_\beta)}{m} \dots \\ & \quad \quad + i \frac{k_\sigma \cdot (p' - \hbar k_\beta + \hbar k_\alpha)}{m} - i \frac{\hbar k_\mu \cdot k_\nu}{m} + i\omega_k)} \\ & \quad (\gamma_1 - i(\Delta_\nu - \Delta_\mu) + i \frac{(k_\nu - k_\mu) \cdot (p' - \hbar k_\beta)}{m} \dots \\ & \quad \quad - i \frac{\hbar k_\mu \cdot k_\nu}{m} + 2i\omega_k)} \\ & \quad (\gamma + i\Delta_\mu - i \frac{k_\mu \cdot (p' - \hbar k_\beta + \hbar k_\nu - \hbar k_\mu)}{m} - i\omega_k) \end{aligned}$$

$$\begin{aligned} & \times W(p + \hbar k_\alpha - \hbar k_\sigma, p' - \hbar k_\beta + \hbar k_\nu - \hbar k_\mu) \quad (4.a) \\ & + \int \Gamma N(q) dq e^{(+i \frac{(p' - \hbar k_\beta) \cdot q}{m} - i \frac{(p + \hbar k_\alpha - \hbar k_\sigma) \cdot q}{m}) t} \times \end{aligned}$$

$$\begin{aligned} & i(\Omega_\beta^* \Omega_\alpha^* \Omega_\sigma \Omega_\nu \Omega_\mu^* \times \dots \\ & \left\{ e^{(-i(-\Delta_\beta - \Delta_\alpha + \Delta_\sigma + \Delta_\nu - \Delta_\mu) + i \frac{(k_\nu - k_\mu) \cdot (p' - \hbar k_\beta + \hbar q)}{m} + i \frac{k_\sigma \cdot (p + \hbar k_\alpha)}{m} - i \frac{k_\alpha \cdot p}{m} - i \frac{k_\beta \cdot p'}{m} + i \frac{\hbar k_\mu \cdot k_\nu}{m} - 5i\omega_k) t} \right. \\ & \quad (\gamma - i(-\Delta_\beta - \Delta_\alpha + \Delta_\sigma + \Delta_\nu - \Delta_\mu) + i \frac{(k_\nu - k_\mu) \cdot (p' - \hbar k_\beta + \hbar q)}{m} + i \frac{k_\sigma \cdot (p + \hbar k_\alpha)}{m} \dots \\ & \quad \quad - i \frac{k_\alpha \cdot p}{m} - i \frac{k_\beta \cdot p'}{m} + i \frac{(p' - \hbar k_\beta) \cdot q}{m} - i \frac{(p + \hbar k_\alpha - \hbar k_\sigma) \cdot q}{m} + i \frac{\hbar k_\mu \cdot k_\nu}{m} - 5i\omega_k) \\ & \quad (\gamma_1 - i(-\Delta_\alpha + \Delta_\sigma + \Delta_\nu - \Delta_\mu) + i \frac{(k_\nu - k_\mu) \cdot (p' - \hbar k_\beta + \hbar q)}{m} + i \frac{k_\sigma \cdot (p + \hbar k_\alpha)}{m} \dots \\ & \quad \quad - i \frac{k_\alpha \cdot p}{m} + i \frac{(p' - \hbar k_\beta) \cdot q}{m} - i \frac{(p + \hbar k_\alpha - \hbar k_\sigma) \cdot q}{m} + i \frac{\hbar k_\mu \cdot k_\nu}{m} - 4i\omega_k) \\ & \quad (\gamma - i(\Delta_\sigma + \Delta_\nu - \Delta_\mu) + i \frac{(k_\nu - k_\mu) \cdot (p + \hbar k_\alpha + \hbar q)}{m} + i \frac{k_\sigma \cdot (p + \hbar k_\alpha)}{m} \dots \\ & \quad \quad + i \frac{\hbar k_\mu \cdot k_\nu}{m} - 3i\omega_k + i \frac{(p' - \hbar k_\beta) \cdot q}{m} - i \frac{(p + \hbar k_\alpha - \hbar k_\sigma) \cdot q}{m}) \\ & \quad (\gamma_1 - i(\Delta_\nu - \Delta_\mu) + i \frac{(k_\nu - k_\mu) \cdot (p + \hbar k_\alpha - \hbar k_\sigma + \hbar q)}{m} + i \frac{\hbar k_\mu \cdot k_\nu}{m} \dots \\ & \quad \quad - 2i\omega_k + i \frac{(p' - \hbar k_\beta + \hbar q) \cdot q}{m} - i \frac{(p + \hbar k_\alpha - \hbar k_\sigma) \cdot q}{m}) \\ & \quad (\gamma_2 - i(\Delta_\nu - \Delta_\mu) + i \frac{(k_\nu - k_\mu) \cdot (p + \hbar k_\alpha - \hbar k_\sigma + \hbar q)}{m} \dots \\ & \quad \quad \quad + i \frac{\hbar k_\mu \cdot k_\nu}{m} - 2i\omega_k) \\ & \quad \left. (\gamma + i\Delta_\mu - i \frac{k_\mu \cdot (p' - \hbar k_\beta + \hbar q)}{m} + i\omega_k) \right\} \end{aligned}$$

$$\times W(p + \hbar k_\alpha - \hbar k_\sigma + \hbar q - \hbar k_\nu, p' - \hbar k_\beta + \hbar q - \hbar k_\mu) \quad (4.b)$$

$$\begin{aligned} & i(\Omega_\beta^* \Omega_\alpha^* \Omega_\sigma \Omega_\nu \Omega_\mu^* \times \dots \\ & \left. e^{(i(\Delta_\beta + \Delta_\alpha - \Delta_\sigma + \Delta_\nu - \Delta_\mu) - i \frac{(k_\nu - k_\mu) \cdot (p' - \hbar k_\beta + \hbar q)}{m} + i \frac{k_\sigma \cdot (p + \hbar k_\alpha)}{m} - i \frac{k_\alpha \cdot p}{m} - i \frac{k_\beta \cdot p'}{m} + i \frac{\hbar k_\mu \cdot k_\nu}{m} + i\omega_k) t} \right. \\ & \quad (\gamma + i(\Delta_\beta + \Delta_\alpha - \Delta_\sigma + \Delta_\nu - \Delta_\mu) - i \frac{(k_\nu - k_\mu) \cdot (p' - \hbar k_\beta + \hbar q)}{m} + i \frac{k_\sigma \cdot (p + \hbar k_\alpha)}{m} - i \frac{k_\alpha \cdot p}{m} - i \frac{k_\beta \cdot p'}{m} \dots \\ & \quad \quad + i \frac{(p' - \hbar k_\beta) \cdot q}{m} - i \frac{(p + \hbar k_\alpha - \hbar k_\sigma) \cdot q}{m} + i \frac{\hbar k_\mu \cdot k_\nu}{m} + i\omega_k) \\ & \quad (\gamma_1 + i(\Delta_\alpha - \Delta_\sigma + \Delta_\nu - \Delta_\mu) - i \frac{(k_\nu - k_\mu) \cdot (p' - \hbar k_\beta + \hbar q)}{m} + i \frac{k_\sigma \cdot (p + \hbar k_\alpha)}{m} \dots \\ & \quad \quad - i \frac{k_\alpha \cdot p}{m} + i \frac{(p' - \hbar k_\beta) \cdot q}{m} - i \frac{(p + \hbar k_\alpha - \hbar k_\sigma) \cdot q}{m} + i \frac{\hbar k_\mu \cdot k_\nu}{m}) \\ & \quad (\gamma + i(-\Delta_\sigma + \Delta_\nu - \Delta_\mu) - i \frac{(k_\nu - k_\mu) \cdot (p' - \hbar k_\beta + \hbar q)}{m} + i \frac{k_\sigma \cdot (p + \hbar k_\alpha)}{m} \dots \\ & \quad \quad + i \frac{\hbar k_\mu \cdot k_\nu}{m} + i\omega_k + i \frac{(p' - \hbar k_\beta) \cdot q}{m} - i \frac{(p + \hbar k_\alpha - \hbar k_\sigma) \cdot q}{m}) \\ & \quad (\gamma_1 + i(\Delta_\nu - \Delta_\mu) - i \frac{(k_\nu - k_\mu) \cdot (p' - \hbar k_\beta + \hbar q)}{m} + i \frac{\hbar k_\mu \cdot k_\nu}{m} + 2i\omega_k \dots \\ & \quad \quad + i \frac{(p' - \hbar k_\beta + \hbar q) \cdot q}{m} - i \frac{(p + \hbar k_\alpha - \hbar k_\sigma) \cdot q}{m}) \\ & \quad (\gamma_2 + i(\Delta_\nu - \Delta_\mu) - i \frac{(k_\nu - k_\mu) \cdot (p' - \hbar k_\beta + \hbar q)}{m} \dots \\ & \quad \quad \quad + i \frac{\hbar k_\mu \cdot k_\nu}{m} + 2i\omega_k) \\ & \quad \left. (\gamma - i\Delta_\mu + i \frac{k_\mu \cdot (p + \hbar k_\alpha - \hbar k_\sigma + \hbar q)}{m} - i\omega_k) \right\} \end{aligned}$$

$$\times W(p' - \hbar k_\beta + \hbar q - \hbar k_\nu, p + \hbar k_\alpha - \hbar k_\sigma + \hbar q - \hbar k_\mu) \quad (3.b)$$

$$\begin{aligned}
& i(\Omega_\beta^* \Omega_\alpha^* \Omega_\sigma \Omega_\nu \Omega_\mu^* \times \dots \\
& - \left\{ \frac{e^{(-i(-\Delta_\beta - \Delta_\alpha + \Delta_\sigma + \Delta_\nu - \Delta_\mu) + i \frac{(k_\nu - k_\mu) \cdot (p + \hbar k_\alpha)}{m} + i \frac{k_\sigma \cdot (p' - \hbar k_\beta)}{m} - i \frac{k_\alpha \cdot p}{m} - i \frac{k_\beta \cdot p'}{m} + i \frac{\hbar k_\mu \cdot k_\nu}{m} - i \omega_k)t}}{(\gamma - i(-\Delta_\beta - \Delta_\alpha + \Delta_\sigma + \Delta_\nu - \Delta_\mu) + i \frac{(k_\nu - k_\mu) \cdot (p + \hbar k_\alpha)}{m} + i \frac{k_\sigma \cdot (p' - \hbar k_\beta)}{m} \dots} \right. \\
& \quad \left. - i \frac{k_\alpha \cdot p}{m} - i \frac{k_\beta \cdot p'}{m} + i \frac{\hbar k_\mu \cdot k_\nu}{m} - i \omega_k) \right. \\
& \quad (\gamma_1 - i(-\Delta_\alpha + \Delta_\sigma + \Delta_\nu - \Delta_\mu) + i \frac{(k_\nu - k_\mu) \cdot (p + \hbar k_\alpha)}{m} + i \frac{k_\sigma \cdot (p' - \hbar k_\beta)}{m} \dots \\
& \quad \quad \left. - i \frac{k_\alpha \cdot p}{m} + i \frac{\hbar k_\mu \cdot k_\nu}{m} - 2i\omega_k) \right. \\
& \quad (\gamma - i(\Delta_\sigma + \Delta_\nu - \Delta_\mu) + i \frac{(k_\nu - k_\mu) \cdot (p + \hbar k_\alpha)}{m} \dots \\
& \quad \quad \left. + i \frac{k_\sigma \cdot (p' - \hbar k_\beta)}{m} + i \frac{\hbar k_\mu \cdot k_\nu}{m} - i\omega_k) \right. \\
& \quad (\gamma_2 - i(\Delta_\nu - \Delta_\mu) + i \frac{(k_\nu - k_\mu) \cdot (p + \hbar k_\alpha)}{m} \dots \\
& \quad \quad \left. + i \frac{\hbar k_\mu \cdot k_\nu}{m} - 2i\omega_k) \right. \\
& \quad \left. (\gamma + i\Delta_\mu - i \frac{k_\mu \cdot (p' - \hbar k_\beta + \hbar k_\sigma)}{m} + i\omega_k) \right\} \\
& \times W(p + \hbar k_\alpha - \hbar k_\nu, p' - \hbar k_\beta + \hbar k_\sigma - \hbar k_\mu) \tag{4.c}
\end{aligned}$$

$$\begin{aligned}
& i(\Omega_\beta^* \Omega_\alpha^* \Omega_\sigma \Omega_\nu^* \Omega_\mu \times \dots \\
& + \frac{e^{(+i(\Delta_\beta + \Delta_\alpha - \Delta_\sigma + \Delta_\nu - \Delta_\mu) - i \frac{(k_\nu - k_\mu) \cdot (p' - \hbar k_\beta + \hbar k_\sigma)}{m} + i \frac{k_\sigma \cdot p}{m} - i \frac{k_\alpha \cdot p}{m} - i \frac{k_\beta \cdot p'}{m} + i \frac{\hbar k_\mu \cdot k_\nu}{m} + 3i\omega_k)t}}{(\gamma + i(\Delta_\beta + \Delta_\alpha - \Delta_\sigma + \Delta_\nu - \Delta_\mu) - i \frac{(k_\nu - k_\mu) \cdot (p' - \hbar k_\beta + \hbar k_\sigma)}{m} \dots} \\
& \quad \left. + i \frac{k_\sigma \cdot p}{m} - i \frac{k_\alpha \cdot p}{m} - i \frac{k_\beta \cdot p'}{m} + i \frac{\hbar k_\mu \cdot k_\nu}{m} + 3i\omega_k) \right. \\
& \quad (\gamma_1 + i(\Delta_\alpha - \Delta_\sigma + \Delta_\nu - \Delta_\mu) - i \frac{(k_\nu - k_\mu) \cdot (p' - \hbar k_\beta + \hbar k_\sigma)}{m} \dots \\
& \quad \quad \left. + i \frac{k_\sigma \cdot p}{m} - i \frac{k_\alpha \cdot p}{m} + i \frac{\hbar k_\mu \cdot k_\nu}{m} + 2i\omega_k) \right. \\
& \quad (\gamma + i(-\Delta_\sigma + \Delta_\nu - \Delta_\mu) - i \frac{(k_\nu - k_\mu) \cdot (p' - \hbar k_\beta + \hbar k_\sigma)}{m} \dots \\
& \quad \quad \left. + i \frac{k_\sigma \cdot p}{m} + i \frac{\hbar k_\mu \cdot k_\nu}{m} + 3i\omega_k) \right. \\
& \quad (\gamma_2 + i(\Delta_\nu - \Delta_\mu) - i \frac{(k_\nu - k_\mu) \cdot (p' - \hbar k_\beta + \hbar k_\sigma)}{m} \dots \\
& \quad \quad \left. + i \frac{\hbar k_\mu \cdot k_\nu}{m} + 2i\omega_k) \right. \\
& \quad \left. (\gamma - i\Delta_\mu + i \frac{k_\mu \cdot (p + \hbar k_\alpha)}{m} - i\omega_k) \right\} \\
& \times W(p' - \hbar k_\beta + \hbar k_\sigma - \hbar k_\nu, p + \hbar k_\alpha - \hbar k_\mu) \tag{3.c}
\end{aligned}$$

$$+ \int \Gamma N(q) dq e^{(-i \frac{p \cdot q}{m} + i \frac{(p' - \hbar k_\beta) \cdot q}{m})t} \times$$

$$\begin{aligned}
& -i(\Omega_\beta^* \Omega_\alpha^* \Omega_\sigma \Omega_\nu^* \Omega_\mu \times \dots \\
& e^{(i(\Delta_\beta + \Delta_\alpha - \Delta_\sigma + \Delta_\nu - \Delta_\mu) - i \frac{(k_\nu - k_\mu) \cdot (p + \hbar q - \hbar k_\sigma)}{m} + i \frac{k_\sigma \cdot (p + \hbar q)}{m} - i \frac{k_\alpha \cdot (p' - \hbar k_\beta + \hbar q)}{m} - i \frac{k_\beta \cdot p'}{m} + i \frac{\hbar k_\mu \cdot k_\nu}{m} - i \omega_k)t}) \\
& \left[\frac{(\gamma + i(\Delta_\beta + \Delta_\alpha - \Delta_\sigma + \Delta_\nu - \Delta_\mu) - i \frac{(k_\nu - k_\mu) \cdot (p + \hbar q - \hbar k_\sigma)}{m} + i \frac{k_\sigma \cdot (p + \hbar q)}{m}) \dots}{-i \frac{k_\alpha \cdot (p' - \hbar k_\beta + \hbar q)}{m} - i \frac{k_\beta \cdot p'}{m} - i \frac{p \cdot q}{m} + i \frac{(p' - \hbar k_\beta) \cdot q}{m} + i \frac{\hbar k_\mu \cdot k_\nu}{m} - i \omega_k)}{(\gamma_1 + i(+\Delta_\alpha - \Delta_\sigma + \Delta_\nu - \Delta_\mu) - i \frac{(k_\nu - k_\mu) \cdot (p + \hbar q - \hbar k_\sigma)}{m} + i \frac{k_\sigma \cdot (p + \hbar q)}{m}) \dots}{-i \frac{k_\alpha \cdot (p' - \hbar k_\beta + \hbar q)}{m} - i \frac{p \cdot q}{m} + i \frac{(p' - \hbar k_\beta) \cdot q}{m} + i \frac{\hbar k_\mu \cdot k_\nu}{m} - 2i \omega_k)}{(\gamma_2 + i(+\Delta_\alpha - \Delta_\sigma + \Delta_\nu - \Delta_\mu) - i \frac{(k_\nu - k_\mu) \cdot (p + \hbar q - \hbar k_\sigma)}{m}) \dots}{+i \frac{k_\sigma \cdot (p + \hbar q)}{m} - i \frac{k_\alpha \cdot (p' - \hbar k_\beta + \hbar q)}{m} + i \frac{\hbar k_\mu \cdot k_\nu}{m} - 2i \omega_k)}{(\gamma + i(-\Delta_\sigma + \Delta_\nu - \Delta_\mu) - i \frac{(k_\nu - k_\mu) \cdot (p + \hbar q - \hbar k_\sigma)}{m}) \dots}{+i \frac{k_\sigma \cdot (p + \hbar q)}{m} + i \frac{\hbar k_\mu \cdot k_\nu}{m} - 3i \omega_k)}{(\gamma_1 + i(\Delta_\nu - \Delta_\mu) - i \frac{(k_\nu - k_\mu) \cdot (p + \hbar q - \hbar k_\sigma)}{m}) \dots}{+i \frac{\hbar k_\mu \cdot k_\nu}{m} - 2i \omega_k)}{(\gamma - i\Delta_\mu + i \frac{k_\mu \cdot (p' - \hbar k_\beta + \hbar q - \hbar k_\alpha)}{m} + i \omega_k)} \\
& \times W(p' - \hbar k_\beta + \hbar q - \hbar k_\alpha, p + \hbar q - \hbar k_\sigma + \hbar k_\nu - \hbar k_\mu) \quad (3.d) \\
& -i(\Omega_\beta^* \Omega_\alpha^* \Omega_\sigma \Omega_\nu \Omega_\mu^* \times \dots \\
& e^{(-i(-\Delta_\beta - \Delta_\alpha + \Delta_\sigma + \Delta_\nu - \Delta_\mu) + i \frac{(k_\nu - k_\mu) \cdot (p' - \hbar k_\beta + \hbar q - \hbar k_\alpha)}{m} + i \frac{k_\sigma \cdot (p + \hbar q)}{m} - i \frac{k_\alpha \cdot (p' - \hbar k_\beta + \hbar q)}{m} - i \frac{k_\beta \cdot p'}{m} - i \frac{\hbar k_\mu \cdot k_\nu}{m} + 3i \omega_k)t}) \\
& \left[\frac{(\gamma - i(-\Delta_\beta - \Delta_\alpha + \Delta_\sigma + \Delta_\nu - \Delta_\mu) + i \frac{(k_\nu - k_\mu) \cdot (p' - \hbar k_\beta + \hbar q - \hbar k_\alpha)}{m} + i \frac{k_\sigma \cdot (p + \hbar q)}{m}) \dots}{-i \frac{k_\alpha \cdot (p' - \hbar k_\beta + \hbar q)}{m} - i \frac{k_\beta \cdot p'}{m} - i \frac{p \cdot q}{m} + i \frac{(p' - \hbar k_\beta) \cdot q}{m} - i \frac{\hbar k_\mu \cdot k_\nu}{m} + 3i \omega_k)}{(\gamma_1 - i(-\Delta_\alpha + \Delta_\sigma + \Delta_\nu - \Delta_\mu) + i \frac{(k_\nu - k_\mu) \cdot (p' - \hbar k_\beta + \hbar q - \hbar k_\alpha)}{m} + i \frac{k_\sigma \cdot (p + \hbar q)}{m}) \dots}{-i \frac{k_\alpha \cdot (p' - \hbar k_\beta + \hbar q)}{m} - \frac{p \cdot q}{m} + \frac{(p' - \hbar k_\beta) \cdot q}{m} - i \frac{\hbar k_\mu \cdot k_\nu}{m} + 2i \omega_k)}{(\gamma_2 - i(+\Delta_\alpha + \Delta_\sigma + \Delta_\nu - \Delta_\mu) + i \frac{(k_\nu - k_\mu) \cdot (p' - \hbar k_\beta + \hbar q - \hbar k_\alpha)}{m}) \dots}{+i \frac{k_\sigma \cdot (p + \hbar q)}{m} - i \frac{k_\alpha \cdot (p' - \hbar k_\beta + \hbar q)}{m} - i \frac{\hbar k_\mu \cdot k_\nu}{m} + 2i \omega_k)}{(\gamma - i(\Delta_\sigma + \Delta_\nu - \Delta_\mu) + i \frac{(k_\nu - k_\mu) \cdot (p' - \hbar k_\beta + \hbar q - \hbar k_\alpha)}{m}) \dots}{+i \frac{k_\sigma \cdot (p + \hbar q)}{m} - i \frac{\hbar k_\mu \cdot k_\nu}{m} + i \omega_k)}{(\gamma_1 - i(\Delta_\nu - \Delta_\mu) + i \frac{(k_\nu - k_\mu) \cdot (p' - \hbar k_\beta + \hbar q - \hbar k_\alpha)}{m}) \dots}{-i \frac{\hbar k_\mu \cdot k_\nu}{m} + 2i \omega_k)}{(\gamma + i\Delta_\mu - i \frac{k_\mu \cdot (p' - \hbar k_\beta + \hbar q - \hbar k_\alpha + \hbar k_\nu - \hbar k_\mu)}{m} - i \omega_k)} \\
& \times W(p + \hbar q - \hbar k_\sigma, p' - \hbar k_\beta + \hbar q - \hbar k_\alpha + \hbar k_\nu - \hbar k_\mu) \quad (4.d) \\
& + \int \Gamma N(q') dq' e^{(+i \frac{(p' - \hbar k_\beta + \hbar q - \hbar k_\alpha) \cdot q'}{m} - i \frac{(p + \hbar q - \hbar k_\sigma) \cdot q'}{m})t} \times
\end{aligned}$$

$$\begin{aligned}
& i(\Omega_\beta^* \Omega_\alpha^* \Omega_\sigma \Omega_\nu \Omega_\mu^* e^{(-i(-\Delta_\beta - \Delta_\alpha + \Delta_\sigma + \Delta_\nu - \Delta_\mu))t} \times \dots \\
& e^{(+i \frac{(k_\nu - k_\mu) \cdot (p + \hbar q + \hbar q')}{m} + i \frac{k_\sigma \cdot (p + \hbar q)}{m} - i \frac{k_\alpha \cdot (p' - \hbar k_\beta + \hbar q)}{m} - i \frac{k_\beta \cdot p'}{m} + i \frac{\hbar k_\mu \cdot k_\nu}{m} - i \omega_k)t}) \\
& \left\{ \frac{(\gamma - i(-\Delta_\beta - \Delta_\alpha + \Delta_\sigma + \Delta_\nu - \Delta_\mu)) + i \frac{(k_\nu - k_\mu) \cdot (p + \hbar q + \hbar q')}{m} + i \frac{k_\sigma \cdot (p + \hbar q)}{m} \dots}{\dots} \right. \\
& \quad - i \frac{k_\alpha \cdot (p' - \hbar k_\beta + \hbar q)}{m} - i \frac{k_\beta \cdot p'}{m} - i \frac{p \cdot q}{m} + i \frac{(p' - \hbar k_\beta) \cdot q}{m} \dots \\
& \quad + i \frac{(p' - \hbar k_\beta + \hbar q - \hbar k_\alpha) \cdot q'}{m} - i \frac{(p + \hbar q - \hbar k_\sigma) \cdot q'}{m} + i \frac{\hbar k_\mu \cdot k_\nu}{m} - i \omega_k) \\
& (\gamma_1 - i(-\Delta_\alpha + \Delta_\sigma + \Delta_\nu - \Delta_\mu)) + i \frac{(k_\nu - k_\mu) \cdot (p + \hbar q + \hbar q')}{m} + i \frac{k_\sigma \cdot (p + \hbar q)}{m} - i \frac{k_\alpha \cdot (p' - \hbar k_\beta + \hbar q)}{m} \dots \\
& \quad + i \frac{(p' - \hbar k_\beta + \hbar q - \hbar k_\alpha) \cdot q'}{m} - i \frac{(p + \hbar q - \hbar k_\sigma) \cdot q'}{m} - \frac{p \cdot q}{m} + \frac{(p' - \hbar k_\beta) \cdot q}{m} \dots \\
& \quad \left. + i \frac{\hbar k_\mu \cdot k_\nu}{m} - 2i\omega_k) \right. \\
& (\gamma_2 - i(-\Delta_\alpha + \Delta_\sigma + \Delta_\nu - \Delta_\mu)) + i \frac{(k_\nu - k_\mu) \cdot (p + \hbar q + \hbar q')}{m} + i \frac{k_\sigma \cdot (p + \hbar q)}{m} \dots \\
& \quad - i \frac{k_\alpha \cdot (p' - \hbar k_\beta + \hbar q)}{m} + i \frac{\hbar k_\mu \cdot k_\nu}{m} - 2i\omega_k \dots \\
& \quad + i \frac{(p' - \hbar k_\beta + \hbar q - \hbar k_\alpha) \cdot q'}{m} - i \frac{(p + \hbar q - \hbar k_\sigma) \cdot q'}{m}) \\
& (\gamma - i(\Delta_\sigma + \Delta_\nu - \Delta_\mu)) + i \frac{(k_\nu - k_\mu) \cdot (p + \hbar q + \hbar q')}{m} + i \frac{k_\sigma \cdot (p + \hbar q)}{m} \dots \\
& \quad + i \frac{\hbar k_\mu \cdot k_\nu}{m} - 3i\omega_k + i \frac{(p' - \hbar k_\beta + \hbar q - \hbar k_\alpha) \cdot q'}{m} \dots \\
& \quad \left. - i \frac{(p + \hbar q - \hbar k_\sigma) \cdot q'}{m} \right) \\
& (\gamma_1 - i(\Delta_\nu - \Delta_\mu)) + i \frac{(k_\nu - k_\mu) \cdot (p + \hbar q - \hbar k_\sigma + \hbar q')}{m} + i \frac{\hbar k_\mu \cdot k_\nu}{m} \dots \\
& \quad - 2i\omega_k + i \frac{(p' - \hbar k_\beta + \hbar q - \hbar k_\alpha + \hbar q') \cdot q'}{m} - i \frac{(p + \hbar q - \hbar k_\sigma) \cdot q'}{m}) \\
& \quad (\gamma_2 \dots \\
& -i(\Delta_\nu - \Delta_\mu)) + i \frac{(k_\nu - k_\mu) \cdot (p + \hbar q - \hbar k_\sigma + \hbar q')}{m} + i \frac{\hbar k_\mu \cdot k_\nu}{m} - 2i\omega_k) \\
& \quad (\gamma + i\Delta_\mu - i \frac{k_\mu \cdot (p' - \hbar k_\beta + \hbar q - \hbar k_\alpha + \hbar q')}{m} + i\omega_k) \\
& \times W(p + \hbar q - \hbar k_\sigma + \hbar q' - \hbar k_\nu, p' - \hbar k_\beta + \hbar q - \hbar k_\alpha + \hbar q' - \hbar k_\mu)
\end{aligned}$$

$$\begin{aligned}
& i(\Omega_\beta^* \Omega_\alpha^* \Omega_\sigma \Omega_\nu \Omega_\mu^* e^{i(\Delta_\beta + \Delta_\alpha - \Delta_\sigma + \Delta_\nu - \Delta_\mu)t} \times \dots \\
& e^{-i \frac{(k_\nu - k_\mu) \cdot (p' - \hbar k_\beta + \hbar q - \hbar k_\alpha + \hbar q')}{m} + i \frac{k_\sigma \cdot (p + \hbar q)}{m} - i \frac{k_\alpha \cdot (p' - \hbar k_\beta + \hbar q)}{m} - i \frac{k_\beta \cdot p'}{m} + i \frac{\hbar k_\mu \cdot k_\nu}{m} + 3i\omega_k)t) \\
+ & \frac{(\gamma + i(\Delta_\beta + \Delta_\alpha - \Delta_\sigma + \Delta_\nu - \Delta_\mu) - i \frac{(k_\nu - k_\mu) \cdot (p' - \hbar k_\beta + \hbar q - \hbar k_\alpha + \hbar q')}{m} + i \frac{k_\sigma \cdot (p + \hbar q)}{m} \dots \\
& - i \frac{k_\alpha \cdot (p' - \hbar k_\beta + \hbar q)}{m} - i \frac{k_\beta \cdot p'}{m} - i \frac{p \cdot q}{m} + i \frac{(p' - \hbar k_\beta) \cdot q}{m} + i \frac{(p' - \hbar k_\beta + \hbar q - \hbar k_\alpha) \cdot q'}{m} \dots \\
& - i \frac{(p + \hbar q - \hbar k_\sigma) \cdot q'}{m} + i \frac{\hbar k_\mu \cdot k_\nu}{m} + 3i\omega_k)}{(\gamma_1 + i(+\Delta_\alpha - \Delta_\sigma + \Delta_\nu - \Delta_\mu) - i \frac{(k_\nu - k_\mu) \cdot (p' - \hbar k_\beta + \hbar q - \hbar k_\alpha + \hbar q')}{m} \dots \\
& + i \frac{k_\sigma \cdot (p + \hbar q)}{m} - i \frac{k_\alpha \cdot (p' - \hbar k_\beta + \hbar q)}{m} + i \frac{(p' - \hbar k_\beta + \hbar q - \hbar k_\alpha) \cdot q'}{m} \dots \\
& - i \frac{(p + \hbar q - \hbar k_\sigma) \cdot q'}{m} - \frac{p \cdot q}{m} + \frac{(p' - \hbar k_\beta) \cdot q}{m} + i \frac{\hbar k_\mu \cdot k_\nu}{m} + 2i\omega_k)}{(\gamma_2 + i(+\Delta_\alpha - \Delta_\sigma + \Delta_\nu - \Delta_\mu) - i \frac{(k_\nu - k_\mu) \cdot (p' - \hbar k_\beta + \hbar q - \hbar k_\alpha + \hbar q')}{m} \dots \\
& + i \frac{k_\sigma \cdot (p + \hbar q)}{m} - i \frac{k_\alpha \cdot (p' - \hbar k_\beta + \hbar q)}{m} + i \frac{\hbar k_\mu \cdot k_\nu}{m} \dots \\
& + 2i\omega_k + i \frac{(p' - \hbar k_\beta + \hbar q - \hbar k_\alpha) \cdot q'}{m} - i \frac{(p + \hbar q - \hbar k_\sigma) \cdot q'}{m})} {(\gamma + i(-\Delta_\sigma + \Delta_\nu - \Delta_\mu) - i \frac{(k_\nu - k_\mu) \cdot (p' - \hbar k_\beta + \hbar q - \hbar k_\alpha + \hbar q')}{m} \dots \\
& + i \frac{k_\sigma \cdot (p + \hbar q)}{m} + i \frac{\hbar k_\mu \cdot k_\nu}{m} + i\omega_k + i \frac{(p' - \hbar k_\beta + \hbar q - \hbar k_\alpha) \cdot q'}{m} \dots \\
& - i \frac{(p + \hbar q - \hbar k_\sigma) \cdot q'}{m})} {(\gamma_1 + i(\Delta_\nu - \Delta_\mu) - i \frac{(k_\nu - k_\mu) \cdot (p' - \hbar k_\beta + \hbar q - \hbar k_\alpha + \hbar q')}{m} \dots \\
& + i \frac{\hbar k_\mu \cdot k_\nu}{m} + 2i\omega_k + \frac{(p' - \hbar k_\beta + \hbar q - \hbar k_\alpha + \hbar q') \cdot q'}{m} \dots \\
& - i \frac{(p + \hbar q - \hbar k_\sigma) \cdot q'}{m})} {(\gamma_2 + i(\Delta_\nu - \Delta_\mu) - i \frac{(k_\nu - k_\mu) \cdot (p' - \hbar k_\beta + \hbar q - \hbar k_\alpha + \hbar q')}{m} \dots \\
& + i \frac{\hbar k_\mu \cdot k_\nu}{m} + 2i\omega_k)} {(\gamma - i\Delta_\mu + i \frac{k_\mu \cdot (p + \hbar q - \hbar k_\sigma + \hbar q')}{m} - i\omega_k)} \\
& \times W(p' - \hbar k_\beta + \hbar q - \hbar k_\alpha + \hbar q' - \hbar k_\nu, p + \hbar q - \hbar k_\sigma + \hbar q' - \hbar k_\mu)] \\
& i(\Omega_\beta^* \Omega_\alpha^* \Omega_\sigma \Omega_\nu \Omega_\mu^* e^{-i(-\Delta_\beta - \Delta_\alpha + \Delta_\sigma + \Delta_\nu - \Delta_\mu)t} \times \dots \\
& e^{+i \frac{(k_\nu - k_\mu) \cdot (p + \hbar q)}{m} + i \frac{k_\sigma \cdot (p' - \hbar k_\beta + \hbar q - \hbar k_\alpha)}{m} - i \frac{k_\alpha \cdot (p' - \hbar k_\beta + \hbar q)}{m} - i \frac{k_\beta \cdot p'}{m} + i \frac{\hbar k_\mu \cdot k_\nu}{m} - i\omega_k)t) \\
+ & \left\{ \frac{(\gamma - i(-\Delta_\beta - \Delta_\alpha + \Delta_\sigma + \Delta_\nu - \Delta_\mu) + i \frac{(k_\nu - k_\mu) \cdot (p + \hbar q)}{m} \dots \\
& + i \frac{k_\sigma \cdot (p' - \hbar k_\beta + \hbar q - \hbar k_\alpha)}{m} - i \frac{k_\alpha \cdot (p' - \hbar k_\beta + \hbar q)}{m} \dots \\
& - i \frac{k_\beta \cdot p'}{m} + i \frac{\hbar k_\mu \cdot k_\nu}{m} - i\omega_k)}{(\gamma_1 - i(-\Delta_\alpha + \Delta_\sigma + \Delta_\nu - \Delta_\mu) + i \frac{(k_\nu - k_\mu) \cdot (p + \hbar q)}{m} \dots \\
& + i \frac{k_\sigma \cdot (p' - \hbar k_\beta + \hbar q - \hbar k_\alpha)}{m} - i \frac{k_\alpha \cdot (p' - \hbar k_\beta + \hbar q)}{m} \dots \\
& - i \frac{p \cdot q}{m} + i \frac{(p' - \hbar k_\beta) \cdot q}{m} + i \frac{\hbar k_\mu \cdot k_\nu}{m} - 2i\omega_k)}{(\gamma_2 - i(-\Delta_\alpha + \Delta_\sigma + \Delta_\nu - \Delta_\mu) + i \frac{(k_\nu - k_\mu) \cdot (p + \hbar q)}{m} \dots \\
& + i \frac{k_\sigma \cdot (p' - \hbar k_\beta + \hbar q - \hbar k_\alpha)}{m} - i \frac{k_\alpha \cdot (p' - \hbar k_\beta + \hbar q)}{m} \dots \\
& + i \frac{\hbar k_\mu \cdot k_\nu}{m} - 2i\omega_k)} {(\gamma - i(\Delta_\sigma + \Delta_\nu - \Delta_\mu) + i \frac{(k_\nu - k_\mu) \cdot (p + \hbar q)}{m} \dots \\
& + i \frac{k_\sigma \cdot (p' - \hbar k_\beta + \hbar q - \hbar k_\alpha)}{m} + i \frac{\hbar k_\mu \cdot k_\nu}{m} - i\omega_k)} {(\gamma_2 - i(\Delta_\nu - \Delta_\mu) + i \frac{(k_\nu - k_\mu) \cdot (p + \hbar q)}{m} + i \frac{\hbar k_\mu \cdot k_\nu}{m} - 2i\omega_k)} \\
& (\gamma + i\Delta_\mu - i \frac{k_\mu \cdot (p' - \hbar k_\beta + \hbar q - \hbar k_\alpha + \hbar k_\sigma)}{m} + i\omega_k)} \\
& \times W(p + \hbar q - \hbar k_\nu, p' - \hbar k_\beta + \hbar q - \hbar k_\alpha + \hbar k_\sigma - \hbar k_\mu) \tag{4.e}
\end{aligned}$$

$$\begin{aligned}
& i(\Omega_\beta^* \Omega_\alpha^* \Omega_\sigma \Omega_\nu^* \Omega_\mu e^{i(\Delta_\beta + \Delta_\alpha - \Delta_\sigma + \Delta_\nu - \Delta_\mu)t} \dots \\
& e^{(-i \frac{(k_\nu - k_\mu) \cdot (p' - \hbar k_\beta + \hbar q - \hbar k_\alpha + \hbar k_\sigma)}{m} + i \frac{k_\sigma \cdot (p' - \hbar k_\beta + \hbar q - \hbar k_\alpha)}{m} - i \frac{k_\alpha \cdot (p' - \hbar k_\beta + \hbar q)}{m} - i \frac{k_\beta \cdot p'}{m} + i \frac{\hbar k_\mu \cdot k_\nu}{m} + 5i\omega_k)t}) \\
& + \frac{(\gamma + i(\Delta_\beta + \Delta_\alpha - \Delta_\sigma + \Delta_\nu - \Delta_\mu) - i \frac{(k_\nu - k_\mu) \cdot (p' - \hbar k_\beta + \hbar q - \hbar k_\alpha + \hbar k_\sigma)}{m} \dots}{\dots} \\
& \quad + i \frac{k_\sigma \cdot (p' - \hbar k_\beta + \hbar q - \hbar k_\alpha)}{m} - i \frac{k_\alpha \cdot (p' - \hbar k_\beta + \hbar q)}{m} - i \frac{k_\beta \cdot p'}{m} \dots \\
& \quad - i \frac{p \cdot q}{m} + i \frac{(p' - \hbar k_\beta) \cdot q}{m} + i \frac{\hbar k_\mu \cdot k_\nu}{m} + 5i\omega_k) \\
& (\gamma_1 + i(+\Delta_\alpha - \Delta_\sigma + \Delta_\nu - \Delta_\mu) - i \frac{(k_\nu - k_\mu) \cdot (p' - \hbar k_\beta + \hbar q - \hbar k_\alpha + \hbar k_\sigma)}{m} \dots}{\dots} \\
& \quad + i \frac{k_\sigma \cdot (p' - \hbar k_\beta + \hbar q - \hbar k_\alpha)}{m} - i \frac{k_\alpha \cdot (p' - \hbar k_\beta + \hbar q)}{m} - \frac{p \cdot q}{m} \dots \\
& \quad + i \frac{(p' - \hbar k_\beta) \cdot q}{m} + i \frac{\hbar k_\mu \cdot k_\nu}{m} + 4i\omega_k) \\
& (\gamma_2 + i(+\Delta_\alpha - \Delta_\sigma + \Delta_\nu - \Delta_\mu) - i \frac{(k_\nu - k_\mu) \cdot (p' - \hbar k_\beta + \hbar q - \hbar k_\alpha + \hbar k_\sigma)}{m} \dots}{\dots} \\
& \quad + i \frac{k_\sigma \cdot (p' - \hbar k_\beta + \hbar q - \hbar k_\alpha)}{m} - i \frac{k_\alpha \cdot (p' - \hbar k_\beta + \hbar q)}{m} \dots \\
& \quad + i \frac{\hbar k_\mu \cdot k_\nu}{m} + 4i\omega_k) \\
& (\gamma + i(-\Delta_\sigma + \Delta_\nu - \Delta_\mu) - i \frac{(k_\nu - k_\mu) \cdot (p' - \hbar k_\beta + \hbar q - \hbar k_\alpha + \hbar k_\sigma)}{m} \dots}{\dots} \\
& \quad + i \frac{k_\sigma \cdot (p' - \hbar k_\beta + \hbar q - \hbar k_\alpha)}{m} + i \frac{\hbar k_\mu \cdot k_\nu}{m} + 3i\omega_k) \\
& (\gamma_2 + i(\Delta_\nu - \Delta_\mu) - i \frac{(k_\nu - k_\mu) \cdot (p' - \hbar k_\beta + \hbar q - \hbar k_\alpha + \hbar k_\sigma)}{m} \dots}{\dots} \\
& \quad + i \frac{\hbar k_\mu \cdot k_\nu}{m} + 2i\omega_k) \\
& (\gamma - i\Delta_\mu + i \frac{k_\mu \cdot (p + \hbar q)}{m} - i\omega_k) \\
& \times W(p' - \hbar k_\beta + \hbar q - \hbar k_\alpha + \hbar k_\sigma - \hbar k_\nu, p + \hbar q - \hbar k_\mu) \} \quad (3.e)
\end{aligned}$$

$$\begin{aligned}
& i(\Omega_\beta^* \Omega_\alpha^* \Omega_\sigma \Omega_\nu \Omega_\mu^* \times \dots \\
& e^{(-i(-\Delta_\beta + \Delta_\alpha - \Delta_\sigma + \Delta_\nu - \Delta_\mu) + i \frac{(k_\nu - k_\mu) \cdot (p' - \hbar k_\beta + \hbar q - \hbar k_\sigma)}{m} - i \frac{k_\sigma \cdot (p' - \hbar k_\beta + \hbar q)}{m} + i \frac{k_\alpha \cdot (p + \hbar q)}{m} - i \frac{k_\beta \cdot p'}{m} - i \frac{\hbar k_\mu \cdot k_\nu}{m} + 3i\omega_k)t}) \\
& + \left[\frac{(\gamma - i(-\Delta_\beta + \Delta_\alpha - \Delta_\sigma + \Delta_\nu - \Delta_\mu) + i \frac{(k_\nu - k_\mu) \cdot (p' - \hbar k_\beta + \hbar q - \hbar k_\sigma)}{m} - i \frac{k_\sigma \cdot (p' - \hbar k_\beta + \hbar q)}{m} \dots}{\dots} \right. \\
& \quad + i \frac{k_\alpha \cdot (p + \hbar q)}{m} - i \frac{k_\beta \cdot p'}{m} - i \frac{p \cdot q}{m} + i \frac{(p' - \hbar k_\beta) \cdot q}{m} - i \frac{\hbar k_\mu \cdot k_\nu}{m} + 3i\omega_k) \\
& (\gamma_1 - i(+\Delta_\alpha - \Delta_\sigma + \Delta_\nu - \Delta_\mu) + i \frac{(k_\nu - k_\mu) \cdot (p' - \hbar k_\beta + \hbar q - \hbar k_\sigma)}{m} - i \frac{k_\sigma \cdot (p' - \hbar k_\beta + \hbar q)}{m} \dots}{\dots} \\
& \quad + i \frac{k_\alpha \cdot (p + \hbar q)}{m} - i \frac{p \cdot q}{m} + i \frac{(p' - \hbar k_\beta) \cdot q}{m} - i \frac{\hbar k_\mu \cdot k_\nu}{m} + 2i\omega_k) \\
& (\gamma_2 - i(+\Delta_\alpha - \Delta_\sigma + \Delta_\nu - \Delta_\mu) + i \frac{(k_\nu - k_\mu) \cdot (p' - \hbar k_\beta + \hbar q - \hbar k_\sigma)}{m} \dots}{\dots} \\
& \quad - i \frac{k_\sigma \cdot (p' - \hbar k_\beta + \hbar q)}{m} + i \frac{k_\alpha \cdot (p + \hbar q)}{m} - i \frac{\hbar k_\mu \cdot k_\nu}{m} + 2i\omega_k) \\
& (\gamma - i(-\Delta_\sigma + \Delta_\nu - \Delta_\mu) + i \frac{(k_\nu - k_\mu) \cdot (p' - \hbar k_\beta + \hbar q - \hbar k_\sigma)}{m} \dots}{\dots} \\
& \quad - i \frac{k_\sigma \cdot (p' - \hbar k_\beta + \hbar q)}{m} - i \frac{\hbar k_\mu \cdot k_\nu}{m} + 3i\omega_k) \\
& (\gamma_1 - i(\Delta_\nu - \Delta_\mu) + i \frac{(k_\nu - k_\mu) \cdot (p' - \hbar k_\beta + \hbar q - \hbar k_\sigma)}{m} - i \frac{\hbar k_\mu \cdot k_\nu}{m} + 2i\omega_k) \\
& \quad \left. (\gamma + i\Delta_\mu - i \frac{k_\mu \cdot (p + \hbar q)}{m} - i\omega_k) \right] \\
& \times W(p + \hbar q - \hbar k_\alpha, p' - \hbar k_\beta + \hbar q - \hbar k_\sigma + \hbar k_\nu - \hbar k_\mu) \quad (1.d)
\end{aligned}$$

$$\begin{aligned}
& i(\Omega_\beta^* \Omega_\alpha \Omega_\sigma^* \Omega_\nu^* \Omega_\mu \times \dots \\
& e^{i(\Delta_\beta - \Delta_\alpha + \Delta_\sigma + \Delta_\nu - \Delta_\mu) - i \frac{(k_\nu - k_\mu) \cdot (p + \hbar q - \hbar k_\alpha)}{m} - i \frac{k_\sigma \cdot (p' - \hbar k_\beta + \hbar q)}{m} + i \frac{k_\alpha \cdot (p + \hbar q)}{m} - i \frac{k_\beta \cdot p'}{m} + i \frac{\hbar k_\mu \cdot k_\nu}{m} - i \omega_k) t) \\
& \frac{(\gamma + i(\Delta_\beta - \Delta_\alpha + \Delta_\sigma + \Delta_\nu - \Delta_\mu) - i \frac{(k_\nu - k_\mu) \cdot (p + \hbar q - \hbar k_\alpha)}{m} - i \frac{k_\sigma \cdot (p' - \hbar k_\beta + \hbar q)}{m} \dots}{\dots} \\
& \quad + i \frac{k_\alpha \cdot (p + \hbar q)}{m} - i \frac{k_\beta \cdot p'}{m} - i \frac{p \cdot q}{m} + i \frac{(p' - \hbar k_\beta) \cdot q}{m} + i \frac{\hbar k_\mu \cdot k_\nu}{m} - i \omega_k)}{\dots} \\
& (\gamma_1 + i(-\Delta_\alpha + \Delta_\sigma + \Delta_\nu - \Delta_\mu) - i \frac{(k_\nu - k_\mu) \cdot (p + \hbar q - \hbar k_\alpha)}{m} - i \frac{k_\sigma \cdot (p' - \hbar k_\beta + \hbar q)}{m} \dots}{\dots} \\
& \quad + i \frac{k_\alpha \cdot (p + \hbar q)}{m} - i \frac{p \cdot q}{m} + i \frac{(p' - \hbar k_\beta) \cdot q}{m} + i \frac{\hbar k_\mu \cdot k_\nu}{m} - 2i\omega_k)}{\dots} \\
& (\gamma_2 + i(-\Delta_\alpha + \Delta_\sigma + \Delta_\nu - \Delta_\mu) - i \frac{(k_\nu - k_\mu) \cdot (p + \hbar q - \hbar k_\alpha)}{m} - i \frac{k_\sigma \cdot (p' - \hbar k_\beta + \hbar q)}{m} \dots}{\dots} \\
& \quad + i \frac{k_\alpha \cdot (p + \hbar q)}{m} + i \frac{\hbar k_\mu \cdot k_\nu}{m} - 2i\omega_k)}{\dots} \\
& (\gamma + i(\Delta_\sigma + \Delta_\nu - \Delta_\mu) - i \frac{(k_\nu - k_\mu) \cdot (p + \hbar q - \hbar k_\alpha)}{m} \dots}{\dots} \\
& \quad - i \frac{k_\sigma \cdot (p' - \hbar k_\beta + \hbar q)}{m} + i \frac{\hbar k_\mu \cdot k_\nu}{m} - i \omega_k)}{\dots} \\
& (\gamma_1 + i(\Delta_\nu - \Delta_\mu) - i \frac{(k_\nu - k_\mu) \cdot (p + \hbar q - \hbar k_\alpha)}{m} \dots}{\dots} \\
& \quad + i \frac{\hbar k_\mu \cdot k_\nu}{m} - 2i\omega_k)}{\dots} \\
& (\gamma - i\Delta_\mu + i \frac{k_\mu \cdot (p + \hbar q - \hbar k_\alpha + \hbar k_\nu - \hbar k_\mu)}{m} + i \omega_k) \\
& \times W(p' - \hbar k_\beta + \hbar q - \hbar k_\sigma, p + \hbar q - \hbar k_\alpha + \hbar k_\nu - \hbar k_\mu) \tag{2.d} \\
& + \int \Gamma N(q') dq' e^{(-i \frac{(p + \hbar q - \hbar k_\alpha) \cdot q'}{m} + i \frac{(p' - \hbar k_\beta + \hbar q - \hbar k_\sigma) \cdot q'}{m}) t} \times
\end{aligned}$$

$$\begin{aligned}
& i(\Omega_\beta^* \Omega_\alpha \Omega_\sigma^* \Omega_\nu^* \Omega_\mu \times \dots \\
& \left\{ e^{i(\Delta_\beta - \Delta_\alpha + \Delta_\sigma + \Delta_\nu - \Delta_\mu) - i \frac{(k_\nu - k_\mu) \cdot (p' - \hbar k_\beta + \hbar q + \hbar q')}{m} - i \frac{k_\sigma \cdot (p' - \hbar k_\beta + \hbar q)}{m} + i \frac{k_\alpha \cdot (p + \hbar q)}{m} - i \frac{k_\beta \cdot p'}{m} - i \frac{\hbar k_\mu \cdot k_\nu}{m} + 3i\omega_k) t \right\} \\
& \frac{(\gamma + i(\Delta_\beta - \Delta_\alpha + \Delta_\sigma + \Delta_\nu - \Delta_\mu) - i \frac{(k_\nu - k_\mu) \cdot (p' - \hbar k_\beta + \hbar q + \hbar q')}{m} \dots}{\dots} \\
& \quad - i \frac{k_\sigma \cdot (p' - \hbar k_\beta + \hbar q)}{m} + i \frac{k_\alpha \cdot (p + \hbar q)}{m} - i \frac{k_\beta \cdot p'}{m} - i \frac{p \cdot q}{m} + i \frac{(p' - \hbar k_\beta) \cdot q}{m} \dots}{\dots} \\
& \quad - i \frac{(p + \hbar q - \hbar k_\alpha) \cdot q'}{m} + i \frac{(p' - \hbar k_\beta + \hbar q - \hbar k_\sigma) \cdot q'}{m} - i \frac{\hbar k_\mu \cdot k_\nu}{m} + 3i\omega_k)}{\dots} \\
& (\gamma_1 + i(-\Delta_\alpha + \Delta_\sigma + \Delta_\nu - \Delta_\mu) - i \frac{(k_\nu - k_\mu) \cdot (p' - \hbar k_\beta + \hbar q + \hbar q')}{m} \dots}{\dots} \\
& \quad - i \frac{k_\sigma \cdot (p' - \hbar k_\beta + \hbar q)}{m} + i \frac{k_\alpha \cdot (p + \hbar q)}{m} - i \frac{(p + \hbar q - \hbar k_\alpha) \cdot q'}{m} + i \frac{(p' - \hbar k_\beta + \hbar q - \hbar k_\sigma) \cdot q'}{m} \dots}{\dots} \\
& \quad - i \frac{p \cdot q}{m} + i \frac{(p' - \hbar k_\beta) \cdot q}{m} - i \frac{\hbar k_\mu \cdot k_\nu}{m} + 2i\omega_k)}{\dots} \\
& (\gamma_2 + i(-\Delta_\alpha + \Delta_\sigma + \Delta_\nu - \Delta_\mu) - i \frac{(k_\nu - k_\mu) \cdot (p' - \hbar k_\beta + \hbar q + \hbar q')}{m} - i \frac{k_\sigma \cdot (p' - \hbar k_\beta + \hbar q)}{m} \dots}{\dots} \\
& \quad + i \frac{k_\alpha \cdot (p + \hbar q)}{m} - i \frac{\hbar k_\mu \cdot k_\nu}{m} + 2i\omega_k - i \frac{(p + \hbar q - \hbar k_\alpha) \cdot q'}{m} \dots}{\dots} \\
& \quad + i \frac{(p' - \hbar k_\beta + \hbar q - \hbar k_\sigma) \cdot q'}{m})}{\dots} \\
& (\gamma + i(\Delta_\sigma + \Delta_\nu - \Delta_\mu) - i \frac{(k_\nu - k_\mu) \cdot (p' - \hbar k_\beta + \hbar q + \hbar q')}{m} - i \frac{k_\sigma \cdot (p' - \hbar k_\beta)}{m} \dots}{\dots} \\
& \quad - i \frac{\hbar k_\mu \cdot k_\nu}{m} + 3i\omega_k - i \frac{(p + \hbar q - \hbar k_\alpha) \cdot q'}{m} + i \frac{(p' - \hbar k_\beta + \hbar q - \hbar k_\sigma) \cdot q'}{m})}{\dots} \\
& (\gamma_1 + i(\Delta_\nu - \Delta_\mu) - i \frac{(k_\nu - k_\mu) \cdot (p' - \hbar k_\beta + \hbar q - \hbar k_\sigma + \hbar q')}{m} \dots}{\dots} \\
& \quad - i \frac{\hbar k_\mu \cdot k_\nu}{m} + 2i\omega_k - i \frac{(p + \hbar q - \hbar k_\alpha + \hbar q') \cdot q'}{m} \dots}{\dots} \\
& \quad + i \frac{(p' - \hbar k_\beta + \hbar q - \hbar k_\sigma) \cdot q'}{m})}{\dots} \\
& (\gamma_2 + i(\Delta_\nu - \Delta_\mu) - i \frac{(k_\nu - k_\mu) \cdot (p' - \hbar k_\beta + \hbar q - \hbar k_\sigma + \hbar q')}{m} \dots}{\dots} \\
& \quad - i \frac{\hbar k_\mu \cdot k_\nu}{m} + 2i\omega_k) \\
& (\gamma - i\Delta_\mu + i \frac{k_\mu \cdot (p + \hbar q - \hbar k_\alpha + \hbar q')}{m} - i \omega_k) \\
& \times W(p' - \hbar k_\beta + \hbar q - \hbar k_\sigma + \hbar q' - \hbar k_\nu, p + \hbar q - \hbar k_\alpha + \hbar q' - \hbar k_\mu)
\end{aligned}$$

$$\begin{aligned}
& i(\Omega_\beta^* \Omega_\alpha \Omega_\sigma^* \Omega_\nu \Omega_\mu^* \times \dots \\
& e^{(-i(-\Delta_\beta + \Delta_\alpha - \Delta_\sigma + \Delta_\nu - \Delta_\mu) + i \frac{(k_\nu - k_\mu) \cdot (p + \hbar q - \hbar k_\alpha + \hbar q)}{m} - i \frac{k_\sigma \cdot (p' - \hbar k_\beta + \hbar q)}{m} + i \frac{k_\alpha \cdot (p + \hbar q)}{m} - i \frac{k_\beta \cdot p'}{m} - i \frac{\hbar k_\mu \cdot k_\nu}{m} - i \omega_k) t)} \\
& + \frac{i(\Omega_\beta^* \Omega_\alpha \Omega_\sigma^* \Omega_\nu \Omega_\mu^* \times \dots}{(\gamma - i(-\Delta_\beta + \Delta_\alpha - \Delta_\sigma + \Delta_\nu - \Delta_\mu) + i \frac{(k_\nu - k_\mu) \cdot (p + \hbar q - \hbar k_\alpha + \hbar q)}{m} - i \frac{k_\sigma \cdot (p' - \hbar k_\beta + \hbar q)}{m} + i \frac{k_\alpha \cdot (p + \hbar q)}{m} \dots} \\
& \quad - i \frac{k_\beta \cdot p'}{m} - i \frac{p \cdot q}{m} + i \frac{(p' - \hbar k_\beta) \cdot q}{m} - i \frac{(p + \hbar q - \hbar k_\alpha) \cdot q'}{m} \dots \\
& \quad + i \frac{(p' - \hbar k_\beta + \hbar q - \hbar k_\sigma) \cdot q'}{m} - i \frac{\hbar k_\mu \cdot k_\nu}{m} - i \omega_k) \\
& \quad (\gamma_1 - i(\Delta_\alpha - \Delta_\sigma + \Delta_\nu - \Delta_\mu) + i \frac{(k_\nu - k_\mu) \cdot (p + \hbar q - \hbar k_\alpha + \hbar q)}{m} \dots \\
& \quad - i \frac{k_\sigma \cdot (p' - \hbar k_\beta + \hbar q)}{m} + i \frac{k_\alpha \cdot (p + \hbar q)}{m} - i \frac{(p + \hbar q - \hbar k_\alpha) \cdot q'}{m} \dots \\
& \quad + i \frac{(p' - \hbar k_\beta + \hbar q - \hbar k_\sigma) \cdot q'}{m} - \frac{p \cdot q}{m} + \frac{(p' - \hbar k_\beta) \cdot q}{m} \dots \\
& \quad - i \frac{\hbar k_\mu \cdot k_\nu}{m} - 2i\omega_k) \\
& \quad (\gamma_2 - i(\Delta_\alpha - \Delta_\sigma + \Delta_\nu - \Delta_\mu) + i \frac{(k_\nu - k_\mu) \cdot (p + \hbar q - \hbar k_\alpha + \hbar q')}{m} - i \frac{k_\sigma \cdot (p' - \hbar k_\beta + \hbar q)}{m} + i \frac{k_\alpha \cdot (p + \hbar q)}{m} \dots \\
& \quad - i \frac{\hbar k_\mu \cdot k_\nu}{m} - 2i\omega_k - i \frac{(p + \hbar q - \hbar k_\alpha) \cdot q'}{m} + i \frac{(p' - \hbar k_\beta + \hbar q - \hbar k_\sigma) \cdot q'}{m} \dots \\
& \quad (\gamma - i(-\Delta_\sigma + \Delta_\nu - \Delta_\mu) + i \frac{(k_\nu - k_\mu) \cdot (p + \hbar q - \hbar k_\alpha + \hbar q')}{m} - i \frac{k_\sigma \cdot (p' - \hbar k_\beta + \hbar q)}{m} \dots \\
& \quad - i \frac{\hbar k_\mu \cdot k_\nu}{m} - i\omega_k - i \frac{(p + \hbar q - \hbar k_\alpha) \cdot q'}{m} + i \frac{(p' - \hbar k_\beta + \hbar q - \hbar k_\sigma) \cdot q'}{m} \dots \\
& \quad (\gamma_1 - i(\Delta_\nu - \Delta_\mu) + i \frac{(k_\nu - k_\mu) \cdot (p + \hbar q - \hbar k_\alpha + \hbar q')}{m} - i \frac{\hbar k_\mu \cdot k_\nu}{m} - 2i\omega_k - \dots \\
& \quad i \frac{(p + \hbar q - \hbar k_\alpha + \hbar q') \cdot q'}{m} + i \frac{(p' - \hbar k_\beta + \hbar q - \hbar k_\sigma) \cdot q'}{m} \dots \\
& \quad (\gamma_2 - i(\Delta_\nu - \Delta_\mu) + i \frac{(k_\nu - k_\mu) \cdot (p + \hbar q - \hbar k_\alpha + \hbar q')}{m} \dots \\
& \quad - i \frac{\hbar k_\mu \cdot k_\nu}{m} - 2i\omega_k) \\
& \quad (\gamma + i\Delta_\mu - i \frac{k_\mu \cdot (p' - \hbar k_\beta + \hbar q - \hbar k_\sigma + \hbar q')}{m} + i\omega_k) \\
& \times W(p + \hbar q - \hbar k_\alpha + \hbar q' - \hbar k_\nu, p' - \hbar k_\beta - \hbar k_\beta + \hbar q - \hbar k_\sigma + \hbar q' - \hbar k_\mu) \} \\
& - \left\{ \frac{i(\Omega_\beta^* \Omega_\alpha \Omega_\sigma^* \Omega_\nu \Omega_\mu^* \times \dots}{e^{(i(\Delta_\beta - \Delta_\alpha + \Delta_\sigma + \Delta_\nu - \Delta_\mu) - i \frac{(k_\nu - k_\mu) \cdot (p' - \hbar k_\beta + \hbar q)}{m} - i \frac{k_\sigma \cdot (p + \hbar q - \hbar k_\alpha)}{m} + i \frac{k_\alpha \cdot (p + \hbar q)}{m} - i \frac{k_\beta \cdot p'}{m} - i \frac{\hbar k_\mu \cdot k_\nu}{m} + i \omega_k) t)} \right. \\
& \quad (\gamma + i(\Delta_\beta - \Delta_\alpha + \Delta_\sigma + \Delta_\nu - \Delta_\mu) - i \frac{(k_\nu - k_\mu) \cdot (p' - \hbar k_\beta + \hbar q)}{m} - i \frac{k_\sigma \cdot (p + \hbar q - \hbar k_\alpha)}{m} + i \frac{k_\alpha \cdot (p + \hbar q)}{m} \dots \\
& \quad - i \frac{k_\beta \cdot p'}{m} - i \frac{p \cdot q}{m} + i \frac{(p' - \hbar k_\beta) \cdot q}{m} - i \frac{\hbar k_\mu \cdot k_\nu}{m} + i \omega_k) \\
& \quad (\gamma_1 + i(-\Delta_\alpha + \Delta_\sigma + \Delta_\nu - \Delta_\mu) - i \frac{(k_\nu - k_\mu) \cdot (p' - \hbar k_\beta + \hbar q)}{m} - i \frac{k_\sigma \cdot (p + \hbar q - \hbar k_\alpha)}{m} \dots \\
& \quad + i \frac{k_\alpha \cdot (p + \hbar q)}{m} - \frac{p \cdot q}{m} + \frac{(p' - \hbar k_\beta) \cdot q}{m} - i \frac{\hbar k_\mu \cdot k_\nu}{m} \dots \\
& \quad (\gamma_2 + i(-\Delta_\alpha + \Delta_\sigma + \Delta_\nu - \Delta_\mu) - i \frac{(k_\nu - k_\mu) \cdot (p' - \hbar k_\beta + \hbar q)}{m} - i \frac{k_\sigma \cdot (p + \hbar q - \hbar k_\alpha)}{m} \dots \\
& \quad + i \frac{k_\alpha \cdot (p + \hbar q)}{m} - i \frac{\hbar k_\mu \cdot k_\nu}{m} \dots \\
& \quad (\gamma + i(\Delta_\sigma + \Delta_\nu - \Delta_\mu) - i \frac{(k_\nu - k_\mu) \cdot (p' - \hbar k_\beta + \hbar q)}{m} - i \frac{k_\sigma \cdot (p + \hbar q - \hbar k_\alpha)}{m} \dots \\
& \quad - i \frac{\hbar k_\mu \cdot k_\nu}{m} + i \omega_k) \\
& \quad (\gamma_2 + i(\Delta_\nu - \Delta_\mu) - i \frac{(k_\nu - k_\mu) \cdot (p' - \hbar k_\beta + \hbar q)}{m} \dots \\
& \quad - i \frac{\hbar k_\mu \cdot k_\nu}{m} + 2i\omega_k) \\
& \quad (\gamma - i\Delta_\mu + i \frac{k_\mu \cdot (p + \hbar q - \hbar k_\alpha + \hbar k_\sigma)}{m} - i\omega_k) \\
& \times W(p' - \hbar k_\beta + \hbar q - \hbar k_\nu, p + \hbar q - \hbar k_\alpha + \hbar k_\sigma - \hbar k_\mu) \} \tag{2.e}
\end{aligned}$$

$$\begin{aligned}
& i(\Omega_\beta^* \Omega_\alpha \Omega_\sigma^* \Omega_\nu \Omega_\mu^* \times \dots \\
& e^{(-i(-\Delta_\beta - \Delta_\alpha + \Delta_\sigma + \Delta_\nu - \Delta_\mu) + i \frac{(k_\nu - k_\mu) \cdot (p + \hbar q - \hbar k_\alpha + \hbar k_\sigma)}{m} - i \frac{k_\sigma \cdot (p + \hbar q - \hbar k_\alpha)}{m} + i \frac{k_\alpha \cdot (p + \hbar q)}{m} - i \frac{k_\beta \cdot p'}{m} - i \frac{\hbar k_\mu \cdot k_\nu}{m} - 3i\omega_k)t)} \\
& + \frac{(\gamma - i(-\Delta_\beta + \Delta_\alpha - \Delta_\sigma + \Delta_\nu - \Delta_\mu) + i \frac{(k_\nu - k_\mu) \cdot (p + \hbar q - \hbar k_\alpha + \hbar k_\sigma)}{m} - i \frac{k_\sigma \cdot (p + \hbar q - \hbar k_\alpha)}{m} \dots}{(\gamma - i(-\Delta_\beta + \Delta_\alpha - \Delta_\sigma + \Delta_\nu - \Delta_\mu) + i \frac{(k_\nu - k_\mu) \cdot (p + \hbar q - \hbar k_\alpha + \hbar k_\sigma)}{m} - i \frac{k_\sigma \cdot (p + \hbar q - \hbar k_\alpha)}{m} \dots} \\
& \quad + i \frac{k_\alpha \cdot (p + \hbar q)}{m} - i \frac{k_\beta \cdot p'}{m} - i \frac{p \cdot q}{m} + i \frac{(p' - \hbar k_\beta) \cdot q}{m} \dots}{+ i \frac{k_\alpha \cdot (p + \hbar q)}{m} - i \frac{k_\beta \cdot p'}{m} - i \frac{p \cdot q}{m} + i \frac{(p' - \hbar k_\beta) \cdot q}{m} \dots} \\
& \quad - i \frac{\hbar k_\mu \cdot k_\nu}{m} - 3i\omega_k)}{(\gamma - i(-\Delta_\beta + \Delta_\alpha - \Delta_\sigma + \Delta_\nu - \Delta_\mu) + i \frac{(k_\nu - k_\mu) \cdot (p + \hbar q - \hbar k_\alpha + \hbar k_\sigma)}{m} - i \frac{k_\sigma \cdot (p + \hbar q - \hbar k_\alpha)}{m} \dots} \\
& \quad + i \frac{k_\alpha \cdot (p + \hbar q)}{m} - i \frac{p \cdot q}{m} + i \frac{(p' - \hbar k_\beta) \cdot q}{m} - i \frac{\hbar k_\mu \cdot k_\nu}{m} - 4i\omega_k)}{(\gamma - i(-\Delta_\beta + \Delta_\alpha - \Delta_\sigma + \Delta_\nu - \Delta_\mu) + i \frac{(k_\nu - k_\mu) \cdot (p + \hbar q - \hbar k_\alpha + \hbar k_\sigma)}{m} - i \frac{k_\sigma \cdot (p + \hbar q - \hbar k_\alpha)}{m} \dots} \\
& \quad + i \frac{k_\alpha \cdot (p + \hbar q)}{m} - i \frac{\hbar k_\mu \cdot k_\nu}{m} - 4i\omega_k)}{(\gamma - i(-\Delta_\sigma + \Delta_\nu - \Delta_\mu) + i \frac{(k_\nu - k_\mu) \cdot (p + \hbar q - \hbar k_\alpha + \hbar k_\sigma)}{m} - i \frac{k_\sigma \cdot (p + \hbar q - \hbar k_\alpha)}{m} \dots} \\
& \quad - i \frac{\hbar k_\mu \cdot k_\nu}{m} - 3i\omega_k)}{(\gamma - i(-\Delta_\sigma + \Delta_\nu - \Delta_\mu) + i \frac{(k_\nu - k_\mu) \cdot (p + \hbar q - \hbar k_\alpha + \hbar k_\sigma)}{m} - i \frac{k_\sigma \cdot (p + \hbar q - \hbar k_\alpha)}{m} \dots} \\
& \quad - i \frac{\hbar k_\mu \cdot k_\nu}{m} - 2i\omega_k)}{(\gamma + i\Delta_\mu - i \frac{k_\mu \cdot (p' - \hbar k_\beta + \hbar q)}{m} + i\omega_k)} \\
& \times W(p + \hbar q - \hbar k_\alpha + \hbar k_\sigma - \hbar k_\nu, p' - \hbar k_\beta + \hbar q - \hbar k_\mu) \} \quad (1.e)
\end{aligned}$$

]

-

[

$$\begin{aligned}
& -i(\Omega_\beta^* \Omega_\alpha \Omega_\sigma \Omega_\nu^* \Omega_\mu \times \dots \\
& e^{(i(\Delta_\beta + \Delta_\alpha - \Delta_\sigma + \Delta_\nu - \Delta_\mu) - i \frac{(k_\nu - k_\mu) \cdot (p + \hbar k_\beta - \hbar k_\sigma)}{m} + i \frac{k_\sigma \cdot (p + \hbar k_\beta)}{m} - i \frac{k_\alpha \cdot p'}{m} - i \frac{k_\beta \cdot p}{m} + i \frac{\hbar k_\mu \cdot k_\nu}{m} - 3i\omega_k)t)} \\
& \left[- \frac{(\gamma + i(\Delta_\beta + \Delta_\alpha - \Delta_\sigma + \Delta_\nu - \Delta_\mu) - i \frac{(k_\nu - k_\mu) \cdot (p + \hbar k_\beta - \hbar k_\sigma)}{m} + i \frac{k_\sigma \cdot (p + \hbar k_\beta)}{m} \dots}{(\gamma + i(\Delta_\beta + \Delta_\alpha - \Delta_\sigma + \Delta_\nu - \Delta_\mu) - i \frac{(k_\nu - k_\mu) \cdot (p + \hbar k_\beta - \hbar k_\sigma)}{m} + i \frac{k_\sigma \cdot (p + \hbar k_\beta)}{m} \dots} \\
& \quad - i \frac{k_\alpha \cdot p'}{m} - i \frac{k_\beta \cdot p}{m} + i \frac{\hbar k_\mu \cdot k_\nu}{m} - 3i\omega_k)}{(\gamma + i(\Delta_\beta + \Delta_\alpha - \Delta_\sigma + \Delta_\nu - \Delta_\mu) - i \frac{(k_\nu - k_\mu) \cdot (p + \hbar k_\beta - \hbar k_\sigma)}{m} + i \frac{k_\sigma \cdot (p + \hbar k_\beta)}{m} \dots} \\
& \quad - i \frac{k_\alpha \cdot p'}{m} + i \frac{\hbar k_\mu \cdot k_\nu}{m} - 2i\omega_k)}{(\gamma + i(-\Delta_\sigma + \Delta_\nu - \Delta_\mu) \dots} \\
& \quad - i \frac{(k_\nu - k_\mu) \cdot (p + \hbar k_\beta - \hbar k_\sigma)}{m} + i \frac{k_\sigma \cdot p}{m} + i \frac{\hbar k_\mu \cdot k_\nu}{m} - 3i\omega_k)}{(\gamma + i(\Delta_\nu - \Delta_\mu) - i \frac{(k_\nu - k_\mu) \cdot (p + \hbar k_\beta - \hbar k_\sigma)}{m} \dots} \\
& \quad + i \frac{\hbar k_\mu \cdot k_\nu}{m} - 2i\omega_k)}{(\gamma - i\Delta_\mu + i \frac{k_\mu \cdot (p' - \hbar k_\alpha)}{m} + i\omega_k)} \\
& \times W(p' - \hbar k_\alpha, p + \hbar k_\beta - \hbar k_\sigma + \hbar k_\nu - \hbar k_\mu) \quad (3.f)
\end{aligned}$$

$$\begin{aligned}
& \frac{-i(\Omega_\beta^* \Omega_\alpha^* \Omega_\sigma \Omega_\nu \Omega_\mu^* e^{(-i(-\Delta_\beta - \Delta_\alpha + \Delta_\sigma + \Delta_\nu - \Delta_\mu) + i \frac{(k_\nu - k_\mu) \cdot (p' - \hbar k_\alpha)}{m} + i \frac{k_\sigma \cdot (p + \hbar k_\beta)}{m} - i \frac{k_\alpha \cdot p'}{m} - i \frac{k_\beta \cdot p}{m} - i \frac{\hbar k_\mu \cdot k_\nu}{m} + i \omega_k) t)}}{(\gamma - i(-\Delta_\beta - \Delta_\alpha + \Delta_\sigma + \Delta_\nu - \Delta_\mu) + i \frac{(k_\nu - k_\mu) \cdot (p' - \hbar k_\alpha)}{m} + i \frac{k_\sigma \cdot (p + \hbar k_\beta)}{m} \dots} \\
& \quad - i \frac{k_\alpha \cdot p'}{m} - i \frac{k_\beta \cdot p}{m} - i \frac{\hbar k_\mu \cdot k_\nu}{m} + i \omega_k) \\
& \quad (\gamma_2 - i(-\Delta_\alpha + \Delta_\sigma + \Delta_\nu - \Delta_\mu) + i \frac{(k_\nu - k_\mu) \cdot (p' - \hbar k_\alpha)}{m} + i \frac{k_\sigma \cdot (p + \hbar k_\beta)}{m} \dots \\
& \quad \quad - i \frac{k_\alpha \cdot p'}{m} - i \frac{\hbar k_\mu \cdot k_\nu}{m} + 2i \omega_k) \\
& \quad (\gamma - i(\Delta_\sigma + \Delta_\nu - \Delta_\mu) + i \frac{(k_\nu - k_\mu) \cdot (p' - \hbar k_\alpha)}{m} + i \frac{k_\sigma \cdot (p + \hbar k_\beta)}{m} \dots \\
& \quad \quad - i \frac{\hbar k_\mu \cdot k_\nu}{m} + i \omega_k) \\
& \quad (\gamma_1 - i(\Delta_\nu - \Delta_\mu) + i \frac{(k_\nu - k_\mu) \cdot (p' - \hbar k_\alpha)}{m} - i \frac{\hbar k_\mu \cdot k_\nu}{m} + 2i \omega_k) \\
& \quad (\gamma + i \Delta_\mu - i \frac{k_\mu \cdot (p' - \hbar k_\alpha + \hbar k_\nu - \hbar k_\mu)}{m} - i \omega_k) \\
& \times W(p + \hbar k_\beta - \hbar k_\sigma, p' - \hbar k_\alpha + \hbar k_\nu - \hbar k_\mu) \tag{4.f} \\
& + \int \Gamma N(q) dq e^{(+i \frac{(p' - \hbar k_\alpha) \cdot q}{m} - i \frac{(p + \hbar k_\beta - \hbar k_\sigma) \cdot q}{m}) t} \times
\end{aligned}$$

$$\begin{aligned}
& \frac{i(\Omega_\beta^* \Omega_\alpha^* \Omega_\sigma \Omega_\nu \Omega_\mu^* \times \dots}{\left\{ \frac{e^{(-i(-\Delta_\beta - \Delta_\alpha + \Delta_\sigma + \Delta_\nu - \Delta_\mu) + i \frac{(k_\nu - k_\mu) \cdot (p + \hbar k_\beta + \hbar q)}{m} + i \frac{k_\sigma \cdot (p + \hbar k_\beta)}{m} - i \frac{k_\alpha \cdot p'}{m} - i \frac{k_\beta \cdot p}{m} + i \frac{\hbar k_\mu \cdot k_\nu}{m} - i \omega_k) t)}}{(\gamma - i(-\Delta_\beta - \Delta_\alpha + \Delta_\sigma + \Delta_\nu - \Delta_\mu) + i \frac{(k_\nu - k_\mu) \cdot (p + \hbar k_\beta + \hbar q)}{m} + i \frac{k_\sigma \cdot (p + \hbar k_\beta)}{m} - i \frac{k_\alpha \cdot p'}{m} \dots} \right.} \\
& \quad - i \frac{k_\beta \cdot p}{m} + i \frac{(p' - \hbar k_\alpha) \cdot q}{m} - i \frac{(p + \hbar k_\beta - \hbar k_\sigma) \cdot q}{m} \dots \\
& \quad \quad \quad \left. + i \frac{\hbar k_\mu \cdot k_\nu}{m} - i \omega_k \right) \\
& \quad (\gamma_2 - i(-\Delta_\alpha + \Delta_\sigma + \Delta_\nu - \Delta_\mu) + i \frac{(k_\nu - k_\mu) \cdot (p + \hbar k_\beta + \hbar q)}{m} + i \frac{k_\sigma \cdot (p + \hbar k_\beta)}{m} \dots \\
& \quad \quad - i \frac{k_\alpha \cdot p'}{m} + i \frac{\hbar k_\mu \cdot k_\nu}{m} - 2i \omega_k + i \frac{(p' - \hbar k_\alpha) \cdot q}{m} \dots \\
& \quad \quad \quad - i \frac{(p + \hbar k_\beta - \hbar k_\sigma) \cdot q}{m}) \\
& \quad (\gamma - i(\Delta_\sigma + \Delta_\nu - \Delta_\mu) + i \frac{(k_\nu - k_\mu) \cdot (p + \hbar k_\beta + \hbar q)}{m} + i \frac{k_\sigma \cdot (p + \hbar k_\beta)}{m} + i \frac{\hbar k_\mu \cdot k_\nu}{m} \dots \\
& \quad \quad - 3i \omega_k + i \frac{(p' - \hbar k_\alpha) \cdot q}{m} - i \frac{(p + \hbar k_\beta - \hbar k_\sigma) \cdot q}{m}) \\
& \quad (\gamma_1 - i(\Delta_\nu - \Delta_\mu) + i \frac{(k_\nu - k_\mu) \cdot (p + \hbar k_\beta - \hbar k_\sigma + \hbar q)}{m} + i \frac{\hbar k_\mu \cdot k_\nu}{m} \dots \\
& \quad \quad - 2i \omega_k + i \frac{(p' - \hbar k_\alpha + \hbar q) \cdot q}{m} - i \frac{(p + \hbar k_\beta - \hbar k_\sigma) \cdot q}{m}) \\
& \quad (\gamma_2 - i(\Delta_\nu - \Delta_\mu) + i \frac{(k_\nu - k_\mu) \cdot (p + \hbar k_\beta - \hbar k_\sigma + \hbar q)}{m} \dots \\
& \quad \quad \quad \left. + i \frac{\hbar k_\mu \cdot k_\nu}{m} - 2i \omega_k \right) \\
& \quad (\gamma + i \Delta_\mu - i \frac{k_\mu \cdot (p' - \hbar k_\alpha + \hbar q)}{m} + i \omega_k) \\
& \times W(p + \hbar k_\beta - \hbar k_\sigma + \hbar q - \hbar k_\nu, p' - \hbar k_\alpha + \hbar q - \hbar k_\mu) \tag{4.g}
\end{aligned}$$

$$\begin{aligned}
& i(\Omega_\beta^* \Omega_\alpha^* \Omega_\sigma \Omega_\nu^* \Omega_\mu \times \dots \\
& e^{i(\Delta_\beta + \Delta_\alpha - \Delta_\sigma + \Delta_\nu - \Delta_\mu) - i \frac{(k_\nu - k_\mu) \cdot (p' - \hbar k_\alpha + \hbar q)}{m} + i \frac{k_\sigma \cdot (p + \hbar k_\beta)}{m} - i \frac{k_\alpha \cdot p'}{m} - i \frac{k_\beta \cdot p}{m} + i \frac{\hbar k_\mu \cdot k_\nu}{m} + i \omega_k) t) \\
& + \frac{(\gamma + i(\Delta_\beta + \Delta_\alpha - \Delta_\sigma + \Delta_\nu - \Delta_\mu) - i \frac{(k_\nu - k_\mu) \cdot (p' - \hbar k_\alpha + \hbar q)}{m} + i \frac{k_\sigma \cdot (p + \hbar k_\beta)}{m} - i \frac{k_\alpha \cdot p'}{m} \dots \\
& \quad - i \frac{k_\beta \cdot p}{m} + i \frac{(p' - \hbar k_\alpha) \cdot q}{m} - i \frac{(p + \hbar k_\beta - \hbar k_\sigma) \cdot q}{m} + i \frac{\hbar k_\mu \cdot k_\nu}{m} + i \omega_k)}{(\gamma_2 + i(+\Delta_\alpha - \Delta_\sigma + \Delta_\nu - \Delta_\mu) - i \frac{(k_\nu - k_\mu) \cdot (p' - \hbar k_\alpha + \hbar q)}{m} + i \frac{k_\sigma \cdot (p + \hbar k_\beta)}{m} \dots \\
& \quad - i \frac{k_\alpha \cdot p'}{m} + i \frac{\hbar k_\mu \cdot k_\nu}{m} + 2i\omega_k + i \frac{(p' - \hbar k_\alpha) \cdot q}{m} - i \frac{(p + \hbar k_\beta - \hbar k_\sigma) \cdot q}{m})} \\
& \quad (\gamma + i(-\Delta_\sigma + \Delta_\nu - \Delta_\mu) - i \frac{(k_\nu - k_\mu) \cdot (p' - \hbar k_\alpha + \hbar q)}{m} + i \frac{k_\sigma \cdot (p + \hbar k_\beta)}{m} \dots \\
& \quad + i \frac{\hbar k_\mu \cdot k_\nu}{m} + i \omega_k + i \frac{(p' - \hbar k_\alpha) \cdot q}{m} - i \frac{(p + \hbar k_\beta - \hbar k_\sigma) \cdot q}{m})} \\
& \quad (\gamma_1 + i(\Delta_\nu - \Delta_\mu) - i \frac{(k_\nu - k_\mu) \cdot (p' - \hbar k_\alpha + \hbar q)}{m} + i \frac{\hbar k_\mu \cdot k_\nu}{m} \dots \\
& \quad + 2i\omega_k + \frac{(p' - \hbar k_\alpha + \hbar q) \cdot q}{m} - \frac{(p + \hbar k_\beta - \hbar k_\sigma) \cdot q}{m})} \\
& \quad (\gamma_2 + i(\Delta_\nu - \Delta_\mu) - i \frac{(k_\nu - k_\mu) \cdot (p' - \hbar k_\alpha + \hbar q)}{m} \dots \\
& \quad + i \frac{\hbar k_\mu \cdot k_\nu}{m} + 2i\omega_k) \\
& \quad (\gamma - i\Delta_\mu + i \frac{k_\mu \cdot (p + \hbar k_\beta - \hbar k_\sigma + \hbar q)}{m} - i\omega_k) \\
& \times W(p' - \hbar k_\alpha + \hbar q - \hbar k_\nu, p + \hbar k_\beta - \hbar k_\sigma + \hbar q - \hbar k_\mu) \} \tag{3.g}
\end{aligned}$$

$$\begin{aligned}
& i(\Omega_\beta^* \Omega_\alpha^* \Omega_\sigma \Omega_\nu \Omega_\mu^* \times \dots \\
& e^{-i(-\Delta_\beta + \Delta_\alpha + \Delta_\sigma + \Delta_\nu - \Delta_\mu) + i \frac{(k_\nu - k_\mu) \cdot (p + \hbar k_\beta)}{m} + i \frac{k_\sigma \cdot (p' - \hbar k_\alpha)}{m} - i \frac{k_\alpha \cdot p'}{m} - i \frac{k_\beta \cdot p}{m} + i \frac{\hbar k_\mu \cdot k_\nu}{m} - 3i\omega_k) t) \\
& + \left\{ \begin{aligned}
& (\gamma - i(-\Delta_\beta + \Delta_\alpha + \Delta_\sigma + \Delta_\nu - \Delta_\mu) + i \frac{(k_\nu - k_\mu) \cdot (p + \hbar k_\beta)}{m} + i \frac{k_\sigma \cdot (p' - \hbar k_\alpha)}{m} \dots \\
& \quad - i \frac{k_\alpha \cdot p'}{m} - i \frac{k_\beta \cdot p}{m} + i \frac{\hbar k_\mu \cdot k_\nu}{m} - 3i\omega_k) \\
& (\gamma_2 - i(-\Delta_\alpha + \Delta_\sigma + \Delta_\nu - \Delta_\mu) + i \frac{(k_\nu - k_\mu) \cdot (p + \hbar k_\beta)}{m} + i \frac{k_\sigma \cdot (p' - \hbar k_\alpha)}{m} \dots \\
& \quad - i \frac{k_\alpha \cdot p'}{m} + i \frac{\hbar k_\mu \cdot k_\nu}{m} - 2i\omega_k) \\
& (\gamma - i(\Delta_\sigma + \Delta_\nu - \Delta_\mu) + i \frac{(k_\nu - k_\mu) \cdot (p + \hbar k_\beta)}{m} \dots \\
& \quad + i \frac{k_\sigma \cdot (p' - \hbar k_\alpha)}{m} + i \frac{\hbar k_\mu \cdot k_\nu}{m} - i\omega_k) \\
& (\gamma_2 - i(\Delta_\nu - \Delta_\mu) + i \frac{(k_\nu - k_\mu) \cdot (p + \hbar k_\beta)}{m} + i \frac{\hbar k_\mu \cdot k_\nu}{m} - 2i\omega_k) \\
& (\gamma + i\Delta_\mu - i \frac{k_\mu \cdot (p' - \hbar k_\alpha + \hbar k_\sigma)}{m} + i\omega_k)
\end{aligned} \right. \\
& \times W(p + \hbar k_\beta - \hbar k_\nu, p' - \hbar k_\alpha + \hbar k_\sigma - \hbar k_\mu) \tag{4.h}
\end{aligned}$$

$$\begin{aligned}
& i(\Omega_\beta^* \Omega_\alpha^* \Omega_\sigma \Omega_\nu^* \Omega_\mu \times \dots \\
& e^{i(\Delta_\beta + \Delta_\alpha - \Delta_\sigma + \Delta_\nu - \Delta_\mu) - i \frac{(k_\nu - k_\mu) \cdot (p' - \hbar k_\alpha + \hbar k_\sigma)}{m} + i \frac{k_\sigma \cdot (p' - \hbar k_\alpha)}{m} - i \frac{k_\alpha \cdot p'}{m} - i \frac{k_\beta \cdot p}{m} + i \frac{\hbar k_\mu \cdot k_\nu}{m} + 3i\omega_k) t) \\
& + \frac{(\gamma + i(\Delta_\beta + \Delta_\alpha - \Delta_\sigma + \Delta_\nu - \Delta_\mu) - i \frac{(k_\nu - k_\mu) \cdot (p' - \hbar k_\alpha + \hbar k_\sigma)}{m} + i \frac{k_\sigma \cdot (p' - \hbar k_\alpha)}{m} \dots \\
& \quad - i \frac{k_\alpha \cdot p'}{m} - i \frac{k_\beta \cdot p}{m} + i \frac{\hbar k_\mu \cdot k_\nu}{m} + 3i\omega_k)}{(\gamma_2 + i(+\Delta_\alpha - \Delta_\sigma + \Delta_\nu - \Delta_\mu) - i \frac{(k_\nu - k_\mu) \cdot (p' - \hbar k_\alpha + \hbar k_\sigma)}{m} \dots \\
& \quad + i \frac{k_\sigma \cdot (p' - \hbar k_\alpha)}{m} - i \frac{k_\alpha \cdot p'}{m} + i \frac{\hbar k_\mu \cdot k_\nu}{m} + 4i\omega_k)} \\
& \quad (\gamma + i(-\Delta_\sigma + \Delta_\nu - \Delta_\mu) - i \frac{(k_\nu - k_\mu) \cdot (p' - \hbar k_\alpha + \hbar k_\sigma)}{m} \dots \\
& \quad + i \frac{k_\sigma \cdot (p' - \hbar k_\alpha)}{m} + i \frac{\hbar k_\mu \cdot k_\nu}{m} + 3i\omega_k) \\
& \quad (\gamma_2 + i(\Delta_\nu - \Delta_\mu) - i \frac{(k_\nu - k_\mu) \cdot (p' - \hbar k_\alpha + \hbar k_\sigma)}{m} \dots \\
& \quad + i \frac{\hbar k_\mu \cdot k_\nu}{m} + 2i\omega_k) \\
& \quad (\gamma - i\Delta_\mu + i \frac{k_\mu \cdot (p + \hbar k_\beta)}{m} - i\omega_k) \\
& \times W(p' - \hbar k_\alpha + \hbar k_\sigma - \hbar k_\nu, p + \hbar k_\beta - \hbar k_\mu) \} \tag{3.h}
\end{aligned}$$

$$\begin{aligned}
& i(\Omega_\beta^* \Omega_\alpha \Omega_\sigma^* \Omega_\nu \Omega_\mu^* \times \dots \\
& e^{(-i(-\Delta_\beta + \Delta_\alpha - \Delta_\sigma + \Delta_\nu - \Delta_\mu) + i \frac{(k_\nu - k_\mu) \cdot (p' - \hbar k_\sigma)}{m} - i \frac{k_\sigma \cdot p'}{m} + i \frac{k_\alpha \cdot (p + \hbar k_\beta)}{m} - i \frac{k_\beta \cdot p}{m} - i \frac{\hbar k_\mu \cdot k_\nu}{m} + i \omega_k)t} \\
& + \left[\left[- \frac{(\gamma - i(-\Delta_\beta + \Delta_\alpha - \Delta_\sigma + \Delta_\nu - \Delta_\mu) + i \frac{(k_\nu - k_\mu) \cdot (p' - \hbar k_\sigma)}{m} - i \frac{k_\sigma \cdot p'}{m} + i \frac{k_\alpha \cdot (p + \hbar k_\beta)}{m} \dots}{-i \frac{k_\beta \cdot p}{m} - i \frac{\hbar k_\mu \cdot k_\nu}{m} + i \omega_k)} \right. \right. \\
& \quad (\gamma_2 - i(\Delta_\alpha - \Delta_\sigma + \Delta_\nu - \Delta_\mu) + i \frac{(k_\nu - k_\mu) \cdot (p' - \hbar k_\sigma)}{m} - i \frac{k_\sigma \cdot p'}{m} \dots \\
& \quad \quad + i \frac{k_\alpha \cdot (p + \hbar k_\beta)}{m} - i \frac{\hbar k_\mu \cdot k_\nu}{m} + 2i\omega_k) \\
& \quad (\gamma - i(-\Delta_\sigma + \Delta_\nu - \Delta_\mu) + i \frac{(k_\nu - k_\mu) \cdot (p' - \hbar k_\sigma)}{m} \dots \\
& \quad \quad - i \frac{k_\sigma \cdot p'}{m} - i \frac{\hbar k_\mu \cdot k_\nu}{m} + 3i\omega_k) \\
& \quad (\gamma_1 - i(\Delta_\nu - \Delta_\mu) + i \frac{(k_\nu - k_\mu) \cdot (p' - \hbar k_\sigma)}{m} \dots \\
& \quad \quad - i \frac{\hbar k_\mu \cdot k_\nu}{m} + 2i\omega_k) \\
& \quad \left. \left. (\gamma + i\Delta_\mu - i \frac{k_\mu \cdot (p + \hbar k_\beta - \hbar k_\alpha)}{m} - i\omega_k) \right] \right] \\
& \times W(p + \hbar k_\beta - \hbar k_\alpha, p' - \hbar k_\sigma + \hbar k_\nu - \hbar k_\mu) \tag{1.f}
\end{aligned}$$

$$\begin{aligned}
& i(\Omega_\beta^* \Omega_\alpha \Omega_\sigma^* \Omega_\nu \Omega_\mu^* \times \dots \\
& e^{(i(\Delta_\beta - \Delta_\alpha + \Delta_\sigma + \Delta_\nu - \Delta_\mu) - i \frac{(k_\nu - k_\mu) \cdot (p + \hbar k_\beta - \hbar k_\alpha)}{m} - i \frac{k_\sigma \cdot p'}{m} + i \frac{k_\alpha \cdot (p + \hbar k_\beta)}{m} - i \frac{k_\beta \cdot p}{m} + i \frac{\hbar k_\mu \cdot k_\nu}{m} - 3i\omega_k)t} \\
& \frac{(\gamma + i(\Delta_\beta - \Delta_\alpha + \Delta_\sigma + \Delta_\nu - \Delta_\mu) - i \frac{(k_\nu - k_\mu) \cdot (p + \hbar k_\beta - \hbar k_\alpha)}{m} \dots}{-i \frac{k_\sigma \cdot p'}{m} + i \frac{k_\alpha \cdot (p + \hbar k_\beta)}{m} - i \frac{k_\beta \cdot p}{m} + i \frac{\hbar k_\mu \cdot k_\nu}{m} - 3i\omega_k)} \\
& \quad (\gamma_2 + i(-\Delta_\alpha + \Delta_\sigma + \Delta_\nu - \Delta_\mu) - i \frac{(k_\nu - k_\mu) \cdot (p + \hbar k_\beta - \hbar k_\alpha)}{m} \dots \\
& \quad \quad - i \frac{k_\sigma \cdot p'}{m} + i \frac{k_\alpha \cdot (p + \hbar k_\beta)}{m} + i \frac{\hbar k_\mu \cdot k_\nu}{m} - 2i\omega_k) \\
& \quad (\gamma + i(\Delta_\sigma + \Delta_\nu - \Delta_\mu) - i \frac{(k_\nu - k_\mu) \cdot (p + \hbar k_\beta - \hbar k_\alpha)}{m} - i \frac{k_\sigma \cdot p'}{m} \dots \\
& \quad \quad + i \frac{\hbar k_\mu \cdot k_\nu}{m} - i\omega_k) \\
& \quad (\gamma_1 + i(\Delta_\nu - \Delta_\mu) - i \frac{(k_\nu - k_\mu) \cdot (p + \hbar k_\beta - \hbar k_\alpha)}{m} \dots \\
& \quad \quad + i \frac{\hbar k_\mu \cdot k_\nu}{m} - 2i\omega_k) \\
& \quad \left. (\gamma - i\Delta_\mu + i \frac{k_\mu \cdot (p + \hbar k_\beta - \hbar k_\alpha + \hbar k_\nu - \hbar k_\mu)}{m} + i\omega_k) \right] \\
& \times W(p' - \hbar k_\sigma, p + \hbar k_\beta - \hbar k_\alpha + \hbar k_\nu - \hbar k_\mu) \tag{2.f}
\end{aligned}$$

$$+ \int \Gamma N(q) dq e^{(-i \frac{(p + \hbar k_\beta - \hbar k_\alpha) \cdot q}{m} + i \frac{(p' - \hbar k_\sigma) \cdot q}{m})t} \times$$

$$\begin{aligned}
& i(\Omega_\beta^* \Omega_\alpha \Omega_\sigma^* \Omega_\nu^* \Omega_\mu \times \dots \\
& e^{i(\Delta_\beta - \Delta_\alpha + \Delta_\sigma + \Delta_\nu - \Delta_\mu) - i \frac{(k_\nu - k_\mu) \cdot (p' + \hbar q)}{m} - i \frac{k_\sigma \cdot p'}{m} + i \frac{k_\alpha \cdot (p + \hbar k_\beta)}{m} - i \frac{k_\beta \cdot p}{m} - i \frac{\hbar k_\mu \cdot k_\nu}{m} + i \omega_k t) \\
& \left\{ \frac{(\gamma + i(\Delta_\beta - \Delta_\alpha + \Delta_\sigma + \Delta_\nu - \Delta_\mu) - i \frac{(k_\nu - k_\mu) \cdot (p' + \hbar q)}{m} - i \frac{k_\sigma \cdot p'}{m} + i \frac{k_\alpha \cdot (p + \hbar k_\beta)}{m} - i \frac{k_\beta \cdot p}{m} \dots}{\dots} \right. \\
& \quad - i \frac{(p + \hbar k_\beta - \hbar k_\alpha) \cdot q}{m} + i \frac{(p' - \hbar k_\sigma) \cdot q}{m} - i \frac{\hbar k_\mu \cdot k_\nu}{m} + i \omega_k) \\
& \quad (\gamma_2 + i(-\Delta_\alpha + \Delta_\sigma + \Delta_\nu - \Delta_\mu) - i \frac{(k_\nu - k_\mu) \cdot (p' + \hbar q)}{m} - i \frac{k_\sigma \cdot p'}{m} + i \frac{k_\alpha \cdot (p + \hbar k_\beta)}{m} - i \frac{\hbar k_\mu \cdot k_\nu}{m} \dots \\
& \quad \quad + 2i\omega_k - i \frac{(p + \hbar k_\beta - \hbar k_\alpha) \cdot q}{m} + i \frac{(p' - \hbar k_\sigma) \cdot q}{m}) \\
& \quad (\gamma + i(\Delta_\sigma + \Delta_\nu - \Delta_\mu) - i \frac{(k_\nu - k_\mu) \cdot (p' + \hbar q)}{m} - i \frac{k_\sigma \cdot p'}{m} - i \frac{\hbar k_\mu \cdot k_\nu}{m} + 3i\omega_k \dots \\
& \quad \quad - i \frac{(p + \hbar k_\beta - \hbar k_\alpha) \cdot q}{m} + i \frac{(p' - \hbar k_\sigma) \cdot q}{m}) \\
& \quad (\gamma_1 + i(\Delta_\nu - \Delta_\mu) - i \frac{(k_\nu - k_\mu) \cdot (p' - \hbar k_\sigma + \hbar q)}{m} - i \frac{\hbar k_\mu \cdot k_\nu}{m} + 2i\omega_k \dots \\
& \quad \quad - i \frac{(p + \hbar k_\beta - \hbar k_\alpha + \hbar q) \cdot q}{m} + i \frac{(p' - \hbar k_\sigma) \cdot q}{m}) \\
& \quad (\gamma_2 + i(\Delta_\nu - \Delta_\mu) - i \frac{(k_\nu - k_\mu) \cdot (p' - \hbar k_\sigma + \hbar q)}{m} \dots \\
& \quad \quad - i \frac{\hbar k_\mu \cdot k_\nu}{m} + 2i\omega_k) \\
& \quad (\gamma - i\Delta_\mu + i \frac{k_\mu \cdot (p + \hbar k_\beta - \hbar k_\alpha + \hbar q)}{m} - i\omega_k) \\
& \times W(p' - \hbar k_\sigma + \hbar q - \hbar k_\nu, p + \hbar k_\beta - \hbar k_\alpha + \hbar q - \hbar k_\mu) \quad (2.g) \\
& + \frac{i(\Omega_\beta^* \Omega_\alpha \Omega_\sigma^* \Omega_\nu \Omega_\mu^* \times \dots}{e^{i(-\Delta_\beta + \Delta_\alpha - \Delta_\sigma + \Delta_\nu - \Delta_\mu) + i \frac{(k_\nu - k_\mu) \cdot (p + \hbar k_\beta - \hbar k_\alpha + \hbar q)}{m} - i \frac{k_\sigma \cdot p'}{m} + i \frac{k_\alpha \cdot p}{m} - i \frac{k_\beta \cdot p}{m} - i \frac{\hbar k_\mu \cdot k_\nu}{m} - 3i\omega_k t)} \\
& \quad (\gamma - i(-\Delta_\beta + \Delta_\alpha - \Delta_\sigma + \Delta_\nu - \Delta_\mu) + i \frac{(k_\nu - k_\mu) \cdot (p + \hbar k_\beta - \hbar k_\alpha + \hbar q)}{m} - i \frac{k_\sigma \cdot p'}{m} + i \frac{k_\alpha \cdot p}{m} \dots \\
& \quad \quad - i \frac{k_\beta \cdot p}{m} - i \frac{(p + \hbar k_\beta - \hbar k_\alpha) \cdot q}{m} + i \frac{(p' - \hbar k_\sigma) \cdot q}{m} - i \frac{\hbar k_\mu \cdot k_\nu}{m} - 3i\omega_k) \\
& \quad (\gamma_2 - i(\Delta_\alpha - \Delta_\sigma + \Delta_\nu - \Delta_\mu) + i \frac{(k_\nu - k_\mu) \cdot (p + \hbar k_\beta - \hbar k_\alpha + \hbar q)}{m} - i \frac{k_\sigma \cdot p'}{m} + i \frac{k_\alpha \cdot (p + \hbar k_\beta)}{m} - i \frac{\hbar k_\mu \cdot k_\nu}{m} \dots \\
& \quad \quad - 2i\omega_k - i \frac{(p + \hbar k_\beta - \hbar k_\alpha) \cdot q}{m} + i \frac{(p' - \hbar k_\sigma) \cdot q}{m}) \\
& \quad (\gamma - i(-\Delta_\sigma + \Delta_\nu - \Delta_\mu) + i \frac{(k_\nu - k_\mu) \cdot (p + \hbar k_\beta - \hbar k_\alpha + \hbar q)}{m} - i \frac{k_\sigma \cdot p'}{m} - i \frac{\hbar k_\mu \cdot k_\nu}{m} \dots \\
& \quad \quad - i\omega_k - i \frac{(p + \hbar k_\beta - \hbar k_\alpha) \cdot q}{m} + i \frac{(p' - \hbar k_\sigma) \cdot q}{m}) \\
& \quad (\gamma_1 - i(\Delta_\nu - \Delta_\mu) + i \frac{(k_\nu - k_\mu) \cdot (p + \hbar k_\beta - \hbar k_\alpha + \hbar q)}{m} - i \frac{\hbar k_\mu \cdot k_\nu}{m} \dots \\
& \quad \quad - 2i\omega_k - i \frac{(p + \hbar k_\beta - \hbar k_\alpha + \hbar q) \cdot q}{m} + i \frac{(p' - \hbar k_\sigma) \cdot q}{m}) \\
& \quad (\gamma_2 - i(\Delta_\nu - \Delta_\mu) + i \frac{(k_\nu - k_\mu) \cdot (p + \hbar k_\beta - \hbar k_\alpha + \hbar q)}{m} \dots \\
& \quad \quad - i \frac{\hbar k_\mu \cdot k_\nu}{m} - 2i\omega_k) \\
& \quad (\gamma + i\Delta_\mu - i \frac{k_\mu \cdot (p' - \hbar k_\sigma + \hbar q)}{m} + i\omega_k) \\
& \times W(p + \hbar k_\beta - \hbar k_\alpha + \hbar q - \hbar k_\nu, p' - \hbar k_\sigma + \hbar q - \hbar k_\mu) \quad (1.g) \\
& - \left\{ \frac{i(\Omega_\beta^* \Omega_\alpha \Omega_\sigma^* \Omega_\nu^* \Omega_\mu \times \dots}{e^{i(\Delta_\beta - \Delta_\alpha + \Delta_\sigma + \Delta_\nu - \Delta_\mu) - i \frac{(k_\nu - k_\mu) \cdot p'}{m} - i \frac{k_\sigma \cdot (p + \hbar k_\beta - \hbar k_\alpha)}{m} + i \frac{k_\alpha \cdot (p + \hbar k_\beta)}{m} - i \frac{k_\beta \cdot p}{m} - i \frac{\hbar k_\mu \cdot k_\nu}{m} + i \omega_k t)} \right. \\
& \quad (\gamma + i(\Delta_\beta - \Delta_\alpha + \Delta_\sigma + \Delta_\nu - \Delta_\mu) - i \frac{(k_\nu - k_\mu) \cdot p'}{m} - i \frac{k_\sigma \cdot (p + \hbar k_\beta - \hbar k_\alpha)}{m} + i \frac{k_\alpha \cdot (p + \hbar k_\beta)}{m} \dots \\
& \quad \quad - i \frac{k_\beta \cdot p}{m} - i \frac{\hbar k_\mu \cdot k_\nu}{m} + i \omega_k) \\
& \quad (\gamma_2 + i(-\Delta_\alpha + \Delta_\sigma + \Delta_\nu - \Delta_\mu) - i \frac{(k_\nu - k_\mu) \cdot p'}{m} - i \frac{k_\sigma \cdot (p + \hbar k_\beta - \hbar k_\alpha)}{m} \dots \\
& \quad \quad + i \frac{k_\alpha \cdot (p + \hbar k_\beta)}{m} - i \frac{\hbar k_\mu \cdot k_\nu}{m}) \\
& \quad (\gamma + i(\Delta_\sigma + \Delta_\nu - \Delta_\mu) - i \frac{(k_\nu - k_\mu) \cdot p'}{m} - i \frac{k_\sigma \cdot (p + \hbar k_\beta - \hbar k_\alpha)}{m} \dots \\
& \quad \quad - i \frac{\hbar k_\mu \cdot k_\nu}{m} + i \omega_k) \\
& \quad (\gamma_2 + i(\Delta_\nu - \Delta_\mu) - i \frac{(k_\nu - k_\mu) \cdot p'}{m} - i \frac{\hbar k_\mu \cdot k_\nu}{m} + 2i\omega_k) \\
& \quad (\gamma - i\Delta_\mu + i \frac{k_\mu \cdot (p + \hbar k_\beta - \hbar k_\alpha + \hbar k_\sigma)}{m} - i\omega_k) \\
\end{aligned}$$

$$\begin{aligned}
& \times W(p' - \hbar k_\nu, p + \hbar k_\beta - \hbar k_\alpha + \hbar k_\sigma - \hbar k_\mu) \tag{2.h} \\
& i(\Omega_\beta^* \Omega_\alpha \Omega_\sigma^* \Omega_\nu \Omega_\mu^* \times \dots \\
& e^{(-i(-\Delta_\beta + \Delta_\alpha - \Delta_\sigma + \Delta_\nu - \Delta_\mu) + i \frac{(k_\nu - k_\mu) \cdot (p + \hbar k_\beta - \hbar k_\alpha + \hbar k_\sigma)}{m} - i \frac{k_\sigma \cdot (p + \hbar k_\beta - \hbar k_\alpha)}{m} + i \frac{k_\alpha \cdot (p + \hbar k_\beta)}{m} - i \frac{k_\beta \cdot p}{m} - i \frac{\hbar k_\mu \cdot k_\nu}{m} - 3i\omega_k)t)} \\
& + \frac{(\gamma + -i(-\Delta_\beta + \Delta_\alpha - \Delta_\sigma + \Delta_\nu - \Delta_\mu) + i \frac{(k_\nu - k_\mu) \cdot (p + \hbar k_\beta - \hbar k_\alpha + \hbar k_\sigma)}{m} - i \frac{k_\sigma \cdot (p + \hbar k_\beta - \hbar k_\alpha)}{m} \dots}{(\gamma + -i(-\Delta_\beta + \Delta_\alpha - \Delta_\sigma + \Delta_\nu - \Delta_\mu) + i \frac{(k_\nu - k_\mu) \cdot (p + \hbar k_\beta - \hbar k_\alpha + \hbar k_\sigma)}{m} - i \frac{k_\sigma \cdot (p + \hbar k_\beta - \hbar k_\alpha)}{m} \dots} \\
& \quad + i \frac{k_\alpha \cdot (p + \hbar k_\beta)}{m} - i \frac{k_\beta \cdot p}{m} - i \frac{\hbar k_\mu \cdot k_\nu}{m} - 3i\omega_k) \\
& \quad (\gamma_2 - i(\Delta_\alpha - \Delta_\sigma + \Delta_\nu - \Delta_\mu) + i \frac{(k_\nu - k_\mu) \cdot (p + \hbar k_\beta - \hbar k_\alpha + \hbar k_\sigma)}{m} - i \frac{k_\sigma \cdot (p + \hbar k_\beta - \hbar k_\alpha)}{m} \dots}{(\gamma_2 - i(\Delta_\alpha - \Delta_\sigma + \Delta_\nu - \Delta_\mu) + i \frac{(k_\nu - k_\mu) \cdot (p + \hbar k_\beta - \hbar k_\alpha + \hbar k_\sigma)}{m} - i \frac{k_\sigma \cdot (p + \hbar k_\beta - \hbar k_\alpha)}{m} \dots} \\
& \quad + i \frac{k_\alpha \cdot (p + \hbar k_\beta)}{m} - i \frac{\hbar k_\mu \cdot k_\nu}{m} - 4i\omega_k) \\
& \quad (\gamma - i(-\Delta_\sigma + \Delta_\nu - \Delta_\mu) + i \frac{(k_\nu - k_\mu) \cdot (p + \hbar k_\beta - \hbar k_\alpha + \hbar k_\sigma)}{m} \dots}{(\gamma - i(-\Delta_\sigma + \Delta_\nu - \Delta_\mu) + i \frac{(k_\nu - k_\mu) \cdot (p + \hbar k_\beta - \hbar k_\alpha + \hbar k_\sigma)}{m} \dots} \\
& \quad - i \frac{k_\sigma \cdot (p + \hbar k_\beta - \hbar k_\alpha)}{m} - i \frac{\hbar k_\mu \cdot k_\nu}{m} - 3i\omega_k) \\
& \quad (\gamma_2 - i(\Delta_\nu - \Delta_\mu) + i \frac{(k_\nu - k_\mu) \cdot (p + \hbar k_\beta - \hbar k_\alpha + \hbar k_\sigma)}{m} \dots}{(\gamma_2 - i(\Delta_\nu - \Delta_\mu) + i \frac{(k_\nu - k_\mu) \cdot (p + \hbar k_\beta - \hbar k_\alpha + \hbar k_\sigma)}{m} \dots} \\
& \quad - i \frac{\hbar k_\mu \cdot k_\nu}{m} - 2i\omega_k) \\
& \quad (\gamma + i\Delta_\mu - i \frac{k_\mu \cdot p'}{m} + i\omega_k)} \\
& \times W(p + \hbar k_\beta - \hbar k_\alpha + \hbar k_\sigma - \hbar k_\nu, p' - \hbar k_\mu) \} \tag{2.h} \\
&]
\end{aligned}$$

The different colors label similar terms in terms of Rabi frequency ordering. For computation, each of these terms are grouped into four categories (corresponding to four colors) and labeled accordingly :

- (1) the terms in $\Omega_\beta^* \Omega_\alpha \Omega_\sigma^* \Omega_\nu \Omega_\mu^*$ order are written in **blue**.
- (2) the terms in $\Omega_\beta^* \Omega_\alpha \Omega_\sigma^* \Omega_\nu^* \Omega_\mu$ order are written in **magenta**.
- (3) the terms in $\Omega_\beta^* \Omega_\alpha^* \Omega_\sigma \Omega_\nu^* \Omega_\mu$ order are written in **red**.
- (4) the terms in $\Omega_\beta^* \Omega_\alpha^* \Omega_\sigma \Omega_\nu \Omega_\mu^*$ order are written in **brown**.

$\alpha, \beta, \sigma, \nu, \mu$ are running indices for any of the fields and are summed for combinations that gives a field in the probe direction. The terms, left in black are associated to processes that involve double spontaneous emissions.

C.1.7.1 Selection of terms

In terms of the Rabi frequency ordering, all the different possible terms in the fifth order coherence are possible, but we can:

- neglect terms with more than one signal Rabi frequencies, as pump fields are much stronger.

- select the terms responsible for the generation of phase conjugate field i.e. with the relevant wave-vector.

The only relevant terms are:

$$\begin{aligned}
& \Omega_{p1}^* \Omega_{p1} \Omega_{p1}^* \Omega_s \Omega_{p2}^* + \Omega_{p1}^* \Omega_{p1} \Omega_{p2}^* \Omega_s \Omega_{p1}^* + \dots \\
& \dots \Omega_{p1}^* \Omega_{p1} \Omega_{p2}^* \Omega_{p1}^* \Omega_s + \Omega_{p1}^* \Omega_{p1} \Omega_{p1}^* \Omega_{p2}^* \Omega_s + \Omega_{p1}^* \Omega_{p2} \Omega_{p2}^* \Omega_{p2}^* \Omega_s + \dots \\
& \dots \Omega_{p1}^* \Omega_s \Omega_{p1}^* \Omega_{p1} \Omega_{p2}^* + \Omega_{p1}^* \Omega_s \Omega_{p1}^* \Omega_{p2}^* \Omega_{p1} + \dots \\
& \dots \Omega_{p1}^* \Omega_s \Omega_{p2}^* \Omega_{p1} \Omega_{p1}^* + \Omega_{p1}^* \Omega_s \Omega_{p2}^* \Omega_{p2} \Omega_{p1}^* + \dots \\
& \dots \Omega_{p1}^* \Omega_s \Omega_{p2}^* \Omega_{p1}^* \Omega_{p1} + \Omega_{p1}^* \Omega_s \Omega_{p2}^* \Omega_{p2}^* \Omega_{p2} + \dots \\
& \dots \Omega_{p1}^* \Omega_{p1}^* \Omega_s \Omega_{p1} \Omega_{p2}^* + \Omega_{p1}^* \Omega_{p1}^* \Omega_{p1} \Omega_{p2}^* \Omega_s + \dots \\
& \dots \Omega_{p1}^* \Omega_{p1}^* \Omega_s \Omega_{p2}^* \Omega_{p1} + \Omega_{p1}^* \Omega_{p2}^* \Omega_{p1} \Omega_s \Omega_{p1}^* + \dots \\
& \dots \Omega_{p1}^* \Omega_{p2}^* \Omega_{p1} \Omega_s \Omega_{p2}^* + \Omega_{p1}^* \Omega_{p2}^* \Omega_{p1} \Omega_{p1}^* \Omega_s + \dots \\
& \dots \Omega_{p1}^* \Omega_{p2}^* \Omega_{p2} \Omega_s \Omega_{p2}^* + \Omega_{p1}^* \Omega_{p2}^* \Omega_{p2} \Omega_{p2}^* \Omega_s + \dots \\
& \dots \Omega_{p1}^* \Omega_{p2}^* \Omega_s \Omega_{p1} \Omega_{p1}^* + \Omega_{p1}^* \Omega_{p2}^* \Omega_s \Omega_{p2} \Omega_{p2}^* + \dots \\
& \dots \Omega_{p1}^* \Omega_{p2}^* \Omega_s \Omega_{p1}^* \Omega_{p1} + \Omega_{p1}^* \Omega_{p2}^* \Omega_s \Omega_{p2} \Omega_{p2}^* + \dots \\
& \dots \Omega_{p1}^* \Omega_{p2}^* \Omega_s \Omega_{p1} \Omega_{p1}^* + \Omega_{p1}^* \Omega_{p2}^* \Omega_s \Omega_{p2}^* \Omega_{p2} + \dots \\
& \dots \Omega_{p1}^* \Omega_{p2}^* \Omega_s \Omega_{p1}^* \Omega_{p1} + \Omega_{p1}^* \Omega_{p2}^* \Omega_s \Omega_{p1}^* \Omega_s + \dots \\
& \dots \Omega_{p2}^* \Omega_{p2} \Omega_{p1}^* \Omega_s \Omega_{p2}^* + \Omega_{p2}^* \Omega_{p2} \Omega_{p2}^* \Omega_s \Omega_{p1}^* + \dots \\
& \dots \Omega_{p2}^* \Omega_{p2} \Omega_{p2}^* \Omega_{p1}^* \Omega_s + \Omega_{p2}^* \Omega_{p2} \Omega_{p1}^* \Omega_{p2}^* \Omega_s + \dots \\
& \dots \Omega_{p2}^* \Omega_s \Omega_{p1}^* \Omega_{p1} \Omega_{p1}^* + \Omega_{p2}^* \Omega_s \Omega_{p1}^* \Omega_{p2} \Omega_{p2}^* + \dots \\
& \dots \Omega_{p2}^* \Omega_s \Omega_{p1}^* \Omega_{p1}^* \Omega_{p1} + \Omega_{p2}^* \Omega_s \Omega_{p1}^* \Omega_{p2}^* \Omega_{p2} + \dots \\
& \dots \Omega_{p2}^* \Omega_s \Omega_{p2}^* \Omega_{p2} \Omega_{p1}^* + \Omega_{p2}^* \Omega_s \Omega_{p2}^* \Omega_{p1}^* \Omega_{p2} + \dots \\
& \dots \Omega_{p2}^* \Omega_{p1}^* \Omega_{p1} \Omega_s \Omega_{p1}^* + \Omega_{p2}^* \Omega_{p1}^* \Omega_{p2} \Omega_{p2}^* \Omega_s + \dots \\
& \dots \Omega_{p2}^* \Omega_{p1}^* \Omega_{p1} \Omega_s \Omega_{p1}^* + \Omega_{p2}^* \Omega_{p1}^* \Omega_{p1} \Omega_{p1}^* \Omega_s + \dots \\
& \dots \Omega_{p2}^* \Omega_{p1}^* \Omega_{p2} \Omega_s \Omega_{p1}^* + \Omega_{p2}^* \Omega_{p1}^* \Omega_{p2} \Omega_{p1}^* \Omega_s + \dots \\
& \dots \Omega_{p2}^* \Omega_{p1}^* \Omega_s \Omega_{p1} \Omega_{p1}^* + \Omega_{p2}^* \Omega_{p1}^* \Omega_s \Omega_{p2} \Omega_{p2}^* + \dots \\
& \dots \Omega_{p2}^* \Omega_{p1}^* \Omega_s \Omega_{p1}^* \Omega_{p1} + \Omega_{p2}^* \Omega_{p1}^* \Omega_s \Omega_{p2}^* \Omega_{p2} + \dots \\
& \dots \Omega_{p2}^* \Omega_{p2}^* \Omega_{p1} \Omega_{p2} \Omega_s \Omega_{p2}^* + \Omega_{p2}^* \Omega_{p2}^* \Omega_{p2} \Omega_s \Omega_{p1}^* + \Omega_{p2}^* \Omega_{p2}^* \Omega_{p2} \Omega_{p1}^* \Omega_s + \dots \\
& \dots \Omega_{p2}^* \Omega_{p2}^* \Omega_s \Omega_{p2} \Omega_{p1}^* + \Omega_{p2}^* \Omega_{p2}^* \Omega_s \Omega_{p1}^* \Omega_{p2} + \dots
\end{aligned}$$

So that we get 46 terms, where the subscripts $p1$ and $p2$ denote the two counter propagating pump Rabi frequencies, and the term Ω_s is for the signal. Figures C.1 to C.4 show the various real imaginary and absolute values of different terms plotted as a function of coupling-signal detuning δ . Some of them just add a constant background, while others exhibit resonances.

Nevertheless, the fig. 4.7 demonstrates that with the experimental parameters, only four terms dominate, which could then be used for faster simulations. The four are $\Omega_{p1}^* \Omega_{p1} \Omega_s \Omega_{p2}^* \Omega_{p1}^*$, $\Omega_{p1} \Omega_{p2}^* \Omega_s \Omega_{p2}^* \Omega_{p1}^*$, $\Omega_{p2}^* \Omega_{p2} \Omega_s \Omega_{p2}^* \Omega_{p1}^*$, $\Omega_{p2} \Omega_{p2}^* \Omega_s \Omega_{p2}^* \Omega_{p1}^*$. The detailed pathways for these four terms are listed in page 92.

$$\Omega_\beta^* \Omega_\alpha \Omega_\sigma^* \Omega_\nu \Omega_\mu^*$$

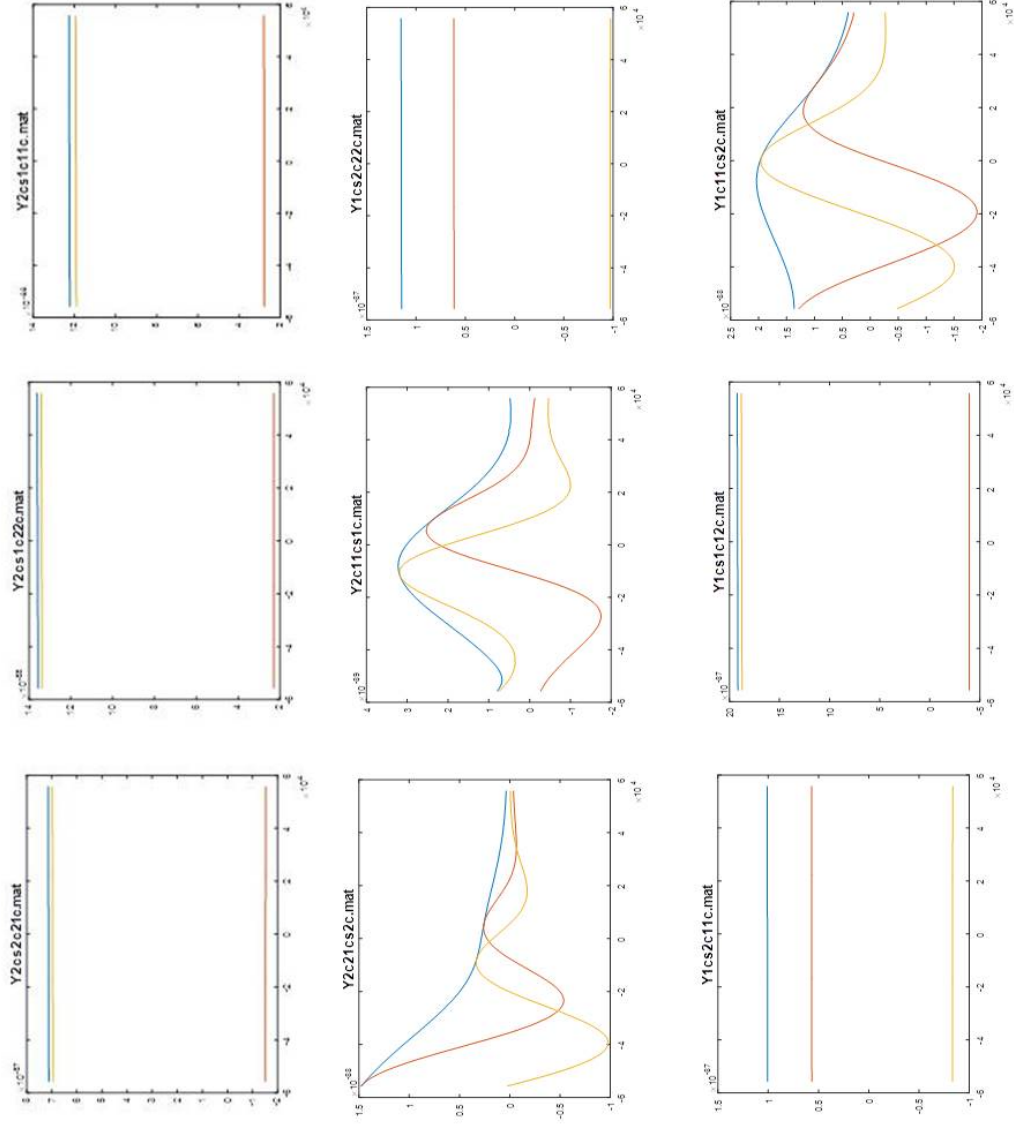

FIGURE C.1: Fifth order coherence terms with order of Rabi frequencies as $\Omega_\beta^* \Omega_\alpha \Omega_\sigma^* \Omega_\nu \Omega_\mu^*$. The greek indices can take any value from $\{1, 2, s\}$ where 1 denotes the forward moving pump, 2 denotes the backward moving pump and s is for signal. In each of the subplots, the red curve is the real, the yellow curve the imaginary and the blue one is for the absolute value of the term, as a function of coupling signal detuning $\delta/2\pi = -60$ to 60 kHz.

$$\Omega_{\beta}^* \Omega_{\alpha} \Omega_{\sigma}^* \Omega_{\nu} \Omega_{\mu}^*$$

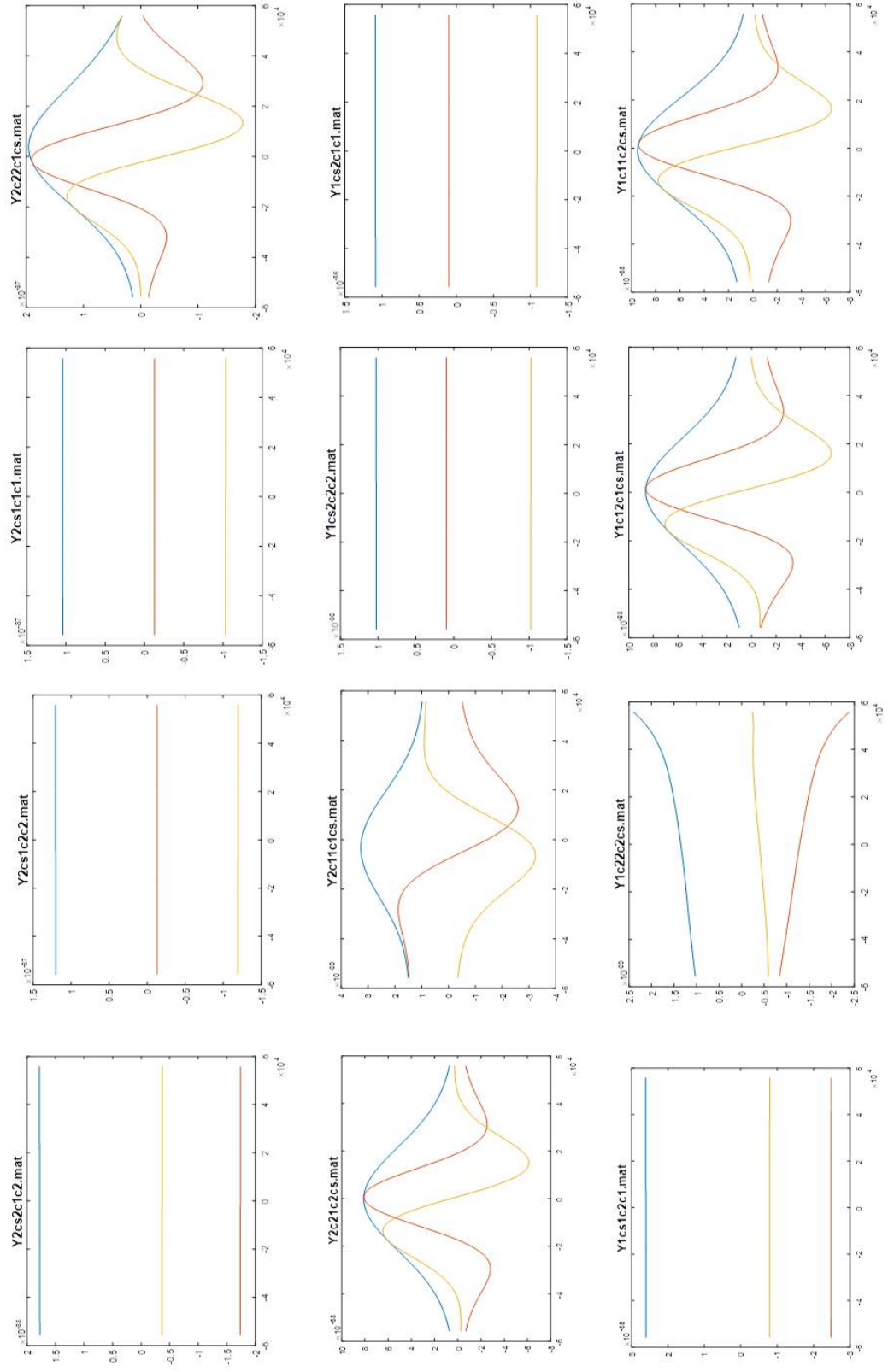

FIGURE C.2: Fifth order coherence terms with order of Rabi frequencies as $\Omega_{\beta}^* \Omega_{\alpha} \Omega_{\sigma}^* \Omega_{\nu} \Omega_{\mu}^*$. The greek indices can take any value from $\{1, 2, s\}$ where 1 denotes the forward moving pump, 2 denotes the backward moving pump and s is for signal. In each of the subplots, the red curve is the real, the yellow curve the imaginary and the blue one is for the absolute value of the term, as a function of coupling signal detuning $\delta/2\pi = 60 + i\Gamma$.

$$\Omega_{\beta}^* \Omega_{\alpha}^* \Omega_{\sigma} \Omega_{\nu}^* \Omega_{\mu}$$

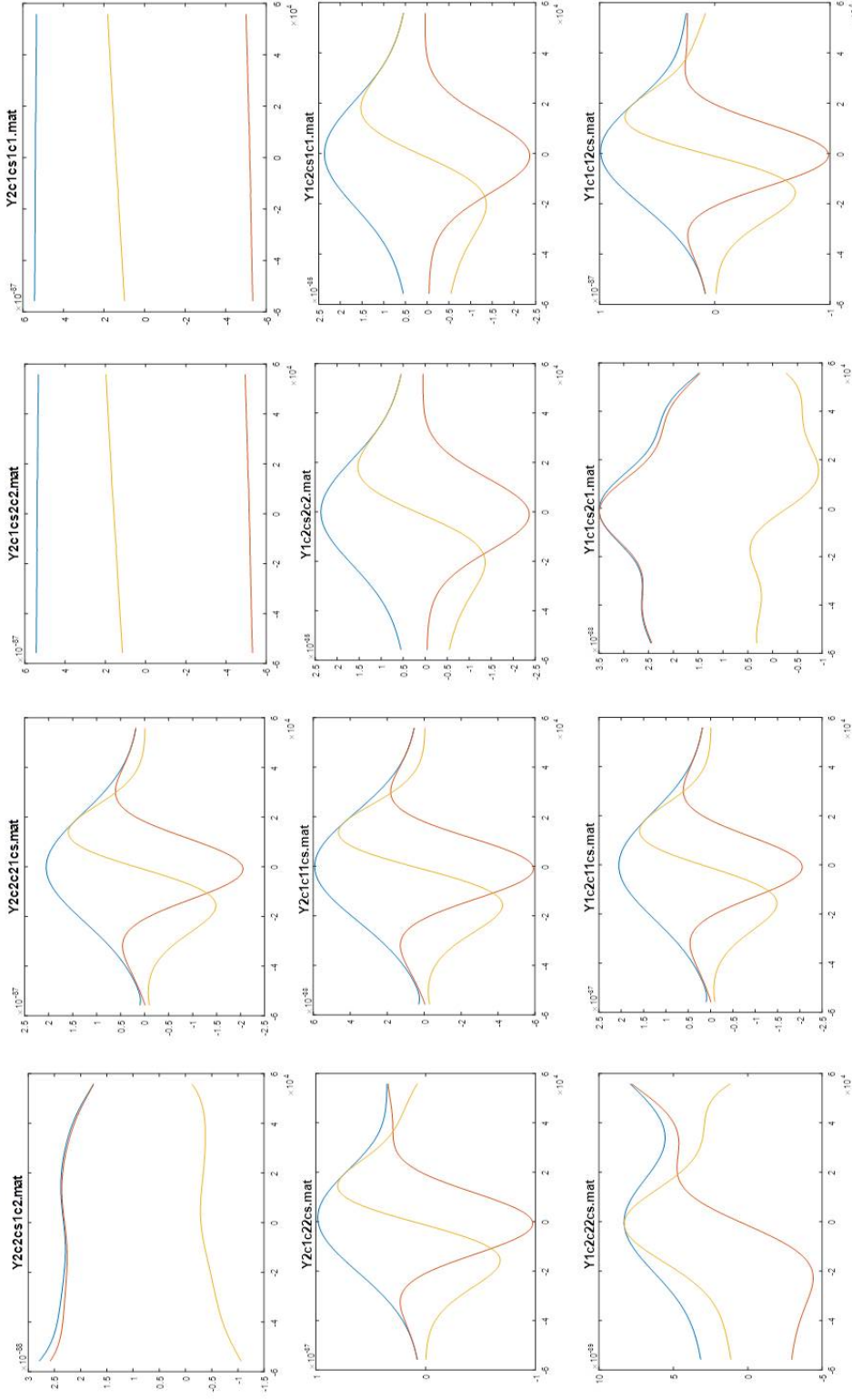

FIGURE C.3: Fifth order coherence terms with order of Rabi frequencies as $\Omega_{\beta}^* \Omega_{\alpha}^* \Omega_{\sigma} \Omega_{\nu}^* \Omega_{\mu}$. The greek indices can take any value from $\{1, 2, s\}$ where 1 denotes the forward moving pump, 2 denotes the backward moving pump and s is for signal. In each of the subplots, the red curve is the real, the yellow curve the imaginary and the blue one is for the absolute value of the term, as a function of coupling signal detuning $\delta/2\pi = -60$ to 60 kHz.

$$\Omega_\beta^* \Omega_\alpha^* \Omega_\sigma \Omega_\nu \Omega_\mu^*$$

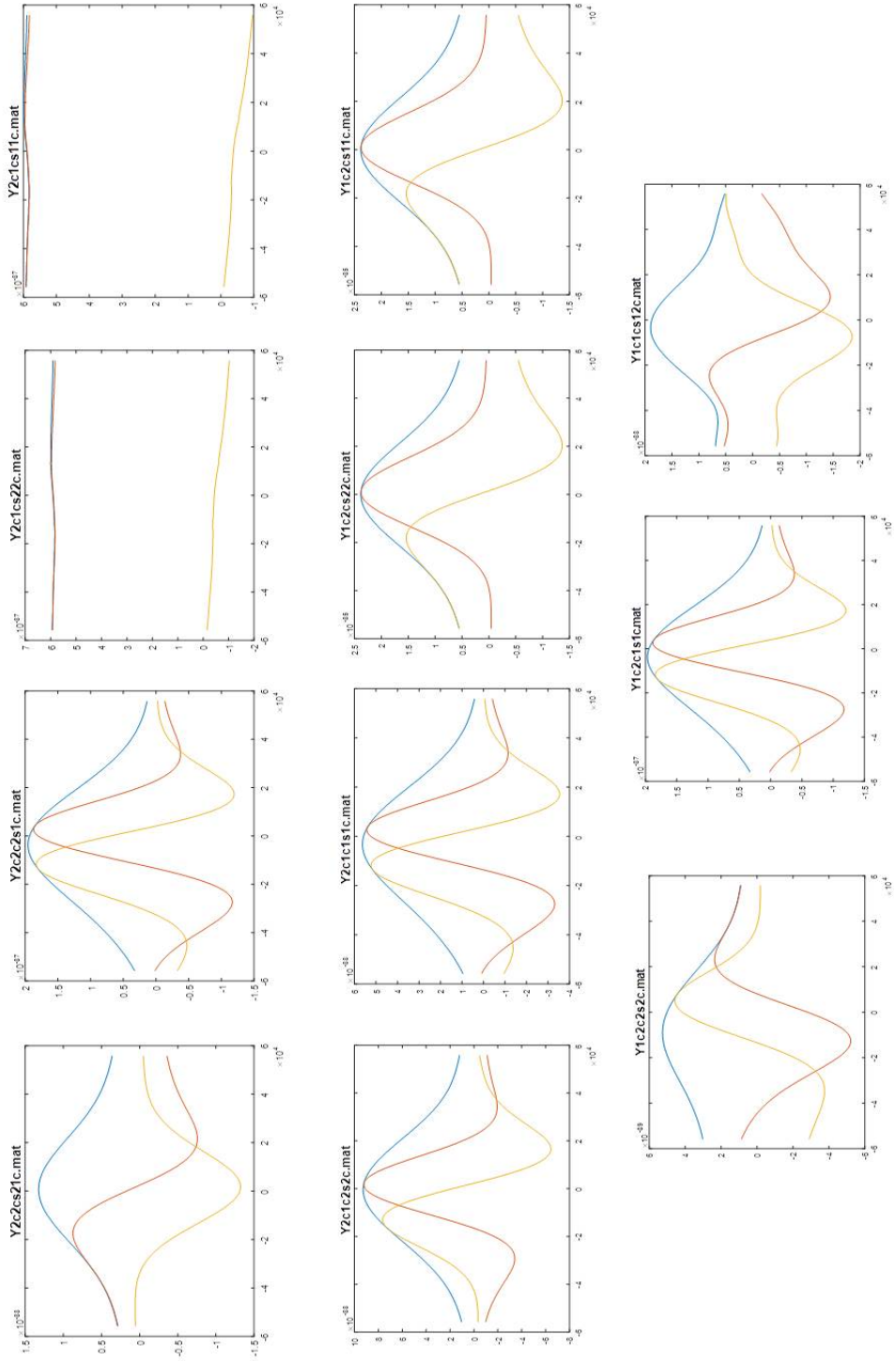

FIGURE C.4: Fifth order coherence terms with order of Rabi frequencies as $\Omega_\beta^* \Omega_\alpha^* \Omega_\sigma \Omega_\nu \Omega_\mu^*$. The greek indices can take any value from $\{1, 2, s\}$ where 1 denotes the forward moving pump, 2 denotes the backward moving pump and s is for signal. In each of the subplots, the red curve is the real, the yellow curve the imaginary and the blue one is for the absolute value of the term, as a function of coupling signal detuning $\delta/2\pi = -60$ to 60 kHz.

Bibliography

- Abbott, B. P. et al. (2016). “Observation of Gravitational Waves from a Binary Black Hole Merger”. In: *Phys. Rev. Lett.* 116 (6), p. 061102. DOI: [10.1103/PhysRevLett.116.061102](https://doi.org/10.1103/PhysRevLett.116.061102). URL: <https://link.aps.org/doi/10.1103/PhysRevLett.116.061102>.
- Agarwal, G. S. (1986). “Generation of Pair Coherent States and Squeezing via the Competition of Four-Wave Mixing and Amplified Spontaneous Emission”. In: *Phys. Rev. Lett.* 57 (7), pp. 827–830. DOI: [10.1103/PhysRevLett.57.827](https://doi.org/10.1103/PhysRevLett.57.827). URL: <https://link.aps.org/doi/10.1103/PhysRevLett.57.827>.
- Almeida, A. J. F. de et al. (2016). “Nonvolatile optical memory via recoil-induced resonance in a pure two-level system”. In: *Phys. Rev. A* 94 (6), p. 063834. DOI: [10.1103/PhysRevA.94.063834](https://doi.org/10.1103/PhysRevA.94.063834). URL: <https://link.aps.org/doi/10.1103/PhysRevA.94.063834>.
- Arecchi, F. T. (1965). “Measurement of the Statistical Distribution of Gaussian and Laser Sources”. In: *Phys. Rev. Lett.* 15 (24), pp. 912–916. DOI: [10.1103/PhysRevLett.15.912](https://doi.org/10.1103/PhysRevLett.15.912). URL: <https://link.aps.org/doi/10.1103/PhysRevLett.15.912>.
- Arimondo, Ennio (1996). “Relaxation processes in coherent-population trapping”. In: *Phys. Rev. A* 54 (3), pp. 2216–2223. DOI: [10.1103/PhysRevA.54.2216](https://doi.org/10.1103/PhysRevA.54.2216). URL: <https://link.aps.org/doi/10.1103/PhysRevA.54.2216>.
- Aspect, A., E. Arimondo, R. Kaiser, N. Vansteenkiste, and C. Cohen-Tannoudji (1988). “Laser Cooling below the One-Photon Recoil Energy by Velocity-Selective Coherent Population Trapping”. In: *Phys. Rev. Lett.* 61 (7), pp. 826–829. DOI: [10.1103/PhysRevLett.61.826](https://doi.org/10.1103/PhysRevLett.61.826). URL: <https://link.aps.org/doi/10.1103/PhysRevLett.61.826>.
- Babichev, S. A., J. Appel, and A. I. Lvovsky (2004). “Homodyne Tomography Characterization and Nonlocality of a Dual-Mode Optical Qubit”. In: *Phys. Rev. Lett.* 92 (19), p. 193601. DOI: [10.1103/PhysRevLett.92.193601](https://doi.org/10.1103/PhysRevLett.92.193601). URL: <https://link.aps.org/doi/10.1103/PhysRevLett.92.193601>.
- Bishop, David M. and Brenda Lam (1988). “Ab initio study of third-order nonlinear optical properties of helium”. In: *Phys. Rev. A* 37 (2), pp. 464–

469. DOI: [10.1103/PhysRevA.37.464](https://doi.org/10.1103/PhysRevA.37.464). URL: <https://link.aps.org/doi/10.1103/PhysRevA.37.464>.
- Boyd, Robert W (2003). *Nonlinear optics*. Academic press.
- Boyd, Robert W., Daniel J. Gauthier, and E. Wolf (Jan. 2002). “Chapter 6 - “Slow” and “fast” light”. In: *Progress in Optics*. Vol. 43. Elsevier, pp. 497–530. URL: <http://www.sciencedirect.com/science/article/pii/S0079663802800300>.
- Boyer, V., A. M. Marino, R. C. Pooser, and P. D. Lett (2008). “Entangled Images from Four-Wave Mixing”. In: *Science* 321.5888, pp. 544–547. DOI: [10.1126/science.1158275](https://doi.org/10.1126/science.1158275).
- Brzozowska, Maria, Tomasz M. Brzozowski, Jerzy Zachorowski, and Wojciech Gawlik (2006). “Bound and free atoms diagnosed by the recoil-induced resonances: One-dimensional optical lattice in a working magneto-optical trap”. In: *Phys. Rev. A* 73 (6), p. 063414. DOI: [10.1103/PhysRevA.73.063414](https://doi.org/10.1103/PhysRevA.73.063414). URL: <https://link.aps.org/doi/10.1103/PhysRevA.73.063414>.
- Brzozowski, Tomasz M., Maria Brzozowska, Jerzy Zachorowski, Michał Zawada, and Wojciech Gawlik (2005). “Probe spectroscopy in an operating magneto-optical trap: The role of Raman transitions between discrete and continuum atomic states”. In: *Phys. Rev. A* 71 (1), p. 013401. DOI: [10.1103/PhysRevA.71.013401](https://doi.org/10.1103/PhysRevA.71.013401). URL: <https://link.aps.org/doi/10.1103/PhysRevA.71.013401>.
- Caves, Carlton M. (1982). “Quantum limits on noise in linear amplifiers”. In: *Phys. Rev. D* 26 (8), pp. 1817–1839. DOI: [10.1103/PhysRevD.26.1817](https://doi.org/10.1103/PhysRevD.26.1817). URL: <https://link.aps.org/doi/10.1103/PhysRevD.26.1817>.
- Cooper, Merlin, Laura J. Wright, Christoph Söller, and Brian J. Smith (2013). “Experimental generation of multi-photon Fock states”. In: *Opt. Express* 21.5, pp. 5309–5317. DOI: [10.1364/OE.21.005309](https://doi.org/10.1364/OE.21.005309). URL: <http://www.opticsexpress.org/abstract.cfm?URI=oe-21-5-5309>.
- Corzo, N. V., A. M. Marino, K. M. Jones, and P. D. Lett (2012). “Noiseless Optical Amplifier Operating on Hundreds of Spatial Modes”. In: *Phys. Rev. Lett.* 109 (4), p. 043602. DOI: [10.1103/PhysRevLett.109.043602](https://doi.org/10.1103/PhysRevLett.109.043602). URL: <https://link.aps.org/doi/10.1103/PhysRevLett.109.043602>.
- Corzo, Neil, Alberto M. Marino, Kevin M. Jones, and Paul D. Lett (Oct. 2011). “Multi-spatial-mode single-beam quadrature squeezed states of light from four-wave mixing in hot rubidium vapor”. In: *Opt. Express* 19.22, pp. 21358–21369. URL: <http://www.opticsexpress.org/abstract.cfm?URI=oe-19-22-21358>.

- Courtois, J-Y and G Grynberg (1996). “Stimulated Rayleigh resonances and recoil-induced effects”. In: *Advances in Atomic, Molecular, and Optical Physics*. Vol. 36. Elsevier, pp. 87–140.
- Courtois, J.-Y., G. Grynberg, B. Lounis, and P. Verkerk (1994). “Recoil-induced resonances in cesium: An atomic analog to the free-electron laser”. In: *Phys. Rev. Lett.* 72 (19), pp. 3017–3020. DOI: [10.1103/PhysRevLett.72.3017](https://doi.org/10.1103/PhysRevLett.72.3017). URL: <https://link.aps.org/doi/10.1103/PhysRevLett.72.3017>.
- Crouzil, T. and M. A. Bouchene (2009). “Propagation of light pulses in a fast-light medium: Interplay between gain and dispersion”. In: *Phys. Rev. A* 80 (5), p. 055802. DOI: [10.1103/PhysRevA.80.055802](https://doi.org/10.1103/PhysRevA.80.055802). URL: <https://link.aps.org/doi/10.1103/PhysRevA.80.055802>.
- DeLange, O. E. (1968). “Optical heterodyne detection”. In: *IEEE Spectrum* 5.10, pp. 77–85. ISSN: 0018-9235. DOI: [10.1109/MSPEC.1968.5215385](https://doi.org/10.1109/MSPEC.1968.5215385).
- Du, Shengwang, Eun Oh, Jianming Wen, and Morton H. Rubin (2007). “Four-wave mixing in three-level systems: Interference and entanglement”. In: *Phys. Rev. A* 76 (1), p. 013803. DOI: [10.1103/PhysRevA.76.013803](https://doi.org/10.1103/PhysRevA.76.013803). URL: <https://link.aps.org/doi/10.1103/PhysRevA.76.013803>.
- Ducloy, Martial, Fernando A. M. de Oliveira, and Daniel Bloch (1985). “Theory of resonant Doppler-broadened backward four-wave mixing in the pump saturation regime”. In: *Phys. Rev. A* 32 (3), pp. 1614–1623. DOI: [10.1103/PhysRevA.32.1614](https://doi.org/10.1103/PhysRevA.32.1614). URL: <https://link.aps.org/doi/10.1103/PhysRevA.32.1614>.
- Eberle, T. et al. (June 2010). “Quantum Enhancement of the Zero-Area Sagnac Interferometer Topology for Gravitational Wave Detection”. In: *Physical Review Letters* 104.25, 251102, p. 251102. DOI: [10.1103/PhysRevLett.104.251102](https://doi.org/10.1103/PhysRevLett.104.251102). arXiv: [1007.0574 \[quant-ph\]](https://arxiv.org/abs/1007.0574).
- Einstein, Albert (1917). “Zur Quantentheorie der Strahlung”. In: *Phys. Z.* 18, pp. 121–128.
- Ferrini, G. et al. (July 2014). *Symplectic approach to the amplification process in a nonlinear fiber: Role of signal-idler correlations and application to loss management*. Vol. 31.
- Fleischhauer, M. and M. D. Lukin (2002). “Quantum memory for photons: Dark-state polaritons”. In: *Phys. Rev. A* 65 (2), p. 022314. DOI: [10.1103/PhysRevA.65.022314](https://doi.org/10.1103/PhysRevA.65.022314). URL: <https://link.aps.org/doi/10.1103/PhysRevA.65.022314>.
- Freund, I. and M. Deutsch (Feb. 1986). “Second-harmonic microscopy of biological tissue”. In: *Optics Letters* 11, pp. 94–96. DOI: [10.1364/OL.11.000094](https://doi.org/10.1364/OL.11.000094).

- Gerry, Christopher and Peter Knight (2004). *Introductory Quantum Optics*. Cambridge: Cambridge University Press. DOI: [10.1017/cbo9780511791239](https://doi.org/10.1017/cbo9780511791239). URL: <https://www.cambridge.org/core/books/introductory-quantum-optics/B9866F1F40C45936A81D03AF7617CF44>.
- Goldfarb, F. et al. (2008). “Observation of ultra-narrow electromagnetically induced transparency and slow light using purely electronic spins in a hot atomic vapor”. In: *EPL (Europhysics Letters)* 82.5, p. 54002. URL: <http://stacks.iop.org/0295-5075/82/i=5/a=54002>.
- Grynberg, Gilbert, Alain Aspect, and Claude Fabre (2010). *Introduction to Quantum Optics: From the Semi-classical Approach to Quantized Light*. Cambridge: Cambridge University Press. DOI: [10.1017/cbo9780511778261](https://doi.org/10.1017/cbo9780511778261). URL: <https://www.cambridge.org/core/books/introduction-to-quantum-optics/F45DCE785DC8226D4156EC15CAD5FA9A>.
- Guo, J., P. R. Berman, B. Dubetsky, and G. Grynberg (1992). “Recoil-induced resonances in nonlinear spectroscopy”. In: *Phys. Rev. A* 46 (3), pp. 1426–1437. DOI: [10.1103/PhysRevA.46.1426](https://doi.org/10.1103/PhysRevA.46.1426). URL: <https://link.aps.org/doi/10.1103/PhysRevA.46.1426>.
- Hall, J. L., C. J. Bordé, and K. Uehara (1976). “Direct Optical Resolution of the Recoil Effect Using Saturated Absorption Spectroscopy”. In: *Phys. Rev. Lett.* 37 (20), pp. 1339–1342. DOI: [10.1103/PhysRevLett.37.1339](https://doi.org/10.1103/PhysRevLett.37.1339). URL: <https://link.aps.org/doi/10.1103/PhysRevLett.37.1339>.
- Harris, S. E., J. E. Field, and A. Imamoglu (1990). “Nonlinear optical processes using electromagnetically induced transparency”. In: *Phys. Rev. Lett.* 64 (10), pp. 1107–1110. DOI: [10.1103/PhysRevLett.64.1107](https://doi.org/10.1103/PhysRevLett.64.1107). URL: <https://link.aps.org/doi/10.1103/PhysRevLett.64.1107>.
- Hashmi, F. A. and M. A. Bouchene (2008). “Slowing light through Zeeman coherence oscillations in a duplicated two-level system”. In: *Phys. Rev. A* 77 (5), p. 051803. DOI: [10.1103/PhysRevA.77.051803](https://doi.org/10.1103/PhysRevA.77.051803). URL: <https://link.aps.org/doi/10.1103/PhysRevA.77.051803>.
- Hau, Lene Vestergaard, S. E. Harris, Zachary Dutton, and Cyrus H. Behroozi (Feb. 1999). “Light speed reduction to 17 metres per second in an ultracold atomic gas”. In: *Nature* 397, p. 594. URL: <https://doi.org/10.1038/17561>.
- Heinze, Georg, Christian Hubrich, and Thomas Halfmann (2013). “Stopped Light and Image Storage by Electromagnetically Induced Transparency up to the Regime of One Minute”. In: *Phys. Rev. Lett.* 111 (3), p. 033601. DOI: [10.1103/PhysRevLett.111.033601](https://doi.org/10.1103/PhysRevLett.111.033601). URL: <https://link.aps.org/doi/10.1103/PhysRevLett.111.033601>.

- Hemmer, P. R. et al. (May 1995). “Efficient low-intensity optical phase conjugation based on coherent population trapping in sodium”. In: *Opt. Lett.* 20.9, pp. 982–984. URL: <http://ol.osa.org/abstract.cfm?URI=ol-20-9-982>.
- Hänsch, T.W. and A.L. Schawlow (1975). “Cooling of gases by laser radiation”. In: *Optics Communications* 13.1, pp. 68–69. DOI: [10.1016/0030-4018\(75\)90159-5](https://doi.org/10.1016/0030-4018(75)90159-5).
- Hodgman, S. S. et al. (2009). “Metastable Helium: A New Determination of the Longest Atomic Excited-State Lifetime”. In: *Phys. Rev. Lett.* 103 (5), p. 053002. DOI: [10.1103/PhysRevLett.103.053002](https://doi.org/10.1103/PhysRevLett.103.053002). URL: <https://link.aps.org/doi/10.1103/PhysRevLett.103.053002>.
- Imajuku, W. and A. Takada (2003). “Noise figure of phase-sensitive parametric amplifier using a Mach-Zehnder interferometer with lossy Kerr media and noisy pump”. In: *IEEE Journal of Quantum Electronics* 39.6, pp. 799–812. ISSN: 0018-9197.
- Ji, Z. et al. (Feb. 2018). “Pump-probe and Four-wave Mixing Spectra Arising from Recoil-induced Resonance in an Operating Cesium Magneto-Optical Trap”. In: *Journal of the Physical Society of Japan* 87.2, 024301, p. 024301. DOI: [10.7566/JPSJ.87.024301](https://doi.org/10.7566/JPSJ.87.024301).
- Kelley, P. L. (1965). “Self-Focusing of Optical Beams”. In: *Phys. Rev. Lett.* 15 (26), pp. 1005–1008. DOI: [10.1103/PhysRevLett.15.1005](https://doi.org/10.1103/PhysRevLett.15.1005). URL: <https://link.aps.org/doi/10.1103/PhysRevLett.15.1005>.
- Klein, Anne, Marcos Oria, Daniel Bloch, and Martial Ducloy (1989). “Saturation behavior and dynamic Stark splitting of nearly-degenerate four-wave and multiwave mixing in a forward boxcar configuration”. In: *Optics Communications* 73.2, pp. 111–116. DOI: [10.1016/0030-4018\(89\)90153-3](https://doi.org/10.1016/0030-4018(89)90153-3).
- Kolchenko, AP, SG Rautian, and RI Sokolovskii (1969). “Interaction of atoms with a strong electromagnetic field with the recoil effect taken into consideration”. In: *Sov. Phys. JETP* 28, p. 986.
- Kuzmin, N. V. et al. (2016). “Third harmonic generation imaging for fast, label-free pathology of human brain tumors”. In: *Biomed. Opt. Express* 7.5, pp. 1889–1904. DOI: [10.1364/BOE.7.001889](https://doi.org/10.1364/BOE.7.001889). URL: <http://www.osapublishing.org/boe/abstract.cfm?URI=boe-7-5-1889>.
- Lauprêtre, Thomas (Dec. 2012). “Coherent processes and applications of the slow and fast light phenomena in metastable helium at room temperature”. Theses. Université Paris Sud - Paris XI. URL: <https://tel.archives-ouvertes.fr/tel-00772326>.
- Leduc, Michèle and Claude Cohen-Tannoudji (2010). “Ultracold metastable helium: from atoms to exotic molecules”. In: *Laser Physics* 20.1, pp. 13–22.

- ISSN: 1555-6611. DOI: [10.1134/S1054660X09170101](https://doi.org/10.1134/S1054660X09170101). URL: <https://doi.org/10.1134/S1054660X09170101>.
- Lee, Myungjun, Michael E Gehm, and Mark A Neifeld (2010). “Systematic design study of an all-optical delay line based on Brillouin scattering enhanced cascade coupled ring resonators”. In: *Journal of Optics* 12.10, p. 104012. DOI: [10.1088/2040-8978/12/10/104012](https://doi.org/10.1088/2040-8978/12/10/104012).
- Leonhardt, Ulf (1997). *Measuring of Quantum State of Light*. 1st ed. Cambridge Studies in Modern Optics. ISBN: 0521497302,9780521497305.
- Lippitz, Markus, Meindert A. van Dijk, and Michel Orrit (Apr. 2005). “Third-Harmonic Generation from Single Gold Nanoparticles”. In: *Nano Lett.* 5.4, pp. 799–802. ISSN: 1530-6984. DOI: [10.1021/nl10502571](https://doi.org/10.1021/nl10502571). URL: <https://doi.org/10.1021/nl10502571>.
- Lounis, B., P. Verkerk, J.-Y. Courtois, C. Salomon, and G. Grynberg (Jan. 1993). “Quantized atomic motion in 1D cesium molasses with magnetic field”. In: *EPL (Europhysics Letters)* 21, p. 13. DOI: [10.1209/0295-5075/21/1/003](https://doi.org/10.1209/0295-5075/21/1/003).
- Lu, Wentao T., Salvatore Savo, B. Didier F. Casse, and Srinivas Sridhar (2009). “Slow microwave waveguide made of negative permeability metamaterials”. In: *Microwave and Optical Technology Letters* 51.11, pp. 2705–2709. DOI: [10.1002/mop.24727](https://doi.org/10.1002/mop.24727).
- Lundström, Carl, Zhi Tong, Magnus Karlsson, and Peter A. Andrekson (2011). “Phase-to-phase and phase-to-amplitude transfer characteristics of a nondegenerate idler phase-sensitive amplifier”. In: *Opt. Lett.* 36.22, pp. 4356–4358. DOI: [10.1364/OL.36.004356](https://doi.org/10.1364/OL.36.004356). URL: <http://ol.osa.org/abstract.cfm?URI=ol-36-22-4356>.
- Ma, Rong, Wei Liu, Zhongzhong Qin, Xiaojun Jia, and Jiangrui Gao (2017). “Generating quantum correlated twin beams by four-wave mixing in hot cesium vapor”. In: *Physical Review A* 96.4. DOI: [10.1103/physreva.96.043843](https://doi.org/10.1103/physreva.96.043843).
- Maynard, Marie-Aude (Nov. 2016). “Light storage in metastable helium at room temperature”. Theses. Université Paris-Saclay. URL: <https://tel.archives-ouvertes.fr/tel-01483918>.
- McCormick, C. F., A. M. Marino, V. Boyer, and P. D. Lett (Oct. 2008). “Strong low-frequency quantum correlations from a four-wave-mixing amplifier”. In: *PRA* 78.4, p. 043816. URL: <https://link.aps.org/doi/10.1103/PhysRevA.78.043816>.
- McKinstrie, C. J. and M. Karlsson (2013). “Schmidt decompositions of parametric processes I: Basic theory and simple examples”. In: *Opt. Express*

- 21.2, pp. 1374–1394. DOI: [10.1364/OE.21.001374](https://doi.org/10.1364/OE.21.001374). URL: <http://www.opticsexpress.org/abstract.cfm?URI=oe-21-2-1374>.
- Meacher, D. R., D. Boiron, H. Metcalf, C. Salomon, and G. Grynberg (1994). “Method for velocimetry of cold atoms”. In: *Phys. Rev. A* 50 (3), R1992–R1994. DOI: [10.1103/PhysRevA.50.R1992](https://doi.org/10.1103/PhysRevA.50.R1992). URL: <https://link.aps.org/doi/10.1103/PhysRevA.50.R1992>.
- Nersisyan, G., T. Morrow, and W. G. Graham (2004). “Measurements of helium metastable density in an atmospheric pressure glow discharge”. In: *Applied Physics Letters* 85.9, pp. 1487–1489. DOI: [10.1063/1.1784514](https://doi.org/10.1063/1.1784514).
- Neveu, P. et al. (Mar. 2018). “Phase Sensitive Amplification Enabled by Coherent Population Trapping”. In: *ArXiv e-prints*. arXiv: [1803.05435](https://arxiv.org/abs/1803.05435) [quant-ph].
- Neveu, Pascal, Fabien Bretenaker, Fabienne Goldfarb, and Etienne Brion (2019). “Quantum properties of light propagating in a Coherent Population Oscillation Storage Medium”. In: *arXiv e-prints*, arXiv:1902.01120, arXiv:1902.01120. arXiv: [1902.01120](https://arxiv.org/abs/1902.01120) [quant-ph].
- Oria, M., D. Bloch, M. Fichet, and M. Ducloy (1989). “Efficient phase conjugation of a cw low-power laser diode in a short Cs vapor cell at 852 nm”. In: *Optics Letters* 14.19, p. 1082. DOI: [10.1364/ol.14.001082](https://doi.org/10.1364/ol.14.001082).
- Otterstrom, N., R. C. Pooser, and B. J. Lawrie (2014). “Nonlinear optical magnetometry with accessible in situ optical squeezing”. In: *Opt. Lett.* 39.22, pp. 6533–6536. DOI: [10.1364/OL.39.006533](https://doi.org/10.1364/OL.39.006533). URL: <http://ol.osa.org/abstract.cfm?URI=ol-39-22-6533>.
- Pepper, David M., John AuYeung, Dan Fekete, and Amnon Yariv (1978). “Spatial convolution and correlation of optical fields via degenerate four-wave mixing”. In: *Opt. Lett.* 3.1, pp. 7–9. DOI: [10.1364/OL.3.000007](https://doi.org/10.1364/OL.3.000007). URL: <http://ol.osa.org/abstract.cfm?URI=ol-3-1-7>.
- Phillips, D. F., A. Fleischhauer, A. Mair, R. L. Walsworth, and M. D. Lukin (2001). “Storage of Light in Atomic Vapor”. In: *Phys. Rev. Lett.* 86 (5), pp. 783–786. DOI: [10.1103/PhysRevLett.86.783](https://doi.org/10.1103/PhysRevLett.86.783). URL: <https://link.aps.org/doi/10.1103/PhysRevLett.86.783>.
- Pinard, M and F Laloë (1980). “The role of the Pauli principle in metastability exchange collisions”. In: *Journal de Physique* 41.8, pp. 799–818.
- Polzik, E. S., J. Carri, and H. J. Kimble (1992). “Spectroscopy with squeezed light”. In: *Phys. Rev. Lett.* 68 (20), pp. 3020–3023. DOI: [10.1103/PhysRevLett.68.3020](https://doi.org/10.1103/PhysRevLett.68.3020). URL: <https://link.aps.org/doi/10.1103/PhysRevLett.68.3020>.
- Qin, Zhongzhong et al. (2014). “Experimental Generation of Multiple Quantum Correlated Beams from Hot Rubidium Vapor”. In: *Phys. Rev. Lett.* 113

- (2), p. 023602. DOI: [10.1103/PhysRevLett.113.023602](https://doi.org/10.1103/PhysRevLett.113.023602). URL: <https://link.aps.org/doi/10.1103/PhysRevLett.113.023602>.
- Reid, M. D. and P. D. Drummond (1988). “Quantum Correlations of Phase in Nondegenerate Parametric Oscillation”. In: *Phys. Rev. Lett.* 60 (26), pp. 2731–2733. DOI: [10.1103/PhysRevLett.60.2731](https://doi.org/10.1103/PhysRevLett.60.2731). URL: <https://link.aps.org/doi/10.1103/PhysRevLett.60.2731>.
- Schmidt, O., R. Wynands, Z. Hussein, and D. Meschede (1996). “Steep dispersion and group velocity below $\frac{c}{3000}$ in coherent population trapping”. In: *Phys. Rev. A* 53 (1), R27–R30. DOI: [10.1103/PhysRevA.53.R27](https://doi.org/10.1103/PhysRevA.53.R27). URL: <https://link.aps.org/doi/10.1103/PhysRevA.53.R27>.
- Schulz, K. et al. (1996). “Observation of New Rydberg Series and Resonances in Doubly Excited Helium at Ultrahigh Resolution”. In: *Phys. Rev. Lett.* 77 (15), pp. 3086–3089. DOI: [10.1103/PhysRevLett.77.3086](https://doi.org/10.1103/PhysRevLett.77.3086). URL: <https://link.aps.org/doi/10.1103/PhysRevLett.77.3086>.
- Scully, Marlan O. and M. Suhail Zubairy (1997). *Quantum Optics*. Cambridge: Cambridge University Press. DOI: [10.1017/cbo9780511813993](https://doi.org/10.1017/cbo9780511813993). URL: <https://www.cambridge.org/core/books/quantum-optics/08DC53888452CBC6CDC0FD8A1A1A4D>
- Shen, Y. R. (1984). *The principles of nonlinear optics*.
- Shlyapnikov, G. V., J. T. M. Walraven, U. M. Rahmanov, and M. W. Reynolds (1994). “Decay Kinetics and Bose Condensation in a Gas of Spin-Polarized Triplet Helium”. In: *Phys. Rev. Lett.* 73 (24), pp. 3247–3250. DOI: [10.1103/PhysRevLett.73.3247](https://doi.org/10.1103/PhysRevLett.73.3247). URL: <https://link.aps.org/doi/10.1103/PhysRevLett.73.3247>.
- Slavič, Radan et al. (Sept. 2010). “All-optical phase and amplitude regenerator for next-generation telecommunications systems”. In: *Nature Photonics* 4, p. 690. URL: <http://dx.doi.org/10.1038/nphoton.2010.203>.
- Slusher, R. E., L. W. Hollberg, B. Yurke, J. C. Mertz, and J. F. Valley (Nov. 1985). “Observation of Squeezed States Generated by Four-Wave Mixing in an Optical Cavity”. In: *PRL* 55.22, pp. 2409–2412. URL: <https://link.aps.org/doi/10.1103/PhysRevLett.55.2409>.
- Steinlechner, Sebastian et al. (June 2013). “Quantum-dense metrology”. In: *Nature Photonics* 7, p. 626. URL: <https://doi.org/10.1038/nphoton.2013.150>.
- Stolen, R. H. and A. Ashkin (Mar. 1973). “Optical Kerr effect in glass waveguide”. In: *Appl. Phys. Lett.* 22.6, pp. 294–296. ISSN: 0003-6951. DOI: [10.1063/1.1654644](https://doi.org/10.1063/1.1654644). URL: <https://doi.org/10.1063/1.1654644>.
- Takeno, Yuishi, Mitsuyoshi Yukawa, Hidehiro Yonezawa, and Akira Furusawa (2007). “Observation of -9 dB quadrature squeezing with improvement of

- phase stability in homodyne measurement”. In: *Opt. Express* 15.7, pp. 4321–4327. DOI: [10.1364/OE.15.004321](https://doi.org/10.1364/OE.15.004321). URL: <http://www.opticsexpress.org/abstract.cfm?URI=oe-15-7-4321>.
- Taylor, Michael A. et al. (Feb. 2013). “Biological measurement beyond the quantum limit”. In: *Nature Photonics* 7, p. 229. URL: <https://doi.org/10.1038/nphoton.2012.346>.
- Triche, Christine (Dec. 1997). “Refroidissement et dynamique d’atomes dans des potentiels lumineux : mélasses grises, réseaux de plots et réseaux brillants”. Theses. Ecole Polytechnique X. URL: <https://pastel.archives-ouvertes.fr/tel-00011782>.
- Vahlbruch, Henning, Moritz Mehmet, Karsten Danzmann, and Roman Schnabel (2016). “Detection of 15 dB Squeezed States of Light and their Application for the Absolute Calibration of Photoelectric Quantum Efficiency”. In: *Phys. Rev. Lett.* 117 (11), p. 110801. DOI: [10.1103/PhysRevLett.117.110801](https://doi.org/10.1103/PhysRevLett.117.110801). URL: <https://link.aps.org/doi/10.1103/PhysRevLett.117.110801>.
- Vasilyev, Michael, Sang-Kyung Choi, Prem Kumar, and G. Mauro D’Ariano (2000). “Tomographic Measurement of Joint Photon Statistics of the Twin-Beam Quantum State”. In: *Phys. Rev. Lett.* 84 (11), pp. 2354–2357. DOI: [10.1103/PhysRevLett.84.2354](https://doi.org/10.1103/PhysRevLett.84.2354). URL: <https://link.aps.org/doi/10.1103/PhysRevLett.84.2354>.
- Wang, Wenli, Jianliao Deng, and Yuzhu Wang (2015). “Recoil-induced resonance spectroscopy and nondestructive temperature measurement of cold rubidium atoms inside an integrating sphere”. In: *J. Opt. Soc. Am. B* 32.12, pp. 2441–2447. DOI: [10.1364/JOSAB.32.002441](https://doi.org/10.1364/JOSAB.32.002441). URL: <http://josab.osa.org/abstract.cfm?URI=josab-32-12-2441>.
- Weisskopf, V. and E. Wigner (Jan. 1930). “Berechnung der natürlichen Linienbreite auf Grund der Diracschen Lichttheorie”. In: *Zeitschrift für Physik* 63.1, pp. 54–73. ISSN: 0044-3328. URL: <https://doi.org/10.1007/BF01336768>.
- Wu, Ling-An, H. J. Kimble, J. L. Hall, and Huifa Wu (1986). “Generation of Squeezed States by Parametric Down Conversion”. In: *Phys. Rev. Lett.* 57 (20), pp. 2520–2523. DOI: [10.1103/PhysRevLett.57.2520](https://doi.org/10.1103/PhysRevLett.57.2520). URL: <https://link.aps.org/doi/10.1103/PhysRevLett.57.2520>.
- Yariv, A. (1978). “Phase conjugate optics and real-time holography”. In: *IEEE Journal of Quantum Electronics* 14.9, pp. 650–660. ISSN: 0018-9197.

- Yonezawa, H. and A. Furusawa (Feb. 2010). “Continuous-variable quantum information processing with squeezed states of light”. In: *Optics and Spectroscopy* 108.2, pp. 288–296. ISSN: 1562-6911. URL: <https://doi.org/10.1134/S0030400X10020189>.
- Yuen, H. and J. Shapiro (1978). “Optical communication with two-photon coherent states—Part I: Quantum-state propagation and quantum-noise”. In: *IEEE Transactions on Information Theory* 24.6, pp. 657–668. ISSN: 0018-9448. DOI: [10.1109/TIT.1978.1055958](https://doi.org/10.1109/TIT.1978.1055958).
- Zanon, T. et al. (2005). “High Contrast Ramsey Fringes with Coherent-Population-Trapping Pulses in a Double Lambda Atomic System”. In: *Phys. Rev. Lett.* 94 (19), p. 193002. DOI: [10.1103/PhysRevLett.94.193002](https://doi.org/10.1103/PhysRevLett.94.193002). URL: <https://link.aps.org/doi/10.1103/PhysRevLett.94.193002>.
- Zelevinsky, T. (2004). “Helium 23P fine structure measurement in a discharge cell”. PhD thesis. Harvard University, Cambridge, Massachusetts.
- Zhong, Qin and John T. Fourkas (Dec. 2008). “Optical Kerr Effect Spectroscopy of Simple Liquids”. In: *J. Phys. Chem. B* 112.49, pp. 15529–15539. ISSN: 1520-6106. DOI: [10.1021/jp807730u](https://doi.org/10.1021/jp807730u). URL: <https://doi.org/10.1021/jp807730u>.

Titre : Etude expérimentale et théorique de deux processus non-linéaires induits par des résonances atomiques ultra-fines

Mots clés : Optique non-linéaire, mélange à quatre et six ondes, amplification sensible à la phase, états comprimés, Résonance induite par recul, piégeage cohérent de population

Résumé : Dans ce travail de thèse, je considère deux phénomènes distincts, tous deux liés aux interactions non-linéaires entre la lumière et des atomes. La première partie est dédiée à du mélange à 4 ondes basé sur des degrés de liberté internes d'atomes d'hélium à température ambiante, et l'utilise pour des processus d'amplification et de la génération d'états comprimés. Le second phénomène étudié est basé sur des degrés de liberté externes d'atomes de césium froids et est utilisé pour du stockage de lumière et la génération d'un champ conjugué en phase par mélange d'ondes. J'ai expérimentalement observé et caractérisé de l'amplification sensible à la phase par mélange à quatre ondes dans de l'hélium métastable à température ambiante. J'ai obtenu un gain maximum d'environ 9 dB avec une bande passante d'environ 300 kHz. Les fonctions de transfert phase/phase obtenues ont montré une forte compression de phase,

indiquant que le phénomène était presque exempt de processus indésirables.

Dans la seconde partie, j'explique comment les résonances de recul, dues à un transfert de quantité de mouvement entre un photon et un atome, peuvent être utilisées pour du stockage de lumière. J'explique également comment ce phénomène peut conduire à la génération d'un champ conjugué, et pourquoi la théorie existante ne permet pas de modéliser le creux qui apparaît dans le spectre de génération du champ conjugué lorsqu'on augmente la puissance optique. Pour reproduire ce nouvel élément, j'ai effectué un développement jusqu'au 5e ordre, qui démontre qu'il dépend de la cohérence qui est excitée entre des niveaux de moments atomiques différents.

Je montre ensuite qu'un modèle plus simple, basé sur trois niveaux atomiques définis par des degrés de liberté interne et externe de l'atome, peut expliquer le phénomène observé.

Title : Experimental and theoretical study of two non-linear processes induced by ultra-narrow resonances in atoms

Keywords : non-linear optics, four and six wave mixing, phase sensitive amplification, squeezed states, Recoil Induced Resonance, Coherent population trapping

Abstract: In this PhD work, two distinct phenomena are considered, which are both related to non-linear interactions between light and atoms. The first part of the thesis is dedicated to four wave mixing based on the internal degrees of freedom of room temperature helium atoms and uses it for amplification processes and generation of squeezed light. The second studied process is based on external degrees of freedom of cold cesium atoms and used for light storage and phase conjugate field generation through multi-wave mixing. I experimentally observed and characterized phase sensitive amplification via four-wave mixing in metastable helium at room temperature. I have obtained about 9 dB of maximum gain with a bandwidth of about 300 kHz. The obtained phase transfer functions showed a strong phase squeezing,

indicating that the phenomenon was almost free of unwanted processes.

In the second part, I explain how recoil induced resonances, which are due to the transfer of momentum between a photon and an atom, can be used to store light. I also explain how this phenomenon can lead to generation of a phase conjugate field, and why the existing theory fails to model the dip, which appears in the phase conjugate generation spectrum when the field power is increased. I extend the model to the fifth order so that it can reproduce this new feature and demonstrate that it depends on the decay rate of the coherence, which is excited between atomic levels of different momenta. I then show that a simpler model, which is based on three levels defined by internal and external degrees of freedom of the atom, can explain the observed phenomenon.

