



HAL
open science

Analytic moduli spaces of non quasi-homogeneous functions

Jinan Loubani

► **To cite this version:**

Jinan Loubani. Analytic moduli spaces of non quasi-homogeneous functions. Functional Analysis [math.FA]. Université Paul Sabatier - Toulouse III, 2018. English. NNT : 2018TOU30198 . tel-02282098

HAL Id: tel-02282098

<https://theses.hal.science/tel-02282098>

Submitted on 9 Sep 2019

HAL is a multi-disciplinary open access archive for the deposit and dissemination of scientific research documents, whether they are published or not. The documents may come from teaching and research institutions in France or abroad, or from public or private research centers.

L'archive ouverte pluridisciplinaire **HAL**, est destinée au dépôt et à la diffusion de documents scientifiques de niveau recherche, publiés ou non, émanant des établissements d'enseignement et de recherche français ou étrangers, des laboratoires publics ou privés.



THÈSE

En vue de l'obtention du DOCTORAT DE L'UNIVERSITÉ DE TOULOUSE

Délivré par l'Université Toulouse 3 - Paul Sabatier

Cotutelle internationale : Pavia University

Présentée et soutenue par

Jinan LOUBANI

Le 27 novembre 2018

Espaces de modules analytiques de fonctions non quasi-homogènes

Ecole doctorale : **EDMITT - Ecole Doctorale Mathématiques, Informatique et Télécommunications de Toulouse**

Spécialité : **Mathématiques et Applications**

Unité de recherche :
IMT : Institut de Mathématiques de Toulouse

Thèse dirigée par
Yoann GENZMER et Ludovico PERNAZZA

Jury

M. Frank LORAY, Rapporteur
M. Franck JEDRZEJEWSKI, Examineur
Mme Francesca ACQUISTAPACE, Examineur
Mme Paola FREDIANI, Examineur
M. Emmanuel PAUL, Examineur
M. Stéphane LAMY, Examineur
M. Yohann GENZMER, Directeur de thèse
M. Ludovico PERNAZZA, Co-directeur de thèse

Acknowledgements.

I would like to start my thesis by thanking all the persons who supported me during this work hoping not to forget anyone.

First of all, I would like to express my gratitude to my supervisors Yohann Genzmer and Ludovico Pernazza. The first time I knew about foliations was through a course given by Yohann through my second master year, which was my first year in Toulouse. Although I expected to work on something completely different for my PhD studies, his way of teaching made me like this area so that I made my master thesis under his supervision and finally my PhD as well. I found out that he is not only a very good teacher but also a great director. I want to thank you very much Yohann for suggesting me this nice subject and for guiding me to discover the interesting details of dealing with it in particular and with research in general. The effective discussions I have had with you as well as your valuable advice are greatly appreciated. You taught me how good mathematics is done. It was an amazing experience for me to work with a serious person like you who loves so much what he does. Thank you very much for your availability, patience, support, motivation and confidence. Ludovico, I want to thank you very much for supervising me. Although being a supervisor for a subject which is not so close to the person's domain of research is not that easy, you were careful to give me enough time. Due to this fact, you allowed me to look at the mathematical problems in a different way. Our interesting discussions are unforgettable. I greatly appreciate your effort.

I would like to thank also Frank Loray and Filippo Bracci for accepting being the referees of my thesis. Thank you very much for the useful remarks and comments. Many thanks go to Franck Jedrzejewski, Francesca Acquistapace and Paola Frediani who accepted to take part of the committee. In particular, special thanks go to Frank Loray who accepted to be a member of the committee although he is passing a quite busy period.

In Toulouse, I want to thank all the persons whom I met and had a direct or indirect positive influence on me. I start by thanking all the members of Paul Sabatier University in general and the members of the team Picard as well as the participants of the common seminars and workshops in particular. I am very thankful also to all the PhD students and post-doc researchers with whom I shared this nice experience. Special thanks go to Dat with whom I started this journey since our M2. Thank you so much Dat for being there all the time, for your advice and friendliness. I want to thank also Andre, who is now an assistant professor, for the useful discussions with him at the university and at

the common conferences where we have been together. Many thanks go to Damien who has been always a great representative of PhD students. Thanks a lot also to all my office mates Anas, Fabien, Florian, Jean-Marc, Samuel and Silvere. Finally, I want to express my gratefulness to all my friends from Lebanon, who succeeded at constructing a big family of master and PhD students from different disciplines to share together the experience of leaving the home country for the purpose of science.

In Milan, I thank all the members of Milano-Bicocca University, in particular Professor Thomas Weigel, the coordinator of the joint PhD program (Pavia-Milano Bicocca-INdAM) for his support. I want to thank also my colleagues very much especially those of the same cycle as me, Alberto, Andrea, Daniela, Jessica and Martino. I can not forget the interesting discussions and nice moments we shared together as well as the difficulties which we have managed to overcome together. I want to thank also Franz and Iman for the interesting and useful discussions we have had. I can not pass without thanking as well Alessandro, Ariana, Benedetta, Elia, Federico and Matteo. I want to thank Daniela again who was not only my colleague but also my friend or even my sister. Thank you so much Daniela for showing me the true version of real friendship. You perfectly succeeded at making me feel at home. I want to end up this part by thanking my dear friends in Milan, Abrar, Bardha, Dita, Evi, Fatimah, Francesca, Masoud and Yan. Special thanks go to Bardha and Evi with whom I passed unforgettable moments during my first period in Milan.

In Pavia, I thank as well all the members of Pavia University, in particular Professor Pierluigi Colli, the vice-coordinator of the joint PhD program for his support. I thank also my colleagues very much, in particular my office mates Christian, Marco, Maria-Gioia, Salvatore and Sonia for sharing thoughts and ideas and having useful discussions, as well as Alberto, Anderson, Barbara and Irene. Many thanks to my friends and acquaintances in Pavia, Abeer, Amineh, Costy, Hassan, Hemam, Kayal, Osama and Pablo.

In Lebanon, although at that time I have not had started my PhD yet, I feel the necessity to thank a lot of persons especially those who have made part of my first step to study in Europe. I would like to thank all my teachers at the Lebanese university for their continuous support and motivation in particular Bilal Barakeh, Chady El Mir, Haysam Ezzaldine and Talal Khawaja. Special thanks go to Bilal Barakeh for his guiding and precious advice even after I moved to France. I would like to thank Chady El Mir very much for suggesting me to make my M2 in Toulouse and for helping me in applying for a CIMI scholarship.

Finally, I would like to deeply thank all the members of my family who supported me despite the big distance between us. I want to thank my parents very much for everything they did and for all the sacrifices they made for me and my siblings. I owe you my success in my studies and being able to attain a PhD degree now. I am very lucky to have great parents like you. I want to thank my sister very much as well who had to listen sometimes to mathematics without understanding anything. Thank you so much Jihan for being my sister, my friend and my soulmate and for playing the basic role in helping me to get out of stress during my thesis. I want to thank also my brothers Mohammad and Khalil.

The nice relaxing vacations we spent altogether played an important role in the success of my thesis. I would like to thank also my dearest uncle Salim who has been always in contact with me to support and motivate me. I end up this part by special thanks to my grandfather for his support and precious advice and my grandmother for her continuous motivation.

Introduction.

Soit f un germe de fonction holomorphe à deux variables qui s'annule à l'origine,

$$f(x, y) \in \mathbb{C}\{x, y\}, \quad (x, y) \in \mathbb{C}^2, \quad f(0, 0) = 0.$$

L'ensemble zéro de cette fonction, $S = \{f(x, y) = 0\}$, définit un germe de courbe analytique. Bien que la classification topologique d'un tel germe est bien connue depuis les travaux de Zariski [52], la classification analytique est encore largement ouverte. En 2012, Hefez et Hernandes [7] ont résolu le cas irréductible et ils ont annoncé le cas à deux composants. En 2015, Genzmer et Paul [59] ont résolu le cas des fonctions topologiquement quasi-homogènes. L'objectif principal de cette thèse est d'étudier la première classe topologique de fonctions non quasi-homogènes. Nous décrivons l'espace de modules local des feuilletages dans cette classe et nous donnons des formes normales analytiques. Nous prouvons également l'unicité de ces formes normales. Enfin, nous présentons un algorithme permettant de calculer la dimension des strates génériques de l'espace de modules local des courbes.

Position du problème.

Un germe de fonction holomorphe $f : (\mathbb{C}^2, 0) \rightarrow (\mathbb{C}, 0)$ est dit *quasi-homogène* si et seulement si f appartient à son idéal jacobien $J(f) = (\frac{\partial f}{\partial x}, \frac{\partial f}{\partial y})$. Si f est quasi-homogène, alors il existe des coordonnées (x, y) et des entiers positifs coprimés k et l tels que le champ de vecteur quasi radial $R = kx \frac{\partial}{\partial x} + ly \frac{\partial}{\partial y}$ satisfait $R(f) = d \cdot f$, où l'entier d est le (k, l) -*degré quasi-homogène* de f [41]. Le couple (k, l) est appelé le *poids* des branches de f . Dans [59], Genzmer et Paul ont construit des formes normales analytiques pour les *fonctions topologiquement quasi-homogènes*, les fonctions holomorphes topologiquement équivalentes à une fonction quasi-homogène.

Dans cette thèse, nous étudions l'une des classes topologiques les plus simples au-delà des singularités quasi-homogènes, et nous considérons la famille de fonctions suivante

$$f_{M,N} = \prod_{i=1}^N (y + a_i x) \prod_{i=1}^M (y + b_i x^2).$$

Selon leur processus de réduction, pour $M, N \geq 2$, ces fonctions ne sont pas quasi homogènes.

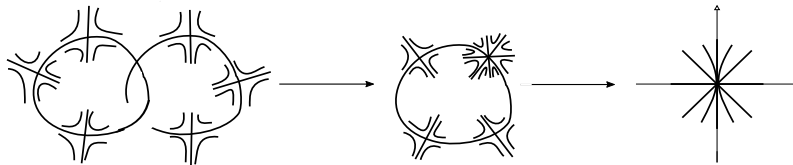

Figure 1 – Désingularization de $f_{M,N}$ pour $M = N = 3$

La symétrie R mentionnée ci-dessus est un outil essentiel pour l'étude de l'espace de modules de fonctions quasi-homogènes. D'une certaine manière, cela a permis Genzmer et Paul de compacter l'espace de modules et de le décrire globalement à partir d'une étude locale. Cependant, dans notre cas, il n'existe pas une telle symétrie et nous devons donc introduire une nouvelle approche.

Pour toute série convergente f dans $\mathbb{C}\{x, y\}$, nous pouvons reconnaître trois objets mathématiques différents associés: un germe de fonction holomorphe défini par la somme de cette série, un germe de feuilletage dont les feuilles sont les composantes connexes des courbes de niveau $f = \text{constant}$, et une courbe plongée $f = 0$. Par conséquent, il existe trois relations d'équivalence analytique différentes:

- La classification des fonctions (ou équivalence à droite):
 $f_1 \sim_r f_2 \Leftrightarrow \exists \phi \in \text{Diff}(\mathbb{C}^2, 0), f_2 = f_1 \circ \phi.$
- La classification des feuilletages (ou équivalence gauche-droite):
 $f_1 \sim f_2 \Leftrightarrow \exists \phi \in \text{Diff}(\mathbb{C}^2, 0), \psi \in \text{Diff}(\mathbb{C}, 0), \psi \circ f_2 = f_1 \circ \phi.$
- La classification des courbes:
 $f_1 \sim_c f_2 \Leftrightarrow \exists \phi \in \text{Diff}(\mathbb{C}^2, 0), u \in \mathcal{O}_2, u(0) \neq 0, u f_2 = f_1 \circ \phi.$

Dans ce qui suit, nous allons examiner les deux dernières relations d'équivalence pour les feuilletages et les courbes. La comparaison entre les deux premières classifications analytiques a été étudiée dans [45]. Nous soulignons que dans notre travail, nous exigeons toujours que les conjugaisons qui apparaissent ci-dessus respectent une numérotation fixe des branches de $f = 0$. En d'autres termes, si nous numérotions les branches, nous exigeons que la classification laisse invariant cette numérotation (appelée *espace de modules marqué*).

On note par $\mathcal{T}_{M,N}$ l'ensemble de fonctions holomorphes topologiquement équivalentes à $f_{M,N}$,

$$\mathcal{T}_{M,N} = \{f \in \mathbb{C}\{x, y\} \mid \exists \phi \in \text{Hom}(\mathbb{C}^2, 0), \psi \in \text{Hom}(\mathbb{C}, 0), \psi \circ f = f_{M,N} \circ \phi\}.$$

Le but principal de cette thèse est de décrire l'espace de modules $\mathcal{M}_{M,N}$ qui est la classe topologique $\mathcal{T}_{M,N}$ quotientnée par l'équivalence gauche-droite.

$$\mathcal{M}_{M,N} = \mathcal{T}_{M,N} / \sim.$$

Dans le chapitre 2, nous donnons une famille universelle de formes normales analytiques et nous prouvons son unicité globale.

Dans le chapitre 3, nous étudions l'espace de modules des courbes qui est l'espace $\mathcal{M}_{M,N}$ quotientnée par la troisième relation d'équivalence. En particulier, nous présentons un algorithme pour calculer sa dimension générique.

Le chapitre 4 présente une autre famille universelle de formes normales analytiques, qui est aussi globalement unique. En effet, il n'existe pas de modèle canonique pour la distribution de l'ensemble des paramètres sur les branches. Donc, avec cette famille, nous pouvons voir que la famille précédente n'est pas la seule et qu'il est possible de construire des formes normales en considérant une autre distribution des paramètres.

Enfin, en ce qui concerne la globalisation, nous discuterons au chapitre 5 une stratégie basée sur la théorie géométrique des invariants et nous discuterons des raisons pour lesquelles cela ne fonctionne pas jusqu'à présent.

Le chapitre 1 est une introduction générale sur les feuilletages, comprenant les définitions et les propriétés des objets utilisés dans cette thèse.

Présentation des résultats.

Un résultat général de J.F. Mattei [29] implique en particulier que l'espace tangent à l'espace de modules $\mathcal{M}_{M,N}$ est donné par le premier groupe de cohomologie de Čech $H^1(D, \Theta_{\mathcal{F}})$, où D est le diviseur exceptionnel de la désingularisation de $f_{M,N}$ et $\Theta_{\mathcal{F}}$ est le faisceau de germes des champs de vecteurs tangents au feuilletage désingularisé du feuilletage induit par $df_{M,N} = 0$. Ainsi, une première étape vers l'étude de l'espace de modules $\mathcal{M}_{M,N}$ consiste à calculer la dimension du groupe $H^1(D, \Theta_{\mathcal{F}})$. Soit $\mathcal{Q}_{M,N}$ la région dans l'union des demi-plans réels (X, Y) , $X \geq 0$ et $Y \geq 0$, délimitée par $Y - X + (M - 1) > 0$ et $2Y - X - (N - 1) < 0$.

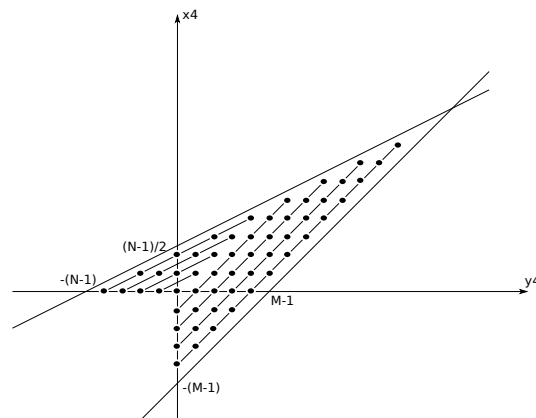

Figure 2 – La région $\mathcal{Q}_{M,N}$ pour $M = N = 6$

Proposition. *La dimension $\delta_{M,N}$ du premier groupe de cohomologie $H^1(D, \Theta_{\mathcal{F}})$ est égale au nombre de points entiers dans la région $\mathcal{Q}_{M,N}$ qui peut être exprimé par la formule suivante*

$$\delta_{M,N} = \frac{(M+N-2)(M+N-3)}{2} + \frac{(M-1)(M-2)}{2}.$$

Compte tenu de cette proposition, une famille universelle doit dépendre de $\delta_{M,N}$ paramètres. Pour cela, on note par \mathcal{P} l'ensemble ouvert suivant de $\mathbb{C}^{\delta_{M,N}}$

$$\mathcal{P} = \left\{ (\cdots, a_{k,i}, \cdots, b_{k',i'}, \cdots) \text{ tels que } a_{1,i} \neq 0, b_{1,j} \neq 0, 1 \text{ et} \right. \\ \left. a_{1,i} \neq a_{1,j}, b_{1,i'} \neq b_{1,j'} \text{ pour } i \neq j \text{ et } i' \neq j' \right\},$$

où les index k, i, k' et i' satisfont certaines inégalités qui seront développées plus tard. Nous prenons un paramètre $p = (\cdots, a_{k,i}, \cdots, b_{k',i'}, \cdots) \in \mathcal{P}$ et nous introduisons la famille de les fonctions

$$N_p^{(M,N)} = xy(y+x^2) \prod_{i=1}^{N-1} \left(y + \sum_{k=1}^i a_{k,i} xy^{k-1} \right) \prod_{i=1}^{M-2} \left(y + \sum_{k=1}^{N-1+2i} b_{k,i} x^{k+1} \right).$$

Ces fonctions semblent être de bons candidats pour paramétrer l'espace de modules $\mathcal{M}_{M,N}$. Le premier résultat principal du chapitre 2 garantit qu'au niveau infinitésimal, il s'agit bien de formes normales analytiques. Plus précisément, si nous considérons le feuilletage saturé $\mathcal{F}_p^{(M,N)}$ défini par la 1-forme $dN_p^{(M,N)}$ sur $\mathbb{C}^{2+\delta_{M,N}}$, alors nous pouvons montrer que:

Theorem (Existence locale). *Pour tout p_0 dans \mathcal{P} , le germe du déploiement $\left\{ \mathcal{F}_p^{(M,N)}, p \in (\mathcal{P}, p_0) \right\}$ est un déploiement équisingulier universel -suivant [29]- du feuilletage $\mathcal{F}_{p_0}^{(M,N)}$.*

En particulier, pour tout déploiement équisingulier \mathcal{F}_t , $t \in (\mathcal{T}, t_0)$ qui définit $\mathcal{F}_{p_0}^{(M,N)}$ pour $t = t_0$, il existe un map $\lambda : (\mathcal{T}, t_0) \rightarrow (\mathcal{P}, p_0)$ telle que la famille \mathcal{F}_t est analytiquement équivalente à $N_{\lambda(t)}^{(M,N)}$. De plus, le différentiel de λ au point t_0 est unique. Pour l'unicité du map λ , elle découle de l'unicité des formes normales.

Pour étudier l'unicité de ces formes normales, nous considérons le difféomorphisme défini par $h_\lambda(x, y) = (\lambda x, \lambda^2 y)$ et nous avons donc:

$$N_p \circ h_\lambda = \lambda^{2M+2N-1} N_{\lambda \cdot p}, \\ \lambda \cdot p = \lambda \cdot (a_{k,i}, b_{k,i}) = (\lambda^{2k-3} a_{k,i}, \lambda^{k-1} b_{k,i}).$$

Cette action de \mathbb{C}^* ne peut pas être utilisée pour *localiser* le problème de l'unicité comme dans [59] car, contrairement au cas quasi-homogène, la classe topologique de la famille

$$\lambda \mapsto \frac{N_p \circ h_\lambda}{\lambda^{2M+2N-1}}$$

saute quand λ passe à zéro. Cependant, nous sommes toujours en mesure de prouver ce qui suit:

Theorem (Unicité globale). *Les feuilletages définis par N_p et N_q , p et q sont dans \mathcal{P} , sont équivalents si et seulement s'il existe λ dans \mathbb{C}^* tel que $p = \lambda \cdot q$.*

Dans le chapitre 3, nous considérons la troisième relation d'équivalence sur l'espace de modules $\mathcal{M}_{M,N}$, et nous obtenons ainsi l'espace de modules de la courbe associée.

$$S = \{f_{M,N} = 0\}.$$

Le troisième objectif principal de cette thèse est de décrire cet espace de modules, ou en d'autres termes, d'étudier le *problème de Zariski* associé dans le cas générique. Ce problème n'a que quelques réponses: Zariski [52] pour le tout premier traitement de certains cas particuliers, Hefez et Hernandez [5] [6] [7] pour les courbes irréductibles, Granger [28] et Genzmer et Paul [58] pour la classe topologique homogène et [25] pour des résultats qui sont des cas particuliers de la classe topologique quasi-homogène traitée ultérieurement par Genzmer et Paul [59]. Nous suivons ici la stratégie introduite par Genzmer et Paul: sur l'espace de modules de feuilletages $\mathcal{M}_{M,N}$, nous considérons la distribution intégrable \mathcal{C} dont les feuilles correspondent aux feuilletages tels que les ensembles analytiques invariants associés -la séparatrice du feuilletage- définissent la même courbe à \sim_c près. En étudiant la famille des champs de vecteurs induits par la distribution \mathcal{C} sur $\mathcal{M}_{M,N}$, nous présentons une formule permettant de calculer la dimension des strates génériques de cet espace de modules local. Si on considère

$$\begin{aligned} \tau_0 = & \sum_{\substack{r=0 \\ q_{N+1+r} \geq \lfloor \frac{N-3+2r}{3} \rfloor + \lfloor \frac{r}{2} \rfloor - \lfloor \frac{r-1}{2} \rfloor + 2}}^{N-4} q_{N+1+r} - \left(\left\lfloor \frac{N-3+2r}{3} \right\rfloor + \left\lfloor \frac{r}{2} \right\rfloor - \left\lfloor \frac{r-1}{2} \right\rfloor + 2 \right) \\ & + \sum_{\substack{r=N-3 \\ q_{N+1+r} \geq N-2 + \lfloor \frac{r-N+4}{2} \rfloor + \lfloor \frac{r}{2} \rfloor - \lfloor \frac{r-1}{2} \rfloor}}^{2M-6} q_{N+1+r} - \left(N-2 + \left\lfloor \frac{r-N+4}{2} \right\rfloor + \left\lfloor \frac{r}{2} \right\rfloor - \left\lfloor \frac{r-1}{2} \right\rfloor \right), \end{aligned}$$

où $q_k = \lfloor \frac{k+N-2}{2} \rfloor + M - k$ désigne le nombre de points entiers dans l'intersection entre la région de modules et la droite de l'équation ($y_4 = k - 1$) si $N \leq k \leq N + 2M - 5$, alors nous avons ce qui suit:

Theorem. *La dimension des strates génériques de l'espace de modules de $S = \{f_{M,N} = 0\}$ est donnée par*

1. *si $M, N \neq 2$ et N est pair:*

$$\begin{aligned} \tau_{M,N} = & \tau_0 + 3N - 7 + (M - 3) \left(\frac{N}{2} + 2 \right) + \frac{(N-4)(N-6)}{4} \\ & + \sum_{\substack{i=0 \\ \lfloor \frac{2i+1}{3} \rfloor + 1 \leq M-3}}^{\frac{N}{2}-3} \left(M - 4 - \left\lfloor \frac{2i+1}{3} \right\rfloor \right) \end{aligned}$$

2. si $M, N \neq 2$ et $N \neq 3$ est impair:

$$\begin{aligned} \tau_{M,N} = & \tau_0 + 3N - 7 + (M - 3) \left(\frac{N-1}{2} + 2 \right) + \frac{(N-5)^2}{4} \\ & + \sum_{\substack{i=0 \\ \lfloor \frac{2i}{3} \rfloor + 1 \leq M-3}}^{\frac{N+1}{2}-3} \left(M - 4 - \left\lfloor \frac{2i}{3} \right\rfloor \right) \end{aligned}$$

3. si $N = 3, M \neq 2$:

$$\tau_{M,N} = q_4 + 3M + 3N - 17 + \sum_{r=1}^{2M-6} \left(q_{r+4} - \left\lfloor \frac{r}{2} \right\rfloor - 2 \right)$$

4. si $M = 2, N \neq 2$:

$$\tau_{M,N} = 2N - 5 + \sum_{d=2}^{\lfloor \frac{N-1}{2} \rfloor} (N - 2d - 1)$$

5. si $N = 2$:

$$\tau_{M,N} = 2(M - 2) + \sum_{\substack{r=0 \\ q_{r+3} \geq \lfloor \frac{r+2}{2} \rfloor + \lfloor \frac{r}{2} \rfloor - \lfloor \frac{r-1}{2} \rfloor}}^{2M-6} q_{r+3} - \left(\left\lfloor \frac{r+2}{2} \right\rfloor + \left\lfloor \frac{r}{2} \right\rfloor - \left\lfloor \frac{r-1}{2} \right\rfloor \right),$$

où exceptionnellement $q_{N+1} = M - 3$.

Finalement, nous remarquons que la famille précédente de formes normales n'est pas la seule famille de formes normales. Considérant le même espace de paramètres \mathcal{P} , pour $p \in \mathcal{P}$, nous définissons une autre forme normale analytique par

$$N_p^{(M,N)} = xy(y+x) \prod_{i=1}^{N-2} \left(y + \sum_{k=1}^i a_{k,i} xy^{k-1} \right) \prod_{i=1}^{M-1} \left(y + \sum_{k=1}^{N-3+2i} b_{k,i} x^{k+1} \right).$$

Dans la construction précédente des formes normales, nous avons fixé la courbe $y+x^2=0$ et nous avons distribué les paramètres sur les $N-1$ branches restantes de poids $(1,1)$ et $M-2$ branches de poids $(1,2)$. Cependant, nous choisissons ici de fixer la courbe $y+x=0$, de sorte qu'il reste $N-2$ branches de poids $(1,1)$ et $M-1$ branches de poids $(1,2)$ sur lesquels on distribue les paramètres. Si nous considérons le feuilletage saturé $\mathcal{F}_p^{(M,N)}$ défini par la 1-forme $dN_p^{(M,N)}$ sur $\mathbb{C}^{2+\delta_{M,N}}$, de même, nous montrons au chapitre 4 que pour tout p_0 dans \mathcal{P} le germe du déploiement $\left\{ \mathcal{F}_p^{(M,N)}, p \in (\mathcal{P}, p_0) \right\}$ est un déploiement équisingulier universel du feuilletage $\mathcal{F}_{p_0}^{(M,N)}$. De plus, nous montrons également que cette famille est globalement unique.

Introduction.

Let f be a germ of holomorphic function in two variables which vanishes at the origin,

$$f(x, y) \in \mathbb{C}\{x, y\}, \quad (x, y) \in \mathbb{C}^2, \quad f(0, 0) = 0.$$

The zero set of this function, $S = \{f(x, y) = 0\}$, defines a germ of analytic curve. Although the topological classification of such a germ is well known since the work of Zariski [52], the analytical classification is still widely open. In 2012, Hefez and Hernandez [7] solved the irreducible case and announced the two components case. In 2015, Genzmer and Paul [59] solved the case of topologically quasi-homogeneous functions. The main purpose of this thesis is to study the first topological class of non quasi-homogeneous functions. We describe the local moduli space of the foliations in this class and give analytic normal forms. We also prove the uniqueness of these normal forms. Finally, we present an algorithm to compute the dimension of the generic strata of the local moduli space of curves.

Position of the problem.

A germ of holomorphic function $f : (\mathbb{C}^2, 0) \rightarrow (\mathbb{C}, 0)$ is said to be *quasi-homogeneous* if and only if f belongs to its jacobian ideal $J(f) = \left(\frac{\partial f}{\partial x}, \frac{\partial f}{\partial y}\right)$. If f is quasi-homogeneous, then there exist coordinates (x, y) and positive coprime integers k and l such that the quasi-radial vector field $R = kx\frac{\partial}{\partial x} + ly\frac{\partial}{\partial y}$ satisfies $R(f) = d \cdot f$, where the integer d is the *quasi-homogeneous (k, l) -degree* of f [41]. The couple (k, l) is referred to as the *weight* of the branches of f . In [59], Genzmer and Paul constructed analytic normal forms for *topologically quasi-homogeneous functions*, the holomorphic functions topologically equivalent to a quasi-homogeneous function.

In this thesis, we study one of the simplest topological classes beyond the quasi-homogeneous singularities, and we consider the following family of functions

$$f_{M,N} = \prod_{i=1}^N (y + a_i x) \prod_{i=1}^M (y + b_i x^2).$$

According to their reduction process, for $M, N \geq 2$, these functions are not quasi homogeneous.

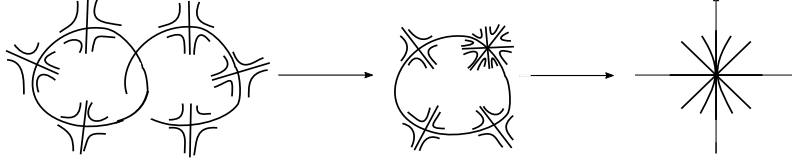

Figure 3 – Desingularization of $f_{M,N}$ for $M = N = 3$

The symmetry R mentioned above is a key tool to study the moduli space of quasi-homogeneous functions. In some sense, it allowed Genzmer and Paul to compactify the moduli space and to describe it globally from a local study. However, in our case, we lack the existence of such a symmetry and thus we have to introduce a new approach.

For any convergent series f in $\mathbb{C}\{x, y\}$, we can recognize three different associated mathematical objects: a germ of holomorphic function defined by the sum of this series, a germ of foliation whose leaves are the connected components of the level curves $f = \text{constant}$, and an embedded curve $f = 0$. Therefore, there are three different analytic equivalence relations:

- The classification of functions (or right equivalence):
 $f_1 \sim_r f_2 \Leftrightarrow \exists \phi \in \text{Diff}(\mathbb{C}^2, 0), f_2 = f_1 \circ \phi.$
- The classification of foliations (or left-right equivalence):
 $f_1 \sim f_2 \Leftrightarrow \exists \phi \in \text{Diff}(\mathbb{C}^2, 0), \psi \in \text{Diff}(\mathbb{C}, 0), \psi \circ f_2 = f_1 \circ \phi.$
- The classification of curves:
 $f_1 \sim_c f_2 \Leftrightarrow \exists \phi \in \text{Diff}(\mathbb{C}^2, 0), u \in \mathcal{O}_2, u(0) \neq 0, u f_2 = f_1 \circ \phi.$

In what follows, we are going to consider the last two equivalence relations for foliations and curves. The comparison between the first two analytical classifications has been studied in [45]. We emphasize that in our work, we will always require that the conjugacies which appear above will respect a fixed numbering of the branches of $f = 0$. In other words, if we number the branches, we require that the classification keeps this numbering invariant (what is referred to as the *marked moduli space*).

We denote by $\mathcal{T}_{M,N}$ the set of holomorphic functions which are topologically equivalent to $f_{M,N}$,

$$\mathcal{T}_{M,N} = \{f \in \mathbb{C}\{x, y\} \mid \exists \phi \in \text{Hom}(\mathbb{C}^2, 0), \psi \in \text{Hom}(\mathbb{C}, 0), \psi \circ f = f_{M,N} \circ \phi\}.$$

The main purpose of this thesis is to describe the moduli space $\mathcal{M}_{M,N}$ which is the topological class $\mathcal{T}_{M,N}$ up to left-right equivalence

$$\mathcal{M}_{M,N} = \mathcal{T}_{M,N} / \sim.$$

In chapter 2, we give a universal family of analytic normal forms and prove its global uniqueness.

In chapter 3, we study the moduli space of curves which is the space $\mathcal{M}_{M,N}$ up to the third equivalence relation. In particular, we present an algorithm to compute its generic dimension.

Chapter 4 presents another universal family of analytic normal forms which is globally unique as well. Indeed, there is no canonical model for the distribution of the set of parameters on the branches. So, with this family, we can see that the previous family is not the only one and that it is possible to construct normal forms by considering another distribution of the parameters.

Finally, concerning the globalization, we discuss in chapter 5 a strategy based on geometric invariant theory and why it does not work so far.

Chapter 1 is a general introduction about foliations including definitions and properties of objects used in this thesis.

Presentation of the results.

A general result of J.F. Mattei [29] implies in particular that the tangent space to the moduli space $\mathcal{M}_{M,N}$ is given by the first Čech cohomology group $H^1(D, \Theta_{\mathcal{F}})$, where D is the exceptional divisor of the desingularization of $f_{M,N}$, and $\Theta_{\mathcal{F}}$ is the sheaf of germs of vector fields tangent to the desingularized foliation of the foliation induced by $df_{M,N} = 0$. So, a first step towards studying the moduli space $\mathcal{M}_{M,N}$ is to compute the dimension of the group $H^1(D, \Theta_{\mathcal{F}})$. Let $\mathcal{Q}_{M,N}$ be the region in the union of the real half planes (X, Y) , $X \geq 0$ and $Y \geq 0$, delimited by $Y - X + (M - 1) > 0$ and $2Y - X - (N - 1) < 0$.

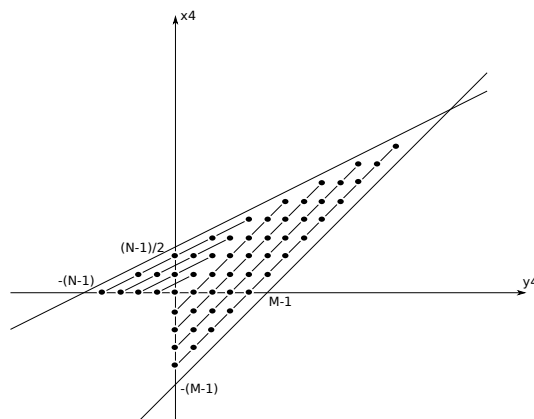

Figure 4 – The region $\mathcal{Q}_{M,N}$ for $M = N = 6$

Proposition. *The dimension $\delta_{M,N}$ of the first cohomology group $H^1(D, \Theta_{\mathcal{F}})$ is equal to the number of the integer points in the region $\mathcal{Q}_{M,N}$ which can be expressed by the following formula*

$$\delta_{M,N} = \frac{(M + N - 2)(M + N - 3)}{2} + \frac{(M - 1)(M - 2)}{2}.$$

In view of this proposition, a universal family must depend on $\delta_{M,N}$ parameters. For that, we denote by \mathcal{P} the following open set of $\mathbb{C}^{\delta_{M,N}}$

$$\mathcal{P} = \left\{ (\cdots, a_{k,i}, \cdots, b_{k',i'}, \cdots) \text{ such that } a_{1,i} \neq 0, b_{1,j} \neq 0, 1 \text{ and} \right. \\ \left. a_{1,i} \neq a_{1,j}, b_{1,i'} \neq b_{1,j'} \text{ for } i \neq j \text{ and } i' \neq j' \right\},$$

where the indexes k, i, k' and i' satisfy some inequalities which will be developed later. We take a parameter $p = (\cdots, a_{k,i}, \cdots, b_{k',i'}, \cdots) \in \mathcal{P}$ and introduce the family of functions

$$N_p^{(M,N)} = xy(y+x^2) \prod_{i=1}^{N-1} \left(y + \sum_{k=1}^i a_{k,i} xy^{k-1} \right) \prod_{i=1}^{M-2} \left(y + \sum_{k=1}^{N-1+2i} b_{k,i} x^{k+1} \right).$$

These functions seem to be good candidates for parameterizing the moduli space $\mathcal{M}_{M,N}$. The first main result of chapter 2 ensures that at the infinitesimal level, they are actually analytic normal forms. More precisely, if we consider the saturated foliation $\mathcal{F}_p^{(M,N)}$ defined by the one-form $dN_p^{(M,N)}$ on $\mathbb{C}^{2+\delta_{M,N}}$, then we can show that:

Theorem (Local existence). *For any p_0 in \mathcal{P} , the germ of unfolding $\left\{ \mathcal{F}_p^{(M,N)}, p \in (\mathcal{P}, p_0) \right\}$ is a universal equireducible unfolding -following [29]- of the foliation $\mathcal{F}_{p_0}^{(M,N)}$.*

In particular, for any equireducible unfolding \mathcal{F}_t , $t \in (\mathcal{T}, t_0)$ which defines $\mathcal{F}_{p_0}^{(M,N)}$ for $t = t_0$, there exists a map $\lambda : (\mathcal{T}, t_0) \rightarrow (\mathcal{P}, p_0)$ such that the family \mathcal{F}_t is analytically equivalent to $N_{\lambda(t)}^{(M,N)}$. Furthermore, the differential of λ at the point t_0 is unique. As for the uniqueness of the map λ , it follows from the uniqueness of the normal forms.

To study the uniqueness of these normal forms, we consider the diffeomorphism defined by $h_\lambda(x, y) = (\lambda x, \lambda^2 y)$ and so we have:

$$N_p \circ h_\lambda = \lambda^{2M+2N-1} N_{\lambda \cdot p}, \\ \lambda \cdot p = \lambda \cdot (a_{k,i}, b_{k,i}) = (\lambda^{2k-3} a_{k,i}, \lambda^{k-1} b_{k,i}).$$

This action of \mathbb{C}^* cannot be used to *localize* the uniqueness problem as done in [59] because, contrary to the quasi-homogeneous case, the topological class of the family

$$\lambda \mapsto \frac{N_p \circ h_\lambda}{\lambda^{2M+2N-1}}$$

jumps while λ goes to zero. However, we are still able to prove the following:

Theorem (Global uniqueness). *The foliations defined by N_p and N_q , p and q are in \mathcal{P} , are equivalent if and only if there exists λ in \mathbb{C}^* such that $p = \lambda \cdot q$.*

In chapter 3, we consider the third equivalence relation on the moduli space $\mathcal{M}_{M,N}$, and so we get the moduli space of the associated curve

$$S = \{f_{M,N} = 0\}.$$

The third main purpose of this thesis is to describe this moduli space, or in other words, to study the associated *Zariski problem* in the generic case. This problem has only some answers: Zariski [52] for the very first treatment of some particular cases, Hefez and Hernandez [5][6][7] for the irreducible curves, Granger [28] and Genzmer and Paul [58] for the homogeneous topological class and [25] for some results which are particular cases of the quasi homogeneous topological class treated later by Genzmer and Paul [59]. Here, we follow the strategy introduced by Genzmer and Paul: on the moduli space of foliations $\mathcal{M}_{M,N}$, we consider the integrable distribution \mathcal{C} whose leaves correspond to the foliations such that the related invariant analytic sets -the separatrix of the foliation- define the same curve up to \sim_c . Studying the family of vector fields induced by the distribution \mathcal{C} on $\mathcal{M}_{M,N}$, we present a formula to compute the dimension of the generic strata of this local moduli space. If we let

$$\begin{aligned} \tau_0 = & \sum_{\substack{r=0 \\ q_{N+1+r} \geq \lfloor \frac{N-3+2r}{3} \rfloor + \lfloor \frac{r}{2} \rfloor - \lfloor \frac{r-1}{2} \rfloor + 2}}^{N-4} q_{N+1+r} - \left(\left\lfloor \frac{N-3+2r}{3} \right\rfloor + \left\lfloor \frac{r}{2} \right\rfloor - \left\lfloor \frac{r-1}{2} \right\rfloor + 2 \right) \\ & + \sum_{\substack{r=N-3 \\ q_{N+1+r} \geq N-2 + \lfloor \frac{r-N+4}{2} \rfloor + \lfloor \frac{r}{2} \rfloor - \lfloor \frac{r-1}{2} \rfloor}}^{2M-6} q_{N+1+r} - \left(N-2 + \left\lfloor \frac{r-N+4}{2} \right\rfloor + \left\lfloor \frac{r}{2} \right\rfloor - \left\lfloor \frac{r-1}{2} \right\rfloor \right), \end{aligned}$$

where $q_k = \lfloor \frac{k+N-2}{2} \rfloor + M - k$ denotes the number of integer points in the intersection between the region of moduli and the straight line of equation $(y_4 = k - 1)$ if $N \leq k \leq N + 2M - 5$, then we have the following:

Theorem. *The dimension of the generic strata of the moduli space of $S = \{f_{M,N} = 0\}$ is given by*

1. if $M, N \neq 2$ and N is even:

$$\begin{aligned} \tau_{M,N} = & \tau_0 + 3N - 7 + (M - 3) \left(\frac{N}{2} + 2 \right) + \frac{(N-4)(N-6)}{4} \\ & + \sum_{\substack{i=0 \\ \lfloor \frac{2i+1}{3} \rfloor + 1 \leq M-3}}^{\frac{N}{2}-3} \left(M - 4 - \left\lfloor \frac{2i+1}{3} \right\rfloor \right) \end{aligned}$$

2. if $M, N \neq 2$ and $N \neq 3$ is odd:

$$\begin{aligned} \tau_{M,N} = & \tau_0 + 3N - 7 + (M - 3) \left(\frac{N-1}{2} + 2 \right) + \frac{(N-5)^2}{4} \\ & + \sum_{\substack{i=0 \\ \lfloor \frac{2i}{3} \rfloor + 1 \leq M-3}}^{\frac{N+1}{2}-3} \left(M - 4 - \left\lfloor \frac{2i}{3} \right\rfloor \right) \end{aligned}$$

3. if $N = 3, M \neq 2$:

$$\tau_{M,N} = q_4 + 3M + 3N - 17 + \sum_{r=1}^{2M-6} \left(q_{r+4} - \left\lfloor \frac{r}{2} \right\rfloor - 2 \right)$$

4. if $M = 2$, $N \neq 2$:

$$\tau_{M,N} = 2N - 5 + \sum_{d=2}^{\lfloor \frac{N-1}{2} \rfloor} (N - 2d - 1)$$

5. if $N = 2$:

$$\tau_{M,N} = 2(M - 2) + \sum_{\substack{r=0 \\ q_{r+3} \geq \lfloor \frac{r+2}{2} \rfloor + \lfloor \frac{r}{2} \rfloor - \lfloor \frac{r-1}{2} \rfloor}}^{2M-6} q_{r+3} - \left(\left\lfloor \frac{r+2}{2} \right\rfloor + \left\lfloor \frac{r}{2} \right\rfloor - \left\lfloor \frac{r-1}{2} \right\rfloor \right),$$

where exceptionally $q_{N+1} = M - 3$.

Finally, we remark that the previous family of normal forms is not the only family of normal forms. Considering the same space of parameters \mathcal{P} , for $p \in \mathcal{P}$, we define another analytic normal form by

$$N_p^{(M,N)} = xy(y+x) \prod_{i=1}^{N-2} \left(y + \sum_{k=1}^i a_{k,i} xy^{k-1} \right) \prod_{i=1}^{M-1} \left(y + \sum_{k=1}^{N-3+2i} b_{k,i} x^{k+1} \right).$$

In the previous construction of normal forms, we fixed the curve $y+x^2 = 0$ and distributed the parameters on the remaining $N - 1$ branches of weight $(1, 1)$ and $M - 2$ branches of weight $(1, 2)$. However, here we choose to fix the curve $y+x = 0$, and so it remains $N - 2$ branches of weight $(1, 1)$ and $M - 1$ branches of weight $(1, 2)$ on which we distribute the parameters. If we consider the saturated foliation $\mathcal{F}_p^{(M,N)}$ defined by the one-form $dN_p^{(M,N)}$ on $\mathbb{C}^{2+\delta_{M,N}}$, we show similarly in chapter 4 that for any $p_0 \in \mathcal{P}$ the germ of unfolding $\left\{ \mathcal{F}_p^{(M,N)}, p \in (\mathcal{P}, p_0) \right\}$ is a universal equireducible unfolding of the foliation $\mathcal{F}_{p_0}^{(M,N)}$. Moreover, we also show that this family is globally unique.

Contents

1	Basics and properties.	10
1.1	A germ of foliation in \mathbb{C}^2 .	10
1.2	Equireducible unfolding.	13
2	First universal family of normal forms of foliations.	16
2.1	The dimension of $H^1(D, \Theta_{\mathcal{F}})$.	16
2.2	The local normal forms.	18
2.3	Proof of Theorem A for $M = N = 3$.	20
2.4	Proof of Theorem A for the general case.	27
2.5	The uniqueness of the normal forms.	35
3	The dimension of the moduli space of curves.	42
3.1	The infinitesimal generators of \mathcal{C} .	42
3.2	The dimension of the generic strata.	60
3.3	Examples.	71
4	Second universal family of normal forms of foliations.	80
4.1	The local normal forms.	80
4.2	The uniqueness of the normal forms.	88
5	Globalization and relation with GIT	93
5.1	Presentation of the approach.	93
5.2	Geometric quotients.	94
5.3	Related results.	99
5.4	Counter example.	104

Chapter 1

Basics and properties.

A *holomorphic foliation* \mathcal{F} of dimension p on a complex manifold M of dimension n is the data of an atlas

$$\{\psi_i : U_i \subset M \longrightarrow \mathbb{C}^p \times \mathbb{C}^{n-p}\}$$

such that the change of charts mappings are holomorphic and of the form

$$(x, t) \mapsto (\psi(x, t), \phi(t)), \quad x = (x_1, \dots, x_p), t = (t_1, \dots, t_{n-p}).$$

It can be also given by a covering by open sets $\{U_i\}_{i \in J}$ equipped with submersions

$$(H_i : U_i \longrightarrow \mathbb{C}^{n-p})_{i \in I}$$

satisfying, on every intersection $U_i \cap U_j$, the gluing condition

$$H_j = \psi_{ij} \circ H_i$$

for a biholomorphism $\psi_{ij} : H_i(U_i \cap U_j) \longrightarrow H_j(U_i \cap U_j)$ [12]. On the open set U_i , the relation *x and y belong to the same component connected by arc of a fiber of H_i* defines an equivalence relation \mathcal{R}_i . Every equivalence class of the equivalence relation on M generated by the family of relations $(\mathcal{R}_i)_{i \in I}$ is called a *leaf* of the foliation \mathcal{F} . The gluing conditions ensure that the relations \mathcal{R}_i and \mathcal{R}_j coincide on $U_i \cap U_j$.

1.1 A germ of foliation in \mathbb{C}^2 .

A *germ of singular holomorphic foliation* \mathcal{F} in \mathbb{C}^2 corresponds to the data of a germ of holomorphic 1-form

$$a(x, y)dx + b(x, y)dy \tag{1.1}$$

up to the action of the group of germs of unities \mathcal{O}_2^* . Here, the functions a and b are germs of holomorphic functions which vanish at the origin of \mathbb{C}^2 . The *singular set* of the foliation is the zero set of a and b . When the singular set is of codimension 1, a and b have a non-trivial common factor in $\mathbb{C}\{x, y\}$. The foliation associated to the 1-form

$$\frac{a(x, y)}{\gcd(x, y)}dx + \frac{b(x, y)}{\gcd(x, y)}dy$$

extends the foliation (1.1) to a regular foliation outside the origin. It is called the *saturated foliation* associated to the foliation defined by (1.1). From now on, the singularity of (1.1) is supposed to be *isolated*, which is to say that a and b do not have a common factor in $\mathbb{C}\{x, y\}$.

Reduced singularity.

A germ of foliation is said to be *reduced* if there exists a system of coordinates in which it is defined by a 1-form of the form

$$\lambda xdy + \mu ydx + \dots, \quad \mu \neq 0, \quad \frac{\lambda}{\mu} \notin \mathbb{Q}_-^*.$$

This quotient is an important invariant of the foliation. It is called the *Camacho-Sad index* of foliation [10]. This singularity of the foliation is said to be of type [42]

1. hyperbolic if $\frac{\lambda}{\mu} \notin \mathbb{R}$,
2. node if $\frac{\lambda}{\mu} \in \mathbb{R}_-^*$,
3. saddle if $\frac{\lambda}{\mu} \in \mathbb{R}_+^*$,
4. saddle-node if $\lambda = 0$,
5. resonant if $\frac{\lambda}{\mu} \in \mathbb{Q}$.

We note that a reduced singularity produces only reduced singularities after a standard blow-up centered at the singularity. We are going to explain now the principle of reduction of non-reduced singularities.

Reduction of singularities of a foliation.

Regarding the reduction of non-reduced singularities, the notion of a reduced singularity with respect to a germ of curve specifies that of a reduced singularity. It leads to a reduction of singularities which is finer than that associated to the simple notion of a reduced singularity.

Definition 1.1.1. *Let \mathcal{F} be a germ of foliation and S a germ of curve. The couple (\mathcal{F}, S) is said to be reduced if one of the following conditions is satisfied*

1. \mathcal{F} is reduced and singular and S is invariant.
2. \mathcal{F} is regular, S is not invariant and all the leaves of \mathcal{F} are transverse to S .

To define the reduction of singularities, we call a *blow-up process* at $0 \in \mathbb{C}^2$ the data of a commutative diagram

$$\begin{array}{ccccccccccc}
 M^h & \xrightarrow{E^h} & \dots & \longrightarrow & M^j & \xrightarrow{E^j} & M^{j-1} & \longrightarrow & \dots & \xrightarrow{E^1} & M^0 & = & \mathbb{C}^2 \\
 \uparrow & & & & \uparrow & & \uparrow & & & & \uparrow & & \\
 \Sigma^h & \longrightarrow & \dots & \longrightarrow & \Sigma^j & \longrightarrow & \Sigma^{j-1} & \longrightarrow & \dots & \longrightarrow & \Sigma^0 & = & \{0\} \\
 \uparrow & & & & \uparrow & & \uparrow & & & & \uparrow & & \\
 S^h & \longrightarrow & \dots & \longrightarrow & S^j & \longrightarrow & S^{j-1} & \longrightarrow & \dots & \longrightarrow & S^0 & = & \{0\}
 \end{array} \tag{1.2}$$

where M^j is a complex analytic variety of dimension 2; Σ^j , called the *singularity set*, is a finite set of points contained in the curve

$$D^j := (E^1 \circ \dots \circ E^j)^{-1}(S^0),$$

called the *j*th exceptional divisor of the blow-up; E^{j+1} is the standard blow-up of center S^j , called the *j*th center of blow-up. The application $E_h := E^1 \circ \dots \circ E^h$ is called the *total morphism* of the process. We denote by $\text{Comp}(D^j)$ the set of irreducible components of D^j . The integer h is called the *height* of the blow-up process and the triplet (M^h, D^h, Σ^h) the *tree* of the blow-up process. The triplet (M^0, D^0, Σ^0) is the *socle* of the process.

Considering a germ of foliation \mathcal{F} , the theorem of Seidenberg says that:

Theorem 1.1.1 ([8][31]). *There exists a blow-up process of height h such that*

1. *for every $j = 0, \dots, h$, the center S^j is the set of non-reduced singularities of $E^{j*}\mathcal{F}$ with respect to the divisor D^j ,*
2. *for every $j = 0, \dots, h$, the set Σ^j is the set of singularities of the foliation $E^{j*}\mathcal{F}$,*
3. $S^h = \emptyset$.

The second condition of the definition (1.1.1) avoids the situation of a foliation locally regular whose one of the leaves would be tangent to the divisor. When the considered blow-up process is the minimal among those which satisfy the properties of theorem (1.1.1), we talk about the *reduction process* of \mathcal{F} and the tree $(M, D, \Sigma) := (M^h, D^h, \Sigma^h)$ is called the *reduction tree* of \mathcal{F} . This tree and its total morphism are unique up to the permutation of the order of some intermediate blow-up applications.

A *separatrix* is an irreducible component of the closure of an invariant curve of the regular foliation induced by \mathcal{F} outside the singularity whose closure is an analytic curve. The existence of a reduction process is a basic point in the proof of the classic theorem:

Theorem 1.1.2 ([10]). *Every germ of singular holomorphic foliation admits at least a separatrix.*

As every separatrix can be lifted through the reduction tree to a curve which is transverse to the divisor turning it into a smooth separatrix of a reduced singularity, the reduction process of a foliation desingularizes the singularities of the separatrices. The strategy adopted for the proof of theorem (1.1.2) is to show, by a combinatorial argument, the

existence of a reduced singularity for the reduced foliation admitting a separatrix transverse to the divisor of the reduction tree. This curve contracts then at the origin to a germ of analytic curve constituting a separatrix.

If the divisor of the reduction tree is not an invariant curve, then the foliation is said to be *dicritical* and it is said to be *non-dicritical* in the contrary case. This alternative corresponds to the presence or not of a finite number of separatrices.

If the reduced foliation does not have any saddle-node singularity, then it is said to be of a *generalized curve* type. It is not required for the foliation to be non-dicritical. The foliations of a generalized curve type admit a reduction process which is easy to describe:

Theorem 1.1.3 ([11]). *The reduction processes of a germ of foliation of a generalized curve type and its separatrices are the same.*

This result explains the terminology *generalized curve*. In this thesis, we work with foliations defined by holomorphic functions. Thus, they are clearly non-dicritical and of a generalized curve type.

To describe the topology of the reduction tree, there is a combinatorial invariant controlling the topological type of the reduction process: so, using the notations of (1.2), the dual tree $\mathbb{A}^*(\mathcal{F})$ of a foliation \mathcal{F} is defined by the data of an oriented graph whose set of vertices is the set $\text{Comp}(D^h)$; two vertices D and D' are linked by an edge if and only if $D \cdot D' = 1$.

1.2 Equireducible unfolding.

Let \mathcal{F}_0 be a germ of holomorphic foliation at $0 \in \mathbb{C}^2$ with isolated singularity 0. An unfolding of \mathcal{F}_0 of base $P = (\mathbb{C}^p, 0)$ is the data of a germ of saturated foliation \mathcal{F}_p of codimension 1 at the origin of $(\mathbb{C}^{2+p}, 0)$ of singular set $\Sigma(\mathcal{F}_p)$ such that the leaves of \mathcal{F}_p are transverse to the fibers of the projection

$$\Pi : (\mathbb{C}^{2+p}, 0) \rightarrow P, \quad \Pi(x, t) = t,$$

with $x = (x_1, x_2), t = (t_1, \dots, t_p)$, and such that we have the equality

$$i^*(\mathcal{F}_p) = \mathcal{F}_0,$$

where $i : (\mathbb{C}^2, 0) \hookrightarrow (\mathbb{C}^{2+p}, 0)$ designs the embedding $i(x) = (x, 0)$.

In other words, it is the data of a germ of holomorphic 1-form

$$\Omega = A_1(x, t)dx_1 + A_2(x, t)dx_2 + \sum_{j=1}^p C_j(x, t)dt_j, \quad (1.3)$$

such that

1. A_1, A_2 and C_1, \dots, C_p are germs of holomorphic functions at a neighborhood of $\{0\}$,

2. Ω is integrable, i.e. $\Omega \wedge d\Omega \equiv 0$,
3. The singular set $\Sigma(\mathcal{F}_p)$ is the zero set of the ideal $(A_1, A_2, C_1, \dots, C_p) \subset \mathcal{O}_{2+p}$,
4. (C_1, \dots, C_p) is a sub-ideal of $\sqrt{(A_1, A_2)}$.

The last condition corresponds to the transversality of the leaves and the fibers.

Two unfoldings \mathcal{F}_p and \mathcal{F}'_p of the same base P are said to be *holomorphically conjugated*, or *equivalent*, if there exists a germ of holomorphic automorphism ϕ of $(\mathbb{C}^{2+p}, 0)$ such that

$$\phi^* \mathcal{F}_p = \mathcal{F}'_p \quad \text{and} \quad \Pi \circ \phi = \Pi.$$

When ϕ is only a C^k -homeomorphism, we say that \mathcal{F}_p and \mathcal{F}'_p are *C^k -conjugated*. An unfolding \mathcal{F}_p is said to be trivial if it is conjugated to a constant unfolding $\mathcal{F}_0 \times P$, i.e. defined by (1.3) with

$$A_i(x, t) \equiv A_i(x, 0), \quad C_j(x, t) \equiv 0, \quad i = 1, 2, \quad j = 1, \dots, p.$$

The equireducibility of an unfolding corresponds to the existence of reduction of singularities in family:

Definition 1.2.1. *We say that an unfolding \mathcal{F}_p of \mathcal{F}_0 of base $P = (\mathbb{C}^p, 0)$ is equireducible if there exists a sequence of blow-ups $E_p^i : M_p^i \rightarrow M_p^{i-1}$ such that*

1. *The singular sets Σ_p^i are smooth; the centers S_p^i are constituted of irreducible components of Σ_p^i ; $S_p^h = \emptyset$.*
2. *Considering $E_{i,p} := E_p^1 \circ \dots \circ E_p^i$, the restrictions of $\Pi_{i,p} := \Pi \circ E_{i,p}$ on Σ_p^i are étale.*
3. *The foliations $E_{i,p}^* \mathcal{F}_p$ are transverse to the fibers of $\Pi_{i,p}$ at every regular point.*
4. *The succession of blow-ups obtained by restricting every $E_{i,p}$ to the fibers of $\Pi_{i,p}$ and $\Pi_{i-1,p}$ is exactly the succession of blow-ups of the reduction process of \mathcal{F}_0 .*

The argument followed in the proof of Theorem A is mainly based on the following result about equireducible unfoldings.

Theorem 1.2.1 (J.F. Mattei [29]). *If \mathcal{F}_p is an equireducible unfolding of \mathcal{F}_0 , then $\tilde{\mathcal{F}}_p := E_{h,p}^* \mathcal{F}_p$ is locally analytically trivial.*

If \mathcal{F}_0 is defined by an exact one-form, then we can suppose that the unfolding is given by the one-form

$$dF_p = \frac{\partial F_p}{\partial x} dx + \frac{\partial F_p}{\partial y} dy + \sum_{r=1}^p \frac{\partial F_p}{\partial p_r} dp_r.$$

Let m be any regular or singular point of the exceptional divisor D , in some local chart (x_i, y_i) of D . According to the proof of the previous theorem, for each parameter p_r , we can find a local vector field in some neighborhood U of m

$$X_r = \alpha_r(x_i, y_i, p) \frac{\partial}{\partial x_i} + \beta_r(x_i, y_i, p) \frac{\partial}{\partial y_i} - \frac{\partial}{\partial p_r},$$

such that $d\tilde{F}_p(X_r) = 0$, which can also be written as

$$\frac{\partial \tilde{F}_p}{\partial p_r} = \alpha_r(x_i, y_i, p) \frac{\partial \tilde{F}_p}{\partial x_i} + \beta_r(x_i, y_i, p) \frac{\partial \tilde{F}_p}{\partial y_i}. \quad (1.4)$$

The local trivialization φ_U on U is obtained by successive integrations of the vector fields X_r . A direct corollary of the previous theorem is the following:

Corollary 1.2.1 ([29]). *If \mathcal{F}_p is an equireducible unfolding of \mathcal{F}_0 , then \mathcal{F}_p is topologically trivial.*

Following [29], the set of the classes of equireducible unfoldings $\tilde{\mathcal{F}}_p$ of $\tilde{\mathcal{F}}_0$ up to analytic equivalence is in bijection with the first non abelian cohomology group $H^1(D, G_P)$, where G_P is the sheaf on D of the germs of automorphisms of the trivial deformation on $M \times P$ which commute with the projection on P , and are equal to the identity on the divisor. This map is defined by the cocycle $\{\varphi_{U,V}\}$ induced by the local trivializations φ_U previously obtained. Consider the sheaf $\Theta_{\mathcal{F}_0}$ of germs of vector fields tangent to the desingularized foliation $\tilde{\mathcal{F}}_0$ of the foliation \mathcal{F}_0 . We adopt the following definition:

Definition 1.2.2. *We call class of infinitesimal equireducible unfolding of \mathcal{F}_0 every element of the first Čech cohomology group $H^1(D, \Theta_{\mathcal{F}_0})$.*

For each direction defined by v in T_0P , the derivative of $\{\varphi_{U,V}\}$ in this direction defines a map from T_0P into $H^1(D, \Theta_{\mathcal{F}_0})$. We denote this map by $T\mathcal{F}_p$: if X_U is a collection of local vector fields solutions of (1.4), then the cocycle $\{X_{U,V} = X_U - X_V\}$ evaluated at $p = 0$ is the image of the direction $\partial/\partial p_r$ in $H^1(D, \Theta_{\mathcal{F}_0})$ by $T\mathcal{F}_p$. We also have that:

Theorem 1.2.2 ([29]). *For every linear application L of T_0P into $H^1(D, \Theta_{\mathcal{F}_0})$, there exists an equireducible unfolding \mathcal{F}_p of base P such that $L = T\mathcal{F}_p$.*

The geometric meaning of this theorem is that the \mathbb{C} -space $H^1(D, \Theta_{\mathcal{F}_0})$ can be interpreted as the tangent space to $H^1(D, G_P)$ at \mathcal{F}_0 . The following result is the main tool of the proof of Theorem A:

Theorem 1.2.3 ([29]). *The unfolding \mathcal{F}_p , $p \in P$ is universal among the equireducible unfoldings of \mathcal{F}_0 if and only if the map $T\mathcal{F}_p : T_0P \rightarrow H^1(D, \Theta_{\mathcal{F}_0})$ is a bijective map.*

Chapter 2

First universal family of normal forms of foliations.

The purpose of this chapter is to describe the local moduli space of the foliations in the topological class $\mathcal{T}_{M,N}$ and give a universal family of analytic normal forms. We give the infinitesimal description and local parametrization of the moduli space $\mathcal{M}_{M,N}$ using the cohomological tools considered by J.F. Mattei in [29]: the tangent space to the moduli space is given by the first Čech cohomology group $H^1(D, \Theta_{\mathcal{F}})$, where D is the exceptional divisor of the desingularization of $f_{M,N}$, and $\Theta_{\mathcal{F}}$ is the sheaf of germs of vector fields tangent to the desingularized foliation of the foliation induced by $df_{M,N} = 0$. Using a particular covering of D , we give a presentation of the space $H^1(D, \Theta_{\mathcal{F}})$ in section (2.1). In section (2.2), we exhibit a universal family of analytic normal forms (Theorem A). This way, we obtain local description of $\mathcal{M}_{M,N}$. We give the proof of the main result for the particular case $M = N = 3$ in section (2.3) and for the general case in section (2.4). The last section (2.5) is devoted to the proof of the global uniqueness of these normal forms (Theorem B).

2.1 The dimension of $H^1(D, \Theta_{\mathcal{F}})$.

The foliations induced by the elements of $\mathcal{T}_{M,N}$ can be desingularized after two standard blow-ups of points. So, we consider the composition of two blow-ups

$E : (\mathcal{M}, D) \longrightarrow (\mathbb{C}^2, 0)$ with its exceptional divisor $D = E^{-1}(0)$. On the manifold \mathcal{M} , we consider the three charts $V_2(x_2, y_2)$, $V_3(x_3, y_3)$ and $V_4(x_4, y_4)$ in which E is defined by $E(x_2, y_2) = (x_2 y_2, y_2)$, $E(x_3, y_3) = (x_3, x_3^2 y_3)$ and $E(x_4, y_4) = (x_4 y_4, x_4 y_4^2)$.

In particular, once $M \geq 2$ and $N \geq 2$, any function in $\mathcal{T}_{M,N}$ is not topologically quasi-homogeneous since the weighted desingularization process is a topological invariant [49].

Notation. Let $\mathcal{Q}_{M,N}$ be the region in the union of the real half planes (X, Y) , $X \geq 0$ and $Y \geq 0$, delimited by

$$Y - X + (M - 1) > 0$$

$$2Y - X - (N - 1) < 0$$

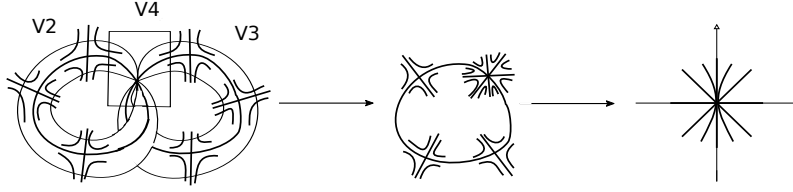
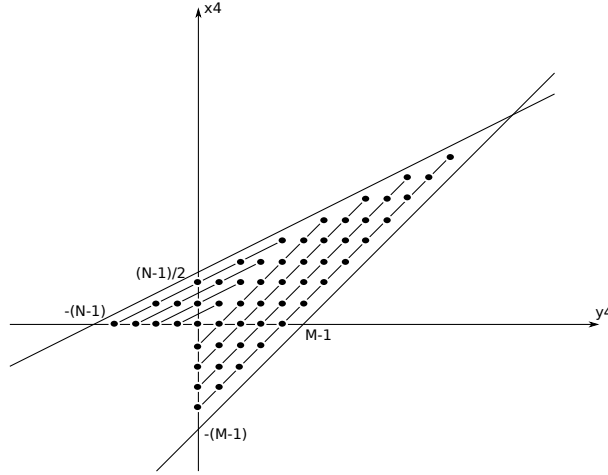
 Figure 2.1 – Desingularization of $f_{M,N}$ for $M = N = 3$

 Figure 2.2 – The region $\mathcal{Q}_{M,N}$ for $M = N = 6$

Proposition 2.1.1. *The dimension $\delta_{M,N}$ of the first cohomology group $H^1(D, \Theta_{\mathcal{F}})$ is equal to the number of the integer points in the region $\mathcal{Q}_{M,N}$ which can be expressed by the following formula*

$$\delta_{M,N} = \frac{(M+N-2)(M+N-3)}{2} + \frac{(M-1)(M-2)}{2}.$$

Proof. We consider the vector field θ_f with an isolated singularity defined by

$$\theta_f = -\frac{\partial f}{\partial x} \frac{\partial}{\partial y} + \frac{\partial f}{\partial y} \frac{\partial}{\partial x}.$$

We consider the following covering of the divisor introduced above $D = V_2 \cup V_3 \cup V_4$. The sheaf $\Theta_{\mathcal{F}}$ is a coherent sheaf, and according to Siu [60], the covering $\{V_2, V_3, V_4\}$ can be supposed to be Stein. Thus, the first cohomology group $H^1(D, \Theta_{\mathcal{F}})$ is given by the quotient

$$H^1(D, \Theta_{\mathcal{F}}) = \frac{H^0(V_2 \cap V_4, \Theta_{\mathcal{F}}) \oplus H^0(V_3 \cap V_4, \Theta_{\mathcal{F}})}{\eta(H^0(V_2, \Theta_{\mathcal{F}}) \oplus H^0(V_3, \Theta_{\mathcal{F}}) \oplus H^0(V_4, \Theta_{\mathcal{F}}))},$$

where η is the operator defined by $\eta(X_2, X_3, X_4) = (X_2 - X_4, X_3 - X_4)$. In order to compute each term of the quotient, we consider the following vector field

$$\theta_{\text{is}} = \frac{E^* \theta_f}{x_4^{M+N-2} y_4^{2M+N-3}}.$$

This vector field has isolated singularities and defines the foliation on the two intersections $V_2 \cap V_4$ and $V_3 \cap V_4$. Therefore, we have $H^0(V_2 \cap V_4, \Theta_{\mathcal{F}}) = \mathcal{O}(V_2 \cap V_4) \cdot \theta_{\text{is}}$ and $H^0(V_3 \cap V_4, \Theta_{\mathcal{F}}) = \mathcal{O}(V_3 \cap V_4) \cdot \theta_{\text{is}}$, and each element θ_{24} in $H^0(V_2 \cap V_4, \Theta_{\mathcal{F}})$ and θ_{34} in $H^0(V_3 \cap V_4, \Theta_{\mathcal{F}})$ can be written

$$\theta_{24} = \left(\sum_{i \in \mathbb{N}, j \in \mathbb{Z}} \lambda_{ij} x_4^i y_4^j \right) \cdot \theta_{\text{is}} \text{ and } \theta_{34} = \left(\sum_{i \in \mathbb{Z}, j \in \mathbb{N}} \lambda_{ij} x_4^i y_4^j \right) \cdot \theta_{\text{is}}.$$

Similarly, we find that the elements θ_2 in $H^0(V_2, \Theta_{\mathcal{F}})$ and θ_3 in $H^0(V_3, \Theta_{\mathcal{F}})$ can be written

$$\theta_2 = \left(\sum_{i, j \in \mathbb{N}} \alpha_{ij} x_4^j y_4^{2j-i-(N-1)} \right) \cdot \theta_{\text{is}} \text{ and } \theta_3 = \left(\sum_{i, j \in \mathbb{N}} \beta_{ij} x_4^{i-j-(M-1)} y_4^i \right) \cdot \theta_{\text{is}}.$$

The cohomological equation describing $H^1(D, \Theta_{\mathcal{F}})$ is thus equivalent to

$$\begin{cases} \theta_{24} = \theta_2 - \theta_4 \\ 0 = \theta_3 - \theta_4 \end{cases} \iff \theta_{24} = \theta_2 - \theta_3 \text{ and } \begin{cases} 0 = \theta_2 - \theta_4 \\ \theta_{34} = \theta_3 - \theta_4 \end{cases} \iff \theta_{34} = \theta_3 - \theta_2,$$

which means that its dimension corresponds to the number of elements which do not have a solution in any of the above two systems. This implies that the dimension of the cohomology group is equal to the number of integer points in the region $\mathcal{Q}_{M,N}$ that can be expressed by the following formula

$$\delta_{M,N} = \frac{(M+N-2)(M+N-3)}{2} + \frac{(M-1)(M-2)}{2}.$$

□

2.2 The local normal forms.

We denote by \mathcal{P} the following open set of $\mathbb{C}^{\delta_{M,N}}$

$$\mathcal{P} = \{(\dots, a_{k,i}, \dots, b_{k',i'}, \dots) \text{ such that } a_{1,i} \neq 0, b_{1,j} \neq 0, 1 \text{ and } a_{1,i} \neq a_{1,j}, b_{1,i'} \neq b_{1,j'} \text{ for } i \neq j \text{ and } i' \neq j'\},$$

where the indexes k, i, k' and i' satisfy the following system of inequalities

$$\begin{cases} 0 \leq k-1 \leq i-1 \\ -(N-2) \leq 2k-i-1 \leq 2i-2 \\ -(M-2) \leq k'-i'-1 \leq N-3+2i' \\ 0 \leq k'-1 \leq N-2+2i' \end{cases}$$

For $p \in \mathcal{P}$, we define the analytic normal form by

$$N_p^{(M,N)} = xy(y+x^2) \prod_{i=1}^{N-1} \left(y + \sum_{k=1}^i a_{k,i} xy^{k-1} \right) \prod_{i=1}^{M-2} \left(y + \sum_{k=1}^{N-1+2i} b_{k,i} x^{k+1} \right).$$

We consider the saturated foliation $\mathcal{F}_p^{(M,N)}$ defined by the one-form $dN_p^{(M,N)}$ on $\mathbb{C}^{2+\delta_{M,N}}$.

The first main result is the following:

Theorem A. *For any p_0 in \mathcal{P} the germ of unfolding $\left\{ \mathcal{F}_p^{(M,N)}, p \in (\mathcal{P}, p_0) \right\}$ is a universal equireducible unfolding of the foliation $\mathcal{F}_{p_0}^{(M,N)}$.*

As mentioned in the introduction, this means that for any equireducible unfolding \mathcal{F}_t , $t \in (\mathcal{T}, t_0)$ which defines $\mathcal{F}_{p_0}^{(M,N)}$ for $t = t_0$, there exists a map $\lambda : (\mathcal{T}, t_0) \rightarrow (\mathcal{P}, p_0)$ such that the family \mathcal{F}_t is analytically equivalent to $N_{\lambda(t)}$. The differential of λ at the point t_0 is unique and the uniqueness of the map λ follows from Theorem B.

Consider the sheaf $\Theta_{\mathcal{F}_{p_0}^{(M,N)}}$ of germs of vector fields tangent to the desingularized foliation $\tilde{\mathcal{F}}_{p_0}^{(M,N)}$ of the foliation $\mathcal{F}_{p_0}^{(M,N)}$ induced by $dN_{p_0}^{(M,N)} = 0$. In chapter 1, we said that according to [29], one can define the derivative of the deformation as a map from $T_{p_0}\mathcal{P}$ into $H^1(D, \Theta_{\mathcal{F}_{p_0}^{(M,N)}})$. We denote this map by $T\mathcal{F}_{p_0}^{(M,N)}$: since, according to theorem (1.2.1), after desingularization any equireducible unfolding is locally analytically trivial, there exists X_l , $l \in \{2, 3, 4\}$, a collection of local vector fields solutions of

$$\frac{\partial \tilde{N}_p^{(M,N)}}{\partial p_{1,i}} = \alpha_{1,i}(x_l, y_l, a_{1,i}, b_{1,i}) \frac{\partial \tilde{N}_p^{(M,N)}}{\partial x_l} + \beta_{1,i}(x_l, y_l, a_{1,i}, b_{1,i}) \frac{\partial \tilde{N}_p^{(M,N)}}{\partial y_l}, \quad (2.1)$$

where $p_{1,i} \in \{a_{1,i}, b_{1,i}\}$. The cocycle $\{X_{2,4} = X_2 - X_4, X_{3,4} = X_3 - X_4\}$ evaluated at $p = p_0$ is the image of the direction $\frac{\partial}{\partial p_{1,i}}$ in $H^1(D, \Theta_{\mathcal{F}_{p_0}^{(M,N)}})$ by $T\mathcal{F}_{p_0}^{(M,N)}$. To prove Theorem A, we will make use of the following result stated before in chapter 1:

Theorem 2.2.1 ([29]). *The unfolding \mathcal{F}_t , $t \in (\mathcal{T}, t_0)$ is universal among the equireducible unfoldings of \mathcal{F}_{t_0} if and only if the map $T\mathcal{F}_{t_0} : T_{t_0}\mathcal{T} \rightarrow H^1(D, \Theta_{\mathcal{F}})$ is a bijective map.*

Theorem A is thus a consequence of the following proposition.

Proposition 2.2.1. *We consider the unfolding $\tilde{\mathcal{F}}_p^{(M,N)}$ defined by the blowing up of $N_p^{(M,N)}$, $p \in (\mathcal{P}, p_0)$. The image of the family $\left\{ \frac{\partial}{\partial a_{k,i}}, \frac{\partial}{\partial b_{k,i}} \right\}_{k,i}$ in $H^1(D, \Theta_{\mathcal{F}_{p_0}^{(M,N)}})$ by $T\mathcal{F}_{p_0}^{(M,N)}$ is linearly free.*

Let S be the subset of \mathcal{P} defined by its elements at the first level $k = k' = 1$ i.e.

$$S = \left\{ (\dots, a_{1,i}, \dots, b_{1,i'}, \dots) \text{ such that } 1 \leq i \leq N-1 \text{ and } 1 \leq i' \leq M-2 \right\}.$$

We denote by A_1 the square matrix of size $M + N - 3$, representing the decomposition of the images of $\left\{ \frac{\partial}{\partial a_{1,i}}, \frac{\partial}{\partial b_{1,i}} \right\}$ in $H^1(D, \Theta_{\mathcal{F}_{p_0}^{(M,N)}})$ by $T\mathcal{F}_{p_0}^{(M,N)}$ on the corresponding basis. We note that the corresponding basis is in bijection with the set

$$\left\{ x^\alpha y^\beta / (\alpha, \beta) = (0, 1 - i), 1 \leq i \leq N - 1 \text{ or } (\alpha, \beta) = (-i, 0), 1 \leq i \leq M - 2 \right\}.$$

Therefore, the proof of the proposition results from the following two lemmas.

Lemma 2.2.1. *The matrix A_1 is invertible.*

Lemma 2.2.2. *The square matrix \mathcal{A} of size $\delta_{M,N}$, representing the decomposition of the images of $\left\{ \frac{\partial}{\partial a_{k,i}}, \frac{\partial}{\partial b_{k,i}} \right\}_{k,i}$ in $H^1(D, \Theta_{\mathcal{F}_{p_0}^{(M,N)}})$ by $T\tilde{\mathcal{F}}_p(p_0)$ on its basis, is an invertible matrix.*

2.3 Proof of Theorem A for $M = N = 3$.

In this section we give the proof of lemma (2.2.1) and lemma (2.2.2) for the case $M = N = 3$. In this case, the function $f_{M,N}$ is given by

$$f_{3,3} = \prod_{i=1}^3 (y + a_i x) \prod_{i=1}^3 (y + b_i x^2),$$

and the dimension $\delta_{M,N}$ of the first cohomology group $H^1(D, \Theta_{\mathcal{F}})$ is equal to $\delta_{3,3} = 7$, where the region $Q_{M,N}$ is given by the following figure.

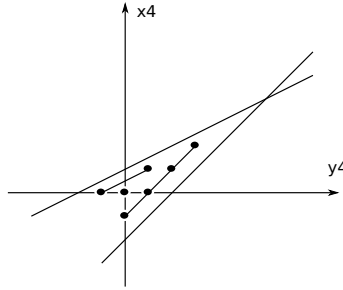

Figure 2.3 – The region $Q_{3,3}$

Considering the open set \mathcal{P} of $\mathbb{C}^{\delta_{3,3}}$ in this case

$$\mathcal{P} = \{(a_{1,1}, a_{1,2}, a_{2,2}, b_{1,1}, b_{2,1}, b_{3,1}, b_{4,1}) \text{ such that } a_{1,1}, a_{1,2} \neq 0, b_{1,1} \neq 0, 1 \text{ and } a_{1,1} \neq a_{1,2}\},$$

for $p \in \mathcal{P}$, the analytic normal form is given by

$$N_p^{(3,3)} = xy (y + x^2) (y + a_{1,1}x) (y + a_{1,2}x + a_{2,2}xy) (y + b_{1,1}x^2 + b_{2,1}x^3 + b_{3,1}x^4 + b_{4,1}x^5).$$

Proof of Lemma 2.2.1 for $M = N = 3$. The matrix A_1 is given by

$$A_1 = \begin{pmatrix} \frac{\partial}{\partial a_{1,1}} & \frac{\partial}{\partial a_{1,2}} & \frac{\partial}{\partial b_{1,1}} \\ \frac{1}{y_4} \begin{pmatrix} e_{1,1} & e_{1,2} & e_{1,3} \\ e_{2,1} & e_{2,2} & e_{2,3} \\ e_{3,1} & e_{3,2} & e_{3,3} \end{pmatrix} \end{pmatrix}.$$

We start by computing the entries $e_{3,1}$ and $e_{3,2}$. In the chart V_4 , we have to solve

$$\frac{\partial \tilde{N}_p^{(3,3)}}{\partial a_{1,i}} = \alpha_{1,i}(x_4, y_4, a_{1,1}, a_{1,2}, b_{1,1}) \frac{\partial \tilde{N}_p^{(3,3)}}{\partial x_4} + \beta_{1,i}(x_4, y_4, a_{1,1}, a_{1,2}, b_{1,1}) \frac{\partial \tilde{N}_p^{(3,3)}}{\partial y_4}. \quad (2.2)$$

Since E is defined on V_4 by $E(x_4, y_4) = (x_4 y_4, x_4 y_4^2)$, we find that

$$\begin{aligned} \tilde{N}_p^{(3,3)}(x_4, y_4) &= x_4^6 y_4^9 (1 + x_4) (y_4 + a_{1,1}) (y_4 + a_{1,2} + a_{2,2} x_4 y_4^2) \\ &\quad (1 + b_{1,1} x_4 + b_{2,1} x_4^2 y_4 + b_{3,1} x_4^3 y_4^2 + b_{4,1} x_4^4 y_4^3). \end{aligned}$$

We have

$$\begin{aligned} \frac{\partial \tilde{N}_p^{(3,3)}}{\partial a_{1,1}} &= \frac{\tilde{N}_p^{(3,3)}}{y_4 + a_{1,1}} = \frac{y_4^9}{a_{1,1}} (Q(x_4) + y_4(\dots)) \\ \frac{\partial \tilde{N}_p^{(3,3)}}{\partial a_{1,2}} &= \frac{\tilde{N}_p^{(3,3)}}{y_4 + a_{1,2} + a_{2,2} x_4 y_4^2} = \frac{y_4^9}{a_{1,2}} (Q(x_4) + y_4(\dots)) \end{aligned}$$

with

$$Q(x_4) = a_{1,1} a_{1,2} x_4^6 (1 + x_4) (1 + b_{1,1} x_4)$$

and where the suspension points (\dots) correspond to auxiliary holomorphic functions in (x_4, y_4) . Since $\tilde{N}_p^{(3,3)} = y_4^9 (Q(x_4) + y_4(\dots))$, we find that

$$\begin{aligned} \frac{\partial \tilde{N}_p^{(3,3)}}{\partial x_4} &= y_4^9 (Q'(x_4) + y_4(\dots)) \\ \frac{\partial \tilde{N}_p^{(3,3)}}{\partial y_4} &= 9y_4^8 Q(x_4) + y_4^9(\dots). \end{aligned} \quad (2.3)$$

Setting $\beta_{1,i} = y_4 \tilde{\beta}_{1,i}$, we deduce from (2.2) that

$$\frac{Q(x_4)}{a_{1,i}} = \alpha_{1,i}(x_4, 0) Q'(x_4) + 9 \tilde{\beta}_{1,i}(x_4, 0) Q(x_4) + y_4(\dots) \quad (2.4)$$

Using Bézout identity, there exist polynomials W and Z in x_4 such that

$$Q \wedge Q' = W Q' + Z Q$$

where $Q \wedge Q'$ is the great common divisor of Q and Q' . We can choose the polynomial function W to be of degree 2. We denote by

$$S(x_4) = x_4(1 + x_4)(1 + b_{1,1} x_4)$$

the polynomial function satisfying $Q = (Q \wedge Q')S$. Therefore we obtain a solution of (2.2) in the chart V_4 of the form

$$\begin{aligned}\alpha_{1,i} &= \frac{W(x_4)S(x_4)}{a_{1,i}} + y_4(\dots) \\ \beta_{1,i} &= \frac{y_4}{9} \frac{Z(x_4)S(x_4)}{a_{1,i}} + y_4^2(\dots) \\ \text{i.e. } X_{1,i}^{(4)} &= \frac{W(x_4)S(x_4)}{a_{1,i}} \frac{\partial}{\partial x_4} + y_4(\dots).\end{aligned}$$

Similarly, in the chart V_3 we have to solve

$$\frac{\partial \tilde{N}_p^{(3,3)}}{\partial a_{1,i}} = \alpha_{1,i}(x_3, y_3, a_{1,1}, a_{1,2}, b_{1,1}) \frac{\partial \tilde{N}_p^{(3,3)}}{\partial x_3} + \beta_{1,i}(x_3, y_3, a_{1,1}, a_{1,2}, b_{1,1}) \frac{\partial \tilde{N}_p^{(3,3)}}{\partial y_3}. \quad (2.5)$$

We have

$$\begin{aligned}\tilde{N}_p^{(3,3)}(x_3, y_3) &= x_3^9 y_3 (y_3 + 1) (x_3 y_3 + a_{1,1}) (x_3 y_3 + a_{1,2} + a_{2,2} x_3^2 y_3) \\ &\quad (y_3 + b_{1,1} + b_{2,1} x_3 + b_{3,1} x_3^2 + b_{4,1} x_3^3).\end{aligned}$$

Similarly, we write

$$\begin{aligned}\frac{\partial \tilde{N}_p^{(3,3)}}{\partial a_{1,1}} &= \frac{\tilde{N}_p^{(3,3)}}{x_3 y_3 + a_{1,1}} = \frac{x_3^9}{a_{1,1}} (P(y_3) + x_3(\dots)) \\ \frac{\partial \tilde{N}_p^{(3,3)}}{\partial a_{1,2}} &= \frac{\tilde{N}_p^{(3,3)}}{x_3 y_3 + a_{1,2} + a_{2,2} x_3^2 y_3} = \frac{x_3^9}{a_{1,2}} (P(y_3) + x_3(\dots))\end{aligned}$$

with

$$P(y_3) = a_{1,1} a_{1,2} y_3 (y_3 + 1) (y_3 + b_{1,1}).$$

Since $\tilde{N}_p^{(3,3)} = x_3^9 (P(y_3) + x_3(\dots))$, we obtain

$$\begin{aligned}\frac{\partial \tilde{N}_p^{(3,3)}}{\partial x_3} &= 9x_3^8 P(y_3) + x_3^9(\dots) \\ \frac{\partial \tilde{N}_p^{(3,3)}}{\partial y_3} &= x_3^9 (P'(y_3) + x_3(\dots)).\end{aligned} \quad (2.6)$$

Setting $\alpha_{1,i} = x_3 \tilde{\alpha}_{1,i}$, we deduce from (2.5) that

$$\frac{P(y_3)}{a_{1,i}} = 9 \tilde{\alpha}_{1,i}(0, y_3) P(y_3) + \beta_{1,i}(0, y_3) P'(y_3) + x_3(\dots).$$

We set $P \wedge P' = UP' + VP$ and $P = (P \wedge P')S$ with

$$R(y_3) = y_3 (y_3 + 1) (y_3 + b_{1,1})$$

Also, we can assume that the degree of U is 2, and so we obtain the solution

$$\begin{aligned}\alpha_{1,i} &= \frac{x_3}{9} V(y_3) R(y_3) + x_3^2(\dots) \\ \beta_{1,i} &= \frac{U(y_3) R(y_3)}{a_{1,i}} + x_3(\dots) \\ \text{i.e. } X_{1,i}^{(3)} &= \frac{U(y_3) R(y_3)}{a_{1,i}} \frac{\partial}{\partial y_3} + x_3(\dots).\end{aligned}$$

To compute the cocycle we write $X_{1,i}^{(3)}$ in the chart V_4 . Using the standard change of coordinates $x_4 = 1/y_3$ and $y_4 = x_3y_3$ and since we have

$$U(y_3) = \frac{\tilde{U}(x_4)}{x_4^2} \text{ and } R(y_3) = \frac{S(x_4)}{x_4^4}$$

where \tilde{U} is a polynomial function, we find the first part of the first term of the cocycle

$$X_{1,i}^{(3,4)} = X_{1,i}^{(3)} - X_{1,i}^{(4)} = -\frac{S(x_4)}{a_{1,i}} \left[\frac{\tilde{U}(x_4)}{x_4^4} + W(x_4) \right] \frac{\partial}{\partial x_4} + y_4(\dots).$$

Let Θ_0 be a holomorphic vector field with isolated singularities defining $\tilde{\mathcal{F}}_{p_0}^{(3,3)}$ on $V_3 \cap V_4$. We have

$$X_{1,i}^{(3,4)} = \Phi_{1,i}^{(3,4)} \Theta_0.$$

We can choose $\Theta_0 = \frac{E^* \Theta_{N_p^{(3,3)}}}{x_4^4 y_4^6}$ with $\Theta_{N_p^{(3,3)}} = \frac{\partial N_p^{(3,3)}}{\partial x} \frac{\partial}{\partial y} - \frac{\partial N_p^{(3,3)}}{\partial y} \frac{\partial}{\partial x}$. According to Proposition (2.1.1), the set of the coefficients of the Laurent's series of $\Phi_{1,i}^{(3,4)}$ characterizes the class of $X_{1,i}^{(3,4)}$ in $H^1(D, \Theta_{\mathcal{F}_{p_0}^{(3,3)}})$. Using the relations

$$\frac{\partial}{\partial x} = \frac{2}{y_4} \frac{\partial}{\partial x_4} - \frac{1}{x_4} \frac{\partial}{\partial y_4} \quad \text{and} \quad \frac{\partial}{\partial y} = \frac{-1}{y_4^2} \frac{\partial}{\partial x_4} + \frac{1}{x_4 y_4} \frac{\partial}{\partial y_4},$$

we write

$$\Theta_0 = \frac{1}{x_4^4 y_4^6} \left(\frac{-1}{x_4 y_4^2} \frac{\partial \tilde{N}_p}{\partial y_4} \frac{\partial}{\partial x_4} + \frac{1}{x_4 y_4^2} \frac{\partial \tilde{N}_p}{\partial x_4} \frac{\partial}{\partial y_4} \right).$$

Now, according to (2.3), we get the equality

$$\Phi_{1,i}^{(3,4)} = \frac{1}{9a_{1,i}a_{1,1}a_{1,2}} \left[\frac{\tilde{U}(x_4)}{x_4^4} + W(x_4) \right] + y_4(\dots).$$

Since $\tilde{U}(x_4)$ is of degree 2, then the coefficient of $1/x_4$ in the Laurent series of $\frac{\tilde{U}(x_4)}{x_4^4}$ is zero. So the entries $e_{3,1}$ and $e_{3,2}$ are zeros.

We proceed similarly to compute the entry $e_{3,3}$. So, in the chart V_4 , we have to solve the following equation

$$\frac{\partial \tilde{N}_p^{(3,3)}}{\partial b_{1,1}} = \eta_{1,1}(x_4, y_4, a_{1,1}, a_{1,2}, b_{1,1}) \frac{\partial \tilde{N}_p^{(3,3)}}{\partial x_4} + \gamma_{1,1}(x_4, y_4, a_{1,1}, a_{1,2}, b_{1,1}) \frac{\partial \tilde{N}_p^{(3,3)}}{\partial y_4}. \quad (2.7)$$

Following the same algorithm, we obtain the second part of the first term of the cocycle

$$Y_{1,1}^{(3,4)} = Y_{1,1}^{(3)} - Y_{1,1}^{(4)} = -\frac{S(x_4)}{1 + b_{1,1}x_4} \left[\frac{\tilde{U}(x_4)}{x_4^3} + x_4 W(x_4) \right] \frac{\partial}{\partial x_4} + y_4(\dots).$$

Setting $Y_{1,1}^{(3,4)} = \Psi_{1,1}^{(3,4)} \Theta_0$, we obtain the following expression of $\Psi_{1,1}^{(3,4)}$

$$\Psi_{1,1}^{(3,4)} = \frac{1}{9a_{1,1}a_{1,2}(1+b_{1,1}x_4)} \left[\frac{\tilde{U}(x_4)}{x_4^3} + x_4 W(x_4) \right] + y_4(\dots).$$

Now, to compute the coefficient of $1/x_4$, we write

$$\tilde{U}(x_4) = u_0 + u_1x_4 + u_2x_4^2 \text{ and } \frac{1}{1+b_{1,1}x_4} = \sum_{s=0}^{\infty} (-1)^s b_{1,1}^s x_4^s.$$

So, we obtain the following equality

$$\frac{\tilde{U}(x_4)}{(1+b_{1,1}x_4)x_4^3} = b_{1,1}^2 \tilde{U} \left(\frac{-1}{b_{1,1}} \right) \frac{1}{x_4} + \frac{T(x_4)}{x_4^3} + x_4(\dots) + \text{cst},$$

where T is a polynomial in x_4 of degree 1. This yields the following expression of $e_{3,3}$

$$e_{3,3} = \frac{b_{1,1}^2}{9a_{1,1}a_{1,2}} \tilde{U} \left(\frac{-1}{b_{1,1}} \right),$$

which is different from zero. We note that $\tilde{U} \left(\frac{-1}{b_{1,1}} \right)$ is different from zero because $-b_{1,1}$ is a root of the polynomial P which satisfies the Bézout identity $P \wedge P' = UP' + VP$.

Now we compute the second cocycle. In the chart V_4 , we can write $\tilde{N}_P^{(3,3)}$ as

$$\tilde{N}_P^{(3,3)}(x_4, y_4) = x_4^6 (A(y_4) + y_4^9 x_4(\dots))$$

where $A(y_4) = y_4^9(y_4 + a_{1,1})(y_4 + a_{1,2})$. So, we obtain the following expressions

$$\begin{aligned} \frac{\partial \tilde{N}_P^{(3,3)}}{\partial a_{1,i}} &= \frac{x_4^6}{y_4 + a_{1,i}} (A(y_4) + y_4^9 x_4(\dots)) \\ \frac{\partial \tilde{N}_P^{(3,3)}}{\partial x_4} &= 6x_4^5 A(y_4) + y_4^9 x_4^6(\dots) \\ \frac{\partial \tilde{N}_P^{(3,3)}}{\partial y_4} &= x_4^6 (A'(y_4) + y_4^8 x_4(\dots)) \end{aligned} \quad (2.8)$$

Setting $\alpha_{1,i} = x_4 \tilde{\alpha}_{1,i}$, we deduce from (2.2) that

$$\frac{A(y_4)}{y_4 + a_{1,i}} = 6\tilde{\alpha}_{1,i}(0, y_4)A(y_4) + \beta_{1,i}(0, y_4)A'(y_4) + y_4^8 x_4(\dots). \quad (2.9)$$

Using Bézout identity, there exist polynomials B and C in y_4 such that

$$A \wedge A' = BA' + CA.$$

As before, we can choose the polynomial function B to be of degree 2. We denote by $D(y_4) = y_4(y_4 + a_{1,1})(y_4 + a_{1,2})$ the polynomial function satisfying $A = (A \wedge A')D$. Therefore we obtain a solution of (2.2) in the chart V_4

$$X_{1,i}^{(4)} = \frac{B(y_4)D(y_4)}{y_4 + a_{1,i}} \frac{\partial}{\partial y_4} + x_4(\dots).$$

Similarly, in the chart V_2 we write

$$\tilde{N}_p^{(3,3)}(x_2, y_2) = y_2^6(J(x_2) + x_2^2 y_2(\dots))$$

with

$$J(x_2) = x_2(1 + a_{1,1}x_2)(1 + a_{1,2}x_2).$$

We set $J \wedge J' = KJ' + LJ = 1$. Again, we can assume that the degree of K is 2 and so we obtain the solution

$$X_{1,i}^{(2)} = \frac{x_2}{1 + a_{1,i}x_2} K(x_2) J(x_2) \frac{\partial}{\partial x_2} + y_2(\dots).$$

Using the change of coordinates $x_4 = x_2^2 y_2$ and $y_4 = 1/x_2$, we find the first part of the second term of the cocycle

$$X_{1,i}^{(2,4)} = X_{1,i}^{(2)} - X_{1,i}^{(4)} = -\frac{1}{y_4 + a_{1,i}} \left[\frac{\tilde{K}(y_4)A(y_4)}{y_4^{12}} + B(y_4)D(y_4) \right] \frac{\partial}{\partial y_4} + x_4(\dots)$$

where \tilde{K} is the polynomial function satisfying $K(x_2) = \frac{\tilde{K}(y_4)}{y_4^4}$.

Finally, we obtain the following expression of $\Phi_{1,i}^{(2,4)}$

$$\Phi_{1,i}^{(2,4)} = \frac{-1}{6(y_4 + a_{1,i})} \left[\frac{\tilde{K}(y_4)}{y_4^4} + B(y_4) \right] + x_4(\dots).$$

Similarly, we find that $\Phi_{1,i}^{(2,4)}$ can be written as

$$\Phi_{1,i}^{(2,4)} = \frac{-1}{6} \left[-\frac{\tilde{K}(-a_{1,i})}{a_{1,i}^4} \frac{1}{y_4} + \frac{\tilde{K}(-a_{1,i})}{a_{1,i}^5} + \frac{B(0)}{a_{1,i}} + \frac{R(y_4)}{y_4^4} + y_4(\dots) \right] + x_4(\dots).$$

So, the entries $(e_{ji})_{1 \leq i, j \leq 2}$ are given by

$$e_{ji} = \begin{cases} \frac{\tilde{K}(-a_{1,i})}{6a_{1,i}^4} & \text{if } j = 1 \\ \frac{-1}{6} \left(\frac{\tilde{K}(-a_{1,i})}{a_{1,i}^5} + \frac{B(0)}{a_{1,i}} \right) & \text{if } j = 2. \end{cases}$$

A simple computation shows that the determinant of the block matrix formed by these entries is given by

$$\det(e_{ji})_{1 \leq i, j \leq 2} = \frac{\tilde{K}(-a_{1,1})\tilde{K}(-a_{1,2})}{36a_{1,1}^4 a_{1,2}^4} \left[\left(\frac{1}{a_{1,1}} - \frac{1}{a_{1,2}} \right) + B(0) \left(\frac{a_{1,1}^3}{\tilde{K}(-a_{1,1})} - \frac{a_{1,2}^3}{\tilde{K}(-a_{1,2})} \right) \right].$$

Let us compute the terms $\tilde{K}(-a_{1,i})$ and $B(0)$. In fact, we know that $\tilde{K}(y_4) = y_4^2 K(x_2)$ with $y_4 = 1/x_2$. This implies that

$$\tilde{K}(-a_{1,i}) = a_{1,i}^2 K\left(-\frac{1}{a_{1,i}}\right).$$

But, we also know that $K\left(-\frac{1}{a_{1,i}}\right) = \frac{1}{J'\left(\frac{-1}{a_{1,i}}\right)}$. Computing the term $J'\left(\frac{-1}{a_{1,i}}\right)$, we get the following expressions

$$\tilde{K}(-a_{1,1}) = \frac{-a_{1,1}^2}{a_{1,2}\left(\frac{1}{a_{1,2}} - \frac{1}{a_{1,1}}\right)} \quad \text{and} \quad \tilde{K}(-a_{1,2}) = \frac{-a_{1,2}^2}{a_{1,1}\left(\frac{1}{a_{1,1}} - \frac{1}{a_{1,2}}\right)}. \quad (2.10)$$

A simple computation using Bézout identity shows that the term $B(0)$ is given by

$$B(0) = \frac{1}{9a_{1,1}a_{1,2}}. \quad (2.11)$$

Finally, we get the following expression of the determinant

$$\det(e_{ji})_{1 \leq i, j \leq 2} = \frac{-11}{324} \frac{1}{a_{1,1}^2 a_{1,2}^2 (a_{1,2} - a_{1,1})},$$

which is different from zero because $a_{1,1} \neq a_{1,2}$.

Proof of Lemma 2.2.2 for $M = N = 3$. After proving the invertibility of the matrix A_1 , it remains to study the propagation of these coefficients along the higher levels. In fact, we have to solve the following equations

$$\frac{\partial \tilde{N}_p^{(3,3)}}{\partial a_{k,i}} = \alpha_{k,i}(x_4, y_4, a_{k,i}, b_{k,i}) \frac{\partial \tilde{N}_p^{(3,3)}}{\partial x_4} + \beta_{k,i}(x_4, y_4, a_{k,i}, b_{k,i}) \frac{\partial \tilde{N}_p^{(3,3)}}{\partial y_4} \quad (2.12)$$

$$\frac{\partial \tilde{N}_p^{(3,3)}}{\partial b_{k,i}} = \eta_{k,i}(x_4, y_4, a_{k,i}, b_{k,i}) \frac{\partial \tilde{N}_p^{(3,3)}}{\partial x_4} + \gamma_{k,i}(x_4, y_4, a_{k,i}, b_{k,i}) \frac{\partial \tilde{N}_p^{(3,3)}}{\partial y_4}. \quad (2.13)$$

We note that we have the following relations

$$\frac{\partial \tilde{N}_p^{(3,3)}}{\partial a_{2,2}} = x_4 y_4^2 \frac{\partial \tilde{N}_p^{(3,3)}}{\partial a_{1,2}} \quad \text{and} \quad \frac{\partial \tilde{N}_p^{(3,3)}}{\partial b_{k,i}} = x_4^{k-1} y_4^{k-1} \frac{\partial \tilde{N}_p^{(3,3)}}{\partial b_{1,i}}, \quad k = 2, 3, 4. \quad (2.14)$$

This implies that if $X_{k,i} = \alpha_{k,i} \frac{\partial}{\partial x_4} + \beta_{k,i} \frac{\partial}{\partial y_4}$ and $Y_{k,i} = \eta_{k,i} \frac{\partial}{\partial x_4} + \gamma_{k,i} \frac{\partial}{\partial y_4}$ are solutions of (2.12) and (2.13) respectively for $k = 1$, then we obtain solutions for the other values of k setting

$$X_{2,2} = x_4 y_4^2 X_{1,2} \quad \text{and} \quad Y_{k,i} = x_4^{k-1} y_4^{k-1} Y_{1,i}.$$

This propagation can be described using the region $\mathcal{Q}_{M,N}$ as shown in figure (2.3). In fact, the decomposition of the vector fields $X_{k,i}^{(2,4)}$, $X_{k,i}^{(3,4)}$, $Y_{k,i}^{(2,4)}$ and $Y_{k,i}^{(3,4)}$ on the basis

of $H^1(D, \Theta_{\mathcal{F}_{p_0}}^{(M,N)})$ corresponds to the decomposition of the series $\Phi_{k,i}^{(2,4)}$, $\Phi_{k,i}^{(3,4)}$, $\Psi_{k,i}^{(2,4)}$ and $\Psi_{k,i}^{(3,4)}$ on the basis

$$\{1/x_4, 1, 1/y_4, x_4y_4, y_4, x_4y_4^2, x_4^2y_4^3\}.$$

As a consequence of the previous relations, this decomposition can be expressed by the following matrix

$$\mathcal{A} = \begin{bmatrix} A_1 & 0 & 0 & 0 \\ * & A_2 & 0 & 0 \\ * & * & A_3 & 0 \\ * & * & * & A_4 \end{bmatrix}$$

where A_1 is as in the previous lemma and A_k , $k = 2, 3, 4$, is given by

$$A_2 = \frac{x_4y_4}{y_4} \begin{pmatrix} \frac{\partial}{\partial a_{2,2}} & \frac{\partial}{\partial b_{2,1}} \\ e_{1,2} & 0 \\ 0 & e_{3,3} \end{pmatrix} \quad A_3 = x_4y_4^2 \begin{pmatrix} \frac{\partial}{\partial b_{3,1}} \\ e_{3,3} \end{pmatrix} \quad A_4 = x_4^2y_4^3 \begin{pmatrix} \frac{\partial}{\partial b_{4,1}} \\ e_{3,3} \end{pmatrix}.$$

The fact that $e_{1,2} = \frac{1}{6a_{1,2}(a_{1,1}-a_{1,2})}$ is different from zero shows that the whole matrix \mathcal{A} is invertible.

Remark. *If we consider the germs of functions defined by*

$$\hat{N}_p^{(3,3)} = xy(y+x^2)(y+a_{1,1}x)(y+a_{1,2}x+a_{2,2}x^2)(y+b_{1,1}x^2+b_{2,1}x^3+b_{3,1}x^4+b_{4,1}x^5),$$

we find that the matrix \mathcal{A} is not invertible everywhere. In fact, in this case, we have the relation

$$\frac{\partial}{\partial a_{2,2}} = x_4y_4 \frac{\partial}{\partial a_{1,2}},$$

and so the matrix A_2 is given by

$$A_2 = \frac{x_4y_4}{y_4} \begin{pmatrix} \frac{\partial}{\partial a_{2,2}} & \frac{\partial}{\partial b_{2,1}} \\ e_{2,2} & 0 \\ 0 & e_{3,3} \end{pmatrix}.$$

The fact that the term $e_{2,2} = \frac{a_{1,2}-10a_{1,1}}{6a_{1,2}^2}$ vanishes on the hypersurface of equation $(a_{1,2}-10a_{1,1}=0)$, shows that this family of functions is not universal, it is only "generically" universal.

2.4 Proof of Theorem A for the general case.

In this section, we give the proof of lemma (2.2.1) and lemma (2.2.2) for the general case.

Proof of Lemma 2.2.1. The matrix A_1 is given by

$$A_1 = \begin{array}{c} \frac{1}{y_4^{N-2}} \\ \frac{1}{y_4^{N-3}} \\ \vdots \\ \frac{1}{y_4} \\ 1 \\ \frac{1}{x_4} \\ \frac{1}{x_4^2} \\ \vdots \\ \frac{1}{x_4^{M-2}} \end{array} \left(\begin{array}{cccc|cccc} \frac{\partial}{\partial a_{1,1}} & \frac{\partial}{\partial a_{1,2}} & \cdots & \frac{\partial}{\partial a_{1,N-1}} & \frac{\partial}{\partial b_{1,1}} & \frac{\partial}{\partial b_{1,2}} & \cdots & \frac{\partial}{\partial b_{1,M-2}} \\ & & & & & & & \\ & & & M_1 & & & & M_2 \\ & & & & & & & \\ & & & & & & & \\ & & & & & & & \\ & & & M_3 & & & & M_4 \\ & & & & & & & \end{array} \right).$$

We start by computing the matrix M_3 . In the chart V_4 , we have to solve

$$\frac{\partial \tilde{N}_p^{(M,N)}}{\partial a_{1,i}} = \alpha_{1,i}(x_4, y_4, a_{1,i}, b_{1,i}) \frac{\partial \tilde{N}_p^{(M,N)}}{\partial x_4} + \beta_{1,i}(x_4, y_4, a_{1,i}, b_{1,i}) \frac{\partial \tilde{N}_p^{(M,N)}}{\partial y_4}. \quad (2.15)$$

Since E is defined on V_4 by $E(x_4, y_4) = (x_4 y_4, x_4 y_4^2)$, we find that

$$\tilde{N}_p^{(M,N)}(x_4, y_4) = x_4^{M+N} y_4^{2M+N} (1 + x_4) \prod_{i=1}^{N-1} \left(y_4 + \sum_{k=1}^i a_{k,i} x_4^{k-1} y_4^{2k-2} \right) \prod_{i=1}^{M-2} \left(1 + \sum_{k=1}^{N-1+2i} b_{k,i} x_4^k y_4^{k-1} \right).$$

We have

$$\frac{\partial \tilde{N}_p^{(M,N)}}{\partial a_{1,i}} = \frac{\tilde{N}_p^{(M,N)}}{y_4 + \sum_{k=1}^i a_{k,i} x_4^{k-1} y_4^{2k-2}} = \frac{y_4^{2M+N}}{a_{1,i}} (Q(x_4) + y_4(\dots))$$

with

$$Q(x_4) = x_4^{M+N} (1 + x_4) \prod_{j=1}^{N-1} a_{1,j} \prod_{j=1}^{M-2} (1 + b_{1,j} x_4)$$

and where the suspension points (...) correspond to auxiliary holomorphic functions in (x_4, y_4) . Since $\tilde{N}_p^{(M,N)} = y_4^{2M+N} (Q(x_4) + y_4(\dots))$, we find that

$$\begin{aligned} \frac{\partial \tilde{N}_p^{(M,N)}}{\partial x_4} &= y_4^{2M+N} (Q'(x_4) + y_4(\dots)) \\ \frac{\partial \tilde{N}_p^{(M,N)}}{\partial y_4} &= (2M + N) y_4^{2M+N-1} Q(x_4) + y_4^{2M+N}(\dots) \end{aligned} \quad (2.16)$$

Setting $\beta_{1,i} = y_4 \tilde{\beta}_{1,i}$, we deduce from (2.15) that

$$\frac{Q(x_4)}{a_{1,i}} = \alpha_{1,i}(x_4, 0) Q'(x_4) + (2M + N) \tilde{\beta}_{1,i}(x_4, 0) Q(x_4) + y_4(\dots) \quad (2.17)$$

Using Bézout identity, there exist polynomials W and Z in x_4 such that

$$Q \wedge Q' = WQ' + ZQ$$

where $Q \wedge Q'$ is the great common divisor of Q and Q' . We can choose the polynomial function W to be of degree $M - 1$. We denote by

$$S(x_4) = x_4(1 + x_4) \prod_{i=1}^{M-2} (1 + b_{1,i}x_4)$$

the polynomial function satisfying $Q = (Q \wedge Q')S$. Therefore we obtain a solution of (2.15) in the chart V_4 of the form

$$\begin{aligned} \alpha_{1,i} &= \frac{W(x_4)S(x_4)}{a_{1,i}} + y_4(\dots) \\ \beta_{1,i} &= \frac{y_4}{2M+N} \frac{Z(x_4)S(x_4)}{a_{1,i}} + y_4^2(\dots) \\ \text{i.e. } X_{1,i}^{(4)} &= \frac{W(x_4)S(x_4)}{a_{1,i}} \frac{\partial}{\partial x_4} + y_4(\dots). \end{aligned}$$

Similarly, in the chart V_3 we write

$$\tilde{N}_p^{(M,N)} = x_3^{2M+N} (P(y_3) + x_3(\dots))$$

with

$$P(y_3) = y_3(y_3 + 1) \prod_{j=1}^{N-1} a_{1,j} \prod_{j=1}^{M-2} (y_3 + b_{1,j}).$$

We set $P \wedge P' = UP' + VP$ and $P = (P \wedge P')R$ with

$$R = y_3(y_3 + 1) \prod_{i=1}^{M-2} (y_3 + b_{1,i}).$$

Also, we can assume that the degree of U is $M - 1$ and so we obtain the solution

$$X_{1,i}^{(3)} = \frac{U(y_3)R(y_3)}{a_{1,i}} \frac{\partial}{\partial y_3} + x_3(\dots).$$

To compute the cocycle we write $X_{1,i}^{(3)}$ in the chart V_4 . Using the standard change of coordinates $x_4 = 1/y_3$ and $y_4 = x_3y_3$ and since we have

$$U(y_3) = \frac{\tilde{U}(x_4)}{x_4^{M-1}} \text{ and } R(y_3) = \frac{S(x_4)}{x_4^{M+1}}$$

where \tilde{U} is a polynomial function, we find the first part of the first term of the cocycle

$$X_{1,i}^{(3,4)} = X_{1,i}^{(3)} - X_{1,i}^{(4)} = -\frac{S(x_4)}{a_{1,i}} \left[\frac{\tilde{U}(x_4)}{x_4^{2M-2}} + W(x_4) \right] \frac{\partial}{\partial x_4} + y_4(\dots).$$

Let Θ_0 be a holomorphic vector field with isolated singularities defining $\tilde{\mathcal{F}}_{p_0}^{(M,N)}$ on $V_3 \cap V_4$. We have

$$X_{1,i}^{(3,4)} = \Phi_{1,i}^{(3,4)} \Theta_0.$$

We can choose $\Theta_0 = \frac{E^* \Theta_{N_p^{(M,N)}}}{x_4^{M+N-2} y_4^{2M+N-3}}$ with $\Theta_{N_p^{(M,N)}} = \frac{\partial N_p^{(M,N)}}{\partial x} \frac{\partial}{\partial y} - \frac{\partial N_p^{(M,N)}}{\partial y} \frac{\partial}{\partial x}$. According to Proposition (2.1.1), the set of the coefficients of the Laurent's series of $\Phi_{1,i}^{(3,4)}$ characterizes the class of $X_{1,i}^{(3,4)}$ in $H^1(D, \Theta_{\mathcal{F}_{p_0}^{(M,N)}})$. Now, according to (2.16), we get the equality

$$\Phi_{1,i}^{(3,4)} = \frac{1}{(2M+N)a_{1,i} \prod_{j=1}^{N-1} a_{1,j}} \left[\frac{\tilde{U}(x_4)}{x_4^{2M-2}} + W(x_4) \right] + y_4(\dots).$$

Since $\tilde{U}(x_4)$ is of degree $M-1$, then the coefficients of $1/x_4^l$ for $1 \leq l \leq M-2$ in the Laurent series of $\frac{\tilde{U}(x_4)}{x_4^{2M-2}}$ are zeros. So the matrix M_3 is the zero matrix.

We proceed similarly to compute the matrix M_4 . So, in the chart V_4 , we have to solve the following equation

$$\frac{\partial \tilde{N}_p^{(M,N)}}{\partial b_{1,i}} = \eta_{1,i}(x_4, y_4, a_{1,i}, b_{1,i}) \frac{\partial \tilde{N}_p^{(M,N)}}{\partial x_4} + \gamma_{1,i}(x_4, y_4, a_{1,i}, b_{1,i}) \frac{\partial \tilde{N}_p^{(M,N)}}{\partial y_4}. \quad (2.18)$$

Following the same algorithm, we obtain the second part of the first term of the cocycle

$$Y_{1,i}^{(3,4)} = Y_{1,i}^{(3)} - Y_{1,i}^{(4)} = -\frac{S(x_4)}{1+b_{1,i}x_4} \left[\frac{\tilde{U}(x_4)}{x_4^{2M-3}} + x_4 W(x_4) \right] \frac{\partial}{\partial x_4} + y_4(\dots).$$

Setting $Y_{1,i}^{3,4} = \Psi_{1,i}^{3,4} \Theta_0$, we obtain the following expression of $\Psi_{1,i}^{(3,4)}$

$$\Psi_{1,i}^{(3,4)} = \frac{1}{(2M+N) \prod_{j=1}^{N-1} a_{1,j} (1+b_{1,i}x_4)} \left[\frac{\tilde{U}(x_4)}{x_4^{2M-3}} + x_4 W(x_4) \right] + y_4(\dots).$$

Now, to study the invertibility of the matrix M_4 , we write

$$\tilde{U}(x_4) = \sum_{l=0}^{M-1} u_l x_4^l \text{ and } \frac{1}{1+b_{1,i}x_4} = \sum_{s=0}^{\infty} (-1)^s b_{1,i}^s x_4^s.$$

So, we obtain the following equality

$$\frac{\tilde{U}(x_4)}{(1+b_{1,i})x_4^{2M-3}} = \sum_{j=1}^{M-2} d_{ji} \frac{1}{x_4^{M-j-1}} + \frac{T(x_4)}{x_4^{2M-3}} + x_4(\dots) + \text{cst},$$

where T is a polynomial in x_4 of degree $M-2$ and d_{ji} is given by

$$d_{ji} = \sum_{r=0}^{M-1} (-1)^{M-r+j} u_r b_{1,i}^{M+j-r-2} = (-1)^{M+j} b_{1,i}^{M+j-2} \tilde{U} \left(\frac{-1}{b_{1,i}} \right).$$

This yields the following expression of $\Psi_{1,i}^{(3,4)}$

$$\Psi_{1,i}^{(3,4)} = \frac{1}{(2M+N) \prod_{l=1}^{N-1} a_{1,l}} \left[\sum_{j=1}^{M-2} \frac{(-1)^{j+1} b_{1,i}^{2M-j-3}}{x_4^j} \tilde{U} \left(\frac{-1}{b_{1,i}} \right) + \frac{T(x_4)}{x_4^{2M-3}} + x_4(\dots) + \text{cst} \right] + y_4(\dots).$$

Thus, the matrix $M_4 = (m_{ji})_{1 \leq i, j \leq M-2}$ is given by

$$m_{ji} = \frac{(-1)^{j+1} b_{1,i}^{2M-j-3}}{(2M+N) \prod_{l=1}^{N-1} a_{1,l}} \tilde{U} \left(\frac{-1}{b_{1,i}} \right) \quad \forall 1 \leq i, j \leq M-2$$

which defines a Vandermonde matrix. We note that $\tilde{U} \left(\frac{-1}{b_{1,i}} \right)$ is different from zero for all $1 \leq i \leq M-2$ because the different values $\{-b_{1,i}\}_{1 \leq i \leq M-2}$ are roots of the polynomial P which satisfies the Bézout identity $P \wedge P' = UP' + VP$. So the matrix M_4 is invertible.

Now we compute the second cocycle. In the chart V_4 , we can write $\tilde{N}_P^{(M,N)}$ as

$$\tilde{N}_P^{(M,N)} = x_4^{M+N} \left(A(y_4) + y_4^{2M+N} x_4(\dots) \right)$$

where $A(y_4) = y_4^{2M+N} \prod_{j=1}^{N-1} (y_4 + a_{1,j})$. So, we obtain the following expressions

$$\begin{aligned} \frac{\partial \tilde{N}_P^{(M,N)}}{\partial a_{1,i}} &= \frac{x_4^{M+N}}{y_4 + a_{1,i}} \left(A(y_4) + y_4^{2M+N} x_4(\dots) \right) \\ \frac{\partial \tilde{N}_P^{(M,N)}}{\partial x_4} &= (M+N) x_4^{M+N-1} A(y_4) + y_4^{2M+N} x_4^{M+N}(\dots) \\ \frac{\partial \tilde{N}_P^{(M,N)}}{\partial y_4} &= x_4^{M+N} \left(A'(y_4) + y_4^{2M+N-1} x_4(\dots) \right) \end{aligned} \quad (2.19)$$

Setting $\alpha_{1,i} = x_4 \tilde{\alpha}_{1,i}$, we deduce from (2.15) that

$$\frac{A(y_4)}{y_4 + a_{1,i}} = (M+N) \tilde{\alpha}_{1,i}(0, y_4) A(y_4) + \beta_{1,i}(0, y_4) A'(y_4) + y_4^{2M+N-1} x_4(\dots). \quad (2.20)$$

Using Bézout identity, there exist polynomials B and C in y_4 such that

$$A \wedge A' = BA' + CA.$$

As before, we can choose the polynomial function B to be of degree $N-1$. We denote by $D(y_4) = y_4 \prod_{j=1}^{N-1} (y_4 + a_{1,j})$ the polynomial function satisfying $A = (A \wedge A')D$. Therefore we obtain a solution of (2.15) in the chart V_4

$$X_{1,i}^{(4)} = \frac{B(y_4)D(y_4)}{y_4 + a_{1,i}} \frac{\partial}{\partial y_4} + x_4(\dots).$$

Similarly, in the chart V_2 we write

$$\tilde{N}_P^{(M,N)} = y_2^{M+N} (J(x_2) + x_2^2 y_2(\dots))$$

with

$$J(x_2) = x_2 \prod_{j=1}^{N-1} (1 + a_{1,j}x_2).$$

We set $J \wedge J' = KJ' + LJ = 1$. Again, we can assume that the degree of K is $N - 1$ and so we obtain the solution

$$X_{1,i}^{(2)} = \frac{x_2}{1 + a_{1,i}x_2} K(x_2) J(x_2) \frac{\partial}{\partial x_2} + y_2(\dots).$$

Using the change of coordinates $x_4 = x_2^2 y_2$ and $y_4 = 1/x_2$, we find the first part of the second term of the cocycle

$$X_{1,i}^{(2,4)} = X_{1,i}^{(2)} - X_{1,i}^{(4)} = -\frac{1}{y_4 + a_{1,i}} \left[\frac{\tilde{K}(y_4)A(y_4)}{y_4^{2M+3N-3}} + B(y_4)D(y_4) \right] \frac{\partial}{\partial y_4} + x_4(\dots)$$

where \tilde{K} is the polynomial function satisfying $K(x_2) = \frac{\tilde{K}(y_4)}{y_4^{N-1}}$.

Finally, we obtain the following expression of $\Phi_{1,i}^{(2,4)}$

$$\Phi_{1,i}^{(2,4)} = \frac{-1}{(M+N)(y_4 + a_{1,i})} \left[\frac{\tilde{K}(y_4)}{y_4^{2N-2}} + B(y_4) \right] + x_4(\dots).$$

Similarly, we find that $\Phi_{1,i}^{(2,4)}$ can be written as

$$\Phi_{1,i}^{(2,4)} = \frac{-1}{M+N} \left[\sum_{j=1}^{N-1} \frac{(-1)^{N+j-1} \tilde{K}(-a_{1,i})}{a_{1,i}^{N+j}} \frac{1}{y_4^{N-j-1}} + \frac{B(0)}{a_{1,i}} + \frac{R(y_4)}{y_4^{2N-2}} + y_4(\dots) \right] + x_4(\dots).$$

So, the matrix $M_1 = (m_{ji})_{1 \leq i, j \leq N-1}$ is given by

$$m_{ji} = \begin{cases} \frac{(-1)^{N+j}}{(M+N)a_{1,i}^{N+j}} \tilde{K}(-a_{1,i}) & \text{for } j \neq N-1 \\ \frac{1}{M+N} \left(\frac{-1}{a_{1,i}^{2N-1}} \tilde{K}(-a_{1,i}) - \frac{B(0)}{a_{1,i}} \right) & \text{for } j = N-1. \end{cases}$$

A simple computation shows that the determinant of the matrix M_1 is given by

$$\det(M_1) = \frac{(-1)^{N^2-1}}{(M+N)^{N-1}} \prod_{i=1}^{N-1} \frac{\tilde{K}(-a_{1,i})}{a_{1,i}^{N+1}} \left[\prod_{1 \leq i < j \leq N-1} \left(\frac{1}{a_{1,i}} - \frac{1}{a_{1,j}} \right) - B(0) \sum_{i=1}^{N-1} \frac{(-1)^i a_{1,i}^N}{\tilde{K}(-a_{1,i})} \mathcal{M}_{(N-1)i} \right]$$

where $\mathcal{M}_{(N-1)i} = \prod_{\substack{1 \leq j < j' \leq N-1 \\ j, j' \neq i}} \left(\frac{1}{a_{1,j}} - \frac{1}{a_{1,j'}} \right)$ is the determinant of the matrix obtained by deleting the $(N-1)^{\text{th}}$ row and i^{th} column of the Vandermonde $(N-1)$ -matrix of $\left\{ \frac{-1}{a_{1,i}} \right\}_{1 \leq i \leq N-1}$.

Let us compute the term $B(0) \sum_{i=1}^{N-1} \frac{(-1)^i a_{1,i}^N}{\tilde{K}(-a_{1,i})} \mathcal{M}_{(N-1)i}$. In fact, we know that $\tilde{K}(y_4) = y_4^{N-1} K(x_2)$ with $y_4 = 1/x_2$. This implies that

$$\tilde{K}(-a_{1,i}) = (-a_{1,i})^{N-1} K\left(-\frac{1}{a_{1,i}}\right).$$

But, we also know that $K\left(-\frac{1}{a_{1,i}}\right) = \frac{1}{J'\left(\frac{-1}{a_{1,i}}\right)}$. Computing the term $J'\left(\frac{-1}{a_{1,i}}\right)$, we get the following expression

$$\tilde{K}(-a_{1,i}) = \frac{(-1)^N a_{1,i}^{N-1}}{\prod_{\substack{j=1 \\ j \neq i}}^{N-1} a_{1,j} \left(\frac{1}{a_{1,j}} - \frac{1}{a_{1,i}} \right)}. \quad (2.21)$$

Moreover, one can see that the term $(-1)^i \prod_{\substack{j=1 \\ j \neq i}}^{N-1} \left(\frac{1}{a_{1,j}} - \frac{1}{a_{1,i}} \right) \mathcal{M}_{(N-1)i}$ is equal to $(-1)^{\alpha+i} \prod_{1 \leq i < j \leq N-1} \left(\frac{1}{a_{1,i}} - \frac{1}{a_{1,j}} \right)$, where α is equal to the number of integer numbers in the interval $[i+1, N-1]$. When N is even $(-1)^{\alpha+i}$ is equal to -1 but when N is odd it is equal to 1 . This implies that we have the following equality

$$B(0) \sum_{i=1}^{N-1} \frac{(-1)^i a_{1,i}^N}{\tilde{K}(-a_{1,i})} \mathcal{M}_{(N-1)i} = -(N-1) B(0) \prod_{j=1}^{N-1} a_{1,j} \prod_{1 \leq i < j \leq N-1} \left(\frac{1}{a_{1,i}} - \frac{1}{a_{1,j}} \right).$$

A simple computation using Bézout identity shows that the term $B(0)$ is given by

$$B(0) = \frac{1}{(2M+N) \prod_{j=1}^{N-1} a_{1,j}}. \quad (2.22)$$

Finally, we get the following expression of the determinant of the matrix M_1

$$\det(M_1) = \frac{(-1)^{N^2-1}}{(M+N)^{N-1}} \frac{2M+2N-1}{2M+N} \prod_{i=1}^{N-1} \frac{\tilde{K}(-a_{1,i})}{a_{1,i}^{N+1}} \prod_{1 \leq i < j \leq N-1} \left(\frac{1}{a_{1,i}} - \frac{1}{a_{1,j}} \right).$$

Like for \tilde{U} , we also have that $\tilde{K}(-a_{1,i})$ is different from zero for all $1 \leq i \leq N-1$ and $a_{1,i}$ is different from $a_{1,j}$ for all $i \neq j$. This ensures that the matrix M_1 is invertible.

Proof of Lemma 2.2.2. After proving the invertibility of the matrix A_1 , it remains to study the propagation of these coefficients along the higher levels. In fact, we have to solve the following equations

$$\frac{\partial \tilde{N}_p^{(M,N)}}{\partial a_{k,i}} = \alpha_{k,i}(x_4, y_4, a_{k,i}, b_{k,i}) \frac{\partial \tilde{N}_p^{(M,N)}}{\partial x_4} + \beta_{k,i}(x_4, y_4, a_{k,i}, b_{k,i}) \frac{\partial \tilde{N}_p^{(M,N)}}{\partial y_4} \quad (2.23)$$

$$\frac{\partial \tilde{N}_p^{(M,N)}}{\partial b_{k,i}} = \eta_{k,i}(x_4, y_4, a_{k,i}, b_{k,i}) \frac{\partial \tilde{N}_p^{(M,N)}}{\partial x_4} + \gamma_{k,i}(x_4, y_4, a_{k,i}, b_{k,i}) \frac{\partial \tilde{N}_p^{(M,N)}}{\partial y_4}. \quad (2.24)$$

We note that we have the following relations

$$\frac{\partial \tilde{N}_p^{(M,N)}}{\partial a_{k,i}} = x_4^{k-1} y_4^{2k-2} \frac{\partial \tilde{N}_p^{(M,N)}}{\partial a_{1,i}} \quad \text{and} \quad \frac{\partial \tilde{N}_p^{(M,N)}}{\partial b_{k,i}} = x_4^{k-1} y_4^{k-1} \frac{\partial \tilde{N}_p^{(M,N)}}{\partial b_{1,i}}. \quad (2.25)$$

This implies that if $X_{k,i} = \alpha_{k,i} \frac{\partial}{\partial x_4} + \beta_{k,i} \frac{\partial}{\partial y_4}$ and $Y_{k,i} = \eta_{k,i} \frac{\partial}{\partial x_4} + \gamma_{k,i} \frac{\partial}{\partial y_4}$ are solutions of (2.23) and (2.24) respectively for $k = 1$, then we obtain solutions for the other values of k setting

$$X_{k,i} = x_4^{k-1} y_4^{2k-2} X_{1,i} \quad \text{and} \quad Y_{k,i} = x_4^{k-1} y_4^{k-1} Y_{1,i}.$$

This propagation can be described using the region $\mathcal{Q}_{M,N}$ as shown in figure (2.2). In fact, the decomposition of the vector fields $X_{k,i}^{(2,4)}$, $X_{k,i}^{(3,4)}$, $Y_{k,i}^{(2,4)}$ and $Y_{k,i}^{(3,4)}$ on the basis of $H^1(D, \Theta_{\mathcal{F}_{p_0}^{(M,N)}})$ corresponds to the decomposition of the series $\Phi_{k,i}^{(2,4)}$, $\Phi_{k,i}^{(3,4)}$, $\Psi_{k,i}^{(2,4)}$ and $\Psi_{k,i}^{(3,4)}$ on the basis

$$\left\{ x_4^i y_4^j \mid (i, j) \in \mathbb{N} \times \mathbb{Z} \cup \mathbb{Z} \times \mathbb{N} \text{ such that } j - 2i + (N - 1) > 0 \text{ and } j - i - (M - 1) < 0 \right\}.$$

As a consequence of the previous relations, this decomposition can be expressed by the following matrix

$$\mathcal{A} = \begin{bmatrix} A_1 & 0 & 0 & \cdots & 0 \\ * & A_2 & 0 & \cdots & 0 \\ * & * & A_3 & \cdots & 0 \\ \vdots & \vdots & \vdots & \ddots & \vdots \\ * & * & * & * & A_{N+2M-5} \end{bmatrix}$$

where $A_1 = \begin{bmatrix} M_1 & M_2 \\ M_3 & M_4 \end{bmatrix}$ and A_k is given by

$$\frac{\begin{matrix} x_4^{k-1} \\ y_4^{N-2k} \\ \vdots \\ x_4^{k-1} y_4^{k-1} \\ x_4^{k-2} y_4^{k-1} \\ \vdots \\ y_4^{k-1} \\ x_4^{M-k-1} \end{matrix}}{\begin{matrix} \frac{\partial}{\partial a_{k,1}} & \cdots & \frac{\partial}{\partial a_{k,N-k}} & \frac{\partial}{\partial b_{k,1}} & \cdots & \frac{\partial}{\partial b_{k,M-2}} \end{matrix}} \left(\begin{array}{c|c} \begin{matrix} M_1^k = M_1 \setminus \text{last} \\ k-1 \\ \text{column and row} \end{matrix} & \begin{matrix} \\ \\ 0 \end{matrix} \\ \hline \begin{matrix} 0 \\ \\ M_4 \end{matrix} & \begin{matrix} \\ \\ \end{matrix} \end{array} \right) \quad \text{if } 2 \leq k \leq N-1$$

$$\frac{y_4^{k-1}}{x_4^{M-k-q_k}} \left(\begin{array}{ccc} \frac{\partial}{\partial b_{k,M-1-q_k}} & \cdots & \frac{\partial}{\partial b_{k,M-2}} \\ & M_4^k = M_4 \setminus \text{first} & \\ & M-2-q_k & \\ & \text{column and row} & \end{array} \right) \quad \text{if } N \leq k \leq N+2M-5$$

with $q_k = \lfloor \frac{k-1+(N-1)}{2} \rfloor + M - k$, where $\lfloor x \rfloor$ is the strict integer part m of x defined by $m < x \leq m + 1$. For $2 \leq k \leq N - 1$, the determinant of the matrix M_1^k is given by

$$\text{Vandermonde} \left(\frac{1}{a_{1,1}}, \dots, \frac{1}{a_{1,N-k}} \right) \frac{\prod_{i=1}^{N-k} (-1)^{N+i} \tilde{K}(-a_{1,i})}{(M+N)^{N-k} \prod_{i=1}^{N-k} a_{1,i}^{N+1}}.$$

Since $\tilde{K}(-a_{1,i})$ is different from zero for all $1 \leq i \leq N - 1$ and $a_{1,i}$ is different from $a_{1,j}$ for all $i \neq j$, then the matrix M_1^k is invertible for all $2 \leq k \leq N - 1$. Similarly, for $N \leq k \leq N + 2M - 5$, the determinant of the matrix M_4^k is given by

$$\text{Vandermonde} \left(\frac{1}{b_{1,M-1-q_k}}, \dots, \frac{1}{b_{1,M-2}} \right) \frac{\prod_{i=M-1-q_k}^{M-2} (-1)^{i+1} b_{1,i}^{M-2+q_k} \tilde{U} \left(\frac{-1}{b_{1,i}} \right)}{(2M+N)^{q_k} \prod_{i=1}^{N-1} a_{1,i}^{q_k}}.$$

Also since $\tilde{U} \left(\frac{-1}{b_{1,i}} \right)$ is different from zero for all $1 \leq i \leq M - 2$ and $b_{1,i}$ is different from $b_{1,j}$ for all $i \neq j$, then the matrix M_4^k is invertible for all $N \leq k \leq N + 2M - 5$. This shows that the whole matrix \mathcal{A} is invertible.

Remark. *The fact that the matrix M_1^k is a principal minor of M_1 is essential for its determinant to be written under the form above. As we saw in the previous section, some coefficients of the last row of $M_1 \left(\frac{-1}{a_{1,i}^{2N-1}} \tilde{K}(-a_{1,i}) - \frac{B(0)}{a_{1,i}} \right)$ may vanish.*

2.5 The uniqueness of the normal forms.

This section is devoted to study the uniqueness of the normal forms. From now on, we will consider N_p as a notation for the normal form instead of $N_p^{(M,N)}$.

Let h_λ be the diffeomorphism defined by: $h_\lambda(x, y) = (\lambda x, \lambda^2 y)$. We have:

$$N_p \circ h_\lambda = \lambda^{2M+2N-1} N_{\lambda \cdot p} \text{ with } \lambda \cdot p = \lambda \cdot (a_{k,i}, b_{k,i}) = (\lambda^{2k-3} a_{k,i}, \lambda^{k-1} b_{k,i}).$$

Again, this action of \mathbb{C}^* cannot be used to "localize" the uniqueness problem as done in [59] because, contrary to the quasi-homogeneous case, the topological class of the function $\frac{N_p \circ h_\lambda}{\lambda^{2M+2N-1}}$ jumps while λ goes to zero. However, we have:

Theorem B. *The foliations defined by N_p and N_q , p and q are in \mathcal{P} , are equivalent if and only if there exists λ in \mathbb{C}^* such that $p = \lambda \cdot q$.*

We start by the following lemma:

Lemma 2.5.1. *Let X be a germ of formal vector field given by its decomposition into the sum of its homogeneous components $X = X_{\nu_0+1} + X_{\nu_0+2} + \dots$. If $N_p \circ e^{X_{\nu_0+1}+\dots} = N_q$, then for all $1 \leq i \leq N-1$ and $1 \leq k \leq \nu_0$ we have $a_{k,i} = a'_{k,i}$ and for all $1 \leq i \leq M-2$ and $1 \leq k \leq \nu_1$ we have $b_{k,i} = b'_{k,i}$, where $\nu_1 + 1$ is the order of tangency of $\tilde{\phi}$, the lifted biholomorphism of $\phi = e^X$ by the blowing up E_1 defined by $E_1(x_1, y_1) = (x_1, x_1 y_1)$.*

Proof. We consider the decomposition of the normal form into its homogeneous components:

$$N_p = N_p^{(M+N)} + N_p^{(M+N+1)} + \dots$$

Since we have

$$(e^{X_{\nu_0+1}+\dots})^* N_p = N_p + X_{\nu_0+1} \cdot N_p + \dots,$$

we obtain that $N_p^{(M+N+l)} = N_q^{(M+N+l)}$ for l from 0 to $\nu_0 - 1$. The expression of $N_p^{(M+N+l)}$ only depends on the variables $a_{k,i}$ for $k \leq l+1$ and $b_{k,i}$ for $k \leq l$. Setting $\tilde{\phi} = e^{\tilde{X}_{\nu_1+1}+\dots}$, the initial hypothesis leads to the following equality

$$\tilde{N}_p \circ e^{\tilde{X}_{\nu_1+1}+\dots} = \tilde{N}_q,$$

where

$$\tilde{N}_p(x_1, y_1) = x_1 y_1 (y_1 + x_1) \prod_{i=1}^{N-1} \left(y_1 + \sum_{k=1}^i a_{k,i} x_1^{k-1} y_1^{k-1} \right) \prod_{i=1}^{M-2} \left(y_1 + \sum_{k=1}^{N-1+2i} b_{k,i} x_1^k \right).$$

Similarly we obtain $\tilde{N}_p^{(M+1+l)} = \tilde{N}_q^{(M+1+l)}$ for l from 0 to $\nu_1 - 1$. The expression of $\tilde{N}_p^{(M+1+l)}$ only depends on the variables $a_{k,i}$ for $k \leq l$ (except for $l = 0$ as $\tilde{N}_p^{(M+1)}$ depends on $a_{1,i}$) and $b_{k,i}$ for $k \leq l+1$. Now, we claim that for all l from 0 to $\nu_0 - 1$,

$$N_p^{(M+N+l)} = N_q^{(M+N+l)} \quad \text{and} \quad \tilde{N}_p^{(M+1+l)} = \tilde{N}_q^{(M+1+l)} \Leftrightarrow a_{k,i} = a'_{k,i} \quad \text{and} \quad b_{k,i} = b'_{k,i} \quad \forall k \leq l+1.$$

This fact can be proved by induction on $l \leq \nu_0 - 1$. For $l = 0$, we have the following two equalities

$$N_p^{(M+N)} = N_q^{(M+N)} \quad \text{and} \quad \tilde{N}_p^{(M+1)} = \tilde{N}_q^{(M+1)}.$$

Since the conjugacy preserves a fixed numbering of the branches, we obtain that $a_{1,i} = a'_{1,i}$ and $b_{1,i} = b'_{1,i}$. Suppose that $a_{k,i} = a'_{k,i}$ and $b_{k,i} = b'_{k,i}$ for $l < \nu_0 - 1$. Then we have $N_p^{(M+N+l)} = N_q^{(M+N+l)}$ with

$$N_p^{(M+N+l)} = \sum_{i=1}^{N-1} a_{l+1,i} x y^l \frac{N_p^{(M+N)}}{y + a_{1,i} x} + \sum_{i=1}^{M-2} b_{l,i} x^{l+1} \frac{N_p^{(M+N)}}{y} + H_{a,b}(x, y),$$

where $H_{a,b}$ is a function which depends on $a_{k,i}$ for $k < l + 1$ and $b_{k,i}$ for $k < l$. This implies that $a_{l+1,i} = a'_{l+1,i}$. Similarly, we have $\tilde{N}_p^{(M+1+l)} = \tilde{N}_q^{(M+1+l)}$ with

$$\tilde{N}_p^{(M+1+l)} = \sum_{i=1}^{N-1} a_{\frac{l}{2}+1,i} x_1^{\frac{l}{2}} y_1^{\frac{l}{2}} \frac{\tilde{N}_p^{(M+1)}}{a_{1,i}} + \sum_{i=1}^{M-2} b_{l+1,i} x_1^{l+1} \frac{\tilde{N}_p^{(M+1)}}{y_1 + b_{1,i} x_1} + \tilde{H}_{a,b}(x_1, y_1)$$

where the first term exists only if l is even and greater than or equal to two and $\tilde{H}_{a,b}(x_1, y_1)$ is a function which depends on $a_{k,i}$ for $k < l$ and $b_{k,i}$ for $k < l + 1$. This implies that $b_{l+1,i} = b'_{l+1,i}$.

Now, we know that $\nu_0 \leq \nu_1$. So we claim that for all $\nu_0 \leq l \leq \nu_1 - 1$,

$$\tilde{N}_p^{(M+1+l)} = \tilde{N}_q^{(M+1+l)} \iff b_{k,i} = b'_{k,i} \quad \forall k \leq l + 1.$$

For $l = \nu_0$, we know that $a_{\nu_0,i} = a'_{\nu_0,i}$ and $b_{\nu_0,i} = b'_{\nu_0,i}$. Similarly we obtain that $b_{\nu_0+1,i} = b'_{\nu_0+1,i}$. Suppose that $b_{k,i} = b'_{k,i}$ for $l < \nu_1 - 1$. Then we have $\tilde{N}_p^{(M+1+l)} = \tilde{N}_p^{(M+1+l)}$ where

$$\begin{aligned} \tilde{N}_p^{(M+1+l)} = & \sum_{i=1}^{N-1} a_{\frac{l}{2}+1,i} x_1^{\frac{l}{2}} y_1^{\frac{l}{2}} \frac{\tilde{N}_p^{(M+1)}}{a_{1,i}} + \sum_{i=1}^{M-2} b_{l+1,i} x_1^{l+1} \frac{\tilde{N}_p^{(M+1)}}{y_1 + b_{1,i} x_1} + \\ & \sum_{i=1}^{N-1} \sum_{j=1}^{M-2} \sum_{\substack{2k_1+k_2=l+3 \\ k_1, k_2 \neq 1}} a_{k_1,i} b_{k_2,j} x_1^{k_1+k_2-1} y_1^{k_1-1} \frac{\tilde{N}_p^{M+1}}{a_{1,i}(y_1 + b_{1,j} x_1)} + \tilde{H}_{a,b}(x_1, y_1). \end{aligned}$$

To show that $b_{l+1,i} = b'_{l+1,i}$, it is enough to show that $k_1 < \nu_0 + 1$. In fact, by definition we have $k_1 = \frac{l+3-k_2}{2}$. So, using that $l \leq \nu_1 - 1$, $k_2 > 1$ and that $\nu_1 \leq 2\nu_0$, we conclude that $k_1 < \nu_0 + 1$. \square

A process of blowing-up E is said to be a *chain process* if, either E is the standard blowing-up of the origin of \mathbb{C}^2 , or $E = E' \circ E''$ where E' is a chain process and E'' is the standard blowing-up of the of a point that belongs to the smooth part of the highest irreducible component of E' . The length of a chain process of blowing-up is the total number of blowing-up and the height of an irreducible component D of the exceptional divisor of E is the minimal number of blown-up points so that D appears. A chain process of blowing-up admits *privileged systems of coordinates* (x, y) in a neighborhood of the component of maximal height such that E is written

$$E : (x, t) \longmapsto (x, tx^h + t_{h-1}x^{h-1} + t_{h-2}x^{h-2} + \dots + t_1x).$$

The values t_i are the positions of the successive centers in the successive privileged coordinates and $x = 0$ is a local equation of the divisor.

Let ϕ be a germ of biholomorphism tangent to the identity map at order $\nu_0 + 1 \geq 2$ and fixing the curves $\{x = 0\}$ and $\{y = 0\}$. The function ϕ is written

$$(x, y) \longmapsto (x(1 + A_{\nu_0}(x, y) + \dots), y(1 + B_{\nu_0}(x, y) + \dots)) \quad (2.26)$$

where A_{ν_0} and B_{ν_0} are homogeneous polynomials of degree ν_0 . The following lemma can be proved by induction on the height of the component:

Lemma 2.5.2. *The biholomorphism ϕ can be lifted-up through any chain process E of blowing-up with length smaller $\nu_0 + 1$: there exists $\tilde{\phi}$ such that $E \circ \tilde{\phi} = \phi \circ E$. The action of $\tilde{\phi}$ on any component of the divisor of height less than ν_0 is trivial. Its action on any component of height $\nu_0 + 1$ is written in privileged coordinates*

$$(0, t) \longmapsto (0, t + t_1 B_{\nu_0}(1, t_1) - t_1 A_{\nu_0}(1, t_1))$$

where t_1 is the coordinate of the blown-up point on the first component of the irreducible divisor.

Definition 2.5.1. *A germ of biholomorphism ϕ is said to be dicritical if ϕ can be written*

$$(x, y) \longmapsto (x + A_{\nu}(x, y) + \dots, y + B_{\nu}(x, y) + \dots),$$

with $x B_{\nu}(x, y) - y A_{\nu}(x, y)$ vanishing.

We can now prove the main Theorem B of this section.

Proof of Theorem B. Suppose that there exists a conjugacy relation

$$N_p \circ \phi = \psi \circ N_q. \quad (2.27)$$

Following [45], we can suppose that ψ is a homothety γId . The biholomorphism ϕ can be supposed tangent to the identity. In fact, since ϕ lets the curves $\{x = 0\}$, $\{y = 0\}$ and $\{y + x^2 = 0\}$ invariant, then it can be written

$$(x, y) \longmapsto (\lambda x(1 + A_{\nu_0}(x, y) + \dots), \lambda^2 y(1 + B_{\nu_0}(x, y) + \dots)),$$

for some $\lambda \neq 0$. Then

$$N_p \circ \phi \circ h_{\lambda}^{-1} = \gamma N_q \circ h_{\lambda}^{-1} = c N_{\lambda^{-1} \cdot q},$$

where c stands for some non vanishing number. Since $\phi \circ h_{\lambda}^{-1}$ is tangent to the identity, we find that $c = 1$. Thus, setting for the sake of simplicity $q = \lambda^{-1} \cdot q$ and $\phi = \phi \circ h_{\lambda}^{-1}$, we are led to the relation

$$N_p \circ \phi = N_q,$$

where ϕ can be written under the form (2.26).

The proof reduces to show that in this situation, we have $p = q$. Using Lemma (2.5.1), we know that for all $1 \leq i \leq N - 1$ and $1 \leq k \leq \nu_0$ we have $a_{k,i} = a'_{k,i}$ and for all $1 \leq i \leq M - 2$ and $1 \leq k \leq \nu_1$ we have $b_{k,i} = b'_{k,i}$. This means that, based on the structure of the normal form, to show that for any $k \leq N - 1$, $a_{k,i} = a'_{k,i}$, it is enough to show that $\nu_0 \geq N - 1$. In the same way, to show that for any $k \leq 2M - N - 5$, $b_{k,i} = b'_{k,i}$, it is enough to show that $\nu_1 \geq N + 2M - 5$. Thus, the proof results from the following proposition:

Proposition 2.5.1. *If $N_p \circ \phi = N_q$, then the following assertions hold:*

1. If ϕ is dicritical then $p = q$.
2. If ϕ is non-dicritical then $\nu_0 \geq N$.
3. If ϕ and $\tilde{\phi}$ are non-dicritical then $\nu_1 \geq 2M + N - 5$.
4. If $\tilde{\phi}$ is dicritical then $p = q$.

Proof. 1. If $\nu_0 \geq 2M + N - 5$ then $\nu_1 \geq 2M + N - 5$ and $\nu_0 \geq N - 1$. So, by Lemma (2.5.1), we have $p = q$. Suppose that $\nu_0 < 2M + N - 5$. Since ϕ is tangent to the identity, then it is the time one of the flow of a formal dicritical vector field

$$\phi = e^{\hat{X}}.$$

Its homogeneous part of degree $\nu_0 + 1$ is radial and is written $\phi_{\nu_0} R$ where ϕ_{ν_0} stands for a homogeneous polynomial function of degree ν_0 and R for the radial vector field $x\partial_x + y\partial_y$. The initial hypothesis can be expressed as follows

$$(e^{\hat{X}})^* N_p = N_p + \phi_{\nu_0} R.N_p + \dots = N_q.$$

In this relation, the valuation of $\phi_{\nu_0} R.N_p$ is at least $\nu_0 + M + N$. Lemma (2.5.1) implies that the first non-trivial homogeneous part of the previous relation is of valuation $\nu_0 + M + N$ and it is written

$$N_p^{(\nu_0+M+N)} + \phi_{\nu_0} R.N_p^{(M+N)} = N_q^{(\nu_0+M+N)}.$$

Since $N_p^{(M+N)}$ is homogeneous, then this relation becomes

$$N_p^{(\nu_0+M+N)} - N_q^{(\nu_0+M+N)} + (M+N)\phi_{\nu_0} N_p^{(M+N)} = 0.$$

The homogeneous component of degree $\nu_0 + M + N$ in N_p is written

- If $\nu_0 + 1 \leq N - 1$, then

$$N_p^{(\nu_0+M+N)} = \sum_{i=1}^{N-1} a_{\nu_0+1,i} x y^{\nu_0} \frac{N_p^{(M+N)}}{y + a_{1,i} x} + \sum_{i=1}^{M-2} b_{\nu_0,i} x^{\nu_0+1} \frac{N_p^{(M+N)}}{y} + H_{a,b}(x, y)$$

where $H_{a,b}$ is a function which depends on $a_{k,i}$ for $k < \nu_0 + 1$ and $b_{k,i}$ for $k < \nu_0$. Since $a_{1,i} = a'_{1,i}$ and $b_{\nu_0,i} = b'_{\nu_0,i}$, then the difference $N_p^{(\nu_0+M+N)} - N_q^{(\nu_0+M+N)}$ is written

$$N_p^{(M+N)} \left(\sum_{i=1}^{N-1} \frac{\lambda_i x y^{\nu_0}}{y + a_{1,i} x} \right),$$

where $\lambda_i = a_{\nu_0+1,i} - a'_{\nu_0+1,i}$. Therefore, the polynomial function ϕ_{ν_0} must coincide with

$$-\frac{1}{M+N} \sum_{i=1}^{N-1} \frac{\lambda_i x y^{\nu_0}}{y + a_{1,i} x}$$

which happens to be polynomial if and only if λ_i vanishes for all i and therefore ϕ_{ν_0} must be the zero polynomial.

- If $\nu_0 + 1 > N - 1$, then

$$N_p^{(\nu_0+M+N)} = \sum_{i=1}^{M-2} b_{\nu_0,i} x^{\nu_0+1} \frac{N_p^{(M+N)}}{y} + H_{a,b}(x, y)$$

where $H_{a,b}$ is a function which depends on $b_{k,i}$ for $k < \nu_0$. Since $b_{\nu_0,i} = b'_{\nu_0,i}$, then the difference $N_p^{(\nu_0+M+N)} - N_q^{(\nu_0+M+N)}$ is zero. As a consequence ϕ_{ν_0} must be the zero polynomial.

2. We suppose that $\nu_0 < N$. We know that ϕ can be written as follows

$$(x, y) \mapsto (x(1 + A_{\nu_0}(x, y) + \dots), y(1 + B_{\nu_0}(x, y) + \dots)).$$

Since the action of ϕ on any component of height $\nu_0 + 1$ conjugates the complete cones, then the function $tB_{\nu_0}(1, t) - tA_{\nu_0}(1, t)$ vanishes on $\{0, \infty, a_{1,1}, \dots, a_{1,\nu_0}\}$, which is the common tangent cone of N_p and N_q . Since the degree of $tB_{\nu_0}(1, t) - tA_{\nu_0}(1, t)$ is at most $\nu_0 + 1$, then it is the zero polynomial. Hence,

$$xyB_{\nu_0}(x, y) - xyA_{\nu_0}(x, y) = 0,$$

which is impossible since ϕ is non-dicritical.

3. Suppose that $\nu_1 < 2M + N - 5$. The functions A_{ν_0} and B_{ν_0} are homogeneous of degree ν_0 . So, we write them as

$$A_{\nu_0}(x, y) = \sum_{i+j=\nu_0} \alpha_{i,j} x^i y^j \text{ and } B_{\nu_0}(x, y) = \sum_{i+j=\nu_0} \beta_{i,j} x^i y^j.$$

Since $\nu_0 \geq N$, then the function $f(t)$, defined by

$$f(t) = tB_{\nu_0}(1, t) - tA_{\nu_0}(1, t) = t \sum_{i+j=\nu_0} (\beta_{i,j} - \alpha_{i,j}) t^j,$$

vanishes at $\{0, \infty, a_{1,1}, \dots, a_{1,N-1}\}$. The biholomorphism $\tilde{\phi}$ is given by $\tilde{\phi} = E_1^{-1} \circ \phi \circ E_1$. So, it can be written as

$$\tilde{\phi}(x_1, y_1) = (x_1(1 + A(x_1, x_1 y_1)), y_1(1 + B(x_1, x_1 y_1) - A(x_1, x_1 y_1) + \dots)),$$

where the lifted homogeneous parts of degree ν_0 of A and B has the form

$$A_{\nu_0}(x_1, x_1 y_1) = \sum_{i+j=\nu_0} \alpha_{i,j} x_1^{\nu_0} y_1^j \text{ and } B_{\nu_0}(x_1, x_1 y_1) = \sum_{i+j=\nu_0} \beta_{i,j} x_1^{\nu_0} y_1^j.$$

Since the order of tangency of ϕ is $\nu_0 + 1$ then there exists i and j satisfying $i + j = \nu_0$ such that $\alpha_{i,j} \neq 0$ or $\beta_{i,j} \neq 0$. Let j_0 be the smallest such j . So, we have

$$\tilde{\phi}(x_1, y_1) = \left(x_1(1 + \tilde{A}_{\nu_1}(x_1, y_1) + \dots), y_1(1 + \tilde{B}_{\nu_1}(x_1, y_1) + \dots) \right),$$

where

$$\tilde{A}_{\nu_1}(x_1, y_1) = \sum_{i+j=\alpha_0 \leq j_0} \alpha'_{i,j} x_1^{\nu_0+i} y_1^j \text{ and } \tilde{B}_{\nu_1}(x_1, y_1) = \sum_{i+j=\alpha_0 \leq j_0} (\beta'_{i,j} - \alpha'_{i,j}) x_1^{\nu_0+i} y_1^j.$$

So, the order of tangency of $\tilde{\phi}$, $\nu_1 + 1$, is equal to $\nu_0 + \alpha_0 + 1$. We define the function \tilde{f} by

$$\tilde{f}(t) = t\tilde{B}_{\nu_1}(1, t) - t\tilde{A}_{\nu_1}(1, t).$$

We know that $\nu_1 \geq \nu_0 \geq N$. Since the action of $\tilde{\phi}$ on any component of height $\nu_1 + 1$ conjugates the complete cones, then, if $\nu_1 = N$, the function \tilde{f} vanishes at $0, 1$ and ∞ . Since $\tilde{\phi}$ is non-dicritical then $\alpha_0 + 1$ must be greater than or equal to 3. This implies that $j_0 \geq 2$ and so for all $j < 2$ satisfying $i + j = \nu_0$, we have $\alpha_{i,j} = \beta_{i,j} = 0$. However, the function $f(t) = t^3 \sum_{i+j=\nu_0} (\beta_{i,j} - \alpha_{i,j}) t^{j-2}$ vanishes at $\{0, \infty, a_{1,1}, \dots, a_{1,N-1}\}$. Since ϕ is non-dicritical, then $\nu_0 - 2$ must be greater than or equal to N . This implies that ν_1 must be at least $N + 4$ which is impossible. Thus, ν_1 must be greater than N . We proceed similarly at each level. Finally, if $\nu_1 = 2M + N - 6$, then the function \tilde{f} vanishes at $\{0, 1, \infty, b_{1,1}, \dots, b_{1,M-3}\}$. Since $\tilde{\phi}$ is non-dicritical, then $\alpha_0 + 1$ must be at least M . This implies that $j_0 \geq M - 1$. Similarly, we must have $\nu_0 - M + 1 \geq N$. As a consequence, ν_1 must be at least $2M + N - 2$ which is impossible.

4. The proof is similar to that of the first point, noting that we necessarily have $a_{k,i} = a'_{k,i}$ for all $1 \leq i \leq N - 1$ and $1 \leq k \leq \nu_0$.

□

Chapter 3

The dimension of the moduli space of curves.

This chapter is devoted to the study of the distribution \mathcal{C} related to the following equivalence relation on the moduli space $\mathcal{M}_{M,N}$ of foliations: two points in $\mathcal{M}_{M,N}$ are equivalent if and only if the separatrices of the corresponding class of foliations are in the same analytic class of curves. In section (3.1), we describe the infinitesimal generators of the distribution \mathcal{C} and give some properties about them. The main result of this section is proposition (3.1.4) in which we show the algebraic independence of some coefficients of the \mathcal{O}_2 -generator of \mathcal{C} . Section (3.2) presents an algorithm to compute the dimension of the generic strata of the local moduli space of curves (Theorem C). Finally, we give some examples in section (3.3).

3.1 The infinitesimal generators of \mathcal{C} .

We first recall general facts proved in [58], which are valid in every topological class. Let \mathcal{F} be a foliation defined by a holomorphic function f (or more generally by any generic non dicritical differential form ω), and let S be the curve defined by $f = 0$ (or by the separatrix set of ω). Let $E : M \rightarrow (\mathbb{C}^2, 0)$ be the desingularization map of the foliation, and D its exceptional divisor. We denote by \tilde{f} , $\tilde{\mathcal{F}}$ and \tilde{S} the pull back by E on M of f , \mathcal{F} and S . The tangent space to the point $[S]$ in the moduli space of curves is the cohomological group $H^1(D, \Theta_S)$ where Θ_S is the sheaf on D of germs of vector fields tangent to \tilde{S} [30]. The inclusion of $\Theta_{\mathcal{F}}$ into Θ_S induces a map i :

$$H^1(D, \Theta_{\mathcal{F}}) \xrightarrow{i} H^1(D, \Theta_S)$$

whose kernel represents the directions of unfolding of foliations with trivial associate unfolding of curves.

Definition 3.1.1. *An open set U of M is a quasi-homogeneous open set (relatively to f) if there exists a holomorphic vector field R_U on U such that $R_U(\tilde{f}) = \tilde{f}$.*

In our case, we can always cover D by three quasi-homogenous open sets V_2 , V_3 and V_4 . The cocycle of the quasi-homogeneity $[R_{3,4}, R_{2,4}]$ of \mathcal{F} is the element of $H^1(D, \Theta_{\mathcal{F}})$ induced by $(R_3 - R_4, R_2 - R_4)$.

Noting that $H^1(D, \Theta_{\mathcal{F}})$ has a natural structure of \mathcal{O}_2 -module, we have:

Theorem 3.1.1 ([58]). *The kernel of the map i is generated by the cocycle of quasi-homogeneity, i.e.:*

$$\ker(i) = \{h \cdot [R_{3,4}, R_{2,4}], h \in \mathcal{O}_2\}.$$

In particular, the distribution induced by these directions is integrable and defines a singular foliation \mathcal{C} on \mathcal{P} .

Let $X_{m,n}$ be the vector fields on \mathcal{P} generated by $x^m y^n \cdot [R_{3,4}, R_{2,4}]$. We give the expression of $X_{0,0}$ in the basis $\left\{ \frac{\partial}{\partial a_{k,i}}, \frac{\partial}{\partial b_{k,i}} \right\}_{k,l}$ of the vector space generated by the set \mathcal{P} :

Proposition 3.1.1. *The \mathcal{O}_2 -generator of \mathcal{C} is given by:*

$$\begin{aligned} X_{0,0} &= [R_3 - R_4, R_2 - R_4] \\ &= \frac{-1}{2M+2N-1} \left(\sum_{i=1}^{N-1} \sum_{k=1}^i (2k-3) a_{k,i} \frac{\partial}{\partial a_{k,i}} + \sum_{i=1}^{M-2} \sum_{k=1}^{N-1+2i} (k-1) b_{k,i} \frac{\partial}{\partial b_{k,i}} \right). \end{aligned}$$

Proof. Let p be in \mathcal{P} and consider the following deformation

$$(\lambda, p) \in (\mathbb{C}, 1) \times (\mathcal{P}, p) \mapsto N_{p,\lambda}(x, y) = N_p(\lambda x, \lambda^2 y) = \lambda^{2M+2N-1} N_{\lambda \cdot p}(x, y).$$

This deformation is analytically trivial in λ . Hence, its related cocycle is trivial. Blowing the deformation up yields

$$\begin{aligned} \tilde{N}_{p,\lambda}(x_4, y_4) &= \lambda^{2M+2N-1} x_4^{M+N} y_4^{2M+N} (1+x_4) \prod_{i=1}^{N-1} \left(y_4 + \sum_{k=1}^i \lambda^{2k-3} a_{k,i} x_4^{k-1} y_4^{2k-2} \right) \\ &\quad \prod_{i=1}^{M-2} \left(1 + \sum_{k=1}^{N-1+2i} \lambda^{k-1} b_{k,i} x_4^k y_4^{k-1} \right), \end{aligned}$$

and so we have

$$\begin{aligned} \tilde{N}_{p,\lambda}^{-1} \frac{\partial \tilde{N}_{p,\lambda}}{\partial \lambda} &= (2M+2N-1) \lambda^{-1} + \sum_{i=1}^{N-1} \frac{\sum_{k=1}^i (2k-3) \lambda^{2k-4} a_{k,i} x_4^{k-1} y_4^{2k-2}}{y_4 + \sum_{k=1}^i \lambda^{2k-3} a_{k,i} x_4^{k-1} y_4^{2k-2}} + \\ &\quad \sum_{i=1}^{M-2} \frac{\sum_{k=1}^{N-1+2i} (k-1) \lambda^{k-2} b_{k,i} x_4^k y_4^{k-1}}{1 + \sum_{k=1}^{N-1+2i} \lambda^{k-1} b_{k,i} x_4^k y_4^{k-1}}. \end{aligned}$$

The vector field R_4 is defined as a solution on V_4 of $R_4 \tilde{N}_p = \tilde{N}_p$. Moreover, $\frac{\partial}{\partial a_{k,i}}$ and $\frac{\partial}{\partial b_{k,i}}$ are defined by the cocycle related to the vector fields $X_{k,i}^{(j)}$ and $Y_{k,i}^{(j)}$ respectively

such that $X_{k,i}^{(j)} \tilde{N}_p = \frac{\partial \tilde{N}_p}{\partial a_{k,i}}$ and $Y_{k,i}^{(j)} \tilde{N}_p = \frac{\partial \tilde{N}_p}{\partial b_{k,i}}$. Setting $\lambda = 1$, we obtain

$$\begin{aligned} \frac{\partial \tilde{N}_{p,\lambda}}{\partial \lambda} \Big|_{\lambda=1} &= \left((2M + 2N - 1)R_4 + \sum_{i=1}^{N-1} \sum_{k=1}^i (2k - 3)a_{k,i}X_{k,i}^{(4)} \right. \\ &\quad \left. + \sum_{i=1}^{M-2} \sum_{k=1}^{N-1+2i} (k - 1)b_{k,i}Y_{k,i}^{(4)} \right) \tilde{N}_{p,\lambda} \\ &= C^{(4)} \tilde{N}_{p,\lambda}. \end{aligned}$$

The same computation in the other two charts leads to

$$\begin{aligned} C^{(3)} &= \left((2M + 2N - 1)R_3 + \sum_{i=1}^{N-1} \sum_{k=1}^i (2k - 3)a_{k,i}X_{k,i}^{(3)} + \sum_{i=1}^{M-2} \sum_{k=1}^{N-1+2i} (k - 1)b_{k,i}Y_{k,i}^{(3)} \right) \\ C^{(2)} &= \left((2M + 2N - 1)R_2 + \sum_{i=1}^{N-1} \sum_{k=1}^i (2k - 3)a_{k,i}X_{k,i}^{(2)} + \sum_{i=1}^{M-2} \sum_{k=1}^{N-1+2i} (k - 1)b_{k,i}Y_{k,i}^{(2)} \right). \end{aligned}$$

The triviality of the cocycle induced by $(C^{(3)} - C^{(4)}, C^{(2)} - C^{(4)})$ ends the proof. \square

We shall make use of the following result:

Proposition 3.1.2 ([58]). *The vector field $X_{m,n}$ on $\text{Vect}(\mathcal{P})$ is related to the cocycle $x^m y^n \cdot [R_3 - R_4, R_2 - R_4]$ if and only if there exists a germ of vector field*

$$Z_{m,n} = \alpha_{m,n}(x, t, p) \frac{\partial}{\partial x} + \beta_{m,n}(x, t, p) \frac{\partial}{\partial y}$$

such that

$$X_{m,n} \cdot N_p = Z_{m,n} \cdot N_p + x^m y^n N_p.$$

From now on, we denote by $q_k = \lfloor \frac{k+N-2}{2} \rfloor + M - k$ the number of integer points in the intersection between the region of moduli and the straight line of equation $(y_4 = k - 1)$ if $N \leq k \leq N + 2M - 5$.

We consider the following two subspaces of the vector space generated by the set \mathcal{P}

$$\mathcal{P}_a = \text{Vect} \left\{ \frac{\partial}{\partial a_{k,i}} \right\}_{\substack{i=1, \dots, N-1 \\ k=1, \dots, i}} \quad \text{and} \quad \mathcal{P}_b = \text{Vect} \left\{ \frac{\partial}{\partial b_{k,i}} \right\}_{\substack{i=1, \dots, M-2 \\ k=1, \dots, N-1+2i}}.$$

For $1 \leq l_a \leq N - 1$ (respectively $1 \leq l_b \leq N + 2M - 5$), we denote by $\mathcal{P}_a^{l_a}$ (respectively $\mathcal{P}_b^{l_b}$) the level of height l_a (respectively l_b) of the subspace \mathcal{P}_a (respectively \mathcal{P}_b), i.e.

$$\begin{aligned} \mathcal{P}_a^{l_a} &= \text{Vect} \left\{ \frac{\partial}{\partial a_{i,i}} \right\}_{i=l_a, \dots, N-1} \\ \mathcal{P}_b^{l_b} &= \begin{cases} \text{Vect} \left\{ \frac{\partial}{\partial b_{i,i}} \right\}_{i=1, \dots, M-2} & \text{if } 1 \leq l_b \leq N \\ \text{Vect} \left\{ \frac{\partial}{\partial b_{i,i}} \right\}_{i=M-1-q_{l_b}, \dots, M-2} & \text{if } N + 1 \leq l_b \leq N + 2M - 5. \end{cases} \end{aligned}$$

We have the following direct decomposition of \mathcal{P}

$$\mathcal{P} = \bigoplus_{\substack{1 \leq l_b \leq N-1 \\ l_a = l_b}} \text{Vect} \left\{ \mathcal{P}_a^{l_a}, \mathcal{P}_b^{l_b} \right\} \bigoplus_{\substack{l_b = N+2M-5 \\ l_b = N}} \mathcal{P}_b^{l_b}.$$

The decomposition of each vector field X on \mathcal{P} is denoted by

$$X = X^\nu + X^{\nu+1} + \dots + X^{N+2M-5}$$

where $X^\nu = X^{a,\nu_a} + X^{b,\nu_b}$, such that $\nu_b = \nu_a$, is the first non vanishing component of X .

Now, we consider the following two subsets of the region $Q_{M,N}$ corresponding to the subspaces \mathcal{P}_a and \mathcal{P}_b respectively

$$\begin{aligned} I_a &= \left\{ (i, j) \mid 0 \leq i \leq N-2 \text{ and } -(N-2) + 2i \leq j \leq i \right\} \\ I_b &= \left\{ (i, j) \mid 0 \leq j \leq N-1 \text{ and } -(M-2) + j \leq i \leq j-1 \right. \\ &\quad \left. N \leq j \leq N+2M-6 \text{ and } -(M-2) + j \leq i \leq j-1 - (M-2 - q_{j+1}) \right\}, \end{aligned}$$

where the levels l_a and l_b are given by the straight lines of equations $x_4 = l_a - 1$ and $y_4 = l_b - 1$ respectively.

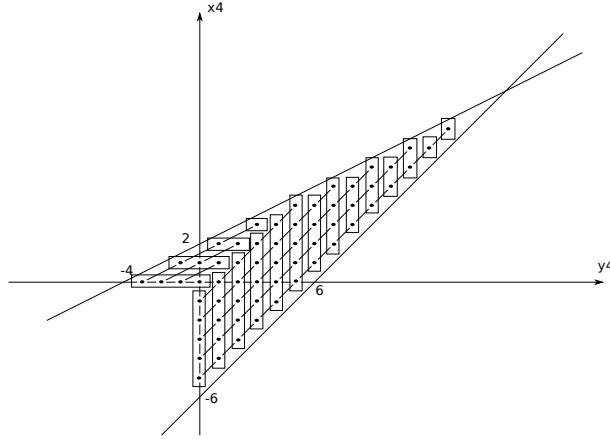

Figure 3.1 – The Corresponding decomposition of the region $Q^{M,N}$ for $N = 5$, $M = 7$

Let Θ_0 be a holomorphic vector field with isolated singularities defining $\tilde{\mathcal{F}}_{p_0}^{(M,N)}$ on the two intersections $V_2 \cap V_4$ and $V_3 \cap V_4$. We denote by $[x_4^i y_4^j]$ the class of $x_4^i y_4^j (\Theta_0, 0)$ (respectively $x_4^i y_4^j (0, \Theta_0)$) in $H^1(D, \Theta_{\tilde{\mathcal{F}}_{p_0}^{(M,N)}})$ if $(i, j) \in I_a$ (respectively $(i, j) \in I_b$). Below, we describe some properties of the distribution induced by the vector fields $X_{m,n}$.

Proposition 3.1.3. 1. The coefficients of $\frac{\partial}{\partial a_{k,l}}$ and $\frac{\partial}{\partial b_{k,l}}$ in the basis

$$\left\{ \left[x_4^i y_4^j \right] \mid (i, j) \in \mathbb{N} \times \mathbb{Z} \cup \mathbb{Z} \times \mathbb{N} \text{ s.t. } j - 2i + (N-1) > 0 \text{ and } j - i - (M-1) < 0 \right\}$$

are in the ring $\mathbb{C}(a_{1,\cdot}, b_{1,\cdot})[a_{2,\cdot}, \dots, a_{N-1,\cdot}, b_{2,\cdot}, \dots, b_{N+2M-5,\cdot}]$.

2. The coefficients of $X_{m,n}$ in the basis $\left\{ \frac{\partial}{\partial a_{k,l}}, \frac{\partial}{\partial b_{k,l}} \right\}_{k,l}$ are in the ring $\mathbb{C}(a_{1,\cdot}, b_{1,\cdot})[a_{2,\cdot}, \dots, a_{N-1,\cdot}, b_{2,\cdot}, \dots, b_{N+2M-5,\cdot}]$.

3. For any m, n , we have

$$[(2M + 2N - 1)X_{0,0}, X_{m,n}] = (m + 2n)X_{m,n}.$$

The coefficients of $X_{m,n}^{a,\nu}$ and $X_{m,n}^{b,\nu}$ are homogeneous with respect to the weight $X_{0,0}$ of degrees $(m + 2n - (2\nu - 3))$ and $(m + 2n - (\nu - 1))$ respectively. In particular, they only depend on the variables a_j , and b_j , respectively, where $j \leq \nu - 1$.

Proof. 1. In the proof of Theorem A in the previous chapter, the equations (2.23) and (2.24) can be solved the following way: looking at the homogeneous part of order ν yields

$$\begin{aligned} J_\nu \left(\frac{\partial \tilde{N}_p}{\partial a_{k,i}} \right) &= \sum_{r+s=\nu} J_r(\alpha_{k,i}) J_s \left(\frac{\partial \tilde{N}_p}{\partial x_4} \right) + J_r(\beta_{k,i}) J_s \left(\frac{\partial \tilde{N}_p}{\partial y_4} \right) \\ J_\nu \left(\frac{\partial \tilde{N}_p}{\partial b_{k,i}} \right) &= \sum_{r+s=\nu} J_r(\eta_{k,i}) J_s \left(\frac{\partial \tilde{N}_p}{\partial x_4} \right) + J_r(\gamma_{k,i}) J_s \left(\frac{\partial \tilde{N}_p}{\partial y_4} \right). \end{aligned}$$

Hence, we find the following induction relations

$$\begin{aligned} &J_{\nu-\nu_0}(\alpha_{k,i}) J_{\nu_0} \left(\frac{\partial \tilde{N}_p}{\partial x_4} \right) + J_{\nu-\nu_0}(\beta_{k,i}) J_{\nu_0} \left(\frac{\partial \tilde{N}_p}{\partial y_4} \right) \\ &= J_\nu \left(\frac{\partial \tilde{N}_p}{\partial a_{k,i}} \right) - \sum_{\substack{r+s=\nu \\ s \neq \nu_0}} J_r(\alpha_{k,i}) J_s \left(\frac{\partial \tilde{N}_p}{\partial x_4} \right) + J_r(\beta_{k,i}) J_s \left(\frac{\partial \tilde{N}_p}{\partial y_4} \right) \\ &J_{\nu-\nu_0}(\eta_{k,i}) J_{\nu_0} \left(\frac{\partial \tilde{N}_p}{\partial x_4} \right) + J_{\nu-\nu_0}(\gamma_{k,i}) J_{\nu_0} \left(\frac{\partial \tilde{N}_p}{\partial y_4} \right) \\ &= J_\nu \left(\frac{\partial \tilde{N}_p}{\partial b_{k,i}} \right) - \sum_{\substack{r+s=\nu \\ s \neq \nu_0}} J_r(\eta_{k,i}) J_s \left(\frac{\partial \tilde{N}_p}{\partial x_4} \right) + J_r(\gamma_{k,i}) J_s \left(\frac{\partial \tilde{N}_p}{\partial y_4} \right), \end{aligned}$$

where $\nu_0 = 3M + 2N - 1$. The coefficients of $J_{\nu_0} \left(\frac{\partial \tilde{N}_p}{\partial x_4} \right)$ and $J_{\nu_0} \left(\frac{\partial \tilde{N}_p}{\partial y_4} \right)$ depend only on the variables $a_{1,\cdot}$ and $b_{1,\cdot}$. Moreover, the coefficients of $J_s \left(\frac{\partial \tilde{N}_p}{\partial x_4} \right)$ and $J_s \left(\frac{\partial \tilde{N}_p}{\partial y_4} \right)$ are polynomial. Hence, an induction on ν ensures that for all ν the coefficients of $J_\nu(\alpha_{k,i})$, $J_\nu(\beta_{k,i})$, $J_\nu(\eta_{k,i})$ and $J_\nu(\gamma_{k,i})$ can be chosen rational in $a_{1,\cdot}$ and $b_{1,\cdot}$ and polynomial in the variables $a_{k,\cdot}$ and $b_{k,\cdot}$, $k \geq 2$. The same result holds for the relations (2.23) and (2.24) in the other two charts. Now, following the computation of the cocycle in the proof of Theorem A makes it obvious that the coefficients in its Laurent development are in $\mathbb{C}(a_{1,\cdot}, b_{1,\cdot})[a_{2,\cdot}, \dots, a_{N-1,\cdot}, b_{2,\cdot}, \dots, b_{N+2M-5,\cdot}]$. So are the coordinates of $\frac{\partial}{\partial a_{k,i}}$ and $\frac{\partial}{\partial b_{k,i}}$ in the standard basis.

2. Combining proposition (3.1.1) and the previous point ensures that the coefficients of $X_{0,0}$ in the standard basis are in $\mathbb{C}(a_{1,\cdot}, b_{1,\cdot})[a_{2,\cdot}, \dots, a_{N-1,\cdot}, b_{2,\cdot}, \dots, b_{N+2M-5,\cdot}]$. Since

the multiplication by $x^m y^n$ is a linear shift, the coefficients of $X_{m,n}$ are also in the previous ring. Now, if we order the basis $\left\{ \left[x_4^i y_4^j \right] \right\}_{i,j}$ and $\left\{ \frac{\partial}{\partial a_{k,l}}, \frac{\partial}{\partial b_{k,l}} \right\}_{k,l}$ using the lexicographic order on \mathbb{N}^2 , then the matrix of basis changing is diagonal by blocks with coefficients in $\mathbb{C}(a_{1,\cdot}, b_{1,\cdot})[a_{2,\cdot}, \dots, a_{N-1,\cdot}, b_{2,\cdot}, \dots, b_{N+2M-5,\cdot}]$. Moreover, the diagonal blocks only depend on the variables $a_{1,\cdot}$ and $b_{1,\cdot}$. Thus, the coefficients of the inverse matrix are in $\mathbb{C}(a_{1,\cdot}, b_{1,\cdot})[a_{2,\cdot}, \dots, a_{N-1,\cdot}, b_{2,\cdot}, \dots, b_{N+2M-5,\cdot}]$, which proves the claim.

3. From proposition (3.1.2), we know that there exists a vector field $Z = A(\cdot) \frac{\partial}{\partial x} + B(\cdot) \frac{\partial}{\partial y}$ such that

$$x^m y^n N_p + Z \cdot N_p = X_{m,n} \cdot N_p.$$

In particular and using proposition (3.1.1), there exists a vector field R' such that

$$\frac{1}{2M+2N-1} R' \cdot N_p = N_p - X_{0,0} \cdot N_p.$$

It is clear that the vector field $R' = x \frac{\partial}{\partial x} + 2y \frac{\partial}{\partial y}$ satisfies the above relation. We note that $[R', X_{m,n}] = 0$. Therefore, we can perform the following computation

$$\begin{aligned} [X_{0,0}, X_{m,n}] \cdot N_p &= X_{0,0} (x^m y^n N_p + Z \cdot N_p) - X_{m,n} (N_p - c_0 R' \cdot N_p) \\ &= x^m y^n (N_p - c_0 R' \cdot N_p) + X_{0,0} \cdot Z \cdot N_p - x^m y^n N_p \\ &\quad - Z \cdot N_p + c_0 R' (x^m y^n N_p + Z \cdot N_p) \\ &= -c_0 x^m y^n R' \cdot N_p + [X_{0,0}, Z] \cdot N_p + Z \cdot X_{0,0} \cdot N_p - Z \cdot N_p \\ &\quad + c_0 x^m y^n R' \cdot N_p + (m+2n)c_0 x^m y^n N_p + c_0 R' \cdot Z \cdot N_p \\ &= [X_{0,0}, Z] \cdot N_p + Z (N_p - c_0 R' \cdot N_p) - Z \cdot N_p \\ &\quad + (m+2n)c_0 x^m y^n N_p + c_0 R' \cdot Z \cdot N_p \\ &= [X_{0,0}, Z] \cdot N_p + c_0 [R', Z] \cdot N_p + (m+2n)c_0 x^m y^n N_p, \end{aligned}$$

where $c_0 = \frac{1}{2M+2N-1}$. Since the vector $[X_{0,0}, Z]$ is written under the form $(\cdot) \frac{\partial}{\partial x} + (\cdot) \frac{\partial}{\partial y}$, the previous relation ensures that $[X_{0,0}, X_{m,n}] = (m+2n)c_0 X_{m,n}$. Now, if we decompose the vector field $X_{m,n}$ on the basis $\left\{ \frac{\partial}{\partial a_{k,l}}, \frac{\partial}{\partial b_{k,l}} \right\}_{k,l}$ and inject this decomposition in the Lie bracket, it follows

$$\begin{aligned} [X_{0,0}, X_{m,n}] &= \sum_{\nu \geq m+n+1} [X_{0,0}, X_{m,n}^\nu] \\ &= \sum_{\nu \geq m+n+1} \left[X_{0,0}, \sum_i \alpha_{m,n}^{\nu,i}(p) \frac{\partial}{\partial a_{\nu,i}} + \sum_i \beta_{m,n}^{\nu,i}(p) \frac{\partial}{\partial b_{\nu,i}} \right] \\ &= \sum_{\nu \geq m+n+1} \sum_i (X_{0,0} \cdot \alpha_{m,n}^{\nu,i}(p) + c_0(2\nu-3)\alpha_{m,n}^{\nu,i}(p)) \frac{\partial}{\partial a_{\nu,i}} \\ &\quad + \left(X_{0,0} \cdot \beta_{m,n}^{\nu,i}(p) + c_0(\nu-1)\beta_{m,n}^{\nu,i}(p) \right) \frac{\partial}{\partial b_{\nu,i}}. \end{aligned}$$

Hence, identifying the coefficients in the basis $\left\{ \frac{\partial}{\partial a_{k,l}}, \frac{\partial}{\partial b_{k,l}} \right\}_{k,l}$ leads to the following relations

$$\begin{aligned} X_{0,0} \cdot \alpha_{m,n}^{\nu,i}(p) + c_0(2\nu - 3)\alpha_{m,n}^{\nu,i}(p) &= (m + 2n)c_0\alpha_{m,n}^{\nu,i} \\ X_{0,0} \cdot \beta_{m,n}^{\nu,i}(p) + c_0(\nu - 1)\beta_{m,n}^{\nu,i}(p) &= (m + 2n)c_0\beta_{m,n}^{\nu,i}. \end{aligned}$$

Therefore $\alpha_{m,n}^{\nu,i}$ (respectively $\beta_{m,n}^{\nu,i}$) is homogeneous with respect to $X_{0,0}$. Its weight is $-c_0(2\nu - 3 - (m + 2n))$ (respectively $-c_0(\nu - 1 - (m + 2n))$). In particular, since $m + 2n > 1$, $\alpha_{m,n}^{\nu,i}$ (respectively $\beta_{m,n}^{\nu,i}$) does not depend on a_j , (respectively b_j .) with $j \geq \nu$ since it is of weight $-c_0(2j - 3)$ (respectively $-c_0(j - 1)$). \square

We can write the standard basis of $H^1\left(D, \Theta_{\mathcal{F}_{p_0}^{(M,N)}}\right)$ as $B = B_a \cup B_b$ where

$$\begin{aligned} B_a &= \left\{ \left[x_4^i y_4^j \right] \mid (i, j) \in I_a \right\} \\ B_b &= \left\{ \left[x_4^i y_4^j \right] \mid (i, j) \in I_b \right\}. \end{aligned}$$

If we denote by $\left\langle \frac{\partial}{\partial a_{1,l}}, x_4^i y_4^j \right\rangle$ the coefficient of $\left[x_4^i y_4^j \right]$ in the decomposition of $\frac{\partial}{\partial a_{1,l}}$ on the standard basis of $H^1\left(D, \Theta_{\mathcal{F}_{p_0}^{(M,N)}}\right)$, then we have the following:

Lemma 3.1.1. *The term $\left\langle \frac{\partial}{\partial a_{1,l}}, \frac{y_4}{x_4^{i-1}} \right\rangle$ is equal to the coefficient of $\frac{1}{x_4^{i-1}}$ in the development of $\Phi_l(x_4)$ in Laurent series where $\Phi_l(x_4)$ is given by*

$$\begin{aligned} \Phi_l(x_4) &= \frac{-(2M+N+1)}{(2M+N)^2 a_{1,l} \prod_{j=1}^{N-1} a_{1,j} (1+x_4)} \left(\frac{\tilde{U}(x_4)}{x_4^{2M-2}} + W(x_4) \right) \\ &\quad \left(\frac{x_4}{\prod_{j=1}^{M-1} (1+b_{1,j}x_4)} \sum_{j=1}^{M-2} \frac{b_{2,j}}{1+b_{1,j}x_4} + \frac{\sum_{i=1}^{N-1} \frac{1}{a_{1,i}}}{x_4 \prod_{j=1}^{M-2} (1+b_{1,j}x_4)} \right) \\ &\quad - \frac{1}{(2M+N)a_{1,l}^2 \prod_{j=1}^{N-1} a_{1,j}} \left(\frac{\tilde{U}(x_4)}{x_4^{2M-2}} + W(x_4) \right). \end{aligned}$$

where W and \tilde{U} are the polynomial functions of degree $M - 1$ defined in the proof of Theorem A.

Proof. We proceed similarly like in the proof of Theorem A. In the chart V_4 , we have to solve

$$\frac{\partial \tilde{N}_p^{(M,N)}}{\partial a_{1,i}} = \alpha_{1,i}(x_4, y_4, a_{1,i}, b_{1,i}) \frac{\partial \tilde{N}_p^{(M,N)}}{\partial x_4} + \beta_{1,i}(x_4, y_4, a_{1,i}, b_{1,i}) \frac{\partial \tilde{N}_p^{(M,N)}}{\partial y_4}. \quad (3.1)$$

Since E is defined on V_4 by $E(x_4, y_4) = (x_4 y_4, x_4 y_4^2)$, we find that

$$\begin{aligned} \tilde{N}_p^{(M,N)}(x_4, y_4) &= x_4^{M+N} y_4^{2M+N} (1 + x_4) \\ &\quad \prod_{i=1}^{N-1} \left(y_4 + \sum_{k=1}^i a_{k,i} x_4^{k-1} y_4^{2k-2} \right) \prod_{i=1}^{M-2} \left(1 + \sum_{k=1}^{N-1+2i} b_{k,i} x_4^k y_4^{k-1} \right). \end{aligned}$$

We have

$$\frac{\partial \tilde{N}_p^{(M,N)}}{\partial a_{1,i}} = \frac{\tilde{N}_p^{(M,N)}}{y_4 + \sum_{k=1}^i a_{k,i} x_4^{k-1} y_4^{2k-2}} = \frac{y_4^{2M+N}}{y_4 + a_{1,i}} (Q(x_4, y_4) + y_4^2(\dots))$$

with

$$Q(x_4, y_4) = x_4^{M+N} (1 + x_4) \prod_{j=1}^{N-1} (y_4 + a_{1,j}) \prod_{j=1}^{M-2} (1 + b_{1,j} x_4 + b_{2,j} x_4^2 y_4)$$

and where the suspension points (...) correspond to auxiliary holomorphic functions in (x_4, y_4) . We can write

$$Q(x_4, y_4) = Q(x_4) + y_4 Q_1(x_4) + y_4^2(\dots),$$

with

$$Q(x_4) = x_4^{M+N} (1 + x_4) \prod_{j=1}^{N-1} a_{1,j} \prod_{j=1}^{M-2} (1 + b_{1,j} x_4)$$

and

$$Q_1(x_4) = x_4^{M+N} (1 + x_4) \left(\prod_{j=1}^{N-1} a_{1,j} x_4^2 \sum_{j=1}^{M-2} b_{2,j} \prod_{\substack{i=1 \\ i \neq j}}^{M-2} (1 + b_{1,i} x_4) + \sum_{j=1}^{N-1} \prod_{\substack{i=1 \\ i \neq j}}^{N-1} a_{1,i} \prod_{i=1}^{M-2} (1 + b_{1,i} x_4) \right).$$

Since $\tilde{N}_p^{(M,N)} = y_4^{2M+N} (Q(x_4) + y_4 Q_1(x_4) + y_4^2(\dots))$, we find that

$$\begin{aligned} \frac{\partial \tilde{N}_p^{(M,N)}}{\partial x_4} &= y_4^{2M+N} (Q'(x_4) + y_4 Q_1'(x_4) + y_4^2(\dots)) \\ \frac{\partial \tilde{N}_p^{(M,N)}}{\partial y_4} &= y_4^{2M+N-1} ((2M+N)Q(x_4) + (2M+N+1)y_4 Q_1(x_4) + y_4^2(\dots)) \end{aligned} \quad (3.2)$$

Setting $\beta_{1,i} = y_4 \tilde{\beta}_{1,i}$, we deduce from (3.1) that

$$\begin{aligned} \frac{Q(x_4)}{a_{1,i}} &= \alpha_{1,i}(x_4, 0) Q'(x_4) + (2M+N) \tilde{\beta}_{1,i}(x_4, 0) Q(x_4) \\ \frac{Q_1(x_4)}{a_{1,i}} - \frac{Q(x_4)}{a_{1,i}^2} &= \alpha_{1,i}(x_4) Q'(x_4) + \alpha_{1,i}(x_4, 0) Q_1'(x_4) + (2M+N) \tilde{\beta}_{1,i}(x_4) Q(x_4) \\ &\quad + (2M+N+1) \tilde{\beta}_{1,i}(x_4, 0) Q_1(x_4), \end{aligned} \quad (3.3)$$

where $\alpha_{1,i}(x_4, y_4) = \alpha_{1,i}(x_4, 0) + \alpha_{1,i}(x_4) y_4 + y_4^2(\dots)$ and $\tilde{\beta}_{1,i}(x_4, y_4) = \tilde{\beta}_{1,i}(x_4, 0) + \tilde{\beta}_{1,i}(x_4) y_4 + y_4^2(\dots)$. Using Bézout identity, there exist polynomials W and Z in x_4 such that

$$Q \wedge Q' = W Q' + Z Q$$

where $Q \wedge Q'$ is the great common divisor of Q and Q' . We can choose the polynomial function W to be of degree $M - 1$. We denote by

$$S(x_4) = x_4(1 + x_4) \prod_{i=1}^{M-2} (1 + b_{1,i}x_4)$$

the polynomial function satisfying $Q = (Q \wedge Q')S$. Therefore, we obtain a solution of the first equation of system (3.3) of equations of the form

$$\begin{aligned} \alpha_{1,i}(x_4, 0) &= \frac{W(x_4)S(x_4)}{a_{1,i}} \\ \tilde{\beta}_{1,i}(x_4, 0) &= \frac{Z(x_4)\tilde{S}(x_4)}{(2M+N)a_{1,i}}. \end{aligned}$$

The second equation can be written then as

$$\begin{aligned} \frac{Q_1(x_4)}{a_{1,i}} - \frac{Q(x_4)}{a_{1,i}^2} &= \alpha_{1,i}(x_4)Q'(x_4) + \frac{W(x_4)S(x_4)}{a_{1,i}}Q'_1(x_4) + (2M + N)\tilde{\beta}_{1,i}(x_4)Q(x_4) \\ &+ \frac{2M+N+1}{2M+N} \frac{Z(x_4)S(x_4)}{a_{1,i}}Q_1(x_4). \end{aligned}$$

Writing

$$Q_1(x_4) = \left(x_4^2 \sum_{j=1}^{M-2} \frac{b_{2,j}}{1 + b_{1,j}x_4} + \sum_{i=1}^{N-1} \frac{1}{a_{1,i}} \right) Q(x_4),$$

we obtain a solution of it of the form

$$\begin{aligned} \alpha_{1,i}(x_4) &= -\frac{W(x_4)S(x_4)}{a_{1,i}^2} \\ \tilde{\beta}_{1,i}(x_4) &= -\frac{Z(x_4)S(x_4)}{(2M+N)a_{1,i}} \left(\frac{1}{a_{1,i}} + \frac{1}{2M+N} \left(x_4^2 \sum_{j=1}^{M-2} \frac{b_{2,j}}{1 + b_{1,j}x_4} + \sum_{i=1}^{N-1} \frac{1}{a_{1,i}} \right) \right). \end{aligned}$$

Thus, we obtain a solution of (3.1) in the chart V_4 of the form

$$X_{1,i}^{(4)} = \left(\frac{W(x_4)S(x_4)}{a_{1,i}} - \frac{W(x_4)S(x_4)}{a_{1,i}^2} y_4 \right) \frac{\partial}{\partial x_4} + \left(\frac{1}{2M+N} \frac{Z(x_4)S(x_4)}{a_{1,i}} \right) \frac{\partial}{\partial y_4} + y_4^2(\dots).$$

Similarly, in the chart V_3 we write

$$\tilde{N}_p^{(M,N)} = x_3^{2M+N} (P(y_3) + x_3 P_1(y_3) + x_3^2(\dots))$$

with

$$P(y_3) = y_3(y_3 + 1) \prod_{j=1}^{N-1} a_{1,j} \prod_{j=1}^{M-2} (y_3 + b_{1,j})$$

and

$$P_1(y_3) = y_3(y_3 + 1) \left(\prod_{j=1}^{N-1} a_{1,j} \sum_{j=1}^{M-2} b_{2,j} \prod_{\substack{i=1 \\ i \neq j}}^{M-2} (y_3 + b_{1,i}) + \sum_{j=1}^{N-1} y_3 \prod_{\substack{i=1 \\ i \neq j}}^{N-1} a_{1,i} \prod_{i=1}^{M-2} (y_3 + b_{1,i}) \right).$$

We set $P \wedge P' = UP' + VP$ and $P = (P \wedge P')R$ with

$$R = y_3(y_3 + 1) \prod_{i=1}^{M-2} (y_3 + b_{1,i}).$$

Also, we can assume that the degree of U is $M - 1$ and so we obtain the solution

$$X_{1,i}^{(3)} = \frac{1}{2M+N} \frac{V(y_3)R(y_3)}{a_{1,i}} x_3 \frac{\partial}{\partial x_3} + \left(\frac{U(y_3)R(y_3)}{a_{1,i}} - \frac{U(y_3)R(y_3)}{a_{1,i}^2} x_3 y_3 \right) \frac{\partial}{\partial y_3} + x_3^2(\dots).$$

To compute the cocycle we write $X_{1,i}^{(3)}$ in the chart V_4 . Using the standard change of coordinates $x_4 = 1/y_3$ and $y_4 = x_3 y_3$ and since we have

$$U(y_3) = \frac{\tilde{U}(x_4)}{x_4^{M-1}}, R(y_3) = \frac{S(x_4)}{x_4^{M+1}} \text{ and } V(y_3) = \frac{\tilde{V}(x_4)}{x_4^{M-2}}$$

where \tilde{U} and \tilde{V} are polynomial functions, we find the first part of the first term of the cocycle

$$\begin{aligned} X_{1,i}^{(3,4)} = X_{1,i}^{(3)} - X_{1,i}^{(4)} = & -\frac{S(x_4)}{a_{1,i}} \left[\frac{\tilde{U}(x_4)}{x_4^{2M-2}} + W(x_4) \right] \frac{\partial}{\partial x_4} \\ & + \frac{S(x_4)}{a_{1,i}} \left(\frac{1}{2M+N} \frac{\tilde{V}(x_4)}{x_4^{2M-1}} + \frac{\tilde{U}(x_4)}{x_4^{2M-1}} - \frac{Z(x_4)}{2M+N} \right) y_4 \frac{\partial}{\partial y_4} \\ & + \frac{S(x_4)}{a_{1,i}^2} \left(\frac{\tilde{U}(x_4)}{x_4^{2M-2}} + W(x_4) \right) y_4 \frac{\partial}{\partial x_4} + y_4^2(\dots). \end{aligned}$$

We have

$$X_{1,i}^{(3,4)} = \Phi_{1,i}^{(3,4)} \Theta_0.$$

We can choose $\Theta_0 = \frac{E^* \Theta_{N_p^{(M,N)}}}{x_4^{M+N-2} y_4^{2M+N-3}}$ with $\Theta_{N_p^{(M,N)}} = \frac{\partial N_p^{(M,N)}}{\partial x} \frac{\partial}{\partial y} - \frac{\partial N_p^{(M,N)}}{\partial y} \frac{\partial}{\partial x}$. According to Proposition (2.1.1), the set of the coefficients of the Laurent's series of $\Phi_{1,i}^{(3,4)}$ characterizes the class of $X_{1,i}^{(3,4)}$ in $H^1(D, \Theta_{\mathcal{F}_{p_0}^{(M,N)}})$. Now, according to (3.2), we get the equality

$$\Phi_{1,i}^{(3,4)} = \frac{1}{(2M+N)a_{1,i} \prod_{j=1}^{N-1} a_{1,j}} \left[\frac{\tilde{U}(x_4)}{x_4^{2M-2}} + W(x_4) \right] + y_4 \Phi_i(x_4) + y_4^2(\dots),$$

where

$$\begin{aligned} \Phi_i(x_4) = & \frac{-(2M+N+1)}{(2M+N)^2 a_{1,i} \prod_{j=1}^{N-1} a_{1,j} (1+x_4)} \left(\frac{\tilde{U}(x_4)}{x_4^{2M-2}} + W(x_4) \right) \\ & \left(\frac{x_4}{\prod_{j=1}^{M-1} (1+b_{1,j} x_4)} \sum_{j=1}^{M-2} \frac{b_{2,j}}{1+b_{1,j} x_4} + \frac{\sum_{i=1}^{N-1} \frac{1}{a_{1,i}}}{x_4 \prod_{j=1}^{M-2} (1+b_{1,j} x_4)} \right) \\ & - \frac{1}{(2M+N)a_{1,i}^2 \prod_{j=1}^{N-1} a_{1,j}} \left(\frac{\tilde{U}(x_4)}{x_4^{2M-2}} + W(x_4) \right), \end{aligned}$$

which ends the proof. \square

The next proposition is the basic tool for the proof of the main result of this chapter.

Proposition 3.1.4. *If we decompose the vector field $X_{0,0}$*

$$X_{0,0} = \frac{-1}{2M+2N-1} \left(\sum_{j=0}^{N-1} X_{0,0}^{a,j} \left[\frac{1}{y_4^j} \right] + \sum_{i=1}^{M-2} X_{0,0}^{b,i} \left[\frac{y_4}{x_4^{i-1}} \right] + \sum_{j=0}^{N-3} Y_{0,0}^{a,j} \left[\frac{x_4}{y_4^{j-1}} \right] \right) + \dots$$

where the dots correspond to the decomposition of $X_{0,0}$ at the levels l_a and l_b with $l_a \geq 3$ and $l_b \geq 3$, then the functions $X_{0,0}^{a,j}$ are the zero functions for $1 \leq j \leq N-2$ and the functions $\{X_{0,0}^{a,0}, X_{0,0}^{b,i}, Y_{0,0}^{a,j}\}_{i=1, \dots, M-2, j=0, \dots, N-3}$ are algebraically independent.

Proof. Let us write the decomposition of the first term of the cocycle $\left\{ \frac{\partial}{\partial a_{1,l}}, \frac{\partial}{\partial b_{1,l}} \right\}$ in the standard basis of $H^1(D, \Theta_{\mathcal{F}_{p_0}}^{(M,N)})$

$$\frac{\partial}{\partial a_{1,l}} = \sum_{i,j \in B} R_{ij}^l(p) \left[x_4^i y_4^j \right],$$

where $p \in \mathcal{P}$. In view of Theorem A and using the notation introduced in its proof, the first term of the cocycle associated to $\frac{\partial}{\partial a_{1,l}}$ is written $\left\{ \Phi_{1,l}^{3,4}, \Phi_{1,l}^{2,4} \right\}$ where

$$\begin{aligned} \Phi_{1,l}^{(3,4)} &= \frac{1}{(2M+N)a_{1,l} \prod_{s=1}^{N-1} a_{1,s}} \left[\frac{\tilde{U}(x_4)}{x_4^{2M-2}} + W(x_4) \right] + y_4(\dots) \\ \Phi_{1,l}^{(2,4)} &= \frac{-1}{(M+N)(y_4+a_{1,l})} \left[\frac{\tilde{K}(y_4)}{y_4^{2N-2}} + B(y_4) \right] + x_4(\dots). \end{aligned}$$

In fact, $R_{-i,0}^l(p)$ is the coefficient of $\frac{1}{x_4^i}$ in the development of $\Phi_{1,l}^{(3,4)}$ in Laurent series, which is zero for all $1 \leq i \leq M-2$ and $R_{0,-j}^l(p)$ is the coefficient of $\frac{1}{y_4^j}$ in the development of $\Phi_{1,l}^{(2,4)}$ which can be written as

$$\Phi_{1,l}^{(2,4)} = \frac{-1}{M+N} \left[\sum_{j=1}^{N-1} \frac{(-1)^{N+j-1} \tilde{K}(-a_{1,l})}{a_{1,l}^{N+j}} \frac{1}{y_4^{N-j-1}} + \frac{B(0)}{a_{1,l}} + \frac{R(y_4)}{y_4^{2N-2}} + y_4(\dots) \right] + x_4(\dots).$$

For simplicity, we will replace the notation $R_{0,-j}^l(p)$ by $R_{0,j}^l(p)$. So, we can write $R_{0,j}^l(p)$ as follows

$$R_{0,j}^l(p) = \begin{cases} \frac{-1}{M+N} \left[\frac{\tilde{K}(-a_{1,l})}{a_{1,l}^{2N-1}} + \frac{B(0)}{a_{1,l}} \right] & \text{if } j = 0 \\ \frac{1}{M+N} \frac{(-1)^{j-1} \tilde{K}(-a_{1,l})}{a_{1,l}^{2N-j-1}} & \text{if } 1 \leq j \leq N-2. \end{cases}$$

It is clear that $R_{0,j}^l(p)$ satisfies the following relation

$$\begin{cases} R_{0,0}^l(p) &= -\frac{R_{0,1}^l(p)}{a_{1,l}} - \frac{1}{M+N} \frac{B(0)}{a_{1,l}} \\ R_{0,j}^l(p) &= (-1)^{j-1} a_{1,l}^{j-1} R_{0,1}^l(p) \end{cases} \quad \text{if } 1 \leq j \leq N-2.$$

Thus, we obtain the following equality

$$\begin{aligned} \frac{\partial}{\partial a_{1,l}} = & -\frac{1}{M+N} \frac{B(0)}{a_{1,l}} + \sum_{j=0}^{N-2} (-a_{1,l})^{j-1} R_{0,1}^l(p) \left[\frac{1}{y_4^j} \right] + \sum_{\substack{B_a \\ i \neq 0}} \left\langle \frac{\partial}{\partial a_{1,l}}, x_4^i y_4^j \right\rangle [x_4^i y_4^j] \\ & + \sum_{\substack{B_b \\ j \neq 0}} \left\langle \frac{\partial}{\partial a_{1,l}}, x_4^i y_4^j \right\rangle [x_4^i y_4^j]. \end{aligned}$$

Proposition (3.1.1) yields a decomposition of the cocycle $X_{0,0}$ in the standard basis which can be written as

$$\begin{aligned} X_{0,0} = & c \left(\sum_{j=0}^{N-2} X_{0,0}^{a,j} \left[\frac{1}{y_4^j} \right] + \sum_{i=1}^{M-2} X_{0,0}^{b,i} \left[\frac{y_4}{x_4^{i-1}} \right] + \sum_{j=0}^{N-3} Y_{0,0}^{a,j} \left[\frac{x_4}{y_4^{j-1}} \right] \right) \\ & + c \left(\sum_{\substack{B_a, i \neq 0, 1 \\ B_b, j \neq 0, 1}} \sum_{l=1}^{N-1} -a_{1,l} \left\langle \frac{\partial}{\partial a_{1,l}}, x_4^i y_4^j \right\rangle [x_4^i y_4^j] + \sum_{\substack{B_a, i \neq 0, 1 \\ B_b, j \neq 0, 1}} \sum_{l=2}^{N-1} a_{2,l} \left\langle \frac{\partial}{\partial a_{2,l}}, x_4^i y_4^j \right\rangle [x_4^i y_4^j] \right. \\ & + \sum_{\substack{B_b, j \neq 0 \\ B_a, i \neq 0, 1}} \sum_{l=1}^{M-2} b_{2,l} \left\langle \frac{\partial}{\partial b_{2,l}}, x_4^i y_4^j \right\rangle [x_4^i y_4^j] + \sum_{l=3}^{N-1} \sum_{k=3}^l (2k-3) a_{k,l} \frac{\partial}{\partial a_{k,l}} \\ & \left. + \sum_{l=1}^{M-2} \sum_{k=3}^{N-1+2l} (k-1) b_{k,l} \frac{\partial}{\partial b_{k,l}} \right) \end{aligned}$$

where

$$\begin{aligned} X_{0,0}^{a,0} &= \frac{N-1}{M+N} B(0) + \sum_{l=1}^{N-1} R_{0,1}^l(p) \\ X_{0,0}^{a,j} &= \sum_{l=1}^{N-1} (-a_{1,l})^j R_{0,1}^l(p) \\ X_{0,0}^{b,i} &= \sum_{l=1}^{M-2} b_{2,l} \left\langle \frac{\partial}{\partial b_{2,l}}, \frac{y_4}{x_4^{i-1}} \right\rangle + \sum_{l=1}^{N-1} -a_{1,l} \left\langle \frac{\partial}{\partial a_{1,l}}, \frac{y_4}{x_4^{i-1}} \right\rangle \\ Y_{0,0}^{a,j} &= \sum_{l=1}^{M-2} b_{2,l} \left\langle \frac{\partial}{\partial b_{2,l}}, \frac{x_4}{y_4^{j-1}} \right\rangle + \sum_{l=2}^{N-1} a_{2,l} \left\langle \frac{\partial}{\partial a_{2,l}}, \frac{x_4}{y_4^{j-1}} \right\rangle + \sum_{l=1}^{N-1} -a_{1,l} \left\langle \frac{\partial}{\partial a_{1,l}}, \frac{x_4}{y_4^{j-1}} \right\rangle \end{aligned}$$

and c is constant given by

$$c = \frac{-1}{2M + 2N - 1}.$$

We note that the term $\left\langle \frac{\partial}{\partial a_{2,l}}, \frac{y_4}{x_4^{i-1}} \right\rangle$ is zero for all $1 \leq i \leq M-2$.

Now, using the expression of $\tilde{K}(-a_{1,l})$ in (2.21), we find that $R_{0,1}^l(p)$ is given by

$$R_{0,1}^l(p) = \frac{1}{M+N} \frac{(-1)^N}{a_{1,l} \prod_{\substack{j=1 \\ j \neq l}}^{N-1} (a_{1,l} - a_{1,j})}.$$

To compute the term $X_{0,0}^{a,0}$, we introduce the polynomial F_0 in the variable x_4 defined by

$$F_0(x_4) = \prod_{j=1}^{N-1} (x_4 - a_{1,j}).$$

Clearly, we have the following equality

$$\frac{1}{F_0(x_4)} = \sum_{j=1}^{N-1} \frac{1}{(x_4 - a_{1,j}) \prod_{\substack{j'=1 \\ j' \neq j}}^{N-1} (a_{1,j} - a_{1,j'})}.$$

So, we can write $X_{0,0}^{a,0}$ as

$$\begin{aligned} X_{0,0}^{a,0} &= \frac{N-1}{M+N} B(0) + \frac{1}{M+N} \sum_{l=1}^{N-1} \frac{(-1)^N}{a_{1,l} \prod_{\substack{j=1 \\ j \neq l}}^{N-1} (a_{1,l} - a_{1,j})} \\ &= \frac{N-1}{M+N} B(0) + \frac{(-1)^{N+1}}{M+N} \frac{1}{F_0(0)}. \end{aligned}$$

The initial expression of $F_0(x_4)$ implies that $F_0(0) = \prod_{j=1}^{N-1} (-a_{1,j})$. Since from (2.22) we have $B(0) = \frac{1}{(2M+N) \prod_{j=1}^{N-1} a_{1,j}}$, we obtain the following expression of $X_{0,0}^{a,0}$

$$X_{0,0}^{a,0} = \frac{2M + 2N - 1}{M + N} B(0),$$

which is different from zero.

Similarly, to compute the term $X_{0,0}^{a,j}$, we introduce the polynomial F_j in the variable x_4 defined by

$$F_j(x_4) = \frac{Q(x_4)}{P_j(x_4)}$$

where $Q(x_4) = \prod_{i=1}^{N-1} (x_4 - a_{1,i})$ and $P_j(x_4) = (-x_4)^j$ for all $1 \leq j \leq N-2$. Also, we have the following equality

$$\frac{1}{F_j(x_4)} = \sum_{i=1}^{N-1} \frac{(-a_{1,i})^j}{(x_4 - a_{1,i}) \prod_{\substack{i'=1 \\ i' \neq i}}^{N-1} (a_{1,i} - a_{1,i'})}.$$

So, we can write $X_{0,0}^{a,j}$ as

$$X_{0,0}^{a,j} = \frac{(-1)^N}{M+N} \sum_{l=1}^{N-1} \frac{(-a_{1,l})^j}{a_{1,l} \prod_{\substack{j=1 \\ j \neq l}}^{N-1} (a_{1,l} - a_{1,j})} = \frac{(-1)^{N+1}}{F_j(0)}.$$

The initial expression of $F_j(x_4)$ implies that $X_{0,0}^{a,j} = 0$ for all $1 \leq j \leq N-2$.

Now, for the terms $X_{0,0}^{b,i}$, lemma (3.1.1) shows that the term $\sum_{l=1}^{N-1} -a_{1,l} \left\langle \frac{\partial}{\partial a_{1,l}}, \frac{y_4}{x_4^{i-1}} \right\rangle$ is equal to the coefficient of $\frac{1}{x_4^{i-1}}$ in the development of $\sum_{l=1}^{N-1} -a_{1,l} \Phi_l(x_4)$ in Laurent series where $\Phi_l(x_4)$ is given by

$$\begin{aligned} \Phi_l(x_4) = & \frac{-(2M+N+1)}{(2M+N)^2 a_{1,l} \prod_{j=1}^{N-1} a_{1,j} (1+x_4)} \left(\frac{\tilde{U}(x_4)}{x_4^{2M-2}} + W(x_4) \right) \\ & \left(\frac{x_4}{\prod_{j=1}^{M-1} (1+b_{1,j}x_4)} \sum_{j=1}^{M-2} \frac{b_{2,j}}{1+b_{1,j}x_4} + \frac{\sum_{i=1}^{N-1} \frac{1}{a_{1,i}}}{x_4 \prod_{j=1}^{M-2} (1+b_{1,j}x_4)} \right) \\ & - \frac{1}{(2M+N) a_{1,l}^2 \prod_{j=1}^{N-1} a_{1,j}} \left(\frac{\tilde{U}(x_4)}{x_4^{2M-2}} + W(x_4) \right). \end{aligned}$$

Since $\frac{\partial}{\partial b_{2,l}} = x_4 y_4 \frac{\partial}{\partial b_{1,l}}$, then we have the following relation

$$\left\langle \frac{\partial}{\partial b_{2,l}}, \frac{y_4}{x_4^{i-1}} \right\rangle = \left\langle \frac{\partial}{\partial b_{1,l}}, \frac{1}{x_4^i} \right\rangle,$$

and so in view of the proof of Theorem (A), the term $\sum_{l=1}^{M-2} b_{2,l} \left\langle \frac{\partial}{\partial b_{2,l}}, \frac{y_4}{x_4^{i-1}} \right\rangle$ is equal to

the coefficient of $\frac{1}{x_4^{i-1}}$ in the development of $\sum_{l=1}^{M-2} b_{2,l} x_4 \Psi_{1,l}^{(3,4)}(x_4)$ in Laurent series where $\Psi_{1,l}^{(3,4)}(x_4)$ is given by

$$\Psi_{1,l}^{(3,4)} = \frac{1}{(2M+N) \prod_{j=1}^{N-1} a_{1,j} (1+b_{1,l}x_4)} \left[\frac{\tilde{U}(x_4)}{x_4^{2M-3}} + x_4 W(x_4) \right] + y_4(\dots).$$

We can write

$$\begin{aligned} \prod_{j=1}^{N-1} a_{1,j} \sum_{l=1}^{N-1} -a_{1,l} \Phi_l(x_4) &= \frac{c_1}{(1+x_4) \prod_{j=1}^{M-2} (1+b_{1,j}x_4)} \frac{\tilde{U}(x_4)}{x_4^{2M-3}} \sum_{j=1}^{M-2} \frac{b_{2,j}}{1+b_{1,j}x_4} \\ &+ x_4(\dots) + \text{cst} + \dots \\ \prod_{j=1}^{N-1} a_{1,j} \sum_{l=1}^{M-2} b_{2,l} x_4 \Psi_{1,l}^{(3,4)}(x_4) &= \sum_{l=1}^{M-2} \frac{b_{2,l} x_4}{(2M+N)(1+b_{1,l}x_4)} \frac{\tilde{U}(x_4)}{x_4^{2M-3}} + x_4(\dots) + y_4(\dots), \end{aligned}$$

where $c_1 = \frac{(2M+N+1)(N-1)}{(2M+N)^2}$ and the dots stand for terms which do not contain $b_{2,j}$.

The coefficient of $b_{2,l}$ in the sum $\prod_{j=1}^{N-1} a_{1,j} \sum_{l=1}^{N-1} -a_{1,l} \Phi_l(x_4) + \prod_{j=1}^{N-1} a_{1,j} \sum_{l=1}^{M-2} b_{2,l} x_4 \Psi_{1,l}^{(3,4)}(x_4)$ is given by

$$E(x_4) = \frac{1}{x_4^{2M-3}} \frac{\tilde{U}(x_4)}{(1+b_{1,l}x_4)} \left[\frac{c_1}{(1+x_4) \prod_{j=1}^{M-2} (1+b_{1,j}x_4)} + c_2 x_4 \right]$$

where $c_2 = \frac{1}{2M+N}$. This implies that the coefficient of $b_{2,l}$ in the expression of $X_{0,0}^{b,i}$ is the coefficient of $\frac{1}{x_4^{i-1}}$ in the previous expression.

The next part of the proof is devoted to showing that if we consider the functions $X_{0,0}^{b,i}$ as linear functions of the $M-2$ variables $b_{2,l}$, where $1 \leq l \leq M-2$, then their determinant is not the zero function. Hence, for a generic choice of the variables $b_{2,1}, \dots, b_{2,M-2}$, these $M-2$ linear functions are independent as linear functions of $M-2$ variables. Thus they are algebraically independent.

In fact, we know, from the proof of Theorem A and lemma (3.1.1), that \tilde{U} is a polynomial function in x_4 defined by the equality

$$\tilde{U}(x_4) = x_4^{M-1} U(y_3)$$

where U is the polynomial function of degree $M-1$ satisfying the Bezout identity

$$P \wedge P' = UP' + VP.$$

Since we are interested in the generic independence, we restrict the proof to the following case

$$\begin{cases} \prod_{j=1}^{M-2} b_{1,j} = 1 & \text{and } (-b_{1,j})^{M-1} = -1 \quad \forall 1 \leq j \leq M-2 \quad \text{if } M \text{ is even} \\ \prod_{j=1}^{M-2} b_{1,j} = -1 & \text{and } (-b_{1,j})^{M-1} = 1 \quad \forall 1 \leq j \leq M-2 \quad \text{if } M \text{ is odd.} \end{cases}$$

So, the function P , which is given by

$$P(y_3) = \prod_{i=1}^{N-1} a_{1,i} y_3 (y_3 + 1) \prod_{j=1}^{M-2} (y_3 + b_{1,j}),$$

can be written as

$$P(y_3) = \begin{cases} \prod_{i=1}^{N-1} a_{1,i} y_3 (y_3^{M-1} + 1) & \text{if } M \text{ is even} \\ \prod_{i=1}^{N-1} a_{1,i} y_3 (y_3^{M-1} - 1) & \text{if } M \text{ is odd.} \end{cases}$$

If M is even, then using euclidean division, we find that \tilde{U} is given by

$$\tilde{U}(x_4) = x_4^{M-1} + \frac{M}{M-1}.$$

In this case, the expression E is equal to

$$E(x_4) = \frac{1}{x_4^{2M-3}} \frac{\tilde{U}(x_4)}{(1 + b_{1,l}x_4)} \left[\frac{c_1}{1 + x_4^{M-1}} + c_2 x_4 \right].$$

Also, from the proof of theorem A, we have the following equality

$$\frac{\tilde{U}(x_4)}{(1 + b_{1,l}x_4)x_4^{2M-3}} = \sum_{j=0}^{M-2} d_{jl} \frac{1}{x_4^j} + \frac{T(x_4)}{x_4^{2M-3}} + x_4(\dots),$$

where T is a polynomial in x_4 of degree $M - 2$ and d_{jl} is given by

$$d_{jl} = (-1)^{j+1} b_{1,l}^{2M-j-3} \tilde{U} \left(\frac{-1}{b_{1,l}} \right).$$

In this case, we have

$$d_{jl} = \frac{(-1)^{j+1}}{M-1} b_{1,l}^{2M-j-3}$$

and the polynomial T satisfies the equality

$$\frac{T(x_4)}{x_4^{2M-3}} = \sum_{j=M-1}^{2M-3} c_{jl} \frac{1}{x_4^j},$$

where

$$c_{jl} = (-1)^{j-1} b_{1,l}^{2M-3-j} \frac{M}{M-1}.$$

Thus, the decomposition of $X_{0,0}^{b,i}$, where $1 \leq i \leq M - 2$, on the family $b_{2,l}$, where $1 \leq l \leq M - 2$, is given by the matrix

$$\begin{matrix} & X_{0,0}^{b,1} & & X_{0,0}^{b,2} & & \dots & & X_{0,0}^{b,M-2} \\ \begin{matrix} b_{2,1} \\ b_{2,2} \\ \vdots \\ b_{2,M-2} \end{matrix} & \left(\begin{array}{cccc} c_2 d_{1,1} + c_1 d_{0,1} - c_1 c_{M-1,1} & c_2 d_{2,1} + c_1 d_{1,1} - c_1 c_{M,1} & \dots & c_2 d_{M-2,1} + c_1 d_{M-3,1} - c_1 c_{2M-4,1} \\ c_2 d_{1,2} + c_1 d_{0,2} - c_1 c_{M-1,2} & c_2 d_{2,2} + c_1 d_{1,2} - c_1 c_{M,2} & \dots & c_2 d_{M-2,2} + c_1 d_{M-3,2} - c_1 c_{2M-4,2} \\ \vdots & \vdots & \dots & \vdots \\ c_2 d_{1,M-2} + c_1 d_{0,M-2} - c_1 c_{M-1,M-2} & c_2 d_{2,M-2} + c_1 d_{1,M-2} - c_1 c_{M,M-2} & \dots & c_2 d_{M-2,M-2} + c_1 d_{M-3,M-2} - c_1 c_{2M-4,M-2} \end{array} \right) \end{matrix}$$

From the expressions of $c_{i+M-2,l}$ and $d_{i-1,l}$, we have the following relation

$$d_{i-1,l} = -\frac{1}{M} c_{i+M-2,l}.$$

Since $d_{i,l} = -1/b_{1,l} d_{i-1,l}$, we can write the following relation

$$c_2 d_{i,l} + c_1 d_{i-1,l} - c_1 c_{i+M-2,l} = \left[-\frac{1}{M} \left(c_1 - \frac{c_2}{b_{1,l}} \right) - c_1 \right] c_{i+M-2,l}.$$

Thus, the determinant of the above matrix is equal to

$$\prod_{l=1}^{M-2} \left[\frac{1}{M} \left(c_1 - \frac{c_2}{b_{1,l}} \right) + c_1 \right] \det (c_{i+M-2,l})_{\substack{1 \leq i \leq M-2 \\ 1 \leq l \leq M-2}}$$

which is equal to

$$\left(\frac{M}{M-1} \right)^{M-2} \prod_{l=1}^{M-2} \left[\frac{1}{M} \left(c_1 - \frac{c_2}{b_{1,l}} \right) + c_1 \right] \text{Vand} (-b_{1,1}, \dots, -b_{1,M-2}).$$

Since $b_{1,i} \neq b_{1,j}$ for $i \neq j$, the determinant is not the zero function.

The case where M is odd can be treated similarly. If M is odd, then \tilde{U} is given by

$$\tilde{U}(x_4) = -x_4^{M-1} + \frac{M}{M-1}.$$

The expression E is equal to

$$E(x_4) = \frac{1}{x_4^{2M-3}} \frac{\tilde{U}(x_4)}{(1+b_{1,l}x_4)} \left[\frac{c_1}{1-x_4^{M-1}} + c_2x_4 \right].$$

In this case, we have

$$d_{jl} = \frac{(-1)^{j+1}}{M-1} b_{1,l}^{2M-j-3},$$

where $0 \leq j \leq M-2$ and

$$c_{jl} = (-1)^{j-1} b_{1,l}^{2M-3-j} \frac{M}{M-1},$$

where $M-1 \leq j \leq 2M-3$. Thus, the decomposition of $X_{0,0}^{b,i}$, where $1 \leq i \leq M-2$, on the family $b_{2,l}$, where $1 \leq l \leq M-2$, is given by the matrix

$$\begin{matrix} & X_{0,0}^{b,1} & & X_{0,0}^{b,2} & & \cdots & & X_{0,0}^{b,M-2} \\ \begin{matrix} b_{2,1} \\ b_{2,2} \\ \vdots \\ b_{2,M-2} \end{matrix} & \left(\begin{array}{cccc} c_2d_{1,1} + c_1d_{0,1} + c_1c_{M-1,1} & c_2d_{2,1} + c_1d_{1,1} + c_1c_{M,1} & \cdots & c_2d_{M-2,1} + c_1d_{M-3,1} + c_1c_{2M-4,1} \\ c_2d_{1,2} + c_1d_{0,2} + c_1c_{M-1,2} & c_2d_{2,2} + c_1d_{1,2} + c_1c_{M,2} & \cdots & c_2d_{M-2,2} + c_1d_{M-3,2} + c_1c_{2M-4,2} \\ \vdots & \vdots & \ddots & \vdots \\ c_2d_{1,M-2} + c_1d_{0,M-2} + c_1c_{M-1,M-2} & c_2d_{2,M-2} + c_1d_{1,M-2} + c_1c_{M,M-2} & \cdots & c_2d_{M-2,M-2} + c_1d_{M-3,M-2} + c_1c_{2M-4,M-2} \end{array} \right) \end{matrix}.$$

Similarly, we have the following relation

$$d_{i-1,l} = \frac{1}{M} c_{i+M-2,l}.$$

Again, since $d_{i,l} = -1/b_{1,l}d_{i-1,l}$, we can write the following relation

$$c_2d_{i,l} + c_1d_{i-1,l} + c_1c_{i+M-2,l} = \left[\frac{1}{M} \left(c_1 - \frac{c_2}{b_{1,l}} \right) + c_1 \right] c_{i+M-2,l}.$$

Thus, the determinant of the matrix is equal to

$$\prod_{l=1}^{M-2} \left[\frac{1}{M} \left(c_1 - \frac{c_2}{b_{1,l}} \right) + c_1 \right] \det (c_{i+M-2,l})_{\substack{1 \leq i \leq M-2 \\ 1 \leq l \leq M-2}}$$

which is equal to

$$\left(\frac{M}{M-1} \right)^{M-2} \prod_{l=1}^{M-2} \left[\frac{1}{M} \left(c_1 - \frac{c_2}{b_{1,l}} \right) + c_1 \right] \text{Vand}(-b_{1,1}, \dots, -b_{1,M-2}).$$

Now, for the terms $Y_{0,0}^{a,j}$, we have

$$\left\langle \frac{\partial}{\partial b_{2,l}}, \frac{x_4}{y_4^{j-1}} \right\rangle = \left\langle \frac{\partial}{\partial b_{1,l}}, \frac{1}{y_4^j} \right\rangle = 0$$

for all $0 \leq j \leq N-3$. Since $\frac{\partial}{\partial a_{2,l}} = x_4 y_4^2 \frac{\partial}{\partial a_{1,l}}$, we have

$$\left\langle \frac{\partial}{\partial a_{2,l}}, \frac{x_4}{y_4^{j-1}} \right\rangle = \left\langle \frac{\partial}{\partial a_{1,l}}, \frac{1}{y_4^{j+1}} \right\rangle = (-a_{1,l})^j R_{0,1}^l(p)$$

for all $0 \leq j \leq N-3$.

Again, computations similar to those in the proof of Theorem A and lemma (3.1.1)

show that the term $\sum_{l=1}^{N-1} -a_{1,l} \left\langle \frac{\partial}{\partial a_{1,l}}, \frac{x_4}{y_4^{j-1}} \right\rangle$ is equal to the coefficient of $\frac{1}{y_4^{j-1}}$ in the

development of $\sum_{l=1}^{N-1} -a_{1,l} \Psi_l(y_4)$ in Laurent series where $\Psi_l(y_4)$ is given by

$$\begin{aligned} \Psi_l(y_4) = & \frac{(M+N+1)}{(M+N)^2(y_4+a_{1,l})} \left[1 + \sum_{i=1}^{M-2} b_{1,i} + \sum_{i=2}^{N-1} \frac{a_{2,i} y_4^2}{y_4 + a_{1,i}} \right] \left[\frac{\tilde{K}(y_4)}{y_4^{2N-2}} + B(y_4) \right] \\ & + \frac{a_{2,l}}{(M+N)(y_4+a_{1,l})^2} \left[\frac{\tilde{K}(y_4)}{y_4^{2N-4}} + y_4^2 B(y_4) \right]. \end{aligned}$$

Now, the coefficient of $a_{2,l}$ in the expression of $\sum_{l=1}^{N-1} -a_{1,l} \Psi_l(y_4) = \sum_{l=2}^{N-1} -a_{1,l} \Psi_l(y_4)$ (as $\Psi_1(y_4) = 0$) is given by

$$-c a_{1,l} \frac{\tilde{K}(y_4)}{(y_4 + a_{1,l})^2 y_4^{2N-4}}$$

where $c = \frac{2M+2N+1}{(M+N)^2}$. Thus the coefficient of $a_{2,l}$ in $Y_{0,0}^{a,j}$ is equal to $(-a_{1,l})^j R_{0,1}^l(p)$ added to the coefficient of $\frac{1}{y_4^{j-1}}$ in the previous expression. Simple computations show that it is given by

$$\left(\frac{1}{M+N} + c(2N-2-j) \right) \frac{(-1)^j \tilde{K}(-a_{1,l})}{a_{1,l}^{2N-2-j}} - c \frac{(-1)^j}{a_{1,l}^{2N-2-j}} \sum_{i=0}^{N-1} (-1)^i i a_{1,l}^i k_i$$

where the complex numbers k_i are such that $\tilde{K}(y_4) = \sum_{i=0}^{N-1} k_i y_4^i$. Similarly, we can show that if we consider the functions $Y_{0,0}^{a,j}$ as linear functions of the $N-2$ variables $a_{2,l}$, where $2 \leq l \leq N-1$, then their determinant is not the zero function. Hence, for a generic choice of the variables $a_{2,2}, \dots, a_{2,N-1}$, these $N-2$ linear functions are independent as linear functions of $N-2$ variables. Thus they are algebraically independent. Finally, it is clear that considering the functions $X_{0,0}^{a,0}$, $X_{0,0}^{b,i}$ and $Y_{0,0}^{a,j}$ where $1 \leq i \leq M-2$ and $0 \leq j \leq N-3$ as linear functions of $1, a_{2,l}$ and $b_{2,l'}$ where $2 \leq l \leq N-1$ and $1 \leq l' \leq M-2$, we can deduce that they are algebraically independent. \square

3.2 The dimension of the generic strata.

The dimension τ of the generic strata of the local moduli space of curves corresponds to the codimension of the distribution \mathcal{C} at a generic point of M . According to proposition (3.1.4), the family of coefficients $\{X_{0,0}^{a,0}, X_{0,0}^{b,i}, Y_{0,0}^{a,j}\}_{i=1,\dots,M-2, j=0,\dots,N-3}$ of $X_{0,0}$ is functionally independent: thus, any family of r vector fields in dimension r whose coefficients are chosen among $\{X_{0,0}^{a,0}, X_{0,0}^{b,i}, Y_{0,0}^{a,j}\}_{i=1,\dots,M-2, j=0,\dots,N-3}$ is generically free: indeed, their determinant cannot identically vanish since it would produce a functional relation between $\{X_{0,0}^{a,0}, X_{0,0}^{b,i}, Y_{0,0}^{a,j}\}_{i=1,\dots,M-2, j=0,\dots,N-3}$. Thus, to compute the dimension of the generic strata, we just have to browse the region of moduli and to compute at each level how many moduli can actually be reached by the vector fields $X_{m,n}$. For the following considerations, we recommend to refer at each step to Example 3.3.1 presented at the end of the section.

From now on, we denote by l the levels of the region of moduli in correspondence with the decomposition of the set \mathcal{P} introduced before. In fact, for $1 \leq l_b \leq N-1$, it implies that it is the level formed by $l_a = l_b$ of the subspace \mathcal{P}_a and l_b of the subspace \mathcal{P}_b , and for $N \leq l_b \leq N+2M-5$, it is just the level formed by l_b . Proposition (3.1.4) shows that the first level at which the vector field $X_{0,0}$ starts action is $l=1$. We note that we say a vector field $X_{m,n}$ starts action at a level l if there is at least one non zero coefficient in its decomposition on this level and all the coefficients in its decomposition on the previous levels are zero. The main purpose of this section is to show:

Lemma 3.2.1. *If $M, N > 2$, then the vector space generated by the vector fields $X_{m,n}$*

which act at the level $l = 1, \dots, N + 2M - 5$ admits as a basis:

$$\left\{ \begin{array}{ll} l = 1 & \{X_{0,0}\} \\ l = 2 & \{X_{1,0}\} \\ l = 3 & \{X_{2,0}, X_{0,1}\} \\ 4 \leq l \leq \left[\frac{N}{2}\right] + 1 & \{X_{l-1,0}, X_{l-3,1}, X_{0,l-2}, \dots, X_{l-4,2}\} \\ l = \left[\frac{N}{2}\right] + 2 & \{X_{l-1,0}, X_{l-3,1}, X_{0,l-2}, \dots, X_{N-l-2,2l-N}\} \\ l = \frac{N}{2} + 3 + i, \quad 0 \leq i \leq \frac{N}{2} - 5, & \{X_{l-1,0}, X_{l-3,1}, X_{0,l-2}, \dots, X_{N-l-2,2l-N}, \\ & \left. X_{\frac{N}{2}-2+i,2}, X_{\frac{N}{2}-4+i,3}, \dots, X_{\frac{N}{2}+i-2m_1,m_1+1}\right\} \\ l = \frac{N+1}{2} + 2 + i, \quad 0 \leq i \leq \frac{N+1}{2} - 5, & \{X_{l-1,0}, X_{l-3,1}, X_{0,l-2}, \dots, X_{N-l-2,2l-N}, \\ & \left. X_{\frac{N-1}{2}-2+i,2}, X_{\frac{N-1}{2}-4+i,3}, \dots, X_{\frac{N-1}{2}+i-2m_2,m_2+1}\right\} \\ l = N - 1, \quad N \neq 6 & \{X_{l-1,0}, X_{l-3,1}, X_{N-6,2}, X_{N-8,3}, \dots, \\ & X_{N-4-2\min([\frac{N-7}{3}]+1, M-3), \min([\frac{N-7}{3}]+1, M-3)+1}\} \\ l = N - 1, \quad N = 6 & \{X_{4,0}, X_{2,1}\} \\ l = N & \{X_{l-3,1}, X_{N-5,2}, X_{N-7,3}, \dots, \\ & X_{N-3-2\min([\frac{N-5}{3}]+1, M-3), \min([\frac{N-5}{3}]+1, M-3)+1}\} \\ l = N + 1 + r, \quad 0 \leq r \leq N - 4 & \{X_{N-3, \frac{r+1}{2}+1}, X_{N-5, \frac{r+1}{2}+2}, \dots, X_{N+r-2n_1, n_1}, \\ & \left. X_{N-1+r,0}, X_{N-3+r,1}, \dots, X_{N, \frac{r-1}{2}}\right\}^* \\ l = N + 1 + r, \quad 0 \leq r \leq N - 4, & \{X_{N-2, \frac{r}{2}+1}, X_{N-4, \frac{r}{2}+2}, \dots, X_{N+r-2n_2+2, n_2-1}, \\ & \left. X_{N-1+r,0}, X_{N-3+r,1}, \dots, X_{N-1, \frac{r}{2}}\right\}^* \\ l = N + 1 + r, \quad N - 3 \leq r \leq 2M - 6, & \{X_{N-3, \frac{r+1}{2}+1}, X_{N-5, \frac{r+1}{2}+2}, \dots, X_{N+r-2n_3, n_3}, \\ & \left. X_{N-1+r,0}, X_{N-3+r,1}, \dots, X_{N, \frac{r-1}{2}}\right\}^* \\ l = N + 1 + r, \quad N - 3 \leq r \leq 2M - 6, & \{X_{N-2, \frac{r}{2}+1}, X_{N-4, \frac{r}{2}+2}, \dots, X_{N+r-2n_4+2, n_4-1}, \\ & \left. X_{N-1+r,0}, X_{N-3+r,1}, \dots, X_{N-1, \frac{r}{2}}\right\}^* . \end{array} \right.$$

where $m_1 = \min([\frac{2i+1}{3}] + 1, M - 3)$, $m_2 = \min([\frac{2i}{3}] + 1, M - 3)$, $n_1 = [\frac{N-3+2r}{3}] + 2$, $n_2 = [\frac{N-3+2r}{3}] + 3$, $n_3 = [\frac{r-N+4}{2}] + N - 2$ and $n_4 = [\frac{r-N+4}{2}] + N - 1$. The asterisk (*) means that this family is a basis if its cardinal is less than or equal to q_l , otherwise, any subfamily of cardinal q_l form a basis.

Since $X_{0,0}^{a,0}$ is a non zero coefficient among the coefficients $\{X_{0,0}^{a,j}\}$ in the decomposition of $X_{0,0}$, the vector fields $X_{m,0}$ may start action on the subspace \mathcal{P}_a . The first level of the subspace \mathcal{P}_a at which $X_{m,0}$ may have an action is $l_a = m + 1$ and that of the subspace \mathcal{P}_b is $l_b = m + 2$: this is because $X_{m,0} = x^m X_{0,0} = x_4^m y_4^m X_{0,0}$ and the levels of the subspace \mathcal{P}_a are determined by the powers of x_4 and those of the subspace \mathcal{P}_b are determined by the powers of y_4 and since $X_{m,0} = x^m X_{0,0}$, its projection on the previous levels vanish. For $1 \leq l_b \leq N - 1$, $l_a = l_b$, the vector fields $X_{m,0}$ can be used to kill only one modulus at each level $l_a = m + 1$ of the subspace \mathcal{P}_a . For $N \leq l_b \leq N + 2M - 5$, the monomial

term having $X_{0,0}^{a,0}$ as a coefficient in the decomposition of $X_{m,0}$ is outside the region of moduli (at these levels we are outside the subspace \mathcal{P}_a) and so we will see that the vector field $X_{m,0}$ acts only on the subspace \mathcal{P}_b starting precisely at the level $l_b = m + 2$.

The vector fields $X_{m,1}$ may start action on the subspaces \mathcal{P}_a and \mathcal{P}_b . The first level of the subspace \mathcal{P}_a at which $X_{m,1}$ may have an action is $l_a = m + 3$ and that of the subspace \mathcal{P}_b is $l_b = m + 3$ as well. If $M = 2$, then there are no moduli in the region associated to the subspace \mathcal{P}_b , and so we can use the vector field $X_{m,1}$ to kill one modulus at each level $l_a = m + 3$ of the subspace \mathcal{P}_a . If $M > 2$, then for $3 \leq l_b \leq N + 1$, $l_a = l_b$, the vector fields $X_{m,1}$ can be used to kill one modulus at each level $l_b = m + 3$ of the subspace \mathcal{P}_b . For $N + 2 \leq l_b \leq N + 2M - 5$, the monomial term having $X_{0,0}^{a,0}$ as a coefficient in the decomposition of $X_{m,1}$ is outside the region of moduli, and so we will see that this vector field acts only on the subspace \mathcal{P}_b starting precisely at the level $l_b = m + 4$.

For $n \neq 0, 1$, the vector fields $X_{m,n}$ may start action on the subspace \mathcal{P}_a . The first level of the subspace \mathcal{P}_a at which $X_{m,n}$ may have an action is $l_a = m + n + 2$ and that of the subspace \mathcal{P}_b is $l_b = m + 2n + 1$ which is strictly greater than $m + n + 2$ as $n \geq 2$: in fact, $X_{m,n} = x^m y^n X_{0,0} = x_4^{m+n} y_4^{m+2n} X_{0,0}$ and the levels of the subspace \mathcal{P}_a are determined by the powers of x_4 and those of the subspace \mathcal{P}_b are determined by the powers of y_4 . For $l_a \geq 4$, $X_{m,n}$ can be used to kill a modulus which is exactly at the level $l_a = m + n + 2$ of the subspace \mathcal{P}_a . However, once all the moduli at a certain level are killed, the extra vector fields acting at this level can be used to kill moduli at the level $l_b = m + 2n + 1$ of the subspace \mathcal{P}_b if the monomial term having $X_{0,0}^{a,0}$ as a coefficient in the decomposition of $X_{m,n}$ is inside the region of moduli. Otherwise, if it is outside the region of moduli, then either the extra vector fields $X_{m,n}$ do not act at the level $l_b = m + 2n + 1$ but act and can be used to kill moduli at the level $l_b = m + 2n + 2$ of the subspace \mathcal{P}_b , or they actually act at the level $l_b = m + 2n + 1$ of the subspace \mathcal{P}_b but all the moduli at this level and the next levels are killed. This also works for the extra vector fields acting at the higher levels of the subspace \mathcal{P}_a .

Based on that, we denote by $\nu_{m,n} + 1 = m + 2n + 1$ the first level of the subspace \mathcal{P}_b at which a vector field $X_{m,n}$ may have an action.

We note that if $M > 2$, then killing moduli on the subspace \mathcal{P}_b always starts at the level $l_b = 3$ and this is because we use $X_{0,0}$ to kill a modulus at the first level of the subspace \mathcal{P}_a and $X_{1,0}$ to kill a modulus at the second level (if it exists, i.e. $N > 2$), so $X_{0,1}$ will be used at the third level of the subspace \mathcal{P}_b (if $N = 2$ then both $X_{1,0}$ and $X_{0,1}$ will be used at the third level of the subspace \mathcal{P}_b).

Using the equations of the edges of the region of moduli, we find that the monomial term having $X_{0,0}^{a,0}$ as a coefficient in the decomposition of $X_{m,n}$, which is $x_4^{m+n} y_4^{m+2n}$, is inside the region of moduli when m and n satisfy the following inequalities

$$\begin{cases} n + 1 & \leq M - 1 \\ m + 1 & \leq N - 1. \end{cases}$$

The vector fields $X_{m,n}$ such that $m \geq N - 1$ and $n \neq 0$ do not actually act at the level

$\nu_{m,n} + 1$ of the subspace \mathcal{P}_b . The following lemma shows that they act at the next level. We note that they do not even act on the subspace \mathcal{P}_a .

Lemma 3.2.2. *For a fixed integer d , the vector fields $X_{m,n}$ such that $\nu_{m,n} + 1 = d + 1$ and $m \geq N - 1$ act at the level $\nu_{m,n} + 2 = m + 2n + 2 = d + 2$ of the subspace \mathcal{P}_b when there are moduli at this level.*

Proof. If $m \geq N - 1$, then the vector fields $X_{m,n}$ such that $\nu_{m,n} + 1 = d + 1$ do not act at the level $\nu_{m,n} + 1 = N + 1 + i$ where $-1 \leq i \leq 2M - 6$: $X_{m,0}$ does not act at the level $\nu_{m,n} + 1$ of the subspace \mathcal{P}_a and $X_{m,n}$ such that $n \neq 0$ does not act at the level $\nu_{m,n} + 1$ of the subspace \mathcal{P}_b . They are given by

$$\begin{cases} \left\{ X_{N-1+2j, \frac{i+1}{2}-j} \right\}_{0 \leq j \leq \frac{i+1}{2}} & \text{if } i \text{ is odd} \\ \left\{ X_{N+2j, \frac{i}{2}-j} \right\}_{0 \leq j \leq \frac{i}{2}} & \text{if } i \text{ is even.} \end{cases}$$

If $i = -1$, then $X_{N-1,0} = x_4^{N-1} y_4^{N-1} X_{0,0}$ is the only vector field $X_{m,n}$ such that $m \geq N - 1$ and $\nu_{m,n} + 1 = N$ which does not act at the level N of the subspace \mathcal{P}_a (because it does not exist actually): indeed it is the first vector field for which the monomial term having $X_{0,0}^{a,0}$ as a coefficient in its decomposition, which is $x_4^{N-1} y_4^{N-1}$, is outside the region of moduli: it is actually at the edge of equation $(2x_4 - y_4 - (N - 1) = 0)$ of the region. Supposing that $M > 2$ (otherwise there are no moduli in the region associated to the subspace \mathcal{P}_b), the coefficient of y_4 in the decomposition of $X_{0,0}$, which is $X_{0,0}^{b,1}$, is different from zero. So, the vector field $X_{N-1,0}$ acts at the level $N + 1$ of the subspace \mathcal{P}_b : in its decomposition, $X_{0,0}^{b,1}$ is the coefficient of $x_4^{N-1} y_4^N$ which is the first monomial term inside the region of moduli at the level $N + 1$.

If $0 \leq i \leq 2M - 6$, such that i is odd, then since $X_{N-1, \frac{i+1}{2}} = y^{\frac{i+1}{2}} X_{N-1,0}$, the monomial term having $X_{0,0}^{a,0}$ as a coefficient in the decomposition of $X_{N-1, \frac{i+1}{2}}$ is also at the edge of equation $(2x_4 - y_4 - (N - 1) = 0)$ of the region of moduli (as $y = x_4 y_4^2$). Again since $M > 2$, the vector field $X_{N-1, \frac{i+1}{2}}$, which does not act at the level $N + 1 + i$ of the subspace \mathcal{P}_b , acts at the level $N + 1 + (i + 1)$: also in its decomposition, $X_{0,0}^{b,1}$ is the coefficient of $x_4^{N-1+\frac{i+1}{2}} y_4^{N-1+i+2}$ which is the first monomial term inside the region of moduli at the level $N + 1 + (i + 1)$. Now, for the other vector fields, we have

$$X_{N-1+2j, \frac{i+1}{2}-j} = \frac{x_4^{2j}}{y_4^j} X_{N-1, \frac{i+1}{2}} = x_4^j X_{N-1, \frac{i+1}{2}}.$$

If $j + 1 \leq M - 2$, then the coefficient of $\frac{y_4}{x_4^j}$ in the decomposition of $X_{0,0}$, which is $X_{0,0}^{b,j+1}$, is different from zero, and so the first monomial term inside the region at the level $N + 1 + (i + 1)$ which is $x_4^{N-1+\frac{i+1}{2}} y_4^{N-1+i+2}$ will have $X_{0,0}^{b,j+1}$ as a coefficient in the decomposition of $X_{N-1+2j, \frac{i+1}{2}-j}$. This means that to show that the vector fields

$\left\{X_{N-1+2j, \frac{i+1}{2}-j}\right\}_{0 \leq j \leq \frac{i+1}{2}}$ act at the level $N + 1 + (i + 1)$, it is enough to show that we have the following inequality

$$j + 1 \leq M - 2$$

for $0 \leq j \leq \frac{i+1}{2}$, which ensures the existence of $\frac{y_4}{x_4^j}$ for all $0 \leq j \leq \frac{i+1}{2}$ in the decomposition of $X_{0,0}$. In fact, it is enough to show that these vector fields act at the level $\nu_{m,n} + 2 = N + 1 + (i + 1) = d + 2$ when there are moduli at this level. More precisely, we need to consider the action of the r vector fields $\left\{X_{N-1+2j, \frac{i+1}{2}-j}\right\}_{0 \leq j \leq r-1}$ at the level $d + 2$ if the number of points at this level is greater than or equal to r i.e. if we have the following inequality $q_{d+2} \geq r$ where $q_{d+2} = \lfloor \frac{d+N}{2} \rfloor + M - (d + 2)$. It clearly implies that $j + 1 \leq M - 2$ for all $0 \leq j \leq r - 1$.

If $0 \leq i \leq 2M - 6$, such that i is even, then we have

$$X_{N+2j, \frac{i}{2}-j} = x^{2j+1} y^{\frac{i}{2}-j} X_{N-1,0} = \left(x_4^{j+1} y_4\right) \left(x_4 y_4^2\right)^{\frac{i}{2}} X_{N-1,0}.$$

Similarly if $j + 2 \leq M - 2$, then the coefficient of $\frac{y_4}{x_4^{j+1}}$ in the decomposition of $X_{0,0}$, which is $X_{0,0}^{b,j+2}$, is different from zero, and so the first monomial term inside the region of moduli at the level $N + 1 + (i + 1)$ which is $x_4^{N-1+\frac{i}{2}} y_4^{N-1+i+2}$ will have $X_{0,0}^{b,j+2}$ as a coefficient in the decomposition of $X_{N+2j, \frac{i}{2}-j}$. This means that to show that the vector fields $\left\{X_{N+2j, \frac{i}{2}-j}\right\}_{0 \leq j \leq \frac{i}{2}}$ act at the level $N + 1 + (i + 1)$, it is enough to show that we have the following inequality

$$j + 2 \leq M - 2$$

for $0 \leq j \leq \frac{i}{2}$, which ensures the existence of $\frac{y_4}{x_4^{j+1}}$ for all $0 \leq j \leq \frac{i}{2}$ in the decomposition of $X_{0,0}$. As before, it is enough to show that these vector fields act at the level $\nu_{m,n} + 2 = N + 1 + (i + 1) = d + 2$ when there are moduli at this level. More precisely, we need to consider the action of the r vector fields $\left\{X_{N+2j, \frac{i}{2}-j}\right\}_{0 \leq j \leq r-1}$ at the level $d + 2$ if the number of points at this level is greater than or equal to r i.e. if we have the following inequality $q_{d+2} \geq r$ where $q_{d+2} = \lfloor \frac{d+N}{2} \rfloor + M - (d + 2)$. It clearly implies that $j + 2 \leq M - 2$ for all $0 \leq j \leq r - 1$. \square

If $M > 2$, then the vector fields $X_{m,n}$ such that $n \geq M - 1$, which are extra from the region associated to the subspace \mathcal{P}_a , may start action at the level $\nu_{m,n} + 1$ of the subspace \mathcal{P}_b . In the next lemma, which deals with the generic dimension of the distribution \mathcal{C} , we will see that all the moduli at such a level as well as the next levels are killed. Lemma (3.2.1) is equivalent to:

Lemma 3.2.3. *If $M > 2$ and $N \geq 6$, then for any $d = 0, \dots, N + 2M - 6$, the dimension of the vector space generated by the vector fields $X_{m,n}$ which act at the level $l = d + 1$ is*

given by:

$$\left\{ \begin{array}{ll} 1 & \text{if } d = 0, 1 \\ 2 & \text{if } d = 2 \\ 1 + \min(N - d - 1, d - 1) & \text{if } 3 \leq d \leq \lfloor \frac{N+2}{2} \rfloor \\ N - d + \min(M - 3, \lfloor \frac{2i+1}{3} \rfloor + 1) & \text{if } d = \frac{N}{2} + 2 + i \text{ where} \\ & 0 \leq i \leq \frac{N}{2} - 3 \text{ and } N \text{ is even} \\ N - d + \min(M - 3, \lfloor \frac{2i}{3} \rfloor + 1) & \text{if } d = \frac{N+1}{2} + 1 + i \text{ where} \\ & 0 \leq i \leq \frac{N+1}{2} - 3 \text{ and } N \text{ is odd} \\ 1 + \min(M - 3, \lfloor \frac{N-3}{3} \rfloor + 2) & \text{if } d = N \\ \min(q_{N+1+r}, \lfloor \frac{N-3+2r}{3} \rfloor + \lfloor \frac{r}{2} \rfloor - \lfloor \frac{r-1}{2} \rfloor + 2) & \text{if } d = N + r \text{ where } 1 \leq r \leq N - 4 \\ \min(q_{N+1+r}, N - 2 + \lfloor \frac{r-N+4}{2} \rfloor + \lfloor \frac{r}{2} \rfloor - \lfloor \frac{r-1}{2} \rfloor) & \text{if } d = N + r \text{ where} \\ & N - 3 \leq r \leq 2M - 6. \end{array} \right.$$

Proof. It is clear that only $X_{0,0}$ acts at the level $l = 1$ and $X_{1,0}$ acts at the level $l = 2$. The vector fields $X_{2,0}$ and $X_{0,1}$ act at the level $l = 3$ and they are linearly independent. In fact, their decomposition is given by the following invertible matrix

$$\begin{array}{cc} & X_{2,0} \quad X_{0,1} \\ \begin{array}{c} x_4^2 y_4^2 \\ x_4 y_4^2 \end{array} & \begin{pmatrix} X_{0,0}^{a,0} & Y_{0,0}^{a,1} \\ 0 & X_{0,0}^{a,0} \end{pmatrix}. \end{array}$$

For $d \geq 3$, the vector field $X_{m,0}$ such that $m+1 = d+1$ acts at the level $l_a = d+1$ of the subspace \mathcal{P}_a . The vector field $X_{m,1}$ such that $m+3 = d+1$ acts at the level $l_b = d+1$ of the subspace \mathcal{P}_b (it also acts at the level $l_a = d+1$ of the subspace \mathcal{P}_a but we will consider its action on the subspace \mathcal{P}_b as $M > 2$). The number of vector fields $X_{m,n}$ such that $n \neq 0, 1$ and $m+n+2 = d+1$ is equal to $d-2$ and the number of points at the level $l_a = d+1$ of the subspace \mathcal{P}_a is equal to $N-d-1$.

If N is even, then the first level of the subspace \mathcal{P}_a having all the moduli killed corresponds to $d = \frac{N}{2}$ and there are no extra vector fields at this level. For $d = \frac{N}{2} + 1$, there are two extra vector fields acting at the level $l_a = d+1$. Among them, the vector field $X_{m,n}$ with the smallest n is given by $X_{\frac{N}{2}-2,2}$. This vector field acts on the subspace \mathcal{P}_b starting precisely at the level $l_b = \frac{N}{2} + 3$. Thus, if $3 \leq d \leq \frac{N}{2} + 1$, then the dimension of the vector space generated by the vector fields $X_{m,n}$ which act at the level $l = d+1$ is equal to $1 + \min(N-d-1, d-1)$. In fact, if $3 \leq d \leq \frac{N}{2}$, then their decomposition is given by the matrix

$$\begin{array}{c} x_4^d y_4^2 \\ \vdots \\ x_4^d y_4^{d-1} \\ x_4^d y_4^d \\ x_4^{d-1} y_4^d \end{array} \begin{pmatrix} X_{0,d-1} & X_{1,d-2} & \cdots & X_{d-3,2} & X_{d,0} & X_{d-2,1} \\ Y_{0,0}^{a,2d-3} & Y_{0,0}^{a,2d-4} & \cdots & Y_{0,0}^{a,d} & 0 & Y_{0,0}^{a,d-1} \\ \vdots & \vdots & & \vdots & \vdots & \vdots \\ Y_{0,0}^{a,d} & Y_{0,0}^{a,d-1} & \cdots & Y_{0,0}^{a,3} & 0 & Y_{0,0}^{a,2} \\ Y_{0,0}^{a,d-1} & Y_{0,0}^{a,d-2} & \cdots & Y_{0,0}^{a,2} & X_{0,0}^{a,0} & Y_{0,0}^{a,1} \\ 0 & 0 & \cdots & 0 & 0 & X_{0,0}^{a,0} \end{pmatrix}$$

which is clearly invertible. If $d = \frac{N}{2} + 1$ and $d \neq N - 2$, then their decomposition is given by the matrix

$$\begin{matrix}
 x_4^d y_4^{2d-N+2} \\
 \vdots \\
 x_4^d y_4^{d-1} \\
 x_4^d y_4^d \\
 x_4^{d-1} y_4^d
 \end{matrix}
 \begin{pmatrix}
 X_{0,d-1} & X_{1,d-2} & \cdots & X_{N-d-3,2d-N+2} & X_{d,0} & X_{d-2,1} \\
 Y_{0,0}^{a,N-3} & Y_{0,0}^{a,N-4} & \cdots & Y_{0,0}^{a,d} & 0 & Y_{0,0}^{a,N-d-1} \\
 \vdots & \vdots & & \vdots & \vdots & \vdots \\
 Y_{0,0}^{a,d} & Y_{0,0}^{a,d-1} & \cdots & Y_{0,0}^{a,2d-N+3} & 0 & Y_{0,0}^{a,2} \\
 Y_{0,0}^{a,d-1} & Y_{0,0}^{a,d-2} & \cdots & Y_{0,0}^{a,2d-N+2} & X_{0,0}^{a,0} & Y_{0,0}^{a,1} \\
 0 & 0 & \cdots & 0 & 0 & X_{0,0}^{a,0}
 \end{pmatrix}$$

which is clearly invertible as well. We note that if $d = \frac{N}{2} + 1 = N - 2$, then the associated matrix is the principle submatrix of the above matrix corresponding to the vector fields $X_{d,0}$ and $X_{d-2,1}$.

To know the number of vector fields which act at the level l_b of the subspace \mathcal{P}_b for $\frac{N}{2} + 3 \leq l_b \leq N$, we have to count the extra vector fields acting at the levels $\frac{N}{2} + 2 \leq l_a \leq N - 1$ of the subspace \mathcal{P}_a . For that we write $d = \frac{N}{2} + j$ where $1 \leq j \leq \frac{N}{2} - 2$, and so the number of the extra vector fields acting at the level $l_a = d + 1$ is equal to $2j$. We can easily check that among them the number of those which act at the level $l_b = \frac{N}{2} + 3 + i$ where $0 \leq i \leq \frac{N}{2} - 3$ is equal to $\lceil \frac{2i+1}{3} \rceil + 1$. We note that at the levels $\frac{N}{2} + 3 \leq l_a \leq N$, all the moduli are killed. Thus, if $\frac{N}{2} + 2 \leq d \leq N - 3$, then the decomposition of the vector fields which act at the level $l = d + 1$ is given by the following invertible matrix

$$\begin{matrix}
 x_4^d y_4^{2d-N+2} \\
 \vdots \\
 x_4^d y_4^{d-1} \\
 x_4^d y_4^d \\
 x_4^{d-1} y_4^d \\
 \hline
 x_4^{d-2} y_4^d \\
 x_4^{d-3} y_4^d \\
 \vdots \\
 x_4^{d-1-m_1} y_4^d
 \end{matrix}
 \begin{pmatrix}
 X_{0,d-1} & X_{1,d-2} & \cdots & X_{N-d-3,2d-N+2} & X_{d,0} & X_{d-2,1} & X_{\frac{N}{2}-2+i,2} & X_{\frac{N}{2}-4+i,3} & \cdots & X_{\frac{N}{2}+i-2m_1,m_1+1} \\
 Y_{0,0}^{a,N-3} & Y_{0,0}^{a,N-4} & \cdots & Y_{0,0}^{a,d} & 0 & Y_{0,0}^{a,N-d-1} & & & & \\
 \vdots & \vdots & & \vdots & \vdots & \vdots & & & & \\
 Y_{0,0}^{a,d} & Y_{0,0}^{a,d-1} & \cdots & Y_{0,0}^{a,2d-N+3} & 0 & Y_{0,0}^{a,2} & & & * & \\
 Y_{0,0}^{a,d-1} & Y_{0,0}^{a,d-2} & \cdots & Y_{0,0}^{a,2d-N+2} & X_{0,0}^{a,0} & Y_{0,0}^{a,1} & & & & \\
 0 & 0 & \cdots & 0 & 0 & X_{0,0}^{a,0} & & & & \\
 \hline
 & & & & & & X_{0,0}^{a,0} & & & * \\
 & & & & & & & X_{0,0}^{a,0} & & \\
 & & & & & & & & \ddots & \\
 & & & 0 & & & & & & X_{0,0}^{a,0}
 \end{pmatrix},$$

where $m_1 = \min(\lceil \frac{2i+1}{3} \rceil + 1, M - 3)$. If $d = N - 2$ (respectively $d = N - 1$), then their decomposition is given by a matrix of the above form such that the first block matrix reduces to its principle submatrix corresponding to the vector fields $X_{d,0}$ and $X_{d-2,1}$ (respectively $X_{d-2,1}$).

Now, for $d = N - 1$, the number of vector fields $X_{m,n}$ such that $n \neq 0, 1$ and $m + n + 2 = d + 1$ is equal to $d - 2 = N - 3$. Actually, if we write d as before i.e. $d = \frac{N}{2} + j$ with $j = \frac{N}{2} - 1$, then this number is not equal to $2j = N - 2$. The vector field among them having the greatest n is given by $X_{0,N-2}$. Since this vector field starts action at the level $l_b = 2N - 3$ of the subspace \mathcal{P}_b , then we can not use the previous formula to find the number of vector fields which act at the levels $l_b \geq 2N - 2$ of the subspace \mathcal{P}_b . If we write $d = 2N - 3 + j$ where $0 \leq j \leq 2M - N - 3$, we can easily check that among them

the number of those which act at the level $l_b = d + 1$ is equal to $N - 3 + \left\lceil \frac{j+1}{2} \right\rceil$. For the levels $l_b = d + 1 = N + 1 + r$ where $0 \leq r \leq 2M - 6$, we know from lemma (3.2.2) that among the vector fields $X_{m,n}$ such that $n \neq 0, 1$ and $m + 2n + 1 = d + 1$, there are $\left\lceil \frac{r-1}{2} \right\rceil$ vector fields such that $m \geq N - 1$ which do not act at the level $l_b = d + 1$. They are given by the family

$$\begin{cases} \left\{ X_{d-4,2}, \dots, X_{N-1, \frac{r+1}{2}} \right\} & \text{if } r \geq 3 \text{ is odd} \\ \left\{ X_{d-4,2}, \dots, X_{N, \frac{r}{2}} \right\} & \text{if } r \geq 4 \text{ is even.} \end{cases}$$

However, we also know from lemma (3.2.2), that at the previous level $l_b = d_{r-1} + 1$ where $d_{r-1} = N + (r - 1)$, there are $\left\lceil \frac{r}{2} \right\rceil + 1$ vector fields $X_{m,n}$ such that $m + 2n + 1 = d_{r-1} + 1$ which do not act at the level $l_b = d_{r-1} + 1$ because $m \geq N - 1$ but act at the level $l_b = d_r + 1$ where $d_r = N + r$. They are given by the family

$$\begin{cases} \left\{ X_{N-1+r,0}, \dots, X_{N, \frac{r-1}{2}} \right\} & \text{if } r \text{ is odd} \\ \left\{ X_{N-1+r,0}, \dots, X_{N-1, \frac{r}{2}} \right\} & \text{if } r \text{ is even.} \end{cases}$$

We note that the vector fields $X_{m,n}$ such that $m \geq N - 1$ do not act on the subspace \mathcal{P}_a . Thus, if $0 \leq r \leq N - 4$ and r is odd, then if the number of the vector fields which act at the level $l_b = N + 1 + r$, which is equal to $n_1 = \left\lceil \frac{N-3+2r}{3} \right\rceil + 2$, is less than or equal to the number of points at this level, then their decomposition is given by the matrix

$$\begin{array}{l} \begin{array}{l} x_4^{N+\frac{r+1}{2}-2} y_4^{N+r} \\ x_4^{N+\frac{r+1}{2}-3} y_4^{N+r} \\ \vdots \\ x_4^{N+r-n_1} y_4^{N+r} \\ x_4^{N+r-n_1-1} y_4^{N+r} \\ \vdots \\ x_4^{N+\frac{r+1}{2}-n_1-1} y_4^{N+r} \end{array} \begin{pmatrix} X_{N-3, \frac{r+1}{2}+1} & X_{N-5, \frac{r+1}{2}+2} & \cdots & X_{N+r-2n_1, n_1} & X_{N-1+r,0} & X_{N-3+r,1} & \cdots & X_{N, \frac{r-1}{2}} \\ X_{0,0}^{a,0} & & & * & X_{0,0}^{b, \frac{r-1}{2}+2} & X_{0,0}^{b, \frac{r-1}{2}+1} & \cdots & X_{0,0}^{b,2} \\ & X_{0,0}^{a,0} & & & X_{0,0}^{b, \frac{r-1}{2}+3} & X_{0,0}^{b, \frac{r-1}{2}+2} & \cdots & X_{0,0}^{b,3} \\ & & \ddots & & \vdots & \vdots & & \vdots \\ 0 & & & X_{0,0}^{a,0} & X_{0,0}^{b, n_1} & X_{0,0}^{b, n_1-1} & \cdots & X_{0,0}^{b, n_1 - \frac{r-1}{2}} \\ \hline & & & & X_{0,0}^{b, n_1+1} & X_{0,0}^{b, n_1} & \cdots & X_{0,0}^{b, n_1 - \frac{r-3}{2}} \\ & & 0 & & \vdots & \vdots & & \vdots \\ & & & & X_{0,0}^{b, n_1 + \frac{r+1}{2}} & X_{0,0}^{b, n_1 + \frac{r-1}{2}} & \cdots & X_{0,0}^{b, n_1+1} \end{pmatrix} \cdot \end{array}$$

We note that having vector fields less than the number of points at that level is equivalent to having the following inequality

$$n_1 \leq M - 2 - \frac{r+1}{2}.$$

This ensures that all the entries $X_{0,0}^{b,j}$ in the last block matrix of the above matrix satisfy $j \leq M - 2$ and so they are different from zero. Otherwise, if their number is greater than the number of the points at that level, then their decomposition is given by a principal sub-matrix of size q_{N+1+r} of the above matrix. So, it is invertible.

Similarly, if $0 \leq r \leq N - 4$ and r is even, then if the number of the vector fields which act at the level $l_b = N + 1 + r$, which is equal to $n_2 = \left\lceil \frac{N-3+2r}{3} \right\rceil + 3$, is less than or equal

to the number of points at this level, then their decomposition is given by the matrix

$$\begin{array}{c} x_4^{N+\frac{r}{2}-1} y_4^{N+r} \\ x_4^{N+\frac{r}{2}-2} y_4^{N+r} \\ \vdots \\ x_4^{N+r-n_2+1} y_4^{N+r} \\ x_4^{N+r-n_2} y_4^{N+r} \\ \vdots \\ x_4^{N+\frac{r}{2}-n_2} y_4^{N+r} \end{array} \left(\begin{array}{cccc|cccc} X_{N-2, \frac{r}{2}+1} & X_{N-4, \frac{r}{2}+2} & \cdots & X_{N+r-2n_2+2, n_2-1} & X_{N-1+r, 0} & X_{N-3+r, 1} & \cdots & X_{N-1, \frac{r}{2}} \\ X_{0,0}^{a,0} & & & * & X_{0,0}^{b, \frac{r}{2}+1} & X_{0,0}^{b, \frac{r}{2}} & \cdots & X_{0,0}^{b,1} \\ & X_{0,0}^{a,0} & & & X_{0,0}^{b, \frac{r}{2}+2} & X_{0,0}^{b, \frac{r}{2}+1} & \cdots & X_{0,0}^{b,2} \\ & & \ddots & & \vdots & \vdots & & \vdots \\ & & & X_{0,0}^{a,0} & X_{0,0}^{b, n_2-1} & X_{0,0}^{b, n_2-2} & \cdots & X_{0,0}^{b, n_2 - \frac{r}{2} - 1} \\ 0 & & & & X_{0,0}^{b, n_2} & X_{0,0}^{b, n_2-1} & \cdots & X_{0,0}^{b, n_2 - \frac{r}{2}} \\ & & & & \vdots & \vdots & & \vdots \\ & 0 & & & X_{0,0}^{b, n_2 + \frac{r}{2}} & X_{0,0}^{b, n_2 + \frac{r}{2} - 1} & \cdots & X_{0,0}^{b, n_2} \end{array} \right).$$

Having vector fields less than the number of points at that level is equivalent to having the following inequality

$$n_2 \leq M - 2 - \frac{r}{2}.$$

This ensures that all the entries $X_{0,0}^{b,j}$ in the last block matrix of the above matrix satisfy $j \leq M - 2$ and so they are different from zero. Otherwise their decomposition is given by a principal sub-matrix of size q_{N+1+r} of the above matrix. So, it is invertible.

Now, if $N - 3 \leq r \leq 2M - 6$ and r is odd, then the number of the vector fields which act at the level $l_b = N + 1 + r$ is equal to $n_3 = \lceil \frac{r-N+4}{2} \rceil + N - 2$. If this number is less than or equal to the number of points at this level, then their decomposition is given by the matrix

$$\begin{array}{c} x_4^{N+\frac{r+1}{2}-2} y_4^{N+r} \\ x_4^{N+\frac{r+1}{2}-3} y_4^{N+r} \\ \vdots \\ x_4^{n_3+1} y_4^{N+r} \\ x_4^{n_3} y_4^{N+r} \\ \vdots \\ x_4^{\frac{N}{2}} y_4^{N+r} \end{array} \left(\begin{array}{cccc|cccc} X_{N-3, \frac{r+1}{2}+1} & X_{N-5, \frac{r+1}{2}+2} & \cdots & X_{N+r-2n_3, n_3} & X_{N-1+r, 0} & X_{N-3+r, 1} & \cdots & X_{N, \frac{r-1}{2}} \\ X_{0,0}^{a,0} & & & * & X_{0,0}^{b, \frac{r-1}{2}+2} & X_{0,0}^{b, \frac{r-1}{2}+1} & \cdots & X_{0,0}^{b,2} \\ & X_{0,0}^{a,0} & & & X_{0,0}^{b, \frac{r-1}{2}+3} & X_{0,0}^{b, \frac{r-1}{2}+2} & \cdots & X_{0,0}^{b,3} \\ & & \ddots & & \vdots & \vdots & & \vdots \\ & & & X_{0,0}^{a,0} & X_{0,0}^{b, n_3} & X_{0,0}^{b, n_3-1} & \cdots & X_{0,0}^{b, \frac{N}{2}} \\ 0 & & & & X_{0,0}^{b, n_3+1} & X_{0,0}^{b, n_3} & \cdots & X_{0,0}^{b, \frac{N}{2}+1} \\ & & & & \vdots & \vdots & & \vdots \\ & 0 & & & X_{0,0}^{b, \frac{N}{2}+r} & X_{0,0}^{b, \frac{N}{2}+r-1} & \cdots & X_{0,0}^{b, \frac{N+r+1}{2}} \end{array} \right).$$

which is invertible for the same previous reason. Otherwise their decomposition is given by a principal sub-matrix of size q_{N+1+r} of the above matrix.

If $N - 3 \leq r \leq 2M - 6$ and r is even, then the number of the vector fields which act at the level $l_b = N + 1 + r$ is equal to $n_4 = \lfloor \frac{r-N+4}{2} \rfloor + N - 1$. Similarly, if this number is less than or equal to the number of points at this level, then their decomposition is given by the following invertible matrix

$$\begin{array}{c} x_4^{N+\frac{r}{2}-1} y_4^{N+r} \\ x_4^{N+\frac{r}{2}-2} y_4^{N+r} \\ \vdots \\ x_4^{n_4-1} y_4^{N+r} \\ x_4^{n_4-2} y_4^{N+r} \\ \vdots \\ x_4^{\frac{N}{2}-1} y_4^{N+r} \end{array} \left(\begin{array}{cccc|cccc} X_{N-2, \frac{r}{2}+1} & X_{N-4, \frac{r}{2}+2} & \cdots & X_{N+r-2n_4+2, n_4-1} & X_{N-1+r, 0} & X_{N-3+r, 1} & \cdots & X_{N-1, \frac{r}{2}} \\ X_{0,0}^{a,0} & & & * & X_{0,0}^{b, \frac{r}{2}+1} & X_{0,0}^{b, \frac{r}{2}} & \cdots & X_{0,0}^{b,1} \\ & X_{0,0}^{a,0} & & & X_{0,0}^{b, \frac{r}{2}+2} & X_{0,0}^{b, \frac{r}{2}+1} & \cdots & X_{0,0}^{b,2} \\ & & \ddots & & \vdots & \vdots & & \vdots \\ & & & X_{0,0}^{a,0} & X_{0,0}^{b, n_4-1} & X_{0,0}^{b, n_4-2} & \cdots & X_{0,0}^{b, \frac{N}{2}} \\ 0 & & & & X_{0,0}^{b, n_4} & X_{0,0}^{b, n_4-1} & \cdots & X_{0,0}^{b, \frac{N}{2}+1} \\ & & & & \vdots & \vdots & & \vdots \\ & 0 & & & X_{0,0}^{b, \frac{N}{2}+r+1} & X_{0,0}^{b, \frac{N}{2}+r} & \cdots & X_{0,0}^{b, n_4} \end{array} \right).$$

Otherwise their decomposition is given by a principal sub-matrix of size q_{N+1+r} of the above matrix.

We note that if M is odd, then the number of the extra vector fields acting at the level $l_a = d + 1$, where $d = \frac{N}{2} + j$ and $1 \leq j \leq \frac{N}{2} - 2$, is greater than or equal to the number of the remaining points at the horizontal line of equation ($y_4 = d$) of the subspace \mathcal{P}_b if $j \geq \frac{M-3}{2}$. This means that at the levels $l_b \geq \frac{N+3M-1}{2} - 3$, all the moduli are killed. The vector fields $X_{m,n}$ such that $n \geq M - 1$, which act at the level $l_a = m + n + 2$ but extra, satisfy the inequality $m + n \geq \frac{M+N-3}{2}$. Thus, they may start action at the level $l_b \geq \frac{N+3M-3}{2}$ where all the moduli are killed. The number of the vector fields $X_{m,n}$ such that $m + n + 2 = N + s$, where $s \geq 0$, is greater than or equal to the number of points at the horizontal line of equation ($y_4 = N - 1 + s$) of the subspace \mathcal{P}_b if $N - 1 + s \geq M - 2$, so at the levels $l_b \geq N + M - 4$, all the moduli are killed. The vector fields $X_{m,n}$ such that $m + n + 2 = N + s$ and $n \geq M - 1$, where $s \geq 0$, may start action at the levels $l_b \geq M + N - 2$ where all the moduli are killed. A similar argument works if M is even.

The next part of the proof is devoted to the case where N is odd. If N is odd, then the first level of the subspace \mathcal{P}_a having all the moduli killed corresponds to $d = \frac{N+1}{2}$ and there is one extra vector fields at this level. We can choose the vector field $X_{m,n}$ with the smallest n which is given by $X_{\frac{N+1}{2}-3,2}$. This vector field acts on the subspace \mathcal{P}_b starting precisely at the level $l_b = \frac{N+1}{2} + 2$. Thus, if $3 \leq d \leq \frac{N+1}{2}$, then the dimension of the vector space generated by the vector fields $X_{m,n}$ which act at the level $l = d + 1$ is equal to $1 + \min(N - d - 1, d - 1)$.

As in the case where N is even, to know the number of vector fields which act at the level l_b of the subspace \mathcal{P}_b for $\frac{N+1}{2} + 2 \leq l_b \leq N$, we have to count the extra vector fields acting at the levels $\frac{N+1}{2} + 1 \leq l_a \leq N - 1$ of the subspace \mathcal{P}_a . For that we write $d = \frac{N+1}{2} + j$ where $0 \leq j \leq \frac{N+1}{2} - 3$, and so the number of the extra vector fields acting at the level $l_a = d + 1$ is equal to $2j + 1$. Similarly, we can check that among them the number of those which act at the level $l_b = \frac{N+1}{2} + 2 + i$ where $0 \leq i \leq \frac{N+1}{2} - 3$ is equal to $\left\lfloor \frac{2i}{3} \right\rfloor + 1$. Also, we note that at the levels $\frac{N+1}{2} + 2 \leq l_a \leq N$, all the moduli are killed. Now, for $d = N - 1$, the number of vector fields $X_{m,n}$ such that $n \neq 0, 1$ and $m + n + 2 = d + 1$ is equal to $d - 2 = N - 3$. If we write d as before i.e. $d = \frac{N+1}{2} + j$ with $j = \frac{N+1}{2} - 2$, then this number is not equal to $2j + 1 = N - 2$. The vector field among them having the greatest n is given by $X_{0,N-2}$. Since this vector field starts action at the level $l_b = 2N - 3$ of the subspace \mathcal{P}_b , then we can not use the previous formula to find the number of vector fields which act at the levels $l_b \geq 2N - 2$ of the subspace \mathcal{P}_b . Similarly, if we write $d = 2N - 3 + j$ where $0 \leq j \leq 2M - N - 3$, we can easily check that among them the number of those which act at the level $l_b = d + 1$ is equal to $N - 3 + \left\lfloor \frac{j+1}{2} \right\rfloor$. Thus, for the levels $N + 1 \leq l_b \leq 2M + N - 5$, the same argument as the case where N is even works. \square

Remark. If $M > 2$ and $N \leq 5$, then for any $d = 0, \dots, N + 2M - 6$, the dimension of the vector space generated by the vector fields $X_{m,n}$ which act at the level $l = d + 1$ is given by:

1. $N = 5$

$$\begin{cases} 1 & \text{if } d = 0, 1 \\ 2 & \text{if } d = 2, 3 \\ 1 + \min(1, M - 3) & \text{if } d = 4 \\ 1 + \min(2, M - 3) & \text{if } d = 5 \\ \min(3, M - 3) & \text{if } d = 6 \\ \min(q_{r+6}, \lfloor \frac{r}{2} \rfloor + 3) & \text{if } d = r + 5 \text{ where } 2 \leq r \leq 2M - 6. \end{cases}$$

2. $N = 4$

$$\begin{cases} 1 & \text{if } d = 0, 1, 3 \\ 2 & \text{if } d = 2 \\ 1 + \min(2, M - 3) & \text{if } d = 4 \\ \min(q_{r+5}, 2 \lfloor \frac{r}{2} \rfloor - \lfloor \frac{r-1}{2} \rfloor + 2) & \text{if } d = r + 4 \text{ where } 1 \leq r \leq 2M - 6. \end{cases}$$

3. $N = 3$

$$\begin{cases} 1 & \text{if } d = 0, 1, 2 \\ 1 + \min(1, M - 3) & \text{if } d = 3 \\ \min(q_{r+4}, r - \lfloor \frac{r-1}{2} \rfloor + 1) & \text{if } d = r + 3 \text{ where } 1 \leq r \leq 2M - 6. \end{cases}$$

4. $N = 2$

$$\begin{cases} 1 & \text{if } d = 0 \\ 0 & \text{if } d = 1 \\ 1 + \min(1, M - 3) & \text{if } d = 2 \\ \min(q_{r+3}, 2 \lfloor \frac{r}{2} \rfloor - \lfloor \frac{r-1}{2} \rfloor + 1) & \text{if } d = r + 2 \text{ where } 1 \leq r \leq 2M - 6. \end{cases}$$

We note that we can easily check that if the number of the vector fields acting at some level is less than that at the previous level by one (which is the only possible case and it is only possible if $l_b \geq N + 1$), then the number of points at this level is less than the number points at the previous level by one. So, we do not need to consider the vector fields, which are extra at some level, at the next level.

If we let

$$\begin{aligned} \tau_0 = & \sum_{\substack{r=0 \\ q_{N+1+r} \geq \lfloor \frac{N-3+2r}{3} \rfloor + \lfloor \frac{r}{2} \rfloor - \lfloor \frac{r-1}{2} \rfloor + 2}}^{N-4} q_{N+1+r} - \left(\left\lfloor \frac{N-3+2r}{3} \right\rfloor + \left\lfloor \frac{r}{2} \right\rfloor - \left\lfloor \frac{r-1}{2} \right\rfloor + 2 \right) \\ & + \sum_{\substack{r=N-3 \\ q_{N+1+r} \geq N-2 + \lfloor \frac{r-N+4}{2} \rfloor + \lfloor \frac{r}{2} \rfloor - \lfloor \frac{r-1}{2} \rfloor}}^{2M-6} q_{N+1+r} - \left(N - 2 + \left\lfloor \frac{r-N+4}{2} \right\rfloor + \left\lfloor \frac{r}{2} \right\rfloor - \left\lfloor \frac{r-1}{2} \right\rfloor \right), \end{aligned}$$

where exceptionally $q_{N+1} = M - 3$, then the previous lemma implies that we have the following:

Theorem C. *The dimension of the generic strata of the moduli space of $S = \{f_{M,N} = 0\}$ is given by*

1. *if $M, N \neq 2$ and N is even:*

$$\begin{aligned} \tau_{M,N} = & \tau_0 + 3N - 7 + (M - 3) \left(\frac{N}{2} + 2 \right) + \frac{(N-4)(N-6)}{4} \\ & + \sum_{\substack{i=0 \\ \lfloor \frac{2i+1}{3} \rfloor + 1 \leq M-3}}^{\frac{N}{2}-3} \left(M - 4 - \left\lfloor \frac{2i+1}{3} \right\rfloor \right) \end{aligned}$$

2. *if $M, N \neq 2$ and $N \neq 3$ is odd:*

$$\begin{aligned} \tau_{M,N} = & \tau_0 + 3N - 7 + (M - 3) \left(\frac{N-1}{2} + 2 \right) + \frac{(N-5)^2}{4} \\ & + \sum_{\substack{i=0 \\ \lfloor \frac{2i}{3} \rfloor + 1 \leq M-3}}^{\frac{N+1}{2}-3} \left(M - 4 - \left\lfloor \frac{2i}{3} \right\rfloor \right) \end{aligned}$$

3. *if $N = 3, M \neq 2$:*

$$\tau_{M,N} = q_4 + 3M + 3N - 17 + \sum_{r=1}^{2M-6} \left(q_{r+4} - \left\lfloor \frac{r}{2} \right\rfloor - 2 \right)$$

4. *if $M = 2, N \neq 2$:*

$$\tau_{M,N} = 2N - 5 + \sum_{d=2}^{\lfloor \frac{N-1}{2} \rfloor} (N - 2d - 1)$$

5. *if $N = 2$:*

$$\tau_{M,N} = 2(M - 2) + \sum_{\substack{r=0 \\ q_{r+3} \geq \lfloor \frac{r+2}{2} \rfloor + \lfloor \frac{r}{2} \rfloor - \lfloor \frac{r-1}{2} \rfloor}}^{2M-6} q_{r+3} - \left(\left\lfloor \frac{r+2}{2} \right\rfloor + \left\lfloor \frac{r}{2} \right\rfloor - \left\lfloor \frac{r-1}{2} \right\rfloor \right).$$

3.3 Examples.

In this section, we present some explicit examples.

Example 3.3.1. *For $N = 8, M = 7$, we have $\tau_{7,8} = 49$. In fact, the region of moduli $\mathcal{Q}_{M,N}$ is given by*

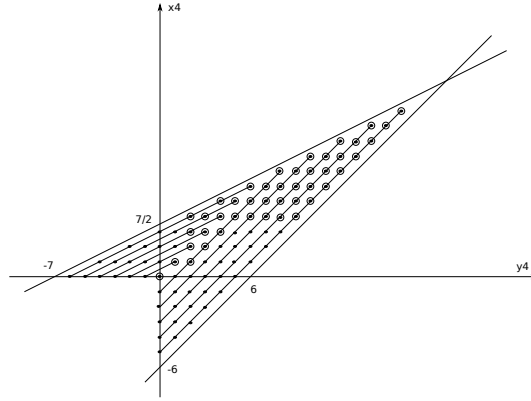
 Figure 3.2 – The region $\mathcal{Q}_{M,N}$ for $N = 8$, $M = 7$

The vector field $X_{0,0}$ is given by

$$X_{0,0} = X_{0,0}^{a,0} + \sum_{i=1}^5 X_{0,0}^{b,i} \left[\frac{y_4}{x_4^{i-1}} \right] + \sum_{j=0}^5 Y_{0,0}^{a,j} \left[\frac{x_4}{y_4^{j-1}} \right] + \dots$$

The vector fields $X_{m,n}$ satisfying $m+n = d$ for $d = 0, \dots, 8$ are given by

$m+n=0$:	$X_{0,0}$	$(l_a = 1)$				
$m+n=1$:	$X_{1,0}$	$(l_a = 2)$	$X_{0,1}$	$(l_b = 3)$		
$m+n=2$:	$X_{2,0}$	$(l_a = 3)$	$X_{1,1}$	$(l_b = 4)$	$X_{0,2}$	$(l_a = 4)$
$m+n=3$:	$X_{3,0}$	$(l_a = 4)$	$X_{2,1}$	$(l_b = 5)$	$X_{1,2}$	$(l_a = 5)$
$m+n=4$:	$X_{4,0}$	$(l_a = 5)$	$X_{3,1}$	$(l_b = 6)$	$X_{2,2}$	$(l_b = 7)$
	$X_{0,4}$	$(l_a = 6)$				$X_{1,3}$
$m+n=5$:	$X_{5,0}$	$(l_a = 6)$	$X_{4,1}$	$(l_b = 7)$	$X_{3,2}$	$(l_b = 8)$
	$X_{1,4}$	$(l_b = 10)$	$X_{0,5}$	$(l_b = 11)$		$X_{2,3}$
$m+n=6$:	$X_{6,0}$	$(l_a = 7)$	$X_{5,1}$	$(l_b = 8)$	$X_{4,2}$	$(l_b = 9)$
	$X_{2,4}$	$(l_b = 11)$	$X_{1,5}$	$(l_b = 12)$	$X_{0,6}$	$(l_b = 13)$
$m+n=7$:	$X_{7,0}$	$(l_b = 9)$	$X_{6,1}$	$(l_b = 9)$	$X_{5,2}$	$(l_b = 10)$
	$X_{3,4}$	$(l_b = 12)$	$X_{2,5}$	$(l_b = 13)$	$X_{1,6}$	$(l_b = 14)$
$m+n=8$:	$X_{8,0}$	$(l_b = 10)$	$X_{7,1}$	$(l_b = 11)$	$X_{6,2}$	$(l_b = 11)$
	$X_{4,4}$	$(l_b = 13)$	$X_{3,5}$	$(l_b = 14)$	$X_{2,6}$	$(l_b = 15)$
	$X_{0,8}$	$(l_b = 17)$				$X_{1,7}$

where the level in the parenthesis is the level at which the vector field acts.

The decomposition of the vector fields acting at the level l such that $l = d + 1$ on the corresponding basis is given by:

- For $l = 1$, we have $X_{0,0}$.
- For $l = 2$, we have $X_{1,0}$.

- For $l = 3$, we have $X_{2,0}$ and $X_{0,1}$.

$$\begin{array}{c} X_{2,0} \quad X_{0,1} \\ x_4^2 y_4^2 \left(\begin{array}{cc} X_{0,0}^{a,0} & Y_{0,0}^{a,1} \\ 0 & X_{0,0}^{a,0} \end{array} \right) \\ x_4 y_4^2 \end{array}$$

- For $l = 4$, we have $X_{0,2}$, $X_{3,0}$ and $X_{1,1}$.

$$\begin{array}{c} X_{0,2} \quad X_{3,0} \quad X_{1,1} \\ x_4^3 y_4^2 \left(\begin{array}{ccc} Y_{0,0}^{a,3} & 0 & Y_{0,0}^{a,2} \\ Y_{0,0}^{a,2} & X_{0,0}^{a,0} & Y_{0,0}^{a,1} \\ 0 & 0 & X_{0,0}^{a,0} \end{array} \right) \\ x_4^3 y_4^3 \\ x_4^2 y_4^3 \end{array}$$

- For $l = 5$, we have $X_{0,3}$, $X_{1,2}$, $X_{4,0}$ and $X_{2,1}$.

$$\begin{array}{c} X_{0,3} \quad X_{1,2} \quad X_{4,0} \quad X_{2,1} \\ x_4^4 y_4^2 \left(\begin{array}{cccc} Y_{0,0}^{a,5} & Y_{0,0}^{a,4} & 0 & Y_{0,0}^{a,3} \\ Y_{0,0}^{a,4} & Y_{0,0}^{a,3} & 0 & Y_{0,0}^{a,2} \\ Y_{0,0}^{a,3} & Y_{0,0}^{a,2} & X_{0,0}^{a,0} & Y_{0,0}^{a,1} \\ 0 & 0 & 0 & X_{0,0}^{a,0} \end{array} \right) \\ x_4^4 y_4^3 \\ x_4^4 y_4^4 \\ x_4^3 y_4^4 \end{array}$$

- For $l = 6$, we have $X_{0,4}$, $X_{5,0}$ and $X_{3,1}$.

$$\begin{array}{c} X_{0,4} \quad X_{5,0} \quad X_{3,1} \\ x_4^5 y_4^4 \left(\begin{array}{ccc} Y_{0,0}^{a,5} & 0 & Y_{0,0}^{a,2} \\ Y_{0,0}^{a,4} & X_{0,0}^{a,0} & Y_{0,0}^{a,1} \\ 0 & 0 & X_{0,0}^{a,0} \end{array} \right) \\ x_4^5 y_4^5 \\ x_4^4 y_4^5 \end{array}$$

- For $l = 7$, we have $X_{6,0}$, $X_{4,1}$ and $X_{2,2}$.

$$\begin{array}{c} X_{6,0} \quad X_{4,1} \quad X_{2,2} \\ x_4^6 y_4^6 \left(\begin{array}{ccc} X_{0,0}^{a,0} & Y_{0,0}^{a,1} & * \\ 0 & X_{0,0}^{a,0} & Y_{0,0}^{a,1} \\ 0 & 0 & X_{0,0}^{a,0} \end{array} \right) \\ x_4^5 y_4^6 \\ x_4^4 y_4^6 \end{array}$$

- For $l = 8$, we have $X_{5,1}$, $X_{3,2}$ and $X_{1,3}$.

$$\begin{array}{c} X_{5,1} \quad X_{3,2} \quad X_{1,3} \\ x_4^6 y_4^7 \left(\begin{array}{ccc} X_{0,0}^{a,0} & Y_{0,0}^{a,1} & * \\ 0 & X_{0,0}^{a,0} & Y_{0,0}^{a,1} \\ 0 & 0 & X_{0,0}^{a,0} \end{array} \right) \\ x_4^5 y_4^7 \\ x_4^4 y_4^7 \end{array}$$

- For $l = 9$, we have $X_{6,1}$, $X_{4,2}$, $X_{2,3}$ and $X_{7,0}$.

$$\begin{array}{c}
 x_4^7 y_4^8 \\
 x_4^6 y_4^8 \\
 x_4^5 y_4^8 \\
 x_4^4 y_4^8
 \end{array}
 \begin{pmatrix}
 X_{6,1} & X_{4,2} & X_{2,3} & X_{7,0} \\
 X_{0,0}^{a,0} & Y_{0,0}^{a,1} & * & X_{0,0}^{b,1} \\
 0 & X_{0,0}^{a,0} & Y_{0,0}^{a,1} & X_{0,0}^{b,2} \\
 0 & 0 & X_{0,0}^{a,0} & X_{0,0}^{b,3} \\
 0 & 0 & 0 & X_{0,0}^{b,4}
 \end{pmatrix}$$

- For $l = 10$, we have $X_{5,2}$, $X_{3,3}$, $X_{1,4}$ and $X_{8,0}$.

$$\begin{array}{c}
 x_4^7 y_4^9 \\
 x_4^6 y_4^9 \\
 x_4^5 y_4^9 \\
 x_4^4 y_4^9
 \end{array}
 \begin{pmatrix}
 X_{5,2} & X_{3,3} & X_{1,4} & X_{8,0} \\
 X_{0,0}^{a,0} & Y_{0,0}^{a,1} & * & X_{0,0}^{b,2} \\
 0 & X_{0,0}^{a,0} & Y_{0,0}^{a,1} & X_{0,0}^{b,3} \\
 0 & 0 & X_{0,0}^{a,0} & X_{0,0}^{b,4} \\
 0 & 0 & 0 & X_{0,0}^{b,5}
 \end{pmatrix}$$

Example 3.3.2. For $N = 9$, $M = 6$, we have $\tau_{6,9} = 47$. The vector field $X_{0,0}$ is given by

$$X_{0,0} = X_{0,0}^{a,0} + \sum_{i=1}^4 X_{0,0}^{b,i} \left[\frac{y_4}{x_4^{i-1}} \right] + \sum_{j=0}^6 Y_{0,0}^{a,j} \left[\frac{x_4}{y_4^{j-1}} \right] + \dots$$

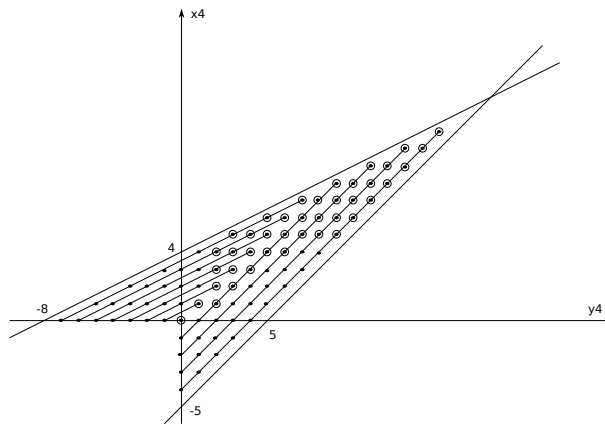

Figure 3.3 – The region $\mathcal{Q}_{M,N}$ for $N = 9$, $M = 6$

The vector fields $X_{m,n}$ satisfying $m + n = d$ for $d = 0, \dots, 9$ are given by

$$\begin{array}{l}
m + n = 0 : X_{0,0} \quad (l_a = 1) \\
m + n = 1 : X_{1,0} \quad (l_a = 2) \quad X_{0,1} \quad (l_b = 3) \\
m + n = 2 : X_{2,0} \quad (l_a = 3) \quad X_{1,1} \quad (l_b = 4) \quad X_{0,2} \quad (l_a = 4) \\
m + n = 3 : X_{3,0} \quad (l_a = 4) \quad X_{2,1} \quad (l_b = 5) \quad X_{1,2} \quad (l_a = 5) \quad X_{0,3} \quad (l_b = 5) \\
m + n = 4 : X_{4,0} \quad (l_a = 5) \quad X_{3,1} \quad (l_b = 6) \quad X_{2,2} \quad (l_b = 7) \quad X_{1,3} \quad (l_a = 6) \\
\quad X_{0,4} \quad (l_a = 6) \\
m + n = 5 : X_{5,0} \quad (l_a = 6) \quad X_{4,1} \quad (l_b = 7) \quad X_{3,2} \quad (l_b = 8) \quad X_{2,3} \quad (l_b = 9) \\
\quad X_{1,4} \quad (l_b = 10) \quad X_{0,5} \quad (l_a = 7) \\
m + n = 6 : X_{6,0} \quad (l_a = 7) \quad X_{5,1} \quad (l_b = 8) \quad X_{4,2} \quad (l_b = 9) \quad X_{3,3} \quad (l_b = 10) \\
\quad X_{2,4} \quad (l_b = 11) \quad X_{1,5} \quad (l_b = 12) \quad X_{0,6} \quad (l_b = 13) \\
m + n = 7 : X_{7,0} \quad (l_a = 8) \quad X_{6,1} \quad (l_b = 9) \quad X_{5,2} \quad (l_b = 10) \quad X_{4,3} \quad (l_b = 11) \\
\quad X_{3,4} \quad (l_b = 12) \quad X_{2,5} \quad (l_b = 13) \quad X_{1,6} \quad (l_b = 14) \quad X_{0,7} \quad (l_b = 15) \\
m + n = 8 : X_{8,0} \quad (l_b = 10) \quad X_{7,1} \quad (l_b = 10) \quad X_{6,2} \quad (l_b = 11) \quad X_{5,3} \quad (l_b = 12) \\
\quad X_{4,4} \quad (l_b = 13) \quad X_{3,5} \quad (l_b = 14) \quad X_{2,6} \quad (l_b = 15) \quad X_{1,7} \quad (l_b = 16) \\
\quad X_{0,8} \quad (-) \\
m + n = 9 : X_{9,0} \quad (l_b = 11) \quad X_{8,1} \quad (l_b = 12) \quad X_{7,2} \quad (l_b = 12) \quad X_{6,3} \quad (l_b = 13) \\
\quad X_{5,4} \quad (l_b = 14) \quad X_{4,5} \quad (l_b = 15) \quad X_{3,6} \quad (l_b = 16) \quad X_{2,7} \quad (-) \\
\quad X_{1,8} \quad (-) \quad X_{0,9} \quad (-)
\end{array}$$

where the dash means that the vector field does not act at any level.

The decomposition of the vector fields acting at the level l such that $l = d + 1$ on the corresponding basis is given by:

- For $l = 1$, we have $X_{0,0}$.
- For $l = 2$, we have $X_{1,0}$.
- For $l = 3$, we have $X_{2,0}$ and $X_{0,1}$.

$$\begin{array}{cc}
& X_{2,0} & X_{0,1} \\
x_4^2 y_4^2 & \left(\begin{array}{cc} X_{0,0}^{a,0} & Y_{0,0}^{a,1} \\ 0 & X_{0,0}^{a,0} \end{array} \right) \\
x_4 y_4^2 & &
\end{array}$$

- For $l = 4$, we have $X_{0,2}$, $X_{3,0}$ and $X_{1,1}$.

$$\begin{array}{ccc}
& X_{0,2} & X_{3,0} & X_{1,1} \\
x_4^3 y_4^2 & \left(\begin{array}{ccc} Y_{0,0}^{a,3} & 0 & Y_{0,0}^{a,2} \\ Y_{0,0}^{a,2} & X_{0,0}^{a,0} & Y_{0,0}^{a,1} \\ 0 & 0 & X_{0,0}^{a,0} \end{array} \right) \\
x_4^3 y_4^3 & & & \\
x_4^2 y_4^3 & & &
\end{array}$$

- For $l = 5$, we have $X_{0,3}$, $X_{1,2}$, $X_{4,0}$ and $X_{2,1}$.

$$\begin{array}{c} x_4^4 y_4^2 \\ x_4^4 y_4^3 \\ x_4^4 y_4^4 \\ x_4^3 y_4^4 \end{array} \begin{pmatrix} X_{0,3} & X_{1,2} & X_{4,0} & X_{2,1} \\ Y_{0,0}^{a,5} & Y_{0,0}^{a,4} & 0 & Y_{0,0}^{a,3} \\ Y_{0,0}^{a,4} & Y_{0,0}^{a,3} & 0 & Y_{0,0}^{a,2} \\ Y_{0,0}^{a,3} & Y_{0,0}^{a,2} & X_{0,0}^{a,0} & Y_{0,0}^{a,1} \\ 0 & 0 & 0 & X_{0,0}^{a,0} \end{pmatrix}$$

- For $l = 6$, we have $X_{0,4}$, $X_{1,3}$, $X_{5,0}$ and $X_{3,1}$.

$$\begin{array}{c} x_4^5 y_4^3 \\ x_4^5 y_4^4 \\ x_4^5 y_4^5 \\ x_4^4 y_4^5 \end{array} \begin{pmatrix} X_{0,4} & X_{1,3} & X_{5,0} & X_{3,1} \\ Y_{0,0}^{a,6} & Y_{0,0}^{a,5} & 0 & Y_{0,0}^{a,3} \\ Y_{0,0}^{a,5} & Y_{0,0}^{a,4} & 0 & Y_{0,0}^{a,2} \\ Y_{0,0}^{a,4} & Y_{0,0}^{a,3} & X_{0,0}^{a,0} & Y_{0,0}^{a,1} \\ 0 & 0 & 0 & X_{0,0}^{a,0} \end{pmatrix}$$

- For $l = 7$, we have $X_{0,5}$, $X_{6,0}$, $X_{4,1}$ and $X_{2,2}$.

$$\begin{array}{c} x_4^6 y_4^5 \\ x_4^6 y_4^6 \\ x_4^5 y_4^6 \\ x_4^4 y_4^6 \end{array} \begin{pmatrix} X_{0,5} & X_{6,0} & X_{4,1} & X_{2,2} \\ Y_{0,0}^{a,6} & 0 & Y_{0,0}^{a,2} & * \\ Y_{0,0}^{a,5} & X_{0,0}^{a,0} & Y_{0,0}^{a,1} & * \\ 0 & 0 & X_{0,0}^{a,0} & Y_{0,0}^{a,1} \\ 0 & 0 & 0 & X_{0,0}^{a,0} \end{pmatrix}$$

- For $l = 8$, we have $X_{7,0}$, $X_{5,1}$ and $X_{3,2}$.

$$\begin{array}{c} x_4^7 y_4^7 \\ x_4^6 y_4^7 \\ x_4^5 y_4^7 \end{array} \begin{pmatrix} X_{7,0} & X_{5,1} & X_{3,2} \\ X_{0,0}^{a,0} & Y_{0,0}^{a,1} & * \\ 0 & X_{0,0}^{a,0} & Y_{0,0}^{a,1} \\ 0 & 0 & X_{0,0}^{a,0} \end{pmatrix}$$

- For $l = 9$, we have $X_{6,1}$, $X_{4,2}$ and $X_{2,3}$.

$$\begin{array}{c} x_4^7 y_4^8 \\ x_4^6 y_4^8 \\ x_4^5 y_4^8 \end{array} \begin{pmatrix} X_{6,1} & X_{4,2} & X_{2,3} \\ X_{0,0}^{a,0} & Y_{0,0}^{a,1} & * \\ 0 & X_{0,0}^{a,0} & Y_{0,0}^{a,1} \\ 0 & 0 & X_{0,0}^{a,0} \end{pmatrix}$$

- For $l = 10$, we have to choose four vector fields among $X_{7,1}$, $X_{5,2}$, $X_{3,3}$, $X_{1,4}$ and $X_{8,0}$.

$$\begin{array}{c}
 X_{7,1} \quad X_{5,2} \quad X_{3,3} \quad X_{1,4} \\
 x_4^8 y_4^9 \begin{pmatrix} X_{0,0}^{a,0} & Y_{0,0}^{a,1} & * & * \\ x_4^7 y_4^9 & 0 & X_{0,0}^{a,0} & Y_{0,0}^{a,1} \\ x_4^6 y_4^9 & 0 & 0 & X_{0,0}^{a,0} & Y_{0,0}^{a,1} \\ x_4^5 y_4^9 & 0 & 0 & 0 & X_{0,0}^{a,0} \end{pmatrix}
 \end{array}$$

Example 3.3.3. For $N = 5$, $M = 7$, we have $\tau_{7,5} = 30$. The vector field $X_{0,0}$ is given by

$$X_{0,0} = X_{0,0}^{a,0} + \sum_{i=1}^5 X_{0,0}^{b,i} \left[\frac{y_4}{x_4^{i-1}} \right] + \sum_{j=0}^2 Y_{0,0}^{a,j} \left[\frac{x_4}{y_4^{j-1}} \right] + \dots$$

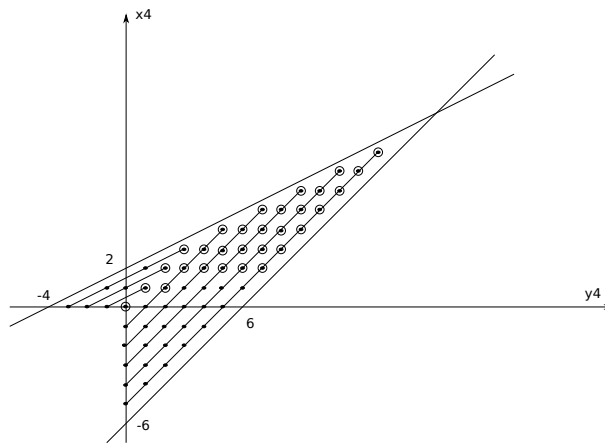

Figure 3.4 – The region $\mathcal{Q}_{M,N}$ for $N = 5$, $M = 7$

The vector fields $X_{m,n}$ satisfying $m + n = d$ for $d = 0, \dots, 8$ are given by

$$\begin{array}{l}
m + n = 0 : X_{0,0} \quad (l_a = 1) \\
m + n = 1 : X_{1,0} \quad (l_a = 2) \quad X_{0,1} \quad (l_b = 3) \\
m + n = 2 : X_{2,0} \quad (l_a = 3) \quad X_{1,1} \quad (l_b = 4) \quad X_{0,2} \quad (l_b = 5) \\
m + n = 3 : X_{3,0} \quad (l_a = 4) \quad X_{2,1} \quad (l_b = 5) \quad X_{1,2} \quad (l_b = 6) \quad X_{0,3} \quad (l_b = 7) \\
m + n = 4 : X_{4,0} \quad (l_b = 6) \quad X_{3,1} \quad (l_b = 6) \quad X_{2,2} \quad (l_b = 7) \quad X_{1,3} \quad (l_b = 8) \\
\quad \quad \quad X_{0,4} \quad (l_b = 9) \\
m + n = 5 : X_{5,0} \quad (l_b = 7) \quad X_{4,1} \quad (l_b = 8) \quad X_{3,2} \quad (l_b = 8) \quad X_{2,3} \quad (l_b = 9) \\
\quad \quad \quad X_{1,4} \quad (l_b = 10) \quad X_{0,5} \quad (l_b = 11) \\
m + n = 6 : X_{6,0} \quad (l_b = 8) \quad X_{5,1} \quad (l_b = 9) \quad X_{4,2} \quad (l_b = 10) \quad X_{3,3} \quad (l_b = 10) \\
\quad \quad \quad X_{2,4} \quad (l_b = 11) \quad X_{1,5} \quad (l_b = 12) \quad X_{0,6} \quad (l_b = 13) \\
m + n = 7 : X_{7,0} \quad (l_b = 9) \quad X_{6,1} \quad (l_b = 10) \quad X_{5,2} \quad (l_b = 11) \quad X_{4,3} \quad (l_b = 12) \\
\quad \quad \quad X_{3,4} \quad (l_b = 12) \quad X_{2,5} \quad (l_b = 13) \quad X_{1,6} \quad (l_b = 14) \quad X_{0,7} \quad (l_b = 15) \\
m + n = 8 : X_{8,0} \quad (l_b = 10) \quad X_{7,1} \quad (l_b = 11) \quad X_{6,2} \quad (l_b = 12) \quad X_{5,3} \quad (l_b = 13) \\
\quad \quad \quad X_{4,4} \quad (l_b = 14) \quad X_{3,5} \quad (l_b = 14) \quad X_{2,6} \quad (-) \quad X_{1,7} \quad (-) \\
\quad \quad \quad X_{0,8} \quad (-)
\end{array}$$

The decomposition of the vector fields acting at the level l such that $l = d + 1$ on the corresponding basis is given by:

- For $l = 1$, we have $X_{0,0}$.
- For $l = 2$, we have $X_{1,0}$.
- For $l = 3$, we have $X_{2,0}$ and $X_{0,1}$.

$$\begin{array}{cc}
& X_{2,0} & X_{0,1} \\
x_4^2 y_4^2 & \left(\begin{array}{cc} X_{0,0}^{a,0} & Y_{0,0}^{a,1} \\ 0 & X_{0,0}^{a,0} \end{array} \right) \\
x_4 y_4^2 & &
\end{array}$$

- For $l = 4$, we have $X_{3,0}$ and $X_{1,1}$.

$$\begin{array}{cc}
& X_{3,0} & X_{1,1} \\
x_4^3 y_4^3 & \left(\begin{array}{cc} X_{0,0}^{a,0} & Y_{0,0}^{a,1} \\ 0 & X_{0,0}^{a,0} \end{array} \right) \\
x_4^2 y_4^3 & &
\end{array}$$

- For $l = 5$, we have $X_{2,1}$ and $X_{0,2}$.

$$\begin{array}{cc}
& X_{2,1} & X_{0,2} \\
x_4^3 y_4^4 & \left(\begin{array}{cc} X_{0,0}^{a,0} & Y_{0,0}^{a,1} \\ 0 & X_{0,0}^{a,0} \end{array} \right) \\
x_4^2 y_4^4 & &
\end{array}$$

- For $l = 6$, we have $X_{3,1}$, $X_{1,2}$ and $X_{4,0}$.

$$\begin{array}{c} X_{3,1} \quad X_{1,2} \quad X_{4,0} \\ x_4^4 y_4^5 \begin{pmatrix} X_{0,0}^{a,0} & Y_{0,0}^{a,1} & X_{0,0}^{b,1} \\ 0 & X_{0,0}^{a,0} & X_{0,0}^{b,2} \\ 0 & 0 & X_{0,0}^{b,3} \end{pmatrix} \\ x_4^3 y_4^5 \\ x_4^2 y_4^5 \end{array}$$

- For $l = 7$, we have $X_{2,2}$, $X_{0,3}$ and $X_{5,0}$.

$$\begin{array}{c} X_{2,2} \quad X_{0,3} \quad X_{5,0} \\ x_4^4 y_4^6 \begin{pmatrix} X_{0,0}^{a,0} & Y_{0,0}^{a,1} & X_{0,0}^{b,2} \\ 0 & X_{0,0}^{a,0} & X_{0,0}^{b,3} \\ 0 & 0 & X_{0,0}^{b,4} \end{pmatrix} \\ x_4^3 y_4^6 \\ x_4^2 y_4^6 \end{array}$$

- For $l = 8$, we have $X_{3,2}$, $X_{1,3}$, $X_{6,0}$ and $X_{4,1}$.

$$\begin{array}{c} X_{3,2} \quad X_{1,3} \quad X_{6,0} \quad X_{4,1} \\ x_4^5 y_4^7 \begin{pmatrix} X_{0,0}^{a,0} & Y_{0,0}^{a,1} & X_{0,0}^{b,2} & X_{0,0}^{b,1} \\ 0 & X_{0,0}^{a,0} & X_{0,0}^{b,3} & X_{0,0}^{b,2} \\ 0 & 0 & X_{0,0}^{b,4} & X_{0,0}^{b,3} \\ 0 & 0 & X_{0,0}^{b,5} & X_{0,0}^{b,4} \end{pmatrix} \\ x_4^4 y_4^7 \\ x_4^3 y_4^7 \\ x_4^2 y_4^7 \end{array}$$

- For $l = 9$, we can choose three vector fields among $X_{2,3}$, $X_{0,4}$, $X_{7,0}$ and $X_{5,1}$.

$$\begin{array}{c} X_{2,3} \quad X_{0,4} \quad X_{7,0} \\ x_4^5 y_4^8 \begin{pmatrix} X_{0,0}^{a,0} & Y_{0,0}^{a,1} & X_{0,0}^{b,3} \\ 0 & X_{0,0}^{a,0} & X_{0,0}^{b,4} \\ 0 & 0 & X_{0,0}^{b,5} \end{pmatrix} \\ x_4^4 y_4^8 \\ x_4^3 y_4^8 \end{array}$$

- For $l = 10$, we can choose three vector fields among $X_{3,3}$, $X_{1,4}$, $X_{8,0}$, $X_{6,1}$ and $X_{4,2}$.

$$\begin{array}{c} X_{3,3} \quad X_{1,4} \quad X_{8,0} \\ x_4^6 y_4^9 \begin{pmatrix} X_{0,0}^{a,0} & Y_{0,0}^{a,1} & X_{0,0}^{b,3} \\ 0 & X_{0,0}^{a,0} & X_{0,0}^{b,4} \\ 0 & 0 & X_{0,0}^{b,5} \end{pmatrix} \\ x_4^5 y_4^9 \\ x_4^4 y_4^9 \end{array}$$

Chapter 4

Second universal family of normal forms of foliations.

In this chapter, we present another universal family of analytic normal forms in section (4.1) (Theorem D). We also prove its global uniqueness in section (4.2) (Theorem E).

4.1 The local normal forms.

Considering the same space of parameters \mathcal{P} , for $p \in \mathcal{P}$, we define the analytic normal form by

$$\underline{N}_p^{(M,N)} = xy(y+x) \prod_{i=1}^{N-2} \left(y + \sum_{k=1}^i a_{k,i} xy^{k-1} \right) \prod_{i=1}^{M-1} \left(y + \sum_{k=1}^{N-3+2i} b_{k,i} x^{k+1} \right).$$

We consider the saturated foliation $\underline{\mathcal{F}}_p^{(M,N)}$ defined by the one-form $d\underline{N}_p^{(M,N)}$ on $\mathbb{C}^{2+\delta_{M,N}}$, and so we have:

Theorem D. *For any p_0 in \mathcal{P} the germ of unfolding $\left\{ \underline{\mathcal{F}}_p^{(M,N)}, p \in (\mathcal{P}, p_0) \right\}$ is a universal equireducible unfolding of the foliation $\underline{\mathcal{F}}_{p_0}^{(M,N)}$.*

Similarly, since, according to theorem (1.2.1), after desingularization any equireducible unfolding is locally analytically trivial, there exists X_l , $l \in \{2, 3, 4\}$, a collection of local vector fields solutions of

$$\frac{\partial \tilde{N}_p^{(M,N)}}{\partial p_{1,i}} = \alpha_{1,i}(x_l, y_l, a_{1,i}, b_{1,i}) \frac{\partial \tilde{N}_p^{(M,N)}}{\partial x_l} + \beta_{1,i}(x_l, y_l, a_{1,i}, b_{1,i}) \frac{\partial \tilde{N}_p^{(M,N)}}{\partial y_l}, \quad (4.1)$$

where $p_{1,i} \in \{a_{1,i}, b_{1,i}\}$. The cocycle $\{X_{2,4} = X_2 - X_4, X_{3,4} = X_3 - X_4\}$ evaluated at $p = p_0$ is the image of the direction $\frac{\partial}{\partial p_{1,i}}$ in $H^1(D, \Theta_{\underline{\mathcal{F}}_{p_0}^{(M,N)}})$ by $T\underline{\mathcal{F}}_{p_0}^{(M,N)}$.

As in the first universal family of analytic normal forms, Theorem D is a consequence of the following proposition.

Proposition 4.1.1. *We consider the unfolding $\tilde{\mathcal{F}}_p^{(M,N)}$ defined by the blowing up of $\underline{N}_p^{(M,N)}$, $p \in (\mathcal{P}, p_0)$. The image of the family $\left\{ \frac{\partial}{\partial a_{k,i}}, \frac{\partial}{\partial b_{k,i}} \right\}_{k,i}$ in $H^1(D, \Theta_{\tilde{\mathcal{F}}_{p_0}^{(M,N)}})$ by $T\tilde{\mathcal{F}}_{p_0}^{(M,N)}$ is linearly free.*

Denoting by A_1 the square matrix of size $M + N - 3$, representing the decomposition of the images of $\left\{ \frac{\partial}{\partial a_{1,i}}, \frac{\partial}{\partial b_{1,i}} \right\}$ in $H^1(D, \Theta_{\tilde{\mathcal{F}}_{p_0}^{(M,N)}})$ by $T\tilde{\mathcal{F}}_{p_0}^{(M,N)}$ on the corresponding basis, the proof of the proposition results from the following two lemmas.

Lemma 4.1.1. *The matrix A_1 is invertible.*

Proof. The matrix A_1 is given by

$$A_1 = \begin{array}{c} \frac{1}{y_4^{N-2}} \\ \frac{1}{y_4^{N-3}} \\ \vdots \\ \frac{1}{y_4} \\ \hline \frac{1}{x_4} \\ \frac{1}{x_4} \\ \vdots \\ \frac{1}{x_4^{M-2}} \end{array} \left(\begin{array}{cccc|cccc} \frac{\partial}{\partial a_{1,1}} & \frac{\partial}{\partial a_{1,2}} & \cdots & \frac{\partial}{\partial a_{1,N-2}} & \frac{\partial}{\partial b_{1,1}} & \frac{\partial}{\partial b_{1,2}} & \cdots & \frac{\partial}{\partial b_{1,M-1}} \\ & & & & & & & \\ & & & M_1 & & & & M_2 \\ & & & & & & & \\ & & & & & & & \\ & & & & & & & \\ & & & M_3 & & & & M_4 \\ & & & & & & & \end{array} \right).$$

We start by computing the matrix M_1 . In the chart V_4 , we have to solve

$$\frac{\partial \tilde{N}_p^{(M,N)}}{\partial a_{1,i}} = \alpha_{1,i}(x_4, y_4, a_{1,i}, b_{1,i}) \frac{\partial \tilde{N}_p^{(M,N)}}{\partial x_4} + \beta_{1,i}(x_4, y_4, a_{1,i}, b_{1,i}) \frac{\partial \tilde{N}_p^{(M,N)}}{\partial y_4}. \quad (4.2)$$

Since E is defined on V_4 by $E(x_4, y_4) = (x_4 y_4, x_4 y_4^2)$, we find that

$$\tilde{N}_p^{(M,N)}(x_4, y_4) = x_4^{M+N} y_4^{2M+N} (1 + y_4) \prod_{i=1}^{N-2} \left(y_4 + \sum_{k=1}^i a_{k,i} x_4^{k-1} y_4^{2k-2} \right) \prod_{i=1}^{M-1} \left(1 + \sum_{k=1}^{N-3+2i} b_{k,i} x_4^k y_4^{k-1} \right).$$

We have

$$\frac{\partial \tilde{N}_p^{(M,N)}}{\partial a_{1,i}} = \frac{\tilde{N}_p^{(M,N)}}{y_4 + \sum_{k=1}^i a_{k,i} x_4^{k-1} y_4^{2k-2}} = \frac{x_4^{M+N}}{y_4 + a_{1,i}} \left(A(y_4) + y_4^{2M+N} x_4(\dots) \right)$$

with

$$A(y_4) = y_4^{2M+N} (y_4 + 1) \prod_{j=1}^{N-2} (y_4 + a_{1,j})$$

and where the suspension points (...) correspond to auxiliary holomorphic functions in (x_4, y_4) . Since $\tilde{N}_P^{(M,N)} = x_4^{M+N} \left(A(y_4) + y_4^{2M+N} x_4(\dots) \right)$, we find that

$$\begin{aligned} \frac{\partial \tilde{N}_P^{(M,N)}}{\partial x_4} &= (M+N)x_4^{M+N-1} A(y_4) + y_4^{2M+N} x_4^{M+N}(\dots) \\ \frac{\partial \tilde{N}_P^{(M,N)}}{\partial y_4} &= x_4^{M+N} \left(A'(y_4) + y_4^{2M+N-1} x_4(\dots) \right) \end{aligned} \quad (4.3)$$

Setting $\alpha_{1,i} = x_4 \tilde{\alpha}_{1,i}$, we deduce from (4.2) that

$$\frac{A(y_4)}{y_4 + a_{1,i}} = (M+N)\tilde{\alpha}_{1,i}(0, y_4)A(y_4) + \beta_{1,i}(0, y_4)A'(y_4) + y_4^{2M+N-1}x_4(\dots). \quad (4.4)$$

Using Bézout identity, there exist polynomials B and C in y_4 such that

$$A \wedge A' = BA' + CA.$$

where $A \wedge A'$ is the great common divisor of A and A' . We can choose the polynomial function B to be of degree $N-1$. We denote by

$$D(y_4) = y_4(y_4 + 1) \prod_{j=1}^{N-2} (y_4 + a_{1,j})$$

the polynomial function satisfying $A = (A \wedge A')D$. Therefore we obtain a solution of (4.2) in the chart V_4 of the form

$$\begin{aligned} \alpha_{1,i} &= \frac{x_4}{M+N} \frac{C(y_4)D(y_4)}{y_4 + a_{1,i}} + y_4^{2M+N-1} x_4^2(\dots) \\ \beta_{1,i} &= \frac{B(y_4)D(y_4)}{y_4 + a_{1,i}} + y_4^{2M+N-1} x_4(\dots) \\ \text{i.e. } X_{1,i}^{(4)} &= \frac{B(y_4)D(y_4)}{y_4 + a_{1,i}} \frac{\partial}{\partial y_4} + x_4(\dots). \end{aligned}$$

Similarly, in the chart V_2 we write

$$\tilde{N}_P^{(M,N)} = y_2^{M+N} (J(x_2) + x_2 y_2(\dots))$$

with

$$J(x_2) = x_2(1 + x_2) \prod_{j=1}^{N-2} (1 + a_{1,j}x_2).$$

We set $J \wedge J' = KJ' + LJ = 1$. Also, we can assume that the degree of K is $N-1$ and so we obtain the solution

$$X_{1,i}^{(2)} = \frac{x_2}{1 + a_{1,i}x_2} K(x_2)J(x_2) \frac{\partial}{\partial x_2} + y_2(\dots).$$

To compute the cocycle we write $X_{1,i}^{(2)}$ in the chart V_4 . Using the standard change of coordinates $x_4 = x_2^2 y_2$ and $y_4 = 1/x_2$ and since we have

$$K(x_2) = \frac{\tilde{K}(y_4)}{y_4^{N-1}}$$

where \tilde{K} is a polynomial function, we find the first part of the first term of the cocycle

$$X_{1,i}^{(2,4)} = X_{1,i}^{(2)} - X_{1,i}^{(4)} = -\frac{1}{y_4 + a_{1,i}} \left[\frac{\tilde{K}(y_4)A(y_4)}{y_4^{2M+3N-3}} + B(y_4)D(y_4) \right] \frac{\partial}{\partial y_4} + x_4(\dots).$$

Let Θ_0 be a holomorphic vector field with isolated singularities defining $\tilde{\mathcal{F}}_{p_0}^{(M,N)}$ on $V_2 \cap V_4$. We have

$$X_{1,i}^{(2,4)} = \Phi_{1,i}^{(2,4)} \Theta_0.$$

We can choose $\Theta_0 = \frac{E^* \Theta_{\mathcal{N}_p^{(M,N)}}}{x_4^{M+N-2} y_4^{2M+N-3}}$ with $\Theta_{\mathcal{N}_p^{(M,N)}} = \frac{\partial \mathcal{N}_p^{(M,N)}}{\partial x} \frac{\partial}{\partial y} - \frac{\partial \mathcal{N}_p^{(M,N)}}{\partial y} \frac{\partial}{\partial x}$. According to Proposition (2.1.1), the set of the coefficients of the Laurent's series of $\Phi_{1,i}^{(2,4)}$ characterizes the class of $X_{1,i}^{(2,4)}$ in $H^1(D, \Theta_{\mathcal{F}_{p_0}^{(M,N)}})$. Now, according to (4.3), we get the equality

$$\Phi_{1,i}^{(2,4)} = \frac{-1}{(M+N)(y_4 + a_{1,i})} \left[\frac{\tilde{K}(y_4)}{y_4^{2N-2}} + B(y_4) \right] + x_4(\dots).$$

To study the invertibility of the matrix M_1 , we write

$$\tilde{K}(y_4) = \sum_{l=0}^{N-1} c_l y_4^l \quad \text{and} \quad \frac{1}{y_4 + a_{1,i}} = \frac{1}{a_{1,i}} \sum_{s=0}^{\infty} (-1)^s \frac{1}{a_{1,i}^s} y_4^s.$$

So, we obtain the following equality

$$\frac{\tilde{K}(y_4)}{(y_4 + a_{1,i})y_4^{2N-2}} = \sum_{j=1}^{N-2} d_{ji} \frac{1}{y_4^{N-j-1}} + \frac{R(y_4)}{y_4^{2N-2}} + y_4(\dots) + \text{cst},$$

where R is a polynomial in y_4 of degree $N-1$ and d_{ji} is given by

$$d_{ji} = \sum_{r=0}^{N-1} (-1)^{N-r+j-1} \frac{c_r}{a_{1,i}^{N+j-r}} = \frac{(-1)^{N+j-1}}{a_{1,i}^{N+j}} \tilde{K}(-a_{1,i}).$$

This yield the following expression of $\Phi_{1,i}^{(2,4)}$

$$\Phi_{1,i}^{(2,4)} = \frac{-1}{M+N} \left[\sum_{j=1}^{N-2} \frac{(-1)^{N+j-1} \tilde{K}(-a_{1,i})}{a_{1,i}^{N+j}} \frac{1}{y_4^{N-j-1}} + \frac{R(y_4)}{y_4^{2N-2}} + y_4(\dots) + \text{cst} \right] + x_4(\dots).$$

Thus, the matrix $M_1 = (m_{ji})_{1 \leq i, j \leq N-2}$ is given by

$$m_{ji} = \frac{(-1)^{N+j}}{(M+N)a_{1,i}^{N+j}} \tilde{K}(-a_{1,i}),$$

which defines a Vandermonde matrix. We note that $\tilde{K}(-a_{1,i})$ is different from zero for all $1 \leq i \leq N-2$ because the different values values $\left\{ \frac{-1}{a_{1,i}} \right\}_{1 \leq i \leq N-2}$ are roots of the

polynomial J which satisfies the Bézout identity $KJ' + LJ = 1$. So, the matrix M_1 is invertible.

We proceed similarly to compute the matrix M_2 . So, in the chart V_4 , we have to solve the following equation

$$\frac{\partial \tilde{N}_p^{(M,N)}}{\partial b_{1,i}} = \eta_{1,i}(x_4, y_4, a_{1,i}, b_{1,i}) \frac{\partial \tilde{N}_p^{(M,N)}}{\partial x_4} + \gamma_{1,i}(x_4, y_4, a_{1,i}, b_{1,i}) \frac{\partial \tilde{N}_p^{(M,N)}}{\partial y_4}. \quad (4.5)$$

The same argument allows us to obtain the following expressions

$$\begin{aligned} \frac{\partial \tilde{N}_p^{(M,N)}}{\partial b_{1,i}} &= x_4^{M+N+1} y_4^{2M+N} (\dots) \\ \frac{\partial \tilde{N}_p^{(M,N)}}{\partial x_4} &= (M+N) x_4^{M+N-1} A(y_4) + y_4^{2M+N} x_4^{M+N} (\dots) \\ \frac{\partial \tilde{N}_p^{(M,N)}}{\partial y_4} &= x_4^{M+N} \left(A'(y_4) + y_4^{2M+N-1} x_4 (\dots) \right) \end{aligned} \quad (4.6)$$

and so we deduce from (4.5) that

$$(M+N) \tilde{\alpha}_{1,i}(0, y_4) A(y_4) + \beta_{1,i}(0, y_4) A'(y_4) + y_4^{2M+N-1} x_4 (\dots) = 0. \quad (4.7)$$

Therefore we obtain a solution of (4.5) in the chart V_4

$$X_{1,i}^{(4)} = x_4 (\dots).$$

Similarly in the chart V_2 we obtain the solution

$$X_{1,i}^{(2)} = y_2 (\dots).$$

Thus, we find the second part of the first term of the cocycle

$$X_{1,i}^{(2,4)} = X_{1,i}^{(2)} - X_{1,i}^{(4)} = x_4 (\dots)$$

Finally, we obtain the following expression of $\Phi_{1,i}^{(2,4)}$

$$\Phi_{1,i}^{(2,4)} = x_4 (\dots).$$

So, the matrix M_2 is the zero matrix.

Now, we compute the second cocycle. In the chart V_4 , we can write

$$\tilde{N}_p^{(M,N)} = y_4^{2M+N} (Q(x_4) + y_4 (\dots)),$$

with $Q(x_4) = x_4^{M+N} \prod_{j=1}^{N-2} a_{1,j} \prod_{j=1}^{M-1} (1 + b_{1,j} x_4)$. So, we obtain the following expressions

$$\begin{aligned} \frac{\partial \tilde{N}_p^{(M,N)}}{\partial b_{1,i}} &= y_4^{2M+N} \left(\frac{x_4}{1+b_{1,i}x_4} Q(x_4) + y_4 (\dots) \right) \\ \frac{\partial \tilde{N}_p^{(M,N)}}{\partial x_4} &= y_4^{2M+N} (Q'(x_4) + y_4 (\dots)) \\ \frac{\partial \tilde{N}_p^{(M,N)}}{\partial y_4} &= (2M+N) y_4^{2M+N-1} Q(x_4) + y_4^{2M+N} (\dots) \end{aligned} \quad (4.8)$$

Setting $\gamma_{1,i} = y_4 \tilde{\gamma}_{1,i}$, we deduce from (4.5) that

$$\frac{x_4}{1 + b_{1,i}x_4}Q(x_4) = \eta_{1,i}(x_4, 0)Q'(x_4) + (2M + N)\tilde{\gamma}_{1,i}(x_4, 0)Q(x_4) + y_4(\dots).$$

Using Bézout identity, there exist polynomials W and Z in x_4 such that

$$Q \wedge Q' = WQ' + ZQ.$$

As before, we can choose the polynomial function W to be of degree $M - 1$. We denote by $S(x_4) = x_4 \prod_{i=1}^{M-1} (1 + b_{1,i}x_4)$ the polynomial function satisfying $Q = (Q \wedge Q')S$. Therefore we obtain a solution of (4.5) in the chart V_4

$$Y_{1,i}^{(4)} = \frac{x_4}{1 + b_{1,i}x_4}W(x_4)S(x_4)\frac{\partial}{\partial x_4} + y_4(\dots).$$

Similarly, in the chart V_3 we write

$$\tilde{N}_p^{(M,N)} = x_3^{2M+N}(P(y_3) + x_3(\dots))$$

with

$$P(y_3) = y_3 \prod_{j=1}^{N-2} a_{1,j} \prod_{j=1}^{M-1} (y_3 + b_{1,j}).$$

We set $P \wedge P' = UP' + VP$. Again, we can assume that the degree of U is $M - 1$. We denote by $R(y_3) = y_3 \prod_{i=1}^{M-1} (y_3 + b_{1,i})$ the polynomial function satisfying $P = (P \wedge P')R$ and so we obtain the solution

$$Y_{1,i}^{(3)} = \frac{U(y_3)R(y_3)}{y_3 + b_{1,i}}\frac{\partial}{\partial y_3} + x_3(\dots).$$

Using the change of coordinates $x_4 = 1/y_3$ and $y_4 = x_3y_3$ and since we have

$$U(y_3) = \frac{\tilde{U}(x_4)}{x_4^{M-1}} \text{ and } R(y_3) = \frac{S(x_4)}{x_4^{M+1}}$$

where \tilde{U} is a polynomial function, we find the second part of the second term of the cocycle

$$Y_{1,i}^{(3,4)} = Y_{1,i}^{(3)} - Y_{1,i}^{(4)} = -\frac{S(x_4)}{1 + b_{1,i}x_4} \left[\frac{\tilde{U}(x_4)}{x_4^{2M-3}} + x_4W(x_4) \right] \frac{\partial}{\partial x_4} + y_4(\dots).$$

Thus, we obtain the following expression of $\Psi_{1,i}^{(3,4)}$

$$\Psi_{1,i}^{(3,4)} = \frac{1}{(2M + N) \prod_{j=1}^{N-2} a_{1,j} (1 + b_{1,i}x_4)} \left[\frac{\tilde{U}(x_4)}{x_4^{2M-3}} + x_4W(x_4) \right] + y_4(\dots).$$

Similarly, we find that $\Psi_{1,i}^{(3,4)}$ can be written as

$$\Psi_{1,i}^{(3,4)} = \frac{1}{(2M+N) \prod_{l=1}^{N-2} a_{1,l}} \left[\sum_{j=0}^{M-2} \frac{(-1)^{j+1} b_{1,i}^{2M-j-3}}{x_4^j} \tilde{U} \left(\frac{-1}{b_{1,i}} \right) + \frac{T(x_4)}{x_4^{2M-3}} + x_4(\dots) \right] + y_4(\dots),$$

where T is a polynomial in x_4 of degree $M-2$. So, the matrix $M_4 = (m_{ji})_{1 \leq i, j \leq M-1}$ is given by

$$m_{ji} = \frac{(-1)^{j+1} b_{1,i}^{2M-j-3}}{(2M+N) \prod_{l=1}^{N-2} a_{1,l}} \tilde{U} \left(\frac{-1}{b_{1,i}} \right) \quad \forall 1 \leq i, j \leq M-1$$

which defines a Vandermonde matrix. Like for \tilde{K} , we also have that $\tilde{U} \left(\frac{-1}{b_{1,i}} \right)$ is different from zero for all $1 \leq i \leq M-1$ because the different values $\{-b_{1,i}\}_{1 \leq i \leq M-1}$ are roots of the polynomial P which satisfies the Bézout identity $P \wedge P' = UP' + VP$. So, the matrix M_4 is invertible. \square

Lemma 4.1.2. *The square matrix \mathcal{A} of size δ , representing the decomposition of the images of $\{\frac{\partial}{\partial a_{k,i}}, \frac{\partial}{\partial b_{k,i}}\}_{k,i}$ in $H^1(D, \Theta_{\mathcal{F}_{p_0}}^{(M,N)})$ by $T\tilde{\mathcal{F}}_p(p_0)$ on its basis, is an invertible matrix.*

Proof. After proving the invertibility of the matrix A_1 , it remains to study the propagation of these coefficients along the higher levels. In fact, we have to solve the following equations

$$\frac{\partial \tilde{N}_p^{(M,N)}}{\partial a_{k,i}} = \alpha_{k,i}(x_4, y_4, a_{k,i}, b_{k,i}) \frac{\partial \tilde{N}_p^{(M,N)}}{\partial x_4} + \beta_{k,i}(x_4, y_4, a_{k,i}, b_{k,i}) \frac{\partial \tilde{N}_p^{(M,N)}}{\partial y_4} \quad (4.9)$$

$$\frac{\partial \tilde{N}_p^{(M,N)}}{\partial b_{k,i}} = \eta_{k,i}(x_4, y_4, a_{k,i}, b_{k,i}) \frac{\partial \tilde{N}_p^{(M,N)}}{\partial x_4} + \gamma_{k,i}(x_4, y_4, a_{k,i}, b_{k,i}) \frac{\partial \tilde{N}_p^{(M,N)}}{\partial y_4}. \quad (4.10)$$

We note that we have the following relations

$$\frac{\partial \tilde{N}_p^{(M,N)}}{\partial a_{k,i}} = x_4^{k-1} y_4^{2k-2} \frac{\partial \tilde{N}_p^{(M,N)}}{\partial a_{1,i}} \quad \text{and} \quad \frac{\partial \tilde{N}_p^{(M,N)}}{\partial b_{k,i}} = x_4^{k-1} y_4^{k-1} \frac{\partial \tilde{N}_p^{(M,N)}}{\partial b_{1,i}}. \quad (4.11)$$

This implies that if $X_{k,i} = \alpha_{k,i} \frac{\partial}{\partial x_4} + \beta_{k,i} \frac{\partial}{\partial y_4}$ and $Y_{k,i} = \eta_{k,i} \frac{\partial}{\partial x_4} + \gamma_{k,i} \frac{\partial}{\partial y_4}$ are solutions of (4.9) and (4.10) respectively for $k=1$, then we obtain solutions for the other values of k setting

$$X_{k,i} = x_4^{k-1} y_4^{2k-2} X_{1,i} \quad \text{and} \quad Y_{k,i} = x_4^{k-1} y_4^{k-1} Y_{1,i}.$$

This propagation can be described using the region $\mathcal{Q}_{M,N}$ as shown in figure (2.2). In fact, the decomposition of the vector fields $X_{k,i}^{(2,4)}$, $X_{k,i}^{(3,4)}$, $Y_{k,i}^{(2,4)}$ and $Y_{k,i}^{(3,4)}$ on the basis

of $H^1\left(D, \Theta_{\mathcal{F}_{P_0}}(M, N)\right)$ corresponds to the decomposition of the series $\Phi_{k,i}^{(2,4)}$, $\Phi_{k,i}^{(3,4)}$, $\Psi_{k,i}^{(2,4)}$ and $\Psi_{k,i}^{(3,4)}$ on the basis

$$\left\{x_4^i y_4^j \mid (i, j) \in \mathbb{N} \times \mathbb{Z} \cup \mathbb{Z} \times \mathbb{N} \text{ such that } j - 2i + (N - 1) > 0 \text{ and } j - i - (M - 1) < 0\right\}.$$

As a consequence of the previous relations, this decomposition can be expressed by the following matrix

$$\mathcal{A} = \begin{bmatrix} A_1 & 0 & 0 & \cdots & 0 \\ * & A_2 & 0 & \cdots & 0 \\ * & * & A_3 & \cdots & 0 \\ \vdots & \vdots & \vdots & \ddots & \vdots \\ * & * & * & * & A_{N+2M-5} \end{bmatrix}$$

where $A_1 = \begin{bmatrix} M_1 & M_2 \\ M_3 & M_4 \end{bmatrix}$ and A_k is given by

$$\left. \begin{array}{c} \frac{x_4^{k-1}}{y_4^{N-2k}} \\ \vdots \\ x_4^{k-1} y_4^{k-2} \\ x_4^{k-1} y_4^{k-1} \\ \vdots \\ \frac{y_4^{k-1}}{x_4^{M-k-1}} \end{array} \left(\begin{array}{ccc|ccc} \frac{\partial}{\partial a_{k,k}} & \cdots & \frac{\partial}{\partial a_{k,N-2}} & \frac{\partial}{\partial b_{k,1}} & \cdots & \frac{\partial}{\partial b_{k,M-1}} \\ & M_1^k = M_1 \setminus \text{last} & & & & \\ & (k-1) \text{ row and} & & & 0 & \\ & \text{first } (k-1) \text{ column} & & & & \\ \hline & * & & & M_4 & \end{array} \right) \right\} \text{ if } 2 \leq k \leq N-2$$

$$\left. \begin{array}{c} \frac{y_4^{k-1}}{x_4^{M-k-q_k}} \\ \vdots \\ \frac{y_4^{k-1}}{x_4^{M-k-1}} \end{array} \left(\begin{array}{ccc|ccc} \frac{\partial}{\partial b_{k,M-q_k}} & \cdots & \frac{\partial}{\partial b_{k,M-1}} & & & \\ & M_4^k = M_4 \setminus \text{first} & & & & \\ & M-1-q_k & & & & \\ & \text{column and row} & & & & \end{array} \right) \right\} \text{ if } N-1 \leq k \leq N+2M-5$$

with $q_k = \lfloor \frac{k-1+(N-1)}{2} \rfloor + M - k$, where $\lfloor x \rfloor$ is the strict integer part m of x defined by $m < x \leq m + 1$. For $2 \leq k \leq N - 2$, the determinant of the matrix M_1^k is given by

$$\text{Vandermonde} \left(\frac{1}{a_{1,k}}, \dots, \frac{1}{a_{1,N-2}} \right) \frac{\prod_{i=k}^{N-2} (-1)^{N+i} \tilde{K}(-a_{1,i})}{(M+N)^{N-1-k} \prod_{i=k}^{N-2} a_{1,i}^{N+1}}.$$

Since $\tilde{K}(-a_{1,i})$ is different from zero for all $1 \leq i \leq N - 2$ and $a_{1,i}$ is different from $a_{1,j}$ for all $i \neq j$, then the matrix M_1^k is invertible for all $2 \leq k \leq N - 2$. Similarly, for

$N - 1 \leq k \leq N + 2M - 5$, the determinant of the matrix M_4^k is given by

$$\text{Vandermonde} \left(\frac{1}{b_{1,M-q_k}}, \dots, \frac{1}{b_{1,M-1}} \right) \frac{\prod_{i=M-q_k}^{M-1} (-1)^{i+1} b_{1,i}^{M-1+q_k} \tilde{U} \left(\frac{-1}{b_{1,i}} \right)}{(2M+N)^{q_k} \prod_{i=1}^{N-2} a_{1,i}^{q_k}}.$$

Also since $\tilde{U} \left(\frac{-1}{b_{1,i}} \right)$ is different from zero for all $1 \leq i \leq M - 1$ and $b_{1,i}$ is different from $b_{1,j}$ for all $i \neq j$, then the matrix M_4^k is invertible for all $N - 1 \leq k \leq N + 2M - 5$. This shows that the whole matrix \mathcal{A} is invertible. \square

4.2 The uniqueness of the normal forms.

This section is devoted to study the uniqueness of the normal forms. We will also consider \underline{N}_p as a notation for the normal form instead of $\underline{N}_p^{(M,N)}$.

Let h_λ be the diffeomorphism defined by: $h_\lambda(x, y) = (\lambda x, \lambda y)$. We have:

$$\underline{N}_p \circ h_\lambda = \lambda^{M+N} \underline{N}_{\lambda \cdot p} \text{ with } \lambda \cdot p = \lambda \cdot (a_{k,i}, b_{k,i}) = (\lambda^{k-1} a_{k,i}, \lambda^k b_{k,i}).$$

Although the topological class of the function $\frac{\underline{N}_p \circ h_\lambda}{\lambda^{2M+2N-1}}$ jumps while λ goes to zero, we are still able to prove the following:

Theorem E. *The foliations defined by \underline{N}_p and \underline{N}_q , p and q are in \mathcal{P} , are equivalent if and only if there exists λ in \mathbb{C}^* such that $p = \lambda \cdot q$.*

The following lemma can be proved exactly the same way as lemma (2.5.1):

Lemma 4.2.1. *Let X be a germ of formal vector field given by its decomposition into the sum of its homogeneous components $X = X_{\nu_0+1} + X_{\nu_0+2} + \dots$. If $\underline{N}_p \circ e^{X_{\nu_0+1}+\dots} = \underline{N}_q$, then for all $1 \leq i \leq N - 2$ and $1 \leq k \leq \nu_0$ we have $a_{k,i} = a'_{k,i}$ and for all $1 \leq i \leq M - 1$ and $1 \leq k \leq \nu_1$ we have $b_{k,i} = b'_{k,i}$, where $\nu_1 + 1$ is the order of tangency of $\tilde{\phi}$, the lifted biholomorphism of $\phi = e^X$ by the blowing up E_1 defined by $E_1(x_1, y_1) = (x_1, x_1 y_1)$.*

Let ϕ be a germ of biholomorphism tangent to the identity map at order $\nu_0 + 1 \geq 2$ and fixing the curves $\{x = 0\}$ and $\{y = 0\}$. The function ϕ is written

$$(x, y) \mapsto (x(1 + A_{\nu_0}(x, y) + \dots), y(1 + B_{\nu_0}(x, y) + \dots)) \quad (4.12)$$

where A_{ν_0} and B_{ν_0} are homogeneous polynomials of degree ν_0 .

We give now the proof of the main Theorem E of this section.

Proof of Theorem E. Suppose that there exists a conjugacy relation

$$\underline{N}_p \circ \phi = \psi \circ \underline{N}_q. \quad (4.13)$$

Also, following [45], we can suppose that ψ is a homothety γId . The biholomorphism ϕ can be supposed tangent to the identity. In fact, since ϕ lets the curves $\{x = 0\}$, $\{y = 0\}$ and $\{y + x = 0\}$ invariant, then it can be written

$$(x, y) \longmapsto (\lambda x(1 + A_{\nu_0}(x, y) + \dots), \lambda y(1 + B_{\nu_0}(x, y) + \dots)),$$

for some $\lambda \neq 0$. Then

$$\underline{N}_p \circ \phi \circ h_\lambda^{-1} = \gamma \underline{N}_q \circ h_\lambda^{-1} = c \underline{N}_{\lambda^{-1} \cdot q},$$

where c stands for some non vanishing number. Since $\phi \circ h_\lambda^{-1}$ is tangent to the identity, we find that $c = 1$. Thus, setting for the sake of simplicity $q = \lambda^{-1} \cdot q$ and $\phi = \phi \circ h_\lambda^{-1}$, we are led to the relation

$$\underline{N}_p \circ \phi = \underline{N}_q,$$

where ϕ can be written under the form (4.12).

The proof reduces to show that in this situation, we have $p = q$. Using Lemma (4.2.1), we know that for all $1 \leq i \leq N - 2$ and $1 \leq k \leq \nu_0$ we have $a_{k,i} = a'_{k,i}$ and for all $1 \leq i \leq M - 1$ and $1 \leq k \leq \nu_1$ we have $b_{k,i} = b'_{k,i}$. This means that, based on the structure of the normal form, to show that for any $k \leq N - 2$, $a_{k,i} = a'_{k,i}$, it is enough to show that $\nu_0 \geq N - 1$. In the same way, to show that for any $k \leq 2M - N - 5$, $b_{k,i} = b'_{k,i}$, it is enough to show that $\nu_1 \geq N + 2M - 5$. Thus, the proof results from the following proposition:

Proposition 4.2.1. *Let $X = X_{\nu_0+1} + X_{\nu_0+2} + \dots$ be a germ of formal vector field such that $\phi = e^X$. If $\underline{N}_p \circ \phi = \underline{N}_q$, then we have:*

1. $\nu_0 \geq M + N - 1$.
2. $\nu_1 \geq 2M + N - 5$.

Proof. 1. It suffices to prove that $\nu_0 < M + N - 1$ leads to a contradiction. The first non-trivial relation of the above equality is given by

$$X_{\nu_0+1} \cdot \underline{N}_p^{(M+N)} = \underline{N}_q^{(M+N+\nu_0)} - \underline{N}_p^{(M+N+\nu_0)} \quad (4.14)$$

where $\underline{N}_p^{(M+N)} = xy^M(y+x) \prod_{i=1}^{N-2} (y + a_{1,i}x)$. We can write it as

$$\begin{aligned} X_{\nu_0+1} \cdot \underline{N}_p^{(M+N)} &= \sum_{i=1}^{N-2} \sum_{j=1}^{M-1} \sum_{\substack{k_1+k_2=\nu_0+1 \\ k_1 \neq 1}} (a'_{k_1,i} b'_{k_2,j} - a_{k_1,i} b_{k_2,j}) x^{k_2+2} y^{k_1-1} \frac{\underline{N}_p^{(M+N)}}{y(y+a_{1,i}x)} \\ &+ \sum_{i=1}^{N-2} (a'_{\nu_0+1,i} - a_{\nu_0+1,i}) xy^{\nu_0} \frac{\underline{N}_p^{(M+N)}}{y+a_{1,i}x} + \sum_{i=1}^{M-1} (b'_{\nu_0,i} - b_{\nu_0,i}) x^{\nu_0+1} \frac{\underline{N}_p^{(M+N)}}{y}. \end{aligned}$$

Since $k_1 \leq \nu_0$ and $k_2 \leq \nu_0 \leq \nu_1$, then according to Lemma (4.2.1), we have $a'_{k_1,i} = a_{k_1,i}$, $b'_{k_2,j} = b_{k_2,j}$ and $b'_{\nu_0,i} = b_{\nu_0,i}$. So, dividing (4.14) by $\underline{N}_p^{(M+N)}$ leads to

$$\begin{aligned} \sum_{i=1}^{N-2} \frac{X_{\nu_0+1} \cdot (y + a_{1,i}x)}{y + a_{1,i}x} + \frac{X_{\nu_0+1} \cdot (y + x)}{y + x} + \frac{X_{\nu_0+1} \cdot x}{x} \\ + M \frac{X_{\nu_0+1} \cdot y}{y} = xy^{\nu_0} \sum_{i=1}^{N-2} \frac{a'_{\nu_0+1,i} - a_{\nu_0+1,i}}{y + a_{1,i}x}. \end{aligned}$$

We take the pull-back of the previous equality with respect to the map E and write it in the coordinates (x_4, y_4) :

$$\begin{aligned} \sum_{i=1}^{N-2} \frac{\tilde{X}_{\nu_0+1} \cdot (x_4 y_4 (y_4 + a_{1,i}))}{x_4 y_4 (y_4 + a_{1,i})} + \frac{\tilde{X}_{\nu_0+1} \cdot (x_4 y_4 (y_4 + 1))}{x_4 y_4 (y_4 + 1)} + \frac{\tilde{X}_{\nu_0+1} \cdot x_4 y_4}{x_4 y_4} \\ + M \frac{\tilde{X}_{\nu_0+1} \cdot x_4 y_4^2}{x_4 y_4^2} = y_4^{\nu_0} \sum_{i=1}^{N-2} \frac{a'_{\nu_0+1,i} - a_{\nu_0+1,i}}{y_4 + a_{1,i}}, \end{aligned}$$

where \tilde{X}_{ν_0+1} stands for the vector field $\frac{E^* X_{\nu_0+1}}{x_4^{\nu_0} y_4^{\nu_0}}$. Evaluating the residue at $y_4 = -a_{1,i}$ yields the relation

$$\tilde{X}_{\nu_0+1} \cdot y_4 (-a_{1,i}) = (-a_{1,i})^{\nu_0} (a'_{\nu_0+1,i} - a_{\nu_0+1,i}). \quad (4.15)$$

Now, in view of the construction of the normal form, the coefficient $\delta_{\nu_0+1,i} = a'_{\nu_0+1,i} - a_{\nu_0+1,i}$ has to be zero for ν_0 values of i . A straightforward computation shows that $\tilde{X}_{\nu_0+1} \cdot y_4$ is a polynomial function of degree at most $\nu_0 + 1$ in y_4 . Noting that 0 and 1 are also roots of it (by evaluating the residue also), it must be the zero polynomial function. Hence, the vector field X_{ν_0+1} has to be tangent to $\underline{N}_p^{(M+N)}$ which is a contradiction with the hypothesis $\nu_0 < M + N - 1$.

2. Similarly, we show that $\nu_1 < 2M + N - 5$ leads to a contradiction. Denoting by $\tilde{\phi}$ the biholomorphism $\tilde{\phi} = E_1^{-1} \circ \phi \circ E_1$, the first non-trivial relation of the equality $\tilde{N}_p \circ \tilde{\phi} = \tilde{N}_q$ is given by

$$\tilde{X}_{\nu_1+1} \cdot \tilde{N}_p^{(2M+N)} = \tilde{N}_q^{(2M+N+\nu_1)} - \tilde{N}_p^{(2M+N+\nu_1)} \quad (4.16)$$

where $\tilde{N}_p^{(2M+N)} = \prod_{i=1}^{N-2} x_1^{M+N} y_1 \prod_{i=1}^{M-1} (y_1 + b_{1,i} x_1)$. We can write

$$\begin{aligned} \tilde{X}_{\nu_1+1} \cdot \tilde{N}_p^{(2M+N)} &= \sum_{i=1}^{N-2} \sum_{j=1}^{M-1} (b'_{\nu_1,j} - b_{\nu_1,j}) x_1^{\nu_1} y_1 \frac{\tilde{N}_p^{(2M+N)}}{a_{1,i} (y_1 + b_{1,j} x_1)} \\ &+ \sum_{i=1}^{N-2} \sum_{j=1}^{M-1} \sum_{\substack{2k_1+k_2=\nu_1+3 \\ k_1, k_2 \neq 1}} (a'_{k_1,i} b'_{k_2,j} - a_{k_1,i} b_{k_2,j}) x_1^{k_1+k_2-1} y_1^{k_1-1} \frac{\tilde{N}_p^{(2M+N)}}{a_{1,i} (y_1 + b_{1,j} x_1)} \\ &+ \sum_{j=1}^{M-1} (b'_{\nu_1+1,j} - b_{\nu_1+1,j}) x_1^{\nu_1+1} \frac{\tilde{N}_p^{(2M+N)}}{y_1 + b_{1,j} x_1} + \underbrace{\sum_{i=1}^{N-2} \left(a'_{\frac{\nu_1+2}{2},i} - a_{\frac{\nu_1+2}{2},i} \right) x_1^{\frac{\nu_1}{2}} y_1^{\frac{\nu_1}{2}} \frac{\tilde{N}_p^{(2M+N)}}{a_{1,i}}}_{\text{exists only if } \nu_1 \text{ is even}}. \end{aligned}$$

Since $k_1 \leq N-2 \leq \nu_0$ and $k_2 \leq \nu_1-1$, then according to Lemma (4.2.1), we have $a'_{k_1,i} = a_{k_1,i}$ and $b'_{k_2,j} = b_{k_2,j}$. So, dividing (4.16) by $\tilde{N}_p^{(2M+N)}$ leads to

$$\begin{aligned} \sum_{j=1}^{M-1} \frac{\tilde{X}_{\nu_1+1} \cdot (y_1 + b_{1,j} x_1)}{y_1 + b_{1,j} x_1} &+ \frac{\tilde{X}_{\nu_1+1} \cdot y_1}{y_1} + (M+N) \frac{\tilde{X}_{\nu_1+1} \cdot x_1}{x_1} \\ &= \sum_{i=1}^{N-2} \frac{a'_{\frac{\nu_1+2}{2},i} - a_{\frac{\nu_1+2}{2},i}}{a_{1,i}} x_1^{\frac{\nu_1}{2}} y_1^{\frac{\nu_1}{2}} + \sum_{j=1}^{M-1} \frac{b'_{\nu_1+1,j} - b_{\nu_1+1,j}}{y_1 + b_{1,j} x_1} x_1^{\nu_1+1}. \end{aligned}$$

Similarly, we take the pull-back of the previous equality with respect to the map E and write it in the coordinates (x_4, y_4) :

$$\begin{aligned} \sum_{j=1}^{M-1} \frac{\tilde{X}_{\nu_1+1} \cdot (y_4 (1 + b_{1,j} x_4))}{y_4 (1 + b_{1,j} x_4)} &+ \frac{\tilde{X}_{\nu_1+1} \cdot y_4}{y_4} + (M+N) \frac{\tilde{X}_{\nu_1+1} \cdot x_4 y_4}{x_4 y_4} \\ &= \sum_{i=1}^{N-2} \frac{a'_{\frac{\nu_1+2}{2},i} - a_{\frac{\nu_1+2}{2},i}}{a_{1,i}} x_4^{\frac{\nu_1}{2} - \nu_0} + \sum_{j=1}^{M-1} \frac{b'_{\nu_1+1,j} - b_{\nu_1+1,j}}{1 + b_{1,j} x_4} x_4^{\alpha_0+1}, \end{aligned}$$

where \tilde{X}_{ν_1+1} stands for the vector field $\frac{E^* \tilde{X}_{\nu_1+1}}{x_4^{\nu_0} y_4^{\nu_0 + \alpha_0}}$ and $\alpha_0 = \nu_1 - \nu_0$. Evaluating the residue at $x_4 = -1/b_{1,j}$ yields the relation

$$b_{1,j} \tilde{X}_{\nu_1+1} \cdot x_4 \left(\frac{-1}{b_{1,j}} \right) = \left(\frac{-1}{b_{1,j}} \right)^{\alpha_0+1} (b'_{\nu_1+1,j} - b_{\nu_1+1,j}). \quad (4.17)$$

A simple computation shows that $\tilde{X}_{\nu_1+1} \cdot x_4$ is a polynomial function of degree at most $\alpha_0 + 1$ in x_4 . Now, in the relation (4.17), we know that $d = \frac{\nu_1}{2} - \nu_0 \leq 0$. So, we have the following three cases:

- If $d = 0$, then since $\nu_0 \geq M + N - 1$, we should have $\nu_1 \geq 2M + 2N - 2$ which is a contradiction with the hypothesis $\nu_1 < 2M + N - 5$.

- If $d = -1$, then $\tilde{X}_{\nu_1+1} \cdot x_4(0) = \sum_{i=1}^{N-2} \frac{a'_{\frac{\nu_1+2}{2},i} - a_{\frac{\nu_1+2}{2},i}}{a_{1,i}} = 0$.
- If $d < 1$, then $\sum_{i=1}^{N-2} \frac{a'_{\frac{\nu_1+2}{2},i} - a_{\frac{\nu_1+2}{2},i}}{a_{1,i}} = 0$.

In the last two cases, we can write

$$\tilde{X}_{\nu_1+1} \cdot \tilde{N}_p^{(2M+N)} = \sum_{j=1}^{M-1} (b'_{\nu_1+1,j} - b_{\nu_1+1,j}) x_1^{\nu_1+1} \frac{\tilde{N}_p^{(2M+N)}}{y_1 + b_{1,j}x_1}.$$

In view of the construction of the normal form, the coefficient $\delta_{\nu_1+1,j} = b'_{\nu_1+1,j} - b_{\nu_1+1,j}$ has to be zero for $\frac{\nu_1-N}{2} + 1$ values of j . We note that 0 is also a root of the polynomial function $\tilde{X}_{\nu_1+1} \cdot x_4$. However, we know that it is at most of degree $\alpha_0 + 1$. We also know that $\nu_1 \geq \nu_0 \geq M + N - 1$. So, if $\nu_1 = M + N - 1$, then α_0 must be zero. But in this case we have $\frac{\nu_1-N}{2} + 1 = \frac{M-1}{2} + 1$. So, $\tilde{X}_{\nu_1+1} \cdot x_4$ must be the zero polynomial function. Hence, the vector field \tilde{X}_{ν_1+1} has to be tangent to $\tilde{N}_p^{(2M+N)}$ which is a contradiction with the hypothesis $\nu_1 < 2M + N - 5$. This implies that ν_1 must be greater than or equal to $M + N$. We proceed similarly at each level. Finally, if $\nu_1 = 2M + N - 6$, then α_0 can be at most $M - 5$. Since in this case we have $\frac{\nu_1-N}{2} + 1 = M - 2$, we obtain that the polynomial function $\tilde{X}_{\nu_1+1} \cdot x_4$ must be the zero function. Similarly, the vector field \tilde{X}_{ν_1+1} has to be tangent to $\tilde{N}_p^{(2M+N)}$ which is a contradiction with the hypothesis $\nu_1 < 2M + N - 5$. \square

Remark. *If we consider the germs of functions defined by*

$$\hat{N}_p^{(M,N)} = xy(y+x) \prod_{i=1}^{N-2} \left(y + \sum_{k=1}^i a_{k,i} x^k \right) \prod_{i=1}^{M-1} \left(y + \sum_{k=1}^{N-3+2i} b_{k,i} x^{k+1} \right),$$

then proceeding similarly to the proof of Theorem D, we can show that this family is universal as well. However, this family does not seem to satisfy the uniqueness property. In fact, one can easily check that lemma (4.2.1), which is basic in the proof of the uniqueness, is not valid for this family of functions.

Chapter 5

Globalization and relation with geometric invariant theory.

As mentioned in section (2.5) of chapter 2 about the uniqueness of the analytic normal forms, the \mathbb{C}^* action cannot be used to globalize the local existence as done in [59]. In this chapter, we present another formulation of the globalization problem using the context of geometric invariant theory. The main purpose would be to analyze the conjecture: for any function f in $\mathcal{T}^{(M,N)}$, there exists p in \mathcal{P} such that f is analytically equivalent to $N_p^{(M,N)}$. In section (5.1), we present a possible approach using GIT. In section (5.2), we talk about geometric quotients by algebraic group actions. Section (5.3) presents some related results. The last section (5.4) is about a counter example to the proposed approach.

5.1 Presentation of the approach.

An element f in $\mathcal{T}^{(M,N)}$ can be written as

$$f = xy(y + x^2) \prod_{i=1}^{N-1} (y + a_{1,i}x) \prod_{i=1}^{M-2} (y + b_{1,i}x^2) + \sum_{i+j \geq M+N+1} \alpha_{i,j} x^i y^j.$$

We denote by $\mathcal{T}_{\text{fix}}^{(M,N)}$ the subspace of $\mathcal{T}^{(M,N)}$ of elements having fixed $a_{1,i}$ and $b_{1,i}$. A result of Mather ([35], [36]) implies that f is topologically equivalent to its jet of order $k \geq \mu + 1$ where μ is the milnor number of f . We recall that the k -jet of a function $f \in \mathcal{O} = \mathcal{O}_{(\mathbb{C}^{n+1}, 0)}$ is the class $j_k f \in \mathcal{O}/m^{k+1}$, where $m \subset \mathcal{O}$ is the maximal ideal. Using this result, we can easily check that we have the following lemma:

- Lemma 5.1.1.** 1. The space $j_k \mathcal{T}_{\text{fix}}^{(M,N)}$ of jets of order k of the space $\mathcal{T}_{\text{fix}}^{(M,N)}$ is in bijection with \mathbb{C}^L . We denote this bijection by ϕ .
2. Let $G = \{\phi : (\mathbb{C}^2, 0) \rightarrow (\mathbb{C}^2, 0) \text{ biholomorphism} / \phi(x, y) = (x(1 + \dots), y(1 + \dots))\}$. The algebraic group $j_k G$ is linear and acts on $j_k \mathcal{T}_{\text{fix}}^{(M,N)}$.

If we denote by $\Sigma_{M,N}$ the space of the normal forms $N_p^{(M,N)}$ with $p \in \mathcal{P}$, we deduce from the above lemma that the space $\Sigma_{M,N} \cap j_k \mathcal{T}_{\text{fix}}^{(M,N)}$ of normal forms with fixed $a_{1,i}$ and $b_{1,i}$ is in bijection with $\mathbb{C}^{\delta-(M+N-3)}$.

Thus, we can define the map Ψ as follows

$$\Psi : \mathbb{C}^{\delta-(M+N-3)} \longrightarrow \mathbb{C}^L / j_k G$$

for any normal form $N_{p,\text{fix}}^{(M,N)}$, we set $\Psi(p) = j_k G \cdot \phi(N_p)$.

With this construction, the globalization problem is equivalent to the conjecture:

Conjecture 1. *The map Ψ is surjective.*

The idea of the proof can be split into four parts:

1. Show that there exists a finitely generated subalgebra of the algebra $\mathbb{C}[\mathbb{C}^L]^G$ of G -invariant polynomial functions on \mathbb{C}^L which separates the orbits.
2. The local result implies that its dimension is equal to $\delta - (M + N - 3)$ (as the whole map is locally invertible).
3. The normal forms are unique, so the whole map is injective.
4. Apply the theorem of Ax about the surjectivity of any injective morphism of an algebraic variety into itself [24].

With this formulation, the proof reduces to showing the first point. For that, we would like to see under which conditions such an algebra exists to be able to know if they are satisfied in our case.

5.2 Geometric quotients.

A *linear algebraic group* is a subgroup of the group of invertible $n \times n$ matrices that is defined by polynomial equations. Given a vector space V over a field K , it has an underlying affine space A obtained by forgetting the origin with V acting by translations. The *affine group* of A can be described as the semi-direct product of V by $\text{GL}(V)$. It is clear that every linear algebraic group is affine. Conversely, a result of Chevalley [1] says that every affine algebraic group is linear, i.e. it is isomorphic to a closed subgroup of $\text{GL}(n, K)$. We start by showing that our group $j_k G$ is linear algebraic.

Proof of lemma 5.1.1. The first point is clear. For the second point, we know that $j_k G$ acts on a finite dimensional vector space $V \subset \mathbb{C}[x, y]/\mathfrak{m}^{k+1}$:

$$j_k G \times V \longrightarrow V, \quad (\phi, p) \longmapsto p \circ \phi.$$

For $\phi \in j_k G$, we define the map $\rho_\phi : V \longrightarrow V$, $f \longmapsto f \circ \phi$. This map is a linear map, so we can define $\rho : j_k G \longrightarrow \text{GL}(V)$, $\phi \longmapsto \rho_\phi$. The morphism ρ is a group homomorphism

which is a morphism of varieties. Moreover, it is an embedding because the action is free. So, ρ is injective and the $j_k G$ is a subgroup of $\mathrm{GL}(V)$. Finally, the ring morphism $\rho^* : \mathbb{C}[\mathrm{GL}(V)] \rightarrow \mathbb{C}[j_k G]$, $g \mapsto g \circ \rho$ is surjective, so ρ is a closed embedding which concludes the proof.

A linear algebraic group G is said to be *unipotent* if there exists a sequence of subgroups $G \supset G_N \supset \dots \supset G_1 = \{1\}$ such that G_i is normal in G_{i+1} and the quotient G_{i+1}/G_i is isomorphic to the additive group $(\mathbb{C}, +)$. It is said to be *reductive* if it does not contain any closed normal unipotent subgroup.

We note that we always work with the base field \mathbb{C} , so we do not distinguish between reductive and linearly reductive groups.

A *G-variety* is a variety X equipped with an action of the algebraic group G which is also a morphism of varieties. A regular function $f \in \mathbb{C}[X]$ is said to be *G-invariant* if $f(g \cdot x) = f(x)$ for all $g \in G$. For reductive group actions, the action can be described in a nice way. We have:

Theorem ([46]). *Let G be a reductive algebraic group, and X an affine G -variety. Then:*

1. *The subalgebra $\mathbb{C}[X]^G \subset \mathbb{C}[X]$ (consisting of regular G -invariant functions) is finitely generated.*
2. *Let f_1, \dots, f_n be generators of the algebra $\mathbb{C}[X]^G$. Then the image of the morphism*

$$X \longrightarrow \mathbb{C}^n, \quad x \longmapsto (f_1(x), \dots, f_n(x))$$

is closed and independent of the choice of f_1, \dots, f_n .

3. *Denote by $X//G$ the image and by*

$$\pi = \pi_X : X \longrightarrow X//G$$

the surjective morphism defined by (2). Then every G -invariant morphism $f : X \rightarrow Y$, where Y is an affine variety, factors through a unique morphism $\phi : X//G \rightarrow Y$.

4. *For any closed G -stable subset $Y \subset X$, the induced morphism $Y//G \rightarrow X//G$ is a closed immersion. In other words, the restriction of π_X to Y may be identified with π_Y . Moreover, given another closed G -stable subset $Y' \subset X$, we have $\pi_X(Y \cap Y') = \pi_X(Y) \cap \pi_X(Y')$.*
5. *Each fiber of π_X contains a unique closed G -orbit.*
6. *If X is irreducible, then so is $X//G$.*

The above map π is uniquely determined by the universal property (3); it is called a *categorical quotient* (for affine varieties). Also, $X//G$ may be viewed as the space of closed orbits by (5).

Given an algebraic group G and a G -variety X , a *geometric quotient* of X by G consists of a morphism $\pi : X \rightarrow Y$ satisfying the following properties:

1. π is surjective, and its fibers are exactly the G -orbits in X .
2. A subset $U \subset Y$ is open if and only if $\pi^{-1}(U)$ is open.
3. For any open subset $U \subset Y$, the comorphism $\pi^\#$ yields an isomorphism $\mathbb{C}[U] \cong \mathbb{C}[\pi^{-1}(U)]^G$.

Under these assumptions, the topological space Y may be identified with the orbit space X/G equipped with the quotient topology, in view of (1) and (2). Moreover, the structure of variety on Y is uniquely defined by (3) (which may be rephrased as the equality of sheaves $\mathcal{O}_Y = \pi_*(\mathcal{O}_X)^G$). In particular, if X is irreducible, then so is Y , and we have the equality of function fields $\mathbb{C}(Y) = \mathbb{C}(X)^G$.

We now give the definition of an open subset of X that admits a geometric quotient. Let G be a reductive group, and X an affine G -variety. A point $x \in X$ is said to be *stable* if the orbit $G \cdot x$ is closed in X and the isotropy group G_x is finite. The (possibly empty) set of stable points is denoted by X^s .

Proposition ([46]). *With the preceding notation and assumptions, $\pi(X^s)$ is open in $X//G$, we have $X^s = \pi^{-1}\pi(X^s)$ (in particular, X^s is an open G -stable subset of X), and the restriction $\pi^s : X^s \rightarrow \pi(X^s)$ is a geometric quotient.*

In his book [13], where Hertling considered a more general case than our case, he proved that all the orbits are closed and have the same dimension. In view of that and the previous result, if our group $j_k G$ is reductive, then conjecture 1 holds. However, the group $j_k G$ is not reductive. In fact, we can easily check that we have:

Lemma 5.2.1. *The group $j_k G$ is unipotent.*

Unfortunately, the above results about reductive group actions are not valid for unipotent group actions. A first difference is that the algebra of G -invariant regular functions is not necessarily finitely generated (the so-called Hilbert's fourteenth problem) due to the famous counter example of Nagata [50]. In fact, even if it is finitely generated, it does not in general separate closed orbits having finite isotropy group as in the following example:

Example 5.2.1 ([46]). *Let $G = \mathbb{C}$ act on $X = \mathbb{C}^3$, viewed as the space of polynomials of degree at most 2 in a variable x , by translation on x :*

$$t \cdot (ax^2 + 2bx + c) := a(x+t)^2 + 2b(x+t) + c = ax^2 + 2(at+b)x + at^2 + 2bt + c.$$

Then all orbits are closed, and contained in the fibers of the map

$$\pi : \mathbb{C}^3 \longrightarrow \mathbb{C}^2, \quad (a, b, c) \longmapsto (a, ac - b^2).$$

Specifically, the fiber over (x, y) consists of one orbit if $x \neq 0$, and two orbits if $x = 0$ but $y \neq 0$; all these orbits have trivial isotropy group. Moreover, the fiber over $(0, 0)$ is the line l defined by $b = c = 0$, and consisting of the G -fixed points. It follows that $\mathbb{C}(X)^G = \mathbb{C}(a, ac - b^2)$ and that X admits no geometric quotients, nor does the G -stable open subset $X \setminus l$ consisting of orbits with trivial isotropy group.

In fact, for any unipotent algebraic group G which acts regularly on a quasi-affine variety X , all orbits are closed [51] and there are no finite stabilizers which are not trivial. So, to define a subset of X which admits a geometric quotient in the unipotent case, the previous definition of stable points, introduced for reductive group actions, does not make sense. With another definition of stable points, Greuel and Pfister proved the existence of geometric quotients for unipotent group actions [18]. Moreover, they produced a criterion for deciding when all the points are stable. The next part of this section is devoted to recalling some definitions and fixing some notations before announcing this criterion.

Before we start, we recall that Hertling in the same book [13] showed that in our case the quotient space is an analytic geometric quotient. He proved that using the criterion of Holmann [19] for the existence of analytic geometric quotient which requires the two conditions: having a Hausdorff quotient and the existence of holomorphic functions in a neighbourhood of $j_k f$ in \mathbb{C}^L , which are constant on the $j_k G$ -orbits and which separate points in different orbits. Moreover, a result of Rosenlicht [21] says that for regular algebraic group action on an irreducible variety X , there exists an open subset U such that the field of rational functions on U/G is isomorphic to the subfield $K(X)^G$ of G -invariant rational functions on X , where K is an algebraically closed field. If G is unipotent, we have some thing more. In fact, an orbit $G \cdot x$ is called G -separated if for any $y \in X$, $y \notin G \cdot x$, there is an $f \in K[X]^G$ so that $f(y) \neq f(x)$. So, if we let $\Omega(X, G)$ be the interior of the union of all the G -separated orbits, then $\Omega(X, G)$ is dense in X [27]. In fact, this result is true for any quasi-affine variety X over a field K of any characteristic. For affine varieties over a field K of characteristic zero, it results from:

Theorem ([53]). *If a unipotent group G acts on an affine variety $\text{Spec}A$, where A is a K -algebra of finite type without nilpotent elements and $\text{Spec}A$ denotes the set of all prime ideals of A , then there exists $t \in A^G$ such that $A_t = (A_t)^G[\xi_1, \dots, \xi_m]$ (polynomial ring) and such that $(A_t)^G = (A^G)_t$ separates the G -orbits of $\text{Spec}A$.*

From now on, let G be a unipotent algebraic group which acts regularly on an affine variety $X = \text{Spec}A$ where A is a noetherian K -algebra and K is a field of characteristic zero. We start by the definition of a stable point:

Definition 5.2.1. *Let $\pi : X \rightarrow \text{Spec}A^G$ denote the canonical map. A point $x \in X$ is said to be stable if there exists $f \in A^G$ with $x \in X_f = \{x \in X \mid f(x) \neq 0\}$ such that the induced map $\pi_f : X_f \rightarrow (\text{Spec}A^G)_f$ is open and an orbit map i.e. the fibers are exactly the G -orbits in X .*

In view of this definition, we have:

Proposition ([18]). *The quotient X^s/G exists and is quasi-affine, and the map $\pi|_{X^s} : X^s \rightarrow \pi(X^s)$ is a geometric quotient.*

Before announcing the criterion, we recall that a *Lie algebra* is a vector space V over a field K together with a binary operation $[\cdot, \cdot] : V \times V \rightarrow V$ called the Lie bracket that satisfies the following axioms:

1. $[\cdot, \cdot]$ is bilinear.
2. $[x, x] = 0$ for all $x \in V$.
3. $[\cdot, \cdot]$ satisfies the Jacobi identity $[x, [y, z]] + [z, [x, y]] + [y, [z, x]] = 0$ for all $x, y, z \in V$.

To every Lie group we can associate a Lie algebra whose underlying vector space is the tangent space of the Lie group at the identity element and which completely captures the local structure of the group. The Lie bracket of the Lie algebra is related to the corresponding commutator.

So, we denote by $\text{Lie}G$ the Lie algebra of G and recall that there exists an exponential map $\exp : \text{Lie}G \rightarrow G$ given by $\exp(x) = \sum_{k=0}^{\infty} x^k/k!$ for linear algebraic groups [48]. The action of G on $\text{Spec}A$ induces a representation $\rho : G \rightarrow \text{Aut}_K(A)$ and $\rho_* : \text{Lie}G \rightarrow \text{Der}_K^{\text{nil}}(A)$, fitting into a commutative diagram [18]

$$\begin{array}{ccc} \text{Lie}G & \xrightarrow{\rho_*} & \text{Der}_K^{\text{nil}}(A) \\ \exp \downarrow & & \downarrow \exp \\ G & \xrightarrow{\rho} & \text{Aut}_K(A) \end{array}$$

where $\text{Aut}_K(A)$ is the group of K -algebra automorphisms, and $\text{Der}_K^{\text{nil}}(A)$ denotes the set of nilpotent K -linear derivations of A . We say that $\delta \in \text{Der}_K(A)$ is *nilpotent* if, for each $a \in A$, there is an $n(a)$ such that $\delta^{n(a)}(a) = 0$; $(\exp \delta)(a) := \sum_{i \geq 0} (1/i!) \delta^i(a)$ for $\delta \in \text{Der}_K^{\text{nil}}(A)$. The algebra $\text{Lie}G$ is a finite-dimensional Lie algebra which is nilpotent. We can now present the criterion called column-minor criterion:

Theorem ([18]). *Let $\delta_1, \dots, \delta_n \in \text{Der}_K^{\text{nil}}(A)$ and $x_1, \dots, x_n \in A$, satisfy the following properties:*

1. $[\delta_i, \delta_j] \in \sum_{\nu=1}^n A\delta_\nu$,
2. $\det(\delta_i(x_j))$ is a unit in A ,
3. for any $k = 1, \dots, n$ and any k -minor M of the first k columns of $(\delta_i(x_j))$, we have

$$\Delta(M) \in \sum_{\nu < k} A\Delta(x_\nu),$$

with the conventions $x_0 = 0$ and $\Delta = (\delta_1, \dots, \delta_n)^t$.

Let $L \subset \sum_{\nu=1}^n A\delta_\nu$ be any K -Lie algebra such that $\delta_1, \dots, \delta_n \in L$. Then $A^L[x_1, \dots, x_n] = A$ and x_1, \dots, x_n are algebraically independent over A^L . In particular, $(\text{Spec}(A))^s = \text{Spec}A$.

Greuel and Pfister proved this theorem using the following two lemmas:

Lemma 5.2.2 ([18]). *Let $\delta \in \text{Der}_K^{\text{nil}}(A)$, $x \in A$ and $\delta(x) \in A^\delta$ be a unit. Then $A^\delta[x] = A$ and x is transcendental over A^δ .*

In this case, they remarked that the invariant functions can be easily obtained by putting

$$i(y) = \sum_{\nu \geq 0} (1/\nu!) (-1)^\nu \delta^\nu(y) x^\nu, \quad \text{for } y \in A.$$

Then $i(y) \in A^\delta$ and $i(y) = \delta^0(y) = y$ if $y \in A^\delta$.

Let L be a nilpotent Lie algebra of finite dimension such that the unipotent group $G = \exp(L)$ acts on $\text{Spec}A$. If $\delta_1, \dots, \delta_n$ is a basis of L and $[\delta_i, \delta_j] = \sum_k c_{ijk} \delta_k$, then $H^1(L, A) = \ker d_1 / \text{Im} d_0$ where

$$\begin{aligned} d_0 : A &\longrightarrow A^n, & \text{with } d_0(a) &= (\delta_1(a), \dots, \delta_n(a)), \\ d_1 : A^n &\longrightarrow \wedge^2 A^n, & \text{with } d_1(a) &= (\delta_i(a_j) - \delta_j(a_i) - \sum_k c_{ijk} a_k)_{i < j}. \end{aligned}$$

Lemma 5.2.3 ([18]). *If L is abelian, then $H^1(L, A) = 0$ if and only if there are $x_1, \dots, x_n \in A$ such that $\delta_i(x_j) = \delta_i^j$. Moreover, in this case $A = A^L[x_1, \dots, x_n]$ and x_1, \dots, x_n are algebraically independent over A^L .*

In the same work, Greuel and Pfister gave another similar criterion called row-minor criterion which deals with rows instead of columns. These two criteria seem to be a nice way to determine whether all the points are stable or not. However, to be able to use them, the action has to be explicitly describable. Unfortunately, in our case the action is quite general, so we can not apply them.

5.3 Related results.

A group action is said to be *proper* if the mapping $G \times X \rightarrow X \times X$ ($(g, x) \mapsto (gx, x)$) is a proper map, i.e., the inverses of compact sets are compact. By Artin [44] and Kollár [32], proper actions admit geometric quotients in the category of algebraic spaces. Since in our case, the isotropy groups contain the flow maps of the vector fields tangent to the foliation, they are not compact and so the action is not proper. We say that the quotient is *locally trivial* if there exists a covering $\{U_i\}_i$ whose pre-images under the map $G \times X \rightarrow X/G$ are isomorphic to $G \times U_i$. A result of Bérczi, Hawes, Kirwan and Doran [17] says that if a locally trivial quotient exists, then it is affine if and only if $X \rightarrow X/G$ is a trivial G -bundle. However, in our case the quotient is not locally trivial for the same reason. We remark that every orbit of a unipotent group action is isomorphic to an affine space [55].

Let G be a linear algebraic group acting on an affine variety X over an algebraically closed field K . A subset $S \subset K[X]$ is called *separating* if for all $x, y \in X$, the existence of a function $f \in K[X]^G$ with $f(x) \neq f(y)$ implies the existence of a function $f \in S$ with $f(x) \neq f(y)$. We know that if G is unipotent, then the invariant field $K(X)^G$ is equal to the field of fractions of the invariant ring $K[X]^G$ [56], but the latter is not necessarily finitely generated. However, Arzhantsev, Celic and Hausen proved that, under some conditions, $K(X)^G$ is the field of fractions of a finitely generated separating subalgebra [23]. In fact, an affine variety is said to be *normal* if the ring of regular functions on X is

an integrally closed domain. Following [23], we say that the action of G on X is *factorial*, if every invariant hypersurface is the zero set of an invariant function $f \in K[X]^G$: in particular if G is unipotent and X is a vector space, then the G -action is factorial. We have:

Theorem ([23]). *For any algebraic group action there exists a finitely generated separating subalgebra $A \subset K[X]^G$. Moreover, if X is normal and the G -action is factorial, then one may choose A to have $K(X)^G$ as its field of fractions.*

This interesting result applies in our case because $X = \mathbb{C}^L$ and $j_k G$ is unipotent. In view of that, a possible lemma would be:

Possible Lemma 5.3.1. *Suppose that $\mathbb{C}(\mathbb{C}^L)^G = \mathbb{C}(f_1, \dots, f_\beta)$ such that $\{f_1, \dots, f_\beta\} \subset \mathbb{C}[\mathbb{C}^L]^G$ is a separating set. Let $\pi : \mathbb{C}^L \rightarrow \mathbb{C}^\beta$ be the polynomial map defined by (f_1, \dots, f_β) . If \mathbb{C}^L/G is an analytic geometric quotient, then the orbits are separated (i.e. $\bar{\pi} : \mathbb{C}^L/G \rightarrow \mathbb{C}^\beta$ is injective).*

A possible way to prove this lemma is to show that if the set of orbits which cannot be separated is nonempty, then it must contain non isolated orbits. The idea would be to show that if there is a function which has the same value for two different orbits i.e. some level of this function contains the two orbits, then another level contains other two orbits, and so on until we get very close orbits and obtain a contradiction with the result of Hertling which ensures the existence of an analytic geometric quotient. We note that example 5.2.1 is not a counter example to this lemma because the quotient in this example is not an analytic geometric quotient.

A *semi-algebraic* subset of \mathbb{R}^n is a union of finitely many subsets of the form

$$\{x \in \mathbb{R}^n; P(x) = 0, Q_1(x) > 0, \dots, Q_l(x) > 0\},$$

where $l \in \mathbb{N}$ and $P, Q_1, \dots, Q_l \in \mathbb{R}[x_1, \dots, x_n]$. A useful tool which can be used to show that the existence of non separated orbits must be in family, is the small path lemma, which holds also for semi analytic sets:

Lemma (Small path lemma [37]). *Let E be a semi-algebraic subset of \mathbb{R}^n and let x be an adherent point to E . Then, there exists a real algebraic path $p : [0, \delta[\rightarrow \mathbb{R}^n$ such that $p(0) = x$ and $p(t) \in E$ for all $t \neq 0$.*

The idea of the proof of lemma (5.3.1) would be to proceed by contradiction. Suppose that there exist $x, y \in \mathbb{C}^L$ such that $Gx \neq Gy$ with $\bar{\pi}(Gx) = \bar{\pi}(Gy) = 0$. This means that the following set is nonempty

$$S = \{(x, y) \in \mathbb{C}^L \times \mathbb{C}^L \mid Gx \neq Gy \text{ and } \bar{\pi}(Gx) = \bar{\pi}(Gy) = 0\} \neq \emptyset.$$

Considering the maps

$$\text{Pr}_i : \mathbb{C}^L \times \mathbb{C}^L \longrightarrow \mathbb{C}^L, (x_1, x_2) \longmapsto x_i \text{ and } P : \mathbb{C}^L \longrightarrow \mathbb{C}^L/G, x \longmapsto Gx,$$

we can write $S = S_1 \cap S_2$ with

$$\begin{aligned} S_1 &= \{(x, y) \in \mathbb{C}^L \times \mathbb{C}^L \mid \|P \circ \text{Pr}_1(x, y) - P \circ \text{Pr}_2(x, y)\| > 0\} \\ S_2 &= \{(x, y) \in \mathbb{C}^L \times \mathbb{C}^L \mid \bar{\pi} \circ P \circ \text{Pr}_1(x, y) = \bar{\pi} \circ P \circ \text{Pr}_2(x, y) = 0\}, \end{aligned}$$

where $\|Gx\| = \max_{g \in G} \|gx\|$. The set S is a semi algebraic subset of \mathbb{R}^{4L} . Suppose that S is not closed and that its closure is obtained by relaxing the strict inequalities. If we take a point $(x, y) \in \bar{S} \setminus S_1$, then we have $(x, y) \in \bar{S}_1 \setminus S_1$, and so $Gx = Gy$. By the small path lemma, there exists a map

$$p : [0, \delta[\rightarrow \mathbb{R}^{4L}$$

such that $p(0) = (x, y)$ and $p(t) \in S$ for all $t \neq 0$. Let $(t_\epsilon)_\epsilon$ be a sequence in $[0, \delta[$ such that $t_\epsilon \neq 0$ for all $\epsilon \neq 0$ and $t_\epsilon \xrightarrow{\epsilon \rightarrow 0} 0$. Since $p(t_\epsilon) \in S$, we have $p(t_\epsilon) = (x_\epsilon, y_\epsilon)$ such that $Gx_\epsilon \neq Gy_\epsilon$ and $\bar{\pi}(Gx_\epsilon) = \bar{\pi}(Gy_\epsilon) = 0$. Moreover, $P(t_\epsilon)$ tends to $P(0) = (x, y)$ as ϵ tends to zero. This means that $x_\epsilon \rightarrow x$ and $y_\epsilon \rightarrow y$, and so $Gx_\epsilon \rightarrow Gx$ and $Gy_\epsilon \rightarrow Gy$. Now, for any neighborhood U of Gx , there exists ϵ such that $Gx_\epsilon, Gy_\epsilon \in U$. But $Gx_\epsilon \neq Gy_\epsilon$ and $\bar{\pi}(Gx_\epsilon) = \bar{\pi}(Gy_\epsilon) = 0$ which is a contradiction if $\mathbb{C}(\mathbb{C}^L)^G$ separates the orbits locally. A possible way to show this is to use the fact that \mathbb{C}^L/G is an analytic geometric quotient and that the foliation generated by G is regular (see lemma (5.3.1)).

However, even if $\mathbb{C}(\mathbb{C}^L)^G$ separates the orbits locally, we still have two problems: the set S may be closed, and even if it is not so, then its closure is not necessarily obtained by relaxing the strict inequalities. So, a first possible lemma would be to show that: if we have two algebraic subsets X and Y of \mathbb{C}^L such that their intersection is nonempty and X is not included in Y , then $X \setminus Y$ is not closed. For instance, this is true if we take X to be the zero set of x and Y the zero set of y in \mathbb{C}^2 . If such a lemma is true, then we can apply it for $X = \{(x, y) \in \mathbb{C}^L \times \mathbb{C}^L \mid \bar{\pi}(Gx) = \bar{\pi}(Gy)\}$ and $Y = \{(x, y) \in \mathbb{C}^L \times \mathbb{C}^L \mid Gx = Gy\}$. A possible proof would be to show that X is connected or its connected components contain infinitely many points with Y not being a connected component of X . However, since the action is not explicit, we can not make sure that such a statement holds. We know that the connected components, in the euclidean topology, of an algebraic set are generally only semi-algebraic [2]. The image of an algebraic set under a regular mapping, even a linear projection of the euclidean space, is in general only semi-algebraic. A semi-algebraic set has finitely many connected components in the euclidean topology and each such a component is semi-algebraic. As for the second problem regarding the closure, we know that

Proposition ([47]). *Every closed semi-algebraic subset of a real algebraic manifold is locally a finite union of sets of the form*

$$\{x : f_1(x) \geq 0, \dots, f_k(x) \geq 0\}$$

where the f_i are algebraic functions.

The same statement works for the closure of a semi-analytic subset of \mathbb{R}^n [16]. Also, according to Lojaciwicz [54], the closure, the interior, the boundary and the complement of any semi-analytic set is in general semi-analytic.

A result of Thom says that, under some conditions, the closure of a semi-algebraic set in one variable is obtained by relaxing the strict inequalities:

Proposition (Thom's lemma, [47]). *Let $P_1, \dots, P_s \in \mathbb{R}[x]$ be a finite family of nonzero polynomials, which is closed under derivation (i.e., if the derivative P_i' is nonzero, there is j such that $P_i' = P_j$). For $\epsilon = (\epsilon_1, \dots, \epsilon_s) \in \{-1, 0, 1\}^s$, let $A_\epsilon \subset \mathbb{R}$ be defined by*

$$A_\epsilon = \{x \in \mathbb{R}; \text{sign}(P_i(x)) = \epsilon_i \text{ for } i = 1, \dots, s\}.$$

Then

1. either $A_\epsilon = \emptyset$,
2. or A_ϵ is a point (necessarily, at least one of the ϵ_i is 0),
3. or A_ϵ is a nonempty open interval (necessarily, all ϵ_i are ± 1).

Let

$$A_{\bar{\epsilon}} = \{x \in \mathbb{R}; \text{sign}(P_1(x)) \in \bar{\epsilon}_1, \dots, \text{sign}(P_s(x)) \in \bar{\epsilon}_s\},$$

where $\bar{\epsilon}$ is given by

$$\bar{\epsilon} = \begin{cases} \{0\} & \text{if } \epsilon = 0 \\ \{0, 1\} & \text{if } \epsilon = 1 \\ \{0, -1\} & \text{if } \epsilon = -1. \end{cases}$$

Then $A_{\bar{\epsilon}}$ is either empty, or a point, or a closed interval different from a point, and the interior of this interval is A_ϵ .

Consider two polynomials $P = a_0x^d + \dots + a_d$ of degree d and $Q = b_0x^e + \dots + b_e$ of degree e . The *resultant* of P and Q is the determinant of the *Sylvester matrix* of P and Q , which is the square matrix of size $d + e$ whose rows are the coordinates of $x^{e-1}P, \dots, xP, P, Q, xQ, \dots, x^{d-1}Q$, respectively, in the monomial basis $x^{d+e-1}, \dots, x, 1$. For $0 \leq j \leq \min(d, e)$, $\text{PSRC}_j(P, Q)$ denotes the *principle subresultant coefficient* of order j of P and Q , which is defined by the determinant of the square matrix of size $d + e - 2j$ which is obtained from the Sylvester matrix of P and Q by deleting the first j rows, the last j rows, the first j columns and the last j columns. The resultant of P and Q is $\text{PSRC}_0(P, Q)$.

If P is a polynomial in $\mathbb{R}[x_1, \dots, x_n]$, we consider it as a polynomial in the variable x_n with coefficients in $\mathbb{R}[x_1, \dots, x_{n-1}]$. Let P_1, \dots, P_r be a family of polynomials in $\mathbb{R}[x_1, \dots, x_n]$. We denote by $\text{PROJ}(P_1, \dots, P_r)$ the smallest family of polynomials in $\mathbb{R}[x_1, \dots, x_{n-1}]$ satisfying the following conditions:

1. If $\deg_{x_n} P_i = d \geq 2$, then $\text{PROJ}(P_1, \dots, P_i, \dots, P_r)$ contains all non constant polynomials among $\text{PSRC}_j(P_i, \partial P_i / \partial x_n)$ for $j = 0, \dots, d - 1$.
2. If $1 \leq d = \min(\deg_{x_n} P_i, \deg_{x_n} P_k)$, then $\text{PROJ}(P_1, \dots, P_i, \dots, P_k, \dots, P_r)$ contains all non constant $\text{PSRC}_j(P_i, P_k)$ for $j = 0, \dots, d$.

3. If $\deg_{x_n} P_i \geq 1$ and the leading coefficient of P_i is not constant, then $\text{PROJ}(P_1, \dots, P_i, \dots, P_r)$ contains the leading coefficient of P_i and $\text{PROJ}(P_1, \dots, \text{trunc}(P_i), \dots, P_r)$, where $\text{trunc}(P_i)$ denotes the truncated polynomial obtained by deleting its leading term.
4. If $\deg_{x_n} P_i = 0$ and P_i is not constant, then $\text{PROJ}(P_1, \dots, P_i, \dots, P_r)$ contains P_i .

The following theorem is a generalization of Thom's lemma for several variables:

Theorem ([47]). *Let $(P_{i,j})$ be a family of polynomials with real coefficients, $1 \leq i \leq n$, $1 \leq j \leq s_i$, such that:*

1. *for fixed i , $(P_{i,1}, \dots, P_{i,s_i})$ is a family of polynomials in $\mathbb{R}[x_1, \dots, x_i]$, all quasi-monic with respect to x_i , closed under derivation with respect to x_i ,*
2. *for $i < n$, the family of polynomials $(P_{i,1}, \dots, P_{i,s_i})$ contains the family $\text{PROJ}(P_{i+1,1}, \dots, P_{i+1,s_{i+1}})$.*

For $0 < k \leq n$, given a family $\epsilon = (\epsilon_{i,j})$ of signs in $\{-1, 0, 1\}$ indexed by $i = 1, \dots, k$ and $j = 1, \dots, s_i$, set

$$C_\epsilon = \{x \in \mathbb{R}^k; \text{sign}(P_{i,j}(x)) = \epsilon_{i,j} \text{ for } i = 1, \dots, k \text{ and } j = 1, \dots, s_i\},$$

$$C_{\bar{\epsilon}} = \{x \in \mathbb{R}^n; \text{sign}(P_{i,j}(x)) \in \bar{\epsilon}_{i,j} \text{ for } i = 1, \dots, n \text{ and } j = 1, \dots, s_i\}.$$

The closure of the nonempty cell C_ϵ is $C_{\bar{\epsilon}}$, which is a union of cells.

Clearly, since in our case, the action is not explicit, these conditions cannot be tested.

The contraction obtained by the end of the idea of the proof is partially due to the following lemma:

Lemma 5.3.1. *If \mathbb{C}^L/G is an analytic geometric quotient, then the foliation generated by G is regular.*

Proof. By Rosenlicht [21], there exists an algebraic invariant manifold Z such that the field of rational functions on U/G , where $U = \mathbb{C}^L \setminus Z$, is isomorphic to the subfield $\mathbb{C}(\mathbb{C}^L)^G$ of G -invariant rational functions on \mathbb{C}^L . This means that the orbits of G on \mathbb{C}^L define an algebraic foliation which is completely integrable by rational functions. So, there exist $f_1, \dots, f_k \in \mathbb{C}(\mathbb{C}^L)^G$ such that the generic leaf $L \subset \{f_1 = c_1, \dots, f_k = c_k\}$ with $\dim L = L - k$. As the rational forms df_1, \dots, df_k generate the foliation, a singular locus of such a foliation is given by $df_1 \wedge \dots \wedge df_k = 0$. If the singular locus has the same dimension as that of the leaves, then this is not a geometric singular locus, i.e. it is not a singular locus of the foliation, only of the form. If the singular locus is geometric, then its dimension is strictly smaller than that of the leaf because the singular locus is defined by C_L^k equations which is strictly greater than k . Moreover, it is invariant by the action because the fact that the foliation is completely integrable by rational functions means that g^*df_i is a linear combination of df_j . This implies that $g^*df_1 \wedge \dots \wedge df_k$ is a multiple of $df_1 \wedge \dots \wedge df_k$ by a holomorphic function. So, the set $df_1 \wedge \dots \wedge df_k = 0$ is invariant by G . In particular, it contains leaves of strictly smaller dimension which is impossible. \square

We remark that if we go back to the case considered by Hertling [13] and replace the quasi-affine variety by \mathbb{C}^L and the group by a unipotent group, then we have to check if in this case the quotient is algebraic. A variety X is said to be *complete* if it is separated and universally closed which means that for any variety Y , the projection map $Y \times X \rightarrow Y$ sends closed sets to closed sets. Chow's lemma shows that a complete variety is not far from a projective variety.

Theorem (Chow's Lemma). *For every complete irreducible variety V , there exists a surjective regular map $f : V' \rightarrow V$ from a projective algebraic variety V' to V such that for some dense open subset U of V , f induces an isomorphism $f^{-1}(U) \rightarrow U$ (in particular, f is birational).*

The next theorem implies that complete quotients which are analytic geometric quotients are not far from algebraic quotients.

Theorem (Chow's Theorem [57]). *Every closed analytic subset of a projective variety is algebraic.*

A direct application of this theorem is:

Theorem ([57]). *Every compact analytic subset of an algebraic variety is algebraic.*

If the base field is the field of complex numbers, then X is complete is and only if X with the classical topology coming from \mathbb{C} is compact, and if X is quasi-projective, then complete is equivalent to projective. Based on this remark, we cannot make use of the previous results because our quotient is not complete in general.

5.4 Counter example.

Deveney and Finston constructed an example of an action of the additive group on \mathbb{C}^5 such that the algebra of invariants does not separate the orbits [26]. Since this example satisfies the conditions of the possible lemma (5.3.1), it implies that the lemma as it is, is not true, and so to obtain the desired conclusion we need to add more hypothesis which is not known for the moment. This section is devoted to present this example. For the convenience of the reader, we present most of the details established by Deveney and Finston in [26].

Let G_a denotes the additive group of complex numbers, X a variety over \mathbb{C} , and $\sigma : G_a \times X \rightarrow X$ a rational action of G_a on X . The action is said to admit an *equivariant trivialization* if X is (G_a) equivariantly isomorphic to $Y \times \mathbb{C}$, with the group action fixing the first coordinate and acting by addition on the second. In that case, the affine variety Y is a geometric quotient. The action is said to be *locally trivial* (in the Zariski topology) if X is covered by G_a stable (affine) open subsets on each of which the action admits an equivariant trivialization.

As we mentioned before, if $(\sigma, \text{id}) : G_a \times X \rightarrow X \times X$ is a proper morphism of varieties, we say that σ is a proper action. A proper action of G_a on $X = \mathbb{C}^n$ is *locally trivial*

if $\mathbb{C}[X]$ is a flat extension of its subring of G_a invariants and *equivariantly trivial* if the extension is faithfully flat [33]. Moreover, under those conditions the geometric quotient exists as a quasiaffine variety.

These results were used to show that all proper fixed point free G_a actions on \mathbb{C}^3 admit equivariant trivializations. Fauntleroy [3] has shown that locally trivial G_a actions are necessarily proper. Smith [15] and Winkelmann [40] have given examples of fixed point free actions on \mathbb{C}^4 for which the space of orbits is not Hausdorff in the quotient topology induced from the complex topology on \mathbb{C}^4 . These examples are clearly nonproper, and admit no geometric quotient. In the same paper, Winkelmann has given an example of a proper action on \mathbb{C}^5 which is locally trivial in the Zariski topology but does not admit an equivariant trivialization.

In [26], James K. Deveney and David R. Finston constructed an example of a proper action on complex affine five space which is not locally trivial. They noted that Fauntleroy [3] has shown that if distinct orbits of a proper G_a action on a quasifactorial variety can be separated by invariant rational functions (i.e., if the action is properly stable), then the action is locally trivial. Based on that, they found out that it is the stability that is lacking by their example. An assertion which would imply that any proper, fixed point free G_a action on a normal variety is locally trivial and admits a quasiprojective quotient appears in a paper of Magid and Fauntleroy [4], and the source of the error is pointed out in [3]. The example of Deveney and Finston indicates that no such general result is possible.

We start by presenting some features of proper rational algebraic G_a actions on \mathbb{C}^n discussed by them aiming to give some indication of how close proper actions are to being locally trivial. Let $\sigma : G_a \times X \rightarrow X$ be a rational action of G_a on $X = \mathbb{C}^n$, $\hat{\sigma} : \mathbb{C}[X] \rightarrow \mathbb{C}[X, t]$ the induced map on coordinate rings, and $\tilde{\sigma}$ the morphism $G_a \times X \rightarrow X \times X$ given by $(t, x) \mapsto (x, \sigma(t, x))$. Differentiating $\hat{\sigma}$ yields a locally nilpotent derivation δ of $\mathbb{C}[X]$:

$$\delta(P) = \frac{\hat{\sigma}(P) - P}{t} \Big|_{t=0}, \quad \hat{\sigma} = \exp(t\delta).$$

Every $\hat{\sigma}$, hence every rational G_a action, arises as the exponential of a locally nilpotent derivation. It should be noted that the ring of invariants of the G_a action is identical to the kernel of δ and that the fixed point set for the action is the set of common zeros of $\{\delta x_i : 1 \leq i \leq n\}$ where x_i , $1 \leq i \leq n$ are coordinates on X .

Properness of the action is expressed in terms of coordinate rings: $\tilde{\sigma}$ induces a \mathbb{C} -algebra homomorphism $\bar{\sigma} : \mathbb{C}[X \times X] \rightarrow \mathbb{C}[X \times G_a] \cong \mathbb{C}[X, t]$. It was proved in [33] that σ is proper if and only if $\bar{\sigma}$ is surjective, and locally trivial if and only if $\text{im}(\delta) \cap \mathbb{C}[X]^{G_a}$ generates the unit ideal in $\mathbb{C}[X]$. In the latter case the action admits a quasiaffine geometric quotient. An easy consequence of the surjectivity of $\bar{\sigma}$ is the absence of fixed points. Moreover, for proper G_a actions, Deveney and Finston have shown that the action is locally trivial if and only if the ring extension $\mathbb{C}[X]^{G_a} \hookrightarrow \mathbb{C}[X]$ is flat, and equivariantly trivial if and only if the extension is faithfully flat [33]. If there is a slice for the action, i.e. $s \in \mathbb{C}[X]$ with $\hat{\sigma}(s) = s + t$ (equivalently, $\delta(s) = 1$), then clearly

$\bar{\sigma}$ is surjective. Moreover, if a slice exists, then the action is equivariantly trivial, i.e., $X \cong X/G_a \times G_a$.

Assume that σ is a proper action of G_a on $X = \mathbb{C}^n$, so that for some $P \in \mathbb{C}[X \times X] = \mathbb{C}[x_1, \dots, x_n, y_1, \dots, y_n]$, we have

$$t = \bar{\sigma}P(x_1, \dots, x_n, y_1, \dots, y_n) = P(x_1, \dots, x_n, \hat{\sigma}x_1, \dots, \hat{\sigma}x_n). \quad (5.1)$$

For $a = (a_1, \dots, a_n) \in X$ define $P_a = P(a_1, \dots, a_n, x_1, \dots, x_n) \in \mathbb{C}[X]$. Clearly P_a provides an algebraic isomorphism from the orbit of a to \mathbb{C} . In particular, each orbit is a complete intersection [38]. The following remarks by Deveney and Finston show how close P_a is to a slice. Differentiating (5.1) with respect to t , using the fact that $\hat{\sigma} = \exp(t\delta)$, leads to

$$1 = \sum_{i=1}^n \frac{\partial P_a}{\partial x_i} \delta x_i(a_i).$$

The definition of the tangent space to the zero set of P_a at a (e.g., [[22], p. 73]) shows that the zero set of P_a intersects the orbit of a transversally at a [[22], p. 82], and it is clear that a is the unique point in the intersection. If $\{h_1, \dots, h_{n-1}\}$ is a minimal generating set for the ideal of the orbit of a , then h_1, \dots, h_{n-1}, P_a are local parameters at a in X . Moreover, since a is simple on the zero set of P_a , only one component, say $Z_a =$ the zero set of q , passes through it. The h_i need not be invariants, however. If the orbit of a can be determined as the vanishing set of invariant rational functions g_i , then on an affine neighborhood U_a of a , $Z_a \cap U_a$ gives a local quotient for the action. Indeed, because Z_a intersects the orbit of a transversally, the local parameters g_i, q form a coordinate system for U_a at a . In particular, orbits on U_a are determined by values of the rational functions g_i .

Now, we present the counter example of Deveney and Finston. The action is determined by the locally nilpotent derivation δ of $\mathbb{C}[x_1, x_2, y_1, y_2, z]$ given by

$$x_2 \xrightarrow{\delta} x_1 \xrightarrow{\delta} 0, \quad y_2 \xrightarrow{\delta} y_1 \xrightarrow{\delta} 0, \quad z \xrightarrow{\delta} (1 + x_1 y_2^2).$$

To see that the action is proper, observe that $t = \hat{\sigma}z - z - y_2^2(\hat{\sigma}x_2 - x_2) - y_2(\hat{\sigma}x_2 - x_2)(\hat{\sigma}y_2 - y_2) - \frac{(\hat{\sigma}x_2 - x_2)(\hat{\sigma}y_2 - y_2)^2}{3}$. They showed that there are distinct orbits which are not separable by invariant rational functions. In fact, generators for the ring of invariants are explicitly given, from which it is clear that the ring of invariants is not regular. They note that with aid of the computer algebra program MAPLE, it is easy to check that the action is unstable by checking the elements of a Gröbner basis for the kernel of $\hat{\sigma}$ against those of a Gröbner basis for the ideal of $\mathbb{C}[X, Y]$ generated by $\{c(X) - c(Y) : c \in \mathbb{C}[X]^{G_a}\}$. They clarified that instability clearly is due to the inability to separate orbits by G_a invariants: the use of computational methods is mentioned to emphasize their utility in problems such as these.

The ring of invariants is generated by the five polynomials $c_1 = x_1, c_2 = y_1$, and

$$\begin{aligned} c_3 &= x_1 y_2 - x_2 y_1, \\ c_4 &= 3y_1 z - x_1 y_2^3 - 3y_2, \\ c_5 &= \frac{x_1^2 c_4 + c_3^3 + 3x_1 c_3}{y_1}. \end{aligned}$$

These generators were obtained by implementing a form of the algorithm in [43], easily extended to locally nilpotent, but not necessarily linear, derivations of polynomial rings. Van den Essen has given a treatment of the algorithm, suitable for computer implementation, in [9]. Since the latter reference may not be easily accessible, Deveney and Finston sketched the application to the example at hand, referring to [43] for details. It follows from [34] that the ring of G_a invariants for the action extended to $\mathbb{C}[X, \frac{1}{y_1}]$ is generated by $\{\frac{1}{y_1}, c_1, c_2, c_3, c_4\}$. Indeed, $\frac{y_2}{y_1}$ is a slice for the extended action. Deveney and Finston built a chain of subrings C_i of the ring of G_a invariants in $\mathbb{C}[X]$ as follows:

Set $C_1 = \mathbb{C}[c_1, c_2, c_3, c_4]$ and $\bar{C}_1 = \frac{C_1}{(y_1)}$. View \bar{C}_1 as the homomorphic image of the polynomial ring $\mathbb{C}[z_1, z_2, z_3]$ under the mapping which sends z_i to the residue class of c_i . Since \bar{C}_1 is a two-dimensional domain, the kernel is a principal ideal, easily seen to be generated by $z_1^2 z_4 + z_3^3 + 3z_1 z_3$. In other words, $x_1^2 c_4 + c_3^3 + 3x_1 c_3$ lies in the ideal of C_1 generated by y_1 . The invariant c_5 is obtained by dividing out the highest power ($= 1$) of y_1 dividing $x_1^2 c_4 + c_3^3 + 3x_1 c_3$ and C_2 is defined to be $C_1[c_5]$. Repeating this procedure with $\bar{C}_2 = C_2/(y_1)$, one finds that the residue class of c_5 is algebraically independent from the classes c_1, c_2, c_3, c_4 . In particular, no new relations, and hence no new invariants, arise. Thus, the ring of invariants C is isomorphic to $\mathbb{C}[u_1, u_2, u_3, u_4, u_5]/\langle u_2 u_5 - u_1^2 u_4 - u_3^3 - 3u_1 u_3 \rangle$ which is the coordinate ring of a variety with singularities at all points $p_\alpha = (0, 0, 0, a, 0)$. Denoting $\text{spec } C$ by Y and by π the morphism induced by the inclusion $C \hookrightarrow \mathbb{C}[X]$, the fiber $\pi^{-1}(p_\alpha)$ is two dimensional, consisting of all points $(0, \beta, 0, \frac{-\alpha}{3}, \gamma)$. In particular, the extension $C \hookrightarrow \mathbb{C}[X]$ is not flat [[20], Theorem 15.1].

Deveney and Finston remarked that for an action locally trivial in the Zariski topology, the extension $C \hookrightarrow \mathbb{C}[X]$ is necessarily flat: local triviality implies that there is an open cover of X by principal affine subsets $X_{f_i} \cong Y_i \times \mathbb{C}$, where $f_i \in C \cap \text{image}(\delta)$. The projection morphism $X_{f_i} \rightarrow Y_i$ is flat. Since flatness is a local condition, the result follows.

They added that distinct orbits can, however, be separated by algebraic functions. By the method of Seshandri [[14], Theorem 6.1], the G_a action extends to the normalization Z of X in a certain degree six Galois extension of $\mathbb{C}(X)$. The action on Z is locally trivial and admits a geometric quotient W , which is a variety (necessarily not quasiprojective by [[14], p. 543]). If G denotes the Galois group of $\mathbb{C}(Z)/\mathbb{C}(X)$, then, as indicated in [3], the geometric quotient of X is the algebraic space W/G . The affine variety Z is constructed as follows. Let S_1 be the hyperplane in X defined by $z = 0$ and S_2 the hyperplane $x_2 = y_2$. One checks that $X = \sigma(G_a \times S_1) \cup \sigma(G_a \times S_2)$. Denote $\mathbb{C}(G_a \times S_i)$ by K_i , observing that they are field extensions of $\mathbb{C}(X)$ since the U_i are dense in X . If $u_{11} = x_1, u_{12} = x_2, u_{13} = y_1$, and $u_{14} = y_2$ are coordinates on S , and t is the coordinate on G_a , then the field extension $\mathbb{C}(X) \hookrightarrow K_1$ is given by $x_1 \mapsto u_{11}, x_2 \mapsto u_{12} + t u_{12}, y_1 \mapsto u_{13}, y_2 \mapsto u_{13} + t u_{14}, z \mapsto t(1 + u_{11} u_{14}^2) + t^2 u_{11} u_{13} u_{14} + \frac{t^3}{3} u_{11} u_{13}^2$. Applying the invariants c_1, \dots, c_5 to these expressions shows that t satisfies a cubic polynomial over $\mathbb{C}(X)$ and $K_1 = \mathbb{C}(X)(t)$. A similar procedure shows that $K_2 = \mathbb{C}(X)$. Now Z is taken to be the normalization of X in the normal closure of K_1 over $\mathbb{C}(X)$. The slices on Z are given by $\frac{x_2}{x_1}, \frac{y_2}{y_1}$, and the three roots of the minimal polynomial for t in $\mathbb{C}(Z)$.

Bibliography

- [1] A. Borel: *Linear algebraic groups*, 126, Springer (1991).
- [2] A. Broer: *Representation theories and algebraic geometry*, 514, Springer (1998).
- [3] A. Fauntleroy: *Geometric invariant theory for general algebraic groups*, *Compositio Math.* 55(1985), 63-87.
- [4] A. Fauntleroy and A. Magid: *Proper G_a actions*, *Duke Math. J.* 43 (1976), 723-729.
- [5] A. Hefez and M. Hernandez: *Analytic classification of plane branches up to multiplicity 4*, *J. Symbolic Comput.* 44-6 (2009).
- [6] A. Hefez and M. Hernandez: *The analytic classification of plane branches*, *Bull. Lond. Math. Soc.* 43-2 (2011).
- [7] A. Hefez and M. E. Hernandez: *Algorithms for the implementation of the analytic classification of plane branches*. *J. Symbolic Comput.*, 50:308-313, 2013.
- [8] A. Seidenberg: *Reduction of singularities of the differential equation $Ady = Bdx$* . *Amer. J. Math.*, 90 :248-269, (1968).
- [9] A. van den Essen: *Locally finite and locally nilpotent derivations with applications to polynomial flows, morphisms, and G_a actions*. II, Report 9206, Catholic Univ., Nijmegen.
- [10] C. Camacho and P. Sad: *Invariant varieties through singularities of holomorphic vector fields*. *Ann. of Math. (2)*, 115(3) :579-595, (1982).
- [11] C. Camacho, A. Lins Neto, and P. Sad: *Topological invariants and equidesingularization for holomorphic vector fields*. *J. Differential Geom.*, 20(1) :143-174, (1984).
- [12] C. Godbillon: *Feuilletages, etudes géométriques*, *Progr. Math.*, vol. 98, Birkhauser, Boston and Basel, 1991.
- [13] C. Hertling: *Frobenius manifolds and moduli spaces for singularities*, volume 151 of *Cambridge Tracts in Mathematics*. Cambridge University Press, Cambridge, 2002.
- [14] C. S. Seshandri: *Quotient spaces modulo reductive algebraic groups*, *Ann. of Math.* 95 (1972), 511-556.

- [15] D. Snow: *Unipotent actions on affine space*, Topological Methods in Algebraic Transformation Groups, Birkhauser, Boston, 1989.
- [16] E. Bierstone and P. Milman: *Semianalytic and subanalytic sets*, Inst. Hautes Études Sci. Publ. Math. 67 (1988), 5-42.
- [17] G. Bérczi, B. Doran, T. Hawes, and F. Kirwan: *Constructing quotients of algebraic varieties by linear algebraic group actions*, Handbook of Group Actions, (eds. Ji, L., Papadopoulos, A. and Yau, S.-T.) Advanced Lectures in Mathematics (ALM), Vol. III (Higher Education Press and International Press).
- [18] G.-M. Greuel and G. Pfister: *Geometric quotients of unipotent group actions*, Proc. London Math. Soc. 67 (1993), 75-105.
- [19] H. Holmann: *Komplexe Raume mit komplexen Transformationsgruppen*. Math. Ann. 150 (1963), 327-360.
- [20] H. Matsumura: *Commutative ring theory*, Cambridge Stud. Adv. Math., vol. 8, Cambridge Univ. Press, Cambridge, 1989.
- [21] I. Dolgachev: *Lectures on Invariant theory*, LMS Lecture notes series 296, Cambridge Univ. Press (2003).
- [22] I. R. Shafarevitch: *Basic algebraic geometry*, Springer-Verlag, Berlin, 1977.
- [23] I. V. Arzhantsev, D. Celic and J. Hausen: *Factorial algebraic group actions and categorical quotients*, J. Algebra 387 (2013), 87-98.
- [24] J. Ax: *The elementary theory of finite fields*. Ann. Math. 88, 239-271 (1968).
- [25] J. Briancon, M. Granger, and Ph. Maisonobe: *Le nombre de modules du germe de courbe plane $x^a + y^b = 0$* , Math. Ann. 279-3 (1988).
- [26] James K. Deveney and David R. Finston: *A proper \mathbb{G}_a -action on \mathbb{C}^5 which is not locally trivial*, Proc. Amer. Math. Soc. 123 (1995), 651-655.
- [27] J. Dixmier, M. Raynaud: *Sur le quotient d'une variété algébrique par un groupe algébrique*. Mathematical analysis and applications, Part A, pp. 327-344, Adv. in Math. Suppl. Stud., 7a, Academic Press, New York-London, 1981.
- [28] J.M. Granger: *Sur un espace de modules de germe de courbe plane*, Bull. Sc. math. 103-2 (1979).
- [29] J.F. Mattei: *Modules de feuilletages holomorphes singuliers: I équisingularité*, Invent.Math.103 (1991).
- [30] J.F. Mattei: *Quasihomogénéité et équiréductibilité de feuilletages holomorphes en dimension 2*, Astérisque 261 S.M.F. (2000) p. 253-276.

- [31] J.-F. Mattei and R. Moussu: *Holonomie et intégrales premières*. Ann. Sci. École Norm. Sup. (4), 13(4) :469-523, (1980).
- [32] J. Kollár: *Quotient spaces modulo algebraic groups*, Ann. of Math. (2) 145 (1997), no. 1,33-79.
- [33] J. K. Deveney, D. R. Finston, and M. Gehrke: *G_a actions on \mathbb{C}^n* , Comm. Algebra 22 (1994), 4977-4988.
- [34] J. K. Deveney and D. R. Finston: *Fields of G_1 invariants are ruled*, Canad. Math. Bull. 37 (1994), 37-41.
- [35] J. Mather: *Stability of \mathbb{C}^∞ -maps III. Finitely determined map germs.*, Publ. Math. I.H.E.S. 35 (1968), 127-156.
- [36] J. Mather: *Stability of \mathbb{C}^∞ -maps IV. Classification of stable germs by \mathbb{R} -algebras.* Publ. Math. I.H.E.S. 37 (1969), 223-248.
- [37] J. Milnor: *Singular points of complex hypersurfaces*, Ann. of Math. Stud., Princeton.
- [38] J. Ohm: *Space curves as ideal theoretic complete intersections*, Studies in Algebraic Geometry, MAA Stud. Math., vol. 20, Math. Assoc. Amer., Washington, DC, 1980.
- [39] J.-P. Serre: *Géométrie algébrique et géométrie analytique*, Ann. Inst. Fourier, t. VI (1955-56), p. 1-42.
- [40] J. Winkelmann: *On free holomorphic \mathbb{C} -actions on \mathbb{C}^n and homogeneous Stein manifolds*, Math. Ann. 286 (1990), 593-612.
- [41] K. Saito: *Quasihomogene isolierte Singularitäten von Hyperflächen*, Invent. Math. 14 (1971).
- [42] Loray, F.: *Pseudo-groupe d'une singularité de feuilletage holomorphe en dimension deux*, Prépublication IRMAR (2005).
- [43] L. Tan: *An algorithm for explicit generators of the invariants of the basic Graciions*, Comm. Algebra 17 (1989), 565-572.
- [44] M. Artin: *Versal deformations and algebraic stacks*, Inv. Math. 27 (1974) 165-189.
- [45] M. Berthier, D. Cerveau and R. Meziani: *Transformations isotropes des germes de feuilletages holomorphes*, J. Math. Pures Appl. 9-78 (1999).
- [46] M. Brion: *Introduction to actions of algebraic groups*, Notes of the course "Actions hamiltoniennes : invariants et classification" (CIRM, Luminy,2009).
- [47] M. Coste: *An introduction to semialgebraic geometry*. Istituti editoriali e poligrafici internazionali, Pisa (1998).

- [48] M. Demazure and P. Gabriel: *Groupes algébriques*, Masson and North Holland, Amsterdam, 1970.
- [49] M. Lejeune-Jalabert: *Sur l'équivalence des courbes algébroides planes. Coefficients de Newton. Contribution à l'étude des singularités du point de vue du polygone de Newton*, Université de Paris VII, Paris, (1973).
- [50] M. Nagata: *On the fourteenth problem of Hilbert*, Amer. J. Math. 81, n3 (1959), 766-772.
- [51] M. Rosenlicht: *On quotient varieties and the affine embedding of certain homogeneous spaces*, Trans. Amer. Math. Soc., 101 (1961), 211-223.
- [52] O. Zariski: *Le problème des modules pour les branches planes*. Hermann, Paris, second edition, 1986. Course given at the Centre de Mathématiques de l'École Polytechnique, Paris, October-November 1973, With an appendix by Bernard Teissier.
- [53] R. Rentschler: *L'injectivité de l'application de Dixmier pour les algèbres de Lie résolubles*, Invent. Math., 23 (1974), pp. 49-72.
- [54] S. Lojasiewicz: *Triangulation of semi-analytic sets*, Annali della Scuola Normale Superiore di Pisa-Classe di Scienze, Série 3 : Volume 18 (1964) no. 4 , p. 449-474.
- [55] T. Kambayashi, M. Miyanishi, and M. Takeuchi: *Unipotent algebraic groups*. Springer-Verlag, Berlin, 1974. Lecture Notes in Mathematics, Vol. 414.
- [56] T. Kamke and G. Kemper: *Algorithmic invariant theory of nonreductive group*. Qualitative Theory of Dynamical Systems, 11:79-110, 2012.
- [57] W. L. Chow: *On compact complex analytic varieties*. Amer. J. of Math., 71, 1949, pp. 893-914.
- [58] Y. Genzmer and E. Paul: *Normal forms of foliations and curves defined by a function with a generic tangent cone*, Moscow Math. J., 2011, n.1.
- [59] Y. Genzmer and E. Paul: *Moduli spaces for topologically quasi-homogeneous functions*, Journal of Singularities, 2015.
- [60] Y.T. Siu: *Every Stein subvariety admits a Stein neighborhood*, Invent. Math 38,89-100, (1976).