



**HAL**  
open science

# Shared representation of work-related musculoskeletal risk factors and comparison of assessment methods: an experimental study in the truck manufacturing industry

Mohsen Zare Mahmoudabadi

## ► To cite this version:

Mohsen Zare Mahmoudabadi. Shared representation of work-related musculoskeletal risk factors and comparison of assessment methods: an experimental study in the truck manufacturing industry. Human health and pathology. Université d'Angers, 2015. English. NNT: 2015ANGE0075. tel-02289364

**HAL Id: tel-02289364**

**<https://theses.hal.science/tel-02289364v1>**

Submitted on 16 Sep 2019

**HAL** is a multi-disciplinary open access archive for the deposit and dissemination of scientific research documents, whether they are published or not. The documents may come from teaching and research institutions in France or abroad, or from public or private research centers.

L'archive ouverte pluridisciplinaire **HAL**, est destinée au dépôt et à la diffusion de documents scientifiques de niveau recherche, publiés ou non, émanant des établissements d'enseignement et de recherche français ou étrangers, des laboratoires publics ou privés.

# Thèse de Doctorat

**Mohsen ZARE  
MAHMOUDABADI**

*Mémoire présenté en vue de l'obtention du  
grade de Docteur de l'Université d'Angers  
sous le label de L'Université Nantes Angers Le Mans*

École doctorale : **Biologie-Santé**

Discipline : **Recherche Industrielle, Santé au Travail**

Spécialité : *Ergonomie Industrielle*

Unité de recherche : **Laboratoire d'ergonomie et d'épidémiologie en santé au travail (LEEST)**

Soutenue le *11 décembre 2015*

Thèse N° : *15983*

## **Shared Representation of Work-related Musculoskeletal Risk Factors and Comparison of Assessment Methods: An Experimental Study in the Truck Manufacturing Industry**

### **JURY**

Rapporteurs :	<b>Nancy BLACK</b> , Professeur, Département de génie mécanique, Faculté d'ingénierie, Université de Moncton, Canada <b>Alain GARRIGOU</b> , Professeur, Département Hygiène, Sécurité & Environnement, IUT & Equipe EPICENE (Epidémiologie des cancers et Expositions Environnementales), Centre Inserm U1219, Université de Bordeaux, France
Examineurs :	<b>Alexis DESCATHA</b> , Professeur, Université de Versailles Saint Quentin en Yvelines, France <b>Christophe CORNU</b> , Professeur, Université de Nantes, France <b>Christian ROBLEDO</b> , Maître de Conférences, ISTIA, Université d'Angers, France <b>Agnès AUBLET-CUVELIER</b> , Directeur de Recherche, Institut national de recherche et de sécurité (INRS), Vandoeuvre-lès-Nancy, France
Invités :	<b>Robert HOGLUND</b> , M.Sc.M.E, Plant Manager, Chassis Assembly, SCANIA CV AB, Södertälje, Sweden <b>Farhad Hossein ARABI</b> , Docteur, Biomécanique et Ergonomie, Peugeot Citroën Automobiles (PSA), Paris, France
Directeur de Thèse :	<b>Yves ROQUELAURE</b> , Professeur, Laboratoire d'Ergonomie et d'Epidémiologie en Santé et Travail (LEEST), Universités d'Angers, France



**L'auteur du présent document vous autorise à le partager, reproduire, distribuer et communiquer selon les conditions suivantes :**



- Vous devez le citer en l'attribuant de la manière indiquée par l'auteur (mais pas d'une manière qui suggérerait qu'il approuve votre utilisation de l'œuvre).
- Vous n'avez pas le droit d'utiliser ce document à des fins commerciales.
- Vous n'avez pas le droit de le modifier, de le transformer ou de l'adapter.

**Consulter la licence creative commons complète en français :  
<http://creativecommons.org/licences/by-nc-nd/2.0/fr/>**

Ces conditions d'utilisation (attribution, pas d'utilisation commerciale, pas de modification) sont symbolisées par les icônes positionnées en pied de page.





# Acknowledgements

This study is part of the project entitled « Apport de l'ergonomie dans l'alliance de travail entre médecins et préventeurs dans le processus de retour au travail après maladies chroniques » undertaken in the Laboratory of Ergonomics and Epidemiology in Occupational Health (LEEST). The core project was financed by The French National Research Program for Environmental and Occupational Health of Anses (2012/2/007), and SCANIA production Angers has provided extra financial support for this thesis. I would like to express warm and heartfelt thanks to a number of people who have contributed and helped in this research and supported me all the way during my PhD, particularly my colleagues in LEEST and all the staff of the SCANIA group.

I would like, first, to express my warmest gratitude to Professor Yves ROQUELAURE – my head supervisor – who trusted me and gave me the possibility of working on this project. Thanks for providing infinite support, encouragement, scientific expertise and optimism. I have appreciated the freedom that you have given me, your patience and our numerous discussions – they were very useful and enriching.

My sincere gratitude to Dr. Michel CROQ – occupational medicine of SCANIA during the study; you have provided me with an endless supply of enthusiasm, scientific and professional support, and skillful guidance and encouragement during our collaboration. Your supportive comments and feedback, particularly for my presentations, were very useful and I have gained many experiences – thanks for everything.

I would like to thank the head of SCANIA production Angers - Robert HÖGLUND. The interest that you have shown in this research project, our discussions, your comments and criticisms has allowed me to develop the ideas and to progress in this work. You have always found the time to answer my questions, to read my writing and to provide me with valuable advice. It was very enriching to present the results of this research to the direction committee of the factory and workers Union (CHSCT) - I appreciate and am grateful to everyone on these committees.

I wish to thank two managers of the section under study P42 (F.A. 1.4) – Frédéric GUIBERT and Philippe MARTIN – who showed special interest in my work and provided all that was required for the experiments. Moreover, I appreciate the support and help of the process engineers – Benoit COCHARD and Boris LENOIR. Finally, warm and special thanks to all the operators in this section who provided a wonderful and positive atmosphere and contributed patiently in all stages of the experiments. The following people deserve special thanks: Christophe CATILLON, Christian PICQUET, David COURTEILLE, Jeremy MAILLET, Nicolas BELLOIR, Pascal MOSSET, Damien CHAUCHEAU, Laurent MOUILLE, Christian GODEAU, Abdoulaye DIAGNE, Thierry BINIER, Tony HERBERT, Frederic LAPOSTOLLE.

Special thanks to my colleagues in Pôle Santé – Agnes MALINGE, Alexandra VETOIS, Cécile PICHET, Claire COLIN, Marie-Pierre DENARIE, Xavier LALLOIS et Jean-Pierre COMTE, Lovasoa ORY. You have provided me a welcoming atmosphere and helped me to learn French quickly. It was a good experience working with you for three years.

I would like to thank Dr. Farhad Hossein ARABI, ergonomist at PSA; we had many discussions together and you shared with me your knowledge of ergonomics, particularly French attitude relating to ergonomic concept – it was grateful. Furthermore, a special thanks to the NOVA team of the PSA for welcoming me to the team and letting me to visit Exoskeleton project – it was interesting and useful.

A special thanks to Antoine GOURLEY, signal processing engineer. You processed the data and signals recorded by electronic devices.

I also thank all my colleagues of LEEST. I offer special thanks to my closest colleague and friend Rene BRUNET. You have collaborated throughout this project and provided me many with valuable advice and constructive support. It was very good to experience the interventions and discussions that we had in the field with the operators – I appreciate that. Special thanks to Sophie BIAU; she helped me to develop a biomechanical method and shared her expertise in this field. Thanks to Julie BODIN and Natacha FOUQUET for guiding me through the epidemiology and statistics and, finally, I am greatly appreciative of the secretaries of the LEEST – Virginie BELLANGER and Sandra MOILLE. You did a lot of work in a friendly manner to make the administration and paper works easier.

Thanks to all my supportive close friends in Angers, my friends at Vox Campus and Karate Kyokushin Avrille club, thanks for good company and the delightful time that we shared.

Finally my deepest thanks and gratitude to my family – my father, my mother, Ali, Saeed and Fayeze. You have been supportive and constantly present throughout the years. Your encouragement and reliance, even though you were far from here, helped me considerably during my PhD – thanks for everything.



## RÉSUMÉ

Les facteurs de risque de troubles musculo-squelettiques (TMS) tels que les facteurs physiques, organisationnels et psychosociaux sont un défi commun pour les industries de l'assemblage automobile qui entraînent des effets indésirables sur le système et les humains. L'ergonomie a déjà été intégrée dans les systèmes de production de ces industries pour la prise en charge de la prévention des TMS. La question est de savoir si l'approche ergonomique actuelle des industries automobiles, sur la base de normes à l'entreprise et des méthodes d'observation, peut fournir une connaissance partagée des facteurs ergonomiques pour les divers intervenants et pour faciliter l'amélioration des conditions de travail.

Cette étude aborde la problématique du positionnement des différentes méthodes d'évaluation (utilisées par les différents intervenants) et compare les résultats et apports de chaque méthode d'évaluation. Cette thèse propose que la procédure actuelle d'évaluation des risques de TMS ne favorise pas une connaissance partagée entre les intervenants dans les industries automobiles. On constate que les évaluations par auto-questionnaire (opérateurs) sont significativement différentes de celles issues des méthodes d'observation (ergonome) et des mesures directes (analyse biomécanique). Cependant, les opinions et jugements des opérateurs concernant les facteurs ergonomiques sont importants pour faciliter la réussite d'une approche ergonomique. Un entretien structuré et systématisé, basé sur des données objectives (Video-observations ou de mesure directe) liées aux activités et stratégies des opérateurs, pourrait être une procédure appropriée pour faire progresser l'ergonomie des situations de travail.

Enfin, la connaissance tirée de cette thèse souligne que la variabilité des tâches dans l'industrie automobile nécessite une approche ergonomique qui partage les connaissances des risques entre les intervenants. Dans cette approche, les attitudes et les comportements des opérateurs sont pris en compte dans les projets d'amélioration continue. De plus, la participation des intervenants devrait être intégrée afin d'améliorer la prise en compte de l'ergonomie dans la production. Une synthèse de cette thèse en Français a été fournie dans l'annexe première.

**mots-clés :** Ergonomie, Troubles musculo-squelettiques (TMS), Facteurs de risques physiques, Evaluation de l'exposition, Méthode d'observation, Auto-questionnaire, Mesure directe, Représentation partagée, Intervention, Variabilité, Usine de fabrication de camion.

## ABSTRACT

Musculoskeletal risk factors such as physical, organizational and psychosocial factors are a common challenge for the automotive assembly industries and result in adverse human and system effects. Ergonomics has already been integrated in the production systems of such factories to eliminate work-related musculoskeletal disorders (WR-MSDs). The issue is whether the current ergonomic approach of car industries, based on corporate standards and observational methods, can provide a shared knowledge of ergonomic factors for various stakeholders and facilitate ergonomic improvement.

This study focuses on the positioning of the different assessment methods (used by various stakeholders), agreement between their results in evaluation of physical risk factors and the influence of intervention and improvement following ergonomic assessment. This thesis proposes that the current procedure of risk factor assessment cannot provide a shared knowledge and representation of risks between stakeholders in manufacturing industries. It was found that the operators' assessments of risk factors (self-reported questionnaire) were significantly different from those assessed by observational methods (ergonomist) and direct measurement. However, the operators' opinions and judgments of ergonomic factors of a job are of particular importance to the success of an ergonomic approach. A structured interview based on objective data (video-observation or direct measurement) linked the activities and strategies of at risk operators might be an appropriate procedure to advance ergonomics.

The knowledge gained from this study emphasizes that the variable nature of tasks in manufacturing industries needs an ergonomic approach which shares knowledge and representation of risks between stakeholders. In such an approach, attitudes and behaviors of operators are taken into consideration in developing new intervention processes, organizational and technical remedies. Moreover, involvement of stakeholders should be integrated and this should result in improving production ergonomics. A summary of this thesis in French is provided in Appendix 1.

**keywords :** Ergonomics, Work-related musculoskeletal disorders, Physical risk factors, Exposure assessment, Observational method, Self-reported questionnaire, Direct measurement, Shared representation, Intervention, Diversity, Truck manufacturing plant





# Table of Content

<b>1.</b>	<b>Introduction.....</b>	<b>1</b>
1.1.	Work-Related Musculoskeletal Disorders (WR-MSDS) .....	2
1.1.1.	Risk models for WR-MSDs.....	4
	a) Physical Ergonomics .....	4
	b) Work-Related Psychosocial Risk Factors.....	5
	c) Factors Related to Work Organization and Management Practices .....	5
1.1.2.	Theoretical Models .....	6
1.1.3.	The Effects of Ergonomics Approach on A System .....	7
1.2.	Prevention of WR-MSDs.....	8
1.3.	Ergonomic Risk Assessment .....	10
1.3.1.	Observational Methods .....	11
	a) In-house observational ergonomic methods.....	15
1.3.2.	Self-reported Questionnaires.....	19
1.3.3.	Direct measurement methods .....	20
1.3.4.	Analysis Method of Physical Risk Factor INRS Reference 6161 .....	22
1.3.5.	Hierarchical Methods .....	22
1.4.	CASE STUDY: Introduction to SCANIA Production Plant.....	25
1.4.1.	Production Plant and Assembly Line .....	26
1.4.2.	Organization of the Sectors.....	27
1.4.3.	Standards and Element Sheets for Workstations .....	28
1.4.4.	Cycle Time (Takt Time) .....	28
1.4.5.	Production Mix.....	29
1.4.6.	SCANIA Safety, Health and Environment (SHE) Standard.....	29
1.5.	Representation of risk factors for WR-MSDs.....	30
1.6.	Research Aims.....	32
1.7.	Thesis Structure .....	33
<b>2.</b>	<b>Assessment of physical risk factors by Observational methods.....</b>	<b>36</b>
2.1.	Evaluation of physical risk factors by the SES method and the NIOSH equation method.....	36
2.1.1.	<b>Article 2:</b> Evaluation of physical WR-MSDs risk factors in a truck manufacturing plant: case study in SCANIA Production Angers .....	36
2.2.	Variation in exposure to physical risk factors .....	58
2.2.1.	Definition of variation and diversity.....	58
2.2.2.	Measuring diversity within and between operators .....	59
2.2.3.	Diversity between operators identified by the SES method .....	59
2.2.4.	Within-operator diversity by the SES method.....	61
2.2.5.	Is diversity useful or should it be eliminated? .....	62
<b>3.</b>	<b>WR-MSDs risk factors assessment by self-reported questionnaire .....</b>	<b>63</b>
3.1.	Physical, organizational and psychosocial risk factors evaluation by self-reported questionnaire.....	63
3.1.1.	<b>Article 3:</b> Evaluation of Ergonomic Approach and Musculoskeletal Disorders in Two Different Organizations in a Truck Assembly Plant.....	63

<b>4.</b>	<b>Assessment of physical risk factors by direct measurement methods (biomechanical methods).....</b>	<b>83</b>
4.1.	Development of biomechanical methods for direct measurement of Physical risk factors .....	83
4.1.1.	<b>Article 4:</b> Development of a biomechanical method for ergonomic evaluation: comparison with observational methods .....	83
4.2.	Development of a quantitative method to evaluate head movements in the real workplace .....	93
4.2.1.	<b>Article 5:</b> A comparison of neck bending and flexion measurement methods for assessment of awkward neck posture .....	93
4.3.	Quantitative measurement of physical risk factors in the assembly line .....	106
4.3.1.	<b>Article 6:</b> Quantification of physical ergonomic work load in truck assembly operators: Neck, back, arms and wrists .....	106
<b>5.</b>	<b>Comparison of Risk Assessment Methods for evaluation of WR-MSDs risk factors .....</b>	<b>125</b>
5.1.	Comparison of the SES method with the self-reported questionnaire.....	125
5.1.1.	<b>Article 7:</b> Are There Differences Between the Results of Risk Assessment Methods? Self-Reported Questionnaire and Observational Method .....	125
5.2.	Comparison of observational method, self-reported questionnaire and direct measurement.....	144
5.2.1.	<b>Article 9:</b> Comparison of three methods for evaluation of WR-MSDs risk factors in a truck assembly plant: observational method, self-reported questionnaire and direct measurement method.....	144
<b>6.</b>	<b>Prevention of WR-MSDs.....</b>	<b>165</b>
6.1.	Ergonomic intervention in SCANIA truck manufacturing plant.....	165
6.1.1.	<b>Article 10:</b> Ergonomic intervention procedure to improve work conditions in SCANIA truck manufacturing plant .....	165
<b>7.</b>	<b>Conclusion .....</b>	<b>191</b>
<b>8.</b>	<b>Further research .....</b>	<b>193</b>
<b>9.</b>	<b>References .....</b>	<b>194</b>

## List of Tables

Table 1: Characteristics of the most common observational risk assessment tools appearing in the ergonomics literature .....	12
Table 2: Methods and low back risk assessment tools related to MMH .....	25
Table 3: Assessment of WR-MSDs risk factors at the "Mounting SCR tank" workstation by the SES method .....	60
Table 4: Assessment of WR-MSDs risk factors at the "Preparation of bumper workstation 2" by the SES method .....	61
Table 5: Within-individual diversity of risk factors at the "Mounting SCR tank" workstation assessed by the SES method .....	61
Table 6: Assessment of WR-MSDs risk factors at the "Mounting SCR tank" workstation by the SES method .....	62

## List of Figures

Figure 1: Conceptual model of factors contributing to development of WR-MSDs .....	7
Figure 2: Conceptual model showing the impact of ergonomic approach on a system.....	8
Figure 3: Visualization of the results of the SES method in the factory. ....	17
Figure 4: Four phases of implementing of INRS method reference 6161 .....	23
Figure 5: SCANIA Production System (SPS) .....	26
Figure 6: Current organization of the sector under study.....	27

## List of Appendix

Appendix 1: A summary of these research in French

Appendix 2: **Article 1** - Does Ergonomics Improve Product Quality and Reduce Costs? A Review Article

Appendix 3: The SCANIA Ergonomic Standard Method (SES)

Appendix 4: An example of a Position Standard

Appendix 5: The examples of elementary sheet

Appendix 6: Corporate standard for Safety, Health and the Environment (SHE)

Appendix 7: The published version for **Article 3** - Evaluation of Ergonomic Approach and Musculoskeletal Disorders in Two Different Organizations in a Truck Assembly Plant

Appendix 8: Questionnaires used to evaluate ergonomic factors

Appendix 9: The published version for **Article 4** - Development of a biomechanical method for ergonomic evaluation: comparison with observational methods

Appendix 10: The published version for **Article 5** - A comparison of neck bending and flexion measurement methods for assessment of awkward neck posture

Appendix 11: Data processing of the direct measurement

Appendix 12: **Article 8** - Comparaison de deux outils d'évaluation des risques ergonomiques dans la prévention des troubles musculo-squelettiques : de l'auto-questionnaire à la méthode d'observation

# 1. Introduction

The manufacturing industry needs to be competitive in the marketplace due to increases in the quantity of products. Manufacturing success in the competitive industrial world depends on developing employee health, productivity, and quality (Falck and Rosenqvist, 2012; Törnström et al., 2008). The automotive industries and heavy manufacturing plants are physically strenuous (Fredriksson et al., 2001). The operators in these industries usually perform cyclical/repetitive tasks and they are exposed to high physical workloads. Furthermore, psycho-social factors (high psychological demand, low decision latitude and lack of social support) and work organization (such as workstation content, inherent tasks, cycle time, work-rest cycle) can influence human well-being and the production system in the automotive industries (Vandergrift et al., 2012). Previous studies have proved that the integration of ergonomics in a manufacturing production system can improve work situation and reduce occupational diseases such as musculoskeletal disorders (Morken et al., 2003; Morse, 2013; Törnström et al., 2008). Work-related musculoskeletal disorders (WR-MSDs) that develop due to exposure to risk factors represent one third of all diagnosed work-related diseases in many countries (Chiasson et al., 2012). They are the main causes of disability and impact on quality of life which lead to more absenteeism and early retirement than other work-related illnesses (Punnett and Wegman, 2004; Roquelaure et al., 2006b). WR-MSDs also have significant financial and social consequences which result in more than 40% of occupational costs such as medical charges, lost work time, workers' compensation claims and absenteeism (Speklé et al., 2010). Many industries in France have experienced increases in the number of workers' compensation claims in recent decades (Rivière et al., 2014; Roquelaure et al., 2006b). In the USA, 29% of lost-time workplace injuries are reported to be due to WR-MSDs (Chiasson et al., 2012). Furthermore, the effects of WR-MSDs risk factors are not only illness and social costs (human effects), but also system performance (quality and productivity) can be influenced (Falck et al., 2010; Neumann and Dul, 2010; Zare et al., 2015).

WR-MSDs risk factors have to be eliminated in manufacturing industries in order to improve system and human performance. The procedures available that ensure ergonomic improvement are management policy, stakeholders' involvement, shared representation of risk factors and risk identification tools (such as screening tools, code of practice, etc.). Depending on the manufacturing context, different stakeholders may have various viewpoints on the risk factors/exposure and they might consequently believe in different control strategies

(Berlin, 2011). A modern ergonomic approach needs the contributions of various stakeholders to provide shared knowledge and a shared representation of work activity for ergonomic improvement.

The tools available (observation, interview, questionnaire and direct measurement) that might be used to identify and monitor ergonomic problems in a manufacturing industry depend on contextual factors (such as production volume, organization culture, stakeholders' involvement and the presence of an ergonomist). The observation approach is frequently used in the manufacturing industry. An ergonomist or a trained employee uses this approach to assess the ergonomic situation. Many observational methods (tools) have been developed and several automotive industries possess their own observational tools related to their risk factors. The issue that needs to be considered is whether an observation procedure provides sufficient accurate data on the exposure to risk factors. Can the observational procedure (that is based on the assessment of a trained individual) supply a shared representation of the work activity? Should observational information be supplemented by other methods such as questionnaires or direct measurement? These are the issues that are seldom reported in the scientific literature.

This thesis was designed at the Laboratory of Ergonomics and Epidemiology in Occupational Health (LEEST) in response to the above questions. It is based mainly on field studies conducted at the Angers SCANIA truck assembly plant. In this research, various ergonomic risk assessment methods (an in-house observational method, a self-reported questionnaire and the direct measurement method) were used to analyze WR-MSDs risk factors in an automotive industry. The problem studied is divided into several parts. Firstly, WR-MSDs risk factors were evaluated by an ergonomist, estimated by operators (self-reported questionnaire) and measured by the quantitative method (a method widely accepted by engineers). Then, the agreement between these methods was explored for identification of physical risk factors. Finally, following the ergonomic assessment, an ergonomic intervention was implemented with the contribution of stakeholders.

## 1.1. Work-Related Musculoskeletal Disorders (WR-MSDs)

**Definition:** Work-related musculoskeletal disorders (WR-MSDs) of the upper limbs and back are responsible for pain, discomfort, disability and difficulty in performing work tasks in industry and service workers (Leclerc et al., 2001). WR-MSDs include both peripheral nerve entrapments, mainly carpal tunnel syndrome (CTS) and ulnar tunnel syndrome, and peripheral enthesopathies, mainly shoulder tendinitis, lateral epicondylitis and hand-wrist tendinitis (Sluiter et al., 2001). Numerous non-specific musculoskeletal pain disorders can also be included under this term.

**Epidemiology:** The prevalence of WR-MSDs has been reported to be high in developed and developing countries (Widanarko, 2013). Eurostat (2004) reported that approximately 45 million employees in Europe experienced WR-MSD symptoms (Parot-Schinkel, 2012). In France, WR-MSDs are the main cause of occupational disease and they represented 87% of all diagnosed occupational diseases in 2013 and 86% in 2011-2012 (CNAM-TS, 2013; Parot-Schinkel, 2012). The total cost of occupational disease was €2250 million in 2011 of which 45% (€1006 million) were related to WR-MSDs (Parot-Schinkel, 2012). In Sweden, the total costs of all occupational diseases and absenteeism were more than 110 billion SEK in 2003 and it was estimated that half of this cost was related to WR-MSDs (Neumann, 2004). Musculoskeletal disorders are the main cause of absenteeism and work related disabilities in many developed countries such as the US, UK and Canada (Côté et al., 2013). The costs of WR-MSDs accounted for \$12.75 billion (U.S.) in the USA in 2009 and similarly in Canada the cost of WR-MSDs was \$20 billion (CND) in 2005 (Lowe et al., 2014). In addition to direct costs due to medical treatment, loss and compensation, there are various indirect costs such as mental effects in the workplace, training new employees and time losses. Indirect costs might have greater social and economic impact than direct costs but they are often ignored by decision makers (Neumann, 2004; Oxenburgh and Marlow, 2005). The prevalence of musculoskeletal disorders in heavy and light vehicle industries is four times higher than the general occurrence of WR-MSDs (Punnett and Wegman, 2004). Nur et al (2014) reported a high prevalence of WR-MSDs (67%) among automotive company operators (Nur et al., 2014). In a cohort study in a large French employee population, Roquelaure et al (2006) reported a high prevalence of WR-MSD symptoms for cyclical jobs (under time pressure) and repetitive tasks (Roquelaure et al., 2006b). Industrial workers, farmers, artisans and low-skilled workers of the service sectors are the main working population exposed to WR-MSDs (Ha et al., 2011). The prevalence rate for at least one WR-MSD symptom for men in the automotive and transport industries was 20% higher than for the other occupational sectors in a cohort study in France (Roquelaure et al., 2006b).

As shown in the ergonomic literature, WR-MSDs risk factors can cause various types of musculoskeletal disorders, particularly in the automotive industries. Physical risk factors still remain an important adverse element for WR-MSDs, although the contribution of other ergonomic factors (organizational and psychosocial) to the development of WR-MSDs is considerable.



### 1.1.1. Risk models for WR-MSDs

Ergonomic discipline involves several domains of human activity such as physical, cognitive, psychosocial, organizational and environmental dimensions. Ergonomic practices that include these dimensions might improve the workplace situation and have positive effects on system and human performance (Côté et al., 2013; Fuller et al., 2011; Widanarko, 2013). Indeed, a successful ergonomic approach has to include a broad aspect of work in order to provide a better understanding of work characteristics. According to the International Ergonomics Association (IEA), ergonomics refers to "the scientific discipline concerned with the understanding of the interactions among humans and other elements of a system, and the profession that applies theoretical principles, data and methods to design in order to optimize human well being and overall system performance". As underlined by Falzon (2005), this definition mentions the two fundamental goals of ergonomics, on one hand performance-centered goals –which can be translated into efficiency, productivity, reliability, quality, etc.- and person-centered goals – which translate into health, safety, stress and workload, comfort, ease, satisfaction, interest of work, etc. Others say, "ergonomics practice sets out a fundamental challenge: the challenge to satisfy simultaneously performance-centered goals and person-centered goals, as far as possible" (Falzon, 2005).

#### a) Physical Ergonomics

Physical risk factors such as Repetitive Work, Work Posture, Lifting and Material handling/Packaging, Workload and Energy Consumption, and Tooling are common in various jobs and industries, but some of them are found specifically at car assembly workstations (Falck et al., 2014). Furthermore, some factors such as the frequency of actions per minute, lack of recovery time and duration of repetitive tasks over a working day can intensify the impact of physical risk factors (Sociali, 2012). The Ergonomics literature has demonstrated that physical risk factors are the required elements for development of WR-MSDs (Widanarko, 2013). Widanarko (2013) reviewed nine studies and reported that manual material handling, awkward posture, and whole-body vibration are the main causes of low back pain. Heavy physical work was also reported to be a risk factor for low back pain in six review papers (Widanarko, 2013). Manual material handling and bending/twisting of the back were reported to be work-related risk factors for back pain in several review articles (Lötters et al., 2003; Pehkonen, 2010). Some studies showed that repetitive work and hand-intensive tasks increase the risk of hand/wrist disorders such as epicondylitis, tendinitis, and carpal tunnel syndrome. Handling load >20kg and repetitive work >2h/day were reported as the risk factors for lateral and medial epicondylitis. Furthermore, the risk of

epicondylitis rises considerably with high gripping force (van Rijn et al., 2009). Van der Windt et al. (2000) identified repetitive movements, abducted/adducted arms and arm elevation as risk factors that contribute to the development of shoulder disorders (van der Windt et al., 2000). Furthermore, different studies showed that awkward neck and trunk posture, prolonged arm posture and arm elevation were related to neck and shoulder pain (Côté et al., 2008; Palmer and Smedley, 2007). Most studies have shown that repetitive and hand-intensive tasks amplify the effects of awkward posture on wrist/hand disorders (Pehkonen, 2010). Vandergrift et al. (2012) reported that psychosocial factors were related to WR-MSDs only among employees who had exposure to physical risk factors (Vandergrift et al., 2012). A study among German nurses showed that psychosocial factors had greater adverse effects on WR-MSDs if there was greater exposure to physical risk factors (Hollmann et al., 2001). The literature has highlighted the role of physical risk factors in WR-MSDs. Identification and analyses of physical risk factors are therefore the important aims of ergonomics in manufacturing industries.

### **b) Work-Related Psychosocial Risk Factors**

Several studies have shown that psychosocial risk factors at work can contribute to a range of work related disorders, particularly WR-MSDs (Cooper, 1998). The role of psychosocial factors and their interaction with other WR-MSDs risk factors have been given more attention recently (Hoogendoorn et al., 2000). Work-related psychosocial factors are defined as the interaction between work and individual characteristics such as job content, capacity, needs, cultures, interpersonal relationships etc. They can influence human well-being and system performance (Cooper, 1998). Some studies have classified psychosocial factors in terms of organizational factors but many studies have emphasized the need to distinguish between them. Organizational factors represent structural characteristics of a system (which is more objective) while psychosocial factors represent perceptions of employees concerning work characteristics, particularly organizational factors (subjective aspects) (Carayon et al., 1999; Huang et al., 2002).

### **c) Factors Related to Work Organization and Management Practices**

Work organization influences the production system via policy and procedures of a company, distribution of tasks, cycle time, work-rest cycle, etc. Previous studies have revealed the relationship between WR-MSDs and factors related to work organization. Petit et al. (2015) found a significant association between CTS and work organizational factors such as payment on a piecework basis and work pace dependent on automatic rate (Petit

et al., 2015b). In view of the major challenge of competition between international automotive companies, different organizational strategies are used such as lean production (Krafcik, 1988), just-in-time (Abegglen and Stalk, 1985) and total quality management (Deming, 1982) to improve productivity and decrease waste (non-added value tasks, time, costs). In recent years, the lean strategy has been integrated into many car industries, and the organizational structure of these industries rationalized to achieve "zero waste" and "zero deviations". This can lead to work intensification such as reduction of the cycle time and small repetitive task series (Kazmierczak et al., 2005). Changes in process organization on the basis of the lean concept without considering human factors can have adverse effects on employees and quality/productivity. Some studies have therefore proposed an integrated approach of lean strategy with ergonomic principles so that the system and employees can benefit (Morse, 2013; Zare et al., 2015). Integrating a lean strategy with ergonomic principles should reduce wastage and the potential for accidents/injuries in the production system. Nahmens (2011) reported success with an integrated approach using ergonomics and lean principles in the organization of the industries investigated (Nahmens and Ikuma, 2011). Several companies such as Toyota and Honda have successfully used lean principles and ergonomics in an integrated manner and reduced waste and non-added value time, particularly after ergonomic interventions (Morse, 2013). However, few studies have investigated whether the integration of a lean strategy and ergonomics can improve work organization and significantly reduce WR-MSDs. Different theories are explained in the following section that describes the effects of the above mentioned work characteristics on WR-MSDs.

### 1.1.2. Theoretical Models

Several theoretical models have been proposed in the ergonomics literature concerning elements contributing to the development of WR-MSDs (Armstrong et al., 1993; Carayon et al., 1999; Davis and Heaney, 2000; Karsh, 2006; Kumar, 2001; Kuorinka et al., 1995; Sauter and Moon, 1996). The models developed before 1999 such as Armstrong et al. (1993), Hagberg et al. (1995), Sauter and Swanson (1996) considered physical risk factors to be a main cause of WR-MSDs, and other factors (organizational and psychosocial) as intermediate and mediating variables. Karsh (2006) and Widanarko (2013) developed models that took into account many mechanisms and factors in addition to physical workload as elements contributing to the development of WR-MSDs (Karsh, 2006; Widanarko, 2013). These models showed the importance of work organization that can influence physical exposure. Roquelaure (2014) proposed a model that explains the effects of different factors on WR-MSDs (Figure 1). This model describes company policy and organization and managerial practice that

determine the organization of a job (workplace) and physical exposure. These elements can subsequently cause WR-MSDs in combination with other components such as psychosocial and individual factors.

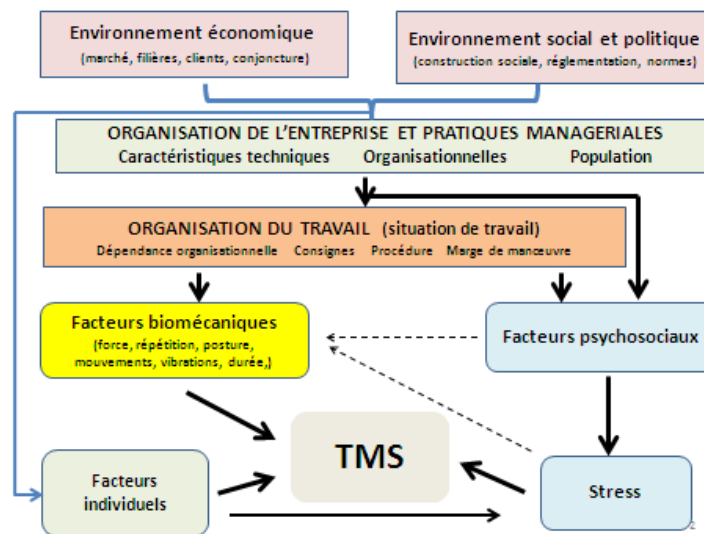

Figure 1: Conceptual model of factors contributing to development of WR-MSDs  
(Adapted from Roquelaure 2014)

The models described above explain the effects of ergonomic elements on WR-MSDs (human effects) while the system effects of WR-MSDs risk factors were ignored. Many studies have demonstrated that these risk factors can cause adverse effects in a manufacturing industry system (Neumann and Dul, 2010). A conceptual model was therefore developed in this study taking into account several elements of ergonomics that can influence not only humans (WR-MSDs) but also production systems (Figure 2). As shown in this model, ergonomics are subcategorized into physical, organizational, cognitive and psychosocial factors in a production system which separately or interactively affect both humans and the system.

### 1.1.3. The Effects of Ergonomics Approach on A System

The role of ergonomics is changing from a tool only for prevention of WR-MSDs to a method of cost reduction. Although some survey studies have shown that managers of automotive industries still consider ergonomics as a way of decreasing WR-MSDs and absenteeism (Thun et al., 2011), awareness related to the effects of ergonomics on reducing costs is increasing. To explore this issue, we performed a wide literature review on the relationship between ergonomics and system effects, particularly in terms of product quality. The first paper in this thesis represents this literature review study. Twenty-five empirical studies were reviewed and evidence of

the effects of WR-MSDs risk factors was demonstrated in relation to quality errors, mainly in the automotive industry (Appendix 2).

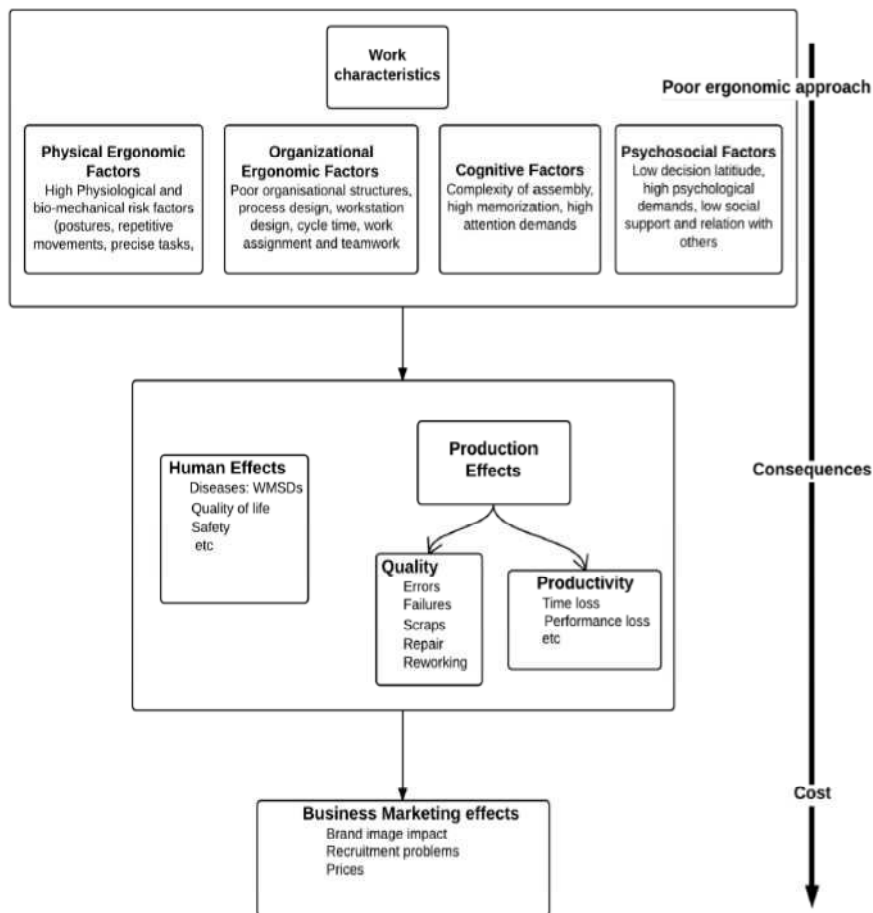

Figure 2: Conceptual model showing the impact of ergonomic approach on a system

## 1.2. Prevention of WR-MSDs

A substantial proportion of WR-MSD could be prevented by workplace ergonomic interventions (Roquelaure et al., 2009). According to recent literature (Driessen et al., 2010; Kennedy et al., 2010; Rivilis et al., 2008; Shaw et al., 2008), multidimensional and participatory ergonomics interventions are more effective in preventing WR-MSDs than simple interventions on the workstation or on the operators (e.g., training sessions).

The most efficient interventions combine actions at three levels of prevention:

- Primary prevention, essentially to limit the incidence of WR-MSDs by risk reduction at the source
- Secondary prevention, to avoid worsening of pain and difficulties at work, by means of early detection and appropriate management

- Tertiary prevention, to facilitate remaining at work and/or early return to work of workers experiencing chronic pain and disability.

Combination of the three levels of intervention should increase the efficacy of the prevention, since even in job situations in which primary interventions are ineffective, the severity of disorders can be decreased and their prognosis can be improved by integrated preventive actions at all stages of WR-MSDs (from acute to chronic WR-MSDs). Such a global and integrated strategy of WR-MSD prevention is in line with the WHO global plan of action on workers' health (Organization, 2007). Health promotion actions conducted at the workplace could be used to inform workers of good practice in WR-MSD prevention and to promote some preventive interventions at work (e.g. stretching program) and/or at home (e.g. diet or exercise programs) (Petit et al., 2015a).

The large manufacturers in Europe such as SCANIA, Volvo Car Corporation (VVC), Volkswagen (VW), Fiat Group and Peugeot-Citroen (PSA) have developed their own ergonomic prevention practices which have often focused on the first level of prevention. This means that WR-MSDs risk factors are evaluated by ergonomists or trained employees (technicians) by means of an in-house observational method (check-list and video-observation) and reactive or sometimes proactive measures (mainly technical/engineering remedies or designing of workstations) are put in place to limit the incidence of WR-MSDs at source (Falck et al., 2010; Hägg, 2003). These corrective measures basically represent the views of ergonomists/engineers related to workplaces which are based on their experience, knowledge and corporate or national standards (use as a baseline for analyzing jobs). Nevertheless, the other characteristics of a job and coherence between other stakeholders regarding WR-MSDs risk factors and preventive measures are less often considered. Berlin (2011) explained this problem as:

*"The issue that should be resolved is whether to associate ergonomics assessment with human operators or with product- or production-related parameters (e.g. product construction features, workstations, equipment or materials)."*

This means that different stakeholders might believe in various control strategies (reactive; such as modification in the workstation and reducing workload or proactive; such as giving feedback to production designers and changing process design) (Berlin, 2011). Furthermore, another issue that is less often considered is the operators' perceptions of risks and preventive measures. Operators are the important stakeholders who are directly involved with the work and are influenced by WR-MSD risk factors.

The success of preventive interventions depends on the evaluation of risk factors and considering "work" representation from the viewpoint of different stakeholders. Ergonomic intervention is complex because of the

various components included. Developing and reproducing an intervention is thus difficult (Campbell et al., 2000). Ergonomic interventions have often been unsuccessful, particularly when only based on physical risk factors identified by observational tools. Westgaard et al (1997) reviewed 92 ergonomic intervention studies in which 20 studies reported mechanical exposure interventions. Although these studies claimed positive outcomes for the preventive actions, the evidence was not sufficient to show effective ergonomic intervention. Review of 32 intervention studies on production system and 39 intervention studies on modifiers (such as physiotherapy, health education, exercise, relaxation training, work technique and multiple measures) showed that the chance of success increased when risk factors and problems had been identified accurately and when various stakeholders actively supported intervention studies (Westgaard and Winkel, 1997).

In a review study, Denis et al (2008) reported that intervention approaches used for prevention of WR-MSDs are diverse, and classical intervention models based on observational evaluation and technical remedies are not necessarily effective. According to the scope of the intervention, the complexity of WR-MSDs should be considered and sufficient details have to be provided, particularly about the diversity and specificity of the workplace, risk factors and preventive measures (Denis et al., 2008). Silverstein and Clark (2004) reviewed 20 randomized control studies, 17 semi-experimental studies with a control group and 36 case studies of ergonomic interventions to reduce WR-MSDs. The evidence in these studies showed that, although individual technical remedies or administrative controls can be useful, combinations of measures after a comprehensive job analysis would be more effective (Silverstein and Clark, 2004). Gathering information from different sources increases the quality of evaluation and intervention (Silverstein and Clark, 2004).

Effective intervention is required that can first reduce the risk of WR-MSDs and then facilitate the process of return to work and rehabilitation of injured employees. More effective ergonomic intervention might be achieved by comprehensive assessment of risk factors and developing a new procedure that provides a joint process of decision making by various stakeholders (shared representation). This procedure is based on unambiguous information on the potential risk factors of jobs and can significantly contribute to developing effective preventive measures. The next section describes the current methods and procedures that have been developed to identify and monitor WR-MSDs risk factors.

### **1.3. Ergonomic Risk Assessment**

As mentioned above, the focus of this study was evaluation and analysis of physical risk factors in a manufacturing industry. The precise and accurate evaluation that represents exposure to physical risk factors

can play an important role in the success of ergonomic intervention. There is a common interest between several stakeholders such as ergonomists, engineers and operators in measuring physical risk factors as a basis for ergonomic intervention (David, 2005). Traditional ergonomic programs in the manufacturing industries have been based on ergonomists' assessments, and then engineers' solutions. The ergonomists are often considered as expert advisors or internal consultants who, placed between operators and managers, analyze jobs and help the engineers who are improvement agents to find solutions for ergonomic problems (Berlin, 2011). There are often misunderstandings between ergonomists and engineers in this process because engineers communicate with numbers and metrics while the ergonomist's methods (observational methods) for identifying the problems are subjective and qualitative (Berlin, 2011). Moreover, the operators are usually ignored in this process.

Various methods have been developed to evaluate physical risk factors and they are often categorized in three main classes: Observational Methods, Self-reported Questionnaires and Direct Measurement Methods. Ergonomists and practitioners often used observational methods. Numerous observational methods have been developed that measure different physical risk factors. They are often qualitative/semi-qualitative, and ergonomic programs in car manufacturing industries are usually based on using these methods. Risk assessment by observational methods might be performed by ergonomists, trained employees (technicians or engineers) or workers themselves.

Self-reported questionnaires, on the other hands, are used to collect data on exposure to physical risk factors from the operators' viewpoint. These methods are widely used in epidemiological studies to find dose-exposure relationship for WR-MSDs. Moreover, they provide data for other ergonomic elements such as psychosocial and organizational factors. Direct measurement methods rely on sensors to measure physical risk factors. These methods give precise numbers and metrics which engineers trust. It is possible sometimes to use two or several methods for data collection, depending on the resources available (David, 2005; Pehkonen, 2010). The observational method, self-reported questionnaire and direct measurement method are described in the following sections.

### **1.3.1. Observational Methods**

Several observational methods have been developed to evaluate physical risk factors in workplaces. These methods have advantages and limitations for risk assessment (Chiasson et al., 2012; Denis et al., 2000; Hignett and McAtamney, 2000; Juul-Kristensen et al., 1997; Kee and Karwowski, 2007; Punnett, 2000; Punnett



et al., 2000; Stanton et al., 2004; Takala et al., 2010). Table 1 presents the characteristics of the most common observational tools appearing in ergonomics literature.

**Table 1: Characteristics of the most common observational risk assessment tools appearing in the ergonomics literature**

Risk assessment methods	Description	Assessment Criteria	Available
OWAS: The Ovako Working Posture Analysis System	Tool for whole body posture analysis	Posture, Force	<a href="http://www.iosh.co.uk/~media/Documents/Books%20and%20resources/Musculoskeletal%20disorders/OWAS.pdf?la=en">http://www.iosh.co.uk/~media/Documents/Books%20and%20resources/Musculoskeletal%20disorders/OWAS.pdf?la=en</a>
PLIBEL: Plan för identifiering av belastningsfaktorer	Checklist measuring physical risk factors	Posture, Force, Movement	<a href="http://www.ttl.fi/en/ergonomics/methods/workload_exposure_methods/table_and_methods/Documents/PLIBEL.pdf">http://www.ttl.fi/en/ergonomics/methods/workload_exposure_methods/table_and_methods/Documents/PLIBEL.pdf</a>
QEC: Quick exposure check	Tool for whole body assessment of exposure for static and dynamic tasks	Posture, Force, Movement	<a href="http://www.ini.wa.gov/Safety/SprainsStrains/pdfs/QECReferenceGuide.pdf">http://www.ini.wa.gov/Safety/SprainsStrains/pdfs/QECReferenceGuide.pdf</a>
VIDAR: Video- och datorbaserad arbetsanalys	Video-based tool in which operator participates and evaluates physical workload and perceived exertion force (combination of Borg scale and QEC)	Posture, Force, Movement	<a href="http://www.ttl.fi/en/ergonomics/methods/workload_exposure_methods/table_and_methods/Documents/VIDAR.pdf">http://www.ttl.fi/en/ergonomics/methods/workload_exposure_methods/table_and_methods/Documents/VIDAR.pdf</a>
LUBA: Postural loading on the upper-body assessment	Method to evaluate sitting and standing posture	Posture	<a href="http://www.ttl.fi/en/ergonomics/methods/workload_exposure_methods/table_and_methods/Documents/LUBA.pdf">http://www.ttl.fi/en/ergonomics/methods/workload_exposure_methods/table_and_methods/Documents/LUBA.pdf</a>
REBA: Rapid entire body assessment	Assessment tool for evaluating whole body posture	posture, force, movement, repetition, and coupling	<a href="http://ergo-plus.com/wp-content/uploads/REBA-A-Step-by-Step-Guide.pdf">http://ergo-plus.com/wp-content/uploads/REBA-A-Step-by-Step-Guide.pdf</a>
Back-EST: Back Exposure Sampling	Tool for physical risk assessment of back exposure that is applicable for wide range of jobs	Posture, Force, Vibration	<a href="http://www.ttl.fi/en/ergonomics/methods/workload_exposure_methods/table_and_methods/Documents/BackEST.pdf">http://www.ttl.fi/en/ergonomics/methods/workload_exposure_methods/table_and_methods/Documents/BackEST.pdf</a>
AET: Ergonomic Job Analysis Procedure	Checklist providing wide description of work characteristics including stress analysis, task and demand analysis	Posture, Movement, Vibration	<a href="http://www.ttl.fi/en/ergonomics/methods/workload_exposure_methods/table_and_methods/Documents/AET.pdf">http://www.ttl.fi/en/ergonomics/methods/workload_exposure_methods/table_and_methods/Documents/AET.pdf</a>
Analysis of hand wrist by Stetson	Observational method used to analyse hand exertion during gripping, using tightening machine, using palm as a tool etc.	Posture, Force, Vibration	<a href="http://www.ttl.fi/en/ergonomics/methods/workload_exposure_methods/table_and_methods/Documents/Stetsonschecklistforhandandwrist.pdf">http://www.ttl.fi/en/ergonomics/methods/workload_exposure_methods/table_and_methods/Documents/Stetsonschecklistforhandandwrist.pdf</a>
ACGIH TLV for low back risk	Tool for analyzing repeated lifting tasks. The location, frequency and daily duration of lifting tasks determine the TLV for weighting the loads	Posture, Force	<a href="http://www.ttl.fi/en/ergonomics/methods/workload_exposure_methods/table_and_methods/Documents/ACGIHLiftingTLV.pdf">http://www.ttl.fi/en/ergonomics/methods/workload_exposure_methods/table_and_methods/Documents/ACGIHLiftingTLV.pdf</a>
ACGIH TLV for Hand Activity Limit (HAL)	A tool for evaluating risk factors for hand wrist and forearm by using peak hand force and hand activity level. It is appropriate for jobs with >4 hand repetitive tasks	Movement, Force	<a href="http://www.ttl.fi/en/ergonomics/methods/workload_exposure_methods/table_and_methods/Documents/ACGIHTLVforHandActivityLevel_HAL_.pdf">http://www.ttl.fi/en/ergonomics/methods/workload_exposure_methods/table_and_methods/Documents/ACGIHTLVforHandActivityLevel_HAL_.pdf</a>
ARBOUW, guidelines on physical workload for the construction industry	Analyses five area of physical workload including lifting, pushing/pulling, carrying, static workload and repetitive movement. It uses traffic light method for prioritization of WR-MSDs risk factors	Posture, Force	<a href="http://www.lhsfna.org/files/ARBOUW_Guidelines.pdf">http://www.lhsfna.org/files/ARBOUW_Guidelines.pdf</a> x

HARBO: Hand Relative to the Body	Method for assessment of exposure applicable for all types of job. The postures of body segments are evaluated based on hand position. It can be used for epidemiological study or ergonomic prevention and intervention program	Posture	<a href="http://www.ttl.fi/en/ergonomics/methods/workload_exposure_methods/table_and_methods/Documents/HARBO.pdf">http://www.ttl.fi/en/ergonomics/methods/workload_exposure_methods/table_and_methods/Documents/HARBO.pdf</a>
OCRA: Occupational repetitive actions	Tool for assessing workload in upper limbs due to repetitive movements	Posture, Force, Vibration	<a href="http://www.epmresearch.org/userfiles/files/Revised%20OCRA%20Checklist%20Book.pdf">http://www.epmresearch.org/userfiles/files/Revised%20OCRA%20Checklist%20Book.pdf</a>
HSE Upper Limb risk assessment method	Two-stage tool used as the first step to determine the situation under risk by filter analysis and then high risk jobs are analyzed in detail by risk assessment worksheet	Posture, Movement, Force, Vibration	<a href="http://www.ttl.fi/en/ergonomics/methods/workload_exposure_methods/table_and_methods/Documents/HSEUpperlimbriskassessment.pdf">http://www.ttl.fi/en/ergonomics/methods/workload_exposure_methods/table_and_methods/Documents/HSEUpperlimbriskassessment.pdf</a> <a href="http://www.hse.gov.uk/msd/pdfs/worksheets.pdf">http://www.hse.gov.uk/msd/pdfs/worksheets.pdf</a>
MAC: Manual Handling Assessment Chart	A tool for practitioner to evaluate risk factors of manual handling tasks (lifting, carrying and team handling). It uses traffic light model for prioritization of tasks	Posture, Force	<a href="http://www.hse.gov.uk/pubns/indg383.pdf">http://www.hse.gov.uk/pubns/indg383.pdf</a>
Revised NIOSH Lifting Equation	Tool for analyzing repetitive lifting tasks.	Posture, Force	<a href="http://www.cdc.gov/niosh/docs/94-110/pdfs/94-110.pdf">http://www.cdc.gov/niosh/docs/94-110/pdfs/94-110.pdf</a>
PEO: Portable Ergonomic Observation	Observation computerized tool to calculate cumulative exposure directly from workplaces. Physical exposure related to several tasks obtained with this method	Posture, Movement, Force	<a href="http://www.ttl.fi/en/ergonomics/methods/workload_exposure_methods/table_and_methods/Documents/PEO.pdf">http://www.ttl.fi/en/ergonomics/methods/workload_exposure_methods/table_and_methods/Documents/PEO.pdf</a>
Postural Workload Evaluation System by Chung	Tool to assess body postures according to Discomfort score	Posture	<a href="http://www.ttl.fi/en/ergonomics/methods/workload_exposure_methods/table_and_methods/Documents/PosturalworkloadevaluationbyChung.pdf">http://www.ttl.fi/en/ergonomics/methods/workload_exposure_methods/table_and_methods/Documents/PosturalworkloadevaluationbyChung.pdf</a>
RULA: Rapid Upper Limb Assessment	Tool for upper limb assessment	Posture, Force	<a href="http://ergo.human.cornell.edu/ahRULA.html">http://ergo.human.cornell.edu/ahRULA.html</a>
SI: Strain Index	Simple tool evaluating risk level for developing a disorder of the distal upper extremities. It evaluates hand exertion	Posture, Fore	<a href="http://ergo.human.cornell.edu/Pub/AHquest/JSIWorksheetbw.pdf">http://ergo.human.cornell.edu/Pub/AHquest/JSIWorksheetbw.pdf</a>
Washington State Ergonomic Checklist	Tool for identification of WR-MSD risk factors	Posture, Movement, Force, Vibration and Contact force	<a href="http://www.lni.wa.gov/SAFETY/SPRAINSSTRAINS/TOOLS/DEFAULT.ASP">http://www.lni.wa.gov/SAFETY/SPRAINSSTRAINS/TOOLS/DEFAULT.ASP</a>
SES: Scania Ergonomic Standard	In-house observational tool used to assess ergonomic workload in truck assembly plant. It uses traffic light method to prioritize risk factors.	Posture, Movement and Force	Contact Scania Group
METEO: The Work and Organization Assessment Method	In-house method developed by PSA to evaluate biomechanical, psychosocial and organizational risk factors	Posture, Movement, Force, Cycle time	Contact Peugeot-Citroen Group (PSA)
EAWS: European Assembly Worksheet	Tool adapted for automotive industries. Widely used by big companies such as VW	Posture, Movement, Force, Manual Handling	<a href="http://www.tandfonline.com/doi/abs/10.1080/1463922X.2012.678283">http://www.tandfonline.com/doi/abs/10.1080/1463922X.2012.678283</a>

By using these methods, an observer (ergonomist/expert) follows the work process either in the field or from recorded videos and evaluates risk factors on the basis of a checklist or grid (David, 2005; Hignett and McAtamney, 2000; Juul-Kristensen et al., 1997). Magnitude, duration and frequency of risk factors are

determined qualitatively or quantitatively. Various observational methods measure different types of physical risk factors. In addition to posture assessment, that is a prevailing risk factor in observational methods, force, movement and manual material handling frequently appear in many observational methods (Pehkonen, 2010).

Selection of an observational method for a workplace is always difficult due to the large number of methods, different purposes and needs, and validity/reliability of methods. Literature reports propose the criteria for selecting a method such as objectives, characteristics of a job and users, and resources available (time, costs etc.) for data collection (David, 2005; Takala et al., 2010). David (2005) divided observational methods into simple and advanced methods. The simple observational methods included 15 paper-based ergonomic tools that assess exposure and record on a sheet/grid (OWAS (Karhu et al., 1977), PLIBEL (Kemmlert, 1995), QEC (David et al., 2008), REBA (Hignett and McAtamney, 2000), ergonomic checklist (Keyserling et al., 1992), RULA (McAtamney and Corlett, 1993), NIOSH Lifting Equation (Waters et al., 1993), The Strain Index (Steven Moore and Garg, 1995), OCRA (Occhipinti, 1998), Manual Handling Guidance (Handling, 1998), FIOH risk factor checklist (Ketola et al., 2001), ACGIH TLVs (Potvin et al., 2001), LUBA (Kee and Karwowski, 2001), Upper Limb Disorder Guidance HSG 60 (Hobson, 2002), and MAC (Monnington et al., 2003)). The advanced observational tools included various video-based or computerized observational techniques the results of which are analyzed by software. It was concluded that the methods covering a wide range of risk factors are probably usable across different jobs. Observational methods are suitable for practitioners in industries but they should be aware of the constraints of the techniques and features of the situation under study. However, there is no a single tool that is applicable for different workplaces, and a combination of methods provides more reliable results (David, 2005).

In a systematic review study, Takala et al (2010) identified 30 observational tools in the ergonomic literature. These methods were categorized under three headings according to the focus and objectives of the methods: measurement of general workload, upper limb activity and manual material handling. The main dimensions of physical workload, including posture, force, duration and frequency, were measured in most methods reviewed. Most of these methods had been compared with other methods such as direct measurement and their validity had been reported. Furthermore, inter-observer repeatability for these methods was moderate to good. The authors concluded that none of the observational methods can comprehensively evaluate and analyze jobs and that it might be useful to apply several methods in a field. The importance of having a shared representation of risk factors was emphasized by using the techniques such as interview and considering operators' perceptions

(Takala et al., 2010). Wells et al (1997) suggested a toolbox that allows the practitioner to select one method or combinations of the methods, depending on the workplace under assessment (Wells et al., 1997).

Village et al (2009) aimed to develop a comprehensive tool measuring physical risk factors for the back that would be suitable for a wide range of workplace and epidemiological studies. The Back-EST tool was designed comprising 20 measurement criteria such as posture, manual handling and whole body vibration. The authors reported good validity for this tool compared to the direct measurement method and a high percentage of inter-rater reliability both in the laboratory and in the field. Although the researchers tested this tool in a wide variety of heavy industries and claimed that it is applicable for a variety of jobs, this tool only measured back risk factors and it included many variables that made its usability difficult in practice. Furthermore, its results should be validated in comparison to operators' perceptions (questionnaire or interview) (Village et al., 2009).

In a survey study among 308 Certified Professional Ergonomists in the US, Dempsey et al (2005) showed that a wide variety of practitioners used video-based techniques. Observational tools such as RULA, NIOSH lifting Equation, Biomechanical model, Psychophysical material handling data and body discomfort map were applied by more than 50% of the practitioners who participated in the study. The aim of this survey was to provide information for developing an ergonomic toolkit for widespread use. The authors concluded that video recording, manual material handling tools and direct measurement tools (such as hand force and push/pull measurement) and body discomfort chart should be included in any ergonomic toolkit (Dempsey et al., 2005). The authors therefore proposed a combination of tools that could provide a shared representation of risk factors in the workplace. Kilbom (1994) emphasized using other sources in addition to observation (Kilbom, 1994).

Observational methods also have some limitations such as inter-rater variability, low reliability and variety of ways of sampling. Bao et al (2009) investigated inter-rater reliability between different observers who assessed a job from video recording. They reported a low precision between different observers and better reliability was observed for evaluation of the large body parts. Furthermore, a wider angle interval (30° angle intervals) provides appropriate reliability (Bao et al., 2009).

#### **a) In-house observational ergonomic methods**

The automotive industries are pioneers in ergonomics of the workplace and they integrate ergonomics in their production systems (Hägg, 2003). Several in-house ergonomic methods have been specifically adapted to automotive industry work tasks. Companies such as SCANIA, PSA, VW, Renault and the Fiat Group have developed their own in-house methods for evaluation of WR-MSDs risk factors. The risk assessment tools used

in automotive companies usually have a similar structure. The issue is whether the current ergonomic approach of car industries, based on corporate standards and observational methods, can provide a shared representation of ergonomic factors.

Engineers often disagree with the results of observational methods and the operator's perception is usually not considered in the evaluation. Moreover, the validity and reliability of most companies' tools are not assessed. Among the companies' tools reviewed, the BME model of Volvo Car Corp (Törnström et al., 2008) and the EWAS (Schaub et al., 2013) are the published methods although their validity and reliability were not reported. Another issue is highly variable nature of assembly tasks (diversity between/within individuals). The observational tools in the automotive industries assess a workstation for a standard model of vehicle and an experienced operator. This means that variations (different models of vehicle) and diversity (various strategies of operators when performing the same tasks) in a workstation are overlooked. Moreover, most car manufacturing industries use technicians or operators to evaluate workstations by observational methods. These individuals have received training to use these methods but their ergonomic knowledge is often poor. As shown in previous studies, the quality and reliability of the results of observational methods depend on the training and experience of the evaluator (Denis et al., 2000). Ergonomic assessment that is conducted by evaluators such as technicians or operators is therefore questionable in terms of the quality of evaluation. All these limitations increase the need for a new procedure to represent WR-MSDs risk factors in car manufacturing industries. The in-house methods of automotive industries are presented in the following section.

### ***SCANIA Ergonomic Standard (SES)***

The SES production method is used to evaluate assembly operations and work cycle in the manufacturing process. It is an observational screening tool originally developed by the SAAB group and Scania bought the license to use it. Part of the material in the SES method comes from North America, Industrial Engineering, Manufacturing Ergonomics Lab General Motors, USA. Other parts are based on individual experience and literature studies. The tool fulfils the load ergonomics requirements set by General Motors International Organization (GMIO) as well as Swedish legislation in this field and Scania's Health and Work Environment Policy. It evaluates WR-MSDs risk factors in four areas including awkward postures, repetitive movements, energy consumption and material handling. Each area has subsections (criteria) that evaluate specific types of risk factors, and finally 20 risk factors are evaluated by different criteria in the SES method. This method is

explained in detail in Chapter Two and its grid is provided in Appendix 3. Figure 3 showed how the results of the SES method are illustrated in the factory.

20/4/07/21			Arrière 3 - 113 - SPPSSanté2				Cadence 48	SES - Standard Ergonomie Scania - Angers																																												
Station	Station	Chassis type	Charge physique (SES) Coeur de la variante	NOSH - Equation de levage	Date	Cadence	Nombre de cycles par heure	Taux d'apparition (%) - 2013,06	Intervalle de rotation, heure	3.1 Répétitions	3.1 Postures de travail	3.2.2 Accès, assemblage, masqué ou outils	3.2.3 Dégagement pour mains, doigts ou	3.2.4 Espace de travail pour les mains	3.2.5 Poignée de manutention	3.2.6 Zone de surface, surface de pression	3.2.7 Taille / distribution du composant	3.2.8 Posture de travail statique - Dors	3.2.9 Posture de travail statique - Couv	3.2.10 Posture de travail statique - Epaul	3.2.11 Posture de travail - Poignet	3.2.1 Effort de levage, levage à 2 mains	3.2 Levage à une main	3.4.1 Force de poussée / traction corps entier	3.4.2 Force de poussée / traction main, bras	3.4.3 Poussée, écrasement, traction avec	3.4.4 Mouvements (pas continus)	3.4.5 Grimper / enjamber	3.4.5 Coupes de serrage, outil manuel	Nombre de points "vert"	Nombre de points "jaune"	Nombre de points "jaune + rouge"	Nombre de points "double rouge" (DR)	Nombre de points "rouge + double rouge"	Charge physique (SES) - Colation N-1																	
1	St2 droite (marche piéci)	Standard	16,00	16,00	16,00	55	7	30%	2	2	2	2	2	2	2	2	1	1	1	1	1	1	1	1	1	1	1	1	1	1	1	1	1	1	1	1	1	1	7	0	0	13										
2	St2 gauche (marche piéci)	Standard	16,00	16,00	16,00	55	7	30%	2	2	2	2	2	2	2	2	1	1	1	1	1	1	1	1	1	1	1	1	1	1	1	1	1	1	1	1	1	1	1	1	1	1	7	0	0	13						
3	St3 crotte (garde boue + par chateur)	Standard	16,00	16,00	16,00	55	7	60%	2	2	2	2	2	2	2	2	2	2	2	2	2	2	2	2	2	2	2	2	2	2	2	2	2	2	2	2	2	2	2	2	2	2	10	6	4	10						
4	St3 gauche (garde boue + cepra cabine)	Standard	16,00	16,00	16,00	55	7	60%	2	2	2	2	2	2	2	2	2	2	2	2	2	2	2	2	2	2	2	2	2	2	2	2	2	2	2	2	2	2	2	2	2	2	11	4	5	9						
5	PA para choc St1	Standard	11,00	11,00	11,00	55	7	80%	2	2	2	2	2	2	2	2	2	2	2	2	2	2	2	2	2	2	2	2	2	2	2	2	2	2	2	2	2	2	2	2	2	2	7	7	7	14						
6	PA para choc St2	Standard	11,00	11,00	11,00	55	7	80%	2	2	2	2	2	2	2	2	2	2	2	2	2	2	2	2	2	2	2	2	2	2	2	2	2	2	2	2	2	2	2	2	2	2	2	15	4	5	9					
7	PA para choc St3	Standard	11,00	11,00	11,00	55	7	80%	2	2	2	2	2	2	2	2	2	2	2	2	2	2	2	2	2	2	2	2	2	2	2	2	2	2	2	2	2	2	2	2	2	2	2	12	6	7	13					
8	PA para choc St4	Standard	11,00	11,00	11,00	55	7	80%	2	2	2	2	2	2	2	2	2	2	2	2	2	2	2	2	2	2	2	2	2	2	2	2	2	2	2	2	2	2	2	2	2	2	2	10	5	5	10					
9	St ligne pose para choc	Standard	11,00	11,00	11,00	55	7	80%	2	2	2	2	2	2	2	2	2	2	2	2	2	2	2	2	2	2	2	2	2	2	2	2	2	2	2	2	2	2	2	2	2	2	7	9	4	12						
10	FA SCR	Euro5 Euro6/6.0 lit	27,00	27,00	27,00	55	7	5%	2	2	2	2	2	2	2	2	2	2	2	2	2	2	2	2	2	2	2	2	2	2	2	2	2	2	2	2	2	2	2	2	2	2	2	106	59	35	0					
11	Passe SCR ligne	Euro5 Euro6/6.0 lit	14,00	14,00	14,00	55	7	0%	2	2	2	2	2	2	2	2	2	2	2	2	2	2	2	2	2	2	2	2	2	2	2	2	2	2	2	2	2	2	2	2	2	2	2	2	10	9	2	11				
12	Picking filtre, pare chateur	Standard	11,00	11,00	11,00	55	7	95%	2	2	2	2	2	2	2	2	2	2	2	2	2	2	2	2	2	2	2	2	2	2	2	2	2	2	2	2	2	2	2	2	2	2	2	2	2	10	7	5	1			
13	Picking valais SCR	Standard	11,00	11,00	11,00	55	7	98%	2	2	2	2	2	2	2	2	2	2	2	2	2	2	2	2	2	2	2	2	2	2	2	2	2	2	2	2	2	2	2	2	2	2	2	2	2	9	6	7	12			
14	St accés filtre, vaim, rat 0001	Standard	11,00	11,00	11,00	55	7	80%	2	2	2	2	2	2	2	2	2	2	2	2	2	2	2	2	2	2	2	2	2	2	2	2	2	2	2	2	2	2	2	2	2	2	2	2	2	2	2	2	6	7	7	14

Figure 3: Visualization of the results of the SES method in the factory.

The green shows the minimum risk of WR-MSDs, the yellow is moderate risk and the red/violet represent excessive risk of WR-MSDs

SCANIA has another observational tool for the design stage that is used by design engineers. This tool assesses single articles/components in the first phase of production. It can evaluate also certain operations in the

planning stage such as sealing, welding, pressing. Three separate evaluations are conducted when using this tool. The first evaluates the design and shape of the product. The second evaluates the prerequisites of the work and the third the manual material handling.

### **PSA Group (Peugeot-Citroen)**

The PSA group replaced the OCRA method with the Work and Organization Assessment Method (METEO) to analyze workstations at production sites in 1998. This method evaluates physical and physiological workload, and psychosocial and organizational aspects of a workstation. The METEO includes five areas, i.e. physical and physiological workload, cognitive workload (information processes and operators' attention), organizational factors, ergonomic structure of workstation (distance, visibility and control of the machine) and workplace physical conditions (noise, lighting, temperature, etc.). Each area is divided into subsections and finally 22 risk factors are evaluated by different criteria. This method uses a traffic light model and classifies the identified risks into three categories:

- Green: Score to 2.5
- Yellow: Score between 2.6 and 3.5
- Red: Score between 3.6 and 5

### **Renault Group**

The Ergonomic Analysis Sheet (FAE) is an observational method that evaluates physical, cognitive and organizational factors at production sites of the Renault Group. This method has the same structure as the METEO.

### **Volvo Car Corporation**

Volvo Car Corporation developed an observational method known as the Ergonomic Assessment Model (BME model). This model is specifically adapted to assembly tasks and standardizes the risk assessment procedure. Posture, force and frequency are the criteria that used to assess each work task. This method evaluates the tasks that are only characterized as added value. Multiplying three criteria grades provides the final risk score (based on the cube model) (Sperling et al., 1993). The risk score interpretation is as follows:

- Green work task: Risk score 1-4.4
- Yellow work task: Risk score 4.5-7.5
- Red work task: Risk score >7.6

A risk score is calculated for each car model, each work task and for a number of work tasks in a line using this method (Törnström et al., 2008).

### **Fiat and Volkswagen Group**

These two automotive industries use the European Work Assessment Sheet (EWAS) to analyze workstations. This observational tool only analyzes physical risk factors, which are subdivided into five areas: Force, posture, exertion, manual material handling and repetitive movements. The final risk score is calculated according to sum of values of the different criteria and the traffic light method is used to prioritize the risk potential. The scores between 0-25 are green, between 26-50 yellow and >50 red (Schaub et al., 2013).

### 1.3.2. Self-reported Questionnaires

Various self-reported methods have been developed to collect data (i.e. worker diaries, interviews and questionnaires). A more recent method of self-reporting is self-evaluation of videotapes of work tasks (Kadefors and Forsman, 2000), known as self-confrontation and divided into simple or cross-confrontation. This method is widely used in France (Clôt, 2005). Self-reporting provides operators' own views and asks directly for information. Workers' perceptions of ergonomic factors in a workplace can be obtained by self-reporting methods. A self-reported questionnaire provides operators' evaluation of risk factors such as physical workload in a workplace.

Many studies have used self-reported questionnaires to identify physical risk factors such as postural situations, subjective force exertion and musculoskeletal symptoms (pain, numbness, etc) (Roquelaure et al., 2006a; Roquelaure et al., 2009; Roquelaure et al., 2002). A self-reported questionnaire can ask about many variables such as physical, organizational, cognitive and psychosocial factors as well as pain perception. Moreover, retrospective data on exposure over a long period of time can be gathered by questionnaire, particularly when objective data are not available (histories of exposure) (Stock et al., 2005). To establish a dose-response relationship of WR-MSDs, a large population of subjects is needed. The self-reported questionnaire makes it possible to survey a large population and it is the principal method used in epidemiological studies of WR-MSDs (Roquelaure et al., 2006b). It can evaluate general exposure to WR-MSD risk factors of many job titles, a wide variety of workstations and occupational tasks.

However, some disadvantages have been reported for application of the self-reported questionnaire. The validity of the self-reported questionnaire is a matter of debate in the literature. The respondents are not always truthful and the answers are related to their own feelings, and this might be different for various subjects (Barrero et al., 2009). Self-reported questionnaires use different questions to measure similar physical risk factors due to different cultures, languages and attitudes (Barriera-Viruet et al., 2006). Furthermore, having severe musculoskeletal pain or psychological pressure regarding work situation or individual life probably



impact on reporting WR-MSDs risk factors (Balogh et al., 2004; Barrero et al., 2009; Viikari-Juntura et al., 1996). Balogh et al (2004) reported that musculoskeletal complaints led to higher estimation of exposure to physical risk factors (Balogh et al., 2004). The same results were reported by Hansson et al (2001) and Barriera-Viruet et al (2006) (Barriera-Viruet et al., 2006; Hansson et al., 2001a). Stock et al (2005) explained some possible reasons to explain low validity of self-reported questionnaires such as operators' knowledge about WR-MSDs risk factors, capacity to judge, respondents' comprehension of the questions, response scale and methodological limitations of the studies which determine the validity of a questionnaire (Stock et al., 2005). The reproducibility of questions was low for the duration and frequency of specific body postures (neck, wrist, trunk and shoulders) and kneeling, squatting and jumping or climbing. Furthermore, the agreement of these questions with reference methods such as observational and direct measurement methods was poor. However, questions on general body postures such as sitting, standing and walking, and questions on material handling, physical effort and vibration exposure had good reproducibility (Barrero et al., 2009; Stock et al., 2005; Takala et al., 2010). Agreement for questions about material handling was related to the response scale. Narrow intervals and different ranges of weights provided poor agreement with reference methods (Stock et al., 2005). In a review study, Barriera-Viruet et al (2006) reported low-to-moderate agreement between assessment by the direct measurement/observational method and the self-reported questionnaire for force duration and frequency. However, critical appraisal of the studies reviewed showed that several confounding factors influenced the results. Descatha et al (2009) reported that the questionnaire was more sensitive to identify high physical exposure than observational assessment using a checklist (Descatha et al., 2009). Barrero et al (2009) reported the difficulty of validity evaluation of self-reported questionnaires with current validity assessment research. They mentioned that the current view about low to moderate validity of self-reported physical risk factors should be changed. Furthermore, validity assessment of self-reported methods against observational method should be considered cautiously because the validity of observational methods is still arguable (Barrero et al., 2009).

### **1.3.3. Direct measurement methods**

Various direct measurement methods such as electromyography (EMG), inclinometers, goniometers and accelerometers have been developed that use sensors attached to body segments and measure physical exposure (David, 2005). All these methods are used with synchronous recording and computer analysis. An electro-goniometer measures the angles of wrist and elbow directly across articulating joints while an

inclinometer measure the inclination of specific body segments. Goniometers are not suitable to measure movements of multiple joints with dynamic axes (Vieira and Kumar, 2004). The sources of error for the goniometer were instrument problems, rater errors, inconsistency among raters and variation/diversity of subjects. A mean error of 8° and 14.16° was reported between various measurements (same rater) and various raters, respectively (Vieira and Kumar, 2004).

Most studies used two inclinometers to measure a specific body segment because one inclinometer, for example, to measure spin movements provides the sum movements of spin, pelvis and hip. However, using two inclinometers provides the specific movements of spin by subtracting the value of the lower inclinometer from the value of upper one (Vieira and Kumar, 2004). We used two inclinometers in this study to measure the specific angles of the neck (Chapter Four). Vieira and Kumar reported low intra and inter-rater agreement for inclinometer measuring spin movement (Vieira and Kumar, 2004) but Hansson et al and Trask et al in several studies reported a good validity and reliability for inclinometer measurement of neck and shoulder movement (Hansson et al., 2010; Hansson et al., 2006; Trask et al., 2014; Trask et al., 2010).

The tri-axial accelerometer is suitable for calculating the movements and postures of body segments. Various studies have used the tri-axial accelerometer for posture and movement evaluation. Hansson et al (2001b) reported that the tri-axial accelerometer is suitable for objective assessment of posture over the whole working day. However, rotation around the line of gravity for the back and neck cannot be assessed.

*"For example, in the upright position, the neck flexion/extension and lateral flexion, but not the neck rotation, can be calculated from the data for the head and the back, whereas, in a 90° forward bent position (of both the head and the back), the neck flexion/extension and rotation, but not its lateral flexion, can be calculated"* (Hansson et al., 2001b).

Moreover, it is not possible to distinguish flexion/extension from abduction during arm evaluation by a tri-axial accelerometer (Amasay et al., 2009; Bernmark and Wiktorin, 2002).

Direct measurement methods provide quantitative and accurate data on exposure variables such as postures, movements and velocity. Engineers rely on this kind of data more than on the results of observational methods and self-reported questionnaires. Some studies have compared the results of direct measurement methods and other physical exposure assessment tools. Spielholz et al (2001) reported better measurement of duration of flexion/extension and repetition for the wrist by a goniometer. Furthermore, forearm rotation, repetition, grip force and velocity were better assessed by goniometer and EMG. However, the duration and frequency of wrist deviation were less accurate than the video-observation method. The authors reported the poor measurement of physical risk factors by self-reported questionnaire (Spielholz et al., 2001).

Although direct measurement methods have been accepted as precise and accurate methods that provide a large quantity of data for exposure to physical risk factors, these methods have many limitations. Application of these methods is difficult in industrial settings and they inconvenience operators in performing their tasks. Furthermore, operators might change their behaviors due to the new materials attached to the body, and being followed by video recording is known to produce the "hawthorn effect" (Campbell et al., 1995). It is very difficult to gather data from a large population because of the time, costs and skills needed to apply these methods. Moreover, the data collected might not be a sample of exposure to risk factors (particularly for jobs with much variation/diversity) because direct methods measure only a short period of time (Åkesson et al., 2012; Arvidsson et al., 2012; David, 2005; Takala et al., 2010).

#### **1.3.4. Analysis Method of Physical Risk Factor INRS Reference 6161**

The French National Institute for Occupational Health (INRS: Institut National de Recherche et de Sécurité pour la prévention des accidents du travail et des maladies professionnelles) has proposed an approach for physical workload analysis and preventive measures including four phases (INRS, 2014):

- Identification and prioritization of physical workload in a company
- Analysis of physical workload with regard to five elements (physical effort, design, time, environmental characteristics and organization)
- Looking for preventive measures
- Evaluation of the preventive measures

This method is based on ergonomic principles that help to identify the risks, analyze them, provide the solution and finally evaluate the efficacy of improvement measures. Figure 4 shows the four phases of this method. This method can be implemented by different stakeholders in industries such as managers, technicians, engineers, safety and health practitioners, workers union members, workers' representatives, external inspectors and professional organizations.

#### **1.3.5. Hierarchical Methods**

As shown before, a wide range of methods for physical risk assessment has been identified by recent systematic reviews, including self-reporting, observational methods and direct measurement (David, 2005; Malchaire et al., 2001; Takala et al., 2010). However, the selection of an appropriate method or combination of methods that might be routinely used remains a challenge since the available literature is not sufficient to select one method in particular.

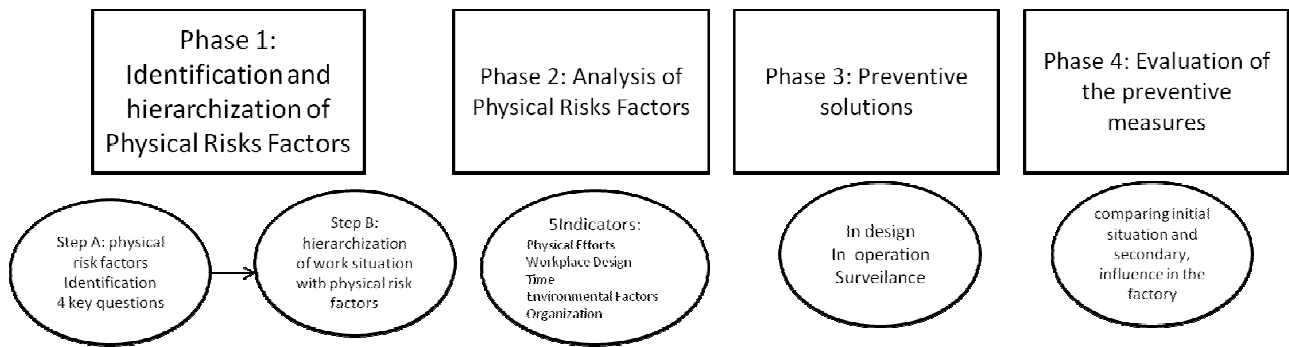

Figure 4: Four phases of implementing of INRS method reference 6161

The French good practice guidelines for management of the risk of low back pain among workers exposed to manual material handling (Petit et al., 2015c) proposed a hierarchical strategy of risk assessment of work situations based on:

- Participatory ergonomics in order to promote a global approach to work-related risks and preventive interventions
- A stepwise strategy to assess the risks of low back disorders related to manual handling. For this purpose, the assessment should be based on a clear definition of the objectives and resources required for risk assessment, with stepwise combinations of risk assessment tools, and be regularly adjusted in response to changes in the company and job characteristics.
- A systemic approach to the job situation (including organizational and psychosocial characteristics) and risks (posture, vibration, etc.), due to the multiplicity of types of occupational exposure”.

The guidelines recommend following “a three-level stepwise approach in line with the recommendations of the Belgian “SOBANE” strategy of occupational risk management (Malchaire, 2007):

- First level: Systematic detection at company level of work situations associated with of low back disorders. To achieve this, it is recommended that i) job characteristics are analysed in order to identify those work situations with confirmed (high level of low back pain) or potential (high levels of reported low back constraints) risks of low back disorders, ii) tools that can be routinely applied by company personnel, including analysis of existing risk assessment documents (company dispensary logs, insurance records, workers’ compensation

records, accident reports, absentee records, etc.) and analysis of the difficulties (and complaints) reported by workers in performing certain tasks.

- Second level: Analysis of work situations considered to be potentially associated with high risk of low back disorder. To achieve this, it is recommended that i) dangers are identified and the risk level of each work situation estimated, and ii) a risk assessment strategy is defined using readily available tools (Table 2), including self-reporting methods and tools (interviews, questionnaires, etc.), observational methods and tools (checklists, worksheets, etc.) and workload self-assessment tools (visual analogue scale, Borg's scale, etc.). Such analyses require the participation of workers and the technical expertise of the multidisciplinary occupational health team.
- Third level: In-depth analysis of complex situations. When the risk level cannot be determined by the preceding steps, experts in ergonomics and in-depth analysis methods should be called upon (Table 2) to conduct a detailed analysis of the job characteristics and work situation".

Finally, the guidelines recommended that "the above risk assessment of work situations should be combined (when possible) with the combined health surveillance data provided by medical examinations of exposed workers to estimate the risk level for low back disorders related to MMH". However, "the risk assessment must not delay the search for preventive solutions when a high level of exposure to low back risk is obvious and must allow measurement of the efficacy of any preventive solutions implemented based on direct feedback from management and workers".

The strategy and methods proposed could improve the understanding of the working activities of the workers/patients of all the practitioners involved in both the prevention of WR-MSDs in the workplace and the clinical management of WR-MSDs. The tools suggested have been selected on their practicability and potentially wide diffusion in the French speaking occupational health community, without selecting any particular tools in order to leave the choice to the OHS and practitioners. Such methods and tools could increase the reliability of the representations of their workers/patients' work situation and, finally, to ensure the consistency of the prevention messages delivered by the numerous practitioners involved in the multidisciplinary management and prevention of WR-MSDs. The main recommendations of these guidelines are the hierarchical method of risk

assessment based on participatory ergonomics and the suggested assessment tools that can be used routinely by both occupational health specialists and workers themselves and their supervisors.

**Table 2: Methods and low back risk assessment tools related to MMH**

Stepwise evaluation of risks related to MMH			
	STEP	METHODS	TOOLS
1st level	Systematic detection of confirmed or potential work situations with risk of low back disorders	Analysis of company health and safety documents	Company dispensary logs Insurance and workers' compensation records Accident reports Absentee records
		Global analysis of the difficulty of performing certain tasks	Feedback from workers and supervisors reporting pain or difficulties in performing certain tasks
2nd level	Risk identification  Estimation of the risk level for the work situations selected at level 1	Observational methods	Quick check-lists Check-list with scoring methods (Monnington et al., 2003) International standards
		Self-assessment methods - physical workload  - risk factors	Borg scale (RPE, CR10) (Borg, 1990) Visual Analogue Scale  Interviews , Questionnaires
3rd level	Analysis of complex situations	Detailed job analysis	Ergonomic job analysis Heart rate monitoring NIOSH lifting equation Biomechanical modelling

## 1.4. CASE STUDY: Introduction to SCANIA Production Plant

SCANIA is an international company producing trucks, buses and industrial/marine engines. This company has various production sites around the world and this thesis is based on intervention in the truck assembly site of SCANIA in Angers, France. This factory started its production in 1992 and employs around 620 people. It assembles 45 trucks per day in one shift. The production volume depends on customer demand and this has varied between 35 to 56 trucks per day over the past years. Approximately, one and a half days are required for the assembly of a truck. Various models of vehicle are assembled on the same production line.

SCANIA's industrial process is based on a Production System (called SCANIA Production System), which includes values, principles and methods. It is represented as a "house" (Figure 5). The main purpose of this system is to ensure continuous improvement in order to reach better quality and productivity. It also includes personnel development because the improvement process is based on stakeholders' involvement. The

“standardized working method” principle is related to the Lean manufacturing concept. The following sections describe the SCANIA assembly line process.

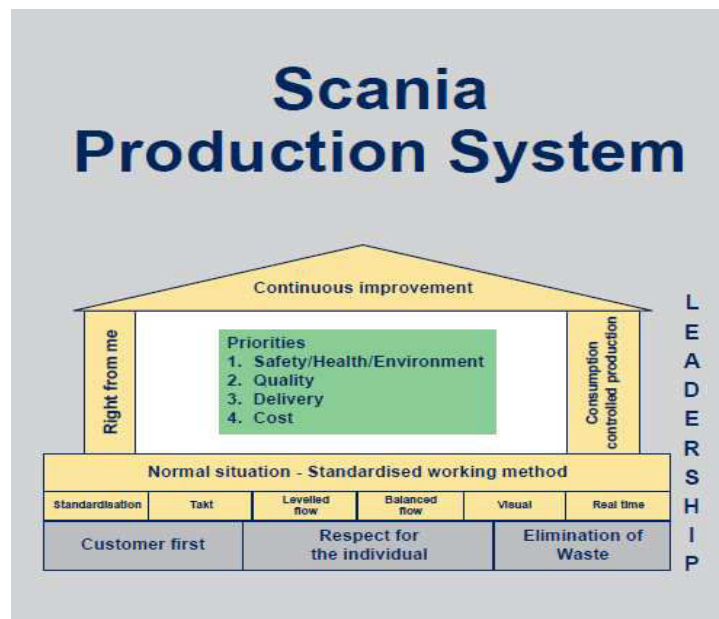

Figure 5: SCANIA Production System (SPS)

#### 1.4.1. Production Plant and Assembly Line

The SCANIA assembly process is based on a continuous flow, and the rhythm is governed by customer demand. It defines the cycle time (referred to as the takt time in the factory). The production site is organized around a main assembly line (on-going conveyor) and pre-assembly areas (fixed working positions). The truck assembly line is divided into 16 responsibility sectors (referred to as clusters in the factory). Each sector corresponds to the specific assembly of components or truck functions, including work stations on the line and pre-assembly work positions. The present study was performed in sector F.A 4.1 (P42). The parts assembled in this sector were: Air filter, cab tilt cylinder, Selective Catalytic Reduction (SCR) tank, front bumper, left/right boarding steps and left/right front and rear mudguards. Furthermore, there were three pre-assembly areas in which the air filter, cab tilt cylinder, bumper and SCR tank were prepared. Each assembly sector ends up with quality control. Figure 6 presents a diagram of the sector under study (this organization of the sector is related to the current situation of the cluster and some differences occurred over the time of the study; see Chapter Four).

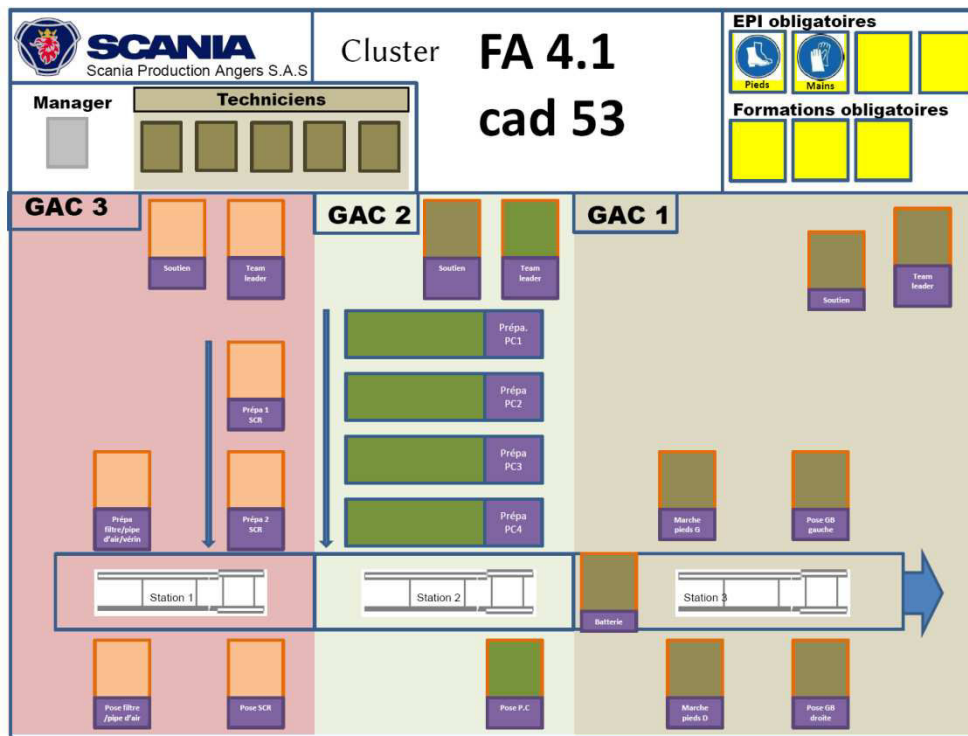

Figure 6: Current organization of the sector under study

(Some differences occurred in this organization compared to that at the time of performing this study; see Chapter Four)

### 1.4.2. Organization of the Sectors

Each sector (“cluster”) is considered as a small factory including several workstations. Each has a manager who is in charge of assembly, quality, safety and ergonomics, work improvement, resources required, etc. Each “cluster” is then divided into several Improvement Groups (IGs). An improvement Group (IG) is a small working group that allows industries to increase the commitment of people in a specific area for continuous improvement (Liljedahl and Muftic, 2012). The purpose is to develop and educate the operators in order to improve safety, quality and productivity. Every IG has its own team leader (TL) who is the responsible for planning the daily operations, training new operators and supporting the group in handling deviations or errors (referred as Andon in the factory). Each operator is a member of a specific IG and is responsible for improving the assembly process (to ensure about quality and productivity) and working conditions (including safety and ergonomics). The IG is composed of four to seven team members. They rotate between the same number of workstations (referred to as work positions in the factory) in that specific area.

Each cluster (and IG) is supported by two technicians i.e. a process technician and a product technician. The Process technician is responsible for designing the workplace (balanced workload, tools, and work instructions



including safety and ergonomics standards). The Product technician is responsible for coordination of product changes between SCANIA's Research/development department and the process technician.

#### **1.4.3. Standards and Element Sheets for Workstations**

Many standards have been developed and used in the assembly line. The number and sequence of assembly tasks for each workstation are formulated in the "Position Standard" and the operators should follow this standard during assembly operation. Information such as the name of the workstation, types of assembly tasks (added-value tasks or non-added value tasks), assembly sequence tasks, time required for performing each task, and the tasks for variant models of a truck are presented for a Position Standard. The aim of this standard is to reduce diversity and provide a guideline to support assembly operation and avoid deviations and errors. Balancing of the workload in a workstation is performed by the sector's manager, process technicians and the Team Leader. Change in the production volume (the cycle time) causes substantial variations in the distribution and sequence of the tasks in a workstation. An example of a Position Standard is presented in Appendix 4.

#### **1.4.4. Cycle Time (Takt Time)**

Cycle time is defined by the volume of trucks to be produced each day. The number of tasks that an operator should perform at a specific workstation depends on the number workstations in a sector, the number of operators and the time needed to perform each task. These tasks are documented sequentially in the "Position Standard" and the detail of each task (how to perform a task to guarantee safety and quality) is described in the "Elementary sheet" (see Appendix 5). There is often a time interval for recovery after finishing the tasks of a workstation before starting the new cycle time. The cycle time in the factory under study is referred to as the takt time. It may change due to variations in the mid- or long-term market demands. Changing the cycle time affects the organization of a sector in different ways such as task sequences, the distribution of tasks between workstations and the number of operators. Well-balanced workstations in terms of ergonomic workload reduce physical and mental stress: overloading the number of assembly tasks and ignoring recovery time create stressful (physical and mental) workstations. During our study, the cycle time was changed from 8 minutes to 11 minutes. There are three breaks during the day: two short breaks (morning and afternoon) lasting 10 minutes and a break for lunch lasting fifty minutes. The operators rotate between workstations in an area (IG) after each break. This means that each operator works at three different workstations over one work shift.

#### 1.4.5. Production Mix

Several variant models of truck are assembled on one assembly line. The pre-assembly areas are meant to absorb part of the production mix and also balance the work according to the cycle time. During a work shift, the type and quantity of truck models that should be assembled in one workstation is complex. Each workstation has several "Position Standards", describing the most frequent main truck variants. Leveling the production mix is performed during the planning phase, in advance, on the basis of the main bottle necks in the process (technical or organizational) in relation to the cycle time. A "reasonable" number of complex trucks in the line may be assigned during a work shift, with suitable intervals in order to cope with the extra assembly time needed over the cycle time. The organizational solution is to plan extra resources for those complex trucks, which are referred as "variant positions" in each sector.

Furthermore, "Call Assistant" or "Andon system" supports the process in order to correct the deviations (errors), as soon as possible, or help an operator at a workstation to finish his/her tasks during a cycle time. The number of calls for Andon shows the difficulties in performing all the operations of a workstation within a cycle time. Moreover, other types of deviation (i.e. poor quality of parts, lack of training on rare truck models, delay in delivery of parts to the assembly workstation, etc.) increase the number of calls for Andon. The "Andon" is one of the key roles of the Team Leader.

#### 1.4.6. SCANIA Safety, Health and Environment (SHE) Standard

In order to achieve safe workplaces, well-being and minimal environmental impact SCANIA has developed a corporate standard for Safety, Health and the Environment (SHE). It includes 16 SHE requirements that are essential to work at a SCANIA worksite. The requirements introduced in this standard are as follows:

Responsibilities, Legal compliance, Management of change, Diversity, Workplace design, Psychosocial work environment, Machines, Work equipment, Lifting safety, Ergonomics, Chemicals, Accidents and near-accidents, Emergency preparedness, Work adaptation and rehabilitation, Lifestyle, Traffic safety and business travel, Resource efficiency, and Emissions and waste handling. In this standard, it is noticeable that ergonomics has a specific heading. Furthermore, the importance of ergonomics is emphasized by the development of standard ergonomic methods for improvement of ergonomic situations. Appendix 6 shows the corporate standard for Safety, Health and the Environment (SHE).

## 1.5. Representation of risk factors for WR-MSDs

Ergonomics is a motivation for investment in the manufacturing industry, particularly by relating it to quality and productivity that help companies to reduce costs and survive in a competitive market. As pioneers in the development of industrial aspects such as ergonomics, automotive industries started to establish/integrate ergonomic approaches in company production systems. Automotive assembly lines involve various WR-MSDs risk factors including physical, organizational and psychosocial/cognitive factors. An effective ergonomic approach that can provide a shared representation of risk factors by involvement of stakeholders is thus essential for improving work situations. Although ergonomics has already been integrated in the production system of such factories, a limited amount is known regarding representations of risk factors from the viewpoints of various stakeholders. The challenge of a current ergonomic approach is whether it would be able to provide a valid representation of the WR-MSDs risk factors of a job.

Representation reflects thoughts, beliefs and attitudes of a person regarding an issue (Coutu et al., 2011). Representations of WR-MSDs risk factors are constructed on the basis of thinking, knowledge and information obtained through education, observation and practice. Employee representation of ergonomic issues may reflect attitudes, social interactions, and perceptions of a job. Ergonomists' representations are generally based on knowledge and are conveyed through discussion and observation of a job (evaluation of a job by observational tools). Representation of ergonomic problems in a workplace might be different for various stakeholders such as ergonomists, employees and engineers, as well as the healthcare personnel who are involved in rehabilitation and return to work of injured employees (Petit et al., 2014). Similarly, the control strategies (intervention remedies) might be different for various stakeholders.

A shared representation of WR-MSDs risk factors can provide convergence and coherence between stakeholders in their perception of a job (Coutu, 2008) and would help to achieve an effective ergonomic intervention. A shared representation can reduce gaps in understanding and beliefs between ergonomists and other stakeholders, particularly employees. Typical ergonomic programs often focus on analysis of a job by ergonomists. In other words, ergonomists identify and prioritize WR-MSDs risk factors (mostly physical risk factors such as movement, awkward posture, force, etc.). However, operator representations and those of other stakeholders such as engineers, occupational therapists and occupational physicians are overlooked. It is therefore essential to develop a systematic approach that can take into account the complexity of various risk factors from the viewpoint of different stakeholders.

The manufacturing industry under study (SCANIA Truck Production) has already integrated ergonomics in their Production System (SPS). An in-house ergonomic observational tool (SCANIA Ergonomic Standard) has been used in this factory by ergonomists to identify and analyze physical risk factors. On the basis of this ergonomic analysis, remedies and preventive projects were proposed and managed by technicians and engineers. Finally, the remedies were implemented to improve working conditions and reduce WR-MSDs. In other words, problems were identified by one individual (ergonomist), solved by another stakeholder (engineer) and applied by the operators. Although sometimes the problems and the solutions were discussed in the meetings by engineers or operators, these procedures were not systematic and were performed without exchange of information and discussion of preferences between stakeholders. The decision to accept interventions therefore included uncertainties and there were sometimes conflicts between stakeholders that caused failure of the proposed preventive actions.

This study was designed to develop the concept of shared representation in manufacturing industries. Indeed, the aim of this study was not to propose a new method or procedure for achieving shared representations of risk factors (which might be the next stage of this study) whereas the purpose, at the initial step, was to question current methods and procedures that are widely used in manufacturing industries. We hypothesized that there was a significant difference between an ergonomist's analyses of the workplace by observational tools and employees' estimations of risk factors, often evaluated by self-reported questionnaire. The effects of the interventions proposed and managed by engineers following the ergonomist evaluation were also investigated.

This study comprises several sub-studies; in the initial stage, an ergonomist analyzed the workstations using the SCANIA Ergonomic Standard (SES) tool (results presented in Chapter Two). Then a self-reported questionnaire, including physical risk factors, organizational and psychosocial factors was used to evaluate the viewpoints of operators regarding their jobs (Chapter Three). These two evaluations of ergonomic factors were then compared and agreement between them was investigated. Finally, to determine the accuracy of each method, direct measurement methods were developed and applied to measure physical risk exposure directly. The results of the SES method and self-reported questionnaire were then compared with the real measurement method to demonstrate their agreement. The common factors between the different methods were compared, as a questionnaire can investigate extensive ergonomic factors including physical, organizational and psychosocial factors but observational method and direct measurement often evaluate only physical risk

factors. Direct measurement methods measure fewer variables due to their limitations in the field and difficulties in data processing and analysis.

The aim of second part of the study (performed in parallel with the first part) was to present the results of ergonomic analysis to stakeholders (managers, engineers and operators) and to implement technical/engineering interventions. Furthermore, organizational interventions such as changes in the organization of workstations (workplace redesign) and the distribution of tasks (workload) were implemented. The effects of technical/engineering remedies and organizational interventions on physical risk factors were subsequently investigated.

The focus of this thesis was more to assess physical risk factors and less to investigate organizational and psychosocial factors. Nevertheless, some organizational and psychosocial factors were evaluated and the results are provided in Chapter Three. Furthermore, the effects of change in the cycle time of the assembly line on physical risk factors were taken into account. The cycle time, in many car industries often vary due to the design of new products, customer demands and new technology. This was the case in the factory under investigation. These changes influence physical ergonomics, and thus we performed our experiments in two different cycle times.

## 1.6. Research Aims

The general aim of this study was to perform a comprehensive risk assessment to investigate the potential risk factors of WR-MSD in an automotive industry and compare the results of risk assessment Methods. The secondary aim was to implement preventive measures to reduce the identified risk factors.

The specific objectives of this study were as follows:

- a) To identify and understand exposure to WR-MSD risk factors in a truck assembly plant using an observational method and to determine the variation and diversity of risk factors (Paper 2)
- b) To evaluate subjective estimation of operators regarding physical exposure and, organizational and psychosocial factors by self-reported questionnaire (Paper 3)
- c) To develop biomechanical methods and protocols for direct measurement of physical risk exposure in real assembly workstations (Paper 4)
- d) To develop a quantitative method for evaluating head movements in the sagittal plane (Paper 5)
- e) To quantify the duration of exposure to physical workload for the head, arms, back and wrists for truck assembly operators (Paper 6)

- f) To determine the agreement between the results of the observational method and the self-reported questionnaire (Paper 7 & 8)
- g) To compare the results of the observational method and self-reported questionnaire with the direct measurement method when assessing the risk factors for the upper limbs and the back in truck assembly operators (Paper 9)
- h) To recommend and realize preventive measures, i.e. technical and organizational interventions, with the contribution of the stakeholders (Paper 10)

## 1.7. Thesis Structure

This thesis comprises six chapters and several journal papers are included based on the gaps in knowledge and the aims of the study. Chapter One explains the rationale for analysis of exposure to WR-MSD risk factors and preventive measures in automotive industries. The costs and consequences of the prevalence of WR-MSDs are discussed. The effects of risk factors on poor quality of products are reviewed. The results of this review have been published as *Zare M, Croq M, Arabi FH, Brunet R, Roquelaure Y. (2015). Does Ergonomics Improve Product Quality and Reduce Costs? A Review Article. Human Factors and Ergonomics in Manufacturing & Service Industries Journal (Appendix 2)*. Moreover, risk assessment methods with a focus on automotive industries are described and an overview of the SCANIA Production group is provided. At the end of the introductory Chapter, the research aims and the thesis structure are presented.

Chapter 2 comprises two sections. Section 1 addresses physical risk factors on the assembly line for the initial cycle time assessed by Scania Ergonomic Standard (SES) tool (observational method). The manual handling tasks were also evaluated by NIOSH equation method. The results of investigation by the observational methods have been accepted for publication as *Zare M, Malinge-Oudenot A, Höglund R, Biau S, Roquelaure Y. Evaluation of physical risk factors in a truck manufacturing plant: case study in SCANIA Production Angers, Industrial Health Vol. 54, No. 2, March 2016*. The second section of this chapter addresses variation and diversity of risk factors at a workstation in assembly line.

Chapter 3 describes self-reported estimation of physical risk factors evaluated by the questionnaire. Furthermore, organizational and psychosocial factors are addressed. The results for both cycle times are presented and are compared with the reference data of a French cohort study. This chapter has been published as *Zare M, Bodin J, Cercier E, Brunet R, Roquelaure Y. Evaluation of Ergonomic Approach and Musculoskeletal*

*Disorders in Two Different Organizations in a Truck Assembly Plant. International Journal of Industrial Ergonomics. 2015: 50, 34-42.* The published paper for this chapter has been provided in Appendix 7 the questionnaire used to evaluate WR-MSDs risk factors is presented in Appendix 8.

Chapter 4 presents biomechanical measurement in this study. This chapter comprises three sections. The first section addresses the development of the biomechanical method for direct measurement of physical risk exposure. The paper has been published as *M. Zare, S. Biau, M. Corq, Y. Roquelaure. (2014) Development of A Biomechanical Method for Ergonomic Evaluation: Comparison With Observational Methods. International Journal of Social, Management, Economics and Business Engineering. 8(1):223-227.* The published paper for this chapter is provided in Appendix 9 Section 2 of this chapter presents a quantitative analysis method to measure head movements in the sagittal plane. The manuscript has been published as *M. Zare, S. Biau, R. Brunet, A. Gourlay and Y. Roquelaure. (2015) A comparison of neck bending and flexion measurement methods for risk assessment. The International Journal of Occupational Safety and Ergonomics (JOSE).* The published paper for Section 2 is presented in Appendix 10 Section 3 addresses quantitative measurements of the physical risk factors for the upper limbs and lower back at different assembly workstations in the second cycle time. The proportion of time in awkward posture was measured by the biomechanical methods described in the other two sections of this chapter. The manuscript has been submitted for publication as *Zare M, Biau S, Roquelaure Y. Quantification of physical ergonomic work load in truck assembly operators: Neck, back, arms and wrist.* Data processing of the direct measurement by the sensors and electronic devices was performed by an engineer of signal processing and the report of the analysis is presented in Appendix 11.

Chapter 5 presents the comparison between risk assessment methods. This chapter comprises two sections. Section 1 addresses the comparison between SES method (observational method) and the self-reported questionnaire. These methods were compared in both cycle times. The findings of the initial cycle time are presented in this section and the manuscript has been submitted for publication as *Zare M, Norval M, Bodin J, Roquelaure Y. Are There Differences Between the Results of Risk Assessment Tools? Self-Reported Questionnaire and Observational Method.* The results of the second cycle time are presented in Appendix 12 of this thesis in French. The manuscript has been submitted for publication as *Zare M, Norval M, Bodin J, Roquelaure Y. Comparaison de deux outils d'évaluation des risques ergonomiques dans la prévention des troubles musculo-squelettiques : de l'auto-questionnaire à la méthode d'observation.* Section 2 addresses the

comparison between three methods i.e. the SES, the self-reported questionnaire and the direct measurement. These methods were compared in both cycle times. The manuscript has been submitted for publication as *Zare M, Biau S, Brunet R, Roquelaure Y. Comparison of three methods for evaluation of risk factors in a truck assembly plant: observational method, self-reported questionnaire and direct measurement method.*

Chapter Six describes preventive interventions including technical/engineering remedies and organizational interventions that were implemented following the observational evaluation by the SES method at the initial cycle time. This section also presents the involvement of stakeholders for implementation of preventive measures. Risk exposure changes that were evaluated by the SES method in the second cycle time are reported. The manuscript has been submitted for publication as *Zare M, Guibert F, Hunault G, Roquelaure Y. Ergonomic intervention program to improve work conditions in SCANIA truck manufacturing plant.*



## 2. Assessment of physical risk factors by Observational methods

### 2.1. Evaluation of physical risk factors by the SES method and the NIOSH equation method

As discussed in the previous Chapter, WR-MSDs risk factors are common in automotive assembly plants and little is known about ergonomic evaluation from a practitioner’s viewpoint. This Chapter represents the ergonomic evaluation using an in-house ergonomic method (SES method) and the NIOSH lifting equation in a truck assembly plant. The following table summarizes the gaps, aims and findings of Article 2 in which the evaluation of physical risk factors in a truck assembly line are clarified.

Gaps	Aims	Findings
Little is known about physical risk factors in a truck assembly line	To assess ergonomic physical exposure in a truck assembly line with the SES method and the NIOSH lifting equation	Awkward trunk posture, hand/wrist risk factors and awkward shoulder posture were common ergonomic workloads in the truck assembly plant.
There are few studies reporting risk factors by an in-house observational method	To compare the results of both methods for material handling tasks	The SES method was biased towards sensitivity and over-estimation of material handling risks
The sensitivity of the SES method to identify material handling risks is a matter of debate		These results could be re-used by practitioners to perform a valid and reliable ergonomic evaluation of the assembly workstations

Furthermore, inter and intra individual diversity that was assessed by the SES method is reported in the second section. Following the risk evaluation conducted in the first section, we questioned the diversity of risk factors in similar situations. Diversity was observed between and within operators for the same workstations. The diversity was greater in the workstation with high ergonomic workload than for the workstation with lower ergonomic workload.

#### 2.1.1. Article 2: Evaluation of physical WR-MSDs risk factors in a truck manufacturing plant: case study in SCANIA Production Angers

Zare M, Malinge-Oudenot A, Höglund R, Biau S, Roquelaure Y. Evaluation of physical risk factors in a truck manufacturing plant: case study in SCANIA Production Angers. *Ind Health*, vol. 54 No. 2, Mar 2016. doi={10.2486/indhealth.2015-0055}

## **Title Page: Field Report**

# **Evaluation of physical risk factors in a truck manufacturing plant: case study in SCANIA Production Angers**

**Mohsen Zare<sup>1</sup>**

**Agnes Malinge-Oudenot<sup>2</sup>**

**Robert Höglund<sup>3</sup>**

**Sophie Biau<sup>1,4</sup>**

**Yves Roquelaure<sup>1</sup>**

<sup>1</sup>LUNAM, University of Angers, Laboratory of Ergonomic and Epidemiology in Occupational Health (LEEST), Angers, France

<sup>2</sup>Ergonomist coordinator, Safety and Health Department, SCANIA Production Angers SAS, Anger, France

<sup>3</sup>Managing Director, MA, SCANIA Production Angers SAS, Angers, France

<sup>4</sup>French Institute of Equitation, National School of Equitation, Saumur Cedex, France

Corresponding Author: Mohsen Zare

LUNAM, Université d'Angers, Laboratoire d'ergonomie et d'épidémiologie en santé au travail (LEEST), Angers, France. Email: [mohsen@zare.fr](mailto:mohsen@zare.fr) Tel: +33787722141

## Abstract

The aims of this study were 1) to assess the physical risk factors from practitioner's viewpoint in a truck assembly plant with an in-house observational method and the NIOSH lifting equation, and 2) to compare the results of both methods and their differences. The in-house ergonomic observational method for truck assembly i.e. the SCANIA Ergonomics Standard (SES) and the NIOSH lifting equation were applied to evaluate physical risk factors and lifting of loads by operators. Both risk assessment approaches revealed various levels of risk, ranging from low to high. Two workstations were identified by the SES method as high risk. The NIOSH lifting index (LI) was greater than two for four lifting tasks. The results of the SES method disagreed with the NIOSH lifting equation for lifting tasks. Moreover, meaningful variations in risk patterns were found for various truck models at each workstation. These results provide a better understanding of the physical ergonomic exposure from practitioner's point of view in the automotive assembly plant.

**Keywords:** Ergonomics, Workload, Variability, Assembly Manufacturing plant

## Introduction

The prevalence of work related musculoskeletal disorders (WR-MSDs) is high in the automotive industry<sup>1, 2</sup>. Many tasks have to be performed in an automotive assembly line including tightening, picking up, lifting and material handling. These operations involve physical risk factors such as repetition, forceful exertion, awkward postures, vibration etc. Furthermore, short cycle time and insufficient recovery time related to assembly line have often accumulative effects on exposure to the risk factors<sup>3, 4</sup>. A dose-response relationship between exposure to physical risk factors and the prevalence of WR-MSDs has been reported in the automotive assembly operations<sup>5, 6</sup>.

Measurement of physical risk factors in different occupations has been a challenge for ergonomists/practitioners and managers. They need to assess physical risk factors accurately to establish priorities for ergonomic interventions<sup>7</sup>. Many scientific methods are available for assessing physical risk factors, including observational methods, subjective or self-reported assessment and direct measurement techniques<sup>6, 8</sup>. Due to constraints of time and resources in most industries, practitioners prefer observational methods. A number of observational methods (such as RULA<sup>9</sup>, REBA<sup>10</sup>, OCRA<sup>11</sup>, QEC<sup>12</sup>, the NIOSH equation<sup>13</sup>) etc.) have been developed in the ergonomic literature<sup>6, 14, 15</sup>. Kee and Karwowski (2007) applied REBA, RULA, and OWAS in various industrial sectors and compared their results<sup>15</sup>. Chiasson et al (2012) compared eight methods including QEC, FIOH, RULA, REBA, HAL, JSI, OCRA and EN 1005-3 standards over four years at 224 workstations<sup>16</sup>. However, automotive companies have created in-house observational method which is customized to their own risk factors<sup>17</sup>. Few literatures involved have addressed applied researches that assess ergonomic workloads with the in-house ergonomic method<sup>16, 17</sup>. Törnström et al. (2008) reported factors supporting and hindering the implementation and application of an in-house ergonomic method<sup>18</sup>. Berlin et al. (2009) compared Swedish national legislation with an in-house ergonomic method in an automotive corporation to determine whether they are equivalent<sup>17</sup>. To our knowledge, few research studies have reported risk factors with an in-house method from a practitioner's perspective and most of existing studies are research-oriented on the base of expert's perspective<sup>17</sup>. Furthermore, no research has compared an in-house ergonomic method with commonly used methods such as the NIOSH equation. The aim of this study was therefore to assess WR-MSDs risk factors in a truck assembly plant from practitioner's viewpoint by use of an in-house ergonomic method. A further objective was to compare the results of its lifting component with the NIOSH lifting equation.

## Methods

### Workplace Descriptions

Eleven workstations (known as work position in the factory) were selected from one sector (known as cluster) of a truck assembly plant for data collection. The workstations studied involved various assembly tasks. Seventeen operators worked in these workstations, and the mean age and the length of work experience in the current job were 42.0 ( $\pm 7.6$ ) years and 15.2 ( $\pm 7.2$ ) years, respectively. The factory created smaller groups of operators (Improvement Groups (IGs)) in the sector under investigation to achieve continuous improvement. The operators rotated between the workstations of each group every two hours. Table 1 presents three IGs and the number of workstations and tasks.

**Table 1: Workstations, truck types, approximate number of tasks performed, task description and predominant risk factors for each workstation**

Workstations	Truck types	Number of tasks	Task description	Principle risk factors
<b>Improvement Group 1 (IG<sub>1</sub>)</b>				
Preparation of air filter and cab tilt cylinder	Standard	60	Air filter, air pipe, heat cover and cab tilt cylinder pre-assembly	Awkward posture, forceful exertion, material handlings
	Other model (High air intake)			
Air filter and cab tilt cylinder mounting	Standard	28	Air filter, air pipe, heat cover and cab tilt cylinder assembly	Heavy material handling, repetitions, space restriction
	Other model (Air Pipe)			
	Other model (High air intake)			
Boarding steps and mudguards; left and right	Standard	40	Assembly of left and right boarding steps + Assembly of left and right rear mudguards with side lamps	Heavy material handling, repetitions, vibration
Variant Workstation	Hydraulic kit	9	Hydraulic kit assembly	Heavy material handling
	Middle mudguards	22	Assembly of middle mudguards	Heavy material handling, repetitions
	Y mudguards		Assembly of Y mudguards	
	Additional boarding steps	7	Assembly of boarding steps	Repetition
<b>Improvement Group 2 (IG<sub>2</sub>)</b>				
Picking Area	Picking up Bumper	29	Preparing kit for bumper; Placing bumper beam in sequence; Preparing sun visor; Picking up rear beam	Heavy and light material handling, bending and twisting
	Picking up Equipment			
	Sun Visor			
	Rear Bar			
Preparation Bumper 1	Standard	33	Bumper pre-assembly and washer container assembly	Force exertion, awkward posture
	Other model (Heavy Duty Front)			
	Other model (Protruded)			
Preparation Bumper 2	Standard	17	Bumper pre-assembly near the line	Force exertion, awkward posture
	Other model (Heavy Duty Front)			
Bumper Assembly on Truck	Standard	27	Finishing bumper pre-assembly, filling washer liquid, placing bumper on the chassis	Force exertion, awkward posture, bending, twisting, vibration
	Other model (Heavy duty front)			
	Other model (Protruding)			
<b>Improvement Group 3 (IG<sub>3</sub>)</b>				
Mounting Selective Catalytic Reduction (SCR) Tank	Standard	38	SCR Tank assembly preparation of lighting box	Force exertion, heavy material handling, repetitions
	Other model (Euro 6 SCR)			
Preparation SCR Tank	Standard	23	SCR Pre-assembly and sequencing	Awkward posture, forceful exertion, movement
	Other model (Euro 6 SCR)			
Variant Workstation	Hydraulic kit	9	Hydraulic kit assembly	Heavy material handling
	Lighting Box	13	Preparation front lighting box	Awkward posture

Given the variations in truck models for each workstation, there are extra or different tasks which cause variations in physical risk factors. We therefore considered significant variations in truck models as well as standard trucks, and finally 28 assessments were performed. The cycle time (known as takt time in the factory) for each workstation was 11 minutes, which included the time for performing the assigned tasks plus recovery time. The production volume of the factory was based on the cycle time and 35 trucks were daily produced. The reasons for studying these workstations were either operators' complaints or the amount of absenteeism. Ergonomic assessments were performed with both the SCANIA Ergonomic Standard method (SES) and the NIOSH lifting equation. Assessment was undertaken for one operator for each workstation. Where a workstation needed more than one operator, e.g. middle mudguard assembly, two operators were assessed.

## **Data Collection**

A checklist was filled out to collect descriptions of workstations (tools, constraints etc.) before the ergonomic assessment. Weights of objects (dynamometer), magnitude of forces (dynamometer), and handle diameters (calliper) were measured and recorded. Video recording was performed for all workstations assessed, and the ergonomist attempted to position a mobile camera in order to record the whole body throughout video recording. The recordings allowed the researcher to perform a more precise evaluation of the workstations. The study was performed from September 2012 to March 2013 as the majority of workstations were observed and assessed several times. Changes in the workstations were therefore taken into account over this period. An ergonomist analysed workstations using the SES method and recorded movies, and in some cases two ergonomists discussed and decided the assessment scores. If workstations evaluated with the SES method involved high risk lifting tasks, they were analysed more precisely by the NIOSH revised equation method and the results of the NIOSH equation were taken into account to determine the final evaluation of each workstation.

## **Concept and background of the SES method**

The SES is an in-house observational method which was implemented by SCANIA group to identify the potential of physical risk factors in the truck manufacturing plant. This screening tool was developed by Saab Automobile and adapted to Scania conditions according to the ergonomic requirements of Swedish legislation and Scania's health and work environment policy. By assessing multi-tasks workstations on the line, it evaluates the postures of the whole body or body region, manual force exerted, and manual handling. The SES method includes 20 criteria which are classified in four categories; including repetition, work posture, lifting and energy consumption (Table 2). The evaluation index of this method is not only based on subjective assessment, but also on measurable factors such as weight, mechanical forces (measured by dynamometer), object diameter and distance. The results are sorted into zones for prioritization of each assessment. Green or normal zones have minimal risk of musculoskeletal disorders, and these are acceptable. Yellow zones have moderate risk of musculoskeletal disorders, and workstation assigned yellow might need some improvement in the future. Red indicates an action zone with considerable risks of musculoskeletal disorders, and changes are required as soon as possible. Finally, double red zones have potentially excessive risks. Tasks assessed as double red should be stopped immediately and a solution found to eliminate or reduce the risk. While the operator was working, each

criterion (in reality and again on video) was evaluated in the SES template, either as Green, Yellow, Red or DR (Double Red) depending on risk factor arising (Table 2).

**Table 2: Risk factors taken into account by both the SES and NIOSH equation methods**

Risk factors	SES component (prioritization: Green, Yellow, Red, Double red)	NIOSH equation
Repetition	<b>Repetition per hour</b> < 150 rep/hour <b>Green</b> 150-300 rep/hour <b>Yellow</b> > 300 rep/hour <b>Red</b> >600 rep/hour <b>Double red</b>	- Frequency - Duration of lifting period (time/min )
Occurrence of work posture	<b>Work postures during the operation</b> Standing/walking/sitting <b>Green</b> Uncomfortable/twisted position while standing/sitting <b>Yellow</b> Lying, kneeling, squatting, reclining on one side or back, standing on one leg <b>Red</b>	- Horizontal lifting distance (H) - Vertical lifting height (V) - Asymmetry (A) - Vertical travel distance (D)
Access, hidden assembly	<b>Access hidden by obstructions in the workspace</b> Top or front Free access, no obstruction <b>Green</b> Side Workplace <b>Yellow</b> Under or behind <b>Red</b>	NA <sup>+</sup>
Clearance for hand and finger	<b>Clearance for manual fitting of parts</b> Hand distance      Finger distance ≥ 2,5 cm <b>Green</b> ≥ 1,0 cm <b>Green</b> < 2,5 cm <b>Red</b> < 1,0 cm <b>Red</b>	NA
Hand workspace	<b>The workspace (box) in which the hands must be held during the operation</b> In box <b>Green</b> Outside box <b>Red</b>	NA
Hand grip	<b>Quality of handgrip, diameter/thickness of the tool</b> Ø >2-4 cm. Even and not slippery <b>Green</b> Ø 0,6-2 cm or > 4-7 cm <b>Yellow</b> Ø < 0,6 or >7 cm Sharp edges, slippery or hot surfaces <b>Red</b>	Gripping (C)
Surface area for pressure	<b>Accessible surface of a part which fingers has contact during activity (&gt; 1 kg)</b> Finger      Palm Ø ≥ 1,5 cm or A ≥ 1,7 cm <sup>2</sup> Ø ≥ 3,0 cm or A ≥ 7 cm <sup>2</sup> <b>Green</b> Ø < 1,5 cm or A<1,7 cm <sup>2</sup> Ø < 3,0 cm or A < 7 cm <sup>2</sup> <b>Red</b>	NA
Component size	<b>Component size when handling: (Size (mm) = Length + Height + Width)</b> - < 1000 mm <b>Green</b> - 1000-2000 mm <b>Yellow</b> - > 2000 mm <b>Red</b> - >4000mm <b>Double red</b>	NA
Back posture	<b>Static work posture ≥ 5 seconds – Back</b> 0 – 20° bending forward <b>Green</b> 20 – 45° bending forward/ 20° - 45° sideways/rotation <b>Yellow</b> > 45° bending forward or > 45° sideways/rotation or bending backward <b>Red</b>	NA

Neck posture	<b>Static work posture <math>\geq</math> 5 seconds – Neck</b> 0-20° bending forward <b>Green</b> 20-45° bending forward or 20-30° sideways/rotation <b>Yellow</b> > 45° bending forward or > 30° sideways/rotation or bending backwards <b>Red</b>	NA
Shoulder posture	<b>Static work posture <math>\geq</math> 5 seconds: Shoulder/Arm bending movement forward/outward movement</b> < 45° upper arm lifting <b>Green</b> 45°-90° upper arm lifting <b>Yellow</b> > 90° upper arm lifting <b>Red</b>	NA
Wrist posture	<b>Work posture – Wrist</b> Neutral wrist <b>Green</b> Non-neutral wrist <b>Red</b> - 30° bending upward, 45° bending downward, > 10° bending sideways	NA
Lifting torque – Two-handed lifts	<b>The torque for a two handed lift: Weight (kg) <math>\times</math> Horizontal distance (m) <math>\times</math> 10 N = Lifting torque (Nm)</b> < 10 Nm <b>Green</b> 10-35 Nm <b>Yellow</b> > 35 Nm <b>Red</b> >70 Nm <b>Double red</b>	Lifting Index High risk >1.6
One-handed lifts	<b>The weight of the object being lifted or held in one hand</b> < 2 kg <b>Green</b> 2-5 kg <b>Yellow</b> > 5 kg <b>Red</b> >10 kg <b>Double red</b>	NA
Whole Body Push /Pull Force	<b>Force required for pushing/pulling</b> Initial force (starting)      Continuous < 100 N                              < 50 N <b>Green</b> 100-150 N                              50-110 N <b>Yellow</b> > 150 N                                      > 110 N <b>Red</b> >300 N                                      >220 N <b>Double red</b>	NA
Hand pushing and pulling	<b>Force required to insert/remove an object, fastener, tighten with a torque wrench, etc., using the palm or the whole of one hand/arm.</b> Neutral wrist                              Non-neutral wrist < 45 N                                      < 10 N <b>Green</b> 45-90 N                                      10-45 N <b>Yellow</b> > 90 N    > 45 N <b>Red</b> >180 N                                      >90 N <b>Double red</b>	NA
Pushing, pulling with fingers	<b>The force required to squeeze/insert/remove an object, fastener, connector, seal, hose, etc., using a finger or holding an object using fingertips and thumb in a pinch grasp.</b> Neutral wrist                              Non-neutral wrist < 10 N                                      < 5 N <b>Green</b> 10-45 N                                      5-25 N <b>Yellow</b> > 45 N    > 25 N <b>Red</b> >90 N    >50 N <b>Double red</b>	NA



Movement	<p><b>Number of continuous steps taken within the workspace</b></p> <p>1-10 cont. steps <b>Green</b>  11-30 cont. steps <b>Yellow</b>  &gt; 30 cont. steps <b>Red</b></p>	NA																																																
Climbing / stepping over	<p><b>Total distance of steps up and down over one minute: stepping / climbing up or down from raised floors, ramps, trucks</b></p> <p>&lt; 0,6 m/min <b>Green</b>  0,6 - 1,5 m/min <b>Yellow</b>  &gt; 1,5 m/min <b>Red</b>  &gt;3m/min <b>Double red</b></p>	NA																																																
Tightening torque, hand and power tools	<p><b>Rotational force needed to achieve a specified tightening torque</b></p> <table border="0"> <tr> <td></td> <td colspan="2">Two hand grip</td> <td colspan="2">One hand grip</td> <td></td> </tr> <tr> <td></td> <td colspan="2">Angle machine</td> <td colspan="2">Pistol machine</td> <td></td> </tr> <tr> <td></td> <td>El</td> <td>Pneumatic</td> <td>El</td> <td>Pneumatic</td> <td></td> </tr> <tr> <td>&lt; 20 Nm</td> <td>&lt; 10 Nm</td> <td>&lt; 4 Nm</td> <td>&lt; 2 Nm</td> <td><b>Green</b></td> <td></td> </tr> <tr> <td>20-50 Nm</td> <td>10-40 Nm</td> <td>4-8 Nm</td> <td>2-6 Nm</td> <td><b>Yellow</b></td> <td></td> </tr> <tr> <td>&gt; 50 Nm</td> <td>&gt; 40 Nm</td> <td>&gt; 8 Nm</td> <td>&gt; 6 Nm</td> <td><b>Red</b></td> <td></td> </tr> <tr> <td colspan="5">Straight machine &lt; 3 Nm without reaction bar <b>Green</b></td> <td></td> </tr> <tr> <td colspan="5">&gt; 3 Nm without reaction bar <b>DRV</b></td> <td></td> </tr> </table>		Two hand grip		One hand grip				Angle machine		Pistol machine				El	Pneumatic	El	Pneumatic		< 20 Nm	< 10 Nm	< 4 Nm	< 2 Nm	<b>Green</b>		20-50 Nm	10-40 Nm	4-8 Nm	2-6 Nm	<b>Yellow</b>		> 50 Nm	> 40 Nm	> 8 Nm	> 6 Nm	<b>Red</b>		Straight machine < 3 Nm without reaction bar <b>Green</b>						> 3 Nm without reaction bar <b>DRV</b>						NA
	Two hand grip		One hand grip																																															
	Angle machine		Pistol machine																																															
	El	Pneumatic	El	Pneumatic																																														
< 20 Nm	< 10 Nm	< 4 Nm	< 2 Nm	<b>Green</b>																																														
20-50 Nm	10-40 Nm	4-8 Nm	2-6 Nm	<b>Yellow</b>																																														
> 50 Nm	> 40 Nm	> 8 Nm	> 6 Nm	<b>Red</b>																																														
Straight machine < 3 Nm without reaction bar <b>Green</b>																																																		
> 3 Nm without reaction bar <b>DRV</b>																																																		

†NA: Not applicable

When the evaluation was performed and the template was completed, a risk colour is calculated for each workstation according to the number of yellows, reds and double reds identified (Table 3). The worst colour being considered the final evaluation of the workstation. These color coding was extracted from the Toyota method of visualization and the Swedish legislation for Ergonomics<sup>17)</sup>.

### NIOSH lifting equation

This method assesses the risk of musculoskeletal disorders in repeated lifting tasks. Seven factors including load (L), horizontal lifting distance (H), vertical lifting height (V), vertical travel distance (D), asymmetry (A), duration of lifting period (F) and gripping (C) are entered into the equation and multiplying them provides a recommended weight limit (RWL) for the task (Table 2).

The ratio of the actual weight lifted to the RWL yields the lifting index (LI). The NIOSH lifting equation assumes that non-lifting manual activities are minimal, but assembly jobs include many non-lifting tasks such as pushing, pulling, carrying and walking during one cycle time. To customize the NIOSH equation results to the assembly process, it was decided to consider an action zone for a lifting index >1.6, the reason being that there were other tasks such as pushing, pulling, climbing and carrying in the assembly process besides lifting tasks<sup>13, 19)</sup>. Thus, when the lifting index value was less than one, the task was considered to be a green or safe zone, when it was between 1-1.6 the task was regarded as a yellow or risk zone and the task was considered to be a red or action zone for a lifting index of more than 1.6 (Table 3). The NIOSH equation was calculated both at the origin and destination of the material handling tasks and the worst lifting index was recorded.

**Table 3: Prioritization of risk factors by both methods**

Methods	Evaluation Criteria	Green	Yellow	Red
Ergonomic Standard method (SES)	Number of Yellows†	0-8	9-16	≥ 17
	Number of Reds	0-6	7-9	≥ 10
	Number of Yellows + Reds	0-16	-	≥ 17
	Number of Double Reds	0	-	1-32
NIOSH Lifting Equation	Lifting Index	<1	1 -1.6	>1.6

†The worst colour dictates the final evaluation of the workstation

### Comparison between Methods

Table 2 shows the risk factors assessed by both methods used in this study. The SES method assessed lifting tasks by taking into account the weight and the distance from the body. The torque for two handed lifting was calculated and then evaluated according to a four-point colour scale (Table 2). Lifting torque > 35 Nm was considered to be red and lifting torque > 70 Nm was double red. These components of the SES method were compared to the results of the NIOSH equation.

### Results

Out of 580 components of the SES method evaluated, 2.9% were assessed as having excessive risk (double red), 25.1% as high risk (red) and 34% as moderate (yellow). Most of the excessive risks were related to two-handed lifting tasks. The results of the SES method showed that 41.4% of lifting tasks were double red (torque for two-handed lifting tasks > 70 Nm), 20.7% red (torque for two-handed lifting tasks > 35 Nm) and 24.1% yellow (torque for two-handed lifting tasks > 10 Nm). The NIOSH equation method was therefore used to reassess these lifting tasks and the results of the NIOSH equation were taken into consideration to calculate the final colour of the workstations. Table 4 provides a summary of the NIOSH equation results for 20 lifting tasks. The lifting index varied between 0.2 for the additional boarding step lifting task to 2.8 for the hydraulic kit lifting task. The mean lifting indices for these tasks at origin and destination were 1.14 (±0.6) and 1.12 (±0.66), respectively. Out of the tasks evaluated, 35% had a lifting index higher than 1.6 (red), 20% had a lifting index between 1-1.6 and 45% had a lifting index of less than 1. Four lifting tasks in which the objects lifted weighed more than 14 kg were assigned LI > 2. Manipulation of the hydraulic kit was identified as the highest risk task, the lifting index of which was 2.6 at origin and 2.8 at destination. The results showed that assessment of the SES component for lifting loads disagreed with the NIOSH equation and the lifting tasks were assessed as higher risks by the SES method compared to the NIOSH equation method (Table 4).

More red assessments were identified at two workstations ('Preparation of Air Filter and Cab Tilt Cylinder' and 'Boarding Steps & Mudguards', 40% and 38% of SES components, respectively) than at the other workstations (Table 5). The principle high risk tasks (40% of red assessments) at the 'Preparation of Air Filter and Cab Tilt Cylinder' workstation were manual lifting and carrying the Selective Catalytic Reduction (SCR) tank, cab tilt cylinder and air filter. The other tasks, including tightening and carrying small parts, were assessed as yellow (25%) and green (35%). The main tasks which were evaluated as high risk in the 'Boarding Steps & Mudguards' workstation consisted of connecting the electrical cables, picking up and placing boarding steps, handling and positioning mudguards. The main risk factors at this workstation were manual lifting of two

mudguards (15.2 kg) which was evaluated as red for the left side and yellow for the right side by the NIOSH equation.

**Table 4: Evaluation of lifting tasks by NIOSH equation and SES method**

Lifting Tasks	NIOSH equation					SES method	
	Weight (kg)	Horizontal distance (cm)	Vertical distance (cm)	Lifting Index	Color	Lifting Torque (Nm)	Color
Lifting completed air filter (end of pallet)	12	80	108	1.9	Red	96	Double red
Lifting completed air filter	13	40	122	1.1	Yellow	52	Red
Lifting cab tilt cylinder	10	50	140	1.2	Yellow	50	Red
Lifting Air intake	5.9	85	140	1.1	Yellow	50.1	Red
Lifting and carrying right mudguards	15.2	40	104	1.2	Yellow	62.4	Red
Lifting and carrying left mudguards	15.2	58	105	1.7	Red	87.9	Double red
Lifting 3rd boarding steps	2	68	70	0.2	Green	13.6	Yellow
Lifting SCR tank	12	90	70	2.1	Red	108	Double red
Lifting beam cable	5	50	40	0.5	Green	25	Yellow
Lifting light box	5.3	60	160	0.8	Green	31.8	Yellow
Lifting socket screwdriver 1	7.4	50	80	0.7	Green	36.8	Red
Lifting socket screwdriver 2	6.4	53	80	0.6	Green	31.8	Yellow
Lifting pallet lid	6	58	147	0.8	Green	36	Red
Lifting pallet lid of sun visor	15	60	120	2.3	Red	90	Double red
Lifting plastic box	9.5	44	128	0.9	Green	41.8	Red
Lifting plastic box	8.4	40	105	0.6	Green	33.6	Yellow
Lifting assembled SCR tank	14.5	57	100	1.7	Red	82.6	Double red
Lifting heat shield	4.6	65	104	0.6	Green	52.2	Red
Lifting assembled SCR tank (small)	13.7	40	80	1	Yellow	90.2	Double red
Lifting hydraulic kit	14.5	90	110	2.8	Red	129	Double red
Lifting middle mudguard	14	70	1.2	2.6	Red	98	Double red

The operators were also exposed to repeated actions for more than 30% of the cycle time (Table 6). The duration of exposure to awkward back, shoulder, and wrist postures for this workstation was 18.8 minutes per two hours. The same pattern of exposure to risk factors was observed for left and right workstations (Table 7).

**Table 5: Ergonomic evaluation for different workstations evaluated by SES methods and NIOSH equation**

Workstation	Truck type	Occurrence Rate of truck in the line (%)	Double red evaluations <sup>†</sup> n(%)	Red evaluations <sup>†</sup> n(%)	Yellow evaluations <sup>†</sup> n(%)	Final colour of workstation <sup>†</sup>
<b>Working Group 1</b>						
Preparation of air filter and cab tilt cylinder	Standard	35	0	8 (40)	5 (25)	Yellow
	Other (Higher Air Intake)	19	0	8 (40)	4(20)	Yellow
Air filter and cab tilt cylinder mounting	Standard	35	0	7 (33.3)	8 (38)	Yellow
	Other (Air Pipe)	5	0	7 (35)	7(35)	Yellow
	Other (Higher Air Intake)	20	0	7 (33.3)	8(38)	Yellow
Boarding steps and mudguards; left and right	Right	100	0	8 (38)	8 (38)	Yellow
	Left	100	0	7 (33.3)	9 (42.8)	Yellow
Variant Workstation	Middle Mudguards	10	0	5 (25)	6 (30)	Green
	Y Mudguards	4	0	3 (15)	4 (20)	Green
	Additional Boarding Steps	4	0	5 (23.8)	5 (23.8)	Green
<b>Working Group 2</b>						
Picking area	Picking up Bumper	100	0	2 (10)	6 (30)	Green
	Picking up Equipment	100	0	4(20)	6(30)	Green
	Sun Visor	100	0	6 (28.5)	5 (23.8)	Green
	Rear Bar	7	0	2 (10)	6 (35)	Green
Preparation Bumper 1	Standard	80	0	3 (14.3)	12 (57.1)	Yellow
	Other (Heavy Duty Front)	6	0	6 (30)	6 (30)	Green
	Other (Protruded)	12	0	4 (20)	8 (40)	Green
Preparation Bumper 2	Standard	80	0	4 (20)	7 (35)	Green
	Other (Heavy Duty Front)	6	0	4 (20)	8 (40)	Green
Bumper Assembly on Truck	Standard	80	1 (4.8)	5 (23.8)	8 (38)	Red
	Other (Heavy Duty Front)	6	0	4 (20)	6 (30)	Green
	Other (Protruded)	12	1 (5)	7 (35)	5 (25)	Red
<b>Working Group 3</b>						
Mounting Selective Catalytic Reduction (SCR) Tank	Standard	65	1 (5)	6 (30)	8 (40)	Red
	Other (SCR Euro 6)	4	1 (5)	7 (35)	7 (35)	Red
	Other (SCR 50 Lit)	3	1 (5)	6 (30)	6 (30)	Red
Preparation of SCR Tank	Standard	65	0	3 (15)	8 (40)	Green
	Other (SCR Euro 6)	4	0	5 (25)	6 (30)	Green
Variant Workstations	Hydraulic Kit	4	0	4 (20)	9 (45)	Yellow
	Lighting Box	100	0	1 (5)	6 (30)	Green

<sup>†</sup>The results of the SES method and the NIOSH equation

At the 'Air Filter & Cab tilt Cylinder Mounting' workstation, 33.3% of the SES components were red, 38% of the components were yellow and 28.7% were green. The lifting the air filter (LI=1.9) and the cab tilt cylinder (LI=1.2) from trolley, carrying and mounting, and connecting the cables and hoses were identified as high risk tasks at this workstation. At this workstation, the pattern of risks for variations in truck models was substantially different from that for standard trucks, while the number of red and yellow assessments was approximately the same (Figure 1). Awkward back and shoulder postures were reported for other truck models while these risk factors were minor for standard truck model (Table 7).

**Table 6: number of tasks requiring repeated action in workstations evaluated**

Repeated tasks	Number of articles per cycle time	Repetition per cycle time for each article	repetition per hour	Total colour of repetition
Inserting mudguard screws	9	4	180	Yellow (>30% of cycle time)
Inserting cab tilt nuts and screws	13	2	130	Green
Tightening nuts of cab tilt on the chassis	16	2	160	Yellow (>30% of cycle time)
Inserting bolts for bumper	10	4	200	Yellow (>30% of cycle time)
Fitting cable tie with a stripe pistol	12	-	60	Green
Pushing and inserting clips	17	2	170	Yellow (>30% of cycle time)
Tightening screws with screw drivers	30	-	150	Yellow (>30% of cycle time)

The 'Bumper Assembly on Truck' and 'Mounting SCR Tank' workstations were found to be the highest ergonomic physical workload workstations. At the 'Bumper Assembly on Truck' workstation, the unlocking lifting tool task was assessed as double red, the positioning and tightening of bumper tasks were red (30% of SES component), the bumper movement and preparation tasks were yellow (40%) and the other tasks were green (25%). The overall colour evaluation of this workstation was red. The total number of repeated actions for this workstation was 200 similar actions per hour that were related to inserting screws for mounting the bumper on the chassis (Table 6). The risk factors for other truck models were different at this workstation as 20% of the SES component was red for the Heavy Duty Front truck model, and the double red task did not exist.

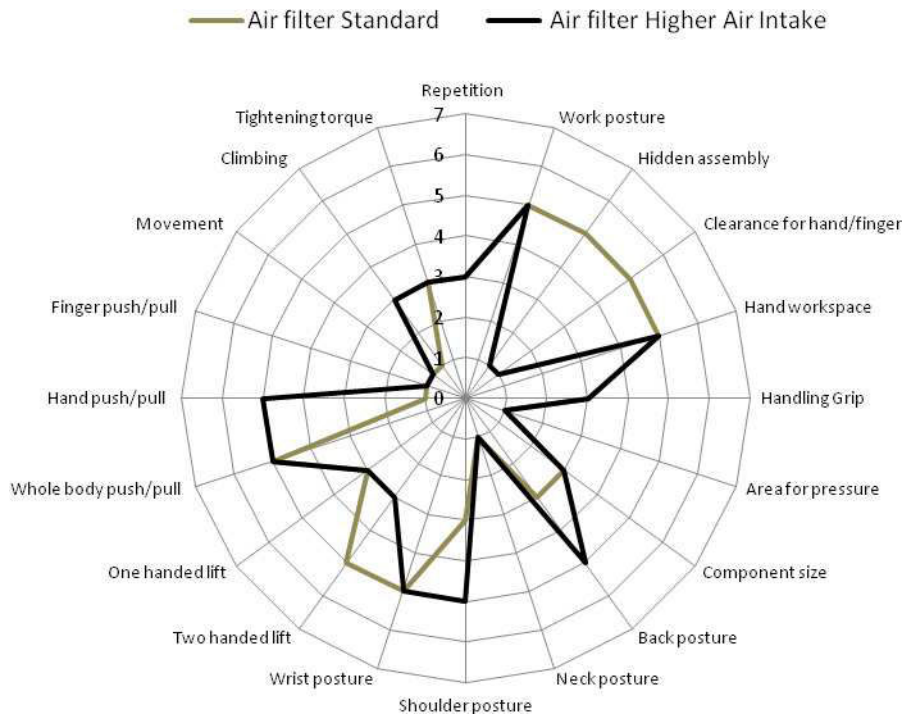

Figure 1. Pattern of risk factors at 'Mounting Air filter and cab tilt cylinder on chassis' workstation for standard and variant (higher air intake) trucks

The hose connecting task was assessed as double red at the 'Mounting SCR Tank' workstation because it required excessive whole body and arm force. Furthermore, lifting (LI=1.7) and mounting the SCR tank, tightening and cabling were the high risk tasks (30% red points of SES component) at this workstation. Squatting and awkward wrist postures were found at this workstation for standard trucks though the duration of exposure every two hours was six minutes. The overall ergonomic evaluation score for the 'Mounting SCR Tank' station was red. At the 'Sun Visor Preparation' workstation, manipulation of the box lid, as shown in Table 4, was evaluated by the NIOSH equation as a red lifting task (LI=2.3). A significant number of red (28.5%) and yellow (23.8%) tasks were identified at this workstation by the SES method (Table 5). Red evaluations were related to picking up and handling tasks as well as positioning the sun visor. The inserting clips task was repeated 170 times per hour and was assessed as a moderate risk factor. Moreover, the force that was required to squeeze and insert clips by fingers and thumbs was 70N (red).

The results of the SES evaluation for each component (criterion) are presented in Table 8. Exposure to high risk factors for wrist postures was observed at 86% of the workstations. High risk shoulder postures and awkward work postures (lying, kneeling and squatting) were found at approximately 45% of the workstations. Moderate exposure (yellow) to different risk factors (SES components) was observed more frequently than excessive exposure (red and double red). Eighty percent of the workstations were exposed to moderate risk of hand grip and using screwdrivers (excessive torque) (Table 8).

**Table 7: Duration of exposure for trunk, back, neck, shoulders and wrists in each cycle time (11 minutes) for different workstation assessed by SES method**

Workstation	Truck Types	Occurrence Rate %	Work posture <sup>a</sup> (S)	Static back posture <sup>b</sup> (S)	Static neck posture <sup>c</sup> (S)	Shoulder and Arm posture <sup>d</sup> (S)	Wrist posture <sup>e</sup> (S)	Duration of exposure for awkward postures per 2 hours (min )
Preparation of air filter and cab tilt cylinder	Standard	66	NA†	NA	15	NA	24	4
	Higher Air Intake	22	NA	NA	45	NA	45	3
Air filter and cab tilt cylinder mounting	Standard	66	51	NA	NA	NA	57	12
	Air Pipe	5	21	10	NA	59	41	1
	Higher Air Intake	22	51	10	NA	20	55	5
Boarding steps and mudguards; left and right	Right	100	NA	10	6	29	68	18.8
	Left	100	6	29	NA	27	51	18.8
Variant Workstation	Middle Mudguards	10	NA	30	NA	NA	82	0.19
	Y Mudguards	4	NA	NA	NA	NA	54	0.04
	Additional Boarding Steps	4	41	23	13	NA	28	0.07
Picking Area	Picking Equipment	100	NA	NA	NA	42	5	8
Preparation Bumper 1	Standard	80	NA	NA	NA	NA	79	11
	Heavy Duty Front	6	101	41	17	36	92	3
	Protruded	12	NA	56	10	NA	62	1
Preparation Bumper 2	Standard	80	NA	NA	NA	57	28	12
	Heavy Duty Front	6	9	NA	NA	22	20	1
Bumper Assembly on Truck	Standard	87	51	10	NA	NA	15	11
	Heavy Duty Front	6	11	NA	NA	45	8	1
	Protruded	12	35	NA	NA	18	5	1
Mounting SCR Tank	Standard	65	13	NA	NA	NA	51	6
	Euro 6SCR	4	110	NA	43	NA	101	3
	50 Lit SCR	3	25	NA	22	NA	67	0.19
Preparation SCR Tank	Euro 6 SCR	4	0	14	49	56	34	2
Variant Workstation	Hydraulic Kit	4	0	0	25	0	18	0.29

<sup>a</sup>Lying, kneeling, squatting

<sup>b</sup>> 45° bending forward or sideways/rotation

<sup>c</sup>> 45° bending forward or > 30° sideways/rotation or bending backwards

<sup>d</sup>> 90° forward bending movement (flexion) or outward movement (abduction)

<sup>e</sup>> 30° bending upward, > 45° bending downward, > 10° bending sideways

†Not applicable, this workstation had no awkward postures

The levels of risk for standard vehicles and other models at an overall glance showed that the majority of workstations (53.6%) were evaluated as moderate (yellow), 17.8% (5 stations) were classified as high risk (red) and 28.6% as low risk (green).

## Discussion

This study was designed to identify exposure to risk factors that might contribute to WR-MSDs in a truck assembly plant. An in-house ergonomic method and the NIOSH equation were applied as screening tools to evaluate workstations from practitioner’s viewpoint and the results were compared. Most of the workstations (for standard trucks and other models) in the study were evaluated as having moderate exposure to risk factors.

**Table 8: Distribution of different risk factors at workstations**

Risk factors	High risk (red and double red)		Moderate risk (yellow)	
	N	%	N	%
Repetition	0	0	7	24.1
Work posture	13	<b>44.8</b>	7	24.1
Access, hidden assembly	11	37.9	7	24.1
Clearance for hand, finger or tool	9	31	0	0
Workspace for hands	11	37.9	0	0
Hand grip	4	13.8	24	<b>82.7</b>
Surface area for pressure	3	10.3	0	0
Component size	6	20.7	13	44.8
Static back posture	10	34.5	17	<b>58.6</b>
Static neck posture	11	37.9	15	48.3
Static shoulder posture	13	<b>44.8</b>	13	44.8
Wrist posture	25	<b>86.2</b>	0	0
Lifting with two hands (NIOSH method equation)	9	31	4	13.8
One-handed lifts	3	10.3	19	<b>65.5</b>
Pushing/Pulling Force - Whole Body	9	31%	16	55.2
Pushing/pulling with the hand, arm	6	20.7	6	20.7
Pushing, squeezing, and pulling with fingers	6	20.7	11	37.9
Movement (continuous steps)	1	3.4	7	24.1
Climbing / stepping over	0	0	1	3.4
Tightening torque, hand and power tools	5	17.2	20	<b>87</b>

<sup>†</sup>Considerable exposure in bold

The disagreement was observed between the results of the SES method and the NIOSH equation. The main reason is that the variables of exposure assessment were considered differently in each method. SES evaluates lifting torque using weight of objects lifted and the horizontal distance from the body (based on Swedish



legislation), while the NIOSH equation considers not only horizontal distance but also other lifting variables such as vertical distance, coupling, asymmetry and frequency. According to the standard NIOSH equation method, a lifting index  $>3$  would be a significant risk for low back pain<sup>13)</sup>, whereas we modified the prioritization scale and a lifting index  $>1.6$  was considered high risk in this survey. The reason for this modification was the combination of other tasks such as pushing, pulling, climbing and carrying in the assembly process besides the lifting tasks. Despite this modification and the increased sensitivity of the NIOSH method, the NIOSH approach ranked most lifting tasks as moderate or low risk compared to the SES method. The results of the NIOSH equation seem to be closer to reality because the SES component overestimated exposure to the risk, and even loads weighing  $<5\text{kg}$  were assessed as moderate risk (Yellow). Horizontal distance had a significant effect on the results of both methods, and precise measurement of horizontal distance is difficult in the real situation when operators have to perform their tasks over a determined cycle time. A laboratory assessment showed that frequency and horizontal distance had the greatest effect on the NIOSH results, although these parameters were subject to high measurement errors<sup>20)</sup>. Using the NIOSH approach as a routine method would be somewhat difficult for practitioners because it requires measurement of several variables and interferes with the normal pace of the assembly process.

Awkward posture was a frequent risk factor at various workstations. The durations of exposure to awkward work postures for operators at the '*Boarding step and Mudguard*' workstation (left & right) were longest compared to other workstations, the possible reason being the quantity of tasks (assembly of two main parts of a truck i.e. mudguards (front and rear) and boarding steps) that had to be performed at this workstation. Hidden access and obstructions in the workspace were the reasons for many awkward postures which forced the operator to bend over the side of a truck or required turning to gain visual or manual access. At the air filter workstation, tightening the air intake pipe in an obstructed workspace required awkward postures of the neck, wrists and hands for which replacing current screwdrivers with new long nose ones was suggested. Unloading parts from a pallet forced operators to work out of the hand workspace which caused awkward postures. Changing the packaging of the pallet was recommended to reduce this risk factor. Tightening the screws below the bumper (hidden access) required kneeling with awkward neck and back postures at the '*Bumper Assembly on Truck*' workstation (Figure 2). It is therefore suggested that another tightening tool should be developed to avoid hidden access and facilitate tightening the screws below the truck chassis.

Hand/wrist risk factors such as wrist bending, hand/finger clearance, hand grip and excessive hand/finger force were observed to be high or moderate in approximately for most of workstations. Furthermore, exposure to moderate hand/wrist risk factors related to use of screwdrivers was relatively high for the workstations analysed. The main reasons for finding high risk for the hand/wrist were the characteristics of truck assembly jobs which required intensive hand activities. Activities and tasks in many workstations involved short clearance between hand and parts/tools for manually assembled elements (small space). More force was therefore required or there was a risk of catching/knocking the hand/finger in such tasks<sup>21)</sup>. Operations for connecting or removing hoses, small parts, fasteners, and electrical connectors involved forceful hand movements and wrist bending. Unlocking the bumper lifting tool operation required such excessive force for fingers that these tasks were evaluated as double red. Immediate improvement was therefore needed and changes were recommended in the anti-lock system of the lifting tool in our further research. Furthermore, the majority of tasks at different

workstations required using screwdrivers (weighing between 2-4kg) which were vibrating tools with sometimes a forceful reaction at the end of tightening. All these operations increased the risk of musculoskeletal disorders for the hand/wrist. The same risk pattern has been reported in other studies in the automotive industry<sup>22</sup>). Recent studies showed an association between high levels of hand force, wrist bending and vibration with the incidence of carpal tunnel syndrome (CTS). In a cross sectional study a significant relationship was observed between hand force and CTS<sup>23</sup>).

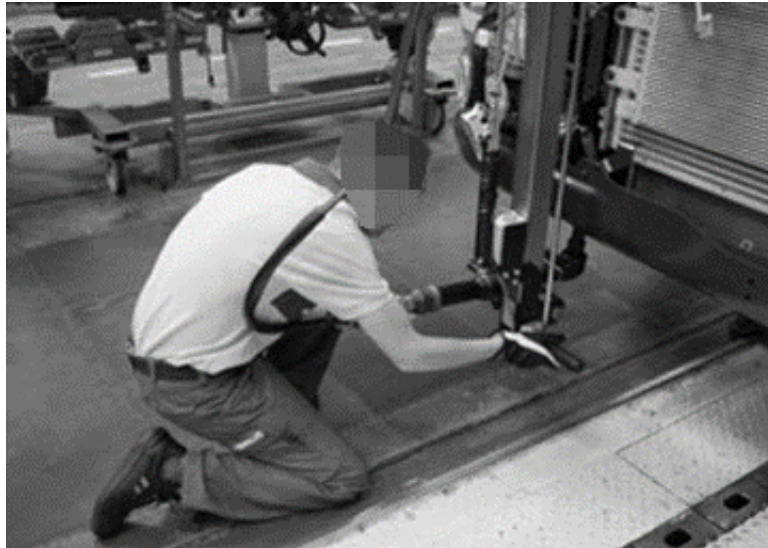

Figure 2: Tightening screws at 'Mounting bumper on chassis' workstation caused awkward trunk and neck postures

Shoulder elevation ( $>90^\circ$ ) or abduction to the side were observed in most workstation and they are clearly risk factors for shoulder disorders. The main reasons for awkward shoulder postures were picking up the parts from the racks, assembling and mounting the parts high on the trucks and using screwdrivers suspended at height. Furthermore, the gestures of some operators when tightening with screwdrivers necessitated excessive arm elevation, whereas this was not the case for all operators for the same task. However, mild abduction was observed for most tightening tasks with screwdrivers. In another study in an automobile assembly plant, shoulder flexion was often recorded for the operation of hand-held tools<sup>24</sup>). Organizational changes are recommended to distribute high risk tasks for shoulders (red) to other workstations. This allows avoiding several high risk tasks in sequence at one workstation. It is of note that, although the nature of truck assembly requires excessive arm elevation due to the size of vehicles, a small number of single tasks required excessive arm elevation for prolonged durations. The SES method did not have the criteria to measure left and right shoulder risk factors separately and the static shoulder postures reported in this study were an accumulation of assessments for both sides.

Approximately 35% of workstations were evaluated as high risk for back posture (bending back forward  $>45^\circ$  or rotation). This percentage was less than those for neck, shoulders and wrists. Nevertheless, back disorders are common, particularly among truck assemblers. Other reasons such as lifting heavy objects and material handling might be the main cause of the high prevalence of back disorders in truck assembly plants. Lifting heavy objects was a routine task at most workstations due to the size of objects and parts related to truck

assembly. Strong evidence found in recent studies showed that manual lifting and handling of heavy objects are the main risk factors for low back pain<sup>25</sup>).

Highly repetitive tasks (>150 times/hour<sup>26</sup>) were mostly observed for the inserting and tightening screws/bolts, tightening with a torque wrench and turning the handle of an assembly wagon. Most workstations involved inserting and turning screws, which was a repetitive action for wrists and fingers. Such repeated rotation in the wrist might result in symptoms of CTS in workers<sup>27</sup>). Studies have demonstrated increased incidence of CTS in workers exposed to repeated wrist flexion, extension and rotation<sup>28</sup>). It is proposed in further research to modify the design of the assembly wagon to reduce the amount of repetition.

The SES results assessing risk factors for other truck models generally indicated greater risk than for standard trucks. Our findings prove that we have to take into account variations in truck models in workstations on the assembly line and evaluate/analyse their risk factors. Most assembly manufacturers currently believe that assessing the potential of risk factors for more frequent types of products is sufficient. However, we observed that risk factors changed during eight working hours at one workstation or the pattern of risks was very dissimilar for different products.

The final colour of each workstation was the indicator of risk factors for interventions and improvements in this factory. However, the results of this study showed that two workstations with the same final colour (for example yellow) did not always have the similar number of red or yellow risk factors (different ergonomic workloads). It was a limitation of the SES method which considered a range of yellow or red evaluations as the same final colour. It was therefore decided in the factory that ergonomists and engineers should take into account not only the final colour of each workstation but also the numbers of double red, red and even yellow evaluations. Another limitation of the SES method, and perhaps of many observational methods, was that the duration of exposure and frequency of risk factors could not be measured. When using the SES method, observers should estimate the angles of a posture and classify it in the three-color ranking scale. The ability to identify neutral or non-neutral postures is sometimes a problem, particularly for micro-postures such as the wrist and neck<sup>14</sup>). This might be the source of variability and disagreement between the results of different users of the SES. Moreover, postures such as twisting, extension, flexion and lateral bending were not evaluated separately and a single item assessed all these risk factors for each body part. A red evaluation for back, neck or shoulders might thus relate to flexion, extension, twisting or using two bad postures simultaneously (flexion and twisting) except when the observer provided supplementary explanation in a note (the SES method allows observers to provide supplementary notes). Awkward postures might therefore be underestimated by combining several risk factors in one item.

In conclusion, the evaluation of the ergonomic physical exposure by an in-house ergonomic method (SES) showed that awkward trunk postures, hand/wrist risk factors and awkward shoulder postures were the common ergonomic workload in the truck assembly plant. Furthermore, comparing the results of the SES method with the NIOSH lifting equation for lifting heavy objects (frequent tasks at most workstations) showed that the SES method was biased towards sensitivity and over-estimation of material handling risks. However, application of the NIOSH equation interfered with the normal pace of work process in the assembly plant.

## **Acknowledgements**

This study was sponsored by SCANIA production Angers and the French National Research Program for Environmental and Occupational Health of Anses (2012/2/007). The authors are grateful for the collaboration of the managers and operators of the SCANIA group and all members of LEEST who helped with this project. A previous version of this paper was presented at the Annual Conference of the IEHF, Southampton, UK, 7-10 April, 2014.

## **Authors' contribution**

All authors had contributions to the design and progress of this research. MZ collected and analyzed the data, wrote the paper and interpreted the results. AM and RH contributed to the progress of study and the interpretation of the results. SB helped in the interpretation of the results. The study was performed under supervision of YR and he contributed to the interpretation of the results.

## References

1. Bernard BP, Putz-Anderson V (1997) Musculoskeletal disorders and workplace factors: a critical review of epidemiologic evidence for work-related musculoskeletal disorders of the neck, upper extremity, and low back, U.S. Department of Health and Human Services.
2. Roquelaure Y, Ha C, Leclerc A, Touranchet A, Sauteron M, Melchior M, Imbernon E, Goldberg M (2006) Epidemiologic surveillance of upper-extremity musculoskeletal disorders in the working population. *Arthritis Rheum* 55, 765-78.
3. Punnett L, Wegman DH (2004) Work-related musculoskeletal disorders: the epidemiologic evidence and the debate. *J Electromyogr Kinesiol* 14, 13-23.
4. Winkel J, Mathiassen SE (1994) Assessment of physical work load in epidemiologic studies: concepts, issues and operational considerations. *Ergonomics* 37, 979-88.
5. Jones T, Kumar S (2007) Comparison of ergonomic risk assessments in a repetitive high-risk sawmill occupation: Saw-filer. *Int J Ind Ergon* 37, 744-53.
6. David G (2005) Ergonomic methods for assessing exposure to risk factors for work-related musculoskeletal disorders. *Occup Med* 55, 190-9.
7. Van der Beek AJ, Erik Mathiassen S, Windhorst J, Burdorf A (2005) An evaluation of methods assessing the physical demands of manual lifting in scaffolding. *Appl Ergon* 36, 213-22.
8. Li G, Buckle P (1999) Current techniques for assessing physical exposure to work-related musculoskeletal risks, with emphasis on posture-based methods. *Ergonomics* 42, 674-95.
9. McAtamney L, Corlett EN (1993) RULA: a survey method for the investigation of work-related upper limb disorders. *Appl Ergon* 24, 91-9.
10. Hignett S, McAtamney L (2000) Rapid entire body assessment (REBA). *Appl Ergon* 31, 201-5.
11. Occhipinti E (1998) OCRA: a concise index for the assessment of exposure to repetitive movements of the upper limbs. *Ergonomics* 41, 1290-311.
12. David G, Woods V, Li G, Buckle P (2008) The development of the Quick Exposure Check (QEC) for assessing exposure to risk factors for work-related musculoskeletal disorders. *Appl Ergon* 39, 57-69.
13. Waters TR, Putz-Anderson V, Garg A, Fine LJ (1993) Revised NIOSH equation for the design and evaluation of manual lifting tasks. *Ergonomics* 36, 749-76.
14. Takala E-P, Pehkonen I, Forsman M, Hansson G-Å, Mathiassen SE, Neumann WP, Sjøgaard G, Veiersted KB, Westgaard RH, Winkel J (2010) Systematic evaluation of observational methods assessing biomechanical exposures at work. *Scand J Work Environ Health* 36, 3-24.
15. Kee D, Karwowski W (2007) A comparison of three observational techniques for assessing postural loads in industry. *Int J Occup Saf Ergon* 13, 3-14.
16. Chiasson M-È, Imbeau D, Aubry K, Delisle A (2012) Comparing the results of eight methods used to evaluate risk factors associated with musculoskeletal disorders. *Int J Ind Ergon* 42, 478-88.
17. Berlin C, Örtengren R, Lämkkull D, Hanson L (2009) Corporate-internal vs. national standard-A comparison study of two ergonomics evaluation procedures used in automotive manufacturing. *Int J Ind Ergon* 39, 940-6.

18. Törnström L, Amprazis J, Christmansson M, Eklund J (2008) A corporate workplace model for ergonomic assessments and improvements. *Appl Ergon* 39, 219-28.
19. Nussbaum MA, Chaffin DB, Page GB (1995) A biomechanical investigation of the asymmetric multiplier in the revised NIOSH lifting equation. *Proceedings of the Human Factors and Ergonomics Society Annual Meeting*, SAGE Publications.
20. Dempsey PG, Burdorf A, Fathallah FA, Sorock GS, Hashemi L (2001) Influence of measurement accuracy on the application of the 1991 NIOSH equation. *Appl Ergon* 32, 91-9.
21. Armstrong TJ (1986) Ergonomics and cumulative trauma disorders. *Hand Clin* 2, 553-65.
22. Keyserling WM, Stetson DS, Silverstein BA, Brouwer ML (1993) A checklist for evaluating ergonomic risk factors associated with upper extremity cumulative trauma disorders. *Ergonomics* 36, 807-31.
23. Neumann WP, Village J (2012) Ergonomics action research II: a framework for integrating HF into work system design. *Ergonomics* 55, 1140-56.
24. Punnett L, Fine LJ, Keyserling WM, Herrin GD, Chaffin DB (2000) Shoulder disorders and postural stress in automobile assembly work. *Scand J Work Environ Health* 26, 283-91.
25. Van der Molen HF, Sluiter JK, Hulshof CT, Vink P, Frings-Dresen MH (2005) Effectiveness of measures and implementation strategies in reducing physical work demands due to manual handling at work. *Scand J Work Environ Health* 31, 75-87.
26. Putz-Anderson V (1994) *Cumulative Trauma Disorders: A Manual for Musculoskeletal Diseases of the Upper Limbs*: Taylor and Francis, London.
27. Feldman RG, Travers PH, Chirico-Post J, Keyserling WM (1987) Risk assessment in electronic assembly workers: carpal tunnel syndrome. *J Hand Surg Am* 12, 849-55.
28. Mackinnon SE, Novak CB (1997) Repetitive strain in the workplace. *J Hand Surg Am* 22, 2-18.

## 2.2. Variation in exposure to physical risk factors

### 2.2.1. Definition of variation and diversity

The scientific literature has generally reported that variation in exposure to physical risk factors can reduce the risk of WR-MSDs (Mathiassen, 2006; Rissén et al., 2002). Researchers often recommend reduction exposure to risk factors using variation (Fallentin et al., 2000; Wells et al., 2007). Exposure variation allows transmission of workload to other muscles and increases utilization of different body region. A relationship between variation in physical exposure and health can therefore be hypothesized as the risk of WR-MSDs decreases according to the above mentioned theory (Mathiassen, 2006). However, very little empirical research has been reported on the possible effects of variation in physical exposure on health promotion, and their results and suggestions are vague. Furthermore, one important question is: how much and which kind of variation would provide sufficient risk reduction?

The definition of variation of exposure to physical risk factors is also vague in the ergonomics literature and hence for ergonomists, managers and engineers in the field. According to Mathiassen (2006), variation is defined as "the change in exposure across time" (Mathiassen, 2006). "Variation" constitutes differences in exposure between tasks, jobs and vehicle models. Manufacturers, scientific researchers and legislators consensually believe that variation in physical exposure is beneficial for WR-MSDs and health. Most automotive industries (such as the factory under study) use job rotation and production mix to increase variation in physical exposure.

However, variation might be related to physical risk factors in individual exposure over time. Two similar and consecutive cycle times, for example, might be different in terms of physical exposure (posture, force or muscle activity) within and between subjects. Mathiassen (2006) has suggested the term "diversity" for this concept. "Diversity" is therefore defined as "the extent that exposure entities differ" (Mathiassen, 2006). Although "variation" is known as a useful tool to reduce physical risk factors and it is, for example, emphasized in the ergonomic standard manual of the factory under study (following phrase) - this is not the case for diversity:

*"It is important that work tasks vary during the day with possibilities to rotate between different positions (workstations)"*

Industrial companies indicate a tendency to eliminate "Diversity" particularly following implementation of the lean principle. A trend in automotive industries points to standardization of the work and workstations by the use of element sheets, position standards, and best practices (performing the tasks in the same way). Furthermore, in-house ergonomic methods are often used to evaluate workstations and not individuals, and intervention is then implemented based on the assessment for a workstation and an experienced operator. As stated in the ergonomic standard manual of the factory under study:

*"It is always important to base the assessment on the way an experienced operator does it. If there exist a better ergonomic way/method of carrying out a particular job this should be discussed in the group and written into the position standard/work instructions."*

All of the above indicators suggest that automotive industries aim to achieve less diversity within and between subjects. The goal is that all operators have to perform their tasks in the same manner. However, several studies have shown that professional activities involve cycle-to-cycle diversity (Mathiassen et al., 2003; Möller et al., 2004; Roquelaure et al., 2001).

As current risk assessment methods do not consider diversity for assessing a workstation (assessment for an experienced operator and a standard truck), the questions are whether diversity presents in truck assembly workstations? Is it useful or should it be reduced? And the current assessment that overlooks diversity can be a representation of physical exposure in the truck assembly plant. The aim in this section is therefore to investigate the diversity within and between operators when performing the same task. Cycle-to-cycle diversity for performing identical tasks for an individual was assessed. In parallel, physical exposure diversity between operators for performing the same tasks was also investigated.

### **2.2.2. Measuring diversity within and between operators**

Although many methods have been developed for measurement of physical exposure (see Chapter 1; section 1.3), a standard method for measuring diversity and variability is rare (Mathiassen and Christmansson, 2004). The SES method was used to evaluate two workstations several times for all the operators who worked at those workstations. These workstations were selected following the results of Section 1 (Article 2 of this thesis). The first workstation was "Mounting SCR tank" where four permanent operators assembled the SCR on trucks in rotation. The potential of physical risk factors was identified to be highest at this workstation. The second workstation selected was "Preparation of bumper workstation 2" in which the potential of physical risk factors was lowest. Each operator who worked at these two workstations was evaluated several times in order to determine diversity between and within individuals. To avoid factors that may bias the results, the evaluations were conducted during the same period of the day. All observations were performed between 10am and 12am several times for each subject. In total, seven subjects (four operators at the "Mounting SCR tank" workstation; three operators at the "Preparation of bumper workstation 2") were investigated and 30 observations were performed at both workstations. Each operator was observed at least two times and four operators were studied more than four times.

### **2.2.3. Diversity between operators identified by the SES method**

Four operators were assessed at the "Mounting SCR tank" workstation. The diversity of exposure to risk factors was investigated between operators based on 20 risk factors of the SES method. As shown in Table 3, six risk factors (including Access: hidden assembly, Back, Neck, Shoulder posture, Two-handed lift, Hand pushing and pulling) were different between four operators of this workstation. Furthermore, "Pushing/pulling with fingers" and "Movement" risk factors were slightly different between the four operators that we did not take into account. The "Hidden assembly" risk factor was low for operator 1, moderate for operators 2 & 4, and high risk (red) for operator 3 at the "Mounting SCR tank" workstation. The same results were observed for the "back posture" and "Hand pushing and pulling" risk factors (Table 3).



**Table 3: Assessment of WR-MSDs risk factors at the "Mounting SCR tank" workstation by the SES method**

(Four operators were observed on several consecutive cycle times)

Risk factors	Operator 1	Operator 2	Operator 3	Operator 4
Repetition	High	High	High	High
Work posture	High	High	High	High
Access, hidden assembly	High	Moderate	High	Moderate
Clearance for hand, finger or tool	High	High	High	High
Workspace for hands	High	High	High	High
Hand grip	Moderate	Moderate	Moderate	Moderate
Surface area for pressure	High	High	High	High
Component size	Moderate	Moderate	Moderate	Moderate
Static back posture	High	High	High	Moderate
Static neck posture	Moderate	High	High	Moderate
Static shoulder posture	Moderate	Moderate	High	Moderate
Wrist posture	High	High	High	High
Two handed lifts (NIOSH method)	Moderate	High	High	High
One-handed lifts	Moderate	Moderate	Moderate	Moderate
Pushing/Pulling Force - Whole Body	High	High	High	High
Pushing/pulling with the hand, arm	High	Moderate	High	Moderate
Pushing/pulling with fingers	High	High	High	High
Movement (continuous steps)	High	High	High	High
Climbing / stepping over	High	High	High	High
Tightening torque	High	High	High	High

The same investigation was conducted at the "Preparation of bumper workstation 2" at which the workload was lowest. Three operators were observed several times. Table 4 presents the results of exposure to risk factors of WR-MSDs for each operator based on the SES method. Five risk factors (including Access: hidden assembly, Clearance for hand and finger, Back, Neck posture, Pushing/Pulling-Whole Body) were different between the three operators (Table 4). The neck posture was analyzed at two different risk levels. The activity of operators 1 & 3 was assessed as moderate risk level and operator 2 was rated as high risk level (Table 4). Overall, diversity for this workstation was lower than for the "Mounting SCR tank" workstation.

**Table 4: Assessment of WR-MSDs risk factors at the "Preparation of bumper workstation 2" by the SES method**

(Three operators were observed on several consecutive cycle times)

Risk factors	Operator 1	Operator 2	Operator 3
Repetition	Green	Green	Green
Work posture	Green	Green	Green
Access, hidden assembly	Green	Green	Yellow
Clearance for hand, finger or tool	Yellow	Green	Green
Workspace for hands	Green	Green	Green
Hand grip	Yellow	Yellow	Yellow
Surface area for pressure	Red	Red	Red
Component size	Green	Green	Green
Static back posture	Yellow	Yellow	Green
Static neck posture	Yellow	Red	Yellow
Static shoulder posture	Red	Red	Red
Wrist posture	Red	Red	Red
Two handed lifts (NIOSH method)	Green	Green	Green
One-handed lifts	Yellow	Yellow	Yellow
Pushing/Pulling Force - Whole Body	Yellow	Green	Yellow
Pushing/pulling with the hand, arm	Yellow	Yellow	Yellow
Pushing/pulling with fingers	Red	Red	Red
Movement (continuous steps)	Green	Green	Green
Climbing / stepping over	Green	Green	Green
Tightening torque	Yellow	Yellow	Yellow

**2.2.4. Within-operator diversity by the SES method**

To observe the diversity of risk factors for a single operator at a workstation, the analysis was performed in seven cycle times for the same operator at the "Mounting SCR tank" workstation. Table 5 shows the results of observation of an operator over seven cycle times for the within-individual diverse risk factors.

**Table 5: Within-individual diversity of risk factors at the "Mounting SCR tank" workstation assessed by the SES method**

(Operator 1 was observed on seven consecutive cycle times)

Risk factors	Cycle time 1	Cycle time 2	Cycle time 3	Cycle time 4	Cycle time 5	Cycle time 6	Cycle time 7
Access, hidden assembly	Green	Yellow	Yellow	Green	Yellow	Green	Green
Static back posture	Yellow	Yellow	Red	Yellow	Yellow	Red	Red
Static shoulder posture	Red	Red	Yellow	Yellow	Yellow	Yellow	Yellow
Pushing/pulling with the hand, arm	Yellow	Yellow	Green	Green	Green	Green	Green
Movement (continuous steps)	Green	Green	Green	Green	Green	Yellow	Yellow

Five risk factors, including Access hidden assembly, Back posture, Shoulder posture, Hand pushing and pulling, and Movement, were diverse in the similar and consecutive cycle times for the operator under study. Indeed, different levels of risk were observed in similar situation. The access assembly risk factor, for example, was assessed as low risk (Level 1) over four cycle times and moderate risk over three other cycle times. Similar results were observed for the other risk factors (Table 5).

The study was conducted in the same manner with another operator in order to increase the validity of our results. Operator 2 was observed during activity at the "Mounting SCR tank" workstation over eight cycle times. Five risk factors were diverse within-operator over several consecutive cycle times (Table 6).

**Table 6: Assessment of WR-MSDs risk factors at the "Mounting SCR tank" workstation by the SES method**

(Operator 2 was observed on seven consecutive cycle times)

Risk factors	Cycle time 1	Cycle time 2	Cycle time 3	Cycle time 4	Cycle time 5	Cycle time 6	Cycle time 7	Cycle time 8
Access, hidden assembly	Yellow	Red	Green	Yellow	Yellow	Yellow	Yellow	Yellow
Static shoulder posture	Yellow	Red	Red	Red	Yellow	Yellow	Yellow	Yellow
Pushing/pulling with hand, arm	Yellow	Yellow	Yellow	Green	Green	Red	Yellow	Red
Pushing/pulling with fingers	Red	Red	Red	Red	Yellow	Yellow	Yellow	Yellow
Movement (continuous steps)	Green	Yellow	Green	Green	Green	Green	Green	Green

**2.2.5. Is diversity useful or should it be eliminated?**

The aim of this investigation was to demonstrate diversity between and within operators in a truck assembly plant. The results revealed the wide diversity between and within operators for performing the same assembly tasks, particularly for posture risk factors in the consecutive cycle times. The results are consistent with those of reported by Roquelaure et al (2001) that confirmed wide diversity between the strategies of different people in performing the same tasks (Roquelaure et al., 2001). Different work strategies that each operator chose to undertake his tasks result in diversity. The results of current assessment methods are often the representation of one work strategy in automotive industries because these methods usually evaluate an experienced operator. Although some strategies cause over exposure to risk factors, previous studies showed no relationship between operators' strategies and increasing the risk of WR-MSDs in similar jobs (Roquelaure et al., 2001). It is a matter of debate in the literature whether "diversity" (the extent that exposure entities differ) can be useful for reducing workload. Roquelaure et al 2001 concluded the importance of diversity for reducing WR-MSDs, but in a review study Mathiassen (2006) revealed little empirical evidence (Mathiassen, 2006; Roquelaure et al., 2001). It can be concluded that diversity is a part of work activity and it is essential to provide sufficient flexibility for the operators to select the best strategy that would be appropriate with their personal characteristics. However, manufacturers believe that standardization and less diversity allow less error in work activity and improve quality and productivity. "It is not possible to let the operators work as they want and they should follow the strategies defined by the factory"; declared a middle manager in one automotive industry. The main challenge is to find an appropriate balance between standardization which assure the quality and productivity and the diversity which is naturally a part of different operators' activities. It is essential to perform further research, particularly in the automotive assembly plant, to investigate what optimal diversity and flexibility should be considered.

### 3. WR-MSDs risk factors assessment by self-reported questionnaire

#### 3.1. Physical, organizational and psychosocial risk factors evaluation by self-reported questionnaire

Self-reported questionnaire as discussed in the first chapter is useful to obtain WR-MSDs risk factor information from operators' perspectives. It allows collection of a large number of data from a large population. Workers' self-reporting of physical risk factors (workload) is an important method, particularly in epidemiological studies to report dose-response relationships of WR-MSDs. Article 3 addresses the operators' self-reporting of physical, organizational and psychosocial factors of the assembly line. The following table summarizes the gaps, aims and findings of Article 3 in which the operators reported WR-MSDs risk factors in a truck assembly line.

Gaps	Aims	Findings
Operators' perspectives regarding WR-MSDs risk factors are less considered in automotive industries	To assess physical, organizational and psychosocial risk factors from operators' perspectives in a truck assembly line (operators' self-reports)	Potential physical risk factors were significant for the upper limb and WR-MSD symptoms were reported to be high for elbows, shoulders, hands/wrists, and lower back in assembly plant operators
Little is known about the effects of reorganization and technical/engineering intervention on operators' feelings on ergonomic factors	To study the likely changes in the ergonomic factors from operators' perspectives after reorganization and technical/engineering intervention	The subjective assessment of risk factors for new cycle time was better because of organizational changes and technical/engineering improvement
Evaluation and control of psychosocial factors are less considered in the truck assembly line	To assess psychosocial factors and how to reduce job strain	Low decision latitude and high psychological demand were common factors among assembly operators but good quality of social support reduced job strain

##### 3.1.1. Article 3: Evaluation of Ergonomic Approach and Musculoskeletal Disorders in Two Different Organizations in a Truck Assembly Plant

Zare M, Bodin J, Cercier E, Brunet R, Roquelaure Y. Evaluation of ergonomic approach and musculoskeletal disorders in two different organizations in a truck assembly plant. *International Journal of Industrial Ergonomics*. 2015;50:34-42 (the published version of this paper is appeared in Appendix 7).

**Title Page: Original Article**

**Evaluation of Ergonomic Approach and Musculoskeletal Disorders in  
Two Different Organizations in a Truck Assembly Plant**

**Running Title: Ergonomic Approach in Truck Assembly Plant**

**Mohsen Zare<sup>1</sup>**

**Julie Bodin<sup>1</sup>**

**Elodie Cercier<sup>1</sup>**

**Rene Brunet<sup>1</sup>**

**Yves Roquelaure<sup>1,2</sup>**

<sup>1</sup>LUNAM, University of Angers, Laboratory of Ergonomics and Epidemiology in Occupational Health (LEEST),  
Angers, France

<sup>2</sup>CHU Angers, France

**Corresponding Author: Mohsen Zare**

**Address:** LUNAM, Université d'Angers, Laboratoire d'ergonomie et d'épidémiologie en santé au travail (LEEST),  
Angers, France

**Email Address:** zare@hlth.mui.ac.ir

**Tell:** +33787722141

## Abstract

The aim of this study was to assess the ergonomic physical exposure, organizational and psychosocial factors in a truck assembly plant for two different cycle times (11 minutes and 8 minutes). A self-reported questionnaire was applied to evaluate subjective physical exposure, organizational and psychosocial factors by operators in two organization of an assembly process. The initial cycle time was 11 minutes (system A) and the new was 8 minutes (system B). The same work and assembly tasks had to be completed in both systems. However, the organization and distribution of the tasks and workstations were reorganized. The results of the questionnaire showed that subjective estimation by the operators regarding musculoskeletal risk factors was better in the new organization and self-reported WR-MSDs symptoms were fewer. However, exposure to risk factors and WR-MSDs symptoms was not statistically different between two cycle times. The findings provide better understanding of how organizational changes can modify ergonomic exposure in manufacturing assembly industries. Effective interventions are thus not only engineering solutions but also organizational and administrative adaptations.

**Keywords:** Ergonomic, Cycle time, Assembly plant, Self-reported questionnaire

## Introduction

Manufacturing success in the competitive industrial world depends on employees' wellness and reducing costs [1, 2]. Although ergonomics is integrated in the production system of many industries to improve human wellbeing and to prevent work related-musculoskeletal disorders (WR-MSDs), these disorders are still the main cause of occupational disease in many countries [3, 4]. Claims for WR-MSDs have increased and it is estimated that 40% of occupational costs are related to WR-MSDs [5]. Forty-five million employees are affected by WR-MSDs in Europe, and in France 46,537 of all occupational claims in 2012 (86%) were for WR-MSDs [6, 7]. In addition to the effects of WR-MSDs on business performance, they have considerable impact on human quality of life as they are the main causes of discomfort and pain in the workplace. WR-MSDs present serious ergonomic problems, particularly in the automobile industry due to the wide variety of ergonomic high risk tasks including tightening, picking up, lifting, material handling, as well as the characteristics of assembly line work [8]. Several dimensions of ergonomics such as physical, organizational and psychosocial risk factors may be reasons for disorders among assembly operators. Physical risk factors, including repetition, awkward postures, forceful movements and heavy lifting can increase the risk of WR-MSDs [9-11]. Organizational risk factors such as time constraints, work rate and workload also have a role in the prevalence of WR-MSDs. Furthermore, psychosocial risk factors such as low decision latitude, high psychological demands, and low social support may influence these disorders. Recent studies have shown that these factors may independently increase the risk of musculoskeletal disorders or the interactive effect between them may cause WR-MSDs [10, 12]. Huang et al (2003) showed that the odds of WR-MSDs for physical risk factors and time constraints (organizational risk factors) was 2.61, while the independent effects of these risk factors was less than one [13]. In a study in a large population, Widanarko et al (2014) showed that physical, organizational and psychosocial risk factors were independently associated with WR-MSDs. Moreover, the combined effects of these risk factors significantly increased the risk of WR-MSDs. However, good conditions of organizational and psychosocial factors can reduce the adverse effects of high physical workloads [10-12].

In order to adjust work situations and reduce WR-MSDs, there are many physically oriented intervention studies in manufacturing assembly industries. However, few studies have investigated organizational changes and their consequence for WR-MSDs. The effects of long and short cycle times were investigated by Johansson et al in a truck manufacturing company, and musculoskeletal symptoms were similar in both systems. However, fewer physical risk factors were reported for the long cycle time [14]. Fredriksson et al (2001) reported that changing from a line out system with a long cycle time (20 minutes) to a line system with a short cycle time (90 seconds) decreased physical risk factors significantly [9]. However, musculoskeletal symptoms and perceived physical exertion increased. It was concluded that psychosocial factors and poor organization design could increase musculoskeletal disorders although the new organization had improved physical working conditions. A new designed flow-line process increased the prevalence of musculoskeletal symptoms for fish-filleting plant operators. The authors concluded that all dimensions of work characteristics should be taken into account to reduce musculoskeletal symptoms [15]. Some advantages of a long cycle time were reported if physical and psychosocial aspects were considered in the design of the production line. The complex nature of musculoskeletal disorders means there is a need to evaluate the various elements of the ergonomic approach and consider them as a principle for designing new organization [14, 16, 17].

Reorganization of workstations for the reason of increase of production volumes were undertaken in a truck assembly plant in France. The cycle time was decreased from 11 minutes to 8 minutes and over this reorganization ergonomic approach was considered. Furthermore, technical improvements were implemented in the reorganized production line in order to reduce the physical ergonomic workload. The purpose of this study was both to investigate ergonomic approach elements in truck assemblers including physical, organizational and psychosocial factors from operator's viewpoint and to evaluate the likely changes in the ergonomic factors after reorganization in the new cycle time. Our hypothesis was that fewer physical risk factors and musculoskeletal symptoms should occur in the new system because of reorganization of the high workload tasks between different workstation, technical ergonomic changes and reduced working at the hard workstations.

## Materials & Methods

### Workplace Description

This study was carried out as a follow up investigation into two production cycle times of a truck assembly plant in France. The cycle time (known as takt time in the factory) is defined as time for performing the assigned tasks in addition to recovery time. The initial cycle time was 11 minutes (system A) and the second cycle time was 8 minutes (system B). Eleven workstations (known as work position in the factory) from one sector of the truck production plant were selected for data collection and each workstation included a number of sequential assembly tasks. For production reasons the factory decided to change the cycle time from 11 minutes to 8 minutes. The organization of the workstations was therefore changed and some tasks were transferred between workstations and certain new posts were created. Furthermore, extra operators joined a variety of workstations. However, the main tasks of most workstations remained unchanged. In system A, the "Selective Catalyst Reduction (SCR) tank" workstation included unloading and transferring the support by means of a lifting tool. The principle components of the SCR support tank were then assembled in sequence and finally the completed assembly was fed up the line by wagon. The changes regarding system B at this workstation were almost entirely organizational. As the layout and the zone of SCR support assembly was changed, many non-necessary movements which related to picking up components were eliminated. Furthermore, another operator was added to this area to perform the extra tasks so that the tasks at this workstation in the new cycle time were the same as the former system. Completed SCR support tanks were assembled in the truck chassis at another workstation on the line. In system A, this post included tasks such as assembling and tightening the reservoir, and connecting hoses and cables. In the new system connecting two hoses, tightening hose clamps and finishing cable routing on the top of the SCR tank were performed by another operator. The third workstation in system A was preparation and picking up the air filter, air pipe, heat cover, SCR tank, cab tilt cylinder and straining cylinder. One operator performed these tasks in three cycle times. In system B, this post was broken down into two posts i.e. "picking up the SCR tank and cab tilt cylinder" as well as "preparation and picking up air filter, air pipe, and heat cover". Furthermore, the straining cylinder task was transferred to another post (assembling air filters in the line) but some extra tasks were added into "picking up the SCR tank and cab tilt cylinder" workstation because of changes in the production. Some modifications were also performed in the layout and organization of this zone.



Preparation and integration of the bumper on the chassis was performed in the zone near the assembly line in system A and it included four workstations in which one operator worked (11 minutes for each post). The main tasks of these series of workstations were preparation of the washer tank, fog lamp, cab tilt pump, picking up bumper and sun visor, preparation of the bumper, assembly of light box, and bumper assembly on the chassis and tightening. In system B, this workstation was divided into five workstations (8 minutes for each post). The tasks in this zone were almost the same as the initial system but two tasks including picking up the bumper and sun visor were transferred to other sectors of the factory. The "air filter assembly on the chassis" workstation included assembling the air filter, air pipe, cab tilt cylinder, heat cover and connecting hoses on the chassis in the initial system. In system B, the heat cover assembling task was transferred to the right mudguard workstation and the cylinder straining task was added to this post. Two workstations, i.e. boarding steps and mudguards left and right on the initial system, were distributed to four workstations (i.e. boarding steps left and right and mudguards left and right). Fitting together the air pipe and the inlet pipe task and heat cover assembly task were added to these workstations. Overall in system B, two tasks (picking up the bumper and sun visor) were eliminated (transferred to other parts of the factory) and one task (Fitting together air pipe and inlet pipe) were transferred to this zone. System A comprised eleven workstations and system B fourteen workstations (Table 1).

## **Procedures and Subjects**

The first part of the study for initial cycle time was performed before the summer vacation in July 2013. The new system and organization were then established during the holiday. The second part of study was carried out in March 2014 seven month after changing the cycle time, when the operators had adapted to the new conditions. The operators in the initial and second phase were the same but extra people were employed at the new workstations. System A, therefore, comprised 17 workers and system B included 24. Fifteen and 21 operators from systems A and B participated in this study, respectively, and twelve were in both cycle times. The reasons that two people from system A and three people from system B did not participate in the study were either unwillingness or absence. Data collection was performed by the ergonomist with the help of industrial engineers and technicians. Each subject in the two cycle times answered the self-reported questionnaires about physical ergonomic exposure, organizational/psychosocial factors, and musculoskeletal symptoms. Furthermore, interviews using the Borg scale were performed to measure perceived physical exertion in both cycle times.

## **Reference Group**

French surveillance data were used as reference group. We selected the subjects from a cohort study named COSALI [18, 19]. The aim for this cohort was to assess the prevalence of WR-MSDs and their risk factors in the working population in France's Pays de la Loire region. This cohort included 3710 workers, among them 362 were blue-collar operators in the manufacturing and assembly industries, and these were chosen as reference group. The results of self-reported questionnaires for the variables used in our study were compared. The mean age of the reference group was 39.6 ( $\pm 10.1$ ) and the length of work experience for 43% of them was more than 10 years.

**Table 1: Changes in the workstations and task distributions in the new organization (system B)**

Workstations (System A)	Changes in system B
Preparation and assembly of SCR tank	
Preparation of Selective Catalyst Reduction (SCR) Tank	Without changes in tasks, another operator was added
Mounting SCR Tank	Connection of two hoses, tightening hose clamp, and finishing SCR cable performing in another position
Bumper Zone	
Picking up bumper, sun visor, rear bar, pump, washer tank and fog lamp preparation	Picking up bumper and sun visor tasks were transferred to another section, pump, washer tank and fog lamp preparation merged in the following work station
Preparation Bumper 1	Bumper preparation station 1 (pump preparation was added, bumper cable rooting was transferred to station 2, putting bumper on the beam was eliminated)
	Bumper preparation station 2 (bumper cable rooting, washer tank preparation)
Preparation Bumper 2	Bumper preparation station 3 (Fog lamp assembly, front right assembly)
	Bumper preparation station 4 (washer tank filling, light cable rooting, tightening light box, fog lamp cable rooting)
Bumper Assembly on Truck	Bumper assembly and tightening Station 5 (washer tank filling, tightening light box, front light cable rooting transferred)
Filter Preparation and Assembly	
Preparation of air filter and cab tilt cylinder	Air filter, air pipe, heat cover preparation
	Picking and preparation SCR, cab tilt cylinder
Air filter and cab tilt cylinder mounting	Assembly of Air filter, air pipe, cab tilt cylinder, pump and hoses (heat cover assembly task was transferred)
Boarding Step and Mudguard Assembly zone	
Right Boarding steps and Mudguards	Boarding step assembly and right rear mudguard bracket
	Right Mudguard assembly (fit air pipe to air inlet pipe)
Left Boarding steps and Mudguards	Boarding steps assembly and rear mudguard bracket left
	Right Mudguard assembly (heat cover assembly task transferred)

### Self-reported Musculoskeletal Symptoms

Musculoskeletal symptoms in the neck, shoulders, elbows/forearms, hands/wrists, back and lower limbs were evaluated by a modified version of the Nordic Musculoskeletal Questionnaire [20]. The prevalence of musculoskeletal symptoms was defined as pain, numbness or stiffness for different parts of the musculoskeletal system. We asked the operators to determine their pain or discomfort in each region of the body at the moment of filling out the questionnaire on a 0-10 scale. Pain intensity  $\geq 5$  at the time of filling out the questionnaire was

considered as a musculoskeletal symptom. We did not compare the results with reference data because the reference group reported symptoms experienced during the preceding 12 months.

### **Self-reported Physical and Organizational Risk Factors**

The second part of the questionnaire evaluated subjective estimation of physical ergonomic exposure. This section was developed according to the European consensus criteria on WMSD risk factors in the upper limbs [21]. One question including repeated actions/gestures asked about repetition. Two illustrated questions evaluated the duration of neck flexion/extension. Work with the arms  $>90^\circ$  and between  $45^\circ$  to  $90^\circ$  as well as rotation of the arms were illustrated to assess shoulder postures. Seven illustrated questions assessed wrist and forearm risk factors. Finally, to evaluate material handling and push/pull activity, five questions asked about the weight of loads to be lifted or carried during the working day. Physical exposure was assessed by a four-point scale, i.e. "never", "sometimes", "often" and "always". If the operators answered "often" or "always", it was defined as 2 hours/day and 4 hours/day exposure to risk factors, respectively. We also interviewed operators to evaluate perceived physical exertion on the RPE Borg scale [22]. The interview was performed by an ergonomist using the Borg scale in two periods of time, the Friday afternoon and Monday morning. The aim was to evaluate the difference between perceived physical exertion at the end of the week and after resting over the weekend. The original Borg method with the scale ranging from 6 "very very light" to 20 (very very hard) was used in this study. We considered the third quartile (score  $\geq 15$ ) as high perceived physical exertion for both cycle times.

We asked employees to report organizational constraints in the workplace. Two categories of questions were defined including workload (working hours, attention and high load activities and etc.) and work rate which are related to organizational factors (technical constraints, dependence to the others, mandatory procedures, monitoring and etc.). As for self-reported physical risk factors, the four-point scale was used to rate organizational risk factors.

### **Psychosocial Factors**

Work psychosocial factors were evaluated by the French version of Karasek Job Content Questionnaire [23, 24]. This questionnaire includes 26 questions categorized into three dimensions. The first dimension involves decision latitude which includes questions such as control over work, and work stimulus. The second dimension involves psychological workload and the third dimension social support at work, defined as supervisor climate and relationships with colleagues. To determine the prevalence of job strain and iso-strain in the study population, the scores for low decision latitude, high psychological demand and low social support were dichotomized according to the median of the French Medical Surveillance of Occupational Risk Exposure (SUMER) study. High psychological demands and low decision latitude were thus two dimensions which determined job strain and high psychological demand and low decision latitude and low social support together provided iso-strain.

## Results

### Self-reported Musculoskeletal Symptoms

All the subjects in this study were men, with a mean age of 42.0 ( $\pm 7.6$ ) years for cycle time A and 38.1 ( $\pm 8.7$ ) years for cycle time B. The mean length of work experience in the current job was 16.0 ( $\pm 6.6$ ) years for cycle time A and 13.0 ( $\pm 8.1$ ) years for B.

**Table 2: Musculoskeletal symptoms for two cycle times in truck assembly workers at the time of filling out the questionnaire**

	All respondents				Same respondents				P-value*
	Cycle time A (n=15)		Cycle time B (n=21)		Cycle time A (n=11)		Cycle time B (n=11)		
	n	%	N	%	n	%	n	%	
Neck, VAS** $\geq 5$	5	33	2	10	3	27	1	9	0.63
Shoulders and arm, VAS $\geq 5$	10	67	7	35	6	55	4	36	0.63
Elbows and forearms, VAS $\geq 5$	8	53	8	40	5	45	4	36	1.00
Wrist and hands, VAS $\geq 5$	7	47	8	40	4	36	3	27	1.00
Fingers, VAS $\geq 5$	5	33	4	20	2	18	2	18	1.00
Upper back, VAS $\geq 5$	5	33	5	25	5	45	2	18	0.25
Lower back, VAS $\geq 5$	7	47	7	35	5	45	3	27	0.50
Hip and thigh, VAS $\geq 5$	4	27	2	10	3	27	1	9	0.63
Knee and leg, VAS $\geq 5$	3	20	6	30	3	27	3	27	1.00
Ankle / Foot, VAS $\geq 5$	4	27	4	20	3	27	2	18	1.00

\* Mac Nemar exact test for 11 operators who responded for both cycle times

\*\*Visual analog scale for pain

Table 2 shows the prevalence of musculoskeletal symptoms among the study population in both cycle times. The prevalence of symptoms for the shoulders, elbows and wrists was 67%, 53% and 47%, respectively, for cycle time A. In cycle time B, the prevalence of shoulder, elbow and wrist symptoms was reported as 35%, 40% and 40% respectively. The prevalence of symptoms in the lower back was also reported to be as high as 47% for subjects in cycle time A and 35% for subjects in cycle time B. The study population in cycle time A had higher prevalence of symptoms in the upper limbs, back and lower limbs compared to cycle time B (except for knee symptoms). Analysis of differences regarding prevalence of musculoskeletal symptoms showed no significant difference between cycle times A and B.

### Subjective Assessment of Physical and Organizational Ergonomics Workload

Table 3 shows organizational ergonomic characteristics related to work rate and workload for both cycle times. More than 70% of the operators reported technical constraints (mandatory use of tools and devices) imposed by work rate in both cycle times. Dependence on other operators' activities increased in cycle time B by 67%, compared to 47% in cycle time A. However, Mac Nemar exact test between the same respondents for this factor showed non-significant differences in both cycle times (P-value=0.38). Other organizational characteristics imposed by work rate were reported to be high in both cycle times (Table 3). Organizational characteristics due to the workload were less often reported by operators. Fifty-two percent of operators reported "working outside normal hours" in cycle time B more than the percentage reported in cycle time A

(33%). Working too fast for precise operation was reported to be 47% in cycle time A versus 25% in cycle time B. The difference between organizational risk factors was measured with Mac Nemar exact test for the same respondents in both cycle times. None of the organizational characteristics were significantly different between the two cycle times.

**Table 3: Organizational ergonomic characteristics for two cycle times reported by truck assembly workers**

	All respondents				Same respondents				p-value
	Cycle time A (n=15)		Cycle time B (n=21)		Cycle time A		Cycle time B		
	n	%	N	%	N	%	n	%	
During a typical workday, work rate imposed by:									
Technical constraints (mandatory screwdriver, or tools etc.)	12	80	15	71	9	75	8	67	1.00*
Immediate dependence on the work of one or more colleagues	7	47	14	67	6	50	9	75	0.38*
Inter-section activity (inter working group, inter cluster, logistics, etc.)	9	60	13	65	7	64	8	73	1.00**
Following safety procedures	15	100	17	81	12	100	9	75	NA*
Following production procedure	14	93	19	100	11	100	11	100	NA**
Permanent (or at least daily) monitoring or control by hierarchy	6	40	8	40	4	33	5	42	1.00*
Following or monitoring computerized process (Production Process)	8	53	11	52	8	67	8	67	NA*
Workload necessities									
exceeding normal hours	5	33	11	52	4	33	7	58	0.38*
Shortening or skipping a meal	3	20	0	0	2	18	0	0	NA**
Missing a break	1	7	0	0	1	9	0	0	NA**
Working too fast for an operation that requires care	7	47	5	25	5	45	3	27	0.63**
Abandoning a task to do another unplanned activity	3	20	2	11	2	18	2	18	NA**
NOT completing an activity	3	20	2	10	2	18	1	9	1.00**

\* Mac Nemar exact test for 12 operators who responded for both cycle times.

\*\* Mac Nemar exact test for 11 operators who responded for both cycle times.

NA : Not Applicable

Table 4 shows biomechanical risk factors reported by assemblers. Back risk factors (back flexion >2hours) were reported by 100% of operators in cycle time A and 75% in cycle time B. In the reference data from other industries in France, 55% of the operators reported back flexion. However, truck assembly operators reported a low percentage of back flexion >4hours, that was similar to reference data. Shoulder risk factors including abducted arms and arms working above shoulder level were reported by 53% and 33% in cycle time A, while for cycle time B they were 52% and 24%, respectively.

**Table 4: Subjective assessment of physical risk factors for two cycle times reported by truck assembly workers**

	All respondents				Same respondents				p-value	Reference Data*** (n=362)	
	Cycle time A (n=15)		Cycle time B (n=21)		Cycle time A		Cycle time B			n	%
	N	%	N	%	N	%	n	%			
Repeating same action ( $\geq 4$ h/day)	4	27	3	14	2	17	2	17	1.00*	139	39
Neck flexion ( $>4$ h/j)	3	20	2	10	2	17	1	8	1.00*	137	38
Neck extension ( $>4$ h/j)	0	0	0	0	0	0	0	0	NA*	8	2
Arms at or above shoulder level ( $\geq 2$ h/day)	5	33	5	24	3	25	2	17	1.00*	55	15
Arms abducted ( $\geq 2$ h/day)	8	53	11	52	5	42	4	33	1.00*	81	22
Holding the hand behind the trunk ( $\geq 2$ h/day)	0	0	2	10	0	0	2	17	NA*	21	6
Elbow flexion/extension ( $\geq 2$ h/day)	12	80	13	62	9	75	7	58	0.63*	173	48
Pronation/supination movements ( $\geq 2$ h/day)	9	64	8	38	6	55	3	27	0.38**	95	26
Putting elbow on the rigid surfaces ( $\geq 2$ h/day)	1	7	2	10	1	8	1	8	NA*	83	23
Wrist bending in extreme postures ( $\geq 2$ h/day)	7	47	11	52	5	42	5	42	1.00*	188	53
Pressing with the base of the palm ( $\geq 2$ h/day)	5	33	1	5	4	33	0	0	0.13*	48	13
Holding tools or objects in a pinch grip ( $\geq 2$ h/day)	11	73	9	43	8	67	5	42	0.25*	104	29
Use of vibrating hand tools ( $\geq 2$ h/day)	6	40	8	38	4	33	4	33	1.00*	84	23
Back Flexion/twisting ( $\geq 2$ h/day)	15	100	15	75	11	100	8	73	NA**	198	55
Back Flexion/ twisting ( $\geq 4$ h/day)	2	13	0	0	2	18	0	0	NA**	41	11
Carrying 1- 10 kg ( $\geq 4$ h/day)	4	27	3	14	3	25	2	17	1.00*	31	10
Carrying 10 - 25 kg ( $\geq 4$ h/day)	2	13	0	0	2	17	0	0	NA	9	3
Handling 1 - 4 kg ( $\geq 4$ h/day)	7	47	6	29	5	42	3	25	0.50*	64	20
Handling loads $> 4$ kg ( $\geq 4$ h/day)	3	20	3	14	1	8	1	8	NA*	36	11
Push pull ( $\geq 2$ h/day)	3	20	2	17	2	17	2	17	1.00*	76	21

\* Mac Nemar exact test for 12 operators who responded for both cycle times

\*\* Mac Nemar exact test for 11 operators who responded for both cycle times.

\*\*\* Data from epidemiologic study among blue-collar operators in the manufacturing and assembly industries in a French region (Pays de la Loire)

NA : Not Applicable

Elbow and wrist risk factors were also reported to be high for both cycle times. The subjects reported higher exposure to elbow flexion (cycle time A=80% and B=62%), pronation/supination movements (cycle time A=64% and B=38%), pinch grip (cycle time A=73% and B=43%), and hand-arm vibration (cycle time A=40%

and B=38%) compared to reference data on French blue-collar operators in the manufacturing and assembly industries. However, blue-collar operators in the French reference data had higher percentages of repeated actions than in our study (Table 4).

Component handling was mainly related to weights below 4 kg, and 47% of the subjects in system A and 29% in system B reported exposure to material handling below 4kg. Exposure to material handling was reduced in cycle time B, although the difference between the two cycle times was not significant. Relationships were studied between physical risk factors and musculoskeletal symptoms in operators in truck manufacturing. In general, there were no significant relationships between the symptoms for each body section and physical risk factors. Table 5 shows the percentage of perceived physical exertion for three types of working day on Friday and Monday. More than 60% of the operators reported perceived physical exertion equal or greater than 15 (hard) for high workload days on Friday and Monday for both cycle times. There was no significant difference between perceived physical exertion on Friday and Monday. The situation was similar for both cycle times.

**Table 5. Perceived physical exertion force $\geq$ 15 according to Borg scale reported by truck assemblers on Friday and Monday for three types of working day workload**

	Friday						Monday					
	Low workload workday		Typical Workday		High workload workday		Low workload workday		Typical Workday		High workload workday	
	n	%	n	%	n	%	n	%	n	%	n	%
Cycle Time A (n=15)	1	7	3	20	9	60	0	0	3	20	10	67
Cycle Time B (n=20)	1	5	2	10	12	60	0	0	2	13	12	75

One subject was absent at the time of interviews for cycle time B.

## Psychosocial Factors

Table 6 presents psychosocial factors, including high psychological demands, low decision latitude and low social support. In this study, 79% of operators in cycle time A and 90% of the subjects in cycle time B reported low decision latitude. Psychological demands were also reported to be relatively high in both cycle times. Therefore the job strain that was derived from these two dimensions was 43% for cycle time A and 62% for cycle time B. Figure 1 shows the patterns of job strain between study populations in both cycle times. It was shown that 40% of the people in cycle times A and 62% of them in cycle time B were classified in the high strain zone (lower right), 33% in cycle time A and 29% of people in cycle time B in the passive zone (lower left), 13% and 10% of people in cycle times A and B in the low strain zone (upper left) and 7% in cycle time A in the active zone (upper right). None of operators in cycle time B were classified in active zone.

**Table 6: Subjective assessment of psychosocial risk factors for two cycle times reported by truck assembly workers**

	All respondents				Same respondents				P-value	Reference Data*** (n=362)	
	Cycle time A (n=15)		Cycle time B (n=21)		Cycle time A		Cycle time B			n	%
	n	%	N	%	n	%	n	%			
High psychological demands	8	53	13	62	6	50	8	67	0,69*	147	41
Low decision latitude	11	79	19	90	9	75	11	92	0,50*	249	70
Job strain	6	43	13	62	5	42	8	67	0,38*	98	28
Low social support	8	53	5	25	5	45	5	45	NA**	170	48
Isostrain	3	21	2	10	2	18	2	18	1.00**	52	15

\* Mac Nemar exact test for 12 operators who responded for both cycle times

\*\* Mac Nemar exact test for 11 operators who responded for both cycle times.

\*\*\* Data from epidemiologic study among blue-collar operators in the manufacturing and assembly industries in a French region (Pays de la Loire)

NA : Not Applicable

Low decision latitude and high psychological demands of reference data were reported by 70% and 41%, respectively. Another dimension investigated was social support. Twenty-five percent of subjects in cycle time B reported low social support whereas 53% of operators in cycle time A complained of low social support. Iso-strain was reported by 10% of subjects in cycle time B and 21% of subjects in cycle time A. Mac Nemar's exact test did not show any difference between the two cycle times. Low social support was reported to be higher in reference data than in cycle time B (48% of people complained low social support). Iso-strain was therefore higher in the reference data than in truck assembly operators for cycle time B.

## Discussion

The purpose of this study was to evaluate subjectively three dimensions of the ergonomic approach in a truck assembly manufacturing plant. Physical, organizational and psychosocial risk factors were evaluated by self-reported methods for the two cycle times (11 minutes and 8 minutes). The operators also reported their musculoskeletal symptoms. The results of the study showed that musculoskeletal symptoms were more frequent in the upper limbs (shoulders/elbows /wrists) and lower back. The prevalence of symptoms in the lower limbs was low. Although the operators reported fewer symptoms in cycle time B (8 minutes) than in cycle time A (11 minutes), the results were not significantly different for the same respondents in the two cycle times. The reason might be related to the low number of subjects who were included in the study. Upper limb and lower back symptoms were frequent complaints in other studies in automotive assembly industries. Johansson et al reported that the neck, shoulders, lower back and hands were complained of frequently by truck assemblers although the symptoms for short (6 or 12 minutes) and long (20 or 45 minutes) cycle times were reported to be similar [14]. Engstrom et al reported a high prevalence of musculoskeletal symptoms in the Volvo manufacturing industry, with the exception of the lower limbs [17]. Widanarko et al showed that neck/shoulder, wrists, arm/elbow and lower back were most common areas of complaint in a study of 3000 participants with different occupations [10-12]. All these results are consistent with our findings and indicate the prevalence of upper limb musculoskeletal disorders in manufacturing assemblers.



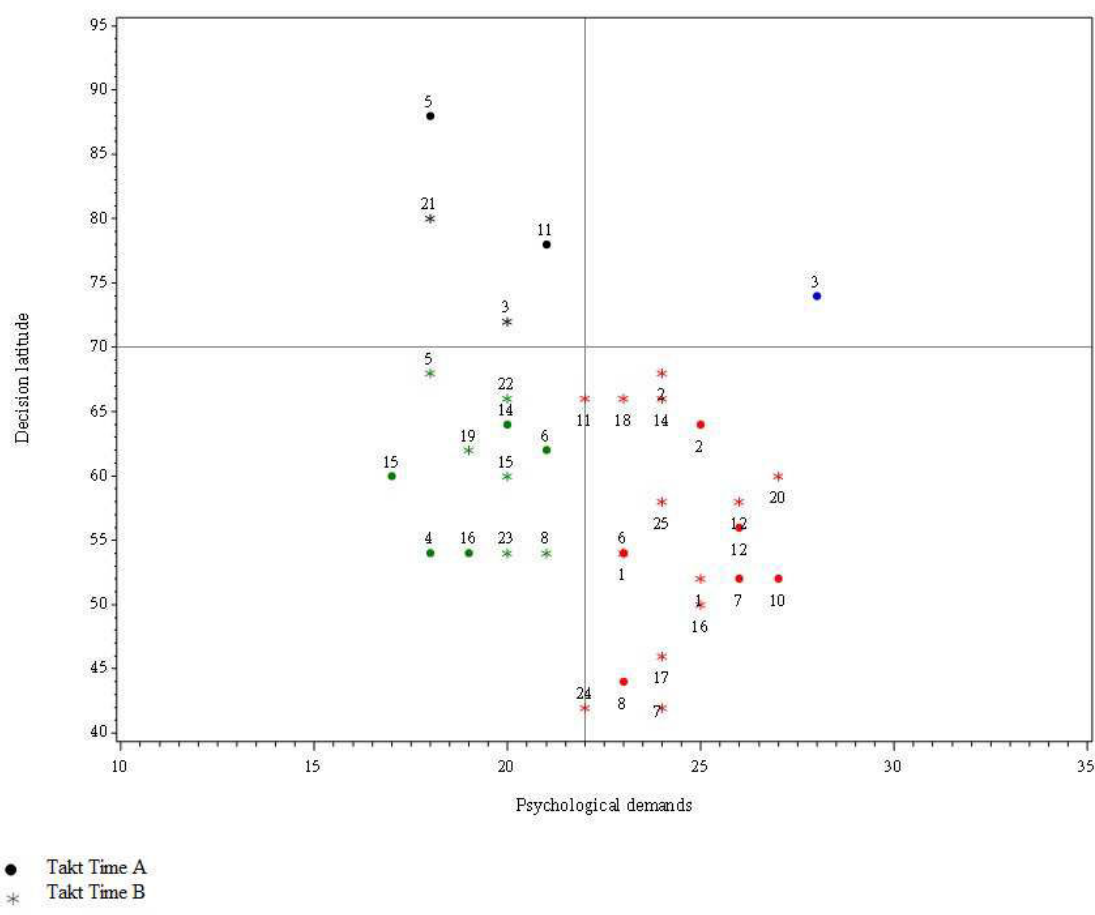

Figure 1. Job strain derived from psychological demand and decision latitude dimensions for two Cycle times

Exposure to shoulder risk factors is common in automotive manufacturing assembly, particularly in the truck assembly industries. When comparing this study with epidemiologic reference data in France, shoulder risk factors were more frequent in our study. This was to be expected because the tasks to be accomplished in truck assembly require elevation of the arms in excess of 60° depending on truck size. In the study by Johansson et al, 39% of truck assemblers reported arm elevation above shoulder level [14]. Engstrom et al reported that 35% of assembly operators were exposed to arm elevation above shoulder level two hours or more per day [17]. In his ergonomic evaluation by direct measurement methods for forty-three types of work, Hansson et al reported the highest levels for shoulder risk factors (arm elevation) among automotive assemblers [25]. All of these results are consistent with our results as the study population reported 33% and 24% arm elevation (>90°) for cycle times A and B, respectively. Arm abduction (<90°) that represents moderate exposure to shoulder risk factors was reported by more than half of the operators in both cycle times. To our knowledge there are few self-reported studies reporting moderate exposure to shoulder risk factors. However, accumulation of moderate and high workload shoulder risk factors will generate shoulder disorders. Exposure to elbow and hand/wrist risk factors was also common, although it was reported less frequently for cycle time B. Elbow flexion and pronation/supination of the forearm were relatively high in both cycle times. Many tasks in assembly workstations required the use of electrical or manual screwdrivers and these actions involved pronation/supination of the elbows. Furthermore, the elbow is usually bent during assembly tasks. Bending the wrist usually happened when operators used hand-held power tools to tighten screws and nuts.

Other tasks such as pushing a wagon also involved wrist bending. The operators usually gripped light and thin objects (1-2 kg) such as supports, pumps etc with pinching or squeezing actions. These activities contain main risk factors for elbows/hands/wrists and more than half of the subjects reported exposure to these risks. Exposure to elbow and hand/wrist risk factors in reference data was as frequent as our findings in truck assemblers, but pronation/supination movements and pinching grip were less often reported. Other studies reported a high prevalence of elbow/hand pain in automotive assemblers because of workloads and few attempts to reduce elbow/hand risk factors. When using screwdrivers routinely, the screwdriver's weight and reaction forces produced at the end of tightening were reported to be the main reasons for elbow/hand/wrist complaints in previous studies [17, 26, 27]. Other reasons for the high prevalence of elbow/ hand/wrist disorders might be related to accumulative working with hands during the working day. Most claims involving musculoskeletal illness in an European truck assembly plant over the last 20 years were related to elbow disorders.

Back flexion for more than two hours/day was reported by all subjects in cycle time A and more than half of the operators in cycle time B. Although extreme back flexion occurred less frequently for truck assembly, the operators habitually bent their backs forward slightly, along with exertion force for performing their tasks. Back risk exposure reported by the operators was fairly high and it seems that they overestimated their exposure. However, the prevalence of lower back symptoms was also high in the study population and in the reference data. A possible reason for back risk factors is handling heavy parts and components. In our study the operators usually handled components ranging from 5kg to 15kg, depending on the workstation. About half of the operators in both cycle times handled materials or tools for more than 4 hours/day. The percentage of material handling was reduced in the new cycle time, although the difference was not significant. As reported in other studies, handling heavy components, frequent standing/walking with little opportunity to sit down are other reasons for the high prevalence of low back disorders among truck assemblers that we also observed in our study [9, 14, 17]. Perceived physical exertion force was relatively similar in both cycle times. However, for a typical workday perceived exertion force ( $\geq 15$ ) was reported more frequently in cycle time A than in cycle time B. Other studies showed that the Borg rating is not only an index of physical activity but also an indicator of psychological factors [22, 28]. Our hypothesis in this study was that operators might perceive an increase in physical exertion on Fridays compared to Mondays. However, we found that the perceived physical exertion was identical on Fridays and Mondays for both cycle times. The exertion perceived on high workload days was much more than on other types of work day. A high load workday was defined in this study as a day when the operators had to assemble difficult truck options. Therefore, the distribution of truck options in the assembly line should be more carefully considered by engineers. Loading up the line imbalance by truck options might expose operators to extra perceived physical exertion (fatigue).

The operators in cycle time B reported less exposure to physical risk factors than those in cycle time A. Statistical tests did not show a significant difference, which might be related to the small numbers in the study population. The possible reasons why the operators' subjective assessment decreased in the new cycle time might be related to the technical/engineering improvements, reorganization and new design workstations. Four new workstations were created in the new system and high risk tasks were distributed between different workstations. Furthermore, some technical improvements such as using a lifting tool at the mudguard station

and changing the design of the unlocking system in the “bumper assembly on chassis” station were incorporated which also reduced risk factors in the new system. Although the new cycle time reduced the content of each workstation because of shorter time, performing fewer unacceptable tasks (high risk) meant that the operators had felt better in the new cycle time. Furthermore, the new concept was not completely changed and most alterations were related to balancing, reorganization and modification.

In this study organizational characteristics were evaluated according to two main categories, i.e. work rate and workload. The assemblers reported more complaints regarding work rate compared to workload. Operators reported a high percentage of work rate imposed by mandatory use of tools, screwdrivers, lifting devices, etc, in both cycle times. In an assembly plant, assemblers must use different tools (sometimes more than 8 screwdrivers and torque wrench during one cycle time) and this causes extra movement and memorization of use of the right tool. Furthermore, following the standards and assembly procedures was reported by nearly all of the operators in both cycle times. For each workstation there were approximately three truck options with different assembly procedures that the operators had to follow. Each assembler worked in at least four different workstations during the day, and therefore had to memorize and follow many instructions regarding each truck option and workstation. The combination of these organizational constraints with physical risk factors could increase the risk of musculoskeletal disorders [10, 11]. However, the organizational factors that were imposed by workload such as exceeding normal hours of work, working too fast and unplanned activity were reported to be low in both cycle times. In contrast to another study where time constraints were reported by assemblers, in our study the operators were satisfied with the time organization as few subjects reported missing break, having short meals or skipping meals, working too fast, etc. The possible reason for this was the structure and organization of the assembly line in our study in which each workstation had its own support post (known as variant position in the factory) for helping the operators [10, 14].

Various reports have shown an association between psychosocial risk factors at the workplace and musculoskeletal symptoms [10-12, 14, 17]. In our study the operators in both cycle times reported high levels of psychological demand and low decision latitude. The reference data also showed that low decision latitude and high psychological demand were common psychosocial factors in blue-collar operators in France. However, the percentage reported was less than in our study. In the assembly line, there is naturally a low possibility for active learning or motivation for creativity and developing new behaviors. Operators’ stress and strain is therefore increased due to low decision latitude and high psychological workload. Job stress and strain in the workplace could influence musculoskeletal disorders due to muscle tension and result in behavior changes as workers might report more musculoskeletal symptoms [29, 30]. On the other hand, social support, another dimension of psychosocial factors, was reported to be satisfactory by more than 70% of the subjects in cycle time B. This dimension was developed in the new cycle time and it was better compared to reference data. It is interesting to note when this dimension was considered, the final calculated percentage of iso-strain decreased significantly and it was lower than the reference data. It can be concluded that it is possible to reduce strain by good social support, although, due to the nature of operations and processes in the assembly plant, it is difficult to match high decision latitude and to decrease psychological demands. In general the importance of managing psychosocial risk factors is highlighted in other studies because the combination and interactive effect of this

risk factor along with high physical workload not only increase the risk of musculoskeletal outcomes but also influence productivity and the quality of products [1].

## **Conclusions**

The findings of this study showed that potential physical risk factors mainly involving the upper limbs were significant among truck assembly operators. Most subjects reported risk factors for elbows, shoulders and hands/wrists, and the percentages of WR-MSDs symptoms reported in the upper limbs were also considerable. Perceived physical exertion increased on the high workload working day. However, it was not considerable on the typical and low workload working days. Perceived physical exertion was not different for Mondays and Fridays for assemblers. Our results showed that, although low decision latitude and high psychological demands were common psychosocial risk factors among our subjects, good quality social support reduced the strain. Reorganization with taking into account ergonomic approach reduced musculoskeletal symptoms and physical risk factors in the new cycle time but the difference from the initial concept was not significant.

## **Acknowledgements**

The authors would like to appreciate SCANIA staff and managers for their contribution in this research. This research is granted by SCANIA production Angers and the French National Research Program for Environmental and Occupational Health of Anses (2012/2/007).

## **Authors' contribution**

All authors had contributions to the design and progress of this research. MZ collected and inserted the data into the database, wrote the paper and interpreted the results. JB and EC analyzed the data and created the tables and graphs. RB contributed to the progress of study and the interpretation of the results. The study was performed under supervision of YR; he contributed to the interpretation of the results and the revision of the paper.

## References

- [1] A.C. Falck, M. Rosenqvist, What are the obstacles and needs of proactive ergonomics measures at early product development stages? - An interview study in five Swedish companies, *International Journal of Industrial Ergonomics*, 42 (2012) 406-415.
- [2] L. Törnström, J. Amprazis, M. Christmansson, J. Eklund, A corporate workplace model for ergonomic assessments and improvements, *Applied ergonomics*, 39 (2008) 219-228.
- [3] V. Putz-Anderson, B.P. Bernard, S.E. Burt, L.L. Cole, C. Fairfield-Estill, L.J. Fine, K.A. Grant, C. Gjessing, L. Jenkins, J.J. Hurrell Jr, *Musculoskeletal disorders and workplace factors*, National Institute for Occupational Safety and Health (NIOSH), (1997).
- [4] Y. Roquelaure, C. Ha, M. Sauteron, Réseau expérimental de surveillance épidémiologique des troubles musculosquelettiques dans les Pays de la Loire, *Surveillance en entreprises en*, 2005 (2002).
- [5] E.M. Speklé, J. Heinrich, M.J. Hoozemans, B.M. Blatter, A.J. van der Beek, J.H. van Dieën, M.W. van Tulder, The cost-effectiveness of the RSI QuickScan intervention programme for computer workers: Results of an economic evaluation alongside a randomised controlled trial, *BMC musculoskeletal disorders*, 11 (2010) 259.
- [6] Y. Roquelaure, J. Mariel, S. Fanello, J. Boissiere, H. Chiron, C. Dano, D. Bureau, D. Penneau-Fontbonne, Active epidemiological surveillance of musculoskeletal disorders in a shoe factory, *Occupational and environmental medicine*, 59 (2002) 452-458.
- [7] Caisse nationale de l'assurance maladie des travailleurs salariés. , in, *Direction des Risques Professionnels*, france, 2012, pp. 57.
- [8] Z.-X. Wang, R.-L. Qin, Y.-Z. Li, X.-Y. Zhang, N. Jia, Q.-L. Zhang, G. Li, J. Zhao, H.-H. Li, H.-Q. Jiang, [The epidemiological study of work-related musculoskeletal disorders and related factors among automobile assembly workers], *Zhonghua lao dong wei sheng zhi ye bing za zhi= Zhonghua laodong weisheng zhiyebing zazhi= Chinese journal of industrial hygiene and occupational diseases*, 29 (2011) 572-578.
- [9] K. Fredriksson, C. Bildt, G. Hägg, Å. Kilbom, The impact on musculoskeletal disorders of changing physical and psychosocial work environment conditions in the automobile industry, *International Journal of Industrial Ergonomics*, 28 (2001) 31-45.
- [10] B. Widanarko, S. Legg, J. Devereux, M. Stevenson, The combined effect of physical, psychosocial/organisational and/or environmental risk factors on the presence of work-related musculoskeletal symptoms and its consequences, *Applied ergonomics*, 45 (2014) 1610-1621.
- [11] B. Widanarko, S. Legg, J. Devereux, M. Stevenson, Interaction between physical and psychosocial work risk factors for low back symptoms and its consequences amongst Indonesian coal mining workers, *Applied ergonomics*, 46 (2015) 158-167.
- [12] B. Widanarko, Interaction between physical and psychosocial work risk factors for low back symptoms: a study of prevalence, risk factors, and interaction between physical and psychosocial work risk factors for low back symptoms and its consequences (reduced activities and absenteeism) in a random sample of workers in New Zealand and in Indonesian coal mining workers: a thesis presented in fulfilment of the requirements for the degree of Doctor of Philosophy in Ergonomics at Massey University, Manawatu, New Zealand, in, 2013.

- [13] R.R. Inman, D.E. Blumenfeld, N. Huang, J. Li, Designing production systems for quality: Research opportunities from an automotive industry perspective, *International Journal of Production Research*, 41 (2003) 1953-1971.
- [14] J.Å. Johansson, R. Kadefors, S. Rubenowitz, U. Klingenstierna, I. Lindström, T. Engström, M. Johansson, Musculoskeletal symptoms, ergonomic aspects and psychosocial factors in two different truck assembly concepts, *International Journal of Industrial Ergonomics*, 12 (1993) 35-48.
- [15] H. Ólafsdóttir, V. Rafnsson, Increase in musculoskeletal symptoms of upper limbs among women after introduction of the flow-line in fish-fillet plants, *International Journal of Industrial Ergonomics*, 21 (1998) 69-77.
- [16] R. Kadefors, T. Engström, J. Petzäll, L. Sundström, Ergonomics in parallelized car assembly: a case study, with reference also to productivity aspects, *Applied Ergonomics*, 27 (1996) 101-110.
- [17] T. Engström, J.J. Hanse, R. Kadefors, Musculoskeletal symptoms due to technical preconditions in long cycle time work in an automobile assembly plant: a study of prevalence and relation to psychosocial factors and physical exposure, *Applied Ergonomics*, 30 (1999) 443-453.
- [18] Y. Roquelaure, C. Ha, A. Leclerc, A. Touranchet, M. Sauteron, M. Melchior, E. Imbernon, M. Goldberg, Epidemiologic surveillance of upper extremity musculoskeletal disorders in the working population, *Arthritis Care & Research*, 55 (2006) 765-778.
- [19] Y. Roquelaure, C. Ha, A. Leclerc, A. Touranchet, C. Mariot, E. Imbernon, M. Goldberg, Troubles musculo-squelettiques en France: données du réseau pilote de surveillance épidémiologique dans les entreprises des Pays de la Loire en 2002 et 2003, *Santé, Société et Solidarité*, 5 (2006) 35-43.
- [20] I. Kuorinka, B. Jonsson, A. Kilbom, H. Vinterberg, F. Biering-Sørensen, G. Andersson, K. Jørgensen, Standardised Nordic questionnaires for the analysis of musculoskeletal symptoms, *Applied ergonomics*, 18 (1987) 233-237.
- [21] J.K. Sluiter, K.M. Rest, M.H. Frings-Dresen, Criteria document for evaluating the work-relatedness of upper-extremity musculoskeletal disorders, *Scandinavian journal of work, environment & health*, (2001) 1-102.
- [22] G. Borg, Psychophysical scaling with applications in physical work and the perception of exertion, *Scandinavian journal of work, environment & health*, (1990) 55-58.
- [23] R. Karasek, C. Brisson, N. Kawakami, I. Houtman, P. Bongers, B. Amick, The Job Content Questionnaire (JCQ): an instrument for internationally comparative assessments of psychosocial job characteristics, *Journal of occupational health psychology*, 3 (1998) 322.
- [24] I. Niedhammer, J.-F. Chastang, S. David, L. Barouhiel, G. Barrandon, Psychosocial work environment and mental health: Job-strain and effort-reward imbalance models in a context of major organizational changes, *International Journal of Occupational and Environmental Health*, 12 (2006) 111-119.
- [25] G.-Å. Hansson, I. Balogh, K. Ohlsson, L. Granqvist, C. Nordander, I. Arvidsson, I. Åkesson, J. Unge, R. Rittner, U. Strömberg, Physical workload in various types of work: Part II. Neck, shoulder and upper arm, *International Journal of Industrial Ergonomics*, 40 (2010) 267-281.
- [26] S. Byström, C. Hall, T. Welander, Å. Kilbom, Clinical disorders and pressure-pain threshold of the forearm and hand among automobile assembly line workers, *The Journal of Hand Surgery: British & European Volume*, 20 (1995) 782-790.

- [27] C. Zetterberg, A. Forsberg, E. Hansson, H. Johansson, P. Nielsen, B. Danielsson, G. Inge, B.-M. Olsson, Neck and upper extremity problems in car assembly workers. A comparison of subjective complaints, work satisfaction, physical examination and gender, *International Journal of Industrial Ergonomics*, 19 (1997) 277-289.
- [28] M. Josephson, M. Hagberg, E.W. Hjelm, Self-Reported Physical Exertion in Geriatric Care: A Risk Indicator for Low Back Symptoms?, *Spine*, 21 (1996) 2781-2785.
- [29] P. Carayon, M.J. Smith, M.C. Haims, Work organization, job stress, and work-related musculoskeletal disorders, *Human Factors: The Journal of the Human Factors and Ergonomics Society*, 41 (1999) 644-663.
- [30] P.M. Bongers, A.M. Kremer, J.t. Laak, Are psychosocial factors, risk factors for symptoms and signs of the shoulder, elbow, or hand/wrist?: A review of the epidemiological literature, *American journal of industrial medicine*, 41 (2002) 315-342.

## 4. Assessment of physical risk factors by direct measurement methods (biomechanical methods)

### 4.1. Development of biomechanical methods for direct measurement of Physical risk factors

Direct measurement might reveal more reliable data that could be the evidence of exposure dose for awkward body/limb postures. This measurement provides the proportion of time exposure to awkward postures, the degree of flexion/extension, the precise amount of variation and diversity which are not often measurable by other methods (i.e. observation, interview and self-reported questionnaire). Furthermore, quantitative measurements are required in epidemiological studies to establish dose-response relationships for WR-MSDs. This Chapter addresses the quantitative measurement of awkward postures by direct measurement methods. Before workplace measurement with biomechanical methods, the right protocol should be developed showing what sensor should be used and how the measurement should be done. The first section of this Chapter (article 4) therefore presents developing a correct protocol for biomechanical measurement in a manufacturing assembly plant. The following table addresses the gaps, aims and findings of article 4.

Gaps	Aims	Findings
A reliable protocol is required to measure physical risk factors in a real assembly plant	To develop the right protocol for biomechanical measurement in SCANIA assembly line.  To test this protocol over performing four simulated tasks	Accelerometer on the arms and back could be used instead of inclinometer and would provide data such as movement angle and velocity, motion symmetric and repetition. Attention must be paid to for reference position when using inclinometer and goniometry for evaluating the neck and wrist posture.
This protocol should be tested and compared with other common methods before applying in the field	To compare the results of direct measurement with the results of two observational methods (SES and RULA) for simulated tasks	The three methods provided the similar results although the direct measurement method showed more precise data. However, inconsistency was observed for neck and wrist posture evaluation.

#### 4.1.1. Article 4: Development of a biomechanical method for ergonomic evaluation: comparison with observational methods

Zare M, Biau S, Croq M, Roquelaure Y. Development of a Biomechanical Method for Ergonomic Evaluation: Comparison with Observational Methods. *International Journal of Social, Management, Economics and Business Engineering*. 2014;8:223-7. (the published version of this paper is appeared in Appendix 9).



## Title Page

# Development of a Biomechanical Method for Ergonomic Evaluation: Comparison with Observational Methods

**Mohsen Zare<sup>1</sup>**

**Sophie Biau<sup>2</sup>**

**Michel Croq<sup>3</sup>**

**Yves Roquelaure<sup>1</sup>**

<sup>1</sup>LUNAM, University of Angers, Laboratory of Ergonomics and Epidemiology in Occupational Health (LEEST), Angers, France

<sup>2</sup>Ecole Nationale d'Equitation BP 207 - 49411 Saumur Cedex France (e-mail: [sophie.biau@ifce.fr](mailto:sophie.biau@ifce.fr))

<sup>3</sup>Pôle Santé, XSXEA Scania Production Angers SAS Angers Cedex 01 – France (e-mail: [michel.croq@scania.com](mailto:michel.croq@scania.com))

**Corresponding Author: Mohsen Zare**

**Address:** LUNAM, Université d'Angers, Laboratoire d'ergonomie et d'épidémiologie en santé au travail (LEEST), Angers, France

**Email Address:** [zare@hlth.mui.ac.ir](mailto:zare@hlth.mui.ac.ir)

**Tell:** +33787722141

## Abstract

A wide variety of observational methods have been developed to evaluate the ergonomic workloads in manufacturing. However, the precision and accuracy of these methods remain a subject of debate. The aims of this study were to develop biomechanical methods to evaluate ergonomic workloads and to compare them with observational methods.

Two observational methods, i.e. SCANIA Ergonomic Standard (SES) and Rapid Upper Limb Assessment (RULA), were used to assess ergonomic workloads at two simulated workstations. They include four tasks such as tightening & loosening, attachment of tubes and strapping as well as other actions. Sensors were also used to measure biomechanical data (Inclinometers, Accelerometers, and Goniometers).

Our findings showed that in assessment of some risk factors both RULA & SES were in agreement with the results of biomechanical methods. However, there was disagreement on neck and wrist postures. In conclusion, the biomechanical approach was more precise than observational methods, but some risk factors evaluated with observational methods were not measurable with the biomechanical techniques developed.

**Keywords:** Ergonomic, Observational Method, Biomechanical method, Workload

## Introduction

As discussed in various studies, work-related musculoskeletal disorders are widespread in the manufacturing industries and they are known as multi-factorial occupational diseases for which physical workload, psychosocial, organizational and individual factors are the most important causes [1], [2]. Physical risk factors, including forceful exertion, awkward postures, lifting, manual material handling and vibrations are considered to be the obvious risk factors contributing to Work Musculoskeletal Disorders (WMSDs) [3]-[5]. To manage and control physical risk factors, several methods have been developed for assessment of exposure and estimation risks of injury in various occupations [1]. Paper-based observational methods such as RULA, OCRA, REBA, etc, are the most common applied techniques by ergonomists for posture assessments [6]. Strain Index and ACGIH hand level activity are the methods for measuring forceful exertion. Manual material handling is evaluated by the NIOSH equation, MAC (UK), ManTRA (Australia), and New Zealand code [7]. Although many studies have applied these methods to analyze job stations, their validity is still a matter of debate. Furthermore, many industrial companies have developed their own internal methods for ergonomic analysis, and a few research articles have addressed the efficacy of using in-housing methods [6]. It is essential for ergonomists and manufacturers that the accuracy and precision of the methods should be applicable for workplace analysis. Risk management policies related to WMSDs are unsuccessful without accurate risk assessment [1].

In addition to observational methods, biomechanical methods (direct measurement) have been developed that rely on sensors for recording body movement [8]. Goniometry, inclinometry, accelerometry, and electromyography are the most popular straightforward methods to measure postures, movements and force exertion. A large quantity of precise data related to exposure variables can be provided by biomechanical procedures, and developing the right protocol for applying them is vital. Comparing the results of straightforward methods with observational techniques would provide the opportunity to improve the validity of observational methods. Developing an accurate protocol showing which sensors should be used and how the measurements should be performed is necessary, before workplace analysis with biomechanical methods.

The aim of this study was therefore to develop an appropriate protocol for biomechanical measurement in manufacturing assembly. Testing this protocol and comparing it with two observational methods, i.e. SCANIA Ergonomic Standard (SES) and RULA, were the other aims of our study. SES is an in-house observational method that is used for measuring posture, force, lifting and repetition, and RULA is a common method for posture assessment.

## Methods

### Biomechanical measurement

The first step in our study was selection of sensors to measure the repetition, movements and postures of body regions. An electronic measurement system included acquisition software, sensors (inclinometer, accelerometer and goniometer) and a data logger (CAPTIV system, TEA, France) was used. Inclinometers were used to measure the inclination of body regions such as the head and upper back in a recent study [8]. To measure neck posture, information was sampled using loggers as well as two inclinometers placed on the occipital bone (a saucer-shaped membrane bone situated at the lower back of the cranium) and on the cervico-thoracic spine

at the C7-Th1 level. The accuracy of the inclinometer was  $1^\circ$  if  $<15^\circ$  and  $2^\circ$  if  $>15^\circ$ . Its resolution and frequency were 12 bits and 16 Hz, respectively. The total number of times when the head posture was more than  $10^\circ$  forward or backward compared to the upper back were characterized as head postures.

Two triaxial accelerometers were placed along the upper arms in the middle of the humerus. The line from the rounded head of the acromion to the lateral epicondyle was measured and divided into two for the placement of accelerometers on the humerus. They were fixed laterally on both hands with their Y-axes on the vertical. Arm elevations as well as hand repetitions were therefore calculated. Another accelerometer was placed on L3 of the lumbar spine to assess back posture. Recordings were performed between +1g and -1g, with the frequency of 128 Hz and the resolution of 3mg.

Biaxial electro-goniometers were used to measure flexion and extension deviations of the right and left wrists, the flexion and extension of the wrist being characterized in this study as hand postures. All sensors were small and placed on the body with double-sided adhesive tape (Fig. 1). The accuracy and frequency of measurement by goniometer were  $2^\circ$  and 32 Hz, respectively.

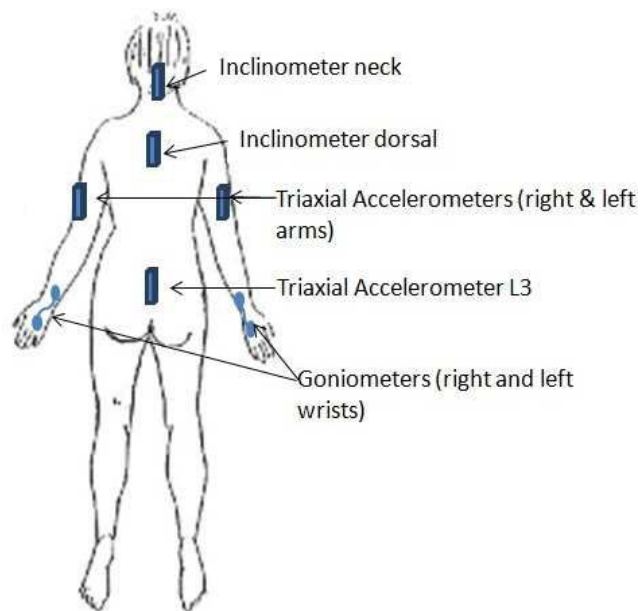

Fig. 1 Sensor placement for measurement of body movements

The zero positions for the head and upper back were defined at the first data recording when the subjects were standing upright in their usual postures and looking at a point of eye height. The reference positions for the upper arms and lower back were established when the subjects stood upright with their arms hanging at the side of the body. Once the wrists were relaxed alongside the body, this was taken as the reference position of the wrist.

The experiment was performed on one subject. All the postures and movements were recorded by data logger and camera recorder either in reference positions or during performing four simulated tasks. All the data were then transferred to the computer and actions were synchronized between movie and logger data. The two job stations selected were Air Component & Tie Wrapping which are simulated job stations in truck manufacturing for operator training. They include following tasks:

1. Tightening with hand and tool (duration 296 seconds)
2. Placing tubes and wrapping with Plastic Strap (duration 462.5 seconds)
3. Loosening with hand and tool (duration 148 seconds)
4. Other actions to test limits of sensor (duration 70 seconds)

## Observational methods

The first observational method to evaluate the potential risk in the simulated job stations was SCANIA in-house Ergonomic Standard method (SES). This method is adapted to the risk requirements in assembly manufacturing and designed to evaluate multi-task work stations. SES not only assesses postures but also evaluates force and lifting tasks. Twenty parameters are classified in 5 categories to define its ergonomic criteria. To prioritize the assessments, the results are sorted in the following order: Green or normal zone which shows minimal risk of WMSDs, and these kinds of risk are acceptable. Yellow shows the zone which has moderate risk of WMSDs. Yellow tasks and job stations might need some improvement action in the future. Red is an action zone where there are considerable risks of WMSDs for workers, and changes are required as soon as possible. Finally, double red (DR) shows the potential for excessive risk for the tasks assessed as DR, so they should be stopped immediately and the solutions found. The numbers of yellows, reds and DRs are then added and the colors of workstations are determined. The worst color is considered to be the final evaluation of the workstation.

TABLE I: Comparison of Risk Prioritization by RULA and SES Methods

Category	RULA Score	SES Color	Definition
Level 1	1-2	Green	Acceptable
Level 2	3-4	Yellow	More investigation needed
Level 3	5-6	Red	Modification needed soon

The other observational method used in this study was The Rapid Upper Limb Assessment (RULA). This method is widely used by ergonomists and researchers in various occupations to assess the risk of upper limb disorders. RULA measures risk based on postures, weight, duration and frequency, and then provides a score showing the risk of injury for the tasks evaluated. The scale rate for posture assessment varies from one to seven, one showing the best and seven the worst. In RULA the body is divided in two zones, A and B, of which A includes the upper arms, lower arms, and wrist positions, and group B the neck and trunk. Table I shows the categorization of the scores generated by SES and RULA. The observational methods were undertaken by an experienced ergonomist and were analyzed by Excel. MATLAB software was used to analyze biomechanical data.

## Wrapping with plastic strap

The task duration in which all the different actions were performed was approximately 8 minutes. The RULA score for neck posture for 51% of the task time was 2 ( $10^\circ < \text{neck flexion} < 20^\circ$ ) and for 19% of the task time was 3 ( $20^\circ < \text{neck flexion}$ ). The overall score for the neck was 4 because sometimes the neck was bending to the side during this task. The SES method showed red ( $45^\circ < \text{neck flexion and sideways/rotation} > 30^\circ$ ) for neck posture for just 10 seconds of the whole task time (2% of task time), while for most of the task duration the neck posture was assessed as yellow. Since the worst color governs the final evaluation in the SES method, the final color for neck posture was red. The direct method showed the neck was in flexion of  $10^\circ$  and  $20^\circ$  for 26% of the task time (Table II). In this study side bending of the neck posture was not assessed with the inclinometer. The results of observational methods were in conflict with the inclinometer recording for this task. The RULA score for 70% of the task time for back posture was 3, defined as back flexion more than  $20^\circ$  and less than  $60^\circ$ . Trunk twisting and side bending were not observed in this task. Trunk posture was assessed by SES as yellow, which shows bending forward between  $20^\circ$  and  $45^\circ$ . The accelerometer at L3 showed lower back flexion between  $20^\circ$  and  $45^\circ$  for 68% of task duration, and for 13% of the task time the trunk posture was more than  $45^\circ$ . The three methods provided similar results for back posture for this task (Table II). The RULA score for the upper arms was 4 (upper arm lifting  $> 90^\circ$ ) for less than 5 seconds of total task time whereas for 95% of the task duration this score was 2 ( $20^\circ < \text{upper arm lifting} < 45^\circ$ ). Static posture of the shoulders and arms was assessed by SES as green (upper arm lifting  $< 45^\circ$ ). The left and right arm positions were evaluated at more than  $40^\circ$  by the direct methods for only 1 % of the task time, and this was consistent with the other methods (Table II). Wrist postures were assessed as 3 by RULA, showing flexion or extension of more than  $15^\circ$ , and the result on SES for this task was red. Electro-goniometry demonstrated that the wrist postures were more than  $15^\circ$  for 65% of the task period. The overall RULA score in this task was 5 and the final color for the SES method was green, as for the tightening task (Table II).

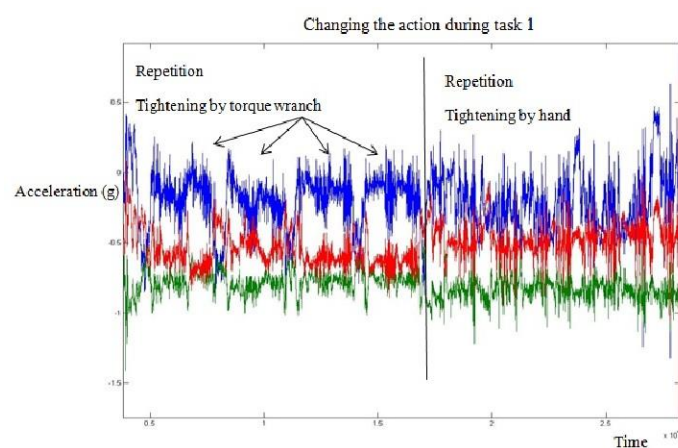

Fig. 2 Cyclic accelerations of the arm for two consecutive tasks: The lower signals are vertical accelerations (green), the upper signals are longitudinal accelerations (blue) and the middle signals are lateral acceleration (red)

## Loosening with Hand/Tools and Other Actions

The results of posture assessments during the loosening task were the same as the tightening task, especially for the neck, back and upper arms. However, the duration of awkward postures was shorter for the tightening task and the numbers of repetitions were also different. Table II shows the results of observational methods and the direct method for these tasks.

TABLE II: Comparison of Ergonomic Risk Assessment by RULA, SES and Direct Method

		RULA score	SES color	Direct method
Tightening Task	Neck	4	Red	Neck flexion <20°
	Back	2	Green	Back flexion <20°
	Arm	2	Green	Arm lifting <40°
	Wrist	1	Green	flexions and extension >15°
Wrap with plastic strap	Neck	4	Red	Neck flexion <20°
	Back	3	Yellow	Back flexion >45°
	Arm	2	Green	Arm lifting <40°
	Wrist	3	Red	flexions and extension >15°
Un-tightening task	Neck	4	Red	Neck flexion <20°
	Back	2	Green	20° < Back flexion <45°
	Arm	2	Green	Arm lifting <40°
	Wrist	1	Green	flexions and extension >15°
Other tasks	Neck	1	Green	Neck flexion <20°
	Back	4	Red	Flexion >45°
	Arm	5	Red	Arm lifting >40°
	Wrist	3	Red	flexions and extension >15°

The two accelerations with the left and right arms provided further information about hand movements and the symmetry of the body movements. As shown in Table III, although the tightening task involved the same amount of work, with both tools and hands, acceleration between the two hands for these actions was not the same. Tightening with a tool was more symmetric for both arms compared to tightening by hand.

TABLE III: Asymmetric Movements of the Arm during Manual Tightening Compare to Tightening with a Tool Calculated by Acceleration (G)

Action type	Arm	RMS	RMS
Manual	Right Arm	0.77	1.34
	Left Arm	0.57	
	Right Arm	0.95	1.23
	Left Arm	0.3	
Tool	Right Arm	0.82	1.31
	Left Arm	0.49	
	Right Arm	0.93	1.26
	Left Arm	0.33	

## Discussion

This study was undertaken to develop a biomechanical method which allows measurement and calculation of movements and positions in assembly and manufacturing plants. We compared the results of biomechanical measurements with two observational methods. Overall, we did not find a great difference between the three methods. For most parts of the body all methods demonstrated the same results, although the biomechanical method provided more precise information. However, some inconsistencies were observed, especially in assessment of the neck and wrists. As explained, for tightening and loosening tasks the results of both observational methods for the neck were in the action zone and further changes should be proposed as soon as possible, whereas the inclinometer measured neck angles of less than 20° in these tasks which is in the normal zone and acceptable. One reason for this conflict is probably that the observers looked at the neck in terms of an anatomical straight line while the inclinometer provided the neck angles in relation to upper back position. Evidently, neck bending accompanies upper back bending.

Furthermore, some differences were found between the methods for assessing wrist postures. In contrast to neck posture, the electro-goniometer provided angle values for both wrists that were much worse than the results of observational methods. The reference positions for the wrist when measuring with the goniometer might be the reason for these differences. Goniometers measure the flexion and extension of a functional position of the hands.

The direct method would provide the possibility of measuring exactly how many repetitions occurred during an individual task. In addition, symmetry of movement is another criterion which we could never assess with the observational method. However, further investigations are required, particularly in real workplaces, to confirm the results of this study.

## Conclusions

In conclusion, our results showed that sensors were more precise than observational methods as they decrease raters' errors. Accelerometers on the arms and back should be sufficient to assess postures instead of inclinometers which also provide complementary information about movement speeds, symmetry and repetitions.

## Acknowledgements

We thank all of our colleagues in SCANIA production, Angers, and in the Laboratory of Ergonomics & Epidemiology in Occupational Health for their valuable collaboration.

## Authors' contribution

All authors had contributions to the design and progress of this research. MZ and SB collected and analyzed the data. MZ wrote the paper and interpreted the results. SB and MC contributed to the progress of study and the interpretation of the results. The study was performed under supervision of YR and he contributed to the interpretation of the results.



## References

- [1] G. C. David, "Ergonomic methods for assessing exposure to risk factors for work-related musculoskeletal disorders," *Occupational Medicine*, 55(3), 2005: 190-199.
- [2] Li, Guangyan, and Peter Buckle. "Current techniques for assessing physical exposure to work-related musculoskeletal risks, with emphasis on posture-based methods." *Ergonomics* 42, no. 5 (1999): 674-695.
- [3] F. Gerr, R., Letz, P. J. Landrigan. "Upper-extremity musculoskeletal disorders of occupational origin," *Annual Review of Public Health*, 12, 1991: 543-566.
- [4] A. Burdorf, "Exposure assessment of risk factors for disorders of the back in occupational epidemiology," *Scandinavian Journal of Work, Environment and Health*, 18, 1992: 1-9H.
- [5] A. Ê . Kilbom, Repetitive work of the upper extremity: Part II The scientific basis (knowledge base) for the guide," *International Journal of Industrial Ergonomics*, 14, 1994a:59-86.
- [6] C. Berlin, R. Örtengren, D. Lämkuil, L, Hanson. "Corporate-internal vs. national standard–A comparison study of two ergonomics evaluation procedures used in automotive manufacturing." *International Journal of Industrial Ergonomics*, 39(6), 2009: 940-946.
- [7] E-P., Takala, I., Pehkonen, M., Forsman, G-A, Hansson, SE, Mathiassen, P. Neumann, et al. "Systematic evaluation of observational methods assessing biomechanical exposures at work" 17th World Congress on Ergonomics, IEA2009; Aug 9-14, 2009; Beijing, China: International Ergonomics Association.
- [8] Foltran, F. A., Silva, L. C., Sato, T. O., & Coury, H. J. "Wrist electrogoniometry: are current mathematical correction procedures effective in reducing crosstalk in functional assessment?" *Brazilian Journal of Physical Therapy*, 17(1), 2013: 32-40.

## 4.2. Development of a quantitative method to evaluate head movements in the real workplace

Measuring head flexion is an important part of gesture evaluation. Direct measurement has been widely used to measure the magnitude of movement of the cervical spine for clinical purposes. Measurement of head movements in workplaces is a matter of debate in the literature. Some previous studies have used head bending compared to the vertical axis from the reference position (known as Method 2 in our study) to report head movement. The issue is whether measurement of head bending compared to the vertical axis could provide reliable measurement of neck posture. Article 5 therefore addresses evaluation of forward/backward bending of the head relative to the vertical axis compared to evaluation of flexion/extension of the head in the sagittal plane in the real work situations. The gaps, aims and findings of Article 5 are presented in the following table.

Gaps	Aims	Findings
Little is known about the methods to measure head movements quantitatively	To test and compare two quantitative methods, i.e. measurement of bending with an inclinometer attached to the head, and measurement of flexion/extension by using an additional inclinometer located at C7/T1.	Method 1 (flexion/extension of the head in the sagittal plane) measures head inclination in relation to C7/T1. Evaluation of forward and backward bending of the head relative to the vertical line (Method 2) should be avoided because it overlooks inter-individual differences leading to over-estimation of the risks
	To compare these two quantitative methods with a qualitative video observation method	The observation method did not consider the reference position. An observation method to evaluate neck posture is questionable because there is a discrepancy between the very precise angles and the inherent limitations of the human eye, and practical limitations of observing workers in real work situations.

### 4.2.1. Article 5: A comparison of neck bending and flexion measurement methods for assessment of awkward neck posture

Zare M, Biau S, Gourlay A, Brunet R, Roquelaure Y. A comparison of neck bending and flexion measurement methods for assessment of ergonomic risk. *International Journal of Occupational Safety and Ergonomics (JOSE) 2015a; Vol. 21, No. 3, 330–335.* <http://dx.doi.org/10.1080/10803548.2015.1081772> (the published version of this paper is appeared in Appendix 10).

## **Title Page: Original Article**

# **A comparison of neck bending and flexion measurement methods for assessment of risk**

**Running Title: neck bending and flexion measurement**

**Mohsen Zare<sup>1</sup>**

**Sophie Biau<sup>2</sup>**

**Rene Brunet<sup>1</sup>**

**Antoine Gourlay<sup>1</sup>**

**Yves Roquelaure<sup>1,3</sup>**

<sup>1</sup>LUNAM, University of Angers, Laboratory of Ergonomics and Epidemiology in Occupational Health (LEEST), Angers, France

<sup>2</sup>French Institute of Horse and Equitation, National School of Equitation, BP 207 - 49411 Saumur Cedex, France

<sup>3</sup>Centre Hopital Université (CHU) Angers, France

**Corresponding Author:** Mohsen Zare

**Address:** LUNAM, Université d'Angers, Laboratoire d'ergonomie et d'épidémiologie en santé au travail (LEEST), Angers, France

**Email Address:** zare@hlth.mui.ac.ir

**Tel:** +33787722141

## Abstract

Head movements of workers were measured in the sagittal plane in order to establish a precise and accurate assessment method to be used in real work situations. Measurements were performed using two inclinometers connected to an embedded recording system. Two quantitative analysis methods were tested, i.e. measurement of bending with an inclinometer attached to the head, and measurement of flexion/extension by using an additional inclinometer located at C7/T1. The results were also compared with a video observation method (qualitative).

The results showed that bending measurements were significantly different from those of flexion/extension for angles between  $0^\circ$  and  $20^\circ$ , and angles  $> 45^\circ$ . There were also significant differences between workers for flexion  $> 45^\circ$ , reflecting individual variability. Additionally, several limitations of observational methods were revealed by this study.

**Keywords:** ergonomic, flexion, bending, head, cervical spine.

## Introduction

Both the duration and frequency of postural constraints can be risk factors for musculoskeletal disorders. It is therefore important to detect these risk factors in real work situations, and then evaluate them in order to reduce and balance workstation loads. Many studies have examined direct measurement methods for posture assessment, but most have been undertaken in the laboratory and cannot easily be adapted to actual work situations. Measuring head flexion is an important part of gesture evaluation.

Authors have studied head movements using different methods such as video observation, motion analysis and direct measurement. Non-invasive, direct measurement devices such as electro-goniometers (1), Polhemus fastrack 3D (2), ultrasound using the Zebris system (3), and potentiometers with the CA6000 system (4) can be used to measure head movements more precisely. Furthermore, forward head posture can be measured by the craniovertebral (CV) angle. This angle is defined as a horizontal line drawn through the seventh cervical (C7) vertebra and a line joining the C7 vertebra with the tragus of the ear. It can be quantified by a Head Posture Spinal Curvature Instrument (HPSCI) or Electronic Head Posture Instrument (EHPI) (5). However, the craniovertebral angle is highly variable and thus a static posture that qualifies head flexion and extension is preferred (6). Many studies have used direct measurement methods for clinical purposes and to measure the maximum magnitude of the cervical rachis in standing and seated positions. However, few studies have applied direct measurement methods in the work situation because of size and long setup times. Results can be widely different because of inter-individual variability, variability between methods, and context differences (laboratory vs. field situation).

## Reference position

The reference position is an important factor for direct measurement of head movements. The French organization for standardization (AFNOR) advises using the  $\pm 10^\circ$  forward-facing horizontal field of view. Anatomically, the reference position describes the human body in a standing position, feet together, arms beside the body and palms facing inwards. Some authors have allowed each measured individual choose their own reference position, which has to be reproducible without age-related changes (7). Some authors have even considered that the variability in reproducing the neutral position is an indicator of the proprioceptive state of the cervical rachis (8). This approach is advantageous in that it takes into account morphological and functional differences between individuals. We believe that this is an essential requirement for a study that evaluates work activities during different cycle times and task distributions. Other authors have chosen to physically set the reference position at the zero position of inclinometers and goniometers (9). Taking into account the reference position for each recording makes it possible to correct positioning errors, especially for the head inclinometer which is placed in a position that is much harder to locate reproductively than the C7/T1 inclinometer.

Using this reference position, flexion indicates a forward movement in the sagittal plane, and extension indicates a backward movement in the sagittal plane. In this study head movements were exclusively evaluated in the sagittal plane.

The purpose of this study was, in one hand, to compare two quantitative methods for evaluating head movements in the real work situations, i.e. evaluation of flexion/extension of the head in the sagittal plane and evaluation of forward and backward bending of the head relative to the vertical line. On the other hands, we compared these two quantitative methods with a qualitative video observation method.

## Material and Methods

### Recording process (Table 1)

This is a case study in which four workers on a truck assembly line were included. They worked in four workstations where their main tasks were preparing and installing bumpers on chassis. Rotation was applied through all stations and the workers changed workstations every two hours. The operators therefore worked in all stations that were recorded except for one operator who did not work at station four. Finally 16 data recording were performed. Each station has 20-30 elementary tasks (such as tightening, wiring, headlight installation, pushing/pulling carts, and fitting the bumper on the chassis). Each worker spent 11 minutes at each station, except for station 4 which required 33 minutes. Only actual work time was taken into account in the measurements. All workers were filmed with a digital camcorder.

Table 1: Arrangement of recording for 4 operators (age= 44.5±11 years; size= 178±8 cm; weight= 70±14 kg; length of work=15±6 years) for 4 stations, the exception is operator AB who did 3 stations.

Operator	St1	St2	St3	St4
DA	X	X	X	X
CH	X	X	X	X
LA	X	X	X	X
AB	X	X	X	

### Inclinometers

Head movements were evaluated using an inclinometer kept in place by a strap at the back of the head that measured the bending of the head in the sagittal plane compared to the vertical axis (Figure 1). Another inclinometer was taped to the skin at C7/T1 to measure bending of the upper back in relation to the vertical axis. The inclinometer's margin of error was 1° for angles < 15°, and 2° for angles > 15°. The signal was sampled at 16Hz. Angles measured by the two inclinometers could be used together to evaluate flexion/extension relative to C7/T1. Positive values represented flexion, and negative values extension.

The reference position was defined as "standing up straight, arms beside the body, eyes looking straight ahead". This position was recorded before and after videoing each station for each operator. If the two reference positions before and after finishing the station were different, the recording was excluded from the study.

Three methods for evaluating head movements in the sagittal plane

1. Evaluation of flexion/extension of the head (M1)

M1: flexion/extension of the head compared to C7/T1 angle from the reference position (in degrees)

$$\text{Flexion}_{\text{head}} = \text{Angle}_{\text{head}} - \text{Reference}_{\text{head}} - (\text{Angle}_{\text{C7}} + \text{Reference}_{\text{C7}})$$

2. Evaluation of forward and backward bending of the head (M2)

M2: head bending compared to the vertical axis from the reference position (in degrees)

$$\text{Bending}_{\text{head}} = \text{Angle}_{\text{head}} - \text{Reference}_{\text{head}}$$

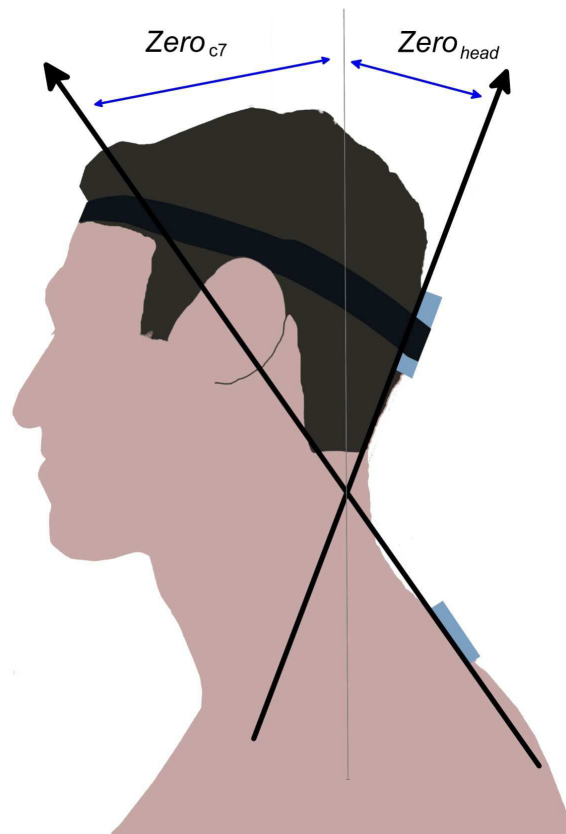

Figure 1: Reference position for each individual «standing, right up, arms beside of body, looking at forward». For this person,  $zero_{C7}=38^\circ$  et  $zero_{head}=9^\circ$ .  $Zero_{head}$ = Value of the inclinometer placed in the behind of the head in neutral position ;  $Zero_{C7}$ = Value of the inclinometre placed in C7/T1 in neutral position

The results of both methods were classified into five categories. The thresholds were extracted from the observation method:

- Extension  $> 30^\circ$
- Extension between  $0^\circ$  and  $30^\circ$
- Flexion between  $0^\circ$  and  $20^\circ$
- Flexion between  $20^\circ$  and  $45^\circ$
- Flexion  $> 45^\circ$

The results are presented as percentages of the whole work duration. To compare the difference between two quantified methods, we used Analysis of variance (ANOVA) statistical test.

### 3. Video Observation method:

Workers were filmed while performing their work using a digital camcorder. An ergonomist then analyzed the tasks at each station and determined the neck posture. The neck postures of each subject at different stations were graded according the following criteria. These criteria were derived from an in-house observational method in a truck assembly plant (10):

- Red if the worker spent more than 5 seconds in flexion  $> 45^\circ$  or extension  $> 30^\circ$ .
- Yellow if the worker spent more than 5 seconds in flexion between 20 and  $45^\circ$ .

- Green for flexion < 20° and extension < 30°.

## Results

The results from the three methods for all four stations and four operators are shown in Table 2. To compare M1 and M2 results with the observation method, a color was also attributed to them using the same criteria. 33% of the results from the observation method differed from the biomechanical measurements (yellow for the observation method versus red for biomechanical evaluation).

The results of M1 and M2 were statistically different for two categories:

- Flexion between 0° and 20° (p=0.0427)
- Flexion > 45° (p=0.0005)

Moreover, workers were significantly different (p=0.01) for flexion > 45° with the M1 method.

Table 2: The percentage of the time exposure to risk factors over data recording for methods M1 and M2. Four stations were performed by each operator (15 data recording). The colors show risk zone classification by each method; the red is high exposure to risk factors and the yellow is moderate exposure

Nom	Station	Method	Extension>30° (%)	0°<extension <30° (%)	0° <flexion <20° (%)	20°<flexion <45° (%)	Flexion <45° (%)
OP1	ST1 (12:11 min)	M1	0	7	49	43	0
		M2	0	2	23	62	14
		Observation	Yellow (20-45) >5 second				
	ST2 (10:09 min)	M1	0	7	75	18	0
		M2	0	6	55	37	2
		Observation	Yellow (20-45) >5 second				
	ST3 (15:03 min)	M1	0	29	48	23	0
		M2	0	14	42	39	6
		Observation	Red (>45) >5 second				
	ST4 (25min)	M1	8	44	39	11	1
		M2	0	41	38	18	3
		Observation	Red (>45) >5 second				
OP2	ST1 (9:07 min)	M1	6	62	33	0	0
		M2	1	22	36	42	0
		Observation	Red (>45) >5 second				
	ST2 (9:28 min)	M1	0	9	44	47	1
		M2	0	2	23	59	17
		Observation	Red (>45) >5 second				



	ST3 (17:15 min)	M1	0	13	43	42	2
		M2	0	9	38	36	18
		Observation	Red (>45) >5 second				
	ST4 (33 min)	M1	6	29	29	34	3
		M2	7	27	26	28	14
			Observation	Red (>45) >5 second			
OP3	ST1 (10 min)	M1	0	0	22	72	5
		M2	0	0	8	54	38
			Observation	Yellow (20-45) >5 second			
	ST2 (12:18 min)	M1	0	0	38	47	8
		M2	0	2	20	60	18
			Observation	Yellow (20-45) >5 second			
	ST3 (11 min)	M1	0	0	35	49	4
		M2	0	1	24	54	21
			Observation	Red (>45) >5 second			
	ST4 (23:18 min)	M1	0	26	40	29	4
		M2	2	16	36	40	9
			Observation	Yellow (20-45) >5 second			
OP4*	ST1 (10:00 min)	M1	0	3	18	72	7
		M2	0	1	14	39	47
			Observation	Yellow (20-45) >5 second			
	ST2 (8:52 min)	M1	0	4	21	67	9
		M2	0	1	18	54	26
			Observation	Yellow (20-45) >5 second			
	ST3 (7:17 min)	M1	3	24	43	31	0
		M2	0	12	23	50	15
			Observation	Red (>45) >5 second			

\*Data recording was performed for Operator 4 over three stations

## Discussion

The aim of this study was to evaluate head movements in the sagittal plane by various methods and compare the results. Head movements cause movement of the cervical and superior-dorsal rachis, and even sometime

the lumbar rachis. It is thus difficult to evaluate the exact mobility of the head, particularly by eye. Observers usually evaluate head movements compared to the vertical axis (11), without taking into account the workers' characteristics (particularly their reference position). A high value for the reference position of C7/T1 can significantly affect and decrease the flexion percentage or increase the extension percentage. For the same tasks, M2 led to a high percentage of flexion  $> 45^\circ$  whereas M1 classified them in the  $0^\circ$  to  $20^\circ$  flexion category. Hence, M2 was stricter than M1: head bending in the sagittal plane was higher than flexion. High bending values (M2) are caused by trunk bending and head inclination not being separated. Workers had two options when looking toward their work, bending the neck or bending the back. The C7/T1 inclinometer measures the back's contribution. It therefore takes into account inter-individual variability, which explains the statistically significant difference between M1 and M2 for flexion  $> 45^\circ$ . Some tasks displace the back to greater or lesser extent depending on the worker. Posture measurement of dentists has indicated high levels of inclination of the head due to bending of the back ( $15^\circ$ ) and head flexion ( $39^\circ$ ) (12). For the same task, workers select a preferred motor control strategy that can depend on age, sex and morphological parameters such as weight (13) and physical fitness (14). This variability can be exhibited for similar activities (15); (16); (7). Although the four workers recorded in this study came from a homogeneous group, they still displayed different strategies for the same tasks. This inter-individual variability suggests that different workers are exposed to different levels of risk, and has to be taken into account to improve risk evaluation. The M1 method specifically evaluates risk factors of the cervical rachis, whereas M2 evaluates risk factors of the rachis overall.

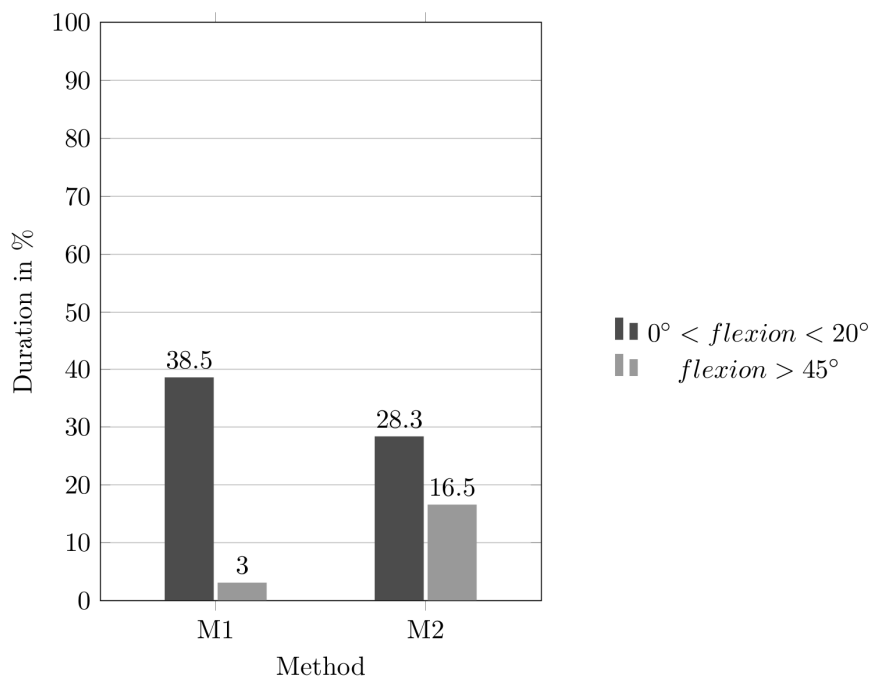

Figure 2: The mean of duration (percentage of total time of station) in flexions  $<20^\circ$  et  $>45^\circ$  for method M1 and method M2.

In the video observation method (method most commonly used by ergonomists and practitioners in industries), the observer has to evaluate head movements by eye according to very precise values indicated in the method. Indeed, most observational methods specify both durations and thresholds for flexion/extension of the neck,

e.g. the worker should not spend more than 5 seconds within a cycle time in flexion  $> 45^\circ$  or extension  $> 30^\circ$ . However, results obtained by direct measurement method (inclinometer) showed that the 5-second threshold was sometime exceeded regardless of the method used (M1 or M2). This explains the red ratings for M1/M2 whereas the observation method rated the station yellow. The observer underestimates the time spent in the awkward postures. Despite the instructions for the observation method, the observer does not have the visual capacity to evaluate a worker's movements precisely and compare them to the limits. Indeed, head movements are complex because they are three-dimensional. Human eyes cannot extract movement in a plane from a single point of view. Furthermore, the observer's mobility is constrained by work situation limitations. The observer is not always in a favorable position to evaluate movement in the required plane, especially since they have to evaluate magnitude, frequency and duration at the same time (Figure 2). As a result, this study indicates that the observation method under-evaluates movements, which is in accordance with the literature (17). However, Juul-Kristensen (18) compared head bending evaluated by both observation method and inclinometer. Their results showed that the observation method reported longer durations of flexion  $> 20^\circ$  than the direct method.

This study was performed in the real field which the lack of participants were the main limitation. Furthermore, time and technical constraint relating to assembly line caused difficulties over the measurement. Hawthorn effect might be the confounding factor in our study as operators may change their behavior when they are recorded or observed. However, we asked them to perform their tasks in a usual way as much as possible. Several data recording that performed for one operators in this study can also reduce this effect.



Figure 3: Operator in the workstation with two inclinometers placed at the behind of the head and adhered to C7/T1. This picture shows the difficulty of the observer to assess the movements of head from just one viewpoint as it is constrained by the actual work situation inappropriate for evaluating head bending

We recommend evaluating head movements in the sagittal plane using the M1 method. This method measures head inclination in relation to C7/T1, i.e. the flexion/extension of the head. For risk factor analysis, the M2 method should be avoided when evaluating head bending since it does not take into account inter-individual differences, leading to an over-estimation of the risks. As for the observation method, it does not take into account the reference position, and there is a discrepancy between the very precise angles and the inherent limitations of the human eye, along with the practical limitations of observing workers in real work situations. Therefore, using an observation method to evaluate neck risk factors is questionable.

## **Acknowledgements**

We thank all of our colleagues in SCANIA production, Angers, and in the Laboratory of Ergonomics & Epidemiology in Occupational Health for their valuable collaboration. This work was supported by the French National Research Program for Environmental and Occupational Health of Anses (2012/2/007) and the SCANIA Angers Production group.

## **Authors' contribution**

All authors had contributions to the design and progress of this research. MZ and SB collected and analyzed the data. The paper is written by SB, MZ and AG. RB contributed to the progress of study and the interpretation of the results. The study was performed under supervision of YR and he contributed to the interpretation of the results.

## References

1. Law EYH, Chiu TT-W. Measurement of Cervical Range of Motion (CROM) by electronic CROM goniometer: A test of reliability and validity. *Journal of back and musculoskeletal rehabilitation*. 2013;26(2):141-8.
2. Jordan K, Dziedzic K, Jones P, Ong B, Dawes P. The reliability of the three-dimensional FASTRAK measurement system in measuring cervical spine and shoulder range of motion in healthy subjects. *Rheumatology*. 2000;39(4):382-8.
3. Dvir Z, Prushansky T. Reproducibility and instrument validity of a new ultrasonography-based system for measuring cervical spine kinematics. *Clinical Biomechanics*. 2000;15(9):658-64.
4. Mannion A, Klein G, Dvorak J, Lanz C. Range of global motion of the cervical spine: intraindividual reliability and the influence of measurement device. *European Spine Journal*. 2000;9(5):379-85.
5. Lau HMC, Chiu TTW, Lam T-H. Measurement of craniovertebral angle with electronic head posture instrument: criterion validity. *Journal of rehabilitation research and development*. 2010;47(9):911-8.
6. Edmondston SJ, Henne S-E, Loh W, Østvold E. Influence of cranio-cervical posture on three-dimensional motion of the cervical spine. *Manual therapy*. 2005;10(1):44-51.
7. Demaille-Wlodyka S, Chiquet C, Lavaste J-F, Skalli W, Revel M, Poiraudau S. Cervical range of motion and cephalic kinesthesia: ultrasonographic analysis by age and sex. *Spine*. 2007;32(8):E254-E61.
8. Loudon JK, Ruhl M, Field E. Ability to reproduce head position after whiplash injury. *Spine*. 1997;22(8):865-8.
9. Youdas JW, Garrett TR, Suman VJ, Bogard CL, Hallman HO, Carey JR. Normal range of motion of the cervical spine: an initial goniometric study. *Physical Therapy*. 1992;72(11):770-80.
10. Bjurvald M. Ergonomic Strain Unit, Swedish Work Environment Authority, Guide values for loads, Technical Occupational Health Care Association, 1991/2 pages 13-18.
11. Zare M, Biau S, Croq M, Roquelaure Y. Development of a Biomechanical Method for Ergonomic Evaluation: Comparison with Observational Methods. *International Journal of Social, Management, Economics and Business Engineering*. 2014;8(1):223-7.
12. Åkesson I, Hansson G-Å, Balogh I, Moritz U, Skerfving S. Quantifying work load in neck, shoulders and wrists in female dentists. *International archives of occupational and environmental health*. 1997;69(6):461-74.
13. Malmström E-M, Karlberg M, Fransson PA, Melander A, Magnusson M. Primary and coupled cervical movements: the effect of age, gender, and body mass index. A 3-dimensional movement analysis of a population without symptoms of neck disorders. *Spine*. 2006;31(2):E44-E50.
14. Castro WH, Sautmann A, Schilgen M, Sautmann M. Noninvasive three-dimensional analysis of cervical spine motion in normal subjects in relation to age and sex: an experimental examination. *Spine*. 2000;25(4):443-9.
15. Hansson G-Å, Balogh I, Ohlsson K, Granqvist L, Nordander C, Arvidsson I, et al. Physical workload in various types of work: Part II. Neck, shoulder and upper arm. *International Journal of Industrial Ergonomics*. 2010;40(3):267-81.
16. Möller T, Mathiassen SE, Franzon H, Kihlberg S. Job enlargement and mechanical exposure variability in cyclic assembly work. *Ergonomics*. 2004;47(1):19-40.
17. Leskinen T, Hall C, Rauas S, Ulin S, Tönnnes M, Viikari-Juntura E, et al. Validation of Portable Ergonomic

Observation (PEO) method using optoelectronic and video recordings. *Applied Ergonomics*. 1997;28(2):75-83.

18. Juul-Kristensen B, Hansson G-Å, Fallentin N, Andersen J, Ekdahl C. Assessment of work postures and movements using a video-based observation method and direct technical measurements. *Applied ergonomics*. 2001;32(5):517-

### 4.3. Quantitative measurement of physical risk factors in the assembly line

After developing the protocol and selecting the right method for direct measurement in the assembly line, the assessment was performed for different body segments. Article 6 addresses the results of measurement of head, arm, back and wrist postures and movements in truck assembly operators for the second cycle time. Data processing and analysis of direct measurement by electronic devices were performed by a signal processing engineer. The report of the data processing is presented in Appendix 11. It provides how the data was treated and other details such as sampling rate, specifications of the sensors, etc. The following table shows the gaps, aims and findings of this investigation in the truck assembly line.

Gaps	Aims	Findings
Few studies have reported physical exposure workload for truck assembly operators quantitatively.	To measure quantitatively physical workload for head, arm, back and wrist in truck assembly operators	The findings revealed precise information about time exposure, variability and potential risk factors which occur in the real workplace
Dose-response relationship for WR-MSDs and variability of exposure to risk factors are vague among truck assembly operators.	To calculate the duration of exposure at each workstation and explore variation based on workstations and Improvement Groups (IG)	<p>The result is helpful to improve the methods that evaluate individual exposure</p> <p>Precise measurements provide objective data that facilitate the discourse about work strategies, movements and posture for a group of operators performing the same or similar tasks</p>

#### 4.3.1. Article 6: Quantification of physical ergonomic work load in truck assembly operators: Neck, back, arms and wrists

Zare M, Biau S, Roquelaure Y. *Quantification of physical ergonomic work load in truck assembly operators: Neck, back, arms and wrists. Under review by Applied Ergonomics.*

## Title Page: Original Article

# Quantification of physical ergonomic work load in truck assembly operators: Neck, back, arms and wrists

Running Title: Quantitative workload measurement

**Mohsen Zare<sup>1</sup>**

**Sophie Biau<sup>1,2</sup>**

**Yves Roquelaure<sup>1</sup>**

1 LUNAM, University of Angers, Laboratory of Ergonomics and Epidemiology in Occupational Health (LEEST), Angers, France

2 French Institute of Horse and Equitation, National School of Equitation, BP 207 - 49411 Saumur Cedex, France

**Corresponding Author:** Mohsen Zare

**Address:** LUNAM, Université d'Angers, Laboratoire d'ergonomie et d'épidémiologie en santé au travail (LEEST), Angers, France

**Email Address:** mohsen@zare.fr

Tel: +33787722141



## Abstract

**Objectives:** To investigate the potential risk factors of musculoskeletal disorders in automotive industry, physical workload was measured for head, arm, back and wrist for truck assembly operators. We quantified the proportion of time in postures above set thresholds for each workstation.

**Background:** Quantitative measurements are useful to address all aspects of the job that might cause the development of WMSDs. These data provide insight into the range of awkward postures experienced by automotive assembly operators.

**Methods:** Fourteen work positions (13 individuals) of a truck assembly plant were selected for the study and seven sensors including tri-axial accelerometers for the arms and back, inclinometers for the neck and electrogoniometry for quantifying flexion/extension of the right and left hands were fixed to the body segments of each operator.

**Results:** The proportions of time in moderate awkward postures (yellow) were high at all workstations. Neck exposure to moderate and high risks was greater than for the other body segments and the percentages of flexion/extension of the wrist (left and right) were also high. The percentages of exposure to risk factors (moderate and high) for the right arm were higher than for the left arm although they were correlated.

**Conclusion:** The findings provide objective and quantitative data about time exposure, variability and potential risk factors in the real workplace which are appropriate for estimating the risk of musculoskeletal disorders.

**Application:** Quantitative measurements in the field provide objective data of the body postures and movements of work tasks that can be helpful in the WMSDs prevention program.

**Keywords:** Quantitative measurement, Flexion/extension, Body parts, Automotive assembly plant

## Introduction

Ergonomic workloads are currently a challenge for many automotive industries (Zare et al., 2015). Physical workloads can lead to work-related musculoskeletal disorders (WR-MSDs), poor product quality and productivity (Falck, Ortengren, & Hogberg, 2010; Pereira Da Silva, Amaral, Mandagara, & Leso, 2014). This industry involves tasks with many risk factors such as awkward postures and movements, and hand-intensive tasks (Hägg, 2003). The car industry thus needs strategies and approaches to control physical workloads and reduce WR-MSDs. Ergonomic programs have been developed, most of which focus on physical ergonomics (Hägg, 2003; Neumann, 2004; Neumann & Village, 2012). In contrast to other adverse occupational risk factors, assessing physical workloads is mostly qualitative. Qualitative/semi-qualitative methods are useful as screening tools for identifying major risk factors and visualizing the ergonomic situation, but quantitative measurements might provide more reliable information that manufacturers need to create new improvement strategies. Current risk assessment methods used in the automotive industry in general reveal little evidence of exposure dose for awkward body/limb postures and they are unable to show variability. Furthermore, the precise time of exposure to risk factors and the degree of flexion/extension, particularly for micro postures (such as neck and wrist postures), are not often measurable by video observation methods (Takala et al., 2010). Qualitative methods often ignore duration of exposure to moderate risk factors (yellow level) in one task when high risk exposure (red level) is identified in this task. However, recent studies have shown that moderate risks might intensify the effects of high risk exposure (Falck et al., 2010; Zare et al., 2015). Furthermore, quantitative measurements are needed in epidemiological studies to establish dose-response relationships for WR-MSDs (Akesson, Balogh, & Hansson, 2012).

The study presented here focused on quantitative measurement of movements and postures of truck assembly operators who are susceptible to the development of musculoskeletal symptoms, particularly in the upper limb and the back (Hussain 2004). Few studies quantified exposure of different body segments to awkward postures in the truck assembly industry. However, it is valuable to have quantitative data obtained from live workers performing real work, which provide insight into work postures of operators for completing their tasks. Hansson et al examined the usability of an inclinometer based on a triaxial accelerometer and a goniometer in a series of laboratory studies in three standardized assembly tasks (Balogh et al., 2009; Hansson et al., 2006). They have then measured the quantitative physical workloads of the head, arms and wrists in a wide variety of real work tasks (Hansson et al., 2010). Norman et al (1998) measured biomechanical back risk factors in the automotive assembly industry and reported the strong association with the risk of low back pain (Norman et al., 1998). McClellan et al (2009) and Punnett et al (2000) have quantitatively reported biomechanical shoulder loading in the automobile assembly plant (McClellan et al., 2009; Punnett et al., 2000). However, the present study reports quantitative values of head, arm, back and wrist postures and movements in a truck assembly plant. The aim of this study was therefore to quantify the proportion of time in awkward posture for a series of truck assembly workstations. The specific purpose was to provide quantitative information of body segments' postures experienced by operators.

# Materials and Methods

## Workplace description

Quantitative measurement of body movements was performed on operators in a truck assembly plant in France. One sector of this factory with 14 workstations (known as work positions in the factory) was selected (Figure 1). Some workstations were broken down into several positions in order to facilitate data collection. However, we tried to record data as close as possible to a usual working day. Each workstation had its own group of operators who often worked in this area. The assemblers rotated between workstations in this area every two hours. Many companies create smaller groups of operators to achieve continuous improvement within a working area (Liljedahl & Muftic, 2012). The factory studied applied this principle and there were three Improvement Groups (IGs) in the sector under investigation (Figure 1). The roles of each IG and the number of workstations and operators were as follows:

- Improvement Group 1 (IG1): Assembly of left/right boarding steps and left/right mudguards (four workstations, 6 operators)
- Improvement Group 2 (IG2): Pre-assembly and assembly of bumper (five workstations, 7 operators)
- Improvement Group 3 (IG3): Pre-assembly and assembly of Selective Catalytic Reduction (SCR) system, pre-assembly of air filter, cab tilt cylinder and material picking (five workstations, 8 operators) (Figure 1).

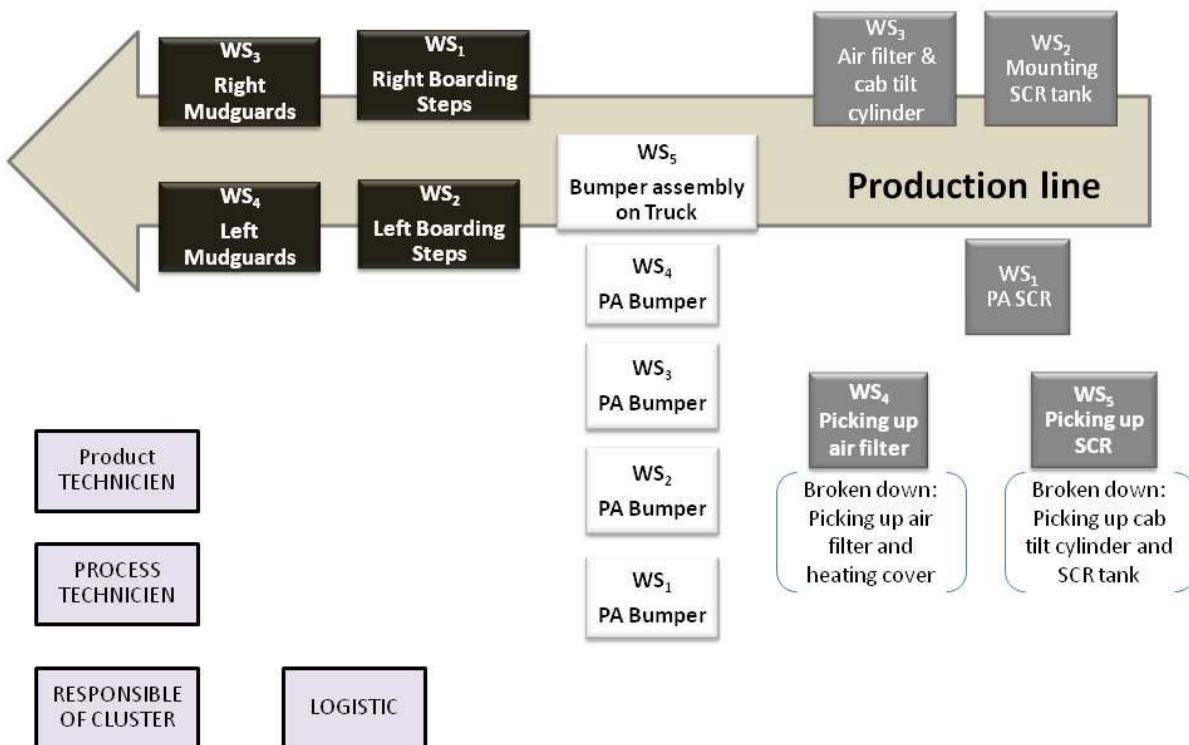

Figure 1. Organization of Workstations (WS), IG1 (Improvement Groups1) - black, IG2 – white (PA: Pre-assembly), IG3 – grey (two models of truck – SCR Euro 5 & 6 – were assembled at WS1 & WS2 of IG3).

This sector had 21 operators, 13 of whom participated in our study (IG1=4; IG2=5 and IG3=4 operators). Temporary operators without enough experience and operators with the history of musculoskeletal disorders were excluded from the study. All the participants were men, and the mean age was 39.0 ( $\pm 8.7$ ) years and the mean length of work experience in the current job was 13.9 ( $\pm 7.3$ ) years. The mean of weight and height of the participants were 175.5 ( $\pm 5.9$ ) and 72.8 ( $\pm 8.8$ ), respectively. All subjects consented to participate in the investigation. The cycle time for each workstation was 8 minutes. The cycle time, known as takt time in the factory, was adapted according to production volume and customer demand in the assembly plant.

## Measurement

We used a measurement system that included acquisition software, seven sensors and a data logger (CAPTIV system, TEA, France). Data logger (attached to the operator's belt) was configured with sensors wirelessly and it recorded each measurement and stored in a memory. After the measuring period, the data logger was connected to the computer and the CAPTIV software was used to read out the data and display the measurement signals over time. Operators were filmed throughout measurements in order to obtain a visual reference and the movies were synchronized with exposure recordings.

The sensors included accelerometers, inclinometers and goniometers were fixed with double-sided adhesive directly on the skin and additional straps used to ensure their position remained fixed. The sensors were placed on the participants according to the previous study (Hansson et al., 2010; Kazmierczak et al., 2005). Two tri-axial accelerometers were placed in lateral side of the right/left arms in the middle of the humerus (the Y-axis was vertical). The line from the rounded head of the acromion to the lateral epicondyle was measured and divided into two for the placing of accelerometers on the humerus. Another accelerometer was placed with the vertical Y-axis at L3 on the lower back. Each accelerometer measured between +1 g and -1 g, with the frequency of 128 Hz and the resolution of 3mg. To measure the neck posture, data were sampled using two inclinometers placed on the occipital bone (a saucer-shaped membrane bone situated on the lower part of the cranium) and on the cervico-thoracic spine at C7-T1. This method of calculation of head posture has been published in comparison with other methods (Zare, Biau, Gourlay, Brunet, & Roquelaure, 2015). The accuracy of the inclinometer was 1° if  $<15^\circ$  and 2° if  $>15^\circ$ . Its resolution and frequency were 12 bits and 16 Hz, respectively. Biaxial electro-goniometry was used to measure flexion/extension of the right and left hands. Two goniometers were fixed over the third metacarpal bone of the hand and to the distal dorsal side of the forearm. The accuracy and frequency of measurement by goniometer were 2° and 32 Hz, respectively. The inclinometer provided one signal that represented the angle of flexion/extension, sampled at a frequency of 16 Hz,. The goniometer provided one signal representing the angle of hand flexion/extension, sampled at a frequency of 64 Hz,. The accelerometer provided three signals which represented the acceleration (g number, acceleration of earth gravity) at three orthogonal axes of the sensor, sampled at a frequency of 128 Hz.

During the field data collection, all operators who worked at a workstation were recorded (at least four/five work cycles for each workstation). Data were recorded continuously and the average data collection time was 41 min, 38 min and 97 min for IG1, IG2 and IG3, respectively. The records were then broken down into single workstation using CAPTIV software where the results for several cycles were averaged to evaluate the mean exposure per cycle for all the operators. The participants were recorded in the morning or afternoon at the start

of a shift. A total of 126 recordings were made for 13 operators and 14 workstations (each workstation was recorded at least four cycles).

## Data Processing

All data processing was carried out in Scilab (free open-source alternatives to Matlab) (Enterprises Scilab, 2012). The primary aim of the data processing was to obtain the right/left arm and back posture from acceleration signal, the angle between head and upper back, i.e. flexion/extension of the neck and flexion/extension of the wrist from zero position (corresponding to the wrist posture in alignment with the forearm). All sensors were calibrated to ensure that the z-axis accelerometers and inclinometers corresponded to the vertical, and the goniometers corresponded to the perfectly aligned position of joints being measured. Inclinometers and goniometers provided angular data which required no special pre-treatment, but several processes such as calculation of angles and filtering of signals (to eliminate vibrations and micro-movements) were required. Measurement of angles based on a tri-axial accelerometer was performed according to the literature (Hansson, Asterland, Holmer, & Skerfving, 2001). The accelerometer measures the magnitude ( $\rho$ ), inclination ( $\varphi$ ) and direction ( $\theta$ ) of the body segment acceleration. The position of the sensor is described by the spherical coordinates ( $\rho$ ,  $\varphi$ ,  $\theta$ ). However, each sensor comprises three uni-axial accelerometers that were mounted orthogonally according to x, y and z axes. The initial signals have to be converted from orthonormal vector of the sensor into spherical coordinate system, via the change of basis of the vectors:

$$x = \rho \sin(\theta) \cos(\varphi); y = \rho \sin(\theta) \sin(\varphi); z = \rho \cos(\theta)$$
$$\rho \geq 0; 0^\circ \leq \theta \leq 180^\circ; -180^\circ \leq \varphi \leq 180^\circ$$

During static conditions,  $\rho$  corresponds to gravitation ( $\rho \approx g \approx 9.81 \text{ms}^{-2}$ ),  $\varphi$  represents the extent of inclination relative to vertical and  $\theta$  provides the direction of inclination. According to the literature, it is assumed that the conditions are quasistatic, or at least that the dynamic acceleration component do not influence the calculation of inclination ( $\varphi$ ) (Hansson, Asterland, et al. 2001). To convert Cartesian coordinates into spherical, the following equation was used:

$$\varphi = \tan^{-1} \left( \frac{y}{\sqrt{x^2 + z^2}} \right)$$

A low-pass Butterworth filter of 4th order with cutoff frequency of 5 Hz (Hansson et al. 2001, Bernmark, and Wiktorin 2002) was used to distinguish periods of activity/rest of a body segment (Figure 2).

## Reference position

One challenge in measuring operator movements was the selection of reference positions. Absolute zero inclination (compare to vertical, in most cases) is the actual reference used when the sensors are calibrated, but this is seldom a real zero reference position. The reference position, anatomically, is described as the human body upright, feet close together, the arms beside the body and the palms facing inward. Recent literature cites the importance of taking into account the morphological and functional differences between individuals (Hansson et al., 2006; Kazmierczak et al., 2005; Zare et al., 2014; Zare et al., 2015). The reference position of each operator was therefore recorded in this study at the beginning and the end of data recording for each workstation, while the operator maintained his own reference position for about 5 seconds. The mean over 5 second measurement was used as a reference position to calculate the angles of movements of body parts.

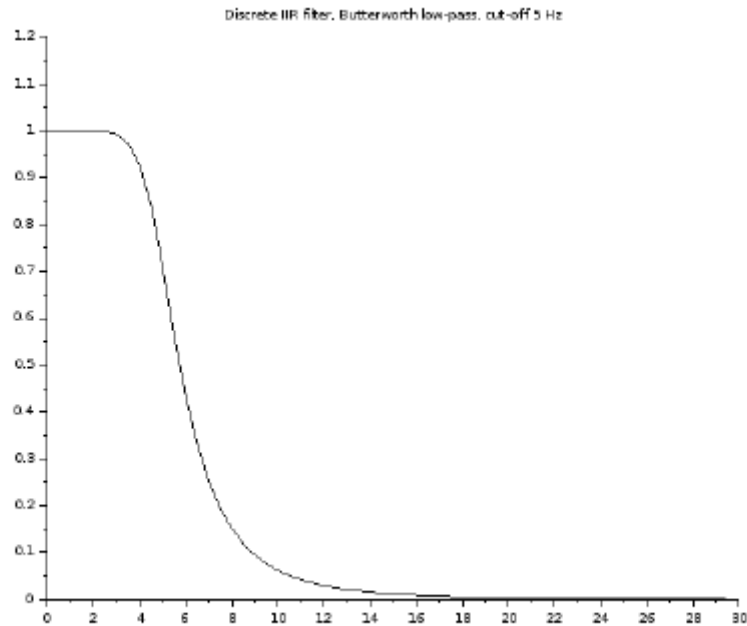

Figure 2: A low-pass Butterworth filter used to distinguish periods of activity/rest of a body segment

## Classification of physical workload

Angle measurements were classified in several categories according to predetermined thresholds (the thresholds of the in-house observational method used in the factory under study). These thresholds were similar to those were reported in pervious study (Lowe et al. 2014, Lowe 2004a, Lowe 2004b) and in ISO 11226: 2000. If a static awkward posture for a body segment lasted for at least five seconds in a cycle time (8 minutes), it was considered as risk factors (yellow or red):

- For the arms: angles from 0° to 45° were considered without risk (green ), 45° to 90° moderate risk (yellow), and >90° extreme risk (red).
- For the back: the thresholds of these risk categories were defined as: 0° to 20° flexion non-risk (green), 20° to 45° moderate risk (yellow) and >45° extreme risk (red)
- For the neck: angles between -30° (extension) and 20° (flexion) were considered without risk (green), 20° to 45° moderate risk (yellow), and inclinations > 45° or <-30° high risk (red)
- For the wrists: angles <-30° (extension) and >45° (flexion) were considered as high risk (red) and the other angles were without risk (green).

The percentage of time that the angles of body segments fell in the defined risk zone as well as the 9th and 91st percentiles were calculated.

## Results

Final analysis of the data was performed for the workstations in each IG and the proportion of the time in awkward postures during one cycle time are presented in Tables 1 and 2.

## Proportion of the time in awkward posture in IG1

The right arm was in the red zone for 3.3% of cycle time for workstation one (right boarding step) and 5.2% of cycle time for workstation two (left boarding step). The mudguards were assembled in workstations three & four, and exposure to high risk posture (red) for the right arm was less than 1% (Table 1).

The risk for the lower back was red for less than 1% of the cycle time, except at workstation Four (more than 2%). The neck was in moderate flexion/extension (yellow) for more than 30% of the cycle time for workstations one to four.

Table 1: the proportion of the time in awkward postures for workstations (WS) over one cycle time for Improvement Groups one (IG<sub>1</sub>) and two (IG<sub>2</sub>) for different risk levels

Body segment	Risk zone	IG1				IG2				
		WS*1 Right Boarding steps	WS 2 Left Boarding steps	WS 3 Right mudguard	WS 4 Left mudguard	WS 1 Bumper pre-assembly	WS 2 Bumper pre-assembly	WS 3 Bumper pre-assembly	WS 4 Bumper pre-assembly	WS 5 Bumper assembly
Right Arm (%)	Green	73.3	68.3	79.8	79.9	81.1	73.2	74.3	76.4	82.7
	Yellow	23.4	26.5	19.7	19.8	17.9	26.0	23.2	23.1	17.1
	Red	3.3	5.2	0.5	0.4	1.0	0.8	2.6	0.4	0.2
Left Arm (%)	Green	84.7	76.8	89.7	86.1	89.1	81.4	84.2	85.5	85.5
	Yellow	13.4	19.8	10.2	13.9	10.9	18.0	15.1	14.0	13.9
	Red	1.9	3.5	0.1	0.1	0	0.6	0.8	0.5	0.6
Lower Back (%)	Green	87.9	93.9	74.2	74.7	81.7	90.6	83.5	84.4	85.0
	Yellow	11.6	6.0	25.0	23.3	17.9	9.0	16.4	14.7	13.1
	Red	0.4	0.1	0.9	2.1	0.4	0.4	0.2	0.9	2.0
Neck Flexion/extension (%)	Green	53.3	68.6	57.1	55.3	58.1	47.1	69.9	59.9	59.1
	Yellow	43.8	29.2	35.1	38.5	40.2	49.8	28.1	37.7	37.1
	Red	2.9	2.2	7.8	6.2	1.7	3.1	2.0	2.3	3.8
Right wrist (%)	Green	83.7	84.7	84.9	84.1	88.3	97.3	95.6	96.8	96.1
	Red	16.3	15.3	15.1	15.9	11.7	2.7	4.3	3.2	3.9
Left wrist (%)	Green	89.4	95.4	89.2	90.6	89.7	83.2	93.4	83.9	83.9
	Red	10.7	4.6	10.8	9.4	10.4	16.8	6.6	16.2	16.1

\*Workstation

Workstations one and two were red for the right wrist for 16.3% and 15.3% of the cycle time. Although the assembly operation was similar at workstations one and two (assembly of boarding step), high exposure to awkward posture was significantly different for limbs between these two workstations. A similar pattern was observed for workstations three and four (Table 1).

## Proportion of the time in awkward posture in IG2

There were wide differences in exposure to awkward posture between IG1 and IG2. The risks for the right arm were red for 1% and 2.5% of the cycle time at different workstations while for the left arm were red for less

than 1% of the cycle time. Exposure to moderate risk (yellow) was high for all workstations, varying between 17% and 25% of the cycle time (Table 1). Exposure to red levels of risk for the lower back was low. However, exposure to yellow levels of risk was considerable. Neck flexion/extension at red levels was almost 3% at different workstations. In contrast, exposure to yellow levels of risk for neck posture was significantly higher (more than 30% of cycle time). There was a considerable difference between left and right wrist exposure to red levels, and the proportion of time in awkward posture (red level) was high for the left wrist at workstations two to five.

### Proportion of the time in awkward posture in IG3

Right arm exposure to red levels was low at most workstations (about 1% of cycle time). However, the proportion of time in moderate risk for the right arm was high. The same pattern of exposure was observed for the left arm. Exposure to awkward neck postures was significant. We found extreme neck flexion/extension for 14.9% of the cycle time for assembly of the Euro 5 SCR tank on the chassis, while extreme neck flexion/extension occurred in 6.2% of the cycle time for the new generation of SCR tank. The proportion of time in awkward posture increased for assembly of the new generation of SCR tank (high and moderate risk was more than 50% of the cycle time) (Table 2).

Table 2: The proportion of time in awkward postures for workstation (WS) in an assembly plant over one cycle time for Improvement Group three (IG3) for different risk levels

Body segment	Risk zone	WS1* SCR tank Pre-assembly		WS 2 SCR tank assembly		WS 3 assembly of air filter	WS 4 Picking up air filter		WS5 Picking up SCR tank	
		Euro5†	Euro6†	Euro5	Euro6		air filter	heating cover	SCR tank	cab tilt cylinder
Right Arm	Green	72.5	67.9	80.5	74.6	69.6	71.9	69.8	79.6	69.5
	Yellow	26.6	31.5	19.8	25.0	27.8	26.7	27.4	19.2	27.0
	Red	0.9	0.6	0.3	0.4	2.6	1.4	2.8	1.2	3.6
Left Arm	Green	75.4	77.5	76.9	84.0	74.3	77.9	78.0	81.0	73.2
	Yellow	23.2	21.6	22.4	15.6	23.0	20.5	20.8	17.5	24.0
	Red	1.5	0.9	0.7	0.3	2.7	1.6	1.3	1.5	2.7
Lower Back	Green	88.8	84.2	76.9	79.6	79.3	78.0	73.6	78.9	77.3
	Yellow	10.9	15.4	22.0	19.4	18.9	19.2	24.6	20.1	20.9
	Red	0.3	0.4	1.2	1.0	1.7	2.8	1.8	1.0	1.8
Neck Flexion/extension	Green	66.3	38.6	49.1	46.6	65.6	56.7	62.9	39.4	48.0
	Yellow	29.3	57.0	36.0	47.3	30.9	40.1	32.6	54.7	46.3
	Red	4.4	4.5	14.9	6.2	3.5	3.2	4.5	5.9	5.7
Right wrist	Green	83.1	81.3	84.5	87.2	83.2	81.8	66.1	57.9	81.9
	Red	16.9	18.7	15.5	12.8	16.8	18.2	33.9	42.1	18.1
Left wrist	Green	89.9	90.7	91.6	89.8	89.9	90.8	90.0	86.7	92.6
	Red	9.3	9.3	8.4	10.2	10.1	11.0	10.0	13.3	7.4

\* Workstation

† Two types of Selective Catalytic Reduction (SCR) tank were prepared and assembled at these workstations.



Workstation three in IG3 involved assembly of the air filter on the truck chassis. Right and left arms showed similar patterns of exposure to awkward postures, as they were exposed to red levels of risk for 2.6% and 2.7% of the cycle time. The proportion of time in yellow exposure for the right arm was greater (27.8% of cycle time) than for the left arm (23%). Lower back exposure to high and moderate risk levels was 1.7% and 19.9% of cycle time, respectively. The proportion of time to red risk levels for the neck and wrists were high (i.e. 3.5% of cycle time for the neck, 16.8% for the right wrist and 10.1% for the left) (Table 2).

The level of risk for the right arm was red for 2.8% of the cycle time at the SCR picking up workstation and 3.6% of the cycle time for the "picking up heat cover" workstation. The left arm was exposed to high risk for more than 2% of the cycle time only in the "picking up heat cover" workstation. Exposure to moderate risk was roughly similar for left and right arms, and it was more than 20% at most of the picking up workstations. Lower back exposure to awkward postures was high for moderate flexion while extreme flexion represented about 1 or 2% of the cycle time in the picking up workstations. A level of risk for the neck posture existed for more than 60% of the cycle time in moderate or extreme flexion/extension in the picking up/preparation of cab tilt cylinder workstation. The right wrist was at the red level for 33.9% and 42% of the cycle time in the picking up SCR workstation and picking up/preparation of cab tilt cylinder workstation, respectively. In contrast, the risk for the left wrist was red for less than 10% of the cycle time in the picking up workstations except for the picking up/preparation of the cab tilt cylinder workstation (13.3% of the cycle time).

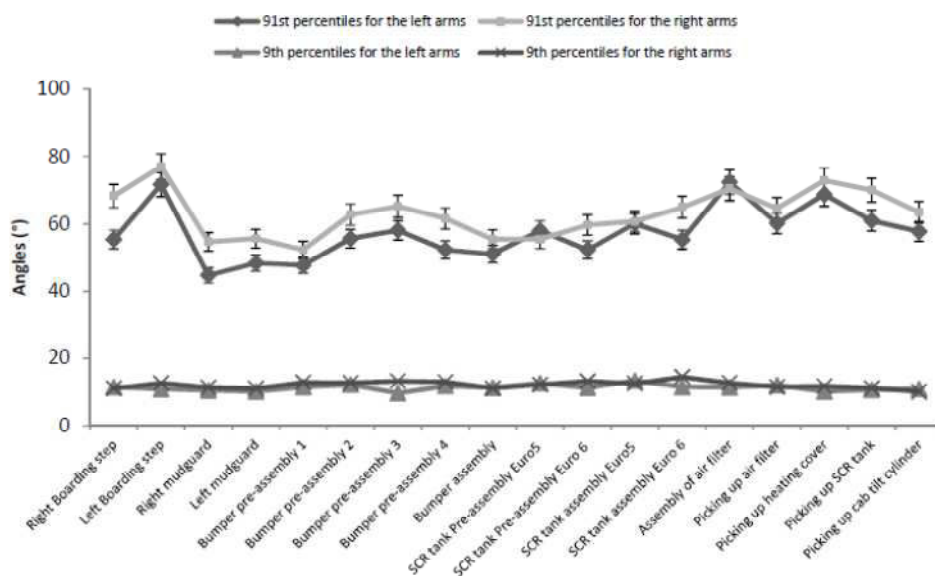

Figure 3. The right and left arms angle values for 91st and 9th percentiles for different workstations in a truck assembly plant. See Figure 1 for description of the workstations.

### Movement of Body Segments

The highest and the lowest values (91st and 9th percentiles) for the right and left arms are illustrated in Figure 3 for all workstations. The highest angle value for arm elevation (mean approximately 70°) was for the assembly of left and right boarding step systems, preparation of the bumper, picking up the SCR and assembly

of the air filter on the truck chassis. Elevation of the right arm was in general higher than the left arm (Figure 3).

The highest value for the 91st percentile for back flexion angles was for assembly of the right mudguards and picking up the SCR. The average back flexion angle for the 91st percentile was 25.4° (Figure 4). The average values of neck angles for the 91st and 9th percentiles were 35.9° and -4.70°, respectively.

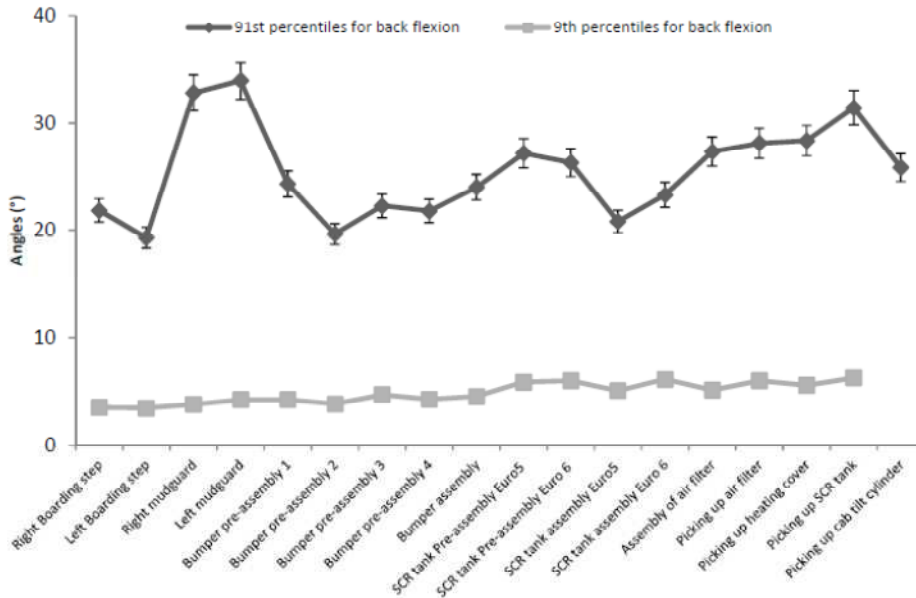

Figure 4. The back angle values for 91st and 9th percentiles for different workstations in the truck assembly plant. See Figure 1 for description of the workstations.

We did not observe any wide difference between the mean neck angles for the 91st (flexion) and 9th (extension) percentiles at various workstations. The difference was very particularly small for the workstations within the IGs (Figure 5).

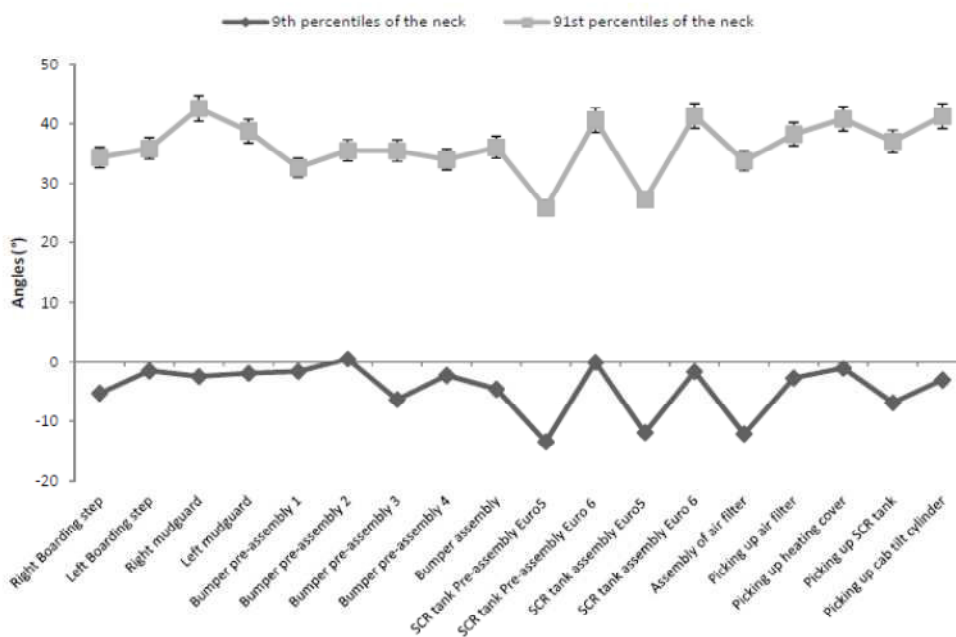

Figure 5. The neck angle values (91st and 9th percentiles) for different workstations in the truck assembly plant. See Figure 1 for description of the workstations.

There were wide differences in right/left wrist angles between workstations for the 9th percentile (extension), although it was similar for the right wrist angles for workstations of IG1 (Figure 6).

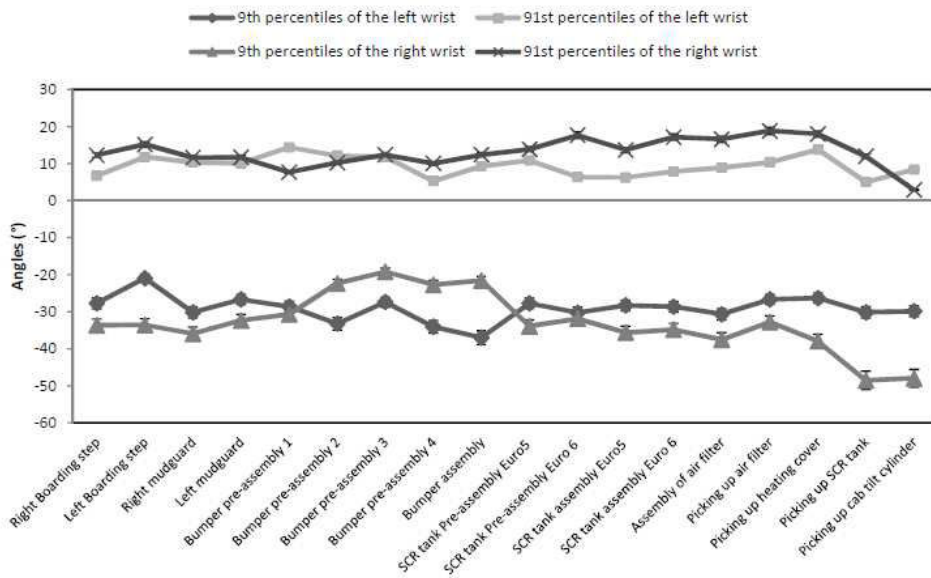

Figure 6. The right/left wrist angle values (91st and 9th percentiles) for different workstations in the truck assembly plant. See Figure 1 for description of the workstations.

## Discussion

This study was designed to quantify the proportion of time in awkward postures of operators in a real assembly plant. Our measurements showed a range of exposures to awkward postures for each body segments over operations. The percentages of exposure to moderately awkward postures (yellow) were much higher than for exposure to high risk awkward postures (red). However, exposure to moderately awkward postures increased when the percentage of exposure to red risks was high at one workstation. Neck exposure to moderate and high risks was greater than for the other body segments and the percentage of exposure during one cycle time was more than 50% at some workstations. The percentages of flexion/extension of the wrist for both sides were also high, although for the wrist we considered two risk levels (i.e. no risk (green) and high risk (red)). The proportion of time in risk (moderate and high) for the right arm was higher than for the left arm although they were correlated.

We used a tri-axial accelerometer as an inclinometer to measure arm elevation and lower back movement. Several studies have shown that this is a valid method with little error (Hansson et al., 2010; Hansson et al., 2001). However, this method has limitations because the accelerometer cannot separate rotation from flexion/extension, i.e. back flexion with rotation or abducted/adducted arm cannot be distinguished from arm flexion/extension (Hansson et al., 2010). We filmed all the workstations measured and synchronised the recordings with the measurements. This enabled us to distinguish rotation from flexion/extension for the assembly tasks, although rotation could not be quantified with this method.

The type of work investigated in this study was real truck assembly work and the most frequent activities were tasks such as tightening with electrical/hydraulic pistol grip screwdrivers or angle nutrunner, lifting/handling of parts and assembly of wires, cables and strips. These tasks were distributed between different workstations and repeated every 8 minutes according to production volume. These tasks were repetitive and sometimes required

force and awkward postures. Although the nature of the truck assembly work was similar at various workstations, we found a significant difference in physical workload between different workstations. The operators had to perform almost identical tasks at workstations assembly of right and left boarding steps in IG1. Despite the identical tasks, we observed that the workloads were different. The reason for this might be that operators' gestures were not the same on the right and left sides. Furthermore, although we measured right/left workstations on the same day, there were some variations in performing the same tasks between different cycle times. These variations were related to production, deviations and intra operator variability. Hansson et al reported such variations as "between-minute" variations which indicate varied work and might decrease the risk of WMSDs (Arvidsson et al., 2012).

Head posture was more constrained than other body segments at most workstations. The percentages of exposure to moderate risk for the neck were extremely high. Neck postures were less constrained for the assembly of new generation SCR on trucks but the exposure to yellow levels of risk in the SCR preparation workstation was higher for the new generation than for the Euro 5 SCR (Table 2). The reason might be related to increased frequency of tightening with screwdrivers that required moderate neck bending. Although the exposure time for the neck was high among assembly operators, they did not report high levels of pain or disorders in the neck. Hansson et al (2010) showed that the neck flexion for the 90th percentile was high in repeated industrial work and was about 30° for car assembly operators (Hansson et al., 2010). In another laboratory study by Hansson et al (2006), the mean of the 90th percentile for neck flexion was between 30° to 50° for three standard assembly tasks (Hansson et al., 2006). We observed similar results in our study as the mean neck flexion for the 91st percentile was 35.9°. On the other hand, neck extension (9th percentile) was -4.7° for truck assembly workers. There have been wide ranging reports for neck extension for different types of industrial work. Hansson et al (2010) reported neck flexion between 0° to 40° for repeated industrial work.

Shoulder posture was a red risk at all workstations although the percentage of exposure was low. The high exposure of right and left arms in IG1 was related to assembly of the boarding steps, the main reasons for arm elevation being cabling and tightening to the side of the truck and over the boarding step. In IG2, assembly of the lighting box on the bumper required arm elevation of more than 90° and the duration was about 3% of cycle time. The height of the wagon for carrying the bumper, and mounting the lighting box on the top of the bumper required excessive right arm elevation. The percentage of moderate arm elevation was markedly higher than for extreme arm elevation, as the mean exposure to yellow risk was 17.5% of cycle time versus 1.2% for red. Hansson (2010) et al reported high arm elevation in a few industrial types of work, and arm elevation was moderate in most types of work in that study (Hansson et al., 2010). Although exposure to high risk was not frequent at most workstations in our study, the main musculoskeletal disorders in operators in the factory were related to the shoulders. These results therefore demonstrate the importance of taking into account not only exposure to high risk awkward posture but also moderate exposure among truck assembly operators, particularly in the shoulders and upper arm in order to reduce musculoskeletal disorders. Nordander et al (2013) reported an increase in the prevalence of complaints with different types of work due to increases in arm elevation, angular velocity and muscular activity (Nordander et al., 2013). The mean upper arm elevation for the 91st percentile in our study was 62° and 57° for right and left arms, respectively, and similar results

were reported in Hansson et al's study as the 99th percentile for upper arm elevation was between 60° to 100° for various types of repeated industrial work (Hansson et al., 2010).

Lower back flexion was moderate for most workstations (mean exposure to moderate flexion: 17% of cycle time). The picking up air filter workstation had the highest exposure to red levels of risk because picking up the air filter from the pallet required extreme back flexion. The back was also in a awkward posture at the mudguard workstation because of the light cabling on the rear of the mudguard. The mean for the 91st percentile for back flexion was 25° in this study. Hansson et al (2006) reported that the means for the 90th percentile for upper back flexion were 14° for standard light/heavy assembly tasks and 35° for picking up equipment (Hansson et al., 2006). Burdorf et al (1991) reported that the mean for trunk posture was 12.3 (±8.4) for workers with activities such as welding, pipe-fitting, repairing and assembling (Burdorf & Laan, 1991). On the basis of work features, task types and people characteristics, the mean for back flexion would probably be different in various workplaces, as we observed in this study compared to other similar research. Although back flexion was not identified as a major WR-MSDs risk factor for assembly operators in this study, the symptoms of low back pain were relatively high. There might be other reasons such as material handling and heavy physical activity, combined with moderate or extreme back flexion that increase back symptoms. Some literature reports have indicated a strong association between heavy lifting, back flexion and low back pain (Walsh, Varnes, Osmond, Styles, & Coggon, 1989). However, other studies have shown that occupational lifting is not an independent causal agent for back disorders (Wai, Roffey, Bishop, Kwon, & Dagenais, 2010) and the mixed effects of leisure time activities, heavy physical work load, vibration, trunk flexion/extension/twisting and heavy lifting on back disorders remain to be established (Bakker, Verhagen, van Trijffel, Lucas, & Koes, 2009).

Wrist flexion/extension was more frequent for picking up the SCR and preparation of cab tilt cylinder tasks. The mean exposure to red levels of risk was 14.8% for the right wrist and 10.2% for the left for the whole study population. Wrists/hands were involved in many tasks such as tightening, picking up and assembling in the truck assembly operations and these tasks often required extra force. The combination of awkward postures, force and repetition might therefore increase WMSDs in the hand/wrist. Hand/wrist symptoms were relatively high in the population under investigated. Balogh et al (2009) reported mean angles of right and left wrist flexion/extension to be -16° and -14°, respectively, for standardized assembly tasks in the laboratory, i.e. more than in our study in a real assembly plant (right wrist: -10.1° and left wrist: -8.9°) (Balogh et al., 2009). There are usually differences between measurements in real workplaces and in simulated work tasks. Furthermore, in real workplaces there are day-to-day differences in ergonomic workload because of variation in work tasks, products (truck models) and individual strategies for performing tasks. These variations are more apparent for micro postures such as wrist and neck flexion/extension. In this study, the right wrist was generally more exposed to risk, with means of flexion/extension for 9th and 91st percentiles of -33.1° (versus -28.7° for left wrist) and 12.8° (versus 9.4° for left wrist), respectively. Similar results were reported in Hansson et al's study of various types of work (Hansson et al., 2009, 2010). However, the proportion of time in awkward postures was higher for the left wrist in IG1 and IG2. The main reason for wrist flexion/extension was tightening using screwdrivers and performing tasks that required extra force such as connecting hoses and pushing/pulling wagons.

The number of subjects under investigation was the main limitation of the study. It was difficult for the operators to perform their tasks with the sensors placed on their bodies. Therefore, we could not conduct the experiments on a large population. We propose measurement of the risk factors in the assembly plant with a larger population for further study, taking into account WMSDs symptoms and their relationships with risk factors. Furthermore, real manufacturing workplaces have many constraints that possible confounding factors lead to bias in the measurements. The main constraints were time limitations (operators had to perform their tasks over determined cycle times) and line stops (because of technical problems) which sometimes caused the operator change his strategy to perform work tasks. The Hawthorn effect might also have occurred in our results as the operators' behaviours were probably influenced when measurement equipment was placed on the body and he was followed and filmed in his work tasks. However, we had several meetings with the operators during this study and the purposes were explained to them and they volunteered to participate in the experiments. Furthermore, we measured several operators for each workstation which should have reduced the confounding factors.

The findings revealed precise information about time exposure, variability and potential risk factors which occur in the real workplace. However, such a biomechanical approach might not be applicable for large populations because of the time required and the costs, but these results may be used to improve the methods that evaluate individual exposure. Furthermore, precise measurements provide a discourse about work strategies, movements and posture for a group of operators performing the same or similar tasks. In other words, self-confrontation and discussion between stakeholders might be more successful and effective for continuous improvements if they were performed on the basis of these quantitative measurements of exposure.

## Key points

- Quantitative measurement of physical risk factors provides critical data for WMSDs prevention and effectiveness of ergonomic intervention, but time and cost constraints limit the ability to apply in manufacturing industry.
- On the basis of a quantitative measurement, we can measure a dose-response relationship of musculoskeletal disorders for car assembly operators.
- Objective data of a quantitative approach are fundamental for convincing different stakeholders to implement ergonomic improvement programs. The proportions of time in awkward postures are different (diversity) for performing similar tasks which opens the efficient discussions between operators that could finally lead to change in their work strategy and reduce exposure to risk factors.

## Acknowledgements

This study was sponsored by the French National Research Program for Environmental and Occupational Health of Anses (2012/2/007) and the SCANIA Angers Production group. The authors are grateful for the collaboration of the managers and operators of the SCANIA group and all members of LEEST who helped with this project. We would also like to show our gratitude to Antoine Gurley, engineer of signal processing, for his collaboration in data processing.

## Authors' contribution

All authors had contributions to the design and progress of this research. MZ collected the data, wrote the paper and interpreted the results. SB contributed to the progress of study and the interpretation of the results. The study was performed under supervision of YR; he contributed to the interpretation of the results and the revision of the paper.

## References

- Akesson, I., Balogh, I., & Hansson, G.A. (2012). Physical workload in neck, shoulders and wrists/hands in dental hygienists during a work-day. *Applied Ergonomics*, 43, 803-811. doi: 10.1016/j.apergo.2011.12.001
- Åkesson, I., Hansson, G.Å., Balogh, I., Moritz, U., & Skerfving, S. (1997). Quantifying work load in neck, shoulders and wrists in female dentists. *International archives of occupational and environmental health*, 69, 461-474.
- Arvidsson, I., Balogh, I., Hansson, G.Å., Ohlsson, K., Åkesson, I., & Nordander, C. (2012). Rationalization in meat cutting – consequences on physical workload. *Applied Ergonomics*, 43, 1026-1032.
- Bakker, E.W., Verhagen, A.P., van Trijffel, E., Lucas, C., & Koes, B.W. (2009). Spinal mechanical load as a risk factor for low back pain: A systematic review of prospective cohort studies. *Spine*, 34, E281-E293.
- Balogh, I., Ohlsson, K., Nordander, C., Skerfving, S., & Hansson, G.Å. (2009). Precision of measurements of physical workload during standardized manual handling part iii: Goniometry of the wrists. *Journal of Electromyography and Kinesiology*, 19, 1005-1012.
- Burdorf, A., & Laan, J. (1991). Comparison of methods for the assessment of postural load on the back. *Scandinavian journal of work, environment & health*, 17, 425-429.
- Enterprises Scilab. (2012). Scilab: Free and open source software for numerical computation. Scilab Enterprises, Orsay, France, 3.
- Falck, A.C., Ortengren, R., & Hogberg, D. (2010). The impact of poor assembly ergonomics on product quality: A cost-benefit analysis in car manufacturing. *Human Factors and Ergonomics in Manufacturing & Service Industries*, 20, 24-41. doi: 10.1002/hfm.20172
- Hägg, G.M. (2003). Corporate initiatives in ergonomics—an introduction. *Applied Ergonomics*, 34, 3-15.
- Hansson, G.Å., Balogh, I., Ohlsson, K., Granqvist, L., Nordander, C., Arvidsson, I., Åkesson, I., Unge, J., Rittner, R., Strömberg, U. (2009). Physical workload in various types of work: Part i. Wrist and forearm. *International Journal of Industrial Ergonomics*, 39, 221-233.
- Hansson, G.Å., Balogh, I., Ohlsson, K., Granqvist, L., Nordander, C., Arvidsson, I., Åkesson, I., Unge, J., Rittner, R., Strömberg, U. (2010). Physical workload in various types of work: Part ii. Neck, shoulder and upper arm. *International Journal of Industrial Ergonomics*, 40, 267-281.
- Hansson, G. Å., Asterland, P., Holmer, N.G., & Skerfving, S. (2001). Validity and reliability of triaxial accelerometers for inclinometry in posture analysis. *Medical and Biological Engineering and Computing*, 39, 405-413.
- Hansson, G.A., Arvidsson, I., Ohlsson, K., Nordander, C., Mathiassen, S.E., Skerfving, S., & Balogh, I. (2006). Precision of measurements of physical workload during standardised manual handling. Part ii: Inclinometry of head, upper back, neck and upper arms. *J Electromyogr Kinesiol*, 16, 125-136. doi: 10.1016/j.jelekin.2005.06.009
- Hussain, T. (2004). Musculoskeletal symptoms among truck assembly workers. *Occupational Medicine*, 54, 506-512. doi:10.1093/occmed/kqh087.
- Kazmierczak, K., Mathiassen, S. E., Forsman, M., Winkel, J. (2005). An integrated analysis of ergonomics and time consumption in Swedish 'craft-type' car disassembly. *Applied ergonomics*, 36, 263-273.
- Liljedahl, A., & Muftic, A. (2012). Managing production deviations: A case study at scania ab. (master of science), KTH, sweden.
- Lowe, B.D. 2004a. "Accuracy and Validity of Observational Estimates of Shoulder and Elbow Posture." *Applied*



Ergonomics 35:159-71.doi:10.1016/j.apergo.2004.01.003.

Lowe, B.D. 2004b. "Accuracy and Validity of Observational Estimates of Wrist and Forearm Posture." *Ergonomics* 47: 527-54.doi: 10.1080/00140130310001653057.

Lowe, B.D., P.L. Weir, and D.M. Andrews. 2014. "Observation-based Posture Assessment: Review of Current Practice and Recommendations for Improvement." US Department of Health and Human Services, Centers for Disease Control and Prevention, National Institute for Occupational Safety and Health, Cincinnati, OH: U.S. DHHS (NIOSH) Publication 2014-131.

McClellan, A. J., Albert, W. J., Fischer, S. L., Seaman, F. A., Callaghan, J. P. (2009). Shoulder loading while performing automotive parts assembly tasks: a field study. *Occupational Ergonomics*, 8, 81-90.

Neumann, W.P. (2004). *Production ergonomics: Identifying and managing risk in the design of high performance work systems*. (PhD thesis), Lund University, Sweden.

Neumann, W.P., & Village, J. (2012). Ergonomics action research ii: A framework for integrating hf into work system design. *Ergonomics*, 55, 1140-1156. doi: 10.1080/00140139.2012.706714

Nordander, C., Ohlsson, K., Åkesson, I., Arvidsson, I., Balogh, I., Hansson, G.-Å., Strömberg, U., Rittner, R., Skerfving, S. (2013). Exposure-response relationships in work-related musculoskeletal disorders in elbows and hands—a synthesis of group-level data on exposure and response obtained using uniform methods of data collection. *Applied ergonomics*, 44, 241-253.

Norman, R., Wells, R., Neumann, P., Frank, J., Shannon, H., Kerr, M. (1998). A comparison of peak vs cumulative physical work exposure risk factors for the reporting of low back pain in the automotive industry. *Clinical Biomechanics*, 13, 561-573.

Pereira Da Silva, M., Amaral, F.G., Mandagara, H., & Leso, B.H. (2014). Difficulties in quantifying financial losses that could be reduced by ergonomic solutions. *Human Factors and Ergonomics in Manufacturing & Service Industries*, 24, 415-427. doi: 10.1002/hfm.20393

Punnett, L., Fine, L. J., Keyserling, W. M., Herrin, G. D., Chaffin, D. B. (2000). Shoulder disorders and postural stress in automobile assembly work. *Scandinavian journal of work, environment & health*, 26, 283-291.

Takala, E.P., Pehkonen, I., Forsman, M., Hansson, G.-Å., Mathiassen, S.E., Neumann, W.P., Sjøgaard, G., Veiersted, K.B., Westgaard, R.H., Winkel, J. (2010). Systematic evaluation of observational methods assessing biomechanical exposures at work. *Scandinavian journal of work, environment & health*, 36, 3-24.

Wai, E.K., Roffey, D.M., Bishop, P., Kwon, B.K., & Dagenais, S. (2010). Causal assessment of occupational lifting and low back pain: Results of a systematic review. *The Spine Journal*, 10, 554-566. doi: <http://dx.doi.org/10.1016/j.spinee.2010.03.033>

Walsh, K., Varnes, N., Osmond, C., Styles, R., & Coggon, D. (1989). Occupational causes of low-back pain. *Scandinavian journal of work, environment & health*, 15, 54-59.

Zare, M., Biau, S., Croq, M., & Roquelaure, Y. (2014). Development of a biomechanical method for ergonomic evaluation: Comparison with observational methods. *International Journal of Social, Management, Economics and Business Engineering*, 8, 223-227.

Zare, M., Biau, S., Gourlay, A., Brunet, R., & Roquelaure, Y. (2015). A comparison of neck bending and flexion measurement methods for assessment of ergonomic risk. *International Journal of Occupational Safety and Ergonomics (JOSE)*, 21, In press.

Zare, M., Croq, M., Hossein-Arabi, F., Brunet, R., & Roquelaure, Y. (2015). Does ergonomics improve product quality and reduce costs? A review article. *Human Factors and Ergonomics in Manufacturing & Service Industries*, In press. doi: 10.1002/hfm.20623

## 5. Comparison of Risk Assessment Methods for evaluation of WR-MSDs risk factors

### 5.1. Comparison of the SES method with the self-reported questionnaire

Automotive industries often use observational methods (such as SES method) mainly for evaluation of physical risk factors. The question is whether this evaluation is valid and could represent WR-MSDs risk factors (that are the primary reasons of WR-MSDs). Furthermore, the other stakeholders' viewpoints (operators and engineers) regarding WR-MSDs risk factors are not considered in this approach. This Chapter therefore addresses the agreement between the results of frequently used risk assessment methods such as observational methods (ergonomist perspective), self-reported questionnaires (operator perception) and direct measurement methods (engineer method). The first section of this Chapter presents the comparison between the SES method (an in-house observational method) and a self-reported questionnaire performed at two different cycle times of a truck assembly plant. The following table shows the gaps, aims and findings of Article 7 which addresses the comparison between these two methods for the initial cycle time (11 minutes). The results of the second cycle time (8 minutes) are similar to the first one. Article 8 which is in French provides the results of the 8 minute cycle time (Appendix 12).

Gaps	Aims	Findings
Few studies have assessed the agreement between an in-house observational method and a self-reported questionnaire	To compare the results of the in-house observational method (SES method) and the self-reported questionnaire which are frequently used in the field.	The observation and self-reported questionnaire represent different risk evaluation as they disagreed in the analysis of certain characteristics of the activity.
There is a diversity of conclusions on the agreement and complementarity of the data obtained by such tools	To investigate the agreement between these physical risk factor assessment methods	Analysis of each of the two tools could not reveal that one is more powerful than the other. However, it raises the question whether two methods had the complementary effect for estimation of WR-MSDs.

#### 5.1.1. Article 7: Are There Differences Between the Results of Risk Assessment Methods? Self-Reported Questionnaire and Observational Method

Zare M, Norval M, Bodin J, Roquelaure Y. Are There Differences Between the Results of Risk Assessment Methods? Self-Reported Questionnaire and Observational Method. Under review by Human Factors.

## **Title Page: Original Article**

# **Are There Differences Between the Results of Ergonomic Risk Assessment Methods? Self-Reported Questionnaire and Observational Method**

**Running Title: Comparison of Risk assessment Methods**

**Mohsen Zare<sup>1</sup>**

**Maxime Norval<sup>1</sup>**

**Julie Bodin<sup>1</sup>**

**Yves Roquelaure<sup>1</sup>**

1 LUNAM, University of Angers, Laboratory of Ergonomics and Epidemiology in Occupational Health (LEEST), Angers, France

**Corresponding Author:** Mohsen Zare

**Address:** LUNAM, Université d'Angers, Laboratoire d'ergonomie et d'épidémiologie en santé au travail (LEEST), Angers, France

**Email Address:** mohsen@zare.fr

Tel: +33787722141

## Abstract

**Purpose:** The importance of ergonomic job analysis tools for prevention of musculoskeletal disorders persuades us to investigate the agreement between two physical risk factors assessment methods in the industrial setting. The objective of this study was to compare the results of the in-house observational method and self-reported questionnaire, which are frequently used in the fields.

**Methods:** For data collection, a sample of operators who worked on eleven assembly workstations was selected from a truck manufacturing plant. Different tasks of these workstations were analyzed for a cycle time of 11 minutes. The risk assessment of the activity was carried out both by observation and by a self-reported questionnaire. The agreement between the two methods was realized with the Kappa coefficient.

**Results:** Our finding shows that the observation and self-reported questionnaire represent different risk estimation as they are disagree in the analysis of certain characteristics of the activity.

**Conclusion:** This analysis of each of the two tools does not reveal that one is more powerful than the other. However, raising the question whether two methods had the complementary effect for estimation of work related musculoskeletal risks.

**Keywords:** Observation, self-reported questionnaire, comparison, assembly line

## Introduction

Work-Related Musculoskeletal Disorders (WR-MSDs) are in their nature multi-factorial, as they are due to several reasons (Vézina 2001). These disorders are most commonly observed in the French industrial sector. In 2013, they represented 87% of all occupational diseases, at a cost of more than €865 million in France (CNAM-TS 2013). Evaluation of job characteristics constitutes a major challenge to identification of levels of exposure to WR-MSDs risk factors. Practitioners need to evaluate the risk factors for WR-MSDs precisely in order to define priorities for ergonomic interventions (Van der Beek et al. 2005). Several methods have been developed to assess exposure to risk factors, including direct measurements, observational methods, questionnaires, interviews (David 2005; Takala et al. 2010).

The precision of risk assessment remains controversial due to numerous possible biases related to data collection methods. Previous research has shown that direct measurement methods provide more reliable data than observation or self-reported questionnaires. However, direct measurement methods are time-consuming and require special support and skills (David 2005). Two methods are commonly used to obtain ergonomic data on workers' activity: observational methods and self-reported questionnaires. Several previous studies have used observational methods to assess the risks of WR-MSDs. Paper-based observational tools such as RULA (McAtamney and Corlett 1993), OCRA (Habibi et al. 2013; Occhipinti 1998), REBA (Chiasson et al. 2012; Hignett and McAtamney 2000) and QEC (Chiasson et al. 2012; David et al. 2008) are widely used to address physical risk factors. Moreover, many large industrial companies have adapted their in-house observational tools to identify the risk factors specific to their sector. Automotive industries such as Volvo Car Corporations (VVC), Peugeot-Citroen (PSA), SCANIA and General Motors developed an in-house tool for their ergonomic program (Hägg 2003; Sociali 2012; Törnström et al. 2008). Furthermore, European Assessment Worksheet (EAW) is used by big company such as Fiat, Bosch and Volkswagen (Schaub et al. 2013). However, engineers and ergonomists need reliable and valid data on WR-MSDs risk factors, taking into account variation and diversity of both job and individual. These data have to share common "work" representation of the different stakeholders' perception.

Self-reported questionnaires are widely used in epidemiological studies, and are recognized as screening tool for estimation of job-related WR-MSDs risk factors by the operators (Roquelaure et al. 2006b; Stock et al. 2005). Self-reported questionnaires and observational methods have been used in various studies (Barrero et al. 2009; Stock et al. 2005). However, few studies have assessed the agreement between an in-house observational method and self-reported questionnaire. Published studies also differ in terms of their methodology, and as they do not all present the same results, their conclusions are not unanimous. Trask et al (2010) and Spielholz et al (2001) showed that the questionnaire was weak relative to observational methods for risk identification (Spielholz et al. 2001; Trask et al. 2010). In contrast, Descatha et al. reported that self-reported questionnaires were more reliable and sensitive tools than observational methods (Descatha et al. 2009). Stock et al (2005) and Barrero et al (2009) mentioned that current studies on self-reported questionnaire cannot show the validity of self-reported exposure methods because of limitations in the study design.

The diversity of conclusions on physical risk assessment tools encouraged us to conduct our own study on the agreement and complementarity of the data obtained by such tools in the industrial sector. A pilot study was

conducted among truck assembly operators in France. The aim was to compare the results of two risk assessment tools, i.e. an in-house observational tool for automotive industry and the self-reported questionnaires.

## Materials and Methods

### Workplace description







This study was performed in a truck manufacturing company. The cycle time was 11 minutes in which the operators performed a series of tasks in a workstation, along with recovery time. Seventeen operators who worked in eleven assembly workstations were included in the study. All the subjects were men, and the mean age and length of work experience in the current job were 42.0 ( $\pm 7.6$ ) years and 15.2 ( $\pm 7.2$ ) years, respectively. The assembly workstations were distributed in three Improvement Groups (IGs) and several variant models of truck were assembled at each workstation. Most variant models in truck assembly were evaluated in this study and each model were considered as a workstation, and thus, 8, 12 and 9 workstations were defined for IG<sub>1</sub>, IG<sub>2</sub> and IG<sub>3</sub>, respectively. The common tasks performed at these workstations were assembly of truck parts, wiring, hose connection, picking up objects from a pallet, lifting and carrying parts (manually or with devices), tightening with screwdrivers, and pushing/pulling wagons. The operators rotated every two hours between the workstations of each IG.







### Data Collection

#### Observational method

An in-house ergonomic observational method (SCANIA Ergonomic Standard (SES) method) with a video recording was used to analyze all the workstations. Finally 29 evaluations (10 workstations plus 19 variant models of truck) in three IGs were conducted. The SES method evaluates 20 ergonomic risk criteria, which are grouped into four categories including repetitiveness, working posture, manual handling and energy consumption (Table 1). Weights of objects, magnitude of forces (dynamometer), and handle diameters (calliper) were measured and recorded in the SES method. Manual handling and lifting of loads with two hands were studied in more detail by means of the NIOSH equation (Waters et al. 1993). The results were classified according to a colour coding scale: the normal or green level indicating an acceptable situation with minimal risk of WR-MSDs; the yellow level indicating a moderate risk situation, which needs to be improved in the future; and the red level corresponding to situations at high risk of WR-MSDs, which must be modified as soon as possible. After studying each criterion of the SES method for each workstation, the numbers of green, yellow and red criteria determined the final colour of that workstation (Table 2). This colour-coded method is based on Swedish guidelines and it has been used in other observational methods particularly in the car industries (Berlin et al. 2009; Törnström et al. 2008). Regarding the daily rotations of the various operators to all workstations in an IG, we developed a colour-coded method of representation of the risk level for each criterion of an IG. This method is based on the logic of colour attribution (mentioned above) to one workstation (Table 2).

Table 1: Explanation of criteria evaluated by each method

	<b>Observational analysis data (indicators: green, yellow, red)</b>	<b>Self-reported questionnaire analysis data (never, rarely/often/always)</b>
Repetitiveness	Number of repeated movements per hour. < 150 rep/hour            Green 150-300 rep/hour        Yellow > 300 rep/hour            Red	Very precise repeated movements. Same movement for reasons of procedure or quality. Repetition of the same action more than twice a minute.
Whole body work postures	Usual working position: Standing/walking/sitting            Green Uncomfortable/twisted position while standing/sitting            Yellow Lying, kneeling, squatting, reclining on one side or back, standing on one leg            Red	Squatting or kneeling position  Twisting or uncomfortable posture
Back posture	Fixed back posture while working: 0 – 20° bending forward            Green 20 – 45° bending forward/ 20° - 45° sideways/rotation            Yellow > 45° bending forward or > 45° sideways/rotation or bending backward            Red	Regular or prolonged anterior flexion or to one side.
Neck posture	Fixed neck posture while working: 0-20° bending forward            Green 20-45° bending forward or 20-30° sideways/rotation            Yellow > 45° bending forward or > 30° sideways/rotation or bending backwards            Red	Regular or prolonged working position with one or both arms abducted.  Regular or prolonged anterior flexion movements of the head.  Regular or prolonged posterior flexion movements of the head. 
Shoulder posture	Fixed shoulder / arm posture while working: < 45° upper arm lifting            Green 45°-90°upper arm lifting            Yellow > 90° upper arm lifting            Red	Regular or prolonged working with one or both arms above the shoulder level.  Holding the hand behind the trunk Regular or prolonged working with one or both arms abducted 

Wrist posture	Wrist working posture:		Full pronosupination movements or extreme wrist bending posture
	Neutral wrist	Green	 Pressing with palm base or holding tools/objects in a pinch grip 
	Non-neutral wrist	Red	
	<ul style="list-style-type: none"> <li>➤ 30° bending upwards</li> <li>➤ 45° bending downwards</li> <li>➤ &gt; 10° bending sideways</li> </ul>		
Effort of palms of hands	Pressure zone area > 1 kg (> 1 kg)		Pressing with palm base
	$A \geq 1.7 \text{ cm}^2$ or $A \geq 7 \text{ cm}^2$ $A < 1.7 \text{ cm}^2$ or $A < 7 \text{ cm}^2$	Green Red	
Force and effort of the whole body	Force of whole body pushing/traction		Pushing or pulling.
	Initial force (starting)	Continuous	
	< 100 N	< 50 N	
	100-150 N	50-110 N	Yellow
> 150 N	> 110 N	Red	Manual handling of very large and cumbersome objects with the arms outstretched.
			
			Manual handling of objects that are difficult to hold, unstable or without handles
			
Handling	Size of component handled (Size (mm) = Length + Height + Width)		Handling very large and cumbersome objects with arms outstretched.
	< 1000 mm	Green	
	1000-2000 mm	Yellow	
> 2000 mm	Red		
Two handed Manual handling of loads (lifting with two hands)	Evaluation by revised NIOSH equation method		Manual handling of a load weighing 1 to 10 k
	< 10 Nm	Green	Manual handling of a load weighing 10 to 25 kg
	10-35 Nm	Yellow	Manual handling of a load weighing more than 25 kg
	> 35 Nm	Red	
One handed Manual handling of loads (lifting with one hand)	Lifting with one hand:		Manual handling of a load weighing 1 to 10 kg
	< 2 kg	Green	Handling of a tool or an object weighing 1 to 4 kg
	2-5 kg	Yellow	
	> 5 kg	Red	



The following five thresholds were therefore defined:

- Threshold<sub>1</sub> (T<sub>1</sub>) was defined as the number of yellow points for one criterion in an IG resulting in a yellow final colour:  $T_1 = (N \div 2) + 1$  N= The number of measurements in IG
- Threshold<sub>2</sub> (T<sub>2</sub>) was defined as the number of yellow points for one criterion in an IG resulting in a final red colour:  $T_2 = N + 1$
- Threshold<sub>3</sub> (T<sub>3</sub>) was defined as the number of red points for one criterion in an IG resulting in a yellow final colour:  $T_3 = (N - 1) \div 3$
- Threshold<sub>4</sub> (T<sub>4</sub>) was defined as the number of red points for one criterion in an IG resulting in a final red colour  $T_4 = N \div 2$
- Threshold<sub>5</sub> (T<sub>5</sub>) was defined as the number of yellow points plus the number of red points for one criterion in an IG resulting in a final red colour:  $T_5 = 0.8 N$

All definitions of thresholds were rounded down and the most severe colour decided the final colour of each criterion for the IG.

### Self-reported questionnaire

A self-reported questionnaire was widely used to evaluate the operators' perceptions of physical exposure of their jobs. Several recent ergonomic epidemiological studies in France applied this tool to evaluate physical exposure dose (Descatha et al. 2007; Roquelaure et al. 2006a). This tool comprises a number of questions designed to identify potential physical risk factors for WR-MSDs. It was developed according to the European consensus criteria document for the evaluation of WR-MSDs (Sluiter et al. 2001). This questionnaire has been used in various epidemiological studies conducted in France. The questions concern repetition, the neck, shoulders, wrists/hands and back postures, material handling and force/effort for the whole body and wrists (Table 1). The response scale for each question comprises four levels: Never/Rarely/Often/ Always. As shown in Table 1, several questions were asked to assess one ergonomic criterion. To have a single answer for each criterion, we therefore combined the responses of several questions. If, for example, the answer to any of the 3 questions was "always", the final answer was then "always". If the answer to one of the 3 questions was "often" final answer was "often", otherwise, it was "never/rarely".

Table 2: Prioritization of risk factors by the SES method and the NIOSH equation method

Methods	Evaluation Criteria	Green	Yellow	Red
Ergonomic method (SES)	Standard			
	Number of Yellows*	0-8	9-16	≥ 17
	Number of Reds	0-6	7-9	≥ 10
	Number of Yellows + Reds	0-16	-	≥ 17
NIOSH Lifting Equation	Lifting Index	<1	1 -1.6	>1.6

\*The worst colour dictates the final evaluation of the work position

Questionnaires were distributed on a Friday to allow operators to fill them out carefully over the weekend and they were collected on Monday, ensuring a high response rate. Fifteen operators responded all of the questions

and included in the final analysis. Informed consent was obtained for all of subjects. This study was performed from September 2012 to August 2013. Analysis by the observational method was conducted from September 2012 to March 2013 but the results were reviewed again and revised on the basis of the video recordings in August. The operators filled out the self-reported questionnaire in July 2013.

## Comparison Criteria

We selected 11 criteria from both the SES method and the self-reported questionnaire for comparison (Table 1). The "manual handling of loads with two hands" and "one hand" criteria were studied at two different levels, as the questions on the self-reported questionnaire concern manual handling of various loads and do not specify whether these loads are handled with one or two hands. Two subgroups were therefore defined for these two items of the questionnaire, i.e. manual handling with two hands allowing analysis of loads weighing between 1 to 10 kg and 10 to 25 kg and loads weighing more than 25 kg, and manual handling with one hand allowing analysis of loads weighing 1 to 4 kg and 1 to 10 kg.

The criteria for effort/force of arms and the effort/force of the whole body corresponded to the same questions in the self-reported questionnaire. The various criteria of the questionnaire and the observational method that were compared are presented and defined in Table 1.

## Statistical Analysis

The agreement between the criteria of two methods was assessed by Kappa coefficient (Bao et al. 2009; Hansson et al. 2001; Stock et al. 2005). The unit of comparison between both methods was the operator. The responses to the questionnaire (exposure to risk factors of different workstations in one IG) were compared with the results of the SES method for the IG. "Never/Rarely" of the questionnaire and "Green" of the SES was considered as low risk; "Often" of the questionnaire and "Yellow" of the SES was moderate risk; and "Always" of the questionnaire and "Red" of the SES was high risk.

## Results

### Observational Method

Table 3 presents the results of the risk assessment for three improvement groups (IG<sub>1</sub>, IG<sub>2</sub> and IG<sub>3</sub>) according to the SES method (the results of various workstations are shown in Appendix of this paper).

Whole body work postures, and back, neck, shoulder, and wrist postures were the main risk factors identified in IG<sub>1</sub>. Awkward wrist posture was reported at all of the workstations. Exposure to risk factors such as one handed manual handling and surface area for pressure was low in IG<sub>1</sub> (Table 3).

The results for IG<sub>2</sub> showed high risk exposure for the wrist and shoulder. Repetitiveness and manual handling with two hands was low, while back and neck posture, manual handling with one hand and whole body force/effort were moderate. Note that the final risk evaluation for back, neck, shoulder and wrist postures and whole body force/effort for this IG was high (red). Awkward body posture was observed at most workstations in IG<sub>3</sub> (see Appendix of this paper). In overall, wrist posture and manual handling with two hands were red at many workstations while repetition and surface area for pressure were green.

Table 3: Analysis of SES method and self-reported questionnaire of physical risk factors for the workstations in the Improvement Groups 1, 2 and 3 (IG<sub>1</sub>, IG<sub>2</sub> and IG<sub>3</sub>) for 11 criteria of ergonomic risk factors (see Appendix of this paper for details).

Item	Analysis of SES method <sup>a</sup>			Self-reported questionnaire estimation of physical risk factors (N=15)					
	Final color <sup>b</sup>			Never/Rarely <sup>b</sup>		Often		Always	
	IG <sub>1</sub>	IG <sub>2</sub>	IG <sub>3</sub>	n	%	n	%	n	%
Repetitiveness	Green	Green	Green	0	0	5	33	10	67
Whole body work postures	Red	Yellow	Yellow	3	20	9	60	3	20
Back posture	Red	Red	Yellow	0	0	13	87	2	13
Neck posture	Red	Red	Red	1	7	11	73	3	20
Shoulder posture	Red	Red	Red	7	47	6	40	2	13
Wrist posture	Red	Red	Red	2	13	9	60	4	27
Effort of palms of hands (Surface area for pressure)	Green	Green	Green	10	67	4	27	1	6
Force/effort whole body	Red	Red	Yellow	1	7	9	60	5	33
Handling (Component size)	Red	Yellow	Red	10	67	5	33	0	0
Manual handling				0	0	8	53	7	47
Two handed (NIOSH method) <sup>c</sup>									
1-10kg <sup>d</sup>				11	73	4	27	0	0
10- 25kg <sup>d</sup>				13	87	2	13	0	0
>25 kg <sup>d</sup>				15	100	0	0	0	0
One handed <sup>c</sup>	Yellow	Yellow	Yellow						
1-4kg <sup>d</sup>				8	53	7	47	0	0
>4kg <sup>d</sup>				12	80	3	20	0	0

<sup>a</sup>Eight workstations were evaluated at the Improvement Group<sub>1</sub>, 12 workstations at the Improvement Group<sub>2</sub> and 9 workstations at the Improvement Group<sub>3</sub> (see the Appendix of this paper)

<sup>b</sup>“Green” and “Never/Rarely” show low risk; “Yellow” and “Often” show moderate risk; “Red” and “Always” show high risk

<sup>c</sup> The items of the SES method for two and one handed manual handling evaluation

<sup>d</sup> The questions of self-reported questionnaire for manual handling evaluation

## Self-reported Questionnaire

Table 3 presents the results of analysis of the self-reported questionnaires. Analysis of the self-reported questionnaires for all three IGs showed that 13 operators (87%) identified back postures as often present at their work positions. Repetitiveness and awkward whole body work postures were identified as being “often” present for 5 (33%) and 9 (60%) operators, respectively. Furthermore, 10 operators (67%) reported “always” exposure to repetitiveness.

Table 4: Comparison between observational method and questionnaire with calculation of kappa factor

	Low (Never/ Rarely; Green)		Moderate (Often; Yellow)		High (Always; Red)		Proportion of agreement	Kappa Coefficient
	n	%	N	%	n	%		
<b>Repetitiveness</b>							0	0
Observational Method	15	100	0	0	0	0		
Self-reported Questionnaire	0	0	5	33	10	67		
<b>Whole body work posture</b>							47	0.05
Observational Method	0	0	9	60	6	40		
Self-reported Questionnaire	3	20	9	60	3	20		
<b>Back posture</b>							13	-0.29
Observational Method	0	0	4	27	11	73		
Self-reported Questionnaire	0	0	13	87	2	13		
<b>Neck Posture</b>							20	0
Observational Method	0	0	0	0	15	100		
Self-reported Questionnaire	1	7	11	73	3	20		
<b>Shoulder Posture</b>							13	0
Observational Method	0	0	0	0	15	100		
Self-reported Questionnaire	7	47	6	40	2	13		
<b>Wrist Posture</b>							27	0
Observational Method	0	0	0	0	15	100		
Self-reported Questionnaire	2	13	9	60	4	27		
<b>Effort of palms of hands (Surface area for pressure)</b>							60	0.14
Observational Method	10	67	5	33	0	0		
Self-reported Questionnaire	10	67	4	27	1	6		
<b>Force/effort whole body</b>							47	0.10
Observational Method	0	0	4	27	11	73		
Self-reported Questionnaire	1	7	9	60	5	33		
<b>Handling (Component size)</b>							7	-0.05
Observational Method	0	0	5	33	10	67		
Self-reported Questionnaire	10	67	5	33	0	0		
<b>Two-handed Manual handling</b>								
Observational Method (NIOSH equation)	5	33	0	0	10	67		
Self-reported Questionnaire (handling 1 to 10kg)	11	73,3	4	26,7	0	0,0	20,0	-0,06
Self-reported Questionnaire (handling >10kg)	13	86,7	2	13,3	0	0,0	26,7	-0,03
Self-reported Questionnaire (handling >25kg)	15	100,0	0	0,0	0	0,0	33,3	0,00
<b>One-handed Manual handling</b>								
Observational Method	0	0	15	100	0	0		
Self-reported Questionnaire (handling 1 to 4kg)	0	0	8	53	7	47	53	0
Self-reported Questionnaire (handling 1 to 10kg)	2	13	9	60	4	27	60	0

All of the operators in IG<sub>1</sub> and IG<sub>2</sub> reported that they were often exposed to awkward back postures. More than half of the operators in IG<sub>1</sub> reported that they were always exposed to manual handling; awkward wrist postures and excessive effort/force of the body. For IG<sub>3</sub>, force and effort of the whole body were often or always present. The great majority of operators reported "often" exposure to different risk factors (see Appendix of this paper).

## Comparison of the Observational Method and Self-Reported Questionnaires

Table 4 presents the results of comparison of data derived from the SES method and from the self-reported questionnaire for three IGs. Both tools identified several risk factors, while the results for certain factors differed considerably according to the method of analysis, especially items such as back (Kappa = -0.29), shoulder, neck, wrist postures and repetitiveness (Kappa = 0). For the majority of criteria, the results of the two tools were similar in the moderate risk range, but were very different for extreme situations (high risk and no risk). The agreement between both methods for whole body effort/force as well as effort of palms of hands was better than for the other criteria (Kappa; 0.1 to 0.14). The calculated Kappa factor for handling criteria (component size) and two-handed manual lifting imply poor agreement between operators' estimation and ergonomist assessment in the material handling criteria (Kappa <0); however the match proportion of 53% and 60% have to be considered as show a moderate agreement between two methods for the one-handed manual lifting criterion.

## Discussion

This study compared the results obtained with two risk assessment tools: the in-house observational method (SES) and the self-reported questionnaire. The agreement of these tools was investigated for identification of physical risk factors in a truck assembly plant. This study shows that the SES method and the self-reported questionnaire do not represent the same risk evaluation, and they provide contradictory results for the analysis of certain physical risk factors. Several studies have undertaken this type of comparison and have reached different conclusions. Descatha et al. (2009) concluded that the results of the self-reported questionnaire differed from those of the observational method, and self-reported questionnaire was better predictor of the incidence of future WR-MSDs. The study by Spielholz et al. (2001) showed that the operators' perceptions were very different from the results of reference methods (observation and direct measurement) and self-reported questionnaire was unreliable. Hansson et al (2001) reported poor agreement between the direct measurement method and self-reported questionnaire. Repetitiveness was analysed by these two methods, which gave different results, as the observation tool revealed a low level of exposure, while the self-reported questionnaire identified repetitiveness as a commonly present risk factor. Other studies have also reported poor agreement for repeated movements evaluated by questionnaires and other reference methods (Juul-Kristensen et al. 2001; Stock et al. 2005).

The results concerning working postures, neck postures and back postures varied considerably, as self-reported questionnaires revealed a lower risk than the observational method. The low kappa coefficient for these criteria indicated poor agreement between the two methods. Burdorf reported that operators considerably underestimated the trunk postures adopted at work (Burdorf and Laan 1991). Takala et al (2010) and Stock et

al (2005) reported that micro-postures (the neck and wrists, and trunk rotations) are difficult for observers and operators to diagnose. These differences in the results could be explained by difficulties that operators have to represent their bodies in space, as it is difficult to take spatial representations into account while working without involving a subjective component. For example, the position of the back in space is not a natural spatial representation and it is therefore difficult for the operator to know the exact position of his back while working.

Observational analysis of shoulder postures revealed high exposure in all IGs, while only 13% of operators identified these postures as being constraining on the self-reported questionnaire. The results for wrist postures presented a similar tendency, with higher sensitivity for the observational study and less clear-cut results for the self-reported questionnaire. Operators' reports often underestimate the postures adopted and tend to focus on the pain experienced at a particular point in time. Some types of pain are experienced in a context of overexposure and it is only at this time that the operator becomes aware of the posture adopted. Previous studies reported inconsistent results regarding the presence of WR-MSDs and estimation of the exposure to risk factors by the operators. Hansson et al (2001) and Balogh et al (2004) reported the impact of WR-MSDs on overestimation of the exposure (Balogh et al. 2004; Hansson et al. 2001) while Burdorf et al (1991) found no relationship between WR-MSDs symptoms and over-exposure reporting (Burdorf and Laan 1991).

The self-reported questionnaire and the SES method did not provide concordant results for handling characteristics. Few studies have compared the results of various analysis tools for this type of criterion. Nevertheless, Stock reported a moderate correlation between the results of such tools for the handling of very large objects (Stock et al. 2005).

Whole body force/effort was identified by both tools as being present during pushing/pulling actions or handling objects. The kappa coefficient was 0.1 that reflects a slight agreement between two methods. The force/effort required by a task was measured by a dynamo-meter and reported as the results of the SES method while the questionnaire provided the general perceptions of the operators. Based on practice and experience, the operators can identify exposure to effort. However, the operator may become so used to the working conditions that he/she no longer accurately perceives the effort involved in carrying out an action. Working habits, each individual's experience and perceptions are important elements in identification of high-risk exposure, as the level of sensitivity of an operator can result in different responses in relation to the same situation. Other studies reporting the results of a similar comparison obtained a kappa coefficient as high as 0.66 for whole body force/effort criterion (Stock et al. 2005). Low agreement was reported in four studies that compared assessing push/pull forces by the questionnaires and observational methods (Barriera-Viruet et al. 2006).

The kappa coefficients for manual handling of loads with two hands and one hand were 0, although the proportions of agreement were 20% and 53%, respectively. Despite certain limitations concerning the analysis of these criteria, our results are in agreement with those reported by Stock et al (2005) who demonstrated poor agreement, particularly for the questions about number of hours/working day spent lifting or carrying loads. In our study, manual handling of loads with one hand corresponded to loads weighing less than 10 kg. In contrast, manual handling of loads with two hands corresponded to loads weighing more than 10 kg and a question about loads between 1 to 10 kg. Therefore, pooling of items, the factors selected and understanding of the questions are all potential sources of error that must be taken into account.

Several explanations can be proposed for the different results obtained with these two methods. First of all, a low Kappa factor that was, generally, observed between compared criteria might not necessarily be related to disagreement between the methods. A highly agreed estimation may receive a low Kappa factor because it is influenced by other factors such as limited variability in the distribution of exposure in the categories (Hansson et al. 2001). A small number of subjects and narrow distribution of exposure in different categories has provided a falsely low Kappa factor despite the percentage of agreement being high (Stock et al. 2005). Furthermore, although an ergonomist observed several times each workstation and analysed them by the SES method (in some cases, two ergonomists discussed and decided the assessment scores), the reliability of observational methods is the matter of debate in ergonomic literature (Denis et al. 2000; Kilbom 1994; Takala et al. 2010). On the other hand, question formulation, the response scale, respondents' pain, fatigue and mental issues were the source of errors of examining by the questionnaire. In the current study, pictograms were used to represent degrees of flexion/extension of each body segment in the questionnaire (Table 1) while the categorical limit was used for observational methods. It could be criticized that we did not compare identical variables. Nevertheless, providing categorical limits in the questionnaire might be a source of error, as operators might estimate the degree of flexion/extension on a numerical scale incorrectly. However, the pictogram took into account workers' mental representations of the workload and provided meaningful measures. The time interval to measure risk factors by each method was short in this study. We revised and modified the results of the SES assessment by using videos recorded less than two months after the questionnaires were filled out by the operators. The variations in the work situation were few over this short time interval.

Some limitations were countered during comparison of these two methods. The level of comparison of the two methods is not the same, as one is based on analysis by workstation (observational method), while the other is based on the responses of an operator who worked in an IG (self-reported questionnaire). Analysis by IG was preferred in order to have the same unit of comparison for both methods. Moreover, the results of the observational method are presented in the form of colours representing levels of exposure (Green, Yellow, Red), while the results of the questionnaire are presented in the form of scale corresponding to the duration of exposure to the risk (Never, Rarely, Often, Always). We considered "Never/Rarely" as Green, "Often" as Yellow and "Always" as Red. This allowed comparison on a common basis, but decreased the power of the comparison.

This study did not analyze the validity of each of these two methods or demonstrate the superiority of one or other of the methods. However, the findings raise a number of questions concerning the level of risk estimation by the two common ergonomic methods in the field. Neither method can be considered to be superior to the other, but the two methods provide different results, raising questions about the place of these two tools in risk assessment and about which of these two methods' results can be representative of the characteristics associated with WR-MSDs risk. There remains the question regarding the level of precision of the risk assessment provided by these two methods. We propose to extend this comparison to other tools used in risk assessment, such as interviews and the direct measurement method, which would provide more information on the validity and the place of each method during risk assessment in the workplace or for the purposes of epidemiological studies.

## Conclusion

This study compares two methods that are used frequently in the field particularly automotive industry. It can be concluded that the poor agreement was observed between the in-house observational method and the self-reported questionnaire. These findings might be explained by the method inherent differences. This comparison will enable us to recognize the positions and roles of these tools in representation of ergonomic work-related risk factors and raising the question of the complementarity of observational tools and self-reported questionnaires.

## Acknowledgements

The authors would like to thank to all of the people and institutions that contributed to this study, particularly SCANIA Angers managers and operators for their collaboration and their participation in this project.

The authors would also like to thank all members of LEEST who provided us with their technical support. This study was financially supported by and the French National Research Program for Environmental and Occupational Health of Anses (2012/2/007) and Angers SCANIA Production.

## Authors' contribution

All authors had contributions to the preparation of this paper. MZ collected the data. MZ and MN wrote the paper and interpreted the results. JB analyzed the data and contributed to the interpretation of the results. The study was performed under supervision of YR; he contributed to the interpretation of the results and the revision of the paper.



## References

- Balogh I, Ørbæk P, Ohlsson K, Nordander C, Unge J, Winkel J, Hansson G-Å (2004) Self-assessed and directly measured occupational physical activities—influence of musculoskeletal complaints, age and gender. *Appl Ergon* 35:49-56.
- Bao S, Howard N, Spielholz P, Silverstein B, Polissar N (2009) Interrater reliability of posture observations. *Human Factors* 51:292-309.
- Barrero LH, Katz JN, Dennerlein JT (2009) Validity of self-reported mechanical demands for occupational epidemiologic research of musculoskeletal disorders. *Scand J Work Environ Health* 35:245-60.
- Barriera-Viruet H, Sobeih TM, Daraiseh N, Salem S (2006) Questionnaires vs observational and direct measurements: a systematic review. *Theor Issues Ergon* 7:261-284.
- Berlin C, Örtengren R, Lämkkull D, Hanson L (2009) Corporate-internal vs. national standard—A comparison study of two ergonomics evaluation procedures used in automotive manufacturing. *Int J Ind Ergon* 39:940-946.
- Burdorf A, Laan J (1991) Comparison of methods for the assessment of postural load on the back. *Scand J Work Environ Health* 17:425-429
- Chiasson M-È, Imbeau D, Aubry K, Delisle A (2012) Comparing the results of eight methods used to evaluate risk factors associated with musculoskeletal disorders. *Int J Ind Ergon* 42:478-488. doi:<http://dx.doi.org/10.1016/j.ergon.2012.07.003>
- CNAM-TS (2013) Rapport de gestion 2013: Bilan financier et sinistralité. Caisse nationale de l'assurance maladie des travailleurs salariés, Paris
- David G (2005) Ergonomic methods for assessing exposure to risk factors for work-related musculoskeletal disorders. *Occup Med (Lond)* 55:190-199.
- David G, Woods V, Li G, Buckle P (2008) The development of the Quick Exposure Check (QEC) for assessing exposure to risk factors for work-related musculoskeletal disorders. *Appl Ergon* 39:57-69.
- Denis D, Lortie M, Rossignol M (2000) Observation procedures characterizing occupational physical activities: critical review. *Int J Occup Saf Ergon* 6:463-491.
- Descatha A, Roquelaure Y, Caroly S, Evanoff B, Cyr D, Mariel J, Leclerc A (2009) Self-administered questionnaire and direct observation by checklist: comparing two methods for physical exposure surveillance in a highly repetitive tasks plant. *Appl Ergon* 40:194-198.
- Descatha A et al. (2007) Epidemiological surveillance of work-related upper limb musculoskeletal disorders. *Archives des Maladies Professionnelles et de L'environnement* 68:153-160
- Habibi E, Zare M, Hagh A, Habibi P, Hassanzadeh A (2013) Assessment of physical risk factors among artisans using occupational repetitive actions and Nordic questionnaire. *Int J Env Health Eng* 2:1-6. doi:10.4103/2277-9183.110158
- Hägg GM (2003) Corporate initiatives in ergonomics—an introduction. *Appl Ergon* 34:3-15.
- Hansson G-Å et al. (2001) Questionnaire versus direct technical measurements in assessing postures and movements of the head, upper back, arms and hands. *Scand J Work Environ Health* 27:30-40.
- Hignett S, McAtamney L (2000) Rapid entire body assessment (REBA). *Appl Ergon* 31:201-205.

- Juul-Kristensen B, Hansson G-Å, Fallentin N, Andersen J, Ekdahl C (2001) Assessment of work postures and movements using a video-based observation method and direct technical measurements. *Appl Ergon* 32:517-524.
- Kilbom Å (1994) Assessment of physical exposure in relation to work-related musculoskeletal disorders-what information can be obtained from systematic observations. *Scand J Work Environ Health* 20:30-45.
- McAtamney L, Corlett EN (1993) RULA: a survey method for the investigation of work-related upper limb disorders. *Appl Ergon* 24:91-99.
- Occhipinti E (1998) OCRA: a concise index for the assessment of exposure to repetitive movements of the upper limbs. *Ergonomics* 41:1290-1311.
- Roquelaure Y, Ha C, Leclerc A, Touranchet A, Mariot C, Imbernon E, Goldberg M (2006a) Troubles musculo-squelettiques en France: données du réseau pilote de surveillance épidémiologique dans les entreprises des Pays de la Loire en 2002 et 2003 *Santé, Société et Solidarité* 5:35-43.
- Roquelaure Y et al. (2006b) Epidemiologic surveillance of upper-extremity musculoskeletal disorders in the working population. *Arthritis Rheum* 55:765-778.
- Schaub K, Caragnano G, Britzke B, Bruder R (2013) The European assembly worksheet. *Theor Issues Ergon* 14:616-639.
- Sluiter JK, Rest KM, Frings-Dresen MH (2001) Criteria document for evaluating the work-relatedness of upper-extremity musculoskeletal disorders. *Scand J Work Environ Health suppl* 1:1-102.
- Sociali IIdREe (2012) Motor Vehicle Manufacturers in Europe: Ergonomic Findings. Industrial European Trade Union, European Union.
- Spielholz P, Silverstein B, Morgan M, Checkoway H, Kaufman J (2001) Comparison of self-report, video observation and direct measurement methods for upper extremity musculoskeletal disorder physical risk factors. *Ergonomics* 44:588-613.
- Stock SR, Fernandes R, Delisle A, Vézina N (2005) Reproducibility and validity of workers' self-reports of physical work demands. *Scand J Work Environ Health* 31:409-437.
- Takala E-P et al. (2010) Systematic evaluation of observational methods assessing biomechanical exposures at work. *Scand J Work Environ Health* 36:3-24.
- Törnström L, Amprazis J, Christmansson M, Eklund J (2008) A corporate workplace model for ergonomic assessments and improvements. *Appl Ergon* 39:219-228.
- Trask C, Teschke K, Morrison J, Village J, Johnson P, Koehoorn M (2010) Using observation and self-report to predict mean, 90th percentile, and cumulative low back muscle activity in heavy industry workers. *Ann Occup Hyg* 54:595-606.
- Van der Beek AJ, Erik Mathiassen S, Windhorst J, Burdorf A (2005) An evaluation of methods assessing the physical demands of manual lifting in scaffolding. *Appl Ergon* 36:213-222.
- Vézina N (2001) La pratique de l'ergonomie face aux TMS: ouverture à l'interdisciplinarité. *Comptes rendus du congrès SELF-ACE*, 44-60.
- Waters TR, Putz-Anderson V, Garg A, Fine LJ (1993) Revised NIOSH equation for the design and evaluation of manual lifting tasks. *Ergonomics* 36:749-776.

## Appendix

In this study, several workstations in a improvement group (IG) evaluated by the SES method and the detailed results for each criteria are provided in Table 1. This table provides the number of workstation identified as exposed to risk in an IG. Table 2 provides the detailed results of self-reported questionnaire for each IG separately. This appendix shows the percentage of risk exposure in various IG.

Table 1: Analysis of SES method for the workstations in the Improvement Groups 1, 2 and 3 (IG<sub>1</sub>, IG<sub>2</sub> and IG<sub>3</sub>) for 11 criteria of WR-MSDs risk factors

Item	Improvement Group <sub>1</sub> <sup>a</sup>							Improvement Group <sub>2</sub>							Improvement Group <sub>3</sub>						
	Green		Yellow		Red		Final colour	Green		Yellow		Red		Final colour	Green		Yellow		Red		Final colour
	n	%	n	%	n	%		n	%	n	%	n	%		n	%	n	%	n	%	
Repetitiveness	4	50	4	50	0	0	Green	9	75	3	25	0	0	Green	9	100	0	0	0	0	Green
Whole body work postures	0	0	3	38	5	62	Red	6	50	1	8	5	42	Yellow	3	33	3	33	3	34	Yellow
Back posture	0	0	4	50	4	50	Red	1	8	8	67	3	25	Red	2	22	5	56	2	22	Yellow
Neck posture	2	25	1	13	5	62	Red	1	5	9	75	2	10	Red	0	0	5	56	4	44	Red
Shoulder posture	2	25	1	13	5	62	Red	0	0	6	50	6	50	Red	1	11	7	78	1	11	Red
Wrist posture	0	0	0	0	8	100	Red	2	17	0	0	10	83	Red	1	11	0	0	8	89	Red
Effort of palms of hands (Surface area for pressure)	8	100	0	0	0	0	Green	9	75	0	0	3	25	Green	9	100	0	0	0	0	Green
Force/effort whole body Handling (Component size)	0	0	4	50	4	50	Red	1	8	8	67	3	25	Red	3	33	3	33	3	34	Yellow
Two handed Manual handling (NIOSH method)	1	13	5	62	2	25	Red	8	67	1	8	3	25	Yellow	1	11	7	78	1	11	Red
One handed Manual handling	1	13	3	37	4	50	Red	11	92	0	0	1	8	Green	4	44	1	11	4	45	Red
	1	13	7	87	0	0	Yellow	4	33	8	67	0	0	Yellow	3	33	4	45	2	22	Yellow

<sup>a</sup>Eight workstations were evaluated at the Improvement Group<sub>1</sub>, 12 workstations at the Improvement Group<sub>2</sub> and 9 workstations at the Improvement Group<sub>3</sub>

Table 2: Self-reported questionnaire of physical risk factors in Improvement Groups 1, 2 and 3 (IG<sub>1</sub>, IG<sub>2</sub> and IG<sub>3</sub>) for 11 criteria of WR-MSDs risk factors

Item	Improvement Group <sub>1</sub> (N=6)						Improvement Group <sub>2</sub> (N=5)						Improvement Group <sub>3</sub> (N=4)						All of the subjects (N=15)					
	Never/ Rarely		Often		Always		Never/ Rarely		Often		Always		Never/ Rarely		Often		Always		Never/ Rarely		Often		Always	
	n	%	n	%	n	%	n	%	n	%	n	%	n	%	n	%	n	%	n	%	n	%	n	%
Repetitiveness	0	0	2	33	4	67	0	0	2	40	3	60	0	0	1	25	3	75	0	0	5	33	10	67
Whole body work posture	2	33	3	50	1	17	0	0	4	80	1	20	1	25	2	50	1	25	3	20	9	60	3	20
Back posture	0	0	6	100	0	0	0	0	5	100	0	0	0	0	2	50	2	50	0	0	13	87	2	13
Neck posture	1	17	3	50	2	33	0	0	4	80	1	20	0	0	4	100	0	0	1	7	11	73	3	20
Shoulder posture	3	50	1	17	2	33	2	40	3	60	0	0	2	50	2	50	0	0	7	47	6	40	2	13
Wrist posture	1	17	2	33	3	50	1	20	4	80	0	0	0	0	3	75	1	25	2	13	9	60	4	27
Effort palms of hands (surface area for pressure)	3	50	2	33	1	17	3	60	2	40	0	0	4	100	0	0	0	0	10	67	4	27	1	6
Force/effort	1	17	2	33	3	50	0	0	4	80	1	20	0	0	3	75	1	25	1	7	9	60	5	33
Handling (Component size)	3	50	3	50	0	0	4	80	1	20	0	0	3	75	1	25	0	0	10	67	5	33	0	0
Manual handling																								
1-10kg	4	67	2	33	0	0	3	60	2	40	0	0	4	100	0	0	0	0	11	73	4	27	0	0
10- 25kg	5	83	1	17	0	0	4	80	1	20	0	0	4	100	0	0	0	0	13	87	2	13	0	0
>25 kg	6	100	0	0	0	0	5	100	0	0	0	0	4	100	0	0	0	0	15	100	0	0	0	0
1-4kg	2	33	4	67	0	0	3	60	2	40	0	0	3	75	1	25	0	0	8	53	7	47	0	0
>4kg	4	67	2	33	0	0	4	80	1	20	0	0	4	100	0	0	0	0	12	80	3	20	0	0

## 5.2. Comparison of observational method, self-reported questionnaire and direct measurement

Section 2 of this Chapter addresses the comparison between the SES method, the self-reported questionnaire and direct measurement methods. As already explained, the SES method is an observational method that represents the assessment of ergonomists regarding physical risk factors in a workplace. The self-reported tool addresses the perception and estimation of the operators regarding WR-MSDs risk factors of their jobs. Finally, the direct measurement method provides quantitative data on physical ergonomic workload which are more reliable and acceptable, particularly by engineers. Article 9 of this thesis addresses the comparison between these methods and the agreement between them. The following table summarizes the gaps, aims and findings of this article.

Gaps	Aims	Findings
Little is known concerning the extent to which ergonomists and operators agree about exposure to risks, whether they have similar evaluations of risk and which evaluation is closer to reality	To compare the results of three risk assessment tools for the upper limbs and back on the assembly line (A self-reported questionnaire, an observational tool and a direct measurement method)	The operators' perceptions disagreed with the ergonomist's assessments of work postures and with the direct measurement method.
Lack of consensus in the literature about the accuracy of measurement methods		Better agreement was observed between the SES method (ergonomist assessment) and the direct measurement method.
Few studies have compared these methods for measurement of exposure to awkward postures for shoulder, back, neck and wrist in a real field		However, the validity and reliability of the observational method and the direct measurement method are still a matter debate.

### 5.2.1. Article 9: Comparison of three methods for evaluation of WR-MSDs risk factors in a truck assembly plant: observational method, self-reported questionnaire and direct measurement method

Zare M, Biau S, Brunet R, Roquelaure Y. Comparison of three methods for evaluation of WR-MSDs risk factors in a truck assembly plant Under review by *Ergonomics*.

## **Title Page: Original Article**

# **Comparison of three methods for evaluation of WR-MSDs risk factors in a truck assembly plant**

**Mohsen Zare<sup>1</sup>**

**Sophie Biau<sup>1,2</sup>**

**Rene Brunet<sup>1</sup>**

**Yves Roquelaure<sup>1</sup>**

<sup>1</sup> LUNAM, University of Angers, Laboratory of Ergonomics and Epidemiology in Occupational Health (LEEST), Angers, France

<sup>2</sup>French Institute of Equitation, National School of Equitation, Saumur, France

**Corresponding Author:** Mohsen Zare

**Address:** LUNAM, Université d'Angers, Laboratoire d'ergonomie et d'épidémiologie en santé au travail (LEEST), Angers, France

**Email Address:** mohsen@zare.fr

Tel: +33787722141

## Abstract

This study was performed to compare the results of three risk assessment tools for the upper limbs and back in the workplace. A self-reported questionnaire, an observational tool and a direct measurement method were used to measure exposure to the risk of truck assembly operators. One sector of a truck assembly plant which included several workstations was selected for data collection and the study was performed in two different cycle times (11 and 8 minutes). McNemar's test and Kappa factor were used to analyze the agreement between methods. The results revealed moderate agreement between the observational tool and the direct measurement method, and poor agreement between the self-reported questionnaire and direct measurement. The Kappa factor showed fair agreement between the SES and direct measurement method for the arm (0.41) and back (0.4) in the second cycle time. The Kappa factor for these methods was poor for the neck (0) and wrist (0) but the observed proportional agreement ( $P_o$ ) was 0.65 for both body segments. The Kappa factor between questionnaire and direct measurement showed poor or slight agreement ( $<0.2$ ) for different body segments in both cycle time.

## Practitioner Summary

This study provides the results of risk assessment by different common ergonomic methods in the field. The results help to develop valid measurements and improve exposure evaluation. Ergonomists could use these findings to perform a valid and reliable ergonomic evaluation of assembly workstations.

**Keywords:** Observational Method; Self-reported Questionnaire; Direct Measurement Method, Truck Assembly Plant

## Introduction

Musculoskeletal disorders (MSDs) are major problems in manufacturing industries (Sterud, Johannessen, and Tynes 2014, Östergren et al. 2005); their social and economic outcomes influence companies' business success (Zare, Croq, et al. 2015). Several aspects of a job such as physical, organizational and psychosocial risk factors contribute to the development of MSDs (Widanarko et al. 2015). Physical risk factors, including awkward postures, forceful exertion, repetitive movements, and manual material handling are frequent risk factors in car manufacturing industries (McGaha et al. 2014, Vijayakumar et al. 2015, Hoozemans et al. 2014). The valid measurement of physical risk factors that provides a shared representation of risks is therefore essential for practitioners and decision makers (David 2005). Risk management policies related to MSDs will be unsuccessful without cooperative action of all stakeholders to achieve accurate risk assessment and consequently intervention strategies (St-Vincent et al. 2007, Denis et al. 2008).

Different stakeholders are involved in manufacturing processes: operators are physically engaged in the work and perceive the risk factors; ergonomists analyze workstations and contribute to solutions in collaboration with industrial engineers, and finally, industrial engineers and managers are often known as ergonomics problem solvers with the contribution of ergonomists (Berlin et al. 2014). Physical risk factors are often evaluated by ergonomists or engineers on the basis of observational methods, while the operator's evaluation is usually obtained by self-reported risk assessment questionnaire (David 2005, Takala et al. 2010). The extent to which ergonomists and operators agree about exposure to risks, whether they have similar evaluations of risk and which evaluation is closer to reality, are still a matter of debate in the literature.

Another category of methods, defined as direct measurement methods, can quantify exposure to physical risk factors in the workplace more precisely. Some studies have considered direct measurement methods as references for comparison with the results of observational methods and questionnaires (Burdorf et al. 1992, De Looze et al. 1994, Village et al. 2009). Spielholz et al (2001) compared three measurement methods (questionnaire/video-observation/direct measurement) to evaluate wrist exposure to risk factors (Spielholz et al. 2001). Takala et al (2010) in a review study reported moderate agreement for body macro-postures for 19 methods that were compared either with expert evaluation from video recordings or direct measurements but low correspondence for wrist/hand, neck and trunk postures (Takala et al. 2010). Stock et al (2005) reported the usability of questionnaires (operators' assessment) as a practical method for exposure measurement (Stock et al. 2005) but Burdorf et al (1991) and Spielholz et al (2001) showed low accuracy of operators' assessments (Burdorf and Laan 1991, Spielholz et al. 2001).

There is a lack of consensus in the literature about the validity of measurement methods for upper limb risk factors. Furthermore, there are very few studies that have compared these methods for shoulder, back, neck and wrist risk exposure in a real field such as a truck assembly plant. The aim of this study was therefore to measure risk factors for upper limb and the back disorders by self-reported questionnaire and an observational/expert evaluation method among truck assembly operators, and then to compare these findings with direct measurement method.



## **Materials and Methods**

### **Workplace description**

This study was performed in a truck manufacturing company. The cycle time was 11 minutes in which the operators performed a series of tasks in a workstation, along with recovery time. Seventeen operators who worked in eleven assembly workstations were included in the study. All the subjects were men, and the mean age and length of work experience in the current job were 42.0 ( $\pm 7.6$ ) years and 15.2 ( $\pm 7.2$ ) years, respectively. The assembly workstations were distributed in three Improvement Groups (IGs) and several variant models of truck were assembled at each workstation. Most variant models in truck assembly were evaluated in this study and each model were considered as a workstation, and thus, 8, 12 and 9 workstations were defined for IG1, IG2 and IG3, respectively. The common tasks performed at these workstations were assembly of truck parts, wiring, hose connection, picking up objects from a pallet, lifting and carrying parts (manually or with devices), tightening with screwdrivers, and pushing/pulling wagons. The operators rotated every two hours between the workstations of each IG.

### **Data Collection**

#### **Observational method**

This study was carried out as a follow up investigation in two different cycle times of one sector of a truck assembly plant. Production volume determined cycle time for each workstation and it was changed from 11 minutes to 8 minutes during this study to increase production. The investigation was therefore repeated in both cycle times. The study workplace was the same for both experiments, but task distributions and workstations were different. However, the main operation, design of the workstations and final products of the sector were similar. The same protocol was followed at both cycle times. The main operations in the sector under investigation were assembly of left/right boarding steps and left/right mudguards (two workstations in the initial cycle time and four workstations in the second cycle time), pre-assembly and assembly of bumper (four workstations in the initial cycle time and five workstations in the second cycle time) and pre-assembly and assembly of the Selective Catalytic Reduction (SCR) system, pre-assembly and assembly of the air filter, cab tilt cylinder and lighting box, and material picking (five workstations in both cycle times). The initial cycle time was 11 minutes (production volume; 35 trucks/day) and the second cycle time was 8 minutes (production volume; 48 trucks/day). Eleven workstations were included for data collection in the initial cycle time. In the second cycle time, the organization of the workstations was changed and some tasks were transferred to other workstations and certain new posts were created. Furthermore, extra operators joined a variety of workstations. The number of workstations included for measurement in the second cycle time was 14, and in order to facilitate data collection, some workstations were broken down into several positions. Therefore, there were 16 workstations in the second cycle time and 20 measurements were performed due to variant models of trucks in certain workstations.

#### **Research Approach and Participants**

The first part of the study was performed from September 2012 to August 2013 in the initial cycle time.

Analyses by the observational method were conducted by viewing work in person and on video during the study from September 2012 to March 2013 but the results were reviewed again and revised on the basis of the video recordings made of direct measurements (to avoid the possible changes might occur over the timeline of the data collections by the SES method and direct measurements). The operators filled out the self-reported questionnaire in July 2013. Finally, direct measurement by electronic devices was performed at the end of August 2013 (approximately two months after the questionnaire analysis). A couple of month time interval between the self-report and the other measurements was related to the constraints of the assembly line that was impossible to perform the measurements altogether. The measurements were therefore repeated in a new cycle time with as short as possible time interval. The new organization (cycle time) was established in the factory. The second part of the study was then carried out from November 2013 to April 2014 several months after changing the cycle time, when the operators had adapted to the new conditions. First, the workstations were analyzed by observational method. The operators responded to the questionnaire in March 2014 and finally direct measurements were performed in April 2014. The time interval between the measurements was short and after measurement by one method, the next method was immediately applied. As for the initial cycle time, the results of the observational method were revised by considering the video recordings made of direct measurement to avoid bias of changes in the measurement conditions. Most of the operators in the initial and second cycle times were the same. The initial cycle time comprised 17 operators, 9 of whom participated in all phases of the study (observational method, direct measurement and questionnaire analysis). The second cycle time had 24 operators, 13 of whom participated in the analysis by all three methods. Operators without enough experience (temporary workers) and those who complained of musculoskeletal problems were excluded. All operators consented to inclusion in the study. All the participants in both cycle times were men, and the mean age for the initial cycle time was 42.0 ( $\pm 7.6$ ) and 39.0 ( $\pm 8.7$ ) years for the second cycle time. The mean length of work experience in the current job was 15.2 ( $\pm 7.2$ ) and 13.9 ( $\pm 7.3$ ) years for the initial and second cycle times, respectively. Data collection was performed by the ergonomist who was involved in the factory for three years with the help of industrial engineers and technicians.





## **Comparison of three evaluation methods**

### **Observational Physical Risk Evaluation Method**

The Ergonomic Standard (SES) is an in-house observation-based method that is adapted to the WR-MSDs risk factors in manufacturing assembly. SES includes 20 factors providing ergonomic analysis such as repetitive movement, work posture, lifting and energy consumption. In this study, different workstations were evaluated by the work posture factors (four factors including arms, back, neck, and wrist assessments) in both cycle times (Table 1) and compared with the other two methods.

The theoretical basis behind the assessment using these factors in the SES method is similar to other common observational methods applied in industry (QEC (David et al. 2008), RULA (McAtamney and Corlett 1993) and EWAS (Schaub et al. 2013)), taking into account operator actions in one cycle time, and scores are based on values for body posture angles and exposure duration (derived from ISO 11226: 2000 (ISO 2000)).

Table 1. Comparison criteria between observational method (SES), questionnaire and direct measurement method for different body segments

Body segments	Observational method (SES)	Self-reported questionnaire	Direct measurement method
Arm/shoulder	Static arm posture while working: exposure time > 5 seconds	Regular or prolonged working with one or both arms in the air (above the shoulders) regularly or in a prolonged manner. 	Static arm posture while working: exposure time > 5 seconds
	< 45° upper limb elevation Green <sup>a</sup>		< 45° upper limb elevation Green
	45°-90° upper limb elevation Yellow <sup>b</sup>		45°-90° upper limb elevation Yellow
	> 90° upper limb elevation Red <sup>c</sup>	Regular or prolonged working with one or both arms outstretched 	> 90° upper limb elevation Red
Back	Static back posture while working: exposure time > 5 seconds	Regular or prolonged anterior flexion or to one side.	Static back posture while working: exposure time > 5 seconds
	0 – 20° flexion Green		0 – 20° flexion Green
	20 – 45° flexions Yellow		20 – 45° flexion Yellow
	> 45° flexion or extension Red		> 45° flexion or extension Red
Neck	Static neck posture while working: exposure time > 5 seconds	Regular or prolonged anterior flexion movements of the head.  Regular or prolonged posterior flexion movements of the head 	Static neck posture while working: exposure time > 5 seconds
	0-20° flexion Green		0-20° flexion Green
	20-45° flexion Yellow		20-45° flexion Yellow
	> 45° flexion or > 30° extension Red		> 45° flexion or > 30° extension Red
Wrist	Wrist working posture: exposure time > 5 seconds	Non-neutral wrist posture (flexion/extension or abduction/adduction) 	Wrist working posture: exposure time > 5 seconds
	Neutral wrist Green		Neutral wrist Green
	Non-neutral wrist > 30° extension or > 45° flexion Red		Non-neutral wrist > 30° extension or > 45° flexion Red

<sup>a</sup> Green: without/minimal risk of MSD

<sup>b</sup> Yellow: moderate MSD risk

<sup>c</sup> Red: high risk of MSD

Each workstation was observed at least four times to reduce bias of measurement. Risk factors were assessed for the workstations over one cycle time and given a rating of green meaning "without/minimal risk of MSD", yellow "moderate MSD risk" (may require improvement actions) or red "high risk of MSD" (always requires action) (Table 1). If a static awkward posture for a body segment lasted for at least five seconds in a cycle time (11 or 8 minutes), it was considered as risk factors (yellow or red). In addition to viewing work in person, video recordings were also performed over the evaluations by the SES method.

### **Self-reported Questionnaire**

The self-reported questionnaire evaluated subjective estimation of exposure to risk factors for arms, back, neck and wrists over the days worked by the participants. This questionnaire was developed according to the European Consensus Criteria for MSD risk factors for the upper limbs (Sluiter, Rest, and Frings-Dresen 2001). This questionnaire is a valid and reliable tool that has been used for different epidemiological studies in France (Roquelaure, Ha, and Sauteron 2002, Roquelaure et al. 2006). Each question asks about the probability to have an awkward posture over the days worked. This awkward posture is visualized by a pictogram to supplement written information and enhance operators' comprehension of the question and the degree of flexion/extension (Table 1). The response scale was categorized on a four-point scale, i.e. "never", "rarely", "often" and "always". If the operators answered "never/rarely", this was defined as under-exposed or green, and "often" or "always" responses were considered as exposure to moderate (yellow) and high (red) level of risks, respectively. To have a single answer for several questions evaluated a risk factor, we combined the responses of these questions. If, for example, the answer to any of the three questions was "always" the final answer was then "always". If the answer to one of the three questions was "often", the final answer was "often", otherwise, it was "never/rarely".

### **Direct Measurement Method**

An electronic measurement system included acquisition software, sensors and a data logger (CAPTIV system, TEA, France) was used to obtain quantitative data on arm, back, neck and wrist postures. Seven sensors were fixed with double-sided adhesive tape to the body segments of each operator. Two tri-axial accelerometers were placed as inclinometers in lateral side of the right and left arms in the middle of the humerus to measure the upper limb (arm and forearm) movements. Another accelerometer was placed on the vertical Y-axis at L3 on the lower back to assess back posture. Each accelerometer was recorded between +1 g and -1 g, with the frequency of 128 Hz and the resolution of 3mg (Zare et al. 2014). Two inclinometers were placed on the occipital bone and on the cervico-thoracic spine at C7-T1 to measure neck posture (Zare, Biau, et al. 2015). The accuracy of the inclinometer was 1° if <15° and 2° if >15°. Its resolution and frequency were 12 bits and 16 Hz, respectively. Two goniometers were fixed over the third metacarpal bone of the hand and the distal of the radius/ulna of each forearm to measure flexion/extension of the wrist (Figure 1). The accuracy and frequency of measurement by goniometer were 2° and 32 Hz, respectively. All the sensors were connected (wireless) to a data logger attached to the operator's belt that recorded raw signals from the body segments while performing assembly tasks (Zare et al. 2014). Data were recorded continuously for the operators who worked at all of the workstations. These signals are then transferred from the logger to a PC using software and exported for processing. Operators were also filmed throughout the measurements to obtain a visual reference of the actual

tasks undertaken at workstations. The same procedure was applied for both cycle times and 42 and 126 recordings were made for 11 and 13 operators for the initial and the second cycle times, respectively.



Figure 1: Localization of seven sensors used to measure the body segment postures; (a) two goniometers on the right/left wrists and one inclinometer on the head (occipital bone); (b) two accelerometers on the right/left arms in the middle of humerus, one accelerometer on the lower back (L3) and one inclinometer on the upper back at C7-T1.

## Data Processing

Recorded data were synchronized with the video to have the corresponded image for a signal at a given time. Data processing was carried out in Scilab (Enterprises 2012) to calculate:

- The right/left arm and back posture from acceleration signal
- The angle between head and upper back, i.e. flexion/extension of the neck
- The angle flexion/extension of the wrist from zero position (corresponding to the wrist posture in alignment with the forearm)

Measurement of angles based on a tri-axial accelerometer was performed according to the literature (Hansson, Asterland, et al. 2001). The accelerometer measures the magnitude ( $\rho$ ), inclination ( $\varphi$ ) and direction ( $\theta$ ) of the body segment acceleration. The position of the sensor is described by the spherical coordinates ( $\rho$ ,  $\varphi$ ,  $\theta$ ). However, each sensor comprises three uni-axial accelerometers that were mounted orthogonally according to x, y and z axes. The initial signals have to be converted from orthonormal vector of the sensor into spherical coordinate system, via the change of basis of the vectors:

$$x = \rho \sin(\theta) \cos(\varphi); y = \rho \sin(\theta) \sin(\varphi); z = \rho \cos(\theta)$$

$$\rho \geq 0; 0^\circ \leq \theta \leq 180^\circ; -180^\circ \leq \varphi \leq 180^\circ$$

During static conditions,  $\rho$  corresponds to gravitation ( $\rho \approx g \approx 9.81\text{ms}^{-2}$ ),  $\varphi$  represents the extent of inclination

relative to vertical and  $\theta$  provides the direction of inclination. According to the literature, it is assumed that the conditions are quasistatic, or at least that the dynamic acceleration component do not influence the calculation of inclination ( $\varphi$ ) (Hansson, Asterland, et al. 2001). To convert Cartesian coordinates into spherical, the following equation was used:

$$\varphi = \tan^{-1}\left(\frac{y}{\sqrt{x^2 + z^2}}\right)$$

A low-pass Butterworth filter of 4th order with cutoff frequency of 5 Hz (Hansson et al. 2001, Bernmark, and Wiktorin 2002) was used to distinguish periods of activity/rest of a body segment (Figure 2).

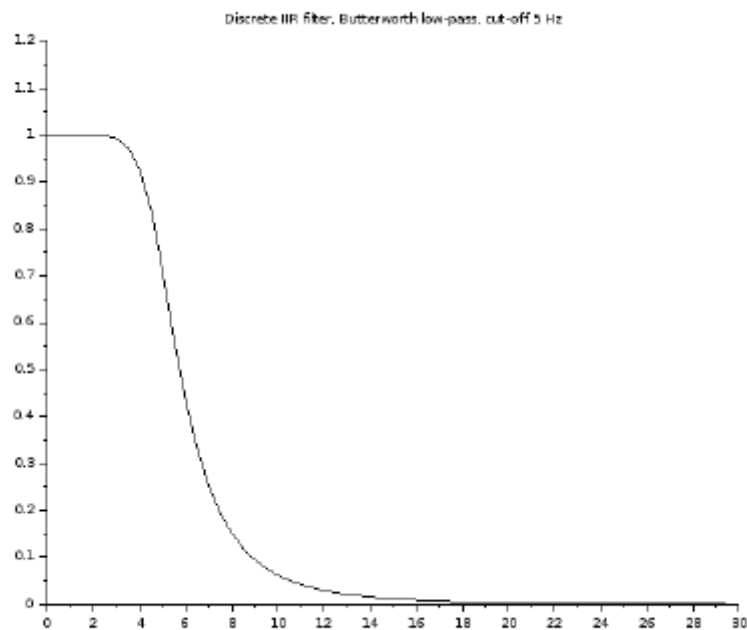

Figure 2: A low-pass Butterworth filter used to distinguish periods of activity/rest of a body segment

The reference position (the human body upright looking at a point at eye level, feet close together, arms beside the body and palms facing inward) of each operator was recorded at the beginning and the end of data recording for each workstation, while the operator maintained his own reference position for about 5 seconds.

To have the similar category scales for comparison, the angle category scale of the SES method (Zare et al. 2015) were used to classify the direct measurements as green, yellow and red (Table 1). The percentage of time that the angles of body segments fell in the risk zone was calculated for each operator and workstation. The unit of comparison between the SES method and the direct measurement method was the workstation and between the questionnaire and the direct measurement was the operator. The results of risk evaluation by the direct measurement method for the right and left arms and wrists were combined to have a single measurement for comparison. If, for example, the measurement for any of the left and right arms and wrists was "red", the final risk was "red". If the measurement for any right/left limb was "yellow" the final risk was "yellow", otherwise, it was "green".

## Data Analysis

The results of posture evaluation by each method were classified into two categories, i.e. exposed and under-exposed. In other words, the green rating by each method was considered as under-exposed and the yellow/red ratings were considered exposed. McNemar's test was then applied to determine "marginal homogeneity" on paired nominal data.

The agreement was calculated between the direct measurement method and the other two methods by Kappa factor. The Kappa factor interpretation is presented in Table 2 (Viera and Garrett, 2005). SPSS 19.0 statistical software was used for data analysis. The comparison between the SES method and the self-reported questionnaire is under investigation in another study because the numbers of comparable risk factors evaluated by the SES method and questionnaire are 11 criteria; much more than the direct measurement method.

Table 2. Interpretation of the Kappa factor

Kappa	Agreement
< 0	Poor agreement
0.01–0.20	Slight agreement
0.21– 0.40	Fair agreement
0.41–0.60	Moderate agreement
0.61–0.80	Substantial agreement
0.81–0.99	Almost perfect agreement

## Results

### Comparison between methods in the initial cycle time

Table 3 shows the differences between the methods compared in the posture assessment of the arms, back, neck and wrists for the initial cycle time. The McNemar test showed that the results of the questionnaire were significantly different from the direct measurement method for the arms and wrists but they were statistically similar for the back and neck. The results of the SES and direct measurement method were not statistically different for various body parts, and the percentages of exposure to yellow/red rating identified by these two methods were more than 80% (Table 3).

The Kappa factor for arm assessment was calculated as 0.1 for the SES and direct measurement method and the observed proportional agreement ( $P_o$ ) was 0.45. The Kappa factor between the SES and direct measurement method was poor for the back (-0.32), neck (0.05) and wrists (0) although  $P_o$  for these body segments were higher: 0.45, 0.27 and 0.82, respectively (Table 4). The Kappa factor and  $P_o$  was poor and showed disagreement between the risk assessment by the self-reported questionnaire and the direct measurement method (Table 5).

### Comparison between methods in the second cycle time

A significant difference was found between the questionnaire and direct measurement method for assessment of the arms and wrists. Neck posture assessment by both methods showed similar results and 90% exposure to

risk factors was identified by both methods (Table 3). Although back exposure assessment by the questionnaire and the direct measurement method was not statistically different ( $p=0.06$ ), the percentage of exposure to yellow/red rating identified by both methods was 64%. Comparison did not show a significant difference in arm, neck and back assessments between the SES and the direct measurement method. However, the results of wrist assessment were different ( $p=0.007$ ).

Table 3. Comparison between observational method (SES), questionnaire and direct measurement method by McNemar statistical test for body segments in both cycle times

		Direct measurement <sup>a</sup>		Questionnaire <sup>a</sup>		p-value <sup>c</sup>	Direct measurement <sup>b</sup>		Observational method (SES) <sup>b</sup>		p-value <sup>c</sup>
		n	% d	n	%		n	%	n	%	
Initial cycle time <sup>e</sup>	Arm	9	100	3	33	0.01	11	100	9	81	0.25
	Back	8	100	5	63	0.125	11	100	11	100	0.5
	Neck	9	100	8	89	0.5	11	100	10	91	0.5
	Wrist	9	100	4	44	0.03	11	100	10	91	0.5
Second cycle time <sup>e</sup>	Arm	11	100	3	27	0.003	20	100	18	90	0.25
	Back	11	100	7	64	0.06	20	100	17	85	0.125
	Neck	10	100	9	90	0.5	20	100	18	90	0.25
	Wrist	12	100	7	58	0.03	20	100	13	65	0.007

<sup>a</sup> Sample sizes (n) 9 and 13 in the initial and the second cycle times, respectively

<sup>b</sup> Number of measurements (workstations) 11 and 20 in the initial and the second cycle times, respectively

<sup>c</sup> Computed by McNemar test for two groups of exposed and under-exposed individual/workstation identified by each method; p-value<0.05 represents significant

<sup>d</sup> Percentage of exposure either yellow or red

<sup>e</sup> Initial cycle time was 11 minutes and second cycle time was 8 minutes

Agreement between the SES and the direct measurement method was 0.41 and 0.4 for the arms and back, respectively (Table 4).  $P_o$  was 70% and 65% for these body segments, and most matched cases were related to exposure to high risk factors (red).  $P_o$  was 65% for the neck and wrists by the SES method and direct measurement method. However, the Kappa factor was zero (Table 4). The rate of agreement for the arms, neck and wrists was poor for the questionnaire and the direct measurement method, as the Kappa factor was zero (Table 5). The Kappa factor and  $P_o$  were 0.15 and 0.55, respectively for the back measurement from both methods.

## Discussion

The risk factors for MSDs that were assessed by two methods, i.e. an observational method (SES tool) and the self-reported questionnaire, were investigated in comparison with the direct measurement method. A common procedure in manufacturing industries is for ergonomist/expert to evaluate using observational tools. Most



ergonomic interventions and solutions that are implemented by decision makers in manufacturing industries are based on observational method analysis. However, we hypothesised that this risk factor assessment was different from the operators' perception of ergonomic problems, and its agreement with real measurements was a matter of debate in the literature. The results of the current study revealed moderate agreement between the SES method and the direct measurement method and poor agreement between the self-reported questionnaire and direct measurement method. The Kappa factor was poor for different body segments for both methods compared to direct measurement, but the observed proportional agreement ( $P_o$ ) was high, particularly for the SES method. Similar results were observed in the measurements over both cycle times.

Table 4. Comparison of direct measurement method and observational method (SES) for body segments, with Kappa factor calculation in both cycle times

	Observational method (SES)	Initial cycle time <sup>a</sup>				Second cycle time <sup>a</sup>			
		Direct measurement method				Direct measurement method			
		Green	Yellow	Red	Total	Green	Yellow	Red	Total
Arm assessment	Green	0	1	1	2	0	1	1	2
	Yellow	0	2	3	5	0	4	1	5
	Red	0	1	3	4	0	3	10	13
	Total	0	4	7	11	0	8	12	20
	$P_o$ <sup>b</sup>	0.45		Kappa	0.1	$P_o$	0.7	Kappa	0.41
$P_e$ <sup>c</sup>	0.39				$P_e$	0.49			
Back assessment	Green	0	0	0	0	0	3	0	3
	Yellow	0	5	4	9	0	5	1	6
	Red	0	2	0	2	0	3	8	11
	Total	0	7	4	11	0	11	9	20
	$P_o$	0.45	Kappa	-0.32		$P_o$	0.65	Kappa	0.40
$P_e$	0.59				$P_e$	0.41			
Neck assessment	Green	0	0	1	1	0	0	2	2
	Yellow	0	1	7	8	0	0	5	5
	Red	0	0	2	2	0	0	13	13
	Total	0	1	10	11	0	0	20	20
	$P_o$	0.27	Kappa	0.05		$P_o$	0.65	Kappa	0
$P_e$	0.23				$P_e$	0.65			
Wrist assessment		Green	Red	Total		Green	Red	Total	
	Green	0	2	2	0	7	7		
	Red	0	9	9	0	13	13		
	Total	0	11	11	0	20	20		
	$P_o$		0.82	Kappa	0	$P_o$	0.65	Kappa	0
$P_e$		0.82			$P_e$	0.65			

<sup>a</sup> Initial cycle time was 11 minutes and second cycle time was 8 minutes

<sup>b</sup> Observed proportional agreement

<sup>c</sup> Probability of agreement chance

A poor Kappa factor was found between methods in this study, although the observed proportional agreement was moderate to high. The Kappa statistic has been used in other studies for investigating the agreement between methods, providing moderate agreement, while other methods such as the interclass correlation coefficient (used for continuous data) and percentage of agreement gave better results, depending on the body segments assessed (Bao et al. 2009). Furthermore, a high observed proportional agreement may receive a poor Kappa factor because it is influenced by other factors such as limited variability in the distribution of exposure in the categories (Hansson, Balogh, et al. 2001).

Table 5. Comparison of self-reported questionnaire and direct measurement method for body segments, with Kappa factor calculation in both cycle times

		Initial cycle time <sup>a</sup>				Second cycle time <sup>a</sup>			
		Direct measurement method				Direct measurement method			
	Self-reported questionnaire	Green	Yellow	Red	Total	Green	Yellow	Red	Total
Arm assessment	Never/Rarely	0	1	5	6	0	4	4	8
	Often	0	1	2	3	0	1	2	3
	Always	0	0	0	0	0	0	0	0
	Total	0	2	7	9	0	5	6	11
	P <sub>o</sub> <sup>b</sup>	0.11	Kappa	0.04		P <sub>o</sub>	0.09	Kappa	- 0.04
	P <sub>e</sub> <sup>c</sup>	0.07				P <sub>e</sub>	0.12		
Back assessment	Never/Rarely	0	2	1	3	0	2	2	4
	Often	0	3	2	5	0	6	1	7
	Always	0	0	0	0	0	0	0	0
	Total	0	5	3	8	0	8	3	11
	P <sub>o</sub>	0.38	Kappa	-0.02		P <sub>o</sub>	0.55	Kappa	0.15
	P <sub>e</sub>	0.39				P <sub>e</sub>	0.46		
Neck assessment	Never/Rarely	0	0	1	1	0	0	1	1
	Often	0	0	7	7	0	0	8	8
	Always	0	0	1	1	0	0	1	1
	Total	0	0	9	9	0	0	10	10
	P <sub>o</sub>	0.11	Kappa	0		P <sub>o</sub>	0.1	Kappa	0
	P <sub>e</sub>	0.11				P <sub>e</sub>	0.1		
Wrist assessment		Green	Red	Total		Green	Red	Total	
	Never/Rarely	0	5	5	0	5	5		
	Often/always	0	4	4	0	7	7		
		0	9	9	0	12	12		
	P <sub>o</sub>	0.44	Kappa	0	P <sub>o</sub>	0.58	Kappa	0	
	P <sub>e</sub>	0.44			P <sub>e</sub>	0.58			

<sup>a</sup> Initial cycle time was 11 minutes and second cycle time was 8 minutes

<sup>b</sup> Observed proportional agreement

<sup>c</sup> Probability of agreement chance

A small number of participants and narrow distribution of exposure in different categories has provided a falsely poor Kappa factor despite the percentage of agreement being high (Stock et al. 2005). Both the Kappa factor and the percentage of agreement were therefore used in the current study to interpret the results. The categorization of exposure to risk factors also had effects on the results of the comparison between the tools. The difference between the results of both the SES and questionnaire method with the direct measurement method was less when a two-category system (exposed and under-exposed) was used, and the McNemar statistical test than a three category system (Green, Yellow and Red), making comparison for severity of exposure. Moreover, the percentage of agreement for both methods was better for wrists where there was a two-category system (Green or Red) for exposure to risk factors. This is consistent with other studies; particularly epidemiological studies that often use two parts exposure parameters (Bao et al. 2009).

The SES method had a six-category scale for evaluating neck and back postures (three categories in flexion, three in extension or torsion), a three-category scale for the upper limb (arm and forearm) postures and a two-category scale for wrist postures (neutral/non-neutral).. The boundaries of these categorical systems are similar to the boundaries have already used in previous studies and proposed by ISO 11226: 2000 (ISO 2000, Lowe et al. 2014, Lowe 2004a, Lowe 2004b, Juul-Kristensen, Fallentin, and Ekdahl 1997, Takala et al. 2010). There is lack of standardization on the category limits for body postures and movement intervals set by different exposure measurement methods. Misclassification of exposure is a limitation of observational assessment methods. The misclassification occurs more frequently in a six-category scale, particularly for the wrist and forearm but two or three category scale has lower precision (Lowe 2004b). The observed proportional agreement for the wrist which has a binominal scale for the assessment was higher between all the methods compared in this study than for the neck, back and arms.

The questionnaire did not have a category limit for assessment of postures and this might be a source of bias in the measurements. However, operators' perceptions in reporting angles of body postures accurately might be systematically biased as the human capacity to remember and estimate body posture angles when performing work tasks is limited (Stock et al. 2005, Spielholz et al. 2001).

The proportional agreement for arm postures by the SES method in the initial and second cycle times was high, while it was less than 15% for the questionnaire in both cycle times. Better agreement was observed between the SES and direct measurement method, but there was disagreement between the questionnaire and the other methods for arm posture assessment. Previous studies have reported similar results (Stock et al. 2005, Hansson, Balogh, et al. 2001). Lowe (2004) reported similar Kappa factor with this study for agreement between ergonomist evaluation (in a three and six category scale) and direct measurement of shoulder posture (Lowe 2004a). Trask et al in the study among airport baggage handlers reported a good precision of observation evaluation for large body parts such as upper arms and trunk rather than the smaller body segments (Trask et al. 2014).

Agreement between both methods and direct measurement for back posture evaluation was higher in the second cycle time compared to the initial cycle time. The results of the SES method for back posture assessment were more in agreement with the direct measurement method than with the self-reported questionnaire. Other studies reported moderate to poor agreement between questionnaire and other methods,

i.e. consistent with our results. Stock et al reported a poor correlation between the questionnaire that focused on duration/frequency of back flexion and the results of other methods (Stock et al. 2005). In our study, the self-reported tool also questioned operators how often they expose to awkward postures, which might be one reason for poor agreement between the questionnaire and the other methods.

Operators' estimation of neck postures disagreed with the direct measurement method for both cycle times. Other studies have reported disagreement between questionnaires and other reference methods for neck assessment (Hansson, Balogh, et al. 2001). However, depending on the questions asked, some studies showed moderate agreement for neck assessment by questionnaire compared to other reference methods (Stock et al. 2005). Better agreement was observed by the SES method for neck postures. However, the results of the two cycle times for the SES method were different, as the  $P_o$  between the SES method and direct measurement for the initial cycle time was 27% compared to 65% for the second cycle time. This can be explained by the low repeatability of the observational methods (Takala et al. 2010). Furthermore, day-to-day variations in the work tasks due to changes in production and inter- or intra-individual diversity of work postures might influence the results of the SES method. Nevertheless, this situation was the same for both cycle times.

Concordance for wrist exposure was better for both questionnaire and SES methods compared to direct measurement. Although the Kappa factor was zero for the questionnaire, the  $P_o$  was about 50% in both cycle times. These results are consistent with those reported by Hansson et al, as the percentage of agreement between questionnaire and direct measurement was about 50% for wrist risk factors, but a low Kappa factor was reported (Hansson, Balogh, et al. 2001). In their review study, Stock et al reported one study that had tested hand/wrist posture questions compared to a reference method and showed fair agreement (Stock et al. 2005). The  $P_o$  of the SES method for the initial and second cycle times was 82% and 65%, respectively, and the kappa factor was zero. Spielholz et al reported moderate disagreement between video analysis and direct measurement. However, they did not report the Kappa factor or percentages of agreement (Spielholz et al. 2001). In general, it was difficult for an observer to assess the flexion/extension of the wrist when operators were assembling trucks. Fast movement and the flexion/extension that was near the border line of the category limits set for the SES method were the main reasons for difficulties in the estimation of wrist posture. Other studies have reported the difficulty of accurate estimation of small body segments with fast movements such as the wrist and neck (Lowe 2004a, Leskinen et al. 1997)

To reduce measurement errors using the SES method, an ergonomist (observer) analysed the workstations in both cycle times. He was involved in this sector of the factory for three years. Video recordings were made to obtain a more precise posture evaluation of all workstations. The majority of tasks at each workstation were observed several times. In some cases, two ergonomists discussed and decided the assessment scores. However, the degree to which stable and consistent results can be provided by observational methods is the matter of debate in the ergonomics literature. Denis et al (2000) reported good reliability in a critical review of observational methods as presented by Kilbom (1994) in a review of 19 grids and Takala et al (2010) in a systematic review of observational methods (Takala et al. 2010, Denis, Lortie, and Rossignol 2000, Kilbom 1994). Nonetheless, the quality of measurement is highly dependent on the skills and training of the observers and the limitations of the workplace such as constraints in the time and observation of a job. In the current

study, random errors such as restrictions in the observation of micro-postures and estimation error of the observer regarding the angle of body parts and systematic errors due to inter/intra operator diversity of work postures might have influenced the repeatability of the SES method (findings of the initial cycle time compared to the second cycle time). The questionnaire results might have been influenced by measurement errors such as question formulation, respondents' mood (pain, fatigue and mental issues) and work task variability. Previous studies also reported these sources of errors by questionnaire measurement (Stock et al. 2005). Operators' capacities in recalling micro postures of the neck/wrist which had occurred in a short period of the time were limited. Formulation of the questions (operators' comprehension) and the response scale that define the duration of exposure might be other sources of measurement errors. Pictograms were used to represent degrees of flexion/extension of each body segment in the questionnaire (Table 1) while the categorical limits were used for observational and direct measurement methods. It could be criticized that we did not compare identical variables. Nevertheless, providing categorical limits in the questionnaire might be a source of error, as operators might estimate the degree of flexion/extension on a numerical scale incorrectly (Stock et al. 2005, Barriera-Viruet et al. 2006). However, the pictogram took into account workers' mental representations of the workload and provided meaningful measures.

The time interval to measure risk factors by each method was a source of bias in previous studies of method comparison. The SES assessment was performed by viewing work in person but its results were revised and modified by using videos recorded throughout direct measurement. It can be claimed that there was no time interval between evaluation by the SES method and direct measurement in both cycle times. It might be criticized that viewing work on video is a potential limitations of these results. However, the measurements, video recordings and analyses of both methods (the SES and direct measurement) were performed by unique evaluator as the workstations were viewed in person several times. The participants answered the questionnaire less than two months before direct measurement in the initial cycle time and variations in the work situation were few over this time interval. However, the measurements were repeated in the second cycle time and the direct measurement was performed immediately after data collection by the questionnaire. Measurement by three methods at the same time was impossible because of assembly line limitations.

The SES method and the self-reported questionnaire underestimated the exposure of body segments to awkward postures compared to direct measurements, particularly for exposure to moderate risk factors. Other studies have reported different results according to the study population. Trask et al found underestimation of the observational method among baggage handlers, while the observational method overestimated the angles of arm postures in a study of hairdressers (Trask et al. 2014). Spielholz et al reported overestimation of extreme wrist postures by questionnaire compared to observation and direct measurement for counting, loading and sawing jobs (Spielholz et al. 2001). The main reason for underestimation by the questionnaire and observational methods in the current study might have been related to measurements of small movements by the inclinometer and goniometers over one cycle time and accumulating them as the exposure to moderate/high risk factors. However, we did not compare the results of observation and questionnaire with the extreme angles (90th percentile) being measured by the direct measurement method.

The direct measurement methods had some limitations, particularly during measurement. The main limitation

of using these methods is the difficulty to have a large sample size, particularly in a real field measurement. Moreover, task variations and measurement device error such as measurement in a short period of a work task, reference position and sensor movement on the skin are the other limitations of using direct measurement methods. The usability of the direct measurement method as a gold standard and reference method is therefore a matter of debate in much ergonomic literature (Stock et al. 2005, Takala et al. 2010, Hansson, Balogh, et al. 2001).

It can be concluded that the operators' perceptions of work postures disagreed with the direct measurement method. Better agreement was observed between the SES method (ergonomist assessment) and the direct measurement method. However, the observational method and the direct measurement method measure exposures to risk factors over a short period of the time and considering only these measurements for whole workday, week or month is limited, particularly for the jobs with high exposure variability such as automotive assembly tasks (Stock et al. 2005). Valid measurements of exposure to risk factors that take into account the perception of operators and contribution of other stakeholders are essential in manufacturing industries to improve the coverage of evaluations and to avoid missing potential risk factors. Ergonomic researchers must therefore carry out further studies to develop new procedures for risk representation. This procedure should take into account not only different stakeholders' perceptions and assessments regarding exposure to risk factors but also individual variability and daily/seasonal variations in jobs.

## **Acknowledgements**

This study was financially supported by and the French National Research Program for Environmental and Occupational Health of Anses (2012/2/007) and the SCANIA Angers Production group. The authors thank the managers and operators of SCANIA group for their collaboration and all members of LEEST who helped us with this project.

## **Authors' contribution**

All authors had contributions to the preparation of this paper. MZ collected and analyzed the data, wrote the paper and interpreted the results. SB and RB contributed to the interpretation of the results. The study was performed under supervision of YR; he contributed to the interpretation of the results and the revision of the paper.

## References

- Bao, S., N. Howard, P. Spielholz, B. Silverstein, and N. Polissar. 2009. "Interrater Reliability of Posture Observations." *Human Factors: The Journal of the Human Factors and Ergonomics Society* 51 (3): 292-309. doi: 10.1177/0018720809340273.
- Barriera-Viruet H., T.M. Sobeih, N. Daraiseh, and S. Salem. 2006. "Questionnaires vs Observational and Direct Measurements: A Systematic Review." *Theoretical Issues in Ergonomics Science* 7 (3): 261-84. doi:10.1080/14639220500090661.
- Berlin, C., W. P. Neumann, N. Theberge, and R. Örtengren. 2014. "AVenues of Entry: How Industrial Engineers and Ergonomists Access and Influence Human Factors and Ergonomics Issues." *European Journal of Industrial Engineering* 8 (3): 325-348. doi: 10.1504/EJIE.2014.060999.
- Bernmark, E., and C. Wiktorin. (2002). "A Triaxial Accelerometer for Measuring Arm Movements." *Applied Ergonomics* 33(6): 541-547. doi:10.1016/S0003-6870(02)00072-8
- Burdorf, Alex, José Derksen, Bart Naaktgeboren, and Marcel van Riel. 1992. "Measurement of trunk bending during work by direct observation and continuous measurement." *Applied Ergonomics* 23 (4):263-267.
- Burdorf, A., J. Derksen, B. Naaktgeboren, and M. van Riel. 1992. "Measurement of Trunk Bending during Work by Direct Observation and Continuous Measurement." *Applied Ergonomics* 23 (4): 263-267. doi:10.1016/0003-6870(92)90154-N
- Burdorf, A., and J. Laan. 1991. "Comparison of Methods for the Assessment of Postural Load on the Back." *Scandinavian Journal of Work, Environment & Health* 17 (6): 425-429. doi:10.5271/sjweh.1679
- David, G.C. 2005. "Ergonomic Methods for Assessing Exposure to Risk Factors for Work-related Musculoskeletal Disorders." *Occupational Medicine* 55 (3): 190-199. doi: 10.1093/occmed/kqi082
- David, G., V. Woods, G. Li, and P. Buckle. 2008. "The Development of the Quick Exposure Check (QEC) for Assessing Exposure to Risk Factors for Work-related Musculoskeletal Disorders." *Applied ergonomics* 39 (1): 57-69. doi:10.1016/j.apergo.2007.03.002
- De Looze, M.P., H.M. Toussaint, J. Ensink, C. Mangnus, and A.J. Van der Beek. 1994. "The Validity of Visual Observation to Assess Posture in a Laboratory-simulated, Manual Material Handling Task." *Ergonomics* 37 (8): 1335-1343. doi: 10.1080/00140139408964912.
- Denis, D., M. St-Vincent, D. Imbeau, C. Jette, and I. Nastasia. 2008. "Intervention Practices in Musculoskeletal Disorder Prevention: A Critical Literature Review." *Applied Ergonomics* 39 (1): 1-14. doi:10.1016/j.apergo.2007.02.002 .
- Denis, D., M. Lortie, and M. Rossignol. 2000. "Observation Procedures Characterizing Occupational Physical Activities: Critical Review." *International Journal of Occupational Safety and Ergonomics* 6 (4): 463-491. doi:10.1080/10803548.2000.11076467.
- Enterprises, Scilab. 2012. "Scilab: Free and Open Source Software for Numerical Computation." Scilab Enterprises, Orsay, France: 3.
- Hansson, G.A., P. Asterland, N.G. Holmer, and S. Skerfving. 2001. "Validity and Reliability of Triaxial Accelerometers for Inclinometry in Posture Analysis." *Medical and Biological Engineering and Computing* 39 (4): 405-413. doi: 10.1007/BF02345361.
- Hansson, G.Å., I. Balogh, J.U. Byström, K. Ohlsson, C. Nordander, P. Asterland, S. Sjölander, L. Rylander, J. Winkel, and S. Skerfving. 2001. "Questionnaire Versus Direct Technical Measurements in Assessing Postures and Movements of the Head, Upper Back, Arms and Hands." *Scandinavian Journal of Work, Environment & Health* 27(1): 30-40. doi: 10.5271/sjweh.584.
- Hoozemans, M.J.M., E.B. Knelange, M.H.W. Frings-Dresen, H.E.J. Veeger, and P.P.F.M. Kuijer. 2014. "Are Pushing and Pulling Work-related Risk Factors for Upper Extremity Symptoms? A Systematic Review of

Observational Studies." *Occupational and Environmental Medicine* 71 (11): 788-795. doi:10.1136/oemed-2013-101837.

ISO. 2000. Ergonomics – Evaluation of Static Working Postures.  
[http://www.iso.org/iso/catalogue\\_detail.htm?csnumber=25573](http://www.iso.org/iso/catalogue_detail.htm?csnumber=25573).

Juul-Kristensen, B., N. Fallentin, and C. Ekdahl. 1997. "Criteria for Classification of Posture in Repetitive Work by Observation Methods: A Review." *International Journal of Industrial Ergonomics* 19 (5): 397-411. doi:10.1016/S0169-8141(96)00013-3.

Leskinen, T., C. Hall, S. Rauas, S. Ulin, M. Tonnes, E. Viikari-Juntura, and E. Takala. 1997. "Validation of Portable Ergonomic Observation (PEO) Method Using Optoelectronic and Video Recordings." *Applied Ergonomics* 28 (2): 75–83. doi:10.1016/S0003-6870(96)00054-3.

Lowe, B.D. 2004a. "Accuracy and Validity of Observational Estimates of Shoulder and Elbow Posture." *Applied Ergonomics* 35:159-71. doi:10.1016/j.apergo.2004.01.003.

Lowe, B.D. 2004b. "Accuracy and Validity of Observational Estimates of Wrist and Forearm Posture." *Ergonomics* 47: 527-54. doi: 10.1080/00140130310001653057.

Lowe, B.D., P.L. Weir, and D.M. Andrews. 2014. "Observation-based Posture Assessment: Review of Current Practice and Recommendations for Improvement." US Department of Health and Human Services, Centers for Disease Control and Prevention, National Institute for Occupational Safety and Health, Cincinnati, OH: U.S. DHHS (NIOSH) Publication 2014-131.

Kilbom, Å. 1994. "Assessment of Physical Exposure in Relation to Work-related Musculoskeletal Disorders-What Information Can Be Obtained from Systematic Observations." *Scandinavian Journal of Work, Environment & Health* 20 special issue: 330-45.

McAtamney, L., and E. Nigel Corlett. 1993. "RULA: A Survey Method for the Investigation of Work-related Upper Limb Disorders." *Applied Ergonomics* 24 (2): 91-99. doi:10.1016/0003-6870(93)90080-S.

McGaha, J., K. Miller, A. Descatha, L. Welch, B. Buchholz, B. Evanoff, and A.M. Dale. 2014. "Exploring Physical Exposures and Identifying High-risk Work Tasks Within the Floor Layer Trade." *Applied Ergonomics* 45 (4): 857-864. doi:10.1016/j.apergo.2013.11.002.

Östergren, P.O., B.S. Hanson, I. Balogh, J. Ektor-Andersen, A. Isacsson, P. Örbaek, J. Winkel, and S.O. Isacsson. 2005. "Incidence of Shoulder and Neck Pain in a Working Population: Effect Modification Between Mechanical and Psychosocial Exposures at Work? Results from A One Year Follow up of th

Malmö Shoulder and Neck Study Cohort." *Journal of Epidemiology and Community Health* 59 (9): 721-728. doi:10.1136/jech.2005.034801.

Roquelaure, Y., C. Ha, A. Leclerc, A. Touranchet, M. Sauteron, M. Melchior, E. Imbernon, and M Goldberg. 2006. "Epidemiologic Surveillance of Upper-extremity Musculoskeletal Disorders in the Working Population." *Arthritis Care & Research* 55 (5): 765-778. doi: 10.1002/art.22222.

Roquelaure, Y., C. Ha, and M. Sauteron. 2002. "Réseau Expérimental de Surveillance Épidémiologique des Troubles Musculo-squelettiques dans les Pays de la Loire." Surveillance en entreprises.  
[http://212.234.146.165/publications/2004/tms\\_131204/rapport\\_tms\\_scc.pdf](http://212.234.146.165/publications/2004/tms_131204/rapport_tms_scc.pdf).

Schaub, K., G. Caragnano, B. Britzke, and R. Bruder. 2013. "The European Assembly Worksheet." *Theoretical Issues in Ergonomics Science* 14 (6): 616-639. doi: 10.1080/1463922X.2012.678283.

Sluiter, J.K., K.M. Rest, and M.H.W. Frings-Dresen. 2001. "Criteria document for evaluating the work-relatedness of upper-extremity musculoskeletal disorders." *Scandinavian Journal of Work, Environment & Health*: 27 Suppl 1: 1-102. doi:10.5271/sjweh.637.



- Spielholz, P., B. Silverstein, M. Morgan, H. Checkoway, and J. Kaufman. 2001. "Comparison of Self-report, Video Observation and Direct Measurement Methods for Upper Extremity Musculoskeletal Disorder Physical Risk Factors." *Ergonomics* 44 (6): 588-613. doi: 10.1080/001401301118050.
- St-Vincent, M., D. Denis, D. Imbeau, and F. Ouellet. 2007. "Apport de Diverses Sources de Données à la Réalisation d'une Intervention Ergonomique." *Perspectives interdisciplinaires sur le travail et la santé* (9-1). <http://pistes.revues.org/2999>
- Sterud, T., H.A. Johannessen, and T. Tynes. 2014. "Work-related Psychosocial and Mechanical Risk Factors for Neck/Shoulder Pain: a 3-Year Follow-up Study of the General Working Population in Norway." *International Archives of Occupational and Environmental Health* 87 (5): 471-481. doi: 10.1007/s00420-013-0886-5.
- Stock, S.R., R. Fernandes, A. Delisle, and N. Vézina. 2005. "Reproducibility and Validity of Workers' Self-reports of Physical Work Demands." *Scandinavian Journal of Work, Environment & Health* 31(6): 409-437. doi:10.5271/sjweh.947.
- Takala, E.P., I. Pehkonen, M. Forsman, G.Å. Hansson, S.E. Mathiassen, W.P. Neumann, G. Sjøgaard, K.B. Veiersted, R.H. Westgaard, and J. Winkel. 2010. "Systematic Evaluation of Observational Methods Assessing Biomechanical Exposures at Work." *Scandinavian Journal of Work, Environment & Health* 36(1): 3-24. doi:10.5271/sjweh.2876.
- Trask, C., S.E. Mathiassen, J. Wahlström, and M. Forsman. 2014. "Cost-efficient Assessment of Biomechanical Exposure in Occupational Groups, Exemplified by Posture Observation and Inclinometry." *Scandinavian Journal of Work, Environment & Health* 40(3): 252-65. doi:10.5271/sjweh.3416.
- Viera, A.J., J.M. Garrett. 2005. "Understanding Interobserver Agreement: The Kappa Statistic." *Family Medicine* 37(5): 360-3.
- Vijayakumar, C., T. Vignesh, A. Murugesan, and N. Bavana. 2015. "Effect of Erroneous in Ergonomics and Its Remedies to Workers in Industries-A Literature Survey." *International Journal on Recent and Innovation Trends in Computing and Communication* 3 (1): 368-377.
- Village, J., C. Trask, N. Luong, Y. Chow, P. Johnson, M. Koehoorn, and K. Teschke. 2009. "Development and Evaluation of An Observational Back-Exposure Sampling Tool (Back-EST) for Work-related Back Injury Risk Factors." *Applied Ergonomics* 40 (3): 538-544. doi:10.1016/j.apergo.2008.09.001.
- Widanarko, B., S. Legg, J. Devereux, and M. Stevenson. 2015. "Interaction Between Physical and Psychosocial Work Risk Factors for Low Back Symptoms and Its Consequences amongst Indonesian Coal Mining Workers." *Applied Ergonomics* 46: 158-167. doi:10.1016/j.apergo.2014.07.016.
- Zare, M., S. Biau, M. Croq, and Y. Roquelaure. 2014. "Development of a Biomechanical Method for Ergonomic Evaluation: Comparison with Observational Methods." *International Journal of Social, Management, Economics and Business Engineering* 8 (1): 223-227.
- Zare, M., S. Biau, A. Gourlay, R. Brunet, and Y. Roquelaure. 2015. "A Comparison of Neck Bending and Flexion Measurement Methods for Assessment of Ergonomic Risk." *International Journal of Occupational Safety and Ergonomics (JOSE)* In press.
- Zare, M., M. Croq, F. Hossein-Arabi, R. Brunet, and Y. Roquelaure. 2015. "Does Ergonomics Improve Product Quality and Reduce Costs? A Review Article." *Human Factors and Ergonomics in Manufacturing & Service Industries* In press. doi: 10.1002/hfm.20623.
- Zare, M., A. Malinge-Oudenot, R. Höglund, S. Biau, and Y. Roquelaure. 2015. "Evaluation of Ergonomic Physical Risk Factors in A Truck Manufacturing Plant: Case Study in SCANIA Production Angers." *Industrial Health* In press. doi: org/10.2486/indhealth.2015-0055.

## 6. Prevention of WR-MSDs

### 6.1. Ergonomic intervention in SCANIA truck manufacturing plant

An effective ergonomic intervention can substantially prevent WR-MSDs. An ergonomic intervention was therefore implemented in the SCANIA assembly line which included technical/engineering remedies and organizational changes. The technical/engineering remedies were proposed and implemented by the ergonomists and engineers. The organizational intervention was performed following the mandatory change in the production volume (cycle time) of the factory and it was mainly re-distribution of the tasks and change the content of workstations. We tried to involve the stakeholders in the intervention process, particularly managers and operators in. Article 10 addresses the intervention procedure to improve work condition. The following table shows the gaps, aims and findings that are presented in this article.

Gaps	Aims	Findings
The automotive industry has not usually documented or published their intervention strategies and there are few reports in the literature describing the intervention processes and the associated degree of success	To evaluate the effectiveness of engineering ergonomic measures	A combination of ergonomic measures including technical and organisation intervention can significantly reduce physical work demands.
More studies are required to recognise the efficacy, advantages and disadvantages of ergonomic strategies, and particularly the overall impact on WMSDs in automotive industries	to involve the stakeholders in ergonomic organizational interventions including redesigning the workplace and balancing the work tasks	Musculoskeletal symptoms decreased after interventions although the effects of interventions on ultimate WMSDs were ambiguous.  Providing feedback for different stakeholders can substantially improve the success of intervention programs.

#### 6.1.1. Article 10: Ergonomic intervention procedure to improve work conditions in SCANIA truck manufacturing plant

Zare M, Guibert F, Hunault G, Roquelaure Y. Ergonomic intervention procedure to improve work conditions in SCANIA truck manufacturing plant. Under review by applied ergonomics.

## Title Page: Original Article

# Ergonomic intervention procedure to improve work conditions in SCANIA truck manufacturing plant

**Mohsen Zare<sup>1</sup>**

**Frédéric Guibert<sup>2</sup>**

**Gilles Hunault<sup>3</sup>**

**Yves Roquelaure<sup>1</sup>**

<sup>1</sup> LUNAM, University of Angers, Laboratory of Ergonomics and Epidemiology in Occupational Health (LEEST), Angers, France

<sup>2</sup> Workshop Supervisor, Scania Production Angers, France

<sup>3</sup> Laboratoire HIFIH, UPRES 3859, IFR 132, Université d'Angers, France

**Corresponding Author:** Mohsen Zare

**Address:** LUNAM, Université d'Angers, Laboratoire d'ergonomie et d'épidémiologie en santé au travail (LEEST), Angers, France

**Email Address:** mohsen@zare.fr

Tel: +33787722141

## Abstract

This study was design to evaluate the effectiveness of intervention ergonomic program including the involvement of the stakeholders, organisational and engineering changes of the workplaces in a truck assembly plant. This is a pre-post cross-sectional study that was performed over three years. The study plant was one sector of a truck assembly plant. Five engineering/technical ergonomic controls were implemented and organisational interventions were considered at the time of a production rate change (cycle time) of the factory. The organisational interventions consisted mostly of transferring and redistributing the tasks i.e. ergonomically balancing and redesigning of the work positions. In order to encourage the involvement of the in the stakeholders in the intervention program, the findings were presented at several meetings throughout the study. This study showed that a combination of ergonomic measures including technical and organisation intervention can significantly reduce physical work demands. Musculoskeletal symptoms decreased after interventions although the difference was not significant. Providing feedback for different stakeholders can substantially improve the success of intervention programs.

**Key words:** Intervention program, Stakeholders, organisational change, truck assembly plant

## Introduction

Work-related musculoskeletal disorders (WMSDs) cause many problems in industry, particularly in the automotive manufacturing industry. The real effects of these problems are not fully understood. However, musculoskeletal disorders represent one-third of all diagnosed work-related diseases in many countries (Szabová et al., 2014). Furthermore, the costs of work-related illness constitute 4-5% of the Gross Domestic Product. This includes direct costs such as compensation, administrative and medical costs and indirect costs, such as poor quality of life, absenteeism and losses related to quality and productivity (Kazmierczak et al., 2007). Adverse work characteristics such as physical, organizational and psychosocial risk factors have been shown to have a dose-response relationship with the prevalence of WMSDs in many occupations, particularly those in automotive assembly plants (Abarqhouei and Nasab, 2011; David, 2005). Operators in automotive assembly plants are exposed to various physical risk factors (repetition, forceful exertion, awkward postures, manual materials handling, vibration) and organisational factors (short cycle times, ergonomically un-balanced workstations and insufficient recovery time) (Otto and Scholl, 2011; Punnett and Wegman, 2004; Winkel and Mathiassen, 1994). The literature shows that such risk factors increase musculoskeletal symptoms, and remedial actions/proactive ergonomics are well known approaches to preventing WMSDs and increasing productivity, quality and efficiency in the automotive industry (van der Molen et al., 2005). However, certain factors such as mal-adapted intervention strategies, ineffective contributions of stakeholders, and poor ergonomic evaluations can prevent the success of an intervention program. Furthermore, most intervention programs suffer from lack of evidence of the effectiveness of ergonomic improvement. The automotive industry has not usually documented or published their intervention strategies and there are few reports in the literature describing the intervention processes and the associated degree of success, and particularly the overall impact on WMSDs in automotive manufacturing plants (Westgaard and Winkel, 1997). In a literature review of ergonomic intervention studies, Westgaard and Winkel showed that intervention programs focusing on identifying and solving specific problems are more successful than generic interventions aimed at reducing exposure to a particular level (Westgaard and Winkel, 1997). Other studies have suggested that a combination of strategies including information, education, both compulsory and voluntary would reduce physical workloads and WMSDs (Knibbe and Friele, 1999; Yassi et al., 2001). Van der Molen et al. recommended that ergonomic engineering controls such as lifting tools, combined with a participatory approach and involvement of stakeholders, would have the best results reducing physical work demand and WMSDs in the long term (van der Molen et al., 2005). Although many studies have shown ergonomic measures and strategies for preventing WMSDs, more studies are required to recognise the efficacy, advantages and disadvantages of ergonomic strategies, particularly in the automotive industry. We therefore designed an ergonomic intervention program in the SCANIA truck assembly plant focusing mainly on engineering and technical problems and also on the ergonomic impact of changing the cycle time within the factory. Automotive industries routinely change their cycle times (production rate) in response to market demands. We encouraged the stakeholders to engage in an ergonomic intervention program and to consider ergonomic principles such as organisational ergonomics (balancing and redesigning the workstations) when changing the cycle time (known as takt time in the factory) to increase the production rate in the assembly plant. Furthermore, engineering and technical controls that were proposed following the ergonomic analysis were implemented. The aim of this study was thus both to

evaluate the effectiveness of engineering ergonomic measures and to involve the stakeholders in ergonomic organisational interventions including redesigning the workplace and balancing the working tasks during routine cycle time changes due to production requirements.

## Materials and Methods

### Study description

This intervention study was designed as pre-post cross-sectional study that was performed over three years. The study plant was one sector of a truck assembly process which was divided to smaller groups of people to enhance continuous improvement within working area (Liljedahl and Muftic, 2012). There were three Improvement Groups (IGs) in the investigated sector and each group included four or five work positions, team leader and operators. The common tasks of this sector were assembly of truck parts, wiring, hose connection, picking up objects from a pallet, lifting and carrying parts (manually or with devices), tightening with screwdrivers, and pushing/pulling wagons. In the first part of the study, eleven work positions of the selected sector were analyzed ergonomically by an in-house ergonomic observational method (SCANIA Ergonomic Standard, SES) and the NIOSH lifting equation. In total 28 assessments were undertaken (including most frequent type of truck and other variant truck models) for the initial cycle time. Indeed, the production assembly system has a modular concept to build the trucks. From a minimum combination of basic components (cab, engine, axle, frame and gear box), there are a various combination of trucks according to customer demands. There is no "standard trucks" at production plant. One type frame could, however, be combined with different numbers of axles, engines, cab, and gearbox. Furthermore, it can be added different options such as air suspension, air conditioning, size of the fuel tank and etc. Due to this modular system, all types of truck are built on the same assembly line. Nevertheless, there are most frequent types of truck being produced in the factory, based on the market demands. This most representative type of truck was mainly evaluated on the work positions in this study although some other variant truck models were also considered for ergonomic evaluation in certain work positions. The most frequent type of truck could differ from one position or IG to another. Thus, the ergonomic evaluation was completed by other type of variants, which are considered as the next most representative, and sometime, by the most "difficult" ones.

An intervention program was then designed based on the risk factors identified and the recommendations for improvement. Five engineering/technical ergonomic remedies were implemented and organisational interventions were considered at the time of a production rate change (cycle time) of the factory. The organisational interventions consisted mostly of transferring and redistributing the tasks i.e. ergonomically balancing and redesigning of the work positions. The ideas for redesigning and balancing the work positions were communicated to the stakeholders over the course of this project and thus they were consequently involved in ergonomically reorganizing the work positions. After implementing all changes, fourteen new work positions were analysed with the SES method, as was used in the first part of the study. With the new cycle time, 34 ergonomic analyses were performed for most frequent types of truck across all the positions and sometimes other variant models of truck were also evaluated in the work positions. A different sector of the factory was selected as control group for this study. The operators of the control sector mainly carried out similar tasks as the study sectors: picking up parts, material handling, lifting, carrying, pushing/pulling and

tightening. However, the truck parts that were assembled in this section were different from the sector being investigated. The number of work positions evaluated prior to changing the cycle time was nine in the control sector and 11 after the cycle time change. The other situations in the factory such as management, work conditions and psychosocial factors were relatively similar in both sectors.

## **Data collection**

Video recording was performed for all workstations assessed, and the majority of tasks at each work position were observed several times before and after interventions. The SES method was used to analyse work positions. This tool includes 20 factors classified in four categories, including repetition, work posture, lifting and energy consumption. For prioritization of each assessment, the results are sorted into four levels. The Green level which shows minimal risk of musculoskeletal disorders and are acceptable. Yellow denotes a level with moderate risk of musculoskeletal disorders; tasks and work position assigned yellow might need some improvement in the future. Red is an action level with considerable risks of musculoskeletal disorders, and changes are required as soon as possible. Finally, double red shows the potential for excessive risks. Tasks assessed as double red should be stopped immediately and a solution found to eliminate or reduce the risk. The number of yellows, reds and double reds then determine the color of a work position classified in one of three categories i.e. green, yellow and red. We also used the NIOSH lifting equation to evaluate manual lifting. In this study, the NIOSH lifting index  $< 1$  indicates a green or safe level, a lifting index between 1-1.6 a yellow, and a lifting index  $> 1.6$  for a red. Ergonomic analysis after intervention was performed at each step for which remedial actions were implemented in the work positions.

Musculoskeletal symptoms in the neck, shoulders, elbows/forearms, hands/wrists, back and lower limbs were evaluated for the operators who worked in the work positions in both situations by a modified version of the Nordic Musculoskeletal Questionnaire (Kuorinka et al., 1987). The prevalence of musculoskeletal symptoms was defined as pain, numbness or stiffness of different parts of the musculoskeletal system. We asked the operators to determine their pain or discomfort in each region of the body on a 0-10 scale at the time of filling out the questionnaire. Pain intensity  $\geq 5$  at the time of filling out the questionnaire was considered to be a musculoskeletal symptom. Musculoskeletal symptoms in the second phase of the study were assessed seven months after changing the cycle time. The operators in the first and second phase were the same but extra people were employed at the new work positions. The initial cycle time, therefore, involved 17 workers and the new one involved 24. Fifteen and 21 operators from the first and second cycle times filled out the questionnaire, respectively, and twelve were the same at both cycle times.

## **Involvement of Stakeholders**

Throughout the study, the findings were presented at several meetings of the stakeholders, i.e. a factory management steering group, engineers, technicians and operators, in order to encourage their involvement in the intervention program. Although the factory had a Safety and Health standard and ergonomics was part of this strategic plan, this study was an opportunity to spread out ergonomic knowledge, find solutions and accelerate their implementation and increase stakeholders commitment in the intervention program. Therefore the aims of the meetings and presentations were first to make the stakeholders aware of ergonomic workload

problems and the measures associated with prevention of musculoskeletal disorders. Second, these gatherings aimed to encourage them to agree to continue the ergonomic program and contribute to/implement the required changes. Feedback was provided to the management committee and operators every six months. In total, five meetings were held with the management committee and the progress of the study was presented. The main subjects discussed at these meetings were the results of the ergonomic evaluation by the SES method, possible interventions, the effects of poor ergonomics on the quality of products and the idea of balancing workload and high risk tasks in different work positions. Three similar meetings were held specifically for the operators who were included in the study. The main subjects of these operator meetings were to make the operators aware of the risk factors and to encourage them to participate in the study. Furthermore, two presentations of the ergonomic evaluation results were provided for the engineers and the workers' union. All these meetings and communications had a significant effect on the development and efficacy of the ergonomic intervention programs. Most of the authors' ideas regarding ergonomic changes were transferred to the stakeholders during these meetings and presentations.

## Statistical Analysis

Due to the small sample sizes ( $n=28$  for the first cycle time,  $n=34$  for the second cycle time), the non-parametric Kruskal-Wallis rank sum test was used for interval variables. The variable associated with the NIOSH score was considered as semi-quantitative and was analyzed using medians. A p-value less than 0.05 (two-tail) was considered significant. All computations and graphics were performed with the R (Team R Core, 2014).

## Intervention Program

### First part: Engineering/technical intervention

#### Lifting tool unlocking system

We evaluated the overall color of the "Bumper Assembly on truck" work positions as red which was one of the highest ergonomic physical workload positions. The unlocking lifting tool task was assessed as double red and was the highest risk task at this position. The operators had to unlock the lifting tool for bumper handling toward the truck chassis with their fingers using hand gripping. This task required approximately 200N (measured by mechanical dynamometer) finger grip or fingertip grip force and was evaluated double red according to our method criteria. The thumb and index finger were involved in this task (Figure 1a).

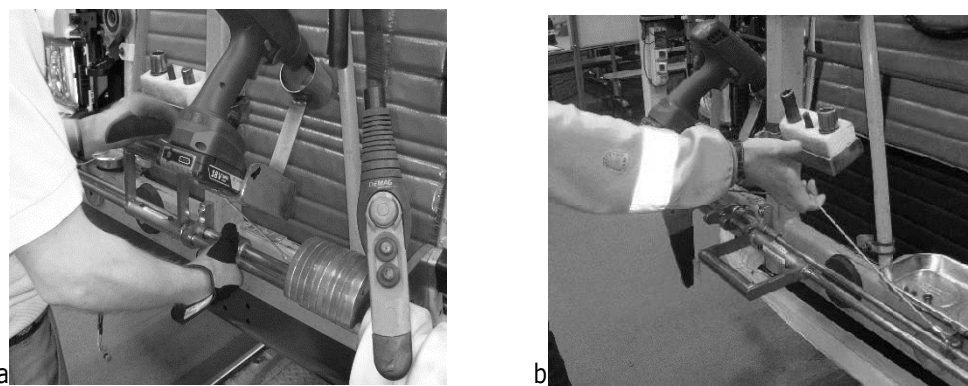

Figure 1a) Initial unlocking system for bumper lifting tool required extra force (200 N) from thumb and index finger, b) new unlocking system for bumper lifting tool eliminated thumb and index finger involvement by using the palm/several fingers



Furthermore, there were other high risk tasks at this work position such as positioning and tightening the bumper tasks (red) and the bumper movement/preparation tasks (yellow). After an in-depth ergonomic evaluation, a meeting was organized to present the findings to the management committee and engineers. It was decided to change the design of the unlocking system and to develop a new handle to reduce the unlocking force required. A new unlocking system was proposed which used a cord to unlock the lifting tool. With the new cord handle, the finger-grip was replaced by involving all fingers and the palm (Figure 1b). The work position was then reevaluated, which determined the criterion for finger force was green due to the elimination of the thumb and index finger unlocking gesture and the overall color of this position was evaluated as yellow (moderate risk down from red or high risk). However, the new unlocking system imposed another ergonomic red risk factor. The surface area that the palm/several fingers had contacted on the new handle (cord) for the unlocking system was less than 7 cm<sup>2</sup> and the force was > 1 kg. Furthermore, some operators preferred using the old system and could not accept the new one possibly because of their entrenched habits.

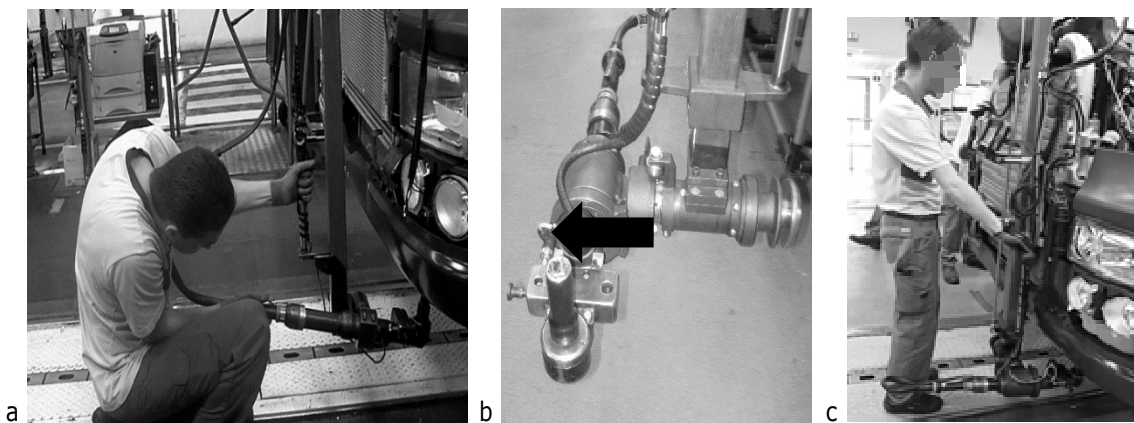

Figure 2a) Old tightening tool for bumper screw required kneeling and awkward neck and back postures; b) new system designed with camera near the jib (the flash in the above picture shows the location of camera) of the lifting tool and monitor at the eyes level of the operator; c) modified tightening tool eliminated kneeling and awkward postures

### **Embedded camera on the hand-held screwdriver machine to facilitate hidden operation**

After performing the first intervention (new unlocking system) at the “Bumper Assembly on truck” work position, we evaluated many kneeling, squatting and awkward postures at this position (approximately 11 min/2hours awkward postures). The majority of awkward postures were related to the hidden operation of tightening several screws below the bumper (hidden access) which required kneeling with awkward neck and back postures (Figure 2). After performing a comprehensive ergonomic analysis and calculating the exposure time in awkward postures, the findings were presented to the section manager and engineers during an internal meeting. They decided to embed a camera near the nose of the hand-held screwdriver machine and to place a monitor beside the jig. Operators could then look at the camera in a standing position, identify the location of the hidden screws below the bumper and tighten them without needing to kneel or bend their neck or back to see the screws. The newly designed tool was tested at the work station and replaced the old one. Ergonomic

analysis was performed after the intervention and the results showed that exposure time to kneeling and awkward neck and back postures was reduced to approximately six minutes. The new intervention could not, however, eliminate all the kneeling and awkward neck and back postures because the tightening of two screws required another electric tightening tool that could not have a camera. Furthermore, the other tasks such as positioning the bumper on the chassis required awkward postures of the back and neck.



Figure 3: Lifting and carrying air filter (12-16 kg) caused low back pain and awkward posture  
Gripping tool for handling air filter

The "Air Filter & Cab tilt Cylinder Mounting" position was evaluated as yellow overall. Thirty-three percent of the ergonomic criteria were red and 38% were yellow. Lifting and carrying the cab tilt cylinder and air filter were identified as high risk tasks at this work position. The completed air filter weighed between 12-16 kg depending on the type of truck. Lifting the air filter from trolley was therefore assessed as red by the NIOSH equation ( $LI=1.9$ ). In some cases, LI varied according to the horizontal distance to the trolley and the weight of the air filter. The operators had to lift the air filter from a trolley with an awkward back posture and work outside the maximum reach volume. When mounting the air filter on the truck they were forced to hold the air filter with one hand while inserting the screws (Figure 3).

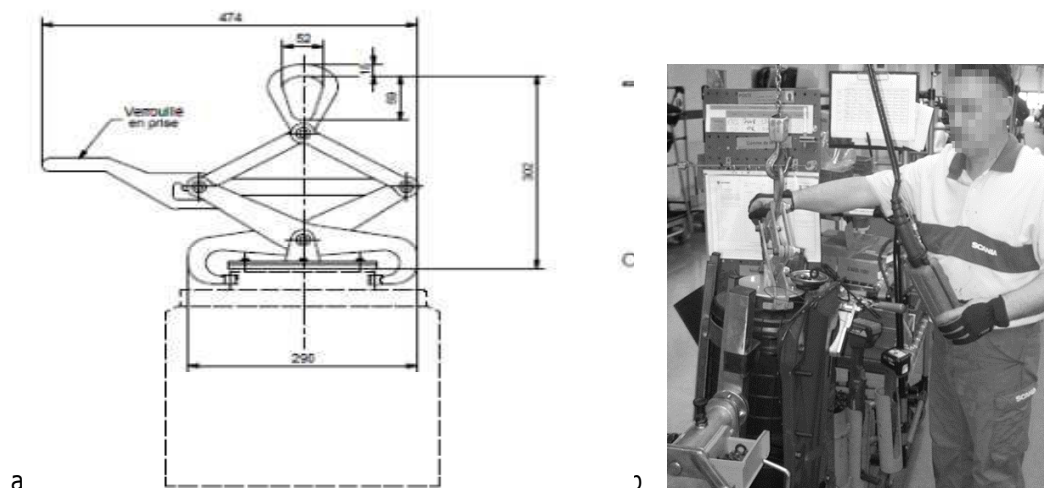

Figure 4: new gripping tool for lifting air filter eliminated risk of low back pain due to lifting heavy object

The combination of these tasks involved high risk factors for the back and hand/wrist. The findings were therefore presented to the sector stakeholders. The team decided to use a gripping tool for lifting and handling air filters. They then set up a project which included selecting the best gripping tool and changing the design of the workplace and trolley. The gripping tool that was chosen for this task is illustrated in Figure 4. This was a

vertical gripping tool for lifting a load at its center of gravity. Its capacity was 20 kg (Figure 4a). The team also designed a new trolley which was adapted to the new gripping tool (Figure 4b). We re-evaluated the work position and the lifting load with two hands criterion was assessed to be yellow by the NIOSH equation after the ergonomic intervention. Although lifting and mounting the air filter on the chassis was eliminated, lifting the air filter from the preparation trolley to the new designed trolley of the position was still manual. Furthermore, manual lifting of cab tilt cylinder was evaluated yellow at this position. The ergonomic intervention therefore reduced the frequency and severity of lifting risk factor at this position but it could not eliminate the risk of manual material handling. In general, technical and mechanical exposure interventions often involve only one exposure dimension (lifting air filter in this case) while the other exposure dimensions cannot be improved (Westgaard and Winkel, 1997). Nevertheless, single technical interventions are effective aspects of ergonomic improvements which can provide positive ongoing results although the ergonomic evaluation method might not have sufficient sensitivity to show a significant difference before and after intervention.

### Lifting tool for handling rear and front mudguards

The main risk factors at the "Boarding Steps & Mudguards" work position were manual lifting of rear and front mudguards (15.2 kg and 12.1kg, respectively) in both left and right side positions (Figure 5). To perform this task, the operator had to lift the mudguards on the wagon situated beside the production line at floor heights ranging from 84 to 122 cm and then transferred them manually for assembly on the chassis at a height of 70 to 114 cm. The lifting index (LI) calculated by the NIOSH equation for this task was red for the left side and yellow for the right side. The LI for the left side rear and front mudguards was 1.7 and 1.3, respectively, and for the right side it was 1.2 for and 0.9, respectively. The reason for this difference was that LI can vary according to the horizontal distance from the body in the origin or destination for loads. This task had significant risk factors in terms the weights and the frequency of handling (12 times/hour for each side).

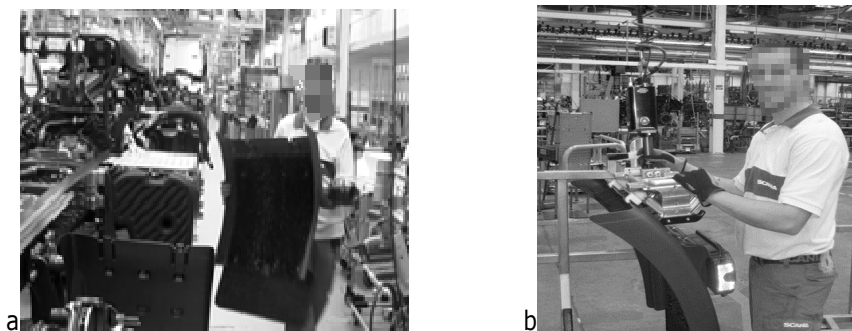

Figure 5a: Lifting and carrying of rear mudguards (15kg) manually, major risk factor for low back pain; b) new lifting tool used for lifting and carrying mudguards

After presenting these results to the sector manager and engineers, they decided to implement a new lifting tool which eliminated the lifting and carrying task of mudguards (Figure 5). The new lifting tool was tested and safety engineers and technicians confirmed its operation. Ergonomic analysis of this position was performed after intervention and the lifting with two hands criterion was evaluated as green. Although using the lifting tool eliminated the lifting and carrying task at this position, some operators still preferred to carry out this task manually.

### Eliminating repeated actions

Repetition was a commonly identified risk factor at most work positions in the assembly plant. The most frequent repeated actions were inserting screws and bolts, tightening with a torque wrench and turning the handles of the trolley. Two tasks with repeated actions were identified at the "Preparation of Selective Catalyst Reduction (SCR) Tank" position i.e. manually tightening the screws to assemble the SCR tank and manual turning of the handle to change the direction of the SCR assembly wagon (Figure 6a). These tasks were evaluated as red by the SES method because the repeated actions occurred approximately >400 times per hour. The working team therefore decided to change the design of the wagon to eliminate the manual handle turning task. An electric screwdriver replaced the manual handle of the wagon and the wagon direction could be changed just by pushing the screwdriver button (Figure 6b).



Figure 6a: Manually turning the SCR wagon handle (intensive repeated action) b) A screwdriver replaced the manual turning handle which eliminated repeated actions

Manual turning of the wagon handle was thus eliminated and the task was accelerated. Manual tightening of screws, however, remained at this position as repetition risk factors. Although the new intervention design of the wagon significantly reduced the number of repeated actions, this work position was still assessed as red for repetition criteria because of the number of repeated actions for the manual screw tightening task.

### Second part of the intervention program: Organizational changes (new cycle time) and workplace redesign

During this intervention period, the factory decided to change the cycle time from 11 minutes to 8 minutes for production reasons (to increase production rates). The cycle time is defined as a cycle time for performing assigned tasks in addition to recovery time (Figure 7).

The organization of the work positions was changed with the new cycle time, and some tasks were transferred to other positions and some new work positions were designed. New operators were also recruited for the new positions. However, the main operation of this sector remained unchanged. Ten work positions were defined in the sector investigated in the initial organisation and fourteen work positions in the new organisation (Table 1).

In the "preparation of the SCR tank" position, the layout of the workplace was changed, many unnecessary movements which related to picking up components were eliminated and the position was transferred nearer to

the production line. A new portable wagon for the SCR tank assembly was designed. Because of changes in the production of the Euro 5 SCR tank, a new generation of SCR tank (Euro 6 SCR) was assembled at this position.

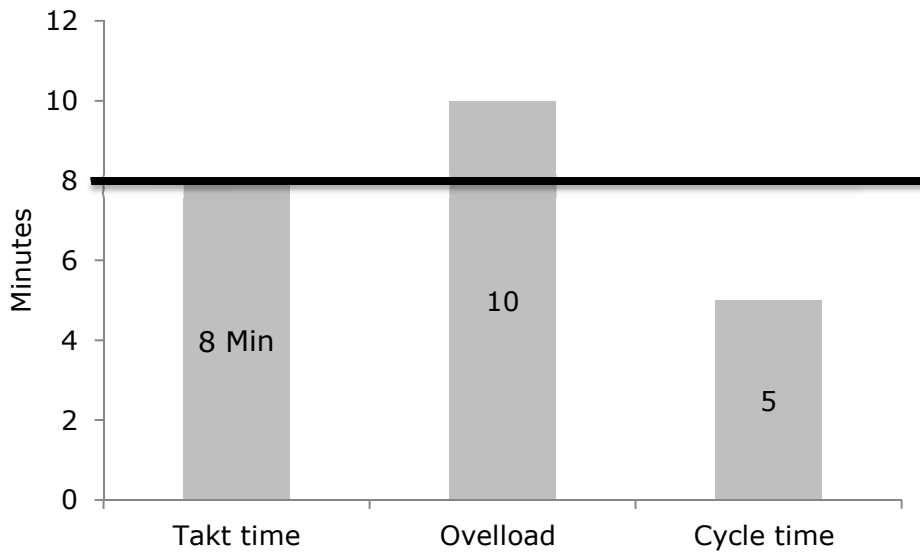

Figure 7: Graphical explanation of the difference between cycle time (time for perform a tasks + recovery time gives answer to customer needs and the production volume of company), cycle time (time to perform a tasks or series of tasks for operators) and overload (where cycle time is greater than cycle time) in the assembly line

The tasks related to the preparation of the Euro 5 SCR Tank had the few changes in the new system. The SES method evaluated the overall color for preparation of the Euro 5 SCR as yellow in both the initial and the new systems. However, repetition was green in the initial system whereas it was assessed as yellow in the new system (repeated actions over 30% of the cycle time). Due to the reduction in the cycle time, the number of repeated actions increased in each cycle. The seven criteria of the ergonomic method were evaluated as yellow in the initial cycle time whereas nine yellow risk factors were identified in the new cycle time. On the other hand, three ergonomic criteria (hand clearance, wrist posture and arm/hand force) at the initial cycle time and one criterion (wrist posture) in the new cycle time were evaluated as red (Table 1). Although the number of criteria rated as red was reduced in the new system, the differences at this position for the Euro 5 SCR tank were not significant between the initial and new systems. The minor variations in the results might be related to the precision (repeatability) of the observational method used. Most tasks for the new SCR tank generation were similar to the Euro 5 SCR tank but connecting hoses that needed excessive hand force had to be implemented at this position, whereas this task was assigned to the "mounting SCR Tank on chassis" position in the initial system. This task was assessed as double red (high risk) for the hand and arm force criterion by the SES method. More screws had to be inserted and tightened manually, so repetition was evaluated as red. As a result, the ergonomic workload increased for the Euro 6 SCR tank (most frequent truck model) at this position (final color red) although good layout and organisation modification were established. Two cycle times were required (16 minutes) to perform all the tasks at this position, so another operator was recruited for this position.

Table 1: Risk evaluation with observational method in the initial and new cycle time

Work positions in the initial system		Work positions in the new system (Changes)	Ergonomic evaluation changes in work positions					
			Initial overall color	New overall color	Number of yellow		Number of red	
					Initial	New	Initial	New
<b>Preparation and assembly of SCR tank</b>								
Preparation of SCR Tank	Euro 5 SCR tank	Layout changes, without changes in tasks, another operator was added	Yellow	Yellow	7	9	3	1
	Euro 6 SCR tank	New SCR tank generation, the similar tasks as the initial generation but hose connection performed in this position	-	Red	-	7	-	4
Assembly of SCR tank on chassis	Euro 5 SCR tank	Lifting of reservoir tank, connecting two hoses, tightening hose clamp, and finishing SCR cable performed in another position	Red	Green	8	7	6	3
	Euro 6 SCR tank	New SCR tank generation: similar tasks as Euro 5 SCR tank but lifting the reservoir performed with the lifting tool and connecting hoses transferred to Preparation SCR position		Green	-	7	-	4
<b>Bumper Zone</b>								
Picking up bumper, sun visor, pump, washer tank and fog lamp preparation		Picking up bumper and sun visor tasks were transferred to another section pump, washer tank and fog lamp preparation were merged in the following work positions	-					
Bumper Preparation position 1	Bumper preparation position 1 (pump preparation was added, bumper cable routing transferred to position 2, putting bumper on the wagon was eliminated)		Yellow	Green	12	6	3	2
	Bumper preparation position 2 (bumper cable routing, washer tank preparation)		-	Green	-	4	-	1
Bumper Preparation position 2	Bumper preparation position 3 (Fog lamp assembly, front right assembly)		Green	Green	7	4	4	4
	Bumper preparation position 4 (filling washer tank, light cable routing, tightening light box, fog lamp cable routing)		-	Yellow	-	9	-	4
Assembly of Bumper on chassis station 2	Bumper assembly and tightening position 5 (filling washer tank, tightening light box, front light cable routing transferred)		Red	Yellow	8	6	5	8
<b>Filter Preparation and Assembly</b>								
Air filter preparation	Air filter, air pipe, heat cover preparation		Yellow	Green	5	7	8	2
	Picking up and preparation of SCR, cab tilt cylinder		-	Green	-	5	-	7
Air filter assembly on chassis	Assembly of Air filter, air pipe, cab tilt cylinder, pump and hoses (heat cover assembly task transferred to another position)		Yellow	Yellow	7	5	7	8
<b>Boarding Step and Mudguard Assembly zone</b>								
Right Boarding steps and Mudguards	Right boarding step assembly and right rear mudguard bracket		Yellow	Yellow	8	5	8	7
	Right mudguard assembly (heat cover assembly task transferred)		-	Green	-	6	-	5
Left boarding steps and Mudguards	Left boarding steps assembly and rear mudguard bracket left		Yellow	Green	9	8	7	5
	Left mudguard assembly (fit air pipe to air inlet pipe)		-	Green	-	4	-	5

The SCR tank (Euro 5 and 6) had to be assembled on the truck chassis at the next work position ("mounting SCR Tank on chassis"). In the new system, tasks such as manually lifting the reservoir tank (13 kg), connecting hoses and cables, tightening hose clamps and finishing cable routing on the top of the tank were performed by another operator for the Euro 5 SCR tank. Therefore, the final color for this position assembling the Euro 5 SCR tank on the truck chassis was green in the new system. The risk factors were different from the initial system because the hose connecting task which was double red (required considerable force from the hands and arms) was performed by an additional operator at the new position who also lifted, carried and positioned the reservoir tank. The number of red risk factors for assembling the Euro 5 SCR was therefore reduced to three from six in the initial system (Table 1). Assembly of the Euro 6 SCR tank was similar to that of the Euro 5 and the risk factors were almost the same, although tightening the Euro 6 SCR support with a manual torque wrench required excessive whole body force (280 N). Manual handling of the Euro 6 SCR tank (8 kg) was eliminated because this task was performed by a lifting tool. The final color of this position for assembling the Euro 6 SCR was also green.

The next work position that was redesigned in the new cycle time was the preparation and picking up of the air filter, air pipe, heat cover, SCR tank, cab tilt cylinder and straining cylinder. One operator performed these tasks in three cycle times (33 minutes) in the initial system. The final color of the ergonomic workload was evaluated as yellow for this position in which 8 red and 5 yellow risk factors were identified (Table 1). This work position was divided into two positions, i.e. "picking up the SCR tank and cab tilt cylinder" and "picking up the air filter, air pipe, and heat cover preparation", in the new cycle time. Furthermore, the physically difficult cylinder task was transferred to another position (assembling air filters in the line) but some extra tasks were defined for "picking up the SCR tank and cab tilt cylinder" position because of the new products. Layout modification and reorganisation of the workplace were also performed. After all these interventions, two new work positions were re-evaluated by the SES method and "the picking up air filter, air pipe, and heat cover preparation" work position was green with just two red criteria (back/wrist posture and lifting/handling of air filter) but picking up the SCR tank and cab tilt cylinder work position was red because a non-standard pallet required excessive whole body force (311 N). The non-standard pallet was replaced by standard one which required only 120 N pushing and pulling forces. The final ergonomic color of this position was green (Table 1).

The "air filter assembly on the chassis" work position included assembling the air filter, air pipe, cab tilt cylinder, heat cover and connecting hoses on the chassis in the initial system. The final ergonomic color of this position was yellow in the initial system with seven red risk factors identified. In the new system, the heat cover assembly task was transferred to the right mudguard position and the cylinder straining task was added to this position. The work position was reassessed and the final ergonomic color was still yellow and seven red points were identified, meaning that the results did not differ between the two systems. Although the heat cover assembly task was transferred to another work position, this did not have any effect on the risk factors identified by the SES method. As explained above, a gripping tool was used at this position for lifting and carrying the air filter which eliminated manual handling of the air filter (a high risk task). However, other high risk tasks such as lifting the cab tilt cylinder, assembling the air pipe and air filter that were similar in both systems resulted in only minor changes in risk factors after all the interventions (Table 1).

The bumper system was first prepared and then mounted on the chassis in the zone near the assembly line in the initial cycle time case. This zone included two workstations (in which there were several positions): "picking up bumper" (carried out in 3 cycle times; 33 minutes) and "bumper preparation and mounting on chassis". The main tasks of these work positions were preparing the washer tank, the fog lamp, and the cab tilt pump, picking up the bumper and sun visor, preparing the bumper, assembling the light box, and finally assembling and tightening the bumper on the chassis. The first workstation, "picking up bumper", included four work positions: 1) picking up bumper, 2) preparing the sun visor, 3) underrun preparation and 4) preparing the bumper equipment. Risk factors were evaluated as green, yellow and green at these four work positions, respectively (Table 1). In the new organisation, sun visor preparation, underrun protection preparation and picking up bumper work positions were transferred to other sectors of the factory and bumper equipment preparation was combined with the "bumper preparation and mounting" workstation. The "Bumper preparation and mounting on chassis" workstation in the initial system included three work positions: bumper preparation work position (1 and 2) and mounting bumper on the chassis work position at which one operator worked for one cycle time (11 minutes). The ergonomic workloads were yellow, green and red, respectively, for these three work positions. Due to merging the bumper equipment preparation tasks (pump, washer tank and fog lamp preparation) into this workstation in the new organisation, five sequential work positions were then designed in which one operator worked for each cycle time (8 minutes). The final ergonomic color for the four bumper preparation work positions was green and it was yellow for mounting the bumper on chassis (Table 1). The 'mounting the bumper on chassis' position was red in the initial cycle time but it was evaluated as yellow in the new system. As explained above, the main reason for this change was the technical modification of the lifting tool antilock system. There were 26 red risk factors (criteria) in the initial system and one task (unlocking the lifting tool) was double red in the bumper zone while in the new system there were 19 red risk factors and the double red task was eliminated. It should be noted that seven red risk factors in the initial system were related to the sun visor preparation work position which was transferred to another part of the factory. In general, the new reorganization of the work positions, distribution of the tasks (balancing workload) between work positions and technical modifications and improvement had significant positive ergonomic effects in this zone.

The boarding step and mudguard parts were assembled at two left and right work positions in the initial system and included the following main tasks: connecting the electrical cables, picking up and placing boarding steps, handling/positioning and tightening mudguards. The total ergonomic workload was evaluated as yellow for these two work positions. In particular, the duration of exposure to awkward back, shoulder, and wrist postures was high (12 minutes per two hours) due to the number of tasks that had to be performed at this position (assembling two main parts of a truck i.e. mudguards - front and rear, and boarding steps). In the new organisation, the tasks from these two work positions were distributed into four work positions (i.e. boarding steps left and right and mudguards left and right). Fitting the air pipe into the inlet pipe task and heat cover assembly task were assigned to these positions. The final ergonomic color was green for three positions in the new system and only the "right boarding step assembly" position was yellow. There were 23 red risk factors in this zone in the new system compared to 15 red evaluations in the initial system. Although the number of red risk factors increased due to the new tasks added to this zone, the high risk tasks were distributed across four work positions, which resulted in acceptable tolerance of risk factors; the final ergonomic color improved as a



result for each work position. Table 2 sets out the characteristics of work positions and workstations before and after reorganization (changes in cycle times).

Table 2: Results of non-parametric Kruskal-Wallis (p-values) by work position and IG for lifting index, and green, yellow, red and double red ergonomic evaluations before and after intervention, significant p-values\*( $<0.05$ ) are shown in bold

Ergonomic workload	By work position			By IG		
	First cycle time (11 min)	Second cycle time (8 min)	Both systems	First cycle time (11 min)	Second cycle time (8 min)	Both systems
NIOSH Equation Lifting Index (LI)	0.1649	0.7504	0.8901	<b>0.00670</b>	0.2567	0.1081
Green ergonomic workload	0.1074	<b>0.0313</b>	0.0873	0.04896	0.3644	0.1264
Yellow ergonomic workload	0.1923	0.0918	0.2606	0.93390	0.4242	0.7547
Red ergonomic workload	<b>0.0359</b>	<b>0.0305</b>	<b>0.0023</b>	<b>0.00111</b>	0.3078	0.0069
Double red ergonomic workload	0.0616	0.1809	0.0904	0.08827	<b>0.0187</b>	<b>0.0448</b>

### Evaluation of Ergonomic Workload Before and After Intervention

It is desirable that high risk tasks (according to ergonomic evaluations) be balanced across work positions and IGs. This was one of the main ideas that were followed over the organizational changes in the sector investigated. Furthermore, it was expected that engineering/technical improvements reduce red and yellow risk factors. Therefore, the results of both the in-house paper-based observational method (SES) and the NIOSH lifting equation were analyzed for both before and after all interventions to determine the possible changes in balancing workloads and reducing high risk tasks. Table 2 summarizes results of the ergonomic analysis by work position and by IG before and after intervention. As shown. The NIOSH lifting index results differed significantly between IGs in the first cycle time ( $p=0.006$ ) while the difference was not significant in the new system. The lifting index was not statistically significant between work positions in either system. The number of green ergonomic evaluations was significantly different between IG in the first cycle time. Green ergonomic evaluations were better distributed between IGs in the new organization of the work place. However, the number of green ergonomic evaluations was significantly different between work positions in the second cycle time. The number of yellow ergonomic workloads was the same in both cycle times per work position and IG.

Red ergonomic workloads were significantly different between IGs in the first cycle time ( $p=0.001$ ) but the difference was not significant in the second cycle time ( $p=0.3$ ). However, a significant difference was found between the numbers of red ergonomic workloads per work position in both cycle times (Table 3).

The majority of risk factors in the assembly plant were lifting loads, which meant that it was a focus of the main intervention in this study. Load lifting was evaluated by the Lifting Index of the NIOSH equation in both cycle times.

Table 3: Musculoskeletal symptoms using a Visual Analogue Scale (VAS)\*\* at the time of filling out the questionnaire before and after changing the cycle times

	All respondents				Same respondents				P-value*
	Initial cycle time (n=15)		New cycle time (n=21)		Initial cycle time (n=11)		New cycle time (n=11)		
	n	%	N	%	N	%	n	%	
Neck, VAS $\geq$ 5	5	33	2	10	3	27	1	9	0.63
Shoulders and arm, VAS $\geq$ 5	10	67	7	35	6	55	4	36	0.63
Elbows and forearms, VAS $\geq$ 5	8	53	8	40	5	45	4	36	1.00
Wrist and hands, VAS $\geq$ 5	7	47	8	40	4	36	3	27	1.00
Fingers, VAS $\geq$ 5	5	33	4	20	2	18	2	18	1.00
Upper back, VAS $\geq$ 5	5	33	5	25	5	45	2	18	0.25
Lower back, VAS $\geq$ 5	7	47	7	35	5	45	3	27	0.50
Hip and thigh, VAS $\geq$ 5	4	27	2	10	3	27	1	9	0.63
Knee and leg, VAS $\geq$ 5	3	20	6	30	3	27	3	27	1.00
Ankle / Foot, VAS $\geq$ 5	4	27	4	20	3	27	2	18	1.00

\* Mac Nemar exact test for 11 operators who responded for both cycle times

\*\*VAS, Visual analog scale for pain

As illustrated in the Figure 8, the mean lifting index in the initial cycle time was 1.0 ( $\pm 0.88$ ), while it reduced significantly after intervention ( $0.27 \pm 0.51$ ). The mean lifting index was  $0.61 \pm 0.79$  across both cycle times. Remedial action involving load lifting significantly affected in the lifting index after intervention. Developing lifting tools for lifting the air filter and mudguards reduced the load lifting risk factors. Furthermore, a new generation of products such as the Euro 6 SCR that is lighter (8 kg vs 13 kg for the SCR Euro 5) and handling with a lift assist device contributed to these changes.

Figure 9 illustrates the results of the green, yellow and red ergonomic evaluations for both cycle times. As shown, the mean ergonomic green evaluation was 8.0 in the initial cycle time but after intervention it increased to 9.6. On the other hand, the moderate ergonomic workload (yellow) was lower in the new cycle time (6.3 after intervention as compared with 7.0 before). The high risk ergonomic workload was evaluated to be lower in the new system than in the initial one. These differences were statistically significant (Kruskal-Wallis rank sum test,  $p < 0.001$ ). It should be noted that the variation in red ergonomic workload values increased in the new cycle time.

Figure 10 shows the distribution of ergonomic workload between IGs for both cycle times. The ergonomic workloads were more homogeneous in the new organization of the workplace. As shown in Figure 10c, the red evaluations in the first IG were significantly more than in two other IGs whereas they were almost balanced between IGs in the new cycle time due to the reorganization of the workplaces and mechanical interventions. The graphs show the same results for the green evaluations.

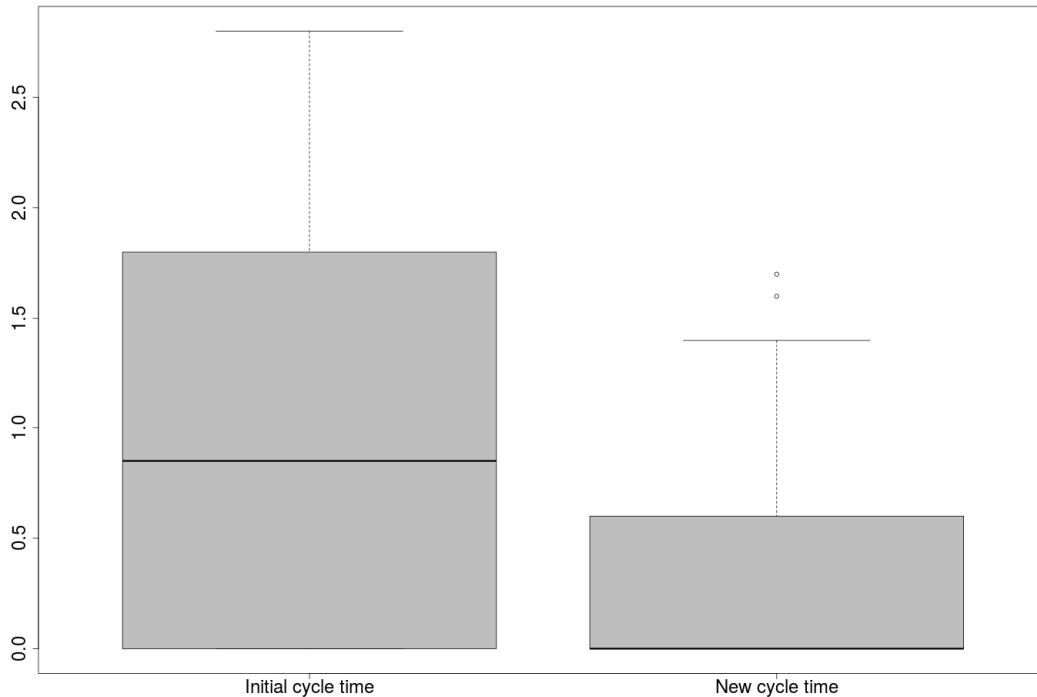

Figure 8: Distribution of lifting index by cycle time illustrating the reduction in mean lifting index after intervention

### Self-reported Musculoskeletal Symptoms Before and After Interventions

The operators who worked at different work positions responded to the Nordic questionnaire concerning the prevalence of musculoskeletal symptoms before and after interventions. Table 3 shows the prevalence of musculoskeletal symptoms in both cycle times. The prevalence of symptoms in the shoulders, elbows and wrists was 67%, 53% and 47%, respectively, for the first cycle time and 35%, 40% and 40% for shoulders, elbows and wrists, respectively, in the second cycle time. The prevalence of symptoms in the lower back was reported to be as high as 47% in the initial cycle time and 35% in the new cycle time. In the initial cycle time there was a higher prevalence of symptoms in the upper limbs, back and lower limbs compared to the new cycle time (except for knee symptoms). Analysis of differences regarding the prevalence of musculoskeletal symptoms showed no significant difference between cycle times.

### Ergonomic Evaluation of Control Group during the Intervention Program

In this study, we selected another sector of the truck assembly plant as a control group. This sector had 9 work positions in the initial cycle time (11 minutes) and 11 work positions in the new cycle time (8 minutes). These work positions were evaluated by the factory's ergonomists in both cycle times based on the general ergonomic strategy of the SCANIA group. According to this strategy, the risk factors were identified by ergonomic methods such as the SES, NIOSH equation, and the Key Indicator Method (KIM) for Pulling/Pushing evaluation, etc. Remedial actions were then developed for high risk work positions (red and double red work positions). The ultimate aim of this program was to achieve as few high risk work positions as possible. All the situations for the control group and the sectors studied were therefore similar in both cycle times except for the intervention programs that we carried out.

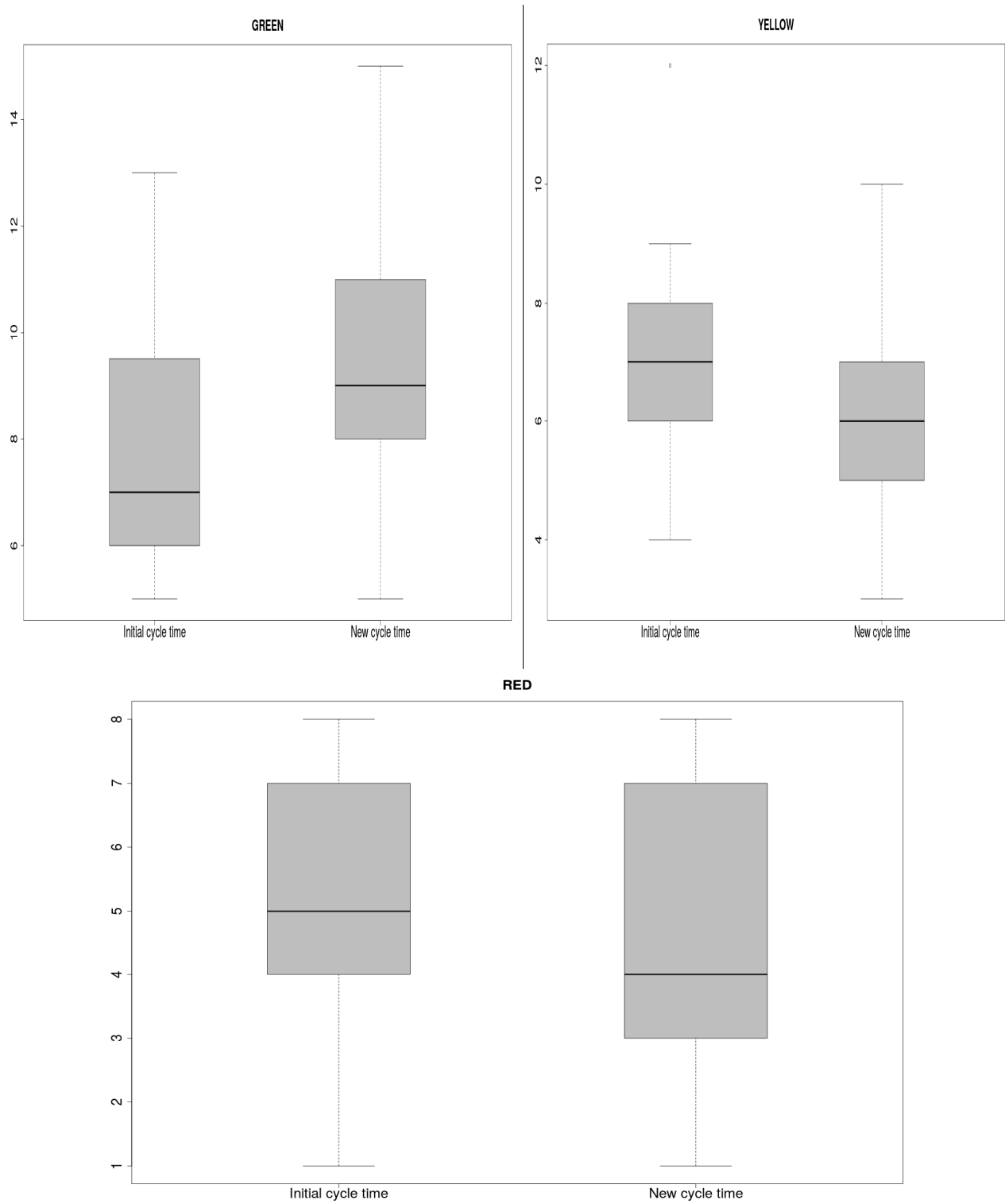

Figure 9: For each of the two cycle times considered, distribution of green ergonomic evaluations yellow ergonomic workload evaluations and red ergonomic evaluations

The ergonomic evaluation by the SES method for the control group showed that out of 181 ergonomic criteria evaluated in the first cycle time, 32.0% were green, 33.7% yellow and 33.1% red. On the other hand, 223 ergonomic criteria were assessed in the new cycle time and the percentages of green, yellow and red ergonomic evaluations were 38.6%, 33.6% and 26.9%, respectively. Although the percentage of high risk criteria (red evaluations) reduced by 6%, the difference was not considerable. Certain remedial actions developed in the control group by the factory and low reproducibility of the SES method results might explain the positive changes in the results for the control group.

## Discussion

This cross-sectional intervention study was performed to improve the ergonomic conditions and reduce physical work demands in a truck assembly plant through ergonomic measures. These measures were a combination of engineering/technical improvements, organization and redesign of workplaces and involvement of stakeholders in the ergonomic programs. Many field studies have shown significant reductions in risk factors following a combination of ergonomic measures (Johansson et al., 1993; van der Molen et al., 2005). However, some studies showed an increase in physical work demands after modification and changes in the workplace (Kemper et al., 1990). In particular, this was observed in a study that reduced the cycle time. Moreau (2003) reported an increase in the incidence of WMSDs in the Peugeot-Citroen manufacturing industry in 1999 because of reduction in the cycle time. These cycle time changes were, however, performed without considering ergonomic principles (Moreau, 2003). In this study we observed a significant reduction in physical work demands after implementing a combination of ergonomic measures, including technical and organizational actions. Van der Molen et al (2005) reported in his review study that, out of six ergonomic interventions that combined technical and organizational measures, four studies showed a reduction in physical work demands (van der Molen et al., 2005). WMSD symptoms were also reduced after intervention, although this finding was statistically non-significant because of the small sample size. It should be noted that three of the technical measures were not completely implemented and adapted to the work positions when the operators filled out the Nordic WMSD symptoms questionnaire. Nevertheless, two technical measures and organizational changes/workplace redesign were entirely integrated when the operators reported their symptoms. Recent studies did not report similar results concerning decrease in WMSDs symptoms and, according to the review study by Van de Molen et al, only four studies reported significant decrease in musculoskeletal symptoms (van der Molen et al., 2005). In a study by Bongers et al (2001), ergonomic measures such as using lifting tools significantly improved body postures of the back, arm and wrist, although the prevalence of musculoskeletal symptoms after 10 months was not significantly different in these parts of the body (van der Molen et al., 2005). This might be due to the complex nature of musculoskeletal disorders, which depend on many factors, and to the duration of assessment before and after intervention.

Engineering and technical ergonomic measures often have a single-factor impact (Westgaard and Winkel, 1997) and they reduced one or two dimensions of physical exposure in the work positions in our study. Designing a new unlocking system significantly reduced fingertip and thumb force but a small contact surface risk factor with relatively high force (>1kg) arose for the palm.

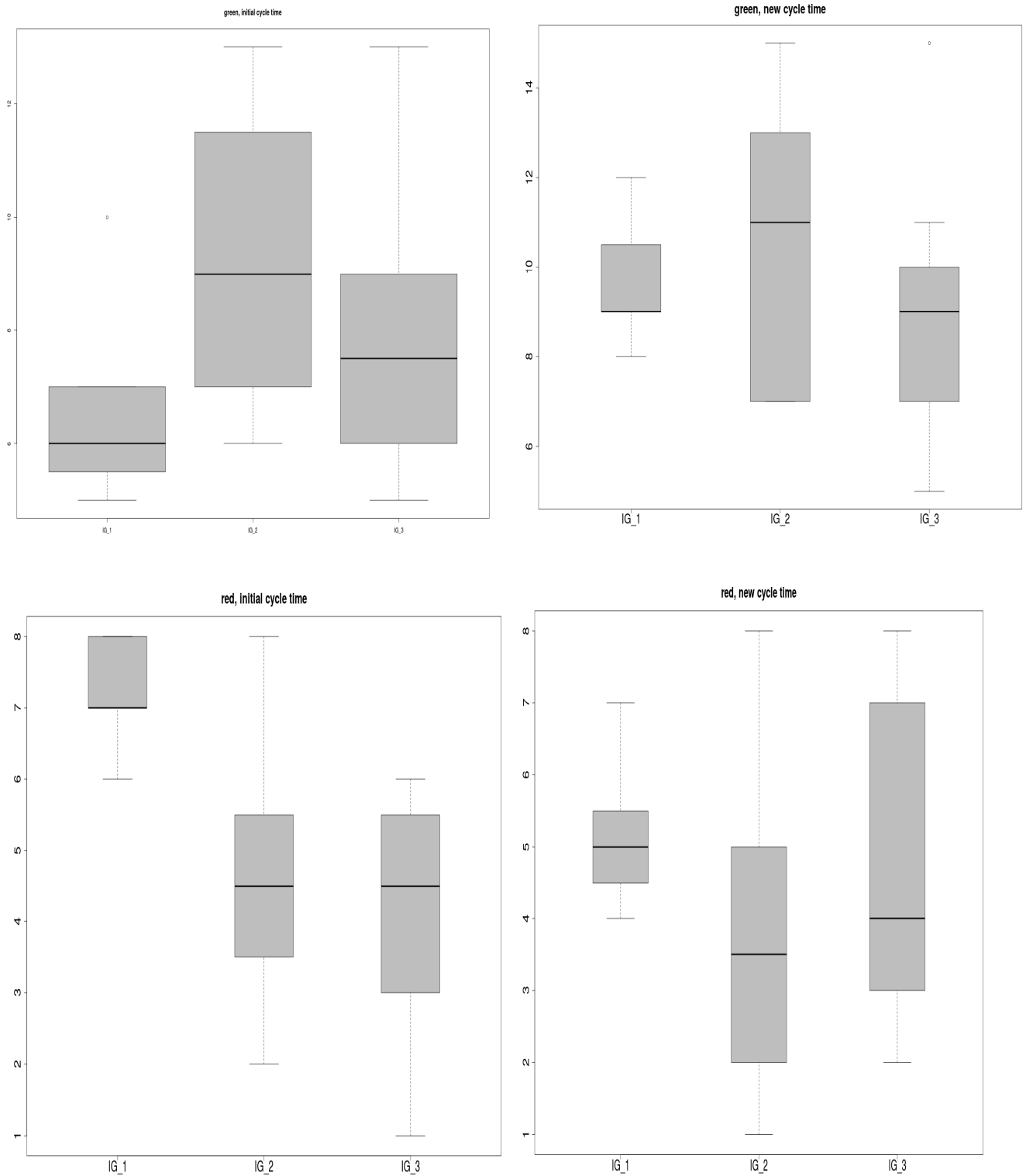

Figure 10: Over three Improvement Groups (IGs); Distribution of green ergonomic evaluations for the initial cycle time, distribution of green ergonomic evaluations for the second cycle time, distribution of red ergonomic evaluations for the first cycle time and distribution of red ergonomic evaluations for the second cycle time

Another limitation of this ergonomic measure was that some operators still preferred the old unlocking system, declaring it to be more comfortable. The operators were used to unlocking the lifting tool with the old system and it is often difficult to change habits. The same problem arose with the new lifting tool for lifting and carrying

the rear and front mudguards. The operators insisted on handling the mudguard manually although it weighed more than 12kg. The operators believed that lifting and carrying with the lifting device would be time-consuming. Furthermore, a limitation in the design of the lifting tool caused complications in applying the new system for lifting the mudguards. Our findings showed that, for ergonomic measures to be successful, operators' and end-users' preferences have to be considered when designing and implementing ergonomic measures. Furthermore, new technical measures must completely eliminate any possibility of using the previous way of performing the task, as the operators' habits often prevent the success of technical measures. Changing people's behavior is necessary in intervention programs which require training, their participation, practice and sometimes compulsory rules (van der Molen et al., 2005). In this study, we benefited from meeting with operators to sensitize them to the potential of risk factors and to the importance of using the tools and devices provided. We could not evaluate the effectiveness of this strategy but it seems that it was less efficient than typical implementation strategies used in the other studies (ex. classroom instruction or a self-paced learning module). Studies have demonstrated that improvement in operator behaviors can be achieved by a combination of implementation strategies including awareness, attitude and ability phases. In their study among health care staff, Knibbe and Friele (1999) reported that a combined strategy, i.e. information, education and facilitation (ergonomic devices), increased the use of lifting devices (Knibbe and Friele, 1999). Three other technical measures successfully achieved the desired objectives. An embedded camera in the hand-held screwdriver machine significantly reduced the duration of exposure to awkward postures. Although this technical measure solved several risk factor exposure dimensions (duration of kneeling, squatting and awkward neck postures), nevertheless we observed some awkward postures at the "Bumper Assembly on truck" work position after integrating its use because of other tasks, such as putting the bumper on the chassis. A gripping tool for handling the air filter succeeded in reducing the duration of exposure to handling the air filter though there was still some manual handling of the air filter. Two interventions were combined in this case, i.e. new lifting device and reorganization/redesign of the workplace and tasks. This combination of measures successfully decreased physical work demands at this work position.

New product generation was effective in this study. This was not initially planned in the context of this research, but it occurred due to ongoing changes in truck products. Although the new products were not always ergonomically well designed, design of the new generation of the SCR tank required lifting and carrying it with lifting devices. Therefore, all the operators had to use the new, safer system whereas in the initial system they handled manually loads of more than 13 kg. Early proactive ergonomics which included well designed products and tasks considering ergonomic principles often improved ergonomic conditions successfully and would be much more effective than reaction ergonomics interventions. Design engineers usually overlook the value of ergonomically designed products and proactive ergonomics (Falck et al., 2010). However, we found in this study that considering ergonomic devices such as lifting tools proactively can effectively eliminate risk factors, and operators then use these devices satisfactorily.

The effectiveness of reorganization and redesign on the ergonomic condition is not clear in the literature. In a review study, Westgaard & Winkel (1997) reported that there was little evidence to confirm a significant effect of redesign in the work system on improving health (Westgaard and Winkel, 1997). Reorganization and new cycle times in this study were related to production rate, but the idea of rebalancing of the workplace and

considering ergonomic situations in the new design was reallocated to the managers, engineers and technicians over several meetings. Reorganization and new design of the work positions was therefore performed with regard to rebalancing the ergonomic workload at the work positions and in the IGs. High risk tasks were distributed between different work positions, and particularly within newly created work positions, and although the new cycle time reduced the content of each work position, performing fewer high risk tasks provided a better ergonomic situation with the new cycle time. Furthermore, the new concept was not completely different and most changes were related to balancing, reorganization and modification. Otto & Scholl (2011) showed that rebalancing at an automobile assembly workstation can significantly reduce risk factors, in many cases without creating new workstations (Otto and Scholl, 2011). The extra work positions created in this study were related to changes in the cycle time and production rate. It should be noted that rebalancing was not via computational experiments on a data set such in Otto & Scholl's study, but the sector manager and engineers reduced the workload at the high risk work positions or IG by transferring the tasks between work positions. Ultimately, balanced work positions were established for which the physical work demand was significantly reduced in the sector investigated compared to the control group. However, we could not distinguish which ergonomic intervention (technical or organisational) had more effect on risk factors because ergonomic measures were performed in parallel. Moreover, changes in the results of the ergonomic assessments might have been related to the low reproducibility of the observational method.

The involvement of stakeholders such as managers, engineers and operators is a key factor in the success of an intervention program. Neuman et al. proposed the involvement of stakeholders from different levels of the system in the ergonomic measures by providing feedback relating to risk factors, disorders, quality defects and productivity (Neumann et al., 2009; Neumann and Village, 2012). This approach helps the stakeholders to find the solutions themselves and aims to reach 20% improvement in both human well-being and system performance. We provided several opportunities for feedback concerning risk factors, symptoms and quality defects to top and middle managers, engineers, technicians and operators. This strategy significantly increased the involvement of decision makers and stakeholders in working condition improvements. However, it was not effective in changing operators' behaviors. Changing operators' behaviors is an essential factor for the success of interventions, i.e. reducing the physical work demands and consequently decreasing musculoskeletal disorders. To achieve effective behavioral changes in operator performance, we propose an implementation strategy that influences awareness, attitudes and performance of people. A psychological method such as simple or cross auto-confrontation (Clot et al., 2000) might be an appropriate approach in order to achieve a successful ergonomic program in the automobile industry.

On the basis of this intervention study, it can be concluded that a combination of ergonomic measures including technical and organisation intervention can significantly reduce physical work demands. Musculoskeletal symptoms decreased after interventions although the effects of interventions on ultimate WMSDs were ambiguous. Providing feedback for different stakeholders can substantially improve the success of intervention programs. However, better results might be achieved if an intervention program was combined with supplementary implementation strategies such as self-confrontation to change operator behaviors.



## **Acknowledgements**

This study was sponsored by the Laboratory of Ergonomic and Epidemiology in Occupational Health (LEEST) and the SCANIA Angers Production group. The authors are grateful for the collaboration of the managers and operators of the SCANIA group and all members of LEEST who helped with this project.

## **Authors' contribution**

All authors had contributions to the preparation of this paper. MZ collected and analyzed the data, wrote the paper and interpreted the results. FG managed and handled intervention projects in the factory. GH contributed to the analysis and interpretation of the results. The study was performed under supervision of YR; he contributed to the interpretation of the results and the revision of the paper.

## References

- Abarqhouei, N.S., Nasab, H.H., 2011. Total Ergonomics and Its Impact in Musculoskeletal Disorders and Quality of Work Life and Productivity. *Open Journal of Safety Science and Technology* 1, 79.
- Clot, Y., Faïta, D., Fernandez, G., Scheller, L., 2000. Entretiens en autoconfrontation croisée: une méthode en clinique de l'activité. *Perspectives interdisciplinaires sur le travail et la santé*.
- David, G., 2005. Ergonomic methods for assessing exposure to risk factors for work-related musculoskeletal disorders. *Occupational Medicine* 55, 190-199.
- Falck, A.C., Ortengren, R., Hogberg, D., 2010. The Impact of Poor Assembly Ergonomics on Product Quality: A Cost-Benefit Analysis in Car Manufacturing. *Human Factors and Ergonomics in Manufacturing & Service Industries* 20, 24-41.
- Johansson, J.Å., Kadefors, R., Rubenowitz, S., Klingenstierna, U., Lindström, I., Engström, T., Johansson, M., 1993. Musculoskeletal symptoms, ergonomic aspects and psychosocial factors in two different truck assembly concepts. *International Journal of Industrial Ergonomics* 12, 35-48.
- Kazmierczak, K., Neumann, W.P., Winkel, J., 2007. A case study of serial-flow car disassembly: Ergonomics, productivity and potential system performance. *Human Factors and Ergonomics in Manufacturing & Service Industries* 17, 331-351.
- Kemper, H.C., Van Aalst, R., Leegwater, A., Maas, S., Knibbe, J., 1990. The physical and physiological workload of refuse collectors. *Ergonomics* 33, 1471-1486.
- Knibbe, J., Friele, R., 1999. The use of logs to assess exposure to manual handling of patients, illustrated in an intervention study in home care nursing. *International Journal of Industrial Ergonomics* 24, 445-454.
- Kuorinka, I., Jonsson, B., Kilbom, A., Vinterberg, H., Biering-Sørensen, F., Andersson, G., Jørgensen, K., 1987. Standardised Nordic questionnaires for the analysis of musculoskeletal symptoms. *Applied ergonomics* 18, 233-237.
- Liljedahl, A., Muftic, A., 2012. Managing Production deviations: A case study at Scania AB, industrial engineering & management. KTH, sweden.
- Moreau, M., 2003. Corporate ergonomics programme at automobiles Peugeot-Sochaux. *Applied Ergonomics* 34, 29-34.
- Neumann, W.P., Ekman, M., Winkel, J., 2009. Integrating ergonomics into production system development - The Volvo Powertrain case. *Applied Ergonomics* 40, 527-537.
- Neumann, W.P., Village, J., 2012. Ergonomics action research II: a framework for integrating HF into work system design. *Ergonomics* 55, 1140-1156.
- Otto, A., Scholl, A., 2011. Incorporating ergonomic risks into assembly line balancing. *Eur. J. Oper. Res.* 212, 277-286.
- Punnett, L., Wegman, D.H., 2004. Work-related musculoskeletal disorders: the epidemiologic evidence and the debate. *Journal of Electromyography and Kinesiology* 14, 13-23.
- Szabová, Z., Čekan, P., Belčík, M., Drhová, J., Balog, K., 2014. Ergonomic analysis applied to work activities of a packer in manufacturing plant, in: Sung, W.P., Kao, J.C.M. (Eds.), 3rd International Conference on Frontier of Energy and Environment Engineering. CRC Press, TaiWan, p. 195.

Team R Core, 2014. R: a language and environment for statistical computing. Vienna, Austria: R Foundation for Statistical Computing; 2012, R Foundation for Statistical Computing, Vienna, Austria.

van der Molen, H.F., Sluiter, J.K., Hulshof, C.T., Vink, P., Frings-Dresen, M.H., 2005. Effectiveness of measures and implementation strategies in reducing physical work demands due to manual handling at work. *Scandinavian journal of work, environment & health*, 75-87.

Westgaard, R.H., Winkel, J., 1997. Ergonomic intervention research for improved musculoskeletal health: a critical review. *International journal of industrial ergonomics* 20, 463-500.

Winkel, J., Mathiassen, S.E., 1994. Assessment of physical work load in epidemiologic studies: concepts, issues and operational considerations. *Ergonomics* 37, 979-988.

Yassi, A., Cooper, J., Tate, R., Gerlach, S., Muir, M., Trottier, J., Massey, K., 2001. A randomized controlled trial to prevent patient lift and transfer injuries of health care workers. *Spine* 26, 1739-1746.

## 7. Conclusion

This study showed that the ergonomist's analysis of the workplace (to assess physical exposure) by observational tools -the SES method- in an automotive industry was significantly different from employees' estimations of risk factors, evaluated by self-reported questionnaire. Comparing the results of both methods (the SES method and questionnaire) with the direct measurement method showed better agreement for the SES method than for the questionnaire. These experiments were performed over two cycle times and the results were almost the same. Although the accuracy of the SES method was better than the self-reported questionnaire in comparison to the direct measurement method, the operators' estimation could not be overlooked and should be considered for its shared representation of risk factors. The observational procedures sample and analyze a short period of work, and the quality and reliability of their results depend on the training and experience of the evaluator. The observational procedure that is only based on the assessment of a trained individual could not be representative of potential risk factors in the workplace. However, this procedure is widely used in English speakers' countries for evaluation of WR-MSDs risk factors and it could be helpful for activity analysis (which is a French approach for ergonomic analysis). The automotive industry should therefore use the observational procedure or direct measurement to obtain objective data of risk factors and then integrate these procedures into a structured interview with the operators or sometimes engineers. The quality of exposure assessment increases in this way and the interventions proposed should be more successful. Furthermore, a hierarchical strategy of risk assessment of work such as "SOBANE" strategy (already explained at Chapter 1; section 3.5) could improve the understanding of the working activities of the operators in the workplace which is also helpful in the clinical management of WR-MSDs. However, the time needed to perform these procedures might be the main challenge for automotive industries.

Another challenge for exposure assessment in this study was the variable nature of the automotive assembly work tasks. The SES method showed wide diversity (particularly in postures) between and within the operators performing the same task which was due to the different work strategies or personality/behavior of the operators. Automotive industries tend to eliminate diversity (different work strategies) by standardization, meaning that the standard truck model and an experienced operator are often evaluated. However, previous studies have shown that operators need the flexibility to select their strategies to perform work activities. Although the question remained regarding how much is "optimal flexibility" (diversity) -the balance between standardization and flexibility - the exposure assessment methods used in automotive industries should take

into account various strategies of operators. A structured interview based on objective data from the video-observation or the direct measurement method can evaluate the operators' strategies and open a discussion between them to select the best and least risky work strategy.

The effects of the interventions proposed and managed by engineers following the ergonomist's evaluation were also investigated. The intervention study showed that a combination of ergonomic measures including technical and organizational interventions can reduce physical workload. Changing the content of the workstations and distribution of the tasks while taking into account their workload had a significant effect on the reduction of risk factors between the two cycle times investigated. Providing feedback for different stakeholders resulted in their contribution to the intervention process and finally improved the success of the interventions.

This study contributed to characterize high risk situation of WR-MSDs by using a classic and sample method such as the SES method – taking into account the variation (different truck models) and diversity (intra and inter operator diversity of exposure to risk factors). The results were communicated with stakeholders and they were progressively enriched by the results of the other methods (self-reported questionnaire and direct measurement methods). The stakeholders (managers, engineers and operators) understanding and knowledge of WR-MSDs risk factors have increased gradually and the shared representation of risk factors has promoted in this manner.

## 8. Further research

This section suggests three avenues for further research:

First, a structured interview procedure based on the video observation or the direct measurement should be developed, tested and applied for assessment of ergonomic exposure in automotive industries. This procedure might be further replaced by the current methods of these industries. It is suggested that this procedure be applied not only as an exposure assessment method but also as a strategic tool for solving ergonomic issues with a focus on improvement of work strategies of operators in a real field. This tool would spontaneously open the discussion between operators concerning various work strategies, particularly after interview. It therefore would be an identifying and controlling tool in collaboration with other stakeholders.

Secondly, there is a need for further research into the effects of "diversity" and "variation" on exposure to WR-MSDs risk factors and the system. Although some recent studies showed the effectiveness of "variation" and "diversity" on reduction of WR-MSDs, manufacturers believe that only variation can be effective and diversity should be eliminated. The research should reveal the extent to which variation (assembling different truck models in one workstation, rotation between workstations and sections (clusters), etc.) can be useful and the extent to which diversity (inter/intra variability between operators when performing the same task) should be limited – balance between standardization and various work strategies of operators. The question is whether to attribute the same work strategy to all operators or to provide sufficient flexibility for each operator to select the best strategy with fewer WR-MSD risk factors.

Finally, organizational intervention such as distribution of high risk tasks between workstations and changing the content of each station by considering ergonomic workloads might be further investigated. Bringing this concept into interventions, particularly during mandatory changes in production such as change in cycle time could increase the possibility of effective and successful ergonomic improvement.

## 9. References

- Abegglen, J.C., Stalk, G., 1985. Kaisha, the Japanese corporation. Basic Books.
- Åkesson, I., Balogh, I., Hansson, G.-Å., 2012. Physical workload in neck, shoulders and wrists/hands in dental hygienists during a work-day. *Applied ergonomics* 43, 803-811.
- Amasay, T., Zodrow, K., Kincl, L., Hess, J., Karduna, A., 2009. Validation of tri-axial accelerometer for the calculation of elevation angles. *International Journal of Industrial Ergonomics* 39, 783-789.
- Armstrong, T.J., Buckle, P., Fine, L.J., Hagberg, M., Jonsson, B., Kilbom, A., Kuorinka, I.A., Silverstein, B.A., Sjogaard, G., Viikari-Juntura, E.R., 1993. A conceptual model for work-related neck and upper-limb musculoskeletal disorders. *Scandinavian journal of work, environment & health*, 73-84.
- Arvidsson, I., Balogh, I., Hansson, G.-Å., Ohlsson, K., Åkesson, I., Nordander, C., 2012. Rationalization in meat cutting – Consequences on physical workload. *Applied Ergonomics* 43, 1026-1032.
- Balogh, I., Ørbæk, P., Ohlsson, K., Nordander, C., Unge, J., Winkel, J., Hansson, G.-Å., 2004. Self-assessed and directly measured occupational physical activities—influence of musculoskeletal complaints, age and gender. *Applied ergonomics* 35, 49-56.
- Bao, S., Howard, N., Spielholz, P., Silverstein, B., Polissar, N., 2009. Interrater reliability of posture observations. *Human Factors: The Journal of the Human Factors and Ergonomics Society*.
- Barrero, L.H., Katz, J.N., Dennerlein, J.T., 2009. Validity of self-reported mechanical demands for occupational epidemiologic research of musculoskeletal disorders. *Scandinavian journal of work, environment & health* 35, 245.
- Barriera-Viruet, H., Sobeih, T.M., Daraiseh, N., Salem, S., 2006. Questionnaires vs observational and direct measurements: a systematic review. *Theoretical Issues in Ergonomics Science* 7, 261-284.
- Berlin, C., 2011. An Organizational Roadmap to Improved Production Ergonomics Dept. of Product and Production Development Chalmers University of Technology Gothenburg, Sweden
- Bernmark, E., Wiktorin, C., 2002. A triaxial accelerometer for measuring arm movements. *Applied ergonomics* 33, 541-547.
- Borg, G., 1990. Psychophysical scaling with applications in physical work and the perception of exertion. *Scandinavian journal of work, environment & health*, 55-58.
- Campbell, J.P., Maxey, V.A., Watson, W.A., 1995. Hawthorne Effect: Implications for Prehospital Research. *Annals of Emergency Medicine* 26, 590-594.
- Campbell, M., Fitzpatrick, R., Haines, A., Kinmonth, A.L., Sandercock, P., Spiegelhalter, D., Tyrer, P., 2000. Framework for design and evaluation of complex interventions to improve health. *Bmj* 321, 694-696.
- Carayon, P., Smith, M.J., Haims, M.C., 1999. Work organization, job stress, and work-related musculoskeletal disorders. *Human Factors: The Journal of the Human Factors and Ergonomics Society* 41, 644-663.
- Chiasson, M.-È., Imbeau, D., Aubry, K., Delisle, A., 2012. Comparing the results of eight methods used to evaluate risk factors associated with musculoskeletal disorders. *International Journal of Industrial Ergonomics* 42, 478-488.

- Clôt, Y., 2005. L'autoconfrontation croisée en analyse du travail: l'apport de la théorie bakhtinienne du dialogue. L'analyse des actions et des discours en situation de travail. Concepts, méthodes et applications, 37-55.
- CNAM-TS, 2013. Rapport de gestion 2013: Bilan financier et sinistralité. Caisse nationale de l'assurance maladie des travailleurs salariés, Paris, p. 57.
- Cooper, C.L., 1998. Theories of organizational stress. Oxford University Press.
- Côté, J.N., Ngomo, S., Stock, S., Messing, K., Vézina, N., Antle, D., Delisle, A., Bellemare, M., Laberge, M., St-Vincent, M., 2013. Quebec research on work-related musculoskeletal disorders: Deeper understanding for better prevention. Relations industrielles/Industrial Relations 68, 643-660.
- Côté, P., van der Velde, G., Cassidy, J.D., Carroll, L.J., Hogg-Johnson, S., Holm, L.W., Carragee, E.J., Haldeman, S., Nordin, M., Hurwitz, E.L., 2008. The burden and determinants of neck pain in workers. European Spine Journal 17, 60-74.
- Coutu, M.-F., 2008. Explorer les types d'écart de représentations entre le clinicien et le travailleur souffrant d'un trouble musculo-squelettique durant le processus de réadaptation au travail. Institut de recherche en santé et en sécurité du travail du Québec.
- Coutu, M.-F., Baril, R., Durand, M.-J., Côté, D., Cadieux, G., 2011. Health and illness representations of workers with a musculoskeletal disorder-related work disability during work rehabilitation: a qualitative study. Journal of occupational rehabilitation 21, 591-600.
- David, G., 2005. Ergonomic methods for assessing exposure to risk factors for work-related musculoskeletal disorders. Occupational Medicine 55, 190-199.
- David, G., Woods, V., Li, G., Buckle, P., 2008. The development of the Quick Exposure Check (QEC) for assessing exposure to risk factors for work-related musculoskeletal disorders. Applied ergonomics 39, 57-69.
- Davis, K.G., Heaney, C.A., 2000. The relationship between psychosocial work characteristics and low back pain: underlying methodological issues. Clinical biomechanics 15, 389-406.
- Deming, W.E., 1982. Quality, productivity, and competitive position. Massachusetts Institute of Technology Center for Advanced En.
- Dempsey, P.G., McGorry, R.W., Maynard, W.S., 2005. A survey of tools and methods used by certified professional ergonomists. Applied Ergonomics 36, 489-503.
- Denis, D., Lortie, M., Rossignol, M., 2000. Observation procedures characterizing occupational physical activities: critical review. International journal of occupational safety and ergonomics 6, 463-491.
- Denis, D., St-Vincent, M., Imbeau, D., Jette, C., Nastasia, I., 2008. Intervention practices in musculoskeletal disorder prevention: a critical literature review. Applied Ergonomics 39, 1-14.
- Descatha, A., Roquelaure, Y., Caroly, S., Evanoff, B., Cyr, D., Mariel, J., Leclerc, A., 2009. Self-administered questionnaire and direct observation by checklist: comparing two methods for physical exposure surveillance in a highly repetitive tasks plant. Applied ergonomics 40, 194-198.
- Driessen, M.T., Proper, K.I., van Tulder, M.W., Anema, J.R., Bongers, P.M., van der Beek, A.J., 2010. The effectiveness of physical and organisational ergonomic interventions on low back pain and neck pain: a systematic review. Occupational and environmental medicine 67, 277-285.



- Falck, A.-C., Örtengren, R., Rosenqvist, M., 2014. Assembly failures and action cost in relation to complexity level and assembly ergonomics in manual assembly (part 2). *International Journal of Industrial Ergonomics* 44, 455-459.
- Falck, A.C., Örtengren, R., Hogberg, D., 2010. The Impact of Poor Assembly Ergonomics on Product Quality: A Cost-Benefit Analysis in Car Manufacturing. *Human Factors and Ergonomics in Manufacturing & Service Industries* 20, 24-41.
- Falck, A.C., Rosenqvist, M., 2012. What are the obstacles and needs of proactive ergonomics measures at early product development stages? - An interview study in five Swedish companies. *International Journal of Industrial Ergonomics* 42, 406-415.
- Fallentin, N., Kilbom, Å., Viikari-Juntura, E., Wærsted, M., 2000. Evaluation of physical workload standards/guidelines from a Nordic perspective, *Proceedings of the Human Factors and Ergonomics Society Annual Meeting*. SAGE Publications, pp. 6-429-426-432.
- Falzon, P., 2005. Developing ergonomics, developing people, *Proceeding of the 8th South East Asian Ergonomics Society Conference [SEAES-IPS]*, Denpasar, Bali, Indonesia.
- Fredriksson, K., Bildt, C., Hägg, G., Kilbom, Å., 2001. The impact on musculoskeletal disorders of changing physical and psychosocial work environment conditions in the automobile industry. *International Journal of Industrial Ergonomics* 28, 31-45.
- Fuller, J.R., Fung, J., Côté, J.N., 2011. Time-dependent adaptations to posture and movement characteristics during the development of repetitive reaching induced fatigue. *Experimental brain research* 211, 133-143.
- Ha, C., Briere, J., Plaine, J., Fouquet, N., Roquelaure, Y., Imbernon, E., 2011. Occupational health indicators from the French epidemiological surveillance programme for work-related musculoskeletal disorders. *Occupational and Environmental Medicine* 68, A31-A31.
- Hägg, G.M., 2003. Corporate initiatives in ergonomics—an introduction. *Applied Ergonomics* 34, 3-15.
- Handling, M., 1998. *Manual Handling Operations Regulations 1992. Guidance for Regulations L23*. London: HSE Books.
- Hansson, G.-Å., Balogh, I., Byström, J.U., Ohlsson, K., Nordander, C., Asterland, P., Sjölander, S., Rylander, L., Winkel, J., Skerfving, S., 2001a. Questionnaire versus direct technical measurements in assessing postures and movements of the head, upper back, arms and hands. *Scandinavian journal of work, environment & health*, 30-40.
- Hansson, G.-Å., Balogh, I., Ohlsson, K., Granqvist, L., Nordander, C., Arvidsson, I., Åkesson, I., Unge, J., Rittner, R., Strömberg, U., 2010. Physical workload in various types of work: Part II. Neck, shoulder and upper arm. *International Journal of Industrial Ergonomics* 40, 267-281.
- Hansson, G., Asterland, P., Holmer, N.-G., Skerfving, S., 2001b. Validity and reliability of triaxial accelerometers for inclinometry in posture analysis. *Medical and Biological Engineering and Computing* 39, 405-413.
- Hansson, G.A., Arvidsson, I., Ohlsson, K., Nordander, C., Mathiassen, S.E., Skerfving, S., Balogh, I., 2006. Precision of measurements of physical workload during standardised manual handling. Part II: Inclinometry of head, upper back, neck and upper arms. *Journal of electromyography and kinesiology : official journal of the International Society of Electrophysiological Kinesiology* 16, 125-136.

Hignett, S., McAtamney, L., 2000. Rapid entire body assessment (REBA). *Applied ergonomics* 31, 201-205.

Hobson, J., 2002. Upper Limb Disorders in the Workplace HSG60 (rev). Published by HSE Books. ISBN: 0-7176-1978-8. Price:£ 9.50. *Occupational Medicine* 52, 364-364.

Hollmann, S., Heuer, H., Schmidt, K.-H., 2001. Control at work: a generalized resource factor for the prevention of musculoskeletal symptoms? *Work & Stress* 15, 29-39.

Hoogendoorn, W.E., van Poppel, M.N., Bongers, P.M., Koes, B.W., Bouter, L.M., 2000. Systematic review of psychosocial factors at work and private life as risk factors for back pain. *Spine* 25, 2114-2125.

Huang, G.D., Feuerstein, M., Sauter, S.L., 2002. Occupational stress and work-related upper extremity disorders: Concepts and models\*. *American journal of industrial medicine* 41, 298-314.

INRS, 2014. Méthode d'analyse de la charge physique de travail, Pris.

Juul-Kristensen, B., Fallentin, N., Ekdahl, C., 1997. Criteria for classification of posture in repetitive work by observation methods: A review. *International Journal of Industrial Ergonomics* 19, 397-411.

Kadefors, R., Forsman, M., 2000. Ergonomic evaluation of complex work: a participative approach employing video-computer interaction, exemplified in a study of order picking. *International Journal of Industrial Ergonomics* 25, 435-445.

Karhu, O., Kansi, P., Kuorinka, I., 1977. Correcting working postures in industry: a practical method for analysis. *Applied ergonomics* 8, 199-201.

Karsh, B.-T., 2006. Theories of work-related musculoskeletal disorders: Implications for ergonomic interventions. *Theoretical Issues in Ergonomics Science* 7, 71-88.

Kazmierczak, K., Mathiassen, S.E., Forsman, M., Winkel, J., 2005. An integrated analysis of ergonomics and time consumption in Swedish 'craft-type' car disassembly. *Applied ergonomics* 36, 263-273.

Kee, D., Karwowski, W., 2001. LUBA: an assessment technique for postural loading on the upper body based on joint motion discomfort and maximum holding time. *Applied Ergonomics* 32, 357-366.

Kee, D., Karwowski, W., 2007. A comparison of three observational techniques for assessing postural loads in industry. *International Journal of Occupational Safety and Ergonomics* 13, 3-14.

Kemmlert, K., 1995. A method assigned for the identification of ergonomic hazards—PLIBEL. *Applied Ergonomics* 26, 199-211.

Kennedy, C.A., Amick III, B.C., Dennerlein, J.T., Brewer, S., Catli, S., Williams, R., Serra, C., Gerr, F., Irvin, E., Mahood, Q., 2010. Systematic review of the role of occupational health and safety interventions in the prevention of upper extremity musculoskeletal symptoms, signs, disorders, injuries, claims and lost time. *Journal of occupational rehabilitation* 20, 127-162.

Ketola, R., Toivonen IV, R., Viikari-Juntura, E., 2001. Interobserver repeatability and validity of an observation method to assess physical loads imposed on the upper extremities. *Ergonomics* 44, 119-131.

Keyserling, W.M., Brouwer, M., Silverstein, B.A., 1992. A checklist for evaluating ergonomic risk factors resulting from awkward postures of the legs, trunk and neck. *International Journal of Industrial Ergonomics* 9, 283-301.

Kilbom, Å., 1994. Assessment of physical exposure in relation to work-related musculoskeletal disorders-what information can be obtained from systematic observations. *Scandinavian journal of work, environment & health* 20, 30-45.

Krafcik, J.F., 1988. Triumph of the lean production system. *MIT Sloan Management Review* 30, 41.

Kumar, S., 2001. Theories of musculoskeletal injury causation. *Ergonomics* 44, 17-47.

Kuorinka, I., Forcier, L., Hagberg, M., Silverstein, B., Wells, R., Smith, M., 1995. *Work related musculoskeletal disorders (WMSDs): a reference book for prevention*. Taylor & Francis London.

Leclerc, A., Landre, M.-F., Chastang, J.-F., Niedhammer, I., Roquelaure, Y., 2001. Upper-limb disorders in repetitive work. *Scandinavian journal of work, environment & health*, 268-278.

Liljedahl, A., Muftic, A., 2012. *Managing Production deviations: A case study at Scania AB, industrial engineering & management*. KTH, sweden.

Lötters, F., Burdorf, A., Kuiper, J., Miedema, H., 2003. Model for the work-relatedness of low-back pain. *Scandinavian journal of work, environment & health*, 431-440.

Lowe, B., Weir, P., Andrews, D., Cincinatti, O., 2014. *Observation-based posture assessment: review of current practice and recommendations for improvement*. U.S. Department of Health and Human Services, Centers for Disease Control and Prevention, National Institute for Occupational Safety and Health, DHHS (NIOSH).

Malchaire, J., 2007. Participative strategy for the management of musculoskeletal disorders in industry. *Lighten the Load*, 11.

Malchaire, J., Cock, N., Vergracht, S., 2001. Review of the factors associated with musculoskeletal problems in epidemiological studies. *International archives of occupational and environmental health* 74, 79-90.

Mathiassen, S., Christmansson, M., 2004. *Variation and autonomy. Working postures and movements—tools for evaluation and engineering*. Boca Raton, FL, USA: CRC Press/London, UK: Taylor & Francis, 330-366.

Mathiassen, S.E., 2006. Diversity and variation in biomechanical exposure: what is it, and why would we like to know? *Applied ergonomics* 37, 419-427.

Mathiassen, S.E., Möller, T., Forsman, M., 2003. Variability in mechanical exposure within and between individuals performing a highly constrained industrial work task. *Ergonomics* 46, 800-824.

McAtamney, L., Corlett, E.N., 1993. RULA: a survey method for the investigation of work-related upper limb disorders. *Applied ergonomics* 24, 91-99.

Möller, T., Mathiassen, S.E., Franzon, H., Kihlberg, S., 2004. Job enlargement and mechanical exposure variability in cyclic assembly work. *Ergonomics* 47, 19-40.

Monnington, S., Quarrie, C., Pinder, A., Morris, L., 2003. Development of Manual handling Assessment Charts (MAC) for health and safety inspectors. *Contemporary Ergonomics*, 3-8.

Morken, T., Riise, T., Moen, B., Hauge, S.H., Holien, S., Langedrag, A., Pedersen, S., Saue, I.L.L., Seljebø, G.M., Thoppil, V., 2003. Low back pain and widespread pain predict sickness absence among industrial workers. *BMC Musculoskeletal disorders* 4, 21.

Morse, A., 2013. *Evaluating the Impact of Lean on Employee Ergonomics, Safety, and Job Satisfaction in Manufacturing, Construction Management and Industrial Engineering*. Louisiana State University, p. 121.

Nahmens, I., Ikuma, L.H., 2011. Effects of lean construction on sustainability of modular homebuilding. *Journal of Architectural Engineering*.

Neumann, P., 2004. *Production Ergonomics: Identifying and managing risk in the design of high performance work systems*. Lund University.

Neumann, W.P., Dul, J., 2010. Human factors: spanning the gap between OM and HRM. *Int. J. Oper. Prod. Manage.* 30, 923-950.

Nur N.M., Dawal S.Z.M., Dahari, M., 2014. The Prevalence of Work Related Musculoskeletal Disorders Among Workers Performing Industrial Repetitive Tasks in the Automotive Manufacturing Companies, *Proceedings of International Conference on Industrial Engineering and Operations Management*, Bali, Indonesia.

Occhipinti, E., 1998. OCRA: a concise index for the assessment of exposure to repetitive movements of the upper limbs. *Ergonomics* 41, 1290-1311.

Organization, W.H., 2007. *Workers' health: global plan of action*. Sixtieth world health assembly.

Oxenburgh, M., Marlow, P., 2005. The Productivity Assessment Tool: Computer-based cost benefit analysis model for the economic assessment of occupational health and safety interventions in the workplace. *Journal of Safety Research* 36, 209-214.

Palmer, K.T., Smedley, J., 2007. Work relatedness of chronic neck pain with physical findings—a systematic review. *Scandinavian journal of work, environment & health*, 165-191.

Parot-Schinkel, E., 2012. *Etude des troubles musculo-squelettiques multi-sites: données en population salariée dans les Pays de la Loire*. Université d'Angers, Angers.

Pehkonen, I., 2010. *Evaluation and Control of Physical Load Factors at Work*, Health Sciences, . University of Eastern Finland, , Helsinki.

Petit, A., Fouquet, N., Roquelaure, Y., 2015a. Chronic low back pain, chronic disability at work, chronic management issues. *Scandinavian journal of work, environment & health* 41, 106.

Petit, A., Ha, C., Bodin, J., Rigouin, P., Descatha, A., Brunet, R., Goldberg, M., Roquelaure, Y., 2015b. Risk factors for carpal tunnel syndrome related to the work organization: A prospective surveillance study in a large working population. *Applied Ergonomics* 47, 1-10.

Petit, A., Mairiaux, P., Roquelaure, Y., 2014. French Good practice guidelines for the management of the low back pain risk among workers exposed to manual handling of loads, *Third Scientific Conference on work disability prevention and integration*, Toronto, Canada

Petit, A., Rousseau, S., Huez, J., Mairiaux, P., Roquelaure, Y., 2015c. Pre-employment examination for low back risk in workers exposed to manual handling of loads: French guidelines. *International archives of occupational and environmental health*, 1-6.

Potvin, J., Dawson, D., MacPherson, M., Jones, J., 2001. Evaluating the ACGIH TLV guideline for low force/high frequency work. *Technical Report Ford Motor Company*.

Punnett, L., 2000. Commentary on the scientific basis of the proposed Occupational Safety and Health Administration Ergonomics Program Standard. *Journal of Occupational and Environmental Medicine* 42, 970-981.

Punnett, L., Fine, L.J., Keyserling, W.M., Herrin, G.D., Chaffin, D.B., 2000. Shoulder disorders and postural stress in automobile assembly work. *Scandinavian journal of work, environment & health*, 283-291.

Punnett, L., Wegman, D.H., 2004. Work-related musculoskeletal disorders: the epidemiologic evidence and the debate. *Journal of Electromyography and Kinesiology* 14, 13-23.

Rissén, D., Melin, B., Sandsjö, L., Dohns, I., Lundberg, U., 2002. Psychophysiological stress reactions, trapezius muscle activity, and neck and shoulder pain among female cashiers before and after introduction of job rotation. *Work & stress* 16, 127-137.

Rivière, S., Penven, E., Cadéac-Birman, H., Roquelaure, Y., Valenty, M., 2014. Underreporting of musculoskeletal disorders in 10 regions in France in 2009. *American journal of industrial medicine* 57, 1174-1180.

Rivlis, I., Van Eerd, D., Cullen, K., Cole, D.C., Irvin, E., Tyson, J., Mahood, Q., 2008. Effectiveness of participatory ergonomic interventions on health outcomes: a systematic review. *Applied Ergonomics* 39, 342-358.

Roquelaure, Y., Ha, C., Leclerc, A., Touranchet, A., Mariot, C., Imbernon, E., Goldberg, M., 2006a. Troubles musculo-squelettiques en France: données du réseau pilote de surveillance épidémiologique dans les entreprises des Pays de la Loire en 2002 et 2003. *Santé, Société et Solidarité* 5, 35-43.

Roquelaure, Y., Ha, C., Leclerc, A., Touranchet, A., Sauteron, M., Melchior, M., Imbernon, E., Goldberg, M., 2006b. Epidemiologic surveillance of upper-extremity musculoskeletal disorders in the working population. *Arthritis Care & Research* 55, 765-778.

Roquelaure, Y., Ha, C., Rouillon, C., Fouquet, N., Leclerc, A., Descatha, A., Touranchet, A., Goldberg, M., Imbernon, E., 2009. Risk factors for upper-extremity musculoskeletal disorders in the working population. *Arthritis Care & Research* 61, 1425-1434.

Roquelaure, Y., Ha, C., Sauteron, M., 2002. Réseau expérimental de surveillance épidémiologique des troubles musculosquelettiques dans les Pays de la Loire. *Surveillance en entreprises en 2005*.

Roquelaure, Y., Malchaire, J., Cock, N., Martin, Y., Piette, A., Vergracht, S., Chiron, H., Leboulanger, M., 2001. Evaluation d'une méthode de quantification de l'activité gestuelle au cours des tâches répétitives de production de masse. *Documents pour le médecin du travail* 86, 167-176.

Sauter, S., Moon, S.D., 1996. *Beyond biomechanics: psychosocial aspects of musculoskeletal disorders in office work*. CRC Press.

Schaub, K., Caragnano, G., Britzke, B., Bruder, R., 2013. The European assembly worksheet. *Theoretical Issues in Ergonomics Science* 14, 616-639.

Shaw, W., Hong, Q.-n., Pransky, G., Loisel, P., 2008. A literature review describing the role of return-to-work coordinators in trial programs and interventions designed to prevent workplace disability. *Journal of occupational rehabilitation* 18, 2-15.

Silverstein, B., Clark, R., 2004. Interventions to reduce work-related musculoskeletal disorders. *Journal of Electromyography and Kinesiology* 14, 135-152.

Sluiter, J.K., Rest, K.M., Frings-Dresen, M.H., 2001. Criteria document for evaluating the work-relatedness of upper-extremity musculoskeletal disorders. *Scandinavian journal of work, environment & health*, 1-102.

Sociali, I.I.d.R.E.e., 2012. *Motor Vehicle Manufacturers in Europe: Ergonomic Findings*. Industrial European Trade Union, European Union.

Speklé, E.M., Heinrich, J., Hoozemans, M.J., Blatter, B.M., van der Beek, A.J., van Dieën, J.H., van Tulder, M.W., 2010. The cost-effectiveness of the RSI QuickScan intervention programme for computer workers:

Results of an economic evaluation alongside a randomised controlled trial. *BMC musculoskeletal disorders* 11, 259.

Sperling, L., Dahlman, S., Wikström, L., Kilbom, Å., Kadefors, R., 1993. A cube model for the classification of work with hand tools and the formulation of functional requirements. *Applied Ergonomics* 24, 212-220.

Spielholz, P., Silverstein, B., Morgan, M., Checkoway, H., Kaufman, J., 2001. Comparison of self-report, video observation and direct measurement methods for upper extremity musculoskeletal disorder physical risk factors. *Ergonomics* 44, 588-613.

Stanton, N.A., Hedge, A., Brookhuis, K., Salas, E., Hendrick, H.W., 2004. *Handbook of human factors and ergonomics methods*. CRC Press.

Steven Moore, J., Garg, A., 1995. The strain index: a proposed method to analyze jobs for risk of distal upper extremity disorders. *American Industrial Hygiene Association* 56, 443-458.

Stock, S.R., Fernandes, R., Delisle, A., Vézina, N., 2005. Reproducibility and validity of workers' self-reports of physical work demands. *Scandinavian journal of work, environment & health*, 409-437.

Takala, E.-P., Pehkonen, I., Forsman, M., Hansson, G.-Å., Mathiassen, S.E., Neumann, W.P., Sjøgaard, G., Veiersted, K.B., Westgaard, R.H., Winkel, J., 2010. Systematic evaluation of observational methods assessing biomechanical exposures at work. *Scandinavian journal of work, environment & health* 36, 3-24.

Thun, J.-H., Lehr, C.B., Bierwirth, M., 2011. Feel free to feel comfortable—An empirical analysis of ergonomics in the German automotive industry. *International Journal of Production Economics* 133, 551-561.

Törnström, L., Amprazis, J., Christmansson, M., Eklund, J., 2008. A corporate workplace model for ergonomic assessments and improvements. *Applied ergonomics* 39, 219-228.

Trask, C., Mathiassen, S., Wahlström, J., Forsman, M., 2014. Cost-efficient assessment of biomechanical exposure in occupational groups, exemplified by posture observation and inclinometry. *Scandinavian journal of work, environment & health*.

Trask, C., Teschke, K., Morrison, J., Village, J., Johnson, P., Koehoorn, M., 2010. Using observation and self-report to predict mean, 90th percentile, and cumulative low back muscle activity in heavy industry workers. *Annals of occupational hygiene*, meq011.

van der Windt, D.A., Thomas, E., Pope, D.P., de Winter, A.F., Macfarlane, G.J., Bouter, L.M., Silman, A.J., 2000. Occupational risk factors for shoulder pain: a systematic review. *Occupational and environmental medicine* 57, 433-442.

van Rijn, R.M., Huisstede, B.M., Koes, B.W., Burdorf, A., 2009. Associations between work-related factors and specific disorders at the elbow: a systematic literature review. *Rheumatology*, kep013.

Vandergrift, J.L., Gold, J.E., Hanlon, A., Punnett, L., 2012. Physical and psychosocial ergonomic risk factors for low back pain in automobile manufacturing workers. *Occupational and environmental medicine* 69, 29-34.

Vieira, E.R., Kumar, S., 2004. Working postures: a literature review. *Journal of Occupational Rehabilitation* 14, 143-159.

Viikari-Juntura, E., Rauas, S., Martikainen, R., Kuosma, E., Riihimäki, H., Takala, E.-P., Saarenmaa, K., 1996. Validity of self-reported physical work load in epidemiologic studies on musculoskeletal disorders. *Scandinavian journal of work, environment & health*, 251-259.

Village, J., Trask, C., Luong, N., Chow, Y., Johnson, P., Koehoorn, M., Teschke, K., 2009. Development and evaluation of an observational Back-Exposure Sampling Tool (Back-EST) for work-related back injury risk factors. *Applied ergonomics* 40, 538-544.

Waters, T.R., Putz-Anderson, V., Garg, A., Fine, L.J., 1993. Revised NIOSH equation for the design and evaluation of manual lifting tasks. *Ergonomics* 36, 749-776.

Wells, R., Mathiassen, S.E., Medbo, L., Winkel, J., 2007. Time—a key issue for musculoskeletal health and manufacturing. *Applied Ergonomics* 38, 733-744.

Wells, R., Norman, R., Neumann, P., Andrews, D., Frank, J., Shannon, H., Kerr, M., 1997. Assessment of physical work load in epidemiologic studies: common measurement metrics for exposure assessment. *Ergonomics* 40, 51-61.

Westgaard, R.H., Winkel, J., 1997. Ergonomic intervention research for improved musculoskeletal health: A critical review. *International Journal of Industrial Ergonomics* 20, 463-500.

Widanarko, B., 2013. Interaction between physical and psychosocial work risk factors for low back symptoms. Massey University,, Manawatu New Zealand.

Zare, M., Croq, M., Arabi, F.h., Brunet, R., Roquelaure, Y., 2015. Does Ergonomics Improve Product Quality and Reduce Costs? A Review Article. *Human Factors and Ergonomics in Manufacturing & Service Industries*, In press.

# ENGAGEMENT DE NON PLAGIAT

Je, soussigné(e) .....  
déclare être pleinement conscient(e) que le plagiat de documents ou d'une  
partie d'un document publiée sur toutes formes de support, y compris l'internet,  
constitue une violation des droits d'auteur ainsi qu'une fraude caractérisée.  
En conséquence, je m'engage à citer toutes les sources que j'ai utilisées  
pour écrire ce rapport ou mémoire.

signé par l'étudiant(e) le **jj** / **mm** / **aaaa**

**Cet engagement de non plagiat doit être signé et joint  
à tous les rapports, dossiers, mémoires.**

Présidence de l'université  
40 rue de rennes - BP 73532  
49035 Angers cedex  
Tél. 02 41 96 23 23 | Fax 02 41 96 23 00



# Appendix 1

**Appendix 1: Summary of the thesis in French**

# **Représentation partagée des facteurs de risque des troubles musculo-squelettiques et comparaison des méthodes d'évaluation : une étude expérimentale dans le secteur de l'assemblage de camions**

## **Contexte**

Les facteurs des risques de TMS, tels que les facteurs physiques, organisationnels et psychosociaux, sont un défi pour les industries de l'assemblage automobile. Une approche ergonomique efficace qui peut fournir une représentation partagée des facteurs de risque entre des acteurs est nécessaire pour éviter des effets indésirables au niveau de la performance des systèmes industriels mais aussi en termes d'effets sur la santé des opérateurs. La question est de savoir si l'approche ergonomique actuelle des industries automobiles peut fournir une connaissance partagée des facteurs ergonomiques pour les divers intervenants, afin de faciliter l'amélioration des conditions de travail.

La représentation des facteurs des risques de TMS dans un milieu de travail pourrait être différente pour les acteurs de terrain tels que les ergonomes, les opérateurs et les ingénieurs, ainsi que les intervenants impliqués dans le retour au travail. Les programmes ergonomiques « typiques » se concentrent souvent sur l'analyse d'un poste par les ergonomes. En d'autres termes, les ergonomes identifient et hiérarchisent les facteurs de risques ergonomiques (généralement de nature essentiellement physique tels que le mouvement, la posture contraignante, la force, etc.). Cependant, les représentations de l'opérateur et ceux des autres intervenants tels que les ingénieurs et les médecins du travail sont négligées. Il est donc essentiel de développer une approche systématique qui prend en compte la complexité des divers facteurs de risque du point de vue des différents intervenants.

L'entreprise à laquelle est adossée la présente étude, SCANIA Production Angers, a déjà intégré l'ergonomie dans son système de production (SPS). Un outil d'observation (la méthode SES : SCANIA Ergonomic Standard) a déjà été utilisé dans cette usine par des ergonomes interne à l'entreprise pour identifier et analyser les facteurs de risques physiques. Sur la base de cette analyse ergonomique, des projets d'améliorations ont été proposés et gérés par les techniciens et les ingénieurs. Enfin, des améliorations ont été mises en œuvre pour changer les conditions de travail et réduire les TMS. En d'autres termes, les problèmes ont été identifiés par un individu (ergonome), résolus par un autre intervenant (ingénieur) et les solutions ont été appliquées par les opérateurs. Bien que parfois les

problèmes et les solutions aient été discutés en réunion par des ingénieurs ou des opérateurs, ces procédures n'ont pas été systématiquement appliquées et ont été effectuées sans échange d'informations et sans discussion des préférences entre les intervenants. La décision sur les améliorations comprenait donc des incertitudes et a parfois conduit à des conflits entre les intervenants.

Cette étude a été menée en vue de développer le concept de représentation partagée dans l'industrie. En effet, son but n'était pas de proposer une nouvelle méthode ou une procédure innovante pour la réalisation de représentations communes des facteurs de risques de TMS (ce qui pourrait constituer une prochaine étape) ; il s'agissait plutôt ici de remettre en question les méthodes actuelles et les procédures communément utilisées dans l'industrie. L'objectif de cette étude était donc d'effectuer une évaluation complète des facteurs des risques de TMS dans une industrie de l'automobile et de comparer les résultats de trois méthodes d'évaluation des risques. Nous avons émis l'hypothèse qu'il existait une différence entre une analyse par un ergonome avec des outils d'observation et les estimations des facteurs de risques, évalués par un questionnaire d'auto-évaluation. Les résultats de ces deux méthodes ont été comparés avec les méthodes biomécaniques (comme les méthodes plus précises).

## **Premier partie d'étude**

Cette étude comporte plusieurs étapes ; dans la phase initiale (le temps de cycle premier), un ergonome a analysé 11 postes de travail d'un secteur d'une usine d'assemblage de camions en utilisant l'outil SES. Dix-sept opérateurs ont travaillé sur ces postes de travail, l'âge moyen et la durée d'ancienneté dans l'emploi actuel étaient respectivement de 42,0 ( $\pm 7,6$ ) et 15,2 ans ( $\pm 7,2$ ) ans. Les résultats ont montré que la posture du tronc, les postures de la main/poignet et les postures de l'épaule étaient les facteurs de risque les plus fréquents dans l'usine d'assemblage de camions. La méthode SES a surestimé des risques de manutention en comparant avec l'équation de NIOSH. De plus, nous avons mesuré la variabilité inter et intra-individuelle de l'exposition aux facteurs des risques dans des situations similaires. La variabilité de l'exposition aux facteurs des risques a été observée entre les opérateurs et chez un même opérateur plusieurs fois pour les mêmes postes de travail. La variabilité était plus élevée pour un poste de travail avec une forte charge de travail ergonomique que pour un poste de travail avec une faible charge de travail ergonomique.

Ensuite, un questionnaire d'auto-évaluation, portant sur les facteurs de risque physiques, organisationnels et psychosociaux de TMS, a été utilisé pour évaluer les perceptions de vue des

opérateurs par rapport à leurs conditions de travail. Les résultats du questionnaire d'auto-évaluation ont montré que les facteurs de risques physiques étaient fréquents pour le membre supérieur dans deux temps cycles. Des symptômes de TMS ont été déclarés pour les coudes (53%), les épaules (67%), les mains/poignets (47%) et le bas du dos (47) chez les opérateurs pour le premier temps de cycle. Ces symptômes ont été moins indiqués pour le deuxième temps de cycle.

Ces deux évaluations des facteurs de risque de TMS (par la méthode SES et le questionnaire d'auto-évaluation) ont ensuite été comparées. L'observation et le questionnaire d'auto-évaluation ont fourni différentes représentations du risque qui montre leur désaccord dans l'analyse de certaines caractéristiques de l'activité. L'analyse de chacun des deux outils ne permet pas d'établir si l'un est plus puissant que l'autre. Cependant, elle soulève la question de savoir si les deux méthodes ont eu un effet complémentaire pour l'estimation des facteurs des risques liés aux TMS.

Enfin, pour déterminer la précision de chaque méthode, des méthodes biomécaniques ont été élaborées et appliquées pour mesurer l'exposition aux facteurs des risques physiques. Les facteurs communs de la méthode SES et le questionnaire d'auto-évaluation ont été comparés à ceux de la méthode biomécanique. Les résultats ont montré que les perceptions des opérateurs concernant les postures de travail sont en désaccord avec la méthode biomécanique. De plus, des concordances ont été observées entre les résultats de la méthode SES (évaluation par un ergonomiste) et ceux de la méthode biomécanique.

## **Deuxième partie d'étude**

L'objectif de la deuxième partie de l'étude (réalisée en parallèle avec la première partie) était de présenter les résultats de l'analyse ergonomique aux intervenants (le comité direction, les ingénieurs et les opérateurs) et de mettre en œuvre des améliorations techniques/ingénierie. De plus, des améliorations organisationnelles telles que des changements dans l'organisation des postes de travail et la répartition des tâches (charge de travail) ont été mises en œuvre. Les effets des améliorations technique/ingénierie et des interventions organisationnelles sur les facteurs de risque physiques ont été étudiés par la suite. Les résultats ont montré que la combinaison des améliorations ergonomiques, dont une intervention technique et de l'organisation permet de réduire les charges physiques du travail.

## Conclusion

D'un point de vue global, cette étude a montré que l'analyse de l'ergonome (évaluation de l'exposition aux facteurs des risques) par des outils d'observation –méthode SES- dans une industrie automobile était significativement différente de la représentation des opérateurs, évaluée par le biais d'un questionnaire d'auto-évaluation. En comparant les résultats de ces deux méthodes avec la méthode biomécanique, nous avons observé des similarités plus fortes pour la méthode SES que pour le questionnaire. Ces comparaisons ont été effectuées suivant un cycle à deux temps et les résultats étaient quasiment identiques. Bien que la précision de la méthode SES ait été meilleure que le questionnaire d'auto-évaluation, l'estimation des opérateurs ne pouvait pas être négligée et a dû être prise en compte pour la représentation partagée de facteurs de risque de TMS. Les méthodes d'observation analysent une courte période de travail, et la qualité et la fiabilité de leurs résultats dépendent de la formation et de l'expérience de l'évaluateur. Une procédure d'observation uniquement basée sur l'évaluation d'une personne formée pourrait ne pas être représentative des facteurs de risque potentiels sur le travail. La méthode SES ne correspond pas à de l'analyse de l'activité mais la démarche peut être complétée par des approches issues de l'ergonomie de langue française. La méthode observationnelle pourra fournir des éléments complémentaires pour l'analyse d'activité.

L'industrie automobile doit donc utiliser la procédure d'observation ou la méthode biomécanique pour obtenir des données objectives des facteurs de risque et ensuite intégrer ces procédures dans un entretien structuré avec les opérateurs ou parfois les ingénieurs. De cette manière, l'analyse ergonomique serait de meilleures qualités et les interventions proposées pourraient être plus efficaces. Une stratégie hiérarchique de l'évaluation des risques du travail tels que la stratégie "SOBANE" (décrite au chapitre 1, section 3.5) pourrait améliorer la compréhension des activités de travail qui sera également utile dans la gestion clinique des TMS. Cependant, le temps nécessaire pour effectuer ces procédures pourrait être le principal obstacle pour l'industrie automobile.

Un autre défi pour l'évaluation de l'exposition aux facteurs des risques ergonomiques dans cette étude était la variabilité des tâches d'assemblage automobile. La méthode SES a montré une variabilité importante inter et intra opérateurs (en particulier pour les postures) en réalisant la même tâche. Les raisons de cette variabilité étaient liées aux différentes stratégies de travail choisies par les opérateurs pour réaliser leurs missions, ainsi que de la personnalité et le comportement des opérateurs. Les

industries automobiles ont tendance à éliminer la variabilité (des stratégies différentes pour réaliser des tâches similaires) par la standardisation (concept de Lean management). Toutefois, des études antérieures ont montré que les opérateurs ont besoin de flexibilité afin de choisir leur propre stratégie pour effectuer les tâches qu'ils ont à réaliser, bien que la question de la "flexibilité optimale" (ou variabilité optimale) –soit l'équilibrage entre la standardisation et la flexibilité- ne soit pas résolue. Les méthodes d'évaluation de l'exposition aux facteurs des risques ergonomiques utilisées dans l'industrie automobile devraient alors prendre en compte les différentes stratégies des opérateurs. Un entretien structuré basé sur des données objectives, par exemple la vidéo-observation ou la méthode biomécanique, pourrait évaluer les stratégies des opérateurs afin d'ouvrir une discussion entre eux pour choisir la stratégie de travail la meilleure et la moins exposé aux facteurs des risques.

L'apport de l'ergonomie dans la caractérisation des situations à risque de TMS a été de dépasser l'utilisation d'outil classique et simple comme la méthode SES prenant en compte la variabilité des tâches et des opérateurs et de pouvoir discuter et communiquer avec les encadrant. Les compréhensions de chaque intervenant de l'entreprise concernant les tâches et les facteurs des risques ont été progressivement enrichis grâce aux résultats de différents outils d'évaluations. Ceci favorise la représentation partagée des tâches.

## **Perspective**

Cette étude propose donc tout d'abord de développer et de tester une procédure d'entretien structurée basée sur l'observation de la vidéo ou de la méthode biomécanique pour l'évaluation de l'exposition aux facteurs des risques liés aux TMS dans l'industrie automobile. Cette procédure pourrait être amenée à remplacer les méthodes actuellement utilisées par ces industries. De plus, nous pensons que cette procédure pourrait être non seulement appliquée comme méthode d'évaluation de l'exposition aux facteurs des risques, mais aussi comme outil stratégique pour résoudre les problèmes d'ergonomie en mettant l'accent sur l'amélioration des stratégies de travail choisies par des opérateurs. Cet outil serait susceptible d'ouvrir spontanément la discussion entre les opérateurs concernant diverses stratégies de travail.

Deuxièmement, il est nécessaire de poursuivre les recherches sur les effets de la «variabilité» sur l'exposition aux facteurs des risques. Bien que certaines études récentes aient montré l'efficacité de la «variabilité» sur la réduction des facteurs des risques de TMS, les dirigeants d'industrie automobile

estiment que seule la variabilité entre les postes et les modèles de camions peut être efficace et la variabilité inter et intra individuelle doit être éliminée. La recherche devrait révéler dans quelle mesure la variabilité entre les postes et les modèles de camions (assemblage de différents modèles de véhicules sur un poste de travail, rotation entre les postes de travail, etc.) peut être utile et à quel degré la variabilité inter / intra opérateurs lors de l'exécution de la même tâche devrait être limitée - équilibre entre standardisation et différentes stratégies de travail des opérateurs. Il s'agirait donc de se demander s'il serait préférable d'attribuer la même stratégie de travail à tous les opérateurs ou s'il faudrait accorder une flexibilité suffisante à chaque opérateur lui permettant de choisir la meilleure stratégie avec moins de facteurs de risques de TMS.

Enfin, des améliorations organisationnelles, telles que la répartition des tâches entre les postes de travail et la modification des contenus de chaque station en considérant les charges ergonomiques, pourraient efficacement réduire les facteurs des risques de TMS. Intégrer ce concept, en particulier lors des changements obligatoires dans la production (changement dans le temps de cycle) pourrait conduire à une amélioration ergonomique efficace.

# Appendix 2

## Appendix 2: Article 1 Does Ergonomics Improve Product Quality and Reduce Costs? A Review Article

*Zare M, Croq M, Arabi FH, Brunet R, Roquelaure Y. Does Ergonomics Improve Product Quality and Reduce Costs? A Review Article. Human Factors and Ergonomics in Manufacturing & Service Industries. 2015, In Pres*



# Does Ergonomics Improve Product Quality and Reduce Costs? A Review Article

Mohsen Zare,<sup>1,2</sup> Michel Croq,<sup>3</sup> Farhad Hossein-Arabi,<sup>4</sup> Rene Brunet,<sup>1</sup> and Yves Roquelaure<sup>1</sup>

1 Laboratory of Ergonomics and Epidemiology in Occupational Health (LEEST), LUNAM University, University of Angers, Angers, France

2 Department of Occupational Health, School of Health, Shahid Sadoughi University of Medical Sciences, Yazd, Iran

3 Occupational Medicine, Safety and Health Department, SCANIA Production Angers SAS, Anger, France

4 Département de l'Ergonomie Groupe PSA Peugeot-Citroën, Paris, France

## Abstract

Competition is an ongoing challenge confronting industrial corporations, particularly automobile manufacturing. Striving to improve product quality and productivity, automotive industries have used different quality management approaches, such as reduced variability, total quality management, and lean management, over recent years. Furthermore, incorporating proactive ergonomics such as physical and organizational ergonomics and psychosocial factors into the structure of a company is considered to be a support for productivity and quality. Several studies have shown the effects of ergonomics on better quality. Application of both quality management approaches and ergonomics in an integrated manner in the manufacturing production system is emphasized because they are similar concepts with the same objectives, that is, to improve efficiency. In this study, a comprehensive review was undertaken and 25 studies were reviewed in order to define how integration of an ergonomic approach in the manufacturing production system can reduce defects and improve quality in the production process. © 2015 Wiley Periodicals, Inc.

**Keywords:** Ergonomic approach; Product quality; Errors; Automotive industry

## 1. INTRODUCTION

Industrial companies and manufacturers have to be competitive as they face new challenges in the industrial world. Higher quality, lower waste, and efficiency are important factors to achieve success in the market (Falck & Rosenqvist, 2012; Törnström, Amprazis, Christmansson, & Eklund, 2008). Companies have al-

ways tried to attain greater efficiency and the least cost in their processes. Many disciplines were therefore introduced, such as Taylor's theory, total quality management (TQM), Six Sigma, the Toyota Production System, lean management, and kaizen (Liljedahl & Muftic, 2012). The main idea of these tools is to define a set of principles and mechanisms to generate systematic improvement in the process to achieve customer satisfaction and reduce waste (Törnström et al., 2008). However, most of the quality management approaches focus on methods and tools to gain advantages, while human aspects have been ignored or paid little attention to. Reports in the literature have stated that, without considering the ergonomic approach, quality management disciplines will not achieve their goals (Hines, Holweg, & Rich, 2004; Liljedahl & Muftic, 2012; Taleghani, 2010; Williams et al., 1992). Nevertheless,

---

Correspondence to: Mohsen Zare, LUNAM Université, Université d'Angers, Laboratoire d'ergonomie et d'épidémiologie en santé au travail (LEEST), Angers, France. Phone: +33787722141; e-mail: mohsen@zare.fr

Received: 12 July 2014; revised 20 February 2015; accepted 23 February 2015

View this article online at [wileyonlinelibrary.com/journal/hfm](http://wileyonlinelibrary.com/journal/hfm)

DOI: 10.1002/hfm.20623

managers see ergonomics as a strictly health and safety tool that is useful for injury/illness prevention instead of recognizing its potential to improve productivity and quality and to reduce costs. This misconception in companies thus prevents ergonomics thinking within firms' production systems or quality management systems (Neumann & Dul, 2010). Although most manufacturers have recently established production system approaches as principal procedures for production, the role of ergonomics has been seen more as prevention of musculoskeletal disorders (MSDs) than as a tool for quality development.

According to the literatures, adverse ergonomic risk factors influence not only human well-being but also human performance, such as increasing rejection rates and decreasing product quality (Govindaraju, Penathur, & Mital, 2001; Kazmierczak, Neumann, & Winkel, 2007). The costs of errors and failures were estimated about 10–40% of a company's income (Falck & Rosenqvist, 2012). Several studies suggest that errors, rejection rates, and reworking would decrease significantly with the integration of ergonomics in the production system (da Silva, Pruffer, & Amaral, 2012). The new strategy of the SCANIA group for the year 2020 is to produce 120,000 trucks, 15,000 buses, and 20,000 engines with the same staff. They believe that it would be possible to reach this goal if they could achieve zero failures. A study in this group showed that ergonomics and the work environment could help to prevent the frequent occurrence of production failures (poor quality; Liljedahl & Muftic, 2012). The Volkswagen group confirmed the need for ergonomics in the production system to prevent health hazards, to optimize production time, and to improve product quality (Toledo, 2012). Dul and Neumann (2009) showed a link between business factors and ergonomic design of the workplace, and Neumann, Ekman, and Winkel (2009) emphasized the integration of ergonomics in the production system. Battini, Faccio, Persona, and Sgarbossa (2011) developed a new 14-step integrated methodological model to achieve productivity and quality performance in an assembly system in which different tools, such as assembly time measurement, ergonomic evaluation, and ergonomic improvements, were integrated. This framework was tested in two case studies and showed improvement in line flow and in flexibility (Battini et al., 2011).

Integration of ergonomics in firms' strategies or production systems of manufacturing has thus emerged. Companies should be convinced that incorporation

of an ergonomic approach in a firm's production system would be profitable in the short and long term, as its effects may vary, from human aspects, including reduction of discomfort, pain, and fatigue, to system aspects, such as speed of performance, decreased rejection rates, and good quality of service (Genaïdy, Salem, Karwowski, Paez, & Tuncel, 2007). The main purpose of this article is to document empirical evidence that supports the proposition that incorporating an ergonomic approach in a firm's production system should be considered a key business objective because the benefits of ergonomics would have not only effects on health and injury prevention but also on product and process quality by reducing errors and the costs of poor product quality.

## 2. CONCEPTUAL FRAMEWORK FOR EFFECTS OF ERGONOMICS ON COST

The conceptual framework is shown in Figure 1. This framework illustrates the consequences of a poor ergonomic approach in a production system. Work characteristics, including physical ergonomic, organizational ergonomic, cognitive, and psychosocial factors, are defined as the ergonomic approach, and these independent characteristics influence human well-being and production levels. Finally, business and marketing would be affected in terms of brand image reduction, problems with recruitment of new employees, and price. In this study, we reviewed the effects of each dimension of the ergonomic approach on quality of products. A poor ergonomic approach influences production level, particularly quality loss, which would increase errors, scrap, and reworking. The potential quality gains of the appropriate ergonomic approach were more than US\$900,000 per year in a car assembly plant (Falck, Örtengren, & Hogberg, 2010). In this review, we did not study the impact of the ergonomic approach on productivity and human well-being. However, as shown in Figure 1, there are strong interactions between these concepts.

## 3. MATERIALS AND METHODS

This article represents a literature review of the empirical evidence that emanated from the relationship between ergonomics in the workplace and its effects on product quality and rejection rates. According to the guiding principles of the Cochrane Collaboration System (Higgins, Green, & Cochrane Collaboration,

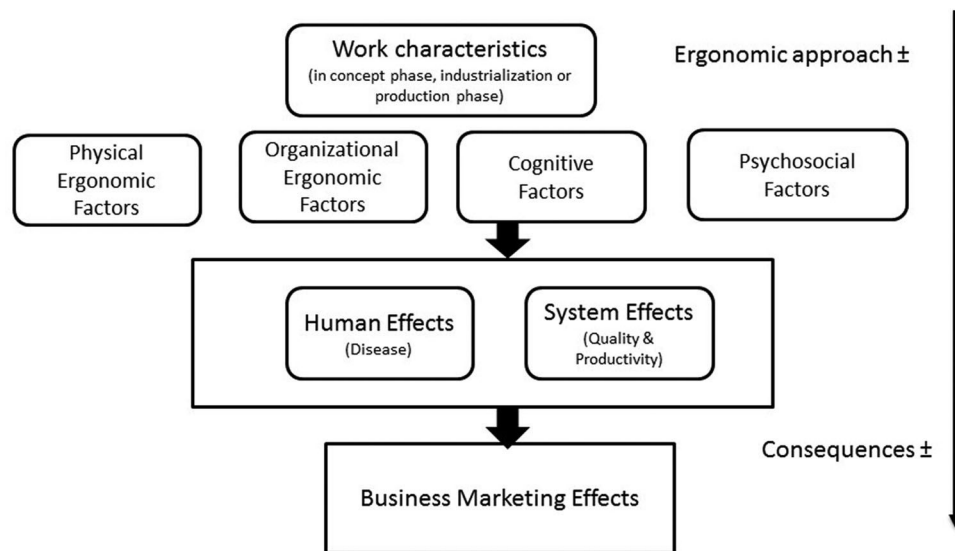

**Figure 1** Conceptual framework illustrates the consequences of poor ergonomic approach

2008), the methodological steps of this literature review were the criteria for considering peer-reviewed articles for inclusion, search methods for identification of peer reviews, selection of peer reviews, appraisal of peer reviews included in the study, and data synthesis. The academic databases, which were searched from 1980 to March 2014, were Google Scholar, EMBASE, Web of Knowledge, Science Directs, Wiley-Blackwell, the Cochran Library, and Springer. In addition, some peer-reviewed journals, such as *Ergonomics* in Taylor & Francis, *Work: A Journal of Prevention, Assessment & Rehabilitation*, *Applied Ergonomics*, and *Human Factors and Ergonomics in Manufacturing & Service Industries* were specifically searched. We used different search strategies and words for each database to obtain the best results and to avoid missing literature. First, to formulate the search strategy, the important concepts within the question were identified. Then, the search terms to describe those concepts were specified, and the synonyms of those terms were considered. Finally, our search strategy was prepared. Our queries consisted of a set of phrases that were combined using different Boolean operators, such as “AND,” “OR,” parenthesis, and wildcards (stemming). As far as possible, we tried to use the phrases that were combinations of words that were found in the exact order in the search documents. In our queries, two or three concepts that included six or seven words were applied. We classified all key words in four categories as ergonomics and occupational health, quality and system

effects, manufacturing and company system, and cost-benefits. The first set of phrases related to ergonomics included 20 terms, for example, Occupational Ergonomics, Human Factors, Human Factor Engineering, Ergonomics Solution, Ergonomics Integrat(ion, ed, ing), Work(s, ing, place) Condition, Workstation Design(ing), Participat(ory, ing, ion) Ergonomics, Occupational Health & Ergonomics. The second category of key words were 25 expressions, for example, Qualit(y, ies), Process Quality, Service(s, ing) Quality, Improv(ed, ing) Quality, Poor Quality, Continu(e, ing) Improv(ement, ing), Production Waste, Rejection Rate, Reduced Scrap, Human Error. The third category included Assembl(y, ing) Plant, Assembl(y, ing) System, Production System, Firm Strateg(y, ies), Manual Assembly, Automotive Manufactur(ing, er, e), Automotive Industry, Production Process. The final category of phrases included key words related to Cost-Savings, Cost Benefits, and Cost Effectiveness. These terms were combined several times and in different ways with the Boolean operators. Furthermore, to ensure that all peer-reviewed articles were reviewed in this area, we checked the reference lists of the relevant articles. Combining the results of all databases and journals searched provided more than 260 results for inclusion in the review. We reviewed the titles and abstracts of the articles identified. Some articles were excluded following scanning of the abstracts and some after reading the full text. The articles included in our review finally consisted of peer-reviewed studies

undertaken in industrial workplaces, particularly the automotive industry throughout the world. Studies in health-care facilities and service sectors, such as medical centers and hospitals, were excluded. Occupational health and safety interventions were excluded unless they had clear ergonomics involvement. Research dealing with the effects of ergonomic interventions on only human effects or productivity was excluded. The articles included were appraised and the information on the aims of the research, interventions, study design, populations, factory and workplaces, confounding factors, outcomes, results, and conclusion were gathered.

## 4. RESULTS

The comprehensive search in the above databases yielded several articles that had investigated the effects of the ergonomics approach on humans and systems. Following a review of the articles found and primary screening of full articles, 29 studies were finally selected for inclusion in our review. Assessment of methodological quality was then undertaken for the 29 eligible studies, from which four were then excluded (da Silva et al., 2012; Drury, 2003; Inman, Blumenfeld, Huang, & Li, 2003; Silva et al., 2012), because of incompatibility with this review. Table 1 shows the characteristics of the 25 articles finally included with key findings and summaries of the investigations conducted. These studies include the effects of organizational and physical ergonomic factors as well as cognitive and psychosocial factors on quality of products. The articles reviewed mainly demonstrated system and human effects of the ergonomic approach elements.

### 4.1. Effects of Physical Ergonomics on Quality

Twelve studies showed the relationship between physical ergonomic risks and product quality. In general, all the studies included showed a strong relationship between quality errors and high ergonomic workload. Falck et al., 2010 conducted a series of case studies in the Volvo manufacturing industry (including car engineering processes, car assembly plant, and quality tracking of completed cars in the market). A considerable relationship was found between poor physical ergonomics and quality errors in all three phases. Of the 352 quality problems logged in the manufacturing engineering phase for three new car models, 23.5% were related to ergonomic problems. In the assembly

plant, 55 assembly tasks were analyzed for 24443 cars. The quality errors related to high physical ergonomic workload assembly tasks (red tasks) were 39%, and for medium physical ergonomic workload assembly tasks (yellow tasks) 48%, while there were 13% for low physical ergonomic (green tasks) workload tasks. Following 216 completed cars over 8 weeks after sales in the market indicated that 70% of the errors were related to red tasks, 27% were related to yellow tasks, and just one error was related to green tasks (Falck et al., 2010). In contrast to the market, yellow tasks caused more in plant-quality errors than red tasks. The possible reasons are the effect of other ergonomic factors (organizational/cognitive/psychosocial) and misclassifications of tasks as red or yellow (observer effects). The authors realized that high-risk tasks, such as working underneath/hidden/at distance, awkward postures, and forceful operations, created more errors. However, material handling, static tasks, and sharp edges showed zero errors. In another similar study by Falck et al. (2010), just one single task, evaluated as yellow, caused 92% of errors identified in the market. The errors identified for red tasks and green tasks were 7.4% and 0.65%, respectively. Analyzing 47 assembly tasks for 47,061 cars in plant showed that the failure rate was 55.1% for red tasks, 37.8% for yellow tasks, and 7.1% for green tasks (Falck, Örtengren, & Rosenqvist, 2014; Falck & Rosenqvist, 2014). In agreement with their hypothesis, the numbers of errors for green tasks were significantly less than for yellow and red tasks in both studies. However, inconsistency was observed between the error rates for yellow and red tasks in both studies of Falck and Rosenqvist (2014) and Falck et al. (2010). Falck et al. (2010) disregarded common physical ergonomic risks that created quality errors in their second study. The results showed that the type of physical ergonomic risks and other dimensions of the ergonomic approach probably changed the rate of failures/errors for high workload tasks. The similar case study by Almgren and Schaurig (2012) in Volvo truck manufacturing showed that red assembly tasks caused 12.68 errors/min on average, while green tasks created 4.79 errors/min. In this study, the authors classified tasks into two categories, and yellow tasks were ignored or distributed between green or red tasks. Furthermore, green tasks were identified in a different way compared to red tasks. Therefore, some tasks might have been classified wrongly (Almgren & Schaurig, 2012). In contrast to the studies by Falck et al. (2010, 2014), in the study by Almgren and

**TABLE 1.** Summary of Research Focus on Link between Ergonomics and Quality Errors

First Authors	Workplace	Variables	Ergonomic Approach Studied	Study Description	Quality Outcomes
Hamrol et al. (2011)	Car wire harness assembly	Workplace risk factors, such as work monotony, noise level, and quality	Psychosocial and organizational factors and environmental ergonomics	Interviews with 100 assembly workers about the main reasons for failures and analysis of the relationships of work monotony, noise level, and their interactions with quality assembly process	Work monotony increased the risk of quality failures and interaction of work monotony threefold and noise level increased the risk of quality failures 10-fold while noise level alone did not have impact on quality
Almgren & Schaurig (2012)	6 sections of assembly line at Volvo truck manufacturing	Ergonomic workload and product quality	Physical ergonomic factors	Red and green tasks were selected, and technical information about them was gathered; quality defects of these tasks in Quils system were collected, and the results were compared	Errors for red were 165% of those for green tasks. The difference between correction times was 186%. Costs for red assembly tasks were more than US\$50,000 in a year.
Axelsson (2000)	Assembly plant	Work postures and quality	Physical ergonomic factors	40 tasks were evaluated by RULA and 17 high-risk tasks were assessed as causing 80% of quality problems. 15 tasks were improved ergonomically; then RULA and quality assessment were performed after intervention	Ergonomic improvements reduced quality defects from 8.9% to 5.0%
Das et al. (2007)	Simulated drill press operations	Ergonomic, work design and modifications, task performance (quantity and quality of products), and worker satisfaction	Physical ergonomic factors	In an intervention study, ergonomic evaluation was undertaken in terms of production tasks, equipment, existing workstations. Workstation redesign and operator training were then performed. The variables were compared in two situations	Increase in output quality was 49.57%, and productivity was 22%. Operator satisfaction scores also increased after intervention

*(Continued)*

**TABLE 1.** Continued

First Authors	Workplace	Variables	Ergonomic Approach Studied	Study Description	Quality Outcomes
De Looze et al. (2010)	Emergency light company	Participatory ergonomic approach	Participatory ergonomics (organizational and physical factors)	A 7-step participatory ergonomic approach was undertaken	25% reduction in reworking related to failure (quality). Benefit from increase in quality was €27250 per year
Eklund (1995)	Swedish car manufacture assembly	Ergonomic conditions and quality outcomes	Organizational, physical, and psychosocial factors	6 phases of study were performed in 8 departments. 58 tasks were categorized as physical demands, psychological demands, and design that made assembly difficult. Quality statistics were gathered and inspectors were interviewed	Relative risk of quality problems for high-risk tasks in final adjustment department was 2.95 ( $P < .05$ ), and in the random disassembly inspection department the relative risk was 1.94
Erdinc & Vayvay (2008)	Machine sewing tasks	Ergonomic risk factors and quality	Physical ergonomic factors	A 3-phase intervention study, including planning, assessment, and implementation, was performed. Ergonomics training and workstation adjustment were undertaken after ergonomic assessment	Defects in products due to operators' errors were reduced from 7% to 3.4%. Ergonomic risk factor and awkward postures significantly reduced
Falck et al. (2014)	Car manufacture assembly	Ergonomics, quality errors, costs	Physical ergonomic factors	47 assembly tasks were categorized as high (16), moderate (18), and low ergonomic workloads. Then 47,061 cars were analyzed regarding error rates related to manual assembly	The percentage of quality errors for high, moderate, and low manual assembly were 55.1%, 37.8%, and 7.1%, respectively
Falck et al. (2014)	Car manufacture assembly	Ergonomics, assembly complexity, quality errors	Cognitive and physical ergonomic factors	Experimental study to analyze cognitive and physical ergonomics relating to errors	Cognitive ergonomics significantly increase quality errors

*(Continued)*

TABLE 1. Continued

First Authors	Workplace	Variables	Ergonomic Approach Studied	Study Description	Quality Outcomes
Falck et al. (2012)	Survey in 5 Swedish companies	Proactive ergonomics, quality and assembly errors, assembly complexity, geometry	Cognitive ergonomic factors	Interviews were conducted with 64 engineers about their opinions, experience, and knowledge of ergonomics. The questions involved assembly ergonomics, product geometry, assembly complexity, and product quality.	78% of respondents believed that poor assembly ergonomics caused quality losses. 89% thought that there are relationships between assembly complexity and assembly errors and scrap
Falck et al. (2010)	Automobile company in Sweden	Quality defects, ergonomics, and costs in 3 processes, including manufacturing engineering, assembly process, and factory complete cars	Physical ergonomic factors	The study started in manufacturing engineering, and 3 new car projects were chosen. Ergonomic workload and quality for assembly items were compared. Then 55 assembly items of 24,443 cars during 8 weeks were analyzed in assembly production. Finally, quality problems for 55 selected assembly items for completed cars were collected over 16 weeks in the after-sale market	In manufacturing engineering, 80% of the tasks with high and medium ergonomic workloads had quality defects. In production assembly, assembly items with high and medium workload had 3 and 3.7 higher quality risks compared to lower physical workload assembly items. In after-sale market, 61% of errors were related to high-risk tasks, 37% to medium-, and 0.01% to low-risk tasks
Fritzsche et al. (2014)	Large automotive industry in Germany	Ergonomics, team diversity, absenteeism, and quality performances	Physical ergonomic factors	In a cross-sectional study over 1 year, 56 automotive assembly teams ( $n = 623$ ) were	High workload tasks increased errors by 80%. Age diversity was not related to

(Continued)

**TABLE 1.** Continued

First Authors	Workplace	Variables	Ergonomic Approach Studied	Study Description	Quality Outcomes
				studied regarding the effects of ergonomics, age, and gender on absenteeism and quality performance	error rates while gender diversity has positive effects on errors
Guimarães et al. (2012)	Brazilian shoe industry	Macro-ergonomic intervention to improve both human well-being and system performance	Participatory ergonomics (organizational and physical factors)	An intervention, including noise reduction, substitution of solvents, changing layout of production area and working hours, and implementation of socio-technical model, was undertaken in a pilot line for 2 years. Human and system benefits were then compared before and after intervention	Reworking and spoilage (quality) decreased to less than 1%, productivity increased by 3%. The savings after intervention were US\$433,347
González et al. (2003)	Metal factory	Ergonomics, production quality	Physical ergonomic factors	Folding sector was selected, then direct observation to identify quality records, and RULA method was applied to identify ergonomic risks. Interventions were performed and new process was defined according to RULA score.	After ergonomic intervention reprocessed parts reduced by 22% and rejected parts reduced by 45%
Il ardi (2012)	Manual deboning process in salmon fish industry in Chile	Quality, productivity, and ergonomics	Physical ergonomic factors	OCRA method and Nordic Questionnaire were used to determine ergonomically high-risk tasks. The information regarding quality of deboned meat was collected	No significant correlation was found between quality and ergonomic high-risk tasks
Larson et al. (2012)	500 companies of US 3M	30 years integration of ergonomics in	Integrating ergonomics in the production	Ergonomic program integrated in 3 phases, including	Reduction in the MSDs and increase in quality and productivity

*(Continued)*



TABLE 1. Continued

First Authors	Workplace	Variables	Ergonomic Approach Studied	Study Description	Quality Outcomes
		US 3M manufacturing	system (organizational and physical factors)	micro-ergonomic strategy, participatory ergonomics, and macro-ergonomics	
Lin et al. (2001)	Assembly of disposable cameras	Ergonomic workload (time pressure and awkward postures), quality performance	Organizational and physical ergonomic factors	2 lines (an older nonautomated and a newer semiautomated line) followed for 6 and 3 weeks, respectively. The regression model for the number of defective cameras (quality index) and ergonomic variables were calculated	The error per week for Line B showed 52.3% variance from Line A
Motamedzadeh et al. (2003)	2 hospital and medical equipment manufacturers	5-stage participatory ergonomics, working conditions, productivity, and quality	Participatory ergonomics (organizational and physical factors)	A 5-stage participatory ergonomic intervention was performed in Factory A (case) while Factory B (control) had an ergonomist consultant who proposed some changes and modification in the processes. To assess the effectiveness of the model, the determined indexes was compared before and after intervention in Factory A and with the results of Factory B	After performing the participatory program in Factory A, quality index showed improvement about 10%. In addition, productivity and working conditions index significantly increased
Neubert et al. (2012)	Volkswagen automotive industry	Model describing positive impact of the ergonomics on reducing losses	Physical ergonomics	Ergonomic workplace design impact on various indicators of production level, workforce level, and business level of the organization to generate efficiency	Reducing reworking, scrap and time, decrease in health risks and finally increase in quality and productivity. 20%

*(Continued)*

**TABLE 1.** Continued

First Authors	Workplace	Variables	Ergonomic Approach Studied	Study Description	Quality Outcomes
Neumann (2004), Neumann et al. (2009), Neumann & Village (2012)	Electronic and automotive industries	Focus on stakeholders to integrate ergonomics	Integrating ergonomics in the production system (organizational and physical factors)	In the new production system, human factors were integrated in various stakeholder groups. Feedback about productivity, quality and health defined	return for ergonomics investment The aim of this model was to achieve 20% improvement in both health and system effects (quality & productivity)
Thun et al. (2012)	German automotive industry	Ergonomic risk factors, worker impact, ergonomic modification, workplace impact, ergonomic modification, and economic and social improvement	Organizational and physical ergonomic factors	Questionnaire containing ergonomic issues such as harmful tasks and conditions, potential ergonomic modifications, and economic and social indicators was filled out by manufacturing managers. The companies were divided into high implementation of ergonomic practice and low implementation of ergonomic practice to assess impact of ergonomics on economic and social factory	Automotive manufacturing managers believed that companies with high implementation of ergonomic practice could achieve better productivity and human effects but not quality improvements
Sen & Yeow (2003)	Electronic motherboard section in a computer manufacturing factory	Cost-effectiveness of ergonomic redesign	Organizational and physical ergonomic factors	First, site walk-through and interview with engineers and managers and operators undertaken to identify ergonomic risks, followed by direct observation and ergonomic redesign	After ergonomic redesign, motherboard defects reduced about 67% and the factory saved US\$469,715
Vieira et al. (2012)	Automotive factory in Brazil	ergonomics and kaizen	Integrating ergonomics in the production	Integrating of ergonomics and kaizen concepts in a	30% increase in vehicle production

*(Continued)*

TABLE 1. Continued

First Authors	Workplace	Variables	Ergonomic Approach Studied	Study Description	Quality Outcomes
			system (organizational and physical factors)	lean production system	without reworking (quality), increase in productivity, decrease in absenteeism and accident index
Yeow & Sen (2006)	Manual component insertion line printed circuit assembly factory	Ergonomic intervention, quality, productivity, and costs	Physical ergonomic factors	Questionnaire filled out to identify ergonomic risks and causes of poor productivity and quality. Then direct observation undertaken for each higher-rated cause. Finally intervention performed for root causes of errors	Intervention decreased quality defects in factory by 29.6% and at customer sites by 11.4%. Productivity increased by 50.1% and revenue raised by 59.8%. Saving was US\$943,296 per year
Yeow & Sen (2003)	Electrical test workstation in printed circuit assembly factory	Ergonomic workstation design, productivity, quality, cost, and occupational safety and health of workers	Physical ergonomic factors	Interviews and subjective assessment performed to identify the ergonomic risks and workstation design requirements. Direct observation was then undertaken and intervention planned for major problems in workplace	Quality defects of customers' site and factory site reduced by 3% and 2.2%, respectively. 6.1% reduction in the cycle time and 6.5% increase in productivity were achieved. Total cost saving was US\$717,600

Schaurig (2012) assembly operators (instead of ergonomists) identified ergonomic high-risk tasks. The validity of the ergonomic evaluation might therefore have been uncertain. This is probably the reason that red tasks in this study influenced quality errors (2.65 times more than green tasks) less than in Falck's study (2014; 7.8 times more than green tasks). Almgren and Schaurig (2012) illustrated common quality errors made with high-risk tasks. However, common physical ergonomic risk factors that had created more failures were overlooked. The most common quality errors made with high-risk tasks in the study of Falck et al. (2010) in a car assembly were fairly consistent

with Almgren and Schaurig's study (2012) in truck assembly. Falck et al. (2010, 2014) and Almgren and Schaurig (2012) gathered information on quality errors in the assembly plant retrospectively as analysis of errors was performed after they took place. With regard to rapid change in manufacturing plant due to customer and production requirements over time, retrospective studies provide confounding factors as ergonomic risks were not similar according to the time-quality errors that occurred. Moreover, interactions between different elements of the ergonomic approach and their impact on quality were disregarded in these studies.

Eklund (1995) showed that relative risk of quality errors for high workload tasks in a car assembly plant was almost three times higher than for other tasks. High-risk physical ergonomic workload tasks resulted in 79 errors per task, and 58% of tasks with high physical ergonomic demands resulted in quality errors. Quality errors increased further along the assembly line as quality errors for ergonomically high-risk tasks were higher in the final adjustment department (RR = 2.95) than the random disassembly inspection department (RR = 1.94; Eklund, 1995). The question regarding where quality errors occurred most frequently in the assembly line and the possibility of quality errors accumulating throughout the process was mostly overlooked in previous studies. In the study by Eklund (1995), various people in each department analyzed the ergonomic workload, which might have increased observer bias in assessing the task workloads. Furthermore, the severity of workloads for each task was not evaluated. Moreover, the types of ergonomic problems that created more quality errors were not revealed. However, Eklund (1995) estimated that 40% of quality errors were more related to fitting deficiencies than material handling tasks.

Fritzsche, Wegge, Schmauder, Kliegel, and Schmidt (2014) conducted a study among 623 assemblers in a German automotive industry. Ergonomic workload was assessed by an in-house version of the Automotive Assembly Worksheet method. A total of 22821 errors were selected and classified according to the Reason method (Reason, 1990) as 53% slips (task execution), 36% lapses (memory failures), and 11% mistakes (work planning). The results showed that in general the errors increased by 80% for the highest physical workloads. Physical workloads increased the risk of slips by 3.66 and lapses by 2.44, although there was no relationship with mistakes. In this study, the confounding factors of age and diversity were considered and common errors were classified (Fritzsche et al., 2014). The type of errors that occurred was consistent with the findings of Falck et al. (2010) and Almgren and Schaurig (2012), as task execution failures were the most frequently identified errors. However, Fritzsche et al. (2014) did not study the impact of different physical workloads, psychosocial factors, and organizational factors.

Axelsson (2000) showed that 17 tasks with high ergonomic risks caused 80% of operators' errors. Intervention was undertaken for 15 tasks out of 17, and the rejection and failure rates reduced by 3.9% (Axelsson,

2000). González et al. (2003) showed that, after physical ergonomic intervention, the quality of products increased by 2%, and reprocessing of parts significantly reduced. Although loss of materials decreased to less than 45%, the number of rejected parts was not statistically different after intervention. The possible reason is that physical ergonomic risk factors were solved by providing facilities (lifting tools) and instructions (for taking good postures) although task workloads remained high in nature. Production changes, design, and other dimensions of the ergonomic approach were not investigated in this intervention study. Amounts of scrap after intervention still remained high, which indicated that intervention had little effect on crucial cases of quality errors. Furthermore, lack of a control group made it difficult to conclude on the effectiveness of intervention on quality (González et al., 2003).

Yeow and Sen (2006) demonstrated in an electronic company that low-cost physical ergonomic interventions can yield 30% error reduction (quality) in plant and 11% at customer sites. Productivity raised by 50% and the factory increased profit by US\$950,000 per year (Yeow & Sen, 2006). The strength of this study was that the authors explained clearly the types of error and the interventions in addition to costs and benefits for each separately. Task execution failures (slips) were the most common errors, and interventions included extra facilities (such as using weighing scales, conveyors, and tools), good illumination, and training. However, assessment of the ergonomic problems was ambiguous, and the effects of its severity on quality were not reported. Furthermore, ergonomic interventions showed a much greater influence on quality and costs than in other similar studies. In another similar study conducted by Yeow and Sen (2003) in an electrical test workstation in the same factory, quality errors decreased by 3% in plant and 2.2% in the market. Productivity also increased by 6% (Sen & Yeow, 2003; Yeow & Sen, 2003). Reductions in quality errors were significantly different in these two similar studies. These positive results might reflect the impact of other elements, not only ergonomic interventions but also factors such as the Hawthorne effect as the operators produced their best performance because of monitoring. Considering a control group might prove the effectiveness of interventions.

Erdinc and Vayvay (2008) undertook low-cost physical ergonomic interventions and ergonomics training in two machine sewing lines. The interventions resulted in 5% reduction in quality defects for Line 1 and 3%

reduction for Line 2 (Erdinc & Vayvay, 2008). The majority of interventions in this study consisted of training and work instructions, which raised the possibility of the Hawthorne effect. The participants might have improved their performance not only for ergonomic interventions but also in response to their awareness of being observed. The effects of other dimensions of an ergonomic approach were not investigated.

Neubert, Bruder, and Toledo (2012) showed that awkward postures led to many quality defects, such as leakages, loose clips, neglected screws, and crooked placements. A model, including production level (cycle time, reworking and scrap), business level (quality and productivity), and operators' level (health and performance), was therefore proposed that was influenced by physical ergonomics. Although the authors did not examine their model experimentally, they estimated that, depending on the industry, ergonomics in such a model could save 20%. Evidence related to the effects of awkward postures on quality errors and reducing costs was not reported in Neubert's study (Neubert et al., 2012).

In an experimental study, Das, Shikdar, and Winters (2007) proposed ergonomic interventions such as suitable chairs and tables, changes in design and layout, and comprehensive training methods (using Methods-Time Measurement (MTM) analysis) in a drill press operation. An experimental investigation that included two groups was then designed to test productivity (number of holes created), quality (number of good holes), and operator satisfaction. There was a significant improvement in quality (50%), and productivity increased by 22% (Das et al., 2007). However, this study was performed in a laboratory in an academic setting in which the participants were not professional operators, and there are many confounding factors, such as workplace conditions, and cognitive and psychosocial factors in the real work environments that affect results.

#### **4.2. Organizational Ergonomics: Integration of Ergonomics in Production Systems**

Three studies reported integrating ergonomics in entire manufacturing production systems and its multiple outcomes such as quality, productivity, and human well-being (Larson, Oshiro, & Camargo, 2012; Larson & Wick, 2012; Neumann et al., 2009; Neumann & Village, 2012; Vieira, Balbinotti, Varasquin, & Gontijo, 2012). In a series of studies, Neumann et al. (2004) proposed a new organizational ergonomic ap-

proach for integration of ergonomics in production systems. This approach required the involvement of a wide range of stakeholders, including manufacturing strategies, selection of new services and products, product design, system and organization design, and implementation in the workplace. Indeed, human factors and ergonomics should be integrated at each stage, and the advantages of ergonomics should encourage the stakeholders to support this approach. Proactive ergonomics and risk tracing would thus be adopted in a regular manner throughout the organization instead of late consideration of ergonomics in the final stages of an existing system. Feedback relating to disorders, quality defects, and productivity would be received by stakeholders at each level to help them find solutions and continuous improvement. This approach aims to reach 20% improvement at three levels in the company (human well-being, business and marketing, and production; Dul & Neumann, 2009; Neumann et al., 2009; Neumann & Village, 2012). Neumann et al. (2004) tested this approach in case studies within the automotive and electronic industries. Although in both studies productivity and ergonomic performance increased significantly, no evidence was shown regarding quality improvements because there was a lack of comparative quality data for the old and new design systems (Neumann, 2004; Neumann, Kihlberg, Medbo, Mathiassen, & Winkel, 2002; Neumann, Winkel, Medbo, Magneberg, & Mathiassen, 2006).

Vieira et al. (2012) integrated ergonomics into a lean production system in an automobile factory in Brazil. This system initially included 5'S, dexterity, standardization, kaizen, time measure, quality control, performance management of resources, just in time, and guidelines for management. The researchers then added ergonomics to this system. They found that the percentage of vehicles without reworking increased from 48% to 78% after integration of ergonomics. There was also a decrease in absenteeism and accidents and an increase in productivity. The main gap in this study was that the authors did not explain clearly the phases in which ergonomics were integrated in the production system (design/development, engineering process, or assembly). Furthermore, lack of information about the nature of the ergonomic interventions (physical, cognitive, or psychosocial) make it difficult to conclude on the effectiveness of the program on quality.

In two linked studies by Larson and Wick (2012), the integration of ergonomics was monitored over 30 years at 3M Company throughout the world. The

company ergonomics program was divided into three stages. The first included micro-ergonomics, the second participatory ergonomics, and the third transition from a U.S. technical program focused on engineering changes to a global program using participatory ergonomics in the framework of macro-ergonomics. The results of this change in the company production system were increase in quality, productivity, and efficiency as well as a 75% decrease in the risk of exposure to MSDs. Moreover, case studies at 3M factories in Brazil and Poland showed significant increases in product quality and quality of life of the workers. However, the evidence of quality improvement was not investigated, and Larson and Wick (2012) just received feedback regarding quality improvements.

Three intervention studies included in the review introduced comprehensive macro-ergonomics and a participatory model and showed cost-benefits. Motamedzade, Shahnavaz, Kazemnejad, Azar, and Karimi (2003) designed a participatory ergonomics model in a medical equipment manufacturing company in Iran. Scraps, reworking, and rejection reduced by 5%, 8%, and 10% after intervention, respectively. Although the researchers demonstrated positive trends in quality and productivity indicators following ergonomics interventions, durable process changes were not observed because there was no commitment by top management. This is the only intervention study reviewed that included a control group in their study design (Motamedzade et al., 2003). Guimarães, Ribeiro, and Renner (2012) investigated the impact of a macro-ergonomic intervention in a large footwear factory. Organizational intervention, such as teamwork and increasing workers' skills, reduced reworking and spoilage by 0.8% and 0.9% in the new pilot line. Furthermore, the cost saving just on quality issues was US\$173400. Guimarães et al. (2012) also reported reduction of accidents, absenteeism, and risk of MSDs. Moreover, the cost-benefit ratio of ergonomic interventions was more than 7 (Guimarães, Ribeiro, & Renner, 2012). Nevertheless, the Hawthorne effect might have positively influenced results. Quality, productivity, and human effect indicators were collected 2 years after launching the intervention (instead of periodically during the study). It is possible that system and human improvements were not merely related to ergonomics interventions and that other aspects of production yielded these findings. Furthermore, they performed a range of ergonomic interventions (organizational and environmental), but the interac-

tions between these dimensions were not reported. De Looze, Vink, Koningsveld, Kuijt-Evers, and Van Rhijn (2010) applied a participative and integrative ergonomic approach in a print assembly company and in final assembly of emergency lighting. It was estimated that reworking and failures reduced by 25% due to the ergonomic intervention. However, the company changed the quality policy, and significantly less reworking in the new situation was also related to the new company policy. The total investment of €141,210 over 5 years provided €215,789 benefits per year in terms of productivity, quality, and health. The benefit related to quality was €27,250 per year (de Looze et al., 2010).

Lin, Drury, and Kim (2001) reported the increase of quality errors per week due to poor physical and organizational ergonomic factors in two lines of camera assembly. The more time pressure and the poorer the work postures the more quality errors produced per week (Lin et al., 2001). However, a small number of workstations and tasks were evaluated. Furthermore, awkward postures and time pressure were the single type of physical and organizational ergonomic factors that were investigated. In a survey among 100 car wire harness assembly operators, Hamrol, Kowalik, and Kujawiński (2011) cited time pressure as the main reason for operators' failures. Though, the authors did not report evidence about relationships between time pressure and risk of errors (Hamrol et al., 2011). Eklund (1995) demonstrated that long assembly time related to the design involved difficult-to-assemble and high workload tasks. However, Falck et al. (2014) reported a nonsignificant relationship between ergonomic level and assembly time. There was a gap in the literature on the relationship between operation times and ergonomics and quality errors.

The literature showed that design of products could significantly influence time operation, ergonomic workloads, and quality. Eklund (1995) reported that design involving difficult assembly led to the largest number of quality errors (130 errors/tasks). Falck et al. (2010) reported that design engineers overlooked the consequences of poor product design on the difficulty of assembly, ergonomic workloads, and quality. Baraldi and Paulo (2011) compared two automotive assembly lines, the first of which was new, with high ergonomic investment in design and organization, and the second was traditional with low consideration of ergonomics. The new assembly line had 30% fewer quality errors compared to the traditional assembly line. Assembly time and absenteeism on the new ergonomic assembly

line were also lower (Baraldi & Paulo, 2011). The interactions between various ergonomic interventions and also their exclusive impact on quality were not investigated in this study. Confounding factors, such as operators' skills and product complexity for each line, were not reported.

Thun, Lehr, and Bierwirth (2011) undertook a questionnaire survey in 55 automotive industries in Germany where the respondents were manufacturing managers. They believed that organizational ergonomics are more harmful than physical ergonomics (task-related risk factors and environmental ergonomic risks). An ergonomic approach (both organizational and physical) could significantly influence systems and human well-being such as increase in productivity, flexibility, safety, work comfort, motivation, and satisfaction. In terms of quality effects, manufacturing managers responded that a high-quality ergonomic situation could not significantly reduce errors in comparison to a poor ergonomic situation. The manufacturers believed that work-focused ergonomics interventions can decrease the risk of mistakes and defects much more than worker-focused intervention. This survey showed that implementation of an ergonomic approach in manufacturing industries requires development of managers' perceptions regarding the impact of ergonomics on poor production quality (Thun et al., 2011).

### 4.3. Impact of Cognitive Ergonomics and Psychosocial Factors on Quality

We found two studies in the literature that investigated the interactions between assembly complexity, physical ergonomics, and quality (Falck et al., 2014; Falck & Rosenqvist, 2012). In this review, we considered assembly complexity as cognitive workload. Falck and Rosenqvist (2012) interviewed 64 engineers in five Swedish companies: 90% of respondents thought poor physical ergonomics led to quality defects, 73% of the engineers perceived that poor ergonomics were related to assembly complexity, and 85% stated that assembly complexity was the cause of errors and scrap. This survey showed the positive opinions of engineers regarding interactions between different ergonomic approaches. In another experimental study, Falck et al. (2014) showed that both physical and cognitive ergonomics (complexity) significantly increased errors in assembly plants. The authors also reported a relationship between physical and cognitive ergonomics.

However, it was unclear which dimension had more effect on quality errors. Action costs for high cognitive workload tasks were 22 times more than low cognitive workload tasks. The authors considered only one aspect of cognitive ergonomics (complexity) while cognitive workloads have various elements (e.g., memory, perception). Furthermore, complexity of assembly is such a complicated concept that its measurement is a matter of debate in the literature.

Very few researchers have investigated the impact of psychosocial factors on quality. In a survey study, Hamrol et al. (2011) reported employee fatigue, work monotony, noise, and manual work as main reasons for operators' failures. The relationship between work monotony, noise level, and the assembly process quality was then investigated. Work monotony increased the risk of failure threefold, whereas noise level did not influence the quality. The interaction of work monotony and noise level increased the risk of failure 10-fold. Eklund (1995) showed that 70% of tasks with quality errors were tasks with high psychological demands. González et al. (2002) reported on the impact of psychosocial factors on quality errors without providing evidence. Revealing a relationship between psychological factors and risk of errors, particularly interactions with other ergonomic approaches, is still a matter of debate because of the subjective nature of psychosocial factors.

## 5. DISCUSSION

The major hypothesis of this review was that a poor ergonomic approach is related to product quality in terms of errors and failures. The concept of the ergonomic impact on quality has been under investigation since the 1990s (Burri & Helander, 1991; Helander & Burri, 1995), but in this study, we included the most recent research. The focus of this review was mainly on studies involving automotive assembly because the link between work conditions and product quality is much stronger in the automotive industry. Of the 25 studies included, 13 studies had been conducted in automobile manufacture. Although there is strong evidence of the relationship between ergonomics and quality in the automotive industries, reviewing the ergonomics programs in many car manufacturing industries showed few links between ergonomics and quality policy. The Volvo Car Corporation (VCC) and Volkswagen are two examples of companies whose ergonomics programs are a part of their quality strategy (Hägg, 2003). The

relationship between ergonomics and better quality is weaker in other industries such as the meat industry. Ilardi (2012) found no relationship between high-risk tasks and quality of deboning in the fish industry. Three studies by Falck et al. (Falck et al., 2014; Falck & Rosenqvist, 2014; Falck et al., 2010) in the VCC, which specifically focused on the quality errors related to physical and cognitive ergonomics provided strong evidence of the impact of ergonomics on quality in the automotive industries. The evidence was not the same in all of Falck's studies, and the risk of failures for high-risk ergonomic tasks varied from two to eight times. Eklund (1995) and Fritzsche et al. (2014) reported the risk of failures as three times and Almgren and Schaurig (2012) discovered more than twice as many errors for ergonomically poor tasks. The differences in ergonomic risk evaluation, work conditions, work methods, and standards might be the main reasons for these variations. Furthermore, the articles reviewed discussed the impact of ergonomically high-risk tasks on quality in general terms, and few articles reported most common ergonomic risk factors that had the most effect. Lifting heavy components does not have the same impact on quality as performing precise tasks. Eklund (1995) reported that 40% of quality errors were related to fitting defects. Falck et al. (2010) showed that obstructions, working underneath, and hidden assembly were main reasons for errors. In their survey among manufacturing managers, Thun et al. (2011) showed that repetition and manipulation are significant reasons for failure. The greatest gap is in empirical research investigating separately the effects of different physical ergonomic workloads on errors. Errors are not only due to the effects of physical ergonomic risk factors, whereas other job characteristics such as organizational, cognitive, and psycho-social factors have a major impact on product quality (Layer, Karwowski, & Furr, 2009). Lin et al. (2001), Thun et al. (2011) and Hamrol et al. (2011) showed that time pressure is an important factor in failures. In his survey among design and manufacturing engineers, Falck and Rosenqvist (2012) showed that cognitive demands (assembly complexity) are related to both failure rates and physical ergonomic workloads. Another empirical study showed a significant relationship between assembly complexity and both ergonomic workload and failure rates (Falck et al., 2014). More studies are required to make it possible to apply these results to other workplaces.

Ten studies involved intervention research, but none were performed in automotive industries. Electrical and computer assembly companies and shoe and metal industries have been the focus of most intervention studies. The results of quality improvement due to ergonomic intervention have varied considerably. Erdinc and Vayvay (2008) and Axelsson (2000) found a reduction in quality defects of about 4% after ergonomic intervention, while Yeow and Sen (2006) found about 30% reduction in errors in a manual component insertion line of printed circuit assembly. However, in another study by Yeow and Sen (2003) in an electrical test workstation, the reduction was about 3%. Laboratory studies (Das et al., 2007) showed a high percentage of quality improvements compared to empirical studies (Erdinc & Yeow, 2011). The Hawthorne effect might have occurred in several. Furthermore, the type of industry, type of ergonomic intervention (physical, organizational, or both), and the definition of quality indicators have a significant effect on these differences. The type of ergonomic intervention varied from solving single technical problems (physical approach) to integrating ergonomics in the company production system (organizational approach). In this review, three investigations proposed integrating ergonomic programs in the overall strategy of the production system. Although all of them mentioned the strong influence of integrating ergonomics in production systems on product quality, the quality and quantity of evidence were not sufficient. However, there was scientific evidence for such an influence on productivity, reduction in physical ergonomic workload, and human well-being (Ashraf Genaidy, Karwowski, & Christensen, 1999). Although some studies such as Hamrol et al. (2011) and Lin et al. (2001) showed that organizational factors had more impact on quality, most of the intervention studies reviewed contained technical and engineering changes through ergonomic modification of workstations and tools (physical ergonomic factors). Few intervention studies reported the effect of organizational factors' modification on quality failures reduction. As there is a lack of studies that prioritize the principal and common ergonomic risk factors that cause quality defects, a similar gap was found in the types of practical ergonomic interventions that could result in better quality or system effects. The range of interventions in the studies included was very wide, and studies focusing on valid ergonomic interventions leading to quality



improvement are rare. However, Hendrick (2003), Erdinc and Vayvay (2008), and Yeow and Sen (2003, 2006) demonstrated that focusing on obvious physical ergonomic risks, which can often be solved by simple and inexpensive improvements, could have significant effects in terms of quality. Modifications such as providing suitable equipment (chairs, footrests, tables), proper layout and adjusting workstations, along with substitution of well-designed tools instead of poor tools sometimes have a highly significant cost-benefit payback (Hendrick, 2003). It is difficult to conclude that any quality improvement in intervention studies is actually related to changes in ergonomic approach because the quality policy and production system of the industries also changed. De Looze et al. (2010) estimated that just 25% of all total improvement in quality was related to ergonomic changes, as most improvements were because of quality policy changes.

Most intervention studies investigated the effects of ergonomics on both human and system outcomes, including quality and productivity. The impact on productivity has been a more frequent focus. In a review study that included 45 articles, Neumann and Dul (2010) showed that the main system effects of studies were productivity (89% of articles), while 31% reported quality effects of ergonomics.

Survey studies have shown the opinions of manufacturing managers, engineers, and workers. Thun et al. (2011) showed that automotive manufacturing managers thought that physical and organizational ergonomic intervention could reduce mistakes and would have cost-saving effects. However, the evidence for system effects was not strong, and the managers' opinions about ergonomics were more on its effectiveness in decreasing workloads and absenteeism, and increasing health, safety, satisfaction, and motivation. Neumann and Dul (2010) stated that managers recognize ergonomics as a health and safety tool. This misconception in companies affects the effectiveness of ergonomics and investment within industries. However, manufacturing engineers and quality inspectors in Sweden believed in the effectiveness of ergonomics for quality improvement (Eklund, 1995; Falck & Rosenqvist, 2012), and assemblers who were interviewed by Hamrol et al. (2011) had similar opinions. Therefore, changing the thinking of manufacturing managers and bringing it closer to the opinions of the engineers and assemblers should be considered.

## 6. CONCLUSION

The aim of this review was to investigate the impact of the ergonomic approach on product quality, particularly in automotive manufacturing. Twenty-five empirical studies were included. The studies reviewed provided evidence of the effects of the poor ergonomic approach on quality errors, mainly in the automotive industry. However, the interaction between different ergonomic dimensions (physical, organizational, cognitive, and psychosocial) and their effects on quality remain undemonstrated. Research on the effects of cognitive ergonomic and psychosocial factors on quality is still scant. Survey studies among manufacturing managers showed that they still see ergonomics as a health and disease prevention tool and not as a method for cost saving and waste reduction.

## References

- Almgren, J., & Schaurig, C. (2012). The influence of production ergonomics on product quality (Unpublished master's thesis). Chalmers University of Technology, Gothenburg, Sweden.
- Axelsson, J. (2000). Quality and ergonomics—towards successful integration (Unpublished doctoral dissertation). Linköping University, Linköping, Sweden.
- Baraldi, E. C., & Paulo, C. (2011). Ergonomic planned supply in an automotive assembly line. *Human Factors and Ergonomics in Manufacturing & Service Industries*, 21(1), 104–119.
- Battini, D., Faccio, M., Persona, A., & Sgarbossa, F. (2011). New methodological framework to improve productivity and ergonomics in assembly system design. *International Journal of Industrial Ergonomics*, 41(1), 30–42.
- Burri, G. J., Jr, & Helander, M. G. (1991). A field study of productivity improvements in the manufacturing of circuit boards. *International Journal of Industrial Ergonomics*, 7(3), 207–215.
- Das, B., Shikdar, A. A., & Winters, T. (2007). Workstation redesign for a repetitive drill press operation: A combined work design and ergonomics approach. *Human Factors and Ergonomics in Manufacturing & Service Industries*, 17(4), 395–410.
- da Silva, M. P., Pruffer, C., & Amaral, F. G. (2012). Is there enough information to calculate the financial benefits of ergonomics projects? *Work: A Journal of Prevention Assessment & Rehabilitation*, 41, 476–483.
- de Looze, M. P., Vink, P., Koningsveld, E. A. P., Kuijters, L., & VanRhijn, G. (2010). Cost-effectiveness of ergonomic interventions in production. *Human*

- Factors and Ergonomics in Manufacturing & Service Industries, 20(4), 316–323.
- Drury, C. (2003). Service, quality and human factors. *AI & SOCIETY*, 17(2), 78–96.
- Dul, J., & Neumann, W. P. (2009). Ergonomics contributions to company strategies. *Applied Ergonomics*, 40(4), 745–752.
- Eklund, J. A. E. (1995). Relationships between ergonomics and quality in assembly work. *Applied Ergonomics*, 26(1), 15–20.
- Erdinc, O., & Vayvay, O. (2008). Ergonomics interventions improve quality in manufacturing: A case study. *International Journal of Industrial and Systems Engineering*, 3(6), 727–745.
- Erdinc, O., & Yeow, P. H. P. (2011). Proving external validity of ergonomics and quality relationship through review of real-world case studies. *International Journal of Production Research*, 49(4), 949–962.
- Falck, A.-C., Örtengren, R., & Hogberg, D. (2010). The impact of poor assembly ergonomics on product quality: A cost-benefit analysis in car manufacturing. *Human Factors and Ergonomics in Manufacturing & Service Industries*, 20(1), 24–41.
- Falck, A.-C., Örtengren, R., & Rosenqvist, M. (2014). Assembly failures and action cost in relation to complexity level and assembly ergonomics in manual assembly (Part 2). *International Journal of Industrial Ergonomics*, 44(3), 455–459.
- Falck, A.-C., & Rosenqvist, M. (2012). What are the obstacles and needs of proactive ergonomics measures at early product development stages? An interview study in five Swedish companies. *International Journal of Industrial Ergonomics*, 42(5), 406–415.
- Falck, A.-C., & Rosenqvist, M. (2014). A model for calculation of the costs of poor assembly ergonomics (Part 1). *International Journal of Industrial Ergonomics*, 44(1), 140–147.
- Fritzsche, L., Wegge, J., Schmauder, M., Kliegel, M., & Schmidt, K.-H. (2014). Good ergonomics and team diversity reduce absenteeism and errors in car manufacturing. *Ergonomics*, 57(2), 148–61.
- Genaidy, A., Karwowski, W., & Christensen, D. (1999). Principles of work system performance optimization: A business ergonomics approach. *Human Factors and Ergonomics in Manufacturing & Service Industries*, 9(1), 105–128.
- Genaidy, A., Salem, S., Karwowski, W., Paez, O., & Tuncel, S. (2007). The work compatibility improvement framework: An integrated perspective of the human-at-work system. *Ergonomics*, 50(1), 3–25.
- González, B. A., Adenso-Díaz, B., & González Torre, P. (2003). Ergonomic performance and quality relationship: An empirical evidence case. *International Journal of Industrial Ergonomics*, 31(1), 33–40.
- Govindaraju, M., Pennathur, A., & Mital, A. (2001). Quality improvement in manufacturing through human performance enhancement. *Integrated Manufacturing Systems*, 12(5), 360–367.
- Guimarães, L. B. d. M., Ribeiro, J. L. D., & Renner, J. S. (2012). Cost-benefit analysis of a socio-technical intervention in a Brazilian footwear company. *Applied Ergonomics*, 43(5), 948–957.
- Hägg, G. M. (2003). Corporate initiatives in ergonomics—an introduction. *Applied Ergonomics*, 34(1), 3–15.
- Hamrol, A., Kowalik, D., & Kujawiński, A. (2011). Impact of selected work condition factors on quality of manual assembly process. *Human Factors and Ergonomics in Manufacturing & Service Industries*, 21(2), 156–163.
- Helander, M. G., & Burri, G. J. (1995). Cost effectiveness of ergonomics and quality improvements in electronics manufacturing. *International Journal of Industrial Ergonomics*, 15(2), 137–151.
- Hendrick, H. W. (2003). Determining the cost-benefits of ergonomics projects and factors that lead to their success. *Applied Ergonomics*, 34(5), 419–427.
- Higgins, J. P., Green, S., & Cochrane Collaboration. (2008). *Cochrane handbook for systematic reviews of interventions* (Vol. 5). Chichester: Wiley-Blackwell.
- Hines, P., Holweg, M., & Rich, N. (2004). Learning to evolve: A review of contemporary lean thinking. *International Journal of Operations & Production Management*, 24(10), 994–1011.
- Ilardi, J. S. (2012). Relationship between productivity, quality and musculoskeletal disorder risk among deboning workers in a Chilean salmon industry. *Work*, 41(Suppl 1), 5334–5338.
- Inman, R. R., Blumenfeld, D. E., Huang, N., & Li, J. (2003). Designing production systems for quality: Research opportunities from an automotive industry perspective. *International Journal of Production Research*, 41(9), 1953–1971.
- Kazmierczak, K., Neumann, W. P., & Winkel, J. (2007). A case study of serial-flow car disassembly: Ergonomics, productivity, and potential system performance. *Human Factors and Ergonomics in Manufacturing & Service Industries*, 17(4), 331–351.
- Larson, N., Oshiro, R., & Camargo, O. (2012). 3M Brazil ergonomics: A success story in the making. *Work*, 41(Suppl 1), 5977–5980.
- Larson, N., & Wick, H. (2012). 30 years of ergonomics at 3M: A case study. *Work*, 41(Suppl 1), 5091–5098.
- Layer, J. K., Karwowski, W., & Furr, A. (2009). The effect of cognitive demands and perceived quality of work life on human performance in manufacturing environments. *International Journal of Industrial Ergonomics*, 39(2), 413–421.

- Liljedahl, A., & Muftic, A. (2012). Managing production deviations: A case study at Scania AB. (Unpublished Master of Science dissertation). KTH University, Sweden.
- Lin, L., Drury, C. G., & Kim, S. W. (2001). Ergonomics and quality in paced assembly lines. *Human Factors and Ergonomics in Manufacturing & Service Industries*, 11(4), 377–382.
- Motamedzade, M., Shahnavaz, H., Kazemnejad, A., Azar, A., & Karimi, H. (2003). The impact of participatory ergonomics on working conditions, quality, and productivity. *International Journal of Occupational Safety and Ergonomics*, 9(2), 135–147.
- Neubert, N., Bruder, R., & Toledo, B. (2012). The charge of ergonomics—a model according to the influence of ergonomic workplace design for economical and efficient indicators of the automotive industry. *Work*, 41(Suppl 1), 4389–4395.
- Neumann, W. P. (2004). Production ergonomics: Identifying and managing risk in the design of high performance work systems (Unpublished doctoral dissertation). Lund University, Sweden.
- Neumann, W. P., & Dul, J. (2010). Human factors: Spanning the gap between OM and HRM. *International Journal of Operations & Production Management*, 30(9–10), 923–950.
- Neumann, W. P., Ekman, M., & Winkel, J. (2009). Integrating ergonomics into production system development—the Volvo Powertrain case. *Applied Ergonomics*, 40(3), 527–537.
- Neumann, W. P., Kihlberg, S., Medbo, P., Mathiassen, S. E., & Winkel, J. (2002). A case study evaluating the ergonomic and productivity impacts of partial automation strategies in the electronics industry. *International Journal of Production Research*, 40(16), 4059–4075.
- Neumann, W. P., & Village, J. (2012). Ergonomics action research II: A framework for integrating HF into work system design. *Ergonomics*, 55(10), 1140–1156.
- Neumann, W. P., Winkel, J., Medbo, L., Magneberg, R., & Mathiassen, S. E. (2006). Production system design elements influencing productivity and ergonomics: A case study of parallel and serial flow strategies. *International Journal of Operations & Production Management*, 26(8), 904–923.
- Reason, J. (1990). *Human error*. Cambridge University Press.
- Sen, R. N., & Yeow, P. H. P. (2003). Cost effectiveness of ergonomic redesign of electronic motherboard. *Applied Ergonomics*, 34(5), 453–463.
- Silva, K. M., Coelho, B. G., Junior, J. V., Faria, L. F., Dutra, L., Alvarenga, M., . . . Echternach, E. H. (2012). The footwear factory's assembly sector: Opposing organizational structure and quality from the ergonomic work analysis. *Work*, 41(Suppl 1), 1683–1690.
- Taleghani, M. (2010). Key factors for implementing the lean manufacturing system. *Journal of American Science*, 6(7), 287–291.
- Thun, J.-H., Lehr, C. B., & Bierwirth, M. (2011). Feel free to feel comfortable—an empirical analysis of ergonomics in the German automotive industry. *International Journal of Production Economics*, 133(2), 551–561.
- Toledo, B. (2012). Global ergonomics strategy in Volkswagen: From the product construction, over the planning until the serial process. *Work*, 41(Suppl 1), 4413–4417.
- Törnström, L., Amprazis, J., Christmansson, M., & Eklund, J. (2008). A corporate workplace model for ergonomic assessments and improvements. *Applied Ergonomics*, 39(2), 219–228.
- Vieira, L., Balbinotti, G., Varasquin, A., & Gontijo, L. (2012). Ergonomics and kaizen as strategies for competitiveness: A theoretical and practical in an automotive industry. *Work*, 41(Suppl 1), 1756–1762.
- Williams, K., Haslam, C., Williams, J., Cultler, T., Adcroft, A., & Johal, S. (1992). Against lean production. *Economy and Society*, 21(3), 321–354.
- Yeow, P. H. P., & Sen, R. N. (2003). Quality, productivity, occupational health and safety and cost effectiveness of ergonomic improvements in the test workstations of an electronic factory. *International Journal of Industrial Ergonomics*, 32(3), 147–163.
- Yeow, P. H. P., & Sen, R. N. (2006). Productivity and quality improvements, revenue increment, and rejection cost reduction in the manual component insertion lines through the application of ergonomics. *International Journal of Industrial Ergonomics*, 36(4), 367–377.

# Appendix 3

## Appendix 3: The SCANIA Ergonomic Standard Method (SES)

<b>Emis par:</b> M.ZARE	<b>Date:</b> 30/10/2013	<b>Version:</b> 1												
<b>Département:</b> P42	<b>Takt time:</b> 7 07:55 475 sec	<b>Cadence:</b> 48												
<b>Poste de travail:</b> Station D Marche pieds	<b>Rotation</b> 2 heures	<b>Nombre de cycles / heure :</b> 7												
<b>Opérateur observé, taille:</b> <input type="checkbox"/> <165cm <input type="checkbox"/> 165-185cm <input type="checkbox"/> >185cm <input checked="" type="checkbox"/> Opérateur <input type="checkbox"/> Station <input type="checkbox"/> avec rotation <input type="checkbox"/> sans rotation														
<b>Description des principales tâches effectuées:</b> Electrique Renvoi d'angle suspendue OE246 diam: 4,6cm T= 24 Nm Electrique Renvoi d'angle OE 386 diam: 4,2cm T= 9,5 Nm W= 1,7 kg Electrique (batterie) pistolet OE79 T= 4 Nm, diam= 4,3 cm, W=1,8kg Outils de levage, dia=3,7cm, Cache marche pieds W=1,4kg 2 clés dynamométriques 12Nm et 8 Nm L=33cm W=0,5 12/033=36N Pneum pistolet suspendu support de GB OP2098 T=135 Nm dia 4,8cm effort de traction= 46 N Pistolet pneumatique suspendue (goujonneuse) OP1942 T=62 Nm dia 4,6cm effort de traction= 34,2 N Pistolet pneumatique OP2005 T=8Nm														
<b>RESUME</b> <table border="1"> <thead> <tr> <th>Couleur</th> <th>Qté Rouge</th> <th>Qté DR</th> <th>NIOSH Index de levage</th> <th>couleur</th> <th>Parties du corps soumises à l'effort:</th> </tr> </thead> <tbody> <tr> <td>Station</td> <td>10</td> <td></td> <td></td> <td></td> <td></td> </tr> </tbody> </table>			Couleur	Qté Rouge	Qté DR	NIOSH Index de levage	couleur	Parties du corps soumises à l'effort:	Station	10				
Couleur	Qté Rouge	Qté DR	NIOSH Index de levage	couleur	Parties du corps soumises à l'effort:									
Station	10													
<b>DR et Rouge / Commentaires, Actions correctives</b>														
3.1.1 voir si possibilité de réduire le nombre d'engagements pour les vis garde boue et pompe basculement														
Répétitivité par heure > à 300 = rouge														

**Vert** : - Zone normale  
 Risque minimum de TMS  
 sauf pour certains groupes,  
 Acceptable.  
 Améliorations non prioritaires.

**Jaune** : - Zone à risque  
 Risque de TMS avec le temps pour certains  
 groupes. Si nécessaire, on peut faire appel à  
 un expert pour effectuer une évaluation  
 plus précise.

**Rouge** : - Zone à risque  
 Risque important de TMS avec le temps  
 pour la majorité des employés.  
**Inacceptable** . Modifications requises. Il convient  
 d'adopter la rotation du travail jusqu'à ce qu'une  
 solution acceptable soit trouvée.  
 Les améliorations sont prioritaires

<b>SES</b>	<b>Emis par:</b> M.ZARE	<b>Date:</b> 30/10/2013		<b>Parties du corps</b> soumises à l'effort		<b>Couleur:</b>
	<b>Poste de travail</b> Station D Marche pieds	<b>Takt time</b> 07:55	<b>JPH:</b>	5% 24 sec	30% 143 sec	60% du Takt Time 285 sec

### 3.1.1 Répétitions par heure

<150 rép/heure	<i>Qu'est-ce qui est répété/quantité?</i>	Vert	<input type="checkbox"/>
150-300 rép/heure		Jaune	<input type="checkbox"/>
>300 rép/heure		Rouge	<input checked="" type="checkbox"/>
>600 rép/heure	<i>mesuré:</i>	DR	<input type="checkbox"/>

Note 1-3

Durée

Couleur		
Vert	Jaune	Rouge
1	2	3

Observations

3 goujons + 4 écrous par garde boue x 4 engagements \* 7/h = 196 + 4 raccords pour pompe basculant x 6 engagements \* 7/heures = 168 + 196 = 364 rep

### 3.2.1 Posture de travail

Debout / marche / assis	Vert	<input checked="" type="checkbox"/>
Position debout /assise inconfortable allongée, agenouillée, accroupie, penchée, sur une jambe	Jaune	<input type="checkbox"/>
	Rouge	<input type="checkbox"/>

% du takt time		
<30	30-60	>60
1	2	3

### 3.2.2 Accès, assemblage masqué

Dessus ou devant. Accès libre, pas d'obstruction.	Vert	<input type="checkbox"/>
Sur le coté. Obstruction de l'espace de travail.	Jaune	<input type="checkbox"/>
Dessous ou derrière.	Rouge	<input checked="" type="checkbox"/>

% du takt time		
<30	30-60	>60
1	2	3

serrage vis manchon (la photo) 14"

### 3.2.3 Dégagement pour mains/doigts ou outils

<i>Main</i>	<i>Doigt, outil</i>	
≥ 2,5 cm	≥ 1,0 cm	Vert
< 2,5cm	< 1,0 cm	Rouge

% du takt time		
<30	30-60	>60
1	2	3

serrage vis manchon 9" + vis sous pipe d'air

### 3.2.4 Espace de travail pour les mains (<5%:vert)

A l'intérieur de la boîte	Vert	<input checked="" type="checkbox"/>
A l'extérieur de la boîte	Rouge	<input type="checkbox"/>

% du takt time		
5<30	30-60	>60
1	2	3

### 3.2.5 Poignée de manutention

Ø > 2 - 4 cm. Plane et non glissante	Vert	<input type="checkbox"/>
Ø 0,6 - 2 or > 4 - 7 cm	Jaune	<input checked="" type="checkbox"/>
Ø < 0,6 or > 7 cm. Bords acérés, surface glissante, chaude	Rouge	<input type="checkbox"/>

% du takt time		
<30	30-60	>60
1	2	3

### 3.2.6 Zone de surface, surface de pression >1 kg

<i>Doigt</i>	<i>Paume</i>	
Ø ≥ dia. 1,5 cm / A ≥ 1,7cm <sup>2</sup> ≥ Ø 3 cm / A ≥ 7 cm <sup>2</sup>		Vert
Ø < dia. 1,5 cm / A < 1,7cm <sup>2</sup> < Ø 3 cm / A < 7 cm <sup>2</sup>		Rouge

% du takt time		
<30	30-60	>60
1	2	3

### 3.2.7 Taille du composant lors de la manipulation (longueur + largeur + hauteur)

<1000 mm	Vert	<input checked="" type="checkbox"/>
1000-2000 mm	Jaune	<input type="checkbox"/>
>2000 mm	Rouge	<input type="checkbox"/>
>4000 mm	DR	<input type="checkbox"/>

% du takt time		
<30	30-60	>60
1	2	3

### 3.2.8 Posture de travail statique - Dos ≥ 5 secs

0- 20° penché en avant	Vert	<input type="checkbox"/>
20 - 45° penché en avant ou 20-45° sur le coté/ torsion	Jaune	<input type="checkbox"/>
> 45° penché en avant ou >45° sur le côté/torsion ou penché en arrière	Rouge	<input checked="" type="checkbox"/>

% du takt time		
<30	30-60	>60
1	2	3

serrage marchepieds 18"

### 3.2.9 Posture de travail statique - Cou ≥ 5 secs

0-20° penché en avant	Vert	<input type="checkbox"/>
20 - 45° penché en avant ou 20-30° sur le coté/ torsion	Jaune	<input type="checkbox"/>
> 45° penché en avant ou >30° sur le côté/torsion ou penché en arrière	Rouge	<input checked="" type="checkbox"/>

% du takt time		
<30	30-60	>60
1	2	3

serrage et assemblage marche pieds 19"

### 3.2.10 Posture de travail statique - Epaule, bras ≥ 5 secs

< 45° levée des bras	Vert	<input type="checkbox"/>
45° - 90° levée des bras	Jaune	<input type="checkbox"/>
> 90° levée des bras	Rouge	<input checked="" type="checkbox"/>

% du takt time		
<30	30-60	>60
1	2	3

serrage vis marchepieds 36"

### 3.2.11 Posture de travail - Poignet

Poignet neutre

Poignet non neutre

Vert	<input type="checkbox"/>
Rouge	<input checked="" type="checkbox"/>

Durée

% du takt time		
<30	30-60	>60
1	2	3

serrage goujons 10"

### 3.3.1 Effort de levage, levage à 2 mains

< 10 Nm

10 - 35 Nm

> 35 Nm

> 70 Nm

Mesuré: \_\_\_\_\_

Poids (kg) x portée horizontale (m) x 10 = Effort de levage (Nm)

Vert	<input checked="" type="checkbox"/>
Jaune	<input type="checkbox"/>
Rouge	<input type="checkbox"/>
DR	<input type="checkbox"/>

répétition par heure		
< 150	150-300	>300
1	2	3

Si rouge calculer le NIOSH

Résultat NIOSH

### 3.3.2 Levage à une main

< 2 kg

2 - 5 kg

> 5 kg ou > 0,5 kg préhension par dessus

> 10 kg ou > 1 kg préhension par dessus

Mesuré: \_\_\_\_\_

Vert	<input type="checkbox"/>
Jaune	<input checked="" type="checkbox"/>
Rouge	<input type="checkbox"/>
DR	<input type="checkbox"/>

répétition par heure		
< 150	150-300	>300
1	2	3

Manchon 1,2 kg, Pistolet pneumatique, prendre marteau

### 3.4.1 Force de poussée/ traction corps entier

Démarrage en continu

< 100 N

< 50N

100 - 150 N

50 - 110 N

> 150 N

> 110 N

> 300 N

> 220N

Mesuré: \_\_\_\_\_

Vert	<input checked="" type="checkbox"/>
Jaune	<input type="checkbox"/>
Rouge	<input type="checkbox"/>
DR	<input type="checkbox"/>

répétition par heure		
<150	150-300	>300
1	2	3

### 3.4.2 Force de poussée/ traction main, bras

Poignet neutre Poignet non neutre

< 45 N

< 10 N

45 - 90 N

10 - 45 N

> 90 N

> 45 N

> 180 N

> 90 N

Mesuré: \_\_\_\_\_

Vert	<input type="checkbox"/>
Jaune	<input checked="" type="checkbox"/>
Rouge	<input type="checkbox"/>
DR	<input type="checkbox"/>

répétition par heure		
< 150	150-300	>300
1	2	3

2 clés dynamométriques  
12Nm et 8 Nm L=33cm  
12Nm / 0,33=36N

### 3.4.3 Poussée, écrasement, traction avec doigts

Poignet neutre Poignet non neutre

< 10 N

< 5 N

10 - 45 N

5 - 25 N

> 45 N

> 25 N

>90 N

> 50 N

Mesuré: \_\_\_\_\_

Vert	<input type="checkbox"/>
Jaune	<input checked="" type="checkbox"/>
Rouge	<input type="checkbox"/>
DR	<input type="checkbox"/>

répétition par heure		
< 150	150-300	>300
1	2	3

connecter fille electric de pipe d'aire

Jaune	4
Rouge	10
Jaune + Rouge	14
DR	0

### 3.4.4 Mouvements (pas continus)

1 - 10 pas continus

11 - 30 pas continus

> 30 pas continus

Vert	<input checked="" type="checkbox"/>
Jaune	<input type="checkbox"/>
Rouge	<input type="checkbox"/>

% du takt time		
<30	30-60	>60
1	2	3

### 3.4.5 Grimper/ enjamber

< 0,6 m/min

0,6 - 1,5 m/min

> 1,5 m/min

> 3 m/min Mesuré: \_\_\_\_\_

Vert	<input checked="" type="checkbox"/>
Jaune	<input type="checkbox"/>
Rouge	<input type="checkbox"/>
DR	<input type="checkbox"/>

Couleur		
Vert	Jaune	Rouge
1	2	3

Nbre de Jaune	
0 - 8	Vert
9 - 16	Jaune
≥ 17	Rouge

Nbre de Rouge	
0 - 6	Vert
7 - 9	Jaune
≥ 10	Rouge

Jaune + Rouge	
0 - 16	Vert
≥ 17	Rouge

Nbre de DR	
0	Vert
1 - 32	Rouge

### 3.4.6 Couple de serrage, outil manuel

Angulaire - 2 mains

Pistolet- 1 main

El.

Pneum.

El.

Pneum

< 20

< 10

< 4

< 2

Vert

20 - 50

10-40

4-8

2-6

Jaune

> 50

> 40

> 8

> 6

Rouge

Machine droite >3 Nm, sans toc de réaction

ou doubler les valeurs de Rouge

DR

Vert	<input type="checkbox"/>
Jaune	<input type="checkbox"/>
Rouge	<input checked="" type="checkbox"/>
DR	<input type="checkbox"/>

répétition par heure		
<150	150-300	>300
1	2	3

Pistolet 8 Nm

<b>Poste de travail:</b>	<b>Date:</b> 30/10/2013	<b>Couleur</b>
--------------------------	----------------------------	----------------

**Etape 1 - compléter les données de base, voir la différence entre les levages simples et multiples**

Poids (kg)	Hand location (cm)				Vertical distance (cm)	Asymmetric angle (degré)		Fréquence (Qté / min)	Durée de levage (s)		Coupling (good / fair / poor)
	Origine		Destination			Origin	Dest.		catégorie		
L	H	V	H	V	D	A	A	F	0	hours	C
					0	0	0				Good

**Etape 2 - Déterminer les facteurs multiplicateurs comme indiqués ci-dessous et calculer le RWL (Poids Limite Recommandé)**

$$RWL = LC \times HM \times VM \times DM \times AM \times FM \times CM$$

ORIGIN RWL = 23 x 1,00 x 0,78 x 1,00 x 1,00 x 1,00 x 1,00 = 17,8

DEST. RWL = 23 x 1,00 x 0,78 x 1,00 x 1,00 x 1,00 x 1,00 = 17,8

**Etape 3 - Renseigner l'index de levage Noter le resultat page 3, point 3.3.1**

ORIGINE lift index =  $\frac{\text{Object Weight (kg)}}{\text{RWL}}$  =  $\frac{0}{17,8}$  = 0,0

DEST. lift index =  $\frac{\text{Object Weight (kg)}}{\text{RWL}}$  =  $\frac{0}{17,8}$  = 0,0

Horizontal Multiplier HM	
HM = 25 / H	
H [cm]	HM
<=25	1,00
28	0,89
30	0,83
32	0,78
34	0,74
36	0,69
38	0,66
40	0,63
42	0,60
44	0,57
46	0,54
48	0,52
50	0,50
52	0,48
54	0,46
56	0,45
58	0,43
60	0,42
63	0,40
>63	0,00

Vertical Multiplier VM	
VM = 1 - 0,003   V - 75	
V [cm]	VM
0	0,78
10	0,81
20	0,84
30	0,87
40	0,90
50	0,93
60	0,96
70	0,99
80	0,99
90	0,96
100	0,93
110	0,90
120	0,87
130	0,84
140	0,81
150	0,78
160	0,75
170	0,72
175	0,70
>175	0,00

Frequency (F) Qty / min	Frequency Multiplier FM					
	t <= 1 h		1 h < t <= 2 h		2 h < t <= 8 h	
	V < 75cm	V >= 75cm	V < 75cm	V >= 75cm	V < 75cm	V >= 75cm
0,2	1,00	1,00	0,95	0,95	0,85	0,85
0,5	0,97	0,97	0,92	0,92	0,81	0,81
1	0,94	0,94	0,88	0,88	0,75	0,75
2	0,91	0,91	0,84	0,84	0,65	0,65
3	0,88	0,88	0,79	0,79	0,55	0,55
4	0,84	0,84	0,72	0,72	0,45	0,45
5	0,80	0,80	0,60	0,60	0,35	0,35
6	0,75	0,75	0,50	0,50	0,27	0,27
7	0,70	0,70	0,42	0,42	0,22	0,22
8	0,60	0,60	0,35	0,35	0,18	0,18
9	0,52	0,52	0,30	0,30	0,00	0,15
10	0,45	0,45	0,26	0,26	0,00	0,13
11	0,41	0,41	0,00	0,23	0,00	0,00
12	0,37	0,37	0,00	0,21	0,00	0,00
13	0,00	0,34	0,00	0,00	0,00	0,00
14	0,00	0,31	0,00	0,00	0,00	0,00
15	0,00	0,28	0,00	0,00	0,00	0,00
>15	0,00	0,00	0,00	0,00	0,00	0,00

Distance Multiplier DM	
DM = 0,82 + 4,5 / D	
D [cm]	DM
<=25	1
40	0,93
55	0,9
70	0,88
85	0,87
100	0,87
115	0,86
130	0,86
145	0,85
160	0,85
175	0,85
>175	0

Asymmetric Multiplier AM	
AM = 1 - 0,0032 A	
A [°]	AM
0	1
15	0,95
30	0,9
45	0,86
60	0,81
75	0,76
90	0,71
105	0,66
120	0,62
135	0,57
>135	0

Coupling Multiplier CM		
Coupling type	CM	
	V < 75cm	V >= 75cm
Good	1,00	1,00
Fair	0,95	1,00
Poor	0,90	0,90

Index	Couleur:
< 1,0	Vert
1,0-1,6	Jaune
1,6-3,2	Rouge
> 3,2	DR

0,00  
A grey field (0.00) means that the value is not applicable according to the calculation





## SITUATION ACTUELLE



3.1.1 repetition, 3.4.2 clé dynamometrique

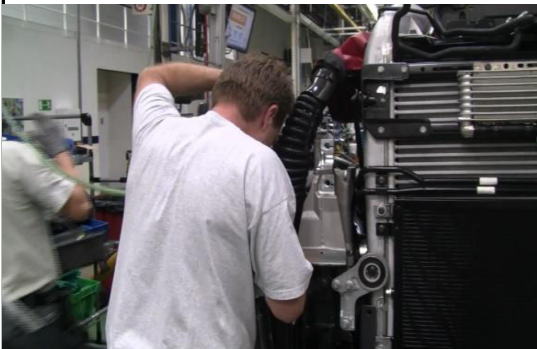

3.2.10 posture de travail epaule 3.2.2 Assemblage masqué



3.2.9 et 11 posture de travail poignet et cou



3.2.8 11 posture de travail dos et à l'extérieur de la boîte

## SITUATION APRES AMELIORATION

# Appendix 4

## Appendix 4: An example of a Position Standard



**Gamme de temps**

**Variante principales**

Conduite à droite

12L SCR

Variante 7

Variante 8



1,1

**Analyse ergonomique**

TMS	1			
EG	1			
M	1			
P	1			

Séquence

N° tâche élémentaire

Cluster  
**P42**  
Poste  
**P42\_Station 1 droite\_Filtre + vérins**

Emetteur/Date  
Benoit, Nicolas 25/06/12 Vidéo Mars 2012

Description Tâches

Important/ penser à...

Séquence	N° tâche élémentaire	Description Tâches	Important/ penser à...	13L		Porteur 16L		13L Conduite à droite		Conduite à droite		12L SCR		Variante 7		Variante 8	
				VA	NVA	VA	NVA	VA	NVA	VA	NVA	VA	NVA	VA	NVA	VA	NVA
1		Aller chercher rislans			8		6		10		6		6				
2	TE	Attacher goulotte faisceau électrique			40	15	35	10	50	10	50	10	35	10			
3		Relever le faisceau électrique				6		5		5		5					
4		Prendre visserie vérin + déplacement et préparer châssis				10		29		13		29					
5		Aller chercher vérin et visseuse				20		20		31		28					
6	TE	Positionner et serrer vérin avec joint sur châssis			12	3	15		12	2	15		15				
7	TE	Connecter et câbler durite sur vérin			13	18	13	18				13	18				
8		Aller chercher clé de serrage durite				2		4		7		8					
9	TE	Serrer durite sur raccord vérin			8	2	5	3	11		10	6	5	3			
10		Aller chercher manchon et le poser sur le châssis				5		5		5		5					
11		Aller chercher filtre, visserie et visseuse				12		20		20		20					
12	TE	Positionner et serrer filtre sur châssis			24	4	28	5	20	2	28	5	28	5			
13	TE	Câbler fils indicateur électronique sur support filtre			51	23	28	5	24	4	10		50	16			
14		Aller chercher pipe d'air, visserie et visseuse				26		24		37		24					
15	TE	Positionner et serrer pipe d'air sur châssis			16	4	24	5	12		12	5	12	5			
16		Aller chercher visseuse				3		7		3		7					
17	TE	Serrer colliers pipe d'air sur filtre et turbo			9	3	15		7	3	15		15				
18		Aller chercher collier(s) et visseuse				10				4		11		12			
19	TE	Connecter durite(s) sur pipe d'air et serrer collier			17	3			15	4	8		30				
20	TE	Connecter et câbler prise sonde sur pipe d'air			30	15			30	8	30	15					
21		Aller chercher visserie, visseuse et pare chaleur				37				28		28		52			
22	TE	Positionner et serrer pare chaleur			45	5			54		50		67				
23	TE	Aller chercher rislans						9		10		9					
24	TE	Câbler feux de côté sur pare chaleur					38	6	38	7	38	6					
25		Aller chercher tabouret				10		10		13		10					
26	TE	Connecter, serrer et câbler durites vérins sur pompe de basculement			50	17	50	17	80	26	50	17	50	17			
27		Pousser chariots vides	(40/3)			13		13		13		13					
28		Retour au poste				7		4		4		4					

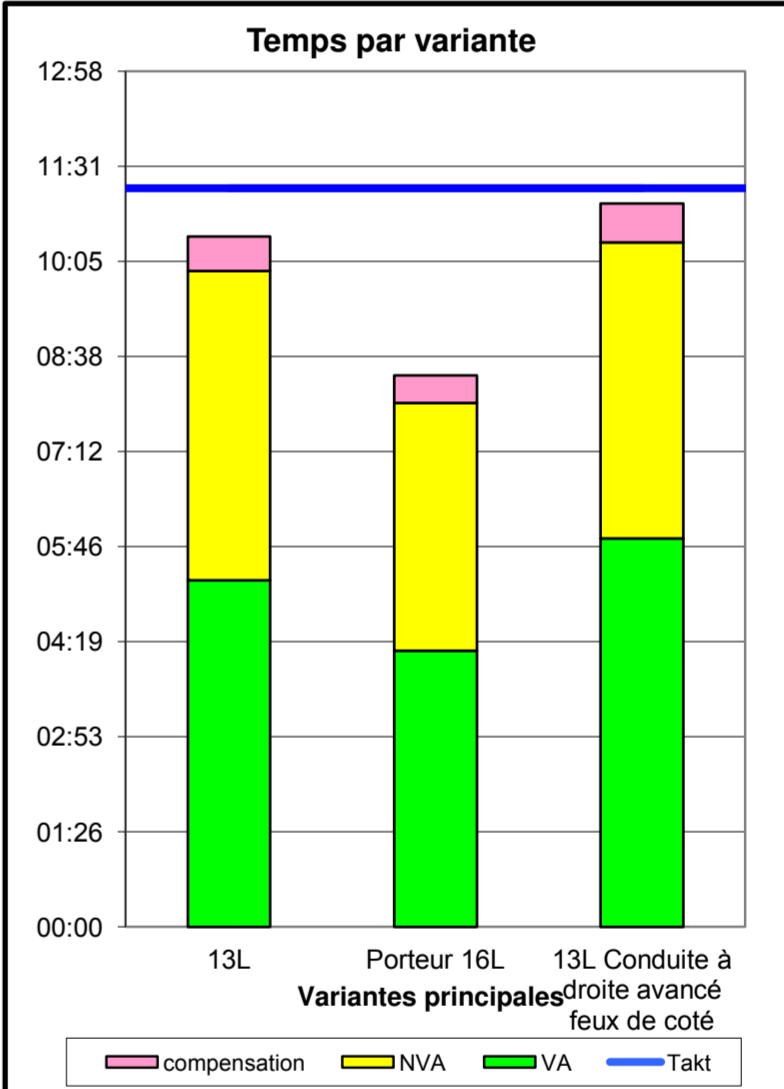
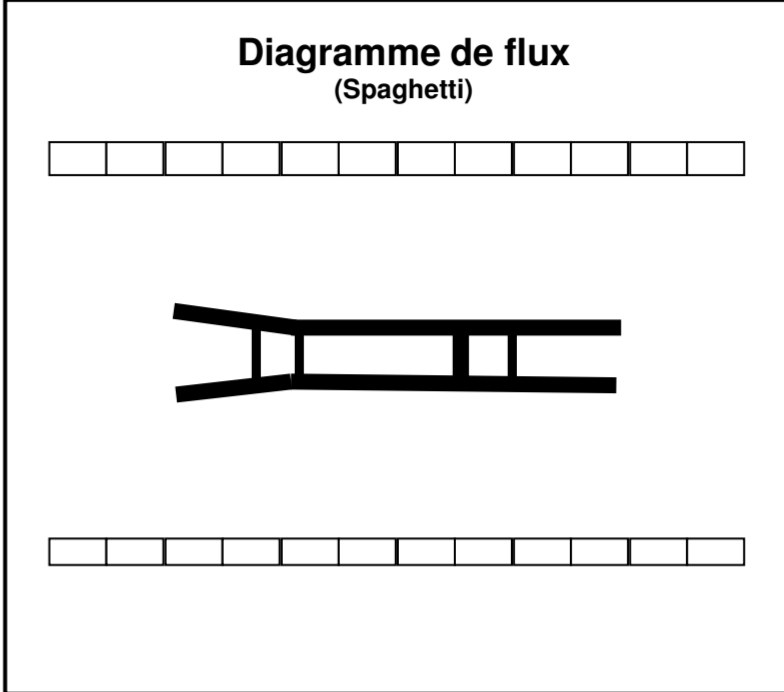

<b>Temps tâche élémentaire (VA)</b>	05:15	04:11	05:53	05:16	05:20	00:00	00:00	00:00
<b>Temps autre (NVA)</b>	04:41	03:45	04:29	04:31	04:45	00:00	00:00	00:00
<b>Cycle total = temps tâche élémentaire + Temps autre</b>	09:56	07:56	10:22	09:47	10:05	00:00	00:00	00:00
<b>Temps total compensé</b>	10:28	08:21	10:57	10:19	10:37	00:00	00:00	00:00
<b>Partie Temps VA (%) = Temps tâche élémentaire / Temps de cycle</b>	53%	53%	57%	54%	53%	0%	0%	0%

**Takt time actuel** **11:11** N° Enreg. / chemin d'accès:

RC	PS	nom	nom	nom	nom	nom	nom	nom	nom	nom	nom	nom	nom	nom	nom
----	----	-----	-----	-----	-----	-----	-----	-----	-----	-----	-----	-----	-----	-----	-----

# Appendix 5

Appendix 5: The examples of elementary sheet











# Appendix 6

**Appendix 6: Corporate standard for Safety, Health and the Environment (SHE)**

# Safety, Health and Environment Standard

## R&D Factory

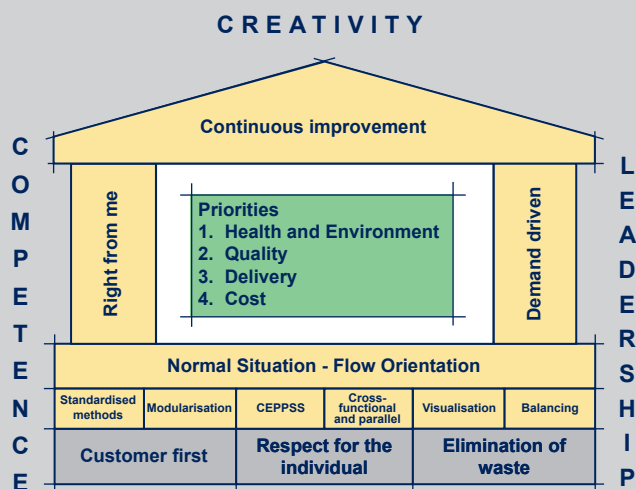

## Scania Production System

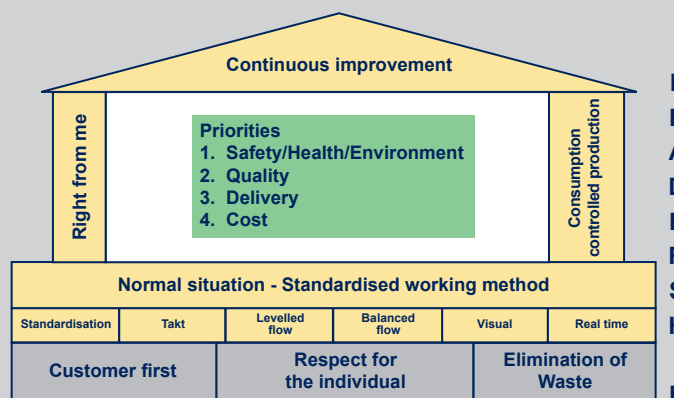

## Scania Retail System

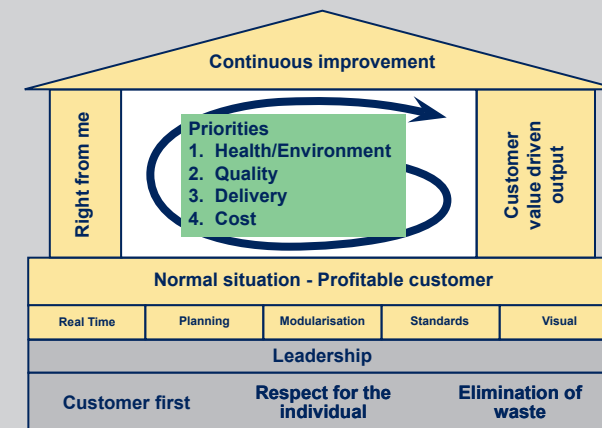

## Content

<b>Safety, Health and Environment Standard</b>	<b>3</b>
<b>1. Responsibilities</b>	<b>4</b>
<b>2. Legal compliance</b>	<b>5</b>
<b>3. Management of change</b>	<b>6</b>
<b>4. Diversity</b>	<b>7</b>
<b>5. Workplace design</b>	<b>8</b>
<b>6. Psychosocial work environment</b>	<b>9</b>
<b>7. Machine, work equipment and lifting safety</b>	<b>10</b>
<b>8. Load ergonomics</b>	<b>11</b>
<b>9. Chemicals</b>	<b>12</b>
<b>10. Accidents and near-accidents</b>	<b>13</b>
<b>11. Emergency preparedness</b>	<b>14</b>
<b>12. Work adaptation and rehabilitation</b>	<b>15</b>
<b>13. Lifestyle</b>	<b>16</b>
<b>14. Traffic safety and business travel</b>	<b>17</b>
<b>15. Resource efficiency</b>	<b>18</b>
<b>16. Emissions and waste handling</b>	<b>19</b>



# Safety, Health and Environment Standard

## – SHE Standard

### Foreword

Two of Scania's core values are respect for the individual and elimination of waste. Being resource efficient and taking good care of our employees contributes to a sustainable organisation.

In order to achieve safe workplaces, well-being and minimised environmental impact the SHE Standard should be given high attention and be integrated in the everyday work.

To prosper and succeed in this work we have defined the requirements in 16 SHE topics. This document describes these 16 topics and is based on the Scania Health and Work Environment Policy and the Scania Environmental Policy.

### Objective

As seen on the front page of this document, safety/health/environment is prioritised within Scania. The SHE Standard provides us with an understanding and knowledge about the topics that are essential to work with. These 16 topics also create clarity and guidance on what the priority tasks are.

Managers are responsible for communicating, meeting and exceeding the SHE requirements in their respective line of work by applying and continuously improving methods for safety, health and environment.

### Business benefits

- Health and good work environment for employees make Scania the employer of choice
- Well-being of employees results in increased healthy attendance and a good working environment
- Well-being of our employees will improve quality, productivity and profitability
- Resource efficiency equals better economy
- Clean technology and good solutions gives Scania a good reputation and the opportunity to meet future requirements in a cost efficient way

### Definition of level

SHE requirements are the minimum level to be achieved in each activity.

### Legislation and local regulations

Fulfilment of legislation and local regulations is fundamental. This is a common requirement for the SHE areas.

### Other areas to consider

Examples of areas that are not described in the SHE Standard are e.g. electrical safety, explosive environment, fire safety, pressure equipment and radiation. Before setting requirements in the fields not covered by the SHE Standard, refer to the applicable legislation and company experts.



# 1. Responsibilities

**Aim:**

Allocation of tasks together with the accompanying responsibilities creates an opportunity for a large organisation to fulfil its commitments in the SHE topics. Through a clear organisation and allocation of tasks, conditions are created so that tasks are carried out and integrated into operations.

**Business benefits:**

Clarity in both the organisation and allocation of responsibilities means that SHE questions can be integrated into the regular activities and thus avoid extra work. This means that these activities will be carried out continuously.

**SHE requirements**

- The operation has a clear allocation of tasks for the SHE topics resulting from the country's legislation
- It is clear what activities and authorities are allocated and to whom.
- Responsible management is aware of the meaning of the division of work duties within the SHE topics
- Managers and other stakeholders are aware of the importance of SHE topics complying with their responsibilities

**Definition:** The top management has ultimate responsibility for the SHE questions and to clarify the allocation of work tasks as well as the roles of different stakeholders. The allocation of work tasks should follow each country's legislation.



## 2. Legal compliance

**Aim:**

*In order to comply with applicable law, Scania's operations have knowledge and a clear process for identification and implementation of applicable laws. There should be systems to ensure compliance.*

**Business benefits:**

*Fulfilling laws will result in a highly regarded operation and make Scania an example for other companies.*

**SHE requirements**

- Managers have knowledge of legislation, regulations from authorities and permits applicable for their own operations
- The operations have a process to identify, evaluate and communicate the new or changed legislation, regulations from authorities and permits
- There is a systematic way for how the legislation, regulations and permits are handled by the operations
- The operations have a process that monitors the compliance of the laws, regulations and permits

**Definition:** *Legislation in this document refers to each respective country's safety, health and environment legislation.*



### 3. Management of change

**Aim:**

Changes in the operation are addressed systematically, with methods available to ensure that we “do right from the beginning” and continuously improve ourselves in the SHE topics. Participation, risk assessment and management of impact is fundamental to our success with this work.

**Business benefits:**

A good management of change means getting things right from the beginning which will lead to lower cost, better environmental performance and more satisfied managers, employees and customers.

**SHE requirements**

- Managers have knowledge of how to manage changes in operations from a SHE perspective
- Future requirements are taken into consideration when changes are carried out in the operation
- Methods are available to carry out changes
- Risk assessments are always carried out in connection with changes based on the current situation and the situation after changes have been made
- Impact on the environment and work environment are handled in a systematic manner when changes are carried out
- Management of change is carried out with the participation of employees

**Definition:** The employer shall assess whether changes in the activity could lead to illness, accidents and other risks and consider whether or not these need to be addressed.

Change management refers to how the work technology, content and organisation affects physical, psychological social and environmental aspects.





## 4. Diversity

### **Aim:**

*The operations create opportunities for all employees to develop and ensures that they are able to influence their work situation.*

### **Business benefits:**

*In an organisation, diversity is a success factor which allows greater access to different perspectives, experiences and knowledge. Working with diversity creates a positive view of the company which in return strengthens Scania.*

### **SHE requirements**

- The organisation is characterised by Scania's core value - respect for the individual
- All employees are given equal opportunities for personal development
- The work atmosphere is open and inclusive
- Continuous improvement is accomplished by utilizing all the employees' expertise, experiences and diversities
- There are methods in place to deal with behaviour which deviates from Scania's core values

**Definition:** Diversity is about people of different characteristics, conditions and life experiences. All are equal regardless of gender, sexual orientation, disability, religion, ethnicity origin and age.



## 5. Workplace design

### **Aim:**

To achieve a proper and healthy work environment with high personal safety in existing workplaces, as well as when designing new.

### **Business benefits:**

Tasks are carried out in a healthy, attractive and creative work environment that provides opportunities to retain and recruit the required personnel. Correctly designed work places creates high personal safety and reliability in service with a low lifetime cost.

### **SHE requirements**

- The operation has knowledge of legislations, policies, standards and Scania requirements for designing workplaces
- In the development of new workplaces, requirements of a good work environment are considered
- When planning changes risk assessments are carried out
- Concerned personnel are involved in the change of the existing and the design of new workplaces
- Methods exist and are used to identify and assess risks in the workplace
- There are procedures to prioritise, implement measures and follow up the results of risk assessments
- Before new workplaces are being used and equipment placed in service, required inspections and surveys are carried out
- Supervision and inspection of equipment and facilities are implemented based on the legal requirements and existing needs

**Definition:** The design of workplaces for physical health and safety aspects for both the individual work place and the work facility and being tailored to the operation and it's staff.



## 6. Psychosocial work environment

### **Aim:**

*Through an encouraging leadership style, foster and promote a healthy psychosocial workplace by managing and preventing psychosocial risks.*

### **Business benefits:**

*Good psychosocial work environment creates good employee health and well-being, as well as improved organisational sustainability.*

### **SHE requirements**

- Psychosocial health promotion and risk management is a continuous process and part of normal business operations
- Psychosocial risks at the workplace are assessed and documented regularly
- Actions to remove or reduce risks are designed, documented, implemented and evaluated regularly (plan, do, check, act)
- The process is managed actively
- All main stakeholders (manager, employee and their representatives) are involved in the process
- The approach is tailored to the local situation

**Definition:** *The psychological and social conditions people experience in the work environment can affect physical and mental health as well as organisational outcomes such as work performance and productivity.*



## 7. Machine, work equipment and lifting safety

### **Aim:**

To achieve efficient, reliable, safe and ergonomic use of machinery, work and lifting equipment.

### **Business benefits:**

Properly designed machines, work and lifting equipment results in high personal safety and reliability with a low lifecycle cost.

### **SHE requirements**

- The operation has knowledge of their machines, work and lifting equipments and what risks they can cause
- Instructions for use and safety guidelines are available at the workplace
- Concerned personnel are involved in procuring new equipment
- Methods exist and are used to identify and assess risks on new and existing machines, work and lifting equipment
- There are procedures to prioritise, implement measures and follow up the results of the risk assessments.
- Before the machines and lifting equipment are put into service required inspections and surveys are carried out
- Surveys and inspections are carried out based on legislation and existing needs

**Definition:** Personal safety and good ergonomics in the use of desktop, mobile and handheld machines, lifting equipment and other work equipment.



## 8. Load ergonomics

### **Aim:**

*Achieve awareness of load ergonomics in order to create good workplaces and thereby minimise the risks of employees getting strain-related disorders.*

### **Business benefits:**

*Good ergonomic conditions contribute to good health, productivity and quality.*

### **SHE requirements**

- The managers and employees have knowledge about load ergonomics relevant for their own area
- When managing changes in the workplace, ergonomic aspects should be taken into account
- Methods exist and are used to identify and assess load ergonomic risks
- In the continuous improvement work there are procedures for prioritising and taking measures
- Actions taken are followed up and evaluated



**Definition:** Load ergonomics deals with working positions, working movements, physical loads and other conditions that can influence e.g. the muscles and joints in the human body. The purpose is to prevent musculoskeletal disorders.

## 9. Chemicals

### **Aim:**

*Achieve safe handling and use of chemicals to minimize negative impact on people and the environment.*

### **Business benefits:**

*Good systematic handling of chemicals contributes to the health of our employees and environmental sustainability.*

### **SHE requirements**

- Managers and employees have a good knowledge of the chemicals used in their work areas and how they are handled safely
- There are methods for the introduction of chemicals
- When introducing new chemicals, one should pay attention to Scania's rules of limitation of hazardous chemical substances (Scania's black and grey list)
- Chemicals with the lowest possible health and environmental risk are selected
- The operation is actively working to limit and restrict the number of chemical products
- Risk assessments are carried out, taking into account the properties of chemicals and planned use
- Methods, procedures and equipment are available regarding safe storage, use, transport, waste management and emergency
- Information about the properties of chemicals, such as material safety data sheets or safety cards, is available

**Definition:** *Safe handling and use of chemicals relate to both substances and mixtures such as hydrochloric acid, adhesives, paint and coolants.*



## 10. Accidents and near-accidents

### Aim:

Working with deviations is a natural part of Scania's operations, which also refers to a systematic approach to incidents. Preventive and corrective actions of accidents and near accidents aims to prevent death, injury, illness or emissions, thereby creating a safe and clean workplace.

### Business benefits:

Safe and clean workplaces contribute to good health, environment, productivity and quality.

### SHE requirements

- Managers and employees have knowledge about the correlation between accidents and near-accidents and the importance of working with these
- Accidents and near-accidents are reported, investigated and actions are taken
- Unsafe situations or other deviations are reported and actions are taken
- Preventive work with risks are managed by observations in the daily work and by risk management
- The organisation is following the Key Performance Indicator for work accidents with sick leave

**Definitions:** An incident is a work-related event that may cause death, injury, illness or emissions (unwanted leakage of dangerous chemicals to surrounding soil, water or air).

An accident at work is an incident that caused death, injury, illness or emissions.

A near-accident is an incident where there has not been death, injury, illness or emissions but it could have happened.

### KPI:

Key figures for Scania are the number of work accidents with absence per million hours worked.



# 11. Emergency preparedness

## Aim:

To minimise injuries or damage to the environment and create preconditions for everyone to be prepared for different kinds of crisis situations.

## Business benefits:

A quick, planned reaction means that the spread of damage can be reduced and the risk of injuries limited.

With more preparation and available procedures the management can handle emergencies, communicate and answer questions that may occur.

## SHE requirements

- Managers and employees have knowledge about risks in their own operations and how to act in different kinds of crisis situations that may occur
- Managers and employees, trained in first aid and crisis support, are present at the workplace and there is a visualisation of these persons
- Accurate emergency plan, alarm procedures and signs are easily accessible
- Accurate first aid material and material for limiting spread of damage is visible and easily accessible
- Various kinds of crisis situations are practiced regularly

**Definition:** Emergency preparedness identifies the risks of accidents in order to mitigate or limit the damage.

First aid is the provision of initial care for an illness or injury, usually performed by a non expert person until professional medical treatment arrives.

Crisis support is a coordinated process of supporting those directly affected by a crisis.





## 12. Work adaptation and rehabilitation

### **Aim:**

*To have employees return to their best possible level of health and work ability by systematically working with work adaptation and rehabilitation.*

### **Business benefits:**

*Early activities with work adaptation and rehabilitation contributes to keep competence and knowledge at Scania.*

### **SHE requirements**

- Managers have knowledge of how work-related disease can occur and how it best can be prevented
- Managers and employees notice early signs of ill-health and substance abuse
- Procedures for work adaptation and rehabilitation exist and are used
- When finding ill health and/or reduced working ability opportunities are investigated for work adaptation and rehabilitation
- There are procedures that clarify the responsibilities of managers and employees
- The operation uses experiences in these areas to contribute to continuous improvements

**Definition:** *A planned approach for returning to or remaining at work following injury, illness or substance abuse, whether work or non-work related.*



## 13. Lifestyle

### **Aim:**

To give Scania's employees the preconditions for improving and retaining a healthy lifestyle.

### **Business benefits:**

A healthy lifestyle for the employee means a good quality of life, high sense of well-being, good performance and a safer work environment.

### **SHE requirements**

- Managers and employees have knowledge about the connection between lifestyle, good health, well-being and healthy attendance
- Scania provides the preconditions for all employees to raise awareness, increase knowledge and develop lifestyle competence, in order to be able to take better care of their own health
- Scania encourages the employees to create a good balance between work and leisure time
- Activities are carried out to prevent local health risks connected to lifestyle matters
- Activities regarding lifestyle matters are performed, followed-up and evaluated continuously

**Definition:** Lifestyle is about an individual's way of living. That may include diet, physical activity, sleep, stress, and substance abuse. These are influenced both by the individual and the circumstances in the workplace.



## 14. Traffic safety and business travel

### **Aim:**

*Securing safe internal transports and business travel.*

### **Business benefits:**

*Increased awareness, modified behaviour and compliance with rules will reduce the number of incidents associated with transport and business travel.*

### **SHE requirements**

#### Internal traffic

- Managers are responsible for ensuring that all employees driving a vehicle receives relevant training, education and knowledge about regulations
- The organisation has traffic rules
- There are established regulations for which vehicles can be used and by whom
- Necessary permits are issued

#### Business travel

- Scania's meeting and travel policy as well as local guidelines are followed
- The traveller is aware of the risks and how to avoid them

#### Travel to and from work

- Employees are aware of specific risks and how to handle them

**Definition:** *Travel occurs without near accidents or accidents and subsequent injuries.*



# 15. Resource efficiency

**Aim:**

To have the whole organisation focus on reducing the use of resources and strive for using alternatives with less environmental impact.

**Business benefits:**

By only using the necessary resources while maintaining high quality and a good work environment, we contribute to a sustainable society. By reducing the use of resources our environmental impact can be minimised in a more cost efficient way than after treatment and waste handling.

**SHE requirements**

- There is knowledge and follow up regarding what resources are used and how this usage can be reduced
- There are actions taken to eliminate over use of resources and creation of waste
- The aim is continuous improvement of the use of energy (e.g. per produced unit, per hour or per service)
- Consider using renewable energy sources

**Definition:** Energy, chemicals, raw material, packing material and sometimes water are limited resources that should be used in an efficient way to minimise our environmental impact.



## 16. Emissions and waste handling

### **Aim:**

*To minimise our environmental impact.*

### **Business benefits:**

*Taking care of waste in a good way and keeping our surrounding environment clean and unaffected gives us a good reputation and reduced costs.*

### **SHE requirements**

- There is knowledge about what emissions the operation has and what can be done to reduce these
- There are plans to reduce emissions by introducing the best available technology
- There is information on how to handle waste
- Bins are clearly marked to ensure proper sorting
- Oils, chemicals, batteries and other hazardous waste are kept separated from other waste and handled in a way to avoid leakage into air, water or soil
- Waste is sorted in a way that it can be re-used or recycled and landfill shall be avoided when possible

**Definition:** Waste handling is what we do with all material that we have no use for and want to get rid of. Emissions are losses of substances into our environment through air, water or soil.



Document id: STD4379en  
Info class: Internal  
Issue: 1  
Date: 31 August 2011  
Approved by: SHE-Council  
Area specialist: TSX, Gunnar Hedlund  
Standard responsible: UTMS, Markku Backholm  
Order the standard from: [brevlada.standard@scania.com](mailto:brevlada.standard@scania.com)



# Appendix 7

## Appendix 7: The published version for Article 3

### Evaluation of Ergonomic Approach and Musculoskeletal Disorders in Two Different Organizations in a Truck Assembly Plant

Zare M, Bodin J, Cercier E, Brunet R, Roquelaure Y. Evaluation of ergonomic approach and musculoskeletal disorders in two different organizations in a truck assembly plant. *International Journal of Industrial Ergonomics*. 2015;50:34-42.



Contents lists available at ScienceDirect

## International Journal of Industrial Ergonomics

journal homepage: [www.elsevier.com/locate/ergon](http://www.elsevier.com/locate/ergon)

## Evaluation of ergonomic approach and musculoskeletal disorders in two different organizations in a truck assembly plant



Mohsen Zare <sup>a, b, \*</sup>, Julie Bodin <sup>a</sup>, Elodie Cercier <sup>a</sup>, Rene Brunet <sup>a</sup>, Yves Roquelaure <sup>a</sup>

<sup>a</sup> LUNAM, University of Angers, Laboratory of Ergonomics and Epidemiology in Occupational Health (LEEST), Angers, France

<sup>b</sup> Department of Occupational Health, School of Health, Shahid Sadoughi University of Medical Sciences, Yazd, Iran

### ARTICLE INFO

#### Article history:

Received 4 December 2014

Received in revised form

3 August 2015

Accepted 11 September 2015

Available online xxx

#### Keywords:

Ergonomic

Cycle time

Assembly plant

Self-reported questionnaire

### ABSTRACT

The aim of this study was to assess the ergonomic physical exposure, organizational and psychosocial factors in a truck assembly plant for two different cycle times (11 min and 8 min). A self-reported questionnaire was applied to evaluate subjective physical exposure, organizational and psychosocial factors by operators in two organization of an assembly process. The initial cycle time was 11 min (system A) and the new was 8 min (system B). The same work and assembly tasks had to be completed in both systems. However, the organization and distribution of the tasks and workstations were reorganized. The results of the questionnaire showed that subjective estimation by the operators regarding ergonomic risk factors was better in the new organization and self-reported WR-MSDs symptoms were fewer. However, exposure to risk factors and WR-MSDs symptoms was not statistically different between two cycle times. The findings provide better understanding of how organizational changes can modify ergonomic exposure in manufacturing assembly industries. Effective interventions are thus not only engineering solutions but also organizational and administrative adaptations.

© 2015 Elsevier B.V. All rights reserved.

### 1. Introduction

Manufacturing success in the competitive industrial world depends on employees' wellness and reducing costs (Falck and Rosenqvist, 2012; Törnström et al., 2008). Although ergonomics is integrated in the production system of many industries to improve human wellbeing and to prevent work related-musculoskeletal disorders (WR-MSDs), these disorders are still the main cause of occupational disease in many countries (Putz-Anderson et al., 1997; Roquelaure et al., 2002a). Claims for WR-MSDs have increased and it is estimated that 40% of occupational costs are related to WR-MSDs (Speklé et al., 2010). Forty-five million employees are affected by WR-MSDs in Europe, and in France 46,537 of all occupational claims in 2012 (86%) were for WR-MSDs (Roquelaure et al., 2002b; Caisse nationale..., 2012). In addition to the effects of WR-MSDs on business performance, they have considerable impact on human quality of life as they are the main causes of discomfort and pain in the workplace. WR-MSDs present serious ergonomic problems, particularly in the automobile industry due to the wide

variety of ergonomic high risk tasks including tightening, picking up, lifting, material handling, as well as the characteristics of assembly line work (Wang et al., 2011). Several dimensions of ergonomics such as physical, organizational and psychosocial risk factors may be reasons for disorders among assembly operators. Physical risk factors, including repetition, awkward postures, forceful movements and heavy lifting can increase the risk of WR-MSDs (Fredriksson et al., 2001; Widanarko et al., 2014, 2015). Organizational risk factors such as time constraints, work rate and workload also have a role in the prevalence of WR-MSDs. Furthermore, psychosocial risk factors such as low decision latitude, high psychological demands, and low social support may influence these disorders. Recent studies have shown that these factors may independently increase the risk of musculoskeletal disorders or the interactive effect between them may cause WR-MSDs (Widanarko et al., 2014; Widanarko, 2013). Inman et al. (2003) showed that the odds of WR-MSDs for physical risk factors and time constraints (organizational risk factors) was 2.61, while the independent effects of these risk factors was less than one (Inman et al., 2003). In a study in a large population, Widanarko et al. (2014) showed that physical, organizational and psychosocial risk factors were independently associated with WR-MSDs. Moreover, the combined effects of these risk factors significantly

\* Corresponding author. LUNAM, Université d'Angers, Laboratoire d'ergonomie et d'épidémiologie en santé au travail (LEEST), Angers, France.

E-mail address: [mohsen@zare.fr](mailto:mohsen@zare.fr) (M. Zare).



increased the risk of WR-MSDs. However, good conditions of organizational and psychosocial factors can reduce the adverse effects of high physical workloads (Widanarko et al., 2014, 2015; Widanarko, 2013).

In order to adjust work situations and reduce WR-MSDs, there are many physically oriented intervention studies in manufacturing assembly industries. However, few studies have investigated organizational changes and their consequence for WR-MSDs. The effects of long and short cycle times were investigated by Johansson et al. in a truck manufacturing company, and musculoskeletal symptoms were similar in both systems. However, fewer physical risk factors were reported for the long cycle time (Johansson et al., 1993). Fredriksson et al. (2001) reported that changing from a line out system with a long cycle time (20 min) to a line system with a short cycle time (90 s) decreased physical risk factors significantly (Fredriksson et al., 2001). However, musculoskeletal symptoms and perceived physical exertion increased. It was concluded that psychosocial factors and poor organization design could increase musculoskeletal disorders although the new organization had improved physical working conditions. A new designed flow-line process increased the prevalence of musculoskeletal symptoms for fish-filleting plant operators. The authors concluded that all dimensions of work characteristics should be taken into account to reduce musculoskeletal symptoms (Ólafsdóttir and Rafnsson, 1998). Some advantages of a long cycle time were reported if physical and psychosocial aspects were considered in the design of the production line. The complex nature of musculoskeletal disorders means there is a need to evaluate the various elements of the ergonomic approach and consider them as a principle for designing new organization (Johansson et al., 1993; Kadefors et al., 1996; Engström et al., 1999).

Reorganization of workstations for the reason of increase of production volumes were undertaken in a truck assembly plant in France. The cycle time was decreased from 11 min to 8 min and over this reorganization ergonomic approach was considered. Furthermore, technical improvements were implemented in the reorganized production line in order to reduce the physical ergonomic workload. The purpose of this study was both to investigate ergonomic approach elements in truck assemblers including physical, organizational and psychosocial factors from operator's viewpoint and to evaluate the likely changes in the ergonomic factors after reorganization in the new cycle time. Our hypothesis was that fewer physical risk factors and musculoskeletal symptoms should occur in the new system because of reorganization of the high workload tasks between different workstation, technical ergonomic changes and reduced working at the hard workstations.

## 2. Materials & methods

### 2.1. Workplace description

This study was carried out as a follow up investigation into two production cycle times of a truck assembly plant in France. The cycle time (known as takt time in the factory) is defined as time for performing the assigned tasks in addition to recovery time. The initial cycle time was 11 min (system A) and the second cycle time was 8 min (system B). Eleven workstations (known as work position in the factory) from one sector of the truck production plant were selected for data collection and each workstation included a number of sequential assembly tasks. For production reasons the factory decided to change the cycle time from 11 min to 8 min. The organization of the workstations was therefore changed and some tasks were transferred between workstations and certain new posts were created. Furthermore, extra operators joined a variety of workstations. However, the main tasks of most workstations

remained unchanged. In system A, the "Selective Catalyst Reduction (SCR) tank" workstation included unloading and transferring the support by means of a lifting tool. The principle components of the SCR support tank were then assembled in sequence and finally the completed assembly was fed up the line by wagon. The changes regarding system B at this workstation were almost entirely organizational. As the layout and the zone of SCR support assembly was changed, many non-necessary movements which related to picking up components were eliminated. Furthermore, another operator was added to this area to perform the extra tasks so that the tasks at this workstation in the new cycle time were the same as the former system. Completed SCR support tanks were assembled in the truck chassis at another workstation on the line. In system A, this post included tasks such as assembling and tightening the reservoir, and connecting hoses and cables. In the new system connecting two hoses, tightening hose clamps and finishing cable routing on the top of the SCR tank were performed by another operator. The third workstation in system A was preparation and picking up the air filter, air pipe, heat cover, SCR tank, cab tilt cylinder and straining cylinder. One operator performed these tasks in three cycle times. In system B, this post was broken down into two posts i.e. "picking up the SCR tank and cab tilt cylinder" as well as "preparation and picking up air filter, air pipe, and heat cover". Furthermore, the straining cylinder task was transferred to another post (assembling air filters in the line) but some extra tasks were added into "picking up the SCR tank and cab tilt cylinder" workstation because of changes in the production. Some modifications were also performed in the layout and organization of this zone.

Preparation and integration of the bumper on the chassis was performed in the zone near the assembly line in system A and it included four workstations in which one operator worked (11 min for each post). The main tasks of these series of workstations were preparation of the washer tank, fog lamp, cab tilt pump, picking up bumper and sun visor, preparation of the bumper, assembly of light box, and bumper assembly on the chassis and tightening. In system B, this workstation was divided into five workstations (8 min for each post). The tasks in this zone were almost the same as the initial system but two tasks including picking up the bumper and sun visor were transferred to other sectors of the factory. The "air filter assembly on the chassis" workstation included assembling the air filter, air pipe, cab tilt cylinder, heat cover and connecting hoses on the chassis in the initial system. In system B, the heat cover assembling task was transferred to the right mudguard workstation and the cylinder straining task was added to this post. Two workstations, i.e. boarding steps and mudguards left and right on the initial system, were distributed to four workstations (i.e. boarding steps left and right and mudguards left and right). Fitting together the air pipe and the inlet pipe task and heat cover assembly task were added to these workstations. Overall in system B, two tasks (picking up the bumper and sun visor) were eliminated (transferred to other parts of the factory) and one task (Fitting together air pipe and inlet pipe) were transferred to this zone. System A comprised eleven workstations and system B fourteen workstations (Table 1).

### 2.2. Procedures and subjects

The first part of the study for initial cycle time was performed before the summer vacation in July 2013. The new system and organization were then established during the holiday. The second part of study was carried out in March 2014 seven month after changing the cycle time, when the operators had adapted to the new conditions. The operators in the initial and second phase were the same but extra people were employed at the new workstations. System A, therefore, comprised 17 workers and system B included

**Table 1**  
Changes in the workstations and task distributions in the new organization (system B).

Workstations (system A)	Changes in system B
<b>Preparation and assembly of SCR tank</b>	
Preparation of Selective Catalyst Reduction (SCR) Tank	Without changes in tasks, another operator was added
Mounting SCR Tank	Connection of two hoses, tightening hose clamp, and finishing SCR cable performing in another position
<b>Bumper Zone</b>	
Picking up bumper, sun visor, rear bar, pump, washer tank and fog lamp preparation	Picking up bumper and sun visor tasks were transferred to another section, pump, washer tank and fog lamp preparation merged in the following work station
Preparation Bumper 1	Bumper preparation station 1 (pump preparation was added, bumper cable rooting was transferred to station 2, putting bumper on the beam was eliminated)
	Bumper preparation station 2 (bumper cable rooting, washer tank preparation)
	Bumper preparation station 3 (Fog lamp assembly, front right assembly)
	Bumper preparation station 4 (washer tank filling, light cable rooting, tightening light box, fog lamp cable rooting)
	Bumper assembly and tightening Station 5 (washer tank filling, tightening light box, front light cable rooting transferred)
<b>Filter Preparation and Assembly</b>	
Preparation of air filter and cab tilt cylinder	Air filter, air pipe, heat cover preparation
	Picking and preparation SCR, cab tilt cylinder
Air filter and cab tilt cylinder mounting	Assembly of Air filter, air pipe, cab tilt cylinder, pump and hoses (heat cover assembly task was transferred)
<b>Boarding Step and Mudguard Assembly zone</b>	
Right Boarding steps and Mudguards	Boarding step assembly and right rear mudguard bracket
	Right Mudguard assembly (fit air pipe to air inlet pipe)
	Boarding steps assembly and rear mudguard bracket left
Left Boarding steps and Mudguards	Right Mudguard assembly (heat cover assembly task transferred)

24. Fifteen and 21 operators from systems A and B participated in this study, respectively, and twelve were in both cycle times. The reasons that two people from system A and three people from system B did not participate in the study were either unwillingness or absence. Data collection was performed by the ergonomist with the help of industrial engineers and technicians. Each subject in the two cycle times answered the self-reported questionnaires about physical ergonomic exposure, organizational/psychosocial factors, and musculoskeletal symptoms. Furthermore, interviews using the Borg scale were performed to measure perceived physical exertion in both cycle times.

### 2.3. Reference group

French surveillance data were used as reference group. We selected the subjects from a cohort study named COSALI (Roquelaure et al., 2006a, 2006b). The aim for this cohort was to assess the prevalence of WR-MSDs and their risk factors in the working population in France's Pays de la Loire region. This cohort included 3710 workers, among them 362 were blue-collar operators in the manufacturing and assembly industries, and these were chosen as reference group. The results of self-reported questionnaires for the variables used in our study were compared. The mean age of the reference group was 39.6 ( $\pm 10.1$ ) and the length of work experience for 43% of them was more than 10 years.

### 2.4. Self-reported musculoskeletal symptoms

Musculoskeletal symptoms in the neck, shoulders, elbows/forearms, hands/wrists, back and lower limbs were evaluated by a modified version of the Nordic Musculoskeletal Questionnaire (Kuorinka et al., 1987). The prevalence of musculoskeletal symptoms was defined as pain, numbness or stiffness for different parts of the musculoskeletal system. We asked the operators to determine their pain or discomfort in each region of the body at the moment of filling out the questionnaire on a 0–10 scale. Pain intensity  $\geq 5$  at the time of filling out the questionnaire was considered as a musculoskeletal symptom. We did not compare the

results with reference data because the reference group reported symptoms experienced during the preceding 12 months.

### 2.5. Self-reported physical and organizational risk factors

The second part of the questionnaire evaluated subjective estimation of physical ergonomic exposure. This section was developed according to the European consensus criteria on WMSD risk factors in the upper limbs (Sluiter et al., 2001). One question including repeated actions/gestures asked about repetition. Two illustrated questions evaluated the duration of neck flexion/extension. Work with the arms  $>90^\circ$  and between  $45^\circ$  and  $90^\circ$  as well as rotation of the arms were illustrated to assess shoulder postures. Seven illustrated questions assessed wrist and forearm risk factors. Finally, to evaluate material handling and push/pull activity, five questions asked about the weight of loads to be lifted or carried during the working day. Physical exposure was assessed by a four-point scale, i.e. “never”, “sometimes”, “often” and “always”. If the operators answered “often” or “always”, it was defined as 2 h/day and 4 h/day exposure to risk, respectively. We also interviewed operators to evaluate perceived physical exertion on the RPE Borg scale (Borg, 1990). The interview was performed by an ergonomist using the Borg scale in two periods of time, the Friday afternoon and Monday morning. The aim was to evaluate the difference between perceived physical exertion at the end of the week and after resting over the weekend. The original Borg method with the scale ranging from 6 “very very light” to 20 (very very hard) was used in this study. We considered the third quartile (score  $\geq 15$ ) as high perceived physical exertion for both cycle times.

We asked employees to report organizational constraints in the workplace. Two categories of questions were defined including workload (working hours, attention and high load activities and etc.) and work rate which are related to organizational factors (technical constraints, dependence to the others, mandatory procedures, monitoring and etc.). As for self-reported physical risk factors, the four-point scale was used to rate organizational risk factors.

## 2.6. Psychosocial factors

Work psychosocial factors were evaluated by the French version of Karasek Job Content Questionnaire (Karasek et al., 1998; Niedhammer et al., 2006). This questionnaire includes 26 questions categorized into three dimensions. The first dimension involves decision latitude which includes questions such as control over work, and work stimulus. The second dimension involves psychological workload and the third dimension social support at work, defined as supervisor climate and relationships with colleagues. To determine the prevalence of job strain and iso-strain in the study population, the scores for low decision latitude, high psychological demand and low social support were dichotomized according to the median of the French Medical Surveillance of Occupational Risk Exposure (SUMER) study. High psychological demands and low decision latitude were thus two dimensions which determined job strain and high psychological demand and low decision latitude and low social support together provided iso-strain.

## 3. Results

### 3.1. Self-reported musculoskeletal symptoms

All the subjects in this study were men, with a mean age of 42.0 ( $\pm 7.6$ ) years for cycle time A and 38.1 ( $\pm 8.7$ ) years for cycle time B. The mean length of work experience in the current job was 16.0 ( $\pm 6.6$ ) years for cycle time A and 13.0 ( $\pm 8.1$ ) years for B.

Table 2 shows the prevalence of musculoskeletal symptoms among the study population in both cycle times. The prevalence of symptoms for the shoulders, elbows and wrists was 67%, 53% and 47%, respectively, for cycle time A. In cycle time B, the prevalence of shoulder, elbow and wrist symptoms was reported as 35%, 40% and 40% respectively. The prevalence of symptoms in the lower back was also reported to be as high as 47% for subjects in cycle time A and 35% for subjects in cycle time B. The study population in cycle time A had higher prevalence of symptoms in the upper limbs, back and lower limbs compared to cycle time B (except for knee symptoms). Analysis of differences regarding prevalence of musculoskeletal symptoms showed no significant difference between cycle times A and B.

### 3.2. Subjective assessment of physical and organizational ergonomics workload

Table 3 shows organizational ergonomic characteristics related

to work rate and workload for both cycle times. More than 70% of the operators reported technical constraints (mandatory use of tools and devices) imposed by work rate in both cycle times. Dependence on other operators' activities increased in cycle time B by 67%, compared to 47% in cycle time A. However, Mac Nemar exact test between the same respondents for this factor showed non-significant differences in both cycle times ( $P$ -value = 0.38). Other organizational characteristics imposed by work rate were reported to be high in both cycle times (Table 3). Organizational characteristics due to the workload were less often reported by operators. Fifty-two percent of operators reported "working outside normal hours" in cycle time B more than the percentage reported in cycle time A (33%). Working too fast for precise operation was reported to be 47% in cycle time A versus 25% in cycle time B. The difference between organizational risk factors was measured with Mac Nemar exact test for the same respondents in both cycle times. None of the organizational characteristics were significantly different between the two cycle times.

Table 4 shows biomechanical risk factors reported by assemblers. Back risk factors (back flexion  $> 2$  h) were reported by 100% of operators in cycle time A and 75% in cycle time B. In the reference data from other industries in France, 55% of the operators reported back flexion. However, truck assembly operators reported a low percentage of back flexion  $> 4$  h, that was similar to reference data. Shoulder risk factors including abducted arms and arms working above shoulder level were reported by 53% and 33% in cycle time A, while for cycle time B they were 52% and 24%, respectively. Elbow and wrist risk factors were also reported to be high for both cycle times. The subjects reported higher exposure to elbow flexion (cycle time A = 80% and B = 62%), pronation/supination movements (cycle time A = 64% and B = 38%), pinch grip (cycle time A = 73% and B = 43%), and hand-arm vibration (cycle time A = 40% and B = 38%) compared to reference data on French blue-collar operators in the manufacturing and assembly industries. However, blue-collar operators in the French reference data had higher percentages of repeated actions than in our study (Table 4). Component handling was mainly related to weights below 4 kg, and 47% of the subjects in system A and 29% in system B reported exposure to material handling below 4 kg. Exposure to material handling was reduced in cycle time B, although the difference between the two cycle times was not significant. Relationships were studied between physical ergonomic risk factors and musculoskeletal symptoms in operators in truck manufacturing. In general, there were no significant relationships between the symptoms for each body section and physical risk factors. Table 5 shows the percentage of perceived physical exertion for three types of

**Table 2**

Musculoskeletal symptoms for two cycle times in truck assembly workers at the time of filling out the questionnaire.

	All respondents				Same respondents				P-value <sup>a</sup>
	Cycle time A (n = 15)		Cycle time B (n = 21)		Cycle time A (n = 11)		Cycle time B (n = 11)		
	n	%	N	%	n	%	n	%	
Neck, VAS <sup>b</sup> $\geq 5$	5	33	2	10	3	27	1	9	0.63
Shoulders and arm, VAS $\geq 5$	10	67	7	35	6	55	4	36	0.63
Elbows and forearms, VAS $\geq 5$	8	53	8	40	5	45	4	36	1.00
Wrist and hands, VAS $\geq 5$	7	47	8	40	4	36	3	27	1.00
Fingers, VAS $\geq 5$	5	33	4	20	2	18	2	18	1.00
Upper back, VAS $\geq 5$	5	33	5	25	5	45	2	18	0.25
Lower back, VAS $\geq 5$	7	47	7	35	5	45	3	27	0.50
Hip and thigh, VAS $\geq 5$	4	27	2	10	3	27	1	9	0.63
Knee and leg, VAS $\geq 5$	3	20	6	30	3	27	3	27	1.00
Ankle/Foot, VAS $\geq 5$	4	27	4	20	3	27	2	18	1.00

<sup>a</sup> Mac Nemar exact test for 11 operators who responded for both cycle times.

<sup>b</sup> Visual analog scale for pain.

**Table 3**  
Organizational ergonomic characteristics for two cycle times reported by truck assembly workers.

	All respondents				Same respondents				P-value
	Cycle time A (n = 15)		Cycle time B (n = 21)		Cycle time A		Cycle time B		
	n	%	N	%	N	%	n	%	
<b>During a typical workday, work rate imposed by:</b>									
Technical constraints (mandatory screwdriver, or tools etc.)	12	80	15	71	9	75	8	67	1.00 <sup>a</sup>
Immediate dependence on the work of one or more colleagues	7	47	14	67	6	50	9	75	0.38 <sup>a</sup>
Inter-section activity (inter working group, inter cluster, logistics, etc.)	9	60	13	65	7	64	8	73	1.00 <sup>b</sup>
Following safety procedures	15	100	17	81	12	100	9	75	NA <sup>a</sup>
Following production procedure	14	93	19	100	11	100	11	100	NA <sup>b</sup>
Permanent (or at least daily) monitoring or control by hierarchy	6	40	8	40	4	33	5	42	1.00 <sup>a</sup>
Following or monitoring computerized process (Production Process)	8	53	11	52	8	67	8	67	NA <sup>a</sup>
<b>Workload necessities</b>									
Exceeding normal hours	5	33	11	52	4	33	7	58	0.38 <sup>a</sup>
Shortening or skipping a meal	3	20	0	0	2	18	0	0	NA <sup>b</sup>
Missing a break	1	7	0	0	1	9	0	0	NA <sup>b</sup>
Working too fast for an operation that requires care	7	47	5	25	5	45	3	27	0.63 <sup>b</sup>
Abandoning a task to do another unplanned activity	3	20	2	11	2	18	2	18	NA <sup>b</sup>
NOT completing an activity	3	20	2	10	2	18	1	9	1.00 <sup>b</sup>

NA: Not Applicable.

<sup>a</sup> Mac Nemar exact test for 12 operators who responded for both cycle times.

<sup>b</sup> Mac Nemar exact test for 11 operators who responded for both cycle times.

**Table 4**  
Subjective assessment of physical ergonomic risk factors for two cycle times reported by truck assembly workers.

	All respondents				Same respondents				P-value	Reference Data <sup>c</sup> (n = 362)	
	Cycle time A (n = 15)		Cycle time B (n = 21)		Cycle time A		Cycle time B			n	%
	n	%	N	%	n	%	n	%			
Repeating same action ( $\geq 4$ h/day)	4	27	3	14	2	17	2	17	1.00 <sup>a</sup>	139	39
Neck flexion ( $>4$ h/j)	3	20	2	10	2	17	1	8	1.00 <sup>a</sup>	137	38
Neck extension ( $>4$ h/j)	0	0	0	0	0	0	0	0	NA <sup>a</sup>	8	2
Arms at or above shoulder level ( $\geq 2$ h/day)	5	33	5	24	3	25	2	17	1.00 <sup>a</sup>	55	15
Arms abducted ( $\geq 2$ h/day)	8	53	11	52	5	42	4	33	1.00 <sup>a</sup>	81	22
Holding the hand behind the trunk ( $\geq 2$ h/day)	0	0	2	10	0	0	2	17	NA <sup>a</sup>	21	6
Elbow flexion/extension ( $\geq 2$ h/day)	12	80	13	62	9	75	7	58	0.63 <sup>a</sup>	173	48
Pronation/supination movements ( $\geq 2$ h/day)	9	64	8	38	6	55	3	27	0.38 <sup>b</sup>	95	26
Putting elbow on the rigid surfaces ( $\geq 2$ h/day)	1	7	2	10	1	8	1	8	NA <sup>a</sup>	83	23
Wrist bending in extreme postures ( $\geq 2$ h/day)	7	47	11	52	5	42	5	42	1.00 <sup>a</sup>	188	53
Pressing with the base of the palm ( $\geq 2$ h/day)	5	33	1	5	4	33	0	0	0.13 <sup>a</sup>	48	13
Holding tools or objects in a pinch grip ( $\geq 2$ h/day)	11	73	9	43	8	67	5	42	0.25 <sup>a</sup>	104	29
Use of vibrating hand tools ( $\geq 2$ h/day)	6	40	8	38	4	33	4	33	1.00 <sup>a</sup>	84	23
Back Flexion/twisting ( $\geq 2$ h/day)	15	100	15	75	11	100	8	73	NA <sup>b</sup>	198	55
Back Flexion/twisting ( $\geq 4$ h/day)	2	13	0	0	2	18	0	0	NA <sup>b</sup>	41	11
Carrying 1–10 kg ( $\geq 4$ h/day)	4	27	3	14	3	25	2	17	1.00 <sup>a</sup>	31	10
Carrying 10–25 kg ( $\geq 4$ h/day)	2	13	0	0	2	17	0	0	NA	9	3
Handling 1–4 kg ( $\geq 4$ h/day)	7	47	6	29	5	42	3	25	0.50 <sup>a</sup>	64	20
Handling loads $>4$ kg ( $\geq 4$ h/day)	3	20	3	14	1	8	1	8	NA <sup>a</sup>	36	11
Push pull ( $\geq 2$ h/day)	3	20	2	17	2	17	2	17	1.00 <sup>a</sup>	76	21

NA: Not Applicable.

<sup>a</sup> Mac Nemar exact test for 12 operators who responded for both cycle times.

<sup>b</sup> Mac Nemar exact test for 11 operators who responded for both cycle times.

<sup>c</sup> Data from epidemiologic study among blue-collar operators in the manufacturing and assembly industries in a French region (Pays de la Loire).

**Table 5**  
Perceived physical exertion force  $\geq 15$  according to Borg scale reported by truck assemblers on Friday and Monday for three types of working day workload.

	Friday						Monday					
	Low workload workday		Typical workday		High workload workday		Low workload workday		Typical workday		High workload workday	
	n	%	n	%	n	%	n	%	n	%	n	%
Cycle Time A (n = 15)	1	7	3	20	9	60	0	0	3	20	10	67
Cycle Time B (n = 20)	1	5	2	10	12	60	0	0	2	13	12	75

One subject was absent at the time of interviews for cycle time B.

working day on Friday and Monday. More than 60% of the operators reported perceived physical exertion equal or greater than 15 (hard) for high workload days on Friday and Monday for both cycle times. There was no significant difference between perceived physical exertion on Friday and Monday. The situation was similar for both cycle times.

### 3.3. Psychosocial factors

Table 6 presents psychosocial factors, including high psychological demands, low decision latitude and low social support. In this study, 79% of operators in cycle time A and 90% of the subjects in cycle time B reported low decision latitude. Psychological demands were also reported to be relatively high in both cycle times. Therefore the job strain that was derived from these two dimensions was 43% for cycle time A and 62% for cycle time B. Fig. 1 shows the patterns of job strain between study populations in both cycle times. It was shown that 40% of the people in cycle times A and 62% of them in cycle time B were classified in the high strain zone (lower right), 33% in cycle time A and 29% of people in cycle time B in the passive zone (lower left), 13% and 10% of people in cycle times A and B in the low strain zone (upper left) and 7% in cycle time A in the active zone (upper right). None of operators in cycle time B were classified in active zone. Low decision latitude and high psychological demands of reference data were reported by 70% and 41%, respectively. Another dimension investigated was social support. Twenty-five percent of subjects in cycle time B reported low social support whereas 53% of operators in cycle time A complained of low social support. Iso-strain was reported by 10% of subjects in cycle time B and 21% of subjects in cycle time A. Mac Nemar's exact test did not show any difference between the two cycle times. Low social support was reported to be higher in reference data than in cycle time B (48% of people complained low social support). Iso-strain was therefore higher in the reference data than in truck assembly operators for cycle time B.

## 4. Discussion

The purpose of this study was to evaluate subjectively three dimensions of the ergonomic approach in a truck assembly manufacturing plant. Physical, organizational and psychosocial risk factors were evaluated by self-reported methods for the two cycle times (11 min and 8 min). The operators also reported their musculoskeletal symptoms. The results of the study showed that musculoskeletal symptoms were more frequent in the upper limbs (shoulders/elbows/wrists) and lower back. The prevalence of symptoms in the lower limbs was low. Although the operators reported fewer symptoms in cycle time B (8 min) than in cycle time A (11 min), the results were not significantly different for the same

respondents in the two cycle times. The reason might be related to the low number of subjects who were included in the study. Upper limb and lower back symptoms were frequent complaints in other studies in automotive assembly industries. Johansson et al. reported that the neck, shoulders, lower back and hands were complained of frequently by truck assemblers although the symptoms for short (6 or 12 min) and long (20 or 45 min) cycle times were reported to be similar (Johansson et al., 1993). Engstrom et al. reported a high prevalence of musculoskeletal symptoms in the Volvo manufacturing industry, with the exception of the lower limbs (Engström et al., 1999). Widanarko et al. showed that neck/shoulder, wrists, arm/elbow and lower back were most common areas of complaint in a study of 3000 participants with different occupations (Widanarko et al., 2014, 2015; Widanarko, 2013). All these results are consistent with our findings and indicate the prevalence of upper limb musculoskeletal disorders in manufacturing assemblers.

Exposure to shoulder risk factors is common in automotive manufacturing assembly, particularly in the truck assembly industries. When comparing this study with epidemiologic reference data in France, shoulder risk factors were more frequent in our study. This was to be expected because the tasks to be accomplished in truck assembly require elevation of the arms in excess of 60° depending on truck size. In the study by Johansson et al., 39% of truck assemblers reported arm elevation above shoulder level (Johansson et al., 1993). Engstrom et al. reported that 35% of assembly operators were exposed to arm elevation above shoulder level two hours or more per day (Engström et al., 1999). In his ergonomic evaluation by direct measurement methods for forty-three types of work, Hansson et al. reported the highest levels for shoulder risk factors (arm elevation) among automotive assemblers (Hansson et al., 2010). All of these results are consistent with our results as the study population reported 33% and 24% arm elevation (>90°) for cycle times A and B, respectively. Arm abduction (<90°) that represents moderate exposure to shoulder risk factors was reported by more than half of the operators in both cycle times. To our knowledge there are few self-reported studies reporting moderate exposure to shoulder risk factors. However, accumulation of moderate and high workload shoulder risk factors will generate shoulder disorders.

Exposure to elbow and hand/wrist risk factors was also common, although it was reported less frequently for cycle time B. Elbow flexion and pronation/supination of the forearm were relatively high in both cycle times. Many tasks in assembly workstations required the use of electrical or manual screwdrivers and these actions involved pronation/supination of the elbows. Furthermore, the elbow is usually bent during assembly tasks. Bending the wrist usually happened when operators used hand-held power tools to tighten screws and nuts. Other tasks such as

**Table 6**  
Subjective assessment of psychosocial risk factors for two cycle times reported by truck assembly workers.

	All respondents				Same respondents				P-value	Reference Data <sup>c</sup>	
	Cycle time A (n = 15)		Cycle time B (n = 21)		Cycle time A		Cycle time B			(n = 362)	
	n	%	N	%	n	%	n	%		n	%
High psychological demands	8	53	13	62	6	50	8	67	0.69 <sup>a</sup>	147	41
Low decision latitude	11	79	19	90	9	75	11	92	0.50 <sup>a</sup>	249	70
Job strain	6	43	13	62	5	42	8	67	0.38 <sup>a</sup>	98	28
Low social support	8	53	5	25	5	45	5	45	NA <sup>b</sup>	170	48
Isostrain	3	21	2	10	2	18	2	18	1.00 <sup>b</sup>	52	15

NA: Not Applicable.

<sup>a</sup> Mac Nemar exact test for 12 operators who responded for both cycle times.

<sup>b</sup> Mac Nemar exact test for 11 operators who responded for both cycle times.

<sup>c</sup> Data from epidemiologic study among blue-collar operators in the manufacturing and assembly industries in a French region (Pays de la Loire).

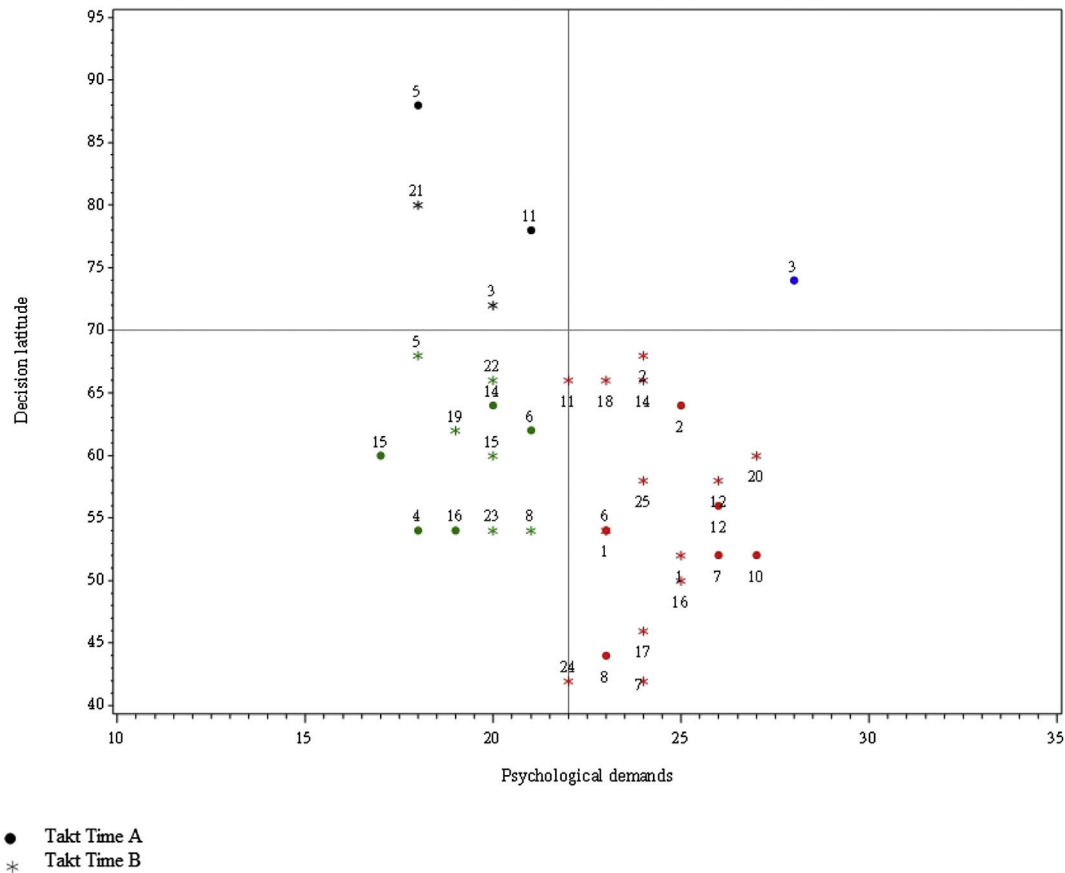

Fig. 1. Job strain derived from psychological demand and decision latitude dimensions for two Takt times.

pushing a wagon also involved wrist bending. The operators usually gripped light and thin objects (1–2 kg) such as supports, pumps etc with pinching or squeezing actions. These activities contain main ergonomic risk factors for elbows/hands/wrists and more than half of the subjects reported exposure to these risks. Exposure to elbow and hand/wrist risk factors in reference data was as frequent as our findings in truck assemblers, but pronation/supination movements and pinching grip were less often reported. Other studies reported a high prevalence of elbow/hand pain in automotive assemblers because of workloads and few attempts to reduce elbow/hand risk factors. When using screwdrivers routinely, the screwdriver's weight and reaction forces produced at the end of tightening were reported to be the main reasons for elbow/hand/wrist complaints in previous studies (Engström et al., 1999; Byström et al., 1995; Zetterberg et al., 1997). Other reasons for the high prevalence of elbow/hand/wrist disorders might be related to accumulative working with hands during the working day. Most claims involving musculoskeletal illness in an European truck assembly plant over the last 20 years were related to elbow disorders.

Back flexion for more than two hours/day was reported by all subjects in cycle time A and more than half of the operators in cycle time B. Although extreme back flexion occurred less frequently for truck assembly, the operators habitually bent their backs forward slightly, along with exertion force for performing their tasks. Back risk exposure reported by the operators was fairly high and it seems that they overestimated their exposure. However, the prevalence of lower back symptoms was also high in the study population and in the reference data. A possible reason for back risk factors is handling heavy parts and components. In our study the operators usually handled components ranging from 5 kg to 15 kg, depending

on the workstation. About half of the operators in both cycle times handled materials or tools for more than 4 h/day. The percentage of material handling was reduced in the new cycle time, although the difference was not significant. As reported in other studies, handling heavy components, frequent standing/walking with little opportunity to sit down are other reasons for the high prevalence of low back disorders among truck assemblers that we also observed in our study (Fredriksson et al., 2001; Johansson et al., 1993; Engström et al., 1999). Perceived physical exertion force was relatively similar in both cycle times. However, for a typical workday perceived exertion force ( $\geq 15$ ) was reported more frequently in cycle time A than in cycle time B. Other studies showed that the Borg rating is not only an index of physical activity but also an indicator of psychological factors (Borg, 1990; Josephson et al., 1996). Our hypothesis in this study was that operators might perceive an increase in physical exertion on Fridays compared to Mondays. However, we found that the perceived physical exertion was identical on Fridays and Mondays for both cycle times. The exertion perceived on high workload days was much more than on other types of work day. A high load workday was defined in this study as a day when the operators had to assemble difficult truck options. Therefore, the distribution of truck options in the assembly line should be more carefully considered by engineers. Loading up the line imbalance by truck options might expose operators to extra perceived physical exertion (fatigue).

The operators in cycle time B reported less exposure to physical risk factors than those in cycle time A. Statistical tests did not show a significant difference, which might be related to the small numbers in the study population. The possible reasons why the operators' subjective assessment decreased in the new cycle time

might be related to the technical/engineering improvements, reorganization and new design workstations. Four new workstations were created in the new system and high risk tasks were distributed between different workstations. Furthermore, some technical improvements such as using a lifting tool at the mudguard station and changing the design of the unlocking system in the “bumper assembly on chassis” station were incorporated which also reduced risk factors in the new system. Although the new cycle time reduced the content of each workstation because of shorter time, performing fewer unacceptable tasks (high risk) meant that the operators had felt better in the new cycle time. Furthermore, the new concept was not completely changed and most alterations were related to balancing, reorganization and modification.

In this study organizational characteristics were evaluated according to two main categories, i.e. work rate and workload. The assemblers reported more complaints regarding work rate compared to workload. Operators reported a high percentage of work rate imposed by mandatory use of tools, screwdrivers, lifting devices, etc, in both cycle times. In an assembly plant, assemblers must use different tools (sometimes more than 8 screwdrivers and torque wrench during one cycle time) and this causes extra movement and memorization of use of the right tool. Furthermore, following the standards and assembly procedures was reported by nearly all of the operators in both cycle times. For each workstation there were approximately three truck options with different assembly procedures that the operators had to follow. Each assembler worked in at least four different workstations during the day, and therefore had to memorize and follow many instructions regarding each truck option and workstation. The combination of these organizational constraints with physical risk factors could increase the risk of musculoskeletal disorders (Widanarko et al., 2014, 2015). However, the organizational factors that were imposed by workload such as exceeding normal hours of work, working too fast and unplanned activity were reported to be low in both cycle times. In contrast to another study where time constraints were reported by assemblers, in our study the operators were satisfied with the time organization as few subjects reported missing break, having short meals or skipping meals, working too fast, etc. The possible reason for this was the structure and organization of the assembly line in our study in which each workstation had its own support post (known as variant position in the factory) for helping the operators (Widanarko et al., 2014; Johansson et al., 1993).

Various reports have shown an association between psychosocial risk factors at the workplace and musculoskeletal symptoms (Widanarko et al., 2014, 2015; Widanarko, 2013; Johansson et al., 1993; Engström et al., 1999). In our study the operators in both cycle times reported high levels of psychological demand and low decision latitude. The reference data also showed that low decision latitude and high psychological demand were common psychosocial factors in blue-collar operators in France. However, the percentage reported was less than in our study. In the assembly line, there is naturally a low possibility for active learning or motivation for creativity and developing new behaviors. Operators' stress and strain is therefore increased due to low decision latitude and high psychological workload. Job stress and strain in the workplace could influence musculoskeletal disorders due to muscle tension and result in behavior changers as workers might report more musculoskeletal symptoms (Carayon et al., 1999; Bongers et al., 2002). On the other hand, social support, another dimension of psychosocial factors, was reported to be satisfactory by more than 70% of the subjects in cycle time B. This dimension was developed in the new cycle time and it was better compared to reference data. It is interesting to note when this dimension was considered, the final calculated percentage of iso-strain decreased significantly and

it was lower than the reference data. It can be concluded that it is possible to reduce strain by good social support, although, due to the nature of operations and processes in the assembly plant, it is difficult to match high decision latitude and to decrease psychological demands. In general the importance of managing psychosocial risk factors is highlighted in other studies because the combination and interactive effect of this risk factor along with high physical workload not only increase the risk of musculoskeletal outcomes but also influence productivity and the quality of products (Falck and Rosenqvist, 2012).

## 5. Conclusions

The findings of this study showed that potential physical risk factors mainly involving the upper limbs were significant among truck assembly operators. Most subjects reported risk factors for elbows, shoulders and hands/wrists, and the percentages of WRMSDs symptoms reported in the upper limbs were also considerable. Perceived physical exertion increased on the high workload working day. However, it was not considerable on the typical and low workload working days. Perceived physical exertion was not different for Mondays and Fridays for assemblers. Our results showed that, although low decision latitude and high psychological demands were common psychosocial risk factors among our subjects, good quality social support reduced the strain. Reorganization with taking into account ergonomic approach reduced musculoskeletal symptoms and physical risk factors in the new cycle time but the difference from the initial concept was not significant.

## Acknowledgments

The authors would like to appreciate SCANIA staff and managers for their contribution in this research. This research is granted by SCANIA Production Angers and the French National Research Program for Environmental and Occupational Health of Anses (2012/2/007).

## References

- Bongers, P.M., Kremer, A.M., Laak, J.t., 2002. Are psychosocial factors, risk factors for symptoms and signs of the shoulder, elbow, or hand/wrist?: a review of the epidemiological literature. *Am. J. Ind. Med.* 41, 315–342.
- Borg, G., 1990. Psychophysical scaling with applications in physical work and the perception of exertion. *Scand. J. Work Environ. Health* 55–58.
- Byström, S., Hall, C., Welander, T., Kilbom, Å., 1995. Clinical disorders and pressure-pain threshold of the forearm and hand among automobile assembly line workers. *J. Hand Surg. Br. Eur. Volume* 20, 782–790.
- Caisse nationale de l'assurance maladie des travailleurs salariés. In: *Direction des Risques Professionnels, France*, 2012, p. 57.
- Carayon, P., Smith, M.J., Haims, M.C., 1999. Work organization, job stress, and work-related musculoskeletal disorders. *Hum. Factors J. Hum. Factors Ergon. Soc.* 41, 644–663.
- Engström, T., Hanse, J.J., Kadefors, R., 1999. Musculoskeletal symptoms due to technical preconditions in long cycle time work in an automobile assembly plant: a study of prevalence and relation to psychosocial factors and physical exposure. *Appl. Ergon.* 30, 443–453.
- Falck, A.C., Rosenqvist, M., 2012. What are the obstacles and needs of proactive ergonomics measures at early product development stages? - an interview study in five Swedish companies. *Int. J. Ind. Ergon.* 42, 406–415.
- Fredriksson, K., Bildt, C., Hägg, G., Kilbom, Å., 2001. The impact on musculoskeletal disorders of changing physical and psychosocial work environment conditions in the automobile industry. *Int. J. Ind. Ergon.* 28, 31–45.
- Hansson, G.-Å., Balogh, I., Ohlsson, K., Granqvist, L., Nordander, C., Arvidsson, I., Åkesson, I., Unge, J., Rittner, R., Strömberg, U., 2010. Physical workload in various types of work: part II. Neck, shoulder and upper arm. *Int. J. Ind. Ergon.* 40, 267–281.
- Inman, R.R., Blumenfeld, D.E., Huang, N., Li, J., 2003. Designing production systems for quality: research opportunities from an automotive industry perspective. *Int. J. Prod. Res.* 41, 1953–1971.
- Johansson, J.Å., Kadefors, R., Rubenowitz, S., Klingensstierna, U., Lindström, I., Engström, T., Johansson, M., 1993. Musculoskeletal symptoms, ergonomic aspects and psychosocial factors in two different truck assembly concepts. *Int. J. Ind. Ergon.* 12, 35–48.

- Josephson, M., Hagberg, M., Hjelm, E.W., 1996. Self-Reported physical exertion in geriatric care: a risk indicator for low back symptoms? *Spine* 21, 2781–2785.
- Kadefors, R., Engström, T., Petzäll, J., Sundström, L., 1996. Ergonomics in parallelized car assembly: a case study, with reference also to productivity aspects. *Appl. Ergon.* 27, 101–110.
- Karasek, R., Brisson, C., Kawakami, N., Houtman, I., Bongers, P., Amick, B., 1998. The Job Content Questionnaire (JCQ): an instrument for internationally comparative assessments of psychosocial job characteristics. *J. Occup. Health Psychol.* 3, 322.
- Kuorinka, I., Jonsson, B., Kilbom, A., Vinterberg, H., Biering-Sørensen, F., Andersson, G., Jørgensen, K., 1987. Standardised Nordic questionnaires for the analysis of musculoskeletal symptoms. *Appl. Ergon.* 18, 233–237.
- Niedhammer, I., Chastang, J.-F., David, S., Barouhiel, L., Barrandon, G., 2006. Psychosocial work environment and mental health: job-strain and effort-reward imbalance models in a context of major organizational changes. *Int. J. Occup. Environ. Health* 12, 111–119.
- Ólafsdóttir, H., Rafnsson, V., 1998. Increase in musculoskeletal symptoms of upper limbs among women after introduction of the flow-line in fish-fillet plants. *Int. J. Ind. Ergon.* 21, 69–77.
- Putz-Anderson, V., Bernard, B.P., Burt, S.E., Cole, L.L., Fairfield-Estill, C., Fine, L.J., Grant, K.A., Gjessing, C., Jenkins, L., Hurrell Jr., J.J., 1997. *Musculoskeletal Disorders and Workplace Factors*. National Institute for Occupational Safety and Health (NIOSH).
- Roquelaure, Y., Ha, C., Sauteron, M., 2002. Réseau expérimental de surveillance épidémiologique des troubles musculosquelettiques dans les Pays de la Loire. *Surveill. Entrep.* 2005.
- Roquelaure, Y., Mariel, J., Fanello, S., Boissiere, J., Chiron, H., Dano, C., Bureau, D., Penneau-Fontbonne, D., 2002. Active epidemiological surveillance of musculoskeletal disorders in a shoe factory. *Occup. Environ. Med.* 59, 452–458.
- Roquelaure, Y., Ha, C., Leclerc, A., Touranchet, A., Sauteron, M., Melchior, M., Imbernon, E., Goldberg, M., 2006. Epidemiologic surveillance of upper-extremity musculoskeletal disorders in the working population. *Arthritis Care Res.* 55, 765–778.
- Roquelaure, Y., Ha, C., Leclerc, A., Touranchet, A., Mariot, C., Imbernon, E., Goldberg, M., 2006. Troubles musculo-squelettiques en France: données du réseau pilote de surveillance épidémiologique dans les entreprises des Pays de la Loire en 2002 et 2003. *Santé Soc. Solidarité* 5, 35–43.
- Sluiter, J.K., Rest, K.M., Frings-Dresen, M.H., 2001. Criteria document for evaluating the work-relatedness of upper-extremity musculoskeletal disorders. *Scand. J. Work Environ. Health* 1–102.
- Speklé, E.M., Heinrich, J., Hoozemans, M.J., Blatter, B.M., van der Beek, A.J., van Dieën, J.H., van Tulder, M.W., 2010. The cost-effectiveness of the RSI QuickScan intervention programme for computer workers: results of an economic evaluation alongside a randomised controlled trial. *BMC Musculoskelet. Disord.* 11, 259.
- Törnström, L., Amprazis, J., Christmansson, M., Eklund, J., 2008. A corporate workplace model for ergonomic assessments and improvements. *Appl. Ergon.* 39, 219–228.
- Wang, Z.-X., Qin, R.-L., Li, Y.-Z., Zhang, X.-Y., Jia, N., Zhang, Q.-L., Li, G., Zhao, J., Li, H.-H., Jiang, H.-Q., 2011. The epidemiological study of work-related musculoskeletal disorders and related factors among automobile assembly workers. *Zhonghua lao dong wei sheng zhi ye bing za zhi = Zhonghua laodong weisheng zhiyebing zazhi = Chin. J. Ind. Hyg. Occup. Dis.* 29, 572–578.
- Widanarko, B., 2013. *Interaction between Physical and Psychosocial Work Risk Factors for Low Back Symptoms: a Study of Prevalence, Risk Factors, and Interaction between Physical and Psychosocial Work Risk Factors for Low Back Symptoms and its Consequences (Reduced Activities and Absenteeism) in a Random Sample of Workers in New Zealand and in Indonesian Coal Mining Workers: a Thesis Presented in Fulfilment of the Requirements for the Degree of Doctor of Philosophy in Ergonomics at Massey University, Manawatu, New Zealand.*
- Widanarko, B., Legg, S., Devereux, J., Stevenson, M., 2014. The combined effect of physical, psychosocial/organisational and/or environmental risk factors on the presence of work-related musculoskeletal symptoms and its consequences. *Appl. Ergon.* 45, 1610–1621.
- Widanarko, B., Legg, S., Devereux, J., Stevenson, M., 2015. Interaction between physical and psychosocial work risk factors for low back symptoms and its consequences amongst Indonesian coal mining workers. *Appl. Ergon.* 46, 158–167.
- Zetterberg, C., Forsberg, A., Hansson, E., Johansson, H., Nielsen, P., Danielsson, B., Inge, G., Olsson, B.-M., 1997. Neck and upper extremity problems in car assembly workers. A comparison of subjective complaints, work satisfaction, physical examination and gender. *Int. J. Ind. Ergon.* 19, 277–289.



# Appendix 8

Appendix 8: Questionnaires used to evaluate ergonomic factors

# QUESTIONNAIRE SANTE – TRAVAIL

## I. IDENTIFICATION

---

1. **Numéro de questionnaire.....**

2. **A quelle date remplissez-vous ce questionnaire ?**   |\_|\_|/ |\_|\_|/ 2013  
  jour       mois   année

3. **Où avez-vous rempli ce questionnaire ?.....**

**Domicile .....**               **Usine.....**               **Autre.....**

4. **Quel est votre âge ?.....|\_|\_|/ ans**

5. **Êtes-vous ?**

Droitier (ère)...

Gaucher (ère)...

Ambidextre...

6. **Travaillez vous des deux mains aisément**

OUI...

NO ...

7. **Depuis combien d'années travaillez-vous (y compris hors de l'entreprise) ?**

|\_|\_| années

8. **Depuis combien d'années travaillez-vous chez SCANIA ?**

|\_|\_| années

9. **Quel est votre moyen de transport pour aller travailler ?**

Transports en commun.....

Véhicule personnel.....

Les 2.....

Covoiturage

10. **Combien de temps vous faut-il pour aller à votre lieu de travail (trajet aller) ?**

<1/2 heure.....    1/2 heure à 1 heure .....

1 à 2 heures .....    > à 2 heures .....

11. **Dans quel GAC travaillez vous habituellement au sein du cluster P<sup>42</sup>?**

GAC 1 .....

GAC 2.....

GAC 3.....

12. **Combien de postes différents faites vous dans votre GAC ?|\_|\_|**

13. **Etes vous polyvalent sur d'autre GAC ou cluster?**

GAC...

Cluster...

Pas de polyvalence...

14. **Si polyvalent sur d'autre GAC**

a. **Combien de fois par semaine ? .....**

b. **Sur combien de poste différents travaillez vous ? .....**

---

**15. Si polyvalent sur d'autre cluster**

**a. Combien de fois par semaine ? .....**

**b. Sur combien de poste différents travaillez vous ? .....**

**16. Pour chacune des zones du corps, comment évaluez-vous l'intensité de la gêne/douleur au moment où vous remplissez le questionnaire.**

**Entourez la case correspondante pour chaque zone corporelle.**

---

Nuque / cou	Ni gêne ni douleur →	_0_ _1_ _2_ _3_ _4_ _5_ _6_ _7_ _8_ _9_ _10_	← Gêne ou douleur intolérable
Epaule / bras	Ni gêne ni douleur →	_0_ _1_ _2_ _3_ _4_ _5_ _6_ _7_ _8_ _9_ _10_	← Gêne ou douleur intolérable
Coude/ avant-bras	Ni gêne ni douleur →	_0_ _1_ _2_ _3_ _4_ _5_ _6_ _7_ _8_ _9_ _10_	← Gêne ou douleur intolérable
Main / poignet	Ni gêne ni douleur →	_0_ _1_ _2_ _3_ _4_ _5_ _6_ _7_ _8_ _9_ _10_	← Gêne ou douleur intolérable
Doigts	Ni gêne ni douleur →	_0_ _1_ _2_ _3_ _4_ _5_ _6_ _7_ _8_ _9_ _10_	← Gêne ou douleur intolérable
Haut du dos	Ni gêne ni douleur →	_0_ _1_ _2_ _3_ _4_ _5_ _6_ _7_ _8_ _9_ _10_	← Gêne ou douleur intolérable
Bas du dos	Ni gêne ni douleur →	_0_ _1_ _2_ _3_ _4_ _5_ _6_ _7_ _8_ _9_ _10_	← Gêne ou douleur intolérable
Hanche/cuisse	Ni gêne ni douleur →	_0_ _1_ _2_ _3_ _4_ _5_ _6_ _7_ _8_ _9_ _10_	← Gêne ou douleur intolérable
Genou/jambe	Ni gêne ni douleur →	_0_ _1_ _2_ _3_ _4_ _5_ _6_ _7_ _8_ _9_ _10_	← Gêne ou douleur intolérable
Cheville/pied	Ni gêne ni douleur →	_0_ _1_ _2_ _3_ _4_ _5_ _6_ _7_ _8_ _9_ _10_	← Gêne ou douleur intolérable

---

**17. A quel niveau vous situez-vous dans votre travail sur l'échelle suivante ?**

**Entourez le chiffre correspondant à votre état, de 0 « pas concerné », à 10 « très concerné ».**

Pas du tout stressé → |\_0\_|\_1\_|\_2\_|\_3\_|\_4\_|\_5\_|\_6\_|\_7\_|\_8\_|\_9\_|\_10\_| ← Très stressé

**attention nécessaire dans le travail**

Peu d'attention → |\_0\_|\_1\_|\_2\_|\_3\_|\_4\_|\_5\_|\_6\_|\_7\_|\_8\_|\_9\_|\_10\_| ← beaucoup d'attention

**mémorisation des tâches et variantes**

Faible de mémorisation → |\_0\_|\_1\_|\_2\_|\_3\_|\_4\_|\_5\_|\_6\_|\_7\_|\_8\_|\_9\_|\_10\_| ← fort de mémorisation

---

### III. CONCERNANT VOTRE TRAVAIL

---

**18. Au cours d'une journée typique de travail, votre rythme de travail vous est-il imposé par ?**

---

	Jamais	Rarement	Souvent	Toujours
a. Des contraintes techniques (visseuse obligatoire, remplissages ou outillage etc.)	<input type="checkbox"/>	<input type="checkbox"/>	<input type="checkbox"/>	<input type="checkbox"/>
b. La dépendance immédiate vis-à-vis du travail d'un ou plusieurs collègues	<input type="checkbox"/>	<input type="checkbox"/>	<input type="checkbox"/>	<input type="checkbox"/>
c. La co-activité interservices (inter GAC, inter cluster, logistique, etc.)	<input type="checkbox"/>	<input type="checkbox"/>	<input type="checkbox"/>	<input type="checkbox"/>
d. Des procédures de sécurité à respecter	<input type="checkbox"/>	<input type="checkbox"/>	<input type="checkbox"/>	<input type="checkbox"/>
e. Des mode opératoire de production à respecter	<input type="checkbox"/>	<input type="checkbox"/>	<input type="checkbox"/>	<input type="checkbox"/>
f. Les contrôles ou une surveillance permanents (ou au moins quotidien) de la hiérarchie	<input type="checkbox"/>	<input type="checkbox"/>	<input type="checkbox"/>	<input type="checkbox"/>
g. Un contrôle ou un suivi informatisé (Prossess Production Environment)	<input type="checkbox"/>	<input type="checkbox"/>	<input type="checkbox"/>	<input type="checkbox"/>

---

**19. En raison de votre charge de travail, vous arrive-t-il de :**

---

	Jamais	Rarement	Souvent	Toujours
a. Dépasser vos horaires normaux (ATV, REC)?	<input type="checkbox"/>	<input type="checkbox"/>	<input type="checkbox"/>	<input type="checkbox"/>
b. Sauter ou écourter un repas ?	<input type="checkbox"/>	<input type="checkbox"/>	<input type="checkbox"/>	<input type="checkbox"/>
c. Ne pas prendre une pause ?	<input type="checkbox"/>	<input type="checkbox"/>	<input type="checkbox"/>	<input type="checkbox"/>
d. Travailler trop vite une opération qui demanderait du soin ?	<input type="checkbox"/>	<input type="checkbox"/>	<input type="checkbox"/>	<input type="checkbox"/>
e. Abandonner une tâche que vous êtes en train de faire pour une autre non prévue ?	<input type="checkbox"/>	<input type="checkbox"/>	<input type="checkbox"/>	<input type="checkbox"/>
f. Ne pas pouvoir terminer une activité ?	<input type="checkbox"/>	<input type="checkbox"/>	<input type="checkbox"/>	<input type="checkbox"/>

---

**20. Au cours d'une journée typique de travail :**

---

	Jamais	Rarement	Souvent	Toujours
a. Devez-vous faire des gestes très précis ?	<input type="checkbox"/>	<input type="checkbox"/>	<input type="checkbox"/>	<input type="checkbox"/>
b. Devez-vous faire exactement le même geste pour des raisons de procédure ou de qualité ?	<input type="checkbox"/>	<input type="checkbox"/>	<input type="checkbox"/>	<input type="checkbox"/>
c. Etes-vous debout ?	<input type="checkbox"/>	<input type="checkbox"/>	<input type="checkbox"/>	<input type="checkbox"/>
d. Devez-vous vous pencher en avant ou sur le côté régulièrement ou de manière prolongée ?	<input type="checkbox"/>	<input type="checkbox"/>	<input type="checkbox"/>	<input type="checkbox"/>
e. Conduisez-vous un engin : P50, fenwick, etc. ?	<input type="checkbox"/>	<input type="checkbox"/>	<input type="checkbox"/>	<input type="checkbox"/>

f. Devez-vous passer du temps à porter une charge qui pèse 1 à 10 kg ?	<input type="checkbox"/>	<input type="checkbox"/>	<input type="checkbox"/>	<input type="checkbox"/>
g. Devez-vous passer du temps à porter une charge qui pèse 10 à 25 kg ?	<input type="checkbox"/>	<input type="checkbox"/>	<input type="checkbox"/>	<input type="checkbox"/>
h. Devez-vous passer du temps à porter une charge qui pèse plus de 25 kg ?	<input type="checkbox"/>	<input type="checkbox"/>	<input type="checkbox"/>	<input type="checkbox"/>
i. Votre travail nécessite-t-il habituellement de répéter les mêmes actions plus de 2 fois environ par minute ?	<input type="checkbox"/>	<input type="checkbox"/>	<input type="checkbox"/>	<input type="checkbox"/>
j. Pouvez-vous interrompre votre travail ou changer de tâche ou d'activité pendant 10 minutes ou plus chaque heure ?	<input type="checkbox"/>	<input type="checkbox"/>	<input type="checkbox"/>	<input type="checkbox"/>
k. Pouvez-vous quitter votre travail des yeux ?	<input type="checkbox"/>	<input type="checkbox"/>	<input type="checkbox"/>	<input type="checkbox"/>
l. Manipulez-vous régulièrement un outil ou un objet qui pèse 1 à 4 kg ?	<input type="checkbox"/>	<input type="checkbox"/>	<input type="checkbox"/>	<input type="checkbox"/>
m. Manipulez-vous régulièrement un outil ou un objet qui pèse plus de 4 kg ?	<input type="checkbox"/>	<input type="checkbox"/>	<input type="checkbox"/>	<input type="checkbox"/>
n. Utilisez-vous des outils vibrants ou devez-vous poser la (es) main(s) sur des machines vibrantes ?	<input type="checkbox"/>	<input type="checkbox"/>	<input type="checkbox"/>	<input type="checkbox"/>













**21. Au cours d'une journée typique de travail :**

	Jamais	Rarement	Souvent	La plupart du temps
a. Etes-vous exposé à une ambiance de travail bruyante (bruit gênant la conversation) ?	<input type="checkbox"/>	<input type="checkbox"/>	<input type="checkbox"/>	<input type="checkbox"/>
b. Etes-vous exposé à des ambiances visuelles gênantes (éblouissement, pénombre, contrejour, etc.) ?	<input type="checkbox"/>	<input type="checkbox"/>	<input type="checkbox"/>	<input type="checkbox"/>
c. Etes-vous exposé à une ambiance de travail empoussiérée ?	<input type="checkbox"/>	<input type="checkbox"/>	<input type="checkbox"/>	<input type="checkbox"/>
d. Etes-vous exposé à une ambiance de travail que vous jugez insalubre ?	<input type="checkbox"/>	<input type="checkbox"/>	<input type="checkbox"/>	<input type="checkbox"/>
e. Etes-vous amené à travailler sur un sol instable ou glissant ?	<input type="checkbox"/>	<input type="checkbox"/>	<input type="checkbox"/>	<input type="checkbox"/>
f. Etes-vous exposé à un sentiment d'insécurité (chariot élévateur, palans, objet au dessus de vous) ?	<input type="checkbox"/>	<input type="checkbox"/>	<input type="checkbox"/>	<input type="checkbox"/>

**22. Au cours d'une journée typique de travail, devez-vous adopter les postures suivantes ?**



	Jamais	Rarement	Souvent	La plupart du temps
a. Travailler avec un ou deux bras en l'air (au-dessus des épaules) régulièrement ou de manière prolongée	<input type="checkbox"/>	<input type="checkbox"/>	<input type="checkbox"/>	<input type="checkbox"/>



b. Attraper régulièrement des objets derrière le dos		<input type="checkbox"/>	<input type="checkbox"/>	<input type="checkbox"/>	<input type="checkbox"/>
c. Travailler avec un ou deux bras écartés du corps régulièrement ou de manière prolongée		<input type="checkbox"/>	<input type="checkbox"/>	<input type="checkbox"/>	<input type="checkbox"/>
d. Reposer vos avant-bras sur un plan de travail		<input type="checkbox"/>	<input type="checkbox"/>	<input type="checkbox"/>	<input type="checkbox"/>
e. Fléchir le(s) coude(s) régulièrement ou de manière prolongée		<input type="checkbox"/>	<input type="checkbox"/>	<input type="checkbox"/>	<input type="checkbox"/>
f. Tourner la main comme pour visser		<input type="checkbox"/>	<input type="checkbox"/>	<input type="checkbox"/>	<input type="checkbox"/>
g. Tordre le poignet		<input type="checkbox"/>	<input type="checkbox"/>	<input type="checkbox"/>	<input type="checkbox"/>
h. Appuyer ou taper avec la base de la main sur un plan dur ou sur un outil		<input type="checkbox"/>	<input type="checkbox"/>	<input type="checkbox"/>	<input type="checkbox"/>
i. Presser ou prendre fermement des objets ou des pièces entre le pouce et l'index		<input type="checkbox"/>	<input type="checkbox"/>	<input type="checkbox"/>	<input type="checkbox"/>
j. Pencher la tête <b>en avant</b> régulièrement ou de manière prolongée		<input type="checkbox"/>	<input type="checkbox"/>	<input type="checkbox"/>	<input type="checkbox"/>
k. Pencher la tête <b>en arrière</b> régulièrement ou de manière prolongée		<input type="checkbox"/>	<input type="checkbox"/>	<input type="checkbox"/>	<input type="checkbox"/>
l. Travailler en hauteur		<input type="checkbox"/>	<input type="checkbox"/>	<input type="checkbox"/>	<input type="checkbox"/>
m. Faible surface d'appui pour les pieds (pointe des pieds)		<input type="checkbox"/>	<input type="checkbox"/>	<input type="checkbox"/>	<input type="checkbox"/>
n. Accroupis et/ou à genou		<input type="checkbox"/>	<input type="checkbox"/>	<input type="checkbox"/>	<input type="checkbox"/>
o. Nécessitant une contorsion (posture inconfortable)		<input type="checkbox"/>	<input type="checkbox"/>	<input type="checkbox"/>	<input type="checkbox"/>
p. Travail en poussant ou tirant		<input type="checkbox"/>	<input type="checkbox"/>	<input type="checkbox"/>	<input type="checkbox"/>

**23. Au cours d'une journée typique de travail, combien de temps passez-vous à faire les tâches ou activités suivantes ?**

**Cochez la case correspondant à la bonne durée pour chaque tâche ou activité décrite ci-dessous.**

		Jamais	Rarement	Souvent	La plupart du temps
a. Porter des objets encombrants et volumineux les bras tendus		<input type="checkbox"/>	<input type="checkbox"/>	<input type="checkbox"/>	<input type="checkbox"/>
b. Porter des objets difficiles à attraper, instables ou sans poignée		<input type="checkbox"/>	<input type="checkbox"/>	<input type="checkbox"/>	<input type="checkbox"/>
c. Pousser ou tirer des charges (cartons, tiroirs, caisses, etc.)		<input type="checkbox"/>	<input type="checkbox"/>	<input type="checkbox"/>	<input type="checkbox"/>
d. Dérouler / tirer un câble (objet difficile à attraper)		<input type="checkbox"/>	<input type="checkbox"/>	<input type="checkbox"/>	<input type="checkbox"/>

**24. Au cours d'une journée typique de travail, utilisez-vous régulièrement ?**

	Non	Moins 2h/jour	Plus 2h/jour
a. Un clavier ou une souris	<input type="checkbox"/>	<input type="checkbox"/>	<input type="checkbox"/>
b. Un écran d'ordinateur ou de contrôle	<input type="checkbox"/>	<input type="checkbox"/>	<input type="checkbox"/>
c. Un outil coupant	<input type="checkbox"/>	<input type="checkbox"/>	<input type="checkbox"/>
d. utilisez-vous une pince à Rilsan (colson)	<input type="checkbox"/>	<input type="checkbox"/>	<input type="checkbox"/>
e. utilisez-vous une clef dynamométrique	<input type="checkbox"/>	<input type="checkbox"/>	<input type="checkbox"/>
f. utilisez-vous une visseuse	<input type="checkbox"/>	<input type="checkbox"/>	<input type="checkbox"/>
g. utilisez-vous un outil de levage	<input type="checkbox"/>	<input type="checkbox"/>	<input type="checkbox"/>
h. utilisez-vous un maillet	<input type="checkbox"/>	<input type="checkbox"/>	<input type="checkbox"/>

**25. Concernant votre espace de travail ?**

	Pas du tout d'accord	Pas d'accord	D'accord	Tout à fait d'accord
a. Il est suffisant pour réaliser l'ensemble de vos tâches	<input type="checkbox"/>	<input type="checkbox"/>	<input type="checkbox"/>	<input type="checkbox"/>
b. Il gêne vos gestes	<input type="checkbox"/>	<input type="checkbox"/>	<input type="checkbox"/>	<input type="checkbox"/>
c. Il génère plus de manipulations	<input type="checkbox"/>	<input type="checkbox"/>	<input type="checkbox"/>	<input type="checkbox"/>
d. Il complique vos postures	<input type="checkbox"/>	<input type="checkbox"/>	<input type="checkbox"/>	<input type="checkbox"/>
e. Il varie en fonction de la co-activité avec vos collègues	<input type="checkbox"/>	<input type="checkbox"/>	<input type="checkbox"/>	<input type="checkbox"/>

**26. Dans le cadre de votre travail, devez-vous former régulièrement de nouveaux arrivants ?**

Oui.....       Non .....

**Si oui, cela modifie-t-il votre travail ?**

Non...      Oui, un peu...      Oui, beaucoup...



**27. Les questions suivantes se rapportent-elles à votre travail habituel au cours des 6 derniers mois ?**

	Pas du tout d'accord	Pas d'accord	D'accord	Tout à fait d'accord
a. Dans mon travail, je dois apprendre des choses nouvelles	<input type="checkbox"/>	<input type="checkbox"/>	<input type="checkbox"/>	<input type="checkbox"/>
b. Dans mon travail, j'effectue des tâches répétitives	<input type="checkbox"/>	<input type="checkbox"/>	<input type="checkbox"/>	<input type="checkbox"/>
c. Mon travail me demande d'être créatif	<input type="checkbox"/>	<input type="checkbox"/>	<input type="checkbox"/>	<input type="checkbox"/>
d. Mon travail me permet souvent de prendre des décisions moi-même	<input type="checkbox"/>	<input type="checkbox"/>	<input type="checkbox"/>	<input type="checkbox"/>
e. Mon travail demande un haut niveau de compétence	<input type="checkbox"/>	<input type="checkbox"/>	<input type="checkbox"/>	<input type="checkbox"/>
f. Dans ma tâche, j'ai très peu de liberté pour décider comment je fais mon travail	<input type="checkbox"/>	<input type="checkbox"/>	<input type="checkbox"/>	<input type="checkbox"/>
g. Dans mon travail, j'ai des activités variées	<input type="checkbox"/>	<input type="checkbox"/>	<input type="checkbox"/>	<input type="checkbox"/>
h. J'ai la possibilité d'influencer le déroulement de mon travail	<input type="checkbox"/>	<input type="checkbox"/>	<input type="checkbox"/>	<input type="checkbox"/>
i. J'ai l'occasion de développer mes compétences professionnelles	<input type="checkbox"/>	<input type="checkbox"/>	<input type="checkbox"/>	<input type="checkbox"/>
j. Mon travail demande de travailler très vite	<input type="checkbox"/>	<input type="checkbox"/>	<input type="checkbox"/>	<input type="checkbox"/>
k. Mon travail demande de travailler intensément	<input type="checkbox"/>	<input type="checkbox"/>	<input type="checkbox"/>	<input type="checkbox"/>
l. On me demande d'effectuer une quantité de travail excessive	<input type="checkbox"/>	<input type="checkbox"/>	<input type="checkbox"/>	<input type="checkbox"/>
m. Je dispose du temps nécessaire pour exécuter mon travail	<input type="checkbox"/>	<input type="checkbox"/>	<input type="checkbox"/>	<input type="checkbox"/>
n. Je reçois des ordres contradictoires de la part d'autres personnes	<input type="checkbox"/>	<input type="checkbox"/>	<input type="checkbox"/>	<input type="checkbox"/>
o. Mon travail nécessite de longues périodes de concentration intense	<input type="checkbox"/>	<input type="checkbox"/>	<input type="checkbox"/>	<input type="checkbox"/>
p. Mes tâches sont souvent interrompues avant d'être achevées, nécessitant de les reprendre plus tard	<input type="checkbox"/>	<input type="checkbox"/>	<input type="checkbox"/>	<input type="checkbox"/>
q. Mon travail est très « bousculé »	<input type="checkbox"/>	<input type="checkbox"/>	<input type="checkbox"/>	<input type="checkbox"/>
r. Attendre le travail de collègues ou d'autres départements ralentit souvent mon propre travail	<input type="checkbox"/>	<input type="checkbox"/>	<input type="checkbox"/>	<input type="checkbox"/>
s. Mon supérieur se sent concerné par le bien-être de ses subordonnés	<input type="checkbox"/>	<input type="checkbox"/>	<input type="checkbox"/>	<input type="checkbox"/>
t. Mon supérieur prête attention à ce que je dis	<input type="checkbox"/>	<input type="checkbox"/>	<input type="checkbox"/>	<input type="checkbox"/>
u. Mon supérieur m'aide à mener ma tâche à bien	<input type="checkbox"/>	<input type="checkbox"/>	<input type="checkbox"/>	<input type="checkbox"/>
v. Mon supérieur réussit facilement à faire collaborer ses subordonnés	<input type="checkbox"/>	<input type="checkbox"/>	<input type="checkbox"/>	<input type="checkbox"/>

w. Les collègues avec qui je travaille sont des gens professionnellement compétents	<input type="checkbox"/>	<input type="checkbox"/>	<input type="checkbox"/>	<input type="checkbox"/>
x. Les collègues avec qui je travaille me manifestent de l'intérêt	<input type="checkbox"/>	<input type="checkbox"/>	<input type="checkbox"/>	<input type="checkbox"/>
y. Les collègues avec qui je travaille sont amicaux	<input type="checkbox"/>	<input type="checkbox"/>	<input type="checkbox"/>	<input type="checkbox"/>
z. Les collègues avec qui je travaille m'aident à mener les tâches à bien	<input type="checkbox"/>	<input type="checkbox"/>	<input type="checkbox"/>	<input type="checkbox"/>
aa. Vous avez le sentiment que dans l'ensemble votre travail est reconnu par votre entourage professionnel	<input type="checkbox"/>	<input type="checkbox"/>	<input type="checkbox"/>	<input type="checkbox"/>
bb. Vous devez faire des choses que vous désapprouvez	<input type="checkbox"/>	<input type="checkbox"/>	<input type="checkbox"/>	<input type="checkbox"/>
cc. Vous travaillez avec la peur de perdre votre emploi	<input type="checkbox"/>	<input type="checkbox"/>	<input type="checkbox"/>	<input type="checkbox"/>

**28. Avez-vous le sentiment qu'une erreur de votre part dans votre travail peut avoir une conséquence grave ?**

	Jamais	Rarement	Souvent	Toujours
a. Pour votre santé	<input type="checkbox"/>	<input type="checkbox"/>	<input type="checkbox"/>	<input type="checkbox"/>
b. Sur l'état du matériel	<input type="checkbox"/>	<input type="checkbox"/>	<input type="checkbox"/>	<input type="checkbox"/>
c. Pour l'entreprise	<input type="checkbox"/>	<input type="checkbox"/>	<input type="checkbox"/>	<input type="checkbox"/>
d. Pour les usagers	<input type="checkbox"/>	<input type="checkbox"/>	<input type="checkbox"/>	<input type="checkbox"/>
e. Pour les collègues	<input type="checkbox"/>	<input type="checkbox"/>	<input type="checkbox"/>	<input type="checkbox"/>

**29. Estimez-vous qu'il vous est facile d'exprimer des difficultés au travail ?**

Facile → |\_0\_|\_1\_|\_2\_|\_3\_|\_4\_|\_5\_|\_6\_|\_7\_|\_8\_|\_9\_|\_10\_| ← Pas du tout facile

**30. Estimez-vous qu'il vous est facile d'exprimer une atteinte à la santé au travail (Maladie professionnelle, accident du travail, etc.) ?**

Facile → |\_0\_|\_1\_|\_2\_|\_3\_|\_4\_|\_5\_|\_6\_|\_7\_|\_8\_|\_9\_|\_10\_| ← Pas du tout facile

**31. Quelle tâche trouvez vous la plus difficile physiquement (serrage de..., câblages de..., etc) ?**

.....

.....

.....

.....

.....

**32. Quelle tâche demande le plus de concentration (serrage de..., câblages de, etc )?**

.....

.....

.....

.....

.....

**33. Quelles propositions suggéreriez vous éventuellement pour améliorer le travail?**

.....

.....

.....

.....

.....

**34. Si vous avez travaillé en cadences 35, lesquels cadences préférez vous et pour quoi (48 ou 35)?**

.....

.....

.....

.....

---

**35. Si vous avez des commentaires, écrivez-les en clair ci-dessous.**

.....

.....

.....

## **Echèle Borg**

1. **Comment évaluez-vous l'intensité des efforts physiques de votre travail dans GAC1 ?**

**Entourez le chiffre correspondant à votre choix sur l'échelle graduée de 6 à 20 ci-dessous, qui va de « pas d'effort du tout » à «épuisant ».**

<b><u>Journée typique de travail</u></b>		<b><u>Journée à forte charge de travail</u></b>		<b><u>Journée à faible charge de travail</u></b>	
6	Pas d'effort du tout	6	Pas d'effort du tout	6	Pas d'effort du tout
7	Extrêmement léger	7	Extrêmement léger	7	Extrêmement léger
8		8		8	
9	Très léger	9	Très léger	9	Très léger
10		10		10	
11	Léger	11	Léger	11	Léger
12		12		12	
13	Un peu dur	13	Un peu dur	13	Un peu dur
14		14		14	
15	Dur	15	Dur	15	Dur
16		16		16	
17	Très dur	17	Très dur	17	Très dur
18		18		18	
19	Extrêmement dur	19	Extrêmement dur	19	Extrêmement dur
20	Epuisant	20	Epuisant	20	Epuisant

**2. Comment évaluez-vous l'intensité des efforts physiques de votre travail dans GAC2 ?**

**Entourez le chiffre correspondant à votre choix sur l'échelle graduée de 6 à 20 ci-dessous, qui va de « pas d'effort du tout » à «épuisant ».**

<u>Journée typique de travail</u>	<u>Journée à forte charge de travail</u>	<u>Journée à faible charge de travail</u>
6 Pas d'effort du tout	6 Pas d'effort du tout	6 Pas d'effort du tout
7 Extrêmement léger	7 Extrêmement léger	7 Extrêmement léger
8	8	8
9 Très léger	9 Très léger	9 Très léger
10	10	10
11 Léger	11 Léger	11 Léger
12	12	12
13 Un peu dur	13 Un peu dur	13 Un peu dur
14	14	14
15 Dur	15 Dur	15 Dur
16	16	16
17 Très dur	17 Très dur	17 Très dur
18	18	18
19 Extrêmement dur	19 Extrêmement dur	19 Extrêmement dur
20 Epuisant	20 Epuisant	20 Epuisant

**3. Comment évaluez-vous l'intensité des efforts physiques de votre travail dans GAC3 ?**

**Entourez le chiffre correspondant à votre choix sur l'échelle graduée de 6 à 20 ci-dessous, qui va de « pas d'effort du tout » à «épuisant ».**

<u>Journée typique de travail</u>	<u>Journée à forte charge de travail</u>	<u>Journée à faible charge de travail</u>
6 Pas d'effort du tout	6 Pas d'effort du tout	6 Pas d'effort du tout
7 Extrêmement léger	7 Extrêmement léger	7 Extrêmement léger
8	8	8
9 Très léger	9 Très léger	9 Très léger
10	10	10
11 Léger	11 Léger	11 Léger
12	12	12
13 Un peu dur	13 Un peu dur	13 Un peu dur
14	14	14
15 Dur	15 Dur	15 Dur
16	16	16
17 Très dur	17 Très dur	17 Très dur
18	18	18
19 Extrêmement dur	19 Extrêmement dur	19 Extrêmement dur
20 Epuisant	20 Epuisant	20 Epuisant

**Vous trouverez ci-dessous 3 schémas corporels identiques qui concernent le GAC 1, GAC2 et GAC 3. Ne remplissez que celui qui vous concerne, si vous faites de l'inter GAC, vous devez remplir 2 schémas.**

**4. Comment évaluez-vous l'intensité de l'effort musculaire de votre travail dans GAC1 pour chaque zone corporelle considérée sur l'échelle ci-dessous ? Pour chacune des zones du corps, entourez la case correspondante.**

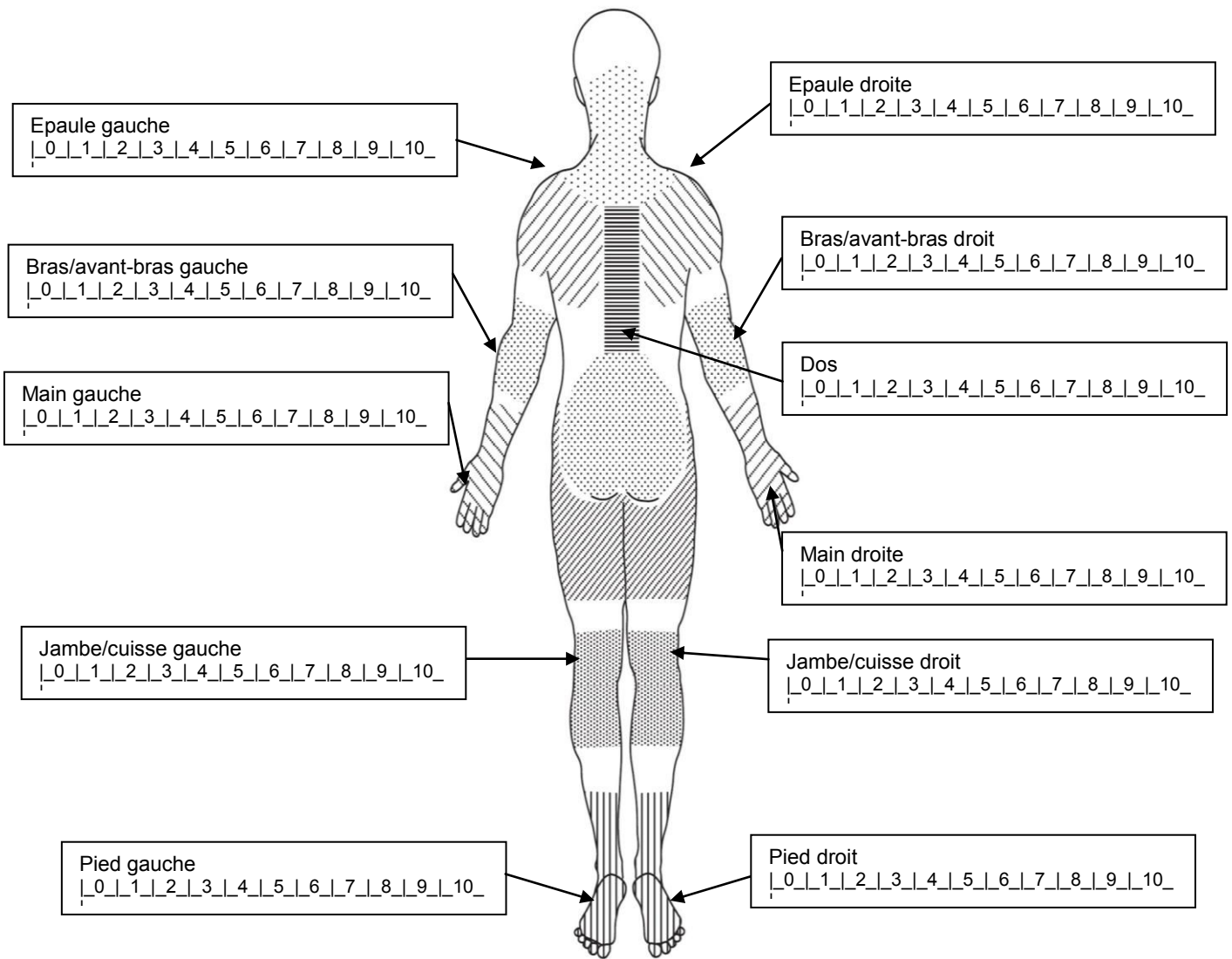

**5. Comment évaluez-vous l'intensité de l'effort musculaire de votre travail dans GAC2 pour chaque zone considérée, sur l'échelle ci-dessous ?**  
**Pour chacune des zones du corps, entourez la case correspondante.**

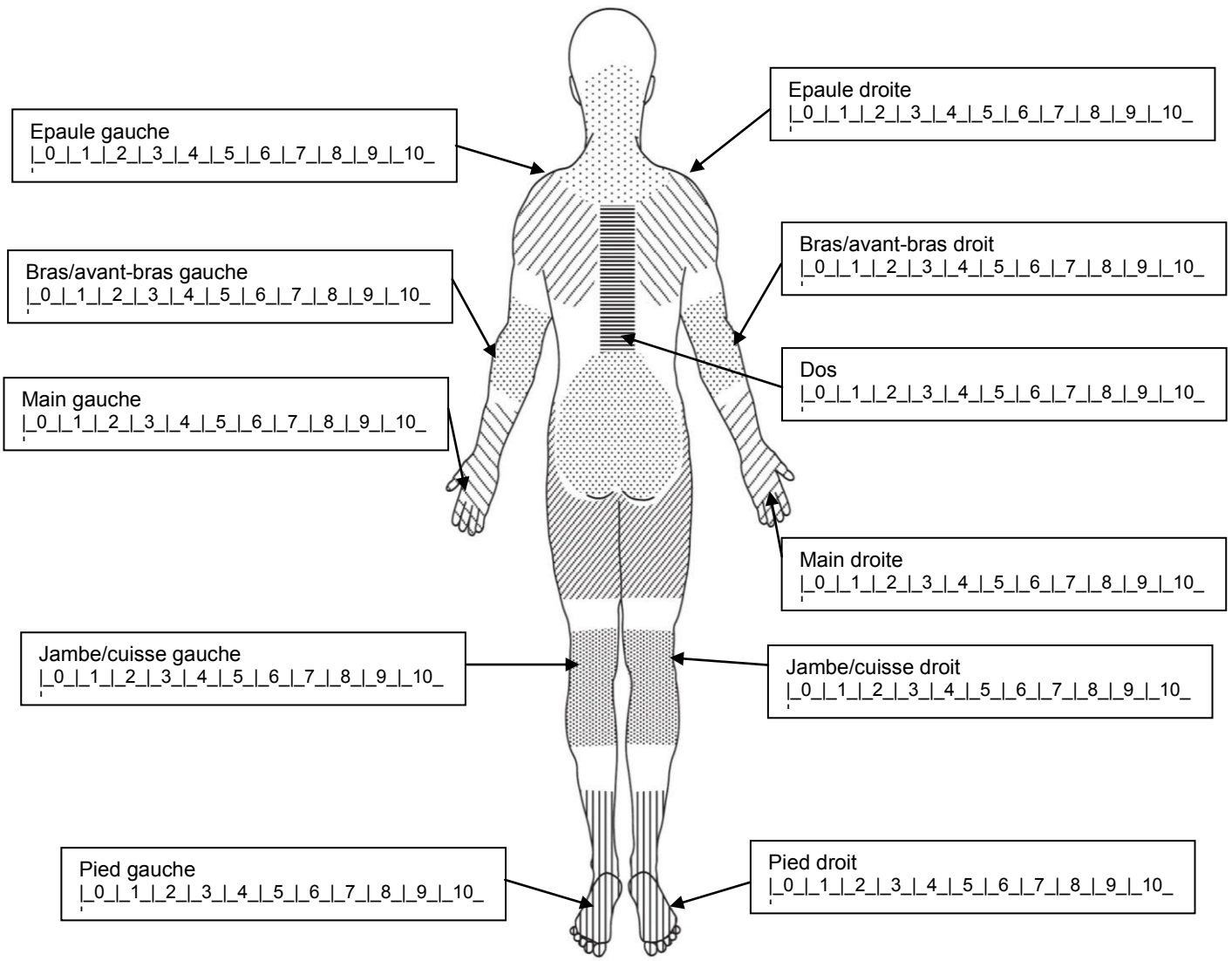



**6. Comment évaluez-vous l'intensité de l'effort musculaire de votre travail dans GAC3 pour chaque zone considérée, sur l'échelle ci-dessous ?**  
**Pour chacune des zones du corps, entourez la case correspondante.**

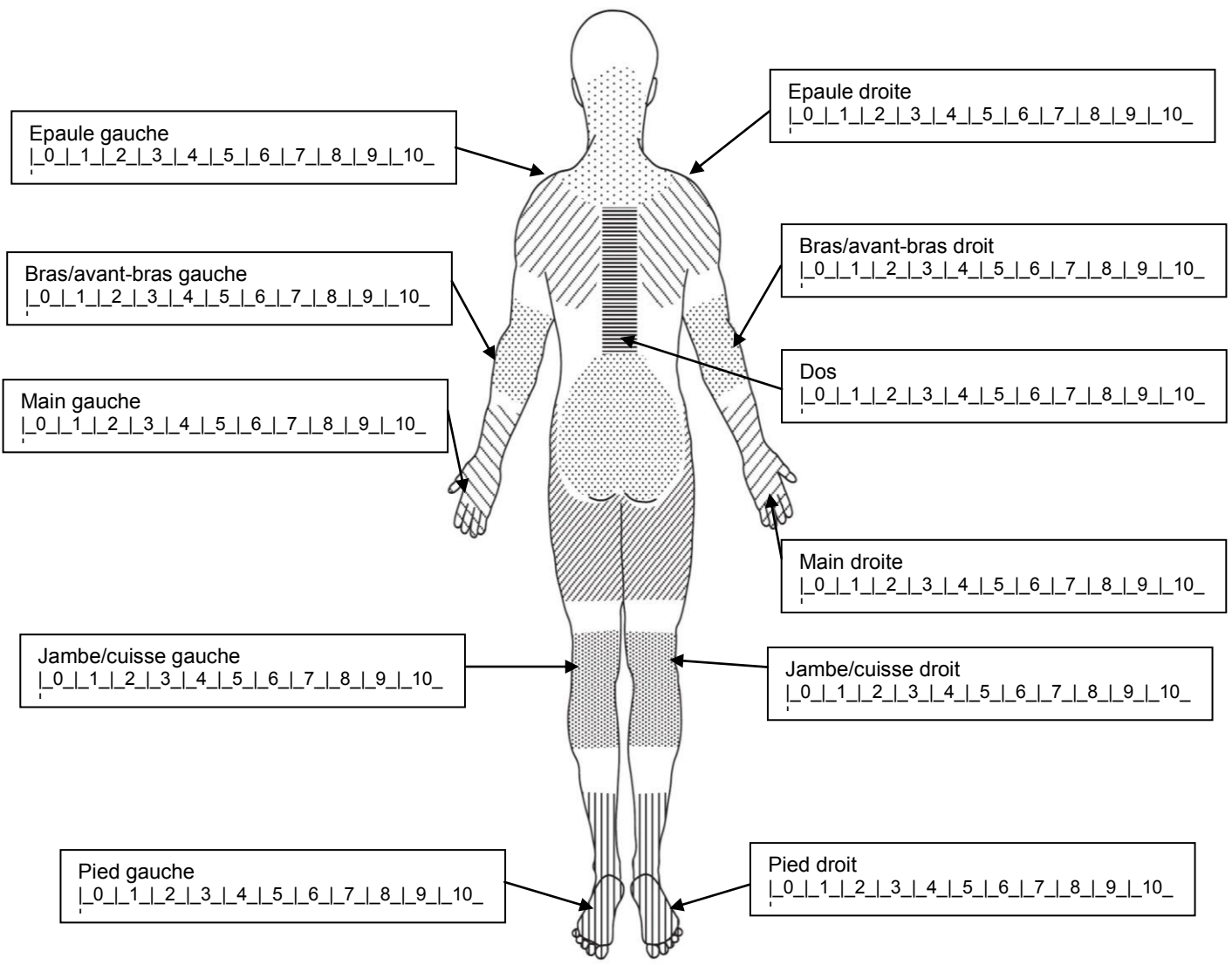

**7. Comment évaluez-vous la contrainte de temps au cours de votre travail dans GAC1 sur l'échelle suivante ?**

**Entourez le chiffre correspondant à votre état, de 0, pas difficile, à 10, très difficile.**

**Journée typique**

Faible → |\_0\_|\_|1\_|\_|2\_|\_|3\_|\_|4\_|\_|5\_|\_|6\_|\_|7\_|\_|8\_|\_|9\_|\_|10\_| ← Très forte

**Journée à forte charge de travail**

Faible → |\_0\_|\_|1\_|\_|2\_|\_|3\_|\_|4\_|\_|5\_|\_|6\_|\_|7\_|\_|8\_|\_|9\_|\_|10\_| ← Très forte

**Journée à faible charge de travail**

Faible → |\_0\_|\_|1\_|\_|2\_|\_|3\_|\_|4\_|\_|5\_|\_|6\_|\_|7\_|\_|8\_|\_|9\_|\_|10\_| ← Très forte

**8. Comment évaluez-vous la contrainte de temps au cours de votre travail dans GAC2 sur l'échelle suivante ?**

**Entourez le chiffre correspondant à votre état, de 0, pas difficile, à 10, très difficile.**

**Journée typique**

Faible → |\_0\_|\_|1\_|\_|2\_|\_|3\_|\_|4\_|\_|5\_|\_|6\_|\_|7\_|\_|8\_|\_|9\_|\_|10\_| ← Très forte

**Journée à forte charge de travail**

Faible → |\_0\_|\_|1\_|\_|2\_|\_|3\_|\_|4\_|\_|5\_|\_|6\_|\_|7\_|\_|8\_|\_|9\_|\_|10\_| ← Très forte

**Journée à faible charge de travail**

Faible → |\_0\_|\_|1\_|\_|2\_|\_|3\_|\_|4\_|\_|5\_|\_|6\_|\_|7\_|\_|8\_|\_|9\_|\_|10\_| ← Très forte

**9. Comment évaluez-vous la contrainte de temps au cours de votre travail dans GAC3 sur l'échelle suivante ?**

**Entourez le chiffre correspondant à votre état, de 0, pas difficile, à 10, très difficile.**

**Journée typique**

Faible → |\_0\_|\_|1\_|\_|2\_|\_|3\_|\_|4\_|\_|5\_|\_|6\_|\_|7\_|\_|8\_|\_|9\_|\_|10\_| ← Très forte

**Journée à forte charge de travail**

Faible → |\_0\_|\_|1\_|\_|2\_|\_|3\_|\_|4\_|\_|5\_|\_|6\_|\_|7\_|\_|8\_|\_|9\_|\_|10\_| ← Très forte

**Journée à faible charge de travail**

Faible → |\_0\_|\_|1\_|\_|2\_|\_|3\_|\_|4\_|\_|5\_|\_|6\_|\_|7\_|\_|8\_|\_|9\_|\_|10\_| ← Très forte

# Appendix 9

## **Appendix 9: The published version for Article 4 Development of a biomechanical method for ergonomic evaluation: comparison with observational methods**

*Zare M, Biau S, Croq M, Roquelaure Y. Development of a Biomechanical Method for Ergonomic Evaluation: Comparison with Observational Methods. International Journal of Social, Management, Economics and Business Engineering. 2014;8:223-7.*

# Development of a Biomechanical Method for Ergonomic Evaluation: Comparison with Observational Methods

M. Zare, S. Biau, M. Croq, Y. Roquelaure

**Abstract**—A wide variety of observational methods have been developed to evaluate the ergonomic workloads in manufacturing. However, the precision and accuracy of these methods remain a subject of debate. The aims of this study were to develop biomechanical methods to evaluate ergonomic workloads and to compare them with observational methods.

Two observational methods, i.e. SCANIA Ergonomic Standard (SES) and Rapid Upper Limb Assessment (RULA), were used to assess ergonomic workloads at two simulated workstations. They included four tasks such as tightening & loosening, attachment of tubes and strapping as well as other actions. Sensors were also used to measure biomechanical data (Inclinometers, Accelerometers, and Goniometers).

Our findings showed that in assessment of some risk factors both RULA & SES were in agreement with the results of biomechanical methods. However, there was disagreement on neck and wrist postures. In conclusion, the biomechanical approach was more precise than observational methods, but some risk factors evaluated with observational methods were not measurable with the biomechanical techniques developed.

**Keywords**—Ergonomic, Observational Method, Biomechanical method, Workload.

## I. INTRODUCTION

AS discussed in various studies, work-related musculoskeletal disorders are widespread in the manufacturing industries and they are known as multi-factorial occupational diseases for which physical workload, psychosocial, organizational and individual factors are the most important causes [1], [2]. Physical ergonomic risk factors, including forceful exertion, awkward postures, lifting, manual material handling and vibrations are considered to be the obvious risk factors contributing to Work Musculoskeletal Disorders (WMSDs) [3]-[5]. To manage and control physical ergonomic risks, several methods have been developed for assessment of exposure and estimation of risks of injury in various occupations [1]. Paper-based observational methods such as RULA, OCRA, REBA, etc, are the techniques most commonly applied by ergonomists for posture assessments

M. Zare is with the Laboratory of Ergonomics & Epidemiology in Occupational Health, Angers, France (phone: +33787722141; e-mail: zare@hlth.mui.ac.ir).

S. Biau is with the Ecole Nationale d'Equitation BP 207 - 49411 Saumur Cedex France (e-mail: sophie.biau@ifce.fr).

M. Croq is with the Pôle Santé, XSXEA Scania Production Angers SAS Angers Cedex 01 – France (e-mail: michel.croq@scania.com).

Y. Roquelaure is with the Laboratory of Ergonomics & Epidemiology in Occupational Health, Angers France (e-mail: yvroquelaure@chu-angers.fr).

[6]. Strain Index and ACGIH hand level activity are the methods for measuring forceful exertion. Manual material handling is evaluated by the NIOSH equation, MAC (UK), ManTRA (Australia), and New Zealand code [7]. Although many studies have applied these methods to analyze job stations, their validity is still a matter of debate. Furthermore, many industrial companies have developed their own internal methods for ergonomic analysis, and a few research articles have addressed the efficacy of using in-housing methods [6]. It is essential for ergonomists and manufacturers that the accuracy and precision of the methods should be applicable for workplace analysis. Risk management policies related to WMSDs are unsuccessful without accurate ergonomic risk assessment [1].

In addition to observational methods, biomechanical methods (direct measurement) have been developed that rely on sensors for recording body movement [8]. Goniometry, inclinometry, accelerometry, and electromyography are the most popular straightforward methods to measure postures, movements and force exertion. A large quantity of precise data related to exposure variables can be provided by biomechanical procedures, and developing the right protocol for applying them is vital. Comparing the results of straightforward methods with observational techniques would provide the opportunity to improve the validity of observational methods. Developing an accurate protocol showing which sensors should be used and how the measurements should be performed is necessary before workplace analysis with biomechanical methods.

The aim of this study was therefore to develop an appropriate protocol for biomechanical measurement in manufacturing assembly. Testing this protocol and comparing it with two observational methods, i.e. SCANIA Ergonomic Standard (SES) and RULA, were the other aims of our study. SES is an in-house observational method that is used for measuring posture, force, lifting and repetition, and RULA is a common method for posture assessment.

## II. METHODS

### A. Biomechanical Measurements

The first step in our study was selection of sensors to measure the repetition, movements and postures of body regions.

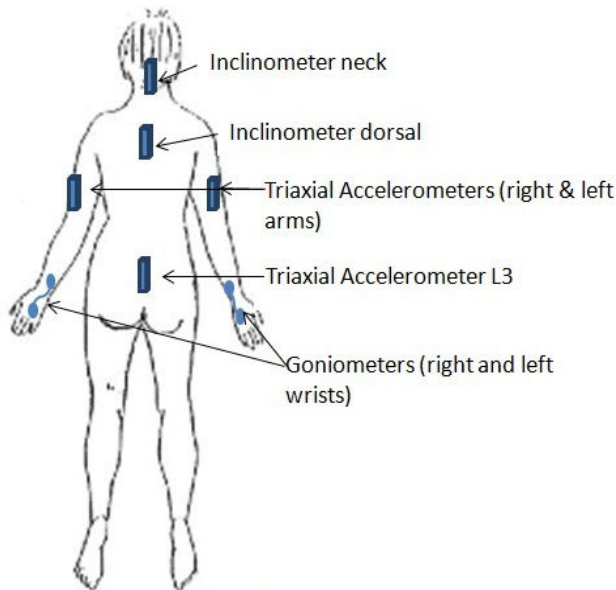

Fig. 1 Sensor placement for measurement of body movements

Inclinometers were used to measure the inclination of body regions such as the head and upper back in a recent study [8]. To measure neck posture, information was sampled using loggers as well as two inclinometers placed on the occipital bone (a saucer-shaped membrane bone situated at the lower back of the cranium) and on the cervico-thoracic spine at the C7-Th1 level. The total number of times when the head posture was more than 10° forward or backward compared to the upper back were characterized as head postures.

Two triaxial accelerometers were placed along the upper arms in the middle of the humerus. The line from the rounded head of the acromion to the lateral epicondyle was measured and divided into two for the placement of accelerometers on the humerus. They were fixed laterally on both hands with their Y-axes on the vertical. Arm elevations as well as hand repetitions were therefore calculated. Another accelerometer was placed on L3 of the lumbar spine to assess back posture. Recordings were performed between +1g and -1g.

Biaxial electro-goniometers were used to measure flexion and extension deviations of the right and left wrists, the flexion and extension of the wrist being characterized in this study as hand postures. All sensors were small and placed on the body with double-sided adhesive tape (Fig. 1).

The zero positions for the head and upper back were defined at the first data recording when the subjects were standing upright in their usual postures and looking at a point of eye level. The reference positions for the upper arms and lower back were established when the subjects stood upright with their arms hanging at the side of the body. Once the wrists were relaxed alongside the body, this was taken as the reference position of the wrist.

All the postures and movements were recorded by data logger and camera recorder either in reference positions or while performing four simulated tasks. All the data were then transferred to the computer and actions were synchronized between movie and logger data. The two job stations selected

were Air Component & Tie Wrapping which are simulated job stations in truck manufacturing for operator training. They include following tasks:

1. Tightening with hand and tool (duration 296 seconds)
2. Placing tubes and wrapping with Plastic Strap (duration 462.5 seconds)
3. Loosening with hand and tool (duration 148 seconds)
4. Other actions to test limits of sensor (duration 70 seconds)

#### B. Observational Methods

The first observational method to evaluate the potential ergonomic risk in the simulated job stations was SCANIA in-house Ergonomic Standard method (SES). This method is adapted to the ergonomic risk requirements in assembly manufacturing and designed to evaluate multi-task work stations. SES not only assesses postures but also evaluates force and lifting tasks. Twenty parameters are classified in 5 categories to define its ergonomic criteria. To prioritize the assessments, the results are sorted in the following order: Green or normal zone which shows minimal risk of WMSDs, and these kinds of risk are acceptable. Yellow shows the zone which has moderate risk of WMSDs. Yellow tasks and job stations might need some improvement action in the future. Red is an action zone where there are considerable risks of WMSDs for workers, and changes are required as soon as possible. Finally, double red (DR) shows the potential for excessive ergonomic risk for the tasks assessed as DR, so they should be stopped immediately and the solutions found.

TABLE I  
COMPARISON OF ERGONOMIC RISK PRIORITIZATION BY RULA AND SES METHODS

Category	RULA Score	SES Color	Definition
Level 1	1-2	Green	Acceptable
Level 2	3-4	Yellow	More investigation needed
Level 3	5-6	Red	Modification needed soon
Level 4	7	Double Red	Modification needed as soon as possible

The numbers of yellows, reds and DRs are then added and the colors of workstations are determined. The worst color is considered to be the final evaluation of the workstation.

The other observational method used in this study was the Rapid Upper Limb Assessment (RULA). This method is widely used by ergonomists and researchers in various occupations to assess the risk of upper limb disorders. RULA measures ergonomic risk based on postures, weight, duration and frequency, and then provides a score showing the risk of injury for the tasks evaluated. The scale rate for posture assessment varies from one to seven, one showing the best and seven the worst. In RULA the body is divided in two zones, A and B, of which A includes the upper arms, lower arms, and wrist positions, and group B the neck and trunk. The final score generated by RULA shows the postures and ergonomic loads as four levels. Table I shows the categorization of the scores generated by SES and RULA.

The observational methods were undertaken by an experienced ergonomist and were analyzed by Excel.

MATLAB software was used to analyze biomechanical data.

### III. RESULTS

Observations and video recordings were performed for all the tasks selected. Our general results showed that posture assessments with the different methods for the tasks evaluated yielded the same results. However, some differences occurred for the neck and wrist postures. Furthermore, direct methods provided a range of information which clearly revealed different aspects of workstations for ergonomists and decision makers. The main advantage of the direct method is observing whether the body movements while performing a task were symmetric.

#### A. Tightening with Hand and with Tools (Task One)

The neck posture score with the RULA method was 4 ( $20^\circ < \text{neck flexion}$ ) for 73% of the total task time, while the SES method showed that the neck posture for 46% of the task time was red ( $45^\circ < \text{neck flexion}$ ), and for 27% of the time period it was yellow ( $20^\circ < \text{neck flexion} < 45^\circ$ ). The inclinometers showed that for 80% of the time for this task the neck was in flexion between  $10^\circ$  and  $20^\circ$ , although they never record flexion of more than  $20^\circ$ . The results for neck posture for this task with the three methods were therefore rather different.

During 13% of the tightening task period, the trunk score was assessed as 2 with RULA ( $10^\circ < \text{back flexion} < 20^\circ$ ). SES yielded green for back posture, as bending forward was less than  $20^\circ$  during this task. The accelerometer that was used as inclinometer for the lower back showed back flexion  $< 20^\circ$  for 81% of the task time. The direct method results for the trunk were therefore consistent with both the RULA and SES methods.

The upper arm score with RULA for 10% of the tightening task was 2 ( $20^\circ < \text{upper arm lifting} < 45^\circ$ ) and for 90% of the time it was 1 ( $\text{upper arm lifting} < 20^\circ$ ). The lower arm position score with RULA was 1 during this task. The SES assessment for static work posture of the shoulder and arm was green, while the bending movement forward or outward was less than  $45^\circ$ . There are no criteria with the SES method for assessing the lower arms. Two accelerometers on the left and right arms showed that the arms were never in flexion or abduction of more than  $40^\circ$  throughout this task. The methods revealed the same results for assessment of arm postures.

Similarly, the RULA score for wrist postures was 1 (neutral wrist) and the same results were observed by the SES method. However, electro-goniometry of both hands showed that for 30% of task duration wrist postures were more than  $15^\circ$ , results which were inconsistent with observational methods.

Repetition was evaluated with SES as red because the tightening actions with either hands or a tool were repeated more than 3 times per minute (according SES criteria). The numbers of repetitions were calculated with an accelerometer, and four repetitions for tightening with a torque wrench as well as eight repetitions for hand tightening were observed for each action (Fig. 2). In total, 50 repetitions with the hand and 32 repetitions with a tool were recorded over 5 minutes in this

task. Although repetition was assessed as an action zone (red) by the SES method (the same result as the direct method), it is difficult to determine real values of repetition numbers by the observational method. The direct method clearly visualized the number and pattern of repetitions.

The final RULA score for this task was 5, which shows that further investigation and changes are required soon. The overall color of this task with the SES method was green, which is in the normal zone and acceptable.

TABLE II  
COMPARISON OF ERGONOMIC RISK ASSESSMENT BY RULA, SES AND DIRECT METHOD

		RULA score	SES color	Direct method
Tightening Task	Neck	4	Red	Neck flexion $< 20^\circ$
	Back	2	Green	Back flexion $< 20^\circ$
	Arm	2	Green	Arm lifting $< 40^\circ$
	Wrist	1	Green	flexion and extension $> 15^\circ$
Wrapping with plastic strap	Neck	4	Red	Neck flexion $< 20^\circ$
	Back	3	Yellow	Back flexion $> 45^\circ$
	Arm	2	Green	Arm lifting $< 40^\circ$
	Wrist	3	Red	flexion and extension $> 15^\circ$
Loosening task	Neck	4	Red	Neck flexion $< 20^\circ$
	Back	2	Green	$20^\circ < \text{Back flexion} < 45^\circ$
	Arm	2	Green	Arm lifting $< 40^\circ$
	Wrist	1	Green	flexion and extension $> 15^\circ$
Other tasks	Neck	1	Green	Neck flexion $< 20^\circ$
	Back	4	Red	Flexion $> 45^\circ$
	Arm	5	Red	Arm lifting $> 40^\circ$
	Wrist	3	Red	flexion and extension $> 15^\circ$

#### B. Placing a Tube and Wrapping with Plastic Strap

The task duration in which all the different actions were performed was approximately 8 minutes. The RULA score for neck posture for 51% of the task time was 2 ( $10^\circ < \text{neck flexion} < 20^\circ$ ) and for 19% of the task time it was 3 ( $20^\circ < \text{neck flexion}$ ). The overall score for the neck was 4 because sometimes the neck was bending to the side during this task. The SES method showed red ( $45^\circ < \text{neck flexion}$  and sideways/rotation  $> 30^\circ$ ) for neck posture for just 10 seconds of the whole task time (2% of task time), while for most of the task duration the neck posture was assessed as yellow. Since the worst color governs the final evaluation in the SES method, the final color for neck posture was red. The direct method showed the neck was in flexion of  $10^\circ$  and  $20^\circ$  for 26% of the task time. In this study side bending of the neck posture was not assessed with the inclinometer. Again, for this task the results of observational methods were in conflict with the inclinometer recording.

The RULA score for 70% of the task time for back posture was 3, defined as back flexion more than  $20^\circ$  and less than  $60^\circ$ . Trunk twisting and side bending were not observed in this task. Trunk posture was assessed by SES as yellow, which shows bending forward between  $20^\circ$  and  $45^\circ$ . The accelerometer at L3 showed lower back flexion between  $20^\circ$  and  $45^\circ$  for 68% of task duration, and for 13% of the task time the trunk posture was more than  $45^\circ$ . The three methods

provided similar results for back posture for this task.

The RULA score for the upper arms was 4 (upper arm lifting  $>90^\circ$ ) for less than 5 seconds of total task time whereas for 95% of the task duration this score was 2 ( $20^\circ <$  upper arm lifting  $<45^\circ$ ). Static posture of the shoulders and arms was assessed by SES as green (upper arm lifting  $<45^\circ$ ). The left and right arm positions were evaluated at more than  $40^\circ$  by the direct methods for only 1% of the task time, and this was consistent with the other methods.

Wrist postures were assessed as 3 by RULA, showing flexion or extension of more than  $15^\circ$ , and the result on SES for this task was red. Electro-goniometry demonstrated that the wrist postures were more than  $15^\circ$  for 65% of the task period.

The overall RULA score in this task was 5 and the final color for the SES method was green, as for the tightening task.

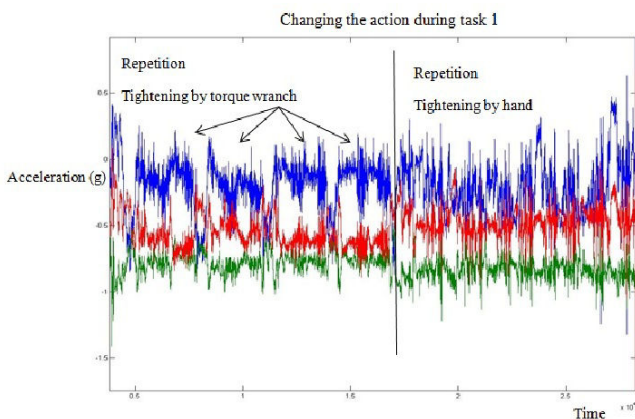

Fig. 2 Cyclic accelerations of the arm for two consecutive tasks: vertical accelerations (green), longitudinal accelerations (blue) and lateral acceleration (red)

### C. Loosening with Hand/Tools and Other Actions

The results of posture assessments during the loosening task were the same as the tightening task, especially for the neck, back and upper arms. However, the duration of awkward postures was shorter for the tightening task and the numbers of repetitions were also different. Table II shows the results of observational methods and the direct method for these tasks.

The two accelerations with the left and right arms provided further information about hand movements and the symmetry of the body movements. As shown in Table III, although the tightening task involved the same amount of work, with both tools and hands, acceleration between the two hands for these actions was not the same. Tightening with a tool was more symmetric for both arms compared to tightening by hand.

TABLE III  
ASYMMETRIC MOVEMENTS OF THE ARM DURING MANUAL TIGHTENING COMPARE TO TIGHTENING WITH A TOOL CALCULATED BY ACCELERATION (G)

Action type	Arm	RMS	RMS
Manual	Right Arm	0.77	1.34
	Left Arm	0.57	
	Right Arm	0.95	1.23
	Left Arm	0.3	
Tool	Right Arm	0.82	1.31
	Left Arm	0.49	
	Right Arm	0.93	1.26
	Left Arm	0.33	

## IV. DISCUSSION

This study was undertaken to develop a biomechanical method which allows measurement and calculation of movements and positions in assembly and manufacturing plants. We compared the results of biomechanical measurements with two observational methods. Overall, we did not find a great difference between the three methods. For most parts of the body all methods demonstrated the same results, although the biomechanical method provided more precise information. However, some inconsistencies were observed, especially in assessment of the neck and wrists. As explained, for tightening and loosening tasks the results of both observational methods for the neck were in the action zone and further changes should be proposed as soon as possible, whereas the inclinometer measured neck angles of less than  $20^\circ$  in these tasks which is in the normal zone and acceptable. One reason for this conflict is probably that the observers looked at the neck in terms of an anatomical straight line while the inclinometer provided the neck angles in relation to upper back position. Evidently, neck bending accompanies upper back bending.

Furthermore, some differences were found between the methods for assessing wrist postures. In contrast to neck posture, the electro-goniometer provided angle values for both wrists that were much worse than the results of observational methods. The reference positions for the wrist when measuring with the goniometer might be the reason for these differences. Goniometers measure the flexion and extension of a functional position of the hands.

The direct method would provide the possibility of measuring exactly how many repetitions occurred during an individual task. In addition, symmetry of movement is another criterion which we could never assess with the observational method. However, further investigations are required, particularly in real workplaces, to confirm the results of this study.

## V. CONCLUSION

In conclusion, our results showed that sensors were more precise than observational methods as they decrease raters' errors. Accelerometers on the arms and back should be sufficient to assess postures instead of inclinometers which also provide complementary information about movement speeds, symmetry and repetitions.

#### ACKNOWLEDGMENT

We thank all of our colleagues in SCANIA production, Angers, and in the Laboratory of Ergonomics & Epidemiology in Occupational Health for their valuable collaboration.

#### REFERENCES

- [1] G. C. David, "Ergonomic methods for assessing exposure to risk factors for work-related musculoskeletal disorders," *Occupational Medicine*, 55(3), 2005: 190-199.
- [2] Li, Guangyan, and Peter Buckle. "Current techniques for assessing physical exposure to work-related musculoskeletal risks, with emphasis on posture-based methods." *Ergonomics* 42, no. 5 (1999): 674-695.
- [3] F. Gerr, R., Letz, P. J. Landrigan. "Upper-extremity musculoskeletal disorders of occupational origin," *Annual Review of Public Health*, 12, 1991: 543-566.
- [4] A. Burdorf, "Exposure assessment of risk factors for disorders of the back in occupational epidemiology," *Scandinavian Journal of Work, Environment and Health*, 18, 1992: 1-9H.
- [5] A. È . Kilbom, Repetitive work of the upper extremity: Part II The scientific basis (knowledge base) for the guide," *International Journal of Industrial Ergonomics*, 14, 1994a:59-86.
- [6] C. Berlin, R. Örtengren, D. Lämkuil, L. Hanson. "Corporate-internal vs. national standard—A comparison study of two ergonomics evaluation procedures used in automotive manufacturing." *International Journal of Industrial Ergonomics*, 39(6), 2009: 940-946.
- [7] E-P., Takala, I., Pehkonen, M., Forsman, G-A, Hansson, SE, Mathiassen, P. Neumann, et al. "Systematic evaluation of observational methods assessing biomechanical exposures at work" 17th World Congress on Ergonomics, IEA2009; Aug 9-14, 2009; Beijing, China: International Ergonomics Association.
- [8] Foltran, F. A., Silva, L. C., Sato, T. O., & Coury, H. J. "Wrist electrogoniometry: are current mathematical correction procedures effective in reducing crosstalk in functional assessment?" *Brazilian Journal of Physical Therapy*, 17(1), 2013: 32-40.



# Appendix 10

## Appendix 10: The published version for Article 5 A comparison of neck bending and flexion measurement methods for assessment of awkward neck posture

Zare M, Biau S, Gourlay A, Brunet R, Roquelaure Y. A comparison of neck bending and flexion measurement methods for assessment of ergonomic risk. *International Journal of Occupational Safety and Ergonomics (JOSE)* 2015a; Vol. 21, No. 3, 330–335. <http://dx.doi.org/10.1080/10803548.2015.1081772>.

## A comparison of neck bending and flexion measurement methods for assessment of ergonomic risk

Mohsen Zare<sup>a\*</sup>, Sophie Biau<sup>b</sup>, Rene Brunet<sup>a</sup>, Antoine Gourlay<sup>a</sup> and Yves Roquelaure<sup>a,c</sup>

<sup>a</sup>University of Angers, France; <sup>b</sup>National School of Equitation, France; <sup>c</sup>Centre Hospital Université (CHU) Angers, France

Head movements of workers were measured in the sagittal plane in order to establish a precise and accurate assessment method to be used in real work situations. Measurements were performed using two inclinometers connected to an embedded recording system. Two quantitative analysis methods were tested, i.e., measurement of bending with an inclinometer attached to the head, and measurement of flexion/extension by using an additional inclinometer located at C7/T1. The results were also compared with a video observation method (qualitative). The results showed that bending measurements were significantly different from those of flexion/extension for angles between 0° and 20°, and angles >45°. There were also significant differences between workers for flexion >45°, reflecting individual variability. Additionally, several limitations of observational methods were revealed by this study.

**Keywords:** ergonomic; flexion; bending; head; cervical spine

### 1. Introduction

Both the duration and frequency of postural constraints can be risk factors for musculoskeletal disorders. It is, therefore, important to detect these risk factors in real work situations, and then evaluate them in order to reduce and balance workstation loads. Many studies have examined direct measurement methods for posture assessment, but most have been undertaken in the laboratory and cannot easily be adapted to actual work situations. Measuring head flexion is an important part of gesture evaluation.

Authors have studied head movements using different methods such as video observation, motion analysis and direct measurement. Non-invasive, direct measurement devices such as electrogoniometers,[1] Polhemus fastrack 3D,[2] ultrasound using the Zebris system [3] and potentiometers with the CA6000 system [4] can be used to measure head movements precisely. Forward head posture can be measured by the craniovertebral (CV) angle. This angle is defined as a horizontal line drawn through the seventh cervical (C7) vertebra and a line joining the C7 vertebra with the tragus of the ear. It can be quantified by a head posture spinal curvature instrument (HPSCI) or electronic head posture instrument (EHPI).[5] However, the CV angle is highly variable and thus a static posture that qualifies head flexion and extension is preferred.[6] Many studies have used direct measurement methods for clinical purposes and to measure the maximum magnitude of the cervical rachis in standing and seated positions.

However, few studies have applied direct measurement methods in the work situation because of size and long setup times. Results can be widely different because of inter-individual variability, variability between methods and context differences (laboratory vs. field situation).

#### 1.1. Reference position

The reference position is an important factor for direct measurement of head movements. The French organization for standardization (AFNOR) advises using the  $\pm 10^\circ$  forward-facing horizontal field of view. Anatomically, the reference position describes the human body in a standing position, feet together, arms beside the body and palms facing inwards. Some authors have allowed each measured individual to choose their own reference position, which has to be reproducible without age-related changes.[7] Some authors have even considered that the variability in reproducing the neutral position is an indicator of the proprioceptive state of the cervical rachis.[8] This approach is advantageous in that it takes into account morphological and functional differences between individuals. We believe that this is an essential requirement for a study that evaluates work activities during different cycle times and task distributions. Other authors have chosen to physically set the reference position at the zero position of inclinometers and goniometers.[9] Taking into account the reference position for each recording makes it possible to correct

\*Corresponding author. Email: [zare@hlth.mui.ac.ir](mailto:zare@hlth.mui.ac.ir)

positioning errors, especially for the head inclinometer which is placed in a position that is much harder to locate reproducibly than the C7/T1 inclinometer.

Using this reference position, flexion indicates a forward movement in the sagittal plane, and extension indicates a backward movement in the sagittal plane. In this study, head movements were exclusively evaluated in the sagittal plane.

The purpose of this study was, first, to compare two qualitative methods for evaluating head movements in real work situations, i.e., evaluation of flexion/extension of the head in the sagittal plane and evaluation of forward and backward bending of the head relative to the vertical line. Second, we compared these two quantitative methods with a qualitative video observation method.

## 2. Material and methods

### 2.1. Recording process (Table 1)

This is a case study in which four workers on a truck assembly line were recorded. They worked at four workstations where their main tasks were preparing and installing bumpers on chassis. Rotation was applied through all stations and the workers changed workstations every 2 h. The operators, therefore, worked in all stations that were recorded except for one operator who did not work at station four. Sixteen data recordings were performed. Each station has 20–30 elementary tasks (such as tightening, wiring, headlight installation, pushing/pulling carts and fitting the bumper on the chassis). Each worker spent 11 min at each station, except for station four which required 33 min. Only actual work time was taken into account in the measurements. All workers were filmed with a digital camcorder.

### 2.2. Inclinometers

Head movements were evaluated using an inclinometer kept in place by a strap at the back of the head that measured the bending of the head in the sagittal plane compared to the vertical axis (Figure 1). Another inclinometer was taped to the skin at C7/T1 to measure bending of the upper back in relation to the vertical axis. The inclinometer's margin of error was 1° for angles <15°, and 2° for

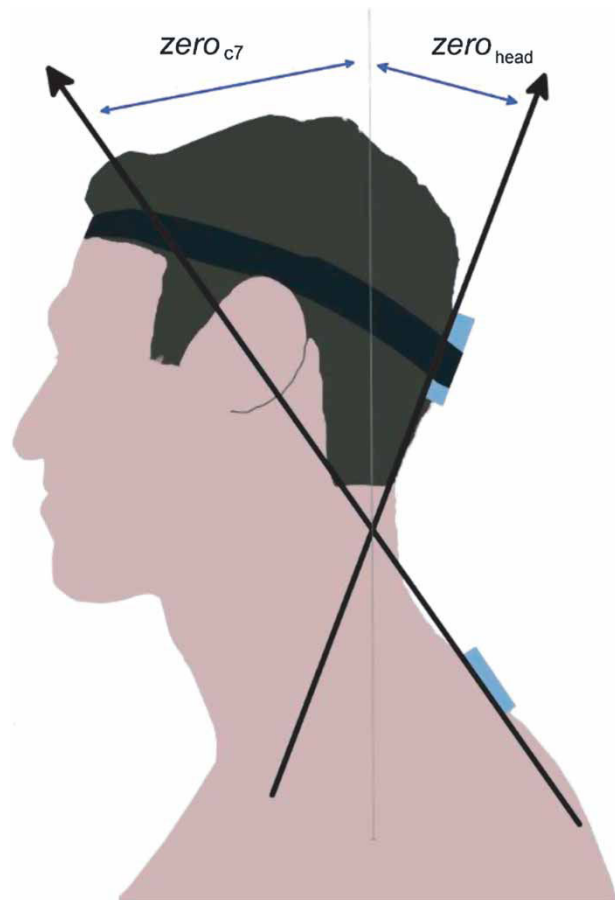

Figure 1. Reference position for each individual 'standing, right up, arms beside of body, looking at forward'. For this person,  $zero_{C7} = 38^\circ$  and  $zero_{head} = 9^\circ$ .

Note:  $zero_{head}$  = value of the inclinometer placed in the behind of the head in neutral position;  $zero_{C7}$  = value of the inclinometer placed in C7/T1 in neutral position.

angles >15°. The signal was sampled at 16 Hz. Angles measured by the two inclinometers could be used together to evaluate flexion/extension relative to C7/T1. Positive values represented flexion, and negative values extension.

The reference position was defined as 'standing up straight, arms beside the body, eyes looking straight ahead'. This position was recorded before and after videoing each station for each operator. If the two reference positions before and after finishing the station were different, the recording was excluded from the study.

### 2.3. Three methods for evaluating head movements in the sagittal plane

- Two biomechanical methods:

M1: flexion/extension of the head compared to C7/T1 angle from the reference position (°)  $flexion_{head} = angle_{head} - reference_{head} - (angle_{C7} + reference_{C7})$

Table 1. Arrangement of recording for four operators (age =  $44.5 \pm 11$ ; size =  $178 \pm 8$ ; weight =  $70 \pm 14$ ; length of work =  $15 \pm 6$ ) for four stations, the exception is operator AB who did three stations.

ST1	ST2	ST3	ST4	Operator
X	x	X	x	DA
X	x	X	x	CH
X	x	X	x	LA
X	x	X		AB

M2: head bending compared to the vertical axis from the reference position ( $^{\circ}$ )  $\text{bending}_{\text{head}} = \text{angle}_{\text{head}} - \text{reference}_{\text{head}}$

The results of both methods were classified into five categories. The thresholds were extracted from the observation method:

- extension  $>30^{\circ}$
- extension  $0^{\circ}$ – $30^{\circ}$
- flexion  $0^{\circ}$ – $20^{\circ}$
- flexion  $20^{\circ}$ – $45^{\circ}$
- flexion  $>45^{\circ}$

The results are presented as percentages of the whole work duration. To compare the differences between two quantified methods, we used analysis of variance (ANOVA) statistical test.

- Video observation method:

Workers were filmed while performing their work using a digital camcorder. An ergonomist then analyzed the tasks at each station and determined the neck posture. The neck postures of each subject at different stations were graded according the following criteria. These criteria were derived from an in-house observational method in a truck assembly plant:[10]

- red if the worker spent more than 5 s in flexion  $>45^{\circ}$  or extension  $>30^{\circ}$ .
- yellow if the worker spent more than 5 s in flexion between  $20^{\circ}$  and  $45^{\circ}$ .
- green for flexion  $<20^{\circ}$  and extension  $<30^{\circ}$ .

### 3. Results

The results from the three methods for all four stations and four operators are shown in Table 2. To compare M1 and M2 results with the observation method, a color was attributed to them using the same criteria. Thirty-three percent of the results from the observation method differed from the biomechanical measurements (yellow for the observation method vs. red for biomechanical evaluation).

The results of M1 and M2 were statistically different for two categories:

- flexion between  $0^{\circ}$  and  $20^{\circ}$  ( $p = 0.043$ )
- flexion  $>45^{\circ}$  ( $p = 0.001$ )

Moreover, workers were significantly different ( $p = 0.01$ ) for flexion  $>45^{\circ}$  with the M1 method.

### 4. Discussion

The aim of this study was to evaluate head movements in the sagittal plane by various methods and compare the results. Head movements cause movement of the cervical and superior-dorsal rachis, and sometimes the lumbar rachis. It is thus difficult to evaluate the exact mobility of the head, particularly by eye. Observers usually evaluate head movements compared to the vertical axis,[11] without taking into account the workers' characteristics (particularly their reference position). A high value for the reference position of C7/T1 can significantly affect and decrease the flexion percentage or increase the extension percentage. For the same tasks, M2 led to a high percentage of flexion  $>45^{\circ}$  whereas M1 classified them in the  $0^{\circ}$  to  $20^{\circ}$  flexion category. Hence, M2 was stricter than M1: head bending in the sagittal plane was higher than flexion. High bending values (M2) are caused by trunk bending and head inclination not being separated. Workers had two options when looking toward their work: bending the neck or bending the back. The C7/T1 inclinometer measures the back's contribution. It, therefore, takes into account inter-individual variability, which explains the statistically significant difference between M1 and M2 for flexion  $>45^{\circ}$ . Some tasks displace the back to a greater or lesser extent depending on the worker. For example, posture measurement of dentists has indicated high levels of inclination of the head due to bending of the back ( $15^{\circ}$ ) and head flexion ( $39^{\circ}$ ).[12] For the same task, workers select a preferred motor control strategy that can depend on age, gender and morphological parameters such as weight [13] and physical fitness.[14] This variability can be exhibited for similar activities.[7, 15, 16] Although the four workers recorded in this study made an homogeneous group, they still displayed different strategies for the same tasks. This inter-individual variability suggests that different workers are exposed to different levels of risk, and this has to be taken into account to improve risk evaluation. The M1 method specifically evaluates risk factors of the cervical rachis, whereas M2 evaluates risk factors of the rachis overall.

In the video observation method (method most commonly used by ergonomists and practitioners in industries), the observer has to evaluate head movements by eye according to very precise values indicated in the method. Indeed, most observational methods specify both durations and thresholds for flexion/extension of the neck, e.g., the worker should not spend more than 5 s within a cycle time in flexion  $>45^{\circ}$  or extension  $>30^{\circ}$ . However, results obtained by direct measurement method (inclinometer) showed that the 5 s threshold was sometime exceeded regardless of the method used (M1 or M2). This explains the red ratings for M1/M2 whereas the observation method rated the station yellow. The observer underestimates the time spent in the awkward postures. Despite the instructions for the observation method, the observer does not

Table 2. Percentage of time exposed to risk for methods M1 and M2. Four stations were performed by each operator (15 data recording). The colors show risk zone classification by each method.

Operator	Station	Method	extension >30° (%)	0° < extension < 30° (%)	0° < flexion < 20° (%)	20° < flexion < 45° (%)	flexion < 45° (%)
OP1	ST1 (12:11 min)	M1	0	7	49	43	0
		M2	0	2	23	62	14
		Observation	yellow (20–45) >5 s				
	ST2 (10:09 min)	M1	0	7	75	18	0
		M2	0	6	55	37	2
		Observation	yellow (20–45) >5 s				
	ST3 (15:03 min)	M1	0	29	48	23	0
		M2	0	14	42	39	6
		Observation	red (>45) >5 s				
	ST4 (25 min)	M1	8	44	39	11	1
		M2	0	41	38	18	3
		Observation	red (>45) >5 s				
OP2	ST1 (9:07 min)	M1	6	62	33	0	0
		M2	1	22	36	42	0
		Observation	red (>45) >5 s				
	ST2 (9:28 min)	M1	0	9	44	47	1
		M2	0	2	23	59	17
		Observation	red (>45) >5 s				
	ST3 (17:15 min)	M1	0	13	43	42	2
		M2	0	9	38	36	18
		Observation	red (>45) >5 s				
	ST4 (33 min)	M1	6	29	29	34	3
		M2	7	27	26	28	14
		Observation	red (>45) >5 s				
OP3	ST1 (10 min)	M1	0	0	22	72	5
		M2	0	0	8	54	38
		Observation	yellow (20–45) >5 s				
	ST2 (12:18 min)	M1	0	0	38	47	8
		M2	0	2	20	60	18
		Observation	yellow (20–45) >5 s				
	ST3 (11 min)	M1	0	0	35	49	4
		M2	0	1	24	54	21
		Observation	red (>45) >5 s				
	ST4 (23:18 min)	M1	0	26	40	29	4
		M2	2	16	36	40	9
		Observation	yellow (20–45) >5 s				
OP4*	ST1 (10:00 min)	M1	0	3	18	72	7
		M2	0	1	14	39	47
		Observation	yellow (20–45) >5 s				
	ST2 (8:52 min)	M1	0	4	21	67	9
		M2	0	1	18	54	26
		Observation	yellow (20–45) >5 s				
	ST3 (7:17 min)	M1	3	24	43	31	0
		M2	0	12	23	50	15
		Observation	red (>45) >5 s				

Note: \* = Data recording was performed for operator 4 over three stations.

have the visual capacity to evaluate a worker's movements precisely and compare them to the limits. Indeed, head movements are complex because they are three-dimensional. Human eyes cannot extract movement in a plane from a single point of view. Furthermore, the observer's mobility is constrained by work situation limitations. The observer is not always in a favorable position to evaluate movement in the required plane, especially since they have to evaluate magnitude, frequency and duration at the same time (Figure 2). As a result, this study indicates

that the observation method under-evaluates movements, which is in accordance with the literature.[17] However, Juul-Kristensen [18] compared head bending evaluated by both observation method and inclinometer. Their results showed that the observation method reported longer durations of flexion >20° than the direct method.

This study was performed in the real field in which the lack of participants was the main limitation. Furthermore, time and technical constraint relating to the assembly line caused difficulties over the measurement. The Hawthorn

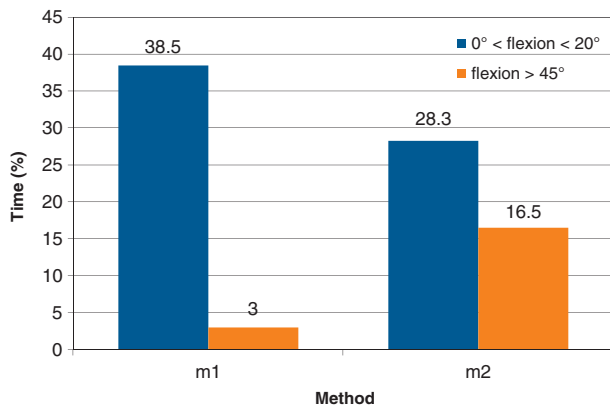

Figure 2. The mean duration (percentage of total time of station) in flexions  $<20^\circ$  and  $>45^\circ$  for methods M1 and M2.

effect might be the confounding factor in our study as operators may change their behavior when they are recorded or observed. However, we asked them to perform their tasks in their usual way as much as possible. Several data recordings for one operator can also reduce this effect.

We recommend evaluating head movements in the sagittal plane using the M1 method. This method measures head inclination in relation to C7/T1, i.e., the flexion/extension of the head. For risk factor analysis, the M2 method should be avoided when evaluating head bending since it does not take into account inter-individual differences, leading to an over-estimation of the risks. As for the observation method, it does not take into account the reference position, and there is a discrepancy between the very precise angles and the inherent limitations of the human eye, along with the practical limitations of observing workers in real work situations. Therefore, using



Figure 3. Operator in the working position with two inclinometers placed behind the head and adhered to C7/T1. This figure shows the difficulty of the observer in assessing movement of the head.

an observation method to evaluate neck risk factors is questionable (Figure 3).

### Disclosure statement

No potential conflict of interest was reported by the authors.

### References

- [1] Law EYH, Chiu TTW. Measurement of Cervical Range of Motion (CROM) by electronic CROM goniometer: a test of reliability and validity. *J Back Musculoskeletal Rehabil.* 2013;26(2):141–148.
- [2] Jordan K, Dzedzic K, Jones P, et al. The reliability of the three-dimensional FASTRAK measurement system in measuring cervical spine and shoulder range of motion in healthy subjects. *Rheumatology.* 2000;39(4):382–388.
- [3] Dvir Z, Prushansky T. Reproducibility and instrument validity of a new ultrasonography-based system for measuring cervical spine kinematics. *Clin Biomech.* 2000;15(9):658–664.
- [4] Mannion A, Klein G, Dvorak J, et al. Range of global motion of the cervical spine: intraindividual reliability and the influence of measurement device. *Eur Spine J.* 2000;9(5):379–385.
- [5] Lau HMC, Chiu TTW, Lam TH. Measurement of craniovertebral angle with electronic head posture instrument: criterion validity. *J Rehabil Res Dev.* 2010;47(9):911–918.
- [6] Edmondston SJ, Henne SE, Loh W, et al. Influence of cranio-cervical posture on three-dimensional motion of the cervical spine. *Manual Ther.* 2005;10(1):44–51.
- [7] Demaille-Wlodyka S, Chiquet C, Lavaste JF, et al. Cervical range of motion and cephalic kinesthesia: ultrasonographic analysis by age and sex. *Spine.* 2007;32(8):E254–E61.
- [8] Loudon JK, Ruhl M, Field E. Ability to reproduce head position after whiplash injury. *Spine.* 1997;22(8):865–868.
- [9] Youdas JW, Garrett TR, Suman VJ, et al. Normal range of motion of the cervical spine: an initial goniometric study. *Phys Ther.* 1992;72(11):770–780.
- [10] Bjurvald M. Ergonomic Strain Unit, Swedish Work Environment Authority, Guide values for loads, Technical Occupational Health Care Association, 1991/2, 13–18.
- [11] Zare M, Biau S, Croq M, et al. Development of a biomechanical method for ergonomic evaluation: comparison with observational methods. *Int J Soc Manag Econ Bus Eng.* 2014;8(1):223–227.
- [12] Åkesson I, Hansson GÅ, Balogh I, et al. Quantifying work load in neck, shoulders and wrists in female dentists. *Int Arch Occ Env Hea.* 1997;69(6):461–474.
- [13] Malmström E-M, Karlberg M, Fransson PA, et al. Primary and coupled cervical movements: the effect of age, gender, and body mass index. A 3-dimensional movement analysis of a population without symptoms of neck disorders. *Spine.* 2006;31(2):E44–E50.
- [14] Castro WH, Sautmann A, Schilgen M, et al. Noninvasive three-dimensional analysis of cervical spine motion in normal subjects in relation to age and sex: an experimental examination. *Spine.* 2000;25(4):443–449.
- [15] Hansson GÅ, Balogh I, Ohlsson K, et al. Physical workload in various types of work: Part II. Neck, shoulder and upper arm. *Int J Ind Ergonom.* 2010;40(3):267–281.
- [16] Möller T, Mathiassen SE, Franzon H, et al. Job enlargement and mechanical exposure variability in cyclic assembly work. *Ergonomics.* 2004;47(1):19–40.

- [17] Leskinen T, Hall C, Rauas S, et al. Validation of Portable Ergonomic Observation (PEO) method using optoelectronic and video recordings. *Appl Ergon.* 1997;28(2):75–83.
- [18] Juul-Kristensen B, Hansson GÅ, Fallentin N, et al. Assessment of work postures and movements using a video-based observation method and direct technical measurements. *Appl Ergon.* 2001;32(5):517–524.

# Appendix 11

## Appendix 11: Data processing of the direct measurement

*This report has been produced by Antoine GOURLAY – specialist of data processing*



# RAPPORT DE TRAVAIL DE FIN D'ÉTUDES

ANTOINE GOURLAY

Traitement de signaux bio-mécaniques pour la comparaison de méthodes  
d'évaluation de risques ergonomiques

11 décembre 2014 –

Antoine Gourlay : *Rapport de Travail de Fin d'Études*, Traitement de signaux bio-mécaniques pour la comparaison de méthodes d'évaluation de risques ergonomiques, © 11 décembre 2014

## TABLE DES MATIÈRES

---

1	CONTEXTE DU STAGE	1
1.1	LEEST . . . . .	1
1.2	Scania Production Angers . . . . .	1
1.3	Projet commun . . . . .	1
2	TRAITEMENT ET ANALYSE DE MESURES BIOMÉCANIQUES	3
2.1	Contexte du projet . . . . .	3
2.1.1	Environnement étudié . . . . .	3
2.1.2	Mesures . . . . .	4
2.2	Traitement du signal . . . . .	5
2.2.1	Calculs d'accélérométrie tri-axiale . . . . .	5
2.2.2	Filtrage . . . . .	7
2.2.3	Position de référence . . . . .	8
2.2.4	Classification . . . . .	9
2.3	Représentation des données . . . . .	9
2.3.1	Affichage d'une mesure . . . . .	9
2.3.2	Comparaison entre opérateurs . . . . .	11
2.3.3	Comparaison entre stations . . . . .	12
2.3.4	Comparaison latérale . . . . .	12
2.3.5	Comparaison des cadences . . . . .	13
2.4	Comparaison des méthodes . . . . .	17
2.4.1	Méthode observationnelle existante (SES) . . . . .	17
2.4.2	Méthode par questionnaires . . . . .	17
2.4.3	Comparaison . . . . .	17
3	CONCLUSION	19
3.1	Réalisation du projet . . . . .	19
3.2	Publications et suites . . . . .	19
A	APPENDICE : QUELQUES FONCTIONS RÉALISÉES	21
	BIBLIOGRAPHIE	25



## CONTEXTE DU STAGE

---

Le stage s'est effectué dans le cadre d'une collaboration entre Scania Production Angers et le LEEST (Laboratoire d'Ergonomie et d'Epidémiologie en Santé au Travail)<sup>1</sup>.

### 1.1 LEEST

Le LEEST est un laboratoire qui fédère les équipes hospitalo-universitaires angevines en santé au travail, médecine physique et de réadaptation. Son objectif est l'étude interdisciplinaire des troubles musculo-squelettiques (TMS), qui posent des problèmes importants pour le maintien dans l'emploi des travailleurs.

### 1.2 SCANIA PRODUCTION ANGERS

Scania Production Angers est l'usine de production française de Scania, le constructeur suédois de poids lourds, autocars et moteurs industriels. L'usine assemble tous les types de camions produits par Scania, principalement pour le marché de l'Europe, avec des méthodes de types *Lean Manufacturing* : 530 salariés assemblent ~60 camions par jour, avec plus de 180 000 camions produits depuis 1991.

### 1.3 PROJET COMMUN

Le stage s'inscrit dans le cadre d'une collaboration existante entre Scania et le LEEST qui a démarrée par une thèse en ergonomie industrielle réalisée par Mohsen Zare, étudiant du LEEST, au sein de l'usine Scania d'Angers.

Dans le cadre de sa thèse il a été appelé à utiliser et comparer différentes méthodes d'évaluation ergonomiques : observationnelles, par auto-questionnaires et biomécanique. Ces méthodes permettent d'évaluer l'exposition aux risques (de TMS, entre autres) qu'un opérateur subit à un poste de travail donné.

Scania a déjà en place une méthode observationnelle d'évaluation des risques des postes de travail (méthode SES, interne à Scania), et M. Zare a par la suite réalisé une étude d'évaluation des risques via un questionnaire rempli par les opérateurs.

Il a ensuite réalisé des mesures biomécaniques en utilisant plusieurs capteurs pour enregistrer les mouvements des opérateurs pen-

---

1. <http://leest.univ-angers.fr>

dant leur travail. L'objectif était multiple : pouvoir quantifier le travail réalisé, estimer les risques de TMS à partir de ces mesures, et finalement comparer ces résultats avec les deux autres méthodes.

Cette méthode nécessite de traiter et analyser des signaux provenant de capteurs, et c'est donc dans le cadre de la réalisation de cette 3<sup>e</sup> méthode que mon stage se déroule.

## TRAITEMENT ET ANALYSE DE MESURES BIOMÉCANIQUES

---

### 2.1 CONTEXTE DU PROJET

Le projet du stage se décompose en trois parties :

1. Le traitement des signaux biomécaniques : automatiser le traitement des signaux de plusieurs capteurs biomécaniques ainsi que l'extraction d'indicateurs utiles pour la comparaison avec les autres méthodes.
2. La représentation des informations ergonomiques obtenues : proposer des statistiques descriptives et des visualisations graphiques utiles afin de représenter les résultats obtenus.
3. La comparaison avec les autres méthodes : proposer à la fois des comparaisons visuelles simples et des tests statistiques pertinents pour comparer les résultats biomécaniques aux résultats des autres méthodes.

Il est d'abord nécessaire d'aborder plus en détail l'environnement industriel étudié, ainsi que la façon dont les mesures ont été précédemment réalisées, pour pouvoir détailler les traitements réalisés par la suite.

#### 2.1.1 *Environnement étudié*

L'étude s'intéresse aux mouvements des bras, des poignets, du dos et de la tête réalisés par l'ensemble des opérateurs d'un cluster de la ligne principale d'assemblage de camions de l'usine. Un cluster est composé d'environ 15 à 20 personnes travaillant collectivement sur une section de la ligne d'assemblage. L'activité des opérateurs de ce cluster est sous-découpée en 3 GACs (Groupe d'Amélioration Continue) de 5 personnes environs, chacun ayant un objectif global précis :

- GAC 1 : la pose des marche-pieds et gardes-boue
- GAC 2 : la préparation et pose des pare-chocs
- GAC 3 : la préparation et pose du système SCR (système de réduction des émissions polluantes)

Enfin, chaque GAC est lui-même composé de plusieurs stations de travail fixes (entre 4 et 6). Un unique opérateur travaille sur chaque station de travail à un instant donné. Par exemple, le GAC 1 contient les stations suivantes :

1. Pose marche-pied droit

2. Pose marche-pied gauche
3. Pose garde-boue droit et pare-chaleur
4. Pose garde-boue gauche et préparation cabine

D'un point de vue temporel, le travail est cadencé par un *takt time* : il correspond au temps maximum qu'un camion doit passer à une station pour satisfaire les objectifs de production. Il est fixé de manière globale à l'avance pour une cadence donnée.

*En pratique le takt time est entre 7 min et 11 min, suivant la cadence courante.*

Les opérateurs de chaque GAC travaillent en rotation sur tous les postes de travail d'un GAC, et changent de poste toutes les 2 heures. On peut ainsi mesurer le travail de chaque opérateur sur la durée d'un *takt time*, sur chacune des stations de son GAC.

### 2.1.2 Mesures

Une première campagne de mesure a été réalisée avant le début du stage (en 2013). Celle-ci a été suivie par un changement de cadence, de la cadence 35 vers 48 pour, respectivement, la production de 35 et 48 camions par jour. Le changement de cadence a nécessité le réaménagement des stations de travail, la modification du *takt time* et le changement du nombre d'opérateur sur le cluster. Le travail réalisé à chaque station étant suffisamment différent entre les deux cadences, il a été décidé de mesurer les deux, et une seconde campagne de mesure a été réalisée sur la nouvelle cadence (également en 2013).

Le système de mesure utilisé est CAPTIV<sup>1</sup>, qui fournit un logiciel d'acquisition et des capteurs et boîtiers d'acquisitions (*dataloggers*) adaptés aux mesures biomécaniques.

Chaque opérateur est équipé de 7 capteurs fixés si possible à même la peau : un accéléromètre dans le bas du dos, un accéléromètre sur chaque bras, un goniomètre à chaque poignets, ainsi qu'un inclinomètre sur le haut du dos et un sur l'arrière de la tête. Ces capteurs sont connectés (sans fil) à un *datalogger* accroché à la ceinture de l'opérateur, qui enregistre les signaux bruts pour leur traitement à posteriori. Les trois capteurs fournissent des signaux différents :

- les inclinomètres fournissent chacun deux signaux représentant des angles de rotation (en rad) entre deux axes orthogonaux du capteur et deux axes de référence, échantillonnés à une fréquence de 16 Hz,
- les goniomètres fournissent chacun deux signaux représentant les angles de rotation (en rad) entre deux axes orthogonaux d'un membre (avant-bras) et deux axes orthogonaux d'un autre membre (main) lié via une articulation (poignet), échantillonnés à une fréquence de 64 Hz,
- les accéléromètres fournissent chacun trois signaux représentant l'accélération (en nombre de g, l'accélération de la pesan-

1. TEA, [www.teaergo.com](http://www.teaergo.com)



teur terrestre)) selon 3 axes orthogonaux du capteur, échantillonnés à une fréquence de 128 Hz.

L'enregistrement tourne en continue pendant que les opérateurs effectuent toutes les stations de leur GAC. Ces signaux sont ensuite transférés depuis le *datalogger* vers un ordinateur via le logiciel CAPTIV et exportée en CSV pour traitement.

Les opérateurs sont par ailleurs filmés pendant la totalité de la prise de mesure afin d'avoir une référence visuelle du travail réellement réalisé pendant chaque mesure.

Un total de 126 enregistrements ont ainsi été réalisés (sur 13 opérateurs et 29 stations de travail différentes).

## 2.2 TRAITEMENT DU SIGNAL

Tous les traitements ont été réalisés dans *Scilab*<sup>2</sup>.

Les enregistrements ont tout d'abord été découpé par station de travail (grâce à des marqueurs présents lors de l'enregistrement) et synchronisés avec la vidéo pour permettre de passer simplement du signal à un instant donné à l'image de la tâche élémentaire réellement réalisée à ce moment.

Le but premier du traitement est d'obtenir :

- l'inclinaison du dos et des bras par rapport à la verticale,
- l'inclinaison (flexion/extension) du poignet autour d'une position  $o$ , correspondant au poignet placé dans l'alignement de l'avant-bras,
- et l'inclinaison de la tête par rapport au haut du dos, c'est à dire la flexion/extension du cou.

Tous les capteurs sont calibrés à l'avance (via le *datalogger* CAPTIV) pour s'assurer que l'axe  $z$  des accéléromètres et inclinomètres corresponde bien à la verticale, et que la position  $o$  des goniomètres corresponde bien à la position parfaitement alignée des deux parties du capteur.

Les inclinomètres et goniomètres fournissent nativement des données angulaires qui ne nécessitent aucun pré-traitement particuliers, mais plusieurs traitements sont nécessaires pour les accéléromètres :

- Le calcul d'un angle d'inclinaison à partir des accélérations
- Le filtrage des signaux d'accélérations pour éviter les vibrations et micro-mouvements

### 2.2.1 Calculs d'accélérométrie tri-axiale

Les accéléromètres utilisés sont en réalité des accéléromètres *tri-axiaux* que l'on cherche à utiliser ici à des fins d'inclinométrie. Ainsi l'accéléromètre attaché au bras mesure l'accélération totale ( $\rho$ ) qui agit sur le bras, l'inclinaison ( $\phi$ ) par rapport à la verticale et la direc-

2. Scilab Entreprises, [www.scilab.org](http://www.scilab.org)

*Scilab : équivalent à Matlab, gratuit et open-source, originellement de l'INRIA.*

$\phi$  est donc l'angle finalement recherché ici : l'inclinaison par rapport à la verticale.

tion ( $\theta$ ) de l'inclinaison. La position du capteur est donc décrite par les coordonnées sphériques  $(\rho, \theta, \phi)$ .

Cependant d'un point de vue mécanique, chaque capteur consiste en réalité de 3 accéléromètres uni-axiaux montés orthogonalement selon des axes  $x$ ,  $y$  et  $z$ . Les signaux initiaux doivent donc être convertis du repère orthonormal du capteur vers le repère sphérique ci-dessus, via le changement de repère de la forme :

$$x = \rho \sin(\theta) \cos(\phi), \quad y = \rho \sin(\theta) \sin(\phi), \quad z = \rho \cos(\theta) \quad (1)$$

$$\rho \geq 0, \quad 0^\circ \leq \theta \leq 180^\circ, \quad -180^\circ \leq \phi \leq 180^\circ$$

*En conditions non-statiques, l'accélération dynamique peut être détectée et quantifiée par l'écart entre  $\rho$  et  $1g$ .*

En conditions statiques,  $\rho$  correspond à l'effet de la gravité ( $\rho \approx g \approx 9.81 \text{ m s}^{-2}$ ), et  $\phi$  correspond directement à l'inclinaison par rapport à la verticale. La composante  $\theta$  fournit par ailleurs la direction de l'inclinaison, mais elle n'est pas utilisée ici.

L'hypothèse est faite dans l'étude (et dans la littérature) que les conditions sont quasi-statiques, ou au moins que la composante d'accélération dynamique n'a pas d'influence sur le calcul de la position  $\phi$  (Hansson et al.).

Parmi les diverses rotations possible (qui ne commutent pas !) pour passer des coordonnées cartésiennes en sphériques, la rotation habituelle fournit  $\phi$  via :

$$\phi = \arctan\left(\frac{y}{x}\right) \quad (2)$$

Cependant, ce calcul devient instable lorsque que  $y \approx x \approx 0$ . Cette condition se produit quand le capteur est aligné avec son axe  $z$  selon la vertical, ce qui a pour conséquence de fournir des angles complètement impossible dans certaines situations. La bibliographie en biomécanique est étonnamment silencieuse sur le sujet<sup>3</sup>, le plus souvent parce que ces calculs sont réalisés directement par les logiciels d'acquisitions utilisés (ce qui n'est pas le cas ici). Après diverses tentatives infructueuses de détection de ces situations, une solution alternative a été trouvée dans [4, Freescale Semiconductor], qui utilise une autre rotation et l'hypothèse des conditions statiques pour justifier que la formule suivante est valide :

$$\phi = \arctan\left(\frac{y}{\sqrt{x^2 + z^2}}\right) \quad (3)$$

On obtient ainsi finalement l'inclinaison par rapport à la verticale à partir des signaux d'accélérométrie.

<sup>3</sup>. au delà de l'optimisation évidente d'utiliser la fonction `atan2` pour calculer l'arc-tangente d'un quotient.

### 2.2.2 Filtrage

Afin d'éliminer les pics hautes-fréquences qui ne sont pas utiles pour l'étude des mouvements et qui peuvent causer problème pour le calcul de l'inclinaison, il est nécessaire de filtrer les signaux d'accéléérations initiaux.

Dans la littérature, les études bio-mécaniques qui utilisent l'accélérométrie tri-axiale dans le contexte de l'ergonomie emploie toutes globalement le même type de filtre ([Bernmark and Wiktorin](#), entre autres) : un filtre de Butterworth du 4<sup>e</sup> ordre, passe-bas, avec une fréquence de coupure de 5 Hz ([Figure 1](#)).

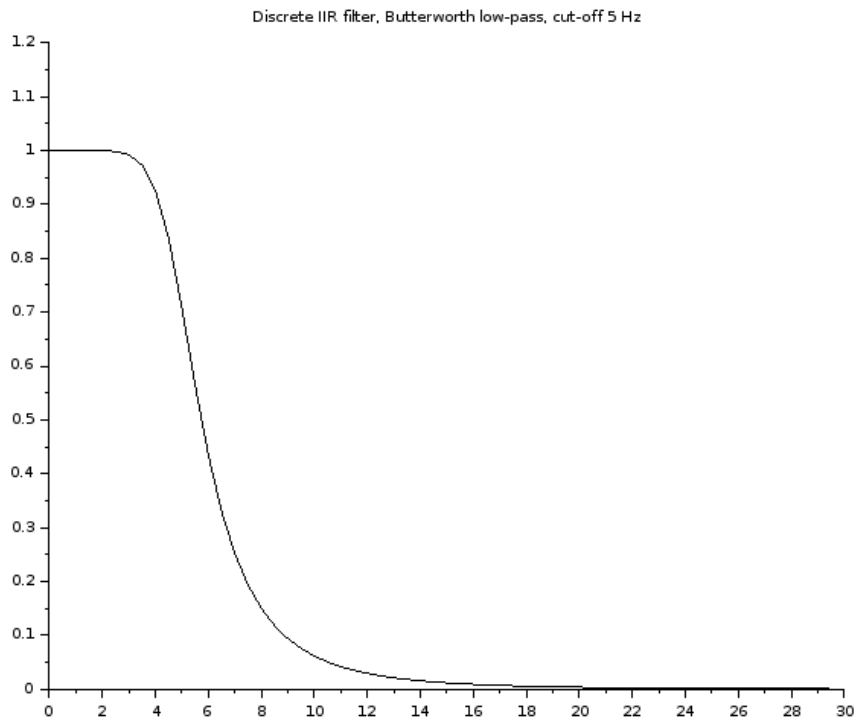

FIGURE 1 – Réponse du filtre de Butterworth utilisé sur les accélérations

Après avoir testé divers filtres similaires et des fréquences de coupure voisines, celui-ci s'est avéré être un choix raisonnable et a été sélectionné.

On obtient alors un signal dans lequel on distingue facilement (même visuellement) les périodes d'activité et de repos du membre. Par exemple, on peut voir sur la [Figure 2](#) l'inclinaison du bras droit (en degrés) en fonction du temps sur une station de travail.

Réaliser un tel filtrage dans *Scilab* est extrêmement simple. Ci-dessous un extrait du code d'import d'un nouvel enregistrement pour la partie de filtrage :

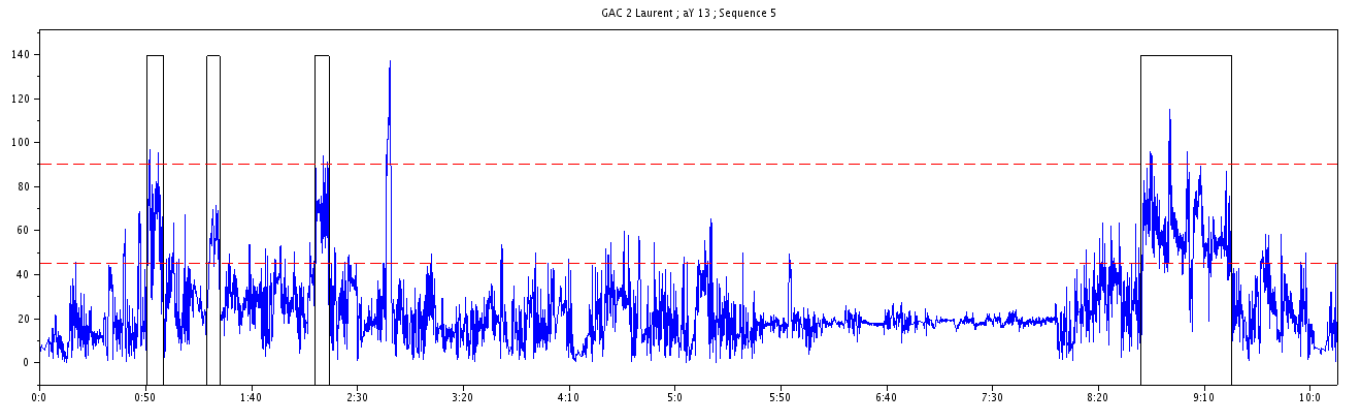

FIGURE 2 – Exemple d'un signal de l'inclinaison du bras droit

```

1  % entree: dX, dY, dZ
   % sortie: yX, yY, yZ

   % cree la fonction de transfer du filtre
   hz = iir(4,'lp','butt',[5/128/2 0],[1]);
6
   % conversion sous forme matricielle
   sl = tf2ss(hz);

   % application du filtre
11 yX = flts(dX, sl);
    yY = flts(dY, sl);
    yZ = flts(dZ, sl);

```

### 2.2.3 Position de référence

La position de référence est un facteur important lors de la mesure directement de mouvements. L'inclinaison absolue (la verticale, le plus souvent) est effectivement une référence en ce qui concerne la calibration des capteurs utilisés pour la mesure, mais cela rarement une référence sémantique : anatomiquement, la position de référence décrit le corps humain debout, les pieds rapprochés, les bras le long du corps et les paumes des mains orientés vers l'intérieur. La plupart des auteurs s'accordent sur l'importance de prendre en compte les différences morphologiques et fonctionnelles entre individus.

La position de référence de chaque opérateur a été enregistré au début et à la fin de chaque enregistrement, où l'opérateur la maintient pour 5 secondes. On se sert de cette information pour re-centrer les signaux angulaires obtenus autour d'une nouvelle référence.

#### 2.2.4 Classification

Pour finir, on classe les points des signaux (angulaires) obtenus précédemment en plusieurs catégories suivant des seuils prédéterminés (les seuils de la méthode observationnelle SES, dérivés de la norme ISO 11226:2000) :

- Pour les bras, les inclinaisons de  $0^\circ$  à  $45^\circ$  sont considérés sans risque,  $45^\circ$  à  $90^\circ$  à risque modéré et  $> 90^\circ$  à risque plus élevé,
- Pour le dos, le seuil entre ces 3 catégories de risques sont  $20^\circ$  et  $45^\circ$ ,
- Pour l'inclinaison du cou, des angles entre  $-30^\circ$  (extension) et  $20^\circ$  (flexion) sont considérés sans risque,  $20^\circ$  à  $45^\circ$  à risque modéré, et les inclinaisons  $> 45^\circ$  ou  $< -30^\circ$  à risque plus élevé,
- Pour les poignets, les angles  $< -30^\circ$  (extension) et  $> 45^\circ$  (flexion) sont considérés à risque élevé, les autres sans risque.

Les deux lignes horizontales rouges représentés sur la [Figure 2](#) correspondent aux deux seuils pour le bras.

Un simple seuillage donne ainsi le nombre de points du signal dans chaque catégorie, c'est à dire le *pourcentage de temps passé en situation à risque de TMS*. C'est cet indicateur que l'on va par la suite comparer aux résultats des méthodes observationnelle et questionnaire.

### 2.3 REPRÉSENTATION DES DONNÉES

J'ai cherché par la suite à décrire et représenter ces résultats (à la fois les signaux eux-mêmes et les indicateurs en pourcentage) de manière parlante, pour pouvoir décrire les données rapidement et permettre d'observer qualitativement des différences simples.

L'objectif était la recherche puis la génération automatique de visualisation pour :

- les résultats d'un seul triplet station/personne/membre
- les différences entre plusieurs opérateurs sur une même station
- la distribution des résultats des opérateurs entre stations
- les différences entre côté gauche / côté droit pour les bras et poignets
- les différences entre les 2 cadences

#### 2.3.1 Affichage d'une mesure

Le but ici était le développement d'une interface permettant à la fois de :

- visualiser le signal (l'affichage de la [Figure 2](#)),
- observer sa distribution (histogramme),
- lister quelques caractéristiques utiles (moyenne, médiane, écart-type, ...),

la SES méthode est décrite plus en détail dans la [Section 2.4.1](#)

- afficher la note qu’aurait eu cette mesure si ces pourcentage de temps avait été obtenus via la méthode observationnelle SES , afin d’avoir une estimation rapide de risque obtenu,
- sauter dans la video à l’instant correspondant à un point donné du signal en cliquant sur le graphe.

L’interface réalisée est illustrée à la [Figure 3](#) dans le cas d’un enregistrement de l’inclinaison du dos. Un histogramme représente sous le signal la distribution des valeurs angulaires. Les lignes verticales rouges y représentent les limites entre les 3 catégories de risque mentionné plus haut (nommée *vert*, *jaune* et *rouge* dans SES). Dans cet exemple, l’enregistrement a assez de valeurs dans la catégorie *rouge* pour obtenir cette note via la méthode SES, avec un total agrégé de plus de 17 s passées en situation à risque le plus fort.

Cliquer sur un point du signal ouvre la vidéo dans le logiciel VLC au *timecode* correspondant.

La fonction implémentant cette interface est listée dans l’[Appendice A](#). Les fonctions implémentant les autres membres sont similaires, avec seulement des différences de seuils et de sélection gauche/droite pour les bras et les poignets.

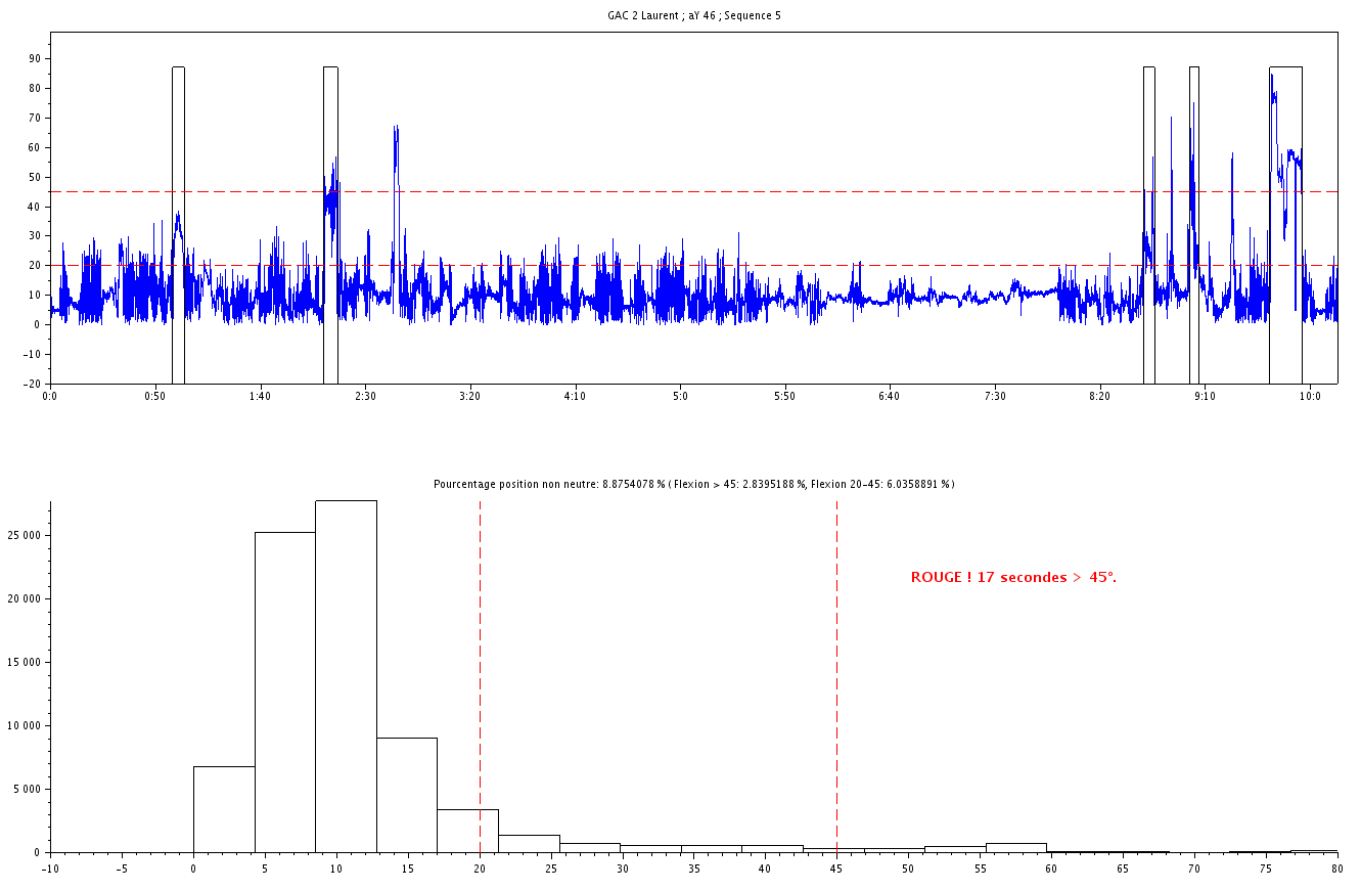

FIGURE 3 – Interface d’un signal d’inclinaison du dos

## 2.3.2 Comparaison entre opérateurs

Il est devenu ensuite nécessaire de pouvoir produire des graphes comparant plusieurs jeux de résultats et de pouvoir les exporter automatiquement en dehors de *Scilab*. Après diverses tentatives au sein de *Scilab*, une solution alternative a été retenue : exporter les données nécessaires en CSV et invoquer la library *PGF*<sup>4</sup> pour créer des graphiques de comparaison, à la demande, à partir d'un *template* préparé à l'avance.

On peut voir sur la [Figure 4](#) un exemple de graphe produit pour la comparaison des pourcentages passés en position à risque entre opérateurs. Chaque section du graphe est dédiée à une partie du corps, avec les pourcentages de temps et la note SES représentée pour chaque opérateur. Ce graphe permet d'observer immédiatement des tendances communes aux opérateurs ainsi que des différences entre opérateurs.

GAC 2 - Séquence 2 - Pourcentage du temps passé en position non neutre

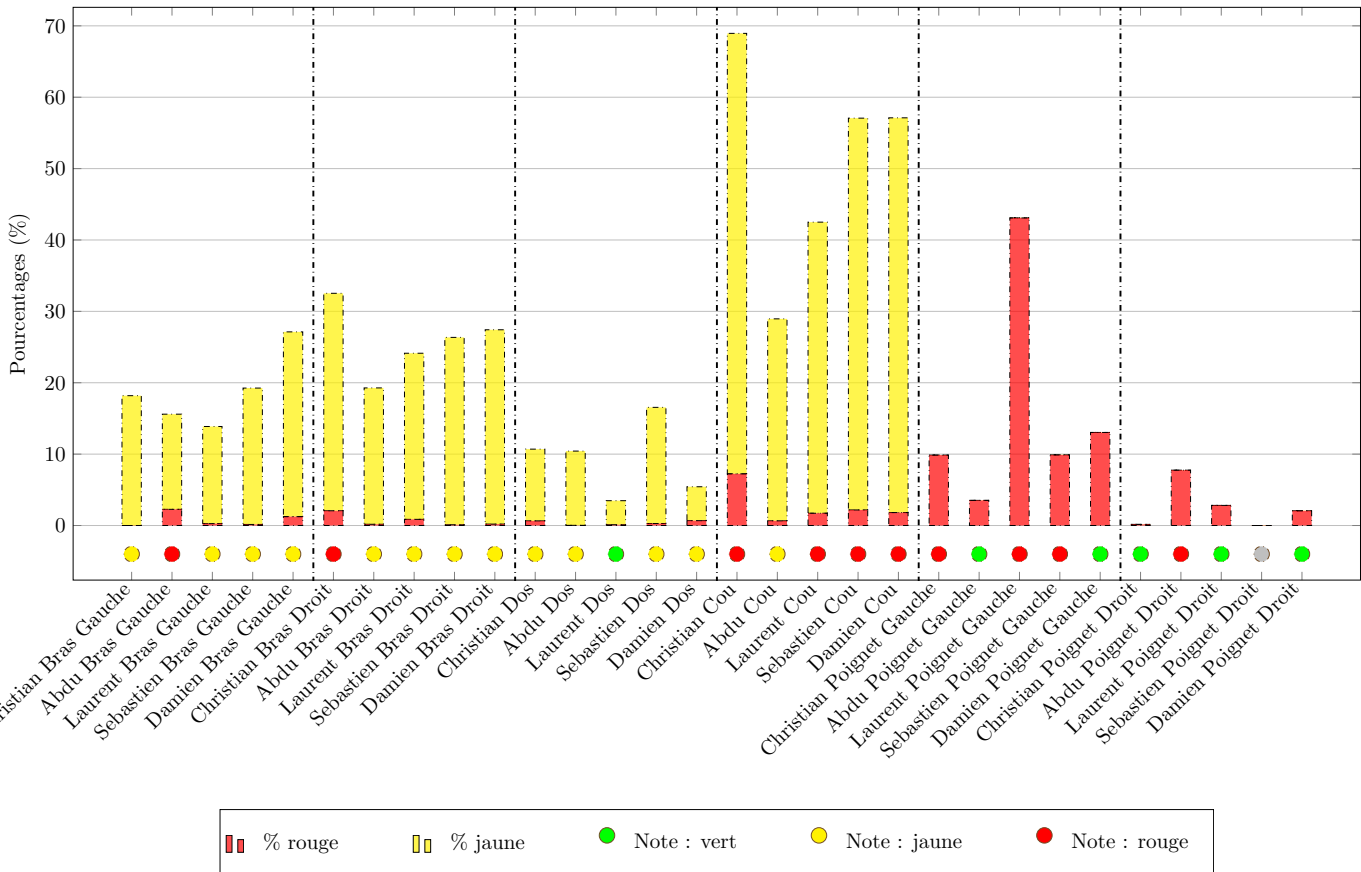

FIGURE 4 – Exemple de comparaison entre opérateurs des pourcentages de temps passés en situation à risque

4. library utilisée souvent en  $\text{L}^{\text{A}}\text{T}_{\text{E}}\text{X}$  pour générer des graphes via *pgfplots*.

Le graphe est généré à la demande et non pas pré-calculé une fois à l'avance, permettant de modifier un paramètre (par exemple un seuil entre deux catégories) et d'observer directement le résultat sur un (nouveau) graph. Le but est ainsi d'avoir un outil interactif permettant d'apprécier les résultats. On pourrait ainsi considérer ces fonctions et interfaces comme une ébauche d'un outil d'analyse de données bio-mécaniques prêt à l'emploi, ce qui était une des idées annexes proposée dans le cadre du stage.

Un second type d'interface représente la distribution des angles par opérateur pour chaque station, illustré à la [Figure 5](#).

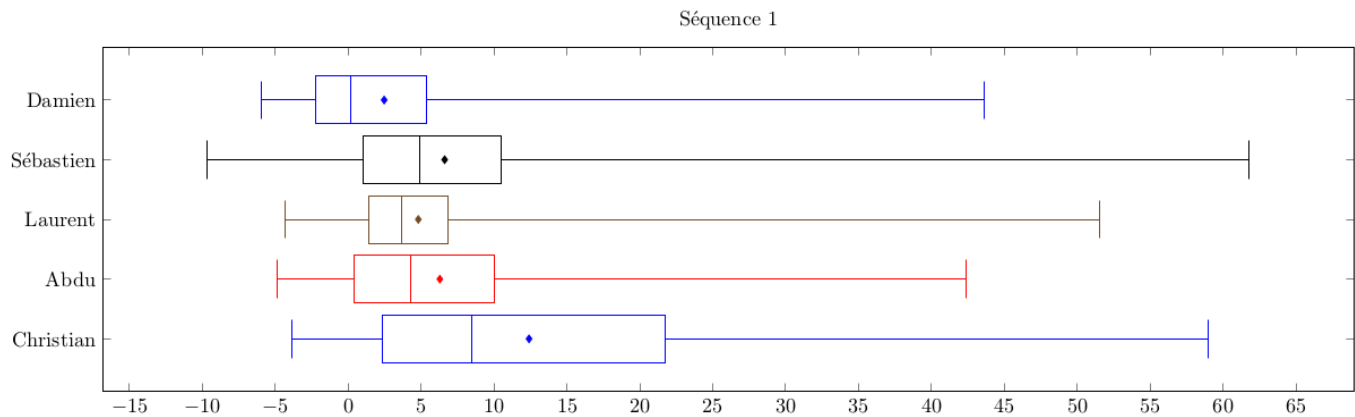

FIGURE 5 – Exemple de comparaison entre opérateurs de la distribution des angles de leur enregistrement pour une station

### 2.3.3 Comparaison entre stations

Par ailleurs, il était intéressant d'étudier quels sont les extrema de flexion/extension des membres mesurées et de les comparer entre stations. La littérature caractérise régulièrement les extrema de flexion/extension d'un membre comme les valeurs d'un centile donné de la distribution du signal (par exemple 10<sup>e</sup> et 90<sup>e</sup> centiles).

Nous comparons donc le 9<sup>e</sup> et 91<sup>e</sup> centile ([Hansson et al.](#)) de chaque opérateur d'une station, entre stations : la [Figure 6](#) et la [Figure 7](#) représentent, respectivement, les extrema d'extension et de flexion entre stations. Au sein d'une seule station sont représenté sur le graphe la moyenne, médiane et la distribution que prennent ces valeurs pour les différents opérateurs de la station.

### 2.3.4 Comparaison latérale

Après divers essais, les deux représentations de la [Figure 8](#) et de la [Figure 9](#) ont été conservés pour présenter la comparaison gauche/droite pour les bras et les poignets.

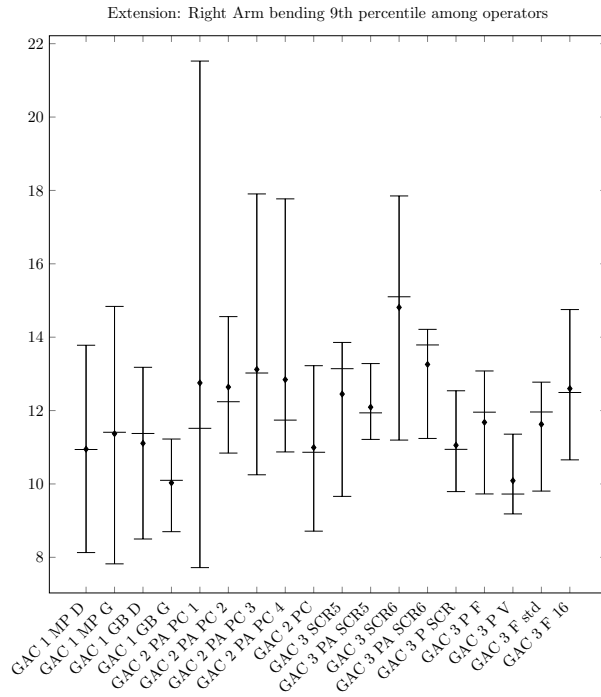

FIGURE 6 – 9<sup>e</sup> centile (extension) entre stations

### 2.3.5 Comparaison des cadences

De même, la méthode de la comparaison latérale a été réutilisée pour la comparaison entre les cadences 35 et 48, voir l'exemple de la [Figure 10](#).

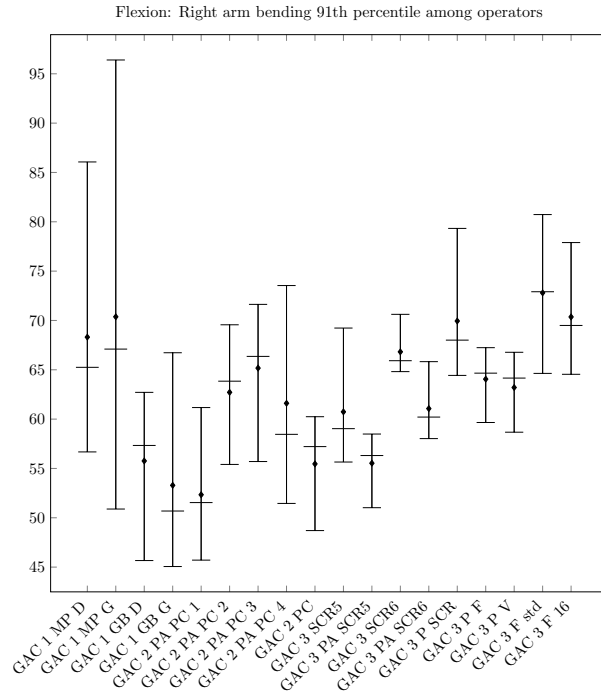

FIGURE 7 – 91<sup>e</sup> centile (flexion) entre stations

9<sup>e</sup> et 91<sup>e</sup> centiles des angles des bras gauche / droit, par station

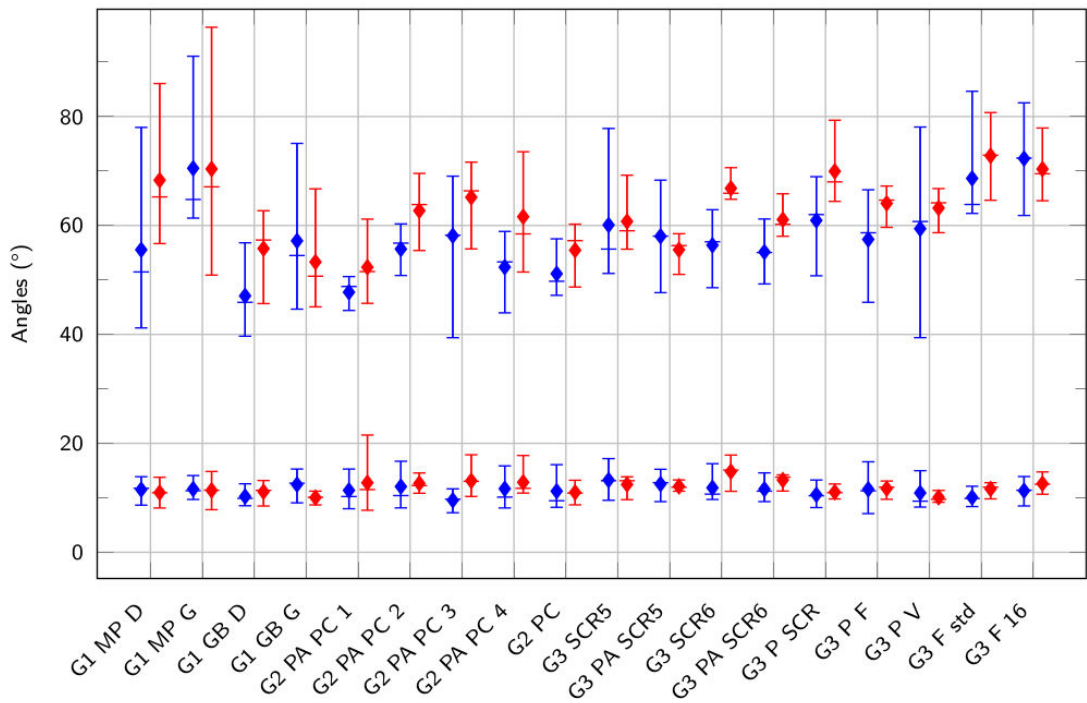

FIGURE 8 – Comparaison gauche/droite

Comparison of the mean 9th and 91th percentile for left/right arm

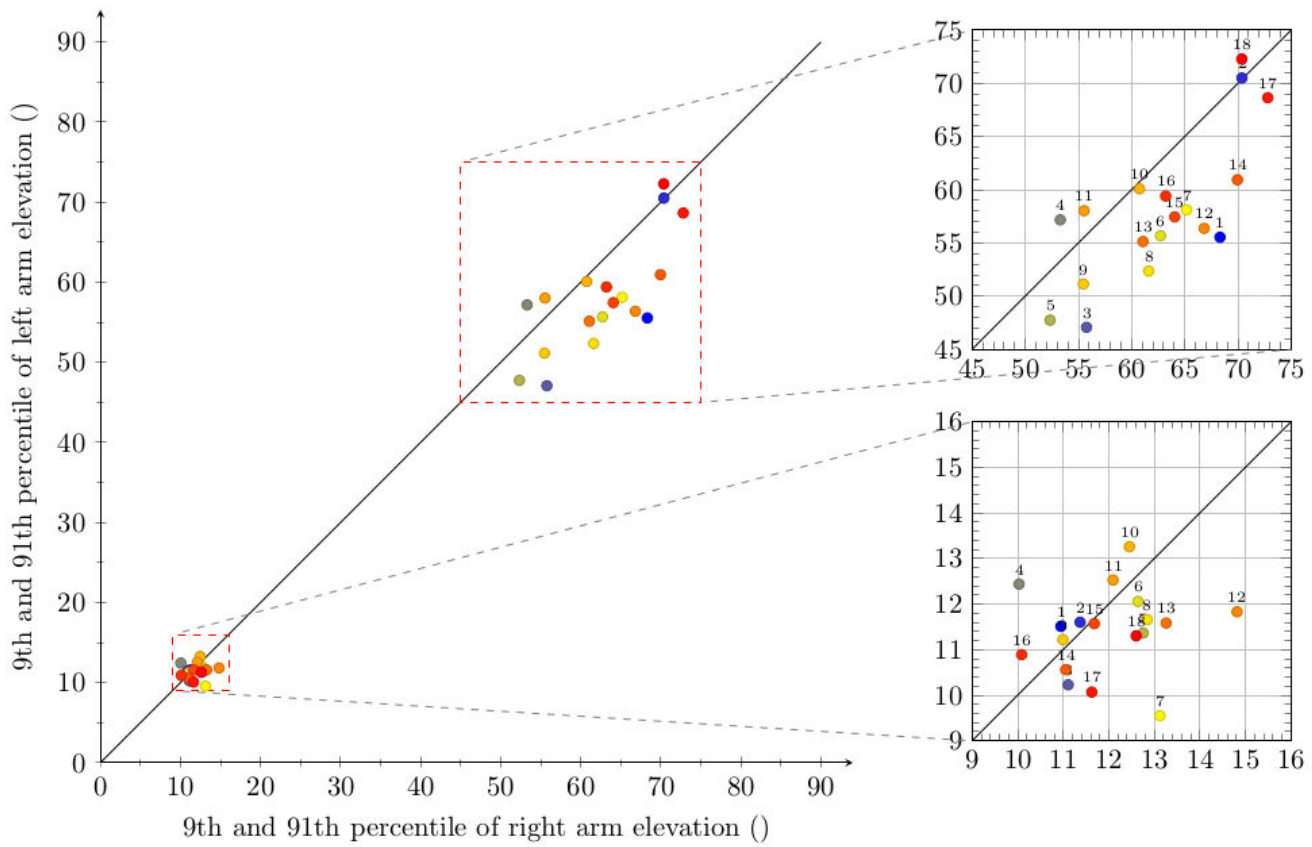

FIGURE 9 – Comparaison gauche/droite alternative

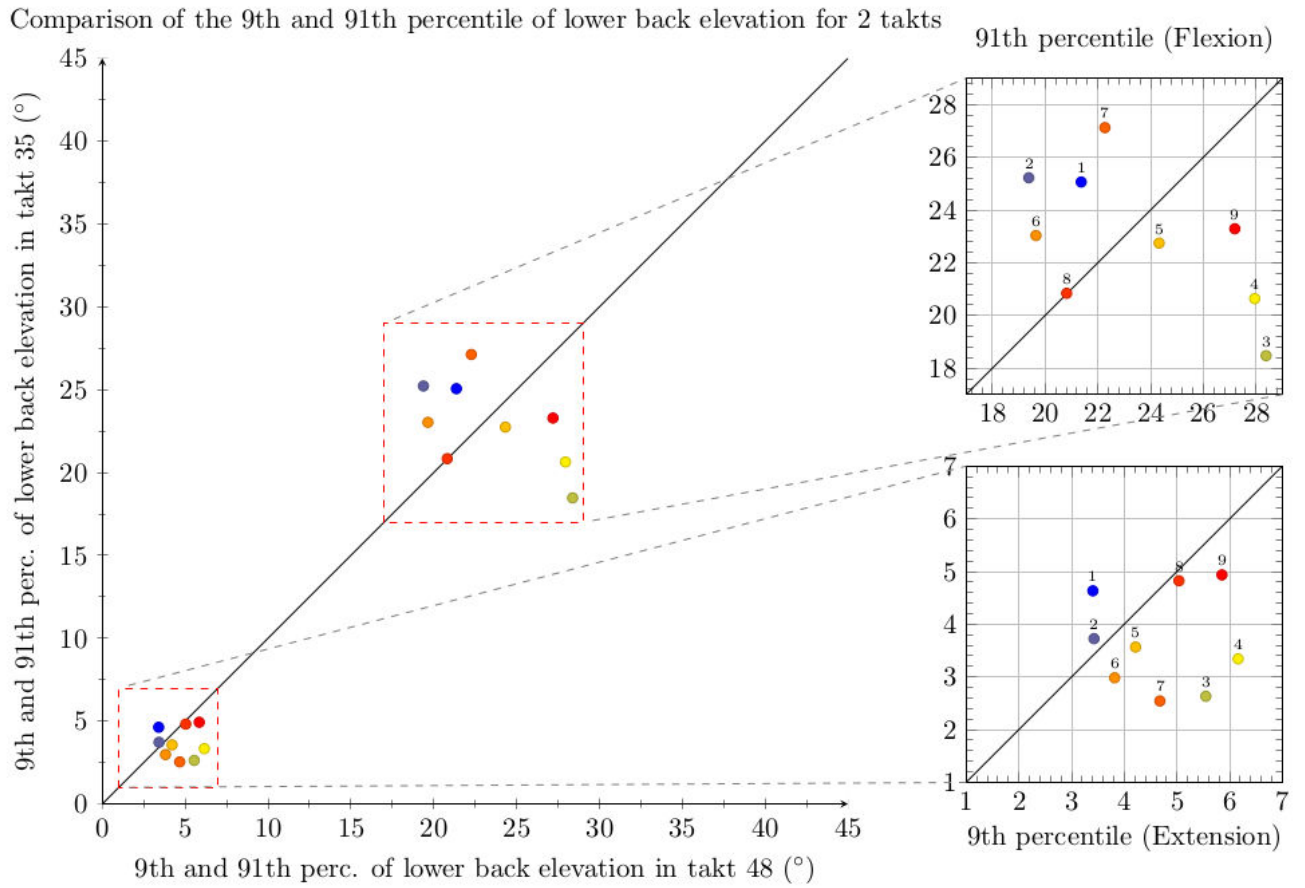

FIGURE 10 – Comparaison gauche/droite alternative

## 2.4 COMPARAISON DES MÉTHODES

Un second objectif partiellement abordé dans le cadre du stage est l'utilisation de ces indicateurs (pourcentage de temps passé par catégorie) comme base de comparaison pour deux autres méthodes d'évaluation des risques ergonomiques.

### 2.4.1 Méthode observationnelle existante (SES)

La première méthode est une méthode observationnelle interne à Scania dénommée SES. Celle-ci consiste à observer et filmer le travail d'un opérateur sur la station de travail (observation faite par un ergonome qualifié) et ensuite d'évaluer (sur place et à posteriori en voyant le film) de nombreux critères portant sur la durée des tâches, les types de mouvements réalisés, la répétition, les charges portées, etc.

Toutes les stations de travail sont évaluées une fois de cette façon, et la station reçoit une note (*vert*, *jaune* ou *rouge*) par critère et une note globale calculée via un barème dédié.

### 2.4.2 Méthode par questionnaires

La seconde méthode a consisté à demander aux opérateurs, via un questionnaire, d'évaluer plusieurs critères comme les douleurs au travail et les postures courantes/rares pour chaque partie du corps, sur une échelle simple (1 à 10 pour les douleurs, jamais/rarement/souvent/toujours pour les postures). Le questionnaire contenait de nombreuses autres questions (épidémiologiques) sur d'autres aspects (psychologique, organisationnels, etc.) qui ne concerne pas directement l'étude réalisée ici.

### 2.4.3 Comparaison

Dans le cadre de la comparaison globale des 3 méthodes, l'objectif premier était de produire un fichier de données commun contenant tous les résultats des trois méthodes en fonction de la cadence, du GAC, de l'opérateur et de la station, qui a pour objectif d'être réutilisable pour des études statistiques futures.

Par manque de temps, l'accent a été mis sur la création de cette base réutilisable plutôt que sur son étude statistique poussée. Quelques tests statistiques ont cependant été réalisés :

- Pour chaque comparaison "biomécanique vs. SES" et pour chaque station, un test d'accord (*kappa*) entre les deux méthodes pour les résultats de chaque opérateur de la station,

- Pour le tableau global "biomécanique vs. SES", un test d'accord global (*kappa*) et un test d'indépendance/corrélation (*Pearson chi squared*),
- Même chose pour la comparaison "biomécanique vs. Questionnaire"

Il en résulte finalement la mise en évidence d'un écart considérable entre les trois méthodes, qui était d'ailleurs déjà très visible visuellement.

## CONCLUSION

---

### 3.1 RÉALISATION DU PROJET

Le stage a abouti à plusieurs livrables :

- le traitement de toutes les données déjà collectées,
- l'automatisation de ce traitement via un ensemble de fonctions *Scilab*
- la génération de tableaux de résultats ainsi que de graphiques de présentation et de comparaison
- la production d'un jeu de données global pour la suite du projet

Les objectifs supplémentaires de traitements statistiques sur les résultats de la comparaison des méthodes se sont révélés cependant trop ambitieux d'un point de vue temps. Tout à cependant été préparé pour être utilisable par la suite, entre autre au sein de la thèse de M. Zare, dont le point central est justement la comparaison des méthodes d'évaluations des risques

### 3.2 PUBLICATIONS ET SUITES

Le stage a donné lieu à une publication acceptée, "A comparison of neck bending and flexion measurement methods for assessment of ergonomic risk", qui sera publié dans la prochaine édition de JOSE ("The International Journal of Occupational Safety and Ergonomics"), et à au moins 2 autres papiers scientifiques en cours de rédaction ou préparation.







## APPENDICE : QUELQUES FONCTIONS RÉALISÉES

---

### Fonction d'affichage des données du dos

```
% Calcul et affiche les donnees du Dos pour un operateur et une
  station.
2 %
% in:
% nbData: operator number
% nbSequence: sequence number
% silent: true if no UI, defaults to false
7 % ss, th: largeur et threshold de la fenetre de moyennage pour
% la detection de zones d'activite
% default: 2*128, 0.8
% showMean: show the mean, defaults to false
% wait: do not return, wait for click on graph
12 % defaults to true
%
% out:
% d: data
% tt: time vector
17 % status: computed SES status and percentages
% sibad, eibad: beginning and end of computed activity zones
function [d, tt, ratios, status, sibad, eibad] = dos(nbData,
nbSequence, silent, ss, th, showMean, wait)
  if argn(2) < 3 | silent == [] then
    silent = %f;
22  end
  if argn(2) < 4 | ss == [] then
    ss = 2*128;
  end
  if argn(2) < 5 | th == [] then
27  th = 0.8;
  end
  if argn(2) < 6 | showMean == [] then
    showMean = %t;
  end
32  if argn(2) < 7 then
    wait = %t;
  end

  if ~silent & showMean then
37    subplot(2,1,1)
  end
  [d, tt] = sequence(nbData, nbSequence,24, %f, %f, silent, %f)
  ;
```

```

42     if isempty(d) then
        disp("No data for " + names(nbData) + ", seq " + string(
            nbSequence));
        ratios = [0; 0; 0];
        status = -1;
        sibad = []; eibad = [];
        return;
47     end

    len = length(d);
    irai = find(d > 45);
    imid = find(d > 20 & d < 45);
52

    ratio = (length(irai) + length(imid))/len;
    ratios = [ratio; length(irai)/len; length(imid)/len];

    // moving indice d > 45
57     pt = ss:len-ss;
    perc = zeros(len ,1);
    for i = pt
        imax = find(d(i-ss+1:i+ss) > 20);
        perc(i) = length(imax) / (ss*2);
62     end

    tbad = perc >= th;
    dperc = diff([0; tbad; 0]);
    eibad = find(dperc < 0);
67     if ~isempty(eibad) then
        eibad = eibad - 1 + ss;
    end
    sibad = find(dperc > 0);
    if ~isempty(sibad) then
72         sibad = sibad - ss;
    end
    inter = find(sibad(2:$) - eibad(1:$-1) + 1 > 0);
    if length(sibad) > 1 then
77         sibad = [sibad(1), sibad(inter+1)];
        eibad = [eibad(inter), eibad($)];

        inter = find(sibad(2:$) - eibad(1:$-1) + 1 > ss*2);
        if ~isempty(inter) then
            sibad = [sibad(1), sibad(inter+1)];
            eibad = [eibad(inter), eibad($)];
82         end
    end

87     redsec = ratios(2)*tt($);
    red = redsec >= 5;
    yellow = ~isempty(sibad)
    if red then
        str = "ROUGE";
        ra = ratios(2);

```

```

92     status = 2;
elseif yellow
    str = "JAUNE";
    ra = ratios(1);
    status = 1;
97 else
    ra = 0;
    str = "VERT"
    status = 0;
end
102 // drawing
if ~silent then
    mm = max(68, max(d) + 2);
    a = get("current_axes");
107     a.data_bounds = [0 -20; tt($) mm+12];

    for k = 1:length(sibad)
        plot([tt(sibad(k)) tt(sibad(k))], [-20 mm], 'k')
        plot([tt(sibad(k)) tt(eibad(k))], [mm mm], 'k')
112     plot([tt(eibad(k)) tt(eibad(k))], [-20 mm], 'k')
    end

    plot([0 tt($)], [20 20], 'r—')
    plot([0 tt($)], [45 45], 'r—')
117 if showMean then
    subplot(2,1,2)
    a = get("current_axes");
    a.tight_limits = "on";
    cf = histplot(20, d, normalization=%f);
122     plot([45 45], [0 max(cf)], 'r—')
    plot([20 20], [0 max(cf)], 'r—')
    a.data_bounds = [-10 0; 80 max(cf)];

    title("Pourcentage position non neutre: " + string(
        ratio*100) + ..
127     " % ( Flexion > 45: " + string(100*length(irai)/len)
        + ..
        " %, Flexion 20-45: " + string(100*length(imid)/len)
        + " %)")
    end

    if ra > 0.6 then
132     str = str + " 3";
    elseif ra > 0.3
        str = str + " 2";
    end
    if red then
137     str = str + " !" + string(round(redsec)) + "
        secondes > 45.";
    end
    if yellow & ra > 0.3 then

```

```
        str = str + " ! " + string(round(100*ra)) + "% du
        taktime > 20";
    end
142
    if showMean then
        xstring(20, max(cf)*0.75, str)
    else
        xstring(d(floor(len*0.5)), mm+2, str)
147
    end
    t=get("hdl");
    t.font_size = 3;
    t.font_style = 8;
    if red then
152        colo = color("red");
    elseif yellow
        colo = color("orange");
    else
        colo = color("green");
157
    end
    t.font_foreground = colo;

    ibutton = 0;
    f = gcf();
162
    if wait & length(f.children == 2) then
        ah = f.children(2); sca(ah);
        while ibutton ~= -1000
            [ibutton, xcoord, ycoord] = xclick();
            if ibutton == 3 then
167                jump_to_video(nbData, nbSequence, xcoord);
            end
        end
    end
    end
172 endfunction
```

## BIBLIOGRAPHIE

---

- [1] E. Bernmark and C. Wiktorin. A triaxial accelerometer for measuring arm movements. *Applied Ergonomics*, 33 :541–547, 2002.
- [2] G.-A. Hansson, P. Asterland, N.-G. Holmer, and S. Skerfving. Validity and reliability of triaxial accelerometers for inclinometry in posture analysis. *Med. Biol. Eng. Comp.*, 39 :405–413, 2001.
- [3] G.-A. Hansson, I. Arvidsson, K. Ohlsson, C. Nordander, S.E. Mathiassen, S. Skerfving, and I. Balogh. Precision of measurements of physical workload during standardised manual handling. Part ii : Inclinometry of head, upper back, neck and upper arms. *Journal of Electromyography and Kinesiology*, 16(AN3461) :125–136, 2006.
- [4] Mark Pedley. Tilt Sensing Using a Three-Axis Accelerometer. *Application Note*, (AN3461), 2013.

#### COLOPHON

This document was typeset using the typographical look-and-feel `classicthesis` developed by André Miede. The style was inspired by Robert Bringhurst's seminal book on typography "*The Elements of Typographic Style*". `classicthesis` is available for both  $\text{\LaTeX}$  and  $\text{\LyX}$  :

<http://code.google.com/p/classicthesis/>

*Final Version* as of 11 décembre 2014 (`classicthesis` ).

# Appendix 12

## Appendix 12: Article 8

**Comparaison de deux outils d'évaluation des risques ergonomiques dans la prévention des troubles musculo-squelettiques : de l'auto-questionnaire à la méthode d'observation**

Under submission

## **RECHERCHE EMPIRIQUE**

# **Comparaison des methodes d'évaluation en ergonomie dans la prevention des troubles musculo-squelettiques : de l'auto-questionnaire a la methode d'observation**

**Titre court : Correspondance des outils d'évaluation des risques en ergonomie**

**Mohsen Zare<sup>1</sup>**

**Maxime Norval<sup>1</sup>**

**Julie Bodin<sup>1</sup>**

**Yves Roquelaure<sup>1</sup>**

<sup>1</sup> LUNAM, Université d'Angers, Laboratoire d'ergonomie et d'épidémiologie en santé au travail (LEEST), Angers, France

**Auteur correspondant** : Mohsen Zare

**Adresse** : LUNAM, Université d'Angers, Laboratoire d'ergonomie et d'épidémiologie en santé au travail (LEEST), Angers, France

**Adresse e-mail**: mohsen@zare.fr

+33787722141



## Summary

### **Comparison of ergonomic risk assessment tools for prevention of musculoskeletal disorders: self-reported questionnaire and observational method**

The objective of this study was to compare the results of the observational method and self-reported questionnaire. For data collection, a sample of operators who worked on thirteen work positions was selected from a truck manufacturing plant. Different tasks of these positions were analyzed for a task time of 8 minutes. The risk assessment of the activity was carried out both by observation and by a self-reported questionnaire. The agreement between the two methods was realized with the Kappa coefficient. Our study shows that the observation and self-questionnaire represent different work characteristics. This analysis of each of the two tools does not reveal that one is more powerful than the other. However, it shows the place of each method for risk analysis and whether two methods have the complementary effect for estimation of work related musculoskeletal risks.

**Keywords:** observation, self-reported questionnaire, comparison, assembly line

## Résumé en français

L'objectif de cette étude était de comparer les résultats de la méthode d'observation et Auto-questionnaire. Pour la collecte des données, un échantillon d'opérateurs qui travail sur 11 postes de travail a été sélectionné dans une usine de fabrication de camions. Différentes tâches de ces postes ont été analysés pour un temps cycle de huit minutes. L'évaluation des risques de l'activité a été réalisée à la fois par l'observation et par un auto-questionnaire. L'accord entre les deux méthodes a été réalisé avec le coefficient Kappa. Notre étude montre que l'observation et l'auto-questionnaire représentent différentes caractéristiques du travail. L'analyse de chacun des deux outils ne révèle pas qu'un des outils est plus puissant que l'autre. Cependant, la question est de savoir si ces deux méthodes ont un effet complémentaire pour l'estimation des risques musculo-squelettiques.

**Mots-clés :** Méthode observation, Auto-questionnaire, Comparaison, Chaîne d'assemblage

## Introduction

Les troubles musculo-squelettiques (TMS) sont regroupés dans cinq tableaux de maladies professionnelles du régime général de la sécurité sociale (57, 69, 79, 97 et 98). En 2013, ils représentaient 87 % des maladies professionnelles indemnisées par le régime général soit un coût de plus de 865 millions d'euros pour l'assurance maladie en France. Les TMS sont les pathologies les plus présentes dans le milieu industriel français (1-4). Ces pathologies sont caractérisées par leur côté multifactoriel et pluridisciplinaire, les causes d'apparition sont multiples et d'origines diverses (5, 6). Les facteurs physiques (amplitude des postures, répétitivité, force/effort), psycho-sociaux/organisationnels (latitude décisionnelle, demande psychologique, support social, satisfaction au travail, reconnaissance et niveau de stress perçu), environnementaux (bruit, température, luminosité) sont identifiés comme jouant un rôle majeur dans l'apparition de cette pathologie (7-9). En raison de la nature des tâches d'assemblage dans l'industrie automobile, les facteurs de risque physique comme les postures de travail, les efforts/forces, les mouvements répétitifs et le port de charge sont considérés comme les facteurs les plus présents. Récemment certaines recherches ont mis en avant les mauvaises postures comme la flexion/rotation du tronc, le maintien des bras en l'air, la rapidité des mouvements et les efforts comme étant les principaux groupes de facteurs de risque physique dans la survenue des TMS (10, 11). Il est pertinent d'étudier les représentations de ces risques physiques dans l'activité, ils sont des enjeux majeurs pour présenter le niveau d'exposition des salariés (11-15). La représentation des risques de l'activité peut être faite sous différentes formes et analysée sous différentes focales. Plusieurs méthodes diagnostiques ont été développées pour évaluer l'exposition aux facteurs de risque : l'analyse des symptômes, l'étude des plaintes, l'observation, les mesures directes, l'auto-questionnaire et l'entretien (16, 17). Deux méthodes sont fréquemment utilisées afin d'obtenir une représentation du risque physique au travail : les méthodes d'observation et les auto-questionnaires de perceptions.

Beaucoup d'études antérieures ont utilisé des méthodes d'observation pour évaluer les risques de TMS (18-22). Les outils d'observation comme REBA (23), RULA (24) et QEC (25) sont présentés et recensés dans la littérature en ergonomie (20, 26-28). Aussi, beaucoup de grandes entreprises industrielles ont construit leurs méthodes d'observation en interne pour les adapter à leurs propres facteurs de risque de leur activité. L'étude de Hagg en 2000 cite les programmes d'ergonomie interne d'industries automobiles: Ford, Saab, BMW, Général Motors et Peugeot qui s'appuient sur des outils d'évaluation par observation développés en interne (13). De plus, l'outil EAWS (Ergonomic Assessment WorkSheet) est utilisé par des grands groupes comme Fiat, Bosch et Volkswagen (29).

La deuxième méthode est l'auto-questionnaire de perception qui est largement utilisé dans les études épidémiologiques et ergonomiques pour évaluer l'exposition à la charge physique (30-33). Les auto-questionnaires sont majoritairement orientés vers l'étude des perceptions d'une population exposée au risque. Cet outil offre la possibilité d'évaluer une population large au travers d'un grand nombre de variables au sein de différents types de métiers (34, 35).

La validité et la qualité de la prédiction de survenue des TMS sont remis en cause pour ces deux outils d'évaluation. Chiasson et col (2012) ont comparé huit outils d'observation sur 224 stations en affirmant

un faible niveau d'accord entre eux, aucun outil ne peut prétendre à une prédiction du niveau de risque d'apparition de TMS. L'étude de Barrero et col (2009) et Trask et col (2010) critique l'outil d'auto-questionnaire notamment sur son niveau de précision dans l'estimation de l'exposition au risque physique (32, 36). L'étude de Descatha et col (2009) présente les auto-questionnaires de ressenti comme un outil plus efficace et plus sensible que la méthode d'observation de l'analyse des risques (37). La diversité des conclusions sur les outils d'évaluation nous pousse à créer notre propre étude sur l'accord des données récoltées par deux outils d'évaluation des risques physiques qui sont fréquemment utilisés dans le milieu industriel. L'étude compare les résultats de l'outil d'observation nommé Scania Ergonomic Standard (SES) et l'auto-questionnaire. Le premier est utilisé de manière courante chez Scania et il est ressemblé à des outils utilisés dans l'industrie automobile. Alors que l'auto-questionnaire a été développé pour réaliser des études des TMS dans plusieurs secteurs d'activité en France (30). Notre objectif est donc d'utiliser les outils déjà mis en place et étudier l'accord entre la perception des opérateurs ayant répondu à l'auto-questionnaire et l'évaluation SES réalisée par des experts. Nous nous interrogeons sur leurs concordances de prévision dans la survenue des TMS, cela nous permettra la création d'une représentation partagée des risques de l'activité.

## **Methode**

### **Contexte des situations de travail**

Cette étude est réalisée dans l'entreprise Scania qui assemble des camions sur son site de production d'Angers. Il y a plusieurs secteurs d'assemblage sur ce site qui réalisent principalement des activités de serrage avec visseuses, de levage, de manutention de charge et de mise en place de câble/durite. Suite à une demande de l'entreprise, notre étude est orientée, vers l'évaluation des risques physique d'un secteur composé de 3 groupes de travail. Le groupe 1 comprend l'activité de 6 opérateurs réalisant des opérations d'assemblage de garde-boue (gauche/droit) et de marche pied (gauche/droite) sur 4 postes de travail. Le groupe 2 est composé de 7 opérateurs réalisant des montages de parechoc sur 5 stations différenciées. Enfin le 3ème groupe est composé de 8 opérateurs travaillant sur 5 postes de travail à la préparation d'équipement, l'assemblage des filtres à air et du système de Réduction Catalytique Sélective (RCS). Notons qu'il y a une diversité de production pour les postes d'assemblage du système RCS et la mise en place du filtre à air, ce qui implique des sollicitations différentes pour chaque variable de production. Nous avons alors évalué chaque diversité comme des postes à part entière soit 10 postes pour le groupe de travail N°3. Pour cette étude le temps de cycle alloué à l'activité de chacun des postes est de 8 min. Le volume de production est de 48 camions/jour, cependant ce rythme peut varier en fonction de la demande en production. Tous les groupes de travail possèdent une rotation interne toutes les deux heures, cela permet une répartition des sollicitations. Vingt-quatre opérateurs qui travaille sur le secteur sélectionnées sont retenus pour notre échantillonnage cependant nous avons exclu 3 personnes ayant répondu partiellement au questionnaire, ainsi nous totalisons dans cette étude 21 opérateurs ayant répondu correctement à l'auto-questionnaire. Les opérateurs participant à cette étude sont tous des hommes, 39,0 ( $\pm 8,7$ ) ans d'âge moyen avec 13,9 ( $\pm 7,3$ ) ans d'ancienneté moyenne.

Le projet a été mené par un ergonome interne à cette entreprise en poste depuis environ 3 ans dans le cadre d'une thèse appliquée qui lui a permis d'acquérir une posture d'expert dans l'utilisation de l'outil d'observation et dans la connaissance de l'organisation. Les résultats de l'évaluation SES sont l'aboutissement de plusieurs observations menées pour chacun des postes. L'évaluation des risques de l'activité avec les deux outils a été réalisée entre novembre 2013 et avril 2014. Une analyse par l'observation a eu lieu aux mois de novembre et décembre 2013. En mars 2014 un auto-questionnaire de ressentis a été administré à l'ensemble des opérateurs du secteur étudié. Un enregistrement vidéo de ces mêmes situations a été réalisé dans le cadre d'un autre projet mené en parallèle. Pour compléter et s'assurer de la qualité des informations récoltées lors du premier passage, une revue des résultats de l'outil d'observation a été faite en avril 2014 (moins de deux mois après la récolte des réponses aux auto-questionnaires opérateurs). Ainsi, l'observation a été réalisée sur plusieurs temps de cycle et les situations les plus à risques ont été retenues. Notons, qu'il n'y a pas eu de changements majeurs durant la période d'étude.











## **Collecte des données**





### **Outil d'observation (SES)**

L'outil d'observation SES a été développé initialement par Saab automobile AB, avec une partie provenant d'une entreprise d'Amérique du nord General Motors, il a été repris en interne par Scania production et adapté à l'activité d'assemblage de camions. L'outil d'observation SES s'appuie sur un enregistrement vidéo de tous les postes des salariés étudiés. Pour un bon enregistrement vidéo, l'ergonome a positionné la caméra afin d'enregistrer l'ensemble du corps en activité. Une échelle de couleurs a été attribuée à chacun des postes de travail à partir de l'analyse des vidéos, de l'expérience de l'ergonome et de la grille d'évaluation utilisée.

L'outil SES évalue les postes de travail multitâches autour de 20 facteurs de risques physique. Ces facteurs sont regroupés en quatre catégories comprenant la répétitivité, la posture de travail, le levage et la consommation énergétique (Tableau 1). Les caractéristiques de port de charge levage deux mains sont étudiées avec l'équation de NIOSH qui permet une étude plus précise (38). Les résultats sont triés pour prioriser chaque évaluation : la zone verte ou normale montre que le risque d'apparition de TMS est minime et que la situation est acceptable, la zone jaune présente une situation à risque modéré qui aurait besoin d'amélioration à l'avenir, la zone rouge caractérise les situations à fort risque d'apparition de TMS qui ont besoin de modifications le plus rapidement possible. Une fois l'ensemble des situations étudié, le nombre de vert, de jaune, de rouge est défini pour chaque facteur, ce qui détermine la couleur du poste de travail (Tableau 2). L'effet de la rotation nous a obligé de développer une méthode (issu des données de Tableau 2) de représentation du niveau de risque (couleurs) pour chaque facteurs et par groupe de travail. Cette représentation par facteurs de risques s'appuie sur les résultats de plusieurs postes permettant d'établir un niveau de risque général par groupe de travail. Nous avons donc cinq seuils comme suit qui nous permettent de définir les couleurs des groupes de travail par facteur de risque :

Tableau 1 : Présentation des groupes d'analyse par thématique

	<b>Données de l'analyse par l'observation (indicateur : vert, jaune, rouge)</b>	<b>Données de l'analyse par l'auto-questionnaire de ressentis (jamais, rarement/ souvent/ toujours)</b>
<b>Répétitivité</b>	<p>Nombre de mouvements répétés par heure:</p> <ul style="list-style-type: none"> <li>- (&gt;150 rép/h) [<b>Vert</b>]</li> <li>- (150-300 rép/h) [<b>Jaune</b>]</li> <li>- (&gt;300 rép/h) [<b>Rouge</b>]</li> </ul>	<ul style="list-style-type: none"> <li>- Geste répétitif très précis.</li> <li>- Même geste pour des raisons de procédure ou de qualité.</li> <li>- Répétition d'une même action plus de deux fois par minute.</li> </ul>
<b>Posture de travail</b>	<p>Position habituelle de travail :</p> <ul style="list-style-type: none"> <li>- Debout / Marche /assis [<b>Vert</b>]</li> <li>- Position debout/ assise inconfortable [<b>Jaune</b>]</li> <li>- Allongée/ agenouillée/ accroupie/penchée/sur une jambe [<b>Rouge</b>]</li> </ul>	<ul style="list-style-type: none"> <li>- Position accroupie et/ou à genou</li> </ul>  <ul style="list-style-type: none"> <li>- Posture nécessitant une contorsion (posture inconfortable).</li> </ul>
<b>Posture du dos</b>	<p>Posture de travail statique –dos &gt; 5sec :</p> <ul style="list-style-type: none"> <li>- 0-20° penché en avant [<b>Vert</b>]</li> <li>- 20-45° penché en avant ou sur le côté en torsion [<b>Jaune</b>]</li> <li>- &gt; 45° penché en avant ou sur le côté en torsion ou penché en arrière [<b>Rouge</b>]</li> </ul>	<ul style="list-style-type: none"> <li>- Flexion en avant ou sur le côté régulièrement ou de manière prolongée.</li> </ul>
<b>Posture du cou</b>	<p>Posture de travail statique- cou &gt; 5 sec :</p> <ul style="list-style-type: none"> <li>- 0-20° penché en avant [<b>Vert</b>]</li> <li>- 20-45° penché en avant ou 20-30° sur le côté en torsion [<b>Jaune</b>]</li> <li>- &gt; 45° penché en avant ou &gt; 30 sur le côté en torsion ou penché en arrière [<b>Rouge</b>]</li> </ul>	<ul style="list-style-type: none"> <li>- Travail avec un ou deux bras écartés du corps régulièrement ou de manière prolongée</li> </ul>  <ul style="list-style-type: none"> <li>- Mouvements de flexion de la tête en avant régulièrement ou de manière prolongée</li> </ul>  <ul style="list-style-type: none"> <li>- Mouvements d'extension de la tête en arrière régulièrement ou de manière prolongée</li> </ul> 
<b>Posture des épaules</b>	<p>Posture de travail statique- épaule, bras &gt; 5 sec :</p> <ul style="list-style-type: none"> <li>- &lt; 45° levée des bras [<b>Vert</b>]</li> <li>- 45°-90° levée des bras [<b>Jaune</b>]</li> <li>- &gt; 90° levée des bras [<b>Rouge</b>]</li> </ul>	<ul style="list-style-type: none"> <li>- Travail avec un ou deux bras en l'air (au-dessus des épaules) régulièrement ou de manière prolongée</li> </ul>  <ul style="list-style-type: none"> <li>- Extension du ou des bras en arrière</li> </ul>  <ul style="list-style-type: none"> <li>- Travail avec un ou deux bras écartés du corps régulièrement ou de manière prolongée.</li> </ul>
<b>Posture des poignets</b>	<p>Posture de travail – Poignet :</p> <ul style="list-style-type: none"> <li>- Poignet neutre [<b>Vert</b>]</li> <li>- Poignet non neutre [<b>Rouge</b>]</li> </ul>	<ul style="list-style-type: none"> <li>- Mouvement de pronation ou supination</li> </ul>  <ul style="list-style-type: none"> <li>- Mouvement de torsion du poignet.</li> </ul>  <ul style="list-style-type: none"> <li>- Appui ou tapement avec la base de la main sur un plan dur</li> </ul>  <ul style="list-style-type: none"> <li>- Utilisation du pouce- index.</li> </ul> 

<b>Effort des paumes de main</b>	Zone de surface, surface de pression > 1kg : - Doigt (≥ dia.1,5 cm/A ≥ 1,7cm²) Paume ( ≥ 3cm/A ≥ 7cm²) [Vert] - Doigt (< dia.1,5 cm/A < 1,7cm²) Paume (< 3cm/A < 7cm²) [Rouge]	- Appui ou tapement avec la base de la main sur un plan dur ou sur un outil 
<b>Force effort corps</b>	Force de poussée / traction corps entier : - Démarrage (<100N) en continu (<50N) [Vert] - Démarrage (100-150N) en continu (50-110N) [Jaune] - Démarrage (>150N) en continu (>110N) [Rouge]	- Travail en poussant ou tirant.  - Port d'objets encombrants et volumineux les bras tendus.  - Port d'objets difficiles à attraper, instables ou sans poignée. 
<b>Manipulation</b>	Taille du composant lors de la manipulation : - (<1000 mm) [Vert] - (1000-2000 mm) [Jaune] - (>2000 mm) [Rouge]	- Port d'objets encombrants et volumineux les bras tendus. 
<b>Port de charge (levage à deux mains)</b>	Effort de levage deux mains : - < 10 Nm [Vert] - 10 – 35 Nm [Jaune] - > 35 Nm [Rouge] Evaluation avec méthode équation révisée de NIOSH	- Port d'une charge qui pèse 1 à 10 kg - Port d'une charge qui pèse 10 à 25 kg - Port d'une charge qui pèse plus de 25 kg
<b>Port de charge (levage à une main)</b>	Levage à une main : - < 2 kg [Vert] - 2 – 5 kg [Jaune] - > 5kg ou > 0,5kg préhension par le dessus [Rouge]	- Port d'une charge qui pèse 1 à 10 kg - Manipulation d'un outil ou d'un objet qui pèse 1 à 4kg - Manipulation d'un outil ou d'un objet qui pèse plus de 4kg

Le seuil 1 est défini par le nombre de points jaunes qui permet l'obtention d'une couleur finale définie comme jaune.

$$\circ T_1 = \frac{N}{2} + 1 \quad N = \text{Nombre de poste évaluer par groupe} \quad T_1 = \text{Seuil 1}$$

- Le seuil 2 est défini par le nombre de points jaunes qui permet l'obtention d'une couleur finale définie comme rouge.

$$\circ T_2 = N + 1$$

- Le seuil 3 est défini par le nombre de points rouges qui permet l'obtention d'une couleur finale jaune.

$$\circ T_3 = \frac{N - 1}{3}$$

- Le seuil 4 est défini par le nombre de points rouges qui permet l'obtention d'une couleur finale définie comme rouge.
  - $T_4 = \frac{N}{2}$
- Le seuil 5 est défini par le nombre de points jaunes + le nombre de points rouges qui permet l'obtention d'une couleur finale rouge.
  - $T_5 = 0.8 N$

Toutes les définitions des seuils seront arrondies aux valeurs inférieures tout en prenant en compte la couleur définissant l'activité la plus à risque, ce qui influe directement sur la couleur finale de chacun des facteurs de risques par groupe de travail.

### L'auto-questionnaire

L'auto-questionnaire de ressenti a été utilisé pour évaluer la perception des opérateurs concernant les facteurs de risque physique durant leurs activités exclusivement réalisées dans le secteur étudié. La partie traitant des facteurs de risque physique de TMS a été développée selon le consensus européen sur le repérage des formes précoces de TMS (39). Ce questionnaire est utilisé dans différentes études épidémiologiques en France (4, 30, 40). Les questions portaient sur la répétition, les postures (cou, épaules, poignets/mains et dos), les efforts (port de charge, pousser/tirer, les efforts des mains). La majorité des questions ont une image permettant de représenter la personne en situation, cela aide les opérateurs à mieux situer leur niveau de réponse (Tableau 1). L'échelle de réponse utilisée était constituée de quatre niveaux : Jamais, Rarement, Souvent, Toujours. Les questionnaires ont été distribués le vendredi pour permettre aux opérateurs de répondre attentivement pendant le weekend, la récolte a été réalisée le lundi permettant un taux de réponse élevé.

Tableau 2: La priorisation des facteurs de risques par la méthode de SES et l'équation du NIOSH

Les Méthodes	Evaluation Criteria	Verst	Jaune	Rouge
L'outil SES (Ergonomic Standard method)	Nombre de jaune*	0-8	9-16	≥ 17
	Nombre de rouge	0-6	7-9	≥ 10
	Nombre de jaune + rouge	0-16	-	≥ 17
L'équation de NIOSH	Index de levage	<1	1 -1.6	>1.6

\* La couleur de risque plus élevé régit l'évaluation finale de la poste de travail

### Les critères de comparaison

Dans notre étude nous avons sélectionné 11 facteurs de risques physiques comparables dans les deux outils (Tableau 1). Les 11 facteurs de l'auto-questionnaire sont constitués de plusieurs questions qui ont été regroupées. Pour exemple, si une des réponses est « toujours » parmi 3 questions alors nous avons sélectionné « toujours » comme la réponse critique.

Les questions interrogent l'opérateur au sujet du port de différentes charges ne précisent pas si ces charges sont portées avec une ou deux mains. Les facteurs de « port de charge levage deux mains » et « port de charge levage une main » ont donc été analysées à deux niveaux différents. Nous avons ainsi réalisé deux sous-groupes pour le facteur de port de charge de l'auto-questionnaire : le levage deux mains comprises entre 1-10kg, 10-25kg et plus de 25kg ont été comparé avec le facteur levage a deux mains dans l'outil SES. Pour le port de charge levage une main, la comparaison a été faite pour les

questions concernant les charges de 1-4 kg et 1-10kg et le facteur levage à une main de l'outil SES. Le facteur effort/force du corps se traduit également en un critère dans l'analyse par auto-questionnaire (Tableau 1).

### **Méthode d'analyse: Tests statistiques**

L'accord entre les deux méthodes a été mesuré par le coefficient Kappa. Ce test est couramment utilisé pour évaluer l'accord inter-évaluateurs et l'accord entre deux méthodes/outils comme l'observation, l'auto-questionnaire et la méthode biomécanique (34, 41, 42). L'unité de comparaison est l'opérateur avec d'un côté ses réponses au questionnaire et de l'autre l'évaluation de leur travail par l'outil SES pour chaque groupe de travail.

## **Résultats**

### **L'outil d'observation (ses)**

Le Tableau 3 montre que les facteurs de risque physique comme les postures de travail (postures du corps entières), les postures du dos, cou, épaules et les postures des poignets ressortent comme un risque élevé (rouge) pour le groupe de travail N°1. Les facteurs de risque forces/efforts du corps entières et port de charge levage à une main ont été identifiés avec un niveau de risque moyen (jaune) sur l'ensemble des situations analysées.

Pour le groupe de travail N°2 (Tableau 3), composé de cinq postes, les postures du cou, des épaules, du poignet, les forces/efforts du corps et le port de charge avec levage à une main sont identifiés comme à risque élevé (rouge). Les facteurs de risque postures de travail, postures du dos, l'effort des paumes de main et la manipulation ressortent comme à risque modéré (jaune).

Les facteurs de risque des postures du dos, des épaules, du poignet sont considérés comme à risque élevé (rouge) pour le groupe de travail N°3 (Tableau 3). Les facteurs de risque postures de travail, postures du cou, force/effort du corps et port de charge avec levage à une main sont identifiés comme à risque modéré (jaune). Pour plus de détail sur la répartition des résultats de l'outil d'observation SES voir Tableau 1 en Annexe.

### **L'auto-questionnaire de ressenti**

Les postures poignet, le port de charge et effort/force ont été identifiés comme « souvent » présents pour la moitié des opérateurs sur les trois groupes de travail. Pour plus de détail sur la répartition des résultats par groupe de travail voir Tableau 2 en Annexe. Sur l'ensemble des trois groupes de travail, comme montré dans le tableau 3, 15 personnes (75 %) ont identifié les mauvaises postures du dos comme « souvent » présentes dans les situations de travail. La répétition et les postures de travail ressortent comme « souvent » présentes pour 12 (57 %) des personnes interrogées (Tableau 3).



Tableau 3: Analyse des observations (méthode SES) et des réponses aux auto-questionnaires pour le groupe de travail n°1, groupe de travail n°2 et groupe de travail n°3 au travers des 11 critères. (Voir l'Annexe pour les détails)

Unité d'information	La méthode SES			Auto-questionnaires Ensemble des salariés (N=21)					
	Couleur Finale (vert; jaune; rouge)			Jamais/ Rarement		Souvent		Toujours	
	Groupe N°1	Groupe N°2	Groupe N°3	N	%	n	%	n	%
Répétition	Vert	Vert	Vert	0	0	12	57	9	43
Posture de travail	Rouge	Jaune	Jaune	6	29	12	57	3	14
Posture du dos	Rouge	Jaune	Rouge	5	25	15	75	0	0
Posture du cou	Rouge	Rouge	Jaune	2	10	16	76	3	14
Posture des épaules	Rouge	Rouge	Rouge	7	33	12	57	2	10
Posture des poignets	Rouge	Rouge	Rouge	5	24	11	52	5	24
Effort des paumes de mains (surface de pression)	Vert	Jaune	Vert	20	95	1	5	0	0
Force et effort corps	Jaune	Rouge	Jaune	4	19	13	62	4	19
Manipulation (Taille du composant)	Vert	Jaune	Vert	17	81	4	19	0	0
Port de charge									
Levage deux mains (NIOSH)	Vert	Vert	Vert	4	19	11	52	6	29
1-10kg				11	52	7	33	3	14
10- 25kg				17	81	4	19	0	0
>25 kg				20	100	0	0	0	0
Levage une main	Jaune	Rouge	Jaune						
1-4kg				5	24	10	48	6	29
>4kg				10	48	8	38	3	14

### Comparaisons observatives et auto-questionnaires pour les 3 groupes de travail

Le Tableau 4 présente les résultats de la comparaison des données tirées de l'outil SES et de l'auto-questionnaire pour l'ensemble des groupes de travail. L'accord entre les résultats des outils SES et auto-questionnaire est modéré pour le facteur force/effort corps ( $Kappa = 0.34$  ;  $Po = 66.7$ ). Les résultats des deux outils d'évaluation pour le facteur posture de travail ont un accord faible ( $Kappa = 0.20$  ;  $Po = 52.4$ ). Malgré un score Kappa très faible pour le facteur manipulation ( $Kappa = 0.15$ ), l'accord observé entre les résultats de ces outils est élevés ( $Po = 76.2$ ). On retrouve cette même tendance pour le facteur effort paume de main avec un kappa nul et un accord observé élevés ( $Kappa = -0.09$  ;  $Po = 66.7$ ).

Certaines données comme les postures du dos (Kappa = 0.08 ; Po = 25), cou (Kappa = 0.05 ; Po = 38.1), épaules (Kappa = 0 ; Po = 9.5) et poignet (Kappa = 0 ; Po = 23.8) sont en accord très faibles entre les résultats des deux outils. Pour le facteur de risques répétition on observe un score kappa et un accord observé à 0, ce qui montre un désaccord entre les résultats de ces deux outils (Tableau 4).

Tableaux 4 : Comparaison des résultats des outils d'évaluation des risques par observation (SES) et par auto-questionnaire

	0		1		2		Proportion d'accord observée	Coefficient Kappa
	n	%	n	%	n	%		
Répétition							0	0
Méthode d'observation	21	100	0	0	0	0		
Auto-Questionnaire	0	0	12	57	9	43		
Posture de travail							52.4	0.20
Méthode d'observation	0	0	13	62	8	38		
Auto-Questionnaire	6	29	12	57	3	14		
Posture du dos							25.0	0.08
Méthode d'observation	0	0	5	25	15	75		
Auto-Questionnaire	5	25	15	75	0	0		
Posture du cou							38.1	0.05
Méthode d'observation	0	0	7	33	14	67		
Auto-Questionnaire	2	10	16	76	3	14		
Posture des épaules							9.5	0
Méthode d'observation	0	0	0	0	21	100		
Auto-Questionnaire	7	33	12	57	2	10		
Posture du poignet							23.8	0
Méthode d'observation	0	0	0	0	21	100		
Auto-Questionnaire	5	24	11	52	5	24		
Effort Paume de main							66.7	-0.09
Méthode d'observation	15	71	6	29	0	0		
Auto-Questionnaire	20	95	1	5	0	0		
Force et effort corps							66.7	0.34
Méthode d'observation	0	0	15	71	6	29		
Auto-Questionnaire	4	19	13	62	4	19		
Manipulation							76.2	0.15
Méthode d'observation	18	86	3	14	0	0		
Auto-Questionnaire	17	81	4	19	0	0		

Port de charge levage 2 mains								
Méthode d'observation (équation NIOSH)	21	100	0	0	0	0		
Auto-Questionnaire (port de charge de 1 à 10kg)	11	53	7	33	3	14	52.4	0
Auto-Questionnaire (port de charge entre >10 et 25kg)	17	81	4	19	0	0	81.0	0
Auto-Questionnaire (port de charge >25kg)	20	100	0	0	0	0	100.0	NA
Port de charge levage 1 main								
Méthode d'observation	0	0	15	71	6	29		
Auto-Questionnaire (manipulation de 1 à 4kg)	5	24	10	48	6	28	57.1	0.26
Auto-Questionnaire (manipulation plus de 4kg)	10	48	8	38	3	14	28.6	-0.04
Auto-questionnaire (port de charge de 1 à 10kg)	11	53	7	33	3	14	23.8	-0.06

NA : Non applicable

Le Kappa pour les facteurs port de charge levage avec une et deux mains est très faible. Pourtant l'accord observé entre deux outils pour le facteur port charge avec deux main est élevés (Kappa=0 ; Po = 81.0 pour port de charge entre >10 et 25kg et Kappa=0 ; Po = 81.0 pour port de charge de 1 à 10kg). L'accord faible et très faible a été obtenu pour les facteurs porte charge à une main (Tableau 4). Dans la majorité des situations les résultats se rapprochent vers le niveau de risque modéré alors que dans les extrêmes (forts risques et sans risques) les résultats sont fortement opposés.

## Discussion

Nous avons choisi de comparer dans cette étude deux outils d'évaluation des risques physique de TMS : l'outil d'observation SES est utilisé de manière courante dans le milieu industriel automobile et l'auto-questionnaire est un outil utilisé surtout dans des études épidémiologiques en France et à l'international (30, 40). L'objectif de notre étude est la comparaison des résultats de ces deux outils pour connaître leur concordance et leur représentativité dans l'évaluation d'une activité industrielle. Notre étude permet de dire que la méthode SES et l'auto-questionnaire présentent des données différentes, celle-ci sont variables pour certains facteurs de risque. Lors de notre étude, 11 facteurs de risque ont été sélectionnés pour permettre la comparaison des résultats de ces deux outils. Les différences de résultats entre les deux outils sont variables en fonction des facteurs analysée. L'étude de la littérature sur les méthodes d'évaluation des risques montre un niveau d'accord faible à modéré entre l'observation et l'auto-questionnaire (33, 34). Les études de Hansson et col (2001), Spielholz et col (2001) et Burdof (1991) présente le faible accord entre les sentiments des opérateurs (l'auto-questionnaire) et les autres méthodes de référence (méthode d'observation et les mesures directes) (11, 41, 43). Descatha et col

(2009) ont conclu que les accords entre l'auto-questionnaire et la méthode d'observation sont faibles, et que l'auto questionnaire estime mieux les probabilités de survenue de TMS (37).

L'observation par la méthode SES s'appuie sur l'évaluation faite par un expert, toutefois son jugement extérieur à l'action est guidé par la grille d'observation, et sa connaissance de l'ergonomie. A contrario, l'auto-questionnaire se base sur la perception de l'opérateur, son jugement de l'activité est subjectif et peut être influencé par des fatigues musculaires ou des douleurs musculo-squelettiques. L'une des critiques apportée à cette méthodologie de comparaison peut être la différence de posture entre l'ergonome et l'opérateur. L'évaluation d'un enregistrement ou d'un temps de cycle, même fait par un ergonome n'a probablement pas la même valeur qu'une évaluation faite par un opérateur qui occupe quotidiennement le poste depuis plusieurs années (27, 34). Dans notre étude, pour atténuer ces différences lors de l'observation, l'ergonome a passé trois ans dans le secteur étudié, il a évalué plusieurs fois chaque poste de travail sur une diversité de modèle de camions.

L'item force et effort du corps sont identifiés par les outils comme étant présents lors d'action de pousser/tirer ou l'action de porter des objets par une prise spécifique. Le kappa à 0.42 montre un accord modéré entre les résultats de la méthode SES et l'auto-questionnaire. Dans la méthode d'observation la force du corps entier a été mesurée par un dynamomètre alors que pour répondre à l'auto-questionnaire l'opérateur s'appuiera sur la pratique et l'expérience pour identifier ses expositions à l'effort. Attention, l'opérateur peut par habitude de travail ne plus ressentir avec précision les efforts qu'il met en jeu pour réaliser une action. L'habitude de travail, la culture de métier et de l'entreprise ou l'expérience et le vécu de chacun sont des éléments importants dans l'identification des expositions à risques, le niveau de sensibilité d'un opérateur peut faire varier les réponses autour d'une même situation. D'autres études réalisent le même type de comparaison avec comme résultat un score kappa qui s'élève à 0,66 pour ce critère de force et d'effort du corps (34).

Les résultats de la méthode SES pour les facteurs de risque comme les efforts des paumes de main et la manipulation sont en accord avec les résultats de l'auto-questionnaire de ressenti. La concordance dans les résultats pour l'effort paume de mains peut s'expliquer par facilité d'identification de cet action par les deux outils. Les représentations des actions de manipulation sont de manière générale, objectives, en effet dans le questionnaire et dans l'observation le volume de l'objet permet de répondre au niveau de risque. Nous avons peu d'études comparant les résultats de plusieurs outils d'analyse pour des thématiques de ce type. Malgré tout, Stock a reporté un lien entre les résultats d'auto-questionnaire et la méthode observation pour la manipulation d'objets de très grande taille (34). Pour les ports de charge levage deux mains le score kappas est faible lors de l'analyse par observation et par auto-questionnaire. Pourtant l'accord observé entre deux outils est élevé qui montre la concorde entre observation par ergonome et l'auto-questionnaire pour ce facteur. Malgré certaines limites d'analyse pour ces critères nos résultats sont en accord avec l'étude de Stock et al (2005) qui montre le lien direct entre les résultats d'analyse par observation et par auto-questionnaire pour des critères de port de charge (Stock et al., 2005).

Les scores de Kappa pour les efforts paumes de mains, les manipulations et le port de charge sont très faibles malgré un accord observé (Po) élevé. Ces score Kappa ne sont pas représentatifs des différences entre les deux méthodes car la répartition des résultats des deux outils n'est pas adapter, le calcul n'est donc pas représentatif. D'autres études montrent que des scores inexacts peuvent être obtenus par le calcul de Kappa malgré un niveau d'accord élevé. Une faible répartition des données et un échantillonnage de faible taille sont les justifications mentionnée par la littérature pour ces scores kappa faible (34, 42). De plus, le teste kappa est habituellement déployé pour comparer le niveau de concordance entre un outil utilisé par plusieurs personnes. Cependant d'autres études ont utilisé ce test pour comparer les résultats de différent outils d'évaluation (34, 41).

Les résultats de la répétitivité évalués par ces deux outils sont variables, l'outil d'observation fait ressortir un niveau d'exposition faible alors que le questionnaire de ressenti fait plutôt apparaitre la répétitivité comme étant un facteur de risque souvent présent. Dans les autres études les mouvements répétitifs évalués par les questionnaires et les méthodes d'observations ont montré un accord faible (34, 37, 44). Les résultats des postures du dos, des postures du cou, des épaules et des poignets sont sensiblement différents entre les deux outils, l'auto-questionnaire fait ressortir un risque plus faible que la méthode observationnelle. Le score kappa faible et l'accord observée pour ces facteurs de risque permet de dire qu'il existe un accord très faible entre les deux outils d'évaluation. Burdorf et col (1991) ont montrés que les opérateurs sous-estiment fortement les postures du tronc prises pendant l'activité (43).

Takala et col (2010) et Stock et col (2005) ont montré que les micros postures prises par le cou, les poignets et les rotations du tronc sont des postures difficiles à diagnostiquer avec les observateurs ou avec les opérateurs (27, 34). L'explication de ces différences de résultats peut être trouvée dans la difficulté qu'a un opérateur à se représenter dans l'espace, en effet lors d'une action il est difficile de prendre en considération ses représentations spatiales sans faire intervenir la subjectivité. Prenons l'exemple de la position du dos dans l'espace, ce n'est pas une représentation naturelle. Il est alors difficile pour l'opérateur de connaître exactement le positionnement de son dos lors de l'action. Cependant à partir du moment où il y a une douleur il y a une prise de conscience sur les postures prises. Lorsqu'un opérateur n'a aucun symptôme de douleur, alors il y a une tendance à sous-estimer les postures prise pendant l'action. Les études de Hansson (2001) et Balogh et al (2004) ont montré l'influence de la douleur qui crée une surestimation des postures de travail (41, 45). En revanche, Burdorf et al (1991) n'ont montré aucune relation significative entre douleur et l'estimation de ses propres postures (43). Dans l'étude de Nordstrom (1998), il y a un lien direct des réponses au questionnaire et des résultats de l'observation pour des personnes déjà atteintes d'un syndrome du canal carpien ou ayant des antécédents médicaux (46).

De plus, bien qu'un ergonome observe plusieurs fois chaque poste de travail en utilisant la méthode d'observation SES, la répétabilité des méthodes d'observation est une question soulevée qui fait débat dans la littérature ergonomique (27, 28, 47). D'autre part, la formulation de la question, l'échelle de réponse, les possibles douleurs et antécédents médicaux des personnes interrogées, la fatigue et

l'activité cognitive de l'opérateur sont des sources d'erreur durant l'extraction des données de l'auto-questionnaire. Dans cette étude, le questionnaire possède des pictogrammes utilisés pour représenter les postures de flexion/extension du chaque segment du corps à différents degrés (Tableau 1). Pour l'obtention de mesure significative, ces pictogrammes ont été rajoutés au questionnaire pour permettre une représentation mentale des seuils auprès des travailleurs. Alors que, dans l'évaluation des risques par observation des seuils ont été définis sur une échelle numérique. Une des critiques qui peut être faite est la non comparaison des pictogrammes de l'auto-questionnaire à l'échelle numérique de l'outil d'observation. Si l'on intègre l'échelle numérique à l'auto-questionnaire cela pourrait être une source d'erreur car les opérateurs peuvent avoir des difficultés à évaluer le degré de flexion/extension au travers des seuils numérique.

Pour la comparaison des résultats de ces deux outils nous avons rencontré plusieurs difficultés. Tout d'abord le niveau de comparaison des deux outils n'est pas le même, l'un évalue un poste de travail (outil SES) et l'autre s'appuie sur les réponses à l'auto-questionnaire d'un opérateur travaillant sur une zone de travail (plusieurs postes par zone de travail avec rotation des opérateurs). C'est dans ces conditions qu'une analyse par groupe de travail a été préférée pour permettre la comparaison des résultats des deux outils sur la même base unitaire. Une autre difficulté rencontrée est l'échelle des réponses aux deux outils, en effet les résultats de l'outil SES sont présentés sous forme de couleurs représentant les différents niveaux de risque (Vert, Jaune, Rouge), alors que les résultats de l'auto-questionnaire sont présentés sous forme d'échelle prenant en compte la durée d'exposition à un risque (Jamais, Rarement, Souvent, Toujours). Nous avons donc considéré que « Jamais/rarement » faisait référence à la couleur verte, « Souvent » fait référence à la couleur jaune et « Toujours » à la couleur rouge. Cette mise à l'échelle des deux résultats a permis la comparaison sur une base commune, mais cette action a amené une diminution de la puissance de comparaison.

## **Conclusion**

Les résultats de deux outils fréquemment utilisés dans l'industrie automobile ont été comparés dans cette étude. Nous pouvons alors conclure qu'il y a un accord faible entre les résultats de l'auto-questionnaire et l'outil d'observation SES lors d'évaluation du risque physique de TMS. Il est alors important de réfléchir à la place de ces deux outils dans l'évaluation des risques du travail. On ne peut pas considérer qu'une méthode d'évaluation est supérieure à l'autre, les deux fournissent des informations différentes. Cela soulève la question de la complémentarité des outils d'observation et des auto-questionnaires. Reste la question du niveau de précision d'évaluation des risques fournie par ces deux outils. Pour tenter de répondre à cette interrogation, cette étude pourrait être étendue à d'autres outils utilisés couramment dans l'évaluation des risques.

## Références

1. CNAM-TS. Rapport de gestion 2013: Bilan financier et sinistralité. Paris: Caisse nationale de l'assurance maladie des travailleurs salariés, 2013.
2. Coutarel F, Daniellou F, Dugué B. La prévention des troubles musculo-squelettiques: quelques enjeux épistémologiques. @ ctivités. 2005;2(1):3-19.
3. Daniellou F. Développement des TMS: désordre dans les organisations et fictions managériales. 2ème congrès francophone sur les troubles musculo-squelettiques: de la recherche à l'action. 2008.
4. Roquelaure Y, Ha C, Sauteron M. Réseau expérimental de surveillance épidémiologique des troubles musculosquelettiques dans les Pays de la Loire. Surveillance en entreprises en. 2002;2005.
5. Aptel M, Vézina N. Quels modèles pour comprendre et prévenir les TMS. Pour une approche holistique et dynamique. 2008;2.
6. Vézina N. La pratique de l'ergonomie face aux TMS: ouverture à l'interdisciplinarité. Comptes rendus du congrès SELF-ACE. 2001.
7. Widanarko B, Legg S, Devereux J, Stevenson M. The combined effect of physical, psychosocial/organisational and/or environmental risk factors on the presence of work-related musculoskeletal symptoms and its consequences. Applied Ergonomics. 2014 11//;45(6):1610-21.
8. Punnett L, Wegman DH. Work-related musculoskeletal disorders: the epidemiologic evidence and the debate. Journal of Electromyography and Kinesiology. 2004;14(1):13-23.
9. Winkel J, Mathiassen SE. Assessment of physical work load in epidemiologic studies: concepts, issues and operational considerations. Ergonomics. 1994 1994/06/01;37(6):979-88.
10. Xu X, Chang C-c, Faber GS, Kingma I, Dennerlein JT. The Validity and Interrater Reliability of Video-Based Posture Observation During Asymmetric Lifting Tasks. Human Factors: The Journal of the Human Factors and Ergonomics Society. 2011 August 1, 2011;53(4):371-82.
11. Spielholz P, Silverstein B, Morgan M, Checkoway H, Kaufman J. Comparison of self-report, video observation and direct measurement methods for upper extremity musculoskeletal disorder physical risk factors. Ergonomics. 2001;44(6):588-613.
12. Landry A, Van AT. L'évaluation, un outil de l'ergonome pour transformer le contexte d'intervention. Perspectives interdisciplinaires sur le travail et la santé. 2010 (12-2).
13. Hägg GM. Corporate initiatives in ergonomics—an introduction. Applied Ergonomics. 2003;34(1):3-15.
14. Hansson G-Å, Balogh I, Ohlsson K, Granqvist L, Nordander C, Arvidsson I, et al. Physical workload in various types of work: Part II. Neck, shoulder and upper arm. International Journal of Industrial Ergonomics. 2010;40(3):267-81.
15. Widanarko B. Interaction between physical and psychosocial work risk factors for low back symptoms. Manawatu New Zealand: Massey University,; 2013.
16. Clot Y, Faïta D. Genres et styles en analyse du travail: concepts et méthodes: Travailler; 2000.
17. Lacoste M. Le chercheur est la caméra. 1996.
18. Jones T, Kumar S. Comparison of ergonomic risk assessments in a repetitive high-risk sawmill occupation: Saw-filer. International Journal of Industrial Ergonomics. 2007;37(9):744-53.

19. Joseph C, Imbeau D, Nastasia I. Measurement consistency among observational job analysis methods during an intervention study. *International Journal of Occupational Safety and Ergonomics*. 2011;17(2):139-46.
20. Kee D, Karwowski W. A comparison of three observational techniques for assessing postural loads in industry. *International Journal of Occupational Safety and Ergonomics*. 2007;13(1):3-14.
21. Keyserling WM, Stetson DS, Silverstein BA, Brouwer ML. A checklist for evaluating ergonomic risk factors associated with upper extremity cumulative trauma disorders. *Ergonomics*. 1993 1993/07/01;36(7):807-31.
22. Keyserling WM, Brouwer M, Silverstein BA. A checklist for evaluating ergonomic risk factors resulting from awkward postures of the legs, trunk and neck. *International Journal of Industrial Ergonomics*. 1992;9(4):283-301.
23. Hignett S, McAtamney L. Rapid entire body assessment (REBA). *Applied ergonomics*. 2000;31(2):201-5.
24. McAtamney L, Corlett EN. RULA: a survey method for the investigation of work-related upper limb disorders. *Applied ergonomics*. 1993;24(2):91-9.
25. David G, Woods V, Li G, Buckle P. The development of the Quick Exposure Check (QEC) for assessing exposure to risk factors for work-related musculoskeletal disorders. *Applied ergonomics*. 2008;39(1):57-69.
26. David G. Ergonomic methods for assessing exposure to risk factors for work-related musculoskeletal disorders. *Occupational Medicine*. 2005;55(3):190-9.
27. Takala E-P, Pehkonen I, Forsman M, Hansson G-Å, Mathiassen SE, Neumann WP, et al. Systematic evaluation of observational methods assessing biomechanical exposures at work. *Scandinavian journal of work, environment & health*. 2010;36(1):3-24.
28. Denis D, Lortie M, Rossignol M. Observation procedures characterizing occupational physical activities: critical review. *International journal of occupational safety and ergonomics*. 2000;6(4):463-91.
29. Schaub K, Caragnano G, Britzke B, Bruder R. The European assembly worksheet. *Theoretical Issues in Ergonomics Science*. 2013;14(6):616-39.
30. Roquelaure Y, Ha C, Leclerc A, Touranchet A, Sauteron M, Melchior M, et al. Epidemiologic surveillance of upper- extremity musculoskeletal disorders in the working population. *Arthritis Care & Research*. 2006;55(5):765-78.
31. Roquelaure Y, Mariel J, Fanello S, Boissiere J, Chiron H, Dano C, et al. Active epidemiological surveillance of musculoskeletal disorders in a shoe factory. *Occupational and environmental medicine*. 2002;59(7):452-8.
32. Barrero LH, Katz JN, Dennerlein JT. Validity of self-reported mechanical demands for occupational epidemiologic research of musculoskeletal disorders. *Scandinavian journal of work, environment & health*. 2009;35(4):245.
33. Barriera-Viruet H, Sobeih TM, Daraiseh N, Salem S. Questionnaires vs observational and direct measurements: a systematic review. *Theoretical Issues in Ergonomics Science*. 2006;7(3):261-84.



34. Stock SR, Fernandes R, Delisle A, Vézina N. Reproducibility and validity of workers' self-reports of physical work demands. *Scandinavian journal of work, environment & health*. 2005;409-37.
35. Somville P-R. Évaluation de l'exposition professionnelle aux facteurs de risque mécaniques de la lombalgie dans un contexte épidémiologique 2007.
36. Trask C, Teschke K, Morrison J, Village J, Johnson P, Koehoorn M. Using observation and self-report to predict mean, 90th percentile, and cumulative low back muscle activity in heavy industry workers. *Annals of occupational hygiene*. 2010;meq011.
37. Descatha A, Roquelaure Y, Caroly S, Evanoff B, Cyr D, Mariel J, et al. Self-administered questionnaire and direct observation by checklist: comparing two methods for physical exposure surveillance in a highly repetitive tasks plant. *Applied ergonomics*. 2009;40(2):194-8.
38. Waters TR, Putz-Anderson V, Garg A, Fine LJ. Revised NIOSH equation for the design and evaluation of manual lifting tasks. *Ergonomics*. 1993;36(7):749-76.
39. Sluiter JK, Rest KM, Frings-Dresen MH. Criteria document for evaluating the work-relatedness of upper-extremity musculoskeletal disorders. *Scandinavian journal of work, environment & health*. 2001;1-102.
40. Descatha A, Roquelaure Y, Ha C, Touranchet A, Chastang J, Mariot C, et al. Epidemiological surveillance of work-related upper limb musculoskeletal disorders. *ARCHIVES DES MALADIES PROFESSIONNELLES ET DE L ENVIRONNEMENT*. 2007;68(2):153-60.
41. Hansson G-Å, Balogh I, Byström JU, Ohlsson K, Nordander C, Asterland P, et al. Questionnaire versus direct technical measurements in assessing postures and movements of the head, upper back, arms and hands. *Scandinavian journal of work, environment & health*. 2001;30-40.
42. Bao S, Howard N, Spielholz P, Silverstein B, Polissar N. Interrater reliability of posture observations. *Human Factors: The Journal of the Human Factors and Ergonomics Society*. 2009.
43. Burdorf A, Laan J. Comparison of methods for the assessment of postural load on the back. *Scandinavian journal of work, environment & health*. 1991;425-9.
44. Juul-Kristensen B, Hansson G-Å, Fallentin N, Andersen J, Ekdahl C. Assessment of work postures and movements using a video-based observation method and direct technical measurements. *Applied ergonomics*. 2001;32(5):517-24.
45. Balogh I, Ørbæk P, Ohlsson K, Nordander C, Unge J, Winkel J, et al. Self-assessed and directly measured occupational physical activities—influence of musculoskeletal complaints, age and gender. *Applied ergonomics*. 2004;35(1):49-56.
46. Nordstrom DL, Vierkant RA, Layde PM, Smith MJ. Comparison of self-reported and expert-observed physical activities at work in a general population. *American journal of industrial medicine*. 1998;34(1):29-35.
47. Kilbom Å. Assessment of physical exposure in relation to work-related musculoskeletal disorders—what information can be obtained from systematic observations. *Scandinavian journal of work, environment & health*. 1994;30-45.

## Annex

Tableau 1: Analyse des observations pour les 4 postes du groupe de travail n°1, les 5 postes du groupe de travail n°2 et pour les 10 évaluations du groupe de travail n°3 au travers des 11 critères

Unité d'information	Groupe N°1 n=8				Groupe N°2 n=6				Groupe N°3 n=7												
	Vert		Jaune		Rouge		Couleur Finale	Vert		Jaune		Rouge		Couleur Finale							
	n	%	n	%	n	%		n	%	n	%	N	%		n	%	n	%	N	%	
Répétition	2	50	2	50	0	0	Vert	3	60	2	40	0	0	Vert	6	60	3	30	1	10	Vert
Posture de travail	0	0	0	0	4	100	Rouge	4	80	0	0	1	20	Jaune	3	30	4	40	3	30	Jaune
Posture du dos	0	0	1	25	3	75	Rouge	1	20	3	60	1	20	Jaune	1	10	4	40	5	50	Rouge
Posture du cou	0	0	2	50	2	50	Rouge	2	40	0	0	3	60	Rouge	2	20	6	60	2	20	Jaune
Posture des épaules	1	25	0	0	3	75	Rouge	1	20	2	40	2	40	Rouge	1	10	3	30	5	50	Rouge
Posture des poignets	0	0	0	0	4	100	Rouge	2	40	0	0	3	60	Rouge	2	20	0	0	8	80	Rouge
Effort des paumes de mains (surface de pression)	4	100	0	0	0	0	Vert	4	80	0	0	1	20	Jaune	10	100	0	0	0	0	Vert
Force et effort corps Manipulation (Taille du composant)	2	50	1	25	1	25	Jaune	1	20	1	20	3	60	Rouge	4	40	4	40	2	20	Jaune
Port de charge Levage deux mains (NIOSH)	3	75	1	25	0	0	Vert	3	60	1	20	1	20	Jaune	5	50	5	50	0	0	Vert
Port de charge Levage une main	4	100	0	0	0	0	Vert	4	80	1	20	0	0	Vert	7	70	2	20	1	10	Vert
	1	25	3	75	0	0	Jaune	0	0	4	80	1	20	Rouge	2	20	7	70	1	10	Jaune

Tableau 2: Analyse des ressentis issus des auto-questionnaires des groupes de travail n°1, 2 et 3 au travers des 11 critères.

Item	Groupe de travail n°1 (N=8)						Groupe de travail n°2 (N=6)						Groupe de travail n°3 (N=7)						Ensemble des salariés (N=21)					
	Jamais/ Rarement		Souvent		Toujours		Jamais/ Rarement		Souvent		Toujours		Jamais/ Rarement		Souvent		Toujours		Jamais/ Rarement		Souvent		Toujours	
	n	%	n	%	n	%	n	%	n	%	n	%	n	%	n	%	n	%	n	%	n	%	n	%
Répétition	0	0	5	63	3	38	0	0	3	50	3	50	0	0	4	57	3	43	0	0	12	57	9	43
Posture de travail	3	38	3	38	2	25	2	33	4	67	0	0	1	14	5	71	1	14	6	29	12	57	3	14
Posture du dos	3	38	5	63	0	0	0	0	5	100	0	0	2	29	5	71	0	0	5	25	15	75	0	0
Posture du cou	1	13	5	63	2	25	1	17	5	83	0	0	0	0	6	86	1	14	2	10	16	76	3	14
Posture des épaules	3	38	3	38	2	25	1	17	5	83	0	0	3	43	4	57	0	0	7	33	12	57	2	10
Posture des poignets	2	25	4	50	2	25	2	33	2	33	2	33	1	14	5	71	1	14	5	24	11	52	5	24
Effort des paumes de mains	8	100	0	0	0	0	6	100	0	0	0	0	6	86	1	14	0	0	20	95	1	5	0	0
Force et effort	3	38	4	50	1	13	1	17	2	33	3	50	0	0	7	100	0	0	4	19	13	62	4	19
Manipulation	7	88	1	13	0	0	5	83	1	17	0	0	5	71	2	29	0	0	17	81	4	19	0	0
Porter une charge																								
1-10kg	5	62,5	1	12,5	2	25,0	4	66,7	2	33,3	0	0,0	2	28,6	4	57,1	1	14,3	11	52,4	7	33,3	3	14,3
10- 25kg	7	87,5	1	12,5	0	0,0	6	100,0	0	0,0	0	0,0	4	57,1	3	42,9	0	0,0	17	81,0	4	19,1	0	0,0
>25 kg	8	100,0	0	0,0	0	0,0	6	100,0	0	0,0	0	0,0	6	100,0	0	0,0	0	0,0	20	100,0	0	0,0	0	0,0
Manipuler régulièrement un outil ou un objet																								
1-4kg	3	37,5	3	37,5	2	25,0	2	33,3	1	16,7	3	50,0	0	0,0	6	85,7	1	14,3	5	23,8	10	47,6	6	28,6
>4kg	4	50,0	3	37,5	1	12,5	2	33,3	3	50,0	1	16,7	4	57,1	2	28,6	1	14,3	10	47,6	8	38,1	3	14,3

# Thèse de Doctorat

Mohsen ZARE MAHMOUDABADI

## Shared representation of work-related musculoskeletal risk factors and comparison of assessment methods: an experimental study in the truck manufacturing industry

Représentation partagée des facteurs de risque des troubles musculo-squelettiques et comparaison des méthodes d'évaluation : une étude expérimentale dans le secteur de l'assemblage de camions

### Résumé

Les facteurs de risque de troubles musculo-squelettiques (TMS) tels que les facteurs physiques, organisationnels et psychosociaux sont un défi commun pour les industries de l'assemblage automobile qui entraînent des effets indésirables sur le système et les humains. L'ergonomie a déjà été intégrée dans les systèmes de production de ces industries pour la prise en charge de la prévention des TMS. La question est de savoir si l'approche ergonomique actuelle des industries automobiles, sur la base de normes à l'entreprise et des méthodes d'observation, peut fournir une connaissance partagée des facteurs ergonomiques pour les divers intervenants et pour faciliter l'amélioration des conditions de travail.

Cette étude aborde la problématique du positionnement des différentes méthodes d'évaluation (utilisées par les différents intervenants) et compare les résultats et apports de chaque méthode d'évaluation. Cette thèse propose que la procédure actuelle d'évaluation des risques de TMS ne favorise pas une connaissance partagée entre les intervenants dans les industries automobiles. On constate que les évaluations par auto-questionnaire (opérateurs) sont significativement différentes de celles issues des méthodes d'observation (ergonome) et des mesures directes (analyse biomécanique). Cependant, les opinions et jugements des opérateurs concernant les facteurs ergonomiques sont importants pour faciliter la réussite d'une approche ergonomique. Un entretien structuré et systématisé, basé sur des données objectives (Video-observations ou de mesure directe) liées aux activités et stratégies des opérateurs, pourrait être une procédure appropriée pour faire progresser l'ergonomie des situations de travail.

Enfin, la connaissance tirée de cette thèse souligne que la variabilité des tâches dans l'industrie automobile nécessite une approche ergonomique qui partage les connaissances des risques entre les intervenants. Dans cette approche, les attitudes et les comportements des opérateurs sont pris en compte dans les projets d'amélioration continue. De plus, la participation des intervenants devrait être intégrée afin d'améliorer la prise en compte de l'ergonomie dans la production. Une synthèse de cette thèse en Français a été fournie dans l'annexe première.

**Mots clés :** Ergonomie, Troubles musculo-squelettiques (TMS), Facteurs de risques physiques, Evaluation de l'exposition, Méthode d'observation, Auto-questionnaire, Mesure directe, Représentation partagée, Intervention, Variabilité, Usine de fabrication de camion.

### Abstract

Musculoskeletal risk factors such as physical, organizational and psychosocial factors are a common challenge for the automotive assembly industries and result in adverse human and system effects. Ergonomics has already been integrated in the production systems of such factories to eliminate work-related musculoskeletal disorders (WR-MSDs). The issue is whether the current ergonomic approach of car industries, based on corporate standards and observational methods, can provide a shared knowledge of ergonomic factors for various stakeholders and facilitate ergonomic improvement.

This study focuses on the positioning of the different assessment methods (used by various stakeholders), agreement between their results in evaluation of physical risk factors and the influence of intervention and improvement following ergonomic assessment. This thesis proposes that the current procedure of risk factor assessment cannot provide a shared knowledge and representation of risks between stakeholders in manufacturing industries. It was found that the operators' assessments of risk factors (self-reported questionnaire) were significantly different from those assessed by observational methods (ergonomist) and direct measurement. However, the operators' opinions and judgments of ergonomic factors of a job are of particular importance to the success of an ergonomic approach. A structured interview based on objective data (video-observation or direct measurement) linked the activities and strategies of at risk operators might be an appropriate procedure to advance ergonomics.

The knowledge gained from this study emphasizes that the variable nature of tasks in manufacturing industries needs an ergonomic approach which shares knowledge and representation of risks between stakeholders. In such an approach, attitudes and behaviors of operators are taken into consideration in developing new intervention processes, organizational and technical remedies. Moreover, involvement of stakeholders should be integrated and this should result in improving production ergonomics.

**Key Words:** Ergonomics, Work-related musculoskeletal disorders, Physical risk factors, Exposure assessment, Observational method, Self-reported questionnaire, Direct measurement, Shared representation, Intervention, Diversity, Truck manufacturing plant