



HAL
open science

A random hike between combinatorics and statistical mechanics

Cong Bang Huynh

► **To cite this version:**

Cong Bang Huynh. A random hike between combinatorics and statistical mechanics. Combinatorics [math.CO]. Université Grenoble Alpes, 2019. English. NNT : 2019GREAM026 . tel-02303529

HAL Id: tel-02303529

<https://theses.hal.science/tel-02303529v1>

Submitted on 2 Oct 2019

HAL is a multi-disciplinary open access archive for the deposit and dissemination of scientific research documents, whether they are published or not. The documents may come from teaching and research institutions in France or abroad, or from public or private research centers.

L'archive ouverte pluridisciplinaire **HAL**, est destinée au dépôt et à la diffusion de documents scientifiques de niveau recherche, publiés ou non, émanant des établissements d'enseignement et de recherche français ou étrangers, des laboratoires publics ou privés.



THÈSE

Pour obtenir le grade de

DOCTEUR DE LA COMMUNAUTÉ UNIVERSITÉ GRENOBLE ALPES

Spécialité : Mathématiques

Arrêté ministériel : 25 mai 2016

Présentée par

Cong Bang HUYNH

Thèse dirigée par **Vincent BEFFARA**, DR
et codirigée par **Benjamin LEVEQUE**, Chercheur, Communauté
Université Grenoble Alpes

préparée au sein du **Laboratoire Institut Fourier**
dans l'**École Doctorale Mathématiques, Sciences et**
technologies de l'information, Informatique

Une promenade aléatoire entre combinatoire et mécanique statistique

A random hike between combinatorics and statistical mechanics

Thèse soutenue publiquement le **27 juin 2019**,
devant le jury composé de :

Monsieur VINCENT BEFFARA

DIRECTEUR DE RECHERCHE, CNRS DELEGATION ALPES, Directeur
de thèse

Monsieur BENJAMIN LEVEQUE

CHARGE DE RECHERCHE, CNRS DELEGATION ALPES, Co-directeur
de thèse

Monsieur CHRISTOPHE GARBAN

PROFESSEUR, UNIVERSITE LYON 1, Président

Madame MARIE ALBENQUE

CHARGE DE RECHERCHE, CNRS ILE-DE-FRANCE-GIF-SUR-
YVETTE, Examineur

Monsieur GILLES SCHAEFFER

DIRECTEUR DE RECHERCHE, CNRS ILE-DE-FRANCE-GIF-SUR-
YVETTE, Rapporteur

Monsieur NATHANAËL ENRIQUEZ

PROFESSEUR, UNIVERSITE PARIS-SUD, Rapporteur

Monsieur RAPHAËL ROSSIGNOL

MAITRE DE CONFERENCES, UNIVERSITE GRENOBLE ALPES,
Examineur

Monsieur ARVIND SINGH

CHARGE DE RECHERCHE, CNRS ILE-DE-FRANCE-GIF-SUR-
YVETTE, Examineur

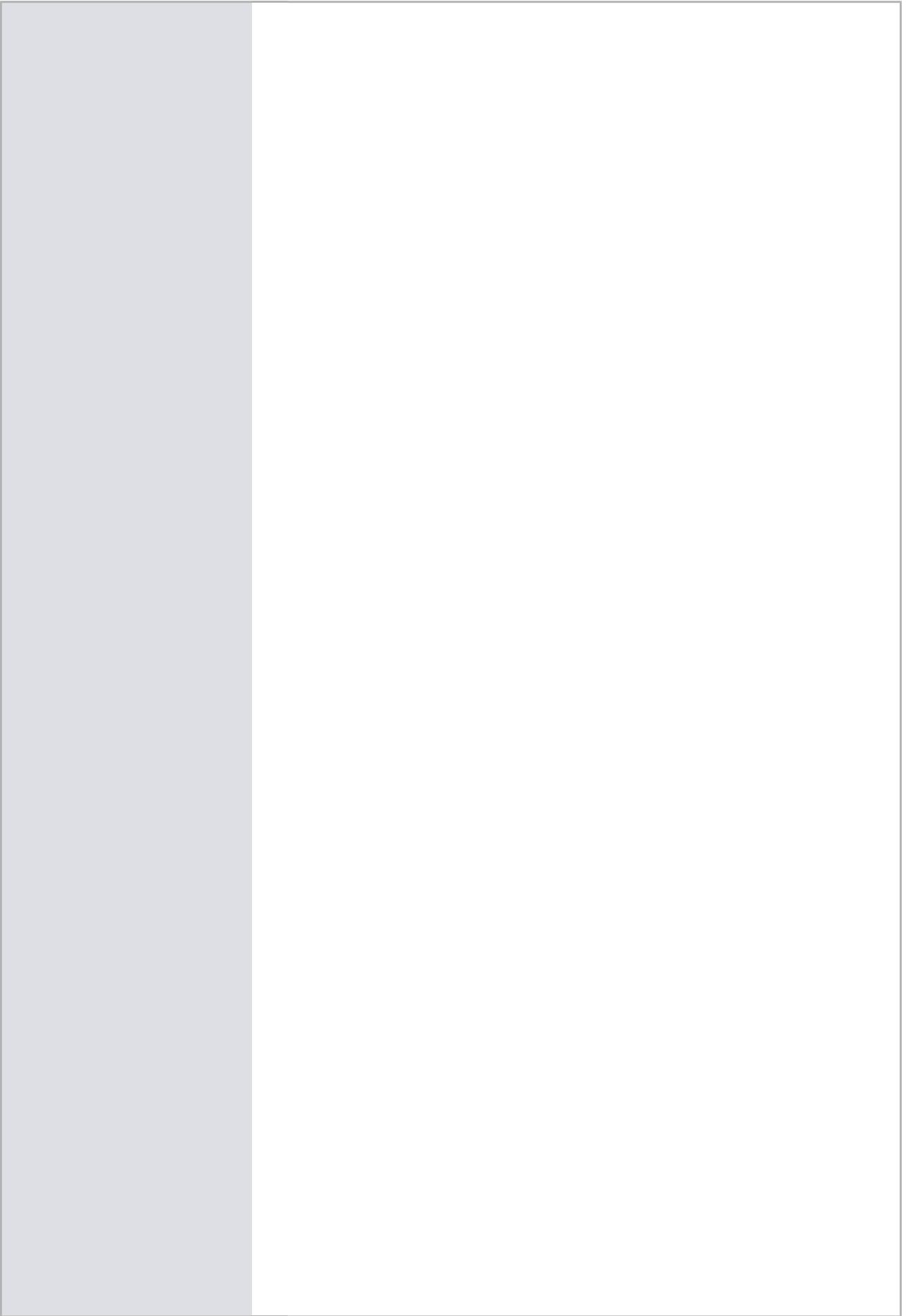

UNE PROMENADE ALÉATOIRE ENTRE
COMBINATOIRE ET MÉCANIQUE STATISTIQUE

Cong Bang Huynh

5 mai 2019

Résumé

Cette thèse se situe à l'interface entre combinatoire et probabilités, et contribue à l'étude de différents modèles issus de la mécanique statistique : polymères, marches aléatoires inter-agissantes ou en milieu aléatoire, cartes aléatoires.

Le premier modèle que nous étudions est une famille de mesures de probabilités sur les chemins auto-évitants de longueur infinie sur un réseau régulier, construites à partir de marches aléatoires biaisées sur l'arbre des chemins auto-évitants finis. Ces mesures, introduites par Beretti et Sokal, existent pour tout biais strictement supérieur à l'inverse de la constante de connectivité, et leur limite en ce biais critique serait l'une des définitions naturelles de la marche aléatoire uniforme en longueur infinie. Le but de ce travail, en collaboration avec Vincent Beffara, est de comprendre le lien entre cette limite, si elle existe, et d'autres chemins aléatoires notamment la mesure de Kesten (qui est la limite faible de la marche auto-évitante uniforme dans le demi-plan) et les interfaces de percolation de Bernoulli critique ; d'une certaine façon le modèle constitue une interpolation entre les deux.

Dans une deuxième partie, nous considérons des marches aléatoires en conductances aléatoires sur un arbre quelconque, dans le cas où la loi des conductances est à queue lourde. L'objectif de notre travail, en collaboration avec Andrea Collecchio et Daniel Kious, est de montrer une transition de phase par rapport au paramètre de la queue ; on exprime le paramètre critique comme une fonction explicite de l'arbre sous-jacent.

Parallèlement, nous étudions des modèles de marches aléatoires excitées sur des arbres et leurs transitions de phase. En particulier, nous étendons une conjecture de Volkov et généralisons des résultats de Basdevant et Singh.

Enfin, une troisième partie en collaboration avec Vincent Beffara et Benjamin Lévêque porte sur les cartes aléatoires en genre supérieur : nous montrons l'existence de limites d'échelle, le long de sous-suites, pour les triangulations simples uniformes sur le tore, étendant à ce cas les résultats d'Addario-Berry et Albenque (sur les triangulations simples de la sphère) et de Bettinelli (sur les quadrangulations du tore). La question de l'unicité de la limite et de son universalité restent ouvertes, mais nous obtenons des résultats partiels dans ce sens.

Abstract

This thesis is at the interface between combinatorics and probability, and contributes to the study of a few models stemming from statistical mechanics: polymers, self-interacting random walks and random walks in random environment, random maps.

The first model that we investigate is a one-parameter family of probability measures on self-avoiding paths of infinite length on a regular lattice, constructed from biased random walks on the tree of finite self-avoiding paths. These measures, initially introduced by Beretti and Sokal, exist for every bias larger than the inverse connectivity constant, and their limit at the critical bias would be among the natural definitions of the uniform self-avoiding walk of infinite length. The aim of our work, in collaboration with Vincent Beffara, is to understand the link between this limit, if it indeed exists, and other random infinite paths such as Kesten's measure (which is the weak limit of uniformly random finite self-avoiding walks in the half-plane) and critical Bernoulli percolation interfaces; the model can be seen as an interpolation between these two.

In a second part, we consider random walks with random conductances on a tree, in the case when the law of the conductances has heavy tail. Our aim, in collaboration with Andrea Collevecchio and Daniel Kious, is to show a phase transition in the tail parameter; we express the critical point as an explicit function of the underlying tree.

In parallel, we study excited random walks on trees and their phase transitions: we extend a conjecture of Volkov's and generalize results by Basdevant and Singh.

Finally, a third part in collaboration with Vincent Beffara and Benjamin Lévêque contributes to the study of random maps of higher genus: we show the existence of subsequential scaling limits for uniformly random simple triangulations of the torus, extending to that setup former results by Addario-Berry and Albenque (on simple triangulations of the sphere) and by Bettinelli (on quadrangulations of the torus). The question of uniqueness and universality of the limit remain open, but we obtain partial results in that direction.

Acknowledgment/Remerciement

Table des matières

Table des matières	5
1 Introduction	11
1 Percolation	11
1.1 A little bit of graph theory	11
1.2 Percolation	17
2 Self-avoiding walks	23
2.1 Some definitions	23
2.2 The connective constant	24
2.3 The Hammersley-Welsh method	25
2.4 Some conjectures	28
3 Random walks on trees	30
3.1 Random walks and electrical networks	30
3.2 Biased random walks on trees	37
3.3 Percolation and random walks on trees	39
3.4 Self-avoiding walks and biased random walks on trees	41
4 Excited RW and RW in random environment	43
4.1 Excited random walk	43
4.2 Phase transition for multi-excited random walk on trees	46
4.3 Random walk in random environment	50
5 Random maps	53
5.1 Some definitions	53
5.2 Triangulations of the torus	55
5.3 Scaling limits	56
5.4 Some recent results	57
5.5 Scaling limits for random simple triangulations on the torus	58
6 Outline of the main body of the thesis	59
I Statistical mechanics	61
2 Trees of self-avoiding walk	63

1	Introduction	64
1.1	The model	64
1.2	Main results	65
1.3	Open questions	66
1.4	Organization of the paper	67
2	Notation and basic definitions	67
2.1	Graphs and trees	67
2.2	Branching and growth	68
2.3	Random walks on trees	69
2.4	The law of the first k steps of the limit walk	71
3	A few examples	72
3.1	Trees with discontinuous conductance	72
3.2	The convergence of the law of the first k steps	74
4	The continuity of effective conductance	78
4.1	Left- and right-continuity of $\mathcal{C}(\mathcal{T}, \lambda)$	78
4.2	Proof of Theorem 1.4	80
5	Self-avoiding walks	83
5.1	Walks and bridges	83
5.2	Kesten's measure	84
5.3	Proof of Proposition 1.1	85
5.4	Proof of Theorem 1.3	87
6	The biased walk on the self-avoiding tree	88
6.1	The limit walk	89
6.2	The case $\lambda = +\infty$ and percolation	89
6.3	Proof of Theorem 1.2	90
6.4	The law of first k -steps of limit walk	104
7	The critical probability measure through biased random walk	105
7.1	The critical probability measure	105
7.2	Conjectures	109
3	Perspectives and conjectures	111
1	A coupling between random walk and supercritical percolation	111
2	The locality property	117
2.1	The space of continuous curves	117
2.2	The locality property of limit walk	118
II Random walks in random environment		127
4	The branching-ruin number as critical parameter of random processes on trees	129
1	Introduction	130

1.1	Random walk on heavy-tailed random conductances	130
1.2	The M -digging random walk	132
2	The models	133
2.1	Notation	133
2.2	The Branching Number and The Branching-Ruin Number	133
2.3	Formal definition of the models	134
3	Main results	136
3.1	Main results about RWRC	136
3.2	Main results about the M -DRW $_{\lambda}$	137
4	Preliminary results	138
5	Proof of Proposition 3.1 and Theorem 1.1	141
5.1	Transience: proof of the first item of Proposition 3.1	141
5.2	Recurrence: proof of the second item of Proposition 3.1	147
6	Proof of Theorem 3.3 and Lemma 3.6	150
7	Extensions	152
8	Proof of Theorem 3.5	154
8.1	Link with percolation	154
8.2	Recurrence in Theorem 3.5: The case $RT(\mathcal{T}, \psi_{M,\lambda}) < 1$	155
8.3	Transience in Theorem 3.5: The case $RT(\mathcal{T}, \psi_{M,\lambda}) > 1$	155
9	Appendix: Proof of Proposition 4.2	158
9.1	Proof of Proposition 4.2 in the case $RT(\mathcal{T}, \psi) < 1$	159
9.2	Proof of Proposition 4.2 in the case $RT(\mathcal{T}, \psi) > 1$	159
5	Phase transition for the Once-excited random walk on general trees 163	
1	Introduction	164
2	The model	166
2.1	Notation	166
2.2	Some quantities on trees	167
2.3	Definition of the model	168
3	Main results	169
3.1	Main results about Once-excited random walk	169
3.2	Main results about critical M -Digging random walk	170
4	An example	170
5	Proof of Theorem 1.2	171
6	Proof of Lemma 3.2 and Theorem 1.1	171
7	Extensions	175
8	Recurrence in Theorem 3.1: The case $RT(\mathcal{T}, \mathbf{X}) < 1$	178
9	Transience in Theorem 3.1: The case $RT(\mathcal{T}, \mathbf{X}) > 1$	178
9.1	Link with percolation	179
9.2	Transience in Theorem 3.1: The case $RT(\mathcal{T}, \mathbf{X}) > 1$	186
10	Proof of Theorem 3.3	186

10.1	Some definitions	187
10.2	Proof of Theorem 3.3	187
III Random maps		193
6	Scaling limits for random triangulations on the Torus	195
1	Introduction	196
1.1	Some definitions	196
1.2	Random planar maps	196
1.3	Main results	197
2	Bijection between toroidal triangulations and unicellular maps	200
2.1	Toroidal unicellular maps	200
2.2	Closure procedure	202
2.3	Canonical orientation and balanced property	203
2.4	Unrooted unicellular maps	205
3	Labeling of the angles and distance properties	206
3.1	Definition and properties of the labeling function	206
3.2	Relation with the graph distance	213
4	Decomposition of unicellular maps	215
4.1	Forests and well-labelings	215
4.2	Relation between well-labeled forests and 3-dominating binary words	219
4.3	Motzkin paths	220
4.4	Decomposition of unicellular maps into well-labeled forests and Motzkin paths	221
4.5	Relation with labels of the unicellular map	227
5	Some variants of Brownian motion	231
6	Convergence of the parameters in the decomposition	233
7	Convergence of uniformly random Motzkin paths	243
8	Convergence of uniformly random 3-dominating binary words	247
8.1	Review and generalization of a result of Bertoin, Chaumont and Pitman	248
8.2	Convergence to the first-passage Brownian bridge	249
9	Convergence of the contour pair of well-labeled forests	254
9.1	Tightness of the contour function	254
9.2	Conditioned Galton-Watson forest	256
9.3	Symmetrization of a forest	257
9.4	Tightness of the labeling function of a symmetrized Galton-Watson forest	260
9.5	Convergence of the contour function	262
9.6	Convergence of the contour pair	265

10	Convergence of uniformly random toroidal triangulations	267
10.1	Convergence of the shifted labeling function of the unicellular map	269
10.2	Subsequential convergence of the pseudo-distance function of the unicellular map	271
10.3	Convergence for the Gromov-Hausdorff distance	272
1	Approximation of distance by labels	275
1.1	Rightmost walks and distance properties	275
1.2	Approximation of distances by labels	288
	Bibliography	293

Chapter 1

Introduction

1 Percolation

1.1 A little bit of graph theory

In this section, we review some basic definitions of graph theory. We refer the readers to [19, 37, 87, 88, 91] for more details.

Graphs

A *graph* is a pair $\mathcal{G} = (V, E)$ that satisfies the condition $E \subset \binom{V}{2}$, where $\binom{V}{2}$ denotes the set of pairs of elements of V . The elements of $V = V(\mathcal{G})$ are called the *vertices* (or *sites*) of \mathcal{G} while the elements of $E = E(\mathcal{G})$ are called *edges* of \mathcal{G} . If u and v satisfy $\{u, v\} \in E$, then u and v are *neighbours* (or *adjacent*) as well as the *endpoints* of the edge $\{u, v\}$. In this case, we also says that the edge $\{u, v\}$ connects u and v .

A *subgraph* of a graph \mathcal{G}_1 is a graph \mathcal{G}_2 which satisfies $V(\mathcal{G}_2) \subset V(\mathcal{G}_1)$ and $E(\mathcal{G}_2) \subset E(\mathcal{G}_1)$. If V' is a subset of $V(\mathcal{G})$ of a graph \mathcal{G} , then the *restriction* of \mathcal{G} to V' is the graph $(V', \binom{V'}{2} \cap E(\mathcal{G}))$. We also say that \mathcal{G} induces the graph structure $(V', \binom{V'}{2} \cap E(\mathcal{G}))$ on V' .

One can define the product of two graphs $\mathcal{G}_i = (V_i, E_i)$ for $i \in \{1, 2\}$ in various ways. One of the most popular ways is the *Cartesian product* $\mathcal{G} = (V, E)$ with $V = V_1 \times V_2$ and

$$E = \{((u_1, u_2), (v_1, v_2)) : (u_1 = v_1, (u_2, v_2) \in E_2) \text{ or } (u_2 = v_2, (u_1, v_1) \in E_1)\}.$$

A *morphism* of \mathcal{G}_1 to \mathcal{G}_2 is a application ϕ from $V(\mathcal{G}_1)$ to $V(\mathcal{G}_2)$ such that for any $\{x, y\} \in E(\mathcal{G}_1)$, we also have $\{\phi(x), \phi(y)\} \in E(\mathcal{G}_2)$. A *isomorphism* is a morphism which is bijective and such that the reciprocal is a morphism. A *automorphism* is a isomorphism from a graph to itself.

Let \mathcal{G} be a graph. If $v \in V(\mathcal{G})$, then the *degree* of v is the number of its neighbors, denoted by $\deg v$. A *path* in a graph is a sequence of vertices where each successive pair of vertices is an edge in the graph. The path is called *self-avoiding* if no pair of vertices are the same. In the remain of this thesis, we assume that we consider only the self-avoiding paths.

A finite path with at least one edge and whose first and last vertices are the same is called a *cycle*. A cycle is called *simple* if no pair of vertices are the same except for its first and last ones. The *length* of a path (or cycle) is the number of edges of path (or cycle). A graph is called *connected* if for all $u, v \in V$, there exists a path joining u to v . The *distance* between u and v is the minimum number of edges among all paths joining u to v and denoted by $d(u, v)$.

Finally, a graph is called *locally finite* if every vertex of \mathcal{G} have finite degree, *d-regular* if each of its vertices is of degree d , and *regular* if there exists $d \in \mathbb{N}$ such that it is d -regular

Trees: Definitions and a few examples

A graph with no cycles is called a *forest*. A *tree* is a connected forest. In a tree, we can choose a particular vertex, denoted by ϱ , this vertex is called *root* of tree.

Let $\mathcal{T} = (V, E)$ be an infinite, locally finite, rooted tree with the root ϱ .

Given two vertices ν, μ of \mathcal{T} , we say that ν and μ are *neighbors*, denoted $\nu \sim \mu$, if $\{\nu, \mu\}$ is an edge of \mathcal{T} .

Let $\nu, \mu \in V \setminus \{\varrho\}$, the *distance* between ν and μ , denoted by $d(\nu, \mu)$, is the minimum number of edges of the unique self-avoiding paths joining x and y . The distance between ν and ϱ is called *height* (or *generation*) of ν , denoted by $|\nu|$. A vertex with no child is called *leaf*. The *parent* of ν is the vertex ν^{-1} such that $\nu^{-1} \sim \nu$ and $|\nu^{-1}| = |\nu| - 1$. We also call ν as a *child* of ν^{-1} .

Denote by \mathcal{T}_n the set of vertices at generation n . We define an order on $V(\mathcal{T})$ as follows: if $\nu, \mu \in V(\mathcal{T})$, we say that $\nu \leq \mu$ if the simple path joining ϱ to μ passes through ν . For each $\nu \in V(\mathcal{T})$, we define the *sub-tree* of \mathcal{T} rooted at ν , denoted by \mathcal{T}^ν , where $V(\mathcal{T}^\nu) := \{\mu \in V(\mathcal{T}) : \nu \leq \mu\}$ and $E(\mathcal{T}^\nu) = E(\mathcal{T})|_{V(\mathcal{T}^\nu) \times V(\mathcal{T}^\nu)}$.

In the remain of this thesis, we only consider the infinite, locally finite and rooted tree. A tree \mathcal{T} is called *spherically symmetric* if for any vertex ν of \mathcal{T} , $\deg \nu$ depends only on $|\nu|$. In the other word, all the vertices in the same generation have the same number of children.

Remark 1.1. A regular tree is a spherically symmetric tree.

Definition 1.2. Let $N \geq 0$: an infinite, locally finite and rooted tree \mathcal{T} with the root ϱ , is said to be

- N -sub-periodic (resp. *periodic*) if for every $\nu \in V(\mathcal{T})$, there exists an injective (resp. *bijective*) morphism $f : \mathcal{T}^\nu \rightarrow \mathcal{T}^{f(\nu)}$ with $|f(\nu)| \leq N$.
- N -super-periodic if for every $\nu \in V(\mathcal{T})$, there exists an injective morphism $f : \mathcal{T} \rightarrow \mathcal{T}^{f(\varrho)}$ with $f(\varrho) \in \mathcal{T}^\nu$ and $|f(\varrho)| - |\nu| \leq N$.

Example. Consider the finite paths in the lattice \mathbb{Z}^2 starting at the origin that go through no vertex more than once. These paths are called self-avoiding and are of substantial interest to mathematical physicists. Form a tree $\mathcal{T}_{\mathbb{Z}^2}$ whose vertices are the finite self-avoiding paths and with two such vertices joined when one path is an extension by one step of the other. Then $\mathcal{T}_{\mathbb{Z}^2}$ is 0-subperiodic and we refer the interested readers to the next chapter for more details on this object.

There is an important class of trees whose structure is periodic. Let \mathcal{G} be a finite graph and $x_0 \in V(\mathcal{G})$. We define a tree \mathcal{T} in the following way: its vertices are the finite path $(x_0, x_1, x_2, \dots, x_n)$ satisfy $x_i \neq x_{i+1}$ for any $0 \leq i \leq n-2$. Join two vertices in \mathcal{T} by an edge when one path is an extension by one vertex of the other. The tree \mathcal{T} is called *universal cover* (based on x_0) of \mathcal{G} . See Figure 1.1 for an example.

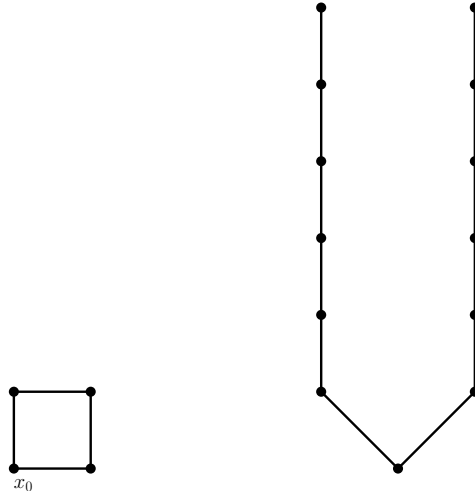

Figure 1.1 – A graph and part of its universal cover

Suppose that \mathcal{G} is a finite directed multigraph and $x_0 \in V(\mathcal{G})$ is any vertex in \mathcal{G} . That is, edges are not required to appear with both orientations, and two vertices can have many edges joining them. Loops are also allowed. We define a tree \mathcal{T} in the following way: its vertices are the finite paths $(e_1, e_2, e_3, \dots, e_n)$ in \mathcal{G} that starts at x_0 . The root is the empty path. We join two vertices in \mathcal{T} as we did in the case of universal cover. The tree \mathcal{T} is called *directed cover* (based on x_0) of \mathcal{G} . See Figure 1.2 for an example.

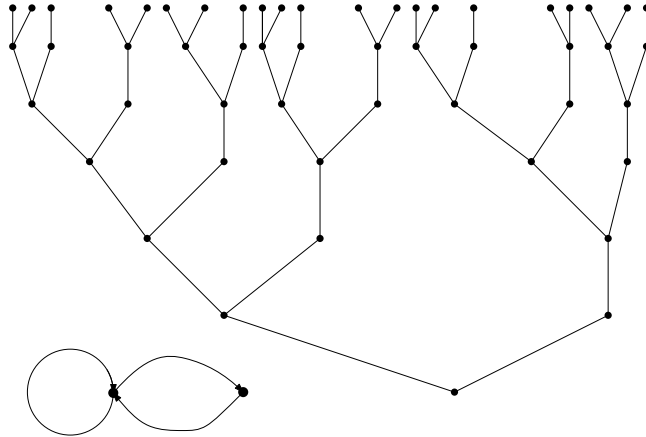

Figure 1.2 – A graph and part of its directed cover

Remark 1.3. All universal cover and directed cover are periodic trees. Conversely, each periodic tree is a directed cover of a graph.

A infinite path starting at the root of a tree \mathcal{T} is called *ray*. The set of rays of \mathcal{T} is called the *boundary* of \mathcal{T} , denoted by $\partial\mathcal{T}$. Define a distance on $\partial\mathcal{T}$ in the following way: if $\xi, \eta \in \partial\mathcal{T}$ have n common edges, we define the distance between ξ, η :

$$d(\xi, \eta) := e^{-n}. \quad (1.1)$$

Proposition 1.4 ([87], page 12). $(\partial\mathcal{T}, d)$ is a compact metric space.

Trees: Branching number and growth rate

Let \mathcal{T} be an infinite, locally finite and rooted tree. A cutset in \mathcal{T} is a set π of edges such that every infinite simple path from a must include an edge in π . The set of cutsets is denoted by Π .

Example. If \mathcal{T} is a tree, then for any $n \geq 1$, we have \mathcal{T}_n is a cutset.

Definition 1.5 ([87], page 81). Let \mathcal{T} be a tree, the branching number of \mathcal{T} is defined by:

$$br(\mathcal{T}) = \sup \left\{ \lambda \geq 1; \inf_{\Pi} \sum_{e \in \Pi} \lambda^{-|e|} > 0 \right\}$$

where we take the inf on the cutsets.

In general, it is difficult to compute the branching number of a tree. So, we will define another quantity that is easy to calculate and to establish relations between this quantity and the branching number.

Definition 1.6. (Growth rate)

Let \mathcal{T} be a tree and we define:

$$\overline{gr(\mathcal{T})} = \limsup |\mathcal{T}_n|^{\frac{1}{n}} \quad (1.2)$$

$$\underline{gr(\mathcal{T})} = \liminf |\mathcal{T}_n|^{\frac{1}{n}} \quad (1.3)$$

In the case of $\overline{gr(\mathcal{T})} = \underline{gr(\mathcal{T})}$, we define the growth rate of \mathcal{T} , denoted by $gr(\mathcal{T})$

$$gr(\mathcal{T}) = \overline{gr(\mathcal{T})} = \underline{gr(\mathcal{T})}. \quad (1.4)$$

Example. If \mathcal{T} is a d -regular tree, then its growth rate is $d - 1$.

In the remain of this section, we establish some relations between the branching number and growth rate of a tree.

Proposition 1.7. Let \mathcal{T} be an infinite, locally finite and rooted tree. We then have

$$br(\mathcal{T}) \leq \underline{gr(\mathcal{T})} \quad (1.5)$$

In general, the inequality in Proposition 1.7 may be strict. For instance, we construct a tree \mathcal{T} (called 1-3 tree) in the following way: its root is ρ . We'll have $|\mathcal{T}_n| = 2^n$, but we will connect them in a funny way. List \mathcal{T}_n in counterclockwise order as $(x_1^n, \dots, x_{2^n}^n)$. Let x_k^n have one child if $k \leq 2^{n-1}$ and three children otherwise (see Figure 1.3).

By the definition of growth rate, we have $gr(\mathcal{T}) = 2$. By using Definition 1.5, we can prove that $br(\mathcal{T}) = 1$. Indeed, it suffices to prove that:

$$\forall \lambda > 1, \inf_{\Pi} \sum_{e: e^- \in \Pi} \lambda^{-|e|} = 0 \quad (1.6)$$

We fix $\lambda > 1$. Consider $x \in V(\mathcal{T})$ and recall that \mathcal{T}^x is the largest subtree of \mathcal{T} rooted at x . For all n and $1 \leq i \leq 2^n$, let x_i^n denote the i -th vertex at generation n (see Figure 1.4). We can see that for all $k > 0$, there exists $\ell > 0$ such that: for all $n \geq \ell$ and i such that $x_i^n \notin \mathcal{T}^{x_{2^k}^k}$, then x_i^n have only one child. We define:

$$\Pi_n^k := \left\{ x_{2^k}^k; \mathcal{T}_n \setminus \mathcal{T}^{x_{2^k}^k} \right\}, \forall n \geq \ell \quad (1.7)$$

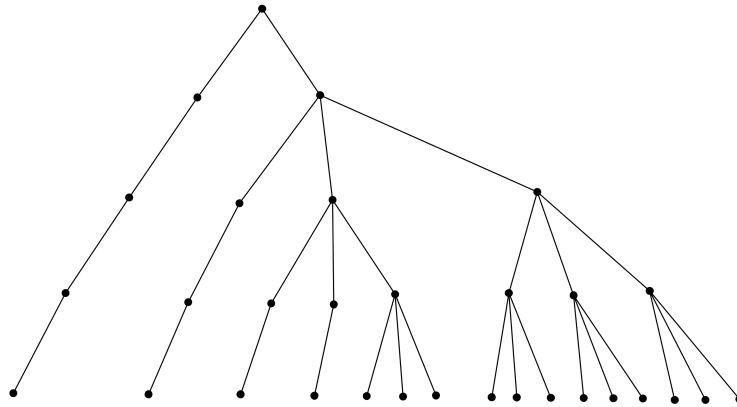

Figure 1.3 – Arbre 1-3

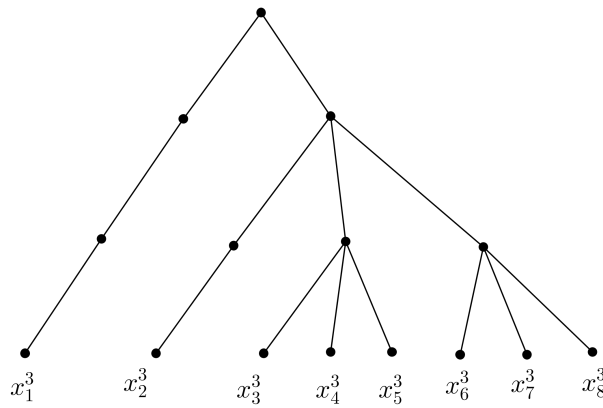

Figure 1.4

We then obtain

$$\sum_{e: e \in \Pi_n^k} \lambda^{-|e|} \leq \frac{1}{\lambda^k} + \frac{c}{\lambda^n} \tag{1.8}$$

where c is the cardinal of $\mathcal{T}_n \setminus \mathcal{T}_{2^k}^{x_{2^k}}$, $n \geq \ell$ which do not depend on n .

By letting n go to $+\infty$ and then k goes to $+\infty$, we obtain

$$\inf_{\Pi} \sum_{e: e \in \Pi} \lambda^{-|e|} = 0. \tag{1.9}$$

It is easy to arise a question: When will the inequality in Proposition 2.4 become an equality? In the remain of this part, we will answer this question in 3 particular classes of trees: spherically symmetric, sub-periodic and super-periodic.

Theorem 1.8 ([87] page 83). *For all \mathcal{T} spherically symmetric such that $gr(\mathcal{T})$ exists, we have $br(\mathcal{T}) = gr(\mathcal{T})$.*

Theorem 1.9 ([87] page 85). *For all sub-periodic tree \mathcal{T} , the growth rate $gr(\mathcal{T})$ exists and $gr(\mathcal{T}) = br(\mathcal{T})$.*

Theorem 1.10 ([87] page 87). *For all super-periodic tree \mathcal{T} with $\overline{gr(\mathcal{T})} < \infty$, $gr(\mathcal{T})$ exists and $gr(\mathcal{T}) = br(\mathcal{T})$.*

1.2 Percolation

In this section, we review some definitions and properties of percolation theory. We refer the interested readers to [26, 56, 91, 119] for more details.

Percolation is a model of statistical mechanics that was introduced in 1957 by Broadbent and Hammersley [26]. Let $\mathcal{G} = (V, E)$ be a graph. A *percolation* (or *edge-percolation*) on \mathcal{G} is a probability measure on 2^E , the set of subsets of E . A *site-percolation* is a probability measure on 2^V . When X denotes E or V , we identify 2^X and $\{0, 1\}^X$. An element of 2^E or 2^V will be denoted by ω .

We think of a (site- or -edge) percolation as encoding a random subgraph of \mathcal{G} . In the case of an edge percolation, an element $\omega \in \{0, 1\}^E$ has an associated graph $\mathcal{G}_\omega = (V, \omega)$. An edge in ω is called *open* while an edge in $E \setminus \omega$ is called *closed*. An *open path* is a path formed by the open edges. For a site percolation, the graph associated to $\omega \in \{0, 1\}^V$ is $(V(\mathcal{G}), \binom{\omega}{2} \cap E)$. A site in ω is called *open* while a site in $V \setminus \omega$ is called *closed*, and a path formed by open sites is called *open path*.

Bernoulli percolation

Given a parameter $p \in [0, 1]$ and a graph $\mathcal{G} = (V, E)$. We define the *Bernoulli percolation* as:

$$\mathbb{P}_p := B(p)^{\otimes E} = (p\delta_1 + (1-p)\delta_0)^{\otimes E}.$$

This definition means that we construct a random configuration $\omega \in \{0, 1\}^E$ by declaring each edge open with probability p and closed otherwise, independently for different edges. Fix a vertex $0 \in V$, denote $\{0 \longleftrightarrow \infty\}$ the event that there exists an infinite open path from 0 , and we define:

$$\theta(p) = \mathbb{P}_p(0 \longleftrightarrow \infty).$$

It is easy to see that θ is an increasing function on $[0, 1]$, then there exists a unique parameter $p_c = p_c(\mathcal{G}) \in [0, 1]$ which depends on \mathcal{G} , called *critical parameter* of \mathcal{G} such that

$$\theta(p) \begin{cases} = 0 & \text{if } p < p_c \\ > 0 & \text{if } p > p_c \end{cases}$$

We say that there is a *phase transition* at p_c . But it is unsuitable to speak of a phase transition if one of the phases is empty (or almost empty), it means p_c is equal to 0 or 1. Peierls' argument guarantees that p_c is positive for every transitive graph.

Proposition 1.11 (Peierls, [100]). *Let $d \geq 2$ and \mathcal{G} be a graph satisfy every vertex of \mathcal{G} has degree at most d . Then, the critical parameter of \mathcal{G} is at least $\frac{1}{d-1}$*

Proof. Let $p < \frac{1}{d-1}$ and o be a vertex of \mathcal{G} . For any $n \geq 1$, there are at most $d(d-1)^{n-1}$ self-avoiding paths of length n starting at the vertex o . For Bernoulli percolation of parameter p , the probability that there is an open self-avoiding path of length n starting at o is at most $d(p(d-1))^{n-1}$. Since $p < \frac{1}{d-1}$, therefore $d(p(d-1))^{n-1}$ tends to 0 when n goes to infinity, and hence $p \leq p_c$. \square

Remark 1.12. — One can use a similar argument to show that the critical parameter of \mathbb{Z}^2 is not equal to 1. This time, one does not give an upper bound for the number of paths starting at the origin but for the number of dual cycles that surround the origin; see [26, 62, 61]. If we proved that $p_c(\mathbb{Z}^2) < 1$, then for any $d \geq 2$ we also have $p_c(\mathbb{Z}^d) < 1$. Indeed, if d is at least 2, then the graph \mathbb{Z}^d contains \mathbb{Z}^2 as a subgraph, and therefore $p_c(\mathbb{Z}) \leq p_c(\mathbb{Z}^2) < 1$.

- Note that if \mathcal{G} is d -regular tree, then the inequality of Proposition 1.11 becomes an equality. This is a consequence of Theorem 1.21 below.
- When is p_c equal to 1? It is easy to see that the graph \mathbb{Z} is an example of an infinite transitive graph that satisfies $p_c = 1$. What else? The tree in Figure 1.3 is an other example. Indeed, we proved that its branching number is equal to 1 and by Theorem 1.21 below, we obtain the result.
- When is p_c equal to 0? By Proposition 1.11, the necessary condition for $p_c = 0$ is that the maximum degree of \mathcal{G} is unbounded. Consider a spherically symmetric tree \mathcal{T} be such that for any $x \in V(\mathcal{T})$, we have $\deg x = |x|$. In this case, we obtain its branching number is ∞ and then its critical parameter is 0. For another reason, for any $d \geq 2$, the tree \mathcal{T} contains a d -regular tree as a subgraph and therefore $p_c(\mathcal{T}) \leq \frac{1}{d-1}$. As a result, when d goes to infinity, we obtain $p_c(\mathcal{T}) = 0$.

The set $\Omega = \{0, 1\}^E$ has a partial ordering \leq defined by:

$$\omega_1 \leq \omega_2 \iff \omega_1(e) \leq \omega_2(e) \text{ for all } e \in E.$$

An event \mathcal{A} is called *increasing* if

$$\omega_1 \leq \omega_2 \text{ and } \omega_1 \in \mathcal{A} \implies \omega_2 \in \mathcal{A}.$$

Example. Let x, y be two sites of \mathcal{G} , the event that there exists a open path starting from x to y , denoted by $\{x \longleftrightarrow y\}$ is an increasing event.

A function $f : \Omega \rightarrow \mathbb{R}$ is called *increasing* if $f(\omega) \leq f(\omega')$ for any $\omega \leq \omega'$. The following theorem, due to Harris [67], which is often called *FKG inequality*, shows that the increasing events have positively correlated:

Theorem 1.13 (FKG inequality). *If \mathcal{A} and \mathcal{B} are two increasing events, then*

$$\mathbb{P}_p(\mathcal{A} \cap \mathcal{B}) \geq \mathbb{P}_p(\mathcal{A}) \mathbb{P}_p(\mathcal{B})$$

More generally, if f and g are two increasing functions in $L^2(\mathbb{P}_p)$, then

$$\mathbb{E}_p(fg) \geq \mathbb{E}_p(f) \mathbb{E}_p(g).$$

Remark 1.14. Forgetting the case where B has probability 0, one can think of this inequality in terms of conditional probabilities:

$$\mathbb{P}_p(A|B) \geq \mathbb{P}_p(A).$$

This inequality is quite intuitive from a Bayesian point of view: “since B is increasing, conditioning this event to happen prompts the edges to be more open than without conditioning, which in return increases the probability of the increasing event A ”.

The next inequality, known as the *BK inequality*, was proved by Van den Berg and Kesten (see [116]), it provides an inequality in the other direction of the FKG inequality. For any finite set $S \subset E$, we introduce the *cylinder*

$$[\omega_S] := \{\omega' \in \Omega : \forall e \in S, \omega'(e) = \omega(e)\}.$$

Consider two events \mathcal{A} and \mathcal{B} depending only on the edges in a finite subset $F = \{e_1, e_2, \dots, e_n\} \subset E$. The *disjoint occurrence* of \mathcal{A} and \mathcal{B} is the event:

$$\mathcal{A} \circ \mathcal{B} := \{\omega \in \Omega : \exists S \subset F \text{ for which } [\omega]_S \in \mathcal{A} \text{ and } [\omega]_{F \setminus S} \in \mathcal{B}\}$$

This definition has a simple intuitive: It means that we can find a set of edges S such that, at the same time, S is enough to ensure that \mathcal{A} holds (it means \mathcal{A} depends only on edges of S) and S^c is enough to ensure that \mathcal{B} holds.

Example. If $\mathcal{A} = \{x_1 \longleftrightarrow y_1\}$ and $\mathcal{B} = \{x_2 \longleftrightarrow y_2\}$, then $\mathcal{A} \circ \mathcal{B}$ is the event that there exist two open paths γ and γ' , from x_1 to y_1 and from x_2 to y_2 , respectively, which have no an common edge, but they can have a common vertex.

Theorem 1.15 (BK inequality). *Let \mathcal{A} and \mathcal{B} be two increasing events, and depend only on finitely many edges, then we have*

$$\mathbb{P}_p(\mathcal{A} \circ \mathcal{B}) \leq \mathbb{P}_p(\mathcal{A}) \mathbb{P}_p(\mathcal{B}).$$

Bernoulli percolation on the square lattice

In this paragraph, we review quickly the Bernoulli percolation on the square lattice. Consider the bond Bernoulli percolation on \mathbb{Z}^2 . As we have discussed in the previous paragraph, the critical parameter is not trivial, i.e $p_c \in (0, 1)$. Moreover, the exact value of p_c was known (see [119], theorem 4.8): For the bond Bernoulli percolation on \mathbb{Z}^2 , we have $p_c = 1/2$. A natural question is risen: What happens at p_c ?. The following theorem is due to Harris [67]:

Theorem 1.16. *For Bernoulli bond percolation on the square lattice, we have $\theta(1/2) = 0$.*

An important property of critical bond Bernoulli percolation is the box-crossing property, which is often called "RSW". This result was first obtained by Russo [109] and Seymour and Welsh [111]:

Theorem 1.17. *For any $t > 0$, there exist two constant $c(t) > 0$ and $N(t) \geq 1$ such that for every $n \geq N(t)$, we have:*

$$1 - c(t) \geq \mathbb{P}_{1/2}[\mathcal{H}([0, \lfloor 2tn \rfloor] \times [-n, n])] \geq c(t),$$

where $\mathcal{H}([0, \lfloor 2tn \rfloor] \times [-n, n])$ is the event that there exists an open horizontal crossing in the box $[0, \lfloor 2tn \rfloor] \times [-n, n]$.

In the case $p < p_c$, let $\Lambda_n = [-n, n] \times [-n, n]$ and consider the event $\{0 \leftrightarrow \partial\Lambda_n\}$. We know that $\lim_{n \rightarrow \infty} \mathbb{P}_p(0 \leftrightarrow \partial\Lambda_n) = \theta(p) = 0$. The following theorem give the speed that it decreases to 0:

Theorem 1.18 (see [92], [2], [40]). *Consider the bond Bernoulli percolation on \mathbb{Z}^2 . For any $p < p_c$, there exists $c = c(p) > 0$ and $n_0 \in \mathbb{N}$ such that for all $n > n_0$*

$$\mathbb{P}_p(0 \leftrightarrow \partial\Lambda_n) \leq \exp(-cn).$$

We also have the similar result for the case $p > p_c$:

Theorem 1.19 (see [119], page 80). *Consider the bond Bernoulli percolation on \mathbb{Z}^2 . For any $p > p_c$, there exists $c = c(p) > 0$ and $n_0 \in \mathbb{N}$ such that for all $n > n_0$*

$$\mathbb{P}_p(0 \leftrightarrow \partial\Lambda_n) \leq \theta(p) + \exp(-cn).$$

At the critical parameter, we have no the exponential decay:

Theorem 1.20 (see [119], page 49). *Consider the critical bond Bernoulli percolation on \mathbb{Z}^2 . There exists $n_0 \in \mathbb{N}$ such that for all $n > n_0$,*

$$\mathbb{P}_p(0 \leftrightarrow \partial\Lambda_n) \geq \frac{1}{2n}.$$

Percolation on trees

In this paragraph, we review some result about percolation on trees. Consider the Bernoulli percolation on a tree \mathcal{T} , thanks to Lyons [85], we can determine the value of critical parameter $p_c(\mathcal{T})$:

Theorem 1.21. *For every locally finite, infinite and rooted tree \mathcal{T} , we have*

$$p_c(\mathcal{T}) = \frac{1}{br(\mathcal{T})}.$$

The idea of the proof of Theorem 1.21 is to use the relation between percolation and random walk on a network which we will introduce in Section 3.

We are interested in the number of survivors in Bernoulli percolation on a tree. The following proposition give us a answer:

Proposition 1.22 (Surviving rays in Bernoulli percolation, see [87], Proposition 5.27). *For $0 < p < 1$ and every tree \mathcal{T} , the number of surviving ray from the root under Bernoulli percolation on \mathcal{T} a.s. either is 0 or has the cardinality of the continuum. More generally, the same holds for every independent percolation on \mathcal{T} such that each ray in \mathcal{T} individually has probability 0 to survive.*

The idea of the proof of Proposition 1.22 is to use the Lévy zero-one law and FKG inequality, we refer the reader to [87] for the proof of this proposition.

To finish this paragraph, we introduce an other type of percolation on a tree which play an important role to study some non-markovian models (for instance, excited random walk, see Chapter 5). Consider a tree \mathcal{T} with the root ϱ . We call a percolation *quasi-independent* if there exists $M < \infty$ such that for all $x, y \in V(\mathcal{T})$ with $\mathbb{P}[\varrho \leftrightarrow x \wedge y] > 0$, then we have:

$$\mathbb{P}[\varrho \leftrightarrow x, \varrho \leftrightarrow y | \varrho \leftrightarrow x \wedge y] \leq M \mathbb{P}[\varrho \leftrightarrow x | \varrho \leftrightarrow x \wedge y] \mathbb{P}[\varrho \leftrightarrow y | \varrho \leftrightarrow x \wedge y],$$

or equivalent, if $\mathbb{P}[\varrho \leftrightarrow x] \mathbb{P}[\varrho \leftrightarrow y] > 0$, then

$$\frac{\mathbb{P}[\varrho \leftrightarrow x, \varrho \leftrightarrow y]}{\mathbb{P}[\varrho \leftrightarrow x]\mathbb{P}[\varrho \leftrightarrow y]} \leq \frac{M}{\mathbb{P}[\varrho \leftrightarrow x \wedge y]}.$$

Remark 1.23. The Bernoulli percolation is the percolation quasi-independent.

Example. Consider a family of independent random variables $(Z(e))_{e \in E(\mathcal{T})}$ that take the values in $\{1, -1\}$ with probability $1/2$ each. Fix an integer $N > 0$. For any $x \in V$, we define $S(x) = \sum_{e \leq x} Z(e)$. Consider the percolation

$$\omega_N := \{e : S(e^-) \in [0, N], S(e^+) \in [0, N]\}.$$

We can see that the component of the root in ω_1 is the same as the component of the root in the case of Bernoulli(1/2) percolation. Now, we verify that for any $N \geq 1$, the percolation ω_N is quasi-independent. Indeed, we write $q_k(n)$ for the probability that simple random walk on \mathbb{Z} stay in the interval $[0, N]$ for n steps when it starts at k . It is easy to see that there exists a constant M such that for any $n \geq 0$ and $k, k' \in [0, N]$, we have $q_k(n) \leq M q_{k'}(n)$. Fix x, y and we let $r = |x \wedge y|$, $m = |x| - r$ and $n = |y| - r$. We also write p_k for the probability that simple random walk at time r is at position k given that it stays in $[0, N]$ for r steps when it starts at ϱ . Then we have:

$$\begin{aligned} \mathbb{P}[\varrho \leftrightarrow x, \varrho \leftrightarrow y | \varrho \leftrightarrow x \wedge y] &= \sum_{k=0}^N q_k(m) q_k(n) p_k \leq M \min_k q_k(n) \times \sum_{k=0}^N q_k(m) p_k \\ &\leq M \sum_{k=0}^N q_k(n) p_k \sum_{k=0}^N q_k(m) p_k = M \mathbb{P}[\varrho \leftrightarrow x | \varrho \leftrightarrow x \wedge y] \mathbb{P}[\varrho \leftrightarrow y | \varrho \leftrightarrow x \wedge y], \end{aligned}$$

this implies that ω_N is quasi-independent.

For this particular percolation ω_N , we define the critical parameter $N_c = \inf\{N \geq 1 : \mathbb{P}_{\omega_N}(\varrho \leftrightarrow \infty) > 0\}$. We have several questions:

1. What is the critical parameter for this percolation ω_N ?
2. How is the number of surviving rays?

The answer for the first question is due to Benjamini and Peres [16]:

Proposition 1.24. *If $br(\mathcal{T}) > 1/\cos(\frac{\pi}{N+2})$, the root belongs to an infinite cluster with probability positive whereas if $br(\mathcal{T}) < 1/\cos(\frac{\pi}{N+2})$ then the root belongs to an infinite cluster with probability zero.*

Proof. See Exemple 3.3. □

By inspiring the proof of Proposition 1.22, we can prove that:

Proposition 1.25. *For all $N \in \mathbb{N}$ and every tree \mathcal{T} , the number of surviving ray from the root under the percolation ω_N on \mathcal{T} a.s. either is 0 or has the cardinality of the continuum.*

2 Self-avoiding walks

In this section, we review some basic definitions and properties on self-avoiding walk; we refer the reader to the books [11, 89] for a more developed treatment.

2.1 Some definitions

Self-avoiding walk (SAW) is a model in statistical mechanics which is defined easily but not to study. This model was first introduced by the chemist Paul Flory [48] in order to model the real-life behavior of chain-like entities such as solvents and polymers, whose physical volume prohibits multiple occupation of the same spatial point. Although physicists have provided numerous conjectures believed to be true and be strongly supported by numerical simulations, there is still many opened questions on the self-avoiding walk from a mathematical perspective.

Consider a regular lattice \mathcal{G} with a particular site called origin (such that hypercube lattice \mathbb{Z}^d , hexagonal lattice...), a *self-avoiding walk* on \mathcal{G} is a path on \mathcal{G} such that it does not visit the same site more than once. Formally, an *n -step self-avoiding walk* γ on \mathcal{G} , starting from a site x , defined as a sequence of sites $[\gamma(0) = x, \gamma(1), \dots, \gamma(n)]$, with $\{\gamma(i), \gamma(i+1)\} \in E(\mathcal{G})$ and $\gamma(i) \neq \gamma(j)$ for all $i \neq j$. We write $|\gamma| = n$ to denote the *length* of γ , and we denote $\gamma_1(j)$ for the first coordinate of $\gamma_1(j)$. The number of n -step self-avoiding walk starting from the origin is denoted by c_n and by convention, $c_0 = 1$.

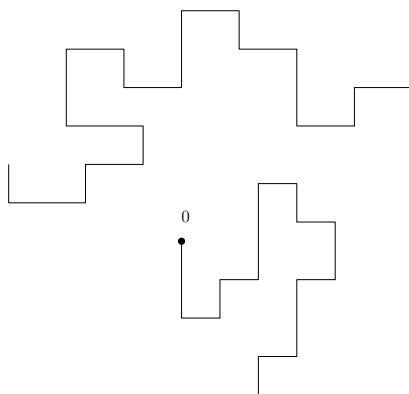

Figure 1.5 – A 111-step self-avoiding walk on \mathbb{Z}^2

We will define a notion of *concatenation* of paths. If $\gamma^1 = [\gamma_0^1, \gamma_1^1, \dots, \gamma_m^1]$ and $\gamma^2 = [\gamma_0^2, \gamma_1^2, \dots, \gamma_n^2]$ are two SAWs with $\gamma_m^1 = \gamma_0^2$. We define $\gamma^1 \oplus \gamma^2$ to be the $m+n$ -step walk

(not necessary sel-avoding walk):

$$\gamma^1 \oplus \gamma^2 = [\gamma_0^1, \gamma_1^1, \dots, \gamma_m^1, \gamma_1^2, \gamma_2^2, \dots, \gamma_n^2].$$

An n -step bridge in \mathbb{Z}^d is an n -step self-avoiding walk γ such that:

$$\forall i = 1, 2, \dots, n, \gamma_1(0) < \gamma_1(i) \leq \gamma_1(n).$$

The number of n -step bridge starting from the origin is denoted by b_n and by convention, $b_0 = 1$.

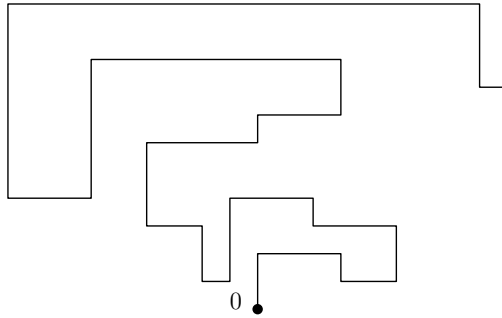

Figure 1.6 – A 86-step bridge on \mathbb{Z}^2

2.2 The connective constant

Definition of connective constant

Recall that c_n is the number of n -step self-avoiding walk starting from origin. One of the first result on the self-avoiding walk is the speed that c_n increase. This result was first observed by Hammersley and Morton [63]:

Proposition 2.1 (Connective constant). *There exists a constant $\mu = \mu(\mathcal{G})$ depending on the lattice such that:*

$$\lim_{n \rightarrow \infty} c_n^{1/n} = \mu,$$

this constant is called the connective constant.

Proof. We claim that for any $m, n \in \mathbb{N}$, we have $c_{m+n} \leq c_m c_n$. Indeed, the product $c_m c_n$ is the cardinality of the set of $(m+n)$ -step walks which are self-avoiding for the m firts steps and the final n steps but not be completely self-avoiding. Then we have:

$$\log c_{m+n} \leq \log c_m + \log c_n.$$

Then the existence of the limit is a consequence of lemma sub-additive. \square

The concatenation of two bridges is another bridge, so $b_m b_n \leq b_{m+n}$ and then $-\log b_{m+n} \leq -\log b_m - \log b_n$. By lemma of sub-additive, the limit

$$\mu_{\text{bridge}} = \lim_{n \rightarrow \infty} b_n^{1/n},$$

exists. Moreover, it is clear that $b_n \leq c_n$, therefore $\mu_{\text{bridge}} \leq \mu$. In fact, Hammersley-Welsh proved that $\mu_{\text{bridge}} = \mu$ (see Section 2.3).

The value of connective constant on some particular lattices

In the case $\mathcal{G} = \mathbb{Z}^d$, by counting only walks that move in positive coordinate directions, and by counting walks that are restricted only to prevent immediate reversals of steps, we obtain:

$$d^n \leq c_n \leq 2d(2d-1)^n, \text{ it implies that } d \leq \mu \leq 2d-1.$$

d	lower bound	estimate	upper bound
2	2,62562 ^a	2,6381585 ^b	2,67919 ^c
3	4,43733 ^d	4,6839066 ^e	4,756 ^f
4	6,71800 ^d	6,7720 ^g	6,832 ^f
5	8,82128 ^d	8,83861 ^h	8,881 ^f
6	10,871199 ^d	10,87879 ^h	10,903 ^f

Table 1.1 – Current best rigorous upper bound and lower bound of the connective constant on hypercube lattice: a. Jensen[70], b. Guttmann and Enting[60], c. Ponitz and Tittmann[105], d. Hara and Slade[65], e. Guttmann[59], f. Alm[6], g. Guttmann[57], h. Guttmann[58].

In the case \mathcal{G} is the hexagonal lattice, in 1982, the arguments based on a Coulomb gas formalism led Nienhuis[99] to predict that on the hexagonal lattice the connective constant is equal to $\sqrt{2+\sqrt{2}}$. This was proved by Duminil-Copin and Smirnov:

Theorem 2.2 (Duminil-Copin and Smirnov [39]). *For the hexagonal lattice, we have*

$$\mu = \sqrt{2 + \sqrt{2}}.$$

2.3 The Hammersley-Welsh method

In this paragraph, we assume that $\mathcal{G} = \mathbb{Z}^d$. It is predicted that for each d there is a constant γ such that $c_n \sim A\mu^n n^{\gamma-1}$. The predicted values of γ are:

$$\gamma = \begin{cases} \frac{43}{32} & \text{if } d = 2 \\ 1.162 & \text{if } d = 3 \\ 1 & \text{with logarithmic corrections if } d = 4 \\ 1 & \text{if } d \geq 5 \end{cases}$$

In the case of $d \geq 5$, this conjecture was proved by Hara and Slade. There is still no rigorous proof of the critical value γ in dimensions two, three and four. The best rigorous upper bounds is c_n/μ^n are essentially of the form $\exp(O(N^p))$ for some constant $0 < p < 1$. It is a major open problem to replace this bound by a polynomial in N . In this paragraph, we review a bound on c_n/μ^n which is called bound Hammersley-Welsh.

Definition 2.3. An n -step half-space walk is an n -step SAW γ with $\gamma_1(0) < \gamma_1(i), \forall i$.

We set h_n be the number of n -step half-space walk with $\gamma(0) = 0$.

Definition 2.4. The span of an n -step SAW γ is

$$\max_{0 \leq i \leq n} \gamma_1(i) - \min_{0 \leq i \leq n} \gamma_1(i).$$

We denote $b_{n,A}$ is the number of n -step bridges with span A .

$$\text{We have } h_n = \sum_{A=1}^n b_{n,A}.$$

Theorem 2.5 (Hardy-Ramanujan [66]). *For $n \in \mathbb{N}^*$, let $P_D(n)$ be the number of way to write $n = n_1 + n_2 + \dots + n_k$ with $n_1 > n_2 > \dots > n_k \geq 1$ for any k , then*

$$\ln P_D(n) \sim \pi \left(\frac{n}{3} \right)^{\frac{1}{2}} \text{ as } n \rightarrow +\infty.$$

Proposition 2.6. $h_n \leq P_D(n) \cdot b_n$ for all $n \geq 1$.

Proof. Set $n_0 = 0$, we define $A_{i+1} = \max_{j > n_i} (-1)^i (\gamma_1(j) - \gamma_1(n))$ and $n_{i+1} = \max\{j > n_i : (-1)^i (\gamma_1(j) - \gamma_1(n)) = A_{i+1}\}$.

We set $h_n(a_1, a_2, \dots, a_k)$ be the number of n -step half-space walks with

$$A = k, A_i = a_i.$$

We have

$$\begin{aligned} h_n(a_1, a_2, \dots, a_k) &\leq h_n(a_1 + a_2, a_3, \dots, a_k) \\ &\leq \dots \leq \\ &\leq h_n(a_1 + a_2 + \dots + a_k) = b_{n, a_1 + a_2 + \dots + a_k}. \end{aligned}$$

Thus,

$$\begin{aligned} h_n &= \sum_{k \geq 1} \sum_{1 \leq a_1 < a_2 < \dots < a_k} h_n(a_1, a_2, \dots, a_k) \\ &\leq \sum_{k \geq 1} \sum_{1 \leq a_1 < a_2 < \dots < a_k} b_{n, a_1 + a_2 + \dots + a_k} \\ &\leq \sum_{A=1}^n P_D(A) \cdot \dots \cdot b_{n,A} \leq P_D(n) \cdot \underbrace{\sum_{A=1}^n b_{n,A}}_{b_n} \end{aligned}$$

We obtain $h_n \leq P_D(n) \cdot b_n$. \square

Theorem 2.7 (Hammersley and Welsh [64]). *Let $d \geq 2$. For any constant $B > \pi\left(\frac{2}{3}\right)^{\frac{1}{2}}$, there exist a constant $B_0(B)$ independent of d such that:*

$$\forall n > B_0(B) : c_n \leq b_{n+1} \cdot e^{B\sqrt{n+1}}.$$

Proof. We will prove that

$$c_n \leq \sum_{m=0}^n h_{n-m} \cdot h_{m+1}.$$

We set $x_1 = \max_{0 \leq i \leq n} \gamma_1(i)$ and $m = \max\{i : \gamma_1(i) = x_1\}$. We erase the edge $\{\gamma(m-1), \gamma(m)\}$ and add 3 edges $\{a_1, a_2, a_3\}$ of the square .

The walk $(\gamma(0), \gamma(1), \dots, \gamma(m-1), a_1, a_2)$ is a $(m+1)$ -step half-space walk, and the walk $(a_3, \gamma(m+1), \dots, \gamma(n))$ is $(n-m)$ -step half-space walk. Thus,

$$c_n \leq \sum_{m=0}^n h_{n-m} \cdot h_{m+1}$$

By using Proposition 2.6, we obtain:

$$\begin{aligned} c_n &\leq \sum_{m=0}^n h_{n-m} \cdot h_{m+1} \leq \sum_{m=0}^n P_D(n-m) \cdot P_D(m+1) \cdot b_{n-m} \cdot b_{m+1} \\ &\leq \sum_{m=0}^n P_D(n-m) \cdot P_D(m+1) \cdot b_{n+1} \end{aligned}$$

By Theorem 2.5, we have: $P_D(n) \sim \pi\left(\frac{n}{3}\right)^{\frac{1}{2}}$ as $n \rightarrow +\infty$, then $\exists \alpha : P_D(n) \leq \alpha e^{B' \cdot \left(\frac{n}{2}\right)^{\frac{1}{2}}}$ where $B > B' > \pi\left(\frac{2}{3}\right)^{\frac{1}{2}}$.

We obtain

$$P_D(n-m) \cdot P_D(m+1) \leq \alpha^2 e^{B' \left[\sqrt{\frac{n-m}{2}} + \sqrt{\frac{m+1}{2}} \right]} \leq \alpha^2 e^{B' \sqrt{n+1}},$$

thus

$$c_n \leq (n+1) \alpha^2 e^{B' \sqrt{n+1}} \cdot b_{n+1}$$

and

$$\exists B_0(B), \forall n \geq B_0(B) : c_n \leq e^{B\sqrt{n+1}} b_{n+1}.$$

\square

Corollary 2.8. $\mu = \mu_{bridge}$.

By Theorem 2.7, we have:

$$c_n \leq e^{B\sqrt{n+1}} b_{n+1} \Rightarrow c_n^n \leq e^{\frac{B\sqrt{n+1}}{n}} b_{n+1}^{\frac{n+1}{n}} \Rightarrow \mu \leq \mu_b.$$

Thus $\mu = \mu_b$.

2.4 Some conjectures

In this section, we assume that $\mathcal{G} = \mathbb{Z}^d$. Consider the uniform measure on the set of n -step self-avoiding walk. The average distance (squared) from the origin after n steps is given by the *mean-square displacement*:

$$\mathbb{E}[|\gamma_n|^2] = \frac{1}{c_n} \sum_{\omega:|\omega|=n} |\omega_n|^2.$$

The sum over ω is the sum over all n -step self-avoiding walks beginning at the origin. The first conjecture on the self-avoiding walk is the behavior of c_n and $\mathbb{E}[|\gamma_n|^2]$.

Conjecture 2.9. *There exists four constants A , B , γ and ν that depend on the dimension, such that:*

$$c_n \sim A\mu^n n^{\gamma-1} \text{ and } \mathbb{E}[|\gamma_n|^2] \sim Bn^{2\nu}.$$

The conjectured values of γ and ν are as follows:

$$\gamma = \begin{cases} \frac{43}{32} & \text{if } d = 2 \\ 1.162 & \text{if } d = 3 \\ 1 & \text{with logarithmic corrections if } d = 4 \\ 1 & \text{if } d \geq 5 \end{cases}$$

and,

$$\nu = \begin{cases} \frac{3}{4} & \text{if } d = 2 \\ 0.59 & \text{if } d = 3 \\ \frac{1}{2} & \text{with logarithmic corrections if } d = 4 \\ \frac{1}{2} & \text{if } d \geq 5 \end{cases}$$

Currently the only rigorous results which confirm the conjectured values of γ and μ for $d \geq 5$.

In 1963, Kesten [71] proved that

$$\lim_{n \rightarrow \infty} \frac{c_{n+2}}{c_n} = \mu^2,$$

but it remains an open problem to prove that the limit $\frac{c_{n+1}}{c_n}$ exists.

Conjecture 2.10. *Let $d \geq 2$, the conjecture is:*

$$\lim_{n \rightarrow \infty} \frac{c_{n+1}}{c_n} = \mu$$

Currently the only rigorous results which confirm the conjecture for $d \geq 5$.

To finish this paragraph, we state a conjecture on the scaling limit of self-avoiding walk in dimension two. Let Ω be a simply connected domain in \mathbb{R}^2 with two points a and b on the boundary. For $\delta > 0$, let Ω_δ be the largest connected component of $\Omega \cap \delta\mathbb{Z}^2$ and let a_δ, b_δ be the two sites of Ω_δ closest to a and b respectively. Let $x > 0$, on $(\Omega_\delta, a_\delta, b_\delta)$, define a probability measure on the finite set of self-avoiding walks in Ω_δ from a_δ to b_δ by the formula:

$$\mathbb{P}_{(\Omega_\delta, a_\delta, b_\delta)}(\gamma) = \frac{x^{|\gamma|}}{Z_{(\Omega_\delta, a_\delta, b_\delta)}(x)},$$

where $Z_{(\Omega_\delta, a_\delta, b_\delta)}(x)$ is a normalizing factor. A *random curve* γ_δ with law

$$\mathbb{P}_{(\Omega_\delta, a_\delta, b_\delta)}$$

is called *self-avoiding walk* with parameter x in the domain $(\Omega_\delta, a_\delta, b_\delta)$. We are interested in the scaling limit of self-avoiding walk with parameter x when δ go to 0. The limit will depend on the value of x .

When $x < \frac{1}{\mu}$, γ_δ converges to a deterministic curve which is the geodesic between a and b in Ω . We refer the reader to Ioffe [69] for the details.

When $x = \frac{1}{\mu}$, the scaling limit is conjectured to be the Schramm-Lowner Evolution of parameter $8/3$. In fact, Lawler-Schramm-Werner [78] proved that if the scaling limit exists, then the limit is the Schramm-Lowner Evolution of parameter $8/3$.

When $x > \frac{1}{\mu}$, the scaling limit is predicted in [112] that it should be the Schramm-Lowner Evolution of parameter 8. In 2014, Duminil Copin-Kozma-Yadin [38] proved a result which quantifies how γ_δ becomes space filling. In particular, the probability that γ_δ reaches the boundary of Ω tends to 1 when δ go to 0. In chapter 2, we introduce a new measure on the set of self-avoiding walk through the random walk on trees. This measure depends much on the geometric of the self-avoiding walk. We also prove that the self-avoiding walk reaches the boundary an infinite many times almost surely with this new measure.

The model makes formal sense for $x = +\infty$, where it corresponds to a uniformly random path of maximal length. In that case, the scaling limit is known to be a Schramm-Loewner Evolution of parameter $\kappa = 8$. For the super-critical measure in chapter 2, we

expect the scaling limit to be the same as for critical percolation, which is conjectured to be a Schramm-Lowner Evolution of parameter $\kappa = 6$.

3 Random walks on trees

Recall that our trees will usually infinite, locally finite and rooted. In this section, we review some results of random walk on trees through an important tool which is the theory of electric networks. This theory is also an important tool that I used in two-thirds of my thesis (Chapters 2, 4 and 5), therefore I desire to review this theory in detail. We refer the reader to the excellent book [87] in more details.

3.1 Random walks and electrical networks

Our principal interest in this section is to develop a mathematically rigorous tools from electrical network theory, to study transience and recurrence of random walks on trees. A *network* is a connected graph $G = (V, E)$ endowed with positive edge weights, $\{c(e)\}_{e \in E}$ (called *conductances*). The reciprocals $r(e) = 1/c(e)$ are called *resistances*.

Harmonic functions and voltages

Let $G = (V, E)$ be a finite network. In physic, we know that when we impose specific voltages at fixed vertices a and z , then current flows through the network according to certain laws (such as the series and parallel laws). An immediate consequence of these laws is that the function from V to \mathbb{R} giving the voltage at each vertex is harmonic at each $x \in V \setminus \{a, z\}$.

Definition 3.1. A function $h : V \rightarrow \mathbb{R}$ is called *harmonic* at a vertex x if:

$$h(x) = \frac{1}{\pi(x)} \sum_{y: y \sim x} c(\{x, y\}) h_y \quad \text{where } \pi(x) = \sum_{y: y \sim x} c(\{x, y\}).$$

Let $S \subset V$, we say that h is harmonic on V if h is harmonic at any vertex $x \in S$.

Instead of starting with the physical laws and proving that voltage is harmonic, we take the axiomatically equivalent approach of definition of voltage to be a harmonic function and deriving the law as corollaries.

Definition 3.2. Given a network $G = (V, E)$ and two distinct vertices a and z of G . A voltage is a function $h : V \rightarrow \mathbb{R}$ which is harmonic on $V \setminus \{a, z\}$.

We finish this paragraph with an important property of voltage:

Proposition 3.3 (Uniqueness principle, see [87], page 20). *For every $\alpha, \beta \in \mathbb{R}$, if h, h' are two voltages satisfying $h(a) = h'(a)$ and $h(z) = h'(z)$, then $h_1 \equiv h_2$.*

Here is a consequence of the uniqueness principle: If h , h_1 and h_2 are harmonic on some finite proper subset $W \subset V$ and $a_1, a_2 \in \mathbb{R}$ with $f = a_1 f_1 + a_2 f_2$ on $V \setminus W$, then $f = a_1 f_1 + a_2 f_2$ on V . This property is called *superposition principle*.

Flows and currents

Let $G = (V, E)$ be a finite network and we denote \vec{E} the set of edges of G and each edge of G endowed with two orientations. We write (x, y) (resp. (y, x)) for the orientation of edge $\{x, y\}$ from x to y (resp. from y to x). Given two subsets A and Z of vertices of G .

Definition 3.4. A flow from A to Z in a network G is a function $\theta : \vec{E} \rightarrow \mathbb{R}$ satisfying $\theta(x, y) = -\theta(y, x)$ for all neighbors x, y and $\sum_{y: y \sim x} \theta(x, y) = 0$ for all $x \notin A \cup Z$. The first condition is called antisymmetry and the second condition is called Kirchhoff's node law.

Definition 3.5. Given a voltage h , the current i associated with h is defined by $i(x, y) := c(x, y)[h(y) - h(x)]$.

In other words, the voltage difference across an edge is the product of the current along the edge with the resistance of the edge. This is known as *Ohm's law*.

Definition 3.6. The strength of a flow θ is

$$\|\theta\| = \sum_{a \in A} \sum_{x: x \sim a} \theta(a, x)$$

The unit current from A to Z is the unique current from A to Z of strength 1.

Claim 3.7. *The current i associated with a voltage h is a flow*

Proof. By definition, it is easy to see that the current i is antisymmetric. For any $x \notin A \cup Z$, we have h is harmonic at x and therefore:

$$\sum_{y: y \sim x} i(x, y) = \sum_{y: y \sim x} c(x, y)h(y) - \sum_{y: y \sim x} c(x, y)h(x) = \pi(x)h(x) - \pi(x)h(x) = 0.$$

□

Claim 3.8. *The current i associated with a voltage h satisfies Kirchhoff's cycle law, that is, for every directed cycle $\vec{e}_1, \dots, \vec{e}_n$, we have*

$$\sum_{k=1}^n r(e_k) i(\vec{e}_k) = 0$$

Effective resistance and probabilistic interpretation

In this paragraph, we assume that $A = \{a\}$ is a singleton. Consider the Markov chain $\{X_n\}$ on the state space V with *transition probability*

$$p(x, y) := \mathbb{P}(X_{n+1} = y | X_n = x) = \frac{c(x, y)}{\pi(x)}.$$

This Markov chain is a *weighted random walk*. Note that if $c(x, y) = 1$ for all $(x, y) \in E$, then this Markov chain is *simple random walk*. We write \mathbb{P}_x and \mathbb{E}_x for the probability and expectation conditioned on $X_0 = x$. For each vertex $x \in V$, we define the *hitting time* of x as follows:

$$\tau_x := \min\{n \geq 0 : X_n = x\}$$

If the chain $\{X_n\}$ starts at x , then we define the *hitting time* of x by letting:

$$\tau_{x+} := \min\{n > 0 : X_n = x\}.$$

We also write $\tau_Z := \min\{n \geq 0 : X_n \in Z\}$ for the hitting time of Z . We want to compute the probability that weighted random walk starting at a will hit Z before it returns to a . We write it as

$$\mathbb{P}[a \rightarrow Z] := \mathbb{P}_a[\tau_Z < \tau_{a+}].$$

Impose a voltage of $v(a)$ at a and 0 on Z . Since $v(\cdot)$ is linear in $v(a)$ by the superposition principle, then we have $\mathbb{P}_x[\tau_a < \tau_Z] = v(x)/v(a)$, whence

$$\begin{aligned} \mathbb{P}[a \rightarrow Z] &= \sum_x p(a, x) (1 - \mathbb{P}_x[\tau_a < \tau_Z]) = \sum_x \frac{c(a, x)}{\pi(a)} \left[1 - \frac{v(x)}{v(a)}\right] \\ &= \frac{1}{v(a)\pi(a)} \sum_x c(a, x)[v(a) - v(x)] = \frac{1}{v(a)\pi(a)} \sum_x i(a, x). \end{aligned}$$

Or equivalent,

$$v(a) = \frac{\sum_x i(a, x)}{\pi(a)\mathbb{P}[a \rightarrow Z]}.$$

Since $\sum_x i(a, x)$ is the total amount of current flowing into the network at a , we may regard the entire circuit between a and Z as a single conductor of *effective conductance*

$$\mathcal{C}_{\text{eff}} := \pi(a)\mathbb{P}[a \rightarrow Z] =: \mathcal{C}(a \leftrightarrow Z) \quad (3.1)$$

If we need to indicate the dependence on network G , we will write $\mathcal{C}(a \leftrightarrow Z; G)$. We define the *effective resistance* $R(a \leftrightarrow Z)$ to be the reciprocal of the effective conductance. Finally, we have $\mathbb{P}[a \rightarrow Z] = \mathcal{C}(a \leftrightarrow Z)/\pi(a)$ and we will see some ways to compute the effective conductance in the next paragraph.

Network reduction

In this paragraph, we review some ways to calculate effective conductance of a network between, say, two vertices a and z . Since we want to replace a network by an equivalent single conductor, it is natural to attempt this by replacing more and more of \mathcal{G} through simple transformations, leaving a and z but possibly removing other vertices. There are, in fact, three such simple transformations: series, parallel, and star-triangle. Remarkably, these three transformations suffice to reduce all finite planar networks according to a theorem of Epifanov (see Truemper [115]). Recall that a conductor c is an edge with a conductance c .

Claim 3.9 (Parallel law). *Two conductors c_1 and c_2 in parallel are equivalent to one conductor $c_1 + c_2$. In other words, if two edges e_1 and e_2 that both join vertices $v_1, v_2 \in V(\mathcal{G})$ are replaced by a single edge e joining v_1 and v_2 of conductance $c(e) := c(e_1) + c(e_2)$, then all voltages and currents in $\mathcal{G} \setminus \{e_1, e_2\}$ are unchanged and the current $i(e)$ equals $i(e_1) + i(e_2)$.*

Claim 3.10 (Series law). *Two resistors r_1 and r_2 in series are equivalent to a single resistor $r_1 + r_2$. In other words, if $w \in V(\mathcal{G})$ ($A \cup Z$) is a node of degree 2 with neighbors u_1, u_2 and we replace the edges (u_i, w) by a single edge (u_1, u_2) having resistance $r(u_1, w) + r(w, u_2)$, then all potentials and currents in \mathcal{G} are unchanged and the current that flows from u_1 to u_2 equals $i(u_1, w)$.*

Claim 3.11 (Star-Triangle law). *The configurations in Figure 1.7 are equivalent when*

$$\forall i \in \{1, 2, 3\} \quad c(w, u_i)c(u_{i-1}, u_{i+1}) = \gamma,$$

where indices are taken mod 3 and $\gamma := \frac{\prod_i c(w, u_i)}{\sum_i c(w, u_i)}$

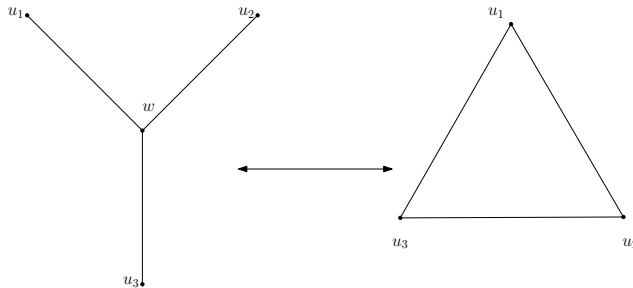

Figure 1.7 – The star-triangle equivalence

Besides these three transformations, we have also an other operation which is called *gluing*. The operation of gluing a subset of vertices $S \subset V$ consists of identifying the vertices of S into a single vertex and keeping all edges and their conductances. By this operation, we can generate parallel edges or loops.

Claim 3.12 (Gluing). *Gluing vertices of the same voltage does not change the effective conductance between A and Z .*

Before finishing this paragraph, we give an example:

Example. Consider a network \mathcal{G} as in Figure 1.8, where each edge of \mathcal{G} has conductance 1. By following the transformations indicated in Figure 1.8, we have $\mathcal{C}(a \leftrightarrow z) = 3/4$ and then:

$$\mathbb{P}[a \rightarrow z] = \frac{\mathcal{C}(a \leftrightarrow z)}{\pi(a)} = \frac{3/4}{2} = 3/8.$$

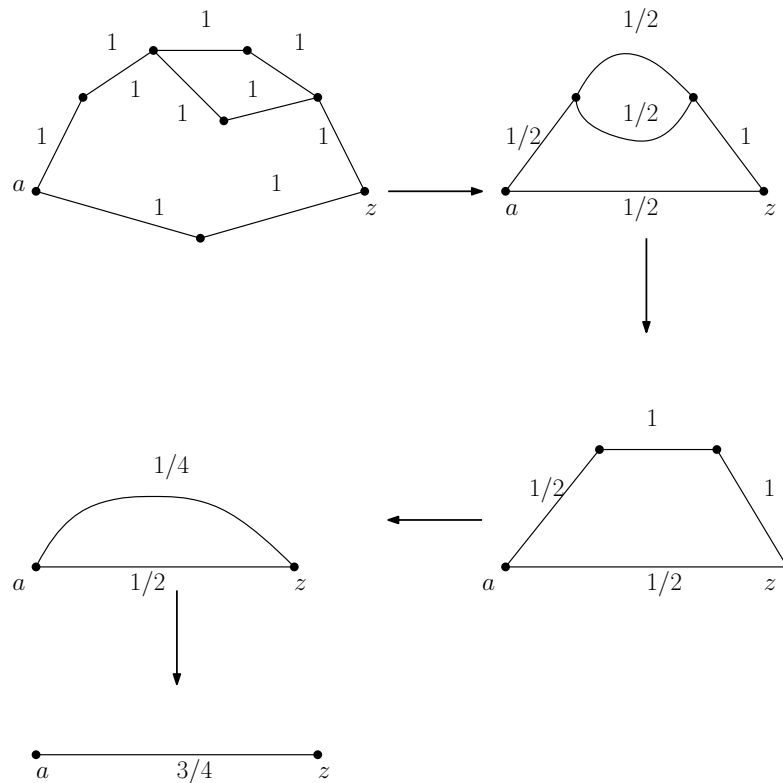

Figure 1.8 – The sequence of transformations

Energy

In this section, we review the ways to bound the effective resistance. Our Physics intuition asserts that the *energy* of the unit current is minimal among all unit flows from a to z . The notion of energy can be made precise and will allow us to obtain valuable monotonicity properties. For instance, removing any edge from an electric network can only increase its effective resistance. Hence, any recurrent graph remains recurrent after removing any subset of edges from it. We will see in this section, the Thomson's

principle, which is used to bound the effective resistance from the above and Dirichlet's principle, allowing to bound it from below.

Definition 3.13. The energy of a flow θ from A to Z , denoted by $\mathcal{E}(\theta)$, is defined by

$$\mathcal{E}(\theta) := \frac{1}{2} \sum_{\vec{e} \in \vec{E}} r(\vec{e}) \theta(\vec{e})^2 = \sum_{e \in E} r(e) \theta(e)^2.$$

Theorem 3.14 (Thomson's Principle). *Let \mathcal{G} be a finite network and A and Z be two disjoint subsets of its vertices. Then we have*

$$\mathcal{R}(A \leftrightarrow Z) = \inf\{\mathcal{E}(\theta) : \|\theta\| = 1, \theta \text{ is a flow from } A \text{ to } Z\},$$

and the unique minimizer is the unit current flow.

The following powerful principle tells us how effective conductance changes, it is a consequence of Thomson's principle.

Corollary 3.15 (Rayleigh's Monotonicity Principle). *If $\{r(e)\}_{e \in E}$ and $\{r'(e)\}_{e \in E}$ are edge resistances on the same graph \mathcal{G} so that $r(e) \leq r'(e)$ for all edges $e \in E$, then*

$$\mathcal{R}(A \leftrightarrow Z; (\mathcal{G}, \{r(e)\}_{e \in E})) \leq \mathcal{R}(A \leftrightarrow Z; (\mathcal{G}, \{r'(e)\}_{e \in E})).$$

Proof. Let θ be a flow on \mathcal{G} , then we have

$$\sum_{e \in E} r(e) \theta(e)^2 \leq \sum_{e \in E} r'(e) \theta(e)^2.$$

This inequality is preserved while taking infimum over all flows with strength 1. By using Theorem 3.14, we obtain the result. \square

Definition 3.16. The energy of a function $h : V \rightarrow \mathbb{R}$, denoted by $\mathcal{E}(h)$, is defined by

$$\mathcal{E}(h) := \sum_{\{x,y\} \in E} c(x,y) (h(x) - h(y))^2.$$

The following theorem give us a lower bound of effective conductance:

Theorem 3.17 (Dirichlet's Principle). *Let \mathcal{G} be a finite network and A and Z be two disjoint subsets of its vertices. Then we have*

$$\frac{1}{\mathcal{R}(A \leftrightarrow Z)} = \inf\{\mathcal{E}(h); \quad h : V \rightarrow \mathbb{R} \text{ such that } h|_A \equiv 0, h|_Z \equiv 1\}.$$

Infinite networks

The way to study an infinite network \mathcal{G} is to take large finite subgraphs of \mathcal{G} . More precisely, for an infinite network \mathcal{G} , let $(\mathcal{G}_n)_{n \geq 1}$ be any sequence of finite subgraphs of \mathcal{G} that exhaust \mathcal{G} , that is, $\mathcal{G}_n \subset \mathcal{G}_{n+1}$ and $\mathcal{G} = \cup \mathcal{G}_n$. Each edge in \mathcal{G}_n is an edge in \mathcal{G} , so we simply give it the same conductance it has in \mathcal{G} . We also assume that \mathcal{G}_n is the graph induced in \mathcal{G} by $V(\mathcal{G}_n)$. Let Z_n be the set of vertices in $\mathcal{G} \setminus \mathcal{G}_n$. Let \mathcal{G}_n^W be the graph obtained from \mathcal{G} by identifying Z_n to a single vertex, z_n , and then removing loops (but keeping multiple edges). This graph will have finitely many vertices but may have infinitely many edges even when loops are deleted if some vertex of \mathcal{G} has infinite degree. Consider the weighted random walk associated to the network \mathcal{G} , if we stop it the first time it reaches Z_n , then we obtain a weighted random walk on \mathcal{G}_n^W until it reaches z_n . Now for every $a \in \mathcal{G}$, it is easy to see that the events $[a \rightarrow Z_n]$ are decreasing in n , so the limit $\lim \mathbb{P}[a \rightarrow Z_n]$ exists and it is the probability of never returning to a in \mathcal{G} , which we call the *escape probability* from a and it is denoted by $\mathbb{P}[a \rightarrow \infty]$. This is positive if and only if the random walk on \mathcal{G} is transient. By Equation 3.1, we have

$$\mathbb{P}[a \rightarrow \infty] = \lim_{n \rightarrow \infty} \mathbb{P}[a \rightarrow Z_n] = \frac{1}{\pi(a)} \lim_{n \rightarrow \infty} \mathcal{C}(a \leftrightarrow Z_n; \mathcal{G}_n^W).$$

We call $\lim_{n \rightarrow \infty} \mathcal{C}(a \leftrightarrow Z_n; \mathcal{G}_n^W)$ the *effective conductance* from a to ∞ in \mathcal{G} and denote it by $\mathcal{C}(a \leftrightarrow \infty)$. Its reciprocal, *effective resistance*, is denoted $\mathcal{R}(a \leftrightarrow \infty)$. Note that the limit $\lim_{n \rightarrow \infty} \mathcal{C}(a \leftrightarrow Z_n; \mathcal{G}_n^W)$ do not depend on the sequence \mathcal{G}_n . Finally, we obtain

$$\mathbb{P}[a \rightarrow \infty] = \frac{\mathcal{C}(a \leftrightarrow \infty)}{\pi(a)}. \quad (3.2)$$

Theorem 3.18 (Transience and Effective Conductance). *The weighted random walk associated to on an infinite connected network is transient if and only if the effective conductance from any of its vertices to infinity is positive.*

Definition 3.19. Let \mathcal{G} be an infinite network. A function $\theta : E(\mathcal{G}) \rightarrow \mathbb{R}$ is a flow from a to ∞ if it is anti-symmetric and satisfies the Kirchhoff's node law on each vertex $v \neq a$.

The following theorem is an easy consequence of Theorem 3.14.

Theorem 3.20 (Thomson's principle for infinite network). *Let \mathcal{G} be an infinite network, then*

$$\mathcal{R}(a \leftrightarrow \infty) = \inf \{ \mathcal{E}(\theta) : \|\theta\| = 1, \theta \text{ is a flow from } a \text{ to } \infty \}$$

An infinite network \mathcal{G} is called *recurrent* if the weighted random walk associated to \mathcal{G} is recurrent. Otherwise, it is called *transient*. The following corollary gives us a method to study the recurrent/transient of a random walk:

Corollary 3.21. *Let G be an infinite network. The weighted random walk associated to \mathcal{G} is transient if and only if there exists a vertex $a \in V(\mathcal{G})$ and an unit flow θ from a to ∞ with $\mathcal{E}(\theta) < \infty$.*

We have seen that effective conductance from any vertex to ∞ is positive if and only if the random walk is transient. Thus, a lower bound on the effective resistance between vertices in a network can be useful to show recurrence. Let A and Z be two disjoint sets of vertices. A set Π of edges separates A and Z if every path with one endpoint in A and the other endpoint in Z must include an edge in Π ; we also call Π a cutset. We say that a set Π of edges separates a and ∞ if every infinite simple path from a must include an edge in Π . In this case, we also call Π a cutset.

Theorem 3.22 (Nash-Williams inequality). *If a and z are distinct vertices in a finite network that are separated by pairwise disjoint cutsets $\Pi_1, \Pi_2, \dots, \Pi_n$ then*

$$\mathcal{R}(a \leftrightarrow z) \geq \sum_{k=1}^n \left(\sum_{e \in \Pi_k} c(e) \right)^{-1}.$$

Theorem 3.23. *If Π_n is a sequence of pairwise disjoint finite cutsets in a locally finite network \mathcal{G} , each of which separates a from ∞ , then*

$$\mathcal{R}(a \leftrightarrow \infty) \geq \sum_{n=1}^{\infty} \left(\sum_{e \in \Pi_n} c(e) \right)^{-1}.$$

In particular, if $\sum_{n=1}^{\infty} \left(\sum_{e \in \Pi_n} c(e) \right)^{-1} = \infty$ then \mathcal{G} is recurrent.

3.2 Biased random walks on trees

In this section, we use the tools from Section 3.1 to study the recurrent/transient of a type of random walk which is called *biased random walk*. We refer the reader to the book [87] for the details.

Firstly, we review some intuitions from the flow. Consider the tree as a network of pipes and imagine water entering the network at the root. However, much water enters a pipe leaves at the other end and splits up among the outgoing pipes (edges). This is formalized in the previous section (see definition of flow in 3.4). We say that $\theta(e)$ is the amount of water flowing along e and that the total amount of water flowing from the root to infinity is $\sum_{i=1}^k \theta(\varrho, x_i)$, where the children of the root ϱ are x_1, \dots, x_k . Notice that if there is a flow from a to ∞ of finite energy on some network with conductances $c(e)_{e \in E(\mathcal{G})}$ and if it is the unit current flow with corresponding voltage function v , then we have $|i(e)| = |c(e)(v(e^+) - v(e^-))| \leq v(a)c(e) = \mathcal{R}(a \leftrightarrow \infty)c(e)$ for all edges e . In particular,

there is a nonzero flow bounded on each edge e by $c(e)$ (for example, the nonzero flow is $i/v(a)$). Then the existence of flows that are bounded by the conductances allows us to study the recurrent/transient of network. A flow θ is called *admissible* if $\theta(e) \leq c(e)$ for every $e \in E$. To determine whether there is a nonzero admissible flow, we use a powerful theorem of Ford and Fulkerson which is often called *max-flow min-cut theorem*.

Theorem 3.24 (Max-flow min-cut theorem, see [50]). *If a is a vertex in a countable directed network \mathcal{G} , then*

$$\begin{aligned} & \max \{ \text{strength}(\theta); \theta \text{ admissible flow from } a \text{ to } \infty \} \\ &= \inf \left\{ \sum_{e \in \Pi} c(e); \Pi \text{ separates } a \text{ and } \infty \right\}. \end{aligned}$$

The max-flow min-cut theorem gives an equivalent of the definition of branching number:

$$br(\mathcal{T}) := \sup \{ \lambda; \text{ there exists a nonflow } \theta \text{ on } \mathcal{T} \text{ with } \forall e \in E(\mathcal{T}) \ 0 \leq \theta(e) \leq \lambda^{-|e|} \}.$$

The Nash-Williams criterion gave a condition sufficient for recurrence, but it was not necessary for recurrence. However, a useful partial converse to the Nash-Williams criterion for trees can be stated as follows.

Proposition 3.25 (Lyons [85]). *Let c be conductances on a locally finite infinite tree \mathcal{T} and w_n be positive numbers with $\sum_{n \geq 1} w_n < \infty$. If θ is a flow on \mathcal{T} satisfying $0 \leq \theta(e) \leq w_{|e|}c(e)$ for all edges e , then θ has finite energy.*

We define the *biased random walk* with parameter λ on \mathcal{T} , denoted by RW_λ as the weighted random walk associated to the network \mathcal{T} with the conductances $\lambda \mapsto \lambda^{-|e|}$. The following theorem give us the phase transition of biased random walk.

Theorem 3.26 (Lyons [85]). *If \mathcal{T} is a locally finite infinite and rooted tree. If $\lambda < br(\mathcal{T})$ then RW_λ is transient and if $\lambda > br(\mathcal{T})$ then RW_λ is recurrent.*

Proof. Let $\lambda \geq 0$ and consider the network (\mathcal{T}, c_λ) where $c_\lambda(e) = \lambda^{-|e|}$ for all $e \in E(\mathcal{T})$. Assume that the network (\mathcal{T}, c_λ) is transient, then there exists a nonzero admissible flow from ϱ to ∞ . By Definition of branching number, we obtain $\lambda \leq br(\mathcal{T})$. It remains to prove that if $\lambda < br(\mathcal{T})$, then the network (\mathcal{T}, c_λ) is transient. For $\lambda < br(\mathcal{T})$, we choose $\lambda' \in (\lambda, br(\mathcal{T}))$ and set $w_n := (\lambda/\lambda')^n$. By Definition of $br(\mathcal{T})$, there is a nonzero flow θ satisfying $0 \leq \theta(e) \leq (\lambda')^{-|e|} = w_{|e|}\lambda^{-|e|}$ and since $\sum_n w_n < \infty$, then by Proposition 3.25, this flow has finite energy. By Corollary 3.21, the network (\mathcal{T}, c_λ) is transient. \square

Remark 3.27. — Sometimes, we also define the *biased random walk* with parameter λ on \mathcal{T} as the weighted random walk associated to the network \mathcal{T} with the

conductances $\lambda \mapsto \lambda^{|e|}$ for any $\lambda > 0$. In this case, the theorem 3.26 becomes: If \mathcal{T} is a locally finite infinite and rooted tree. If $\lambda < 1/br(\mathcal{T})$ then RW_λ is recurrent and if $\lambda > 1/br(\mathcal{T})$ then RW_λ is transient.

- In the case $c(e) = \lambda^{|e|}$, we write $\mathcal{C}(\lambda)$ for the effective conductance of the network (\mathcal{T}, c) , instead of $\mathcal{C}(\varrho \leftrightarrow \infty)$.

3.3 Percolation and random walks on trees

The relation between percolation and electric network was studied in Lyons [84, 85, 86]. In this section, we review the idea of the proof of Theorem 1.21 by using this relation. This method is very useful to study the phase transition of random walk. We refer the reader to Chapter 5 for another application of this method.

Proposition 3.28. *Given a general percolation on \mathcal{T} , we have*

$$\mathbb{P}[\varrho \leftrightarrow \infty] \leq \inf \left\{ \sum_{e \in \Pi} \mathbb{P}[\varrho \leftrightarrow e]; \Pi \text{ separates } \varrho \text{ from infinity} \right\}$$

Proof. For any Π separating ϱ from infinity, we have

$$[\varrho \leftrightarrow \infty] \subset \bigcup_{e \in \Pi} [\varrho \leftrightarrow e]$$

Therefore, we obtain $\mathbb{P}[\varrho \leftrightarrow \infty] \leq \sum_{e \in \Pi} \mathbb{P}[\varrho \leftrightarrow e]$. □

In the case of Bernoulli percolation, we have $\mathbb{P}[\varrho \leftrightarrow e] = p^{|e|}$. Therefore, by Proposition 3.28 and the definition of branching number, we obtain

$$p_c(\mathcal{T}) \geq \frac{1}{br(\mathcal{T})}. \quad (3.3)$$

Given a general percolation on \mathcal{T} . The *adapted conductances* to this percolation is a family of conductances $(c(e))_{e \in E(\mathcal{T})}$ be such that for any $x \in V(\mathcal{T})$, we have:

$$\begin{cases} c(e(x)) = 1 \text{ if } |x| = 1 \\ 1/\mathbb{P}[0 \leftrightarrow x] = 1 + \mathcal{R}(0 \leftrightarrow x) \text{ if } |x| > 1 \end{cases},$$

or equivalent

$$\begin{cases} c(e(x)) = 1 \text{ if } |x| = 1 \\ 1/c(e(x)) = \frac{1}{\mathbb{P}[0 \leftrightarrow x]} - \frac{1}{\mathbb{P}[0 \leftrightarrow x^{-1}]} \text{ if } |x| > 1 \end{cases},$$

where $e(x)$ is an edge such that $(e(x))^+ = x$ and x^{-1} is the parent of x .

These notions lead us to the following results:

Theorem 3.29 (Lyons [85]). *For an independent percolation and adapted conductances on the same tree, we have*

$$\mathbb{P}[\varrho \leftrightarrow \infty] \geq \frac{\mathcal{C}(\varrho \leftrightarrow \infty)}{1 + \mathcal{C}(\varrho \leftrightarrow \infty)}.$$

Theorem 1.21 is an immediate corollary of Theorem 3.29, Theorem 3.18, Theorem 3.26 and 3.3.

Theorem 3.29 is an important tool to study the independent percolations. A generalization of this Theorem to quasi-independent percolation is obtained by Lyons [84]. This generalisation is also one of the central elements of the proofs in Chapter 5.

Theorem 3.30 (Lyons [84]). *For a quasi-independent percolation with constant M and adapted conductances on the same tree \mathcal{T} , we have*

$$\mathbb{P}[\varrho \leftrightarrow \infty] \geq \frac{1}{M} \frac{\mathcal{C}(\varrho \leftrightarrow \infty)}{1 + \mathcal{C}(\varrho \leftrightarrow \infty)}.$$

Example. *We have seen the important role of Theorem 3.29 to study the phase transition of Bernoulli percolation on trees. Let's apply Theorem 3.30 to the proof of Proposition 1.24 (see Chapter 5 for an other application of Theorem 3.30). This proof is due Benjamini and Peres [16]:*

If we consider simple random walk on $[0, N]$ killed on exiting the interval, the corresponding substochastic transition matrix P is symmetric and so real diagonalizable. Let λ_k be its eigenvalues and v_k be the corresponding eigenvectors with $\|v_k\| = 1$. Thus,

$$P^n(i, j) = \sum_k \lambda_k^n v_k(i) v_k(j).$$

By the Perron-Frobenius theorem, $|\lambda_k| \leq l$, where l is the largest positive eigenvalue and the corresponding eigenvector has positive entries. Since this Markov chain has period 2, Then we obtain $P^n(i, j) \sim 2v_k(i)v_k(j)l^n$ when n and $i - j$ have the same parity. If n and $i - j$ have no the same parity, then $P^n(i, j) = 0$. In our case, the top eigenvalue equals $\cos \frac{\pi}{N+2}$ (see Spitzer [114], Chapter 21, Proposition 1), whence $\mathbb{P}(0 \leftrightarrow x) \sim a_{|x|} \left(\cos \frac{\pi}{N+2} \right)^{|x|}$ as $|x| \rightarrow \infty$ for some constants a_m which depends only on the parity of m . This implies that for the conductances $c(e)$ adapted to this percolation, there exists a'_1 and a'_2 such that:

$$a'_1 \left(\cos \frac{\pi}{N+2} \right)^{|e|} \leq c(e) \leq a'_2 \left(\cos \frac{\pi}{N+2} \right)^{|e|}$$

Thus, by using Theorem 3.30, we have $\mathbb{P}(\varrho \leftrightarrow \infty) > 0$ if $br(\mathcal{T}) > 1/\cos(\frac{\pi}{N+2})$. It remains to prove that if $br(\mathcal{T}) < 1/\cos(\frac{\pi}{N+2})$ then $\mathbb{P}(\varrho \leftrightarrow \infty) = 0$. It is an easy consequence Proposition 3.28 and the definition of branching number.

3.4 Self-avoiding walks and biased random walks on trees

The results that we state in this section will be proved in Chapter 2. We are interested in defining a natural probability measure on the set of *infinite* self-avoiding walks (SAW_∞). Such a measure on the set of the infinite self-avoiding half-plane walks has been constructed before as the weak limit of the uniform measures on the finite self-avoiding walks relying on results by Kesten (see [89, 72]), and it is part of our goal to investigate whether that measure and our construction are related.

We consider a one-parameter family of probability measures on SAW_∞ , denoted by $(\mathbb{P}_\lambda)_{\lambda > \lambda_c}$, defined informally as follows. Denote by \mathbb{H} the upper-half plane in \mathbb{Z}^2 and by \mathbb{Q} the first quadrant; let $T_{\mathbb{Z}^2}$ (resp. $T_{\mathbb{H}}$, $T_{\mathbb{Q}}$, with the appropriate modifications in the definition which we will not specify in what follows) be the tree whose vertices are the finite self-avoiding walks in the plane (respectively half-plane, quadrant), where two such vertices are adjacent when one walk is a one-step extension of the other. We will call this tree the *self-avoiding tree* on \mathbb{Z}^2 .

Then, consider the continuous-time biased random walk of parameter $\lambda > 0$ on $T_{\mathbb{Z}^2}$, which from a given location jumps towards the root with rate 1 and towards each of its children vertices with rate λ . If λ is such that the walk is transient, its path determines an infinite branch in $T_{\mathbb{Z}^2}$ which can be seen as a random infinite self-avoiding walk ω_λ^∞ ; we will denote by \mathbb{P}_λ the law of ω_λ^∞ , omitting the mention of \mathbb{Z}^2 in the notation, and call it the *limit walk* with parameter λ .

It is well known that there exists a critical value λ_c such that if $\lambda > \lambda_c$ the biased random walk is transient and if $\lambda < \lambda_c$ it is recurrent. In the general case of biased random walk on a tree, the recurrence or transience of the random walk at the critical point depends in subtle ways on the structure of the tree. The value of λ_c on the other hand is easier to determine: indeed, Lyons [85] proved that it coincides with the reciprocal of the branching rate of the tree. The following proposition give the critical value for self-avoiding trees.

Theorem 3.31 (Beffara-Huynh, [13]). *Let $T_{\mathbb{Z}^2}, T_{\mathbb{H}}, T_{\mathbb{Q}}$ be defined as above. Then,*

$$\lambda_c(T_{\mathbb{Z}^2}) = \lambda_c(T_{\mathbb{H}}) = \lambda_c(T_{\mathbb{Q}}) = \frac{1}{\mu},$$

where μ is the connective constant of lattice \mathbb{Z}^2 .

Notice that it is clear from the definition that μ is the growth rate of $T_{\mathbb{Z}^2}$; there are rather large classes of trees, including $T_{\mathbb{Z}^2}$, for which the branching and growth coincide (for instance, this holds for sub- or super-periodic trees, cf. below, or for typical supercritical Galton-Watson trees), but none of the classical results seem to apply to $T_{\mathbb{H}}$ or $T_{\mathbb{Q}}$.

We now state some properties concerned with the geometry of the limit walk for this family of probability measures.

Theorem 3.32 (Beffara-Huynh, [13]). *For all $\lambda > \lambda_c$, under the \mathbb{P}_λ measure, the infinite self-avoiding walk (in the plane or half-plane) reaches the line $\mathbb{Z} \times \{0\}$ infinitely many times almost surely.*

Theorem 3.33 (Beffara-Huynh, [13]). *For all $\lambda > \lambda_c$, then*

$$\mathbb{P}_\lambda(\limsup_n \mathfrak{R}\omega_\lambda^\infty(n) = +\infty) = 1; \quad \mathbb{P}_\lambda(\liminf_n \mathfrak{R}\omega_\lambda^\infty(n) = -\infty) = 1.$$

These theorems are proved in Section 6.3. We are mostly interested in the behavior of the limit walk as $\lambda \rightarrow \lambda_c$, since this is a natural candidate to be in relation with uniformly sampled long SAWs. We did not quite manage to prove the existence of the limit, but were able to obtain a partial result in this direction by restricting the process to paths formed of bridges of bounded height m , and letting m increase; see Theorem 7.3 for more details.

A useful tool in our proofs is the *effective conductance* of the biased random walk on a tree T , defined as the probability of never returning to the root o of T and denoted by $\mathcal{C}(\lambda, T)$. Along the way, we will be interested in several properties of it as a function of λ . Most important for us will be the question of continuity: in a general tree, the effective conductance is not necessarily a continuous function of λ . We will derive criteria for continuity, which are forms of *uniform transience* of the random walk, and apply them to prove that the effective conductance of self-avoiding trees is a continuous function (see Section 5.4):

Theorem 3.34 (Beffara-Huynh, [13]). *The functions $\mathcal{C}(\lambda, T_{\mathbb{H}})$ and $\mathcal{C}(\lambda, T_{\mathbb{Z}^2})$ are continuous on $(\lambda_c, +\infty)$.*

A related question is that of the convergence of effective conductance along a sequence of trees. More precisely, let $(f_n)_n$ denote the effective conductances for a sequence (T_n) of infinite trees, and we assume that $(f_n)_n$ converges uniformly towards $f \neq 0$. The question is: is f the effective conductance of a certain tree? We study this question on a class of particular trees, spherically symmetric trees (recall that T is spherically symmetric if $\deg x$ depends only on $|x|$, where $|x|$ denote its distance from the root o and $\deg x$ is the number of its neighbors). If \mathbb{S} denotes the set of spherically symmetric trees and $m \in \mathbb{N}^*$ is fixed, define

$$A_m := \{T \in \mathbb{S}; \forall x \in T, \deg x \leq m\} \text{ and}$$

$$\mathbb{F}_m := \{f \in C^0([0, 1]) : \exists T \in A_m, \mathcal{C}(\lambda, T) = f(\lambda)\}.$$

Then (see Section 4.2):

Theorem 3.35 (Beffara-Huynh, [13]). *Let $(f_n)_n$ be a sequence of functions in \mathbb{F}_m . Assume that f_n converges uniformly towards $f \neq 0$. Then $f \in \mathbb{F}_m$.*

4 Excited random walks and random walks in random environment

We can define an interacting process as a random process evolving over time, such that, at any moment, the future behavior of the process depends on its past trajectory. There is the difference between these processes with Markov process: Unlike classical Markov processes, the knowledge of the present state does not contain all the informations needed to predict its future behavior. The study of these process is relatively recent and their behaviors are still poorly understood except in the particular cases. The major difficulty comes from the property non-Markovian of the dynamics that prohibits to use the classical tools of Markov processes and therefore we need to develop new strategies. In Sections 4.1 and 4.2, we study a process of this kind: Excited random walk. The random walk in random environment is introduced in Section 4.3.

4.1 Excited random walk

Once-excited random walk on \mathbb{Z}^d

The model of the once-excited random walk on \mathbb{Z}^d was introduced by Benjamini and Wilson [17]. Roughly speaking, it describes a walk which receives a push in some specific direction each time it reaches a new vertex of \mathbb{Z}^d . More precisely, a random walk on \mathbb{Z}^d is excited (with bias ε/d , $\varepsilon > 0$) if the first time it visits a vertex it steps right with probability $(1 + \varepsilon)/(2d)$, left with probability $(1 - \varepsilon)/(2d)$, and in other directions with probability $1/(2d)$, while on subsequent visits to that vertex the walker picks a neighbor uniformly at random. More formally, we therefore consider an excitation parameter $\varepsilon \in (0, 1)$ and a process that the marginals verify:

$$\mathbb{P}\{X_{n+1} = X_n \pm e_i | X_0, \dots, X_n\} = \begin{cases} \frac{1 \pm \varepsilon}{2d} & \text{if } i = 1 \text{ or } X_n \notin \{X_0, \dots, X_{n-1}\} \\ \frac{1}{2d} & \text{if } i \neq 1 \text{ or } X_n \in \{X_0, \dots, X_{n-1}\} \end{cases}$$

where (e_1, \dots, e_d) denotes the canonical basis of \mathbb{Z}^d . In [17], Benjamini and Wilson proved that the once-excited random walk is recurrent in dimension 1 and it is transient in the direction of bias in dimension $d \geq 2$, whatever the excitation value ε . They also showed that it possessed a non-zero speed when the dimension $d \geq 4$. These results were completed by Kozma [76, 77] and by Bérard and Ramirez [18] who showed that the speed of an once-excited random walk was also strictly positive in dimension 2 and 3 and they also proved the invariance principle:

$$\frac{X_n \cdot e}{n} \xrightarrow[p.s.]{} v > 0 \quad \text{and} \quad \left(\frac{X_{[nt]} \cdot e - v[nt]}{\sqrt{n}}, t \geq 0 \right) \xrightarrow[(d)]{} (B_{\sigma^2 t}, t \geq 0),$$

where B denotes a standard Brownian motion.

Multi-excited random walk on \mathbb{Z}

In [120, 121], Zerner introduced a generalization of this model called multi-excited random walk (or cookie random walk) where the walk receives a push, not only on its first visit to a site, but also on some subsequent visit. More precisely, the model of multi-excited random walk is defined as follows. Let us first fix two quantities, a direction and a constant k . In the case $d = 1$, we always choose $\ell = e_1 \in \mathbb{Z}$ to be the first standard unit vector. In the case $d \geq 2$, we choose $\ell \in \mathbb{R}^d$ be any direction with $|\ell|_1 = 1$. The constant $k \in (0, 1/(2d)]$ will be a uniform lower bound for the probability of the walk to jump from x to any nearest neighbor of x . We define an environment ω for an multi-excited random walk is an element of

$$\Omega := \left\{ \left(\left((\omega(x, e, i))_{|e|=1} \right)_{i \geq 1} \right)_{x \in \mathbb{Z}^d} \in [k, 1 - k]^{2d \times \mathbb{N} \times \mathbb{Z}^d} \right\},$$

satisfies two following conditions: For any $x \in \mathbb{Z}^d$ and $i \geq 1$, we have

$$\begin{cases} \sum_{e \in \mathbb{Z}^d, |e|=1} \omega(x, e, i) = 1 \\ \sum_{e \in \mathbb{Z}^d, |e|=1} \omega(x, e, i) e \cdot \ell \geq 0 \end{cases}$$

A multi-excited random walk starting at $x \in \mathbb{Z}^d$ in an environment ω is a \mathbb{Z}^d -valued process $(X_n)_{n \geq 0}$ on some suitable probability space $(\Omega', \mathcal{F}, \mathbb{P}_{x, \omega})$ for which the history process $(H_n)_{n \geq 0}$ defined by $H_n := (X_m)_{0 \leq m \leq n} \in (\mathbb{Z}^d)^{n+1}$ is a Markov chain which satisfies $\mathbb{P}_{x, \omega}$ -a.s.

$$\mathbb{P}_{x, \omega}(X_0 = x) = 1$$

$$\mathbb{P}_{x, \omega}(X_{n+1} = X_n + e | H_n) = \omega(X_n, e, |\{m \leq n : X_m = X_n\}|).$$

Thus $\omega(x, e, i)$ is the probability to jump upon the i -th visit to x from x to $x + e$. In the case of \mathbb{Z} , to simplify the statements, we consider here only the case of deterministic excitations. The model is now parametrized by an integer M which represents the number of cookies per site and a vector

$$p = (p_1, \dots, p_M) \in [1/2, 1)^M,$$

where p_i is the transition probability after eating the i -th cookie of a site. The multi-excited random walk on Z is defined as a process X moving to nearest neighbor with transition probabilities:

$$\mathbb{P}\{X_{n+1} = X_n + 1 | X_0, \dots, X_n\} = \begin{cases} p_i & \text{if } i = |\{m \leq n : X_m = X_n\}| \leq M \\ \frac{1}{2} & \text{otherwise} \end{cases}$$

In [121], Zerner introduced this model and he proved the following result for the phase transition:

Theorem 4.1 (Zerner [121]). *There is a phase transition according to the value of*

$$\alpha(p) = \sum_{i=1}^M (2p_i - 1).$$

- If $\alpha \leq 1$ then X is recurrent, it means $\limsup X_n = -\liminf X_n = +\infty$
- If $\alpha > 1$ then X is transient toward $+\infty$, it means $\lim X_n = +\infty$.

We can deduce from this theorem that if $M = 1$ then the walk is recurrent whatever the value of $p_1 \in [1/2, 1)$. The walk can become transient with just two cookies and $\alpha(p)$ is enough. In the case of transience, it is natural to study the speed of the walk. In [121], Zerner proved that:

Theorem 4.2 (Zerner, [121]). *There exists a constant $v = v(p) > 0$ such that*

$$\lim_{n \rightarrow \infty} \frac{X_n}{n} = v \quad p.s.$$

In [121], Zerner also proved that if $M = 2$ then $v = 0$. Then Mountford, Pimentel and Valle [96] proved $v > 0$ if M is large enough and $\alpha(p)$ is large enough. A natural question is to understand this second phase transition by determining under what condition, we have $v(p) > 0$. The answer is due to Basdevant and Singh [8]:

Theorem 4.3 (Basdevant-Singh [8]). *We have $v(p) > 0$ if and only if $\alpha(p) > 2$.*

Moreover, in the case $\alpha \in (1, 2]$, Basdevant and Singh [9] proved that:

Theorem 4.4 (Basdevant-Singh [9]). *Assume that the multi-excited random walk X is transient and the speed $v = 0$ i.e $\alpha \in (0, 1]$.*

- If $\alpha < 2$, we have

$$\frac{X_n}{n^\alpha} \xrightarrow{loi} \mathcal{M}_{\alpha/2},$$

where $\mathcal{M}_{\alpha/2}$ is a law of Mittag-Leffler with parameter α .

- If $\alpha = 2$, we have

$$\frac{\log n}{n} X_n \xrightarrow{prob} C,$$

where C is a strictly positive constant.

4.2 Phase transition for multi-excited random walk on trees

It is natural to define the multi-excited random walk on a tree. This model was considered in [118] and [10]. Let us be a bit more precise about the model. We consider an infinite, locally finite and rooted tree \mathcal{T} . At each vertex of the tree, we initially put a pile of $M \geq 0$ "cookies" with strengths $\lambda_1, \dots, \lambda_M \in [0, 1)$. The vector $(\lambda_1, \dots, \lambda_M) \in [0, 1)^M$ is called *cookie environment*. Let us also choose some other parameter $\lambda \in (0, 1)$ representing the bias of the walk after excitation. Then, a cookie random walk on \mathcal{T} is a nearest neighbor random walk $\mathbf{X} = (X_n)_{n \geq 0}$, starting from the root of the tree and moving according to the following rules:

- If $X_n = x$ and there remain the cookies with strengths $\lambda_j, \lambda_{j+1}, \dots, \lambda_M$ at this vertex, then \mathbf{X} eats the cookie with attached strength λ_j and then jumps at time $n + 1$ to the parent of x with probability $\frac{1}{1 + \partial(x)\lambda_j}$ and to each child of x with probability $\frac{\lambda_j}{1 + \partial(x)\lambda_j}$, where $\partial(x)$ is the number of children of x .
- If $X_n = x$ and there is no remaining cookie at site x , then \mathbf{X} jumps at time $n + 1$ to the parent of x with probability $\frac{1}{1 + \partial(x)\lambda}$ and to each child of x with probability $\frac{\lambda}{1 + \partial(x)\lambda}$, where $\partial(x)$ is the number of children of x .

This model is a particular case of self-interacting random walk: the position of \mathbf{X} at time $n + 1$ depends not only of its position at time n but also on the number of previous visits to its present site. Therefore, \mathbf{X} is not a Markov process.

We have some particular cases:

- If $\lambda_j = 0$ for all j , it is called *M-digging random walk* with parameter λ , denoted by $(M\text{-DRW}_\lambda)$.
- If $M = 0$, it is called *biased random walk* with parameter λ (RW_λ).
- If $M = 1$, it is called *once-excited random walk* $((\lambda_1, \lambda)\text{-OERW})$.

This model was considered the first time by Volkov [118] on a tree \mathcal{T} which is an infinite, locally finite and rooted tree, with the property that each vertex, except possibly the root, is incident to at least three vertices. The following theorem was proved by Volkov:

Theorem 4.5 (Volkov [118]). *Assume that \mathcal{T} is an infinite, locally finite and rooted tree, with the property that each vertex, except possibly the root, is incident to at least three vertices.*

- *Let $\lambda_1 \geq 0$ and $\mathcal{C} = (\lambda_1, 1)$. Then the walk in the cookie environment \mathcal{C} is transient.*
- *Let $\mathcal{C} = (0, 0, 1)$. Then the walk in the cookie environment \mathcal{C} is transient.*

The most significant question left open by his paper, is what happens with the *M-digging* random walk for $M \geq 3$. He conjectured that:

Conjecture 4.6 (Volkov [118]). *Let \mathcal{T} be an infinite, locally finite and rooted tree, with the property that each vertex, except possibly the root, is incident to at least three vertices. For any $M \geq 3$, the *M-digging* random walk on \mathcal{T} is transient.*

The case of the multi-excited random walk on a regular tree (b ary tree) \mathbb{T}_b was considered by Basdevant and Arvind Singh in [10]. To state this result, we start with the following definition:

Definition 4.7. — Given a cookie environment $\mathcal{C} = (\lambda_1, \dots, \lambda_M; \lambda)$, we denote by $(\xi_i)_{i \geq 1}$ a sequence of independent random variables taking values in $\{0, 1, \dots, b\}$, with distribution:

$$\mathbb{P}(\xi_i = 0) = \begin{cases} \frac{1}{1+b\lambda_i} & \text{if } i \leq M, \\ \frac{1}{1+b\lambda} & \text{if } i > M, \end{cases}$$

$$\mathbb{P}(\xi_i = 1) = \dots = \mathbb{P}(\xi_i = b) = \begin{cases} \frac{\lambda_i}{1+b\lambda_i} & \text{if } i \leq M, \\ \frac{\lambda}{1+b\lambda} & \text{if } i > M, \end{cases}$$

We say that ξ_i is a "failure" when $\xi_i = 0$.

— We call "cookie environment matrix" the non-negative matrix $(\lambda_{i,j})_{i,j \geq 0}$ whose coefficients are given by $\lambda(0, j) = 1_{\{j=0\}}$ and for any $i \geq 1$, we have

$$\lambda(i, j) = \mathbb{P}\left\{\sum_{k=1}^{\gamma_i} 1_{\{\xi_k=1\}}=j\right\} \quad \text{where } \gamma_i = \inf\left\{n, \sum_{k=1}^n 1_{\{\xi_k=0\}}=i\right\}.$$

Thus, $p(i, j)$ is the probability that there are exactly j random variables taking value 1 before the i -th failure in the sequence (ξ_1, ξ_2, \dots)

Definition 4.8. Given an irreducible non negative matrix Q , its spectral radius is defined as $\lambda = \lim_{n \rightarrow \infty} (q^{(n)}(i, j))^{1/n}$, where $q^{(n)}(i, j)$ denotes the (i, j) coefficient of the matrix Q^n .

Theorem 4.9 (Recurrence/Transience criterion, Basdevant-Singh [10]). *Let $\mathcal{C} = (\lambda_1, \dots, \lambda_M; \lambda)$ be a cookie environment and let $P(\mathcal{C})$ denote its associated cookie environment matrix. This matrix has only a finite number of irreducible classes. Let $\lambda(\mathcal{C})$ denote the largest spectral radius of these irreducible sub-matrices.*

- *If $\frac{\lambda}{1+b\lambda} < \frac{b}{b+1}$ and $\lambda(\mathcal{C}) \leq \frac{1}{b}$, then the walk in the cookie environment \mathcal{C} is recurrent i.e. it hits any vertex of \mathbb{T}_b infinitely often with probability 1. Furthermore, if $\lambda(\mathcal{C}) < \frac{1}{b}$, then the walk is positive recurrent i.e. all the return times to the root have finite expectation.*
- *If $\frac{\lambda}{1+b\lambda} \geq \frac{b}{b+1}$ and $\lambda(\mathcal{C}) > \frac{1}{b}$ then the walk is transient i.e. $\lim_{n \rightarrow \infty} |X_n| = +\infty$.*

The matrix $P(\mathcal{C})$ of Theorem 4.9 is explicit. Its coefficients can be expressed as a rational function of the λ_i 's and λ and its irreducible classes. However, we do not know, except in particular cases, a simple formula for the spectral radius $\lambda(\mathcal{C})$:

Corollary 4.10 (Once excited random walk, Basdevant-Singh[10]).

Let \mathbf{X} denote a $(p; q)$ cookie random walk (i.e $M = 1$) on \mathbb{T}_b and define

$$\alpha := \frac{\lambda^2 + (b-1)\lambda\lambda_1 + \lambda_1}{1 + b\lambda_1} \quad (4.1)$$

Then \mathbf{X} is recurrent if and only if $\lambda \leq 1/b$.

Corollary 4.11 (M-digging random walk, Basdevant-Singh [10]).

Let \mathbf{X} denote a $(p; q)$ cookie random walk (i.e $M = 1$) on \mathbb{T}_b and define

$$\beta := \lambda^{M+1} \quad (4.2)$$

Then \mathbf{X} is recurrent if and only if $\beta \leq 1/b$.

Note that Conjecture 4.6 is a consequence of Corollary 4.11.

In the remain of this section, we consider a general tree \mathcal{T} and we want to extend Conjecture 4.6. Here, we obtain a much finer description of the process and we can prove that this random walk actually undergoes a phase transition on trees with polynomial growth, i.e. on trees \mathcal{T} where the branching-ruin number $br_r(\mathcal{T})$ is finite. The branching-ruin number of a tree \mathcal{T} , denoted by $br_r(\mathcal{T})$, is best described as the polynomial version of the branching number: if a well-behaved tree has spheres of size n^b , then the branching-ruin number of this tree is b . We refer the reader to [33] for more details on the definition of branching-ruin number.

Theorem 4.12 (Collecchio-Huynh-Kious, [32]). *Let \mathcal{T} be an infinite, locally-finite, rooted tree, and let $M \in \mathbb{N}$. If $br_r(\mathcal{T}) < M + 1$ then M -DRW₁ is recurrent and if $br_r(\mathcal{T}) > M + 1$ then M -DRW₁ is transient.*

Moreover, we generalize Corollary 4.11:

Theorem 4.13 (Collecchio-Huynh-Kious, [32]). *Let \mathcal{T} be an infinite, locally-finite, rooted tree, and let $M \in \mathbb{N}$, $\lambda > 0$. Denote \mathbf{X} the M -digging random walk on \mathcal{T} with parameters $\lambda > 0$. We have that*

1. *in the case $\lambda = 1$, if $br_r(\mathcal{T}) < M + 1$ then \mathbf{X} is recurrent and if $br_r(\mathcal{T}) > M + 1$ then \mathbf{X} is transient;*
2. *for any $\lambda > 1$, if $br_r(\mathcal{T}) < \lambda^{M+1}$ then \mathbf{X} is recurrent and if $br_r(\mathcal{T}) > \lambda^{M+1}$ then \mathbf{X} is transient;*
3. *for any $\lambda < 1$, \mathbf{X} is transient.*

Note that, for a b -ary tree \mathbb{T}_b , we have $br_r(\mathbb{T}_b) = b$ and Theorem 4.13 therefore agrees with Corollary 4.11. In [10], Basdevant and Singh proved that the walk is recurrent at

criticality on regular trees, but this is not expected to be true in general. However, we prove the critical M -digging random walk is still recurrent on a particular class of trees which contains the regular trees.

Theorem 4.14 (Huynh, [68]). *Let $M \in \mathbb{N}$ and \mathcal{T} be a superperiodic tree whose upper-growth rate is finite. Then the critical M -digging random walk on \mathcal{T} is recurrent.*

Unlike the case of once-reinforced random walk in [33] or digging-random walk in [32], the phase transition of once-excited random walk (OERW) does not depend only on the branching-ruin number and the branching number of tree. In the case \mathcal{T} is a *spherically symmetric* tree, we give a sharp phase transition recurrence/transience in terms of their *branching number* and *branching-ruin number* and others.

Recall that a tree \mathcal{T} is said to be spherically symmetric if for every vertex ν , $\deg \nu$ depends only on $|\nu|$, where $|\nu|$ denote its distance from the root and $\deg \nu$ is its number of neighbors. Let \mathcal{T} be a spherically symmetric tree. For any $n \geq 0$, let x_n be the number of children of a vertex at level n . For any $\lambda_1 \geq 0$ and $\lambda > 0$, we define the following quantities:

$$\alpha(\mathcal{T}, \lambda_1, \lambda) = \liminf_{n \rightarrow \infty} \left(\prod_{i=1}^n \frac{\lambda^2 + (x_i - 1)\lambda_1\lambda + \lambda_1}{1 + x_i\lambda_1} \right)^{1/n}. \quad (4.3)$$

$$\beta(\mathcal{T}, \lambda_1, \lambda) = \limsup_{n \rightarrow \infty} \left(\prod_{i=1}^n \frac{\lambda^2 + (x_i - 1)\lambda_1\lambda + \lambda_1}{1 + x_i\lambda_1} \right)^{1/n}. \quad (4.4)$$

$$\gamma(\mathcal{T}, \lambda_1) = \liminf_{n \rightarrow \infty} \frac{-\sum_{i=1}^n \ln \left[1 - \frac{(x_i - 1)\lambda_1 + 2}{(1 + x_i\lambda_1)^i} \right]}{\ln n}. \quad (4.5)$$

$$\eta(\mathcal{T}, \lambda_1) = \limsup_{n \rightarrow \infty} \frac{-\sum_{i=1}^n \ln \left[1 - \frac{(x_i - 1)\lambda_1 + 2}{(1 + x_i\lambda_1)^i} \right]}{\ln n}. \quad (4.6)$$

Theorem 4.15 (Huynh, [68]). *Let \mathcal{T} be a spherically symmetric tree, and let $\lambda_1 \geq 0$, $\lambda > 0$. Denote \mathbf{X} the (λ_1, λ) -OERW on \mathcal{T} . Assume that there exists a constant $M > 0$ such that $\sup_{\nu \in V} \deg \nu \leq M$, then we have*

1. *in the case $\lambda = 1$, if $\eta(\mathcal{T}, \lambda_1) < br_r(\mathcal{T})$ then \mathbf{X} is transient and if $\gamma(\mathcal{T}, \lambda_1) > br_r(\mathcal{T})$ then \mathbf{X} is recurrent;*
2. *assume that $\lambda_1 \geq 0$, $\lambda \neq 1$ and $br(\mathcal{T}) > 1$, if $\beta(\mathcal{T}, \lambda_1, \lambda) < \frac{1}{br(\mathcal{T})}$ then \mathbf{X} is recurrent and if $\alpha(\mathcal{T}, \lambda_1, \lambda) > \frac{1}{br(\mathcal{T})}$ then \mathbf{X} is transient.*

Note that, for a b -ary tree \mathbb{T}_b , we have $br(\mathbb{T}_b) = b$ and

$$\alpha(\mathbb{T}_b, \lambda_1, \lambda) = \beta(\mathbb{T}_b, \lambda_1, \lambda) = \frac{\lambda^2 + (b-1)\lambda\lambda_1 + \lambda_1}{1 + b\lambda_1} \quad (4.7)$$

and our result therefore agrees with Corollary 1.6 of [10]. In [10], the authors prove that the walk is recurrent at criticality on regular trees, but this is not expected to be true on any tree). For instance, if $\lambda_1 = \lambda$, the (λ, λ) -OERW \mathbf{X} is the biased random walk with parameter λ . Therefore \mathbf{X} may be recurrent or transient at criticality (see [13], proposition 22).

Volkov [118] conjectured that, any cookie random walk which moves, after excitation, like a simple random walk (i.e. $\lambda = 1$) is transient on any tree containing the binary tree. This conjecture was proved by Basdevant and Singh [10]. Here, we extend this conjecture to any tree \mathcal{T} whose branching number is larger than 1:

Theorem 4.16 (Huynh, [68]). *Let $(\lambda_1, \dots, \lambda_M) \in (\mathbb{R}_+)^M$ and consider $(\lambda_1, \dots, \lambda_M; 1)$ cookie random walk \mathbf{X} on an infinite, locally finite, rooted tree \mathcal{T} . If $br(\mathcal{T}) > 1$, then \mathbf{X} is transient.*

4.3 Random walk in random environment

Random walks in random environments have been at the center of the probabilists' interest for several decades. This model is commonly used to represent some physical or biological systems which it is essential to take account of the spatial heterogeneity of the environment. Indeed, the presence of impurities in the environment leads to be different behavior compared with observed one in the classical framework of a homogeneous environment. The mathematical study of such models has grown considerably over the last thirty years. This growth is due, on the one hand, to the desire to answer the questions posed by physicists and biologists and, on the other hand, to the richness of observed behaviors, we need to introduce the new tools to study these models.

A specific class of such random walks goes under the banner of the *Random Conductance Model* (RWRC). Let us review some basic definitions on this models and we refer the readers to [25] for more details.

We begin with the definition of the problem in the context of random walks in random environments. Consider a countable set \mathcal{V} and suppose that we are given a collection of numbers $(w_{xy})_{x,y \in \mathcal{V}}$ with the following properties: $w_{xy} \geq 0$ with

$$\pi_w(x) := \sum_{y \in \mathcal{V}} w_{xy} \in (0, \infty), \quad x \in \mathcal{V}, \quad (4.8)$$

and the symmetry condition

$$w_{xy} = w_{yx}, \quad x, y \in \mathcal{V}. \quad (4.9)$$

The quantity is called the *conductance* of the pair (x, y) .

When \mathcal{V} has an unoriented-graph structure with edge set \mathcal{E} , we often enforce $w_{xy} = 0$ whenever $(x, y) \notin \mathcal{E}$; in that case, it is called the *nearest-neighbor* model. Such a model is then called *uniformly elliptic* if there is $\alpha \in (0, 1)$ for which

$$\alpha < w_{xy} < \frac{1}{\alpha}, \quad (x, y) \in \mathcal{E}. \quad (4.10)$$

When $\mathcal{V} := \mathcal{Z}^d$, we use the phrase “nearest-neighbor model” for the situation when \mathcal{E} is the set of pairs of vertices that are at the Euclidean distance one from each other.

The random walk in environment w is technically a discrete time Markov chain with state-space \mathcal{V} and the transition probability:

$$P^w(x, y) := \frac{w_{xy}}{\pi_w(x)}. \quad (4.11)$$

Let Ω be the space of all configurations (w_{xy}) of the conductances. This space is naturally endowed with a product σ -algebra \mathcal{F} . Let \mathbf{P} be a probability measure on (Ω, \mathcal{F}) . Denote by $\mathbf{X} := (X_n)_{n \geq 0}$ a sample path of the above Markov chain and let P_x^ω denote the law of \mathbf{X} subject to the initial condition

$$P_x^\omega(X_0 = x) = 1. \quad (4.12)$$

We call P_x^ω the *quenched law*. Finally, we denote by \mathbb{P}_x the *annealed law* of the (RWRC) started at x as the semi-direct product

$$\mathbb{P}_x := \mathbf{P} \times P_x^\omega. \quad (4.13)$$

We are interested in considering the model of (RWRC) defined in a tree. The first kind we shall review have proved useful in the study of random fractals ([45, 46]). This model was study by Lyons [85]; Pemantle [101]; Lyons and Pemantle [86]. Let us define the probability measure \mathbf{P} of this model. Let $\mathcal{T} = (V, E)$ be an infinite, locally finite and rooted tree with the root ϱ . Assign to each edge σ of \mathcal{T} a nonnegative random variable A_σ . Let

$$\omega_\sigma = \prod_{\tau \leq \sigma} A_\tau \quad (4.14)$$

this will be the conductance of the edge σ .

For a vertex $v \in V$, $T(v)$ stands for the *return time* to v , that is

$$T(v) := \inf\{n > 0 : X_n = v\}.$$

A RWRC is said to be *recurrent* if it returns to ϱ , \mathbb{P}_ϱ -almost surely. This process is *transient* if it is not recurrent, that is

$$\mathbb{P}_\varrho(T(\varrho) = \infty) > 0.$$

Assume that the random variables $\{A_\sigma\}$ are independent identically distributed, each has mean p and let A be a random variable with this common distribution. By the Zero-one law, a (RWRC) is a.s. transient or recurrent. We shall determine the phase transition of (RWRC). The *branching number* of a tree \mathcal{T} , denoted by $br(\mathcal{T})$, is a real number greater than or equal to 1 that measures the average number of branches per vertex of the tree. It was showed that, when $A \leq 1$, the (RWRC) is transient or recurrent according to whether $\mathbb{E}(A) br(\mathcal{T})$ is greater or less than 1:

Theorem 4.17 (Lyons, [85]). *Assume that $A \leq 1$. If $\mathbb{E}(A) br(\mathcal{T}) < 1$ then (RWRC) is recurrent and if $\mathbb{E}(A) br(\mathcal{T}) > 1$ the (RWRC) is transient.*

We define

$$p := \min_{0 \leq x \leq 1} \mathbb{E}(A^x). \quad (4.15)$$

Note that in the case of $A \leq 1$, we have $p = \mathbb{E}(A)$. In Theorem 2 of [101], it is shown that if \mathcal{T} is a homogeneous tree or the genealogical tree of a Galton-Watson process on the event of nonextinction, then (RWRC) is a.s. transient or a.s. recurrent according to whether $p br(\mathcal{T})$ is greater or less than 1:

Theorem 4.18 (Pemantle, [101]). *Let \mathcal{T} be a homogeneous tree or the genealogical tree of a Galton-Watson process on the event of nonextinction. If $p br(\mathcal{T}) < 1$ then (RWRC) is recurrent and if $p br(\mathcal{T}) > 1$ the (RWRC) is transient.*

In [86], Lyons and Pemantle proved a generalized version of Theorems 4.17 and 4.18:

Theorem 4.19 (Lyons and Pemantle, [86]). *Let \mathcal{T} be tree. If $p br(\mathcal{T}) < 1$ then (RWRC) is recurrent and if $p br(\mathcal{T}) > 1$ the (RWRC) is transient.*

Now, we define a variant version of the probability measure \mathbf{P} by the following way. Instead of defining the random conductances as in Equation 4.14, we define

$$\omega_\sigma := A_\sigma. \quad (4.16)$$

Assume that $(w_e)_{e \in E}$ is a collection of i.i.d. random variables that are almost surely positive. Moreover, assume that

$$\mathbf{P} \left(w_e \leq \frac{1}{t} \right) = \frac{L(t)}{t^m}, \quad \text{for } t > 0, \quad (4.17)$$

where $L : \mathbb{R} \rightarrow \mathbb{R}$ is a slowly-varying function.

In order to see a phase transition, one needs to consider trees that grow polynomially fast,

and therefore the branching number is not the quantity that would provide a relevant information in this case. Indeed, the branching number does not allow us to distinguish among trees with polynomial growth as the branching number of any tree with sub-exponential growth is equal to 1. In [33], it was proved that the critical parameter for the once-reinforced random walk on trees is equal to the *branching-ruin number* of the tree (see (2.2)). The branching-ruin number of a tree \mathcal{T} , denoted by $br_r(\mathcal{T})$, is best described as the polynomial version of the branching number: if a well-behaved tree has spheres of size n^b , then the branching-ruin number of this tree is b . Now, we give a sharp phase transition of this model in term of the *branching-ruin number*:

Theorem 4.20 (Collecchio, Huynh and Kious, [32]). *Fix an infinite, locally finite, tree \mathcal{T} and let $b = br_r(\mathcal{T}) \in [0, \infty]$ be its branching-ruin number. If $b < 1$, then RWRC is recurrent. Assuming $b > 1$, if $mb > 1$ then RWRC is transient and if $mb < 1$ then it is recurrent.*

5 Random maps

In this section, we review some notions and results on random map. We refer the reader to Grégory Miermont [93], Grégory Miermont and Jean-Francois Le Gall [82], Bettinelli [22] for the details.

5.1 Some definitions

Here, we define maps in the geometric way as in Bettinelli ([22], Section 1.1.1) and Grégory Miermont and Jean-Francois Le Gall ([82], Section 5.1). We refer the reader to Bojan Mohar and Carsten Thomassen [95] for the other definition of maps and the equivalence between these definitions.

The surface classification theorem states that the compact connected orientable surface without boundary are characterized up to homeomorphism by an integer $g \geq 0$ which is called genus. The surface of genus 0 is the sphere \mathbb{S}^2 of \mathbb{R}^3 , and for all $g \geq 1$, the surface of genus g , which is denoted by \mathbb{T}_g and called g -torus, is obtained by connected sum of g torus \mathbb{T}_1 . We also define the torus \mathbb{T}_g as the sphere \mathbb{S}^2 to which we add g anses.

Let \mathbb{G} be a compact connected orientable surface without boundary. An *oriented edge* in \mathbb{G} is a continuous mapping $e : [0, 1] \rightarrow \mathbb{G}$ satisfy either e is injective, or the restriction of e to $[0, 1)$ is injective and $e(0) = e(1)$. In the latter case, e is called *loop*. An oriented edge will always be considered up to reparametrization by a continuous increasing function from $[0, 1]$ to $[0, 1]$ and we will always be interested in properties of edges that do not depend on a particular parameterization. The *extremities* of e is $e^- = e(0)$ and $e^+ = e(1)$. The *reversal* of e is the oriented edge $\bar{e} = e(1 - \cdot)$. An *edge* is a pair $\mathbf{e} = \{e, \bar{e}\}$ where e is an oriented edge. The *interior* of \mathbf{e} is $e((0, 1))$. Consider a finite graph

$\mathcal{G} = (V, E)$ in which V and E are finite and multiple edges and loops are allowed. A graph \mathcal{G} is called *embedded graph* in \mathbb{G} if the following conditions are satisfied:

- V is a subset of \mathbb{G}
- E is a set of edges in \mathbb{G}
- The vertices incident to $\mathbf{e} = \{e, \bar{e}\} \in E$ are $e^+, e^- \in V$
- The interior of an edge $e \in E$ does not intersect V nor the edges of E distinct from e .

The support of an embedded graph $\mathcal{G} = (V, E)$ is $\text{supp}(\mathcal{G}) = V \cup \bigcup_{\{e, \bar{e}\} \in E} e([0, 1])$. A *face* of the embedding is a connected component of the set $\mathbb{G} \setminus \text{supp}(\mathcal{G})$. Now, we lead to the following definition:

Definition 5.1. A map on \mathbb{G} is a connected embedded graph on \mathbb{G} . Equivalently, a map is an embedded graph whose faces are all homeomorphic to the open disk in \mathbb{R}^2 .

A *rooted map* is a pair (\mathbf{m}, e) where $\mathbf{m} = (V, E)$ is a map and $e \in \vec{E}$ is a distinguished oriented edge which is called the *root* of \mathbf{m} .

Note that the root of a map can be a corner (see Section 5.2 for instance) of the map. The genus of a map \mathcal{G} on \mathbb{G} is defined as the genus of surface \mathbb{G} . Let $\mathbf{m} = (V, E)$ be a map, and let $\vec{E} = \{e \in \mathbf{e} : \mathbf{e} \in E\}$ be the set of all oriented edges of \mathbf{m} . Since \mathbb{G} is oriented, it is possible to define, for every oriented edge $e \in \vec{E}$, a unique face f_e of \mathbf{m} , located to the left of the edge e . We call f_e the *face incident* to e . We define the *degree* of a face f as follows:

$$\text{deg}(f) = \text{card} \{e \in E : f_e = f\}.$$

The oriented edges incident to a given face f , are arranged cyclically in counter-clockwise order around the face in what we call the *facial ordering*. With every oriented edge e , we can associate a *corner* incident to e , which is a small simply connected neighborhood of the vertex e^- of e intersected with the face f_e . It is easy to see that the corner of two different oriented edges do not intersect. The degree of a vertex $v \in V$ is defined by:

$$\text{deg}(v) = \text{card} \{e \in \vec{E} : e^- = v\}.$$

An important property of maps which is called *Euler formula*. Euler's formula says that any map \mathbf{m} on an orientable surface of genus g satisfies $|V(\mathbf{m})| + |F(\mathbf{m})| - |E(\mathbf{m})| = 2$, where $V(\mathbf{m})$ $F(\mathbf{m})$ $E(\mathbf{m})$ denote respectively the sets of all vertices, edges and faces of the map \mathbf{m} .

Until now, the set of maps \mathbb{G} is infinity. For the problems of combinatorial and probability, we must identify the maps up to isomorphisms. This lead us to the following definitions.

Definition 5.2. The maps \mathbf{m}, m' on \mathbb{G} are isomorphic if there exists an orientation-preserving homeomorphism h of \mathbb{S}^2 onto itself, such that h induces a graph isomorphism of \mathbf{m} with \mathbf{m}' .

The rooted maps (\mathbf{m}, e) and (\mathbf{m}', e') are isomorphic if \mathbf{m} and \mathbf{m}' are isomorphic through a homeomorphism h satisfy $h(e) = e'$.

Remark 5.3. If \mathbf{m} and \mathbf{m}' are isomorphic, then the graphs associated to \mathbf{m}, m' are isomorphic, but the reverse is not true.

An *automorphism* of a map \mathbf{m} is an isomorphism of \mathbf{m} with itself. It should be interpreted as a symmetry of the map. An important property of automorphism is the following.

Proposition 5.4. *If an automorphism h of a map \mathbf{m} that fixes an oriented edge, then h is identity.*

In a rooted map (\mathbf{m}, e) , the face f_e incident to the root edge e is often called the *external face*, or *root face*. The other faces of (\mathbf{m}, e) are called *internal*. The vertex e^- is called the *root vertex*.

We end this section by introducing the notion of *graph distance* in a map \mathbf{m} . A *chain* of length $k \geq 1$ is a sequence $e_{(1)}, \dots, e_{(k)}$ of oriented edges in $\vec{E}(\mathbf{m})$ such that $e_{(i)}^+ = e_{(i+1)}^-$ for all $1 \leq i \leq k-1$, and in this case we say that the chain starting at the vertex $e_{(1)}^-$ and ending at $e_{(k)}^+$. The graph distance between two vertices $u, v \in V$ is the minimal k such that there exists a chain with length k linking u and v . A chain with minimal length between two vertices is called a *geodesic chain*.

5.2 Triangulations of the torus

A map \mathbf{m} on the torus \mathbb{T}_1 is called *toroidal map*. The universal cover of the torus is a surjective mapping from the plane to the torus that is locally a homeomorphism. If the torus is represented by a square in the plane whose opposite sides are pairwise identified, then the universal cover of the torus is obtained by replicating the square to tile the plane. Given a property \mathcal{P} defined on graphs, we say that a graph G embedded on the torus is *essentially \mathcal{P}* , if its universal cover (i.e. the infinite planar map G^∞ obtained by replicating G in the plane) as property \mathcal{P} . The notion of being essentially "something" often appears naturally while considering toroidal maps.

Recall that a graph is *simple* if it has no loop nor multiple edges. Then a graph G embedded on the torus is *essentially simple* if G^∞ . This is equivalent to the fact that G has no contractible loops (i.e. an edge enclosing a region homeomorphic to an open disk) nor homotopic multiple edges (two edges that have the same extremities and whose union encloses a region homeomorphic to an open disk).

We distinguish paths and cycles from walks and closed walks as the firsts have no repeated vertices. A *triangle* of a toroidal map is a closed walk of size 3 enclosing a region that is homeomorphic to an open disk. This region is called the *interior* of the triangle. Note that a triangle is not necessarily a face of the map as its interior may be not empty. We say that a triangle is *maximal* (by inclusion) if its interior is not strictly contained in the interior of another triangle. We define the *corners* of a triangle as the three angles that appear in the interior of this triangle when its interior is removed (if non empty).

Definition 5.5. We call triangulation is a map whose faces are triangle.

For $n \geq 1$, let $\mathcal{T}(n)$ be the set of essentially simple toroidal triangulations on n vertices (up to isomorphisms) that are rooted at a corner of a maximal triangle.

5.3 Scaling limits

We are interested to the scaling limit of random maps. The concept of scale limit is well known in probability theory and the general principle is as follows. Given a certain class of combinatorial objects for which we have a notion of *volume* and a notion of size. When the volume tends to infinity, we try to normalize the size to obtain an interesting limit. More precisely, we choose a random object among the objects of volume n belonging to this class. It may be that, once the size is properly renormalized, this object tends in law towards a continuous limit object when n go to infinity. for example, in the case of the standard random walk, if we call volume the number of steps and size the value of the step, then the scaling limit of this object is Brownian motion: We choose a path uniformly randomly among the paths consisting of n steps of $\{+1, -1\}$, after renormalizing the time by n and space by \sqrt{n} , this path tends in law towards a Brownian movement defined on $[0, 1]$ according the Donker's theorem. One can also think of various models of trees, for which the volume is for example the number of vertices and the size is the height.

Moreover, the limit object often has a interested property which is called *universality*: one obtains the same scaling limit for several different (but similar) classes of objects. For example, the Brownian motion which appears as the scaling limit of any random walk which satisfy the law of its steps is centered and of finite variance. For two other examples, the continuum real tree is the scaling limit of a lot models of random tree (see David Aldous [4], [5]); or the Brownian map is the scaling limit of many classes of random planar maps (see Le Gall [81]).

In our case, we consider the class of triangulation on torus \mathbb{T}_1 with its size as be the number of its vertices. Since \mathcal{T}_n has the finite cardinality, then we can choose a triangulation G_n uniformly random on \mathcal{T}_n . We must specify the space and its topology to study the scaling limit of this class of maps. The space on which we work is then the set \mathbb{M} of classes of isometry of compact metric spaces. The topology of the space \mathbb{M} is

Gromov Hausdorff topology. We define formally the Gromov-Hausdorff distance between two compact metric spaces. The Hausdorff distance between two non-empty subsets X and Y of a metric space (G, d) is defined by

$$d_{Haus}(X, Y) = \max\{\sup_{x \in X} \inf_{y \in Y} d(x, y), \sup_{y \in Y} \inf_{x \in X} d(x, y)\}.$$

Equivalently,

$$d_{Haus}(X, Y) = \inf\{\varepsilon \geq 0 : X \subset Y_\varepsilon, Y \subset X_\varepsilon\},$$

where Z_ε denotes $\bigcup_{z \in Z} \{m \in M : d(m, z) \leq \varepsilon\}$.

The Gromov-Hausdorff distance between two compact metric spaces (S, δ) and (S', δ') is defined by

$$d_{GH}((S, \delta), (S', \delta')) = \inf\{d_{Haus}(\varphi(S), \varphi'(S'))\},$$

where the infimum is taken over all isometric embeddings $\varphi : S \rightarrow S''$ and $\varphi' : S' \rightarrow S''$ of S and S' into the same metric space (S'', δ'') . The Gromov Hausdorff distance is a distance on \mathbb{M} (see [28], theorem 7.3.30) and the metric space (\mathbb{M}, d_{GH}) is a Polish space (see [28], theorem 7.4.15).

We are wondering if it is possible to normalize the metric space $(V(G_n), d_{G_n})$ such that it admits a convergence in distribution for the Gromov Hausdorff topology? We refer the reader to Chapter 5.5 for a partial answer of this question.

5.4 Some recent results

Consider a random planar map G_n with n vertices which is uniformly distributed over a certain class of planar maps (like planar triangulations, quadrangulations or d -angulations). Equip the vertex set $V(G_n)$ with the graph distance d_{G_n} . It is known that the diameter of the resulting metric space is of order $n^{1/4}$ (see for example [30] for the case of quadrangulations). Thus one can expect that the rescaled random metric spaces $(V(G_n), n^{-1/4}d_{G_n})$ converges in distribution as n tends to infinity towards a certain random metric space. In 2006, Schramm [110] suggested to use the notion of Gromov-Hausdorff distance to formalize this question by specifying the topology of this convergence. He was the first to conjecture the existence of a scaling limit for large random planar triangulations.

Jean-Francois Marckert et Abdelkader Mokrarem [90] were then interested to the problem of the convergence of uniform planar quadrangulations, by considering maps as metric spaces with the graph distance renormalized by $n^{-1/4}$. They proved a convergence, in a certain sense, of the discrete space to a limit space which they called Brownian map. The problem of the convergence in the sense of Gromov Hausdorff topology is still open. One year later, Jean-Francois Le Gall [80] showed the convergence of discrete metric spaces to a random metric space, but only to extraction of subsequences. More

precisely, he showed that the sequence of the laws of these metric spaces is tight, which implies that it admits adherence values, and conjectured that the extraction is not required, this means that there is only one adherence value. This conjecture is often called *the uniqueness of the Brownian map*. This conjecture was proved by Grégory Miermont [94] and Jean-Francois Le Gall [81]. In particular, Jean-Francois Le Gall [81] proved the universality property of Brownian map and the Schramm’s conjecture for the scaling limit of triangulation was also solved.

A question is risen in Jean-Francois Le Gall [81] and Jean-Francois Le Gall and Beltran [15]: Does there exist the scaling limit for *simple triangulation* ? Addario-Berry Louigi and Albenque Marie [1] obtained a positive answer for this question.

5.5 Scaling limits for random simple triangulations on the torus

We address the question of the existence of a scaling limit of random maps on higher genus oriented surfaces. Chapuy, Marcus and Schaeffer [29] extended the bijection known for planar bipartite quadrangulations to any oriented surfaces. This leads Bettinelli [22] to show that random quadrangulations on oriented surface converges in distribution, at least along a subsequence. He conjectured that there is the scaling limit for more general classes of random maps. More precisely, the scaling limit still holds while replacing the class of quadrangulations with some other “reasonable” class of maps. Moreover, he believed that the extraction of subsequences is not required.

Our main result is the following convergence result:

Theorem 5.6 (Beffara-Huynh-Lévêque, [14]). *For $n \geq 1$, let G_n be a uniformly random element of the set of all essentially simple toroidal triangulations on n vertices that are rooted at a corner of a maximal triangle. Then, from any increasing sequence of integers, one can extract a subsequence $(n_k)_{k \geq 0}$ along which the rescaled metric spaces*

$$\left(V(G_{n_k}), n_k^{-1/4} d_{G_{n_k}} \right)_{k \geq 0}$$

converge in distribution for the Gromov-Hausdorff distance.

6 Outline of the main body of the thesis

The remainder of this thesis is organized into several chapters, most corresponding to separate articles. We give a brief outline of each paper below for the convenience of the reader, and refer them either to the introduction above or to each chapter for precise statements of mathematical results.

Chapter 2: Trees of self-avoiding walks [13] (*with V. Beffara*) In this chapter, following Berretti and Sokal, we investigate biased random walks on the tree of all finite self-avoiding paths on a lattice as a tool to construct a probability measure on infinite self-avoiding walks.

Chapter 4: The branching-ruin number as critical parameter of random processes on trees [32] (*with A. Collevecchio and D. Kious*) Here, we extend a previous criterion by Collevecchio, Kious and Sidoravicius to characterize the recurrence or transience of a biased random walk in random conductances and that of a particular multi-excited random process, both on a tree, in terms of a quantity that can be seen as the effective degree of polynomial branching of the tree.

Chapter 5: Phase transition for the Once-excited random walk on general trees [68] In this chapter, we generalize the previous construction to the case of non-infinitely excited walks as a way to characterize the behavior of the once-excited random walk on a tree of polynomial branching.

Chapter 6: Scaling limits for random triangulations on the Torus [14] (*with V. Beffara and B. Lévêque*) In this last chapter, we prove the existence of subsequential scaling limits, in the Gromov-Hausdorff topology, of suitably rescaled simple triangulations of genus 1, thus extending previous works by Addario-Berry and Albenque (for simple triangulations in genus 0) and by Bettinelli (for quadrangulations in genus 1). One of the crucial steps in the argument is to construct a simple labeling on the map and show its convergence to an explicit scaling limit. We moreover show that this labeling approximates the distance to the root up to a uniform correction of order $o(n^{1/4})$ (see Theorem 1.15).

In addition, **Chapter 3** gathers some work in progress and ideas about future research directions related to the results in chapter 2.

Part I

Statistical mechanics

Chapter 2

Trees of self-avoiding walk

Abstract

We consider the biased random walk on a tree constructed from the set of finite self-avoiding walks on a lattice, and use it to construct probability measures on infinite self-avoiding walks. The limit measure (if it exists) obtained when the bias converges to its critical value is conjectured to coincide with the weak limit of the uniform SAW. Along the way, we obtain a criterion for the continuity of the escape probability of a biased random walk on a tree as a function of the bias, and show that the collection of escape probability functions for spherically symmetric trees of bounded degree is stable under uniform convergence.

This chapter is based on [13], which is joint work with Vincent Beffara.

1 Introduction

An n -step self-avoiding walk (SAW) (or a self-avoiding walk of length n) in a regular lattice \mathbb{L} (such as the integer lattice \mathbb{Z}^2 , triangular lattice \mathbb{T} , hexagonal lattice, etc) is a nearest neighbor path $\gamma = (\gamma_0, \gamma_1, \dots, \gamma_n)$ that visits no vertex more than once. Self-avoiding walks were first introduced as a lattice model for polymer chains (see [48]); while they are very easy to define, they are extremely difficult to analyze rigorously and there are still many basic open questions about them (see [89], Chapter 1).

Let c_n be the number of SAWs of length n starting at the origin. The *connective constant* of \mathbb{L} , which we will denote by μ , is defined by

$$c_n = \mu^{n+o(n)} \quad \text{when } n \rightarrow \infty.$$

The existence of the connective constant is easy to establish from the sub-multiplicativity relation $c_{n+m} \leq c_n c_m$, from which one can also deduce that $c_n \geq \mu^n$ for all n ; the existence of μ was first observed by Hammersley and Morton [63]. Nienhuis [99] gave a prediction that for all regular planar lattices, $c_n = \mu^n n^{\alpha+o(1)}$ where $\alpha = \frac{11}{32}$, and this prediction is known to hold under the assumption of the existence of a conformally invariant scaling limit, see *e.g.* [79].

We are interested in defining a natural probability measure on the set SAW_∞ of *infinite* self-avoiding walks (*i.e.*, nearest-neighbors paths $(\gamma_k)_{k \geq 0}$ visiting no vertex more than once, see the sections 5.2 and 6). Such a measure was constructed before in the half-plane case as the weak limit of the uniform measures on finite self-avoiding walks, relying on results by Kesten (see [89, 72]), and it is part of our goal to investigate whether that measure and our construction are related.

1.1 The model

In this paper, we consider a one-parameter family of probability measures on SAW_∞ , denoted by $(\mathbb{P}_\lambda)_{\lambda > \lambda_c}$, defined informally as follows (see Notation 5.6 for a formal definition). Let $\mathcal{T}_{\mathbb{Z}^2}$ be the tree whose vertices are the finite self-avoiding walks in the plane starting at the origin, where two such vertices are adjacent when one walk is a one-step extension of the other. We will call this tree the *self-avoiding tree* on \mathbb{Z}^2 . Denoting by \mathbb{H} the upper-half plane in \mathbb{Z}^2 and by \mathbb{Q} the first quadrant, one can define the self-avoiding trees $\mathcal{T}_{\mathbb{H}}$ and $\mathcal{T}_{\mathbb{Q}}$ accordingly, and all the constructions below can be extended to these cases in a natural fashion which we will not make explicit in this introduction.

Then, consider the continuous-time biased random walk of parameter $\lambda > 0$ on $\mathcal{T}_{\mathbb{Z}^2}$, which from a given location jumps towards the root with rate 1 and towards each of its children vertices with rate λ . If λ is such that the walk is transient, its path determines an infinite branch in $\mathcal{T}_{\mathbb{Z}^2}$ which can be seen as a random infinite self-avoiding walk ω_λ^∞ ; we will denote by $\mathbb{P}_\lambda^{\mathbb{Z}^2}$ the law of ω_λ^∞ , omitting the mention of \mathbb{Z}^2 in the notation when it is clear from the context, and call it the *limit walk* with parameter λ .

The idea of seeing the self-avoiding walk as a dynamical object is very natural, and not new; it seems that the biased walk on the “self-avoiding tree” was first considered, mostly for $\lambda < \lambda_c$, by Berretti and Sokal ([20], see also [113, 107]) as a Monte-Carlo method to estimate connective constants and sample finite-size self-avoiding paths uniformly. The model was discussed informally by one of the authors of the present paper (VB) with S. Sidoravicius and W. Werner a number of years ago, as a failed attempt to understand conformal invariance of the SAW model in the scaling limit, and in particular a proof of Theorem 1.1 was obtained at that time but never written down; one of our informal goals here is to revive this line of thought: even though the question of SAW proper still seems out of reach, the link with critical percolation (cf. Section 6.2) could be a promising direction for further research.

1.2 Main results

It is well-known that there exists a critical value $\lambda_c = \lambda_c(\mathcal{T}_{\mathbb{Z}^2})$ such that if $\lambda > \lambda_c$ the biased random walk is transient and if $\lambda < \lambda_c$ it is recurrent (see Lyons [85]). In the general case of biased random walk on a tree, the recurrence or transience of the random walk at the critical point depends in subtle ways on the structure of the tree. The value of λ_c on the other hand is easier to determine: indeed, Lyons [85] proved that it coincides with the reciprocal of the branching number of the tree (for background on branching numbers and trees in general, see *e.g.* [87]). The following proposition gives the critical value for self-avoiding trees.

Theorem 1.1. *Let $\mathcal{T}_{\mathbb{Z}^2}, \mathcal{T}_{\mathbb{H}}, \mathcal{T}_{\mathbb{Q}}$ be the self-avoiding trees defined as above, respectively in the plan, half-plane and first quadrant. Then,*

$$\lambda_c(\mathcal{T}_{\mathbb{Z}^2}) = \lambda_c(\mathcal{T}_{\mathbb{H}}) = \lambda_c(\mathcal{T}_{\mathbb{Q}}) = \frac{1}{\mu},$$

where μ is the connective constant of lattice \mathbb{Z}^2 as defined above.

This is a direct consequence of Proposition 5.9 below. Notice that it is clear from the definition that μ is the growth rate of $\mathcal{T}_{\mathbb{Z}^2}$; there are rather large classes of trees, including $\mathcal{T}_{\mathbb{Z}^2}$, for which the branching and growth coincide (for instance, this holds for sub- or super-periodic trees, cf. below, or for typical supercritical Galton-Watson trees), but none of the classical results seem to apply to $\mathcal{T}_{\mathbb{H}}$ or $\mathcal{T}_{\mathbb{Q}}$.

The geometry of the limit walk is our main object of interest. As a first property of it, we obtain the following (see section 6.3):

Theorem 1.2. *For all $\lambda > \lambda_c$, under the measures $\mathbb{P}_{\lambda}^{\mathbb{Z}^2}$ and $\mathbb{P}_{\lambda}^{\mathbb{H}}$, the limit walk almost surely visits the line $\mathbb{Z} \times \{0\}$ infinitely many times.*

A useful tool in our proofs is the *effective conductance* of the biased random walk on a tree \mathcal{T} , defined as the probability of never returning to the root o of \mathcal{T} and denoted by $\mathcal{C}(\lambda, \mathcal{T})$ — see [87]. Along the way, we will be interested in several properties of it as a function of λ . Most important for us will be the question of continuity: in a general tree, the effective conductance is not necessarily a continuous function of λ . We will derive criteria for continuity, which are forms of *uniform transience* of the random walk, and apply them to prove that the effective conductance of self-avoiding trees is a continuous function (see Section 5.4):

Theorem 1.3. *The effective conductances $\mathcal{C}(\lambda, \mathcal{T}_{\mathbb{Q}}$, $\mathcal{C}(\lambda, \mathcal{T}_{\mathbb{H}})$ and $\mathcal{C}(\lambda, \mathcal{T}_{\mathbb{Z}^2})$ are continuous functions of λ on the interval $(\lambda_c, +\infty)$.*

A related question is that of the convergence of effective conductance along a sequence of trees. More precisely, let $(\mathcal{C}_n)_n$ denote the effective conductances for a sequence (\mathcal{T}_n) of infinite trees, again seen as functions of the bias parameter λ , and assume that $(\mathcal{C}_n)_n$ converges uniformly towards a function \mathcal{C} that is not identically 0. The question is: is \mathcal{C} the effective conductance of a certain tree? We study this question on the class of spherically symmetric trees (a tree \mathcal{T} is said to be spherically symmetric if for every vertex ν , $\deg \nu$ depends only on $|\nu|$, where $|\nu|$ denote its distance from the root and $\deg \nu$ is its number of neighbors). If \mathbb{S} denotes the set of spherically symmetric trees and $m \in \mathbb{N}^*$ is fixed, define

$$A_m := \{\mathcal{T} \in \mathbb{S}; \forall \nu \in \mathcal{T}, \deg \nu \leq m\} \text{ and}$$

$$\mathbb{F}_m := \{f \in C^0([0, 1]) : \exists \mathcal{T} \in A_m, \forall \lambda > 0, \mathcal{C}(\lambda, \mathcal{T}) = f(\lambda)\}.$$

Then (see Section 4.2):

Theorem 1.4. *Let $(f_n)_n$ be a sequence of functions in \mathbb{F}_m . Assume that f_n converges uniformly towards $f \neq 0$. Then $f \in \mathbb{F}_m$.*

1.3 Open questions

One natural probability measure on the set of infinite self-avoiding walks is the limit of $\mathbb{P}_\lambda^{\mathbb{H}}$ as $\lambda \rightarrow \lambda_c$, assuming that this limit exists. We were not able to show convergence, but obtained partial results in this direction by restricting the set of allowed paths. Our conjecture is that the limit exists and has to do with Kesten's measure, *i.e.* the weak limit of uniform finite self-avoiding walks in the half-plane, in a way similar to the fact that the two definitions of the incipient infinite cluster for percolation (seen as a limit as $p \rightarrow p_c$ or as a limit of conditioned critical percolation) coincide, see [74].

This is motivated by a few observations. First, the model for $\lambda < \lambda_c$ gives rise to a recurrent random walk on $\mathcal{T}_{\mathbb{H}}$ for which the invariant measure μ_λ is rather explicit (by reversibility, the mass of a vertex ν is proportional to $\lambda^{|\nu|}$), in particular it depends only

on the distance to the root, and on the other hand it tends to be concentrated on longer and longer walks as $\lambda \uparrow \lambda_c$. This means that the initial segment of a walk distributed as the stationary measure can be seen as the initial segment of a uniform self-avoiding walk with random total length, and we get convergence to Kesten's measure as soon as we can show that for all ν , $\mu_\lambda(\{\nu\}) \rightarrow 0$ as $\lambda \uparrow \lambda_c$. On the other hand, the behavior of the biased walk in a fixed neighborhood of the origin changes very little when λ is close to λ_c , so for λ slightly larger than λ_c it seems reasonable to predict that the walk will spend a long time close to the origin, following an occupation measure close to $\mu_{\lambda_c^-}$, before escaping to infinity. Unfortunately we were unable to formalize this intuition.

Another observation is that convergence of the law of the limit walk holds within the class of paths for which the bridge decomposition involves only bridges of height less than some fixed bound $m > 0$. More precisely: for fixed m , the critical parameter is $\lambda_{c,m} \geq \lambda_c$, and the limit $\lambda \downarrow \lambda_{c,m}$ followed by $m \rightarrow \infty$ leads to Kesten's measure, while the limit $m \rightarrow \infty$ for fixed λ coincides with the limit walk on $\mathcal{T}_{\mathbb{H}}$ with parameter λ — see Theorem 7.3 for more detail. Exchanging the limits would lead to the claim. Unfortunately, it is not true that this can be done in the general setting of biased walks on trees, due to phenomena similar to those described in section 3, so it seems that a deeper understanding of the structure of $\mathcal{T}_{\mathbb{H}}$ would be necessary to conclude.

1.4 Organization of the paper

The paper is structured as follows. In Section 2, we review some basic definitions on graphs, trees, branching number and growth rate of a tree, as well as a few classical results about random walks on trees. Section 3 gathers some relevant examples and counter-examples exhibiting some similarities to the self-avoiding trees while being treatable explicitly. The criterion for the continuity of the effective conductance is given in Section 4. Then Section 5 provides some background on self-avoiding walks and the self-avoiding trees, and some properties of the limit walks are obtained in Section 6. Finally, we state a few conjectures and conditional results in Section 7.

2 Notation and basic definitions

2.1 Graphs and trees

In this section, we review some basic definitions; we refer the reader to the book [87] for a more developed treatment. A *graph* is a pair $\mathcal{G} = (V, E)$ where V is a set of *vertices* and E is a symmetric subset of $V \times V$ (i.e if $(\nu, \mu) \in E$ then $(\mu, \nu) \in E$), called the *edge set*, containing no element of the form (ν, ν) . If $(\nu, \mu) \in E$, then we call ν and μ *adjacent* or *neighbors* and we write $\nu \sim \mu$. For any vertex $\nu \in V$, denote by $\deg \nu$ its number of neighbors. A *path* in a graph is a sequence of vertices, any two consecutive of which are adjacent. A *self-avoiding path* is a path which does not pass through any

vertex more than once. For any $(\nu, \mu) \in V \times V$, the distance between ν and μ is the minimum number of edges among all paths joining ν and μ , denoted $d(\nu, \mu)$. A graph is *connected* if, for each pair $(\nu, \mu) \in V \times V$, there exist a path starting at ν and ending at μ . A connected graph with no cycles is called a *tree*. A *morphism* from a graph \mathcal{G}_1 to a graph \mathcal{G}_2 is a mapping ϕ from $V(\mathcal{G}_1)$ to $V(\mathcal{G}_2)$ such that the image of any edge of \mathcal{G}_1 is an edge of \mathcal{G}_2 . We will always consider trees to be *rooted* by the choice of a vertex o , called the *root*.

Let $\mathcal{T} = (V, E)$ be an infinite, locally finite, rooted tree with set of vertices V and set of edges E . Let o be the root of \mathcal{T} . For any vertex $\nu \in V \setminus \{o\}$, denote by ν^{-1} its *parent* (we also say that ν is a *child* of ν^{-1}), *i.e.* the neighbour of ν with shortest distance from o . For any $\nu \in V$, let $|\nu|$ be the number of edges in the unique self-avoiding path connecting ν to o and call $|\nu|$ the *generation* of ν . In particular, we have $|o| = 0$.

If a vertex has no child, it is called a *leaf*. For any edge $e \in E$ denote by e^- and e^+ its endpoints with $|e^+| = |e^-| + 1$, and define the generation of an edge as $|e| = |e^+|$. We define an order on $V(\mathcal{T})$ as follows: if $\nu, \mu \in V(\mathcal{T})$, we say that $\nu \leq \mu$ if the simple path joining o to μ passes through ν . For each $\nu \in V(\mathcal{T})$, we define the *sub-tree* of \mathcal{T} rooted at ν , denoted by \mathcal{T}^ν , where $V(\mathcal{T}^\nu) := \{\mu \in V(\mathcal{T}) : \nu \leq \mu\}$ and $E(\mathcal{T}^\nu) = E(\mathcal{T})|_{V(\mathcal{T}^\nu) \times V(\mathcal{T}^\nu)}$.

An infinite simple path starting at o is called a *ray*. The set of all rays, denoted by $\partial\mathcal{T}$, is called the *boundary* of \mathcal{T} . The set $\mathcal{T} \cup \partial\mathcal{T}$ can be equipped with a metric that makes it a compact space, see [87].

The remaining part of this paper, we consider only infinite, locally finite and rooted trees with the root o .

2.2 Branching and growth

Definition 2.1. Let \mathcal{T} be an infinite, locally finite and rooted tree. A E-cutset (resp. V-cutset) in \mathcal{T} is a set π of edges (resp. vertices) such that, for any infinite self-avoiding path $(\nu_i)_{i \geq 0}$ started at the root, there exists a $i \geq 0$ such that $[\nu_{i-1}, \nu_i] \in \pi$ (resp. $\nu_i \in \pi$). In other words, a E-cutset (resp. V-cutset) is a set of edges (resp. vertices) separating the root from infinity. We use Π to denote the set of E-cutsets.

Definition 2.2. Let \mathcal{T} be an infinite, locally finite and rooted tree.

— The *branching number* of \mathcal{T} is defined by:

$$br(\mathcal{T}) = \sup \left\{ \lambda \geq 1 : \inf_{\pi \in \Pi} \sum_{e \in \pi} \lambda^{-|e|} > 0 \right\}$$

— We define also

$$\overline{gr}(\mathcal{T}) = \limsup |\mathcal{T}_n|^{1/n} \quad \text{and} \quad \underline{gr}(\mathcal{T}) = \liminf |\mathcal{T}_n|^{1/n}.$$

In the case $\overline{gr}(\mathcal{T}) = \underline{gr}(\mathcal{T})$, the *growth rate* of \mathcal{T} is defined by their common value and denoted by $gr(\mathcal{T})$.

Remark 2.3. It follows immediately from the definition of branching number that if \mathcal{T}' is a sub-tree of \mathcal{T} , then $br(\mathcal{T}') \leq br(\mathcal{T})$.

Proposition 2.4 ([87]). *Let \mathcal{T} be a tree, then $br(\mathcal{T}) \leq \underline{gr}(\mathcal{T})$.*

In general, the inequality in Proposition 2.4 may be strict: The *1-3 tree* (see [87], page 4) is an example for which the branching number is 1 and the growth rate is 2. There are classes of trees however where branching and growth match.

Definition 2.5. The tree \mathcal{T} is said to be *spherically symmetric* if $\deg \nu$ depends only on $|\nu|$.

Theorem 2.6 ([87] page 83). *For every spherically symmetric tree \mathcal{T} , $br(\mathcal{T}) = \underline{gr}(\mathcal{T})$.*

Definition 2.7. Let $N \geq 0$: an infinite, locally finite and rooted tree \mathcal{T} with the root o , is said to be

- *N -sub-periodic* if for every $\nu \in V(\mathcal{T})$, there exists an injective morphism $f : \mathcal{T}^\nu \rightarrow \mathcal{T}^{f(\nu)}$ with $|f(\nu)| \leq N$.
- *N -super-periodic* if for every $\nu \in V(\mathcal{T})$, there exists an injective morphism $f : \mathcal{T} \rightarrow \mathcal{T}^{f(o)}$ with $f(o) \in \mathcal{T}^\nu$ and $|f(o)| - |\nu| \leq N$.

Theorem 2.8 (see [53, 87]). *Let \mathcal{T} be an infinite, locally finite and rooted tree that is either N -sub-periodic, or N -super-periodic with $\overline{gr}(\mathcal{T}) < \infty$. Then the growth rate of \mathcal{T} exists and $gr(\mathcal{T}) = br(\mathcal{T})$.*

2.3 Random walks on trees

Let \mathcal{T} be a tree, we now define the discrete-time biased random walk on \mathcal{T} . Working in discrete time will make some of the arguments below a little simpler, at the cost of a slightly heavier definition here — notice though that the definition of the measure \mathbb{P}_λ and the main results of the paper are not at all affected by this choice.

Let $\lambda > 0$: the biased walk RW_λ with bias λ on \mathcal{T} is the discrete-time Markov chain on the vertex set of \mathcal{T} with transition probabilities given, at a vertex $x \neq o$ with k children, by

$$p_\lambda(x, y) := \begin{cases} \frac{1}{1+k\lambda} & \text{if } y \text{ is the father of } x, \\ \frac{\lambda}{1+k\lambda} & \text{if } y \text{ is a child of } x, \\ 0 & \text{otherwise.} \end{cases}$$

If the root has $k > 0$ children, then $p_\lambda(o, x)$ is $1/k$ if x is a child of o and 0 otherwise. The degenerate case $T = \{o\}$ where the root has no child will not occur in our context, so we will silently ignore it. We also allow ourselves to consider the cases $\lambda \in \{0, \infty\}$,

with the natural convention that RW_0 remains stuck at the root and that RW_∞ always moves away from the root, getting stuck whenever it reaches a leaf.

Definition 2.9. Let $\mathcal{G} = (V, E)$ be a graph, and $c : E \rightarrow \mathbb{R}_+^*$ be labels on the edges, referred to as *conductances*. Equivalently, one can fix *resistances* by letting $r(e) := 1/c(e)$. The pair (G, c) is called a *network*. Given a subset K of V , the restriction of c to the edges joining vertices in K defines the *induced sub-network* $\mathcal{G}|_K$. The *random walk* on the network (\mathcal{G}, c) is the discrete-time Markov chain on V with transition probabilities proportional to the conductances.

Given a network (\mathcal{T}, c) on a tree, let $\pi(o)$ be the sum of the conductances of the edges incident to the root, and denote by $T(o)$ the first return time to the origin by the walk. Following [87] (page 25), we can define the *effective conductance* of the network by

$$\mathcal{C}_c(\mathcal{T}) := \pi(o)\tilde{\mathcal{C}}_c(\mathcal{T}), \quad (2.1)$$

where $\tilde{\mathcal{C}}_c(\mathcal{T}) := \mathbb{P}[T(o) = +\infty]$. The reciprocal $\mathcal{R}_c(\mathcal{T})$ of the effective conductance is called the *effective resistance*.

The particular case where, on a tree \mathcal{T} , for an edge $e = (x, y)$ between a vertex x and any of its children y , $c(e)$ is chosen to be $\lambda^{|x|}$ will play a special role, because in that case the random walk on the network is exactly the same process as the random walk RW_λ defined earlier. In this setup, we will denote the effective conductance (resp. effective resistance) by $\mathcal{C}(\lambda, \mathcal{T})$ (resp. $\mathcal{R}(\lambda, \mathcal{T})$) to emphasize its dependency on the parameter λ . Let ν be a child of o , we write $\tilde{\mathcal{C}}(\lambda, \mathcal{T}, \nu)$ for the probability of the event that the random walk RW_λ on \mathcal{T} , started at the root (i.e. $X_0 = o$), never returns to it and reached ν at the first step (i.e. $X_1 = \nu$).

Theorem 2.10 (Rayleigh's monotonicity principle [87]). *Let \mathcal{T} be an infinite tree with two assignments, c and c' , of conductances on \mathcal{T} with $c \leq c'$ (everywhere). Then the effective conductances are ordered in the same way: $\mathcal{C}_c(\mathcal{T}) \leq \mathcal{C}_{c'}(\mathcal{T})$.*

Corollary 2.11. *Let $\mathcal{T}, \mathcal{T}'$ be two infinite trees; we say that $\mathcal{T} \subset \mathcal{T}'$ if there exists an injective morphism $f : \mathcal{T} \rightarrow \mathcal{T}'$. If this holds, then for every $\lambda > 0$, $\mathcal{C}(\lambda, \mathcal{T}') \leq \mathcal{C}(\lambda, \mathcal{T})$.*

In the case of spherically symmetric trees, the equivalent resistance is explicit:

Proposition 2.12 (see [87]). *Let \mathcal{T} be spherically symmetric and $(c(e))$ be conductances that are themselves constant on the levels of \mathcal{T} . Then $\mathcal{R}_c(\mathcal{T}) = \sum_{n \geq 1} \frac{1}{c_n |\mathcal{T}_n|}$, where c_n is the conductance of the edges going from level $n - 1$ to level n .*

The following corollaries are the consequences of Proposition 2.12:

Corollary 2.13. *Let \mathcal{T} be a spherically symmetric tree. The effective conductance $\mathcal{C}(\lambda, \mathcal{T})$ is a continuous function on $(\lambda_c, +\infty)$.*

Corollary 2.14. *Let \mathcal{T} be a spherically symmetric tree. Then RW_λ is transient if and only if $\sum_n \frac{1}{\lambda^n |\mathcal{T}_n|} < \infty$.*

Theorem 2.15 (Nash-Williams criterion, see [97]). *If $(\pi_n, n \geq 0)$ is a sequence of pairwise disjoint finite E -cutsets in a locally finite network \mathcal{G} , then*

$$\mathcal{R}_c(\mathcal{T}) \geq \sum_n \left(\sum_{e \in \pi_n} c(e) \right)^{-1}.$$

In particular, if $\sum_n (\sum_{e \in \Pi_n} c(e))^{-1} = +\infty$, then the random walk associated to this family of conductances $(c(e), e \in E(\mathcal{T}))$ is recurrent.

We end this subsection by stating a classical theorem relating the recurrence or transience of RW_λ to the branching of the underlying tree:

Theorem 2.16 (see [85]). *Let \mathcal{T} be an infinite, locally finite and rooted tree. If $\lambda < \frac{1}{br(\mathcal{T})}$ then RW_λ is recurrent, whereas if $\lambda > \frac{1}{br(\mathcal{T})}$, then RW_λ is transient. The critical value of biased random walk on \mathcal{T} is therefore $\lambda_c(\mathcal{T}) := \frac{1}{br(\mathcal{T})}$.*

2.4 The law of the first k steps of the limit walk

Let \mathcal{T} be a tree and $(c(e))$ be conductances on the edges of \mathcal{T} such that the associated random walk (X_n) is transient. For every $k \geq 0$, the walk visits \mathcal{T}_k finitely many times: we can define an infinite path ω^∞ on \mathcal{T} by letting $\omega^\infty(k)$ be the last vertex of \mathcal{T}_k visited by the walk. Equivalently:

$$\omega^\infty(k) = \nu \iff \nu \in \mathcal{T}_k \text{ and } \exists n_0, \forall n > n_0 : X_n \in \mathcal{T}^\nu. \quad (2.2)$$

Let $k \in \mathbb{N}^*$ and $\nu_0 = o, \nu_1, \nu_2, \dots, \nu_k$ be k elements of $V(\mathcal{T})$ such that $(\nu_0, \nu_1, \nu_2, \dots, \nu_k)$ is a simple path: we can then define

$$\varphi_c(\nu_0, \nu_1, \nu_2, \dots, \nu_k) := \mathbb{P}(\omega^\infty(0) = \nu_0, \omega^\infty(1) = \nu_1, \dots, \omega^\infty(k) = \nu_k). \quad (2.3)$$

We will refer to this function as the *law of first k steps of limit walk*. In the case of the biased walk RW_λ , we will denote the function by $\varphi^{\lambda, k}$; this will not lead to ambiguities. We finish this section with the following lemma.

Lemma 2.17. *The value of $\varphi_c(\nu_0, \dots, \nu_k)$ depends continuously on any finite collection of the conductances in the network. More precisely, given a finite set $U = \{e_1, \dots, e_\ell\}$ of edges and a collection $(c(e))$ of conductances, let $\tilde{c}(u_1, \dots, u_\ell)$ be the family of conductances that coincides with c outside U and takes value u_i at e_i : then the map*

$$\psi_{U,c} : (u_1, \dots, u_\ell) \mapsto \varphi_{\tilde{c}(u_1, \dots, u_\ell)}(\nu_0, \dots, \nu_k)$$

is continuous on $(\mathbb{R}_+^)^\ell$.*

Proof. The proof is simple, therefore it is omitted. □

3 A few examples

The self-avoiding tree in the plane, which we alluded to in the introduction and will formally introduce in the next section, is sub-periodic but quite inhomogeneous, and the self-avoiding tree in the half-plane sits in none of the classes of trees defined above. To get an intuition of the kind of behavior we should expect or rule out, we gather here a few examples of trees with some atypical features.

3.1 Trees with discontinuous conductance

Let $0 < \lambda_0 \leq 1$. In the first part of this section, we construct two trees $\mathcal{T}, \bar{\mathcal{T}}$ with $\lambda_c(\mathcal{T}) = \lambda_c(\bar{\mathcal{T}}) = \lambda_0$, such that the effective conductances $C(\lambda, \mathcal{T})$ and $C(\lambda, \bar{\mathcal{T}})$ of the biased random walk RW_λ on \mathcal{T} and $\bar{\mathcal{T}}$ satisfy $C(\lambda_c(\mathcal{T}), \mathcal{T}) = 0$ but $C(\lambda_c(\bar{\mathcal{T}}), \bar{\mathcal{T}}) > 0$. In the second part, we construct a tree \mathcal{T} such that $C(\lambda, \mathcal{T})$ is not continuous on $(\lambda_c, 1)$.

Proposition 3.1. *For every $x \geq 1$, there exist two trees \mathcal{T} and $\bar{\mathcal{T}}$ such that:*

- $br(\mathcal{T}) = br(\bar{\mathcal{T}}) = x$;
- $RW_{1/x}$ is recurrent on \mathcal{T} and transient on $\bar{\mathcal{T}}$.

Proof. We will construct spherically symmetric trees satisfying both conditions. Denoting by $\lfloor y \rfloor$ be the integer part of y . We construct the sequence $(\ell_i)_{i \in \mathbb{N}^*}$ inductively as follows:

$$\ell_1 = \lfloor x \rfloor, \quad \ell_2 = \left\lfloor \frac{x^2}{\ell_1} \right\rfloor, \quad \ell_3 = \left\lfloor \frac{x^3}{\ell_1 \ell_2} \right\rfloor, \quad \dots, \quad \ell_n = \left\lfloor \frac{x^n}{\prod_{i=1}^{n-1} \ell_i} \right\rfloor, \quad \dots$$

and let \mathcal{T} be the tree where vertices at distance i from o have ℓ_i children, so that the sizes of the levels of \mathcal{T} are given by $|\mathcal{T}_n| = \prod_{i=1}^n \ell_i$. We construct the tree $\bar{\mathcal{T}}$ from the degree sequence $(\ell'_i)_{i \in \mathbb{N}}$ by posing $\ell'_i = 2\ell_i$ if i can be written under the form $i = k^2$, and $\ell'_i = \ell_i$ otherwise. Notice that $|\bar{\mathcal{T}}_n| = 2^{\lfloor \sqrt{n} \rfloor} |\mathcal{T}_n|$.

We first show that both trees have branching number x . Since they are spherically symmetric, it is enough to check that their growth rate is x ; the case $x = 1$ is trivial, so assume $x > 1$. From the definition,

$$x^n - \prod_{i=1}^{n-1} \ell_i \leq \prod_{i=1}^n \ell_i \leq x^n \quad \text{hence} \quad x^n - x^{n-1} \leq |\mathcal{T}_n| \leq x^n$$

so $gr(\mathcal{T}) = x$; the case of $\bar{\mathcal{T}}$ follows directly.

The recurrence or transience of the critical random walks can be determined using lemma 2.14:

$$\sum \frac{1}{\lambda_c^n |\mathcal{T}_n|} \geq \sum \frac{1}{\lambda_c^n x^n} = +\infty$$

so the critical walk on $\mathcal{T}(x)$ is recurrent, while for $x > 1$,

$$\sum \frac{1}{\lambda_c^n |\overline{\mathcal{T}}_n|} \leq \sum \frac{1}{\lambda_c^n (x^n - x^{n-1}) 2^{\lfloor \sqrt{n} \rfloor}} = \frac{x}{x-1} \sum \frac{1}{2^{\lfloor \sqrt{n} \rfloor}} < \infty$$

so the critical walk on $\overline{\mathcal{T}}(x)$ is transient. In the case $x = 1$ one gets $\sum 2^{-\lfloor \sqrt{n} \rfloor} < \infty$ instead, and the conclusion is the same. \square

Proposition 3.2. *For every $k \in \mathbb{N}^*$ and $\lambda_c \in (0, 1)$, there exists a tree \mathcal{T} with critical drift $\lambda_c(\mathcal{T}) = \lambda_c$ such that the ratio $C(\lambda)/(\lambda - \lambda_c)^k$ remains bounded away from 0 as $\lambda \rightarrow \lambda_c^+$.*

Proof. We construct a spherically symmetric tree \mathcal{T} which satisfies the conditions of this proposition in a similar way as before. Letting $x = 1/\lambda_c > 1$, define inductively:

$$\ell_1 = \lfloor x \rfloor, \quad \ell_2 = \left\lfloor \frac{x^2}{2^k \ell_1} \right\rfloor, \quad \dots, \quad \ell_n = \left\lfloor \frac{x^n}{n^k \prod_{i=1}^{n-1} \ell_i} \right\rfloor, \quad \dots$$

Let T be the spherically symmetric tree with degree sequence (ℓ_i) . It is easy to check that $br(\mathcal{T}) = x$ like in the previous proposition; in a similar way,

$$x^n - n^k \prod_{i=1}^{n-1} \ell_i \leq n^k \prod_{i=1}^n \ell_i \leq x^n \quad \text{hence} \quad \frac{x^n}{n^k} - \frac{x^{n-1}}{(n-1)^k} \leq |\mathcal{T}_n| \leq \frac{x^n}{n^k}.$$

Recall that $x = 1/\lambda_c$ and by using Proposition 2.12, the effective resistance at parameter $\lambda > \lambda_c$ is given by

$$\mathcal{R}(\lambda, \mathcal{T}) = \sum \frac{1}{\lambda^n |\mathcal{T}_n|} \geq \sum \frac{n^k}{(\lambda x)^n} \sim \frac{C_k}{(\lambda - \lambda_c)^{k+1}}$$

with a lower bound of the same order but with a different constant, leading to the conclusion. \square

We end this subsection with the following proposition, showing that discontinuities can occur elsewhere than at λ_c :

Proposition 3.3. *There exists a tree \mathcal{T} such that the function $C(\lambda, \mathcal{T})$ is not continuous on $(\lambda_c, 1)$, i.e it will be discontinuous at a certain $\lambda' \in (\lambda_c, 1)$.*

Proof. Let $0 < \lambda_1 < \lambda_2 < 1$. By proposition 3.1, there exist two trees \mathcal{H} and \mathcal{G} such that $\lambda_c(\mathcal{H}) = \lambda_1, \lambda_c(\mathcal{G}) = \lambda_2$ and

$$\mathcal{C}(\lambda_1, \mathcal{H}) = 0, \quad \mathcal{C}(\lambda_2, \mathcal{G}) > 0. \quad (3.1)$$

We construct a tree \mathcal{T} rooted at o as follows:

$$\mathcal{T}_1 = \{\nu_1, \nu_2\}, \quad \mathcal{T}^{\nu_1} = \mathcal{H} \quad \text{and} \quad \mathcal{T}^{\nu_2} = \mathcal{G}.$$

Hence,

$$\lambda_c(\mathcal{T}) = \lambda_1.$$

Denote $\deg \nu_1$ (resp. $\deg \nu_2$) the degree of ν_1 (resp. ν_2) in the tree \mathcal{T} . By an easy computation, for any $\lambda \in (\lambda_1, 1)$, we obtain:

$$\mathcal{C}(\lambda, \mathcal{T}) = \frac{1}{2} \times \frac{\lambda \mathcal{C}(\lambda, \mathcal{H}) \deg \nu_1}{1 + \lambda \mathcal{C}(\lambda, \mathcal{H}) \deg \nu_1} + \frac{1}{2} \times \frac{\lambda \mathcal{C}(\lambda, \mathcal{G}) \deg \nu_2}{1 + \lambda \mathcal{C}(\lambda, \mathcal{G}) \deg \nu_2}. \quad (3.2)$$

By corollary 2.13, the function $\mathcal{C}(\lambda, \mathcal{H})$ is continuous on $(\lambda_1, 1)$ and since $\mathcal{C}(\lambda, \mathcal{G}) = 0$ for any $\lambda \in (\lambda_1, \lambda_2)$, therefore:

$$\lim_{\lambda \rightarrow \lambda_2^-} \mathcal{C}(\lambda, \mathcal{T}) = \frac{1}{2} \times \frac{\lambda_2 \mathcal{C}(\lambda_2, \mathcal{H}) \deg \nu_1}{1 + \lambda_2 \mathcal{C}(\lambda_2, \mathcal{H}) \deg \nu_1}. \quad (3.3)$$

By Equations 3.1, 3.2 and 3.3, we obtain:

$$\lim_{\lambda \rightarrow \lambda_2^-} \mathcal{C}(\lambda, \mathcal{T}) < \mathcal{C}(\lambda_2, \mathcal{T}).$$

The latter inequality implies that the function $\mathcal{C}(\lambda, \mathcal{T})$ is discontinuous at λ_2 . \square

Note that continuity properties at $\lambda \geq 1$ are actually easier to obtain, and we will investigate them further below.

3.2 The convergence of the law of the first k steps

If $\lim_{\lambda \rightarrow \lambda_c, \lambda > \lambda_c} \mathcal{C}(\lambda, \mathcal{T}) > 0$, by Lemma 6.13 the limit of $\varphi^{\lambda, k}(y_1, \dots, y_k)$ when λ decreases to λ_c exists. If one has $\lim_{\lambda \downarrow \lambda_c} \mathcal{C}(\lambda, \mathcal{T}) = 0$, the situation is more delicate and we cannot yet conclude on the limit of the function $\varphi^{\lambda, k}(\nu_0, \dots, \nu_k)$ when λ decreases to λ_c . Indeed, convergence does not always hold, as we will see in a counterexample. The idea of what follows is easy to describe: we are going to construct a very inhomogeneous tree with various subtrees of higher and higher branching numbers, at locations alternating between two halves of the whole tree; a biased random walk will wander until it finds the first such sub-tree inside which it is transient, and escape to infinity within this subtree with high probability.

Proposition 3.4. *There exists a tree \mathcal{T} such that the function $\varphi^{\lambda, 1}(y_0, y_1)$ does not converge as $\lambda \rightarrow \lambda_c$.*

Notation 3.5. Let $\mathcal{T}, \mathcal{T}'$ be two trees and $A \subset V(\mathcal{T})$. We can construct a new tree by grafting a copy of \mathcal{T}' at all the vertices of A ; we will denote this new tree by $\mathcal{T} \overset{A}{\oplus} \mathcal{T}'$. Note that for all $x \in A$, $(\mathcal{T} \overset{A}{\oplus} \mathcal{T}')^x \simeq \mathcal{T}'$. In the case $A = \{x\}$, we will use the simpler notation $\mathcal{T} \overset{x}{\oplus} \mathcal{T}'$ for $\mathcal{T} \overset{\{x\}}{\oplus} \mathcal{T}'$.

Proof. Fix $\varepsilon > 0$ small enough. By Proposition 3.1, for all $0 < a \leq 1$, there exists a tree, denoted by $\mathcal{T}(a)$, such that its branching number is $\frac{1}{a}$ and $\mathcal{C}(a, \mathcal{T}(a)) = 0$. Let $\mathcal{H} = \mathbb{Z}$, seen as a tree rooted at 0, so that the integers is the vertices of \mathcal{H} (see the Figure 2.1). We are going to construct a tree inductively.

Let $(a_i)_{i \geq 1}$ be a decreasing sequence such that $a_1 < 1$. Denote $a_c := \lim a_i$ and assume that $a_c > 0$. Choose a sequence $(b_i)_{i \geq 1}$ such that $b_i \in (a_{i+1}, a_i)$ for all i . First, set $\mathcal{H}^0 := (\mathcal{H} \overset{-2}{\oplus} \mathcal{T}(a_1)) \overset{2}{\oplus} \mathcal{T}(a_2)$. We consider the biased random walk RW_{b_1} , then it is recurrent on $\mathcal{T}(a_1)$ and transient on $\mathcal{T}(a_2)$. On \mathcal{H}^0 , the biased random walk RW_{b_1} is transient, and in addition we know that it stays eventually within the copy of $\mathcal{T}(a_2)$. There exists then $N_1 > 2$ such that the probability that the limit walk remains in that copy after time $N_1 - 1$ is greater than $1 - \varepsilon$.

Then we set $\mathcal{H}^1 = (\mathcal{H}^0 \overset{-N_1}{\oplus} \mathcal{T}(a_3))$. On \mathcal{H}^1 , the walk of bias b_1 is still transient and still has probability at least $1 - \varepsilon$ to escape through the copy of $\mathcal{T}(a_2)$, because $\mathcal{T}(a_3)$ is grafted too far to be relevant. On the other hand, consider the biased random walk RW_{b_2} : it is still transient on \mathcal{H}^1 but only through the new copy of $\mathcal{T}(a_3)$. There exists then $N_2 > 2$ such that the probability that the limit walk remains in that copy after time $N_2 - 1$ is greater than $1 - \varepsilon$.

We can set $\mathcal{H}^2 := (\mathcal{H}^1 \overset{N_2}{\oplus} \mathcal{T}(a_4))$ and continue this procedure to graft all the trees $\mathcal{T}(a_i)$, further and further from the origin and alternatively on the left and on the right; we denote by \mathcal{H}^∞ the union of all the \mathcal{H}^k .

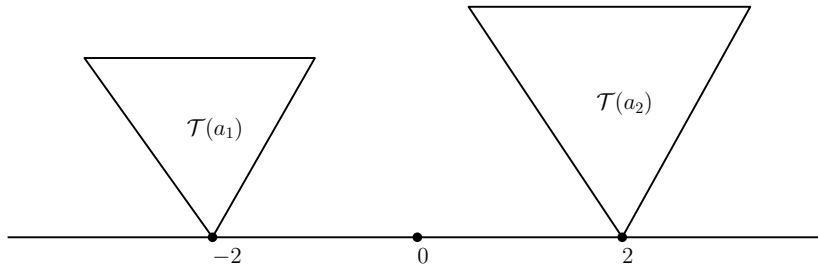

Figure 2.1 – Tree \mathcal{H}^0

It remains to show that the function $\varphi^{\lambda,1}(0,1)$ for the biased random walk on the tree \mathcal{H}^∞ does not converge. We have $br(\mathcal{H}^\infty) = \max_i br(\mathcal{T}(a_i)) = \frac{1}{a_c}$ and $\varphi^{b_i,1}(0,1) \geq 1 - \varepsilon$

if i is odd while $\varphi^{b_i,1}(0, -1) \geq 1 - \varepsilon$ if i is even. Then,

$$\forall k \geq 0, \begin{cases} \varphi^{b_i,1}(0, 1) \geq 1 - \varepsilon & \text{if } i = 2k + 1 \\ \varphi^{b_i,1}(0, 1) \leq \varepsilon & \text{if } i = 2k + 2 \end{cases}$$

This implies that the function $\varphi^{\lambda,1}(0, 1)$ does not converge when λ go to a_c . \square

The tree we just constructed is tailored to be extremely inhomogeneous. At the other end of the spectrum, some trees have enough structure for all the functions we are considering to be essentially explicit:

Definition 3.6. A tree \mathcal{T} is called *periodic* (or *finite type*) if, for all $v \in V(\mathcal{T}) \setminus \{o\}$, there is a bijective morphism $f : \mathcal{T}^v \rightarrow \mathcal{T}^{f(v)}$ with $f(v)$ in a fixed, finite neighborhood of the root of \mathcal{T} .

Definition 3.7. Let \mathcal{T} be a finite tree and $\mathcal{L}(\mathcal{T})$ be the set of leafs of \mathcal{T} . We set $\mathcal{T}^1 = \mathcal{T} \bigoplus_{\mathcal{L}(\mathcal{T})} \mathcal{T}$, $\mathcal{T}^2 = \mathcal{T}^1 \bigoplus_{\mathcal{L}(\mathcal{T}^1)} \mathcal{T}$, \dots , $\mathcal{T}^n = \mathcal{T}^{n-1} \bigoplus_{\mathcal{L}(\mathcal{T}^{n-1})} \mathcal{T}$ for every $n \geq 2$. We continue this procedure an infinite number of times to obtain an infinite tree $\mathcal{T}^{\infty, \mathcal{T}}$. Note that $\mathcal{T}^{\infty, \mathcal{T}}$ is also a periodic tree.

Fact 3.8 (see Lyons [85], theorem 5.1). *Let \mathcal{T} be a periodic tree and $(\nu_0 = o, \nu_1, \nu_2, \dots, \nu_k)$ be a simple path on \mathcal{T} . Then $\varphi^{\lambda, k}(\nu_0, \nu_1, \dots, \nu_k)$ converges when λ decreases to $\lambda_c(\mathcal{T})$.*

In the rest of this section we provide a new proof of a particular case (the case of $\mathcal{T}^{\infty, \mathcal{T}}$) of fact 3.8:

Proposition 3.9. *Let \mathcal{T} be a finite tree and $(\nu_0 = o, \nu_1, \nu_2, \dots, \nu_k)$ be a simple path on $\mathcal{T}^{\infty, \mathcal{T}}$. Then the function $\varphi^{\lambda, k}(\nu_0, \nu_1, \dots, \nu_k)$ of $\mathcal{T}^{\infty, \mathcal{T}}$ converges when λ decreases to $\lambda_c(\mathcal{T}^{\infty, \mathcal{T}})$.*

Before showing the proposition 3.9, we need to show the following lemma:

Lemma 3.10. *Let \mathcal{T} be a tree rooted at o such that $\deg o = d_0$ and*

$$\begin{cases} \mathcal{T}_1 = \{\nu_1, \nu_2, \dots, \nu_{d_0}\} \\ \forall i \in \{1, 2, \dots, d_0\}, \lambda_c(\mathcal{T}) = \lambda_c(\mathcal{T}^{\nu_i}) = \lambda_c \text{ and } \mathcal{C}(\lambda_c, \mathcal{T}) = \mathcal{C}(\lambda_c, \mathcal{T}^{\nu_i}) = 0 \end{cases}$$

Then for all i , we have $\tilde{\mathcal{C}}(\lambda, \mathcal{T}, \nu_i) = \frac{(d_{\nu_i} - 1)\lambda \tilde{\mathcal{C}}(\lambda, \mathcal{T}^{\nu_i})}{d_0(1 + (d_{\nu_i} - 1)\lambda \tilde{\mathcal{C}}(\lambda, \mathcal{T}^{\nu_i}))}$, where $d_{\nu_i} = \deg \nu_i$.

Proof. Recall that $\tilde{\mathcal{C}}(\lambda, \mathcal{T}, \nu_i) = \mathbb{P}(\mathcal{A})$, where \mathcal{A} is the event that the random walk RW_λ on \mathcal{T} , started at the root (i.e $X_0 = o$), never returns to it and reached ν_i at the first step (i.e $X_1 = \nu_i$). We can write

$$\mathcal{A} = \bigcup_{k \geq 0} \mathcal{A}_k$$

where

$$\mathcal{A}_k := \{\#\{j > 0 : X_j = o\} = 0\} \cap \{X_1 = \nu\} \cap \{\#\{j > 1 : X_j = \nu_i\} = k\}.$$

Let $m = \frac{(d_{\nu_i}-1)\lambda}{1+(d_{\nu_i}-1)\lambda}$ and $c = \tilde{\mathcal{C}}(\lambda, \mathcal{T}^{\nu_i})$. Note that the sequence $(\mathcal{A}_k, k \geq 0)$ are pairwise disjoint and $\mathbb{P}(\mathcal{A}_k) = \frac{mc(m(1-c))^k}{d_0}$, therefore we obtain:

$$\tilde{\mathcal{C}}(\lambda, \mathcal{T}, \nu_i) = \frac{mc}{d_0} \sum_{k=0}^{\infty} (m(1-c))^k = \frac{(d_{\nu_i}-1)\lambda \tilde{\mathcal{C}}(\lambda, \mathcal{T}^{\nu_i})}{d_0(1+(d_{\nu_i}-1)\lambda \tilde{\mathcal{C}}(\lambda, \mathcal{T}^{\nu_i}))}. \quad \square$$

Proof of proposition 3.9. First, since $\mathcal{T}^{\infty, \mathcal{T}}$ is a periodic tree, therefore the biased random walk RW_{λ_c} on $\mathcal{T}^{\infty, \mathcal{T}}$ is recurrent (see [85]). Recall that $L(\mathcal{T})$ is the set of all leafs of finite tree \mathcal{T} and S^i be the set of all finite paths starting at origin, ending at one element of $L(\mathcal{T})$ and pass through ν_i . For all $\nu \in L(\mathcal{T})$, we have $(\mathcal{T}^{\infty, \mathcal{T}})^{\nu} = \mathcal{T}^{\infty, \mathcal{T}}$ and we apply several times successive Lemma 3.10 to obtain:

$$\tilde{\mathcal{C}}(\lambda, \mathcal{T}^{\infty, \mathcal{T}}, \nu_i) = \sum_{\gamma \in S^i} f_1^{\gamma}(\lambda) f_2^{\gamma}(\lambda) \cdots f_{|\gamma|}^{\gamma}(\lambda) \tilde{\mathcal{C}}(\lambda, (\mathcal{T}^{\infty, \mathcal{T}})^{\gamma_{|\gamma|}}),$$

where $f_j^{\gamma}(\lambda) = \frac{m_{\gamma_j} \lambda}{m_{\gamma_{j-1}}(1+m_{\gamma_j} \lambda \mathcal{C}(\lambda, \mathcal{T}^{\gamma_j}))}$ and $m_{\gamma_j} = d_{\gamma_j} - 1$ if $j > 1$ and $m_{\gamma_0} = d_0$. Moreover, we have

$$\tilde{\mathcal{C}}(\lambda, (\mathcal{T}^{\infty, \mathcal{T}})^{\gamma_{|\gamma|}}) = \tilde{\mathcal{C}}(\lambda, \mathcal{T}^{\infty, \mathcal{T}})$$

then

$$\tilde{\mathcal{C}}(\lambda, \mathcal{T}^{\infty, \mathcal{T}}, \nu_i) = \sum_{\gamma \in S^i} f_1^{\gamma}(\lambda) f_2^{\gamma}(\lambda) \cdots f_{|\gamma|}^{\gamma}(\lambda) \tilde{\mathcal{C}}(\lambda, \mathcal{T}^{\infty, \mathcal{T}}).$$

By Lemma 6.13, we obtain

$$\varphi^{\lambda, 1}(o, \nu_i) = \frac{\tilde{\mathcal{C}}(\lambda, \mathcal{T}^{\infty, \mathcal{T}}, \nu_i)}{\tilde{\mathcal{C}}(\lambda, \mathcal{T}^{\infty, \mathcal{T}})} = \sum_{\gamma \in S^i} f_1^{\gamma}(\lambda) f_2^{\gamma}(\lambda) \cdots f_{|\gamma|}^{\gamma}(\lambda).$$

Note that for all $\gamma \in S^i$ we have $m_{\gamma_0} = m(\gamma_{|\gamma|})$, this implies that $\varphi^{\lambda, 1}(o, \nu_i)$ converges when λ decreases towards $\lambda_c(\mathcal{T}^{\infty, \mathcal{T}})$ and

$$\lim_{\lambda \rightarrow \lambda_c(\mathcal{T}^{\infty, \mathcal{T}})} \varphi^{\lambda, 1}(\nu_i) = \sum_{\gamma \in S^i} \lambda_c^{|\gamma|}. \quad (3.4) \quad \square$$

Remark 3.11. The equation (3.4) gives us a way to calculate the critical value of RW_{λ} on $\mathcal{T}^{\infty, \mathcal{T}}$, as the solution of the following equation:

$$\sum_{i=1}^{m_o} \sum_{\gamma \in S^i} x^{|\gamma|} = 1.$$

4 The continuity of effective conductance

We end the first half of the paper with a few results on the conductance functions of trees, namely we prove a criterion for the continuity of $\mathcal{C}(\lambda, \mathcal{T})$ in λ (see Theorems 4.3 and 4.4 below) and study the set of conductance functions of spherically symmetric trees of bounded degree (see Theorem 1.4).

4.1 Left- and right-continuity of $\mathcal{C}(\mathcal{T}, \lambda)$

Lemma 4.1. *Let \mathcal{T} be an infinite, locally finite and rooted tree. Then $\mathcal{C}(\lambda, \mathcal{T})$ is right continuous on $(0, +\infty)$.*

Proof. Let $(X_n, n \geq 0)$ be the biased random walk with parameter λ on \mathcal{T} . We define $S_0 := \inf \{k > 0 : X_k = o\}$ and for any $n > 0$,

$$S_n := \inf \{k > 0 : d(o, X_k) = n\}.$$

Recall that the random walk on a network (\mathcal{T}, c) , where $c(e) = \lambda^{|e|}$ is exactly the same process as the biased random walk with parameter λ . We use Equation 2.1 to obtain

$$\mathcal{C}(\lambda, \mathcal{T}) = \pi(o) \lim_{n \rightarrow +\infty} \mathbb{P}(S_n < S_0).$$

We set $\mathcal{C}(\lambda, \mathcal{T}, n) := \pi(o) \mathbb{P}(S_n < S_0)$. It is easy to see that $\mathcal{C}(\lambda, \mathcal{T}, n) \geq \mathcal{C}(\lambda, \mathcal{T}, n+1)$. On the other hand, by Lemma 2.17, we obtain $\mathcal{C}(\lambda, \mathcal{T}, n)$ is a continuous function. Hence, $\mathcal{C}(\lambda, \mathcal{T}, n)$ is a continuous increasing function for each n . It implies that $\mathcal{C}(\lambda, \mathcal{T})$ is the decreasing limit of increasing functions. Therefore $\mathcal{C}(\lambda, \mathcal{T})$ is right continuous. \square

Definition 4.2. Let \mathcal{T} be tree. For each $\nu \in \mathcal{T}$, we let X_n^ν denote the biased random walk on \mathcal{T}^ν (i.e $X_0^\nu = \nu$ and $\forall n > 0 : X_n^\nu \in \mathcal{T}^\nu$). We say that \mathcal{T} is *uniformly transient* if

$$\forall \lambda > \lambda_c, \exists \alpha_\lambda > 0, \forall \nu \in \mathcal{T}, \mathbb{P}(\forall n > 0, X_n^\nu \neq \nu) \geq \alpha_\lambda.$$

It is called *weakly uniformly transient* if there exists a sequence of finite pairwise disjoint V-cutsets $(\pi_n, n \geq 1)$, such that

$$\forall \lambda > \lambda_c, \exists \alpha_\lambda > 0, \forall \nu \in \bigcup_{k=1}^{+\infty} \pi_k, \mathbb{P}(\forall n > 0, X_n^\nu \neq \nu) \geq \alpha_\lambda.$$

It is easy to see that if $\lambda_c(\mathcal{T}) = 1$, then \mathcal{T} is uniformly transient.

Theorem 4.3. *Let \mathcal{T} be a uniformly transient tree. Then $\mathcal{C}(\lambda, \mathcal{T})$ is left continuous on $(\lambda_c, +\infty)$.*

Proof. Fix $\lambda_1 > \lambda_c$, we will prove that $\mathcal{C}(\lambda, \mathcal{T})$ is left continuous at λ_1 . Choose $\lambda_0 \in (\lambda_c, \lambda_1)$. By Theorem 2.10, we can find a constant $\alpha > 0$ (does not depend on $\lambda \in [\lambda_0, \lambda_1]$) such that

$$\forall \lambda \in [\lambda_0, \lambda_1], \forall \nu \in V(\mathcal{T}), \mathbb{P}(\forall n > 0, X_n^\nu \neq \nu) \geq \alpha.$$

Given a family of conductances $c = c(e)_{e \in E(\mathcal{T})} \in (0, +\infty)^E$, let Y_n be the associated random walk. Let $A \subset (0, +\infty)^E$ be the subset of elements of $(0, +\infty)^E$ such that Y_n is transient for those choices of conductances. Then we define the function $\psi : A \rightarrow \mathbb{R}_+^*$ as

$$\psi(c) := \mathcal{C}_c(\mathcal{T}).$$

Recall that \mathcal{T}_k is the collection of all the vertices at distance k from the root: then we have

$$\mathcal{C}(\lambda, \mathcal{T}) = \psi(\underbrace{\lambda, \lambda, \dots, \lambda}_{|\mathcal{T}_1|}, \underbrace{\lambda^2, \lambda^2, \dots, \lambda^2}_{|\mathcal{T}_2|}, \dots).$$

We will abuse notation until the end of the argument, writing

$$\psi(\lambda_1, \lambda_2^2, \lambda_3^3, \dots) \quad \text{for} \quad \psi(\underbrace{\lambda_1, \lambda_1, \dots, \lambda_1}_{|\mathcal{T}_1|}, \underbrace{\lambda_2^2, \lambda_2^2, \dots, \lambda_2^2}_{|\mathcal{T}_2|}, \dots)$$

so that in particular $\mathcal{C}(\lambda, \mathcal{T}) = \psi(\lambda, \lambda^2, \lambda^3, \dots)$.

Let $\varepsilon > 0$, we choose $L \in \mathbb{N}$ such that $(1 - \alpha)^L < \varepsilon$. For $\lambda \in (\lambda_0, \lambda_1)$ we have $|\mathcal{C}(\lambda_1, \mathcal{T}) - \mathcal{C}(\lambda, \mathcal{T})| = |\psi(\lambda_1, \lambda_1^2, \lambda_1^3, \dots) - \psi(\lambda, \lambda^2, \lambda^3, \dots)|$ and by the triangular inequality, we get

$$\begin{aligned} |\mathcal{C}(\lambda_1, \mathcal{T}) - \mathcal{C}(\lambda, \mathcal{T})| &\leq |\psi(\lambda_1, \dots, \lambda_1^L, b_1) - \psi(\lambda, \dots, \lambda^L, b_1)| \\ &\quad + |\psi(\lambda, \dots, \lambda^L, b_1) - \psi(\lambda, \dots, \lambda^L, b)| \end{aligned} \quad (4.1)$$

where $b := (\lambda^{L+k})_{k \geq 1}$ and $b_1 := (\lambda_1^{L+k})_{k \geq 1}$.

Let $\lambda' \in [\lambda_0, \lambda_1]$ we denote $S_n^{\lambda'}$ the first hitting point of \mathcal{T}_n by the random walk with conductances

$$\underbrace{(\lambda, \dots, \lambda)}_{|\mathcal{T}_1|}, \underbrace{\lambda^2, \dots, \lambda^2}_{|\mathcal{T}_2|}, \dots, \underbrace{\lambda^L, \dots, \lambda^L}_{|\mathcal{T}_L|}, \underbrace{(\lambda')^{L+1}, \dots, (\lambda')^{L+1}}_{|\mathcal{T}_{L+1}|}, \dots$$

We can see that the law of $S_L^{\lambda_1}$ and the law of S_L^λ are identical. Since \mathcal{T} is uniformly transient, then when the random walk reaches \mathcal{T}_L , it returns to o with a probability strictly smaller than $(1 - \alpha)^L$. It implies that

$$|\psi(\lambda, \dots, \lambda^L, b_1) - \psi(\lambda, \dots, \lambda^L, b)| \leq 2(1 - \alpha)^L \leq 2\varepsilon. \quad (4.2)$$

It remains to estimate $|\psi(\lambda_1, \dots, \lambda_1^L, b_1) - \psi(\lambda, \dots, \lambda^L, b_1)|$. By Theorem 2.10, we have

$$\psi(\lambda_1, \dots, \lambda_1^L, b_1) \geq \mathcal{C}(\lambda_0, \mathcal{T}) > 0 \quad \text{and} \quad \psi(\lambda, \dots, \lambda^L, b) \geq \mathcal{C}(\lambda_0, \mathcal{T}) > 0.$$

We apply the Lemma 2.17 to obtain

$$\exists \delta > 0, \forall \lambda \in [\lambda_1 - \delta, \lambda_1], |\psi(\lambda_1, \dots, \lambda_1^L, b_1) - \psi(\lambda, \dots, \lambda^L, b_1)| < \varepsilon. \quad (4.3)$$

We combine (4.1), (4.2) and (4.3) to get

$$\exists \delta > 0, \forall \lambda \in [\lambda_0, \lambda_1] \text{ such that } \lambda_1 - \lambda < \delta : |\mathcal{C}(\lambda_1, \mathcal{T}) - \mathcal{C}(\lambda, \mathcal{T})| \leq 3\varepsilon.$$

This implies that $\mathcal{C}(\lambda, \mathcal{T})$ is left continuous at λ_1 . \square

In the same method as in the proof of Theorem 4.3, we can prove the slightly stronger result (the proof of which we omit):

Theorem 4.4. *Let \mathcal{T} be a weakly uniformly transient tree: then the effective conductance $\mathcal{C}(\lambda, \mathcal{T})$ is left continuous on $(\lambda_c, 1]$.*

4.2 Proof of Theorem 1.4

Definition 4.5. Let $(\mathcal{T}^n, n \geq 1)$ be a sequence of infinite, locally finite and rooted trees. We say that \mathcal{T}^n converges locally towards \mathcal{T}^∞ if $\forall k, \exists n_0, \forall n \geq n_0, \mathcal{T}_{\leq k}^n = \mathcal{T}_{\leq k}^\infty$, where $\mathcal{T}_{\leq k}$ is a finite tree defined by:

$$\begin{cases} V(\mathcal{T}_{\leq k}) := \{\nu \in V(\mathcal{T}), d(o, \nu) \leq k\} \\ E(\mathcal{T}_{\leq k}) = E_{|V(\mathcal{T}_{\leq k}) \times V(\mathcal{T}_{\leq k})} \end{cases}$$

Recall from the introduction that \mathbb{F}_m denotes the collection of all effective conductance functions for spherically symmetric trees with degree uniformly bounded by m .

Lemma 4.6. *Let $(f_n, n \geq 1)$ be a sequence of functions in \mathbb{F}_m . Assume that f_n converges uniformly towards f . Then, there exists a function $g \in \mathbb{F}_m$ such that, for any $\lambda > 0$,*

$$f(\lambda) \leq g(\lambda).$$

Proof. Let $(\mathcal{T}^n, n \geq 1)$ be a sequence of elements of A_m such that, for any $n > 0$,

$$f_n(\lambda) = \mathcal{C}(\lambda, \mathcal{T}^n).$$

Since the degree of vertices of \mathcal{T}^n are bounded by m , we can apply the diagonal extraction argument. After renumbering indices, there exists a subsequence of $(\mathcal{T}^n, n \geq 1)$, denoted also by $(\mathcal{T}^n, n \geq 1)$, converges locally towards some tree, denote by \mathcal{T}^∞ . Moreover, we can assume that for any $n > 0$,

$$\mathcal{T}_{\leq n}^n = \mathcal{T}_{\leq n}^\infty \quad (4.4)$$

Since for any $n > 0$, we have $\mathcal{T}^n \in A_m$, then

$$\mathcal{T}^\infty \in A_m \quad (4.5)$$

We set $g(\lambda) = \mathcal{C}(\lambda, \mathcal{T}^\infty)$, it remains to show that for any $\lambda > 0$,

$$f(\lambda) \leq g(\lambda).$$

Assume that there exists λ_0 such that $f(\lambda_0) > g(\lambda_0)$ and we set $c = f(\lambda_0) - g(\lambda_0) > 0$. Since the sequence $(f_n(\lambda_0), n \geq 1)$ converges towards $f(\lambda_0)$, hence

$$\exists \ell_1 > 0, \forall n \geq \ell_1, f_n(\lambda_0) > f(\lambda_0) - \frac{c}{4}. \quad (4.6)$$

Recall the definition of the function $\mathcal{C}(\lambda_0, \mathcal{T}, n)$ in the proof of Lemma 4.1, the sequence $(\mathcal{C}(\lambda_0, \mathcal{T}^\infty, n), n \geq 1)$ decreases towards $g(\lambda_0)$, it implies that

$$\exists \ell_2 > 0, \forall n \geq \ell_2, \mathcal{C}(\lambda_0, \mathcal{T}^\infty, n) < g(\lambda_0) + \frac{c}{4}. \quad (4.7)$$

Let $\ell := \ell_1 \vee \ell_2$, we use 4.6 and 4.7 to obtain:

$$f_\ell(\lambda_0) > f(\lambda_0) - \frac{c}{4} \quad \text{and} \quad \mathcal{C}(\lambda_0, \mathcal{T}^\infty, \ell) < g(\lambda_0) + \frac{c}{4}. \quad (4.8)$$

On the other hand $\mathcal{C}(\lambda_0, \mathcal{T}^\ell, \ell) = \mathcal{C}(\lambda_0, \mathcal{T}^\infty, \ell)$ and by 4.8 we obtain:

$$f_\ell(\lambda_0) > f(\lambda_0) - \frac{c}{4} \quad \text{and} \quad \mathcal{C}(\lambda_0, \mathcal{T}^\ell, \ell) < g(\lambda_0) + \frac{c}{4}. \quad (4.9)$$

The sequence $(\mathcal{C}(\lambda_0, \mathcal{T}^\ell, k), k \geq 1)$ decreases towards $f_\ell(\lambda_0)$ when k goes to $+\infty$. Hence,

$$f_\ell(\lambda_0) \leq \mathcal{C}(\lambda_0, \mathcal{T}^\ell, \ell) < g(\lambda_0) + \frac{c}{4}. \quad (4.10)$$

We combine 4.9 and 4.10 to get:

$$f(\lambda_0) - \frac{c}{4} < f_\ell(\lambda_0) < g(\lambda_0) + \frac{c}{4}.$$

Hence,

$$c = f(\lambda_0) - g(\lambda_0) < \frac{c}{4},$$

this is a contradiction. □

Proof of theorem 1.4. Let $(\mathcal{T}^n, n \geq 1)$ be a sequence of elements of A_m such that, for any $n > 0$,

$$f_n(\lambda) = \mathcal{C}(\lambda, \mathcal{T}^n).$$

Fix a sub-sequence of $(\mathcal{T}^n, n \geq 1)$ which converges locally towards \mathcal{T}^∞ and such that 4.4 holds as in the proof of the Lemma 4.6. We set $g(\lambda) = \mathcal{C}(\lambda, \mathcal{T}^\infty)$ and we need to prove that $f = g$.

By Lemma 4.6, we have $f(\lambda) \leq g(\lambda)$. Assume that there exists λ_0 such that $0 < f(\lambda_0) < g(\lambda_0)$. We prove that for any $\lambda < \lambda_0$, we have $f(\lambda) = 0$.

We set $\beta_0 = \frac{1}{\lambda_0}$ and we use Proposition 2.12 to obtain

$$\begin{cases} \forall n > 0, \mathcal{R}(\lambda_0, \mathcal{T}^n) = \sum_{k=1}^{+\infty} \frac{\beta_0^k}{|\mathcal{T}_k^n|} \\ \mathcal{R}(\lambda_0, \mathcal{T}^\infty) = \sum_{k=1}^{\infty} \frac{\beta_0^k}{|\mathcal{T}_k^\infty|} \end{cases} \quad (4.11)$$

We write

$$\mathcal{R}(\lambda_0, \mathcal{T}^n) = \sum_{k=1}^{+\infty} \frac{\beta_0^k}{|\mathcal{T}_k^n|} = \sum_{k \leq n} \frac{\beta_0^k}{|\mathcal{T}_k^n|} + \sum_{k > n} \frac{\beta_0^k}{|\mathcal{T}_k^n|}.$$

On the other hand, for any $k \leq n$ we have $|\mathcal{T}_k^n| = |\mathcal{T}_k^\infty|$, hence

$$\mathcal{R}(\lambda_0, \mathcal{T}^n) = \sum_{k \leq n} \frac{\beta_0^k}{|\mathcal{T}_k^\infty|} + \sum_{k > n} \frac{\beta_0^k}{|\mathcal{T}_k^n|}. \quad (4.12)$$

Since f_n converges to f , then

$$\begin{cases} \lim_{n \rightarrow \infty} \mathcal{R}(\lambda_0, \mathcal{T}^n) = \frac{1}{f(\lambda_0)} < \infty \\ \lim_{n \rightarrow \infty} \mathcal{R}(\lambda_0, \mathcal{T}^\infty) = \frac{1}{g(\lambda_0)} < \frac{1}{f(\lambda_0)} \end{cases} \quad (4.13)$$

By using 4.12 and 4.13, we obtain

$$\lim_{n \rightarrow +\infty} \sum_{k > n} \frac{\beta_0^k}{|\mathcal{T}_k^n|} = \frac{1}{f(\lambda_0)} - \frac{1}{g(\lambda_0)} > 0. \quad (4.14)$$

Now we take $\beta > \beta_0$ and we apply the Proposition 2.12 in order to get

$$\mathcal{R}\left(\frac{1}{\beta}, \mathcal{T}^n\right) = \sum_{k=0}^{+\infty} \frac{\beta^k}{|\mathcal{T}_k^n|} > \sum_{k > n} \frac{\beta^k}{|\mathcal{T}_k^n|} \geq \left(\frac{\beta}{\beta_0}\right)^n \sum_{k > n} \frac{\beta_0^k}{|\mathcal{T}_k^n|}. \quad (4.15)$$

We combine 4.14 and 4.15 to obtain:

$$\lim_{n \rightarrow \infty} \mathcal{R}\left(\frac{1}{\beta}, \mathcal{T}^n\right) = \infty \quad (4.16)$$

It implies that $f(1/\beta) = \lim_{n \rightarrow \infty} f_n\left(\frac{1}{\beta}\right) = \lim_{n \rightarrow \infty} \frac{1}{\mathcal{R}\left(\frac{1}{\beta}, \mathcal{T}^n\right)} = 0$. Therefore, we proved that:

$$\forall \lambda < \lambda_0, f(\lambda) = 0.$$

As $f \neq 0$, we define $\lambda_c := \inf \{0 \leq \lambda \leq 1 : f(\lambda) > 0\}$. We proved that

$$\forall \lambda > \lambda_c, f(\lambda) = g(\lambda). \quad (4.17)$$

As the sequence $(f_n)_n$ converges uniformly to f , then f is continuous, and then $f(\lambda_c) = 0$. By Lemma 4.1, g is right continuous. Then we obtain:

$$f(\lambda_c) = \lim_{\lambda \rightarrow \lambda_c^+} f(\lambda) = \lim_{\lambda \rightarrow \lambda_c^+} g(\lambda) = g(\lambda_c) = 0. \quad (4.18)$$

On the other hand, by Lemma 2.10 we obtain g is an increasing function, then:

$$\forall \lambda < \lambda_c, g(\lambda) = 0 = f(\lambda) \quad (4.19)$$

We combine 4.17, 4.18 and 4.19 to obtain $f = g$. \square

5 Self-avoiding walks

The main goal of this section is to prove Proposition 1.1 (Section 5.3) and Theorem 1.3 (Section 5.4).

5.1 Walks and bridges

In this section, we review some definitions on the self-avoiding walk, bridges and connective constant (see [89]). Denote by c_n the number of self-avoiding walks of length n , starting at origin on the considered graph. If \mathcal{G} is transitive, the sequence $c_n^{1/n}$ converges to a constant when n goes to infinity. This constant is called the connective constant of \mathcal{G} .

Definition 5.1. An n -step bridge in the plane \mathbb{Z}^2 (or half-plane \mathbb{H}) is an n -step self-avoiding walk (SAW) γ such that

$$\forall i = 1, 2, \dots, n, \quad \gamma_1(0) < \gamma_1(i) \leq \gamma_1(n)$$

where $\gamma_1(i)$ is the first coordinate of $\gamma(i)$. Let b_n denote the number of all n -step bridges with $\gamma(0) = 0$. By convention, set $b_0 = 1$.

We have $b_{m+n} \geq b_m \cdot b_n$, hence we can define

$$\mu_b = \lim_{n \rightarrow +\infty} b_n^{\frac{1}{n}} = \sup_n b_n^{\frac{1}{n}}.$$

Moreover, $b_n \leq \mu_b^n \leq \mu^n$.

Definition 5.2. Given a bridge γ of length n , γ is called an *irreducible bridge* if it can not be decomposed into two bridges of length strictly smaller than n . It means, we can not find $i \in [1, n-1]$ such that $\gamma_{|[0,i]}$, $\gamma_{|[i,n]}$ are two bridges. The set of all irreducible-bridges is denoted by $iSAW$.

5.2 Kesten's measure

For this section, we refer the reader to ([72],[41]) for a more precise description. Denote by SAW_∞ the set of all self-avoiding walks on the plane \mathbb{Z}^2 or half-plane \mathbb{H} . In this section, we review the Kesten measure. He defined a probability measure on the SAW_∞ of half-plane from the finite bridges. We use \mathbb{B} (resp. \mathbb{I}) to denote the set of bridges (resp. irreducible bridges) starting at origin. Let p_n denote the number of irreducible bridges starting at origin, of length n .

We define a notion of concatenation of paths. If $\gamma^1 = [\gamma^1(0), \gamma^1(1), \dots, \gamma^1(m)]$ and $\gamma^2 = [\gamma^2(0), \gamma^2(1), \dots, \gamma^2(n)]$ are two SAWs, we define $\gamma^1 \oplus \gamma^2$ to be the $(m+n)$ -step walk (not necessarily self-avoiding walk)

$$\gamma^1 \oplus \gamma^2 := [0, \gamma^1(1), \dots, \gamma^1(m), \gamma^1(m) + \gamma^2(1) - \gamma^2(0), \dots, \gamma^1(m) + \gamma^2(n) - \gamma^2(0)].$$

Similarly, we can define $\gamma^1 \oplus \gamma^2 \oplus \dots \oplus \gamma^k$. We begin with the following equality

Fact 5.3 (Kesten [72], Theorem 5). *We have*

$$\sum_{n=1}^{+\infty} \frac{p_n}{\mu^n} = 1.$$

Remark 5.4. We have also $\sum_{\omega \in \mathbb{I}} \beta^{|\omega|} < \infty$ if $\beta < \frac{1}{\mu}$ and if $\beta > \frac{1}{\mu}$ then $\sum_{\omega \in \mathbb{I}} \beta^{|\omega|} = \infty$.

Let us now define the Kesten measure on the SAW_∞ in the half-plane. We fix $\beta \leq \frac{1}{\mu}$ and let \mathbb{Q}^β denote the probability measure on \mathbb{I} defined by

$$\mathbb{Q}^\beta(\omega) = \frac{\beta^{|\omega|}}{Z_\beta}, \omega \in \mathbb{I}$$

where $Z_\beta = \sum_{\omega \in \mathbb{I}} \beta^{|\omega|}$. By Fact 5.3 and Remark 5.4, Z_β is finite and thus \mathbb{Q}^β is a probability measure on \mathbb{I} .

Let $k \geq 1$, we consider the product space \mathbb{I}^k and define the product probability measure \mathbb{Q}_k^β . We write \mathbb{Q}_k^β for an extension to SAW in \mathbb{H} as follows, $\mathbb{Q}^\beta(\omega) = 0$ if ω is not of form $\omega^1 \oplus \omega^2 \oplus \dots \oplus \omega^k$ and

$$\mathbb{Q}_k^\beta(\mathbb{H} \setminus \mathbb{I}^k) = 0; \mathbb{Q}_k^\beta(\omega^1 \oplus \omega^2 \oplus \dots \oplus \omega^k) = \mathbb{Q}^\beta(\omega^1) \times \mathbb{Q}^\beta(\omega^2) \times \dots \times \mathbb{Q}^\beta(\omega^k).$$

We define \mathbb{Q}_∞^β on \mathbb{I}^∞ , it is called the β -Kesten measure on SAW_∞ in the half-plane.

Fact 5.5. *Under the β -Kesten measure, the infinite self-avoiding walk, denoted by $\omega_K^{\infty, \beta}$, almost surely does not reach the line $\mathbb{Z} \times \{0\}$.*

Proof. It follows immediately from the definition of β -Kesten measure. \square

5.3 Proof of Proposition 1.1

Notation 5.6. Consider the self-avoiding walks in the lattice \mathbb{Z}^2 starting at the origin. We construct a tree $\mathcal{T}_{\mathbb{Z}^2}$, which is called *self-avoiding tree*, from these self-avoiding walks: The vertices of $\mathcal{T}_{\mathbb{Z}^2}$ are the finite self-avoiding walks and two such vertices joined when one path is an extension by one step of the other. Formally, denote by Ω_n the set of self-avoiding walks of length n starting at the origin and $V := \bigcup_{n=0}^{+\infty} \Omega_n$. Two elements $x, y \in V$ are adjacent if one path is an extension by one step of the other. We then define $\mathcal{T}_{\mathbb{Z}^2} = (V, E)$. In the same way, we can define other self-avoiding trees $\mathcal{T}_{\mathbb{H}}, \mathcal{T}_{\mathbb{Q}}$, where \mathbb{H} is a half-plane and \mathbb{Q} is a quarter-plane.

Remark 5.7. Note that each vertex (resp. a ray) of $\mathcal{T}_{\mathbb{Z}^2}$ (or $\mathcal{T}_{\mathbb{H}}, \mathcal{T}_{\mathbb{Q}}$) is a finite self-avoiding walk (resp. an infinite self-avoiding walk). Moreover, it is easy to see that the number of vertices at generation n of $\mathcal{T}_{\mathbb{Z}^2}$ (or $\mathcal{T}_{\mathbb{H}}, \mathcal{T}_{\mathbb{Q}}$) is the number of self-avoiding walks of length n in \mathbb{Z}^2 (resp. \mathbb{H}, \mathbb{Q}).

Notation 5.8. In [72], Kesten proved that all bridges in a half-plane can be decomposed into a sequence of irreducible bridges in a unique way. For every $m \in \mathbb{N}^*$, we set:

$$A_m := \{\omega \in iSAB, |\omega| \leq m\}.$$

An infinite self-avoiding walk starting at origin, is called "*m-good*" if it possesses a decomposition into irreducible bridges in A_m . Denote by G_m the set of infinite self-avoiding walk which are "*m-good*". Let \mathcal{T}^m be the sub-tree of $\mathcal{T}_{\mathbb{Z}^2}$, which we will refer to as the *m-good tree*, defined by $E(\mathcal{T}^m) := E(\mathcal{T}_{\mathbb{Z}^2})|_{V(\mathcal{T}^m) \times V(\mathcal{T}^m)}$ where,

$$V(\mathcal{T}^m) := \{\omega \in V(\mathcal{T}_{\mathbb{Z}^2}) : \text{there exists } \gamma \in G_m \text{ such that } \gamma|_{[0, |\omega|]} = \omega\}.$$

Proposition 5.9. *Let $\mathcal{T}_{\mathbb{H}}, \mathcal{T}_{\mathbb{Q}}$ be defined as above. Then,*

$$gr(\mathcal{T}_{\mathbb{Z}^2}) = br(\mathcal{T}_{\mathbb{Z}^2}) = gr(\mathcal{T}_{\mathbb{H}}) = br(\mathcal{T}_{\mathbb{H}}) = gr(\mathcal{T}_{\mathbb{Q}}) = br(\mathcal{T}_{\mathbb{Q}}) = \mu,$$

where μ is the connective constant of the lattice \mathbb{Z}^2 .

Proof. As explained in the introduction, there are rather large classes of trees, including $\mathcal{T}_{\mathbb{Z}^2}$, for which the branching and growth coincide (for instance, this holds for sub- or super-periodic trees, cf. below, or for typical supercritical Galton-Watson trees), but none of the classical results seem to apply to $\mathcal{T}_{\mathbb{H}}$ or $\mathcal{T}_{\mathbb{Q}}$.

Note that $\mathcal{T}_{\mathbb{Z}^2}$ is a sub-periodic tree, by Theorem 2.8 and the definition of connective constant, we have

$$gr(\mathcal{T}_{\mathbb{Z}^2}) = br(\mathcal{T}_{\mathbb{Z}^2}) = \mu. \tag{5.1}$$

We know that (see [11], [64]) there exists a constant B and $n_0 \in \mathbb{N}$ such that for any $n > n_0$, we have:

$$c_n \leq b_n e^{B\sqrt{n}} \quad (5.2)$$

We use 5.2 to obtain:

$$\mu \leq \lim_{n \rightarrow \infty} (b_n)^{\frac{1}{n}} \leq gr(\mathcal{T}_{\mathbb{H}}) \leq gr(\mathcal{T}_{\mathbb{Z}^2}) = \mu. \quad (5.3)$$

Hence,

$$gr(\mathcal{T}_{\mathbb{H}}) = \mu. \quad (5.4)$$

By Proposition 2.4, we have:

$$br(\mathcal{T}_{\mathbb{H}}) \leq \mu. \quad (5.5)$$

Let $b_n^{(m)}$ be the number of bridges of length n which possess a decomposition into irreducible bridges in A_m . Recall that $(\mathcal{T}^m)_n$ is the number of vertices of \mathcal{T}^m at generation n . Then for any $n > 0$, we have

$$|(\mathcal{T}^m)_n| \geq b_n^{(m)}. \quad (5.6)$$

Note that \mathcal{T}^m is also a sub-tree of $\mathcal{T}_{\mathbb{H}}$, then by Remark 2.3 we have :

$$br(\mathcal{T}^m) \leq br(\mathcal{T}_{\mathbb{H}}). \quad (5.7)$$

On the other hand, \mathcal{T}^m is m -super-periodic, so we can apply Theorem 2.8 to get $gr(\mathcal{T}^m)$ exists and,

$$br(\mathcal{T}^m) = gr(\mathcal{T}^m). \quad (5.8)$$

We use 5.7 and 5.8 to obtain, for any $m > 0$,

$$br(\mathcal{T}_{\mathbb{H}}) \geq gr(\mathcal{T}^m). \quad (5.9)$$

It remains to prove that $\lim_{n \rightarrow \infty} gr(\mathcal{T}^m) = \mu$. By using 5.3 and noting that the concatenation of two bridges is an another bridge, we see that for any m, n :

$$b_{m+n} \geq b_m b_n \quad \text{and} \quad b_{n_1+n_2}^{(m)} \geq b_{n_1}^{(m)} b_{n_2}^{(m)} \quad \text{and} \quad \lim_{n \rightarrow \infty} (b_n)^{\frac{1}{n}} = \mu. \quad (5.10)$$

By 5.10 and super-additivity lemma, we can define:

$$\mu_m := \lim_{n \rightarrow \infty} \left(b_n^{(m)} \right)^{\frac{1}{n}} \quad \text{and} \quad b_n^{(m)} \leq (\mu_m)^n \quad \text{for all } n > 0. \quad (5.11)$$

Fix $\varepsilon > 0$, by 5.10 there exists m_0 such that for all $m \geq m_0$,

$$\left| \mu - (b_m)^{\frac{1}{m}} \right| \leq \varepsilon. \quad (5.12)$$

As we know (see paragraph 5.8) all bridges in a half-plane can be decomposed into a sequence of irreducible bridges in a unique way. Therefore each bridge in a half-plane of length m possesses a decomposition into irreducible bridges in A_m . Hence, for any $m > m_0$,

$$b_m = b_m^{(m)}. \quad (5.13)$$

We use 5.10, 5.11, 5.12 and 5.13 to obtain, for any $m > m_0$,

$$\mu_m \geq (b_{km}^{(m)})^{\frac{1}{km}} \geq \left((b_m^{(m)})^k \right)^{\frac{1}{km}} = (b_m^{(m)})^{\frac{1}{m}} = (b_m)^{\frac{1}{m}} \geq \mu - \varepsilon. \quad (5.14)$$

By 5.11, the sequence $(b_\ell^{(m)})^{\frac{1}{\ell}}$ increases toward μ_m when ℓ goes to infinity, then $(b_{km}^{(m)})^{\frac{1}{km}} \xrightarrow{k \rightarrow \infty} \mu_m$. By using 5.6 and 5.14, for any $m > m_0$, we have $\mu \geq gr(\mathcal{T}^m) \geq \mu_m \geq \mu - \varepsilon$ and then,

$$\lim_{n \rightarrow \infty} gr(\mathcal{T}^m) = \mu. \quad (5.15)$$

We combine 5.5, 5.9 and 5.15 to obtain $br(\mathcal{T}_{\mathbb{H}}) = \mu$. By following a strategy similar to the proof of the case $\mathcal{T}_{\mathbb{H}}$, we obtain $gr(\mathcal{T}_{\mathbb{Q}}) = br(\mathcal{T}_{\mathbb{Q}}) = \mu$. \square

Proposition 1.1 is a consequence of Theorem 2.16 and Proposition 5.9.

5.4 Proof of Theorem 1.3

Now, we apply the results in Section 4.1 for the self-avoiding trees $\mathcal{T}_{\mathbb{Q}}$, $\mathcal{T}_{\mathbb{H}}$ and $\mathcal{T}_{\mathbb{Z}^2}$.

Notation

For any $n \in \mathbb{N}$, let $\Lambda_n := \llbracket -n, n \rrbracket^2$ be a subdomain of \mathbb{Z}^2 . Denote by $\partial\Lambda_n$ the boundary of Λ_n , i.e.,

$$\partial\Lambda_n := \{(a, b) \in \Lambda_n : |a| = n \text{ or } |b| = n\}.$$

We write $\overset{\circ}{\Lambda}_n := \Lambda_n \setminus \partial\Lambda_n$ for the interior of Λ_n .

Let γ be a finite self-avoiding walk. We say that γ is a *self-avoiding walk of domain Λ_n* if for any $0 \leq k \leq |\gamma|$, we have $\gamma(k) \in \Lambda_n$. Denote by $\Omega(\Lambda_n)$ the set of self-avoiding walks starting at origin of domain Λ_n .

Lemma 5.10. *The functions $\mathcal{C}(\lambda, \mathcal{T}_{\mathbb{Q}})$, $\mathcal{C}(\lambda, \mathcal{T}_{\mathbb{H}})$ and $\mathcal{C}(\lambda, \mathcal{T}_{\mathbb{Z}^2})$ are right continuous on $(\lambda_c, +\infty)$.*

Proof. It follows immediately from Lemma 4.1. \square

Lemma 5.11. *The functions $\mathcal{C}(\lambda, \mathcal{T}_{\mathbb{Q}})$, $\mathcal{C}(\lambda, \mathcal{T}_{\mathbb{H}})$ and $\mathcal{C}(\lambda, \mathcal{T}_{\mathbb{Z}^2})$ are left continuous on $(\lambda_c, +\infty)$.*

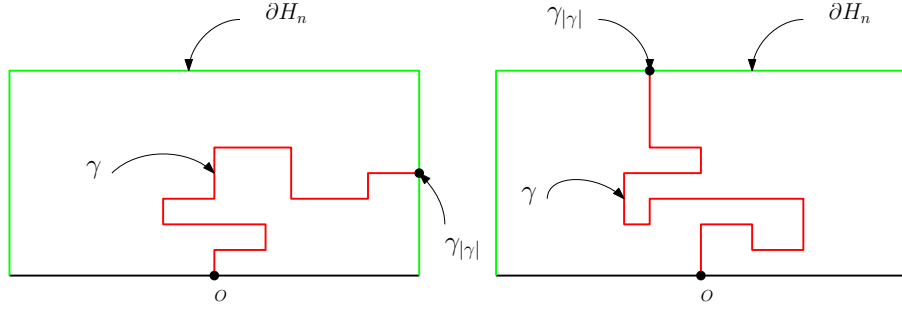

Figure 2.2 – The boundary of \mathbb{H}_n is green and the self-avoiding walk γ is red. Recall that γ is a vertex of the tree $\mathcal{T}_{\mathbb{H}}$. On the left (resp. right), we can add a new quadrant \mathbb{Q} (resp. new half-plane \mathbb{H}) rooted at $\gamma|_{|\gamma|}$. Hence, on the left (resp. on the right) the sub-tree $(\mathcal{T}_{\mathbb{H}})^\gamma$ contains the tree $\mathcal{T}_{\mathbb{Q}}$ (resp. $\mathcal{T}_{\mathbb{H}}$).

Proof. We prove this Lemma for the case $\mathcal{T}_{\mathbb{H}}$ and we use the same argument for other cases ($\mathcal{T}_{\mathbb{Q}}$ and $\mathcal{T}_{\mathbb{Z}^2}$). Note that $\mathcal{T}_{\mathbb{H}}$ is not uniformly transient, therefore we can not use Theorem 4.3. Fortunately, we can prove that $\mathcal{T}_{\mathbb{H}}$ is weakly uniformly transient. For this purpose, we define a sequence of cutsets $(\pi_n, n \geq 1)$ as follows. Set $\mathbb{H}_n := \Lambda_n \cap \mathbb{H}$ and $\partial\mathbb{H}_n := (\partial\Lambda_n) \cap \mathbb{H}$ (see Figure 2.2). Recall that $\Omega(\mathbb{H}_n)$ is the set of self-avoiding walks of domain \mathbb{H}_n . For any $n \geq 1$,

$$\pi_n := \left\{ \gamma \in \Omega(\mathbb{H}_n) : \text{for any } 0 \leq k < |\gamma|, \gamma(k) \in \overset{\circ}{\mathbb{H}}_n \text{ and } \gamma|_{|\gamma|} \in \partial(\mathbb{H}_n) \right\}$$

Since \mathbb{H}_n is a finite domain of \mathbb{H} , therefore any infinite self-avoiding walk starting at origin of \mathbb{H} , must touch the boundary of \mathbb{H}_n . Hence, for any $n \geq 1$, we have π_n is a V-cutset of $\mathcal{T}_{\mathbb{H}}$. We set $\Gamma := \bigcup_{n \geq 1} \pi_n$, it remains to verify that:

$$\forall \lambda > \lambda_c (= \frac{1}{\mu}), \exists \alpha_\lambda > 0, \forall \nu \in \Gamma, \mathbb{P}(\forall n > 0, X_n^\nu \neq \nu) \geq \alpha_\lambda. \quad (5.16)$$

Note that for any $\gamma \in \Gamma$, the sub-tree $(\mathcal{T}_{\mathbb{H}})^\gamma$ contains the tree $T_{\mathbb{H}}$ or $T_{\mathbb{Q}}$ (see Figure 2.2). Hence, 5.16 is a consequence of Proposition 1.1 and Theorem 2.10. We use Theorem 4.4 to complete the proof of Lemma. \square

Theorem 1.4 is a consequence of Lemmas 5.10 and 5.11.

6 The biased walk on the self-avoiding tree

We now begin the study of our main object of interest, which is the biased random walk on the self-avoiding tree. We will use the results that were obtained in the previous section to prove the properties of the limit walk. In the next section, we will gather a few natural conjectures.

6.1 The limit walk

Let $\lambda \in [0, +\infty]$ and consider the biased random walk RW_λ on \mathcal{T} where $\mathcal{T} = \mathcal{T}_{\mathbb{H}}$ or $\mathcal{T} = \mathcal{T}_{\mathbb{Z}^2}$. For $\lambda > \lambda_c$, the biased random walk is transient so almost surely, the random walk does not visit \mathcal{T}_k anymore after a sufficiently large time. We can then define the limit walk, as denoted by ω_λ^∞ in the following way:

$$\omega_\lambda^\infty(i) = x_i \iff \left\{ \begin{array}{l} x_i \in \mathcal{T}_i \\ \exists n_0, \forall n > n_0 : X_n \in \mathcal{T}^{x_i} \end{array} \right\}.$$

ω_λ^∞ is a random ray. Let $\mathbb{P}_\lambda^{\mathbb{H}}$ denote the law of ω_λ^∞ in the half-plane \mathbb{H} and $\mathbb{P}_\lambda^{\mathbb{Z}^2}$, the law of ω_λ^∞ in the plane \mathbb{Z}^2 . We can see $\mathbb{P}_\lambda^{\mathbb{H}}$ (respectively $\mathbb{P}_\lambda^{\mathbb{Z}^2}$) as a probability measure on SAW_∞ in the half-plane (respectively the plane).

For what follows, it will be useful to have the following definition: removing all the finite branches of \mathcal{T}_R (where R is a regular lattice), leads to a new tree without leaf, which we will denote by $\tilde{\mathcal{T}}_R$.

6.2 The case $\lambda = +\infty$ and percolation

First, we review some definitions of percolation theory. Percolation was introduced by Broadbent and Hammersley in 1957 (see [26]). For $p \in [0, 1]$, we consider the triangular lattice \mathbb{T} , a site of \mathbb{T} is open with probability p or closed with probability $1 - p$, independently of the others. This can also be seen as a random colouring (in black or white) of the faces of hexagonal lattice \mathbb{T}^* dual of \mathbb{T} .

We define the exploration curve as follows (see [119], section 6.1.2 for more detail). Let Ω be a simply connected subgraph of the triangular lattice and A, B be two points on its boundary. We can then divide the hexagonal cells of $\partial\Omega$ into two arcs, going from A to B in two directions (clockwise and counter-clockwise). These arcs will be denoted by \mathbb{B} and \mathbb{W} such that $A, \mathbb{B}, B, \mathbb{W}$ is in the clockwise direction. Assume that all of the hexagons in B are colored in black and that all of the hexagons in \mathbb{W} are colored in white. The color of the hexagonal faces in Ω is chosen at random (black with probability p and white with probability $1 - p$), independently of the others. We define the *exploration curve* γ starting at A and ending at B which separates the black component containing \mathbb{B} from the white component containing \mathbb{W} .

Then the exploration curve γ is a self-avoiding walk using the vertices and edges of hexagonal lattice \mathbb{T}^* . We can define this interface γ in an equivalent, dynamical way, informally described as follows. At each step, γ looks at its three neighbors on the hexagonal lattice, one of which is occupied by the previous step of γ . For the next step, γ randomly chooses one of these neighbors that has not yet occupied by γ . If there is just one neighbor that has not yet been occupied, then we choose this neighbor and if there are two neighbors, then we choose the right neighbor with probability p and the left neighbor with probability $1 - p$.

We know that there exists $p_c \in [0, 1]$ such that for $p < p_c$ there is almost surely no infinite cluster, while for $p > p_c$ there is almost surely an infinite cluster. This parameter is called *critical point*. It is known that the critical point of site-percolation on the triangular lattice equals $\frac{1}{2}$. The lower bound of critical point was proven by Harris in [67]. A similar theorem in the case of bond percolation on square lattice was given by Kesten in [73], and the result on the triangular lattice is obtained in a similar fashion.

Now, take $\Omega = \mathbb{T}_+^*$, the half-plane of hexagonal lattice. The hexagons on the boundary of Ω ($\partial\Omega$) and on the right of origin (denoted by $\partial^+\Omega$) are colored in black and the hexagons on $\partial\Omega$ and on the left of origin ($\partial^-\Omega$) are colored in white. In this case, the exploration curve is an (random) infinite self-avoiding walk. Denote by $\mathcal{T}_{\mathbb{T}_+^*}$ the self-avoiding tree constructed from the self-avoiding walks in \mathbb{T}_+^* .

In the case $\lambda = +\infty$, one can reinterpret the second construction of the exploration curve as the limit walk ω^∞ on $\tilde{\mathcal{T}}_{\mathbb{T}_+^*}$. This is very useful because every feature of the curve γ is also one for ω^∞ and can therefore be restated in terms of the biased walk on the self-avoiding tree. One of these properties is that γ almost surely reaches the boundary of Ω an infinite times, which follows from Russo-Seymour-Welsh type arguments. As we will see below, this property is still valid in the case RW_λ , for all $\lambda > \lambda_c$ (see Theorem 1.2).

6.3 Proof of Theorem 1.2

In this section, for any $z \in \mathbb{Z}^2$, we write $\Re z$ (resp. $\Im z$) for the real part (resp. imaginary part) of z . To prove the theorem 1.2, we need the following function (the ‘‘head of the snake’’):

$$p : x \in V(\mathcal{T}) \mapsto x_{|x|} \in \mathbb{Z}^2 \text{ where } \mathcal{T} = \mathcal{T}_{\mathbb{H}} \text{ or } \mathcal{T} = \mathcal{T}_{\mathbb{Z}^2}. \quad (6.1)$$

The proof of theorem 1.2 has several steps. In the first step, we study the trajectory of the biased random walk X_n . We prove that, under the measures $\mathbb{P}_\lambda^{\mathbb{H}}$ and $\mathbb{P}_\lambda^{\mathbb{Z}^2}$, $p(X_n)$ almost surely reaches the line $\mathbb{Z} \times \{0\}$. In the second step, we prove that it almost surely reaches the line $\mathbb{Z} \times \{0\}$ an infinite number of times. In the third step, we prove that under $\mathbb{P}_\lambda^{\mathbb{Z}^2}$, the limit walk almost surely reaches the line $\mathbb{Z} \times \{0\}$ an infinite number of times. In the last step, we prove that under $\mathbb{P}_\lambda^{\mathbb{H}}$, the limit walk almost surely reaches the line $\mathbb{Z} \times \{0\}$ an infinite number of times. For simplicity, we will write Y_n for $p(X_n)$.

The first step

In this step, we study the trajectory of RW_λ . We begin with the following simple lemma:

Lemma 6.1. *Let $\lambda > \lambda_c$ and consider the biased random walk RW_λ on $\mathcal{T}_{\mathbb{Z}^2}$ or $\mathcal{T}_{\mathbb{H}}$. Then almost surely $\limsup |\Re(Y_n)| = +\infty$.*

Proof. We prove the lemma in the case $\mathcal{T}_{\mathbb{H}}$; the result for $\mathcal{T}_{\mathbb{Z}^2}$ can be obtained in a similar way. The idea of the argument is straightforward: if the real part of $p(X_n)$ is

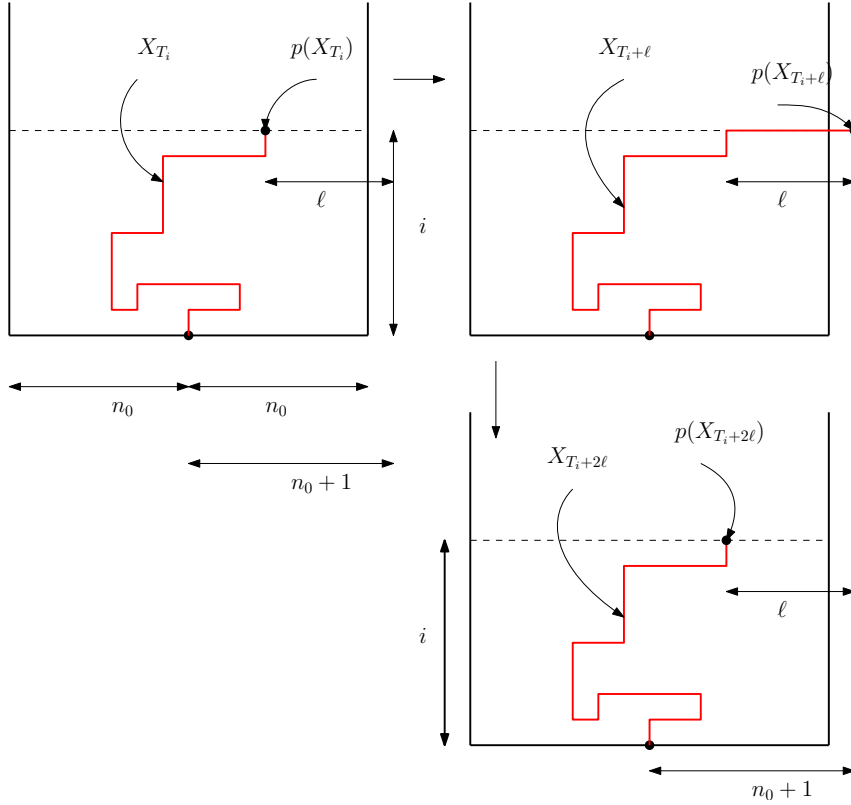

Figure 2.3 – Illustration of the proof of Lemma 6.1

constrained, then its imaginary part has to take large values and every time it visits a new height, the real part has a chance of becoming large: what follows is a formalization of this. Assume that $\alpha := \mathbb{P}(\limsup |\Re(Y_n)| < +\infty) > 0$, then there exists a constant $n_0 > 0$ such that,

$$\beta := \mathbb{P} \{ \text{for all } n > 0 : -n_0 \leq \Re(Y_n) \leq n_0 \} > 0. \quad (6.2)$$

For any $i \geq 0$, define

$$T(i) := \inf \{ n \geq 0 : \Im(Y_n) = i \}. \quad (6.3)$$

Note that $T(i) < +\infty$ on the event $\{ \text{for all } n > 0 : -n_0 \leq \Re(Y_n) \leq n_0 \}$. We remark that, at time $T(i)$, X can always go towards the left or the right. For any $i \geq 0$, define

$$S_i := \{ \exists ! k : |\Re(Y_k)| = n_0 + 1, \Im(X_k) = i \text{ and } \forall n \neq k : -n_0 \leq \Re(Y_n) \leq n_0 \}.$$

If the walk is at time $T(i)$, then we go towards the left or the right to reach the domain

$$\{ \Re z = n_0 + 1 \} \cup \{ \Re z = -n_0 - 1 \},$$

and after, we go back to $X_{T(i)}$ (see Figure 2.3). We need at most $2n_0$ steps to do this. Then, there exist a constant $c > 0$ such that for any $i > 0$,

$$\mathbb{P}(S_i) \geq c\beta. \tag{6.4}$$

On the other hand, we have

$$\bigcup_{i=0}^{+\infty} S_i \subset \{ \text{for all } n \geq 0 : -n_0 - 1 \leq \Re(Y_n) \leq n_0 + 1 \}. \tag{6.5}$$

Since these S_i are pairwise disjoint, by using 6.4 and 6.5 we obtain:

$$\mathbb{P}(\text{for all } n \geq 0 : -n_0 - 1 \leq \Re(Y_n) \leq n_0 + 1) \geq \sum_{i=0}^{\infty} \mathbb{P}(S_i) \geq \sum_{i=0}^{\infty} c\beta = +\infty.$$

This is a contradiction and therefore almost surely $\limsup |\Re(Y_n)| = +\infty$. \square

Lemma 6.2. *Let $\lambda > \lambda_c$ and consider the biased random walk RW_λ on $\mathcal{T}_{\mathbb{Z}^2}$ or $\mathcal{T}_{\mathbb{H}}$. Then $\#\{n > 0 : \Im(Y_n) = 0\} \geq 1$ almost surely.*

Proof. We again deal separately with two cases.

Case I: The tree $\mathcal{T}_{\mathbb{Z}^2}$. Assume that $\alpha := \mathbb{P}(\forall n > 0, \Im(Y_n) > 0) > 0$, hence

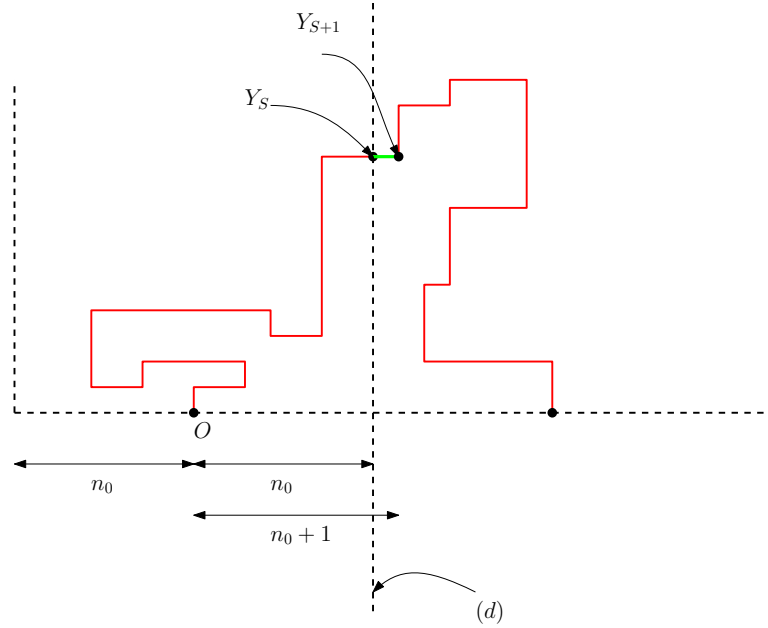

Figure 2.4 – Illustration of the proof of Lemma 6.2

$$0 < \mathbb{P}(\exists n > 0, \Im(Y_n) = 0) = 1 - \alpha < 1. \tag{6.6}$$

Given that the sequence $(\{\exists k \in (0, n] : \mathfrak{S}(Y_k) = 0\})_{n \geq 1}$ is an increasing sequence,

$$1 - \alpha = \mathbb{P}(\exists n > 0 : \mathfrak{S}(Y_n) = 0) = \lim_n \mathbb{P}(\exists k \in (0, n] : \mathfrak{S}(Y_k) = 0). \quad (6.7)$$

Let $\varepsilon > 0$, by using 6.6, then there exist n_0 such that for all $n \geq n_0$,

$$\mathbb{P}(\exists k \in (0, n] : \mathfrak{S}(Y_k) = 0) \geq 1 - \alpha - \varepsilon. \quad (6.8)$$

We know that the biased random walk does not reach the line $\mathbb{Z} \times \{0\}$ with a probability $p > 0$. By Lemma 6.1, the random walk X_n must reach the domain $H := \{\Re(z) = n_0\} \cup \{\Re(z) = -n_0\}$ with a probability 1. We consider the first time S , that the random walk X_n reaches H and we assume that it reaches the line $\{\Re(z) = n_0\}$. We continue one step on the random walk to reach the line $\{\Re(z) = n_0 + 1\}$.

The key observation, which we will use several times in similar forms in what follows, is that the behavior of the walk after time S , and until its first visit to the parent X_S^{-1} , matches the similar process defined in the domain $\mathbb{Z}^2 \setminus \{X_S(k) : 0 \leq k < |X_S|\}$. Here, this domain contains the half-plane

$$Y_S := \{(x, y) \in \mathbb{Z}^2 : x \geq \Re(Y_S)\}$$

and our running hypothesis implies that the random walk after the time S will stay in this half-plane with probability α (see Figure 2.4). As a shortcut, we will later refer to this kind of construction as *considering a new half-plane with origin Y_S* .

From the previous discussion,

$$\mathbb{P}(\forall k \leq n_0 : \mathfrak{S}(Y_k) > 0 \text{ and } \exists k > n_0 : \mathfrak{S}(Y_k) = 0) = \frac{\lambda \alpha^2}{1 + 3\lambda}. \quad (6.9)$$

Because the two events $\{\forall k \leq n_0 : \mathfrak{S}(Y_k) > 0 \text{ and } \exists k > n_0 : \mathfrak{S}(Y_k) = 0\}$ and $\{\exists k \in (0, n_0] : \mathfrak{S}(Y_k) = 0\}$ are disjoint and included in the event $\{\exists n > 0 : \mathfrak{S}(Y_n) = 0\}$, we use 6.8 and 6.9 to get

$$1 - \alpha = \mathbb{P}(\{\exists n > 0 : \mathfrak{S}(Y_n) = 0\}) \geq 1 - \alpha - \varepsilon + \frac{\lambda \alpha^2}{1 + 3\lambda}.$$

If we take small enough ε , then we obtain a contradiction.

Case II: The tree $\mathcal{T}_{\mathbb{H}}$. Now, we prove that $|\{n : \mathfrak{S}(Y_n) = 0\}| \geq 1$ a.s for the tree $\mathcal{T}_{\mathbb{H}}$. We set $\alpha = \mathbb{P}(\forall n > 0 : \mathfrak{S}(Y_n) > 0)$. Assume that $p > 0$, because the random walk in the domain $\{\mathfrak{S}(z) > 0\}$ of the half-plane has the same law as the random walk in this domain of the plan. This implies that the random walk X_n on the plan does not reach the line $\mathbb{Z} \times \{0\}$ with a positive probability. This is a contradiction with step 1 and then $p = 0$. \square

The second step

The goal of this step is to prove the following lemma:

Lemma 6.3. *Let $\lambda > \lambda_c$ and consider the biased random walk RW_λ on $\mathcal{T}_{\mathbb{Z}^2}$ or $\mathcal{T}_{\mathbb{H}}$. Then almost surely $\#\{n > 0 : \mathfrak{S}(Y_n) = 0\} = +\infty$.*

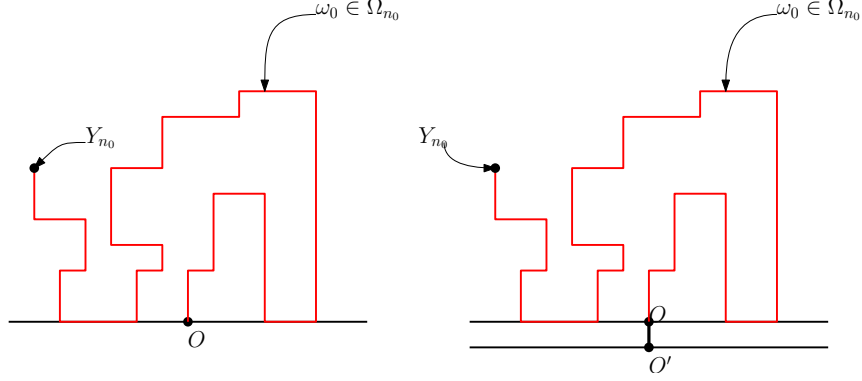

Figure 2.5 – Illustration of the proof of Lemma 6.3, case $\mathcal{T}_{\mathbb{H}}$

Proof. We again need to deal separately with two cases.

Case I: the tree $\mathcal{T}_{\mathbb{H}}$. We denote by A the following event:

$$A := \{\#\{n > 0 : \mathfrak{S}Y_n = 0\} = \infty\}.$$

Or equivalently, $A = \{\forall k, \exists n > k : \mathfrak{S}Y_n = 0\}$. Assume that $\mathbb{P}(A) < 1$, we have then $\mathbb{P}(A^c) > 0$. Hence, there exists $n_0 > 0$ such that,

$$\mathbb{P}(\forall n > n_0 : \mathfrak{S}Y_n > 0) > 0. \quad (6.10)$$

Now, consider the random walk until time n_0 . Denote by Ω_{n_0} the set of all configurations $(Y_0, Y_1, \dots, Y_{n_0})$. For each $\omega \in \Omega_{n_0}$, we define the event A_ω as follows:

$$A_\omega := \{\text{for all } n > n_0, \text{ we have } \mathfrak{S}(Y_n) > 0 \text{ and } (Y_0, Y_1, \dots, Y_{n_0}) = \omega\}. \quad (6.11)$$

Hence,

$$\mathbb{P}(\forall n > n_0 : \mathfrak{S}Y_n > 0) = \sum_{\omega \in \Omega_{n_0}} \mathbb{P}(A_\omega) > 0. \quad (6.12)$$

Since the cardinal of Ω_{n_0} is finite, there exists $\omega_0 \in \Omega_{n_0}$ such that $\mathbb{P}(A_{\omega_0}) > 0$. We add a new line under the line $\mathbb{Z} \times \{0\}$ and consider a new half-plane \mathbb{H}' with origin O' (see the Figure 2.5 and the discussion in the proof of Lemma 6.2).

Observe the biased random walk X'_n with parameter λ on $\mathcal{T}_{\mathbb{H}'}$ and denote $Y'_n = p(X'_n)$. Conditioned on the events $\{Y_0 = O', Y'_1 = \omega_0(1), \dots, Y'_n(n_0) = \omega_0(n_0)\}$ and A_{ω_0} , X and

X' have the same law. This implies that the random walk X' on $\mathcal{T}_{\mathbb{H}'}$ does not reach the line $\mathbb{Z} \times \{0\}$ of \mathbb{H}' with a positive probability. This is a contradiction and then $\mathbb{P}(A) = 1$, which concludes the proof of Lemma 6.3 in the case $T_{\mathbb{H}}$.

Case II: the tree $\mathcal{T}_{\mathbb{Z}^2}$.

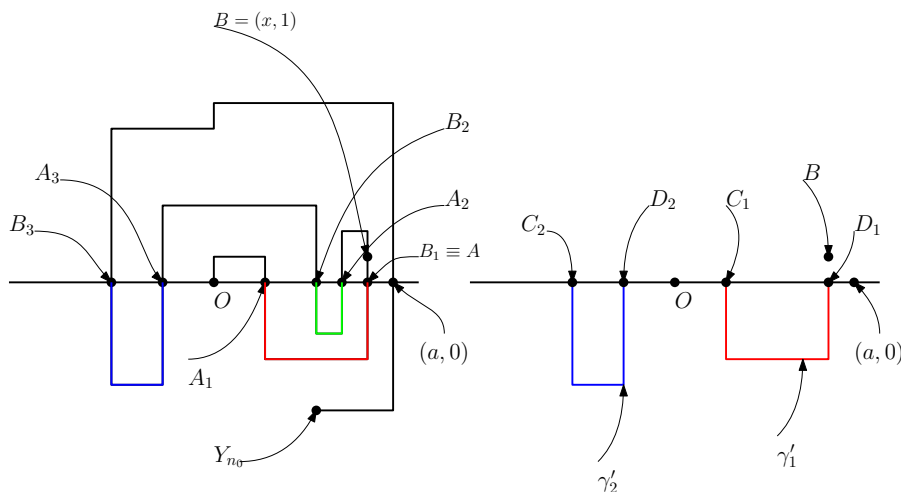

Figure 2.6 – Illustration of the proof of Lemma 6.3, case $\mathcal{T}_{\mathbb{Z}^2}$

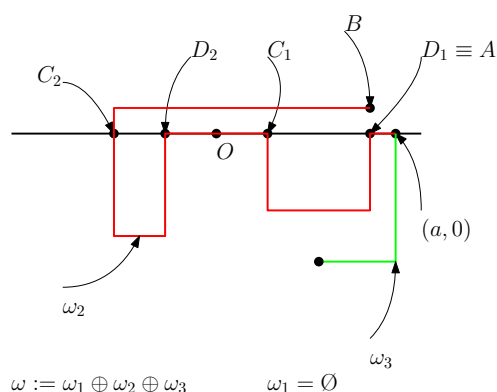

Figure 2.7 – Illustration of the proof of Lemma 6.3, case $\mathcal{T}_{\mathbb{Z}^2}$

Assume that the random walk reaches the line $\mathbb{Z} \times \{0\}$ an infinite number of times with a probability strictly less than 1. By using the same argument as in the case $T_{\mathbb{H}}$, there exists a configuration ω_0 and a positive number n_0 such that $\mathbb{P}(A_{\omega_0}) > 0$ where A_{ω_0} is defined as in 6.11.

Let $A_1 = (a_1, 0), B_1 = (b_1, 0) \dots, A_k = (a_k, 0), B_k = (b_k, 0)$ be $2k$ points of intersections of the line $\mathbb{Z} \times \{0\}$ with ω along the curve ω such that for any $1 \leq i \leq k$, there exists a self-avoiding walk γ_i in ω starting at $(a_i, 0)$ and ending at $(b_i, 0)$ which is below the

line $\mathbb{Z} \times \{0\}$. Denote by $(a, 0)$ the last point of intersection of the line $\mathbb{Z} \times \{0\}$ with ω before that the random walk does not reach the line $\mathbb{Z} \times \{0\}$. Let $A := (x, 0)$ to be $(a_i, 0)$ or $(b_i, 0)$ which maximises the first coordinate and we set $B = (x, 1)$ (see Figure 2.6, on the left).

Consider a new plane \mathbb{Z}^2 with an origin at B and consider the random walk RW_λ on the tree $\mathcal{T}_{\mathbb{H}}$ starting at B . Let $\Gamma = (\gamma_1, \gamma_2, \dots, \gamma_k)$ be a set of k self-avoiding walks in ω which connect $(a_i, 0)$ to $(b_i, 0)$. If there exist i, j such that $[a_j \wedge b_j, a_j \vee b_j] \subset [a_i \wedge b_i, a_i \vee b_i]$, then we remove the self-avoiding walk γ_j from Γ . Finally, we obtain a subset $\Gamma' = (\gamma'_1, \gamma'_2, \dots, \gamma'_m)$ of Γ in which there are no i, j such that $[a_j \wedge b_j, a_j \vee b_j] \subset [a_i \wedge b_i, a_i \vee b_i]$. We can assume that γ'_i connect $C_i = (c_i, 0)$ to $D_i = (d_i, 0)$ and for all $i \in \{1, \dots, m\}$, we have $c_1 > c_2 > \dots > c_m$ and $c_i < d_i$ (see Figure 2.6, on the right).

Define a self-avoiding walk ω starting at B as follows (see the Figure 2.7):

Set $u = \sup \{1 \leq i \leq m : c_i > a\}$ and define the three following self-avoiding walks:

$$\begin{cases} \omega_1 := [BA] \oplus \gamma_1 \oplus [(d_2, 0), (c_1, 0)] \oplus \gamma_2 \oplus [(d_3, 0), (c_2, 0)] \oplus \dots \oplus \gamma_u \oplus [(c_u, 0), (c_u, 1)] \\ \omega_2 := [(c_u, 1), (c_m, 1)] \oplus [(c_m, 1), (c_m, 0)] \oplus \gamma_m \oplus [(d_m, 0), (c_{m-1}, 0)] \dots \oplus \gamma_{u+1}, [(d_{u+1}, 0), (a, 0)] \\ \omega_3 := \omega|_{[t, n_0]} \text{ where } \omega(t) = (a, 0), \end{cases}$$

and we define $\omega := \omega_1 \oplus \omega_2 \oplus \omega_3$.

Consider the biased random walk X_n with parameter λ on $\mathcal{T}_{\mathbb{H}}$, where \mathbb{H} is the half-plane with the origin B . Recall that $Y_n = p(X_n)$. Note that, conditioned to the event $\{(Y_0, \dots, Y_{|\omega|}) = \omega\}$, with a positive probability, the random walk reach a finite number of times the half-plane \mathbb{H} . This is a contradiction with the case $\mathcal{T}_{\mathbb{H}}$ above. \square

Remark 6.4. All of results that we proved in the first step and second step for $\mathcal{T}_{\mathbb{Z}^2}$ and $\mathcal{T}_{\mathbb{H}}$, are still valid for $\tilde{\mathcal{T}}_{\mathbb{H}}$ and $\tilde{\mathcal{T}}_{\mathbb{Z}^2}$. Note that it is sufficient to prove the theorem 1.2 in the case $\tilde{\mathcal{T}}_{\mathbb{H}}$ and $\tilde{\mathcal{T}}_{\mathbb{Z}^2}$, which means the biased random walk on $\tilde{\mathcal{T}}_{\mathbb{H}}$ and $\tilde{\mathcal{T}}_{\mathbb{Z}^2}$ almost surely reaches the line $\mathbb{Z} \times \{0\}$ an infinite number of times).

The third step

In this step, we give a proof of Theorem 1.2 in the case $\mathbb{P}_\lambda^{\mathbb{Z}^2}$. We start with the following definition

Definition 6.5. Let C be a closed, simple curve of \mathbb{Z}^2 . The interior of C , denoted by $I(C)$ is a sub-domain of \mathbb{R}^2 which is surrounded by C (see Figure 2.8). Where $S(C)$ denotes the area of this domain. The exterior of C is defined by

$$E(C) := \mathbb{R}^2 \setminus I(C).$$

Lemma 6.6. Let $((a_1, 0), (a_2, 0), \dots, (a_{2n}, 0))$ be a sequence of points on the line $\mathbb{Z} \times \{0\}$ such that $a_1 < a_2 < \dots < a_{2n}$. For each i , we denote γ_i as the self-avoiding walk starting

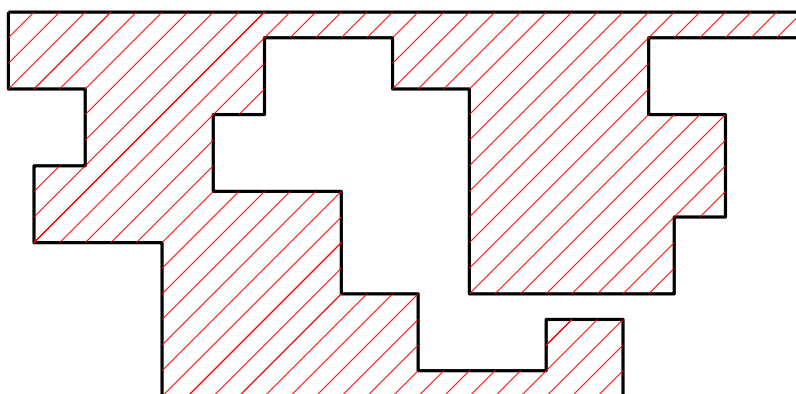

Figure 2.8 – A closed, simple curve C of \mathbb{Z}^2 with its interior in red

at $(a_{2i-1}, 0)$ and ending at $(a_{2i}, 0)$ which is below the line $\mathbb{Z} \times \{0\}$. Suppose that for any i , we have

$$\gamma_i \cap \gamma_j = \emptyset.$$

We set $A := \bigcup \gamma_i$ and $B = \partial A \cup ((\bigcup_{i=1}^n [a_{2i-1}, a_{2i}]) \times \{0\})$ where,

$$\partial A := \left\{ z \in \mathbb{Z}^2 : \exists x \in A, 0 < d(x, z) \leq \sqrt{2} \right\} \text{ and } d \text{ is euclidean distance.}$$

Then there exists a self-avoiding walk in B starting at $(a_1-1, 0)$ and ending at $(a_{2n}+1, 0)$.

Proof. The statement is intuitively clear. The proof is a simple but tedious issue of book-keeping, and is omitted here. \square

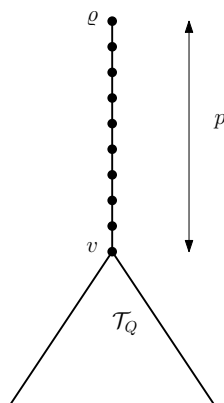

Figure 2.9 – The tree \mathcal{T}

Proof of Theorem 1.2 in the case of $\mathbb{P}_\lambda^{\mathbb{Z}^2}$. We denote by A the following event:

$$A := \{ \# \{ n > 0 : \mathfrak{S}\omega_\lambda^\infty(n) = 0 \} = \infty \}.$$

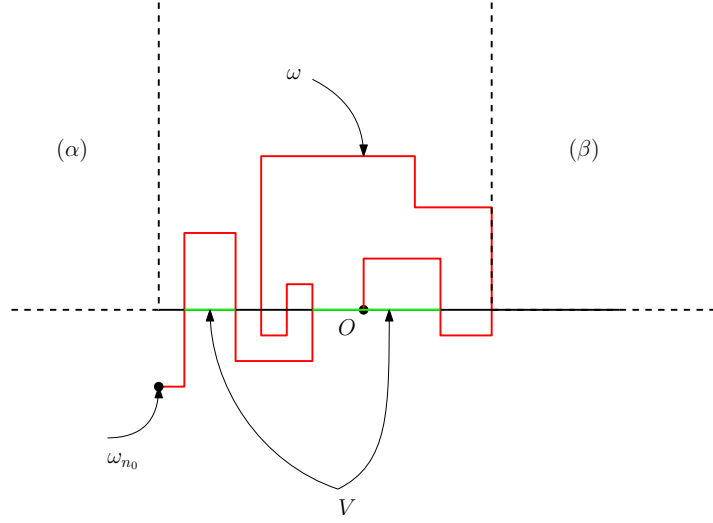

Figure 2.10 – The self-avoiding walk ω is colored by red; the domain D is the union of two quadrants α and β and the set V is colored by green.

Assume that $\mathbb{P}(A) < 1$, by using the same argument as in the second step, there exist $n_0 > 0$ and a self-avoiding walk $\omega := [\omega(0), \omega(1), \dots, \omega(n_0)]$ starting at 0 such that the following event has a strictly positive probability (see Figure 2.10):

$$B := \left\{ \begin{array}{l} \omega_\lambda^\infty(0) = \omega(0), \omega_\lambda^\infty(1) = \omega(1), \dots, \omega_\lambda^\infty(n_0) = \omega(n_0) \\ \forall n > n_0 : \Im \omega_\lambda^\infty(n) < 0 \end{array} \right.$$

Define

$$D := \left\{ (x, y) \in \mathbb{Z}^2 : y \geq 0 \text{ and } x \notin \{\Re \omega_\lambda^\infty(i) : 0 \leq i \leq n_0\} \right\}.$$

and let V be a subset of $\mathbb{Z} \setminus D$ such that for all $x \in V$, there exists an infinite self-avoiding walk in half-plane $\{\Im z \leq 0\}$, starting at x and it does not reach the self-avoiding walk ω (see Figure 2.10).

For each $x \in V$, we denote by Γ_x the set of self-avoiding walks starting at x , which does not reach the path $(\omega(0), \dots, \omega(n_0))$, and reaches the domain D at only one point and such that, for each $z \in \gamma_x$, z belongs to the line $\mathbb{Z} \times \{0\}$ or z belongs to the boundary of self-avoiding walk $(\omega(0), \omega(1), \dots, \omega(n_0))$. By Lemma 6.6, Γ_x is not empty. We then set $p := \sup_{x \in V} \sup_{\gamma \in \Gamma_x} |\gamma|$.

Let \mathcal{T} be an infinite, locally finite and rooted tree defined by (see Figure 2.9):

$$\left\{ \begin{array}{l} |\mathcal{T}_i| = 1 \text{ for all } i \leq p \\ \mathcal{T}_p = \{v\} \\ \mathcal{T}^v = \mathcal{T}_\mathbb{Q} \end{array} \right.$$

We apply Lemma 6.3. Almost surely, the random walk reaches the line $\mathbb{Z} \times \{0\}$ an infinite number of times and, thus, it almost surely reaches the line $\mathbb{Z} \times \{0\}$ at least k

times. Every time it reaches the line $\mathbb{Z} \times \{0\}$ at a point x , we can go on the random walk at most p steps to reach the domain D (we can do this because $TSL_{\mathbb{Z}^2}$ have no leaf and then x belongs to V). Then, the limit walk stays within the half-plane $\{\Im z < 0\}$ after the step n_0 with a probability smaller than $(1 - \mathcal{C}(\lambda, \mathcal{T}))$, where $\mathcal{C}(\lambda, \mathcal{T})$ is the effective conductance for the network (\mathcal{T}, c) with $c(e) = \lambda^{|e|}$. Hence, for any $k > 0$, we have

$$\mathbb{P}(B) \leq (1 - \mathcal{C}(\lambda, \mathcal{T}))^k$$

Because we have $\mathcal{C}(\lambda, \mathcal{T}) > 0$ (and because it contains the tree $\mathcal{T}_{\mathbb{Q}}$), then $\mathbb{P}(B) = 0$. This is a contradiction and implies Theorem 1.2 in the case \mathbb{Q}_λ -measure. \square

The last step

In this section, we give a proof of Theorem 1.2 in the case $\mathbb{P}_\lambda^{\mathbb{H}}$.

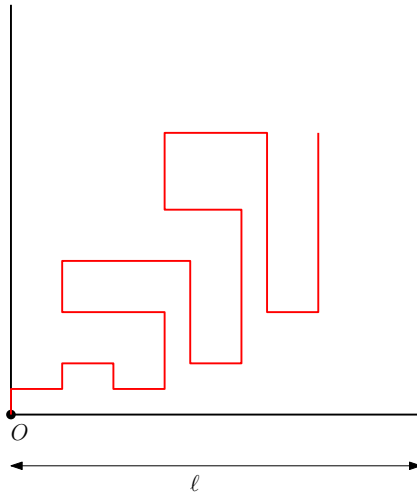

Figure 2.11 – A bridge of a strip B_ℓ

Notation 6.7. A strip B_ℓ of size ℓ is a sub-domain of \mathbb{Z}^2 , which is limited by two lines $\{\Im z = a\}$ and $\{\Im z = b\}$ (or $\{\Re z = a\}$ and $\{\Re z = b\}$) such that $|a - b| = \ell$. Fix an origin $O \in \{\Im z = a\} \cup \{\Im z = b\}$ (or $\{\Re z = a\} \cup \{\Re z = b\}$) of B_ℓ . Let γ be a finite self-avoiding walk starting at O . We say that γ is a *self-avoiding walk of the strip B_ℓ* if for any $0 \leq k \leq |\gamma|$, we have $\gamma(k) \in B_\ell$. We define the self-avoiding tree \mathcal{T}_{B_ℓ} from the self-avoiding walks starting at O as in Notation 5.6.

Consider a strip B_ℓ . We define the bridge (resp. irreducible bridge) of B_ℓ in the same way as the definition of bridge (resp. irreducible bridge) in half-plane. (see Figure 2.11).

Lemma 6.8 (The subadditivity property). *Let ℓ, n be two positive natural numbers, denote by $p_n^{(\ell)}$ the number of bridges of length n starting at origin of the strip B_ℓ . For*

any $\ell, n, m, k \in \mathbb{N}^*$,

$$p_{n+m}^{(2\ell)} \geq p_m^{(\ell)} p_n^{(\ell)} \quad \text{and} \quad p_{kn}^{(2\ell)} \geq (p_n^{(\ell)})^k.$$

Proof. Divide the strip $B_{2\ell}$ into two small strip $B_{2\ell}^1, B_{2\ell}^2$ of size ℓ (see Figure 2.12). For any $z \in \mathbb{Z}^2$, denote by $L(z)$ the line goes through z and orthogonal to $\mathbb{Z} \times \{0\}$. Denote by S_z the orthogonal symmetry with respect to $L(z)$.

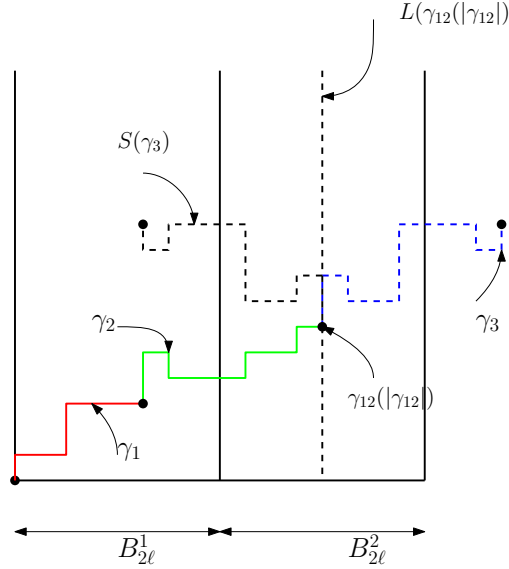

Figure 2.12 – A concatenation of 3 bridges in $B_{2\ell}^1$.

Consider γ_1, γ_2 two bridges of the strip $B_{2\ell}^1$ of length m and n , we concatenate γ_1 and γ_2 to obtain a new bridge $\gamma_{12} := \gamma_1 \oplus \gamma_2$ of length $m + n$ of the strip $B_{2\ell}$ (see Figure 2.12). Hence, for any $\ell, n, m \in \mathbb{N}^*$,

$$p_{n+m}^{(2\ell)} \geq p_m^{(\ell)} p_n^{(\ell)}.$$

If one takes the third bridge γ_3 of $B_{2\ell}^1$ of length t , we concatenate γ_{12} and γ_3 as follows (see Figure 2.12):

$$\begin{cases} \gamma_{123} = \gamma_{12} \oplus \gamma_3 & \text{if } \gamma_{12}(|\gamma_{12}|) \in B_{2\ell}^1 \\ \gamma_{123} = \gamma_{12} \oplus S_{\gamma_{12}(|\gamma_{12}|)}(\gamma_3) & \text{if } \gamma_{12}(|\gamma_{12}|) \in B_{2\ell}^2 \end{cases}$$

Note that γ_{123} is a bridge of length $m + n + t$ of the strip $B_{2\ell}$. Hence, for any $\ell, n, m, t \in \mathbb{N}^*$,

$$p_{n+m+t}^{(2\ell)} \geq p_m^{(\ell)} p_n^{(\ell)} p_t^{(\ell)}.$$

By repeating the same strategy, we obtain the result of Lemma 6.8. \square

Lemma 6.9. Denote by $\mu(\ell)$ the connective constant of the strip B_ℓ . Then we have,

$$\lim_{\ell \rightarrow \infty} \mu(\ell) = \mu,$$

where μ is the connective constant of \mathbb{Z}^2 .

Proof. Denote by $b_n^{\mathbb{Q}}$ the number of bridges of length n of \mathbb{Q} , starting at origin. Note that for any ℓ , we have:

$$\lim_{n \rightarrow \infty} (p_n^{(\ell)})^{\frac{1}{n}} = \mu(\ell) \text{ and } p_\ell^{(\ell)} = b_\ell^{\mathbb{Q}}. \quad (6.13)$$

Moreover, we also have:

$$\lim_{n \rightarrow \infty} \left(b_n^{\mathbb{Q}} \right)^{\frac{1}{n}} = \mu. \quad (6.14)$$

By using Lemma 6.8, for any ℓ, n, k :

$$p_{kn}^{(2\ell)} \geq (p_n^{(\ell)})^k. \quad (6.15)$$

Fix $\varepsilon > 0$ and by 6.14, there exists n_0 such that for any $n > n_0$, we have

$$\left| \left(b_n^{\mathbb{Q}} \right)^{\frac{1}{n}} - \mu \right| \leq \varepsilon. \quad (6.16)$$

Let $\ell > n_0$ and $k > 0$. By 6.13, 6.15 and 6.16, we have:

$$\left(p_{k\ell}^{(2\ell)} \right)^{\frac{1}{k\ell}} \geq \left(p_\ell^{(\ell)} \right)^{\frac{1}{\ell}} = \left(b_\ell^{\mathbb{Q}} \right)^{\frac{1}{\ell}} \geq \mu - \varepsilon. \quad (6.17)$$

Since the sequence $(p_{k\ell}^{(2\ell)})^{\frac{1}{k\ell}}$ converges towards $\mu(2\ell)$ when k goes to infinity, we use 6.17 to obtain:

$$\mu \geq \mu_{2\ell} \geq \mu - \varepsilon, \quad (6.18)$$

where inequality $\mu \geq \mu_{2\ell}$ is obvious. Hence, the sequence $(\mu(\ell), \ell \geq 1)$ converges towards μ when ℓ goes to $+\infty$. \square

Proposition 6.10. *Denote by $br(\mathcal{T}_{B_\ell})$ the branching number of \mathcal{T}_{B_ℓ} . Then we have,*

$$\lim_{\ell \rightarrow \infty} br(\mathcal{T}_{B_\ell}) = \mu,$$

where μ is the connective constant of \mathbb{Z}^2 .

Proof. Recall the definition of A_m in the proof of Proposition 5.9:

$$A_m := \{ \omega \in iSAB, |\omega| \leq m \},$$

where $iSAB$ is the set of irreducible-bridges in half-plane \mathbb{H} . Let γ be an infinite self-avoiding walk starting at origin of B_ℓ , it is called "m-nice walk" if it possesses a decomposition into irreducible bridges in A_m . Denote by $G_m(B_\ell)$ the set of infinite self-avoiding

walk of B_ℓ which are "m-nice". Let $\mathcal{T}_{B_\ell}^{(m)}$ be a sub-tree of \mathcal{T}_{B_ℓ} , which we will refer to as the *m-nice tree*, defined by $E(\mathcal{T}_{B_\ell}^{(m)}) := E(\mathcal{T}_{B_\ell})|_{V(\mathcal{T}_{B_\ell}^{(m)}) \times V(\mathcal{T}_{B_\ell}^{(m)})}$ where,

$$V(\mathcal{T}_{B_\ell}^{(m)}) := \{\omega \in V(\mathcal{T}_{B_\ell}) : \text{there exists } \gamma \in G_m(B_\ell) \text{ such that } \gamma|_{[0,|\omega|]} = \omega\}.$$

Denote by $p_n^{(\ell, m)}$ be the number of bridges starting at origin of B_ℓ , of length n which possess a decomposition in A_m . Recall that $p_n^{(\ell)}$ is the number of bridges of length n starting at origin of the strip B_ℓ and $(\mathcal{T}_{B_\ell}^{(m)})_n$ is the number of vertices of $\mathcal{T}_{B_\ell}^{(m)}$ at generation n . Then for any $n > 0$, we have

$$\left| (\mathcal{T}_{B_\ell}^{(m)})_n \right| \geq p_n^{(m)}. \quad (6.19)$$

By using Lemma 6.8, for any ℓ, m, n, k we have:

$$p_{nk}^{(2\ell)} \geq (p_n^{(\ell)})^k \text{ and } p_{nk}^{(2\ell, m)} \geq (p_n^{(\ell, m)})^k. \quad (6.20)$$

As we know (see paragraph 5.8) all bridges in a half-plane can be decomposed into a sequence of irreducible bridges in a unique. Therefore each bridge in B_ℓ of length m possesses a decomposition into irreducible bridges in A_m . Hence, for any $m, \ell > 0$,

$$p_m^{(\ell)} = p_m^{(\ell, m)}. \quad (6.21)$$

Fix $\varepsilon > 0$, by Lemma 6.9, there exists ℓ_0 such that for any $\ell > \ell_0$,

$$\mu \geq \mu(2\ell) > \mu - \varepsilon. \quad (6.22)$$

Moreover, since $\mu(2\ell) = \lim_{n \rightarrow \infty} (p_n^{(2\ell)})^{\frac{1}{n}}$, then there exists n_0 such that for any $n > n_0$:

$$(p_n^{(2\ell)})^{\frac{1}{n}} > \mu(2\ell) - \varepsilon. \quad (6.23)$$

Hence by 6.21, 6.20, 6.22 and 6.23,

$$(p_{kn}^{(4\ell, n)})^{\frac{1}{kn}} \geq (p_n^{(2\ell, n)})^{\frac{1}{n}} = (p_n^{(2\ell)})^{\frac{1}{n}} \geq \mu(2\ell) - \varepsilon \geq \mu - 2\varepsilon. \quad (6.24)$$

Therefore for $\ell > \ell_0$ and $n > n_0(\ell)$ (i.e n_0 depends on ℓ), we have

$$\overline{gr(\mathcal{T}_{B_{4\ell}}^n)} \geq \mu - 2\varepsilon. \quad (6.25)$$

On the other hand, note that $\mathcal{T}_{B_{4\ell}}^n$ is $(n + 4\ell)$ -super-periodic and $\overline{gr(\mathcal{T}_{B_{4\ell}}^n)} < +\infty$, we use Theorem 2.8 to get:

$$gr(\mathcal{T}_{B_{4\ell}}^n) \text{ exists and } gr(\mathcal{T}_{B_{4\ell}}^n) = br(\mathcal{T}_{B_{4\ell}}^n). \quad (6.26)$$

Since $\mathcal{T}_{B_{4\ell}}^n \subset \mathcal{T}_{B_{4\ell}}$, by using 6.25, 6.26 and Proposition 2.4 we obtain for any $\ell > \ell_0$:

$$\mu \geq br(\mathcal{T}_{B_{4\ell}}) \geq \mu - 2\varepsilon, \quad (6.27)$$

where we used $\mathcal{T}_{B_{4\ell}} \subset \mathcal{T}_{\mathbb{H}}$ for the first inequality. Therefore, the sequence $(br(\mathcal{T}_{B_\ell}))_{\ell \geq 1}$ converges towards μ when ℓ goes to infinity. \square

Proposition 6.11. *We consider the biased random walk RW_λ on $\tilde{\mathcal{T}}_{\mathbb{H}}$. Let $(B_\ell)_{\ell \geq 1}$ be the sequence of strips of \mathbb{H} where B_ℓ is the strip between two lines $\Im z = 0$ and $\Im z = \ell$. Suppose that $\lambda > \frac{1}{\mu}$, where μ is the connective constant of \mathbb{H} . Then, there exists $\ell > 0$ such that the limit walk ω_λ^∞ almost surely touches the strip B_ℓ an infinite number of times.*

Proof. We fix $\lambda > \frac{1}{\mu}$. Assume that, for all $\ell > 0$, the limit walk reaches the strip B_ℓ a finite number of times with a strictly positive probability. By Proposition 6.10, there exists ℓ_0 such that $\lambda > \frac{1}{br(\mathcal{T}_{B_{\ell_0}})}$. We use again the same argument as in the second step, there then exists $n_0 > 0$ and a self-avoiding walk $\omega = [\omega(0), \omega(1), \dots, \omega(n_0)]$ such that the following event has a strictly positive probability:

$$B := \begin{cases} \omega_\lambda^\infty(0) = \omega(0), \omega_\lambda^\infty(1) = \omega(1), \dots, \omega_\lambda^\infty(n_0) = \omega(n_0) \\ \forall n > n_0 : \Im \omega_\lambda^\infty(n) > \ell_0 \end{cases}$$

By Lemma 6.3, we know that the random walk almost surely reaches the line $\mathbb{Z} \times \{0\}$ an infinite number of times and then it must reach the line $\{\Im z = \ell_0\}$ an infinite number of times almost surely. By using the same argument as in the third step, for any $k > 0$, we have:

$$\mathbb{P}(B) \leq (1 - \mathcal{C}(\lambda, \mathcal{T}_{B_{\ell_0}}))^k.$$

Because we have $\mathcal{C}(\lambda, \mathcal{T}_{B_{\ell_0}}) > 0$ (and because we have taken $\lambda > \lambda_c(\mathcal{T}_{B_{\ell_0}})$), then $\mathbb{P}(B) = 0$. This is a contradiction. We conclude that there exists $\ell > 0$ such that the limit walk on the tree $\tilde{\mathcal{T}}_{\mathbb{H}}$ almost surely reaches the strip B_ℓ . \square

Proof of Theorem 1.2 in the case of $\mathbb{P}^{\mathbb{H}}$. By Proposition 6.11, we can fix a number ℓ such that the limit walk almost surely reaches the domain B_ℓ an infinite number of times. Now, we prove that the limit walk almost surely reaches an infinite number of times the line $\mathbb{Z} \times \{0\}$.

Assume that $\mathbb{P}(\#\{n : \Im \omega^\infty(n) = 0\} < +\infty) > 0$, then there exist n_0 and a self-avoiding walk ω of length n_0 starting at origin such that the following event occurs with a strictly positive probability:

$$C := \begin{cases} \omega_\lambda^\infty(0) = \omega(0); \omega_\lambda^\infty(1) = \omega(1); \dots; \omega_\lambda^\infty(n_0) = \omega(n_0) \\ \forall n > n_0 : \Im \omega_\lambda^\infty(n) > 0 \end{cases}$$

Let \mathcal{T}^* be a tree defined by

$$\begin{cases} |\mathcal{T}_i^*| = 1 \text{ for all } t \leq \ell \\ \mathcal{T}_\ell^* = \{v\} \\ (\mathcal{T}^*)^v = \mathcal{T}_{B_\ell} \end{cases}$$

Recall that $Y_n := p(X_n)$. Let U be a set of naturals n such that: $\Re Y_n = \sup_{0 \leq i \leq n; Y_i \in B_\ell} \Re Y_i$ or $\Re Y_n = \inf_{0 \leq i \leq n; Y_i \in B_\ell} \Re Y_i$. For each $n \in U$, we go on the walk in the vertical direction

until it reaches the line $\mathbb{Z} \times \{0\}$. When it reaches the line $\mathbb{Z} \times \{0\}$, it remains in reach of the line $\mathbb{Z} \times \{0\}$ with a probability that is greater than $c \times \mathcal{C}(\lambda, \mathcal{T}^*)$ where c is a constant that does not depend on n .

Because the walk almost surely touches the line $\mathbb{Z} \times \{0\}$ an infinite number of times, we then have $|U| = +\infty, p.s.$ This implies that $\mathbb{P}(C) = 0$. This is a contradiction. \square

6.4 The law of first k -steps of limit walk

We consider the biased random walk RW_λ on $\mathcal{T}_{\mathbb{H}}$. Recall that ω_λ^∞ is the associated limit walk and $\mathbb{P}_\lambda^{\mathbb{H}}$ denotes its law.

Let $k \in \mathbb{N}^*$ and y_1, y_2, \dots, y_k be k elements of $V(\mathcal{T}_{\mathbb{H}})$ such that $(o, y_1, y_2, \dots, y_k)$ is a simple path starting at o of $\mathcal{T}_{\mathbb{H}}$. For each $\lambda > \lambda_c$, recall that the law of first k -steps is defined by:

$$\varphi^{\lambda, k}(y_1, y_2, \dots, y_k) = \mathbb{P}_\lambda^{\mathbb{H}}(\omega_\lambda^\infty(1) = y_1, \omega_\lambda^\infty(2) = y_2, \dots, \omega_\lambda^\infty(k) = y_k). \quad (6.28)$$

We prove the continuity of this function.

Theorem 6.12. *For every $k \in \mathbb{N}^*$ and $(y_1, y_2, \dots, y_k) \in V^k$, the function $\varphi^{\lambda, k}$ is a continuous function of λ on $(\lambda_c, +\infty)$.*

Let \mathcal{T} be an infinite, locally finite and rooted tree and ν is a child of the root. Recall the definition of $\tilde{\mathcal{C}}(\lambda, \mathcal{T})$ and $\tilde{\mathcal{C}}(\lambda, \mathcal{T}, \nu)$ in Section 2.3. To prove the theorem 6.12, we need the following lemma:

Lemma 6.13. *We have*

$$\varphi^{\lambda, k}(y_1, y_2, \dots, y_k) = \frac{\tilde{\mathcal{C}}(\lambda, \mathcal{T}, y_1)}{\tilde{\mathcal{C}}(\lambda, \mathcal{T})} \times \frac{\tilde{\mathcal{C}}(\lambda, \mathcal{T}^{y_1}, y_2)}{\tilde{\mathcal{C}}(\lambda, \mathcal{T}^{y_1})} \times \dots \times \frac{\tilde{\mathcal{C}}(\lambda, \mathcal{T}^{y_{k-1}}, y_k)}{\tilde{\mathcal{C}}(\lambda, \mathcal{T}^{y_{k-1}})}.$$

Proof. We prove this lemma in the case $k = 1$, and leave the (slightly more complicated, but following the same lines) cases $k \geq 2$ to the reader.

The case $k = 1$ We let $\tilde{\mathcal{C}}_i(\lambda, \mathcal{T})$ denote the probability return to origin k times before going to infinite for the biased random walk on the tree \mathcal{T} . We define the events $\mathcal{A} := \{\omega_\lambda^\infty(1) = y_1\}$ and \mathcal{A}_i denote the random walk return to origin k times before it goes to infinity by passing through y_1 . In other words,

$$\mathcal{A}_i := \{\omega_\lambda^\infty(1) = y_1 \text{ and } \#\{n > 0 : X_n = o\} = k\}.$$

The events \mathcal{A}_i are disjoint, we can then see that

$$\mathcal{A} = \bigcup_{i=0}^{+\infty} \mathcal{A}_i. \quad (6.29)$$

On the other hand, by the Markov property, for any $i \geq 0$, we have

$$\mathbb{P}(\mathcal{A}_i) = \tilde{\mathcal{C}}(\lambda, \mathcal{T}, y_1) \left(1 - \tilde{\mathcal{C}}(\lambda, \mathcal{T})\right)^i. \tag{6.30}$$

By 6.29 and 6.30, we obtain:

$$\mathbb{P}(\mathcal{A}) = \sum_{i=0}^{+\infty} \mathbb{P}(\mathcal{A}_i) = \frac{\tilde{\mathcal{C}}(\lambda, \mathcal{T}, y_1)}{\tilde{\mathcal{C}}(\lambda, \mathcal{T})}.$$

Therefore, $\varphi^{\lambda,1}(y_1) = \mathbb{P}(\mathcal{A}) = \frac{\tilde{\mathcal{C}}(\lambda, \mathcal{T}, y_1)}{\tilde{\mathcal{C}}(\lambda, \mathcal{T})}$. □

Proof of Theorem 6.12. By Lemma 6.13, we have

$$\varphi^{\lambda,k}(y_1, y_2, \dots, y_k) = \frac{\tilde{\mathcal{C}}(\lambda, \mathcal{T}, y_1)}{\tilde{\mathcal{C}}(\lambda, \mathcal{T})} \times \frac{\tilde{\mathcal{C}}(\lambda, \mathcal{T}^{y_1}, y_2)}{\tilde{\mathcal{C}}(\lambda, \mathcal{T}^{y_1})} \times \dots \times \frac{\tilde{\mathcal{C}}(\lambda, \mathcal{T}^{y_{k-1}}, y_k)}{\tilde{\mathcal{C}}(\lambda, \mathcal{T}^{y_{k-1}})}.$$

It is enough to prove that $\tilde{\mathcal{C}}(\lambda, \mathcal{T}^{y_i}, y_{i+1})$ and $\tilde{\mathcal{C}}(\lambda, \mathcal{T}^{y_i})$ are continuous. For the continuity of $\tilde{\mathcal{C}}(\lambda, \mathcal{T}^{y_i})$, we use the same method as in the proof of theorem 1.3 (see Section 5.4). For the continuity of $\tilde{\mathcal{C}}(\lambda, \mathcal{T}^{y_i}, y_{i+1})$, this function can be written in terms of λ and $\tilde{\mathcal{C}}(\lambda, \mathcal{T}^{y_i})$. □

Remark 6.14. Theorem 6.12 is still valid in the case $\mathcal{T}_{\mathbb{Z}^2}$.

7 The critical probability measure through biased random walk

7.1 The critical probability measure

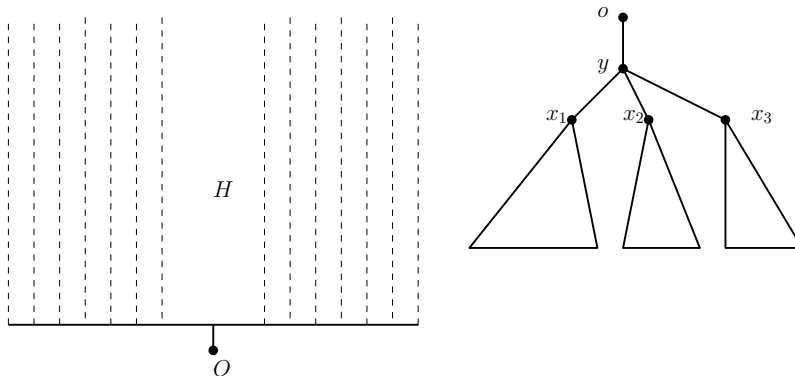

Figure 2.13 – The upper-half plane on the left and the tree $\mathcal{T}_{\mathbb{H}}$ on the right.

In this section, \mathbb{H} is the upper-half plane (i.e. $\mathbb{H} = \{\Im z > 0\} \cup \{(0, 0)\}$) and consider the self-avoiding tree $\mathcal{T}_{\mathbb{H}}$ which is defined from finite self-avoiding walks on upper-half plane \mathbb{H} (see Figure 2.13). Note that the root o of $\mathcal{T}_{\mathbb{H}}$ has only one child, denoted by y .

We aim to construct a critical probability measure through the biased random walk on self-avoiding tree. First, we review the construction of Madras and Slade (see [89] for detail). Recall that b_n is the number of all n -step bridges that begin at O and \mathcal{B}_n denote the set of all n -step bridges that begin at O . Given $n \geq m$ and an m -step self-avoiding walk γ in \mathbb{H} . Let $\mathbb{P}_{m,n}^{\mathcal{B}}(\gamma)$ denote the fraction of n -step bridges that extend γ , it means

$$\mathbb{P}_{m,n}^{\mathcal{B}}(\gamma) = \frac{|F_n(\gamma) \cap \mathcal{B}_n|}{b_n} = \frac{|\mathcal{F}_n(\gamma)|}{b_n}, \quad (7.1)$$

where $\mathcal{F}_n(\gamma)$ is the set of all n -step bridges which extend γ . The equality (7.1) is the probability that a long bridge (uniformly chosen from among all n -step bridges) is an extension of γ . Define

$$\mathbb{P}_m^{\mathcal{B}}(\omega) := \lim_{n \rightarrow \infty} \mathbb{P}_{m,n}^{\mathcal{B}}(\gamma). \quad (7.2)$$

Fact 7.1 ([89], Theorem 8.3.1). *Let γ be an m -step self-avoiding walk in \mathbb{H} . Then the limit (7.2) exists.*

The existence of the measures $\mathbb{P}_m^{\mathcal{B}}$ allows us to define a measure $\mathbb{P}_{\infty}^{\mathcal{B}}$ on the set SAW_{∞} of \mathbb{H} . For each $\gamma^{\infty} \in SAW_{\infty}$, $\gamma^{\infty}[0, m]$ denote the initial segment $(\gamma^{\infty}(0), \gamma^{\infty}(1), \dots, \gamma^{\infty}(m))$, then

$$\mathbb{P}_{\infty}^{\mathcal{B}}(\gamma^{\infty}[0, m] = \gamma) = \mathbb{P}_m^{\mathcal{B}}(\gamma), \text{ for every } \gamma.$$

Fact 7.2 ([89], Theorem 8.3.2). *$\mathbb{P}_{\infty}^{\mathcal{B}}$ is the $\frac{1}{\mu}$ -Kesten measure, where μ is the connective constant of the square lattice.*

Recall that for all $m \geq 1$, \mathcal{T}^m is the m -good tree (see Notation 5.8). Fix $k \geq 1$ and $y_0 = o, y_1 = y, y_2, \dots, y_k \in V(\mathcal{T}_{\mathbb{H}})$, the function $\varphi^{m, \lambda, k}(y_0, y_1, \dots, y_k)$ (respectively $\varphi^{\mathbb{H}, \lambda, k}(y_0, y_1, \dots, y_k)$) denotes the law of first k -steps of RW_{λ} on \mathcal{T}^m (respectively $\mathcal{T}_{\mathbb{H}}$) (see 1.8). We write $\lambda_c (= \frac{1}{\mu})$ for the critical parameter of RW_{λ} on $\mathcal{T}_{\mathbb{H}}$.

Theorem 7.3. *We have*

1. *The function $\varphi^{m, \lambda, k}(y_0, y_1, \dots, y_k)$ converges towards a limit, denoted by $\varphi^{m, \lambda_m, k}(y_0, y_1, \dots, y_k)$ when λ decreases towards $\lambda_m = \lambda_c(\mathcal{T}^m)$.*
2. *The function $\varphi^{m, \lambda_m, k}(y_0, y_1, \dots, y_k)$ converges towards a limit, denoted by $\varphi^{\lambda_c, k}(y_0, y_1, \dots, y_k)$.*
3. *Moreover, we have the following diagram:*

$$\begin{array}{ccc} \varphi^{m, \lambda, k}(y_0, y_1, \dots, y_k) & \xrightarrow[\lambda > \lambda_c(\mathcal{T}_{\mathbb{H}})]{m \rightarrow +\infty} & \varphi^{\mathbb{H}, \lambda, k}(y_0, y_1, \dots, y_k) \\ \lambda \rightarrow \lambda_c(\mathcal{T}^m) \downarrow & & \downarrow ? \\ \varphi^{m, \lambda_m, k}(y_0, y_1, \dots, y_k) & \xrightarrow{m \rightarrow +\infty} & \varphi^{\lambda_c, k}(y_0, y_1, \dots, y_k) \end{array}$$

Proof of points 1 and 2 of Theorem 7.3. It suffices to prove the theorem in the case $k = 2$ and we use the same method for all $k \geq 3$.

Proof of item 1: By using the same method as the proof of Proposition 3.9, for all $i \in \{1, 2, 3\}$, we have:

$$\lim_{\lambda \rightarrow \lambda_c(\mathcal{T}^m)} \varphi^{m, \lambda, 2}(o, y, x_i) = \sum_{\gamma \in S^i} \lambda_m^{|\gamma|}, \quad (7.3)$$

where x_1, x_2, x_3 are three children of y and S^i is a set of all irreducible bridges which pass through x_i and $\lambda_c(\mathcal{T}^m) = \lambda_m$. Let $p_{i,n}$ be the number of irreducible bridges of length n which are pass through x_i . We use 7.3 to obtain:

$$\lim_{\lambda \rightarrow \lambda_c(\mathcal{T}^m)} \varphi^{m, \lambda, 2}(o, y, x_i) = \sum_{n=1}^m p_{i,n} \lambda_m^n. \quad (7.4)$$

Hence,

$$\varphi^{m, \lambda_m, 2}(o, y, x_i) = \sum_{n=1}^m p_{i,n} \lambda_m^n. \quad (7.5)$$

Moreover, for all m we have $\lambda_m \geq \lambda_c (= \lambda_c(\mathcal{T}_{\mathbb{H}}))$ because $\mathcal{T}^m \subset \mathcal{T}_{\mathbb{H}}$. Therefore,

$$\varphi^{m, \lambda_m, 2}(o, y, x_i) \geq \sum_{n=1}^m p_{i,n} \lambda_c^n. \quad (7.6)$$

Proof of item 2: We need to prove that $\varphi^{m, \lambda_m, 2}(o, y, x_i)$ converges to $\varphi^{\lambda_c, 2}(o, y, x_i)$ when m goes to infinity. Assume that there exists a subsequence $(m_k)_k$ such that for any $i \in \{1, 2, 3\}$, we have:

$$\lim_{k \rightarrow +\infty} \varphi^{m_k, \lambda_{m_k}, 2}(o, y, x_i) = \alpha_i. \quad (7.7)$$

Moreover, we assume that there exists $i \in \{1, 2, 3\}$ such that

$$\alpha_i > \sum_{n=1}^{+\infty} p_{i,n} \lambda_c^n. \quad (7.8)$$

For any $m > 0$, we have $\sum_{i=1}^3 \varphi^{m, \lambda_m, 2}(o, y, x_i)$, therefore,

$$\alpha_1 + \alpha_2 + \alpha_3 = 1. \quad (7.9)$$

By 7.6, for any $i \in \{1, 2, 3\}$, we have:

$$\alpha_i \geq \sum_{n=1}^{+\infty} p_{i,n} \lambda_c^n. \quad (7.10)$$

We use Fact 5.3 to obtain

$$\sum_{i=1}^3 \sum_{n=1}^{+\infty} p_{i,n} \lambda_c^n = 1. \quad (7.11)$$

By 7.8, 7.9, 7.10 and 7.11, we obtain the following contradiction:

$$1 = \alpha_1 + \alpha_2 + \alpha_3 > \sum_{i=1}^3 \sum_{n=1}^{+\infty} p_{i,n} \lambda_c^n = 1$$

We conclude that $\varphi^{m, \lambda_m, 2}(o, y, x_i)$ converges towards $\sum_{n=1}^{+\infty} p_{i,n} \lambda_c^n$ when $m \rightarrow +\infty$. \square

Proof of point 3 of Theorem 7.3. It remains to prove that

$$\lim_{m \rightarrow +\infty, \lambda > \lambda_c(T_{\mathbb{H}})} \varphi^{m, \lambda, k}(y_1, \dots, y_k) = \varphi^{\mathbb{H}, \lambda, k}(y_1, \dots, y_k).$$

It is enough to prove the theorem in the case $k = 2$, we use the same method for $k \geq 3$. Fix $\lambda > \lambda_c(T_{\mathbb{H}})$ and $\varepsilon > 0$. By Proposition 6.10, we have

$$\lim_{m \rightarrow +\infty} \lambda_c(\mathcal{T}^m) = \lambda_c(T_{\mathbb{H}}). \quad (7.12)$$

Therefore, there exists $m_0 > 0$ such that for any $m \geq m_0$,

$$\lambda > \lambda_c(\mathcal{T}^m) \quad \text{and} \quad (1 - C(\lambda, \mathcal{T}^m))^m < \varepsilon. \quad (7.13)$$

Let \mathcal{T} be the tree defined by:

$$\begin{cases} |\mathcal{T}_i| = 1 \text{ for all } i \leq m \\ \mathcal{T}_p = \{v\} \\ \mathcal{T}^v = \mathcal{T}^m \end{cases}$$

We choose n_0 (depends on m) such that for all $n > n_0$, we have

$$(1 - C(\lambda, \mathcal{T}^n))^n < \varepsilon$$

By considering the self-avoiding walks in the rectangle whose vertices are $(-n_0, 1); (-n_0, m_0); (n_0, m_0); (n_0, 1)$ and by a simple argument, we can see that for all $n > m_0 n_0$,

$$\left| \varphi^{n, \lambda, k}(y_1, \dots, y_k) - \varphi^{\mathbb{H}, \lambda, k}(y_1, \dots, y_k) \right| < 2\varepsilon.$$

Since ε is arbitrary, this complete the proof of theorem. \square

Remark 7.4. Theorem 7.3 allows us to define a critical probability measure \mathbb{P}_{λ_c} on $T_{\mathbb{H}}$. Note that this critical probability measure is exactly Kesten's measure as in Section 5.2.

7.2 Conjectures

If we take a sequence of cutsets $\pi_n := \mathcal{T}_n$ and we set $c(e) = \left(\frac{1}{\mu}\right)^{|e|}$, then

$$\sum_n \left(\sum_{e \in \pi_n} c(e) \right)^{-1} = \sum_{n=1}^{+\infty} \frac{\mu^n}{c_n}.$$

If the prediction of Nienhuis [99] holds, we obtain

$$\sum_{n=1}^{+\infty} \frac{\mu^n}{c_n} \geq c \sum_{n=1}^{+\infty} \frac{1}{n^{\frac{11}{32}}} = +\infty$$

By Theorem 2.15, we can establish the following conjecture.

Conjecture 7.5. *The biased random walk RW_{λ_c} on $T_{\mathbb{H}}$ (or $T_{\mathbb{Z}^2}$) is recurrent.*

Finally, we believe that for every $k \geq 1$ and $y_1, y_2, \dots, y_k \in V(T_{\mathbb{H}})$,

$$\lim_{\lambda \rightarrow \lambda_c(T_{\mathbb{H}})} \varphi^{\mathbb{H}, \lambda, k}(y_1, \dots, y_k) = \varphi^{\lambda_c, k}(y_1, \dots, y_k).$$

Conjecture 7.6. *The following convergence diagram holds*

$$\begin{array}{ccc} \varphi^{m, \lambda, k}(y_0, y_1, \dots, y_k) & \xrightarrow[\lambda > \lambda_c(T_{\mathbb{H}})]{m \rightarrow +\infty} & \varphi^{\mathbb{H}, \lambda, k}(y_0, y_1, \dots, y_k) \\ \lambda \rightarrow \lambda_c(T^m) \downarrow & & \downarrow \lambda \rightarrow \lambda_c \\ \varphi^{m, \lambda_m, k}(y_0, y_1, \dots, y_k) & \xrightarrow{m \rightarrow +\infty} & \varphi^{\lambda_c, k}(y_0, y_1, \dots, y_k) \end{array}$$

Chapter 3

Perspectives and conjectures

1 A coupling between random walk and supercritical percolation

Recall the definition of the self-avoiding tree $\tilde{\mathcal{T}}_{\mathbb{T}_+^*}$ as in (chapter 2, section 6.2). For any vertex ν of $\tilde{\mathcal{T}}_{\mathbb{T}_+^*}$, it has either two children, denoted by ν_1, ν_2 or just only one child, denoted by $\bar{\nu}$. The parent of ν is denoted by $p(\nu)$ or ν^{-1} . Denote by $\partial(\nu)$ the number of children of ν .

Let $\lambda > 0$ and $\eta \in [0, 1/2]$ be such that

$$\frac{\lambda}{1 + 2\lambda} - \eta \geq 0 \tag{1.1}$$

Define a stochastic process $\mathbf{X} := (X_n)_{n \geq 0}$ on some probability space, taking the values in $\tilde{\mathcal{T}}_{\mathbb{T}_+^*}$ with the transition probability defined by the following way.

$$\mathbb{P}(X_0 = \varrho) = 1,$$

— If $\partial(X_n) = 2$, then

$$\mathbb{P}(X_{n+1} = (X_n)_1 | X_0, \dots, X_n) = \frac{\lambda}{1 + 2\lambda} - \eta \tag{1.2}$$

$$\mathbb{P}(X_{n+1} = (X_n)_2 | X_0, \dots, X_n) = \frac{\lambda}{1 + 2\lambda} + \eta \tag{1.3}$$

$$\mathbb{P}(X_{n+1} = (X_n)^{-1} | X_0, \dots, X_n) = \frac{1}{1 + 2\lambda} \tag{1.4}$$

— If $\partial(X_n) = 1$, then

$$\mathbb{P}(X_{n+1} = \overline{X_n} | X_0, \dots, X_n) = \frac{\lambda}{1 + \lambda} \tag{1.5}$$

$$\mathbb{P}(X_{n+1} = (X_n)^{-1} | X_0, \dots, X_n) = \frac{1}{1 + \lambda} \quad (1.6)$$

$$(1.7)$$

Denote by $\omega_{\lambda, \eta}^\infty$ the *limit walk* associated with the random walk \mathbf{X} (see Chapter 2, Equation 2.2).

Remark 1.1. — If $\eta = 0$, then \mathbf{X} is the biased random walk with parameter λ .
 — If $\lambda = \infty$, by the same argument as in (chapter 2, section 6.2), the limit walk $\omega_{\lambda, \eta}^\infty$ has the same law as the *exploration curve* of supercritical percolation with parameter $1/2 + \eta$.

We prove that if λ is large enough, then the limit walk $\omega_{\lambda, \eta}^\infty$ has some properties that are similar to the exploration curve of supercritical percolation with parameter $1/2 + \eta$.

Theorem 1.2. Denote by $\beta := \mathcal{C}(\frac{3}{5}, \mathbb{N})$ the effective conductance of biased random walk with parameter $\frac{3}{5}$ on \mathbb{N} . We then have,

$$\forall \eta > 0, \forall \lambda > \max\left(\frac{4}{1 + 2\eta}, \frac{1}{2\beta\eta}\right), \exists \varepsilon > 0, c > 0, \forall n \geq 1, \\ \mathbb{P}((\omega^\infty \cap [n, 2n]) \neq \emptyset) \geq (1 - cn^{-\varepsilon})^3.$$

In order to prove Proposition 1.2, we compare the limit walk ω^∞ with the exploration curve γ of site-percolation on the triangular lattice by the coupling method. Now, we recall some results of site-percolation on the triangular lattice. We denote $A[2n, n]$ being the event that exists a path formed of the open sites which is contained in the rectangle $[0, 2n] \times [0, n]$ and connects to $\{0\} \times [0, n]$ to $\{2n\} \times [0, n]$.

Theorem 1.3 (RSW [12]). For any $p > \frac{1}{2}$, there exists $\varepsilon = \varepsilon(p) > 0$ and $c = c(p) > 0$ such that for all $n \geq 1$,

$$\mathbb{P}_p(A[2n, n]) \geq 1 - cn^{-\varepsilon}.$$

Theorem 1.4 (FKG [51]). For any $p \in [0, 1]$ and A, B are two increasing events,

$$\mathbb{P}_p(A \cap B) \geq \mathbb{P}_p(A)\mathbb{P}_p(B).$$

Let $k \in \mathbb{N}^*$ and y_1, y_2, \dots, y_k be k elements of $V(\tilde{\mathcal{T}}_{\mathbb{T}_+^*})$ such that $(o, y_1, y_2, \dots, y_k)$ is a simple path starting at o of $\tilde{\mathcal{T}}_{\mathbb{T}_+^*}$. For each $\lambda > \lambda_c$, recall that the law of first k -steps is defined by:

$$\varphi^{\lambda, k}(y_1, y_2, \dots, y_k) = \mathbb{P}_\lambda^{\tilde{\mathcal{T}}_{\mathbb{T}_+^*}(\omega_\lambda^\infty(1) = y_1, \omega_\lambda^\infty(2) = y_2, \dots, \omega_\lambda^\infty(k) = y_k). \quad (1.8)$$

Recall Lemma 6.13 of Chapter 2:

Lemma 1.5. *We have*

$$\varphi^{\lambda,k}(y_1, y_2, \dots, y_k) = \frac{\tilde{\mathcal{C}}(\lambda, \mathcal{T}, y_1)}{\tilde{\mathcal{C}}(\lambda, \mathcal{T})} \times \frac{\tilde{\mathcal{C}}(\lambda, \mathcal{T}^{y_1}, y_2)}{\tilde{\mathcal{C}}(\lambda, \mathcal{T}^{y_1})} \times \dots \times \frac{\tilde{\mathcal{C}}(\lambda, \mathcal{T}^{y_{k-1}}, y_k)}{\tilde{\mathcal{C}}(\lambda, \mathcal{T}^{y_{k-1}})}.$$

Theorem 1.6 (Rayleigh's monotonicity principle [87]). *Let \mathcal{T} be an infinite tree with two assignments, c and c' , of conductances on \mathcal{T} with $c \leq c'$ (everywhere). Then the effective conductances are ordered in the same way: $\mathcal{C}_c(\mathcal{T}) \leq \mathcal{C}_{c'}(\mathcal{T})$.*

Lemma 1.7. *Let $p > \frac{1}{2}$, there exists $\varepsilon = \varepsilon(p) > 0$ and $c = c(p) > 0$ such that for any $n \geq 1$,*

$$\mathbb{P}_p(\gamma \cap ([n, 2n] \times \{0\}) \neq \emptyset) \geq (1 - cn^{-\varepsilon})^3. \quad (1.9)$$

Proof. Consider the following rectangles:

$$R_1 = [-2n, -n] \times [0, 2n]; R_2 = [-2n, 2n] \times [0, 2n]; R_3 = [n, 2n] \times [0, 2n].$$

Denote by A_1 (resp. A_2, A_3) the event R_1 is crossed vertically (resp. R_2 is crossed horizontally and R_1 is crossed vertically). By Theorem 1.3, there exists $\varepsilon = \varepsilon(p) > 0$ and $c = c(p) > 0$ such that for any $n \geq 1$,

$$\mathbb{P}_p(A_1) \geq 1 - cn^{-\varepsilon} \quad (1.10)$$

$$\mathbb{P}_p(A_2) \geq 1 - cn^{-\varepsilon} \quad (1.11)$$

$$\mathbb{P}_p(A_3) \geq 1 - cn^{-\varepsilon} \quad (1.12)$$

The events A_1, A_2, A_3 are increasing, we use Theorem 1.4 to obtain:

$$\mathbb{P}_p(A_1 \cap A_2 \cap A_3) \geq \prod_{i=1}^3 \mathbb{P}_p(A_i) \geq (1 - cn^{-\varepsilon})^3. \quad (1.13)$$

It is simple to see that if there exists a path of open sites that joining $[-2n, -n] \times \{0\}$ to $[n, 2n] \times \{0\}$, then the exploration curve γ must touch the interval $[n, 2n] \times \{0\}$ (see Figure 3.4). This implies that

$$\bigcap_{i=1}^3 A_i \subset \{\gamma \cap ([n, 2n] \times \{0\}) \neq \emptyset\}. \quad (1.14)$$

We concludes the proof of Lemma by combining 1.13 and 1.14. □

Fix $\eta \in [0, 1/2]$ and $\lambda > \max\left(\frac{4}{1+2\eta}, \frac{\beta+2}{2\beta\eta}\right)$. For each finite path ω of $\tilde{\mathcal{T}}_{\mathbb{T}_+^*}$ starting at o , such that $\omega_{|\gamma|}$ has two children, then we set

$$\alpha_\omega := \mathbb{P}\left(\omega_{|[0,|\omega|+1]}^\infty = \omega \oplus e(\omega_{|\omega|})_2 \mid \omega_{|[0,|\omega|]}^\infty = \omega\right). \quad (1.15)$$

By Lemma 1.5, we have

$$\alpha_\omega := \frac{\mathbb{P}\left(\omega_{|[0,|\omega|+1]}^\infty = \omega \oplus e(\omega_{|\omega|})_2\right)}{\mathbb{P}\left(\omega_{|[0,|\omega|]}^\infty = \omega\right)} = \frac{\tilde{\mathcal{C}}(\lambda, \mathcal{T}^{\omega(|\omega|)}, e(\omega_{|\omega|})_2)}{\tilde{\mathcal{C}}(\lambda, \mathcal{T}^{\omega(|\omega|)})}. \quad (1.16)$$

Denote by \mathcal{A} the set of finite paths ω of $\tilde{\mathcal{T}}_{\mathbb{T}_+^*}$ such that α_ω is well defined. We need the following lemma:

Lemma 1.8. *We have*

$$\forall \eta > 0, \forall \lambda > \max\left(\frac{4}{1+2\eta}, \frac{1}{2\beta\eta}\right), \exists \alpha = \alpha(\lambda, \eta, \beta) > \frac{1}{2}, \forall \omega \in \mathcal{A} : \alpha_\omega \geq \alpha. \quad (1.17)$$

Proof. Fix $\eta > 0$ and $\lambda > \max\left\{\frac{4}{1+2\eta}, \frac{1}{2\beta\eta}\right\}$. It is simple to see that for any $\omega \in \mathcal{A}$

$$\tilde{\mathcal{C}}(\lambda, \mathcal{T}^{\omega(|\omega|)}, e(\omega_{|\omega|})_2) \geq \frac{1}{2} - \frac{1}{2\lambda} + \eta - \frac{1}{\lambda \tilde{\mathcal{C}}(\lambda, \mathcal{T}^{\omega(|\omega|)})}. \quad (1.18)$$

By Rayleigh's monotonicity principle (see Theorem 1.6), for any $\omega \in \mathcal{A}$, we have

$$\tilde{\mathcal{C}}(\lambda, \mathcal{T}^{\omega_{|\omega|}2}) \geq \beta. \quad (1.19)$$

By 1.18 and 1.19 we have:

$$\tilde{\mathcal{C}}(\lambda, \mathcal{T}^{\omega(|\omega|)}, e(\omega_{|\omega|})_2) \geq \frac{1}{2} - \frac{1}{2\lambda} + \eta - \frac{1}{\lambda\beta}. \quad (1.20)$$

By using 1.16 and 1.20, for any $\omega \in \mathcal{A}$ we have:

$$\alpha_\omega \geq \frac{1}{2} - \frac{1}{2\lambda} + \eta - \frac{1}{\lambda\beta}. \quad (1.21)$$

Because $\lambda > \frac{1}{2\beta\eta}$, therefore $\alpha_\omega > \frac{1}{2}$ uniformly in ω . Hence, there exists $\alpha > \frac{1}{2}$ depends on λ and η such that for all $\omega \in \mathcal{A}$, we have $\alpha_\omega \geq \alpha$. \square

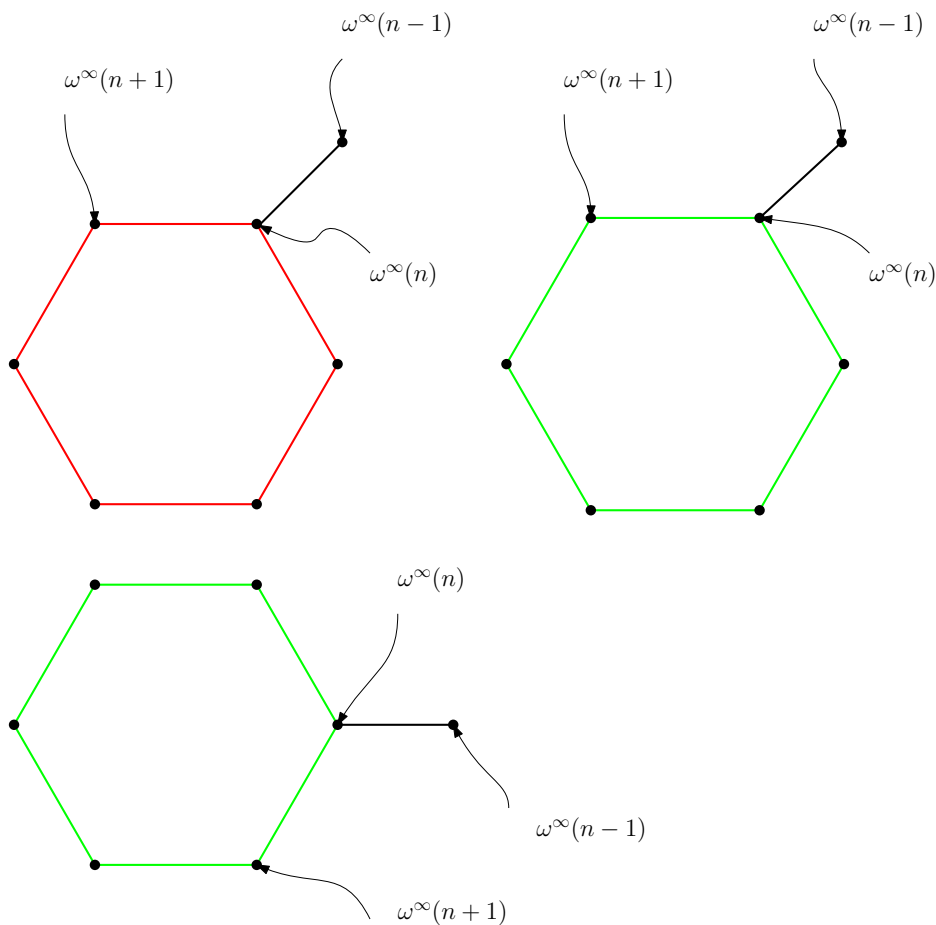

Figure 3.1

Proof of Theorem 1.2. Consider the supercritical Bernoulli percolation with parameter $\alpha(\lambda, \eta) > \frac{1}{2}$. Given a configuration of percolation, we will construct the limit walk $\omega_{\lambda, \eta}^\infty$ thank to Lemma 1.8 by the following way:

Assume that we have constructed the limit walk $\omega_{\lambda, \eta}^\infty$ until the step n . We construct the $(n+1)$ -th step by the following way:

1. If there is only one possibility to extend $\omega_{\lambda, \eta}^\infty$ from n -th step to $(n+1)$ -th step, we take this extension.
2. Assume that there are two possibilities to extend $\omega_{\lambda, \eta}^\infty$ from n -th step to $(n+1)$ -th step. In this cas, we look at the color of the hexagon that is in front (see Figure 3.1):
 - If it is red (open), we will turn right.
 - If it is green (closed), we have two possibilities:
 - We turn right with probability $\frac{\alpha_\gamma - \alpha(\lambda, \eta)}{1 - \alpha(\lambda, \eta)} \geq 0$ (by Lemma 1.8).

— We turn left with probability $\frac{1-\alpha_\gamma}{1-\alpha(\lambda,\eta)}$.

It is simple to see that this is a construction of limit walk. Denote by A_n the event there exists a path of open site that joining $[-2n, -n] \times \{0\}$ to $[n, 2n] \times \{0\}$. By Lemma 1.7, we have

$$\mathbb{P}_\alpha(A_n) \geq (1 - cn^{-\varepsilon})^3 \quad (1.22)$$

We need to prove that

$$\mathbb{P}_\lambda^{\tilde{\mathcal{T}}_{\mathbb{T}^+}}(\omega_{\lambda,\eta}^\infty \cap ([n, 2n] \times \{0\}) \neq \emptyset) \geq \mathbb{P}_\alpha(A_n) \quad (1.23)$$

Fix a configuration θ of A_n . Consider the path ℓ formed of red hexagons (open) which minimizes the area of the domain between the path ℓ and the real axis. Denote by U_ℓ the domain limited by path ℓ and the real axis. We consider the first time that the limit walk $\omega_{\lambda,\eta}^\infty$ leaves the domain U_ℓ (i.e touch the black path, see Figure 3.4). We prove that the limit walk will hit the black path the first time in point of intersection between the path ℓ and the interval $[n, 2n] \times \{0\}$ (see Figure 3.4). If it does not, it will hit the black path the first time at another point. There are possibilities, in every possibility, one find a contradiction.

Case 1: In the Figure 3.5 and 3.6, it touches the black path the first time at step n (the green arrow). Assume that the step $n - 1$ is like in these figures. In these cases, we arrive a red hexagon after the step $n - 1$. According to the construction of the limit walk $\omega_{\lambda,\eta}^\infty$, we turn to the left if we can not extend the path to the right (it will be blocked if we turn to the right). By analyzing the previous steps, we obtain: in Figure 3.5, the limit walk $\omega_{\lambda,\eta}^\infty$ is not a self-avoiding walk and in Figure 3.6, it touches the black path the first time by the purple arrow that is not no green arrow. These are contradictions.

Case 2: In Figure 3.7, 3.8 and 3.9, it touches the black path the first time at step n (the green arrow). Assume that the step $n - 1$ is like in these figures. By analyzing the previous steps, we obtain the following contradiction: the limit walk touches the black path at a step $k < n$.

We then obtain

$$\mathbb{P}_\lambda^{\tilde{\mathcal{T}}_{\mathbb{T}^+}}(\omega_{\lambda,\eta}^\infty \cap ([n, 2n] \times \{0\}) \neq \emptyset) \geq \mathbb{P}_\alpha(A_n) \geq (1 - cn^{-\varepsilon})^3 \quad (1.24)$$

In particular, we have

$$\lim_{n \rightarrow +\infty} \mathbb{P}(\omega_{\lambda,\eta}^\infty \cap ([n, 2n] \times \{0\}) \neq \emptyset) = 1. \quad (1.25)$$

□

By using the same argument as in the proof of Theorem 1.2, we obtain the following theorem:

Theorem 1.9. *Denote by $\beta := \mathcal{C}(\frac{3}{5}, \mathbb{N})$ the effective conductance of biased random walk with parameter $\frac{3}{5}$ on \mathbb{N} . We then have,*

$$\lim_{n \rightarrow +\infty} \mathbb{P}(\omega_{\lambda, \eta}^\infty \cap ([-2n, -n] \times \{0\}) \neq \emptyset) = 0.$$

If $\eta = 0$, then \mathbf{X} is the biased random walk with parameter λ . It is hoped that by comparing with the critical percolation, we can prove the property Russo-Seymour-Welsh for this case:

Conjecture 1.10. *For any $\lambda > \lambda_c$, there exists a constant $c > 0$ such that for all $n > 0$,*

$$\mathbb{P}_\lambda^{\tilde{\tau}_{\mathbb{T}^*}}((\omega_{\lambda, 0}^\infty \cap [n, 2n]) \neq \emptyset) \geq c. \quad (1.26)$$

2 The locality property

2.1 The space of continuous curves

In this section, we review some definitions on the space of continuous curves. We refer the reader to [3] for more details.

We regard continuous curves as equivalence classes of continuous functions, modulo reparametrizations. More precisely, two continuous functions f_1 and f_2 from \mathbb{R}_+ into \mathbb{C} describe the same curve if and only if there exist two monotone continuous bijections $\varphi_i : \mathbb{R}_+ \rightarrow \mathbb{R}_+$, $i = 1, 2$ such that $f_1(\varphi_1(t)) = f_2(\varphi_2(t))$ for all $t \in \mathbb{R}_+$.

The space of curves in a closed subset Ω of \mathbb{C} is denoted by S_Ω . In the remain of this section, we take Ω the half-plane \mathbb{H} of \mathbb{C} and Ω' is a bounded, simply connected domain of \mathbb{C} (for example the unit disk) such that there exists a conform application, denoted by f , from Ω onto Ω' . The distance between two curves \mathcal{C}_1 and \mathcal{C}_2 of S_Ω is measured by:

$$d_\Omega(\mathcal{C}_1, \mathcal{C}_2) = \inf_{\varphi_1, \varphi_2} \sup_{t \in \mathbb{R}_+} |f(f_1[\varphi_1(t)]) - f(f_2[\varphi_2(t)])|, \quad (2.1)$$

where f_1 and f_2 is any pair of continuous functions representing \mathcal{C}_1 and \mathcal{C}_2 , and the infimum is over the set of all strictly monotone continuous functions from \mathbb{R}_+ onto itself.

Lemma 2.1 (see [3]). *Equation 2.1 defines a metric on the space S_Ω .*

Proof. Clearly, $d(\mathcal{C}_1, \mathcal{C}_2)$ is nonnegative, symmetric, satisfies the triangle inequality and $d(\mathcal{C}, \mathcal{C}) = 0$. To prove strict positivity, assume $d(\mathcal{C}_1, \mathcal{C}_2) = 0$, and choose parametrizations

f_1 and f_2 . We need to show that f_1 and f_2 describe the same curve, i.e., $\mathcal{C}_1 = \mathcal{C}_2$. We may choose f_1 and f_2 to be non-constant on any interval. Under these assumptions, there exist sequences of reparametrizations ϕ_1^i and ϕ_2^i such that

$$\sup_{t \in [0,1]} |f_1 \circ \phi_1^i \circ (\phi_2^i)^{-1}(t) - f_2(t)| = \sup_{t \in [0,1]} |f_1 \circ \phi_1^i(t) - f_2 \circ \phi_2^i(t)| \xrightarrow{i \rightarrow \infty} 0. \quad (2.2)$$

Monotonicity and uniform boundedness imply (Helly's theorem) that there are subsequences (again denoted ϕ_1^i and ϕ_2^i) so that $\phi_2^i \circ (\phi_1^i)^{-1}$ and their inverses $\phi_1^i \circ (\phi_2^i)^{-1}$ converge pointwise, at all but countably many points, to monotone limiting functions ϕ and $\tilde{\phi}$, with $f_1 = f_2 \circ \phi$ and $f_2 = f_1 \circ \tilde{\phi}$. To see that ϕ has no discontinuities, note that jumps of ϕ would correspond to intervals where $\tilde{\phi}$ is constant. But $\tilde{\phi}$ cannot be constant on an interval, since, by our choice of parametrization, f_2 is not constant on any interval. \square

Lemma 2.2 (see [3]). *The space (S_Ω, d_Ω) is polonais (metric, complete, separated) but, even for compact Ω it is not compact.*

2.2 The locality property of limit walk

First, we review the definitions of Fortet distance and total variation distance.

Definition 2.3. Let (S, d) be a metric space, with the Borelian tribu. We define a distance between two probability measures μ et ν , sometimes called the Fortet distance:

$$d_F(\mu, \nu) = \sup\{|\mu(f) - \nu(f)|, f \in Lip_b(S), \|f\|_{Lip} \leq 1, \|f\|_\infty \leq 1\}, \quad (2.3)$$

where $Lip_b(S)$ is the set of Lipschitz and bounded functions, from S into \mathbb{R} , the total variation distance is defined by:

$$d_{VT}(\mu, \nu) = \sup\{|\mu(f) - \nu(f)|, f \in \mathcal{F}_b(S), \|f\|_\infty \leq 1\}, \quad (2.4)$$

where $\mathcal{F}_b(S)$ is the set of bounded functions from S into \mathbb{R} .

Fact 2.4. *Equations 2.3 and 2.4 define the metrics on the set of probability measure on $S_{\mathbb{H}}$.*

Fact 2.5. *Let (S, d) be a separated metric space with the Borelian tribu. Then $d_F(\mu_n, \mu) \rightarrow 0$ if and only if μ_n converge weakly toward μ .*

Lemma 2.6 (Skorokhod's theorem). *Let (S, d) be a metric space, with the Borelian tribu $\mathcal{B}(S)$ and $(\mu_n)_{n \geq 1}$ be a sequence of probability measures on S such that μ_n converges weakly to some probability measure μ_∞ on S as $n \rightarrow \infty$. Suppose that the support of μ_∞ is separable. Then there exists random variables X_n and X_∞ defined on a common probability space $(\Omega, \mathcal{F}, \mathbb{P})$ such that:*

- $X_n \rightarrow X_\infty$ almost surely.
- For all $n \in \mathbb{N}$, the law of X_n is μ_n and X_∞ has law μ_∞ .

For each $n \in \mathbb{N}$, denote by \mathbb{H}^n the discrete half-plane with size $\frac{1}{n}$. Fix $\lambda > \lambda_c$ and consider the biased random walk with parameter λ on $\mathcal{T}_{\mathbb{H}^n}$ and $\omega_\lambda^{\infty, n}$ is the limit walk associated. Assume that $\omega_\lambda^{\infty, n}$ converge weakly in $(S_{\mathbb{H}}, d_{\mathbb{H}})$ toward a (random) continuous curve $\gamma^{\lambda, \mathbb{H}}$.

Theorem 2.7. *For any $\lambda > 1$, the continuous curve γ^λ has the locality property.*

Proof. Let A be a subset of \mathbb{H} such that $\mathbb{H} \setminus A$ is simply connected. We need to prove that

$$\mathcal{L}((\gamma_t^{\lambda, \mathbb{H}})_{0 \leq t \leq \tau_A}) \stackrel{(d)}{=} \mathcal{L}((\gamma_t^{\lambda, \mathbb{H} \setminus A})_{0 \leq t \leq \tau_A}), \quad (2.5)$$

where $\tau_A := \inf\{t : \gamma^{\lambda, \mathbb{H}} \in A\}$.

In the remain of this proof, we set

$$\varepsilon_n = \frac{1}{\sqrt{n}} \quad (2.6)$$

and

$$A^n := A \cap \mathbb{H}^n \quad (2.7)$$

$$A^{\varepsilon_n} := \{z \in \mathbb{R} \times \mathbb{R}_+ : d(z, A) \leq \varepsilon_n\} \quad (2.8)$$

$$A^{n, \varepsilon_n} := (A^{\varepsilon_n} \setminus A) \cap \mathbb{H}^n. \quad (2.9)$$

Note that A^n and A^{n, ε_n} are discrete subsets of \mathbb{C} ; A and A^{ε_n} are simply connected subsets of \mathbb{C} . Consider $(X_k^\lambda)_{k \geq 1}$ (resp. $(\tilde{X}_k^\lambda)_{k \geq 1}$) the biased random walk on $\mathcal{T}_{\mathbb{H}}$ (resp. $\mathcal{T}_{\mathbb{H} \setminus A}$). We define

$$\tau_{A^n} := \inf\{k : p(X_k^\lambda) \in A^n\} \quad (2.10)$$

$$\tau_{A^{n, \varepsilon}} := \inf\{k : p(X_k^\lambda) \in A^{n, \varepsilon_n}\} \quad (2.11)$$

where p is defined as in (chapter 2, equation 6.1). It is simple to see that

$$\mathcal{L}(X_k^\lambda, k \leq \tau_{A^n}) = \mathcal{L}(\tilde{X}_k^\lambda, k \leq \tau_{A^n}). \quad (2.12)$$

Because the branching number of \mathbb{N} is equal to 1, we then have

$$\beta := \mathcal{C}(\lambda, \mathbb{N}) > 0. \quad (2.13)$$

For any $\tau_{A^n, \varepsilon} \leq k \leq \tau_{A^n}$, we have

$$\mathbb{N} \subset (\mathcal{T}_{\mathbb{H}^n})^{p(X_k^\lambda)} \quad (2.14)$$

$$\mathbb{N} \subset (\mathcal{T}_{\mathbb{H}^n \setminus A^n})^{p(X_k^\lambda)} \quad (2.15)$$

We use Equations 2.13, 2.14 and 2.15, for any $\tau_{A^n, \varepsilon} \leq k \leq \tau_{A^n}$, we have:

$$\mathcal{C}(\lambda, (\mathcal{T}_{\mathbb{H}^n})^{p(X_k^\lambda)}) \geq \beta \text{ et } \mathcal{C}(\lambda, (\mathcal{T}_{\mathbb{H}^n \setminus A^n})^{p(X_k^\lambda)}) \geq \beta. \quad (2.16)$$

Consider X_k^λ and \tilde{X}_k^λ until the time τ_{A^n} . If after this time, the random walks X_k^λ and \tilde{X}_k^λ do not come back to $X_{\tau_{A^n, \varepsilon}}^\lambda$, then

$$\omega_\lambda^{\infty, \mathbb{H}^n} [0, \tau_{A^n, \varepsilon}] = \omega_\lambda^{\infty, \mathbb{H}^n \setminus A^n} [0, \tau_{A^n, \varepsilon}]. \quad (2.17)$$

Define on the same probability space, a coupling (X, Y) such that X has law $\mathcal{L}(\omega_\lambda^{\infty, \mathbb{H}^n} [0, \tau_{A^n, \varepsilon_n}])$ and Y has law $\mathcal{L}(\omega_\lambda^{\infty, \mathbb{H}^n \setminus A^n} [0, \tau_{A^n, \varepsilon_n}])$. We then obtain:

$$d_{TV}(\mathcal{L}(\omega_\lambda^{\infty, \mathbb{H}^n} [0, \tau_{A^n, \varepsilon_n}]), \mathcal{L}(\omega_\lambda^{\infty, \mathbb{H}^n \setminus A^n} [0, \tau_{A^n, \varepsilon_n}])) \leq \mathbb{P}(X \neq Y) \leq 2(1 - \beta)^{n(\tau_{A^n, \varepsilon_n} - \tau_{A^n})}. \quad (2.18)$$

We use Equation 2.6 to obtain:

$$\tau_{A^n, \varepsilon_n} - \tau_{A^n} \geq \frac{1}{\sqrt{n}}. \quad (2.19)$$

By combining Equations 2.18 and 2.19, we obtain:

$$d_{TV}(\mathcal{L}(\omega_\lambda^{\infty, \mathbb{H}^n} [0, \tau_{A^n, \varepsilon_n}]), \mathcal{L}(\omega_\lambda^{\infty, \mathbb{H}^n \setminus A^n} [0, \tau_{A^n, \varepsilon_n}])) \leq 2(1 - \beta)^{\sqrt{n}} \quad (2.20)$$

Because $d_F \leq d_{TV}$, therefore:

$$d_F(\mathcal{L}(\omega_\lambda^{\infty, \mathbb{H}^n} [0, \tau_{A^n, \varepsilon_n}]), \mathcal{L}(\omega_\lambda^{\infty, \mathbb{H}^n \setminus A^n} [0, \tau_{A^n, \varepsilon_n}])) \leq 2(1 - \beta)^{\sqrt{n}}. \quad (2.21)$$

By hypothesis, we have

$$\omega_\lambda^{\infty, \mathbb{H}^n} \xrightarrow{(d)} \gamma^{\lambda, \mathbb{H}} \text{ and } \omega_\lambda^{\infty, \mathbb{H}^n \setminus A^n} \xrightarrow{(d)} \gamma^{\lambda, \mathbb{H} \setminus A}. \quad (2.22)$$

Because $(S_{\mathbb{H}}, d_{\mathbb{H}})$ is a polonais space, by Lemma Fait 2.6, we can assume the convergences in 2.22 are almost surely. We then have

$$\omega_\lambda^{\infty, \mathbb{H}^n} [0, \tau_{A^n, \varepsilon_n}] \xrightarrow{p.s} \gamma^{\lambda, \mathbb{H}} [0, \tilde{\tau}_A] \text{ et } \omega_\lambda^{\infty, \mathbb{H}^n \setminus A^n} [0, \tau_{A^n, \varepsilon_n}] \xrightarrow{p.s} \gamma^{\lambda, \mathbb{H} \setminus A} [0, \tilde{\tau}_A]. \quad (2.23)$$

Because $(S_{\mathbb{H}}, d_{\mathbb{H}})$ is separated metric space, by Fact 2.5, we have:

$$d_F(\mathcal{L}(\omega_{\lambda}^{\infty, \mathbb{H}^n} [0, \tau_{A^n, \varepsilon_n}]), \mathcal{L}(\gamma^{\lambda, \mathbb{H}} [0, \tilde{\tau}_A])) \rightarrow 0. \quad (2.24)$$

$$d_F(\mathcal{L}(\omega_{\lambda}^{\infty, \mathbb{H}^n \setminus A^n} [0, \tau_{A^n, \varepsilon_n}]), \mathcal{L}(\gamma^{\lambda, \mathbb{H} \setminus A} [0, \tilde{\tau}_A])) \rightarrow 0. \quad (2.25)$$

By triangular inequality, for any $n > 0$,

$$\begin{aligned} d_F(\mathcal{L}(\gamma^{\lambda, \mathbb{H}} [0, \tilde{\tau}_A]), \mathcal{L}(\gamma^{\lambda, \mathbb{H} \setminus A} [0, \tilde{\tau}_A])) &\leq d_F(\mathcal{L}(\gamma^{\lambda, \mathbb{H}} [0, \tilde{\tau}_A]), \mathcal{L}(\omega_{\lambda}^{\infty, \mathbb{H}^n} [0, \tau_{A^n, \varepsilon_n}])) \\ &\quad + d_F(\mathcal{L}(\omega_{\lambda}^{\infty, \mathbb{H}^n} [0, \tau_{A^n, \varepsilon_n}]), \mathcal{L}(\omega_{\lambda}^{\infty, \mathbb{H}^n \setminus A^n} [0, \tau_{A^n, \varepsilon_n}])) \\ &\quad + d_F(\mathcal{L}(\omega_{\lambda}^{\infty, \mathbb{H}^n \setminus A^n} [0, \tau_{A^n, \varepsilon_n}]), \mathcal{L}(\gamma^{\lambda, \mathbb{H} \setminus A} [0, \tilde{\tau}_A])). \end{aligned}$$

By 2.21, 2.24 and 2.25 we have:

$$d_F(\mathcal{L}(\gamma^{\lambda, \mathbb{H}} [0, \tilde{\tau}_A]), \mathcal{L}(\gamma^{\lambda, \mathbb{H} \setminus A} [0, \tilde{\tau}_A])) = 0. \quad (2.26)$$

Hence,

$$\mathcal{L}(\gamma^{\lambda, \mathbb{H}} [0, \tilde{\tau}_A]) = \mathcal{L}(\gamma^{\lambda, \mathbb{H} \setminus A} [0, \tilde{\tau}_A]), \quad (2.27)$$

this completes the proof of Theorem. \square

Theorem 2.8. *For any $\lambda > \lambda_c$, the continuous curve γ^{λ} has the weakly locality property.*

Proof. This is a consequence of Lemma 2.9 and the same argument as the proof of Theorem 2.7, therefore we omit the proof. \square

Consider a sequence of rectangles $(B^i)_{i \geq 1}$ such that for each i , the rectangles B^i has the size $L \times \ell_i$. We set $\ell = \min_{i \geq 1} \ell_i$ and we consider an infinite domain from these rectangles by the following way: We attach a vertex of B^{i+1} to a vertex of B^i such that $B^i \cap B^{i+1}$ has only one element for all $i \geq 1$ and $B^i \cap B^j = \emptyset$ if $|i - j| > 1$ (see Figure 3.2). We then obtain an infinite domain which is denoted by $B_L^{\infty, \ell}$.

Consider the self-avoiding walks of $B_L^{\infty, \ell}$ which have the following property. It starts from a vertex of one side of B^1 . If it touches the opposite side of B^1 , it will follow that side up to the common vertex between B^1 and B^2 . The following steps of the path are in B^2 and repeat the procedure. The tree is built from these self-avoiding walks is denoted by $\mathcal{T}_{B_L^{\infty, \ell}}$. Recall that B_L (resp. \mathcal{T}_{B_L}) the strip of size L (resp. the tree is built from the self-avoiding walks in the strip B_L).

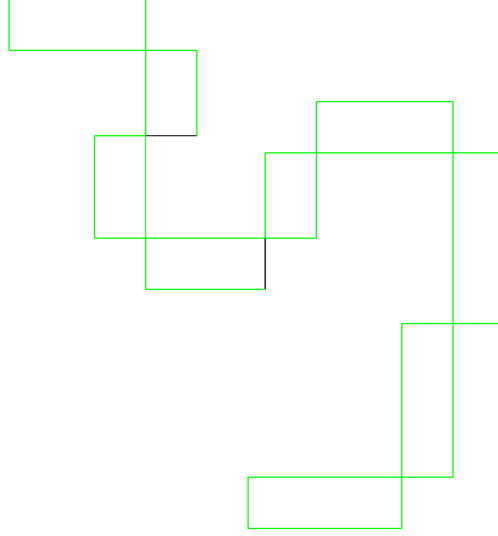

Figure 3.2

Lemma 2.9. For all $\lambda > \lambda_c(\mathcal{T}_{B_L})$, there exist $\alpha > 0$ and $h(L) \in \mathbb{N}$, such that $m\ell > h(L)$, we have

$$\mathcal{C}(\lambda, \mathcal{T}_{B_L^{\infty, \ell}}) \geq \alpha. \quad (2.28)$$

Before proving this Lemma, we need the following theorem:

Theorem 2.10 (Thomson's principle [87]). Given disjoint vertex sets A and Z in a finite network (\mathcal{T}, c) , we may express the effective resistance between A and Z by Thomson's principle as

$$R(A \leftrightarrow Z) = \min_{\theta} \left\{ \sum_{e \in E(\mathcal{T})} r(e) \theta(e)^2 \right\}$$

Proof of Lemma 2.9. Fix $\lambda > \lambda_c(\mathcal{T}_{B_L})$ and we choose θ such that:

$$R(\lambda, \mathcal{T}_{B_L}) = \sum_{e \in E(\mathcal{T})} \left(\frac{\theta(e)^2}{\lambda^{|e|}} \right). \quad (2.29)$$

We can rewrite Equation 2.29:

$$R(\lambda, \mathcal{T}_{B_L}) = \sum_{n \geq 0} \frac{1}{\lambda^n} \left(\sum_{|e|=n} \theta(e)^2 \right). \quad (2.30)$$

We take $\varepsilon = 1/2$, there exists $h(L) > 0$ such that for any $n_0 \geq h(L)$:

$$\sum_{n \geq n_0} \frac{1}{\lambda^n} \left(\sum_{|e|=n} \theta(e)^2 \right) < \frac{\varepsilon \lambda^L}{L} \tag{2.31}$$

Define a flow θ' on $\mathcal{T}_{B_L^\infty, \ell}$ by the following way: For each finite self-avoiding walk γ in $B_L^{\infty, \ell}$, one can decompose in the unique ways into self-avoiding walks $(\gamma_i)_{1 \leq i \leq i_0}$ and $(\beta_i)_{1 \leq i \leq i_0}$ such that γ_i is a self-avoiding walk in B^i which intersects the side that does not contain the starting point of this walk in B^i , in at most 1 point and $\beta_i := (\gamma \setminus \gamma_i) \cap B^i$ (see Figure 3.3).

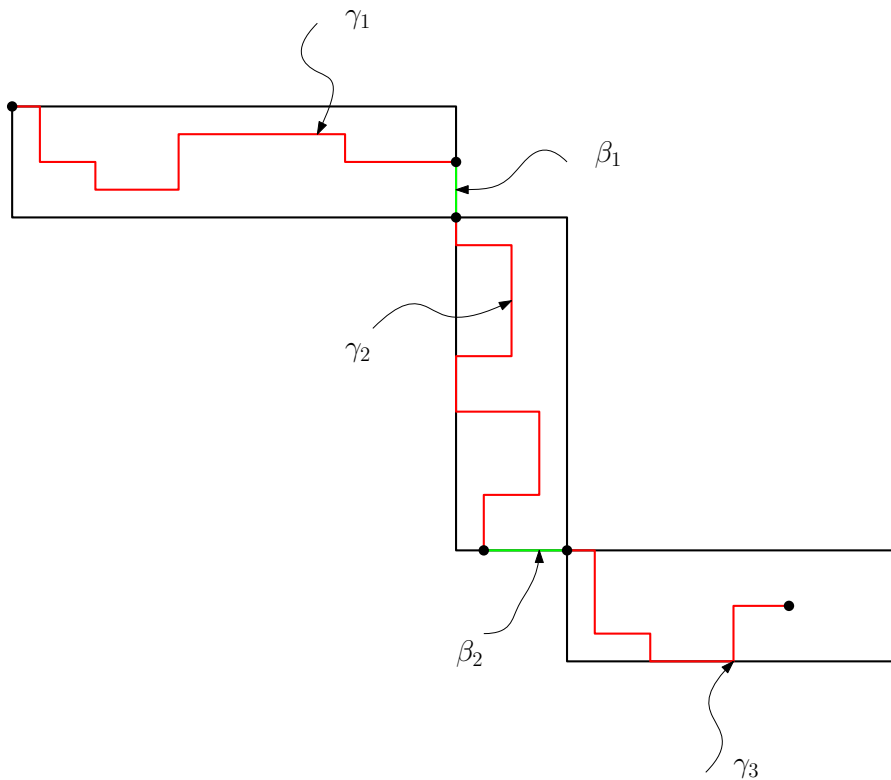

Figure 3.3

For each i , we have B^i is a sub-domain of $B_{\mathbb{L}}$ and then γ_i is also a self-avoiding walk of the strip $B_{\mathbb{L}}$. Then we set:

$$\theta'(\gamma) = \prod_{i=1}^{i_0} \theta(\{\varphi_{B_L}(\gamma_i), p(\varphi_{B_L}(\gamma_i))\}), \tag{2.32}$$

where $p(\varphi_{B_L}(\gamma_i))$ is the parent of $\varphi_{B_L}(\gamma_i)$ in the tree \mathcal{T}_{B_L} . We can see that θ' is a flow on $\mathcal{T}_{B_L^\infty, \ell}$. We want to estimate the following difference:

$$\left| \mathcal{R}(\lambda, \mathcal{T}_{B_L^{\infty, \ell}}) - \mathcal{R}(\lambda, \mathcal{T}_{B_L}) \right| \quad (2.33)$$

Because $\mathcal{T}_{B_L^{\infty, \ell}} \subset \mathcal{T}_{B_L}$, by Theorem 2.10, we have:

$$\mathcal{R}(\lambda, \mathcal{T}_{B_L^{\infty, \ell}}) \geq \mathcal{R}(\lambda, \mathcal{T}_{B_L}) = \mathcal{E}(\theta) \quad (2.34)$$

Moreover, by Theorem 2.10, we have:

$$\mathcal{R}(\lambda, \mathcal{T}_{B_L^{\infty, \ell}}) \leq \mathcal{E}(\theta'). \quad (2.35)$$

We then obtain:

$$\mathcal{E}(\theta') \geq \mathcal{R}(\lambda, \mathcal{T}_{B_L^{\infty, \ell}}) \geq \mathcal{R}(\lambda, \mathcal{T}_{B_L}) = \mathcal{E}(\theta). \quad (2.36)$$

We use Equation 2.36 to obtain:

$$\left| \mathcal{R}(\lambda, \mathcal{T}_{B_L^{\infty, \ell}}) - \mathcal{R}(\lambda, \mathcal{T}_{B_L}) \right| \leq |\mathcal{E}(\theta') - \mathcal{E}(\theta)|. \quad (2.37)$$

By the construction of θ' , if $\ell \geq h(L)$ we have:

$$|\mathcal{E}(\theta') - \mathcal{E}(\theta)| \leq \sum_{i=1}^{\infty} iL \left(\frac{1}{\lambda} \right)^{iL} \frac{\lambda^{iL}}{L^i} \varepsilon^i < 1. \quad (2.38)$$

By Equations 2.37 and 2.38, if $\ell > h(L)$, we have:

$$\mathcal{R}(\lambda, \mathcal{T}_{B_L^{\infty, \ell}}) \leq \mathcal{R}(\lambda, \mathcal{T}_{B_L}) + 1. \quad (2.39)$$

Therefore, for any $\ell > h(L)$,

$$\mathcal{C}(\lambda, \mathcal{T}_{B_L^{\infty, \ell}}) \geq \frac{\mathcal{C}(\lambda, \mathcal{T}_{B_L})}{1 + \mathcal{C}(\lambda, \mathcal{T}_{B_L})} > 0, \quad (2.40)$$

this completes the proof of lemma. □

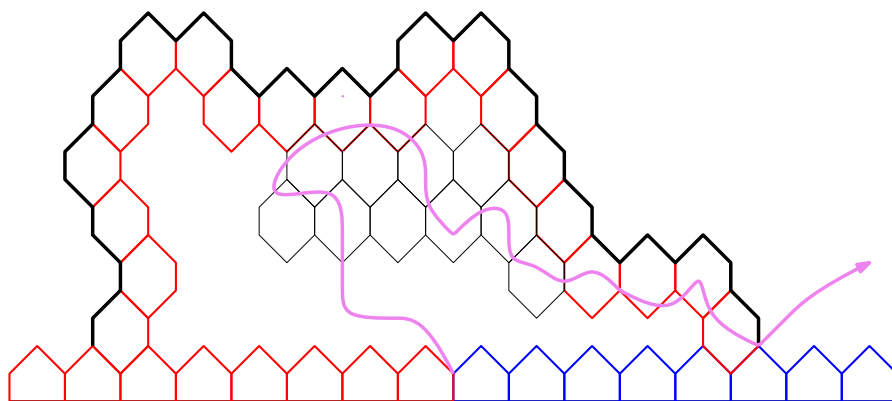

Figure 3.4

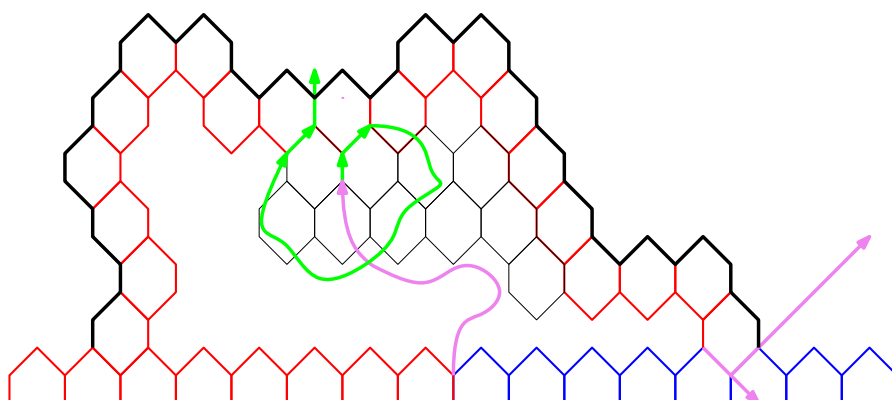

Figure 3.5

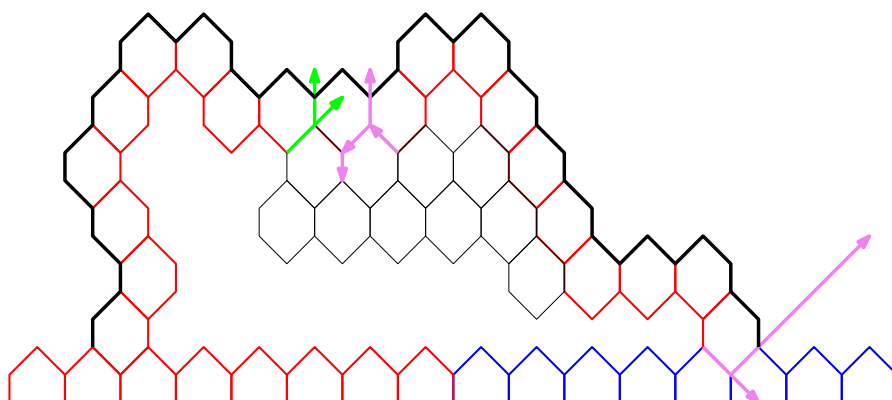

Figure 3.6

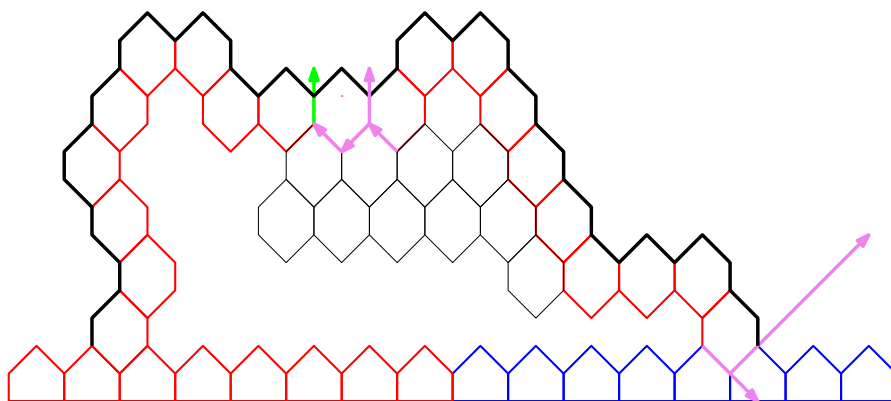

Figure 3.7

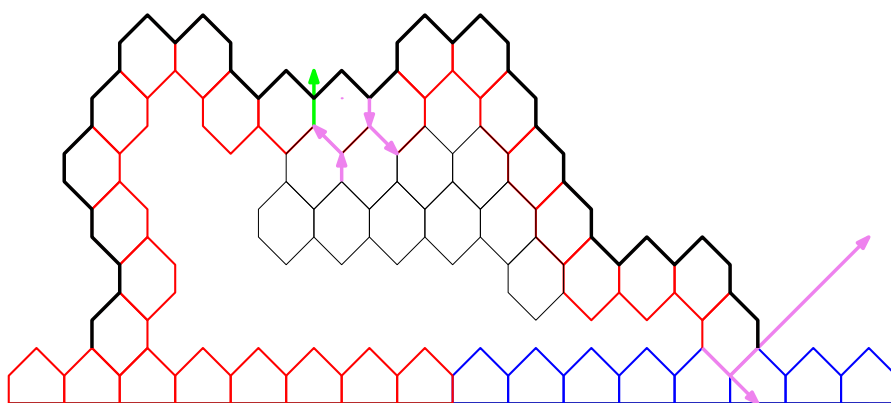

Figure 3.8

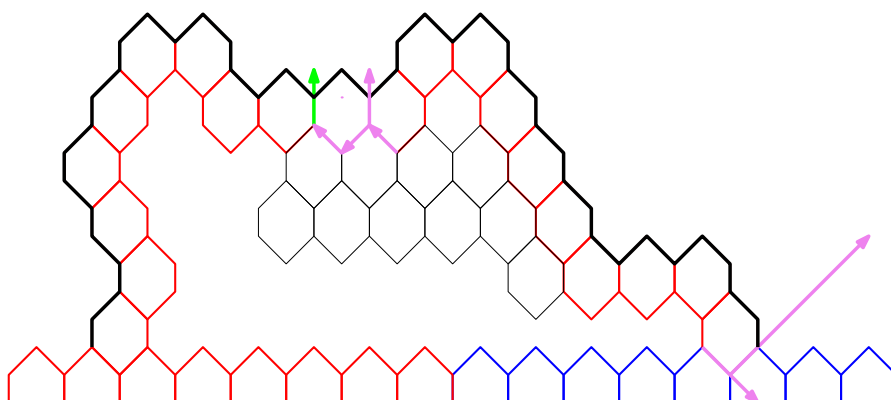

Figure 3.9

Part II

Random walks in random environment

Chapter 4

The branching-ruin number as critical parameter of random processes on trees

Abstract

The *branching-ruin number* of a tree, which describes its asymptotic growth and geometry, can be seen as a polynomial version of the branching number. This quantity was defined by Collecchio, Kious and Sidoravicius (2018) in order to understand the phase transitions of the once-reinforced random walk (ORRW) on trees. Strikingly, this number was proved to be equal to the critical parameter of ORRW on trees.

In this paper, we continue the investigation of the link between the branching-ruin number and the criticality of random processes on trees.

First, we study random walks on random conductances on trees, when the conductances have an heavy tail at 0, parametrized by some $p > 1$, where $1/p$ is the exponent of the tail. We prove a phase transition recurrence/transience with respect to p and identify the critical parameter to be equal to the branching-ruin number of the tree.

Second, we study a multi-excited random walk on trees where each vertex has M cookies and each cookie has an infinite strength towards the root. Here again, we prove a phase transition recurrence/transience and identify the critical number of cookies to be equal to the branching-ruin number of the tree, minus 1. This result extends a conjecture of Volkov (2003). Besides, we study a generalized version of this process and generalize results of Basdevant and Singh (2009).

This chapter is based on [31], which is joint work with Andrea Collecchio and Daniel Kious.

1 Introduction

Let us consider a random process on a tree which is parametrized with one parameter p . We say that this process undergoes a *phase transition* if there exists a *critical parameter* p_c such that the (macroscopic) behavior of the random process is significantly different for $p < p_c$ and for $p > p_c$. This is, for instance, the case of Bernoulli percolation on trees, biased random walks (see [85, 86, 87]) or linearly edge-reinforced random walks [101] on trees.

In [85], R. Lyons proved the following beautiful result. Bernoulli percolation and biased random walks (among others) share the same critical parameter which is equal to the *branching number* of the tree. The branching number, defined by Furstenberg [53], is, roughly speaking, a quantity that provides a precise information on the asymptotic growth and geometry of a tree, at the exponential scale (see (2.1) for a definition). For instance, for trees that are “well-behaved” (such as spherically symmetric trees) and whose spheres of diameter n have size m^n , the branching number is equal to m . This description is actually not accurate as some trees have a peculiar geometry, and the size of their spheres is not a good indicator of their asymptotic complexity.

The phase transition of the once-reinforced random walk was studied in [33]. In order to see a phase transition, one needs to consider trees that grow polynomially fast (see [75]), and therefore the branching number is not the quantity that would provide a relevant information in this case. Indeed, the branching number does not allow us to distinguish among trees with polynomial growth as the branching number of *any* tree with sub-exponential growth is equal to 1. In [33], it was proved that the critical parameter for the once-reinforced random walk on trees is equal to the *branching-ruin number* of the tree (see (2.2)). The branching-ruin number of a tree is best described as the polynomial version of the branching number: if a well-behaved tree has spheres of size n^b , then the branching-ruin number of this tree is b . Again, this fact is not true in general because of the possible complex asymptotic geometry of trees.

The purpose of the current paper is to emphasize two other examples where the branching-ruin number appears as the critical parameter of a random process, as it was done for the branching number. We study random walks on random conductances with heavy-tails and a model of excited random walks called the M -digging random walk. In the next two subsections, we describe our results. In the first one, we relate the branching-ruin number to the critical weight of the tails of the conductances. In the second result, we relate the critical number of cookies per site to the branching-ruin number and, in particular, our result extends a conjecture of Volkov [118].

1.1 Random walk on heavy-tailed random conductances

First, we study random walks on random conductances in the case where the conductances have heavy tails at zero. Consider an infinite, locally finite, tree \mathcal{T} with

branching-ruin number b (see (2.2) for a definition). Even though our results hold for any branching-ruin number, for the sake of the following explanations, let us temporarily assume that $b > 1$, so that simple random walk is transient on this tree (see Theorem 1.2, or [33]). Assign i.i.d. conductances, or weights, to each edge of \mathcal{T} and let us define a nearest-neighbor random walk which jumps through an edge with a probability proportional to the conductance of this edge. This model is very classical and has been extensively study on various graph, including \mathbb{Z} and \mathbb{Z}^d . The behavior of the walk depends on the common law of the conductances.

For instance, if the conductances are bounded away from 0 and from the infinity, the behavior of the walk is close to the one of simple random walk and it will therefore be transient on \mathcal{T} , moving at a speed similar to that of simple random walk.

If the conductances can be very large, i.e. unbounded and for instance with an heavy-tail at infinity, this should not affect the transience of the walk. Nevertheless, this would have an important impact on the time that the random walk spends on small areas of the environment. We do not prove anything in this direction in this paper as our main interest is in the recurrence/transience of the walk, but we would like to describe here what should happen. If the conductances can be extremely large with a not-so-small probability, then the walker will meet, here and there, an edge with an overwhelmingly large conductance and will cross this edge back-and-forth for a very large number of times before moving on. The consequence of this mechanism is that the random walker will spend most of its time on these *traps* and will move at a speed much smaller than simple random walk on the same tree. This phenomenon is reminiscent of Bouchaud's trap model, see [49, 42, 44, 43], or [52] where an explicit link is made between Bouchaud's trap model and biased random walk on random conductances.

The last possible scenario is when the conductances could be extremely small, which is what we are mainly interested in here. The extreme case would be percolation where the random walk is recurrent as soon as the percolation is subcritical. In our case, the conductances remain positive but have an heavy-tail at 0. This creates "barriers" of edges with atypically small conductances that can make the walker come back to the root infinitely often, even when the tree is transient for simple random walk. Let us now describe our results.

Recall that \mathcal{T} is an infinite, locally finite, tree and let E be the set of all its edges. Let $(C_e)_{e \in E}$ be a collection of i.i.d. random conductances that are almost surely positive. Moreover, assume that

$$\mathbf{P} \left(C_e \leq \frac{1}{t} \right) = \frac{L(t)}{t^m}, \quad \text{for } t > 0, \quad (1.1)$$

where $L : \mathbb{R} \rightarrow \mathbb{R}$ is a slowly-varying function. For simplicity, we will also assume that $\mathbf{P}(C_e \geq 1) > 0$ without loss of generality.

For a realisation of the environment (C_e) , we can define a random walk on these conductances which jumps through an edge e with a probability proportional to C_e . For a formal definition of this random walk on random conductances (RWRC), we refer to Section 2.3. In the following, we say that a walk is *transient* if it does not return to its starting point with positive probability. If a walk is not transient, it comes back to the root almost surely and it is called *recurrent*. We also give a formal definition of recurrence and transience in Section 2.3. Finally, the branching-ruin number of \mathcal{T} , formally defined in (2.2), is denoted by $br_r(\mathcal{T})$.

Theorem 1.1. *Fix an infinite, locally finite, tree \mathcal{T} and let $b = br_r(\mathcal{T}) \in [0, \infty]$ be its branching-ruin number. If $b < 1$, then RWRC is recurrent. Assuming $b > 1$, if $mb > 1$ then RWRC is transient and if $mb < 1$ then it is recurrent.*

1.2 The M -digging random walk

Our second main result concerns a model of multi-excited random walks on trees, also known as *cookie random walks*.

Excited random walks were introduced by Benjamini and Wilson in [17] on \mathbb{Z}^d , and have been extensively studied (see [7, 18, 76, 77, 117]). Zerner [121, 120] introduced a generalization of this model called multi-excited random walks (or cookie random walk). These walks are well understood on \mathbb{Z} , but not much is known in higher dimensions.

Here, we study an extreme case of multi-excited random walks on trees, introduced by Volkov [118], called the M -digging random walk (M -DRW). We also study its biased version and generalize a result by Basdevant and Singh [10], see Theorem 3.3, who studied it on regular trees.

Assign to each vertex M cookies, where M is a non-negative integer. Define a nearest-neighbor random walk \mathbf{X} as follows. Each time it visits a vertex, if there is any cookie left there, it eats one of them and then jumps to the parent of that vertex. If no cookies are detected, then it jumps to one of the neighbors with uniform probability. We refer to section 2.3 for a formal definition of this process.

Volkov [118] conjectured that this process is transient on any tree containing the binary, which was proved by Basdevant and Singh [10]. Here, we obtain a much finer description of the process and we can prove that this random walk actually undergoes a phase transition on trees with polynomial growth, i.e. on trees \mathcal{T} where the branching-ruin number $br_r(\mathcal{T})$ is finite.

[118]

Theorem 1.2. *Let \mathcal{T} be an infinite, locally-finite, rooted tree, and let $M \in \mathbb{N}$. If $br_r(\mathcal{T}) < M + 1$ then M -DRW is recurrent and if $br_r(\mathcal{T}) > M + 1$ then M -DRW is*

transient.

We refer to Theorem 3.3 for the more general result on the biased case and Theorem 3.1 for the case where the number of cookies on each vertex is inhomogeneous over the tree.

2 The models

In this section, we define relevant vocabulary and conventions. We then recall the definition of the *branching number* and *branching-ruin number* of a tree, and finally we formally define the models.

2.1 Notation

Let $\mathcal{T} = (V, E)$ be an infinite, locally finite, rooted tree with set of vertices V and set of edges E . Let ϱ be the root of \mathcal{T} .

Two vertices $\nu, \mu \in V$ are called *neighbors*, denoted $\nu \sim \mu$, if $\{\nu, \mu\} \in E$.

For any vertex $\nu \in V \setminus \{\varrho\}$, denote by ν^{-1} its parent, i.e. the neighbour of ν with shortest distance from ϱ .

For any $\nu \in V$, let $|\nu|$ be the number of edges in the unique self-avoiding path connecting ν to ϱ and call $|\nu|$ the *generation* of ν . In particular, we have $|\varrho| = 0$.

For any edge $e \in E$ denote by e^- and e^+ its endpoints with $|e^+| = |e^-| + 1$, and define the generation of an edge as $|e| = |e^+|$.

For any pair of vertices ν and μ , we write $\nu \leq \mu$ if ν is on the unique self-avoiding path between ϱ and μ (including it), and $\nu < \mu$ if moreover $\nu \neq \mu$. Similarly, for two edges e and g , we write $g \leq e$ if $g^+ \leq e^+$ and $g < e$ if moreover $g^+ \neq e^+$. For two vertices $\nu < \mu \in V$, we will denote by $[\nu, \mu]$ the unique self-avoiding path connecting ν to μ . For two neighboring vertices ν and μ , we use the slight abuse of notation $[\nu, \mu]$ to denote the edge with endpoints ν and μ (note that we allow $\mu < \nu$).

For two edges $e_1, e_2 \in E$, we denote $e_1 \wedge e_2$ the vertex with maximal distance from ϱ such that $e_1 \wedge e_2 \leq e_1^+$ and $e_1 \wedge e_2 \leq e_2^+$.

2.2 The Branching Number and The Branching-Ruin Number

In order to define the branching number and the branching-ruin number of a tree, we will need the notion of *cutsets*.

Let \mathcal{T} be an infinite, locally finite and rooted tree. A cutset in \mathcal{T} is a set π of edges such that, for any infinite self-avoiding path $(\nu_i)_{i \geq 0}$ started at the root, there exists a unique $i \geq 1$ such that $[\nu_{i-1}, \nu_i] \in \pi$. In other words, a cutset is a minimal set of edges separating the root from infinity. We use Π to denote the set of cutsets.

The branching number of \mathcal{T} is defined as

$$br(\mathcal{T}) := \sup \left\{ \gamma > 0 : \inf_{\pi \in \Pi} \sum_{e \in \pi} \gamma^{-|e|} > 0 \right\} \in [1, \infty]. \quad (2.1)$$

branching-ruin number of \mathcal{T} is defined as

$$br_r(\mathcal{T}) := \sup \left\{ \gamma > 0 : \inf_{\pi \in \Pi} \sum_{e \in \pi} |e|^{-\gamma} > 0 \right\} \in [0, \infty]. \quad (2.2)$$

These quantities provide good ways to measure respectively the exponential growth and the polynomial growth of a tree. For instance, a tree which is spherically symmetric (or regular) and whose n generation grows like b^n , for $b \geq 1$, has a branching number equal to b . On the other hand, if such a tree grows like n^b , for some $b \geq 0$, its branching-ruin number is equal to b . We refer the reader to [87] for a detailed investigation of the branching number and [33] for discussions on the branching-ruin number.

2.3 Formal definition of the models

The random walk on heavy-tailed random conductances

In this section, we provide a formal definition of the random walk on random conductances (RWRC).

First let us define the environment of the walk. To the edges of \mathcal{T} , we associate i.i.d. random conductances $C_e \in (0, \infty)$, $e \in E$, with common law \mathbf{P} , where \mathbf{E} denotes the corresponding expectation. We will assume that

$$\mathbf{P} \left(C_e \leq \frac{1}{t} \right) = \frac{L(t)}{t^m}, \quad \text{for } t > 0, \quad (2.3)$$

where $L : \mathbb{R} \rightarrow \mathbb{R}$ is a slowly varying function.

Given a realisation of the environment $(C_e)_{e \in E}$, we define a reversible Markov chain $\mathbf{X} = (X_n)_n$. We denote P_ν^ω the law of this Markov chain when it is started from a vertex $\nu \in V$. Under P_ϱ^ω , we have that $X_0 = \varrho$ and, if $X_n = \nu$ and $\mu \sim \nu$, we have that

$$P_\varrho^\omega (X_{n+1} = \mu | X_n = \nu) = P_\nu^\omega (X_1 = \mu) = \frac{C_{[\nu, \mu]}}{\sum_{\mu' \sim \nu} C_{[\nu, \mu']}}.$$

We call P^ω the *quenched law* of the random walk and denote E^ω the corresponding expectation. We define the *annealed law* of \mathbf{X} started at ϱ as the semi-direct product $\mathbb{P}_\varrho = \mathbf{P} \times P_\varrho^\omega$, that is the random walk averaged over the environment. We denote \mathbb{E}_ϱ the corresponding annealed expectation.

For a vertex $v \in V$, $T(v)$ stands for the *return time* to v , that is

$$T(v) := \inf\{n > 0 : X_n = v\}.$$

A RWRC is said to be *recurrent* if it returns to ϱ , \mathbb{P}_ϱ -almost surely. This process is *transient* if it is not recurrent, that is

$$\mathbb{P}_\varrho(T(\varrho) = \infty) > 0.$$

As $\mathbb{P}_\varrho(T(\varrho) = \infty) = \mathbf{E} \left(P_\varrho^\omega(T(\varrho) = \infty) \right)$, \mathbf{X} is transient if, with positive \mathbf{P} -probability, we have that

$$P_\varrho^\omega(T(\varrho) = \infty) > 0.$$

Finally, as \mathbf{X} is a Markov chain under P^ω , we have that it is transient if and only if the walk returns finitely often to the root ϱ and, using a zero-one law on the environment, we can prove that this happens with probability 0 or 1. Therefore, the notions of recurrence and transience are well defined in the quenched and annealed sense.

The M -digging random walk

Let $\mathcal{T} = (V, E)$ be an infinite, locally-finite, tree rooted at a vertex ϱ . We are going to define a biased version of the M -DRW described above, which will also allow for an inhomogeneous initial number of cookies.

Let $\bar{M} = (m_\nu, \nu \in V)$ be a collection of non-negative integers, with $m_\varrho = 0$, and fix $\lambda > 0$. For convenience, for $e \in E$, we denote $m_e = m_{e^+}$.

Let us define a random walk $\mathbf{X} = (X_n)_{n \geq 0}$ as follows. For any vertex $\nu \in V$, define

$$\ell_n(\nu) = |\{k \in \{0, \dots, n\} : X_k = \nu\}|. \quad (2.4)$$

For each edge $e \in E$ and each time $n \in \mathbb{N}$, we associate the following weight:

$$W_n(e) := \left(1 - \mathbb{1}_{\{\ell_n(e^-) \leq m_{e^-}\}}\right) \lambda^{-|e|+1}. \quad (2.5)$$

As can be seen in (2.6) below, the model remains unchanged if, in the above definition, we use $\lambda^{-|e|}$ instead of $\lambda^{-|e|+1}$. Our choice turns out to be convenient in the proofs.

For a non-oriented edge $[\nu, \mu]$, we will simply write $W_n(\nu, \mu) = W_n(\mu, \nu) = W_n([\nu, \mu])$. We start the random walk at $X_0 = \varrho$. At time $n \geq 0$, for any $\nu \in V$, on the event $\{X_n = \nu\}$, we define, for any $\mu \sim \nu$,

$$\mathbb{P}(X_{n+1} = \mu | \mathcal{F}_n) = \frac{W_n(\nu, \mu)}{\sum_{\mu' \sim \nu} W_n(\nu, \mu')}, \quad (2.6)$$

where $\mathcal{F}_n = \sigma(X_0, \dots, X_n)$ is the σ -field generated by the history of \mathbf{X} up to time n . We call this walk an M -digging random walk with bias λ and denote it M -DRW $_\lambda$.

It will be very convenient to observe \mathbf{X} only at times when it is on vertices with no more cookies. For this purpose, let us define $\tilde{\mathbf{X}} = (\tilde{X}_n)_n$ a nearest-neighbor random walk on \mathcal{T} as follows. Let $\sigma_0 = 0$ and, for any $n \in \mathbb{N}$,

$$\sigma_{n+1} = \inf \{k > \sigma_n : X_k \neq X_{\sigma_n}, \ell_k(X_k) \geq m_{X_k} + 1\}. \quad (2.7)$$

We define, for all $n \in \mathbb{N}$, $\tilde{X}_n = X_{\sigma_n}$.

Next, we want to define notions of recurrence and transience for \mathbf{X} . As above, we define the *return time* of \mathbf{X} , or $\tilde{\mathbf{X}}$, to a vertex $\nu \in V$ by

$$T(\nu) := \inf\{k \geq 1 : \tilde{X}_k = \nu\}. \quad (2.8)$$

In words, we consider that a vertex ν is *hit* by \mathbf{X} when it is hit by $\tilde{\mathbf{X}}$ in the usual sense. The fact to choose this time to be greater than 1 will be convenient technically to accommodate with the particularities of the root.

We say that \mathbf{X} , or $\tilde{\mathbf{X}}$, is *transient* if

$$\mathbb{P}(T(\varrho) = \infty) > 0. \quad (2.9)$$

Otherwise, we say that \mathbf{X} , or $\tilde{\mathbf{X}}$, is *recurrent*.

Note that if we choose $m_\nu = M \in \mathbb{N}$ for all $\nu \in V \setminus \{\varrho\}$ and $\lambda = 1$, then \mathbf{X} is the M -DRW described in Section 1.2.

3 Main results

We are about to state a sharp criterion of recurrence/transience in terms of a quantity $RT(\mathcal{T}, \mathbf{X})$, first introduced in [33].

For a function $\psi : E \rightarrow \mathbb{R}^+$, we define the quantity

$$RT(\mathcal{T}, \psi) := \sup \left\{ \gamma > 0 : \inf_{\pi \in \Pi} \sum_{e \in \pi} \left(\prod_{g \leq e} \psi(g) \right)^\gamma > 0 \right\}. \quad (3.1)$$

As we will see, for the relevant function ψ , the recurrence or transience of the walks will be related to this quantity being smaller or greater than 1.

3.1 Main results about RWRC

It is straightforward to see that the two following results together imply Theorem 1.1. The proof of Proposition 3.1 is given in Section 5.

Let us define, for any $e \in E$, $\psi_{RC}(e) = 1$ if $|e| = 1$ and, if $|e| > 1$,

$$\psi_{RC}(e) = \frac{\sum_{g < e} C_g^{-1}}{\sum_{g \leq e} C_g^{-1}}. \quad (3.2)$$

Proposition 3.1. *Fix an infinite, locally finite, tree \mathcal{T} and let $b = br_r(\mathcal{T}) \in [0, \infty]$ be its branching-ruin number. If $b < 1$ then $RT(\mathcal{T}, \psi_{RC}) < 1$, \mathbf{P} -almost surely. Assuming $b > 1$, we have that*

1. if $mb > 1$ then $RT(\mathcal{T}, \psi_{RC}) > 1$ with positive \mathbf{P} -probability;
2. if $mb < 1$ then $RT(\mathcal{T}, \psi_{RC}) < 1$, \mathbf{P} -almost surely.

The following result is a direct consequence of Theorem 5 of [33], recalling the discussion at the end of Section 2.3 and noting that condition (2.5) in [33] is trivially satisfied by Markov chains, which in that context is translated into non-reinforced environments. Therefore, we will omit its proof.

Proposition 3.2 (Theorem 5 of [33]). *Fix an infinite, locally finite, tree \mathcal{T} . We have that*

1. if $RT(\mathcal{T}, \psi_{RC}) > 1$ with positive \mathbf{P} -probability then RWRC is transient;
2. if $RT(\mathcal{T}, \psi_{RC}) < 1$ \mathbf{P} -almost surely then RWRC is recurrent.

3.2 Main results about the M -DRW $_\lambda$

The following Theorem is more general than Theorem 1.2 in the introduction and deals with the homogeneous case where $\overline{M} = (m_\nu; \nu \in V)$ is such that $m_\varrho = 0$ and $m_\nu = M$ for all $\nu \in V \setminus \{\varrho\}$. Let us emphasize that, in item (1) below, the phase transition is given in terms of branching-ruin number whereas, in item (2), the phase transition is given in terms of branching number.

Theorem 3.3. *Let \mathcal{T} be an infinite, locally-finite, rooted tree, and let $M \in \mathbb{N}$, $\lambda > 0$. Denote \mathbf{X} the M -DRW $_\lambda$ on \mathcal{T} with parameters $\lambda > 0$ and $\overline{M} = (m_\nu; \nu \in V)$ such that $m_\varrho = 0$ and $m_\nu = M$ for all $\nu \in V \setminus \{\varrho\}$. We have that*

1. in the case $\lambda = 1$, if $br_r(\mathcal{T}) < M + 1$ then \mathbf{X} is recurrent and if $br_r(\mathcal{T}) > M + 1$ then \mathbf{X} is transient;
2. for any $\lambda > 1$, if $br(\mathcal{T}) < \lambda^{M+1}$ then \mathbf{X} is recurrent and if $br(\mathcal{T}) > \lambda^{M+1}$ then \mathbf{X} is transient;
3. for any $\lambda < 1$, \mathbf{X} is transient.

Remark 3.4. If, for a tree \mathcal{T} , $br(\mathcal{T}) > 1$, then we have that $br_r(\mathcal{T}) = \infty$, as proved of Case V of the proof of Lemma 3.2. Therefore, the items (1) and (2) in Theorem 3.3 are not contradictory.

Note that, for a b -ary tree, $br(\mathcal{T}) = b$ and our result therefore agrees with Corollary 1.7 of [10]. In [10], the authors prove that the walk is recurrent at criticality on regular trees, but this is not expected to be true in general.

We are about to state a sharp criterion of recurrence/transience in terms of a quantity $RT(\mathcal{T}, \cdot)$ as defined in (3.1), which will apply to the general case $\overline{M} = (m_\nu; \nu \in V) \in \mathbb{N}^V$.

We will then prove that Theorem 3.3 is a simple corollary of this general result.

For this purpose, we need some notation. Let us define a function $\psi_{M,\lambda}$ on the edges of E such that, for any $e \in E$, $\psi_{M,\lambda}(e) = 1$ if $|e| = 1$ and, for any $e \in E$ with $|e| > 1$,

$$\begin{aligned} \psi_{M,\lambda}(e) &:= \left(\frac{\lambda^{|e|-1} - 1}{\lambda^{|e|} - 1} \right)^{m_{e^+} + 1} && \text{if } \lambda \neq 1, \\ \psi_{M,\lambda}(e) &:= \left(\frac{|e| - 1}{|e|} \right)^{m_{e^+} + 1} && \text{if } \lambda = 1. \end{aligned} \tag{3.3}$$

As we will see in Section 7, $\psi_{M,\lambda}(e)$ corresponds to the probability that \mathbf{X} , or $\tilde{\mathbf{X}}$, when restricted to $[\varrho, e^+]$ (i.e. the path from the root to e^+), hits e^+ before returning to ϱ , after having hit e^- .

We will prove the following result in Section 8.

Theorem 3.5. *Consider an M -DRW $_\lambda$ \mathbf{X} on an infinite, locally finite, rooted tree \mathcal{T} , with parameters $\lambda > 0$ and $\bar{M} = (m_\nu; \nu \in V) \in \mathbb{N}^V$. If $RT(\mathcal{T}, \psi_{M,\lambda}) < 1$ then \mathbf{X} is recurrent. If $RT(\mathcal{T}, \psi_{M,\lambda}) > 1$ and if*

$$\exists M \in \mathbb{N} \text{ such that } \sup_{\nu \in V} m_\nu \leq M, \tag{3.4}$$

then \mathbf{X} is transient.

The following result concerns the homogeneous case. Theorem 3.3 is a straightforward consequence of Theorem 3.5 and Lemma 3.2.

Lemma 3.6. *Consider an M -DRW $_\lambda$ \mathbf{X} on an infinite, locally finite, rooted tree \mathcal{T} , with parameters $\lambda > 0$ and $M = (m_\nu; \nu \in V)$ such that $m_\varrho = 0$ and $m_\nu = M$ for all $\nu \in V \setminus \{\varrho\}$. We have that*

1. for $\lambda = 1$, if $br_r(\mathcal{T}) < M + 1$ then $RT(\mathcal{T}, \psi_{M,\lambda}) < 1$ and if $br_r(\mathcal{T}) > M + 1$ then $RT(\mathcal{T}, \psi_{M,\lambda}) > 1$;
2. for $\lambda > 1$, if $br(\mathcal{T}) < \lambda^{M+1}$ then $RT(\mathcal{T}, \psi_{M,\lambda}) < 1$ and if $br(\mathcal{T}) > \lambda^{M+1}$ then $RT(\mathcal{T}, \psi_{M,\lambda}) > 1$;
3. for $\lambda < 1$, we have $RT(\mathcal{T}, \psi_{M,\lambda}) < 1$.

The proofs of Theorem 3.5 and Lemma 3.6 are given in Section 6.

4 Preliminary results

Proposition 4.2 below can be proved following line by line the argument in Section 8 of [33]. For the sake of completeness, we give an outline of the proof in the Appendix 9.

It relies on the concept of quasi-independent percolation defined as below (see also [87], page 144). In the following, we denote by $\mathcal{C}(\varrho)$ the cluster of open edges containing the root ϱ .

Definition 4.1. An edge-percolation is said to be *quasi-independent* if there exists a constant $C_Q \in (0, \infty)$ such that, for any two edges $e_1, e_2 \in E$ with common ancestor $e_1 \wedge e_2$, we have that

$$\begin{aligned} \mathbf{P}(e_1, e_2 \in \mathcal{C}(\varrho) | e_1 \wedge e_2 \in \mathcal{C}(\varrho)) &\leq C_Q \mathbf{P}(e_1 \in \mathcal{C}(\varrho) | e_1 \wedge e_2 \in \mathcal{C}(\varrho)) \\ &\quad \times \mathbf{P}(e_2 \in \mathcal{C}(\varrho) | e_1 \wedge e_2 \in \mathcal{C}(\varrho)). \end{aligned} \quad (4.1)$$

This previous notion is useful when one tries to prove the super-criticality of a correlated percolation.

Proposition 4.2. Consider an edge-percolation (not necessarily independent), such that edges at generation 1 are open almost surely and, for $e_1 \in E$ with $|e_1| > 1$,

$$\mathbf{P}(e_1 \in \mathcal{C}(\varrho) | e_0 \in \mathcal{C}(\varrho)) = \psi(e_1) > 0, \quad (4.2)$$

where $e_0 \sim e_1$ and $e_0 < e_1$. If $RT(\mathcal{T}, \psi) < 1$ then $\mathcal{C}(\varrho)$ is finite almost surely. If the percolation is quasi-independent and if $RT(\mathcal{T}, \psi) > 1$ then $\mathcal{C}(\varrho)$ is infinite with positive probability.

The proof of Proposition 4.2 above is postponed in Appendix 9.

Let us first apply this to a particular percolation in order to obtain a sufficient criterion for subcriticality.

Corollary 4.3. Let \mathcal{T} be a tree with branching ruin number $br_r(\mathcal{T}) = b \in [0, \infty]$. Fix a parameter $\delta > 0$ and perform a percolation (not necessarily independent) on \mathcal{T} such that (4.2) holds and assume moreover that $\psi(e) = 1 - \delta|e|^{-1}$ as soon as $|e| > n_0$, for some integer $n_0 > 1$. If $\delta > b$ then the percolation is subcritical.

Proof. For a cutset π , let $|\pi| = \inf\{|e| : e \in \pi\}$. First, note that for any $\alpha > b$,

$$\inf_{\pi \in \Pi: |\pi| \leq n_0} \sum_{e \in \pi} |e|^{-\alpha} \geq n_0^{-\alpha} > 0,$$

and therefore

$$\inf_{\pi \in \Pi: |\pi| > n_0} \sum_{e \in \pi} |e|^{-\alpha} = \inf_{\pi \in \Pi} \sum_{e \in \pi} |e|^{-\alpha} = 0.$$

Second, for any $\gamma > b/\delta$, we have

$$\begin{aligned}
 \inf_{\pi \in \Pi} \sum_{e \in \pi} \prod_{g \leq e} (\psi(g))^\gamma &\leq \inf_{\pi \in \Pi: |\pi| > n_0} \sum_{e \in \pi} \prod_{g \leq e} (\psi(g))^\gamma \\
 &\leq \inf_{\pi \in \Pi: |\pi| > n_0} \sum_{e \in \pi} \prod_{g \leq e} (1 - \delta |g|^{-1})^\gamma \\
 &\leq \inf_{\pi \in \Pi: |\pi| > n_0} \sum_{e \in \pi} \exp \left(-\gamma \delta \sum_{i=1}^{|e|} i^{-1} \right) \\
 &\leq \inf_{\pi \in \Pi: |\pi| > n_0} \sum_{e \in \pi} |e|^{-\gamma \delta} = 0.
 \end{aligned} \tag{4.3}$$

Hence $RT(\mathcal{T}, \psi) < 1$ and by using Proposition 4.2 the cluster \mathcal{T}_δ is finite, almost surely. \square

Next, we use Proposition 4.2 and Corollary 4.3 to prove the following result.

Proposition 4.4. *Let \mathcal{T} be a tree with branching ruin number $br_r(\mathcal{T}) = b \in [0, \infty]$. Fix a parameter $\delta > 0$ and perform a quasi-independent percolation on \mathcal{T} such that (4.2) holds and assume moreover that $\psi(e) \geq 1 - \delta |e|^{-1}$ as soon as $|e| > n_0$, for some integer $n_0 > 1$. Let \mathcal{T}_δ be the connected cluster containing the root ρ . We have that*

1. if $\delta < b$ then \mathcal{T}_δ is infinite with positive probability;
2. for any $\delta \in (0, b)$ we have that, with positive probability, $br_r(\mathcal{T}_\delta) \geq b - 2\delta$.

Proof. First we prove (1). For $\pi \in \Pi$, we define $|\pi| = \min\{|e|; e \in \pi\}$. Notice that, for any $\gamma > 1$, as $\psi(e) > 0$ for every $e \in E$,

$$\inf_{\pi \in \Pi: |\pi| \leq n_0} \sum_{e \in \pi} \prod_{g \leq e} (\psi(g))^\gamma > 0. \tag{4.4}$$

If $\delta < b$, then for any $\gamma \in (1, b/\delta)$, we have

$$\begin{aligned}
 \inf_{\pi \in \Pi: |\pi| > n_0} \sum_{e \in \pi} \prod_{g \leq e} (\psi(g))^\gamma &\geq \inf_{\pi \in \Pi: |\pi| > n_0} \sum_{e \in \pi} \prod_{g \leq e} (1 - \delta |g|^{-1})^\gamma \\
 &\geq c \inf_{\pi \in \Pi} \sum_{e \in \pi} \exp \left(-\gamma \delta \sum_{i=1}^{|e|} i^{-1} \right) \\
 &\geq 2^{-b} c \inf_{\pi \in \Pi} \sum_{e \in \pi} |e|^{-\gamma \delta} > 0,
 \end{aligned} \tag{4.5}$$

where c is some positive constant. Putting (4.4) and (4.5) together, we have that $RT(\mathcal{T}, \psi) > 1$. By Proposition 4.2, as the percolation is quasi-independent, the cluster \mathcal{T}_δ is infinite with positive probability.

Next, we turn to the proof of (2). Consider the previous percolation, with $\delta < b$ and fix $p < b - \delta$.

On the event $\{\mathcal{T}_\delta \text{ is infinite}\}$, which has positive probability, we perform an independent percolation on \mathcal{T}_δ for which an edge e stays open with probability $(1 - p|e|^{-1})$. We proved that if $p < br_r(\mathcal{T}_\delta)$ then the percolation is supercritical and if $p > br_r(\mathcal{T}_\delta)$ then it is subcritical. We denote $\mathcal{T}'_{\delta+p}$ the resulting cluster of the root.

On the other hand, performing this percolation on \mathcal{T}_δ is equivalent to performing a quasi-independent percolation on the whole tree \mathcal{T} where an edge e stays open with probability $\psi(e)(1 - p|e|^{-1})$. As $\psi(e)(1 - p|e|^{-1}) \geq (1 - \delta|e|^{-1})(1 - p|e|^{-1}) \geq 1 - (\delta + p)|e|^{-1}$, for $|e| > n_0$, if $p + \delta < b$, this percolation is supercritical, i.e. $\mathcal{T}'_{p+\delta}$ is infinite with positive probability.

This implies that, on the event $\{\mathcal{T}_\delta \text{ is infinite}\}$, the cluster $\mathcal{T}'_{\delta+p}$ is infinite with positive probability. Therefore, by Corollary 4.3, $br_r(\mathcal{T}_\delta) \geq p$ with positive probability. As this holds for any $p < b - \delta$, we obtain the conclusion. \square

5 Proof of Proposition 3.1 and Theorem 1.1

First, note that Theorem 1.1 is a straightforward consequence of Proposition 3.1 and Proposition 3.2. Therefore, it remains to prove Proposition 3.1.

5.1 Transience: proof of the first item of Proposition 3.1

In this section, we will prove that $RT(\mathcal{T}, \psi_{RC}) > 1$, where we recall that this quantity is defined in (3.1) and ψ_{RC} is defined in (3.2).

In particular, we can rewrite

$$RT(\mathcal{T}, \psi_{RC}) = \sup \left\{ \lambda > 0 : \inf_{\pi \in \Pi} \sum_{e \in \pi} \left(\frac{1}{\sum_{i \leq e} C_i^{-1}} \right)^\lambda > 0 \right\}. \quad (5.1)$$

Besides, notice that $\psi(e)$ represents the probability that a one-dimensional random walk on the conductances $(C_e)_{e \in E}$, restricted to the ray connecting ϱ to e^+ and started at e^- , hits e^+ before returning to ϱ .

Proposition 5.1. *For any $p \in \mathbb{N}$, and for any $\tau > 0$, there exists a positive finite constant $K_{p,\tau}$ such that*

$$\mathbf{E} \left[\left(\sum_{i=1}^n C_i^{-1} \right)^p \mid \bigcap_{i=1}^n \{C_i^{-1} \leq i^{\frac{1+\tau}{m}}\} \right] \leq K_{p,\tau} n^{p(1 \vee \frac{(1+\tau)^2}{m})}, \quad \text{for all } n \in \mathbb{N}. \quad (5.2)$$

Proof. Recall that for any non-negative random variable Z we have, for $a > 1$,

$$\mathbf{E}[Z^a] = \int_0^\infty au^{a-1} \mathbb{P}(Z \geq u) du.$$

For any $b > 0$ we have that any slowly varying function $L(u)$ is $o(u^b)$, as $u \rightarrow \infty$. Hence, for any $\tau > 0$, there exists a constant $K_\tau, i_0 > 0$ depending only on L and τ , such that, for $i \geq i_0$,

$$\begin{aligned} \mathbf{E}[C_i^{-a} \mid C_i^{-1} \leq i^{\frac{1+\tau}{m}}] &\leq \left(1 + \int_1^{i^{\frac{1+\tau}{m}}} au^{a-1} \frac{L(u)}{u^m} du\right) \left(\frac{1}{1 - i^{-(1+\tau)} L(i^{\frac{1+\tau}{m}})}\right) \\ &\leq 2 \left(1 + \frac{K_\tau}{a-m} i^{a(1+\tau)^2/m-1} - 1\right) \\ &:= b_i^{(a,\tau)}. \end{aligned} \quad (5.3)$$

For simplicity we drop τ from the notation, and use $(b_i^{(a)})_i$. Notice that the sequence $(b_i^{(a)})_i$, when $a \geq 1$, is $O(i^{\frac{a(1+\tau)^2}{m}-1} \vee 1)$, that is there exists $\tilde{K}_a > 0$ depending only on L , a and τ such that

$$b_i^{(a)} \leq \tilde{K}_a \left(i^{\frac{a(1+\tau)^2}{m}-1} \vee 1\right),$$

for all $i \in \mathbb{N}$. In order to prove the proposition, we proceed by double induction. First we prove that (5.2) holds for $p = 1$ and all $n \in \mathbb{N}$. In fact, for $m > 0$, we have

$$\mathbf{E} \left[\left(\sum_{i=1}^n C_i^{-1} \right) \mid \bigcap_{i=1}^n \{C_i^{-1} \leq i^{\frac{1+\tau}{m}}\} \right] \leq \sum_{i=1}^n \tilde{K}_1 \left(i^{\frac{(1+\tau)^2}{m}-1} \vee 1\right) = O(n^{\frac{(1+\tau)^2}{m} \vee 1}). \quad (5.4)$$

Note that, in the previous inequality, we use that $\mathbf{P}[C_e \geq 1] > 0$ for any $e \in E$, so that the conditional probability on the left-hand side is well-defined.

Assume that (5.2) holds for all $p \leq \beta - 1$ and for all $n \in \mathbb{N}$. Notice that (5.2) is trivially true for $n = 1$ and $p = \beta$. Suppose it is true for all $n \leq N$ and for $p = \beta$. To simplify the notation, set $\eta = \frac{(1+\tau)^2}{m} \vee 1$. Next we prove the result for $N + 1$. We can suppose that K_β is larger than

$$\beta \max_{0 \leq j \leq \beta-1} \binom{\beta}{j} K_j \tilde{K}_{\beta-j}, \quad (5.5)$$

where $K_0 = 1$. We have

$$\begin{aligned} &\mathbf{E} \left[\left(\sum_{i=1}^{N+1} C_i^{-1} \right)^\beta \mid \bigcap_{i=1}^{N+1} \{C_i^{-1} \leq i^{\frac{1+\tau}{m}}\} \right] \\ &= \mathbf{E} \left[\left(\sum_{i=1}^N C_i^{-1} \right)^\beta + C_{N+1}^{-\beta} + \sum_{j=1}^{\beta-1} \binom{\beta}{j} \left(\sum_{i=1}^N C_i^{-1} \right)^j C_{N+1}^{-\beta+j} \mid \bigcap_{i=1}^{N+1} \{C_i^{-1} \leq i^{\frac{1+\tau}{m}}\} \right] \\ &\leq K_\beta N^{\beta\eta} + b_{N+1}^{(\beta)} + \sum_{j=1}^{\beta-1} \binom{\beta}{j} \mathbf{E} \left[\left(\sum_{i=1}^N C_i^{-1} \right)^j \mid \bigcap_{i=1}^{N+1} \{C_i^{-1} \leq i^{\frac{1+\tau}{m}}\} \right] b_{N+1}^{(\beta-j)} \\ &\leq K_\beta N^{\beta\eta} + \tilde{K}_\beta \left((N+1)^{\frac{\beta(1+\tau)^2}{m}-1} \vee 1 \right) + \sum_{j=1}^{\beta-1} \binom{\beta}{j} K_j N^{j\eta} \tilde{K}_{\beta-j} \left((N+1)^{\frac{(\beta-j)(1+\tau)^2}{m}-1} \vee 1 \right). \end{aligned} \quad (5.6)$$

In the step before the last one, we used independence between C_{N+1} and $(C_i)_{i \leq N}$. As we can choose K_β to be larger than (5.5), we have

$$\mathbf{E} \left[\left(\sum_{i=1}^{N+1} C_i^{-1} \right)^\beta \mid \bigcap_{i=1}^{N+1} \{C_i^{-1} \leq i^{\frac{1+\tau}{m}}\} \right] \leq K_\beta \left(N^{\beta\eta} + (N+1)^{\beta\eta-1} \right). \quad (5.7)$$

It remains to prove that the right-hand side of (5.7) is less than $K_\beta(N+1)^{\beta\eta}$. Notice that the right-hand side of (5.7) equals

$$(N+1)^{\beta\eta} K_\beta \left(\left(1 - \frac{1}{N+1}\right)^{\beta\eta} + \frac{1}{N+1} \right) \leq K_\beta(N+1)^{\beta\eta},$$

where we used $(1-x)^a \leq 1-x$ for all $x \in (0,1)$ and $a > 1$. □

Corollary 5.2. *For any $\varepsilon \in (0,1)$, any $t > 0$, there exist $C_{\varepsilon,t} > 0$ such that, for any $e \in E$, we have that*

$$\mathbf{P} \left(\sum_{g \leq e} C_g^{-1} > |e|^{(1 \vee \frac{1}{m}) + \frac{m+3}{m}\varepsilon} \mid \bigcap_{g \leq e} \{C_g^{-1} \leq |g|^{\frac{1+\varepsilon}{m}}\} \right) \leq C_{\varepsilon,t} |e|^{-t}.$$

Proof. Using Proposition 5.1 and Markov's inequality gives that, for any $p \in \mathbb{N}$,

$$\mathbf{P} \left(\sum_{g \leq e} C_g^{-1} > |e|^{\left(1 \vee \frac{(1+\varepsilon)^2}{m}\right) + \varepsilon} \mid \bigcap_{g \leq e} \{C_g^{-1} \leq |g|^{\frac{1+\varepsilon}{m}}\} \right) \leq K_{p,\varepsilon} |e|^{-p\varepsilon}. \quad (5.8)$$

This gives the conclusion by choosing $p = \lceil t/\varepsilon \rceil$ and by noting that $\left(1 \vee \frac{(1+\varepsilon)^2}{m}\right) + \varepsilon \leq \left(1 \vee \frac{1}{m}\right) + \frac{m+3}{m}\varepsilon$ □

Next, we will define a quasi-independent percolation on the tree \mathcal{T} . Let us fix $\varepsilon \in (0, 1 \wedge b)$ small enough, such that the following conditions are satisfied

$$(1+\varepsilon) \frac{1+(m+3)\varepsilon}{m} \leq b-2\varepsilon \quad \text{if } bm > 1, \quad (5.9)$$

$$(1+4\varepsilon)(1+\varepsilon) \leq b-2\varepsilon \quad \text{if } b > 1. \quad (5.10)$$

Let us define the percolation such that, for $e \in E$ with $|e| = 1$, e is open almost surely and if $|e| > 1$ then

$$\{e \text{ is open}\} := \left\{ C_e^{-1} \leq |e|^{\frac{1+\varepsilon}{m}} \right\} \cap \left\{ \sum_{g \leq e} C_g^{-1} \leq |e|^{(1 \vee \frac{1}{m}) + \frac{m+3}{m}\varepsilon} \right\}. \quad (5.11)$$

We will denote by \mathcal{T}_C the cluster of open edges containing the root. Let us define the function ψ_C on edges such that $\psi_C(e) = 1$ if $|e| = 1$ and, if $|e| > 1$ and e_0 is the parent of e , that is the unique edge such that $e_0^+ = e^-$, then

$$\psi_C(e) := \mathbf{P}(e \in \mathcal{T}_C | e_0 \in \mathcal{T}_C). \quad (5.12)$$

Proposition 5.3. *The percolation defined by (5.11) is quasi-independent. Moreover, $RT(\mathcal{T}, \psi_C) > 1$ and, with positive \mathbf{P} -probability $br_r(\mathcal{T}_C) \geq b - \varepsilon$.*

Proof. Let us prove that there exists a constant $p_0 > 0$ such that, for any $e \in E$,

$$\mathbf{P}\left(e \in \mathcal{T}_C \mid \bigcap_{g \leq e} \{C_g^{-1} \leq |g|^{\frac{1+\varepsilon}{m}}\}\right) = \mathbf{P}\left(\bigcap_{g \leq e} \{g \in \mathcal{T}_C\} \mid \bigcap_{g \leq e} \{C_g^{-1} \leq |g|^{\frac{1+\varepsilon}{m}}\}\right) \geq p_0. \quad (5.13)$$

Indeed, the conditioning in the above expression is equivalent to picking a sequence of independent conductances $(C_j)_{j \geq 1}$ under a measure $\tilde{\mathbf{P}}$ such that C_j is picked under the conditioned law $\mathbf{P}(\cdot | C_j^{-1} \leq j^{\frac{1+\varepsilon}{m}})$, and looking at the events corresponding to the second event on the right hand side of (5.11), that is

$$A_j = \left\{ \sum_{i \leq j} C_i^{-1} \leq j^{(1 \vee \frac{1}{m}) + \frac{m+3}{m} \varepsilon} \right\}.$$

By Corollary 5.2 (applied with $t = 2$ for instance) and Borel-Cantelli Lemma, there exists $k \in \mathbb{N}$ (deterministic) such that $\tilde{\mathbf{P}}(\cap_{n \geq k} A_n) > 0$. Now, if one replaces C_j by $\tilde{C}_j = \max(C_j, 1)$ for $1 \leq j \leq k$, and let \tilde{A}_n be the the same event as A_n but where C_j is replaced by \tilde{C}_j , then $\tilde{A}_1, \dots, \tilde{A}_k$ always happen and $\tilde{\mathbf{P}}(\cap_{n \geq 1} \tilde{A}_n) \geq \tilde{\mathbf{P}}(\cap_{n \geq k} A_n) > 0$. Finally, we can choose

$$p_0 = \tilde{\mathbf{P}}(\cap_{n \geq 1} \tilde{A}_n) = \tilde{\mathbf{P}}(\cap_{n \geq 1} \tilde{A}_n) \times \tilde{\mathbf{P}}(\cap_{1 \leq j \leq k} \{C_j \geq 1\}) > 0,$$

which proves the claim (5.13).

Let us prove that the percolation is quasi-independent. Let $e_1, e_2 \in E$ and let e be their

common ancestor with highest generation. We have that

$$\begin{aligned}
& \mathbf{P} \left(e_1, e_2 \in \mathcal{T}_C \mid e \in \mathcal{T}_C \right) = \frac{\mathbf{P} (e_1, e_2 \in \mathcal{T}_C)}{\mathbf{P} (e \in \mathcal{T}_C)} \\
&= \prod_{e < g \leq e_1 \text{ or } e < g \leq e_2} \mathbf{P} \left(C_g^{-1} \leq |g|^{\frac{1+\varepsilon}{m}} \right) \frac{\mathbf{P} \left(e_1, e_2 \in \mathcal{T}_C \mid \bigcap_{g \leq e_1, e_2} \left\{ C_g^{-1} \leq |g|^{\frac{1+\varepsilon}{m}} \right\} \right)}{\mathbf{P} \left(e \in \mathcal{T}_C \mid \bigcap_{g \leq e} \left\{ C_g^{-1} \leq |g|^{\frac{1+\varepsilon}{m}} \right\} \right)} \\
&\leq \frac{1}{p_0} \times \prod_{e < g \leq e_1 \text{ or } e < g \leq e_2} \mathbf{P} \left(C_g^{-1} \leq |g|^{\frac{1+\varepsilon}{m}} \right) \\
&= \frac{1}{p_0} \times \frac{\prod_{g \leq e_1} \mathbf{P} \left(C_g^{-1} \leq |g|^{\frac{1+\varepsilon}{m}} \right)}{\prod_{g \leq e} \mathbf{P} \left(C_g^{-1} \leq |g|^{\frac{1+\varepsilon}{m}} \right)} \times \frac{\prod_{g \leq e_2} \mathbf{P} \left(C_g^{-1} \leq |g|^{\frac{1+\varepsilon}{m}} \right)}{\prod_{g \leq e} \mathbf{P} \left(C_g^{-1} \leq |g|^{\frac{1+\varepsilon}{m}} \right)} \tag{5.14} \\
&\leq \frac{1}{p_0^3} \times \frac{\prod_{g \leq e_1} \mathbf{P} \left(C_g^{-1} \leq |g|^{\frac{1+\varepsilon}{m}} \right)}{\prod_{g \leq e} \mathbf{P} \left(C_g^{-1} \leq |g|^{\frac{1+\varepsilon}{m}} \right)} \times \frac{\prod_{g \leq e_2} \mathbf{P} \left(C_g^{-1} \leq |g|^{\frac{1+\varepsilon}{m}} \right)}{\prod_{g \leq e} \mathbf{P} \left(C_g^{-1} \leq |g|^{\frac{1+\varepsilon}{m}} \right)} \\
&\quad \times \frac{\mathbf{P} \left(e_1 \in \mathcal{T}_C \mid \bigcap_{g \leq e_1} \left\{ C_g^{-1} \leq |g|^{\frac{1+\varepsilon}{m}} \right\} \right)}{\mathbf{P} \left(e \in \mathcal{T}_C \mid \bigcap_{g \leq e} \left\{ C_g^{-1} \leq |g|^{\frac{1+\varepsilon}{m}} \right\} \right)^2} \mathbf{P} \left(e_2 \in \mathcal{T}_C \mid \bigcap_{g \leq e_2} \left\{ C_g^{-1} \leq |g|^{\frac{1+\varepsilon}{m}} \right\} \right) \\
&= \frac{1}{p_0^3} \mathbf{P} \left(e_1 \in \mathcal{T}_C \mid e \in \mathcal{T}_C \right) \times \mathbf{P} \left(e_2 \in \mathcal{T}_C \mid e \in \mathcal{T}_C \right),
\end{aligned}$$

where the first equality simply uses the definition of conditional probability, the second uses (5.13) and bounds the probability in the numerator by 1, the third is a simple re-writing, the fourth uses again (5.13) and bounds the probability in the denominator by 1 and, finally, the fifth one is just using the definition of conditional probability.

This proves that the percolation is quasi-independent.

Let e be a generic edge with $|e| > 1$, and denote by e_0 its parent. Using (5.13), (5.11)

and again Corollary 5.2, we have that, there exists $c_0 > 0$ such that

$$\begin{aligned}
 \mathbf{P}\left(e \notin \mathcal{T}_C \mid C_e^{-1} \leq |e|^{\frac{1+\varepsilon}{m}}, e_0 \in \mathcal{T}_C\right) &= \frac{\mathbf{P}\left(e \notin \mathcal{T}_C, C_e^{-1} \leq |e|^{\frac{1+\varepsilon}{m}}, e_0 \in \mathcal{T}_C\right)}{\mathbf{P}\left(C_e^{-1} \leq |e|^{\frac{1+\varepsilon}{m}}, e_0 \in \mathcal{T}_C\right)} \\
 &= \frac{\mathbf{P}\left(e \notin \mathcal{T}_C, C_e^{-1} \leq |e|^{\frac{1+\varepsilon}{m}}, e_0 \in \mathcal{T}_C\right)}{\mathbf{P}(e_0 \in \mathcal{T}_C) \mathbf{P}\left(C_e^{-1} \leq |e|^{\frac{1+\varepsilon}{m}}\right)} \\
 &= \frac{\mathbf{P}\left(e \notin \mathcal{T}_C, C_e^{-1} \leq |e|^{\frac{1+\varepsilon}{m}}, e_0 \in \mathcal{T}_C\right)}{\mathbf{P}(e_0 \in \mathcal{T}_C) \mathbf{P}\left(\bigcap_{g \leq e} \left\{C_g^{-1} \leq |g|^{\frac{1+\varepsilon}{m}}\right\}\right)} \mathbf{P}\left(\bigcap_{g \leq e_0} \left\{C_g^{-1} \leq |g|^{\frac{1+\varepsilon}{m}}\right\}\right) \quad (5.15) \\
 &\leq \frac{\mathbf{P}\left(e \notin \mathcal{T}_C, C_e^{-1} \leq |e|^{\frac{1+\varepsilon}{m}}, \bigcap_{g \leq e_0} \left\{C_g^{-1} \leq |g|^{\frac{1+\varepsilon}{m}}\right\}\right)}{\mathbf{P}\left(\bigcap_{g \leq e} \left\{C_g^{-1} \leq |g|^{\frac{1+\varepsilon}{m}}\right\}\right)} \frac{\mathbf{P}\left(\bigcap_{g \leq e_0} \left\{C_g^{-1} \leq |g|^{\frac{1+\varepsilon}{m}}\right\}\right)}{\mathbf{P}(e_0 \in \mathcal{T}_C)} \\
 &\leq \frac{\mathbf{P}\left(e \notin \mathcal{T}_C \mid \bigcap_{g \leq e} \left\{C_g^{-1} \leq |g|^{\frac{1+\varepsilon}{m}}\right\}\right)}{\mathbf{P}\left(e_0 \in \mathcal{T}_C \mid \bigcap_{g \leq e_0} \left\{C_g^{-1} \leq |g|^{\frac{1+\varepsilon}{m}}\right\}\right)} \leq \frac{c_0}{|e|^{1+\varepsilon}}.
 \end{aligned}$$

Thus, we obtain that

$$\begin{aligned}
 1 - \psi_C(e) &= \mathbf{P}(e \notin \mathcal{T}_C \mid e_0 \in \mathcal{T}_C) \\
 &\leq \mathbf{P}\left(C_e^{-1} > |e|^{\frac{1+\varepsilon}{m}}\right) + \mathbf{P}\left(e \notin \mathcal{T}_C \mid C_e^{-1} \leq |e|^{\frac{1+\varepsilon}{m}}, e_0 \in \mathcal{T}_C\right) \quad (5.16) \\
 &\leq \frac{c_0 + L|e|^{\frac{1+\varepsilon}{m}}}{|e|^{1+\varepsilon}}.
 \end{aligned}$$

Therefore, there exists $n_0 > 1$ such that, for any $e \in E$ with $|e| > n_0$, we have that

$$\psi_C(e) \geq 1 - \frac{\varepsilon}{2}|e|^{-1}.$$

By Proposition 4.4, as the percolation defined by (5.11) is quasi-independent and $\varepsilon < b$, we have that $br_r(\mathcal{T}_C) \geq b - \varepsilon$ with positive probability. \square

Let us consider different cases and prove that $RT(\mathcal{T}, \psi_{RC}) > 1$, where we refer to (5.1) for a definition of this quantity.

Proposition 5.4. *If $m \in (0, 1)$ and $bm > 1$ then $RT(\mathcal{T}, \psi_{RC}) > 1$ with positive P -probability.*

Proof. Recall the percolation \mathcal{T}_C defined in (5.11). Let us denote Π_C the set of all the cutsets in \mathcal{T}_C . By Proposition 5.3, we have that $br_r(\mathcal{T}_C) \geq b - \varepsilon$ with positive

\mathbf{P} -probability. On this event, we have that

$$\begin{aligned} \inf_{\pi \in \Pi} \sum_{e \in \pi} \left(\frac{1}{\sum_{i \leq e} C_i^{-1}} \right)^{1+\varepsilon} &\geq \inf_{\pi \in \Pi_C} \sum_{e \in \pi} \left(\frac{1}{\sum_{g \leq e} C_g^{-1}} \right)^{1+\varepsilon} \\ &\geq \inf_{\pi \in \Pi_C} \sum_{e \in \pi} \left(|e|^{-\frac{1}{m} - \frac{m+3}{m}\varepsilon} \right)^{1+\varepsilon} \\ &\geq \inf_{\pi \in \Pi_C} \sum_{e \in \pi} |e|^{-(b-2\varepsilon)} > 0, \end{aligned} \quad (5.17)$$

where we used (5.9). This implies that $RT(\mathcal{T}, \psi_{RC}) > 1$ with positive \mathbf{P} -probability, as defined in (5.1). \square

Proposition 5.5. *If $m \geq 1$ and if $b > 1$ then $RT(\mathcal{T}, \psi_{RC}) > 1$ with positive \mathbf{P} -probability.*

Proof. Recall the percolation \mathcal{T}_C defined in (5.11). By Proposition 5.3, we have that $br_r(\mathcal{T}_C) \geq b - \varepsilon$ with positive probability. Let us denote Π_C the set of all the cutsets in \mathcal{T}_C . On this event, we have that, if $b > 1$,

$$\begin{aligned} \inf_{\pi \in \Pi} \sum_{e \in \pi} \left(\frac{1}{\sum_{i \leq e} C_i^{-1}} \right)^{1+\varepsilon} &\geq \inf_{\pi \in \Pi_C} \sum_{e \in \pi} \left(\frac{1}{\sum_{g \leq e} C_g^{-1}} \right)^{1+\varepsilon} \\ &\geq \inf_{\pi \in \Pi_C} \sum_{e \in \pi} \left(|e|^{-1-4\varepsilon} \right)^{1+\varepsilon} \\ &\geq \inf_{\pi \in \Pi_C} \sum_{e \in \pi} |e|^{-(b-2\varepsilon)} > 0, \end{aligned} \quad (5.18)$$

where we used (5.10). This implies that $RT(\mathcal{T}, \psi_{RC}) > 1$ with positive \mathbf{P} -probability, as defined in (5.1). \square

5.2 Recurrence: proof of the second item of Proposition 3.1

We will again consider different cases and prove this time that $RT(\mathcal{T}, \psi_{RC}) < 1$, where we refer to (5.1) for a definition of this quantity.

Proposition 5.6. *If $b \geq 1$ and $bm < 1$ then $RT(\mathcal{T}, \psi_{RC}) < 1$, \mathbf{P} -almost surely.*

Proof. Fix two positive parameters δ and ε such that $(1/m) - \delta > 0$ and

$$\left(\frac{1}{m} - \delta \right) (1 - \varepsilon) \geq b + \delta. \quad (5.19)$$

The latter is possible as $mb < 1$.

We have that

$$\begin{aligned} \mathbb{P} \left(\sum_{i \leq e} C_i^{-1} \leq |e|^{\frac{1}{m}-\delta} \right) &\leq \mathbb{P} \left(\bigcap_{i \leq e} C_i^{-1} \leq |e|^{\frac{1}{m}-\delta} \right) \\ &= \left(1 - \frac{L \left(|e|^{\frac{1}{m}-\delta} \right)}{|e|^{(\frac{1}{m}-\delta)m}} \right)^{|e|} \leq \exp \left\{ -|e|^{\delta m} L \left(|e|^{\frac{1}{m}-\delta} \right) \right\}. \end{aligned} \quad (5.20)$$

By the definition of branching-ruin number, there exists a sequence of cutsets $(\pi_n, n \geq 1)$ such that for any $n > 0$,

$$\sum_{e \in \pi_n} \frac{1}{|e|^{b+\delta}} < \exp\{-n\}. \quad (5.21)$$

On the other hand, for any $n > 0$ we have,

$$\begin{aligned} \mathbb{P} \left(\bigcup_{e \in \pi_n} \left\{ \sum_{i \leq e} C_i^{-1} \leq |e|^{\frac{1}{m}-\delta} \right\} \right) &\leq \sum_{e \in \pi_n} \mathbb{P} \left(\sum_{i \leq e} C_i^{-1} \leq |e|^{\frac{1}{m}-\delta} \right) \\ &\leq \sum_{e \in \pi_n} \exp \left\{ -|e|^{\delta m} L \left(|e|^{\frac{1}{m}-\delta} \right) \right\}. \end{aligned} \quad (5.22)$$

Note that there exists n_0 such that for any $n > n_0$, we have,

$$\sum_{e \in \pi_n} \exp \left\{ -|e|^{\delta m} L \left(|e|^{\frac{1}{m}-\delta} \right) \right\} \leq \sum_{e \in \pi_n} \frac{1}{|e|^{b+\delta}} < \exp\{-n\}$$

Therefore, we have that

$$\sum_{n \geq 1} \mathbb{P} \left(\bigcup_{e \in \pi_n} \left\{ \sum_{i \leq e} C_i^{-1} \leq |e|^{\frac{1}{m}-\delta} \right\} \right) < \infty.$$

In virtue of the first Borel Cantelli Lemma, all edges $e \in \bigcup_{n \geq 1} \pi_n$, with the exception of finitely many, satisfy

$$\sum_{i \leq e} C_i^{-1} > |e|^{\frac{1}{m}-\delta}. \quad (5.23)$$

Hence, for n large enough

$$\sum_{e \in \pi_n} \frac{1}{(\sum_{i \leq e} C_i^{-1})^{(1-\varepsilon)}} \leq \sum_{e \in \pi_n} \frac{1}{|e|^{(\frac{1}{m}-\delta)(1-\varepsilon)}} \leq \sum_{e \in \pi_n} \frac{1}{|e|^{b+\delta}} < \exp\{-n\}. \quad (5.24)$$

where we used (5.19). Hence,

$$\lim_{n \rightarrow \infty} \sum_{e \in \pi_n} \frac{1}{(\sum_{i \leq e} C_i^{-1})^{(1-\varepsilon)}} = 0. \quad (5.25)$$

Therefore, we have that

$$0 \leq \inf_{\pi \in \Pi} \sum_{e \in \pi} \left(\frac{1}{\sum_{i \leq e} C_i^{-1}} \right)^{1-\varepsilon} \leq \inf_{n \geq 1} \sum_{e \in \pi_n} \left(\frac{1}{\sum_{i \leq e} C_i^{-1}} \right)^{1-\varepsilon} = 0. \quad (5.26)$$

Hence $RT(\mathcal{T}, \psi_{RC}) \leq 1 - \varepsilon$. \square

The next result concludes the proof of Theorem 1.1.

Proposition 5.7. *If $b < 1$ then $RT(\mathcal{T}, \psi_{RC}) < 1$, \mathbf{P} -almost surely.*

Proof. First, fix $\delta \in (0, 1)$ such that

$$(1 - \delta)^2 > b + \delta. \quad (5.27)$$

The latter is possible as $b < 1$. Then, note that, for any $\varepsilon \in (0, 1)$, there exists $\eta > 0$ such that

$$\mathbb{P}(C_0^{-1} > \eta) > 1 - \varepsilon. \quad (5.28)$$

In the following, we denote $(C_j)_{j \geq 0}$ a sequence conductances distributed like a generic conductance C_e . There exists a constant $c_{\delta, \varepsilon} > 0$ such that, for any $e \in E$,

$$\begin{aligned} \mathbb{P} \left(\sum_{i \leq |e|} C_i^{-1} \leq \eta |e|^{1-\delta} \right) &\leq \mathbb{P} \left(\bigcup_{k=1}^{\lfloor |e|/\lfloor |e|^\delta \rfloor} \bigcap_{j=(k-1)\lfloor |e|^\delta \rfloor + 1}^{k\lfloor |e|^\delta \rfloor} \{C_j^{-1} \leq \eta\} \right) \\ &\leq \frac{2}{1-\varepsilon} |e|^{1-\delta} \mathbb{P}(C_0^{-1} \leq \eta)^{|e|^\delta} \\ &\leq \frac{2}{1-\varepsilon} |e|^{1-\delta} \varepsilon^{|e|^\delta} \\ &\leq c_{\delta, \varepsilon} |e|^{-b-\delta}. \end{aligned} \quad (5.29)$$

Indeed, to prove the first inequality above, note that

$$\begin{aligned} \left\{ \bigcup_{k=1}^{\lfloor |e|/\lfloor |e|^\delta \rfloor} \bigcap_{j=(k-1)\lfloor |e|^\delta \rfloor + 1}^{k\lfloor |e|^\delta \rfloor} \{C_j^{-1} \leq \eta\} \right\}^c &= \bigcap_{k=1}^{\lfloor |e|/\lfloor |e|^\delta \rfloor} \bigcup_{j=(k-1)\lfloor |e|^\delta \rfloor + 1}^{k\lfloor |e|^\delta \rfloor} \{C_j^{-1} > \eta\} \\ &\subset \left\{ \sum_{i \leq |e|} C_i^{-1} > \eta |e|^{1-\delta} \right\} = \left\{ \sum_{i \leq |e|} C_i^{-1} \leq \eta |e|^{1-\delta} \right\}^c. \end{aligned} \quad (5.30)$$

By the definition of branching-ruin number, there exists a sequence of cutsets $(\pi_n, n \geq 1)$ such that for any $n > 0$,

$$\sum_{e \in \pi_n} \frac{1}{|e|^{b+\delta}} < \frac{1}{c_{\delta, \varepsilon}} \exp\{-n\}. \quad (5.31)$$

We use (5.29) and (5.31) to obtain

$$\mathbb{P} \left(\bigcup_{e \in \pi_n} \left\{ \sum_{g \leq e} C_g^{-1} \leq \eta |e|^{1-\delta} \right\} \right) \leq c_{\delta, \varepsilon} \sum_{e \in \pi_n} |e|^{-b-\delta} \leq \exp(-n). \quad (5.32)$$

Therefore, by Borel-Cantelli Lemma, as soon as n is large enough, we have that

$$\bigcap_{e \in \pi_n} \left\{ \sum_{i \leq e} C_i^{-1} > \eta |e|^{1-\delta} \right\}$$

holds, which implies that

$$\sum_{e \in \pi_n} \frac{1}{(\sum_{i \leq e} C_i^{-1})^{(1-\delta)}} \leq \frac{1}{\eta^{1-\delta}} \sum_{e \in \pi_n} \frac{1}{|e|^{(1-\delta)(1-\delta)}} \leq \frac{1}{\eta^{1-\delta}} \sum_{e \in \pi_n} \frac{1}{|e|^{b+\delta}} < \frac{\exp\{-n\}}{c_{\delta, \varepsilon} \eta^{1-\delta}}, \quad (5.33)$$

where we used (5.27). Hence, following a strategy similar to (5.25), (5.26), we have that $RT(\mathcal{T}, \psi_{RC}) \leq 1 - \delta$, \mathbf{P} -almost surely. \square

6 Proof of Theorem 3.3 and Lemma 3.6

In this section, we prove Lemma 3.6. With this in hand, Theorem 1.2 and Theorem 3.3 will then trivially follow from Theorem 3.5 (proved in Section 8) by noting that (3.4) is satisfied when $m_\nu = M \in \mathbb{N}$ for all $\nu \in V \setminus \{\varrho\}$.

For any $e \in E$, we define

$$\Psi_{M, \lambda}(e) := \prod_{g \leq e} \psi_{M, \lambda}(g). \quad (6.1)$$

As we will see in Section 7, $\Psi_{M, \lambda}(e)$ corresponds to the probability that \mathbf{X} , or $\tilde{\mathbf{X}}$, when restricted to $[\varrho, e^+]$ and started from ϱ , hits e^+ before returning to ϱ .

Proof of Lemma 3.6. Here, we assume that $(m_\nu; \nu \in V)$ such that $m_\varrho = 0$ and $m_\nu = M \in \mathbb{N}$ for all $\nu \in V \setminus \{\varrho\}$. Thus, by (3.1) and (3.3), we have that, if $\lambda \neq 1$,

$$\Psi_{M, \lambda}(e) = \left(\frac{\lambda - 1}{\lambda |e| - 1} \right)^{M+1}, \quad (6.2)$$

and, if $\lambda = 1$,

$$\Psi_{M, \lambda}(e) = |e|^{-M-1}. \quad (6.3)$$

We will proceed by distinguishing a few cases.

Case I: if $\lambda > 1$ and $br(\mathcal{T}) < \lambda^{M+1}$.

By (2.1), there exists $\delta \in (0, 1)$ such that

$$\inf_{\pi \in \Pi} \sum_{e \in \Pi} \left(\lambda^{(M+1)(1-\delta)} \right)^{-|e|} = 0. \quad (6.4)$$

For any $\pi \in \Pi$, we have that

$$\begin{aligned} \sum_{e \in \pi} \Psi_{M,\lambda}(e)^{1-\delta} &= (\lambda - 1)^{(M+1)(1-\delta)} \sum_{e \in \pi} \left(\frac{1}{\lambda^{|e|} - 1} \right)^{(M+1)(1-\delta)} \\ &= (\lambda - 1)^{(M+1)(1-\delta)} \sum_{e \in \pi} \frac{\lambda^{-|e|(M+1)(1-\delta)}}{(1 - \lambda^{-|e|})^{(M+1)(1-\delta)}} \\ &\leq \frac{(\lambda - 1)^{(M+1)(1-\delta)}}{(1 - \lambda^{-1})^{(M+1)(1-\delta)}} \sum_{e \in \pi} \lambda^{-|e|(M+1)(1-\delta)}. \end{aligned} \quad (6.5)$$

Therefore, by (6.4),

$$\inf_{\pi \in \Pi} \sum_{e \in \pi} \Psi_{M,\lambda}(e)^{1-\delta} = 0, \quad (6.6)$$

which implies that $RT(\mathcal{T}, \psi_{M,\lambda}) < 1$.

Case II: if $\lambda < 1$ or if $\lambda > 1$ and $br(\mathcal{T}) > \lambda^{M+1}$.

Next, we prove that there exists $\delta > 0$ and $\varepsilon > 0$ such that

$$\inf_{\pi \in \Pi} \sum_{e \in \pi} \left(\lambda^{(M+1)(1+\delta)} \right)^{-|e|} > \varepsilon. \quad (6.7)$$

To prove the previous inequality, first note that this holds trivially if $\lambda < 1$; second, if $\lambda > 1$, we use the definition of the branching number and choose δ such that $\lambda^{(1+\delta)(M+1)} < br(\mathcal{T})$. A computation similar to (6.5) yields

$$\begin{aligned} \inf_{\pi \in \Pi} \sum_{e \in \pi} \Psi_{M,\lambda}(e)^{1+\delta} &\geq (\lambda - 1)^{(M+1)(1+\delta)} \inf_{\pi \in \Pi} \sum_{e \in \pi} \lambda^{-|e|(M+1)(1+\delta)} \\ &> \varepsilon. \end{aligned} \quad (6.8)$$

Therefore, we have that $RT(\mathcal{T}, \psi_{M,\lambda}) > 1$.

Case III: $br_r(\mathcal{T}) > M + 1$ and $\lambda = 1$.

By (2.2), we have that there exists $\delta > 0$ and $\varepsilon > 0$ such that

$$\inf_{\pi \in \Pi} \sum_{e \in \pi} |e|^{-(1+\delta)(M+1)} > \varepsilon. \quad (6.9)$$

Therefore, by (6.3), we have that

$$\inf_{\pi \in \Pi} \sum_{e \in \pi} (\Psi_{M,\lambda}(e))^{1+\delta} = \inf_{\pi \in \Pi} \sum_{e \in \pi} |e|^{-(1+\delta)(M+1)} > \varepsilon, \quad (6.10)$$

which in turn implies that $RT(\mathcal{T}, \psi_{M,\lambda}) > 1$.

Case IV: $br_r(\mathcal{T}) < M + 1$ and $\lambda = 1$.

We have that there exists $\delta > 0$ such that

$$\inf_{\pi \in \Pi} \sum_{e \in \pi} |e|^{-(1-\delta)(M+1)} = 0. \quad (6.11)$$

Therefore, by (6.3), we have that

$$\inf_{\pi \in \Pi} \sum_{e \in \pi} (\Psi_{M,\lambda}(e))^{1-\delta} = \inf_{\pi \in \Pi} \sum_{e \in \pi} |e|^{-(1-\delta)(M+1)} = 0. \quad (6.12)$$

Therefore, we have that $RT(\mathcal{T}, \psi_{M,\lambda}) < 1$.

Case V: $br(\mathcal{T}) > \lambda^{M+1}$ and $\lambda = 1$.

Let us prove that $br(\mathcal{T}) > 1$ implies that $br_r(\mathcal{T}) = \infty$, which gives the conclusion by Case III. We have that there exists $\delta > 0$ and $\varepsilon > 0$ such that

$$\inf_{\pi \in \Pi} \sum_{e \in \pi} (1 + \delta)^{-|e|} > \varepsilon. \quad (6.13)$$

Therefore, for any $\gamma > 0$, there exists a constant $c_0 > 0$ depending only on γ , δ and ε , such that

$$\sum_{e \in \pi} |e|^{-\gamma} \geq c_0 \sum_{e \in \pi} (1 + \delta)^{-|e|} > c_0 \varepsilon. \quad (6.14)$$

Taking the infimum over $\pi \in \Pi$ allows to conclude that $br_r(\mathcal{T}) \geq \gamma$, for any $\gamma > 0$, hence $br_r(\mathcal{T}) = \infty$. \square

7 Extensions

Here, we define the same construction as in [31] and [33], which is a particular case of Rubin's construction. A large part of this section is a verbatim of Section 5 of [33].

The following construction will allow us to emphasize useful independence properties of the walk on disjoint subsets of the tree.

Let $(\Omega, \mathcal{F}, \mathbf{P})$ denote a probability space on which

$$\mathbf{Y} = (Y(\nu, \mu, k) : (\nu, \mu) \in V^2, \text{ with } \nu \sim \mu, \text{ and } k \in \mathbb{N}) \quad (7.1)$$

is a family of independent random variables, where (ν, μ) denotes an *ordered* pair of vertices, and such that

- if $\nu = \mu^{-1}$ and $k = 0$, then $Y(\nu, \mu, 0)$ a Gamma random variable with parameters $m_\mu + 1$ and 1;
- otherwise, $Y(\nu, \mu, k)$ is an exponential random variable with mean 1.

Remark 7.1. Recall that a Gamma random variable with parameters $m_\mu + 1$ and 1 has the same distribution as the sum of $m_\mu + 1$ i.i.d. exponential random variables with mean 1.

Below, we use these collections of random variables to generate the steps of $\tilde{\mathbf{X}}$. Moreover, we define a *family* of coupled walks using the same collection of ‘clocks’ \mathbf{Y} .

Define, for any $\nu, \mu \in V$ with $\nu \sim \mu$, the quantities

$$r(\nu, \mu) := \lambda^{-|\nu| + |\mu| + 1} \quad (7.2)$$

We are now going to define a family of coupled processes on the subtrees of \mathcal{T} . For any rooted subtree \mathcal{T}' of \mathcal{T} , we define the *extension* $\tilde{\mathbf{X}}^{(\mathcal{T}')} = (V', E')$ on \mathcal{T}' as follows. Let the root ϱ' of \mathcal{T}' be defined as the vertex of V' with smallest distance to ϱ . For a collection of nonnegative integers $\bar{k} = (k_\mu)_{\mu: [\nu, \mu] \in E'}$, let

$$A_{\bar{k}, n, \nu}^{(\mathcal{T}')} = \{\tilde{X}_n^{(\mathcal{T}')} = \nu\} \cap \bigcap_{\mu: [\nu, \mu] \in E'} \{\#\{1 \leq j \leq n: (\tilde{X}_{j-1}^{(\mathcal{T}'), \tilde{X}_j^{(\mathcal{T}')} = (\nu, \mu)\} = k_\mu\}.$$

Note that the event $A_{\bar{k}, n, \nu}^{(\mathcal{T}')}$ deals with jumps along oriented edges.

Set $\tilde{X}_0^{(\mathcal{T}')} = \varrho'$ and, for ν, ν' such that $[\nu, \nu'] \in E'$ and for $n \geq 0$, on the event

$$A_{\bar{k}, n, \nu}^{(\mathcal{T}')} \cap \left\{ \nu' = \arg \min_{\mu: [\nu, \mu] \in E'} \left\{ \sum_{i=0}^{k_\mu} \frac{Y(\nu, \mu, i)}{r(\nu, \mu)} \right\} \right\}, \quad (7.3)$$

we set $\tilde{X}_{n+1}^{(\mathcal{T}')} = \nu'$, where the function r is defined in (7.2) and the clocks Y 's are from the same collection \mathbf{Y} fixed in (7.1).

Thus, this defines $\tilde{\mathbf{X}}^{(\mathcal{T})}$ as the extension on the whole tree. It is easy to check, from properties of independent exponential and Gamma random variables, the memoryless property and Remark 7.1, that this provides a construction of $\tilde{\mathbf{X}}$ on the tree \mathcal{T} .

This continuous-time embedding is classical: it is called *Rubin's construction*, after Herman Rubin (see the Appendix in [34]).

Now, if we consider proper subtrees \mathcal{T}' of \mathcal{T} , one can check that, with these definitions, the steps of $\tilde{\mathbf{X}}$ on the subtree \mathcal{T}' are given by the steps of $\tilde{\mathbf{X}}^{(\mathcal{T}')}$ (see [31] for details). As it was noticed in [31], for two subtrees \mathcal{T}' and \mathcal{T}'' whose edge sets are disjoint, the extensions $\tilde{\mathbf{X}}^{(\mathcal{T}'')}$ and $\tilde{\mathbf{X}}^{(\mathcal{T}'')}$ are independent as they are defined by two disjoint sub-collections of \mathbf{Y} .

Of particular interest will be the case where $\mathcal{T}' = [\varrho, \nu]$ is the unique self-avoiding path connecting ϱ to ν , for some $\nu \in \mathcal{T}$. In this case, we write $\tilde{\mathbf{X}}^{(\nu)}$ instead of $\tilde{\mathbf{X}}^{([\varrho, \nu])}$, and we

denote $T^{(\nu)}(\cdot)$ the return times associated to $\tilde{\mathbf{X}}^{(\nu)}$. For simplicity, we will also write $\tilde{\mathbf{X}}^{(e)}$ and $T^{(e)}(\cdot)$ instead of $\tilde{\mathbf{X}}^{(e^+)}$ and $T^{(e^+)}(\cdot)$ for $e \in E$. Finally, it should be noted that, for any $e \in E$ and any $g \leq e$,

$$\psi_{M,\lambda}(g) = \mathbf{P} \left(T^{(e)}(g^+) \circ \theta_{T^{(e)}(g^-)} < T^{(e)}(\varrho) \circ \theta_{T^{(e)}(g^-)} \right), \quad (7.4)$$

$$\Psi_{M,\lambda}(e) = \mathbf{P} \left(T^{(e)}(e^+) < T^{(e)}(\varrho) \right), \quad (7.5)$$

where θ is the canonical shift on the trajectories.

Remark 7.2. Note that, for any vertex ν , only the clocks $Y(\nu, \mu, 0)$ with $\mu \sim \nu$, $\nu < \mu$, have a particular law. They follow a Gamma distribution instead of following an Exponential distribution. This resembles what would happen for a once-reinforced random walk (see [33]). In this case, these clocks would still have an Exponential distribution but with a different parameter than the other ones (related to the reinforcement). This means that an M -DRW $_{\lambda}$ is, in nature, very close to a once-reinforced random walk.

8 Proof of Theorem 3.5

In this section, we follow the blueprint of Section 7 of [33]. In order to prove transience, the idea is to interpret the set of edges crossed before returning to ϱ as the open edges in a certain correlated percolation.

A key step is to prove that this correlated percolation is emph quasi-independent, which will allow us to conclude its super-criticality from the super-criticality of some independent percolation.

Note that we will prove the transience of $\tilde{\mathbf{X}}$ which is equivalent to the transience of \mathbf{X} .

8.1 Link with percolation

Denote by $\mathcal{C}(\varrho)$ the set of edges which are crossed by $\tilde{\mathbf{X}}$ before returning to ϱ , that is:

$$\mathcal{C}(\varrho) = \{e \in E : T^{(e^+)} < T(\varrho)\}. \quad (8.1)$$

This set can be seen as the cluster containing ϱ in some correlated percolation. Next, we consider a different correlated percolation which will be more convenient to us. Recall Rubin's construction and the extensions introduced in Section 7. We define:

$$\mathcal{C}_{CP}(\varrho) = \{e \in E : T^{(e)}(e^+) < T^{(e)}(\varrho)\}. \quad (8.2)$$

This defines a correlated percolation in which an edge $e \in E$ is open if $e \in \mathcal{C}_{CP}(\varrho)$.

Lemma 8.1. *We have that*

$$\mathbb{P}(T(\varrho) = \infty) = \mathbb{P}(|\mathcal{C}(\varrho)| = \infty) = \mathbb{P}(|\mathcal{C}_{CP}(\varrho)| = \infty). \quad (8.3)$$

Proof. We can follow line by line the proof of Lemma 11 in [33], except that one should replace \mathbf{X} by $\tilde{\mathbf{X}}$. \square

8.2 Recurrence in Theorem 3.5: The case $RT(\mathcal{T}, \psi_{M,\lambda}) < 1$

The following result states the recurrence in Theorem 3.5.

Proposition 8.2 (Proof of recurrence in Theorem 3.5: the case $RT(\mathcal{T}, \psi_{M,\lambda}) < 1$). *If $RT(\mathcal{T}, \psi_{M,\lambda}) < 1$ then \mathbf{X} is recurrent.*

Proof. This follows directly from Lemma 8.1 and Proposition 4.2. \square

8.3 Transience in Theorem 3.5: The case $RT(\mathcal{T}, \psi_{M,\lambda}) > 1$

Now, we want to prove the transience in Theorem 3.5. For this purpose, we need to check that the assumptions in Proposition 4.2 are satisfied.

For simplicity, for a vertex $v \in V$, we write $v \in \mathcal{C}_{\text{CP}}(\varrho)$ if one of the edges incident to v is in $\mathcal{C}_{\text{CP}}(\varrho)$. Besides, recall that for two edges e_1 and e_2 , their common ancestor with highest generation is the vertex denoted $e_1 \wedge e_2$.

Lemma 8.3. *Assume that the condition (3.4) holds with some constant M . Then the correlated percolation induced by \mathcal{C}_{CP} is quasi-independent, as defined in Definition 4.1.*

Proof. Here, we need to adapt the argument from the proof of Lemma 12 in [33].

Recall the construction of Section 7. Note that if $e_1 \wedge e_2 = \varrho$, then the extensions on $[\varrho, e_1]$ and $[\varrho, e_2]$ are independent, then the conclusion of Lemma holds with $C = 1$.

Assume that $e_1 \wedge e_2 \neq \varrho$, and note that the extensions on $[\varrho, e_1]$ and $[\varrho, e_2]$ are dependent since they use the same clocks on $[\varrho, e_1 \wedge e_2]$. Denote by e the unique edge of \mathcal{T} such that $e^+ = e_1 \wedge e_2$. We define the following quantities

$$\begin{aligned} N(e) &:= \left| \left\{ 0 \leq n \leq T^{(e)}(\varrho) \circ \theta_{T^{(e)}(e^+)} : (\tilde{X}_n^{(e)}, \tilde{X}_{n+1}^{(e)}) = (e^+, e^-) \right\} \right|, \\ L(e) &:= \sum_{j=0}^{N(e)-1} \frac{Y(e^+, e^-, j)}{r(e^+, e^-)}, \end{aligned} \tag{8.4}$$

where $|A|$ denotes the cardinality of a set A and θ is the canonical shift on trajectories. Note that $L(e)$ is the time consumed by the clocks attached to the oriented edge (e^+, e^-) before $\tilde{\mathbf{X}}^{(e)}$, $\tilde{X}^{(e_1)}$ or $\tilde{X}^{(e_2)}$ goes back to ϱ once it has reached e^+ . Recall that these three extensions are coupled and thus the time $L(e)$ is the same for the three of them.

For $i \in \{1, 2\}$, let v_i be the vertex which is the offspring of e^+ lying the path from ϱ to

e_i . Note that v_i could be equal to e_i^+ . We define for $i \in \{1, 2\}$:

$$\begin{aligned} N^*(e_i) &= \left| \left\{ 0 \leq n \leq T^{(e_i)}(e_i^+) : (\tilde{X}_n^{[e^+, e_i^+]}, \tilde{X}_{n+1}^{[e^+, e_i^+]}) = (e^+, v_i) \right\} \right|, \\ L^*(e_i) &= \sum_{j=0}^{N^*(e_i)-1} \frac{Y(e^+, e^-, j)}{r(e^+, e^-)}. \end{aligned} \quad (8.5)$$

Here, $L^*(e_i)$, $i \in \{1, 2\}$, is the time consumed by the clocks attached to the oriented edge (e^+, v_i) before $\tilde{\mathbf{X}}^{(e_i)}$, or $\tilde{\mathbf{X}}^{[e^+, e_i^+]}$, hits e_i^+ .

Notice that the three quantities $L(e)$, $L^*(e_1)$ and $L^*(e_2)$ are independent, and we also have:

$$\{e_1, e_2 \in \mathcal{C}_{CP}(\varrho)\} = \{T^{(e)}(e^+) < T^{(e)}(\varrho)\} \cap \{L(e) > L^*(e_1)\} \cap \{L(e) > L^*(e_2)\}. \quad (8.6)$$

Now, conditioned on the event $\{T^{(e)}(e^+) < T^{(e)}(\varrho)\}$, the random variable $N(e)$ is simply a geometric random variable (counting the number of trials) with success probability $\lambda^{|e|-1} / \sum_{g \leq e} \lambda^{|g|-1}$. The random variable $N(e)$ is independent of the family $Y(e^+, e^-, \cdot)$. As $Y(e^+, e^-, j)$ are independent exponential random variable for $j \geq 0$, we then have that $L(e)$ is an exponential random variables with parameter

$$p := \frac{\lambda^{|e|-1}}{\sum_{g \leq e} \lambda^{|g|-1}} \times \lambda^{-|e|+1} = \frac{1}{\sum_{g \leq e} \lambda^{|g|-1}}. \quad (8.7)$$

A priori, $L^*(e_1)$ and $L^*(e_2)$ are not exponential random variable, but they have a continuous distribution. Denote f_1 and f_2 respectively the densities of $L^*(e_1)$ and $L^*(e_2)$. Then, we have that

$$\begin{aligned} \mathbb{P}(e_1, e_2 \in \mathcal{C}_{CP}(\varrho) | e_1 \wedge e_2 \in \mathcal{C}_{CP}(\varrho)) &= \mathbb{P}(L(e) > L^*(e_1) \vee L^*(e_2)) \\ &= \int_0^{+\infty} \int_0^{+\infty} \int_{x_1 \vee x_2}^{+\infty} p e^{-pt} f_1(x_1) f_2(x_2) dt dx_1 dx_2 \\ &= \int_0^{+\infty} \int_0^{+\infty} e^{-p(x_1 \vee x_2)} f_1(x_1) f_2(x_2) dx_1 dx_2. \\ &\leq \int_0^{+\infty} \int_0^{+\infty} e^{-\frac{p}{2}(x_1+x_2)} f_1(x_1) f_2(x_2) dx_1 dx_2. \end{aligned} \quad (8.8)$$

Thus, one can write

$$\begin{aligned} &\mathbb{P}(e_1, e_2 \in \mathcal{C}_{CP}(\varrho) | e_1 \wedge e_2 \in \mathcal{C}_{CP}(\varrho)) \\ &\leq \left(\int_0^{+\infty} e^{-px_1/2} f_1(x_1) dx_1 \right) \cdot \left(\int_0^{+\infty} e^{-px_2/2} f_2(x_2) dx_2 \right). \end{aligned} \quad (8.9)$$

Note that, for $i \in \{1, 2\}$,

$$\int_0^{+\infty} e^{-px_i/2} f_i(x_i) dx_i = \mathbb{P}\left(\tilde{L}(e) > L^*(e_i)\right), \quad (8.10)$$

where $\tilde{L}(e)$ is an exponential variable with parameter $p/2$. Note that, in view of (8.7), $\tilde{L}(e)$ has the same law as $L(e)$ when we replace the weight of an edge g' by $\lambda^{-|g'|+1}/2$ for $g' \leq e$ only, and keep the other weights the same.

For $g \in E$ such that $e < g$, define the function $\tilde{\psi}$ in a similar way as ψ , except that we replace the weight of an edge g' by $\lambda^{-|g'|+1}/2$ for $g' \leq e$ only, and keep the other weights the same, that is, for $g \in E$, $e < g$,

$$\tilde{\psi}_{M,\lambda}(g) = \left(\frac{2p^{-1} + \sum_{v:e < g' < g} \lambda^{|g'|-1}}{2p^{-1} + \sum_{v:e < g' \leq g} \lambda^{|g'|-1}} \right)^{m_g+1}$$

We obtain:

$$\begin{aligned} \mathbb{P}(\tilde{L}(e) > L^*(e_1)) &= \prod_{g:e < g \leq e_1} \tilde{\psi}(g) = \prod_{g:e < g \leq e_1} \left(\frac{2p^{-1} + \sum_{g':e < g' < g} \lambda^{|g'|-1}}{2p^{-1} + \sum_{g':e < g' \leq g} \lambda^{|g'|-1}} \right)^{m_g+1} \\ &= \mathbb{P}(L(e) > L^*(e_1)) \times \prod_{g:e < g \leq e_1} \left(1 + \frac{p^{-1}}{p^{-1} + \sum_{g':e < g' < g} \lambda^{|g'|-1}} \right)^{m_g+1} \\ &\quad \times \left(1 - \frac{p^{-1}}{2p^{-1} + \sum_{g':e < g' \leq g} \lambda^{|g'|-1}} \right)^{m_g+1} \\ &= \mathbb{P}(L(e) > L^*(e_1)) \\ &\quad \times \prod_{g:e < g \leq e_1} \left(1 + \frac{p^{-1} \lambda^{|g|-1}}{\left(p^{-1} + \sum_{g':e < g' < g} \lambda^{|g'|-1} \right) \left(2p^{-1} + \sum_{g':e < g' \leq g} \lambda^{|g'|-1} \right)} \right)^{m_g+1} \end{aligned} \quad (8.11)$$

Hence,

$$\begin{aligned}
& \mathbb{P}(\tilde{L}(e) > L^*(e_1)) \\
& \leq \mathbb{P}(L(e) > L^*(e_1)) \\
& \quad \times \exp \left[(M+1) \sum_{g:e < g \leq e_1} \left(\frac{p^{-1} \lambda^{|g|-1}}{\left(p^{-1} + \sum_{g':e < g' < g} \lambda^{|g'|-1} \right) \left(p^{-1} + \sum_{g':e < g' \leq g} \lambda^{|g'|-1} \right)} \right) \right] \\
& \leq \mathbb{P}(L(e) > L^*(e_1)) \exp \left[(M+1) \sum_{g:e < g \leq e_1} \left(\frac{p^{-1} \lambda^{|g|-1}}{\left(\sum_{g':g' < g} \lambda^{|g'|-1} \right) \left(\sum_{g':g' \leq g} \lambda^{|g'|-1} \right)} \right) \right] \\
& \leq \mathbb{P}(L(e) > L^*(e_1)) \exp \left[(M+1) p^{-1} \sum_{g:e < g \leq e_1} \left(\frac{\sum_{g':g' \leq g} \lambda^{|g'|-1} - \sum_{g':g' < g} \lambda^{|g'|-1}}{\left(\sum_{g':g' < g} \lambda^{|g'|-1} \right) \left(\sum_{g':g' \leq g} \lambda^{|g'|-1} \right)} \right) \right] \\
& \leq \mathbb{P}(L(e) > L^*(e_1)) \exp \left[(M+1) p^{-1} \sum_{g:e < g \leq e_1} \left(\frac{1}{\sum_{g':g' < g} \lambda^{|g'|-1}} - \frac{1}{\sum_{g':g' \leq g} \lambda^{|g'|-1}} \right) \right] \\
& \leq \mathbb{P}(L(e) > L^*(e_1)) \exp \left[(M+1) p^{-1} \left(\frac{1}{\sum_{g':g' \leq e} \lambda^{|g'|-1}} - \frac{1}{\sum_{g':g' \leq e_1} \lambda^{|g'|-1}} \right) \right] \\
& \leq \exp(M+1) \times \mathbb{P}(L(e) > L^*(e_1)), \tag{8.12}
\end{aligned}$$

where we used condition (3.4), the fact that we have a telescopic sum and where we used the definition (8.7) of p .

We have just proved that

$$\int_0^{+\infty} e^{-px_1/2} f_1(x_1) dx_1 \leq \exp\{M+1\} \times \mathbb{P}(e_1 \in \mathcal{C}_{CP}(\varrho) | e_1 \wedge e_2 \in \mathcal{C}_{CP}(\varrho)). \tag{8.13}$$

By doing a very similar computation, one can prove that

$$\int_0^{+\infty} e^{-px_2/2} f_1(x_2) dx_2 \leq \exp\{M+1\} \times \mathbb{P}(e_2 \in \mathcal{C}_{CP}(\varrho) | e_1 \wedge e_2 \in \mathcal{C}_{CP}(\varrho)). \tag{8.14}$$

The conclusion (4.1) follows by using (8.9) together with (8.13) and (8.14). \square

Proof of transience in Theorem 3.5: The case $RT(\mathcal{T}, \psi_{M,\lambda}) > 1$. This follows directly from Lemma 8.1, Lemma 8.3 and Proposition 4.2. \square

9 Appendix: Proof of Proposition 4.2

As above, we define a function Ψ on the set of edges such that, for $e \in E$,

$$\Psi(e) = \prod_{g \leq e} \psi(e). \tag{9.1}$$

By (4.2), we have that

$$\mathbb{P}[e \in \mathcal{C}(\varrho)] = \Psi(e). \quad (9.2)$$

9.1 Proof of Proposition 4.2 in the case $RT(\mathcal{T}, \psi) < 1$

Proposition 9.1. *If $RT(\mathcal{T}, \psi) < 1$, then a percolation such that (4.2) holds is subcritical.*

Proof. We use a first moment method. For any cutset π , we have

$$\mathbb{1}_{\{|\mathcal{C}(\varrho)|=+\infty\}} \leq \sum_{e \in \pi} \mathbb{1}_{\{e \in \mathcal{C}(\varrho)\}}$$

and then

$$\mathbb{P}[|\mathcal{C}(\varrho)| = +\infty] = \mathbb{E}[\mathbb{1}_{\{|\mathcal{C}(\varrho)|=+\infty\}}] \leq \sum_{e \in \pi} \mathbb{E}[\mathbb{1}_{\{e \in \mathcal{C}(\varrho)\}}] = \sum_{e \in \pi} \mathbb{P}[e \in \mathcal{C}(\varrho)]$$

Therefore

$$\mathbb{P}[|\mathcal{C}(\varrho)| = +\infty] \leq \sum_{e \in \pi} \Psi(e).$$

Taking the infimum over $\pi \in \Pi$ allows to conclude that:

$$\mathbb{P}[|\mathcal{C}(\varrho)| = +\infty] \leq \inf_{\pi \in \Pi} \sum_{e \in \pi} \Psi(e). \quad (9.3)$$

If $RT(\mathcal{T}, \psi) < 1$, the definition of $RT(\mathcal{T}, \psi)$ (see (3.1)) implies that

$$\inf_{\pi \in \Pi} \sum_{e \in \pi} \Psi(e) = 0 \quad (9.4)$$

We conclude the proof of proposition thanks to (9.3) and (9.4). \square

9.2 Proof of Proposition 4.2 in the case $RT(\mathcal{T}, \psi) > 1$

As we are considering a quasi-independent percolation, we are able to lower-bound the probability of this correlated percolation to be infinite by the probability that some *independent* percolation is infinite. We do this by proving that a certain modified effective conductance is positive.

Definition 9.2. For any edge $e \in E$, let $c(e) = 1$ if $|e| = 1$ and, if $|e| > 1$, define the adapted conductances

$$c(e) = \frac{1}{1 - \psi(e)} \Psi(e). \quad (9.5)$$

Define \mathcal{C}_{eff} the effective conductance of \mathcal{T} when the conductance $c(e)$ is assigned to every edge $e \in E$. For a definition of effective conductance, see [87] page 27.

Proposition 9.3. Let $\mathcal{C}(\varrho)$ be the cluster of the root in a percolation such that (4.2) holds. If the percolation is quasi-independent, then there exists $C_Q \in (0, \infty)$ such that

$$\frac{1}{C_Q} \times \frac{\mathcal{C}_{eff}}{1 + \mathcal{C}_{eff}} \leq \mathbf{P}(|\mathcal{C}(\varrho)| = \infty).$$

Proof of Proposition 9.3. We can use the lower-bound in Theorem 5.19 (page 145) of [87] to obtain the result. \square

Recall that a flow (θ_e) on a tree is a nonnegative function on E such that, for any $e \in E$, $\theta_e = \sum_{g \in E: g^- = e^+} \theta_g$. A flow is said to be a unit flow if moreover $\sum_{e: |e|=1} \theta_e = 1$. A usual technique in order to prove that some effective conductance is positive is to find a unit flow with finite energy. This is the content of the following statement, which is a simple consequence of classical results.

Lemma 9.4. Assume that (3.4) is satisfied. Consider the tree \mathcal{T} with the conductances defined in Definition 9.2 and assume that there exists a unit flow $(\theta_e)_{e \in E}$ on \mathcal{T} from ϱ to infinity which has a finite energy, that is

$$\sum_{e \in E} \frac{(\theta_e)^2}{c(e)} < \infty.$$

Then, a quasi-independent percolation such that (4.2) holds is supercritical.

Proof. Using Proposition 9.3, if $\mathcal{C}_{eff} > 0$ then a quasi-independent percolation such that (4.2) holds is supercritical. By Theorem 2.11 (page 39) of [87], $\mathcal{C}_{eff} > 0$ if and only if there exists a unit flow $(\theta_e)_{e \in E}$ on \mathcal{T} from ϱ to infinity which has a finite energy. \square

The following result, from [33], is inspired by Corollary 4.2 of R. Lyons [85], which is itself a consequence of the max-flow min-cut Theorem. This result will provide us with a sufficient condition for the existence of a unit flow with finite energy.

Proposition 9.5. For any collection of positive numbers $(u_e)_{e \in E}$ such that $\sum_{e: |e|=1} u_e = 1$ and

$$\inf_{\pi \in \Pi} \sum_{e \in \pi} u_e c(e) > 0, \quad (9.6)$$

there exists a nonzero flow whose energy is upper-bounded by

$$\lim_{n \rightarrow \infty} \max_{e \in E: |e|=n} \sum_{g \leq e} u_g.$$

The proof is ended once we have proved the following proposition.

Proposition 9.6. *If $RT(\mathcal{T}, \psi) > 1$, then a quasi independent percolation such that (4.2) holds is supercritical.*

Proof. This proof follows line by line the proof of Proposition 18 in [33].

Fix a real number $\gamma \in (1, RT(\mathcal{T}, \psi))$ and, for any edge $e \in E$, let us define $u_e = 1$ if $|e| = 1$ and, if $|e| > 1$,

$$u_e = (1 - \psi(e)) \prod_{g \leq e} (\psi(g))^{\gamma-1}.$$

On one hand, we have that, for any $e \in E$,

$$\sum_{g \leq e} u_g \leq C_\gamma. \tag{9.7}$$

Indeed, for each $e \in E$, we can apply Proposition 17 of [33] to functions f_e defined by $f_e(0) = 1$ and, for $n \geq 1$, $f_e(n) = 1 - \psi(g)$ with g the unique edge such that $g \leq e$ and $|g| = n \wedge |e|$. We emphasize that (9.7) holds with a uniform bound.

On the other hand, using (9.5), we have

$$\begin{aligned} \inf_{\pi \in \Pi} \sum_{e \in \pi} u_e c(e) &= \inf_{\pi \in \Pi} \sum_{e \in \pi} \left((1 - \psi(e)) (\Psi(e))^{\gamma-1} \right) \times \frac{\Psi(e)}{1 - \psi(e)} \\ &= \inf_{\pi \in \Pi} \sum_{e \in \pi} (\Psi(e))^\gamma > 0. \end{aligned}$$

Proposition 9.5 and (9.7) imply that there exists a nonzero flow (θ_e) whose energy is bounded as

$$\sum_{e \in E} \frac{(\theta_e)^2}{c(e)} \leq \lim_{n \rightarrow \infty} \max_{e \in E: |e|=n} \sum_{g \leq e} u_g \leq C_\gamma.$$

Therefore, there exists a unit flow with finite energy and Lemma 9.4 implies the result. \square

Chapter 5

Phase transition for the Once-excited random walk on general trees

Abstract

The phase transition of M -digging random walk on a general tree was studied by Collevocchio, Huynh and Kious [32]. In this paper, we study particularly the critical M -digging random walk on a superperiodic tree that is proved to be recurrent.

We keep using the techniques introduced by Collevocchio, Kious and Sidoravicius [33] with the aim of investigating the phase transition of Once-excited random walk on general trees.

In addition, we prove if \mathcal{T} is a tree whose branching number is larger than 1, any multi-excited random walk on \mathcal{T} moving, after excitation, like a simple random walk is transient.

This chapter is based on [68].

1 Introduction

Excited random walks were introduced by Benjamini and Wilson in [17] on \mathbb{Z}^d , and have been extensively studied (see [7, 18, 76, 77, 117]). Zerner [121, 120] introduced a generalization of this model called multi-excited random walks (or cookie random walk). These walks are well understood on \mathbb{Z} , but not much is known in higher dimensions.

In this paper, we study a particular case of multi-excited random walks on trees, introduced by Volkov [118], called the once-excited random walk.

Let $M \in \mathbb{N}$, $(\lambda_1, \dots, \lambda_M) \in (\mathbb{R}_+)^M$ and $\lambda > 0$. Let \mathcal{T} be an infinite, locally-finite, tree rooted at ϱ . The $(\lambda_1, \dots, \lambda_M, \lambda)$ -ERW on \mathcal{T} , is a nearest-neighbor random walk (X_n) started at ϱ such that if X_n is on a site for the i -th time for $i \leq M$, then the walker takes a random step of a biased random walk with bias λ_i (i.e. it jumps on its parent with probability proportional to 1, or jumps on a particular offspring of ν with probability proportional to λ_i); and if $i > M$, then X_n takes a random step of a biased random walk with bias λ . In the case of $M = 1$, it is called the once-excited random walk with parameters (λ_1, λ) . We write (λ_1, λ) -OERW for (λ_1, λ) -ERW. A formal definition of multi-excited random walk will be showed in Section 2.3.

The phase transition of once-reinforced random walk (see [33]) or digging-random walk (see [32]) can be performed via the *branching number* and *branching-ruin number*. Whereas the phase transition of OERW does not depend only on the branching-ruin number and the branching number of tree (see Section 4 for more details). It can be such that there is no explicit formula for the phase transition of OERW, except that \mathcal{T} is a *spherically symmetric* tree, we give a explicit formula for the phase transition in terms of their *branching number* and *branching-ruin number* and others (see Theorem 1.1 below). We refer the readers to Theorem 3.1 for the more general result about once-excited random walk on a general tree.

In the following, we denote $br(\mathcal{T})$ the branching number of a tree \mathcal{T} and $br_r(\mathcal{T})$ the branching-ruin number of a tree \mathcal{T} , see (2.1) and (2.2) for their definitions. Let us simply emphasize that, for any tree \mathcal{T} , its branching number is at least one, i.e. $br(\mathcal{T}) \geq 1$, whereas the branching-ruin number is nonnegative, i.e. $br_r(\mathcal{T}) \geq 0$.

A tree \mathcal{T} is said to be spherically symmetric if for every vertex ν , $\deg \nu$ depends only on $|\nu|$, where $|\nu|$ denote its distance from the root and $\deg \nu$ is its number of neighbors. Let \mathcal{T} be a spherically symmetric tree. For any $n \geq 0$, let x_n be the number of children of a vertex at level n . For any $\lambda_1 \geq 0$ and $\lambda > 0$, we define the following quantities:

$$\alpha(\mathcal{T}, \lambda_1, \lambda) = \liminf_{n \rightarrow \infty} \left(\prod_{i=1}^n \frac{\lambda^2 + (x_i - 1)\lambda_1\lambda + \lambda_1}{1 + x_i\lambda_1} \right)^{1/n}. \quad (1.1)$$

$$\beta(\mathcal{T}, \lambda_1, \lambda) = \limsup_{n \rightarrow \infty} \left(\prod_{i=1}^n \frac{\lambda^2 + (x_i - 1)\lambda_1\lambda + \lambda_1}{1 + x_i\lambda_1} \right)^{1/n}. \quad (1.2)$$

$$\gamma(\mathcal{T}, \lambda_1) = \liminf_{n \rightarrow \infty} \frac{-\sum_{i=1}^n \ln \left[1 - \frac{(x_i - 1)\lambda_1 + 2}{(1 + x_i\lambda_1)^i} \right]}{\ln n}. \quad (1.3)$$

$$\eta(\mathcal{T}, \lambda_1) = \limsup_{n \rightarrow \infty} \frac{-\sum_{i=1}^n \ln \left[1 - \frac{(x_i - 1)\lambda_1 + 2}{(1 + x_i\lambda_1)^i} \right]}{\ln n}. \quad (1.4)$$

Theorem 1.1. *Let \mathcal{T} be a spherically symmetric tree, and let $\lambda_1 \geq 0$, $\lambda > 0$. Denote \mathbf{X} the (λ_1, λ) -OERW on \mathcal{T} . Assume that there exists a constant $M > 0$ such that $\sup_{\nu \in V} \deg \nu \leq M$, then we have*

1. *in the case $\lambda = 1$, if $\eta(\mathcal{T}, \lambda_1) < br_r(\mathcal{T})$ then \mathbf{X} is transient and if $\gamma(\mathcal{T}, \lambda_1) > br_r(\mathcal{T})$ then \mathbf{X} is recurrent;*
2. *assume that $\lambda_1 \geq 0$, $\lambda \neq 1$ and $br(\mathcal{T}) > 1$, if $\beta(\mathcal{T}, \lambda_1, \lambda) < \frac{1}{br(\mathcal{T})}$ then \mathbf{X} is recurrent and if $\alpha(\mathcal{T}, \lambda_1, \lambda) > \frac{1}{br(\mathcal{T})}$ then \mathbf{X} is transient.*

Note that, for a b -ary tree, we have $br(\mathcal{T}) = b$ and

$$\alpha(\mathcal{T}, \lambda_1, \lambda) = \beta(\mathcal{T}, \lambda_1, \lambda) = \frac{\lambda^2 + (b - 1)\lambda\lambda_1 + \lambda_1}{1 + b\lambda_1} \quad (1.5)$$

and our result therefore agrees with Corollary 1.6 of [10]. In [10], the authors prove that the walk is recurrent at criticality on regular trees, but this is not expected to be true on any tree). For instance, if $\lambda_1 = \lambda$, the (λ, λ) -OERW \mathbf{X} is the biased random walk with parameter λ . Therefore \mathbf{X} may be recurrent or transient at criticality (see [13], proposition 22).

Volkov [118] conjectured that, any cookie random walk which moves, after excitation, like a simple random walk (i.e. $\lambda = 1$) is transient on any tree containing the binary tree. This conjecture was proved by Basdevant and Singh [10]. Here, we extend this conjecture to any tree \mathcal{T} whose branching number is larger than 1:

Theorem 1.2. *Let $(\lambda_1, \dots, \lambda_M) \in (\mathbb{R}_+)^M$ and consider $(\lambda_1, \dots, \lambda_M, 1)$ -ERW \mathbf{X} on an infinite, locally finite, rooted tree \mathcal{T} . If $br(\mathcal{T}) > 1$, then \mathbf{X} is transient.*

The techniques used our paper rely on the strategy adopted in [33] or [32]. In particular, for the proof of transience, we here too view the set of edges crossed by \mathbf{X} before returning to ρ as the cluster of the root in a particular correlated percolation.

There are two key ingredients that allow us to use the rest of the strategy from [33].

First, we need to define *extensions* of \mathbf{X} , which are a family of coupled continuous-time versions of \mathbf{X} defined on subtrees of \mathcal{T} . As in [33], we do this through Rubin's construction in Section 7. But we will see in Section 7, this construction is actually very different to a once-reinforced random walk in [33] or M -digging random walk in [32]. Second, we need to prove that the correlated percolation mentioned above is in fact a *quasi-independent* percolation, see Lemma 8.3. From there, the problem boils down to proving that a certain quasi-independent percolation is supercritical. We refer to Theorem 3.1 for the more general result on a general tree.

2 The model

First, we review some basic definitions of graph theory and then we define the model of multi-excited random walk on trees which was introduced by Volkov[118] and then made general by Basdevant and Singh[10].

2.1 Notation

Let $\mathcal{T} = (V, E)$ be an infinite, locally finite, rooted tree with the root ϱ .

Given two vertices ν, μ of \mathcal{T} , we say that ν and μ are *neighbors*, denoted $\nu \sim \mu$, if $\{\nu, \mu\}$ is an edge of \mathcal{T} .

Let $\nu, \mu \in V \setminus \{\varrho\}$, the *distance* between ν and μ , denoted by $d(\nu, \mu)$, is the minimum number of edges of the unique self-avoiding paths joining x and y . The distance between ν and ϱ is called *height* of ν , denoted by $|\nu|$. The *parent* of ν is the vertex ν^{-1} such that $\nu^{-1} \sim \nu$ and $|\nu^{-1}| = |\nu| - 1$. We also call ν is a *child* of ν^{-1} .

For any $\nu \in V$, denote by $\partial(\nu)$ the number of children of ν and $\{\nu_1, \dots, \nu_{\partial\nu}\}$ is the set of children of ν . We define an order on \mathcal{T} by the following way. For all ν and μ , we say that $\nu \leq \mu$ if the unique self-avoiding path joining ϱ and μ contains ν , and we say that $\nu < \mu$ if moreover $\nu \neq \mu$.

Denote by \mathcal{T}_n the set of vertices of \mathcal{T} at height n . For any $\nu \in \mathcal{T}$, denote by \mathcal{T}^ν the biggest sub-tree of \mathcal{T} rooted at ν , i.e. $\mathcal{T}^\nu = \mathcal{T}[V^\nu]$, where

$$V^\nu := \{v \in V(\mathcal{T}) : \nu \leq v\}.$$

For any edge e of \mathcal{T} , denote by e^+ and e^- its endpoints with $|e^+| = |e^-| + 1$, and we define the *height* of e as $|e| = |e^+|$.

For two edges e and g of \mathcal{T} , we write $g \leq e$ if $g^+ \leq e^+$ and $g < e$ if moreover $g^+ \neq e^+$. For two vertices ν and μ of \mathcal{T} such that $\nu < \mu$, we denote by $[\nu, \mu]$ the unique self-avoiding path joining ν to μ . For two neighboring vertices ν and μ , we use the slight abuse of notation $[\nu, \mu]$ to denote the edge with endpoints ν and μ (note that we allow $\mu < \nu$).

For two edges e_1 and e_2 of E , denote by $e_1 \wedge e_2$ the vertex with maximal distance from

the root such that $e_1 \wedge e_2 \leq e_1^+$ and $e_1 \wedge e_2 \leq e_2^+$.

Finally, we define a particular class of trees, which is called *superperiodic tree*. Let $\mathcal{T}_1 = (V_1, E_1)$ and $\mathcal{T}_2 = (V_2, E_2)$ be two trees. A *morphism* of \mathcal{T}_1 to \mathcal{T}_2 is a map $f : \mathcal{T}_1 \rightarrow \mathcal{T}_2$ such that whenever ν and μ are incident in \mathcal{T}_1 , then so are $f(\nu)$ and $f(\mu)$ in \mathcal{T}_2 .

Let $N \geq 0$. An infinite, locally finite and rooted tree \mathcal{T} with the root ρ , is said to be *N-superperiodic* if for every $\nu \in V(\mathcal{T})$, there exists an injective morphism $f : \mathcal{T} \rightarrow \mathcal{T}^{f(o)}$ with $f(o) \in \mathcal{T}^\nu$ and $|f(o)| - |\nu| \leq N$. A tree \mathcal{T} is called *superperiodic tree* if there exists $N \geq 0$ such that it is *N-superperiodic*.

2.2 Some quantities on trees

In this section, we review the definitions of branching number, growth rate and branching-ruin number. We refer the reader to ([53], [87]) for more details on the branching number and growth rate and [33] for more details on the branching-ruin number.

In order to define the branching number and the branching-ruin number of a tree, we will need the notion of *cutsets*.

Let \mathcal{T} be an infinite, locally finite and rooted tree. A cutset in \mathcal{T} is a set π of edges such that every infinite simple path from a must include an edge in π . The set of cutsets is denoted by Π .

The branching number of \mathcal{T} is defined as

$$br(\mathcal{T}) = \sup \left\{ \gamma > 0 : \inf_{\pi \in \Pi} \sum_{e \in \pi} \gamma^{-|e|} > 0 \right\} \in [1, \infty]. \quad (2.1)$$

The branching-ruin number of \mathcal{T} is defined as

$$br_r(\mathcal{T}) = \sup \left\{ \gamma > 0 : \inf_{\pi \in \Pi} \sum_{e \in \pi} |e|^{-\gamma} > 0 \right\} \in [0, \infty]. \quad (2.2)$$

These quantities depend on the structure of the tree. If \mathcal{T} is spherically symmetric, then there is really no information in the tree than that contained in the sequence $(|\mathcal{T}_n|, n \geq 0)$. Therefore, a tree which is spherically symmetric and whose n generation grows like b^n (resp. n^b), for $b \geq 1$, has a branching number (resp. branching-ruin number) equal to b . For more general trees, this becomes more complicated. In the other word, there exists a tree whose n generation grows like b^n (resp. n^b), for $b \geq 1$, but its branching number (resp. branching-ruin number) is not equal to b . For instance, the tree 1-3 in ([87], page 4) is an example.

Finally, we review the definition of *growth rate* of an infinite, locally finite and rooted tree \mathcal{T} . Define the *lower growth rate* of \mathcal{T} by

$$\underline{gr}(\mathcal{T}) = \liminf |\mathcal{T}_n|^{\frac{1}{n}}. \quad (2.3)$$

Similarly, we can define *upper growth rate* of \mathcal{T} by

$$\overline{gr}(\mathcal{T}) = \limsup |\mathcal{T}_n|^{\frac{1}{n}}. \quad (2.4)$$

In the case $\overline{gr}(\mathcal{T}) = \underline{gr}(\mathcal{T})$, we define the *growth rate* of \mathcal{T} , denoted by $gr(\mathcal{T})$, by taking the common value of $\overline{gr}(\mathcal{T})$ and $\underline{gr}(\mathcal{T})$.

Now, we state a relationship between the branching number and growth rate of a superperiodic tree.

Theorem 2.1 (see [87]). *Let \mathcal{T} be a N -superperiodic tree with $\overline{gr}(\mathcal{T}) < \infty$. Then the growth rate of \mathcal{T} exists and $gr(\mathcal{T}) = br(\mathcal{T})$. Moreover, we have $|\mathcal{T}_n| \leq gr(\mathcal{T})^{n+N}$.*

2.3 Definition of the model

Now, we define the model of multi-excited random walk on trees. Let $\mathcal{C} = (\lambda_1, \dots, \lambda_M; \lambda) \in (\mathbb{R}_+)^M \times \mathbb{R}_+^*$ and $\mathcal{T} = (V, E)$ be an infinite, locally finite and rooted tree with the root ϱ . A \mathcal{C} multi-excited random walk is a stochastic process $\mathbf{X} := (X_n)_{n \geq 0}$ defined on some probability space, taking the values in \mathcal{T} with the transition probability defined by:

$$\mathbb{P}(X_0 = \varrho) = 1,$$

$$\mathbb{P}(X_{n+1} = (X_n)_i | X_0, \dots, X_n) = \begin{cases} \frac{\lambda_j}{1 + \partial(X_n)\lambda_j} & \text{if } j \leq M \\ \frac{\lambda}{1 + \partial(X_n)\lambda} & \text{if } j > M \end{cases}$$

$$\mathbb{P}(X_{n+1} = X_n^{-1} | X_0, \dots, X_n) = \begin{cases} \frac{1}{1 + \partial(X_n)\lambda_j} & \text{if } j \leq M \\ \frac{1}{1 + \partial(X_n)\lambda} & \text{if } j > M \end{cases}$$

where $i \in \{1, \dots, k\}$ and $j = |\{0 \leq k \leq n : X_k = X_n\}|$.

We have some particular cases:

- If $\mathcal{C} = (0, \dots, 0; \lambda)$, then \mathcal{C} multi-excited random walk is M -digging random walk with parameter λ (M -DRW $_\lambda$), which was studied in [32].
- If $M = 0$, then \mathcal{C} multi-excited random walk is the biased random walk with parameter λ , which was studied in [85].
- If $\mathcal{C} = (\lambda_1; \lambda)$, then \mathcal{C} multi-excited random walk is (λ_1, λ) -OERW.

The *return time* of \mathbf{X} to a vertex ν is defined by:

$$T(\nu) := \inf\{n \geq 1 : X_n = \nu\}. \tag{2.5}$$

We say that \mathbf{X} is *transient* if

$$\mathbb{P}(T(\varrho) = \infty) > 0. \tag{2.6}$$

Otherwise, we say that \mathbf{X} is *recurrent*.

3 Main results

3.1 Main results about Once-excited random walk

Let $\lambda_1 \geq 0$ and $\lambda > 0$ and we consider the model (λ_1, λ) -OERW on an infinite, locally finite and rooted tree \mathcal{T} . First, we define the following functions. For any $e \in E$, we set $\psi(e, \lambda) = 1$ and $\phi(e, \lambda_1, \lambda) = 1$ if $|e| = 1$ and, for any $e \in E$ with $|e| > 1$, we set

$$\begin{aligned} \psi(e, \lambda) &= \frac{\lambda^{|e|-1} - 1}{\lambda^{|e|} - 1} \text{ if } \lambda \neq 1, \\ \psi(e, \lambda) &= \frac{|e| - 1}{|e|} \text{ if } \lambda = 1. \end{aligned} \tag{3.1}$$

$$\phi(e, \lambda_1, \lambda) = \frac{\lambda_1}{1 + \partial(e^-)\lambda_1} + \frac{1}{1 + \partial(e^-)\lambda_1} \psi(e, \lambda)\psi(e^{-1}, \lambda) + \frac{(\partial(e^-) - 1)\lambda_1}{1 + \partial(e^-)\lambda_1} \psi(e, \lambda) \tag{3.2}$$

Finally, for any $e \in E$, we define:

$$\Psi(e, \lambda_1, \lambda) = \prod_{g \leq e} \phi(g, \lambda_1, \lambda). \tag{3.3}$$

We refer the reader to Lemma 7.2 for the probabilistic interpretation of these functions.

In the following, we assume that

$$\exists M \in \mathbb{N} \text{ such that } \sup\{\deg \nu : \nu \in V\} \leq M. \tag{3.4}$$

Let us define the quantity $RT(\mathcal{T}, \mathbf{X})$ which was introduced in [33]:

$$RT(\mathcal{T}, \mathbf{X}) = \sup\{\gamma > 0 : \inf_{\pi \in \Pi} \sum_{e \in \pi} (\Psi(e))^\gamma > 0\}. \tag{3.5}$$

Theorem 3.1. *Consider an (λ_1, λ) -OERW on an infinite, locally finite, rooted tree \mathcal{T} , with parameters $\lambda_1 \geq 0$ and $\lambda > 0$. If $RT(\mathcal{T}, \mathbf{X}) < 1$ then \mathbf{X} is recurrent. If $RT(\mathcal{T}, \mathbf{X}) > 1$ and if (3.4) holds, then \mathbf{X} is transient.*

In the following, we consider the case \mathcal{T} is spherically symmetric.

Lemma 3.2. *Consider a (λ_1, λ) -OERW \mathbf{X} on a spherically symmetric \mathcal{T} , with parameters $\lambda_1 \geq 0$ and $\lambda > 0$. Assume that there exists a constant $M > 0$ such that $\sup_{\nu \in V} \deg \nu \leq M$. We have that*

1. *in the case $\lambda = 1$, if $\eta(\mathcal{T}, \lambda_1) < br_r(\mathcal{T})$ then $RT(\mathcal{T}, \mathbf{X}) > 1$ and if $\gamma(\mathcal{T}, \lambda_1) > br_r(\mathcal{T})$ then $RT(\mathcal{T}, \mathbf{X}) < 1$;*
2. *assume that $\lambda_1 \geq 0$, $\lambda \neq 1$ and $br(\mathcal{T}) > 1$, if $\beta(\mathcal{T}, \lambda_1, \lambda) < \frac{1}{br(\mathcal{T})}$ then $RT(\mathcal{T}, \mathbf{X}) < 1$ and if $\alpha(\mathcal{T}, \lambda_1, \lambda) > \frac{1}{br(\mathcal{T})}$ then $RT(\mathcal{T}, \mathbf{X}) > 1$.*

Note that Theorem 1.1 is a consequence of Theorem 3.1 and Lemma 3.6.

3.2 Main results about critical M -Digging random walk

Let $M \in \mathbb{N}^*$, $\lambda > 0$ and we consider the model M -DRW $_\lambda$ on an infinite, locally finite and rooted tree \mathcal{T} . In [32], Collecchio-Huynh-Kious was proved that there is a phase transition with respect to the parameter λ , i.e there exists a critical parameter λ_c . A natural question that arises: what happens if $\lambda = \lambda_c$? As we said in the introduction, there is no a good answer for this question.

In [10], Basdevant-Singh proved the critical M -digging random walk is recurrent on the regular trees. In this paper, we prove the critical M -digging random walk is still recurrent on a particular class of trees which contains the regular trees.

Theorem 3.3. *Let $M \in \mathbb{N}^*$ and \mathcal{T} be a superperiodic tree whose upper-growth rate is finite. Then the critical M -digging random walk on \mathcal{T} is recurrent.*

4 An example

In this section, we give an example to prove that the phase transition of once-excited random walk (λ_1, λ) – OERW on a tree \mathcal{T} does not depend only on the branching-ruin number and the branching number of \mathcal{T} .

If \mathcal{T} is a spherically symmetric tree, recall that $x_n(\mathcal{T})$ is the number of children of a vertex at level n .

Let \mathcal{T} (resp. $\tilde{\mathcal{T}}$) be a spherically symmetric such that for any $n \geq 0$, we have $x_n(\mathcal{T}) = 2$ (resp. $x_n(\tilde{\mathcal{T}}) = 1$ if n is odd and $x_n(\tilde{\mathcal{T}}) = 4$ if not). Then we obtain :

$$br(\mathcal{T}) = br(\tilde{\mathcal{T}}) = 2. \tag{4.1}$$

$$br_r(\mathcal{T}) = br_r(\tilde{\mathcal{T}}) = \infty. \tag{4.2}$$

Lemma 4.1. *Consider a $(1, (\sqrt{3} - 1)/2)$ -OERW \mathbf{X} (resp. \mathbf{Y}) on \mathcal{T} (resp. $\tilde{\mathcal{T}}$). Then \mathbf{X} is recurrent, but \mathbf{Y} is transient.*

Proof. Note that \mathcal{T} is a binary tree, then we can apply Corollary 1.6 of [10] to imply that \mathbf{X} is recurrent. On the other hand, by a simple computation we have

$$\alpha \left(\tilde{\mathcal{T}}, 1, \frac{\sqrt{3} - 1}{2} \right) = \beta \left(\tilde{\mathcal{T}}, 1, \frac{\sqrt{3} - 1}{2} \right) > \frac{1}{2}. \tag{4.3}$$

By Theorem 1.1 and 4.3, we obtain \mathbf{Y} is transient. □

5 Proof of Theorem 1.2

Lemma 5.1. *Let \mathcal{T} be an infinite, locally finite and rooted tree. If $br(\mathcal{T}) > 1$ then $br_r(\mathcal{T}) = +\infty$.*

Proof. See ([32], proof of Lemma 8, Case V). □

Lemma 5.2. *Let $(\lambda_1, \dots, \lambda_M) \in (\mathbb{R}_+)^M$ and \mathcal{T} be an infinite, locally finite and rooted tree. If M -DRW₁ is transient, then $(\lambda_1, \dots, \lambda_M, 1)$ -ERW is transient.*

Proof. See ([10], Section 3). □

Remark 5.3. Let $T(\varrho)$ (resp. $S(\varrho)$) the return of of M -DRW₁ (resp. $(\lambda_1, \dots, \lambda_M, 1)$ -ERW) to the root ϱ of \mathcal{T} . It is simple to see that

$$\mathbb{P}(T(\varrho) < \infty) \leq \mathbb{P}(S(\varrho) < \infty). \tag{5.1}$$

Proposition 5.4. *Let $(\lambda_1, \dots, \lambda_M) \in (\mathbb{R}_+)^M$ and consider $(\lambda_1, \dots, \lambda_M, 1)$ -ERW \mathbf{X} on an infinite, locally finite, rooted tree \mathcal{T} . If $br(\mathcal{T}) > 1$, then \mathbf{X} is transient.*

Proof. Note that if $\lambda_i = 0$ for all $1 \leq i \leq M$ and $\lambda = 1$, then \mathbf{X} is a M -digging random walk with parameter 1 (M -DRW₁). On the other hand, we have $(\lambda_1, \dots, \lambda_M, 1)$ -ERW is more transient than M -DRW₁, i.e if M -DRW₁ is transient then $(\lambda_1, \dots, \lambda_M, 1)$ -ERW is transient. We complete the proof by using Lemma (5.1) and Theorem 2 in [32]. □

6 Proof of Lemma 3.2 and Theorem 1.1

In this section, we prove Lemma 3.2. Theorem 1.1 then trivially follows from Theorem 3.1.

Lemma 6.1. *Recall the definition of $\Psi(e, \lambda_1, \lambda)$ as in 3.3. We have that, if $\lambda \neq 1$, for any $|e| > 1$,*

$$\Psi(e, \lambda_1, \lambda) = \left(\prod_{g \leq e, |g| > 1} \frac{\lambda^2 + (\partial(g^-) - 1)\lambda_1\lambda + \lambda_1}{1 + \partial(g^-)\lambda_1} \right) \prod_{g \leq e, |g| > 1} \left(\frac{1 - \lambda^{|g|} \left(\frac{1 + \partial(g^-)\lambda_1}{\lambda^2 + (\partial(g^-) - 1)\lambda_1\lambda + \lambda_1} \right)}{1 - \lambda^{|g|}} \right). \quad (6.1)$$

and if $\lambda = 1$, for any $|e| > 1$,

$$\Psi(e, \lambda_1, \lambda) = \prod_{g \leq e, |g| > 1} \left(1 - \frac{(\partial(g^-) - 1)\lambda_1 + 2}{|g|(1 + \partial(g^-)\lambda_1)} \right). \quad (6.2)$$

Proof. We compute the quantity $\Psi(e, \lambda, \lambda_1)$ by using (3.1), 3.2 and (3.3). We will proceed by distinguishing two cases.

Case I: $\lambda \neq 1$.

By (3.1), 3.2 and (3.3), we have

$$\begin{aligned} \Psi(e, \lambda_1, \lambda) &= \prod_{g \leq e, |g| > 1} \phi(g, \lambda_1, \lambda) \\ &= \prod_{g \leq e, |g| > 1} \left(\frac{\lambda_1}{1 + \partial(g^-)\lambda_1} + \frac{1}{1 + \partial(g^-)\lambda_1} \psi(e, \lambda) \psi(e^{-1}, \lambda) + \frac{(\partial(g^-) - 1)\lambda_1}{1 + \partial(g^-)\lambda_1} \psi(e, \lambda) \right) \\ &= \left(\prod_{g \leq e, |g| > 1} \frac{1}{1 + \partial(g^-)\lambda_1} \right) \prod_{g \leq e, |g| > 1} (\lambda_1 + \psi(e, \lambda) \psi(e^{-1}, \lambda) + (\partial(g^-) - 1)\lambda_1 \psi(e, \lambda)) \end{aligned}$$

By 3.1, we have:

$$\begin{aligned} &\lambda_1 + \psi(g, \lambda) \psi(g^{-1}, \lambda) + (\partial(g^-) - 1)\lambda_1 \psi(g, \lambda) \\ &= \lambda_1 + \left(\frac{1 - (1/\lambda)^{|g|-2}}{1 - (1/\lambda)^{|g|}} \right) + \left((\partial(g^-) - 1)\lambda_1 \frac{1 - (1/\lambda)^{|g|-1}}{1 - (1/\lambda)^{|g|}} \right) \\ &= \lambda_1 + \left(\frac{\lambda^{|g|} - \lambda^2}{\lambda^{|g|} - 1} \right) + (\partial(g^-) - 1)\lambda_1 \left(\frac{\lambda^{|g|} - \lambda}{\lambda^{|g|} - 1} \right) \\ &= \frac{\lambda^2 + (\partial(g^-) - 1)\lambda_1\lambda + \lambda_1 - \lambda^{|g|} (1 + \partial(g^-)\lambda_1)}{1 - \lambda^{|g|}} \\ &= (\lambda^2 + (\partial(g^-) - 1)\lambda_1\lambda + \lambda_1) \left(\frac{1 - \lambda^{|g|} \left(\frac{1 + \partial(g^-)\lambda_1}{\lambda^2 + (\partial(g^-) - 1)\lambda_1\lambda + \lambda_1} \right)}{1 - \lambda^{|g|}} \right). \end{aligned} \quad (6.3)$$

Therefore we obtain 6.1.

Case II: $\lambda = 1$.

By (3.1), 3.2 and (3.3), we have

$$\begin{aligned} \Psi(e, \lambda_1, \lambda) &= \prod_{g \leq e, |g| > 1} \phi(g, \lambda_1, \lambda) \\ &= \prod_{g \leq e, |g| > 1} \left(\frac{\lambda_1}{1 + \partial(g^-)\lambda_1} + \frac{1}{1 + \partial(g^-)\lambda_1} \psi(e, \lambda) \psi(e^{-1}, \lambda) + \frac{(\partial(g^-) - 1)\lambda_1}{1 + \partial(g^-)\lambda_1} \psi(e, \lambda) \right) \\ &= \left(\prod_{g \leq e, |g| > 1} \frac{1}{1 + \partial(g^-)\lambda_1} \right) \prod_{g \leq e, |g| > 1} (\lambda_1 + \psi(e, \lambda) \psi(e^{-1}, \lambda) + (\partial(g^-) - 1)\lambda_1 \psi(e, \lambda)) \end{aligned}$$

By 3.1, we have:

$$\begin{aligned} &\lambda_1 + \psi(g, \lambda) \psi(g^{-1}, \lambda) + (\partial(g^-) - 1)\lambda_1 \psi(g, \lambda) \\ &= \lambda_1 + \frac{|g| - 2}{|g|} + (\partial(g^-) - 1)\lambda_1 \frac{|g| - 1}{|g|} \\ &= \frac{\lambda_1 |g| + |g| - 2 + (\partial(g^-) - 1)\lambda_1 (|g| - 1)}{|g|} \\ &= 1 + \partial(g^-)\lambda_1 - \frac{(\partial(g^-) - 1)\lambda_1 + 2}{|g|} \end{aligned} \tag{6.4}$$

Therefore we obtain 6.2. □

Proof of Lemma 3.2. We will proceed by distinguishing a few cases.

Case I: $\lambda \neq 1$, $br(\mathcal{T}) > 1$ and $\beta(\mathcal{T}, \lambda_1, \lambda) < \frac{1}{br(\mathcal{T})}$.

By (2.1), there exists $\delta \in (0, 1)$ such that

$$\inf_{\pi \in \Pi} \sum_{e \in \Pi} \beta^{(1-\delta)^2 |e|} = 0. \tag{6.5}$$

As $\beta < \beta^{(1-\delta)}$, there exists $c > 0$, for any $n > 0$,

$$\prod_{i=1}^n \frac{\lambda^2 + (x_i - 1)\lambda_1 \lambda + \lambda_1}{1 + x_i \lambda_1} \leq c \beta^{(1-\delta)n}. \tag{6.6}$$

By 6.1 and 6.6, there exists $C > 0$ such that for any $\pi \in \Pi$,

$$\sum_{e \in \pi} \Psi(e)^{1-\delta} \leq C \sum_{e \in \Pi} \beta^{(1-\delta)^2 |e|}. \tag{6.7}$$

Therefore, by (6.5),

$$\inf_{\pi \in \Pi} \sum_{e \in \pi} \Psi(e)^{1-\delta} = 0, \quad (6.8)$$

which implies that $RT(\mathcal{T}, \mathbf{X}) < 1$.

Case II: $\lambda \neq 1$, $br(\mathcal{T}) > 1$ and $\alpha(\mathcal{T}, \lambda_1, \lambda) > \frac{1}{br(\mathcal{T})}$.

First, note that if $\lambda > 1$ and $br(\mathcal{T}) > 1$ then \mathbf{X} is transient. Now, assume that $\lambda < 1$, $br(\mathcal{T}) > 1$ and $\alpha(\mathcal{T}, \lambda_1, \lambda) > \frac{1}{br(\mathcal{T})}$. We have that there exists $\delta > 0$ and $\varepsilon > 0$ such that

$$\inf_{\pi \in \Pi} \sum_{e \in \pi} \alpha^{(1+\delta)^2|e|} > \varepsilon. \quad (6.9)$$

By 1.1 and $\lambda < 1$, we obtain $\alpha < 1$, therefore $\alpha^{1+\delta} < \alpha$. We have that there exists $c > 0$, for any $n > 0$,

$$\prod_{i=1}^n \frac{\lambda^2 + (x_i - 1)\lambda_1\lambda + \lambda_1}{1 + x_i\lambda_1} \geq c\alpha^{(1+\delta)n}. \quad (6.10)$$

By 6.1 and 6.10, there exists $C > 0$ such that for any $\pi \in \Pi$,

$$\sum_{e \in \pi} \Psi(e)^{1+\delta} \geq C \sum_{e \in \pi} \alpha^{(1+\delta)^2|e|}. \quad (6.11)$$

Therefore, by (6.9),

$$\inf_{\pi \in \Pi} \sum_{e \in \pi} \Psi(e)^{1+\delta} > 0, \quad (6.12)$$

which implies that $RT(\mathcal{T}, \mathbf{X}) > 1$.

Case III: $\lambda = 1$ and $\eta(\mathcal{T}, \lambda_1) < br_r(\mathcal{T})$.

We have that there exists $\delta > 0$ and $\varepsilon > 0$ such that

$$\inf_{\pi \in \Pi} \sum_{e \in \pi} |e|^{-(1+\delta)^2\eta} > \varepsilon. \quad (6.13)$$

As $\eta < (1 + \delta)\eta$, by 1.4 there exists $c > 0$, for any $n > 0$,

$$\prod_{i=1}^n \left[1 - \frac{(x_i - 1)\lambda_1 + 2}{(1 + x_i\lambda_1)i} \right] \geq cn^{-(1+\delta)\eta}. \quad (6.14)$$

By 6.2 and 6.14, there exists $C > 0$ such that for any $\pi \in \Pi$,

$$\sum_{e \in \pi} \Psi(e)^{1+\delta} \geq C \sum_{e \in \pi} |e|^{-(1+\delta)^2\eta}. \quad (6.15)$$

Therefore, by (6.13),

$$\inf_{\pi \in \Pi} \sum_{e \in \pi} \Psi(e)^{1+\delta} > 0, \quad (6.16)$$

which implies that $RT(\mathcal{T}, \mathbf{X}) > 1$.

Case IV: $\lambda = 1$ and $\gamma(\mathcal{T}, \lambda_1) > br_r(\mathcal{T})$

We have that there exists $\delta > 0$ such that

$$\inf_{\pi \in \Pi} \sum_{e \in \pi} |e|^{-(1-\delta)^2 \eta} = 0. \tag{6.17}$$

As $\eta > (1 - \delta)\eta$, by 1.4 there exists $c > 0$, for any $n > 0$,

$$\prod_{i=1}^n \left[1 - \frac{(x_i - 1)\lambda_1 + 2}{(1 + x_i \lambda_1)i} \right] \leq c n^{-(1-\delta)\eta}. \tag{6.18}$$

By 6.2 and 6.18, there exists $C > 0$ such that for any $\pi \in \Pi$,

$$\sum_{e \in \pi} \Psi(e)^{1-\delta} \leq C \sum_{e \in \Pi} |e|^{-(1-\delta)^2 \eta}. \tag{6.19}$$

Therefore, by (6.17),

$$\inf_{\pi \in \Pi} \sum_{e \in \pi} \Psi(e)^{1-\delta} > 0, \tag{6.20}$$

which implies that $RT(\mathcal{T}, \mathbf{X}) < 1$. □

7 Extensions

First of all, let us describe the dynamic of this model. If \mathbf{X} visits a vertex ν for the first time, three cases can occur for visiting ν_1 (see Figure 5.1):

- It eats the cookie at ν and returns to the parent of ν (i.e. ν^{-1}) with probability $\frac{1}{1+\partial(\nu)\lambda_1}$. It then visits ν for the second time, and goes to ν_1 with probability $\frac{\lambda}{1+\partial(\nu)\lambda}$.
- It goes directly to ν_1 with probability $\frac{\lambda_1}{1+\partial(\nu)\lambda_1}$.
- It goes to one of the children of ν except for ν_1 , with probability $\frac{(\partial\nu-1)\lambda_1}{1+\partial(\nu)\lambda_1}$. It then visits ν for the second time, and goes to ν_1 with probability $\frac{\lambda}{1+\partial(\nu)\lambda}$.

Now, we introduce a construction of once-excited random walk by using the Rubin's construction. Let $(\Omega, \mathcal{F}, \mathbf{P})$ denote a probability space on which

$$\mathbf{Y} = (Y(\nu, \mu, k) : (\nu, \mu) \in V^2, \text{ with } \nu \sim \mu, \text{ and } k \in \mathbb{N}) \tag{7.1}$$

$$\mathbf{Z} = (Z(\nu, \mu) : (\nu, \mu) \in V^2, \text{ with } \nu \sim \mu) \tag{7.2}$$

are two families of independent mean 1 exponential random variables, where (ν, μ) denotes an *ordered* pair of vertices. Let

$$\mathbf{U} = (U_\nu : \nu \in V) \tag{7.3}$$

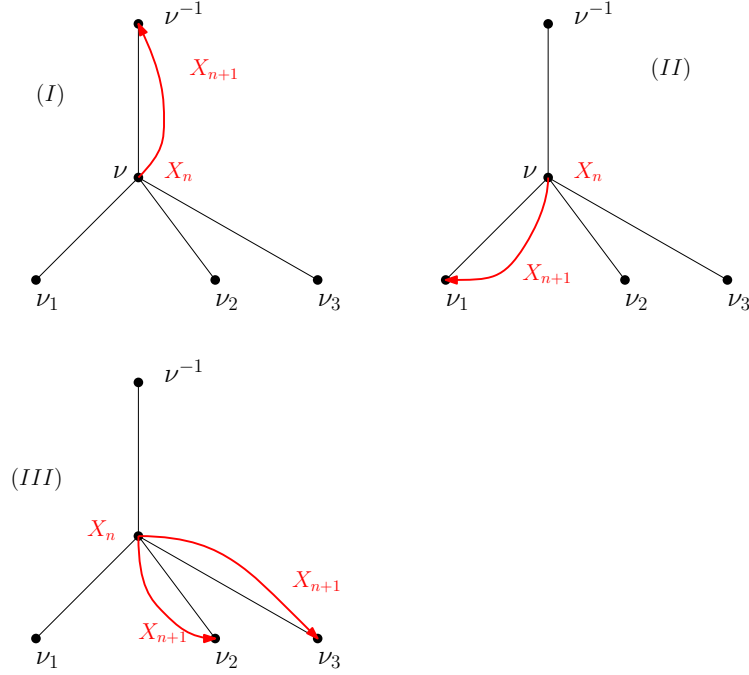

Figure 5.1 – The movement of \mathbf{X} to ν_1 after visiting ν .

is a family of independent uniformly random variables on $[0, 1]$ which is independent to \mathbf{Y} and \mathbf{Z} .

For any pair vertices $\nu, \mu \in V$ with $\nu \sim \mu$, we define the following quantities

$$r(\nu, \mu) = \begin{cases} \lambda^{|\nu|-1}, & \text{if } \mu < \nu, \\ \lambda^{|\mu|-1}, & \text{if } \nu < \mu. \end{cases} \quad (7.4)$$

Let \mathcal{T}' be a sub-tree of \mathcal{T} , we define the *extension* $\mathbf{X}^{(\mathcal{T}')} = (V', E')$ on \mathcal{T}' in the following way. Denote by ϱ' the root of \mathcal{T}' which be defined as the vertex of V' with smallest distance to the root of \mathcal{T} . For any family of nonnegative integers $\bar{k} = (k_\mu)_{\mu: [\nu, \mu] \in E'}$, we let

$$A_{\bar{k}, n, \nu}^{(\mathcal{T}')} := \{X_n^{(\mathcal{T}')} = \nu\} \cap \bigcap_{\mu: [\nu, \mu] \in E'} \{\#\{1 \leq j \leq n: (X_{j-1}^{(\mathcal{T}'), X_j^{(\mathcal{T}')} = (\nu, \mu)\} = k_\mu\}. \quad (7.5)$$

$$t_\nu(n) := \#\{1 \leq j \leq n: X_j^{(\mathcal{T}')} = \nu\}. \quad (7.6)$$

$$h_\nu := \inf\{i \geq 1: t_\nu(i) = 2\}. \quad (7.7)$$

$$\tilde{A}_{\bar{k}, n, \nu}^{(\mathcal{T}')} := \{X_n^{(\mathcal{T}')} = \nu\} \cap \bigcap_{\mu: [\nu, \mu] \in E'} \{\#\{h_\nu \leq j \leq n: (X_{j-1}^{(\mathcal{T}'), X_j^{(\mathcal{T}')} = (\nu, \mu)\} = k_\mu\}. \quad (7.8)$$

$$\mathcal{I}^{\mathcal{T}}(\nu) := \#\{i \in \{1, 2, \dots, \partial(\nu)\} : \nu_i \in V(\mathcal{T}')\}. \quad (7.9)$$

Set $X_0^{(\mathcal{T}')} = \varrho'$ and on the event $A_{k,n,\nu}^{(\mathcal{T}')} \cap \{t_\nu(n) \leq 1\}$:

- If $U_\nu < \frac{1}{1+\partial(\nu)\lambda_1}$, then we set $X_{n+1}^{(\mathcal{T}')} = \nu^{-1}$.
- If $U_\nu \in \left[\frac{1+(j-1)\lambda_1}{1+\partial(\nu)\lambda_1}, \frac{1+j\lambda_1}{1+\partial(\nu)\lambda_1} \right]$ and $j \in \mathcal{I}^{\mathcal{T}}(\nu)$, then we set $X_{n+1}^{(\mathcal{T}')} = \nu_j$.
- If $U_\nu \in \left[\frac{1+(j-1)\lambda_1}{1+\partial(\nu)\lambda_1}, \frac{1+j\lambda_1}{1+\partial(\nu)\lambda_1} \right]$ for some $j \notin \mathcal{I}^{\mathcal{T}}(\nu)$ and

$$\left\{ \nu' = \arg \min_{\mu: [\nu, \mu] \in E'} \left\{ \frac{Z(\nu, \mu)}{r(\nu, \mu)} \right\} \right\},$$

we set $X_{n+1}^{(\mathcal{T}')} = \nu'$.

On the event

$$\tilde{A}_{k,n,\nu}^{(\mathcal{T}')} \cap \{t_\nu(n) \geq 2\} \cap \left\{ \nu' = \arg \min_{\mu: [\nu, \mu] \in E'} \left\{ \sum_{i=0}^{k_\mu} \frac{Y(\nu, \mu, i)}{r(\nu, \mu)} \right\} \right\}, \quad (7.10)$$

we set $X_{n+1}^{(\mathcal{T}')} = \nu'$, where the function r is defined in (7.4) and the clocks Y 's are from the same collection \mathbf{Y} fixed in (7.1).

Thus, this defines $\mathbf{X}^{(\mathcal{T})}$ as the extension on the whole tree. By using the properties of independent exponential random variables, it is easy to check that this construction is a construction of (λ_1, λ) -OERW on the tree \mathcal{T} . We refer the reader to ([32], section 7) for more discussions on this construction.

In the case $\mathcal{T}' = [\varrho, \nu]$ for some vertex ν of \mathcal{T} , we write $\mathbf{X}^{(\nu)}$ instead of $\mathbf{X}^{([\varrho, \nu])}$, and we denote $T^{(\nu)}(\cdot)$ the return times associated to $\mathbf{X}^{(\nu)}$. For simplicity, we will also write $\mathbf{X}^{(e)}$ and $T^{(e)}(\cdot)$ instead of $\mathbf{X}^{(e^+)}$ and $T^{(e^+)}(\cdot)$ for $e \in E$.

Remark 7.1. Let \mathcal{T}' be a proper subtree of \mathcal{T} . Note that $\mathbf{X}^{(\mathcal{T}')}$ is not (λ_1, λ) -OERW on \mathcal{T}' , that is different with M -digging random walk (see [32], section 7) and once-reinforced random walk (see [33], section 5).

Finally, we give a probabilistic interpretation of the functions ϕ and Ψ :

Lemma 7.2. *For any $e \in E$ and any $g \leq e$, we have*

$$\phi(g, \lambda_1, \lambda) = \mathbb{P} \left(T^{(e)}(g^+) \circ \theta_{T^{(e)}(g^-)} < T^{(e)}(\varrho) \circ \theta_{T^{(e)}(g^-)} \right), \quad (7.11)$$

$$\Psi(e, \lambda_1, \lambda) = \mathbb{P} \left(T^{(e)}(e^+) < T^{(e)}(\varrho) \right), \quad (7.12)$$

where θ is the canonical shift on the trajectories.

Proof. Let $e \in E$ and $g \leq e$. For simplicity, we set

$$\mathcal{A} := \{T^{(e)}(g^+) \circ \theta_{T^{(e)}(g^-)} < T^{(e)}(\varrho) \circ \theta_{T^{(e)}(g^-)}\},$$

$$\mathcal{I}_1 := \left[\frac{1 + (j-1)\lambda_1}{1 + \partial(g^-)\lambda_1}, \frac{1 + j\lambda_1}{1 + \partial(g^-)\lambda_1} \right],$$

$$\mathcal{I}_2 := [0, 1] \setminus \left(\left[\frac{1 + (j-1)\lambda_1}{1 + \partial(g^-)\lambda_1}, \frac{1 + j\lambda_1}{1 + \partial(g^-)\lambda_1} \right] \cup \left[0, \frac{1}{1 + \partial(g^-)\lambda_1} \right] \right),$$

where $j \in \{1, \dots, \partial(g^-)\}$ such that $(g^-)_j = g^+$. We have that

$$\begin{aligned} \mathbb{P}(\mathcal{A}) &= \mathbb{P}\left(A \mid U_{g^-} < \frac{1}{1 + \partial(g^-)\lambda_1}\right) \times \mathbb{P}\left(U_{g^-} < \frac{1}{1 + \partial(g^-)\lambda_1}\right) \\ &+ \mathbb{P}(A|\mathcal{I}_1) \times \mathbb{P}(U_{g^-} \in \mathcal{I}_1) + \mathbb{P}(A|\mathcal{I}_2) \times \mathbb{P}(U_{g^-} \in \mathcal{I}_2). \end{aligned} \quad (7.13)$$

On the other hand, we have the following equalities:

$$\mathbb{P}\left(A \mid U_{g^-} < \frac{1}{1 + \partial(g^-)\lambda_1}\right) \times \mathbb{P}\left(U_{g^-} < \frac{1}{1 + \partial(g^-)\lambda_1}\right) = \frac{1}{1 + \partial(g^-)\lambda_1} \psi(g, \lambda) \psi(g^{-1}, \lambda) \quad (7.14)$$

$$\mathbb{P}(A|\mathcal{I}_1) \times \mathbb{P}(U_{g^-} \in \mathcal{I}_1) = \frac{\lambda_1}{1 + \partial(g^-)\lambda_1}. \quad (7.15)$$

$$\mathbb{P}(A|\mathcal{I}_2) \times \mathbb{P}(U_{g^-} \in \mathcal{I}_2) = \frac{(\partial(g^-) - 1)\lambda_1}{1 + \partial(g^-)\lambda_1} \psi(g, \lambda). \quad (7.16)$$

We use (7.13), (7.14), (7.15) and (7.16) to obtain the results. \square

8 Recurrence in Theorem 3.1: The case $RT(\mathcal{T}, \mathbf{X}) < 1$

Proposition 8.1. *If*

$$\inf_{\pi \in \Pi} \sum_{e \in \pi} \Psi(e) = 0, \quad (8.1)$$

then \mathbf{X} is recurrent.

Proof. The proof is identical to the proof of Proposition 10 of [33]. \square

9 Transience in Theorem 3.1: The case $RT(\mathcal{T}, \mathbf{X}) > 1$

In order to prove transience, we use the relationship between the walk \mathbf{X} and its associated percolation.

9.1 Link with percolation

Denote by $\mathcal{C}(\varrho)$ the set of edges which are crossed by \mathbf{X} before returning to ϱ , that is:

$$\mathcal{C}(\varrho) = \{e \in E : T(e^+) < T(\varrho)\}. \quad (9.1)$$

We define an other percolation which will be more easy to study. In order to do this, we use the Rubin's construction and the extensions introduced in Section 7. We define

$$\mathcal{C}_{CP}(\varrho) = \{e \in E : T^{(e)}(e^+) < T^{(e)}(\varrho)\}. \quad (9.2)$$

We say that an edge $e \in E$ is open if and only if $e \in \mathcal{C}_{CP}(\varrho)$.

Lemma 9.1. *We have that*

$$\mathbb{P}(T(\varrho) = \infty) = \mathbb{P}(|\mathcal{C}(\varrho)| = \infty) = \mathbb{P}(|\mathcal{C}_{CP}(\varrho)| = \infty). \quad (9.3)$$

Proof. We can follow line by line the proof of Lemma 11 in [33]. \square

For simplicity, for a vertex $v \in V$, we write $v \in \mathcal{C}_{CP}(\varrho)$ if one of the edges incident to v is in $\mathcal{C}_{CP}(\varrho)$. Besides, recall that for two edges e_1 and e_2 , their common ancestor with highest generation is the vertex denoted $e_1 \wedge e_2$.

Lemma 9.2. *Let $\lambda_1 \geq 0$, $\lambda > 0$ and \mathcal{T} be an infinite, locally finite and rooted tree with the root ϱ . Assume that the condition (3.4) holds with some constant M . Then the correlated percolation induced by \mathcal{C}_{CP} is quasi-independent, i.e. there exists a constant $C_Q \in (0, +\infty)$ such that, for any two edges e_1, e_2 , we have that*

$$\begin{aligned} \mathbb{P}(e_1, e_2 \in \mathcal{C}_{CP}(\varrho) | e_1 \wedge e_2 \in \mathcal{C}_{CP}(\varrho)) &\leq C_Q \mathbb{P}(e_1 \in \mathcal{C}_{CP}(\varrho) | e_1 \wedge e_2 \in \mathcal{C}_{CP}(\varrho)) \\ &\times \mathbb{P}(e_2 \in \mathcal{C}_{CP}(\varrho) | e_1 \wedge e_2 \in \mathcal{C}_{CP}(\varrho)). \end{aligned} \quad (9.4)$$

Proof. Recall the construction of Section 7. Note that if $e_1 \wedge e_2 = \varrho$, then the extensions on $[\varrho, e_1]$ and $[\varrho, e_2]$ are independent, then the conclusion of Lemma holds with $C = 1$. Assume that $e_1 \wedge e_2 \neq \varrho$, and note that the extensions on $[\varrho, e_1]$ and $[\varrho, e_2]$ are dependent since they use the same clocks on $[\varrho, e_1 \wedge e_2]$. Denote by e the unique edge of \mathcal{T} such that $e^+ = e_1 \wedge e_2$. For $i \in \{1, 2\}$, let v_i be the vertex which is the offspring of e^+ lying the path from ϱ to e_i . Note that v_i could be equal to e_i^+ . Let i_1 (resp. i_2) be an element of $\{1, \dots, \partial(e^+)\}$ such that $(e^+)_{i_1} = v_1$ (resp. $(e^+)_{i_2} = v_2$).

As the events $\{e \in \mathcal{C}_{CP}\}$ and $U_{e_1 \wedge e_2}$ are independent, therefore:

$$\mathbb{P}(e_1, e_2 \in \mathcal{C}_{CP}(\varrho) | e \in \mathcal{C}_{CP}(\varrho)) = A + B + C + D,$$

where

$$A = \mathbb{P}\left(e_1, e_2 \in \mathcal{C}_{CP}(\varrho) \mid e \in \mathcal{C}_{CP}(\varrho), U_{e^+} < \frac{1}{1 + \partial(e^+)\lambda_1}\right) \mathbb{P}\left(U_{e^+} < \frac{1}{1 + \partial(e^+)\lambda_1}\right) \quad (9.5)$$

$$B = \mathbb{P} \left(e_1, e_2 \in \mathcal{C}_{CP}(\varrho) \mid e \in \mathcal{C}_{CP}(\varrho), U_{e^+} \in \left[\frac{1 + (i_1 - 1)\lambda_1}{1 + \partial(e^+)\lambda_1}, \frac{1 + i_1\lambda_1}{1 + \partial(e^+)\lambda_1} \right] \right) \\ \times \mathbb{P} \left(U_{e^+} \in \left[\frac{1 + (i_1 - 1)\lambda_1}{1 + \partial(e^+)\lambda_1}, \frac{1 + i_1\lambda_1}{1 + \partial(e^+)\lambda_1} \right] \right). \quad (9.6)$$

$$C = \mathbb{P} \left(e_1, e_2 \in \mathcal{C}_{CP}(\varrho) \mid e \in \mathcal{C}_{CP}(\varrho), U_{e^+} \in \left[\frac{1 + (i_2 - 1)\lambda_1}{1 + \partial(e^+)\lambda_1}, \frac{1 + i_2\lambda_1}{1 + \partial(e^+)\lambda_1} \right] \right) \\ \times \mathbb{P} \left(U_{e^+} \in \left[\frac{1 + (i_2 - 1)\lambda_1}{1 + \partial(e^+)\lambda_1}, \frac{1 + i_2\lambda_1}{1 + \partial(e^+)\lambda_1} \right] \right). \quad (9.7)$$

$$D = \mathbb{P} \left(e_1, e_2 \in \mathcal{C}_{CP}(\varrho) \mid e \in \mathcal{C}_{CP}(\varrho), U_{e^+} \in \bigcup_{i \in \{1, \dots, \partial(e^+)\} \setminus \{i_1, i_2\}} \left[\frac{1 + (i - 1)\lambda_1}{1 + \partial(e^+)\lambda_1}, \frac{1 + i\lambda_1}{1 + \partial(e^+)\lambda_1} \right] \right) \\ \times \mathbb{P} \left(U_{e^+} \in \bigcup_{i \in \{1, \dots, \partial(e^+)\} \setminus \{i_1, i_2\}} \left[\frac{1 + (i - 1)\lambda_1}{1 + \partial(e^+)\lambda_1}, \frac{1 + i\lambda_1}{1 + \partial(e^+)\lambda_1} \right] \right). \quad (9.8)$$

In the same way, for any $j \in \{1, 2\}$, we have:

$$\mathbb{P}(e_j \in \mathcal{C}_{CP}(\varrho) \mid e \in \mathcal{C}_{CP}(\varrho)) = E_j + F_j + G_j,$$

where

$$E_j = \mathbb{P} \left(e_j \in \mathcal{C}_{CP}(\varrho) \mid e \in \mathcal{C}_{CP}(\varrho), U_{e^+} < \frac{1}{1 + \partial(e^+)\lambda_1} \right) \mathbb{P} \left(U_{e^+} < \frac{1}{1 + \partial(e^+)\lambda_1} \right) \quad (9.9)$$

$$F_j = \mathbb{P} \left(e_j \in \mathcal{C}_{CP}(\varrho) \mid e \in \mathcal{C}_{CP}(\varrho), U_{e^+} \in \left[\frac{1 + (i_j - 1)\lambda_1}{1 + \partial(e^+)\lambda_1}, \frac{1 + i_j\lambda_1}{1 + \partial(e^+)\lambda_1} \right] \right) \\ \times \mathbb{P} \left(U_{e^+} \in \left[\frac{1 + (i_j - 1)\lambda_1}{1 + \partial(e^+)\lambda_1}, \frac{1 + i_j\lambda_1}{1 + \partial(e^+)\lambda_1} \right] \right) \quad (9.10)$$

$$G_j = \mathbb{P} \left(e_j \in \mathcal{C}_{CP}(\varrho) \mid e \in \mathcal{C}_{CP}(\varrho), U_{e^+} \in \bigcup_{i \in \{1, \dots, \partial(e^+)\} \setminus \{i_j\}} \left[\frac{1 + (i - 1)\lambda_1}{1 + \partial(e^+)\lambda_1}, \frac{1 + i\lambda_1}{1 + \partial(e^+)\lambda_1} \right] \right) \\ \times \mathbb{P} \left(U_{e^+} \in \bigcup_{i \in \{1, \dots, \partial(e^+)\} \setminus \{i_j\}} \left[\frac{1 + (i - 1)\lambda_1}{1 + \partial(e^+)\lambda_1}, \frac{1 + i\lambda_1}{1 + \partial(e^+)\lambda_1} \right] \right). \quad (9.11)$$

Lemma 9.3. *There exists four constants $(\alpha_1, \alpha_2, \alpha_3, \alpha)$ depend on \mathcal{T} , λ and λ_1 such that:*

$$A \leq \alpha_1 E_1 E_2. \quad (9.12)$$

$$B \leq \alpha_2 F_1 E_2. \quad (9.13)$$

$$C \leq \alpha_3 F_2 E_1. \quad (9.14)$$

$$D \leq \alpha_4 G_1 G_2. \quad (9.15)$$

We deduce from Lemma 9.3 that

$$A + B + C + D \leq \alpha(E_1 + F_1 + G_1)(E_2 + F_2 + G_2),$$

where $\alpha = \max_{i \in \{1,2,3,4\}} \alpha_i$. The latter inequality concludes the proof of Proposition. \square

Proof of Lemma 9.3. Now, we will adapt the argument from the proof of Lemma 12 in [33]. We prove that there exists α_1 such that $A \leq \alpha_1 E_1 E_2$ and we use the same argument for the other inequalities.

First, by using condition 3.4, note that,

$$\mathbb{P}\left(U_{e^+} < \frac{1}{1 + \partial(e^+)\lambda_1}\right) = \frac{1}{1 + \partial(e^+)\lambda_1} \geq \frac{1}{1 + M\lambda_1}, \text{ we then obtain:}$$

$$\mathbb{P}\left(U_{e^+} < \frac{1}{1 + \partial(e^+)\lambda_1}\right) \leq (1 + M\lambda_1) \left[\mathbb{P}\left(U_{e^+} < \frac{1}{1 + \partial(e^+)\lambda_1}\right)\right]^2. \quad (9.16)$$

On the event $\left\{e \in \mathcal{C}_{CP}(\varrho), U_{e^+} < \frac{1}{1 + \partial(e^+)\lambda_1}\right\}$ we have $X_{T^{(e)}(e^+) + 1}^{(e)} = e^-$. We then define $\tilde{T}^{(e)}(e^+) := \inf\left\{n \geq T^{(e)}(e^+) + 1 : X_n^{(e)} = e^+\right\}$. We define the following quantities:

$$\begin{aligned} N(e) &= \left| \left\{ \tilde{T}^{(e)}(e^+) \leq n \leq T^{(e)}(\varrho) \circ \theta_{\tilde{T}^{(e)}(e^+)} : (X_n^{(e)}, X_{n+1}^{(e)}) = (e^+, e^-) \right\} \right|, \\ L(e) &= \sum_{j=0}^{N(e)-1} \frac{Y(e^+, e^-, j)}{r(e^+, e^-)}, \end{aligned} \quad (9.17)$$

where $|A|$ denotes the cardinality of a set A and θ is the canonical shift on trajectories. Note that $L(e)$ is the time consumed by the clocks attached to the oriented edge (e^+, e^-) before $\mathbf{X}^{(e)}$, $X^{(e_1)}$ or $X^{(e_2)}$ goes back to ϱ once it has returned e^+ after the time $T^{(e)}(e^+)$. Recall that these three extensions are coupled and thus the time $L(e)$ is the same for the three of them.

For $i \in \{1, 2\}$, recall that v_i is the vertex which is the offspring of e^+ lying the path from ϱ to e_i . Note that v_i could be equal to e_i^+ . We define for $i \in \{1, 2\}$:

$$\begin{aligned}
 N^*(e_i) &= \left| \left\{ \tilde{T}^{(e)}(e^+) \leq n \leq T^{(e_i)}(e_i^+) : (X_n^{[e^+, e_i^+]}, X_{n+1}^{[e^+, e_i^+]}) = (e^+, v_i) \right\} \right|, \\
 L^*(e_i) &= \sum_{j=0}^{N^*(e_i)-1} \frac{Y(e^+, e^-, j)}{r(e^+, e^-)}.
 \end{aligned} \tag{9.18}$$

Here, $L^*(e_i)$, $i \in \{1, 2\}$, is the time consumed by the clocks attached to the oriented edge (e^+, v_i) before $\mathbf{X}^{(e_i)}$, or $\mathbf{X}^{[e^+, e_i^+]}$, hits e_i^+ .

Notice that the three quantities $L(e)$, $L^*(e_1)$ and $L^*(e_2)$ are independent, and we also have:

$$\begin{aligned}
 \mathbb{P} \left(e_1, e_2 \in \mathcal{C}_{CP}(\varrho) \mid e \in \mathcal{C}_{CP}(\varrho), U_{e^+} < \frac{1}{1 + \partial(e^+)\lambda_1} \right) \\
 = \psi(e, \lambda) \mathbb{P}(L(e) > L^*(e_1) \vee L^*(e_2)).
 \end{aligned} \tag{9.19}$$

$$\mathbb{P} \left(e_1 \in \mathcal{C}_{CP}(\varrho) \mid e \in \mathcal{C}_{CP}(\varrho), U_{e^+} < \frac{1}{1 + \partial(e^+)\lambda_1} \right) = \psi(e, \lambda) \mathbb{P}(L(e) > L^*(e_1)). \tag{9.20}$$

$$\mathbb{P} \left(e_2 \in \mathcal{C}_{CP}(\varrho) \mid e \in \mathcal{C}_{CP}(\varrho), U_{e^+} < \frac{1}{1 + \partial(e^+)\lambda_1} \right) = \psi(e, \lambda) \mathbb{P}(L(e) > L^*(e_2)). \tag{9.21}$$

Now, the random variable $N(e)$ is simply a geometric random variable (counting the number of trials) with success probability $\lambda^{1-|e|} / \sum_{g \leq e} \lambda^{1-|g|}$. The random variable $N(e)$ is independent of the family $Y(e^+, e^-, \cdot)$. As $Y(e^+, e^-, j)$ are independent exponential random variable for $j \geq 0$, we then have that $L(e)$ is an exponential random variables with parameter

$$p := \frac{\lambda^{1-|e|}}{\sum_{g \leq e} \lambda^{1-|g|}} \times \lambda^{|e|-1} = \frac{1}{\sum_{g \leq e} \lambda^{1-|g|}}. \tag{9.22}$$

A priori, $L^*(e_1)$ and $L^*(e_2)$ are not exponential random variable, but they have a continuous distribution. Denote f_1 and f_2 respectively the densities of $L^*(e_1)$ and $L^*(e_2)$. Then, we have that

$$\begin{aligned}
 \mathbb{P}(L(e) > L^*(e_1) \vee L^*(e_2)) &= \int_0^{+\infty} \int_0^{+\infty} \int_{x_1 \vee x_2}^{+\infty} p e^{-pt} f_1(x_1) f_2(x_2) dt dx_1 dx_2 \\
 &= \int_0^{+\infty} \int_0^{+\infty} e^{-p(x_1 \vee x_2)} f_1(x_1) f_2(x_2) dx_1 dx_2. \\
 &\leq \int_0^{+\infty} \int_0^{+\infty} e^{-\frac{p}{2}(x_1+x_2)} f_1(x_1) f_2(x_2) dx_1 dx_2.
 \end{aligned} \tag{9.23}$$

Thus, one can write

$$\begin{aligned} & \mathbb{P}(L(e) > L^*(e_1) \vee L^*(e_2)) \\ & \leq \left(\int_0^{+\infty} e^{-px_1/2} f_1(x_1) dx_1 \right) \cdot \left(\int_0^{+\infty} e^{-px_2/2} f_2(x_2) dx_2 \right). \end{aligned} \quad (9.24)$$

Note that:

$$\int_0^{+\infty} e^{-px_1/2} f_1(x_1) dx_1 = \mathbb{P}\left(\tilde{L}(e) > L^*(e_1)\right), \quad (9.25)$$

where $\tilde{L}(e)$ is an exponential variable with parameter $p/2$. Note that, in view of (9.22), $\tilde{L}(e)$ has the same law as $L(e)$ when we replace the weight of an edge g' by $\lambda^{-|g'|+1}/2$ for $g' \leq e$ only, and keep the other weights the same.

For simplicity, for any $g \in E$, we set $w(g) = \lambda^{|g|-1}$. For $g \in E$ such that $e < g$, define the functions $\tilde{\psi}$ and $\tilde{\phi}$ in a similar way as ψ and ϕ , except that we replace the weight of an edge g' by $\lambda^{-|g'|+1}/2$ for $g' \leq e$ only, and keep the other weights the same, that is, for $g \in E$, $e < g$,

$$\tilde{\psi}(g, \lambda) = \frac{\sum_{g' < g} w(g')^{-1} + \sum_{g' \leq e} w(g')^{-1}}{\sum_{g' \leq g} w(g')^{-1} + \sum_{g' \leq e} w(g')^{-1}}. \quad (9.26)$$

$$\tilde{\phi}(g, \lambda_1, \lambda) = \frac{\lambda_1}{1 + \partial(g^-)\lambda_1} + \frac{1}{1 + \partial(g^-)\lambda_1} \tilde{\psi}(g, \lambda) \tilde{\psi}(g^{-1}, \lambda) + \frac{(\partial(g^-) - 1)\lambda_1}{1 + \partial(g^-)\lambda_1} \tilde{\psi}(g, \lambda). \quad (9.27)$$

We obtain:

$$\begin{aligned} \mathbb{P}(\tilde{L}(e) > L^*(e_1)) &= \prod_{e < g \leq e_1} \tilde{\phi}(g, \lambda_1, \lambda) = \prod_{e < g \leq e_1} \phi(g, \lambda_1, \lambda) \prod_{e < g \leq e_1} \left(\frac{\tilde{\phi}(g, \lambda_1, \lambda)}{\phi(g, \lambda_1, \lambda)} \right) \\ &= \mathbb{P}(L(e) > L^*(e_1)) \times \prod_{e < g \leq e_1} \left(\frac{\lambda_1 + \tilde{\psi}(g, \lambda) \tilde{\psi}(g^{-1}, \lambda) + (\partial(g^{-1}) - 1)\lambda_1 \tilde{\psi}(g, \lambda)}{\lambda_1 + \psi(g, \lambda) \psi(g^{-1}, \lambda) + (\partial(g^{-1}) - 1)\lambda_1 \psi(g, \lambda)} \right) \\ &= \mathbb{P}(L(e) > L^*(e_1)) \\ & \quad \times \prod_{e < g \leq e_1} \left(1 + \frac{\tilde{\psi}(g, \lambda) \tilde{\psi}(g^{-1}, \lambda) - \psi(g, \lambda) \psi(g^{-1}, \lambda) + (\partial(g^{-1}) - 1)\lambda_1 (\tilde{\psi}(g, \lambda) - \psi(g, \lambda))}{\lambda_1 + \psi(g, \lambda) \psi(g^{-1}, \lambda) + (\partial(g^{-1}) - 1)\lambda_1 \psi(g, \lambda)} \right). \end{aligned} \quad (9.28)$$

Now, we compute the product:

$$\prod_{e < g \leq e_1} \left(1 + \frac{\tilde{\psi}(g, \lambda) \tilde{\psi}(g^{-1}, \lambda) - \psi(g, \lambda) \psi(g^{-1}, \lambda) + (\partial(g^{-1}) - 1)\lambda_1 (\tilde{\psi}(g, \lambda) - \psi(g, \lambda))}{\lambda_1 + \psi(g, \lambda) \psi(g^{-1}, \lambda) + (\partial(g^{-1}) - 1)\lambda_1 \psi(g, \lambda)} \right)$$

$$\leq \prod_{e < g \leq e_1} \left(1 + \frac{\tilde{\psi}(g, \lambda)\tilde{\psi}(g^{-1}, \lambda) - \psi(g, \lambda)\psi(g^{-1}, \lambda) + (\partial(g^{-1}) - 1)\lambda_1(\tilde{\psi}(g, \lambda) - \psi(g, \lambda))}{\lambda_1} \right).$$

$$\leq \exp \left(\frac{1}{\lambda_1} \sum_{e < g \leq e_1} \left(\tilde{\psi}(g, \lambda)\tilde{\psi}(g^{-1}, \lambda) - \psi(g, \lambda)\psi(g^{-1}, \lambda) + (\partial(g^{-1}) - 1)\lambda_1(\tilde{\psi}(g, \lambda) - \psi(g, \lambda)) \right) \right)$$

Lemma 9.4. *There exists a constant $c = c(\lambda_1, \lambda)$ which do not depend on e , e_1 and e_2 , such that:*

$$\sum_{e < g \leq e_1} \left(\tilde{\psi}(g, \lambda) - \psi(g, \lambda) \right) \leq c. \quad (9.29)$$

On the other hand, by using Lemma 9.4, for any e and e_1 we have that

$$\sum_{e < g \leq e_1} \left(\tilde{\psi}(g, \lambda)\tilde{\psi}(g^{-1}, \lambda) - \psi(g, \lambda)\psi(g^{-1}, \lambda) \right) \leq 2c. \quad (9.30)$$

By using 9.30, Lemma 9.4 and condition (3.4), we obtain:

$$\prod_{e < g \leq e_1} \left(1 + \frac{\tilde{\psi}(g, \lambda)\tilde{\psi}(g^{-1}, \lambda) - \psi(g, \lambda)\psi(g^{-1}, \lambda) + (\partial(g^{-1}) - 1)\lambda_1(\tilde{\psi}(g, \lambda) - \psi(g, \lambda))}{\lambda_1 + \psi(g, \lambda)\psi(g^{-1}, \lambda) + (\partial(g^{-1}) - 1)\lambda_1\psi(g, \lambda)} \right)$$

$$\leq \exp \left(Mc + \frac{2c}{\lambda_1} \right). \quad (9.31)$$

We have just proved that

$$\int_0^{+\infty} e^{-px_1/2} f_1(x_1) dx_1 \leq \exp \left(Mc + \frac{2c}{\lambda_1} \right) \times \mathbb{P}(e_1 \in \mathcal{C}_{CP}(\varrho) | e_1 \wedge e_2 \in \mathcal{C}_{CP}(\varrho)). \quad (9.32)$$

By doing a very similar computation, one can prove that

$$\int_0^{+\infty} e^{-px_2/2} f_1(x_2) dx_2 \leq \exp \left(Mc + \frac{2c}{\lambda_1} \right) \times \mathbb{P}(e_2 \in \mathcal{C}_{CP}(\varrho) | e_1 \wedge e_2 \in \mathcal{C}_{CP}(\varrho)). \quad (9.33)$$

Moreover, we have

$$\psi(e, \lambda) \geq \frac{\lambda}{1 + \lambda}. \quad (9.34)$$

The conclusion (9.4) follows by using (9.16), (9.24), (9.34), together with (9.32) and (9.33). \square

It remains to prove Lemma 9.4.

Proof of Lemma 9.4. By a simple computation, for any $e < g \leq e_1$,

$$\tilde{\psi}(g, \lambda) - \psi(g, \lambda) = \frac{\left(\sum_{g' \leq e} w(g')^{-1}\right) w(g)^{-1}}{\left(\sum_{g' \leq g} w(g')^{-1} + \sum_{g' \leq e} w(g')^{-1}\right) \left(\sum_{g' \leq g} w(g')^{-1}\right)}. \quad (9.35)$$

We will proceed by distinguishing three cases.

Case I: $\lambda < 1$.

By (9.35), we have that

$$\tilde{\psi}(g, \lambda) - \psi(g, \lambda) = \frac{\left(1 - \frac{1}{\lambda^{|e|}}\right) \frac{1}{\lambda^{|g|-1}}}{\left(1 - \frac{1}{\lambda^{|g|}} + 1 - \frac{1}{\lambda^{|e|}}\right) \left(1 - \frac{1}{\lambda^{|g|}}\right)} \times \left(1 - \frac{1}{\lambda}\right). \quad (9.36)$$

Hence, there exists a constants c_1 such that

$$0 \leq \tilde{\psi}(g, \lambda) - \psi(g, \lambda) \leq c_1 \lambda^{|g|-|e|}. \quad (9.37)$$

Therefore we obtain

$$\sum_{e < g \leq e_1} \left(\tilde{\psi}(g, \lambda) - \psi(g, \lambda)\right) \leq c_1 \sum_{e < g \leq e_1} \lambda^{|g|-|e|} \leq c_1 \sum_{i \geq 0} \lambda^i < \infty. \quad (9.38)$$

Case II: $\lambda = 1$.

By (9.35), we have that

$$\tilde{\psi}(g, \lambda) - \psi(g, \lambda) = \frac{|e|}{|g|(|g| + |e|)}. \quad (9.39)$$

Therefore we obtain

$$\begin{aligned} \sum_{e < g \leq e_1} \left(\tilde{\psi}(g, \lambda) - \psi(g, \lambda)\right) &\leq \sum_{n \geq |e|} \left(\frac{|e|}{n(n + |e|)}\right) \leq \sum_{n \geq |e|} \left(\frac{1}{n} - \frac{1}{n + |e|}\right) \\ &\leq \sum_{n=|e|}^{2|e|-1} \frac{1}{n}. \end{aligned} \quad (9.40)$$

On the other hand, we have:

$$\lim_{n \rightarrow \infty} \left(\sum_{k=n}^{2n-1} \frac{1}{k}\right) = \lim_{k \rightarrow \infty} \left(\sum_{k=0}^{n-1} \frac{1}{n+k}\right) = \lim_{k \rightarrow \infty} \left(\frac{1}{n} \sum_{k=0}^{n-1} \frac{1}{1+k/n}\right) = \int_0^1 \frac{dx}{1+x}. \quad (9.41)$$

We use (9.40) and (9.41) to obtain the result.

Case III: $\lambda > 1$.

By (9.35), we have that

$$\tilde{\psi}(g, \lambda) - \psi(g, \lambda) = \frac{\left(1 - \frac{1}{\lambda^{|e|}}\right) \frac{1}{\lambda^{|g|-1}}}{\left(1 - \frac{1}{\lambda^{|g|}} + 1 - \frac{1}{\lambda^{|e|}}\right) \left(1 - \frac{1}{\lambda^{|g|}}\right)} \times \left(1 - \frac{1}{\lambda}\right). \quad (9.42)$$

Hence, there exists a constants c_2 such that

$$0 \leq \tilde{\psi}(g, \lambda) - \psi(g, \lambda) \leq \frac{c_2}{\lambda^{|g|}}. \quad (9.43)$$

Therefore we obtain

$$\sum_{e < g \leq e_1} \left(\tilde{\psi}(g, \lambda) - \psi(g, \lambda)\right) \leq c_2 \sum_{e < g \leq e_1} \frac{1}{\lambda^{|g|}} \leq c_2 \sum_{i \geq 0} \left(\frac{1}{\lambda}\right)^i < \infty. \quad (9.44)$$

□

9.2 Transience in Theorem 3.1: The case $RT(\mathcal{T}, \mathbf{X}) > 1$

Proposition 9.5. *If $RT(\mathcal{T}, \mathbf{X}) > 1$ and if (3.4) is satisfied then \mathbf{X} is transient.*

Proof. The proof is now easy, we can follow line by line the Appendix A.2 of [32]. □

10 Proof of Theorem 3.3

This section is independent with the previous sections. In this section, we prove a criterion which can apply to the critical M -digging random walk on superperiodic trees. We will use the Rubin's construction (resp. the definition of $\mathcal{C}(\varrho)$, $\mathcal{C}_{CP}(\varrho)$) from section 7 (resp. section 8.1) of [32]. We will allow ourselves to omit these definitions and refer the readers to [32] for more details.

The main idea for the proof of Theorem 3.3 is that the number of surviving rays of the percolation $\mathcal{C}_{CP}(\varrho)$ almost surely is either zero or infinite. This property was proved in the case of *Bernoulli percolation* (see [87] proposition 5.27) or *target percolation* (see [102], lemma 4.2). The main difficulty that we have to face is that the FKG inequality is not true for our percolation.

10.1 Some definitions

Let $\lambda > 0$, $M \in \mathbb{N}$ and \mathcal{T} be an infinite, locally finite and rooted tree. For each $v \in V(\mathcal{T})$, recall the definition of subtree \mathcal{T}^v of \mathcal{T} from Section 2.1. Let $\mathbf{X}^{v,\lambda}$ be the M -digging random walk on \mathcal{T}^v . We say that \mathcal{T} is *uniformly transient* if for any λ such that the M -digging random walk on \mathcal{T} with parameter λ is transient (i.e. $\mathbf{X}^{\varrho,\lambda}$ is transient),

$$\exists \alpha_\lambda > 0, \forall v \in V(\mathcal{T}), \mathbb{P}(\forall n > 0, X_n^{v,\lambda} \neq v) \geq \alpha_\lambda. \tag{10.1}$$

It is called *weakly uniformly transient* if there exists a sequence of finite pairwise disjoint π_n such that

$$\exists \alpha_\lambda > 0, \forall v \in \bigcup_n V(\pi_n), \mathbb{P}(\forall n > 0, X_n^{v,\lambda} \neq v) \geq \alpha_\lambda \tag{10.2}$$

where $V(\pi_n) = \{e^- : e \in \pi_n\}$.

Remark 10.1. — If \mathcal{T} is uniformly transient, then \mathcal{T} is also weakly uniformly transient, but the reverse is not always true.

— The superperiodic trees are uniformly transient.

An infinite self-avoiding path starting at ϱ is called a *ray*. The set of all rays, denoted by $\partial\mathcal{T}$, is called the *boundary* of \mathcal{T} . Let $\phi : \mathbb{Z}^+ \rightarrow \mathbb{R}$ be a decreasing positive function with $\phi(n) \rightarrow 0$ as $n \rightarrow \infty$. The *Hausdorff measure* of \mathcal{T} in gauge ϕ is

$$\liminf_{\Pi} \sum_{v \in \Pi} \phi(|v|),$$

where the \liminf is taken over Π such that the distance from ϱ to the nearest vertex in Π goes to infinity. We say that \mathcal{T} has σ -finite Hausdorff measure in gauge ϕ if $\partial\mathcal{T}$ is the union of countably many subsets with finite Hausdorff measure in gauge ϕ .

Finally, If λ is such that the M -digging random walk X with parameter λ on \mathcal{T} is transient, on the event $\{T(\varrho) = \infty\}$, its path determines an infinite branch in \mathcal{T} , which can be seen as a random ray ω^∞ , and call it the *limit walk* of X . Equivalently, on the event $\{T(\varrho) = \infty\}$, we define the limit walk as follows: For any $k \geq 1$,

$$\omega^\infty(k) = v \iff v \in \mathcal{T}_k \text{ and } \exists n_0, \forall n > n_0 : X_n \in \mathcal{T}^v. \tag{10.3}$$

Note that $\mathbb{P}(\omega^\infty(0) = \varrho) = 1$. For any $k \geq 1$, we call the k -first steps of ω^∞ is $(\omega^\infty(0), \dots, \omega^\infty(k))$, denoted by $\omega_{[[0,k]]}^\infty$.

10.2 Proof of Theorem 3.3

We begin with the following proposition:

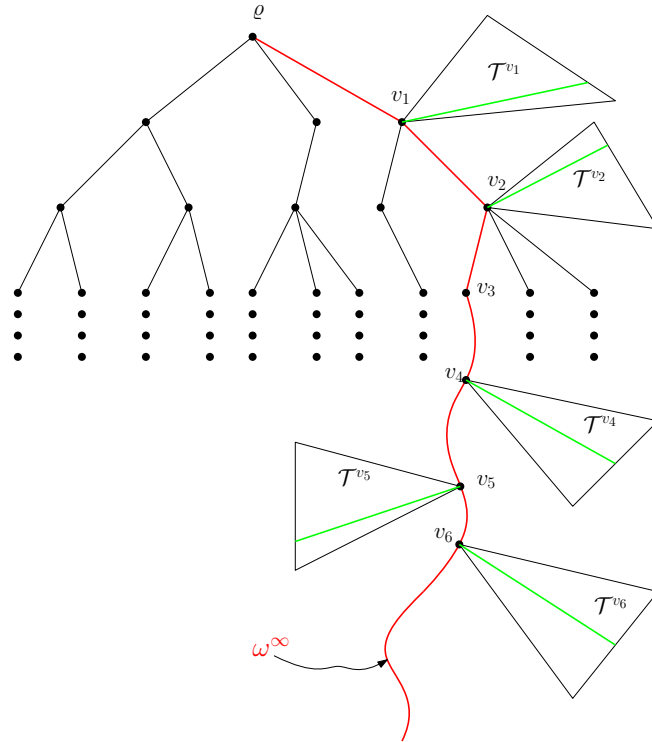

Figure 5.2 – The proof’s idea of Proposition 10.2. The limit walk ω^∞ is in red. Conditioning on the event $\{\omega^\infty(0) = \rho, \omega^\infty(1) = v_1, \dots, \omega^\infty(6) = v_6\}$ and denote by ℓ the last time the critical M -digging random walk \mathbf{X} on \mathcal{T} visits v_6 . For each $1 \leq i \leq 6$, running the walk $\mathbf{X}^{v_i, \lambda_c}$ on \mathcal{T}^{v_i} . The property of uniformly transient implies that there exists a surviving ray (in green) in \mathcal{T}^{v_i} with probability is larger than a constant which do not depend on i .

Proposition 10.2. *Let X be a M -digging random walk with parameter λ_c on an uniformly transient tree \mathcal{T} and recall the definition of \mathcal{C}_{CP} from \mathbf{X} as in ([32], Section 7). Consider the percolation induced by \mathcal{C}_{CP} and let $\phi(n) = \mathbb{P}(\rho \leftrightarrow v)$ for $v \in \mathcal{T}_n$.*

1. *Almost surely, the number of surviving rays is either zero or infinite.*
2. *If $\partial\mathcal{T}$ has σ -finite Hausdorff measure in the gauge $\{\phi(n)\}$, then $\mathbb{P}(\rho \leftrightarrow \infty) = 0$. In particular, \mathbf{X} is recurrent.*

The overall strategy for the proof of Proposition 10.2 is as follows. First, if \mathbf{X} is recurrent, then the percolation induced by \mathcal{C}_{CP} almost surely have no surviving ray. Next, assume that \mathbf{X} is transient. On the event $\{T(\rho) = \infty\}$, the limit walk ω^∞ is a surviving ray of $\mathcal{C}_{CP}(\rho)$. Given $n \in \mathbb{N}$ and conditioning on $\omega^\infty_{[0,n]}$, by using the Rubin’s construction and the definition of uniformly transient, we prove that there exists a surviving ray in

$\mathcal{T}^{\omega^\infty(i)}$ with probability larger than a constant c which do not depend on i and ω^∞ (see Figure 5.2). The following basic lemma is necessary:

Lemma 10.3. *Let $\lambda > 0$ and \mathcal{T} be an infinite, locally finite and rooted tree. Let $\bar{M} := (m_v, v \in V(\mathcal{T}))$ be a family of non-negative integers. Denote by \mathbf{X} the M -digging random walk with parameter λ and \mathbf{Y} the \bar{M} -digging random walk associated with the inhomogeneous initial number of cookies \bar{M} with parameter λ (see [32], section 2.3.2 for more details on the definition of \bar{M} -digging random walk). Denote by $T^{\mathbf{X}}(\varrho)$ (resp. $T^{\mathbf{Y}}(\varrho)$) the return time of \mathbf{X} (resp. \mathbf{Y}) to ϱ . Assume that $m(v) \leq M$ for all $v \in V(\mathcal{T})$, we then have*

$$\mathbb{P}(T^{\mathbf{X}}(\varrho) < \infty) \leq \mathbb{P}(T^{\mathbf{Y}}(\varrho) < \infty). \tag{10.4}$$

Proof. The proof is simple, therefore it is omitted. □

Proof of Proposition 10.2. Let \mathcal{A}_k denote the event that exactly k rays survive and assume that

$$\mathbb{P}(\mathcal{A}_k) > 0, \tag{10.5}$$

Hence,

$$P(|\mathcal{C}_{CP}(\varrho)| = \infty) > 0. \tag{10.6}$$

By (10.6) and Lemma 22 in [32], we have that:

$$\mathbb{P}(T(\varrho) = \infty) > 0, \tag{10.7}$$

and therefore \mathbf{X} is transient.

On the event $\{T(\varrho) = \infty\}$, the limit walk ω^∞ of \mathbf{X} is well defined and it is a surviving ray. Let n be a positive integer and $\gamma := (\gamma_0 = \varrho, \gamma_1 = v_1, \dots, \gamma_n = v_n)$ be a path of length n of \mathcal{T} . Denote by $B_{n,\gamma}$ the following event:

$$\mathcal{B}_{n,\gamma} := \{\omega_{|[0,n]}^\infty = \gamma\}. \tag{10.8}$$

For any $1 \leq k \leq n$, define a sub-tree \mathcal{T}^{v_i} of \mathcal{T} in the following way (see Figure 5.2).

- The root of \mathcal{T}^{v_i} is the vertex v_i .
- If $\partial(v_i) < 2$ then \mathcal{T}^{v_i} is a tree with a single vertex v_i : for example, \mathcal{T}^{v_3} in Figure 5.2.
- If $\partial(v_i) \geq 2$, choose one of its children which is different to v_{i+1} , denoted by v . We then set:

$$\begin{cases} (\mathcal{T}^{v_i})_1 = \{v\} \\ (\mathcal{T}^{v_i})^v = \mathcal{T}^v \end{cases}$$

Note that for every pair $(i, j) \in [1, n]^2$, we have $V(\mathcal{T}^{v_i}) \cap V(\mathcal{T}^{v_j}) = \emptyset$.

Now, conditioning on the event $\mathcal{B}_{n,\gamma}$. Let ℓ be the last time \mathbf{X} visits v_n , i.e.

$$\ell := \sup\{k > 0 : X_k = v_n\}. \quad (10.9)$$

By the definition of limit walk, ℓ is finite on the event $\mathcal{B}_{n,\gamma}$. For each $i \in [1, n]$ and for all $v \in V(\mathcal{T}^{v_i})$, denote by $m^i(v)$ the remaining number of cookies at v after time ℓ , i.e.

$$m^i(v) := (M - \#\{k \leq \ell : X_k = v\}) \vee 0. \quad (10.10)$$

By using the extensions introduced in ([32], Section 7), the next steps on the tree \mathcal{T}^{v_i} are given by the digging random walk associated with the inhomogeneous initial number of cookies $(m^i(v), v \in V(\mathcal{T}^{v_i}))$ and the same parameter λ_c as \mathbf{X} , denoted by $\mathbf{X}^{v_i, m^i, \lambda_c}$ (see [32], section 2.3.2 for more details on the definition of $\mathbf{X}^{v_i, m^i, \lambda_c}$). Denote by T^{v_i, m^i, λ_c} the return time of $\mathbf{X}^{v_i, m^i, \lambda_c}$ to the root v_i of \mathcal{T}^{v_i} . By the definition of uniformly transient and Lemma 10.3, there exists a constant $c > 0$ which do not depend on n and γ such that for any i ,

$$\mathbb{P}\left(T^{v_i, m^i, \lambda_c} < \infty\right) > c. \quad (10.11)$$

On the event $\{T^{v_i, m^i, \lambda_c} < \infty\}$, note that \mathcal{C}_{CP} contains a surviving ray in \mathcal{T}^{v_i} . By (10.11), we have

$$\mathbb{P}(\mathcal{A}_k | \mathcal{B}_{n,\gamma}) \leq \binom{n}{k} (1-c)^{n-k} \quad (10.12)$$

On the other hand, we have $\mathcal{A}_k \subset \bigcup_{\gamma: |\gamma|=n} \mathcal{B}_{n,\gamma}$, therefore by (10.12) we obtain:

$$\mathbb{P}(\mathcal{A}_k) = \sum_{\gamma: |\gamma|=n} \mathbb{P}(\mathcal{A}_k | \mathcal{B}_{n,\gamma}) \times \mathbb{P}(\mathcal{B}_{n,\gamma}) \leq \left(\sum_{i=1}^k \binom{n}{i} \right) (1-c)^n \underbrace{\sum_{\gamma: |\gamma|=n} \mathbb{P}(\mathcal{B}_{n,\gamma})}_{\leq 1} \leq \left(\sum_{i=1}^k \binom{n}{i} \right) (1-c)^n. \quad (10.13)$$

Since 10.13 holds for any n then we obtain the following contradiction

$$\mathbb{P}(\mathcal{A}_k) = 0. \quad (10.14)$$

For part (2), the proof is similar to part (ii), Lemma 4.2 in [102]. \square

In the same method as in the proof of Proposition 10.2, we can prove the slightly stronger result (the proof of which we omit):

Proposition 10.4. *Let \mathbf{X} be a M -digging random walk with parameter λ_c on a weakly uniformly transient tree \mathcal{T} and recall the definition of \mathcal{C}_{CP} from \mathbf{X} as in ([32], Section 7). Consider the percolation induced by \mathcal{C}_{CP} and let $\phi(n) = \mathbb{P}(\varrho \leftrightarrow v)$ for $v \in \mathcal{T}_n$.*

1. *With probability one, the number of surviving rays is either zero or infinite.*
2. *If $\partial\mathcal{T}$ has σ -finite Hausdorff measure in the gauge $\{\phi(n)\}$, then $\mathbb{P}(\varrho \leftrightarrow \infty) = 0$. In particular, \mathbf{X} is recurrent.*

The following corollary is an immediate consequence of Proposition 10.4.

Corollary 10.5. *Let $M \in \mathbb{N}$ and \mathcal{T} be a weakly uniformly transient tree such that $\partial\mathcal{T}$ has σ -finite Hausdorff measure in the gauge $\{\phi(n)\} = \left(\frac{1}{br(\mathcal{T})}\right)^n$ if $br(\mathcal{T}) > 1$ and $\{\phi(n)\} = \frac{1}{n^{M+1}}$ if $br(\mathcal{T}) = 1$. Then the critical M -digging random walk on \mathcal{T} is recurrent.*

Proposition 10.6. *Let $M \in \mathbb{N}^*$ and \mathcal{T} be a superperiodic tree whose upper-growth rate is finite. The critical M -digging random walk on \mathcal{T} is recurrent.*

Proof. This is a consequence of Corollary 10.5 and Theorem 2.1. □

Remark 10.7. If $M = 0$, then M -DRW $_\lambda$ is the biased random walk with parameter λ . The recurrence of critical biased random walk on \mathcal{T} is a consequence of Theorem 2.1 and Nash-Williams criterion (see [87] or [97]).

Part III

Random maps

Chapter 6

Scaling limits for random triangulations on the Torus

This chapter is based on [14], which is joint work with Vincent Beffara and Benjamin Lévêque.

Abstract

We study the scaling limit of essentially simple triangulations on the torus. We consider, for every $n \geq 1$, a uniformly random triangulation G_n over the set of (appropriately rooted) essentially simple triangulations on the torus with n vertices. We view G_n as a metric space by endowing its set of vertices with the graph distance denoted by d_{G_n} and show that the random metric space $(V(G_n), (\frac{3}{4n})^{1/4} d_{G_n})$ converges in distribution in the Gromov–Hausdorff sense when n goes to infinity, at least along subsequences, toward a random metric space. One of the crucial steps in the argument is to construct a simple labeling on the map and show its convergence to an explicit scaling limit. We moreover show that this labeling approximates the distance to the root up to a uniform correction of order $o(n^{1/4})$.

1 Introduction

1.1 Some definitions

Recall that the *Hausdorff distance* between two non-empty subsets X and Y of a metric space (M, d) is defined as

$$d_{Haus}(X, Y) = \inf\{\varepsilon \geq 0 : X \subset Y_\varepsilon \quad \text{and} \quad Y \subset X_\varepsilon\},$$

where Z_ε denotes $\{m \in M : d(m, Z) \leq \varepsilon\}$. The *Gromov-Hausdorff distance* between two compact metric spaces (S, δ) and (S', δ') is defined as

$$d_{GH}((S, \delta), (S', \delta')) = \inf\{d_{Haus}(\varphi(S), \varphi'(S'))\},$$

where the infimum is taken over all isometric embeddings $\varphi : S \rightarrow S''$ and $\varphi' : S' \rightarrow S''$ of S and S' into a common metric space (S'', δ'') . Note that $d_{GH}((S, \delta), (S', \delta'))$ is equal to 0 if and only if the metric spaces S and S' are isometric to each other. We refer the reader to *e.g.* ([1], section 3) for a detailed investigation of the Gromov-Hausdorff distance).

In this paper, we are considering some random graphs seen as random metric spaces and consider their convergence in distribution in the sense of the Gromov-Hausdorff distance. In general, the graphs we consider may contain loops and multiple edges. A graph is called *simple* if it contains no loop nor multiple edges. A graph embedded on a surface is called a *map* on this surface if all its faces are homeomorphic to open disks. In this paper we consider orientable surface of genus g where the plane is the surface of genus 0, the torus the surface of genus 1, etc. For $p \geq 3$, a map is called a p -angulation if all its faces have size p . For $p = 3$ (resp. $p = 4$), such maps are respectively called triangulations (resp. quadrangulations).

1.2 Random planar maps

Let us first review some results on random planar maps. Consider a random planar map G_n with n vertices which is uniformly distributed over a certain class of planar maps (like planar triangulations, quadrangulations or p -angulations). Equip the vertex set $V(G_n)$ with the graph distance d_{G_n} . It is known that the diameter of the resulting metric space is of order $n^{1/4}$ (see for example [30] for the case of quadrangulations). Thus one can expect that the rescaled random metric spaces $(V(G_n), n^{-1/4}d_{G_n})$ converge in distribution as n tends to infinity toward a certain random metric space. In 2006, Schramm [110] suggested to use the notion of Gromov-Hausdorff distance to formalize this question by specifying the topology of this convergence. He was the first to conjecture the existence of a scaling limit for large random planar triangulations. In 2011, Le Gall [81] proved the existence of the scaling limit of the rescaled random metric spaces $(V(G_n), n^{-1/4}d_{G_n})$ for p -angulations when $p = 3$, or, $p \geq 4$ and p is even. The case $p = 3$ solves the conjecture

of Schramm. Miermont [94] gave an alternative proof in the case of quadrangulations ($p = 4$). Addario-Berry and Albenque [1] prove the case $p = 3$ for simple triangulations (*i.e.* triangulations with no loop nor multiple edges). An important aspect of all these results is that, up to a constant rescaling factor, all these classes converge toward the same object called the Brownian map.

It is natural to address the question of the existence of a scaling limit of random maps on higher genus oriented surfaces. Chapuy, Marcus and Schaeffer [29] extended the bijection known for planar bipartite quadrangulations to any oriented surfaces. This lead Bettinelli [22] to show that random quadrangulations on oriented surfaces converge in distribution, at least along a subsequence. More formally:

Theorem 1.1 (Bettinelli [22]). *For $g \geq 1$ and $n \geq 1$, let G_n be a uniformly random element of the set of all corner-rooted bipartite quadrangulations with n vertices on the oriented surface of genus g . Then, from any increasing sequence of integers, one can extract a subsequence $(n_k)_{k \geq 0}$ along which the rescaled metric spaces*

$$\left(V(G_{n_k}), n_k^{-1/4} d_{G_{n_k}} \right)_{k \geq 0}$$

converge in distribution for the Gromov-Hausdorff distance.

Contrary to the planar case, the uniqueness of the subsequential limit is not proved there. Nevertheless, a phenomenon of universality is expected: it is conjectured that the sequence does converge and that moreover, up to a deterministic multiplicative constant on the distance, the limit is the same for many models of random maps of a given genus. In genus 1, the conjectured limit is described in [22] and referred to as the *toroidal Brownian map*.

The goal of the present article is to extend Theorem 1.1 to the case of (essentially simple) triangulations of the torus. In that respect, it is comparable to the paper of Addario-Berry and Albenque [1] which did the same in the planar setup and contributes to the understanding of universality for random toroidal maps.

1.3 Main results

A *contractible loop* is an edge enclosing a region homeomorphic to an open disk. A pair of *homotopic multiple edges* is a pair of edges that have the same extremities and whose union encloses a region homeomorphic to an open disk. A graph G embedded on the torus is called *essentially simple* if it has no contractible loop nor homotopic multiple edges. Being essentially simple for a toroidal map is the natural generalization of being simple for a planar map.

In this paper, we distinguish paths and cycles from walks and closed walks as the firsts have no repeated vertices. A *triangle* of a toroidal map is a closed walk of size 3 enclosing

a region that is homeomorphic to an open disk. This region is called the *interior* of the triangle. Note that a triangle is not necessarily a face of the map as its interior may be not empty. We say that a triangle is *maximal* (by inclusion) if its interior is not strictly contained in the interior of another triangle. We define the *corners* of a triangle as the three angles that appear in the interior of this triangle when its interior is removed (if non empty).

Our main result is the following convergence result:

Theorem 1.2. *For $n \geq 1$, let G_n be a uniformly random element of the set of all essentially simple toroidal triangulations on n vertices that are rooted at a corner of a maximal triangle. Then, from any increasing sequence of integers, one can extract a subsequence $(n_k)_{k \geq 0}$ along which the rescaled metric spaces*

$$\left(V(G_{n_k}), n_k^{-1/4} d_{G_{n_k}} \right)_{k \geq 0}$$

converge in distribution for the Gromov-Hausdorff distance.

Remark 1.3. The reason for the particular choice of rooting in Theorem 1.2 is of a technical nature due to the bijection that we use in Section 2. It is a natural conjecture that compactness, and thus also the existence of subsequential scaling limits, would still hold *e.g.* for triangulations rooted at a uniformly random angle. This is based on the following reasoning: if the inside of every maximal triangle has diameter of smaller order than $n^{1/4}$, then rooting inside such a triangle rather than at one of its corners would affect distances by a quantity that would be smoothed out by the normalization. On the other hand, having one maximal triangle containing αn vertices has very small probability, because of the relative growths of the number of triangulations of genus 0 and 1. The remaining obstruction would be the existence of a maximal triangle with an inside containing much fewer than n vertices but having diameter of order $n^{1/4}$, which would presumably be ruled out by a precise control of the geometry of simple triangulations of genus 0. This is a possible direction for future work, but we chose not to investigate it further due to the already large size of the present paper.

We also show in an appendix that with high probability, the labeling function that we define as a crucial tool in our argument (see Section 3 for a formal definition) approximates the distance to the root up to a uniform $o(n^{1/4})$ correction (see Theorem 1.15). Such a comparison estimate is an essential step in proving the uniqueness of the subsequential scaling limit, and thus the convergence, in frameworks similar to that of our main result — see [1] for the case of genus 0, it is also likely that a similar argument would be applicable to quadrangulations of the torus [23] (those two quantities are actually equal in the case of bipartite quadrangulations on any surface with positive genus, but it seems that a bound of the order $o(n^{1/4})$ is enough).

The overall strategy for the proof of Theorem 1.2 is the same as in [22], as well as in [81] and [94]: obtain a bijection between maps and simpler combinatorial objects (typically decorated trees), then show convergence of these objects to a non-trivial continuous random limit from which relevant information can then be extracted about the original model. As a result, most of the structure of the paper is largely inspired by [22] (for the main argument) and [1] (for methods specific to triangulations).

The bijection that we use here is based on a recent generalization of Schnyder woods to higher genus [55, 54, 83]. One issue when going to higher genus is that the set of Schnyder woods of a given triangulation is no longer a single distributive lattice like in the planar case, it is rather a collection of distributive lattices. Nevertheless, it is possible to single out one of these distributive lattices, in the toroidal case, by requiring an extra property, called *balanced*, that defines a unique minimal element used as a *canonical orientation* for the toroidal triangulation. The particular properties of this canonical orientation leads to a bijection between essentially simple toroidal triangulation and particular toroidal unicellular maps [36] (a *unicellular* map is a map with only one face, i.e. the natural generalization of trees when going to higher genus). Then the main difficulty that we have to face is that the metric properties of the initial map are less apparent in the unicellular map than in the planar case or in the bipartite quadrangulations setup. In particular, lower bounds for the graph distance are more difficult to extract from the labeling function, requiring a delicate argument involving rightmost paths and precise control of its relation with shortest paths.

Structure of the paper

The bijection between toroidal triangulations and particular unicellular maps is presented in Section 2 with some related properties. In Section 3, we define a labeling function of the angles of a unicellular map and prove some relations with the graph distance in the corresponding triangulation. In Section 4 we explain how to decompose the particular unicellular maps given by the bijection into simpler elements with the use of Motzkin paths and well-labeled forests. In Section 5, we review some results on variants of the Brownian motion. The proof of Theorem 1.2 then proceeds in several steps. In Section 6, we study the convergence of the parameters of the discrete map in the scaling limit. In Sections 7, 8 and 9 we review and extend classical convergence results for conditioned random walks and random forests. Finally, in Section 10, we combine the previous ingredients to build the proof of the main theorem. In Appendix 1, we exploit the canonical orientation of the triangulation to define rightmost paths and relate them to shortest paths, thus obtaining the announced upper bound on the difference between distances and labels.

This work has been partially supported by the LabEx PERSYVAL-Lab (ANR-11-LABX-0025-01) funded by the French program Investissement d'avenir and the ANR project GATO (ANR-16-CE40-0009-01) funded by the French Agence National de la Recherche.

2 Bijection between toroidal triangulations and unicellular maps

For $n \geq 1$, let $\mathcal{G}(n)$ be the set of essentially simple toroidal triangulations on n vertices that are rooted at a corner of a maximal triangle.

Consider an element G of $\mathcal{G}(n)$. The corner of the maximal triangle where G is rooted is called the *root corner*. Note that, since G is essentially simple, there is a unique triangle, called the *root triangle* whose corner is the root corner (and this root triangle is maximal by assumption). The vertex of the root triangle corresponding to the root corner is called the *root vertex*. We also define, in a unique way, a particular angle of the map, called the *root angle*, that is the angle of G that is in the interior of the root triangle, incident to the root vertex and the last one in counterclockwise order around the root vertex. Note that it is possible to retrieve the root corner from the root angle in a unique way (indeed, the root angle defines already one edge of the root triangle and the side of its interior, thus it remains to find the third vertex of the root triangle such that the interior is maximal). Thus rooting G on its root corner or root angle is equivalent. We call *root face*, the face of G containing the root angle. We introduce in the rest of this section some terminology and results adapted from [36] (see also [83]).

2.1 Toroidal unicellular maps

Recall that a unicellular map is a map with only one face. There are two types of toroidal unicellular maps since two cycles of a toroidal unicellular map may intersect either on a single vertex (square case) or on a path (hexagonal case). On the first row of Figure 6.1 we have represented these two cases into a square box that is often use to represent a toroidal object (its opposite side are identified). On the second row of Figure 6.1 we have represented again these two cases by a square and hexagon by copying some vertices and edges of the map (here again the opposite sides are identified). Depending on what we want to look at we often move from one representation to the other in this paper. We call *special* the vertices of a toroidal unicellular map that are on all the cycles of the map. Thus the number of special vertices of a square (resp. hexagon) toroidal unicellular map is exactly one (resp. two).

Given a map, we call *stem*, a half-edge that is added to the map, attached to an angle of a vertex and whose other extremity is dangling in the face incident to this angle.

For $n \geq 1$, let $\mathcal{T}_r(n)$ denote the set of toroidal unicellular maps T rooted on a particular angle, with exactly n vertices, $n + 1$ edges and $2n - 1$ stems distributed as follows (see figure 6.2 for an example in $\mathcal{T}_r(7)$ where the root angle is represented with the usual "root" symbol in the whole paper.). The vertex incident to the root angle is called the *root vertex*. A vertex that is not the root vertex, is incident to exactly 2 stems if it is not a special vertex, 1 stem if it is the special vertex of a hexagon and 0 stem if it is

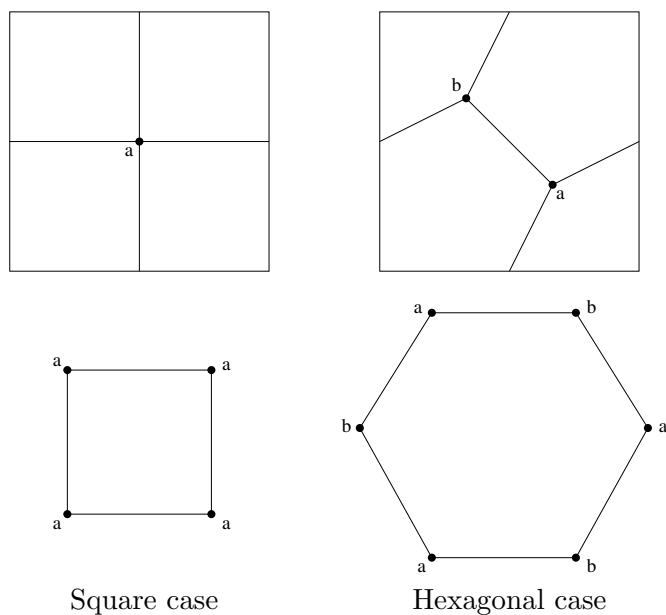

Figure 6.1 – The two types of toroidal unicellular maps with two different representations for each case.

the special vertex of a square. The root vertex is incident to 1 additional stem, i.e. it is incident to exactly 3 stems if it is not a special vertex, 2 stems if it is the special vertex of a hexagon and 1 stem if it is the special vertex of a square. Moreover, one of the stem incident to the root vertex, called the *root stem*, is incident to the root angle and just after the root angle in counterclockwise order around the root vertex.

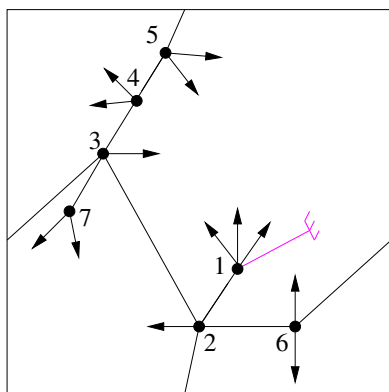

Figure 6.2 – Example of an element of $\mathcal{T}_r(7)$.

2.2 Closure procedure

Given an element of T of $\mathcal{T}_r(n)$, there is a generic way to reattach step by step all the dangling extremities of the stems of T to build a toroidal triangulation. Let $T_0 = T$, and, for $1 \leq k \leq 2n - 1$, let T_k be the map obtained from T_{k-1} by reattaching one of its stem (we explicit below which stems can be reattached and how). The *special face* of T_0 is its only face. For $1 \leq k \leq 2n - 1$, the *special face* of T_k is the face on the right of the stem of T_{k-1} that is reattached to obtain T_k (the stem is by convention oriented from its incident vertex toward its dangling part). For $0 \leq k \leq 2n - 1$, the border of the special face of T_k consists of a sequence of edges and stems. We define an *admissible triple* as a sequence (e_1, e_2, s) , appearing in counterclockwise order along the border of the special face of T_k , such that $e_1 = (u, v)$ and $e_2 = (v, w)$ are edges of T_k and s is a stem attached to w . The *closure* of this admissible triple consists in attaching s to u , so that it creates an edge (w, u) oriented from w to u and so that it creates a triangular face (u, v, w) on its left side. The *complete closure* of T consists in closing a sequence of admissible triples, i.e. for $1 \leq k \leq 2n - 1$, the map T_k is obtained from T_{k-1} by closing any admissible triple.

Figure 6.3 is the hexagonal representation of the example of Figure 6.2 on which a complete closure is performed. We have represented here the unicellular map as an hexagon since it is easier to understand what happen in the unique face of the map. The map obtained by performing the complete closure procedure is the clique on seven vertices K_7 .

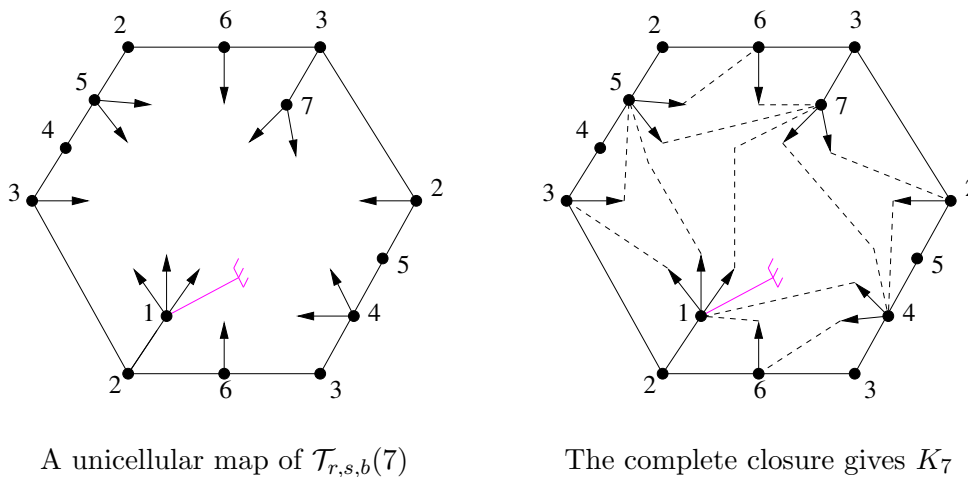

Figure 6.3 – Example of the complete closure procedure.

Note that, for $0 \leq k \leq 2n - 1$, the special face of T_k contains all the stems of T_k . The closure of a stem reduces the number of edges on the border of the special face and the number of stems by 1. At the beginning, the unicellular map T_0 has $n + 1$ edges and

$2n - 1$ stems. So along the border of its special face, there are $2n + 2$ edges and $2n - 1$ stems. Thus there is exactly three more edges than stems on the border of the special face of T_0 and this is preserved while closing stems. So at each step there is necessarily at least one admissible triple and the sequence T_k is well defined. Since the difference of three is preserved, the special face of T_{2n-2} is a quadrangle with exactly one stem. So the reattachment of the last stem creates two faces that have size three and at the end T_{2n-1} is a toroidal triangulation. Note that at a given step there might be several admissible triples but their closure are independent and the order in which they are closed does not modify the obtained triangulation T_{2n-1} .

When a stem is reattached on the root angle, then, by convention, the new root angle is maintained on the right side of the extremity of the stem, i.e. the root angle is maintained in the special face. A particularly important property when reattaching stems is when the complete closure procedure described here never *wraps over the root angle*, i.e. when a stem is reattached, the root angle is always on its right side in the special face. The property of never wrapping over the root angle is called *safe* (an analogous property is sometimes called "balanced" in the planar case but we prefer to keep the word "balanced" for something else in the current paper). Let $\mathcal{T}_{r,s}(n)$ denote the set of elements of $\mathcal{T}_r(n)$ that are safe.

Consider an element T of $\mathcal{T}_{r,s}(n)$ with root angle a_0 . Then for $0 \leq k \leq 2n - 2$, let s be the first stem met while walking counterclockwise from a_0 in the special face of T_k . An essential property from [36] is that before s , at least two edges are met and thus the last two of these edges form an admissible triple with s . So one can reattach all the stems of T by starting from the root angle a_0 and walking along the face of T in counterclockwise order around this face: each time a stem is met, it is reattached in order to create a triangular face on its left side. Note that in such a sequence of admissible triples closure, the last stem that is reattached is the root stem of T .

2.3 Canonical orientation and balanced property

For $n \geq 1$, consider an element T of $\mathcal{T}_r(n)$ whose edges and stems are oriented w.r.t. the root angle a_0 as follows (see Figure 6.4 that corresponds to the example of Figure 6.2): the stems are all outgoing, and while walking clockwise around the unique face of T from a_0 , the first time an edge is met, it is oriented counterclockwise w.r.t. the face of T . This orientation plays a particular role and is called the *canonical orientation* of T .

For a cycle C of T , given with a traversal direction, let $\gamma(C)$ be the number of outgoing edges and stems that are incident to the right side of T minus the number of outgoing edges and stems that are incident to its left side. A unicellular map of $\mathcal{T}_r(n)$ is said to be *balanced* if $\gamma(C) = 0$ for all its (non-contractible) cycles C . Let us call $\mathcal{T}_{r,s,b}(n)$ the set of balanced elements of $\mathcal{T}_{r,s}(n)$.

Figure 6.4 is an example of an element of $\mathcal{T}_{r,s,b}(7)$. The value γ of the cycles of the

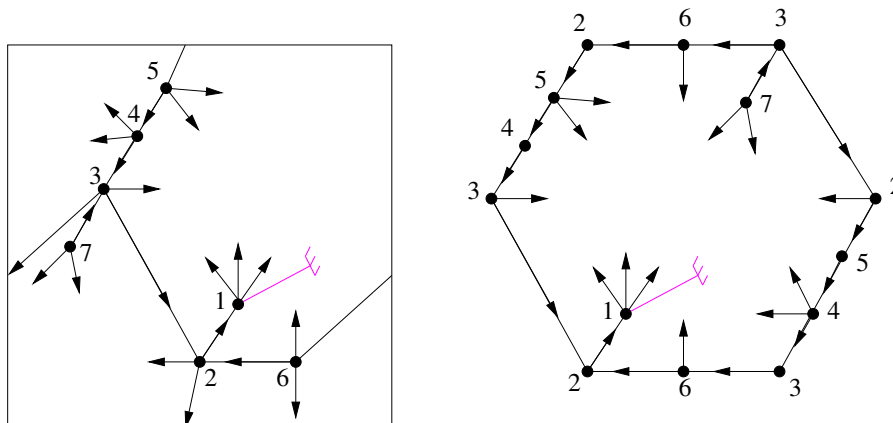

Figure 6.4 – Orientation of the edges and stems of an element of $\mathcal{T}_r(7)$.

unicellular map are much more easier to compute on the left representation.

A consequence of [36] (see the proof of Theorem 7 where $\mathcal{T}_{r,s,b}(n)$ is called $\mathcal{U}'_{r,b,\gamma_0}(n)$ and $\mathcal{G}(n)$ is called $\mathcal{T}'_r(n)$), is that, for $n \geq 1$, the complete closure procedure is indeed a bijection between elements of $\mathcal{T}_{r,s,b}(n)$ and $\mathcal{G}(n)$, that we note Φ here:

Theorem 2.1 ([36]). *For $n \geq 1$, there is a bijection between $\mathcal{T}_{r,s,b}(n)$ and $\mathcal{G}(n)$.*

The left of Figure 6.3 gives an example of a hexagonal unicellular map in $\mathcal{T}_{r,s,b}(7)$. Note that on the right of Figure 6.3, the face containing the root angle, after the closure procedure, is indeed a maximal triangle, so the obtained triangulation is an element of $\mathcal{G}(7)$ if rooted on the corner of the face corresponding to the root angle.

Given an element T of $\mathcal{T}_{r,s,b}(n)$, the canonical orientation of T , defined previously, induces an orientation of the edges of the corresponding triangulation G of $\mathcal{G}(n)$ that is also called the *canonical orientation* of G . Note that in this orientation of G , all the vertices have outdegree exactly 3, we call such an orientation a *3-orientation*. In fact this orientation corresponds to a particular 3-orientation that is called the *minimal balanced Schnyder wood of G w.r.t. to the root face* (see [83] for more on Schnyder woods in higher genus). We extend the definition of function γ to G by the following. For a cycle C of G , given with a traversal direction, let $\gamma(C)$ be the number of outgoing edges that are incident to the right side of T minus the number of outgoing edges that are incident to its left side. As shown in [83], the canonical orientation of G as the particular property that $\gamma(C) = 0$ for all its non-contractible cycles C , we call this property *balanced*.

Figure 6.5, gives the canonical orientation of K_7 obtained from the canonical orientation of its corresponding element in $\mathcal{T}_{r,s,b}(7)$ after a complete closure procedure.

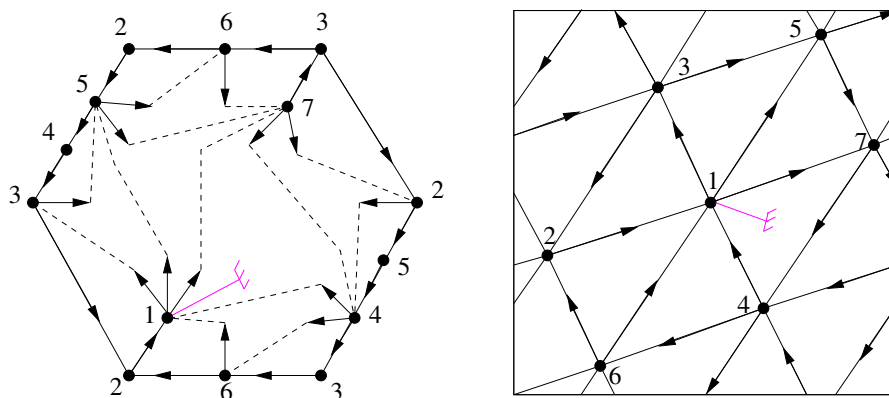

Figure 6.5 – The canonical orientation of K_7 .

2.4 Unrooted unicellular maps

Given an element T of $\mathcal{T}_{r,s,b}(n)$, we have seen that the root stem s_0 can be the last stem that is reattached by the complete closure procedure. Consequently, if one removes the root stem s_0 from T to obtain an unicellular map U with n vertices, $n + 1$ edges and $2n - 2$ stems, one can recover the graph T_{2n-2} by applying the closure procedure on U .

For $n \geq 1$, let $\mathcal{U}(n)$ denote the set of (non-rooted) toroidal unicellular maps, with exactly n vertices, $n + 1$ edges and $2n - 2$ stems satisfying the following: a vertex is incident to exactly 2 stems if it is not a corner, 1 stem if it is the corner of a hexagon and 0 stem if it is the corner of a square. Thus, given an element T of $\mathcal{T}_r(n)$, the element U obtained from T by removing the root angle and the root stem is an element of $\mathcal{U}(n)$.

Since an element U of $\mathcal{U}(n)$ is non-rooted, it has no "canonical orientation" as defined previously for elements of $\mathcal{T}_r(n)$. Nevertheless one can still orient all the stems as outgoing and compute γ on the cycles of U by considering only its stems in the counting (and not the edges nor the root stem anymore). For a cycle C of U , given with a traversal direction, let $\gamma(C)$ be the number of outgoing stems that are incident to the right side of U minus the number of outgoing stems that are incident to its left side. A unicellular map of $\mathcal{U}(n)$ is said to be *balanced* if $\gamma(C) = 0$ for all its (non-contractible) cycles C . Let us call $\mathcal{U}_b(n)$ the set of elements of $\mathcal{U}(n)$ that are balanced.

As remarked in [36], an interesting property is that an element U of $\mathcal{U}(n)$ is balanced if and only if any element T of $\mathcal{T}_r(n)$ obtained from U by adding a root stem anywhere in U is balanced (recall that in U we use the canonical orientation to compute γ). Moreover, given an element T of $\mathcal{T}_{r,b}(n)$, then the element U of $\mathcal{U}(n)$, obtained by removing the root angle, (the canonical orientation,) and the root stem is balanced.

Figure 6.6 is the element of $\mathcal{U}_b(7)$ corresponding to Figure 6.4.

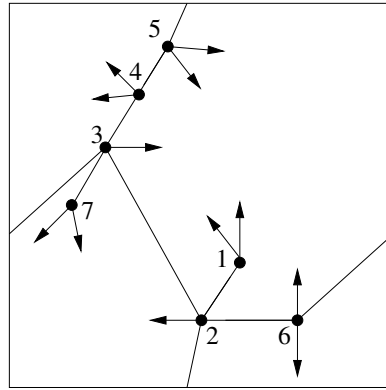

Figure 6.6 – Example of an element of $\mathcal{U}_b(7)$.

3 Labeling of the angles and distance properties

3.1 Definition and properties of the labeling function

For $n \geq 1$, let T be an element of $\mathcal{T}_{r,s,b}(n)$, and $G = \Phi(T)$ the corresponding element of $\mathcal{G}(n)$ by Theorem 2.1. Let V (resp. E) denotes the set of vertices (resp. edges) of G . Let a_0 be the root angle of T and v_0 be its root vertex. We use the same notations for the root angle and vertex of G (while maintaining the root angle on the right side of every stem during the complete closure procedure, as explained in Section 2). In this section, we prove a relation between the graph distance in the triangulation G from a vertex to the root vertex and a particular labeling of the vertices defined on the unicellular map T as follows.

Let $\ell = 4n + 1$ be the number of angles of T . We add a special dangling half-edge incident to the root angle of T , called the *root half-edge* (and not considered as a stem). Let Γ be the obtained unicellular map. We define the *root angle* of Γ as the angle of Γ just after the root half-edge in counterclockwise order around its incident vertex. Let $A = (a_0, \dots, a_\ell)$ be the sequence of consecutive angles of Γ in clockwise order around the unique face of Γ such that a_0 is the root angle. Note that a_ℓ is incident to the root half-edge. For $0 \leq i \leq \ell - 1$, two angles a_i and a_{i+1} are either consecutive around a stem or consecutive around an edge of Γ . We define a labeling function $\lambda : A \rightarrow \mathbb{Z}$ as follows. Let $\lambda(a_0) = 3$. For $0 \leq i \leq \ell - 1$, let $\lambda(a_{i+1}) = \lambda(a_i) + 1$ if a_i and a_{i+1} are consecutive around a stem, and let $\lambda(a_{i+1}) = \lambda(a_i) - 1$ if they are consecutive around an edge. By definition, the unicellular map Γ has $n + 1$ edges and $2n - 1$ stems. While going clockwise around the unique face of Γ , each edge is encountered twice, so $\lambda(a_\ell) = 2n - 1 - 2(n + 1) + \lambda(a_0) = 0$. Figure 6.7 gives an example of the labeling function of the unicellular map of Figure 6.4.

Given a stem s of Γ , we define the label $\lambda(s)$ of s as the label of the angle that is just before s in counterclockwise order around its incident vertex.

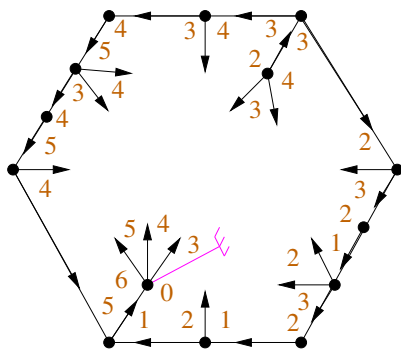

Figure 6.7 – Labeling of the angles of the unicellular map.

The complete closure procedure is formally defined on T but we can consider that it behaves on Γ since the presence of the root half-edge in Γ does not change the procedure as T is safe (the root half-edge is maintained on the right of every stem during the closure). Let $\Gamma_0 = \Gamma$, and, for $1 \leq k \leq 2n - 1$, let Γ_k be the map obtained from Γ_{k-1} by closing an admissible triple of Γ_{k-1} . By the bijection Φ we have that Γ_{2n-1} is the graph G with an additional dangling half-edge incident to the root angle, we call this graph G^+ . We propagate the labeling λ of Γ during the closure procedure by the following. For $1 \leq k \leq 2n - 1$, when the stem s of Γ_{k-1} is reattached, it splits an angle a of Γ_{k-1} into two angles of Γ_k that both inherit the label of a in Γ_{k-1} . In other words, the complete closure procedure just splits some angles that keeps the same label on each side of the split. We still note λ the labeling of the angles of Γ_k . It is clear that the labeling of $G^+ = \Gamma_{2n-1}$ that is obtained is independent from the order in which the admissible triples are closed. We denote $\mathcal{A}(i)$ the set of angles of G^+ which are splitted from a_i by the complete closure procedure. Note that for all $a \in \mathcal{A}(i)$, we have $\lambda(a) = \lambda(a_i)$. Given a stem s of Γ , we denote $a(s)$ the angle of Γ corresponding to where s is reattached during the complete closure procedure (i.e. s is reattached to an angle that comes from some splittings of $a(s)$).

Consider a stem s of T . Let i, j , be such that a_i is the angle just before s in counter-clockwise order around its incident vertex and $a_j = a(s)$. The fact that T is safe implies that $0 \leq i < j \leq \ell$.

Lemma 3.1. *For $0 \leq k \leq 2n - 1$, the rules that are used to define the labeling function λ are still valid around the special face of Γ_k , i.e. the root angle of Γ_k is labeled 3, and while walking clockwise around the special face of Γ_k , the labels are increasing by one around a stem and decreasing by one along an edge until finishing at label 0 at the last angle.*

In particular, for each stem s of Γ , we have $\lambda(a(s)) = \lambda(s) - 1$. Moreover, all the angles of Γ that appear strictly between s and $a(s)$ in clockwise order along the unique face of Γ have labels that are greater or equal to $\lambda(s)$.

Proof. We prove the first part of the lemma by induction on k . Clearly the statement is true for $k = 0$ by definition and properties of λ . Suppose now that for $1 \leq k \leq 2n - 1$, the statement is true for Γ_{k-1} . Let s be the stem of Γ_{k-1} that is reattached to obtained Γ_k . Let (e_1, e_2, s) be the admissible triple of Γ_{k-1} involving s , when s is reattached. Let $\alpha_0, \alpha_1, \alpha_2, \alpha_3$ be the angles of the special face of Γ_{k-1} that appears along the admissible triple (e_1, e_2, s) , such that $\alpha_0, s, \alpha_1, e_1, \alpha_2, e_2, \alpha_3$ appears consecutively in clockwise order around the special face. So we have that the dangling part of s is attached to the angle α_3 to form Γ_k . Since T is safe, the root angle of Γ_{k-1} is distinct from α_1, α_2 . So, by induction, the rules of the labeling function applies in Γ_{k-1} from α_0 to α_3 . Thus $\lambda(\alpha_1) = \lambda(\alpha_0) + 1$, $\lambda(\alpha_2) = \lambda(\alpha_1) - 1$, $\lambda(\alpha_3) = \lambda(\alpha_2) - 1$. So $\lambda(\alpha_3) = \lambda(\alpha_1) - 1$, and the rules still apply in the special face of Γ_k .

A direct consequence of the above paragraph, is that for each stem s of Γ , we have $\lambda(a(s)) = \lambda(s) - 1$.

Suppose by contradiction that there is a stem s and an angle of Γ that appear strictly between s and $a(s)$ in clockwise order along the unique face of Γ whose label is less or equal to $\lambda(a(s))$. We choose such an angle α whose label is minimum. With the same notations of the angles α_1, α_2 as above, since $\lambda(\alpha_2) = \lambda(a(s)) + 1$ and $\lambda(\alpha_1) = \lambda(a(s)) + 2$, we have that neither α_1 nor α_2 comes from a splits of α . So there exists an admissible triple s' , closed before s is the complete closure procedure, and whose one of the two internal angles α'_1, α'_2 (with analogous notations as above) is α (or comes from a split of α). By the rule of the labeling, we have $\lambda(\alpha) \in \{\lambda(a(s')) + 1, \lambda(a(s')) + 2\}$ (depending on which internal angle it is, either α'_1 or α'_2). Thus by minimality of α , we have $a(s') = a(s)$, but then $\lambda(\alpha) \in \{\lambda(a(s)) + 1, \lambda(a(s)) + 2\}$, a contradiction. \square

Lemma 3.2. *Consider a (non-contractible) cycle C of Γ of length k that does not contain the root vertex. Then there is exactly $k - 1$ stems attached to each side of C .*

Proof. As explained in Section 2.4, when one remove from T the root stem, the canonical orientation and the root angle, one obtain an element of $\mathcal{U}_b(n)$. So we have that the number of stems attached to the left and right side of C are the same. In both cases, whether Γ is a square or hexagonal unicellular map, we have that C is incident to exactly $2(k - 1)$ stems, so there is exactly $k - 1$ stems attached to each side of C . \square

Note that if $v_0 \in C$ then the conclusion of Lemma 3.2 is not true since there is an additional stem attached to the root vertex.

Lemma 3.3. *For $0 \leq i \leq \ell - 1$, we have $\lambda(a_i) > 0$.*

Proof. Assume that there exists $0 \leq i \leq \ell - 1$, such that $\lambda(a_i) \leq 0$. Let $k = \max\{0 \leq i \leq \ell - 1 : \lambda(a_i) \leq 0\}$. If a_k and a_{k+1} are consecutive along an edge, then we have $\lambda(a_{k+1}) = \lambda(a_k) - 1 < 0$. If a_k and a_{k+1} are separated by a stem, then, by Lemma 3.1, we have $\lambda(a(s)) = \lambda(a_k) - 1$, so there exists $k' > k$ such that $\lambda(a_{k'}) < 0$. In both cases, there is a contradiction to the definition of k . \square

Let V_S be the set of special vertices of Γ (defined in Section 2). We call *proper* the edges and vertices of Γ that are on at least one cycle of Γ . Let V_P (respectively E_P) be the set of proper vertices (respectively edges) of Γ . Note that $V_S \subseteq V_P$.

We call *root path* the (unique) shortest path of Γ from the root vertex to a proper vertex. Note that the root path might have length 0 if v_0 is proper. The sequence of vertices along the root path is denoted $V_R = (r_0, r_1, \dots, r_s)$, with $s \geq 0$, $r_0 = v_0$ and r_s is proper. The set of edges of the root path is denoted E_R . Let $V_N = V \setminus (V_P \cup V_R)$ be the set of *normal vertices* of Γ and $E_N = E \setminus (E_P \cup E_R)$ be the set of *normal edges* of Γ .

The *canonical orientation* of Γ is the orientation of the edges and stems of Γ that corresponds to the canonical orientation of T (the special dangling half edge added in the root angle has no particular orientation). Consider an edge e of Γ with its orientation in the canonical orientation, then by the orientation rule, the angles of γ incident to e that are on its right side have greater indices in the set A than the angles that are on its left side, i.e. they are seen after while going in clockwise order around the unique face of Γ starting from the root angle.

Lemma 3.4. *Consider an edge $e = uv$ of Γ that is oriented from u to v in the canonical orientation of Γ . Let $0 \leq i < j < \ell$ such that $a_i, a_{i+1}, a_j, a_{j+1}$ appear in this order in counterclockwise order around e with a_i, a_{j+1} incident to v and a_{i+1}, a_j incident to u . Then we have the following (see Figure 6.8):*

$$\lambda(a_{j+1}) - \lambda(a_i) = \begin{cases} 0 & \text{if } e \in E_N \\ -3 & \text{if } e \in E_P \\ -6 & \text{if } e \in E_R \end{cases} \quad \text{and}$$

$$\lambda(a_{i+1}) - \lambda(a_j) = \begin{cases} -2 & \text{if } e \in E_N \\ +1 & \text{if } e \in E_P \\ +4 & \text{if } e \in E_R \end{cases}$$

Proof. Note first that by the labeling rule we have $\lambda(a_{i+1}) = \lambda(a_i) - 1$ and $\lambda(a_{j+1}) = \lambda(a_j) - 1$. So $(\lambda(a_{i+1}) - \lambda(a_j)) + (\lambda(a_{j+1}) - \lambda(a_i)) = -2$.

Suppose first that $e \in E_N$. While going clockwise around the unique face of Γ starting from a_i to a_{j+1} , we encounter only normal vertices and edges. So we go around a planar tree whose edges are encountered twice and whose number of stems is equal to twice the number of edges. This implies that $\lambda(a_{j+1}) - \lambda(a_i) = 0$ and so $\lambda(a_{i+1}) - \lambda(a_j) = -2$.

The case where $e \in E_R$ is quite similar. While going clockwise around the unique face of Γ starting from a_j to a_{i+1} , we are in the same situation as above except that we go over the root vertex. The root vertex is incident to 1 more stem than normal vertices and there is a jump of 3 from the label of a_ℓ to a_0 around the root vertex. This implies that $\lambda(a_{i+1}) - \lambda(a_j) = 4$ and so $\lambda(a_{j+1}) - \lambda(a_i) = -6$.

It only remains to consider the case where $e \in E_N$. We suppose here that Γ is hexagonal. The case where Γ is square can be proved similarly.

The value $\lambda(a_{j+1}) - \lambda(a_i)$ is equal to the number of stems minus the number of edges that are encountered while going clockwise around the unique face of Γ starting from a_i to a_{j+1} , with $i < j$. Each normal edge that is met is encountered twice and the number of stems that are met and attached to normal vertices is equal to exactly twice this number of edges. So there number does not affect the value $\lambda(a_{j+1}) - \lambda(a_i)$. Thus we just have to look at proper edges and stems attached to proper vertices.

Let s be the first special vertex that is encountered. Note that s is encountered twice along the computation and the other special vertex only once. Let P be the unique path of Γ between v and s with no special inner vertices. Let k be the length of P . All the stems attached to inner vertices of P are encountered exactly once and all the edges of P are encountered exactly twice. Since each inner vertex of P is incident to exactly two stems, and there one more edges in P than inner vertices, this part results in value -2 in the computation of $\lambda(a_{j+1}) - \lambda(a_i)$.

It remains to look at the part encountered between the two copies of s . This corresponds to exactly a cycle C of Γ of length k' , where all its edges and all the stems incident to one of its side are encountered exactly once. Note that v_0 does not belong to C since $i < j$. Then by Lemma 3.2, there are exactly $k' - 1$ stems attached to each side of C . So this part results in value $(k' - 1) - k' = -1$ in the computation of $\lambda(a_{j+1}) - \lambda(a_i)$.

Finally, in total we obtain $\lambda(a_{j+1}) - \lambda(a_i) = -3$ and so $\lambda(a_{i+1}) - \lambda(a_j) = 1$. \square

One can remark on Figure 6.8 that an incoming edge of Γ corresponds to a variation of the labeling in counterclockwise order around its incident vertex that is always ≤ 0 .

By Lemma 3.4, we can deduce the variation of the labels around the different kind of possible vertices that may appear on Γ . They are many different such vertices, the 12 different cases are represented on Figures 6.9.(a) to (ℓ). The stems are not represented on the figures, except the root stem, but their number is indicated below each figure. These stems can be incident to any angle of the figures, except the angles incident to the root symbol that are marked with an empty set. Recall that each of this stem results in a $+1$ in the variation of the labels while going counterclockwise around their incident vertex. The incoming normal edges are not represented either. There can be an arbitrary number of such edges incident to each angle of the figures. By Lemma 3.4, there is no variation of the labels around them. When $v = v_0$, i.e. v is the root vertex, we have

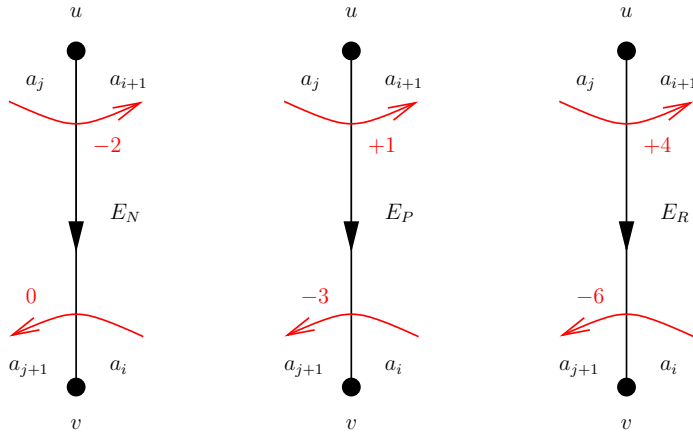

Figure 6.8 – Variations of the labeling around the three different kind of edges of Γ .

represented the root stem and the special dangling root symbol. In this particular case, there is no stem nor incoming normal edges incident to the angles incident to the root symbol by the safe property.

For each $u \in V$, let $A(u)$ be the set of angles incident to u , let $m(u) = \min_{a \in A(u)} \lambda(a)$, and let $M(u) = \max_{a \in A(u)} \lambda(a)$. On Figures 6.9.(a) to (l) we have represented the position of the label $M(v)$ and $m(v)$ wherever the missing stems are. We also have given the value of $M(v) - m(v)$ or an inequality on it. This case analysis gives the following lemma :

Lemma 3.5. *For all $v \in V$, we have $M(v) - m(v) \leq 6$.*

Lemma 3.6. *For all $\{u, v\} \in E(G)$, we have $|m(u) - m(v)| \leq 7$.*

Proof. Let $e \in E(G)$ with extremities u and v . We consider two cases whether e is an edge of Γ or not.

- *e is an edge of Γ :* While walking clockwise around the special face of Γ from the root angle, there is an angle α incident to u and an angle β incident to v that appears consecutively. By definition of the labels, we have $\lambda(\beta) = \lambda(\alpha) - 1$. Moreover by Lemma 3.5, we have $m(u) \in \llbracket \lambda(\alpha) - 6, \lambda(\alpha) \rrbracket$ and $m(v) \in \llbracket \lambda(\beta) - 6, \lambda(\beta) \rrbracket$. This implies that $|m(u) - m(v)| \leq 7$.
- *e is not an edge of Γ :* Thus e comes from the reattachment of a stem s of Γ by the complete closure procedure. W.l.o.g., we may assume that s is incident to u . By Lemma 3.1, we have $\lambda(a(s)) = \lambda(s) - 1$. By lemma 3.5, we have $m(u) \in \llbracket \lambda(s) - 6, \lambda(s) \rrbracket$ and $m(v) \in \llbracket \lambda(s) - 7, \lambda(s) - 1 \rrbracket$. This implies that $|m(u) - m(v)| \leq 7$.

□

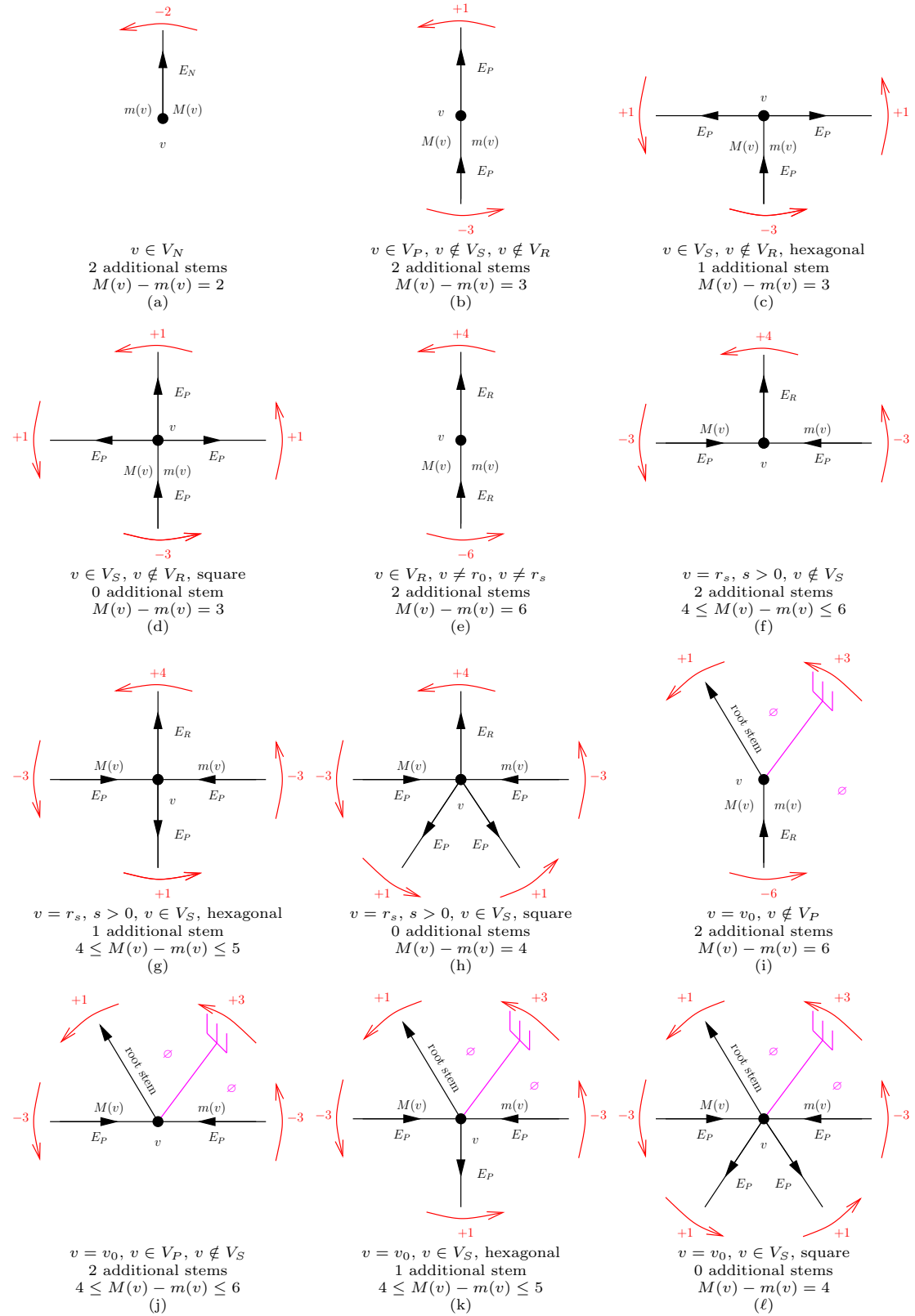

Figure 6.9 – Variations of the labeling around the different kind of possible vertices of Γ .

3.2 Relation with the graph distance

For $(u, v) \in V$, we denote by $d_G(u, v)$ the length (i.e. the number of edges) of a shortest path in G starting at u and ending at v .

Given an angle α of Γ , let $v(\alpha)$ denote the vertex of Γ incident to α .

Lemma 3.7. *For all $v \in V$, we have $\frac{m(v)}{7} \leq d_G(v_0, v) \leq m(v)$.*

Proof. We prove first the left inequality. Let $P = (w_0, w_1, \dots, w_k)$ be a shortest path in G starting at $w_0 = v$ and ending at $w_k = v_0$, thus $d_G(v_0, v) = k$. We want to prove that $k \geq \frac{m(v)}{7}$. By Lemma 3.6, for all $0 \leq i \leq k-1$, we have $m(w_{i+1}) \geq m(w_i) - 7$. Thus we have $m(w_k) - m(w_0) = \sum_{i=0}^{k-1} (m(w_{i+1}) - m(w_i)) \geq -7k$. Moreover $m(w_k) = m(v_0) = 0$ and $m(w_0) = m(v)$. This implies that $k \geq \frac{m(v)}{7}$.

We now prove the right inequality. We define a walk $W = (w_i)_{i \geq 0}$ of G , starting at v by the following. Let $w_0 = v$ and assume that w_i is defined for $i \geq 0$. If $w_i = v_0$, then the procedure stops. If w_i is distinct from v_0 , we consider an angle α incident to w_i such that $\lambda(\alpha) = m(w_i)$. Let α' be the angle of the unique face of Γ , just after α in clockwise order around this face. If α and α' are separated by a stem s , we set $w_{i+1} = v(a(s))$. If α and α' are consecutive along an edge of Γ , we set $w_{i+1} = v(\alpha')$. In both cases, we prove that $m(w_{i+1}) \leq m(w_i) - 1$. When α and α' are separated by a stem s , then, by Lemma 3.1, we have $m(w_{i+1}) \leq \lambda(a(s)) = \lambda(\alpha) - 1 = m(w_i) - 1$. When α and α' are consecutive along an edge of Γ , then, by the definition of the labeling function, we have $m(w_{i+1}) \leq \lambda(\alpha') = \lambda(\alpha) - 1 = m(w_i) - 1$. So, the sequence $(m(w_i))_{i \geq 0}$ is strictly decreasing along the walk W . By Lemma 3.3, the function m is ≥ 0 , and equal to zero only for v_0 . So the procedure ends on v_0 . Let k be the length of W , we have $k \leq m(v)$. So finally, we have $d_G(v_0, v) \leq k \leq m(v)$. \square

Recall that $A = (a_0, a_1, \dots, a_\ell)$ is the set of angles of Γ and for $v \in V$, we have $A(v)$ is the set of angles incident to v . For $v \in V$, let $b(v) = \min\{i : a_i \in A(v)\}$.

For $v \in V$, we define the sequence $J(v) = (j(i))_{i \geq 0}$ of elements of \mathbb{N} by the following. Let $j(0) = b(v)$ and assume that $j(i)$ is defined for $i \geq 0$. If $j(i) = \ell$, then the procedure stops. If $j(i) \neq \ell$, then we define $j(i+1)$ by the following. If the two consecutive angles $a_{j(i)}$ and $a_{j(i)+1}$ of A are separated by a stem s , then let $j(i+1)$ be such that $a_{j(i+1)} = a(s)$. If $a_{j(i)}$ and $a_{j(i)+1}$ are consecutive along an edge of Γ , then let $j(i+1) = j(i) + 1$. Note that in both cases, by Lemma 3.1 or the labeling rule, we have $\lambda(a_{j(i+1)}) = \lambda(a_{j(i)}) - 1$. So $(\lambda(a_{j(i)}))_{i \geq 0}$ is decreasing by exactly one at each step. Let $k = \lambda(a_{b(v)})$. Then for $i \geq 0$, we have $\lambda(a_{j(i)}) = k - i$. Thus the procedure ends on ℓ after k steps, i.e. $J(v) = (j(i))_{0 \leq i \leq k}$. Moreover we have that the sequence $J(v)$ is strictly increasing since, as already remarked, by the safe property, a stem s is always reattached to an angle with greater index than the index of the angles incident to s . We also define the corresponding walk $W_J(v) = (v(a_{j(i)}))_{0 \leq i \leq k}$ of G .

We have the following lemma:

Lemma 3.8. *Consider $v \in V$ with $k = \lambda(a_{b(v)})$ and $J(v) = (j(i))_{0 \leq i \leq k}$. Then, $k > 0$, and for $0 \leq i \leq k$, we have $j(i) = \min\{z \geq b(v) : \lambda(a_z) = k - i\}$.*

Proof. First, suppose by contradiction that $k = 0$. Then we have $b(v) = \ell$, so $v = v_0$ and thus $b(v) = 0$. This contradicts $\ell = 4n + 1$ and $n \geq 1$. So $k > 0$.

Let y be such that $0 \leq y < k$. We claim that for all z such that $j(y) \leq z < j(y + 1)$, we have $\lambda(a_z) \geq k - y$. Recall that we have $\lambda(a_{j(y)}) = k - y$ so the claim is true for $z = j(y)$. If the two consecutive angles $a_{j(y)}$ and $a_{j(y)+1}$ of A are consecutive along an edge of Γ , then we are done since $j(y + 1) = j(y) + 1$. Suppose now that $a_{j(y)}$ and $a_{j(y)+1}$ are separated by a stem s , then we have $a_{j(y)+1} = a(s)$. By Lemma 3.1, for $j(y) < z < j(y + 1)$, we have $\lambda(a_z) \geq \lambda(a_{j(y)}) = k - y$. This concludes the proof of the claim.

Let i be such that $0 \leq i < k$. So, by the claim applied for $0 \leq y \leq i$, we have the following: for $b(v) \leq z < j(i + 1)$, we have $\lambda(a_z) \geq k - i$. Since $\lambda(a_{j(i+1)}) = k - i - 1$, we have $j(i + 1) = \min\{z \geq b(v) : \lambda(a_z) = k - (i + 1)\}$. Moreover, we clearly have $j(0) = \min\{z \geq b(v) : \lambda(a_z) = k\}$. \square

We say that a vertex v is the successor of a vertex u if $b(u) \leq b(v)$ and denote this by $u \preceq v$. Then for all $u, v \in V$, we define

$$\overline{m}(u, v) = \begin{cases} \min\{\lambda(a_k) : b(u) \leq k \leq b(v)\} & \text{if } u \preceq v \\ \min\{\lambda(a_k) : b(v) \leq k \leq b(u)\} & \text{if } v \preceq u \end{cases}.$$

Lemma 3.9. *For all $u, v \in V$, we have $d_G(u, v) \leq m(u) + m(v) - 2\overline{m}(u, v) + 14$.*

Proof. By symmetry, we can assume that $u \preceq v$. If $u = v$, then, by Lemma 3.5, we have $\overline{m}(u, v) \leq m(u) + 6$ and the lemma is clear since $d_G(u, v) = 0$. If u is equal to v_0 , then $\overline{m}(u, v) \leq \lambda(b(v_0)) = \lambda(a_0) = 3$ and the lemma is clear by Lemma 3.7. We now assume that u is distinct from v and v_0 . Thus v is also distinct from v_0 since $u \preceq v$. Then, by Lemma 3.3, we have $\overline{m}(u, v) > 0$.

Let $k = \lambda(b(u))$ and $k' = \lambda(b(v))$. Consider the two sequences $J(u) = (j(i))_{0 \leq i \leq k}$ and $J(v) = (j'(i))_{0 \leq i \leq k'}$. By definition, we have $\overline{m}(u, v) \leq k$ and $\overline{m}(u, v) \leq k'$. Moreover we have $\overline{m}(u, v) > 0$. Let $t > 0$ and $t' > 0$ be such that $k - t = k' - t' = \overline{m}(u, v) - 1$. By Lemma 3.8, we have $j(t) = \min\{z \geq b(u) : \lambda(a_z) = k - t\}$ and $j'(t') = \min\{z \geq b(v) : \lambda(a_z) = k' - t'\}$. By definition of $\overline{m}(u, v)$, we have $j(t) > b(v)$ and so $j(t) = j'(t')$. So the two walks $W_J(u)$ and $W_J(v)$ of G are reaching vertex $v(a_{j(t)}) = v(a_{j'(t)})$ in respectively t and t' steps. So $d_G(u, v) \leq t + t' \leq k + k' - 2\overline{m}(u, v) + 2$.

By Lemma 3.5, we have $k \leq m(u) + 6$ and $k' \leq m(v) + 6$. So finally we obtain $d_G(u, v) \leq m(u) + m(v) - 2\overline{m}(u, v) + 14$ \square

4 Decomposition of unicellular maps

4.1 Forests and well-labelings

We introduce a formal definition of forest from [98].

Let $\mathbb{N} = \{0, 1, 2, \dots\}$ and $\mathbb{N}^* = \mathbb{N} \setminus \{0\}$. Let \mathcal{F} be the set of all n -uplets of elements of \mathbb{N}^* for $n \geq 1$, i.e.:

$$\mathcal{F} = \bigcup_{n=1}^{\infty} (\mathbb{N}^*)^n,$$

For $n \geq 1$, if $u \in (\mathbb{N}^*)^n$, we write $|u| = n$. Let $u = u_1 u_2 \dots u_n$ and $v = v_1 v_2 \dots v_p$ be two elements of \mathcal{F} , then $uv = u_1 u_2 \dots u_n v_1 v_2 \dots v_p$ is the *concatenation* of u and v . If $w = uv$ for some $u, v \in \mathcal{F}$, we say u is an *ancestor* of w . In the particular case where $|v| = 1$, we say that u is the *parent* of w , denoted by $pa(w)$, and w is a *child* of u .

For $F \subseteq \mathcal{F}$ and $i \geq 1$, we denote $F_i = \{u \in F : |u| = i\}$ and $F_{\geq i} = \{u \in F : |u| \geq i\}$.

Definition 4.1. A *forest* is a non-empty finite subset F of \mathcal{F} satisfying the following (see example of Figure 6.10):

1. There exists $t(F) \in \mathbb{N}$ such that $F_1 = \llbracket 1, t(F) + 1 \rrbracket$.
2. If $u \in F_{\geq 2}$, then $pa(u) \in F$.
3. For all $u \in F$, there exists $c_u(F) \in \mathbb{N}$ such that: for all $i \in \mathbb{N}^*$, we have $ui \in F$ if and only if $i \leq c_u(F)$.
4. $c_{t(F)+1}(F) = 0$.

Given a forest $F \in \mathbb{F}$. The integer $t(F)$ of Definition 4.1 is called the *number of trees* of F . The set F_1 is called the set of *floors* of F . For $n \geq 1$, if $u = u_1 u_2 \dots u_n$ is an element of F , then we denote $fl(u) = u_1$. Note that $fl(u) \in F$ by Definition 4.1 (item 2.). So $fl(u)$ is a floor of the forest that we call the *floor of u* . The set of ancestor of u in F is denoted $A_u(F)$. For $1 \leq j \leq t(F)$, the j -th *tree* of F , denoted by F^j , is the set of elements of F that have floor j . We say that j is the *floor of F^j* . The set of all forests F with τ trees and $\rho + \tau + 1$ elements is denoted by \mathbb{F}_τ^ρ .

A plane rooted tree is a connected acyclic graph represented in the plane that is rooted at a particular angle. We represent a forest as a plane rooted tree by the following (see example of Figure 6.10). The set of vertices are the elements of F . The set of oriented edges are the couples (u, v) , with u, v in F , such that $pa(v) = u$, or there exists $i \in \llbracket 1, t(F) \rrbracket$ such that $u = i$ and $v = i + 1$. The tree is embedded in the plane such that it satisfies the following:

- Around the vertex 1 appear in counterclockwise order : the root angle, then, if $c_1(F) \geq 1$, the vertices 11 to 1 $c_1(F)$, then vertex 2.

- Around a vertex $i \in \llbracket 2, t(F) \rrbracket$ appear in counterclockwise order : the vertex $(i-1)$, then, if $c_i(F) \geq 1$, the vertices $i 1$ to $i c_i(F)$, then vertex $(i+1)$.
- Around a vertex $u \in F_{\geq 2}$ appear in counterclockwise order : the vertex $pa(u)$, then, if $c_u(F) \geq 1$, the vertices $u 1$ to $u c_u(F)$.

One can recover the set of floors of F from the plane rooted tree by considering, as on figure 6.10, the left most path starting from the root angle. A vertex which is not a floor, is called a *tree-vertex*. An edge between two floors is called *floor-edge*. An edge which is not a floor-edge is called *tree-edge*

Note that there is indeed a bijection between \mathbb{F}_τ^ρ , and, plane rooted trees with $\tau + 1$ floors and ρ tree-vertices.

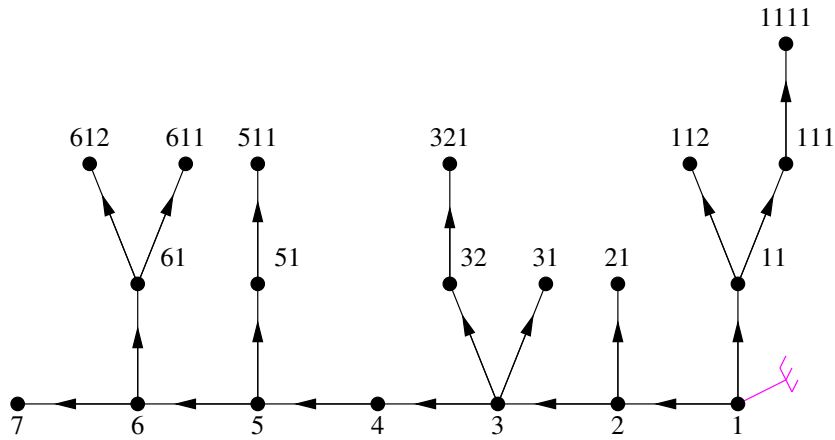

$$F = \{1, 11, 111, 1111, 112, 2, 21, 3, 31, 32, 321, 4, 5, 51, 511, 6, 61, 611, 612, 7\}$$

Figure 6.10 – Representation of a forest of \mathbb{F}_6^{13} .

Definition 4.2. A *labeled forest* is a pair (F, ℓ) , where F is a forest and $\ell : F \rightarrow \mathbb{Z}$ such that for all $u \in F_1$, we have $\ell(u) = 0$,

Definition 4.3. A *well-labeled forest* is labeled forest (F, ℓ) , where ℓ satisfies the following conditions (see example of Figure 6.11):

1. For all $u \in F_2$, we have $\ell(u) = -1$,
2. For all $u \in F_{\geq 2}$ and $c_u(F) \geq 1$, we have $\ell(u) - 1 \leq \ell(u 1) \leq \ell(u 2) \leq \dots \leq \ell(u c_u(F)) \leq \ell(u) + 1$.

The set of all well-labeled forests (F, ℓ) such that $F \in \mathbb{F}_\tau^\rho$ is denoted by \mathcal{F}_τ^ρ .

The function d of a well-labeled forest (F, ℓ) can be represented on the plane rooted tree representing F by adding two stems incident to each tree-vertex of F (see figure 6.12). A variation into the value ℓ of two consecutive children indicates the position of a stem.

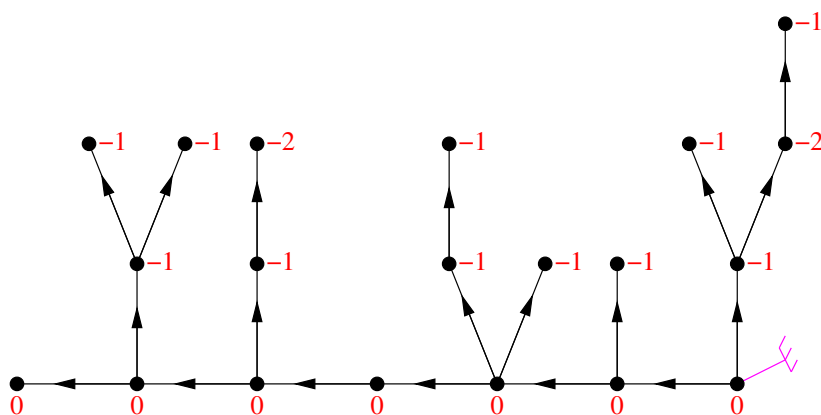

Figure 6.11 – Example of a well-labeled forest of \mathcal{F}_6^{13} .

Note that there is a bijection between \mathcal{F}_τ^ρ , and, plane rooted tree with $\tau + 1$ floors and ρ tree-vertices each being incident to two additional stems.

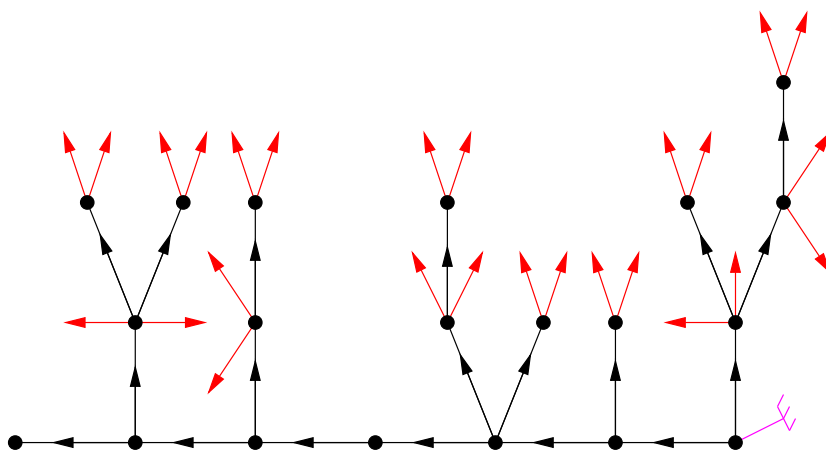

Figure 6.12 – Representation of the well-labeled forest of Figure 6.11 by a plane rooted tree with two additional stems incident to each tree-vertex.

We now encode forests and well-labeled forest similarly as in [22]. To do this, we need to define the contour and labeling functions.

Consider a forest F of \mathbb{F}_τ^ρ .

We define the vertex contour function of F as the function $r_F : \llbracket 0, 2\rho + \tau \rrbracket \rightarrow F$, such that $r_F(0) = 1$ and for $0 \leq i < 2\rho + \tau$, we have the following:

- If $r_F(i)$ have children which do not belong to the set $\{r_F(0), \dots, r_F(i-1)\}$, then $r_F(i+1) = r_F(i)j$ where $j = \min\{k \in \mathbb{N}^* : r_F(i)k \notin \{r_F(0), \dots, r_F(i-1)\}\}$.
- If all children of $r_F(i)$ belong to $\{r_F(0), \dots, r_F(i-1)\}$ then, $r_F(i+1) = pa(r_F(i))$ if $|r_F(i)| \geq 2$, and, $r_F(i+1) = r_F(i) + 1$ otherwise

Note that $r_F(2\rho + \tau) = \tau + 1$ by a simple counting argument.

The vertex contour function of a forest corresponds to a counterclockwise walk around its representation, starting from the root angle. For the example of Figure 6.10, one obtain the following vertex contour function:

$$r_F(\llbracket 0, 2\rho + \tau \rrbracket) = (1, 11, 111, 1111, 111, 11, 112, 11, 1, 2, 21, 2, 3, 31, 3, 32, 321, 32, 3, 4, 5, 51, 511, 51, 5, 6, 61, 611, 61, 612, 61, 6, 7)$$

We now define the *contour function* of F as the continuous function $C_F : [0, 2\rho + \tau] \rightarrow \mathbb{R}$ defined for $i \in \llbracket 0, 2\rho + \tau \rrbracket$ by

$$C_F(i) = f(r_F(i)) - |r_F(i)|$$

and linearly interpolated between integer values. Note that $C_F(0) = 0$ and $C_F(2\rho + \tau) = \tau$.

For example, the contour function of the forest of Figure 6.10 is defined on its integer values by:

$$C_F(\llbracket 0, 2\rho + \tau \rrbracket) = (0, -1, -2, -3, -2, -1, -2, -1, 0, 1, 0, 1, 2, 1, 2, 1, 0, 1, 2, 3, 4, 3, 2, 3, 4, 5, 4, 3, 4, 3, 4, 5, 6)$$

Note that one can recover a forest F from its contour function C_F .

Now consider (F, ℓ) a labeled forest with $F \in \mathbb{F}_\tau^\ell$.

We defined the *labeling function* of (F, ℓ) as the continuous function $L_{(F, \ell)} : [0, 2\rho + \tau] \rightarrow \mathbb{R}$ defined for $i \in \llbracket 0, 2\rho + \tau \rrbracket$ by

$$L_{(F, \ell)}(i) = \ell(r_F(i))$$

and linearly interpolated between integer values.

For example, the labeling function of the well-labeled forest of Figure 6.11 is defined on its integer values by:

$$L_F(\llbracket 0, 2\rho + \tau \rrbracket) = (0, -1, -2, -1, -2, -1, -1, -1, 0, 0, -1, 0, 0, -1, 0, -1, -1, -1, 0, 0, 0, -1, -2, -1, 0, 0, -1, -1, -1, -1, -1, 0, 0)$$

Note that one can recover (F, ℓ) from the pair $(C_F, L_{(F, \ell)})$. This pair is called the *contour pair* of (F, ℓ) .

4.2 Relation between well-labeled forests and 3-dominating binary words

In this section, we show how to compute the value of $|\mathcal{F}_\tau^\rho|$.

Consider $b \in \{0, 1\}^p$. If $b = b_1 \dots b_p$, then we define the *inverse of b* by $b^{-1} = b_p \dots b_1$. For $x \in \{0, 1\}$, we denote $|b|_x = |\{1 \leq i \leq p : b_i = x\}|$. We say that b is *k -dominating*, for $k > 0$, if for $1 \leq i \leq p$, we have $|b_1 \dots b_i|_0 > k |b_1 \dots b_i|_1$. For example, the sequence 01001 is not 1-dominating and the sequence 000011001 is 1-dominating but not 2-dominating. We have the following lemma from [35]:

Lemma 4.4 ([35]). *Consider $b \in \{0, 1\}^{p+q}$ with $|b|_0 = p$ and $|b|_1 = q$. For $k \in \mathbb{N}^*$, if $p \geq kq$, then there exist exactly $p - kq$ elements of $\{b_j b_{j+1} \dots b_{p+q} b_1 b_2 \dots b_{j-1} : 1 \leq j \leq p + q\}$ that are k -dominating.*

The set of elements $b \in \{0, 1\}^{p+q}$ with $|b|_0 = p$ and $|b|_1 = q$ that are 3-dominating is denoted $\mathcal{D}_{3,p,q}$. The elements whose inverse is in $\mathcal{D}_{3,p,q}$ are called *inverse 3-dominating binary words* and their set is denoted $\mathcal{D}_{3,p,q}^{-1}$.

Lemma 4.5. *There is a bijection between \mathcal{F}_τ^ρ and $\mathcal{D}_{3,3\rho+\tau,\rho}^{-1}$.*

Proof. As already mentioned \mathcal{F}_τ^ρ is in bijection with plane rooted tree with τ floors and ρ tree-vertices each being incident to two stems.

Similarly as in [106], we encode these plane rooted trees by the following method. Let α be the (unique) angle of the last vertex of the left most path from the root angle. We walk around the tree starting from the root angle in counterclockwise order, and ending at α . We write a "1" when going along an outgoing tree-edge, and a "0" when going along an ingoing tree-edge, or around a stem of F , or along an outgoing floor-edge (see Figure 6.13). By doing so, we obtain an element b of $\{0, 1\}^{4\rho+\tau}$ with $|b|_1 = \rho$ such that b is the inverse of a 3-dominating word. Indeed, while walking around the tree in reverse order, i.e. starting from α , walking in clockwise order around the tree and ending at the root angle, we go along an outgoing tree-edge e , and the two stems incident to its terminal vertex before going along this tree-edge e in the other direction. Thus we have seen three "0" before the "1" corresponding to edge e . Moreover, this walk starts by going along an ingoing floor-edge, therefore we start with an additional "0". Thus b^{-1} is 3-dominating so $b \in \mathcal{D}_{3,3\rho+\tau,\rho}^{-1}$. As in [106], one can see that the rooted plane tree can be recovered from b . Moreover, it is easy to see that any $b \in \mathcal{D}_{3,3\rho+\tau,\rho}^{-1}$ corresponds to such a tree. So there is a bijection between \mathcal{F}_τ^ρ and $\mathcal{D}_{3,3\rho+\tau,\rho}^{-1}$. □

Lemma 4.6. *For $\rho \in \mathbb{N}^*$ and $\tau \in \mathbb{N}^*$, we have:*

$$|\mathcal{F}_\tau^\rho| = \frac{\tau}{4\rho + \tau} \binom{4\rho + \tau}{\rho}.$$

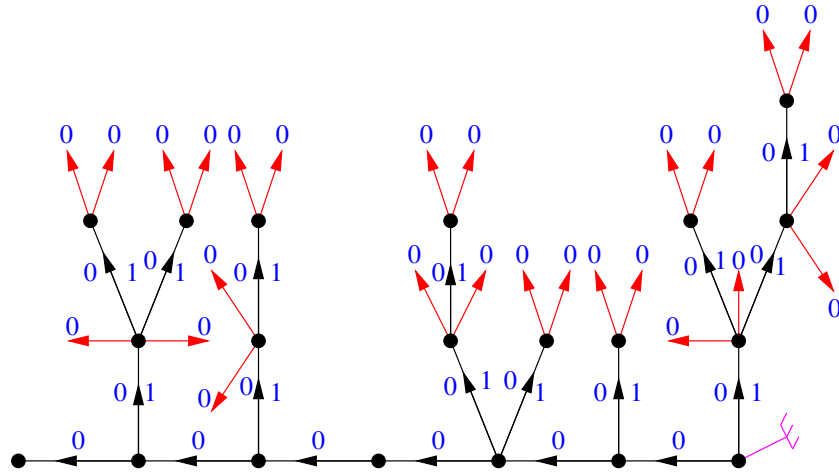

$b = 1100100000100000010000100010100000001100000001010001000000$

Figure 6.13 – Encoding a forest with two stem at each tree-vertex.

Proof. By Lemma 4.5, it suffices to prove that

$$|\mathcal{D}_{3,3\rho+\tau,\rho}| = \frac{\tau}{4\rho+\tau} \binom{4\rho+\tau}{\rho}.$$

The number of elements $b \in \{0, 1\}^{4\rho+\tau}$ with $|b|_0 = 3\rho + \tau$ and $|b|_1 = \rho$ is $\binom{4\rho+\tau}{\rho}$.

By Lemma 4.4, for each such element b , there are exactly $3\rho + \tau - 3\rho = \tau$ elements of $\{b_j b_{j+1} \dots b_{4\rho+\tau} b_1 b_2 \dots b_{j-1} : 1 \leq j \leq 4\rho + \tau\}$ that are 3-dominating. Thus we obtain the result. \square

4.3 Motzkin paths

A *Motzkin path* of length $\sigma \in \mathbb{N}$, from 0 to $\gamma \in \mathbb{Z}$, with $|\gamma| \leq \sigma$, is a sequence of integers $M = (M_i)_{0 \leq i \leq \sigma}$, such that $M_0 = 0$, $M_\sigma = \gamma$, and for all $0 \leq i \leq \sigma - 1$, we have $M_{i+1} - M_i \in \{-1, 0, 1\}$. The set of Motzkin path of length σ from 0 to γ is denoted $\mathcal{M}_\sigma^\gamma$.

An example of a Motzkin path in \mathcal{M}_5^{-2} is the following:

$$M = (0, 1, 0, 0, -1, -2) \tag{4.1}$$

Consider $M \in \mathcal{M}_\sigma^\gamma$.

We define the *extension* of M as a sequence of integers denoted $\widetilde{M} = (\widetilde{M}_i)_{0 \leq i \leq 2\sigma+\gamma}$ and defined by the following. We obtain \widetilde{M} from $M = (M_0, \dots, M_\sigma)$ by considering

consecutive values M_i, M_{i+1} , for $0 \leq i < \sigma$. When $M_{i+1} = M_i$ we add the value $(M_i + 1)$ between M_i and M_{i+1} in the sequence of \widetilde{M} . When $M_{i+1} = M_i + 1$ we add the two values $(M_i + 1), (M_i + 2)$ between M_i and M_{i+1} in the sequence of \widetilde{M} . When $M_{i+1} = M_i - 1$ we add nothing between M_i and M_{i+1} in the sequence of \widetilde{M} . So at each step i , the number of values that are added to obtain \widetilde{M} is exactly $M_{i+1} - M_i + 1$. Note that the extension of an element of $\mathcal{M}_\sigma^\gamma$ is an element of $\mathcal{M}_{2\sigma+\gamma}^\gamma$.

With this definition, the extension of the example of Motzkin path M given by (4.1) is the following element of \mathcal{M}_8^{-2} (where added values from M are represented in red):

$$\widetilde{M} = (0, , , 1, 0, , 0, -1, -2) \tag{4.2}$$

We also define the *inverse of M* as a sequence of integers denoted $\underline{M} = ((\underline{M})_i)_{0 \leq i \leq \sigma}$ and equal to $(M_\sigma - \gamma, M_{\sigma-1} - \gamma, \dots, M_0 - \gamma)$. Thus informally, \underline{M} is the Motzkin path obtained by "reading" the variation of M in reverse order. Note that the inverse of an element of $\mathcal{M}_\sigma^\gamma$ is an element of $\mathcal{M}_\sigma^{-\gamma}$.

With this definition, the inverse of the example of Motzkin path M given by (4.1) is the following element of \mathcal{M}_5^2 :

$$\underline{M} = (0, 1, 2, 2, 3, 2) \tag{4.3}$$

Then one can consider the *extension of the inverse of M* , that is defined by the composition of the inverse then the extension of a Motzkin path. It is thus denoted by $\widetilde{\underline{M}}$ or $\widetilde{\underline{M}}$ for simplicity. Note that the extension of the inverse of an element of $\mathcal{M}_\sigma^\gamma$ is an element of $\mathcal{M}_{2\sigma-\gamma}^{-\gamma}$.

The extension of the inverse of the example of Motzkin path M given by (4.1) is thus the extension of the Motzkin path \underline{M} given by (4.3), and thus the following element of \mathcal{M}_{12}^2 (where added values from \underline{M} are represented in red):

$$\widetilde{\underline{M}} = (0, , , 1, , , 2, , 2, , , 3, 2) \tag{4.4}$$

4.4 Decomposition of unicellular maps into well-labeled forests and Motzkin paths

Consider $n \geq 1$, and U an element of $\mathcal{U}(n)$ or $\mathcal{T}_r(n)$. As in Section 3, we call proper the set of vertices of U that are on at least one cycle of U . The *core C* of U is obtained from U by deleting all the vertices that are not proper (and keeping all the stems attached to proper vertices). In C , or U , we call *maximal chain* a path P whose extremities are special vertices and all inner vertices vertices of P are not special. Then the *kernel K* of U is obtained from C by replacing every maximal chain P by an edge (and thus

removing the inner vertices and the stems incident to them). Note that we keep the stems incident to special vertices in the kernel.

Let $\mathcal{U}_r(n)$ be the set of elements U of $\mathcal{U}(n)$ that are rooted at a half-edge of the kernel that is not a stem. Note that if $U \in \mathcal{U}(n)$ is hexagonal there is 6 such half-edges, and if U is square there is 4 such half-edges. Let $\mathcal{U}_{r,b}(n)$ be the set of elements of $\mathcal{U}_r(n)$ that are balanced. Finally, let $\mathcal{U}_{r,b}^H(n)$, $\mathcal{U}_{r,b}^S(n)$, $\mathcal{T}_{r,s,b}^H(n)$ and $\mathcal{T}_{r,s,b}^S(n)$ be the elements of $\mathcal{U}_{r,b}(n)$ and $\mathcal{T}_{r,s,b}(n)$ that are respectively hexagonal and square.

Next lemma enables to avoid the safe property while studying $\mathcal{T}_{r,s,b}(n)$.

Lemma 4.7. *There is a bijection between $\llbracket 1, 3 \rrbracket \times \mathcal{T}_{r,s,b}(n)$ and*

$$(\llbracket 1, 3 \rrbracket \times \mathcal{U}_{r,b}^S(n)) \cup (\llbracket 1, 2 \rrbracket \times \mathcal{U}_{r,b}^H(n)).$$

Proof. Let $Z(n)$ be the set of elements of $\mathcal{T}_{r,s,b}(n)$ that are moreover rooted at a half-edge of the kernel that is not a stem. Let $Z^H(n)$ (resp. $Z^S(n)$) be the set of elements of Z that are hexagonal (resp. square). Given an element of $\mathcal{T}_{r,s,b}^H(n)$, there are 6 possible roots. So there is a bijection between $Z^H(n)$ and $\llbracket 1, 6 \rrbracket \times \mathcal{T}_{r,s,b}^H(n)$. Given an element of $\mathcal{T}_{r,s,b}^S(n)$, there are 4 possible roots. So there is a bijection between $Z^S(n)$ and $\llbracket 1, 4 \rrbracket \times \mathcal{T}_{r,s,b}^S(n)$.

Given an element U of $\mathcal{U}_{r,b}(n)$, there are four angles where a root stem can be added to obtain an element of $Z(n)$. Indeed, these four angles corresponds to the four angles remaining in the special face when the complete closure procedure is applied on U . So there is a bijection between $Z^S(n)$ and $\llbracket 1, 4 \rrbracket \times \mathcal{U}_{r,b}^S(n)$ and a bijection between $Z^H(n)$ and $\llbracket 1, 4 \rrbracket \times \mathcal{U}_{r,b}^H(n)$. Finally $\mathcal{T}_{r,s,b}(n) = \mathcal{T}_{r,s,b}^S(n) \cup \mathcal{T}_{r,s,b}^H(n)$ and we obtain the result. \square

Let $n \geq 1$. There are different possible kernels for element of $\mathcal{U}_r(n)$, depending on the position of the possible stems. All the possible kernels of elements of $\mathcal{U}_r(n)$ are depicted on Figure 6.14 where the root half-edge of the kernel is depicted in pink. There are exactly 10 such possibilities and, for $0 \leq k \leq 9$, we say that an element of $\mathcal{U}_r(n)$ is of type k if its kernel corresponds to type k of Figure 6.14. We decompose the elements $U \in \mathcal{U}_{r,b}(n)$ depending on their types.

Given an element of $U \in \mathcal{U}_{r,b}(n)$ of a given type, we decompose it into its core C and a set of forests. We orient and denote the maximal chains of U as on Figure 6.14. Each of these maximal chain as two sides. For $t = 3$ when U is hexagonal and $t = 2$ when U is square, we define $2t$ particular angles $\alpha_1, \dots, \alpha_{2t}$ of U as depicted on Figure 6.15 and moreover we set $\alpha_{2t+1} = \alpha_1$. Note that the angles $\alpha_1, \dots, \alpha_{2t+1}$ are formally defined on U but with a slight abuse of notations, we also consider them to be defined on C (with exactly the same definition as Figure 6.15).

Let $[\alpha, \beta[$ denote the set of angles of U between α and β , while walking along the border of the unique face of U in clockwise order, including α and excluding β . Let $[\alpha, \beta[\cap C$ denote the set of angles of $[\alpha, \beta[$ that are also incident to the core C . For $1 \leq i \leq t$, let

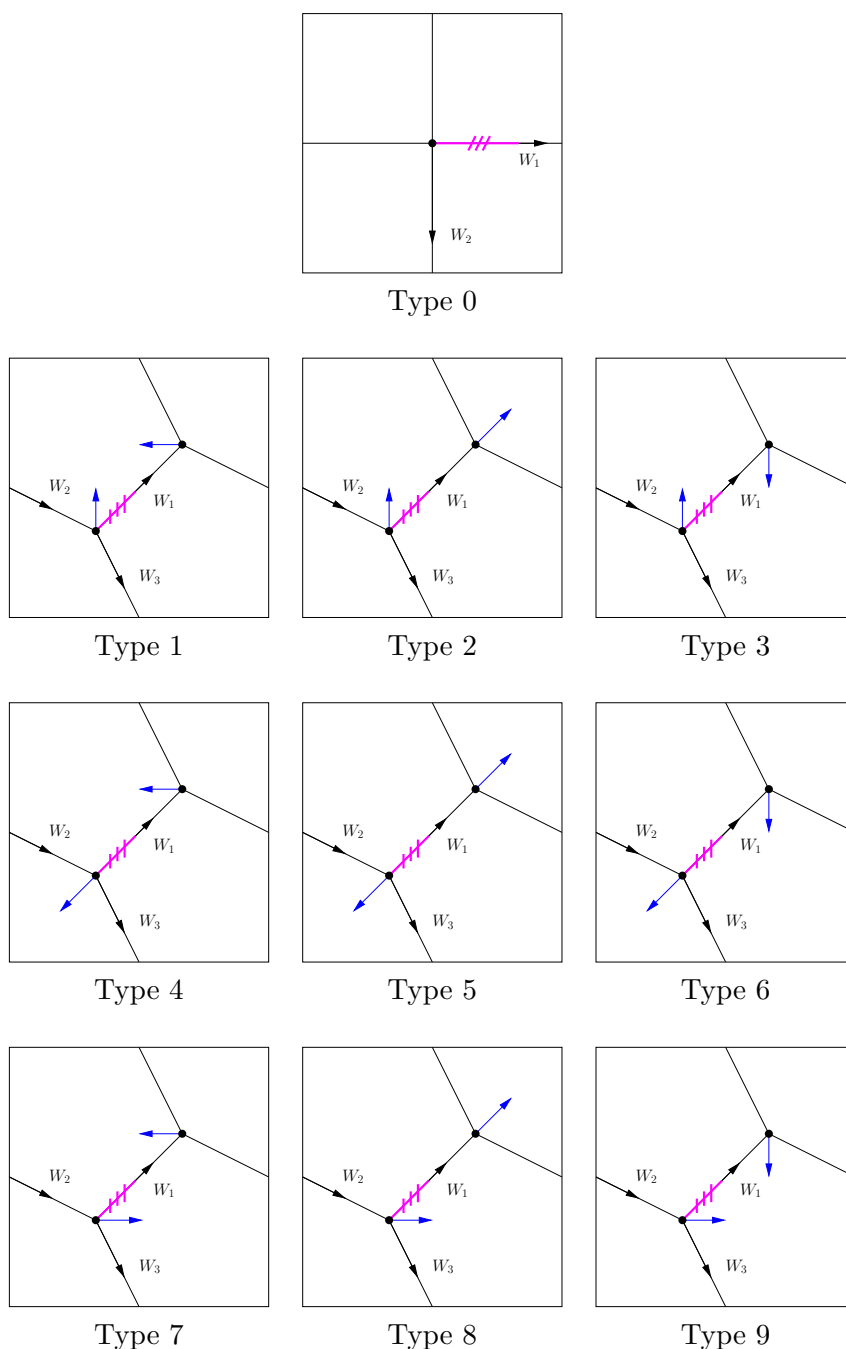

Figure 6.14 – The ten possible types of kernels for an element of $\mathcal{U}_r(n)$. The red half-edge indicates the root half-edge.

S_i (resp. S_{i+t}) be the maximal chain W_i with all the stems of U that are incident to an angle of $[\alpha_i, \alpha_{i+1}[\cap C_i$ (resp. $[\alpha_{i+t}, \alpha_{i+t+1}[\cap C$). Then U is decomposed into its core C

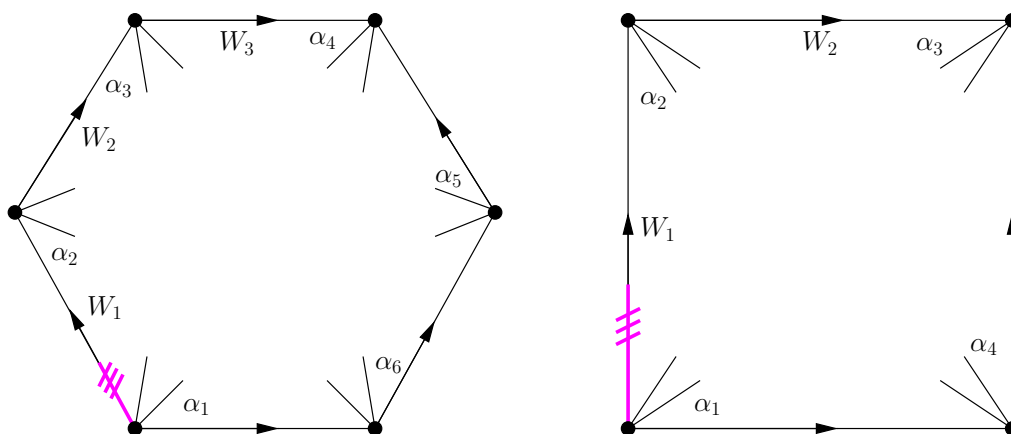

Figure 6.15 – Definition of the angles $\alpha_1, \dots, \alpha_{2t}$.

plus $2t$ parts where the i -th part is the part of U “attached to (the right side of) S_i ”. More formally, for $1 \leq i \leq t$, the i -th part (resp. the $(i+t)$ -th part) corresponds to all the components of $U \setminus C$ that are connected to the rest of U via an edge of U that is incident to an angle of $[\alpha_i, \alpha_{i+1}[\cap C$ (resp. $[\alpha_{i+t}, \alpha_{i+t+1}[\cap C$). Each of these $2t$ parts can be represented by one well-labeled forest (see Figure 6.16 where S_i is represented in green): the floor vertices of the forest corresponds to the angles of C in $[\alpha_i, \alpha_{i+1}[$ and the tree-vertices, tree-edges and stems of the forest represents the part of U “attached” to S_i . Thus, the unicellular map U is decomposed into its core C plus $2t$ well-labeled forests $((F_i, \ell_i))_{1 \leq i \leq 2t}$. For $1 \leq i \leq 2t$, let τ_i be the number of angles $[\alpha_i, \alpha_{i+1}[\cap C$ and ρ_i be the number of vertices of the part of U attached to S_i . So we have $(F_i, \ell_i) \in \mathcal{F}_{\tau_i}^{\rho_i}$ for $1 \leq i \leq 2t$.

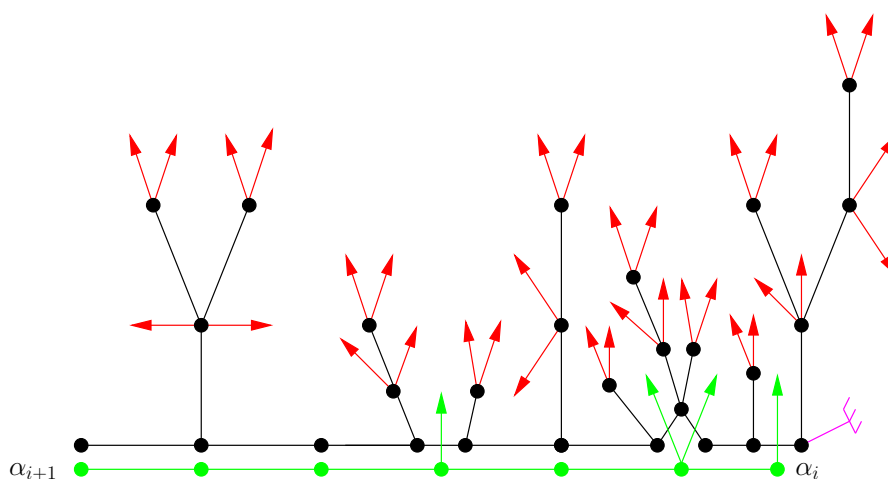

Figure 6.16 – The forest “attached” to S_i .

We now decompose the core C of U .

For $1 \leq i \leq t$, we define R_i as the maximal chain W_i of U with all the stems of U that are incident to an inner vertex of W_i . Note that the “union” of S_i and S_{i+t} , almost gives R_i except that R_i contains no stems incident to special vertices. Then we decompose C into the type of its kernel (see Figure 6.14) plus $(R_i)_{1 \leq i \leq t}$.

For $1 \leq i \leq t$, all the inner vertices of R_i are incident to exactly 2 stems. Let γ_i be half of the number of stems incident to the right side of R_i minus half of the number of stems incident to the left side of R_i . Note that γ_i is an integer. Let σ_i be the number of inner vertices of R_i .

When U is square, we have $\gamma_1 = \gamma_2 = 0$ by the balanced property of U . In this case, for $1 \leq i \leq 2$, the total number of angles of R_i and incident to inner vertices of R_i is $4\sigma_i$. So the number of angles of R_i on one of its side and incident to inner vertices is $2\sigma_i$. So for $1 \leq i \leq 2$, $\tau_i = \tau_{i+2} = 2\sigma_i + 1$. For convenience, let $\gamma_1 = \gamma_2 = 0$ in this case.

When U is hexagonal, the value of $\gamma_1 + \gamma_2$ and $\gamma_2 + \gamma_3$ is given by the type of U and the fact that U is balanced, see Table 6.1. As for the square case, we have a relation between τ and σ , but this times it depends on the type and of the γ_i 's. For $1 \leq i \leq 6$, let $c_i \in \{0, 1\}$ such that $c_i = 1$ if and only if there is a stem incident to the angle α_i . The value of c_1, \dots, c_6 is given in Table 6.1. For $1 \leq i \leq 3$, we have $\tau_i = 2\sigma_i + 1 + \gamma_i + c_i$, and $\tau_{3+i} = 2\sigma_i + 1 - \gamma_i + c_{3+i}$.

	$\gamma_1 + \gamma_2$	$\gamma_2 + \gamma_3$	c_1	c_2	c_3	c_4	c_5	c_6
Type 1	1	0	0	0	0	1	1	0
Type 2	1	1	0	0	0	0	1	1
Type 3	0	0	0	1	0	0	1	0
Type 4	0	-1	0	0	1	1	0	0
Type 5	0	0	0	0	1	0	0	1
Type 6	-1	-1	0	1	1	0	0	0
Type 7	0	0	1	0	0	1	0	0
Type 8	0	1	1	0	0	0	0	1
Type 9	-1	0	1	1	0	0	0	0

Table 6.1 – Values of $\gamma_1 + \gamma_2$, $\gamma_2 + \gamma_3$, c_1, \dots, c_6 , depending of the type.

For $1 \leq i \leq t$, we represent R_i by a Motzkin path M_i of length σ_i from 0 to γ_i , thus $M_i \in \mathcal{M}_{\sigma_i}^{\gamma_i}$. Two stems on the right (resp. left) side of R_i corresponds to a step of 1 (resp. -1) in the Motzkin path. A stem on each side of R_i corresponds to a step of 0 in the Motzkin path.

The path R_i corresponding to the example S_i of Figure 6.16 is represented on Figure 6.17 with the corresponding Motzkin path in \mathcal{M}_5^{-2} (from right to left). This Motzkin path is precisely the example given in (4.1). Note that from Figure 6.16, the stem that was

incident to α_i has been removed since R_i contains no stems incident to special vertices (the Motzkin path M_i represents only the stems incident to inner vertices of W_i).

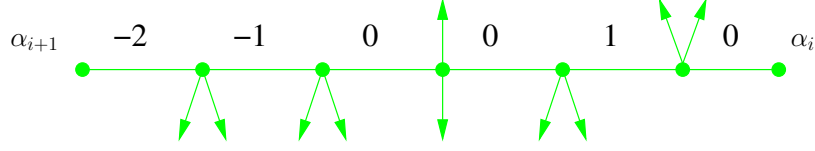

Figure 6.17 – The Motzkin path corresponding to R_i (from right to left).

Finally, we have a relation between the number of vertices n and the value σ_i and ρ_i :

$$n = \rho_1 + \cdots + \rho_{2t} + \sigma_1 + \cdots + \sigma_t + (t - 1)$$

Definition 4.8. For $n \geq 1$, let

$$\mathcal{R}^0(n) = \bigcup_{\substack{(\rho_1, \dots, \rho_4) \in \mathbb{N}^4 \\ (\tau_1, \dots, \tau_4) \in (\mathbb{N}^*)^4 \\ (\sigma_1, \sigma_2) \in \mathbb{N}^2}} \mathcal{F}_{\tau_1}^{\rho_1} \times \cdots \times \mathcal{F}_{\tau_4}^{\rho_4} \times \mathcal{M}_{\sigma_1}^0 \times \mathcal{M}_{\sigma_2}^0$$

where

$$n = \rho_1 + \cdots + \rho_4 + \sigma_1 + \sigma_2 + 1$$

and for $1 \leq i \leq 2$, we have $\tau_i = \tau_{2+i} = 2\sigma_i + 1$.

Thus, for $n \geq 1$, there is a bijection between the set of (square) unicellular maps $\mathcal{U}_{r,b}^S(n)$ and \mathcal{R}^0 .

Definition 4.9. For $n \geq 1$ and $1 \leq k \leq 9$, let

$$\mathcal{R}^k(n) = \bigcup_{\substack{(\rho_1, \dots, \rho_6) \in \mathbb{N}^6 \\ (\tau_1, \dots, \tau_6) \in (\mathbb{N}^*)^6 \\ (\gamma_1, \gamma_2, \gamma_3) \in \mathbb{Z}^3 \\ (\sigma_1, \sigma_2, \sigma_3) \in \mathbb{N}^3}} \mathcal{F}_{\tau_1}^{\rho_1} \times \cdots \times \mathcal{F}_{\tau_6}^{\rho_6} \times \mathcal{M}_{\sigma_1}^{\gamma_1} \times \mathcal{M}_{\sigma_2}^{\gamma_2} \times \mathcal{M}_{\sigma_3}^{\gamma_3}$$

where

$$n = \rho_1 + \cdots + \rho_6 + \sigma_1 + \sigma_2 + \sigma_3 + 2$$

for $1 \leq i \leq 3$, we have $\tau_i = 2\sigma_i + 1 + \gamma_i + c_i$ and $\tau_{3+i} = 2\sigma_i + 1 - \gamma_i + c_{3+i}$

for $1 \leq i \leq 3$, we have $|\gamma_i| \leq \sigma_i$

with $\gamma_1 + \gamma_2, \gamma_2 + \gamma_3, c_1, \dots, c_6$ given by line k of Table 6.1.

Thus, by above discussion, for $n \geq 1$ and $1 \leq k \leq 9$, there exists a bijection between elements of $\mathcal{U}_{r,b}^H(n)$ with kernel of type k and $\mathcal{R}^k(n)$.

So by Lemma 4.7 we have the following:

Lemma 4.10. *For $n \geq 1$, there exists a bijection between $\llbracket 1, 3 \rrbracket \times \mathcal{T}_{r,s,b}(n)$ and*

$$(\llbracket 1, 3 \rrbracket \times \mathcal{R}^0(n)) \cup \left(\llbracket 1, 2 \rrbracket \times \bigcup_{1 \leq k \leq 9} \mathcal{R}^k(n) \right)$$

4.5 Relation with labels of the unicellular map

We use the same notations as in previous section where U is an element of $\mathcal{U}_{r,b}(n)$ that is decomposed into the type k of its kernel, $2t$ well-labeled forests $((F_i, \ell_i))_{1 \leq i \leq 2t}$, with $(F_i, \ell_i) \in \mathcal{F}_{\tau_i}^{\rho_i}$, and t Motzkin paths $(M_i)_{1 \leq i \leq t}$, with $M_i \in \mathcal{M}_{\sigma_i}^{\gamma_i}$.

We explain in this section how the well-label forests Motzkin paths and type are linked to the labeling function λ defined in Section 3.

As in the proof of Lemma 4.7, there are four angles of U where a root stem can be added to obtain an element of $\mathcal{T}_{r,s,b}(n)$ (after forgetting the root of U). Consider one such element $T \in \mathcal{T}_{r,s,b}(n)$. Let G be the image of T by the bijection Φ of Theorem 2.1 and V the set of vertices of G . Let Γ be the unicellular map obtained from T by adding a dangling root half-edge incident to its root angle. Let λ be the labeling function of the angles of Γ as defined in Section 3. For all $u, v \in V$, let $m(u)$ and $\bar{m}(u, v)$ be as defined in as defined in Section 3.

Recall that the labeling function λ is defined on the angles of Γ by the following: while going clockwise around the unique face of Γ starting from the root angle with λ equals to 3, the variation of λ is “+1” if going around a stem and “-1” if going along an edge.

Recall that, for $1 \leq i \leq t$, the Motzkin path M_i is used to represent the part R_i of the unicellular map U (see Section 4.4). Consider the extension \widetilde{M}_i of M_i , defined in Section 4.3. Note that \widetilde{M}_i can be used to encode the variation of the labels along the path R_i between α_i (excluded) and α_{i+1} (included) as if we were computing λ around R_i . Figure 6.18 is an example obtained by superposing the example R_i of Figure 6.17 and the extension of the corresponding Motzkin path given by (4.2). One can check that, from α_i (excluded) to α_{i+1} (included), we get “+1” around a stem and “-1” along an edge, like in the definition of λ .

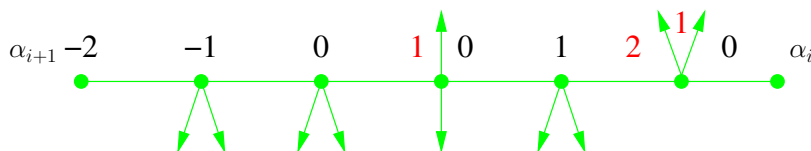

Figure 6.18 – The extension of the Motzkin path (from right to left).

Note also that \widetilde{M}_i encode the variation of the labels along the path R_i between α_{i+t} (excluded) and α_{i+t+1} (included). Figure 6.19 is an example obtained by superposing

the example R_i of Figure 6.17 and the extension of the inverse of the corresponding Motzkin path given by (4.4).

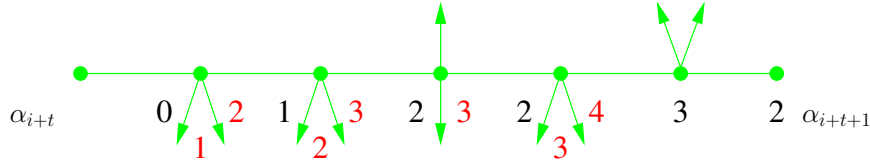

Figure 6.19 – The inverse of the extension of the Motzkin path (from left to right).

For convenience, we define $\widetilde{M}_i = \widetilde{M}_{i-t}$ for $t + 1 \leq i \leq 2t$. So the sequence $\widetilde{M}_1, \dots, \widetilde{M}_{2t}$ corresponds to the parts of the R_i appearing consecutively while going clockwise around the unique face of U .

Now we need to extend a bit more \widetilde{M}_i so it also encodes α_i and a possible stem incident to α_i . For a Motzkin path $\widetilde{M} \in \mathcal{M}_{2\sigma+\gamma}^\gamma$ and $c \in \{0, 1\}$, we define the c -shift of \widetilde{M} as the following Motzkin path in $\mathcal{M}_{2\sigma+\gamma+c+1}^{\gamma+c-1}$:

$$\widetilde{M}^c = \begin{cases} (0, (\widetilde{M})_1 - 1, \dots, (\widetilde{M})_{2\sigma+\gamma} - 1) & \text{if } c = 0 \\ (0, 1, (\widetilde{M})_1, \dots, (\widetilde{M})_{2\sigma+\gamma}) & \text{if } c = 1 \end{cases}$$

For $1 \leq k \leq 9$ and $1 \leq i \leq 6$, let $c_i(k)$ be the value of c_i given by line k of Table 6.1. We also define $c_1(0) = c_2(0) = c_3(0) = c_4(0) = 0$. If $k = 0$, let $\gamma_1 = \gamma_2 = 0$. For $t + 1 \leq i \leq 2t$, let $\gamma_i = -\gamma_{i-t}$ and $\sigma_i = \sigma_{i-t}$. With these notations, for $1 \leq i \leq 2t$, we can consider the Motzkin path $\widetilde{M}_i^{c_i(k)}$ that is an element of $\mathcal{M}_{\tau_i + c_i(k) - 1}^{\gamma_i + c_i(k) - 1}$ (see Definitions 4.8 and 4.9 for the relation between τ, γ, σ, c). Now $\widetilde{M}_i^{c_i(k)}$ encode “completely” R_i from α_i to α_{i+1} (both included) with also the stems incident to special vertices depending on the type.

Now we explain the links between λ and the well-labeled forests. Consider a tree of a well-labeled forest (F, ℓ) . Figure 6.20 gives an example represented either with its labels (on the left side) or with its stems (on the right side). Note that it is the first tree of the well-labeled forest of Figures 6.11 and 6.12 (i.e. the one on the right).

If one computes the variation of λ on the angles of the tree “above the floor line”. Then one can note that the first angle of each vertex that is encountered receive precisely the label given by the function ℓ of (F, ℓ) . Figure 6.21, show this computation on the example of Figure 6.20 where the correspondence with the values of ℓ is represented in red.

Now with the help of the c -shift extensions of Motzkin paths we can encode completely the variation of the labels around the well-labeled forests. For $1 \leq i \leq 2t$, consider the vertex contour function r_{F_i} and contour pair $(C_{F_i}, L_{(F_i, \ell_i)})$ of (F_i, ℓ_i) . For $0 \leq t \leq 2\rho_i + \tau_i$, let $\overline{C_{F_i}}(t) = \max_{s \leq t} C_{F_i}(s)$. Note that for $0 \leq t \leq 2\rho_i + \tau_i$ the value of $\overline{C_{F_i}}(t) + 1$ is the

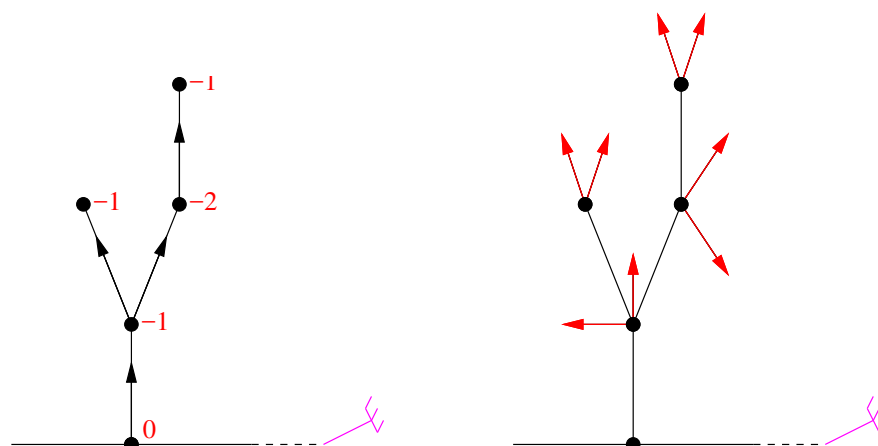

Figure 6.20 – Example of a tree of a well-labeled forest.

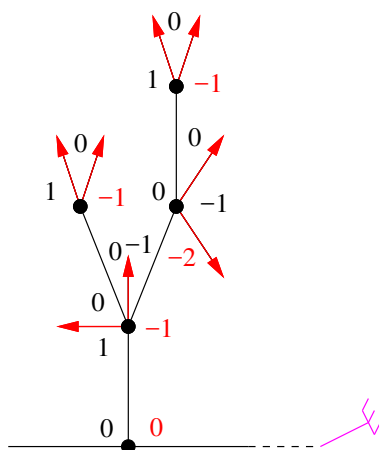

Figure 6.21 – Computation of the label λ around a tree of a well-labeled forest.

floor of the vertex $r_{F_i}(t)$. For $0 \leq t \leq 2\rho_i + \tau_i$, we define

$$S_i(t) = L_{(F_i, \ell_i)}(t) + \widetilde{M}_i^{c_i(k)}(\overline{C_{F_i}}(t)).$$

With this definition, if one computes the variations of λ around F_i , starting from α_i with value 0, an ending at α_{i+1} then the first angle of each vertex v that is encountered receives the value $S_i(t)$ where t is any value $0 \leq t \leq 2\rho_i + \tau_i$ such that $r_{F_i}(t) = v$.

For f, g two functions defined on $\llbracket 0, s \rrbracket$ and $\llbracket 0, t \rrbracket$ respectively, taking values in \mathbb{Z} and such that $g(0) = 0$. We define the *concatenation* of f, g , denoted $f \bullet g$, as the function defined on $\llbracket 0, s + t \rrbracket$ by the following:

$$(f \bullet g)(i) = \begin{cases} f(i) & \text{if } 0 \leq i \leq s \\ f(s) + g(i - s) & \text{if } s \leq i \leq s + t \end{cases}$$

Let $I = \sum_{1 \leq i \leq 2t} (2\rho_i + \tau_i)$. Let $S^\bullet = S_1 \bullet \cdots \bullet S_{2t}$ be the function defined on $\llbracket 0, \sum_{1 \leq i \leq 2t} (2\rho_i + \tau_i) \rrbracket$. Note that $S^\bullet(0) = S^\bullet(I) = 0$. Note also that $I = \sum_{1 \leq i \leq 2t} (2\rho_i + \tau_i) = (2n + 2) + 2 \times (\sigma_1 + \cdots + \sigma_t) + 2 \times \mathbb{1}_{k \neq 0}$.

As in Section 3, we call *proper*, the vertices of U that are on at least one cycle of Γ . Let P be the unicellular map obtained from U by removing all the stems that are not incident to proper vertices. We still denote by $\alpha_1, \dots, \alpha_{2t}$ the angles of P corresponding to the angles $\alpha_1, \dots, \alpha_{2t}$ of U . Note that P has precisely I angles. So we see S^\bullet as a function from the angles of P to \mathbb{Z} by starting at α_1 and walking clockwise around the unique face of P .

We define *the vertex contour function of P* as the function $r_P : \llbracket 0, I \rrbracket \rightarrow V$ as follows: while walking clockwise around the unique face of P , starting at α_1 , let $r_P(i)$ denote the i -th vertex of P that is encountered.

Recall that for $u \in V$, $m(u)$ is the minimum of the values of λ that appears in the angles incident u .

We explain that $S^\bullet(i)$ is almost equal to $m(r_P(i)) - m(r_P(0))$. On one hand, we have explain above that S^\bullet almost acts as computing a “variation” of λ around U from α_1 . On the other hand the value of m is obtained by computing λ around Γ from its root angle a_0 . This angle a_0 can be anywhere in U . Since we are considering $m(r_P(i)) - m(r_P(0))$ we have shifted m so its corresponds to “computing λ from α_1 . Let a_0, a_1, \dots, a_ℓ denote the angles of Γ as in Section 3. There is a jump of 4 in the computation of λ from a_ℓ to a_1 . Thus in the “variation” of λ computed around the well-labeled forests we can get a +4 at some place. Moreover in such computations, we match the computation of λ just at the first angle of each vertex that is encountered around the forest. So by Lemma 3.5, at the other angles it can differ by ± 6 . Thus in total we have, for $i \in \llbracket 0, I \rrbracket$, $|S^\bullet(i) - (m(r_P(i)) - m(r_P(0)))| \leq 4 + 6 + 6 = 16$.

Note that P contains exactly $2 \times (\sigma_1 + \cdots + \sigma_t) + 2 \times \mathbb{1}_{k \neq 0}$ stems. Let Q be the unicellular map obtained from P by removing all its stems. We also denote by $\alpha_1, \dots, \alpha_{2t}$ the corresponding angles of Q . Note that Q has exactly $2n + 2$ angles. We now define *the vertex contour function of Q* as the function $r_Q : \llbracket 0, 2n + 1 \rrbracket \rightarrow V$ as follows: while walking clockwise around the unique face of W , starting at α_1 , let $r_Q(i)$ denote the i -th vertex of Q that is encountered.

We define the sequence $(S(i))_{0 \leq i \leq 2n+1}$ as the sequence that is obtained from $(S^\bullet(i))_{0 \leq i \leq I}$ by removing all the values of (S^\bullet) that appear in an angle of P that is just after a stem of P in clockwise order around its incident vertex. So we see S as a function from the angles of Q to \mathbb{Z} by starting at α_1 and walking clockwise around the unique face of Q . We call S the *shifted labeling function* of the unicellular map U .

For $i \in \llbracket 0, 2n + 1 \rrbracket$, we have

$$|S(i) - (m(r_Q(i)) - m(r_Q(0)))| \leq 16. \tag{4.5}$$

We now introduce the following pseudo-distance function. For $i, j \in \llbracket 0, 2n + 1 \rrbracket$, let

$$d^o(i, j) = m(r_Q(i)) + m(r_Q(j)) - 2\bar{m}(r_Q(i), r_Q(j))$$

By (4.5), we obtained the following: for $i, j \in \llbracket 0, 2n + 1 \rrbracket$,

$$|d^o(i, j) - (S(i) + S(j) - 2\bar{S}(i, j))| \leq 64 \quad (4.6)$$

where $\bar{S}(i, j) = \min_{i \leq t \leq j} S(t)$.

5 Some variants of Brownian motion

Let

$$\mathcal{H} = \bigcup_{x \in \mathbb{R}_+} C([0, x], \mathbb{R}),$$

where $C([0, x], \mathbb{R})$ is the set of continuous functions from $[0, x]$ to \mathbb{R} .

We use the following standard notation: $x \wedge y = \min(x, y)$ for $x, y \in \mathbb{R}^2$. For an element $f \in \mathcal{H}$, let $\sigma(f)$ be the only x such that $f \in C([0, x], \mathbb{R})$. Then we define the following metric on \mathcal{H} :

$$d_{\mathcal{H}}(f, g) = |\sigma(f) - \sigma(g)| + \sup_{y \geq 0} |f(y \wedge \sigma(f)) - g(y \wedge \sigma(g))|.$$

Given a function $f : [0, x] \rightarrow \mathbb{R}$, for $0 \leq t \leq x$, let $\bar{f}(t) = \sup_{r \in [0, t]} f(r)$.

Let p (resp. p_a) denote the density of the standard Gaussian random variable (resp. the centered Gaussian random variable with variance a), i.e. for $x \in \mathbb{R}$, $p(x) = \frac{1}{\sqrt{2\pi}} e^{-\frac{x^2}{2}}$ (resp. $p_a(x) = \frac{1}{\sqrt{a}} p(\frac{x}{\sqrt{a}})$). Let p'_a denotes the derivative of p_a .

Let β be the standard Brownian motion.

Consider $\tau, \rho \in \mathbb{R}_+^*$. Intuitively, the Brownian bridge $B_{[0, \rho]}^{0 \rightarrow \tau}$ is the standard Brownian motion on $[0, \rho]$ conditioned to take value τ at time ρ and the first-passage Brownian bridge $F_{[0, \rho]}^{0 \rightarrow \tau}$ is the Brownian bridge conditioned to take value τ at time ρ for the first time. Since the probabilities of these conditioning events are equal to 0, these processes need to be more formally defined. There are many equivalent definitions (see for example [21, 24, 108]) and we use the following one (as explained in [47], lemma 1).

Then, the *Brownian bridge* $B_{[0, \rho]}^{0 \rightarrow \tau}$ is the unique continuous process $(B_t)_{t \in [0, \rho]}$ taking value τ at time ρ and satisfying, for every $\rho' \in [0, \rho[$ and every continuous $f : \mathcal{H} \rightarrow \mathbb{R}$, the identity

$$\mathbb{E}[f(B_{[0, \rho']})] = \mathbb{E} \left[f(\beta|_{[0, \rho']}) \frac{p_{\rho - \rho'}(\tau - \beta_{\rho'})}{p_{\rho}(\tau)} \right].$$

Similarly, the *first-passage Brownian bridge* $F_{[0,\rho]}^{0 \rightarrow \tau}$ is the unique continuous process $(F_t)_{t \in [0,\rho]}$ taking value τ at time ρ for the first time and satisfying, for every $\rho' \in [0, \rho[$ and every continuous $f : \mathcal{H} \rightarrow \mathbb{R}$, the identity

$$\mathbb{E}[f(F|_{[0,\rho']})] = \mathbb{E} \left[f(\beta|_{[0,\rho']}) \frac{p'_{\rho-\rho'}(\tau - \beta_{\rho'})}{p'_{\rho'}(\tau)} \mathbb{1}_{\bar{\beta}_{\rho'} < \tau} \right].$$

For convenience we define:

$$\tilde{F}_{[0,\rho]}^{0 \rightarrow \tau} = \frac{1}{2} \left(F_{[0,\rho]}^{0 \rightarrow \tau} + \overline{F_{[0,\rho]}^{0 \rightarrow \tau}} \right).$$

Given a function $f : [0, \rho] \rightarrow \mathbb{R}$, for $0 \leq s \leq t \leq \rho$, let $\check{f}(s, t) = \inf_{r \in [s,t]} (\bar{f}(r) - f(r))$.

We now define the Brownian snake's head driven by a first-passage Brownian bridge. To simplify the notation, let F denote the first-passage Brownian bridge $F_{[0,\rho]}^{0 \rightarrow \tau}$. The *Brownian snake's head* $Z = Z_{[0,\rho]}^\tau$ driven by F is, conditionally on F , define as the centered Gaussian process satisfying, for $0 \leq s \leq t \leq \rho$:

$$\text{Cov}(Z(s), Z(t)) = \check{F}(s, t)$$

We can assume that $Z_{[0,2\rho]}^\tau$ is almost surely (a.s.) continuous.

Now, define an equivalence relation as follows: for any $0 \leq s \leq t \leq \rho$, we say that $s \sim_F t$ if $\check{F}(s, s) = \check{F}(t, t) = \check{F}(s, t)$. Then the *Brownian continuum random forest* $(\mathcal{T}_F, d_{\mathcal{T}_F})$ is defined as the space $\mathcal{T}_F = [0, \rho] / \sim_F$ equipped with the distance function $d_{\mathcal{T}_F}(s, t) = \check{F}(s, s) + \check{F}(t, t) - 2\check{F}(s, t)$ for any pair (s, t) such that $0 \leq s \leq t \leq 2\rho$.

Remark 5.1. Note that if $s \sim_F t$ then $\mathbb{E}[(Z_{[0,\rho]}^\tau(s) - Z_{[0,\rho]}^\tau(t))^2] = 0$, meaning that as usual $Z_{[0,\rho]}^\tau$ can be seen as a continuous Gaussian process defined on \mathcal{T}_F .

We now give some definitions and results from ([22], see also [104]):

The *maximal span* of an integer-valued random variable X is the greatest $h \in \mathbb{N}$ for which there exists an integer a such that almost surely $X \in a + h\mathbb{Z}$.

Consider $(X_i)_{i \geq 0}$ a sequence of independent and identically distributed *i.i.d.* integer-valued centered random variables with a moment of order r_0 for some $r_0 \geq 3$. Let $\eta^2 = \text{Var}(X_1)$, h be the maximal span of X_i and a be the integer such that *a.s.* $X_i \in a + h\mathbb{Z}$. Let $\Sigma_k = \sum_{i=0}^k X_i$ and $Q_k(i) = \mathbb{P}(\Sigma_k = i)$.

Lemma 5.2 ([22]). *We have:*

$$\sup_{i \in ka + h\mathbb{Z}} \left| \frac{\eta}{h} \sqrt{k} Q_k(i) - p \left(\frac{i}{\eta \sqrt{k}} \right) \right| = o(k^{-\frac{1}{2}}),$$

and, for all $2 \leq r \leq r_0$, there exists a constant C such that for all $i \in \mathbb{Z}$ and $k \geq 1$,

$$\left| \frac{\eta}{h} \sqrt{k} Q_k(i) \right| \leq \frac{C}{1 + \left| \frac{i}{\eta \sqrt{k}} \right|^r}.$$

Consider $(\rho_n) \in \mathbb{N}^{\mathbb{N}}$ and $(\tau_n) \in \mathbb{Z}^{\mathbb{N}}$ two sequences of integers such that there exists $\rho, \tau \in \mathbb{R}_+^*$ satisfying:

$$\frac{\rho_n}{n} \rightarrow \rho \text{ and } \frac{\tau_n}{\eta \sqrt{n}} \rightarrow \tau$$

Let $(B_n(i))_{0 \leq i \leq \rho_n}$ be the process whose law is the law of $(\Sigma_i)_{0 \leq i \leq \rho_n}$ conditioned on the event

$$\Sigma_{\rho_n} = \tau_n,$$

which we suppose occurs with positive probability.

We write B_n the linearly interpolated version of B_n and define its rescaled version by:

$$B_{(n)} = \left(\frac{B_n(ns)}{\eta \sqrt{n}} \right)_{0 \leq s \leq \frac{\rho_n}{n}}$$

Lemma 5.3 ([22]). *There exists an integer $n_0 \in \mathbb{N}$ such that, for every $2 \leq q \leq q_0$, there exists a constant C_q satisfying, for all $n \geq n_0$ and $0 \leq s \leq t \leq \frac{\rho_n}{n}$,*

$$\mathbb{E}[|B_{(n)}(t) - B_{(n)}(s)|^q] \leq C_q |t - s|^{\frac{q}{2}}.$$

Theorem 5.4 ([22]). *The process $B_{(n)}$ converges in law toward the process $B_{[0,\rho]}^{0 \rightarrow \tau}$, in the space $(\mathcal{H}, d_{\mathcal{H}})$, when n goes to infinity.*

6 Convergence of the parameters in the decomposition

For all $n \geq 1$, consider a random pair (u_n, U_n) that is uniformly distributed over the set $\llbracket 1, 3 \rrbracket \times \mathcal{T}_{r,s,b}(n)$. Let (r_n, R_n) be the image of (u_n, U_n) by the bijection of Lemma 4.10. Let $k_n \in \llbracket 0, 9 \rrbracket$ be such that $R_n \in \mathcal{R}^{k_n}(n)$. We have $r_n \in \llbracket 1, 3 \rrbracket$ if $k_n = 0$ (i.e. U is a square) and $r_n \in \llbracket 1, 2 \rrbracket$ otherwise (i.e. U is hexagonal). In what follows, we need some rather heavy additional notation, and the cases $k_n = 0$ and $k_n > 0$ have to be treated slightly differently, even though the general approach is parallel between both.

If $k_n = 0$, let $(\rho_n^1, \dots, \rho_n^4) \in \mathbb{N}^4$, $(\tau_n^1, \dots, \tau_n^4) \in (\mathbb{N}^*)^4$, $(\sigma_n^1, \sigma_n^2) \in \mathbb{N}^2$, $((F_n^1, \ell_n^1), \dots, (F_n^4, \ell_n^4)) \in \mathcal{F}_{\tau_n^1}^{\rho_n^1} \times \dots \times \mathcal{F}_{\tau_n^4}^{\rho_n^4}$ and $(M_n^1, M_n^2) \in \mathcal{M}_{\sigma_n^1}^{\gamma_n^1} \times \mathcal{M}_{\sigma_n^2}^{\gamma_n^2}$ be such that $R_n = ((F_n^1, \ell_n^1), \dots, (F_n^4, \ell_n^4), M_n^1, M_n^2)$ (see Definition 4.8). If $k_n \neq 0$, let $(\rho_n^1, \dots, \rho_n^6) \in \mathbb{N}^6$, $(\tau_n^1, \dots, \tau_n^6) \in (\mathbb{N}^*)^6$, $(\gamma_n^1, \gamma_n^2, \gamma_n^3) \in \mathbb{Z}^3$, $(\sigma_n^1, \sigma_n^2, \sigma_n^3) \in \mathbb{N}^3$, $((F_n^1, \ell_n^1), \dots, (F_n^6, \ell_n^6)) \in \mathcal{F}_{\tau_n^1}^{\rho_n^1} \times \dots \times \mathcal{F}_{\tau_n^6}^{\rho_n^6}$, $(M_n^1, M_n^2, M_n^3) \in \mathcal{M}_{\sigma_n^1}^{\gamma_n^1} \times \mathcal{M}_{\sigma_n^2}^{\gamma_n^2} \times \mathcal{M}_{\sigma_n^3}^{\gamma_n^3}$ be such that $R_n = ((F_n^1, \ell_n^1), \dots, (F_n^6, \ell_n^6), M_n^1, M_n^2, M_n^3)$ (see Definition 4.9).

We define $t(k)$, for $k \in \llbracket 0, 9 \rrbracket$, such that $t(0) = 2$ and $t(k) = 3$ if $k \in \llbracket 1, 9 \rrbracket$. For convenience again, we write t_n for $t(k_n)$.

When $k_n = 0$, let $\gamma_n^1 = \gamma_n^2 = 0$; for $k_n \in \llbracket 0, 9 \rrbracket$ and $i \in \llbracket t_n + 1, 2t_n \rrbracket$, let $\gamma_n^i = -\gamma_n^{i-t_n}$ and $\sigma_n^i = \sigma_n^{i-t_n}$.

We often denote simply by x the vector (x^1, \dots, x^{2t}) ; in particular, $\rho_n, \tau_n, \gamma_n, \sigma_n$ denote the families $(\rho_n^i)_{1 \leq i \leq 2t_n}, (\tau_n^i)_{1 \leq i \leq 2t_n}, (\gamma_n^i)_{1 \leq i \leq 2t_n}, (\sigma_n^i)_{1 \leq i \leq 2t_n}$, respectively. For $k \in \llbracket 1, 9 \rrbracket$, let $(c^1(k), \dots, c^6(k)) \in \{0, 1\}^6$ denote the constants given by line k of Table 6.1. Moreover, let $c^1(0) = \dots = c^4(0) = 0$. Let $c(k) = (c^1(k), \dots, c^{t(k)}(k))$. For convenience, we write $c_n = c(k_n)$, i.e. $(c_n^1, \dots, c_n^{t_n}) = (c^1(k_n), \dots, c^{t_n}(k_n))$.

With these notations, by Definitions 4.8 and 4.9, we have the following equality:

$$\tau_n = 2\sigma_n + \gamma_n + c_n + 1. \quad (6.1)$$

Conditionally on the vector $(k_n, \rho_n, \tau_n, \gamma_n, \sigma_n)$, the forests and paths $F_n^1, \dots, F_n^{2t_n}, M_n^1, M_n^2, M_n^{t_n}$ are independent and:

- for every $i \in \llbracket 1, 2t_n \rrbracket$, the well-labeled forest (F_n^i, ℓ_n^i) is uniformly distributed over the set $\mathcal{F}_{\tau_n^i}^{\rho_n^i}$,
- for every $i \in \llbracket 1, t_n \rrbracket$, the Motzkin path M_n^i is uniformly distributed over the set $\mathcal{M}_{\sigma_n^i}^{\gamma_n^i}$.

For every $n > 0$, we define the renormalized version $\rho_{(n)}, \gamma_{(n)}, \sigma_{(n)}$ by letting $\rho_{(n)} = \frac{\rho_n}{n}$, $\gamma_{(n)} = (\frac{9}{8n})^{1/4} \gamma_n$ and $\sigma_{(n)} = \frac{\sigma_n}{\sqrt{2n}}$.

For $k \in \{0, \dots, 9\}$, we repeatedly use two vector spaces in what follows, a “small space” $(\mathbb{R}_+)^{2t(k)-1} \times \mathbb{R}^{t(k)-2} \times (\mathbb{R}_+)^{t(k)}$ and a “big space” $(\mathbb{R}_+)^{2t(k)} \times \mathbb{R}^{2t(k)} \times (\mathbb{R}_+)^{2t(k)}$, and use the terms “small” and “big” in what follows as shortcuts for these spaces. The small space can be seen as a subspace of the big one by imposing the following relations between coordinates in the big space. Every triple $(\rho, \gamma, \sigma) \in (\mathbb{R}_+)^{2t(k)-1} \times \mathbb{R}^{t(k)-2} \times (\mathbb{R}_+)^{t(k)}$ can be extended into a triple in $(\mathbb{R}_+)^{2t(k)} \times \mathbb{R}^{2t(k)} \times (\mathbb{R}_+)^{2t(k)}$ by letting:

- $\rho^{2t(k)} = 1 - \sum_{i=1}^{2t(k)-1} \rho^i$
- for $i \in \llbracket 2, 2t(k) \rrbracket$, $\gamma^i = (-1)^{i-1} \gamma^1$,
- for $i \in \llbracket t(k) + 1, 2t(k) \rrbracket$, $\sigma^i = \sigma^{i-t(k)}$,

The idea is that combinatorial constraints coming from our previous constructions will impose these relations on the scaling limits: the natural limit takes place in the big space, but the degrees of freedom correspond to the coordinates in the small space and so will the integration variables in what follows. As a particularly useful notation, we several times extend functions from the small space to the big space, more precisely: if $(\rho, \gamma, \sigma) \in (\mathbb{R}_+)^{2t(k)-1} \times \mathbb{R}^{t(k)-2} \times (\mathbb{R}_+)^{t(k)}$ is a point in the small space and $f : (\mathbb{R}_+)^{2t(k)} \times \mathbb{R}^{2t(k)} \times (\mathbb{R}_+)^{2t(k)} \rightarrow \mathbb{R}$, we denote by $f(\rho, \gamma, \sigma)$ the value of f at the point in the big space obtained by computing the extra coordinates as above.

We make use of

$$\Delta_k = \left\{ x \in (\mathbb{R}_+)^{2t(k)} : \sum_{i=1}^{2t(k)} x^i = 1 \right\},$$

the simplex of dimension $2t(k) - 1$. Note that ρ lies in the simplex Δ_k as long as $\rho^{2t(k)} \geq 0$. Now, define a probability measure μ on the set $\mathcal{L} = \bigcup_{k \in \llbracket 0, 9 \rrbracket} (\{k\} \times \Delta_k \times \mathbb{R}^{2t(k)} \times (\mathbb{R}_+)^{2t(k)})$ as follows: for every non-negative measurable function φ on \mathcal{L} , let

$$\begin{aligned} \mu(\varphi) = & \frac{1}{\Upsilon} \sum_{k=1}^9 \int_{\mathcal{X}} (\mathbb{1}_{\rho^6 \geq 0} \times \varphi(k, \rho, \gamma, \sigma) \times \\ & \prod_{i=1}^6 \left(\frac{\sigma^i}{\sqrt{2} \rho^i} \times \frac{2}{\sqrt{6\pi} \rho^i} \times e^{\frac{-(\sigma^i)^2}{3\rho^i}} \times \left(\frac{4}{3}\right)^{c^i(k)+1} \right) \times \prod_{i=1}^3 p_{\sigma^i}(\gamma^i) \right) dX \end{aligned}$$

where like above $(c^1(k), \dots, c^6(k))$ is given by line k of Table 6.1, where dX is the Lebesgue measure on

$$\mathcal{X} = (\mathbb{R}_+)^5 \times \mathbb{R} \times (\mathbb{R}_+)^3,$$

and where the renormalization constant

$$\Upsilon = \sum_{k=1}^9 \int_{\mathcal{X}} \left(\mathbb{1}_{\rho^6 \geq 0} \prod_{i=1}^6 \left(\frac{\sigma^i}{\sqrt{2} \rho^i} \times \frac{2}{\sqrt{6\pi} \rho^i} \times e^{\frac{-(\sigma^i)^2}{3\rho^i}} \times \left(\frac{4}{3}\right)^{c^i(k)+1} \right) \times \prod_{i=1}^3 p_{\sigma^i}(\gamma^i) \right) dX$$

is chosen so that μ has total mass 1. Note that μ is supported on a subspace of the big space. The goal of this section is to prove the following convergence result:

Lemma 6.1. *The law μ_n of the random variable $(k_n, \rho(n), \gamma(n), \sigma(n))$ converges weakly toward the probability measure μ .*

We say that a random, infinite Motzkin path $(M_i)_{i \geq 0}$ is *uniform* if its steps are independent and uniformly distributed in $\{-1, 0, 1\}$ (which means that for every $\sigma > 0$, the restricted path $(M_i)_{0 \leq i \leq \sigma}$ is uniformly distributed among Motzkin paths of length σ). There is a relation between Motzkin paths with prescribed final value and uniform Motzkin paths:

$$|\mathcal{M}_\sigma^\gamma| = 3^\sigma \mathbb{P}(M_\sigma = \gamma). \tag{6.2}$$

Consider $n \geq 1$ and $k \in \llbracket 0, 9 \rrbracket$. Let $\mathcal{C}_n^k \subseteq \mathbb{N}^{2t(k)} \times (\mathbb{N}^*)^{2t(k)} \times \mathbb{Z}^{2t(k)} \times \mathbb{N}^{2t(k)}$ be the set of t -uples $(\rho, \tau, \gamma, \sigma)$ satisfying the following conditions:

$$\text{when } k = 0: \quad \gamma^1 = \gamma^2 = 0; \tag{6.3}$$

$$\text{when } k \neq 0: \quad \gamma^1 + \gamma^2, \gamma^2 + \gamma^3, \text{ are given by line } k \text{ of Table 6.1}; \tag{6.4}$$

$$\text{for } i \in \llbracket t(k) + 1, 2t(k) \rrbracket: \quad \gamma^i = -\gamma^{i-t(k)} \text{ and } \sigma^i = \sigma^{i-t(k)}; \tag{6.5}$$

$$n = \rho^1 + \dots + \rho^{2t(k)} + \sigma^1 + \dots + \sigma^{t(k)} + t(k) - 1 \tag{6.6}$$

$$\tau = 2\sigma + \gamma + c(k) + 1 \quad (6.7)$$

$$\text{for } i \in \llbracket 1, 2t(k) \rrbracket: \quad |\gamma^i| \leq \sigma^i. \quad (6.8)$$

For $(k, \rho, \tau, \gamma, \sigma) \in \llbracket 0, 9 \rrbracket \times \mathcal{C}_n^k$, we define:

$$\mathbb{P}_n(k, \rho, \tau, \gamma, \sigma) = \mathbb{P}\left((k_n, \rho_n, \tau_n, \gamma_n, \sigma_n) = (k, \rho, \tau, \gamma, \sigma)\right)$$

Then, by Lemmas 4.6 and 4.10, Definitions 4.8 and 4.9, Equations (6.1) and (6.2), we have:

$$\begin{aligned} \mathbb{P}_n(k, \rho, \tau, \gamma, \sigma) &= \frac{2 + \mathbb{1}_{k=0}}{3|\mathcal{T}_{r,s,b}(n)|} \prod_{i=1}^{2t(k)} |\mathcal{F}_{\tau^i}^{\rho^i}| \prod_{i=1}^{t(k)} |\mathcal{M}_{\sigma^i}^{\gamma^i}| \\ &= \frac{2 + \mathbb{1}_{k=0}}{3|\mathcal{T}_{r,s,b}(n)|} \times \prod_{i=1}^{2t(k)} \frac{\tau^i}{4\rho^i + \tau^i} \binom{4\rho^i + \tau^i}{\rho^i} \times \prod_{i=1}^{t(k)} 3^{\sigma^i} \mathbb{P}(M_{\sigma^i} = \gamma^i) \end{aligned} \quad (6.9)$$

where $(M_i)_{i \geq 0}$ is a uniform Motzkin path. To get a grasp on this quantity, we now collect a few combinatorial results.

Lemma 6.2. *For $a, b \in \mathbb{N}$, we have*

$$\binom{4a+b}{a} = \binom{4a}{a} \times \left(\frac{4}{3}\right)^b \times \frac{\prod_{p=1}^b \left(1 + \frac{p}{4a}\right)}{\prod_{p=1}^b \left(1 + \frac{p}{3a}\right)}.$$

Proof. A straightforward computation shows that

$$\begin{aligned} \frac{\binom{4a+b}{a}}{\binom{4a}{a}} &= \frac{(4a+b)!}{(a)!(3a+b)!} \times \frac{(a)!(3a)!}{(4a)!} = \frac{(4a+b)!}{(4a)!} \times \frac{(3a)!}{(3a+b)!} = \frac{\prod_{p=1}^b (4a+p)}{\prod_{p=1}^b (3a+p)} \\ &= \frac{(4a)^b \prod_{p=1}^b \left(1 + \frac{p}{4a}\right)}{(3a)^b \prod_{p=1}^b \left(1 + \frac{p}{3a}\right)} = \left(\frac{4}{3}\right)^b \frac{\prod_{p=1}^b \left(1 + \frac{p}{4a}\right)}{\prod_{p=1}^b \left(1 + \frac{p}{3a}\right)} \quad \square \end{aligned}$$

By Lemma 6.2, the binomial term in (6.9) can be rewritten:

$$\begin{aligned} \binom{4\rho^i + \tau^i}{\rho^i} &= \binom{4\rho^i + 2\sigma^i + \gamma^i + c^i(k) + 1}{\rho^i} \\ &= \binom{4\rho^i + 2\sigma^i + \gamma^i}{\rho^i} \prod_{p=1}^{c^i(k)+1} \frac{4\rho^i + 2\sigma^i + \gamma^i + p}{3\rho^i + 2\sigma^i + \gamma^i + p} \\ &= \binom{4\rho^i}{\rho^i} \left(\frac{4}{3}\right)^{2\sigma^i + \gamma^i} \frac{\prod_{p=1}^{2\sigma^i + \gamma^i} \left(1 + \frac{p}{4\rho^i}\right)}{\prod_{p=1}^{2\sigma^i + \gamma^i} \left(1 + \frac{p}{3\rho^i}\right)} \prod_{p=1}^{c^i(k)+1} \frac{4\rho^i + 2\sigma^i + \gamma^i + p}{3\rho^i + 2\sigma^i + \gamma^i + p}. \end{aligned} \quad (6.10)$$

For $x \in \mathbb{R}$, let $\lfloor x \rfloor$ denote the largest integer that is bounded above by x .

Lemma 6.3. For $(\rho, \gamma, \sigma) \in \mathbb{R}_+^* \times \mathbb{R} \times \mathbb{R}_+^*$, as n goes to infinity

$$\frac{\prod_{p=1}^{2\lfloor\sqrt{2n\sigma}\rfloor + \lfloor(8n/9)^{1/4}\gamma\rfloor} \left(1 + \frac{p}{4\lfloor n\rho\rfloor}\right)}{\prod_{p=1}^{2\lfloor\sqrt{2n\sigma}\rfloor + \lfloor(8n/9)^{1/4}\gamma\rfloor} \left(1 + \frac{p}{3\lfloor n\rho\rfloor}\right)} \rightarrow e^{-\frac{\sigma^2}{3\rho}}.$$

Proof. For $n \geq 1$, let a_n denote the left-hand term in the statement of the lemma. By Lemma 6.2, we have:

$$\begin{aligned} a_n &= \binom{4\lfloor n\rho\rfloor + 2\lfloor\sqrt{2n\sigma}\rfloor + \lfloor(8n/9)^{1/4}\gamma\rfloor}{\lfloor n\rho\rfloor} \times \left(\frac{3}{4}\right)^{2\lfloor\sqrt{2n\sigma}\rfloor + \lfloor(8n/9)^{1/4}\gamma\rfloor} / \binom{4\lfloor n\rho\rfloor}{\lfloor n\rho\rfloor} \\ &= \frac{(4\lfloor n\rho\rfloor + 2\lfloor\sqrt{2n\sigma}\rfloor + \lfloor(8n/9)^{1/4}\gamma\rfloor)! (3\lfloor n\rho\rfloor)!}{(3\lfloor n\rho\rfloor + 2\lfloor\sqrt{2n\sigma}\rfloor + \lfloor(8n/9)^{1/4}\gamma\rfloor)! (4\lfloor n\rho\rfloor)!} \times \left(\frac{3}{4}\right)^{2\lfloor\sqrt{2n\sigma}\rfloor + \lfloor(8n/9)^{1/4}\gamma\rfloor}. \end{aligned}$$

Using the Stirling formula, we obtain:

$$\begin{aligned} a_n &\sim \frac{(4\lfloor n\rho\rfloor + 2\lfloor\sqrt{2n\sigma}\rfloor + \lfloor(8n/9)^{1/4}\gamma\rfloor)^{4\lfloor n\rho\rfloor + 2\lfloor\sqrt{2n\sigma}\rfloor + \lfloor(8n/9)^{1/4}\gamma\rfloor} (3\lfloor n\rho\rfloor)^{3\lfloor n\rho\rfloor}}{(3\lfloor n\rho\rfloor + 2\lfloor\sqrt{2n\sigma}\rfloor + \lfloor(8n/9)^{1/4}\gamma\rfloor)^{3\lfloor n\rho\rfloor + 2\lfloor\sqrt{2n\sigma}\rfloor + \lfloor(8n/9)^{1/4}\gamma\rfloor} (4\lfloor n\rho\rfloor)^{4\lfloor n\rho\rfloor}} \\ &\quad \times \left(\frac{3}{4}\right)^{2\lfloor\sqrt{2n\sigma}\rfloor + \lfloor(8n/9)^{1/4}\gamma\rfloor} \\ &\sim \frac{\left(\frac{4\lfloor n\rho\rfloor + 2\lfloor\sqrt{2n\sigma}\rfloor + \lfloor(8n/9)^{1/4}\gamma\rfloor}{4\lfloor n\rho\rfloor}\right)^{4\lfloor n\rho\rfloor}}{\left(\frac{3\lfloor n\rho\rfloor + 2\lfloor\sqrt{2n\sigma}\rfloor + \lfloor(8n/9)^{1/4}\gamma\rfloor}{3\lfloor n\rho\rfloor}\right)^{3\lfloor n\rho\rfloor}} \\ &\quad \times \frac{(4\lfloor n\rho\rfloor + 2\lfloor\sqrt{2n\sigma}\rfloor + \lfloor(8n/9)^{1/4}\gamma\rfloor)^{2\lfloor\sqrt{2n\sigma}\rfloor + \lfloor(8n/9)^{1/4}\gamma\rfloor}}{(3\lfloor n\rho\rfloor + 2\lfloor\sqrt{2n\sigma}\rfloor + \lfloor(8n/9)^{1/4}\gamma\rfloor)^{2\lfloor\sqrt{2n\sigma}\rfloor + \lfloor(8n/9)^{1/4}\gamma\rfloor}} \\ &\quad \times \left(\frac{3}{4}\right)^{2\lfloor\sqrt{2n\sigma}\rfloor + \lfloor(8n/9)^{1/4}\gamma\rfloor} \\ &\sim \frac{\left(1 + \frac{2\lfloor\sqrt{2n\sigma}\rfloor + \lfloor(8n/9)^{1/4}\gamma\rfloor}{4\lfloor n\rho\rfloor}\right)^{4\lfloor n\rho\rfloor}}{\left(1 + \frac{2\lfloor\sqrt{2n\sigma}\rfloor + \lfloor(8n/9)^{1/4}\gamma\rfloor}{3\lfloor n\rho\rfloor}\right)^{3\lfloor n\rho\rfloor}} \times \frac{\left(1 + \frac{2\lfloor\sqrt{2n\sigma}\rfloor + \lfloor(8n/9)^{1/4}\gamma\rfloor}{4\lfloor n\rho\rfloor}\right)^{2\lfloor\sqrt{2n\sigma}\rfloor + \lfloor(8n/9)^{1/4}\gamma\rfloor}}{\left(1 + \frac{2\lfloor\sqrt{2n\sigma}\rfloor + \lfloor(8n/9)^{1/4}\gamma\rfloor}{3\lfloor n\rho\rfloor}\right)^{2\lfloor\sqrt{2n\sigma}\rfloor + \lfloor(8n/9)^{1/4}\gamma\rfloor}} \end{aligned}$$

We have the following estimates as $n \rightarrow \infty$:

$$\left(1 + \frac{2\lfloor\sqrt{2n\sigma}\rfloor + \lfloor(8n/9)^{1/4}\gamma\rfloor}{4\lfloor n\rho\rfloor}\right)^{4\lfloor n\rho\rfloor} \sim e^{2\lfloor\sqrt{2n\sigma}\rfloor + \lfloor(8n/9)^{1/4}\gamma\rfloor - \sigma^2/\rho}, \tag{6.11}$$

$$\left(1 + \frac{2 \lfloor \sqrt{2n\sigma} \rfloor + \lfloor (8n/9)^{1/4} \gamma \rfloor}{3 \lfloor n\rho \rfloor}\right)^{3 \lfloor n\rho \rfloor} \sim e^{2 \lfloor \sqrt{2n\sigma} \rfloor + \lfloor (8n/9)^{1/4} \gamma \rfloor - \frac{4\sigma^2}{3\rho}}, \quad (6.12)$$

$$\left(1 + \frac{2 \lfloor \sqrt{2n\sigma} \rfloor + \lfloor (8n/9)^{1/4} \gamma \rfloor}{4 \lfloor n\rho \rfloor}\right)^{2 \lfloor \sqrt{2n\sigma} \rfloor + \lfloor (8n/9)^{1/4} \gamma \rfloor} \rightarrow e^{2\sigma^2/\rho}, \quad (6.13)$$

$$\left(1 + \frac{2 \lfloor \sqrt{2n\sigma} \rfloor + \lfloor (8n/9)^{1/4} \gamma \rfloor}{3 \lfloor n\rho \rfloor}\right)^{2 \lfloor \sqrt{2n\sigma} \rfloor + \lfloor (8n/9)^{1/4} \gamma \rfloor} \rightarrow e^{\frac{8\sigma^2}{3\rho}}. \quad (6.14)$$

Combining these completes the proof. \square

We are now ready to prove Lemma 6.1:

Proof of Lemma 6.1. Let φ be a bounded continuous function on the set \mathcal{L} and define $\mathbb{E}_n(\varphi) = \mathbb{E}(\varphi(k_n, \rho(n), \gamma(n), \sigma(n)))$. We need to prove that $\mathbb{E}_n(\varphi)$ converges toward $\mu(\varphi)$ as n goes to infinity.

Let $n \in \mathbb{N}$. For a given value of k , we identify $(\rho, \gamma, \sigma) \in \mathbb{N}^{2t(k)-1} \times \mathbb{Z}^{t(k)-2} \times \mathbb{N}^{t(k)}$ with an element $p(\rho, \gamma, \sigma) = (\rho, \tau, \gamma, \sigma)$ of $(\mathbb{N}^{2t(k)-1} \times \mathbb{Z}) \times (\mathbb{N}^*)^{2t(k)} \times \mathbb{Z}^{2t(k)} \times \mathbb{N}^{2t(k)}$ by setting the missing coordinates so that they satisfy the conditions (6.3) to (6.7). Note that $\rho^{2t(k)}$ depends not only on n and the ρ^i for $i \leq 2t(k) - 1$ but also on the σ^i . Note also that $p(\rho, \gamma, \sigma)$ is an element of \mathcal{C}_n^k provided that the conditions lead to $\rho^{2t(k)} \geq 0$ and for any $i \in [1, 2t(k)]$ we have $|\gamma^i| \leq \sigma^i$. By Equations (6.9) and (6.10) we have

$$\begin{aligned} \mathbb{E}_n(\varphi) &= \sum_{k=0}^9 \sum_{(\rho, \tau, \gamma, \sigma) \in \mathcal{C}_n^k} \left(\mathbb{P}_n(k, \rho, \tau, \gamma, \sigma) \varphi \left(k, \frac{\rho}{n}, \left(\frac{9}{8n} \right)^{1/4} \gamma, \frac{\sigma}{\sqrt{2n}} \right) \right) \\ &= \sum_{k=0}^9 \frac{2 + \mathbb{1}_{k=0}}{3 |\mathcal{T}_{\tau, s, b}(n)|} \sum_{(\rho, \tau, \gamma, \sigma) \in \mathcal{C}_n^k} (f(k, \rho, \gamma, \sigma) \times g(k, \gamma, \sigma) \times h(k, \rho, \gamma, \sigma)) \end{aligned}$$

where we introduced the functions

$$\begin{aligned} f(k, \rho, \gamma, \sigma) &= \prod_{i=1}^{2t(k)} \left(\left(\frac{2\sigma^i + \gamma^i + c^i(k) + 1}{4\rho^i + 2\sigma^i + \gamma^i + c^i(k) + 1} \right) \left(\frac{4\rho^i}{\rho^i} \right) \left(\frac{4}{3} \right)^{2\sigma^i + \gamma^i} \right. \\ &\quad \left. \frac{\prod_{p=1}^{2\sigma^i + \gamma^i} \left(1 + \frac{p}{4\rho^i} \right)^{c^i(k)+1}}{\prod_{p=1}^{2\sigma^i + \gamma^i} \left(1 + \frac{p}{3\rho^i} \right)} \prod_{p=1}^{c^i(k)+1} \frac{4\rho^i + 2\sigma^i + \gamma^i + p}{3\rho^i + 2\sigma^i + \gamma^i + p} \right), \\ g(k, \gamma, \sigma) &= \prod_{i=1}^{t(k)} 3^{\sigma^i} \mathbb{P}(M_{\sigma^i} = \gamma^i), \\ h(k, \rho, \gamma, \sigma) &= \varphi \left(k, \frac{\rho}{n}, \left(\frac{9}{8n} \right)^{1/4} \gamma, \frac{\sigma}{\sqrt{2n}} \right). \end{aligned}$$

In order to derive the asymptotic behavior of the discrete objects above, we are going to compare discrete sums to integrals. To do that, we need some more notation.

For $k \in \llbracket 0, 9 \rrbracket$, $n \geq 0$ and $(\rho, \gamma, \sigma) \in (\mathbb{R}_+)^{2t(k)-1} \times \mathbb{R}^{t(k)-2} \times (\mathbb{R}_+)^{t(k)}$, we define $(\lfloor \rho \rfloor, \lfloor \gamma \rfloor, \lfloor \sigma \rfloor) \in (\mathbb{N}^{2t(k)-1} \times \mathbb{Z}) \times \mathbb{Z}^{2t(k)} \times \mathbb{N}^{2t(k)}$ by the following. For every $i \in \{1, \dots, 2t(k)-1\}$, let $\lfloor \rho \rfloor^i = \lfloor \rho^i \rfloor$. If $k \neq 0$, let $\lfloor \gamma \rfloor^1 = \lfloor \gamma^1 \rfloor$. For every $i \in \{1, \dots, t(k)\}$, let $\lfloor \sigma \rfloor^i = \lfloor \sigma^i \rfloor$. Then we choose $\lfloor \rho \rfloor^{2t(k)}$, $\lfloor \gamma \rfloor^{t(k)-1}$, $\dots, \lfloor \gamma \rfloor^{2t(k)}$, $\lfloor \sigma \rfloor^{t(k)+1}$, $\dots, \lfloor \sigma \rfloor^{2t(k)}$ so that $\lfloor \rho \rfloor$, $\lfloor \gamma \rfloor$, $\lfloor \sigma \rfloor$ satisfies the relation (6.3), (6.4), (6.5), and (6.6).

Note that the set of all preimages of a given joint integral value for $(\lfloor \rho \rfloor, \lfloor \sigma \rfloor, \lfloor \gamma \rfloor)$ is a unit cube in the “small space”. Note as well that this definition does not coincide with first computing the extra coordinates as before and then taking integral parts coordinatewise on the big space: we choose this particular definition so that the constraints on coordinates match better between the discrete and continuous versions.

Writing the sum over \mathcal{C}_n^k in the form of an integral, we have:

$$\mathbb{E}_n(\varphi) = \sum_{k=0}^9 \frac{2 + \mathbb{1}_{k=0}}{3|\mathcal{T}_{r,s,b}(n)|} \int_{\mathcal{X}^k} \left(\mathbb{1}_{\mathcal{E}_n^k}(\lfloor \rho \rfloor, \lfloor \gamma \rfloor, \lfloor \sigma \rfloor) \times f(k, \lfloor \rho \rfloor, \lfloor \gamma \rfloor, \lfloor \sigma \rfloor) \right. \\ \left. \times g(k, \lfloor \gamma \rfloor, \lfloor \sigma \rfloor) \times h(k, \lfloor \rho \rfloor, \lfloor \gamma \rfloor, \lfloor \sigma \rfloor) \right) dX^k$$

where dX^k is the Lebesgue measure on $\mathcal{X}^k = (\mathbb{R}_+)^{2t(k)-1} \times \mathbb{R}^{t(k)-2} \times (\mathbb{R}_+)^{t(k)}$ and

$$\mathcal{E}_n^k = \left\{ (\rho, \gamma, \sigma) \in (\mathbb{R}_+)^{2t(k)-1} \times \mathbb{R}^{t(k)-2} \times (\mathbb{R}_+)^{t(k)} : \right. \\ \left. \lfloor \rho \rfloor^{2t(k)} \geq 0 \text{ and } \forall i \in \llbracket 1, t(k) \rrbracket, |\gamma^i| \leq \sigma^i \right\}.$$

We now do a change of variables by setting $\rho' = \frac{\rho}{n}$, $\gamma' = \left(\frac{9}{8n}\right)^{\frac{1}{4}}\gamma$, $\sigma' = \frac{\sigma}{\sqrt{2n}}$ (but still write the new variables as (ρ, γ, σ) below for simpler notation). The change of variables is linear and acts like a multiplication by n on $\rho \in (\mathbb{R}_+)^{2t(k)-1}$, by $(8n/9)^{1/4}$ on $\gamma \in (\mathbb{R})^{t(k)-2}$ and by $\sqrt{2n}$ on $\sigma \in (\mathbb{R}_+)^{t(k)}$, so its Jacobian is equal to $n^{2t(k)-1}(8n/9)^{(t(k)-2)/4}(\sqrt{2n})^{t(k)}$. Therefore we obtain:

$$\mathbb{E}_n(\varphi) = \sum_{k=0}^9 \frac{2 + \mathbb{1}_{k=0}}{3|\mathcal{T}_{r,s,b}(n)|} \int_{\mathcal{X}^k} \left(\mathbb{1}_{\mathcal{E}_n^k} \left(\lfloor n\rho \rfloor, \left\lfloor (8n/9)^{\frac{1}{4}}\gamma \right\rfloor, \left\lfloor \sqrt{2n}\sigma \right\rfloor \right) \right. \\ \left(n^{2t(k)-1} \left(\frac{8n}{9}\right)^{\frac{t(k)-2}{4}} (\sqrt{2n})^{t(k)} \right) \\ \times f \left(k, \lfloor n\rho \rfloor, \left\lfloor (8n/9)^{\frac{1}{4}}\gamma \right\rfloor, \left\lfloor \sqrt{2n}\sigma \right\rfloor \right) \\ \times g \left(k, \left\lfloor (8n/9)^{\frac{1}{4}}\gamma \right\rfloor, \left\lfloor \sqrt{2n}\sigma \right\rfloor \right) \\ \left. \times h \left(k, \lfloor n\rho \rfloor, \left\lfloor (8n/9)^{\frac{1}{4}}\gamma \right\rfloor, \left\lfloor \sqrt{2n}\sigma \right\rfloor \right) \right) dX^k.$$

Note that, for every $k \in \llbracket 0, 9 \rrbracket$, due to the way we defined $\lfloor \cdot \rfloor$, we have:

$$\begin{aligned} & \prod_{i=1}^{2t(k)} \left(\frac{4}{3} \right)^{2 \lfloor \sqrt{2n\sigma^i} \rfloor + \lfloor (8n/9)^{1/4} \gamma^i \rfloor} \prod_{i=1}^{t(k)} 3^{\lfloor \sqrt{2n\sigma^i} \rfloor} \\ &= \left(\frac{256}{27} \right)^{\sum_{i=1}^{t(k)} \lfloor \sqrt{2n\sigma^i} \rfloor} \\ &= \left(\frac{256}{27} \right)^{n - \sum_{i=1}^{2t(k)} \lfloor n\rho^i \rfloor - (t(k)-1)}. \end{aligned}$$

Hence, we can rewrite $\mathbb{E}_n(\varphi)$ as

$$\begin{aligned} \mathbb{E}_n(\varphi) &= \sum_{k=0}^9 \frac{2 + \mathbb{1}_{k=0}}{3|\mathcal{T}_{r,s,b}(n)|} n^{\frac{t(k)-3}{2}} (\sqrt{2})^{t(k)} \left(\frac{9}{8} \right)^{1/2} \left(\frac{256}{27} \right)^{n-t(k)+1} \int_{\mathcal{X}^k} \\ & \quad \left(\mathbb{1}_{\mathcal{E}_n^k} \left(\lfloor n\rho \rfloor, \lfloor (8n/9)^{1/4} \gamma \rfloor, \lfloor \sqrt{2n\sigma} \rfloor \right) \right. \\ & \quad \left. h \left(k, \lfloor n\rho \rfloor, \lfloor (8n/9)^{1/4} \gamma \rfloor, \lfloor \sqrt{2n\sigma} \rfloor \right) \right. \\ & \quad \prod_{i=1}^{2t(k)} \left(\left(\sqrt{n} \frac{2 \lfloor \sqrt{2n\sigma^i} \rfloor + \lfloor (8n/9)^{1/4} \gamma^i \rfloor + c^i(k) + 1}{4 \lfloor n\rho^i \rfloor + 2 \lfloor \sqrt{2n\sigma^i} \rfloor + \lfloor (8n/9)^{1/4} \gamma^i \rfloor + c^i(k) + 1} \right) \right. \\ & \quad \times \sqrt{n} \left(\frac{27}{256} \right)^{\lfloor n\rho^i \rfloor} \binom{4 \lfloor n\rho^i \rfloor}{\lfloor n\rho^i \rfloor} \\ & \quad \times \left(\frac{\prod_{p=1}^{2 \lfloor \sqrt{2n\sigma^i} \rfloor + \lfloor (8n/9)^{1/4} \gamma^i \rfloor} \left(1 + \frac{p}{4 \lfloor n\rho^i \rfloor} \right)}{\prod_{p=1}^{2 \lfloor \sqrt{2n\sigma^i} \rfloor + \lfloor (8n/9)^{1/4} \gamma^i \rfloor} \left(1 + \frac{p}{3 \lfloor n\rho^i \rfloor} \right)} \right) \\ & \quad \times \left(\prod_{p=1}^{c^i(k)+1} \frac{4 \lfloor n\rho^i \rfloor + 2 \lfloor \sqrt{2n\sigma^i} \rfloor + \lfloor (8n/9)^{1/4} \gamma^i \rfloor + p}{3 \lfloor n\rho^i \rfloor + 2 \lfloor \sqrt{2n\sigma^i} \rfloor + \lfloor (8n/9)^{1/4} \gamma^i \rfloor + p} \right) \\ & \quad \times \left. \prod_{i=1}^{t(k)} (8n/9)^{1/4} \mathbb{P} \left(M_{\lfloor \sqrt{2n\sigma^i} \rfloor} = \lfloor (8n/9)^{1/4} \gamma^i \rfloor \right) \right) \\ & \quad dX^k \end{aligned}$$

We are now going to use dominated convergence to show that every integral term appearing in \mathbb{E}_n converges. We have the following:

$$- \lfloor n\rho \rfloor^{2t(k)} = n - \sum_{i=1}^{2t(k)-1} \lfloor n\rho \rfloor^i - \sum_{i=1}^{t(k)} \lfloor \sqrt{2n\sigma} \rfloor^i - (t(k) - 1), \text{ and therefore}$$

$$\frac{\lfloor n\rho \rfloor^{2t(k)}}{n} = 1 - \sum_{i=1}^{2t(k)-1} \frac{\lfloor n\rho \rfloor^i}{n} - \sum_{i=1}^{t(k)} \frac{\lfloor \sqrt{2n\sigma} \rfloor^i}{n} - \frac{t(k) - 1}{n} \rightarrow 1 - \sum_{i=1}^{2t(k)-1} \rho^i = \rho^{2t(k)}.$$

On the other hand, for every $i \in \llbracket 1, t(k) \rrbracket$ we have: $\mathbb{1}_{\left\{ \left| \lfloor (8n/9)^{\frac{1}{4}} \gamma^i \rfloor \rfloor \leq \lfloor \sqrt{2n\sigma} \rfloor \right. \right\}} \rightarrow \mathbb{1}_{\{\sigma^i \geq 0\}}$, and hence,

$$\mathbb{1}_{\mathcal{E}_n^k} \left(\lfloor n\rho \rfloor, \lfloor (8n/9)^{\frac{1}{4}} \gamma \rfloor, \lfloor \sqrt{2n\sigma} \rfloor \right) \rightarrow \mathbb{1}_{\{\rho^{2t(k)} \geq 0\}}.$$

— $h \left(k, \lfloor n\rho \rfloor, \lfloor (8n/9)^{\frac{1}{4}} \gamma \rfloor, \lfloor \sqrt{2n\sigma} \rfloor \right) = \varphi \left(k, \frac{\lfloor n\rho \rfloor}{n}, \frac{\lfloor (8n/9)^{\frac{1}{4}} \gamma \rfloor}{(8n/9)^{\frac{1}{4}}}, \frac{\lfloor \sqrt{2n\sigma} \rfloor}{\sqrt{2n}} \right) \rightarrow \varphi(k, \rho, \gamma, \sigma).$

— By Lemma 6.3, we obtain:

$$\frac{\prod_{p=1}^2 \frac{2^{\lfloor \sqrt{2n\sigma^i} \rfloor + \lfloor (8n/9)^{1/4} \gamma^i \rfloor} (1 + \frac{p}{4 \lfloor n\rho^i \rfloor})}{2^{\lfloor \sqrt{2n\sigma^i} \rfloor + \lfloor (8n/9)^{1/4} \gamma^i \rfloor} (1 + \frac{p}{3 \lfloor n\rho^i \rfloor})} \rightarrow e^{-\frac{(\sigma^i)^2}{3\rho^i}}.$$

— By Lemma 5.2 with $(\eta, h) = \left(\sqrt{\frac{2}{3}}, 1 \right)$, we obtain (with some simple calculus) :

$$(8n/9)^{1/4} \mathbb{P} \left(M_{\lfloor \sqrt{2n\sigma^i} \rfloor} = \lfloor (8n/9)^{1/4} \gamma^i \rfloor \right) \rightarrow p_{\sigma^i}(\gamma^i).$$

— If $\rho^i > 0$, then

$$\sqrt{n} \left(\frac{27}{256} \right)^{\lfloor n\rho^i \rfloor} \binom{4 \lfloor n\rho^i \rfloor}{\lfloor n\rho^i \rfloor} \rightarrow \frac{2}{\sqrt{6\pi\rho^i}}.$$

— $\prod_{p=1}^{c^i(k)+1} \frac{4^{\lfloor n\rho^i \rfloor + 2\lfloor \sqrt{2n\sigma^i} \rfloor + \lfloor (8n/9)^{1/4} \gamma^i \rfloor + p}}{3^{\lfloor n\rho^i \rfloor + 2\lfloor \sqrt{2n\sigma^i} \rfloor + \lfloor (8n/9)^{1/4} \gamma^i \rfloor + p}} \rightarrow \left(\frac{4}{3} \right)^{c^i(k)+1}.$

— $\sqrt{n} \frac{2^{\lfloor \sqrt{2n\sigma^i} \rfloor + \lfloor (8n/9)^{1/4} \gamma^i \rfloor + c^i(k)+1}}{4^{\lfloor n\rho^i \rfloor + 2\lfloor \sqrt{2n\sigma^i} \rfloor + \lfloor (8n/9)^{1/4} \gamma^i \rfloor + c^i(k)+1}} \rightarrow \frac{\sigma^i}{\sqrt{2\rho^i}}.$

It remains to prove domination of the summand, which follow from the following bounds:

— $\left| \varphi \left(k, \frac{\lfloor n\rho \rfloor}{n}, \frac{\lfloor (8n/9)^{\frac{1}{4}} \gamma \rfloor}{(8n/9)^{\frac{1}{4}}}, \frac{\lfloor \sqrt{2n\sigma} \rfloor}{\sqrt{2n}} \right) \right| \leq \|\varphi\|_{\infty}.$

— If $\lfloor n\rho^i \rfloor = 0$, then $\sqrt{n\rho^i} < 1$. Hence,

$$\sqrt{n\rho^i} \left(\frac{27}{256} \right)^{\lfloor n\rho^i \rfloor} \binom{4 \lfloor n\rho^i \rfloor}{\lfloor n\rho^i \rfloor} \leq 1.$$

If on the other hand $\lfloor n\rho^i \rfloor > 0$, by using Stirling formula, there exists a constant c do not depend on n, ρ^i such that:

$$\sqrt{n} \left(\frac{27}{256} \right)^{\lfloor n\rho^i \rfloor} \binom{4 \lfloor n\rho^i \rfloor}{\lfloor n\rho^i \rfloor} \leq \frac{c}{\sqrt{\rho^i}}.$$

Let $C = \max\{1, c\}$. For all $n \geq 1$ and $0 < \rho^i < 1$, we obtain:

$$\sqrt{n} \left(\frac{27}{256} \right)^{\lfloor n\rho^i \rfloor} \binom{4 \lfloor n\rho^i \rfloor}{\lfloor n\rho^i \rfloor} \leq \frac{C}{\sqrt{\rho^i}}.$$

— Since $|\lfloor (8n/9)^{1/4}\gamma^i \rfloor| \leq \lfloor \sqrt{2n\sigma^i} \rfloor$, $c^i(k) \in \{0, 1\}$ and $\lfloor \sqrt{2n\sigma^i} \rfloor \geq 1$, we get $c^i + 1 \leq 2 \leq 2 \lfloor \sqrt{2n\sigma^i} \rfloor$. By using the inequality $\lfloor x \rfloor^{-1} \leq 2/x$ for all $x \geq 1$ and $|\lfloor x \rfloor| \leq |x| + 1$, then we obtain:

$$\left| \sqrt{n} \frac{2 \lfloor \sqrt{2n\sigma^i} \rfloor + \lfloor (8n/9)^{1/4}\gamma^i \rfloor + c^i(k) + 1}{4 \lfloor n\rho^i \rfloor + 2 \lfloor \sqrt{2n\sigma^i} \rfloor + \lfloor (8n/9)^{1/4}\gamma^i \rfloor + c^i(k) + 1} \right| \leq \frac{5\sqrt{2}\sigma^i}{2\rho^i}.$$

— $\prod_{p=1}^{c^i(k)+1} \frac{4 \lfloor n\rho^i \rfloor + 2 \lfloor \sqrt{2n\sigma^i} \rfloor + \lfloor (8n/9)^{1/4}\gamma^i \rfloor + p}{3 \lfloor n\rho^i \rfloor + 2 \lfloor \sqrt{2n\sigma^i} \rfloor + \lfloor (8n/9)^{1/4}\gamma^i \rfloor + p} \leq \left(\frac{4}{3}\right)^{c^i(k)+1}$.
 — By using Lemma 5.2 with $r = 2$, there exists $C_1 \mathbb{R}_+$, such that

$$(8n/9)^{1/4} \mathbb{P} \left(M_{\lfloor \sqrt{2n\sigma^i} \rfloor} = \lfloor (8n/9)^{1/4}\gamma^i \rfloor \right) \leq \frac{C_1}{\sqrt{\sigma^i}} \left(1 + \frac{(\gamma^i)^2}{\sigma^i} \right)^{-1}.$$

— For any $p \in \mathbb{N}$, we have $\frac{1 + \frac{p+1}{4 \lfloor n\rho^i \rfloor}}{1 + \frac{p+1}{3 \lfloor n\rho^i \rfloor}} \leq \frac{1 + \frac{p}{4 \lfloor n\rho^i \rfloor}}{1 + \frac{p}{3 \lfloor n\rho^i \rfloor}}$ and therefore, since $|\lfloor (8n/9)^{1/4}\gamma^i \rfloor| \leq \lfloor \sqrt{2n\sigma^i} \rfloor$

$$\begin{aligned} \frac{\prod_{p=1}^{2 \lfloor \sqrt{2n\sigma^i} \rfloor + \lfloor (8n/9)^{1/4}\gamma^i \rfloor} \left(1 + \frac{p}{4 \lfloor n\rho^i \rfloor} \right)}{\prod_{p=1}^{2 \lfloor \sqrt{2n\sigma^i} \rfloor + \lfloor (8n/9)^{1/4}\gamma^i \rfloor} \left(1 + \frac{p}{3 \lfloor n\rho^i \rfloor} \right)} &\leq \frac{\prod_{p=\lfloor \frac{\sqrt{2n\sigma^i}}{2} \rfloor}^{\lfloor \sqrt{2n\sigma^i} \rfloor} \left(1 + \frac{p}{4 \lfloor n\rho^i \rfloor} \right)}{\prod_{p=\lfloor \frac{\sqrt{2n\sigma^i}}{2} \rfloor}^{\lfloor \sqrt{2n\sigma^i} \rfloor} \left(1 + \frac{p}{3 \lfloor n\rho^i \rfloor} \right)} \\ &\leq \left(\frac{1 + \frac{\lfloor \frac{\sqrt{2n\sigma^i}}{2} \rfloor}{4 \lfloor n\rho^i \rfloor}}{1 + \frac{\lfloor \frac{\sqrt{2n\sigma^i}}{2} \rfloor}{3 \lfloor n\rho^i \rfloor}} \right)^{\lfloor \frac{\sqrt{2n\sigma^i}}{2} \rfloor} \leq e^{\frac{-(\sigma^i)^2}{24\rho^i}}. \end{aligned}$$

By the dominated convergence theorem, the integral in the term of index k in $\mathbb{E}_n(\varphi)$ converges to

$$\int_{\mathcal{X}^k} \left(\mathbb{1}_{\{\rho^{2t(k)} \geq 0\}} \varphi(k, \rho, \gamma, \sigma) \times \prod_{i=1}^{2t(k)} \left(\frac{\sigma^i}{\sqrt{2}\rho^i} \times \frac{2}{\sqrt{6\pi}\rho^i} \times e^{-\frac{(\sigma^i)^2}{3\rho^i}} \times \left(\frac{4}{3}\right)^{c^i(k)+1} \right) \times \prod_{i=1}^{t(k)} p_{\sigma^i}(\gamma^i) \right) dX^k.$$

The term $n^{\frac{t(k)-3}{2}}$ is equal to $n^{-1/2}$ if $k = 0$ and 1 if $k \in \llbracket 1, 9 \rrbracket$ (so in the end the case $k = 0$ will not contribute).

Choosing $\varphi = 1$ provides the estimate

$$|\mathcal{T}_{r,s,b}(n)| \sim 2 \Upsilon \left(\frac{256}{27} \right)^{n-2}.$$

Finally, we obtain the convergence of $\mathbb{E}_n(\varphi)$ to

$$\frac{1}{\Upsilon} \sum_{k=1}^9 \int_{\mathcal{X}^k} \left(\mathbb{1}_{\{\rho^6 \geq 0\}} \times \varphi(k, \rho, \gamma, \sigma) \times \prod_{i=1}^6 \frac{\sigma^i}{\sqrt{2} \rho^i} \times \frac{2}{\sqrt{6\pi} \rho^i} \times e^{\frac{-(\sigma^i)^2}{3\rho^i}} \times \left(\frac{4}{3}\right)^{c^i(k)+1} \times \prod_{i=1}^3 p_{\sigma^i}(\gamma^i) \right) dX^k,$$

For $k \in \llbracket 1, 9 \rrbracket$, we have $\mathcal{X}^k = \mathcal{X}$ which completes the proof of the lemma. □

An immediate consequence of Lemma 6.1 is the following:

Corollary 6.4. *There exists two constants $c, c' \in \mathbb{R}_+^*$ such that for all $n \geq 1$,*

$$c \leq n \times \mathbb{P} \left(\exists i, i' \in \llbracket 1, 2t_n \rrbracket : \rho_n^i = \rho_n^{i'} \right) \leq c',$$

$$c \leq \sqrt{n} \times \mathbb{P} \left(\exists i, i' \in \llbracket 1, t_n \rrbracket : \sigma_n^i = \sigma_n^{i'} \right) \leq c'.$$

In the proof of Lemma 6.1 we compute an asymptotic of $\mathcal{T}_{r,s,b}(n)$; by Theorem 2.1, we obtain a reformulation of the asymptotic of the number of rooted essentially simple triangulations:

Corollary 6.5. *For $n \geq 1$, the set $\mathcal{G}(n)$ of essentially simple toroidal triangulations on n vertices that are rooted at a corner of a maximal triangle satisfies:*

$$|\mathcal{G}(n)| \sim 2 \Upsilon \left(\frac{256}{27} \right)^{n-2},$$

where Υ is the constant defined earlier.

It is possible that the formula defining Υ could be amenable to an explicit computation, but we did not manage to find a simple way to do it.

7 Convergence of uniformly random Motzkin paths

Consider $(\sigma_n) \in (\mathbb{N}^*)^{\mathbb{N}}$, $(\gamma_n) \in \mathbb{Z}^{\mathbb{N}}$ such that, there exist $\sigma \in \mathbb{R}_+^*$ and $\gamma \in \mathbb{R}$ satisfying :

$$\frac{\sigma_n}{\sqrt{2n}} \longrightarrow \sigma \text{ and } \left(\frac{9}{8n} \right)^{1/4} \gamma_n \rightarrow \gamma.$$

Let M_n be a uniformly random element of $\mathcal{M}_{\sigma_n}^{\gamma_n}$ and let M_n also denote its piecewise linear interpolation which is therefore a random element of \mathcal{H} . Let $M_{(n)}$ denote the rescaled process defined as:

$$M_{(n)} = \left(\left(\frac{9}{8n} \right)^{1/4} M_n(\sqrt{2ns}) \right)_{0 \leq s \leq \frac{\sigma_n}{\sqrt{2n}}}$$

By Theorem 5.4 with $(\eta, h) = (\sqrt{\frac{2}{3}}, 1)$, we have the following:

Lemma 7.1. *The process $M_{(n)}$ converges in law toward the Brownian bridge $B_{[0,\sigma]}^{0 \rightarrow \gamma}$ in the space $(\mathcal{H}, d_{\mathcal{H}})$, when n goes to infinity.*

Recall from Section 4.3 that \widetilde{M}_n is the extension of M_n and let \widetilde{M}_n also denote its piecewise linear interpolation. When $2\sigma_n + \gamma_n < 2\sqrt{2n}\sigma$, we assume that \widetilde{M}_n is extended to take value γ_n on $[2\sigma_n + \gamma_n, 2\sqrt{2n}\sigma]$. Then we define the rescaled versions:

$$\widetilde{M}_{(n)} = \left(\left(\frac{9}{8n} \right)^{1/4} \widetilde{M}_n(\sqrt{2ns}) \right)_{0 \leq s \leq \max\left(\frac{2\sigma_n + \gamma_n}{\sqrt{2n}}, 2\sigma\right)}$$

Lemma 7.2. *The process $\widetilde{M}_{(n)}$ converges in law toward the Brownian bridge $B_{[0,2\sigma]}^{0 \rightarrow \gamma}$ in the space $(\mathcal{H}, d_{\mathcal{H}})$, when n goes to infinity.*

Proof. Let $t \in \llbracket 0, \sigma_n \rrbracket$. By the construction of \widetilde{M}_n , we have

$$M_n(t) = \widetilde{M}_n(2t + M_n(t))$$

Let t, s be distinct element of $\llbracket 0, 2\sigma_n + \gamma_n \rrbracket$. Note that there exist t_1, s_1 distinct element of $\llbracket 0, \sigma_n \rrbracket$ such that

$$|t - (2t_1 + M_n(t_1))| \leq 2 \quad \text{and} \quad |s - (2s_1 + M_n(s_1))| \leq 2$$

Therefore, we obtain

$$\begin{aligned} & \left| \widetilde{M}_n(t) - \widetilde{M}_n(s) \right| \\ &= \left| \widetilde{M}_n(t) - \widetilde{M}_n(2t_1 + M_n(t_1)) + \widetilde{M}_n(2t_1 + M_n(t_1)) - \widetilde{M}_n(2s_1 + M_n(s_1)) \right. \\ & \quad \left. + \widetilde{M}_n(2s_1 + M_n(s_1)) - \widetilde{M}_n(s) \right| \\ &\leq \left| \widetilde{M}_n(t) - \widetilde{M}_n(2t_1 + M_n(t_1)) \right| + \left| \widetilde{M}_n(2t_1 + M_n(t_1)) - \widetilde{M}_n(2s_1 + M_n(s_1)) \right| \\ & \quad + \left| \widetilde{M}_n(2s_1 + M_n(s_1)) - \widetilde{M}_n(s) \right| \\ &\leq 4 + \left| \widetilde{M}_n(2t_1 + M_n(t_1)) - \widetilde{M}_n(2s_1 + M_n(s_1)) \right| \\ &\leq 4 + |M_n(t_1) - M_n(s_1)| \end{aligned}$$

The convergence of $M_{(n)}$ by Lemma 7.1 implies that there exists $\alpha < 1/2$ such that

$$\forall \varepsilon > 0 \quad \exists C \quad \forall n \quad \mathbb{P}(\|M_{(n)}\|_{\alpha} \leq C) > 1 - \varepsilon. \quad (7.1)$$

Consider $\varepsilon > 0$. Let C be such that (7.1) is satisfied.

Conditioned on $\|M_{(n)}\|_\alpha \leq C$, we have

$$\left| \widetilde{M}_n(t) - \widetilde{M}_n(s) \right| \leq 4 + C \left(\frac{8n}{9} \right)^{1/4} \left| \frac{t_1}{\sqrt{2n}} - \frac{s_1}{\sqrt{2n}} \right|^\alpha \tag{7.2}$$

Since $\alpha < 1/2$, there exists a constant C_1 which do not depend on t_1 and s_1 such that:

$$4 \leq C_1 \left(\frac{8n}{9} \right)^{1/4} \left| \frac{t_1}{\sqrt{2n}} - \frac{s_1}{\sqrt{2n}} \right|^\alpha \tag{7.3}$$

By using (7.2) and (7.3), there exists a constant C_2 such that:

$$\left| \widetilde{M}_n(t) - \widetilde{M}_n(s) \right| \leq C_2 \left(\frac{8n}{9} \right)^{1/4} \left| \frac{t_1}{\sqrt{2n}} - \frac{s_1}{\sqrt{2n}} \right|^\alpha$$

Note that $|t_1 - s_1| \leq |t - s| + 4 \leq 5|t - s|$. So there exist a constant C_3 , such that:

$$\left| \widetilde{M}_{(n)} \left(\frac{t}{\sqrt{2n}} \right) - \widetilde{M}_{(n)} \left(\frac{s}{\sqrt{2n}} \right) \right| \leq C_3 \left| \frac{t}{\sqrt{2n}} - \frac{s}{\sqrt{2n}} \right|^\alpha.$$

This inequality is satisfied for $0 \leq x < y \leq \frac{2\sigma_n + \tau_n}{\sqrt{2n}}$ such that $2nx, 2ny \in \mathbb{N}$. It is also satisfied for all $0 \leq x < y \leq \frac{2\sigma_n + \tau_n}{\sqrt{2n}}$ by linear interpolation. So we have:

$$\forall n \quad \mathbb{P}(\|\widetilde{M}_{(n)}\|_\alpha \leq C_3) > 1 - \varepsilon.$$

Therefore the family of laws of $\left(\widetilde{M}_{(n)} \right)_{n \geq 1}$ is tight in the space of probability measures on \mathcal{H} .

Let $0 \leq t < 2\sigma$ and $\varepsilon > 0$. Since $\frac{2\sigma_n + \tau_n}{\sqrt{2n}}$ converge toward 2σ , there exists N such that $t \leq \min_{n \geq N} \frac{2\sigma_n + \tau_n}{\sqrt{2n}}$. Note that there exists $0 \leq s < \sigma$ such that

$$\left| \lfloor \sqrt{2nt} \rfloor - \left(2\lfloor \sqrt{2ns} \rfloor + M_n \left(\lfloor \sqrt{2ns} \rfloor \right) \right) \right| \leq 2.$$

Therefore we obtain:

$$\left| \widetilde{M}_n \left(\lfloor \sqrt{2nt} \rfloor \right) - \widetilde{M}_n \left(2\lfloor \sqrt{2ns} \rfloor + M_n \left(\lfloor \sqrt{2ns} \rfloor \right) \right) \right| \leq 2.$$

Since $\widetilde{M}_n \left(2\lfloor \sqrt{2ns} \rfloor + M_n \left(\lfloor \sqrt{2ns} \rfloor \right) \right) = M_n \left(\lfloor \sqrt{2ns} \rfloor \right)$ and $\lfloor \sqrt{2ns} \rfloor = \frac{1}{2} \left(\lfloor \sqrt{2nt} \rfloor - M_n \left(\lfloor \sqrt{2ns} \rfloor \right) \right) + e$, with $e = O(1)$. We then obtain:

$$\widetilde{M}_n \left(\lfloor \sqrt{2nt} \rfloor \right) = M_n \left[\frac{1}{2} \left(\lfloor \sqrt{2nt} \rfloor - M_n \left(\lfloor \sqrt{2ns} \rfloor \right) \right) + e \right].$$

Since the family of laws of $(M_n)_{n \geq 1}$ is tight, there exists a constant c_1 such that

$$\inf_{n \geq N} \mathbb{P} \left(\sup_{k \in [0, \sigma_n]} |M_n(k)| < c_1 n^{1/4} \right) \geq 1 - \varepsilon. \quad (7.4)$$

Let \mathcal{E}_n the event:

$$\left\{ \sup_{k \in [0, \sigma_n]} |M_n(k)| < c_1 n^{1/4} \right\}.$$

Now we define a random variable Y_n as follows:

$$Y_n = M_n \left[\frac{1}{2} \left(\lfloor \sqrt{2nt} \rfloor - M_n \left(\lfloor \sqrt{2ns} \rfloor \right) \mathbb{1}_{\mathcal{E}_n} \right) + e \right]$$

By Lemma 7.1, we have $\left(\left(\frac{9}{8n} \right)^{1/4} Y_n \right)_{n \geq N}$ converge toward $B_{[0, \sigma]}^{0 \rightarrow \gamma}(t/2)$ when n goes to infinity. Let f be a bounded continuous function from \mathbb{R} to \mathbb{R} . Thus by (7.4), there exists $n_0 \geq N$ such that for all $n \geq n_0$:

$$\begin{aligned} & \left| \mathbb{E}[f(\widetilde{M}_{(n)}(t))] - \mathbb{E} \left[f \left(B_{[0, \sigma]}^{0 \rightarrow \gamma}(t/2) \right) \right] \right| \\ & \leq \left| \mathbb{E}[f(\widetilde{M}_{(n)}(t))] - \mathbb{E} \left[f \left(\left(\frac{9}{8n} \right)^{1/4} Y_n \right) \right] \right| + \left| \mathbb{E} \left[f \left(\left(\frac{9}{8n} \right)^{1/4} Y_n \right) \right] - \mathbb{E} \left[f \left(B_{[0, \sigma]}^{0 \rightarrow \gamma}(t/2) \right) \right] \right| \\ & \leq 2 \mathbb{E}[1 - \mathbb{1}_{\mathcal{E}_n}] \|f\|_{\infty} + \varepsilon. \\ & \leq (2 \|f\|_{\infty} + 1) \varepsilon. \end{aligned}$$

This implies that $\left(\mathbb{E}[f(\widetilde{M}_{(n)}(t))] \right)_{n \geq N}$ converge toward $\mathbb{E} \left[f \left(B_{[0, \sigma]}^{0 \rightarrow \gamma}(t/2) \right) \right]$.

We now prove the finite dimensional convergence of $\widetilde{M}_{(n)}$. Let $k \geq 1$ and consider $0 \leq t_1 < t_2 < \dots < t_k < 2\sigma$. Let N such that $t_k \leq \min_{n \geq N} \frac{2\sigma_n + \gamma_n}{\sqrt{2n}}$. By above arguments, for $1 \leq i \leq k$, we have $(\widetilde{M}_{(n)}(t_i))_{n \geq N}$ converge in law toward $B_{[0, \sigma]}^{0 \rightarrow \gamma}(t_i/2)$. It remains to deal with the point 2σ .

$$\begin{aligned} \left| \widetilde{M}_{(n)}(2\sigma) - \gamma \right| &= \left| \widetilde{M}_{(n)} \left(2\sigma \wedge \frac{2\sigma_n + \gamma_n}{\sqrt{2n}} \right) - \gamma \right| \\ &= \left| \widetilde{M}_{(n)} \left(2\sigma \wedge \frac{2\sigma_n + \gamma_n}{\sqrt{2n}} \right) - \widetilde{M}_{(n)} \left(\frac{2\sigma_n + \gamma_n}{\sqrt{2n}} \right) + \widetilde{M}_{(n)} \left(\frac{2\sigma_n + \gamma_n}{\sqrt{2n}} \right) - \gamma \right| \\ &\leq \left| \widetilde{M}_{(n)} \left(2\sigma \wedge \frac{2\sigma_n + \gamma_n}{\sqrt{2n}} \right) - \widetilde{M}_{(n)} \left(\frac{2\sigma_n + \gamma_n}{\sqrt{2n}} \right) \right| + |\gamma_n - \gamma| \end{aligned}$$

Consider $\varepsilon > 0$. Since the family of laws of $\widetilde{M}_{(n)}$ is tight, there exists α and C such that for all n : $\mathbb{P}\left(\|\widetilde{M}_{(n)}\|_\alpha \leq C\right) > 1 - \varepsilon$. Condition on the event $\{\|\widetilde{M}_{(n)}\|_\alpha \leq C\}$, we have

$$\begin{aligned} \left| \widetilde{M}_{(n)}\left(2\sigma \wedge \frac{2\sigma_n + \gamma_n}{2n}\right) - \widetilde{M}_{(n)}\left(\frac{2\sigma_n + \gamma_n}{2n}\right) \right| &\leq C \left| 2\sigma \wedge \frac{2\sigma_n + \gamma_n}{\sqrt{2n}} - \frac{2\sigma_n + \gamma_n}{\sqrt{2n}} \right|^\alpha \\ &\leq C \left| 2\sigma - \frac{2\sigma_n + \gamma_n}{\sqrt{2n}} \right|^\alpha \end{aligned}$$

Since $\frac{2\sigma_n + \gamma_n}{\sqrt{2n}} \rightarrow 2\sigma$ and $\gamma_n \rightarrow \gamma$, for n large enough, we have:

$$\left| \widetilde{M}_{(n)}(2\sigma) - \gamma \right| \leq \varepsilon$$

Therefore we obtain for n large enough:

$$\mathbb{P}\left(\left| \widetilde{M}_{(n)}(2\sigma) - \gamma \right| > \varepsilon\right) \leq \mathbb{P}\left(\|\widetilde{M}_{(n)}\|_\alpha > C\right) \leq \varepsilon.$$

This implies that $\widetilde{M}_{(n)}(2\sigma)$ converges in probability toward the deterministic value γ . So Slutsky's lemma shows that $\widetilde{M}_{(n)}(2\sigma)$ converges in law toward γ . Note that $\left(B_{[0,2\sigma]}^{0 \rightarrow \gamma}(t)\right)_{0 \leq t \leq 2\sigma}$ and $\left(B_{[0,\sigma]}^{0 \rightarrow \gamma}(t/2)\right)_{0 \leq t \leq 2\sigma}$ have the same law. Thus we have proved the convergence of the finite-dimensional marginals of $\widetilde{M}_{(n)}$ toward $B_{[0,2\sigma]}^{0 \rightarrow \gamma}$. Moreover, $\widetilde{M}_{(n)}$ is tight so Prokhorov's lemma give the result. \square

8 Convergence of uniformly random 3-dominating binary words

Consider $(\rho_n) \in \mathbb{N}^{\mathbb{N}}$, $(\tau_n) \in \mathbb{N}^{\mathbb{N}}$ and recall that $\mathcal{D}_{3,3\rho_n+\tau_n,\rho_n}^{-1}$ is the set of elements $b \in \{0,1\}^{p+q}$ with $|b|_0 = 3\rho_n + \tau_n$ and $|b|_1 = \rho_n$ that are inverse of 3-dominating binary words (see Section 4.2). The goal of this section is to prove the convergence of uniform random elements of the set $\mathcal{D}_{3,3\rho_n+\tau_n,\rho_n}^{-1}$, in which we assume that, there exists $\rho, \tau \in \mathbb{R}_+$, such that:

$$\rho_n = \frac{\rho_n}{n} \rightarrow \rho \text{ and } \tau_n = \frac{\tau_n}{\sqrt{n}} \rightarrow \tau.$$

Given a element b of $\mathcal{D}_{3,3\rho_n+\tau_n,\rho_n}^{-1}$, we can replace the bits "1" by -3 and the bits "0" by 1, getting an encoding of a (random) inverse 3-dominating binary word of length $4\rho_n + \tau_n$ by a (random) path of the same length $w = (w(0), w(1), \dots, w(4\rho_n + \tau_n))$ in \mathbb{Z} such that

$$w(0) = 0, w(4\rho_n + \tau_n) = \tau_n, \bar{w}(4\rho_n + \tau_n) < \tau_n \text{ and } w(i+1) - w(i) \in \{-3, 1\} (\forall i),$$

where $\bar{w}(t) = \sup_{s < t} w(s)$. If b is uniformly distributed in $\mathcal{D}_{3,3\rho_n+\tau_n,\rho_n}^{-1}$, then w is uniformly distributed in the set $\mathcal{P}_{3,3\rho_n+\tau_n,\rho_n}$ of all paths of length $4\rho_n + \tau_n$ starting at 0, with increments in $\{-3, 1\}$ and taking value τ_n at their last step for the first time.

Let W_n be a uniformly random element of $\mathcal{P}_{3,3\rho_n+\tau_n,\rho_n}$ and let W_n also denote its piecewise linear interpolation which is therefore a random element of \mathcal{H} . Let $W_{(n)}$ denote the rescaled process defined as:

$$W_{(n)} = \left(\frac{W_n(2ns)}{\sqrt{3n}} \right)_{0 \leq s \leq \frac{4\rho_n+\tau_n}{2n}} \quad (8.1)$$

The goal of this section is to prove the following convergence result:

Lemma 8.1. *The process $W_{(n)}$ converges in law toward the first-passage Brownian bridge $F_{[0,2\rho]}^{0 \rightarrow \tau}$ in the space $(\mathcal{H}, d_{\mathcal{H}})$, when n goes to infinity.*

8.1 Review and generalization of a result of Bertoin, Chaumont and Pitman

We are going to extend a result in [21], showing that its proof is still valid for the case of a random path with increments in $\{-3, 1\}$ as above. Fix two integers β and n such that $1 \leq \beta \leq n$, and let $(X_i)_{1 \leq i \leq n}$ be a sequence of *i.i.d.* random variables of law:

$$\mathbb{P}(X_i = -3) = \frac{1}{4} \text{ and } \mathbb{P}(X_i = 1) = \frac{3}{4}.$$

Let $S = (S_i)_{0 \leq i \leq n}$ be the random path started at 0 and with increments given by the X_i , conditioned on the event $\{S_n = \beta\}$. For any $k = 0, 1, \dots, n-1$, define the shifted chain:

$$\theta_k(S)_i = \begin{cases} S_{i+k} - S_k & \text{if } 0 \leq i \leq n-k, \\ S_{k+i-n} + S_n - S_k & \text{if } n-k \leq i \leq n. \end{cases}$$

For $k = 0, 1, \dots, \beta-1$, define the first time at which S reaches its maximum minus k as follows:

$$m_k(S) = \inf \left\{ i : S_i = \max_{0 \leq j \leq n} S_j - k \right\}.$$

For convenience, we write $\theta_{m_k}(S)$ for $\theta_{m_k(S)}(S)$ in what follows.

Denote by Γ the support of the law of S . For every $\gamma \in \Gamma$, define the sequence $\Lambda(s) = (s, \theta_1(s), \dots, \theta_{n-1}(s))$. Let $\bar{\Lambda}(s)$ be the subsequence of the paths in $\Lambda(s)$ which first hit their maximum at time n . We need the following lemma.

Lemma 8.2. *For every $s \in \Gamma$, $\bar{\Lambda}(s)$ contains exactly β elements and more precisely:*

$$\bar{\Lambda}(s) = (\theta_{m_{\beta-1}}(s), \dots, \theta_{m_0}(s)).$$

Proof. One can see that the path $\theta_{m_k}(s)$ is contained in $\bar{\Lambda}(s)$ and the cycle lemma gives us that the cardinality of $\bar{\Lambda}(s)$ is exactly β . \square

The following is an extension of a result of Bertoin, Chaumont, Pitman [21]:

Lemma 8.3. *Let ν be a random variable which is independent of S and uniformly distributed on $\{0, 1, \dots, \beta - 1\}$. The chain $\theta_{m_\nu}(S)$ has the same law as that of S conditioned on the event $\{m_0 = n\}$ and independent from m_ν .*

Proof. For every bounded function f defined on $\{0, 1, \dots, n\}$ and every bounded function F defined on \mathbb{Z}^{n+1} , we have

$$\mathbb{E}[F(\theta_{m_\nu}(S))f(m_\nu)] = \sum_{s \in \Gamma} \mathbb{P}(S = s) \frac{1}{\beta} \sum_{j=0}^{\beta-1} F(\theta_{m_j}(s))f(m_j). \quad (8.2)$$

By Lemma 8.2, we obtain

$$\sum_{j=0}^{\beta-1} F(\theta_{m_j}(s))f(m_j) = \sum_{k=0}^{n-1} F(\theta_k(s))f(k) \mathbb{1}_{\{m_0(\theta_k(s))=n\}}.$$

Replacing in (8.2), we get

$$\mathbb{E}[F(\theta_{m_\nu}(S))f(m_\nu)] = \frac{n}{\beta} \mathbb{E}[F(\theta_U(S))f(U) \mathbb{1}_{\{m_0(\theta_U(S))=n\}}]$$

where U is uniform on $\{0, 1, \dots, n - 1\}$ and independent of S . This can be rewritten as

$$\mathbb{E}[F(\theta_{m_\nu}(S))f(m_\nu)] = \mathbb{E}[F(S)|m_0(S) = n] \mathbb{E}[f(U)],$$

which concludes the proof of the lemma. \square

8.2 Convergence to the first-passage Brownian bridge

In this section, we prove Lemma 8.1. Let $a \in (0, 1)$ and let $(X_n^a)_{n \geq 1}$ be a sequence of *i.i.d.* random variables with distribution $a\delta_{-3} + (1 - a)\delta_1$ (i.e. whose steps are in $\{-3, 1\}$ with probability a for “-3” and $(1 - a)$ for “1”). We define $S_0^a = 0$ and $S_n^a = \sum_{i=1}^n X_i^a$. We begin with the following basic lemma.

Lemma 8.4. *For all $a \in (0, 1)$ and $\rho, \tau \in \mathbb{N}$, we have:*

$$\mathcal{L}((S^a)_{0 \leq i \leq 4\rho + \tau} | S_{4\rho + \tau}^a = \tau, \bar{S}_{4\rho + \tau - 1}^a < \tau) = \mathcal{U}(\mathcal{P}_{3, 3\rho + \tau, \rho}),$$

where $\bar{S}_k^a = \max_{0 \leq i \leq k} S_i^a$ and $\mathcal{U}(\mathcal{P}_{3, 3\rho + \tau, \rho})$ is the uniform law on $\mathcal{P}_{3, 3\rho + \tau, \rho}$.

Proof. Let $w = (w_0 = 0, w_1, \dots, w_{4\rho+\tau} = \tau) \in \mathcal{P}_{3,3\rho+\tau,\rho}$.

$$\mathbb{P}((S^a)_{0 \leq i \leq 4\rho+\tau} = \omega | S_{4\rho+\tau}^a = \tau, \overline{S}_{4\rho+\tau-1}^a < \tau) = \frac{(1-a)^{3\rho+\tau} a^\rho}{\mathbb{P}(S_{4\rho+\tau}^a = \tau, \overline{S}_{4\rho+\tau-1}^a < \tau)},$$

which does not depend on ω . This concludes the proof of lemma. \square

We are now ready to prove Lemma 8.1:

Proof of Lemma 8.1. Let $S_n = (S_n(i))_{0 \leq i \leq 4\rho_n + \tau_n}$ be the random path started at 0 and with increments given by the X_i (defined in section 8.1). Let F_n be the random path S_n conditioned to take value τ_n at time $4\rho_n + \tau_n$ for the first time. Let the same notations S_n and F_n denote their piecewise linear interpolation which is therefore a random element of \mathcal{H} . When $4\rho_n + \tau_n < 4n\rho$, we assume that F_n is extended to take value τ_n on $[4\rho_n + \tau_n, 4n\rho]$. Let $S_{(n)}$ and $F_{(n)}$ denote the rescaled processes:

$$S_{(n)} = \left(\frac{S_n(2ns)}{\sqrt{3n}} \right)_{0 \leq s \leq \frac{4\rho_n + \tau_n}{2n}}$$

$$F_{(n)} = \left(\frac{F_n(2ns)}{\sqrt{3n}} \right)_{0 \leq s \leq \max(\frac{4\rho_n + \tau_n}{2n}, 2\rho)}$$

Let $\mathcal{F}_i = \sigma \{S_n(k), 0 \leq k \leq i\}$ be the natural filtration associated with S .

By Lemma 8.4, the law of W_n is the same of F_n . By Donsker's theorem and Skorokhod's theorem, we may assume that as $n \rightarrow \infty$, $S_{(n)}$ converges almost surely toward a standard Brownian motion $(\beta_s)_{0 \leq s \leq 2\rho}$ for the uniform topology.

Claim 8.5. *Suppose $\rho > 0$ and consider $0 \leq \rho' < 2\rho$. For n large enough $2n\rho' < 4\rho_n + \tau_n$ and $(F_{(n)}(s))_{0 \leq s \leq \rho'}$ converge in law toward $(F_{[0,2\rho]}^{0 \rightarrow \tau})_{0 \leq s \leq \rho'}$.*

Proof. It is clear that for n large enough we have $2n\rho' < 4\rho_n + \tau_n$. Let f be a continuous bounded function from \mathcal{H} to \mathbb{R} . We have

$$\mathbb{E}[f((F_{(n)}(s))_{0 \leq s \leq \rho'})] =$$

$$\mathbb{E}[f((S_{(n)}(s))_{0 \leq s \leq \rho'}) | S_n(4\rho_n + \tau_n) = \tau_n, \overline{S}_n(4\rho_n + \tau_n - 1) < \tau_n].$$

By the definition of conditional probability and the fact that $(S_{(n)}(s))_{0 \leq s \leq \rho'}$ is measurable with respect to $\mathcal{F}_{2n\rho'}$, we have:

$$\mathbb{E}[f((F_{(n)}(s))_{0 \leq s \leq \rho'})] =$$

$$\mathbb{E} \left[f((S_{(n)}(s))_{0 \leq s \leq \rho'}) \frac{\mathbb{P}(S_n(4\rho_n + \tau_n) = \tau_n, \overline{S}_n(4\rho_n + \tau_n - 1) < \tau_n | \mathcal{F}_{2n\rho'})}{\mathbb{P}(S_n(4\rho_n + \tau_n) = \tau_n, \overline{S}_n(4\rho_n + \tau_n - 1) < \tau_n)} \right].$$

Recall the notation $Q_k^S(i) = \mathbb{P}(S_k = i)$; by Lemmas 8.2, we have:

$$\mathbb{P}(S_n(4\rho_n + \tau_n) = \tau_n, \overline{S}_n(4\rho_n + \tau_n - 1) < \tau_n) = \frac{\tau_n}{4\rho_n + \tau_n} \mathbb{P}(S_n(4\rho_n + \tau_n) = \tau_n).$$

Using the Markov property, we obtain, denoting by T_n an independent copy of S_n :

$$\begin{aligned} & \mathbb{P}(S_n(4\rho_n + \tau_n) = \tau_n, \overline{S}_n(4\rho_n + \tau_n - 1) < \tau_n | \mathcal{F}_{2n\rho'}) \\ &= \mathbb{P}(T_n(4\rho_n + \tau_n - 2n\rho') = \tau_n - S_n(2n\rho'), \overline{T}_n(4\rho_n + \tau_n - 2n\rho' - 1) < \tau_n - S_n(2n\rho')) \\ & \quad \mathbb{1}_{\overline{S}_n(2n\rho') < \tau_n} \\ &= \frac{\tau_n - S_n(2n\rho')}{4\rho_n + \tau_n - 2n\rho'} \mathbb{P}(T_n(4\rho_n + \tau_n - 2n\rho') = \tau_n - S_n(2n\rho')) \mathbb{1}_{\overline{S}_n(2n\rho') < \tau_n}. \end{aligned}$$

We now verify that the ratio

$$\frac{\mathbb{P}(S_n(4\rho_n + \tau_n) = \tau_n, \overline{S}_n(4\rho_n + \tau_n - 1) < \tau_n | \mathcal{F}_{2n\rho'})}{\mathbb{P}(S_n(4\rho_n + \tau_n) = \tau_n, \overline{S}_n(4\rho_n + \tau_n - 1) < \tau_n)}$$

converges almost surely to $\frac{p'_{2\rho-\rho'}(\tau-\beta_{\rho'})}{p'_{2\rho}(\tau)} \mathbb{1}_{\overline{\beta}(\rho') < \tau}$. Indeed, by using the Lemma 5.2 for the random walk S with $(\eta, h) = (\sqrt{3}, 4)$, we obtain:

$$\begin{aligned} & \frac{\sqrt{3}}{4} \sqrt{4\rho_n + \tau_n} \times \mathbb{P}(S_n(4\rho_n + \tau_n) = \tau_n) \rightarrow p\left(\frac{\tau}{2}\right) \text{ and} \\ & \frac{\sqrt{3}}{4} \sqrt{4\rho_n + \tau_n - n\rho'} \times \mathbb{P}(T_n(4\rho_n + \tau_n - n\rho') = \tau_n - S_n(n\rho')) \rightarrow p\left(\frac{\tau - \beta_{\rho'}}{\sqrt{2\rho - \rho'}}\right). \end{aligned}$$

We can see also that:

$$\begin{aligned} & \frac{\tau_n - S_n(n\rho')}{4\rho_n + \tau_n - n\rho'} \frac{4\rho_n + \tau_n}{\tau_n} \frac{\sqrt{4\rho_n + \tau_n}}{\sqrt{4\rho_n + \tau_n - n\rho'}} \\ &= \frac{4\rho_n + \tau_n}{4\rho_n + \tau_n - n\rho'} \frac{\sqrt{4\rho_n + \tau_n}}{\tau_n} \frac{\tau_n - S_n(n\rho')}{\sqrt{4\rho_n + \tau_n - n\rho'}} \end{aligned}$$

converges toward $\frac{8(\tau-\beta_{\rho'})}{\tau(2\rho-\rho')^{\frac{3}{2}}}$. This implies that

$$\frac{\mathbb{P}(S_n(4\rho_n + \tau_n) = \tau_n, \overline{S}_n(4\rho_n + \tau_n - 1) < \tau_n | \mathcal{F}_{n\rho'})}{\mathbb{P}(S_n(4\rho_n + \tau_n) = \tau_n, \overline{S}_n(4\rho_n + \tau_n - 1) < \tau_n)}$$

converges toward $\frac{p'_{2\rho-\rho'}(\tau-\beta_{\rho'})}{p'_{\rho'}(\tau)} \mathbb{1}_{\overline{\beta}(\rho') < \tau}$, and the Lemma 5.2 ensures that this convergence is dominated. So,

$$\mathbb{E}[f((F_n(s))_{0 \leq s \leq \rho'})] \rightarrow \mathbb{E}\left[f((\beta_s)_{0 \leq s \leq \rho'}) \frac{p'_{2\rho-\rho'}(\tau - \beta_{\rho'})}{p'_{2\rho}(\tau)} \mathbb{1}_{\overline{\beta}(\rho') < \tau}\right]$$

$$= \mathbb{E} \left[f \left(\left(F_{[0,2\rho]}^{0 \rightarrow \tau}(s) \right)_{0 \leq s \leq \rho'} \right) \right].$$

◇

Claim 8.6. *There exists a constant $\alpha > 0$ such that*

$$\forall \varepsilon > 0 \quad \exists C \quad \forall n \quad \mathbb{P}(\|F_{(n)}\|_\alpha \leq C) > 1 - \varepsilon.$$

In particular, the family of laws of $(F_{(n)})_{n \geq 1}$ is tight for the space of probability measure on \mathcal{H} .

Proof. For any $\alpha \in (0, 1/2)$ and $X = (X(s))_{0 \leq s \leq x} \in \mathcal{H}$, we write

$$\|X\|_\alpha = \sup_{0 \leq s < t \leq x} \frac{|X(t) - X(s)|}{|t - s|^\alpha}$$

its α -Holder norm. We prove a stochastic domination of the α -Holder norm of $F_{(n)}$ by that of $B_{(n)}$, where B_n denotes the random walk S_n conditioned to have the appropriate final value τ_n at time $4\rho_n + \tau_n$ and $B_{(n)}$ is the rescaled version of B_n . By Lemma 8.3, we can assume that F_n is realized as $\theta_{m_{\nu_n}}(B_n)$. We consider the following two cases, noticing that

$$|F_{(n)}(t) - F_{(n)}(s)| = \frac{1}{\sqrt{3n}} |\theta_{m_{\nu_n}}(B_n)(2nt) - \theta_{m_{\nu_n}}(B_n)(2ns)|.$$

— If $0 \leq s \leq t \leq \frac{4\rho_n + \tau_n}{2n} - \frac{m_{\nu_n}(B_n)}{2n}$, then by the definition of θ , we have:

$$\theta_{m_{\nu_n}}(B_n)(2nt) = B_n(m_{\nu_n}(B_n) + 2nt) - B_n(m_{\nu_n}(B_n)),$$

$$\theta_{m_{\nu_n}}(B_n)(2ns) = B_n(m_{\nu_n}(B_n) + 2ns) - B_n(m_{\nu_n}(B_n))$$

and we get:

$$|F_{(n)}(t) - F_{(n)}(s)| = \frac{1}{\sqrt{3n}} |B_n(m_{\nu_n}(B_n) + 2nt) - B_n(m_{\nu_n}(B_n) + 2ns)|$$

$$= \left| B_{(n)} \left(\frac{m_{\nu_n}(B_n)}{2n} + t \right) - B_{(n)} \left(\frac{m_{\nu_n}(B_n)}{2n} + s \right) \right| \leq \|B_{(n)}\|_\alpha |t - s|^\alpha$$

— If $\frac{4\rho_n + \tau_n}{2n} - \frac{m_{\nu_n}(B_n)}{2n} \leq s \leq t \leq \frac{4\rho_n + \tau_n}{2n}$, then by the definition of θ , we have:

$$\theta_{m_{\nu_n}(B_n)}(B_n)(2nt) =$$

$$B_n(m_{\nu_n}(B_n) + 2nt - (4\rho_n + \tau_n)) - B_n(m_{\nu_n}(B_n)) + B_n(4\rho_n + \tau_n),$$

$$\theta_{m_{\nu_n}(B_n)}(B_n)(2ns) =$$

$$B_n(m_{\nu_n}(B_n) + 2ns - (4\rho_n + \tau_n)) - B_n(m_{\nu_n}(B_n) + B_n(4\rho_n + \tau_n)),$$

and we get:

$$\begin{aligned} & |F_{(n)}(t) - F_{(n)}(s)| \\ &= \frac{1}{\sqrt{3n}} |B_n(m_{\nu_n}(B_n) + 2nt - (4\rho_n + \tau_n)) - B_n(m_{\nu_n}(B_n) + 2ns - (4\rho_n + \tau_n))| \\ &= \left| B_{(n)} \left(\frac{m_{\nu_n}(B_n)}{2n} + t - \frac{(4\rho_n + \tau_n)}{2n} \right) - B_{(n)} \left(\frac{m_{\nu_n}(B_n)}{2n} + s - \frac{(4\rho_n + \tau_n)}{2n} \right) \right| \\ &\leq \|B_{(n)}\|_\alpha |t - s|^\alpha. \end{aligned}$$

Using the triangular inequality to deal with the third case, i.e. $0 \leq s \leq \frac{4\rho_n + \tau_n}{2n} - \frac{m_{\nu_n}(B_n)}{2n} \leq t \leq \frac{4\rho_n + \tau_n}{2n}$, we obtain $\|F_{(n)}\|_\alpha \leq 2 \|B_{(n)}\|_\alpha$.

Let $\varepsilon > 0$, thanks to Lemma 5.3 and Kolmogorov's criterion, we can find some constant C such that

$$\sup_n \mathbb{P}(\|F_{(n)}\|_\alpha > C) < \varepsilon.$$

By Ascoli's theorem, this implies that the laws of $F_{(n)}$'s are tight. \diamond

Claim 8.5 shows that for any $p \geq 1$ and $0 \leq s_1 < s_2 \cdots < s_p < 2\rho$,

$$(F_{(n)}(s_1), F_{(n)}(s_2), \dots, F_{(n)}(s_p)) \rightarrow (F_{[0,2\rho]}^{0 \rightarrow \tau}(s_1), F_{[0,2\rho]}^{0 \rightarrow \tau}(s_2), \dots, F_{[0,2\rho]}^{0 \rightarrow \tau}(s_p)).$$

It only remain to deal with the point 2ρ . Consider $\varepsilon > 0$. By Claim 8.6, there exists α and C such that for all n , we have $\mathbb{P}(\{\|F_{(n)}\|_\alpha \leq C\}) > 1 - \varepsilon$.

Condition on the event $\{\|F_{(n)}\|_\alpha \leq C\}$, we have

$$\begin{aligned} \left| F_{(n)} \left(2\rho \wedge \frac{4\rho_n + \tau_n}{2n} \right) - F_{(n)} \left(\frac{4\rho_n + \tau_n}{2n} \right) \right| &\leq C \left| 2\rho \wedge \frac{4\rho_n + \tau_n}{2n} - \frac{4\rho_n + \tau_n}{2n} \right|^\alpha \\ &\leq C \left| 2\rho - \frac{4\rho_n + \tau_n}{2n} \right|^\alpha \end{aligned}$$

Since $\frac{4\rho_n + \tau_n}{2n} \rightarrow 2\rho$ and $\tau_n \rightarrow \tau$, for n large enough, we have:

$$|F_{(n)}(2\rho) - \tau| \leq \varepsilon$$

Therefore we obtain for n large enough:

$$\mathbb{P}(|F_{(n)}(2\rho) - \tau| > \varepsilon) \leq \mathbb{P}(\|F_{(n)}\|_\alpha > C) \leq \varepsilon.$$

This implies that $F_{(n)}(2\rho)$ converges in probability toward the deterministic value τ . So Slutsky's lemma shows that $F_{(n)}(2\rho)$ converges in law toward τ . Thus we have proved the convergence of the finite-dimensional marginals of $F_{(n)}$ toward $\tilde{F}_{[0,2\rho]}^{0 \rightarrow \tau}$. By Lemma 9.2, $F_{(n)}$ is tight so Prokhorov's lemma give the result. \square

9 Convergence of the contour pair of well-labeled forests

Consider $(\rho_n) \in \mathbb{N}^{\mathbb{N}}, (\tau_n) \in \mathbb{N}^{\mathbb{N}}$ such that, there exists $\rho, \tau \in \mathbb{R}_+^*$ satisfying:

$$\frac{\rho_n}{n} \longrightarrow \rho \text{ and } \frac{\tau_n}{\sqrt{n}} \rightarrow \tau.$$

For $n \geq 1$, let (F_n, ℓ_n) be a random well-labeled forest uniformly distributed in $\mathcal{F}_{\tau_n}^{\rho_n}$. For convenience, we write (C_n, L_n) the contour pair $(C_{F_n}, L_{(F_n, \ell_n)})$ of (F_n, ℓ_n) (see Section 4.1 for the definitions). Let the same notation C_n, L_n denote its piecewise linear interpolation. When $2\rho_n + \tau_n < 2n\rho$, we assume that C_n is extended to take value τ_n on $[2\rho_n + \tau_n, 2n\rho]$. Then we define the rescaled versions:

$$C_{(n)} = \left(\frac{C_n(2ns)}{\sqrt{3n}} \right)_{0 \leq s \leq \max(\frac{2\rho_n + \tau_n}{2n}, \rho)} \text{ and } L_{(n)} = \left(\frac{L_n(2ns)}{n^{1/4}} \right)_{0 \leq s \leq \frac{2\rho_n + \tau_n}{2n}}$$

The goal of this section is to prove the following lemma:

Lemma 9.1. *In the sense of weak convergence in the space $(\mathcal{H}, d_{\mathcal{H}})^2$ when n goes to infinity, we have:*

$$(C_{(n)}, L_{(n)}) \rightarrow \left(\tilde{F}_{[0, \rho]}^{0 \rightarrow \tau}, Z_{[0, \rho]}^{\tau} \right).$$

9.1 Tightness of the contour function

Recall that $\|\cdot\|_{\alpha}$ denotes the α -Hölder norm.

Lemma 9.2 (Tightness of contour function). *There exists a constant $\alpha > 0$ such that*

$$\forall \varepsilon > 0 \quad \exists C \quad \forall n \quad \mathbb{P}(\|C_{(n)}\|_{\alpha} \leq C) > 1 - \varepsilon.$$

In particular, the family of laws of $(C_{(n)})_{n \geq 1}$ is tight in the space of probability measures on \mathcal{H} .

Proof. By the bijection of Lemma 4.5 and Section 8, we can consider W_n the element of $\mathcal{P}_{3, 3\rho_n + \tau_n, \rho_n}$ corresponding to (F_n, ℓ_n) . Note that W_n is a uniform random element of $\mathcal{P}_{3, 3\rho_n + \tau_n, \rho_n}$.

The convergence of $W_{(n)}$ (see Lemma 8.1) implies that:

$$\exists \alpha > 0 \quad \forall \varepsilon > 0 \quad \exists C \quad \forall n \quad \mathbb{P}(\|W_{(n)}\|_{\alpha} \leq C) > 1 - \varepsilon.$$

Note that an integer k such that $0 \leq k \leq 2\rho_n + \tau_n$ corresponds to an angle $a(k)$ of the plane rooted tree representing F (see Section 4.1). While encoding (F, d) with a binary word of $\mathcal{D}_{3, 3\rho_n + \tau_n, \rho_n}^{-1}$ starting from the root angle, we denote \tilde{k} the number of bits written before reaching angle $a(k)$.

One can check that for all $k, k' \in \llbracket 0, 2\rho_n + \tau_n \rrbracket$, we have:

$$|C_n(k) - C_n(k')| \leq |W_n(\tilde{k}) - W_n(\tilde{k}')|,$$

and

$$|k - k'| \leq |\tilde{k} - \tilde{k}'| \leq 3|k - k'|.$$

We use the definition of function f and r_F defined in Section 4.1

Consider $0 \leq x < y \leq \frac{2\rho_n + \tau_n}{2n}$ such that $2nx, 2ny \in \mathbb{N}$. Let $s = 2nx$ and $t = 2ny$. It is always possible to choose $u, v \in \mathbb{N}$, such that $s \leq u \leq v \leq t$, and satisfying:

- if $fl(r_F(s)) \neq fl(r_F(t))$, then $r_F(u), r_F(v) \in F_1$, $r_F(u) = fl(r_F(s))$ and $r_F(v) = fl(r_F(t))$
- if $fl(r_F(s)) = fl(r_F(t))$, then $u = v$ and $r_F(u)$ is the nearest common ancestor of $r_F(s)$ and $r_F(t)$.

Using the triangular inequality, we get:

$$\begin{aligned} |C_n(s) - C_n(t)| &\leq |C_n(s) - C_n(u)| + |C_n(u) - C_n(v)| + |C_n(v) - C_n(t)| \\ &\leq |W_n(\tilde{s}) - W_n(\tilde{u})| + |W_n(\tilde{u}) - W_n(\tilde{v})| + |W_n(\tilde{v}) - W_n(\tilde{t})| \end{aligned}$$

We obtain

$$\begin{aligned} |C_{(n)}(x) - C_{(n)}(y)| &\leq |W_{(n)}(\tilde{s}/2n) - W_{(n)}(\tilde{u})| + |W_{(n)}(\tilde{u}) - W_{(n)}(\tilde{v})| \\ &\quad + |W_{(n)}(\tilde{v}) - W_{(n)}(\tilde{t})| \\ &\leq C(|\tilde{s}/2n - \tilde{u}|^\alpha + |\tilde{u} - \tilde{v}|^\alpha + |\tilde{v} - \tilde{t}|^\alpha) \\ &\leq C \left(\frac{3}{2n} \right)^\alpha (|s - u|^\alpha + |u - v|^\alpha + |v - t|^\alpha). \end{aligned}$$

Using the inequality $a^\alpha + b^\alpha + c^\alpha \leq 3(a + b + c)^\alpha$, we get

$$\begin{aligned} |C_{(n)}(x) - C_{(n)}(y)| &\leq 3C \left(\frac{3}{2n} \right)^\alpha (|s - u| + |u - v| + |v - t|)^\alpha \\ &\leq 3C \left(\frac{3}{2n} \right)^\alpha |s - t|^\alpha \\ &\leq 3^{\alpha+1} C |x - y|^\alpha \end{aligned}$$

This inequality is satisfied for $0 \leq x < y \leq \frac{2\rho_n + \tau_n}{2n}$ such that $2nx, 2ny \in \mathbb{N}$. It is also satisfied for all $0 \leq x < y \leq \frac{2\rho_n + \tau_n}{2n}$ by linear interpolation. \square

9.2 Conditioned Galton-Watson forest

In this section, we introduce the notion of Galton-Watson forest which allows us to present the law of uniform random well-labeled forests.

Let (F, ℓ) be a well-labeled forest in \mathcal{F}_τ^ρ . For convenience, in this section, we extend the function d to the set of tree-edges of F by letting: for all $u \in F$ such that $c_u(F) \geq 1$, for all $i \in \{1, \dots, c_u(F)\}$, we define:

$$\ell(\{u, ui\}) = \ell(ui) - \ell(u)$$

Note that the value of ℓ on the set of tree-edges of F is sufficient to recover ℓ .

For $\tau \in \mathbb{N}$, let $\mathbb{F}_\tau^\infty = \bigcup_{\rho \geq 0} \mathbb{F}_\tau^\rho$.

Let G be a random variable with geometric law of parameter $3/4$ (i.e. $\mathbb{P}(G = c) = \frac{3}{4} \left(\frac{1}{4}\right)^c$ for $c \in \mathbb{N}$). Let B be a random variable with law given by:

$$\mathbb{P}(B = c) = \frac{\binom{c+2}{2} \mathbb{P}(G = c)}{\mathbb{E} \left[\binom{G+2}{2} \right]}, \text{ for } c \in \mathbb{N}.$$

Definition 9.3. For $\tau \in \mathbb{N}$, a τ -Galton-Watson forest is a random element F' of \mathbb{F}_τ^∞ such that, independent for each $u \in F'$, we have $c_u(F')$ has law G if u is a floor and $c_u(F')$ has law B if u is a tree-vertex.

Let H be a τ -Galton-Watson forest conditioned to have ρ tree-vertices. For each tree-vertex v of F' , we add two stems incident to v , uniformly at random from among the $\binom{c_v(F')+1}{2} + \binom{c_v(F')+1}{1} = \binom{c_v(F')+2}{2}$ possibilities. Let (H, ℓ) be the resulting forest of \mathcal{F}_τ^ρ (see Section 4.1 for the correspondence between stems and the function ℓ).

Lemma 9.4. (H, ℓ) is uniformly distributed over \mathcal{F}_τ^ρ .

Proof. Let $(F, \ell') \in \mathcal{F}_\tau^\rho$. For each $1 \leq i \leq \tau$, assume that the list of vertices of F^i (the i -th tree of F as in Section 4.1) in lexicographic order is $v_{i1}, v_{i2}, \dots, v_{in_i}$. Then (H, ℓ) is equal to (F, ℓ') if and only if all the vertices of H and F have the same number of children and the stems are inserted at the right place to obtain (H, ℓ) from H . Hence we have:

$$\begin{aligned} \mathbb{P}((H, \ell) = (F, \ell')) &\propto \prod_{i=1}^{\tau} \left[\mathbb{P}(G = c_{v_{i1}}(F)) \prod_{j=2}^{n_i} \frac{\mathbb{P}(B = c_{v_{ij}}(F))}{\binom{c_{v_{ij}}(F)+2}{2}} \right] \\ &= \prod_{i=1}^{\tau} \left[\mathbb{P}(G = c_{v_{i1}}(F)) \prod_{j=2}^{n_i} \frac{\binom{c_{v_{ij}}(F)+2}{2} \mathbb{P}(G = c_{v_{ij}}(F))}{\binom{c_{v_{ij}}(F)+2}{2} \mathbb{E} \left[\binom{G+2}{2} \right]} \right] \end{aligned}$$

$$= \frac{3^{\rho+\tau}}{4^{2\rho+\tau} \left(\mathbb{E} \left[\binom{G+2}{2} \right] \right)^\rho}.$$

Since the last term does not depend on (F, ℓ') , this concludes the proof of the Lemma. \square

Definition 9.5. Consider $(\rho, \tau) \in \mathbb{N}^2$, and $\mu = (\mu_k)_{k \geq 1}$ where μ_k is a probability measure on \mathbb{R}^k . Let $LGW(\mu, \rho, \tau)$ be the law of the well-labeled forest $(F, \ell) \in \mathcal{F}_\tau^\rho$ such that:

- F has the law of the τ -Galton-Watson forest conditioned to have ρ tree vertices,
- Conditionally on H , independently for each tree-vertex v of H such that $c_v(H) \geq 1$, let $(\ell(\{v, vj\}))_{1 \leq j \leq c_v(H)}$ be a random vector with law $\mu_{c_v(H)}$

Consider $\nu = (\nu_k)_{k \geq 1}$ where ν_k is the uniform law over non-decreasing vectors $(X_1, X_2, \dots, X_k) \in \{-1, 0, 1\}^k$ (i.e. $X_1 \leq \dots \leq X_k$).

Remark 9.6. A consequence of Lemma 9.4, is that if (F, ℓ) is uniformly distributed on \mathcal{F}_τ^ρ , then the law of (F, ℓ) is $LGW(\nu, \rho, \tau)$.

9.3 Symmetrization of a forest

We adapt a notion first applied in the case of plane trees [1] to well-labeled forest. We begin this section with the following definition.

Definition 9.7. Let μ be a probability measure on \mathbb{R}^k . The *symmetrization* of μ , denoted by $\hat{\mu}$, is obtained by uniformly permuting the marginals of μ . In other words, if (X_1, X_2, \dots, X_k) has law μ , and σ is a uniformly random in the set of permutations of $\{1, 2, \dots, k\}$, then $(X_{\sigma(1)}, X_{\sigma(2)}, \dots, X_{\sigma(k)})$ has law $\hat{\mu}$.

We now describe the symmetrization of $\nu = (\nu_k)_{k \geq 1}$ where ν_k is the uniform law over non-decreasing vectors of $\{-1, 0, 1\}^k$ (as in previous section). Assume that (X_1, X_2, \dots, X_k) has law ν_k , and σ is a uniform random element of the set of permutations of $\{1, 2, \dots, k\}$. Then, for $x = (x_1, x_2, \dots, x_k) \in \{-1, 0, 1\}^k$, we have:

$$\hat{\nu}_k\{x\} = \mathbb{P} \left\{ (X_1, X_2, \dots, X_k) = (x_{\sigma_x(1)}, x_{\sigma_x(2)}, \dots, x_{\sigma_x(k)}) ; \sigma^{-1} = \sigma_x \right\},$$

where σ_x is a permutation of $\{1, 2, \dots, k\}$ such that $(x_{\sigma_x(1)}, x_{\sigma_x(2)}, \dots, x_{\sigma_x(k)})$ is non-decreasing. Thus, for $x = (x_1, x_2, \dots, x_k) \in \{-1, 0, 1\}^k$, we have:

$$\hat{\nu}_k\{x\} \propto (n_{-1}(x))!(n_0(x))!(n_1(x))!,$$

where $n_{-1}(x), n_0(x), n_1(x)$ denotes the number of occurrences of $-1, 0, 1$ in x , respectively. Note that the marginals of $\hat{\nu}_k$ are not i.i.d, but that each of them has uniform law on $\{-1, 0, 1\}$.

Let (F, ℓ) be a well-labeled forest in \mathcal{F}_τ^ρ for $\rho, \tau \in \mathbb{N}$. We define the following set of vectors of permutations:

$$\mathcal{P}(F) = \{(\mathbf{p}_v)_{v \in F, c_v(F) > 0} : \mathbf{p}_v \text{ is a permutation of } \{1, 2, \dots, c_v(F)\}\}.$$

The *symmetrization of F with respect to $\mathbf{p} \in \mathcal{P}(F)$* is the forest $F_{\mathbf{p}}$ obtained from F by permuting the order of the children at each tree-vertex v according to \mathbf{p}_v . More formally, we have

$$F_{\mathbf{p}} = \{\bar{\mathbf{p}}(v) : v \in F\},$$

where for $v = v_1 \dots v_k$ in F , we define

$$\bar{\mathbf{p}}(v) = v_1 \mathbf{p}_{v_1}(v_2) \mathbf{p}_{v_1 v_2}(v_3) \dots \mathbf{p}_{v_1 \dots v_{k-1}}(v_k).$$

Note that F and $F_{\mathbf{p}}$ are isomorphic in terms of (non-embedded) graphs (the image of a vertex v of F is precisely $\bar{\mathbf{p}}(v)$ in $F_{\mathbf{p}}$). We now define two variants of labeling function $\ell_{\mathbf{p}}^0, \ell_{\mathbf{p}}^1$ of $F_{\mathbf{p}}$ by the following: for each tree-edge $\{u, ui\}$ of F , let

$$\ell_{\mathbf{p}}^0(\bar{\mathbf{p}}(u), \bar{\mathbf{p}}(ui)) = \ell(u, ui)$$

$$\ell_{\mathbf{p}}^1(\bar{\mathbf{p}}(u), \bar{\mathbf{p}}(ui)) = \ell(u, ui).$$

Informally, for $\ell_{\mathbf{p}}^1$, the labels of F are attached to edges during the permutation of the children and for $\ell_{\mathbf{p}}^0$, the labels stay at their initial position and do not move.

The *partial symmetrization of (F, ℓ) with respect to $\mathbf{p} \in \mathcal{P}(F)$* is the well-labeled forest $(F_{\mathbf{p}}, \ell_{\mathbf{p}}^0)$. The *complete symmetrization of (F, ℓ) with respect to $\mathbf{p} \in \mathcal{P}(F)$* is the labeled forest $(F_{\mathbf{p}}, \ell_{\mathbf{p}}^1)$. Note that $(F_{\mathbf{p}}, \ell_{\mathbf{p}}^1)$ is not necessarily a well-labeled forest.

Lemma 9.8. *Let (F, ℓ) be a random element on \mathcal{F}_τ^ρ with law $LGW(\nu, \rho, \tau)$ and \mathbf{p} be a uniform element on $\mathcal{P}(F)$, then $(F_{\mathbf{p}}, \ell_{\mathbf{p}}^0)$ has law $LGW(\nu, \rho, \tau)$ and $(F_{\mathbf{p}}, \ell_{\mathbf{p}}^1)$ has law $LGW(\hat{\nu}, \rho, \tau)$.*

Proof. It follows from the branching property of Galton-Watson processes that F and $F_{\mathbf{p}}$ have the same law. The rest follows from the definitions of $\ell_{\mathbf{p}}^0, \ell_{\mathbf{p}}^1, \hat{\nu}$. \square

Recall some notations from Section 4.1. For $u \in F$, with $|u| \geq 2$, $pa(u)$ denotes the parent of u in F . For $u \in F$, $A_u(F)$ denotes the set of ancestors of u in F . For $u, v \in F$, we say that $v < u$ if $v \in A_u(F)$. Similarly, we say that $v \leq u$ if $v \in (A_u(F) \cup \{u\})$.

Let U be a set of tree-vertices of F . We denote $A_U(F) = \cup_{u \in U} A_u(F)$. Let $O_U(F)$ denote the set of vertices of F that have exactly one child in $A_U(F)$. Note that $O_U(F) \subseteq A_U(F)$. We define $\mathcal{P}_U(F)$ as the subset of vectors \mathbf{p} of $\mathcal{P}(F)$ such that for all $v \in (F \setminus O_U(F))$, we have \mathbf{p}_v is equal to identity. For $\mathbf{p} \in \mathcal{P}_U(F)$, we define $\bar{\mathbf{p}}(U) = \{\bar{\mathbf{p}}(u) : u \in U\}$.

Lemma 9.9. *Let (F, ℓ) be a random element on \mathcal{F}_τ^ρ with law $\text{LGW}(\nu, \rho, \tau)$. Let $k \in \llbracket 0, \rho + \tau + 1 \rrbracket$ and U be a set of k independent and uniformly random vertices of F . Let \mathbf{p} be a uniformly random element of $\mathcal{P}_U(F)$. Then (F, ℓ, U) and $(F_{\mathbf{p}}, \ell_{\mathbf{p}}^0, \bar{\mathbf{p}}(U))$ have the same law.*

Proof. Let $(F', \ell') \in \mathcal{F}_\tau^\rho$, U' be a set of k vertices of F' . We have:

$$\mathbb{P}[(F, \ell, U) = (F', \ell', U')] = \mathbb{P}[(F, \ell) = (F', \ell')] \times \frac{1}{(\rho + \tau + 1)^k}$$

$$\begin{aligned} \mathbb{P}[(F_{\mathbf{p}}, \ell_{\mathbf{p}}^0, \bar{\mathbf{p}}(U)) = (F', \ell', U')] &= \sum_{\mathbf{p}' \in \mathcal{P}(F, U)} [\mathbb{P}[(F_{\mathbf{p}}, \ell_{\mathbf{p}}^0) = (F', \ell'); \bar{\mathbf{p}}(U) = U'; \mathbf{p} = \mathbf{p}']] \\ &= \sum_{\mathbf{p}' \in \mathcal{P}(F, U)} [\mathbb{P}[(F_{\mathbf{p}}, \ell_{\mathbf{p}}^0) = (F', \ell') \mid \bar{\mathbf{p}}(U) = U'; \mathbf{p} = \mathbf{p}'] \times \mathbb{P}[\bar{\mathbf{p}}(U) = U' \mid \mathbf{p} = \mathbf{p}'] \times \mathbb{P}[\mathbf{p} = \mathbf{p}']] \end{aligned}$$

for all $\mathbf{p}' \in \mathcal{P}_U(F)$ we have $\mathbb{P}[(F_{\mathbf{p}}, \ell_{\mathbf{p}}^0) = (F', \ell') \mid \bar{\mathbf{p}}(U) = U'; \mathbf{p} = \mathbf{p}'] = \mathbb{P}[(F, \ell) = (F', \ell')]$ and

$$\mathbb{P}[\bar{\mathbf{p}}(U) = U' \mid \mathbf{p} = \mathbf{p}'] = \frac{1}{(\rho + \tau + 1)^k} \text{ thus we obtain the result. } \quad \square$$

We obtain the following lemma (similar to [1, Corollary 6.7]).

Lemma 9.10. *Let (F, ℓ) be a random element on \mathcal{F}_τ^ρ with law $\text{LGW}(\nu, \rho, \tau)$. Let $k \in \llbracket 0, \rho + \tau + 1 \rrbracket$ and U be a set of k independent and uniformly random vertices of F . Let $(\widehat{F}, \widehat{\ell})$ be a random element with law $\text{LGW}(\widehat{\nu}, \rho, \tau)$. Let \widehat{U} be a set of k independent and uniformly random vertices of \widehat{F} . Let $U = \{u_1, \dots, u_k\}$ and $\widehat{U} = \{\widehat{u}_1, \dots, \widehat{u}_k\}$ such that u_1, \dots, u_k and $\widehat{u}_1, \dots, \widehat{u}_k$ are lexicographically ordered. For $1 \leq i \leq k$, let*

$$S_i = \sum_{\substack{v \leq u_i \\ w \in O_U(F) \\ w = pa(v)}} \ell(w, v)$$

$$\widehat{S}_i = \sum_{\substack{v \leq \widehat{u}_i \\ w \in O_{\widehat{U}}(\widehat{F}) \\ w = pa(v)}} \widehat{\ell}(w, v).$$

Then $(|u_1|, \dots, |u_k|, S_1, \dots, S_k)$ and $(|\widehat{u}_1|, \dots, |\widehat{u}_k|, \widehat{S}_1, \dots, \widehat{S}_k)$ have the same law.

Proof. Let \mathbf{p} be a uniformly random element of $\mathcal{P}_U(F)$ and consider $(F_{\mathbf{p}}, \ell_{\mathbf{p}}^0, \bar{\mathbf{p}}(U))$. For $v \in F_{\geq 2}$, if $\{pa(v), v\}$ is a tree-edge of F such that $pa(v) \in O_U(F)$, then the partial symmetrization of (F, ℓ) with respect to \mathbf{p} uniformly permutes the children of $pa(v)$

but the labels are not permuted. Consider two distinct vertices $u, v \in F$ such that $c_u(F), c_v(F)$ are at least 1. If u', v' are children of u, v , respectively, then the values of $\ell(u, u')$ and $\ell(v, v')$ are independent. It follows that the random variables

$$\{\ell_{\mathbf{p}}^0(\bar{\mathbf{p}}(w), \bar{\mathbf{p}}(v)) : v \in F, w \in O_U(F) \text{ and } w = pa(v)\}$$

are independent and uniformly distributed on $\{-1, 0, 1\}$.

Thus, by Lemma 9.9, the random variables

$$\{\ell(w, v) : v \in F, w \in O_U(F) \text{ and } w = pa(v)\}$$

are independent and uniformly distributed on $\{-1, 0, 1\}$.

Finally, the trees F and \widehat{F} have the same law, so $(|u_1|, \dots, |u_k|) \stackrel{(d)}{=} (|\widehat{u}_1|, \dots, |\widehat{u}_k|)$. Moreover, by the definition of $\widehat{\nu}$, the random variables

$$\{\widehat{\ell}(w, v) : v \in \widehat{F}, w \in O_{\widehat{F}}(\widehat{F}) \text{ and } w = pa(v)\}$$

are independent and uniformly distributed on $\{-1, 0, 1\}$, and the result follows. \square

9.4 Tightness of the labeling function of a symmetrized Galton-Watson forest

Recall that $\nu = (\nu_k)_{k \geq 1}$ where ν_k is the uniform law over non-decreasing vectors of $\{-1, 0, 1\}^k$ and $\widehat{\nu}$ is the symmetrization of ν as defined in previous section.

By Remark 9.6, (F_n, ℓ_n) is a random element with law $LGW(\nu, \tau_n, \rho_n)$. Now consider $(\widehat{F}_n, \widehat{\ell}_n)$ a random element with law $LGW(\widehat{\nu}, \tau_n, \rho_n)$. For convenience, we write $(\widehat{C}_n, \widehat{L}_n)$ the contour pair $(C_{\widehat{F}_n}, L_{(\widehat{F}_n, \widehat{\ell}_n)})$ of $(\widehat{F}_n, \widehat{\ell}_n)$. As before, we consider that \widehat{C}_n and \widehat{L}_n are linearly interpolated. We extend \widehat{C}_n to be equal to τ_n on $[2\rho_n + \tau_n, 2n\rho]$ when $2\rho_n + \tau_n < 2n\rho$. Then we define the rescaled versions:

$$\widehat{C}_{(n)} = \left(\frac{\widehat{C}_n(2ns)}{\sqrt{3n}} \right)_{0 \leq s \leq \max(\frac{2\rho_n + \tau_n}{2n}, \rho)} \quad \text{and} \quad \widehat{L}_{(n)} = \left(\frac{\widehat{L}_n(2ns)}{n^{1/4}} \right)_{0 \leq s \leq \frac{2\rho_n + \tau_n}{2n}}$$

The aim of this section is to prove the tightness of the labeling function $\widehat{L}_{(n)}$.

Since F_n and \widehat{F}_n do not depend on ν and $\widehat{\nu}$, they have the same law. So the contour functions \widehat{C}_n and C_n have the same law (but not necessarily \widehat{L}_n and L_n). Thus we can couple the two labeled forests $(\widehat{F}_n, \widehat{\ell}_n)$ and (F_n, ℓ_n) so that $\widehat{C}_n = C_n$.

We need the following classical inequality:

Lemma 9.11 (Rosenthal's inequality, [103]). *For each $p \geq 2$, there exists a constant $C_p > 0$ such that for $k \geq 1$ we have the following. Consider X, X_1, \dots, X_k a sequence of i.i.d. centered random variables in \mathbb{R} . Let $\Sigma = \sum_{i=1}^k X_i$. Then:*

$$\mathbb{E}(|\Sigma|^p) \leq C_p \left(k \mathbb{E}(|X|^p) + (k \mathbb{E}(X^2))^{p/2} \right).$$

We now prove the main result of this section:

Lemma 9.12 (Tightness of the labeling function). *The family of laws of $(\widehat{L}_{(n)})_{n \geq 1}$ is tight for the space of probability measure on \mathcal{H} .*

Proof. By Lemma 9.2, there exists a constant $\alpha > 0$ such that

$$\forall \varepsilon > 0 \quad \exists C \quad \forall n \quad \mathbb{P}(\|C_{(n)}\|_\alpha \leq C) > 1 - \varepsilon.$$

Let $\varepsilon > 0$ and C that satisfies the above inequality.

We assume that $C_{(n)}$ is conditioned on $\|C_{(n)}\|_\alpha \leq C$.

Let X be uniformly distributed in $\{-1, 0, 1\}$. Recall that the marginals of $\widehat{\nu}_k$ for $k \geq 1$, have the same law as X . So for all $a, b \in \widehat{F}$ with $a = p(b)$, we have $\widehat{\ell}_n(a, b)$ and X have the same law.

One can check that for all $i, j \in \llbracket 0, 2\rho_n + \tau_n \rrbracket$, with $u = r_{\widehat{F}_n}(i)$, $v = r_{\widehat{F}_n}(j)$, $u \in A_v(\widehat{F}_n)$, we have:

$$\widehat{L}_n(j) - \widehat{L}_n(i) = \sum_{\substack{u < b \leq v \\ a = p(b)}} \widehat{\ell}_n(a, b)$$

Let $k = |v| - |u|$. Note that $k = C_n(j) - C_n(i)$. Then by Lemma 9.11, we have, for $p \geq 2$, there exists a constant $C_p > 0$ such that:

$$\begin{aligned} \mathbb{E} \left(\left| \widehat{L}_n(j) - \widehat{L}_n(i) \right|^p \right) &\leq C_p \left(k \mathbb{E}(|X^p|) + (k \mathbb{E}(X^2))^{p/2} \right) \\ &\leq C_p \left((C_n(j) - C_n(i)) \mathbb{E}(|X^p|) + ((C_n(j) - C_n(i)) \mathbb{E}(X^2))^{p/2} \right) \\ &\leq C_p C \sqrt{3n} \left(\left| \frac{j-i}{2n} \right|^\alpha \mathbb{E}(|X^p|) + \left(\left| \frac{j-i}{2n} \right|^\alpha \mathbb{E}(X^2) \right)^{p/2} \right) \end{aligned}$$

As in the proof of Lemma 9.2, consider $0 \leq x < y \leq \frac{2\rho_n + \tau_n}{2n}$ such that $2nx, 2ny \in \mathbb{N}$. Let $s = 2nx$ and $t = 2ny$. Let $u = r_{\widehat{F}}(s)$ and $v = r_{\widehat{F}}(t)$. It is always possible to choose $p, q \in \mathbb{N}$, such that $s \leq i \leq j \leq t$, and satisfying:

- if $fl(u) \neq fl(v)$, then $r_{\widehat{F}}(i), r_{\widehat{F}}(j) \in (\widehat{F})_1$, $r_{\widehat{F}}(i) = fl(u)$ and $r_{\widehat{F}}(j) = fl(v)$
- if $fl(u) = fl(v)$, then $i = j$ and $r_{\widehat{F}}(i)$ is the nearest common ancestor of u and v .

Note that $\widehat{L}_n(i) = \widehat{L}_n(j) = 0$, so we have:

$$\begin{aligned} \mathbb{E} \left[\left| \widehat{L}_n(s) - \widehat{L}_n(t) \right|^p \right] &\leq 3^p \left(\mathbb{E} \left[\left| \widehat{L}_n(s) - \widehat{L}_n(i) \right|^p \right] + \mathbb{E} \left[\left| \widehat{L}_n(i) - \widehat{L}_n(j) \right|^p \right] \right. \\ &\quad \left. + \mathbb{E} \left[\left| \widehat{L}_n(j) - \widehat{L}_n(t) \right|^p \right] \right) \end{aligned}$$

$$\begin{aligned} &\leq 3^p C_p C \sqrt{3n} \left(\left| \frac{s-i}{2n} \right|^\alpha \mathbb{E}(|X^p|) + \left(\left| \frac{s-i}{2n} \right|^\alpha \mathbb{E}(X^2) \right)^{p/2} \right. \\ &\quad \left. + \left| \frac{j-t}{2n} \right|^\alpha \mathbb{E}(|X^p|) + \left(\left| \frac{j-t}{2n} \right|^\alpha \mathbb{E}(X^2) \right)^{p/2} \right) \end{aligned}$$

Thus for the rescaled version, we have:

$$\begin{aligned} \mathbb{E} \left[\left| \widehat{L}_{(n)}(x) - \widehat{L}_{(n)}(y) \right|^p \right] &\leq n^{-p/4} 3^p C_p C \sqrt{3n} \left(\left| \frac{s-i}{2n} \right|^\alpha \mathbb{E}(|X^p|) + \left(\left| \frac{s-i}{2n} \right|^\alpha \mathbb{E}(X^2) \right)^{p/2} \right. \\ &\quad \left. + \left| \frac{j-t}{2n} \right|^\alpha \mathbb{E}(|X^p|) + \left(\left| \frac{j-t}{2n} \right|^\alpha \mathbb{E}(X^2) \right)^{p/2} \right) \\ &\leq n^{-p/4} 3^p C_p C \sqrt{3n} \left(|x-y|^\alpha \mathbb{E}(|X^p|) + (|x-y|^\alpha \mathbb{E}(X^2))^{p/2} \right) \end{aligned}$$

Consider p such that $p > 10$. So we have $n^{-p/4+1/2} \leq 1/n^2$. Since $2nx, 2ny \in \mathbb{N}$, and $x \neq y$, we have $|x-y| \geq \frac{1}{2n}$. So $n^{-p/4+1/2} \leq 4|x-y|^2$. Moreover, we have $|x-y| \leq \frac{2\rho_n + \tau_n}{2n}$ which converge to ρ . So there exists a constant C' , such that:

$$\mathbb{E} \left[\left| \widehat{L}_{(n)}(x) - \widehat{L}_{(n)}(y) \right|^p \right] \leq C' |x-y|^2$$

Since \widehat{L}_n is linearly interpolated, the above inequality holds for for all $x, y \in \left[0, \frac{2\rho_n + \tau_n}{2n}\right]$. By Billingsley ([24], Theorem 12.3), the family of laws of $\left(\widehat{L}_{(n)}\right)_{n \geq 1}$ is tight, which completes the proof of the Lemma. \square

9.5 Convergence of the contour function

We consider $\widehat{F}_n, \widehat{\ell}_n, \widehat{L}_n, \widehat{L}_{(n)}$ as in previous section.

Here, we prove the convergence of the contour function by using the convergence of uniformly random 3-dominating binary words from Section 8 and the tightness of $\widehat{L}_{(n)}$ from Section 9.4.

We need the following bound:

Lemma 9.13. *For all $\varepsilon > 0$, there exists a constant C such that*

$$\sup_n \mathbb{P} \left(\sup_{v \in \widehat{F}_n} |\ell_n(v)| \geq C n^{1/4} \right) < \varepsilon.$$

Proof. For any $\varepsilon > 0$, by Lemma 9.12, there exists a constant C such that:

$$\sup_n \mathbb{P} \left(\sup_{v \in \widehat{F}_n} |\widehat{\ell}_n(v)| \geq C n^{1/4} \right) < \varepsilon.$$

Let \mathbf{p} be a uniform random element of $\mathcal{P}(F_n)$. Denote by $(\ell_n)_{\mathbf{p}}^1$ the labeling function of $(F_n)_{\mathbf{p}}$ as defined in Section 9.3. For convenience we write $\ell'_n = (\ell_n)_{\mathbf{p}}^1$ and $F'_n = (F_n)_{\mathbf{p}}$. Note that for all $v \in F_n$, we have $\ell_n(v) = \ell'_n(\overline{\mathbf{p}}(v))$. Then we have

$$\sup_{v \in F_n} |\ell_n(v)| = \sup_{v \in F'_n} |\ell'_n(v)|.$$

By Lemma 9.8, we have (F'_n, ℓ'_n) has law $LGW(\widehat{\nu}, \tau_n, \rho_n)$, i.e. (F'_n, ℓ'_n) and $(\widehat{F}_n, \widehat{\ell}_n)$ have the same law. So

$$\sup_{v \in F_n} |\ell_n(v)| = \sup_{v \in \widehat{F}_n} |\widehat{\ell}_n(v)|.$$

This completes the proof of the Lemma. □

Lemma 9.14 (Convergence of contour function). *The process $C_{(n)}$ converges in law toward $\widetilde{F}_{[0, \rho]}^{0 \rightarrow \tau}$ in the space $(\mathcal{H}, d_{\mathcal{H}})$, when n goes to infinity.*

Remark 9.15. Note that the limit in this lemma is indeed $\widetilde{F}_{[0, \rho]}^{0 \rightarrow \tau}$ and not $F_{[0, \rho]}^{0 \rightarrow \tau}$ as the corresponding result in [22] would seem to indicate. This is due to the fact that our decomposition of the unicellular map into Motzkin paths and well-labeled forests is not exactly the same as in the case of quadrangulations.

Proof. Let f be a bounded continuous function from \mathbb{R} to \mathbb{R} . Let $0 \leq t < \rho$ and $\varepsilon > 0$. Since $\frac{2\rho_n + \tau_n}{2n}$ converge toward ρ , there exists N such that $t \leq \min_{n \geq N} \frac{2\rho_n + \tau_n}{2n}$. For $n \geq N$, we define

$$T_n(t) = \min \{k \in \llbracket 0, 2\rho_n + \tau_n \rrbracket : r_{F_n}(k) = fl(r_{F_n}(\lfloor 2nt \rfloor))\}.$$

Note that $r_{F_n}(T_n(t))$ is an integer that we denote by i_n .

As in the proof of Lemma 9.2, we consider W_n the element of $\mathcal{P}_{3, 3\rho_n + \tau_n, \rho_n}$ corresponding to (F_n, ℓ_n) . Note that for $k \in \llbracket 0, 2\rho_n + \tau_n \rrbracket$, such that $r_{F_n}(k)$ is a floor of F_n , we have $C_n(k) = W_n(2k - r_{F_n}(k))$. So in particular:

$$C_n(T_n(t)) = W_n(2T_n(t) + i_n).$$

For convenience, let $j_n = L_n(\lfloor 2nt \rfloor)$ and $k_n = i_n - j_n + |r_{F_n}(\lfloor 2nt \rfloor)|$. Note that we have:

$$C_n(\lfloor 2nt \rfloor) - C_n(T_n(t)) = \frac{1}{2} (W_n(2\lfloor 2nt \rfloor + k_n) - W_n(2T_n(t) + i_n) - j_n).$$

Thus we have:

$$C_n(\lfloor 2nt \rfloor) = \frac{1}{2} (W_n(2\lfloor 2nt \rfloor + k_n) + W_n(2T_n(t) + i_n) - j_n).$$

Note that $W_n(2T_n(t) + i_n) = \max_{s \leq 2\lfloor 2nt \rfloor + k_n} W_n(s)$, therefore:

$$C_n(\lfloor 2nt \rfloor) = \frac{1}{2} \left(W_n(2\lfloor 2nt \rfloor + k_n) + \max_{s \leq 2\lfloor 2nt \rfloor + k_n} W_n(s) - j_n \right).$$

By Lemma 9.2, there exists a constant c_1 such that

$$\inf_{n \geq N} \mathbb{P} \left(\sup_{k \in [0, 2\rho_n + \tau_n]} |C_n(k)| < c_1 n^{1/2} \right) \geq 1 - \varepsilon. \quad (9.1)$$

Moreover, by Lemma 9.13, there exists a constant c_2 such that

$$\inf_{n \geq N} \mathbb{P} \left(\sup_{k \in [0, 2\rho_n + \tau_n]} |L_n(k)| < c_2 n^{1/4} \right) \geq 1 - \varepsilon. \quad (9.2)$$

By (9.1) and (9.2), there exists a constant $c > 0$ such that:

$$\inf_{n \geq N} \mathbb{P} \left(\sup_{k \in [0, 2\rho_n + \tau_n]} |C_n(k)| < cn^{1/2}; \sup_{k \in [0, 2\rho_n + \tau_n]} |L_n(k)| < cn^{1/4} \right) \geq 1 - 2\varepsilon.$$

So we have:

$$\inf_{n \geq N} \mathbb{P} \left(|i_n| \leq cn^{1/2}, |j_n| \leq cn^{1/4}, |k_n| \leq cn^{1/2} \right) \geq 1 - 2\varepsilon. \quad (9.3)$$

Let \mathcal{E}_n the event:

$$\left\{ |i_n| \leq cn^{1/2}, |j_n| \leq cn^{1/4}, |k_n| \leq cn^{1/2} \right\}.$$

Now we define a random variable Y_n as follows:

$$Y_n = \frac{1}{2} \left(W_n(2[2nt] + k_n \mathbb{1}_{\mathcal{E}_n}) + \max_{s \leq 2[2nt] + k_n} W_n(s) - j_n \mathbb{1}_{\mathcal{E}_n} \right).$$

By Lemma 8.1, we have $\left(\frac{Y_n}{\sqrt{3n}} \right)_{n \geq N}$ converge toward $\frac{1}{2} \left(F_{[0, 2\rho]}^{0 \rightarrow \tau}(2t) + \overline{F_{[0, 2\rho]}^{0 \rightarrow \tau}}(2t) \right) = \tilde{F}_{[0, \rho]}^{0 \rightarrow \tau}(t)$ when n goes to infinity. Thus by (9.3), there exists $n_0 \geq N$ such that for all $n \geq n_0$:

$$\begin{aligned} & \left| \mathbb{E}[f(C_{(n)}(t))] - \mathbb{E} \left[f \left(\tilde{F}_{[0, \rho]}^{0 \rightarrow \tau}(t) \right) \right] \right| \\ & \leq \left| \mathbb{E}[f(C_{(n)}(t))] - \mathbb{E} \left[f \left(\frac{Y_n}{\sqrt{3n}} \right) \right] \right| + \left| \mathbb{E} \left[f \left(\frac{Y_n}{\sqrt{3n}} \right) \right] - \mathbb{E} \left[f \left(\tilde{F}_{[0, \rho]}^{0 \rightarrow \tau}(t) \right) \right] \right| \\ & \leq 2 \mathbb{E}[1 - \mathbb{1}_{\mathcal{E}_n}] \|f\|_{\infty} + \varepsilon. \\ & \leq (4 \|f\|_{\infty} + 1) \varepsilon. \end{aligned}$$

This implies that $(\mathbb{E}[f(C_{(n)}(t))])_{n \geq N}$ converge toward $\mathbb{E} \left[f \left(\tilde{F}_{[0, \rho]}^{0 \rightarrow \tau}(t) \right) \right]$.

We now prove the finite dimensional convergence of $C_{(n)}$. Let $k \geq 1$ and consider $0 \leq t_1 < t_2 < \dots < t_k < \rho$. Let N such that $t_k \leq \min_{n \geq N} \frac{2\rho_n + \tau_n}{2n}$. By above arguments, for $1 \leq i \leq k$, we have $(C_{(n)}(t_i))_{n \geq N}$ converge in law toward $\tilde{F}_{[0, \rho]}^{0 \rightarrow \tau}(t_i)$

It remains to deal with the point ρ .

$$\begin{aligned} |C_{(n)}(\rho) - \tau| &= \left| C_{(n)}\left(\rho \wedge \frac{2\rho_n + \tau_n}{2n}\right) - \tau \right| \\ &= \left| C_{(n)}\left(\rho \wedge \frac{2\rho_n + \tau_n}{2n}\right) - C_{(n)}\left(\frac{2\rho_n + \tau_n}{2n}\right) + C_{(n)}\left(\frac{2\rho_n + \tau_n}{2n}\right) - \tau \right| \\ &\leq \left| C_{(n)}\left(\rho \wedge \frac{2\rho_n + \tau_n}{2n}\right) - C_{(n)}\left(\frac{2\rho_n + \tau_n}{2n}\right) \right| + |\tau_n - \tau| \end{aligned}$$

Suppose that

Consider $\varepsilon > 0$. By Lemma 9.2, there exists α and C such that for all n : $\mathbb{P}(\|C_{(n)}\|_\alpha \leq C) > 1 - \varepsilon$. Condition on the event $\{\|C_{(n)}\|_\alpha \leq C\}$, we have

$$\begin{aligned} \left| C_{(n)}\left(\rho \wedge \frac{2\rho_n + \tau_n}{2n}\right) - C_{(n)}\left(\frac{2\rho_n + \tau_n}{2n}\right) \right| &\leq C \left| \rho \wedge \frac{2\rho_n + \tau_n}{2n} - \frac{2\rho_n + \tau_n}{2n} \right|^\alpha \\ &\leq C \left| \rho - \frac{2\rho_n + \tau_n}{2n} \right|^\alpha \end{aligned}$$

Since $\frac{2\rho_n + \tau_n}{2n} \rightarrow \rho$ and $\tau_n \rightarrow \tau$, for n large enough, we have:

$$|C_{(n)}(\rho) - \tau| \leq \varepsilon$$

Therefore we obtain for n large enough:

$$\mathbb{P}(|C_{(n)}(\rho) - \tau| > \varepsilon) \leq \mathbb{P}(\|C_{(n)}\|_\alpha > C) \leq \varepsilon.$$

This implies that $C_{(n)}(\rho)$ converges in probability toward the deterministic value τ . So Slutsky's lemma shows that $C_{(n)}(\rho)$ converges in law toward τ . Thus we have proved the convergence of the finite-dimensional marginals of $C_{(n)}$ toward $\tilde{F}_{[0,\rho]}^{0 \rightarrow \tau}$. By Lemma 9.2, $C_{(n)}$ is tight so Prokhorov's lemma give the result. \square

Remark 9.16. In the case when $\tau_n = 1$ for all n , this provides an alternative proof of a particular case of a theorem of Aldous ([4], Theorem 2).

9.6 Convergence of the contour pair

We consider $F_n, \ell_n, C_n, L_n, \widehat{F}_n, \widehat{\ell}_n, \widehat{L}_n$, as in previous sections.

By Lemma 9.14, the rescaled contour function $C_{(n)}$ converge. So as in [22, Corollary 16] one obtain the following lemma which proof is omitted:

Lemma 9.17. *In the sense of weak convergence in the space $(\mathcal{H}, d_{\mathcal{H}})^2$ when n does to infinity, we have:*

$$(C_{(n)}, \widehat{L}_{(n)}) \rightarrow (\tilde{F}_{[0,\rho]}^{0 \rightarrow \tau}, Z_{[0,\rho]}^\tau).$$

Lemma 9.18. *The family of laws of $(L_{(n)})_{n \geq 1}$ is tight in the space of probability measures on \mathcal{H} .*

Proof. We prove that for all $\varepsilon > 0$, there exists $\delta > 0$ such that

$$\limsup_n \mathbb{P} \left(\sup_{|i-j| \leq \delta(2\rho_n + \tau_n)} |L_n(i) - L_n(j)| > \varepsilon n^{1/4} \right) < \varepsilon \quad (9.4)$$

For $n \geq 1$, let \mathbf{p}_n be a uniformly random element of $\mathcal{P}(F_n)$ and let $(F'_n, \ell'_n) = ((F_n)_{\mathbf{p}_n}, (\ell_n)_{\mathbf{p}_n}^1)$ be the complete symmetrization of F_n with respect to \mathbf{p}_n (see Section 9.3 for the definition).

By Lemma 9.17, we have

$$((3n)^{-1/2} C_n, n^{-1/4} \widehat{L}_n) \rightarrow (F_{[0,\rho]}^{0 \rightarrow \tau}, Z_{[0,\rho]}^\tau). \quad (9.5)$$

This implies that for all $\varepsilon > 0$, there exist $\alpha > 0$ and $\beta > 0$ such that:

$$\sup_n \mathbb{P} \left(\sup_{|i-j| \leq \alpha(2\rho_n + \tau_n)} |\widehat{L}_n(i) - \widehat{L}_n(j)| > \varepsilon n^{1/4} \right) < \varepsilon \quad \text{and} \quad (9.6)$$

$$\sup_n \mathbb{P} \left(\sup_{\substack{i,j \in [0, 2\rho_n + \tau_n] \\ d_{F'_n}(\overline{\mathbf{p}}(r_{F_n}(i)), \overline{\mathbf{p}}(r_{F_n}(j))) \leq \beta n^{1/2}} |\widehat{L}_n(i) - \widehat{L}_n(j)| > \varepsilon n^{1/4} \right) < \varepsilon. \quad (9.7)$$

Indeed, the existence of α is a direct consequence of the convergence of the sequence $(n^{-1/4} \widehat{L}_n)$ seen as functions on the integers, while the existence of β follows from the continuity of $Z_{[0,\rho]}^\tau$ on $\mathcal{T} = \mathcal{T}_{F_{[0,\rho]}^{0 \rightarrow \tau}}$ equipped with the distance $d_{\mathcal{T}}$ (see Remark 5.1 and the paragraphs before it): fix $\varepsilon > 0$ and $\eta > 0$, n_0 after which $d_{\mathcal{H}}((3n)^{-1/2} C_n, F_{[0,\rho]}^{0 \rightarrow \tau}) < \eta$ and $d_{\mathcal{H}}(n^{-1/4} \widehat{L}_n, Z_{[0,\rho]}^\tau) < \varepsilon/3$ and use the domination of $d_{\mathcal{T}}$ by d_F (the limit of d_{F_n}) to write for $n \geq n_0$

$$\sup_{\substack{i,j \in [0, 2\rho_n + \tau_n] \\ d_{F_n}(r_{F_n}(i), r_{F_n}(j)) \leq \beta n^{1/2}}} |\widehat{L}_n(i) - \widehat{L}_n(j)| \leq \frac{2\varepsilon}{3} + \sup_{\substack{u,v \in [0,\rho] \\ d_{\mathcal{T}}(u,v) \leq \beta + 2\eta}} |Z_{[0,\rho]}^\tau(u) - Z_{[0,\rho]}^\tau(v)| \quad (9.8)$$

which can be made smaller than ε by choosing β and η appropriately; the (finitely many) cases $n < n_0$ can be taken into account by making β even smaller if needed.

Next, one can see that, for all $i, j \in [0, 2\rho_n + \tau_n]$:

$$d_{F_n}(r_{F_n}(i), r_{F_n}(j)) = d_{F'_n}(\overline{\mathbf{p}}(r_{F_n}(i)), \overline{\mathbf{p}}(r_{F_n}(j))), \quad \text{and}$$

$$|L_n(i) - L_n(j)| = |\ell_n(r_{F_n}(i)) - \ell_n(r_{F_n}(j))| = |\ell'_n(\overline{\mathbf{p}}(r_{F_n}(i))) - \ell'_n(\overline{\mathbf{p}}(r_{F_n}(j)))| = |\widehat{L}_n(i) - \widehat{L}_n(j)|.$$

We have for all $n \geq 1$ and $\delta \in [0, 1]$:

$$\begin{aligned} & \mathbb{P} \left(\sup_{\substack{i, j \in \llbracket 0, 2\rho_n + \tau_n \rrbracket \\ |i-j| \leq \delta(2\rho_n + \tau_n)}} |L_n(i) - L_n(j)| > \varepsilon n^{1/4} \right) \\ &= \mathbb{P} \left(\sup_{\substack{i, j \in \llbracket 0, 2\rho_n + \tau_n \rrbracket \\ |i-j| \leq \delta(2\rho_n + \tau_n)}} |\widehat{L}_n(i) - \widehat{L}_n(j)| > \varepsilon n^{1/4} \right) \\ &\leq \mathbb{P} \left(\exists i, j : i, j \in \llbracket 0, 2\rho_n + \tau_n \rrbracket, d_{F'_n}(\overline{\mathbf{p}}(r_{F_n}(i)), \overline{\mathbf{p}}(r_{F_n}(j))) \leq \beta n^{1/2}, |\widehat{L}_n(i) - \widehat{L}_n(j)| > \varepsilon n^{1/4} \right) \\ &\quad + \mathbb{P} \left(\exists i, j : i, j \in \llbracket 0, 2\rho_n + \tau_n \rrbracket, |i-j| \leq \delta(2\rho_n + \tau_n), d_{F'_n}(\overline{\mathbf{p}}(r_{F_n}(i)), \overline{\mathbf{p}}(r_{F_n}(j))) \geq \beta n^{1/2} \right). \\ &\leq \varepsilon + \mathbb{P} \left(\exists i, j : i, j \in \llbracket 0, 2\rho_n + \tau_n \rrbracket, |i-j| \leq \delta(2\rho_n + \tau_n), d_{F_n}(r_{F_n}(i), r_{F_n}(j)) \geq \beta n^{1/2} \right). \end{aligned}$$

Moreover, we can see that

$$\begin{aligned} & \sup \{ d_{F_n}(r_{F_n}(i), r_{F_n}(j)) : i, j \in \llbracket 0, 2\rho_n + \tau_n \rrbracket, |i-j| \leq \delta(2\rho_n + \tau_n) \} \\ &\leq 3 \sup \{ |C_n(i) - C_n(j)| : i, j \in \llbracket 0, 2\rho_n + \tau_n \rrbracket, |i-j| \leq \delta(2\rho_n + \tau_n) \} \\ &\leq 3\sqrt{3n} \sup \left\{ |C_n(x) - C_n(y)| : x, y \in \left[0, \frac{2\rho_n + \tau_n}{2n} \right], |x-y| \leq \delta \frac{2\rho_n + \tau_n}{2n} \right\}. \end{aligned}$$

By Lemma 9.14, C_n converges in law toward $\widetilde{F}_{[0, \rho]}^{0 \rightarrow \tau}$. Since $\widetilde{F}_{[0, \rho]}^{0 \rightarrow \tau}$ is almost surely continuous on $[0, \rho]$, there exists δ small enough such that:

$$\sup_n \mathbb{P}(\exists i, j : i, j \in \llbracket 0, 2\rho_n + \tau_n \rrbracket, |i-j| \leq \delta(2\rho_n + \tau_n), d_{F_n}(r_{F_n}(i), r_{F_n}(j)) \geq \beta n^{1/2}) < \varepsilon.$$

For this δ , we have:

$$\sup_n \mathbb{P} \left(\sup_{\substack{i, j \in \llbracket 0, 2\rho_n + \tau_n \rrbracket \\ |i-j| \leq \delta(2\rho_n + \tau_n)}} |L_n(i) - L_n(j)| > \varepsilon n^{1/4} \right) < 2\varepsilon,$$

this completes the proof of the Lemma. □

Then the proof of Theorem 9.1 follows from Lemmas 9.17 and 9.18 by applying exactly the same steps as in [1]. We omit the details.

10 Convergence of uniformly random toroidal triangulations

In this section, we prove our main theorem. Combining the results of previous sections, we have all the necessary tools to adapt the method of Addario-Berry and Albenque ([1],

lemma 6.1); we extend the arguments of Bettinelli ([22], Theorem 1) and Le Gall [80] to obtain Theorem 1.2.

For $n \geq 1$, let G_n be a uniformly random element of $\mathcal{G}(n)$. Let V_n be the vertex set of G_n . Recall that Φ denotes the bijection from $\mathcal{T}_{r,s,b}(n)$ to $\mathcal{G}(n)$ of Theorem 2.1. Let $T_n = \Phi^{-1}(G_n)$. Therefore T_n is a uniformly random element of $\mathcal{T}_{r,s,b}(n)$.

We now consider t_n that is uniformly distributed over $\llbracket 1, 3 \rrbracket$. Then, the random pair (t_n, T_n) is uniformly distributed over the set $\llbracket 1, 3 \rrbracket \times \mathcal{T}_{r,s,b}(n)$. Then we consider (r_n, R_n) be the image of (t_n, T_n) by the bijection of Lemma 4.10. Let $k_n \in \llbracket 0, 9 \rrbracket$ be such that $R_n \in \mathcal{R}^{k_n}(n)$, so that we have $r_n \in \llbracket 1, 3 \rrbracket$ if $k_n = 0$ (i.e. T is a square) and $r_n \in \llbracket 1, 2 \rrbracket$ otherwise (i.e. T is hexagonal). By Lemma 6.1, almost surely $k \neq 0$ so we can consider that T_n is always hexagonal.

By the discussion on the decomposition of unicellular map in Section 4.4, the elements of $\cup_{0 \leq j \leq 9} \mathcal{R}^j(n)$ are in bijection with $\mathcal{U}_{r,b}(n)$. Let U_n be the element of $\mathcal{U}_{r,b}(n)$ that is decomposed into R_n .

As in Section 4.5, we define Q_n the unicellular map obtained from U_n by removing all its stems and let $r_n = r_{Q_n}$ be the vertex contour function of Q_n .

We define a pseudo-distance d_n on $\llbracket 0, 2n+1 \rrbracket$ by the following: for $i, j \in \llbracket 0, 2n+1 \rrbracket^2$, let

$$d_n(i, j) = d_{G_n}(r_n(i), r_n(j)).$$

Then we define the associated equivalence relation: for $i, j \in \llbracket 0, 2n+1 \rrbracket$, we say that $i \sim_n j$ if $d_n(i, j) = 0$. Thus we can see d_n as a metric on $\llbracket 0, 2n+1 \rrbracket / \sim_n$. We extend the definition of d_n to non-integer values by the following linear interpolation: for $s, t \in [0, 2n+1]$, let

$$d_n(s, t) = \underline{s} \underline{t} d_n(\lceil s \rceil, \lceil t \rceil) + \underline{s} \bar{t} d_n(\lceil s \rceil, \lfloor t \rfloor) + \bar{s} \underline{t} d_n(\lfloor s \rfloor, \lceil t \rceil) + \bar{s} \bar{t} d_n(\lfloor s \rfloor, \lfloor t \rfloor),$$

where $\lfloor x \rfloor = \sup \{k \in \mathbb{Z} : k \leq x\}$, $\lceil x \rceil = \lfloor x \rfloor + 1$, $\underline{x} = x - \lfloor x \rfloor$ and $\bar{x} = \lceil x \rceil - x$. We define its rescaled version by the following:

$$d_{(n)} = \left(\frac{d_n((2n+1)s, (2n+1)t)}{n^{1/4}} \right)_{s,t \in [0,1]^2}.$$

Note that the metric space $\left(\frac{1}{2n+1} \llbracket 0, 2n+1 \rrbracket / \sim_n, d_{(n)} \right)$ is isometric to $(V_n, n^{-1/4} d_{G_n})$. Therefore we obtain

$$d_{GH} \left(\left(\frac{1}{2n+1} \llbracket 0, 2n+1 \rrbracket / \sim_n, d_{(n)} \right), (V_n, n^{-1/4} d_{G_n}) \right) = 0. \quad (10.1)$$

The goal of this section is to prove the following lemma which implies Theorem 1.2

Lemma 10.1. *There exists a subsequence $(n_k)_{k \geq 0}$ and a pseudo-metric d on $[0, 1]$ such that*

$$\left(\frac{1}{2n_k + 1} \llbracket [0, 2n_k + 1] \rrbracket / \sim_{n_k}, d_{(n_k)} \right) \xrightarrow[k \rightarrow \infty]{(d)} ([0, 1] / \sim_d, d)$$

for the Gromov-Hausdorff distance, where for $x, y \in [0, 1]^2$, we say that $x \sim_d y$ if $d(x, y) = 0$.

10.1 Convergence of the shifted labeling function of the unicellular map

Let $(\rho_n^1, \dots, \rho_n^6) \in \mathbb{N}^6$, $(\tau_n^1, \dots, \tau_n^6) \in (\mathbb{N}^*)^6$, $(\gamma_n^1, \gamma_n^2, \gamma_n^3) \in \mathbb{Z}^3$, $(\sigma_n^1, \sigma_n^2, \sigma_n^3) \in \mathbb{N}^3$, $((F_n^1, \ell_n^1), \dots, (F_n^6, \ell_n^6)) \in \mathcal{F}_{\tau_n^1}^{\rho_n^1} \times \dots \times \mathcal{F}_{\tau_n^6}^{\rho_n^6}$, $(M_n^1, M_n^2, M_n^3) \in \mathcal{M}_{\sigma_n^1}^{\gamma_n^1} \times \mathcal{M}_{\sigma_n^2}^{\gamma_n^2} \times \mathcal{M}_{\sigma_n^3}^{\gamma_n^3}$ be such that $R_n = ((F_n^1, \ell_n^1), \dots, (F_n^6, \ell_n^6), M_n^1, M_n^2, M_n^3)$ (see Definition 4.9). As in Section 6, for $i \in \llbracket 4, 6 \rrbracket$, let $\gamma_n^i = -\gamma_n^{i-3}$ and $\sigma_n^i = \sigma_n^{i-3}$. Moreover, for every $n > 0$, we define the renormalized version $\rho_{(n)}, \gamma_{(n)}, \sigma_{(n)}$ by letting $\rho_{(n)} = \frac{\rho_n}{n}$, $\gamma_{(n)} = \left(\frac{9}{8n}\right)^{1/4} \gamma_n$ and $\sigma_{(n)} = \frac{\sigma_n}{\sqrt{2n}}$. For $1 \leq k \leq 9$ and $1 \leq i \leq 6$, let $c_i(k)$ be the value of c_i given by line k of Table 6.1.

As in Section 4.5, we need several definitions. For $j \in \llbracket 0, 2\rho_n^i + \tau_n^i \rrbracket$, we define

$$S_n^i(j) = L_{(F_n^i, \ell_n^i)}(j) + \widetilde{M_n^i}^{c_i(k_n)}(\overline{C_{F_n^i}}(j)),$$

Let $S_n^\bullet = S_n^1 \bullet \dots \bullet S_n^{2t}$. Let P_n be the the unicellular map obtained from U_n by removing all the stems that are not incident to proper vertices and its vertex contour function r_{P_n} . We see S_n^\bullet as a function from the angles of P_n to \mathbb{Z}

Note that P contains exactly $2 \times (\sigma_1 + \dots + \sigma_t) + 2 \times \mathbb{1}_{k \neq 0}$ stems.

We define the sequence $(S_n(i))_{0 \leq i \leq 2n+1}$ as the sequence that is obtained from S_n^\bullet by removing all the values that appear in an angle of P_n that is just after a stem of P_n in clockwise order around its incident vertex. So S_n is the shifted labeling function of the unicellular map U_n (as defined in Section 4.5) and is seen as a function from the angles of Q_n to \mathbb{Z} .

We consider that S_n is linearly interpolated between its integer values and define its rescaled version:

$$S_{(n)} = \left(\frac{S_n((2n+1)x)}{n^{1/4}} \right)_{0 \leq x \leq 1}$$

Lemma 10.2. $S_{(n)}$ converge converge in law toward a limit S in the space $(\mathcal{H}, d_{\mathcal{H}})$ when n goes to infinity.

Proof. By Lemma 6.1, the vector $(k_n, \rho_{(n)}, \gamma_{(n)}, \sigma_{(n)})$ converges in law toward a random vector $(k, \rho, \gamma, \sigma)$ whose law is the probability measure μ of Section 6.

For convenience, for $1 \leq i \leq 6$, let (C_n^i, L_n^i) denote the contour pair $(C_{F_n^i}, L_{(F_n^i, \ell_n^i)})$ of the well-labeled forest (F_n^i, ℓ_n^i) . As usual, (C_n^i, L_n^i) is linearly interpolated and we denote the rescaled version by $(C_{(n)}^i, L_{(n)}^i)$ as in Section 9. By 9.1, conditionally on $(k, \rho, \gamma, \sigma)$, we have $(C_{(n)}^i, L_{(n)}^i)$ converge in law toward $(C^i, L^i) = \left(\widetilde{F}_{[0, \rho^i]}^{0 \rightarrow \tau^i}, Z_{[0, \rho^i]}^{\tau^i} \right)$.

Similarly as in Section 7 we consider that \widetilde{M}_n^i and $\widetilde{M}_n^{i, c_i(k_n)}$ are linearly interpolated and we define their rescaled versions:

$$\begin{aligned} \widetilde{M}_{(n)}^i &= \left(\left(\frac{9}{8n} \right)^{1/4} \widetilde{M}_n^i(\sqrt{2ns}) \right)_{0 \leq s \leq \frac{2\sigma_n^i + \gamma_n^i}{\sqrt{2n}}} \\ \widetilde{M}_{(n)}^{i, c_i(k_n)} &= \left(\left(\frac{9}{8n} \right)^{1/4} \widetilde{M}_n^{i, c_i(k_n)}(\sqrt{2ns}) \right)_{0 \leq s \leq \frac{2\sigma_n^i + \gamma_n^i}{\sqrt{2n}}} \end{aligned}$$

By Lemma 7.2, $\widetilde{M}_{(n)}^i$ converges in law toward $\widetilde{M}^i = B_{[0, 2\sigma^i]}^{0 \rightarrow \gamma^i}$. Note that $\widetilde{M}_{(n)}^{i, c_i(k_n)}$ also converge toward the same limit.

Note that the processes (C^i, L^i) , $i \in \llbracket 1, 6 \rrbracket$ and \widetilde{M}^i , $i \in \llbracket 1, 3 \rrbracket$ are independent. Moreover, by Skorokhod's theorem, we can assume that these convergences hold almost surely.

We consider that S_n^i is linearly interpolated between its integer values and we define its rescaled version:

$$S_{(n)}^i = \left(\frac{S_n^i(2ns)}{n^{1/4}} \right)_{0 \leq s \leq \frac{2\rho_n^i + \tau_n^i}{2n}}.$$

We have

$$\begin{aligned} S_{(n)}^i(s) &= \frac{1}{n^{1/4}} S_n^i(2ns) \\ &= \frac{1}{n^{1/4}} L_n(2ns) + \frac{1}{n^{1/4}} \widetilde{M}_n^{i, c_i(k_n)}(\overline{C}_n(2ns)) \\ &= L_{(n)}(s) + \left(\frac{8}{9} \right)^{1/4} \widetilde{M}_{(n)}^{i, c_i(k_n)} \left(\sqrt{\frac{3}{2}} \overline{C}_{(n)}(s) \right) \end{aligned}$$

So $S_{(n)}^i$ converge in law toward a limit $S^i : [0, \rho^i] \rightarrow \mathbb{R}$ in the space $(\mathcal{H}, d_{\mathcal{H}})$, where, for $t \in [0, \rho^i]$, we have:

$$S^i(t) = L^i(t) + \left(\frac{8}{9} \right)^{1/4} \widetilde{M}^i \left(\sqrt{\frac{3}{2}} \overline{C}^i(t) \right)$$

We consider that S_n^\bullet is linearly interpolated between its integer values and we define its rescaled version:

$$S_n^\bullet = \left(\frac{S_n^\bullet((2n)s)}{n^{1/4}} \right)_{0 \leq s \leq \frac{2n + \sum_i \sigma_i + 4}{2n}}$$

Therefore we have that the rescaled version of S_n^\bullet converge in law toward $S^\bullet = S^1 \bullet \dots \bullet S^6$ in the space $(\mathcal{H}, d_{\mathcal{H}})$.

It remains to show the convergence of $S_{(n)}$ given that of $S_{(n)}^\bullet$. This is done by noticing that S_n is within bounded distance (in the uniform topology on continuous functions) from a time-change of S_n^\bullet , where the time change itself is within $O(\sqrt{n})$ from the identity. This and the tension of both sequences (or a priori bounds on their moduli of continuity) imply that $S_{(n)}$ and $S_{(n)}^\bullet$ converge to the same limit. \square

10.2 Subsequential convergence of the pseudo-distance function of the unicellular map

We now introduce several definitions similar to those in Section 3. Let a_n^0 be the root angle of T_n and v_n^0 be its root vertex. Let $\ell_n = 4n + 1$. Let Γ_n be the unicellular map obtained from T_n by adding a special dangling half-edge, called the root half-edge, incident to the root angle of T_n . Let λ_n be the labeling function of the angles of Γ_n as defined in Section 3. For each $u \in V_n$, let $A_n(u)$ be the set of angles of Γ_n incident to u . For all $u, v \in V$, let $m(u)$ and $\overline{m}(u, v)$ be as defined in as defined in Section 3.

As in Section 4.5, we define the following pseudo-distance: for $i, j \in \llbracket 0, 2n + 1 \rrbracket$,

$$d_n^o(i, j) = m_n(r_n(i)) + m_n(r_n(j)) - 2\overline{m}_n(r_n(i), r_n(j)).$$

We extend the definition of d_n^o to non-integer values and define its rescaled version $d_{(n)}^o$ as for d_n .

For $s, t \in [0, 1]$, we define:

$$d^o(s, t) = S(s) + S(t) - 2 \min_{x \in [s, t]} S(x).$$

Lemma 10.3. $d_{(n)}^o$ converges in law toward d^o when n goes to infinity.

Proof. By (4.6) we have: for $i, j \in \llbracket 0, 2n + 1 \rrbracket$,

$$|d_n^o(i, j) - (S_n(i) + S_n(j) - 2\overline{S}_n(i, j))| \leq 64 \tag{10.2}$$

By Lemma 3.6 for any $i, j \in \llbracket 0, 2n + 1 \rrbracket$, we have

$$d_n^o(i + 1, j), d_n^o(i, j + 1), d_n^o(i + 1, j + 1) \in \llbracket d_n^o(i, j) - 28, d_n^o(i, j) + 28 \rrbracket.$$

Thus, for $s, t \in [0, 2n + 1]$, we have

$$|d_n^o(s, t) - d_n^o(\lfloor s \rfloor, \lfloor t \rfloor)| \leq 28$$

So, for $s, t \in [0, 1]^2$, we have:

$$\left| d_{(n)}^o(s, t) - d_{(n)}^o\left(\frac{\lfloor (2n+1)s \rfloor}{2n+1}, \frac{\lfloor (2n+1)t \rfloor}{2n+1}\right) \right| \leq \frac{28}{n^{1/4}}$$

Since every vertex is incident to at most two stems and the variation of S^\bullet is at most 1, we have for $s, t \in [0, 2n+1]$:

$$\begin{aligned} |S_n(s) - S_n(\lfloor s \rfloor)| &\leq 3 \\ |\bar{S}_n(s, t) - \bar{S}_n(\lfloor s \rfloor, \lfloor t \rfloor)| &\leq 6 \end{aligned}$$

So, for $s, t \in [0, 1]^2$, we have:

$$\begin{aligned} \left| S_{(n)}(s) - S_{(n)}\left(\frac{\lfloor (2n+1)s \rfloor}{2n+1}\right) \right| &\leq \frac{3}{n^{1/4}} \\ \left| \bar{S}_{(n)}(s, t) - \bar{S}_{(n)}\left(\frac{\lfloor (2n+1)s \rfloor}{2n+1}, \frac{\lfloor (2n+1)t \rfloor}{2n+1}\right) \right| &\leq \frac{6}{n^{1/4}} \end{aligned}$$

Then by (10.2), for $C = 28 + 3 + 3 + 2 \times 6 + 64 = 110$, we have, for all $s, t \in [0, 1]^2$:

$$|d_{(n)}^o(s, t) - (S_{(n)}(s) + S_{(n)}(t) - 2\bar{S}_{(n)}(s, t))| \leq \frac{C}{n^{1/4}} \quad (10.3)$$

where $\bar{S}_{(n)}(s, t) = \max_{x \in [s, t]} S_{(n)}(x)$.

By Lemma 10.2, $S_{(n)}$ converge in law toward S in the space $(\mathcal{H}, d_{\mathcal{H}})$. So $d_{(n)}^o$ converges in law toward d^o . \square

10.3 Convergence for the Gromov-Hausdorff distance

We use the same notations as in previous sections. We first prove the tightness of $d_{(n)}$ and then the convergence for the Gromov-Hausdorff distance.

Lemma 10.4. *The sequence of the laws of the processes*

$$(d_{(n)}(s, t))_{0 \leq s, t \leq 1}$$

is tight in the space of probability measures on $C([0, 1]^2, \mathbb{R})$.

Proof. For every $s, s', t, t' \in [0, 1]$, by triangular inequality for d_{G_n} , we have:

$$\begin{aligned} d_{(n)}(s, t) &\leq d_{(n)}(s, s') + d_{(n)}(s', t') + d_{(n)}(t', t) \\ d_{(n)}(s', t') &\leq d_{(n)}(s', s) + d_{(n)}(s, t) + d_{(n)}(t, t') \end{aligned}$$

Therefore we obtain:

$$|d_{(n)}(s, t) - d_{(n)}(s', t')| \leq d_{(n)}(s, s') + d_{(n)}(t, t').$$

By Lemma 3.9, we have, for $s, t \in [0, 1]$

$$d_{(n)}(s, t) \leq d_{(n)}^o(s, t) + \frac{14}{n^{1/4}}.$$

So we have:

$$|d_{(n)}(s, t) - d_{(n)}(s', t')| \leq d_{(n)}^o(s, s') + d_{(n)}^o(t, t') + \frac{28}{n^{1/4}}.$$

Consider $\varepsilon, \eta > 0$. By Lemma 10.3, $d_{(n)}^o$ converge toward d^o , so by using Fatou's lemma, we have for every $\delta > 0$,

$$\limsup_{n \rightarrow \infty} \mathbb{P} \left(\sup_{|s-s'| \leq \delta} d_{(n)}^o(s, s') \geq \eta \right) \leq \mathbb{P} \left(\sup_{|s-s'| \leq \delta} d^o(s, s') \geq \eta \right). \quad (10.4)$$

Since d^o is continuous and null on the diagonal, therefore there exists $\delta_\varepsilon > 0$ such that:

$$\mathbb{P} \left(\sup_{|s-s'| \leq \delta_\varepsilon} d^o(s, s') \geq \eta \right) \leq \varepsilon. \quad (10.5)$$

By (10.4),(10.5) there exists $n_0 \in \mathbb{N}$ such that for every $n \geq n_0$ we have:

$$\mathbb{P} \left(\sup_{|s-s'| \leq \delta_\varepsilon} d_{(n)}^o(s, s') \geq \eta \right) \leq \varepsilon.$$

By taking n_0 large enough (if necessary) such that $\frac{28}{n^{1/4}} \leq \eta$, we have for every $n \geq n_0$:

$$\mathbb{P} \left(\sup_{|s-s'| \leq \delta_\varepsilon; |t-t'| \leq \delta_\varepsilon} |d_{(n)}(s, t) - d_{(n)}(s', t')| \geq 3\eta \right) \leq 2\varepsilon.$$

By Ascoli's theorem, this completes the proof of lemma. □

We are now able to prove the main result of this section.

Proof of Lemma 10.1. By Lemma 10.4, there exists a subsequence $(n_k)_{k \geq 0}$ and a function $d \in C([0, 1]^2, \mathbb{R})$ such that

$$d_{(n_k)} \xrightarrow{(d)} d. \quad (10.6)$$

By the Skorokhod theorem, we will assume that this convergence holds almost surely. As the triangular inequality holds for each $d_{(n)}$ function, the function d also satisfies the triangular inequality. On the other hand, for $s \in [0, 2n + 1]$, note that we have $d_{(n)}(s, s) \leq 1$. So for $x \in [0, 1]$, we have $d_{(n)}(x, x) = O(n^{-1/4})$. Therefore the function d is actually a pseudo-metric. For $x, y \in [0, 1]^2$, we say that $x \sim_d y$ if $d(x, y) = 0$.

We use the characterization of the Gromov-Hausdorff distance via correspondence. Recall that a *correspondence* between two metric spaces (S, δ) and (S', δ') is a subset $R \subseteq S \times S'$ such that for all $x \in S$, there exists at least one $x' \in S'$ such that $(x, x') \in R$ and vice-versa. The distortion of R is defined by:

$$\text{dis}(R) = \sup \{ |\delta(x, y) - \delta'(x', y')| : (x, x'), (y, y') \in R \}.$$

Therefore we have (see [28])

$$d_{GH}((S, \delta), (S', \delta')) = \frac{1}{2} \inf_R \text{dis}(R),$$

where the infimum is taken over all correspondence R between S and S' .

We define the correspondence R_n between $(\frac{1}{2n+1} \llbracket 0, 2n+1 \rrbracket / \sim_n, d_{(n)})$ and $([0, 1] / \sim_d, d)$ as the set

$$R_n = \left\{ \left(\frac{\pi_n(\lfloor (2n+1)x \rfloor)}{2n+1}, \pi_\infty(x) \right), x \in [0, 1] \right\},$$

where π_n the canonical projection from $\llbracket 0, 2n+1 \rrbracket$ to $\llbracket 0, 2n+1 \rrbracket / \sim_n$ and π is the canonical projection from $[0, 1]$ to $[0, 1] / \sim_d$.

We have

$$\text{dis}(R_n) = \sup_{0 \leq x, y \leq 1} \left| d_{(n)} \left(\frac{\lfloor (2n+1)x \rfloor}{2n+1}, \frac{\lfloor (2n+1)y \rfloor}{2n+1} \right) - d(x, y) \right|$$

By 10.6, we have $\text{dis}(R_{n_k})$ converges toward 0 and thus the following convergence for the Gromov-Hausdorff distance:

$$\left(\frac{1}{2n_k+1} \llbracket 0, 2n_k+1 \rrbracket / \sim_{n_k}, d_{(n_k)} \right) \xrightarrow[k \rightarrow \infty]{(d)} ([0, 1] / \sim_d, d).$$

□

1 Approximation of distance by labels

In this appendix, we show that with high probability, the labeling function defined in Section 4.1 approximates the distance to the root up to a uniform $o(n^{1/4})$ correction. As we mentioned in the introduction, we believe that this is an essential step toward proving uniqueness of the subsequential limit in Theorem 1.2. The proof is quite technical and the estimate itself is not needed in the proof of Theorem 1.2; since it exploits the same rather involved combinatorial construction, we chose to include it here as an appendix rather than to write it as a separate article.

1.1 Rightmost walks and distance properties

Definition and properties of rightmost walks

We use the same notations as in Sections 2 and 3.

For $n \geq 1$, let T be an element of $\mathcal{T}_{r,s,b}(n)$, and $G = \Phi(T)$ the corresponding element of $\mathcal{G}(n)$. The canonical orientation of G is noted D_0 . Recall that, as already mentioned, every vertex of G has outdegree exactly three in D_0 .

For an (oriented) edge e of D_0 , we define the *rightmost walk* from e as the sequence of edges starting by following e , and at each step taking the rightmost outgoing edge among the three outgoing edges at the current vertex. Note that a rightmost walk is necessarily ending on a periodic closed walk since G is finite.

We have the following essential lemma concerning rightmost walks:

Lemma 1.1. *For any edge e of D_0 , the ending part of the rightmost walk from e is the root triangle with the interior of the triangle on its right side.*

Proof. The proof is based on results from [83]. Let e be an edge of D_0 . By [83, Lemma 37], i.e. by the balanced property of the orientation D_0 , the end of the rightmost walk from e is a triangle A with the interior of the triangle on its right side. By [83, Lemma 25], i.e. by minimality of the orientation D_0 , the interior of A must contain the root face f_0 of G . The root face is incident to the root triangle A_0 by definition. Since the outdegree of all the edges is three, a classic counting argument using Euler's formula gives that all the edges in the interior of A_0 and incident to it are entering A_0 . So it is not possible that A is entering in the interior of A_0 . Since f_0 is in the interior of both A and A_0 , we have that the interior of A contains the interior of A_0 . Then by maximality of A_0 , we have that $A = A_0$. \square

By Lemma 1.1, any rightmost walk visit the root vertex. For an edge e of D_0 , we define the *right-to-root walk*, noted $W_R(e)$, as the subwalk of the rightmost walk started from e that stops at the first visit of the root vertex v_0 .

Recall that, for $0 \leq i \leq \ell$, the set $\mathcal{A}(i)$ denote the set of angles of G^+ which are splitted from a_i by the complete closure procedure. Let f be the mapping that associate to an angle α of G^+ the integer i such that $\alpha \in \mathcal{A}(i)$. Let g be the mapping that associate to an angle α of Γ the integer i such that $\alpha = a_i$.

Depending of the type of the unicellular map, i.e. hexagonal or square, and the fact that r_s is special or not, we define three particular angles x_1, x_2 and x_3 of Γ , as represented on Figure .22. Note that in the particular case where $r_s \in S$, we have $x_1 = x_2$. Moreover, let $x_0 = a_0$ and $x_4 = a_\ell$. Then, for $1 \leq j \leq 4$, let $X_j = \bigcup_{g(x_{j-1}) \leq i < g(x_j)} \mathcal{A}(i)$. Note that $X_2 = \emptyset$ if $x_1 = x_2$. Thus the set of angles of G^+ is partitioned into the four sets X_1, \dots, X_4 such that if $\alpha \in X_i$ and $\alpha' \in X_j$, with $i < j$, then $f(\alpha) < f(\alpha')$.

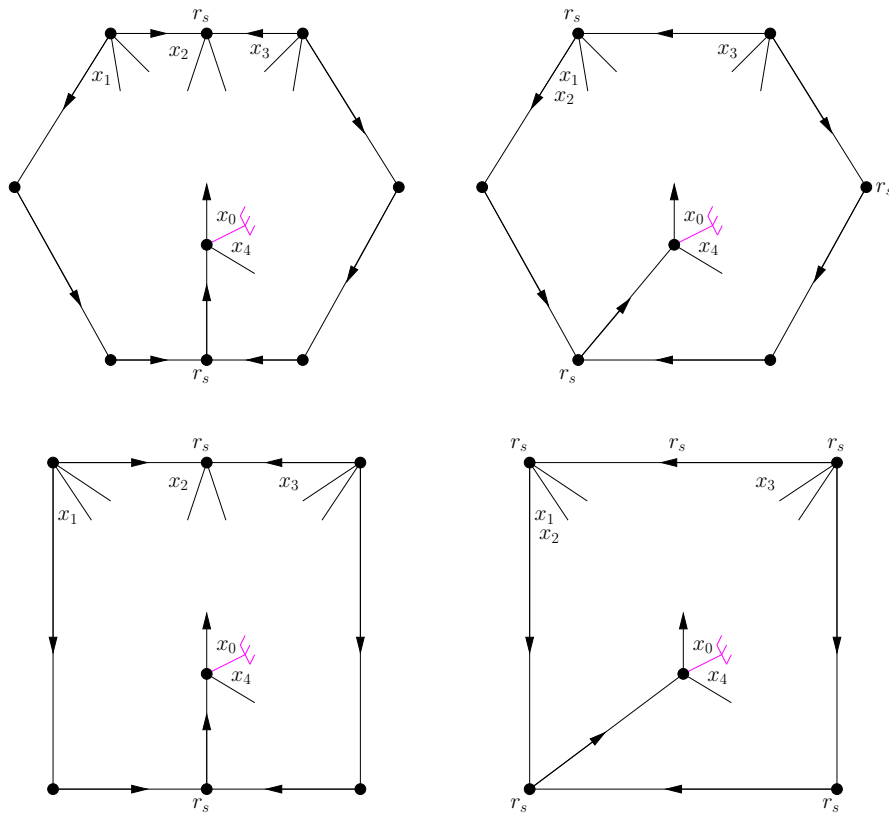

Figure .22 – Definition of the angles x_1, x_2 and x_3 depending on the type of unicellular map.

The partition (X_1, \dots, X_4) has been defined to satisfied the following property. Consider an edge $e = uv$ of $E_P \cup E_R$, oriented from u to v in the canonical orientation, with angles a, a' of G^+ incident to e that appears in counterclockwise order around v . Then, one can see on Figure .22 that $a \in (X_1 \cup X_3)$. Moreover if a in X_1 (resp. in X_3), then a' is in $X_2 \cup X_3 \cup X_4$ (resp. in X_4).

Given an edge $\{u, v\}$ of G^+ , we note $a^\ell(u, v)$ (respectively $a^r(u, v)$) the angle incident to u that is just after $\{u, v\}$ in counterclockwise order (resp clockwise order) around u .

Consider $e \in D_0$, and $W_R(e)$ the right-to-root walk starting from e , whose sequence of vertices is $(u_j)_{0 \leq j \leq k}$, with $k > 0$. We define two sequence of angles of G^+ incident to the right side of W_R . For $0 \leq i \leq k - 1$, let $\alpha_i = a^r(u_i, u_{i+1})$. For $1 \leq i \leq k$, let $\beta_i = a^\ell(u_i, u_{i-1})$. Note that, for $0 < i < k$, we might have $\alpha_i = \beta_i$ if there is no edges incident to the right side of $W_R(e)$ at u_i .

Lemma 1.2. *For $0 \leq i \leq k - 1$, we have $\lambda(\beta_{i+1}) - \lambda(\alpha_i) = -1$. For $1 \leq i \leq k - 1$, we have $-6 \leq \lambda(\alpha_i) - \lambda(\beta_i) \leq 0$. Moreover $|\{i \in \llbracket 1, k - 1 \rrbracket : \lambda(\alpha_i) < \lambda(\beta_i)\}| \leq 2$ and $f(\alpha_0) < f(\beta_1) \leq f(\alpha_1) < \dots < f(\beta_{k-1}) \leq f(\alpha_{k-1}) < f(\beta_k)$.*

Proof. Let $0 \leq i \leq k - 1$ and consider the edge $\{u_i, u_{i+1}\}$. We have $\{u_i, u_{i+1}\}$ is either in $E(\Gamma)$ or not. If $\{u_i, u_{i+1}\} \notin E(\Gamma)$, let s be a stem such that we reattach s to an angle that comes from $a(s)$ to form the edge $\{u_i, u_{i+1}\}$ of G . By Lemma 3.1, we have $\lambda(\beta_{i+1}) = \lambda(a(s)) = \lambda(s) - 1 = \lambda(\alpha_i) - 1$. Moreover since U is safe, we have $f(\beta_{i+1}) > f(\alpha_i)$. If $\{u_i, u_{i+1}\} \in E(\Gamma)$, we also have $\lambda(\beta_{i+1}) = \lambda(\alpha_i) - 1$ and $f(\beta_{i+1}) > f(\alpha_i)$.

Consider $1 \leq i \leq k - 1$. By Lemma 3.5, we have $-6 \leq \lambda(\alpha_i) - \lambda(\beta_i)$. Let $(\gamma_1^i, \dots, \gamma_{p_i}^i)$, with $p_i \geq 1$, be the set of consecutive angles of G^+ between $\beta_i = \gamma_1^i$ and $\alpha_i = \gamma_{p_i}^i$ in counterclockwise order around u_i . Since $W_R(e)$ is a right-to-root walk, if $p_i > 1$, then all the edges that are incident to u_i between two consecutive angles γ_j^i and γ_{j+1}^i , with $1 \leq j < p_i$, are entering u_i . So, by Lemma 3.4, for $1 \leq j < p_i$, we have $\lambda(\gamma_{j+1}^i) - \lambda(\gamma_j^i) \leq 0$. Moreover, we have $\lambda(\gamma_{j+1}^i) - \lambda(\gamma_j^i) < 0$ if and only if the edge entering u_i between γ_j^i and γ_{j+1}^i is in $E_P \cup E_R$. Thus we have $\lambda(\alpha_i) - \lambda(\beta_i) \leq 0$, and, for $1 \leq j < p_i$, we have $f(\gamma_{j+1}^i) \geq f(\gamma_j^i)$.

We obtain that the sequence

$$(f_p)_{0 \leq p \leq r} = (f(\alpha_0), f(\gamma_1^1), \dots, f(\gamma_{p_1}^1), \dots, f(\gamma_1^{k-1}), \dots, f(\gamma_{p_{k-1}}^{k-1}), f(\beta_k))$$

is increasing and thus $f(\alpha_0) < f(\beta_1) \leq f(\alpha_1) < \dots < f(\beta_{k-1}) \leq f(\alpha_{k-1}) < f(\beta_k)$. This also implies that the sequence $I = (\{i : f_p \in X_i\})_{0 \leq p \leq r}$ is increasing.

If there is a couple (i, j) , with $1 \leq i \leq k - 1$, and $1 \leq j < p_i$, such that the edge incident to γ_j^i and γ_{j+1}^i is in $E_P \cup E_R$, then either $\gamma_j^i \in X_1$ and $\gamma_{j+1}^i \in X_2 \cup X_3 \cup X_4$, or, $\gamma_j^i \in X_3$ and $\gamma_{j+1}^i \in X_4$. Since I is increasing, this implies that there is at most two such couples (i, j) . So $|\{i \in \llbracket 1, k - 1 \rrbracket : \lambda(\alpha_i) < \lambda(\beta_i)\}| \leq 2$. \square

Lemma 1.3. *For all $e = uv \in D_0$, we have*

$$m(u) - 18 \leq |W_R(e)| \leq m(u) + 6.$$

Proof. By Lemma 1.2, the sequence $(\lambda(\alpha_0), \lambda(\beta_1), \lambda(\alpha_1), \dots, \lambda(\beta_{k-1}), \lambda(\alpha_{k-1}), \lambda(\beta_k))$ is decreasing by one between α_i and β_{i+1} , for $0 \leq i \leq k-1$, it is constant between β_i and α_i , for $1 \leq i \leq k-1$, except for at most two value $1 \leq i \leq k-1$ where it can decrease by at most 6. So $\lambda(\alpha_0) - \lambda(\beta_k) - 2 \times 6 \leq |W_R(e)| \leq \lambda(\alpha_0) - \lambda(\beta_k)$. By Lemma 3.5, we have $m(u) \leq \lambda(\alpha_0) \leq m(u) + 6$ and $0 \leq \lambda(\beta_k) \leq 6$. So $m(u) - 18 \leq |W_R(e)| \leq m(u) + 6$. \square

We define

$$t = \begin{cases} 3 & \text{if } \Gamma \text{ is hexagonal and } r_s \notin S \\ 4 & \text{if } \Gamma \text{ is hexagonal and } r_s \in S \\ 4 & \text{if } \Gamma \text{ is square and } r_s \notin S \\ 5 & \text{if } \Gamma \text{ is square and } r_s \in S \end{cases}$$

and $t-1$ particular angles y_1, \dots, y_{t-1} of Γ , as represented on Figure .23. Moreover, let $y_0 = a_0$ and $y_t = a_\ell$. Then, for $1 \leq j \leq t$, let $Y_j = \bigcup_{g(y_{j-1}) \leq i < g(y_j)} \mathcal{A}(i)$. Thus the set of angles of G^+ is partitioned into the t sets (Y_1, \dots, Y_t) such that if $\alpha \in Y_i$ and $\alpha' \in Y_j$, with $i < j$, then $f(\alpha) < f(\alpha')$.

The partition (Y_1, \dots, Y_t) has been defined to satisfied the following property. For any vertex v , each set of consecutive angles around v that is delimited by edges of $E_P \cup E_R$ lies in a different set Y_j .

We define the *right-to-root path* $P_R(e)$ starting at e and ending at v_0 , obtained by deleting edges from $W_R(e)$ by the following method. We follow $W_R(e)$ from e , the first time we meet a vertex v that appears twice in the sequence of vertices $(u_i)_{0 \leq i \leq k}$ of $W_R(e)$. Let $m = \min\{i : u_i = v\}$ and $M = \max\{i : u_i = v\}$. Then we delete all the edges of $W_R(e)$ between u_m and u_M . We repeat the process until reaching v_0 . Note that $P_R(e)$ is not ‘‘rightmost’’. For $e \in D_0$, let $h(e)$ be the set of inner vertices of $P_R(e)$ that have outgoing edges on the right side of $P_R(e)$.

Lemma 1.4. $|P_R(e)| \leq |W_R(e)| \leq |P_R(e)| + 24$ and $|h(e)| \leq 4$.

Proof. Consider a vertex v appearing at least twice in the sequence $(u_i)_{0 \leq i \leq k}$. Let $m = \min\{i : u_i = v\}$ and $M = \max\{i : u_i = v\}$. We have $0 \leq m < M \leq k$. By Lemma 1.2, we have $f(\alpha_m) < f(\beta_M)$ and $\lambda(\beta_M) \leq \lambda(\alpha_m) - (M - m)$. By Lemma 3.5, we have $\lambda(\alpha_m) - 6 \leq \lambda(\beta_M)$. So $M - m \leq 6$.

Suppose by contradiction that there is $1 \leq p \leq t$, such that α_m and β_m are in Y_p . Then α and β lie in the same set of consecutive angles around v delimited by edges of $E_P \cup E_R$. Since $f(\alpha_m) < f(\beta_M)$, there is no edge of $E_P \cup E_R$ incident to v in the counterclockwise sector from α_m to β_M . Moreover, all the edges of E_N incident to v in this sector are entering v . So By Lemma 3.4, the sequence of labels from α_m to β_M is

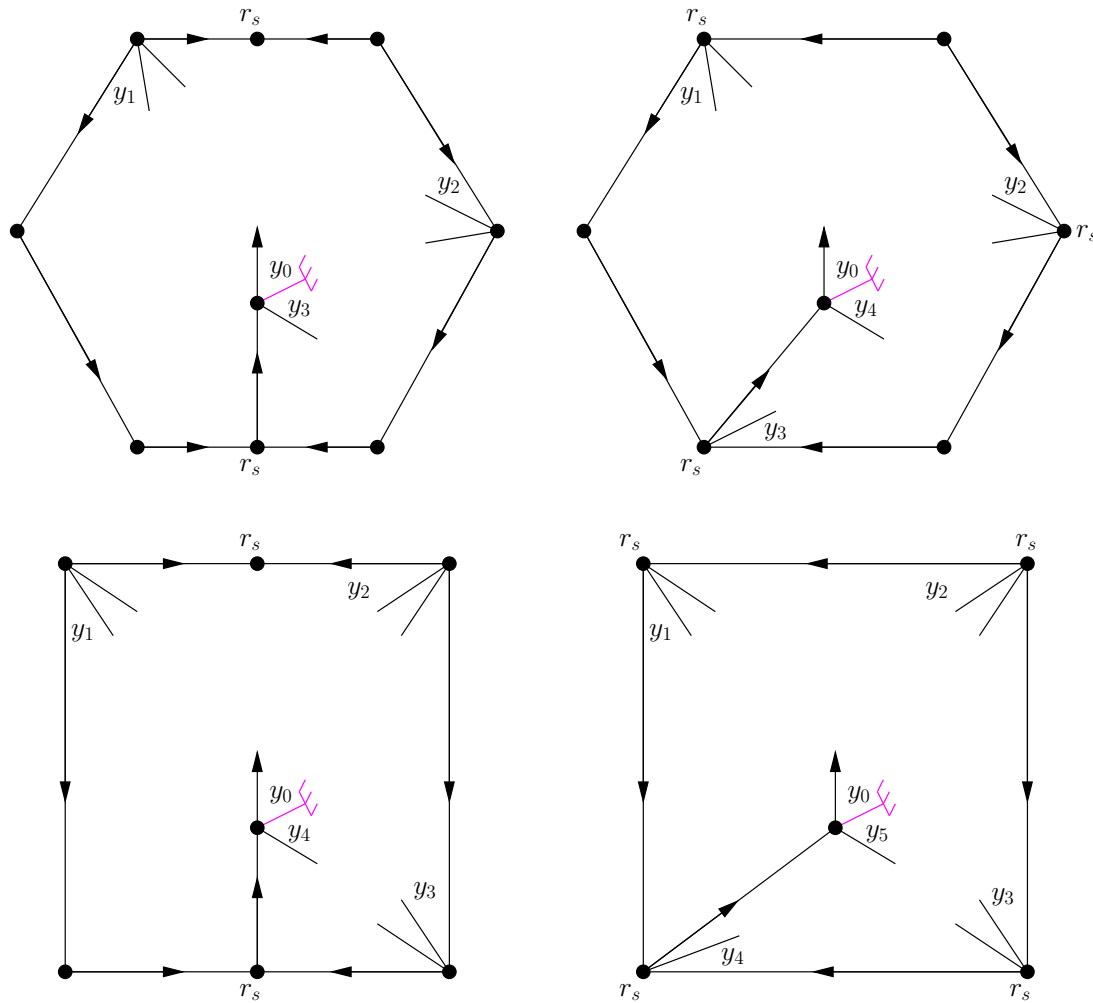

Figure .23 – Definition of the angles y_1, \dots, y_{t-1} .

increasing around v in counterclockwise order. So $\lambda(\alpha_m) \leq \lambda(\beta_M)$, a contradiction. So there exists $1 \leq p < q \leq t$, such that $\alpha_m \in Y_p$ and $\beta_M \in Y_q$.

With the same notations as in Lemma 1.2, the sequence

$$(f_p)_{0 \leq p \leq r} = (f(\alpha_0), f(\gamma_1^1), \dots, f(\gamma_{p_1}^1), \dots, f(\gamma_1^{k-1}), \dots, f(\gamma_{p_{k-1}}^{k-1}), f(\beta_k))$$

is increasing. Thus the sequence $I = (\{i : f_p \in Y_i\})_{0 \leq p \leq r}$ is increasing.

The path $P_R(e)$ is obtained by following $W_R(e)$ from e , each time we meet a vertex v that appears twice in the sequence of vertices of $W_R(e)$, then we delete all the edges of $W_R(e)$ between u_m and u_M . Since $M - m \leq 6$, we have deleted at most 6 edges from $W_R(e)$. Since there exists $1 \leq p < q \leq t \leq 5$ with $\alpha_m \in Y_p$ and $\beta_M \in Y_q$, and the sequence I is increasing, there is at most 4 such steps of deletions. Thus in total, we

have deleted at most 24 edges to obtain $P_R(e)$ from $W_R(e)$ and there are at most 4 inner vertices of $P_R(e)$ that have outgoing edges on the right side of $P_R(e)$. \square

Finally we obtain the following lemma by combining Lemmas 1.3 and 1.4:

Lemma 1.5. *For all $e = uv \in D_0$, we have*

$$m(u) - 42 \leq |P_R(e)| \leq m(u) + 6$$

Relation with shortest paths

Let $e = uv \in D_0$. Consider $P_R(e) = (u_0 = u, u_1 = v, \dots, u_k = v_0)$ the right-to-root path starting at e and $h(e)$ the set of inner vertices of $P_R(e)$ that have outgoing edges on the right side of $P_R(e)$. Recall that $|h(e)| \leq 4$ by Lemma 1.4.

Let $S = (w_0, w_1, \dots, w_p)$ be a path of G with distinct extremities and meeting $P(e)$ only at w_0 and w_p , such that $w_0 = u_i$ and $w_p = u_j$ for $0 \leq i < j \leq k$. Let $C = (w_0, \dots, w_p = u_j, \dots, u_i)$ be the cycle formed by the union of S and (u_i, \dots, u_j) , given with the traversal direction corresponding to S oriented from w_0 to w_p .

We say that S leaves $P_R(e)$ from the right if $i > 0$ and S leaves $P_R(e)$ by its right side. Otherwise, we say that S leaves $P_R(e)$ from the left. In particular, if $i = 0$, then S leaves $P_R(e)$ from the left, by convention. Likewise, we say that S enters $P_R(e)$ from the right if $j < k$ and S enters $P_R(e)$ by its right side. Otherwise, we say that S enters $P_R(e)$ from the left. In particular, if $j = k$, then S enters $P_R(e)$ from the left, by convention.

We define different possible types for S , depending on whether S is leaving/entering on the left or right side of $P_R(e)$, whether C is contractible or not, and whether C contains some vertices of $V(e)$ or not. We say that S has type LR (respectively type RR , type RL , type LL) if S leaves $P_R(e)$ from the left (respectively right, right, left), enters $P_R(e)$ from the right (respectively right, left, left). When C is contractible, we add the subscript ℓ or r depending on whether C delimits a region homeomorphic to an open disk on its left or right side. When C is non-contractible, we add the subscript n . When C contains some vertices of $h(e)$, we add the superscript h . Thus we have defined twenty-four types $LR_\ell, RR_\ell, RL_\ell, LL_\ell, LR_r, RR_r, RL_r, LL_r, LR_n, RR_n, RL_n, LL_n, LR_\ell^h, RR_\ell^h, RL_\ell^h, LL_\ell^h, LR_r^h, RR_r^h, RL_r^h, LL_r^h, LR_n^h, RR_n^h, RL_n^h, LL_n^h$ so that a path S as defined above is of exactly one type.

We show the following inequality between p , i and j depending on the type:

Lemma 1.6. *We have $p \geq j - i + c$ where c is a constant given in Table .2 that depends on the type of S .*

Proof. Suppose first that C is contractible. Let R be the region homeomorphic to an open disk that is delimited by C . Let t be the size of C , so $t = j - i + p$. Let G' be the

LR_ℓ	RR_ℓ	RL_ℓ	LL_ℓ	LR_r	RR_r	RL_r	LL_r	LR_n	RR_n	RL_n	LL_n
-2	0	-3	-5	4	6	3	1	1	3	0	-2

LR_ℓ^h	RR_ℓ^h	RL_ℓ^h	LL_ℓ^h	LR_r^h	RR_r^h	RL_r^h	LL_r^h	LR_n^h	RR_n^h	RL_n^h	LL_n^h
-10	-8	-11	-13	-4	-2	-5	-7	-3	-1	-4	-6

Table .2 – Values of c in Lemma 1.6.

planar map formed by all the vertices and edges that lie in R (including its border). Let n', m', f' be the number of vertices, edges, faces of G' respectively. By Euler's formula, we have $n' - m' + f' = 2$. All inner faces of G' have degree three and its outer face has degree t , so $3(f' - 1) = 2m' - t$. Let y be the number of edges in the interior of R incident to C and leaving C . Since G is 3-orientation, it follows that $m' = 3(n' - t) + y + t$. So, by combining the three equalities, we have

$$y = t - 3 \tag{1.1}$$

Assume that S is of type LR_ℓ . For $i < m \leq j$, the number of edges that are in the interior of R and leaving u_m is 0. Then we obtain $y \leq 3p - p - 1$. By (1.1), we obtain $p \geq j - i - 2$.

Assume that S is of type RR_ℓ . For $i \leq m \leq j$, the number of edges that are in the interior of R and leaving u_m is 0. Then we obtain $y \leq 3(p - 1) - p$. By (1.1), we obtain $p \geq j - i$.

Assume that S is of type RL_ℓ . For $i \leq m < j$, the number of edges that are in the interior of R and leaving u_m is 0. Then we obtain $y \leq 3p - p$. By (1.1), we obtain $p \geq j - i - 3$.

Assume that S is of type LL_ℓ . For $i < m < j$, the number of edges that are in the interior of R and leaving u_m is 0. Then we obtain $y \leq 3(p + 1) - p - 1$. By (1.1), we obtain $p \geq j - i - 5$.

When S is of type $LR_\ell^h, RR_\ell^h, RL_\ell^h, LL_\ell^h$. The argument is exactly the same as above except that there might be some vertices of $h(e)$ along C . Each such vertex has at most 2 edges leaving in the interior of R and there is at most 4 such vertices along C . So we obtain a difference of 8 between the two rows of Table .2 for these cases.

Assume that S is of type LR_r . For $i < m \leq j$, the number of edges that are in the interior of R and leaving u_m is 2 if $m < j$ and 3 if $m = j$. Then we obtain $y \geq 2(j - i - 1) + 3$. By (1.1), we obtain $p \geq j - i + 4$.

Assume that S is of type RR_r . For $i \leq m \leq j$, the number of edges that are in the interior of R and leaving u_m is 2 if $m < j$ and 3 if $m = j$. Then we obtain $y \geq 2(j - i) + 3$. By (1.1), we obtain $p \geq j - i + 6$.

Assume that S is of type RL_r . For $i \leq m < j$, the number of edges that are in the interior of R and leaving u_m is 2. Then we obtain $y \geq 2(j - i)$. By (1.1), we obtain $p \geq j - i + 3$.

Assume that S is of type LL_r . For $i < m < j$, the number of edges that are in the interior of R and leaving u_m is 2. Then we obtain $y \geq 2(j - i - 1)$. By (1.1), we obtain $p \geq j - i + 1$.

Again, when S is of type $LR_r^h, RR_r^h, RL_r^h, LL_r^h$. The argument is exactly the same as above except that there might be some vertices of $h(e)$ along C . Each such vertex has at most 2 edges leaving on the right side of $P_R(e)$, i.e. outside R , and there is at most 4 such vertices along C . So we obtain a difference of 8 between the two rows of Table .2 for these cases.

Suppose now that C is non-contractible

Assume that S is of type LR_n . For $i < m \leq j$, the number of outgoing edges that are incident to u_m and leaving C by its right side is equal to 2 if $m < j$ and 3 if $m = j$. So the number of edges leaving C by its right is at least $2(j - i - 1) + 3$. Moreover the number of edges leaving C by its left side is at most $3p - p - 1$. Since D_0 is balanced, we have exactly the same number of outgoing edges incident to each side of C . Then we obtain $p \geq j - i + 1$.

Assume that S is of type RR_n . For $i \leq m \leq j$, the number of outgoing edges that are incident to u_m and leaving C by its right side is equal to 2 if $m < j$ and 3 if $m = j$. So the number of edges leaving C by its right is at least $2(j - i) + 3$. Moreover the number of edges leaving C by its left side is at most $3(p - 1) - p$. Since D_0 is balanced, we obtain $p \geq j - i + 3$.

Assume that S is of type RL_n . For $i \leq m < j$, the number of outgoing edges that are incident to u_m and leaving C by its right side is equal to 2. So the number of edges leaving C by its right is at least $2(j - i)$. Moreover the number of edges leaving C by its left side is at most $3p - p$. Since D_0 is balanced, we obtain $p \geq j - i$.

Assume that S is of type LL_n . For $i < m < j$, the number of outgoing edges that are incident to u_m and leaving C by its right side is equal to 2. So the number of edges leaving C by its right is at least $2(j - i - 1)$. Moreover the number of edges leaving C by its left side is at most $3(p + 1) - p - 1$. Since D_0 is balanced, we obtain $p \geq j - i - 2$.

Again, when S is of type $LR_n^h, RR_n^h, RL_n^h, LL_n^h$. The argument is exactly the same as above except that there might be some vertices of $h(e)$ along C . There is a division by two in the computation of these cases that results in a difference of 4 between the two rows of Table .2 for these cases. \square

Let Q be a shortest path from u to v_0 that maximizes the number of common edges with $P_R(e)$. Subdivide Q into edge-disjoint sub-paths S_1, S_2, \dots, S_t , each of which meets

$P_R(e)$ only at its (distinct) endpoints. For $1 \leq q \leq t$, note that S_q is not necessarily edge-disjoint from $P_R(e)$, but if S_q share an edge with $P(e)$ then it has length 1. We assume that S_1, S_2, \dots, S_t are ordered so that Q is the concatenation of S_1, S_2, \dots, S_t , so in particular, u_0 is the first vertex of S_1 and u_k is the last vertex of S_t . For $1 \leq q \leq t$, note that S_q is not necessarily of a type define previously since such a path might starts (resp. ends) at a vertex u_i (resp. u_j) of $P_R(e)$ such that $j < i$.

For i, j in $\{0, k\}$, the sub-path of $P_R(e)$ between u_i and u_j is denoted by $P_R(e)[i, j]$. Likewise, if u_i, u_j are vertices of Q , then the sub-path of Q between u_i and u_j is denoted by $Q[i, j]$.

Lemma 1.7. *Consider $1 \leq q \leq q + 9 \leq q' \leq t$ such that S_q starts at a vertex u_i , ends at vertex u_j , with $i < j$, and $(u_{i'}, u_{j'})$ are the extremities of $S_{q'}$ with $i' \leq j'$ (note that $S_{q'}$ may starts at $u_{i'}$ or $u_{j'}$). Then we have $j < i'$.*

Proof. Suppose by contradiction that $i' \leq j$. We define:

$$q_1 = \min\{q \in \llbracket 1, t \rrbracket : S_q \text{ starts at } u_{i''}, \text{ ends at } u_{j''} \text{ with } i'' \leq i' \leq j''\}$$

Note that $q_1 \leq q$. Let (i_1, j_1) be such that S_{q_1} starts at u_{i_1} , ends at u_{j_1} . For $2 \leq r \leq 8$, let $q_r = q_1 + r$. Note that $q_8 < q + 9 \leq q'$. Let p_1, \dots, p_8 be the lengths of S_{q_1}, \dots, S_{q_8} respectively. By Lemma 1.6, we have $p_1 \geq j_1 - i_1 - 13$. Moreover, we have $|Q[i_1, i']| \geq p_1 + \dots + p_8 \geq p_1 + 7$. Since Q is a shortest path, we have $|P_R(e)[i', j_1]| \geq |Q[j_1, i']| \geq p_2 + \dots + p_8 \geq 7$. We obtain the following contradiction:

$$|P_R(e)[i_1, i']| = |P_R(e)[i_1, j_1]| - |P_R(e)[i', j_1]| \leq j_1 - i_1 - 7 \leq p_1 + 6 \leq |Q[i_1, i']| - 1.$$

□

For all types $\xi \in \{LR_\ell, RR_\ell, RL_\ell, LL_\ell, LR_r, RR_r, RL_r, LL_r, LR_n, RR_n, RL_n, LL_n\}$, let $n_\xi(Q, e) = |\{j \in \{1, \dots, t\} : S_j \text{ has type } \xi\}|$.

Lemma 1.8. $n_{LL_\ell}(Q, e) \leq 2$

Proof. Suppose by contradiction that $n_{LL_\ell}(Q, e) \geq 3$. Let q_1, q_2, q_3 be three distinct elements of $\{1, \dots, t\}$ such that S_{q_1}, S_{q_2} and S_{q_3} have type LL_ℓ . For $1 \leq r \leq 3$, let (u_{i_r}, u_{j_r}) , be the extremities of S_{q_r} , such that S_{q_r} starts at u_{i_r} and ends at u_{j_r} . Let p_1, p_2 and p_3 be the length of S_{q_1}, S_{q_2} and S_{q_3} . We assume, w.l.o.g., that $i_1 < i_2 < i_3$. Then, one can see that $i_1 < i_2 < i_3 < j_3 < j_2 < j_1$. By Lemma 1.6, we have $p_1 \geq j_1 - i_1 - 5$. Let $q_m = \min\{q_1, q_2, q_3\}$ and $q_M = \max\{q_1, q_2, q_3\}$. Since Q is a shortest path we have $|P_R(e)[i_1, i_m]| + |P_R(e)[j_M, j_1]| \geq |Q[i_m, i_1]| + |Q[j_1, j_M]|$. Moreover, whenever $q_1 = q_m$, $q_1 = q_M$ or $q_m < q_1 < q_M$, one can check that $|Q[i_m, i_1]| + |Q[j_1, j_M]| \geq 4$. We also have $|Q[i_m, j_M]| \geq p_1 + p_2 + p_3 + 2 \geq p_1 + 4$.

Then we obtain the following contradiction:

$$\begin{aligned}
 |P_R(e)[i_m, j_M]| &= |P_R(e)[i_1, j_1]| - |P_R(e)[i_1, i_m]| - |P_R(e)[j_M, j_1]| \\
 &\leq (j_1 - i_1) - |Q[i_m, i_1]| - |Q[j_1, j_M]| \\
 &\leq (j_1 - i_1) - 4 \\
 &\leq p_1 + 1 \\
 &\leq |Q[i_m, j_M]| - 3
 \end{aligned}$$

□

For $1 \leq z \leq |h(e)|$, we define

$$t_z = \min\{q \in \llbracket 1, t \rrbracket : S_q \text{ ends at } u_j \text{ with } P_R(e)[0, u_j] \text{ contains at least } z \text{ elements of } h(e)\}$$

Let $X = \cup_{1 \leq z \leq h(e)} \llbracket t_z, t_z + 18 \llbracket$ and $Y = \llbracket 1, t \rrbracket \setminus X$ and $Z = \llbracket 1, t \rrbracket \setminus Y$. So $\llbracket 1, t \rrbracket$ is partitioned into Y, Z . By Lemma 1.4, we have $h(e) \leq 4$, so $|Z| \leq 4 \times 18 = 72$. Note that Y has been defined so that it satisfies the following by Lemma 1.7: if $q, q' \in \llbracket 1, t \rrbracket$ are such that $q \in Y$, $q-9 \leq q' \leq q$, and $S_{q'}$ has extremities (u_i, u_j) , then $P_R(e)[i, j]$ contains no vertex of $h(e)$. For $q \in \{1, \dots, t\}$, we say that S_q has type h if S_q is of one of the type $LR_\ell^h, RR_\ell^h, RL_\ell^h, LL_\ell^h, LR_r^h, RR_r^h, RL_r^h, LL_r^h, LR_n^h, RR_n^h, RL_n^h, LL_n^h$.

Lemma 1.9. *Consider $q_1, q_2 \in Y$, such that $q_1 < q_2$ and S_{q_1}, S_{q_2} are of type LL_n . If i_1, j_1, i_2, j_2 are such that S_{q_1}, S_{q_2} have extremities (u_{i_1}, u_{j_1}) and (u_{i_2}, u_{j_2}) with $i_1 < j_1$ and $i_2 < j_2$, then $j_1 \leq i_2$.*

Proof. Suppose by contradiction that $i_2 < j_1$. Let p_1, p_2 be the length of S_{q_1} and S_{q_2} . By Lemma 1.6, we have $p_1 \geq j_1 - i_1 - 2$. Since $q_1 < q_2$ we have $i_1 \neq j_2, i_1 \neq i_2$ and $j_1 \neq j_2$. We consider the four following cases: $j_2 < i_1$ or $i_1 < j_2 < j_1$ or $i_2 < i_1 < j_1 < j_2$ or $i_1 < i_2 < j_1 < j_2$.

- If $j_2 < i_1$: Let $q_0 = \max\{q \in \llbracket 1, q_1 \rrbracket : S_q \text{ starts at } u_i, \text{ ends at } u_j \text{ with } i \leq j_2 \leq j\}$. Let (u_{i_0}, u_{j_0}) be the extremities of S_{q_0} with $i_0 \leq j_2 \leq j_0$. Let p_0 be the length of S_{q_0} . Since $i_0 \leq j_2 \leq j_0$, by definition of Y and Lemma 1.7, we have that S_{q_0} is not of type h . By Lemma 1.6, we have $p_0 \geq j_0 - i_0 - 5$. Moreover, we have $|Q[i_0, j_2]| \geq p_0 + p_1 + p_2 + 1 \geq p_0 + 3$. Since Q is a shortest path, we have $|P_R(e)[j_2, j_0]| \geq |Q[j_0, j_2]| \geq p_1 + p_2 + 1 \geq 3$. We obtain the following contradiction:

$$|P_R(e)[i_0, j_2]| = |P_R(e)[i_0, j_0]| - |P_R(e)[j_2, j_0]| \leq j_0 - i_0 - 3 \leq p_0 + 2 \leq |Q[i_0, j_2]| - 1$$

- If $i_1 < j_2 < j_1$: We have $|Q[i_1, j_2]| \geq p_1 + p_2 + 1 \geq p_1 + 2$. Since Q is a shortest path, we have $|P_R(e)[j_2, j_1]| \geq |Q[j_1, j_2]| \geq 1 + p_2 \geq 2$. We obtain the following contradiction:

$$|P_R(e)[i_1, j_2]| = |P_R(e)[i_1, j_1]| - |P_R(e)[j_2, j_1]| \leq j_1 - i_1 - 2 \leq p_1 \leq |Q[i_1, j_2]| - 2$$

- If $i_2 < i_1 < j_1 < j_2$: Let $q_0 = \max\{q \in \llbracket 1, q_1 \rrbracket : S_q \text{ starts at } u_i, \text{ ends at } u_j \text{ with } i \leq i_2 \leq j\}$. Let (u_{i_0}, u_{j_0}) be the extremities of S_{q_0} with $i_0 \leq i_2 \leq j_0$. Let p_0 be the length of S_{q_0} . Since $i_0 \leq i_2 \leq j_0$, by definition of Y and Lemma 1.7, we have that S_{q_0} is not of type h . We consider two cases depending on whether $j_2 \leq j_0$ or not.
 - $j_2 \leq j_0$: By Lemma 1.6, we have $p_0 \geq j_0 - i_0 - 5$. Moreover, we have $|Q[i_0, j_2]| \geq p_0 + p_1 + p_2 + 2 \geq p_0 + 4$. Since Q is a shortest path, we have $|P_R(e)[j_0, j_2]| \geq p_1 + p_2 + 2 \geq 4$. We obtain the following contradiction:

$$\begin{aligned} |P_R(e)[i_0, j_2]| &= |P_R(e)[i_0, j_0]| - |P_R(e)[j_2, j_0]| \leq j_0 - i_0 - 4 \leq p_0 + 1 \\ &\leq |Q[i_0, j_2]| - 3 \end{aligned}$$

- $j_0 < j_2$: We have $i_0 < i_2 < j_0 < j_2$ so one can remark that S_{q_0} is not of type LL_ℓ . By Lemma 1.6, we have $p_0 \geq j_0 - i_0 - 3$. Moreover, we have $|Q[i_0, i_2]| \geq p_0 + p_1 + 1 \geq p_0 + 2$. Since Q is a shortest path, we have $|P_R(e)[i_2, j_0]| \geq |Q[j_0, i_2]| \geq p_1 + 1 \geq 2$. We obtain the following contradiction:

$$|P_R(e)[i_0, i_2]| = |P_R(e)[i_0, j_0]| - |P_R(e)[i_2, j_0]| \leq j_0 - i_0 - 2 \leq p_0 + 1 \leq |Q[i_0, i_2]| - 1$$

- $i_1 < i_2 < j_1 < j_2$: We have $|Q[i_1, i_2]| \geq p_1 + 1$. Since Q is a shortest path, we have $|P_R(e)[i_2, j_1]| \geq |Q[j_1, i_2]| \geq 1$. We obtain the following:

$$|P_R(e)[i_1, i_2]| = |P_R(e)[i_1, j_1]| - |P_R(e)[i_2, j_1]| \leq j_1 - i_1 - 1 \leq p_1 + 1 \leq |Q[i_1, i_2]|$$

Since Q is a shortest path, we obtain $|P_R(e)[i_1, i_2]| = |Q[i_1, i_2]|$. Consider the walk Q' obtain by replacing the part $Q[i_1, i_2]$ in Q by $P_R(e)[i_1, i_2]$. Thus Q' is a walk from u_0 to v_0 that have the same length as Q , so Q' is a shortest path. Moreover Q' has strictly more edges of $P_R(e)$ than Q , a contradiction. □

Let $n_{LL_n}^Y(Q, e)$ be the number of integers in $q \in Y$ such that S_q has type LL_n .

Lemma 1.10. $n_{LL_n}^Y(Q, e) \leq 2$

Proof. Suppose by contradiction that $n_{LL_n}^Y(Q, e) \geq 3$. Let q_1, q_2, q_3 be three distinct elements of Y such that S_{q_1}, S_{q_2} and S_{q_3} are of type LL_n and $q_1 < q_2 < q_3$. Let $(u_{i_1}, u_{j_1}), (u_{i_2}, u_{j_2})$ and (u_{i_3}, u_{j_3}) be the extremities of S_{q_1}, S_{q_2} and S_{q_3} . Then by Lemma 1.9, we have $i_1 < j_1 \leq i_2 < j_2 \leq i_3 < j_3$. Let C_1 (resp. C_2, C_3) be the cycle formed by the union of S_1 (resp. S_2, S_3) and $P_R(e)[i_1, j_1]$ (resp. $P_R(e)[i_2, j_2], P_R(e)[i_3, j_3]$). The two non contractible cycle C_1 and C_3 are vertex disjoint. Thus we are in the situation of Figure .24, where C_1, C_3 are homotopic but with opposite traversal direction. Then the union of C_1, C_3 and $P_R(e)[j_1, i_3]$ delimit a contractible region whose interior contain all the edges of S_2 . Then C_2 is contractible, a contradiction. □

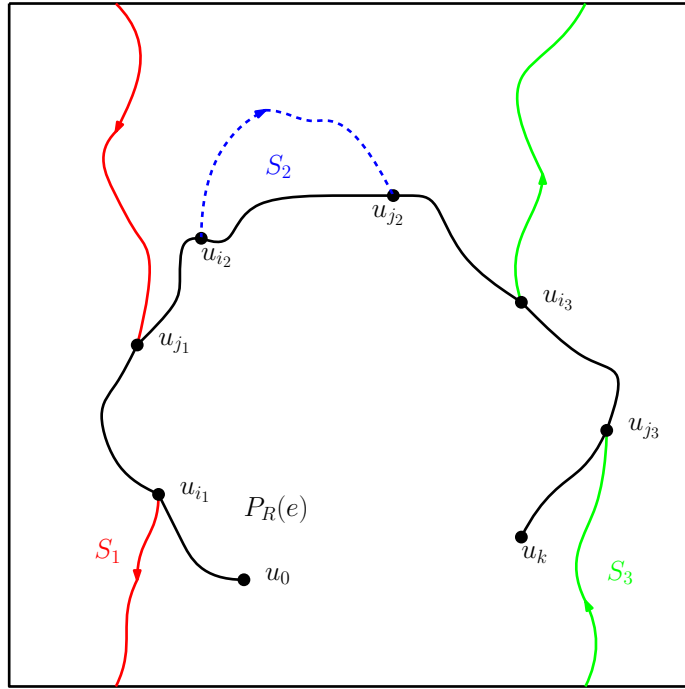

Figure .24 – Situation of Lemma 1.10.

Lemma 1.11.

$$|Q| \geq |P_R(e)| - 2n_{LR_\ell}(Q, e) - 3n_{RL_\ell}(Q, e) - 922.$$

Proof. By Lemmas 1.6, we have

$$|Q| = \sum_{q=1}^t |S_q| \geq |P_R(e)| - 2n_{LR_\ell}(Q, e) - 3n_{RL_\ell}(Q, e) - 5n_{LL_\ell}(Q, e) - 2n_{LL_n^Y}(Q, e) - 13 \times |Z|.$$

Thus we obtain the lemma by Lemmas 1.8 and 1.10 and since $|X| \leq 72$. \square

Lemma 1.12. Consider $q_1, q_2 \in Y$, such that $q_1 \neq q_2$ and S_{q_1}, S_{q_2} are both of type LR_ℓ or RL_ℓ . If S_{q_1}, S_{q_2} have extremities (u_{i_1}, u_{j_1}) and (u_{i_2}, u_{j_2}) with $i_1 < j_1, i_2 < j_2$ and $i_1 < i_2$, then $q_1 < q_2$.

Proof. Suppose by contradiction that $q_1 > q_2$. Let p_1, p_2 be the length of S_{q_1} and S_{q_2} . By Lemma 1.6, we have $p_1 \geq j_1 - i_1 - 3$ and $p_2 \geq j_2 - i_2 - 3$. Since $q_2 < q_1$, we have $i_2 \neq j_1$. We consider the two following cases: $i_2 < j_1$ or $j_1 < i_2$.

– If $i_2 < j_1$: We have $|Q[i_2, j_1]| \geq p_1 + p_2 + 1 \geq p_2 + 2$. Since Q is a shortest path, we have $|P_R(e)[j_1, j_2]| \geq |Q[j_2, j_1]| \geq p_1 + 1 \geq 2$. We obtain the following contradiction:

$$|P_R(e)[i_2, j_1]| = |P_R(e)[i_2, j_2]| - |P_R(e)[j_1, j_2]| \leq j_2 - i_2 - 2 \leq p_2 + 1 \leq |Q[i_2, j_1]| - 1.$$

- If $j_1 < i_2$: Let $q_0 = \max\{q \in \llbracket q_1, q_2 \rrbracket : \text{the extremities } i, j \text{ of } S_q \text{ are such that } i \leq j_1 \leq j\}$. Let (u_{i_0}, u_{j_0}) be the extremities of S_{q_0} with $i_0 \leq j_1 \leq j_0$. Let p_0 be the length of S_{q_0} . Since $i_0 \leq j_1 \leq j_0$, by definition of Y and Lemma 1.7, we have that S_{q_0} is not of type h . By Lemma 1.6, we have $p_0 \geq j_0 - i_0 - 5$. Moreover, we have $|Q[i_0, j_1]| \geq p_0 + p_1 + p_2 + 1 \geq p_0 + 3$. Since Q is a shortest path, we have $|P_R(e)[j_0, j_1]| \geq p_1 + p_2 + 1 \geq 3$. We obtain the following contradiction:

$$|P_R(e)[i_0, j_1]| = |P_R(e)[i_0, j_0]| - |P_R(e)[j_0, j_1]| \leq j_0 - i_0 - 3 \leq p_0 + 2 \leq |Q[i_0, j_1]| - 1.$$

□

We now state two lemmas which are analogous to Proposition 11 and Proposition 12 of [1].

Consider C a contractible cycle of G , given with a traversal direction. Then C separates the map G into two regions. We define $V_\ell(C)$ (respectively $V_r(C)$) the set of vertices lying in the region on the left (resp. right) side of C , including C . The graphs $G[V_\ell(C)]$ and $G[V_r(C)]$ denotes the subgraph of G induced by these set of vertices.

Lemma 1.13. *If $n_{LR_\ell}(Q, e) > 0$ (resp. $n_{RL_\ell}(Q, e) > 0$), then there exists a contractible cycle C of G , given with a traversal direction, such that $G[V_\ell(C)]$ and $G[V_r(C)]$ both have diameter at least $\lfloor n_{LR_\ell}(Q, e)/2 \rfloor - 1$ (resp. $\lfloor n_{RL_\ell}(Q, e)/2 \rfloor - 1$), and, for all $\iota \in \{\ell, r\}$, we have $\max_{u \in V_\iota(C)} m(u) - \min_{u \in V_\iota(C)} m(u)$ is at least $\lfloor n_{LR_\ell}(Q, e)/2 \rfloor - 79$ (resp. $\lfloor n_{RL_\ell}(Q, e)/2 \rfloor - 79$).*

Proof. We prove the lemma for $n_{LR_\ell}(Q, e) > 0$ (the proof for $n_{RL_\ell}(Q, e) > 0$ is similar). For $1 \leq q \leq t$, let $n_{LR_\ell}(q)$ be the number of sub-paths of type LR_ℓ among $\{S_1, \dots, S_q\}$. Let $s = \lfloor n_{LR_\ell}(Q, e)/2 \rfloor$, and let $q \in \llbracket 1, t \rrbracket$ be minimal such that $n_{LR_\ell}(q) = s$. Note that S_q is of type LR_ℓ and $s \leq q$. Note also that $q \leq t - s$. Let $S_q = (w_0, \dots, w_p)$ with $w_0 = u_i, w_p = u_j$ for some $0 \leq i < j \leq k$ and let $C = (w_0, \dots, w_p = u_j, \dots, u_i)$. Since $s \leq q \leq t - s$, we have $|Q[0, i]| \geq s - 1$ and $|Q[j, k]| \geq s - 1$. So $G[V_\ell(C)]$ and $G[V_r(C)]$ each have diameter at least $s - 1$.

Finally, by Lemma 1.12, one of $G[V_\ell(C)]$ or $G[V_r(C)]$ contains all sub-paths of type LR_ℓ among $(S_1, \dots, S_q) \cap \{\bigcup_{i \in Y} S_i\}$ and the other contains all sub-paths of type LR_ℓ among $(S_q, \dots, S_t) \cap \{\bigcup_{i \in Y} S_i\}$. Therefore, each of $G[V_\ell(C)]$ and $G[V_r(C)]$ contains at least $s - 18 \times 4$ vertices of $P_R(e)$. By Lemmas 1.2 and 3.5, we obtain $\max_{u \in V_\iota(C)} m(u) - \min_{u \in V_\iota(C)} m(u) \geq s - 72 - 7$ for all $\iota \in \{\ell, r\}$. □

Lemma 1.14. *If $n_{LR_\ell}(Q, e) > 3$ (resp. $n_{RL_\ell}(Q, e) > 3$), then there exists a contractible cycle C in G , given with a direction of traversal, of length at most $\frac{6|Q|}{n_{LR_\ell}(Q, e) - 3} + 2$ (resp. $\frac{6|Q|}{n_{RL_\ell}(Q, e) - 3} + 3$) such that $G[V_\ell(C)]$ and $G[V_r(C)]$ both have diameter at least $\lfloor n_{LR_\ell}(Q, e)/3 \rfloor - 1$ (resp. $\lfloor n_{RL_\ell}(Q, e)/3 \rfloor - 1$), and, for all $\iota \in \{\ell, r\}$, we have $\max_{u \in V_\iota(C)} m(u) - \min_{u \in V_\iota(C)} m(u)$ is at least $\lfloor n_{LR_\ell}(Q, e)/3 \rfloor - 79$ (resp. $\lfloor n_{RL_\ell}(Q, e)/3 \rfloor - 79$).*

Proof. We prove the lemma for $n_{LR_\ell}(Q, e) > 3$ (the proof for $n_{RL_\ell}(Q, e) > 3$ is similar). The proof is very similar to that of Lemma 1.13 and we use the same notation $n_{LR_\ell}(q)$ as in Lemma 1.13. Let $s = \lfloor n_{LR_\ell}(Q, e)/3 \rfloor$. Let Z be the set of elements $1 \leq q \leq t$, such that S_q is of type LR_ℓ and $s + 1 \leq n_{LR_\ell}(q) \leq 2s$. Let $q^* \in Z$ such that $|S_{q^*}| = \min\{|S_q| : q \in Z\}$. Let $S_{q^*} = (w_0, \dots, w_p)$ with $w_0 = u_i$, $w_p = u_j$ for some $0 \leq i < j \leq k$ and let $C = (w_0, \dots, w_p = u_j, \dots, u_i)$. Then

$$|Q| \geq sp \geq \frac{n_{LR_\ell}(Q, e) - 3}{3}p$$

By Lemma 1.6, we have $p \geq j - i - 2$. Then $|C| = p + j - i \leq 2p + 2 \leq \frac{6|Q|}{n_{LR_\ell}(Q, e) - 3} + 2$ edges.

From now, the rest of the proof is similar to the proof of Lemma 1.13 (with q^* playing the role of q) and is omitted. \square

1.2 Approximation of distances by labels

As in Section 10, for $n \geq 1$, let G_n be a uniformly random element of $\mathcal{G}(n)$. Let d_n denote the graph distance d_{G_n} . Recall that Φ denotes the bijection from $\mathcal{T}_{r,s,b}(n)$ to $\mathcal{G}(n)$ of Theorem 2.1. Let $T_n = \Phi^{-1}(G_n)$. Therefore T_n is a uniformly random element of $\mathcal{T}_{r,s,b}(n)$.

We need several definitions similar to Section 3. Let V_n be the set of vertices of T_n . Let a_n^0 be the root angle of T_n and v_n^0 be its root vertex. Let $\ell_n = 4n + 1$. We define Γ_n as the unicellular map obtained from T_n by adding a special dangling half-edge, called the root half-edge, incident to the root angle of T_n . The root angle of Γ_n , still noted a_n^0 , is the angle of Γ_n just after the root half-edge in counterclockwise order around its incident vertex. Let $A_n = (a_n^0, \dots, a_n^{\ell_n})$ be the sequence of consecutive angles of Γ_n in clockwise order around the unique face of Γ_n starting from a_n^0 . Let λ_n be the labeling function of Γ_n as defined in Section 3. For each vertex u of V_n , let $m_n(u)$ be the minimum of the labels incident to u .

The main result of this section is the following:

Theorem 1.15. *For all $\varepsilon > 0$, we have*

$$\lim_{n \rightarrow \infty} \mathbb{P} \left(\exists u \in V_n : |d_n(u, v_n^0) - m_n(u)| > \varepsilon n^{1/4} \right) = 0.$$

Before going into the proof, we need some additional notations. For $0 \leq i \leq \ell_n$, let $r_n(i)$ be the vertex of V_n incident to angle a_n^i (i.e the vertex contour function of Γ). Given an integer $0 \leq i \leq \ell_n$ and $\Delta > 0$, we denote

$$p_n(i, \Delta) = \max(\{0\} \cup \{j < i : |m_n(r_n(j)) - m_n(r_n(i))| \geq \Delta\}),$$

$$q_n(i, \Delta) = \min(\{\ell_n\} \cup \{j > i : |m_n(r_n(j)) - m_n(r_n(i))| \geq \Delta\}) \text{ and}$$

$$N_n(i, \Delta) = |\{r_n(j) : \exists j \in \llbracket p_n(i, \Delta), q_n(i, \Delta) \rrbracket\}|.$$

The proof of the following lemma is omitted, it is almost identical to [1, Lemma 8.2]:

Lemma 1.16. *For all $\varepsilon > 0$ and $\beta > 0$, there exists $\alpha > 0$ and $n_0 \in \mathbb{N}$ such that for every $n \geq n_0$,*

$$\mathbb{P}\left(\inf\left\{N_n(i, \beta n^{1/4}) : 0 \leq i \leq 2n + 1\right\} \geq \alpha n\right) \geq 1 - \varepsilon.$$

We are now ready to prove the main theorem of this section.

Proof of Theorem 1.15. By Lemma 3.7, for $n \geq 1$ and $u \in V_n$, we have $d_n(v_n^0, u) \leq m_n(u)$. So it suffices to prove that for all $\varepsilon > 0$

$$\lim_{n \rightarrow \infty} \mathbb{P}\left(\exists u \in V_n : d_n(v_n^0, u) < m_n(u) - \varepsilon n^{1/4}\right) = 0.$$

This is equivalent to show that for all $\varepsilon > 0$,

$$\limsup_{n \rightarrow \infty} \mathbb{P}\left(\exists u \in V_n : d_n(v_n^0, u) < m(u) - 15\varepsilon n^{1/4} + 964\right) \leq 4\varepsilon.$$

Denote by $\text{diam}(G_n)$ the diameter of the graph G_n . Consider $\varepsilon > 0$. By Lemma 10.4, there exists $y > 0$ such that $\mathbb{P}\{\text{diam}(G_n) \geq yn^{1/4}\} < \varepsilon$.

Now, assume that there exists $n_0 \in \mathbb{N}$, such that for all $n \geq n_0$, there exists $u_n \in V_n$ such that $d_{G_n}(u_n, v_n^0) < m(u_n) - 15\varepsilon n^{1/4} - 964$. Consider the canonical orientation of G_n and let e_n be an outgoing edge of u_n . With the notations of Section 1.1, let $P_n = P_R(e_n)$ be the right-to-root path starting at e_n . Let Q_n be a shortest path from u_n to v_n^0 that maximizes the number of common edges with P_n .

By Lemmas 1.5 and 1.11, we have

$$\begin{aligned} 2n_{LR_\ell}(Q_n, e_n) + 3n_{RL_\ell}(Q_n, e_n) &\geq |P_n| - |Q_n| - 922 \\ &\geq (m_n(u) - 42) - (m_n(u) - 15\varepsilon n^{1/4} - 964) - 922 \\ &\geq 15\varepsilon n^{1/4} \end{aligned}$$

Thus for n_0 large enough we have (for each $n \geq n_0$) either $n_{LR_\ell}(Q_n, e_n) \geq \max(3, 3\varepsilon n^{1/4})$ or $n_{RL_\ell}(Q_n, e_n) \geq \max(3, 3\varepsilon n^{1/4})$. We call B_n the event G_n contains a contractile cycle C of length at most $(2y/\varepsilon + 4)$, given with a traversal direction, such that for both $\iota \in \{l, r\}$, we have

$$\max_{u \in V_\iota(C)} m_n(u) - \min_{u \in V_\iota(C)} m_n(u) \geq \varepsilon n^{1/4} - 79.$$

We deduce from Lemma 1.14 that, for n_0 large enough and all $n \geq n_0$, either $\text{diam}(G_n) \geq yn^{1/4}$ or B_n occurs.

Therefore it suffices to prove that

$$\mathbb{P}(B, \text{diam}(G_n) \leq yn^{1/4}) \leq 3\varepsilon.$$

Consider $n \geq n_0$ such that B occurs. Let C be as in the definition of B . Let F be the subgraph of T_n induced by $V(G_n) \setminus V(C)$. Recall that $G_n[V_l(C)]$ (resp. $G_n[V_r(C)]$) is the sub-graph of G_n induced by $V_l(C)$ (resp. $V_r(C)$). Then each component of F is contained in $G_n[V_l(C)]$ or $G_n[V_r(C)]$. By Lemma 3.6, for $\{u, v\} \in E(G_n)$ we have $|m(u) - m(v)| \leq 7$. It follows that, for $\iota \in \{l, r\}$, there exists one component F_ι of F such that

$$\max_{u \in V(F_\iota)} m_n(u) - \min_{u \in V(F_\iota)} m_n(u) \geq \varepsilon^2 n^{1/4} / (2y + 4\varepsilon) - 79.$$

By using Lemma 3.6, then for $\iota \in \{l, r\}$, there exists $v_\iota \in F_\iota$ such that

$$\begin{aligned} \min_{v \in V(C)} |m(v_\iota) - m(v)| &\geq \left(\frac{\varepsilon^2 n^{1/4}}{2y + 4\varepsilon} - 79 \right) / 2 - 7 - (2y/\varepsilon + 2) \times 7 \\ &\geq \frac{\varepsilon^2 n^{1/4}}{4y + 8\varepsilon} - 19 - 14y/\varepsilon. \end{aligned}$$

Now for $\iota \in \{l, r\}$, let $j_\iota = \inf\{0 \leq i \leq \ell_n : r_n(i) = v_\iota\}$. Fix any $\beta \in (0, \varepsilon^2/(4y + 8\varepsilon))$. By Lemma 1.16, there exists $\alpha > 0$ such that for n large enough,

$$\mathbb{P}\left(\min\{|N_n(j_\ell, \beta n^{1/4})|, |N_n(j_r, \beta n^{1/4})|\} \leq \alpha n\right) \leq \varepsilon.$$

For n sufficiently large, we have $\frac{\varepsilon^2 n^{1/4}}{4y + 8\varepsilon} - 19 - 14y/\varepsilon > \beta n^{1/4}$. Then we have for $\iota \in \{l, r\}$, $N(j_\iota, \beta n^{1/4}) \subset V_\iota(C)$. It follows that for n large enough,

$$\mathbb{P}(B, \text{diam}(G_n) \leq yn^{1/4}) \leq$$

$$\varepsilon + \mathbb{P}(\exists C \text{ contractile cycle, } |C| \leq 2y/\varepsilon + 4, \min\{|V_l(C)|, |V_r(C)|\} \geq \alpha n).$$

The event $\{\exists C \text{ contractile cycle, } |C| \leq 2y/\varepsilon + 4, \min\{|V_l(C)|, |V_r(C)|\} \geq \alpha n\}$ means that G_n contains a separating contractile cycle of length at most $2y/\varepsilon + 4$ that separates G_n into two sub-triangulations both of size at least αn . It remains to prove that this has probability going to 0 when n goes to infinity. Let $p_{n,m}$ (resp. $t_{n,m}$) be the number of simple triangulation of an m -gon with n inner vertices (resp. the number of essentially simple toroidal maps on the torus with n vertices, such that all faces have size three except one that has size m), rooted at a maximal triangle. From previously known estimates, there exist two constants A_m (see [27]) and B_m (by Corollary 6.4) such that

$$p_{n,m} \leq A_m n^{-5/2} \left(\frac{256}{27}\right)^n \quad \text{and} \quad t_{n,m} \leq B_m \left(\frac{256}{27}\right)^n$$

(the upper bound for $p_{n,m}$ estimates the number of arbitrarily rooted triangulations, of which there are more than the type counted by $p_{n,m}$ itself).

Let Γ_n be the event G_n contains a separating contractile cycle of length at most $2y/\varepsilon + 4$ that separates G_n into two sub-triangulations both of size at least αn . We have:

$$\begin{aligned} \mathbb{P}(\Gamma_n) &\leq \Upsilon^{-1} \left(\frac{256}{27}\right)^{-n} \sum_{k=3}^{\lfloor 2y/\varepsilon+4 \rfloor} \sum_{\ell=\lfloor \alpha n \rfloor}^{\lfloor (1-\alpha)n \rfloor} p_{\ell,k} t_{n-\ell,k} \\ &\leq \Upsilon^{-1} \left(\frac{256}{27}\right)^{-n} \sum_{k=3}^{\lfloor 2y/\varepsilon+4 \rfloor} \sum_{\ell=\lfloor \alpha n \rfloor}^{\lfloor (1-\alpha)n \rfloor} A_k \ell^{-5/2} \left(\frac{256}{27}\right)^{\ell} B_k \left(\frac{256}{27}\right)^{n-\ell} \\ &\leq \Upsilon^{-1} \sum_{k=3}^{\lfloor 2y/\varepsilon+4 \rfloor} A_k B_k \sum_{\ell=\lfloor \alpha n \rfloor}^{\lfloor (1-\alpha)n \rfloor} \ell^{-5/2} \leq \Upsilon^{-1} \sum_{k=3}^{\lfloor 2y/\varepsilon+4 \rfloor} A_k B_k n (\alpha n)^{-5/2}. \end{aligned}$$

Therefore $\mathbb{P}(\Gamma_n)$ converges towards 0 when n goes to infinity, which concludes the proof of the Theorem. \square

Bibliography

- [1] L. ADDARIO-BERRY AND M. ALBENQUE, *The scaling limit of random simple triangulations and random simple quadrangulations*, Annals of Probability, 45 (2017), pp. 2767–2825.
- [2] M. AIZENMAN AND D. J. BARSKY, *Sharpness of the phase transition in percolation models*, Communications in Mathematical Physics, 108 (1987), pp. 489–526.
- [3] M. AIZENMAN, A. BURCHARD, ET AL., *Hölder regularity and dimension bounds for random curves*, Duke mathematical journal, 99 (1999), pp. 419–453.
- [4] D. ALDOUS, *The continuum random tree ii: an overview*, Stochastic analysis, 167 (1991), pp. 23–70.
- [5] ———, *The continuum random tree iii*, The Annals of Probability, (1993), pp. 248–289.
- [6] S. E. ALM, *Upper bounds for the connective constant of self-avoiding walks*, Combinatorics, Probability and Computing, 2 (1993), pp. 115–136.
- [7] G. AMIR, I. BENJAMINI, AND G. KOZMA, *Excited random walk against a wall*, Probability Theory and Related Fields, 140 (2008), pp. 83–102.
- [8] A.-L. BASDEVANT AND A. SINGH, *On the speed of a cookie random walk*, Probability Theory and Related Fields, 141 (2008), pp. 625–645.
- [9] A.-L. BASDEVANT, A. SINGH, ET AL., *Rate of growth of a transient cookie random walk*, Electron. J. Probab, 13 (2008), pp. 811–851.
- [10] ———, *Recurrence and transience of a multi-excited random walk on a regular tree*, Electronic Journal of Probability, 14 (2009), pp. 1628–1669.
- [11] R. BAUERSCHMIDT, H. DUMINIL-COPIN, J. GOODMAN, AND G. SLADE, *Lectures on self-avoiding walks*, Probability and Statistical Physics in Two and More Dimensions (D. Ellwood, CM Newman, V. Sidoravicius, and W. Werner, eds.), Clay Mathematics Institute Proceedings, 15 (2012), pp. 395–476.
- [12] V. BEFFARA AND H. DUMINIL-COPIN, *Planar percolation with a glimpse of Schramm–Loewner evolution*, Probability Surveys, 10 (2013), pp. 1–50.

- [13] V. BEFFARA AND C. B. HUYNH, *Trees of self-avoiding walks*, arXiv preprint arXiv:1711.05527, (2017).
- [14] V. BEFFARA, C. B. HUYNH, AND B. LÉVÊQUE, *Scaling limits for random triangulations on the torus*, En préparation, (2019).
- [15] J. BELTRAN, J.-F. LE GALL, ET AL., *Quadrangulations with no pendant vertices*, Bernoulli, 19 (2013), pp. 1150–1175.
- [16] I. BENJAMINI AND Y. PERES, *Tree-indexed random walks on groups and first passage percolation*, Probability Theory and Related Fields, 98 (1994), pp. 91–112.
- [17] I. BENJAMINI, D. WILSON, ET AL., *Excited random walk*, Electronic Communications in Probability, 8 (2003), pp. 86–92.
- [18] J. BÉRARD AND A. RAMIREZ, *Central limit theorem for the excited random walk in dimension at least 2*, Electron. Comm. Probab, 12 (2007), pp. 303–314.
- [19] C. BERGE, *Graphs*, vol. 6, North-Holland, 1985.
- [20] A. BERRETTI AND A. D. SOKAL, *New Monte Carlo method for the self-avoiding walk*, Journal of Statistical Physics, 40 (1985), pp. 483–531.
- [21] J. BERTOIN, L. CHAUMONT, AND J. PITMAN, *Path transformations of first passage bridges*, Electronic Communications in Probability, 8 (2003), pp. 155–166.
- [22] J. BETTINELLI, *Scaling limits for random quadrangulations of positive genus*, Electronic Journal of Probability, 15 (2010), pp. 1594–1644.
- [23] J. BETTINELLI AND G. MIERMONT, *Personal communication*. 2019.
- [24] P. BILLINGSLEY, *Convergence of probability measures*, John Wiley & Sons, 2013.
- [25] M. BISKUP, *Recent progress on the random conductance model*, Probability Surveys, 8 (2011).
- [26] S. R. BROADBENT AND J. M. HAMMERSLEY, *Percolation processes: I. crystals and mazes*, in Mathematical Proceedings of the Cambridge Philosophical Society, vol. 53, Cambridge University Press, 1957, pp. 629–641.
- [27] W. G. BROWN, *Enumeration of triangulations of the disk*, Proceedings of the London Mathematical Society, 3 (1964), pp. 746–768.
- [28] D. BURAGO, Y. BURAGO, AND S. IVANOV, *A course in metric geometry*, vol. 33, American Mathematical Soc., 2001.
- [29] G. CHAPUY, M. MARCUS, AND G. SCHAEFFER, *A bijection for rooted maps on orientable surfaces*, SIAM Journal on Discrete Mathematics, 23 (2009), pp. 1587–1611.

- [30] P. CHASSAING AND G. SCHAEFFER, *Random planar lattices and integrated superbrownian excursion*, Probability Theory and Related Fields, 128 (2004), pp. 161–212.
- [31] A. COLLEVECCHIO, M. HOLMES, D. KIOUS, ET AL., *On the speed of once-reinforced biased random walk on trees*, Electronic Journal of Probability, 23 (2018).
- [32] A. COLLEVECCHIO, C. B. HUYNH, AND D. KIOUS, *The branching-ruin number as critical parameter of random processes on trees*, arXiv preprint arXiv:1811.08058, (2018).
- [33] A. COLLEVECCHIO, D. KIOUS, AND V. SIDORAVICIUS, *The branching-ruin number and the critical parameter of once-reinforced random walk on trees*, arXiv preprint arXiv:1710.00567, (2017).
- [34] B. DAVIS, *Reinforced random walk*, Probability Theory and Related Fields, 84 (1990), pp. 203–229.
- [35] N. DERSHOWITZ AND S. ZAKS, *The cycle lemma and some applications*, European Journal of Combinatorics, 11 (1990), pp. 35–40.
- [36] V. DESPRÉ, D. GONÇALVES, AND B. LÉVÊQUE, *Encoding toroidal triangulations*, Discrete & Computational Geometry, 57 (2017), pp. 507–544.
- [37] R. DIESTEL, *Graph theory (Graduate texts in mathematics)*, vol. 173, Springer Heidelberg, 2005.
- [38] H. DUMINIL-COPIN, G. KOZMA, A. YADIN, ET AL., *Supercritical self-avoiding walks are space-filling*, in Annales de l’Institut Henri Poincaré, Probabilités et Statistiques, vol. 50, Institut Henri Poincaré, 2014, pp. 315–326.
- [39] H. DUMINIL-COPIN AND S. SMIRNOV, *The connective constant of the honeycomb lattice equals*, Annals of Mathematics, 175 (2012), pp. 1653–1665.
- [40] H. DUMINIL-COPIN AND V. TASSION, *A new proof of the sharpness of the phase transition for bernoulli percolation and the ising model*, Communications in Mathematical Physics, 343 (2016), pp. 725–745.
- [41] B. DYHR, M. GILBERT, T. KENNEDY, G. F. LAWLER, AND S. PASSON, *The self-avoiding walk spanning a strip*, Journal of Statistical Physics, 144 (2011), pp. 1–22.
- [42] N. ENRIQUEZ, C. SABOT, AND O. ZINDY, *Limit laws for transient random walks in random environment on z* , in Annales de l’institut Fourier, vol. 59, 2009, pp. 2469–2508.
- [43] ———, *Limit laws for transient random walks in random environment on z* , in Annales de l’institut Fourier, vol. 59, 2009, pp. 2469–2508.

- [44] ———, *A probabilistic representation of constants in kesten's renewal theorem*, Probability Theory and Related Fields, 144 (2009), pp. 581–613.
- [45] K. J. FALCONER, *Random fractals*, in Mathematical Proceedings of the Cambridge Philosophical Society, vol. 100, Cambridge University Press, 1986, pp. 559–582.
- [46] K. J. FALCONER, *Cut-set sums and tree processes*, Proceedings of the American Mathematical Society, 101 (1987), pp. 337–346.
- [47] P. FITZSIMMONS, J. PITMAN, AND M. YOR, *Markovian bridges: construction, palm interpretation, and splicing*, in Seminar on Stochastic Processes, 1992, Springer, 1993, pp. 101–134.
- [48] P. J. FLORY, *Principles of polymer chemistry*, Cornell University Press, 1953.
- [49] L. R. G. FONTES, M. ISOPI, C. M. NEWMAN, ET AL., *Random walks with strongly inhomogeneous rates and singular diffusions: convergence, localization and aging in one dimension*, The Annals of Probability, 30 (2002), pp. 579–604.
- [50] L. FORD AND D. FULKERSON, *Flows in networks princeton university press*, Princeton, New Jersey, 276 (1962), p. 22.
- [51] C. M. FORTUIN, P. W. KASTELEYN, AND J. GINIBRE, *Correlation inequalities on some partially ordered sets*, Communications in Mathematical Physics, 22 (1971), pp. 89–103.
- [52] A. FRIBERGH, D. KIOUS, ET AL., *Scaling limits for sub-ballistic biased random walks in random conductances*, The Annals of Probability, 46 (2018), pp. 605–686.
- [53] H. FURSTENBERG, *Intersections of cantor sets and transversality of semigroups*, Problems in analysis (Sympos. Salomon Bochner, Princeton Univ., Princeton, NJ, 1969), (1970), pp. 41–59.
- [54] D. GONÇALVES, K. B. KNAUER, AND B. LÉVÊQUE, *Structure of schnyder labelings on orientable surfaces*, CoRR, abs/1501.05475 (2015).
- [55] D. GONÇALVES AND B. LÉVÊQUE, *Toroidal maps: Schnyder woods, orthogonal surfaces and straight-line representations*, Discrete & Computational Geometry, 51 (2014), pp. 67–131.
- [56] G. GRIMMETT, *What is percolation?*, in Percolation, Springer, 1999, pp. 1–31.
- [57] A. GUTTMANN, *On the zero-field susceptibility in the $d=4$, $n=0$ limit: analysing for confluent logarithmic singularities*, Journal of Physics A: Mathematical and General, 11 (1978), p. L103.
- [58] ———, *Correction to scaling exponents and critical properties of the n -vector model with dimensionality ≥ 4* , Journal of Physics A: Mathematical and General, 14 (1981), p. 233.

- [59] ———, *On the critical behaviour of self-avoiding walks*, Journal of Physics A: Mathematical and General, 20 (1987), p. 1839.
- [60] A. GUTTMANN AND I. ENTING, *The size and number of rings on the square lattice*, Journal of Physics A: Mathematical and General, 21 (1988), p. L165.
- [61] J. HAMMERSLEY, *Percolation processes. ii. the connective constant*, Proc. Camb. Phil. Soc, (1957), pp. 642–645.
- [62] ———, *Bornes supérieures de la probabilité critique dans un processus de filtration*, Le Calcul des Probabilités et ses Applications, CNRS, Paris, (1959), pp. 17–37.
- [63] J. M. HAMMERSLEY AND K. W. MORTON, *Poor man's monte carlo*, Journal of the Royal Statistical Society. Series B (Methodological), (1954), pp. 23–38.
- [64] J. M. HAMMERSLEY AND D. J. WELSH, *Further results on the rate of convergence to the connective constant of the hypercubical lattice*, The Quarterly Journal of Mathematics, 13 (1962), pp. 108–110.
- [65] T. HARA AND G. SLADE, *The lace expansion for self-avoiding walk in five or more dimensions*, Reviews in Mathematical Physics, 4 (1992), pp. 235–327.
- [66] G. H. HARDY AND S. RAMANUJAN, *Asymptotic formula for the distribution of integers of various types*, Proceedings of the London Mathematical Society, 2 (1917), pp. 112–132.
- [67] T. E. HARRIS, *A lower bound for the critical probability in a certain percolation process*, in Mathematical Proceedings of the Cambridge Philosophical Society, vol. 56, Cambridge University Press, 1960, pp. 13–20.
- [68] C. B. HUYNH, *Phase transition for the once-excited random walk on general trees*, arXiv preprint arXiv:1812.02331, (2018).
- [69] D. IOFFE, *Ornstein-Zernike behaviour and analyticity of shapes for self-avoiding walks on Zd* , WIAS, 1998.
- [70] I. JENSEN, *Improved lower bounds on the connective constants for two-dimensional self-avoiding walks*, Journal of Physics A: Mathematical and General, 37 (2004), p. 11521.
- [71] H. KESTEN, *On the number of self-avoiding walks*, Journal of Mathematical Physics, 4 (1963), pp. 960–969.
- [72] ———, *On the number of self-avoiding walks*, Journal of Mathematical Physics, 4 (1963), pp. 960–969.
- [73] ———, *The critical probability of bond percolation on the square lattice equals $1/2$* , Communications in mathematical physics, 74 (1980), pp. 41–59.

- [74] ———, *The incipient infinite cluster in two-dimensional percolation*, Probability Theory and Related Fields, 73 (1986), pp. 369–394.
- [75] D. KIOUS, V. SIDORAVICIUS, ET AL., *Phase transition for the once-reinforced random walk on z -like trees*, The Annals of Probability, 46 (2018), pp. 2121–2133.
- [76] G. KOZMA, *Excited random walk in three dimensions has positive speed*, arXiv preprint math/0310305, (2003).
- [77] ———, *Excited random walk in two dimensions has linear speed*, arXiv preprint math/0512535, (2005).
- [78] G. F. LAWLER, O. SCHRAMM, AND W. WERNER, *On the scaling limit of planar self-avoiding walk*, arXiv preprint math/0204277, (2002).
- [79] ———, *On the scaling limit of planar self-avoiding walk*, in Fractal geometry and applications: a jubilee of Benoît Mandelbrot, Part 2, vol. 72 of Proc. Sympos. Pure Math., Amer. Math. Soc., Providence, RI, 2004, pp. 339–364.
- [80] J.-F. LE GALL, *The topological structure of scaling limits of large planar maps*, Inventiones mathematicae, 169 (2007), pp. 621–670.
- [81] J.-F. LE GALL ET AL., *Uniqueness and universality of the brownian map*, The Annals of Probability, 41 (2013), pp. 2880–2960.
- [82] J.-F. LE GALL, G. MIERMONT, ET AL., *Scaling limits of random trees and planar maps*, Probability and statistical physics in two and more dimensions, 15 (2012), pp. 155–211.
- [83] B. LÉVÊQUE, *Generalization of schnyder woods to orientable surfaces and applications*, Habilitation manuscript, arXiv:1702.07589, (2017).
- [84] R. LYONS, *The ising model and percolation on trees and tree-like graphs*, Communications in Mathematical Physics, 125 (1989), pp. 337–353.
- [85] ———, *Random walks and percolation on trees*, The annals of Probability, (1990), pp. 931–958.
- [86] R. LYONS AND R. PEMANTLE, *Random walk in a random environment and first-passage percolation on trees*, The Annals of Probability, (1992), pp. 125–136.
- [87] R. LYONS AND Y. PERES, *Probability on Trees and Networks*, Cambridge University Press, 2016. Available at <http://pages.iu.edu/~rdlyons/>.
- [88] B. LÉVÊQUE, *Corolation de graphes: Structures et Algorithmes*, 2007. Available at <https://pagesperso.g-scop.grenoble-inp.fr/~levequeb/Publications/these.pdf>.

- [89] N. MADRAS AND G. SLADE, *The self-avoiding walk*, Springer Science & Business Media, 2013.
- [90] J.-F. MARCKERT, A. MOKKADEM, ET AL., *Limit of normalized quadrangulations: the brownian map*, *The Annals of Probability*, 34 (2006), pp. 2144–2202.
- [91] S. MARTINEAU, *Percolation sur les groupes et modèles dirigés*, 2014.
- [92] M. V. MENSHIKOV, *Coincidence of critical points in percolation problems*, in *Soviet Mathematics Doklady*, vol. 33, 1986, pp. 856–859.
- [93] G. MIERMONT, *Random maps and their scaling limits*, in *Fractal geometry and stochastics IV*, Springer, 2009, pp. 197–224.
- [94] ———, *The brownian map is the scaling limit of uniform random plane quadrangulations*, *Acta mathematica*, 210 (2013), pp. 319–401.
- [95] B. MOHAR AND C. THOMASSEN, *Graphs on surfaces. johns hopkins studies in the mathematical sciences*, 2001.
- [96] T. MOUNTFORD, L. P. PIMENTEL, AND G. VALLE, *On the speed of the one-dimensional excited random walk in the transient regime*, arXiv preprint math/0602041, (2006).
- [97] C. S. J. NASH-WILLIAMS, *Random walk and electric currents in networks*, in *Mathematical Proceedings of the Cambridge Philosophical Society*, vol. 55, Cambridge University Press, 1959, pp. 181–194.
- [98] J. NEVEU, *Arbres et processus de galton-watson*, *Ann. Inst. H. Poincaré Probab. Statist.*, 22 (1986), pp. 199–207.
- [99] B. NIENHUIS, *Exact critical point and critical exponents of $o(n)$ models in two dimensions*, *Physical Review Letters*, 49 (1982), pp. 1062–1065.
- [100] R. PEIERLS, *On ising’s model of ferromagnetism*, in *Mathematical Proceedings of the Cambridge Philosophical Society*, vol. 32, Cambridge University Press, 1936, pp. 477–481.
- [101] R. PEMANTLE ET AL., *Phase transition in reinforced random walk and rwre on trees*, *The Annals of Probability*, 16 (1988), pp. 1229–1241.
- [102] R. PEMANTLE AND Y. PERES, *Critical random walk in random environment on trees*, *The Annals of Probability*, (1995), pp. 105–140.
- [103] V. V. PETROV, *Limit theorems of probability theory: sequences of independent random variables*, (1995).
- [104] V. V. PETROV, *Sums of independent random variables*, vol. 82, Springer Science & Business Media, 2012.

- [105] A. PÖNITZ AND P. TITTMANN, *Improved upper bounds for self-avoiding walks in zd* , *Electron. J. Combin.*, 7 (2000).
- [106] D. POULALHON AND G. SCHAEFFER, *Optimal coding and sampling of triangulations*, *Algorithmica*, 46 (2006), pp. 505–527.
- [107] D. RANDALL, *Counting in lattices: combinatorial problems from statistical mechanics*, PhD thesis, International Computer Science Institute (ICSI) Technical Report Number TR-055-94, 1994.
- [108] D. REVUZ AND M. YOR, *Continuous martingales and Brownian motion*, vol. 293, Springer Science & Business Media, 2013.
- [109] L. RUSSO, *On the critical percolation probabilities*, *Zeitschrift für Wahrscheinlichkeitstheorie und verwandte Gebiete*, 56 (1981), pp. 229–237.
- [110] O. SCHRAMM, *Conformally invariant scaling limits*, in *Proceedings of the International Congress of Mathematicians, Madrid, 2006*.
- [111] P. D. SEYMOUR AND D. J. WELSH, *Percolation probabilities on the square lattice*, in *Annals of Discrete Mathematics*, vol. 3, Elsevier, 1978, pp. 227–245.
- [112] S. SMIRNOV, *Towards conformal invariance of 2d lattice models*, arXiv preprint arXiv:0708.0032, (2007).
- [113] A. D. SOKAL, *Monte Carlo methods for the self-avoiding walk*, *Nuclear Physics B - Proceedings Supplements*, 47 (1996), pp. 172–179.
- [114] F. SPITZER, *Principles of random walk*, vol. 34 of Graduate Texts in Mathematics, Springer-Verlag, 1976.
- [115] K. TRUEMPER, *On the delta- ω reduction for planar graphs*, *Journal of graph theory*, 13 (1989), pp. 141–148.
- [116] J. VAN DEN BERG AND H. KESTEN, *Inequalities with applications to percolation and reliability*, *Journal of applied probability*, 22 (1985), pp. 556–569.
- [117] R. VAN DER HOFSTAD AND M. HOLMES, *Monotonicity for excited random walk in high dimensions*, *Probability theory and related fields*, 147 (2010), pp. 333–348.
- [118] S. VOLKOV ET AL., *Excited random walk on trees*, *Electronic Journal of Probability*, 8 (2003).
- [119] W. WERNER, *Percolation et modèle d’Ising*, Société mathématique de France, 2009.
- [120] M. ZERNER ET AL., *Recurrence and transience of excited random walks on zd and strips*, *Electronic Communications in Probability*, 11 (2006), pp. 118–128.
- [121] M. P. ZERNER, *Multi-excited random walks on integers*, *Probability theory and related fields*, 133 (2005), pp. 98–122.