



HAL
open science

Sustainable resource management in european steel supply chains

Julian Pinto

► **To cite this version:**

Julian Pinto. Sustainable resource management in european steel supply chains. Economics and Finance. Université Clermont Auvergne [2017-2020]; Háskóli Islands, 2019. English. NNT : 2019CLFAD002 . tel-02308333

HAL Id: tel-02308333

<https://theses.hal.science/tel-02308333v1>

Submitted on 8 Oct 2019

HAL is a multi-disciplinary open access archive for the deposit and dissemination of scientific research documents, whether they are published or not. The documents may come from teaching and research institutions in France or abroad, or from public or private research centers.

L'archive ouverte pluridisciplinaire **HAL**, est destinée au dépôt et à la diffusion de documents scientifiques de niveau recherche, publiés ou non, émanant des établissements d'enseignement et de recherche français ou étrangers, des laboratoires publics ou privés.



**ÉCOLE DOCTORALE SCIENCES ÉCONOMIQUES,
JURIDIQUES, POLITIQUES ET DE GESTION**
Université Clermont Auvergne

Ecole Doctorale des Sciences Economiques, Juridiques, Politiques et de gestion
Centre d'Etudes et de Recherche sur le Développement International (CERDI)

Université Clermont Auvergne, CNRS, IRD, CERDI, F-63000 Clermont-Ferrand, France

SUSTAINABLE RESOURCE MANAGEMENT IN EUROPEAN STEEL SUPPLY CHAINS

Thèse présentée et soutenue publiquement le 1er Avril 2019
pour l'obtention du titre de Docteur en Sciences Economiques

par

JULIAN TORRES DE MIRANDA PINTO

sous la direction de ARNAUD DIEMER et
HARALD U. SVERDRUP

Membres du Jury

Prof. Dr. Gilles Dussap	Polytech, Délégué General	Président
Prof. Dr. Jackie Krafft	CNRS, Directrice de Recherche	Rapporteur
Prof. Dr. Bruno Oberle	EPFL, Professeur	Rapporteur
Prof. Dr. Vianney Dequiedt	CERDI, Vice-président	Suffragant
Prof. Dr. Arnaud Diemer	CERDI, Professeur	Directeur thèse
Prof. Dr. Harald U. Sverdrup	Université d'Islande, Professeur	Co-directeur

L'université Clermont Auvergne n'entend donner aucune approbation ni improbation aux opinions émises dans cette thèse. Ces opinions doivent être considérées comme propres à leur auteur.

ABSTRACT FRANÇAIS

La présente thèse entend examiner les interactions présentes et futures entre l'industrie sidérurgique européenne et son environnement, avec pour objectifs principaux, l'amélioration de la prise de décision et l'élaboration de politiques industrielles en matière de durabilité et de circularité. La thèse contribue à l'émergence de propositions contribuant à façonner l'avenir de l'acier dans l'Union Européenne. L'industrie sidérurgique européenne est utilisée ici comme un cas d'école, visant à explorer les avantages potentiels pour l'économie circulaire et l'écologie industrielle, d'une intégration d'un outil (Analyse du Cycle de Vie – ACV) dans une méthodologie (Dynamique des Systèmes – SD). Un modèle modulaire pour l'industrie sidérurgique européenne a été construit et, pour 4 des 5 articles développés dans la thèse, 21 simulations ont été effectuées. 12 simulations ont permis d'identifier les contraintes potentielles et les avantages des stratégies de fin de vie; 5 d'évaluer les avantages et les inconvénients des différentes stratégies d'intégration de la chaîne d'approvisionnement (SCI) dans la filière européenne de l'acier; et 4 de traiter des interactions entre les dynamiques biophysiques et économiques sur le marché de l'acier. Le dernier article s'appuie sur une nouvelle méthodologie – les Cercles de Durabilité et le Métabolisme Urbain Durable – pour évaluer les défis et les contributions de l'acier dans le cadre de l'éco-fonctionnalité en milieu urbain. Les résultats ont montré que l'intégration de l'ACV dans les stratégies de développement durable permettait de reproduire assez fidèlement les résultats et les scénarios d'études scientifiques antérieures, tout en suggérant des apports méthodologiques relativement novateurs. Cette recherche opérationnelle est susceptible d'intéresser les managers et des chefs d'entreprises qui s'attachent aux questions d'efficacité et de résilience de l'outil industriel, ainsi que les décideurs politiques qui souhaitent cerner les enjeux d'une pénurie de matières premières ou d'une politique de recyclage de l'acier à l'échelle européenne. D'après les résultats de chaque article, il a été observé que (a) le recyclage et la réutilisation pourraient générer des résultats intéressants à moyen et à long terme en matière de circularité, en abandonnant notamment les combustibles fossiles et en développant un tout nouveau marché autour des services de fin de vie; (b) différentes approches en matière de chaîne logistique intégrée semblent être prometteuses d'un point de vue environnemental et stratégique; (c) six variables biophysiques clés peuvent avoir une incidence notable sur les cours au comptant, les cours à terme, les marges d'EBITDA, l'utilisation des capacités de production, la distribution des dividendes et les coûts de fabrication de l'acier; et (d) la dynamique servicielle dans le cadre de l'éco-fonctionnalité peut apporter des avantages significatifs aux villes durables, tout en modifiant considérablement la structure de l'offre sur le marché de l'acier.

ENGLISH ABSTRACT

The present thesis delved into the current and future interactions within the European Steel Industry and of it with the environment it is a part of, with the main objective of supporting decision- and policy-making efforts oriented towards sustainability and circularity, helping to shape the future of steel in the European Community. The thesis used the European Steel Industry as a case study to explore the potential benefits of integrating Life Cycle Assessment (LCA) into System Dynamics (SD) under the scopes of Circular Economy and Industrial Ecology. A model representative of the European Steel Industry was built modularly in Stella Architect, following ILCD and ISO guidelines and standards for LCA. Throughout 4 of the 5 articles developed for the present thesis, 21 simulation runs were performed on the aforementioned model: 12 on identifying potential constraints and benefits of End-of-Life policies; 5 assessing the advantages and disadvantages of different Supply Chain Integration (SCI) strategies along European steel supply chains; and 4 addressing the interactions between biophysical and economic dynamics in the steel market. An additional article was developed using the methodologies of Circles of Sustainability and Sustainable Urban Metabolism to appraise the challenges and contributions of steel as part of servitization initiatives in urban environments. Overall results indicated that integrating LCA into SD was not only feasible and capable of reproducing results, trends and behaviors from previous scientific studies, but also of contributing to both methodologies in different levels. This approach has potential to interest policy-makers who seek more granularity within the European Steel Industry as well as decision-makers searching for a broader understanding of their operation's dynamics beyond the gates, notably regarding raw material scarcity, resource self-sufficiency, and resource ownership retention. From the results of each article it was observed that, (a) pushing for recycling and reuse could generate interesting medium- to long-term results for circularity, transitioning away from fossil fuels and developing a whole new market around end-of-life services; (b) different SCI approaches can be environmentally and strategically promising; (c) six key biophysical variables can distinctively affect spot prices, future prices, EBITDA margins, capacity utilization, dividend payouts, and costs of steelmaking; and (d) servitization can provide significant benefits to sustainable cities, while also being able to substantially alter the supply-side dynamics of steelmaking, highlighting how important it is for steelmakers to pay close attention to the service-providing initiatives that may concern their clients and products.

PLEDGE

I hereby certify this document to be the original and authentic output of the author's research work. All sources and references are duly listed, and consist mostly of published scientific articles and papers, technical books, database sets from applied research institutes and official reports from international agencies or governmental organizations.

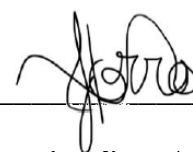

Julian Torres de Miranda Pinto
Clermont-Ferrand, France
April 1st, 2019

SUPERVISORS

Prof. Doctor Arnaud DIEMER (arnaud.diemer@uca.fr)
Université Clermont Auvergne (UCA), School of Economic, Juridical, Political and Managerial Sciences

Prof. Doctor Harald Ulrich SVERDRUP (hus@hi.is)
University of Iceland (HI), Department of Industrial Engineering

RESEARCH COMMITTEE

Prof. Doctor Jackie KRAFFT (jackie.krafft@gredeg.cnrs.fr)
Centre National de la Recherche Scientifique (CNRS, France), Research in Economics – Director;

Prof. Doctor Bruno OBERLE (bruno.oberle@epfl.ch)
École Polytechnique Fédérale de Lausanne (EPFL, Switzerland), Green Economy and Resource Governance – Chairman;

Prof. Doctor Vianney DEQUIEDT (vianney.dequiedt@uca.fr)
Université Clermont Auvergne (UCA), Centre d'Études et Recherches sur Développement International (CERDI, France) – Vice-President of Research;

PREFACE

The present thesis was developed under the European Commission's Horizon 2020 Programme, the largest European Research and Innovation initiative aimed at delivering and promoting breakthroughs, discoveries and benchmarks by taking great ideas from the lab to the market.

Among the many fields of action encompassed by Horizon 2020 stand the Innovative Training Networks (ITN), comprised of multiple projects that share a common goal: to train a new generation of creative, entrepreneurial and innovative researchers that are able to face current and future challenges and to convert knowledge and ideas into products and services for the economic and social benefit of the European Community.

Adaptation to a New Economic Reality (AdaptEconII) is one these projects, proposing a transdisciplinary framework for tackling environmental, social, political, technical, and economic issues by supporting decision- and policy-making efforts oriented towards sustainability, while simultaneously empowering the development of twelve early-stage researchers (ESRs).

This project was made possible by the Marie Skłodowska-Curie Actions on Excellent Research, a fellowship program that provides researchers of all ages and nationalities with the financial means necessary to work across disciplines and to cooperate with industry, governments and research institutions to enhance employability and career development.

By managing the funds made available by Grant Agreement 675153, AdaptEconII exposed the ESRs to creative and critical environments, either providing or supporting the formation and improvement of skills and competencies on topics ranging from biophysical dynamics to systems thinking, thus facilitating knowledge exchange and granting them the opportunity to reach beyond ordinary solutions so as to become the shepherds of the measures necessary to drive the European economy towards a more sustainable future.

In the particular case of this thesis, the author was able to work directly alongside and to partake in the knowledge of professors, experts and consultants from the University of Iceland and from the Institute of Economic Structures Research (GWS), located in Osnabrück, Germany, institution this which primarily pursues a macroeconomic and econometric research approach, favoring bottom-up models in which macroeconomic changes result from events in the individual sectors of the economy.

Furthermore, during the development of the thesis, multiple exchanges were conducted with industrial stakeholders WorldSteel Association, Umicore and ArcelorMittal, with the International Society of Industrial Ecology (ISIE), and with the professionals present in the scientific and academic events to which the author attended in six different countries. Altogether, these experiences helped shape the professional, the researcher and the results achieved in this thesis, representing not only the efforts of its author, but of the entire community and network that supported its development.



European
Commission

Horizon 2020
European Union funding
for Research & Innovation



MARIE CURIE ACTIONS



GWS

“Inside my empty bottle I was constructing a lighthouse
while all the others were making ships.”

Charles Simić

ACKNOWLEDGEMENTS

Mr. Mark Meyer, GWS, Partner

Dr. Gregor Wernet, Ecoinvent, Executive Director

Mrs. Clare Broadbent, WorldSteel Association, Head of Product Sustainability

EXECUTIVE SUMMARY

THE EUROPEAN STEEL INDUSTRY RECLAIMING THE HELM

Steelmakers should consider diverting capital to the end-of-life services that promote circularity as a new strategy towards resource ownership retention and raw material self-sufficiency. These hold the key to curbing steel supply concerns in the long-term while creating new sources of revenue in the secondary metals market, alongside servitization.

Doing so will require the combined efforts of industry and political institutions so environmental commitments continue to be met, calling for circular measures involving either steelmakers or their customers to prioritize investments in supply chain integration, and the recovery of specialty alloys and of scarce alloying elements during recycling.

Furthermore, focus on operational efficiency, by-product recycling, technology and cost reduction now trumps production scale, as per the Chinese lessons of the last decade. Therefore, steelmakers should pay close attention to logistic costs and capital costs as the balance between prices and capacity utilization becomes more delicate and the use of hedging more intensive.

Since high-grade iron ores will go through either technical or economic scarcity between 2051 and 2054, BFBOF steelmakers will continue struggle to manage competition and capacity utilization. Moreover, the continuing transition towards EAF steelmaking will be hindered by increasing electricity and alloying element prices and, although steel scrap continues to leave European borders, its prices will go down more moderately than expected.

However, what stimulates some sectors of the economy might discourage others, since those that contribute the most to steel scrap generation tend to be those in which products containing steel have the shortest life cycles. But despite the fact that increasing circularity by extending steel's life cycle will likely result in lower demand for new steel, there is a balance to be found and it relies on the European Steel Industry reclaiming the helm.

TABLE OF CONTENTS

LIST OF ABBREVIATIONS	IV
LIST OF FIGURES	V
LIST OF TABLES	VII
1. INTRODUCTION	1
1.1. <i>Main objectives</i>	5
1.2. <i>Specific objectives</i>	5
2. LITERATURE REVIEW	7
2.1. <i>From Industrial Economics to the Steel Industry</i>	7
2.1.1. <i>Brief history and concepts of Industrial Economics</i>	7
2.1.2. <i>The evolution and the presence of steel in society</i>	11
2.1.3. <i>The dynamics of the global steel market</i>	15
2.1.4. <i>Opening the Steel Industry's black box</i>	29
2.2. <i>Tools and strategies to manage environmental challenges</i>	35
2.2.1. <i>Value Chain Management</i>	35
2.2.2. <i>Corporate Social Responsibility and Environmental Values</i>	46
2.2.3. <i>Environmental challenges for the future of steel</i>	48
2.3. <i>Towards environmental sustainability in the Steel Industry</i>	53
2.3.1. <i>The Industrial Ecology toolbox</i>	54
2.3.2. <i>Circular Economy</i>	59
2.3.3. <i>Steel and circular policy</i>	65
2.3.4. <i>Sustainable Cities and the steel closest to society</i>	72
3. METHODOLOGY	77
3.1. <i>Life Cycle Assessment</i>	77
3.2. <i>System Dynamics</i>	81
3.3. <i>Research design</i>	87
3.4. <i>Model description</i>	89
3.5. <i>Model parameterizing</i>	91
3.6. <i>Testing and simulations</i>	94
3.7. <i>Secondary methodology</i>	97
3.7.1. <i>Tools</i>	98
3.7.2. <i>Case studies</i>	101
4. RESULTS AND DISCUSSIONS	105
4.1. <i>Integrated Model</i>	105
4.2. <i>End-of-Life Policies</i>	113
4.3. <i>Supply Chain Integration</i>	120
4.4. <i>Economic Dynamics</i>	129
4.5. <i>Steel & Servitization</i>	140

5. CONCLUSIONS	149
5.1. <i>Specific Conclusions</i>	149
5.1.1. Integrated Model	149
5.1.2. End-of-Life Policies	150
5.1.3. Supply Chain Integration.....	152
5.1.4. Economic Dynamics	154
5.1.5. Steel & Servitization.....	156
5.2. <i>Overarching Conclusions</i>	158
5.2.1. Recommendations for the European Steel Industry.....	165
5.2.2. Recommendations for European policy on Steel	166
5.2.3. Suggestions of future research topics	168
6. REFERENCES	169
7. APPENDICES	198
7.1. <i>Ethics Assessment</i>	198
7.2. <i>Business Process Map of the Steel Value Chain</i>	201
7.3. <i>Causal Loop Diagram (CLD) of the biophysical system</i>	202
7.4. <i>Flow Chart (FC) Interface Diagram of the model's biophysical module (highlighting Fe)</i>	203
7.5. <i>Flow Chart (FC) Interface Diagram of the model's control panel (highlighting Fe)</i>	204
7.6. <i>Flow Chart (FC) Interface Diagram of the model's economic module</i>	205
ARTICLE no. 1 - INTEGRATING LIFE CYCLE ASSESSMENT INTO SYSTEM DYNAMICS: THE CASE OF STEEL IN EUROPE.....	206
ARTICLE no. 2 - THE ROLE OF POLICY ON END-OF-LIFE SERVICES TO FOSTER BIOPHYSICAL CIRCULARITY IN THE EUROPEAN STEEL INDUSTRY.....	237
ARTICLE no. 3 - BIOPHYSICAL CIRCULARITY AS DRIVER FOR SUPPLY CHAIN INTEGRATION IN THE EUROPEAN STEEL INDUSTRY.....	270
ARTICLE no. 4 - POTENTIAL LONG-TERM RAMIFICATIONS OF SUPPLY-SIDE CIRCUMSTANCES ON STEEL'S ECONOMIC DYNAMICS	303
ARTICLE no. 5 - SERVICIZATION IN SUPPORT OF SUSTAINABLE CITIES: WHAT ARE STEEL'S CONTRIBUTIONS AND CHALLENGES?	335

LIST OF ABBREVIATIONS

ABM	Agent Based Modelling	GSCM	Green Supply Chain Management
AISI	American Iron and Steel Institute	IE	Industrial Ecology
BAT	Best Available Techniques	ILCD	International Reference Life Cycle Data System
BAU	Business-as-usual	ISO	International Standardization Organization
BF	Blast Furnace	IOA	Input Output Analysis
BOF	Basic Oxygen Furnace	LCA	Life Cycle Assessment
BPM	Business Process Mapping	LME	London Metal Exchange
BRIC	Brazil, Russia, India and China	MFA	Material Flow Analysis
C2C	Cradle-to-Cradle	MCX	Multi Commodity Exchange
C2G	Cradle-to-Gate	NAV	Net Added Value
CAPEX	Capital Expenditures	NYMEX	New York Mercantile Exchange
CE	Circular Economy	OHF	Open-Hearth Furnace
CLD	Causal Loop Diagram	OPEX	Operational Expenditures
CLSC	Closed Loop Supply Chains	PEF	Product Environmental Footprint
CRM	Critical Raw Material	RL	Reverse Logistics
CSR	Corporate Social Responsibility	SAE	Society of Automotive Engineers
CSV	Creation of Shared Value	SCI	Supply Chain Integration
EAF	Electric Arc Furnace	SCM	Supply Chain Management
EBITDA	Earnings Before Interests, Taxes, Depreciation and Amortization	SD	System Dynamics
EFA	Energy Flow Analysis	SHFE	Shanghai Futures Exchange
EOL	End-of-Life	SFA	Substance Flow Analysis
FC	Flow Chart	TCE	Technology Critical Element
FSC	Forest Stewardship Council	UNEP	United Nations' Environmental Programme
FU	Functional Unit	UNS	Unified Numbering System
GPP	Green Public Procurement	VCM	Value Chain Management

LIST OF FIGURES

Figure 2.1.2.01 - Presence of steel in society (WS, 2017).....	11
Figure 2.1.2.02 - Annual steel production in million tons, from 1950 to 2012 (WS, 2013a).....	13
Figure 2.1.2.03 - Geographic distribution of production and apparent use (WS, 2013a).....	15
Figure 2.1.3.04 - Steel intensity over time (EY, 2014).....	17
Figure 2.1.3.05 - EBITDA vs Self-Sufficiency (EY, 2014).	19
Figure 2.1.3.06 - Estimated steel demand growth after 2014 (EY, 2014).	21
Figure 2.1.3.07 - Economic dynamics of the steel industry (developed by the author).	22
Figure 2.1.3.08 - Spot Price Loop (developed by the author).	23
Figure 2.2.2.09 - Capital Accumulation Loop (developed by the author).	25
Figure 2.1.3.10 - Hedging dynamics (developed by the author).	27
Figure 2.1.3.11 - Speculation dynamics (developed by the author).....	28
Figure 2.1.3.12 - Arbitrage dynamics (developed by the author).	28
Figure 2.1.4.13 - Steelmaking routes (WS, 2016).	30
Figure 2.1.4.14 - Crude steel production Value Chain, adapted from (Tata Steel, 2014).....	32
Figure 2.1.4.15 - Steel transactions between 2008 and 2014 (EY, 2015).	33
Figure 2.2.1.16 - Value chains' primary and support activities (SM Study, 2015).....	37
Figure 2.2.1.17 - EBITDA margin vs Self-Sufficiency (EY, 2014).	42
Figure 2.2.1.18 - Supply chain integration approaches (developed by the author).	44
Figure 2.2.3.19 - Energy transformations in steel production (AISI, 2005).	49
Figure 2.2.3.20 - Environmental impacts from three steel production scenarios (Olmez et al., 2015).	50
Figure 2.3.1.21 - Example of Material Flow Analysis (IFU, 2011).	56
Figure 2.3.1.22 - Example of Relevance Matrix Stakeholder Analysis (TVO, 2012).	58
Figure 2.3.2.23 - Outline of a Circular Economy (EMF, 2017).	61
Figure 2.3.3.24 - Steel circularity today (a), and desired state of circularity equilibrium (b) (EUROFER, 2017b).	69
Figure 3.1.25 - Steel's life cycle as per the Circular Economy framework (developed by the author).....	79
Figure 3.2.26 - Example of causal loop diagram (Zhou, 2017).	82
Figure 3.2.27 - Example of flow chart (SDC, 2010).....	83
Figure 3.3.28 - CLD of the biophysical system under study, made in OmniGraffle.	89
Figure 3.4.29 - Flow Chart (FC) Interface Diagram of the model's biophysical module and control panel (both highlighting Fe), and the economic module.....	90
Figure 3.7.1.30 - The city as a system (adapted from Rogers, 1997).....	99
Figure 3.7.1.31 - Circles of Sustainability (adapted from James, 2015).	100
Figure 4.1.32 - High-grade iron ore depletion.	106
Figure 4.1.33 - Results for ore, scrap, steel input and circularity (tons).....	107
Figure 4.1.34 - Steel output and the sources of iron (tons).....	108
Figure 4.1.35 - Presence of iron in the economy, per sector.	110
Figure 4.2.36 - Destination of end-of-life steel, per sector (BAU, kg).....	113
Figure 4.2.37 - Effect on scrap generation, per sector (runs 1 through 6).	114

Figure 4.2.38 - (a) effect on steel input into the economy, per sector (runs 1 through 6); and (b) potential reduction of ore consumption, per sector (runs 1 through 6, in kg/h).	116
Figure 4.2.39 - (a) effect on steel input into the economy, per sector (runs 7 through 12); and (b) potential reduction of ore consumption, per sector (runs 7 through 12, in kg/h).	118
Figure 4.2.40 - (a) effect on Fe circularity within each sector (runs 7 through 12); and (b) effect of each sector on overall Fe circularity (runs 7 through 12).....	119
Figure 4.3.41 - Impact on ore consumption.....	121
Figure 4.3.42 - Recoverable iron in slag (kg).	122
Figure 4.3.43 - Worldwide technically extractable ore reserves (kg).	123
Figure 4.3.44 - Impact on ore, scrap, and steel output.....	125
Figure 4.3.45 - Iron retained within the supply chain (kg).	126
Figure 4.3.46 - Impact on supply side dynamics.	127
Figure 4.3.47 - Impact on End-of-Life dynamics.	128
Figure 4.4.48 - Long-term trends in production, consumption, and capacity utilization (right axis).	130
Figure 4.4.49 - Long-term trends in ore prices, scrap prices, and EBITDA margin (right axis).	131
Figure 4.4.50 - Long-term trends in costs, revenues, reinvestments, and dividends (right axis).	132
Figure 4.4.51 - Long-term trends in spot prices, future prices, and volume of traded futures (right axis).	133
Figure 4.4.52 - Increasing steel output's impacts on spot and future prices, dividends, and EBITDA margins.	134
Figure 4.4.53 - Logistic costs volatility's range of impacts on prices, dividends, and EBITDA margins.	135
Figure 4.4.54 - Impacts of projected energy prices on steel prices, costs, dividends, and EBITDA margins.	137
Figure 4.4.55 - Impacts of projected Ni and Cr prices on steel prices, costs, dividends, and EBITDA margins.	139
Figure 4.5.1.56 - Energy case's perceived key contributions to sustainability.	141
Figure 4.5.2.57 - Housing case's perceived key contributions to sustainability.	144
Figure 4.5.3.58 - Mobility case's perceived key contributions to sustainability.	147

LIST OF TABLES

Table 2.2.1.01 - Examples of supply chain integration in steel supply chains.	40
Table 2.3.3.02 - Summary of available BATs for iron and metals mining, processing, and steel production. ..	67
Table 3.1.03 - SWOT Analysis of Life Cycle Assessment.....	81
Table 3.2.04 - SWOT Analysis of System Dynamics.	86
Table 3.5.05 - Summary of data inputs.	92
Table 3.5.06 - Summary of parameters used in the model.	93
Table 3.5.07 - Summary of baseline costs in €/ton.	93
Table 3.6.08 - Summary of simulation runs (article no. 2).....	95
Table 3.6.09 - Summary of simulation runs (article no. 3).....	96
Table 3.6.10 - Summary of simulation runs (article no. 4).....	97
Table 4.1.11 - Summary of observed slag and emission compositions.	109
Table 5.1.1.12 - Summary of quantitative and qualitative results.	149
Table 5.1.3.13 - Summary of results (article no. 3).	153
Table 5.1.4.14 - Summary of observed trends and behaviors from simulation runs 18 to 21.....	155
Table 5.1.5.15 - Summary of results and discussions (article no. 5).	157

1. INTRODUCTION

The present thesis delves into the current and future interactions within the European Steel Industry and of it with the environment it is a part of, with the main objective of supporting decision- and policy-making efforts oriented towards sustainability and circularity, helping to shape the future of steel in the European Community. To do so, a better understanding of steel supply chains was deemed important, beginning by how its steelmakers are organized and behaving throughout the development of their business activities.

Knowledge on Industrial Economics was defined as the stepping stone, especially regarding Firm Theory as seen through the descriptive, microeconomic and governance approaches. Understanding how markets are structured and how industries elaborate their strategies subsequently led to a better apprehension of how they perform and of what permeates their decision-making.

It was also important to explore the reality of steel supply chain operations, which, for this project, were concentrated in the European Union. However, remaining in macro-level analysis would not have sufficed, requiring also an approach in the language spoken by the industry to enable the investigation of operational aspects: Supply Chain Management. A good grasp of its concepts and applications was necessary, since navigating through this field of studies one will not only encounter new managerial trends – such as Value Chain Management –, but also useful tools – like Stakeholder Management and Business Process Mapping.

The first is what many consider a natural development of Supply Chain Management, shifting the focus towards adding and sharing values and encompassing managerial sections once seen as secondary or of supporting role. The following two are tools that support decision-makers by identifying the leverage, influence and pressure points that derive from

the different agents that interact in a supply chain; and by improving the understanding and efficiency of individual processes within a business activity; respectively.

The more one knows the processes and stakeholders involved in the European Steel Industry, the more it becomes clear that its steel supply chains are far from being isolated operations and, consequently, regulatory aspects come into play. These aspects can derive directly from governments in the form of legislation, but also from the market and its agencies in the form of standards. Furthermore, as steel's importance for economy and society remain as high as it has even been since the Industrial Revolution – to the point of becoming a matter of national security –, understanding the inner workings of international trade that surrounds and percolates through this sector could not have been left aside.

But the challenges that the Steel Industry face do not only come from outside Europe's borders: its high energy demand, its environmental impacts and the chemical and physical requirements of its production processes bind this economic activity to a constant state of pressure. And given the economic developments of the last decade, this sector needs to consider all strategies available in order to keep supply and profitability while honoring their environmental commitments.

Industrial Ecology is one example among many concepts that aim to better measure and manage the physical interactions of industries with the environment and, as Circular Economy became more widespread in policy during recent decades, so did the many tools used by experts to approach industrial operational reality and how to improve it. Environmental Management Systems and Integrated Chain Management are now part of managerial vocabulary and are often put to practice. Moreover, it is no longer difficult to find industries that are Ecolabelling their products, as well as services based on the results of growingly deployed tools such as Life Cycle Assessment and Material Flow Analysis.

Most of these tools, however good they are at pinpointing issues and driving applied solutions, eventually leave aside a key aspect of linking an industrial activity to its environment: systemic behaviors. No decision is taken without affecting an entire series of factors and events that, unless properly identified and mapped, can be lost in the analyses. To mend these fissures that can inadvertently lead to chasms, recent attention has been given to System Dynamics (SD), a methodology that can add a holistic correlational layer to the physical flows and stocks well known by executives worldwide. Input and output accounting no longer suffice to drive an industry – even less an entire supply chain – towards a more circular and sustainable future.

Based on the author's experience in industrial environments and with Life Cycle Assessment (LCA), the first article developed for this thesis compiled relevant SD and LCA studies on steel and presented SWOT analyses for each of them. From the opportunity identified in this investigation, a model integrating LCA into SD was developed, using the European Steel Industry as case study. This paper configured the methodological core of the thesis and permeated four of its five articles. Its main contribution was the development of a new type of model, in which the whole methodology of Life Cycle Analysis was brought into the System Dynamics modeling environment. This model was not only capable of reproducing results from previous studies that used the aforementioned methodologies, but also of increasing the understanding of the dynamics of the European Steel Industry, becoming a potentially interesting tool for both policy- and decision-makers.

The second article assessed European policies based on Circular Economy and their interactions with either steel or its end-of-life. Then, the model built during the development of the previous article was used to test different scenarios and discuss policy approaches that could further improve the biophysical circularity of end-of-life steel in Europe. Its main contribution was bringing to light the importance that European Circular Economy policies

that concern the steel industry target more incisively the development and improvement of the secondary raw materials market.

The third article discussed current Supply Chain Integration practices in the European Steel Industry and proposed alternative approaches to integration focusing on improving biophysical circularity that close material loops. Using the aforementioned model, different strategies were tested and the best types of integration suited for either supply- or demand-side dynamics were identified, notably regarding raw material self-sufficiency and resource ownership retention.

After using Systems Thinking to analyze the economic dynamics of the steel market, the fourth article added an economic layer to the biophysical model created in the first article. Having performed different tests while tracking the long-term trends of spot prices, future prices, EBITDA margins, dividend payouts and costs, the results pointed to six key biophysical variables and their effects on economic dynamics and on steelmaking managerial behavior.

The last article was the only one developed with a methodology different from the previous ones, and began its assessment by contextualizing the concepts of Sustainable Cities and Servitization and discussing how commodities, notably steel, may interact with service-oriented initiatives. By using the criteria of Sustainable Urban Metabolism and of Circles of Sustainability, three case studies were analyzed and served to exemplify different contributions and challenges that steel supply chains could face regarding servitization. Its main contribution was highlighting the importance that steel has on supporting servitization in adding environmental values to a community in what regards to sustainability, resilience, eco-efficiency and self-sufficiency.

1.1. Main objectives

As previously stated, the main objective of the present thesis was to support decision- and policy-making efforts oriented towards sustainability and circularity, helping to shape the future of steel in the European Community. To do so, it aimed to identify key points of action from the perspective of industries and governments.

From the opportunity identified by the author, a hypothesis was formulated: integrating Life Cycle Assessment's criteria and standards into a System Dynamics modelling environment can provide and uphold new insights for the future of the European Steel Industry in what regards to circularity and sustainability.

To verify if this hypothesis would yield the results it intended, the following overarching questions were devised to drive the development of the project:

- Can the integration of LCA into SD provide and uphold new insights for the future of the European Steel Industry in what regards circularity and sustainability?
- What are the key measures that stakeholders of the European Steel Chain can take in order to improve sustainability and circularity?
- How best to put these measures into practice in face of the current and upcoming biophysical and economic landscape?

1.2. Specific objectives

The specific objectives derived from the main objectives and were set in the form of the questions below in order to enable a more objective investigation. The joint interpretation of their answers, present throughout the articles, supported the author in achieving his conclusions.

- Literature Review: What are the historical and contemporary developments that permeate the current reality of the Steel Industry?
- Literature Review: What are the concepts, methods and tools currently available for understanding and analyzing the dynamics of the Steel Industry?
- Article no. 1: Can the integration of LCA into SD reproduce the results or behaviors previously observed in studies that used LCA or SD separately?
- Article no. 1: What potential benefits derive from this integration toward decision-making on the biophysical aspects of long-term materials sourcing?
- Article no. 2: Would a more aggressive policy-based approach to end-of-life steel better support the European Steel Industry in its transition towards a more circular model?
- Article no. 3: Can the implementation of different Supply Chain Integration strategies help improve the biophysical circularity of steel and its components by closing material loops in either a European level or in the supply chains therein?
- Article no. 4: What are the key biophysical variables that drive the economic dynamics in the Steel Industry?
- Article no. 4: How can economic dynamics be articulated within a biophysical model based on the Life Cycle Assessment of the steel products?
- Article no. 5: What are the Steel Industry's contributions and challenges when interacting with servitization initiatives in urban environments?

2. LITERATURE REVIEW

Keeping in mind the scope and objectives introduced in the previous section, this section compiles the pertinent historical and conceptual aspects concerning or encompassing the topic at hand that were used for the development of the thesis as a whole, as well as of each article. Throughout the text, relevant classic contributions as well as contemporary advancements are brought to light in order to support methodological arguments and discussions.

2.1. From Industrial Economics to the Steel Industry

This subsection begins by introducing the concepts of Industrial Economics that are applicable to the objectives of the present thesis. It then proceeds to explore the presence and evolution of steel in the society before delving into the behaviors, strategies and processes of steel industries.

2.1.1. Brief history and concepts of Industrial Economics

Manufacturing activities began to professionalize themselves after the 15th century as a result of technical and scientific progress and, thus, gradually drove civilizations into what is now known as industrial societies. In order to better grasp this new phenomenon in human interactions and in market behavior, many concepts of *industry* arose between the 1700's and the 1900's, and the majority defined it as a series of economic units of production organized to transform materials into goods (Cotta, 1968; Cabral, 2000; Levet, 2004; Morvan, 1985; Schmalensee & Willig, 2008).

As minor variations of this concept solidified in the vocabulary of economists, so did theories about market models. The first models that allowed industries to be better understood in their roles within a market were those of duopoly and oligopoly developed by

Cournot in 1838 and Bertrand in 1883, respectively, giving way to the one about perfect competition created by Arrow-Debreu in 1954, in which multiple industries with virtually identical products compete in an environment with negligible entry barriers. This model did not encompass the entirety of reality, thus driving the creation of the monopoly model, in which one industry rules the market virtually unopposed, differentiating the product in order to supply consumers. These diametrically opposing models then jumpstarted nuanced discussions that eventually led to the oligopoly and the monopolistic competition models – currently the most representative ones –, in which different quantities of industries compete in markets with varying entry barriers, differentiating their products based on resource allocation or competitive strategies (Arena et al., 1991; Cabral, 2000; Cotta, 1968; Engwall, 1973; Levet, 2004; Lipczynski et al., 2005).

After the first World War, however, economic theories still had difficulties understanding the reasons why industries and businesses existed, how they were organized, how they interacted with each other and how they conducted their activities in the market. In order to fill this gap, many Theories of the Firm emerged and, roughly put, suggested that industries exist to maximize profits and that the decisions made therein in terms of resources allocation and prices always tend to revolve around the achievement of this goal (Levet, 2004; Cabral, 2000; Cotta, 1968; Arena et al., 1991; Clarke & Tony, 1987; Morvan, 1985; Willig & Schmalensee, 2008).

Even though current knowledge on the history of the Theories of the Firm is consolidated, their emergence gave room to variations stemming from different fields of economic study. Baumol (1959), for example, suggested that maximizing profits is also a function of the decision-makers' desire for compensation and prestige, which can lead job security to affect the goals of the shareholders. Marris (1964), Cyert & March (1964) and Williamson (1966) suggested that the firm is also subject to financial and resource

constraints, affecting the operation directly or indirectly via decision-making bound to the managers' individual perceptions. Coase (1937), on the other hand, suggested that the reduction of transaction costs is the main justification for the existence of industrial organizations that seek profit – a line of thought that later influenced managerial scientists into focusing in the efficiency of the transactions within a firm, be them resource- or knowledge-based (Lipczynski et al., 2005; Levet, 2004; Willig & Schmalensee, 2008; Schmalensee & Willig, 2008; Carlton & Perloff, 2008).

As of today, Industrial Economics is a branch of Microeconomics focused on the behavior of markets and of the firms within it, particularly on what regards to their organization, behavior and performance in empirical and managerial form. It has evolved from the Theories of the Firm by going deeper into the operational details of companies' structures, decisions and boundaries, giving birth to many specialties of modern managerial sciences. Furthermore, Industrial Economics is now approached more broadly, also studying commerce and services as activities capable of creating and rearranging the use of capital, as well as more recent and complex drivers of decisions regarding resources, such as economies of scale, international trading, consumer utility and even sustainability – the latter being considered as a part of a long run of profit maximization (Tirole, 2015; Cabral, 2000; Levet, 2004; Lipczynski et al., 2005; Boyle, 1972; Beacham & Williams, 1961; Carlton & Perloff, 2008).

Due to ever growing complexity, however, many economists still see firms as *black boxes*, in which productive activities are conducted mechanically, with inputs and outputs being less affected by decision-making rather than by the markets themselves. Progress in delving into firms is nowadays led mostly by the managerial sciences that flourished in the 1980s, in which agency, uncertainty, ownership and demand play bigger roles as variables

of industrial behavior, decision-making and performance (Lipczynski et al., 2005; Levet, 2004; Clarke & Tony, 1987; Carlton & Perloff, 2008).

The more that globalization, new technologies, new market practices and the demand for innovation become present as drivers of competition, the more must industries reorganize themselves. The speed with which changes in business models have been occurring since the early 2000s has shortened operational and productive cycles, imposing flexibility as a new factor to industries once unfamiliar with practices such as cooperation, decentralization, real-time decision-making, supply chain alignment and interdisciplinarity (Levet, 2004; Lipczynski et al., 2005; Schmalensee & Willig, 2008; Willig & Schmalensee, 2008).

This has given new meanings and new applications to other adjacent Industrial Economics' theories such as Neumann and Morgenstern's Game Theory, Jensen and Meckling's Agency Theory, Coase's Theory of Transaction Costs, and Hart and Holmström's Contracts Theory. These now configure the ground from which managerial sciences built up their tools and methods to deal with asymmetric information, intra- and inter-company interactions, internet-based operations, the emergence of new risks, as well as with new variables in the relations between supply and demand (Tirole, 2015; Lipczynski et al., 2005; Levet, 2004; Willig & Schmalensee, 2008; Schmalensee & Willig, 2008; Carlton & Perloff, 2008; Coase, 1937; Hart, 1995; Jensen & Meckling, 1976; Neumann & Morgenstern, 1944).

Industrial Economics now faces important challenges in what regards to the improvement of demand anticipation, investments on intangible assets, generation and distribution of value throughout supply chains, complexity management, product quality and consumption behavior responsiveness. Such demands steadily foster the rise of managerial sciences, increasingly capable of unveiling the inner works of the ever-mysterious *black box* of the firm from an operational perspective (Lipczynski et al., 2005; Levet, 2004; Carlton & Perloff, 2008).

In order to explore this black box, as is common in many fields of scientific inquiry, a case-study will be used. For the purposes of the current study, the Steel Industry will be the main source of empirical data and its characteristics will be described from the next section onwards.

2.1.2. The evolution and the presence of steel in society

Steel is the most commonly used alloy of iron and has been, for the past 200 years, one of the most essential materials worldwide. Its presence can be perceived in most aspects of everyday life, from infrastructure to transport, from canned food to electronics, as seen in Figure 2.1.2.01. Steel's cycle through environment and society originates in the ores mined from mountains and underground reserves and most commonly meets its end inside long service life structures or as recyclable scrap (WS, 2012; Warriar, 2012; Vaclav, 2016; EY, 2014; Beddows, 2014).

Figure 2.1.2.01 - Presence of steel in society (WS, 2017).



Steel can be produced in different grades and for different applications by including additional processes in the iron smelting production line, in which different chemical elements are inserted in small quantities, altering iron's mechanical properties. Steel grades are currently classified by the AISI/SAE system, created by the Society of Automotive Engineers with the support of the American Iron and Steel Institute. In this system, there are four main categories: stainless steels – corrosion resistant alloys with chromium content varying between 10-20%, separated by crystalline structure into austenitic, ferritic or martensitic –, (b) carbon steels – with carbon content varying between 0.04-1.50%, separated into low, medium and high carbon –, (c) alloy steels – which contain different amounts of different alloying substances such as manganese, silicon, nickel, titanium, copper and aluminum, in order to attain different mechanical properties –, and (d) tool steels – containing different amounts of tungsten, cobalt, molybdenum and vanadium, focusing on heat resistance and strength, and subdivided by shape and application (Beddows, 2014; WS, 2012/2013a; Vaclav, 2016; Warrian, 2012).

These types of steel stem from its accidental discovery as a byproduct of iron forging for tools and weapons during the Iron Age. Ever since then it has been continuously improved and its presence has never stopped growing, as seen in Figure 2.1.2.02. Furthermore, many of the biggest steel producers (e.g. ThyssenKrupp, Nippon Steel and Sumitomo Metals) share their history with the booming of this material around the Industrial Revolution in Europe, posing as examples of how traditional this industry has become (Beddows, 2014; WS, 2012; Vaclav, 2016; Warrian, 2012).

Figure 2.1.2.02 - Annual steel production in million tons, from 1950 to 2012 (WS, 2013a).

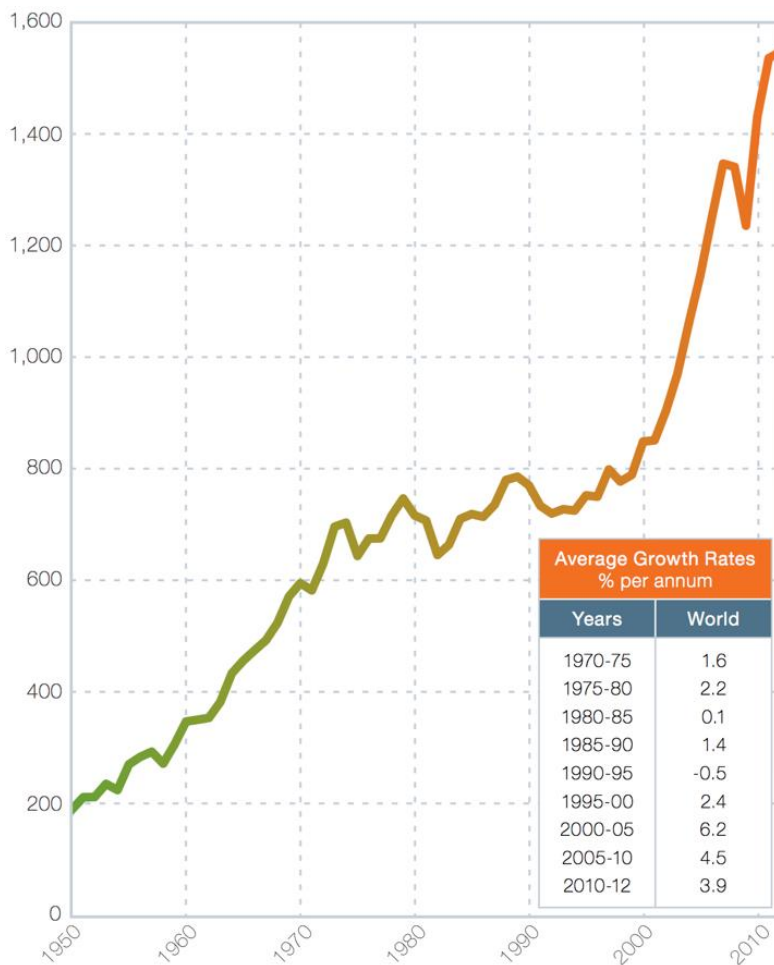

Steel's success in modern society derives from the work of inventors like Bessemer – who removed impurities in steel by injecting air into iron smelting –, Huntsman – who created uniform ingots by using a crucible –, Martin and Siemens – who controlled temperature more precisely by using an open hearth –, and Kelly and Mushet – who increased steel strength by reinserting air blown carbon back into the iron. In the early 1900s, with the help of Durrer – creator of the basic oxygen steelmaking process –, Korf – inventor of the electric arc furnace –, and Iverson – the first industrialist to adopt the mini-mill model –, steel production began to migrate from wood coal to coke and eventually electric arc furnaces, from traditional production to continuous casting, from ore-only to partial scrap input, and from bulk steel to specialty products and recycling (Beddows, 2014; Vaclav, 2016; Warrion, 2012; WS, 2012).

After a demand boost from the two World Wars, steel in the second half of the 1900s continued its technical improvement trend, seeing, at the same time, many state-owned mills be privatized and many new mini-mills emerge. Furthermore, during the same period, additional competition rose from the East – especially from Japan, South Korea and Russia, stimulating the creation of the European Coal and Steel Community –, and a global competitive market later consolidated itself with the addition of big new players from India, China and Brazil (WS, 2012; Vaclav, 2016; Beddows, 2014).

The steel market since the beginning of the 2000s, as seen in Figure 2.1.2.03, is substantially different from what it was in the early years of its industrialized steel production. Once dominated by the United Kingdom and the United States, technical advancements became more common in Germany and Japan as a consequence of the World Wars, making them considerably more efficient and competitive. Also, logistics were barely capable of coping with existing trades, so when developing economies began to require more steel to support their urbanization and overall industrialization, more effort was put into producing steel locally instead of importing. Competition became fiercer and, currently, BRIC countries (Brazil, Russia, India and China) are the only large producers still capable of promoting substantial growth in their production in comparison to their developed counterparts. As African, Latin and Middle-Eastern nations increased their demand for steel products, new sales opportunities were created for the emergent players, but even though this helped spreading the market share throughout different companies, most of the share was captured by steelmakers based in China (WS, 2013a/2017; Vaclav, 2016; Warrian, 2012; EY, 2014).

Figure 2.1.2.03 - Geographic distribution of production and apparent use (WS, 2013a).

Crude steel production

World total: 1,547 million tonnes

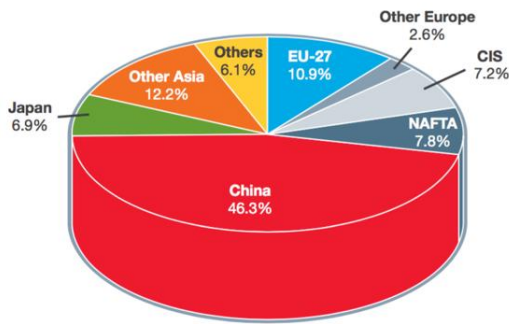

Others comprise:

Africa	1.0%	Central and South America	3.1%
Middle East	1.6%	Australia and New Zealand	0.4%

Apparent steel use (finished steel products)

World total: 1,413 million tonnes

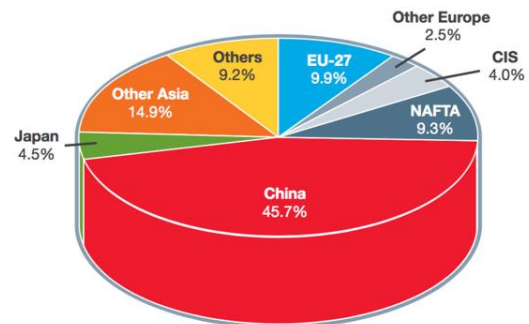

Others comprise:

Africa	1.9%	Central and South America	3.3%
Middle East	3.5%	Australia and New Zealand	0.5%

Today, steel is recycled at a 70% rate and most of its byproducts can be reused in other industries. In comparison to the 1980s, the average production process now uses 50% less energy per ton, and stronger and lighter steel alloys help vehicles to become more fuel efficient and reduce their emissions, sometimes being very environmentally competitive against plastics and aluminum products as well (Warran, 2012; Vaclav, 2016; WS, 2017; Yellishetty et al., 2012).

Once knowing how the steel industry is present in society and how it has evolved through time, the next section will introduce the global steel market.

2.1.3. The dynamics of the global steel market

The steel industry today is very much influenced by technology as a driver of competitiveness derived from reducing productive costs and efficiency or from innovation, specialization and quality. This is a consequence of the great amount of innovation conducted in Japan, Korea and in Germany after the Second World War, which led the United States, the United Kingdom and other developed producers to face new competitors. Furthermore, as wages increased in developed countries, it became more attractive from a productive

scale perspective to shift production to developing areas such as China, Russia, India and Brazil in which variable costs were more competitive and the technology in use had lower capital costs (D'Costa, 1999; EY, 2014; Vaclav, 2016; Yellishetty et al., 2012; Warriar, 2012).

As the demand for steel products in developed economies decreased and stabilized itself, as seen in Figure 2.1.3.04 industries in North America and Western Europe focused on using technology to improve quality and portfolio specialization. On developing areas of the globe, however, demand is still strongly driven by urbanization and industrialization, being most of the deployed technologies derived from transferred know-how focused on maximizing output capacity and on improving price competitiveness. Their output now not only supplies internal growth demands, but also creates international trading competition for those previously consolidated advanced economies, creating the need for their steel industry to restructure itself (D'Costa, 1999; Yellishetty et al., 2012; Warriar, 2012; WS, 2013b).

Figure 2.1.3.04 - Steel intensity over time (EY, 2014).



Currently, the steel industry has excess capacity worldwide, operating at particularly high costs in developed economies, a situation that would likely point to a tendency of reduction. However, this is not the case: industries still use their capacity as strategic means to flood the market and discourage new entrants. Reactions to these dynamics include the European Trade Defense – which enforces penalties for dumping and flooding practices – and the current administration of the United States of America considering reinstating and increasing protectionism policies and barrier to foreign steel (Beddows, 2014; Yellishetty et al., 2012; Warran, 2012; EY, 2015; The Economist, 2018/2019).

Political environment is another reason why capacity is often not reduced: unions and institutional forces, whether regulated by the state or by the market, tend to avoid laying off

factory workers in large scales. In some cases, though, the steel industry from developed economies is itself investing in developing areas to transfer capacity and technology as well as to decentralize sourcing. In other cases, excess steel capacity is gradually being converted into new capacity for more specialized products or higher valued ones that corroborate with a trend of reducing overall steel intensity (Beddows, 2014; D'Costa, 1999; Yellishetty et al., 2012; Warrian, 2012; Chevalier, 1995; EY, 2015).

Due to the capital-intensive and long-term investment characteristic of the steel industry, however, these strategic shifts have industries committing to large-scale restructuring efforts while also potentially devaluing their current technology, however productive and efficient it may still be in comparison to those industries in developing economies (EY, 2014; Beddows, 2014; WS, 2013b; D'Costa, 1999; Warrian, 2012).

Regarding these two practices, specialist say that decentralizing is limited by logistics, resource availability and international trade agreements; while others argue that specializing portfolio, even if good for reducing financial risk, weakens market share and may leave the company more vulnerable to market dynamics (WS, 2013b; D'Costa, 1999; EY, 2014; Beddows, 2014; Chevalier, 1995). Figure 2.1.3.05 depicts recent results of the steel industry in relation to their raw material self-sufficiency, in which it is possible to see that decentralized sourcing is not necessarily a recipe for success (e.g. MMK and Sail), as much as it shows that specialized portfolios in industries oriented towards high added-value products and portfolio variety can create very different results (e.g. Thyssenkrupp and Hyundai Steel).

Figure 2.1.3.05 - EBITDA vs Self-Sufficiency (EY, 2014).

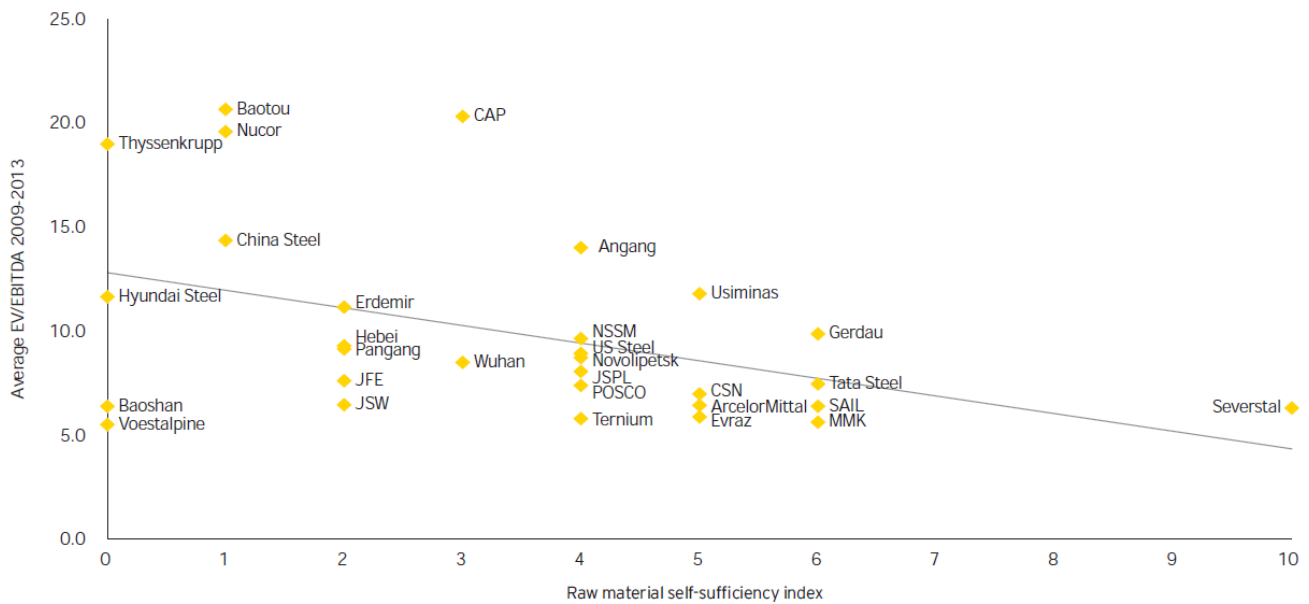

Additionally, in both cases, the role of the state can be constructive or destructive. In terms of decentralizing sourcing, taxation policies on exports and imports can make or break the cost effectiveness of geographically decentralizing steel supply chains; in terms of specializing portfolio, new productive infrastructure and technology to support the development of alternative sources of profit might often require the state to actively insert capital into these activities (WS, 2013b; D'Costa, 1999; EY, 2014; Beddows, 2014).

Consequently, and especially in the short-term, transferring technology and know-how does not mean mastering them, and capital can be locked in place while productive maturity is achieved. For decentralization, this represents less of a risk due to the lower costs of production and to a growing demand in the developing economies, but, for specialization, it almost overshadows the benefits of expanded or specialized portfolios. In both cases, nevertheless, the more present the state's capital is, the more regulated and less market-dependent the decision-making tends to be. Even though developed economies usually have more available capital to support its industry, the financial stakes are high in both situations: specializing production to supply specific sectors can disrupt overall economic behavior, and

allowing industries to source from decentralized operations does not guarantee that this money will reintegrate the economy in the future (Beddows, 2014; EY, 2014; Warrian, 2012; Yellishetty et al., 2012).

While consolidated industries had difficult strategic decisions to make when changing from open hearth furnace (OHF) to basic oxygen furnace (BOF) after the World Wars, so do modern steel makers struggle to shift from BOF to electric arc furnaces (EAF). This enables new entrants to skip a transitional period and invest their capital directly into the newest technology, better for processing scrap metal, allowing for faster and more cost-effective responsiveness to market dynamics. However, considering that the most recent and most internationally relevant entrants are in their majority located in developing economies and are already operating under capacity, it is unlikely that BOF will be surpassed by EAF in the near future. This levels the market even more, making strategies based on decentralization or specialization more common than direct capacity investments (Yellishetty et al., 2012; Beddows, 2014; EY, 2014; Vaclav, 2016; Warrian, 2012; WS, 2013b).

Recently, however, geopolitical circumstances, the ever-growing presence of Chinese and Indian steelmakers and the decreased demand from the automotive and energy sectors in Western Europe and developed Asian nations, as seen in Figure 2.1.3.06, do not favor bold decision-making. As a consequence, idle capacity globally is around 30% on average, compromising margins, increasing the relative risk of both decentralization and specialization and making strategies more conservative. As the steel market *waits and sees* how demand and prices are going to rearrange themselves in the near future, even Africa – a continent where demands have substantially grown and full local supply is unavailable – sees international steelmakers preferring to compete to export instead of investing on local plants (EY, 2014; WS, 2013a/2017; Vaclav, 2016).

Figure 2.1.3.06 - Estimated steel demand growth after 2014 (EY, 2014).

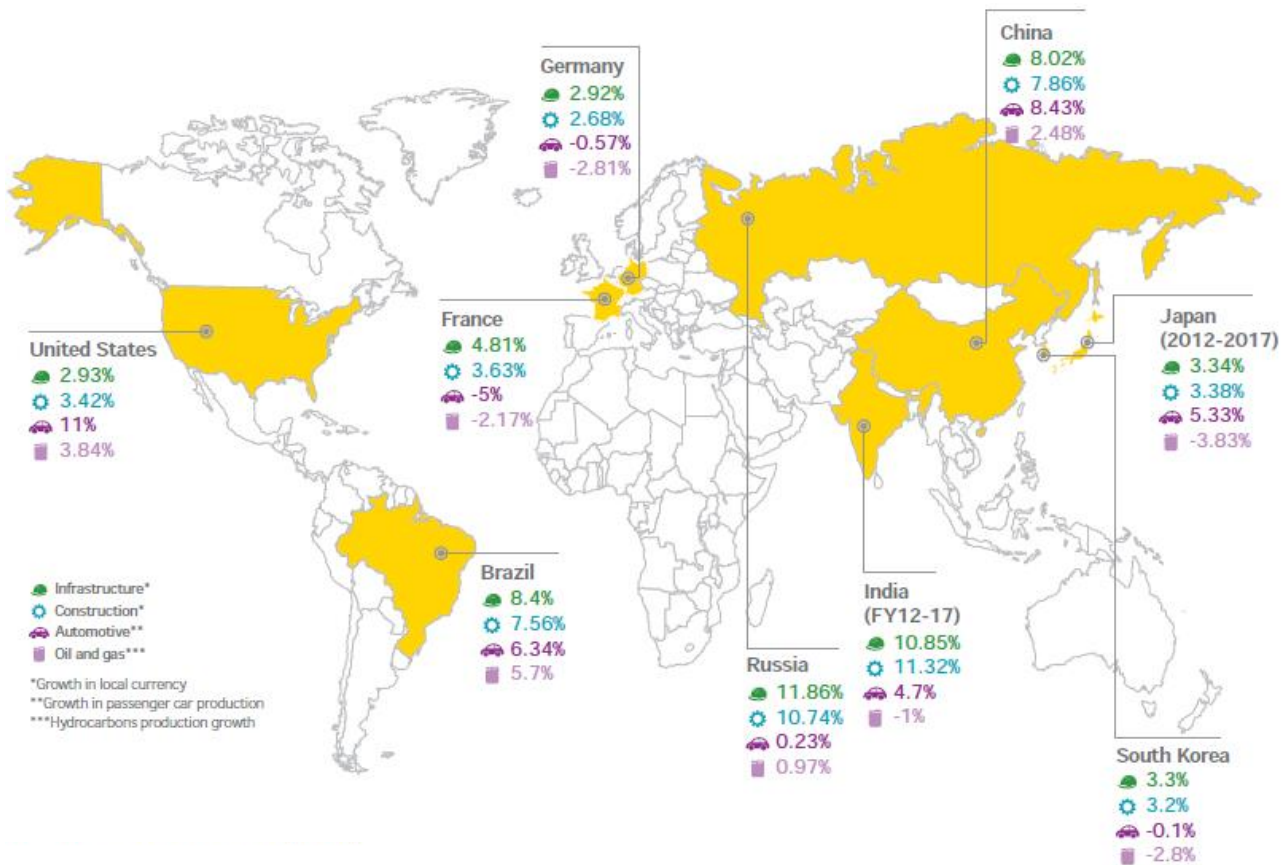

To better grasp the behaviors inherent to global steel market, the author used the support of Systems Thinking – the backbone of System Dynamics – to summarize the economic dynamics of the steel industry, as seen in Figure 2.1.3.07. This Causal Loop Diagram (CLD) encompasses (a) a spot market loop, (b) a capital accumulation and distribution loop, and (c) a futures market loop, further analyzed alongside real-world examples.

Figure 2.1.3.07 - Economic dynamics of the steel industry (developed by the author).

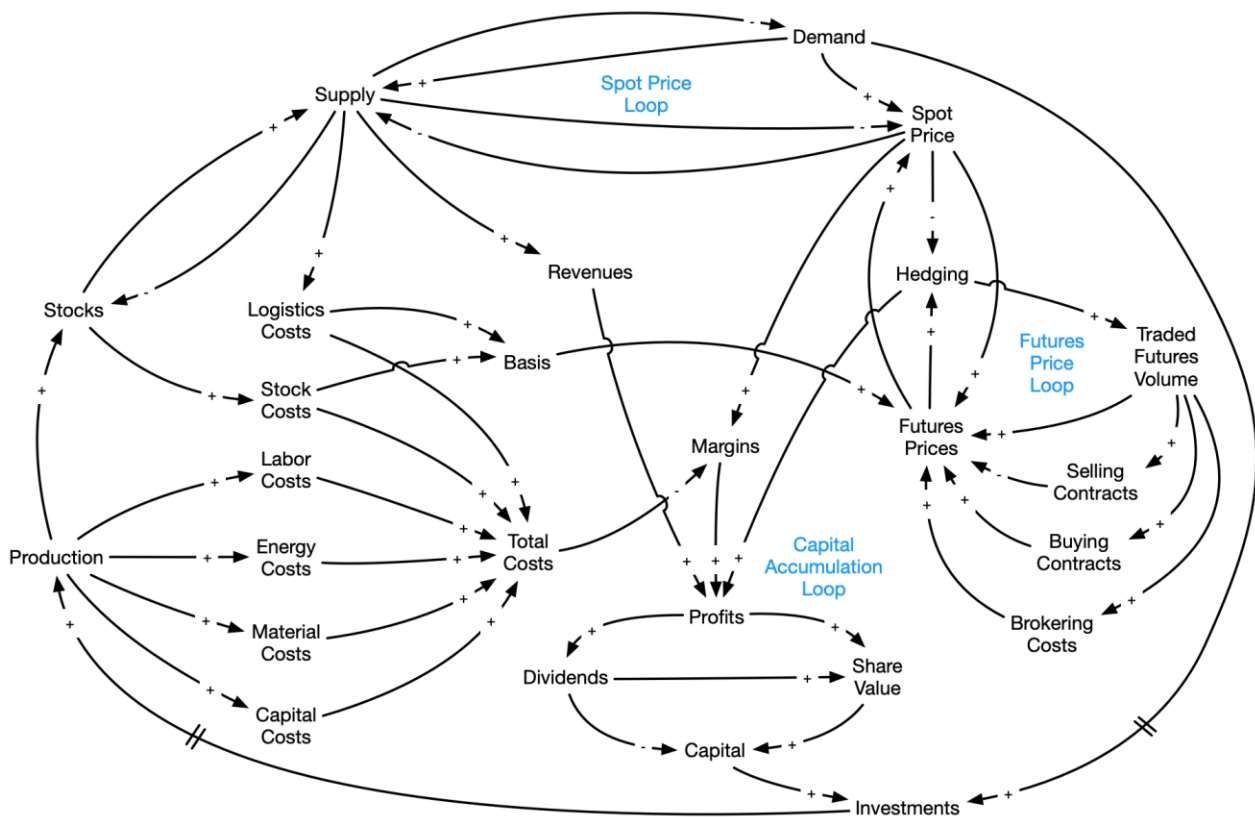

Considering that steel's spot price is heavily influenced by demand, trade and stocks, spot market dynamics consequently rely on the outcomes of productive variables (Rossen, 2015). Since 2010, however, steel has been facing higher supply than demand due to overcapacity, with only 70% of production operational (Pooler & Feng, 2017; OECD, 2018). If the steel industry had been operating at full capacity, it is estimated that additional 730 million tons of steel would have been made available to the spot market in 2016 alone (OECD, 2018; WS, 2018).

Many Western steelmakers hold China responsible for this situation due to the fact that the nation doubled its production in the period between 2004 to 2014, growing its share from about 25% to 50% of total world production, becoming market leader by 2017, and significantly reducing spot prices worldwide (Fickling, 2017). This allowed China to profit in scale instead of by margin alone, while significantly hindering their competitors' negotiation

leverage and, consequently, their market shares. This is particularly noticeable when focusing on the spot price loop of steel's economic dynamics, as seen in Figure 2.1.3.08.

Figure 2.1.3.08 - Spot Price Loop (developed by the author).

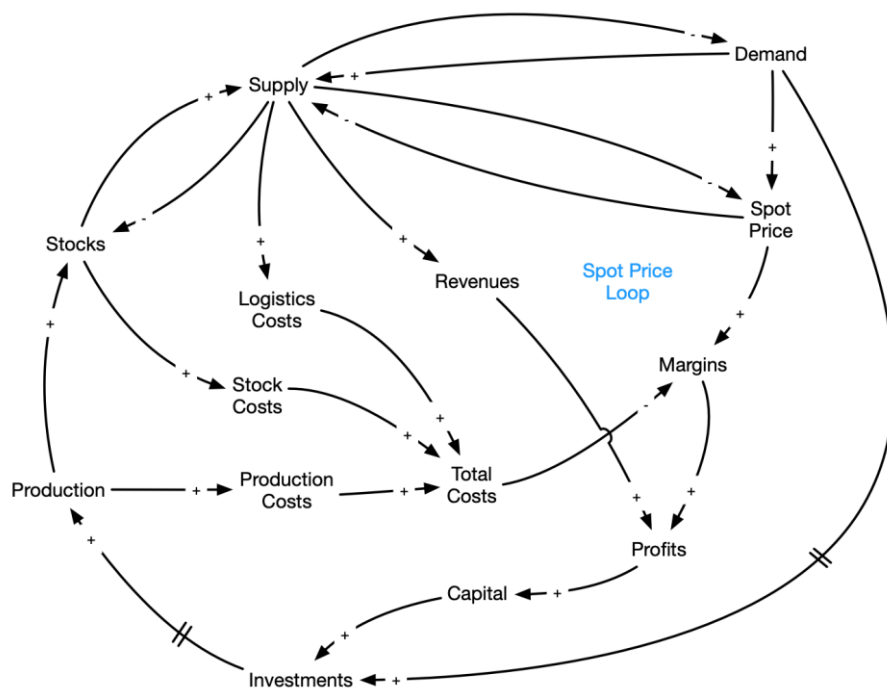

China's state-owned productivist policy was particularly important after the 2008 financial crisis as China's growth slowed, serving as a tool for mitigating the rise of unemployment and the associated risks of social crises in the context of the prevailing economic slowdown (Fickling, 2017). To counter what was considered by many as unfair competition, the European Commission has introduced anti-dumping duties on imports of a range of steel products from China; and similar measures have been under consideration by the current administration of the United States of America (The Economist, 2017/2018).

Some North American and Western European steelmakers saw this as an opportunity to repeat the behavior of steelmakers during the post-War – when Japan, South Korea and Germany rejoined the steel market (D'Costa, 1999) – and boost their margins by using technology to help reduce production costs and improve efficiency (e.g. ArcelorMittal), while

others chose focus on quality and portfolio specialization (e.g. Thyssenkrupp) (EY, 2014/2015; WS, 2013).

In 2016, having recognized the problem that overproduction created and beginning to fall victim to it themselves, the Chinese launched a policy to reduce steel production by 150 Mt by 2020 and to improve air quality in the heavily polluted provinces where loosely regulated steel production takes place (Reuters, 2018; GreenPeace, 2017). It is unlikely, however, that these reductions will solve the problem since now India has decided to triple production by 2030, and Russia, Iran and Turkey decided to direct their production mostly towards exports (Chandrasekhar, 2017).

Still, the global steel market remains in overcapacity despite prices rising since 2015. Due to the strength of this trend in global production and the context of declining demand, spot market operators expect prices to fall in the short term, but to recover in the medium term due to China's market share (Statista, 2019). Furthermore, production electrification – i.e. migration to Electric Arc Furnaces (EAF) supplied by the secondary metals market – as well as the increasing prices of other raw materials may play an important role in the long-term developments of steel's spot market (MKC, 2018; Gonzales-Hernandez et al., 2018).

Directing attention to capital dynamics – seen in Figure 2.1.3.09 – not only reinforces the importance of the spot market as a source of income, but also introduces reinvestments and dividends distribution as factors that can boost or hinder production. Reinvestments can directly affect capacity and efficiency of production, but balancing how much to reinvest and how much to pay as dividends can indirectly affect the perception of outside investors through the value of a company's share and through signaling expected increases in profitability (Batabyal & Robinson, 2017).

despite the context of overcapacity and indicating that price increases may occur without severely affecting the dynamics of the spot market.

As per the dynamics in Figure 2.1.3.09, this phenomenon indicates that the steel industry seems less concerned about finding a balance between reinvestments and dividends distribution than it is concerned about managing these variables cyclically. At first, focus is given to improving margins by reinvesting on technology, efficiency and integration, even if at the expense of dividends. Once revenues increase as consequence of higher margins, dividend distribution takes place, thus raising share value and signaling a price increase that could potentially attract external capital towards either improving capacity and market share – still a common strategy despite current overcapacity – or, if the cycle is to be repeated, towards cost reduction and higher margins.

Still, this cyclic behavior of capital accumulation and distribution relies heavily on supply-side dynamics to ensure profitability and could be proven precarious unless steelmakers cover or compensate investment risks. Since production costs can significantly affect margins, exchanges in commodity futures markets became commonplace and grew substantially after 2008 (LME, 2019; SHFE, 2019).

The steel futures market plays a key role in the evolution of price and on the expectations of traders and investors. In it, steel is exchanged in the form of contracts that represent a commitment to deliver steel in a future date with a price set when the contract is negotiated (Schwager, 1984; Clenow, 2013). The reference quotation for steel comes from the London Metal Exchange (LME) but many secondary institutions such as the New York Mercantile Exchange (NYMEX), the Shanghai Futures Exchange (SHFE) or the Multi Commodity Exchange (MXC) also provide price signals to traders.

The main type of operation on a futures market is *hedging*, in which the operator aims to reduce exposure to the risk of price fluctuations. If supply is higher than demand – which

is the case today on the spot market –, spot price tends to go down. To compensate for the risk of this price reduction affecting their profits, steelmakers sell steel contracts today with a future price that, on delivery, covers their targeted earnings. If the price in fact goes down, profit lost by the steelmaker on the spot market is covered by the margins they got on the futures market (Schwager, 1984; Clenow, 2013).

The opposite would take place if prices are estimated to increase. These dynamics are depicted in Figure 2.1.3.10, in which two loops (Reinforcing, Balancing) can have either a reinforcing or balancing behavior, respectively.

Figure 2.1.3.10 - Hedging dynamics (developed by the author).

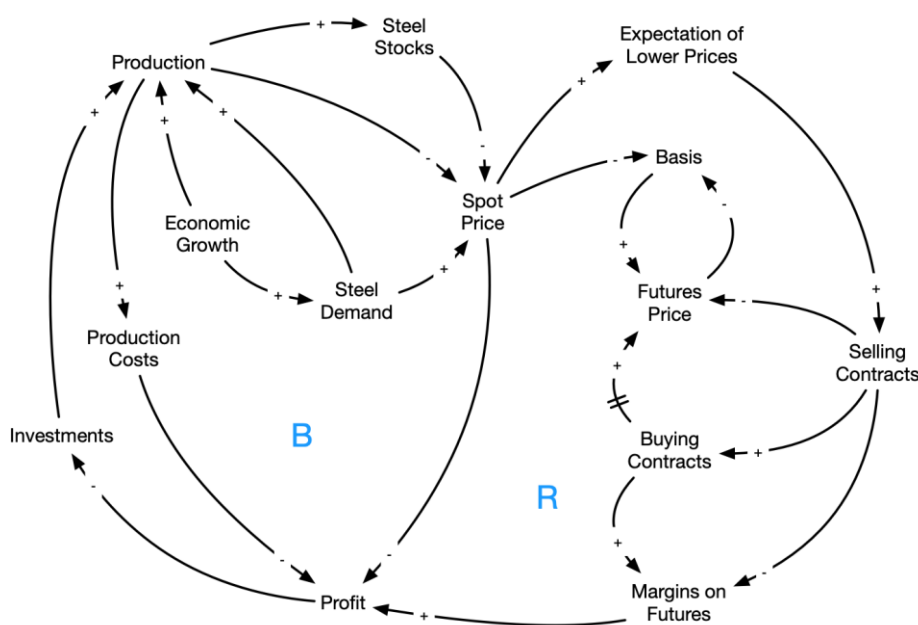

While *hedging* aims to avoid an exposure to price volatility, *speculation* aims to use this situation to get increase profits further. Instead of liquidating a good or contract to attain revenue or to cover for losses, respectively, operators hold on to them in order to sell them for as high a price as possible in the future (Schwager, 1984; Clenow, 2013; Boyd et al., 2018), as seen in Figure 2.1.3.11.

Figure 2.1.3.11 - Speculation dynamics (developed by the author).

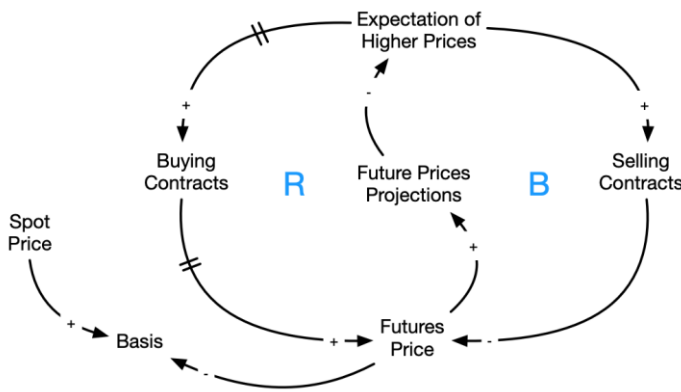

A third type of operation is called *arbitrage*, and consists of minimizing risks by taking advantage of abnormal price mismatches between different but mostly symmetrical instruments, whether between different markets or between spot and futures markets of a same good (Schwager, 1984; Clenow, 2013). Therefore, the larger the gap in price between contracts, the higher the profit of the overall transaction set, as seen in Figure 2.1.3.12.

Figure 2.1.3.12 - Arbitrage dynamics (developed by the author).

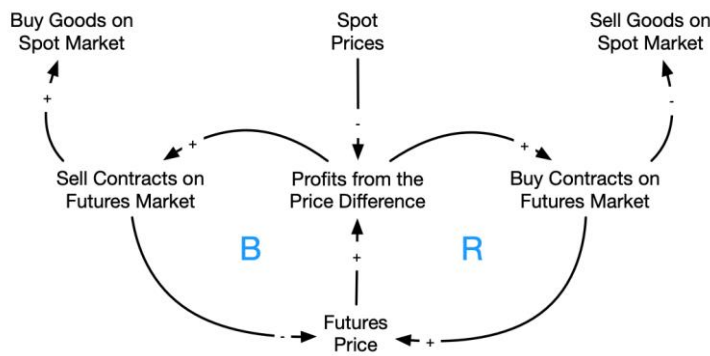

Regardless of operation, spot prices and future prices do not evolve in exactly the same way, even if they tend to move in tandem. The theoretical future price is equivalent to the spot price plus or minus what is called a *basis*, which considers three components: (a) carrying cost – which represents the cost of financing, insuring and storing the product until delivery, (b) logistics – which represents the transportation costs of the goods to be delivered

–, and (c) product quality – in terms of deviations from what was negotiated (Schwager, 1984; Clenow, 2013).

As the delivery date approaches, spot price and future price converge towards one another and the operator can choose to either run the contract and have the goods be delivered as negotiated or to sell the contract before delivery, depending on the need for the goods vs the need for capital to compensate losses (Schwager, 1984; Clenow, 2013). In the case of steel, *hedging* is the most common type of futures operation, followed by *arbitrage*, and leaving *speculation* as the least common type of operation due to its lower effectiveness with commodities (Statista, 2017c; Haase et al., 2016).

The complexity that originates from these dynamics, especially amidst the developments of recent years has helped to highlight the importance of managerial tools as means to support and improve decision-making in the Steel Industry. Now more familiar with the history, the evolution, and the current economic circumstances of the global steel market, the reader will be guided through the *black box* itself. In the next section, operational, regulatory and trading specifics of the Steel Industry will be introduced.

2.1.4. Opening the Steel Industry's black box

In order to better address and approach the Steel Industry, it is important to begin by understanding how its production process is carried out. With that in mind, there are two main resources that can be converted into steel: iron ore and scrap metals. Iron ore is mined from Hematite (Fe_2O_3 , ~70% Fe content), Magnetite (Fe_3O_4 , ~72% Fe content), Limonite ($2\text{Fe}_2\text{O}_3+3\text{H}_2\text{O}$, ~59% Fe content), Goethite ($\text{Fe}_2\text{O}_3+\text{H}_2\text{O}$ ~63% Fe content) or Siderite (FeCO_3 , ~48% Fe content) and goes through three stages of production, namely (a) raw material preparation, (b) iron-making and (c) steel-making. Scrap metals, on the other hand,

are collected from recycling centers, junkyards and landfills, and go straight to the third stage (Beddows, 2014; Warriar, 2012; Stahl, 2017; WS, 2012).

As seen in Figure 2.1.4.13, each production stage comprises different transformation processes. In the first stage, coal is converted into coke so as to join iron, now in the form of pellets or sinter. During the second stage, oil, natural gas and oxygen also come into the production depending on the chosen iron-making process: blast furnace, shaft furnace, rotary kiln furnace or fluidized bed – all of which aim to melt the ore and to separate iron from slag. Finally, molten iron then goes into either an Open-Hearth Furnace (OHF), Basic Oxygen Furnace (BOF) or Electric Arc Furnace (EAF), where it is converted into crude steel by the addition of limestone or the injection of air and other inert gases, further removing slag and other impurities. Scrap metal can join the molten iron in both OHFs and BOFs as means to control temperature and fusion homogeneity, but it is mostly directed towards EAFs (Vaclav, 2016; Warriar, 2012; WS, 2012; Stahl, 2017; Jones, 2017; Stubbles, 2017).

Figure 2.1.4.13 - Steelmaking routes (WS, 2016).

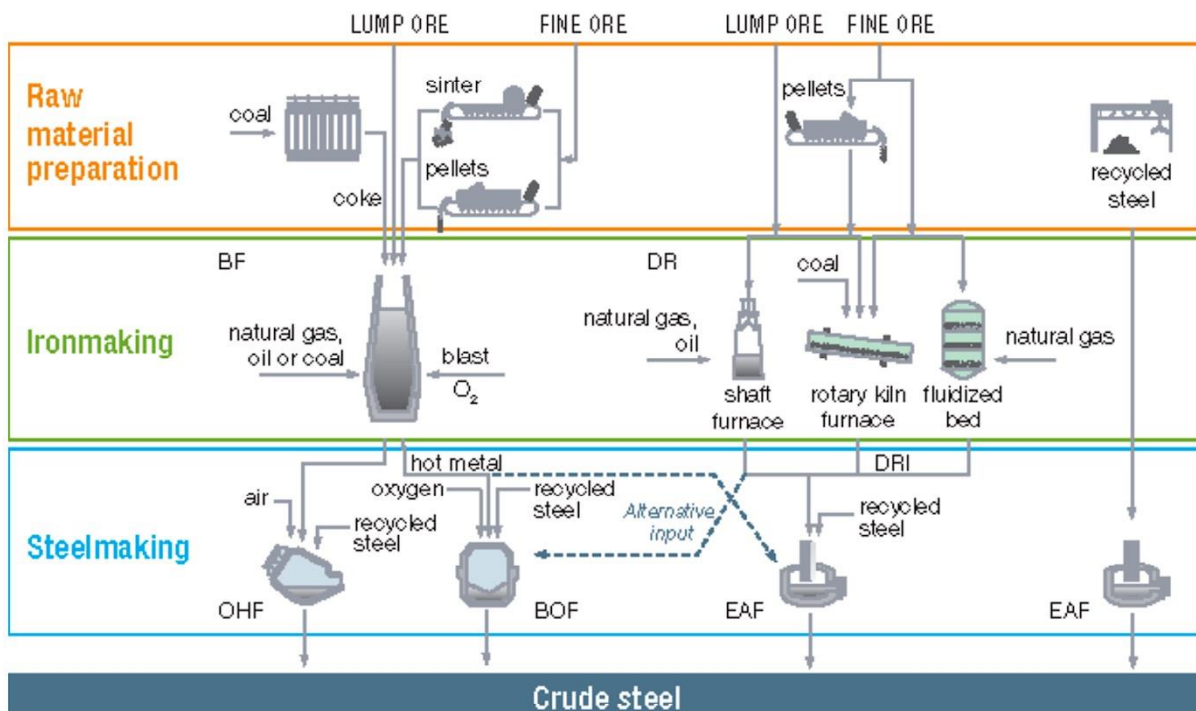

Once in its crude form, steel can be directly casted into molds, slabs, rolls or other forms, but also go through additional metallurgical treatments such as alloying – which can take place during or immediately after processing in BOFs and EAFs –, in order to add other metallic elements capable of improving steel's physical and mechanical attributes (Stahl, 2017; Stubbles, 2017; Jones, 2017; WS, 2012; Kozak & Dzierzawski, 2017). In addition to converting iron ore and scrap metals into many different types of steel, this production process also generates other outputs, most of which can be environmentally hazardous and represent challenges for the future of this sector, as to be further analyzed in section 2.2.3.

Such a complex production process naturally requires the support of many different fields of knowledge – notably physics, chemistry and engineering – as well as the participation of many different agents, as seen in Figure 2.1.4.14. Each of these agents, denominated stakeholders, have different roles and contribute to the creation of the final products in different levels and during different stages of the production. When it comes to interaction, it is virtually unavoidable that all of these stakeholders share goals, contracts and information flows in order to ensure efficiency and profitability of the entire chain, even more so when considering that steel alloying demands inputs from other metal industries. In terms of integration, however, it is more common to see raw material production and iron-making integrated to each other than to steel making, which requires more specialized techniques and higher investments, often unavailable in underdeveloped or developing regions (Beddows, 2014; WS, 2012; D'Costa, 1999; Stahl, 2017).

Nevertheless, due to decentralizing their operations, large steel manufacturers today tend to either own or to be important shareholders of entire value chains, from mining to casting, avoiding the need to import or transport intermediary inputs during the production process. It is still common, however, to see large cargo ships loaded with iron ore, sinter, pellets or coke travel across oceans to supply iron-makers, or even to see large loads of

crude steel be shipped to developed regions for metallurgic treatment. Knowing that production efficiency and margins increase from mining to metallurgy, it has also become common to see mining and raw material preparation activities operate with idle capacity for reasons either based on costs or on market strategies (Vaclav, 2016; EY, 2015; Warriani, 2012), as discussed in section 2.1.3.

Figure 2.1.4.14 - Crude steel production Value Chain, adapted from (Tata Steel, 2014).

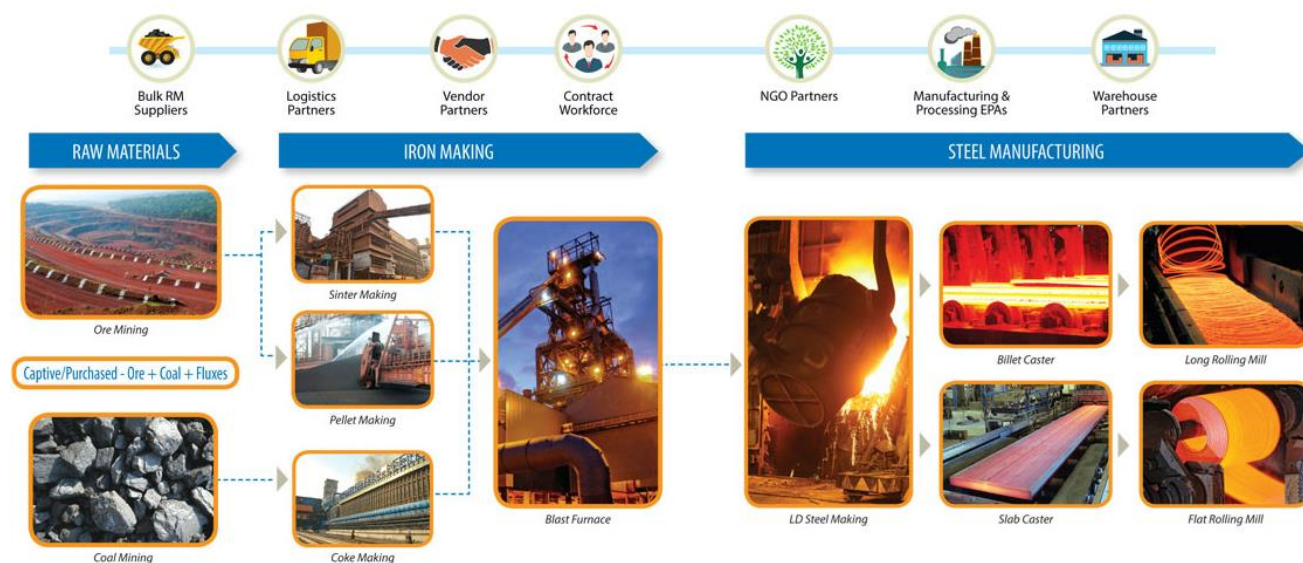

Furthermore, governments are stakeholders that can exert significant influence on steel manufacturing activities, being trade regulation and international diplomacy two of the most impactful means by which steel manufacturing strategies can be affected. Since the first World War, steel has been perceived as an important resource of national security by most developed and developing nations, notably the United States, western Europe, Russia, India and China. In the last decade more than ever, however, steel's importance for infrastructure construction, energy generation, industrial production and military applications has been largely highlighted in policy-making and diplomatic missions. As a result, private shareholders of this sector see themselves under increasing pressure not only originated in their client base – in terms of price, quality and responsiveness –, but also originated in the public sector,

regarding investment strategies and trade regulations (AAM, 2016; AISI, 2007; OECD, 2009a; WS, 2017).

The most noteworthy examples of national policies in this matter are (a) the creation of publicly-funded subsidies to directly support private domestic steel production, (b) the reduction of public and private banks' and funds' interest rates for capital to invest in specific domestic steel-related industrial activities or technologies, (c) the increase of fees and taxes to discourage steel-related imports, (d) the increase of public and private banks' and funds' interest rates for capital to invest in off-shore decentralized sourcing or in production capacity abroad, and (e) the additional taxation of shipping and transportation services, as well as technology and capital transfers and exchanges from and towards international branches or subsidiaries. Although these measures do not forbid shareholders from using their capital as they see fit, they do however directly or indirectly increase financial costs of overall global trade, reducing the volume and scale of transactions (as seen in Figure 2.1.4.15) as well as reducing the Steel Industry's capacity to react to shifts in global demand (OECD, 2009a; EY, 2014/2015; Warran, 2012; D'Costa, 1999).

Figure 2.1.4.15 - Steel transactions between 2008 and 2014 (EY, 2015).

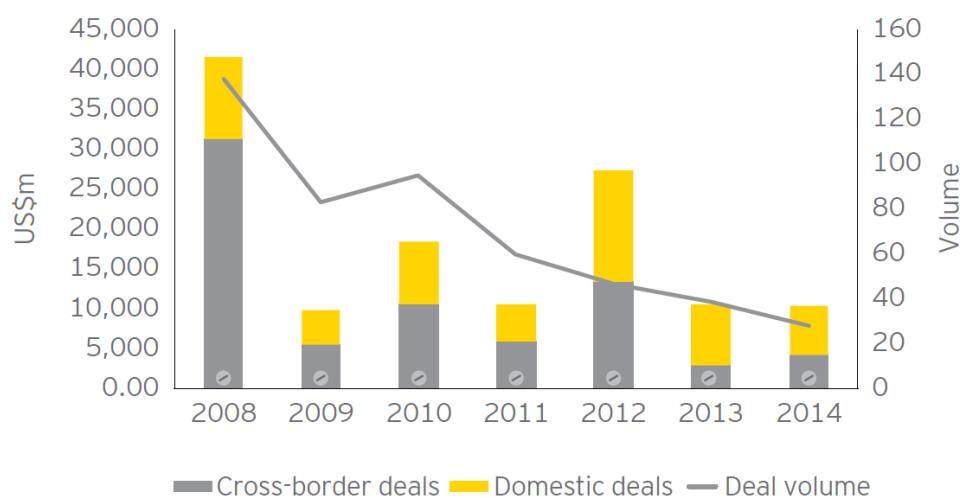

In the past, diplomatic missions' main targets used to be the exploration and the creation of new markets to increase demand and attract investments in all sectors. Nowadays, however, fees, taxes, subsidies, boycotts, sanctions and stimulus packages have become part of most diplomatic agendas, often sending committees specialized in the Steel Industry and even partially consisting of private sector specialists and representatives. Some critics say that this increased presence and participation of the Steel Industry in the policy-making may favor private interests over public ones, while defenders of this approach argue that it is a way to compensate for this industry's current vulnerable condition after series of crashes and crises, as well as to ensure that governments do not *take over* their operations (AISI, 2007; Beddows, 2014; Warriar, 2012; OECD, 2009a; AAM, 2016).

In any case, as much as for any other industrial activity, keeping up with regulations and legislation is an important part of management. As of today, regulation and legislation in all levels – regional, national and international – has become an important factor when steel manufacturers make decisions aimed at finding a balance between how much to globalize and how much to centralize their operations. While trying to benefit from international ore reserves, new demand and reduced operational costs, for example, a company might face increased taxation, commercial entry barriers and logistics costs that either require diplomatic or governmental support to be compensated or eventually end up hindering the implementation of the desired strategy (EY, 2014/2015; WS, 2013a/2017; D'Costa, 1999; Beddows, 2014).

The next section introduces the idea of value, of its management and of how companies have been approaching it in order to improve their results.

2.2. Tools and strategies to manage environmental challenges

Once the key stakeholders present in the Steel Industry are known, it becomes important to find means by which change can be driven. Knowing that this sector is influenced by diplomacy, national security issues and market strategies, the present study begins approaching the potential environmental improvements by introducing the concept of Value Chain Management, better described in this section and supported by Corporate Responsibility managerial behaviors.

2.2.1. Value Chain Management

Especially focusing on the efficiency of industries which transform physical inputs into physical outputs, many managerial tools and techniques were created, being Supply Chain Management (SCM) one of the most consolidated and most often used ones worldwide. Currently, however, SCM practices are gradually being improved by Michael Porter's (1985) Value Chain, a model perceived as better suited for systemic decision-making in industries inserted into global markets where marketing, trading, technology and support services have grown in importance through the years (Porter, 1985; McGuffog, 2016; Presutti Jr. & Mawhinney, 2013; Lièvre et al., 2004; UNCTAD, 2013).

Similarly to SCM, Value Chain Management (VCM) is a strategic tool that rigorously analyzes the internal activities of a company, but while SCM is focused on efficiency and process integration – seeing profit and competitiveness as natural but indirect consequences of proper management –, VCM sees profit and competitiveness as direct results of the processes themselves, being those no longer merely responsible for transforming inputs into outputs, but for adding value into the final product (Myerson, 2012; Jacobs et al., 2011; Hugos, 2011; Cohen & Roussel, 2013; McGuffog, 2016; Porter, 1985; Presutti Jr. & Mawhinney, 2013).

This shift in approach tries to identify the most valuable processes and then work on their efficiency, instead of globally addressing efficiency without properly understanding each process's ability to contribute to competitiveness and profit. In other words, if a process is not adding value to the final product, either (a) remove it – and its costs –, (b) improve it so it has less negative effects on competitiveness and profit, (c) replace it by another process capable of adding value, or (d) if strictly necessary, outsource it or subcontract it so that its risks and costs are transferred outside of your direct value chain (Presutti Jr. & Mawhinney, 2013; Porter, 1985; McGuffog, 2016; Myerson, 2012).

In this context, value is understood as tangible or intangible attributes or utilities that can be added by a process to a final product, helping increase the profit generated from its sale. Value can derive from sources endogenous to the company – its production or marketing strategies, for example – or from exogenous sources – such as the consumers' perceived value or market-attributed value. As each process' Net Added Value (NAV) cumulatively contributes to the final products aggregated value, it is important to understand not only the processes themselves, but also the entire chain of events that connect even the primordial raw material inputs to what will eventually become profit. At this point, VCM differentiates itself by bringing into its scope managerial aspects seen by SCM as secondary, namely Marketing and Services. Marketing now not only represents a source of demand for the entire chain, but a client who needs to be supplied with a valuable final product. Services, instead of being considered mere costs, are now potential value-adding processes that support and improve the consumer experience with the final product, potentially helping increase sales or even becoming a source of profit by themselves (Porter, 1985; Presutti Jr. & Mawhinney, 2013; McGuffog, 2016; Jacobs et al., 2011; Hugos, 2011; UNCTAD, 2013).

But, as said above, in order for Marketing and Services to be able to contribute to profit and competitiveness, they need to be provided with a valuable final product, and that is where

the SCM core of VCM still runs strong, especially with the support of Business Process Mapping (BPM) tools. Bottlenecks, demand uncertainty, and bullwhip effects are still targets of improvement and, as seen in Figure 2.2.1.16, Inbound Logistics, Operations and Outbound Logistics still have important roles in the manufacturing process. However, instead of approaching primary activities as *links in a chain*, VCM approaches them as complex subsystems with precise value-adding goals, supported by secondary activities that need not interfere with the transformation of input into output, but merely ensure that the primary activities have all they need to do good and efficient value-adding (Cohen & Roussel, 2013; Myerson, 2012; Presutti Jr. & Mawhinney, 2013; Porter, 1985; IFM, 2017).

Figure 2.2.1.16 - Value chains' primary and support activities (SM Study, 2015).



In this model, the primary activities have distinct but objective roles, being (a) Inbound Logistics responsible for receiving, storing and distributing inputs inside the company; (b) Operations responsible for all processes that transform inputs into outputs; (c) Output Logistics responsible for collecting, storing and distributing the final products to the

consumers; (d) Marketing responsible for promoting, informing, inducing and facilitating sales; and (e) Services responsible for maintaining and supporting the final product during its use. The same can be said about supporting activities, namely (a) Procurement – acquiring resources for the company –, (b) Human Resources – recruiting, hiring, training, compensating and managing human labor –, (c) Technology – providing hardware, software and knowledge –, and (d) Infrastructure – responsible for the company’s administrative needs such as accounting, legal issues, public affairs, etc. (Myerson, 2012; Presutti Jr. & Mawhinney, 2013; Porter, 1985; McGuffog, 2016).

When compared to companies which base their strategic analyses on SCM, those which work with VCM have been taking more advantage of growing marketing and technology trends – such as social medias, virtual reality and direct user reviews –, as well as of service-based economic models like voluntary work, shared ownership, decentralization and crowdfunding. While SCM would focus on the supply chain itself and often avoid adding complexity, costs or operational steps, VCM sees these recent developments as potential value-adding processes to bring into its subsystems, given that their NAV is favorable (SM Study, 2015; McGuffog, 2016; Presutti Jr. & Mawhinney, 2013).

Integrating services into the portfolio in order to support the customers before and after sales has also grown significantly in importance, especially when associated with marketing strategies. Most of the pre-sale services encompass structural and chemical surveying of the customer specific steel needs, design engineering and prototype testing. After-sale services, on the other hand, focus on transportation, troubleshooting, scrap collection and separation, as well as audit support (Huang et al., 1999; Bowonder & Miyake, 1992; Ottosson & Kindström, 2016; SGS, 2011).

The bulk of value-adding in the Steel Industry, however, revolves around the manufacturing process itself, and Supply Chain Integration is among the most common

strategies to operationalize interactions between stakeholders seeking to add or increase value in their processes. It is most commonly defined as the strategic collaboration within a supply chain, among its stakeholders, in order to improve the management of intra- and inter-organization processes (Shou et al., 2017; Lii & Kuo, 2016; Wiengarten et al., 2016; Van der Vaart & Van Donk, 2004, 2008). As per the North American National Research Council's Committee on Supply Chain Integration (NRC, 2000: p.27), "an integrated supply chain can be defined as an association of customers and suppliers who, using management techniques, work together to optimize their collective performance in the creation, distribution, and support of an end product. It may be helpful to think of the participants as the divisions of a large, vertically integrated corporation, although the independent companies in the chain are bound together only by trust, shared objectives, and contracts entered into on a voluntary basis".

SCI initiatives aim at effectiveness and efficiency throughout the chain, encompassing decisions regarding material flows, resource management, services, information and capital (Bowersox et al., 1999; Sengupta et al., 2006). Integration is often driven by the main manufacturer in the supply chain, which can choose to focus on integrating processes with its supplier side, with its customer side, or both, always depending on what said company perceives as its key strategic assets (Bowersox et al., 1999; Wiengarten et al., 2016; Shou et al., 2017).

To properly address costs, performance and risks, the integration itself requires intense exchange and cooperation with the involved stakeholders and subcontractors and can be approached in three different manners: (a) horizontally – in which information, strategies, decisions and flows are shared but ownership and management of each company in the supply chain remain independent or decentralized –; (b) vertically – in which capital, ownership and management are also shared or centralized by means of mergers,

acquisitions and equity efforts –; and (c) hedging – which can occur either vertically or horizontally, but focuses mostly on ensuring profitability across markets, by having different branches of a supply chain’s operation be more or less active than others according to market variations (Vickery et al., 2003; Wiengarten et al., 2016; Van der Vaart & Van Donk, 2008; Gunasekaran & Ngai, 2004).

In all cases, however, SCI worldwide tends to follow a similar deployment path: starting from the strengthening of the relations between the stakeholders of a supply chain, then moving through phases of unification in measurements and metrics, sharing of planning and technological information, alignment of material and service flows, and closing with the joint optimization of internal processes (Gunasekaran & Ngai, 2004; Van der Vaart & Van Donk, 2008; Lii & Kuo, 2016). Table 2.2.1.01 lists examples of different integration approaches used by different steelmakers in their supply chains.

Table 2.2.1.01 - Examples of supply chain integration in steel supply chains.

	MINING	STEELMAKING	METALWORKING	CUSTOMER	END-OF-LIFE OR BY-PRODUCT
ArcelorMittal	Own + VI + VH	Own + VI + VH	Own	HI	Slag (Own)
SSAB	VH	Own + VI + VH	Own + VI	HI	Repair (VI) + Slag (Own)
SIJ Group	-	Own + VI	Own + VI	-	Scrap (VI)
Severstal	Own + VI	Own + VI	Own + VI	-	-
Hyundai Steel	VH	Own + VI	Own + VI	HH + HI	Slag (Own)
Voestalpine	VH	Own + VI	Own + VI	HI	Slag (Own)
ThyssenKrupp	VH	Own	Own	HI	Slag (Own)
Tata Europe	VH + VI	Own + VI + VH	VI	HH + HI	Slag (Own)

VI = Vertical integration; VH = Vertical hedging; HI = Horizontal integration; HH = Horizontal hedging.
 Observation: summarized information available on each company’s institutional website.

European steelmakers are commonly the key manufacturers in their respective supply chains and tend to focus on supplier side integration – mostly vertically – due to the commoditization of steel in the global market. Still, it is not uncommon to see European steelmakers giving attention to horizontal customer side integration, especially when

providing goods to the automotive or to the heavy transportation industry (Meixell & Gargeya, 2005). Hedging integration occurs mostly vertically and most commonly on the supplier side, with European steelmakers controlling many different operations abroad in order to compensate for ore prices, logistical expenditures, currency exchange rates and geopolitical circumstances when deemed necessary (Gardner & Buzacott, 1999).

Whether integrating vertically or for hedging, investing in developing nations happens mostly for the transfer of unspecialized portfolio capacity or for the decentralization of sourcing (D'Costa, 1999). The capacity and the capital that remain in Europe are then gradually mobilized and converted into specialized products that better align with horizontal integration on the customer side, or into higher added-value products that corroborate with the growing trend of reducing overall steel intensity (Chevalier, 1995; Yellishetty et al., 2012; Shou et al., 2017). Many successful examples of these types of integrations currently exist, and even companies based in developing countries have managed to find profitability by vertically integrating into Europe (D'Costa, 1999).

Due to the capital-intensive and long-term investment characteristic of the steel industry, strategic shifts focused on vertical or hedging integrations have European steelmakers committing to large-scale projects that can potentially devalue their current assets and operations however productive and efficient they may still be in comparison to the industries they control in developing economies (EY, 2014/2015; Beddows, 2014; WS, 2013b; D'Costa, 1999; Warran, 2012).

With that in mind, hedging-oriented integration would be preferable to vertical integration due to the latter's vulnerability to prices, logistics, resource availability and international trade agreements; on the other hand, market shares may be affected and that the company may be left more sensitive to future market shortcomings if capital is then mobilized towards higher valued or more specialized activities (D'Costa, 1999; EY,

2014/2015). Nevertheless, there seems to be a *quasi-unanimity* on the argument that horizontal integration is largely preferable on the customer side – as corroborated by results from the industry –, but that nowadays it would be naïve to focus on this side alone (WS, 2013b; Beddows, 2014; Chevalier, 1995; Swierczek, 2014).

Figure 2.2.1.17 shows recent results of the steel industry in relation to their raw material self-sufficiency, depicting industries whose shareholders opted for vertical integration but did not necessarily find a recipe for success, regardless of capital mobilization (e.g. MMK and Sail). It also shows that industries that were strategically oriented towards high added-value products and portfolio specialization can generate very different results even when focusing on horizontal integration with some of their customers (e.g. ThyssenKrupp and Hyundai Steel).

Figure 2.2.1.17 - EBITDA margin vs Self-Sufficiency (EY, 2014).

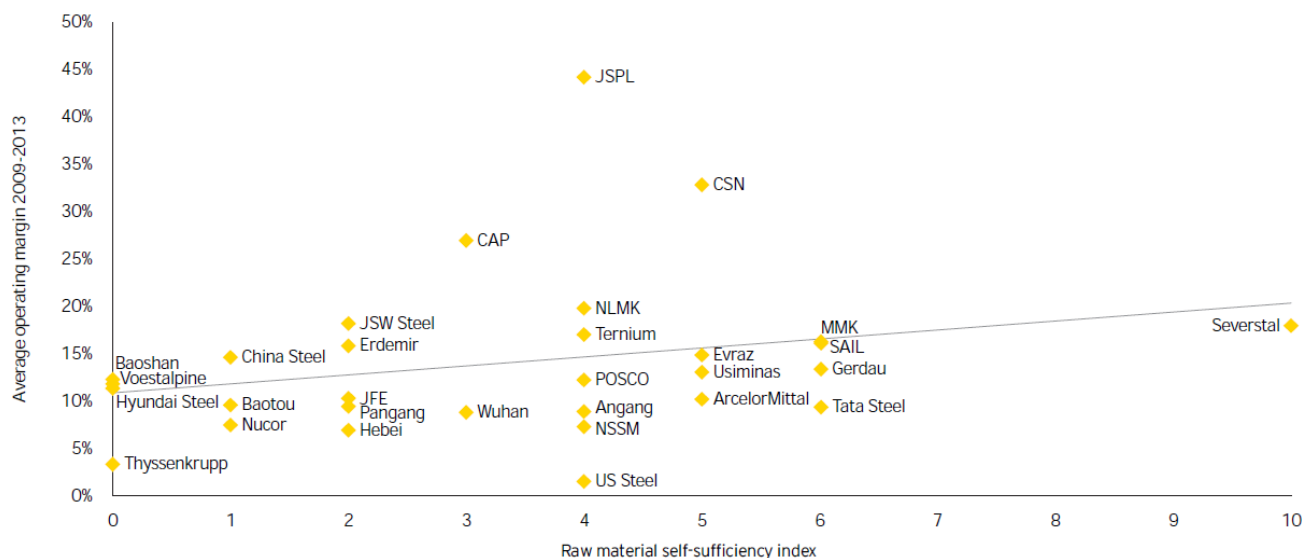

Additionally, the role of governments can be either constructive or destructive, especially towards vertical integration. Trade policies can make or break the cost effectiveness of geographically decentralizing a steel supply chain, potentially requiring subsidies during the capital mobilization phase (WS, 2013b; D'Costa, 1999; Wiengarten et

al., 2016). A similar logic applies to horizontal integrations, though governments tend to have lower impact on them. Still, integrating a supply chain on the customer side may require investments that can substantially affect liquidity, cash flow and indebtedment unless those factors are well-covered by long-term shared-responsibility contracts and insurances, especially when the steelmaker's portfolio somehow limits the attraction of new customers (EY, 2014, 2017; Beddows, 2014).

The more present a government's capital is, the more regulated and less market-dependent the decision-making tends to be, but the financial stakes are high in all SCI situations. Mobilizing capital to another nation – be it for hedging or for vertical integration – can disrupt the local supply chain's finances without the guarantee that this money will reintegrate the steelmaker's balance in the future (Beddows, 2014; EY, 2014, 2017; Wiengarten et al., 2016). And especially in the short-term, transferring technology, capacity and know-how can cause capital to be locked in place while productive maturity is achieved, a considerable risk despite lower costs of production or the growing demand in developing economies (Warrian, 2012; Yellishetty et al., 2012).

SCI's potential contributions in addressing environmental challenges derive mostly from its ability to support the development of Closed Loop Supply Chains (CLSC), which focus on recapturing the value of goods or byproducts after their consumption or use (Govindan & Soleimani, 2016; Gaur et al., 2016; Hosoda & Disney, 2018; Lewandowski, 2016). To do so, CLSCs should not only plan, control and manage the flow of goods or byproducts during their use/consumption and end-of-life (EoL) phases back to different stakeholders – using reverse logistics (RL) – (Jayaram & Tan, 2010; Cardoso et al., 2013), but also define the most effective means to reinsert those materials back into the operation, be it reuse, repair, refurbishment or recycling (Islam & Huda, 2018; Golroudbary & Zahraee, 2015; Prosman et al., 2017).

Consequently, monitoring when, where and how much of each different material leaves the use/consumption phase becomes strategically important, allowing the key manufacturer in the supply chain to better visualize and control the availability of potential alternative raw materials that originate in the EoL phase (Cannella et al., 2016; Hey, 2017; Xu & Wang, 2018).

Furthermore, deciding whether to centralize, decentralize or outsource different steps of reverse logistics can have significant impact on lead-times, raw material self-sufficiency, resource ownership, environmental performance, and even on demand-related risks (Braz et al., 2018; Miao et al., 2017; Bhattacharyya et al., 2017; Wang et al., 2018). With that in mind, Figure 2.2.1.18 not only summarizes the SCI strategies introduced thus far, but also presents where in steel supply chains they could operate optimally to close material loops.

Figure 2.2.1.18 - Supply chain integration approaches (developed by the author).

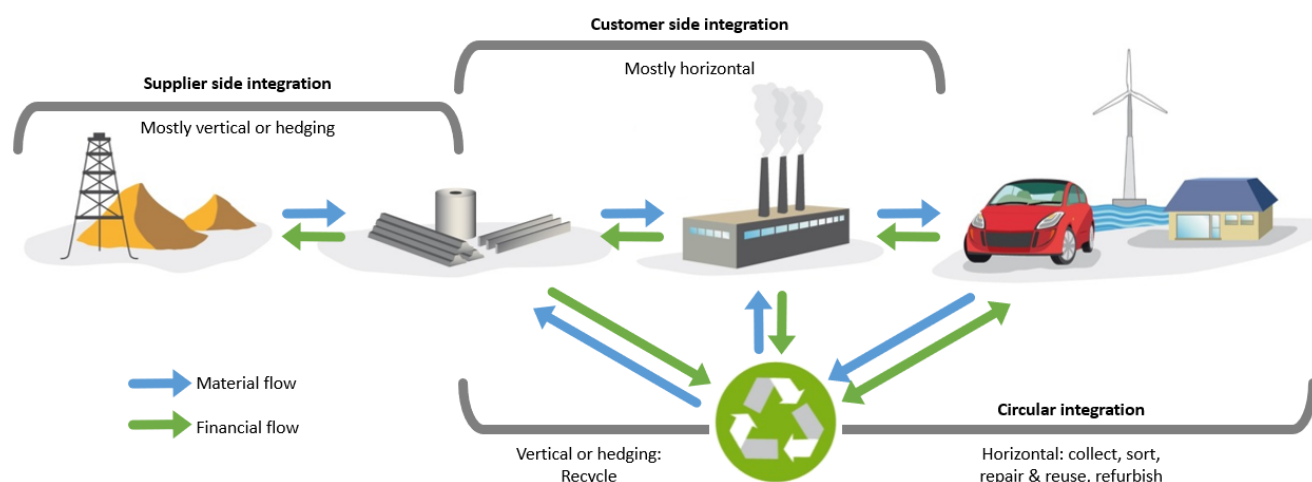

Vertical or hedging integration strategies tend to be more effective, even if imperfect, in dealing with raw material self-sufficiency and resource ownership (Van der Vaart & Van Donk, 2004). Thus, choosing these approaches would better address material loops that go as far back as possible in the steel supply chain than horizontal integrations would, to the point of fully or partially replacing primary inputs (Wang et al., 2018; Prosman et al., 2017).

Recycling and refurbishing of end-of-life steel products or the recycling of steelmaking byproducts are activities performed mostly outside of the steelmakers' realm of direct control and influenced indirectly by supplier-client relationships based on leveraging and negotiation (Prosman et al., 2017; Wang et al., 2018). Vertically integrating such activities would give steelmakers increased ownership of a raw material alternative to iron ore while simultaneously improving self-sufficiency and overall environmental performance, but would tend, in the long-term, to push the operation away from iron ore as a whole due to either technical or economic scarcity and, depending on the characteristics of the installed capacity, potentially risk overall output and force portfolio migration (Prosman et al., 2017; Wang et al., 2018).

Hedging these activities, on the other hand, however less conducive to directly increasing ownership and self-sufficiency, would enable ore-based operations to have a finer control over inputs from scrap or byproducts, better allowing for efficiency or cost related adjustments according to market circumstances. Nevertheless, the more horizontal the hedging integration, the stronger third-party reverse logistics become as a decision-making factor and the least favorable its environmental performance (Cannella et al., 2016; Xu & Wang, 2018; Cardoso et al., 2013).

When it comes to the collection, sorting, repair for reuse, maintenance, and redistribution, steel products in end-of-life do not configure a direct input to steelmaking, but in fact reducers of overall steel demand. Furthermore, business-wise, these activities stray away from the main scope of steelmaking and closer to the service sector. As such, vertical or hedging integration strategies for these processes would pose as significant investments with questionable returns (Schultmann et al., 2006; Bhattacharyya et al., 2017; Golroudbary & Zahraee, 2015).

Horizontally integrating these services, however, could be strategically advantageous from the perspective of long-term resource ownership retention, reverse logistics and environmental performance. Although not directly controlling these activities, a steelmaker could (a) better keep track of its steel as it moves through the economy – ideally recycling it back into the same operation –, (b) reduce reverse logistics costs by having influence or leverage over its decision-making, and (c) actively manage the amounts of EoL steel that flows between servicing and steelmaking (Wang et al., 2018; Schultmann et al., 2006; Bhattacharyya et al., 2017; Islam & Huda, 2018).

Even when direct competitive advantage cannot be attained due to regulatory frameworks regarding pricing, the benefits of resource ownership retention for a theoretically infinitely recyclable material are clear from the environmental perspective. It would be strategically interesting to have as much control as possible over the circulation of the resources already supplied to the economy so as to accrue the most value before reinsertion into the biosphere is necessary (Schenkel et al., 2015; EMF, 2015a).

2.2.2. Corporate Social Responsibility and Environmental Values

As VCM emerged as a way to focus on value throughout a supply chain, Corporate Social Responsibility (CSR) became popular as a way to ensure that, regardless of a company's business activity, society and environment would be safeguarded. In terms, it is to say that a company can have its own sense of responsibility – as if a citizen –, ensuring that its operation's needs and practices do not overrule, override nor disturb social or ecological values, focusing on sustainability (Presutti Jr. & Mawhinney, 2013; Schmidpeter & Hansen, 2014; ISO, 2010; McWilliams & Siegel, 2001; Mota et al., 2014).

Although CSR is widely regarded as an important practice by the consumers, their exogenous perception of how it should be used can be severely affected by cultural aspects.

When it comes to the endogenous understanding of CSR by the companies themselves, however, value creation and a shift towards sustainable business models are clear targets. Creating value that also involves society and environment, however, is not a unilateral effort by the company and requires interaction with agents from all sides – a practice known as Creation of Shared Value (CSV) (Porter & Kramer, 2006; Martin, 2002; Porter & Kramer, 2011; Zadek, 2004).

CSV then means attempting to find a common-ground between what is perceived by society as value and what is necessary for the environment to keep its value or have it restored. From a social point of view – even though philanthropy and engagement in public social projects are practices adopted by many large companies – most companies invest in CSR that can feed back to its business model, focusing on providing training, expertise, amenities and services to support their employees and their immediate families. From an environmental point of view, a minority of companies invests in CSR for recovery or treatment of contaminated or explored areas, while the majority focuses on environmental benefits that also feed back to their operations in the form of reduced costs, such as efficiency on resource usage, pollution reduction and biodiversity protection (Herva & Roca, 2013; Epstein & Roy, 1998; Kovacs, 2008; Lu & Abeysekera, 2014; Martinez-Conesa et al., 2017; Lee, 2016).

Early attempts in including environmental concerns in the scope of business practices came in the form of Green Supply Chain Management (GSCM), a variation of SCM that was supported by Lean Manufacturing concepts and that defended operational strategies towards increasing productive efficiency and reducing costs as means to simultaneously reduce overall environmental impacts. Although efficient in the means to do so, the environmental objectives were often left aside and were mostly minor, representing more of an update to SCM than a new decision-making paradigm. Additionally, with time, GSCM began to replicate the bullwhip effect – well known among SCM scholars and professionals – by transferring

environmental requirements along the supply chain, instead of actually addressing them. As a result – and with the rise of VCM and CSR – GSCM is gradually losing ground among managerial experts and scientists (Ahi & Searcy, 2013; Fahimina et al., 2015; Dües et al., 2013; Sarkis et al., 2011; Tognetti et al., 2015; Lee et al., 2014).

But even alongside VCM, not all CSR practices are created equal. During the last decade, even though studies have shown that numerous companies have been able to derive benefits from investments on CSR – such as brand differentiation, reduced employee turnovers, reduced environmental impacts, improved relations with suppliers and even reduced scrutiny by regulatory agencies – many critics began to question CSR's motives and point to potential ethical misdirection. The main arguments suggest that CSR can configure a proactive way to reduce the strength of law enforcement due to *good managerial behavior*, as well as the use of CSR to mask or deviate attention from other unethical behaviors of a company, especially those which businesses or clients involve weapons, ammunitions, alcohol or drugs (Armstrong & Green, 2013; Chin et al., 2013; Rangan et al., 2015; McWilliams & Siegel, 2000; Alhouti et al., 2016).

These criticisms can allude to the political, diplomatic and trading aspects of the Steel Industry as well, thus requiring any CSR and VCM initiatives towards environmental sustainability to be carefully devised in order to avoid loss of operational effectiveness and potential loss of brand value, stakeholder value and consumer value (Kovacs, 2008; Jenkins & Yakovleva, 2006).

2.2.3. Environmental challenges for the future of steel

In addition to the issues introduced this far, the Steel Industry also faces environmental challenges that need to be addressed in order to safeguard results and operational sustainability in the context of an ever-growing *ecological conscience* in society as a whole,

especially considering projected wellbeing and consumption projections (Mont et al., 2014). Alongside VCM and CSR, it is important that this sector keeps its energy sources, potential substitutes, environmental impacts and ore scarcity in check as plans to the future are made (OECD, 2012).

As of today, the Steel Industry spends on average 25% of its budget on energy, being responsible for the second highest demand worldwide, mostly from non-renewable sources such as coal, oil and natural gas. This derives from the characteristic heat-intensive treatment necessary to turn scrap and iron ore into steel, however, many losses and undesired byproducts of using these energy sources exist, as seen in Figure 2.2.3.19 (AISI, 2005; Mousa et al., 2016; Milford et al., 2013; Morfeldt et al., 2014; OECD, 2015; IEA, 2014).

Figure 2.2.3.19 - Energy transformations in steel production (AISI, 2005).

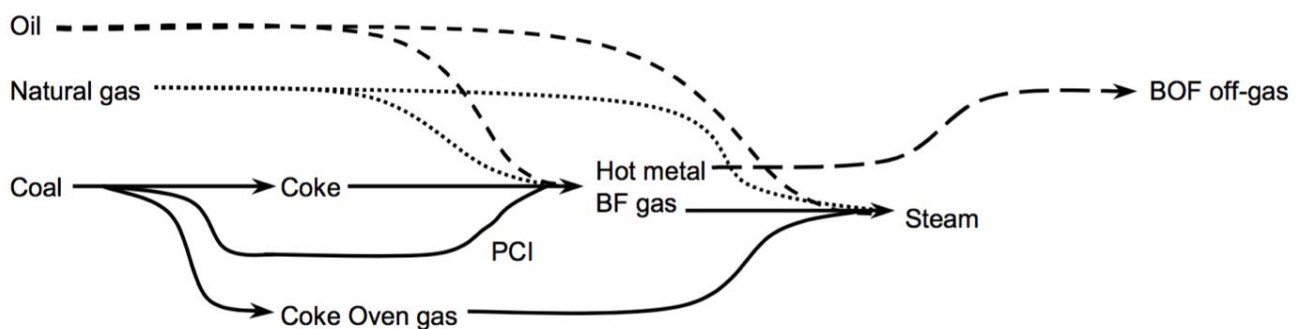

Coke Oven gas, Blast Furnace gas, BOF gas and steam account for most of the emissions of steel production and their contents are remarkably hazardous for the environment. In order to reduce the use of non-renewables and their consequent emissions, current developments on these production processes suggest alternative sources such as (a) vegetal charcoal from silage and sawmill wastes, (b) hydrogen, (c) bio-based fuels, (d) synthetic gasification of coal, and (e) electrolytic winning. When it comes to EAFs, however, the discussion is mostly centered around hydrogen, nuclear, hydraulic and renewables – solar, wind and geothermal –, where the key objective is to reduce the participation of nuclear

energy by increasing the participation of (1) renewables, (2) hydraulic, and (3) hydrogen, preferably in that order (Mousa et al., 2016; Morfeldt et al., 2014; Milford et al., 2013; IEA, 2014; OECD, 2015; Burchart-Korol, 2014).

Even though atmospheric emissions are substantial in steel production and highly responsible for suspended particulate matter, global warming and ozone layer depletion, they are not the only existing environmental impacts. As seen in Figure 2.2.3.20, carcinogens, radiation, eutrophication, acidification and eco-toxicity are also present in the life cycle of steel products. Another often neglected impact is land occupation, associated with the social context of sustainability due to its potential for creating ownership, labor and cultural conflicts (Yellishetty et al., 2010; Burchart-Korol, 2014; EUROFER, 2014; Gu, et al., 2015; Nuss & Eckelman, 2014; Olmez et al., 2015).

Figure 2.2.3.20 - Environmental impacts from three steel production scenarios (Olmez et al., 2015).

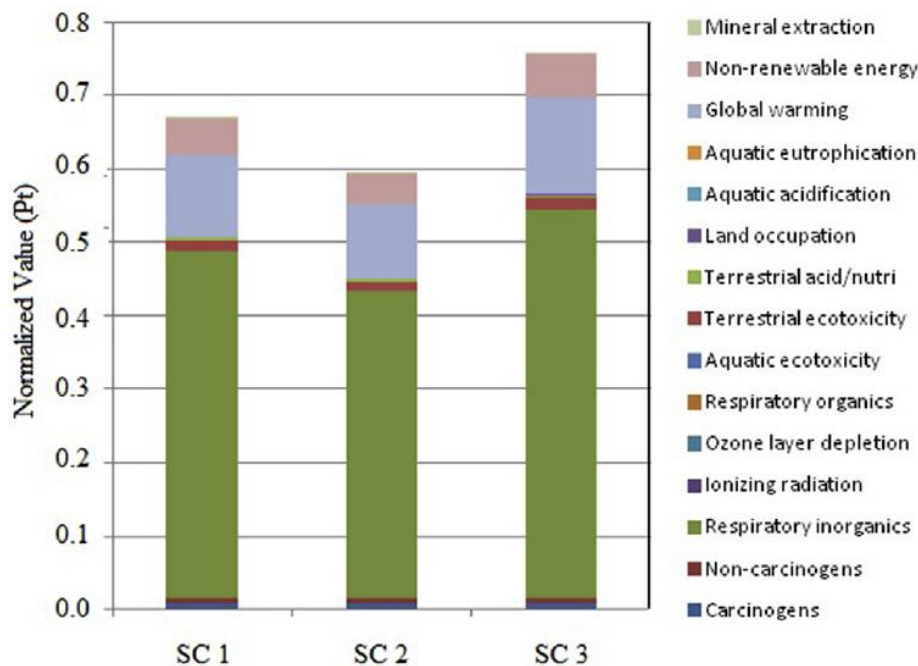

The solution to most of these problems is in fact mainly related to the energy sources, but also to the way land is used – in terms of both acquisition and mining practices – and

substantially so to the way manufacturing is conducted and managed in terms of efficiency, emission control, compliance and governance. Different mindsets and frameworks that encompass these practices – such as Circular Economy, Industrial Ecology, VCM and CSR – have already driven environmental progress in the Steel Industry, however further adoption is necessary. Especially during the last decade, public policies have also targeted the Steel Industry in order to provide support for improving environmental sustainability, a potentially cost-beneficial strategy considering two other big challenges: scarcity and substitutes (Giurco et al., 2014; Cullen et al., 2012; Basu & van Zyl, 2006; Daddi et al., 2017; EC, 2013).

Scarcity in the Steel Industry is not only understood as the absolute unfeasibility of mining iron ore, but also as a relative reduction of ore grade as a function of the potential gains from processing it. As is inherent in many mining-based activities, geochemists search for areas where the concentration – known as ore grade – of the desired element is higher in the soil, thus increasing productivity and reducing cost per ton. As the land with the highest available ore grade is mined and eventually exhausted of the desired mineral, geochemists then point to other regions where the same element can be mined, but now with slightly lower ore grade. The repetition of this behavior eventually leads to what is known as scarcity, a break-even point where ore grade productivity is as low as costs can go up to begin hindering the achievement of the desired financial results (Sverdrup & Ragnarsdottir, 2014; Pauliuk et al., 2013; Yellishetty et al., 2010; Yellishetty & Mudd, 2014; Hatayama et al., 2010; Wang et al., 2015).

As of today, relative scarcity is already a decision-making reality for many steel manufacturers worldwide, with ore grades going as low as 18% iron content in extreme cases. Furthermore, as new demand and supply projections arise, discussing absolute scarcity has become increasingly common. It is estimated that deposits containing rich and high-grade ore will be exhausted by the end of 2030, severely affecting mining operations worldwide until

2200, year when absolute scarcity levels are estimated to be reached. Keeping in mind that oil, natural gas and coal are the main types of energy used in this industry, scarcity of non-renewable energy sources becomes an additional concern. With oil's absolute scarcity estimated to take place before 2050 and natural gas's and coal's to take place until 2100, many manufacturers of these energy sources have already passed their historical peak production stage and are now on decline (Sverdrup & Ragnarsdottir, 2014; Pauliuk et al., 2013; Yellishetty et al., 2010; Yellishetty & Mudd, 2014; Hatayama et al., 2010; Wang et al., 2015).

Fortunately, iron ore mining from mountains and deposits is not the only source of raw material input to the Steel Industry: it can also be done in urban environments – a practice known as urban mining or recycling. Not only is recycling a source of iron and steel most times above 75% content, but the energy required to process scrap metals is in most cases up to 60% lower than even iron ores of the highest grades. Furthermore, EAFs can be much more easily converted into accepting renewable energy sources than OHFs and BOFs. As a result, the Steel Industry is today the first more recycling-intensive sector worldwide, taking back in over 68% of their products. All of these numbers, however, are still far from optimal, leaving ground for improvement (Xuan & Yue, 2016; Pauliuk et al., 2013; Sverdrup & Ragnarsdottir, 2014; Wübbecke & Heroth, 2014; Giurco et al., 2014).

Substitutes, on the other hand, challenge the Steel Industry from the market perspective, as additional competition. This competition traditionally came from other metals such as aluminum and copper, depending on the required application. Copper lost ground in the last decade – especially in telecommunications due to the advent of optical fibers – but aluminum has seen substantial growth originated especially in consumer goods and electronics; Nowadays, however, substitutes are emerging in almost every client base where the Steel Industry is present, reducing market-share and adding pressure to margins and

costs. Many steelmakers have brought differentiated portfolios into their value chains, including precision alloys, rare/precious metals separation and even carbon fiber manufacturing in their production lines, however, some competitors derive from completely different business models (EY, 2017).

In the construction sector, steel reinforced concrete is being sometimes replaced with bamboo fiber reinforced concrete; in aerospace and aeronautics, new aluminum and carbon alloys have achieved similar strength with less weight; polymeric and plastic-based materials have been used in automotive and electronics industries; and nanotechnology has been used to test new rare-earth and ceramic fibers and alloys for surgical applications (di Prisco et al., 2013; Leventis et al., 2002; Kumar, 1994; Chaallal et al., 1998).

Nevertheless, all of these new technologies can be seen by the Steel Industry as reasons to add value into their chains by (a) investing in research and development, (b) investing even more in portfolio differentiation, (c) investing in services that revolve around steel-based products, (d) investing in specialty and customized products which quality and margin tend to be higher, while altogether adding environmental values and reaping their benefits (EY, 2017). The next section delves into the available tools chosen for this study in terms of adding environmental value, such as modelling techniques capable of supporting VCM to better understand the effects of changing productive processes in face of new challenges, as well as ways to achieve a better understanding of other stakeholders in order to maximize the usefulness of strategies regarding the inner workings of the steelmaking process (Kremer, et al., 2015; Brandenburg et al., 2014; Govindan, 2016).

2.3. Towards environmental sustainability in the Steel Industry

Once acquainted with the history, the strategies and the operation of the Steel Industry as well as the challenges for its future, it is then necessary to familiarize the reader with some

of the tools and techniques that are available to support the development of potential solutions based on a corporately and environmentally responsible approach to steel value chains.

2.3.1. The Industrial Ecology toolbox

Brought to light by Frosch and Gallopoulos (1989) and renowned worldwide after the success of the Kalundborg Industrial Park, Industrial Ecology (IE) does not have a formal definition yet, but among the first ones was “the study of the flows of materials and energy in industrial and consumer activities, of the effects of these flows on the environment, and of the influences of economic, political, regulatory, and social factors on the flow, use, and transformation of resources” (Ayres & Ayres, 2002).

Its application and results, however, cannot be denied. In principle, it approaches industrial activities and its interactions with the environment by, at first, separating them into biosphere and technosphere. Then, each component of the technosphere is metaphorically associated with its equivalent in the biosphere (e.g. competition and natural selection, industrial parks and ecosystems, companies and living organisms). This allows for processes, stocks and flows of materials and energy to be modelled more organically and to be more representative of a natural closed-loop system – in which outputs can become inputs – instead of a traditional open-loop one – in which outputs end up in sinks (Ehrenfeld, 2004; Taddeo, 2016; Prossman et al., 2017; Nielsen, 2007; Ehrenfeld, 1997; Erkman, 1997).

IE aims to better integrate humans to the environment by delving into the quantifiable components of each stage in systems-based complex productive activities, tangibly addressing (a) material and energy flows – also known as Industrial Metabolism –, (b) technological change, (c) eco-design, (d) life-cycle planning, (e) dematerialization, (f) decarbonization, (g) corporate responsibility and stewardship, and (h) industrial parks – also

known as Industrial Symbiosis. To do so, IE currently benefits from the multidisciplinary knowledge of professionals from almost all fields of scientific enquiry, all aiming at the sustainability of human-nature interactions (Leigh & Li, 2015; Gibbs & Deutz, 2007; Cohen-Rosenthal, 2004; Despeisse et al., 2012; Korhonen, 2004; Seager & Theis, 2002; Liao et al., 2012).

In order to deal with the complexity of the IE endeavor, many tools were created under its scope (Baas & Boons, 2004; van Berkel et al., 1997). The ones which present concepts, methods and techniques deemed applicable and capable of improving the Value Chain Management perspective given to the present study are introduced below, e.g. Life Cycle Assessment (LCA) – to be introduced in section 3.1. due to its role in the present thesis –, Material Flow Analysis (MFA), Input-Output Analysis (IOA), Stakeholder Analysis and Agent Based Modelling (ABM).

Material Flow Analysis (MFA) is commonly used by companies and governments due to its often broad boundaries and ability to condensate decision-worthy information. It is "*a systematic assessment of the flows and stocks of materials within a system defined in space and time. It connects the sources, the pathways, and the intermediate and final sinks of a material*" (Brunner & Rechberger, 2005). As seen in Figure 2.3.1.21, sequences of processes become easier to interpret when analyzed by MFA techniques, especially due to its characteristic graphical representation of inputs, outputs, stocks and flows. Once the balance between amounts of materials within flows and throughout the system is understood, sources, sinks and stocks can be identified and measured, allowing decision-makers used to SCM to better pinpoint excesses, inefficiencies and productive bottlenecks (Blass & Corbett, 2017; Binder, 2007; Binder et al., 2009; Huang et al., 2012).

Figure 2.3.1.21 - Example of Material Flow Analysis (IFU, 2011).

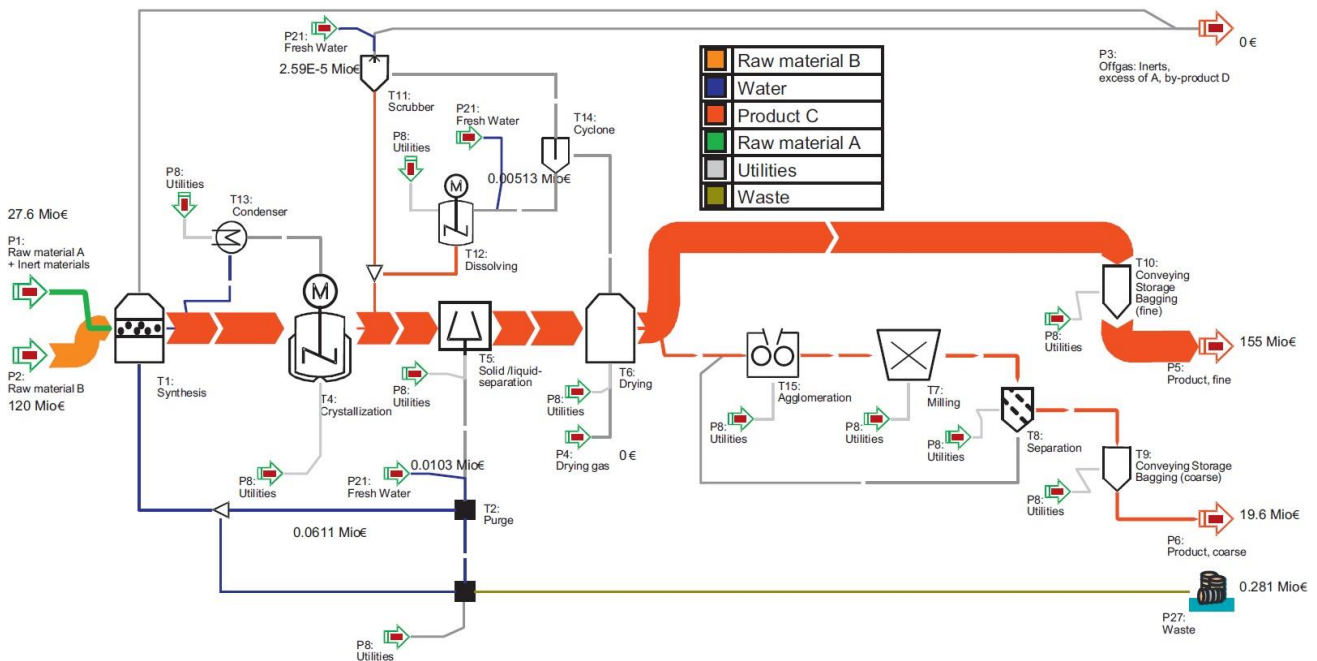

When built upon specific technical and operational data, MFA is capable of depicting objective, reliable and complete information about the paths of materials and energy within series of processes. It is from these results that decision-makers can better predict and understand how the environment might react to the business activity (Brunner & Rechberger, 2005; Fischer-Kowalski & Hüttler, 1999; Allen et al., 2009; Suh, 2005).

MFA broadens the scope by analyzing the materials and the energy used in production structure as a whole, often being used for regional and national studies as well. Especially in the last decade, furthermore, MFA has begun to include energy planning by increasing the detail level in energy accounting, a practice now known as Energy Flow Analysis (EFA). The same is also done for toxic chemical outputs, known as Substance Flow Analysis (SFA) (Blass & Corbett, 2017; Brunner & Rechberger, 2005; Fischer-Kowalski & Hüttler, 1999; Allen et al., 2009; Suh, 2005).

Moving from the operational and tactical to the strategic level, Stakeholder Analysis is a tool often used in the contexts of IE, but originally derived from managerial sciences'

schools of project management, and aims to identify and understand agents that interact with a given reality based on their utility and power (Freeman, 1984). In that context, agents are a collection of institutions, companies or representatives of specific interests, encompassed by either private or public sectors and ranging from competitors to supporters. The reality with which they interact, on the other hand, can be that of a specific project, of a productive process, or of any other situation that one wishes to address. The objective is to map where, when and how each agent – hereby named stakeholder – affects or is affected by the situation at hand, being these exchanges often approached in the sense of their influence, power, attitude and impact. By assessing and mapping specific demands, obligations and expectations of each stakeholder, it is also possible to weigh and balance how their interactions could unfold in what regards to the issue at hand, helping devise better strategic decision-making (Reed et al., 2009; Vilchez et al., 2017; Hein et al., 2017; Earl & Clift, 1999; Kurtz, 2012; Lièvre et al., 2006).

Using quantitative and qualitative techniques to perform Stakeholder Analyses is common in the early stages of project planning and, as of today, increasingly present in regular Corporate Responsibility and Environmental Performance practices. The most common tools that support this practice are SWOT Analyses, Mindmaps, Relevance Matrices and Weighted Impact-Influence-Interest Matrices, often leaving behind a traditional approach focused on each stakeholder to favor a modern one, focused on the issues that require attention themselves, as seen in Figure 2.3.1.22 (Elsawah et al., 2015; Fletcher et al., 2003; Mitchell et al., 1997; Bell et al., 2012).

Figure 2.3.1.22 - Example of Relevance Matrix Stakeholder Analysis (TVO, 2012).

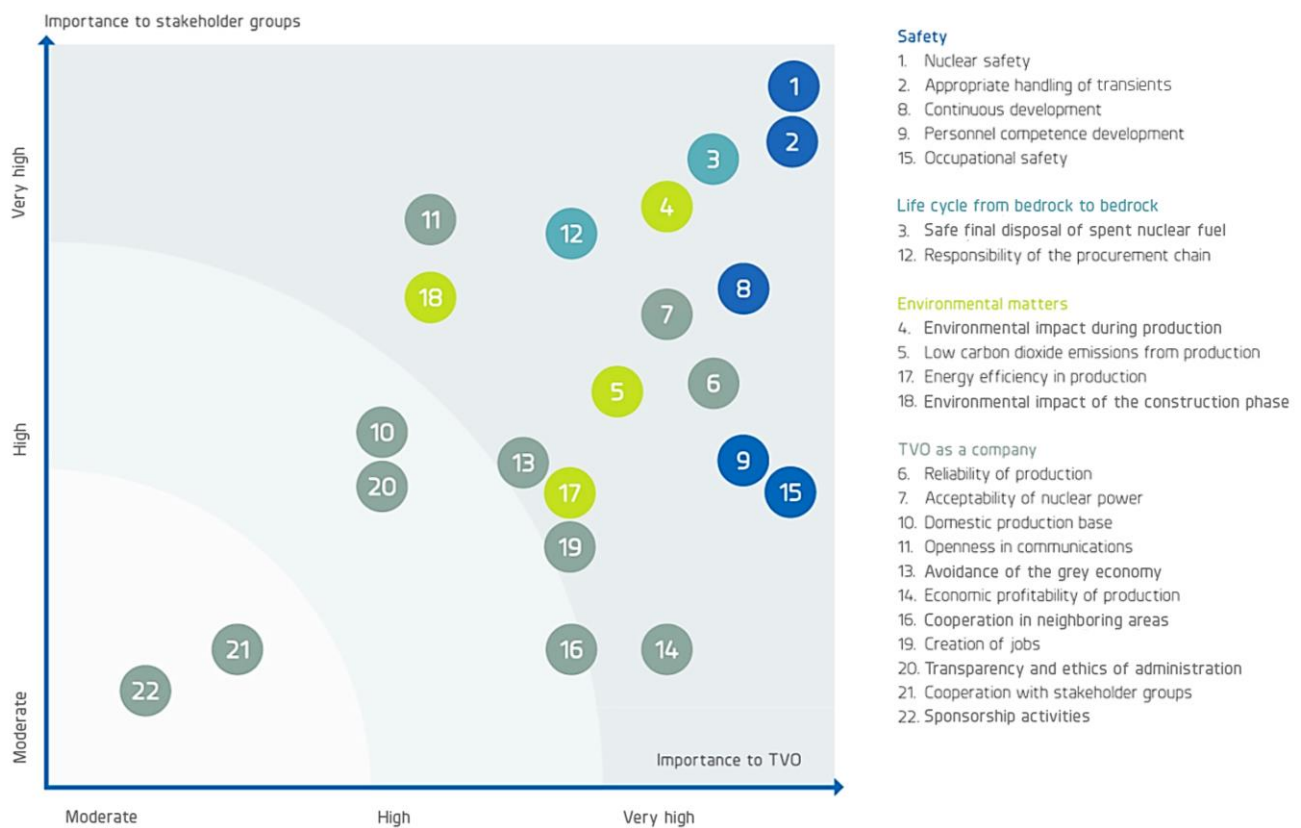

Agent-based Modelling (ABM) also approaches complex systems by studying the agents involved, but instead of having its origins on managerial sciences, it derived from empirical applications in biology and social sciences. Back in the time of its origins – in the 1970s –, ABM aimed at identifying and measuring equilibrium-seeking or equilibrium-avoiding behaviors such as cohesion, separation and alignment among people or animals, nowadays – after noticing its many potential applications – managerial sciences use it for decision-making, supply chain optimization, portfolio management and even to create market behavior projections alongside economists (Casti, 1997; Axelrod, 1997; North & Macal, 2007; El Sawah et al., 2015)

Each agent's characteristics and behavior are studied and given a *rule* – often defined by an equation or algorithm. Once all involved agents and their respective *rules* are modelled into the same system, simulations are conducted based on environmental parameters to

identify how the system itself will change as each agent pushes and pulls in different directions and with different intensities based on their objectives, agendas or interests. The results are then often presented in concise and objective diagrams, neighborhood grids, network maps or geographic information systems, enabling a quick and visual interpretation (North & Macal, 2007; Casti, 1997; Axelrod, 1997).

2.3.2. Circular Economy

In addition to IE and its tools, other economic and managerial models and concepts can provide useful insights to the improvement of overall environmental performance in the Steel Industry. This section explores more examples of applications that could be beneficial for the transition of the Steel Industry into more environmentally sustainable practices.

One example is the Circular Economy (CE) model, created in the late 1980s, proposing that industrial activities reduce pollution and waste generation by designing and implementing products and productive processes in such a way that all or most of its outputs can be reinserted into the economy in one way or another (Pearce & Turner, 1989; EMF, 2012/2013/2014b; Tukker, 2015; Geissdoerfer et al., 2017).

The contemporary understanding of the Circular Economy counts on abundant conceptual and theoretical literature, ranging from its practical applications in industrial processes to its macro-economic effects, being the 3R Principle (reduce, reuse, recycle) a noteworthy example (Lewandowski, 2016; Haas et al., 2015; Ghisellini et al., 2016). Geissdoerfer et al. (2017) defined Circular Economy as a regenerative system in which resource input, waste, emission, and energy leakage are minimized by slowing, closing, and narrowing material and energy loops, via long-lasting design, maintenance, repair, reuse, remanufacturing, refurbishing and recycling; while Prieto-Sandoval et al. (2018) considered

Circular Economy to be a paradigm shift that requires industries, policy-makers and consumers to innovate in the way they produce, legislate and consume, respectively.

CE approaches materials from two perspectives, as seen in Figure 2.3.2.23: (a) biological nutrients – that should eventually reintegrate the biosphere without causing any harm –, and (b) technical nutrients – which circulate in the economy. In order to promote the shift from traditional linear production economies towards circular behavior, CE suggests that all industrial activity should be performed keeping in mind the use of wastes as inputs, the adoption of renewable and clean energy sources and that the outputs should be designed in such a way that allows for collection, recycling, refurbishing, reuse, redistribution, maintenance and sharing throughout their life span (EMF, 2014a/2015c/2016/2017; Park et al., 2010; Haas et al., 2015).

Figure 2.3.2.23 - Outline of a Circular Economy (EMF, 2017).

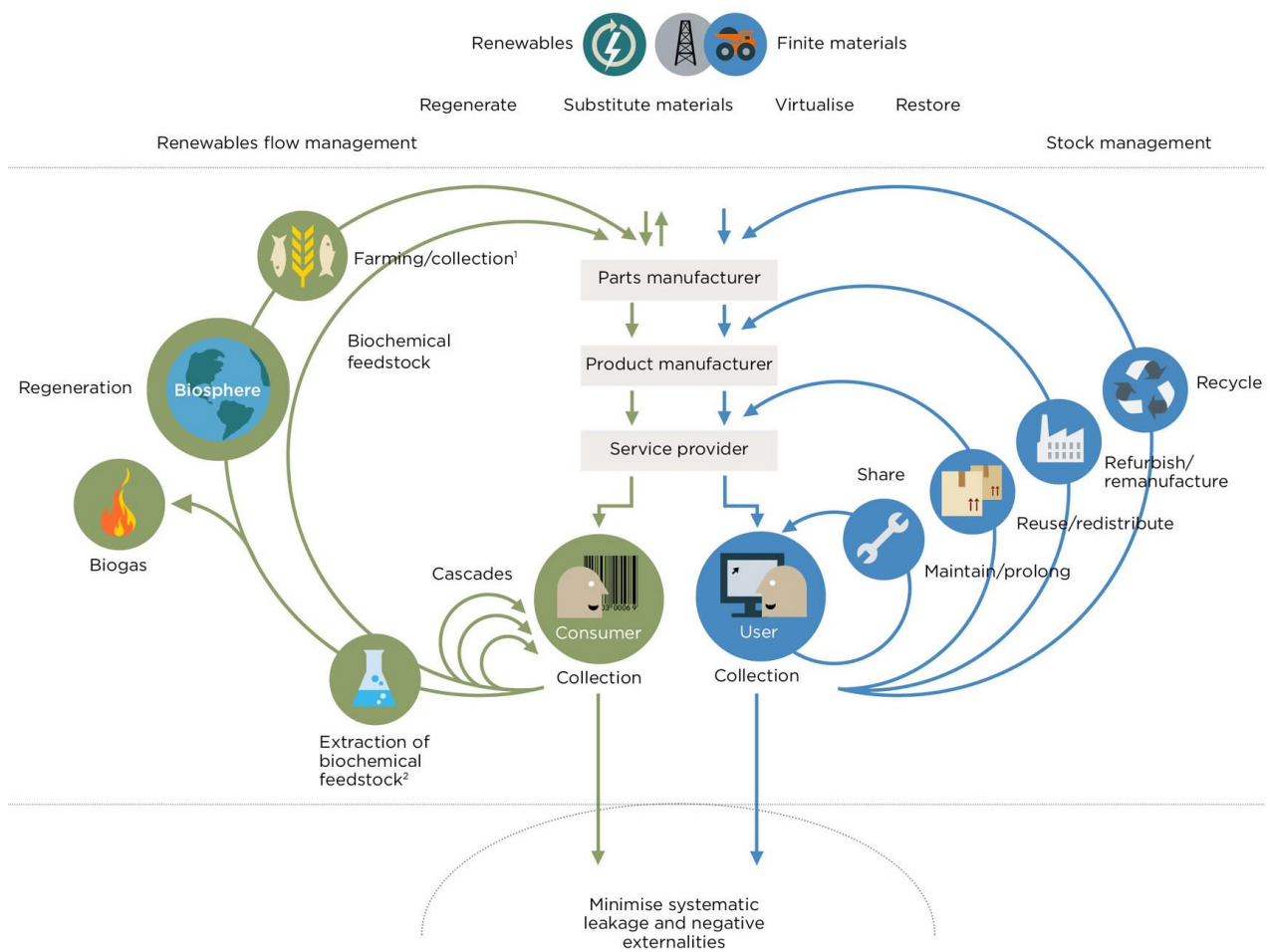

Additionally, CE also suggests that the monetary flows that permeate the materials in circulation directly reflect the biophysical costs of their extraction, transformation, use and reinsertion into either economy or biosphere, minimizing speculation as much as possible in order to protect the cost-effectiveness of the model. In 2012, Europe has committed itself to the application of CE as its economic model, boosting a transition to resource-efficient practices that eventually lead to regenerative progress towards nature (EMF, 2015b; EC, 2012; Lewandowski, 2016; Zhijun & Nailing, 2007; Su et al., 2013; Kahle & Gurel-Atay, 2014; UNEP, 2011; Pomponi & Moncaster, 2017; Gregson et al., 2015; Winans et al., 2017).

The Ellen MacArthur Foundation played an important role not only in the popularization of the concept in the 2010's, but also in the development of many Circular Economy tools for

businesses, academia and policy-makers. From a practical point of view, what caught industries' attention the most were the concepts within CE, some of which that borrowed from the previous Green Economy Framework: Biomimetics, Cradle-to-Cradle Design and Eco-labelling, and the already introduced Industrial Ecology (Winans et al., 2017; EMF, 2013/2014a,b/2015b).

Since then, significant attention has been given to industrial activities to the point of having Circular Economy be defined as “an industrial system that is restorative by intention and design. In a circular economy, products are designed for ease of reuse, disassembly and manufacturing – or recycling – with the understanding that it is the reuse of vast amounts of material reclaimed from end-of-life products, rather than the extraction of new resources, that is the foundation of economic growth” (EMF, 2012).

Biomimetics is a concept that encompasses fields from biology to engineering in the attempt to use nature itself as a source of inspiration and measurement for the development of products and processes. The overall approach is to understand and emulate in the industry how natural systems process materials, energy and waste, making production not only more efficient and less pollutant, but also more capable of generating products that are easier to reintegrate into the biosphere. Notable examples that inspired the modern concept of Biomimetic date back to the 1500s with Leonardo da Vinci's *flying machine* – inspired by a bird's anatomy –, and to the 1950s with George Mestral's *Velcro* – inspired by burrs that clung to his pants during a hike. As of today, designers worldwide are becoming increasingly aware of this concept and its use has grown significantly over the last decade, being responsible for the emergence of technologies such as nanofabrication, protein folding, 3D-printing and biomorphic mineralization (Vincent et al., 2006; Pauw et al., 2014; Benyus, 1997).

Cradle-to-cradle Design borrows from the biomimetic concept by also attempting to emulate nature's behaviors in terms of circularity and using waste as input – as per CE

definitions – but approaches it from a systemic angle. Its purpose is not to create new product or process designs, but to drive entire productive processes towards circularity by analyzing the complex interactions that exist within and between transformation stages of production. Similar to Industrial Ecology, the objective is to arrange and configure a productive process so that its inputs and flows generate outputs that can be completely reintegrated to nature – thus from cradle to cradle – after cycling through the economy. Tools such as LCA and MFA often have its boundaries and scopes defined by cradle-to-cradle parameters, and have provided results in the form of productive processes capable of producing packaging, batteries, foam and even shoes that fit within CE goals (McDonough & Michael, 2002; Wang et al., 2017; Niero et al., 2016; Llorach-Massana et al., 2015).

Eco-labelling, on the other hand, does not directly address a product design or a productive process, but aims to measure and categorize their different aspects in order to better communicate to the consumer the efforts that an industry puts into improving the environmental performance of its practices. Present in the market since the 1970s, eco-labels grew in significance and reliability when regulated by the International Standardization Organization (ISO) in its 14000 series on Environmental Management Systems. To be certified eco-friendly in a specific aspect of product design or of productive process, an industry must ensure that it complies with the criteria defined by norms 14020 and 14025, verified *in loco* and through lab test auditing. Different results then categorize the targeted product or process within the layers/bands of performance previously defined for that environmental aspect. Noteworthy examples of the application of this concept were put in place by the Forest Stewardship Council (FSC) – for products derived from vegetal source extraction and processing – and the Energy Star – commonly seen on consumer goods and electronics (Hale, 1996; Clift, 1993; Bratt et al., 2011; Prieto-Sandoval et al., 2016; Acquaye et al., 2015).

Thus far, Circular Economy has influenced the policy-making strategies of many governments and intergovernmental agencies at local, regional and national levels, eventually leading to the development of Europe's *Circular Economy Package* (EC, 2015a). For the Commission, Circular Economy is defined as an "economic system in which the value of products and materials is maintained for as long as possible; waste and resource use are minimized, and resources are kept within the economy when a product has reached the end of its life, to be used again and again to create further value" (EC, 2012).

The aforementioned package seeks to stimulate Europe's transition towards a circular economy capable of boosting Europe's competitiveness, fostering sustainable economic growth and generating new jobs (EC, 2015b). And even though some of the main targets defined in the Action Plan include increasing the recycling of municipal to 65% and the recycling of packaging waste to 75% – both by 2030 – (EC, 2014/2015a/2017), considerable potential for economic benefits have been estimated in terms of resource efficiency, being the European Commission itself responsible for estimating net savings of €600 billion on business turnover, the creation of 580.000 jobs, and the reduction of total annual greenhouse gas emissions between 2 and 4% – i.e. 450 million tons of CO₂ by 2030 (EESC, 2016; Tukker, 2015).

Coasts & Benton (2015) calculated that an ambitious Circular Economy strategy for Europe could enable at least 270.000 unemployed people in Italy, Poland and Germany alone to rejoin the workforce all the while saving at least €3 billion in related institutional costs. The study also outlined that a transition towards Circular Economy would naturally be different in each of the EU's member states, for example: in Italy it should likely revitalize its southern agricultural economy; in Poland it should boost productivity; and in Germany it could help manufacturers to adhere to servitization and to business practices aimed at redistribution.

Considering all policies in force, major focus has been given to the life cycle of plastics, food waste reduction, hazardous and chemical fertilizers, critical raw materials, construction waste and bio-based materials (EC, 2015b). Moreover, a set of indicators, a monitoring framework and regulations on Green Public Procurement (GPP) have been put in place not only to monitor the evolution of the transition to a circular economy, but also to support small and medium enterprises less capable of transitioning on their own capital alone (EC, 2008/2014b/2018a,b).

2.3.3. Steel and circular policy

Due to the commoditization of its products and of its raw materials, the steel industry traditionally pays close attention to factors and productive variables that can affect price and competitiveness just as much as quality, so for decades this industry has been using some of the principles of Circular Economy even before it became a widespread concept or as a European economic model, being recycling and by-product reuse the most consolidated environmentally-friendly practices in this economic activity (EC, 2013b; WS, 2016).

As environmental concerns, demands and pressure grew in all sectors, steelmakers were grouped with other industrial activities when addressed by policies aimed at the assessment, reduction, prevention and mitigation of environmental impacts. In Europe, most policies came into force or were revised close to the turn of the century, notably the Environmental Assessment Directive 2011/92/EU (EP, 2011), the Industrial Emissions Directive 2010/78/EU (EP, 2010), the Air Quality Directive 2008/50/EC (EP, 2008a), the Water Framework Directive 2000/60/EC (EP, 2000a), the Packaging Waste Directive 94/62/EC (EP, 1994), the Waste and Hazardous Waste Framework Directive 2008/98/EC (EP, 2008b), and the Landfill Directive 99/31/EC (EU, 1999).

These documents present broad guidelines on how industries should conduct their activities so as to properly manage, control and report the direct and indirect outputs that are undesired or potentially hazardous for different compartments of the environment, but minimal attention is given to input alternatives, resource efficiency or circular behaviors, and no particular or direct attention is given to the steel industry (EP, 2000a/2008a,b/2010/2011; EU, 1999).

The same happened for the mining industry – often considered outside of steelmaking boundaries for policy purposes –, to which substantial attention was given regarding the treatment and disposal of outputs but not so much as to their recovery or to their role in contributing to this industry's own circularity or that of its customers (e.g. steelmaking), as per the Extracting and Mining Waste Directive 2006/21/EC (EP, 2006a).

Then the action plan focused on the steel industry was created, mostly to summarize the situation of the European steel industry as of 2012 and to bring to light the difficulties faced by the sector in terms of prices, competitiveness, trading and energy – all of which were perceived as obstacles to furthering environmental progress on resource efficiency and climate (EC, 2013b). Among its many suggestions, it highlighted the need for developing secondary metals markets in order to boost the production of steel from scrap while raising awareness to the fact that a revision of the current regulatory framework would be necessary so as to reduce excessive burdens, gaps and inconsistencies that hinder fair and competitive trading (EC, 2013b).

From that point on, the European Commission and the European Council created multiple policy-supporting documents based on the aforementioned action plan (EC, 2014), such as (a) specific action plans for the automotive and construction sectors (EC, 2012b/c), (b) a competitiveness-proofing toolkit (EC, 2012a), (c) eco-design requirements for energy equipment (EP, 2009). From an operational point of view, the most notable document was

the Best Available Techniques (BAT) for Iron and Steel Production (EC, 2013a), which, along Directive 2006/21/EC and the BAT for the Ferrous Metals Processing Industry (EC, 2001), proposed operational techniques capable of directly addressing certain environmental impacts and, when possible and pertinent, suggested potential circular integrations, as summarized in Table 2.3.3.02.

Table 2.3.3.02 - Summary of available BATs for iron and metals mining, processing, and steel production.

PRODUCTION PROCESS	EMISSIONS	EFFLUENTS	WASTE	ENERGY	NOISE
Mining	•	•	•		
Sintering	•	•	•	•	
Pelletisation	•	•	•	•	
Coking	•	•	•	•	
Blast Furnace (BF)	•	•	•	•	
Basic Oxygen Furnace (BOF)	•	•	•	•	
Electric Arc Furnace (EAF)	•	•	•	•	•
Continuous Casting	•	•	•	•	
Rolling	•	•	•		
Drawing		•	•		
Coating	•	•	•		
Galvanizing	•		•		

Sources: (EC, 2001/2013a; EP, 2006a)

Still, the previously mentioned policies and most of their supporting documents either address steel indirectly through other sectors or approach different stakeholders/process of the steel supply chain separately. This counterintuitively hinders circularity and has been deemed insufficient even for sectors like the automotive, where more policy-based support is available (Diener & Tillman, 2016; Dunant et al., 2018). Even the Best Available Techniques (BAT) documents were deemed insufficient to address climate and resource efficiency issues unless more attention was to be given to end-of-life steel, energy sourcing and systemic/holistic approaches such as Life Cycle Assessment (LCA) (EC, 2013b/2014).

Thus, when understanding how the Circular Economy framework applies to the steel industry, it is possible to see many more areas where additional support and stimuli policies – and not only regulation – would be either necessary or welcome (e.g. repair & reuse,

refurbishment/remanufacture) (Material Economics, 2018). As of today, however, support and stimuli policies are limited and most progress towards circular behavior depends on the efforts of representative associations and on business pressure on certain aspects of regulation, such as Council Regulation EU 333/2011 (EU, 2011a) – which determines the criteria that differentiate recyclable and recoverable steel scrap from disposable waste.

Although regulation can help in some cases, it is important to note that compliance to regulation can have not only administrative and operational effects but also financial ones. In a study commissioned by the European Commission itself, aimed at identifying the costs associated with deploying compliance measures (CEPS, 2013), it was noticed that for the legislation in force, Blast Furnace and Basic Oxygen Furnace (BFBOF) steelmakers spend an annual average of €1,035 per ton of crude steel (of which €0,614 OPEX and €0,421 CAPEX) while Electric Arc Furnace (EAF) steelmakers spend an annual average of €0,642/t (of which €0,335 OPEX and €0,307 CAPEX). And even though these costs are directly related to the reduction of environmental impacts, their effects on steel price are only reverted or compensated for in the long-term (Mayer et al., 2019).

In order to have a clear understanding of where the CE-based policies mentioned in the previous section could lead the European steel industry, it is important to understand not only the *status quo*, but also the overarching goals set by the stakeholders therein. Such an example is depicted in Figure 2.3.3.24, in which a transition of steelmaking from mining (BFBOF) to recycling (EAF) is visible as well as increased yields of reuse and refurbishment/remanufacturing. According to EUROFER (2017b), the main long-term objectives are to boost the development economic activities centered around end-of-life services and secondary raw materials, as well as to reduce the dependence on primary natural resources. Although the EU's steel needs can be supplied by up to 85% by 2050, according to estimations (Material Economics, 2018), EUROFER argues that an equilibrium

as shown in Figure 2.3.3.24 would not be achieved before 2050 due mainly to the fact that a significant amount of the customers of the European steel industry are located in developing countries with very high demand for all types of steel.

Figure 2.3.3.24 - Steel circularity today (a), and desired state of circularity equilibrium (b) (EUROFER, 2017b).

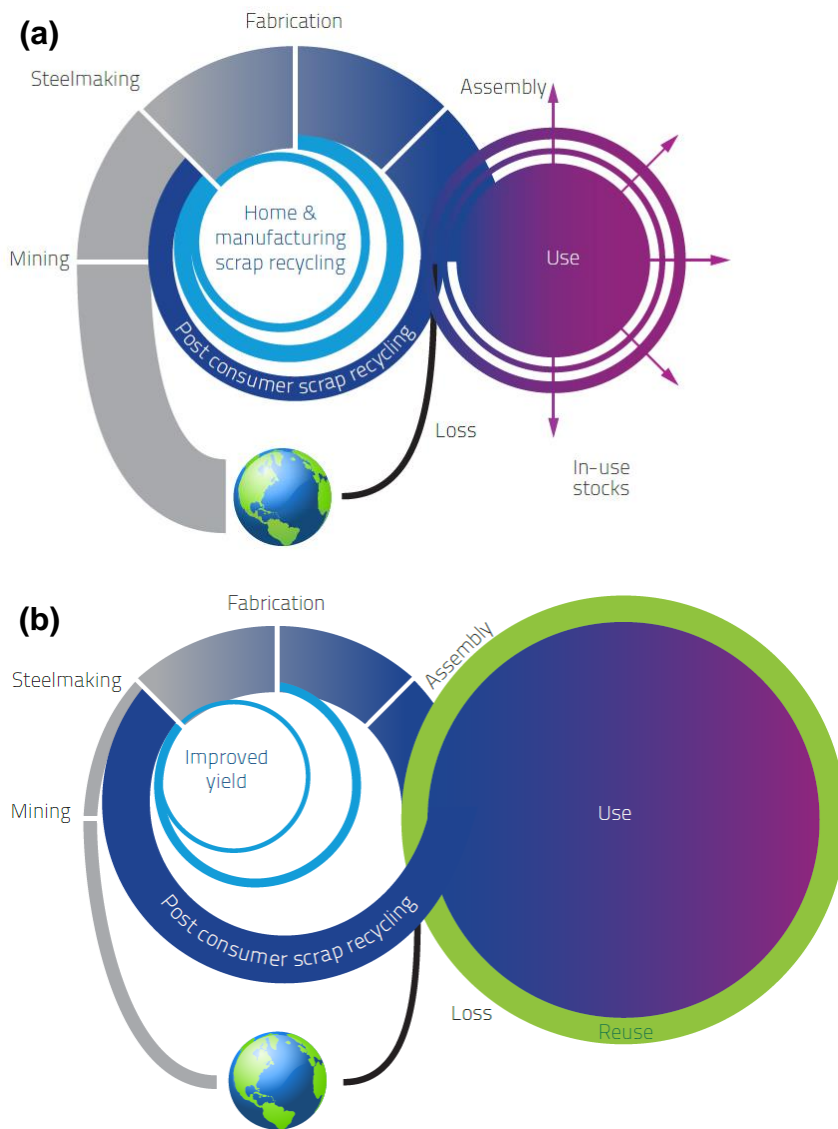

Furthermore, it argues that such an equilibrium would never completely eradicate the need for primary resources because value losses (EMF, 2015a) and downcycling – i.e. loss of alloying quality over multiple life cycles – would always require eventual material

replenishment in order to rejoin the economy competitively, even at 100% recycling, reuse or refurbishment/remanufacture rates (EUROFER, 2015/2017b). Keeping in mind that over 1.600 Mt of steel were produced in 2017 (BIR, 2017) and that most of the environmental impacts of steel take place either during production or indirectly during its use phase (EUROFER, 2017b; EC 2013b; Olmez et al., 2015), increasingly large amounts of environmentally-oriented investments have been made by the European steel industry, ranging from 65 to 80% on end-of-life solutions and from 20 to 35% on solutions directly integrated to the production, depending on which EU28 nation is analyzed (CEPS, 2013).

Although the industry itself gives attention to end-of-life as an alternative source of raw materials to reduce the overall environmental impacts of production and to improve resource efficiency (Waugh, 2016), most of the policies regarding this sector's end-of-life materials often lead to regulation instead of support and stimuli (CEPS, 2013; EUROFER, 2017b; EC, 2013b/2014/2017; Hagelüken et al., 2016).

Despite the fact that for each ton of recycled steel in Europe, an average of 1.400 kg of iron ore, 740 kg of coaking coal, and 120 kg of limestone can be saved regardless of application, and that EAF steelmaking have significantly lower environmental impacts (IETD, 2018; WS, 2016; Waugh, 2016; EC 2013b; Material Economics, 2018), the ratio of steel scrap to crude steel has experienced multiple domestic declines in the EU28 zone while the steel scrap import/export balance continues to move steel abroad (BIR, 2016) – direct results of end-of-life services reacting to market dynamics but struggling to find domestic customers, still slow to transition out of BFBOF steelmaking (Waugh, 2016; Hagelüken et al., 2016).

Naturally, issues such as remelting losses, obsolete alloys, inaccessible scrap stocks, inefficient collection and separation, and copper contamination cannot be ignored – representing 17%, on average, of end-of-life steel depending on EU member state – (Material Economics, 2018; Haupt et al., 2016), but the steel industry worldwide – not only in Europe

– has been proactive in funding its own research and development initiatives to solve these issues (IETD, 2018). The recycling or reuse of steelmaking by-products such as slag, dust and off-gas – which together account for approximately 32% of the process' output – has also received more technological and standardization attention after joint initiatives with the cement, fertilizers, road construction and energy generation equipment industries than from CE-based policies themselves (EC, 2013b; EUROFER, 2015; WS, 2014).

Moreover, inconsistencies and discrepancies have been found among existing policies, resulting in environmentally-oriented projects having issues getting approved, funded or be deemed compliant with circular practices (EUROFER, 2015). Many of these issues were summarized in an open letter from EUROFER (2015) to the European Commission, highlighting (a) the overlap of CE-based policies with sector-specific regulations, overburdening compliance; (b) the lack of a sector-specific holistic supply chain approach towards circularity; (c) the inadequacy of simplified target setting, which can result in under or overestimation of feasibility and capacity, often ignoring solutions that have nation-specific characteristics; and (d) the misalignment of definitions and classifications, creating regulatory hindrances to the use of end-of-life materials instead of primary ones (EUROFER, 2015).

Examples of conflicting or insufficient regulation include compliance criteria and material definitions for collection, separation and treatment of different steel scraps under the REACH Regulation EC 1907/2006 (EP, 2006b), as well as OECD and EU28 alignment of criteria regarding the shipping of imported and exported categories of steel scraps, as per Regulation EC 1013/2006 (EP, 2006c). Consequently, although bold steps have been taken towards the implementation of a circular model in Europe (Mayer et al., 2018; Hagelüken et al., 2016), its steel industry finds itself at an impasse: the European steel industry has been

requested to transition from its current situation towards a more circular model, but policy support to do so is currently limited.

Considering the policies in force, potential solutions developed by both industry and academia regarding end-of-life steel still struggle to gain substantial traction, despite the predictions of the End-of-Waste Criteria for Iron and Steel Scrap (JRC, 2010): direct reuse of shipping containers for temporary or architecturally diverse housing, direct reuse or refurbishment/remanufacturing of tracks from discontinued railways, and the reuse of steel from demolished heavy-duty bridges in new lighter-duty ones are examples of activities not covered by CE-based policies (WS, 2016). And when it comes to refurbishment/remanufacturing, eco-design, servitization and redistribution, no direct stimuli or empirical guidance is found in policies for the European steel industry, even when results of studies from representative associations point to significantly cheaper products at lower production or service costs, while also saving energy and materials (WS, 2016).

In light of the apparent misalignment between the potential contribution of steel to a European Circular Economy and the policies devised to implement it, another concern needs to be brought forward: how to bring society closer to these issues, so that it too can support progress towards facing the environmental challenges of the steel industry? Perhaps, part of the answer lies where the final consumers of steel are, and on how they use steel on a daily basis.

2.3.4. Sustainable Cities and the steel closest to society

The historic conceptual evolution of Sustainable Cities was based on that of sustainable development – term that later gained political connotations with the Brundtland Commission –, and which can be traced back to 18th century forestry management in Germany (Grober, 2007; Bibri & Krogstie, 2017; Ahvenniemi et al., 2017). In the report *Our Common Future*, sustainable development was defined as development that meets the

needs of the present without compromising the ability of future generations to meet their own needs (Brundtland Commission, 1987). At that time, the idea of 'sustainable city' was an automatic derivative related to urban development policies.

By the 90's it was fleshed out in the Aalborg Charter (1994) by more than 700 cities worldwide, and in the Melbourne Principles of the Local Agenda 21 (UNEP, 2002). From then on, the concept of a sustainable city grew and, in practice, became strongly intertwined with the idea of a *triple bottom line* – or *three pillars* –, denoting a close relationship between economic, social and environmental sustainability with a combination of indicators to measure each of them (Sartori et al., 2014; Bibri & Krogstie, 2017; Ahvenniemi et al., 2017).

Meadows (1993) and Brugmann (2009) approached the term from a more environmentally-oriented perspective and proposed that it should include indicators for pollution and carbon emissions, water consumption and quality, energy mix and demand, waste management, green built environment, and forest and agricultural land management. However, Burdett & Sudjic (2011) adopted a more socio-economic interpretation, in which social equity alongside a greener living environment should be considered for the development of sustainable cities, also suggesting that cities should offer proximity, density and variety enough to engender productivity benefits for firms and help stimulate innovation and job creation.

The overall mindset began to change, however, at the beginning of the 21st century when Rogers (1997) conceptualized a sustainable city as a place where a higher quality of life is realized in tandem with policies which effectively reduce the demand for resources and draw from the city's hinterland to become a more self-sufficient and cohesive economic, social, and environmental unit or ecosystem. As autonomous as a cell can be, a sustainable city is unable to live fully independently outside the organism of its nation, therefore, renewed attention was then given to some of the economic aspects of sustainable cities, rekindling the

academic interest in contributing to policy-making, notably on the transitional and structural measures necessary to shift the interactions between urban stakeholders from linear and production-oriented to circular and service-oriented ones (de Jong et al., 2015; Alberti et al., 2017; Ahvenniemi et al., 2017).

Fully embracing this shift is the concept of servitization, created to describe the idea of product manufacturers, wholesalers and retailers reducing their tangible portfolio in favor of an intangible one (Levitt, 1969; Lay, 2014). Currently, the application of this concept is closer to its origin in the 1980s, in which the idea was to deliver to the customers a package of services, goods, support and knowledge that together represent a solution, and not only a sale (Kohtamäki et al., 2018; Vandermerwe & Rada, 1988). Most modern companies adopt it in either the stages of pre-sale – e.g. trials, demonstrations and custom design –; sale – e.g. installation and training –; or post-sale – e.g. maintenance, support and warranty (Frambach, 1997; Boyt & Harvey, 1997).

Nevertheless, actual reductions in the overall amounts of resources and energy consumed usually derive from services that – with the support of information technology – actually shift product ownership or that do not require the customer to acquire the product in the first place, instead buying the results it delivers – e.g. leasing, renting and pooling (Mathieu, 2001; Tukker, 2004). In 2009, 84,8% of manufacturing companies offered services to support their products, being only 12,1% of these directly related to the changing product ownership or to a product being operation by the manufacturer as service to the customer (Lightfoot et al., 2013; Baines et al., 2009).

Although well aligned with concomitantly developing concepts such as Circular Economy, the servitization trend evolved in parallel and gained its largest share of attention after the photocopier industry decided to lease or rent their multifunctional products to foster a *pay-per-printed-page* solution instead of a *one-photocopier-per-office* business model (Lay,

2014). Once customers started perceiving direct or indirect financial benefits, this phenomenon opened the doors for discussions in all related matters: from the potential innovations in business models to the psychology of product ownership; from unique selling propositions (USPs) to sustainable resource management (Coombs & Miles, 2000, Oliva & Kallenberg, 2003).

Service-providing initiatives then became commonplace in marketing management but little to no attention was given to the resources being saved, but instead to the costs being reduced in the search for profit (Zhang & Banerji, 2017; Tukker, 2015). Although headed in the right direction from an environmental standpoint, this counterintuitively went against some of the principles of sustainability: selling services without addressing their resource demands ended up, in some cases, increasing material consumption (Kowalkowski et al., 2017; Green et al., 2017). It was when academics involved in what is called *redistribution* and *sharing* within the Circular Economy framework drove their attention to service-providing practices already in place that servitization found new grounds and began receiving more support as a mean to retain resources longer in the economy, creating value from service and circularity instead of value from natural resource extraction and transformation (Burton et al., 2017; Tukker, 2015; Rothenberg, 2007).

Although the variety of resources that circulate within a given society can be theoretically infinite, steel is a key component of everyday life, and in the aforementioned photocopier example alone, the reduction in total demand for the specific steel components necessary for these machines to operate configures in itself a fitting argument for how servitization can be a tool for reducing natural resource exploitation when its effects are passed along the steelmaking supply chain.

Along with the other commodities present within the goods potentially targeted by servitization, steel's presence in service-oriented projects would be, even if indirectly, a factor

capable of affecting, for example, (a) the importance of steel products' quality and durability, (b) the quantities, quality, and accessibility of recyclable scrap, (c) the development of other end-of-life and circularity services such as repair, maintenance, reuse, sharing, refurbishment, and remanufacture, as well as (d) the gradual shift towards operational longevity instead of component replacement, counteracting trends of planned and designed obsolescence.

3. METHODOLOGY

From the perspective of Industrial Economics, the use of modelling and simulation techniques has been growing since the 1970s. They have proven to be very useful for understanding firms' behaviors and how these connect to the markets which they are a part of, but, most recently, these techniques have also been used to support strategic decision-making. When a firm and its economic processes are deconstructed and understood in depth, it becomes easier to identify action points capable of driving actual change (Boumans, 2007, Meadows et al., 1982; Pruyt, 2013; Richardson, 1999; Senge, 1990; Morgan, 2012).

This detailed understanding of a system also supports tactical and operational decision-making in Supply Chain Management, especially on matters of integrated productivity and alignment with the other companies involved. When Corporate Social Responsibility and Environmental Values are brought into the decision-making mindset, previously unknown outputs that can be harmful to the environment, to society, to the communities involved, and even to overall governance within the company, are brought to light (Karnopp et al., 2006; Meadows, 1970; Meadows et al., 1974; Pruyt, 2013).

This section describes the methodology used throughout the development of the thesis and of the articles it comprises. The first one is Life Cycle Assessment (LCA), and particular attention was given to System Dynamics, both of which were subjected to SWOT analysis in order to uphold the decision to use them in tandem. Next, all of the necessary steps taken to achieve the results of this project are presented, along with the collected data, and the 21 simulation runs performed in addition to the baseline.

3.1. Life Cycle Assessment

Life Cycle Assessment (LCA) is among the tools of IE and allows for the measurement of environmental impacts and environmental performance of a product throughout a supply

chain, enabling detailed analyses and also comparisons with similar goods (Tietenberg, 2004; ISO 2006).

Life Cycle Assessment (LCA) has gained ground over the years due to its great potential for quantitative diagnosis, helping companies identify potential improvement possibilities in their production processes. By individually analyzing the environmental impacts of the raw materials, the types and amounts of energy used to transform and transport inputs and byproducts, as well as the wastes and pollutants generated by the manufacturing process itself, LCA allows product designers and managers to better visualize the ramifications of inserting a product into the market. This then allows for the revision and correction of products' and processes' characteristics in order to make them less harmful to the environment (Sonnemann et al., 2004; Tietenberg, 2004; Hunt & Franklin, 1996; Ferreira, 2004; ISO, 2009).

Although it has grown in significance and popularity, LCA can have its application limited in fields of knowledge in which subjectivity, data unavailability, data unreliability data, variable scale, and excessive uncertainty are often present. Due to its focus on single products and on their environmental aspects, LCA also often leaves aside social and economic issues throughout the accounting of materials and energy (Ferreira, 2004; Hunt & Franklin, 1996; Sonnemann et al., 2004; Daddi et al., 2017). However, *“it is understood that the main function of this tool is to support decision-making at a tactical and strategic level, and not necessarily to provide detailed analysis for operation or production”* (Pinto, 2017).

Steel's life cycle is summarized in Figure 3.1.25, analysis of which begins with the two main raw materials: iron ore and steel scrap. Steel can leave the manufacturing stage in many forms and with many different chemical and mechanical characteristics, depending on the application to which it was designed (Beddows, 2014; Stahl, 2017), and after it goes

through its use stage, it will either be repaired, reused, or refurbished, until losses in quality demand its recycling (WS, 2012; Vaclav, 2016).

Figure 3.1.25 - Steel's life cycle as per the Circular Economy framework (developed by the author).

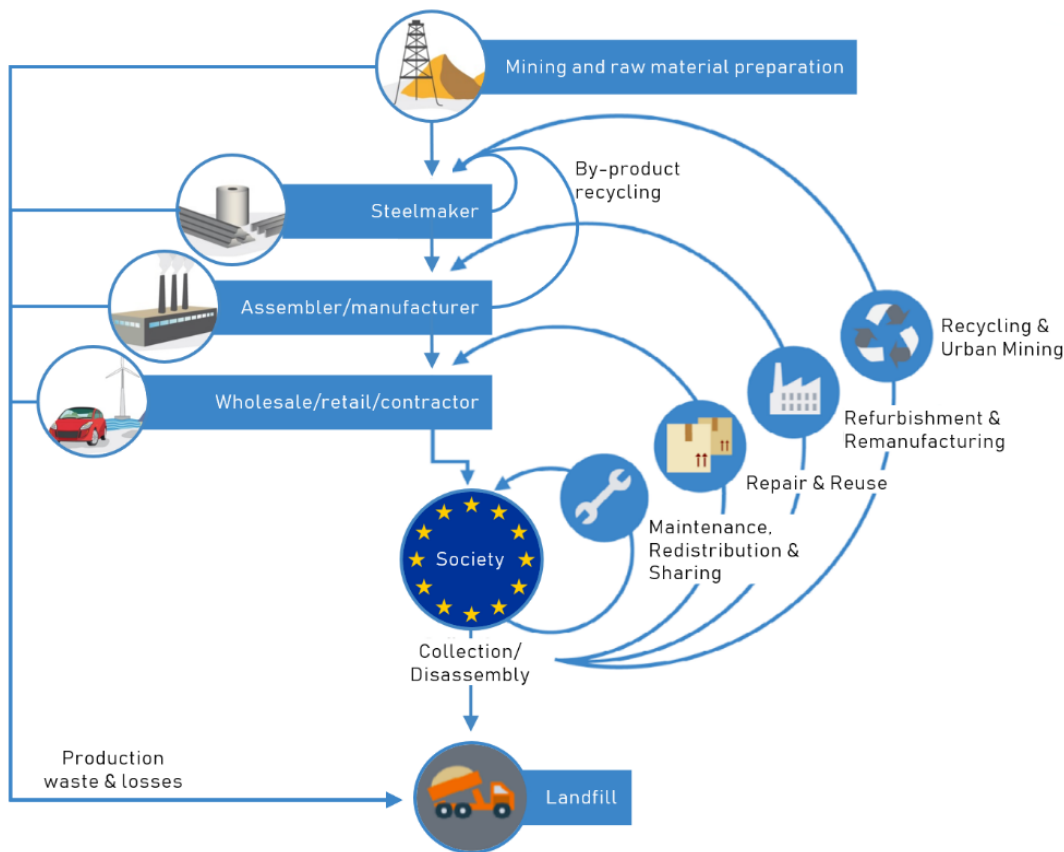

Throughout this entire sequence of stages, however, energy is consumed, byproducts are created and environmental impacts are generated, all of which can be measured by LCA. Below, three studies are used to exemplify previous LCA applications in the steel industry. These studies also served as a comparison parameter for the verification of the methodological integrity of LCA within the model used throughout the present thesis.

By following the guidelines of ISO 14040:2006 and using Simapro as a modelling platform to analyze data from Ecoinvent, Burchart-Korol (2013) developed the LCA of the Polish steel industry. In the study, the functional unit was set to one ton of cast steel produced within Polish cradle-to-gate boundaries, resulting in CO₂eq emissions measurements

according to IPCC and CED criteria, as well as in ReCiPe Midpoint indicators for 17 different categories of environmental impacts per main productive process. Not only were the author capable of identifying the human health and environmental risks posed by the raw materials as well as the energy demand of each productive process, but also to suggest changes in energy sourcing that could allow for the Electric Arc Furnace (EAF) method to be less emission-intensive (Burchart-Korol, 2013).

A similar study was performed in the Turkish steel industry, in which 14 IMPACT2002+ Midpoint indicators were used instead of ReCiPe's 17, focusing on five different steel products: billet, slab, hot rolled wire rod, hot rolled coil (Olmez et al., 2015). The main contributions of this study were (a) identifying hot rolled products as the most environmentally hazardous due to their intensive emission of inorganic particles – thus requiring efficient dust collection methods –, and (b) highlighting the significant Global Warming Potential of this industry as a whole due to its high consumption of fossil fuels (Olmez et al., 2015).

Another similar example of LCA pertinent to the discussion at hand took place in Italy, additionally considering emissions from logistics while focusing on a functional unit of 1 million tons of steel slab (Renzulli et al., 2016). Unlike previous studies, this one suggested the regional reuse of BOF and BF slag for agriculture or infrastructure purposes as a mean to help reduce the overall environmental impact of the production process, while also suggesting a partnership with nearby power plants in order to improve energy efficiency (Renzulli et al., 2016).

Based on literature, on the examples above, and on the author's experience, Table 3.1.03 summarizes the analysis of strengths, weaknesses, opportunities and threats (SWOT) executed by the author.

Table 3.1.03 - SWOT Analysis of Life Cycle Assessment.

STRENGTHS	WEAKNESSES
<ul style="list-style-type: none"> ▪ Focus on environmentally friendly product design and its development; ▪ Strong diagnostic and planning approach; ▪ Clear depiction of stocks and flows of a product along a supply chain; ▪ Stakeholder involvement in the supply chain is made visible; ▪ Internationally accepted and indicator-friendly; ▪ Linear, bottom-up approach; ▪ Model structure is objectively representative; 	<ul style="list-style-type: none"> ▪ Complex inputs and outputs; ▪ Limited comparability due to high specificity; ▪ High time and effort requirements; ▪ Limited to one product/good at a time; ▪ Limited scenario analyses, often requiring One-Factor-at-a-Time (OFAT) approach; ▪ Lack of a time frame can limit long-term decision-making application; ▪ Disaggregation level can pollute the identification of key issues; ▪ Standard application does not consider market dynamics;
OPPORTUNITIES	THREATS
<ul style="list-style-type: none"> ▪ Allows for ISO certification; ▪ Can spearhead public image efforts regarding a company's environmental concerns; ▪ Standardization allows for cross-cultural exchanges; 	<ul style="list-style-type: none"> ▪ Interpretation of results can be confusing, misleading or complex for general management or communication purposes; ▪ Scarce expertise; ▪ Vulnerable to data availability; ▪ Data inputs regarding future trends or behaviors depend on exogenous sources;

Sources: Hunt & Franklin (1996), Huijbregts (2002), Ferreira (2004), Sonnemann et al. (2004), ISO (2006), Finnveden et al. (2009), Curran (2012), Ahmed (2012), Daddi et al. (2017).

It is from understanding and experiencing some of the limitations above as well as the limited availability of literature on LCA for steel that the author considered also exploring how SD can support decision-making in the European Steel Industry.

3.2. System Dynamics

While LCA is capable of giving scholars and decision-makers a very insightful snapshot of a supply chain, System Dynamics (SD) can, in turn, transform that snapshot into a film. Decision-makers gain, thus, the means to analyze a supply chain as it progresses through the effects of multiple feedbacks and loops of which visibility, relevance or scale could only become evident with the passage of time or with their simultaneous interactions (Forrester, 1962; Booth & Meadows, 1995).

SD derived from the school of Systems Thinking of the 1950s and 60s, which intended to support and improve productive decision-making (Forrester, 1962; Booth & Meadows 1995), and its application begins on the definition of a clear question. It then proceeds to

conceptualize the system where the problem is located by deconstructing a system into smaller more understandable pieces and analyzes their behavior alone as well as when they interact with other pieces. These pieces are usually defined as stocks, flows, feedbacks or delays, and the manner by which each of them affect a system can generate balancing or reinforcing loops that help determine the system's overall behavior (Forrester, 1969; Coyle, 1996; Haraldson, 2004; Morgan, 2012; Capra & Luisi, 2014).

Modern applications mostly linked to modelling techniques seen in software like Stella, Vensim, Embed, Consideo, Sysdea, MapleSim, Forio, Lumina and Minsky, but regardless of the chosen modelling software, the first intermediary result is a Causal Loop Diagram (CLD), exemplified in Figure 3.2.26. Next, each component is classified and their material or biophysical relations are depicted in Flow Charts (FC), exemplified in Figure 3.2.27, highlighting inputs and outputs of each stock, as well as the delays that exist in each flow. It is important to note that the coherence and consistency between these two intermediary results is of utmost relevance for the continuity of the methodology (Booth & Meadows, 1995; Karnopp et al., 1990; Sterman, 2000; Ogata, 1998; Randers, 1980; Forrester, 1969; Albin, 1997; Morgan, 2012; Capra & Luisi, 2014; Haraldson, 2004).

Figure 3.2.26 - Example of causal loop diagram (Zhou, 2017).

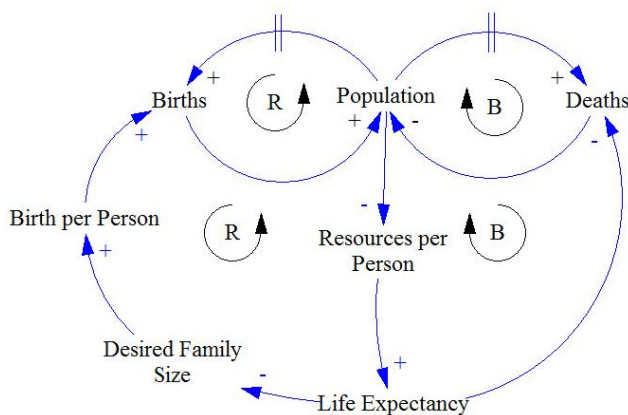
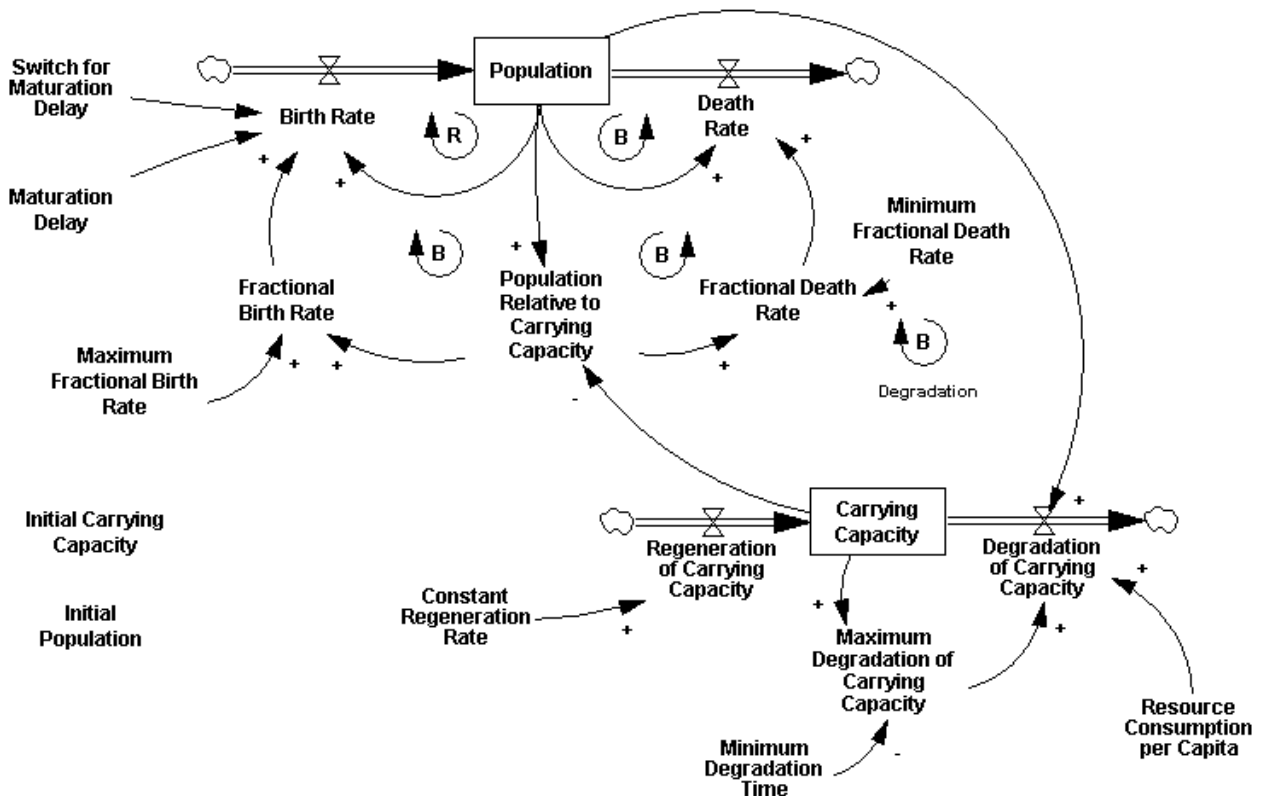

Figure 3.2.27 - Example of flow chart (SDC, 2010).



Once the CLD and the FC have been consolidated, data can be brought into the model, comprising empirical values capable of quantifying the components of the system, of changing their state, magnitude or size, as well as supporting structural and contextual behavior brought in by qualitative assumptions. The data used for modelling in system dynamics can be categorized as (a) system boundaries, (b) initial conditions, (c) system structures, (d) system parameters, and (e) system states, being the first four used for configuration of the model before any simulations, and the last one to verify how accurately the model can represent the system in what regards to the problem statement (Forrester, 1971; Booth & Meadows, 1995; Karnopp, et al., 1990; Meadows et al., 1982; Ogata, 1998; Randers, 1980; Richmond, 2004; Roberts et al., 1982; Sterman, 2000).

Data collection usually occurs simultaneously with the construction of the model in a modelling software, which carries out calculations according to the instructions derived from

the conceptual stage. Instead of pushing data through series of stocks and flows – as LCA commonly does –, SD lets the ensemble of interactions between each correlated pair of variables define the behavior of the system and more easily represents circular behaviors when compared to other methodologies (Ogata, 2003; Ruth & Hannon, 2012). This approach allows for very small-scale problem-solving just as much as it allows for the analysis of large-scale interactions, often encompassing market dynamics and relying on endogenous data to create projections and trends (Sterman, 2000; Ruth & Hannon, 2012).

Once a fully configured model adequately represents the system which the problem statement wishes to address, it then allows researchers to test assumptions and scenarios. These can be inserted into the model as variables that modify the role or magnitude of other components, as parallel loops that affect the system indirectly, or even as unknown sources or sinks of materials. To conduct these tests, scenarios are defined and these new variables are run through a simulation, often creating results that substantially change the researcher's understanding of the system itself. One of the most famous examples of this practice is the World Model, that eventually helped bring to light the many environmental issues that can stem from current economic and industrial behavior. From this point on, researchers can choose to test and simulate new scenarios, eventually compiling them into series of suggestions, policies and decisions to answer to the problem statement's concern (Meadows, 1999; Ackoff & Gharajedaghi, 1996; Meadows & Randers, 2002; Morgan, 2012; Nabavi et al., 2017).

When inputs, outputs, stocks and flows are mapped and their interactions are identified, the resulting model naturally represents the metabolism of the company within its environment – be it a natural one or an economic one –, an approach very much representative of what Industrial Ecology aims to achieve. With this in mind, feedback loops support the creation and improvement of circularity among the specific processes impacted

by *in company* decision-making, but also the development of circularity and cooperation in regional and even national context depending on the materials and types of energy deployed (Meadows & Randers, 1993/2002; Pruyt, 2013; Randers, 2012; Senge et al., 2008). Below, the author presents examples of SD studies on steel, performed by researchers in China, Iran, Sweden and the United Kingdom. As with LCA, these studies also served as a comparison parameter for the verification of the methodological integrity of the model used throughout the present thesis, but for SD instead.

The first study consisted of a macro-level analysis of the sintering process, one of the raw material preparation steps commonly used in the ironmaking stage. Both CLDs and FCs were created, resulting in a SD model capable of replicating the known behavior of sintering operations in the Anshan Iron and Steel Corporation (AISC) (Liu et al., 2015). The model was then used to run a multi-variable simulation comparing the AISC's operation to the Shouqin Corporation's operation, pointing to the latter as capable of delivering sinter with better compactedness and higher iron content to the Chinese market (Liu et al., 2015).

The next study focused on reducing the consumption of natural gas and oil in Iranian national steelmaking by simulating the energy requirements through 20 years of subsidies, exports and consumption (Ansari & Seifi, 2012). A macroeconomic SD model was created to test the aforementioned variables simultaneously and in face of price variations, resulting in up to 33% reductions in fossil fuel consumption depending on the mix of subsidy reforms, recycling stimuli and EAF deployment scenarios (Ansari & Seifi, 2012).

Next, researchers studied how SD can support decision-makers in identifying the main obstacles for extending a product's lifespan so as to comprise multiple life cycles (Asif et al., 2015). Global and North American data on steel was used to build a simplified global SD model in which resource scarcity and steel consumption were defined as the main drivers (Asif et al., 2015). As a result, the researchers suggested that enterprises and nations should

attempt to keep scarce or non-renewable resources within their supply chains for as long as possible during multiple life cycles in order to accrue the most economic and environmental advantage possible (Asif et al., 2015).

The last study brought to the reader’s attention was one of the earliest concerning the steel industry using SD as a methodology. In it, the researchers attempted to create a model capable of reproducing the effects of bottlenecks, breakdowns and other operational constraints in steelmaking supply chains which adopt Minimum Reasonable Inventory (MRI) as a business strategy (Hafeez et al., 1996). After simulating different operational scenarios, the main outcome of the study was a set of strategies to achieve MRI for each individual stock unit according to system-wide operational risks, instead of altogether uniformly, which would tend to require either operational risk insurances or higher levels of working capital binding (Hafeez et al., 1996).

As previously performed for LCA, Table 3.2.04 summarizes the SWOT analysis of SD considering the examples above as well as other relevant literature. After having finished SWOT analyses for both LCA and SD, the author identified multiple points of divergence but also of convergence. Most importantly, however, is that in situations where one flounders, the other often excels, thus pointing to the potential benefits of a combined approach.

Table 3.2.04 - SWOT Analysis of System Dynamics.

STRENGTHS	WEAKNESSES
<ul style="list-style-type: none"> ▪ Focus on circularity, causality and the effects of variables over time; ▪ Strong for strategic analyses and problem-solving; ▪ Can include subjective or abstract variables; ▪ Allows for the analysis of more than one product/good at a time; ▪ Model structure is easy to adapt and change if necessary; ▪ Non-linear, top-down approach; ▪ Can be used for modelling market dynamics; 	<ul style="list-style-type: none"> ▪ Strategic analyses often do not suffice for effective decision-making; ▪ Visualization of stakeholder involvement is highly dependent on how the model is built; ▪ Levels of error and uncertainty are harder to determine; ▪ Aggregation can hide or ignore important variables if not done carefully; ▪ Model structure might not be objectively representative; ▪ Limited support for using indicators;
OPPORTUNITIES	THREATS
<ul style="list-style-type: none"> ▪ Can be of great use for communication purposes; ▪ Can foster the development of multidisciplinary studies; ▪ Can generate endogenous trends and projections; 	<ul style="list-style-type: none"> ▪ Scarce expertise; ▪ Analyses can become over-simplistic; ▪ Vulnerable to data reliability;

Sources: Forrester (1962), Booth & Meadows (1995), Coyle (1996), Hafeez et al. (1996), Ogata (2003), Haraldson (2004), Ansari & Seifi (2012), Capra & Luisi (2014), Asif et al. (2015), Liu et al. (2015), Kunc (2017).

3.3. Research design

Bringing LCA and SD together is a relatively recent idea as of the development of this thesis, with earliest attempts dating back only to 2011. In the scientific studies published so far, systems thinking was used to pursue the same results generated by either LCA (Onat et al., 2016; Halog & Manik, 2011) or Material Flow Analysis (MFA) (Sprecher et al., 2015) while adding broadened and deepened understandings of the relations between an empirical environment with another more complex or less tangible one.

These efforts brought significant advancements to the discussion of how approaching LCA and MFA with a SD mindset can be productive and insightful for answering questions regarding sustainability's triple bottom line or regarding different environmental nexus with larger scopes and boundaries, reinforcing the importance that decision- and policy-makers include both methodologies in their scientific toolkit (Onat et al., 2017).

Having learned from these experiments, this thesis tries something different: to bring the entire LCA methodology into the SD modelling environment and – unlike previous attempts –, to use a bottom-up approach instead of a top-down one. It is to say that, in addition to using SD to broaden and deepen the achievements of LCA, an attempted was made to create a *win-win* environment in which LCA can provide its own contributions to SD as well.

Considering that neither SD nor LCA was originally devised to work with each other, as well as the limited number of available attempts of their integration until now, the primary concern was to properly envision where, when and how LCA and SD could supplant each other's weaknesses while maintaining their own strengths. To that end, the case study used for testing this integration was the European steel industry, chosen by the author due to its current transition towards more environmentally-oriented decision-making, to its importance for the European economy, security and sovereignty, to its global contextual concerns

regarding the rise of international competitors, and due to the policy limitations regarding its environmental aspects. Therefore, as boundary, the study took into account the EU28 zone, represented by the supply chains of the steelmakers members of the WorldSteel Association that operate within it, which account for 84% of the entire European steel industry.

In order to adequately represent this industrial activity and give focus to the biophysical transformations that take place throughout the supply chain while keeping in mind European average steel production behavior, the study was conducted using the following methodological steps:

1. Business Process Mapping (BPM) – carried out with the support of the BizAgi software and aimed at identifying all the core processes of steelmaking in Europe, available in [Appendix 7.2](#);
2. Causal Loop Diagramming (CLD) – made with the support of the OmniGraffle tool so as to represent the steelmaking supply chain in a systematic and holistic manner;
3. Flow Charting (FC) – within the SD modelling environment of the Stella Architect software (ISEE Systems, 2016), respecting not only the CLD, but the structural definitions of the ILCD Handbook (EC, 2010) and the standards set by ISO14044:2006 (ISO, 2006) in order to ensure the adequate operationalization of LCA;
4. Data collection – using the data cohesion and reliability criteria of the ILCD Handbook (EC, 2010) and the standards set by ISO14044:2006 (ISO, 2006), further comparing them to equivalent data points in the WorldSteel Association’s Life Cycle Inventory Study for Steel Products (WS, 2017c) and EUROSTAT Databases (EUROSTAT, 2009/2017/2018a,b);
5. Model parameterizing (detailed in section 3.5); and
6. Testing and simulations (detailed in section 3.6).

Iron was defined as the driving chemical element of steelmaking, while steel scrap and iron ore were defined as the key raw materials. Nevertheless, connections to all other chemical elements and raw materials involved in steelmaking were included, as summarized in Figure 3.3.28. Furthermore, two different levels of aggregation were adopted: cradle-to-gate processes were disaggregated down to chemical level, while gate-to-cradle processes were aggregated to product level. This choice was made in order to give decision-making granularity for the steelmakers without over encumbering macro-level analyses that could affect policy-making on end-of-life and circularity services.

Figure 3.3.28 - CLD of the biophysical system under study, made in OmniGraffle.

<< Please refer to the high-resolution image in [Appendix 7.3](#) >>

In order to obtain the desired alloys, the material needs of the furnaces were used to define the amounts of raw materials pulled from their respective sources. This *pulling* behavior is present in the system until liquid steel becomes an intermediary output, point in which the system then *pushes* materials through the subsequent processes so as to reproduce the continuous casting operation. Additionally, attention was given to the feedbacks that *close the loop* (e.g. recycling, repair, refurbishment), so as to enable the system to operate under the definitions of CE and IE.

3.4. Model description

In total, twenty modules were created, one for each chemical element involved in the steel supply chain (e.g. iron, carbon, nickel, chromium, zinc, oxygen), all of which used a functional unit (FU) of 1 ton of steel and were built to be structurally identical, being specific flows and stocks introduced whenever necessary so as to properly represent the typical behaviors of each chemical element throughout the supply chain.

Within each module, the production processes and the stocks of steelmaking were approached modularly and established as individual LCA-based units, capable of being displaced, rearranged or replicated with minimal interference in the overall structure of the model. This allowed for the user interface to be less polluted than traditional SD models and should enable this model to be easily adapted to the reality of different stakeholders in the future, as shown in Figure 3.4.29.

Figure 3.4.29 - Flow Chart (FC) Interface Diagram of the model's biophysical module and control panel (both highlighting Fe), and the economic module.

<< Please refer to the high-resolution images in Appendices [7.4](#), [7.5](#) and [7.6](#), respectively >>

The productive processes were grouped into macro-processes based on their most common occurrence in the European steel industry, namely (a) EAF and (b) BFBOF – each encompassing sintering, pelletizing, degassing, alloying, desiliconization, desulfurization, homogenization or dephosphorization, whenever applicable; (c) Casting – which encompasses all shape, heat and surface treatments; (d) Metallurgy – which encompasses all forming and metalworking processes; (e) Economic Sectors – divided in Construction, Automotive, Other Transportation, Tools and Machinery, Appliances and Electronics, and Heavy Mechanical Equipment, as per WorldSteel Association standards; (f) Recycling – which feeds back into the stock of scrap used as input for “a” and “b”; (g) Repair/Refurbishment – which feeds back into each economic sector according to their share in its demand; and (h) Losses and Landfills – which configures a process-based sink.

It is important to note, however, that (1) due to the lack of available disaggregated data, emissions from mining, casting and metallurgy were attributed to the EAF and the BFBOF macro-processes accordingly and proportionally; (2) dust and particulate matter generation were incorporated into the mass of emissions; (3) no disaggregated emission data

was found for end-of-life and circularity solutions; (4) energy flows were considered only in the form of consumed amounts of fossil fuels or electricity, and not in the form of heat – which was given a fossil fuel or electricity equivalent whenever applicable.

3.5. Model parameterizing

Table 3.5.05 summarizes the data inputs used in the study, all of which encompassed the interval between 2001 and 2016, and were verified for cohesion, coherence and reliability based on the criteria of the ILCD Handbook (EC, 2010) and of ISO14044:2006 (ISO, 2006)¹, as well as being compared to their equivalent data points in the WorldSteel Association's Life Cycle Inventory Study for Steel Products (WS, 2017c) and EUROSTAT Databases (EUROSTAT, 2009/2017/2018a,b).

¹ The author also considered adopting Product Environmental Footprint (PEF) standards (JRC, 2012), however, in its current state, it presented itself as a less consolidated and less disseminated methodology, with available applications focused mainly in the construction sector.

Table 3.5.05 - Summary of data inputs.

TYPE	VARIABLE	UNIT	SOURCES
EAF Inputs	Scrap, Oxygen, Natural Gas, Coal, Limestone, Dolomite, Water, Ore	kg/kg of steel	Shamsuddin (2016), WS (2012a/b, 2018, 2017c), EU (2011b), Madias (2013), Cullen et al. (2012), Yellishetty et al. (2011), EUROFER (2017a), EUROSTAT (2009, 2018b)
BFBOF Inputs	Ore, Hot Blast, Scrap, Water, Limestone, Coke, Dolomite	kg/kg of steel	
Typical Chemical Compositions of the Inputs	Scrap, Ore, Coke, Natural Gas, Coal, Dolomite, Limestone, Hot Blast	%	MINDAT (2018) WEBMINERAL (2018)
Typical Compositions of Steel Alloys, as Outputs	UNS S30400, UNS S31600, UNS S43000, UNS S17400, UNS S32205, UNS S40900	%	Bringas (2004)
Typical Slag Composition Ranges	EAF Slag, BF Slag, BOF Slag	%	Yildirim & Prezzi (2011), Adegoloye et al. (2016), EUROSLAG (2018)
Typical Composition Ranges of Emissions to the Atmosphere	EAF Emissions, BF Emissions, BOF Emissions	%	Ferreira & Leite (2015), Ramírez-Santos et al. (2018), Uribe-Soto et al. (2017), Schubert & Gottschling (2011)
Stocks in Use	Automotive, Construction, Tools & Machinery, Appliances & Electronics, Heavy Mechanical Equipment, Other Transportation	tons	Pauliuk et al. (2013), EC (2017)
Participation of Economic Sectors in Steel Demand		%	WS (2018), EUROSTAT (2009, 2018b)
Typical Lifespan and Service Life of Steel per Economic Sector		years	Cooper et al. (2014), EC (2017), EUROSTAT (2009, 2018b)
Recycling and Refurbishment Rates per Economic Sector (<i>business as usual</i>)		%	NFDC (2012), EUROSTAT (2018a), Björkman & Samuelsson (2014), BIR (2017), Panasiyk et al. (2016), EUROFER (2017b), Eckelman et al. (2014)
Repair and Reuse Rates per Economic Sector (<i>business as usual</i>)			NFDC (2012), EUROSTAT (2018a), Dindarian & Gibson (2011), Truttmann & Rechberger (2006), Bovea et al. (2016), Kissling et al. (2013), RREUSE (2012), Eckelman et al. (2014),
Distribution and End-of-Life Losses			Pauliuk et al. (2017)
Typical Cooling Water Reuse and Recycling Rates		EAF Cooling Water, BFBOF Cooling Water	%
Ore Prices (historical)	China FOB 63,5% Fe	€/ton	IM (2019), Trading Economics (2019)
Steel Prices (historical)	Global average, FOB Hot-rolled Coil		MEPS (2017), SB (2018)
Freight Shipping Index	Baltic Dry Index (BDI)		Bloomberg (2019)
Future Price (historical)	Future Prices		
Futures Contracts Exchange	Exchanged Volumes	tons	SHFE (2019), LME (2019)
Financial Results (historical)	EBITDA	%	NYU Stern (2018)
	Dividend payout		CSI (2019)

The model was then parameterized for annual calculations during a period of 200 years, assuming that the demand for steel focused on the 6 most produced types of steel

(UNS S30400, UNS S31600, UNS S43000, UNS S17400, UNS S32205, UNS S40900). The yields of the EAF and the BFBOF production macro-processes were set according to their respective capacity and productivity, as well as to their share of participation in the EU28. The parameters can be seen in Tables 3.5.06 and 3.5.07.

Table 3.5.06 - Summary of parameters used in the model.

Parameter	Value	Unit	Sources
EAF Tap-to-Tap Time ⁽¹⁾	0,80	hours	Shamsuddin (2016), WS (2012a/b, 2018, 2017c), EU (2011b), Madias (2013), Cullen et al. (2012), Yellishetty et al. (2011, 2011a), EUROFER (2017a,b)
EAF Furnace Capacity	100,00	tons	
BFBOF Cycle Capacity	42,00	tons/batch	
BFBOF Productivity ⁽¹⁾	7,00	batches/h	
Share of EAF Production	30, 00	%	WS (2017b)
Share of BFBOF Production	70,00		
Recoverable High-grade Iron Ore	82 billion	tons	Sverdrup & Ragnarsdottir (2014), UNCTAD (2017)
Recoverable Low-grade Iron Ore	92 billion		
Recoverable Very low-grade Iron Ore	166 billion		
Global average capacity utilization, steel industry	70,00	%	Statista (2016), Pooler & Feng (2017)
Global average reinvestment rate, steel industry	67,50	% / year	NYU Stern (2018)
Global average economic inflation growth	0,05		IMF (2019), PWC (2019)
Interest rate	5,00		Trading Economics (2018)
Global average GDP growth	3,60		IMF (2019)
Compound annual demand growth rate, steel industry	1,50		WS (2018), Statista (2018)

(1) As both delay and yield factor.

Table 3.5.07 - Summary of baseline costs in €/ton.

	EAF			BFBOF		
	FIXED	VARIABLE	TOTAL	FIXED	VARIABLE	TOTAL
Ore ⁽¹⁾	€ 0,00	€ 0,00	€ 0,00	€ 0,00	€ 93,98	€ 93,98
Scrap ⁽¹⁾	€ 0,00	€ 271,92	€ 271,92	€ 0,00	€ 36,47	€ 36,47
Industrial gases	€ 0,00	€ 1,25	€ 1,25	€ 0,00	€ 13,06	€ 13,06
Alloying elements	€ 0,00	€ 19,49	€ 19,49	€ 0,00	€ 11,69	€ 11,69
Coal ⁽¹⁾	€ 0,00	€ 0,00	€ 0,00	€ 0,00	€ 20,81	€ 20,81
Fluxes	€ 0,00	€ 3,39	€ 3,39	€ 0,00	€ 106,91	€ 106,91
Other ⁽²⁾	€ 2,31	€ 31,94	€ 34,26	€ 2,83	€ 13,67	€ 16,50
Labor	€ 1,72	€ 5,16	€ 6,88	€ 3,90	€ 11,69	€ 15,59
Electricity	€ 5,44	€ 30,84	€ 36,28	€ 1,17	€ 6,64	€ 7,81
Capital	€ 12,77	€ 0,00	€ 12,77	€ 24,39	€ 0,00	€ 24,39
Byproducts	€ 0,00	€ 0,00	€ 0,00	€ 0,00	-€ 11,63	-€ 11,63
Net thermal energy	€ 0,00	-€ 3,01	-€ 3,01	€ 0,00	-€ 44,06	-€ 44,06
TOTAL	€ 22,24	€ 360,99	€ 383,23	€ 32,30	€ 259,24	€ 291,54

Sources: Statista (2017b/2019b), WS (2018), WSD (2019).

(1) Includes logistics and transportation;

(2) Includes furnace maintenance;

Keeping in mind that all of the steelmakers considered within the boundaries of the study either import iron ore or ship it from their international branches, inherent behaviors of the model structure include (a) the gradual transition from BFBOF production to EAF production as function of steel scrap availability, iron ore quality decrease and iron ore scarcity over time (Waugh, 2016); (b) the gradual shift towards consuming steel scrap instead of iron ore as a function of iron content and availability, still respecting alloying and operational requirements; and (c) steel scrap downcycling over time due to alloying quality loss during repeated service lives. Finally, all circularity and end-of-life behaviors were set to respond in a *business-as-usual* pattern, with no direct or indirect stimulus of any kind, evolving only in proportion to the demands of the elements present in steel scrap.

3.6. Testing and simulations

Once the development of the model was completed, the author proceeded to verify if the integration could reproduce results of studies that used LCA or SD independently. To do so, *business-as-usual* (BAU) data was used to parameterize the model alongside the data specific to the studies taken under consideration – respectively described in sections 3.1 and 3.2. After performing these tests and having verified the model's performance, as well as the integrity of each methodology while operating in tandem, the forcing functions and steady variables used for the tests were removed to allow for the model's dynamics to run unobstructed. Then, a consolidated BAU run was set as baseline – as per Article no. 1 – and served all comparisons carried out from that point onward.

For the assessment of the potential effects of end-of-life policies – as per Article no. 2 –, 12 runs were performed according to the description in Table 3.6.08. The first 6 runs focused on testing the effects of achieving the maximum theoretical recycling potential of end-of-life steel in different sectors, and the next 6 runs focused on the potential outcomes

of doubling the rates of repair & reuse of end-of-life steel in different sectors. All of the testing considered a linear phase-in period of 10 years (from 2020 to 2030) and runs were then compared to the BAU run for the analyses.

Table 3.6.08 - Summary of simulation runs (article no. 2).

RUN	TARGET SECTOR	VARIABLES	INITIAL VALUE	FINAL VALUE	TRACKED PARAMETERS
1	Appliances & Electronics	Recycling Rates	46,9%	100%*	<ul style="list-style-type: none"> • Input of steel into the economy; • Ore consumption; • Ore consumption reduction potential; • Scrap generation; • Stimulus for transition toward EAF.
2	Tools & Machinery		70,0%		
3	Heavy Mechanical Equipment		57,0%		
4	Other Transportation		54,6%		
5	Automotive		93,8%		
6	Construction		91,0%		
7	Appliances & Electronics	Rates of Repair & Reuse	19,0%	38,0%	<ul style="list-style-type: none"> • Input of steel into the economy; • Ore consumption; • Ore consumption reduction potential; • Overall iron circularity; • Iron feedback per sector.
8	Tools & Machinery		15,0%	30,0%	
9	Heavy Mechanical Equipment		21,0%	42,0%	
10	Other Transportation		22,0%	44,0%	
11	Automotive		6,0%	12,0%	
12	Construction		5,0%	10,0%	

* As primary end-of-life output. Operational losses attributed downstream, accordingly.

The author acknowledges that these simulation runs represent aggressive measures and that their direct application in actual European reality would be unlikely in their current form. It is important to remind the reader that the goal of these simulations do not aim to directly support the redaction of a policy, but to test and discuss the effects and behaviors that such policy-based approaches could potentially generate in terms of biophysical circularity, helping to compose an answer to the proposed question.

For the assessment of the potential effect of different Supply Chain Integration strategies on closing material loops in steel supply chains – as per Article no. 3 –, five runs were performed as described in Table 3.6.09. All of the testing considered a phase-in period of 10 years (from 2020 to 2030) and runs were then compared to the BAU run for the analyses.

Table 3.6.09 - Summary of simulation runs (article no. 3).

RUN	OBJECT	PROPOSITION	CIRCULARITY DRIVER	SCI APPROACH	DEPLOYMENT	VARIABLES
13	Slag	Integrate slag recycling into furnace operations, instead of transferring it to third-party recyclers	Recycling for recovery	Vertical	Direct source of iron replacing ore	Recycling yields ¹ : EAF: 20 to 60% BF: 10 to 20% BOF: 20 to 40%
14				Vertical hedging	Hedged source of iron against ore	
15	End-of-Life steel products	Integrate steel refurbishment and repair back into metallurgy, instead of having it be performed by third-party services	Refurbishment and repair for reuse	Horizontal hedging	As hedged input against new steel	Yields ^{1,2} : 0 to 30%
16		Integrate third-party EoL services, stimulating or deterring its operation	Repair for reuse and maintenance	Horizontal	As tracked repaired goods	20% deterred
17						20% stimulated

(1) As iron content output to input ratio, linear increase during the phase-in period;

(2) As performed within the steelmakers supply chain, being the remainder still performed by a third-party;

In terms of modelling, the following structural adaptations were performed alongside variable manipulation in order to adequately run the aforementioned simulations:

- Runs 13 and 14: the slag flows from EAF and BFBOF operations that once left the boundaries of the supply chain towards third-party recycling were entirely brought into the supply chain and fed back into each operation respectively, following the yields in Table 3.6.09;
- Run 15: the flows of EoL steel from each sector that once left the boundaries of the supply chain towards third-party refurbishment or repair were partially brought into the supply chain and fed back into metallurgy, considering the yields in Table 3.6.09;
- Runs 16 and 17: the flows of repaired steel products from third-party services towards each sector remained outside of the supply chain boundaries but were subjected to being deterred or stimulated by the steelmakers according to the rates in Table 3.6.09.

Finally, for the assessment of the effects of different supply-side dynamics on the economic parameters – as per Article no. 4 –, four runs were performed according to the

description in Table 3.6.10. All of the testing considered value changes taking place in January 2020, and runs were then compared to the BAU run for the analyses.

Table 3.6.10 - Summary of simulation runs (article no. 4).

RUN	VARIABLE	INITIAL VALUE	TESTED VALUE	TRACKED PARAMETERS
18	Capacity Utilization ⁽¹⁾	BAU	BAU + 10,00%	<ul style="list-style-type: none"> • Future Price; • Spot Price; • EBITDA Margin; • Dividends;
19	Logistics Volatility	BDI	BDI ± 10,00%	
20	Electricity (average of industrial nuclear, industrial hydropower, electricity coal)	BAU	BAU + 6,00%/year	<ul style="list-style-type: none"> • Future Price; • Spot Price; • EBITDA Margin; • Dividends; • Total Costs of BFBOF Steelmaking; • Total Costs of EAF Steelmaking;
	Fossil Fuels (average of coking coal, PCI coal, natural gas)		BAU – 4,00%/year	
21	Nickel prices	BAU	BAU + 2,50%/year	
	Chromium prices		BAU + 2,10%/year	

Sources: MKC (2017), KPMG (2018), ÖKO (2016), Oomen (2012), Jung (2015), IEEFA (2018), Papandreou & Ruzzenenti (2016).

(1) Considering 445,00 €/kg (EAF) and 327,00 €/kg (BFBOF) reinvestment in installed capacity, depreciated over a period of 50 years.

Run 18’s goal was to determine how much the economic dynamics involved would tend to be affected if steelmakers operating with idle capacity decided to increase their market shares by means of offer alone. Run 19’s, on the other hand, aimed at determining how steelmakers would tend to react in face of volatility in logistics. Finally, runs 20 and 21 sought to understand the potential economic effects beyond a direct and proportional price increase that variations in energy and raw material costs could have on steelmaking.

3.7. Secondary methodology

In order to understand the potential contributions that steel could bring through servitization to a sustainable city, as well as the challenges steel could face while attempting to do so – as per Article no. 5 –, the present thesis adopted a secondary methodology.

Assessing the behaviors and dynamics within an urban environment is a task that can be carried out by substantially different approaches, methods, and tools – including LCA and

SD. Nevertheless, given the focus on steel's contribution and challenges via servitization towards resilience, sustainability and self-sufficiency, the author opted for the *ex post* use of two tools, deemed better suited for the assessment of qualitative factors in urban environments: Sustainable Urban Metabolism and Circles of Sustainability.

3.7.1. Tools

As detailed next, these tools were chosen based on their different approaches to stakeholders' involvement, eco-services and eco-efficiency. While the first one provides support for decision- and policy-making based on urban ecosystems theory, the second one is intended to be flexible and modular in order to align empirical solutions to the social conditions that permeate them (Graedel & Allenby, 1995; Rogers, 1997; James, 2015).

Sustainable Urban Metabolism

The underlying principle of Urban Metabolism is the conservation of mass towards the transformation of industrial activities in an urban environment from what is largely known as non-sustainable and linear systems to what would resemble sustainable and circular ones (Graedel & Allenby, 1995), being reminiscent of CE. As seen in Figure 3.7.1.30, it begins by employing Material and Energy Flow Analysis (MFA and EFA, respectively) for the identification and quantification of material and energy usage, as well as assessing their impacts on the environment (Petit-Boix et al., 2017).

Figure 3.7.1.30 - The city as a system (adapted from Rogers, 1997).

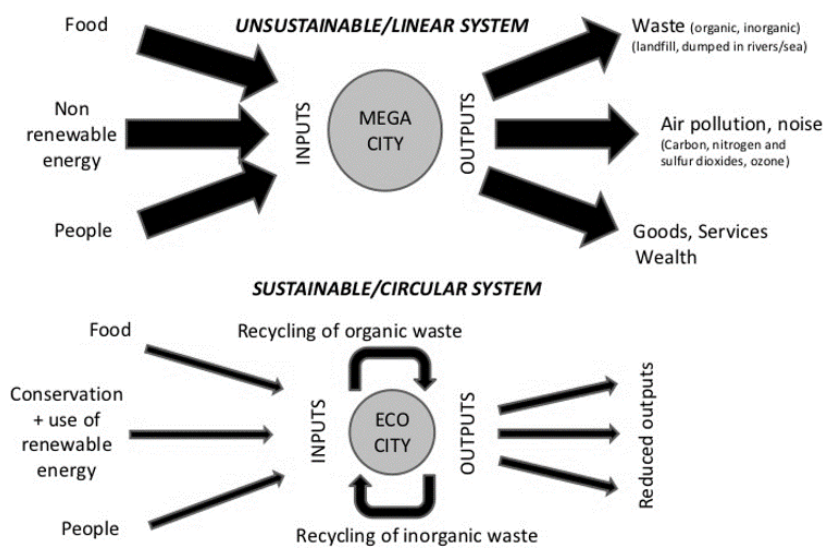

This metabolic assessment takes into account the basic consumption of the households within a city – such as heat, electricity, water and food – and links them to the local means of production that have corresponding benefits in terms of local economy, employment, greenhouse gas reduction, etc. Depending on the intensity of the flows of each resource and on how they evolve through time, the urban metabolism can gradually shift to patterns of zero waste, positive energy, closed water cycles, etc. (Rogers, 1997; Ferrao & Fernandez, 2013).

From that point on, having a clearer holistic and systemic understanding of a city's metabolism, measures for delivering improvements to each of the subsections of the assessment become the focus (Rogers, 1997). Finding ways to balance inputs and outputs among the multiple stakeholders involved naturally includes social and economic aspects, thus stimulating the development of new technologies and business models capable of reducing stocks and improving circularity without negatively affecting quality of life and wellbeing (Rogers, 1997; Ferrao & Fernandez, 2013).

This thesis' use of this tool considered the *before & after* conditions of inputs, outputs, stocks and flows in the context of each case study, aiming to identify how each case study

was able to affect the qualitative aspects of the urban environment they were a part of. Furthermore, this tool served as a base to identify the amounts, origins and destinations of the steel embedded in the servitization solutions deployed.

Circles of Sustainability

Circles of Sustainability, on the other hand, focuses primarily on qualitative aspects of a city’s metabolism. Although it encompasses environment and economy for the purposes of flow optimization, it’s main attributes are the intersections it provides with social conditions such as resilience, cooperation and proximity within a community (James, 2015; Ferrao & Fernandez, 2013). This tool is intended to be flexible and modular, and addresses the four domains of Ecology, Economics, Politics and Culture by diving them each into seven key aspects, all with their own criteria for conducting discrete semi-directed interviews with key actors and stakeholders of a city, resulting in the 9-points scale seen in Figure 3.7.1.31 (James, 2015; Ferrao & Fernandez, 2013).

Figure 3.7.1.31 - Circles of Sustainability (adapted from James, 2015).

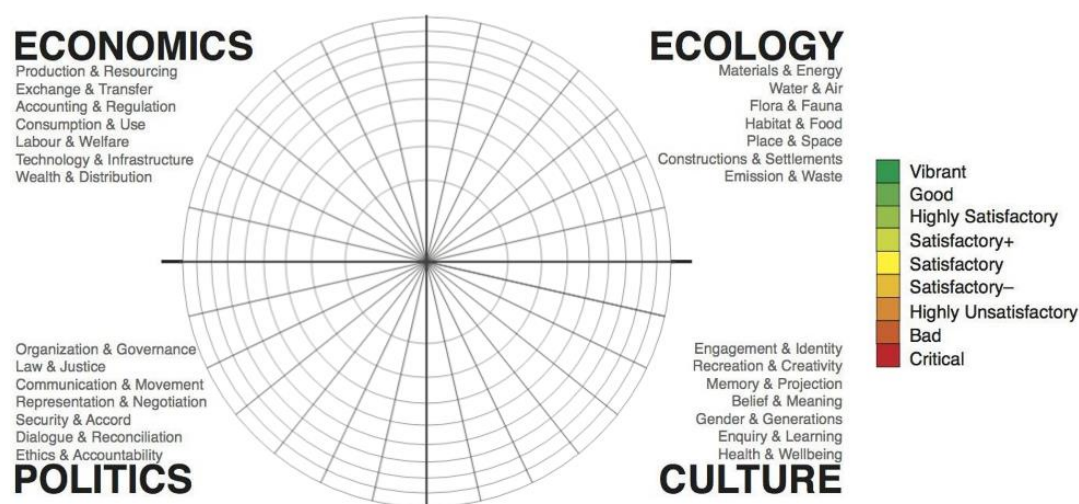

Multiple cities – e.g. Melbourne, Porto Alegre, Milwaukee, New Delhi – have assessed their sustainability using this tool, enabling not only a diagnostic understanding of their

situation, but also the intake of feedback and knowledge from the participation of their industries, communities and decision-makers (CoS, 2018). In Johannesburg, it helped its Department of Transportation to redefine public mobility goals; in Port Moresby, it helped the municipality in finding new solutions to land use management issues concerning informal employment and ethnical disputes, and; in Valetta, it improved the understanding of the cultural obstacles and political barriers responsible for hindering the development of an educational system to be capable of retaining qualified workforce (CoS, 2018).

In this thesis, this tool was used to identify where within the domains of a sustainable city each case study's contribution would help improve sustainability and, in conjunction with the previous tool, to which extent these effects were linked or not to the presence of steel.

3.7.2. Case studies

The case studies chosen for this study have four aspects in common: (a) being based on real life applications, (b) seeking benefits and improvements from an environmental and sustainability perspective, (c) considering the policy and social factors of the context in which they are inserted, and (d) discussing their results not only in present terms, but also in perspectives for future contributions. The author believes each of the case studies illustrates a different role that steel can play when servitization is used towards improving sustainability.

Energy

In an urban environment, electricity not only supplies industrial and commercial activities, but also guarantees particular levels of provision such as lighting, room temperatures and humidity control (Sorrell, 2007). Servitization in energy is, therefore, a conjunction of energy supply and energy-related services aiming at efficiency, savings and sustainability (Neely, 2008/2013; Benedetti et al., 2015). It can also refer to outsourcing and decentralization processes, involving third-party contractors for distribution and maintenance

or even the deployment of energy generation technologies directly onto a customer's property, often creating potential for energy feedback to either grid or supplier (Polzin et al., 2015; Hamwi et al., 2016).

A good example of decentralization based on electricity feedback to the grid was developed by Pinto et al. (2016), in which photovoltaic solar panels installed on the roof of houses of a social program were shown not only capable of creating energetic independence for home owners facing a structural national crisis, but also of reducing overall generation demand due to the creation of localized electricity feedback networks when given proper policy support.

The study considered three different electricity consumption scenarios for houses in five different regions of Brazil, keeping in mind specific solar irradiations, quantity of panels, costs of deployment, generation potential and sensitivity analysis. Results indicated monthly bill savings between 8 and 52% per house, with potential electricity feedback to the grid up to 47% under adequate policy support (Pinto et al., 2016).

Housing

Developing sustainable housing is an essential component of sustainable cities, not only because globally over one-third of all final energy and half of electricity are consumed by housing and generates approximately one-third of global carbon emissions (IEA, 2017), but also because multiple aspects of housing directly affect inhabitants' health, comfort, wellbeing, quality of life and workforce productivity (Koch-Orvad & Thuesen, 2016). Sustainable housing is designed, constructed, operated, renovated and disposed of in accordance with ecological principles for the purposes of minimizing the environmental impact and promoting occupants' health and resource efficiency (Kibert, 2003).

Although retrofitting – i.e. upgrading existing buildings to improve their energy efficiency and decrease emissions of greenhouse gasses – seems to be technically viable

and sometimes economically attractive, multiple barriers prevent optimal applications (Wu et al., 2016; Leed, 2010). Servitization of sustainable housing takes into account the entire life cycle of a building in an attempt to re-use, recycle and upcycle by means of, for example, the adoption of design-for-disassembly of individual parts and components that need to be fixed or replaced.

In their study, Céron-Palma et al. (2013) focused on the operation stage of a house – i.e. while citizens inhabit the building –, proposing measures to reduce emissions linked to energy consumption and to decrease food dependence with the subsidized replacement of standard appliances with eco-efficient alternatives and by creating green spaces and productive gardens. The study collected consumption data to feed a Life Cycle Assessment model that encompassed all operational aspects of living in that environment in Merida, Mexico – e.g. products' packaging, and material logistics.

After testing six different scenarios, results indicated that replacing appliances with more eco-efficient alternatives and that making use of a green space or garden for food cultivation could save an average of 1 ton of CO₂eq emissions every year per house, i.e. 67% less emissions than a standard Mexican home (Céron-Palma et al., 2013).

Mobility

The transport sector consumes 2.200 million tons of oil equivalent, accounting for about 19% of global energy demand and for 24,3% of the greenhouse gas emissions (WEC, 2018). Consumption is expected to increase by between 80% and 130% above today's level until 2030 and, unlike other sectors – which decreased their emissions by circa 15% between 1990 and 2007 –, transportation increased it by 36% during the same period (WEC, 2018).

Servitization in transportation contributes the most to sustainable cities in terms of Sustainable Urban Mobility (SUM), a transport model that stimulates interaction among all involved stakeholders in order to develop a comprehensive mobility service offer that

responds to citizens' needs for flexibility and convenience, *door-to-door*, removing the need for vehicle ownership by combining different shares of, for example, public transportation, car-sharing, taxis and shared taxis, bicycle and bike-sharing, car-pooling, or park & ride (Cerfontaine, 2014; Petros-Sebhatu & Enquist, 2016).

Diez et al. (2018) focused on the city of Burgos, Spain, in which fifteen different measures were put in place in 2005 by a CiViTaS project initiative. Measures included (a) switching public transportation to biodiesel, (b) increasing the amount of pedestrian-preferential areas, (c) underground parking areas, (d) higher capacity public transportation vehicles, (e) schedule alignment between different transportation methods, (f) bicycle lanes, rentals, parking and bike-sharing, and (g) restrictions on heavy load traffic.

The city saw multiple positive results in the span of five years, most related to citizen behavior transition towards bicycles and public transportation instead of private vehicles (Diez et al., 2018). When considering a twenty years period, up to 47.000 tons of CO₂eq emissions were expected to be avoided at the expense of € 7.2 million in investments, well within estimations of European authorities for funding similar projects (Diez et al., 2018).

4. RESULTS AND DISCUSSIONS

This section compiles the results achieved by each article towards answering the questions devised as specific objectives (section 1.2). Along with the results, the discussions that permeate them were of utmost importance in achieving the conclusions of the present thesis.

4.1. Integrated Model

Once the baseline run of the integrated model was set, the author analyzed the insights it could provide to the European Steel Industry while making a parallel to the results observed in the studies that supported its testing.

As the biophysical depletion of recoverable high-grade iron ore reserves takes place, as seen in Figure 4.1.32, BFBOF production would be forced to migrate to inferior grades of iron ores by 2051, and its availability would become critical in 2054, i.e. 53 years after the initial data point of 2001. These results very much reproduced those of Sverdrup & Ragnarsdottir (2014), in which such a condition would take place by the year 2050. Having analyzed and reproduced the means by which their results were achieved, the author identified that the 4-years difference occurred due to two main factors: Sverdrup & Ragnarsdottir (2014) used (a) longer data series and (b) considered the aggregate demand for all steel types instead of specific alloys.

Figure 4.1.32 - High-grade iron ore depletion.

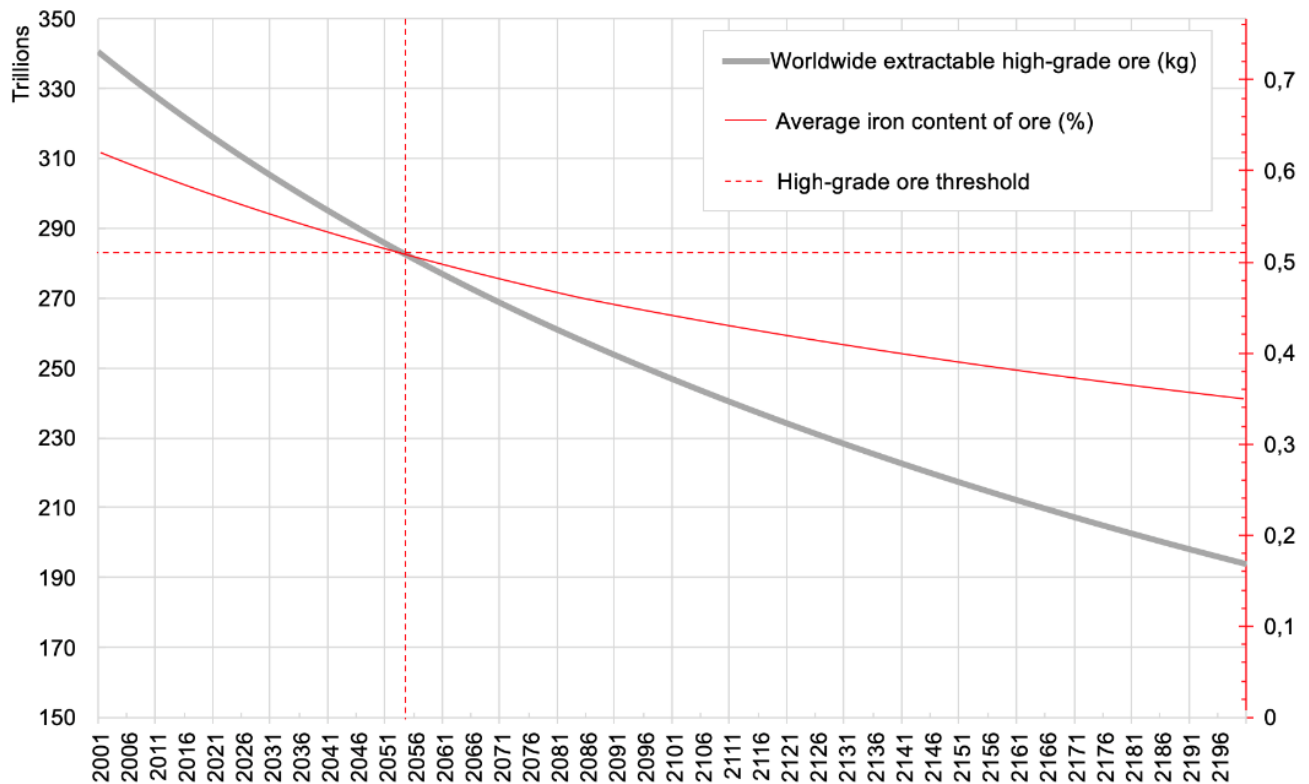

When analyzed alongside Figure 4.1.33, the decrease in iron ore consumption associated with its loss in iron content had a direct effect on the input of steel into the economy, despite a strong trend of increasing steel scrap generation until around 2060. This happened due to a delayed transition from BFBOF towards EAF, limiting the amount of steel delivered to the economy even with BFBOF eventually operating at maximum capacity during phase-out, corroborating the conclusions of Asif et al. (2015).

As high-grade iron ore becomes scarcer, higher priority should be given to retaining the resources and materials originated from it within a same supply chain, in order to accrue as much environmental and economic benefits from them as possible. The same logic applies to all of the TCEs and CRMs involved in the production of different steel alloys, notably nickel, niobium, titanium, vanadium and molybdenum. To do so in the EU28 while keeping in mind CE would require stakeholders within a supply chain to work on improving and integrating

their operations, also an argument brought up by Asif et al. (2015) and Nuss & Blengini (2018).

Figure 4.1.33 - Results for ore, scrap, steel input and circularity (tons).

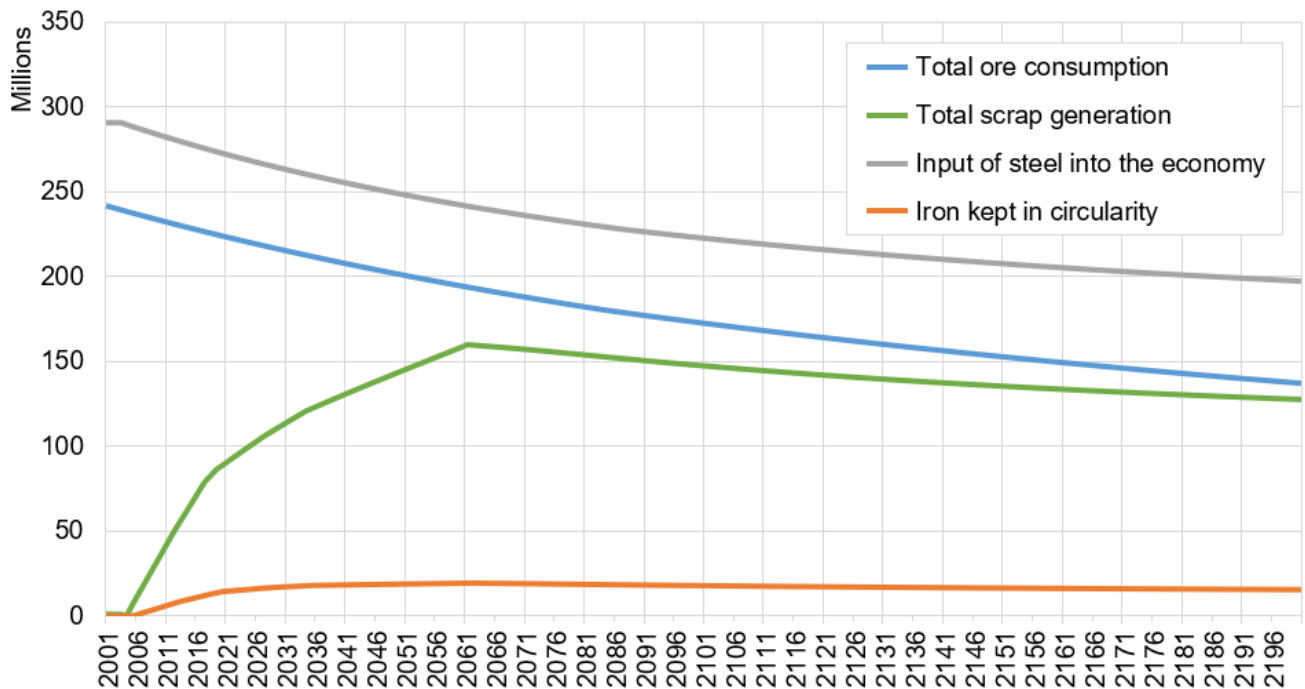
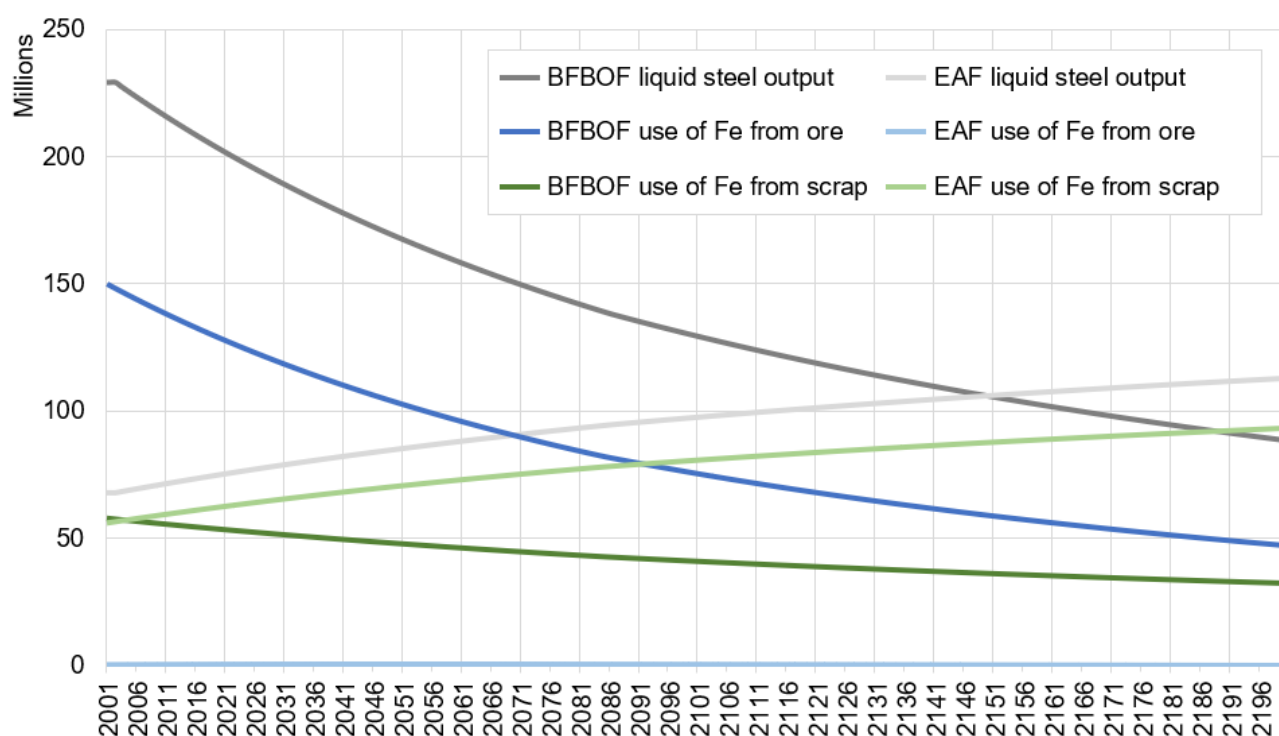

Figure 4.1.33 also points to iron circularity being hardly affected, phenomenon replicated to other elements until biophysical exhaustion, and consequent of a balancing effect in which (a) even though more steel scrap is generated, more of it is consumed, and (b) no additional stimulus is being given to increasing circularity other than by responding to the demand for scrap and the elements within it. If a transition from BFBOF to EAF production occurs as is, steel’s presence in the EU28 economy would be forced to go through a decline not only due to availability restrictions on other alloying elements, but due to iron itself – argument also previously brought forward by Ansari & Seifi (2012) and Sverdrup & Ragnarsdottir (2014).

Figure 4.1.34 reinforces this notion, in which by maintaining the *status quo*, EAF will not be able to cover for the liquid steel output reduction of BFBOF steelmaking, even if by

using more scrap and less ore, the depletion of ore itself is slowed down. One of the main drawbacks of such a situation is the undesired and indirect stimuli potentially given to the market for developing materials alternative to steel, which could add competition detrimental to steelmakers' margins (Asif et al., 2015). Therefore, if a faster transition towards EAF steelmaking is desired, policy-based initiatives towards the development and strengthening of a secondary raw materials market is necessary, as highlighted before not only by the European Commission (EC, 2013b), but also by EUROFER (2015).

Figure 4.1.34 - Steel output and the sources of iron (tons).



Next, regarding LCA, the results were also favorable, but one of its features could not be reproduced. As an example, the average CO₂eq emissions of 837,41kg/FU from EAF steelmaking and 2.255,39kg/FU from BFBOF steelmaking were aligned with those of Burchart-Korol (2013), however, determining the impacts of these emissions on specific environmental compartments as per ReCiPe indicators, for example, was not feasible. The same outcome occurred for slag generation: while the average results of 459,84kg/FU from

the BFBOF and 121,17kg/FU from the EAF aligned with those from Renzulli et al. (2016), determining specific impact indicators was, notwithstanding, unachievable at this point. In the cases of both slag and emissions, nevertheless, the integrated model allowed for easier analysis of individual chemical elements, as exemplified in Table 4.1.11.

Table 4.1.11 - Summary of observed slag and emission compositions.

	EMISSIONS		SLAG		COMMENTS
	BFBOF	EAF	BFBOF	EAF	
CO	39,1%	62,7%	-	-	From partial oxidation in the furnaces.
CO₂	20,8%	3,1%	-	-	From the combustion of fossil fuels.
N	3,4%	30,8%	-	-	Mostly in the form of oxides (NO _x).
H	32,6%	3,3%	-	-	Either as CH ₄ or as H ₂ .
H₂O	4,0%	-	-	-	Byproduct.
Ca	-	-	28,5%	30,6%	As part of CaO and CaS.
O	-	-	36,3%	32,8%	Present in all oxides.
Si	-	-	11,4%	7,3%	As part of SiO ₂ .
Mg	-	-	4,5%	3,8%	As part of MgO.
Al	-	-	3,9%	2,3%	As part of Al ₂ O ₃ .
Cr	*	*	11,8%	1,1%	Free ion or as part of Cr ₂ O ₃ .
Mn	*	*	1,5%	3,3%	As part of MnO.
Fe	*	*	0,4%	17,6%	As part of FeO and Fe ₂ O ₃ .
P	-	-	0,4%	0,8%	As part of P ₂ O ₅ .
S	-	-	1,0%	0,2%	Free ion or as part of CaS.
Zn	*	*	0,3%	0,2%	Free ion or as part of ZnO.
Ti	-	-	*	*	Free ion or as part of TiO ₂ .

* Trace amounts, less than 0,1% altogether.

The results and analyses derived from the integrated model answered favorably the first question, indicating that the integration did not interfere with the results of either LCA or SD. The use of indicators, however, – one of LCA’s features – was rendered impractical. While LCA incorporates indicators from the very beginning of its approach, SD requires them to be modelled individually, point on which more extensive research and development would be necessary.

Circularity was perceived by the author as considerably improved, with the addition of a more detailed understanding of the dynamics of steel in the economy outside of the

steelmakers' gates. Long-term perspective, on the other hand, saw SD give LCA a substantial boost in terms of how many years of steelmaking operation could be simulated or projected using only endogenous data feedback. Whether calculating annually for a period of 200 years – as performed in this study – or even down to hourly calculations for a certain period of interest, SD's delay and feedback mechanics allowed LCA to have a better grasp on how the gate-to-cradle dynamics loop back into its mostly cradle-to-gate approach.

The contribution to the improvement of LCA's macro analysis potential derived mostly from the possibility to track many different elements while concurrently simulating changes in more than one variable at a time throughout the entire supply chain, as exemplified in Figure 4.1.35. Moreover, not only did stocks and flows help influence the system's overall behavior, but so did both feedbacks and delays, features characteristic of SD that broadened LCA's range of analysis.

Figure 4.1.35 - Presence of iron in the economy, per sector.

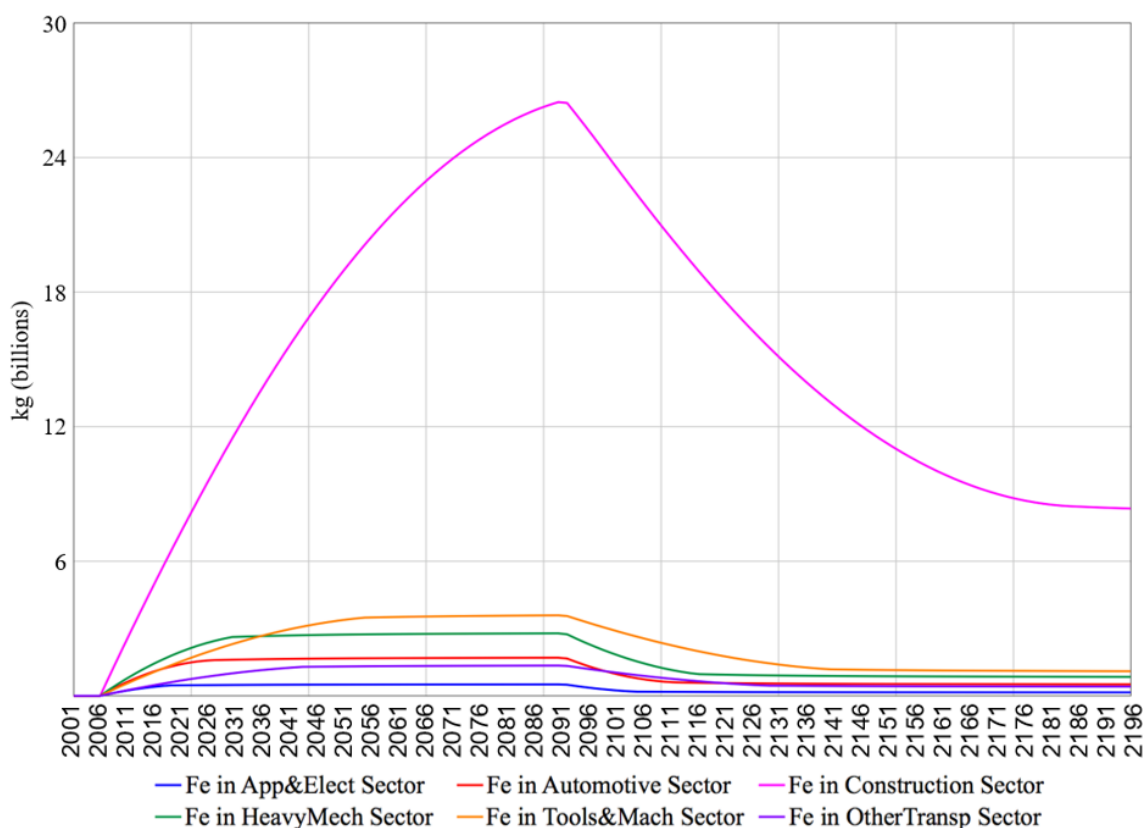

With respect to stakeholder involvement identification, bringing LCA into SD did in fact allow for more precisely and objectively visualizing and accounting the stocks and flows of materials through and within the involved stakeholders, notably after steel leaves the industry and cycles through the economy and through end-of-life and circularity services. The collection and input of case-specific data following the LCA guidelines of ILCD and ISO improved the reliability and especially the granularity of the SD analyses, which were better supported by objective and empirical results such as those exemplified in Table 4.1.11.

For these reasons, the practical usefulness of the results across managerial levels was also perceived as improved, which could allow for different decision-makers to use the same model for variables that range from chemical composition all the way to ore scarcity and demand planning. In all cases, nevertheless, further improvements to its managerial applicability could be achieved by linking such a model to real-time operational data inputs.

The author understands that verifying the feasibility and the potential benefits of integrating SD and LCA very much depends on how the integration itself is performed and, considering the methodological steps and the modelling approach used in this study, the integration was deemed not only feasible, but also capable of better supporting stakeholders that would previously only consider SD or LCA, adding to their individual strengths.

With this in mind, it is important to note that LCA seemed to contribute more for the improvement of SD than the other way around. It is to say that, overall, the distinctive diagnostic and process efficiency features of LCA emerged much more tangibly as a result of the integration process than SD's problem-solving orientation.

For professionals or academics used to LCA applications, the current obstacles for working with indicators might configure enough of a barrier to avoid either a transition or an integration into SD. Future improvements on this integration could potentially solve such issues and favor its adoption. Nevertheless, the aforementioned strategic gains should suffice

to attract attention to the discussion and to entice interested agents to further investigate gate-to-cradle dynamics and their feedbacks into production.

For SD scholars, however, the benefits of integrating LCA expertise into SD modelling were substantial. Enhancing the reliability, the granularity and the stakeholder visibility in the results can compensate for many of the weaknesses identified in the SWOT analysis of standard SD applications, notably helping to mitigate the threat of over-simplistic analyses. SD practitioners and policy-makers could take advantage of this approach to better uphold their analyses, adding to the levels of objectivity and representativeness of their studies, especially when process efficiency is a key decision factor.

Additionally, particularly from cradle-to-gate, the integrated model was very reminiscent of what IE calls Industrial Metabolism. Certain similarities to other IE tools such as Material Flow Analysis (MFA) and its dynamic form (dMFA) became evident as well, especially regarding the visibility of flows and stocks. Also, due to the characteristics of the European steel industry, the model posed as another good example of how CE envisions end-of-life processes as suppliers to the earlier stages of the supply chain. Further studies would need to be done, however, in order to add more renewable energy sources into the operation, as well as to better manage how some chemical elements rejoin the biosphere.

Finally, the author believes that if data in more disaggregated levels were available, even better results would have been achieved. This could lead to significantly better analyses of individual processes such as sintering, pelletizing, mining, forming, metalworking and recycling, especially regarding emissions and the use of energy directly in the form of heat and electricity.

4.2. End-of-Life Policies

Having verified in the baseline run from that *business-as-usual* practices would be unfit for addressing the long-term end-of-life dynamics of the European steel industry, Article no. 2 took into consideration how the unevenness of end-of-life steel distribution – as seen in Figure 4.2.36 – to base its study on end-of-life policies.

Due to downcycling, there is a tendency that sectors which require larger quantities or which do not require precision alloys would take bigger slices of the available end-of-life steel, potentially affecting other sectors' ability to benefit from a shift towards EAF steelmaking. And although reparability and reusability can extend the life cycle of steel products, their effects at BAU rates are not enough to compensate downcycling.

Figure 4.2.36 - Destination of end-of-life steel, per sector (BAU, kg).

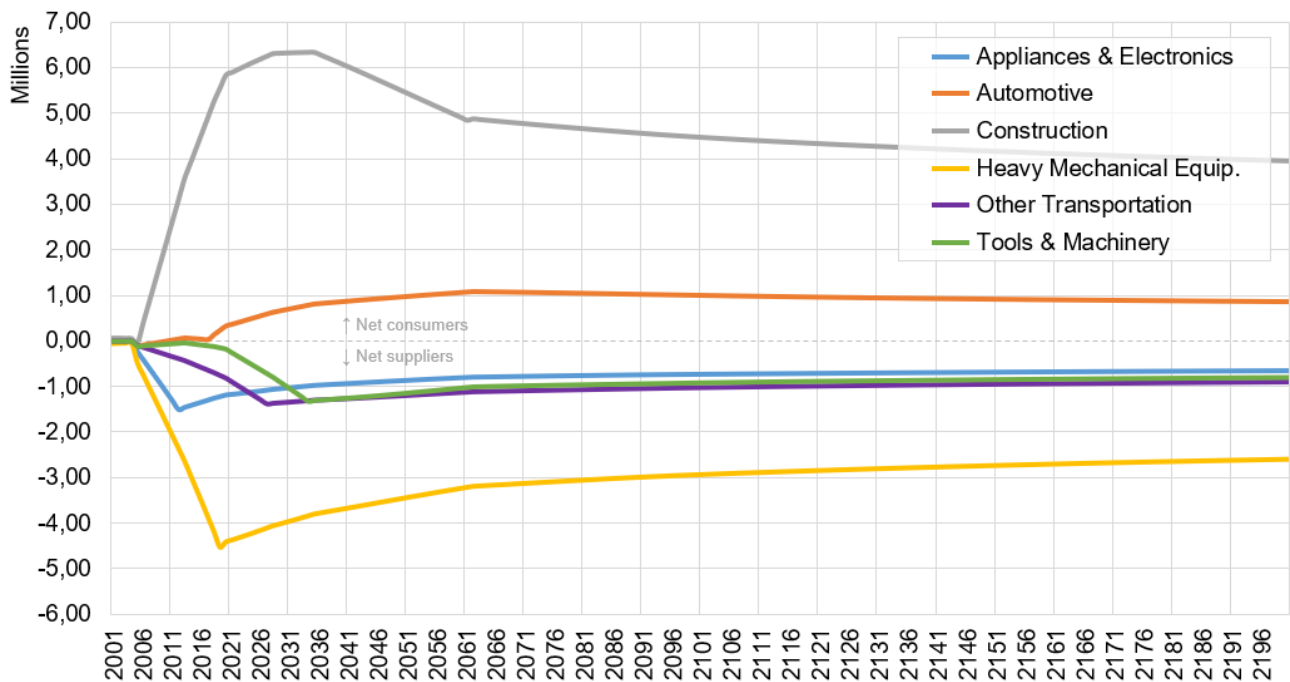

When analyzing runs 1 through 6 – in which the BAU recycling rates were set to their full theoretical potential –, however, the results presented interesting grounds for discussion.

As seen in Figure 4.2.37, scrap generation tended to grow more in sectors with shorter steel service lives and large steel stocks in the economy.

Contrasting sectors such as Construction – with large steel stocks in the economy but very long service life – and Appliances & Electronics – with significantly smaller steel stocks but very short service life – had similar results due to this balancing behavior. Heavy Mechanical Equipment – with large steel stocks and a medium service life – was the sector with most growth in scrap generation, but also the one with the largest drop due to its participation as a net supplier of end-of-life steel, as previously seen in Figure 4.2.36, of which a substantial amount leaves the EU28 boundaries.

Figure 4.2.37 - Effect on scrap generation, per sector (runs 1 through 6).

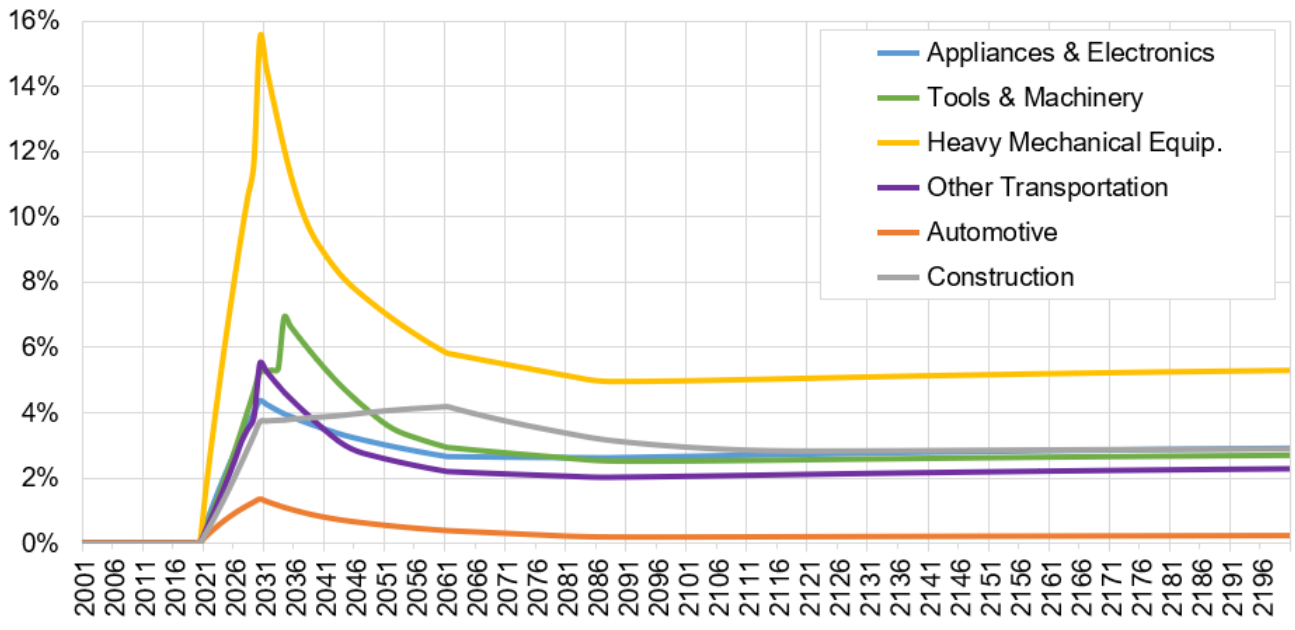

The Automotive sector, however, saw the least increase in contribution to scrap generation due mostly to two reasons: (1) already operating at very high recycling rates and (2) being a net consumer of end-of-life steel. It is important to note, nevertheless, that alongside Construction and Heavy Mechanical Equipment, that sector’s representativeness

in terms of demand more than justifies a continuous effort towards improving recycling due to the large amounts of steel that circulate within it.

In Figure 4.2.38a it is possible to see that the shorter a sector's service life is, the more noticeable is the effect on steel input into the economy by increasing recycling alone. Appliances & Electronics and Other Transportation were the sectors most capable of contributing to a transition towards EAF steelmaking – thus increasing overall steel circularity – despite their smaller share in steel demand. Still, it is important to keep in mind that these sectors have specific recycling and alloying needs that may make end-of-life services costlier.

Figure 4.2.38a was also the first to visually depict the fact that increasing recycling rates could push the depletion of technically available high-grade ore further into the future (up to 2083 in this study), easing BFBOF phase-out and further reducing overall ore depletion due to a tendency of steelmakers preferring higher iron contents. This could potentially trigger the interest of not only EAF steelmakers but also BFBOF steelmakers in advancing recycling due to indirect effects.

Figure 4.2.38 - (a) effect on steel input into the economy, per sector (runs 1 through 6); and (b) potential reduction of ore consumption, per sector (runs 1 through 6, in kg/h).

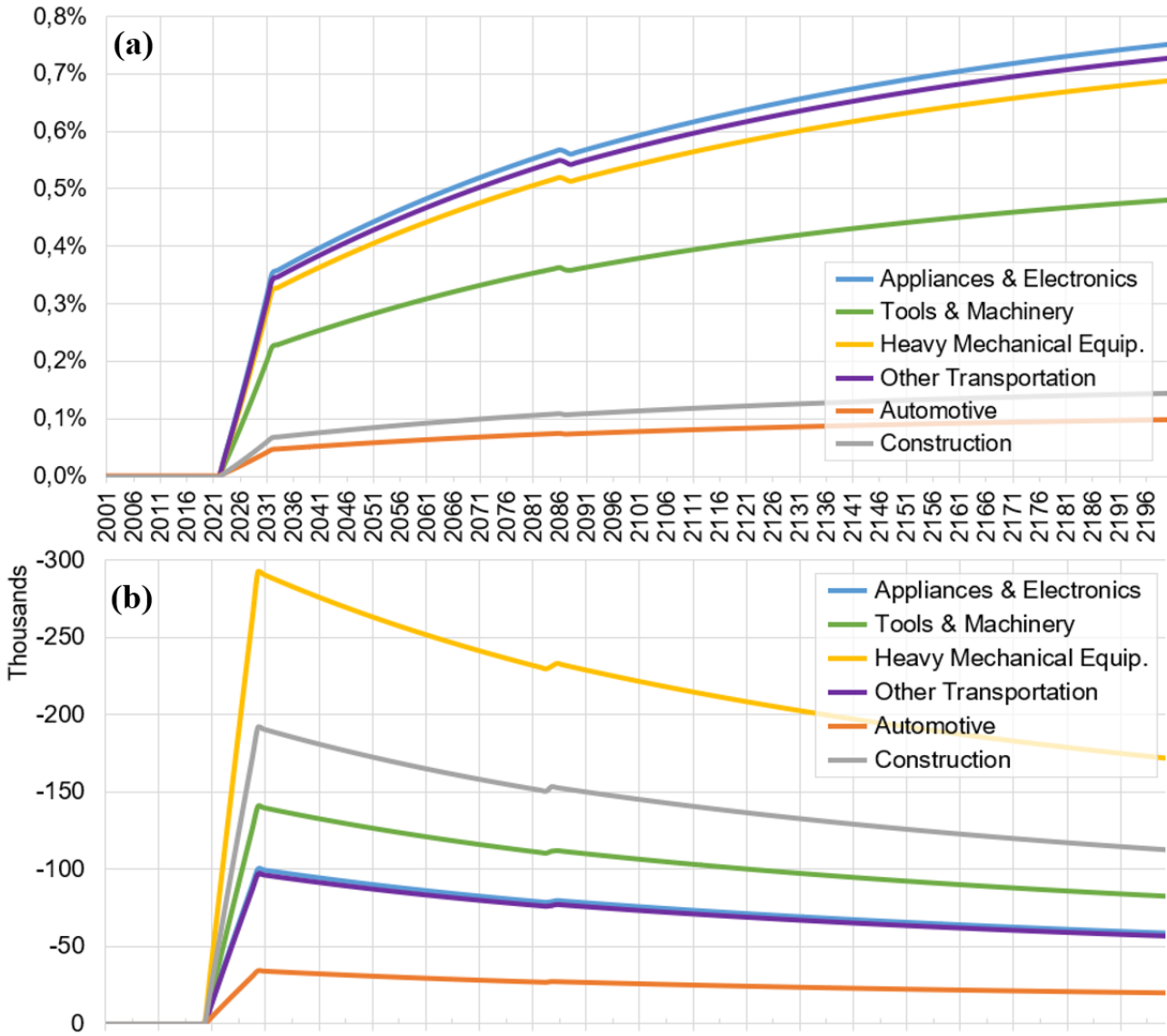

When it comes to ore consumption, a better understanding of the effects of increased recycling can be seen in Figure 4.2.38b. Although sectors with less room to improve when compared to their respective BAU recycling rates have shown less relative potential for overall ore consumption reduction, it is important to keep in mind that their substantial share in demand makes for a very significant amount of BFBOF ore-dependent steel. It is also important to note that the shorter the service life in a sector, the more recycling cycles can take place, thus the higher its potential for reducing ore consumption in the long-term.

When focus was given to doubling the rates of repair & reuse – runs 7 through 12 –, however, the effects on steel input into the economy (Figure 4.2.39a) were not only lower but also delayed when compared to runs 1 through 6. The shorter a sector's service life, the shorter the delay and the higher the effect on steel input, even when the steel consumption within the sector is comparatively low (e.g. Appliances & Electronics). The opposite behavior was also noticed: regardless of large steel consumption, sectors in which service lives are long demonstrated longer delays and lower effects on steel input into the economy (e.g. Construction and Automotive).

While runs 1 through 6 could potentially reduce ore consumption by providing more scrap as an alternative that boosts the transition towards EAF steelmaking – to the point of overcoming a prolonged BFBOF capacity's lifespan –, runs 7 through 12 would impact ore consumption by retaining steel longer in the economy, i.e. increasing circularity and reducing demand for new steel (Figure 4.2.39b). Intensifying repair & reuse would not only push the depletion of technically available high-grade ore further into the future (circa 2087 in this study), but also delay recycling, thus being less helpful towards a transition to EAF steelmaking.

Figure 4.2.39 - (a) effect on steel input into the economy, per sector (runs 7 through 12); and (b) potential reduction of ore consumption, per sector (runs 7 through 12, in kg/h).

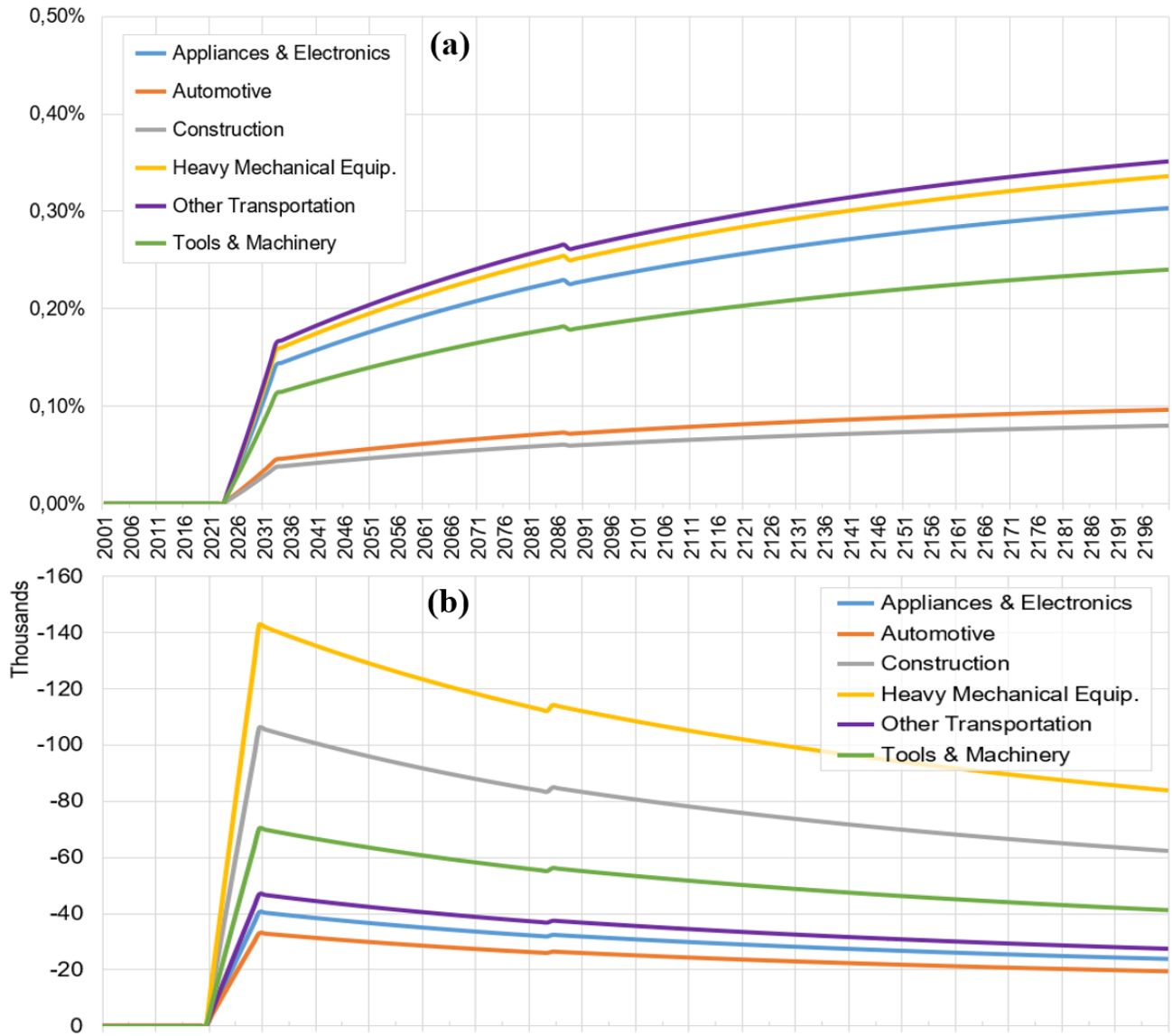

Furthermore, Figure 4.2.39b also depicts how more noticeable the effects of increasing rates of repair & reuse were on ore consumption from sectors with high demand for steel and high available steel stocks in the economy (e.g. Heavy Mechanical Equipment and Construction).

When analyzing the circularity of iron, the direct feedback into a sector increased mostly in proportion to its demand for steel – as seen in Figure 4.2.40a. Still, just as with recycling, one sector would tend to concede more iron to others over time the more prone to

recycling it already is (e.g. Automotive), the higher its alloying requirements (e.g. Appliances & Electronics) or due to an eventual downcycling induced by repair & reuse prolonging its service lives (e.g. Other Transportation) – and thus have less direct feedback improvements.

Figure 4.2.40 - (a) effect on Fe circularity within each sector (runs 7 through 12); and (b) effect of each sector on overall Fe circularity (runs 7 through 12).

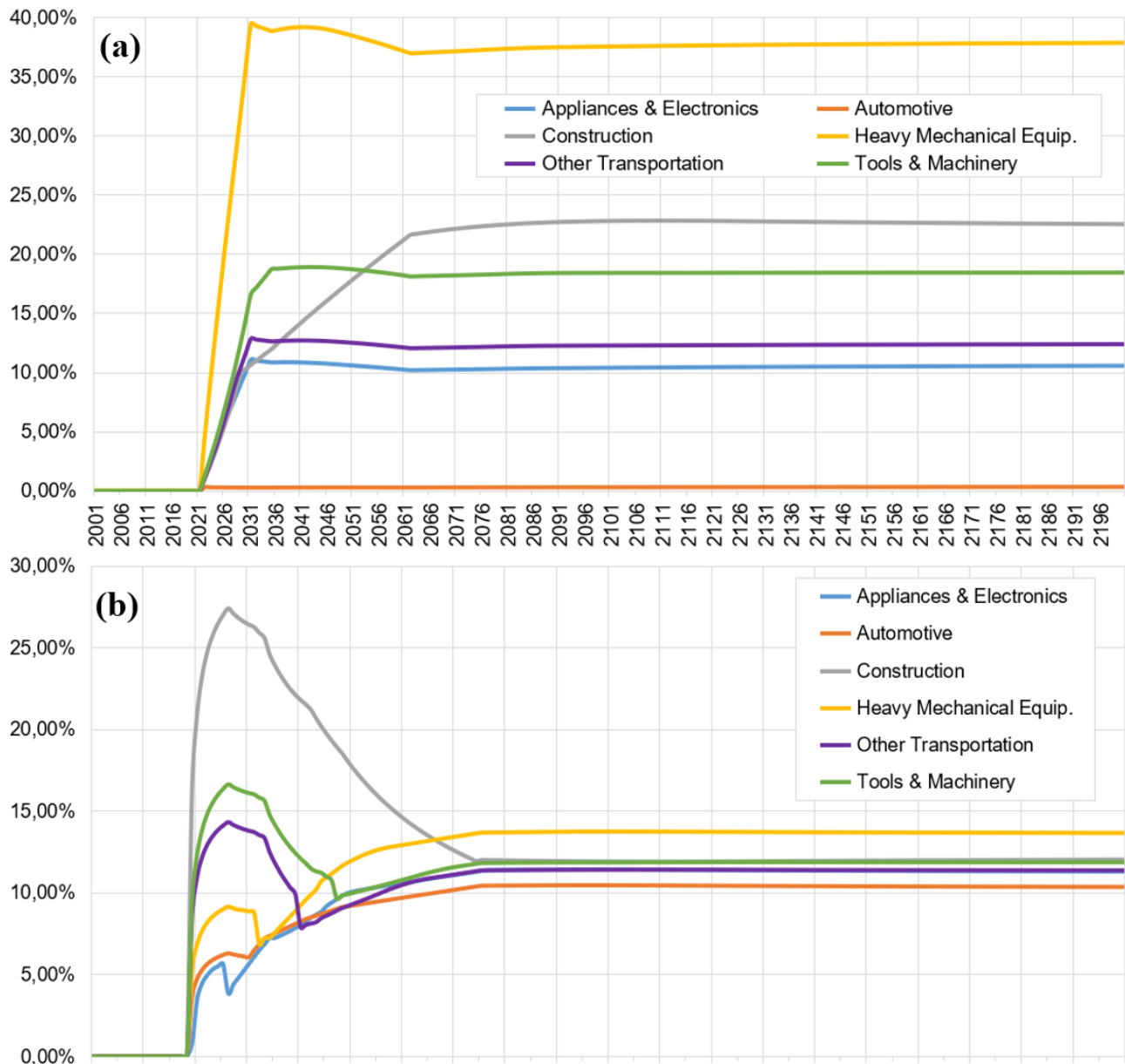

It is important to note that although repair & reuse affects the length of steel service life and steel demand, repairability and reusability are not infinite and eventually balance with

recycling and downcycling. An initial peak increase followed by decline and stability is visible in both Figures 4.2.40a and 4.2.40b for most sectors. Meaning that the effects of fostering repair & reuse, however substantial, are eventually absorbed by the industry and might even decay in the long-term.

This phenomenon is more evident when analyzing each sector's contribution to the overall circularity of iron in the economy (Figure 4.2.40b), in which measures as aggressive as doubling repair & reuse would generate results that range only between 10 and 15% in the long-term, even when improvements within a sector could go up to 40% (Figure 4.2.40a).

4.3. Supply Chain Integration

From performing simulation runs 13 and 14 it was perceived that both vertically integrating and vertically hedging slag recycling into the steelmaking operation would result in reduced consumption of iron ore, as seen in Figure 4.3.41. In both cases, the endogenous feedback behavior of the model has also shown that the stimulus to recycle slag increases as a function of its yield, being also inversely proportional to the decay of iron content in the ore over time.

The results were naturally more substantial when regarding BFBOF operations, but better results were achieved by vertically hedging the slag recycling process. Doing so would enable multiple sources of BFBOF slag to be used as input (e.g. multiple furnace operations in a same supply chain); unlike in vertical integration, in which slag recycling would be dedicated to each operation.

Figure 4.3.41 - Impact on ore consumption.

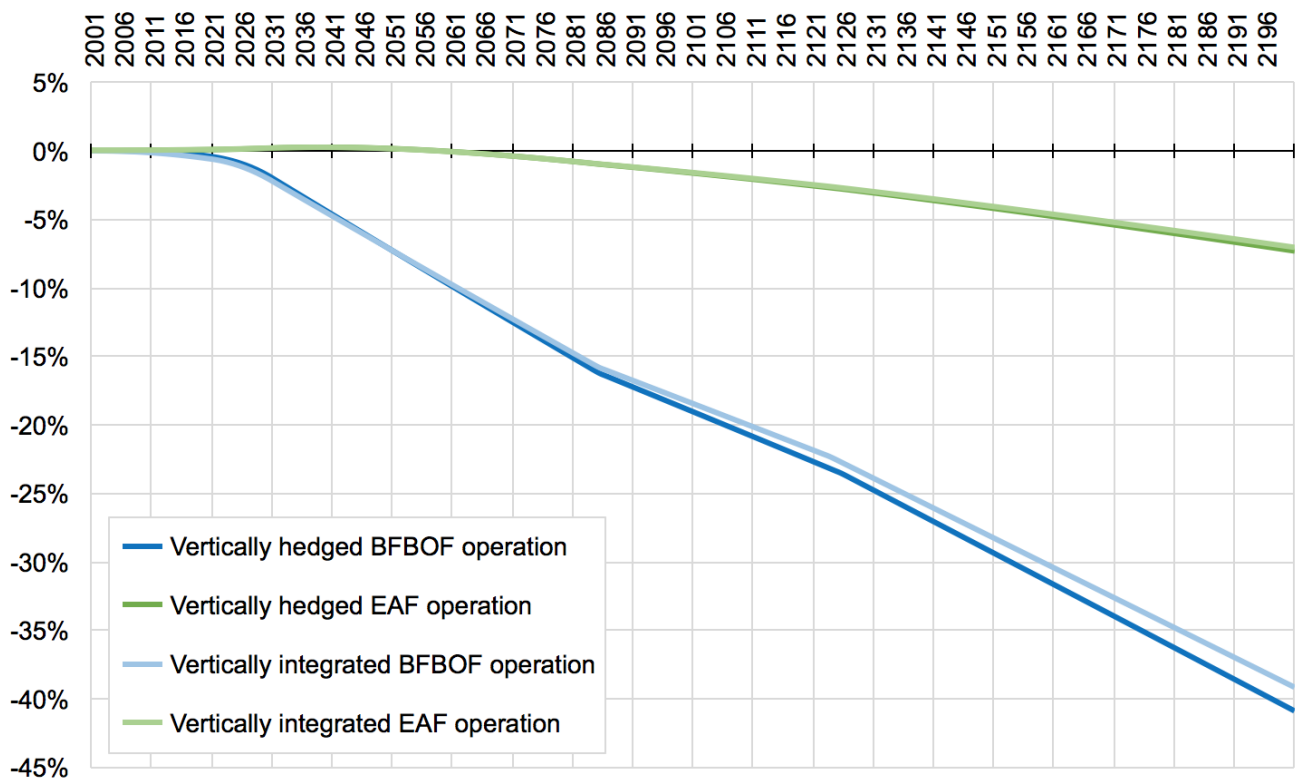

More iron was recovered by the vertically integrated slag recycling solution than by the vertically hedged one – as seen in Figure 4.3.42 –, pointing to better potential for increasing raw material self-sufficiency. Nevertheless, the flexibility to supply different furnace operations and to be supplied by multiple sources of slag favors the adoption of a vertical hedging approach if the strategic priority is to have resource ownership retention increased throughout the supply chain.

Figure 4.3.42 - Recoverable iron in slag (kg).

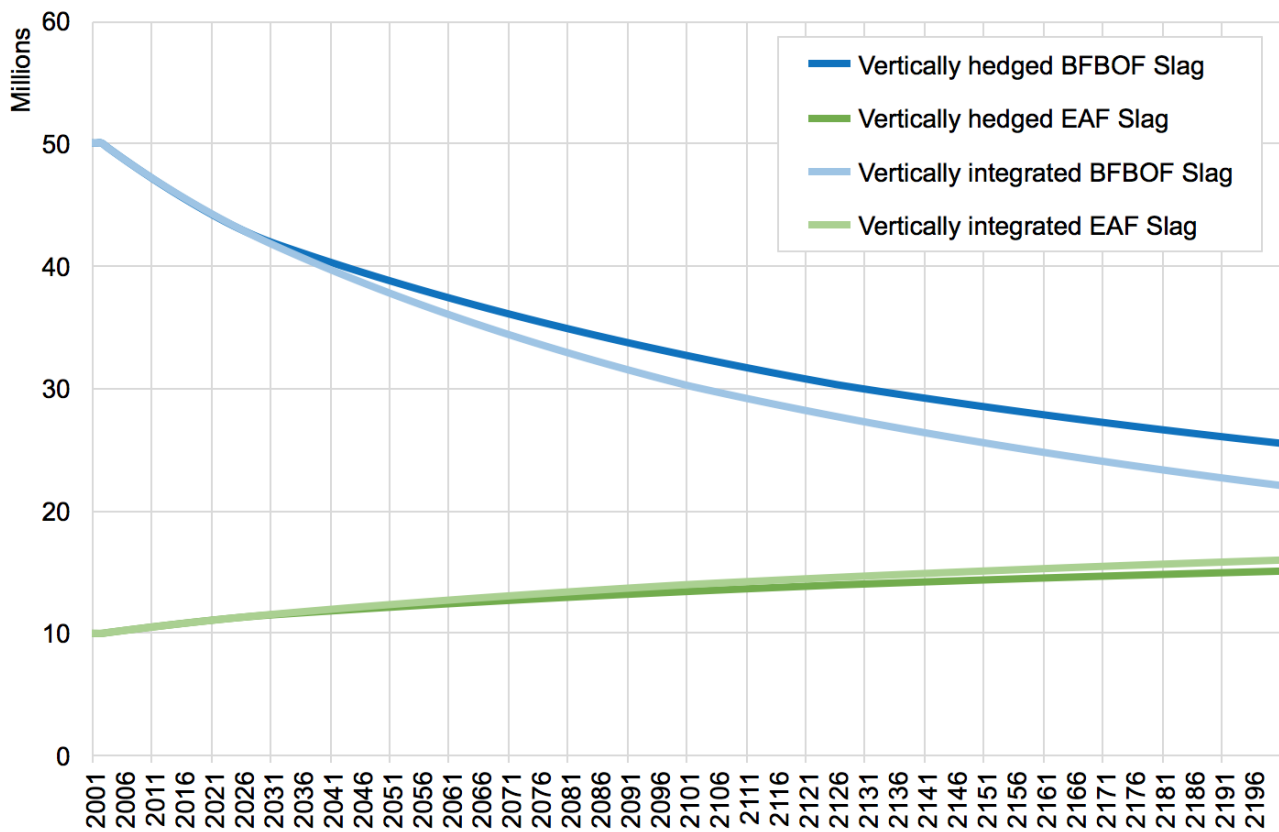

From the perspective of iron ore availability, runs 13 and 14 were also promising, as seen in Figure 4.3.43. In both cases, the threshold of high-grade ore technical scarcity was pushed forward in time, from year 2054 (BAU) to 2062 (vertical integration) and 2072 (vertical hedging), giving BFBOF operations prolonged viability for either raw material self-sufficiency or resource ownership retention strategies. Furthermore, the better the slag recycling yield becomes over time, the more it contributes as an iron input, thus lowering the pressure on ore and improving these results further.

Figure 4.3.43 - Worldwide technically extractable ore reserves (kg).

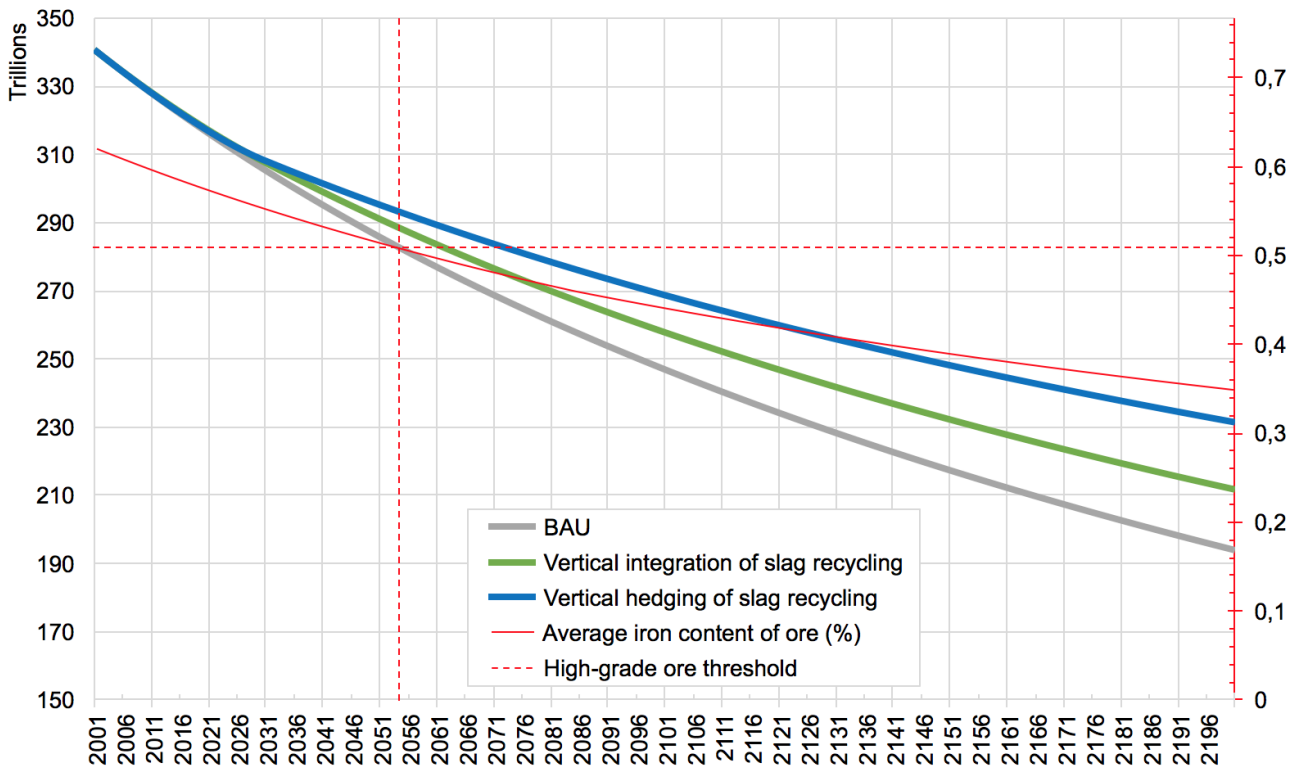

EAF operations were affected only marginally by runs 13 and 14, mostly because (a) its operation relies minimally if at all on iron ore; (b) even high yield recycled slags have lower iron content than most steel scraps; and (c) the increasing availability of steel scrap reinforces the behavior of moving away from ore.

It is important to mention that slag recycling requires the management of impurities (e.g. sulfur, silicon and phosphorus) as well as of other alloying elements (e.g. chromium, zinc, copper and nickel), all of which could be interesting materials to be recovered along with iron or to be redirected as byproducts to completely different sectors. Closing the material loops of these elements could also create new business opportunities for steelmakers, such as a new unit dedicated to supplying unnecessary or excessive elements to other industries.

Focusing on iron alone would provide the most benefits for sectors such as Construction, Heavy Mechanical Equipment, and Tools & Machinery, not only for their considerable demand – which vertically hedging BFBOF slag recycling in bulk could better

support –, but also due to their lower alloying requirements; posing as a potential policy for Europe or for a nation as a whole. Furthermore, vertical hedging in this context can also serve as a sound strategy for financial hedging against ore futures in a European steel market facing increasing pressure from China.

Sectors like Automotive, Appliances & Electronics, and Other Transportation (especially aviation and aerospace), on the other hand, could benefit from vertically integrated EAF slag recycling focused on recovering not only iron, but also specific elements necessary as raw materials for precision alloying (e.g. niobium, molybdenum and cobalt). Due to the lower demands for specialty alloys, this approach would be more suitable for individual supply chains than for a European or national policy.

In what regards to simulation run 15, the results depicted in Figure 4.3.44 highlight the potential impact of horizontally hedging EoL steel as an alternative to new steel, notably on the consumption of ore and scrap, but also in the reduced steel output. The more a same material circulates in the economy before actually being discarded, the less new materials are required, therefore the more important it becomes to retain resource ownership in order to accrue more value from it as it circulates, and not only by inputting it into the economy at first.

Figure 4.3.44 - Impact on ore, scrap, and steel output.

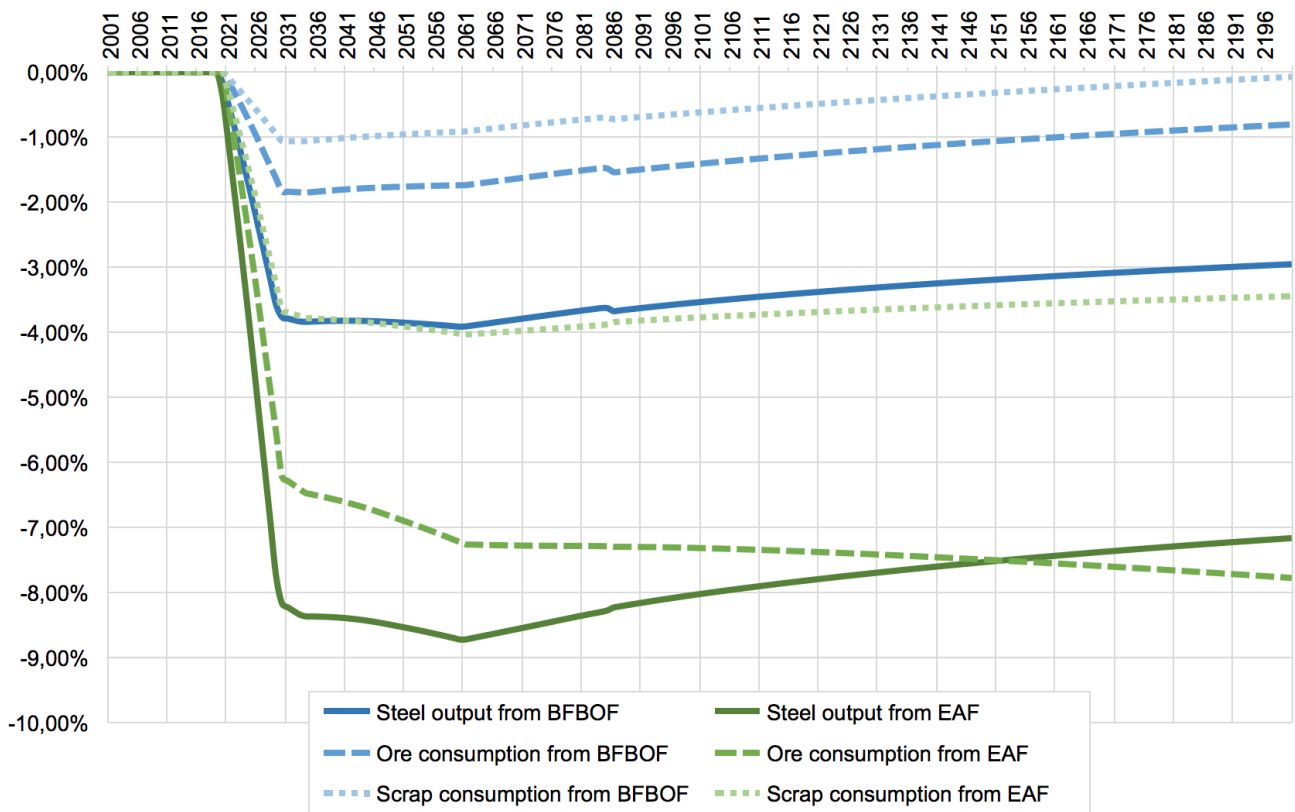

EAF operations were impacted over twice as much as BFBOF, mostly due to their direct dependence on the availability of recycled scrap which declined as a function of the prolonged circulation of iron in the economy. Still, this impact was far from being capable of reversing the trend towards the shift from BFBOF to EAF operations, even if by reducing ore consumption the lifespan of BFBOF operations was lengthened. Horizontal hedging in this context would also support financial measures regarding the futures of scrap, but less so regarding the futures of ore.

As seen in Figure 4.3.45, the amount of iron retained in the supply chain increases and, even if hedged horizontally, bringing in or creating new repair and refurbishment providers gives the steelmaker the strategic possibility to influence the flow of repairs vs refurbishments and to create new dynamics of exchange with its metalworking or assembler customers. Depending on how geographically close and operationally aligned this horizontal

hedging is implemented alongside the other stakeholders in the supply chain, benefits might even extend to reverse logistics.

Figure 4.3.45 - Iron retained within the supply chain (kg).

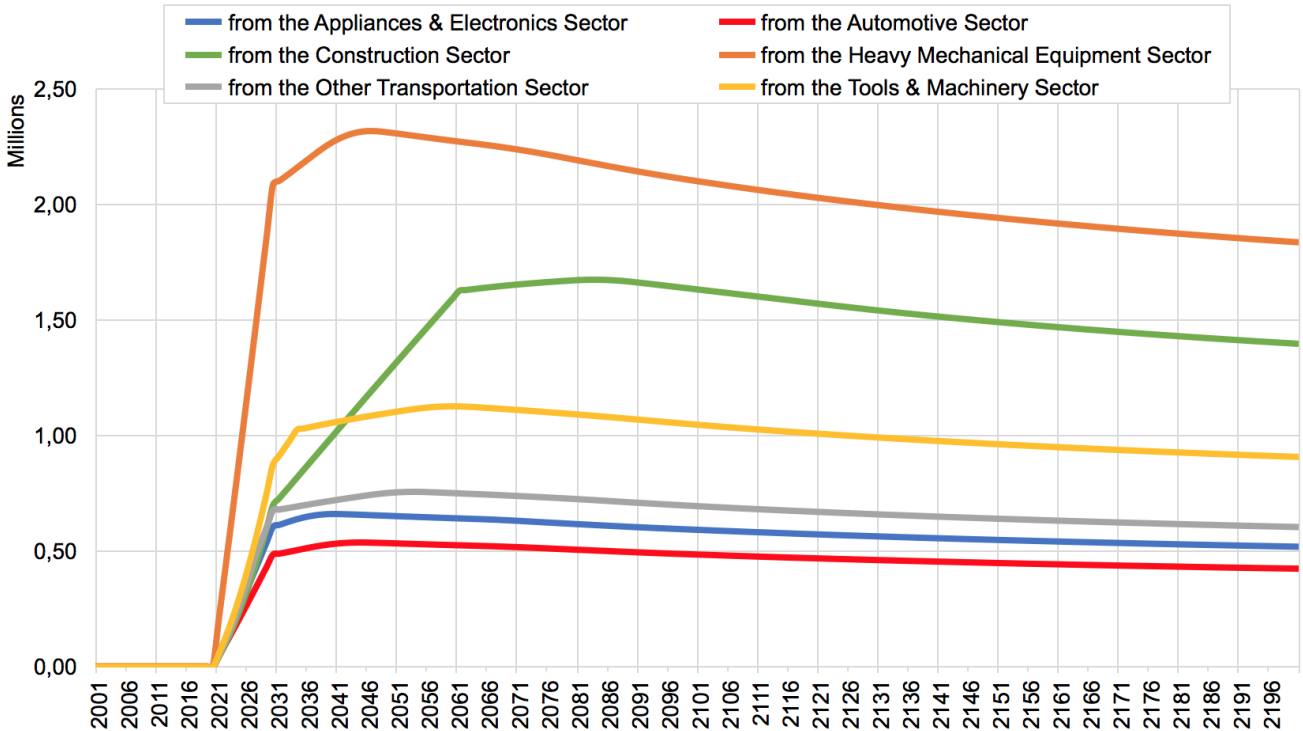

Particularly in this case, steelmakers with strong customer side relations in sectors that are more dependent on specific alloying demands (e.g. Automotive, Appliances & Electronics, and Other Transportation – notably aviation and aerospace) could potentially further benefit from a vertical hedging approach instead of a horizontal one, aiming at the retention of scarcer alloying elements such as cobalt, molybdenum and niobium in their supply chain, and at covering the risks of their futures by increasing raw material self-sufficiency.

Finally, simulation runs 16 and 17 presented horizontal integration as a double-edged sword strategy for EoL steel. Having enough horizontal influence or control to deter circularity (run 16, “4” in the Article’s figure) increased the demand for new steel and, therefore, the

consumption of ore and scrap, as seen in Figure 4.3.46. Naturally, the very opposite occurred in run 17 (“5” in the Article’s figure) when stimulating circularity.

The potential for this integration approach to backfire, however, is always present because although influence or control can be exerted on third-party EoL service providers that are integrated to the steelmaker’s supply chain, nothing can be done regarding those that are not. Therefore, the benefits of either deterring or stimulating circularity as means of feeding back the desired outcomes to the steelmaker can in fact create a *bullwhip* effect. Choosing to close material loops this way would require close attention to return times, backlogged demand and competitor behavior.

Figure 4.3.46 - Impact on supply side dynamics.

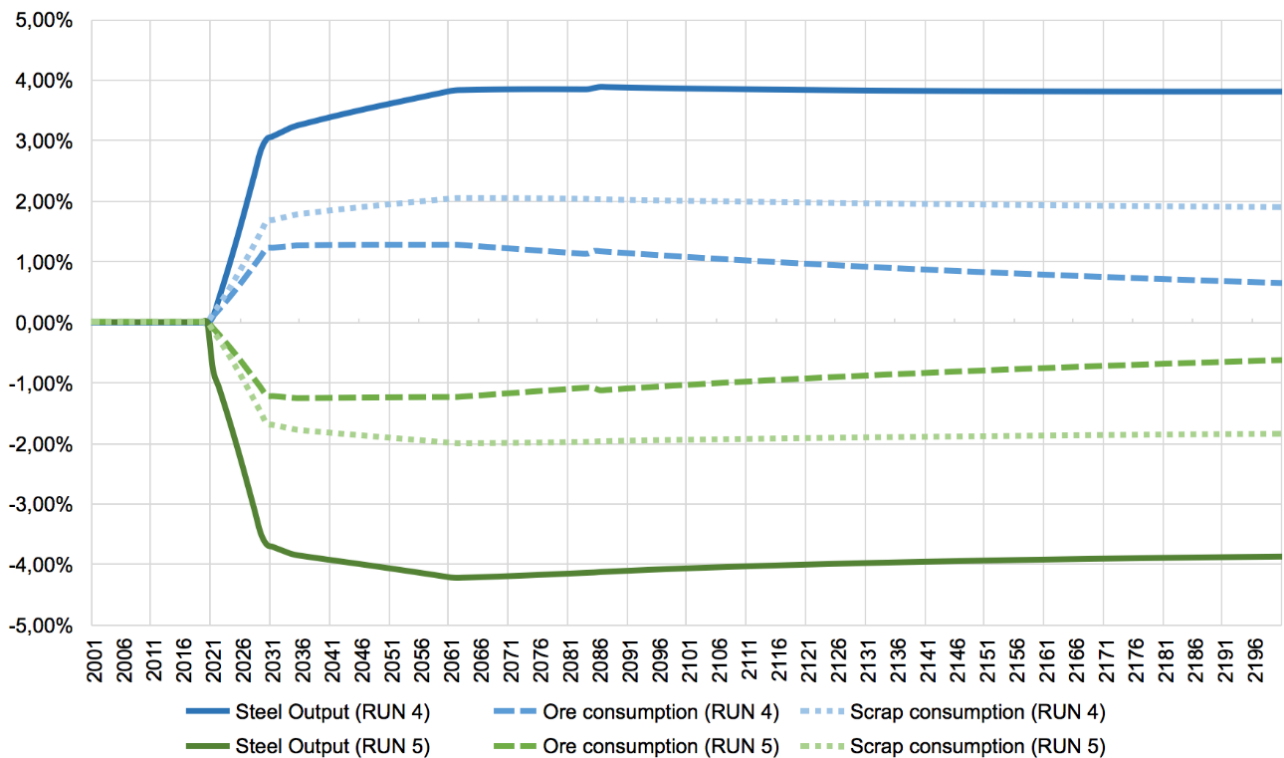

It is to say that, in run 16 (“4” in the Article’s figure), the undersupplied demand for EoL services would be picked up by the competitors of the integrated third-party providers; while in run 5 (“5” in the Article’s figure), the EoL services oversupplied by the integration would

have a delayed feedback and either flood the market with new steel or increase stocks throughout the chain. This becomes evident when analyzing Figures 4.3.46 and 4.3.47 simultaneously, as it is possible to see that the impacts on the supply side dynamics would be over twice as high and begin about a decade earlier than the impacts on the EoL side.

Figure 4.3.47 - Impact on End-of-Life dynamics.

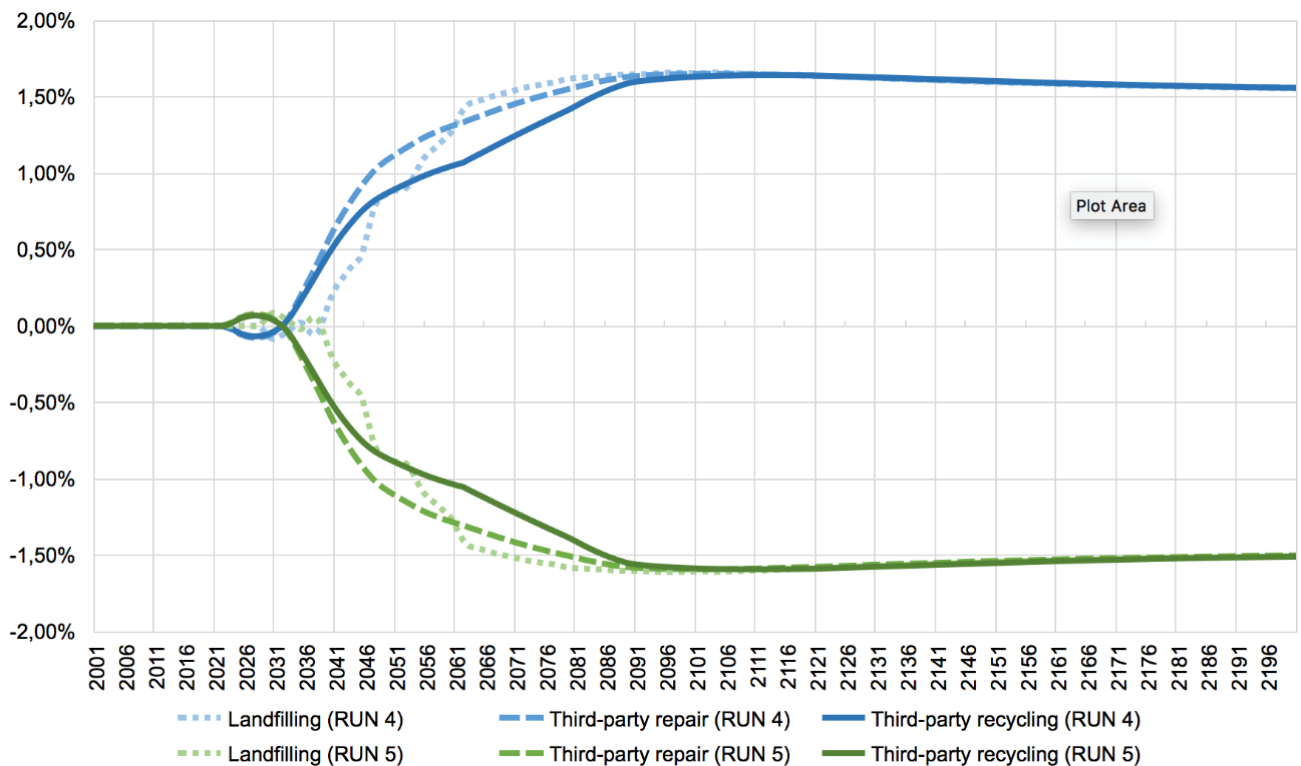

The Automotive sector is an example of how decoupling resource ownership from maintenance and repair services can allow for EoL horizontal integration, but it in fact configures a completely different business, subject to different market dynamics.

Consequently, it would be preferable for most sectors to either (a) include these EoL services as part of the product in the form of support and warranty, (b) develop a new business unit dedicated to its dynamics, (c) implement the proposition from run 15 alone, or (d) to align the propositions of runs 16 and 17 to those of run 15, so as to ensure that any

EoL steel not reinserted into the economy actually remains within the boundaries of the supply chain for refurbishment or recycling.

4.4. Economic Dynamics

The *business-as-usual* run was most useful in verifying if the model was able to reproduce existing trends and projections regarding both biophysical and economic aspects of the steel industry. Figure 4.4.48, for example, depicts the continuation of the overcapacity trend and, despite a marginal increase in steel demand originating from developing nations, production and apparent steel use would follow suit.

This behavior is in large part consequence of (a) the steel industry as a whole slowly transitioning towards EAF steelmaking and secondary metals market sourcing – thus requiring less new steel to be produced –; (b) decreasing BFBOF yields and margins due to lower iron content in ores – partially mitigating potential absolute technical or economic scarcity –, and (c) increasing costs of EAF steelmaking – a balancing paradox between steel scrap availability’s slow response and industrial electricity price increasing due to competition with renewables in residential applications.

Figure 4.4.48 - Long-term trends in production, consumption, and capacity utilization (right axis).

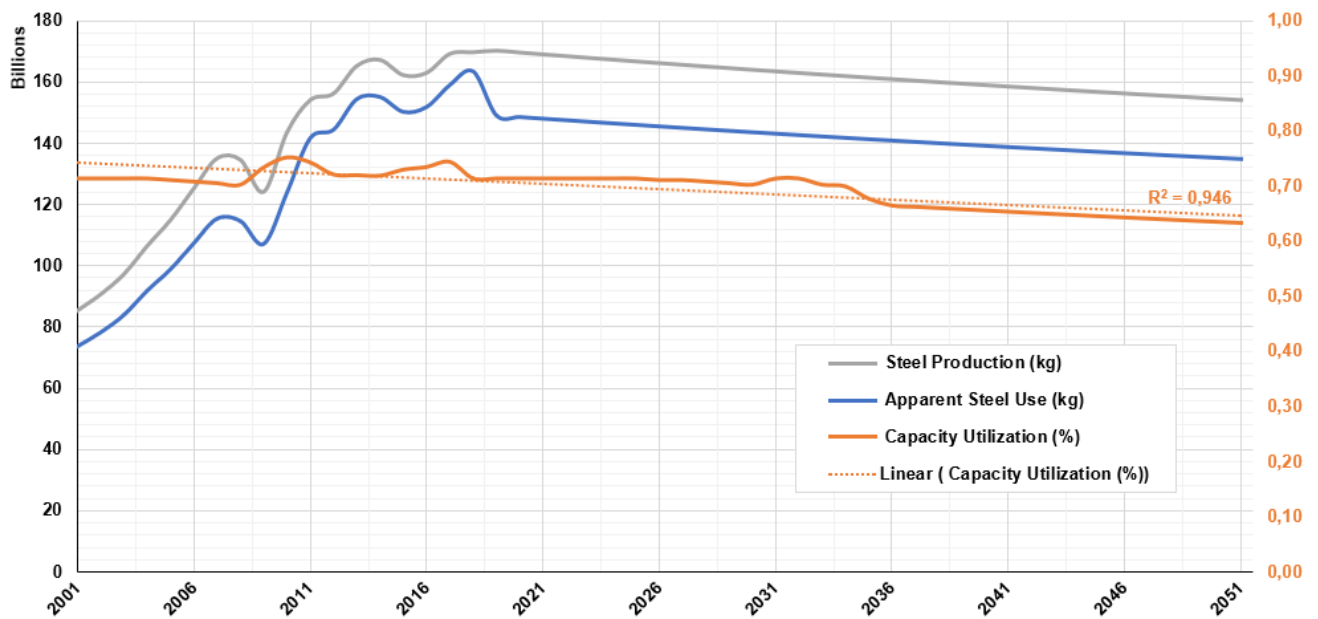
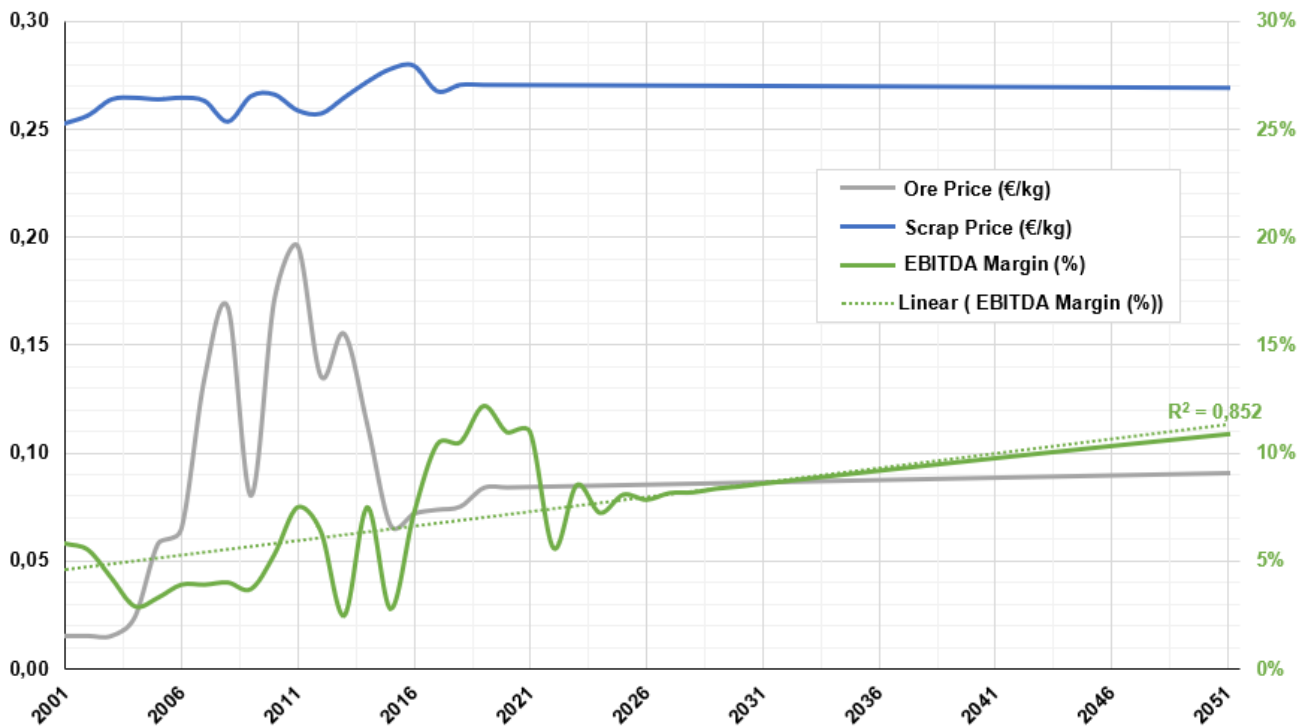

Figure 4.4.49 further illustrates these dynamics, in which steel scrap prices trend slightly downwards in the long-term due to a balancing effect between increasing demand and increasing availability. The opposite occurs with iron ore prices, trending slightly upwards due to relative scarcity and relative yield demand but being counterbalanced by lower overall demand resulting from EAF phase-in. More noteworthy in Figure 4.4.49, however, is evidence that this *quasi* stable raw material conjuncture could favor EBITDA margins in the long-term.

Figure 4.4.49 - Long-term trends in ore prices, scrap prices, and EBITDA margin (right axis).



Although the model was unable to depict the volatility of real-world microeconomics in the commodities market, this long-term trend helps to explain why overcapacity has become prevalent: why increase the variable costs of capital and installed capacity – potentially driving up prices and losing competitiveness – when profitability can be achieved by focusing on reducing costs? Since the latter requires less capital and poses therefore less risk, it is understandable that many steelmakers would prefer to avoid finding themselves in the same delicate position as their Chinese competitors today, even if at the expense of market share.

Figure 4.4.50 provides additional evidence of that, especially when analyzed alongside Figure 4.4.48, given how much less capital is reinvested in efficiency, technology and integration strategies, in comparison to the potential variable costs of increasing capacity utilization. Furthermore, the previously introduced behavior of cyclically managing capital reinvestment and distribution in order to follow improved margins with gains in share value

became visible as well, driving the long-term dividend payout trend upwards, noticeably after projected series of revenue increase (2016-2021).

Figure 4.4.50 - Long-term trends in costs, revenues, reinvestments, and dividends (right axis).

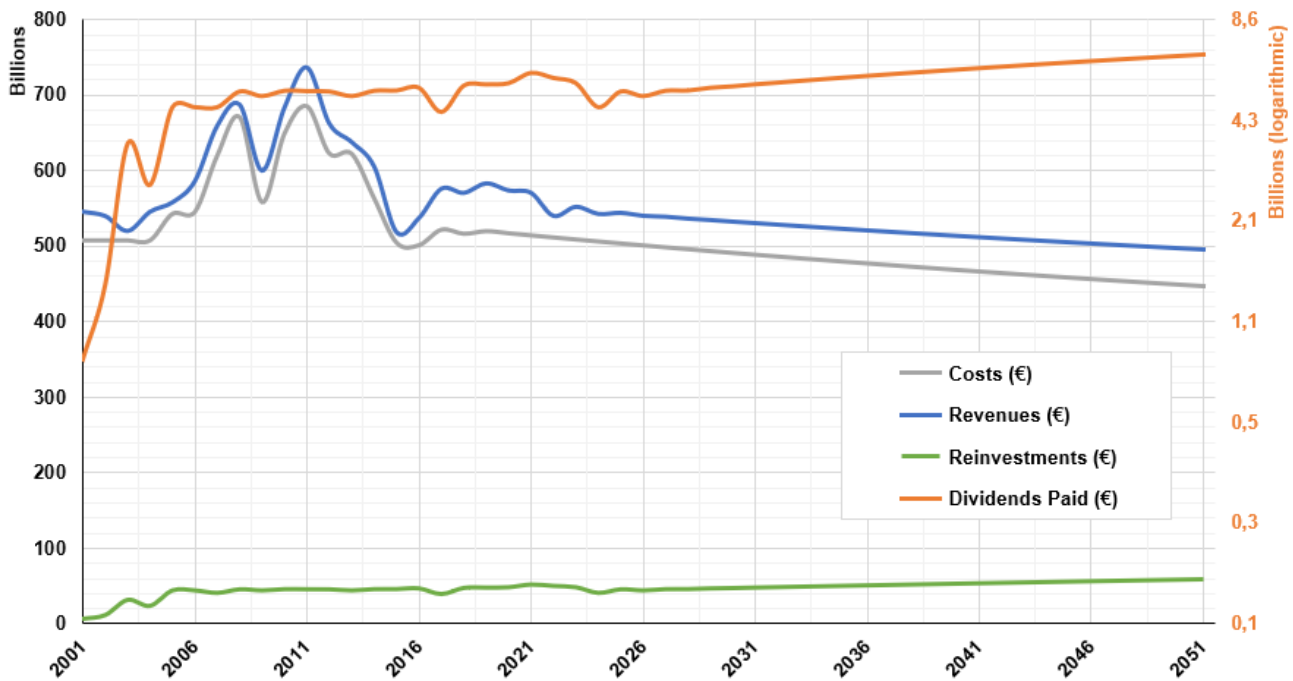

When it came to the spot and future prices of steel, the model was also able to reproduce existing trends, broadly speaking. Nevertheless, the granularity of the analysis was negatively affected. Even though the required datasets were available, the author's attempts to run calculations daily were either met with the limits of the available computational power or created data incoherency with the biophysical calculations. The solution adopted by the author was to run calculations fortnightly and to disregard the futures market data between 2001 and 2008, since it was identified as the source of incoherency.

As seen in Figure 4.4.51, the model was able to depict the stabilization in the volume of steel traded in futures contracts that has been ongoing since the 2008 crisis and projected to continue. Furthermore, a slight long-term spot price increase trend for hot-rolled coiled steel was identified, followed by the equivalent reaction in the futures market. These trends

follow the behavior of the dynamics discussed thus far, notably in terms of reduced costs and increased margins compensating for overcapacity.

Figure 4.4.51 - Long-term trends in spot prices, future prices, and volume of traded futures (right axis).

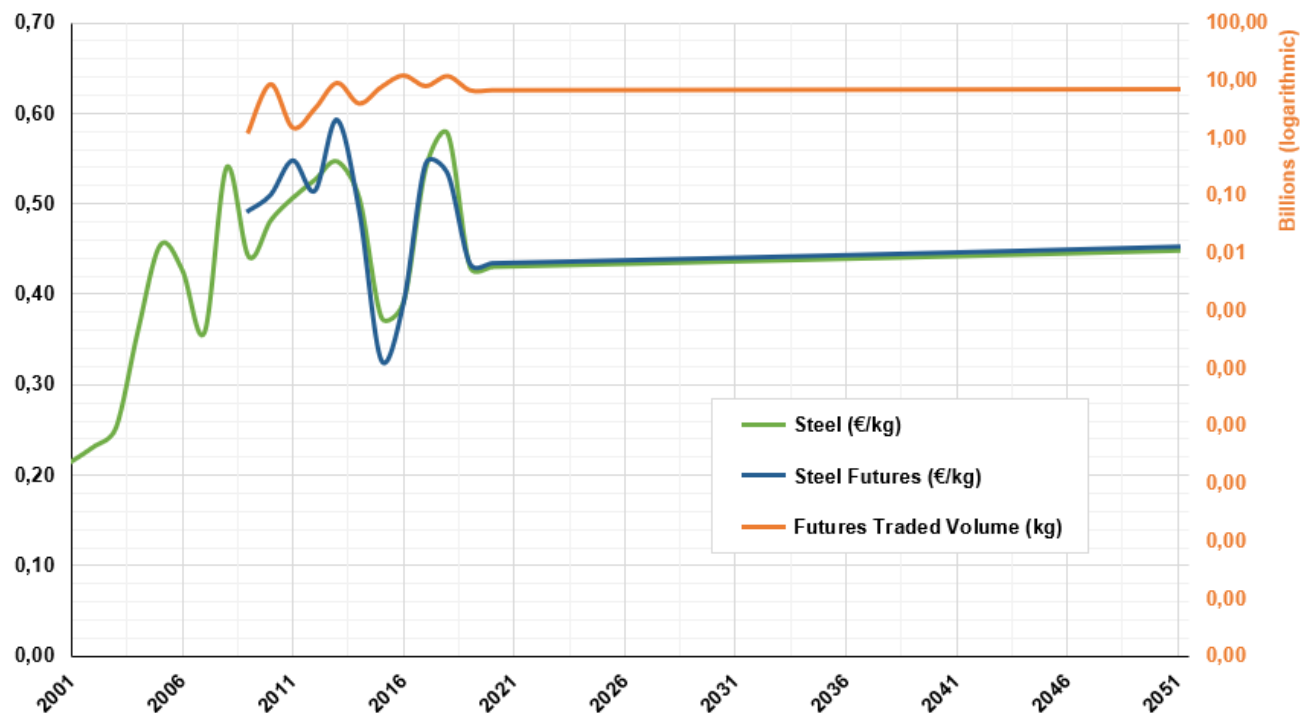

Simulation run 18, in which capacity utilization was increased by 10%, provided further justification to the reason why many steelmakers currently operate with idle capacity. Since most of them would be unable to count solely on scale to compensate an annual average price drop of 1% associated with 14,9% total costs increase, EBITDA margins and the subsequent dividend payouts would be significantly affected, as seen in Figure 4.4.52.

Figure 4.4.52 - Increasing steel output's impacts on spot and future prices, dividends, and EBITDA margins.

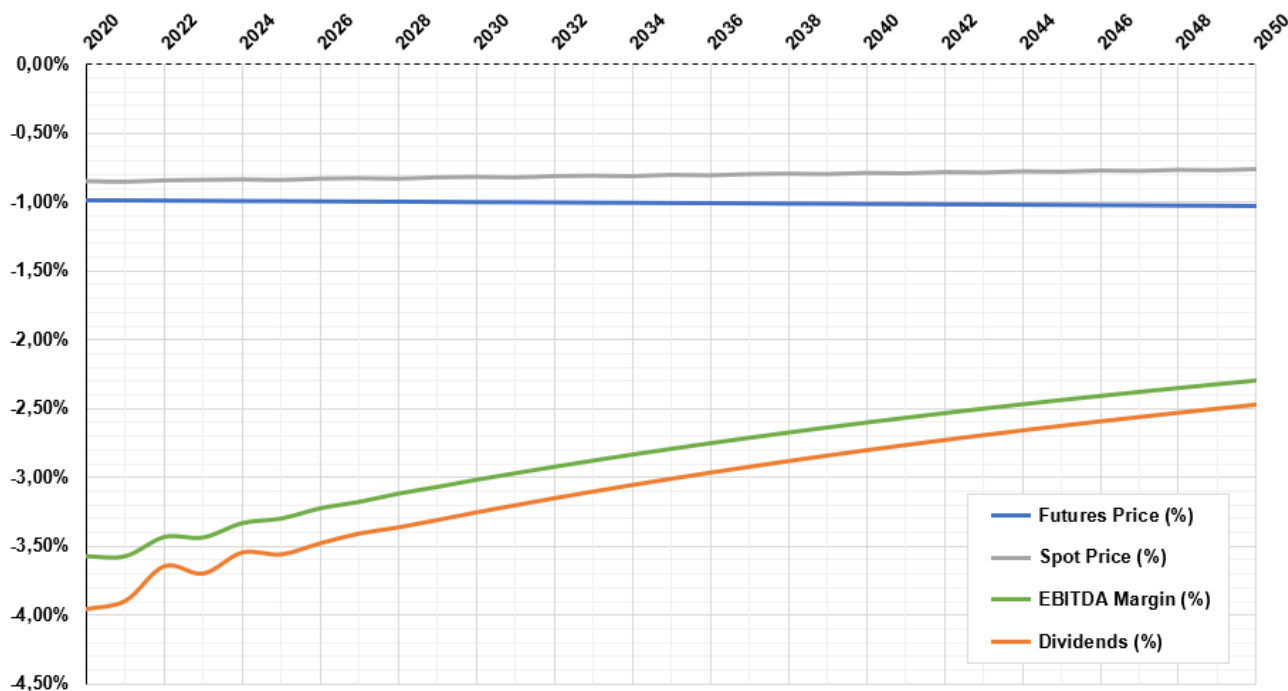

More production output without the proportional demand to consume it would increase the stock of finished products as well as the costs and risks associated with it, which, alongside a contraction in the volume of steel in futures contracts, would cause the *basis* to rise and to gradually widen the gap between spot and future prices. Nevertheless, as seen in Figure 7.4.060, the profits from the futures market would not be enough to compensate for the losses caused by higher costs and lower spot prices.

Although the economic dynamics under study experienced significant changes when increasing steel output, they were shown to be proportionally even more sensitive to the volatility of logistic costs. Simulation run 19 brought to light that, despite logistics being responsible for less than 5% of the total costs of steelmaking on average, increasing or decreasing logistics costs by up to 10% on each direction could substantially affect economic dynamics in this sector.

These costs are directly proportional to most of the biophysical flows spread throughout the entire steelmaking supply chain and even minute variations can, therefore,

have a compounding effect. Figure 4.4.53 portrays both how positive and negative the ensuing average variation of $\pm 0,37\%$ on total costs can be; notably by directly affecting prices and margins.

Since compensating by reducing the amount of materials flowing through the supply chain would ultimately result in lower steel output and less revenues; and that compensating by increasing output to gain in scale would put even more pressure on margins due to higher variable costs, volatile logistic costs force steelmakers to choose between protecting either their margins or their market share.

Figure 4.4.53 - Logistic costs volatility's range of impacts on prices, dividends, and EBITDA margins.

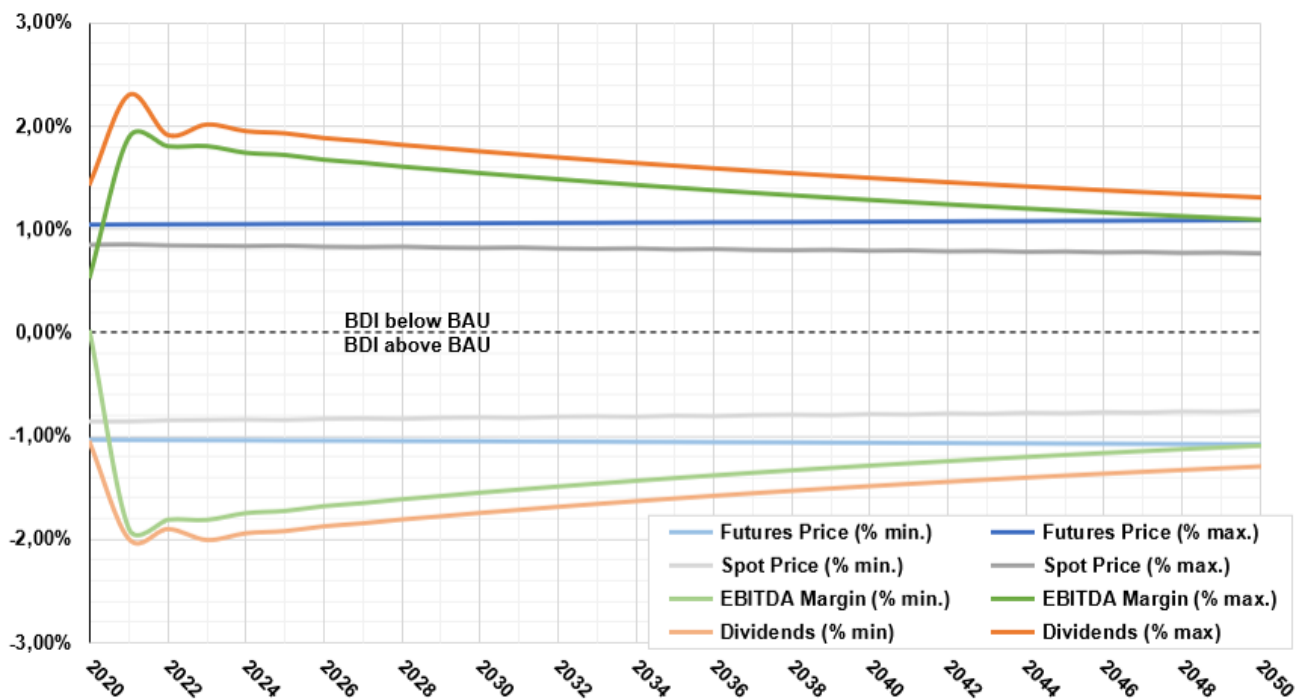

When logistic costs go up, adjusting the margins accordingly will also increase spot prices and potentially reduce sales and revenues. Furthermore, not only do logistic costs directly affect future prices, but the risk to market share posed by higher prices indirectly contributes to a higher *basis* as well. As such, balancing how much to follow suit with the

margins vs how much to *hedge* with futures becomes crucial in managing logistic cost spikes in order to protect market share.

The inverse occurs if steelmakers choose to adjust their margins when logistic costs go down: spot prices go down and potentially allow for gains in market share – assuming that the steelmaker has stocks available for sale. This, however, puts pressure on margins and can be compensated with futures only up to a certain point, still compromising EBITDA margins down the line.

Focusing on the sourcing aspects of supply-side dynamics, simulation runs 20 and 21 approached two resources directly related to productive variable costs: energy – namely electricity and fossil fuels for EAF and BFBOF steelmaking, respectively –, and alloying elements – particularly nickel and chromium, present in most stainless-steel products.

Unlike the case of logistic costs, in which *basis* is directly affected, energy and raw material prices alter economic dynamics mostly as a consequence of and to the extent of biophysical dynamics. Spot prices, for example, are more likely to respond to changes in material demand and offer than to other economic variables such as those comprised in the *basis*. This difference occurs due to logistics being a mostly external influence on biophysical variables, while energy and raw materials are ones that can be more easily influenced from within the steelmakers' realm of agency.

While altering production output would add pressure to finding a balance between market share and margins in the case of logistic costs, choosing to increase or decrease capacity utilization can relieve such pressure when it comes to energy and raw materials. This does not mean, however, that negative effects could be completely mitigated in any circumstance, but it does allow for more control from the part of the steelmakers. In Figure 4.4.54 it is possible to see how the positive effects on the overall EBITDA margins and on

the potential dividend payouts derived from the propositions of the simulation run 20 could diminish over time.

Although total costs of BFBOF steelmaking would tend to go down as consequence of cheaper fossil fuels, the economic benefits from it would eventually be counterbalanced by (a) continuously decreasing iron ore yields – requiring more energy per kg of ore in proportion to iron content extracted –, (b) slightly increasing costs of iron ores – as previously seen in Figure 4.4.49 –, and (c) proportionally less revenues from BFBOF steelmaking due to the transition towards EAF. Furthermore, both the (a) increased participation of EAF steelmaking over time, and (b) the previously discussed tendency of steel scrap becoming cheaper, would not be enough to fully compensate the increase in electricity prices in the long-term, reducing revenue potential.

Figure 4.4.54 - Impacts of projected energy prices on steel prices, costs, dividends, and EBITDA margins.

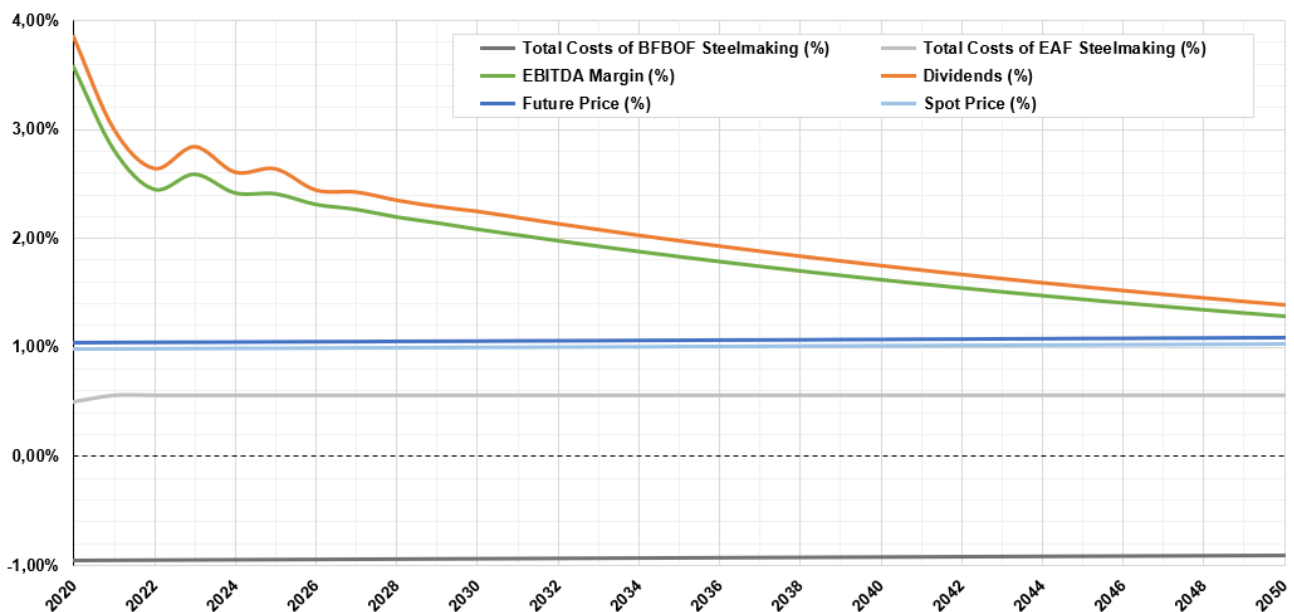

Additionally, it is important to note that these results considered that the most possible use of futures for *hedging* would take place to compensate losses – as per the dynamics discussed thus far –, and that the system dynamically compensated itself towards maximizing

revenues by protecting margins at the expense of, on average, -2,72% capacity utilization per year – instead of attempting to gain on scale, situation which provided worse results for the industry when actively triggered by the author in the model.

While BFBOF total cost reduction would help lessen the effects that higher electricity prices would have on EAF steelmaking for the steel industry as a whole, the same cannot be said about the long-term trends derived from the run 21. In it, prices for both nickel and chromium were expected to increase due to higher demands. Unlike energy sources, however, these raw materials affect EAF and BFBOF very similarly in terms of input to output ratio, since both processes are capable of delivering most steel alloys with the same physical and chemical characteristics.

The economic dynamics outcomes would therefore become more a function of the transition from BFBOF steelmaking towards EAF, as represented by the total costs of each process in Figure 4.4.55. In the long-term, the total costs of BFBOF production trend down proportionally to its reduced participation in the sector, but the diminishing revenues that follow this trend would end up curbing the increasing performance of EAF steelmaking, since the latter is capable of delivering the same products using energy more efficiently.

Figure 4.4.55 - Impacts of projected Ni and Cr prices on steel prices, costs, dividends, and EBITDA margins.

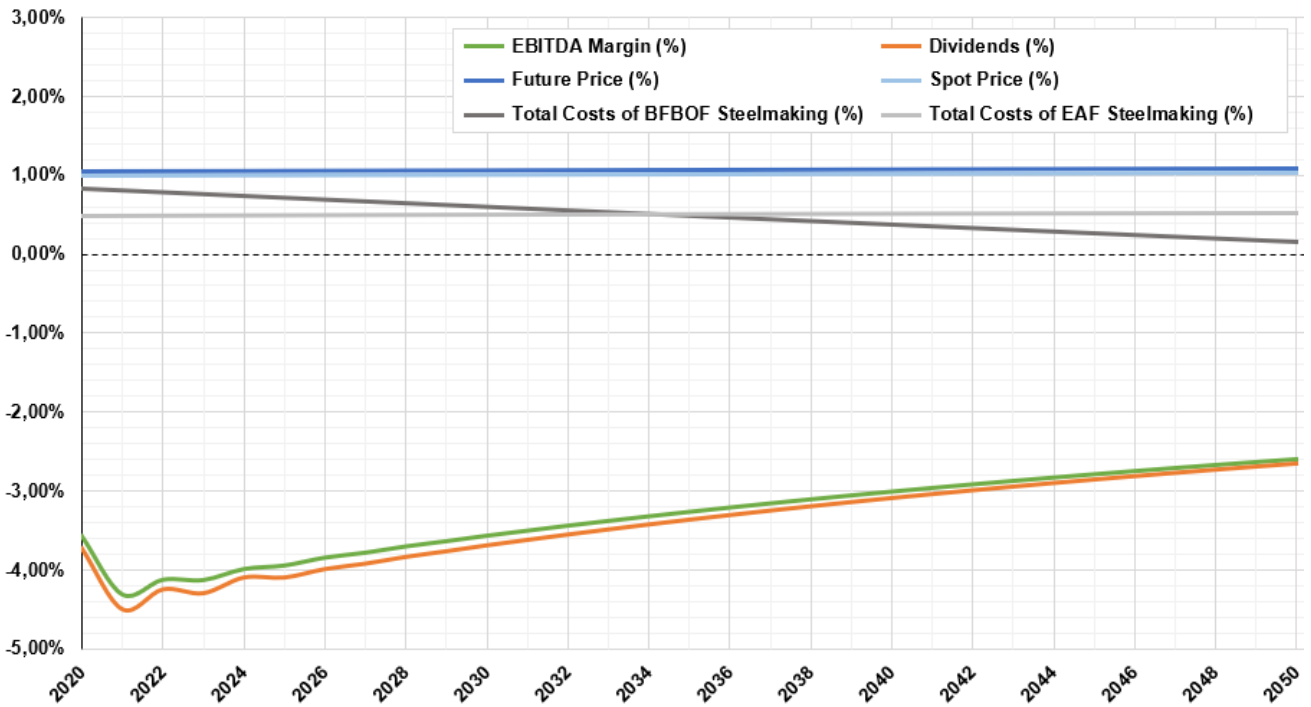

It is precisely this productive characteristic of EAF steelmaking one of the most compelling arguments for continuously transitioning from BFBOF steelmaking, helping compensate many of BFBOFs' limitations in terms of energy sourcing and consumption, and the associated economic repercussions. Additionally, energy efficiency allows for a finer control of variable costs, rendering EAF operations less sensitive to capacity utilization and capable of using it more effectively as a strategy for protecting margins.

This exact behavior was perceived in the model and further differentiated these results from those of the previous simulation run. BFBOF operations dynamically adjusted themselves towards productive scale to offset the cost increase, increasing capacity utilization by 3,13% on average – further lowering EBITDA margins of the sector while having little to no effect on spot prices. EAF operations, on the other hand, tended to do the opposite, being responsible for pushing prices up but substantially risking market share.

Such an economic development would give BFBOF steelmakers more negotiation leverage in terms of prices against those operating EAF, and the ensuing shift in market

shares could decelerate a transition. Nevertheless, even if economically unsustainable in the long-term as discussed in run 18, this could pose as a strategy for BFBOF steelmakers to gain time in either avoiding or delaying the necessary investments towards transitioning.

4.5. Steel & Servitization

The knowledge acquired from evaluating and analyzing each servitization application towards the improvement of sustainability in an urban environment and its interactions with steel is divided below into subsections specific to the case study that originated it.

4.5.1. Energy

The servitization of electricity once bought as a product and delivered to a household merely for consumption into a localized and demand-specific solution capable of reducing costs and adding consumer value as seen in the study by Pinto et al. (2016) relied on two different factors: (a) replacing a mostly hydraulic-based grid electricity supply with decentralized solar sources, and (b) retaining, redistributing and reusing excess energy within the local network by using feedback. The first factor contributes to reducing electricity demand from the installed capacity while reducing the demand for electricity distribution along the grid. On the other hand, the second factor not only contributes to the previous one while providing economic benefits to the citizen, but also adds intangible values such as grid independence, community integration and participation.

From the perspective of Sustainable Urban Metabolism, the propositions of Pinto et al. (2016) help to partially transfer electricity sourcing from outside a city's boundaries to the households within it, directly reducing the required external energy input while strengthening and empowering local stakeholders at the expense of an increase material stock within the city's boundaries. Furthermore, it reduces the amount of electricity wasted by over-generation

as well as electricity lost during long range distribution. Cities in which such a project would be deployed would become altogether more resilient and sustainable while helping reduce emissions, losses and wastes related to electricity generation.

When applying the criteria of Circles of Sustainability to this case study, several contributions were identified, as seen in Figure 4.5.1.56. In the domains of Politics and Culture, minor benefits to Organization & Governance and Engagement & Identity were perceived, respectively related to the required policy adjustments that would enable grid feedback and feed-in tariffs, and to the creation of a local community of households which rooves now include solar panels.

Figure 4.5.1.56 - Energy case's perceived key contributions to sustainability.

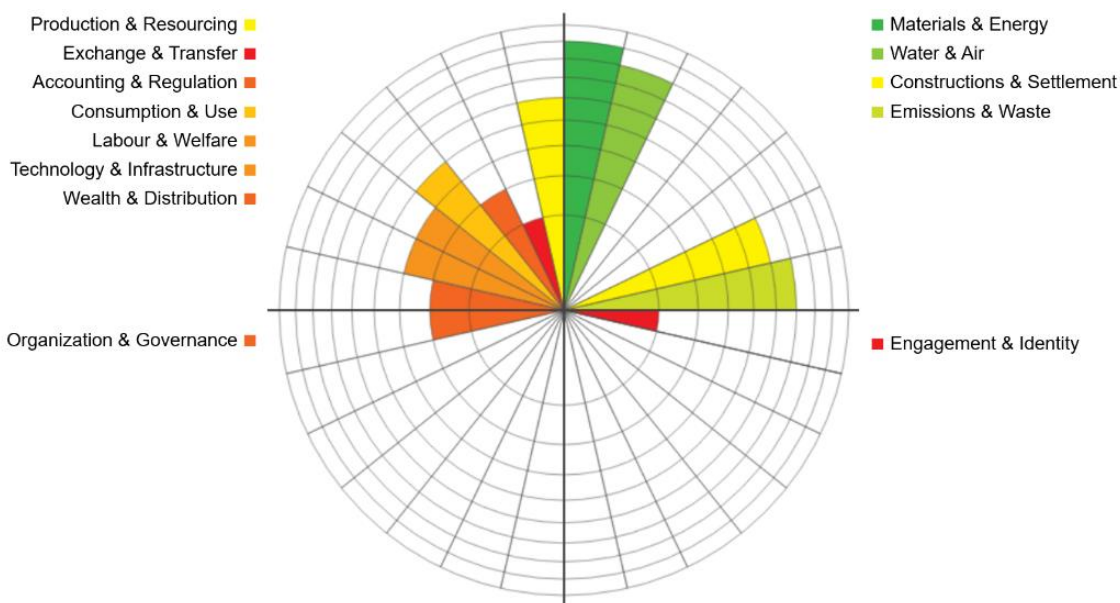

It was in the Ecology and Economy domains, however, that most contributions were perceived. Deploying photovoltaic solar panels onto the rooves of Brazilian households could significantly shift how electricity is used and consumed in relation to its existing matrix, potentially creating new service sector jobs related to installation and maintenance. Moreover, improving infrastructure by using new technologies is a good way to increase local wealth distribution while promoting or changing how knowledge and capital are exchanged.

Additionally, having a network capable of grid feedback also increases the need for proper and engaged accounting and regulation, especially if the study's proposition of feed-in tariff cross-discounts is put in force.

Changing how electricity is generated also changes the materials necessary for the equipment used to generate it. Photovoltaic solar panels use considerably more silicon than iron in their composition, for example, in addition to other materials less pollutant to produce or less impactful to implement than hydraulic energy infrastructure. Consequently, both direct and indirect benefits to air quality, water quality, and reductions in the amounts of emissions and waste generated would be perceived throughout the entire system, thus improving the sustainability of the urban area it would be a part of while potentially reducing the need for environmental impacts outside its boundaries as well.

Although steel presence in photovoltaic solar panels is minimal – 3%, mostly in the frame and in the installation hardware –, it is important to note that the mainly hydraulic Brazilian energy matrix heavily relies on energy generation equipment made of steel and, even if the distribution itself depends mostly on copper and aluminum, steel-intensive machinery is always present (Greiner, 2013; ANEEL, 2009; Souliotis et al., 2018; Bracquene et al., 2018; ISSF, 2015).

The results available in the study by Pinto et al. (2016) point to an average of 153,25 GWh generated by 405.691 solar panels installed onto the rooves of 73.762 houses, the equivalent of the entire electricity generation capacity of the Jupiá hydropower plant in Três Lagoas, Brazil (ANEEL, 2009). Considering that an average hydropower plant contains 10.000 tons of steel in its structure (Greiner, 2013) and taking into account an average photovoltaic solar panel mass of 18 kg (Souliotis et al., 2018; Bracquene et al., 2018), the participation of the steel present in the solar panels is about 0,7 kWh/kg of steel, while the

participation of the steel present in the hydropower plant would be of approximately 0,015 kWh/kg of steel – 45 times less.

This indirect reduction in supply-side steel intensity per kWh generated coming as a result of demand-side servitization points to one of the potential contributions of steel – in this case related to its quantity: although less steel is present, its participation is substantially more relevant. The challenge for steel, in cases like this, resides mostly in identifying where is the least amount of steel capable of providing the most environmental benefits – e.g. small amounts on a solar panel provide more environmental value than very large amounts in a hydropower plant.

4.5.2. Housing

By subsidizing a transition towards eco-efficiency within households and supporting it with maintenance – whether if by leasing or not –, a city can turn appliances previously acquired by its citizens merely as products to be used and discarded into solutions capable of actively supporting the reduction of its required energy inputs as well as its emissions. Servicing this equipment and further supporting this initiative with the creation of green spaces and gardens capable of providing food and consequently reducing the amounts of packaging, food waste and transportation poses as a solid contribution to sustainability.

As per Sustainable Urban Metabolism, the study from Céron-Palma et al. (2013) contributes to reducing inputs and outputs, but minimally – if at all – to reducing stocks. The reduction of inputs derives mostly from the green spaces and garden producing food and avoiding the need for packaging and transportation, while the reductions in outputs are most expressive regarding the energy savings provided by eco-efficient appliances and the consequent reduction in emissions. Céron-Palma et al. (2013) also present the possibility of carbon sequestration in the green spaces and gardens, but with almost negligible effects relative to the other benefits.

Although the amount of materials and food in stock would likely be unaffected, Use & Consumption patterns would change and so would Production & Resourcing, as per the criteria of Circles of Sustainability. As summarized in Figure 4.5.2.57, minor effects on most of the aspects of the Economic and Political domains would nevertheless provide substantial improvements in the Ecology domain. These improvements would be directly related to increases in Health & Wellbeing, while contributing – even if marginally – to the creation of a locally engaged community.

Figure 4.5.2.57 - Housing case's perceived key contributions to sustainability.

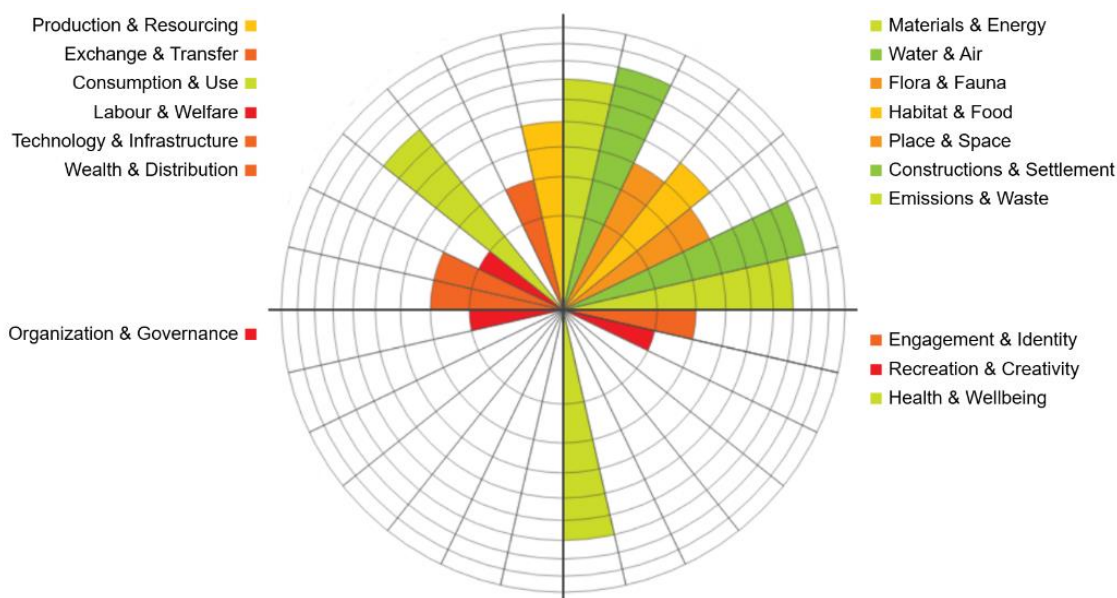

The intersections that exist between all of the aspects of the Ecology domain ended up boosting each other, therefore increasing environmental quality. This points to a reinforcing behavior which, whether intended or not by Céron-Palma et al. (2013), presents major long-term sustainability and resilience benefits: the less issues with Emission & Wastes, the better Water & Air, which by itself helps improve Flora & Fauna and Habitat & Food. Finally, Place & Space improve as well, boosting Health & Wellbeing and fostering Engagement & Identity within the local community, effects of which feed back to the beginning.

As interesting as this behavior may be, its impacts on emissions are less substantial than those of the eco-efficient appliances, highlighting the importance of both being deployed in tandem. Since steel is not present in the green spaces and gardens, focus was given to the eco-efficient appliances when addressing the participation of steel in emissions. All other variables of the case study's Life Cycle Assessment were assumed unchanged, meaning eco-efficiency had no effect on the amount of steel content of each appliance. This choice was made due to the theoretical infinite number of possibilities by which eco-efficiency can be achieved by different manufacturers in different models of each appliance.

According to the results from Céron-Palma et al. (2013), replacing standard appliances with more eco-efficient ones reduced energy consumption by approximately 46%. Considering an average steel content of 60% per 140kg refrigerator, 35% per 76kg washing machine, and 46% per 37kg air conditioning unit (van Schaik & Reuter, 2010; Oguchi et al., 2011; Eco3e, 2018; Öko, 2005; ADEME, 2010), the calculations showed that steel's participation in annual emissions per house was reduced by 32% on average as a result of changing to eco-efficient appliances. More specifically from 4,90 to 3,35 kgCO₂eq/kg of steel (refrigerator), from 1,90 to 1,30 kgCO₂eq/kg of steel (washing machine), and from 84,67 to 57,76 kgCO₂eq/kg of steel (air conditioning unit). These results grow in significance when keeping in mind the case study's scope of 112.000 houses.

In this case, even though the amount of steel per appliance remained the same, steel's contribution would not reside in its quantity, but in the type of steel and in how it is used in an appliance, for example, towards improving its eco-efficiency. Although this demand-side servitization initiative has minor effect on supply-side scale, the steelmakers' challenge would be to decide on which type of steel to produce – e.g. alloys with better electrical conductivity – and how to ensure its optimal use in a product.

4.5.3. Mobility

After five years of the implementation of the CiViTaS project in the city of Burgos, a clear change in its citizens' mobility behavior was noticed: it successfully stimulated approximately 10% of its population to transition from either walking or owning a private car towards using either more public transportation, bicycles or lighter vehicles such as motorcycles (Diez et al., 2018). Considering bicycles and notably public transportation were provided as a service by the city for the population, and that these means of transportation are less – if at all – pollutant in comparison to cars, servitization has proven itself environmentally friendly once again.

Even considering an increase of 1% in the use of motorcycles and a 6% reduction in the amount of people who preferred to walk their commutes, emission results were very favorable, pointing towards a successful mobility solution proposition that positively affects urban environment. Keeping in mind that bicycles now have their dedicated lanes, and that buses and motorcycles contribute to reducing overall traffic in comparison to cars, this mobility solution also presents medium to long-term sustainability benefits.

Using the criteria of Sustainable Urban Metabolism, it is possible to identify that the study conducted by Diez et al. (2018) altered the city's inputs and stocks, by affecting the composition of the city's mass balance due to the different types of vehicles being used. Consequently, the flows related to mobility and transportation are rendered more efficient, still overshadowed, however, by the notable effects that takes place among the outputs. By changing the mobility matrix, not only do different materials become part of the urban system, but also different and more sustainable sources of energy gain traction: less cars meant that gasoline and diesel gave way to buses' biodiesel, for example.

With less of their income being used to own a car, Wealth & Distribution improved from the citizens' perspective as per the criteria of Circles of Sustainability shown in Figure

4.5.3.58. Improving aspects of the Political domain related to organization and communication would not only move Use & Consumption towards a more sustainable behavior, but also help shift Production & Sourcing and to promote Exchange & Transfer of more sustainable knowledge and goods. More transportation services would also require more jobs related to operation and maintenance instead of car parts replacement, even if improvements to Technology & Infrastructure would be minor.

Figure 4.5.3.58 - Mobility case's perceived key contributions to sustainability.

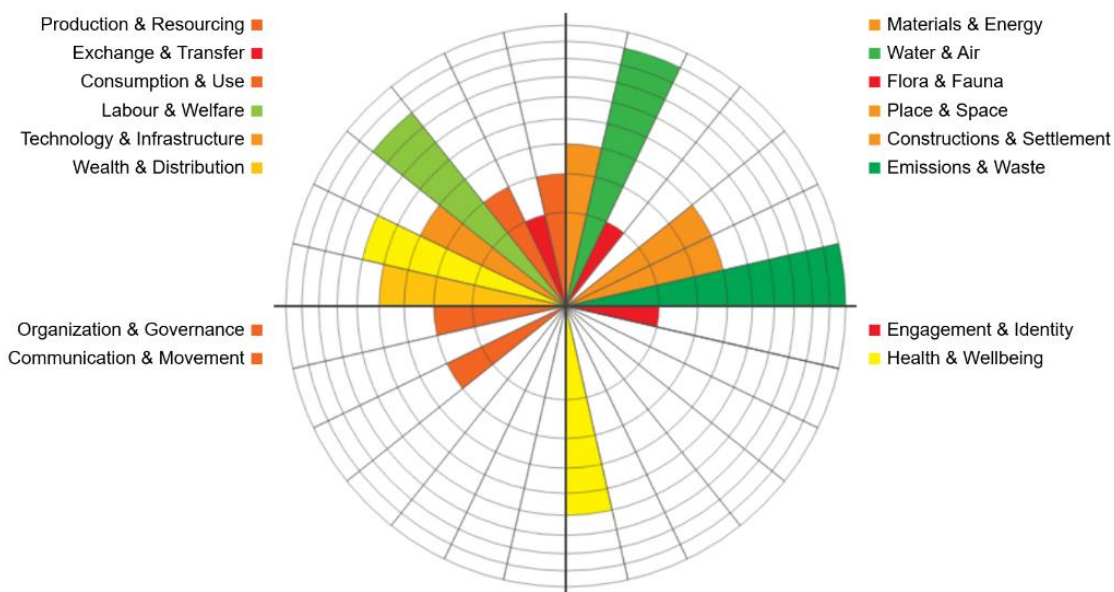

The key contributions, nevertheless, are present in the Ecology domain: measures that help reduce traffic – which relate to Construction & Settlement – further help reduce emissions and contribute to citizens' perception of Place & Space due to better Water & Air, altogether boosting Health & Wellbeing in the Culture domain as well. Therefore, this study configures a good example of Sustainable Urban Mobility, well aligned with the idea of a Sustainable Urban Metabolism.

Having changed which vehicles are used and the frequency of their usage, the study indirectly changed how steel is present in the city as well. Considering that cars, buses, bicycles and motorcycles are built with different amounts of steel – on average 900 kg, 6.000

kg, 6 kg and 70 kg, respectively (Kärnä, 2012; WS, 2018; Leuenberger & Frischknecht, 2010) – not only do the total amounts of steel change, but also their participation in the emissions that occur as a consequence of their presence.

Although using more buses, bikes and motorcycles caused the amount of steel in Burgos to increase by approximately 18,23% – 82,5% of which inside buses –, having steel be a part of vehicles that are less pollutant than cars or that are more efficient due to their capacity or fuel caused steel's participation in annual emissions to decrease by 29,6% – from 11,93 to 8,40 kgCO₂eq/kg of steel.

This increase in steel presence associated with lower participation in emissions highlights the importance of defining when and where to use steel, especially considering that the types of steel used for buses, for example, are not necessarily considered specialty or complex alloys. It is to say that more steel can also be a solution, as long as it is used when and where necessary to support servitization and, further along, sustainability.

5. CONCLUSIONS

This section summarizes the conclusions achieved by the author as means to answer the main questions conceived in section 1.1; first specifically from each article, and then of them as an ensemble. Furthermore, it lists recommendations based on the conclusions for the improvement of the European Steel Industry as a whole, whether by actions from the industry or by policy efforts from governments. Finally, having learned from the case of steel, suggestions are made for future research topics that could further the knowledge on matters related to science, environment, and management.

5.1. Specific Conclusions

5.1.1. Integrated Model

The integration of LCA into SD was deemed feasible and beneficial for both SD and LCA in different levels. Table 5.1.1.12 summarizes the results for both the quantitative and qualitative criteria used in evaluating the performance of the integrated model.

Table 5.1.1.12 - Summary of quantitative and qualitative results.

QUANTITATIVE			QUALITATIVE	
Criterion	Reproduced LCA?	Reproduced SD?	Criterion	Integration evaluation
Emissions	Yes	-	SD improves LCA's circularity analyses	Considerable/minor improvement: more detailed gate-to-cradle dynamics;
Biophysical depletion of iron ore	-	Yes	SD improves LCA's long-term perspective	Substantial/major improvement: allows for full timespan flexibility;
Steel scrap generation and consumption	Yes	Yes	SD improves LCA's macro analyses potential	Substantial/major improvement: allows for the tracking of multiple elements while multiple variables are interacting or changing simultaneously, not only OFAT;
Liquid steel output	Yes	Yes	LCA improves SD's stakeholder involvement identification	Substantial/major improvement: more precise depiction of flows, stocks and roles as per LCA requirements;
Iron circularity	-	Yes	LCA improves SD's analysis reliability	Substantial/major improvement: increased reliability and granularity due to data disaggregation and objectivity;
Steel input into economy	Yes	Yes	LCA improves SD's applicability across managerial levels	Considerable/minor improvement: analyses can range from operational to strategic levels, but depend on how the model is built.

By allowing the simulation of longer periods of time, the testing of multiple simultaneously changing variables, endogenous feedbacks, and a clear visualization of gate-to-cradle dynamics, SD added strategic value to LCA, potentially interesting industrial decision-makers who would like to broaden the understanding of their operations as their goods and products integrate the economy as well as when they leave it.

The benefits that LCA brought to SD were more substantial and revolved around increased granularity, reliability, stakeholder involvement and applicability of the results on different managerial levels, factors that could attract policy-makers in need of a deeper understanding of a specific supply chain. No interferences to the application of SD were identified while reproducing the results of previous studies. The replicability of LCA results from previous studies suffered no interferences either, however, it could not benefit from the use of indicators such as ReCiPe.

5.1.2. End-of-Life Policies

After having compared the first set of simulation runs to *business-as-usual* practices, it was noticed that a policy targeting steelmakers and aimed at maximizing the recycling of end-of-life steel would have substantial positive effects on the supply side dynamics of this sector, providing significant support for a continuous transition from BFBOF steelmaking towards EAF steelmaking – even if BFBOF would face fewer issues with ore availability. Considering that recycling operations have increasingly become an active part of EAF steelmaking reality, and that results point to even BFBOF steelmakers being able to benefit indirectly from it, a significant long-term potential increase in biophysical circularity was perceived.

Still, considering that the majority of effects took place in the supply side, focusing only on increasing recycling would not be, on its own, an optimal measure for increasing circularity by reducing the demand for new steel. This was verified not only by the increase in steel output, but also the increase in the total availability of scrap and on it being less downcycled.

When comparing the second set of simulation runs to BAU, on the other hand, the positive effects of an aggressive stimulus towards steelmakers being involved in end-of-life steel repair & reuse were significant on the demand side, being more subject to pertinent service sector dynamics and posing as effective means of reducing the demand for new steel. Gains in biophysical circularity by increasing steel retention within the economy were noteworthy in the short- and medium-term after policy deployment, but eventually stabilized in the long-term – validating the arguments presented by EUROFER (2017b).

Focusing only on repair & reuse would not, however, support a continuous transition towards EAF steelmaking – and the consequent supply side increase in circularity – as effectively as the previous set of simulation runs. This happened mostly due to the fact that repair & reuse prolonged the total service life of steel, delaying recycling and increasing downcycling in the long-term.

Ideally, then, European policies based on Circular Economy regarding end-of-life steel would need to find a balance between recycling and repair & reuse when addressing biophysical circularity. Such a balance would also depend on market variables not directly addressed in this study (e.g. steel prices, OPEX, CAPEX and investment costs) and would consequently be more effective if evaluated in national scale at first, before a consolidated policy in European level is devised, notably regarding the amounts and compositions of the end-of-life steel being generated or circulated.

In summary, the results point to the possibility that both types of steelmaking operations could benefit from increasing their efforts regarding end-of-life services while

simultaneously contributing to improvements in biophysical circularity. To that end, more CE-based policy attention should be given to the steelmakers' supply chains as a whole as well as to steelmakers themselves, and not only to their customer sectors or their raw material suppliers.

Such policies would need to be not only aggressive so as to transition as soon as possible from BAU, but also to stimulate steelmakers to retain the added value of steel longer within EU28 boundaries by working alongside sectors in which steel has a long service life – focusing on increased recycling, refurbishment/remanufacturing and eco-design –, and alongside those in which steel has short to medium service lives – towards increasing repair & reuse, redistribution and servitization.

5.1.3. Supply Chain Integration

The results brought forward that different approaches can yield both strategic and environmental benefits for the European steel industry as a whole or for individual steel supply chains located within its boundaries – as summarized in Table 5.1.3.13.

Overall, improvements in resource ownership retention were noteworthy when derived from supply side vertical hedging of slag as a potential alternative source of iron, presenting more strategic advantages than vertical integration. Raw material self-sufficiency, on the other hand, was perceived as strategically more interesting when originated from EoL steel goods, especially by vertically hedging for refurbishing or repair.

Table 5.1.3.13 - Summary of results (article no. 3).

CIRCULARITY DRIVER	SCI APPROACH	STRATEGIC BENEFITS	ENVIRONMENTAL BENEFITS	TARGET SECTORS	POTENTIAL SCOPE
Slag recycling for recovery	Vertical integration	<ul style="list-style-type: none"> • Suitable for specialty alloys; • Better recovery rates; • Higher raw material self-sufficiency potential; 	<ul style="list-style-type: none"> • Lower ore consumption; • Higher circularity; 	Automotive, Other Transportation, Appliances & Electronics	Supply chain specific
	Vertical hedging	<ul style="list-style-type: none"> • Scales in bulk; • More flexibility; • Higher resource ownership retention; • Potential protection from ore futures; 		Construction, Heavy Mechanical Equipment, Tools & Machinery	Europe, national
EoL refurbishment or repair	Vertical hedging	<ul style="list-style-type: none"> • Higher resource ownership retention; • Higher raw material self-sufficiency potential; • Suitable for specialty alloys; • Potential protection from scrap futures; 	<ul style="list-style-type: none"> • Lower ore consumption; • Lower scrap consumption; • Higher circularity; • Less reverse logistics; 	Automotive, Other Transportation, Appliances & Electronics	Supply chain specific
	Horizontal hedging	<ul style="list-style-type: none"> • Higher resource ownership retention; 		Construction, Heavy Mechanical Equipment, Tools & Machinery	Europe, national
EoL repair and maintenance	Horizontal integration	<ul style="list-style-type: none"> • Minor resource ownership retention increase; 	<ul style="list-style-type: none"> • Higher circularity; 	Automotive	Supply chain specific

Nevertheless, the raw material self-sufficiency and resource ownership retention benefits of the strategies discussed in this article can go beyond iron and, depending on the targeted sector, pose as key circularity enhancers for alloying elements approaching technical or economic scarcity.

Additionally, the simulation runs performed in the model not only deepened the understanding of how different strategic approaches can affect biophysical circularity within the European steel industry, but also brought to light that (a) there are sectors for which going from horizontal to vertical hedging could be worthwhile, and that (b) horizontally integrating EoL operations that are heavily dependent on the dynamics of the service sector could be imprudent unless the supply chain considers, for example, implementing an entirely new business unit.

5.1.4. Economic Dynamics

Once the biophysical and economic modules were combined, the model was able to reproduce existing trends and projections for the steel sector. The *business-as-usual* simulation run reinforced that overcapacity would tend to continue despite the projected growth in demand from developing countries. Reasons for this include (a) the slow but continuous transition towards EAF steelmaking – hindered by industrial electricity prices and a delayed response from the secondary metals market –, and (b) the diminishing yields of the iron ore available for BFBOF steelmaking.

The overall long-term panorama seems to favor investments and reinvestments in technology, efficiency and cost reduction, since it indicates a certain stability regarding iron ore and steel scrap availability – prices of which would trend only slightly upwards and downwards, respectively, all dynamics considered. This was verified by the model's depiction of steelmakers' current tendency to prefer protecting their margins instead of seeking gains in scale. Furthermore, a cyclical phenomenon between increasing margins and subsequently distributing dividends was identified, a behavior less likely to happen when market share and scale are the strategic focus, as was China's until around 2017.

Despite the losses in the granularity of the analyses due to either computational limitations or data inconsistency, trends regarding the futures market were also verified by the model, indicating the continuous stabilization of the traded volumes that began after the 2008 crisis. Nevertheless, *hedging* remains a crucial tool for steelmakers to either compensate for losses or to offset other strategic decisions. The results can be seen in Table 5.1.4.14, which summarizes the results of the four final simulation runs performed by the model.

Table 5.1.4.14 - Summary of observed trends and behaviors from simulation runs 18 to 21.

VARIABLE		OBSERVED TRENDS						OBSERVED BEHAVIOR
		SPOT PRICE	BASIS	FUTURES PROFITS	EBITDA MARGINS	DIVIDENDS	TOTAL COSTS	
Capacity Utilization	△	▼▼	▼▲	▼▲	▼▲	▼▲	▲■	Reducing costs to protect margins at the expense of market share;
Logistic Costs	△	▲▲	▲▲	▲▲	▼▲	▼▲	▲■	Use of <i>hedging</i> to protect margins and avoid affecting variable costs;
	▽	▼■	▼▲	▼▲	▲▼	▲▼	▼▲	
Energy Prices	△	▲■	▲■	▲■	▼▲	▼▲	▲■	Reducing output and variable costs to improve margins;
	▽	▼▲	▼▲	▼▲	▲▼	▲▼	▼▲	
Raw Materials Prices	△	▲■	▲■	▲■	▼▲	▼▲	▲■	EAF: reducing output and variable costs to improve margins; BFBOF: increasing production scale to protect market share;

Labels: upwards (△), steady (□), downwards (▽), short-term < 5 years (▲▼), long-term > 5 years (▲■▼).

Simulation run 18 helped verify the extent to which increasing capacity utilization would increase variable costs to the point of significantly affecting revenues, despite a favorable widening gap between spot and future prices. In simulation run 19, when faced with volatility in logistic costs, steelmakers would tend to make more use of *hedging* to protect their margins since changes in capacity utilization would only aggravate the matter.

Finally, in simulation runs 20 and 21, different behaviors were perceived between EAF and BFBOF steelmakers. Different price projections for their characteristic energy sources (run 20) triggered the same reaction – reducing capacity utilization to protect margins via variable costs reduction –, while the increasing prices of nickel and chromium (run 21) caused BFBOF steelmakers to opt for focusing on production scale instead. Although economically unsustainable, this suggests that the transition to EAF steelmaking could eventually threaten BFBOF steelmaking’s market share and set off an assertive reaction.

The scenarios in this article were tested independently in order to identify and discuss the dynamic exchanges between biophysical and economic aspects of steelmaking, and

would, in a real-world application, be intertwined. Nevertheless, it was possible to identify key biophysical variables affecting economic dynamics, namely:

- a) steel scrap availability barely offsetting demand growth, creating only marginal price reduction;
- b) iron ore yields offsetting iron ore relative scarcity, only marginally increasing prices;
- c) fossil fuel consumption in BFBOF operations decreasing as EAF phases in, contributing to price reduction;
- d) EAFs' increasing demand for electricity further raising its price;
- e) dependency on alloying elements for stainless steel products forcing steelmakers to make compromises on either scale, margins or market share; and
- f) capacity utilization as more of a tool for margin protection than for market share acquisition;

It is important to note that these biophysical variables behaved as such also due to the endogenous feedback of the economic dynamics along the system, present in all of the tracked parameters and exemplified by the short-term sensitivity to logistics volatility.

Based on these results, the author suggest that next studies attempt to run complex scenarios in tandem, so as to simulate conditions closer to real-world circumstances and improve on the granularity of the daily futures market exchange. Furthermore, additional financial, economic and accounting parameters or indicators could be set to be tracked depending on the needs of a company under study or of the commissioning institution.

5.1.5. Steel & Servitization

Table 5.1.5.15 summarizes the results and discussions derived from analysis and evaluation of steel's presence and role in the case studies, and serves to reinforce how useful all servitization case studies were towards improving eco-efficiency, resilience, sustainability

and self-sufficiency in the cities they were or would be deployed. All three case studies helped (a) lower dependency on external energy inputs, and (b) lower the output of emissions; even if at the expense of increasing local material stocks.

In the case of energy, deploying photovoltaic solar panels onto the rooves of houses significantly changed how energy is produced and consumed. When analyzing the case of housing, creating gardens and switching to eco-efficient appliances had substantial positive impact on health, wellbeing and waste generation. And on what concerned mobility, a combined set of social and infrastructural measures has been proven capable of not only considerably reducing emissions, but also of stimulating job creation.

Table 5.1.5.15 - Summary of results and discussions (article no. 5).

Case study	Main servitization contributions according to		Steel's		
	Sustainable Urban Metabolism	Circles of Sustainability	Presence	Contribution	Challenge
Energy	<ul style="list-style-type: none"> • Lower external energy inputs; • Increased energy circularity and flow within boundaries; • Higher material stocks within boundaries; • Lower emissions outputs. 	<ul style="list-style-type: none"> • Materials & Energy; • Water & Air; • Emissions & Waste; • Production & Sourcing; • Consumption & Use. 	Decreased	Less steel in the right places can help create more environmental value	HOW MUCH steel to use, WHERE to use steel
Housing	<ul style="list-style-type: none"> • Lower inputs overall; • Higher stocks and flows of food and materials within boundaries; • Lower emissions outputs. 	<ul style="list-style-type: none"> • Constructions & Settlement; • Water & Air; • Materials & Energy; • Emissions & Waste; • Health & Wellbeing; • Consumption & Use. 	Steady	Different alloys used to the best of their potential can support other goods' and services' environmental values	WHAT type of steel to use, HOW to use steel optimally
Mobility	<ul style="list-style-type: none"> • Higher materials inputs; • Lower external energy inputs; • Higher materials stocks; • Reduced material flows; • Lower emissions outputs. 	<ul style="list-style-type: none"> • Water & Air; • Emissions & Waste; • Labour & Welfare; • Wealth & Distribution; • Health & Wellbeing. 	Increased	Regardless of quantity, optimal applications of even the simplest of steel alloys can help improve the environmental values of a service or good	WHEN and WHERE to use steel

When evaluating steel's behavior, each case study provided a unique insight. In the first case, steel's presence decreased but its contribution to electricity generation and

emission reduction was improved. In the second case, steel's presence was virtually unaltered but the way it was used highlighted the potential for supporting a servitization initiative's environmental values. And in the third case, steel's presence increased only where and when it was more capable of contributing to the environmental goals at hand.

These differences bring to light the importance that steelmakers also pay close attention to service-providing projects involving their clients and their products, since it was noticed that servitization is capable of altering steel demand in terms of quantity, but also quality and specialization requirements. The effects of servitization on the demand-side can change supply-side dynamics as well, creating both challenges and opportunities for steelmakers.

Steel has a structural role in solar panels, as opposed to a direct operational one as in hydropower plants, this not only changes how much steel is necessary but where it is used, potentially requiring a steelmaker to consider migrating to new and upcoming markets. When it comes to eco-efficient appliances, specialized types of alloys and how they help the product improve efficiency play a bigger role than quantity, situation in which close collaboration with a client's development cycle might favor the steelmaker as well. And directing more production and technology development efforts towards steel alloys that supply manufacturers and assemblers of vehicles which characteristics favor environmental values can pose as an opportunity for portfolio expansion and market share capture.

5.2. Overarching Conclusions

The aggregated value of the present thesis derives not only from each article individually, but mostly from the interpretation of the results as a whole. Although each article delved into the specifics of one component of the Steel Industry at a time, it was from their interactions that the most relevant discussions and lessons emerged.

A substantial amount of time and attention was dedicated to the development of a model integrating Life Cycle Assessment and System Dynamics, based on the opportunity recognized by the author of their potential to deliver more value together than independently. The effort resulted in a model capable of replicating not only previous independent results of both LCA and SD with no methodological interferences, but also of reproducing existing behaviors, trends and projections of the Steel Industry.

Although there remains work to be done regarding the full integration of LCA's indicators and on the computational burden of calculating spot prices and future prices on hourly or daily increments in a system based on biophysical variables, these two methodologies supported one another in mitigating some of their own shortcomings by contributing to the final model in different ways.

SD considerably increased the benefits of LCA by allowing for more flexibility, for the testing of more variables at once, for endogenous feedback, and notably for transforming the LCA's snapshot of a moment in time into a film that, in this case, spanned for 200 years. LCA, on the other hand, gave SD the granularity, reliability, and structure typical of an empirical, tangible and standardized tool used in real-world applications, instilling the objectivity often lost in systems with broad boundaries.

For the time being, the resulting model is as much a feat of LCA and SD as it is of its conception and development, requiring attentive operation and thorough scrutiny of its high-density disaggregated data demands, nevertheless, given continued improvement, the potential for practical application within Steel Industry's stakeholders presents an interesting prospect.

One of the main results was reinforcing the argument that high-grade iron ores will go through either technical or economic scarcity between 2051 and 2054, adding iron to the list of materials that could create bottlenecks alongside steelmaking's alloying elements. This will

pressure BFBOF steelmakers to use progressively more iron ores of lower grades and lower yields, to include more scrap as input at higher costs, to seek alternative sources of iron in slag recycling, for example, or to develop new strategies on supply chain resource ownership retention and raw material self-sufficiency.

Although developments indicated that fossil fuels' prices trend downwards in the long-term, BFBOF steelmakers will struggle to manage the dynamics of iron content in ores, of EAF competition, of nickel and chromium prices going up, and of the limited use they can make of their idle capacity before compromising margins to variable costs. Having learned from the Chinese experience, European BFBOF steelmakers should now, more than ever, face an environment in which focusing on technology, efficiency and cost reduction trumps production scale, especially considering that futures hedging may not be able to cover for all potential losses in the pursuit for market share.

As this takes place, the Steel Industry's transition towards EAF steelmaking will continue to occur, but the progress will be hindered by the secondary metals market being slow to respond to new demand, making steel scrap prices go down more moderately than what would be desirable, all the while the prices of industrial electricity and alloying elements trend upwards.

In Europe, the low stimuli for the EoL services that support steel recycling, and the significant amounts of steel scrap leaving European borders will further obstruct EAF's progress, requiring additional attention to be given to EoL services. With all of their environmental added values, these activities hold the key to preventing that steel supply becomes compromised, situation which would increase steel prices and further worsen the ongoing trend of overcapacity that increases capital costs and upsets the international trade balance.

Given the upcoming panorama, both EAF and BFBOF steelmakers should pay close attention to the volatility of logistic costs and to the evolution of their capital costs in order to avoid losing profitability. The balance between prices and capacity utilization will become more delicate as protecting margins and retaining or expanding market share become stronger obstacles to one another. And although *basis* trending slightly upwards allows for profits to be made in the futures market to cover for strategic decision-making on this matter, the use of hedging should be intensive but not overestimated.

With this context in mind, even BFBOF steelmakers might become interested in encouraging and investing on EoL services, as doing so could create new sources of revenue, extend the availability of high-grade iron ores as well as strategically place a supplier of steel scrap when necessary to compensate for lower iron ore yields. When addressing EoL, however, it is important to keep in mind that, due to steel downcycling, sectors which demand large amounts steel products or steel alloys of lower specialization (e.g. Construction, and Heavy Mechanical Equipment) will likely consume the most steel that originates from processing secondary metals. At a first glance this would not be an issue, but since sectors that contribute the most to steel scrap generation are those in which products containing steel have the shortest life cycles (e.g. Appliances & Electronics, and Automotive), a measure that stimulates some sectors of the economy might discourage others.

Furthermore, downcycling is likely to move even more steel scrap away from the European territory, knowing steelmakers within its borders have a more specialized and quality-oriented portfolio than international competitors. Measures to counter this effect should, therefore, focus not only recycling in general, but prioritize the recovery of specialty alloys and of scarce alloying elements. Still, a paradox among the EoL services stands in the way of optimal measures: while recycling is more effective on the supply-side, better promoting the transition to EAF steelmaking and further reducing iron ore consumption, it

speeds up downcycling. Repair, reuse and refurbishment, on the other hand, perform better on the demand-side, extending steel's life cycle, increasing circularity and decreasing overall demand for new steel.

This paradox, however, resides within another: repair, reuse and refurbishment are particularly interesting to those sectors likely to gain less from investments or stimuli towards recycling, but lengthening a products life cycle would ultimately constrain EAF steelmaking – a key driver in the circularity push –, and cause the input of recycled steel into the economy to be delayed. Consequently, a balance would need to be found in the strategic decision to either prioritize circularity at the expense of steel supply – directly affecting the Steel Industry –, or promoting EAF steelmaking at the expense of the performance of some of the Steel Industry's client sectors.

Despite which side of these paradoxes is favored in political or managerial decision-making, BFBOF steelmaking is unlikely to be bolstered in the long-term, especially considering the environmentalist push of the last few decades. But even if Europe moves towards steady-state or degrowth economies, BFBOF steel will remain necessary for replacing steel either lost or downcycled beyond EAF capabilities, then likely to be imported.

Recycling can also be applied in the supply-side to the by-products of steelmaking, being slag the one with the most potential for serving as additional source of iron and helping push the high-grade ore scarcity further in time while reducing variable costs. Furthermore, the materials not reused in steelmaking can become additional revenue: sulfur and phosphorus can be sold to fertilizer manufacturers, silicon to glass-based industries, and, if processing is deemed too expensive, slag itself can be used in the construction industry. How to recover useful materials from slag, however, can create different results.

Vertically integrating slag recycling individually into each operation is costlier but allows for higher levels of specialization and optimization that can improve the recovery of

not only more iron, but also of other elements. Vertically hedging a slag recycling operation, on the other hand, allows it to process slag from different furnaces and to more easily supply its outputs to different steelmaking plants – within its supply chain or not –, but serving as a raw material hedging tool in this manner will most likely incur lower yields. Nevertheless, both cases favor BFBOF steelmaking more than they do EAF, and opting for one integration strategy over another would also depend on whether a steelmaker's clients require specialty steel alloys or bulk amounts of simpler alloys.

Supply Chain Integration strategies can also be spearheaded by the demand-side of the European Steel Industry, be it by steelmakers' customers getting involved in steel recycling operations to obtain strategic advantages or partnerships with their EAF suppliers; by investing in refurbishment and repair to reduce the overall dependency on steel suppliers (e.g. Appliances & Electronics); or by creating entirely new business units dedicated to maintenance and servitization (e.g. Automotive).

All of these examples increase circularity, reduce overall steel demand and help these stakeholders to improve their self-sufficiency and to retain resources longer under their control, accruing as much value from them as possible before exhaustion or reinsertion into the biosphere. And, with the exception of the latter, all of these possibilities would perform better in the horizontal hedging model of Supply Chain Integration while creating opportunities for revenues in the reverse logistics business as well.

These initiatives would provide the most advantages to sectors in which alloy quality and specialization are more important than volume (e.g. Automotive, Aviation, Aerospace and Electronics), even signaling to possible vertical models of integration when considering the developments of prices and reserves of alloying elements such as cobalt, molybdenum and niobium. Horizontal integration – as sometimes seen in the Automotive sector –,

however, is a double-edged sword in which balancing supply, price and demand can cause market reactions and backlogged demand to backfire and create a bullwhip effect.

But new markets for the European Steel Industry can also come from where it is least expected: servitization – practice created in the 1980's to sell printing as a service instead of just the printer itself and that, with the support of information technology, now represents an entire new segment of the service sector. Steelmakers might have a lot to gain by paying closer attention to the servitization initiatives and projects that involve their products and their client's products.

While some servitization initiatives can cause steel demand to decrease in one sector, they will likely create new demand in other sectors, as is the case with renewable energy. Cases in which demand stays virtually steady might require different types of steel alloys – mostly those that are stronger, tougher, lighter or more conductive –, as it happens with eco-efficient hardware. Even demand growth can be expected when servitization targets areas such as mobility by, for example, providing public transport, car rental, car sharing and bicycle use in urban areas with limited infrastructure.

In summary, the future of the European Steel Industry will require the sector to evolve, especially if it wants to honor its environmental commitments and contribute to European sustainability, resilience and self-sufficiency. Be it by integrating EoL processes into its supply chains, branching out to more circular sources of revenues in the secondary metals market, migrating to EAF, or moving closer to the service-oriented endeavors of its clients, the next steps for this sector have the potential to expand markets while adding environmental value.

It will require, nevertheless, active and combined effort from industry and political institutions, and the model developed for the present thesis could be of significant assistance to both sides, especially if LCA and SD practitioners and academic engage in further advancing it.

5.2.1. Recommendations for the European Steel Industry

- Priority should be given to protecting margins. A virtuous cycle can be jumpstarted by increasing share value as consequence of dividend payouts, in turn attracting capital for reinvestment oriented towards operational efficiency;
- Investments in additional production capacity should be avoided or, at the very least, be made extremely judiciously. Focus should be given to operational efficiency, cost reduction and the search for margins in specialized alloys. The increasing prices of alloying elements further uphold this argument, notably for EAF steelmakers – likely to struggle with industrial electricity prices as well;
- Multiple opportunities for improving operational efficiency lie in Supply Chain Integration strategies. BFBOF steelmakers should prioritize vertically hedging or vertical integration strategies with raw material sources. Both EAF and BFBOF steelmakers should consider horizontally or vertically hedging integration strategies with demand-side circularity-oriented initiatives. Working close to the secondary metals market and to sectors manufacturing products with short service life is distinctively important for EAF steelmakers.
- Steelmakers should go one step further in market prospection and actively examine their clients' clients. New markets are being created by servitization initiatives and steel plays an important role in their development. Steelmakers stand to gain from this trend given they specialize portfolio and improve the quality of their products;
- In the pursuit of market share, BFBOF steelmakers should be wary of increasing capacity utilization rates by more than 3% per year, on average, since steeper increases might negate the reductions in capital costs with the increase in variable costs and overcome futures hedging capability;

- Both EAF and BFBOF steelmakers should refrain from reducing capacity utilization so that capital costs stop increasing; and, if ultimately necessary, reduce capacity utilization by no more than by 2% per year, on average, so that hedging futures is more likely to be effective in compensating the additional capital costs;
- Given the upcoming panorama, logistic costs should be observed attentively and its compounding effect along the supply chains should not be underestimated. Hedging this volatility should be the most effective way to avoid pressure on either margins or market share;
- Investments on the research & development of tools and methods for by-product recycling and reuse should continue to be a part of steelmakers' budget allocations;
- Steelmakers actively involved with end-of-life services and resource circularity – whether in the supply- or in the demand-side – will directly or indirectly increase their raw material self-sufficiency and resource ownership retention, accruing more economic value while adding more environmental value.

5.2.2. Recommendations for European policy on Steel

- International anti-dumping measures should continue in force until overcapacity is no longer a capital costs issue for European steelmakers, but nevertheless be made more responsive;
- The European Trade Defense and the European Emission Trading System should (a) consider revising regulations to reduce the burden on steel alloys directly associated with hardware eco-efficiency so as to improve their competitiveness; and (b) consider adjusting how emissions from energy use are transferred from energy suppliers and service providers to the charges and duties on the Steel Industry;

- The European Circular Economy Package should (a) provide steelmakers with more directed support, not only through upstream and downstream sectors; (b) include support for Supply Chain Integration initiatives and holistic chain-wide approaches oriented towards circularity; (c) improve the support for the development of alternative raw material sources and of resource use efficiency; and (d) develop Best Available Technique documentation to spread knowledge and experience on addressing EoL concerns such as remelting losses, recycling of obsolete alloys, hard-to-access steel scrap stocks, copper contamination, and steel scrap collection and separation;
- Thorough revision of the definitions and classifications of EoL steel scraps, as well as of the overlaps, conflicts and overburdening measures that exist between sector-specific and steel-specific regulations, notably in the case of steel scrap transportation, slag recycling, dust collection, off-gas treatment and recovery, and scrap separation;
- Stimulate the transition towards EAF steelmaking directly by putting in force measures that help retain steel scrap in the domestic market to reduce internal costs, as well as indirectly via industrial electricity infrastructure and output;
- Stimulate the development of the secondary metals market, focusing on improving the recovery of specialty alloys and scarce alloying elements, as well as research & development of techniques that reduce steel downcycling;
- Develop a policy for the emerging EoL services that can boost circularity as a whole, e.g. refurbishment, eco-design, servitization and redistribution/reuse;
- Develop a Circularity Catalyst Programme, in which the united efforts of a Closed Loop Supply Chain, Industrial Symbiosis Project or Eco-Industrial Park – notably the intersectoral ones – in increasing circularity rates are either rewarded, unburden their regulation, or compensate some of their emission trading charges.

5.2.3. *Suggestions of future research topics*

- Further investigate the integration of Life Cycle Assessment and System Dynamics and its applicability for both industrial and political decision-making, notably on what regards environmental impact indicators;
- Examine the dynamics of adequate and sustainable material reintroduction into the biosphere and how to model it; from a material's exhaustion in the economy all the way to its successful reintegration into an ecosystem;
- Survey the capital requirements of Supply Chain Integration initiatives in the Steel Industry, as well as case studies on the reverse logistics therein, in order to create a BAT document linking these strategies to the circularity benefits they can create;
- Study how Closed Loop Supply Chains, Industrial Symbiosis Projects and Eco-Industrial Parks contribute to internal and external circularity;
- Model the economic dynamics of the Materials-Energy-Environment nexus, either on macro or micro scale, focusing on key points of action towards sustainability, resilience and circularity;
- Verify the possibility, advantages and disadvantages of having a non-private institution fully fund the creation of a given link in a supply chain in order to increase local resilience and self-sufficiency instead of allowing the operation to rely on external resources;
- Test different renewable sources of energy as potential partial suppliers to EAF steelmaking;
- Explore the feasibility of operating certain links of the Steel Industry's supply chain under a not-for-profit model.

6. REFERENCES

- AALBORG CHARTER. (1994). Charter of European Cities & Towns Towards Sustainability. Denmark: European Conference on Sustainable Cities & Towns.
- ACKOFF, R. L., & GHARAJEDAGHI, J. (1996). Reflections on Systems and their Models. *Systems Research*, 13, 13.
- ACQUAYE, A. A., YAMOA, F. A., & FENG, K. (2015). An integrated environmental and fair-trade labelling scheme for product supply chains. *Journal of Production Economics*, 11.
- ADEGOLOYE, G.; BEAUCOUR, A. L.; ORTOLA, S.; NOUMOWE, A. (2016). Mineralogical composition of EAF slag and stabilized AOD slag aggregates and dimensional stability of slag aggregate concretes. *Construction and Building Materials* 115, pp 171-178. DOI:10.1016/j.conbuildmat.2016.04.036
- ADEME. (2010). Global inventories of the worldwide fleets of refrigerating and air-conditioning equipment in order to determine refrigerant emissions. French agency for the Environment and Energy Management (ADEME).
- AHI, P., & SEARCY, C. (2013). A comparative literature analysis of definitions for green and sustainable supply chain management. *Journal of Cleaner Production*, 15.
- AHVENNIEMI, H.; HUOVILA, A.; PINTO-SEPPÄ, I.; AIRAKSINEN, M. (2017). What are the differences between sustainable and smart cities? *Cities* 60A, pp. 234-245. DOI:10.1016/j.cities.2016.09.009
- AIISI. (2005). Saving one barrel per ton - A New Roadmap for Transformation of Steelmaking Process. American Iron and Steel Institute.
- AIISI. (2007). Steel and national defense - importance of domestically-produced steel to overall national defense objectives and economic and military security. American Iron and Steel Institute.
- AKANDE, A.; CABRAL, P.; GOMES, P.; CASTELEYN, S. (2019). The Lisbon ranking for smart sustainable cities in Europe. *Sustainable Cities and Society* 44, pp. 475-487. DOI:10.1016/j.scs.2018.10.009
- ALBERTÍ, J.; BALAGUERA, A.; BRODHAG, C.; FULLANA-I-PALMER, P. (2017). Towards life cycle sustainability assessment of cities. A review of background knowledge. *Science of The Total Environment* 609, pp. 1049-1063. DOI:10.1016/j.scitotenv.2017.07.179
- ALBIN, S. (1997). Building a system dynamics model. Boston: MIT Press.
- ALHOUTI, S., JOHNSON, C. M., & HOLLOWAY, B. B. (2016). Corporate social responsibility authenticity: Investigating its antecedents and outcomes. *Journal of Business Research*, 7.
- ALLEN, F. W., HALLORAN, P. A., LEITH, A. H., & LINDSAY, M.-C. (2009). Using Material Flow Analysis for Sustainable Materials Management. *Journal of Industrial Ecology*, 11.
- AAM. (2016). Steel import surge and threatens U.S. national security. Alliance for American Manufacturing.
- AMIOT, M. La longue dégringolade de la sidérurgie européenne. *Les Echos*, (2016). Available at: https://www.lesechos.fr/04/04/2016/LesEchos/22163-026-ECH_la-longue-degringolade-de-la-siderurgie-europeenne.htm Accessed on April 4th 2018.
- ANEEL. (2009). Atlas de energia elétrica do Brasil. Agência Nacional de Energia Elétrica, Brasília, Brazil.
- ANSARI, N.; SEIFI, A. (2012). A system dynamics analysis of energy consumption and corrective policies in Iranian iron and steel industry. *Energy* 43-1, pp 334-343. <https://doi.org/10.1016/j.energy.2012.04.020>

- ARCELORMITTAL. (2018). ArcelorMittal completes transaction to acquire Ilva S.p.A. and launches ArcelorMittal Italia. Press release. Published: November 1st, 2018. Available at: <https://corporate.arcelormittal.com/news-and-media/press-releases/2018/nov/01-11-2018a> Accessed on January 8th, 2019.
- ARCELORMITTAL. (2019). Annual financial reports. Available at: <https://corporate.arcelormittal.com/investors/financial-reports/annual-reports> Accessed on January 8th, 2019.
- ARENA, R., BENZONI, L., BANDT, J., & ROMANI, P. M. (1991). *Traité d'économie industrielle*. Paris: Economica.
- ARIK, E.; MUTLU, E. (2014). Chinese steel market in the post-futures period. *Resources Policy* 42-C, pp. 10-17. DOI:10.1016/j.resourpol.2014.08.002
- ARMSTRONG, J., & Green, K. C. (2013). Effects of corporate social responsibility and irresponsibility policies. *Journal of Business Research* , 7.
- ASIF, F. M. A.; RASHID, A.; BIANCHI, C.; NICOLESCU, C. M. (2015). System dynamics models for decision making in product multiple lifecycles. *Resources, Conservation and Recycling* 101, pp 20-33. <https://doi.org/10.1016/j.resconrec.2015.05.002>
- AXELROD, R. (1997). *The Complexity of Cooperation: Agent-based Models of Competition and Collaboration*. New Jersey: Princeton University Press.
- AYRES, R.U.; AYRES, L.W. (2002). *A Handbook of Industrial Ecology*. Edward Elgar, MPG Books: Cheltenham, UK. ISBN 1840645067
- BAAS, L. W.; BOONS, F. A. (2004). An industrial ecology project in practice: exploring the boundaries of decision-making levels in regional industrial systems. *Journal of Cleaner Production* 12-8, pp 1073-1085. <https://doi.org/10.1016/j.jclepro.2004.02.005>
- BAINES, T.S.; LIGHTFOOT, H.W.; BENEDETTINI, O.; KAY, J.M. (2009). The servitization of manufacturing: A review of literature and reflection on future challenges. *Journal of Manufacturing Technology Management* 20-5, pp. 547-567, DOI: 10.1108/17410380910960984
- BASU, A. J., & van ZYL, D. J. (2006). Industrial ecology framework for achieving cleaner production in the mining and minerals industry. *Journal of Cleaner Production*, 6.
- BATABYAL, S.; ROBINSON, R. (2016). Capital Change and Stability when Dividends Convey Signals. *Quarterly Review of Economics and Finance*. DOI:10.1016/j.qref.2016.08.009
- BAUMOL, W. J. (1959). *Business behavior, value and growth*. New York: Harcourt Brace Jovanovich.
- BEACHAM, A., & WILLIAMS, L. J. (1961). *Economics of industrial organization*. London: Pitman.
- BEDDOWS, R. (2014). *Steel 2050 - How steel transformed the world and now must transform itself*. Kingsbridge: Devonian. ISBN 0993038107
- BELL, S., MORSE, S., & SHAH, R. A. (2012). Understanding stakeholder participation in research as part of sustainable development. *Journal of Environmental Management*, 9.
- BENEDETTI, M.; CESAROTTI, V.; HOLGADO, M.; INTRONA, V.; MACCHI, M. (2015). A Proposal for Energy Services' Classification Including a Product Service Systems Perspective, *Procedia CIRP* 30. Elsevier B.V.
- BENYUS, J. (1997). *Biomimicry - innovation inspired by nature*. New York: William Morrow & Company.

- BENYUS, J.M. (2002). *Biomimicry: Innovation Inspired by Nature*. Harper Perennial. ISBN 9780060533229
- BHATTACHARYYA, S.; CHOUDHARY, A.; SHANKA, R. (2017). A decision model for a strategic closed-loop supply chain to reclaim End-of-Life Vehicles. *International Journal of Production Economics* 195, pp. 273-286. DOI:10.1016/j.ijpe.2017.10.005
- BIBRI, S.E.; KROGSTIE, J. (2017). Smart sustainable cities of the future: An extensive interdisciplinary literature review. *Sustainable Cities and Society* 31, pp. 183-212. DOI:10.1016/j.scs.2017.02.016
- BINDER, C. R. (2007). From material flow analysis to material flow management. *Journal of Cleaner Production*, 8.
- BINDER, C. R., van der VOET, E., & ROSSELOT, K. S. (2009). Implementing the Results of Material Flow Analysis. *Journal of Industrial Ecology*, 9.
- BIR. (2017). *World Steel Recycling in Figures*. Brussels: Bureau of International Recycling.
- BIR. (2016). *EU-28 Steel Scrap Statistics*. Brussels: Bureau of International Recycling.
- BIR. (2015). *World Steel Recycling in Figures*. Brussels: Bureau of International Recycling.
- BJÖRKMAN, B.; SAMUELSSON, C. (2014). Recycling of Steel. chapter in WORRELL, E.; REUTER, M. *Handbook of Recycling*, Elsevier. ISBN 9780123965066
- BLASS, V., & CORBETT, C. J. (2017). Same Supply Chain, Different Models: Integrating Perspectives from Life Cycle Assessment and Supply Chain Management. *Journal of Industrial Ecology*, 9.
- BLOOMBERG. BDI Baltic Exchange Dry Index (BDIY:IND). Available at: <https://www.bloomberg.com/quote/BDIY:IND> Accessed on January 8th, 2019.
- BOOTH, S. L.; MEADOWS, D. (1995). *The systems thinking playbook*. Chelsea Green Publishing. ISBN 9781603582582
- BOULDING, K.E. (1966). *The Economics of the Coming Spaceship Earth*. Baltimore: Johns Hopkins University Press.
- BOUMANS, M. (2007). *How economists model the world into numbers*. United Kingdom: Taylor Francis.
- BOVEA, M. D.; IBÁÑEZ-FORÉS, V.; PÉREZ-BELIS, V.; QUEMADES-BELTRÁN, P. (2016). Potential reuse of small household waste electrical and electronic equipment: Methodology and case study. *Waste Management* 53. DOI: 10.1016/j.wasman.2016.03.038
- BOWERSOX, D.J.; CLOSS, D.J.; STANK, T.P. (1999). *21st century logistics: making supply chain integration a reality*. Council of Logistics Management Professionals, Oak Brook. ISBN 9780965865326
- BOWONDER, B., & MIYAKE, T. (1992). Management of Corporate Innovation: A Case Study from the Nippon Steel Corporation. *Creativity and Innovation Management*, 11.
- BOYD, N.E.; HARRIS, J.H.; LI, B. (2018). An update on speculation and financialization in commodity markets. *Journal of Commodity Markets* 6-4. DOI:10.1016/j.jcomm.2018.05.005
- BOYLE, S. E. (1972). *Industrial organization - an empirical approach*. New York: Holt, Rinehart and Winston.
- BOYT, T.; HARVEY, M. (1997). Classification of industrial services – a model with strategic implications, *Industrial Marketing Management* 26, pp. 291-300.
- BRACQUENE, E.; PEETERS, J.R.; DEWULF, W.; DUFLOU, J.R. (2018). Taking Evolution into Account in a Parametric LCA Model for PV Panels. *Procedia CIRP* 69, pp. 389-394. DOI:10.1016/j.procir.2017.11.103.

- BRANDENBURG, M., GOVINDAN, K., SARKIS, J., & SEURING, S. (2014). Quantitative models for sustainable supply chain management: Developments and directions. *European Journal of Operational Research*, 13.
- BRATT, C., HALLSTEDT, S., ROBERT, K. H., BROMAN, G., & OLDMARK, J. (2011). Assessment of eco-labelling criteria development from a strategic sustainability perspective. *Journal of Cleaner Production*, 7.
- BRAZ, A.C.; MELLO, A.M.; VASCONCELOS GOMES, L.A.; NASCIMENTO, P.T. (2018). The bullwhip effect in closed-loop supply chains: A systematic literature review. *Journal of Cleaner Production* 202, pp. 376-389. DOI:10.1016/j.jclepro.2018.08.042
- BRINGAS, J.E. (2004). *Handbook of Comparative World Steel Standards*. ASTM International. ISBN 0803133626
- BRUGMANN, J. (2009). *Welcome to the Urban Revolution: How Cities Are Changing the World*. Bloomsbury Press. ISBN 9781608190928
- BRUNNER, P. H., & RECHBERGER, H. (2005). *Practical Handbook of Material Flow Analysis*. New York: Lewis Publishers.
- BUCHMAYR, B.; DEGNER, M.; PALKOWSKI, H. (2018). Future Challenges in the Steel Industry and Consequences for Rolling Plant Technologies. *BHM* 163, pp. 76-83. DOI:10.1007/s00501-018-0708-x
- BURCHART-KOROL, D. (2013). Life Cycle Assessment of Steel Production in Poland: A Case Study. *Journal of Cleaner Production* 54, pp 235-243. <https://doi.org/10.1016/j.jclepro.2013.04.031>
- BURCHART-KOROL, D.; KRUCZEK, M. (2015). Water Scarcity Assessment of Steel Production. *Metalurgija* 54, pp 276-278.
- BURDETT, R.; SUDJIC, D. (2011). *Living in the Endless City*. Phaidon Press. ISBN 9780714861180
- BURTON, J.; STORY, V.M.; RADDATS, C.; ZOLKIEWSKI, J. (2017). Overcoming the challenges that hinder new service development by manufacturers with diverse services strategies. *International Journal of Production Economics* 192, pp. 29-39. DOI:10.1016/j.ijpe.2017.01.013
- CABRAL, L. (2000). *Introduction to industrial organization*. MIT Press.
- CANNELLA, S.; BRUCCOLERI, M.; FRAMINAN, J.M. (2016). Closed-loop supply chains: What reverse logistics factors influence performance? *Intern. Journal of Production Economics* 175, pp.35-49. DOI:10.1016/j.ijpe.2016.01.012
- CAPRA, F.; LUISI, P. L. (2014). *The systems view of life - a unifying vision*. Cambridge: Cambridge University Press. ISBN 1107011361
- CARDOSO, S.R.; BARBOSA-PÓVOA, A.P.; RELVAS, S. Design and planning of supply chains with integration of reverse logistics activities under demand uncertainty. *European Journal of Operational Research* 226-3, pp. 436-451, 2013. DOI:10.1016/j.ejor.2012.11.035
- CARLTON, D. W., & Perloff, J. M. (2008). *Industrial Economics*. Brussels: De Boeck.
- CASTI, J. (1997). *Would-Be Worlds: How Simulation Is Changing the World of Science*. New York: John Wiley & Sons.
- CEDED. (2017). *Material Flows of the Home Appliance Industry*. European Committee of Domestic Equipment Manufacturers.

- CEPS. (2013). *Assessment of Cumulative Cost Impact for The Steel Industry*. Centre for European Policy Studies. Brussels, CEPS.
- CERFONTAINE, C. (2014). *Combined mobility: Public transport in synergy with car-sharing, cycling, taxis, etc., a smart way forward*. 5th UITP Combined Mobility Workshop, 30. Hannover, Germany.
- CERÓN-PALMA, I.; SANYÉ-MENGUAL, E.; OLIVER-SOLÀ, J.; MONTERO, J.-I.; PONCE-CABALLERO, C.; RIERADEVALL, J. (2013). *Towards a green sustainable strategy for social neighborhoods in Latin America: Case from social housing in Merida, Yucatan, Mexico*. *Habitat International*, 38, 47–56. DOI:10.1016/j.habitatint.2012.09.008
- CHAALLAL, O., NOLLET, M. J., & PERRATON, D. (1998). *Shear Strengthening of RC Beams by Externally Bonded Side CFRP Strips*. *Journal of Composites for Construction*, 13.
- CHANDRASEKHAR, G. (2017). *Will India be the next China in steel consumption?* The Hindu Business Line. Available at: <http://www.thehindubusinessline.com/markets/commodities/will-india-be-the-next-china-in-steel-consumption/article9916954.ece> Accessed on October 20th, 2018.
- CHEVALIER, J. (1995). *L'économie industrielle des stratégies d'entreprises*. Paris: Montchrestien. ISBN 978-2-7076-1211-3
- CHEVALIER, J.-M. (1995). *L'économie industrielle des stratégies d'entreprises*. Paris: Montchrestien.
- CHIN, M. K., TREVINO, L., & HAMBRICK, D. (2013). *Political Ideologies of CEOs: The Influence of Executives' Values on Corporate Social Responsibility*. Sage Johnson Cornell University, 9.
- CLARKE, R., & TONY, M. (1987). *The economics of the firm*. Oxford: Basil Blackwell.
- CLENOW, A. (2013). *Following the Trend: Diversified Managed Futures Trading*. Wiley. ISBN 9781118410851
- CLIFT, R. (1993). *Life cycle assessment and ecolabelling*. *Journal of Cleaner Production*, 4.
- COASE, R. H. (1937). *The nature of the firm*. Paris: Economica.
- COASTS, E.; BENTON D. (2015). *Unemployment and the circular economy in Europe: A study of opportunities in Italy, Poland and Germany*, Green Alliance. ISBN 9781909980570
- COHEN, S., & ROUSSEL, J. (2013). *Strategic supply chain management - the five disciplines for top performance*. New York: McGraw Hill.
- COHEN-ROSENTHAL, E. (2004). *Making sense out of industrial ecology: a framework for analysis and action*. *Journal of Cleaner Production* 12-8, pp 1111-1123. <https://doi.org/10.1016/j.jclepro.2004.02.009>
- COMMONER, B. (1971). *The Closing Circle: Nature, Man and Technology*. New York: Bantan Books. ISBN 9780394423500
- COOMBS, R.; MILES, I. (2000). *Innovation, measurement and services: the new problematique*. Boston: Kluwer Academics.
- COOPER, D. R.; SKELTON, A. C. H.; MOYNIHAN, M. C.; ALLWOOD, J. M. (2014). *Component level strategies for exploiting the lifespan of steel in products*. *Resources, Conservation and Recycling* 84; pp 24-34. <https://doi.org/10.1016/j.resconrec.2013.11.014>
- COS. (2018). *Circles of Sustainability- Practical tools for creating sustainable cities and communities*. Available at: <https://www.circlesofsustainability.org/cities/> Accessed on: May 5th 2018
- COTTA, A. (1968). *Dictionnaire de science économique*. Mame.
- COYLE, R. G. (1997). *System Dynamics Modelling: a practical approach*. Boston: Chapman and Hall / CRC. ISBN 978-0412617102

- CSI. (2019). Iron & Steel Industry Dividend Information & Trends. CSI Market. Available at: https://csimarket.com/Industry/industry_dividends.php?ind=107 Accessed on January 8th.
- CULLEN, J. M.; ALLWOOD, J. M.; BAMBACH, M.; D. (2012). Mapping the Global Flow of Steel: From Steelmaking to End-Use Goods. *Environmental Science and Technology* 46, pp 13048–13055. DOI:10.1021/es302433p
- CURRAN, M. A.; (2012). *Life Cycle Assessment Handbook: A Guide for Environmentally Sustainable Products*. Beverly: Wiley-Scrivener. ISBN 978-1-118-09972-8
- CYERT, R., & MARCH, J. G. (1964). *A behavioral theory of the firm*. New Jersey: Prentice Hall.
- DADDI, T.; NUCCI, B.; IRALDO, F. (2017). Using Life Cycle Assessment (LCA) to measure the environmental benefits of industrial symbiosis in an industrial cluster of SMEs. *Journal of Cleaner Production* 147, pp 157-164. <https://doi.org/10.1016/j.jclepro.2017.01.090>
- D'COSTA, A. P. (1999). *The global restructuring of the steel industry - innovations, institutions and industrial change*. Oxon: Routledge. ISBN 0415148278
- DE JONG, M.; JOSS, S.; SCHRAVEN, D.; ZHAN, C.; WEIJNEN, M. (2015), Sustainable-smart-resilient-low carbon-eco-knowledge cities; making sense of a multitude of concepts promoting sustainable urbanization. *Journal of Cleaner Production* 109, pp. 25-38. DOI: 10.1016/j.jclepro.2015.02.004
- DEMAILLY, D.; QUIRION P. (2008). European Emission Trading Scheme and Competitiveness: A case study on the iron and steel industry. *Energy Economics* 30-4, pp. 2009-2027.
- DESPEISSE, M.; BALL, P. D.; LEVERS, A.; EVANS, S. (2012). Industrial ecology at factory level – a conceptual model. *Journal of Cleaner Production* 31, pp 30-39. <https://doi.org/10.1016/j.jclepro.2012.02.027>
- di PRISCO, M., COLOMBO, M., & DOZIO, D. (2013). Fiber-reinforced concrete in fib Model: principles, models and test validation. *Structural Concrete*, 8.
- DIENER, D. L.; TILLMAN, A. (2016). Scrapping steel components for recycling, isn't that good enough? Seeking improvements in automotive component end-of-life. *Resources Conservation and Recycling* 110, pp. 48-60. DOI:10.1016/j.resconrec.2016.03.001
- DIEZ, J. M.; LOPEZ-LAMBAS, M. E.; GONZALO, H.; ROJO, M.; GARCIA-MARTINEZ, A. (2018). Methodology for assessing the cost effectiveness of Sustainable Urban Mobility Plans (SUMPs). The case of the city of Burgos. *Journal of Transport Geography*, 68, 22–30. DOI:10.1016/j.jtrangeo.2018.02.006
- DINDARIAN, A.; GIBSON A. P. (2011). Reuse of EEE/WEEE in UK: Review on functionality of EEE/WEEE at the point of disposal. *Sustainable Systems and Technology Conference*. DOI:10.1109/ISSST.2011.5936867
- DÜES, C. M., TAN, K. H., & LIM, M. (2013). Green as the new Lean: how to use Lean practices as a catalyst to greening your supply chain. *Journal of Cleaner Production*, 7.
- DUNANT, C.F.; DREWNIOK, M.P.; SANSOM, M.; CORBEY, S.; CULLEN, J.M., ALLWOOD, J.M. (2018). Options to make steel reuse profitable: An analysis of cost and risk distribution across the UK construction value chain. *Journal of Cleaner Production* 183, pp. 102-111. DOI:10.1016/j.jclepro.2018.02.141
- DUVIGNEAUD P., DENAYER DE SMET S. (1977), « L'écosystème URBS, l'écosystème urbain bruxellois », *Scope*, p. 581 – 599.
- EARL, G., & CLIFT, R. (1999). Stakeholder value analysis: a methodology for integrating stakeholder values into corporate environmental investment decisions. *Business Strategy and the Environment*, 13.

- EC. (2012a). A Competitiveness Proofing Toolkit for use in Impact Assessments. SEC(2012)91. Brussels: European Commission. Available at: http://ec.europa.eu/smart-regulation/impact/key_docs/docs/sec_2012_0091_en.pdf
- EC. (2012b). CARS 2020: Action Plan for a competitive and sustainable automotive industry in Europe. COM(2012)636. Brussels: European Commission. Available at: <https://eur-lex.europa.eu/LexUriServ/LexUriServ.do?uri=COM:2012:0636:FIN:EN:PDF>
- EC. (2018a). Commission Staff Working Document on Measuring progress towards circular economy in the European Union – Key indicators for a monitoring framework. SWD(2018)17. Strasbourg: European Commission. Available at: <https://eur-lex.europa.eu/legal-content/EN/TXT/?uri=CELEX:52018SC0017>
- EC. (2018b). Communication from the Commission to the European Parliament, the Council, the European Economic and Social Committee and the Committee of the Regions on a monitoring framework for the circular economy. COM(2018)29. Strasbourg: European Commission. Available at: <https://eur-lex.europa.eu/legal-content/EN/TXT/?uri=COM%3A2018%3A29%3AFIN>
- EC. (2015a). Communication from the Commission to the European Parliament, the Council, the European Economic and Social Committee and the Committee of the Regions on Closing the loop - An EU action plan for the Circular Economy. COM(2015)614. Brussels, European Commission. Available at: <https://eur-lex.europa.eu/legal-content/EN/TXT/?uri=CELEX:52015DC0614>
- EC. (2014b). Communication from the Commission to the European Parliament, the Council, the European Economic and Social Committee and the Committee of the Regions on the Green Action Plan for SMEs Enabling SMEs to turn environmental challenges into business opportunities. COM(2014)440. Brussels: European Commission. Available at: <https://eur-lex.europa.eu/legal-content/EN/TXT/?uri=CELEX:52014DC0440>
- EC. (2008). Communication from the Commission to the European Parliament, the Council, the European Economic and Social Committee and the Committee of the Regions Public procurement for a better environment. SEC(2008)2124/2125/2126, COM(2008)400. Brussels: European Commission. Available at: <https://eur-lex.europa.eu/legal-content/EN/TXT/?uri=CELEX:52008DC0400>
- EC. (2013b). Communication from the commission to the parliament, the council, the European economic and social committee and the committee of regions: Action Plan for a competitive and sustainable steel industry in Europe. COM(2013) 407. Strasbourg: European Commission. Available at: <https://eur-lex.europa.eu/legal-content/EN/TXT/?uri=celex%3A52013DC0407>
- EC. (2015b). Fact Sheet on Circular Economy Package: Questions & Answers. Brussels: European Commission. Available at: http://europa.eu/rapid/press-release_MEMO-15-6204_en.htm
- EC. (2010). ILCD Handbook: General guide for Life Cycle Assessment - Detailed guidance. Luxembourg: Joint Research Centre - Institute for Environment and Sustainability.
- EC. (2013a). Integrated Pollution Prevention and Control (IPPC) Reference Document on Best Available Techniques for Iron and Steel Production. Brussels: Joint Research Center.
- EC. (2001). Integrated Pollution Prevention and Control (IPPC) Reference Document on Best Available Techniques in the Ferrous Metals Processing Industry. Brussels: Joint Research Center.
- EC. (2012). Manifesto for a resource-efficient Europe. Brussels: European Commission. Available at: http://europa.eu/rapid/press-release_MEMO-12-989_en.htm

- EC. (2017). Report from the Commission to the European Parliament, the Council, the European Economic and Social Committee and the Committee of the Regions on the implementation of the Circular Economy Action Plan. COM(2017)33. Brussels: European Commission.
- EC. (2014a). State of play on implementation of the Commission Communication Action Plan for a competitive and sustainable steel industry in Europe. SWD(2014)215. Brussels: European Commission.
- EC (2012c). Strategy for the sustainable competitiveness of the construction sector and its enterprises. COM(2012)433. Brussels: European Commission. Available at: <https://ec.europa.eu/transparency/regdoc/rep/1/2012/EN/1-2012-433-EN-F1-1.Pdf>
- EC (2017). Study on the review of the list of critical raw materials. Luxembourg: Directorate-General for Internal Market, Industry, Entrepreneurship and SMEs.
- EC (2017a). The future of European steel: innovation and sustainability in a competitive world and EU circular economy. Brussels: Directorate-General for Research and Innovation.
- EC. (2018). On a Monitoring Framework for the Circular Economy. Communication from the Commission to the European Parliament, Strasbourg.
- ECKELMAN, M. J.; CIACCI, L.; KAVLAK, G.; NUSS, P.; RECK, B. K.; GRAEDEL, T.E. (2014). Life cycle carbon benefits of aerospace alloy recycling. *Journal of Cleaner Production* 80, pp. 38-45. <https://doi.org/10.1016/j.jclepro.2014.05.039>
- ECO3E (2018). Eco-design guide of WEEE compliance schemes. Product database. Available at: <http://eco3e.eu/en/ressources/eco-products/> Accessed on: September 28th 2018.
- EESC. (2016). The Circular Economy: Beneficial for All - The Threefold Challenge: Climate Change, Competitiveness & Dependence on Raw Materials. Brussels: European Economic and Social Committee, Employers' Group.
- EHRENFELD, J. R. (1997). Industrial ecology: A framework for product and process design. *Journal of Cleaner Production* 5-1, pp 87-95. [https://doi.org/10.1016/S0959-6526\(97\)00015-2](https://doi.org/10.1016/S0959-6526(97)00015-2)
- EHRENFELD, J. R. (2004). Industrial ecology: a new field or only a metaphor? *Journal of Cleaner Production* 12-8, pp 825-831. <https://doi.org/10.1016/j.jclepro.2004.02.003>
- ELSAWAH, S., GUILLAUME, J. H., FILATOVA, T., ROOK, J., & JAKEMAN, A. J. (2015). A methodology for eliciting, representing, and analyzing stakeholder knowledge for decision making on complex socio-ecological systems: From cognitive maps to agent-based models. *Journal of Environmental Management*, 16.
- EMF. (2017). Circular Economy System Diagram. Retrieved February 07, 2017, from Ellen McArthur Foundation: <https://www.ellenmacarthurfoundation.org/circular-economy/interactive-diagram>
- EMF. (2014a). A new dynamic - effective business in a circular economy. Cowes: Ellen McArthur Foundation.
- EMF. (2015b). Delivering the circular economy - a toolkit for policymakers. Cowes: Ellen McArthur Foundation.
- EMF. (2015a). Growth within - a circular economy vision for a competitive Europe. Cowes: Ellen McArthur Foundation.
- EMF. (2016). Intelligent assets - unlocking the circular economy potential. Cowes: Ellen McArthur Foundation.
- EMF. (2017). The circular economy - a wealth of flows. Cowes: Ellen McArthur Foundation.
- EMF. (2014b). Towards the circular economy - accelerating the scale-up across global supply chains. Cowes: Ellen McArthur Foundation.

- EMF. (2012). Towards the circular economy - an economic and business rationale for an accelerated transition. Cowes: Ellen McArthur Foundation.
- EMF. (2013). Towards the circular economy - opportunities for the consumer goods sector. Cowes: Ellen McArthur Foundation.
- ENGWALL, L. (1973). Models of industrial structure. Lexington: Lexington Books.
- EP. (2000b). Directive 2000/53/EC of the European Parliament and of the Council of 18 September 2000 on end-of life vehicles - Commission Statements. Brussels: Official Journal of the European Union. Available at: <https://eur-lex.europa.eu/legal-content/EN/TXT/?uri=CELEX%3A32000L0053>
- EP. (2000a). Directive 2000/60/EC of the European Parliament and of the Council of 23 October 2000 establishing a framework for Community action in the field of water policy. Brussels: Official Journal of the European Union. Available at: <https://eur-lex.europa.eu/legal-content/EN/TXT/?uri=CELEX:32000L0060>
- EP. (2006a). Directive 2006/21/EC of the European Parliament and of the Council of 15 March 2006 on the management of waste from extractive industries and amending Directive 2004/35/EC - Statement by the European Parliament, the Council and the Commission. Brussels: Official Journal of the European Union. Available at: <https://eur-lex.europa.eu/legal-content/EN/TXT/?uri=CELEX%3A32006L0021>
- EP. (2008a). Directive 2008/50/EC of the European Parliament and of the Council of 21 May 2008 on ambient air quality and cleaner air for Europe. Brussels: Official Journal of the European Union. Available at: <https://eur-lex.europa.eu/legal-content/EN/ALL/?uri=celex:32008L0050>
- EP. (2008b). Directive 2008/98/EC of the European Parliament and of the Council of 19 November 2008 on waste and repealing certain Directives. Brussels: Official Journal of the European Union. Available at: <https://eur-lex.europa.eu/legal-content/EN/ALL/?uri=CELEX%3A32008L0098>
- EP. (2009). Directive 2009/125/EC of the European Parliament and of the Council of 21 October 2009 establishing a framework for the setting of eco-design requirements for energy-related products. Brussels: Official Journal of the European Union. Available at: <https://eur-lex.europa.eu/legal-content/EN/ALL/?uri=CELEX%3A32009L0125>
- EP. (2010). Directive 2010/75/EU of the European Parliament and of the Council of 24 November 2010 on industrial emissions (integrated pollution prevention and control). Brussels: Official Journal of the European Union. Available at: <https://eur-lex.europa.eu/legal-content/EN/TXT/?uri=celex%3A32010L0075>
- EP. (2011). Directive 2011/92/EU of the European Parliament and of the Council of 13 December 2011 on the assessment of the effects of certain public and private projects on the environment. Brussels: Official Journal of the European Union. Available at: <https://eur-lex.europa.eu/legal-content/en/TXT/?uri=CELEX:32011L0092>
- EP. (1994). European Parliament and Council Directive 94/62/EC of 20 December 1994 on packaging and packaging waste. Brussels: Official Journal of the European Union. Available at: <https://eur-lex.europa.eu/legal-content/EN/TXT/?uri=CELEX:01994L0062-20150526>
- EP. (2006c). Regulation (EC) No 1013/2006 of the European Parliament and of the Council of 14 June 2006 on shipments of waste. Brussels: Official Journal of the European Union. Available at: <https://eur-lex.europa.eu/legal-content/EN/ALL/?uri=celex%3A32006R1013>

- EP. (2006b). Regulation (EC) No 1907/2006 of the European Parliament and of the Council of 18 December 2006 concerning the Registration, Evaluation, Authorization and Restriction of Chemicals (REACH). Brussels: Official Journal of the European Union. Available at: <https://eur-lex.europa.eu/legal-content/EN/ALL/?uri=CELEX%3A32006R1907>
- EPSTEIN, M., & Roy, M.J. (1998). Managing corporate environmental performance - A multinational perspective. *European Management Journal*, 12.
- ERKMAN, S. (1997). Industrial ecology: An historical view. *Journal of Cleaner Production* 5-1, pp 1-10. [https://doi.org/10.1016/S0959-6526\(97\)00003-6](https://doi.org/10.1016/S0959-6526(97)00003-6)
- EU. (1999). Council Directive 1999/31/EC of 26 April 1999 on the landfill of waste. Brussels: The Council of The European Union. Available at: <https://eur-lex.europa.eu/legal-content/EN/TXT/?uri=celex%3A31999L0031>
- EU. (2011a). Council Regulation (EU) No 333/2011 of 31 March 2011 establishing criteria determining when certain types of scrap metal cease to be waste under Directive 2008/98/EC of the European Parliament and of the Council. Brussels: The Council of The European Union. Available at: <https://eur-lex.europa.eu/legal-content/EN/TXT/?uri=CELEX%3A32011R0333>
- EU. (2011). Improved EAF Process Control Using On-Line Offgas Analysis – OFFGAS. Luxembourg: European Union.
- EUROFER. (2014). Impact Assessment on the EU Steel Sector. The European Steel Association.
- EUROFER. (2017). Steel, the Backbone of Sustainability in Europe. The European Steel Association, Brussels: EUROFER.
- EUROFER. (2017a). European Steel in Figures. The European Steel Association, Brussels: EUROFER.
- EUROFER. (2015). Open letter to the European Commission: Circular Economy from 12 EU resource manufacturing industries. The European Steel Association, Brussels: EUROFER.
- EUROFER. (2017b). Steel, the Backbone of Sustainability in Europe. The European Steel Association, Brussels: EUROFER.
- EUROSLAG. (2018). European Association of Metallurgical Slag Producers. Available at: <https://www.euroslag.com> (accessed: 05 September 2018).
- EUROSTAT. (2018a). Data reporting on quantity, hazardousness and shipments of waste. Available at: <http://ec.europa.eu/eurostat/web/waste/data> (accessed: 05 September 2018a).
- EUROSTAT. (2009). Iron and steel production and processing statistics, NACE Rev. 1.1. Statistics Explained Database. Available at: https://ec.europa.eu/eurostat/statistics-explained/index.php/Archive:Iron_and_steel_production_and_processing_statistics_-_NACE_Rev._1.1 (accessed: 05 September 2018).
- EUROSTAT. (2018b). Manufacturing statistics - NACE Rev. 2. Statistics Explained Database. Available at: https://ec.europa.eu/eurostat/statistics-explained/index.php?title=Manufacturing_statistics_-_NACE_Rev._2 (accessed: 05 September 2018).
- EUROSTAT. (2017). Mining and quarrying statistics - NACE Rev. 2. Statistics Explained Database. Available at: https://ec.europa.eu/eurostat/statistics-explained/index.php?title=Mining_and_quarrying_statistics_-_NACE_Rev._2 (accessed: 05 September 2018).

- EY. (2014). Global steel 2014 - Planning to profit from opportunity and preparing for future demand. ERNST & YOUNG.
- EY. (2015). Global steel 2015/16 - Globalize or customize - finding the right balance. ERNST & YOUNG.
- EY. (2017). The rising threat of substitution: mining & metals. EY Industries - Mining and Metals. Retrieved February 12, 2017 at <http://www.ey.com/gl/en/industries/mining---metals/the-rising-threat-of-substitution--mining-and-metals>
- FAHIMINA, B., SARKIS, J., & DAVARZANI, H. (2015). Green supply chain management: A review and bibliometric analysis. *International Journal of Production Economics*, 13.
- FAHIMINA, B., SARKIS, J., & ESHRAGH, A. (2015). A tradeoff model for green supply chain planning: A leanness-versus-greenness analysis. *Omega*, 17.
- FERRAO, P.; FERNANDEZ, J.E. (2013). *Sustainable Urban Metabolism*. MIT Press. ISBN 9780262019361
- FERREIRA, H.; LEITE, M. P. G. (2015). A Life Cycle Assessment study of iron ore mining. *Journal of Cleaner Production* 108A, pp 1081-1091. DOI:10.1016/j.jclepro.2015.05.140
- FERREIRA, J. V. (2004). *Análise do ciclo de vida dos produtos*. PhD Thesis. Lisbon: Instituto Politécnico de Viseu.
- FICKLING, D. (2017). The China Steel Trap. *Bloomberg Businessweek*. Available at: <https://www.bloomberg.com/news/articles/2017-06-22/trump-s-china-steel-trap-breaks-an-iron-law-of-economics> Accessed on: June 21st 2018.
- FINNVEDEN, G.; HAUSCHILD, M.Z.; EKVALL, T.; GUINÉE, J.; HEIJUNGS, R.; HELLWEG, S.; KOEHLER, A.; PENNINGTON, D.; SUH, S. (2009). Recent developments in Life Cycle Assessment. *Journal of Environmental Management* 91-1, pp 1-21. DOI: 10.1016/j.jenvman.2009.06.018
- FISCHER-KOWALSKI, M., & HÜTTLER, W. (1999). Society's Metabolism - The Intellectual History of Materials Flow Analysis. *Journal of Industrial Ecology*, 16.
- FLETCHER, A., GUTHRIE, J., STEANE, P., ROOS, G., & PIKE, S. (2003). Mapping stakeholder perceptions for a third sector organization. *Journal of Intellectual Capital*, 22.
- FORRESTER, J. W. (1971). *World dynamics* (2nd ed.). Boston: MIT Press.
- FORRESTER, J. W. (1962). *Industrial Dynamics*. Boston: MIT Press. ISBN 1614275335
- FORRESTER, J. W. (1969). *Urban dynamics*. Boston: MIT Press. ISBN 1883823390
- FRAMBACH, R. T.; WELS-LIPS, I.; GÜNDLACH, A. (1997). Proactive product service strategies – an application in the European health market. *Industrial Marketing Management* 26-4, pp. 341-352.
- FREEMAN, R. E. 1984. *Strategic management: A stakeholder approach*. Boston: Pitman.
- FROSCH, R. A., & GALLOPOULOS, N. E. (1989). Strategies for manufacturing. *Scientific American*, 12.
- GARDNER, D.T.; BUZACOTT, J.A. (1999). Hedging against uncertainty in new technology development: the case of direct steelmaking *IEEE Transactions on Engineering Management* 46-2, pp. 177-189. DOI:10.1109/17.759146
- GAUR, J.; SUBRAMONIAM, R.; GOVINDAN, K.; HUISINGH, D. (2017). Closed-Loop Supply Chain management: From conceptual to an action-oriented framework on core acquisition. *Journal of Cleaner Production* 167, pp. 1415-1424. DOI:10.1016/j.jclepro.2016.12.098

- GEISSDOERFER, M.; SAVAGET, P.; BOCKEN, N. M. P.; HULTNIK, E. J. (2017). The Circular Economy – A new sustainability paradigm? *Journal of Cleaner Production* 143, pp 757-768. DOI:10.1016/j.jclepro.2016.12.048
- GEORGESCU-ROEGEN, N. (1978). *Bioeconomics*. Routledge: New York.
- GHISELLINI, P.; CIALANI, C.; ULGIATI, S. (2015). A Review on Circular Economy: The Expected transition to a Balanced Interplay of Environmental and Economic Systems, *Journal of Cleaner Production* 114, pp 11-32. DOI: 10.1016/j.jclepro.2015.09.007
- GIBBS, D.; DEUTZ, P. (2007). Reflections on implementing industrial ecology through eco-industrial park development. *Journal of Cleaner Production* 15-17, pp. 1683-1695. <https://doi.org/10.1016/j.jclepro.2007.02.003>
- GIURCO, D., LITTLEBOY, A., BOYLE, T., FYFE, J., & WHITE, S. (2014). Circular Economy: Questions for Responsible Minerals, Additive Manufacturing and Recycling of Metals. *Resources*, 22.
- GOLROUBARY, S.R.; ZAHRAEE, S.M. (2015). System dynamics model for optimizing the recycling and collection of waste material in a closed-loop supply chain. *Simulation Modelling Practice and Theory* 53, pp. 88-102. DOI:10.1016/j.simpat.2015.02.001
- GONZALES-HERNANDEZ, A.; PAOLI, L.; & CULLEN, J. M. (2018). How resource-efficient is the global steel industry? *Resources Conservation and Recycling* 133, pp. 132–145. DOI:10.1016/j.resconrec.2018.02.008
- GOVINDAN, K. (2016). Embedding Sustainability Dynamics in Supply Chain Relationship Management and Governance Structures: Introduction, Review and opportunities. *Journal of Cleaner Production*, 34.
- GOVINDAN, K.; SOLEIMANI, H. (2016). A review of Reverse Logistics and Closed-Loop Supply Chains: A *Journal of Cleaner Production Focus*. *Journal of Cleaner Production* 142-1, pp. 371-384. DOI:10.1016/j.jclepro.2016.03.126
- GRAEDEL, T.E.; ALLENBY, B.R. (1995). *Industrial Ecology*. Pearson: London.
- GREENPEACE (2017). Beautiful China: Beijing starts the biggest shutdown of steel factories in history. Published: October 10th, 2017. Available at: <https://unearthed.greenpeace.org/2017/10/30/china-starts-the-biggest-shutdown-of-steel-factories-in-history/> Accessed on January 8th, 2019.
- GREEN, M.H.; DAVIES, P.; NG, I.C.L. (2017). Two strands of servitization: A thematic analysis of traditional and customer co-created servitization and future research directions. *International Journal of Production Economics* 192, pp. 40-53. DOI:10.1016/j.ijpe.2017.01.009
- GREGSON, N.; CRANG, N.; FULLER, S.; HOLMES, H. (2015). Interrogating the circular economy: the moral economy of resource recovery in the EU. *Economy and Society* 44, pp. 218-243. DOI:10.1080/03085147.2015.1013353
- GREINER, R. (2013). High strength steels for hydropower plants – a conference bringing together specialists from many disciplines. *Steel Construction – Design and Research*, editorial. DOI: 10.1002/stco.201310041
- GROBER, U. (2007). Deep roots - A conceptual history of sustainable development. *Wissenschaftszentrum Berlin für Sozialforschung (WZB)*.
- GU, Y., XU, J., KELLER, A. A., YUAN, D., LI, Y., ZHANG, B. (2015). Calculation of water footprint of the iron and steel industry: a case study in Eastern China. *Journal of Cleaner Production*, 8.

- GUNASEKARAN, A.; NGAI, E.W. (2004). Information systems in supply chain integration and management. *European Journal of Operational Research* 159-2, pp. 269-295. DOI:10.1016/j.ejor.2003.08.016
- HAAS, W.; KRAUSMANN, F.; WIEDENHOFER, D.; HEINZ, M. (2015). How Circular is the Global Economy? An Assessment of Material Flows, Waste Production, and Recycling in the European Union and the World in 2005. *Journal of Industrial Ecology* 19-5, pp. 765-777. DOI:10.1111/jiec.12244
- HAASE, M.; ZIMMERMANN, Y.S.; ZIMMERMANN, H. (2016). The impact of speculation on commodity futures markets – A review off the findings of 100 empirical studies. *Journal of Commodity Markets* 3, pp.1-15. DOI:10.1016/j.jcomm.2016.07.006
- HAFEEZ, K.; GRIFFITHS, M.; GRIFFITHS, C.; NAIM, M. M. (1996). Systems design of a two-echelon steel industry supply chain. *International Journal Production Economics* 45-1, pp. 121-130. [https://doi.org/10.1016/0925-5273\(96\)00052-7](https://doi.org/10.1016/0925-5273(96)00052-7)
- HAGELÜKEN, C.; LEE-SHIN, J.U.; CARPENTIER, A.; HERON, C. (2016). The EU Circular Economy and its Relevance to Metal Recycling. *Recycling* 2, pp. 242-253. DOI: 10.3390/recycling1020242
- HALE, M. (1996). Ecolabelling and cleaner production: principles, problems, education and training in relation to the adoption of environmentally sound production processes. *Journal of Cleaner Production*, 10.
- HALOG, A.; MANIK, Y. (2011). Advancing Integrated Systems Modelling Framework for Life Cycle Sustainability Assessment. *Sustainability* 3, pp. 469-499. DOI:10.3390/su3020469
- HAMWI, M.; LIZARRALDE, I.; LEGARDEUR, J.; TECHNOPOLE, I.; BIRDART, F. (2016). Energy Product Service Systems as Core Element of Energy Transition in the Household Sector: The Greenplay Project. 22nd International Sustainable Development Research Society Conference.
- HARALDSON, H. V. (2004). Introduction to system thinking and casual loop diagram. Lund: KFS AB.
- HART, O. (1995). *Firms, contracts and financial structure*. Oxford: Oxford University Press.
- HATAYAMA, H., DAIGO, I., MATSUNO, Y., & ADACHI, Y. (2010). Outlook of the World Steel Cycle Based on the Stock and Flow Dynamics. *Environmental Science and Technology*, 16.
- HAUPT, M.; VADENBO, C.; ZELTNER, C.; HELLWEG, S. (2016). Influence of Input-Scrap Quality on the Environmental Impact of Secondary Steel Production. *Journal of Industrial Ecology* 21-2, pp. 391-401. DOI: 10.1111/jiec.12439
- HEIN, A. M., JANKOVIC, M., FENG, W., FAREL, R., YUNE, J., & YANNOU, B. (2017). Stakeholder Power in Industrial Symbioses: A Stakeholder Value Network Approach. *Journal of Cleaner Production*, 11.
- HERVA, M., & ROCA, E. (2013). Review of combined approaches and multi-criteria analysis for corporate environmental evaluation. *Journal of Cleaner Production*, 16.
- HEY, Y. (2017). Supply risk sharing in a closed-loop supply chain. *Intern. Journal of Production Economics* 183-A, pp. 39-52. DOI:10.1016/j.ijpe.2016.10.012
- HOSODA, T.; DISNEY, S.M. (2018). A unified theory of the dynamics of closed-loop supply chains. *European Journal of Operational Research* 269-1, pp. 313-326. DOI:10.1016/j.ejor.2017.07.020
- HUANG, C.-L., VAUSE, J., MA, H.-W., & YU, C.-P. (2012). Using material/substance flow analysis to support sustainable development assessment: A literature review and outlook. *Resources, Conservation and Recycling*, 12.
- HUANG, X., SCHRODER, B., & STEFFENS, P. (1999). The Chinese steel industry in transition: industry perspective on innovation policy. *R&D Management*, 9.

- HUGOS, M. H. (2011). Essentials of supply chain management. New Jersey: John Wiley & Sons.
- HUIJBREGTS, M. (2002). Uncertainty and variability in environmental life-cycle assessment. *The International Journal of Life Cycle Assessment* 7, p. 173. DOI: 10.1007/BF02994052
- HUNT, R.; FRANKLIN, E. (1996). How it came about - Personal reflections on the origin and the development of LCA in the USA. *International Journal of Life Cycle Assessment* 1-1, pp.4-7.
- IEA. (2014). Energy use in the steel industry - Tracking Industrial Energy Efficiency and CO2 Emissions. International Energy Agency.
- IEA. (2017). Projections: Energy Policies of IEA Countries online data service. Available at: <https://www.iea.org/classicstats/relateddatabases/projectionsenergypoliciesofieacountries/> Accessed on: April 21st 2018.
- IEEFA. (2018). New Oil Price Volatility Will Help Drive Transition from Fossil Fuels. Institute for Energy Economics and Financial Analysis.
- IETD. (2018). Electric Arc Furnaces Technologies & Measures. Institute for Industrial Productivity – Industrial Efficiency Technology Database. Available at: <http://ietd.iipnetwork.org/content/electric-arc-furnace> (accessed: 5 May 2018)
- IFM. (2017). Porter's Value Chain. Retrieved February 07, 2017, from Institute for Manufacturing, University of Cambridge: <http://www.ifm.eng.cam.ac.uk/research/dstools/value-chain/>
- IFU. (2011). Material Flow Based Process Systems Engineering. Retrieved February 08, 2017, from Know the Flow: <https://www.ifu.com/knowtheflow/2011/material-flow-based-process-systems-engineering/>
- IM. (2019). Iron Ore Monthly Price - US Dollars per Dry Metric Ton. IndexMundi. Available at: <https://www.indexmundi.com/commodities/?commodity=iron-ore> Accessed on January 8th, 2019.
- IMF. (2018). IMFDataMapper, World Economic Outlook October 2018. International Monetary Fund. Available at: <https://www.imf.org/external/datamapper/PCPIPCH@WEO/OEMDC/EEQ/WEO WORLD> Accessed on January 8th, 2019.
- IPTS, I. f., & JRC, E. C. (2003). Energy consumption and CO2 emissions from the world iron and steel industry - Report EUR20686. Brussels: European Commission.
- ISEE Systems. Stella Architect (2018). <https://www.iseesystems.com/store/products/stella-architect.aspx> (accessed: 5 May 2018).
- ISLAM, M.T.; HUDA, N. (2018). Reverse logistics and closed-loop supply chain of Waste Electrical and Electronic Equipment WEEE/E-waste: A comprehensive literature review. *Resources, Conservation & Recycling* 137, pp. 48–75. DOI:10.1016/j.resconrec.2018.05.026
- ISO. (2010). ISO 26000 - Social responsibility. Geneva: International Standardization Organization.
- ISO. (2006). ISO 14044 - Environmental management, Life Cycle Assessment, requirement and orientations. Geneva: International Standardization Organization.
- ISSF. (2015). Stainless steel in solar energy use. International Stainless-Steel Forum. ISBN 978-2-930069-53-1
- JACOBS, F. R., BERRY, W. L., WHYBARK, D. C., & VOLLMANN, T. E. (2011). Manufacturing planning and control for supply chain management. New York: McGraw Hill.
- JAMES, P. (2015). Circles of sustainability, Routledge.

- JAYARAM, J.; TAN, K. (2010). Supply chain integration with third-party logistics providers. *Int. J. Production Economics* 125, pp. 262–271. DOI:10.1016/j.ijpe.2010.02.014
- JENKINS, H., & YAKOVLEVA, N. (2006). Corporate social responsibility in the mining industry: Exploring trends in social and environmental disclosure. *Journal of Cleaner Production*, 13.
- JENSEN, M., & MECKLING, W. (1976). Theory of the firm - managerial behavior, agency costs and capital structure. *Journal of Financial Economics*.
- JOHNSON, J.; RECK, B.K.; WANG, T.; GRAEDEL, T.E. (2008). The energy benefit of stainless-steel recycling. *Energy Policy* 36, pp. 181–192. DOI:10.1016/j.enpol.2007.08.028
- JONES, J. A. (2017). Electric Arc Furnace Steelmaking. Retrieved February 11, 2017, from Steelworks: <http://www.steel.org/making-steel/how-its-made/processes/processes-info/electric-arc-furnace-steelmaking.aspx>
- JONES, J. A. T. (2017). Electric Arc Furnace Steelmaking. Steelworks. <http://www.steel.org/making-steel/how-its-made/processes/processes-info/electric-arc-furnace-steelmaking.aspx> (accessed: 11 February 2017).
- JRC. (2012). Product Environmental Footprint (PEF) Guide. Joint Research Centre - Institute for Environment and Sustainability - European Commission: Ispra. Available at: <http://ec.europa.eu/environment/archives/eusds/pdf/footprint/PEF%20methodology%20final%20draft.pdf>
- JRC. (2010). End-of-waste Criteria for Iron and Steel Scrap: Technical Proposals. Joint Research Centre - Institute for Prospective Technological Studies - European Commission: Sevilla.
- JUNG, S.M. (2015). A study on the reasons for sharp decline on the Baltic exchange dry index in 2008. The Maritime Commons Digital Repository, World Maritime University (WMU).
- KAHLE, L. R.; GUREL-ATAY, E. (2014). *Communicating sustainability for the green economy*. New York: M.E. Sharpe. ISBN 0765636816
- KÄRNÄ, P. (2012). Carbon Footprint of the Raw Materials of an Urban Transit Bus - Case Study: Diesel, Hybrid, Electric and Converted Electric Bus. Lahti University of Applied Sciences, Programme in Environmental Technology, Finland.
- KARNOPP, D. C., MARGOLIS, D. L., & ROSENBERG, R. C. (2006). *System dynamics - modelling and simulation of mechatronic systems*. Chicago: John Wiley & Sons.
- KARNOPP, D. C.; ROSENBERG, R. C. (1975). *System dynamics - a unified approach*. New York: John Wiley and Sons. ISBN 0471459402
- KIBERT, C.J. (2003). Green buildings: an overview of progress. *Journal of Land Use & Environment Law* 19-2, pp. 491–502.
- KISSLING, R.; COUGHLAN, D.; FITZPATRICK, C.; BÖNI, H.; LUEPSCHEN, C.; ANDREW, S.; DICKENSON, J. (2013). Success factors and barriers in re-use of electrical and electronic equipment. *Resources, Conservation and Recycling* 80, pp. 21-31. DOI:10.1016/j.resconrec.2013.07.009
- KOCH-ORVAD, N.; THUESEN, C. (2016). Sustainable Building in Scandinavia: Directions of Innovations for Supporting the Transition. Proceedings of the 32nd Annual ARCOM Conference.
- KOHTAMÄKI, M.; BAINES, T.; RABETINO, R.; BIGDELI, A.Z. (2018). *Practices and Tools for Servitization: Managing Service Transition*. Birmingham, Palgrave Macmillan. ISBN 9783319765167

- KORHONEN, J. (2004). Industrial ecology in the strategic sustainable development model: strategic applications of industrial ecology. *Journal of Cleaner Production* 12-8, pp. 809-823. DOI:10.1016/j.jclepro.2004.02.026
- KOVACS, G. (2008). Corporate environmental responsibility in the supply chain. *Journal of Cleaner Production*, 7.
- KOWALKOWSKI, C.; GEBAUER, H.; OLIVA, R. (2017). Service growth in product firms: Past, present, and future. *Industrial Marketing Management* 60, pp. 82-88. DOI:10.1016/j.indmarman.2016.10.015
- KOZAK, B.; DZIERZAWSKI, J. (2017). Continuous Casting of Steel: Basic Principles. *Steelworks*. <http://www.steel.org/making-steel/how-its-made/processes/processes-info/continuous-casting-of-steel---basic-principles.aspx> (accessed: 11 February 2017).
- KPMG. (2018). Commodity insights bulletin: chromite. KPMG.
- KREMER, G. E., HAAPALA, K., MURAT, A., CHINNAM, R. B., KIM, K.-y., MONPLAISIR, L. (2015). Directions for instilling economic and environmental sustainability across product supply chains. *Journal of Cleaner Production*, 13.
- KULSUM, A. (2012). *Getting to Green: A Sourcebook of Pollution Management Policy Tools for Growth and Competitiveness*. Washington: World Bank.
- KUMAR, S. (1994). Chemical modification of wood. *Wood and Fiber Science*, 11.
- KUNC, M. (2017). *System Dynamics: Soft and Hard Operational Research*. Basingstoke: Palgrave Macmillan. ISBN 978-1-349-95257-1
- KURTZ, L. S. (2012). Stakeholder Analysis. In K. H. Baker, & J. R. Nofsinger, *Socially Responsible Finance and Investing - Financial Institutions, Corporations, Investors, and Activists*. New York: John Wiley & Sons.
- LAY, G. (2014). *Servitization in industry*. Switzerland: Springer.
- LEE, S.-Y., KLASSEN, R. D., FURLAN, A., & VINELLI, A. (2014). The green bullwhip effect: Transferring environmental requirements along a supply chain. *International Journal of Production Economics*, 12.
- LEE, T. H. (2016). The status of corporate social responsibility research in public relations: A content analysis of published articles in eleven scholarly journals from 1980 to 2015. *Public Relations Review*, 17.
- LEED. (2010). *Reference guide for green building design and construction*. U.S. Green Building Council, Washington, D.C.
- LEIGH, M.; XIAOHONG L. (2015). Industrial ecology, industrial symbiosis and supply chain environmental sustainability: a case study of a large UK distributor. *Journal of Cleaner Production* 106, pp. 632-643. <https://doi.org/10.1016/j.jclepro.2014.09.022>
- LEUENBERGER, M.; FRISCHKNECHT, R. (2010). *Life Cycle Assessment of Two Wheel Vehicles*. Uster: ESU-services Ltd.
- LEVENTIS, N., SOTIRIOU, C., ZHANG, G., & RAWASHDEH, A.-M. M. (2002). Nanoengineering Strong Silica Aerogels. *Nano Letters*, 12.
- LEVET, J.-L. (2004). *L'économie industrielle et évolution - les faits face aux théories*. Paris: Economica.
- LEVITT, T. (1969). *The marketing mode – pathways to corporate growth*. New York: McGraw-Hill.
- LEWANDOWSKI, M. (2016). Designing the Business Models for Circular Economy - Towards the Conceptual Framework. *Sustainability* 8, pp. 43-51. DOI:10.3390/su8010043

- LIAO, W.; HEIJUNGS, R.; HUPPES, G. (2012). Thermodynamic analysis of human–environment systems: A review focused on industrial ecology. *Ecological Modelling* 228, pp. 76-88. DOI:10.1016/j.ecolmodel.2012.01.004
- LICHTENSTEIN, J.E. (2017). Five Inconvenient Truths for the Global Steel Industry. *Steel Survival Strategies XXXII*, International Panel, New York.
- LIÈVRE, P., & TCHERNEV, N. (2004). *La logistique entre management et optimisation*. Paris: Lavoisier.
- LIÈVRE, P., LECOUTRE, M., & TRAORÉ, M. K. (2006). *Management de projets*. Paris: Lavoisier.
- LIGHTFOOT, H.; BAINES, T.; SMART, P. (2013). The servitization of manufacturing: A systematic literature review of interdependent trends. *International Journal of Operations & Production Management* 33, pp. 1408-1434.
- LII, P.; KUO, F. (2016). Innovation-oriented supply chain integration for combined competitiveness and firm performance. *Intern. Journal of Production Economics* 174, pp. 142-155. DOI:10.1016/j.ijpe.2016.01.018
- LIPCZYNSKI, J., WILSON, J., & GODDARD, J. (2005). *Industrial organization - competition, strategy, policy*. Essex: Prentice Hall.
- LIU, C.; XIE, Z.; SUN, F.; CHEN, L. (2015). System dynamics analysis on characteristics of iron-flow in sintering process. *Applied Thermal Engineering* 82, pp. 206-211. <https://doi.org/10.1016/j.applthermaleng.2015.02.077>
- LLORACH-MASSANA, P., FARRENY, R., & OLIVIER-SOLÀ, J. (2015). Are Cradle to Cradle certified products environmentally preferable? Analysis from an LCA approach. *Journal of Cleaner Production*, 7.
- LME. (2019). *Market Data Reports and Data*. London Metal Exchange. Available at: <https://www.lme.com/en-GB/Market-Data/Reports-and-data> Accessed on January 8th, 2019.
- LU, Y., & ABEYSEKERA, I. (2014). Stakeholders' power, corporate characteristics, and social and environmental disclosure: evidence from China. *Journal of Cleaner Production*, 10.
- LYLE, J.T. (1994). *Regenerative Design for Sustainable Development*. John Wiley & Sons. ISBN 9780471178439
- MADIAS, J. (2013). *Electric Furnace Steelmaking*. chapter in SESHADRI, S. *Treatise on Process Metallurgy*. Elsevier. ISBN 9780080969879
- MARRIS, R. (1964). *The economic theory of managerial capitalism*. London: Macmillan.
- MARTIN, R. L. (2002). The Virtue Matrix: Calculating the Return on Corporate Responsibility. *Harvard Business Review*, 12.
- MARTINEZ-CONESA, I., SOTO-ACOSTA, P., & PALACIOS-MANZANO, M. (2017). Corporate social responsibility and its effect on innovation and firm performance: An empirical research in SMEs. *Journal of Cleaner Production*, 9.
- MATERIAL ECONOMICS. (2018). *The circular economy – a powerful force for climate mitigation*. Stockholm, Material Economics.
- MATHIEU, V. (2001). Service strategies within the manufacturing sector: Benefits, costs and partnerships. *International Journal of Service Industry Management* 12-5, pp. 451-475.
- MAYER, A.; HAAS, W.; WIEDENHOFER, D.; KRAUSMANN, F.; NUSS, P.; BLENGINI, G.A. (2018). Measuring Progress towards a Circular Economy - A Monitoring Framework for Economy-wide Material Loop Closing in the EU28. *Journal of Industrial Ecology*. DOI:10.1111/jiec.12809

- MAYER, J.; BACHNER, G.; STEININGER, K. W. (2019). Macroeconomic implications of switching to process-emission-free iron and steel production in Europe. *Journal of Cleaner Production* 210, pp. 1517-1533. DOI: 10.1016/j.jclepro.2018.11.118
- McDONOUGH, W.; BRAUNGART, M. (2002). *Cradle to Cradle: Remaking the Way We Make Things*. North Point Press. ISBN 9780865475878
- MCGUFFOG, T. (2016). *Building effective value chains - value and its management*. London: Kogan Page.
- MCWILLIAMS, A., & SIEGEL, D. (2000). Corporate social responsibility and financial performance: correlation or misspecification. *Strategic Management*, 11.
- MCWILLIAMS, A., & SIEGEL, D. (2001). Corporate social responsibility: A theory of the firm perspective. *Academy of Management Review*, 9.
- MEADOWS, D. (1970). *Dynamics of commodity production cycles*. United States: Wright Allen Press.
- MEADOWS, D. (1999). *Leverage points - places to intervene in a system*. Hartland: Hartland Sustainability Institute Press.
- MEADOWS, D., & RANDERS, J. (2002). *Limits to growth - the 30 years update*. United States: Chelsea Green.
- MEADOWS, D., BEHRENS, W., NAILL, R. F., RANDERS, J., & ZAHN, E. K. (1974). *Dynamics of growth in a finite world*. United States: Wright Allen Press.
- MEADOWS, D., RICHARDSON, J., & BRUCKMANN, G. (1982). *Groping in the dark*. New York: John Wiley & Sons.
- MEADOWS, D.L.; MEADOWS, D.H.; RANDERS, J. (1993). *Beyond the Limits: Confronting Global Collapse, Envisioning a Sustainable Future*. Chelsea: Green Publishing. ISBN 0930031628
- MEGA, V. (1996). Towards European sustainable cities. *Athens Center of Ekistics*, pp. 273-288.
- MEIXELL, M.J.; GARGEYA, V.B. (2005). Global supply chain design: A literature review and critique. *Transportation Research Part E: Logistics and Transportation Review* 41-6, pp. 531-550. DOI:10.1016/j.tre.2005.06.003.
- MEPS. (2017). World steel prices. MEPS International. Available at: <http://www.meps.co.uk/world-price.htm> Accessed on December 21st, 2018.
- MIAO, Z.; FU, K.; XIA, Z.; WANG, Y. (2017). Models for Closed-Loop Supply Chain with Trade-ins. *Omega* 66-B, pp. 308-326. DOI:10.1016/j.omega.2015.11.001
- MILFORD, R. L., PAULIUK, S., ALLWOOD, J. M., & MÜLLER, D. B. (2013). The Roles of Energy and Material Efficiency in Meeting Steel Industry CO2 Targets. *Environmental Science and Technology*, 8.
- MINDAT. (2018). Mineralogy Database. <https://www.mindat.org/> (accessed: 05 September 2018).
- MITCHELL, R. K., AGLE, B. R., & WOOD, D. J. (1997). Toward a Theory of Stakeholder Identification and Salience: Defining the Principle of Who and What really Counts. *Academy of Management Review*, 35.
- MKC. (2018). *Decarbonization of industrial sectors: the next frontier*. McKinsey & Company.
- MKC. (2016). *The future of Nickel: a class act*. McKinsey & Company.
- MONT, O., NEUVONEN, A., & LÄHTEENOJA, S. (2014). Sustainable lifestyles 2050: stakeholder visions, emerging practices and future research. *Journal of Cleaner Production*, 8.
- MORFELDT, J., NIJS, W., & SILVEIRA, S. (2014). The impact of climate targets on future steel production e an analysis based on a global energy system model. *Journal of Cleaner Production*, 14.

- MORGAN, M. S. (2012). *The world in the model*. Cambridge: Cambridge University Press. ISBN 9781107002975
- MORVAN, Y. (1985). *Fondements d'économie industrielle*. Paris: Economica.
- MOTA, B., GOMES, M. I., CARVALHO, A., & BARBOSA-POVOA, A. P. (2014). Towards supply chain sustainability: economic, environmental and social design and planning. *Journal of Cleaner Production*, 14.
- MOUSA, E., WANG, C., RIESBECK, J., & LARSSON, M. (2016). Biomass applications in iron and steel industry: An overview of challenges and opportunities. *Renewable and Sustainable Energy Reviews*, 19.
- MYERSON, P. (2012). *Lean supply chain and logistics management*. New York: McGraw Hill.
- NABAVI, E., DANIELL, K. A., & NAJAFI, H. (2017). Boundary matters - the potential of system dynamics to support sustainability. *Journal of Cleaner Production*, 11.
- NEELY, A. (2008). Exploring the Financial Consequences of the Servitization of Manufacturing. *Operations Management Research* 1-2, p. 1–50.
- NEELY, A. (2013). *Servitization in Germany: An International Comparison*. Cambridge Service Alliance.
- NEUMANN, J. v., & MORGENSTERN, O. (1944). *The theory of games and economic behavior*. New Jersey: Princeton University Press.
- NFDC. (2012). *The recycling and reuse survey*. Herts: UK National Federation of Demolition Contractors.
- NIELSEN, S. N. (2007). What has modern ecosystem theory to offer to cleaner production, industrial ecology and society? The views of an ecologist. *Journal of Cleaner Production* 15-17, pp. 1639-1653. <https://doi.org/10.1016/j.jclepro.2006.08.008>
- NIERO, M., NEGRELLI, A. J., HOFFMEYER, S. B., OLSEN, S. I., & BIRKVED, M. (2016). Closing the loop for aluminum cans: Life Cycle Assessment of progression in Cradle-to-Cradle certification levels. *Journal of Cleaner Production*, 10.
- NIERO, M.; KALBAR, P.P. (2019). Coupling material circularity indicators and life cycle based indicators: A proposal to advance the assessment of circular economy strategies at the product level. *Resources, Conservation and Recycling* 140, pp. 305-312. DOI:10.1016/j.resconrec.2018.10.002
- NORTH, M. J., & MACAL, C. M. (2007). *Managing Business Complexity: Discovering Strategic Solutions with Agent-Based Modeling and Simulation*. Oxford: Oxford University Press.
- NRC. (2000). *Surviving Supply Chain Integration: Strategies for Small Manufacturers*. Committee on Supply Chain Integration, National Research Council. National Academy Press: Washington, D.C. ISBN 9780309173414
- NUSS, P., & ECKELMAN, M. J. (2014). Life Cycle Assessment of Metals: A Scientific Synthesis. *PLoS ONE*, 12.
- NUSS, P.; BLENGINI, G. A. (2018). Towards better monitoring of technology critical elements in Europe: Coupling of natural and anthropogenic cycles. *Science of The Total Environment* 613–614, pp. 569-578. DOI:10.1016/j.scitotenv.2017.09.117
- NYU Stern. (2018). *Capital Expenditures, Depreciation, Reinvestment Rate and Sales to Capital Ratios by Industry*. Available at: http://people.stern.nyu.edu/adamodar/New_Home_Page/datacurrent.html Accessed on December 21st, 2018.

- OECD. (2009a). Foreign acquisitions and national security - What are genuine threats? What are implausible worries? OECD Global Forum on International Investment. Organization for Economic Co-operation and Development.
- OECD. (2009b). Summary of the Council Working Party. OECD Steel Committee. Organization for Economic Co-Operation and Development.
- OECD. (2012). The future of the steel industry - selected trends and policy issues. Summary of the 73rd Steel Committee Meeting. Organization for Co-Operation and Economic Development.
- OECD. (2015). Energy efficiency in the steel sector - why it works well, but not always.
- OECD. (2018). Stat. Organization for Economic Co-Operation and Development. Available at: <https://stats.oecd.org/Index.aspx> Accessed on December 21st, 2018.
- OGATA, K. (2003). System dynamics. New York: Prentice Hall. ISBN 0131424629
- OGUCHI, M.; MURAKAMI, S.; SAKANAKURA, H.; KIDA, A.; KAMEYA, T. (2011). A preliminary categorization of end-of-life electrical and electronic equipment as secondary metal resources. *Waste Management* 31 9–10, pp. 2150-2160. DOI:10.1016/j.wasman.2011.05.009
- ÖKO. (2005). Eco-Efficiency Analysis of Washing machines. Commissioned by the European Committee of Domestic Equipment Manufacturers (CECED). Freiburg, Öko-Institut e.v.
- ÖKO. (2016). Projected EEG Costs up to 2035: Impacts of Expanding Renewable Energy According to the Long-term Targets of the Energiewende. Agora Energiewende, Öko-Institut.
- OLIVA, R.; KALLENBERG, R. (2003). Managing the transition from products to services. *International Journal of Service Industry Management* 14-2, pp. 160-172.
- OLMEZ, G. M.; DILEK, F. B.; KARANFIL, T.; YETIS, U. (2015). The environmental impacts of iron and steel industry: a life cycle assessment study. *Journal of Cleaner Production* 130, pp. 195-201. DOI:10.1016/j.jclepro.2015.09.139
- ONAT, N.C., KUCUKVAR, M., TATARI, O. (2016). Integration of system dynamics approach toward deepening and broadening the life cycle sustainability assessment framework: a case for electric vehicles. *International Journal of Life Cycle Assessment* 21, p. 1009. DOI:10.1007/s11367-016-1070-4
- ONAT, N.C.; KUCUKVAR, M.; HALOG, A.; CLOUTIER, S. (2017). Systems Thinking for Life Cycle Sustainability Assessment: A Review of Recent Developments, Applications, and Future Perspectives. *Sustainability* 9, p. 706. DOI:10.3390/su9050706
- OOMEN, J.G.M. (2012). The Baltic Dry Index: A predictor of stock market returns? Master Thesis in Finance, Department of Finance, Tilburg University.
- OTTOSSON, M., & KINDSTRÖM, D. (2016). Exploring proactive niche market strategies in the steel industry: Activities and implications. *Industrial Marketing Management*, 11.
- PANASIYK, D.; LARATTE, B.; REMY, S. (2016). Steel stock analysis in Europe from 1945 to 2013. *Conference on Life Cycle Engineering, Procedia CIRP* 48, pp. 348-351. DOI:10.1016/j.procir.2016.04.084
- PAPANDREOU A.; RUZZENENTI, F. (2016). On the effects of fossil fuel prices on the transition towards a low carbon energy system. *Financialization, Economy, Society and Sustainable Development (FESSUD) Working Paper Series No 89. ISSN 20528035*

- PARK, J.; SARKIS, J.; WU, Z. (2010). Creating integrated business and environmental value within the context of China's circular economy and ecological modernization. *Journal of Cleaner Production* 18-15, pp. 1494-1501. DOI:10.1016/j.jclepro.2010.06.001
- PAULI, G. (2010). *The Blue Economy: 10 Years, 100 Innovations, 100 Million Jobs*. Paradigm Publications. ISBN 9780912111902
- PAULIUK, S. (2018). Critical appraisal of the circular economy standard BS 8001:2017 and a dashboard of quantitative system indicators for its implementation in organizations. *Resour. Conserv. Recycl.* 129, pp. 81-92. DOI:10.1016/j.resconrec.2017.10.019
- PAULIUK, S., MILFORD, R. L., MÜLLER, D. B., & ALLWOOD, J. M. (2013). The Steel Scrap Age. *Environmental Science and Technology*, 7.
- PAULIUK, S.; KONDO, Y.; NAKAMURA, S.; NAKAJIMA, K. (2017). Regional distribution and losses of end-of-life steel throughout multiple product life cycles - Insights from the global multiregional MaTrace model. *Resources, Conservation and Recycling* 116, pp. 84-93. <https://doi.org/10.1016/j.resconrec.2016.09.029>
- PAULIUK, S.; WANG, T.; MÜLLER, D. B. (2013). Steel all over the world: Estimating in-use stocks of iron for 200 countries. *Resources, Conservation and Recycling* 71, pp. 22-30. DOI:10.1016/j.resconrec.2012.11.008
- PAUW, I. C., KARANA, E., PRABHU, K., & POPPELAARS, F. (2014). Comparing Biomimicry and Cradle to Cradle with Eco-design: a case study of student design projects. *Journal of Cleaner Production*, 9.
- PEARCE, D. R.; TURNER, K. R. (1989). *Economics of natural resources and the environment*. Baltimore: John Hopkins University Press. ISBN 9780801839870
- PETIT-BOIX, A.; LLORACH-MASSANA, P.; SANJUAN-DELMÁS, D.; SIERRA-PÉREZ, J.; VINYES, E.; GABARRELL, X.; RIERADEVALL, J.; SANYÉ-MENGUAL, E. (2017). Application of life cycle thinking towards sustainable cities: A review. *Journal of Cleaner Production* 166, pp. 939-951. DOI:10.1016/j.jclepro.2017.08.030
- PETROS-SEBHATU, S.; ENQUIST, B. (2016). Sustainable Public Transit Service Value Network for Building Living Cities in Emerging Economies: Multiple Case Studies from Public Transit Services. *Social and Behavioral Science*, pp. 263-268.
- PINTO, J.T.M.; AMARAL, K.J.; HARTARD, S.; JANISSEK, P.R.; HELLING, K. (2017). Reducing the environmental impacts of vitreous optical fiber production – A Life Cycle Impact Assessment. *Journal of Cleaner Production*, 165, 762–776. doi:10.1016/j.jclepro.2017.07.141
- PINTO, J.T.M.; AMARAL, K.J.; JANISSEK, P.R. (2016). Deployment of photovoltaics in Brazil: Scenarios, perspectives and policies for low-income housing. *Solar Energy*, 133, 73–84. DOI:10.1016/j.solener.2016.03.048
- PINTO, J.T.M.; MORALES, M.E.; FEDORUK, M.; KOVALEVA, M.; DIEMER, A. (2019). Servitization in Support of Sustainable Cities: What Are Steel's Contributions and Challenges? *Sustainability* 11(3), p. 855. doi:10.3390/su11030855
- POLZIN, F.; VON FLOTOW, P.; NOLDEN, C. (2015). Exploring the Role of Servitization to Overcome Barriers for Innovative Energy Efficiency Technologies – The Case of Public LED Street Lighting in German Municipalities. SWPS.

- POMPONI, F.; MONCASTER, A. (2017). Circular economy for the built environment: A research framework. *Journal of Cleaner Production* 143, pp. 710-718. <https://doi.org/10.1016/j.jclepro.2016.12.055>
- POOLER, M.; FENG, E. (2017). Steel industry grapples with curse of oversupply. *Financial Times*. Available at: <https://www.ft.com/content/992ad270-b4d3-11e7-aa26-bb002965bce8> Accessed on October 29th, 2018.
- PORTER, M. (1985). *Competitive advantage - creating and sustaining superior performance*. New York: The Free Press.
- PORTER, M. E., & KRAMER, M. R. (2006). Strategy and Society: The Link Between Competitive Advantage and Corporate Social Responsibility. *Harvard Business Review*, 8.
- PORTER, M. E., & KRAMER, M. R. (2011). Creating Shared Value. *Harvard Business Review*, 9.
- PRESUTTI Jr., W. D., & MAWHINNEY, J. R. (2013). *Understanding the dynamics of the value chain*. New York: Business Expert Press.
- PRIETO-SANDOVAL, V., ALFARO, J. A., MEJIA-VILLA, A., & ORMAZABAL, M. (2016). ECO-labels as a multidimensional research topic: Trends and opportunities. *Journal of Cleaner Production*, 12.
- PRIETO-SANDOVAL, V.; JACA, C.; ORMAZABAL, M. (2018). Towards a Consensus on the Circular Economy, *Journal of Cleaner Production* 179, pp 605-615. DOI:10.1016/j.jclepro.2017.12.224
- PROSMAN, E. J.; WAEHRENS, B.; LIOTTA, G. (2017). Closing Global Material Loops: Initial Insights into Firm-Level Challenges. *Journal of Industrial Ecology* 21-3, pp. 641-650. DOI:10.1111/jiec.12535
- PRUYT, E. (2013). *Small system dynamics models for big issues*. Delft: Delft Library Press.
- PWC. (2019). *Global Economy Watch, Economic projections: February 2019*. PriceWaterhouse & Coopers. Available at: <https://www.pwc.com/gx/en/issues/economy/global-economy-watch/projections.html> Accessed on January 8th, 2019.
- RAMÍREZ-SANTOS, A.; CASTEL, C.; FAVRE, E. (2018). A review of gas separation technologies within emission reduction programs in the iron and steel sector: Current application and development perspectives. *Separation and Purification Technology* 194, pp. 425-442. DOI:10.1016/j.seppur.2017.11.063
- RANDERS, J. (2012). *A global forecast for the next 40 years*. United States: Chelsea Green.
- RANDERS, J. (1980). *Elements of the system dynamics method*. Massachusetts: MIT Press. ISBN 0915299399
- RANGAN, V. K., CHASE, L., & KARIM, S. (2015). The truth about CSR. *Harvard Business Review*, 6.
- REED, M. S., GRAVES, A., DANDY, N., POSTHUMUS, H., HUBACEK, K., MORRIS, J. (2009). Who's in and why? A typology of stakeholder analysis methods for natural resource management. *Journal of Environmental Management*, 16.
- RENZULLI, P. A.; NOTARNICOLA, B.; TASSIELLI, G.; ARCESE, G.; DI CAPUA, R. (2016). Life Cycle Assessment of Steel Produced in an Italian Integrated Steel Mill. *Sustainability* 8, pp. 719-728. DOI:10.3390/su8080719
- REPELIN-HILL, V. (1999). Trade and Environment: An Empirical Analysis of the Technology Effect in the Steel Industry. *Journal of Environmental Economics and Management* 38-3, pp. 283-301. DOI:10.1006/jeem.1999.1085
- REUTERS. (2018). China to cut coal use, curb steel in 2018-2020 pollution plan. Published: July 3rd, 2018 @ 12:08 PM. Available at: <https://www.reuters.com/article/us-china-pollution/china-to-cut-coal-use-curb-steel-in-2018-2020-pollution-plan-idUSKBN1JT12J> Accessed on January 8th, 2019.

- RICHARDSON, G. P. (1999). Reflections on the future of system dynamics. *Journal of Operational Research*, 50, 440.
- RICHMOND, B. (2004). *An introduction to systems thinking*. United States: ISEE Systems.
- ROBERTS, N., ANDERSEN, D. F., Deal, R. M., & Shaffer, W. A. (1982). *Introduction to computer simulation - a system dynamics approach*. Chicago: Productivity Press.
- ROGERS, R. (1997). *Cities for a small planet*. Boulder: Westview. ISBN 0813335531
- ROSSEN, A. (2015). What are metal prices like? Co-movement, price cycles and long-run trends. *Resources Policy* 45, pp. 255–276. DOI:10.1016/j.resourpol.2015.06.002
- ROTHENBERG, S. (2007) Sustainability through servicizing. *MIT Sloan Management Review* 48-2, pp. 82-91.
- RREUSE. (2012). *Challenges to boosting reuse rates in Europe*. Brussels: RREUSE.
- RUTH, M.; HANNON, B. (2012). *Modeling Dynamic Economic Systems*. New York: SpringerLink. ISBN 978-1-4614-2209-9
- SARKIS, J., ZHU, Q., & LAI, K.-H. (2011). An organizational theoretic review of green supply chain management literature. *International Journal of Production Economics*, 15.
- SARTORI, S.; SILVA, F.L.; CAMPOS, L.M.S. (2014). Sustainability and sustainable development: a taxonomy in the field of literature. *Ambiente & Sociedade* 17. ISSN 18094422
- SB. (2018). *Price History Tables and Charts*. Steel Benchmark. Available at: <http://www.steelbenchmarker.com/> Accessed on December 21st, 2019.
- SCHENKEL, M.; CANIELS, M.C.J.; KRIKKER, H.; VAN DER LAAN, E. (2015). Understanding value creation in closed loop supply chains – Past findings and future directions. *Journal of Manufacturing Systems* 37-3, pp. 729-745. DOI:10.1016/j.jmsy.2015.04.009
- SCHERER, F. M. (1980). *Industrial market structure and economic performance*. Chicago: Rand McNally.
- SCHMALENSEE, R., & WILLIG, R. D. (2008). *Handbook of industrial organization - volume I*. Amsterdam: North-Holland, Elsevier Science.
- SCHMIDPETER, R., & HANSEN, K. (2014). *CSR und Diversity Management*. Berlin: Springer Gabler.
- SCHUBERT, E. S.; GOTTSCHLING, R. (2011). *Co-generation: A challenge for furnace off-gas cleaning systems*. Southern African Pyrometallurgy Institute.
- SCHULTMANN, F.; ZUMKELLER, M.; RENTZ, O. (2006). Modeling reverse logistic tasks within closed-loop supply chains: An example from the automotive industry. *European Journal of Operational Research* 171-3, pp. 1033-1050. DOI:10.1016/j.ejor.2005.01.016
- SCHULZ, W. H. (2005). Application of system dynamics to empirical industrial organization - the effect of the new toll system. *Review of Economics*, 56, 205.
- SCHWAGER, J.D. (1984). *A Complete Guide to the Futures Markets: Fundamental Analysis, Technical Analysis, Trading, Spreads, and Options*. Wiley. ISBN 9780471893769
- SEAGER, T. P., & THEIS, T. L. (2002). A uniform definition and quantitative basis for industrial ecology. *Journal of Cleaner Production*, 10.
- SEAGER, T. P.; THEIS, T. L. (2002). A uniform definition and quantitative basis for industrial ecology. *Journal of Cleaner Production* 10-3, pp. 225-235. DOI:10.1016/S0959-6526(01)00040-3

- SEETHARAMAN, S. (2013). *Treatise on Process Metallurgy, Volumes 1 to 3: Process Fundamentals, Process Phenomena and Industrial Processes*. Elsevier Online. ASINs B00GY5XF3E, B00H1YWDGW and B00HEMSS88
- SENGE, P. (1990). *The fifth discipline - the art and practice of the learning organization*. New York: Century Business.
- SENGE, P., SMITH, B., SCHLEY, S., LAUR, J., & KRUSCHWITZ, N. (2008). *The necessary revolution - how individuals and organizations are working together to create a sustainable world*. London: Doubleday Currency Press.
- SENGUPTA, K.; HEISER, D.R.; COOK, L.S. (2006). Manufacturing and Service Supply Chain Performance: A Comparative Analysis. *Journal of Supply Chain Management* 42-4, pp.4-15. DOI:10.1111/j.1745-493X.2006.00018.x
- SGS. (2011). *Steel - Industry leading steel, scrap and raw materials solutions*. Société Générale de Surveillance.
- SHAMSUDDIN, M. (2016). *Physical Chemistry of Metallurgical Processes*. Hoboken: Wiley Kindle Edition. ISBN 978-1-119-07833-3
- SHFE. (2019). Annual statistics. Shanghai Futures Exchange. Available at: <http://www.shfe.com.cn/en/MarketData/dataview.html?paramid=yearstat> Accessed on January 8th, 2019.
- SHOU, Y.; LI, Y.; PARK, Y.; KANG, M. (2017). Supply chain integration and operational performance: The contingency effects of production systems. *Journal of Purchasing and Supply Management*, in press. DOI:10.1016/j.pursup.2017.11.004
- SM Study. (2015). What is value chain analysis? Retrieved February 07, 2017, from Sales and Marketing Certifications' Global Accreditation Body: <https://www.smstudy.com/Article/what-is-value-chain-analysis>
- SONNEMANN, G.; CASTELLS, F.; TSANG, M.; SCHUMACHER, M. (2004). *Integrated life-cycle and risk assessment for industrial processes*. Madrid: CRC Press. ISBN 9781566706445
- SORRELL, S. (2007). The Economics of Energy Service Contracts. *Energy Policy* 35, pp. 507–21.
- SOULIOTIS, M.; ARNAOUTAKIS, N.; PANARAS, G.; KAVGA, A.; PAPAETHIMIOU, S. (2018). Experimental study and Life Cycle Assessment (LCA) of Hybrid Photovoltaic/Thermal (PV/T) solar systems for domestic applications. *Renewable Energy* 126, pp. 708-723. DOI:10.1016/j.renene.2018.04.011
- SPRECHER, B.; DAIGO, I.; MURAKAMI, S.; KLEIJN, R.; VOS, M.; KRAMER, G.J. (2015). Framework for Resilience in Material Supply Chains, With a Case Study from the 2010 Rare Earth Crisis. *Environmental Science & Technology* 49-11, pp. 6740-6750. DOI:10.1021/acs.est.5b00206
- STAHL. (2017). Hot metal and crude steel production. German Steel Federation. Available at: <http://en.stahl-online.de/index.php/topics/technology/steelmaking/> (accessed: 11 February 2017).
- STATISTA. (2018). Estimated demand for steel worldwide between 2016 and 2019, by region (in million metric tons). Full report. Available at: <https://www.statista.com/statistics/246397/estimated-demand-for-steel-worldwide-by-region/> Accessed on December 21st, 2018.
- STATISTA. (2016). Global steel industry capacity utilization rate in 2016, by region. Full report. Available at: <https://www.statista.com/statistics/883373/global-steel-industry-capacity-utilization-rate-by-region/> Accessed on December 21st, 2018.

- STATISTA. (2017b). Industrial electricity prices in selected countries in Europe 2017, by amount consumed (in euro cents per kilowatt hour). Full report. Available at: <https://www.statista.com/statistics/267068/industrial-electricity-prices-in-europe> Accessed on December 21st, 2019.
- STATISTA. (2017c). Leading metal futures and options contracts traded globally in 2017, by volume (in millions). Full report. Available at: <https://www.statista.com/statistics/380496/leading-metals-futures-options-by-volume/> Accessed on December 21st, 2018.
- STATISTA. (2019). Projected HRC steel prices worldwide from 2017 to 2020, by major market in U.S. dollars per metric ton. Available at: <https://www.statista.com/statistics/214246/world-steel-prices/> Accessed on January 2nd, 2019.
- STATISTA. (2017). The world's largest iron and steel companies in 2017, based on sales (in billion U.S. dollars). Full report. Available at: <https://www.statista.com/statistics/270128/the-largest-steel-companies-worldwide-based-on-revenue/> Accessed on December 21st, 2018.
- STATISTA. (2019b). Workforce in the Global Steel Industry – Meeting the steel industry's workforce challenges in a multi polar world. Full report.
- STERMAN, J. D. (2000). Business dynamics - systems thinking and modelling for a complex world. New York: McGraw-Hill. ISBN 9780072389159
- STIGLER, G. J. (1968). The organization of industry. Homewood: R. D. Irwin.
- STUBBLES, J. (2017). The Basic Oxygen Steelmaking (BOS) Process. Steelworks. <http://www.steel.org/making-steel/how-its-made/processes/processes-info/the-basic-oxygen-steelmaking-process.aspx> (accessed: 11 February 2017).
- SU, B.; HESHMATI, A.; GENG, Y.; YU, X. (2013). A review of the circular economy in China: moving from rhetoric to implementation. *Journal of Cleaner Production* 42; pp. 215-227. DOI:10.1016/j.jclepro.2012.11.020
- SUH, S. (2005). Theory of materials and energy flow analysis in ecology and economics. *Ecological Modelling*, 9.
- SVERDRUP, H.; RAGNARSDOTTIR, K. V. (2014). Geochemical Perspectives: Natural Resources in a Planetary Perspective. Toulouse: European Association of Geochemistry. DOI:10.7185/geochempersp.3.2
- ŚWIERCZEK, A. (2014). The impact of supply chain integration on the 'snowball effect' in the transmission of disruptions: An empirical evaluation of the model. *International Journal of Production Economics* 157, pp. 89-104. DOI:10.1016/j.ijpe.2013.08.010
- SDC. (2010). Population and carrying capacity. System Dynamics Clips. Retrieved February 6, 2017, from System Dynamics Theory & Modelling: <http://www.sdynamics.co.nr>
- TADDEO, R. (2016). Local industrial systems towards the eco-industrial parks: the model of the ecologically equipped industrial areas. *Journal of Cleaner Production* 131, pp. 189-197. <https://doi.org/10.1016/j.jclepro.2016.05.051>
- TATA STEEL. (2014). Overview of Business Model - Tata Steel's Value Chain. Retrieved February 11, 2017, from Tata Steel 108th annual report: <http://www.tatasteel.com/investors/annual-report-2014-15/html/overview-of-business-model.html>

- TERÖRDE, F. (2006). *Stainless Steel Recycling, Data and Scenarios, Availability of Scrap*. ISSF.
- THE ECONOMIST. (2017). Protecting American steel from imports makes no sense. Available at: <https://www.economist.com/news/finance-and-economics/21721413-far-saving-jobs-it-will-destroy-them-protecting-american-steel-imports> Accessed on April 27th, 2018.
- THE ECONOMIST. (2018). Steel wars. Available at: <https://www.economist.com/news/finance-and-economics/21734469-being-worlds-trade-policeman-tough-work-donald-trumps-difficult-decision> Accessed on January 19th, 2019.
- TIETENBERG, T. H.; LEWIS, L. (2004). *Environmental economics and policy*. New York: Pearson Addison Wesley. ISBN 1292026804
- TIROLE, J. (2015). *Théorie de l'organisation industrielle*. Paris: Economica.
- TOGNETTI, A., GROSSE-RUYKEN, P. T., & WAGNER, S. M. (2015). Green supply chain network optimization and the trade-off between environmental and economic objectives. *International Journal of Production Economics*, 7.
- TRADING ECONOMICS. (2018). Interest rates historical dataset. Available at: <https://tradingeconomics.com/country-list/interest-rate> Accessed on December 21st, 2018.
- TRADING ECONOMICS. (2019). Iron Ore historical dataset. Available at: <https://tradingeconomics.com/commodity/iron-ore> Accessed on January 8th, 2019.
- TRUTTMANN, N.; RECHBERGER, H. (2006). Contribution to resource conservation by reuse of electrical and electronic household appliances. *Resources, Conservation and Recycling* 48-3, pp. 249-262. DOI:10.1016/j.resconrec.2006.02.003
- TUKKER, A. (2004). Eight types of product-service system: Eight ways to sustainability? Experiences from Suspronet. *Business Strategy and the Environment* 13-4, pp. 246-260.
- TUKKER, A. (2015). Product services for a resource-efficient and circular economy – a review. *Journal of Cleaner Production* 97, pp. 76-91. DOI:10.1016/j.jclepro.2013.11.049
- TVO. (2012). *Corporate Social Responsibility Report*. Oulkuoto: Teollisuuden Voima Oyj.
- UNCTAD. (2013). *Global value chains and development - investment and value-added trade in the global economy*. United Nations Conference on Trade and Development. Geneva: UN.
- UNCTAD. (2017). *The Iron Ore Market 2017*. United Nations Conference on Trade and Development – Trust Fund Project in Iron Ore Information.
- UNEP. (2002). *Melbourne Principles for Sustainable Cities*. United Nations Environment Programme - Division of Technology, Industry, And Economics - International Environmental Technology Center.
- UNEP. (2011). *Towards a green economy - pathways to sustainable development and poverty eradication*. Geneva: United Nations' Environmental Programme.
- URIBE-SOTO, W.; PORTHA, J.; COMMENGE, J.; FALK, L. (2017). A review of thermochemical processes and technologies to use steelworks off-gases. *Renewable and Sustainable Energy Reviews* 74, pp. 809-823. DOI:10.1016/j.rser.2017.03.008
- VACLAV, S. (2016). *Still the iron age*. Oxford: Butterworth-Heinemann, Elsevier. ISBN 9780128042359
- van BERKEL, R., & LAFLEUR, M. (1997). Application of an industrial ecology toolbox for the introduction of industrial ecology in enterprises. *Journal of Cleaner Production*, 10.

- VAN BERKEL, R.; WILLEMS, E.; LAFLEUR, M. (1997). Development of an industrial ecology toolbox for the introduction of industrial ecology in enterprises. *Journal of Cleaner Production* 5-1, pp. 11-25. DOI:10.1016/S0959-6526(97)00004-8
- VAN DER VAART, T.; VAN DONK, D.P. (2008). A critical review of survey-based research in supply chain integration. *International Journal of Production Economics* 111-1, pp. 42-55. DOI:10.1016/j.ijpe.2006.10.011
- VAN DER VAART, T.; VAN DONK, D.P. (2004). Buyer focus: Evaluation of a new concept for supply chain integration. *International Journal of Production Economics* 92-1, pp. 21-30. DOI:10.1016/j.ijpe.2003.10.002
- VAN DER VOET, E.; VAN OERS, L.; VERBOON, M.; KUIPERS, K. (2018). Environmental Implications of Future Demand Scenarios for Metals: Methodology and Application to the Case of Seven Major Metals. *Journal of Industrial Ecology Online*. DOI:10.1111/jiec.12722
- VAN SCHAIK, A.; REUTER, M.A. (2010). Dynamic modelling of E-waste recycling system performance based on product design. *Minerals Engineering* 23-3, pp. 192-210. DOI:10.1016/j.mineng.2009.09.004
- VANDERMERWE, S.; RADA, J. (1988). Servitization of business: adding value by adding services. *European Management Journal* 6-4, pp. 314-324.
- VICKERY, S.K.; JAYARAM, J.; DROGE, C.; CALANTONE, R. (2003). The effects of an integrative supply chain strategy on customer service and financial performance: an analysis of direct versus indirect relationships. *Journal of Operations Management* 21, pp. 523–539. DOI:10.1016/j.jom.2003.02.002
- VILCHEZ, V. F., DARNALL, N., & CORREA, J. A. (2017). Stakeholder influences on the design of firms' environmental practices. *Journal of Cleaner Production*, 11.
- VINCENT, J. F., BOGATYREVA, O. A., BOGATYREVA, N. R., BOWYER, A., & PAHL, A.-K. (2006). Biomimetics - its practice and theory. *Journal of the Royal Society*.
- WANG, N.; HE, Q.; JIANG, B. (2018). Hybrid closed-loop supply chains with competition in recycling and product markets. *International Journal of Production Economics*, in press. DOI:10.1016/j.ijpe.2018.01.002
- WANG, P., LI, W., & KARA, S. (2017). Cradle-to-cradle modeling of the future steel flow in China. *Resources, Conservation and Recycling*, 12.
- WARRIAN, P. (2012). *A profile of the steel industry - global reinvention for a new economy*. New York: Business Expert Press. ISBN 1631573845
- WASSON, C. S. (2006). *System analysis - design, development, concepts, principle and practices*. Blackwell: John Wiley & Sons.
- WAUGH, R. (2016). The end of the blast furnace era? *Ironmaking & Steelmaking*. DOI:10.1018/03019233.2016.1153325
- WEBMINERAL. (2018). Mineralogy Database. <http://webmineral.com/> (accessed: 05 September 2018).
- WEC. (2018). *World Energy Trilemma Index*. London: World Energy Council.
- WIENGARTEN, F.; HUMPHREYS, P.; GIMENEZ, C. (2016). Risk, risk management practices, and the success of supply chain integration. *Int. J. Production Economics* 171-3, pp. 361-370. DOI:10.1016/j.ijpe.2015.03.020
- WILLIAMSON, O. E. (1966). *Profit growth and sales maximization*. Paris: Economica.

- WILLIG, R. D., & SCHMALENSSEE, R. (2008). Handbook of industrial organization - volume II. Amsterdam: North-Holland, Elsevier Science.
- WINANS, K.; KENDALL, A.; DENG, H. (2017). The history and current applications of the circular economy concept. *Renewable and Sustainable Energy Reviews* 68-1, pp. 825-833. DOI:10.1016/j.rser.2016.09.123
- WINDSMITH, J. R. (1973). Managerial theories of the firm. London: Martin Robinson.
- WS. (2016). Fact Sheet - Steel and raw materials. World Steel Association.
- WS. (2018). Steel in Automotive. Brussels: WorldSteel Association, available at: <https://www.worldsteel.org/steel-by-topic/steel-markets/automotive.html> Accessed on: September 28th 2018.
- WS. (2017a). Steel markets. Brussels: WorldSteel Association. Available at: <http://www.WorldSteelAssociation.org/steel-by-topic/steel-markets/Buildings-and-infrastructure.html> (accessed: 30 January 2018).
- WS. (2017c). Life cycle inventory study dataset, report and methodology for steel products. Brussels: World Steel Association. Note: Provided by Mr. Mauro Chiapinni under formal and justified direct request approved by Mrs. Clare Broadbent.
- WS. (2015). Steel in the circular economy - a life cycle perspective. Brussels: WorldSteel Association.
- WS. (2016). Steel, the permanent material in the circular economy. Brussels: World Steel Association.
- WS. (2013b). Sustainable steel - policy and indicators 2013. Brussels: WorldSteel Association.
- WS. (2012). Sustainable steel: at the core of a green economy. Brussels: WorldSteel Association,
- WS. (2012). The white book of steel. Brussels: WorldSteel Association.
- WS. (2015). Water management in the steel industry. Brussels: WorldSteel Association.
- WS. (2018). World Steel in Figures. World Steel Association.
- WSD. (2019). Global Steel Information System (GSIS). World Steel Dynamic.
- WSSTP. (2013). Research and Technology Development Needs for Water and Steel. Brussels: Water Supply and Sanitation Technology Platform.
- WU, M.H; NG, T.S; SKITMORE, M.R. (2016). Sustainable building envelope design by considering energy cost and occupant satisfaction. *Energy for Sustainable Development* 31, pp. 118–129.
- WÜBBEKE, J., & HEROTH, T. (2014). Challenges and political solutions for steel recycling in China. *Resources, Conservation and Recycling*, 7.
- XIONG, G.; HELO, P. (2008). Challenges to the supply chain in the steel industry. *International Journal of Logistics Economics and Globalization*, 1(2), p. 160. DOI:10.1504/ijleg.2008.020529
- XU, L.; WANG, C. (2018). Sustainable manufacturing in a closed-loop supply chain considering emission reduction and remanufacturing. *Resources, Conservation and Recycling* 131, pp. 297-304. DOI:10.1016/j.resconrec.2017.10.012
- XUAN, Y., & YUE, Q. (2016). Scenario analysis on resource and environmental benefits of imported steel scrap for China's steel industry. *Resources, Conservation and Recycling*, 13.
- YELLISHETTY, M., & MUDD, G. M. (2014). Substance Flow Analysis of Steel and Long-Term Sustainability of Iron Ore Resources in Australia, Brazil, China and India. *Journal of Cleaner Production*, 11.

- YELLISHETTY, M., RANJITH, P. G., & THARUMARAJAH, A. (2010). Iron ore and steel production trends and material flows in the world: Is this really sustainable? *Resources, Conservation and Recycling*, 10.
- YELLISHETTY, M.; MUDD, G.; MASON, L.; MOHR, S.; PRIOR, T.; GIURCO, D. (2012). *Iron resources and production - technology, sustainability and future prospects*. Sydney: CSIRO and Monash University. ISBN 9781922173461
- YELLISHETTY, M.; MUDD, G.; RANJITH, P. G.; THARUMARAJAH, A. (2011). Environmental life-cycle comparisons of steel production and recycling: sustainability issues, problems and prospects. *Environmental Science and Technology* 14-6, pp. 650-663. DOI:10.1016/j.envsci.2011.04.008
- YELLISHETTY, M.; MUDD, G.M.; RANJITH, P.G. (2011a). Availability, addiction and alternatives: three criteria for assessing the impact of peak minerals on society. *Journal of Cleaner Production* 19, pp. 78-90. DOI: 10.1016/j.jclepro.2010.12.006
- YILDIRIM, I. Z.; PREZZI, M. (2011). Chemical, Mineralogical, and Morphological Properties of Steel Slag. *Advances in Civil Engineering*. DOI:10.1155/2011/463638
- ZADEK, S. (2004). The Path to Corporate Responsibility. *Harvard Business Review*, 8.
- ZHANG, W.; BANERJI, S. (2017). Challenges of servitization: A systematic literature review. *Industrial Marketing Management* 65, pp. 217-227. DOI:10.1016/j.indmarman.2017.06.003
- ZHIJUN, F., & NAILING, Y. (2007). Putting a circular economy into practice in China. *Sustainable Sciences*, 7.
- ZHOU, J. (2017). Learn to read causal loop diagrams. Retrieved February 6, 2017, from *Systems&Us*: <https://systemsandus.com/2012/08/15/learn-to-read-clds/>
- ZORE, Z.; CUCEK, L.; KRAVANJA, Z. (2018). Synthesis of sustainable production systems using an upgraded concept of sustainability profit and circularity. *Journal of Cleaner Production* 201, pp. 1138-1154. DOI:10.1016/j.jclepro.2018.07.150

7. APPENDICES

7.1. Ethics Assessment



RESEARCHER: Julian TORRES
SUPERVISOR: Arnaud DIEMER
RESEARCH CENTER: CERDI UCA
THESIS TITLE: System Dynamics in Value Chain Management: Improving Environmental Sustainability in The European Steel Industry

SUMMARY

The project focuses on the steel industry in Europe. A model is being created by integrating System Dynamics and Life Cycle Assessment, in order to support decision-makers in better managing these industries towards the improvement of environmental performance.

The data used in this model is always and only of scientific or industrial origin, never personal; always identifiable, citable and referenceable; made available to the public directly or indirectly to me upon request. As of the present moment, no company, research institute nor authors of scientific publications involved has asked for any formal agreement of confidentiality, data privacy or restriction of disclosure, on the contrary, they were pleased to be able to openly help an European project. All sources will be cited and referenced. In this regard, the researcher and the supervisor certify that **no ethical concerns were identified**.

RESEARCH RESOURCES DESCRIPTION

TYPES:

- Financial, statistical, production, operational and environmental data in digital format;

SOURCES:

- Scientific publications;
- Institutional, governmental, research or business reports;
- Research datasets;

ORIGINS:

- EU countries;
- Non-EU countries;

AVAILABILITY:

- Direct public availability;
- Indirect public availability
(on-demand with no formal disclosure, privacy or protection requirements);

FORMATS:

- Content extensions: PDF, DOC, DOCX, XLS, XLSX, RTF or XML;
- Distribution extensions: ISO, RAR or ZIP;

STORAGE:

- Location: iCloud online storage;
- Storage provider: Apple Europe Inc.;
- Security measures: Apple SSL Cloud Encryption;
- Account: julian.torres@uca.fr
- Account affiliation: Université Clermont Auvergne;
- Quantity: up to 5 Gigabytes;

USAGE:

- Users: Researcher and direct supervisors;
- Purpose: Modelling, research and scientific publications only;
- Device: Apple MacBook Pro Retina 13" (2016);
- Device identity: Inventory Identification Number 021871;
- Device ownership: Université Clermont Auvergne;
(conceded to the researcher for research use only, for the duration of the project);

ETHICS ASSESSMENT

Potential ethical concerns present in the project:

1. HUMAN EMBRYOS/FETUSES

Does the research involve Human Embryonic Stem Cells (hESCs)?	NO
Will they be directly derived from embryos within this project?	NO
Are they previously established cells lines?	NO
Does the research involve the use of human embryos?	NO
Does the research involve the use of human fetal tissues/cells?	NO

2. HUMANS

Does the research involve human participants?	NO
Are they volunteers for social or human sciences research?	NO
Are they persons unable to give informed consent?	NO
Are they vulnerable individuals or groups?	NO
Are they children/minors?	NO
Are they patients?	NO
Are they healthy volunteers for medical studies?	NO
Does the research involve physical interventions on the study participants?	NO
Does it involve invasive techniques?	NO
Does it involve collection of biological samples?	NO

3. HUMAN CELLS/TISSUES

Does the research involve human cells or tissues?	NO
Are they available commercially?	NO
Are they obtained within this project?	NO
Are they obtained within another project?	NO
Are they deposited in a biobank?	NO

4. PERSONAL DATA

Does it involve the collection and/or processing of sensitive personal data (e.g.: health, sexual orientation, gender, ethnicity, political opinion, religious or philosophical conviction)?	NO
Does it involve processing of genetic information?	NO
Does it involve tracking, interviewing or observation of participants?	NO
Does the research involve further processing of previously collected personal data?	NO

5. ANIMALS

Does the research involve animals?	NO
Are they vertebrates?	NO
Are they non-human primates?	NO
Are they genetically modified?	NO
Are they cloned farm animals?	NO
Are they endangered species?	NO

6. THIRD COUNTRIES

Does the research involve non-EU countries?	YES
Will data from these countries be used in the research project?	YES
How will the data be used?	
- As according to the description in page 1;	
Which non-EU countries are involved?	
- Iceland, Norway, United States of America, Canada, Australia, Switzerland, Brazil, China, Russia, India, Japan, South Korea, South Africa and Mexico;	
How are they involved in your PhD project?	
- University of Iceland is a partner university which has provided co-supervisor Harald Sverdrup, GWS is a partner research institute located in Germany and responsible for providing data and research support, all other countries are hosts to steel industries which can remotely provide potentially useful data according to the description in page 1;	

Does the researcher plan to use local resources (e.g. animal and/or human tissue samples, genetic material, live animals, human remains, materials of historical value, endangered fauna or flora samples, etc.)? NO
 Could the situation in these countries put the researcher at risk? NO
 Does the researcher plan to bring to the EU anyone from a non-EU country listed above? NO
 Does the researcher plan to import/export any material from non-EU countries into the EU? NO
 Does the research involve low- and/or lower-middle income countries? NO

7. ENVIRONMENT & HEALTH and SAFETY

Does the research involve the use of elements that may cause harm to the environment, to animals or plants? NO
 Does it deal with endangered fauna and/or flora and/or protected areas? NO
 Does it involve the use of elements that may cause harm to humans, including research staff? NO

8. DUAL USE

Does the research have the potential for military applications? NO

9. MISUSE

Does the research have the potential for malevolent/criminal/terrorist abuse? NO

10. OTHER ETHICS ISSUES

Are there any other ethics issues that should be taken into consideration? NO

ETHICAL REMARKS:

- **No ethical concerns were identified;**

Clermont-Ferrand, March 14th 2018

Researcher

Supervisor



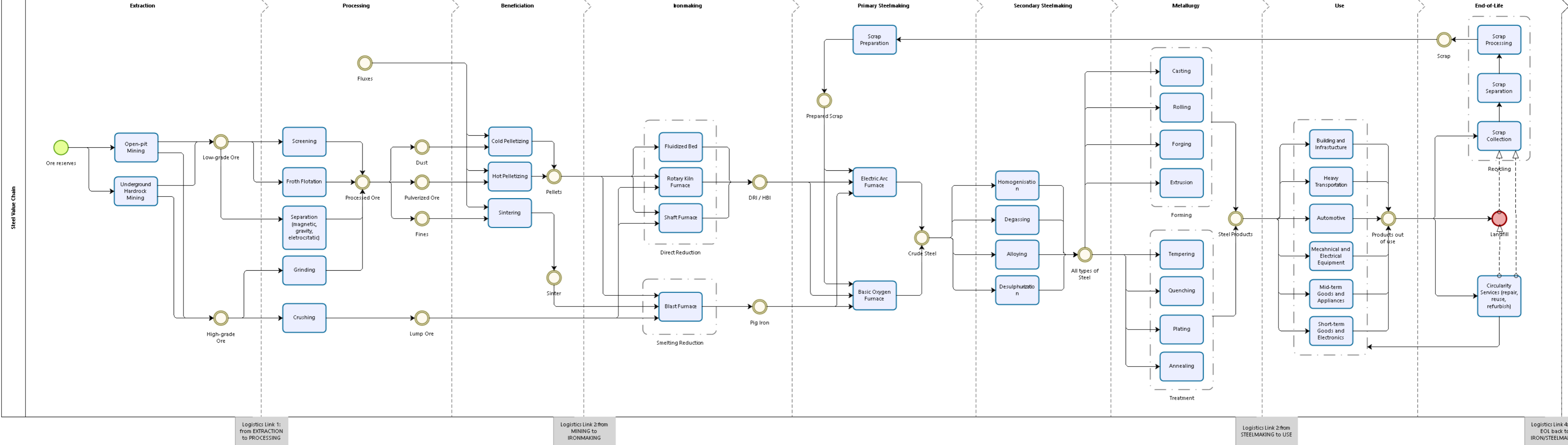

7.2. Business Process Map of the Steel Value Chain.

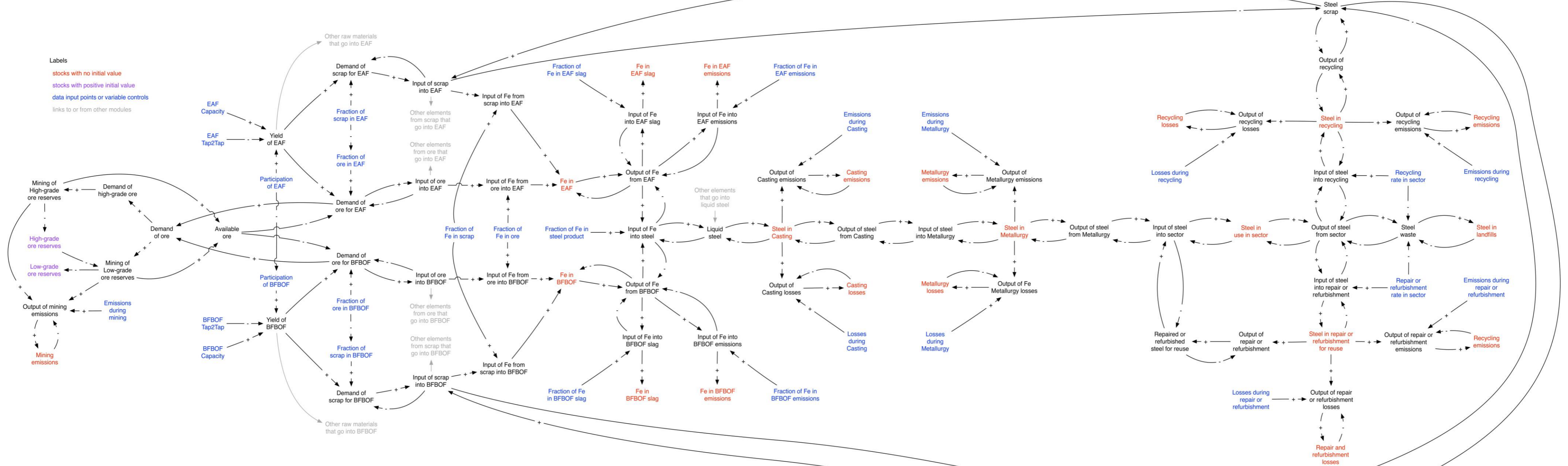

7.3. Causal Loop Diagram (CLD) of the biophysical system.

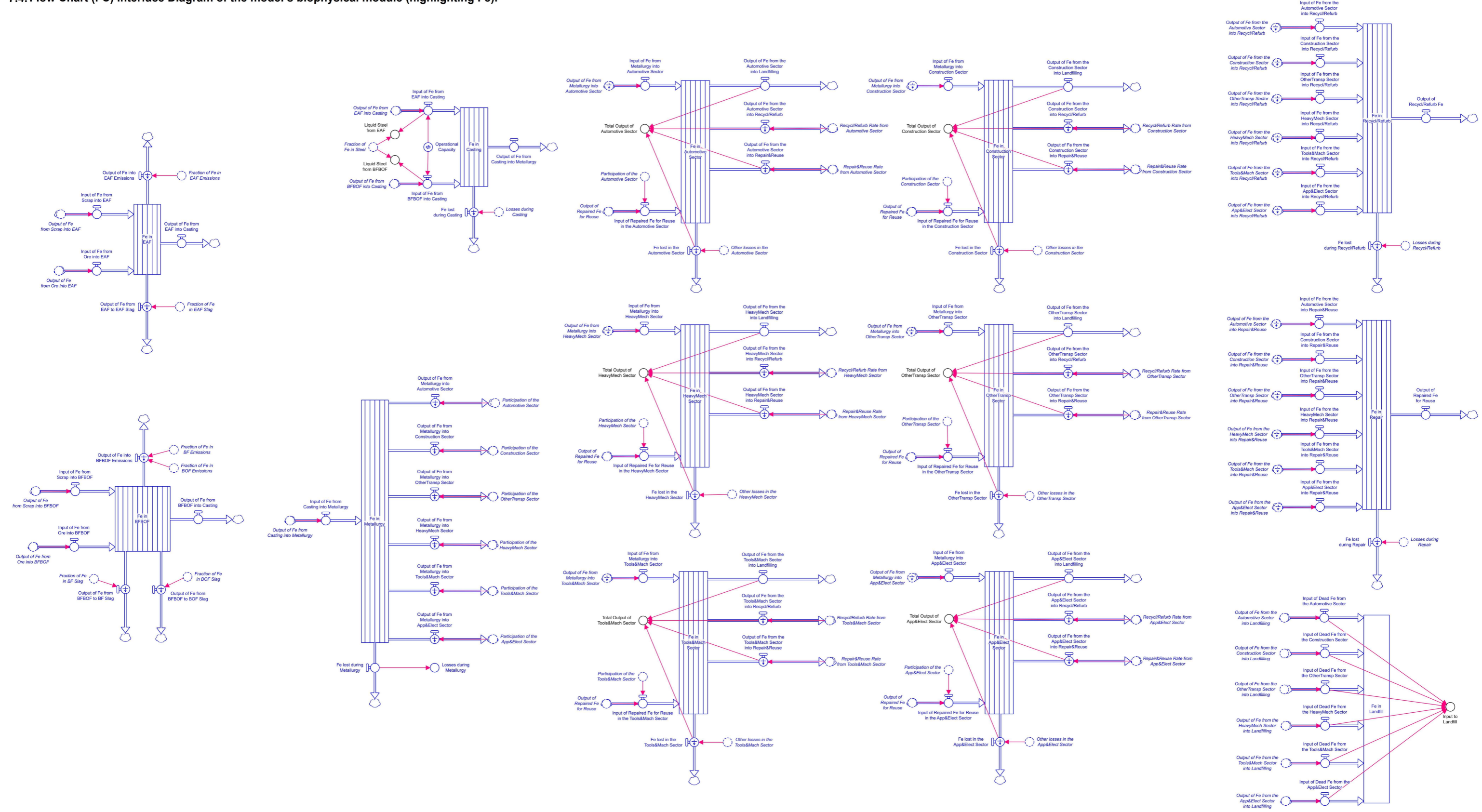

7.4. Flow Chart (FC) Interface Diagram of the model's biophysical module (highlighting Fe).



7.5. Flow Chart (FC) Interface Diagram of the model's control panel (highlighting Fe).

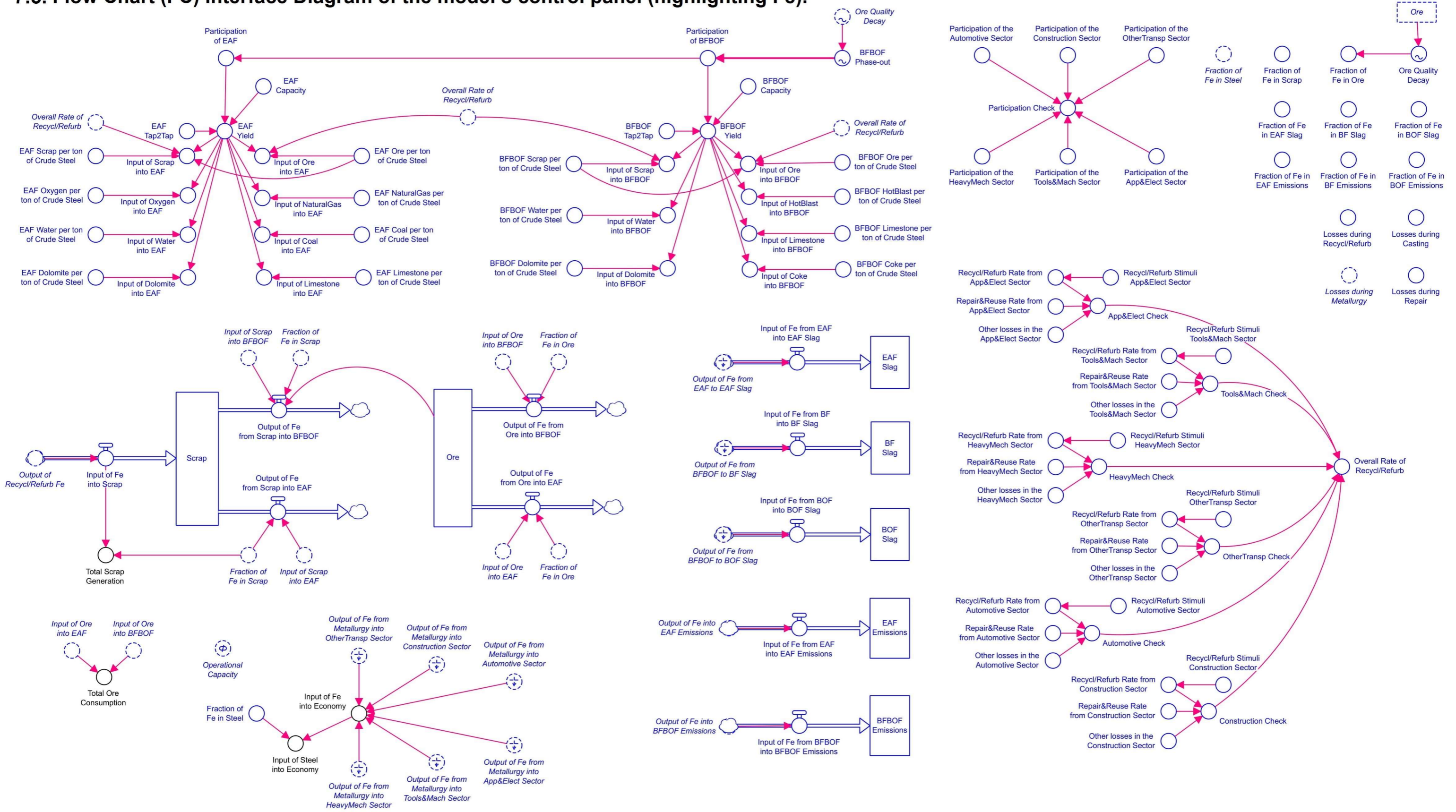

7.6. Flow Chart (FC) Interface Diagram of the model's economic module.

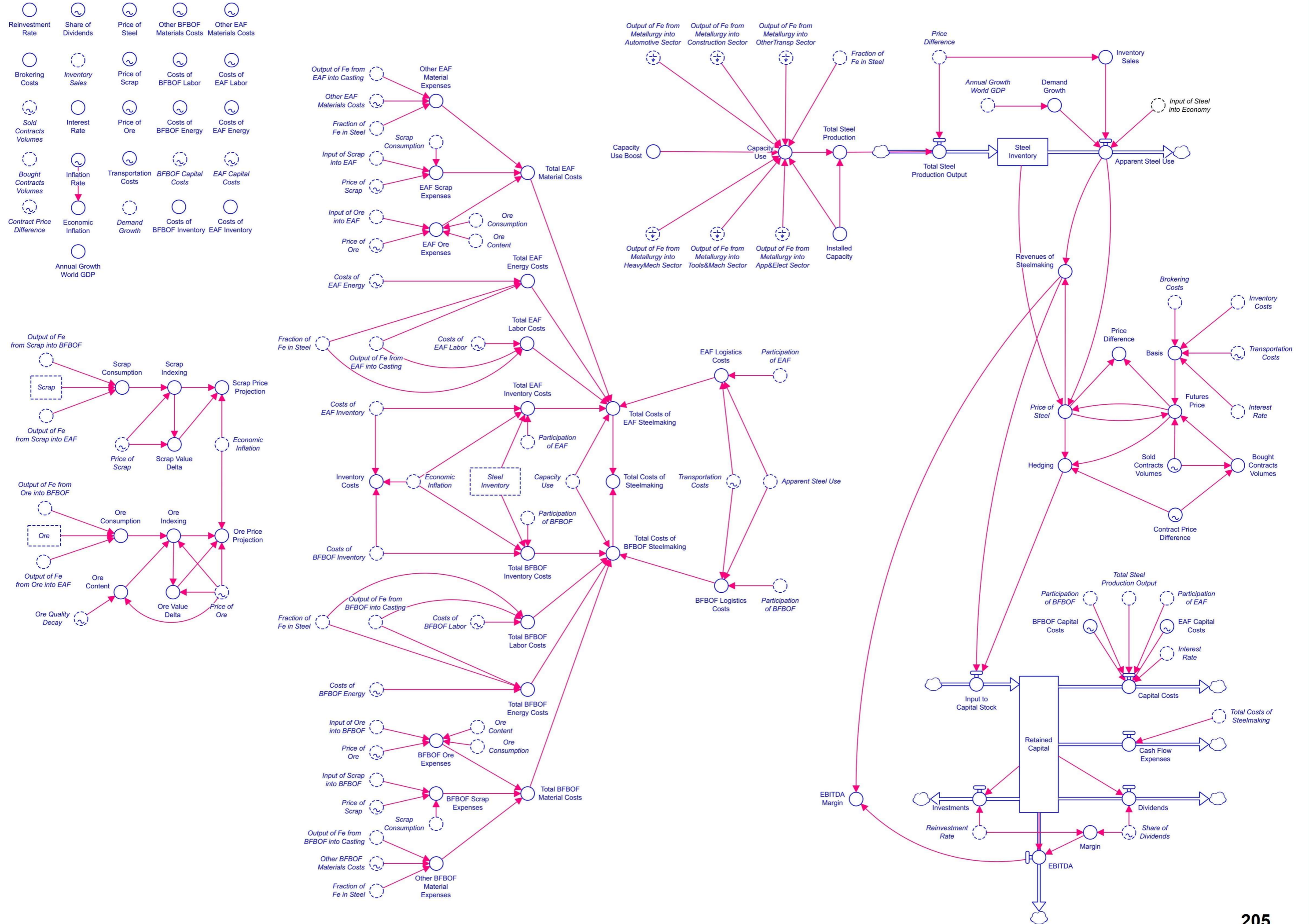

INTEGRATING LIFE CYCLE ASSESSMENT INTO SYSTEM DYNAMICS: THE CASE OF STEEL IN EUROPE

Article status: Submitted, under review (2nd round);
Journal: Environmental Systems Research (Springer);
Co-author: SVERDRUP, H.U. ^a; DIEMER, A ^b

^a Department of Industrial Engineering, University of Iceland, Reykjavik, Iceland;

^b Centre d'Etudes et de Recherches sur le Développement International (CERDI),
Université Clermont-Auvergne, Clermont-Ferrand, France;

Highlights:

- Compiles relevant SD and LCA studies on steel and presents SWOT analyses of both SD and LCA;
- Introduces a model integrating LCA into SD and studies its application in the European steel industry;
- Integration of SD and LCA is deemed feasible and beneficial for both methodologies in different levels;
- Corroborates discussions on raw material scarcity, transition towards EAF steelmaking and resource ownership retention.

Abstract:

Considering steel's importance as a material in modern economies, the environmental impacts derived from its production, the efforts of this industry in addressing these impacts in the last couple of decades, and the development of modelling and assessment tools, this article used the European steel industry as a case study to explore the potential benefits of integrating Life Cycle Assessment (LCA) into System Dynamics (SD) under the scopes of Circular Economy and Industrial Ecology. The goal was to verify if this integration could not only reproduce results generated separately by LCA and SD, but also to provide additional support for decision- and policy-making on the biophysical aspects of long-term materials sourcing. A model representative of the European steel industry was built modularly in Stella Architect, following ILCD and ISO guidelines and standards for LCA. Results indicated that integrating LCA into SD is feasible and capable of contributing to both in different levels, supporting discussions on raw material scarcity, EAF steelmaking and resource ownership retention. This approach has potential to interest policy-makers who seek more granularity within the European steel industry as well as industrial decision-makers searching for a broader understanding of their operation's dynamics beyond the gates.

Keywords:

Steel; Europe; System Dynamics; Life Cycle Assessment; Industrial Ecology; Circular Economy.

INTRODUCTION

Steel is the most commonly used alloy of iron and has historically been one of the most essential materials worldwide. It is present in most aspects of everyday life, from infrastructure to transport, from canned food to electronics (WS, 2012; Beddows, 2014). Steel's cycle through environment and society originates in the ores mined from mountains and underground reserves and most commonly meets its end inside long service life structures or as recyclable scrap (Warrian, 2012; Vaclav, 2016).

Especially during the last decade, steel industries worldwide have expanded their strategic outreach towards environmental goals, improving their supply chain management to encompass both end-of-life and circularity solutions (D'Costa, 1999; Material Economics, 2018). Today, steel in Europe is recycled at a 70% rate and most of its byproducts can be reused in other industries (Yellishetty, et al. 2012; WS, 2017a). In comparison to the 1980s, the average manufacture now uses 50% less energy, helping vehicles become more fuel efficient with stronger and lighter steel alloys, sometimes even being environmentally competitive enough to front plastics and aluminum products (Warrian, 2012; WS, 2013b; Vaclav, 2016; Material Economics, 2018).

As a consequence of the current geopolitical circumstances, the ever-growing presence of Chinese and Indian steelmakers, as well as the decreasing demand from the automotive and energy sectors in Europe and in developed Asian nations, the bold technocentric decision-making behaviors of the post-War period have given way to complex evaluations in capacity, portfolio and environmental impacts of the Technology Critical Elements (TCEs) and Critical Raw Material (CRMs) present in steel (Vaclav, 2016; WS, 2017b; Nuss & Blengini, 2018). In order to better support and inform decision-makers regarding their strategies for the future of steel industries, managerial scientists, engineers

and academics developed new tools and methods (van Berkel et al., 1997; Baas and Boons, 2004).

Renowned worldwide after the success of the Kalundborg Industrial Park, Industrial Ecology (IE) studies, organizes and models industrial activities and their interactions with the environment by approaching them organically, in an attempt to benefit from their potential to behave as natural closed-loop systems – in which outputs can become inputs – instead of a traditional open-loop ones – in which outputs end up in sinks (Erkman, 1997; Ehrenfeld, 1997; Ehrenfeld, 2004; Nielsen, 2007; Taddeo, 2016; Prosman et al., 2017).

IE tangibly and empirically addresses (a) material and energy flows – known as Industrial Metabolism –, (b) technological change, (c) eco-design, (d) life-cycle planning, (e) dematerialization, (f) decarbonization, (g) corporate responsibility and stewardship, and (h) industrial parks – also known as Industrial Symbiosis (Chevalier, 1995; Cohen-Rosenthal, 2004; Gibbs and Deutz, 2007; Despeisse, et al. 2012; Leigh and Li, 2015).

IE professionals nowadays exchange a lot with Circular Economy (CE), which approaches materials from two perspectives: biological nutrients – that should eventually reintegrate the biosphere without causing any harm –, and technical nutrients – which circulate in the economy (Pearce and Turner, 1989; Seager and Theis, 2002; Korhonen, 2004; EMF 2012/2013/2014b; Liao et al., 2012; Tukker, 2015; Geissdoerfer et al. 2017).

Aiming to promote the shift from traditional linear production process towards circular ones, CE suggests that all economic activities should be performed focusing on (a) the use of wastes as inputs, (b) the adoption of renewable and clean energy sources, (c) the accurate biophysical costs of their extraction, transformation, use and reinsertion into either economy or biosphere, and (d) outputs designed from the beginning so as to facilitate collection, recycling, refurbishing, reuse, redistribution, maintenance and sharing throughout their lifespan (Park et al., 2010; EMF, 2014a/2015a/2016/2017; Haas et al. 2015).

Due to the commoditization of its products and of its raw materials, the steel industry traditionally pays close attention to factors and productive variables that can affect price and competitiveness just as much as quality, so for decades this industry has been using putting in place environmentally-friendly practices such as recycling and by-product reuse even before Circular Economy and Industrial Ecology became widespread concepts or part of policy-driven efforts (EC, 2013b; WS, 2016).

In Europe, most policies regarding environmental impacts came into force or were revised close to the turn of the century, notably the Environmental Assessment Directive 2011/92/EU (EP, 2011), the Industrial Emissions Directive 2010/78/EU (EP, 2010), the Air Quality Directive 2008/50/EC (EP, 2008a), the Water Framework Directive 2000/60/EC (EP, 2000a), the Packaging Waste Directive 94/62/EC (EP, 1994), the Waste and Hazardous Waste Framework Directive 2008/98/EC (EP, 2008b), and the Landfill Directive 99/31/EC (EU, 1999). Although these documents address how industries should manage, control and report their undesired or potentially hazardous outputs, minimal attention was given to input alternatives, resource efficiency or circular behaviors, and no particular or direct attention was given to the steel supply chain (EP, 2000a/2008a,b/2010/2011; EU, 1999), with the exception of the Extracting and Mining Waste Directive 2006/21/EC (EP, 2006a).

In 2012 the European Union and its member states committed to the application of a Circular Economy Package as new driver for its economic model, boosting a transition to resource-efficient practices that eventually lead to a regenerative progress toward nature (Zhijun and Nailing, 2007; UNEP, 2011; EC, 2012; Su et al., 2013; Kahle and Gurel-Atay, 2014; EMF, 2015b; Gregson et al., 2015). Soon after, the European Commission conceived an action plan focused on the European steel industry, which summarized the situation of the European steel industry as of 2012 and brought to light the difficulties faced by the sector in terms of prices, competitiveness, trading and energy (EC, 2013b).

To deal with these obstacles while furthering environmental progress on resource efficiency and climate, the action plan highlighted the need for developing secondary metals markets in order to boost the production of steel from scrap (EC, 2013b; EUROFER, 2015). From that point on, the European Commission and the European Council created multiple policy-supporting documents, the most noteworthy being the Best Available Techniques (BAT) for Iron and Steel Production (EC, 2013a), which, along Directive 2006/21/EC and the BAT for the Ferrous Metals Processing Industry (EC, 2001), proposed operational techniques capable of directly addressing certain environmental impacts and, when possible and pertinent, suggested potential circular integrations.

Still, the previously mentioned policies and most of their supporting documents either addressed steel indirectly through other sectors or approached different stakeholders/process of the steel supply chain separately (EUROFER, 2015). This counterintuitively hinders circularity and, along even with the BAT documents, has been deemed insufficient to address climate and resource efficiency issues unless more attention was to be given to end-of-life steel, energy sourcing and systemic/holistic approaches (EC, 2013b/2014; Diener and Tillman, 2016; Dunant et al., 2018; EUROFER, 2015).

In an attempt to help the European steel industry in achieving the goals set by the CE package, this article proposes that the integration of Life Cycle Assessment (LCA) into System Dynamics (SD) could provide additional benefits for decision- and policy-making on the biophysical aspects of long-term materials sourcing (Lewandowski, 2016; Pomponi and Moncaster, 2017; Winans et al., 2017).

First, however, it was deemed important to ensure that both LCA and SD would operate properly together, by assessing whether or not such integration could generate results similar to those in existing literature generated by LCA and SD separately. In the interest of identifying possible barriers or constraints to the integration, available literature

was investigated and both LCA and the SD methodology were subjected to SWOT analyses, as seen next.

LCA AND ITS USES IN THE EUROPEAN STEEL INDUSTRY

As a tool, LCA allows for the measurement of environmental impacts and environmental performance of a product throughout a supply chain, enabling detailed analyses and also comparisons with similar goods (Tietenberg, 2004; ISO 2006). LCA has gained ground over the years due to its quantitative diagnostic applications, helping companies identify improvement opportunities in their supply chains (Hunt & Franklin, 1996; Sonnemann et al., 2004).

By individually analyzing the environmental impacts and environmental performance of each stage of a product's life cycle, LCA allows product designers and decision-makers to better visualize the ramifications of inserting a product into the market (Ferreira, 2004). This then allows for the revision and correction of a product's characteristics or of a supply chain's operation in order to reduce potential harm to the environment (Daddi et al., 2017).

The life cycle of steel, summarized in Figure 1, begins with at least one of two main raw materials: iron ore or steel scrap. Iron ore is mined from Hematite (Fe_2O_3 , ~ 70% Fe content), Magnetite (Fe_3O_4 , ~ 72% Fe content), Limonite ($2\text{Fe}_2\text{O}_3+3\text{H}_2\text{O}$, ~ 59% Fe content), Goethite ($\text{Fe}_2\text{O}_3+\text{H}_2\text{O}$ ~ 63% Fe content) or Siderite (FeCO_3 , ~ 48% Fe content) (Stubbles, 2017; Jones, 2017; Kozak & Dzierzawski, 2017).

Steel scrap, on the other hand, often has over 95% Fe content and, once given the appropriate triage and treatment, goes straight into steelmaking after its collection from manufacturing processes, recycling centers, junkyards or even landfills (Warrian, 2012; WS, 2012; Beddows, 2014; Stahl, 2017).

Figure 1 - Steel's life cycle as per the Circular Economy framework.

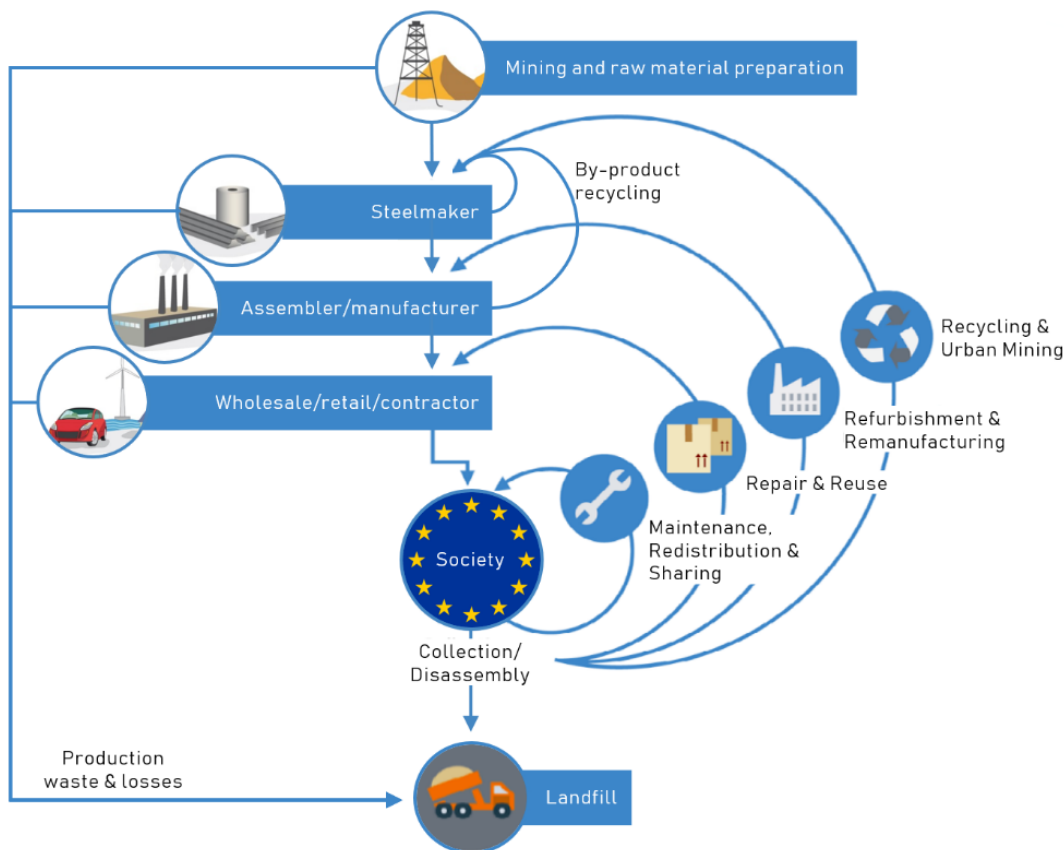

Steel can leave the manufacturing stage in many forms and with many different chemical and mechanical characteristics, depending on the application to which it was designed (Beddows, 2014; Stahl, 2017). Once it goes into the use stage, it will be stored, reused and remanufactured until losses in quality demand its recycling (WS, 2012; Vaclav, 2016). Throughout this entire sequence of stages, however, energy is consumed, byproducts are created and environmental impacts are generated, all of which can be measured by LCA.

By following the guidelines of ISO 14040:2006 and using Simapro as a modelling platform to analyze data from Ecoinvent, Burchart-Korol (2013) developed the LCA of the Polish steel industry. In the study, the functional unit was set to one ton of cast steel produced within Polish cradle-to-gate boundaries, resulting in CO₂eq emissions measurements according to IPCC and CED criteria, as well as in ReCiPe Midpoint indicators for 17 different categories of environmental impacts per main productive process. Not only were the author

capable of identifying the human health and environmental risks posed by the raw materials as well as the energy demand of each productive process, but also to suggest changes in energy sourcing that could allow for the Electric Arc Furnace (EAF) method to be less emission-intensive (Burchart-Korol, 2013).

A similar study was performed in the Turkish steel industry, in which 14 IMPACT2002+ Midpoint indicators were used instead of ReCiPe's 17, focusing on five different steel products: billet, slab, hot rolled wire rod, hot rolled coil (Olmez et al., 2015). The main contributions of this study were (a) identifying hot rolled products as the most environmentally hazardous due to their intensive emission of inorganic particles – thus requiring efficient dust collection methods –, and (b) highlighting the significant Global Warming Potential of this industry as a whole due to its high consumption of fossil fuels (Olmez et al., 2015).

Another similar example of LCA pertinent to the discussion at hand took place in Italy, additionally considering emissions from logistics while focusing on a functional unit of 1 million tons of steel slab (Renzulli et al., 2016). Unlike previous studies, this one suggested the regional reuse of BOF and BF slag for agriculture or infrastructure purposes as a mean to help reduce the overall environmental impact of the production process, while also suggesting a partnership with nearby power plants in order to improve energy efficiency (Renzulli et al., 2016).

Based on literature and practice just as much as on the examples above, Table 1 summarizes the analysis of strengths, weaknesses, opportunities and threats (SWOT) executed by the author of this article.

Table 1 - SWOT Analysis of Life Cycle Assessment.

STRENGTHS	WEAKNESSES
<ul style="list-style-type: none"> ▪ Focus on environmentally friendly product design and its development; ▪ Strong diagnostic and planning approach; ▪ Clear depiction of stocks and flows of a product along a supply chain; ▪ Stakeholder involvement in the supply chain is made visible; ▪ Internationally accepted and indicator-friendly; ▪ Linear, bottom-up approach; ▪ Model structure is objectively representative; 	<ul style="list-style-type: none"> ▪ Complex inputs and outputs; ▪ Limited comparability due to high specificity; ▪ High time and effort requirements; ▪ Limited to one product/good at a time; ▪ Limited scenario analyses, often requiring One-Factor-at-a-Time (OFAT) approach; ▪ Lack of a time frame can limit long-term decision-making application; ▪ Disaggregation level can pollute the identification of key issues; ▪ Standard application does not consider market dynamics;
OPPORTUNITIES	THREATS
<ul style="list-style-type: none"> ▪ Allows for ISO certification; ▪ Can spearhead public image efforts regarding a company's environmental concerns; ▪ Standardization allows for cross-cultural exchanges; 	<ul style="list-style-type: none"> ▪ Interpretation of results can be confusing, misleading or complex for general management or communication purposes; ▪ Scarce expertise; ▪ Vulnerable to data availability; ▪ Data inputs regarding future trends or behaviors depend on exogenous sources;

Sources: Hunt & Franklin (1996), Huijbregts (2002), Ferreira (2004), Sonnemann et al. (2004), ISO (2006), Finnveden et al. (2009), Curran (2012), Ahmed (2012), Daddi et al. (2017).

It is from understanding and experiencing some of the limitations above as well as the limited availability of literature on LCA for European steel that the author of this article considered also exploring how SD can support decision-making in the steel industry.

SD AND ITS USES IN THE STEEL INDUSTRY

While LCA is capable of giving scholars and decision-makers a very insightful snapshot of a supply chain, SD can, in turn, transform that snapshot into a film. Decision-makers gain, thus, the means to analyze a supply chain as it progresses through the effects of multiple feedbacks and loops of which visibility, relevance or scale could only become evident with the passage of time or with their simultaneous interactions (Forrester, 1962; Booth & Meadows, 1995).

SD is a methodology for studying complex nonlinear behavior within systems, often used for simulating new potential behaviors by adding, removing or changing variables, triggers and delays (Sterman, 2000; Ogata, 2003). To do so, it deconstructs a system into

smaller – often binary – interactions and analyzes their behavior not only independently but also as part of the whole, which then generate balancing or reinforcing loops that help determine the system's overall behavior (Ruth & Hannon, 2012).

Instead of pushing data through series of stocks and flows – as LCA commonly does –, SD lets the ensemble of interactions between each correlated pair of variables define the behavior of the system and more easily represents circular behaviors when compared to other methodologies (Ogata, 2003; Ruth & Hannon, 2012). This approach allows for very small-scale problem-solving just as much as it allows for the analysis of large-scale interactions, often encompassing market dynamics and relying on endogenous data to create projections and trends (Sterman, 2000; Ruth & Hannon, 2012).

SD derived from the school of Systems Thinking of the 1950s and 60s, which intended to support and improve productive decision-making (Forrester, 1962; Booth & Meadows 1995), and its application begins on the definition of a clear question. It then proceeds to conceptualize the system where the problem is located, step during which its components, the causal relations and the feedbacks therein are mapped, generating a Causal Loop Diagram (CLD) (Forrester, 1969; Coyle, 1996; Haraldson, 2004; Morgan, 2012; Capra & Luisi, 2014).

Next, the CLD is converted into a Flow Chart (FC), an empirical model which allows for data and variable inputs, usually built in a modelling software such as Stella or Vensim (Morgan, 2012; Ruth & Hannon, 2012). Once a model that precisely represents the reality of the system involved in the question at hand has been built and pertinent data has been added to its components, results and analyses can be derived from the simulation of scenarios (Randers, 1980; Karnopp et al., 1990; Sterman, 2000; Ogata, 2003). Regarding the steel industry, and especially in Europe, not many studies and publications have yet made use of

SD. Below, the author present examples of SD studies on steel performed by researchers in China, Iran, Sweden and the United Kingdom.

The first study consisted of a macro-level analysis of the sintering process, one of the raw material preparation steps commonly used in the ironmaking stage. Both CLDs and FCs were created, resulting in a SD model capable of replicating the known behavior of sintering operations in the Anshan Iron and Steel Corporation (AISC) (Liu et al., 2015). The model was then used to run a multi-variable simulation comparing the AISC's operation to the Shouqin Corporation's operation, pointing to the latter as capable of delivering sinter with better compactedness and higher iron content to the Chinese market (Liu et al., 2015).

The next study focused on reducing the consumption of natural gas and oil in Iranian national steelmaking by simulating the energy requirements through 20 years of subsidies, exports and consumption (Ansari & Seifi, 2012). A macroeconomic SD model was created to test the aforementioned variables simultaneously and in face of price variations, resulting in up to 33% reductions in fossil fuel consumption depending on the mix of subsidy reforms, recycling stimuli and EAF deployment scenarios (Ansari & Seifi, 2012).

Next, researchers studied how SD can support decision-makers in identifying the main obstacles for extending a product's lifespan so as to comprise multiple life cycles (Asif et al., 2015). Global and North American data on steel was used to build a simplified global SD model in which resource scarcity and steel consumption were defined as the main drivers (Asif et al., 2015). As a result, the researchers suggested that enterprises and nations should attempt to keep scarce or non-renewable resources within their supply chains for as long as possible during multiple life cycles in order to accrue the most economic and environmental advantage possible (Asif et al., 2015).

The last study brought to the reader's attention was one of the earliest concerning the steel industry using SD as a methodology. In it, the researchers attempted to create a model

capable of reproducing the effects of bottlenecks, breakdowns and other operational constraints in steelmaking supply chains which adopt Minimum Reasonable Inventory (MRI) as a business strategy (Hafeez et al., 1996). After simulating different operational scenarios, the main outcome of the study was a set of strategies to achieve MRI for each individual stock unit according to system-wide operational risks, instead of altogether uniformly, which would tend to require either operational risk insurances or higher levels of working capital binding (Hafeez et al., 1996).

As previously performed for LCA, Table 2 summarizes the SWOT analysis of SD considering the examples above as well as other relevant literature.

Table 2 - SWOT Analysis of System Dynamics.

STRENGTHS	WEAKNESSES
<ul style="list-style-type: none"> ▪ Focus on circularity, causality and the effects of variables over time; ▪ Strong for strategic analyses and problem-solving; ▪ Can include subjective or abstract variables; ▪ Allows for the analysis of more than one product/good at a time; ▪ Model structure is easy to adapt and change if necessary; ▪ Non-linear, top-down approach; ▪ Can be used for modelling market dynamics; 	<ul style="list-style-type: none"> ▪ Strategic analyses often do not suffice for effective decision-making; ▪ Visualization of stakeholder involvement is highly dependent on how the model is built; ▪ Levels of error and uncertainty are harder to determine; ▪ Aggregation can hide or ignore important variables if not done carefully; ▪ Model structure might not be objectively representative; ▪ Limited support for using indicators;
OPPORTUNITIES	THREATS
<ul style="list-style-type: none"> ▪ Can be of great use for communication purposes; ▪ Can foster the development of multidisciplinary studies; ▪ Can generate endogenous trends and projections; 	<ul style="list-style-type: none"> ▪ Scarce expertise; ▪ Analyses can become over-simplistic; ▪ Vulnerable to data reliability;

Sources: Forrester (1962), Booth & Meadows (1995), Coyle (1996), Hafeez et al. (1996), Ogata (2003), Haraldson (2004), Ansari & Seifi (2012), Capra & Luisi (2014), Asif et al. (2015), Liu et al. (2015), Kunc (2017).

After having finished SWOT analyses for both LCA and SD, the author identified multiple points of divergence but also of convergence. Most importantly, however, is that in situations where one flounders, the other often excels, thus pointing to the potential benefits of a combined approach.

METHODOLOGY

Bringing LCA and SD together is a relatively recent idea as of the development of this article, with earliest attempts dating back to 2011. In the scientific studies published so far, systems thinking was used to pursue the same results generated by either LCA (Onat et al., 2016; Halog & Manik, 2011) or Material Flow Analysis (MFA) (Sprecher et al., 2015) while adding broadened and deepened understandings of the relations between an empirical environment with another more complex or less tangible one. These efforts brought significant advancements to the discussion of how approaching LCA and MFA with a SD mindset can be productive and insightful for answering questions regarding sustainability's triple bottom line or regarding different environmental nexus with larger scopes and boundaries, reinforcing the importance that decision- and policy-makers include both methodologies in their scientific toolkit (Onat et al., 2017).

Having learned from these experiments, this article tries something different: to bring the entire LCA methodology into the SD modelling environment. It is to say that, in addition to using SD to broaden and deepen the achievements of LCA, we have attempted to create a *win-win* environment in which LCA can provide its own contributions to SD as well.

To delve into the details of this endeavor, this section is divided in three parts, namely (a) Research Design – in which the author introduce question, case-study and the methodological steps –; (b) Model Description – in which the model itself and its development are explained –; and (c) Parameterizing and Operation – where details regarding data inputs, variable control and operational behaviors are presented.

RESEARCH DESIGN

Considering that neither SD nor LCA were originally devised to work with each other, as well as the limited number of available attempts of their integration until now, the primary concern was to properly envision where, when and how LCA and SD could supplant each

other's weaknesses while maintaining their own strengths. With that in mind, a methodological question took priority over the originally conceived one, resulting in the following:

1. Can the integration of LCA into SD reproduce the results or behaviors previously observed in studies that used LCA or SD separately?
2. What potential benefits derive from this integration toward decision-making on the biophysical aspects of long-term materials sourcing?

Keeping in mind the frameworks and concepts of both IE and CE, the main expected result of the study was achieving a favorable answer to the first question, which would hypothetically indicate that the integration was realized adequately and to the extent of not interfering with either SD's or LCA's correct implementation. The quantitative criteria for answering both questions, keeping in mind the case study at hand, focused on (a) emissions, (b) biophysical depletion of iron ore, (c) steel scrap generation and consumption, (d) liquid steel output from production, (e) iron circularity, and (f) steel input into the economy, as derived from literature already presented thus far or to be introduced further in this section.

For qualitatively answering them, the SWOT analyses based the search for the following patterns: SD's broader and more flexible modelling approach contributing to LCA's (a) circularity, (b) long-term perspective, and (c) the macro analysis potential; while LCA's objective and empirical representation of an operation improves SD's (d) stakeholder involvement identification, (e) analysis reliability, and (f) applied/practical usefulness across managerial levels.

The case study used for testing this integration was the European steel industry, chosen by the author due to its current transition towards more environmentally-oriented decision-making, to its importance for the European economy, security and sovereignty, to

its global contextual concerns regarding the rise of international competitors, and due to the policy limitations regarding its environmental aspects. Therefore, as boundary, the study took into account the EU28 zone, represented by the supply chains of the steelmakers members of the WorldSteel Association that operate within it, which account for 84% of the entire European steel industry.

In order to adequately represent this industrial activity and give focus to the biophysical transformations that take place throughout the supply chain while keeping in mind European average steel production behavior, the study was conducted using the following methodological steps: (1) Business Process Mapping (BPM), carried out with the support of the BizAgi software and aimed at identifying all the core processes of steelmaking in Europe; (2) Causal Loop Diagramming (CLD), made with the support of the OmniGraffle tool so as to represent the steelmaking supply chain in a systematic and holistic manner; (3) Flow Charting (FC), within the SD modelling environment of the Stella Architect software (ISEE Systems, 2016); (4) data collection and scenario building; (5) model parameterizing and testing; and (6) simulation runs and analyses.

Iron was defined as the driving chemical element of steelmaking, while steel scrap and iron ore were defined as the key raw materials. Nevertheless, connections to all other chemical elements and raw materials involved in steelmaking were included, as summarized in Figure 2. Furthermore, two different levels of aggregation were adopted: cradle-to-gate processes were disaggregated down to chemical level, while gate-to-cradle processes were aggregated to product level. This choice was made in order to give decision-making granularity for the steelmakers without over encumbering macro-level analyses that could affect policy-making on end-of-life and circularity services.

Figure 2 - CLD of the biophysical system under study, made in OmniGraffle.

<< Please refer to the high-resolution image in Appendix 7.3 >>

In order to obtain the desired alloys, the material needs of the furnaces were used to define the amounts of raw materials pulled from their respective sources. This *pulling* behavior is present in the system until liquid steel becomes an intermediary output, point in which the system then *pushes* materials through the subsequent processes so as to reproduce the continuous casting operation. Additionally, attention was given to the feedbacks that *close the loop* (e.g. recycling, repair, refurbishment), so as to enable the system to operate under the definitions of CE and IE.

MODEL DESCRIPTION

In total, twenty modules were created, one for each chemical element involved in the steel supply chain (e.g. iron, carbon, nickel, chromium, zinc, oxygen), all of which used a functional unit (FU) of 1 ton of steel and were built to be structurally identical, being specific flows and stocks introduced whenever necessary so as to properly represent the typical behaviors of each chemical element throughout the supply chain.

Within each module, the production processes and the stocks of steelmaking were approached modularly and established as individual LCA-based units, capable of being displaced, rearranged or replicated with minimal interference in the overall structure of the model. This allowed for the user interface to be less polluted than traditional SD models and should enable this model to be easily adapted to the reality of different stakeholders in the future, as exemplified in Figure 3.

The productive processes were grouped into macro-processes based on their most common occurrence in the European steel industry, namely (a) EAF and (b) BFBOF – each encompassing sintering, pelletizing, degassing, alloying, desiliconization, desulfurization, homogenization or dephosphorization, whenever applicable; (c) Casting – which encompasses all shape, heat and surface treatments; (d) Metallurgy – which encompasses

all forming and metalworking processes; (e) Economic Sectors – divided in Construction, Automotive, Other Transportation, Tools and Machinery, Appliances and Electronics, and Heavy Mechanical Equipment, as per WorldSteel Association standards; (f) Recycling – which feeds back into the stock of scrap used as input for “a” and “b”; (g) Repair/Refurbishment – which feeds back into each economic sector according to their share in its demand; and (h) Losses and Landfills – which configures a process-based sink.

Figure 3 - Flow Chart (FC) Interface Diagram of the model's biophysical module and control panel (highlighting Fe).

<< Please refer to the high-resolution images in Appendices 7.4 and 7.5, respectively >>

It is important to note, however, that (1) due to the lack of available disaggregated data, emissions from mining, casting and metallurgy were attributed to the EAF and the BFBOF macro-processes accordingly and proportionally; (2) dust and particulate matter generation were incorporated into the mass of emissions; (3) no disaggregated emission data was found for end-of-life and circularity solutions; (4) energy flows were considered only in the form of amount of fossil fuels consumed and not in the form of heat or electricity (directly by BFBOF and indirectly from generation for EAF); and (6) no pricing, costing or speculative variables were considered.

Finally, a control panel was created in order to facilitate the visualization and management of data inputs and variable control, as well as for the easier identification of issues. It allowed for the (a) adjustment of variables that affect all 20 modules, (b) monitoring of stocks, flows and outputs of the supply chain, and (c) follow-up on operational losses. Moreover, different levels of granularity were made possible for analysis merely by switching on and off the tracking of individual chemical elements.

PARAMETERIZING AND OPERATION

Table 3 summarizes the data inputs used in the study, all of which encompassed the interval between 2001 and 2014, and were verified for cohesion, coherence and reliability based on the criteria of the ILCD Handbook (EC, 2010) and of ISO14044:2006 (ISO, 2006), as well as being compared to their equivalent data points in the WorldSteel Association's Life Cycle Inventory Study for Steel Products (WS, 2017c) and EUROSTAT Databases (EUROSTAT, 2009/2017/2018a,b).

The author also considered adopting Product Environmental Footprint (PEF) standards (JRC, 2012), however, in its current state, it presented itself as a less consolidated and less disseminated methodology, with available applications focused mainly in the construction sector.

Table 3 - Summary of data inputs.

TYPE	VARIABLE	UNIT	SOURCES
EAF Inputs	Scrap, Oxygen, Natural Gas, Coal, Limestone, Dolomite, Water, Ore	kg/kg of steel	Shamsuddin (2016), WS (2012, 2017b, 2017c), EU (2011), Madias (2013), Cullen et al. (2012), Yellishetty et al. (2011), EUROFER (2017a), EUROSTAT (2009, 2018b), Seetharaman (2013)
BFBOF Inputs	Ore, Hot Blast, Scrap, Water, Limestone, Coke, Dolomite	kg/kg of steel	Shamsuddin (2016), WS (2012, 2017b, 2017c), EU (2011), Madias (2013), Cullen et al. (2012), Yellishetty et al. (2011), EUROFER (2017a), EUROSTAT (2009, 2018b), Seetharaman (2013)
Typical Chemical Compositions of the Inputs	Scrap, Ore, Coke, Natural Gas, Coal, Dolomite, Limestone, Hot Blast	%	MINDAT (2017) WEBMINERAL (2017)
Typical Compositions of Steel Alloys, as Outputs	UNS S30400, UNS S31600, UNS S43000, UNS S17400, UNS S32205, UNS S40900	%	Bringas (2004)
Typical Slag Composition Ranges	EAF Slag, BF Slag, BOF Slag	%	Yildirim and Prezzi (2011), Adegoloye et al. (2016), EUROSLAG (2017)
Typical Composition Ranges of Emissions to the Atmosphere	EAF Emissions, BF Emissions, BOF Emissions	%	Ferreira and Leite (2015), Ramírez-Santos et al. (2018), Uribe-Soto et al. (2017), Schubert and Gottschling (2011), Seetharaman (2013)
Stocks in Use	Automotive, Construction, Tools & Machinery, Appliances & Electronics, Heavy Mechanical Equipment, Other Transportation	tons	Pauliuk et al. (2013), EC (2017)
Participation of Economic Sectors in Steel Demand		%	WS (2017b), EUROSTAT (2009, 2018b)
Typical Lifespan of Steel per Economic Sector (as delays)		years	Cooper, et al. (2014), EUROSTAT (2009, 2018b), EC (2017)
Recycling/Refurbishment Rate per Economic Sector		%	NFDC (2012), EUROSTAT (2018a), Björkman and Samuelsson (2014), BIR (2017), Panasiyk et al. (2016), EUROFER (2017b), Eckelman et al. (2014), Terörde (2006)
Repair/Reuse Rate per Economic Sector		%	NFDC (2012), EUROSTAT (2018a), Dindarian and Gibson (2011), Truttmann and Rechberger (2006), Bovea et al. (2016), Kissling et al. (2013), RREUSE (2012), Eckelman et al. (2014)
Distribution and End-of-Life Losses		%	Pauliuk et al. (2017), Johnson et al. (2008)
Typical Cooling Water Reuse and Recycling Rates		EAF Cooling Water, BFBOF Cooling Water	%

The model was then parameterized for annual calculations during a period of 200 years, assuming that the demand for steel focused on the 6 most produced types of steel (UNS S30400, UNS S31600, UNS S43000, UNS S17400, UNS S32205, UNS S40900). The yields of the EAF and the BFBOF production macro-processes were set according to their respective capacity and productivity, as well as to their share of participation in the EU28. The parameters can be seen in Table 4.

Table 4 - Summary of parameters used to test and run the model.

PARAMETER	VALUE	UNIT	SOURCES
EAF Tap-to-Tap Time ⁽¹⁾	0,8	hours	Shamsuddin (2016), WS (2012, 2017b, 2017c), EU (2011), Madias (2013), Cullen et al. (2012), Yellishetty et al. (2011, 2011a), EUROFER (2017a), Seetharaman (2013)
EAF Furnace Capacity	100.000,00	kg	
BFBOF Cycle Capacity	42.000,00	kg/batch	
BFBOF Productivity ⁽¹⁾	7	batches/h	
Share of EAF Production in the EU28	39,70	%	WS (2017b)
Share of BFBOF Production in the EU28	60,30	%	
Worldwide Recoverable High-grade Iron Ore	82 billion	tons	Sverdrup & Ragnarsdottir (2014), UNCTAD (2017)
Worldwide Recoverable Low-grade Iron Ore	92 billion	tons	
Worldwide Recoverable Very-low-grade Iron Ore	166 billion	tons	

(1) As both delay and yield factor.

Keeping in mind that all of the steelmakers considered within the boundaries of the study either import iron ore or ship it from their international branches, inherent behaviors of the model structure include (a) the gradual transition from BFBOF production to EAF production as function of steel scrap availability, iron ore quality decrease and iron ore scarcity over time (Waugh, 2016); (b) the gradual shift towards consuming steel scrap instead of iron ore as a function of iron content and availability, still respecting alloying and operational requirements; and (c) steel scrap downcycling over time due to alloying quality loss during repeated service lives. Finally, all circularity and end-of-life behaviors were set to respond in a *business-as-usual* pattern, with no direct or indirect stimulus of any kind, evolving only in proportion to the demands of the elements present in steel scrap.

RESULTS AND DISCUSSION

After running the model, the author proceeded to verify if the integration could reproduce results of studies that used SD and LCA separately. In what regarded SD, the results were favorable and all features of SD remained functional.

As the biophysical depletion of recoverable high-grade iron ore reserves takes place, as seen in Figure 4, BFBOF production would be forced to migrate to inferior grades of iron

ores by 2051, and its availability would become critical in 2054, i.e. 53 years after the initial data point of 2001. These results very much reproduced those of Sverdrup & Ragnarsdottir (2014), in which such a condition would take place by the year 2050. Having analyzed and reproduced the means by which their results were achieved, the author identified that the 4-years difference occurred due to two main factors: Sverdrup & Ragnarsdottir (2014) used (a) longer data series and (b) considered the aggregate demand for all steel types.

Figure 4 - High-grade iron ore depletion.

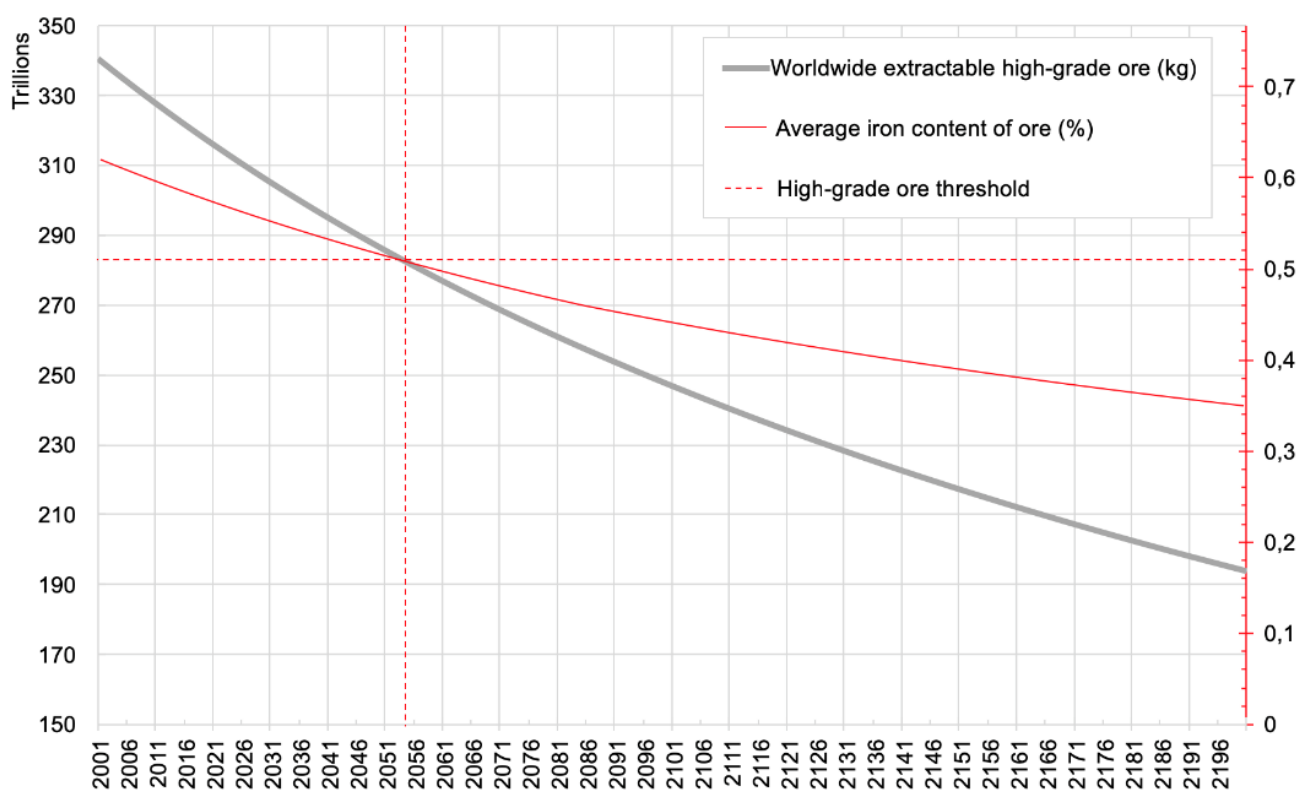

When analyzed alongside Figure 5, the decrease in iron ore consumption associated with its loss in iron content had a direct effect on the input of steel into the economy, despite a strong trend of increasing steel scrap generation until around 2060. This happened due to a delayed transition from BFBOF towards EAF, limiting the amount of steel delivered to the economy even with BFBOF eventually operating at maximum capacity during phase-out, corroborating the conclusions of Asif et al. (2015).

As high-grade iron ore becomes scarcer, higher priority should be given to retaining the resources and materials originated from it within a same supply chain, in order to accrue as much environmental and economic benefits from them as possible. The same logic applies to all of the TCEs and CRMs involved in the production of different steel alloys, notably nickel, niobium, titanium, vanadium and molybdenum. To do so in the EU28 while keeping in mind CE would require stakeholders within a supply chain to work on improving and integrating their operations, also an argument brought up by Asif et al. (2015) and Nuss & Blengini (2018).

Figure 5 - Results for ore, scrap, steel input and circularity (tons).

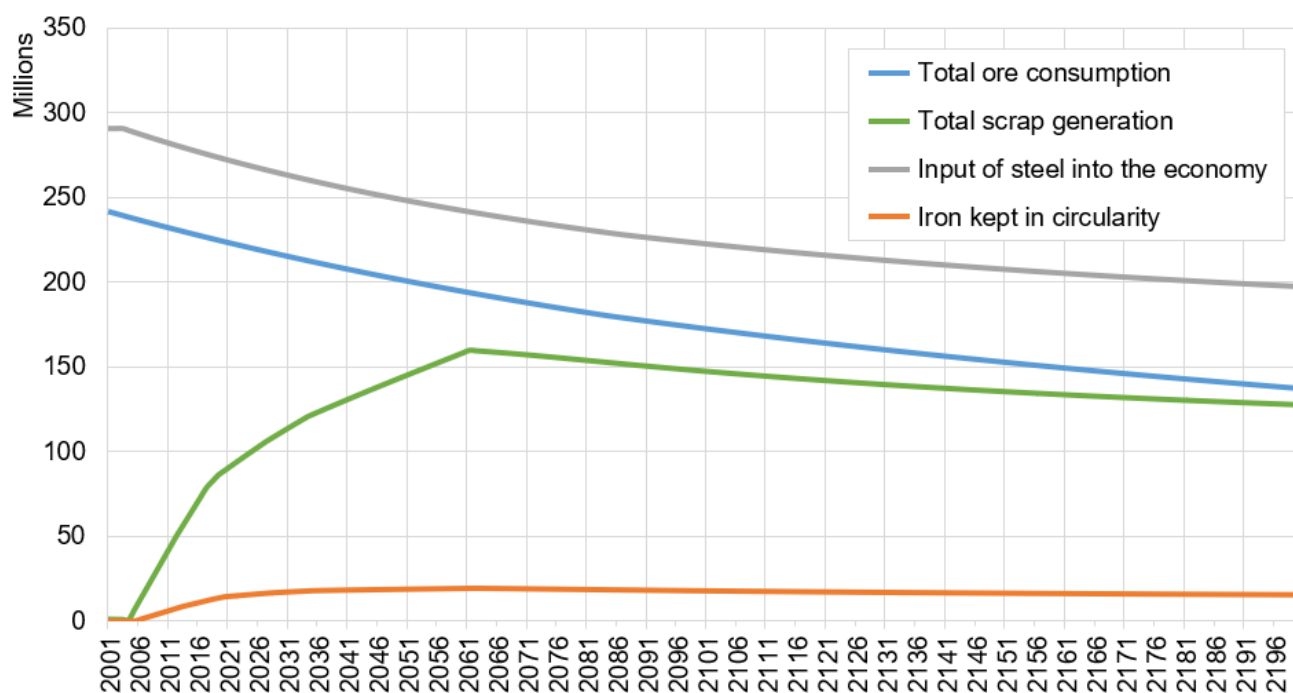
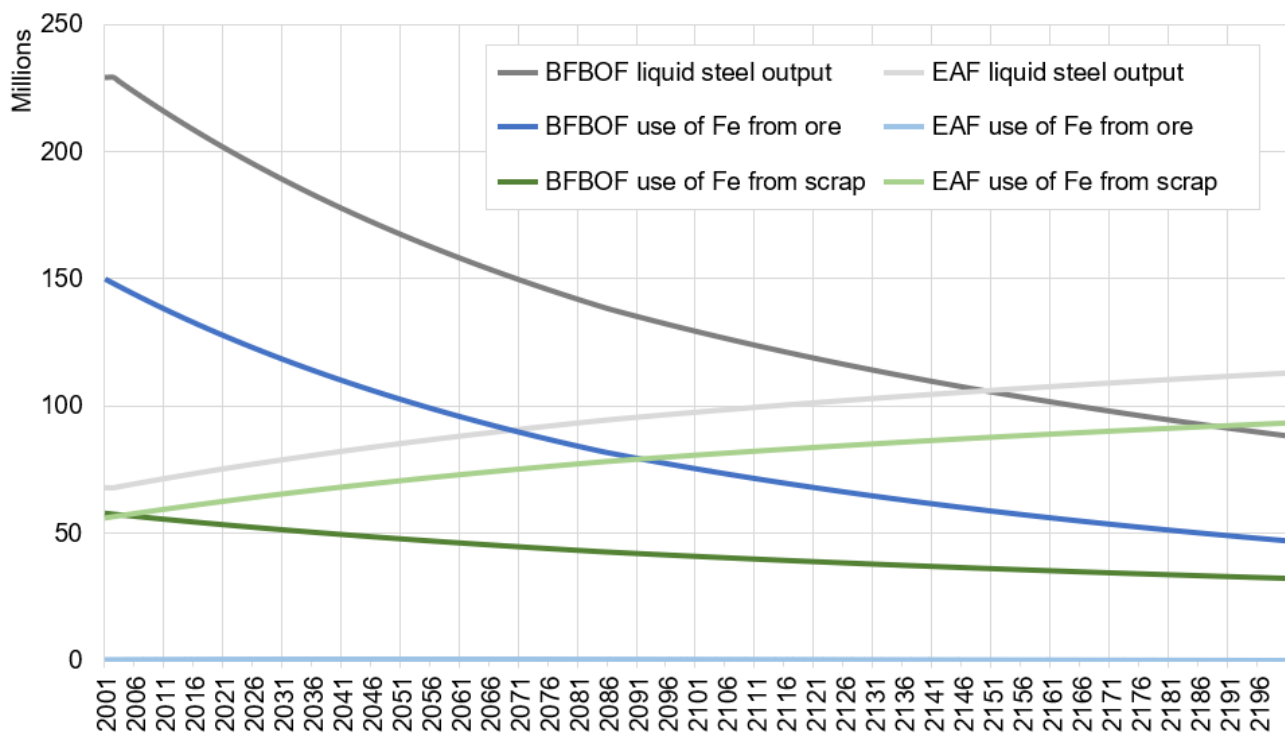

Figure 5 also points to iron circularity being hardly affected, phenomenon replicated to other elements until biophysical exhaustion, and consequent of a balancing effect in which (a) even though more steel scrap is generated, more of it is consumed, and (b) no additional stimulus is being given to increasing circularity other than by responding to the demand for scrap and the elements within it. If a transition from BFBOF to EAF production occurs as is,

steel's presence in the EU28 economy would be forced to go through a decline not only due to availability restrictions on other alloying elements, but due to iron itself – argument also previously brought forward by Ansari & Seifi (2012) and Sverdrup & Ragnarsdottir (2014).

Figure 6 reinforces this notion, in which by maintaining the *status quo*, EAF will not be able to cover for the liquid steel output reduction of BFBOF steelmaking, even if by using more scrap and less ore, the depletion of ore itself is slowed down. One of the main drawbacks of such a situation is the undesired and indirect stimuli potentially given to the market for developing materials alternative to steel, which could add competition detrimental to steelmakers' margins (Asif et al., 2015). Therefore, if a faster transition towards EAF steelmaking is desired, policy-based initiatives towards the development and strengthening of a secondary raw materials market is necessary, as highlighted before not only by the European Commission (EC, 2013b), but also by EUROFER (2015).

Figure 6 - Steel output and the sources of iron (tons).



Next, regarding LCA, the results were also favorable, but one of its features could not be reproduced. As an example, the average CO₂eq emissions of 837,41kg/FU from EAF steelmaking and 2.255,39kg/FU from BFBOF steelmaking were aligned with those of Burchart-Korol (2013), however, determining the impacts of these emissions on specific environmental compartments as per ReCiPe indicators, for example, was not feasible. The same outcome occurred for slag generation: while the average results of 459,84kg/FU from the BFBOF and 121,17kg/FU from the EAF aligned with those from Renzulli et al. (2016), determining specific impact indicators was, notwithstanding, unachievable at this point. In the cases of both slag and emissions, nevertheless, the integrated model allowed for easier analysis of individual chemical elements, as exemplified in Table 5.

Table 5 - Summary of observed slag and emission compositions.

	EMISSIONS		SLAG		COMMENTS
	BFBOF	EAF	BFBOF	EAF	
CO	39,1%	62,7%	-	-	From partial oxidation in the furnaces.
CO₂	20,8%	3,1%	-	-	From the combustion of fossil fuels.
N	3,4%	30,8%	-	-	Mostly in the form of oxides (NO _x).
H	32,6%	3,3%	-	-	Either as CH ₄ or as H ₂ .
H₂O	4,0%	-	-	-	Byproduct.
Ca	-	-	28,5%	30,6%	As part of CaO and CaS.
O	-	-	36,3%	32,8%	Present in all oxides.
Si	-	-	11,4%	7,3%	As part of SiO ₂ .
Mg	-	-	4,5%	3,8%	As part of MgO.
Al	-	-	3,9%	2,3%	As part of Al ₂ O ₃ .
Cr	*	*	11,8%	1,1%	Free ion or as part of Cr ₂ O ₃ .
Mn	*	*	1,5%	3,3%	As part of MnO.
Fe	*	*	0,4%	17,6%	As part of FeO and Fe ₂ O ₃ .
P	-	-	0,4%	0,8%	As part of P ₂ O ₅ .
S	-	-	1,0%	0,2%	Free ion or as part of CaS.
Zn	*	*	0,3%	0,2%	Free ion or as part of ZnO.
Ti	-	-	*	*	Free ion or as part of TiO ₂ .

* Trace amounts, less than 0,1% altogether.

The results and analyses derived from the integrated model answered favorably the first question, indicating that the integration did not interfere with the results of either LCA or

SD. The use of indicators, however, – one of LCA’s features – was rendered impractical. While LCA incorporates indicators from the very beginning of its approach, SD requires them to be modelled individually, point on which more extensive research and development would be necessary.

In order to answer the second question, the author referred back to the criteria listed in the Research Design section. Criterion ‘a’ was perceived by the author as considerably improved, with the addition of a more detailed understanding of the dynamics of steel in the economy outside of the steelmakers’ gates. Criterion ‘b’, on the other hand, saw SD give LCA a substantial boost in terms of how many years of steelmaking operation could be simulated or projected using only endogenous data feedback. Whether calculating annually for a period of 200 years – as performed in this study – or even down to hourly calculations for a certain period of interest, SD’s delay and feedback mechanics allowed LCA to have a better grasp on how the gate-to-cradle dynamics loop back into its mostly cradle-to-gate approach.

The contribution to the improvement of LCA’s macro analysis potential, as per criterion ‘c’, derived mostly from the possibility to track many different elements while concurrently simulating changes in more than one variable at a time throughout the entire supply chain, as exemplified in Figure 7. Moreover, not only did stocks and flows help influence the system’s overall behavior, but so did both feedbacks and delays, features characteristic of SD that broadened LCA’s range of analysis.

Figure 7 - Presence of iron in the economy, per sector.

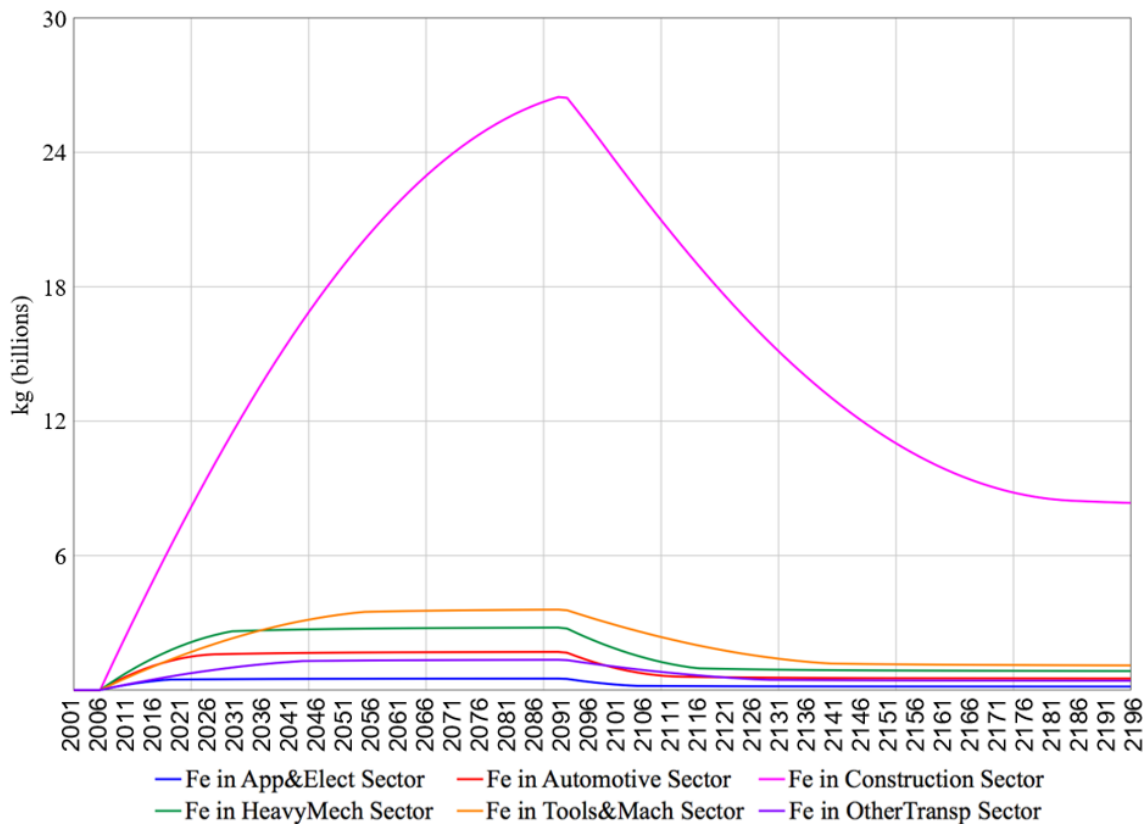

With respect to criterion ‘d’, bringing LCA into SD did in fact allow for more precisely and objectively visualizing and accounting the stocks and flows of materials through and within the involved stakeholders, notably after steel leaves the industry and cycles through the economy and through end-of-life and circularity services. The collection and input of case-specific data following the LCA guidelines of ILCD and ISO improved the reliability and especially the granularity of the SD analyses – as per criterion ‘e’ –, which were better supported by objective and empirical results such as those exemplified in Table 5.

For these reasons, the practical usefulness of the results across managerial levels – criterion ‘f’ – was also perceived as improved, which could allow for different decision-makers to use the same model for variables that range from chemical composition all the way to ore scarcity and demand planning. In all cases, nevertheless, further improvements to its

managerial applicability could be achieved by linking such a model to real-time operational data inputs.

The author understands that verifying the feasibility and the potential benefits of integrating SD and LCA very much depends on how the integration itself is performed and, considering the methodological steps and the modelling approach used in this study, the integration was deemed not only feasible, but also capable of better supporting stakeholders that would previously only consider SD or LCA, adding to their individual strengths.

With this in mind, it is important to note that LCA seemed to contribute more for the improvement of SD than the other way around. It is to say that, overall, the distinctive diagnostic and process efficiency features of LCA emerged much more tangibly as a result of the integration process than SD's problem-solving orientation.

For professionals or academics used to LCA applications, the current obstacles for working with indicators might configure enough of a barrier to avoid either a transition or an integration into SD. Future improvements on this integration could potentially solve such issues and favor its adoption. Nevertheless, the aforementioned strategic gains should suffice to attract attention to the discussion and to entice interested agents to further investigate gate-to-cradle dynamics and their feedbacks into production.

For SD scholars, however, the benefits of integrating LCA expertise into SD modelling were substantial. Enhancing the reliability, the granularity and the stakeholder visibility in the results can compensate for many of the weaknesses identified in the SWOT analysis of standard SD applications, notably helping to mitigate the threat of over-simplistic analyses. SD practitioners and policy-makers could take advantage of this approach to better uphold their analyses, adding to the levels of objectivity and representativeness of their studies, especially when process efficiency is a key decision factor.

Additionally, particularly from cradle-to-gate, the integrated model was very reminiscent of what IE calls Industrial Metabolism. Certain similarities to other IE tools such as Material Flow Analysis (MFA) and its dynamic form (dMFA) became evident as well, especially regarding the visibility of flows and stocks. Also, due to the characteristics of the European steel industry, the model posed as another good example of how CE envisions end-of-life processes as suppliers to the earlier stages of the supply chain. Further studies would need to be done, however, in order to add more renewable energy sources into the operation, as well as to better manage how some chemical elements rejoin the biosphere.

Finally, the author believes that if data in more disaggregated levels were available, even better results would have been achieved. This could lead to significantly better analyses of individual processes such as sintering, pelletizing, mining, forming, metalworking and recycling, especially regarding emissions and the use of energy directly in the form of heat and electricity.

CONCLUSIONS AND RECOMMENDATIONS

This study based itself on SWOT analyses of relevant SD and LCA studies on steel as well as on Business Process Mapping to support the creation of a model that integrated LCA into SD. The model was built in ISEE Stella Architect using the European steel industry as a case study while following ISO and ILCD standards. As the main result, the integration was deemed feasible and beneficial for both SD and LCA in different levels. Table 6 summarizes the results for both the quantitative and qualitative criteria used in evaluating the performance of the integrated model.

Table 6 - Summary of quantitative and qualitative results.

QUANTITATIVE			QUALITATIVE	
Criterion	Reproduced LCA?	Reproduced SD?	Criterion	Integration evaluation
Emissions	Yes	-	SD improves LCA's circularity analyses	Considerable/minor improvement: more detailed gate-to-cradle dynamics;
Biophysical depletion of iron ore	-	Yes	SD improves LCA's long-term perspective	Substantial/major improvement: allows for full timespan flexibility;
Steel scrap generation and consumption	Yes	Yes	SD improves LCA's macro analyses potential	Substantial/major improvement: allows for the tracking of multiple elements while multiple variables are interacting or changing simultaneously, not only OFAT;
Liquid steel output	Yes	Yes	LCA improves SD's stakeholder involvement identification	Substantial/major improvement: more precise depiction of flows, stocks and roles as per LCA requirements;
Iron circularity	-	Yes	LCA improves SD's analysis reliability	Substantial/major improvement: increased reliability and granularity due to data disaggregation and objectivity;
Steel input into economy	Yes	Yes	LCA improves SD's applicability across managerial levels	Considerable/minor improvement: analyses can range from operational to strategic levels, but depend on how the model is built.

By allowing the simulation of longer periods of time, the testing of multiple simultaneously changing variables, endogenous feedbacks, and a clear visualization of gate-to-cradle dynamics, SD added strategic value to LCA, potentially interesting industrial decision-makers who would like to broaden the understanding of their operations as their goods and products integrate the economy as well as when they leave it. The benefits that LCA brought to SD were more substantial and revolved around increased granularity, reliability, stakeholder involvement and applicability of the results on different managerial levels, factors that could attract policy-makers in need of a deeper understanding of a specific supply chain.

No interferences to the application of SD were identified while reproducing the results of previous studies. The replicability of LCA results from previous studies suffered no interferences either, however, it could not benefit from the use of indicators such as ReCiPe. Further research on how to better integrate LCA indicators into SD is required in order to

improve the integration. Moreover, even when integrated into SD, LCA still calls for complex or disaggregated data to be as effective as possible.

Henceforward, the author recommends further investigation into the integration of LCA and SD. However well aligned it already was to the concepts and frameworks of both IE and CE, more attention to environmental impact indicators, renewable energy sources and to the reintroduction of substances into the biosphere is desirable. By giving the model pertinent market data, setting other TCEs or CRMs present in the supply chain as key drivers instead of iron, and by using an industrial case study, researchers should be able to make even more progress towards the implementation of a joint LCA+SD mindset across academia, management and government.

Finally, based on the potential brought forward by the results of this study, the author will extend the exploration of this methodological integration and its application to the European steel industry. Planned developments include (a) testing the benefits that different supply chain integration strategies focused on closed loop operations could bring to biophysical circularity, (b) examining the potential effects of different end-of-life and secondary market development policies on supply- and demand-side dynamics, as well as (c) verifying which biophysical dynamics have the most relevant interactions with steel trade and its futures market.

THE ROLE OF POLICY ON END-OF-LIFE SERVICES TO FOSTER BIOPHYSICAL CIRCULARITY IN THE EUROPEAN STEEL INDUSTRY

Article status: Submitted, under review (2nd round);

Journal: Journal of Cleaner Production (Elsevier);

Co-author: MEYER, M. ^a; DIEMER, A. ^b

^a Gesellschaft für Wirtschaftliche Strukturforchung (GWS) GmbH, Osnabrück, Germany;

^b Centre d'Etudes et de Recherches sur le Développement International (CERDI), Université Clermont-Auvergne, Clermont-Ferrand, France;

Highlights:

- Assesses European policies based on Circular Economy and their interaction with either steel or its end-of-life;
- Tests different end-of-life scenarios on a Life Cycle Assessment and System Dynamics integrated model;
- Discusses policy approaches that could further improve the biophysical circularity of end-of-life steel in Europe;
- Focus on recycling has significant impact on long-term supply side circularity and on transitioning towards EAF;
- Focus on reuse has higher impact on medium-term and boosts the development of service sector dynamics on the demand side.

Abstract:

Given the competitive difficulties being experienced by the European steel industry during the last two decades, the current state of implementation of Circular Economy (CE) in Europe, and the policy efforts derived from this context, addressing environmental challenges has become an increasingly complex task for all stakeholders involved. With that in mind, this article's first concern was to assess potential policy shortcomings, particularly on what concerns end-of-life (EoL) steel, to then propose different approaches that could foster biophysical circularity in the European steel industry. To that end, 13 simulations runs were performed in a Life Cycle Assessment and System Dynamics integrated model, bringing to light the discussion that policies targeting the entire steelmaking supply chain and incisively pushing for recycling and reuse could generate interesting medium- to long-term results for circularity, transitioning away from fossil fuels and developing a whole new market around end-of-life services.

Keywords:

Steel; Europe; End-of-Life; Circular Economy; Policy.

INTRODUCTION

Steel is an essential material of modern societies worldwide, being present in most aspects of everyday life, from civil engineering to transportation, from packaging to consumer electronics (WS, 2012; Beddows, 2014). The life cycle of steel begins in ore mining and often meets its end either inside long service life structures or as recyclable scrap (Warrian, 2012; Vaclav, 2016).

As of today, 70% of the steel in Europe is recycled, most of its byproducts can be reused in other industries and, in comparison to the 1980s, the average steelmaking process uses 50% less energy (Yellishetty, et al. 2012; WS, 2017a/b). These figures highlight not only how much progress has been made by the European steel industry towards environmental goals in the last few decades (d'Costa, 1999; Nuss & Blengini, 2018), but also its potential to help other industries, such as Automotive, in becoming more fuel efficient and less emission intensive by using stronger and lighter steel alloys that are environmentally competitive enough to front plastics and aluminum (Warrian, 2012; WS, 2013b; Vaclav, 2016).

During this same period, managerial scientists, engineers and academics developed new tools and methods to better support decision- and policy-makers in determining the future of the European industry, notably on what concerns the environment (van Berkel et al., 1997; Baas & Boons, 2004). Spearheading this push was Circular Economy (CE), a concept which came to light as a mean to rearrange traditional linear production processes into circular ones, arguing that all economic activities should be performed focusing on (a) the use of wastes as inputs, (b) the adoption of renewable and clean energy sources, (c) the accurate biophysical costs of extraction, transformation, use and reinsertion of materials into either economy or biosphere, and (d) outputs designed from the beginning so as to facilitate collection, recycling, refurbishment/remanufacturing, reuse, disassembly, redistribution,

maintenance and sharing throughout their lifespan (Park et al., 2010; EMF, 2014a,b/2015a/2016/2017; Haas et al. 2015).

In 2012 the European Union and its members committed to the application of Circular Economy as an economic model, boosting a transition to resource-efficient practices that eventually lead to a regenerative progress toward nature (Zhijun & Nailing, 2007; UNEP, 2011; EC, 2012; Su et al., 2013; Kahle & Gurel-Atay, 2014; EMF, 2015b; Gregson et al., 2015). The steel industry, maintaining the existing environmentally-oriented momentum, was among the first to consider and to implement measures that could benefit from these new developments. Not long after, the European Commission (EC, 2013b) conceived an action plan focused on the European steel industry and on how this particular economic activity could surmount the environmental challenges in its future by making direct use of a Circular Economy framework, its methods and its tools.

It is by keeping in mind the importance of the European steel industry and its policy context that this article aims to (a) assess the existing CE-based policies focused on steel, identifying potential shortcomings therein, and (b) discuss alternative approaches to policy that could foster circular behavior in this economic activity, particularly regarding the biophysical circularity of end-of-life (EoL) steel. To begin, the next subsection summarizes existing Circular Economy policies, setting the grounds for a later analysis focused on steel.

CIRCULAR ECONOMY IN POLICY

The concept of Circular Economy has been introduced under different forms during the 70's and the 80's: Boulding (1966) described Earth as a closed and circular system with limited assimilative capacity; and Pearce & Turner (1990) explained how natural resources influence the economy by providing inputs for production and consumption as well as serving as a sink for outputs in the form of waste. Some of the most relevant theoretical influences

come from the Laws of Ecology (Commoner, 1971), Bioeconomics (Georgescu-Roegen, 1978), Regenerative Design (Lyle, 1994), Industrial Ecology (Graedel & Allenby, 1995), Cradle-to-Cradle (McDonough & Braungart, 2002), Biomimicry (Benyus, 2002) and Blue Economy (Pauli, 2010).

The contemporary understanding of the Circular Economy, however, counts on abundant conceptual and theoretical literature, ranging from its practical applications in industrial processes to its macro-economic effects, being the 3R Principle (reduce, reuse, recycle) a noteworthy example (Lewandowski, 2016; Haas et al., 2015; Ghisellini et al., 2016). Geissdoerfer et al. (2017) defined Circular Economy as a regenerative system in which resource input, waste, emission, and energy leakage are minimized by slowing, closing, and narrowing material and energy loops, via long-lasting design, maintenance, repair, reuse, remanufacturing, refurbishing and recycling; while Prieto-Sandoval et al. (2018) considered Circular Economy to be a paradigm shift that requires industries, policy-makers and consumers to innovate in the way they produce, legislate and consume, respectively.

The Ellen MacArthur Foundation played an important role not only in the popularization of the concept in the 2010's, but also in the development of many Circular Economy tools for businesses, academia and policy-makers (Winans et al., 2017; EMF, 2013/2014a,b/2015b). As seen in Figure 1, since then, significant attention has been given to industrial activities to the point of having Circular Economy be defined as “an industrial system that is restorative by intention and design. In a circular economy, products are designed for ease of reuse, disassembly and manufacturing – or recycling – with the understanding that it is the reuse of vast amounts of material reclaimed from end-of-life products, rather than the extraction of new resources, that is the foundation of economic growth” (EMF, 2012).

Figure 1 - Outline of a Circular Economy (EMF, 2017).

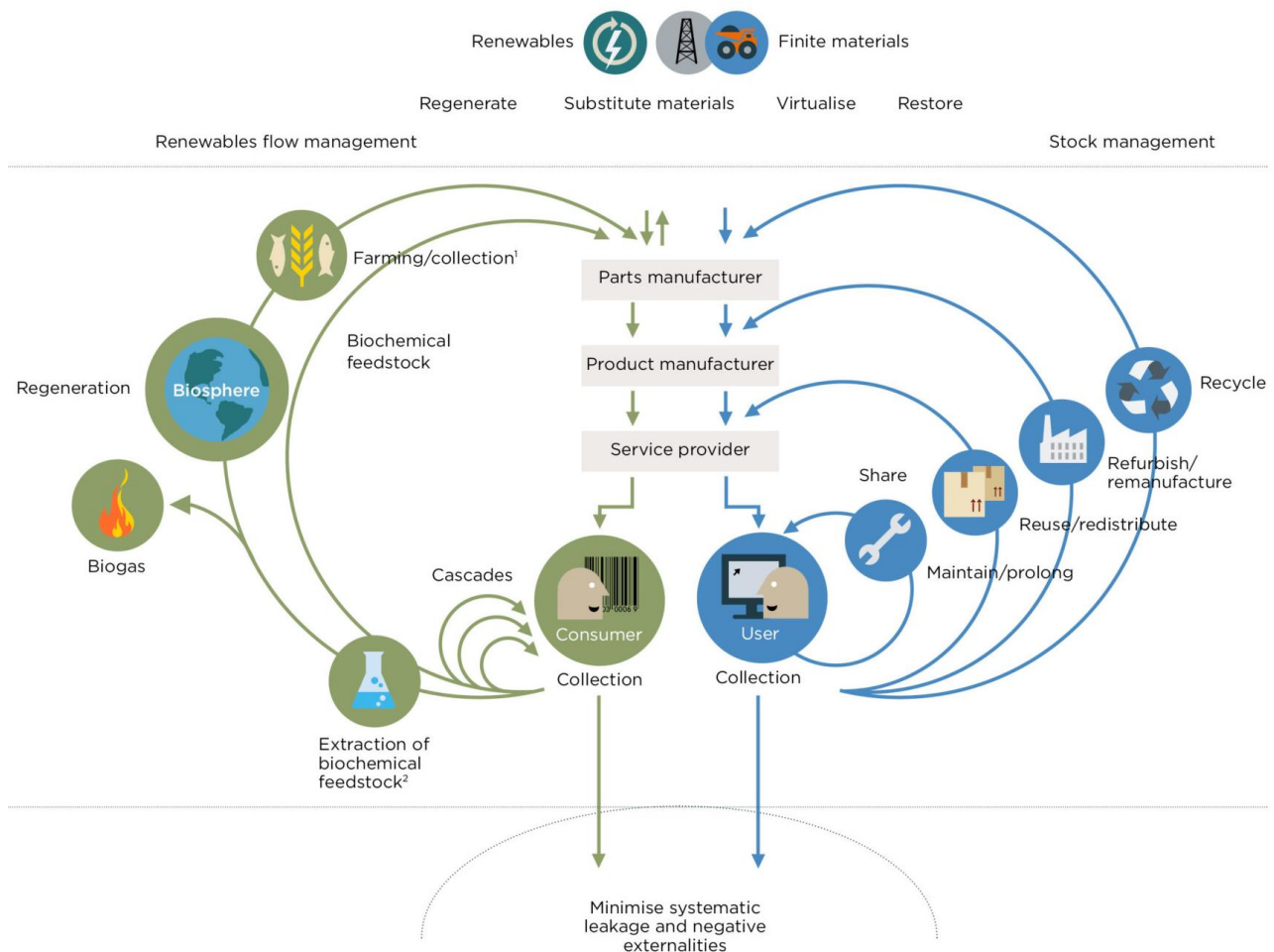

Thus far, Circular Economy has influenced the policy-making strategies of many governments and intergovernmental agencies at local, regional and national levels, eventually leading to the development of Europe’s *Circular Economy Package* (EC, 2015a). For the Commission, Circular Economy is defined as an economic system in which the value of products and materials is maintained for as long as possible; waste and resource use are minimized, and resources are kept within the economy when a product has reached the end of its life, to be used again and again to create further value (EC, 2012).

The aforementioned package seeks to stimulate Europe’s transition towards a circular economy capable of boosting Europe’s competitiveness, fostering sustainable economic growth and generating new jobs (EC, 2015b). And even though some of the main targets

defined in the Action Plan include increasing the recycling of municipal to 65% and the recycling of packaging waste to 75% – both by 2030 – (EC, 2014/2015a/2017), considerable potential for economic benefits have been estimated in terms of resource efficiency, being the European Commission itself responsible for estimating net savings of €600 billion on business turnover, the creation of 580.000 jobs, and the reduction of total annual greenhouse gas emissions between 2 and 4% – i.e. 450 million tons of CO₂ by 2030 (EESC, 2016; Tukker, 2015).

Coasts & Benton (2015) calculated that an ambitious Circular Economy strategy for Europe could enable at least 270.000 unemployed people in Italy, Poland and Germany alone to rejoin the workforce all the while saving at least €3 billion in related institutional costs. The study also outlined that a transition towards Circular Economy would naturally be different in each of the EU's member states, for example: in Italy it should likely revitalize its southern agricultural economy; in Poland it should boost productivity; and in Germany it could help manufacturers to adhere to servitization and to business practices aimed at redistribution.

Considering all policies in force, major focus has been given to the life cycle of plastics, food waste reduction, hazardous and chemical fertilizers, critical raw materials, construction waste and bio-based materials (EC, 2015b). Moreover, a set of indicators, a monitoring framework and regulations on Green Public Procurement (GPP) have been put in place not only to monitor the evolution of the transition to a circular economy, but also to support small and medium enterprises less capable of transitioning on their own capital alone (EC, 2008/2014b/2018a,b).

STEEL AND CIRCULAR POLICY

Due to the commoditization of its products and of its raw materials, the steel industry traditionally pays close attention to factors and productive variables that can affect price and

competitiveness just as much as quality, so for decades this industry has been using some of the principles of Circular Economy even before it became a widespread concept or as a European economic model, being recycling and by-product reuse the most consolidated environmentally-friendly practices in this economic activity (EC, 2013b; WS, 2016).

As environmental concerns, demands and pressure grew in all sectors, steelmakers were grouped with other industrial activities when addressed by policies aimed at the assessment, reduction, prevention and mitigation of environmental impacts. In Europe, most policies came into force or were revised close to the turn of the century, notably the Environmental Assessment Directive 2011/92/EU (EP, 2011), the Industrial Emissions Directive 2010/78/EU (EP, 2010), the Air Quality Directive 2008/50/EC (EP, 2008a), the Water Framework Directive 2000/60/EC (EP, 2000a), the Packaging Waste Directive 94/62/EC (EP, 1994), the Waste and Hazardous Waste Framework Directive 2008/98/EC (EP, 2008b), and the Landfill Directive 99/31/EC (EU, 1999).

These documents present broad guidelines on how industries should conduct their activities so as to properly manage, control and report the direct and indirect outputs that are undesired or potentially hazardous for different compartments of the environment, but minimal attention is given to input alternatives, resource efficiency or circular behaviors, and no particular or direct attention is given to the steel industry (EP, 2000a/2008a,b/2010/2011; EU, 1999).

The same happened for the mining industry – often considered outside of steelmaking boundaries for policy purposes –, to which substantial attention was given regarding the treatment and disposal of outputs but not so much as to their recovery or to their role in contributing to this industry's own circularity or that of its customers (e.g. steelmaking), as per the Extracting and Mining Waste Directive 2006/21/EC (EP, 2006a).

Then the action plan focused on the steel industry was created, mostly to summarize the situation of the European steel industry as of 2012 and to bring to light the difficulties faced by the sector in terms of prices, competitiveness, trading and energy – all of which were perceived as obstacles to furthering environmental progress on resource efficiency and climate (EC, 2013b). Among its many suggestions, it highlighted the need for developing secondary metals markets in order to boost the production of steel from scrap while raising awareness to the fact that a revision of the current regulatory framework would be necessary so as to reduce excessive burdens, gaps and inconsistencies that hinder fair and competitive trading (EC, 2013b).

From that point on, the European Commission and the European Council created multiple policy-supporting documents based on the aforementioned action plan (EC, 2014), such as (a) specific action plans for the automotive and construction sectors (EC, 2012b/c), (b) a competitiveness-proofing toolkit (EC, 2012a), (c) eco-design requirements for energy equipment (EP, 2009).

From an operational point of view, the most notable document was the Best Available Techniques (BAT) for Iron and Steel Production (EC, 2013a), which, along Directive 2006/21/EC and the BAT for the Ferrous Metals Processing Industry (EC, 2001), proposed operational techniques capable of directly addressing certain environmental impacts and, when possible and pertinent, suggested potential circular integrations, as summarized in Table 1.

Table 1 - Summary of available BATs for iron and metals mining, processing, and steel production.

PRODUCTION PROCESS	EMISSIONS	EFFLUENTS	WASTE	ENERGY	NOISE
Mining	•	•	•		
Sintering	•	•	•	•	
Pelletisation	•	•	•	•	
Coking	•	•	•	•	
Blast Furnace (BF)	•	•	•	•	
Basic Oxygen Furnace (BOF)	•	•	•	•	
Electric Arc Furnace (EAF)	•	•	•	•	•
Continuous Casting	•	•	•	•	
Rolling	•	•	•		
Drawing		•	•		
Coating	•	•	•		
Galvanizing	•		•		

Sources: (EC, 2001/2013a; EP, 2006a)

Still, the previously mentioned policies and most of their supporting documents either address steel indirectly through other sectors or approach different stakeholders/process of the steel supply chain separately. This counterintuitively hinders circularity and has been deemed insufficient even for sectors like the automotive, where more policy-based support is available (Diener & Tillman, 2016; Dunant et al., 2018). Even the Best Available Techniques (BAT) documents were deemed insufficient to address climate and resource efficiency issues unless more attention was to be given to end-of-life steel, energy sourcing and systemic/holistic approaches such as Life Cycle Assessment (LCA) (EC, 2013b/2014).

Thus, when understanding how the Circular Economy framework applies to the steel industry, as seen in Figure 2, it is possible to see many more areas where additional support and stimuli policies – and not only regulation – would be either necessary or welcome (e.g. repair & reuse, refurbishment/remanufacture) (Material Economics, 2018).

Figure 2 - Circular Economy outline applied to the European steel industry.

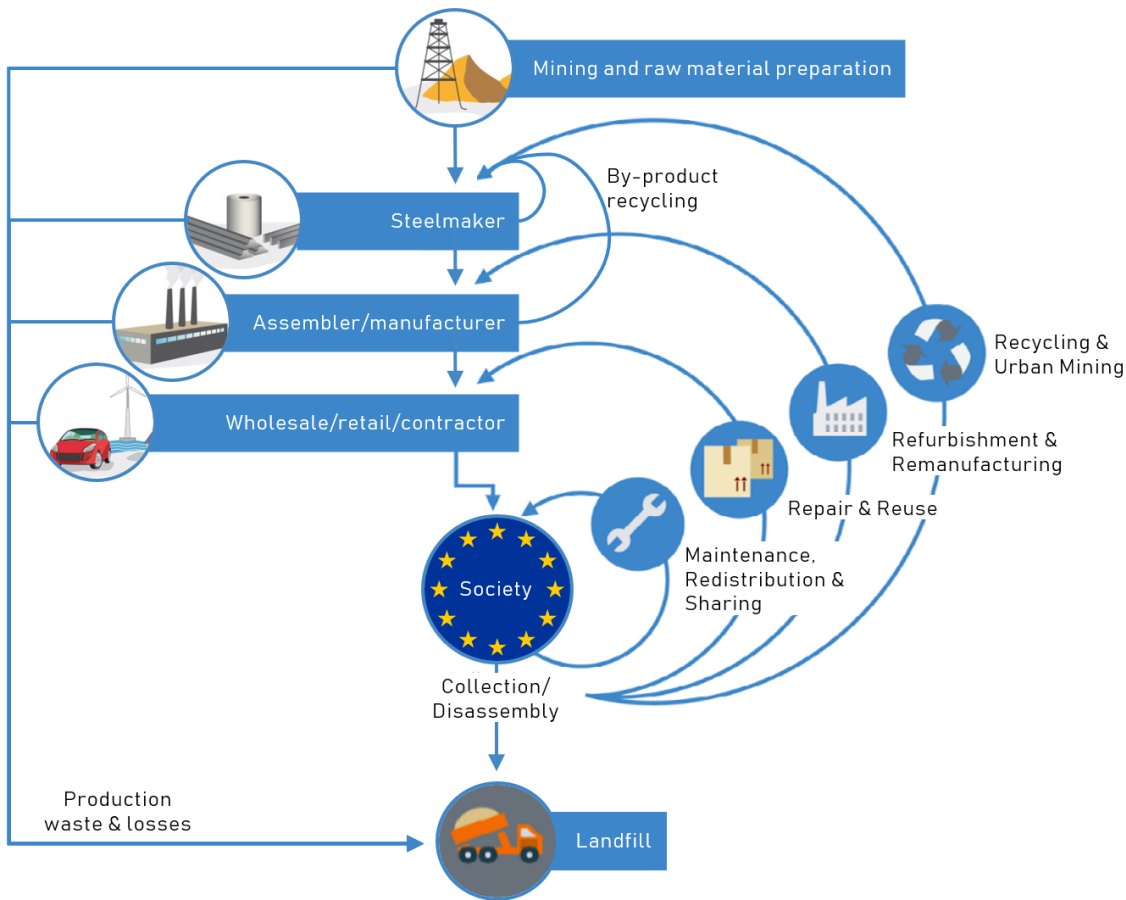

As of today, however, support and stimuli policies are limited and most progress towards circular behavior depends on the efforts of representative associations and on business pressure on certain aspects of regulation, such as Council Regulation EU 333/2011 (EU, 2011a) – which determines the criteria that differentiate recyclable and recoverable steel scrap from disposable waste.

Although regulation can help in some cases, it is important to note that compliance to regulation can have not only administrative and operational effects but also financial ones. In a study commissioned by the European Commission itself, aimed at identifying the costs associated with deploying compliance measures (CEPS, 2013), it was noticed that for the legislation in force, Blast Furnace and Basic Oxygen Furnace (BFBOF) steelmakers spend an annual average of €1,035 per ton of crude steel (of which €0,614 OPEX and €0,421

CAPEX) while Electric Arc Furnace (EAF) steelmakers spend an annual average of €0,642/t (of which €0,335 OPEX and €0,307 CAPEX). And even though these costs are directly related to the reduction of environmental impacts, their effects on steel price are only reverted or compensated for in the long-term (Mayer et al., 2019).

Having identified the lack of policies that directly address end-of-life steel's circularity in a holistic and systemic way, the next subsection delves into the current and future developments of these materials within the boundaries of the policies that address them.

THE ROLE OF POLICY IN EUROPE'S END-OF-LIFE STEEL

In order to have a clear understanding of where the CE-based policies mentioned in the previous section could lead the European steel industry, it is important to understand not only the *status quo*, but also the overarching goals set by the stakeholders therein. Such an example is depicted in Figure 3, in which a transition of steelmaking from mining (BFBOF) to recycling (EAF) is visible as well as increased yields of reuse and refurbishment/remanufacturing.

According to EUROFER (2017b), the main long-term objectives are to boost the development economic activities centered around end-of-life services and secondary raw materials, as well as to reduce the dependence on primary natural resources. Although the EU's steel needs can be supplied by up to 85% by 2050, according to estimations (Material Economics, 2018), EUROFER argues that an equilibrium as shown in Figure 3 would not be achieved before 2050 due mainly to the fact that a significant amount of the customers of the European steel industry are located in developing countries with very high demand for all types of steel.

Figure 3 - Steel circularity today (a), and desired state of circularity equilibrium (b) (EUROFER, 2017b).

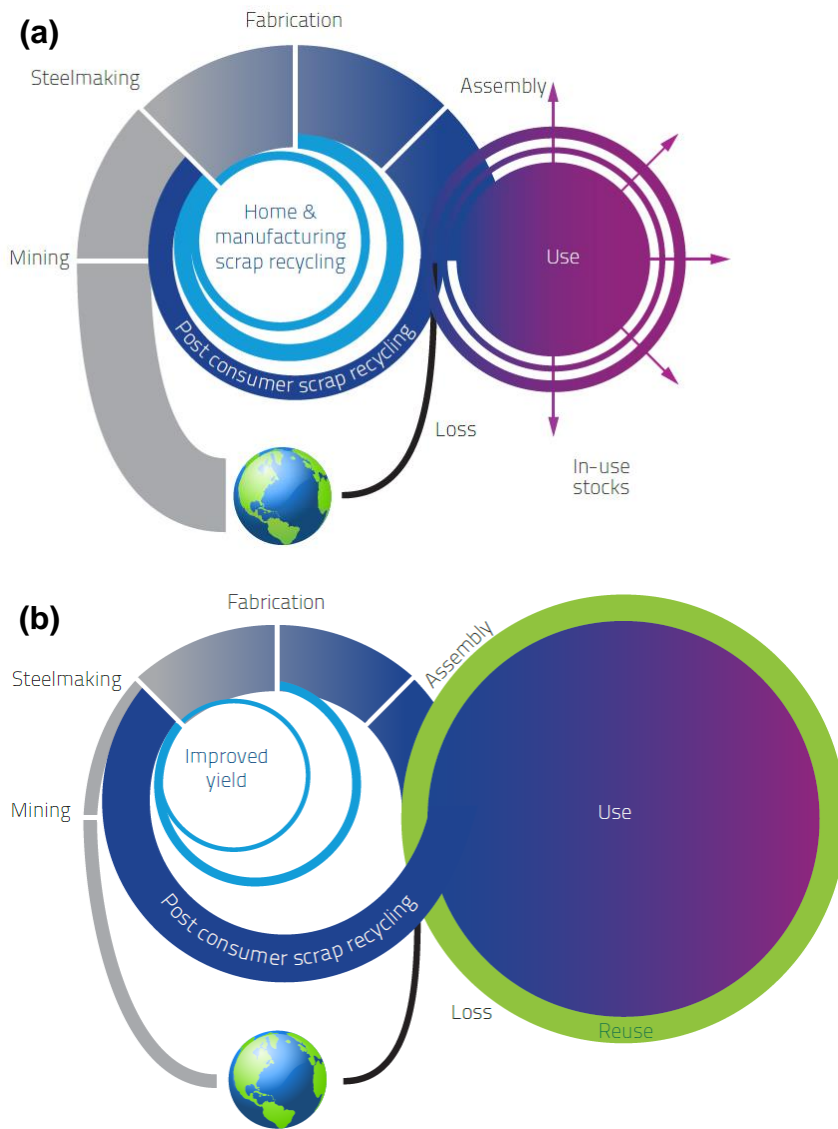

Furthermore, it argues that such an equilibrium would never completely eradicate the need for primary resources because value losses (EMF, 2015a) and downcycling – i.e. loss of alloying quality over multiple life cycles – would always require eventual material replenishment in order to rejoin the economy competitively, even at 100% recycling, reuse or refurbishment/remanufacture rates (EUROFER, 2015/2017b).

Keeping in mind that over 1.600 Mt of steel were produced in 2017 (BIR, 2017) and that most of the environmental impacts of steel take place either during production or indirectly during its use phase (EUROFER, 2017b; EC 2013b; Olmez et al., 2015),

increasingly large amounts of environmentally-oriented investments have been made by the European steel industry, ranging from 65 to 80% on end-of-life solutions and from 20 to 35% on solutions directly integrated to the production, depending on which EU28 nation is analyzed (CEPS, 2013).

Although the industry itself gives attention to end-of-life as an alternative source of raw materials to reduce the overall environmental impacts of production and to improve resource efficiency (Waugh, 2016), most of the policies regarding this sector's end-of-life materials often lead to regulation instead of support and stimuli (CEPS, 2013; EUROFER, 2017b; EC, 2013b/2014/2017; Hagelüken et al., 2016).

Despite the fact that for each ton of recycled steel in Europe, an average of 1.400 kg of iron ore, 740 kg of coaking coal and 120 kg of limestone can be saved regardless of application and that EAF steelmaking have significantly lower environmental impacts (IETD, 2018; WS, 2016; Waugh, 2016; EC 2013b; Material Economics, 2018), the ratio of steel scrap to crude steel has experienced multiple domestic declines in the EU28 zone while the steel scrap import/export balance continues to move steel abroad (BIR, 2016) – direct results of end-of-life services reacting to market dynamics but struggling to find domestic customers, still slow to transition out of BFBOF steelmaking (Waugh, 2016; Hagelüken et al., 2016).

Naturally, issues such as remelting losses, obsolete alloys, inaccessible scrap stocks, inefficient collection and separation, and copper contamination cannot be ignored – representing 17%, on average, of end-of-life steel depending on EU member state – (Material Economics, 2018; Haupt et al., 2016), but the steel industry worldwide – not only in Europe – has been proactive in funding its own research and development initiatives to solve these issues (IETD, 2018).

The recycling or reuse of steelmaking by-products such as slag, dust and off-gas – which together account for approximately 32% of the process' output – has also received

more technological and standardization attention after joint initiatives with the cement, fertilizers, road construction and energy generation equipment industries than from CE-based policies themselves (EC, 2013b; EUROFER, 2015; WS, 2014).

Moreover, inconsistencies and discrepancies have been found among existing policies, resulting in environmentally-oriented projects having issues getting approved, funded or be deemed compliant with circular practices (EUROFER, 2015). Many of these issues were summarized in an open letter from EUROFER (2015) to the European Commission, highlighting (a) the overlap of CE-based policies with sector-specific regulations, overburdening compliance; (b) the lack of a sector-specific holistic supply chain approach towards circularity; (c) the inadequacy of simplified target setting, which can result in under or overestimation of feasibility and capacity, often ignoring solutions that have nation-specific characteristics; and (d) the misalignment of definitions and classifications, creating regulatory hindrances to the use of end-of-life materials instead of primary ones (EUROFER, 2015).

Examples of conflicting or insufficient regulation include compliance criteria and material definitions for collection, separation and treatment of different steel scraps under the REACH Regulation EC 1907/2006 (EP, 2006b), as well as OECD and EU28 alignment of criteria regarding the shipping of imported and exported categories of steel scraps, as per Regulation EC 1013/2006 (EP, 2006c).

Consequently, although bold steps have been taken towards the implementation of a circular model in Europe (Mayer et al., 2018; Hagelüken et al., 2016), its steel industry finds itself at an impasse: the European steel industry has been requested to transition from its current situation towards a more circular model, but policy support to do so is currently limited.

Considering the policies in force, potential solutions developed by both industry and academia regarding end-of-life steel still struggle to gain substantial traction, despite the

predictions of the End-of-Waste Criteria for Iron and Steel Scrap (JRC, 2010): direct reuse of shipping containers for temporary or architecturally diverse housing, direct reuse or refurbishment/remanufacturing of tracks from discontinued railways, and the reuse of steel from demolished heavy-duty bridges in new lighter-duty ones are examples of activities not covered by CE-based policies (WS, 2016).

And when it comes to refurbishment/remanufacturing, eco-design, servitization and redistribution, no direct stimuli or empirical guidance is found in policies for the European steel industry, even when results of studies from representative associations point to significantly cheaper products at lower production or service costs, while also saving energy and materials (WS, 2016).

In light of the apparent misalignment between the potential contribution of steel to a European Circular Economy and the policies devised to implement it, this article aims to answer the following question: Would a more aggressive policy-based approach to end-of-life steel better support the European steel industry in its transition towards a more circular model? The author's hypothesis and the methodological aspects of this study are presented in the next section.

METHODOLOGY

In order to test and discuss the hypothesis that more aggressive policy-based approaches targeting the operational aspects of end-of-life steel could help improve the biophysical circularity of steel in Europe, this article made use of an integrated Life Cycle Assessment and System Dynamics model to perform simulations and verify the effects and behaviors consequent of increasing the rates of recycling or of repair & reuse in the European steel industry. Methodological details are presented in the following subsections.

CASE STUDY AND MODEL

This article used the European steel industry as case study due to its current shift towards environmentally friendlier operations, to its importance for the European economy, and to its trade and market concerns on the rise of international competitors. The boundary was set at the EU28 zone, comprising the supply chains of all steelmakers members of the WorldSteel Association therein, which account for 84% of the entire European steel industry.

The model is an integration of Life Cycle Assessment into a System Dynamics environment, focused on the biophysical interactions that represent the average behavior of the European steel industry as a whole. It was built in three steps: 1) Business Process Mapping (BPM), using the BizAgi BPM software; 2) Causal Loop Diagraming (CLD), using the OmniGraffle software; and 3) Flow Charting (FC), using the ISEE Stella Architect software (ISEE, 2018).

Iron was set as the driving chemical element of steelmaking, steel scrap and iron ore were set as the key raw materials, and all chemical elements and raw materials present in steelmaking adopted two different levels of aggregation: cradle-to-gate processes were disaggregated down to chemical level, while gate-to-cradle processes were aggregated to product level. This choice was made in order to give decision-making granularity without over encumbering macro-level analyses that could affect policy-making on end-of-life and circularity services.

The material needs of the furnaces were used to define the amounts of raw materials pulled from their respective sources. This pulling behavior is present in the system until liquid steel becomes an intermediary output, point in which the system then pushes materials through the subsequent processes so as to represent the continuous casting operation. Additionally, attention was given to the feedbacks that close the loop (e.g. recycling, repair & reuse), so as to enable the system to operate under the definitions of Circular Economy.

Modelling was approached modularly and each process was established as an individual LCA-based unit, capable of being displaced, rearranged or replicated with minimal interference in other processes or modules. This allowed for the model to be as scalable and flexible as possible for use by any stakeholder involved in a European steel supply chain, also reducing user interface cluttering.

In total, twenty modules were created – one for each chemical element involved in the steel supply chain –, all of which used a functional unit of 1 ton of steel and were built to be structurally identical, distinguished only by specific flows necessary to properly represent their typical operational behaviors. The economic limitations imposed by specialty alloying elements – molybdenum, niobium, cobalt and vanadium – were set aside in favor of a biophysical analysis.

As exemplified in Figure 4, individual productive processes were grouped into macro-processes based on their most common occurrence in the European steel industry, namely (a) EAF and (b) BFBOF – each encompassing sintering, pelletizing, degassing, alloying, desiliconization, desulfurization, homogenization or dephosphorization, whenever applicable; (c) Casting – which encompasses all shape, heat and surface treatments; (d) Metallurgy – which encompasses all forming and metalworking processes; (e) Economic Sectors – divided in Construction, Automotive, Other Transportation, Tools & Machinery, Appliances & Electronics, and Heavy Mechanical Equipment; (f) Recycling – which feeds back into the stock of scrap used as input for “a” and “b”; (g) Repair & reuse – which feeds back into each economic sector according to their share in its demand; and (h) Losses & Landfills – which configure process-based sinks.

Figure 4 - Flow Chart (FC) Interface Diagram of the model's biophysical module and control panel (highlighting Fe).

<< Please refer to the high-resolution images in Appendices 7.4 and 7.5, respectively >>

Furthermore, it is important to note that 1) due to the lack of available disaggregated data, emissions from mining, casting and metallurgy were attributed to the EAF and the BFBOF macro-processes accordingly; 2) dust and particulate matter generation were incorporated into the emissions; 3) no disaggregated emission data was found for end-of-life and circularity solutions; 4) energy flows were considered only in the form of amount of fossil fuels consumed, and not in the form of heat or electricity; and 5) no pricing, costing or speculative variables were considered.

Consequently, and as per design, inherent behaviors of the model structure include (a) the gradual transition from BFBOF production to EAF production as function of steel scrap availability, iron ore quality decrease and iron ore scarcity over time (Waugh, 2016); (b) the gradual shift towards consuming steel scrap instead of iron ore as a function of iron content and availability, still respecting alloying and operational requirements; and (c) steel scrap downcycling over time due to alloying quality loss during repeated service lives.

PARAMETERS AND SIMULATION RUNS

Table 2 summarizes the data inputs used in the study, all of which encompassed the interval between 2001 and 2014, and were verified for cohesion, coherence and reliability based on the criteria of the ILCD Handbook (EC, 2010) and of ISO14044:2006 (ISO, 2006), as well as with their equivalent data points in the WorldSteel Association Association's Life Cycle Inventory Study for Steel Products (WS, 2017c) and EUROSTAT Databases (EUROSTAT, 2009/2017/2018a,b).

The author also considered adopting Product Environmental Footprint (PEF) standards (JRC, 2012), however, in its current state, it presented itself as a less consolidated and less disseminated methodology, with available applications focused mainly in the construction sector.

Table 2 - Summary of data inputs.

TYPE	VARIABLE	UNIT	SOURCES
EAF Inputs	Scrap, Oxygen, Natural Gas, Coal, Limestone, Dolomite, Water, Ore	kg/kg of steel	Shamsuddin (2016), WS (2012, 2017b, 2017c), EU (2011b), Madias (2013), Cullen et al. (2012), Yellishetty et al. (2011), EUROFER (2017a), EUROSTAT (2009, 2018b)
BFBOF Inputs	Ore, Hot Blast, Scrap, Water, Limestone, Coke, Dolomite	kg/kg of steel	
Typical Chemical Compositions of the Inputs	Scrap, Ore, Coke, Natural Gas, Coal, Dolomite, Limestone, Hot Blast	%	MINDAT (2018) WEBMINERAL (2018)
Typical Compositions of Steel Alloys, as Outputs	UNS S30400, UNS S31600, UNS S43000, UNS S17400, UNS S32205, UNS S40900	%	Bringas (2004)
Typical Slag Composition Ranges	EAF Slag, BF Slag, BOF Slag	%	Yildirim & Prezzi (2011), Adegoloye et al. (2016), EUROSLAG (2018)
Typical Composition Ranges of Emissions to the Atmosphere	EAF Emissions, BF Emissions, BOF Emissions	%	Ferreira & Leite (2015), Ramírez-Santos et al. (2018), Uribe-Soto et al. (2017), Schubert & Gottschling (2011)
Stocks in Use		tons	Pauliuk et al. (2013), EC (2017)
Participation of Economic Sectors in Steel Demand		%	WS (2017b), EUROSTAT (2009, 2018b)
Typical Lifespan and Service Life of Steel per Economic Sector		years	Cooper, et al. (2014), EC (2017), EUROSTAT (2009, 2018b)
Recycling and Refurbishment Rates per Economic Sector (<i>business as usual</i>)	Automotive, Construction, Tools & Machinery, Appliances & Electronics, Heavy Mechanical Equipment, Other Transportation	%	NFDC (2012), EUROSTAT (2018a), Björkman & Samuelsson (2014), BIR (2017), Panasiyk et al. (2016), EUROFER (2017b), CECED (2017), Terörde (2006), Eckelman et al. (2014)
Repair and Reuse Rates per Economic Sector (<i>business as usual</i>)		%	NFDC (2012), EUROSTAT (2018a), Dindarian & Gibson (2011), Truttmann & Rechberger (2006), Bovea et al. (2016), Kissling et al. (2013), CECED (2017), RREUSE (2012), Eckelman et al. (2014), Terörde (2006)
Distribution and End-of-Life Losses		%	Pauliuk et al. (2017), Johnson et al. (2008)
Typical Cooling Water Reuse and Recycling Rates	EAF Cooling Water, BFBOF Cooling Water	%	WS (2015), WSSTP (2013), Burchart-Korol & Kruczek (2015)

The model was parameterized with the data seen in Table 3, performing annual calculations during a period of 200 years and assuming that the demand for steel focused on steel types UNS S30400, UNS S31600, UNS S43000, UNS S17400, UNS S32205 and UNS S40900. The yield of the EAF and the BFBOF production macro-processes was set according to their respective capacity and productivity, as well as to their share of participation in the EU28.

Table 3 - Summary of parameters used in the model.

PARAMETER	VALUE	UNIT	SOURCES
EAF Tap-to-Tap Time ⁽¹⁾	0,8	hours	Shamsuddin (2016), WS (2012, 2017b, 2017c), EU (2011b), Madias (2013), Cullen et al. (2012), Yellishetty et al. (2011, 2011a), EUROFER (2017a,b)
EAF Furnace Capacity	100,00	tons	
BFBOF Cycle Capacity	42,00	tons/batch	
BFBOF Productivity ⁽¹⁾	7	batches/h	WS (2017b)
Share of EAF Production in the EU28	39,70	%	
Share of BFBOF Production in the EU28	60,30	%	Sverdrup & Ragnarsdottir (2014), UNCTAD (2017)
Recoverable High-grade Iron Ore	82 billion	tons	
Recoverable Low-grade Iron Ore	92 billion	tons	
Recoverable Very low-grade Iron Ore	166 billion	tons	

(1) As both delay and yield factor.

In total, 13 runs were performed according to the description in Table 4. The first run was *business-as-usual* (BAU), the next 6 runs focused on testing the effects of achieving the maximum theoretical recycling potential of end-of-life steel in different sectors, and the final 6 runs focused on the potential outcomes of doubling the rates of repair & reuse of end-of-life steel in different sectors. All of the testing considered a linear phase-in period of 10 years (from 2020 to 2030) and runs were then compared to BAU and analyzed in the next section.

Table 4 - Summary of simulation runs.

RUN	TARGET SECTOR	VARIABLES	INITIAL VALUE	FINAL VALUE	TRACKED PARAMETERS
1	Appliances & Electronics	Recycling Rates	46,9%	100%*	<ul style="list-style-type: none"> • Input of steel into the economy; • Ore consumption; • Ore consumption reduction potential; • Scrap generation; • Stimulus for transition toward EAF.
2	Tools & Machinery		70,0%		
3	Heavy Mechanical Equipment		57,0%		
4	Other Transportation		54,6%		
5	Automotive		93,8%		
6	Construction		91,0%		
7	Appliances & Electronics	Rates of Repair & Reuse	19,0%	38,0%	<ul style="list-style-type: none"> • Input of steel into the economy; • Ore consumption; • Ore consumption reduction potential; • Overall iron circularity; • Iron feedback per sector.
8	Tools & Machinery		15,0%	30,0%	
9	Heavy Mechanical Equipment		21,0%	42,0%	
10	Other Transportation		22,0%	44,0%	
11	Automotive		6,0%	12,0%	
12	Construction		5,0%	10,0%	

* As primary end-of-life output. Operational losses attributed downstream, accordingly.

The author acknowledges that the simulation runs represent aggressive measures and that their direct application in actual European reality would be unlikely in their current form. It is important to remind the reader that the goal of this article is not to redact or develop a policy, but to test and discuss the effects and behaviors that such policy-based approaches could potentially generate in terms of biophysical circularity, helping to compose an answer to the proposed question.

RESULTS AND DISCUSSIONS

The first simulation run showed how unfit *business-as-usual* practices would be for addressing the long-term end-of-life dynamics of the European steel industry. One of its main results was verifying that the depletion of technically available high-grade ore reserves would take place circa 2054 – a result also achieved by previous studies (Sverdrup & Ragnarsdottir, 2014; UNCTAD, 2017). This potentially reduces BFBOF yields and forces this type of steelmaking to either include more scrap as input or to use lower grades of ore that require larger amounts to yield similarly. Consequently, as seen in Figure 5, steel input into the economy would decrease even as EAF gains in participation because it would not phase-in as fast as necessary to fully compensate the increasing yield losses in BFBOF, argument also brought up by Mayer et al. (2019).

Figure 5 - Results for ore, scrap, steel input, and iron circularity (BAU, tons).

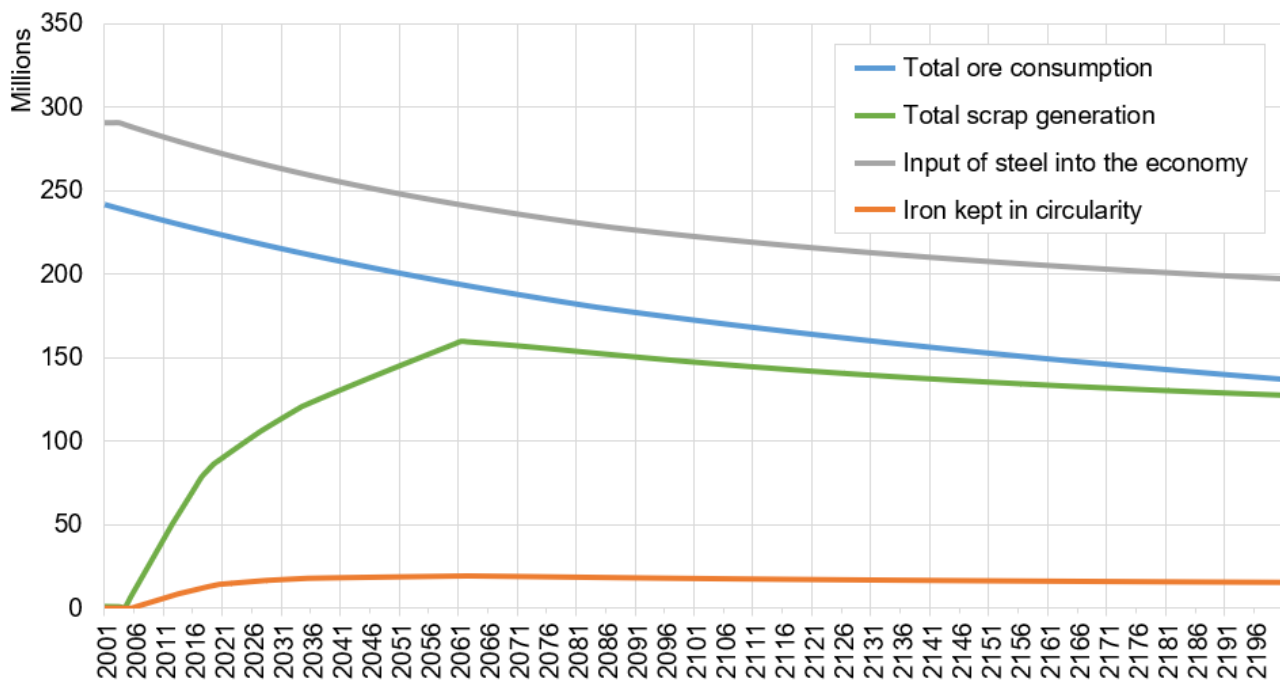

A more aggressive transition would not only require more EAF capacity, but also end-of-life rates higher than those of BAU in order to properly supply EAF steelmaking. Maintaining the *status quo* in the long-term, as seen in Figure 6, would already lead to scrap being consumed faster than it is replaced – especially considering how much scrap is sent abroad (BIR, 2016) – as well as further aggravate overall ore depletion during BFBOF phase-out due to the existence of technically available low-grade and very-low-grade ore reserves.

Figure 6 - Steel output and the sources of iron (BAU, tons).

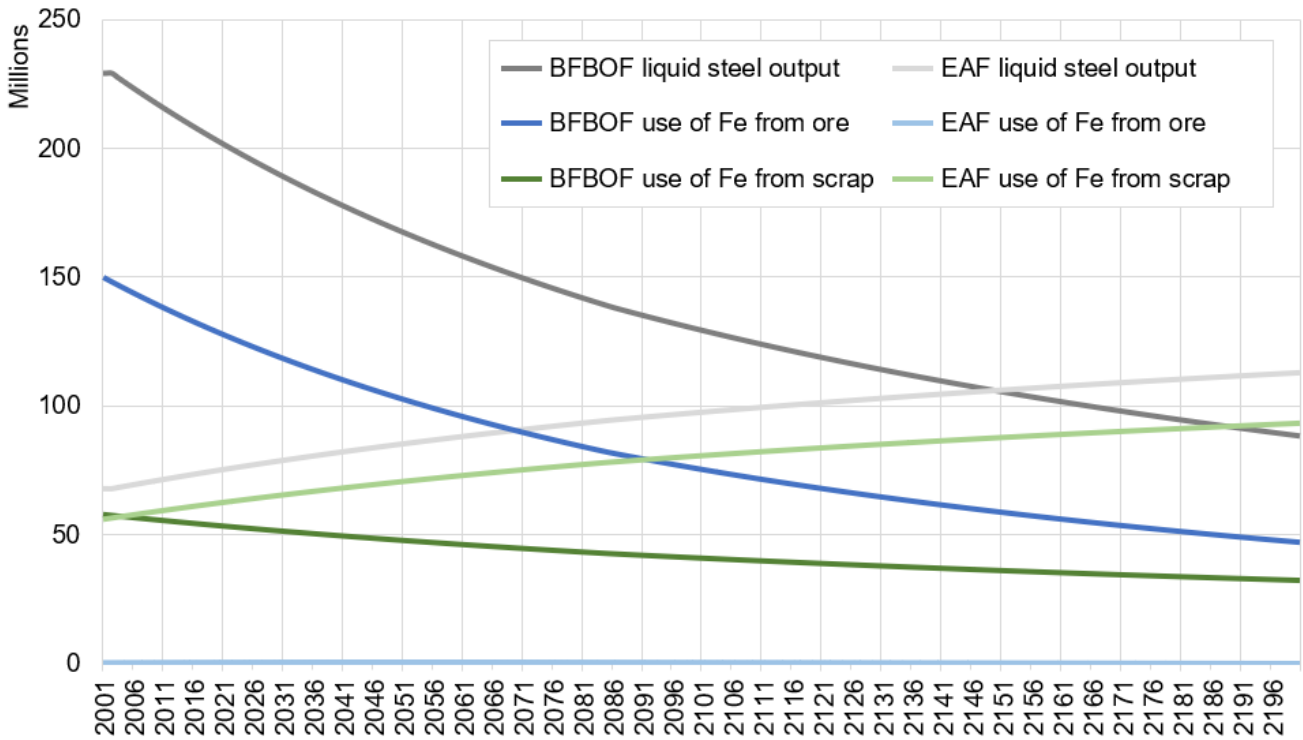
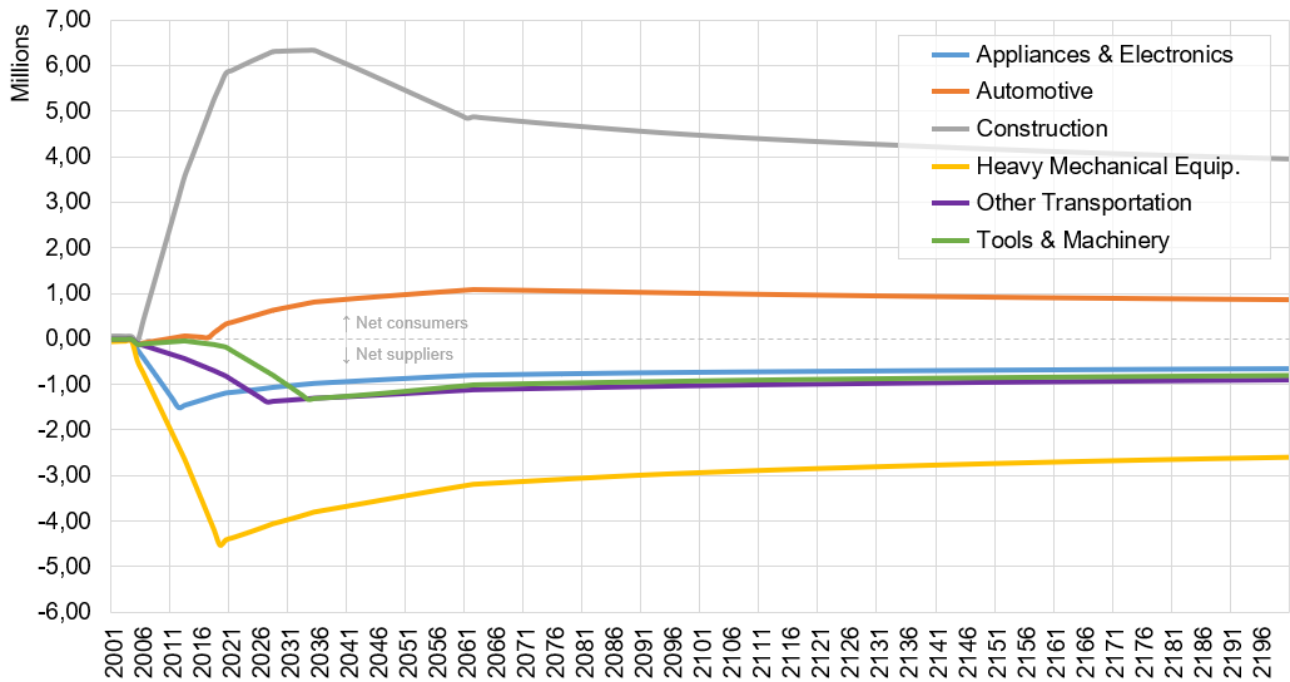

Figure 7, on the other hand, points out how uneven end-of-life steel distribution could be over time as a function of a sectors' demands and alloying requirements. Due to downcycling, there is a tendency that sectors which require larger quantities or which do not require precision alloys would take bigger slices of the available end-of-life steel, potentially affecting other sectors' ability to benefit from a shift towards EAF steelmaking. And although repairability and reusability can extend the life cycle of steel products, their effects at BAU rates are not enough to compensate downcycling.

Figure 7 - Destination of end-of-life steel, per sector (BAU, kg).



When analyzing runs 1 through 6 – in which the BAU recycling rates were set to their full theoretical potential –, however, the results presented interesting grounds for discussion. As seen in Figure 8, scrap generation tended to grow more in sectors with shorter steel service lives and large steel stocks in the economy.

Contrasting sectors such as Construction – with large steel stocks in the economy but very long service life – and Appliances & Electronics – with significantly smaller steel stocks but very short service life – had similar results due to this balancing behavior. Heavy Mechanical Equipment – with large steel stocks and a medium service life – was the sector with most growth in scrap generation, but also the one with the largest drop due to its participation as a net supplier of end-of-life steel, as previously seen in Figure 7, of which a substantial amount leaves the EU28 boundaries.

Figure 8 - Effect on scrap generation, per sector (runs 1 through 6).

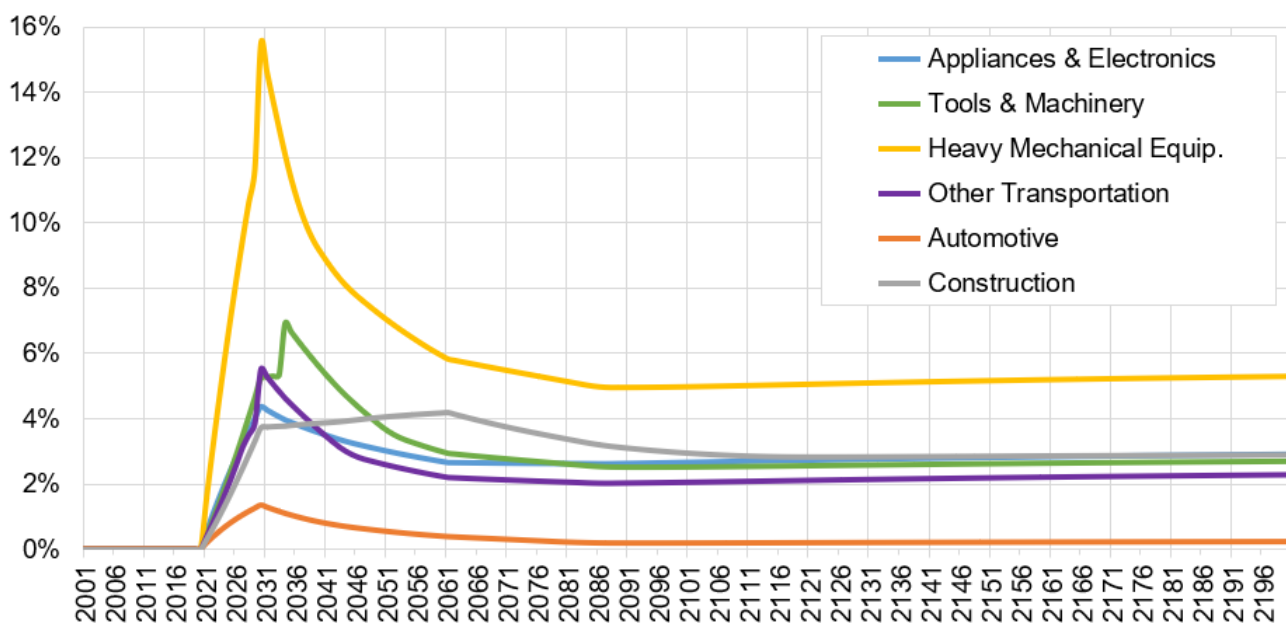

The Automotive sector, however, saw the least increase in contribution to scrap generation due mostly to two reasons: (1) already operating at very high recycling rates and (2) being a net consumer of end-of-life steel. It is important to note, nevertheless, that alongside Construction and Heavy Mechanical Equipment, that sector’s representativeness in terms of demand more than justifies a continuous effort towards improving recycling due to the large amounts of steel that circulate within it.

In Figure 9a it is possible to see that the shorter a sector’s service life is, the more noticeable is the effect on steel input into the economy by increasing recycling alone. Appliances & Electronics and Other Transportation were the sectors most capable of contributing to a transition towards EAF steelmaking – thus increasing overall steel circularity – despite their smaller share in steel demand. Still, it is important to keep in mind that these sectors have specific recycling and alloying needs that may make end-of-life services costlier.

Figure 9a was also the first to visually depict the fact that increasing recycling rates could push the depletion of technically available high-grade ore further into the future (up to 2083 in this study), easing BFBOF phase-out and further reducing overall ore depletion due

to a tendency of steelmakers preferring higher iron contents. This could potentially trigger the interest of not only EAF steelmakers but also BFBOF steelmakers in advancing recycling due to indirect effects.

Figure 9 - (a) effect on steel input into the economy, per sector (runs 1 through 6); and (b) potential reduction of ore consumption, per sector (runs 1 through 6, in kg/h).

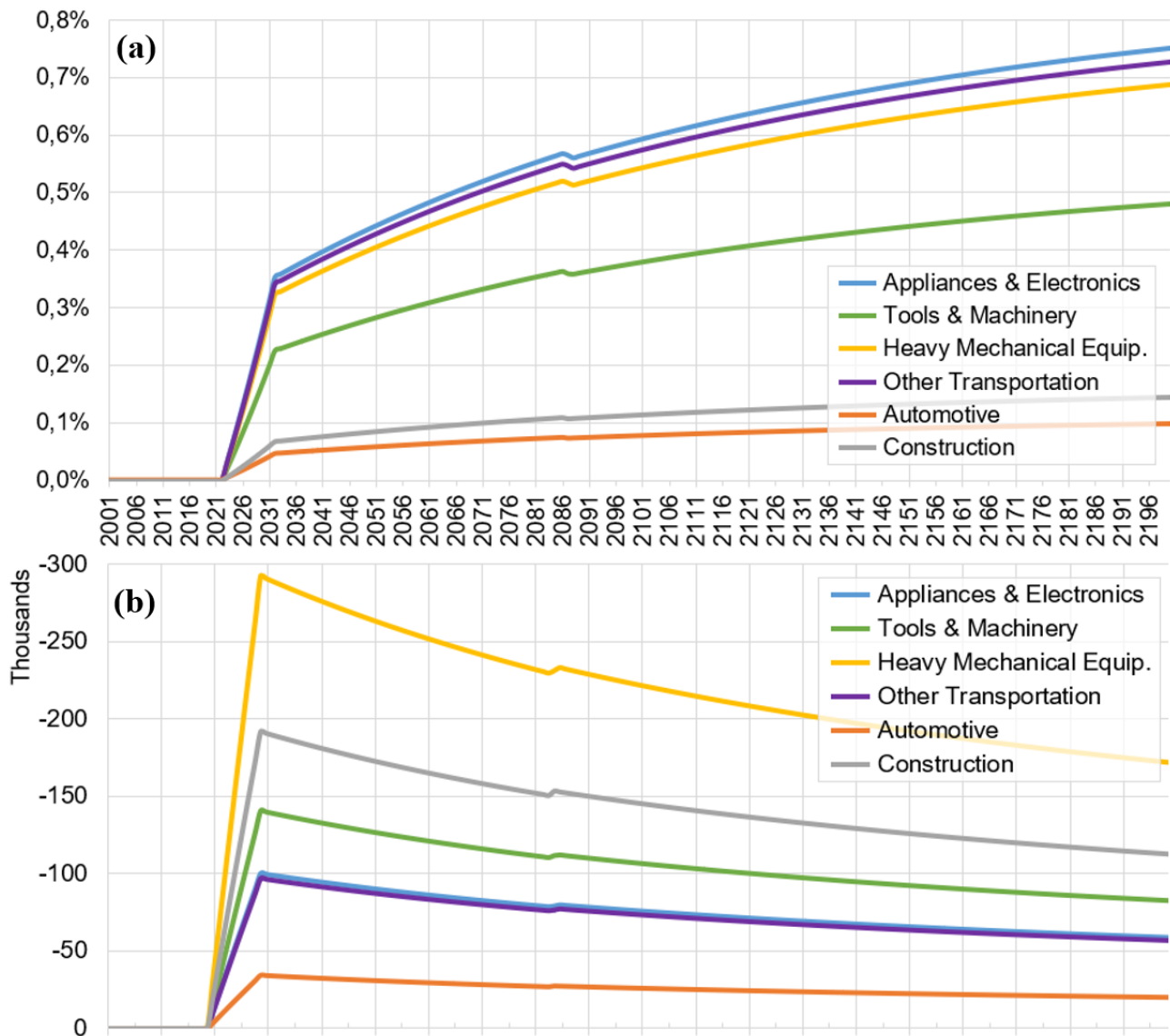

When it comes to ore consumption, a better understanding of the effects of increased recycling can be seen in Figure 9b. Although sectors with less room to improve when compared to their respective BAU recycling rates have shown less relative potential for

overall ore consumption reduction, it is important to keep in mind that their substantial share in demand makes for a very significant amount of BFBOF ore-dependent steel. It is also important to note that the shorter the service life in a sector, the more recycling cycles can take place, thus the higher its potential for reducing ore consumption in the long-term.

When focus was given to doubling the rates of repair & reuse – runs 7 through 12 –, however, the effects on steel input into the economy (Figure 10a) were not only lower but also delayed when compared to runs 1 through 6. The shorter a sector's service life, the shorter the delay and the higher the effect on steel input, even when the steel consumption within the sector is comparatively low (e.g. Appliances & Electronics). The opposite behavior was also noticed: regardless of large steel consumption, sectors in which service lives are long demonstrated longer delays and lower effects on steel input into the economy (e.g. Construction and Automotive).

While runs 1 through 6 could potentially reduce ore consumption by providing more scrap as an alternative that boosts the transition towards EAF steelmaking – to the point of overcoming a prolonged BFBOF capacity's lifespan –, runs 7 through 12 would impact ore consumption by retaining steel longer in the economy, i.e. increasing circularity and reducing demand for new steel (Figure 10b). Intensifying repair & reuse would not only push the depletion of technically available high-grade ore further into the future (circa 2087 in this study), but also delay recycling, thus being less helpful towards a transition to EAF steelmaking.

Figure 10 - (a) effect on steel input into the economy, per sector (runs 7 through 12); and (b) potential reduction of ore consumption, per sector (runs 7 through 12, in kg/h).

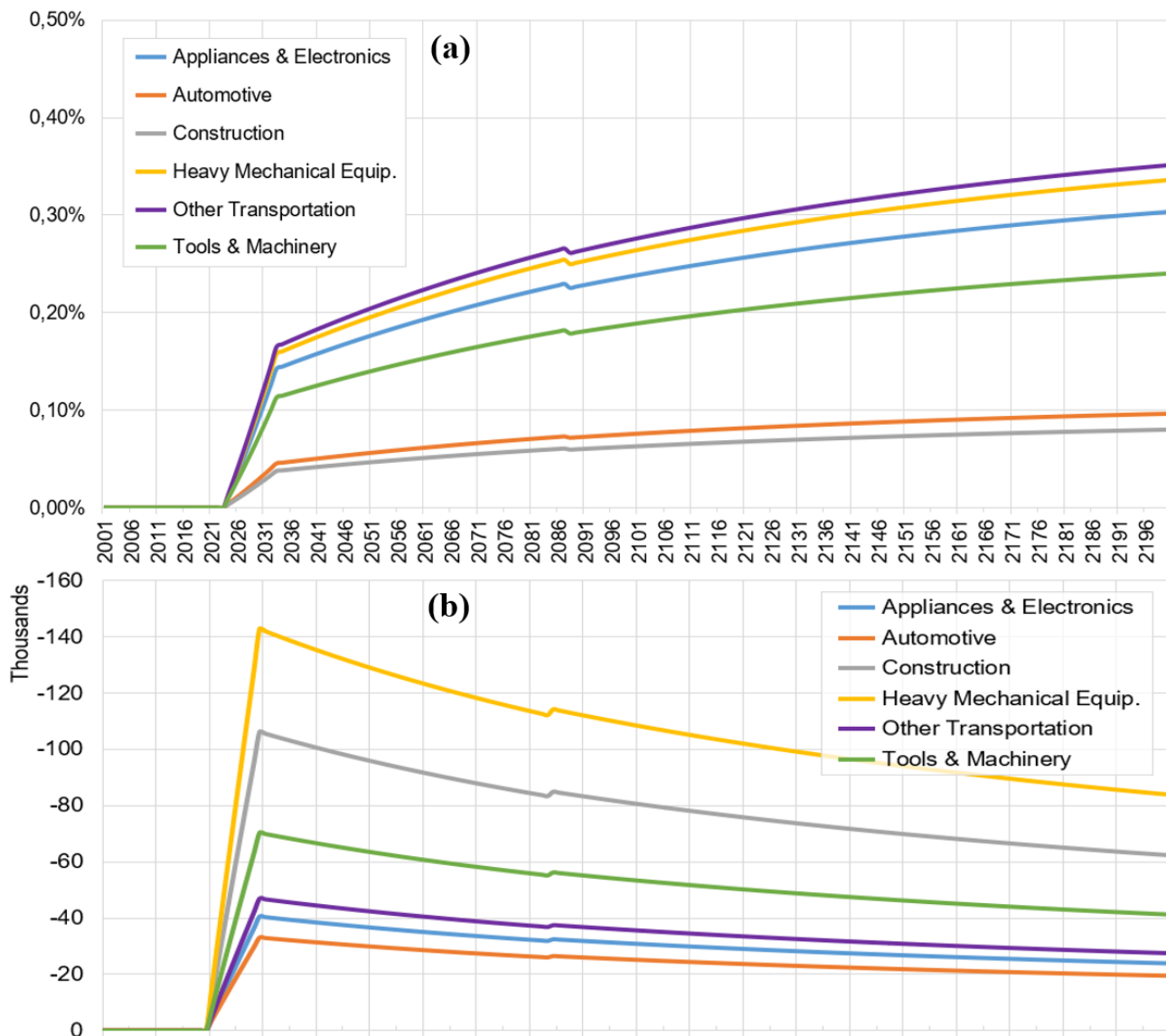

Furthermore, Figure 10b also depicts how more noticeable the effects of increasing rates of repair & reuse were on ore consumption from sectors with high demand for steel and high available steel stocks in the economy (e.g. Heavy Mechanical Equipment and Construction).

When analyzing the circularity of iron, the direct feedback into a sector increased mostly in proportion to its demand for steel – as seen in Figure 11a. Still, just as with recycling, one sector would tend to concede more iron to others over time the more prone to recycling

it already is (e.g. Automotive), the higher its alloying requirements (e.g. Appliances & Electronics) or due to an eventual downcycling induced by repair & reuse prolonging its service lives (e.g. Other Transportation) – and thus have less direct feedback improvements.

Figure 11 - (a) effect on Fe circularity within each sector (runs 7 through 12); and (b) effect of each sector on overall Fe circularity (runs 7 through 12).

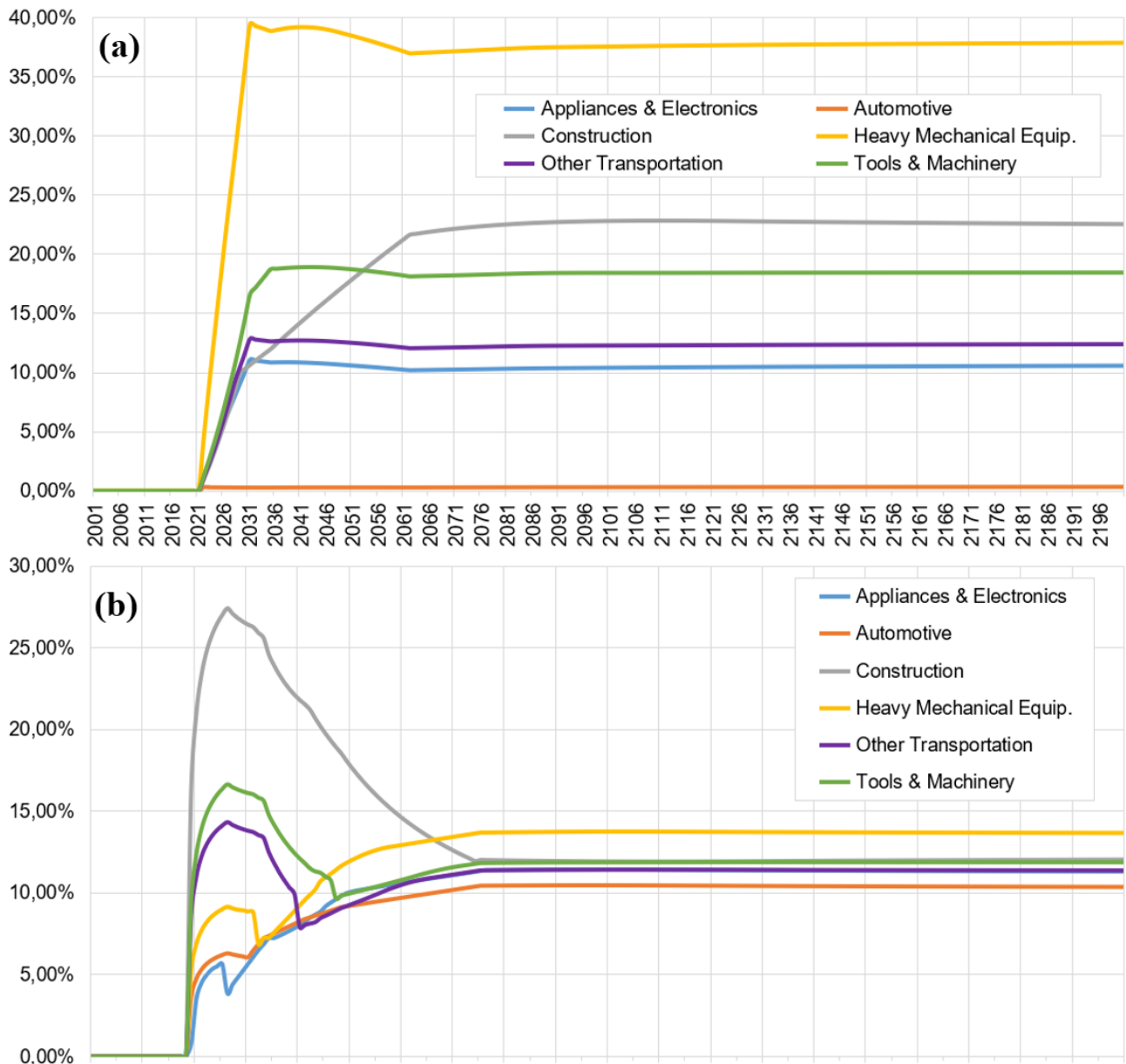

It is important to note that although repair & reuse affects the length of steel service life and steel demand, repairability and reusability are not infinite and eventually balance with

recycling and downcycling. An initial peak increase followed by decline and stability is visible in both Figures 11a and 11b for most sectors. Meaning that the effects of fostering repair & reuse, however substantial, are eventually absorbed by the industry and might even decay in the long-term.

This phenomenon is more evident when analyzing each sector's contribution to the overall circularity of iron in the economy (Figure 11b), in which measures as aggressive as doubling repair & reuse would generate results that range only between 10 and 15% in the long-term, even when improvements within a sector could go up to 40% (Figure 11a).

CONCLUSIONS AND RECOMMENDATIONS

This article tested two different approaches to policies regarding end-of-life steel in Europe and their effects after a 10-year deployment period. In total, 13 simulations were performed, being one *business-as-usual*, 6 focused on maximizing recycling and 6 focused on doubling repair & reuse.

After having compared the first set of simulation runs to *business-as-usual* practices, it was noticed that a policy targeting steelmakers and aimed at maximizing the recycling of end-of-life steel would have substantial positive effects on the supply side dynamics of this sector, providing significant support for a continuous transition from BFBOF steelmaking towards EAF steelmaking – even if BFBOF would face fewer issues with ore availability. Considering that recycling operations have increasingly become an active part of EAF steelmaking reality, and that results point to even BFBOF steelmakers being able to benefit indirectly from it, a significant long-term potential increase in biophysical circularity was perceived.

Still, considering that the majority of effects took place in the supply side, focusing only on increasing recycling would not be, on its own, an optimal measure for increasing circularity

by reducing the demand for new steel. This was verified not only by the increase in steel output, but also the increase in the total availability of scrap and on it being less downcycled.

When comparing the second set of simulation runs to BAU, on the other hand, the positive effects of an aggressive stimulus towards steelmakers being involved in end-of-life steel repair & reuse were significant on the demand side, being more subject to pertinent service sector dynamics and posing as effective means of reducing the demand for new steel. Gains in biophysical circularity by increasing steel retention within the economy were noteworthy in the short- and medium-term after policy deployment, but eventually stabilized in the long-term – validating the arguments presented by EUROFER (2017b).

Focusing only on repair & reuse would not, however, support a continuous transition towards EAF steelmaking – and the consequent supply side increase in circularity – as effectively as the previous set of simulation runs. This happened mostly due to the fact that repair & reuse prolonged the total service life of steel, delaying recycling and increasing downcycling in the long-term.

Ideally, then, European policies based on Circular Economy regarding end-of-life steel would need to find a balance between recycling and repair & reuse when addressing biophysical circularity. Such a balance would also depend on market variables not directly addressed in this study (e.g. steel prices, OPEX, CAPEX and investment costs) and would consequently be more effective if evaluated in national scale at first, before a consolidated policy in European level is devised, notably regarding the amounts and compositions of the end-of-life steel being generated or circulated.

In summary, the results in this article point to the possibility that both types of steelmaking operations could benefit from increasing their efforts regarding end-of-life services while simultaneously contributing to improvements in biophysical circularity. To that end, more CE-based policy attention should be given to the steelmakers' supply chains as a

whole as well as to steelmakers themselves, and not only to their customer sectors or their raw material suppliers.

Such policies would need to be not only aggressive so as to transition as soon as possible from BAU, but also to stimulate steelmakers to retain the added value of steel longer within EU28 boundaries by working alongside sectors in which steel has a long service life – focusing on increased recycling, refurbishment/remanufacturing and eco-design –, and alongside those in which steel has short to medium service lives – towards increasing repair & reuse, redistribution and servitization.

BIOPHYSICAL CIRCULARITY AS DRIVER FOR SUPPLY CHAIN INTEGRATION IN THE EUROPEAN STEEL INDUSTRY

Article status: Submitted, under review (2nd round);

Journal: Resources Conservation and Recycling (Elsevier);

Co-author: DIEMER, A. ^a

^a Centre d'Etudes et de Recherches sur le Développement International (CERDI), Université Clermont-Auvergne, Clermont-Ferrand, France;

Highlights:

- Presents and discusses current Supply Chain Integration practices in the European steel industry;
- Proposes alternative approaches to integration focusing on improving biophysical circularity by closing material loops;
- Tests propositions with simulations on a Life Cycle Assessment and System Dynamics model;
- Results show that different approaches can lead to increased raw material self-sufficiency and resource ownership retention;
- Supply side vertical hedging and end-of-life horizontal hedging are environmentally and strategically promising for recycling, refurbishing and repair.

Abstract:

As the environmental mindset became increasingly present in the steel industry, so did the concerns with the developments of its market. In an attempt to address both sides of this strategic challenge, the objective of this article was to identify how the implementation of different Supply Chain Integration strategies oriented towards developing Closed Loop Supply Chains can help improve the biophysical circularity of steel with regards to raw material self-sufficiency and resource ownership retention. The European steel industry was chosen as case study and the effects of Supply Chain Integration strategies on circularity were tested by running simulations on an integrated Life Cycle Assessment and System Dynamics model. The results brought to light that different approaches can be environmentally and strategically promising, as well as able to drive improvements in raw material self-sufficiency and in resource ownership retention, most notably by adopting supply side vertical hedging or end-of-life horizontal hedging for either recycling, refurbishing or repair operations.

Keywords:

Steel; Europe; Supply Chain Integration; Circular Economy; Closed Loop Supply Chains.

INTRODUCTION

Steel has historically been among the most essential materials for society and, since the Industrial Revolution, it has been present in almost all aspects of modern daily life (WS, 2012; Beddows, 2014). The life cycle of steel begins in the iron ores extracted from open pit or underground mines and often ends as either part of long service life structures or as recyclable scrap (Warrian, 2012; Vaclav, 2016).

In the last couple of decades, steel industries the world over have begun giving attention to strategies that encompass environmental goals, branching out to activities such as end-of-life (EoL) services and solutions (D'Costa, 1999). Today, approximately 70% of European steel is recycled and most byproducts of its production process are serving as resources to other industries (Yellishetty, et al. 2012; WS, 2017a). When compared to the 1980s, the average steelmaking process now consumes 50% less energy and helps final products such as vehicles to become less fuel intensive, to the point of being environmentally competitive enough to give plastics and aluminum manufacturers an additional reason to worry (Warrian, 2012; WS, 2013b; Vaclav, 2016).

Nevertheless, the expansion of global markets and the geopolitical circumstances during the same period gave Chinese, Russian, Brazilian and Indian steelmakers the opportunity to grow their market shares due to increasing urbanization and industrialization demands, all the while developed economies have seen stabilize it or decrease (Figure 1) (EY, 2014/2015). While the former focused on acquiring know-how to maximize output towards price competitiveness, the latter – most notably North American and Western European steelmakers – saw the need for restructuring as an opportunity to focus on quality and portfolio specialization, but such a transition is still ongoing (D'Costa, 1999; WS, 2013b).

Figure 1 - Apparent steel consumption over time, as function of GDP (adapted from EY, 2014).



The influence of technology as a driver of competitiveness had not been left aside, though: research and development still played a major role in the steel industry, helping reduce production costs and improve efficiency (Reppelin-Hill, 1999). But the once aggressive efficiency-oriented strategies adopted during the post-War decades were gradually replaced by complex and nuanced assessments of quality and portfolio (Vaclav, 2016; WS, 2017b; Nuss & Blengini, 2018). This was particularly necessary after the push by Japan, South Korea and Germany to rejoin the steel market after the Second World War, which left the United States, the United Kingdom and the remaining Western European steelmakers temporarily lagging behind (Vaclav, 2016; Yellishetty et al., 2012; Warriar, 2012).

It was when wages increased in developed countries, however, that steelmaking for scale flourished in the developing nations mentioned earlier (D'Costa, 1999; EY, 2015/2017). But wages alone did not cause this shift: over-regulation, increasing tax burdens and prior currency exchange issues also posed as obstacles for North American and Western European steel to regain their former levels of market share, reducing their competitiveness in the global market (Yellishetty et al., 2012; Warrian, 2012).

Previously aggravated by a series of drops in prices from international competitors, North American and Western European steel today see prices rise again and with it the uncertainty regarding the futures market (Demailly & Quirion, 2008). Consequently, investments slow down and the deployment of financial protection strategies becomes commonplace, especially when facing China's substantial hold on the market (Arik & Mutlu, 2014).

Given the circumstances described above, one could think that North American and Western European steelmakers would then focus less on capacity and more on differentiation, especially when operating at particularly higher costs than their competition from abroad. This is often not the case, though: it is common among these steel industries for capacity to be used as strategic means to flood the market and to discourage new entrants and foreign exporters at the expense of profit – a move deemed by many specialists as economically unsustainable (Beddows, 2014; EY, 2015).

Moreover, considering that simply cutting costs could stir the European political scene against the steel industry – because unions tend to look unfavorably at large scale factory workers' lay-offs –, and having realized that competing against international players who run their operations with lower costs was no longer possible by adopting strategies aimed only at the national or regional markets, European steelmakers saw themselves compelled to seek new strategies that could avoid compromising shareholder value (Warrian, 2012). Among

those strategies was the active pursuit of Supply Chain Integration, as presented in the next section.

In an effort to continue fostering the environmental mindset present in today's European steel industry while keeping in mind the developments of its market, this article aims to identify how the implementation of different Supply Chain Integration (SCI) strategies can help improve the biophysical circularity of steel and its components by closing material loops in either a European level or in the supply chains therein.

The effects of Supply Chain Integration on biophysical circularity were tested by running simulations focused on improving raw material self-sufficiency and resource ownership retention in an integrated Life Cycle Assessment (LCA) and System Dynamics (SD) model to be described in the methodology section.

SUPPLY CHAIN INTEGRATION IN EUROPEAN STEEL TODAY

Supply Chain Integration is most commonly defined as the strategic collaboration within a supply chain, among its stakeholders, in order to improve the management of intra- and inter-organization processes (Shou et al., 2017; Lii & Kuo, 2016; Wiengarten et al., 2016; Van der Vaart & Van Donk, 2004, 2008). As per the North American National Research Council's Committee on Supply Chain Integration (NRC, 2000: p.27), "an integrated supply chain can be defined as an association of customers and suppliers who, using management techniques, work together to optimize their collective performance in the creation, distribution, and support of an end product. It may be helpful to think of the participants as the divisions of a large, vertically integrated corporation, although the independent companies in the chain are bound together only by trust, shared objectives, and contracts entered into on a voluntary basis".

SCI initiatives aim at effectiveness and efficiency throughout the chain, encompassing decisions regarding material flows, resource management, services, information and capital (Bowersox et al., 1999; Sengupta et al., 2006). Integration is often driven by the main manufacturer in the supply chain, which can choose to focus on integrating processes with its supplier side, with its customer side, or both, always depending on what said company perceives as its key strategic assets (Bowersox et al., 1999; Wiengarten et al., 2016; Shou et al., 2017).

To properly address costs, performance and risks, the integration itself requires intense exchange and cooperation with the involved stakeholders and subcontractors and can be approached in three different manners: (a) horizontally – in which information, strategies, decisions and flows are shared but ownership and management of each company in the supply chain remain independent or decentralized –; (b) vertically – in which capital, ownership and management are also shared or centralized by means of mergers, acquisitions and equity efforts –; and (c) hedging – which can occur either vertically or horizontally, but focuses mostly on ensuring profitability across markets, by having different branches of a supply chain's operation be more or less active than others according to market variations (Vickery et al., 2003; Wiengarten et al., 2016; Van der Vaart & Van Donk, 2008; Gunasekaran & Ngai, 2004).

In all cases, however, SCI worldwide tends to follow a similar deployment path: starting from the strengthening of the relations between the stakeholders of a supply chain, then moving through phases of unification in measurements and metrics, sharing of planning and technological information, alignment of material and service flows, and closing with the joint optimization of internal processes (Gunasekaran & Ngai, 2004; Van der Vaart & Van Donk, 2008; Lii & Kuo, 2016). Table 1 lists examples of different integration approaches used by different steelmakers in their supply chain.

Table 1 - Examples of supply chain integration in steel supply chains.

	MINING	STEELMAKING	METALWORKING	CUSTOMER	END-OF-LIFE OR BY-PRODUCT
ArcelorMittal	Own + VI + VH	Own + VI + VH	Own	HI	Slag (Own)
SSAB	VH	Own + VI + VH	Own + VI	HI	Repair (VI) + Slag (Own)
SIJ Group	-	Own + VI	Own + VI	-	Scrap (VI)
Severstal	Own + VI	Own + VI	Own + VI	-	-
Hyundai Steel	VH	Own + VI	Own + VI	HH + HI	Slag (Own)
Voestalpine	VH	Own + VI	Own + VI	HI	Slag (Own)
ThyssenKrupp	VH	Own	Own	HI	Slag (Own)
Tata Europe	VH + VI	Own + VI + VH	VI	HH + HI	Slag (Own)

VI = Vertical integration; VH = Vertical hedging; HI = Horizontal integration; HH = Horizontal hedging.
 Observation: summarized information available on each company's institutional website.

European steelmakers are commonly the key manufacturers in their respective supply chains and tend to focus on supplier side integration – mostly vertically – due to the commoditization of steel in the global market. Still, it is not uncommon to see European steelmakers giving attention to horizontal customer side integration, especially when providing goods to the automotive or to the heavy transportation industry (Meixell & Gargeya, 2005). Hedging integration occurs mostly vertically and most commonly on the supplier side, with European steelmakers controlling many different operations abroad in order to compensate for ore prices, logistical expenditures, currency exchange rates and geopolitical circumstances when deemed necessary (Gardner & Buzacott, 1999).

Whether integrating vertically or for hedging, investing in developing nations happens mostly for the transfer of unspecialized portfolio capacity or for the decentralization of sourcing (D'Costa, 1999). The capacity and the capital that remain in Europe are then gradually mobilized and converted into specialized products that better align with horizontal integration on the customer side, or into higher added-value products that corroborate with the growing trend of reducing overall steel intensity (Chevalier, 1995; Yellishetty et al., 2012; Shou et al., 2017). Many successful examples of these types of integrations currently exist,

and even companies based in developing countries have managed to find profitability by vertically integrating into Europe (D'Costa, 1999).

Due to the capital-intensive and long-term investment characteristic of the steel industry, strategic shifts focused on vertical or hedging integrations have European steelmakers committing to large-scale projects that can potentially devalue their current assets and operations however productive and efficient they may still be in comparison to the industries they control in developing economies (EY, 2014/2015; Beddows, 2014; WS, 2013b; D'Costa, 1999; Warran, 2012).

With that in mind, hedging-oriented integration would be preferable to vertical integration due to the latter's vulnerability to prices, logistics, resource availability and international trade agreements; on the other hand, market shares may be affected and that the company may be left more sensitive to future market shortcomings if capital is then mobilized towards higher valued or more specialized activities (D'Costa, 1999; EY, 2014/2015). Nevertheless, there seems to be a *quasi-unanimity* on the argument that horizontal integration is largely preferable on the customer side – as corroborated by results from the industry –, but that nowadays it would be naïve to focus on this side alone (WS, 2013b; Beddows, 2014; Chevalier, 1995; Swierczek, 2014).

Figure 2 shows recent results of the steel industry in relation to their raw material self-sufficiency, depicting industries whose shareholders opted for vertical integration but did not necessarily find a recipe for success, regardless of capital mobilization (e.g. MMK and Sail). It also shows that industries that were strategically oriented towards high added-value products and portfolio specialization can generate very different results even when focusing on horizontal integration with some of their customers (e.g. ThyssenKrupp and Hyundai Steel).

Figure 2 - EBITDA margin vs Self-Sufficiency (EY, 2014).

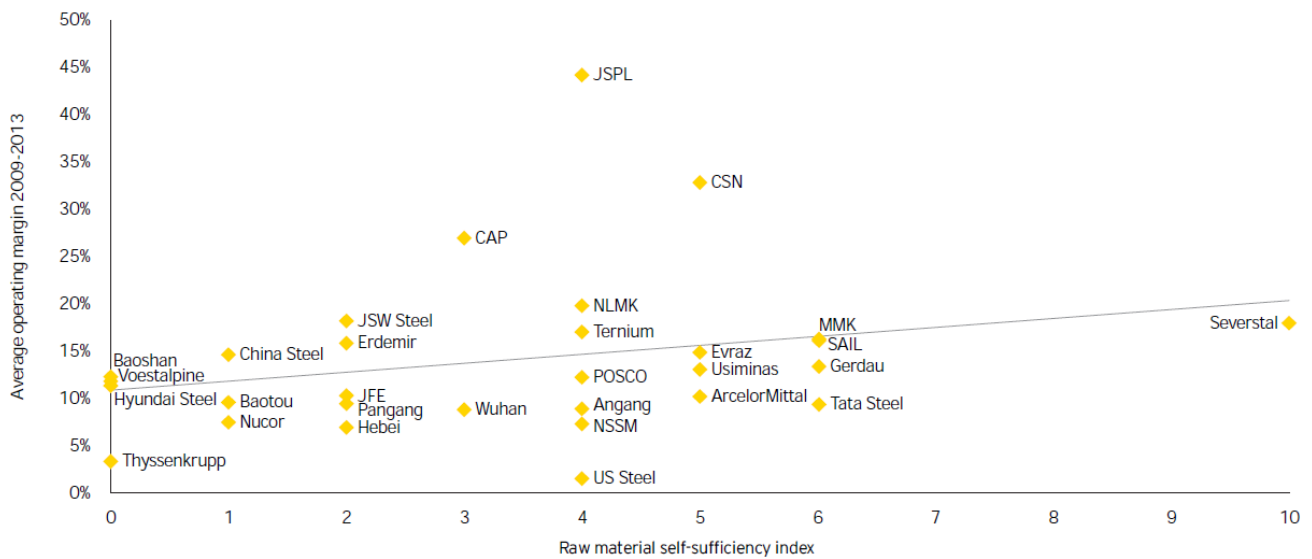

Additionally, the role of governments can be either constructive or destructive, especially towards vertical integration. Trade policies can make or break the cost effectiveness of geographically decentralizing a steel supply chain, potentially requiring subsidies during the capital mobilization phase (WS, 2013b; D'Costa, 1999; Wiengarten et al., 2016). A similar logic applies to horizontal integrations, though governments tend to have lower impact on them. Still, integrating a supply chain on the customer side may require investments that can substantially affect liquidity, cash flow and indebtedment unless those factors are well-covered by long-term shared-responsibility contracts and insurances, especially when the steelmaker's portfolio somehow limits the attraction of new customers (EY, 2014, 2017; Beddows, 2014).

The more present a government's capital is, the more regulated and less market-dependent the decision-making tends to be, but the financial stakes are high in all SCI situations. Mobilizing capital to another nation – be it for hedging or for vertical integration – can disrupt the local supply chain's finances without the guarantee that this money will reintegrate the economy or even the steelmaker's balance in the future (Beddows, 2014; EY, 2014/2017; Wiengarten et al., 2016). And especially in the short-term, transferring

technology, capacity and know-how can cause capital to be locked in place while productive maturity is achieved, a considerable risk despite lower costs of production or the growing demand in developing economies (Warrian, 2012; Yellishetty et al., 2012).

To ensure that the discussions brought to light thus far do not drift away from environmental and resource related concerns, the next section introduces the biophysical concept of circularity as derived from Circular Economy (CE) and positions it as a driver for SCI to close material loops in European supply chains.

SCI TOWARDS CIRCULARITY: CLOSING LOOPS

Circular Economy aims to promote a transition from linear supply chains towards ones imbued with circularity, arguing that every economic activity should consider (a) using wastes and byproducts as inputs, (b) switching to renewable and clean energy sources, (c) managing the biophysical and environmental costs and effects of the operation, (d) safely reinserting end-of-life materials into either other economic activities or back into the biosphere, and (e) designing outputs in such a way that facilitates collection, separation, recycling, refurbishing, repair for reuse, redistribution, maintenance and sharing throughout their lifespans (Park et al., 2010; EMF, 2014a/2015a/2016/2017; Haas et al., 2015; Winans et al., 2017).

CE begins by classifying material resources as either biological nutrients or technical nutrients. Biological nutrients originate in and should eventually reintegrate the biosphere; technical nutrients, however, are those biological ones that were transformed by economic activities and that circulate in the economy until a product's end-of-life phase – as seen in Figure 3 –, moment in which it would be ideal to have it return to its biological form and rejoin nature harmlessly (Pearce & Turner, 1989; Seager & Theis, 2002; Korhonen, 2004; EMF, 2012/2013/2014b; Liao et al., 2012; Tukker, 2015; Geissdoerfer et al. 2017).

Figure 3 - Circular Economy framework applied to the steel industry (adapted from EMF, 2017).

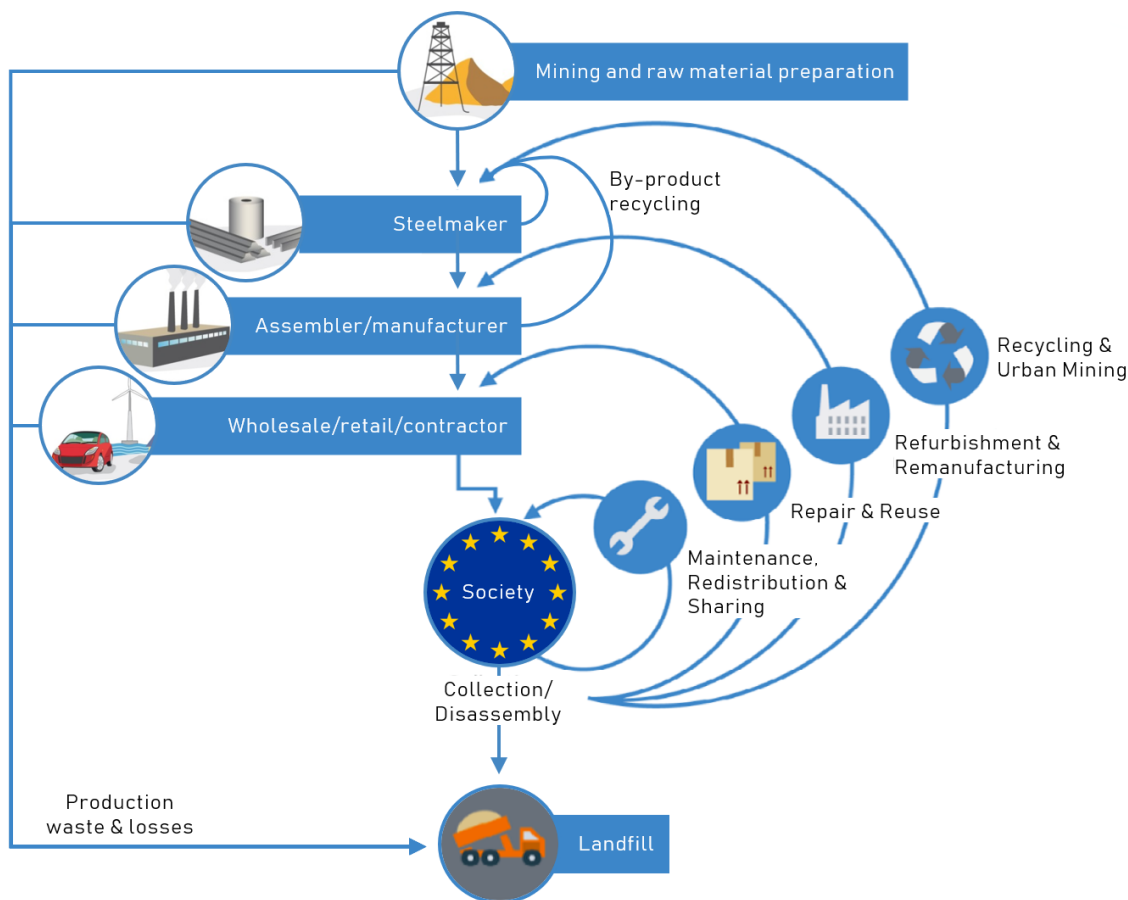

In 2012 the European Union and its members have committed to using CE as their driving economic model, therefore continuously increasing attention to resource-efficient measures that lead to regenerative progress towards nature is to be expected (UNEP, 2011; EC, 2012; Su et al., 2013; Kahle & Gurel-Atay, 2014; EMF, 2015b; Gregson et al., 2015).

One way of looking at CE is by understanding how materials enter, flow and eventually leave the economy. A visual overview of these biophysical dynamics can be provided by material flow diagrams, which show all raw materials – in varying levels of aggregation as well as grouped by categories – as they move through the economy, from extraction to waste, and back (EC, 2018).

Whenever a given material is reinserted into the economy during its use/consumption phase or its end-of-life phase, its flow is considered to have become circular – instead of

linear, which traditionally ends in landfills or in other environmentally undesirable sinks (Zore et al., 2018; Niero & Kalbar, 2019). The more a material is imbued with circularity, the more value it provides during its lifespan and the less pressure is put on nature for new resources (Pauliuk, 2018; Niero & Kalbar, 2019). Material such as steel, and especially iron, have theoretically infinite circularity due to their recyclability characteristics, still, its full potential is yet to be achieved (WS, 2015; EMF, 2013).

Improving circularity, especially from the biophysical perspective, can be achieved by developing Closed Loop Supply Chains (CLSC), which focus precisely on recapturing the value of goods or byproducts after their consumption or use (Govindan & Soleimani, 2016; Gaur et al., 2016; Hosoda & Disney, 2018; Lewandowski, 2016). To do so, CLSCs should not only plan, control and manage the flow of goods or byproducts during their use/consumption and EoL phases back to different stakeholders – using reverse logistics (RL) – (Jayaram & Tan, 2010; Cardoso et al., 2013), but also define the most effective means to reinsert those materials back into the operation, be it reuse, repair, refurbishment or recycling (Islam & Huda, 2018; Golroudbary & Zahraee, 2015; Prosman et al., 2017).

Consequently, monitoring when, where and how much of each different material leaves the use/consumption phase becomes strategically important, allowing the key manufacturer in the supply chain to better visualize and control the availability of potential alternative raw materials that originate in the EoL phase (Cannella et al., 2016; Hey, 2017; Xu & Wang, 2018). Furthermore, deciding whether to centralize, decentralize or outsource different steps of reverse logistics can have significant impact on lead-times, raw material self-sufficiency, resource ownership, environmental performance, and even on demand-related risks (Braz et al., 2018; Miao et al., 2017; Bhattacharyya et al., 2017; Wang et al., 2018).

With that in mind, Figure 4 not only summarizes the SCI strategies introduced in the previous section, but also presents where in the European steel supply chain the author of this article sees integration strategies aimed at biophysical circularity taking place to close material loops, learning from both ends of the strategic spectrum.

Figure 4 - Supply chain integration approaches.

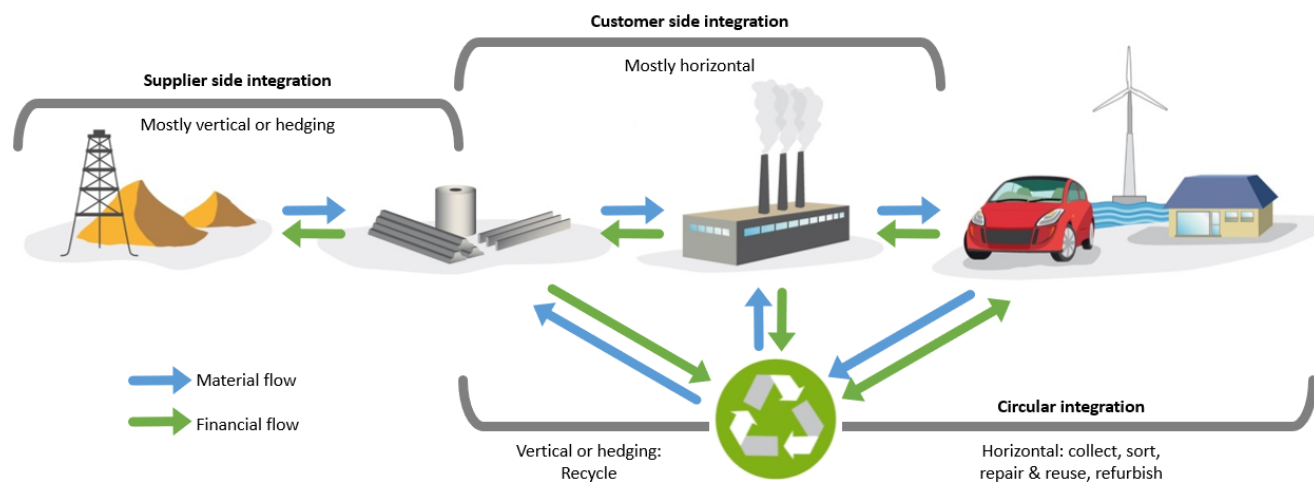

As discussed earlier, vertical or hedging integration strategies tend to be more effective, even if imperfect, in dealing with raw material self-sufficiency and resource ownership (Van der Vaart & Van Donk, 2004). Thus, choosing these approaches would better address material loops that go as far back as possible in the European steel supply chain than horizontal integrations would, to the point of fully or partially replacing primary inputs (Wang et al., 2018; Prosman et al., 2017).

Recycling and refurbishing of end-of-life steel products or the recycling of steelmaking byproducts are activities performed mostly outside of the steelmakers' realm of direct control and influenced indirectly by supplier-client relationships based on leveraging and negotiation (Prosman et al., 2017; Wang et al., 2018).

Vertically integrating such activities would give steelmakers increased ownership of a raw material alternative to iron ore while simultaneously improving self-sufficiency and overall

environmental performance, but would tend, in the long-term, to push the operation away from iron ore as a whole due to either technical or economic scarcity and, depending on the characteristics of the installed capacity, potentially risk overall output and force portfolio migration (Prosman et al., 2017; Wang et al., 2018).

Hedging these activities, on the other hand, however less conducive to directly increasing ownership and self-sufficiency, would enable ore-based operations to have a finer control over inputs from scrap or byproducts, better allowing for efficiency or cost related adjustments according to market circumstances. Nevertheless, the more horizontal the hedging integration, the stronger third-party reverse logistics become as a decision-making factor and the least favorable its environmental performance (Cannella et al., 2016; Xu & Wang, 2018; Cardoso et al., 2013).

When it comes to the collection, sorting, repair for reuse, maintenance, and redistribution of technical nutrients – as seen in Figure 3 –, steel products in end-of-life do not configure a direct input to steelmaking, but in fact reducers of overall steel demand. Furthermore, business-wise, these activities stray away from the main scope of steelmaking and closer to the service sector. As such, vertical or hedging integration strategies for these processes would pose as significant investments with questionable returns (Schultmann et al., 2006; Bhattacharyya et al., 2017; Golroudbary & Zahraee, 2015).

Horizontally integrating these services, however, could be strategically advantageous from the perspective of long-term resource ownership retention, reverse logistics and environmental performance. Although not directly controlling these activities, a steelmaker could (a) better keep track of its steel as it moves through the economy – ideally recycling it back into the same operation –, (b) reduce reverse logistics costs by having influence or leverage over its decision-making, and (c) actively manage the amounts of EoL steel that

flows between servicing and steelmaking (Wang et al., 2018; Schultmann et al., 2006; Bhattacharyya et al., 2017; Islam & Huda, 2018).

Even when direct competitive advantage cannot be attained due to regulatory frameworks regarding pricing, the benefits of resource ownership retention for a theoretically infinitely recyclable material are clear from the environmental perspective. It is to say that, if CE would rather reduce the overall consumption of natural resources, it would be strategically interesting to have as much control as possible over the circulation of the resources already supplied to the economy so as to accrue the most value before reinsertion into the biosphere is necessary (Schenkel et al., 2015; EMF, 2015a).

METHODOLOGY

Having biophysical circularity as a driver, this article made use of an integrated Life Cycle Assessment and System Dynamics model to perform simulations and test the effects of different Supply Chain Integration strategies as means to close material loops in European steel supply chains. Methodological details are presented in the following subsections.

CASE STUDY AND MODEL

This article used the European steel industry as case study due to its current shift towards environmentally friendlier operations, to its importance for the European economy, and to its trade and market concerns on the rise of international competitors. The boundary was set at the EU28 zone, comprising the supply chains of all steelmakers members of the Worldsteel Association therein, which account for 84% of the entire European steel industry.

The model is an integration of Life Cycle Assessment into a System Dynamics environment, focused on biophysical interactions to represent the average behavior of the European steel industry as a whole. It was built in three steps: 1) Business Process Mapping

(BPM), using the BizAgi BPM software; 2) Causal Loop Diagramming (CLD), using the OmniGraffle software; and 3) Flow Charting (FC), using the ISEE Stella Architect software (ISEE, 2018).

Iron was set as the driving chemical element of steelmaking, steel scrap and iron ore were set as the key raw materials, and all chemical elements and raw materials present in steelmaking adopted two different levels of aggregation: cradle-to-gate processes were disaggregated down to chemical level, while gate-to-cradle processes were aggregated to product level. This choice was made in order to give decision-making granularity without over encumbering macro-level analyses that could affect policy-making on end-of-life and circularity services.

The material needs of the furnaces were used to define the amounts of raw materials pulled from their respective sources. This pulling behavior is present in the system until liquid steel becomes an intermediary output, point in which the system then pushes materials through the subsequent processes so as to represent the continuous casting operation. Additionally, attention was given to the feedbacks that close the loop (e.g. recycling, repair for reuse), so as to enable the system to operate under the definitions of CE and CLSC.

Modelling was approached modularly and each process was established as an individual LCA-based unit, capable of being displaced, rearranged or replicated with minimal interference in other processes or modules. This allowed for the model to be as scalable and flexible as possible for use by any stakeholder involved in a European steel supply chain, also reducing user interface cluttering.

In total, twenty modules were created – one for each chemical element involved in the steel supply chain –, all of which used a functional unit (FU) of 1 ton of steel and were built to be structurally identical, distinguished only by specific flows necessary to properly represent their typical operational behaviors.

As exemplified in Figure 5, individual productive processes were grouped into macro-processes based on their most common occurrence in the European steel industry, namely (a) EAF and (b) BFBOF – each encompassing sintering, pelletizing, degassing, alloying, desiliconization, desulfurization, homogenization or dephosphorization, whenever applicable; (c) Casting – which encompasses all shape, heat and surface treatments; (d) Metallurgy – which encompasses all forming and metalworking processes; (e) Economic Sectors – divided in Construction, Automotive, Other Transportation, Tools & Machinery, Appliances & Electronics, and Heavy Mechanical Equipment; (f) Recycling – which feeds back into the stock of scrap used as input for “a” and “b”; (g) Repair for Reuse – which feeds back into each economic sector according to their share in its demand; and (h) Losses & Landfills – which configure process-based sinks.

Figure 5 - Flow Chart (FC) Interface Diagram of the model's biophysical module and control panel (highlighting Fe).

<< Please refer to the high-resolution images in Appendices 7.4 and 7.5, respectively >>

Furthermore, it is important to note that 1) due to the lack of available disaggregated data, emissions from mining, casting and metallurgy were attributed to the EAF and the BFBOF macro-processes accordingly; 2) dust and particulate matter generation were incorporated into the emissions; 3) no disaggregated emission data was found for end-of-life and circularity solutions; 4) energy flows were considered only in the form of amount of fossil fuels consumed, and not in the form of heat or electricity; and 5) no pricing, costing or speculative variables were considered.

Consequently, and as per design, inherent behaviors of the model structure include (a) the gradual transition from BFBOF production to EAF production as function of steel scrap availability, iron ore quality decrease and iron ore scarcity over time; (b) the gradual shift

towards consuming steel scrap instead of iron ore as a function of iron content and availability, still respecting alloying and operational requirements; and (c) steel scrap downcycling over time due to alloying quality loss during repeated service lives.

PARAMETERS AND SIMULATION RUNS

Table 2 summarizes the data inputs used in the study, all of which encompassed the interval between 2001 and 2014, and were verified for cohesion, coherence and reliability based on the criteria of the ILCD Handbook (EC, 2010) and of ISO14044:2006 (ISO, 2006), as well as being compared to their equivalent data points in the Worldsteel Association's Life Cycle Inventory Study for Steel Products (WS, 2017c).

The author also considered adopting Product Environmental Footprint (PEF) standards (JRC, 2012), however, in its current state, it presented itself as a less consolidated and less disseminated methodology, with available applications focused mainly in the construction sector.

Table 2 - Summary of data inputs.

TYPE	VARIABLE	UNIT	SOURCES
EAF Inputs	Scrap, Oxygen, Natural Gas, Coal, Limestone, Dolomite, Water, Ore	kg/kg of steel	Shamsuddin (2016), WS (2012, 2017b, 2017c), EU (2011), Madias (2013), Cullen et al. (2012), Yellishetty et al. (2011), EUROFER (2017a)
BFBOF Inputs	Ore, Hot Blast, Scrap, Water, Limestone, Coke, Dolomite	kg/kg of steel	
Typical Chemical Compositions of the Inputs	Scrap, Ore, Coke, Natural Gas, Coal, Dolomite, Limestone, Hot Blast	%	MINDAT (2018) WEBMINERAL (2018)
Typical Compositions of Steel Alloys, as Outputs	UNS S30400, UNS S31600, UNS S43000, UNS S17400, UNS S32205, UNS S40900	%	Bringas (2004)
Typical Slag Composition Ranges	EAF Slag, BF Slag, BOF Slag	%	Yildirim & Prezzi (2011), Adegoloye et al. (2016), EUROSLAG (2018)
Typical Composition Ranges of Emissions to the Atmosphere	EAF Emissions, BF Emissions, BOF Emissions	%	Ferreira & Leite (2015), Ramírez-Santos et al. (2018), Uribe-Soto et al. (2017), Schubert & Gottschling (2011)
Stocks in Use		tons	Pauliuk et al. (2013), EC (2017)
Participation of Economic Sectors in Steel Demand		%	WS (2017b)
Typical Lifespan and Service Life of Steel per Economic Sector		years	Cooper, et al. (2014), EC (2017)
Recycling and Refurbishment Rates per Economic Sector (<i>business as usual</i>)	Automotive, Construction, Tools & Machinery, Appliances & Electronics, Heavy Mechanical Equipment, Other Transportation	%	NFDC (2012), EUROSTAT (2018), Björkman & Samuelsson (2014), BIR (2015), Panasiyk et al. (2016), EUROFER (2017b), CECED (2017), Terörde (2006), Eckelman et al. (2014)
Repair and Reuse Rates per Economic Sector (<i>business as usual</i>)		%	NFDC (2012), EUROSTAT (2017), Dindarian & Gibson (2011), Truttmann & Rechberger (2006), Bovea et al. (2016), Kissling et al. (2013), CECED (2017), RREUSE (2012), Eckelman et al. (2014), Terörde (2006)
Distribution and End-of-Life Losses		%	Pauliuk et al. (2017), Johnson et al. (2008)
Typical Cooling Water Reuse and Recycling Rates	EAF Cooling Water, BFBOF Cooling Water	%	WS (2015), WSSTP (2013), Burchart-Korol & Kruczek (2015)

The model was parameterized with the data seen in Table 3, performing annual calculations during a period of 200 years and assuming that the demand for steel focused on steel types UNS S30400, UNS S31600, UNS S43000, UNS S17400, UNS S32205 and UNS S40900. The yield of the EAF and the BFBOF production macro-processes was set according to their respective capacity and productivity, as well as to their share of participation in the EU28.

Table 3 - Summary of parameters used in the model.

PARAMETER	VALUE	UNIT	SOURCES
EAF Tap-to-Tap Time ⁽¹⁾	0,8	hours	Shamsuddin (2016), WS (2012, 2017b, 2017c), EU (2011), Madias (2013), Cullen et al. (2012), Yellishetty et al. (2011, 2011a), EUROFER (2017a,b)
EAF Furnace Capacity	100,00	tons	
BFBOF Cycle Capacity	42,00	tons/batch	
BFBOF Productivity ⁽¹⁾	7	batches/h	
Share of EAF Production in the EU28	39,70	%	WS (2017b)
Share of BFBOF Production in the EU28	60,30	%	
Recoverable High-grade Iron Ore	82 billion	tons	Sverdrup & Ragnarsdottir (2014), UNCTAD (2017)
Recoverable Low-grade Iron Ore	92 billion	tons	
Recoverable Very low-grade Iron Ore	166 billion	tons	

(1) As both delay and yield factor.

In total, six runs were performed, being the first *Business-as-usual* (BAU) and the next five focused on testing different integration strategies that could close material loops, as described in Table 4. All of the testing considered a phase-in period of 10 years (from 2020 to 2030) and runs were then compared to the BAU and analyzed in the next section.

Table 4 - Summary of simulation runs.

RUN	OBJECT	PROPOSITION	CIRCULARITY DRIVER	SCI APPROACH	DEPLOYMENT	VARIABLES
1	Slag	Integrate slag recycling into furnace operations, instead of transferring it to third-party recyclers	Recycling for recovery	Vertical	Direct source of iron replacing ore	Recycling yields ¹ : EAF: 20 to 60% BF: 10 to 20% BOF: 20 to 40%
2				Vertical hedging	Hedged source of iron against ore	
3	End-of-Life steel products	Integrate steel refurbishment and repair back into metallurgy, instead of having it be performed by third-party services	Refurbishment and repair for reuse	Horizontal hedging	As hedged input against new steel	Yields ^{1,2} : 0 to 30%
4		Integrate third-party EoL services, stimulating or deterring its operation	Repair for reuse and maintenance	Horizontal	As tracked repaired goods	20% deterred
5						20% stimulated

(3) As iron content output to input ratio, linear increase during the phase-in period;

(4) As performed within the steelmakers supply chain, being the remainder still performed by a third-party;

In terms of modelling, the following structural adaptations were performed alongside variable manipulation in order to adequately run the aforementioned simulations:

- Runs 1 and 2: the slag flows from EAF and BFBOF operations that once left the boundaries of the supply chain towards third-party recycling were entirely brought into the supply chain and fed back into each operation respectively, following the yields in Table 4;
- Run 3: the flows of EoL steel from each sector that once left the boundaries of the supply chain towards third-party refurbishment or repair were partially brought into the supply chain and fed back into metallurgy, considering the yields in Table 4;
- Runs 4 and 5: the flows of repaired steel products from third-party services towards each sector remained outside of the supply chain boundaries but were subjected to being deterred or stimulated by the steelmakers according to the rates in Table 4.

RESULTS AND DISCUSSION

As seen in Figure 6, the model reproduces the long-term trends present in the data, pointing to a transition from operations based on iron ore (i.e. Blast Furnace and Basic Oxygen Furnace - BFBOF) – to those based on scrap (i.e. Electric Arc Furnace - EAF), as well as the consequent impact that such a transition would impose onto these sources of iron.

Figure 6 - Iron input (tons).

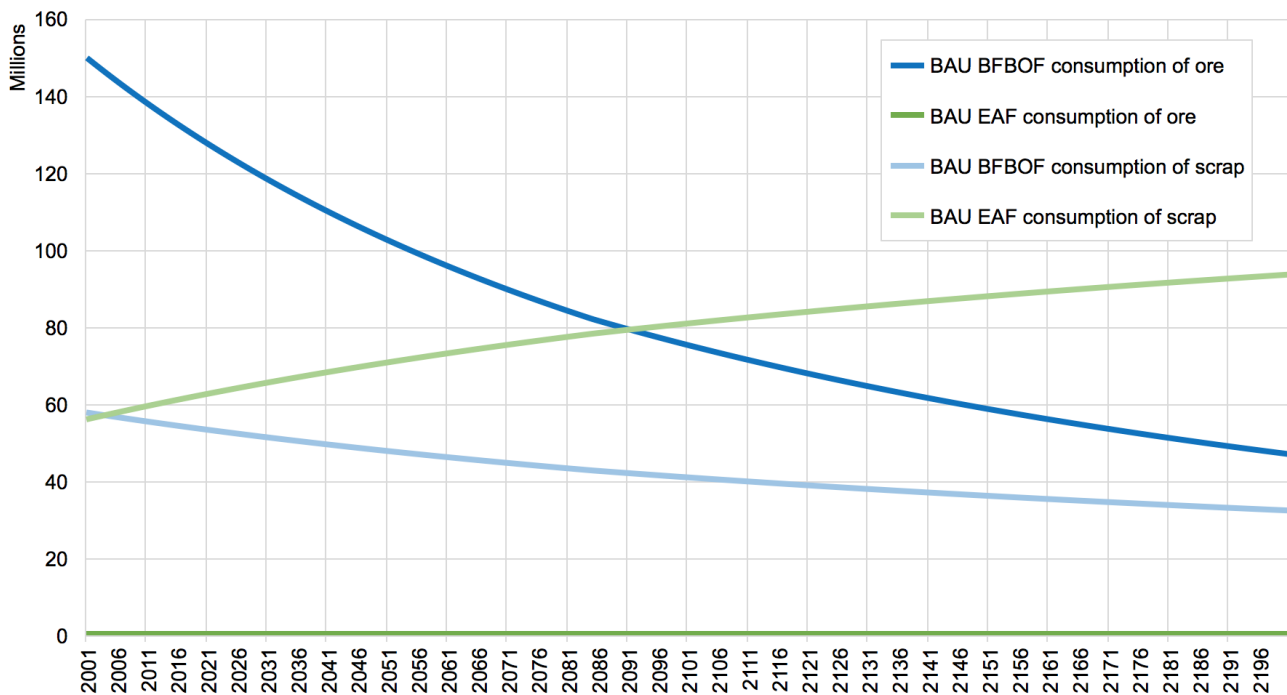

From performing simulation runs 1 and 2 it was perceived that both vertically integrating and vertically hedging slag recycling into the steelmaking operation would result in reduced consumption of iron ore, as seen in Figure 7. In both cases, the endogenous feedback behavior of the model has also shown that the stimulus to recycle slag increases as a function of its yield, being also inversely proportional to the decay of iron content in the ore over time.

The results were naturally more substantial when regarding BFBOF operations, but better results were achieved by vertically hedging the slag recycling process. Doing so would enable multiple sources of BFBOF slag to be used as input (e.g. multiple furnace operations in a same supply chain); unlike in vertical integration, in which slag recycling would be dedicated to each operation.

Figure 7 - Impact on ore consumption.

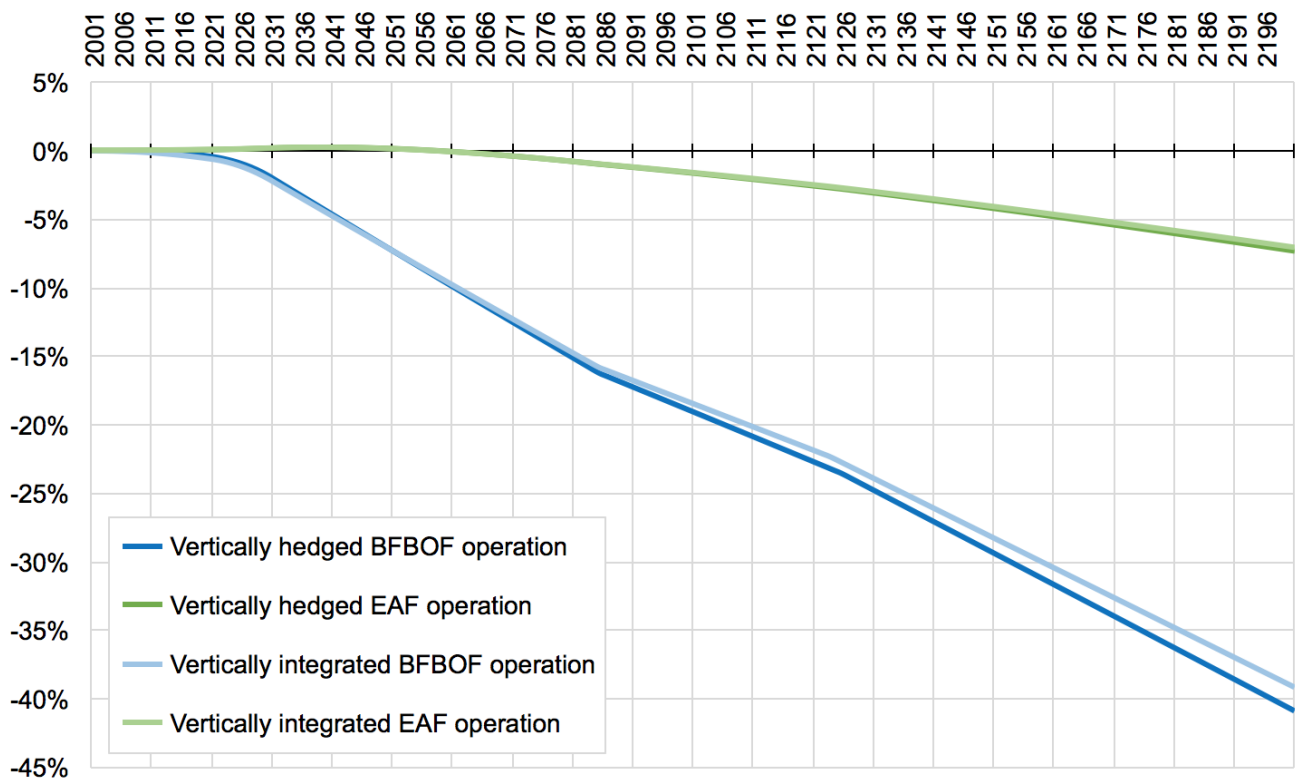

More iron was recovered by the vertically integrated slag recycling solution than by the vertically hedged one – as seen in Figure 8 –, pointing to better potential for increasing raw material self-sufficiency. Nevertheless, the flexibility to supply different furnace operations and to be supplied by multiple sources of slag favors the adoption of a vertical hedging approach if the strategic priority is to have resource ownership retention increased throughout the supply chain.

Figure 8 - Recoverable iron in slag (kg).

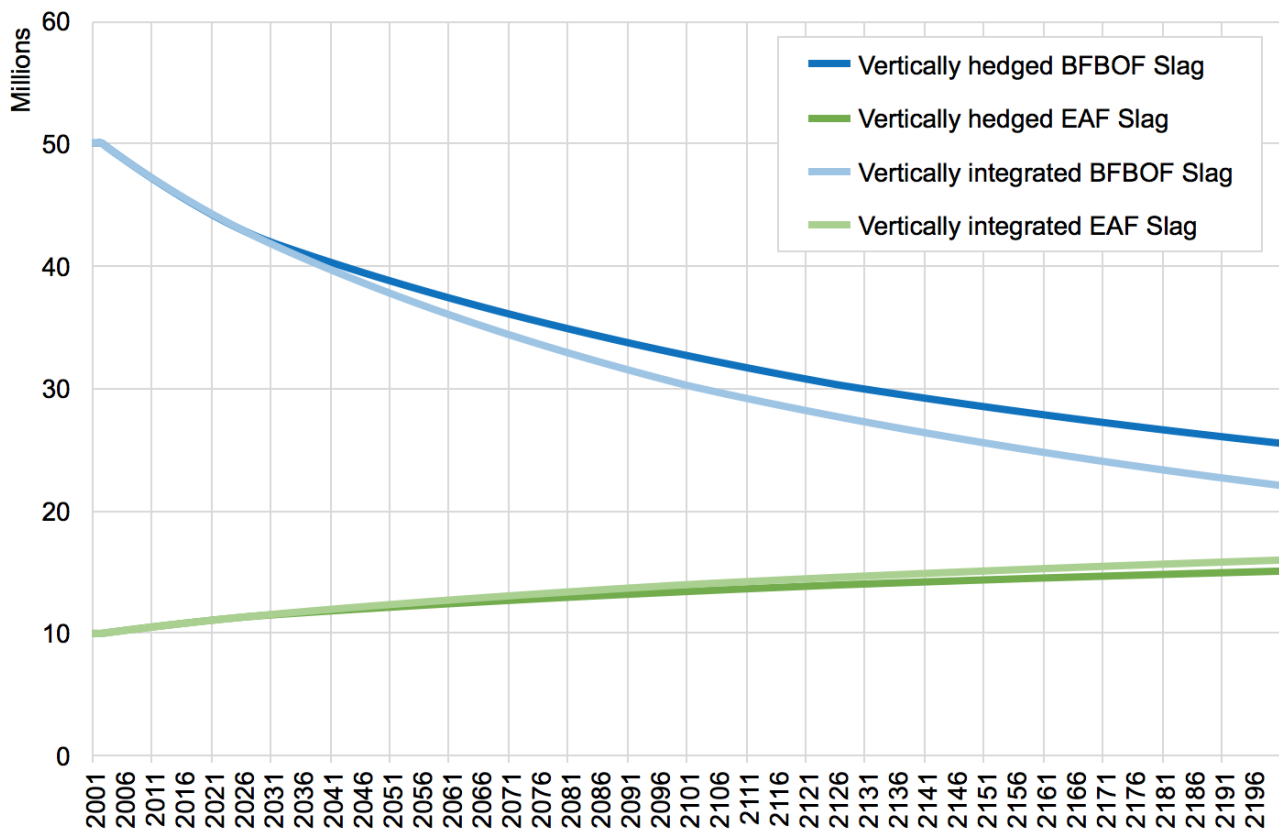

From the perspective of iron ore availability, runs 1 and 2 were also promising, as seen in Figure 9. In both cases, the threshold of high-grade ore technical scarcity was pushed forward in time, from year 2054 (BAU) to 2062 (vertical integration) and 2072 (vertical hedging), giving BFBOF operations prolonged viability for either raw material self-sufficiency or resource ownership retention strategies. Furthermore, the better the slag recycling yield becomes over time, the more it contributes as an iron input, thus lowering the pressure on ore and improving these results further.

Figure 9 - Worldwide technically extractable ore reserves (kg).

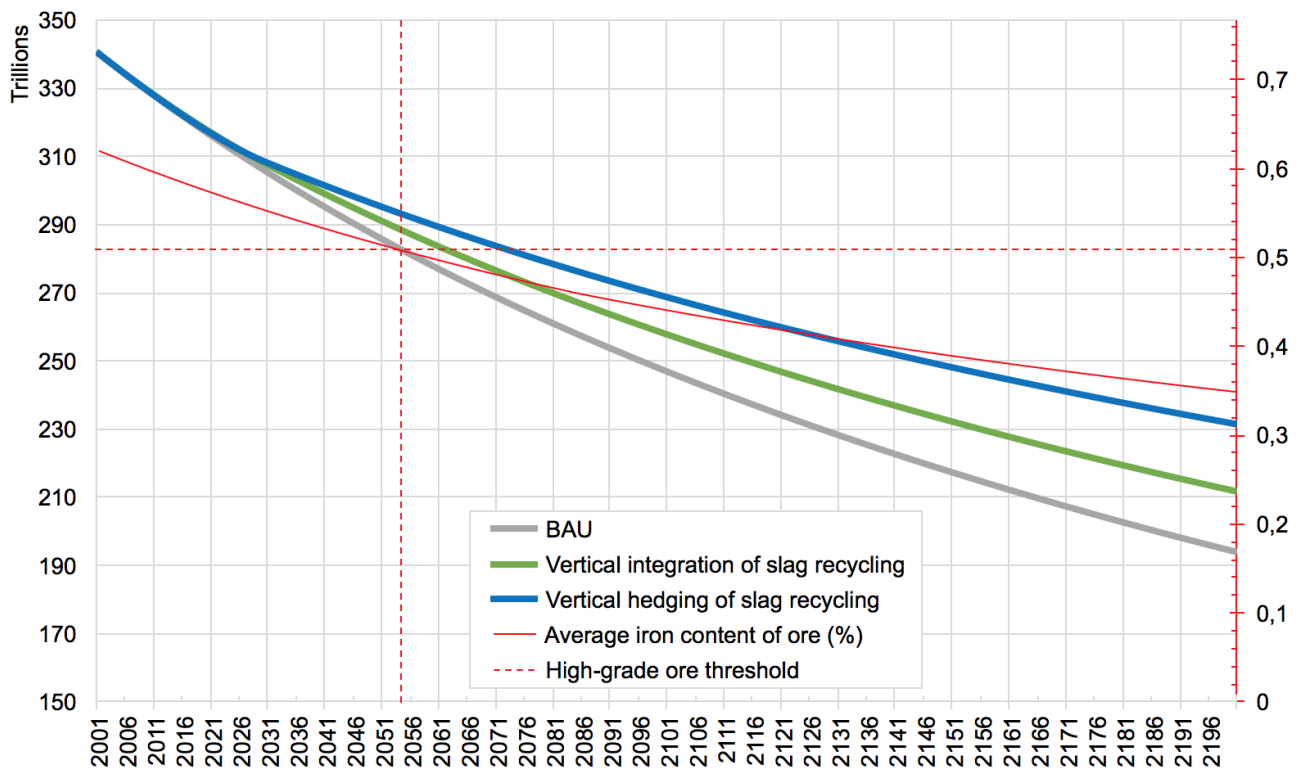

EAF operations were affected only marginally by runs 1 and 2, mostly because (a) its operation relies minimally if at all on iron ore; (b) even high yield recycled slags have lower iron content than most steel scraps; and (c) the increasing availability of steel scrap reinforces the behavior of moving away from ore.

It is important to mention that slag recycling requires the management of impurities (e.g. sulfur, silicon and phosphorus) as well as of other alloying elements (e.g. chromium, zinc, copper and nickel), all of which could be interesting materials to be recovered along with iron or to be redirected as byproducts to completely different sectors. Closing the material loops of these elements could also create new business opportunities for steelmakers, such as a new unit dedicated to supplying unnecessary or excessive elements to other industries.

Focusing on iron alone would provide the most benefits for sectors such as Construction, Heavy Mechanical Equipment, and Tools & Machinery, not only for their considerable demand – which vertically hedging BFBOF slag recycling in bulk could better

support –, but also due to their lower alloying requirements; posing as a potential policy for Europe or for a nation as a whole. Furthermore, vertical hedging in this context can also serve as a sound strategy for financial hedging against ore futures in a European steel market facing increasing pressure from China.

Sectors like Automotive, Appliances & Electronics, and Other Transportation (especially aviation and aerospace), on the other hand, could benefit from vertically integrated EAF slag recycling focused on recovering not only iron, but also specific elements necessary as raw materials for precision alloying (e.g. niobium, molybdenum and cobalt). Due to the lower demands for specialty alloys, this approach would be more suitable for individual supply chains than for a European or national policy.

In what regards to simulation run 3, the results depicted in Figure 10 highlight the potential impact of horizontally hedging EoL steel as an alternative to new steel, notably on the consumption of ore and scrap, but also in the reduced steel output. The more a same material circulates in the economy before actually being discarded, the less new materials are required, therefore the more important it becomes to retain resource ownership in order to accrue more value from it as it circulates, and not only by inputting it into the economy at first.

Figure 10 - Impact on ore, scrap, and steel output.

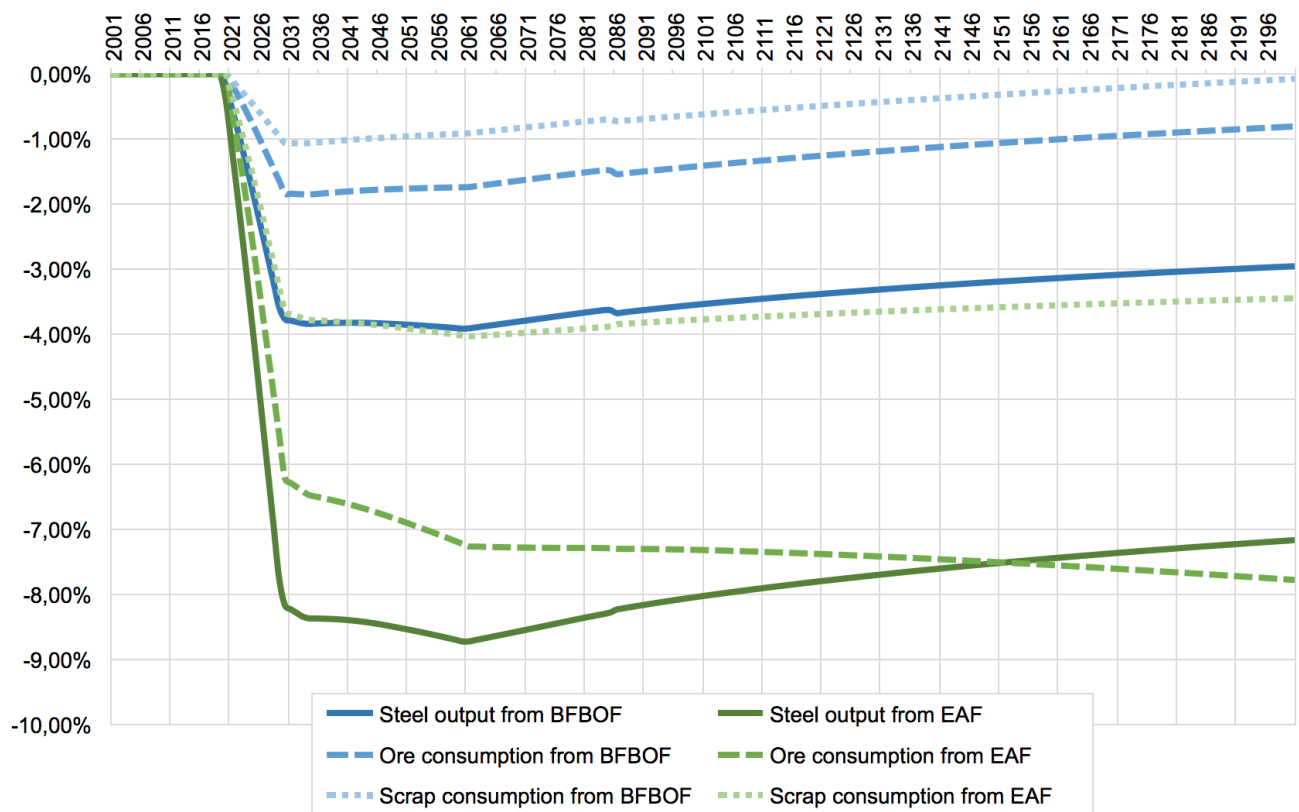

EAF operations were impacted over twice as much as BFBOF, mostly due to their direct dependence on the availability of recycled scrap which declined as a function of the prolonged circulation of iron in the economy. Still, this impact was far from being capable of reversing the trend towards the shift from BFBOF to EAF operations, even if by reducing ore consumption the lifespan of BFBOF operations was lengthened. Horizontal hedging in this context would also support financial measures regarding the futures of scrap, but less so regarding the futures of ore.

As seen in Figure 11, the amount of iron retained in the supply chain increases and, even if hedged horizontally, bringing in or creating new repair and refurbishment providers gives the steelmaker the strategic possibility to influence the flow of repairs vs refurbishments and to create new dynamics of exchange with its metalworking or assembler customers. Depending on how geographically close and operationally aligned this horizontal hedging is

implemented alongside the other stakeholders in the supply chain, benefits might even extend to reverse logistics.

Figure 11 - Iron retained within the supply chain (kg).

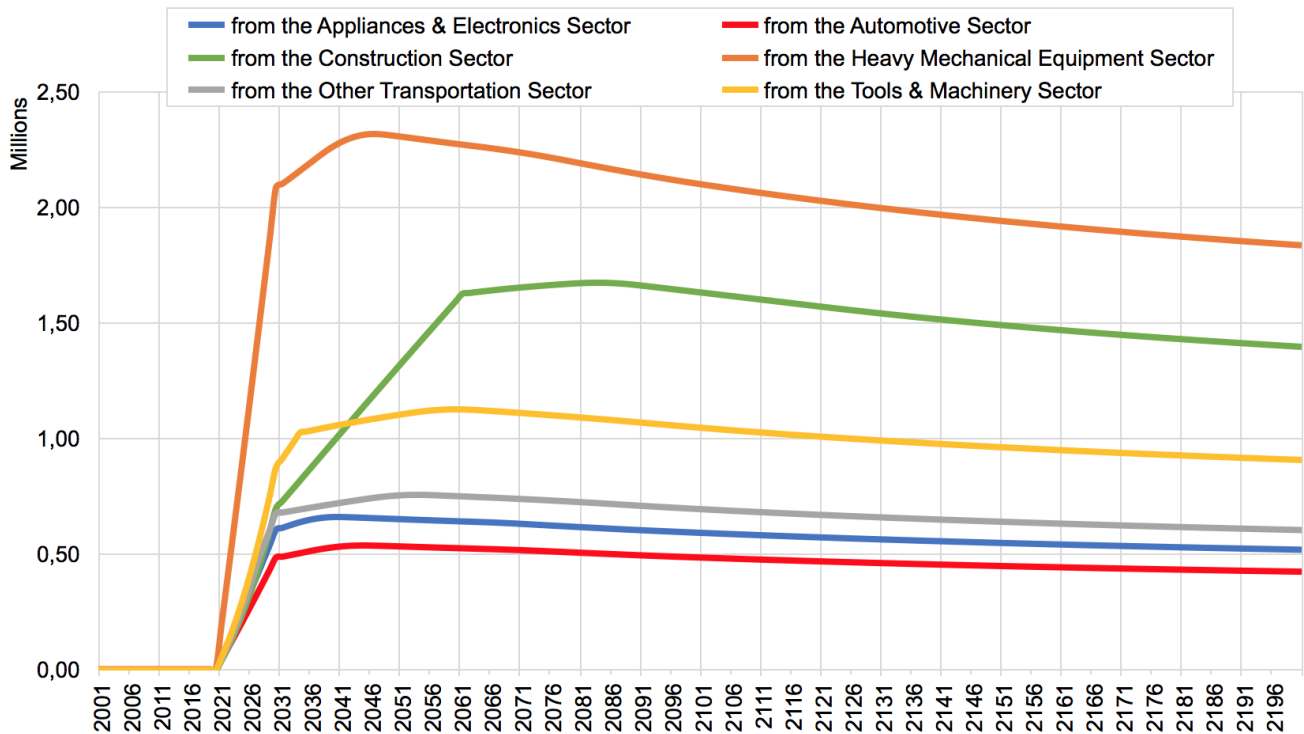

Particularly in this case, steelmakers with strong customer side relations in sectors that are more dependent on specific alloying demands (e.g. Automotive, Appliances & Electronics, and Other Transportation – notably aviation and aerospace) could potentially further benefit from a vertical hedging approach instead of a horizontal one, aiming at the retention of scarcer alloying elements such as cobalt, molybdenum and niobium in their supply chain, and at covering the risks of their futures by increasing raw material self-sufficiency.

Finally, simulation runs 4 and 5 presented horizontal integration as a double-edged sword strategy for EoL steel. Having enough horizontal influence or control to deter circularity (run 4) increased the demand for new steel and, therefore, the consumption of ore and scrap,

as seen in Figure 12. Naturally, the very opposite occurred in run 5 when stimulating circularity.

The potential for this integration approach to backfire, however, is always present because although influence or control can be exerted on third-party EoL service providers that are integrated to the steelmaker's supply chain, nothing can be done regarding those that are not. Therefore, the benefits of either deterring or stimulating circularity as means of feeding back the desired outcomes to the steelmaker can in fact create a *bullwhip* effect. Choosing to close material loops this way would require close attention to return times, backlogged demand and competitor behavior.

Figure 12 - Impact on supply side dynamics.

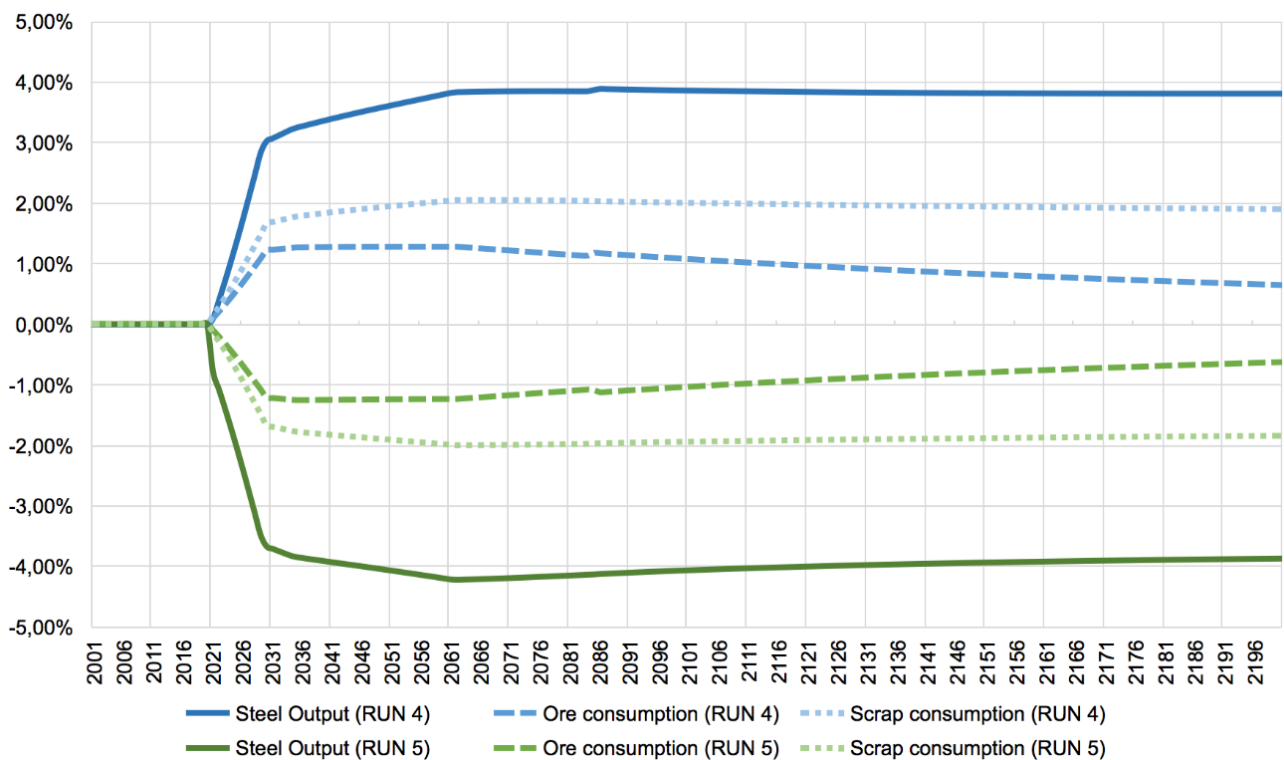

It is to say that, in run 4, the undersupplied demand for EoL services would be picked up by the competitors of the integrated third-party providers; while in run 5, the EoL services oversupplied by the integration would have a delayed feedback and either flood the market

with new steel or increase stocks throughout the chain. This becomes evident when analyzing Figures 12 and 13 simultaneously, as it is possible to see that the impacts on the supply side dynamics would be over twice as high and begin about a decade earlier than the impacts on the EoL side.

Figure 13 - Impact on End-of-Life dynamics.

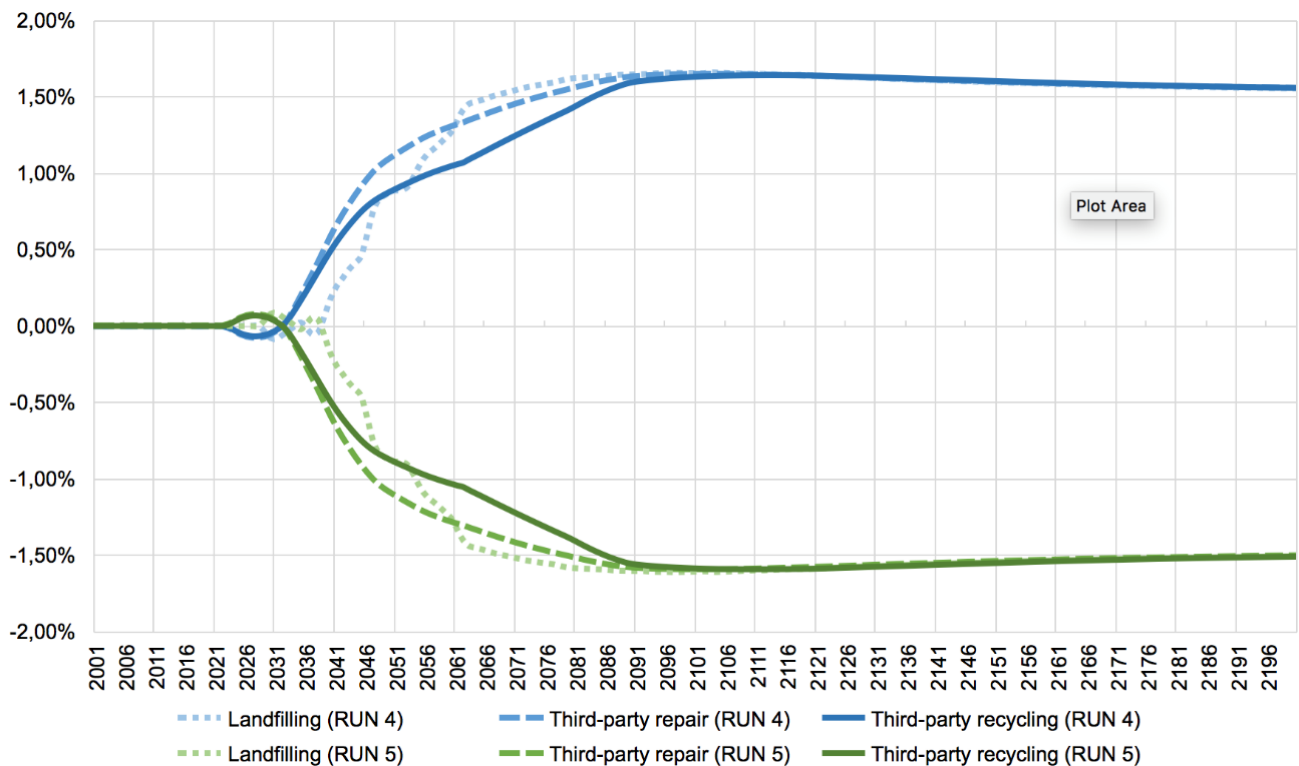

The Automotive sector is an example of how decoupling resource ownership from maintenance and repair services can allow for EoL horizontal integration, but it in fact configures a completely different business, subject to different market dynamics.

Consequently, it would be preferable for most sectors to either (a) include these EoL services as part of the product in the form of support and warranty, (b) develop a new business unit dedicated to its dynamics, (c) implement the proposition from run 3 alone, or (d) to align the propositions of runs 4 and 5 to those of run 3, so as to ensure that any EoL

steel not reinserted into the economy actually remains within the boundaries of the supply chain for refurbishment or recycling.

CONCLUSIONS AND RECOMMENDATIONS

In summary, and as seen in Table 5, the results brought forward that different approaches can yield both strategic and environmental benefits for the European steel industry as a whole or for individual steel supply chains located within its boundaries.

Overall, improvements in resource ownership retention were noteworthy when derived from supply side vertical hedging of slag as a potential alternative source of iron, presenting more strategic advantages than vertical integration. Raw material self-sufficiency, on the other hand, was perceived as strategically more interesting when originated from EoL steel goods, especially by vertically hedging for refurbishing or repair.

Table 5 - Summary of results.

CIRCULARITY DRIVER	SCI APPROACH	STRATEGIC BENEFITS	ENVIRONMENTAL BENEFITS	TARGET SECTORS	POTENTIAL SCOPE
Slag recycling for recovery	Vertical integration	<ul style="list-style-type: none"> • Suitable for specialty alloys; • Better recovery rates; • Higher raw material self-sufficiency potential; 	<ul style="list-style-type: none"> • Lower ore consumption; • Higher circularity; 	Automotive, Other Transportation, Appliances & Electronics	Supply chain specific
	Vertical hedging	<ul style="list-style-type: none"> • Scales in bulk; • More flexibility; • Higher resource ownership retention; • Potential protection from ore futures; 		Construction, Heavy Mechanical Equipment, Tools & Machinery	Europe, national
EoL refurbishment or repair	Vertical hedging	<ul style="list-style-type: none"> • Higher resource ownership retention; • Higher raw material self-sufficiency potential; • Suitable for specialty alloys; • Potential protection from scrap futures; 	<ul style="list-style-type: none"> • Lower ore consumption; • Lower scrap consumption; • Higher circularity; • Less reverse logistics; 	Automotive, Other Transportation, Appliances & Electronics	Supply chain specific
	Horizontal hedging	<ul style="list-style-type: none"> • Higher resource ownership retention; 		Construction, Heavy Mechanical Equipment, Tools & Machinery	Europe, national
EoL repair and maintenance	Horizontal integration	<ul style="list-style-type: none"> • Minor resource ownership retention increase; 	<ul style="list-style-type: none"> • Higher circularity; 	Automotive	Supply chain specific

Nevertheless, the raw material self-sufficiency and resource ownership retention benefits of the strategies discussed in this article can go beyond iron and, depending on the targeted sector, pose as key circularity enhancers for alloying elements approaching technical or economic scarcity.

Additionally, the simulation runs performed in the model not only deepened the understanding of how different strategic approaches can affect biophysical circularity within the European steel industry, but also brought to light that (a) there are sectors for which going from horizontal to vertical hedging could be worthwhile, and that (b) horizontally integrating EoL operations that are heavily dependent on the dynamics of the service sector could be imprudent unless the supply chain considers, for example, implementing an entirely new business unit.

Finally, the author believes that future studies in this field could provide further support for policy- and decision-making by empirically addressing (a) the capital requirements for different strategic investments, (b) the case-by-case reverse logistics gains, or (c) the specific environmental impacts that result from such strategic shifts.

POTENTIAL LONG-TERM RAMIFICATIONS OF SUPPLY-SIDE CIRCUMSTANCES ON STEEL'S ECONOMIC DYNAMICS

Article status: Submitted, under review (1st round);

Journal: Biophysical Economics and Resource Quality (Springer);

Co-author: DIEMER, A. ^a; SVERDRUP, H.U. ^b

^a Centre d'Etudes et de Recherches sur le Développement International (CERDI), Université Clermont-Auvergne, Clermont-Ferrand, France;

^b Department of Industrial Engineering, University of Iceland, Reykjavik, Iceland;

Highlights:

- Uses Systems Thinking to analyze the economic dynamics of the steel market;
- Uses a model integrating Life Cycle Assessment (LCA) and System Dynamics (SD) to run simulations;
- Results of the model reproduce existing trends and projections for the steel industry;
- Tracks the long-term trends of spot prices, future prices, EBITDA margins, dividend payouts and costs;
- Through the behavior of steelmakers, identifies six key biophysical variables and their effects on economic dynamics.

Abstract:

Since the 2008 crisis, the steel industry has been confronting issues regarding prices, energy sourcing, trading and competitiveness. In light of the substantial shift in the international conjuncture of the steel market since then, steelmakers can no longer adopt strategies restricted to national or regional levels alone. In order to understand the dynamics at play, this article proposes to answer two questions: what are the key biophysical variables that drive the economic dynamics in the steel industry? and how to articulate economic dynamics with a biophysical model? Hence, two steps were taken: (a) using Systems Thinking to analyze the key drivers and interactions that influence the steel sector from an economic perspective; and (b) running simulations in a model that integrates Life Cycle Assessment (LCA) and System Dynamics (SD). The model was able to reproduce existing trends and projections for the steel sector, such as the continuing presence of overcapacity despite projected demand growth. By tracking spot prices, future prices, EBITDA margins, capacity utilization, dividend payouts and costs, six key biophysical variables and their respective effects on economic dynamics were identified, resulting in different long-term trend propositions based on the behaviors presented by the steelmakers in the model.

Keywords:

Steel; System Dynamics; Life Cycle Assessment; Resources; Microeconomics.

INTRODUCTION

Since the Industrial Revolution, steel has been among the most essential materials worldwide, present in most aspects of the economy and of everyday life, from infrastructure to manufacture, from canned food to appliances (WS, 2012; Beddows, 2014). Steel's cycle through environment and society begins as iron ore and most commonly ends either inside long service life structures or as recyclable scrap (Warrian, 2012; Vaclav, 2016).

While steel's biophysical dynamics allow us to track the flows and stocks of materials from extraction to use and back via recycling, the economic dynamics of the steel industry provide us with the key drivers to understanding the steel market's behavior (Van der Voet et al., 2018; Demailly & Quirion, 2008; Xiong & Helo, 2008).

Due to its products' requirements and its raw materials' physical and chemical characteristics, the steel industry has traditionally given substantial attention to variables that boost or hinder the quality, quantity and profitability of its outputs and, considering that since 2008 it has been facing the aftermath of the subprime financial crisis, the slowing of Chinese growth, the political instability of Russia and Ukraine, and the Eurozone sovereign debt crisis, including macro- and micro-economic context became increasingly important in any analysis (Lichtenstein, 2017; Buchmayr et al., 2018).

Notably in the last decade, the steel industry has been facing difficulties regarding prices, energy sourcing, trading and competitiveness (EC, 2013) due to the expansion of global markets and to the geopolitical circumstances that gave Chinese, Russian, Brazilian and Indian steelmakers the opportunity to grow their market shares with scale to supply increasing urbanization and industrialization demands, all the while developed economies have seen it either stabilize or decrease (EY, 2014/2015).

North American and Western European steelmakers today see prices rise again and with it the uncertainty regarding the futures market (Lichtenstein, 2017; Buchmayr et al.,

2018). Consequently, investments slow down and the deployment of financial protection strategies becomes commonplace, especially when facing China's substantial hold on the steel market (Arik & Mutlu, 2014). Nevertheless, it is still common among steelmakers to use capacity as strategic means to flood or dump the market when threatened by new entrants or foreign exporters – a move deemed by many specialists as economically unsustainable since its effects occur at the expense of margins (Beddows, 2014; EY, 2015).

Keeping in mind that indiscriminately cutting costs could stir the political scene against the steel industry – notably in very unionized nations –, and realizing that competing against steelmakers who run their operations with lower costs was no longer possible by adopting strategies aimed only at the national or regional markets, the steel industry as a whole sees itself compelled to seek new strategies (Warrian, 2012; Pinto et al., 2019).

An example is the transition towards Electric Arc Furnace (EAF) steelmaking, which recycles steel scrap and is capable of saving 1.400 kg of iron ore, 720 kg of coaking coal and 120 kg of limestone, on average. But even though record-breaking sums of capital have been directed towards this type of operation, many of the economic dynamics involved can pose as obstacles (BIR, 2017; EC, 2013; Waugh, 2016; Pinto et al., 2019).

With this context in mind, this article aimed to answer two questions: (1) What are the key biophysical variables that drive the economic dynamics in the steel industry? And (2) How can economic dynamics be articulated within a biophysical model based on the Life Cycle Assessment of the steel products? To answer these questions, two steps were taken. In the first step, the author analyzed the key drivers and the interactions likely to influence the evolution of the steel sector using Systems Thinking and Causal Loop Diagrams (CLD).

Next, a model representative of the steel industry integrating the biophysical aspects of LCA and the main drivers of economic dynamics in a System Dynamics (SD) environment was used to run different simulations and support the discussion on how variations in the

steel industry's supply-side dynamics – particularly capacity utilization, logistics, and sourcing – can affect economic dynamics.

ECONOMIC DYNAMICS OF THE STEEL INDUSTRY

The economic dynamics of the steel industry are summarized in Figure 1, encompassing (a) a spot market loop, (b) a capital accumulation and distribution loop, and (c) a futures market loop. In the following subsections of this article, in order to uphold the scenarios simulated later on, the author analyzed each of these loops independently alongside real-world examples.

Figure 1 - Economic dynamics of the steel industry.

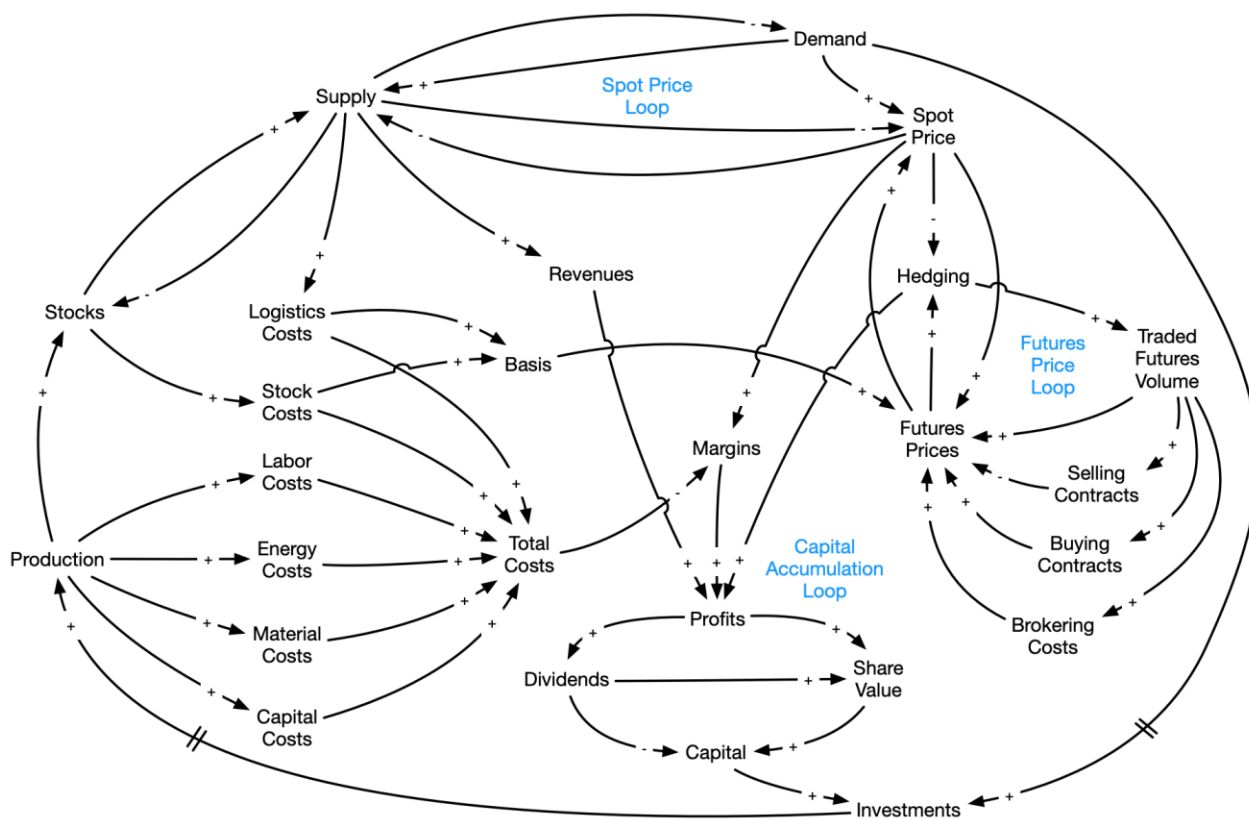

SPOT MARKET DYNAMICS

Considering that steel's spot price is heavily influenced by demand, trade and stocks, spot market dynamics consequently rely on the outcomes of productive variables (Rossen, 2015). Since 2010, however, steel has been facing higher supply than demand due to overcapacity, with only 70% of production operational (Pooler & Feng, 2017; OECD, 2018). If the steel industry had been operating at full capacity, it is estimated that additional 730 million tons of steel would have been made available to the spot market in 2016 alone (OECD, 2018; WS, 2018).

Many Western steelmakers hold China responsible for this situation due to the fact that the nation doubled its production in the period between 2004 to 2014, growing its share from about 25% to 50% of total world production, becoming market leader by 2017, and significantly reducing spot prices worldwide (Fickling, 2017). This allowed China to profit in scale instead of by margin alone, while significantly hindering their competitors' negotiation leverage and, consequently, their market shares. This is particularly noticeable when focusing on the spot price loop of steel's economic dynamics, as seen in Figure 2.

Figure 2 - Spot Price Loop.

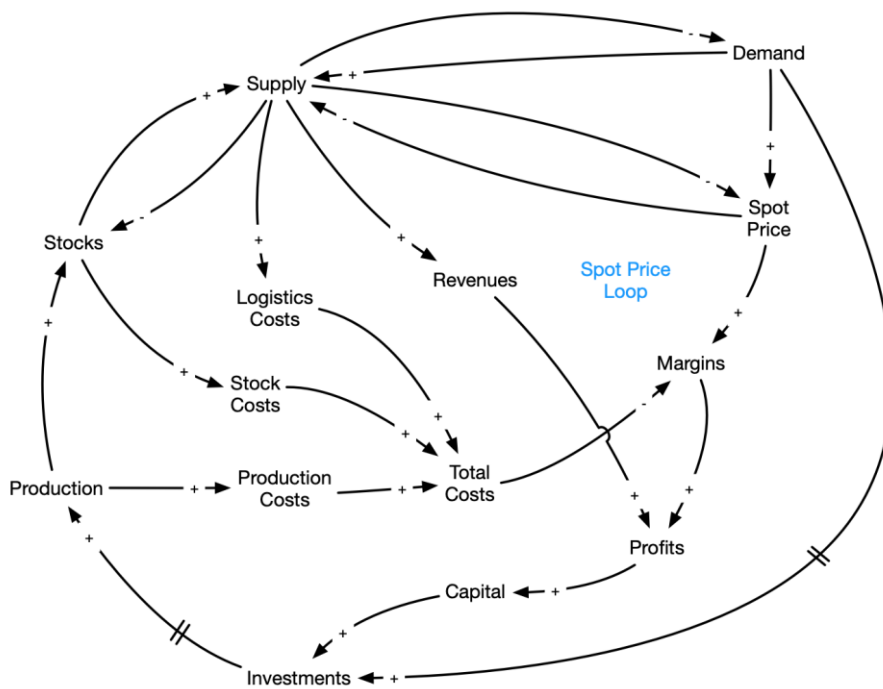

China's state-owned productivist policy was particularly important after the 2008 financial crisis as China's growth slowed, serving as a tool for mitigating the rise of unemployment and the associated risks of social crises in the context of the prevailing economic slowdown (Fickling, 2017). To counter what was considered by many as unfair competition, the European Commission has introduced anti-dumping duties on imports of a range of steel products from China; and similar measures have been under consideration by the current administration of the United States of America (The Economist, 2017/2018).

Some North American and Western European steelmakers saw this as an opportunity to repeat the behavior of steelmakers during the post-War – when Japan, South Korea and Germany rejoined the steel market (D'Costa, 1999) – and boost their margins by using technology to help reduce production costs and improve efficiency (e.g. ArcelorMittal), while others chose focus on quality and portfolio specialization (e.g. Thyssenkrupp) (EY, 2014/2015; WS, 2013).

In 2016, having recognized the problem that overproduction created and beginning to fall victim to it themselves, the Chinese launched a policy to reduce steel production by 150 Mt by 2020 and to improve air quality in the heavily polluted provinces where loosely regulated steel production takes place (Reuters, 2018; GreenPeace, 2017). It is unlikely, however, that these reductions will solve the problem since now India has decided to triple production by 2030, and Russia, Iran and Turkey decided to direct their production mostly towards exports (Chandrasekhar, 2017).

Still, the global steel market remains in overcapacity despite prices rising since 2015. Due to the strength of this trend in global production and the context of declining demand, spot market operators expect prices to fall in the short term, but to recover in the medium term due to China's market share (Statista, 2019). Furthermore, production electrification – i.e. migration to Electric Arc Furnaces (EAF) supplied by the secondary metals market – as well as the increasing prices of other raw materials may play an important role in the long-term developments of steel's spot market (MKC, 2018; Gonzales-Hernandez et al., 2018).

THE DYNAMICS OF CAPITAL ACCUMULATION AND DISTRIBUTION

Directing attention to capital dynamics – seen in Figure 3 – not only reinforces the importance of the spot market as a source of income, but also introduces reinvestments and dividends distribution as factors that can boost or hinder production. Reinvestments can directly affect capacity and efficiency of production, but balancing how much to reinvest and how much to pay as dividends can indirectly affect the perception of outside investors through the value of a company's share and through signaling expected increases in profitability (Batabyal & Robinson, 2017).

Figure 3 - Capital Accumulation Loop.

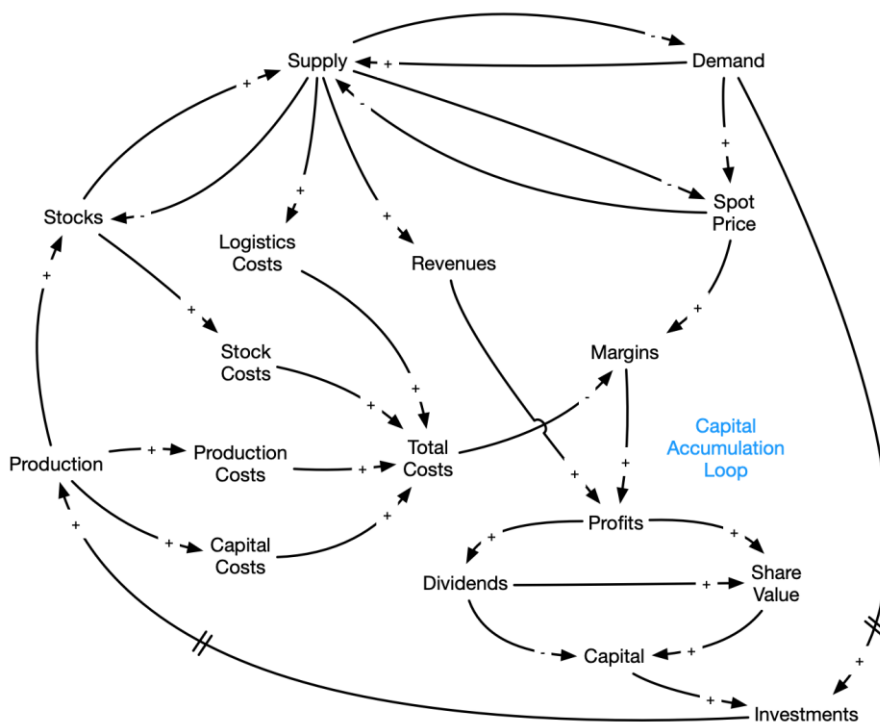

In order to protect their margins, the world’s largest steelmakers made efforts to reduce costs by reinvesting capital instead of paying dividends, such as in the case of ArcelorMittal during 2015 and 2016 (ArcelorMittal, 2019). And although overcapacity was still present, prices started to rise again in 2017 due to slight increases in demand and to the shutdown of a few plants in Europe and China (Amiot, 2016; Statista, 2018).

Keeping with the momentum, European and North American steelmakers engaged in consolidation and integration initiatives. In 2017, for example, ThyssenKrupp and Tata Steel merged their European operations, while almost the same time ArcelorMittal announced the acquisition of Italian company Ilva (ArcelorMittal, 2018), significantly shifting the global distribution of revenues in their favor (Statista, 2017).

Consequently, as EBITDAs rose in that same year, the amount of dividends distributed worldwide by the steel industry increased by 7,7% and reached a new record (CSI, 2019)

despite the context of overcapacity and indicating that price increases may occur without severely affecting the dynamics of the spot market.

As per the dynamics in Figure 3, this phenomenon indicates that the steel industry seems less concerned about finding a balance between reinvestments and dividends distribution than it is concerned about managing these variables cyclically. At first, focus is given to improving margins by reinvesting on technology, efficiency and integration, even if at the expense of dividends. Once revenues increase as consequence of higher margins, dividend distribution takes place, thus raising share value and signaling a price increase that could potentially attract external capital towards either improving capacity and market share – still a common strategy despite current overcapacity – or, if the cycle is to be repeated, towards cost reduction and higher margins.

Still, this cyclic behavior of capital accumulation and distribution relies heavily on supply-side dynamics to ensure profitability and could be proven precarious unless steelmakers cover or compensate investment risks. Since production costs can significantly affect margins, exchanges in commodity futures markets became commonplace and grew substantially after 2008 (LME, 2019; SHFE, 2019).

THE DYNAMICS OF THE FUTURES MARKET

The steel futures market plays a key role in the evolution of price and on the expectations of traders and investors. In it, steel is exchanged in the form of contracts that represent a commitment to deliver steel in a future date with a price set when the contract is negotiated (Schwager, 1984; Clenow, 2013). The reference quotation for steel comes from the London Metal Exchange (LME) but many secondary institutions such as the New York Mercantile Exchange (NYMEX), the Shanghai Futures Exchange (SHFE) or the Multi Commodity Exchange (MXC) also provide price signals to traders.

The main type of operation on a futures market is *hedging*, in which the operator aims to reduce exposure to the risk of price fluctuations. If supply is higher than demand – which is the case today on the spot market –, spot price tends to go down. To compensate for the risk of this price reduction affecting their profits, steelmakers sell steel contracts today with a future price that, on delivery, covers their targeted earnings. If the price in fact goes down, profit lost by the steelmaker on the spot market is covered by the margins they got on the futures market (Schwager, 1984; Clenow, 2013).

The opposite would take place if prices are estimated to increase. These dynamics are depicted in Figure 4, in which two loops (Reinforcing, Balancing) can have either a reinforcing or balancing behavior, respectively.

Figure 4 - Hedging dynamics.

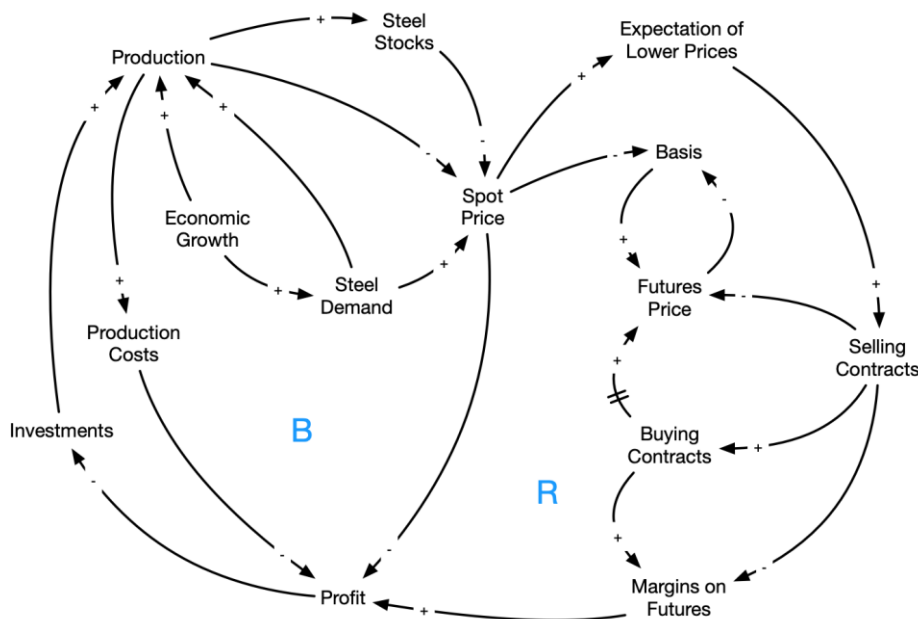

While *hedging* aims to avoid an exposure to price volatility, *speculation* aims to use this situation to get increase profits further. Instead of liquidating a good or contract to attain revenue or to cover for losses, respectively, operators hold on to them in order to sell them

for as high a price as possible in the future (Schwager, 1984; Clenow, 2013; Boyd et al., 2018), as seen in Figure 5.

Figure 5 - Speculation dynamics.

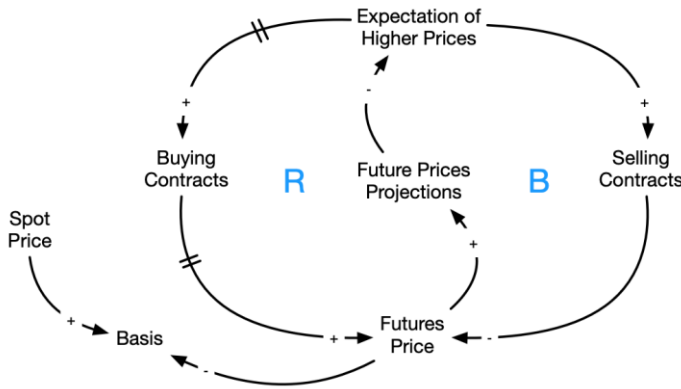

A third type of operation is called *arbitrage*, and consists of minimizing risks by taking advantage of abnormal price mismatches between different but mostly symmetrical instruments, whether between different markets or between spot and futures markets of a same good (Schwager, 1984; Clenow, 2013). Therefore, the larger gap in price between contracts, the higher the profit of the overall transaction set, as seen in Figure 6.

Figure 6 - Arbitrage dynamics.

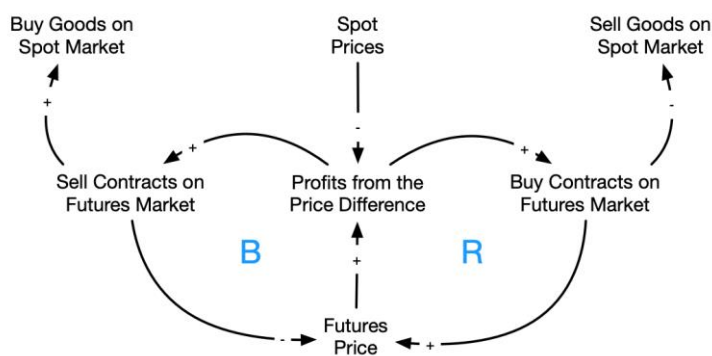

Regardless of operation, spot prices and future prices do not evolve in exactly the same way, even if they tend to move in tandem. The theoretical future price is equivalent to

the spot price plus or minus what is called a *basis*, which considers three components: (a) carrying cost – which represents the cost of financing, insuring and storing the product until delivery, (b) logistics – which represents the transportation costs of the goods to be delivered –, and (c) product quality – in terms of deviations from what was negotiated (Schwager, 1984; Clenow, 2013).

As the delivery date approaches, spot price and future price converge towards one another and the operator can choose to either run the contract and have the goods be delivered as negotiated or to sell the contract before delivery, depending on the need for the goods vs the need for capital to compensate losses (Schwager, 1984; Clenow, 2013). In the case of steel, *hedging* is the most common type of futures operation, followed by *arbitrage*, and leaving *speculation* as the least common type of operation due to its lower effectiveness with commodities (Statista, 2017c; Haase et al., 2016).

MODEL AND METHODOLOGY

In order to test and discuss the potential effects that variations on the steel industry's supply-side dynamics can have on the economic dynamics presented thus far, this article made use of a model representative of an average steel supply chain to perform simulations runs based on four different scenarios.

The model is an integration of LCA into a SD environment, in which biophysical interactions are handled according to the criteria of the ILCD Handbook (EC, 2010) and to the standards of ISO14044:2006 (ISO, 2006), while the economic dynamics are handled by the SD environment, modelled according to the diagram seen in Figure 1 and following three steps: 1) Business Process Mapping (BPM) – using the BizAgi BPM software –; 2) Causal

The author also considered adopting Product Environmental Footprint (PEF) standards (JRC, 2012), however, in its current state, it presented itself as a less consolidated and less disseminated methodology, with available applications focused mainly in the construction sector.

Loop Diagramming (CLD) – using the OmniGraffle software –; and 3) Flow Charting (FC), using the ISEE Stella Architect software (ISEE, 2018).

In the model, iron was set as the driving chemical element of steelmaking, steel scrap and iron ore were set as the key raw materials, and all chemical elements and raw materials present in steelmaking adopted two different levels of aggregation: cradle-to-gate processes were disaggregated down to chemical level, while gate-to-cradle processes were aggregated to product level. This choice was made in order to give decision-making granularity without over encumbering macro-level analyses that could affect policy-making on end-of-life and circularity services.

The material needs of the furnaces were used to define the amounts of raw materials pulled from their respective sources. This pulling behavior is present in the system until liquid steel becomes an intermediary output, point in which the system then pushes materials through the subsequent processes so as to represent the continuous casting operation.

In total, twenty modules were created – one for each chemical element involved in the steel supply chain –, all of which used a functional unit of 1 tons of steel. All modules were built to be structurally identical – distinguished only by specific flows necessary to properly represent their typical operational behaviors – and, with the exception of the iron module, perform their calculations in the background, allowing for the user interface to be less polluted than traditional SD models. Figure 7 depicts the control panel (top left) and the economic module (top right) – both of which are only present in the main interface –, as well as the iron module (bottom).

Figure 7 - Flow Chart (FC) Interface Diagram of the model's biophysical module and control panel (both highlighting Fe), and the economic module.

<< Please refer to the high-resolution images in Appendices 7.4, 7.5 and 7.6, respectively >>

Individual productive processes were grouped into macro-processes based on their most common occurrence in the steel industry, namely (a) EAF and (b) BFBOF – each encompassing sintering, pelletizing, degassing, alloying, desiliconization, desulfurization, homogenization or dephosphorization, whenever applicable; (c) Casting – which encompasses all shape, heat and surface treatments; (d) Metallurgy – which encompasses all forming and metalworking processes; (e) Economic Sectors – divided in Construction, Automotive, Other Transportation, Tools & Machinery, Appliances & Electronics, and Heavy Mechanical Equipment; (f) Recycling – which feeds back into the stock of scrap used as input for “a” and “b”; (g) Repair & reuse – which feeds back into each economic sector according to their share in its demand; and (h) Losses & Landfills – which configure process-based sinks.

Furthermore, it is important to note that 1) due to the lack of available disaggregated data, emissions from mining, casting and metallurgy were attributed to the EAF and the BFBOF macro-processes accordingly; 2) dust and particulate matter generation were incorporated into the emissions; 3) no disaggregated emission data was found for end-of-life and circularity solutions; and 4) energy flows were considered only in the form of consumed amounts of fossil fuels or electricity, and not in the form of heat – which was given a fossil fuel or electricity equivalent whenever applicable.

Consequently, and as per design, inherent behaviors of the model structure include (a) the gradual transition from BFBOF production to EAF production as function of steel scrap availability, iron ore quality decrease and iron ore scarcity over time (Waugh, 2016), still respecting alloying and operational requirements; (b) the gradual shift towards consuming

steel scrap instead of iron ore as a function of iron content and availability, as well as their consequent price fluctuations derived from shifts in the dynamics of demand and offer; and (c) steel scrap downcycling over time due to alloying quality loss during repeated service lives.

Table 1 summarizes the data inputs used in the study, all of which encompassed the interval between 2001 and 2016, and were verified for cohesion, coherence and reliability based on their equivalent data points in the World Steel Association Association's Life Cycle Inventory Study for Steel Products (WS, 2017c) and EUROSTAT Databases (EUROSTAT, 2009/2017/2018a,b).

Table 1 - Summary of data inputs.

TYPE	VARIABLE	UNIT	SOURCES
EAF Inputs	Scrap, Oxygen, Natural Gas, Coal, Limestone, Dolomite, Water, Ore	kg/kg of steel	Shamsuddin (2016), WS (2012a/b, 2018, 2017c), EU (2011b), Madias (2013), Cullen et al. (2012), Yellishetty et al. (2011), EUROFER (2017a), EUROSTAT (2009, 2018b)
BFBOF Inputs	Ore, Hot Blast, Scrap, Water, Limestone, Coke, Dolomite	kg/kg of steel	
Typical Chemical Compositions of the Inputs	Scrap, Ore, Coke, Natural Gas, Coal, Dolomite, Limestone, Hot Blast	%	MINDAT (2018) WEBMINERAL (2018)
Typical Compositions of Steel Alloys, as Outputs	UNS S30400, UNS S31600, UNS S43000, UNS S17400, UNS S32205, UNS S40900	%	Bringas (2004)
Typical Slag Composition Ranges	EAF Slag, BF Slag, BOF Slag	%	Yildirim & Prezzi (2011), Adegoloye et al. (2016), EUROSLAG (2018)
Typical Composition Ranges of Emissions to the Atmosphere	EAF Emissions, BF Emissions, BOF Emissions	%	Ferreira & Leite (2015), Ramírez-Santos et al. (2018), Uribe-Soto et al. (2017), Schubert & Gottschling (2011)
Stocks in Use	Automotive, Construction, Tools & Machinery, Appliances & Electronics, Heavy Mechanical Equipment, Other Transportation	tons	Pauliuk et al. (2013), EC (2017)
Participation of Economic Sectors in Steel Demand		%	WS (2018), EUROSTAT (2009, 2018b)
Typical Lifespan and Service Life of Steel per Economic Sector		years	Cooper et al. (2014), EC (2017), EUROSTAT (2009, 2018b)
Recycling and Refurbishment Rates per Economic Sector (<i>business as usual</i>)		%	NFDC (2012), EUROSTAT (2018a), Björkman & Samuelsson (2014), BIR (2017), Panasiyk et al. (2016), EUROFER (2017b), Eckelman et al. (2014)
Repair and Reuse Rates per Economic Sector (<i>business as usual</i>)			NFDC (2012), EUROSTAT (2018a), Dindarian & Gibson (2011), Truttmann & Rechberger (2006), Bovea et al. (2016), Kissling et al. (2013), RREUSE (2012), Eckelman et al. (2014),
Distribution and End-of-Life Losses			Pauliuk et al. (2017)
Typical Cooling Water Reuse and Recycling Rates		EAF Cooling Water, BFBOF Cooling Water	%
Ore Prices (historical)	China FOB 63,5% Fe	Euros	IM (2019), Trading Economics (2019)
Steel Prices (historical)	Global average, FOB Hot-rolled Coil		MEPS (2017), SB (2018)
Freight Shipping Index	Baltic Dry Index (BDI)		Bloomberg (2019)
Future Price (historical)	Future Prices		
Futures Contracts Exchange	Exchanged Volumes	tons	SHFE (2019), LME (2019)
Financial Results (historical)	EBITDA	%	NYU Stern (2018)
	Dividend payout		CSI (2019)

The model was parameterized with the data seen in Tables 2 and 3, performing monthly calculations during a period of 200 years and assuming that the demand for steel

focused on steel types UNS S30400, UNS S31600, UNS S43000, UNS S17400, UNS S32205 and UNS S40900. The yield of the EAF and the BFBOF production macro-processes was set according to their respective capacity and productivity, as well as to their share of participation in steel output.

Table 2 - Summary of parameters used in the model.

Parameter	Value	Unit	Sources
EAF Tap-to-Tap Time ⁽¹⁾	0,80	hours	Shamsuddin (2016), WS (2012a/b, 2018, 2017c), EU (2011b), Madias (2013), Cullen et al. (2012), Yellishetty et al. (2011, 2011a), EUROFER (2017a,b)
EAF Furnace Capacity	100,00	tons	
BFBOF Cycle Capacity	42,00	tons/batch	
BFBOF Productivity ⁽¹⁾	7,00	batches/h	
Share of EAF Production	30, 00	%	WS (2017b)
Share of BFBOF Production	70,00		
Recoverable High-grade Iron Ore	82 billion	tons	Sverdrup & Ragnarsdottir (2014), UNCTAD (2017)
Recoverable Low-grade Iron Ore	92 billion		
Recoverable Very low-grade Iron Ore	166 billion		
Global average capacity utilization, steel industry	70,00	%	Statista (2016), Pooler & Feng (2017)
Global average reinvestment rate, steel industry	67,50	% / year	NYU Stern (2018)
Global average economic inflation growth	0,05		IMF (2019), PWC (2019)
Interest rate	5,00		Trading Economics (2018)
Global average GDP growth	3,60		IMF (2019)
Compound annual demand growth rate, steel industry	1,50		WS (2018), Statista (2018)

(2) As both delay and yield factor.

Table 3 - Summary of baseline costs in €/ton.

	EAF			BFBOF		
	FIXED	VARIABLE	TOTAL	FIXED	VARIABLE	TOTAL
Ore ⁽¹⁾	€ 0,00	€ 0,00	€ 0,00	€ 0,00	€ 93,98	€ 93,98
Scrap ⁽¹⁾	€ 0,00	€ 271,92	€ 271,92	€ 0,00	€ 36,47	€ 36,47
Industrial gases	€ 0,00	€ 1,25	€ 1,25	€ 0,00	€ 13,06	€ 13,06
Alloying elements	€ 0,00	€ 19,49	€ 19,49	€ 0,00	€ 11,69	€ 11,69
Coal ⁽¹⁾	€ 0,00	€ 0,00	€ 0,00	€ 0,00	€ 20,81	€ 20,81
Fluxes	€ 0,00	€ 3,39	€ 3,39	€ 0,00	€ 106,91	€ 106,91
Other ⁽²⁾	€ 2,31	€ 31,94	€ 34,26	€ 2,83	€ 13,67	€ 16,50
Labor	€ 1,72	€ 5,16	€ 6,88	€ 3,90	€ 11,69	€ 15,59
Electricity	€ 5,44	€ 30,84	€ 36,28	€ 1,17	€ 6,64	€ 7,81
Capital	€ 12,77	€ 0,00	€ 12,77	€ 24,39	€ 0,00	€ 24,39
Byproducts	€ 0,00	€ 0,00	€ 0,00	€ 0,00	-€ 11,63	-€ 11,63
Net thermal energy	€ 0,00	-€ 3,01	-€ 3,01	€ 0,00	-€ 44,06	-€ 44,06
TOTAL	€ 22,24	€ 360,99	€ 383,23	€ 32,30	€ 259,24	€ 291,54

Sources: Statista (2017b/2019b), WS (2018), WSD (2019).

(1) Includes logistics and transportation;

(2) Includes furnace maintenance;

In total, five runs were performed according to the description in Table 4. The first run was *business-as-usual* (BAU) and the next four runs focused on testing the effects of different supply-side dynamics on the economic parameters being tracked, *caeteris paribus*. All of the testing considered value changes taking place in January 2020, and runs were then compared to BAU and analyzed in the next section.

Table 4 - Summary of simulation runs.

RUN	VARIABLE	INITIAL VALUE	TESTED VALUE	TRACKED PARAMETERS
1	Capacity Utilization ⁽¹⁾	BAU	BAU + 10,00%	<ul style="list-style-type: none"> • Future Price; • Spot Price; • EBITDA Margin; • Dividends;
2	Logistics Volatility	BDI	BDI ± 10,00%	
3	Electricity (average of industrial nuclear, industrial hydropower, electricity coal)	BAU	BAU + 6,00%/year	<ul style="list-style-type: none"> • Future Price; • Spot Price; • EBITDA Margin; • Dividends; • Total Costs of BFBOF Steelmaking; • Total Costs of EAF Steelmaking;
	Fossil Fuels (average of coking coal, PCI coal, natural gas)		BAU – 4,00%/year	
4	Nickel prices	BAU	BAU + 2,50%/year	
	Chromium prices		BAU + 2,10%/year	

Sources: MKC (2017), KPMG (2018), ÖKO (2016), Oomen (2012), Jung (2015), IEEFA (2018), Papandreou & Ruzzenenti (2016).

(1) Considering 445,00 €/kg (EAF) and 327,00 €/kg (BFBOF) reinvestment in installed capacity, depreciated over a period of 50 years.

The first run's goal was to determine how much the economic dynamics involved would tend to be affected if steelmakers operating with idle capacity decided to increase their market shares by means of offer alone. The second run, on the other hand, aimed at determining how steelmakers would tend to react in face of volatility in logistics. Finally, the third and fourth runs sought to understand the potential economic effects beyond a direct and proportional price increase that variations in energy and raw material costs could have on steelmaking.

RESULTS AND DISCUSSION

The *business-as-usual* run was most useful in verifying if the model was able to reproduce existing trends and projections regarding both biophysical and economic aspects

of the steel industry. Figure 8, for example, depicts the continuation of the overcapacity trend and, despite a marginal increase in steel demand originating from developing nations, production and apparent steel use would follow suit.

This behavior is in large part consequence of (a) the steel industry as a whole slowly transitioning towards EAF steelmaking and secondary metals market sourcing – thus requiring less new steel to be produced –; (b) decreasing BFBOF yields and margins due to lower iron content in ores – partially mitigating potential absolute technical or economic scarcity –, and (c) increasing costs of EAF steelmaking – a balancing paradox between steel scrap availability’s slow response and industrial electricity price increasing due to competition with renewables in residential applications.

Figure 8 - Long-term trends in production, consumption, and capacity utilization (right axis).

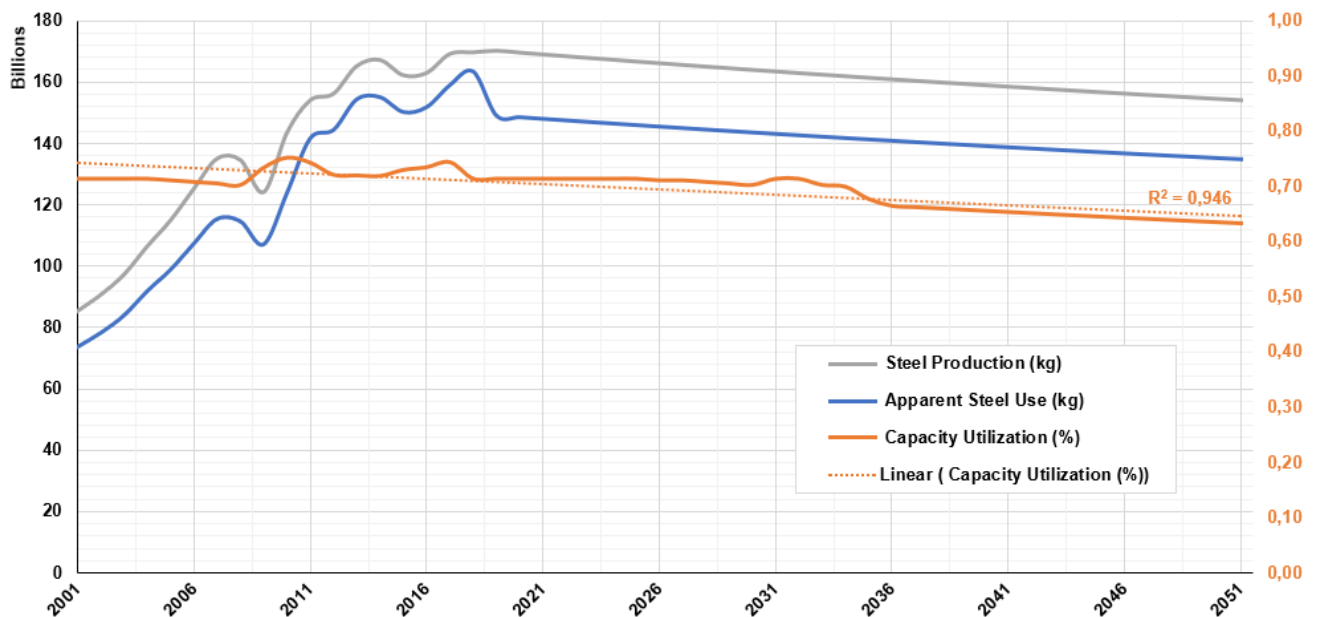
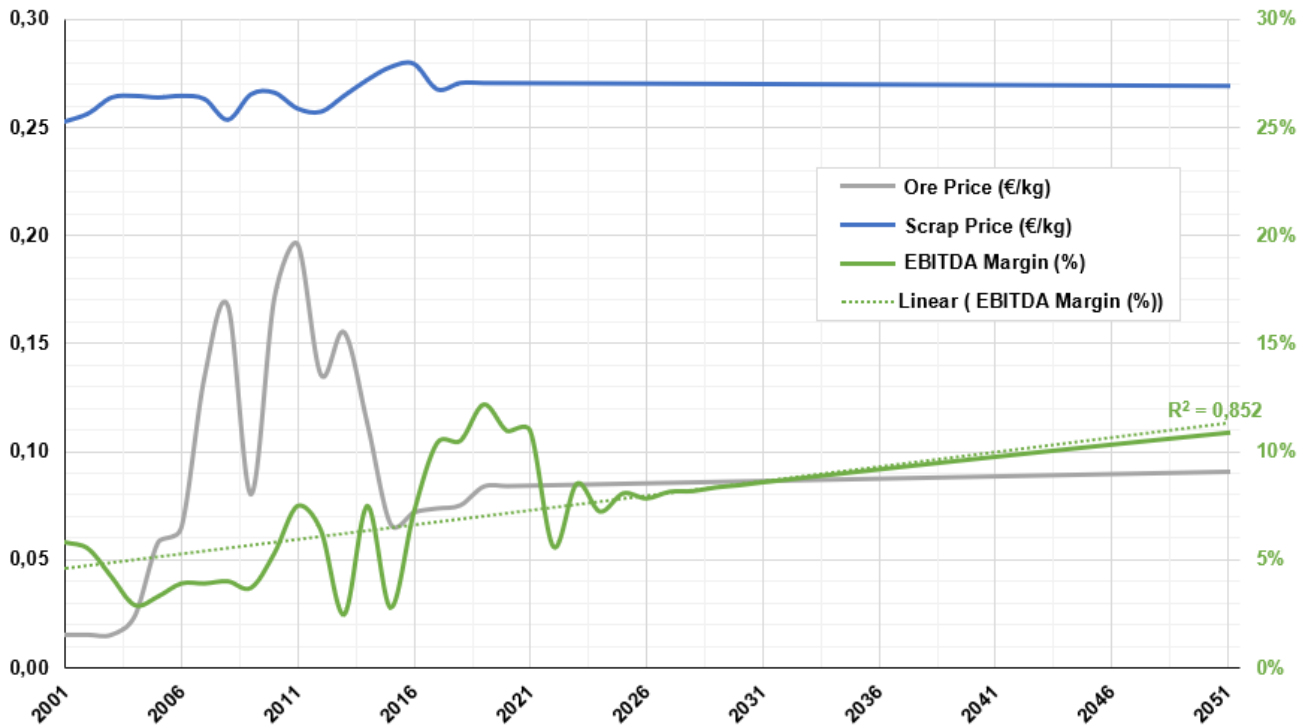

Figure 9 further illustrates these dynamics, in which steel scrap prices trend slightly downwards in the long-term due to a balancing effect between increasing demand and increasing availability. The opposite occurs with iron ore prices, trending slightly upwards due to relative scarcity and relative yield demand but being counterbalanced by lower overall

demand resulting from EAF phase-in. More noteworthy in Figure 9, however, is evidence that this *quasi* stable raw material conjuncture could favor EBITDA margins in the long-term.

Figure 9 - Long-term trends in ore prices, scrap prices, and EBITDA margin (right axis).



Although the model was unable to depict the volatility of real-world microeconomics in the commodities market, this long-term trend helps to explain why overcapacity has become prevalent: why increase the variable costs of capital and installed capacity – potentially driving up prices and losing competitiveness – when profitability can be achieved by focusing on reducing costs? Since the latter requires less capital and poses therefore less risk, it is understandable that many steelmakers would prefer to avoid finding themselves in the same delicate position as their Chinese competitors today, even if at the expense of market share.

Figure 10 provides additional evidence of that, especially when analyzed alongside Figure 8, given how much less capital is reinvested in efficiency, technology and integration strategies, in comparison to the potential variable costs of increasing capacity utilization.

Furthermore, the previously introduced behavior of cyclically managing capital reinvestment and distribution in order to follow improved margins with gains in share value became visible as well, driving the long-term dividend payout trend upwards, noticeably after projected series of revenue increase (2016-2021).

Figure 10 - Long-term trends in costs, revenues, reinvestments, and dividends (right axis).

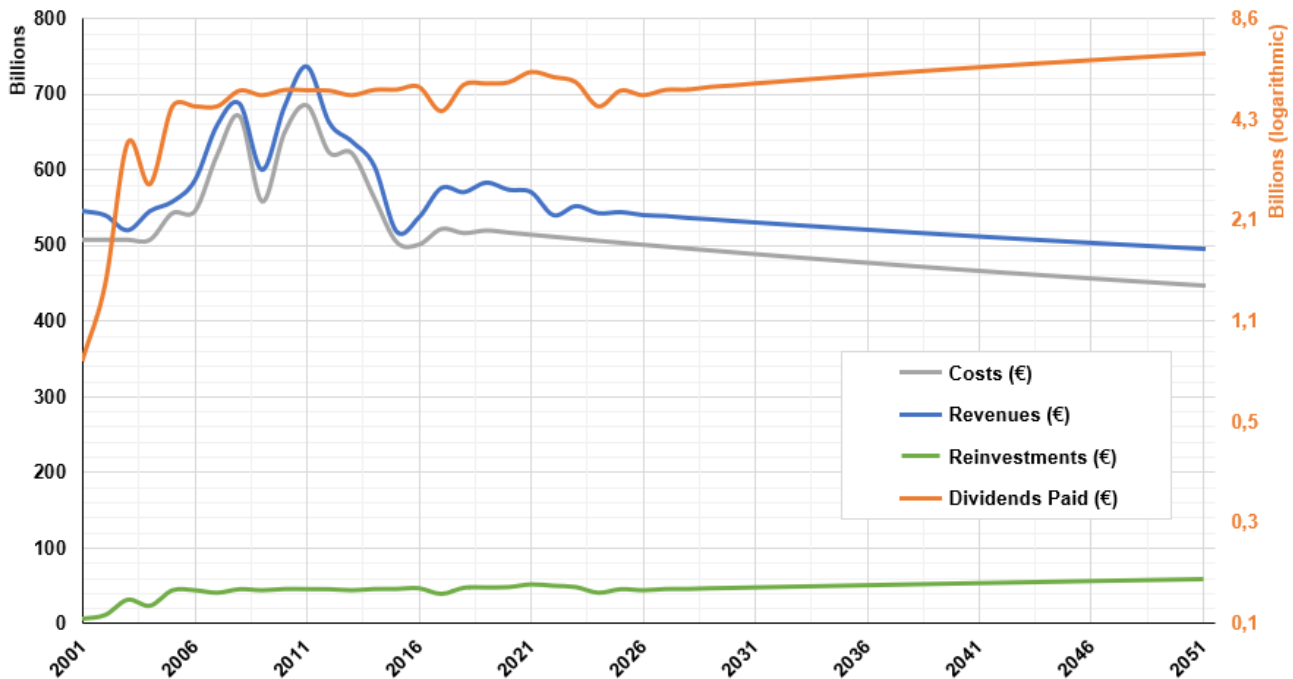

When it came to the spot and future prices of steel, the model was also able to reproduce existing trends, broadly speaking. Nevertheless, the granularity of the analysis was negatively affected. Even though the required datasets were available, the author's attempts to run calculations daily were either met with the limits of the available computational power or created data incoherency with the biophysical calculations. The solution adopted by the author was to run calculations fortnightly and to disregard the futures market data between 2001 and 2008, since it was identified as the source of incoherency.

As seen in Figure 11, the model was able to depict the stabilization in the volume of steel traded in futures contracts that has been ongoing since the 2008 crisis and projected to

continue. Furthermore, a slight long-term spot price increase trend for hot-rolled coiled steel was identified, followed by the equivalent reaction in the futures market. These trends follow the behavior of the dynamics discussed thus far, notably in terms of reduced costs and increased margins compensating for overcapacity.

Figure 11 - Long-term trends in spot prices, future prices, and volume of traded futures (right axis).

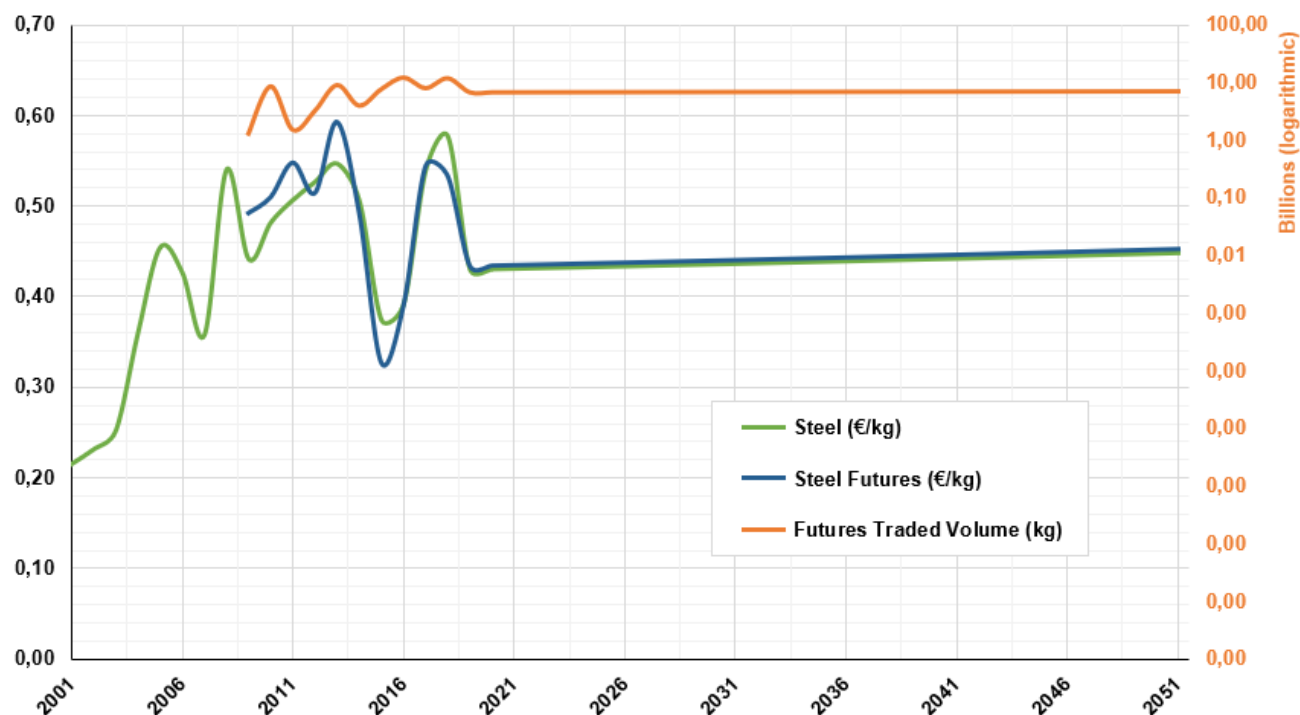

The first simulation run, in which capacity utilization was increased by 10%, provided further justification to the reason why many steelmakers currently operate with idle capacity. Since most of them would be unable to count solely on scale to compensate an annual average price drop of 1% associated with 14,9% total costs increase, EBITDA margins and the subsequent dividend payouts would be significantly affected, as seen in Figure 12.

Figure 12 - Increasing steel output's impacts on spot and future prices, dividends, and EBITDA margins.

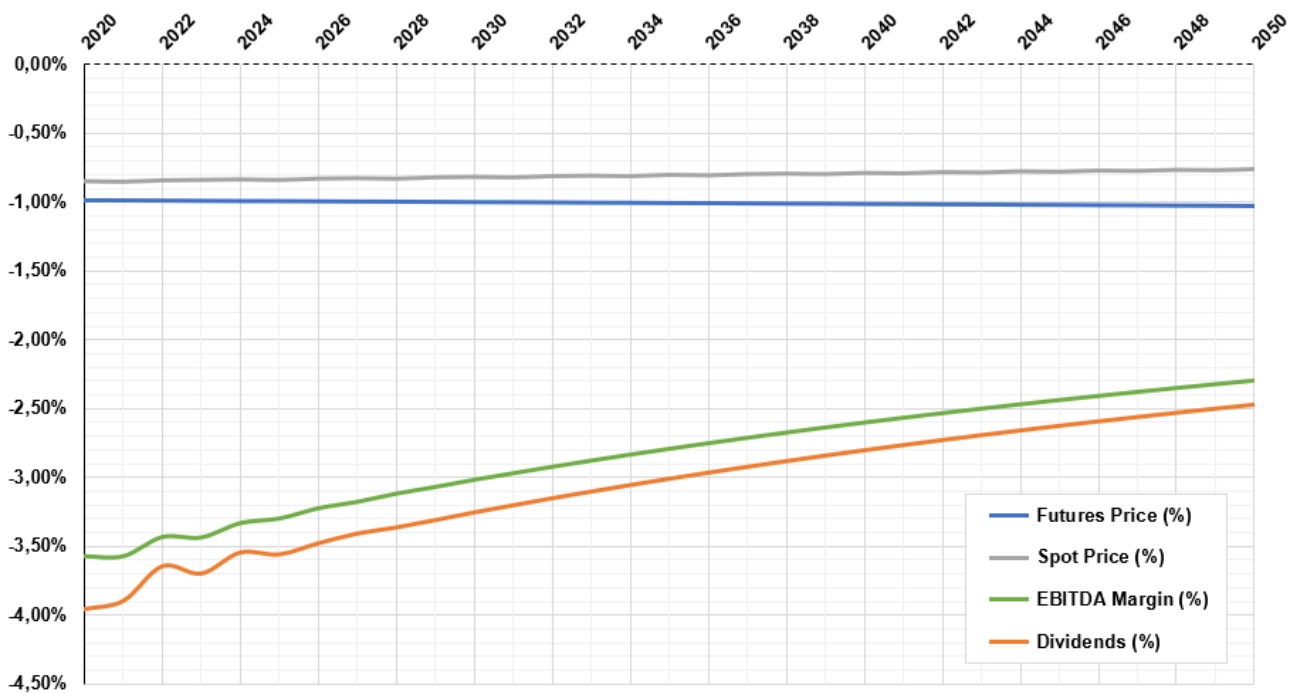

More production output without the proportional demand to consume it would increase the stock of finished products as well as the costs and risks associated with it, which, alongside a contraction in the volume of steel in futures contracts, would cause the *basis* to rise and to gradually widen the gap between spot and future prices. Nevertheless, as seen in Figure 12, the profits from the futures market would not be enough to compensate for the losses caused by higher costs and lower spot prices.

Although the economic dynamics under study experienced significant changes when increasing steel output, they were shown to be proportionally even more sensitive to the volatility of logistic costs. The second simulation run brought to light that, despite logistics being responsible for less than 5% of the total costs of steelmaking on average, increasing or decreasing logistics costs by up to 10% on each direction could substantially affect economic dynamics in this sector.

These costs are directly proportional to most of the biophysical flows spread throughout the entire steelmaking supply chain and even minute variations can, therefore,

have a compounding effect. Figure 13 portrays both how positive and negative the ensuing average variation of $\pm 0,37\%$ on total costs can be; notably by directly affecting prices and margins.

Since compensating by reducing the amount of materials flowing through the supply chain would ultimately result in lower steel output and less revenues; and that compensating by increasing output to gain in scale would put even more pressure on margins due to higher variable costs, volatile logistic costs force steelmakers to choose between protecting either their margins or their market share.

Figure 13 - Logistic costs volatility's range of impacts on prices, dividends, and EBITDA margins.

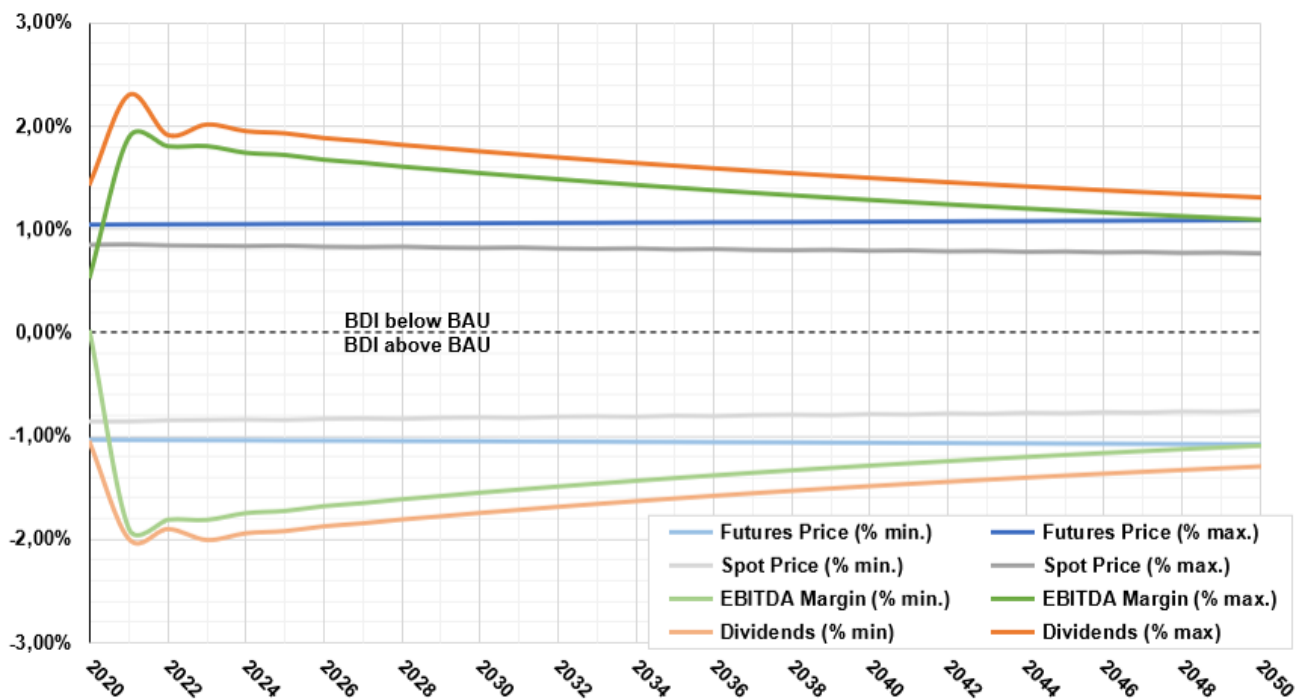

When logistic costs go up, adjusting the margins accordingly will also increase spot prices and potentially reduce sales and revenues. Furthermore, not only do logistic costs directly affect future prices, but the risk to market share posed by higher prices indirectly contributes to a higher *basis* as well. As such, balancing how much to follow suit with the

margins vs how much to *hedge* with futures becomes crucial in managing logistic cost spikes in order to protect market share.

The inverse occurs if steelmakers choose to adjust their margins when logistic costs go down: spot prices go down and potentially allow for gains in market share – assuming that the steelmaker has stocks available for sale. This, however, puts pressure on margins and can be compensated with futures only up to a certain point, still compromising EBITDA margins down the line.

Focusing on the sourcing aspects of supply-side dynamics, the third and fourth simulation runs approached two resources directly related to productive variable costs: energy – namely electricity and fossil fuels for EAF and BFBOF steelmaking, respectively –, and alloying elements – particularly nickel and chromium, present in most stainless-steel products.

Unlike the case of logistic costs, in which *basis* is directly affected, energy and raw material prices alter economic dynamics mostly as a consequence of and to the extent of biophysical dynamics. Spot prices, for example, are more likely to respond to changes in material demand and offer than to other economic variables such as those comprised in the *basis*. This difference occurs due to logistics being a mostly external influence on biophysical variables, while energy and raw materials are ones that can be more easily influenced from within the steelmakers' realm of agency.

While altering production output would add pressure to finding a balance between market share and margins in the case of logistic costs, choosing to increase or decrease capacity utilization can relieve such pressure when it comes to energy and raw materials. This does not mean, however, that negative effects could be completely mitigated in any circumstance, but it does allow for more control from the part of the steelmakers. In Figure 14 it is possible to see how the positive effects on the overall EBITDA margins and on the

potential dividend payouts derived from the propositions of the third simulation run could diminish over time.

Although total costs of BFBOF steelmaking would tend to go down as consequence of cheaper fossil fuels, the economic benefits from it would eventually be counterbalanced by (a) continuously decreasing iron ore yields – requiring more energy per kg of ore in proportion to iron content extracted –, (b) slightly increasing costs of iron ores – as seen in Figure 9 –, and (c) proportionally less revenues from BFBOF steelmaking due to the transition towards EAF. Furthermore, both the (a) increased participation of EAF steelmaking over time, and (b) the previously discussed tendency of steel scrap becoming cheaper, would not be enough to fully compensate the increase in electricity prices in the long-term, reducing revenue potential.

Figure 14 - Impacts of projected energy prices on steel prices, costs, dividends, and EBITDA margins.

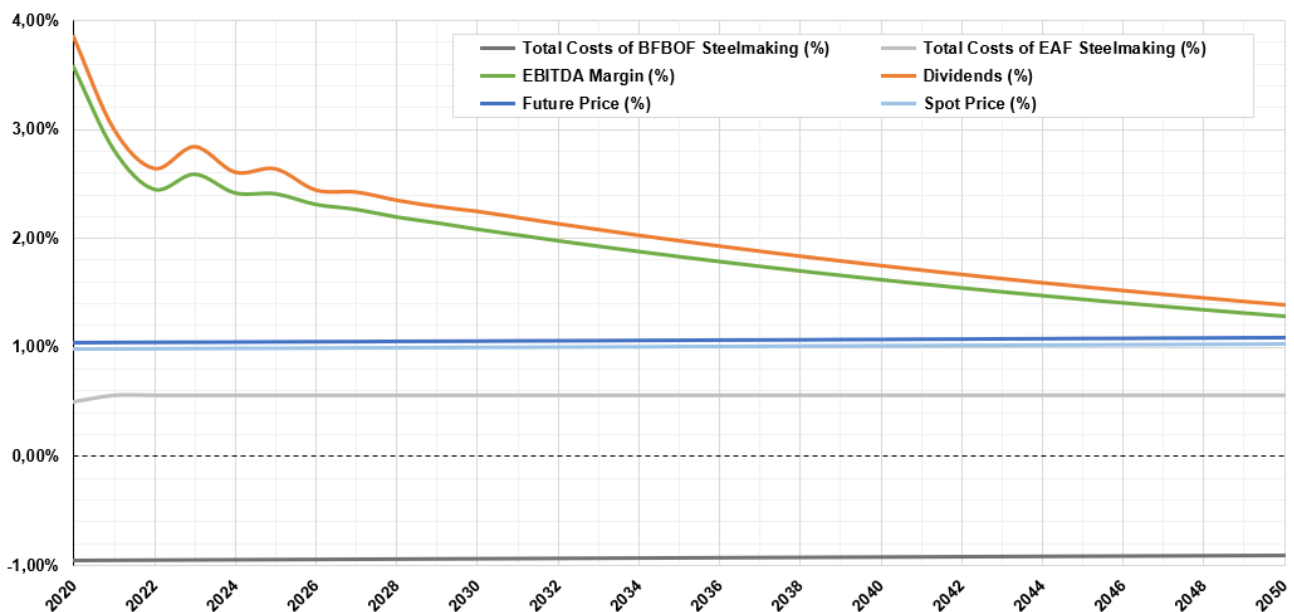

Additionally, it is important to note that these results considered that the most possible use of futures for *hedging* would take place to compensate losses – as per the dynamics discussed thus far –, and that the system dynamically compensated itself towards maximizing

revenues by protecting margins at the expense of, on average, -2,72% capacity utilization per year – instead of attempting to gain on scale, situation which provided worse results for the industry when actively triggered by the author in the model.

While BFBOF total cost reduction would help lessen the effects that higher electricity prices would have on EAF steelmaking for the steel industry as a whole, the same cannot be said about the long-term trends derived from the fourth run. In it, prices for both nickel and chromium were expected to increase due to higher demands. Unlike energy sources, however, these raw materials affect EAF and BFBOF very similarly in terms of input to output ratio, since both processes are capable of delivering most steel alloys with the same physical and chemical characteristics.

The economic dynamics outcomes would therefore become more a function of the transition from BFBOF steelmaking towards EAF, as represented by the total costs of each process in Figure 15. In the long-term, the total costs of BFBOF production trend down proportionally to its reduced participation in the sector, but the diminishing revenues that follow this trend would end up curbing the increasing performance of EAF steelmaking, since the latter is capable of delivering the same products using energy more efficiently.

Figure 15 - Impacts of projected Ni and Cr prices on steel prices, costs, dividends, and EBITDA margins.

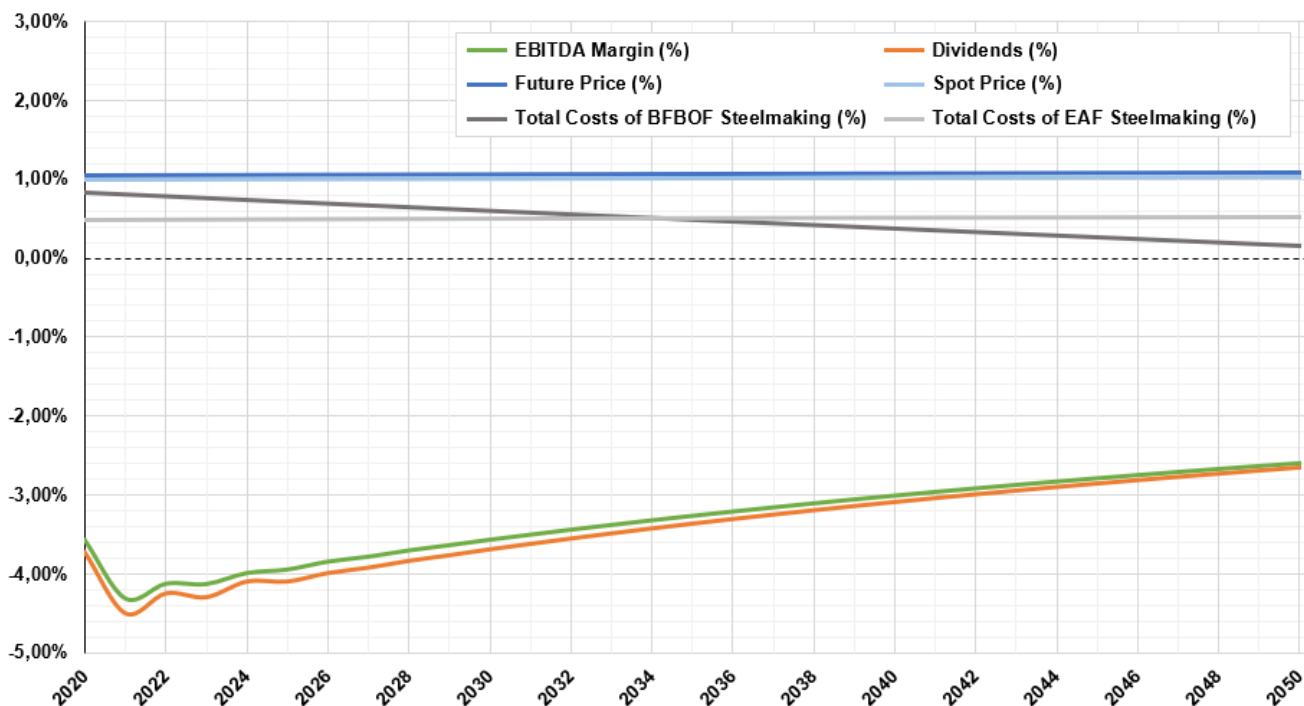

It is precisely this productive characteristic of EAF steelmaking one of the most compelling arguments for continuously transitioning from BFBOF steelmaking, helping compensate many of BFBOFs' limitations in terms of energy sourcing and consumption, and the associated economic repercussions. Additionally, energy efficiency allows for a finer control of variable costs, rendering EAF operations less sensitive to capacity utilization and capable of using it more effectively as a strategy for protecting margins.

This exact behavior was perceived in the model and further differentiated these results from those of the previous simulation run. BFBOF operations dynamically adjusted themselves towards productive scale to offset the cost increase, increasing capacity utilization by 3,13% on average – further lowering EBITDA margins of the sector while having little to no effect on spot prices. EAF operations, on the other hand, tended to do the opposite, being responsible for pushing prices up but substantially risking market share.

Such an economic development would give BFBOF steelmakers more negotiation leverage in terms of prices against those operating EAF, and the ensuing shift in market

shares could decelerate a transition. Nevertheless, even if economically unsustainable in the long-term as discussed in the first run, this could pose as a strategy for BFBOF steelmakers to gain time in either avoiding or delaying the necessary investments towards transitioning.

CONCLUSIONS AND RECOMMENDATIONS

Once the biophysical and economic modules were combined, the model was able to reproduce existing trends and projections for the steel sector. The *business-as-usual* simulation run reinforced that overcapacity would tend to continue despite the projected growth in demand from developing countries. Reasons for this include (a) the slow but continuous transition towards EAF steelmaking – hindered by industrial electricity prices and a delayed response from the secondary metals market –, and (b) the diminishing yields of the iron ore available for BFBOF steelmaking.

The overall long-term panorama seems to favor investments and reinvestments in technology, efficiency and cost reduction, since it indicates a certain stability regarding iron ore and steel scrap availability – prices of which would trend only slightly upwards and downwards, respectively, all dynamics considered. This was verified by the model's depiction of steelmakers' current tendency to prefer protecting their margins instead of seeking gains in scale. Furthermore, a cyclical phenomenon between increasing margins and subsequently distributing dividends was identified, a behavior less likely to happen when market share and scale are the strategic focus, as was China's until around 2017.

Despite the losses in the granularity of the analyses due to either computational limitations or data inconsistency, trends regarding the futures market were also verified by the model, indicating the continuous stabilization of the traded volumes that began after the 2008 crisis. Nevertheless, *hedging* remains a crucial tool for steelmakers to either compensate for losses or to offset other strategic decisions. Further results can be seen in

Table 5, which summarizes the results of the four additional simulations runs performed by the model.

Table 5 - Summary of observed trends and behaviors from the simulation runs.

VARIABLE		OBSERVED TRENDS					OBSERVED BEHAVIOR	
		SPOT PRICE	BASIS	FUTURES PROFITS	EBITDA MARGINS	DIVIDENDS		TOTAL COSTS
Capacity Utilization	△	▼▼	▼▲	▼▲	▼▲	▼▲	▲■	Reducing costs to protect margins at the expense of market share;
	▽	▲▲	▲▲	▲▲	▼▲	▼▲	▲■	
Logistic Costs	△	▲▲	▲▲	▲▲	▼▲	▼▲	▲■	Use of <i>hedging</i> to protect margins and avoid affecting variable costs;
	▽	▼■	▼▲	▼▲	▲▼	▲▼	▼▲	
Energy Prices	△	▲■	▲■	▲■	▼▲	▼▲	▲■	Reducing output and variable costs to improve margins;
	▽	▼▲	▼▲	▼▲	▲▼	▲▼	▼▲	
Raw Materials Prices	△	▲■	▲■	▲■	▼▲	▼▲	▲■	EAF: reducing output and variable costs to improve margins; BFBOF: increasing production scale to protect market share;

Labels: upwards (△), steady (□), downwards (▽), short-term < 5 years (▲■▼), long-term > 5 years (▲■▼).

The first simulation run helped verify the extent to which increasing capacity utilization would increase variable costs to the point of significantly affecting revenues, despite a favorable widening gap between spot and future prices. In the second simulation run, when faced with volatility in logistic costs, steelmakers would tend to make more use of *hedging* to protect their margins since changes in capacity utilization would only aggravate the matter.

Finally, in the last two simulation runs, different behaviors were perceived between EAF and BFBOF steelmakers. Different price projections for their characteristic energy sources (run 3) triggered the same reaction – reducing capacity utilization to protect margins via variable costs reduction –, while the increasing prices of nickel and chromium (run 4) caused BFBOF steelmakers to opt for focusing on production scale instead. Although economically unsustainable, this suggests that the transition to EAF steelmaking could eventually threaten BFBOF steelmaking’s market share and set off an assertive reaction.

The scenarios in this article were tested independently in order to identify and discuss the dynamic exchanges between biophysical and economic aspects of steelmaking, and would, in a real-world application, be intertwined. Nevertheless, it was possible to identify key biophysical variables affecting economic dynamics, namely:

- g) steel scrap availability barely offsetting demand growth, creating only marginal price reduction;
- h) iron ore yields offsetting iron ore relative scarcity, only marginally increasing prices;
- i) fossil fuel consumption in BFBOF operations decreasing as EAF phases in, contributing to price reduction;
- j) EAFs' increasing demand for electricity further raising its price;
- k) dependency on alloying elements for stainless steel products forcing steelmakers to make compromises on either scale, margins or market share; and
- l) capacity utilization as more of a tool for margin protection than for market share acquisition;

It is important to note that these biophysical variables behaved as such also due to the endogenous feedback of the economic dynamics along the system, present in all of the tracked parameters and exemplified by the short-term sensitivity to logistics volatility.

Based on these results, the author suggest that next studies attempt to run complex scenarios in tandem, so as to simulate conditions closer to real-world circumstances and improve on the granularity of the daily futures market exchange. Furthermore, additional financial, economic and accounting parameters or indicators could be set to be tracked depending on the needs of a company under study or of the commissioning institution.

SERVITIZATION IN SUPPORT OF SUSTAINABLE CITIES: WHAT ARE STEEL'S CONTRIBUTIONS AND CHALLENGES?

Article status: Published (DOI:10.3390/su11030855);

Journal: Sustainability (MDPI);

Co-author: MORALES, M.E. ^{a,b}; FEDORUK, M. ^c; KOVALEVA, M. ^d; DIEMER, A. ^a

^a Centre d'Etudes et de Recherches sur le Développement International (CERDI), Université Clermont-Auvergne, Clermont-Ferrand, France;

^b Chair of Industrial Bioeconomy, NEOMA Business School, Reims, France;

^c Institute of Ecological Economics, Ukrainian National Forestry University, Lviv, Ukraine;

^d Department of Environmental Management, American University of Central Asia, Bishkek, Kyrgyzstan;

Highlights:

- Contextualizes the literature on Sustainable Cities and on Servitization;
- Discusses how commodities, notably steel, may interact with service-oriented projects and initiatives;
- Uses the criteria of Sustainable Urban Metabolism and of Circles of Sustainability to analyze three case studies;
- Case studies are used to exemplify different contributions and challenges of steel regarding servitization;
- Steelmakers should attentively consider the roles played by steel in the future of service-providing.

Abstract:

In the pursuit of eco-efficiency, resilience and self-sufficiency, sustainable cities focus on long-term environmental goals instead of only short-term economic ones. To do so, many of them rely on servitization, the practice of replacing tangible solutions for intangible ones. Considering steel's wide range of applications and its pervasive presence, this article's goal was twofold: not only to understand how servitization helps sustainable cities, but also the contributions and challenges of the steel present in service-providing. To do so, the criteria of Sustainable Urban Metabolism and Circles of Sustainability were used to analyze three case studies of servitization: energy, housing and mobility. The results showed that servitization can provide significant benefits to sustainable cities, while also being able to substantially alter the supply-side dynamics of steelmaking by affecting, most notably, demand. This brought to light how important it is for steelmakers to pay close attention to the service-providing initiatives that may concern their clients and products. Nevertheless, further research is necessary to fully understand all of the effects that servitization can have on the commodities involved in its implementation.

Keywords:

Servitization; Sustainable Cities; Steel; Circles of Sustainability; Sustainable Urban Metabolism.

INTRODUCTION

A healthy environment, social cohesion and economic efficiency are trademarks of a sustainable city, a political entity that defies market dynamics by prioritizing long-term political goals instead of short-term economic ones, focusing on eco-efficiency, self-sufficiency and circular environmental management (Mega, 1996; Akande et al., 2019; Bibri & Krogstie, 2017; Alberti et al., 2017; Ahvenniemi et al., 2017). One of the tools available for sustainable cities and the industries within it to manage their resources is servitization: the practice of reducing material needs by changing a product's ownership or its presence altogether in favor of providing a service or solution (Kohtamäki et al., 2018; Kowalkowski et al., 2017; Green et al., 2017).

Although certain forms of servitization – e.g. public transportation, vehicle rentals, shared housing – can already be seen in most modern societies, most research efforts are dedicated to implementing the services themselves on the demand-side, and not to further understanding their effects on the supply-side of the materials and resources involved (Tukker, 2015; Green et al., 2017). One of the most prevalent commodities of modern societies is steel, and however present it may be, its supply chain is often dismissed along with that of other primary and secondary materials when focus is given to service-providing alone (Kohtamäki et al., 2018).

In order to better understand the potential contributions of steel and the challenges it faces when interacting with servitization to help improve urban sustainability, this article used two tools – Sustainable Urban Metabolism and Circles of Sustainability – and supporting bibliography to quantitatively and qualitatively analyze three case studies that exemplify successful applications of servitization.

SUSTAINABLE CITIES: CELLS OF A LARGER ORGANISM

The historic conceptual evolution of sustainable cities was based on that of sustainable development – term that later gained political connotations with the Brundtland Commission –, and which can be traced back to 18th century forestry management in Germany (Grober, 2007; Bibri & Krogstie, 2017; Ahvenniemi et al., 2017). In the report *Our Common Future*, sustainable development was defined as development that meets the needs of the present without compromising the ability of future generations to meet their own needs (Brundtland Commission, 1987). At that time, the idea of ‘sustainable city’ was an automatic derivative related to urban development policies.

By the 90’s it was fleshed out in the Aalborg Charter (1994) by more than 700 cities worldwide, and in the Melbourne Principles of the Local Agenda 21 (UNEP, 2002). From then on, the concept of a sustainable city grew and, in practice, became strongly intertwined with the idea of a *triple bottom line* – or *three pillars* –, denoting a close relationship between economic, social and environmental sustainability with a combination of indicators to measure each of them (Sartori et al., 2014; Bibri & Krogstie, 2017; Ahvenniemi et al., 2017).

Meadows (1993) and Brugmann (2009) approached the term from a more environmentally-oriented perspective and proposed that it should include indicators for pollution and carbon emissions, water consumption and quality, energy mix and demand, waste management, green built environment, and forest and agricultural land management. However, Burdett & Sudjic (2011) adopted a more socio-economic interpretation, in which social equity alongside a greener living environment should be considered for the development of sustainable cities, also suggesting that cities should offer proximity, density and variety enough to engender productivity benefits for firms and help stimulate innovation and job creation.

The overall mindset began to change, however, at the beginning of the 21st century when Rogers (1997) conceptualized a sustainable city as a place where a higher quality of life is realized in tandem with policies which effectively reduce the demand for resources and draw from the city's hinterland to become a more self-sufficient and cohesive economic, social and environmental unit or ecosystem. As autonomous as a cell can be, a sustainable city is unable to live fully independently outside the organism of its nation, therefore renewed attention was then given to some of the economic aspects of sustainable cities, rekindling the academic interest in contributing to policy-making, notably on the transitional and structural measures necessary to shift the interactions between urban stakeholders from linear and production-oriented to circular and service-oriented ones (de Jong et al., 2015; Ahvenniemi et al., 2017).

Keeping in mind that the urban-level approach of sustainable cities provides tangible applications, easier implementation and reduced monitoring complexity when compared to approaches in regional or national scales all the while supporting their results as well (Bibri & Krogstie, 2017; Alberti et al., 2017; Ahvenniemi et al., 2017), the next section of this article introduces one of the tools capable of contributing to resource efficiency and management bottom-up.

SERVITIZATION: DEMAND-SIDE CIRCULARITY FROM WITHIN

The term servitization was created to describe the idea of product manufacturers, wholesalers and retailers reducing their tangible portfolio in favor of an intangible one (Levitt, 1969; Lay, 2014). Currently, the application of this concept is closer to its origin in the 1980s, in which the idea was to deliver to the customers a package of services, goods, support and knowledge that together represent a solution, and not only a sale (Kohtamäki et al., 2018; Vandermerwe & Rada, 1988). Most modern companies adopt it in either the stages of pre-

sale – e.g. trials, demonstrations and custom design –; sale – e.g. installation and training –; or post-sale – e.g. maintenance, support and warranty (Frambach, 1997; Boyt & Harvey, 1997).

Nevertheless, actual reductions in the overall amounts of resources and energy consumed usually derive from services that actually shift product ownership or that do not require the customer to acquire the product in the first place, instead buying the results it delivers – e.g. leasing, renting and pooling (Mathieu, 2001; Tukker, 2004). In 2009, 84,8% of manufacturing companies offered services to support their products, being only 12,1% of these directly related to the changing product ownership or to a product being operation by the manufacturer as service to the customer (Lightfoot et al., 2013; Baines et al., 2009).

Although well aligned with concomitantly developing concepts such as Circular Economy, the servitization trend evolved in parallel and gained its largest share of attention after the photocopier industry decided to lease or rent their multifunctional products to foster a *pay-per-printed-page* solution instead of a *one-photocopier-per-office* business model (Lay, 2014). Once customers started perceiving direct or indirect financial benefits, this phenomenon opened the doors for discussions in all related matters: from the potential innovations in business models to the psychology of product ownership; from unique selling propositions (USPs) to sustainable resource management (Coombs & Miles, 2000, Oliva & Kallenberg, 2003).

Service-providing initiatives then became commonplace in marketing management but little to no attention was given to the resources being saved, but instead to the costs being reduced in the search for profit (Zhang & Banerji, 2017; Tukker, 2015). Although headed in the right direction from an environmental standpoint, this counterintuitively went against some of the principles of sustainability: selling services without addressing their resource demands ended up, in some cases, increasing material consumption (Kowalkowski et al., 2017; Green

et al., 2017). It was when academics involved in what is called *redistribution* and *sharing* within the Circular Economy framework drove their attention to service-providing practices already in place that servitization found new grounds and began receiving more support as a mean to retain resources longer in the economy, creating value from service and circularity instead of value from natural resource extraction and transformation (Burton et al., 2017; Tukker, 2015; Rothenberg, 2007).

Although the variety of resources that circulate within a given society can be theoretically infinite, this article focuses on steel, a commodity with significantly different dynamics from those of the service sector, but that nonetheless counts on plenty of intersections with servitization applications.

THE ROLE OF A COMMODITY IN A SERVICE ECONOMY

Steel is a key commodity in global economies, having applications that range from home appliances to cargo hauling, from construction to telecommunications (WS, 2012; Beddows, 2014). Steel's life cycle starts when iron ore is mined and it ends either within built structures with long lifespans or by being recycled as scrap (Olmez et al., 2015; Warriar, 2012; Vaclav, 2016).

Due to the its products' and its raw materials' physical and chemical characteristics and requirements, the steel industry has traditionally given substantial attention to variables that boost or hinder the quality, quantity and profitability of its outputs, being one the pioneering industries to apply some of the environmental principles of Circular Economy and sustainable development – mainly recycling and by-product reuse (EC, 2013; WS, 2016).

Notably in the last decade, the steel industry has been facing difficulties regarding prices, energy, trading and competitiveness – all understood to be contributing factors to diminishing environmental progress regarding emissions and resource efficiency (EC, 2013).

Consequently, multiple academic, institutional, governmental and industrial experts have highlighted the need for this industry to have an active role in expanding and improving end-of-life markets, mostly to increase production based on steel scrap (EC, 2013).

As important as recycling is – capable of saving 1.400 kg of iron ore, 720 kg of coaking coal and 120 kg of limestone, on average –, and even though record-breaking sums of capital have been directed towards environmental goals, however, minimal attention has been given to redistribution, sharing or servitization, despite 65 to 80% of investments being focused on end-of-life solutions (BIR, 2017; EUROFER, 2017; EC, 2013; CEPS, 2013; IETD, 2018; Waugh, 2016). And policy-wise, regardless of how significant the results of servitization, sharing or redistribution have been when implemented (WS, 2016; Material Economics, 2018), no examples of direct policy-based stimulus or guidance has been found by the author to support service-based practices capable of allowing this industry to contribute to the sustainability of an urban environment.

That said, in the aforementioned photocopier example alone, the reduction in total demand for the specific steel components necessary for these machines to operate configures in itself a fitting argument for how servitization can be a tool for reducing natural resource exploitation when its effects are passed along the steelmaking supply chain.

Along with the other commodities present within the goods potentially targeted by servitization, steel's presence in service-oriented projects would be, even if indirectly, a factor capable of affecting, for example, (a) the importance of steel products' quality and durability, (b) the quantities, quality and accessibility of recyclable scrap, (c) the development of other end-of-life and circularity services such as repair, maintenance, reuse, sharing, refurbishment and remanufacture, and (d) the gradual shift towards operational longevity instead of component replacement, counteracting trends of planned and designed obsolescence.

METHODOLOGY

This article aims to understand the potential contributions that steel could bring through servitization to a sustainable city as well as the challenges steel could face while attempting to do so. The first step taken was evaluating and analyzing what were the contributions that three successful case studies on servitization would provide to a sustainable city; then, steel's participation was identified within each of the case studies and its respective contributions and challenges were discussed.

TOOLS

Assessing the behaviors, performance or structure of sustainable cities is a task that can be carried out by substantially different approaches, methods and tools. Given this article's focus on servitization and on the steel within it, the author opted for the *ex post* use of two tools: a quantitative one – Sustainable Urban Metabolism – and a qualitative one – Circles of Sustainability.

As detailed next, these tools were chosen based on their different approaches to stakeholders' involvement, eco-services and eco-efficiency. While the first one provides quantitative support for decision- and policy-making based on urban ecosystems theory, the second one is intended to be flexible and modular in order to align empirical solutions to the social conditions that permeate them (Graedel & Allenby, 1995; Rogers, 1997; James, 2015).

Sustainable Urban Metabolism

The underlying principle of Urban Metabolism is the conservation of mass towards the transformation of industrial activities in an urban environment from what is largely known as non-sustainable and linear systems to what would resemble sustainable and circular ones (Graedel & Allenby, 1995). As seen in Figure 1, it begins by employing Material and Energy

Flow Analysis (MFA and EFA, respectively) for the identification and quantification of material and energy usage, as well as assessing their impacts on the environment (Petit-Boix et al., 2017).

Figure 1 - The city as a system (adapted from Rogers, 1997).

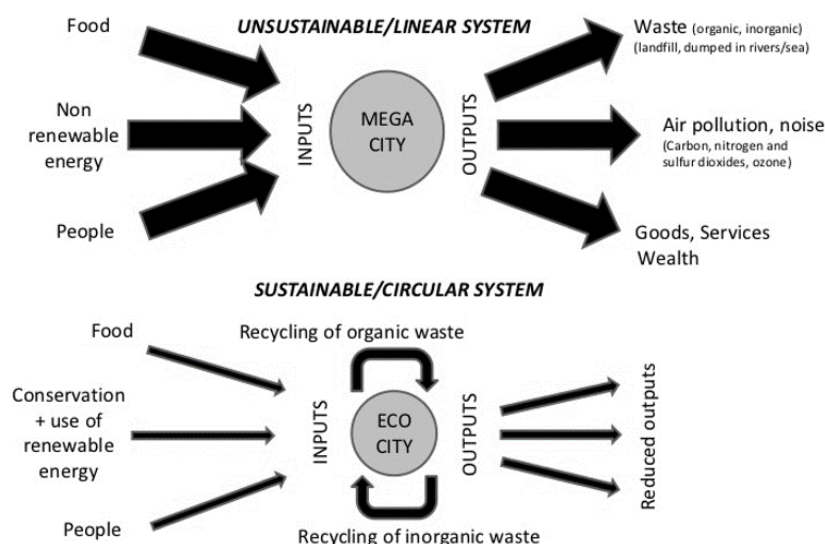

This metabolic assessment takes into account the basic consumption of the households within a city – such as heat, electricity, water and food – and links them to the local means of production that have corresponding benefits in terms of local economy, employment, greenhouse gas reduction, etc. Depending on the intensity of the flows of each resource and on how they evolve through time, the urban metabolism can gradually shift to patterns of zero waste, positive energy, closed water cycles, etc (Rogers, 1997; Ferrao & Fernandez, 2013).

From that point on, having a clearer holistic and systemic understanding of a city's metabolism, measures for delivering improvements to each of the subsections of the assessment become the focus (Rogers, 1997). Finding ways to balance inputs and outputs among the multiple stakeholders involved naturally includes social and economic aspects, thus stimulating the development of new technologies and business models capable of

reducing stocks and improving circularity without negatively affecting quality of life and wellbeing (Rogers, 1997; Ferrao & Fernandez, 2013).

This article's use of this tool considered the *before & after* conditions of inputs, outputs, stocks and flows in the context of each case study, aiming to identify how each case study was able to affect the qualitative aspects of the urban environment they were a part of. Furthermore, this tool served as a base to identify the amounts, origins and destinations of the steel embedded in the servitization solutions deployed.

Circles of Sustainability

Circles of Sustainability, on the other hand, focuses primarily on qualitative aspects of a city's metabolism. Although it encompasses environment and economy for the purposes of flow optimization, it's main attributes are the intersections it provides with social conditions such as resilience, cooperation and proximity within a community (James, 2015; Ferrao & Fernandez, 2013). This tool is intended to be flexible and modular, and addresses the four domains of Ecology, Economics, Politics and Culture by diving them each into seven key aspects, all with their own criteria for conducting discrete semi-directed interviews with key actors and stakeholders of a city, resulting in the 9-points scale seen in Figure 2 (James, 2015; Ferrao & Fernandez, 2013).

Figure 2 - Circles of Sustainability (adapted from James, 2015).

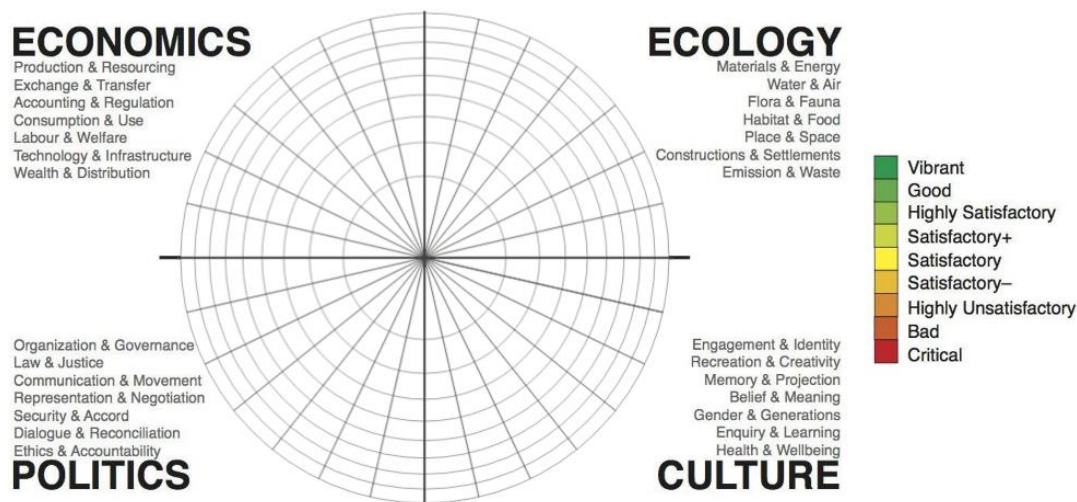

Multiple cities – e.g. Melbourne, Porto Alegre, Milwaukee, New Delhi – have assessed their sustainability using this tool, enabling not only a diagnostic understanding of their situation, but also the intake of feedback and knowledge from the participation of their industries, communities and decision-makers (CoS, 2018). In Johannesburg, it helped its Department of Transportation to redefine public mobility goals; in Port Moresby, it helped the municipality in finding new solutions to land use management issues concerning informal employment and ethnical disputes, and; in Valetta, it improved the understanding of the cultural obstacles and political barriers responsible for hindering the development of an educational system to be capable of retaining qualified workforce (CoS, 2018).

In this article, this tool was used to identify where within the domains of a sustainable city each case study’s contribution would help improve sustainability and, in conjunction with the previous tool, to which extent these effects were linked or not to the presence of steel.

CASE STUDIES

The case studies chosen for this study have four aspects in common: (a) being based on real life applications, (b) seeking benefits and improvements from an environmental and sustainability perspective, (c) considering the policy and social factors of the context in which

they are inserted, and (d) discussing their results not only in present terms, but also in perspectives for future contributions. The author believes each of the case studies illustrate a different role that steel can play when servitization is used towards improving sustainability.

Energy

In an urban environment, electricity not only supplies industrial and commercial activities, but also guarantees particular levels of provision such as lighting, room temperatures and humidity control (Sorrell, 2007). Servitization in energy is, therefore, a conjunction of energy supply and energy-related services aiming at efficiency, savings and sustainability (Neely, 2008/2013; Benedetti et al., 2015). It can also refer to outsourcing and decentralization processes, involving third-party contractors for distribution and maintenance or even the deployment of energy generation technologies directly onto a customer's property, often creating potential for energy feedback to either grid or supplier (Polzin et al., 2015; Hamwi et al., 2016).

A good example of decentralization based on electricity feedback to the grid was developed by Pinto et al. (2016), in which photovoltaic solar panels installed on the roof of houses of a social program were shown not only capable of creating energetic independence for home owners facing a structural national crisis, but also of reducing overall generation demand due to the creation of localized electricity feedback networks when given proper policy support.

The study considered three different electricity consumption scenarios for houses in five different regions of Brazil, keeping in mind specific solar irradiations, quantity of panels, costs of deployment, generation potential and sensitivity analysis. Results indicated monthly bill savings between 8 and 52% per house, with potential electricity feedback to the grid up to 47% under adequate policy support (Pinto et al., 2016).

Housing

Developing sustainable housing is an essential component of sustainable cities, not only because globally over one-third of all final energy and half of electricity are consumed by housing and generates approximately one-third of global carbon emissions (IEA, 2017), but also because multiple aspects of housing directly affect inhabitants' health, comfort, wellbeing, quality of life and workforce productivity (Koch-Orvad & Thuesen, 2016). Sustainable housing is designed, constructed, operated, renovated and disposed of in accordance with ecological principles for the purposes of minimizing the environmental impact and promoting occupants' health and resource efficiency (Kibert, 2003).

Although retrofitting – i.e. upgrading existing buildings to improve their energy efficiency and decrease emissions of greenhouse gasses – seems to be technically viable and sometimes economically attractive, multiple barriers prevent optimal applications (Wu et al., 2016; Leed, 2010). Servitization of sustainable housing takes into account the entire life cycle of a building in an attempt to re-use, recycle and upcycle by means of, for example, the adoption of design-for-disassembly of individual parts and components that need to be fixed or replaced.

In their study, Céron-Palma et al. (2013) focused on the operation stage of a house – i.e. while citizens inhabit the building –, proposing measures to reduce emissions linked to energy consumption and to decrease food dependence with the subsidized replacement of standard appliances with eco-efficient alternatives and by creating green spaces and productive gardens. The study collected consumption data to feed a Life Cycle Assessment model that encompassed all operational aspects of living in that environment in Merida, Mexico – e.g. products' packaging, and material logistics.

After testing six different scenarios, results indicated that replacing appliances with more eco-efficient alternatives and that making use of a green space or garden for food

cultivation could save an average of 1 ton of CO₂eq emissions every year per house, i.e. 67% less emissions than a standard Mexican home (Céron-Palma et al., 2013).

Mobility

The transport sector consumes 2.200 million tons of oil equivalent, accounting for about 19% of global energy demand and for 24,3% of the greenhouse gas emissions (WEC, 2018). Consumption is expected to increase by between 80% and 130% above today's level until 2030 and, unlike other sectors – which decreased their emissions by circa 15% between 1990 and 2007 –, transportation increased it by 36% during the same period (WEC, 2018).

Servitization in transportation contributes the most to sustainable cities in terms of Sustainable Urban Mobility (SUM), a transport model that stimulates interaction among all involved stakeholders in order to develop a comprehensive mobility service offer that responds to citizens' needs for flexibility and convenience, *door-to-door*, removing the need for vehicle ownership by combining different shares of, for example, public transportation, car-sharing, taxis and shared taxis, bicycle and bike-sharing, car-pooling, or park & ride (Cerfontaine, 2014; Petros-Sebhatu & Enquist, 2016).

Diez et al. (2018) focused on the city of Burgos, Spain, in which fifteen different measures were put in place in 2005 by a CiViTaS project initiative. Measures included (a) switching public transportation to biodiesel, (b) increasing the amount of pedestrian-preferential areas, (c) underground parking areas, (d) higher capacity public transportation vehicles, (e) schedule alignment between different transportation methods, (f) bicycle lanes, rentals, parking and bike-sharing, and (g) restrictions on heavy load traffic.

The city saw multiple positive results in the span of five years, most related to citizen behavior transition towards bicycles and public transportation instead of private vehicles (Diez et al., 2018). When considering a twenty years period, up to 47.000 tons of CO₂eq

emissions were expected to be avoided at the expense of € 7.2 million in investments, well within estimations of European authorities for funding similar projects (Diez et al., 2018).

RESULTS AND DISCUSSIONS

This section presents the knowledge acquired from evaluating and analyzing each servitization application towards the improvement of sustainability in an urban environment. Each case study was subjected to *ex post* application of the tools described before and their key attributes were identified along with steel's contributions and challenges.

Energy

The servitization of electricity once bought as a product and delivered to a household merely for consumption into a localized and demand-specific solution capable of reducing costs and adding consumer value as seen in the study by Pinto et al. (2016) relied on two different factors: (a) replacing a mostly hydraulic-based grid electricity supply with decentralized solar sources, and (b) retaining, redistributing and reusing excess energy within the local network by using feedback. The first factor contributes to reducing electricity demand from the installed capacity while reducing the demand for electricity distribution along the grid. On the other hand, the second factor not only contributes to the previous one while providing economic benefits to the citizen, but also adds intangible values such as grid independence, community integration and participation.

From the perspective of Sustainable Urban Metabolism, the propositions of Pinto et al. (2016) help to partially transfer electricity sourcing from outside a city's boundaries to the households within it, directly reducing the required external energy input while strengthening and empowering local stakeholders at the expense of an increase material stock within the city's boundaries. Furthermore, it reduces the amount of electricity wasted by over-generation as well as electricity lost during long range distribution. Cities in which such a project would

be deployed would become altogether more resilient and sustainable while helping reduce emissions, losses and wastes related to electricity generation.

When applying the criteria of Circles of Sustainability to this case study, several contributions were identified, as seen in Figure 3. In the domains of Politics and Culture, minor benefits to Organization & Governance and Engagement & Identity were perceived, respectively related to the required policy adjustments that would enable grid feedback and feed-in tariffs, and to the creation of a local community of households which rooves now include solar panels.

Figure 3 - Energy case's perceived key contributions to sustainability.

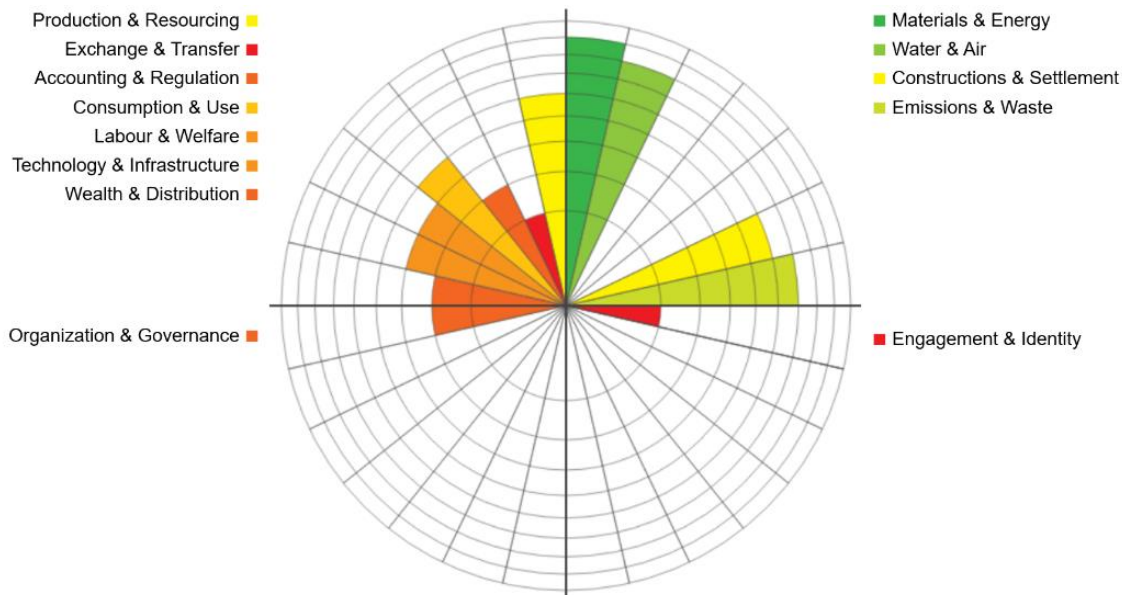

It was in the Ecology and Economy domains, however, that most contributions were perceived. Deploying photovoltaic solar panels onto the rooves of Brazilian households could significantly shift how electricity is used and consumed in relation to its existing matrix, potentially creating new service sector jobs related to installation and maintenance. Moreover, improving infrastructure by using new technologies is a good way to increase local wealth distribution while promoting or changing how knowledge and capital are exchanged. Additionally, having a network capable of grid feedback also increases the need for proper

and engaged accounting and regulation, especially if the study's proposition of feed-in tariff cross-discounts is put in force.

Changing how electricity is generated also changes the materials necessary for the equipment used to generate it. Photovoltaic solar panels use considerably more silicon than iron in their composition, for example, in addition to other materials less pollutant to produce or less impactful to implement than hydraulic energy infrastructure. Consequently, both direct and indirect benefits to air quality, water quality, and reductions in the amounts of emissions and waste generated would be perceived throughout the entire system, thus improving the sustainability of the urban area it would be a part of while potentially reducing the need for environmental impacts outside its boundaries as well.

Although steel presence in photovoltaic solar panels is minimal – 3%, mostly in the frame and in the installation hardware –, it is important to note that the mainly hydraulic Brazilian energy matrix heavily relies on energy generation equipment made of steel and, even if the distribution itself depends mostly on copper and aluminum, steel-intensive machinery is always present (Greiner, 2013; ANEEL, 2009; Souliotis et al., 2018; Bracquene et al., 2018; ISSF, 2015).

The results available in the study by Pinto et al. (2016) point to an average of 153,25 GWh generated by 405.691 solar panels installed onto the rooves of 73.762 houses, the equivalent of the entire electricity generation capacity of the Jupia hydropower plant in Três Lagoas, Brazil (ANEEL, 2009). Considering that an average hydropower plant contains 10.000 tons of steel in its structure (Greiner, 2013) and taking into account an average photovoltaic solar panel mass of 18 kg (Souliotis et al., 2018; Bracquene et al., 2018), the participation of the steel present in the solar panels is about 0,7 kWh/kg of steel, while the participation of the steel present in the hydropower plant would be of approximately 0,015 kWh/kg of steel – 45 times less.

This indirect reduction in supply-side steel intensity per kWh generated coming as a result of demand-side servitization points to one of the potential contributions of steel – in this case related to its quantity: although less steel is present, its participation is substantially more relevant. The challenge for steel, in cases like this, resides mostly in identifying where is the least amount of steel capable of providing the most environmental benefits – e.g. small amounts on a solar panel provide more environmental value than very large amounts in a hydropower plant.

Housing

By subsidizing a transition towards eco-efficiency within households and supporting it with maintenance – whether if by leasing or not –, a city can turn appliances previously acquired by its citizens merely as products to be used and discarded into solutions capable of actively supporting the reduction of its required energy inputs as well as its emissions. Servicing this equipment and further supporting this initiative with the creation of green spaces and gardens capable of providing food and consequently reducing the amounts of packaging, food waste and transportation poses as a solid contribution to sustainability.

As per Sustainable Urban Metabolism, the study from Céron-Palma et al. (2013) contributes to reducing inputs and outputs, but minimally – if at all – to reducing stocks. The reduction of inputs derives mostly from the green spaces and garden producing food and avoiding the need for packaging and transportation, while the reductions in outputs are most expressive regarding the energy savings provided by eco-efficient appliances and the consequent reduction in emissions. Céron-Palma et al. (2013) also present the possibility of carbon sequestration in the green spaces and gardens, but with almost negligible effects relative to the other benefits.

Although the amount of materials and food in stock would likely be unaffected, Use & Consumption patterns would change and so would Production & Resourcing, as per the

criteria of Circles of Sustainability. As summarized in Figure 4, minor effects on most of the aspects of the Economic and Political domains would nevertheless provide substantial improvements in the Ecology domain. These improvements would be directly related to increases in Health & Wellbeing, while contributing – even if marginally – to the creation of a locally engaged community.

Figure 4 - Housing case’s perceived key contributions to sustainability.

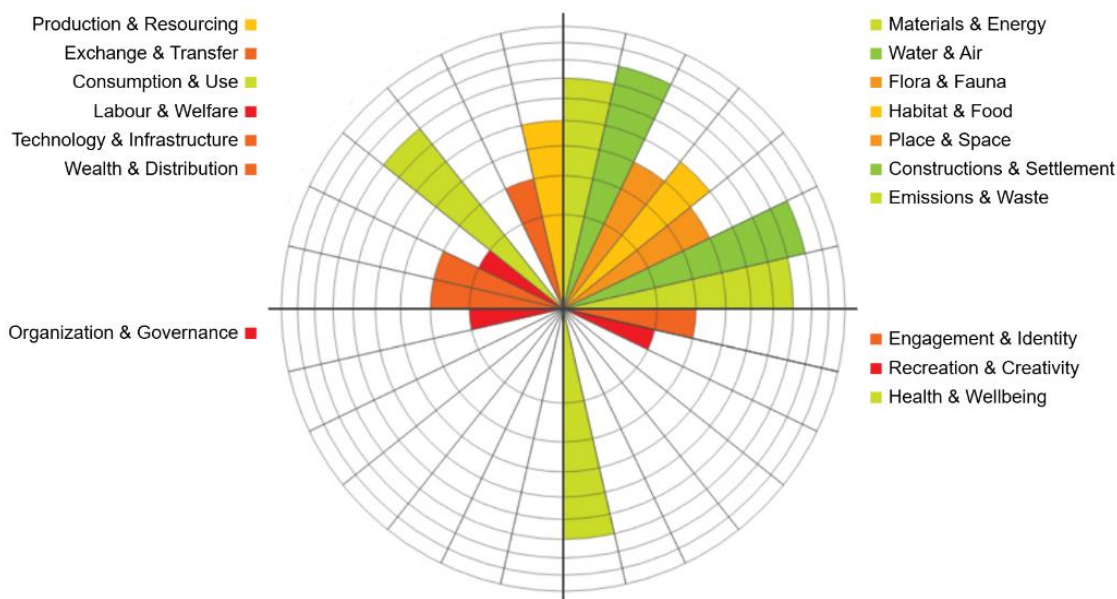

The intersections that exist between all of the aspects of the Ecology domain ended up boosting each other, therefore increasing environmental quality. This points to a reinforcing behavior which, whether intended or not by Céron-Palma et al. (2013), presents major long-term sustainability and resilience benefits: the less issues with Emission & Wastes, the better Water & Air, which by itself helps improve Flora & Fauna and Habitat & Food. Finally, Place & Space improve as well, boosting Health & Wellbeing and fostering Engagement & Identity within the local community, effects of which feed back to the beginning.

As interesting as this behavior may be, its impacts on emissions are less substantial than those of the eco-efficient appliances, highlighting the importance of both being deployed

in tandem. Since steel is not present in the green spaces and gardens, focus was given to the eco-efficient appliances when addressing the participation of steel in emissions. All other variables of the case study's Life Cycle Assessment were assumed unchanged, meaning eco-efficiency had no effect on the amount of steel content of each appliance. This choice was made due to the theoretical infinite number of possibilities by which eco-efficiency can be achieved by different manufacturers in different models of each appliance.

According to the results from Céron-Palma et al. (2013), replacing standard appliances with more eco-efficient ones reduced energy consumption by approximately 46%. Considering an average steel content of 60% per 140kg refrigerator, 35% per 76kg washing machine, and 46% per 37kg air conditioning unit (van Schaik & Reuter, 2010; Oguchi et al., 2011; Eco3e, 2018; Öko, 2005; ADEME, 2010), the calculations showed that steel's participation in annual emissions per house was reduced by 32% on average as a result of changing to eco-efficient appliances. More specifically from 4,90 to 3,35 kgCO₂eq/kg of steel (refrigerator), from 1,90 to 1,30 kgCO₂eq/kg of steel (washing machine), and from 84,67 to 57,76 kgCO₂eq/kg of steel (air conditioning unit). These results grow in significance when keeping in mind the case study's scope of 112.000 houses.

In this case, even though the amount of steel per appliance remained the same, steel's contribution would not reside in its quantity, but in the type of steel and in how it is used in an appliance, for example, towards improving its eco-efficiency. Although this demand-side servitization initiative has minor effect on supply-side scale, the steelmakers' challenge would be to decide on which type of steel to produce – e.g. alloys with better electrical conductivity – and how to ensure its optimal use in a product.

Mobility

After five years of the implementation of the CiViTaS project in the city of Burgos, a clear change in its citizens' mobility behavior was noticed: it successfully stimulated approximately 10% of its population to transition from either walking or owning a private car towards using either more public transportation, bicycles or lighter vehicles such as motorcycles (Diez et al., 2018). Considering bicycles and notably public transportation were provided as a service by the city for the population, and that these means of transportation are less – if at all – pollutant in comparison to cars, servitization has proven itself environmentally friendly once again.

Even considering an increase of 1% in the use of motorcycles and a 6% reduction in the amount of people who preferred to walk their commutes, emission results were very favorable, pointing towards a successful mobility solution proposition that positively affects urban environment. Keeping in mind that bicycles now have their dedicated lanes, and that buses and motorcycles contribute to reducing overall traffic in comparison to cars, this mobility solution also presents medium to long-term sustainability benefits.

Using the criteria of Sustainable Urban Metabolism, it is possible to identify that the study conducted by Diez et al. (2018) altered the city's inputs and stocks, by affecting the composition of the city's mass balance due to the different types of vehicles being used. Consequently, the flows related to mobility and transportation are rendered more efficient, still overshadowed, however, by the notable effects that takes place among the outputs. By changing the mobility matrix, not only do different materials become part of the urban system, but also different and more sustainable sources of energy gain traction: less cars meant that gasoline and diesel gave way to buses' biodiesel, for example.

With less of their income being used to own a car, Wealth & Distribution improved from the citizens' perspective as per the criteria of Circles of Sustainability shown in Figure 5.

Improving aspects of the Political domain related to organization and communication would not only move Use & Consumption towards a more sustainable behavior, but also help shift Production & Sourcing and to promote Exchange & Transfer of more sustainable knowledge and goods. More transportation services would also require more jobs related to operation and maintenance instead of car parts replacement, even if improvements to Technology & Infrastructure would be minor.

Figure 5 - Mobility case's perceived key contributions to sustainability.

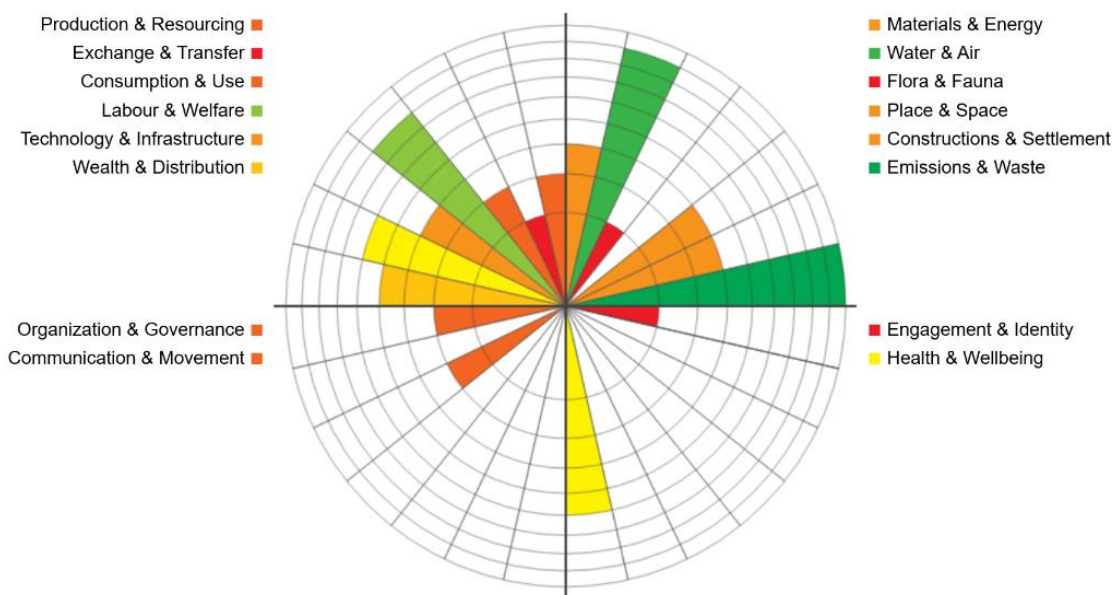

The key contributions, nevertheless, are present in the Ecology domain: measures that help reduce traffic – which relate to Construction & Settlement – further help reduce emissions and contribute to citizens' perception of Place & Space due to better Water & Air, altogether boosting Health & Wellbeing in the Culture domain as well. Therefore, this study configures a good example of Sustainable Urban Mobility, well aligned with the idea of a Sustainable Urban Metabolism.

Having changed which vehicles are used and the frequency of their usage, the study indirectly changed how steel is present in the city as well. Considering that cars, buses, bicycles and motorcycles are built with different amounts of steel – on average 900 kg, 6.000

kg, 6 kg and 70 kg, respectively (Kärnä, 2012; WS, 2018; Leuenberger & Frischknecht, 2010) – not only do the total amounts of steel change, but also their participation in the emissions that occur as a consequence of their presence.

Although using more buses, bikes and motorcycles caused the amount of steel in Burgos to increase by approximately 18,23% – 82,5% of which inside buses –, having steel be a part of vehicles that are less pollutant than cars or that are more efficient due to their capacity or fuel caused steel's participation in annual emissions to decrease by 29,6% – from 11,93 to 8,40 kgCO₂eq/kg of steel.

This increase in steel presence associated with lower participation in emissions highlights the importance of defining when and where to use steel, especially considering that the types of steel used for buses, for example, are not necessarily considered specialty or complex alloys. It is to say that more steel can also be a solution, as long as it is used when and where necessary to support servitization and, further along, sustainability.

CONCLUSIONS AND RECOMMENDATIONS

This article used the criteria of Sustainable Urban Metabolism and of Circles of Sustainability to analyze the contributions that three different case studies of servitization could provide to sustainable cities. Furthermore, the presence, contribution and challenges regarding the steel within their servitization initiatives was evaluated.

Table 1 summarizes the results and discussions derived from analysis and evaluation, and serves to reinforce how useful all servitization case studies were towards improving eco-efficiency, resilience, sustainability and self-sufficiency in the cities they were or would be deployed. All three case studies helped (a) lower dependency on external energy inputs, and (b) lower the output of emissions; even if at the expense of increasing local material stocks.

In the case of energy, deploying photovoltaic solar panels onto the rooves of houses significantly changed how energy is produced and consumed. When analyzing the case of

housing, creating gardens and switching to eco-efficient appliances had substantial positive impact on health, wellbeing and waste generation. And on what concerned mobility, a combined set of social and infrastructural measures has been proven capable of not only considerably reducing emissions, but also of stimulating job creation.

Table 1 - Summary of results and discussions.

Case study	Main servitization contributions according to		Steel's		
	Sustainable Urban Metabolism	Circles of Sustainability	Presence	Contribution	Challenge
Energy	<ul style="list-style-type: none"> • Lower external energy inputs; • Increased energy circularity and flow within boundaries; • Higher material stocks within boundaries; • Lower emissions outputs. 	<ul style="list-style-type: none"> • Materials & Energy; • Water & Air; • Emissions & Waste; • Production & Sourcing; • Consumption & Use. 	Decreased	Less steel in the right places can help create more environmental value	HOW MUCH steel to use, WHERE to use steel
Housing	<ul style="list-style-type: none"> • Lower inputs overall; • Higher stocks and flows of food and materials within boundaries; • Lower emissions outputs. 	<ul style="list-style-type: none"> • Constructions & Settlement; • Water & Air; • Materials & Energy; • Emissions & Waste; • Health & Wellbeing; • Consumption & Use. 	Steady	Different alloys used to the best of their potential can support other goods' and services' environmental values	WHAT type of steel to use, HOW to use steel optimally
Mobility	<ul style="list-style-type: none"> • Higher materials inputs; • Lower external energy inputs; • Higher materials stocks; • Reduced material flows; • Lower emissions outputs. 	<ul style="list-style-type: none"> • Water & Air; • Emissions & Waste; • Labour & Welfare; • Wealth & Distribution; • Health & Wellbeing. 	Increased	Regardless of quantity, optimal applications of even the simplest of steel alloys can help improve the environmental values of a service or good	WHEN and WHERE to use steel

When evaluating steel's behavior, each case study provided a unique insight. In the first case, steel's presence decreased but its contribution to electricity generation and emission reduction was improved. In the second case, steel's presence was virtually unaltered but the way it was used highlighted the potential for supporting a servitization initiative's environmental values. And in the third case, steel's presence increased only where and when it was more capable of contributing to the environmental goals at hand.

These differences bring to light the importance that steelmakers also pay close attention to service-providing projects involving their clients and their products, since it was noticed that servitization is capable of altering steel demand in terms of quantity, but also quality and specialization requirements. The effects of servitization on the demand-side can change supply-side dynamics as well, creating both challenges and opportunities for steelmakers.

Steel has a structural role in solar panels, as opposed to a direct operational one as in hydropower plants, this not only changes how much steel is necessary but where it is used, potentially requiring a steelmaker to consider migrating to new and upcoming markets. When it comes to eco-efficient appliances, specialized types of alloys and how they help the product improve efficiency play a bigger role than quantity, situation in which close collaboration with a client's development cycle might favor the steelmaker as well. And directing more production and technology development efforts towards steel alloys that supply manufacturers and assemblers of vehicles which characteristics favor environmental values can pose as an opportunity for portfolio expansion and market share capture.

When addressing services, notably those with environmental purposes, most research as of the publication of this article focus on the operation, feasibility and impacts of the proposed solution, and not on the holistic and systemic effects that feed back to the supply-side of the materials they replace, reduce or displace. And although different tools can be used to analyze and evaluate the benefits that servitization can provide to a sustainable city, more research is needed on the effects that servitization and other service-providing practices have on the commodities that flow through and within a city as consequence of their implementation.