



**HAL**  
open science

# Mechatronics development of a scalable exoskeleton for the lower part of a handicapped person.

Mohamad Kardofaki

► **To cite this version:**

Mohamad Kardofaki. Mechatronics development of a scalable exoskeleton for the lower part of a handicapped person.. Automatic. Université Paris Saclay (COmUE), 2019. English. NNT : 2019SACLV041 . tel-02320199

**HAL Id: tel-02320199**

**<https://theses.hal.science/tel-02320199>**

Submitted on 18 Oct 2019

**HAL** is a multi-disciplinary open access archive for the deposit and dissemination of scientific research documents, whether they are published or not. The documents may come from teaching and research institutions in France or abroad, or from public or private research centers.

L'archive ouverte pluridisciplinaire **HAL**, est destinée au dépôt et à la diffusion de documents scientifiques de niveau recherche, publiés ou non, émanant des établissements d'enseignement et de recherche français ou étrangers, des laboratoires publics ou privés.

# Mechatronics development of a scalable exoskeleton for the lower part of a handicapped person.

Thèse de doctorat de l'Université Paris-Saclay préparée à l'Université  
de Versailles Saint-Quentin-en-Yvelines

Sciences et Technologies de l'Information et de la Communication  
(STIC)  
Spécialité de doctorat: Robotique

Thèse présentée et soutenue à Vélizy Villacoublay, le 11/ juin/2019, par

**Mohamad KARDOFAKI**

Composition du Jury :

M. Vigen ARAKELIAN Professeur des universités, INSA Rennes	Rapporteur
Mme. Irini GIANNOPULU Professeur des universités, Bond University	Rapporteur
M. Pierre RENAUD Professeur des universités, INSA Strasbourg	Rapporteur
M. Eric DYCHUS Président de Sandyc Industries	Examineur
Mme. Kinda KHALAF Associate Professor, Khalifa University	Examineur
M. David ORLIKOWSKI, Professeur, Hôpital Raymond Poincaré	Président, Examineur
M. Fethi BEN OUEZDOU Professeur des Universités, Université de Versailles	Directeur de thèse
M. Samer ALFAYAD Maître de conférences, HDR, Université de Versailles	Co-Directeur de thèse

**Titre :** Développement mécatronique d'un exosquelette évolutif pour la partie inférieure d'une personne handicapée

**Mots clés :** Réadaptation, Adolescents, Exosquelettes, Actionneurs, Évolutivité, Croissance.

**Résumé :** Cette thèse présente l'importance des exosquelettes évolutifs des membres inférieurs pour les adolescents handicapés souffrant de troubles neuromusculaires et autres pathologies. Le terme « évolutif » décrit la capacité de l'exosquelette à s'adapter à un changement d'ordre dont en assurant ses fonctionnalités et ses performances.

Une analyse distincte des manifestations physiques qui subissent a été faite, en ce qui concerne la poussée de croissance pubertaire et les effets secondaires éventuelles. L'étude de la littérature montre qu'il n'existe pas de dispositif de réadaptation suffisamment adapté aux besoins d'un adolescent en pleine croissance en raison de la croissance rapide de ses membres et de la progressivité des maladies qui cause la perte de mobilité. Comme c'est la première fois que le terme «évolutivité» est utilisé pour les exosquelettes, ses exigences fonctionnelles sont définies. Le développement

mécatronique d'un exosquelette évolutif est aussi présenté, incluant le développement de son actionneur articulaire et sa structure mécanique. Enfin, les résultats préliminaires des performances de l'actionneur articulaire lors de la simulation des mouvements fonctionnels liés à la croissance montrent une grande capacité de suivi et d'exécution des mouvements basés sur les couples, tandis que les résultats liés à la structure évolutive montrent la capacité du système à s'adapter aux différents utilisateurs.

**Title** Mechatronics development of a scalable exoskeleton for the lower part of a handicapped person

**Keywords:** Rehabilitation, Teenagers, Exoskeletons, Actuators, Scalability, Growth.

**Abstract:** This thesis introduces the importance of the scalable lower limb exoskeletons for disabled teenagers suffering from neuromuscular disorders & other pathological conditions. The new term "scalable" describes the ability of the exoskeleton to physically grow up with the user and to be adapted to his/her morphology.

A distinctive analysis of the physical manifestations that the patients experience has been done concerning the pubertal growth spurt and to the future secondary effects. The study of the literature shows that no rehabilitation device is customized enough to the needs of a growing teenagers due to the fast growth of their bodies and to the progressiveness nature of their diseases. As this is the first time the term

"scalability" is brought up for exoskeletons, its functional requirements are defined in order to determine the constraints imposed on the design of the new exoskeleton. The mechatronics development of a scalable exoskeleton is presented, including the development of its joint actuator, its mechanical structure and attachments.

Finally, the preliminary results of the joint actuator performance when simulating functional movements related to the growth show a high capability of trajectory following and executing torques based motions, while the findings associated with the scalable structure show the system able to be adapted to the different user sizes and ages.



# Contents

<b>1</b>	<b>Introduction</b>	<b>1</b>
1.1	Motivation . . . . .	1
1.2	Problematic . . . . .	2
1.3	Goal and approach . . . . .	3
1.4	Thesis Outlines . . . . .	3
<b>2</b>	<b>Bio-anatomical Background</b>	<b>5</b>
2.1	Introduction . . . . .	6
2.2	Nervous System . . . . .	6
2.3	Anatomical Aspect of the Human Lower Limb Movements . . . . .	8
2.3.1	The Pelvis and Hip Complex . . . . .	9
2.3.2	The Knee Joint . . . . .	10
2.3.3	The Ankle and Foot . . . . .	12
2.4	Diseases Classification . . . . .	13
2.4.1	Neuro-Developmantal Diseases . . . . .	14
2.4.2	Accidental Diseases . . . . .	19
2.5	Physical Symptoms . . . . .	20
2.6	Physical Diseases Management . . . . .	21
2.7	Cost Study . . . . .	23
2.8	Conclusion . . . . .	24

<b>3</b>	<b>State of the Art</b>	<b>25</b>
3.1	Introduction . . . . .	26
3.2	Rehabilitation Devices Classification . . . . .	26
3.2.1	Treadmill-based devices . . . . .	26
3.2.2	Portable Devices . . . . .	27
3.2.3	Existing Rehabilitation Devices Limitations . . . . .	30
3.3	Actuation Prior Art . . . . .	32
3.3.1	Electrical Actuators . . . . .	33
3.3.2	Pneumatic Actuation . . . . .	40
3.3.3	Hydraulic Actuation . . . . .	42
3.4	Exoskeleton Structure prior Art . . . . .	47
3.5	Conclusion . . . . .	50
<b>4</b>	<b>Scalable Exoskeleton Mechanical Requirements</b>	<b>53</b>
4.1	Introduction . . . . .	54
4.2	Structural Requirements of Scalability . . . . .	54
4.2.1	Interchangeability in Size . . . . .	54
4.2.2	Interchangeability in exoskeleton shape to ensure the morphology compatibility . . . . .	57
4.2.3	Perfect Alignment of Exoskeleton Joint to the Corresponding Human Joints . . . . .	59
4.2.4	The Kinematic Compatibility . . . . .	62
4.2.5	Summary . . . . .	65
4.3	Actuation Requirements of Scalability . . . . .	66
4.3.1	Selection Criteria of the Exoskeleton Active DOFs . . . . .	66

4.3.2	Interchangeability in the Range of Motion . . . . .	68
4.3.3	Interchangeability in the Power Capabilities . . . . .	69
4.3.4	Joint Actuation Design Requirements . . . . .	75
4.4	Conclusion . . . . .	75
<b>5</b>	<b>Design Methods Towards Scalable Exoskeleton</b>	<b>77</b>
5.1	Introduction . . . . .	78
5.2	Development of Scalable Structure of the Exoskeleton . . . . .	78
5.2.1	The Mechanical Considerations of the Scalable Exoskeleton Structures . . . . .	79
5.2.2	Scalable Exoskeleton Structure . . . . .	81
5.2.3	Kinematic Compatibility and Human/exoskeleton Con- nections . . . . .	92
5.3	Actuator Mechatronic Design . . . . .	102
5.3.1	Actuation Integration . . . . .	102
5.3.2	Mechanical Design . . . . .	105
5.3.3	Material Selection . . . . .	110
5.3.4	Sensors Selection . . . . .	113
5.3.5	Actuator Realization . . . . .	116
5.4	Realisation of the first prototype of scalable exoskeleton "SOL" . . . . .	118
5.5	Discussion . . . . .	119
5.6	Conclusion . . . . .	120
<b>6</b>	<b>SOL Preliminary Experimental Results</b>	<b>121</b>
6.1	Structural Validation by Simulation and Testing . . . . .	121
6.1.1	Scalable Exoskeleton Functionality Validation . . . . .	122

6.1.2	Preliminary Evaluation of the Attachments . . . . .	127
6.2	Actuator Performance Validation . . . . .	129
6.3	Global Validation . . . . .	133
<b>7</b>	<b>Conclusion and Future Works</b>	<b>135</b>
7.1	Conclusions . . . . .	135
7.2	Future Works . . . . .	137
	<b>Publications</b>	<b>139</b>
	<b>bibliographie</b>	<b>141</b>

# List of Figures

2.1	The human nervous system . . . . .	7
2.2	The peripheral nervous system [1] . . . . .	8
2.3	The pelvis and its joints [1] . . . . .	9
2.4	The Knee joint [1] . . . . .	11
2.5	The Foot/Ankle Joint [1] . . . . .	12
2.6	The subtalar joint anatomy [1] . . . . .	13
2.7	Classification of the diseases . . . . .	14
2.8	Spina Bifida levels of severity of the physical disability . . . . .	15
2.9	Cerebral palsy Types . . . . .	16
2.10	Types of muscular dystrophies with illustration of affected muscles (shaded color),(a) Duchenne & Becker, (b) Emery-Dreifuss, (c) Limb-girdle, (d) Facioscapulohumeral, (e) Distal, (f) Oculopharyngeal	17
2.11	Multiple Sclerosis disease . . . . .	18
2.12	Post Polio Syndrome . . . . .	18
2.13	Stroke types . . . . .	19
2.14	Spinal Cord Levels . . . . .	20
2.15	The most common symptoms experienced by disabled teenagers following the studied disease . . . . .	21



2.16	Gross Motor Function Classification System (GMFCS) of Cerebral Palsy with the experienced symptoms . . . . .	22
3.1	Treadmill-based exoskeletons (a) Lokomat (b) Lopes (c) ReoAmbulator . . . . .	27
3.2	Mobile exoskeletons for children (a) WAKE-UP (b) Pediatric Anklebot (c) ATLAS 2020 (d) Tréxo . . . . .	28
3.3	Adult exoskeletons : (a) PheoniX (b) TWIICE (c) Indego (d) Rewalk (e) EKSO GT (f) MINA (g) ARKE (h) ITRI (i) REX (j) ATALANTE (k) VariLeg (l) HANK (m) Fourier X (n) MARCH II (o) ExoAtlet (p) HAL . . . . .	30
3.4	Supported Patient Sizes by the existing exoskeletons . . . . .	31
3.5	actuation of robots in various application . . . . .	33
3.6	Types Electric Motors . . . . .	35
3.7	Comparison between Brushless DC, Brushed DC, and AC motors . . . . .	35
3.8	Serial Rotary Actuator of The Wearable Assistive Device of Sogang University . . . . .	37
3.9	Serial rotary Actuators of Atlas Exoskeleton . . . . .	38
3.10	Varileg Exoskeleton . . . . .	38
3.11	Mindwalker Exoskeleton and its serial elastic actuator . . . . .	39
3.12	Working principle of McKibben artificial muscles . . . . .	40
3.13	The Pneumatic Exoskeleton "Human Friendly Orthosis" Developed by the University of Salford, UK . . . . .	41
3.14	Pneumatic Ankle-Foot-Orthosis exoskeleton Developed by the University of Michigan . . . . .	42
3.15	Bleex Exoskeleton and its actuators . . . . .	43
3.16	Integrated Linear Actuators used in (a) HyQ, (b) Big dog (2008), (c) MKE Quadruped . . . . .	44

3.17	Integrated rotary hydraulic actuators developed by KNR systems and used in several applications (a) MOTIE industrial Exoskeleton, (b) MKE Quadruped, (c) rotary actuator unit RH-D30 by KNR systems . . . . .	45
3.18	Integrated Electro hydraulic actuators combination . . . . .	46
3.19	Integrated Electro hydraulic actuators developed by (a) IEHA by ALFAYAD at university of Versailles, (b) EHA by Habibi at University of Saskatchewan , (c) Hydraulic pump and different rotary actuators by Nakamura at University of Tokyo . . . . .	47
3.20	Rewalk and Indego Exoskeletons with the rigid structure approach .	48
3.21	Harvard Soft Exoskeleton . . . . .	49
3.22	Samsung Semi Rigid Exoskeleton . . . . .	50
4.1	The Body Proportions Series . . . . .	55
4.2	Growth chart of a growing child [2] with the lengths of the thigh bone (femur) and shank bone (tibia) . . . . .	56
4.3	The pelvis interchangeability according to (a) the gender differences, (b) the age of the person . . . . .	56
4.4	Morphology changes of human body to the sex . . . . .	58
4.5	Morphology changes of human body due to the skeletal deformities. (a)Knee Malalignment ,(b) In/Out toeing . . . . .	58
4.6	Morphology changes of human body for different weight, (a) for male/female Children, (b) for male/female Adults . . . . .	59
4.7	Hip alignment mechanisms (a) Kinematic Design with Five Revolute, Three Prismatic and One Ball Joint, (b) four bars mechanism for the hip . . . . .	61
4.8	Knee mechanism (a) Four bars mechanism, (b) the motion of the Condylloid joint . . . . .	62

4.9	The three methods to couple upper body exoskeleton to human arm (a)shoulder 3/elbow 5,(b)shoulder 4/elbow 4,(c)shoulder 5/elbow 4	64
4.10	Types of exoskeleton structures kinematic chaines, (a)Hip 3/knee 5,(b)Hip 4/knee 4,(c)Hip 5/knee 3 . . . . .	64
4.11	Design Constraints of the scalable exoskeleton structure . . . . .	66
4.12	Anatomical Planes of the human body . . . . .	67
4.13	Hip and Knee ranges of motion from years 2 and up to 69 years old as measured by [3] . . . . .	69
4.14	Comparison between the boys body-mass-index for several ages per- centile curves between 2 years 1991 and 2007 . . . . .	71
4.15	Effect of changing leg length on hip and knee speed trajectories during constant speed walking . . . . .	74
4.16	Effect of walking speed on knee angular speed trajectory for nor- mal subject of 12 years old . . . . .	74
4.17	Design Constraints of the scalable joint actuator . . . . .	75
5.1	The Design Methodology of the Scalable Exoskeleton . . . . .	79
5.2	Lower limb Exoskeleton segmentation . . . . .	80
5.3	Mechanical design of the exoskeleton waist . . . . .	82
5.4	Various type of clamping mechanism used to build the center waist	84
5.5	Various types of the used clamping mechanisms to build the half waist . . . . .	84
5.6	variable size and shape of the scalable exoskeleton waist . . . . .	85
5.7	variable size and shape of the scalable exoskeleton waist . . . . .	86
5.8	Mechanical design of the exoskeleton waist . . . . .	86
5.9	Mechanical design and kinematic scheme of the exoskeleton thigh .	87
5.10	Mechanical design and kinematic scheme of the exoskeleton thigh .	88

5.11	Mechanical design and kinematic scheme of the exoskeleton thigh	88
5.12	Mechanical design and kinematic scheme of the exoskeleton thigh	89
5.13	Mechanical design and kinematic scheme of the exoskeleton shank	90
5.14	Mechanical design and kinematic scheme of the exoskeleton thigh	90
5.15	Mechanical design and kinematic scheme of the exoskeleton thigh	91
5.16	Mechanical design and kinematic scheme of the exoskeleton thigh	92
5.17	Schematic of kinematic structure of the scalable exoskeleton	93
5.18	Forces generated by the exoskeleton connection mechanism	96
5.19	The ankle and the thigh/shank attachment	99
5.20	Thigh and Shank 5 Dof Attachment passive mechanism	100
5.21	Mechanical design of the exoskeleton Foot with the connection mechanism	101
5.22	Curved design of the exoskeleton sole	102
5.23	Comparison of the actuator types, "+" means High/Valuable and, "-" means Low/Poor	103
5.24	Actuation type versus the available space between human lower limb joints: a) used space, b) Free space	104
5.25	Robodrive ILM 70x10 and the Harmonic Drive SHG-25-100-2SO	108
5.26	Load Distribution scenario	109
5.27	Assembly View of Joint Actuator	110
5.28	Exploded View of the Modular Actuator	111
5.29	Hard Stopper design	111
5.30	Chart of the Components Volume	112
5.31	Finite Element Analysis(FEA) of the Selected Components	113
5.32	Integrated Sensors Design	114

5.33	sensors adjustment mechanism . . . . .	115
5.34	Actuator Design . . . . .	116
5.35	The Components of the Actuators Outlines . . . . .	117
5.36	The design of SOL Scalable exoskeleton . . . . .	118
6.1	The results of the stress analysis of the exoskeleton' links : saggital plan . . . . .	124
6.2	The results of the stress analysis of the exoskeleton' links : frontal plan . . . . .	124
6.3	Preliminary Results of the load support validation . . . . .	125
6.4	Preliminary Results on SOL Scalable Exoskeleton Clamping Mech- anism Between the Aluminum Links and the Carbon Tubes. . . . .	125
6.5	Preliminary Results on SOL Scalable Exoskeleton Hip Alignment Mechanism . . . . .	126
6.6	Validation of the SOL Scalable Exoskeleton Structural Capacity . . . . .	127
6.7	Validation of the SOL Attachment Solutions Compactness . . . . .	128
6.8	Validation of the SOL Attachment to be localised on a wide range on the thigh/shank . . . . .	128
6.9	Validation of the SOL attachment Exoskeleton Capacity to follow the user limb section shape . . . . .	129
6.10	Experimental Validation Set-Up . . . . .	130
6.11	Sine wave position tracking . . . . .	131
6.12	Current Consumption during Position Tracking . . . . .	131
6.13	Exoskeleton Leg Test Bench of Two Patient Size Performing a Gait Trajectories . . . . .	132
6.14	Actuator response for position and velocity of a)Hip, and b)Knee walking trajectories for 12 years old subject at 0.7 m/s . . . . .	133

6.15 Preliminary Results on SOL Scalable Exoskeleton Via the Walking in the Air Scenario . . . . .	134
---	-----



# List of Tables

2.1	The management of certain symptoms among the patients affected with the studied diseases . . . . .	23
4.1	Normalized joints torques for DLA . . . . .	70
4.2	Weights of Exoskeletons having 4 DOFs . . . . .	72
5.1	Kinematic scheme of the half exoskeleton hip mechanism . . . . .	83
5.2	Possible combination structures of the hip and knee and ankle joint connection chains ( $L1=5$ , $L2=5$ , $L3=5$ ), U: universal joint (2 DOF), R: revolute joint (1 DOF); P: prismatic joint (1 DOF), S: Spherical joint (3 DOF) . . . . .	95
5.3	Final combinations of the thigh and shank connection chains ( $L1 = L2 = 5$ ), U: universal joint (2 DOF), R: revolute joint (1 DOF); P: prismatic joint (1 DOF), S: Spherical joint (3 DOF) . . . . .	98
5.4	Harmonic Drive Gearboxes classifications . . . . .	107
5.5	Harmonic Drive Gearboxes classifications . . . . .	108
5.6	Movement range of each DOF . . . . .	112
5.7	Actuator Characteristics . . . . .	117





# Acknowledgements

During my PhD research in the multidisciplinary held of rehabilitation robotics I've found ample opportunity to meet and collaborate with many people. My gratitude goes out to all those who have contributed to this work scientifically, practically, and personally.

First, I would like to thank my advisors, Prof. Fethi Ben Ouezdou and Dr. Samer ALFAYAD, for providing the opportunity to explore a field that was brand new to me, for their suggestions and advise.

I am grateful to my parents, my wife, my friends for their support and for encouraging me in my endeavors.

Finally, my last words of gratitude are saved for my dad. His faith and relentless support I will never ever forget.



# Chapter 1

## Introduction

### Contents

---

<b>1.1 Motivation</b> . . . . .	<b>1</b>
<b>1.2 Problematic</b> . . . . .	<b>2</b>
<b>1.3 Goal and approach</b> . . . . .	<b>3</b>
<b>1.4 Thesis Outlines</b> . . . . .	<b>3</b>

---

### 1.1 Motivation

Worldwide, it is estimated that around 180 to 220 million of youth live with some kind of disability, 80% of them are living in the developing countries [2]. This number is related only to the youth below 24 years old. If we count adults and the elderly, it is estimated to 15% of the world population making the disabled persons the largest marginalised minority. The physical disability confronts them to many challenges related to: environmental accessibility, self-confidence, psycho-social issues, financial/employment barriers, educational deprivation and multiple forms of discrimination. This social and physical barrier is even bigger for teenagers and not only affect them but also their families, surroundings and care-giving relatives' [4]. Hence, the aim of this thesis is to develop an exoskeleton which is "scalable"

in size and in dynamic performance in order to be used by teenagers suffering from physical disability.

## 1.2 Problematic

According to our study, the main causes of lower limb diseases can be categorized into two types. The first one is the biological diseases which affects the neurological system of the teenagers before/after birth, and the other is the accidental diseases affecting their spinal cord or their brain.

Nowadays, more teenagers have access to wheelchairs only to solve the issue of mobility. But as they start using it at an early age, they become dependent on it throughout their growth. The immobilized and other non-weight-bearing individuals (eg, astronauts) rapidly lose bone mass, suggesting the importance of skeletal loading for bone health. This engenders the long sitting associated problems that worsen their physical capabilities and brings more complications such as bowel and bladder issues, respiratory difficulties, obesity, upper body muscle fatigue/weakness and lack of physical activities. Not to forget that the use of wheelchairs at an early age has a bad implication on their mental health due to the absence of eye to eye communication [5], and on their self-acceptance at the pubertal period where the teenagers are forming their identity.

In parallel to that, the disabled pre-teens and teenagers are oriented to practice ordinary physical rehabilitation to improve their general health and to attempt to delay the disability progress. This is because it has been shown that the best way to delay the onset of secondary injuries is to delay wheelchair usage and start rehabilitation as soon as possible after an injury [6]. This rehabilitation process is costly, time consuming (lifetime follow-up at the hospital), and labor-intensive (a team of healthcare specialists) [7], often requiring an elaborated management plan to cope with the disability symptoms. Not to mention that if ever this process is withdrawn for short period of time, there is an important loss of benefits [8]. This shows that the ordinary physical therapy is necessary but usually not enough for a growing teenager who needs regular physical therapy and activity at an early

age, as widely recommended by the rehabilitation community [9]. Thus, the most effective approach of therapy for teenagers is the early beginning and the continuity throughout the pubertal growth.

### **1.3 Goal and approach**

Recently, the proliferation of robots has been widespread in rehabilitation, providing continuous treatment and strengthening beyond the practitioner's capabilities. The outcome of exoskeleton-based rehabilitation has been demonstrated for a wide variety of users, but unfortunately, there is no scalable device that can be adjusted to fit the disabled teenagers, which can help in evaluating its impact on their general health.

The main goal this thesis is to develop a scalable rehabilitation device, which is able to be mechanically adapted to the fast growth of the teenager body in order to achieve the early and continuous therapy. Such a new system is a matter of two axes of research: The first one related to the progressive and early onset diseases needs and the general requirements of the scalable device, and the other to the mechanical design that incorporates the scalability feature including the exoskeleton actuation unit and their structural elements.

### **1.4 Thesis Outlines**

In this thesis, a full study of the diseases causing disability at an early onset, their key symptoms and consequences during the period of the adolescence were conducted. A survey of the existing technologies dealing with the disability that affects the lower part of teenagers is done and shows that there is no suitable rehabilitation device that can be used in all the pubertal period and at the same time can fit the teenagers' needs. Consequently the various requirements that a lower limb scalable exoskeleton should meet are illustrated. Finally, the mechatronics development of an exoskeleton that demonstrates the scalability concept

is presented, showing the mechanical design procedures of its joint actuators and structure. The system shows preliminary promising results of the actuator behaviour when simulating functional movements related to the growth, and of the different sizes that can be carried out by its scalable structure.

# Chapter 2

## Bio-anatomical Background

### Contents

---

<b>2.1</b>	<b>Introduction</b>	<b>6</b>
<b>2.2</b>	<b>Nervous System</b>	<b>6</b>
<b>2.3</b>	<b>Anatomical Aspect of the Human Lower Limb Move- ments</b>	<b>8</b>
2.3.1	The Pelvis and Hip Complex	9
2.3.2	The Knee Joint	10
2.3.3	The Ankle and Foot	12
<b>2.4</b>	<b>Diseases Classification</b>	<b>13</b>
2.4.1	Neuro-Developmantal Diseases	14
2.4.2	Accidental Diseases	19
<b>2.5</b>	<b>Physical Symptoms</b>	<b>20</b>
<b>2.6</b>	<b>Physical Diseases Management</b>	<b>21</b>
<b>2.7</b>	<b>Cost Study</b>	<b>23</b>
<b>2.8</b>	<b>Conclusion</b>	<b>24</b>

---



## 2.1 Introduction

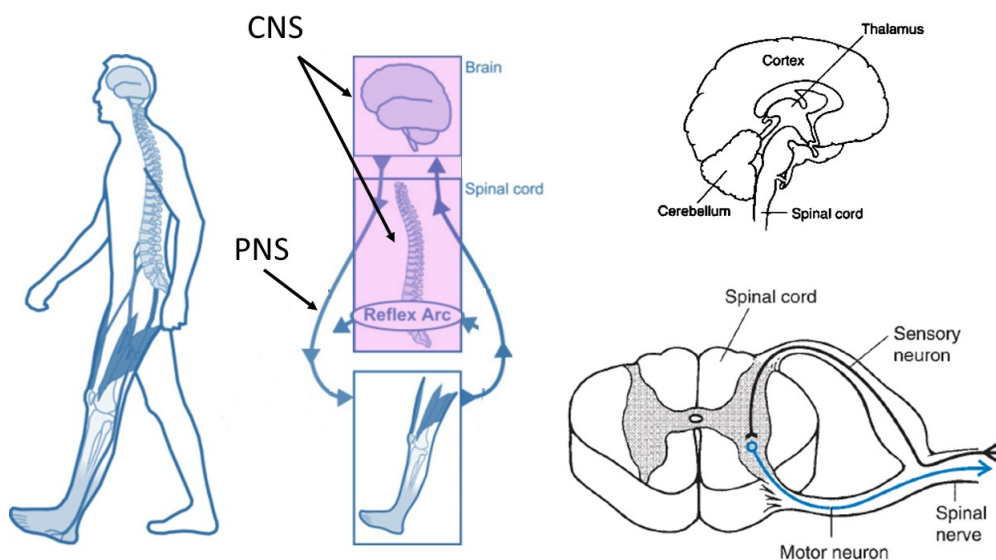
In this chapter, a medical review about the diseases that can cause motor disability for the whole body among adolescents is given, starting by giving general information about the central/peripheral nervous systems (CNS) and (PNS). The studied diseases are selected based on their progressiveness and their physical symptoms. Their classification criteria are shown, and finally their causes, physical symptoms, statistics, management, cost are treated. The motivation of this study is to highlight the importance of understanding of the diseases in order to better design the scalable exoskeleton using several parameters inspired from this study.

## 2.2 Nervous System

It is generally admitted that the human motor function intentions begins from the brain which sends signals of activation and coordination via the motor neurons at the spinal cord level to the limbs' muscles [1]. Human movements are controlled and monitored by the nervous system. The nature of this control is such that many muscles may need to be activated to perform a vigorous movement such as sprinting, or only a few muscles may need to be activated to push a doorbell or make a phone call. The nervous system is responsible for identifying the muscles that will be activated for a particular movement and then generating the stimulus to develop the level of strength that will be required of that muscle. The activation of a certain set of muscles can be voluntary or a result of reflex.

Many human movements require the stabilization of adjacent segments while a fine motor skill is being performed. This requires coordination on the part of the nervous system to stabilize segments such as the arm and forearm while very small range coordinated movements are created with the fingers, as in writing. The neural network is extended because each muscle fiber is individually innervated by a branch of the nervous system. The information comes out of the muscle and enters the nervous system, and the information enters the muscle to trigger muscle activity of a specific nature and magnitude. Through this loop system, which is

interconnected with many other loops of other muscles and with central nervous control, the nervous system is able to coordinate the activity of many muscles at once. Specific force levels can be generated in several muscles simultaneously so that a skill such as kicking can be performed accurately and with strength. Knowledge of the nervous system is useful for improving muscle performance, refining a skill or task, rehabilitating an injury and stretching a muscle group. As shown in Fig. 2.1, the nervous system of a human being consists of two main components: the central nervous system (CNS) including the brain and spinal cord, being the means by which human movement is initiated, controlled, and monitored. And the Peripheral Nervous System (PNS) which is composed of all the nerves that connect the CNS to the limbs. These nerves can be divided into two categories: Nerves that enter the spinal cord on the dorsal, or back, side of the spinal cord are called sensory neurons because they transmit muscle information into the system. The other nerves come out on the front side of the body and are called motor neurons because they carry impulses from the system to the muscle [1].



**Figure 2.1** The human nervous system

The peripheral nervous system consists the branches of the nerves outside the

spinal cord. The peripheral nerves mainly responsible for muscle action are the spinal nerves, which enter through the posterior, or dorsal, side of the spine and exit on the anterior, or ventral, lateral side at each spinal level of the spine cord. Eight pairs of nerves enter and exit the cervix. twelve pairs in the thoracic region, five in both lumbar and sacral region and one in the coccygeal region. Nerve pathways are presented for the lower limb in Fig 2.2.

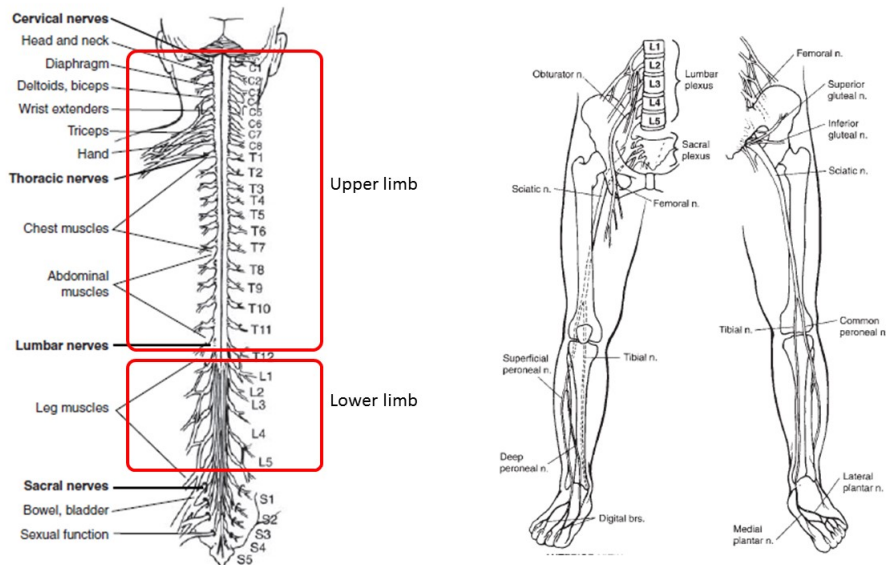


Figure 2.2 The peripheral nervous system [1]

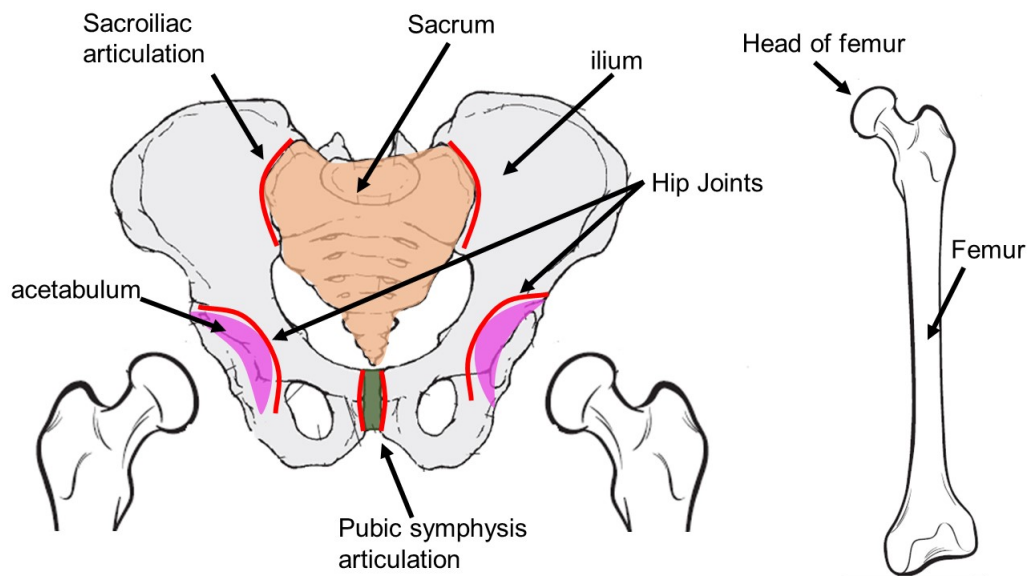
### 2.3 Anatomical Aspect of the Human Lower Limb Movements

The lower limbs are subjected to forces generated by repetitive contacts between the feet and the ground. At the same time, the lower limbs are responsible for supporting the trunk mass and upper limbs. The lower limbs are connected to each other and to the trunk by the pelvis. This establishes a link between the extremities and the trunk that must always be taken into account when examining muscle movements and contributions to lower limb movements. Movements in any part of the lower limbs, pelvis or trunk influence actions elsewhere in the lower

limbs. Thus, a position or movement of the foot can influence the position or movement of the knee or hip of either limb, and a pelvic position can influence actions on the entire lower limb.

### 2.3.1 The Pelvis and Hip Complex

The analysis of the pelvis and hip complex is quite important for the human/device interface study. This is because it can lead us to determine the various deformities and structural constraints when designing the rehabilitation device.



**Figure 2.3** The pelvis and its joints [1]

The pelvic girdle and hip joints are part of a closed kinetic chain system whereby forces travel up from the lower extremity through the hip and the pelvis into the trunk or down from the trunk through the pelvis and the hip to the lower extremity. So the pelvis girdle consists of several cartilaginous joints. The pubic symphysis joint which is connecting the two ilium bones where the movement (DOF) at this joint is limited, maintaining a firm connection between right and left sides of the pelvic girdle. The pelvis is connected to the trunk at the sacroiliac joint, a strong synovial joint containing fibrocartilage and powerful ligamentous

support. The articulating surface on the sacrum faces posteriorly and laterally and articulates with the ilium. The sacroiliac joint transmits the weight of the body to the hip and is subject to loads from the lumbar region and from the ground. It is also an energy absorber of shear forces during gait and it is well reinforced by very strong ligaments. The amount of movement allowed at the sacroiliac joint varies considerably between individuals and sexes. Males do not have mobile sacroiliac joints, while in females, the sacroiliac joint is more mobile because there is greater laxity in the ligaments supporting the joint. More details about this joint and its range of motion can be found in [1].

The final joint in the pelvic girdle complex is the hip joint, which can be generally characterized as stable yet mobile. The hip, which has 3 degrees of freedom, is a ball and socket joint consisting of the articulation between the acetabulum on the pelvis and the head of the femur. The acetabulum is the concave surface of the ball and socket, facing anteriorly, laterally, and inferiorly

Pelvic girdle and hip joint positioning contribute significantly to the maintenance of balance and standing posture by using continuous muscular action to fine-tune and ensure equilibrium.

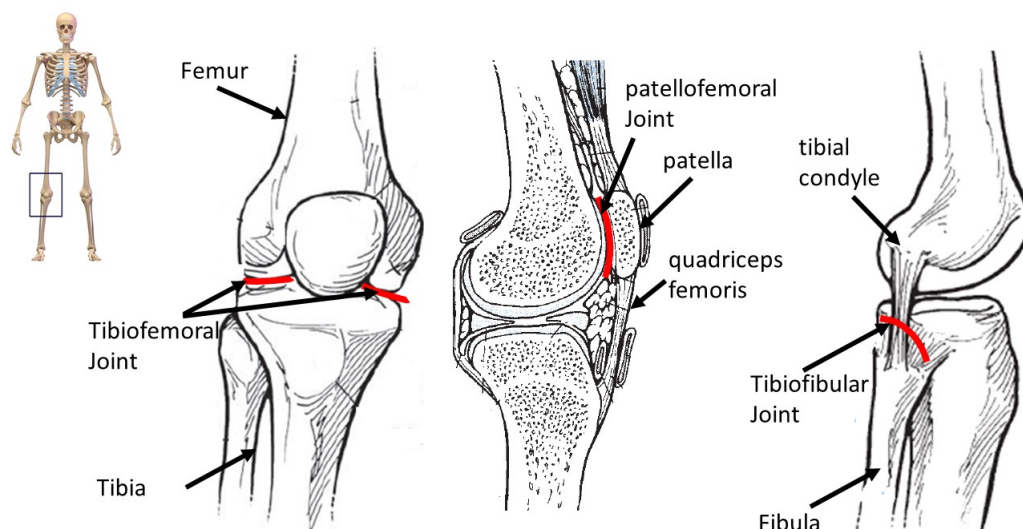
### **2.3.2 The Knee Joint**

The knee joint supports the weight of the body and transmits forces from the ground while allowing a movement between the femur and the tibia. In the extended position, the knee joint is stable due to its vertical alignment, congruence of joint surfaces and the effect of gravity. In any flexed position, the knee joint is mobile and requires special stabilization of the powerful capsule, ligaments and muscles surrounding the joint. The joint is vulnerable to injury due to the mechanical stresses it undergoes and the fact that it depends on soft tissue for support.

There are three articulations in the region known as the knee joint: the tibiofemoral joint, the patellofemoral joint, and the superior tibiofibular joint. The tibiofemoral joint, commonly referred to as the actual knee joint, is the articulation between the two longest and strongest bones in the body, the femur and the

tibia. In this joint, flexion and extension movement are occurred as simple hinge joint. In the knee joint, however, flexion is accompanied by a small but significant amount of rotation.

The second joint in the region of the knee is the patellofemoral joint, consisting of the articulation of the patella with the trochlear groove on the femur. The primary role of the patella is to increase the mechanical advantage of the quadriceps femoris. Positioning of the patella and alignment of the lower extremity in the frontal plane axis is determined by measuring the Q-angle (quadriceps angle). The third and final articulation is the small, superior tibiofibular joint. This joint consists of the articulation between the head of the fibula and the posterolateral and inferior aspect of the tibial condyle. This is a gliding joint moving anteroposteriorly, superiorly, and inferiorly and rotating in response to rotation of the tibia and the foot. More details about this joint and its range of motion can be found in [1].



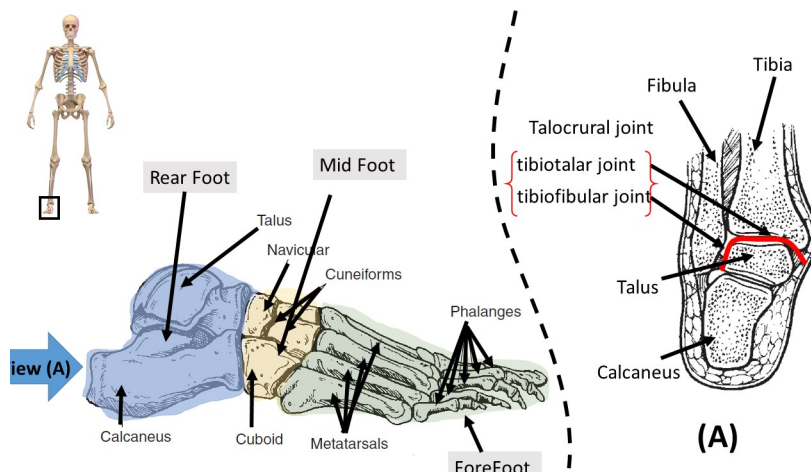
**Figure 2.4** The Knee joint [1]

### 2.3.3 The Ankle and Foot

The foot and ankle make up a complex anatomical skeletal mechanism consisting of 26 irregularly shaped bones, 30 joints, more than 100 ligaments, and 30 muscles acting on the segments. All of these joints must interact harmoniously and in combination to achieve a smooth motion [1].

The foot contributes significantly to the function of the whole lower limb. The foot supports the weight of the body in both standing and locomotion. The foot must be a flexible adapter to uneven surfaces at contact. Also, upon contact with the ground, it serves as a shock absorber, attenuating the large forces resulting from ground contact. When the foot is fixed during stance, it must absorb the rotation of the lower extremity.

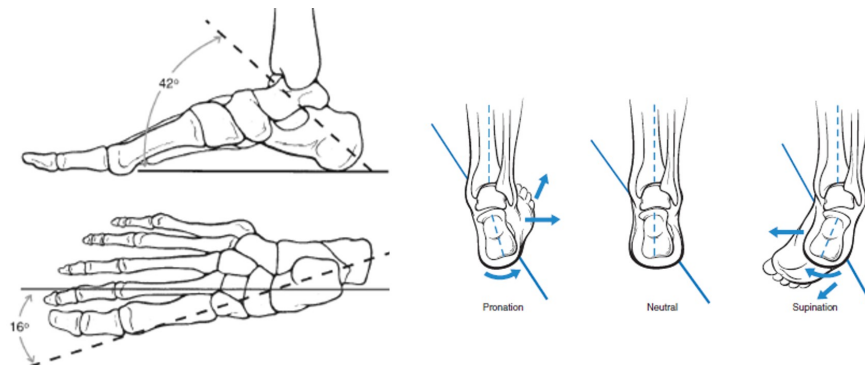
As shown in Fig 2.5, the foot can be divided into three regions. The rearfoot, consisting of the talus and the calcaneus; the midfoot, including the navicular, cuneiforms, and the cuboid; and the forefoot, containing the metatarsals and the phalanges. The talocrural joint, or ankle joint is a uniaxial hinge joint formed by the tibia and fibula (distal tibiofibular joint) and the tibia and talus (tibiotalar joint). This joint is designed for stability rather than mobility. The subtalar joint, which consists of the articulation between the talus and the calcaneus.



**Figure 2.5** The Foot/Ankle Joint [1]

The subtalar joint is supported by five short and powerful ligaments that resist

severe stresses in lower extremity movements. The axis of rotation for the subtalar joint runs obliquely from the posterior lateral plantar surface to the anterior dorsal medial surface of the talus. It is tilted vertically from  $41^\circ$  to  $45^\circ$  from the horizontal axis in the sagittal plane and is slanted from  $16^\circ$  to  $23^\circ$  medially from the longitudinal axis of the tibia in the frontal plane. Because the axis of the subtalar joint is oblique through the sagittal, frontal, and transverse planes of the foot, triplanar motion can occur.



**Figure 2.6** The subtalar joint anatomy [1]

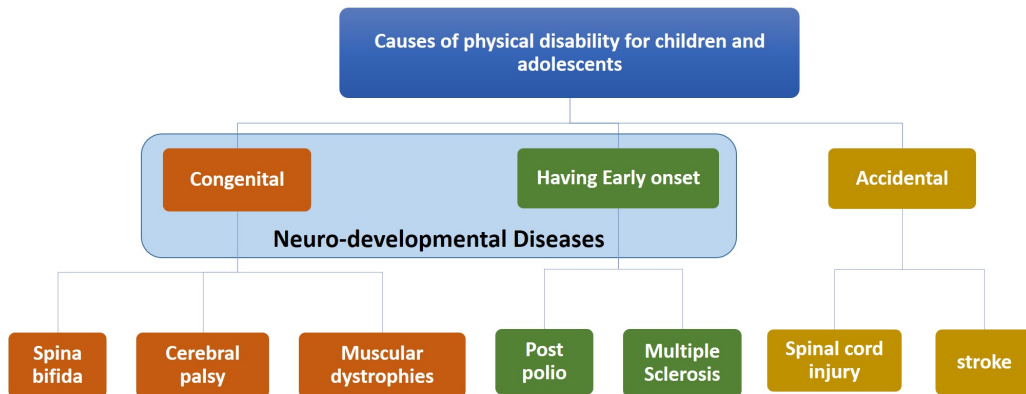
## 2.4 Diseases Classification

The physical disability is caused by a damage on the nervous system (CNS or PNS) after an illness or a shock. Since our study focuses on the adolescence period, we defined certain selection criterion of the diseases that can cause disability during this puberty period of life with regards to their progressiveness and their physical symptoms. Based on these criteria, Fig. 2.7, includes the most common diseases among adolescents who cause physical disability classified into three main categories of selection, where the explanation of each category is shown as follows:

- Congenital: The disease is present at birth or is prenatal;
- Have Early Onset: The disease happened at postnatal period or during the childhood;



- Accidental: The disease is caused by a sudden injury in the spinal cord or in the brain.



**Figure 2.7** Classification of the diseases

The outcomes of the disease selection criteria lead us to consider the neuro-developmental diseases and the accidental ones. The first category is represented by the Spina Bifida, Cerebral Palsy and Muscular Dystrophies under the congenital category, and by Post Polio and Multiple Sclerosis under the early onset category, finally, Spinal Cord Injury and Stroke addressed as accidental diseases. In the next sections, a description of these diseases is given, which is mainly dealing with a general definition, the physical symptoms which affect the lower limb, a statistical study which highlights the impact of the disease on the population, the rehabilitation management methods and their importance on the patient health, and the rehabilitation costs.

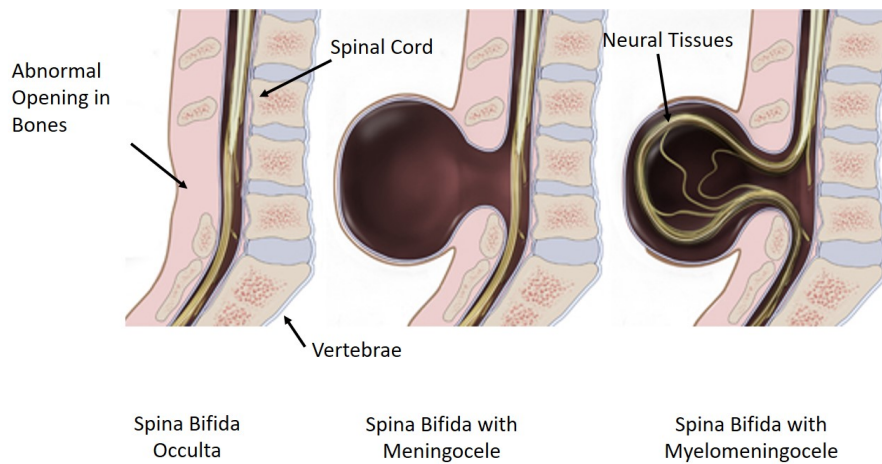
### 2.4.1 Neuro-Developmental Diseases

#### Spina Bifida (SB)

A birth defect resulting in the malformation of the spinal cord due to a problems that occur during the closure of the caudal part of the spincal cord in this stage cause SB and other spinal cord disorders [10]. There are 3 major types of Spina

bifida: Spina bifida occulta, meningocele and myelomeningocele. Often prenatal surgery is performed and has good outcomes but there is still no cure for the already damaged nerve cells, see Fig.2.8.

The incidence of SB varies between 0.2 and 10 per 1000 people in different regions of the world. However, it decreases to 0.2 per 1000 people in the USA [10, 11, 12]. While in Turkey the incidence can be considered as 1.97 per 1000 people [13].

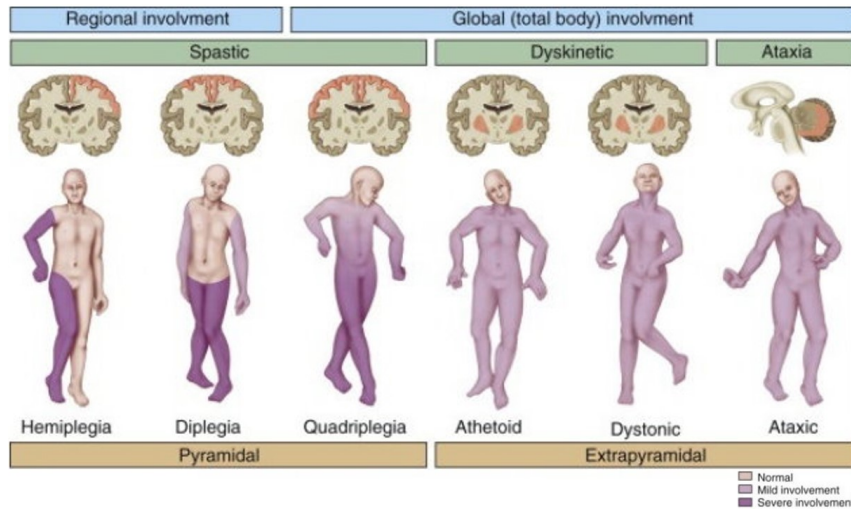


**Figure 2.8** Spina Bifida levels of severity of the physical disability

## Cerebral Palsy

Cerebral palsy "CP" is caused by damage that occurs to the immature, developing brain most often before birth or in the early childhood [14]. People suffering from cerebral palsy may suffer reduced range of motion at various joints of their bodies due to muscle stiffness. There are three categories of CP classified by the affected area in the brain that controls a group of muscle movement. The first type is spastic, and occurs in 70% of the cases, where the child manifests hypertonia, which means having tight leg muscles that can cause the toe-walk. The second category is the dyskinetic CP, which manifests itself by involuntary and sudden gestures. And finally, the ataxic type which is a lack of precise movement such

as holding a cup, typing or writing. Some cerebral palsies are a mixture of all three types. Most of CP young patients show other signs such as stiff joints, and abnormal posture.



**Figure 2.9** Cerebral palsy Types

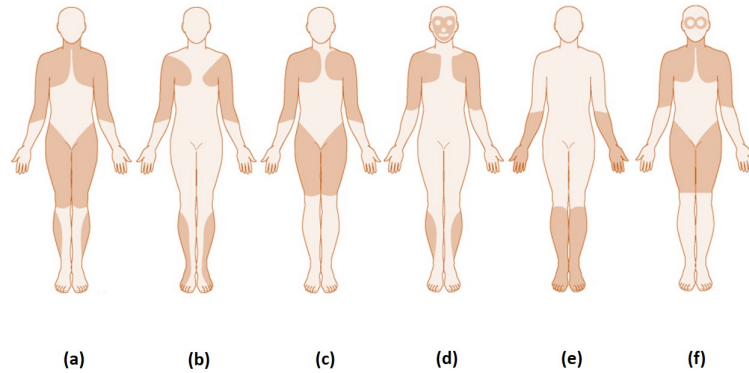
Cerebral palsy is the most common motor disability in childhood with a prevalence between 1.5 to more than 4 per 1000 live births across the world [15, 16].

## Muscular Dystrophy

The muscular dystrophies (MD) represent a group of several genetic diseases marked by progressive deficiency of the skeletal muscles that generate the human movement. Some types of MD can be detected in childhood, while others can be delayed to the middle age or later [17]. The disorders vary according to the distribution of muscle weakness, rate of progression, age of onset. The different types of muscular dystrophies are shown in Fig. 2.10.

The Duchenne & Becker Muscular Dystrophy considered as the most common types and occurring in 70% of the cases among teenagers with a prevalence of 19-25 per 100 000 persons [18]. It is caused by the lack of the protein "dystrophin" which is involved in maintaining the muscle's integrity. This disease has an onset at 3-5

years and progresses until the young teenager become unable to walk by the age of 12.

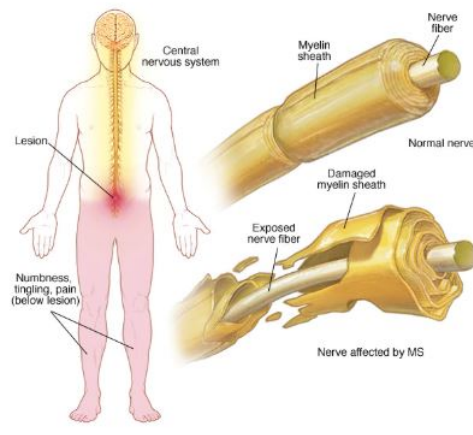


**Figure 2.10** Types of muscular dystrophies with illustration of affected muscles (shaded color), (a) Duchenne & Becker, (b) Emery-Dreifuss, (c) Limb-girdle, (d) Facioscapulohumeral, (e) Distal, (f) Oculopharyngeal

## Multiple sclerosis

Multiple sclerosis (MS) is a progressive disease that affects the myelin, a material that surrounds the nerve cells of the brain or the spinal cord (CNS), disrupting the capacity of several body parts related to movement and balance, see Fig 2.11. The inability to walk independently is an important consequence of MS, which severely limits mobility and the performance of daily activities, reducing full participation and reintegration into the home and community.

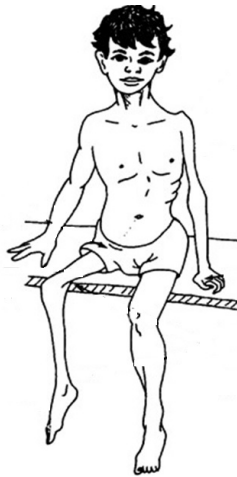
It is estimated that there is more than 1 out of 1000 people living with multiple sclerosis worldwide, (which is approximately about 2.5 million), and half of them are in Europe [19]. Africa rates are less than 0.5 per 100,000, while they are 2.8 per 100,000 in South East Asia, 8.3 per 100,000 in the Americas, and 80 per 100,000 in Europe [20].



**Figure 2.11** Multiple Sclerosis disease

### Post-polio Syndrome

After the initial bout of poliomyelitis or polio virus, the survivors (20 to 40 %) suffer from farther symptoms including weakness, joint/muscle pain and fatigue. These symptoms are known as the post-polio syndrome (PPS).



**Figure 2.12** Post Polio Syndrome

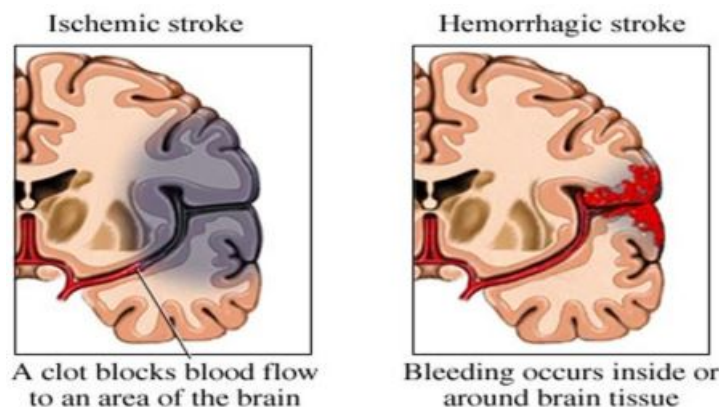
There are currently no absolutely defined causes of PPS. The most widely accepted theory of the mechanism behind the disorder is "neural fatigue". It tends to be progressive and can cause loss of muscle strength. It is estimated that

around 12-20 million people worldwide are disabled following a poliomyelitis [21], which at first affects the motor nerve cells.

### 2.4.2 Accidental Diseases

#### Stroke

One major outcome of stroke is hemiplegia, which means disability on one side of the body or limbs due to a block or bleed in the blood vessels, see Fig. 2.13. Stroke causes a greater range of disabilities than any other condition and can affect lower limbs in 70% of the cases [22]. For the stroke survivors, it often requires a long-term rehabilitation before can regain their independence while some of them never fully recover. Thus, they adjust to a new life where they are unable to walk, to work or to dress alone.



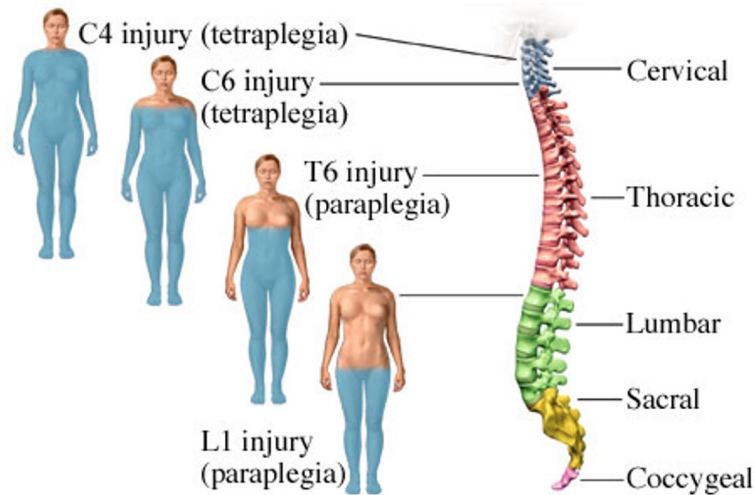
**Figure 2.13** Stroke types

More than 15 million people worldwide are concerned each year and approximately 6 million of them are left disabled permanently [23].

#### Spinal Cord Injury

A spinal cord injury represents a damage to any part of the spinal cord or nerves at the end of the spinal canal. It often causes permanent changes in strength,

sensation and other body functions below the place of the injury as shown in Fig. 2.14. Spinal cord injury (SCI) can be classified as either complete or incomplete. The complete injury means that the sensation is completely lost, and incomplete means that some sensory nerve cells remain functional. Several other complications may include respiratory problems, muscle atrophy, infections and pressure ulcers.



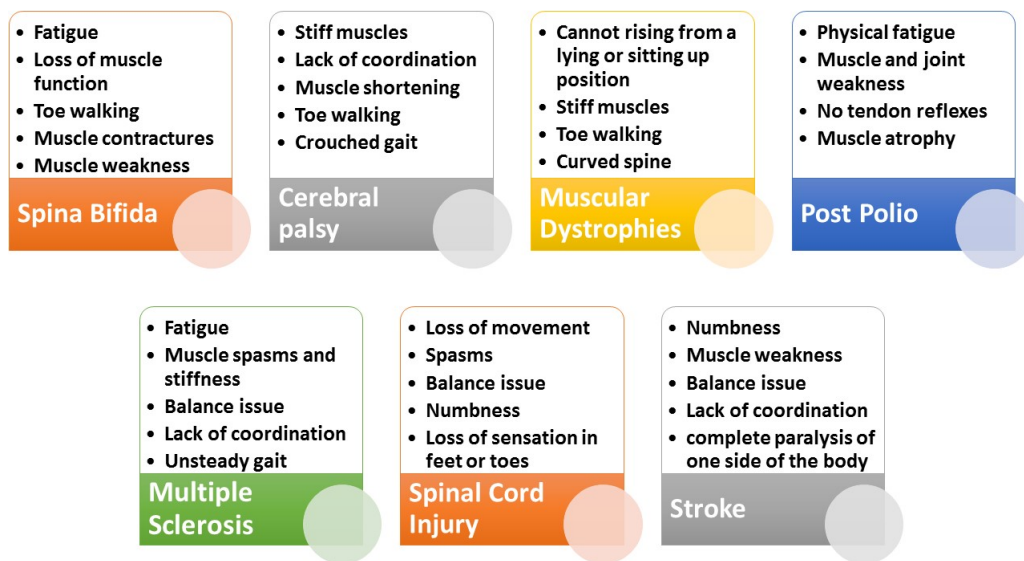
**Figure 2.14** Spinal Cord Levels

Although it is very uncommon among children, it is very frequent among adolescents and young adults, due to the higher risk accidents among this specific population [24]. Very few statistics on pediatric or adolescents SCI is available, on contrary of adults SCI which is estimated between 8 and 55 case per million, at the international level.

## 2.5 Physical Symptoms

These selected diseases have some common physical symptoms [25, 14, 26, 27, 28, 29] as shown in Fig 2.15, where we observed that they are somewhat similar, especially with regard to the motor skills of the weakened muscles. This similarity is obvious as most of the diseases result in the immobilization of the teenager body parts, often the lower extremity. The recurrent symptoms include muscle weakness,

loss of motor function, bladder and bowel loss of control, etc. However, some specific symptoms feature more in a condition than another one. For example, progressive weakness of muscles is a characteristic of Post-polio syndrome and Muscular dystrophies, fatigue is predominant in multiple sclerosis, and impaired sensation and movement commonly occurs after cerebral palsy whereas scoliosis (curved spine) is quiet spread in Spina Bifida.



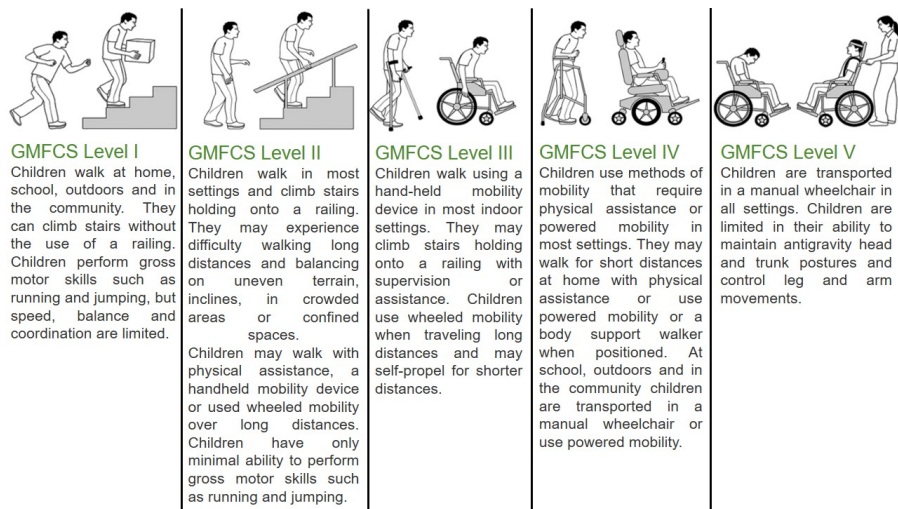
**Figure 2.15** The most common symptoms experienced by disabled teenagers following the studied disease

## 2.6 Physical Diseases Management

Usually, each patient is advised to physical therapy, with a resort to the use of medication in case of certain symptoms (such as pain or spasticity). The physical therapy is a necessity to improve the patient's quality of life, and to keep the body mobility and function from further degradation. It follows the patient throughout his life, either as a primary healthcare treatment or in concert with others treatments.



In general, the therapy consists of biomechanical exercises and movements to prevent the muscle weakness and fatigue in conjunction with management of pain with medication. For example, in the case of Spina Bifida, regular physical activity is important for all people, but especially for those with conditions that affect movement. Passive range of motion exercises a day [30] are usually recommended. Thus teenager patients may benefit from the exoskeleton technology to compensate for lack of strength in the lower limbs and to maintain the joints aligned properly [31]. While in the case of cerebral palsy, as it is the case of all types of paralysis, the treatment is multifaceted. Usually, the Gross Motor Function Classification shown in Fig. 2.16 [32] helps into identifying the physical therapy required accordingly to the physical condition. The general recommendation suggests that the therapy should start very soon after diagnosis to enhance motor skills and it is demonstrated that more frequent and targeted physical activity showed significant strength gains in muscle activity, with an increased cadence and the ability to walk faster [33].



**Figure 2.16** Gross Motor Function Classification System (GMFCS) of Cerebral Palsy with the experienced symptoms

Unfortunately, there is no medical cure for any of the various forms of muscular dystrophies but physical therapy is practiced to manage muscle deterioration, especially with range-of-motion exercises to prevent contractures and scoliosis. Indeed,

standing regularly for a few hours and moving around can keep the limbs stretched and flexible and consequently keeping tendons from shortening and avoiding contractures. Regarding the Multiple Sclerosis disease, despite the fact that its cause is still unknown and that it has no cure, medical management and physical therapies exist to improve the symptoms and prevent the disease progression and disability and it should start as soon as possible according to Kuhlmann et al. [34]. These therapies have yet to be individualistic in order to be truly helpful because the patients with the same type of MS can experience different symptoms. In a study referenced by Motl et al.[35], around 300 individuals with multiple sclerosis performed physical activity for only 7 days had reported lower levels of disability, fatigue and pain. For the Post Polio syndrome, physical fatigue is treated with muscle training, physical activity and avoiding muscle overuse and disuse. As is it the case for pain reduction, besides taking medication, doctors highly recommend weight reduction by practicing a regular exercises [36, 37]. The most common techniques to cope with the uppermost symptoms are summerized in the Table 2.1.

Symptoms	Management of the symptom
Muscle Weakness	Physical activity, muscle traning, avoiding muscle overuse and misuse
Pain	Medication, physiotherapy
Fatigue	Physical activity, muscle training, rest, avoiding muscle overuse and disuse, lifestyle changes, weight reduction, and, if required, medication for restless legs syndrome, depression, and sleep disturbances
Spasticity	Medication and Botulinum toxin treatment

**Table 2.1** The management of certain symptoms among the patients affected with the studied diseases

## 2.7 Cost Study

The therapy of each of the selected diseases engenders a high cost throughout the patient life time. It is critical to evaluate the true cost of the therapy as it varies for each country, and each patient. The cost is related to the rehabilitation which

includes : physical therapy, neurorehabilitation, speech rehabilitation, vocational rehabilitation, occupational therapy, etc. The care plan is established for each patient individually, but it often requires a multifaced team of doctors from these medical specialities, which is inducing a higher cost [38]. Not only does the cost limit the time of the therapy but also the fact that it can be labor-intensive for the therapist, as it generally consists of repetitive motions of the patient's limbs. For example, in France, according to this recent statistics study [39], the cost of health care provided to stroke patients is estimated up to 2.5 million euros per year. For the spinal cord injury, there are very rare cases of full recovery. In fact, most of the survivors, are left disabled, leading to higher cost (more than 1 million dollar at the first year for a quadriplegic and 800 000\$ each subsequent year) for both direct expenses such as rehabilitation sessions and indirect such as loss in productivity and wages [40].

## 2.8 Conclusion

We can observe that there is an important number of diseases that are causing motor disability to the children and adolescent patients, whether they are congenital or acquired. Most of their symptoms are progressive due to the disease nature (such as the muscular dystrophies, or the post-polio syndrome) and some of them are due to lack of physical activity and therapy. Besides, the dual challenge that adolescents are facing is the fact that their body grows very fast while growing up against the disease. This makes them the most vulnerable group of population above all, and are in need of special care and support to overcome these barriers. This support starts as early as possible and should continue along the adolescence growth as it is firmly thought to retard the symptoms progression. Hence, a scalable device for this kind of disease progression and early onset will give an added value for such population. For this purpose, a literature review on the existing caring solutions and rehabilitation devices needs to be addressed in order to better understand their classification and designs. This will help us to better introduce the scalability requirements and parameters for our proposed exoskeleton.

# Chapter 3

## State of the Art on the existing assistive devices, their actuation systems and structural design

### Contents

---

<b>3.1</b>	<b>Introduction</b>	<b>26</b>
<b>3.2</b>	<b>Rehabilitation Devices Classification</b>	<b>26</b>
3.2.1	Treadmill-based devices	26
3.2.2	Portable Devices	27
3.2.3	Existing Rehabilitation Devices Limitations	30
<b>3.3</b>	<b>Actuation Prior Art</b>	<b>32</b>
3.3.1	Electrical Actuators	33
3.3.2	Pneumatic Actuation	40
3.3.3	Hydraulic Actuation	42
<b>3.4</b>	<b>Exoskeleton Structure prior Art</b>	<b>47</b>
<b>3.5</b>	<b>Conclusion</b>	<b>50</b>

---

## 3.1 Introduction

Often, the rehabilitation exercises and movements are applied to patients by a robotic device or a practitioner/therapist. Since the patients will certainly benefit from the robotic-based therapy, due to its longer training time, repetitive tasks and its ability to be started at a young age. A review of the literature is made in regard to the existing medical robotic devices studying their categories, capabilities, limitations, sizes, positive and negative impacts to the patient's body and his/her quality of life. In addition, a survey on the existing type of exoskeleton actuators is made taking into account their problems and mechanical characteristics in order to better select the suitable actuation unit to be used in the scalable exoskeleton. Finally a review on the existing exoskeleton structures in order to define the key factors to address when designing a scalable exoskeleton for teenagers.

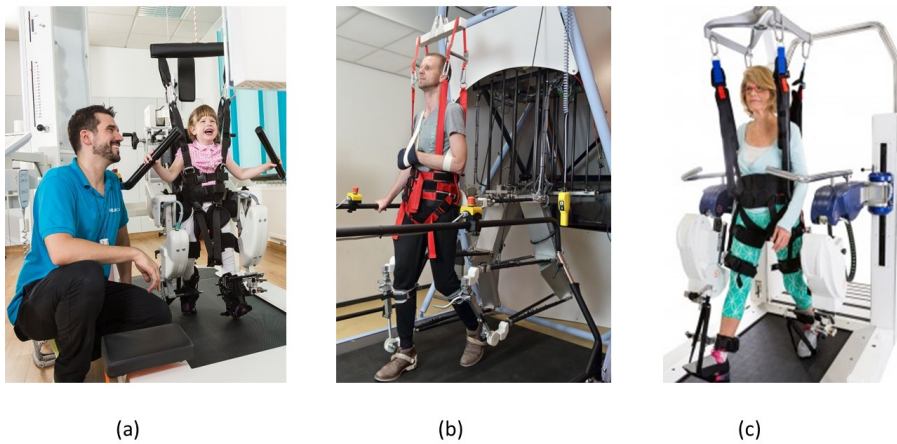
## 3.2 Rehabilitation Devices Classification

The medical robotic devices can be divided into two main categories, the treadmill-based devices and the portable ones. The first type is dedicated for indoor and hospital environments where the patient is held by a body weight support (BWS) and performing lower limb related exercises via a robotised orthosis on a fixed treadmill. The portable type of the medical robotic devices is presented as a device connected to the patients limbs enabling them to move their limbs with or without the aid of walkers/crutch.

### 3.2.1 Treadmill-based devices

As shown in Fig 3.1, the most well-known devices are: LOPES [41] by university of Twente, ReoAmbulator [42] by Motorika, and Lokomat by Hocoma [43]. This kind of robotic medical devices allows therapists to design a customized exercises that works towards improving patient balance, ambulation, coordination, stamina and posture through an intensive, repetitive re-training of normal movement of

the entire leg as well as the pelvis, in order to reproduce reciprocal, synchronized natural gait pattern. Although treadmill-based devices are improving the recovery of the young patients, but on the other hand, they are bulky in size, complicated, not affordable for personal use, and always require an operator or a therapist to adapt the patient into the device. For these reasons, their applications remain in rehabilitation centers or hospitals, making the entire procedure not self-oriented, and not always accessible for the majority of patients. Therefore, the recommended continuous program of rehabilitation can not be achieved resulting in significant loss of recovery benefits, and reduces the efficiency the diseases management.



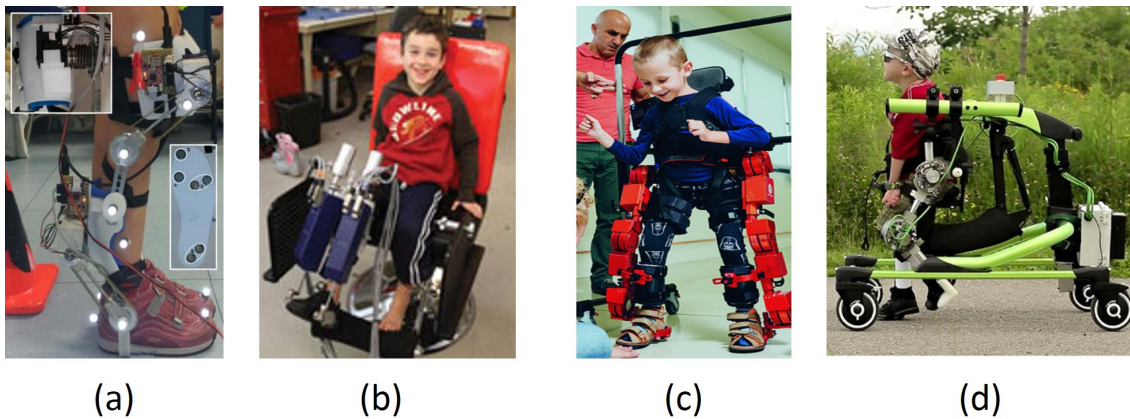
**Figure 3.1** Treadmill-based exoskeletons (a) Lokomat (b) Lopes (c) ReoAmbulator

### 3.2.2 Portable Devices

Parallel to these devices, the portable exoskeletons emerged and are commercialized for a wide range of applications including the rehabilitation and motion restoration. A portable exoskeleton could reduce the number of therapists needed by allowing even the most impaired patient to be trained alone, so the training would be more uniform, more frequent and can be specifically customized for each patient. Hence, the main advantages of using portable exoskeleton instead the

treadmill-based devices are to overcome the intermittent short sessions in the hospitals (e.g. 1 hour per week) by practising the rehabilitation exercises at home in a daily way, and to provide more extra advantages of standing up, walking and doing daily tasks when/ where needed.

Recently, some children exoskeletons are under development like WAKE-UP by the university of Tuscia [44], Pediatric Anklebot [45] by the Massachusetts Institute of Technology, ATLAS 2020 [46] by Marsi Bionics, and Trexo exoskeleton by Trexo robotics as shown in Fig 3.2 a, b, c, and d respectively. The ATLAS 2020 is mainly dedicated for children aged only between 3 to 14 year old to perform walking. Its design consists of 5 degrees-of-freedom per leg, two at the hip, one at the knee, and two at the ankle [46]. Its user's height must be from 100 to 153 cm, and its limbs are adjustable from 24 cm to reach a maximum of 33 cm for both thigh, shank. The Trexo is designed to help children with disabilities experience walking only. Its design consists of an ordinary walker attached two wearable robotics legs. It has two degrees of freedom per leg, both are in the sagittal plan on the hip and the knee providing the flexion and extension movements. The other devices such as the Anklebot or the WAKE-UP are therapy devices and cannot help doing all the daily life activities (e.g. walking, standing-up, etc) since they are designed for level walking trials without body support [45] [47].



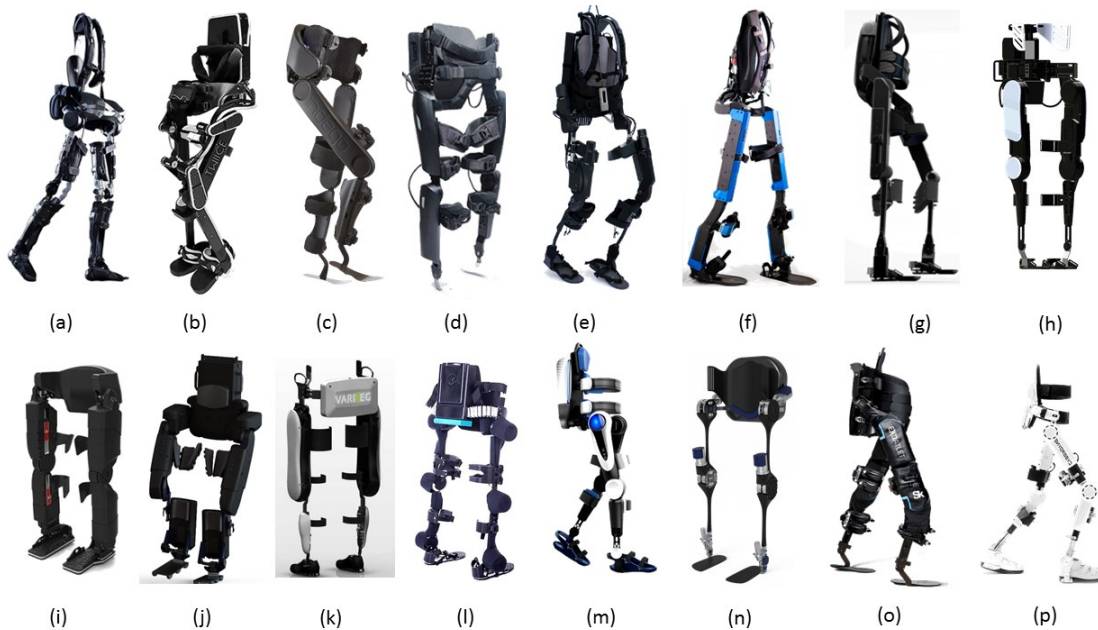
**Figure 3.2** Mobile exoskeletons for children (a) WAKE-UP (b) Pediatric Anklebot (c) ATLAS 2020 (d) Tréxo

The Fig 3.3 illustrates the rehabilitation devices designed for adults patients who can move their upper body and suffer from lower limb diseases [48]. The Indego (Parker Hannifin Company, USA)[49], Rewalk (Argo, Israel)[50], EKSO GT (Ekso Bionics, USA)[51] are commercial exoskeletons for clinical and personal use, except the Ekso GT which it is only for clinical use. They are essentially walking devices, but they can carry out additional activities such as sit-to-stand, stand-to-sit, stairs ascending and descending. For example, Indego cannot achieve the sit-to-stand motion for a fully disabled patient, but it can do that for someone using it to augment his/her muscle strength. On the other hand Rewalk can do all of the predefined activities for all patients type. The workspace of these exoskeletons is included in the sagittal plane(flexion/extension). Their design consists of two active degrees of freedom per leg (hip and knee) and one passive at the ankle. Their limbs lengths can be adjusted with discretized steps as well as their hip width. For example the Rewalk has only 5 fixed limbs length that are 29, 31, 33, 35, and 37 cm [45], and the Indego hip width that can be fitted up to a maximum of 42.2cm. For these reasons, they come in different fixed sets of sizes such as small, medium, and large, fitting users' height and weight from 155-191 cm & 113 kg for Indego, 160-190 cm & 100 kg for Rewalk, and 150-190 cm & 100 kg for Ekso GT.

Other exoskeletons that are under development from academic communities such as X1 Mina V2 (Florida Institute for Human and Machine Cognition), Varileg (Eidgenössische Technische Hochschule Zürich ETHZ, Switzerland), March II (Project March, University of Delft, Netherlands), and from companies Arke (Bionik Lab, Canada), ExoAtlet (ExoAtlet, Russia), ROKI (ROKI Robotics, Mexico), TWIICE (Laboratory of Robotics Systems LSRO, Switzerland), H-Mex (Hyundai, South Korea), and Pheonix (SuitX, USA). Although TWIICE had an older version that had fixed steps adjustable lengths to fit patients from 135-158 cm. but in the last version, it was made for the sake of the Cybathlon competition that only fits the competitor's height of 158cm. The H-Mex is an assistive device that can support up to 40 kg of the patient's weight. Pheonix is a hip exoskeleton and thus cannot perform daily life activities.

On the other hand, REX (Rex Bionics, New Zealand) and ATALANTE (Wan-





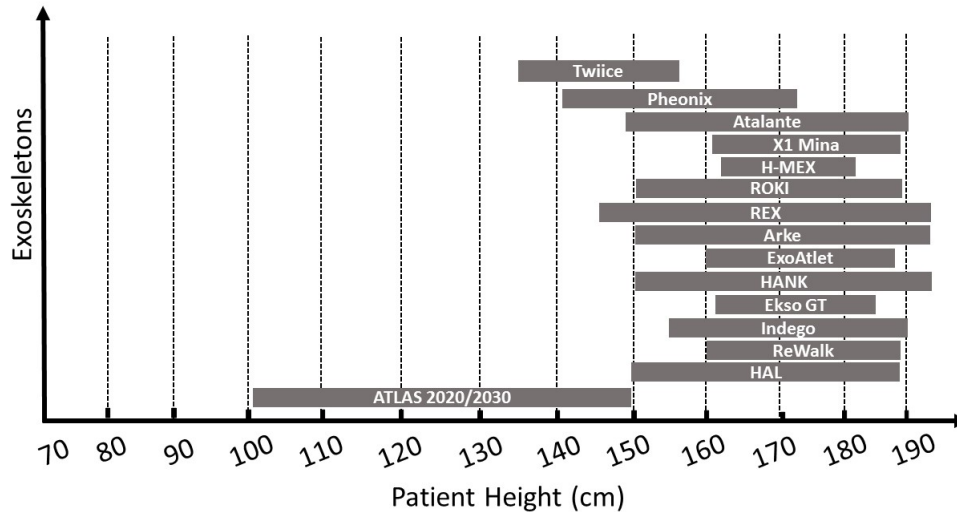
**Figure 3.3** Adult exoskeletons : (a) PheoniX (b) TWIICE (c) Indego (d) Rewalk (e) EKSO GT (f) MINA (g) ARKE (h) ITRI (i) REX (j) ATALANTE (k) VariLeg (l) HANK (m) Fourier X (n) MARCH II (o) ExoAtlet (p) HAL

dercraft, France) are self-stabilizing and hands-free exoskeleton, designed for both rehabilitation and personal use. The REX has 5 active degrees-of-freedom per leg: two at the hip, one at the knee and two at the ankle, whereas ATALANTE has 6 actuated degrees-of-freedom per leg. The REX has fixed sizes to fit different heights of patients from 142 – 193 cm and weighing no more than 100 kg. The hip width is also adjustable to a maximum value of 38.1 cm. ATALANTE is still under development and limited information is available about adjustability.

### 3.2.3 Existing Rehabilitation Devices Limitations

Fig 3.4 shows the supported patients sizes by the existing exoskeleton where a gap can be observed during transition phase of the teenage. Hence, most of the available exoskeletons are only valid for adults with heights varying between 160 and 190 cm. Although, some of them use adjustability as one of their features,

their designs only provides a very limited window for truly adjusting the size. Moreover, this adjustability is discretized in 3 or less steps.



**Figure 3.4** Supported Patient Sizes by the existing exoskeletons

These devices, even the commercial ones, are only functional in a limited and intermittent period of the patients' life, and they are not taking into consideration the size variability of teenager's bodies since they are only dedicated either to children or to adults. Their limitation is not only in their size but also in their dynamic performance, as the required torque varies tremendously throughout the period of growth. Hence, these devices face double challenges when using them by teenagers:

- The complex nature of the teenager body morphology which change rapidly for a relatively short duration of the growth time.
- The progressive nature of the disease itself engendering issues such as the asymmetry and the misalignment between the human- exoskeleton joints.

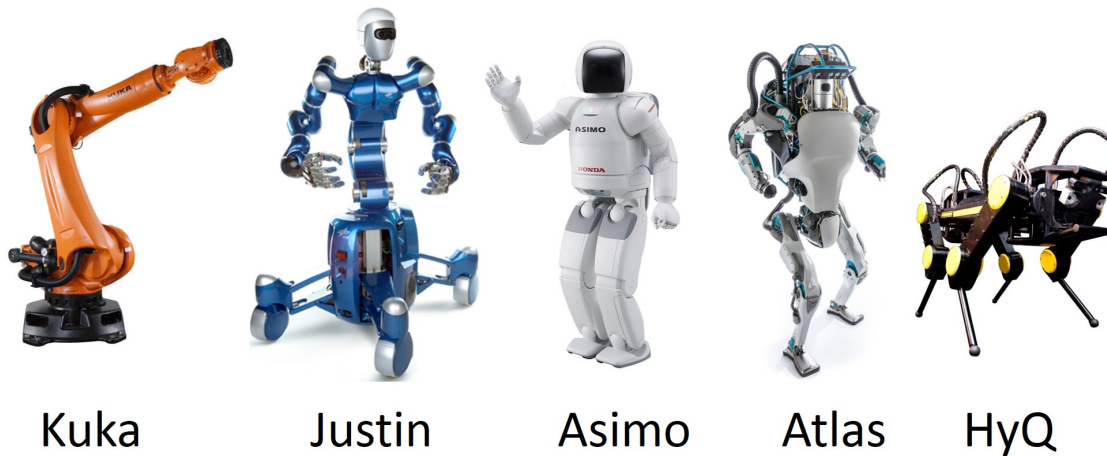
Thus, there is a considerable population of patients (teenagers) that are marginalized and still cannot benefit from the available exoskeletons. One of the

possible solutions for them is to start using a child exoskeleton at first and then switch to an adult exoskeleton later on. But due to their fast growth rate [2], this solution is not preferable as it causes a financial, social, psychological, and physical burdens to change the exoskeleton type (children to adult), and it would be expensive to continuously adapt different devices of the same type to fit patient's body during the adolescence period. So the concept of having only predefined sizes of the device doesn't help in solving such a problems and in fact may end up being rejected and not used so often, brings the necessity of a continuously and smoothly scalable exoskeleton rather than having fixed sizes. This kind of limitation for such exoskeletons is caused by the complexity in their mechanical design and integration. And it needs to be addressed in details in order to better define this limitation impact on the scalability of such systems. Therefore, this leads us to do a review study on their actuation integration and structural design.

### 3.3 Actuation Prior Art

In the wearable robotics field, the problem of actuation remains one of the greatest challenges. Sophisticated control methods are required to improve these systems' performance, while more and more requirements are necessary to ensure safety, compliance since the new generation of robots and devices are interacting with human and their environments. This interaction is essential and has been applied in several of applications as shown in Fig 3.5, such as Humanoid robots (ATLAS and PETMAN produced by Boston Dynamics, HYDROID by the University of Versailles, etc.), robot manipulators such as (DLR Robot manipulator, Kuka Robots), Quadrupeds Robots (Big Dog and SPOT by Boston Dynamics, SheetaH by Massachusetts Institute of Technology, HyQ by the Italian Institute of Technology, and in the wearable devices (Bleex, Rewalk, Lokomat, etc). Since we are treating the problem of the scalable exoskeletons actuation unit, we will focus on the development of the actuation unit in the field of the exoskeleton and rehabilitation devices.

To meet these requirements, actuation technologies are generally designed and



**Figure 3.5** actuation of robots in various application

applied to move exoskeletons by transforming the energy source into mechanical power to produce motion. The essential and desirable properties of actuators must include: (1) high power to weight ratio; (2) ability to produce high power and force; (3) compact size; (4) high efficiency; (5) high ability to be controlled; (6) ability to generate natural human-like motion. It is clear that for safety reasons, the actuator must also ensure the active compliance for these robotic devices. In addition, some engineering requirements should also be fulfilled when designing an actuator e.g. the light weight, affordability, modularity etc. In fact, there are a large number of types of actuators with different properties. The three types of conventional robot joint actuators are electric, pneumatic and hydraulic actuators. They have been successfully used for all kinds of robots in recent decades. Newer actuators can be based on shape memory alloys, electro-rheological fluids, electroactive polymers and piezoelectric actuators. But according to our point of view, we cannot use the majority of them due to their small forces or complexity.

### 3.3.1 Electrical Actuators

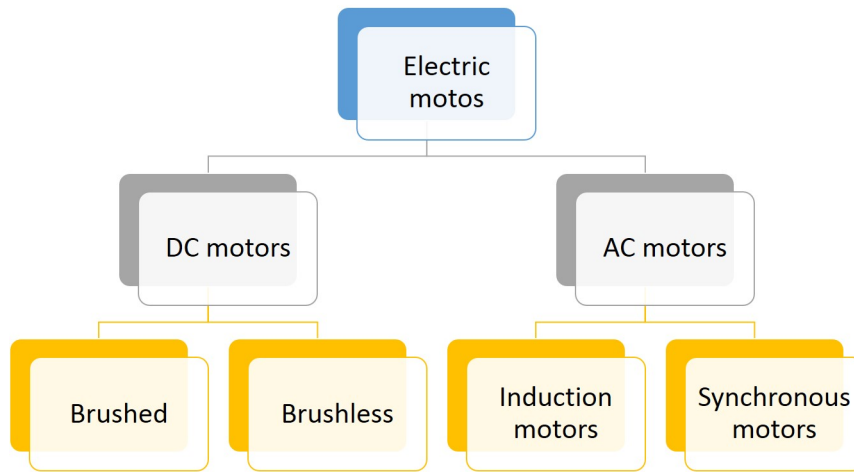
Electrical actuation is typically used in the majority of exoskeletons in different ways (e.g. gait restoration, rehabilitation, power increase, etc.). It should be

noted that electric actuators have the advantage of low cost and ease of use and control. However, a number of disadvantages arise when using electric motors with reduction device.

The principle of all electric actuators is based on the electric motor used, and therefore on the force generated by an electric current flowing inside the wire of a coil in the presence of a magnetic field. There are several types of electric motors that differ mainly in the number of coils, their configuration, the type of synchronization and the current profile (DC or AC). The first classification of the electric motors can be shown as 2 categories, the linear and the rotary. Although linear motors (solenoids) exist, they are not within our scope due to their low generated forces. Thus, Our study will therefore focus on the types of electric rotary actuators.

As shown in Fig 3.6 which describe the classification of the electric motors, the Brushed DC motors are constructed with a wound rotor (with coils) and a stator with either permanent magnets or coils. They usually have two or more poles and use direct current and brushes to alternately power the rotor coils. Brushless DC motors do not have brushes to accomplish the switching of the coils. Instead, they need an electronically controlled commutation system. While the rotor contains the permanent magnet, the coils are located on the outside at the stator. Regarding the AC motors, there are two types, depending on the type of rotor used. The first type is the synchronous motor, which rotates exactly at the supply frequency or a sub-multiple of the supply frequency. The rotor is constructed from either permanent magnets or electromagnets energised by direct current supplied through slip rings. The second type is the induction motor, which turns slightly slower than the supply frequency.

By refereeing to Fig 3.7 the Brushless type (BLDC), fare popular in the robotic field because of their higher speed and torque capabilities, higher power density, low maintenance and improved efficiency in comparison with brushed DC motors and the AC motors. They are faster because they do not have brushes that create friction and require less maintenance because no brushes have to be replaced periodically. They are more efficient because the heat created in the coils of the stator



**Figure 3.6** Types Electric Motors

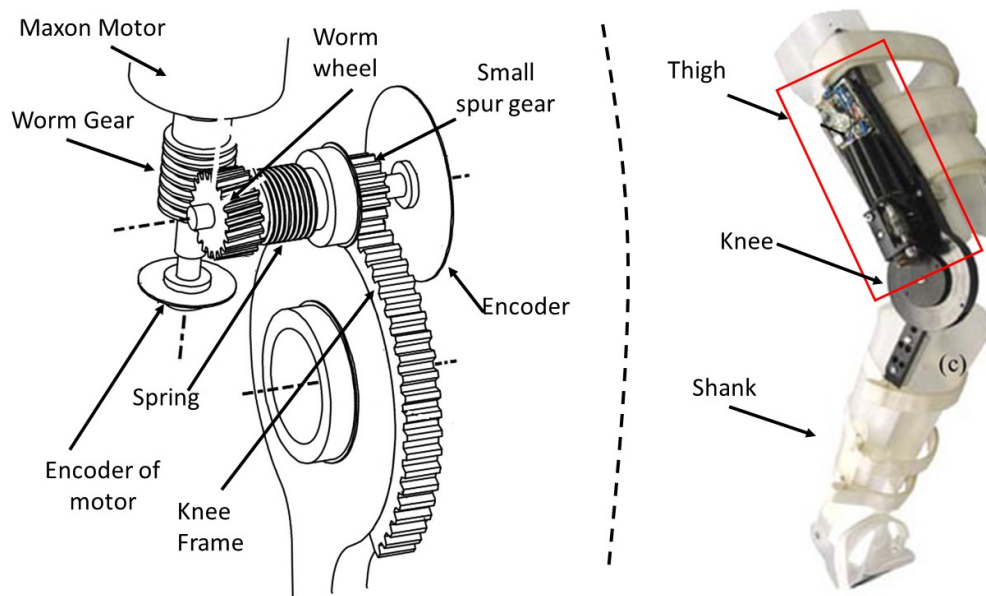
can dissipate more quickly through the motor housing. Disadvantages include high initial cost and more complicated motor controllers according to [52, 53].

Feature	BLDC	BDC	AC
<i>Commutation</i>	No needs to brushes	Brushed commutation	
<i>Maintenance</i>	Low due to the absence of brushes	Depending to the brushes	Low due to absence of brushes
<i>Lifetime</i>	High	Low	High
<i>Efficiency</i>	High, no voltage drop from brushes 90%	Low, voltage drop due to friction 80-90%	5 to 40%
<i>Heat dissipation</i>	High, the stator has the winding connected to the housing	Heat dissipate in the small clearance between the rotor and the stator , thus the temperature increase and limits its power density properties	High, the stator has the winding connected to the housing
<i>Rotor inertia</i>	Low, due to the permanent magnets instead of winding, inertia decreased	High, decrease the dynamic properties	High due to winding
<i>Speed range</i>	High, no mechanical limitation due to the missing of brushes	Low, due to the present of brushes	Intermediate
<i>Noise</i>	Low, no friction	High, due to brushes friction for commutation.	Low, no friction
<i>Control</i>	Complex, controller required for motor running	Simple, no need for controller to let the motor work for constant speed.	Intermediate
<i>Power to weight ratio</i>	High	Low	Low

**Figure 3.7** Comparison between Brushless DC, Brushed DC, and AC motors

On the other hand, when using these motors to build the actuator of a wearable device, and due to the almost rigid connection between the motor and its payload, the lack of the development of a specific control algorithm or the addition of extra mechanical components springs or dampers, it is difficult to produce the necessary changes in stiffness to ensure the needed safety. Moreover using traditional actuators in some wearable robots showed certain inherent limitations, such as a poor torque density of the motors at low speed as well as high friction, backlash, resonance, torque ripple, and noise of the gears. This question has been studied by many researchers in both fields control and mechanical design. This is because the adaptive compliance (mechanically or by control) has proven to be a valuable addition to increasing the safety and stability of human-robot interaction in gait rehabilitation robotics and wearable devices. Elastic actuators with/without variable stiffness were developed for this purpose. Compared to the non-backdrivable actuators, the elastic actuators presents several advantages such as shock tolerance, lower reflected inertia, more accurate stable force control in unconstrained environments, and energy storage.

The Rewalk Exoskeleton is a mechatronic support and movement system that works via a shifting of weight. The motors perform the movements of the hips and knees thanks to four maxon brushed DC motors and gearheads. The RE40 DC motors with a planetary gearhead are designed for up to five years of service or 1,000,000 steps. Made with ceramic components to extend the service life of the motors they had to be 100% reliable, low maintenance and powerful yet small. The same mechanism is used in Ekso Exoskeleton. A similar combination done by Kong et al. [54] called "Compact series elastic actuator" (cRSEA) at Sogang University, South Korea which is designed for assisting the knee joint as shown in Fig 3.8. The proposed device, a compact series elastic actuator, utilizes a torsional spring in the chain of spur gears and worm gears, which allows the accurate control of the generated assistive torque. The proposed system is compact and mobile such that it can be utilized for mobile human assistive systems. Regardless of the interactions with humans and the noise included in the desired torque signal, the cRSEA generated the required torque.



**Figure 3.8** Serial Rotary Actuator of The Wearable Assistive Device of Sogang University

The ATLAS 2020 exoskeleton by Marsi Bionics is a child rehabilitation exoskeletons. It is designed to provide torque assistance to the joints with Rotary Series Elastic Actuator (RSEA), which consists of a servomotor with integrated Proportional Integral Derivative,(PID), position and velocity controller, and a torsional spring on the output shaft of the actuator, as shown in Fig 3.9.

VariLeg Exoskeleton (developed by ETH Zurich) uses impedance control to achieve performance comparable to human legs. Its joints are driven by a variable stiffness actuator (VSA). The VSA is used in an impedance controller to modulate the stiffness according needs of the human gait, which is thought to improve stability and efficiency of ambulation. The actuation of this exoskeleton is achieved by commercial DC motors connected through a transmission via a Harmonic Drive Gearbox. The VSA consists of two motors: one sets the equilibrium position of the shank relative to the lever unit. The other motor pretensions the spring that connects the lever unit to the thigh. See Fig 3.10.

Delft University developed an exoskeleton called MINDWALKER to enable paraplegics, where another serial elastic actuator (SEA) has been used [55] (see



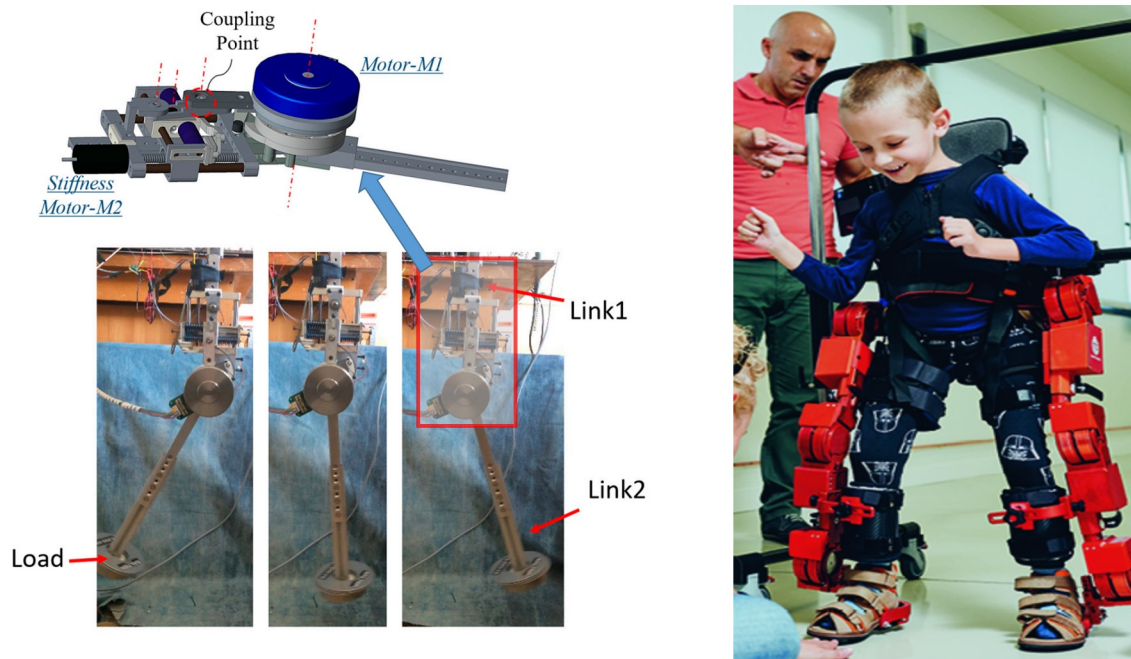


Figure 3.9 Serial rotary Actuators of Atlas Exoskeleton

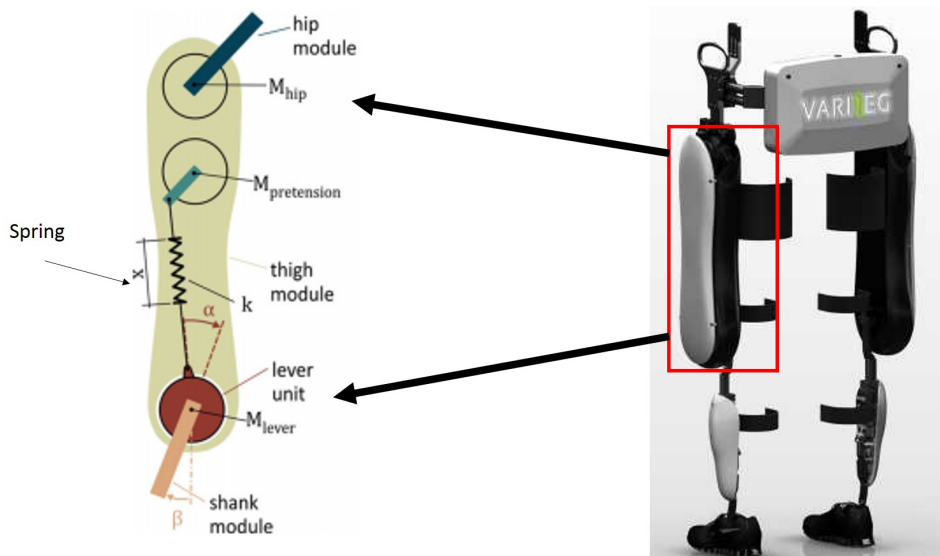
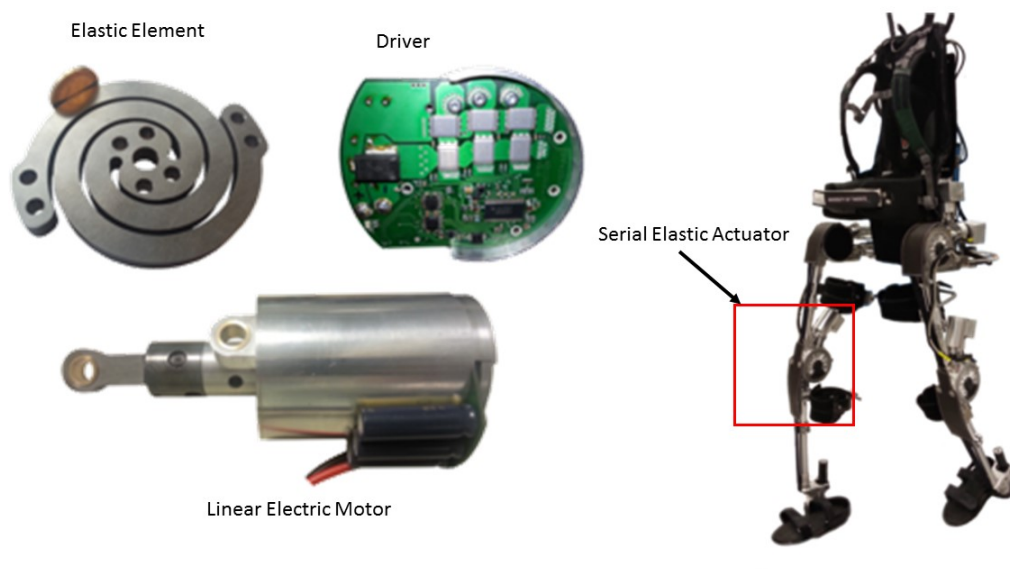


Figure 3.10 Varileg Exoskeleton

Figure 3.11). There are three DoFs at the hip joint, one DoF at the knee joint, and two DoFs at the ankle joint. The abduction/adduction and flexion/extension

of the hip joints and the flexion/extension of the knee joints are powered using the SEA actuators. Each SEA actuator, which consists of a double spiral spring, a lever arm and a linear actuation, can deliver 100 Nm torque and 1 kW power, a brushless DC motor and a ballscrew transmission. Due to the use of the high torque-to-weight ratio SEA, the total weight of the exoskeleton is 28 kg, while the weight of each SEA is 2.9 kg.



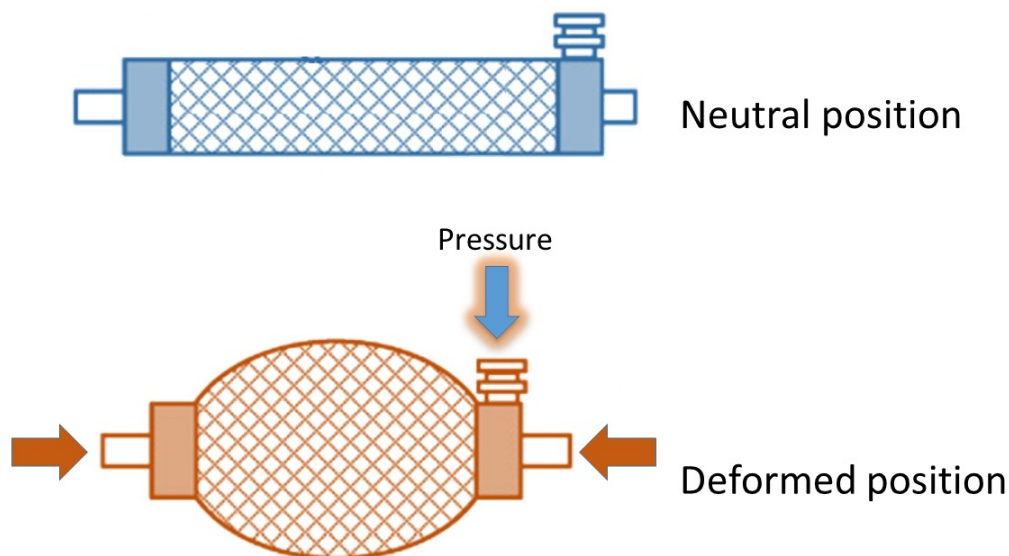
**Figure 3.11** Mindwalker Exoskeleton and its serial elastic actuator

For the above mentioned electrical solutions, adding mechanical components (passive or active) leads irremediably to a substantial increase on the size and the complexity of the mechanical hardware. Although, a high gear box reduction ratio has to be chosen, it is always limited and cannot be increased indefinitely, which is clearly a limitation if the optimisation of the energy consumption is needed. Finally, electric actuation systems have to be sized for the worst case, defined by satisfying the instantaneously highest torque required ("peak" torque for a long period). This leads also to a non-optimal selection: a large electric motor, which will not be used all the time at its full capacity.

### 3.3.2 Pneumatic Actuation

Another possible solution of actuation is represented by the pneumatic power, which can divide the actuators into two types, the conventional pneumatic actuators (linear pistons, rotary pistons, etc) and the artificial muscles. In this thesis and due to the lack of information concerning the conventional types' application in robotics interacting with the human, we will focus on the second type.

According to [56], the first concept of the pneumatic artificial muscle was presented by McKibben for prosthetic applications in the 1950s. The pneumatic artificial muscles are very simple to manufacture and can be used in an antagonistic form similar to that of the human skeletal muscles. The pneumatic artificial muscle is widely considered as an efficient actuation mode for wearable exoskeletons due to its specific characteristics, such as high power/weight ratio, relatively light weight, and inherent compliance. Moreover, they are very safe and suitable for rehabilitation purposes due to their inherent compliance and limited maximum contraction [57].



**Figure 3.12** Working principle of McKibben artificial muscles

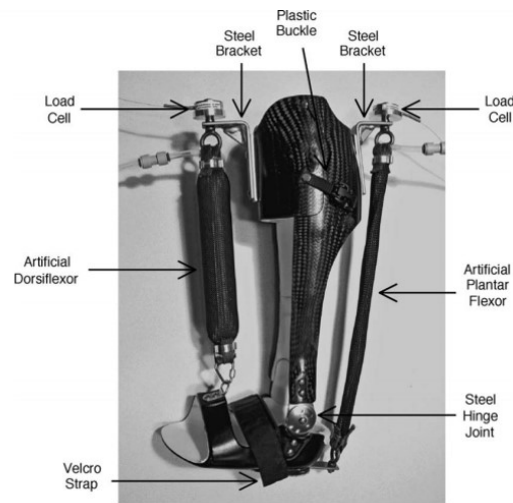
A recent development [58] of a lower body 10-DoF exoskeleton for actively assisting in human walking with the use of artificial pneumatic muscles as actuators (see Fig 3.13) was achieved by University of Salford, United Kingdom. There are 3 DoFs at each hip joint, 1 DoF at each knee joint, and 1 DoF at each ankle joint. Artificial pneumatic muscles are used to provide a flexion/extension torque at each active joint. Due to the use of pneumatic muscles, the resulting exoskeleton is very portable, and the total weight (excluding the power source) is less than 12 kg.



**Figure 3.13** The Pneumatic Exoskeleton "Human Friendly Orthosis" Developed by the University of Salford, UK

A powered lower limb orthosis [59] for motor adaptation and rehabilitation purposes using artificial pneumatic muscles to provide flexion and extension torques at the associated joints. Experiments show that this lower limb orthosis can supply a substantial plantar flexor torque: 57 % of the peak ankle plantar flexor torque during stance and 70 % of the plantar flexor torque generated during normal walking.

The pneumatic actuators are a soft and practical solutions for such devices [60]. However, they have showed nonlinear features, too slow dynamics during position

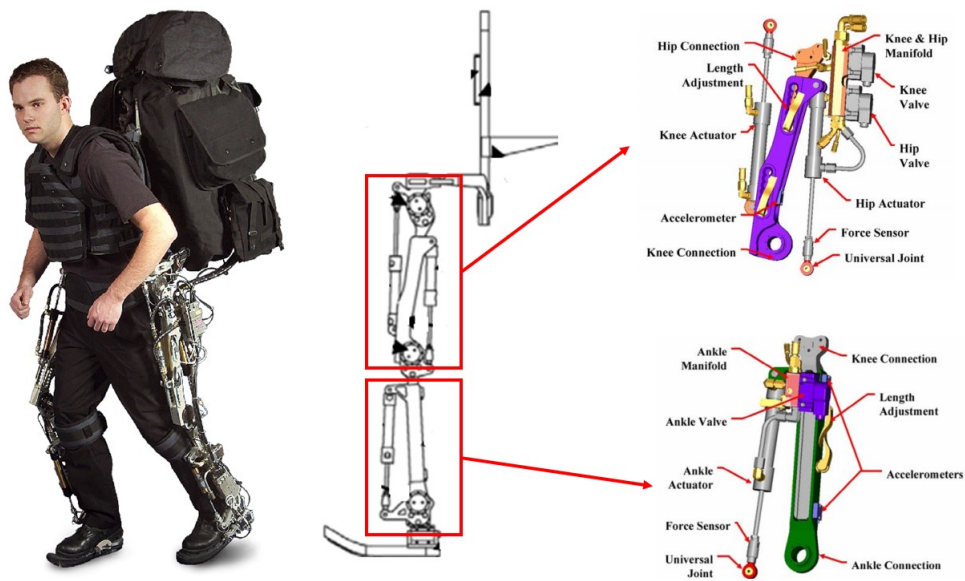


**Figure 3.14** Pneumatic Ankle-Foot-Orthosis exoskeleton Developed by the University of Michigan

control, noisy, and require the use of pressurized air via a bulky tools [61]. For instance, their control bandwidth is relatively low compared to that of hydraulic actuation. This is because the hydraulic fluid is generally incompressible, while the pneumatic muscles use compressible fluid.

### 3.3.3 Hydraulic Actuation

Another interesting technology for actuating the robotic systems such as exoskeletons is the use of hydraulic power. Hydraulic actuators are driven by a pressurized fluid such as mineral or synthetic oil or water. This technology, based on a central hydraulic power unit or integrated electro-hydraulic actuators, has shown exceptional performance in recent years in several applications. Due to the high power to weight ratio of the hydraulic and pneumatic actuators, they are usually considered suitable choices for exoskeletons designed mainly for human performance augmentation. The Berkeley's lower extremity exoskeleton BLEEX, see Fig 3.15, and the Sarcos (XOS 2) exoskeleton are two typical examples of this type of exoskeleton, and both were sponsored by the Defense Advanced Research Projects Agency known as DARPA.

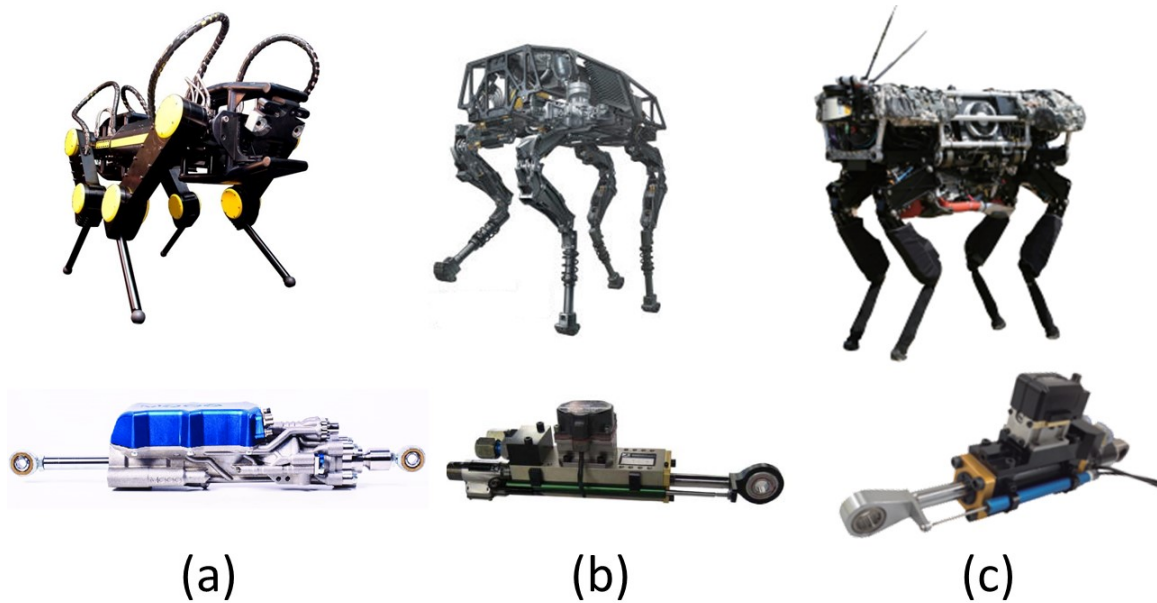


**Figure 3.15** Bleex Exoskeleton and its actuators

The goal of these two exoskeletons is to “increase the capabilities of ground soldiers beyond that of a human” [62]. BLEEX also has other potential applications such as helping disaster relief workers, wildfire fighters and emergency personnel carry major loads typically associated with high-demand labor [63, 64, 65]. Linear hydraulic actuators are used in BLEEX due to their high-force capabilities. The actuators’ size is not compact as shown in Fig 3.15, which make them not suitable for scalable applications. For the above purposes, the BLEEX and Sarcos exoskeletons are used to support their weight and provide the ability to carry extra loads.

Another trials are made to use the hydraulic actuators in robotics application are shown in Fig 3.16, where two hydraulic integrated linear actuators of HyQ and big dog quadrupeds. The Linear hydraulic actuator units consists of a custom made cylinders with integrated 2-stage electro-hydraulic valve, position and force sensors. This actuation strategy is similar to the one used in BLEEX, but it is more compact and modular.

Also, KNR systems has developed several rotary actuators that can be adapted to form different systems, providing high levels of mechanical stiffness and torque

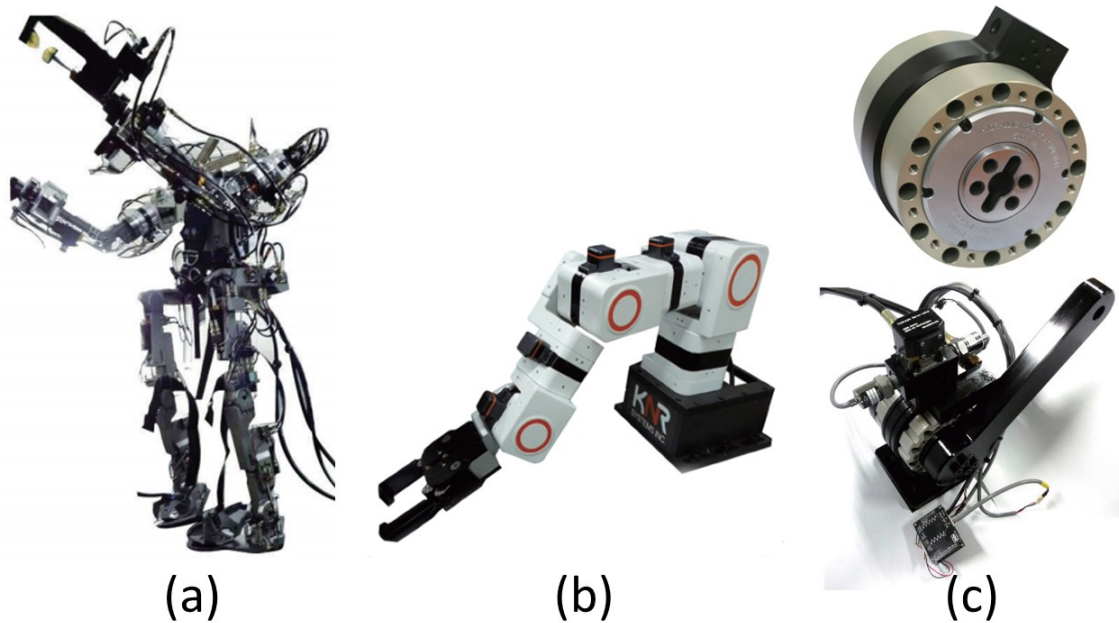


**Figure 3.16** Integrated Linear Actuators used in (a) HyQ, (b) Big dog (2008), (c) MKE Quadruped

(see Fig 3.17). According to the manufacturer, these kinds of actuators can be implemented to yield a torque-to-weight ratio about 10 times higher than a standard motor and Harmonic Drive configuration. One of the advantages of rotary actuators is that they can be added to a system easily, with a simple insertion between two links. There's no need for extra parts, such as bearings and gearheads, so joints are guaranteed to have precise and powerful movements and links have no need for clearance. Their precision makes them ideal not only for robots, but for other industrial applications and testing.

There is different types of mounts, and their actuators have different levels of power from 300 Nm, 500 Nm, and 1000 Nm at 210 bar. They have shown an interesting demonstrations that represent the compliance behaviors of their actuators which make them suitable for wearable robots.

For this kind of hydraulic actuation (conventional), a pump is generally used to produce the pressure and flow required to operate several actuators. This solution has been able to demonstrate high performance, both for high output forces and for



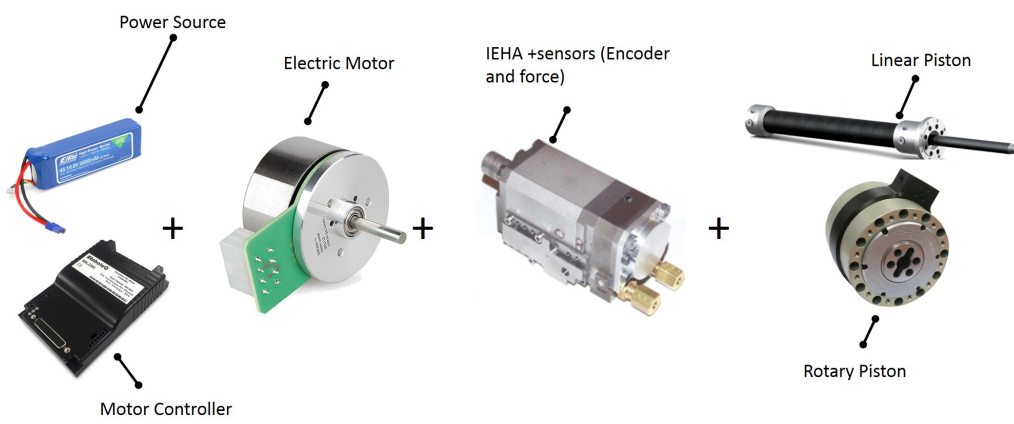
**Figure 3.17** Integrated rotary hydraulic actuators developed by KNR systems and used in several applications (a) MOTIE industrial Exoskeleton, (b) MKE Quadruped, (c) rotary actuator unit RH-D30 by KNR systems

the generation of fluid movements. However, the hydraulic central group solution suffers from several drawbacks. First, and in our opinion, the major one is related to the whole system dimensioning leading to the necessity to satisfy the worst case requirements in terms of low/high pressures needed by all the joints. Another disadvantage is linked to the increase of the whole size and the weight of the system, caused by the fact that each hydraulic actuator needs one servo valve to be driven as required. Moreover, carrying on the hydraulic central group limits drastically the use of this technology in the case of the development of autonomous systems. The used servo valves to control hydraulic actuators leads also to severe decrease in backdrivability. Further drawback concerns the hydraulic tubes passing through the joints needed to connect the hydraulic motors to the central group. This induces an increase of potential leakage in the connections and pressure drop.

Based on the analysis of above mentioned solutions, several researches investigate how to merge them in order to take benefit of their advantages. This leads



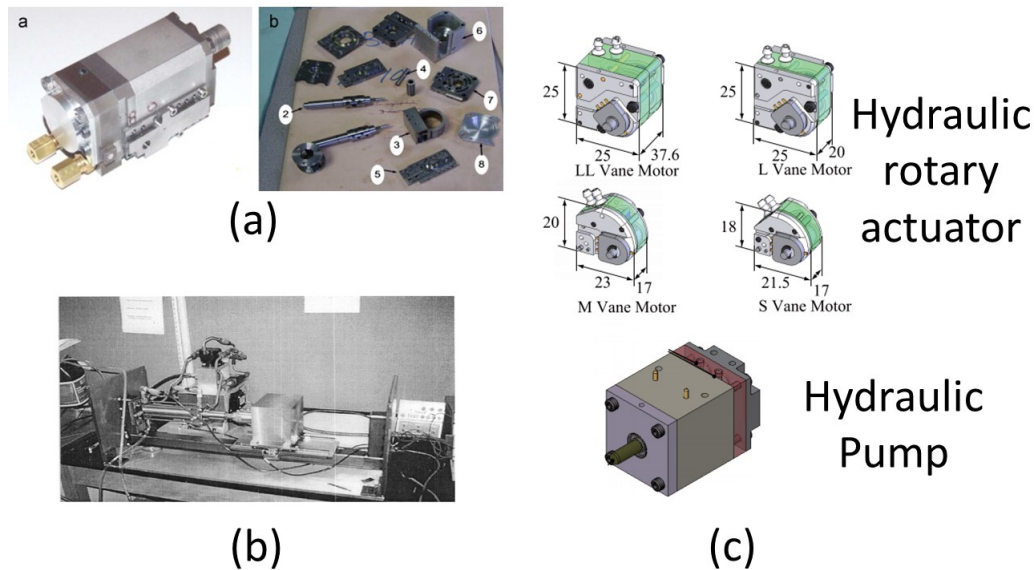
to a technology named Hydrostatic Transmission, first proposed for robotic application by Bobrow and Desai at the beginning of the 1990s [66]. The major objective of using this technology is to take advantage of the high power to mass ratio present by hydrostatic transmission systems versus the conventional type. As shown in Fig 3.18, the main components of an Electro-Hydraulic Actuator (EHA) are: an electric motor, a hydraulic pump (may be bidirectional or not), pressure and positions sensors and its reservoir(s). The last component is the hydraulic actuator itself, which can be either linear or rotary.



**Figure 3.18** Integrated Electro hydraulic actuators combination

Habibi et al. introduced the concept of Electro-Hydraulic Actuator (EHA) based on a fixed displacement pump with speed variation with a controlled motor. They also designed a symmetrical linear actuator to show high performance while moving a 20 kg load, through a high pressure and specific high gain control laws [67]. The same EHA was used to carry out high precision micro and nano-manipulation tasks [68]. Kargov et al. have developed a miniaturised hydraulic actuation system for artificial hands [69]. Recently, Nakamura et al. carried out hydrostatic transmission research to activate an anthropomorphic robot hand and developed a miniature solution composed of hydraulic pump (20mmx20mmx30mm) and different rotary van actuators [70] and a new joint for a humanoid robot [71]. AlFayad et al. has developed the integrated Electro-Hydraulic Actuator (IEHA), where he proposed solution of the hydrostatic transmission is based on the power

transmission from an electric motor to a hydraulic actuator.



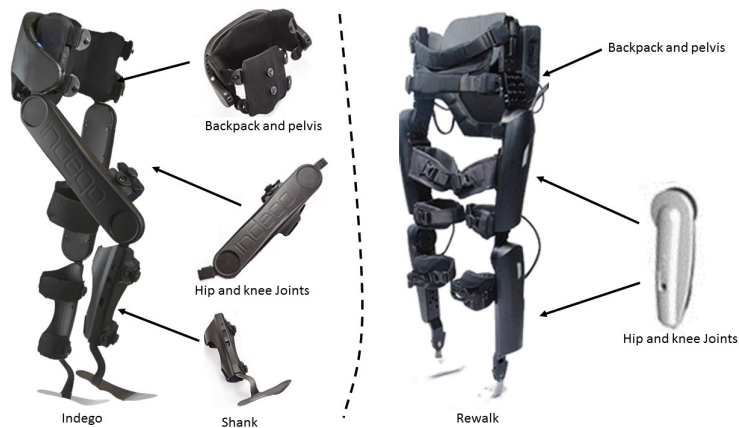
**Figure 3.19** Integrated Electro hydraulic actuators developed by (a) IEHA by ALFAYAD at university of Versailles, (b) EHA by Habibi at University of Saskatchewan , (c) Hydraulic pump and different rotary actuators by Nakamura at University of Tokyo

Other types of actuators such as (shape memroy alloys, and piezo electric properties are not treated in the state of the art due to their low force capacity when comparing them with the electric, pneumatic or the hydraulic actuators.

### 3.4 Exoskeleton Structure prior Art

According to the before described researches on rigid-type exoskeletons for paraplegic patients, the designed systems had partially active hip/knee/ankle joints similar to the lower extremities of humans along with a weight-support frame. Moreover, most of them aimed at rehabilitation of medical patients and the disabled. In spite of these efforts, most of the applicable examples are still limited to hospital use for older adults and the disabled persons. Although, Rewalk, EKSO and Indego, see Fig. 3.20, were approved by the Food and Drug Administration for personal use in the U.S., a main barrier to the popularization of such a devices

is the difficulty to be adapted to the small sized patients (children during growth) and to follow the changes in the human body and skeleton. These exoskeletons use fixed size frames with small adaptation mechanism to support a part of the wearer's weight effectively. However, their shape is difficult to fit well to various wearers' body curvatures; hence, they cannot be scalable enough to wearers' lower bodies.



**Figure 3.20** Rewalk and Indego Exoskeletons with the rigid structure approach

To address the issues associated to the rigid exoskeletons, there has recently some works on developing active soft orthotics. For example, a team at Harvard University has developed a soft exosuit to assist the wearer's natural gait performance in the military and medical fields [72]. As shown in Figure 3.21, unlike traditional exoskeletons with rigid support frames, this exosuit uses soft materials, such as textiles and elastomers (velcro), so that it can be worn like clothing. Although, this structure resolves several issues related to the scalability (size, shape, etc), but it has presented its own inherent limitations, such as the absence of weight-support functionality, instability, low generated force on the limbs, and until now the effectiveness of the device in assisting patient's gait has not been proved. This is because the device pulls the extremity of a human body by the wire directly without load-support frames to assist the joint torque.

A third approach to reduce the limitations of conventional rigid and soft wearable devices, is represented in another trial by Samsung Electronics to design a

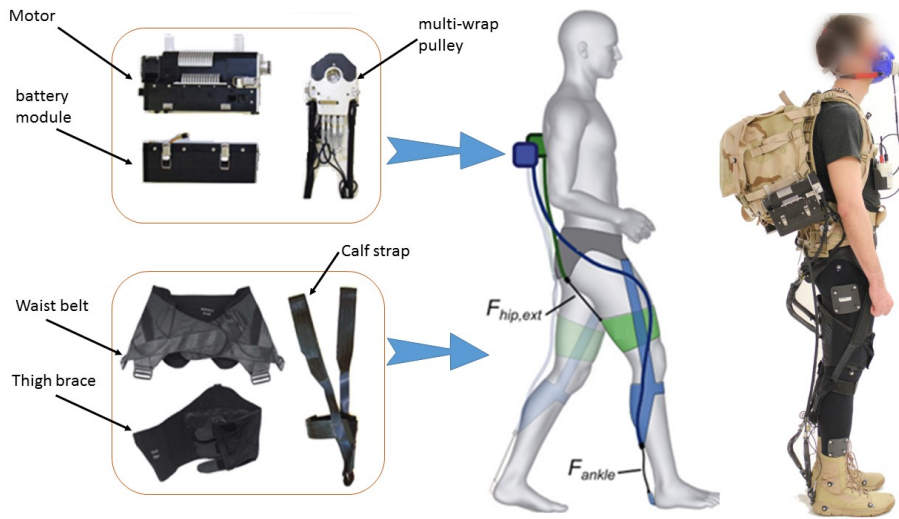


Figure 3.21 Harvard Soft Exoskeleton

novel, tightly fitting, more comfortable walking assist device structure for aged person [73]. They proposed a novel wearable walking assistance device named Samsung walking-assist device for lower extremities (abbreviated as “S-Assist L-type”) for personal use. It was designed to support the geriatric population with moderate impairment to walk or stand. Its biomechanical design takes the advantages of the above two approaches, conjugating a flexible load-support structure for increased wearability and comfort, with a multi-joint kinematics for compliance and self-alignment with anatomical joints. Its structure can follow the human musculoskeletal deformation easily due to its kinematic chain design. Its limitations can be represented by (1) the capacity of this structure to hold the user’s weight in case of paraplegia, since it is design for aged person (they can hold their own weights),(2) the resolution of the each cell in the thigh or shank chain, since the growth is continuous. So the scalability option cannot be guaranteed for all the patient heights. (3) the mechanical capacity of their actuators are not scalable, since the maximum torque provided can reach 20 Nm according to the authors. Hence, even this approach is having limitation and disadvantages in the context of scalability.



Figure 3.22 Samsung Semi Rigid Exoskeleton

### 3.5 Conclusion

In conclusion, we believe that there is a rise for the need of a single scalable exoskeleton that can tackle the growth rate of teenagers to ensure practicing the therapy program without interruption, to get the maximum benefits from the rehabilitation program. This scalable device should be capable to follow the growth rate of the patient's body morphology, and to be customizable according to his disease type.

Electric motors are the most widely used actuators in robotics and many other fields. They are therefore inexpensive and available in a big variety of sizes and specifications. Furthermore, they are popular because of their ease of control. Their biggest disadvantage is limited actuator performance. Electric motors produce lower torques relative to their size and weight. Therefore reduction device is a necessity to convert velocity into torque. The gears, however, introduce undesired friction and backlash to the actuator unit and reduce its efficiency and backdrivability. In fact, these gears are increasingly becoming the weakest element of an electric motor unit [52] with the risk of breaking if their maximum permitted torque is exceeded. The pneumatic actuators are a soft and practical solutions for such devices [60]. However, they have showed nonlinear features, too slow dynamics during position control, noisy, and require the use of pressurized

air via a bulky tools [61]. For instance, their control bandwidth is relatively low compared to that of hydraulic actuation. This is because the hydraulic fluid is generally incompressible, while the pneumatic muscles use compressible fluid. The hydraulic technology shows a promising results to actuate the exoskeletons and especially the scalable one because of their advantages across the other technologies such as the back-drivability, the self locking property, the high power to weight ratio and to volume ratio, the built-in compliance ability, the high precision during actuation to maintain the natural motion and finally, the easy reprogramming of joint position/velocity/acceleration, etc. So, this give us better choices and options to better select the suitable actuator for the scalable exoskeleton which will be treated in the next chapters.

Since we are treating the scalability issue for the first time in the rehabilitation domain. The selected actuators for this phase of development are the electric motors because they offers simplicity in their mechanical design, mechatronic development and controlling them is less complicated than the other types.

The structural design of the exoskeletons that can serve the scalability is still an open question. Several trials have been done in order to overcome this barrier, such as the rigid, soft and semi rigid approaches. Since the teenagers' bodies are subject of continuous changes, non of these approaches can fit the basic requirements related to the scalability. Moreover, in order to use the exoskeleton on adolescents' bodies, we first need to understand the factors and growth indicators related to the adolescent's body. This point will be addressed in detail in the next sections, by defining the requirements of the needed structural design in order to build a scalable exoskeleton for teenagers, and by proposing a design for the structure of a scalable exoskeleton.



# Chapter 4

## Scalable Exoskeleton Mechanical Requirements

### Contents

---

<b>4.1</b>	<b>Introduction</b>	<b>54</b>
<b>4.2</b>	<b>Structural Requirements of Scalability</b>	<b>54</b>
4.2.1	Interchangeability in Size	54
4.2.2	Interchangeability in exoskeleton shape to ensure the morphology compatibility	57
4.2.3	Perfect Alignment of Exoskeleton Joint to the Corresponding Human Joints	59
4.2.4	The Kinematic Compatibility	62
4.2.5	Summary	65
<b>4.3</b>	<b>Actuation Requirements of Scalability</b>	<b>66</b>
4.3.1	Selection Criteria of the Exoskeleton Active DOFs	66
4.3.2	Interchangeability in the Range of Motion	68
4.3.3	Interchangeability in the Power Capabilities	69
4.3.4	Joint Actuation Design Requirements	75



## 4.1 Introduction

The first step towards developing scalable exoskeletons is to analyse their specific anatomical and mechanical constraints such as structural shape, power. Since our study discusses the lower limb diseases and the adolescents body specificity, the functional requirements of the scalable exoskeleton can be detailed according to the following aspects:

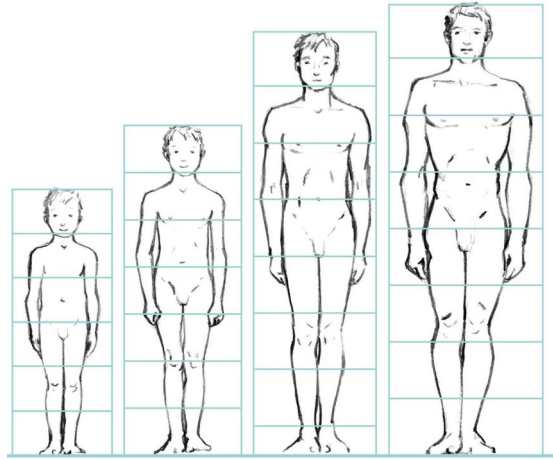
- The device size to fit different the patient ages, and gender;
- The position and direction of its joints to adapt to the different human skeleton deformities and to align to the corresponding joint axis;
- The kinematic compatibility between the exoskeleton and the wearer;
- The range of motion for each degree of freedom;
- The dynamic capabilities of its joint actuators.

Therefore, the requirements mentioned above represent an interchangeability key factors for designing the exoskeleton to address scalability issues from a mechanical point of view which can be categorized as follows: a) structural issue, b) biomechanical issue, c) the choice the actuated joint issue. Each of these factors will be detailed in order to conclude a method to resolve the mechanical limitation associated with scalability.

## 4.2 Structural Requirements of Scalability

### 4.2.1 Interchangeability in Size

Human maturation can be explained in several physical characteristics. The major change during the human growth is the increase of the different body segments size and proportions [74], see Fig. 4.1.



**Figure 4.1** The Body Proportions Series

By studying the chart shown in Fig 4.2, the curves show the growth velocity versus the age for different teenager percentiles [2, 75], where the P50<sup>th</sup> percentile represents 68% of the studied population. It is observed that the remarkable fast growth rate has a maximum of 6.3cm/year for the “P50<sup>th</sup>” population, and last approximately for more than a decade. This fast growth rate starts to decrease at 12 years old and then saturates by 19 years old.

That illustrates the justification for the existing exoskeletons providers (such as Rewalk, Ekso, etc) lean to develop their devices after this puberty period, where the growth rate is neutralized (see Figure 4.2). Moreover they provide different fixed sizes to allow the discrete adjustability for different percentiles.

Regarding the waist of the human, the development of this element is considerable when taking into account the human growth. According to a study made by [76], the variability in the morphology between the males and females is studied when including the existence of the female pregnancy/maternity to the deformation of the pelvis. As shown in Fig. 4.3, the variation of the pelvis shape is considerably important between the childhood (6 years old) and the adulthood (25 years old) which affects the design of the exoskeleton in a scalable way to adapt the patient.

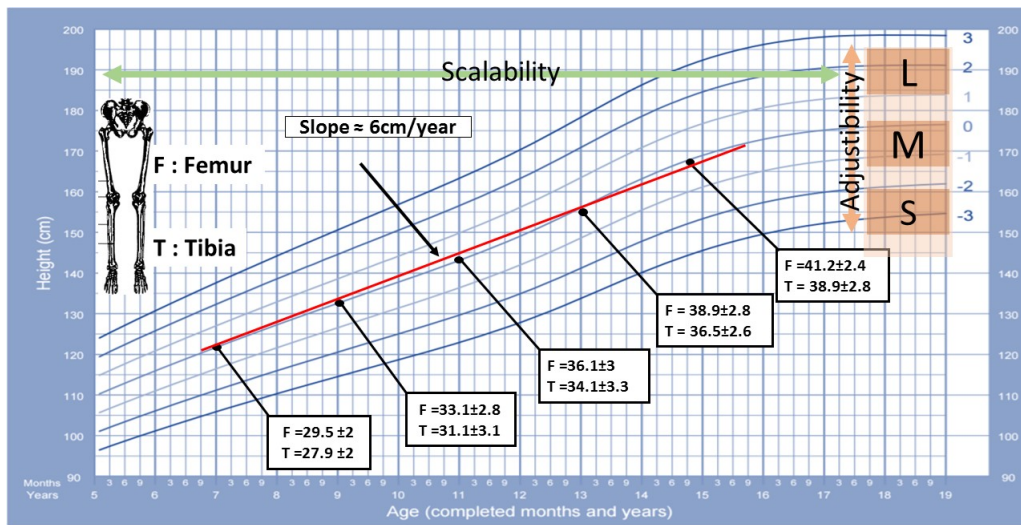


Figure 4.2 Growth chart of a growing child [2] with the lengths of the thigh bone (femur) and shank bone (tibia)

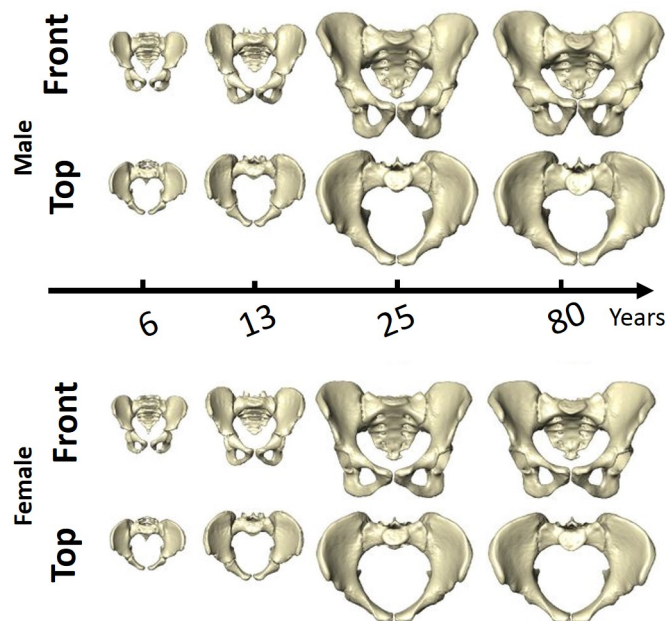


Figure 4.3 The pelvis interchangeability according to (a) the gender differences, (b) the age of the person

Another study made by Colman et al. on 30 children subjects (14 males and 16 females) with different ages shows the average position of the acetabular region

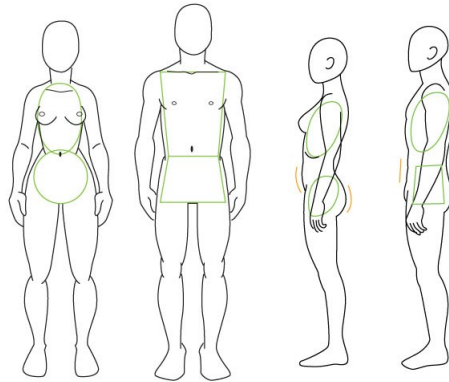
which can differ from 8 to 10 mm [77]. This study adds an extra justification in our investigation to highlight the morphological variations, in terms of size and shape, of the pelvis during the growth.

Hence, regarding the sizing variation, the term “scalable” differs from the “adjustable”, where the adjustability is used to refer just changing the size in fixed increments which are expressed as: Small, Medium, and Large, etc, while the scalability is meant to represent the exoskeleton ability to continuously grow up with the patient during his fast critical stage of growth. Finally, when we project this new term on the exoskeleton devices, we will allow the interchangeability of the exoskeleton dimensions in all the human anatomical planes which ensure fitting scalability.

#### **4.2.2 Interchangeability in exoskeleton shape to ensure the morphology compatibility**

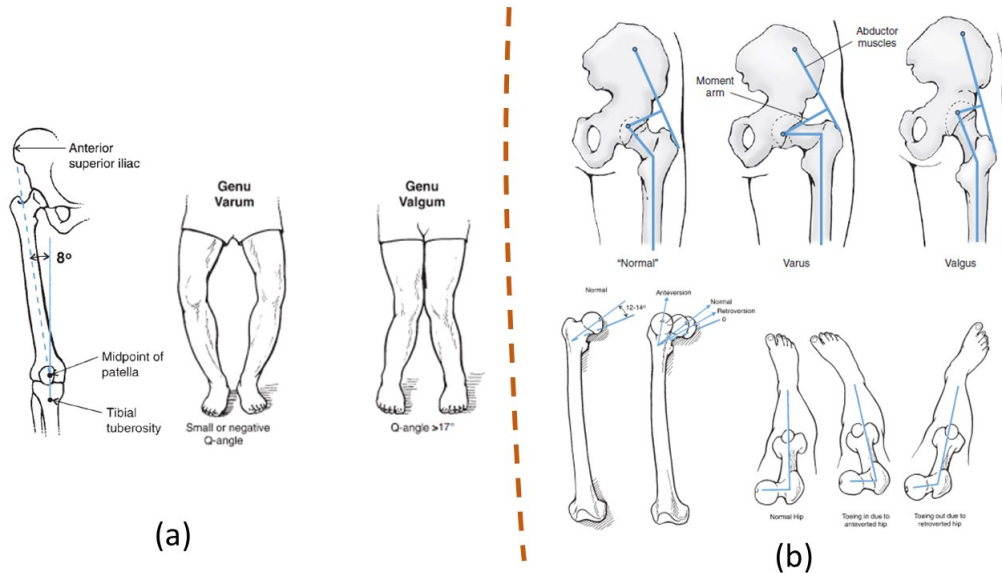
In orthopedics, during the human growth his/her skeletal morphology changes continuously due to several reasons such as (human sex, shape, skeletal deformities, etc.). Hence, there is a non stop changes in his/her joint’s center of rotation pose (location and orientation). As shown in Fig. 4.4, the human morphology and his/her limbs curvatures can change according to the human gender for the same age period. This can create a challenge for the existing exoskeleton to fit the patient into the exoskeleton when having this change. On the other hand, there exists a common subset of design challenges inherent to all exoskeleton systems. One of these challenges is how to fit the exoskeleton to the patient since they are attached to the user limbs.

The misalignment created between the exoskeleton joints and the corresponding patient joints produces unexpected and dangerous internal forces on the human limbs and generate potential forces on the human-robot attachment [78]. Fig 4.5 explains different types of skeletal deformities of the human during growth, such as the varus/valgus [79]. By referring the predefined deformities, some considerations in the exoskeleton frame design should be taken into account in order to follow



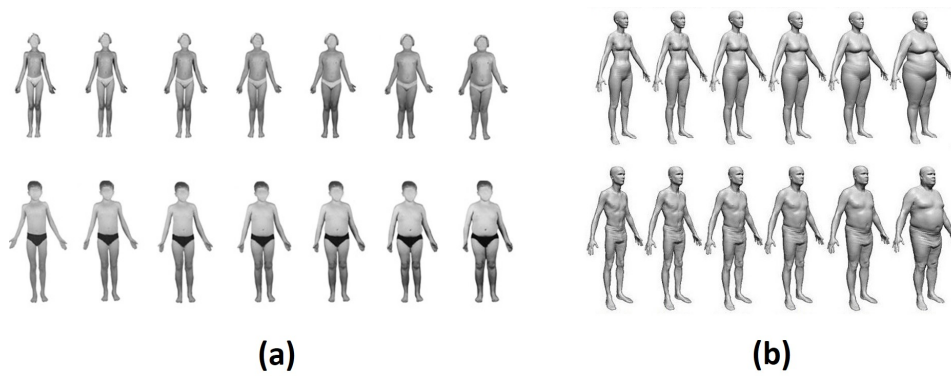
**Figure 4.4** Morphology changes of human body to the sex

this deformities and to prevent the non preferred misalignment.



**Figure 4.5** Morphology changes of human body due to the skeletal deformities. (a) Knee Malalignment ,(b) In/Out toeing

Also, the patient weight represents an important factor in the exoskeleton frame design. As illustrated in Fig. 4.6 (a) and (b) taken from [80], the shape of the human body can change according to its weight. Therefore its impact on the exoskeleton frame cannot be negligible due to the important difference between the normal human and the obese one.



**Figure 4.6** Morphology changes of human body for different weight, (a) for male/female Children, (b) for male/female Adults

Thus, the adaptation of the exoskeleton shape helps to keep the human and the exoskeleton compatible to each others. This may solve the scientific challenge of intra-individual variability, and the morphology compatibility between the exoskeleton and the anatomical human body.

### 4.2.3 Perfect Alignment of Exoskeleton Joint to the Corresponding Human Joints

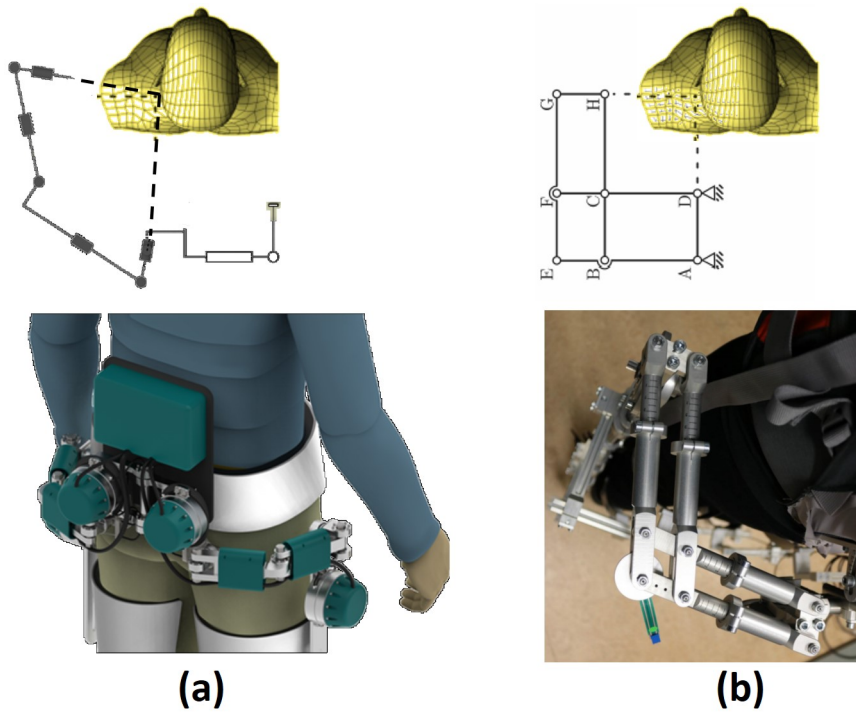
One of the challenges in the design of wearable robots is the importance of their joints' alignment. The requirements to achieve this challenges differ from an application to another. For example, for power augmentation devices, the device should follow its wearer without any kind of non-synchronisation, while for assisting application, the wearer limbs are following the device. Thus, without a perfect alignment between the biological and the mechanical joints, interaction forces between the two can produce pressure sores on the skin, or even force the user into an unnatural gait since the exoskeleton frame is the structurally stiffer component between the human-robot interaction [78]. To solve this issue of the joint misalignment, studies are made on the hip/knee/ankle joints in order to reduce this dangerous interaction.

## Hip

For the hip joint, several studies have been done for this purpose. Beil et al. has developed kinematically compatible conceptual design of an exoskeleton hip to reduce kinematic incompatibilities, caused by the misalignments, between the human and exoskeleton hip axes [81]. The misalignments are caused by inter-subject variability and articulation. The resulting design consists of five revolute, three prismatic and one ball joint (see Fig 4.7.a). On the other side, Bartenbach et al. has developed a passive exoskeleton in order to define constraints caused by an exoskeleton on the human [82]. For the associated internal/external rotation DoF of the hip, a remote center of rotation mechanism was chosen. All four bars of this mechanism can be adjusted in length with a potentiometer on one of its joints( as shown in Fig 4.7.b). Moreover, Lee et al. has developed a mechanism for aligning the exoskeleton hip to the human anatomical hip, where the vertical sliding mechanism is to shorten/lengthen the devices link length owing to the offsets between the hip abduction/adduction axes between the device and the user [73] (see Fig 4.7.c).

## Knee

For the knee joint, a crossed-four bar linkage has reportedly been found to be a reasonable approximation of the trace of the transfemoral axis with respect to the tibia. In fact, the human knee joint is a complex structure formed by the anterior and the posterior cruciate ligaments, the medial and the lateral collateral ligaments, and the femur and the tibia. The patella and the associated ligaments are also part of the knee joint, but may be neglected for the purpose of measuring relative motion between the two major bones—the femur and the tibia. As shown in Fig. 4.8 crossed four-bar linkage is envisioned with links B1 through B4. B1 is attached to the frame of the tibia, which is treated as the reference frame. B3 moves with the frame of the femur. B2 and B4 form the “cross” of the crossed linkage, and thereby connect B1 and B3. The motion of the center of the link B3 (CB3) is to be tracked and compared to the trace of the femoral axis.



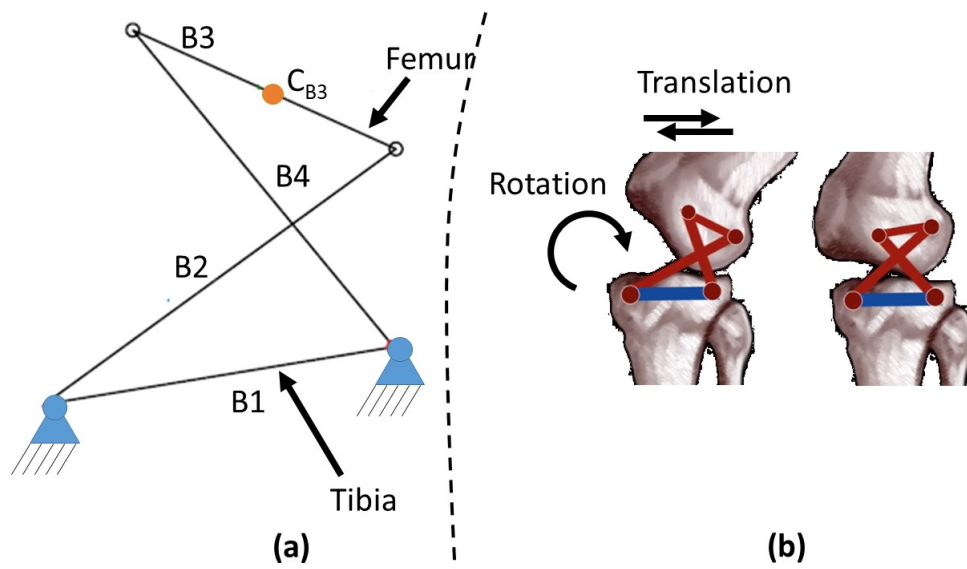
**Figure 4.7** Hip alignment mechanisms (a) Kinematic Design with Five Revolute, Three Prismatic and One Ball Joint, (b) four bars mechanism for the hip

## Ankle

Misalignment at the ankle joint can also induce unexpected motion deviation of all the proximal frames and joints of the device. During the stance phase, when the foot is in contact with the ground, in order for the device to fit the wearer's lower body tightly, the relative motion between the wearer and the device should be minimized. For this purpose, several exoskeleton ankle joints have been proposed, but many of them cannot adequately reflect ankle biomechanics. BLEEX proposed a 3-DOF ankle joint but, except for the flexion joint, the rotation axes did not meet at the wearer's ankle rotation axes. HULC used one ball-socket joint but still had the same joint mismatch problem as BLEEX.

Our strategy is based on the solution proposed by BLEEX, where a series of a revolute/prismatic joints are used to achieve alignment, since it is compatible





**Figure 4.8** Knee mechanism (a) Four bars mechanism, (b) the motion of the Condylloid joint

with the scalable aspect of the exoskeleton.

#### 4.2.4 The Kinematic Compatibility

When studying the kinematics of an exoskeleton generally, it is crucial to consider the human limb kinematics. This creates a number of advantages such as similarity of the workspaces, singularity avoidance, one-to-one mapping of joint force capabilities over the workspace, etc. However, this method suffers from a major disadvantage due to the impossibility to precisely replicate human kinematics with a robot. Indeed, two problems occur, the first one is that the morphology drastically varies between subjects, while the second one is that for a given subject, the joint kinematics are very complex and cannot be imitated by conventional robot joints. The interference between the two kinematic chains therefore seems inevitable. This is due to the connections between several kinematic loops, these discrepancies generate kinematic incompatibilities.

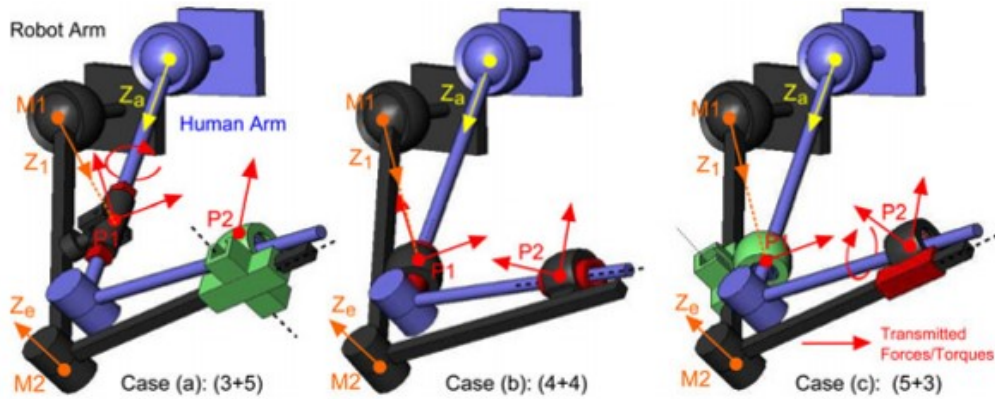
According to [83], this conflict will create a kind of static redundancy of the system which is having a consequences like the impossibility to move and to the

generation of non-controllable internal forces if the connected bodies were rigid. In practice, the rigidity is not ideal, and tiny mobility can be obtained thanks to the deformation of the human skin and tissues. Generally, when a robotic exoskeleton is connected to a human limb via physical interfaces, these deformations will happen on this interface which is defined between the two kinematic chains (human/orthosis) and caused by the low stiffness of human limbs such as skin and tissues.

To solve this problem, several approaches can be concluded from the literature. The first approach consists of adding compliance to the connections, in order to minimize the forces generated. The second approach focuses designing the exoskeleton in a way to maximize its adaptation to the kinematics of human limbs. Two methods can then be used in the second approach. The first method is increasing the adaptability of the robot's kinematic chain by adding adjustable segments or redundant joints. The latter method consists of adding passive or active degrees of freedom (DoF) in series on the robot kinematic chain to align the active joint axes with the human joint axes. Thus inherently lead to complicated design of the system.

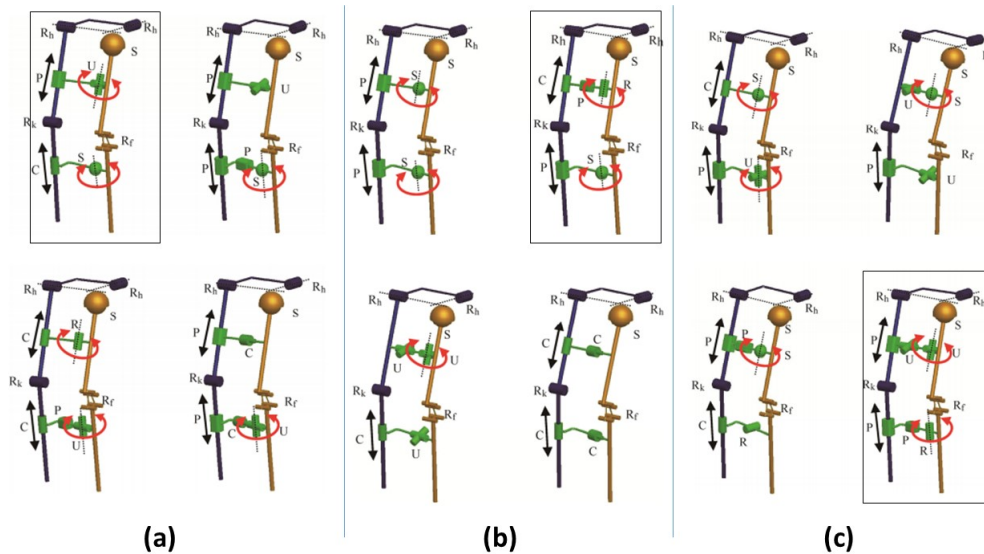
Jarrase et al. have developed a method to connect the human limb to the exoskeleton. This method is applied on the upper limb to actuate a human arm [83]. This research is based on former work research developed by Schiele et al [84] where some limitations have been shown since the proposed complex explicit model and the impossibility be used for spatial exoskeletons. Therefore it only applies to the planar kinematic chains of exoskeletons. On contrary, Jarrase et al. have designed an axis misalignment-free structure by adding passive degrees of freedom in the human machine interaction. Their model is universal and can be applied to the kinematic design of spatial exoskeletons.

On the other side, Li et al. have tried also to find a solution of the attachment mechanism of a lower limb exoskeleton for power augmentation purposes. They have used for the hip actuation two degrees of freedom (Flexion/ extension, Abduction/adduction) [85]. As shown in Fig 4.10, several solutions are proposed using a general design method for the structure of lower limb exoskeletons. A



**Figure 4.9** The three methods to couple upper body exoskeleton to human arm (a)shoulder 3/elbow 5,(b)shoulder 4/elbow 4,(c)shoulder 5/elbow 4

selection method of the optimal mechanisms of lower limb exoskeleton connections is presented. Three optimal exoskeleton structures are selected which are encased in the Fig 4.10.



**Figure 4.10** Types of exoskeleton structures kinematic chains, (a)Hip 3/knee 5,(b)Hip 4/knee 4,(c)Hip 5/knee 3

The limitation of the previous works is illustrated by the consideration of the open parallel chains (human, exoskeleton), where the wrist and the ankle joints

are not taken into account for their design. Hence, a study should be made on the lower limb orthosis in order to design the attachments between the exoskeleton limbs and the human one with consideration of their end effector represented by the ankle joint.

### 4.2.5 Summary

Based on the previous studies, the misalignment compensation mechanisms on each joint of the human/exoskeleton can be realized using different mechanical solutions. The first solution is to integrate a serie of joints (prismatic, revolute, spherical, etc.) to structure to allow a shortening and lengthening of the rigid structure, and then achieving the alignment of the exoskeleton joints to the corresponding human joint. A second solution is proposed to enable the interfaces to move along the rigid exoskeleton structure which would reduce the misalignment issues (e.g. for the knee in [82]). For the scalable exoskeleton applications, the kinematic compatibility is necessary since the exoskeleton tends to follow the human growth from the young childhood to his/her adulthood. Hence, the choice of the kinematics and the attachment is an important factor when designing such exoskeleton.

Consequently, the scalable device structure should be capable to adapt the user size and shape based on the highlighted challenges. This can be achieved by designing an exoskeleton which can ensure the several structural requirements that can help developing the desired scalable exoskeleton such as the kinematic and morphology compatibility, and can reduce the joint misalignment to avoid the internal generated forces on the human limb, add to that the basic requirements such as the portability, the easy wearability and to be light weight and reconfigurable, see Fig. 4.11

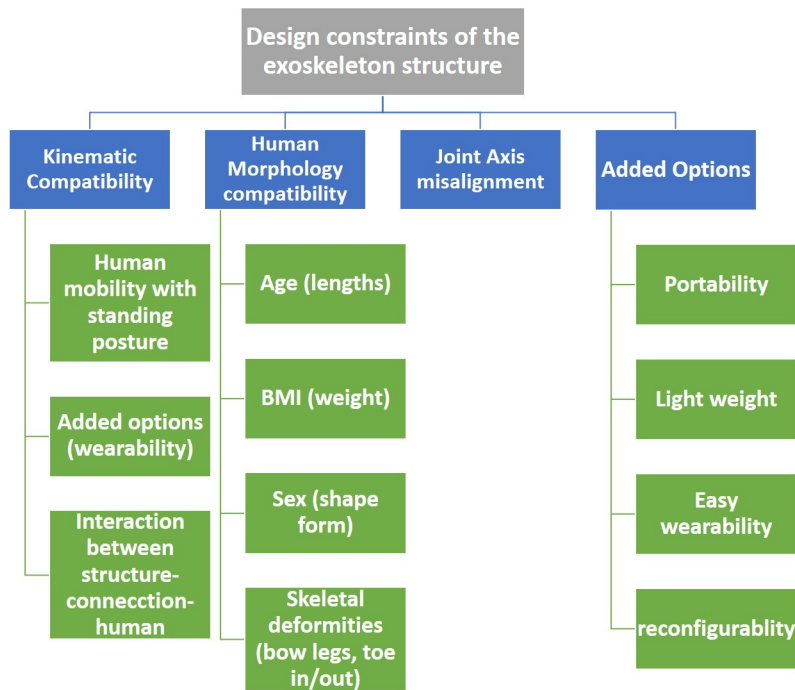
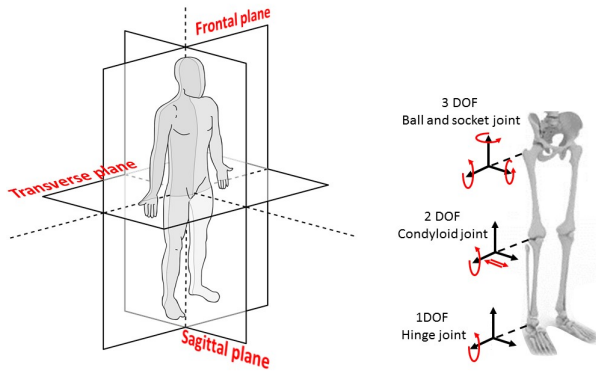


Figure 4.11 Design Constraints of the scalable exoskeleton structure

### 4.3 Actuation Requirements of Scalability

#### 4.3.1 Selection Criteria of the Exoskeleton Active DOFs

When designing a lower limb exoskeleton, the choice of active and passive degrees of freedom for each leg is still an open question because the optimum number of DOFs should be studied to best fit the exoskeleton corresponding requirements. The study of the biomechanics literature reveals that the human leg contains 7 DOFs [65], as seen in Fig 4.12, where three DOFs represent the complex joint of the hip, one DOF for the rotational joint at the knee, and three DOFs for the ankle joint. This enables humans performing complex motions and actions which permits human body maneuverability while maintaining stability. Most of body muscles and bones are in motion during daily life activities. So in order to understand the human body motions, one should take all anatomical planes in consideration during the movement (sagittal, frontal and transverse planes), see Fig 4.12.



**Figure 4.12** Anatomical Planes of the human body

Developing a fully actuated exoskeleton for the lower limb disabilities such as Atalante (by Wandercraft, France), or REX (by REX Robotics, New Zealand), will definitely allow the patient to move without the aid of crutches or walkers, but in contrast, such systems has several disadvantages compared to less actuated DOFs, such as: the cost which is very high due to exoskeleton complexity. Moreover the system transparency, adaptability are not guaranteed, etc. These exoskeletons have shown slower reflex to user commands, that could be reasoned with guaranteeing stability. In general, such fully actuated exoskeletons cannot replicate the human joints using the current technology.

In parallel, it is found that the dominant plane when studying the daily life activities kinematics is the sagittal plane [65], the motions in the 2 remaining planes are also mandatory for performing manoeuvres as well as maintaining stability. Thanks to the aid on walking such as crutches, the stability of the system can be achieved. Hence, the need of the actuation of both transverse and frontal plane can be cancelled. Therefore, we found that to answer on the requirements of scalability in term of kinematic compatibility, cost, complexity, etc, the most common sufficient and necessary degrees of freedom for daily life activities are 3 active degrees of freedom and 2 passive degrees of freedom per leg at the human joints, they are defined as follows:

- Three actuated joints: two for the hip representing flexion/extension and

abduction/adduction, and the other for knee to perform flexion/extension.

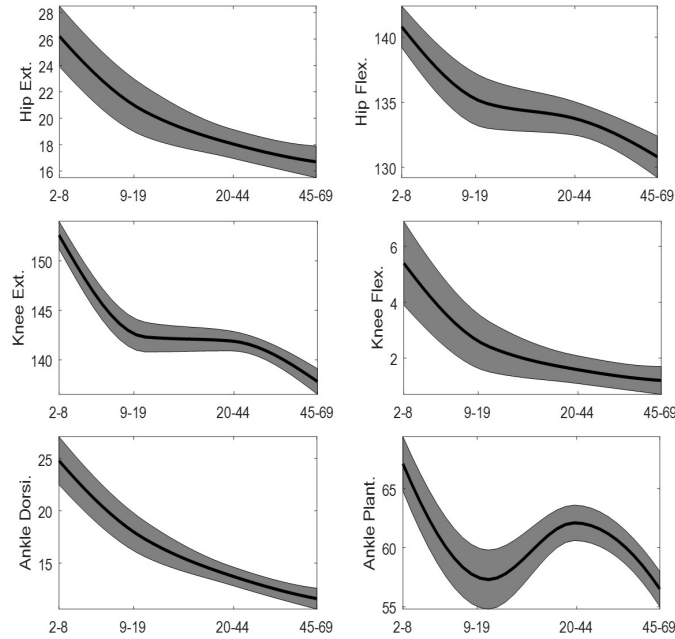
- 2 non-actuated DOFs per ankle allowing the dorsi/plantar flexion, inversion/eversion motion of the foot.

Such a configuration brings several advantages to the design. First of all, it reduces the weight of exoskeleton which leads to reduce the energy consumption and consequently increases the exoskeleton autonomy. Furthermore, the elastic behaviour of the ankle allows the joint to store energy during the loading phase and release the stored energy during the unloading process which helps to return the exoskeleton ankle to its neutral position. Moreover, it lessens the system complexity in terms of assembly, portability, maintenance, control, and transparency.

### 4.3.2 Interchangeability in the Range of Motion

During the growth from the childhood passing by adolescence and raising up to adulthood, the human range of motion (ROM) was found to vary depending on the age, height, weight, gender, and race. The Fig 4.13 gives reference values of the ROM of the hip, knee and the ankle of several subjects aged from 2 to 69 years old, with a standard deviation adapted from [3]. These data constitute a database for our study, where we consider the variation rate of the ROM for teenagers from 9 to 19 years old because at the beginning of the adolescence it is observed that the ROM has a high rate of variation.

Moreover, the disabled patients need ROM exercises to stretch and strengthen their bodies [86], for this reason, they can use these exercises to prevent muscle weakness and its related negative consequences. So the ROM also differs according to the disease type [87] and to the type of the exercise. For example, the hip ROM in the sagittal plane for a healthy subject is 128.4 degree (Flexion) and 17 degree (extension), while when performing the sit-to-stand exercise repetitively, the required ROM on the hip level is 90 degree while during other activities it will differ.



**Figure 4.13** Hip and Knee ranges of motion from years 2 and up to 69 years old as measured by [3]

Based on these assumptions, the variation in the ROM can be achieved by designing the exoskeleton in a way allowing the adaptability of corresponding ROM according to the patient specifications (gender, size, age), the disease type, and rehabilitation exercise needs.

### 4.3.3 Interchangeability in the Power Capabilities

Considering the challenging particularity of teenagers expressed by a great amount of variation in the rate of growth, the issue of providing the required power capabilities needs to be treated and demonstrated. This can be achieved by referring to the studies focusing on the impact of the teenager body growth, to his/her body weight [88]. Moreover, considering the study on the biomechanics and motor control of human gait [89], it would be obvious that the joint power needs is basically dependent on the total body weight, where the joints exert higher torques for heavier subjects.

The sizing of the exoskeleton's actuator is an important key factor to fulfill the



scalability requirements. Since this actuator will serve the growing patients during the adolescence phase, it should fit their required evolutionary power needs. To reach up these needs, bio-mechanical studies of healthy teens and adults are used to get an indication for the power exerted throughout their Daily Life Activities (DLA) e.g. walking, sit to stand (STS), and stair climbing. Based on these studies, our main interest is to determine the power, in terms of torque and angular speed, for each of hip and knee joints in the sagittal plane.

Regarding the torque estimation, our methodology is based on considering the worst case condition for the torque exerted by the joints during the various DLAs. Several bio-mechanical studies such as [33, 90] focus on the calculation of the normalized torques for both hip and knee joints during DLAs as shown in Table 4.1, where the normalized torque  $\tau_{normalized}$  represents the torque exerted by a joint  $\tau_{joint}$  divided by the subject's weight  $m_{subject}$ , according to eq. 4.1. It is observed from the Table 4.1, that the worst case condition is represented as the maximum normalized torque  $2.87N.m/kg$ , which is found at knee joint while performing stand from sitting position.

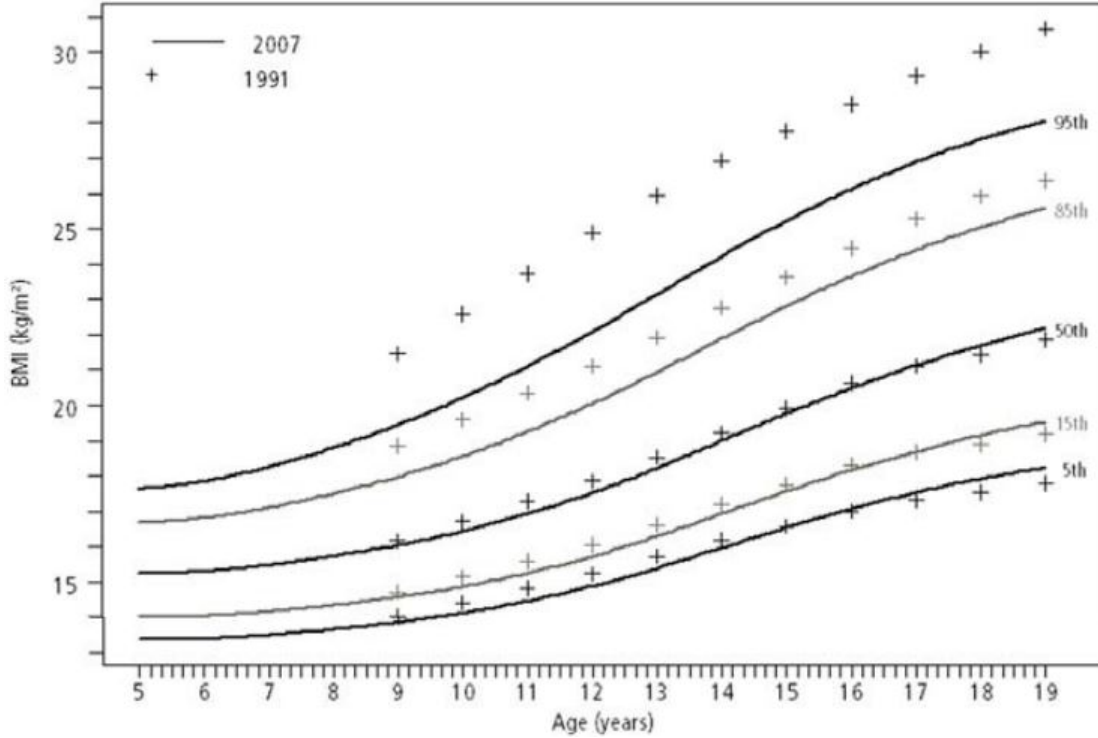
Torques in [N.m/Kg]	Hip	Knee
Walking	1.45	0.8
Sit → Stand	1.4	2.87
Stair Climbing	1.27	1.55

**Table 4.1** Normalized joints torques for DLA

$$\tau_{normalized} = \tau_{joint} \div (m_{subject}) \quad (4.1)$$

In the context of scalability, to obtain an appropriate indication for the torques required by the actuator based on the maximum normalized torque, it is necessary to estimate the maximum weight of the patient. This could be achieved by referring to BMI charts provided by WHO organization [88] shown in Fig 4.14, where the term "BMI" refers to Body Mass Index, and defined as function of body weight  $m_{patient}$  and height  $h$ , (equation (4.2)). To figure out the maximum value of  $m_{patient}$ , it is obvious to consider the maximum values of  $BMI$  from the chart, and  $h$  from

growth chart at 97<sup>th</sup> percentile and the  $3\sigma$ , where it is found to be  $32\text{kg}/\text{m}^2$  and  $200\text{cm}$  respectively at 19 years old.



**Figure 4.14** Comparison between the boys body-mass-index for several ages percentile curves between 2 years 1991 and 2007

Thus, by substituting the latter values in equation (4.2), the maximum patient weight  $m_{patient}$  would barely exceeding 120 kg.

$$m_{patient} = BMI \times h^2 \quad (4.2)$$

As the targeted exoskeleton is meant to be used with aids of crutches, so the patients' weight will be supported by the crutches and the exoskeleton as well. This induces that, the effective weight carried out by the exoskeleton is less than the total weight of the patient.

To figure out the ratio between the effective weight carried out by the exoskeleton compared to the crutches, a study [91] have measured the supportive

axial forces of three SCI patients using force plates, and strain gauged forearm crutches while performing five sit-to-stand activities. From this study, authors have observed that the ratio between the loads supported by the crutches (avg. 25kg per crutch) and the patient weight (avg. 77kg) tends to be 65%. Moreover, the impact of the crutches on load distribution during walking activity is studied by [92]. Where body weight is measured using plate force sensors placed at foot sole during walking, with and without crutches, by 14 healthy subjects. This experiment has revealed that the crutches support the load by 47% of the total body weight.

As shown in Table 4.2, the average exoskeleton's weight which are having the same number of active DOFs can reach up to 21kg. So by considering that  $m_{exoskeleton}$  will take the value of the average exoskeleton weight. Moreover by multiplying the maximum normalized torque  $\tau_{normalized}$  with the corresponding maximum load supported by exoskeleton, the required torque  $\tau_{joint}$  given by equation 4.3 for walking and STS would be 109Nm and 142Nm respectively.

Exoskeleton	Weight[Kg]
Indego	11.8
TWIICE	15
Ekso GT	20
ExoAtlet	20
Fourier X1	20
HAL	22
ReWalk	23.3
X1 Mina	34
Average weight	20.8

**Table 4.2** Weights of Exoskeletons having 4 DOFs

$$\tau_{joint} = \tau_{normalized} \times SF_{exoskeleton} \times (m_{patient} + m_{exoskeleton}) \quad (4.3)$$

Where Supporting Factor  $SF$  is the ratio between the load supported by crutches to the total weight. Regarding joint speed estimation, as the walking activity is considered to be the most repetitive task to be exercised during the nor-

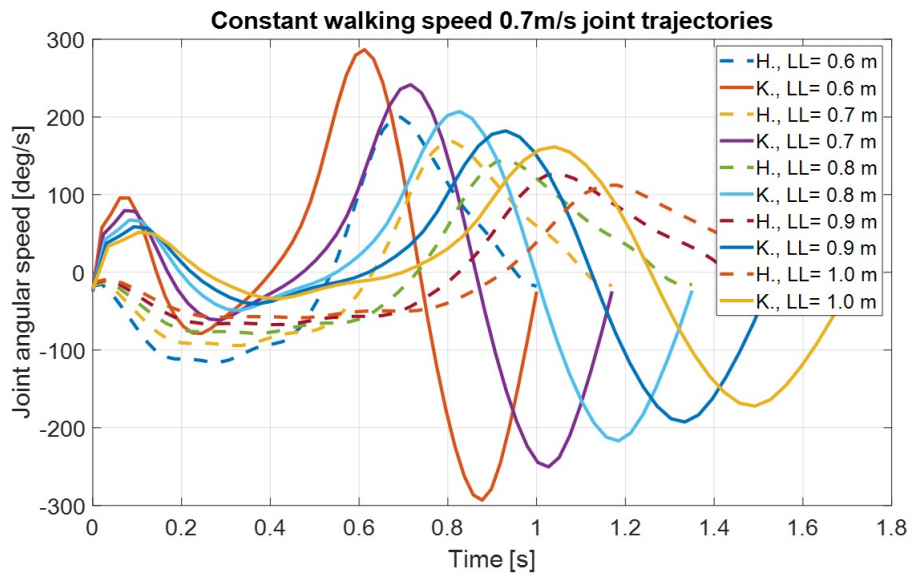
mal life, it is also considered to have the most critical timing to maintain stability. Performing gait motion in very slow motion, burden the patient and considerably reduce system effectiveness during normal life activities. On contrary, walking in too fast manner, lessens the stability and increase the probability of falling.

In order to estimate the maximum required angular speed during walking, its mandatory to study the effect of growing up on the gait cycle trajectories, and also, its impact on the joints speeds.

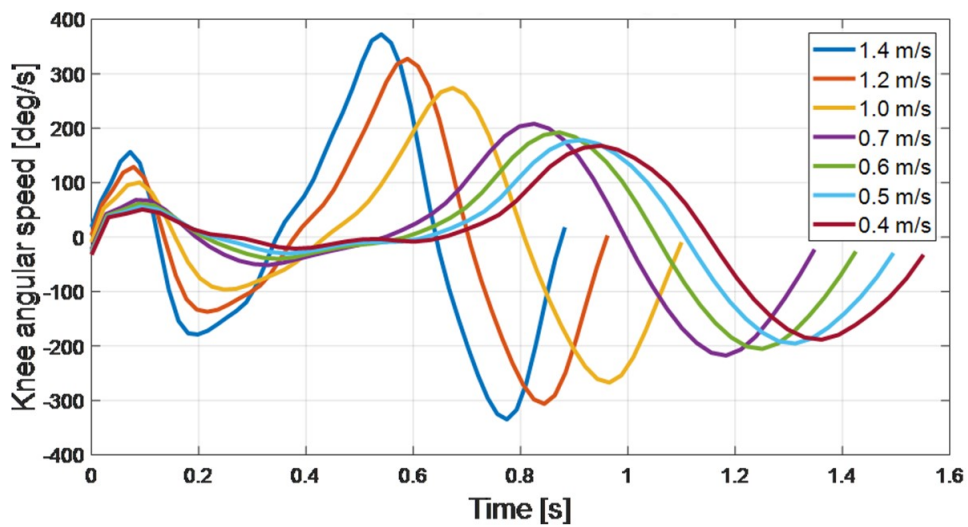
A study made by Stansfield et al. has conducted a linear regression analysis based on dimensionless quantities for gait parameters prediction, using 457 gait trials by 16 healthy subjects aged from 7 to 12 years old [93]. By using these analyses, one can predict the gait trajectories for normal subjects based on "normalized speed" parameter, which is a factor of leg length and the walking speed.

Accordingly, different walking trajectories were presented for different normalized speeds. By analysing Fig. 4.15 taken from [93], it is obvious to find that the knee joint have higher angular speed than the hip joint. In addition, it is notable that for certain walking speed, the leg length has a significant impact on angular speed trajectory. By referring to Fig. 4.16 collected from the same reference, its clear to figure out the impact of changing the walking speed on joint trajectory.

We have selected the worst case scenario to be the methodology to size the angular speed of the actuator, where it is meant to consider the high angular speed joint (knee joint), the minimal leg length of targeted population scope (age of 12 years old), and the normal walking speed of adults with aid of supporting crutches. The selection of the exoskeleton walking speed is based on a survey on the current assistive devices which has revealed that their walking speeds is in range of  $0.5 \sim 0.88m/s$  [94, 51]. Hence, for a teenager of 12 years old walking in speed of  $0.7m/s$ , the maximum peak of knee speed trajectory is  $210deg/s$ , as shown in Fig. 4.16.



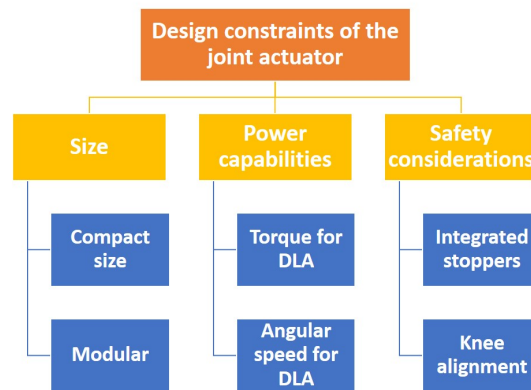
**Figure 4.15** Effect of changing leg length on hip and knee speed trajectories during constant speed walking



**Figure 4.16** Effect of walking speed on knee angular speed trajectory for normal subject of 12 years old

### 4.3.4 Joint Actuation Design Requirements

It would be gainful for a scalable exoskeleton to develop a joint actuator able to empower continuously its joints and taking into consideration the evolution in the teenager patient' kinetics needs. In addition, the specific tasks usually performed by the teenagers are much more demanding and therefore, the scalable actuator can be adaptable accordingly. Fig. 4.17 shows the desired requirements of the scalable joint actuator which will be considered when designing it in order to fulfill the actuator scalability.



**Figure 4.17** Design Constraints of the scalable joint actuator

## 4.4 Conclusion

In this chapter, a study on the physical requirements of the scalable exoskeleton is carried out. The structural inter-changeabilities of the exoskeleton in terms of size, shape, hip/knee joint misalignment effects are detailed in order to define its mechanical design's key factors to be considered. The kinematic compatibility issue of the exoskeleton attachments is detailed based on a recent studies to highlight its importance when studying the growth effects on the human joints. The actuation requirements of the exoskeleton are studied in order to select the active/passive joints of the exoskeleton, the range of motion of each actuated/non-actuated joints.

The sizing of the actuators is investigated by illustrating the recommended power, angular speed and torque of the required daily life activities of the human actuated joints. Finally, the basic functional design requirements of the scalable exoskeleton are illustrated to summarize the strategy to be put into use when defining the design methods of the exoskeleton which will be detailed in the next chapter.

# Chapter 5

## Design Methods Towards Scalable Exoskeleton

### Contents

---

<b>5.1</b>	<b>Introduction</b>	<b>78</b>
<b>5.2</b>	<b>Development of Scalable Structure of the Exoskeleton</b>	<b>78</b>
5.2.1	The Mechanical Considerations of the Scalable Exoskeleton Structures	79
5.2.2	Scalable Exoskeleton Structure	81
5.2.3	Kinematic Compatibility and Human/exoskeleton Connections	92
<b>5.3</b>	<b>Actuator Mechatronic Design</b>	<b>102</b>
5.3.1	Actuation Integration	102
5.3.2	Mechanical Design	105
5.3.3	Material Selection	110
5.3.4	Sensors Selection	113
5.3.5	Actuator Realization	116
<b>5.4</b>	<b>Realisation of the first prototype of scalable exoskeleton "SOL"</b>	<b>118</b>



<b>5.5 Discussion</b> . . . . .	<b>119</b>
<b>5.6 Conclusion</b> . . . . .	<b>120</b>

---

## 5.1 Introduction

The scalable exoskeleton refers to a mobile rehabilitation device worn by the patient allowing him/her to perform physical activities. The exoskeleton's actuators and frame should be designed according to several basic requirements and considerations such as user safety, modularity, portability, lightweight, etc., and the precited scalability requirements.

Our study consists of developing a scalable exoskeleton project called "SOL" which refers to a female patient named Solène, who has a lower limb disability. The patient has paraplegia with at the T12 level injury on her spinal cord due to a congenital malformation of the spinal cord before the birth and can move her upper body trunk and limbs, but she has lost the motor and sensory functions of her lower body.

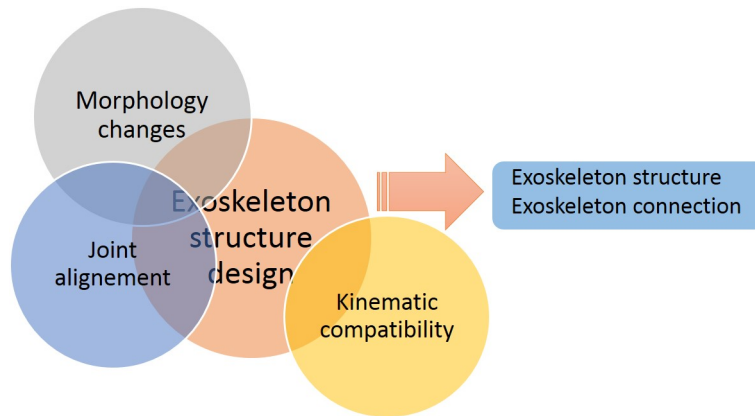
This chapter will detail the design requirements and the development of first exoskeleton scalable structure which tends to follow the body growth of the teenagers and the mechatronic development of the joint actuator used to empower the exoskeleton joints.

## 5.2 Development of Scalable Structure of the Exoskeleton

In the field of portable robotics, considerable research efforts are devoted to the design and development of exoskeletons, which meet the major requirement of a comfortable and safe wearing for the human user. Indeed, the mechanical structure of the rehabilitation devices must transfer the user's weight to the ground through its structure. Hence, basic functional requirements such as mechanical strength, ease of assembly and durability must also be guaranteed. These fundamental

requirements are essential to increase user acceptance and effectively increase user capacity.

Based on the study made in the previous chapter, the scalability requirements are defined in order to provide key factors when designing SOL exoskeleton, (see Fig 5.1). The more tightly the external support frames and joints of a walking assist device fit the wearer, the more discomfort he/she feels when relative motion occurs between the two. Anthropomorphic multi-DOF hip/knee/ankle joints can effectively reduce the kinematic dissimilarity between the wearer and the device during motion. They are presented due to the impact of the rapid adolescent growth rate on the mechanical design of the exoskeleton. So, it is crucial for its structure to ensure the required scalability in terms of joint alignment, kinematic compatibility and morphology changes.



**Figure 5.1** The Design Methodology of the Scalable Exoskeleton

### 5.2.1 The Mechanical Considerations of the Scalable Exoskeleton Structures

As defined before, adding additional powered degrees of freedom will increase the size, weight, and cost of the device due to required infrastructure such as batteries, sensors, and controllers. Moreover, adding non usable passive joints will reduce the device degree of scalability because of the extra needed mechanical accessories. For this purpose, a segmentation of the exoskeleton structure has been done in order

to treat each segment and define its required constraints ensuring the maximum scalable structure (see Figure 5.2).

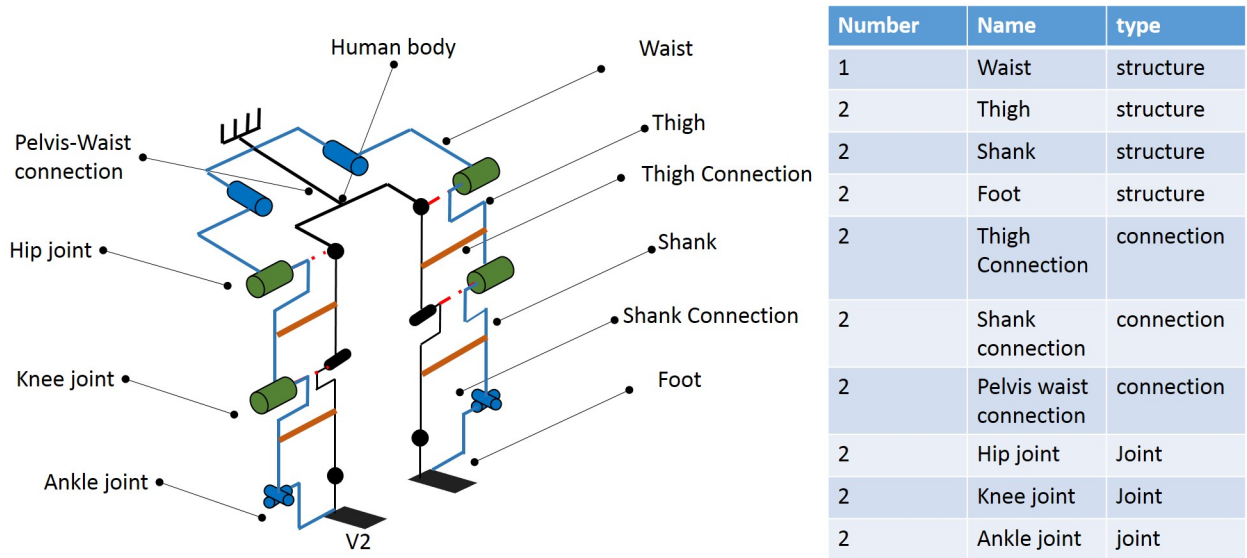


Figure 5.2 Lower limb Exoskeleton segmentation

The proposed segments, categorize the exoskeleton parts into three types, the structures, the connection and the joint actuators. So the exoskeleton contains the following elements:

- Four types of structural elements which are the waist, the thigh, the shank and the foot;
- Three types of connection elements for the thigh, the shank and the pelvis;
- One type of joint actuator.

The objective of this classification method is to study each segment to specify the mechanical joints to be added in the context of morphology interchangeability, the joints alignment and kinematic compatibility.

Referring to the literature and as mentioned before, the exoskeleton joints are necessary to be chosen according to its application because the combination of the kinematic scheme of the exoskeleton can differ from an application to another one.

For example, when considering the power augmentation exoskeletons, the user has already their natural joints, therefore the attached exoskeleton should importantly follow his/her motion without any restriction. But when considering the disabled users holding crutches the case is quite different, because some of his/her joints are responsible to maintain the stability and the others are responsible to move the body during the motion.

Hence, using a non-studied structural configuration can, at best, cause discomfort and at worst, long-term injuries. These consequences are due to several factors such as the slipping movements between the human/structure, misalignment, the non fitting structure, etc. To solve these issues, we will consider several assumptions as follows:

- The study is made on the exoskeleton SOL;
- The exoskeleton has the active hip Abduction/adduction and Flexion/Extension, the active knee Flexion/Extension and the both passive degrees of freedom of the ankle joint as mentioned in chapter 3;
- The connection between the human pelvis and the exoskeleton one is a rigid connection;
- The connection between the human foot and the exoskeleton one is a rigid connection.

### 5.2.2 Scalable Exoskeleton Structure

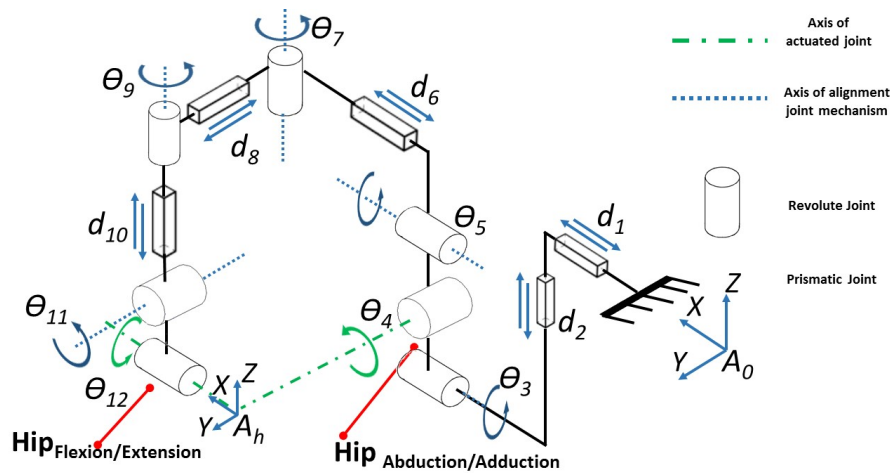
In the wearable devices field, considerable researches are carrying out the mechanical development of exoskeletons, which ensure the requirements of the optimal functionality associated with the safe utilisation. The users structural variability, in terms of the musculoskeletal system, the body proportions and curvatures, the movable articulations and limbs' deformation, tends to complicate the development scalable wearable rehabilitation devices, whose structures and joints are in continuous scalability with the body shape and the joint axes their users. This

complication is caused by several factors such as the misalignments between the joint axes and the under-fitting between the devices to the human.

Hence, to meet these requirements for SOL exoskeleton, such as the joint alignment, and the variable morphologies, we applied several design methods on the exoskeleton structural elements. Their design consists on adding several serial passive Dofs to increase their scalability, comfort and their joint alignment with the corresponding human movable ones. The prismatic and the rotational joints are proposed to be used when modelling the structural elements.

### Waist

For the exoskeleton waist, we developed a design of an off-line adjustment structural chain created by several prismatic and a revolute joints to ensure the fitting and the alignment on the roll, pitch, and yaw axis of the hip joint. This outer structural chain is following the shape of the external side of the human waist which is considered as two circles in order to increase in order to increase adaptability and therefore the scalability.



**Figure 5.3** Mechanical design of the exoskeleton waist

To treat the misalignments after assembling the exoskeleton waist, an off-line adjustment structure is proposed. Its kinematic scheme is shown on Fig 5.3. The

proposed structure has 10 passive Dofs and 2 active ones. The passive Dofs are manually adjustable to allow changing the position of the active degrees of freedom on the hip level. There are six Dofs( $\theta_5, d_6, \theta_7, d_8, d_{10}, \theta_{11}$ ) allowed between the hip abduction/adduction (roll axis) and the hip flexion extension (pitch axis), with one added Dof ( $\theta_9$ ) to adjust the direction of the axis ( $\theta_{11}$ ) when scaling up/down the width of the exoskeleton waist. The Dofs  $d_1, d_2, \theta_3$ , are dedicated to adjust the position of the hip abduction/adduction axis of the different users.

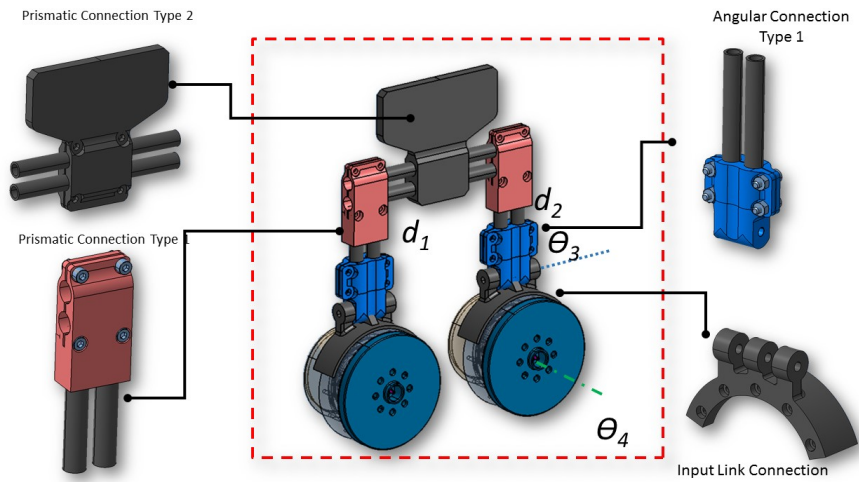
Table 5.1 explains the type and the minimum value of both passive off-line and the active joints of the hip mechanism. while  $\theta_i$  and  $d_i$  represent the possible angular and the translational of an revolute or prismatic joint respectively.

Name	Joint Type	Min Value[mm;deg]
$d1$	Prismatic	50
$d2$	Prismatic	137
$\theta3$	Revolute	0
$\theta4$	Revolute	VAR
$\theta5$	Revolute	0
$d6$	Prismatic	55
$\theta7$	Revolute	95
$d8$	Prismatic	80
$\theta9$	Revolute	95
$d10$	Prismatic	67.5
$\theta11$	Revolute	95
$\theta12$	Revolute	VAR

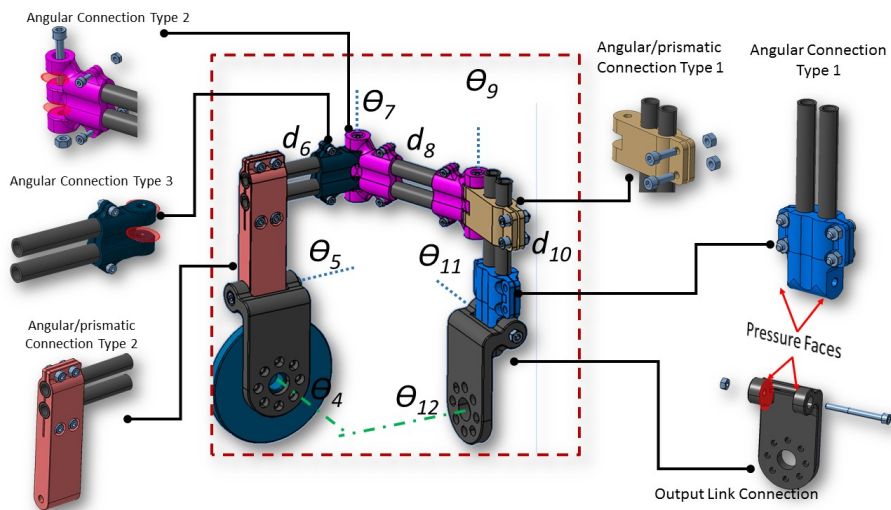
**Table 5.1** Kinematic scheme of the half exoskeleton hip mechanism

As first step, the hip Adduction/Abduction joint  $\theta4$  can be positioned relative to the absolute reference  $A0$  thanks to the passive joints  $d1, d2, \theta3$ . Then, the hip flexion/extension can be positioned to ensure the exact alignment using the allowed six degrees of freedom  $\theta5, d6, \theta7, d8, d10, \theta11$ . The fixation of these positions is achieved using a clamping mechanism for each Dof (see Figure 5.5 and 5.4) where a set of screws and nuts are used to maintain the position after the clamping.

It is clear that the half waist mechanism shown, can help the users to adapt the scalable exoskeleton to their bodies. It is worthy mentioning that such a



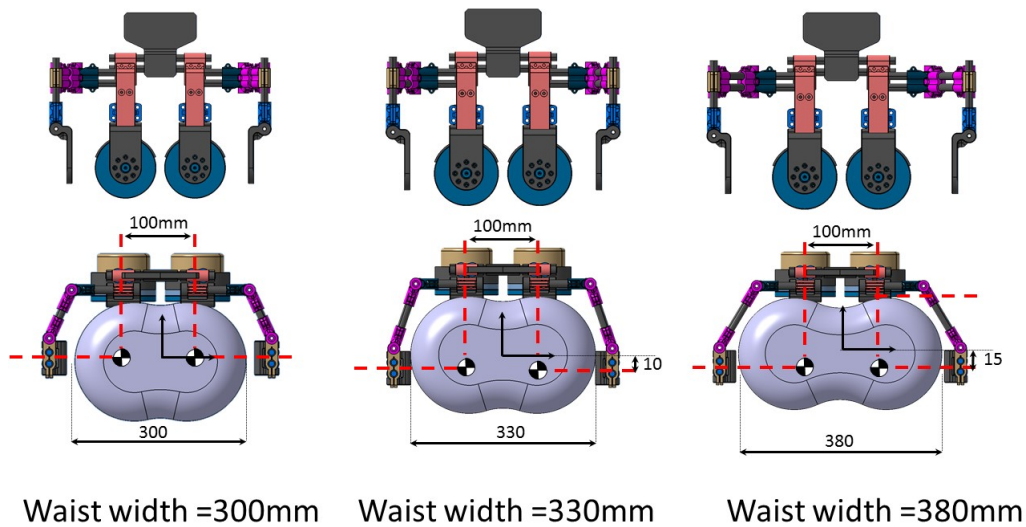
**Figure 5.4** Various type of clamping mechanism used to build the center waist



**Figure 5.5** Various types of the used clamping mechanisms to build the half waist

mechanism can help also to use the exoskeleton in the case of the hip asymmetry. Also, this alignment is important to minimize undesirable residual forces on the user when the actuator is active and to allow the biological rotation of the hip to correspond to the exoskeleton rotations.

The proportions of the human body importantly affect the waist design, where several considerations should be taken into account. Since the waist shape and size change during the adolescence, the proposed width adjustment mechanism can accommodate different wearer sizes thanks to the easiness of changing the structural frame. For this purpose, it is considered to change the length the prismatic joints and the angle of the revolutes ones. In addition, a wide range of pelvis width can be insured, covering a large population of patients starting from their early adolescence phase until their adulthood. As shown in Figure 5.6, different sizes of the user waist are tested in order to validate the design methodology.



**Figure 5.6** variable size and shape of the scalable exoskeleton waist

The waist frames of SOL are made from carbon fiber tubes and they are connected to the torso by a special semi-plastic velcro straps, which allows the rigid connection and the assistive torque transmission between the human body and the exoskeleton thanks to the back support (see Figure 5.8).



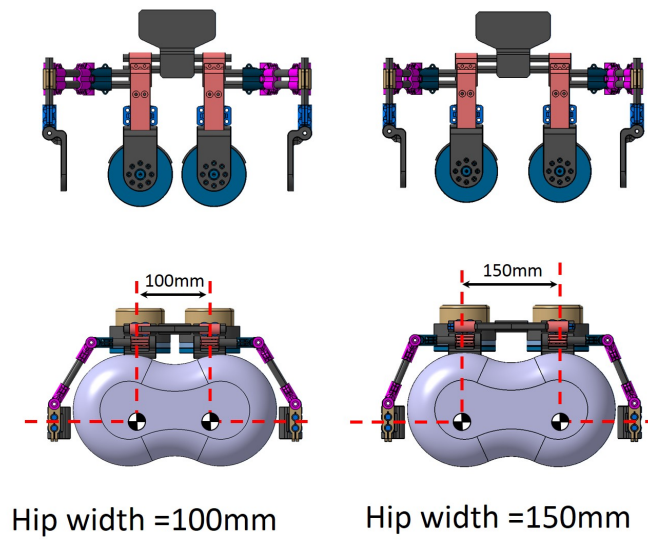


Figure 5.7 variable size and shape of the scalable exoskeleton waist

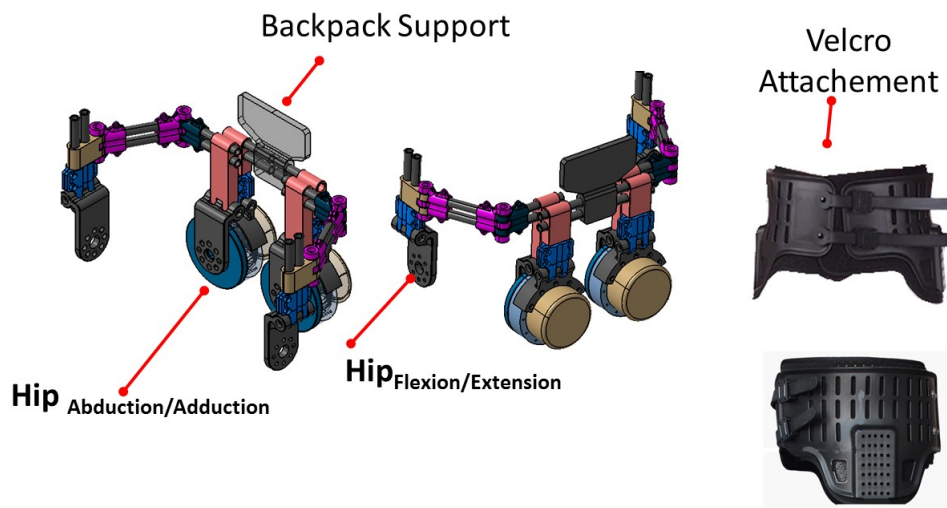


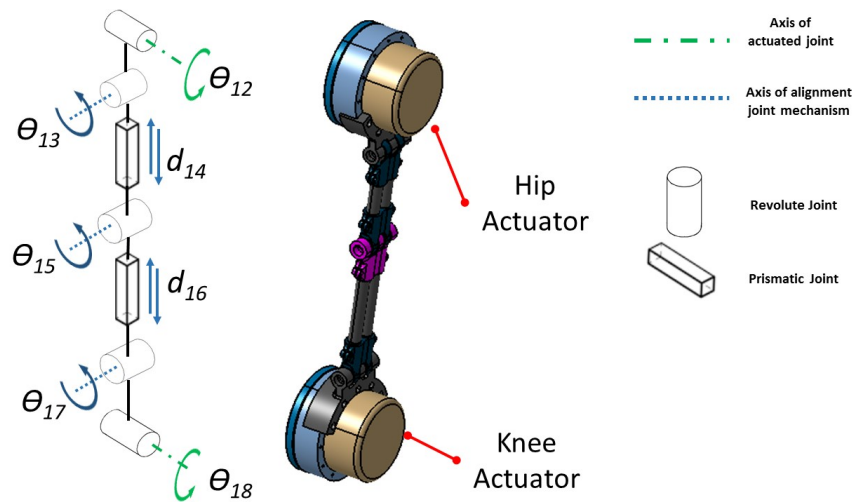
Figure 5.8 Mechanical design of the exoskeleton waist

### Thigh

In most cases, exoskeletons are composed of limited size linkages in order to support their own weight and a portion of the wearer's weight. This limitation in the size

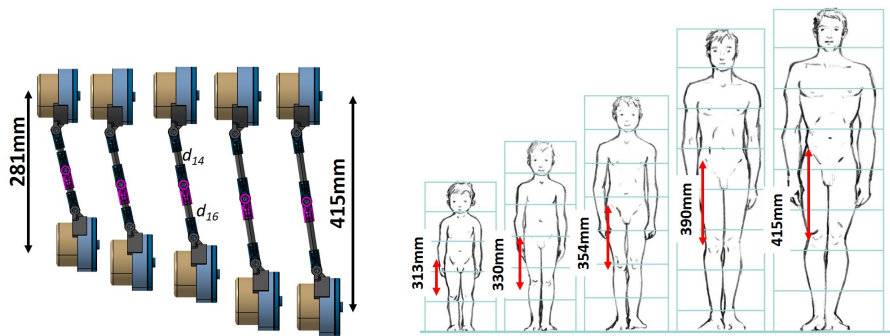
is in contradiction with the predefined scalability requirements because it cannot achieve the variable morphology and joint alignment properties of the exoskeleton frame segments. Hence, the exoskeleton structural elements such as the thigh and the shank should be designed to insure the requirements of the scalability. Up to the author's knowledge, until now there no rehabilitation device that has proved the continuous adjustability of the structural frame to maintain the scalability in the sense of size and shape of its wearer. For this purpose, their mechanical design takes into consideration that the thigh/shank frames are more rigid in the sagittal plane than in frontal plane.

As shown in the Fig 5.9, the structural scheme and the design of the thigh is presented. The represented Dofs  $\theta_{13}, d_{14}, \theta_{15}, d_{16}, \theta_{17}$ , are chosen to maintain the thigh adaptability to the user's body. The same clamping mechanisms for fixation are used in order to ensure the robustness of the exoskeleton during the motion.



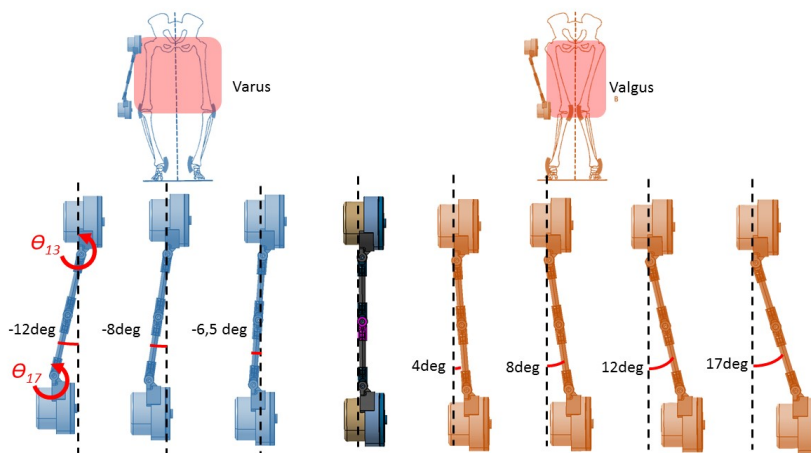
**Figure 5.9** Mechanical design and kinematic scheme of the exoskeleton thigh

$d_{14}$  and  $d_{16}$  represent the prismatic off-line joints. Their adjustments can ensure the variable length of the exoskeleton thigh. By referring to Figure 5.10, the various required lengths of the thigh can be continuously adaptable for each of the growth period, from the childhood until their adulthood.



**Figure 5.10** Mechanical design and kinematic scheme of the exoskeleton thigh

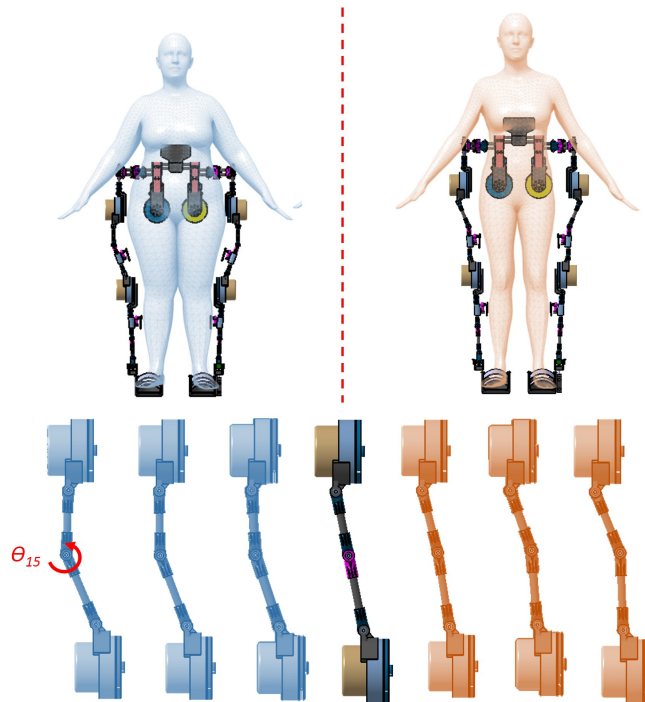
The  $\theta_{13}$  and  $\theta_{17}$  represent the rotational joints that can adapt the inclination of the exoskeleton tibia according to the user skeleton. As shown in Figure 5.11, the physical deformities of the skeletal system of the human body need to be recovered by the corresponding exoskeleton frame. So the used hinge joints help to keep the exoskeleton to follow the human body by changing the inclination the thigh limb. Also they give us the possibility to incline the rotation axis of the knee or the hip if needed.



**Figure 5.11** Mechanical design and kinematic scheme of the exoskeleton thigh

$\theta_{15}$  represents an added option to the scalable structure to follow different types of bodies. Its major importance is related with some human body particularity

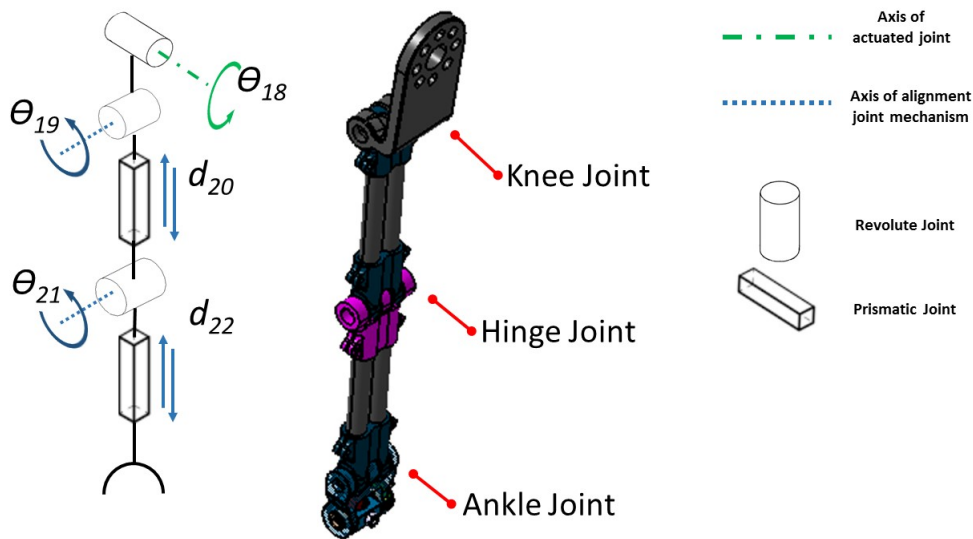
such as obesity and/or skeletal deformities. As illustrated in Figure 5.12, the exoskeleton can adapt to the both users' thighs thanks to this added joint. For the extra outside persons, the body can present several type of abnormal curvatures which represent a challenging constraint for the fixed sized exoskeleton. This joint can be adjusted in the both directions in order to cover all the situations. In addition, its position can be easily changeable by determining the lengths of  $d_{14}$  and  $d_{17}$ .



**Figure 5.12** Mechanical design and kinematic scheme of the exoskeleton thigh

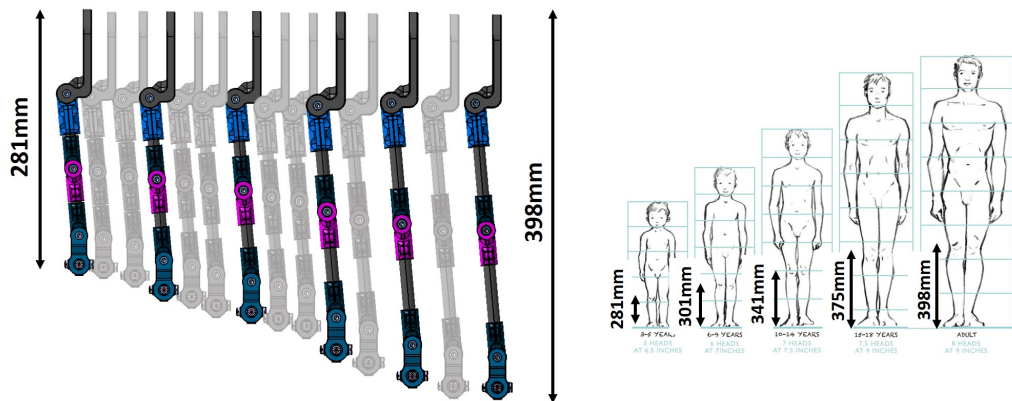
## Shank

The same design strategy of the structural elements as well as the clamping mechanisms is applied to the shank frame to maintain its scalability and robustness. Its design and structural scheme are illustrated in Figure 5.13.



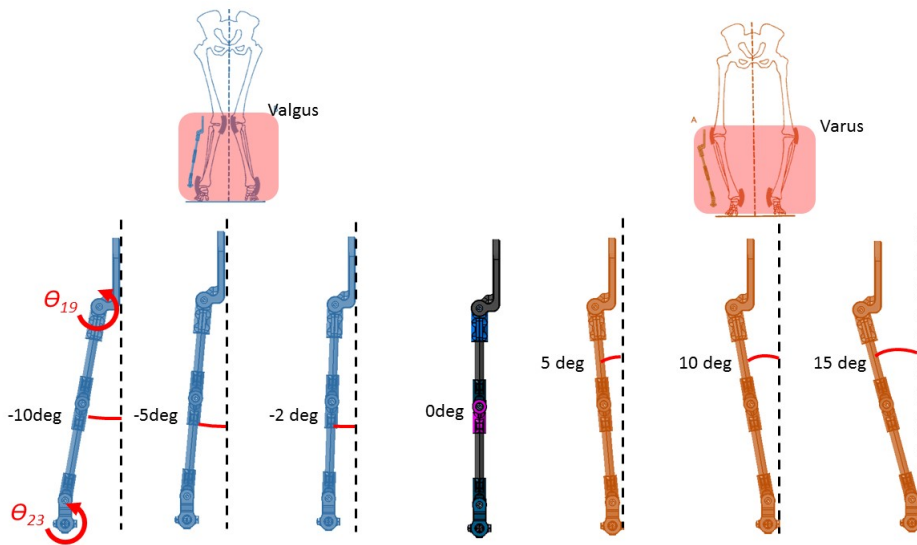
**Figure 5.13** Mechanical design and kinematic scheme of the exoskeleton shank

$d_{20}$  and  $d_{22}$  correspond to the prismatic off-line joints of the shank. They consist of a couple of high strength carbon fiber tubes clamped to the structural elements of the shank in to ensure the rigidity of the whole assembly. Their adjustments can provide the variable length of the exoskeleton shank during growth. Hence, by mentioning Figure 5.14, the various required lengths of the shank can continuously reach each phase of growth.



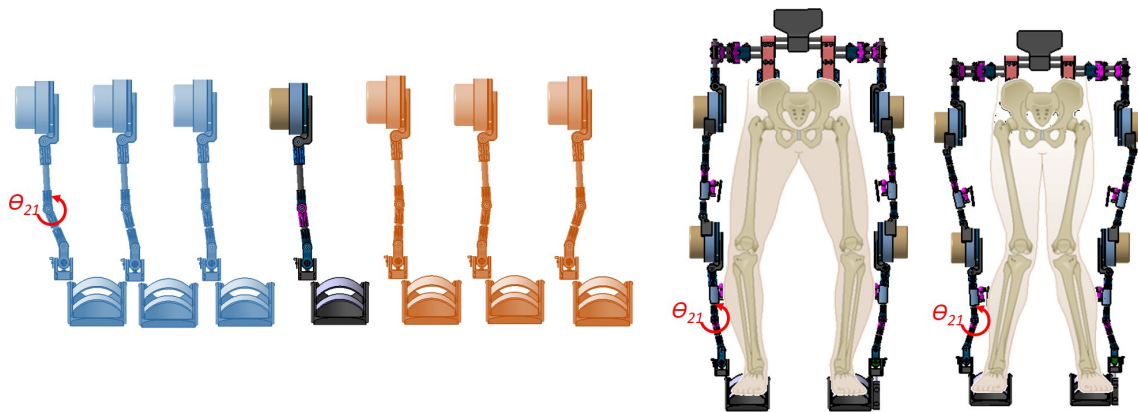
**Figure 5.14** Mechanical design and kinematic scheme of the exoskeleton thigh

The  $\theta_{19}$  and  $\theta_{23}$  represent the off-line hinge joints that can adapt the femur angle according to the user structure. As shown in Figure 5.15, the physical deformities of the skeletal system of the human body, such as Valgus or Varus, need to be recovered by the corresponding exoskeleton frame. So the latter hinge joints help to keep the exoskeleton physically follow the human body by changing the inclination the the shank limb. Also they give us the possibility to incline the rotation axis of the knee or the hip if needed.



**Figure 5.15** Mechanical design and kinematic scheme of the exoskeleton thigh

In the same way of the thigh,  $\theta_{21}$  represents an added option to the scalable shank to follow different type of bodies. Its major importance is related with some human body particularity such as obesity and/or skeletal deformities. As illustrated in Figure 5.16, the exoskeleton can adapt to the both users' thighs thanks to this added joint. For the extra obese persons, the body can present several type of abnormal curvatures that represent a challenging constraint for the fixed sized exoskeleton. This joint can be adjusted in the both directions in order to cover all the situations. In addition, its position can be easily changeable by determining the lengths of  $d_{20}$  and  $d_{22}$ .



**Figure 5.16** Mechanical design and kinematic scheme of the exoskeleton thigh

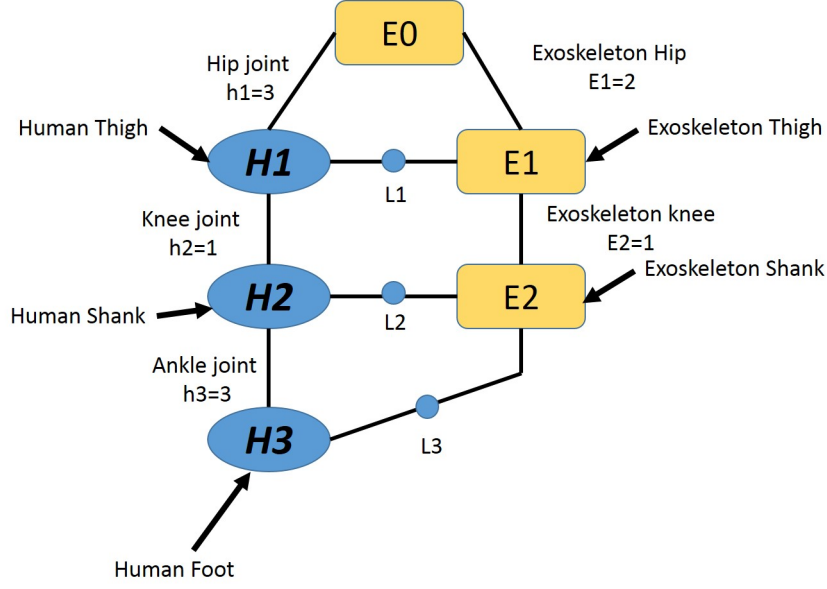
The combination of a set of prismatic and hinge joints allows the scalable thigh/shank frames to be perfectly attached to the user's body, to follow the curved shape of the user's leg, while the actuator is moving the limbs according to the application requirements. Also this added off-line joints can help in reducing the complexity of the needed attachments by reducing the space between the exoskeleton frame and the human body.

The four bars mechanism used to align the knee of the exoskeleton to the human knee is not considered in the design despite its importance in the context of exoskeleton scalability. This may be developed in future work.

### 5.2.3 Kinematic Compatibility and Human/exoskeleton Connections

The multi-body serial chains illustrated in Fig 5.17 represent the connection between the exoskeleton limb  $E$  and the human limb  $H$  through the passive connection chains  $L_j$ . We considered in our application three connections in the exoskeleton/human context .

Normally, the connection mechanism  $L$  is having a minimum and a maximum number of degree of freedom which are defined in the equation 5.1. When the value of  $L$  is null, there is a rigid connection between the exoskeleton and the wearer's corresponding limb (the case of the exoskeleton Rewalk). When this



**Figure 5.17** Schematic of kinematic structure of the scalable exoskeleton

value is one, there is one degree of freedom between the connection and the wearer's corresponding limb, etc. The maximum value that can be taken by  $L_i$  is five where it represents the maximum combination without redundancy.

$$\begin{aligned} \forall i \in \{1, 2, 3\} \\ 0 \leq L_i \leq 5 \end{aligned} \quad (5.1)$$

The study of the Grübler-Kutzbach's criterion, (shown in Equation 5.2) and well known mobility equation, on several exoskeleton structures and limb attachments conduct us to specify the kinematic scheme of the hip and knee connections to maintain the global mechanism isostaticity. The types of the attachments are inspired from the litterature surveys made before [83], but taking into consideration the ankle and the pelvis, which are not considered in the last works, as far as we know.

$$m_i = \sum_{i=1}^j (L_i + E_i) - 6.(j) \quad (5.2)$$



Where  $m_i$  is the DOF of the global mechanism,  $Li$  is the DOF of fixation mechanism which can be zero or more,  $Ei$  represents the total number of exoskeleton links connecting the 2 bodies. If joint connects three links then it must be counted as two joints.  $j$  is the total number of fixation mechanisms. The number 6 is presented in the mobility equation because we are working in a spatial context.

In our application the parameter  $j$  is equal to three because the global mechanism consists of the thigh, the shank and the foot. So according to the Equation 5.3, the resultant of the summation made on  $Li$  and  $Ei$  is equal to 18. This is applicable only when considering the iso-staticity of the system, therefore when  $m_{global} = 0$ .

$$\sum_{i=1}^j (Li + Ei) - 6.(j) = 0 \tag{5.3}$$

$$\sum_{i=1}^j (Li + Ei) = 6.j = 6.3 = 18$$

The values of  $E1$  and  $E2$  are 2 because the hip joint is having 2 actuated Dofs while for the knee only 1 Dof is actuated. So, when replacing these values in the mobility formula, we can obtain in Equation 5.4 the resultant of the number of the passive Dofs of all the connection mechanisms  $Li$  for the global mobility of the exoskeleton/human system.

$$\sum_{i=1}^j Li = 18 - (E1 + E2) = 18 - 2 - 1 = 15 \tag{5.4}$$

Therefore,

$$L1 + L2 + L3 = 15 \tag{5.5}$$

Since the maximum allowable value of the connection links is five. Then the only solution for this kinematic chain is the equality of the connection mechanisms.

Which yields to the following distributions:

$$L1 = L2 = L3 = 5 \quad (5.6)$$

The selection of each connection mechanism  $L_i$  which matches the requirements depends on the exoskeleton application (Power augmentation, rehabilitation.. etc), so, primarily depends on the kinematic constraints of the structure such as the compatibility with the wearer. In our application, the possible solutions of lower limb exoskeleton' connections are based on the combination between the existing joints' types such as (rotational, prismatic, universal and spherical) to reach 5 Dofs, and they are addressed in Table 5.2. In this context, we will consider the following convention for each connection,  $L_{Thigh} = L1, L_{Shank} = L2, L_{Foot} = L3$ .

Connection name	chain	Passive Joints combination
Connection chain Thigh, Shank, Foot		1S2P, 1S2R, 1S1U, 1U2P1R, 1U1P2R, 2U1P, 2U1R, 3R2P, 3P2R

**Table 5.2** Possible combination structures of the hip and knee and ankle joint connection chains ( $L1=5, L2=5, L3=5$ ), U: universal joint (2 DOF), R: revolute joint (1 DOF); P: prismatic joint (1 DOF), S: Spherical joint (3 DOF)

However, to better select the most corresponding connection chain for each limb, several limitations and considerations should be taken into account, which are presented as follow:

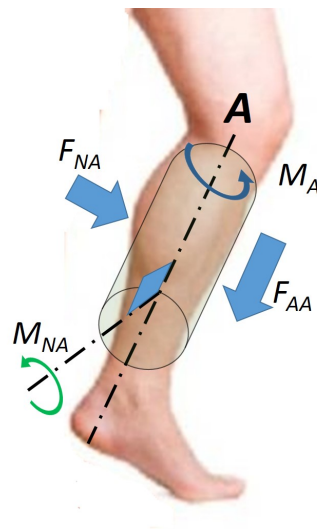
- The combination of the passive joints should not transmit additional forces to the human limb and joints, preventing the kinematic incompatibility.
- It is preferable that the connections are built using the same combination type of Dofs. This is in order to simplify the assembly, and maintain the exoskeleton modularity;
- The allocated space of the attachment should not be too bulky in order to improve the exoskeleton acceptance.

### Selection Criteria of the Attachment Passive DOFs

In order to attach the exoskeleton SOL to different subjects, this can be achieved by designing the connections between the exoskeleton limbs and the user's ones. This fact can be realised by taking into consideration the constraints imposed by the kinematic adaptability which are mentioned before and which can be resumed by the constraints imposed by human body on the systems.

For this purpose, our assumption is to consider the human limb's shapes as cylinders or cones having an axis called  $A$ . To transmit forces on such segments, the connections must surround the shape. These connections convert forces and moments that are generated by the robot into pressures applied through the surface of splints. Specific considerations have to be taken into account in order to preserve human tissues from high pressures.

According to [83], four kinds of stresses can be applied by the robot on the human limb. These stresses are:  $F_{NA}$  forces perpendicular to the axis  $A$ ,  $F_{AA}$  forces along the axis  $A$ ,  $M_{NA}$  moments around the axis perpendicular to  $A$ , and  $M_A$  moments around  $A$  (see Figure 5.18).



**Figure 5.18** Forces generated by the exoskeleton connection mechanism

These applied stresses need to be either transmitted or eliminated in a way

to respect the functionality of the exoskeleton. The following considerations are taken into account to treat each stress.

- For the forces  $F_{NA}$ , the interaction surfaces between the human skin and the exoskeleton attachment need to be as large as possible in order to minimize the contact pressure level. To maximize the force transmission from the robot to the human, fixations should be also positioned, if possible, on high stiffness areas of the human body. Several studies have been done on localizing these specific human-body areas [95].
- The axial forces  $F_{AA}$  must be avoided since it is not a desired movement to be assisted. Moreover, applying these kinds of forces through a tight fixation leads to a transmission by friction that can generate high tangential forces on the skin, and thus, pain or at least discomfort.
- Moments around an axis that is perpendicular to  $A$ ,  $M_{NA}$  should be carefully applied: applying such a moment results in the concentration of the stress that is applied to the limb tissues at two opposite points. The local forces may be high since the dimensions of the connection parts are small for ergonomic purposes. Hence, the use a couple of forces applied to two segments is highly preferable in terms of the local deformations of the skin and muscles.
- Moments around the limb main axis  $A$ ,  $M_A$  should not be transmitted because, this will cause large deformations of the muscles (transmission by friction).

Consequently, the study of these stresses that must be controlled by the exoskeleton actuators accompanied with the requirements presented before leads us to determine the type and the number of DOFs of the each attachment. On the other hand, the desired attachment mechanism should only allow a certain amount of axial and tangential forces in the form of friction on the human body. The magnitude of these forces will be then negligible compared with the perpendicular force at the same location thanks to the allowed movement.

Concerning  $L1$ , among the available solutions, the linear motion along the axis  $A$  is required to eliminate the undesired  $F_{AA}$ . So based on this constraints, we can eliminate the solutions  $2U1R, 1S1U, 1S2R$  whose don't have the prismatic joint. In addition the solutions which contain two universal joints  $2U1P, 2U1R$  can also be eliminated because of the redundancy created. To avoid the undesired redundancy the solution containing the 3 rotational joints can be represented as spherical joint, and the solutions containing more than 3 rotational joints as a total like  $1U1P2R$  can be eliminated from our choices. On the other hand and as mentioned before, the size of the selected mechanism should be as small as possible, and it is preferable that the connection used in the thigh is replicated to the one used in the shank. The solution which contains the three prismatic joints can be eliminated because the linear motion which is perpendicular to the axis in the frontal plane is not required to be freed. For this purpose, we can reduce the number of the available solutions from nine to four which are addressed in Table 5.3.

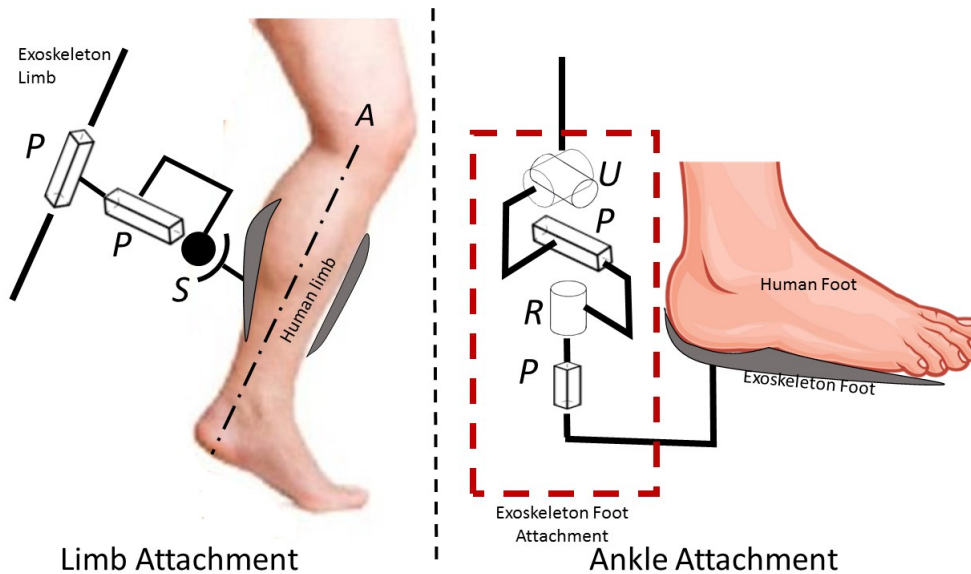
Connection chain	Passive Joints combination
Connection chain Thigh, Shank	1S2P, 1U1R2P, 3R2P

**Table 5.3** Final combinations of the thigh and shank connection chains ( $L1 = L2 = 5$ ), U: universal joint (2 DOF), R: revolute joint (1 DOF); P: prismatic joint (1 DOF), S: Spherical joint (3 DOF)

It seems preferable to keep the rotation around the axis  $A$  for the first passive Dof, because this will cancel the local tissue torsional stresses due to the generated moment around  $A$ . But this solution require a special mechanical design requirements in order to align the rotational axis of the mechanism with the axis  $A$ . In addition, a prismatic joint along  $A$  is chosen to ensure the elimination of the axial force  $F_{AA}$ . And since there is a restriction on the size of the attachment mechanism it should be designed as compact as possible. For these purposes, the solution  $1S2P$  (one spherical joint and two prismatic joints) is chosen for the attachment mechanisms on the thigh and the shank.

Regarding the ankle attachment, since the mechanism  $L_3$  has five Dofs, a uni-

versal joint on the ankle level can be proposed as a first joint to be compatible with the human corresponding ankle. The three remaining joints can be chosen according to the desired forces to be transmitted. A set of rotational in series with a prismatic joint is considered to simulate the motion of the human foot when it is attached to the exoskeleton foot. The last Dof is the limited sliding motion between the foot and the exoskeleton insole. Thus, for this mechanism the solution  $1U1R2P$  is selected to transmit the forces from the exoskeleton to the human body in order to move it.



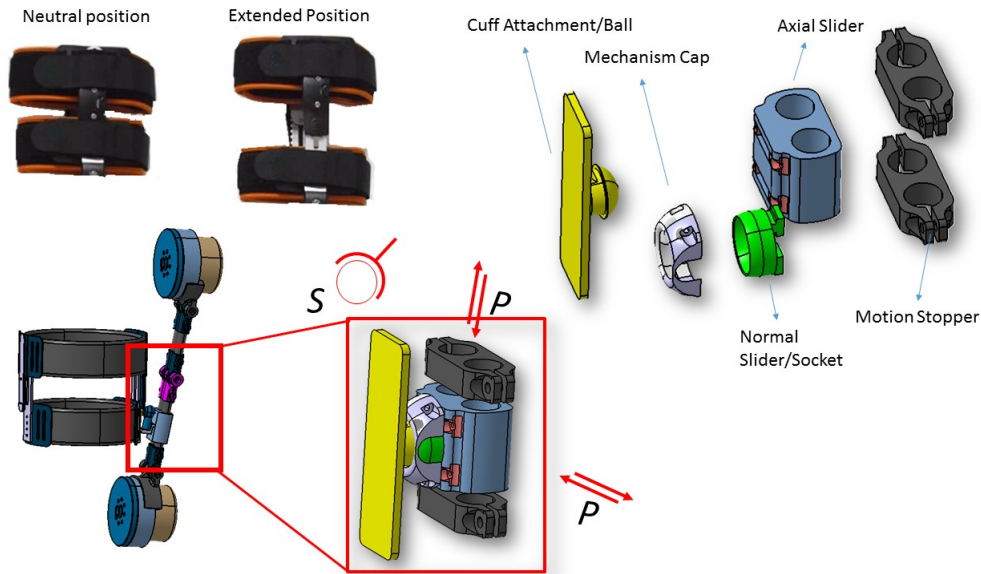
**Figure 5.19** The ankle and the thigh/shank attachment

Based on the predefined kinematic constraints, forces and moments, the structural design the attachments and its corresponding mechanisms is done. Two types of mechanisms are used to interface the exoskeleton braces with the wearer. Their realization are shown in the next section in details.

### Realization of the Thigh and Shank Attachments

As explained before, the thigh and the shank present five degrees of freedom to allow the kinematic compatibility with their wearer. In addition, their adaptabil-

ity to different sizes of the users is achieved by adding one more sliding and a diametrical adaptation mechanisms to extend their shape. These adaptations are proposed to better fit the users whatever the size and the diameter of their limbs. As shown in the Figure 5.20, the conceptual design of the five Dofs 1S2P attachment mechanism on the right side, and the bidirectional extendible (thigh/shank) cuffs on the left side.



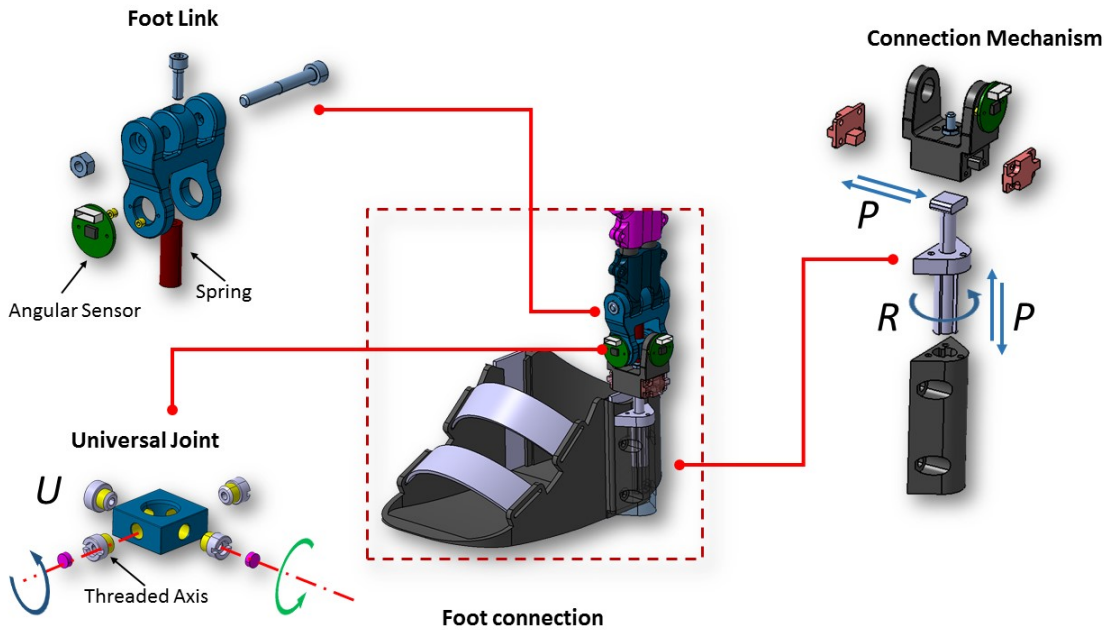
**Figure 5.20** Thigh and Shank 5 Dof Attachment passive mechanism

These flexible cuffs are comprising a thin wall of carbon fiber shape with a medical memory foam for an added comfort when wearing it and a straps to ensure better fitting to the patient body. This design form the connection points to the wearer's thigh and shank braces.

### Realization of the Exoskeleton Foot

For the ankle, a five Dofs Connection element between the shank and the user's foot was designed with respect to the size and the scalability requirements (see Figure 5.21). The flexion/extension and the inversion/eversion motions of the exoskeleton ankle passes through the corresponding human ankle using the universal joint  $U$ .

Moreover, since there is a major link in the movement, it must cooperate securely with the human body, that's why, a spring is added to the mechanism to return the foot to its neutral position during the moment where the foot is not on the ground. Angular sensors will be added to measure the angular position during the motion which will help the exoskeleton control to take the right decision according to its constraints.

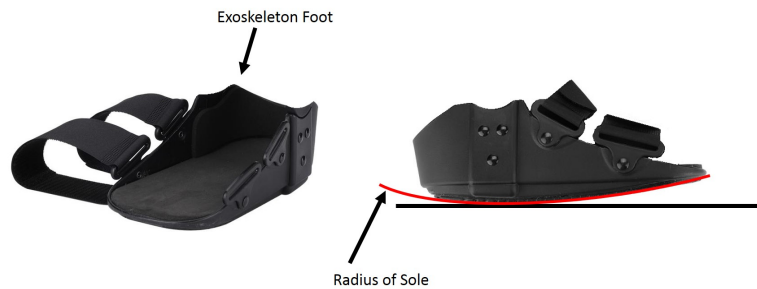


**Figure 5.21** Mechanical design of the exoskeleton Foot with the connection mechanism

The user's foot is attached to a custom made carbon fiber foot, with straps placed over the heel and toes of the user's foot. The foot sole must allow the exoskeleton to perform a natural gait. Thus, the rounded surface of the sole, (see Fig 5.22), helps to swing the body by the corresponding foot as well as lateral weight shift during stance phases of the gait. The feet are sufficiently rigid, only the face which is in contact with the ground is covered by a rubber layer, allowing a high coefficient of friction to avoid slipping on smooth floors. For example, during the single support of the gait cycle, the curved surface of the foot allows the leg to move through the sagittal plane of the foot, which resembles the heel and toe



roles in natural human walking.



**Figure 5.22** Curved design of the exoskeleton sole

## 5.3 Actuator Mechatronic Design

### 5.3.1 Actuation Integration

The integration of the actuator and its accessories into the system must be as simple as possible to keep the space between the exoskeleton joints available to continuously adjust the exoskeleton to members as the user grows, and thus ensure scalability. To effectively assist human motions (walking, sit-to-stand, stairs climbing, etc...), such actuators are required to generate large torques with variable angular speed for each actuated DOF, with a high level of accuracy. Moreover, the assistive robots should be compact and light to minimize discomforts caused by their hardware, which imposes a constraint on the selection of actuators.

Fig 5.23 addresses the selection criteria between different types of actuators. This selection criteria is based on the main constraints of the actuator integration issue and lists the most important properties and performance measures of electric, pneumatic and hydraulic actuation.

The classical hydraulic actuators used in some systems such as (BLEEX, Big-dog, KNR) show good performance providing high power to weight ratio, high force, high efficiency and bandwidth. Unfortunately, this choice is not suitable for the scalable applications due to the fact that linear/rotary classical hydraulic actuators require a vast space to be implemented to the exoskeleton. Moreover

Type of actuator	Type of motion	power to weight ratio	Power to volume ratio	Cost	Controlability	Efficiency	scalability	assembly complexity	Compactness	
Hydraulic	classical actuator	Linear (piston)	+++	+++	---	++	++	+	---	+
		Rotary (piston)	+++	++	---	++	++	++	---	+
	IEHA	Linear (piston)	+++	+++	---	++	++	+	---	++
		Rotary (piston)	+++	+++	---	++	++	+++	---	+++
Electric	Electromagnetic	Linear (ball screw mechanism)	++	++	-	+++	+++	+	-	++
		Rotary (DC motor+ reductor)	++	++	-	++	+++	+++	-	+++
	Piezo electric	Deformation	+	+	--	++	+	++	---	++
Pneumatic	classical actuator	Linear (piston)	++	++	--	++	+	++	--	++
		Rotary (piston)	++	++	--	++	+	++	--	++
	Artificial muscles	Linear (PAM)	++	++	--	+	++	++	--	++
others	Electrheological Fluids	Deformation	+	+	-	0	0	+	---	+
	Electro Active Polymers	Deformation	+	+	-	0	0	+	---	+
	shape memory alloy	Deformation	+	+	-	0	0	+	---	+

**Figure 5.23** Comparison of the actuator types, "+" me High/Valuable and, "-" means Low/Poor

it is difficult to use mechanical stoppers in order to obtain a variable range of motion on the joints, especially, for the degrees of freedom that are not easy to operate (Abduction/Adduction, Inversion/Eversion, etc.). This complexity is due to their crank and rod mechanism. Also, construction of a device with changing configurations can be complex because of the hydraulic oil in the tubes and components.

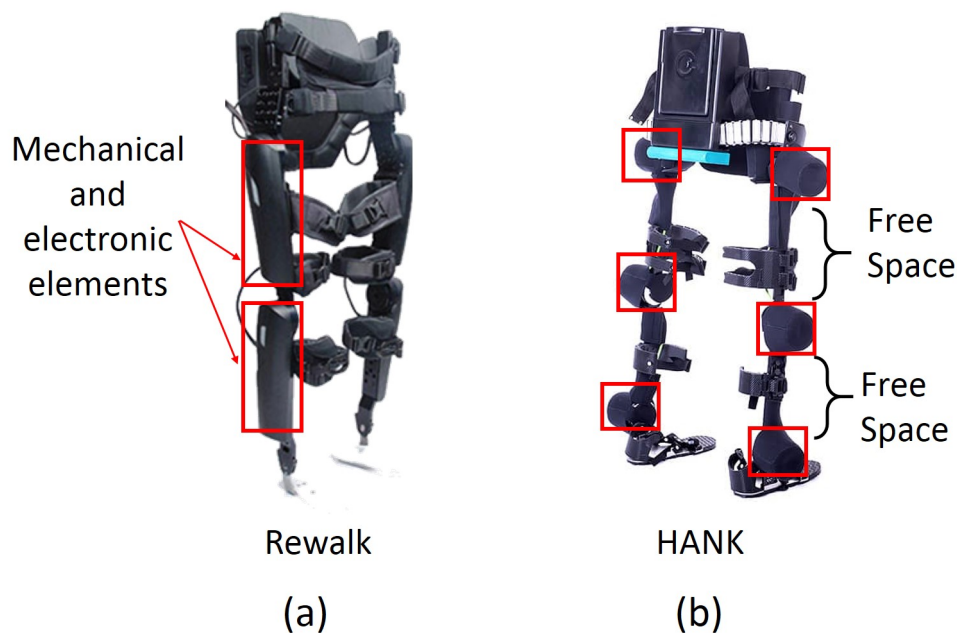
Pneumatic actuators (PMA, Linear, Rotary) are not suitable for a scalable application because they have several disadvantages such as their power to weight/volume ratio, efficiency, complexity in integration (extra accessories are needed), in their control bandwidth, caused by the non stable physical behaviours of the pressurized air (compressibility, expansion due to temperature and pressure, etc.)

Due to the technological advances in the field of electric motors and micro-controllers, electric actuation became more and more popular. Electric motors have become more compact, available in a wide range of sizes and performance, easier to control and less expensive compared to the other actuators. However,

their limitations due to the low power-to-weight ratio and gears are increasingly problematic in the construction of robots designed for dynamic movements.

The other types of actuators based on deformation behaviours (piezo electric, shape memory alloy, ...) are still in their development phase, and their generated forces are small compared to the other choices. They cannot provide the required kinematic/dynamic behaviours to maintain scalability.

In addition to the before-mentioned constraints, and by referring to the Fig 5.24, a comparison between using the space between the joints and keeping this space free of any mechanical element (mechanical and electronic elements) is illustrated. We should notice that most of the existing exoskeletons are using that space, making them losing their ability to be adjusted. At the contrary of few exoskeletons that use the on-joint type where they can easily adjusted in size, see Fig 5.24 a) and b) respectively.



**Figure 5.24** Actuation type versus the available space between human lower limb joints: a) used space, b) Free space

The result of the comparison study reveals that integrated rotary actuators (IEHA [96], Integrated Electromagnetic Rotary Actuator (IERA)) are the most suit-

able choices to design scalable exoskeletons. The benefit of using such actuators is due to their small size. Hence, they can be placed as near as possible to the robot joints to minimize the possible drawbacks of hydraulic actuation units. Compact integrated eletro-hydraulic systems are not yet available on the market and most of the few existing components are still very expensive. For this purpose, we used for our first iteration the second choice represented by the IERA which will be explained in details in the next section.

Our proposed actuation methodology is called "on joint actuation" used to actuate the DOFs of the scalable exoskeleton in a rotational manner. It is clear that this strategy will serve the purposes and the requirements of the scalability such as size interchangeability, kinetics needs, selection of degrees of freedom as well as the pose of joints. This can be achieved by allowing the user to modify the exoskeleton according to his body morphology and size, and will help reducing the space occupied by the joint actuator to drive the corresponding joint and therefore will reduce the system weight and complexity.

### 5.3.2 Mechanical Design

According to our study in the chapter 3, the obtained actuator characteristics impose several mechanical constraints for motor and gear selection, including its required maximum torque  $142Nm$ , required angular speed  $210deg/s$ , variable range of motion, and its desirable compact size to answer the scalable design requirements. Selection of the actuators is a demanding task because they must be able to move at high velocity while good dynamic performance is required to accelerate the links.

On the other hand, for minimal weight of the device, it is essential not to oversize the drives while at the same time appropriate power reserves should be kept. Three major demands on the actuators are:

- High dynamic response;
- High output axis speed;

- High output axis torque over a large speed range.

To find a joint actuator that matches these constraints, we started by studying the available on the shelf electric actuators, which are found to be not corresponding to our design constraints in term of weight, size and power capabilities. This leads us to customize the joint actuator to fit the predefined requirements. We plan to motorise the four actuated DOFs with only one type joint actuator. Thus, to realize such highly integrated joint units with maximum power density it is necessary to use the latest technologies in the field of electrical drives, gears and sensors.

To design the actuator weight and size, the main reasons for us to choose permanent magnet synchronous motors (PMSM) over DC brush motors are robustness, a significantly higher power density, and higher torque and speed bandwidths. PMSM permit larger stall torques for longer intervals than DC motors where mechanical commutation severely limits stall torque. This is particularly important for slow movements or when the robot is stationary, i.e. when the motors are in reverse around zero speed or when joint positions are maintained for a period of time.

A special type of PMSM are frameless motors which consist of a stator lamination stack with three-phase winding plus a rotor with permanent magnets bonded into a ferrous tube. High performance brushless Direct Current Motors (BLDC) from Robodrive was chosen thanks to their superior torque and speed capabilities based on a study made by [97]. These sophisticated BLDC motors with high pole count are optimized for the demands of robotic applications such as high torque capacity and minimal power consumption and losses at low and medium speeds. Moreover, these motors come as frameless motors, which allows for an integrated design optimized for small space and low weight.

On the other side, when dealing with a high speed BLDC motors as an input, a speed reducer is a must to establish the required torques and speeds on the output shaft. In addition, this speed reducer should be small in size, durable, and light weight. Among the existing transmission's technologies (timing belts,

conventional gear stages, planetary gearbox, chains, screws nut mechanism, etc.), the strain wave gearbox (Harmonic Drive) is selected. The advantages of this gearbox is the high gear ratio while maintaining a small size, the zero backlash, and the low weight. Its compact design allows the integration directly into the joint. Motor shaft and bearing have to be customly designed which facilitates a space-saving integration directly into the joint. There is no need to use timing belts or couplings, which makes the entire drive chain backlash-free and slippage and ultimately increases the rigidity and bandwidth of the system.

Thus, based on the required dynamic and kinematic needs of the exoskeleton joints, the combination between the BLDC motor and the Harmonic drive gearbox is a crucial factor to better design the exoskeleton. It should be able to pass the required torque at the output shaft. To achieve good dynamic behavior, minimizing rotor inertia will theoretically maximize acceleration capabilities and increase the system bandwidth. For this purpose, we started by classifying the gear sets that match our needs based on several parameters which are the repeatable torque, average input angular speed, diameter, weight, length, moment of inertia  $J_{in}$  as show in Table 5.4. We excluded from this classification all the gearboxes which are heavier than 1.5 kg, and which are having a gear ratio more than 100 in order to simplify the design and the BLDC motor selection.

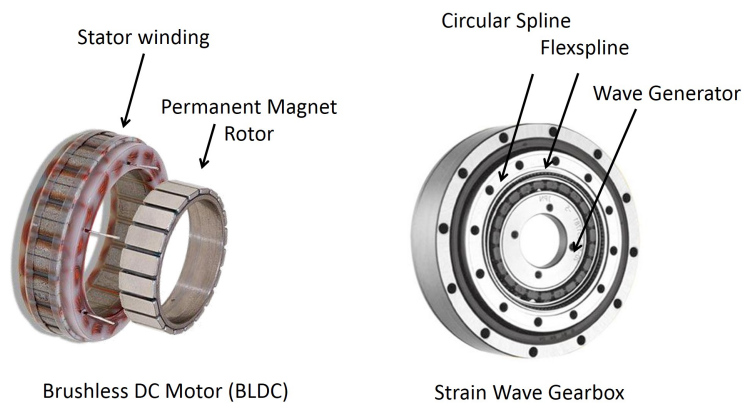
Gearbox Type	Ratio	Rated Torque	Repeatable Torque	Average input Speed	diameter	Weight	Length	Moment of inertia
HFUS-25-100-2SO	100	67N.m	157N.m	3500 rpm	110mm	1.31Kg	37mm	0.413 $10^4 Kgm^2$
SHD-32-50-2SH	50	53N.m	151N.m	3500 rpm	142mm	1.87Kg	27.9mm	1.09 $10^4 Kgm^2$
SHD-32-100-2SH	100	96N.m	233N.m	3500 rpm	142mm	1.87Kg	27.9mm	1.09 $10^4 Kgm^2$
SHG-25-80-2SO	80	83N.m	178N.m	3500 rpm	110mm	1.31Kg	37mm	0.413 $10^4 Kgm^2$
SHG-25-100-2SO	100	87N.m	204N.m	3500 rpm	110mm	1.31Kg	37mm	0.413 $10^4 Kgm^2$

**Table 5.4** Harmonic Drive Gearboxes classifications

The Harmonic Drive™ gearbox of type SHG-25-100-2SO and ratio "100" is selected among the available other gearboxes due to its higher rated torque, repeatable torque, light weight, and small moment of inertia compared the other gearboxes. In order to combine the selected gearbox with the suitable BLDC motor, we have started our calculation based the required angular speed of 210 deg/s on the knee joint, which is equivalent to 35 Rpm after the gear reduction. By referring to the Robodrive technical data, the challenge was to find the appropriate BLDC motor that can provide a minimum speed of 3500 rpm with the required torque which is equivalent to 1.51 N.m. The ILM 70X10 was the only BLDC motor among the robodrive motor sets that can provide 0.74 N.m as a rated torque, 2.3 N.m as a peak torque and can guarantee 3500 Rpm as a rated angular speed. So by combining these 2 components together we can found the following characteristics of the exoskeleton joint actuator, see Table 5.5.

Gearbox Type	BLDC Motor	Rated Output Torque	Peak Torque	output speed	Gear Ratio
SHG-25-100-2SO	ILM 70x10	74N.m	204N.m	35rpm	1/100

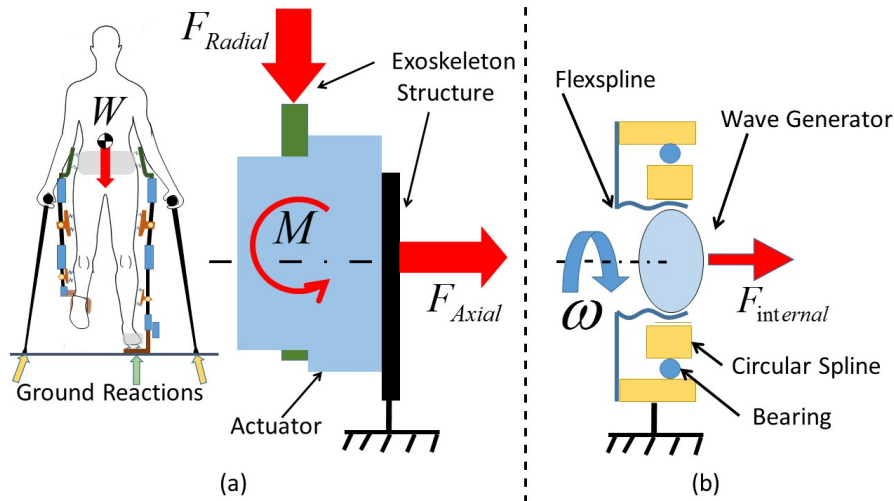
**Table 5.5** Harmonic Drive Gearboxes classifications



**Figure 5.25** Robodrive ILM 70x10 and the Harmonic Drive SHG-25-100-2SO

One of the main gains of such a gearbox is the existing of cross roller bearing

on its output shaft, so it can carry out the different internal and external loads ( $F_{internal}$ ,  $F_{Axial}$ ,  $F_{Radial}$ , and Moment  $M$ ) caused by the user weight  $W$  and the gearbox rotation  $w$ , as represented in Fig 5.26. Furthermore, the output bearing with high tilting capacity often allows direct attachment of heavy payloads without the need for further support, thereby providing simple and space saving design installations.

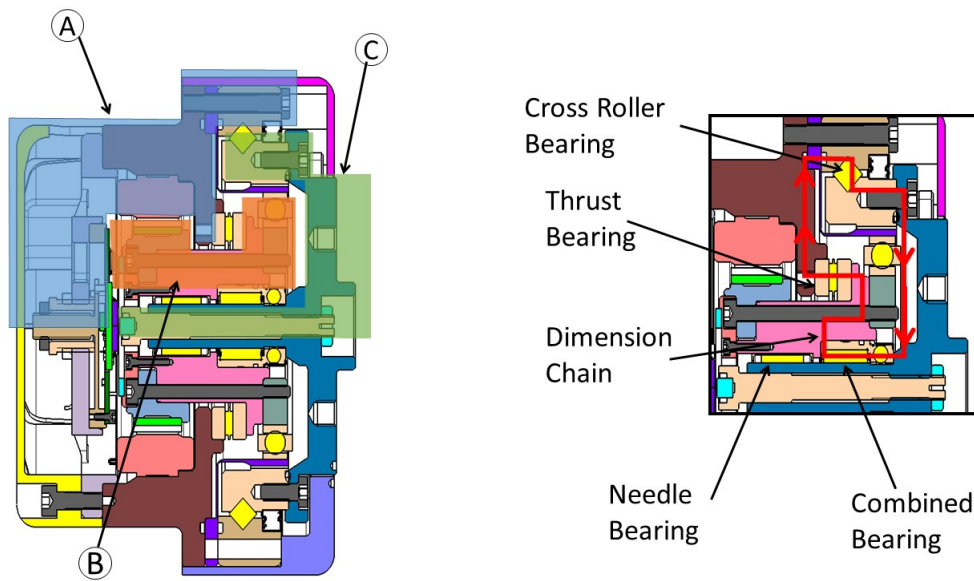


**Figure 5.26** Load Distribution scenario

The mechanical design of the actuator can be represented as a set of 3 blocks of components, connected to each other via one bearing chain to ensure the small size. As shown in Fig 5.27, the block (A) represents the fixed side of the actuator, which includes the BLDC stator inserted into the housing with a thermally conductive adhesive for optimal heat transfer. The encoder board attached to the back holder, the harmonic drive flexspline and its circular spline.

The block (B) represents the actuator input group, including the BLDC rotor and its holders. This block is connected to the block (A) and (C), via thrust and combined bearing respectively. The block (C) includes the output shaft, the gearbox's mobile circular spline, the absolute encoder magnet, and its holder. The connection between block (C) and (A) is maintained by means of the harmonic drive's integrated cross roller bearings. Finally, as shown in Fig 5.27, thanks to





**Figure 5.27** Assembly View of Joint Actuator

the integrated cross roller bearing, one dimension chain is used to assemble the 3 blocks of components together to facilitate the assembly process. In Fig 5.28, the mechanical design of the actuator's components is represented as an exploded view, showing all its components blocks.

To maintain the interchangeability in the ROM, adjustable hard stoppers are added to the actuator as shown in Fig 5.29. Its design consists of using two types of mechanical parts. The first one is attached to the fixed part of the actuator, while the second type is laying on the mobile out shaft in a changeable way. The adjustment mechanism allows a resolution of 5 degrees, in order to change the ROM of the actuator for either the hip or the knee (see Table 5.6 adapted from [98]).

### 5.3.3 Material Selection

The material selection is important for weight optimization of the internal components. The selection criterion is based on certain parameters which are mainly the volume and the applied stresses. The following chart, see Fig 5.30, shows that

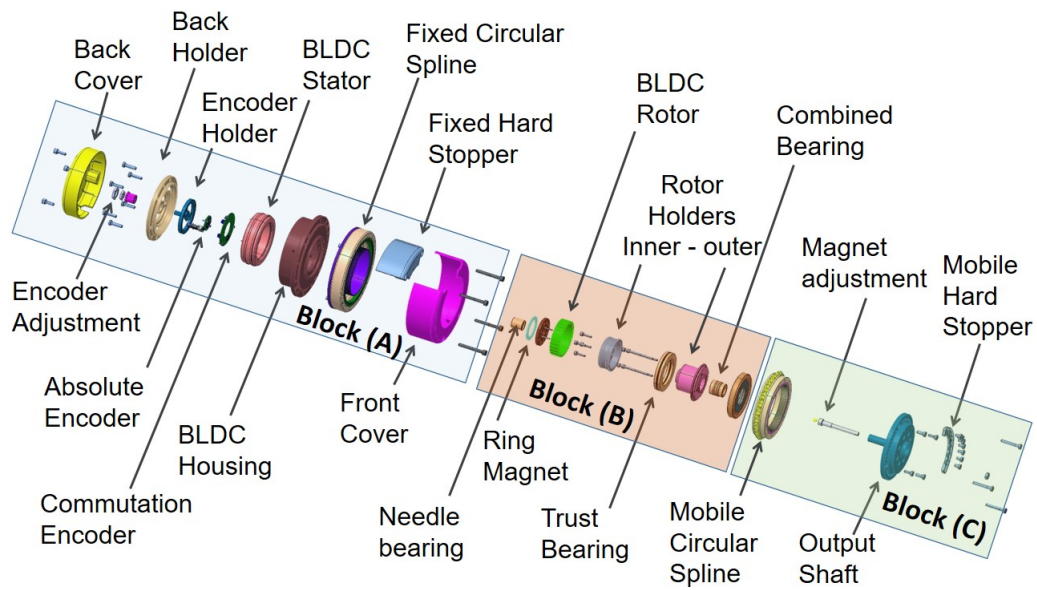


Figure 5.28 Exploded View of the Modular Actuator

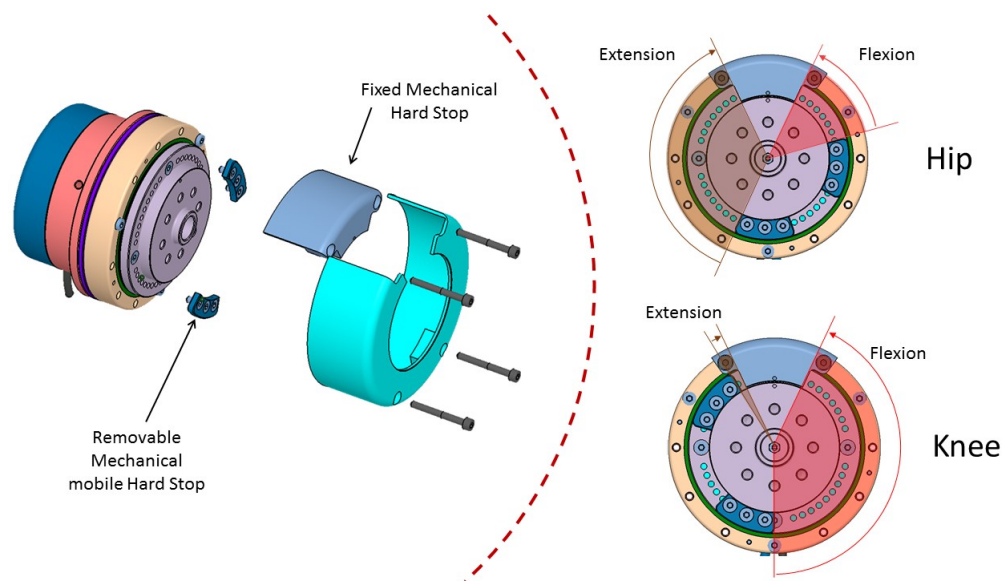


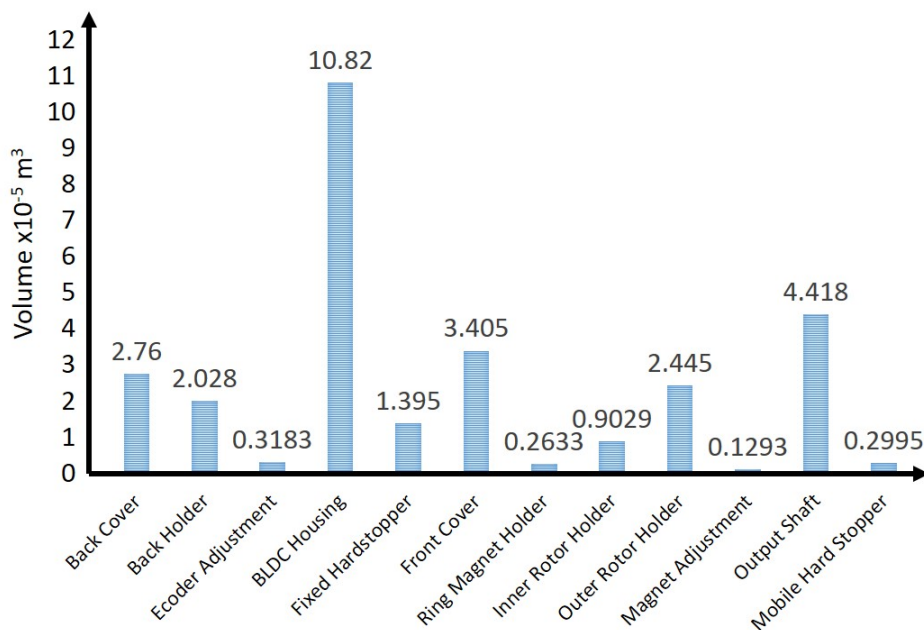
Figure 5.29 Hard Stopper design

among all components, the BLDC Housing, the Output shaft, the Front and Back Cover, and Inner Rotor Holder have the largest volumes over the other components, which leads us to optimize their weight by selecting the appropriate material.

A stress analysis was carried out for the previously stated parts to choose the

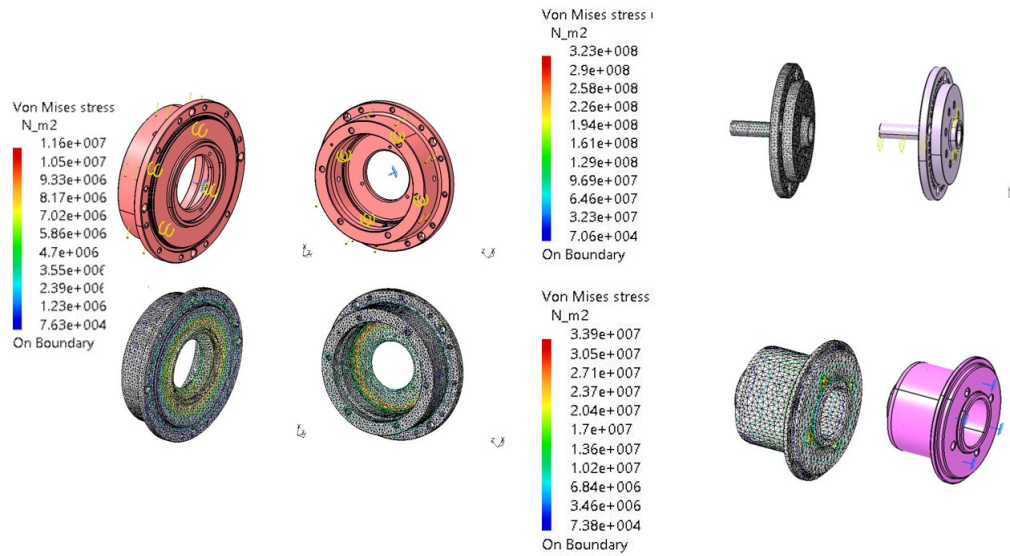
Degrees of Freedom	Movement Range	Design Range
Hip flexion/extension	145°/-10°	120°/-10°
Hip abduction/adduction	25°/-25°	25°/-25°
Knee flexion/extension	135°/0°	120°/0°
Ankle flexion/extension	85°/-90°	45°/-45°
Ankle abduction/adduction	35°/-30°	10°/-10°

**Table 5.6** Movement range of each DOF



**Figure 5.30** Chart of the Components Volume

appropriate material see Fig 5.31. These components are made from aluminum 7075T5 as the yield strength is found to be at least 430 – 480MPa which is considered an acceptable strength against the applied loads. However, the front and back covers are not loaded critically, they are chosen to be manufactured of poly-amid plastic material. It also has the advantage of lightweight compared to other types of metallic materials.



**Figure 5.31** Finite Element Analysis(FEA) of the Selected Components

### 5.3.4 Sensors Selection

The key to the development of such compact and modular actuator is in the design of the sensory integrated subsystem. For this purpose, the encoders have been optimized to be compatible to a wide range of servo drivers.

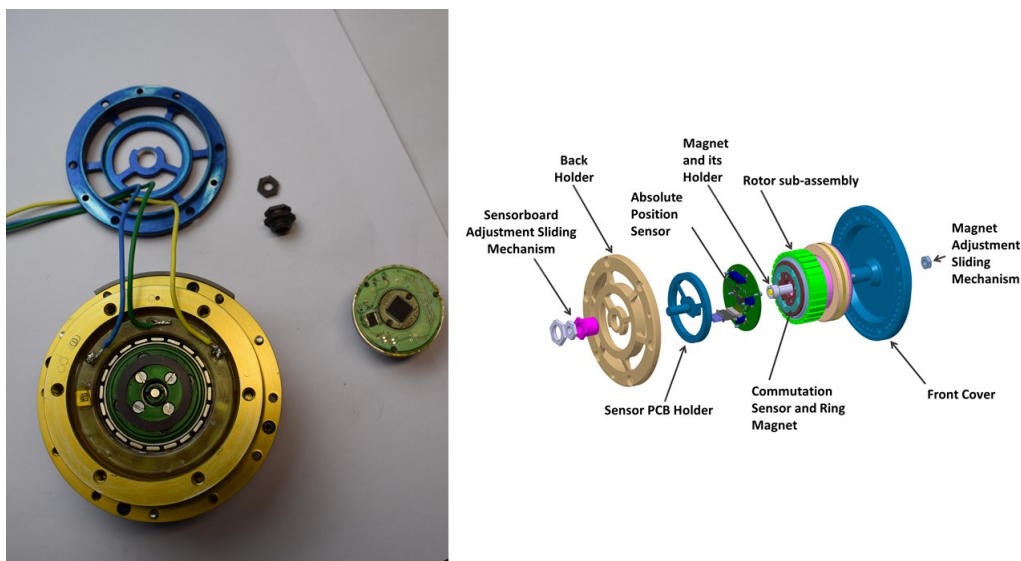
In addition, in order to perform smooth position control on the BLDC motor, it is mandatory to define the relative position of the rotor related to the stator. That is to enable the motor driver to power the proper stator poles with the necessary amount and direction of power flow.

Most of commercial drivers supports ABI quadrature pulses as an input from commutation sensors. The "AS5306" sensor from AMS is found to produce 2880 quadrature pulses when faced to an of- axis ring magnet (MR12-72). Such configuration is interchangeably compatible for each of the sensor itself, the motor, and the driver sub-assembly.

Although, while a position sensor attached to the motor, it is still preferred to add an extra position sensor to the output shaft of the actuator. The importance of such redundant solution allows to double the confidence level of joint angle

measurement, especially in case of a sensor or gearbox failure, which affects safety considerations.

Because the robotic actuator is meant to be attached to the patients' corresponding joint, which has a  $ROM < 2\pi$ , it is highly meaningful to choose the output shaft encoder to be absolute. Small form factor kit 'RMB20SC' from RLS is providing absolute 12 bit resolution when faced to a bipolar magnet of diameter 4 mm. The used protocol of communication is differential SSI which is found to be widely popular among commercial drivers as an auxiliary feedback.



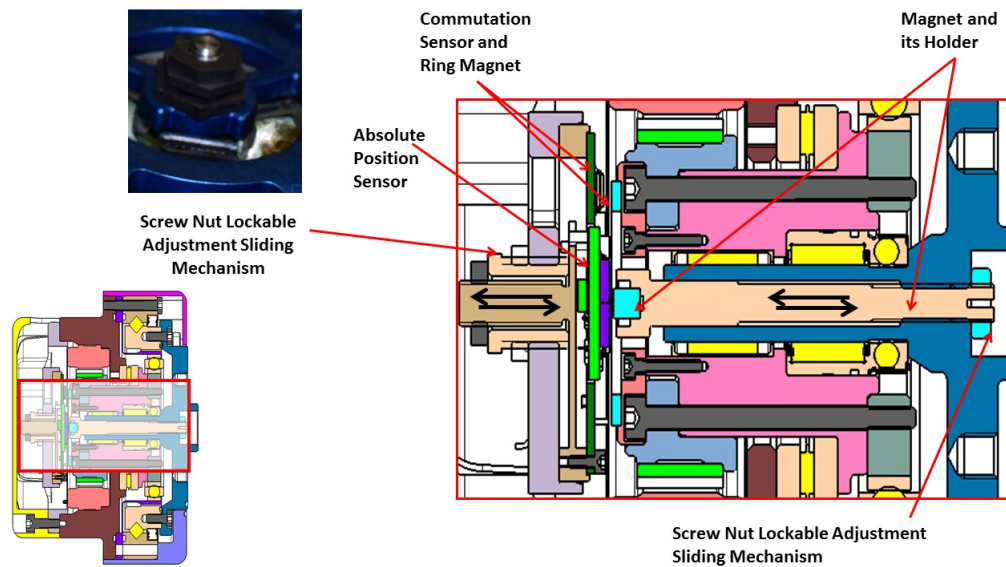
**Figure 5.32** Integrated Sensors Design

Both of commutation and position feedback sensors are chosen to be contact-less magnetic sensors. They are offered in a small form factor, leading to an easy integration in the design. Also, because contact-less sensors have zero wear, it guarantees eliminating measurement errors that are due to vibration, dust, etc. This leads to increasing the robustness and durability of the system. Moreover, on-chip algorithms are deployed to allow programming of mechanical zero position after assembly, which compensates for different types of errors due to minor magnet-to-chip misalignment, temperature, hysteresis, etc.

During sensor installation, sensor manufacturers have defined an allowable

range of overhead distance between the chip and the opposed magnet in order to guarantee a valid readings during position acquisition. Unfortunately, due to mechanical manufacturing tolerances of actuator mechanical parts, and assembly misfitting, there is a risk of disrespecting the allowable range of sensor tolerance defined. Thus, an adjustment mechanism is designed to enable adaptation of the overhead distances after the assembly process.

As shown in Fig. 5.32, both sensor boards are attached and fixed to the same 'Sensor PCB Holder' part. This part is mounted to a moving mechanism using a screw-nut mechanism with "Back Holder".



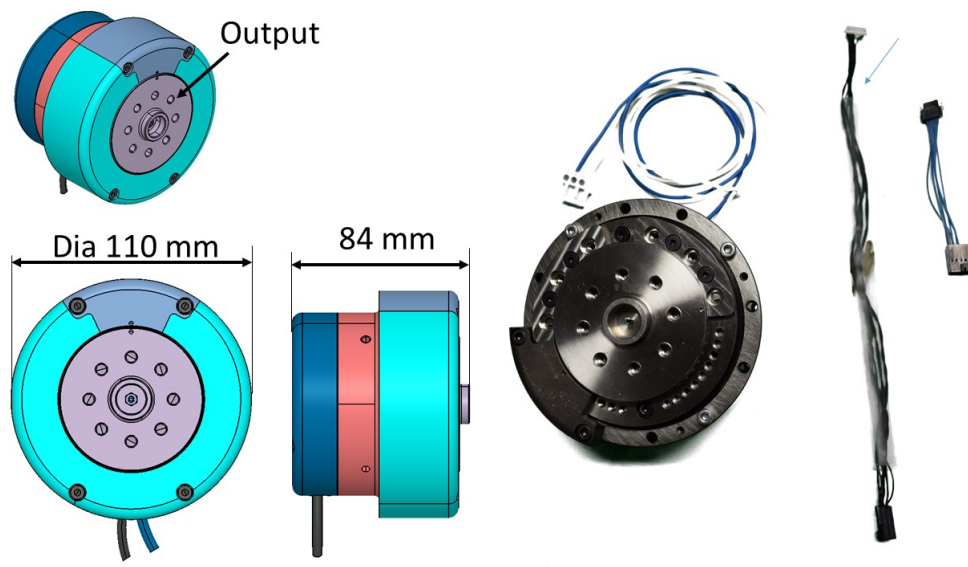
**Figure 5.33** sensors adjustment mechanism

At the end of actuator assembly process, and prior to powering the motor, this mechanism is utilized at first to adapt the distance between the commutation sensor and the magnetic ring attached to the rotor. After that, another screw nut mechanism at the front side is used to allow the adaptability of the distance between the absolute position sensor and the magnet attached to its holder shaft. Verification of proper magnet-sensor overhead tolerances could be validated by means of either the driver GUI, or by the visual aided LEDs added to the custom sensor board at the back end of the actuator. Finally, each of prescribed screw nut

mechanism has an integrated locking nut to ensure proper fixation and grantee resistance over vibrations.

### 5.3.5 Actuator Realization

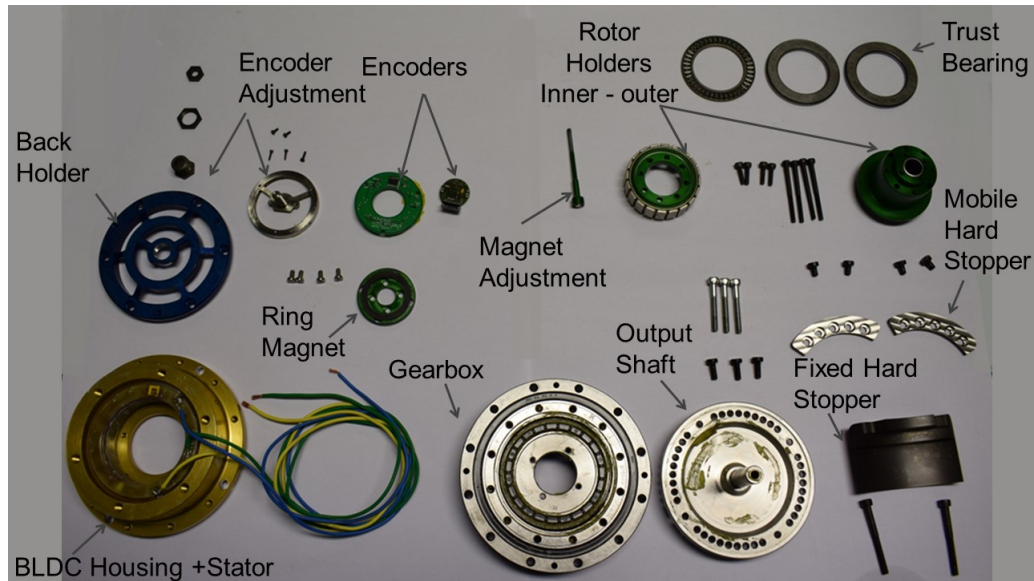
The design of the actuator turn into a cylindrical shape holding all the required elements in a compact form, see Figure 5.34 and Figure 5.35 respectively. The actuator can be implemented to the human needed corresponding joint thanks to its small size when comparing with the existing robots joint actuators. Hence, it uses small size us the advantage of achieving the exoskeleton scalability by allowing the space between the human joints to remain free of any mechanical elements.



**Figure 5.34** Actuator Design

In addition, thanks to the modularity insured by its design, the electrical/cabling setup of each of the actuator will be replicated. This design strategy will not only reduce the actuators' cost and their design time but also shortens the deployment and their testing period.

Also, since the scalable exoskeleton should serve the wearer during a long period, we designed one size of this actuator to cover his/her needs by sizing the



**Figure 5.35** The Components of the Actuators Outlines

actuator according to the worst case scenario defined before. The scalability in this context is the use the same actuator for different size/weight wearer.

The obtained characteristics of the developed actuator can be represented in the Table 5.7, where the capabilities of the joint actuator in term of power to weight ratio, size, torque and speed are shown.

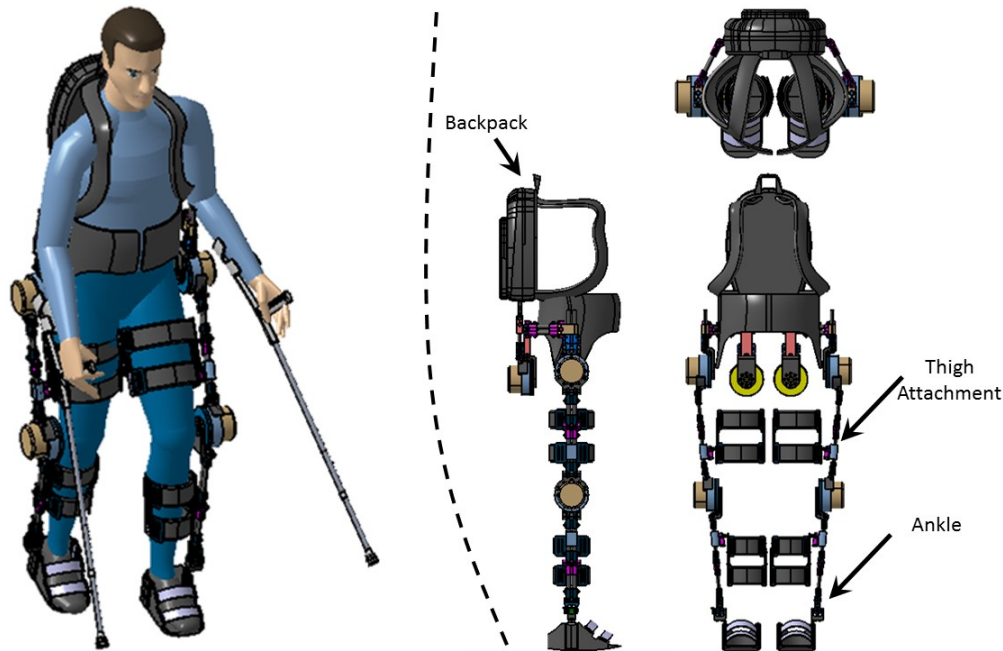
Diameter [mm]	110	Rated Output Torque [N.m]	74
Tickness [mm]	80	Peak Torque[N.m]	204
Power [W]	270	output speed [Rpm]	35
Volume[ $m^3$ ]	0.76	Gear Ratio	100
Weight [Kg]	2.2	Power/weight [W/kg]	122.7
Power/Volume [W/ $m^3$ ]	355	Rated Torque/weight [N.m/kg]	92.7

**Table 5.7** Actuator Characteristics



## 5.4 Realisation of the first prototype of scalable exoskeleton "SOL"

The design of the desired device should include the majority of the natural biological degrees of freedom, but also, it should allow users to disable any degrees of freedom at any time. By referring to Fig. 5.36, the main components of SOL are shown such as (Thigh, Shank, and foots, backpack, pelvis, etc.), and illustrating the user wearing it. Its weight, including the battery pack, is approximately 15 kg. The advantage of using the same light weight mechanical components for different user size give the possibility to provide the same device weight whatever the size. It consists of a two DoF hip joints (flexion/extension, Abduction/ adduction), one Dof on the knee (flexion/extension), two passive DoF ankle joint with spring-loaded mechanism. Therefore, the total number of joints' DoFs provided whatever active or passive is ten.



**Figure 5.36** The design of SOL Scalable exoskeleton

## 5.5 Discussion

Since the exoskeleton SOL is the first prototype of its kind, several critical areas of work including user acceptance, interaction, are not tested yet in a continuous way and on multiple subjects which represent the future step of this project. Its design allows continuous adaptation on the majority of the subject body cases including the different sizes, shape, and skeletal deformities not only for our subject, but also for all the other subjects. This can be achievable by designing the exoskeleton to respect the three scalable pillars which are the morphology changes, the off-line joints alignment and the kinematic compatibility. The weight of the entire first prototype is approximately 15 kg, including actuators and batteries. The batteries weight 380 g and they are designed to operate for 60 minutes daily. To further increase its ease of use, its total mass must be reduced and the operating time must be enhanced. In the end, we think that the device should weigh less than 10 kg and that the operating time should be more than 2-3 hours.

However, load support should also be considered to maximize the functionality and tightness of the fitting mechanisms. Although the contact surface between the device and the skin is somewhat increased inherently compared to non scalable devices. By controlling the flexibility of the support frames and/or using functional fabrics, it is possible to achieve a satisfactory fit and comfort of use.

One scalable modular actuator with variable ROM is developed to generate torques for weight-bearing assistance for the user. Moreover it has a small volume and weight to simplify its use and to afford a simple design of the exoskeleton. The actuator is equipped with built-in mechanical limiters for safety consideration. Hence, when the wearer stretches to a vertical position, the joint motion cannot exceed what the human body can support. This choice will help to reduce the structure complexity by eliminating the limiters to be used in the structure.

## 5.6 Conclusion

This chapter has detailed the methods of mechanical design of scalable exoskeletons, including structural development, attachment mechanisms and the mechatronics development of actuators. The first development method led to the design of multi-joint structural elements that can be adapted to the size and shape of their users as well as their off-line hip joint alignment mechanism. The second approach addressed the issue of kinematic compatibility of attachments by proposing several types of connection mechanisms to better build the interface between the user and the exoskeleton. With regard to actuator development, a comparative analysis was initially carried out between different types of drive technologies in order to obtain the appropriate actuator to use. The actuator is installed by comparing existing exoskeleton actuation strategies and concluding the actuation method that meet the scalability requirements. The development of the actuator design is illustrated in detail showing the choice of DC motors, gearboxes and bearings and their mechatronic integration to obtain a compact custom-made actuator that can be used in the exoskeleton to scale.

As a first iteration towards the design of an scalable exoskeleton, the before-mentioned methods have been experimentally validated in the following chapter by several testing scenarios. Their validation can provide preliminary results regarding the actual performance and strength, therefore, can help prove the hypothesis of the importance and the advantage of having a scalable exoskeleton.

# Chapter 6

## SOL Preliminary Experimental Results

In this chapter the experimental validation of the two proposed contributions will be investigated. A preliminary results of the reconfigurable structure of the exoskeleton is verified in order to follow each patient size and shape. The experimental tests and simulation of the connection show the advantage of using multi DOFs attachment between the exoskeleton and the user in order to ensure the kinematic compatibility. The performance of the scalable custom made actuator to ensure the requirements of the human joints is investigated according to a validation method. Walking in the air scenario is applied on the SOL exoskeleton in order to validate the integration between the actuators and the structure.

### 6.1 Structural Validation by Simulation and Testing

In order to demonstrate the exoskeleton scalability in terms of adaptability ( Exoskeleton Size, Shape and Alignment), and load capacity, an evaluation of the design and its realization is carried out through different steps. First, a finite element analysis is applied on the exoskeleton thigh and shank in order to validate the loads transmission through the structure. Moreover, a test rig has been developed

to validate the capacity of the proposed clamping mechanisms to transmit forces via the exoskeleton skeleton. A validation of the hip joint alignment is done taking into consideration several scenarios where the patient hip is not naturally aligned with the exoskeleton one. Finally, a validation of the structural adaptability is done for different users' size and shape and is showing how the proposed design methods helped the scalable exoskeleton to follow the body shape and curvature on each limb of the human body.

### 6.1.1 Scalable Exoskeleton Functionality Validation

In order to evaluate the functionality of the proposed scalable design methods of the exoskeleton, a set of experimental tests is carried out for the validation process:

- Validation of the load supporting capacity;
- Validation of the efficiency of the clamping mechanism in order to hold a high loads;
- Validation of the hip misalignment mechanism and its testing on a human manikin.

#### Load Supporting Capacity

For the load supporting capacity, we evaluated the strength of the exoskeleton frame structure by applying a Finite Element Analysis "*FEA*" on the structural elements of the exoskeleton. For this purpose, all the linking components of the exoskeleton are made from a high strength aeronautical aluminium alloy of type 7075T6 which has an ultimate tensile strength limit of  $572\text{ MPa}$  and a shear yield strength of  $330\text{ MPa}$ . While the other structural elements of the exoskeleton are represented by the composite circular profiles (carbon fiber standard fabric tubes of diameter =  $20\text{mm}$ ) and they are having  $1500\text{ MPa}$  of flexural strength.

To observe the strength of the scalable frame, a static weight of 100 Kg is applied consistently on the top of each distal element (thigh and shank). The

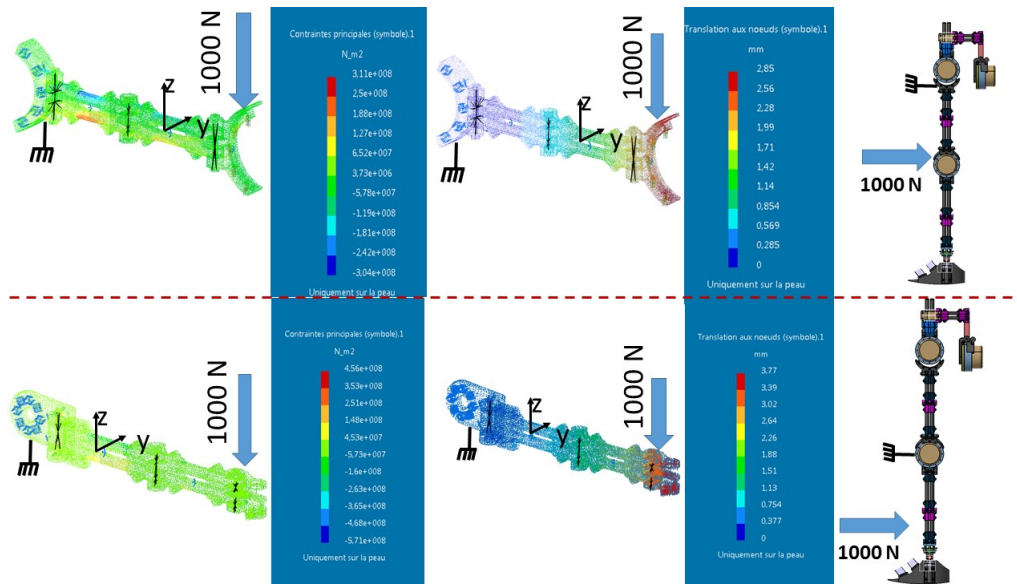
results of the "FEA" give us the magnitude of the Von Mises stresses and the linear displacements. For the validation scenario, although the exoskeleton SOL is design for teenagers from 9 until 19 years old, both thigh and the shank have a length of 450 *mm* which represent the maximum achievable limb's length of an adult male of 95<sup>th</sup> percentile.

The maximum flexural stress is found, for the cases when the load is applied in the sagittal and the frontal planes respectively, on the proximal part of the thigh limb. These results are illustrated in the following figures 6.1, and 6.2. The obtained stress has reached for the case where the applied force is in the sagittal plane a value of 311 *MPa* for the thigh on the aluminum part which and 456 *MPa* for the shank on the composite part while for the second case the maximum value of stress is found to be 1000 *MPa* and 659 *MPa* for the both limbs (thigh and shank). These results are acceptable because they are smaller than the allowable limit of flexural strength of the used aluminum alloy and the carbon fiber tubes. The displacement in the first case can reach 2.58 *mm* and 3.77 *mm* while for the second case it can reach 10 *mm* and 15 *mm* for the thigh and shank respectively. This difference between the both case is caused by the difference in the quadratic moments around the two reference axes  $I_{Gy}$  and  $I_{Gz}$  where  $I_{Gy}$  is smaller than  $I_{Gz}$ .

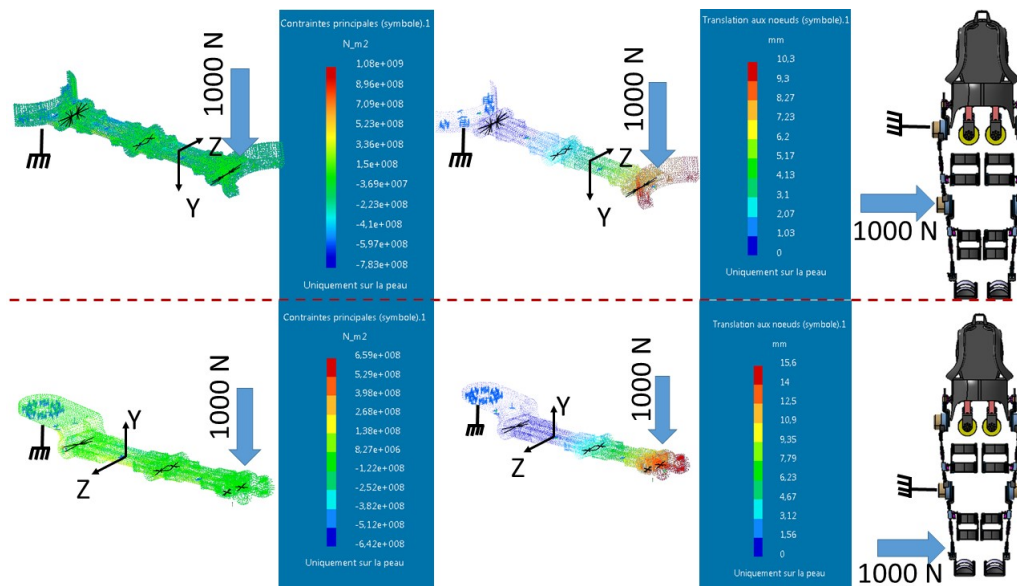
In reality, the experimental tests are made using an existing test rig to measure the displacement using an equivalent force. Two directed forces were applied at the same location to cause flexural forces on the structure. The motion trajectory of the distal link was measured using high resolution video camera to track the set-up. As shown in Fig 6.3, we can observe that the scalable structural limb can support the applied weight. The resulting displacement of the top of the tested links have followed an horizontal trajectory of a 4.4 *mm* for the shank and 3.2 *mm* for the thigh.

### **Clamping Mechanism Efficiency**

In regards to the clamping mechanism validation, a bench test was built for this objective. The testing methods was first to apply an axial traction repetitive shocks

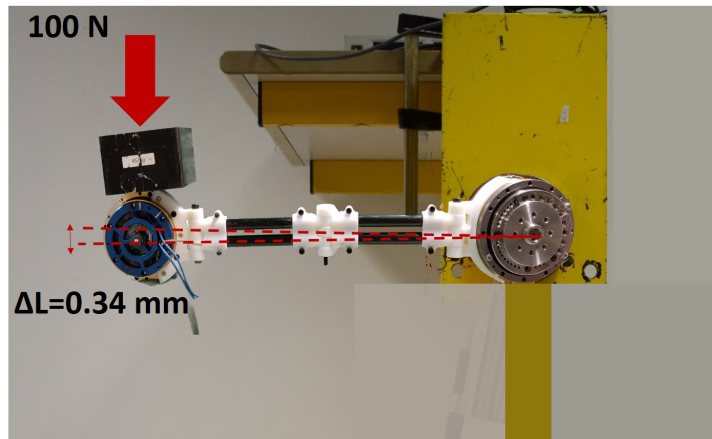


**Figure 6.1** The results of the stress analysis of the exoskeleton' links : saggital plan



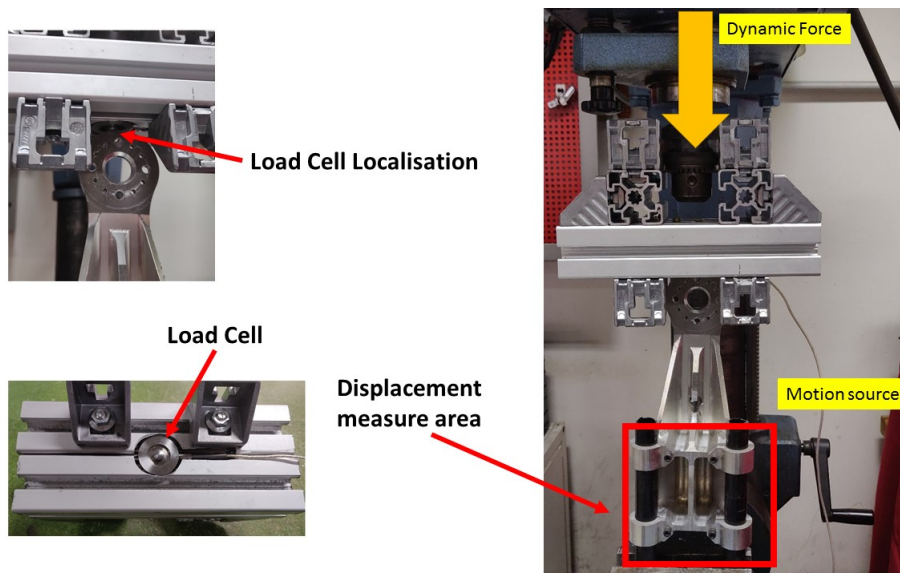
**Figure 6.2** The results of the stress analysis of the exoskeleton' links : frontal plan

having a magnitude of  $300N$  and a linear speed of  $15cm/s$ . with a frequency of  $1Hz$ . The bench is shown in Figure 6.4, where the exoskeleton limb is fixed on the ground and a manual mechanism is applying the dynamic shocks repetitively. To



**Figure 6.3** Preliminary Results of the load support validation

evaluate the performance of the clamping mechanism, we have measured the length of the limb before and after the test using laser measurement system. The results of these measures shows a difference of  $0.2 \text{ mm}$  which is considered acceptable value when applying this kind of efforts repetitively which are rarely achievable during the real performance.

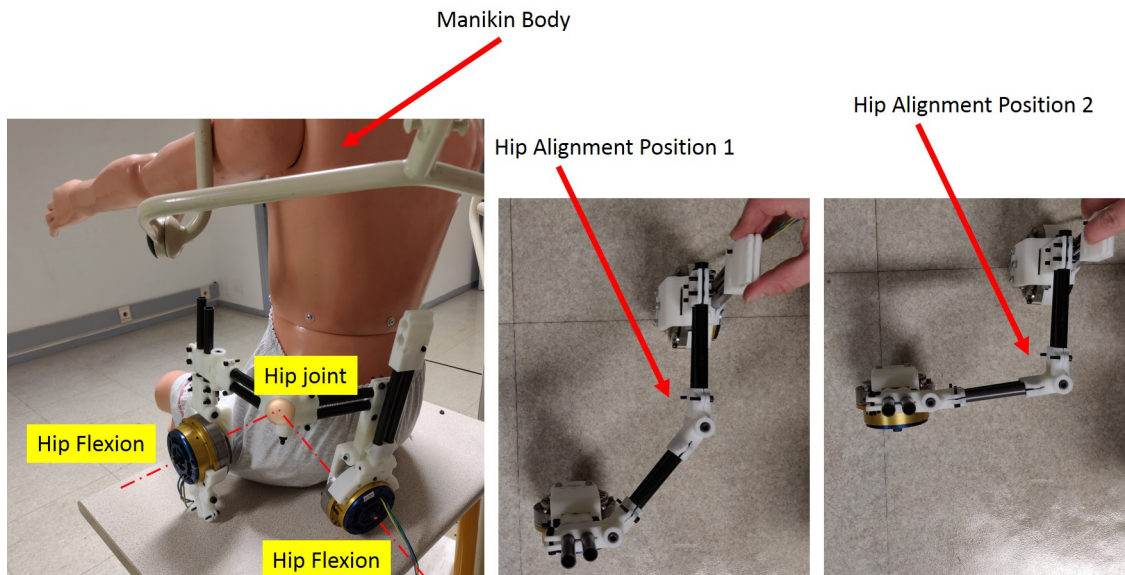


**Figure 6.4** Preliminary Results on SOL Scalable Exoskeleton Clamping Mechanism Between the Aluminum Links and the Carbon Tubes.



### Hip Alignment Mechanism Validation

The validation of the hip alignment mechanism is performed by dressing the exoskeleton of a human dummy (see Figure 6.5). Thanks to the DOFs offered by the proposed design method and the structural advantages of this design, the hip joints (flexion/extension and abduction/adduction) can be easily aligned with the corresponding actual joints of the user's hip. Off-line alignment can be performed by the practitioner who can provide the correct body measurements for the patient. The illustrated tests evaluate the performance of the proposed off-line mechanism in order better fit the user's body whatever its shape and proportions (position 1 and position 2).

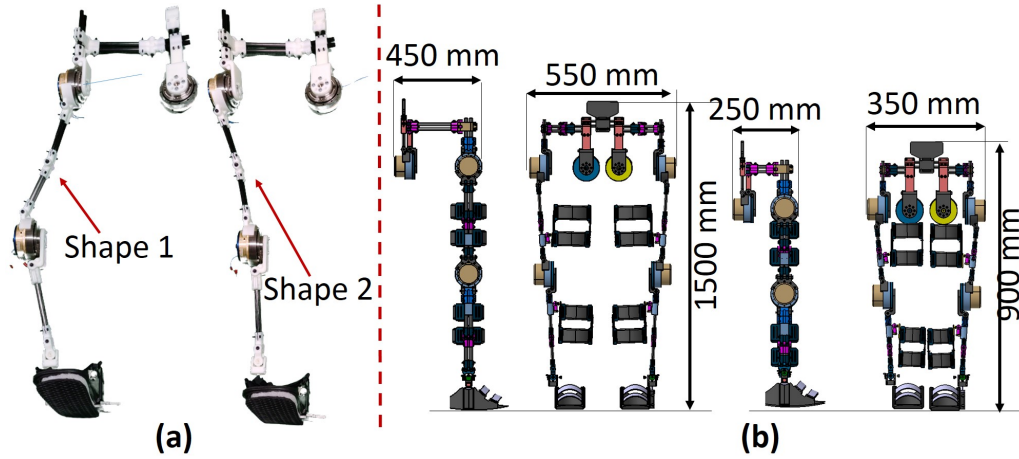


**Figure 6.5** Preliminary Results on SOL Scalable Exoskeleton Hip Alignment Mechanism

### Scalable Exoskeleton Structural Validation

As shown in Figure 6.6, a validation has been made on the exoskeleton structural design to show its scalability in terms of the various achievable shapes and sizes. Figure 6.6 a) represents the shapes of the exoskeleton obtained by changing the

rotational Dofs which are integrated in the exoskeleton limbs (thigh and shank), while Figure 6.6 b) demonstrates the variable achievable sizes of the exoskeleton covering all the adolescence period.



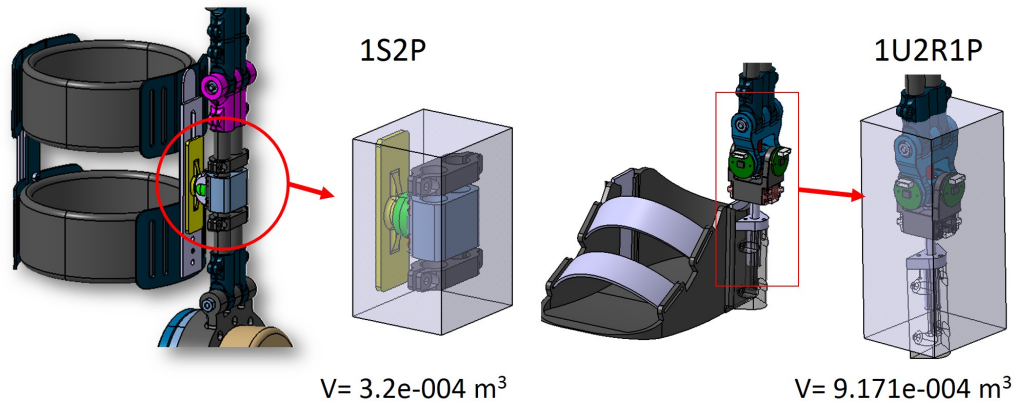
**Figure 6.6** Validation of the SOL Scalable Exoskeleton Structural Capacity

### 6.1.2 Preliminary Evaluation of the Attachments

In order to validate the scalability and the effectiveness of the exoskeleton attachments, a simulation of their positioning is done. For this evaluation, we will consider that the thigh and the shank of the exoskeleton don't include the added rotational joints ( $\theta_{15}$  and  $\theta_{21}$  used in chapter 4), because these excluded angular adjustment joints will cause a size limitation in terms of attachment localization. For the next design phase, we will consider this limitation during the design of the attachment mechanism.

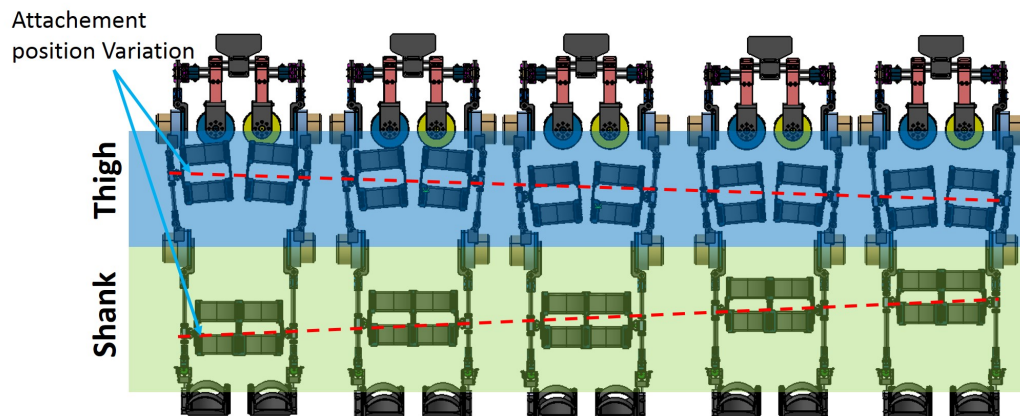
The first evaluations of the proposed thigh/shank mechanisms ( $1S2P$ ) is their higher compactness compared to the other proposed kinematic chains ( $1U1R2P$  and  $3R2P$ ). As shown in Figure 6.7, the used geometrical volume of the  $1S2P$  is measured by  $320 \text{ mm}^3$  cube which represents almost the one third of the same volume taken by the  $1U1R2P$  solution. This difference in compactness represents

a key factor in the scalability context, because it will simplify the design, the wearing and the utilisation of the exoskeleton.

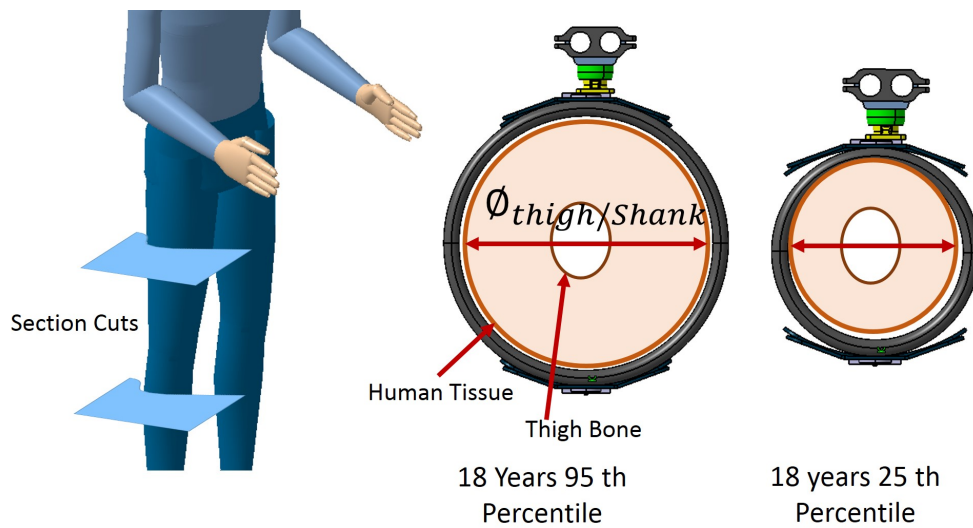


**Figure 6.7** Validation of the SOL Attachment Solutions Compactness

As shown in Figure 6.8 different localisations of attachments can be obtained on both the thigh and shank. This can allow a better a continuous connection to the users limbs whatever their shape.



**Figure 6.8** Validation of the SOL Attachment to be localised on a wide range on the thigh/shank



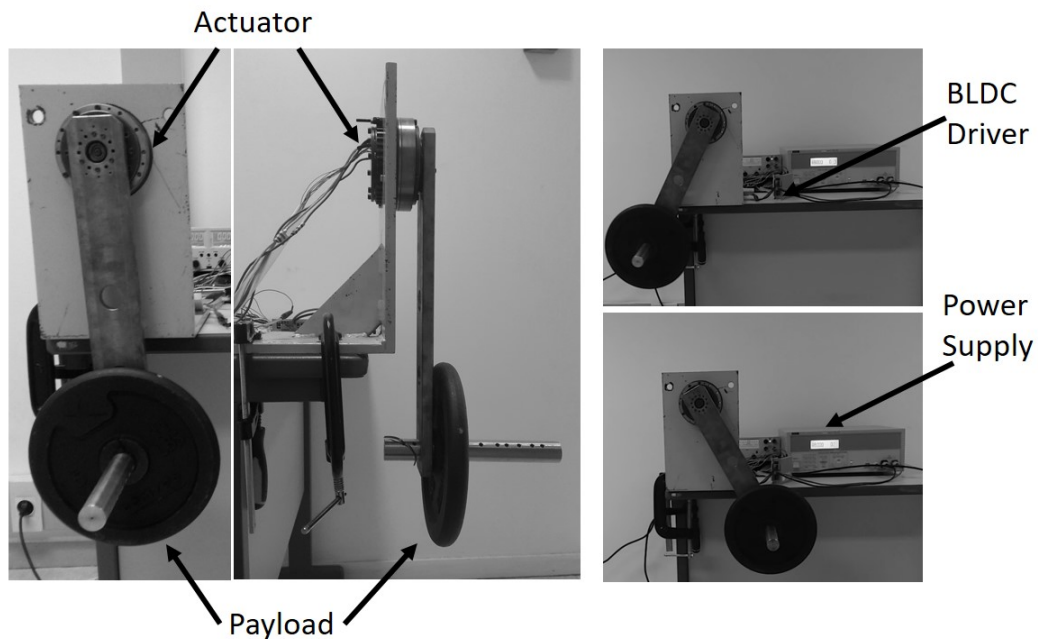
**Figure 6.9** Validation of the SOL attachment Exoskeleton Capacity to follow the user limb section shape

## 6.2 Actuator Performance Validation

To simulate natural scalable gait cycle, and verify the performance of the exoskeleton actuation units, an experimental set-up was arranged to validate two main design parameters which are the actuator rated torque, and hip and knee dynamics during gait cycle. For the experimental validation of the exoskeleton actuator a multiple test benches were deployed without using a human subjects.

A compensatory weights were attached to the test-bench link to match the proportions of a person with a 120 Kg of weight as shown in Figure 6.10. The actuator is fixed to a vertical stand, and a bar of 5 kg is attached to the output shaft as a payload. A range of motion of  $40^\circ$  is allowed using the hard stoppers. The actuator cables are plugged into a commercial BLDC driver. The driver empowers the motor by vector control sinusoidal commutation. Moreover, to validate system functionality, an extra weight of 10 kg is added to simulate a total weight exerted by hip joint during walking.

As a first result, a joint trajectory of sinusoidal function is applied as a position command to the driver using the provided software. The function's amplitude is programmed to vary incrementally by  $5^\circ$  after each periodic motion to validate

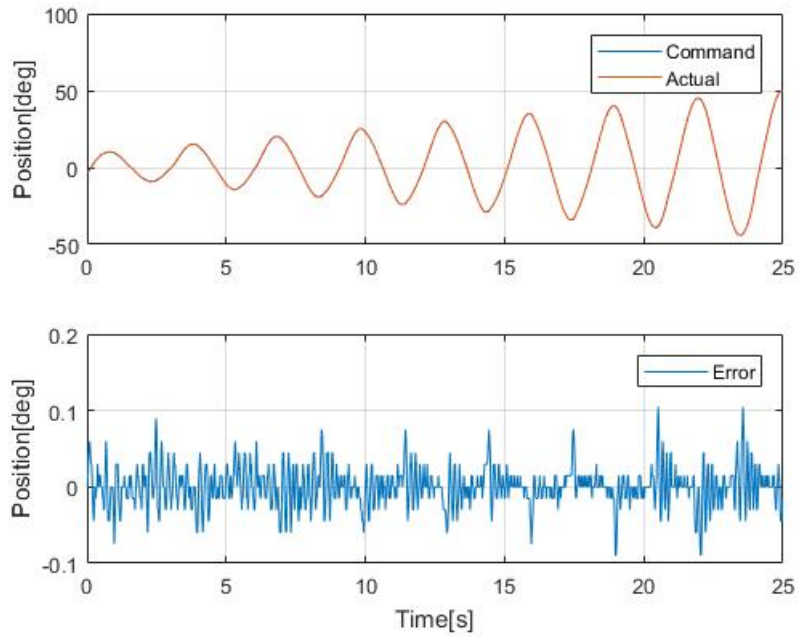


**Figure 6.10** Experimental Validation Set-Up

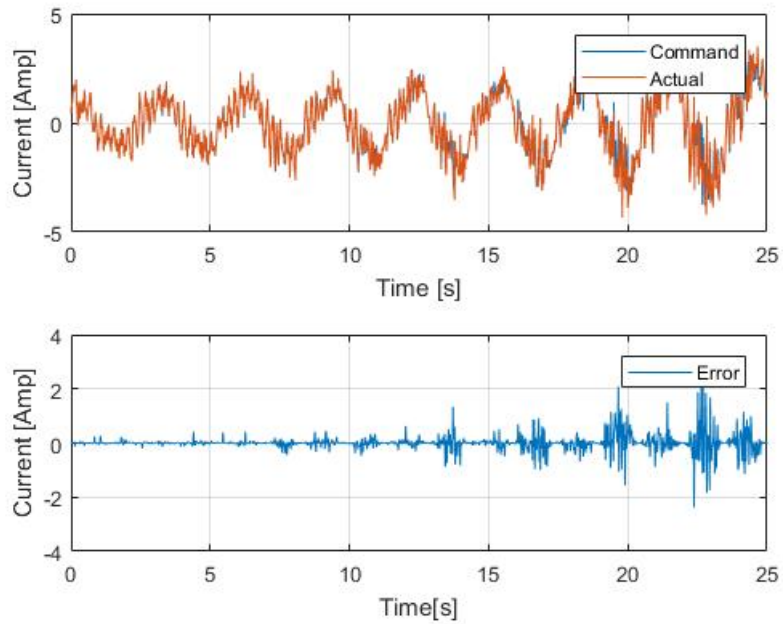
system response with a variable scenarios. Both of targeted and realized trajectories are showed in Fig. 6.11. The actuator have showed an acceptable accuracy in trajectory following under load with an error less than  $\pm 0.1^\circ$ .

In addition, the current consumption (see Fig. 6.12), which is equivalent to the torque applied by the joint, can represent the performance of the actuator when following the required trajectories where a considerable error on the current is detected with the high dynamics in the high amplitude region (from  $t = 20s$  to  $t = 25s$ ). Hence, a correction of the joint dynamics should be taken into consideration to avoid the system failure.

Another experiment is carried out in order to demonstrate the system capabilities when performing a gait cycle. A corresponding test bench is implemented in order to validate this experiment, where an exoskeleton leg is attached to a stand in a vertical way to allow performing a gait cycle in the sagittal plane for two size of patient (9 and 18 years old). The hard stoppers are inserted in both the hip and knee actuators in order to ensure the safety during the experiment (see Fig. 6.13). This experiment is dedicated to verify the joint actuator capabilities

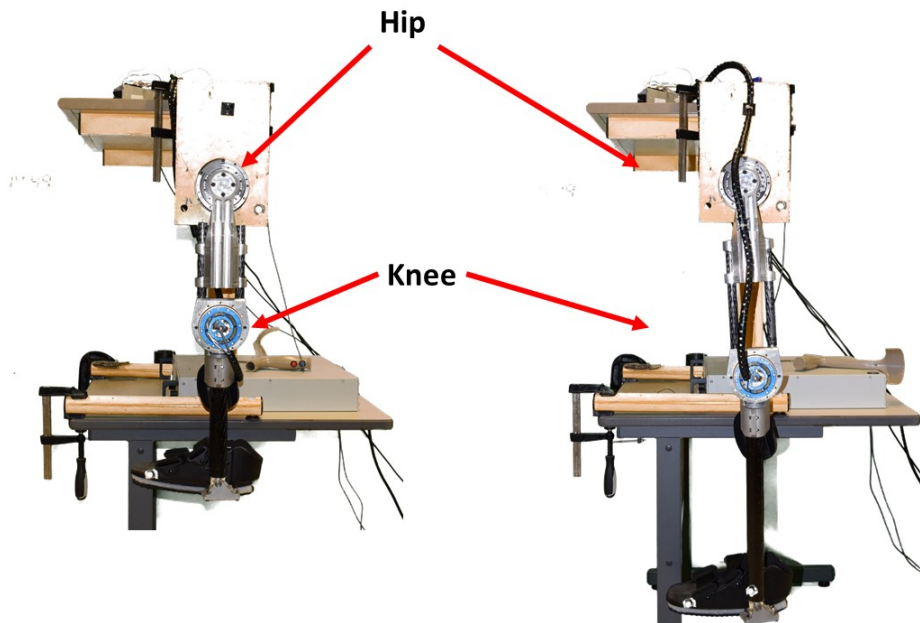


**Figure 6.11** Sine wave position tracking



**Figure 6.12** Current Consumption during Position Tracking

when a worst case scenario is applied ( $0.7m/s$  as a walking speed of a test subject weighing  $120kg$  for the both ages).

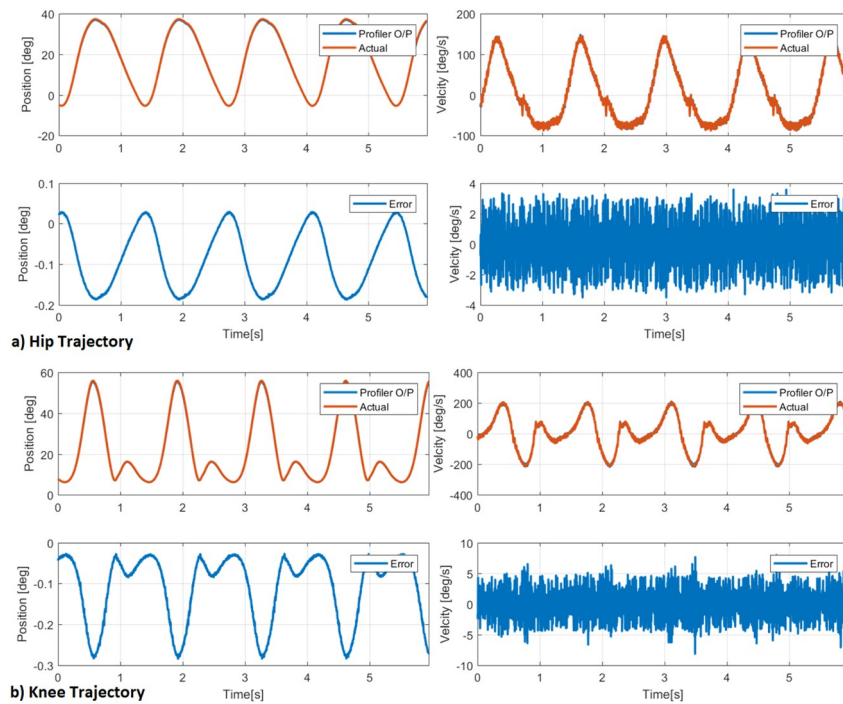


**Figure 6.13** Exoskeleton Leg Test Bench of Two Patient Size Performing a Gait Trajectories

The experiment conditions can be achieved by requesting a maximum speed of  $210deg/s$  on the output while applying counter torque by  $142N.m$ . To simulate this situation, the actuator driver is required to generate a walking trajectory of both of hip and knee joints. A corresponding loads are applied to the actuator which have a value of  $140N.m$ . counter torque. System responses are shown in Fig. 6.14.

The system has shown a performance while performing the worst case scenario. The position tracking error didn't exceed  $0.3deg$  and  $0.2deg$  though out the challenging trajectory of the knee and hip respectively. This position error can grantee a acceptable accuracy for the exoskeleton actuation.

As a Third preliminary results, four joint actuators have been integrated to the first prototype of the "SOL" teenager exoskeleton, forming both of hips and knees. A full body manikin having a real limbs weights is attached to the exoskeleton and



**Figure 6.14** Actuator response for position and velocity of a)Hip, and b)Knee walking trajectories for 12 years old subject at 0.7 m/s

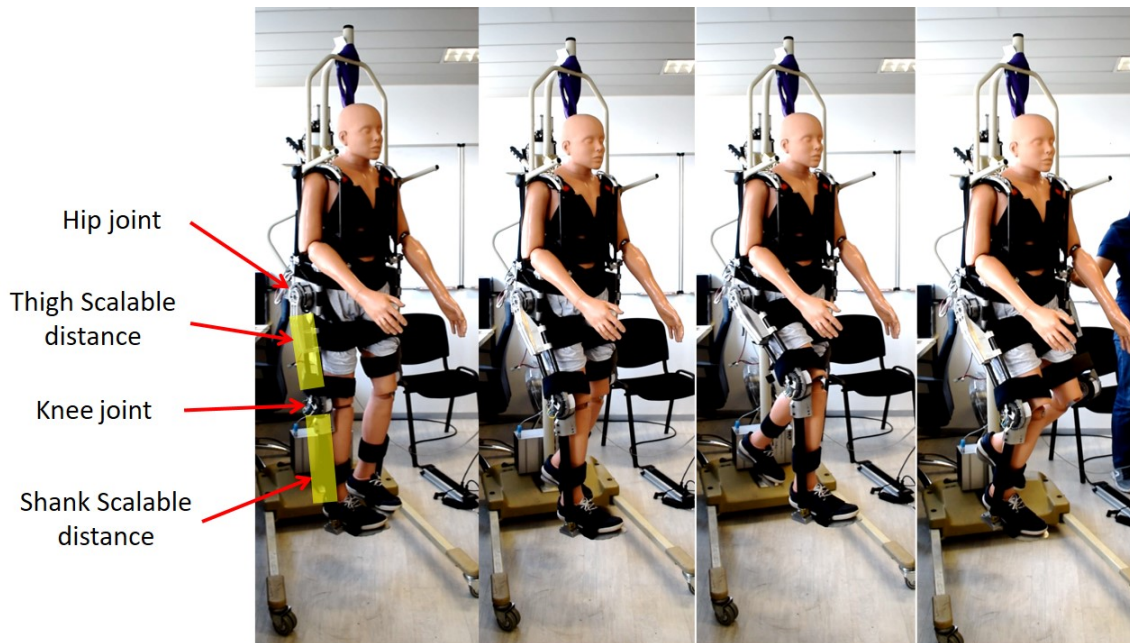
has performed walking in the air. The joints have succeeded to track the required biomechanical gait cycle trajectories in the sagittal plane, for both of hip and knee joints, see Figure 6.15. In addition, the exoskeleton has also shown scalability using this type of actuators, where the space between the joints were available to be scaled.

This test can provide a validation that the exoskeleton actuators could ensure sufficient angular velocity and torque during the gait cycle using several test scenarios.

### 6.3 Global Validation

In conclusion, the actuator has showed an acceptable performance even through out worst case scenario, where the errors were considered in acceptable range. Such actuator is considered to be capable of delivering the necessary power for





**Figure 6.15** Preliminary Results on SOL Scalable Exoskeleton Via the Walking in the Air Scenario

a growing teenager from late childhood passing through adolescence to adulthood during DLAs, which guarantee scalability property of the proposed exoskeleton.

Compared to conventional and soft exoskeletons, the scalable design of the proposed SOL exoskeleton, provides the benefits of the two before-mentioned approaches. We have illustrated using several simulation tools of the exoskeleton structure that it is capable to follow the body shape of a variety of users to be used in several rehabilitation applications. This device not only allows a safe and simple interaction with human wearers, but also it can transmit a portion of the wearer's weight effectively using the proposed scalable attachments mechanisms which are kinematically compatible with the user's skeletal structure using the mobility methods to validate the hypothesis.

# Chapter 7

## Conclusion and Future Works

### 7.1 Conclusions

The work carried out in this thesis has several objectives. It has been started by observing that there is an important number of diseases that are causing motor disability to the adolescent patient, whether they are congenital or acquired. Most of their symptoms are progressive due to the disease nature (such as the muscular dystrophies, or the post-polio syndrome) and some are due to lack of physical activity and therapy. Besides, the dual challenge that adolescents are facing is the fact that their body grows very fast while growing up against the disease. This makes them the most vulnerable group of population above all, and are in need of special care and support to overcome these barriers. This support should start as early as possible and should continue along the adolescence growth as it is firmly thought to retard the symptoms progression.

A state of art is made on the existing rehabilitation solutions to highlight the need of a single scalable exoskeleton. A device that can tackle the growth rate of teenagers such as their size, shape, and capabilities. Also, it should be customizable according to wearer's disease. This scalable device should ensure the therapy program without interruption, to get the maximum benefits from the rehabilitation program.

The first contribution of this thesis can be represented by introducing the importance of the assistive devices scalability for teenagers. This contribution comes up with the scalability mechanical requirements from biomechanical point of view. Three main goals are reached after this study. In the first place, the actuation requirements are introduced, where it would be gainful to develop a single modular joint actuator for that is capable of empowering continuously its joints and taking into consideration the evolution in the teenagers' kinetics needs. Secondly, since the device's structure must be capable to adapt the user size and shape, and its joints should be aligned with the wearer corresponding joint, the requirements of the structural design are addressed in this study. The third goal of the requirement study is dealing with the kinematic compatibility of the exoskeleton connection to the human limbs.

The second objective is represented by proposing new design methods of the scalable exoskeleton actuation system, body structure and the exoskeleton attachments. The mechatronics development of the custom made joint actuator to be used in the scalable exoskeleton is started by a comparison between several types of actuators in order to classify the suitable type of actuator to be used. Its selection and sizing criteria was made according to the worst case scenario of body growth and scale. Its mechanical design has been realized taking into consideration the constraints imposed by the mechanical needs of the exoskeleton including the power/speed, the variable range of motion, the modularity, light weight, etc. The design of the scalable structure of the exoskeleton takes into account the morphological variations and the joint alignment. To reach this objective, a segmentation analysis of the exoskeleton structural elements is made in order to define the kinematic chain of each element. The morphology variation is treated by adding a passive rotational and linear joints for each segment of the thigh and the shank. The alignment mechanism of both the hip and the knee joints is solved by proposing a four bar mechanism at the knee and a six serial kinematic chain to ensure a better performance and to avoid joint misalignment during motion. The connections between the human limbs and the exoskeleton limbs are designed to respect the kinematic compatibility of the system. An analysis of the induced

forces when attaching an exoskeleton to the human is inspired by a previous study taking into account the closed loop of the exoskeleton/human context. A mobility study is carried out on the system exoskeleton/human in order to define the DOFs of each of the connection mechanisms of the thigh/shank/foot. The design of the latter mechanisms is show proposed and selected after a comparison between the available solutions of these mechanisms.

Finally, The manufactured actuator has showed a performance through out worst case scenario, where the errors were considered in acceptable range. Such actuator is considered to be capable of delivering the necessary power for a growing teenager from late childhood passing through adolescence to adultery during DLAs, which grantee scalability property of the proposed exoskeleton. Moreover, the structural design has shown a preliminary advantages of using scalable exoskeleton for different user ages starting from the childhood and to follow the size and shape using multiple validation processes. The experimental validation takes into account the load capacity of the structure, its adaptability, the efficiency of the clamping mechanism, and the hip alignment. The simulation of the attachments, as a first results, shows their capacity to be localized continuously on the human limbs without any limitation based on their compact design.

## 7.2 Future Works

The contributions of this thesis opens new perspectives on the importance of using the exoskeleton for teenagers hood when the body is in the critical phase of growth.

In short term, the exoskeleton must be completely assembled and tested on a real subjects in a passive manner to check the comfort when wearing the exoskeleton joints as well as the structural elements and connections. Then, a thesis work will continue on the high/low level control of the exoskeleton with respecting to the scalability. Since, a correction of all the joint trajectories with is required for each patient disease, age, size and weight.

Another objective is needed to maintain the automatic variation of the exoskeleton scalability parameters of each element of the exoskeleton (for example the

thigh length/inclination and the joint trajectories). This can be done by proposing a structural scalability parameters which can be calculated automatically after updating the status of the patient by the corresponding practitioner.

The latest improvements in the work carried out are the construction of the exoskeleton control architecture, and the appropriate training of the exoskeleton's active joints to ensure its balance during daily tasks. Further research is needed to find a method to generate real-time updated trajectories for each size, speed, task required and for each external disturbance that may occur.

# Publications

## Journals

- Mohamad KARDOFAKI, Moustafa Fouz, Khaled FOUDA, Samer AlFayad, Eric DYCHUS. "Sizing and Actuation of Child Lower Limb Exoskeleton", *International Journal of Materials, Mechanics and Manufacturing*, Accepted in 2017, In Press, 2018
- Moustafa A. FOUZ, Mohamad KARDOFAKI, Khaled FOUDA, Samer AL-FAYAD, Child Lower Limb Exoskeleton: Sizing and Modelling, *International Journal of Scientific & Engineering Research*, Volume 7, Issue 12, December-2016 1585, ISSN 2229-5518.

## International Conference

- Mohamad KARDOFAKI, Nahla TABTI, Samer ALFAYAD, Fethi BEN OUEZDOU, Yacine CHITOUR, Eric DYCHUS. "Mechanical Development of a Scalable Structure for Adolescent Exoskeletons", In *IEEE-RAS-EMBS International Conference on Rehabilitation Robotics (ICORR)*, (ACCEPTED), Toronto, CANADA, 2019.
- Mohamad KARDOFAKI, Moustafa Fouz, Khaled , Samer AlFayad, Eric DYCHUS. "Sizing and Actuation of Child Lower Limb Exoskeleton", *European Conference on Materials, Mechatronics and Manufacturing*, Paris, France, In Press, 2018.

- M.A. Fouz, M. Kardofaki, K.Fouda, S. Alfayad, Mechatronic Design for Child Exoskeleton SOL: Actuation Sizing, In *IEEE International Symposium on Last-Mile*, Paris, France, In Press, 2016.

## National Conference

- Mohamad KARDOFAKI, Moustafa Fouz, Samer AlFayad, Journée Exosquelette, SOL0.1, Teenager Exoskeleton, In *GT1 UPMC*, Paris, France, 2018.
- Mohamad KARDOFAKI, Moustafa Fouz, Samer AlFayad, Child Exoskeleton Mechatronics development, poster In *Icode-2 Final congress*, Paris, France, 2017.
- Mohamad KARDOFAKI, Moustafa Fouz, Samer AlFayad, Child Exoskeleton Mechatronic Design, In *JNRH GDR*, Toulouse, France, 2016.

## Patents

- ALFAYAD Samer, KARDOFAKI Mohamad, and FOUUDA Khaled: OMNIDIRECTIONAL WHEEL AND VEHICLE IMPLEMENTING SAID WHEEL. WO/2018/158445, Priority: 02.03.2017
- ALFAYAD Samer, KARDOFAKI Mohamad, and SLEIMAN Maya: SERVO ELECTROHYDRAULIC ACTUATOR FOR ROBOTICS APPLICATIONS. Pending, Priority: 01.03.2019

# Bibliography

- [1] J. Hamill and K. Knutzen, *Biomechanical basis of human movement*. Wolters Kluwer Health/Lippincott Williams and Wilkins, 2009.
- [2] United Nations, “Fact sheet on Persons with Disabilities,” tech. rep., 2010.
- [3] J. M. Soucie, C. Wang, A. Forsyth, S. Funk, M. Denny, K. E. Roach, and D. Boone, “Range of motion measurements: Reference values and a database for comparison studies,” *Haemophilia*, 2011.
- [4] E. Landfeldt, P. Lindgren, C. F. Bell, M. Guglieri, V. Straub, H. Lochmüller, and K. Bushby, “Quantifying the burden of caregiving in Duchenne muscular dystrophy,” *Journal of Neurology*, 2016.
- [5] S. M. Sawyer, R. A. Affi, L. H. Bearinger, S. J. Blakemore, B. Dick, A. C. Ezeh, and G. C. Patton, “Adolescence: A foundation for future health,” *The Lancet*, 2012.
- [6] B. J. Kemp, “Quality of Life While Aging with a Disability,” *Assistive Technology*, vol. 11, pp. 158–163, dec 1999.
- [7] H. I. Krebs, J. J. Palazzolo, L. Dipietro, M. Ferraro, J. Krol, K. Rannekleiv, B. T. Volpe, and N. Hogan, “Rehabilitation robotics: Performance-based progressive robot-assisted therapy,” *Autonomous Robots*, 2003.
- [8] C. C. Johnson, “The benefits of physical activity for youth with developmental disabilities: A systematic review,” *American Journal of Health Promotion*, 2009.
- [9] R. R. Pate, M. Pratt, S. N. Blair, W. L. Haskell, C. A. Macera, C. Bouchard, D. Buchner, W. Ettinger, G. W. Heath, and A. C. King, “Physical activity and public health. A recommendation from the Centers for Disease Control and Prevention and the American College of Sports Medicine.,” *JAMA*, vol. 273, pp. 402–7, feb 1995.



- [10] A. J. Copp and N. D. E. Greene, “Neural tube defects-disorders of neurulation and related embryonic processes,” *Wiley Interdisciplinary Reviews: Developmental Biology*, vol. 2, pp. 213–227, mar 2013.
- [11] Centers for Disease Control and Prevention (CDC), “Racial/ethnic differences in the birth prevalence of spina bifida - United States, 1995-2005.,” *MMWR. Morbidity and mortality weekly report*, vol. 57, pp. 1409–13, jan 2009.
- [12] K. S. Au, A. Ashley-Koch, and H. Northrup, “Epidemiologic and genetic aspects of spina bifida and other neural tube defects,” *Developmental Disabilities Research Reviews*, vol. 16, no. 1, pp. 6–15, 2010.
- [13] S. Onrat, H. Seyman, and M. Konuk, “Incidence of neural tube defects in Afyonkarahisar, Western Turkey,” Tech. Rep. 1, 2009.
- [14] “Cerebral palsy - Symptoms and causes - Mayo Clinic.”
- [15] C. Arneson, M. Durkin, R. Benedict, R. Kirby, M. Yeargin-Allsopp, K. Van Naarden Braun, and N. Doernberg, “Prevalence of cerebral palsy: Autism and Developmental Disabilities Monitoring Network, three sites, United States, 2004†,” *Disability and Health Journal*, 2009.
- [16] C. Cans, “Surveillance of cerebral palsy in Europe: A collaboration of cerebral palsy surveys and registers,” *Developmental Medicine and Child Neurology*, 2000.
- [17] “Muscular Dystrophy Information Page | National Institute of Neurological Disorders and Stroke.”
- [18] A. Theadom, M. Rodrigues, R. Roxburgh, S. Balalla, C. Higgins, R. Bhattacharjee, K. Jones, R. Krishnamurthi, and V. Feigin, “Prevalence of muscular dystrophies: A systematic literature review,” 2014.
- [19] E. Kingwell, J. J. Marriott, N. Jetté, T. Pringsheim, N. Makhani, S. A. Morrow, J. D. Fisk, C. Evans, S. G. Béland, S. Kulaga, J. Dykeman, C. Wolfson, M. W. Koch, and R. A. Marrie, “Incidence and prevalence of multiple sclerosis in Europe: A systematic review,” *BMC Neurology*, 2013.
- [20] World Health Organization (2008)., “Atlas: Multiple Sclerosis Resources in the World 2008,” tech. rep., Geneva: World Health Organization.
- [21] Postpolio, “Post-Polio Health International’s Official Website.”
- [22] Stroke, “www.stroke.org.uk,” 2018.

- [23] S. Mendis, “Stroke disability and rehabilitation of stroke: World Health Organization perspective,” 2013.
- [24] W. H. O. (WHO), “Youth and road safety,” tech. rep., 2007.
- [25] “Spina bifida - Symptoms and causes - Mayo Clinic.”
- [26] “Muscular dystrophy - Symptoms and causes - Mayo Clinic.”
- [27] C. H. Polman, S. C. Reingold, B. Banwell, M. Clanet, J. A. Cohen, M. Filippi, K. Fujihara, E. Havrdova, M. Hutchinson, L. Kappos, F. D. Lublin, X. Montalban, P. O’Connor, M. Sandberg-Wollheim, A. J. Thompson, E. Waubant, B. Weinschenker, and J. S. Wolinsky, “Diagnostic criteria for multiple sclerosis: 2010 Revisions to the McDonald criteria,” *Annals of Neurology*, vol. 69, pp. 292–302, feb 2011.
- [28] “Spinal cord injury - Diagnosis and treatment - Mayo Clinic.”
- [29] “Stroke - Symptoms and causes - Mayo Clinic.”
- [30] N. Özaras, “Özaras N. Spina Bifida and Rehabilitation,” *Turk J Phys Med Rehab*, vol. 61, pp. 65–74, 2015.
- [31] L. A. Phillips, J. M. Burton, and S. H. Evans, “Spina Bifida Management,” *Current Problems in Pediatric and Adolescent Health Care*, 2017.
- [32] R. Palisano, P. Rosenbaum, S. Walter, D. Russell, E. Wood, and B. Galuppi, “Development and reliability of a system to classify gross motor function in children with cerebral palsy,” *Developmental Medicine & Child Neurology*, 1997.
- [33] H. H. Crowell, A. Boynton, and M. Mungiole, “Exoskeleton power and torque requirements based on human biomechanics,” tech. rep., 2002.
- [34] T. Kuhlmann, “Acute axonal damage in multiple sclerosis is most extensive in early disease stages and decreases over time,” *Brain*, 2002.
- [35] R. W. Motl, E. McAuley, E. M. Snook, and R. C. Gliottoni, “Physical activity and quality of life in multiple sclerosis: Intermediary roles of disability, fatigue, mood, pain, self-efficacy and social support,” *Psychology, Health and Medicine*, 2009.
- [36] H. Gonzalez, T. Olsson, and K. Borg, “Management of postpolio syndrome,” 2010.

- [37] G. Thorsteinsson, “Management of Postpolio Syndrome,” *Mayo Clinic Proceedings*, vol. 72, no. 7, pp. 627–638, 1997.
- [38] D. Anderson, S. Dumont, P. Jacobs, and L. Azzaria, “The personal costs of caring for a child with a disability: A review of the literature,” 2007.
- [39] A. G. Thrift, T. Thayabaranathan, G. Howard, V. J. Howard, P. M. Rothwell, V. L. Feigin, B. Norrving, G. A. Donnan, and D. A. Cadilhac, “Global stroke statistics,” 2017.
- [40] NSCISC, “Spinal cord injury facts and figures at a glance,” *The journal of spinal cord medicine*, 2013.
- [41] J. F. Veneman, R. Kruidhof, E. E. Hekman, R. Ekkelenkamp, E. H. Van Asseldonk, and H. Van Der Kooij, “Design and evaluation of the LOPES exoskeleton robot for interactive gait rehabilitation,” *IEEE Transactions on Neural Systems and Rehabilitation Engineering*, 2007.
- [42] S. K. Banala, S. K. Agrawal, and J. P. Scholz, “Active Leg Exoskeleton (ALEX) for gait rehabilitation of motor-impaired patients,” in *2007 IEEE 10th International Conference on Rehabilitation Robotics, ICORR’07*, 2007.
- [43] S. Jezernik, G. Colombo, T. Keller, H. Frueh, and M. Morari, “Robotic Orthosis Lokomat: A Research and Rehabilitation Tool,” *Neuromodulation*, 2003.
- [44] F. Patane, S. Rossi, F. Del Sette, J. Taborri, and P. Cappa, “WAKE-up exoskeleton to assist children with Cerebral Palsy: design and preliminary evaluation in level walking,” *IEEE Transactions on Neural Systems and Rehabilitation Engineering*, 2017.
- [45] H. I. Krebs, S. Rossi, S. J. Kim, P. K. Artemiadis, D. Williams, E. Castelli, and P. Cappa, “Pediatric anklebot,” in *IEEE International Conference on Rehabilitation Robotics*, 2011.
- [46] E. Garcia, J. Sancho, D. Sanz-Meodio, and M. Prieto, “ATLAS 2020: The Pediatric Gait Exoskeleton Project,” in *Human-Centric Robotics Proceedings*, p. 29, The 20th International Conference Clawar 2017, 2017.
- [47] K. P. Michmizos, S. Rossi, E. Castelli, P. Cappa, and H. I. Krebs, “Robot-Aided Neurorehabilitation: A Pediatric Robot for Ankle Rehabilitation,” *IEEE Transactions on Neural Systems and Rehabilitation Engineering*, vol. 23, pp. 1056–1067, nov 2015.

- [48] L. E. Miller, A. K. Zimmermann, and W. G. Herbert, “Clinical effectiveness and safety of powered exoskeleton-assisted walking in patients with spinal cord injury: systematic review with meta-analysis.,” *Medical devices (Auckland, N.Z.)*, 2016.
- [49] Indego, “www.indego.com.”
- [50] Rewalk, “www.rewalk.com.”
- [51] Ekso, “www.eksobionics.com.”
- [52] N. Tsagarakis and D. G. Caldwell, “A Compliant exoskeleton for multi-planar upper limb physiotherapy and training,” *Advanced Robotics. Invited Paper*, 2007.
- [53] T. R. Kurfess, *Robotics and automation handbook*. CRC Press, 2005.
- [54] K. Kong, J. Bae, and M. Tomizuka, “A Compact Rotary Series Elastic Actuator for Human Assistive Systems,” *IEEE/ASME Transactions on Mechatronics*, vol. 17, pp. 288–297, apr 2012.
- [55] S. Wang, L. Wang, C. Meijneke, E. Van Asseldonk, T. Hoellinger, G. Cheron, Y. Ivanenko, V. La Scaleia, F. Sylos-Labini, M. Molinari, F. Tamburella, I. Pisotta, F. Thorsteinsson, M. Ilzkovitz, J. Gancet, Y. Nevatia, R. Hauffe, F. Zanow, and H. Van Der Kooij, “Design and Control of the MINDWALKER Exoskeleton,” *IEEE Transactions on Neural Systems and Rehabilitation Engineering*, 2015.
- [56] Ching-Ping Chou and B. Hannaford, “Static and dynamic characteristics of McKibben pneumatic artificial muscles,” in *Proceedings of the 1994 IEEE International Conference on Robotics and Automation*, pp. 281–286, IEEE Comput. Soc. Press.
- [57] K. Takashima, J. Rossiter, and T. Mukai, “McKibben artificial muscle using shape-memory polymer,” *Sensors and Actuators, A: Physical*, vol. 164, no. 1-2, pp. 116–124, 2010.
- [58] N. Costa, M. Bezdicek, M. Brown, J. Gray, D. Caldwell, and S. Hutchins, “Joint motion control of a powered lower limb orthosis for rehabilitation,” *IEEE International Journal of Automation and Computing*, 2006.
- [59] D. P. Ferris, K. E. Gordon, G. S. Sawicki, and A. Peethambaran, “An improved powered ankle-foot orthosis using proportional myoelectric control,” *Gait & Posture*, vol. 23, pp. 425–428, jun 2006.

- [60] M. Dzahir and S.-i. Yamamoto, “Recent Trends in Lower-Limb Robotic Rehabilitation Orthosis: Control Scheme and Strategy for Pneumatic Muscle Actuated Gait Trainers,” *Robotics*, 2014.
- [61] B. Vanderborght, A. Albu-Schaeffer, A. Bicchi, E. Burdet, D. G. Caldwell, R. Carloni, M. Catalano, O. Eiberger, W. Friedl, G. Ganesh, M. Garabini, M. Grebenstein, G. Grioli, S. Haddadin, H. Hoppner, A. Jafari, M. Laffranchi, D. Lefeber, F. Petit, S. Stramigioli, N. Tsagarakis, M. Van Damme, R. Van Ham, L. C. Visser, and S. Wolf, “Variable impedance actuators: A review,” *Robotics and Autonomous Systems*, 2013.
- [62] E. Guizzo and H. Goldstein, “The rise of the body bots,” *IEEE Spectrum*, 2005.
- [63] H. Kazerooni and R. Steger, “The Berkeley Lower Extremity Exoskeleton,” *Journal of Dynamic Systems, Measurement, and Control*, 2006.
- [64] A. B. Zoss, H. Kazerooni, and A. Chu, “Biomechanical Design of the Berkeley Lower Extremity Exoskeleton (BLEEX),” *IEEE/ASME Transactions on Mechatronics*, 2006.
- [65] A. Chu, A., Kazerooni, H., Zoss, “On the Biomimetic Design of the Berkeley Lower Extremity Exoskeleton (BLEEX),” *Proceedings of the IEEE*, 2005.
- [66] J. E. Bobrow and J. Desai, “A high torque to weight ratio robot actuator,” *Robotica*, vol. 13, p. 201, mar 1995.
- [67] S. Habibi and A. Goldenberg, “Design of a new high-performance electrohydraulic actuator,” *IEEE/ASME Transactions on Mechatronics*, vol. 5, pp. 158–164, jun 2000.
- [68] S. Habibi, R. Burton, and E. Sampson, “High Precision Hydrostatic Actuation Systems for Micro- and Nanomanipulation of Heavy Loads,” *Journal of Dynamic Systems, Measurement, and Control*, vol. 128, p. 778, dec 2006.
- [69] A. Kargov, T. Werner, C. Pylatiuk, and S. Schulz, “Development of a miniaturised hydraulic actuation system for artificial hands,” *Sensors and Actuators, A: Physical*, 2008.
- [70] H. Kaminaga, T. Yamamoto, J. Ono, and Y. Nakamura, “Backdrivable miniature hydrostatic transmission for actuation of anthropomorphic robot hands,” in *Proceedings of the 2007 7th IEEE-RAS International Conference on Humanoid Robots, HUMANOIDS 2007*, 2008.

- [71] H. Kaminaga, J. Ono, Y. Nakashima, and Y. Nakamura, “Development of backdrivable hydraulic joint mechanism for knee joint of humanoid robots,” in *Proceedings - IEEE International Conference on Robotics and Automation*, 2009.
- [72] F. A. Panizzolo, I. Galiana, A. T. Asbeck, C. Siviyy, K. Schmidt, K. G. Holt, and C. J. Walsh, “A biologically-inspired multi-joint soft exosuit that can reduce the energy cost of loaded walking,” *Journal of NeuroEngineering and Rehabilitation*, vol. 13, p. 43, dec 2016.
- [73] Y. Lee, Y.-J. Kim, J. Lee, M. Lee, B. Choi, J. Kim, Y. J. Park, and J. Choi, “Biomechanical Design of a Novel Flexible Exoskeleton for Lower Extremities,” *IEEE/ASME Transactions on Mechatronics*, vol. 22, pp. 2058–2069, oct 2017.
- [74] T. R. Alley, “Age-related changes in body proportions, body size, and perceived cuteness,” *Perceptual and Motor Skills*, vol. 56, no. May, pp. 615–622, 1983.
- [75] D. O. Abrahamyan, A. Gazarian, and P. M. Braillon, “Estimation of stature and length of limb segments in children and adolescents from whole-body dual-energy X-ray absorptiometry scans,” *Pediatric Radiology*, 2008.
- [76] A. Huseynov, C. P. E. Zollikofer, W. Coudyzer, D. Gascho, C. Kellenberger, R. Hinzpeter, and M. S. Ponce de León, “Developmental evidence for obstetric adaptation of the human female pelvis.,” *Proceedings of the National Academy of Sciences of the United States of America*, vol. 113, pp. 5227–32, may 2016.
- [77] W. H. Coleman, “Sex differences in the growth of the human bony pelvis,” *American Journal of Physical Anthropology*, vol. 31, pp. 125–151, sep 1969.
- [78] A. Schiele and F. C. T. Van Der Helm, “Kinematic design to improve ergonomics in human machine interaction,” *IEEE Transactions on Neural Systems and Rehabilitation Engineering*, 2006.
- [79] S. J. S. J. Hall, *Basic biomechanics*. McGraw-Hill, 2007.
- [80] B. Allen, B. Curless, and Z. Popović, “The space of human body shapes,” *ACM Transactions on Graphics*, vol. 22, no. 3, p. 587, 2003.
- [81] J. Beil, C. Marquardt, and T. Asfour, “No Title,” jul 2017.
- [82] V. Bartenbach, *Constraints Caused by Lower Extremity Exoskeletons*. PhD thesis, ETH ZURICH, 2017.

- [83] N. Jarrasse and G. Morel, “Connecting a Human Limb to an Exoskeleton,” *IEEE Transactions on Robotics*, vol. 28, pp. 697–709, jun 2012.
- [84] A. Schiele, “Ergonomics of exoskeletons: Subjective performance metrics,” in *2009 IEEE/RSJ International Conference on Intelligent Robots and Systems, IROS 2009*, 2009.
- [85] J. Li, Z. Zhang, C. Tao, and R. Ji, “Structure design of lower limb exoskeletons for gait training,” *Chinese Journal of Mechanical Engineering*, vol. 28, no. 5, pp. 878–887, 2015.
- [86] W. D. Bandy, J. M. Irion, and M. Briggler, “The Effect of Static Stretch and Dynamic Range of Motion Training on the Flexibility of the Hamstring Muscles,” *Journal of Orthopaedic & Sports Physical Therapy*, vol. 27, no. 4, pp. 295–300, 1998.
- [87] E. Nordmark, G. Hägglund, H. Lauge-Pedersen, P. Wagner, and L. Westbom, “Development of lower limb range of motion from early childhood to adolescence in cerebral palsy: A population-based study,” *BMC Medicine*, 2009.
- [88] M. De Onis, A. W. Onyango, E. Borghi, A. Siyam, C. Nishida, and J. Siekmann, “Development of a WHO growth reference for school-aged children and adolescents,” *Bulletin of the World Health Organization*, 2007.
- [89] D. Winter, *The Biomechanics and Motor Control of Human Gait: Normal, Elderly and Pathological*. 1991.
- [90] Y. C. Pai and M. W. Rogers, “Speed variation and resultant joint torques during sit-to-stand,” *Archives of Physical Medicine and Rehabilitation*, 1991.
- [91] K. Daines, E. D. Lemaire, A. Smith, and A. Herbert-Copley, “Sit-to-stand and stand-to-sit crutch use for lower extremity powered exoskeletons,” in *Proceedings - 2017 IEEE 5th International Symposium on Robotics and Intelligent Sensors, IRIS 2017*, 2018.
- [92] U. Onen, F. M. Botsali, M. Kalyoncu, M. Tinkir, N. Yilmaz, and Y. Çahin, “Design and actuator selection of a lower extremity exoskeleton,” *IEEE/ASME Transactions on Mechatronics*, 2014.
- [93] B. W. Stansfield, S. J. Hillman, M. E. Hazlewood, and J. E. Robb, “Regression analysis of gait parameters with speed in normal children walking at self-selected speeds,” *Gait and Posture*, 2006.

- [94] Y. J. Jeong and H. Kazerooni, "Design of Low Profile Actuators for Medical Exoskeletons," in *Volume 3: Biomedical and Biotechnology Engineering*, 2015.
- [95] J. L. Pons, *Wearable robots: Biomechatronic exoskeletons*. Hoboken, N.J: Wiley., 6 ed., 2008.
- [96] S. Alfayad, F. B. Ouezdou, F. Namoun, and G. Gheng, "High performance integrated electro-hydraulic actuator for robotics - Part I: Principle, prototype design and first experiments," *Sensors and Actuators, A: Physical*, 2011.
- [97] S. Lohmeier, T. Buschmann, H. Ulbrich, and F. Pfeiffer, "Modular joint design for performance enhanced humanoid robot LOLA," in *Proceedings 2006 IEEE International Conference on Robotics and Automation, 2006. ICRA 2006.*, 2006.
- [98] W. E. Woodson, B. Tillman, and P. Tillman, *Human factors design handbook : information and guidelines for the design of systems, facilities, equipment, and products for human use*. New York N.Y. [etc.]: McGraw-Hill, 2nd ed., 3 ed., 1992.



