



HAL
open science

Approche théorique et expérimentale du choix de source et de la gestion collective des ressources alimentaires chez la fourmi

Olivier Bles

► To cite this version:

Olivier Bles. Approche théorique et expérimentale du choix de source et de la gestion collective des ressources alimentaires chez la fourmi. *Biologie animale*. Université de Strasbourg; Université libre de Bruxelles (1970-..), 2019. Français. NNT : 2019STRAJ007 . tel-02327932

HAL Id: tel-02327932

<https://theses.hal.science/tel-02327932>

Submitted on 23 Oct 2019

HAL is a multi-disciplinary open access archive for the deposit and dissemination of scientific research documents, whether they are published or not. The documents may come from teaching and research institutions in France or abroad, or from public or private research centers.

L'archive ouverte pluridisciplinaire **HAL**, est destinée au dépôt et à la diffusion de documents scientifiques de niveau recherche, publiés ou non, émanant des établissements d'enseignement et de recherche français ou étrangers, des laboratoires publics ou privés.



FACULTÉ
DES SCIENCES



UNIVERSITÉ LIBRE DE BRUXELLES



IPHC-DEPE - UMR 7178

Approche théorique et expérimentale du choix de sources et de la gestion collective des ressources alimentaires chez la fourmi

Thèse présentée par Olivier BLES

en vue de l'obtention du grade académique de docteur en sciences (ULB - UNISTRA)

Année académique 2018-2019

Sous la direction du Professeur Jean-Christophe de BISEAU,
promoteur (Université libre de Bruxelles)

du Professeur Jean-Louis DENEUBOURG,
promoteur (Université libre de Bruxelles),

et du Professeur Cédric SUEUR,
promoteur (Université de Strasbourg)

Jury de thèse :

François CRISCUOLO (Université de Strasbourg, Président)

Jean-Louis DENEUBOURG (Université libre de Bruxelles, Secrétaire)

Cédric DEVIGNE (Université Catholique de Lille, Rapporteur externe)

Damien CHARABIDZE (Université de Lille, Rapporteur externe)

Jean-Christophe de BISEAU (Université libre de Bruxelles, Examineur interne)

Cédric SUEUR (Université de Strasbourg, Examineur interne)

Publications dans des revues à comité de lecture (publiées ou en préparation) :

Chapitre 1: Bles, O., Lozet, N., de Biseau, J.-C., Campo, A. & Deneubourg, J.-L. Effect of the land area elevation on the collective choice in ants. *Scientific Reports* **7**, 8745 (2017)

<https://doi.org/10.1038/s41598-017-08592-9>

Chapitre 2: Bles, O., Boehly, T., Deneubourg, J.-L. & Nicolis, S. C. Same length, different shapes: ants collectively choose a straight foraging path over a bent one. *Biology letters* **14**, 20180070 (2018)

<https://doi.org/10.1098/rsbl.2018.0070>

Chapitre 3: Planckaert, J., Nicolis, S. C., Deneubourg, J.-L., Sueur C. & **Bles, O.** A spatiotemporal analysis of the food dissemination process and the trophallactic network of the ant *Lasius niger*. *Submitted (Scientific Reports)*

Chapitre 4: Bles, O., Deneubourg, J.-L., Sueur C. & Nicolis, S. C. A data-driven simulation of the trophallactic network and intranidal food flow dissemination in ants. *Submitted (American Naturalist)*

Chapitre 5: Bles, O., Deneubourg, J.-L. & Nicolis, S. C. Food dissemination in ants: Robustness of the trophallactic network against resource quality. *Journal of Experimental Biology* (2018)

<https://doi.org/10.1242/jeb.192492>

Annexe 1: Antoine, J., **Bles, O.**, Planckaert, J. & Campo, A. Fiducial marks tracking for animal behaviour analysis. *In prep. (Scientific Reports)*

Annexe 2: Bles, O. & Deneubourg, J.-L. Colony-level but no individual-level consistency of the foraging activity in the ant *Camponotus cruentatus*. *In prep. (Animal Behaviour)*

Liste des communications écrites & orales:

Bles O. & Deneubourg J.-L. - Modelling food flow dynamics and regulation in ants – Juillet 2014 - IUSSI - Cairns – Australie - Communication orale

Bles O. & Campo A. - Automatic monitoring of food sharing process in ants – Avril 2015 - SFCEA – Strasbourg – France – Communication par affiche

Bles O. & Campo A. - Investigation of food flow regulation in ants: modelling and experimental data collection – Avril 2015 – Symposium IGBMC – Strasbourg – France – Communication orale

Bles O. & Deneubourg J.-L. Intranidal mechanisms of food flow dissemination in ants -Décembre 2015 – Cohesion & Conformity - Gottingen – Allemagne – Communication orale

Bles O. & Deneubourg J.-L. - Collective choice and asymmetrical setup in ants – Décembre 2016- Colloque “Agrégation” - Bruxelles – Belgique – Communication orale

Sommaire

Préface	4
Introduction	5
1. Choix collectif : un phénomène émergent au sein des sociétés d'insectes	5
1.1 Comportement individuel & choix collectif, amplifications & non-linéarités dans le contexte de la récolte de nourriture :	5
1.2 Composition chimique de la phéromone de piste :	6
1.3 Choix collectifs & régulation de la récolte : interactions entre phéromones, environnement & comportements individuels.	8
2. Echange de fluides : La trophallaxie et ses fonctions.	10
3. Notion de « flux alimentaire » et ses régulations :	13
3.1 Modalités du recrutement alimentaire et de la récolte : Rôle de l'interface entrée du nid/environnement et phéromone de piste :	13
3.2 Etat des stocks et réponse des ouvrières internes	15
3.3 Composition de la colonie et modulation de la récolte :	18
3.4 Modalités/rôles et régulations des échanges au niveau individuel :	20
4. Concept de réseaux sociaux au sein des sociétés d'insectes :	23
4.1 Réseau dans la colonie et flexibilité individuelle dans le contexte de la division du travail :	23
4.2 Réseaux et diffusion de nourriture au sein des colonies d'insectes sociaux :	27
5. Objectifs & organisation de la thèse	29
Chapitre 1 : Effect of the land area elevation on the collective choice in ants	32
Chapitre 2 : Same length, different shapes: Ants collectively choose a straight foraging path over a bent one	50
Chapitre 3 : AntBook: A spatiotemporal analysis of the social network in the ant <i>Lasius niger</i> through the trophallaxis	65
Chapitre 4 : A data-driven simulation of trophallactic network and intranidal food flow dissemination in ants.	96
Chapitre 5 : Food dissemination in ants: Robustness of the trophallactic network against resource quality.	127
Discussion générale	137
1. Vue générale de la thèse	137
2. Influence de paramètres environnementaux sur les choix collectifs de ressources alimentaires chez la fourmi	138

2.1 Résumé des résultats concernant l'effet de la topographie et de la géométrie de l'environnement sur les choix d'exploitations de sources alimentaires :	138
2.2 Analyse des comportements individuels lors de l'exploration de l'environnement et des trajets de retour au nid :	140
2.3 Analyse de la récolte et hypothèses sous-jacentes aux choix de sources.	142
2.4 Ouverture : Flexibilité, exploitation de sources et propriétés de l'environnement.	144
2.5 Limite des expérimentations en conditions artificielles.	146
3. Réseaux et division du travail dans le contexte de la diffusion de nourriture dans le nid	147
3.1 Dynamique des trophallaxies	148
3.2 Approches expérimentale et théorique des réseaux de trophallaxies et des répartitions du travail :	149
3.3 Modèle et simulations	152
3.4 Limites des analyses de réseaux	155
4. Conclusions générales et ouvertures	157
Annexe 1	163
Annexe 2	217
References	234

Préface

La vaste diversité des formes et modes d'organisation du Vivant sur Terre a fertilement alimenté l'imaginaire de l'Homme au cours des âges, de la Poésie (... chez Rabelais) à la politique (métaphore organique de l'état) en passant par la littérature (chez Balzac dont le texte est traité comme de la matière vivante, le lecteur est expérimentateur, scalpel à la main, les structures sociales sont écosystèmes, (Solomon, 2016)), la philosophie (e.g., la ruche d'Aristote / l'organicisme de Platon, les fourmis chez Plutarque), les religions et les plus récentes techniques de management (Laloux, 2014). Les métaphores, nombreuses, nourrissent et façonnent l'esprit humain. Les sociétés d'insectes et leur organisation, font l'objet, dès l'Antiquité, de fines descriptions dont la justesse est, à quelques approximations/extrapolations près, encore tout à fait appréciable aujourd'hui et difficilement distinguables des écrits des naturalistes à l'œuvre de nos jours. L'organisation de ces sociétés fascine et intrigue les esprits qui les observent et tentent de les comprendre au cours de l'Histoire. Les coopérations observées ont inspiré les bases « scientifiques » du communisme chez Kropotkin (Kropotkin, 1902) quand Freud y voyait la « sublimation parfaite de l'individu à la volonté du groupe », une sublimation « échappant toujours à l'humanité » (Freud, 1930). Les singularités de ces animaux ont longtemps été considérées comme étant une création divine, immuable quand l'entomologie moderne y voit des sociétés complexes dans lesquelles émergent des divisions du travail, des spécialisations, des organisations robustes et flexibles reposant pourtant sur quelques lois simples au niveau individuel. Certains illustrent ces systèmes par la métaphore du jeu d'échec, un jeu dans lequel « un nombre relativement faible de règles peut générer une complexité surprenante », suggérant que l'apparente complexité de ces systèmes biologiques repose sur un corps similaire de règles simples (Holland, 1998). La détermination de ces processus, responsables des propriétés émergeant au niveau collectif, par auto-organisation, nécessite de décrire les composants élémentaires du système et leurs interactions. Ces interactions résident dans des échanges directs de matériel, de nourriture et d'information entre deux ou plusieurs individus, appelés trophallaxies, ou indirects, par communication chimique (phéromones). Ces échanges sont nombreux et essentiels à l'émergence de structures organisées au sein de ces sociétés, dont l'un des enjeux fondamentaux est la gestion collective des ressources alimentaires, en lien direct avec les capacités de croissance et de reproduction de la colonie. Au cours de ce travail ont été investigués et caractérisés, à travers le développement de divers outils, les facteurs déterminants de cette gestion commune mais décentralisée de la nourriture, aussi bien en termes de récolte que de distribution au sein de la colonie et dont les rôles et les implications ne sont encore aujourd'hui pas clairement établis.

Introduction

1. Choix collectif : un phénomène émergent au sein des sociétés d'insectes

1.1 Comportement individuel & choix collectif, amplifications & non-linéarités dans le contexte de la récolte de nourriture :

De nombreuses espèces animales forment des **structures émergentes** à l'échelle du groupe, tels que les nuées d'oiseaux, les bancs de poissons et les essaims d'insectes sociaux. Leurs fonctions peuvent être diverses mais l'élaboration de ces structures au sein d'un large spectre d'espèces présente des similarités, dans la mesure où n'est invoqué aucun plan pré-déterminé orientant ces formations. Chaque individu n'a qu'une connaissance très limitée et locale de **l'information** et de son **environnement** (Garnier et al., 2007). Les propriétés de ces groupes dit **auto-organisés**, ont été le fruit de nombreuses études, révélant l'extrême complexité des structures et organisation collectives (construction du nid/tunnels, migration de nid, défense, etc.) et de leurs multiples fonctions (e.g.,(Franks, 1989; Mlot et al., 2011)), en opposition à la limitation des capacités au **niveau individuel**. A ce niveau le transport d'un cadavre de fourmi à l'intérieur de la fourmilière ou dans son environnement présente un aspect aléatoire car déplacé, abandonné puis ressaisi par différents individus, dans aucune direction précise mais il finit toujours par échouer au «cimetière» (Diez et al., 2014; Theraulaz et al., 2002). Il en est de même lors de l'observation de l'activité de récolte de nourriture (fourragement) chez les fourmis où l'exploration, initialement aléatoire, de l'environnement par un individu à la recherche d'une source de nourriture conduit à **l'exploitation collective** de cette dernière suite au phénomène de recrutement et à la formation de piste (e.g.,(Beckers et al., 1993a; Czaczkes et al., 2015b; de Biseau et al., 1991)).

Dans ce contexte de fourragement, ces décisions collectives se révèlent être d'une grande efficacité dans la mesure où le choix collectif s'oriente vers l'exploitation de la nourriture la plus riche (Beckers et al., 1990) ou l'emploi du chemin le plus court (Goss et al., 1989), ayant conduit à la notion « d'intelligence collective » au sein de ces sociétés d'insectes, source d'inspiration de nombreux travaux dans d'autres domaines (comme la robotique ou l'informatique: (Dorigo et al., 2006; Valentini et al., 2015)). L'émergence de choix collectifs, dans le contexte de récolte de

nourriture, est basée sur des **boucles de rétroactions positives** au sein desquelles la probabilité, pour un individu, de manifester un comportement est une fonction croissante du nombre d'individus à la base de la boucle de rétroaction ou déjà engagés dans ce type de comportement (Sumpter and Pratt, 2009). Ces boucles peuvent être basées sur différentes **communications**, directes (contact antennaire) ou indirectes (phéromone) et conduisent au phénomène de recrutement alimentaire.

Chez les espèces à communications de masse telles que *Lasius niger* ou dans une moindre mesure *Myrmica rubra* entre autres, le dépôt de phéromones sur la piste conduisant à une source de nourriture augmente la probabilité que d'autres individus suivent cette piste. Ces boucles de rétroactions positives conduisent à un phénomène d'emballement et sont contre-balançées par des boucles de **rétroactions négatives**, d'origines diverses (par effet de saturation ou d'encombrement de la piste, d'épuisement de la ressource ou par émission de phéromones spécifiques limitant l'emballement), permettant notamment au système de se stabiliser (Camazine et al., 2001). Au sein de ce système interviennent de nombreuses communications entre individus. Leur comportement est modulé par la circulation de l'information dont le messenger principal est, dans le contexte du fourragement collectif, la phéromone de piste.

1.2 Composition chimique de la phéromone de piste :

Le rôle de ces phéromones est fondamental aux **coordinations** lors de l'exploitation de la source de nourriture (revue de la littérature dans (Czaczkes et al., 2015b)) et sont issues d'interactions avec l'environnement (Detrain et al., 2001). Les molécules présentes dans les phéromones des fourmis sont largement retrouvées chez d'autres espèces, insectes ou autres (champignons, bactéries etc). Chez une espèce de fourmis « coupeuse de feuille » du genre *Atta*, il est fortement suggéré que les composés fondamentaux de la phéromone de piste et notamment responsables du comportement de suivi, les **pyrazines**, ne sont pas synthétisées par la fourmi elle-même mais par une bactérie symbionte, *Serratia marcescens*, dont le genre *Atta* est un hôte (Silva-Junior et al., 2018). Les communications chimiques entre individus et d'autres espèces biologiques sont basées sur une « **convergence** » de la chimie de ces fourmis et leurs symbiontes, conduisant à de nouvelles hypothèses en termes d'interactions interspécifiques (Silva-Junior et al., 2018). Au sein de plusieurs espèces du genre *Lasius*, deux composés chimiques de la phéromone de piste,

essentiellement présent dans la glande à poison, ont une influence fondamentale sur le comportement de suivi de piste, la **melleine** et une **pyranone**, cette dernière se retrouve également dans le genre *Myrmica* (Evershed et al., 1981) ainsi que dans le miellat des pucerons dont elles se nourrissent (Kern et al., 1997), la melléine se retrouve quant à elle chez des champignons du genre *Aspergillus*. Chez *Lasius niger*, une **isocoumarine** notamment présente dans l'ampoule rectale semble être également responsable du comportement de suivi de piste, une molécule retrouvée chez de nombreuses autres espèces d'insectes mais également chez des champignons du genre *Aspergillus*, diffère de la melléine par un groupe méthyle supplémentaire. Des expériences de biosynthèses de cette isocoumarine à partir de précurseurs radioactivement marqués avec lesquelles les fourmis ont été supplémentées (nourries), révèlent que ces précurseurs ne sont, pour la plupart, pas incorporés à l'isocoumarine (hormis un acide propionique retrouvé dans le groupe méthyl supplémentaire de l'isocoumarine), suggérant qu'au moins cette méthylation a lieu après l'ingestion de la molécule marquée. Les **voies de synthèse** de l'isocoumarine demeurent cependant **inconnues** et leur origine potentiellement symbiotique n'est pas à exclure. L'administration d'antibiotiques et antimycotiques aux fourmis n'a pas de conséquence sur la production d'isocoumarine, suggérant une synthèse par l'individu lui-même. La portée de ces antibiotiques et antifongiques et leur assimilation et évolution au sein de l'organisme n'a cependant pas été mesurée, il n'est donc pas à exclure que les **bactéries symbiotiques** aient été protégées de l'action des antibiotiques (Bestmann et al., 1997). La sensibilité individuelle des fourmis à ces phéromones de piste est extrême, chez *Lasius niger*, une réponse est observée dès 500 pg sur une branche (Bestmann et al., 1992), ces quantités infinitésimales, de l'ordre de 10^{-15} kg, rendent leur étude particulièrement complexe. Une réponse à de si faibles quantités de phéromones rend les phénomènes de recrutement et de suivi hautement non-linéaires, il peut suffire qu'un seul individu réussisse pour que le phénomène s'emballe (David Morgan, 2009), un système semblant être d'une grande efficacité.

L'origine et l'évolution de l'attraction de ces composés et de leur utilisation dans les systèmes de communications chimiques au sein des sociétés d'insectes sont encore floues. Les systèmes complexes, tels que les sociétés d'insectes, montrent des propriétés émergentes à partir de la combinaison d'actions individuelles. Ces comportements collectifs présentent aujourd'hui un caractère adaptatif (Camazine et al., 2001) mais ils n'ont pas nécessairement évolué dans ce contexte et ont pu être une manifestation, un **épiphénomène**, d'autres comportements. L'hypothèse

d'une attraction initiale des fourmis hôtes par des bactéries symbiotiques via l'émission de molécules odorantes est envisageable (Silva-Junior et al., 2018), molécules retrouvées et accumulées dans divers organes chez la fourmi (David Morgan, 2009), phénomène à partir duquel ont pu émerger et évoluer, de façon contingente ou par exaptation (Gould and Vrba, 1982), ce mode de communications chez ces insectes aujourd'hui.

1.3 Choix collectifs & régulation de la récolte : interactions entre phéromones, environnement & comportements individuels.

L'effet des phéromones de piste est à intégrer au contexte environnemental dans lequel évolue la colonie, ainsi qu'à l'expérience individuelle. Les caractéristiques physico-chimiques de l'environnement (e.g., température, humidité) et la nature du substrat influencent fortement le niveau de perception des phéromones et donc le comportement de suivi et les choix collectifs qui en résultent (Detrain et al., 2001; Jeanson et al., 2003). Les caractéristiques de la source, telles que la qualité (Portha et al., 2002) ou le volume (Mailleux et al., 2003a) ou la distance par rapport au nid (Devigne and Detrain, 2006) de la nourriture disponible aussi bien que des événements stochastiques (Detrain and Deneubourg, 2008), influencent le dépôt de phéromones. Les modulations de dépôt traduisent une forme de flexibilité au niveau individuel, niveau auquel on retrouve également des effets de mémoire et d'apprentissage de l'environnement pris en compte dans les décisions individuelles. L'information 'privée' ou individuelle peut dans certains cas dépasser l'information 'sociale' et conduire à une décision sous-optimale, telles que l'exploitation de la moins riche de deux sources ou non lorsqu'il s'agit de trouver la plus proche des deux sources (Czaczkes et al., 2016a). Cette sous-optimalité et inflexibilité peut également dans certains cas se retrouver à l'échelle collective, notamment lorsqu'une nourriture de faible qualité commence à être exploitée avant une nourriture de meilleure qualité : les fourmis *L. niger*, une espèce à recrutement de masse, échouent à transférer leur exploitation de la 1^{ère} source envers la 2^{nde}, conséquence d'un piste déjà établie et plus forte vers la 1^{ère} source exploitée (e.g.(Beckers et al., 1990)), de même chez *L. humile* lorsqu'il s'agit non plus de qualité de la nourriture mais de distance entre source et nid (Goss et al., 1989). Ce phénomène de « piège » n'est cependant pas systématique, plusieurs mécanismes permettant d'éviter une solution sous-optimale. Chez *M. sabuleti*, également une espèce à recrutement de groupe et masse, les colonies parviennent rapidement à réallouer leur

activité de la source la moins productive vers la plus productive quand-bien même la piste envers la 1^{ère} est déjà bien développée, une flexibilité supposée autorisée par une modulation du dépôt en fonction de la qualité de la source ou par l'existence de plusieurs phéromones de pistes (de Biseau et al., 1991). Dans le cas de recrutement de groupe, les effets de mémoires chez le leader peuvent également être impliqués dans la flexibilité (Beckers et al., 1990; Collignon et al., 2012; Pasteels et al., 1987). D'autres mécanismes basés sur des boucles de rétroactions négatives, des phéromones répulsives ou des « erreurs » ou de la stochasticité dans les trajets peuvent également éviter aux colonies cette forme de « piège » et ces choix sous-optimaux (Dussutour et al., 2009a; Robinson et al., 2005; Shaffer et al., 2013).

Les décisions collectives présentent ainsi des degrés de flexibilité variables dans un environnement dynamique, en fonction des propriétés et mécanismes de recrutement sur lesquelles elles reposent. De nombreux paramètres physiques, géométriques ou plus généralement le relief de la piste influencent ces choix (voir Introduction du chapitre 1 pour plus de détails concernant ces effets), des paramètres affectant notamment la locomotion et les dépenses énergétiques au niveau individuel (Holt and Askew, 2012). La littérature concernant la primauté du facteur temps par rapport à la dépense énergétique lors du trajet nid-source ne fait cependant pas consensus aujourd'hui dans la mesure où le facteur temps semble prépondérant dans certains cas (Frank et al., 2018) quand l'énergie l'est dans d'autres (Denny et al., 2001). Les facteurs environnementaux influencent donc largement les dynamiques de récoltes alimentaires mais les besoins de l'individu et de la colonie y contribuent également. Les individus ont des besoins nutritionnels précis en quantités et proportions nécessaires au bon fonctionnement et au maintien de l'homéostasie de leur organisme et y adaptent leur activité (Dussutour and Simpson, 2009, 2008a). Si au niveau de l'individu, l'alimentation et sa physiologie sont des problèmes complexes qui se caractérisent par plusieurs échelles de temps, par nombre de régulations intervenant notamment dans l'exploitation de différents nutriments, ces questions prennent une autre dimension dans le cas d'une société où émergent des « conflits d'intérêts », au moins en termes nutritionnels, dûs à un continuum d'âges et de stades de développement des individus et une division du travail impliquant des échanges de nourriture (voir références dans (Sumner et al., 2018)). Chez les fourmis, peu d'individus (les fourrageuses) quittent le nid et récoltent de la nourriture avec pour challenge de satisfaire simultanément leurs besoins alimentaires aussi bien que ceux du reste de la colonie (les ouvrières ayant des besoins en sucre tandis que les larves et la reine requièrent également une nourriture

protéinée, (Dussutour and Simpson, 2009)), impliquant alors des réseaux complexes de communications et des coopérations entre individus. La transmission des informations concernant l'état des stocks et les besoins de la colonie, indispensables dès qu'il s'agit de satisfaire et réguler collectivement la récolte et la distribution de nutriments, est basée sur des interactions sociales, potentiellement d'ordre chimique (phéromone) mais aussi par des contacts directs et des échanges trophallactiques.

2. Echange de fluides : La trophallaxie et ses fonctions.

Des échanges de fluides entre individus sont constatés au sein d'espèces très variées, des mammifères aux insectes (Bernt and Walker, 2007; Hefetz and Grozinger, 2016), dont les fonctions sont bien connues, notamment dans le cas du lait maternel ou du liquide séminal. Les échanges de liquides sont très nombreux au sein des colonies d'insectes sociaux, tels que les abeilles, fourmis ou termites. Ces échanges s'inscrivent, dans ces derniers cas, dans un contexte de systèmes décentralisés rendant particulièrement intéressantes les questions autour du/des rôle(s)/fonction(s) potentiels de ces comportement sociaux. Ce transfert de liquide est appelé **trophallaxie** lorsqu'il est réalisé de bouche-à-bouche entre deux individus (trophallaxie stomodéale) ou d'anus à bouche (trophallaxie proctodéale), qu'il se déroule entre adultes ou entre adultes et jeunes. Entre fourmis adultes il s'agit de trophallaxies stomodéales. Ces comportements sont notamment fondamentaux au maintien de l'**homogénéité de l'identité coloniale associée à des mélanges d'hydrocarbures** (Boulay et al., 2000). Il a récemment été révélé que les mécanismes impliqués dans ce maintien sont plus complexes que ce qui avait été proposé jusqu'à présent (Neupert et al., 2018). En effet, le profil cuticulaire d'individus isolés se différencie de celui de la colonie après seulement 3-4 jours. La ré-introduction d'individus isolés après cette période est encore possible, des échanges trophallactiques conduisant à un réajustement de leur profil cuticulaire à celui de la colonie mère. Cependant, un isolement prolongé menant à des divergences de profils plus marquées entre colonie-mère et individus isolés, rend les individus résidents irréversiblement intolérants aux isolés. Ces profils cuticulaires individuels sont donc dynamiques et homogénéisés au niveau colonial par de nombreux et continus échanges de fluides, contenant notamment des hydrocarbures. Ce n'est que très récemment que la présence et l'échange d'hydrocarbures cuticulaires (CHC) dans et par les fluides trophallactiques ont été totalement confirmés (Leboeuf et al., 2016). Des analyses

fines par spectrométrie de masse et des séquençages d'ARN ont également permis de révéler la présence d'une grande variété de molécules dans ces échanges qui interviennent dans la croissance et le développement (hormone juvénile ou JH ci-après, JH-estérase, vitellogénine etc), les défenses immunitaires, des enzymes digestives, des protéines impliquées

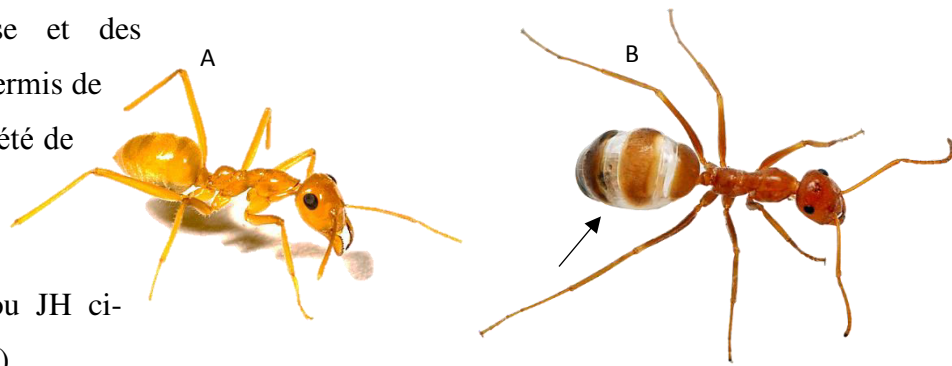

Figure 1. Fourmi avant (A) et après (B) ingestion de liquide sucré, l'abdomen est distendu et les ternes écartés, ici chez *M. mexicanus*. ©Amstrong C.2014

dans la chromatine (histones) et divers micro-ARNs. Il est notamment suggéré que les nourricières influencent/modulent le **développement des larves**, en jouant sur le niveau de JH. La capacité des nourricières à contrôler le niveau hormonal de JH dans le liquide transféré aux larves n'a cependant pas été démontrée et le contrôle du développement des larves serait alors passif, par le transfert de nourriture, sans contrôle actif du niveau de JH. De plus, l'origine de la présence de JH dans le liquide trophallactique n'est pas claire. En effet, cette hormone est synthétisée dans les corpora allata (Goodman and Granger, 2009), situés sous le cerveau, et bien que de nombreuses molécules (protéines) de transports de JH entre hémolymphe et tissus soient connues (et notamment présentes dans le liquide trophallactique), les mécanismes de transports/absorption à travers les tissus et jusque dans l'œsophage ne sont pas bien connus, aussi bien chez les fourmis que chez d'autres insectes. De même, le rôle des micro-ARNs présents dans le liquide trophallactique n'est pas clair (Sarkies and Miska, 2013). De récents travaux ont également montré une augmentation de la proportion (2 fois plus) de larves atteignant le stade de métamorphose lorsque celles-ci sont élevées par des ouvrières dont la nourriture a été supplémentée en JH ou en inhibiteur de JH-estérase (LeBoeuf et al., 2018), étayant ainsi les fonctions du transfert de liquide par trophallaxie. Au-delà des hormones, les trophallaxies sont également l'intermédiaire par lequel sont inoculés aux larves les symbiontes que l'on retrouve au niveau de l'appareil digestif et indispensables à la biosynthèse de certains nutriments et au fonctionnement du métabolisme en général ainsi qu'à la protection de l'individu (Powell et al., 2014). Une autre fonction de ces transferts, considérée comme primaire, est l'échange de **nourriture**. Chez la plupart des espèces de fourmis, la **détermination de la caste** (reproductive ou ouvrière) repose, au moins en partie, sur une asymétrie nutritionnelle : les larves les plus alimentées donnent plus probablement des reines quand les moins alimentées donnent

essentiellement des ouvrières (Trible and Kronauer, 2017). L'explication repose sur la corrélation positive entre quantité/qualité de la nourriture à l'état larvaire et nombre/taille des ovaires chez la femelle adulte, modulant également l'expression de certains gènes responsable d'une moindre sensibilité aux signaux larvaires de régulation des cycles de reproduction au sein de la colonie. Ce mécanisme est supposé fondamental à l'émergence et à l'évolution de **la division reproductive du travail** et à l'eusocialité (Chandra et al., 2018). Facultatif chez des mammifères entre adultes et jeunes (Malcolm and Marten, 1982) ou entre individus au degré de parenté moindre dans le cas des chauves-souris notamment (Wilkinson, 1984), ces échanges de nourriture sont essentiels chez bon nombres d'espèces d'insectes sociaux, particulièrement chez les espèces dont la nourriture est principalement liquide (e.g, *Lasius niger*, en interaction mutualiste avec des pucerons dont elles récupèrent le miellat (Lang and Menzel, 2011)). Chez ces espèces la nourriture liquide est stockée/contenue au sein même de l'organisme, en grande partie dans le jabot, si bien qu'aucune trace n'en est relevée sur le substrat dans le nid (Buffin et al., 2009). En effet l'anatomie de l'appareil digestif des hyménoptères sociaux est particulièrement adaptée à ce type de comportement / stockage : un abdomen très extensible (notamment grâce à la présence de tergites et sternites articulés et soudés par des membranes intersegmentaires élastiques Figure 1 et 2 voir aussi (Hölldobler and Wilson, 1990), p.291) contenant notamment le **jabot** (social), flexible, et un proventricule (séparation appareil digestif/jabot) plus rigide, jouant le rôle de valve (évite que le contenu du jabot passe dans les intestins). Le proventricule contient également un filtre prévenant le passage de bactéries et particules ($\geq 0.2\mu\text{m}$) tout en laissant passer les nutriments dissous dans la nourriture liquide. Ce procédé protège la flore bactérienne de l'intestin des attaques et perturbations potentielles dû à l'ingestion de nourriture ayant déjà transité par d'autres individus auparavant. La flore bactérienne d'un individu lui est transmise dans les premières heures après le stade de puppe, par trophallaxie également et avant que ce filtre ne se mette en place dans le proventricule, l'homogénéité coloniale de la flore bactérienne est ainsi maintenue (Lanan et al., 2016). Le jabot contient le miellat (récupéré des pucerons (Offenberg, 2001)) ou le nectar (fournis par les nectaires présents sur certaines plantes (Engel et al., 2001)) et lorsqu'il est rempli, il peut occuper quasi toute la cavité abdominale. Le transfert de nourriture entre deux individus se fait par la contraction des muscles périphériques qui rapprochent les segments abdominaux (tergites/sternites) et presse le jabot dont le contenu est alors entraîné dans l'œsophage puis vers la cavité buccale avant qu'une goutte de nourriture n'apparaisse entre les mandibules de l'individu donneur. La nourriture liquide

apportée par les fourrageuses est distribuée, par trophallaxie, aux ouvrières non-fourrageuses. Ces dernières redistribuent également la nourriture précédemment acquise, lors de trophallaxies « secondaires », formant des **chaines d'échanges** au sein de la colonie. Ces échanges successifs conduisent à la dispersion des nutriments depuis la/les entrée(s) du nid, vers les parties les plus profondes en partant des fourrageuses, chargées, de retour de la source, vers les nourricières et des nourricières vers les larves (Cassill and Tschinkel, 1995; Wilson and Eisner, 1957).

L'ensemble de ces échanges créent ainsi des **réseaux** qui connectent tous les individus et assurent divers rôles au sein de la colonie. Cependant, la complexité de ces échanges et les mécanismes qui modulent leurs dynamiques sont encore mal identifiés. Ils seront notamment

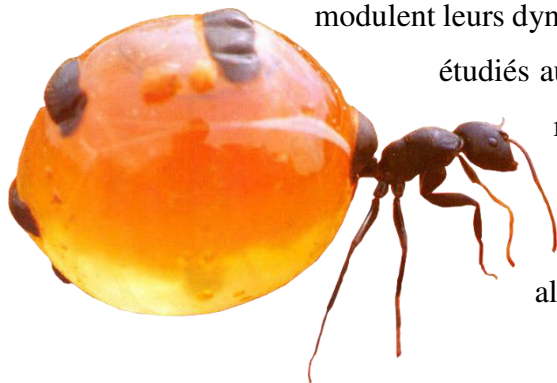

Figure 2. Phénotype extrême d'une stockeuse (honeypot) de l'espèce *Myrmecocystus* sp.

étudiés au cours des deux derniers chapitres de ce manuscrit. Ces réseaux sont également **vecteurs d'informations**, largement diffusée parmi les membres de la colonie. Des informations concernant la disponibilité d'une source alimentaire sont transmises par trophallaxies, depuis les exploratrices/fourrageuses actives vers les ouvrières

et notamment vers les fourrageuses potentielles.

3. Notion de « flux alimentaire » et ses régulations :

3.1 Modalités du recrutement alimentaire et de la récolte : Rôle de l'interface entrée du nid/environnement et phéromone de piste :

L'interface entrée du nid / environnement est une zone où les interactions entre individus sont nombreuses et déterminantes, notamment pour l'activité de récolte de nourriture, ce qui en fait l'objet de nombreuses études, aussi bien en milieu naturel (Davidson and Gordon, 2017; Pinter-Wollman et al., 2013a) qu'en laboratoire e.g.(Cassill, 2003; Mailleux et al., 2011, 2010a; Pinter-Wollman et al., 2011a) et théoriques e.g.(Prabhakar et al., 2012a, 2012b; Udiani and Pinter-Wollman, 2014). Les **interactions** entre fourrageuses entrantes / sortantes et potentielles y sont fondamentales et **régulent les dynamiques de récolte** de nourriture (Gordon, 2002; Gordon et al., 2011, 2007; Schafer et al., 2006). D'un côté les fourrageuses quittant une source de nourriture

déposent derrière elles, notamment lors du trajet de retour au nid, une certaine quantité de phéromones. Chez les espèces à recrutement de masse, l'intensité du dépôt individuel peut-être dépendant (e.g. chez *Lasius niger*, (Beckers et al., 1993a)) ou non (*Solenopsis saevissima*, (Wilson, 1962)) de la qualité de la source. Il est à noter que la nature de la nourriture (e.g protéines vs. sucres) ne semble pas influencer l'intensité du dépôt au niveau individuel chez *Lasius niger*, connu pour être affecté par la concentration en sucre de la nourriture mais seulement la proportion d'individus déposant de la phéromone (Portha et al., 2004). Chez cette dernière espèce, l'information relative à la quantité de nourriture est régie par un mécanisme de type « tout ou rien » : lorsqu'une quantité seuil est ingérée, le dépôt est enclenché (Mailleux et al., 2000). Ce comportement est également à l'origine d'un **feedback négatif**. Lorsque la source est saturée par les fourmis, seuls les individus ayant accès à la nourriture vont déposer de la piste. Un second feedback négatif résultant de la durée de vie limitée de la phéromone (quelques minutes) est également à l'œuvre. Ces boucles de rétroactions conduisent d'abord à un ralentissement de l'arrivée à la nourriture avant une stabilisation du nombre de fourrageuses, fonction de l'aire ou la surface de la nourriture disponible. Les fourrageuses possèdent ainsi ou du moins transmettent des informations concernant la disponibilité de la source de nourriture. A l'autre extrémité de la chaîne d'approvisionnement, dans le nid, les ouvrières intranidales et fourrageuses potentielles, possèdent des informations sur les **besoins de la colonie**. Ainsi ces deux groupes comportementaux (bien qu'un continuum soit possible entre les deux) possèdent des informations cruciales et indispensables au fonctionnement et à la régulation des activités de la colonie. Les échanges et communications entre ces deux groupes ont essentiellement lieu dans une zone restreinte à l'interface de l'entrée du nid et de l'environnement extérieur. En effet, la **ségrégation spatiale** est très marquée, aussi bien dans les nids en milieu naturel (Tschinkel and Hanley, 2017) que dans des environnements artificiels, en laboratoire (Mersch et al., 2013a) ; ce qui atteste du caractère profondément ancré de ce phénomène dans les sociétés d'insectes. Dans le cas de nids de *Pogonomyrmex badius*, les fourrageuses représentent moins de 5% de la population au-delà de 20 cm de l'entrée du nid et plus aucune n'est retrouvée au-delà de 70 cm, la population est alors supposée constituée quasi-exclusivement de nourricières (Tschinkel and Hanley, 2017).

3.2 Etat des stocks et réponse des ouvrières internes

En résumé, le recrutement (ici réduit au dépôt de phéromones) par les fourrageuses ne représente qu'une partie des processus en jeu dans la régulation de l'activité de récolte de nourriture, la réponse des ouvrières internes et fourrageuses potentielles constituant la seconde partie. Les fourrageuses apportent aux nids de la **nourriture** et des **informations** la concernant, cependant ces dernières ne sont pas uniquement transmises via la piste. De plus, le comportement des individus recrutés dans le cadre de la récolte de nourriture n'est pas dicté par celui des fourrageuses. La **piste de phéromones** ne contenant pas systématiquement d'informations quant aux propriétés de la nourriture, les contacts directs entre individus, antennaires ou trophallactiques, participent également aux processus de décisions des fourrageuses potentielles à quitter le nid en quête de nourriture. Les comportements/contacts de recrutement par les fourrageuses envers les recrutées potentielles sont variables entre espèces. Chez certaines espèces, il se limite simplement au dépôt de phéromones quand chez d'autres la fourrageuse peut manifester des **comportements de recrutement** comme des mouvements de la tête, augmentation du rythme de marche, des stimulations directes par des contacts antennaires de la fourrageuse, des partages d'échantillon de nourriture que la fourrageuse maintient entre ses mandibules (e.g.,(Cassill, 2003; Detrain et al., 1999). La recrutée potentielle peut alors évaluer l'échantillon de nourriture (par contacts antennaires ou échange de nourriture) et commencer à fourrager ou non en fonction de son état de satiété et des caractéristiques de l'aliment. Lorsque la qualité de la nourriture est trop faible, l'individu rassasié ou employé à une autre tâche, la résistance des recrutées aux signaux de recrutement est forte. Une augmentation de la qualité de la nourriture, à affamement constant, augmente la proportion d'individus commençant à fourrager bien qu'une part (décroissante) des recrutées potentielles s'abstient toujours de tout comportement de récolte (Cassill, 2003). Une part de ces individus reste inactive dans le nid, notamment près de l'entrée de ce dernier. Ils sont considérés comme des individus de réserve, s'activant en cas de besoins particuliers (Charbonneau and Dornhaus, 2015a; Schmid-Hempel, 1991). Certains travaux montrent que la **probabilité de sortie** chez *Lasius niger* augmente avec l'**affamement** (de 1 à 8 jours) et indépendamment des contacts directs (trophallactiques ou antennaires) entre fourrageuses et recrutées. Cela suggère que le processus de recrutement repose, dans ce cas, essentiellement sur l'émission de phéromone (probablement la même que la piste), dans le nid, par les fourrageuses (Mailleux et al., 2011). La durée de l'affamement diminuerait le **seuil de réponse** des recrutées à cette phéromone et

stimulerait leur sortie. Cependant nos observations suggèrent fortement des mécanismes complémentaires : des contacts antennaires ou des partages de nourriture depuis une fourrageuse vers les ouvrières dans le nid peuvent stimuler la sortie de ces dernières. De plus la probabilité de sortie « spontanée », même en l'absence de phéromone, augmente avec l'affamement. Les comportements de recrutements par les fourrageuses, chez *Lasius niger*, ne sont cependant pas affectés par l'affamement: lorsque le volume de nourriture disponible est supérieur au volume ingérable par un individu (capacité du jabot), la proportion d'individus déposant des phéromones et l'intensité de ce dépôt sont indépendants de l'affamement (Mailleux et al., 2006). De façon intéressante, il est à noter que si le volume de nourriture disponible est inférieur à la capacité individuelle, la proportion d'individus déposant des phéromones diminue lorsque l'affamement augmente. Chez *Lasius niger*, certains comportements accélèrent le phénomène d'**emballement** lors du recrutement dans un contexte d'affamement fort (4 et 8 jours) : contrairement à une idée commune, environ 30% des individus ayant reçu de la nourriture déposent des phéromones, sans avoir visité la source auparavant (Mailleux et al., 2011). Ce comportement n'est pas observé lorsque l'affamement est faible (1 jour). La réponse des **recrutées** semble être à la base du processus de **régulation du fourrage** chez *Lasius niger* tandis que les fourrageuses ne jouent qu'un rôle minime à ce niveau du processus de recrutement: le niveau d'affamement de la fourrageuse (1 ou 8 jours) de retour au nid après un passage à la source n'a pas d'effet sur le niveau de recrutement des recrutées tandis que le niveau d'affamement de celles-ci va augmenter leur probabilité de sortir, que les fourrageuses de retour au nid soient peu ou fortement affamées (Mailleux et al., 2010a).

Chez un vaste spectre d'espèces sociales, l'état nutritionnel est un facteur clé du comportement des individus. La position spatiale d'un individu au sein d'un banc de poissons *Melanotaenia duboulayi* est, entre autres facteurs, également affectée par son état nutritionnel (Hansen et al., 2015). Un individu affamé aura tendance, sans que sa vitesse de déplacement soit modifiée, à s'écarter plus loin et plus longtemps du banc et de ses congénères qu'un individu rassasié. Les bancs exclusivement composés d'individus rassasiés sont plus denses que des bancs d'affamés, impactant les dynamiques de fission-fusions des groupes et potentiellement la probabilité de découvrir des sources de nourriture. Un individu affamé aura tendance à se maintenir plus éloigné d'un autre individu affamé que d'un rassasié, un comportement également supposé augmenter la probabilité, pour un individu affamé, de s'alimenter. Il semble donc exister une capacité, chez ces individus, à

évaluer l'état nutritionnel des congénères et d'y adapter leur comportement. Il est supposé que le mécanisme de détection de l'état nutritionnel est basé sur la perception visuelle de changements physiques, dans la mesure où le corps d'un individu dont l'estomac est rempli, s'élargit et présente une extension dorso-ventrale. Cet état de satiété influence également la position spatiale de l'individu, dans la mesure où l'augmentation du métabolisme impacte négativement l'énergie disponible pour la locomotion, menant l'individu rassasié à une position plus postérieure dans le groupe, abaissant par là-même les coûts liés aux déplacements grâce aux bénéfices hydrodynamiques générés par les individus en position frontale dans le groupe (Krause and Seebacher, 2018).

Chez la fourmi, dont les agrégats et l'organisation sociale sont évidemment plus complexes que chez le poisson, l'affamement modifie l'**occupation spatiale** des recrutes/fourrageuses potentielles au niveau intranidal. Une partie des individus s'agrége à proximité de l'entrée du nid (Mailleux et al., 2010d) et augmente leur probabilité de quitter spontanément le nid, indépendamment de la présence ou de l'activité des fourrageuses. Des synergies entre ces réorganisations spatiales et des modulations des seuils de réponses aux stimuli émis par les fourrageuses, augmentent la réactivité de la colonie à la présence de nourriture. D'un point de vue quantitatif, ces réorganisations diminuent d'un facteur 2 la distance parcourue par une fourrageuse entre deux contacts avec des recrutes, accélérant la vitesse de diffusion de l'information dans la colonie. Les processus à l'œuvre dans le recrutement alimentaire sont donc flexibles et efficaces, conduisant à des dynamiques de récoltes accélérées au niveau colonial lorsque les besoins sont élevés. Les recrutes jouent ici le rôle de tampon et permettent d'adapter la dynamique de récolte et la force ouvrière requise à l'état nutritionnel de la colonie et à la qualité de la nourriture disponible (Mailleux et al., 2010a, 2003b). Bien que pouvant potentiellement présenter un caractère générique, il est à noter que ces mécanismes de régulation de la récolte ne sont pas observés chez l'ensemble des hyménoptères sociaux. En effet, chez l'abeille mellifère, l'observation révèle des **règles de modulation** de la récolte fortement éloignées : les fourrageuses sont à la base de la régulation de l'entrée de nourriture (Anderson and Ratnieks, 1999). Une fourrageuse parvenant à décharger sa nourriture à une ouvrière receveuse en un court délai (< 20 sec) exécute une « waggles dance » transmettant aux fourrageuses inactives des informations concernant la source (distance, direction), exerçant un feedback positif sur le nombre de fourrageuses quittant le nid. Au contraire, si le délai est plus long (> 50 sec environ) alors l'individu exécute une « tremble dance », un

feedback positif concernant les receveuses, dont la population augmente, et négatif pour les fourrageuses exécutant une « waggle dance », diminuant le recrutement de nouvelles fourrageuses. La « waggle dance » des fourrageuses est également spécifiquement régulée par un « stop signal » émis essentiellement par les fourrageuses effectuant également des « tremble dance », un second feedback négatif sur le recrutement (see (Anderson and Ratnieks, 1999; Seeley, 1995) et les références citées). Ce système de régulation met l'accent sur la disponibilité de la ressource dans l'environnement (recrutement de receveuses en cas de manque plutôt que diminution de la récolte) en augmentant les capacités de stockage plutôt que d'adapter le flux alimentaire entrant aux besoins de la colonie, comme dans le cas des fourmis. La dynamique et la régulation des recrutements alimentaires chez *Lasius niger* impliquent dès lors aussi bien les fourrageuses que les recrutées potentielles dans la mesure où ces deux groupes possèdent des informations différentes et complémentaires. Les interactions et échanges entre individus, au niveau de l'interface nid/environnement influencent profondément la régulation des dynamiques de fourragement et leur adaptation aux besoins de la colonie.

3.3 Composition de la colonie et modulation de la récolte :

Les colonies d'insectes sociaux sont composées d'individus dont les caractéristiques, en termes de morphologie, comportement, physiologie ou encore longévité (de plusieurs ordres de grandeur entre individus d'une même colonie, (Kramer et al., 2016), sont très variables. Aussi les besoins nutritionnels, notamment entre les différentes castes, sont différents. Au-delà de l'état des stocks, la composition de la colonie, en particulier la présence/absence de reine(s) et surtout de couvain, influencent les processus de recrutement alimentaire et la récolte/distribution de nourriture. Les fourmis et toutes les sociétés d'insectes font, en effet, face à des besoins complexes en termes de nutrition de la colonie, dans la mesure où les fourrageuses, ne représentant qu'une fraction des ouvrières, récoltent collectivement la nourriture pour l'ensemble des membres de la colonie. De plus, les besoins énergétiques des fourrageuses sont différents des besoins des autres castes, à qui la nourriture récoltée est essentiellement destinée (Cassill and Tschinkel, 1999a; Markin, 1970a). Ainsi de nombreux échanges et communications sont nécessaires à la gestion collective de la nourriture dans la colonie. Les informations concernant les **besoins nutritionnels**, sont transmises via les chaînes de demandes, dérivant des larves et de la reine, jusqu'aux fourrageuses, dont

l'activité de fourrage est modulée/adaptée aux besoins de la colonie, par ces transmissions : les larves sollicitent de la nourriture, sucrée et protéinée (Cassill and Tschinkel, 1999a; Dussutour and Simpson, 2008b), auprès des nourricières qui s'alimentent auprès des individus stockeurs stimulant les fourrageuses qui sortent du nid en quête de nourriture (Sorensen et al., 1983; Sorensen and Vinson, 1981). Cette organisation, depuis les larves jusqu'aux fourrageuses, est décrite pour la première fois et déjà qualifiée de « gradient de faim » par Sudd en 1967 (Sudd, 1967). Chez l'abeille, en plus des chaînes de transmission, les larves émettent, également une phéromone agissant directement (et en complément des autres interactions/échanges avec la colonie), au niveau global, sur les fourrageuses, sans l'intermédiaire des nourricières ou de stimuli visuels/tactiques (Ma et al., 2018), un phénomène non encore observé chez la fourmi. La présence de larves se manifeste par une mobilisation accrue des fourrageuses et par une augmentation de la quantité de nourriture récoltée, qu'elle soit protéinée ou sucrée (Portha et al., 2004). Lorsque le couvain atteint la satiété, le délai nécessaire aux fourrageuses, pour transférer la nourriture récoltée aux nourricières et aux individus réserves, augmente. Les échanges peuvent même être stoppés. La chaîne de demandes/échanges est alors rompue et les fourrageuses ne parvenant plus à décharger le contenu de leur jabot, stoppent l'activité de récolte (Buffin et al., 2009; Seeley, 1989; Sorensen et al., 1985). Le **choix de la nourriture** récoltée par les fourrageuses ne repose pas directement sur la présence/absence de couvain dans le nid mais dépend de la **composition**, en nutriments, de la nourriture, « stockée/présente » dans le nid. Par exemple, une nourriture pauvre en protéines (conséquence d'une source pauvre en protéines et/ou d'une consommation élevée par les larves) conduit à une augmentation de la récolte de ce type de nutriment lorsqu'il est disponible (Cassill and Tschinkel, 1999a). En cas d'introduction simultanée de deux sources de nourritures, l'une protéinée, l'autre sucrée, les fourrageuses, individuellement, ne prélèvent de la nourriture que sur une des deux. La nourriture protéinée est préférentiellement distribuée aux larves tandis que la nourriture sucrée est donnée aux ouvrières. Bien que supposé améliorer l'adaptation fine de la distribution de la nourriture aux besoins hétérogènes au niveau individuel, le maintien de flux séparé n'est cependant pas systématique chez la fourmi (Markin, 1970a), ni chez l'abeille (Eyer et al., 2015) et le mélange des deux types de nutriments peut être observé dans le nid lorsqu'une ouvrière sollicite par exemple de la nourriture auprès des deux types de fourrageuses (Cassill and Tschinkel, 1999a). Le rôle de la division du travail et des mécanismes impliqués dans ces échanges, en l'occurrence « les nourricières sollicitent-elles préférentiellement de la nourriture protéinée et

les autres ouvrières du sucre ou les échanges sont-ils régulés, chez chaque ouvrière, par la composition du liquide présent dans le jabot » sont mal déterminés. De plus, chez plusieurs espèces, une très forte **variation inter-individuelle**, aussi bien en termes de volume que composition du contenu du jabot, est observée, suggérant que d'autres facteurs que la taille et l'âge (classiquement admis dans le cadre de la division du travail) des individus jouent dans le stockage et la distribution de la nourriture (Brian and Abbott, 1977).

3.4 Modalités/rôles et régulations des échanges au niveau individuel :

Cette section a pour objectif de résumer la littérature traitant du comportement d'échange de nourriture à l'échelle de la fourmi, un comportement souvent sous-estimé, et ce même dans les travaux concernant la récolte de nourriture. En effet, la trophallaxie est généralement considérée comme un acte stéréotypé, cette sur-simplification d'un comportement pourtant complexe et fondamental, particulièrement dans le cadre de la gestion collective des stocks de nourriture conduit à négliger son rôle et ses implications au niveau individuel aussi bien qu'au niveau des patterns et des régulations collectives qui en découlent. Le flux de nourriture entrant dans le nid et sa distribution sont régulés par le niveau de satiété du partenaire **receveur** : à chaque instant, les échanges sont influencés, au niveau individuel, par le contenu du jabot et de l'appareil digestif des ouvrières et des larves réceptionnant la nourriture. L'ajustement du flux entrant de nourriture aux besoins de la colonie est basé sur la difficulté des fourrageuses de retour de la source à décharger leur jabot, agissant comme un feedback négatif, sans estimer de façon global l'état des stocks de la colonie (Buffin et al., 2009). Les fourrageuses ne parvenant pas à se décharger, stoppent leur activité de récolte et ne quittent plus le nid. L'« indice » entraînant l'arrêt de l'activité de récolte chez les fourrageuses est un sous-produit de la dynamique des échanges de nourriture, dont le ralentissement est la conséquence directe du niveau de remplissage du jabot des individus receveurs. L'information du niveau des stocks et l'adaptation de l'activité de récolte ne nécessite donc pas l'émission d'un « signal » explicite de la part des receveurs, comme il en existe notamment chez l'abeille mellifère (Anderson and Ratnieks, 1999; Seeley, 1989).

Le niveau d'affamement des fourrageuses régule le flux de nourriture entrant dans la colonie tandis que l'affamement des larves et des ouvrières (autres que les fourrageuses) influence le taux de trophallaxie et la vitesse de dissémination de la nourriture dans le nid. Quantitativement, la

distribution de la nourriture entrant dans le nid repose sur des mécanismes d'échanges, dépendants de **l'offre et la demande** des différentes castes (Cassill, 2003), interactions au cours desquelles la partie receveuse participe activement et n'est pas à considérer comme un simple réservoir se remplissant passivement (Cassill and Tschinkel, 1999b). Aussi il a été montré que dans une colonie affamée, une fourrageuse se décharge de la quasi-totalité de sa nourriture tandis que dans une colonie rassasiée, elle ne s'en décharge qu'à hauteur de 30%. Cependant cette nourriture atteindra une centaine d'individus dans les deux cas (Markin, 1970a). Qualitativement, les échanges de nourriture ne sont pas qu'une simple question de besoins mais semblent constituer un système intégré de communication et de diffusion d'information à travers la colonie. La quantité de nourriture récoltée par une fourrageuse dépasse amplement la satisfaction de ses besoins nutritionnels. La redistribution qui en découle, caractéristique fondamentale de l'organisation des insectes sociaux, repose sur la morphologie particulière de l'appareil digestif de la fourmi (décrite de longue date (Wilson and Eisner, 1952)), et la présence d'un estomac social.

La réponse de l'individu receveur est très variable et fonction aussi bien de la qualité (concentration) de la nourriture apportée par les fourrageuses, que de l'état d'affaînement de l'individu receveur. Un individu peu affamé aura tendance à n'accepter que de la nourriture hautement concentrée en sucre tandis qu'un affaînement plus marqué abaisse le seuil d'acceptabilité et augmente la motivation à recevoir de la nourriture jusqu'à ce que les individus acceptent tout type de nourriture (Mc Cabe et al., 2006; Wallis, 2018).

De récents travaux, bénéficiant des avancées technologiques de ces dernières années, ce sont intéressés au détail des mécanismes à l'œuvre au cours des échanges trophallactiques, confirmant certaines observations et hypothèses de travaux plus anciens au niveau collectif mais révélant également une complexité plus importante dans la régulation des trophallaxies au niveau microscopique, allant à l'encontre de certaines hypothèses communément admises (Greenwald et al., 2015a, 2018). Il y est notamment confirmé que la quantité de nourriture présente/volume encore disponible dans le jabot de l'individu receveur (représentatif de l'état des stocks au niveau de la colonie) détermine le volume et la vitesse de l'échange tandis que la charge du donneur ne les affecte pas mais influence cependant la **probabilité de sortie du nid** du donneur (Greenwald et al., 2018). Une hypothèse avancée dans de nombreux travaux (Buffin et al., 2009; Sendova-Franks et al., 2010), suggère que les fourrageuses ne quittent le nid que lorsqu'elles ont déchargé

l'intégralité du contenu de leur jabot. Cependant, l'expérimentation vient ici contredire cette hypothèse dans la mesure où, à la sortie du nid, les fourrageuses sont encore (en moyenne mais avec une forte variabilité) remplies à hauteur de 40%. Chez l'abeille mellifère, les fourrageuses consomment du miel dans le nid avant de le quitter en quête de nourriture (Mark L. Winston, 1987), elles ne sont donc pas systématiquement affamées au moment de quitter le nid et suggérant que le comportement de fourragement est complexe et ne se limite à des notions purement « physiques ». Quitter le nid en étant partiellement chargé de nourriture pourrait être bénéfique : les fourrageuses pourraient utiliser la nourriture de leur jabot comme « provisions » à consommer lors du trajet (Rytter and Shik, 2016). De plus et contrairement à ce qui est généralement accepté, le receveur ne se remplit pas complètement et systématiquement en un seul échange, quand bien même le donneur possède encore de la nourriture à donner. Enfin, il a été observé qu'au cours d'un échange, le flux de nourriture montrait plusieurs inversions de sens, se traduisant par des allers-retours de nourriture entre les deux partenaires, avec un bilan final de nourriture transférée non directement corrélé à la durée de l'échange (Bonavita-cougourdan and Gavioli, 1981). Les charges de nourriture, semblent donc influencer, chez les donneurs et les receveurs, les processus de **décision** concernant, respectivement, les sorties du nid et les échanges. Revient ici l'idée d'un effet physique, précédemment évoqué chez le poisson, de l'estomac considéré comme un organe élastique, dont l'élargissement/rétrécissement couplé à un mécanisme de **perception**, cette fois interne, de la tension, serait à la base de la modulation des comportements d'échanges de nourriture (Stoffolano and Haselton, 2013). En effet les insectes possèdent des capteurs de tensions au niveau de l'abdomen, capables d'agir comme des feedbacks négatifs lorsque la tension augmente, entraînant un cessation de l'entrée de nourriture (Dethier and Gelperin, 1967). La suppression de cet influx nerveux (par section de ces nerfs), entraîne une hyperphagie qui peut aller jusqu'à l'explosion de l'abdomen (Gwadz, 1969). Ces mécanismes, basés sur la perception du « volume d'estomac disponible », permettent une régulation/adaptation des dynamiques de récolte et de distributions en réponse aux besoins globaux de la colonie sans pour autant en nécessiter l'estimation par chaque individu de ces besoins.

La nourriture réceptionnée et stockée temporairement dans leur jabot social, par les ouvrières/nourricières, est redistribuée aux larves sans avoir été préalablement digérée par les ouvrières, une nourriture donc riche en **nutriments** (Hölldobler and Wilson, 1990). Les larves assimilent et digèrent la nourriture avant d'en excréter l'excédant par sécrétion anales de liquide

(Sorensen et al., 1983). Ce liquide, récupéré par les ouvrières, est redistribué à travers la colonie et ne contient plus que les nutriments non-absorbés par les larves. Il ne constitue cependant pas la seule source de nutriments des ouvrières dont une partie du contenu de leur jabot est directement transférée vers le tube digestif, sans passer par les larves. Cette organisation du flux / distribution de la nourriture dans le nid permet de satisfaire les besoins en nutriments fort variables entre larves et ouvrières, dont le tube digestif absorbe spécifiquement les nutriments requis et conduit à des patterns d'accumulation des nutriments adaptés à chacune des castes (Judd and Fasnacht, 2007). De plus, certaines sources de nourriture contiennent des métabolites néfastes/toxiques pour les larves, dont la concentration/présence est diminuée dans la nourriture redistribuée aux larves par les nourrices soit par mélange de plusieurs types de nourritures ou par détoxification active. Ainsi les nourricières assureraient alors également un rôle de protection des larves (Lucchetti et al., 2018). Un système de filtre (diamètre $0.1\mu\text{m}$) au niveau de l'œsophage permet d'éliminer un certain nombre de pathogènes (spores de champignons etc) présents dans la nourriture limitant les risques de contamination au niveau de la colonie.

4. Concept de réseaux sociaux au sein des sociétés d'insectes :

4.1 Réseau dans la colonie et flexibilité individuelle dans le contexte de la division du travail :

On mesure dès lors les nombreux facteurs sous-jacents à la gestion collective des ressources alimentaires au sein des sociétés d'insectes, cette gestion étant également à intégrer dans la multitude de tâches à réaliser simultanément au sein de la colonie. La combinaison des interactions (liens) entre individus (nœuds), notamment dans le cadre de la récolte/distribution de nourriture, résulte en un « réseau » de communications et d'échanges au niveau de la colonie. Au sein d'un large spectre d'espèces, ces réseaux et leurs variations sont en lien avec de nombreuses caractéristiques du groupe, que ce soit, par exemple, en terme de succès reproducteur (Schülke et al., 2010), de survie (Silk et al., 2010) ou encore de résilience suite à une perturbation (Goldenberg et al., 2016; Puga-Gonzalez et al., 2018; Sueur, 2015). Chez les insectes eusociaux, ces réseaux sont intrinsèquement liés à la notion de division du travail et à la **flexibilité** dont s'accommode cette division dans la mesure où les besoins de la colonie pour les différentes tâches varient au

cours du temps. Le nombre d'individus impliqués dans une tâche est donc dynamique, les phénomènes de recrutement d'individus inactifs ou occupés à une autre tâche permettent de combler les besoins autant que des phénomènes de saturation ou d'inhibition (feedbacks négatifs) conduisent à des abandons de la tâche, l'effort collectif s'adaptant ainsi au besoin d'une tâche spécifique. Un certain nombre de **mécanismes** responsables de la diffusion de l'information quand aux besoins dans les tâches, indispensables aux **modulations** de l'activité au niveau individuel peuvent néanmoins s'avérer coûteux pour l'individu émetteur (Detrain et al., 1999) voire conduire à des informations erronées ou à des choix suboptimaux (Dussutour et al., 2009b), entraînant des coûts supplémentaires au niveau colonial. Ces coûts sont cependant contrebalancés par les gains, en termes de performance et d'efficacité, résultants de ces réseaux d'échanges et de communications, dont bénéficie la colonie. L'individu n'a aucunement besoin d'évaluer le niveau de besoin d'une tâche de façon globale dès lors que les interactions diffusent l'information à travers l'ensemble du réseau (Grüter et al., 2006). Ces **communications** s'avèrent particulièrement fondamentale dans les tâches impliquant plusieurs intermédiaires (Jeanne L, 1996), telles que les chaînes de trophallaxies, depuis les fourrageuses jusqu'aux larves en permettant une adaptation fine des comportements et des échanges (e.g., (Anderson and Ratnieks, 2000; Grüter and Farina, 2007)). Cette notion de réseau s'accompagne d'effets spatio-temporels résultant de l'organisation et de la division du travail dans la colonie (au même titre que l'affaiblissement). La distribution spatiale des individus, dans un nid d'insectes sociaux, est hétérogène (Pinter-Wollman, 2015; Pinter-Wollman et al., 2011b) et notamment dépendante de la tâche effectuée dans la colonie. Les fourrageuses et les individus évacuant les déchets étant par exemple particulièrement éloignés du nid tandis que les nourricières s'affèrent exclusivement dans le nid. Ces hétérogénéités spatiales, également observées à une échelle plus fine dans le nid (Mersch et al., 2013a), peuvent conduire à des variations d'accès à l'information, tel que l'état des stocks, et affecter la distribution des tâches au niveau individuel (Crall et al., 2018). La division du travail sous-entend des **spécialisations**, au niveau individuel, dans la réalisation d'une tâche particulière, un facteur largement considéré comme fondamental dans le succès écologique des insectes sociaux (Hölldobler and Wilson, 1990). Le degré de spécialisation augmente avec la taille de la colonie mais émerge déjà au sein d'un groupe de quelques individus, même parfaitement homogènes (fourmis clones) et s'accompagne d'une augmentation de la cohésion et de l'homéostasie du groupe, appuyant le caractère fondamental de la division du travail au sein des sociétés d'insectes

(Ulrich et al., 2018). Cependant, comme il l'a longuement été exposé au cours de cette introduction, ces spécialisations/répartitions du travail présentent un caractère **flexible et continu** et dynamique, à travers des communications, nombreuses et variées, conduisant à des réallocations au niveau individuel et une exécution des tâches adaptée au besoin de la colonie. Au sein de différents systèmes et notamment chez les espèces sans caste morphologique, un continuum de spécialisation/comportement individuel est observé plus qu'une hétérogénéité marquée (Campos et al., 2016). Aussi, une perte d'une partie des ouvrières à l'œuvre dans une tâche sera compensée par une **réallocation** d'individus précédemment occupés à une autre tâche : la suppression de fourrageuses, chez l'abeille, entraîne une apparition prématurée du comportement de fourrageage chez les nourricières, compensant ainsi la perte (Greenwald et al., 2018) ou augmente l'activité de fourrageuses auparavant peu actives (Beverly et al., 2009; Crall et al., 2018). De plus, bien que les liens entre fidélité spatiale et exécution d'une tâche sont avérés, la réallocation des tâches n'entraîne pas de réorganisation spatiale significative au niveau intranidal. Le pattern d'occupation spatiale apparaît alors comme précurseur de l'activité plutôt que conséquence. Les mécanismes en jeu dans l'émergence de ces patterns spatiaux demeurent cependant largement ignorés.

Cette flexibilité dans la réorganisation, bien que non-systématique (Kwapich and Tschinkel, 2013), se présente sous différentes formes et plus ou moins rapidement (Huang and Robinson, 1996). Elle est notamment dépendante de la sensibilité, au niveau individuel, aux **stimuli spécifiques** des différentes tâches dans le nid. Le niveau de sensibilité, aussi appelé « seuil de réponse » (Theraulaz et al., 2008), est variable entre individu, engendrant de fortes variations dans la réalisation des tâches. Ces variations comportementales au niveau individuel et la division de travail qui y est associée se reflètent dans la structure des réseaux d'interactions dans la colonie. Le **tracking** au niveau individuel, démocratisé ces dernières années ((Crall et al., 2015; Gernat et al., 2017; Mersch et al., 2013a) permet d'observer en détail ces organisations. Il en résulte que le niveau de participation individuel à la réalisation d'une tâche aussi bien que la distribution des interactions entre les membres de la colonie sont distribués de façon fortement hétérogène concernant une majorité, si ce n'est toutes les activités, de la colonie. Dans le contexte de la récolte de nourriture, la majorité des trajets à la source sont effectués par une minorité des fourrageuses (Crall et al., 2018; Tenczar et al., 2014) au cours d'une période de fourrageage (on n'évoque pas ici d'éventuelle persistance, sur plusieurs jours ou période de fourrageage, du comportement au niveau individuel ni de personnalité ou syndrome comportemental). De même, les **interactions**

dans le nid sont, chez la fourmi, distribuées de façon hétérogènes entre individus aussi bien que spatialement (Pinter-Wollman et al., 2011a).

Les facteurs à l'origine de ces **variations inter-individuelles** sont potentiellement divers et nombreux, au niveau de l'individu (génétique, état physiologique, âge, histoire individuelle, taille de l'individu, localisation etc) aussi bien qu'au niveau colonial ou écologique (âge de la colonie, présence/quantité de couvains, état des stocks, température, saison). Ces facteurs impactent potentiellement les seuils comportementaux. Indépendamment, il est observé que les réseaux d'interactions sont généralement de type « scale-free » ou « invariant d'échelle » caractérisés par une distribution des degrés (nombre de connexions par nœud ou individu) approximée par une loi en puissance. Ainsi un nombre réduit d'individus diffusent l'information/la nourriture à la majorité de la colonie, une organisation généralement décrite comme **résiliente** dans la mesure où la perte d'un individu de la majorité peu active n'aura que peu d'effet tandis que la perte d'individus dans un réseau aléatoire/uniforme fragmente rapidement le réseau. En effet, la perte d'un individu fortement connecté dans un réseau « scale-free » peut sévèrement impacter le système au niveau global (Albert and Barabasi, 2002), phénomène contre lesquels les colonies d'insectes possèdent des mécanismes de réaction/adaptation et une flexibilité, notamment dus à certains facteurs à l'origine des variations interindividuelles (Crall et al., 2018; Tenczar et al., 2014). Certains travaux montrent également la forte résilience de réseaux uniformes, avec des réorganisations et un degré de connexion augmenté entre les individus restant, permettant de maintenir les flux d'information/de nourriture après une perturbation. Egalement, le **signal** émis ou l'information transmise lors de l'interaction aussi bien que la sensibilité du receveur au **stimulus** présente un gradient d'intensité se traduisant par un continuum s'étalant d'une réponse déterministe à probabiliste et depuis une réponse tout ou rien à une réponse graduelle. Il est à noter qu'il n'y a pas de réponse unique, optimale dès lors que l'on s'intéresse aux réseaux de communications entre ouvrières. Par exemple, une réponse au niveau individuel maximisant le recrutement d'ouvrières pour une tâche peut s'avérer avantageux dans le cas de défense collective face à un prédateur (Chadab, 1979) mais délétère pour la colonie dans un autre contexte (e.g (Pacala et al., 1996)), nécessitant une réponse modulée, affinée.

Ainsi les différences interindividuelles au niveau des seuils de réponses (observées chez un large spectre d'espèces) et leurs modulations lors d'interactions au niveau local (Chen and Meyer, 2018)

conduisent à l'émergence de patterns d'allocations des tâches adaptés aux besoins de la colonie. Ceci explique comment les colonies d'insectes sociaux, basées sur des réponses simples au niveau individuel, parviennent à des organisations complexes au niveau collectif. Au travers de ce processus décentralisé et auto-organisé, la colonie est vue comme un réseau d'unités dont les interconnexions sont fondamentales à la coordination des actions individuelles. La théorie des réseaux, quantifiant leurs propriétés au niveau local et global et leurs comportements, apporte un éclairage supplémentaire dans la quête de compréhension de ces organisations et plus particulièrement du lien entre la temporalité des interactions entre individus et les patterns et propriétés du système, observables au niveau collectif (voir chapitre 5 et les reviews de (Blonder et al., 2012) et (Holme et al., 2012) pour plus de détails concernant les aspects techniques de ces méthodes d'analyses).

4.2 Réseaux et diffusion de nourriture au sein des colonies d'insectes

sociaux :

Les trophallaxies constituent une large majorité des interactions au sein des colonies d'insectes sociaux, particulièrement dans le contexte de la reconstitution des stocks alimentaires. Le nombre de fourrageuses et la quantité de nourriture récoltée sont liés, de façon assez peu surprenantes, à l'état des stocks, au niveau individuel et collectif (Seeley, 1989; Toth, 2005), affectant la dynamique du flux de nourriture entrant dans le nid (Buffin et al., 2012, 2009). La diffusion de la nourriture est basée sur les décisions d'échanges au niveau individuel, découlant sur des chaînes de trophallaxies dans la colonie et peut être étudiée, de façon non-exclusive et même complémentaire, par des observations comportementales des processus de transfert et/ou par introduction de marqueur/traceur (de différentes natures) dans la nourriture. La détermination de la structure et la fonction de ces réseaux d'échange, leur évolution et l'établissement de liens avec l'organisation spatiale à l'œuvre au sein de la colonie, nécessitent l'identification et le suivi de l'intégralité des individus de la colonie et de leurs comportements, plus particulièrement, dans notre cas, des trophallaxies (voir chapitre 3 et 4 ainsi que l'annexe 1 pour plus de détails méthodologiques). Il est alors possible de construire le réseau complet de trophallaxies, en y identifiant le donneur et le receveur de chacun des échanges ainsi que les dynamiques temporelles et spatiales des échanges. La construction et l'analyse des réseaux dans le cadre de l'étude du

comportement sont de plus en plus répandues mais celles des réseaux impliquant un trait comportemental fonctionnel tel que la trophallaxie, qui de plus intègre l'organisation spatiale, demeurent rares. Cette approche peut révéler des aspects plus nuancés que précédemment imaginés, notamment concernant la temporalité et la structuration des échanges au sein des sociétés d'insectes. Ces réseaux, bien qu'étudiés ici essentiellement dans le cadre de la récolte et de la distribution de nourriture, sont également à intégrer dans un contexte plus large, en y incluant d'autres facteurs fondamentaux pour la colonie, tels que les dispersions de pathogènes et de maladies au sein du nid également, affectant les comportements des niveau individuel et leurs résultantes collectives (Naug, 2008a; Quevillon et al., 2014; Sueur et al., 2018).

5. Objectifs & organisation de la thèse

L'objectif de ce travail est double, s'agissant aussi bien de 1.) parvenir à établir les liens entre les dynamiques de récolte des sources alimentaires, de distribution de la nourriture et leur adaptation aux besoins de la colonie d'une part et les facteurs déterminants de ces récoltes, les réseaux de communications et d'interactions et la division du travail d'autre part 2.) que de développer les outils méthodologiques et analytiques, expérimentaux (tracking) et théoriques (modélisation), adaptés à cette problématique. Il a dès lors été développé un cadre général d'interprétation et une synthèse du phénomène intégré de la récolte et de la gestion collectives des ressources alimentaires (en particulier du sucre) chez la fourmi, mettant en jeu l'organisation globale du système, en déterminant les mécanismes sous-jacents. Les deux premiers chapitres se concentrent sur l'établissement des liens entre les propriétés topographiques et géométriques de l'environnement extranidal et les réponses collectives et leur flexibilité résultant de la compétition entre recrutements dans des expériences de choix binaires de sources et ce chez deux espèces de fourmis, *Lasius niger* et *Myrmica rubra*. Dans les chapitres 3, 4 et 5, les dynamiques spatiales et temporelles de distribution de la nourriture au sein de la colonie ont été investiguées expérimentalement, au niveau individuel et collectif, chez deux espèces de fourmis aux caractéristiques biologiques distinctes, *Lasius niger* et *Camponotus cruentatus*. Ces travaux ont permis de déterminer les liens entre structure des réseaux de trophallaxies, division de travail (ici réduit à la distinction fourrageuse/domestique) et formation des réserves ainsi que la robustesse de ces phénomènes. Cette approche phénoménologique, à travers une description quantitative fine des interactions au sein d'une colonie de fourmis, a été complétée par une approche théorique, de modélisation des patterns expérimentaux d'échanges de nourriture. Cette modélisation a permis de mieux comprendre les liens entre les déterminants de la récolte, l'activité individuelle et la gestion collective des ressources alimentaires au sein de ces sociétés complexes. Enfin en filigrane de la conduite des expérimentations a été développé et validé un outil de tracking d'identité individuelle adapté à la fourmi et aux contraintes expérimentales des travaux menés dans le cadre de cette thèse, outil présenté en annexe 1.

Chapitre 1

Effect of the land area elevation on the collective choice in ants

Publié : **Bles, O.**, Lozet, N., de Biseau, J.-C., Campo, A. & Deneubourg, J.-L. Effect of the land area elevation on the collective choice in ants. *Scientific Reports* **7**, 8745 (2017)

<https://doi.org/10.1038/s41598-017-08592-9>

SCIENTIFIC REPORTS



OPEN Effect of the land area elevation on the collective choice in ants

Olivier Bles¹, Nathanaël Lozet¹, Jean-Christophe de Biseau², Alexandre Campo¹ & Jean-Louis Deneubourg¹

Received: 10 March 2017

Accepted: 11 July 2017

Published online: 18 August 2017

Collective decisions regarding food source exploitation in social insects are influenced by a range of parameters, from source quality to individual preference and social information sharing. Those regarding the elevation of the physical trail towards a food source have been neglected. In this work, we investigated the effect of ascending and descending paths from the nest to a food source on collective choice in two ant species *Lasius niger* and *Myrmica rubra*. Our hypothesis that returning loaded with food from the high source is more energy efficient was validated by choice experiments: when the sources are simultaneously introduced the high food source is preferentially exploited by both species. The flexibility of colony response was then tested by introducing the preferred source (high) incidentally, after recruitment towards the down food source began. Despite the well-known lack of flexibility of *L. niger*, both species showed the ability to reallocate their foraging workforce towards the highest food source. The collective choice and the flexibility are based on the difference between the u-turn rates when foragers are facing the ascending or descending branch. We discuss these results in terms of species-specific characteristics and ecological context.

Collective exploitation of food resources in social insects, such as ants or honeybees, is largely based on a high rate of information sharing among workers in the colony. This communication results in food recruitment, allowing quick and efficient exploitation of large food sources^{1–3}, focusing their activity preferentially on the best-quality food source (for example, in *Apis mellifera*⁴ or in *Lasius niger*⁵), and maximizing energy efficiency⁶. Several mechanisms corresponding to positive feedbacks, occur in the phenomenon of food recruitment in social insects, from the waggle dance in honeybees to indicate the direction of a food source^{7,8}, to physical recruitment of nestmates by tandem running⁹, through pheromone deposition by foragers back and forth between a food source and the nest¹⁰. Other positive feedbacks are also described such as short range interactions at the food source¹¹. Recruitment involving trail is the most widespread type of recruitment in ants¹², providing strong positive and negative feedback to make decisions on colony foraging^{13,14}. It has been shown that the type of recruitment (and thus the species) affects the ability of colonies to direct their foraging activity as a function of the opportunities offered by the environment^{15,16}. For example, when a *L. niger* colony is confronted with two equal food sources of a 1 M sucrose solution, the colony concentrates its activity on one of the two sources or paths. If the solutions are of different quality, e.g., 1 M vs 0.1 M, the colony will select the richer food source. Indeed, a wide range of ants modulate their trail laying in relation to food source quality allowing the preferential exploitation of the most rewarding source when they are discovered simultaneously^{15,17–19}. Thus, foragers of the ants *L. niger*, lay 43% more trail marks when exploiting a 1 M sugar source than those exploiting a 0.1 M source^{1,5}. However, if a poor food source is already being exploited, *L. niger* cannot shift its foraging activity to a more rewarding source presented subsequently¹⁵. By contrast, *Myrmica sabuleti* and *Tetramorium caespitum* rapidly shift, even when the difference in concentration is not so great (e.g., 1 M vs 0.1 M and even 0.5 M in 30% of trials, respectively^{15,20,21}).

It has been suggested that the mechanisms of recruitment to a food source could be the origin of this difference between *L. niger* or even *Myrmica* spp²², which practise mass recruitment, while *Tetramorium* spp. practise more leader-based recruitment¹⁷. Mass recruitment implies a high fidelity to a pheromone path and could lead to a sub-optimal choice if the colony has started to exploit one source while a richer one appears incidentally¹⁵. In contrast, prioritizing the influence of the leaders in groups that recruit towards a newly discovered food source rather than following a chemical trail gives the system a greater flexibility. Owing to their individual memory, the

¹Center for Nonlinear Phenomena and Complex Systems (Cenoli) - CP 231, Université libre de Bruxelles (ULB), Campus Plaine, Boulevard du Triomphe, Building NO - level 5, B-1050, Bruxelles, Belgium. ²Evolutionary Biology and Ecology (EBE) - CP 160, Université libre de Bruxelles (ULB), Campus du Solbosch, 50 Avenue Franklin D, Roosevelt, B-1050, Bruxelles, Belgium. Olivier Bles, Nathanaël Lozet and Jean-Louis Deneubourg contributed equally to this work. Correspondence and requests for materials should be addressed to O.B. (email: olivier.bles@ulb.ac.be)

leaders are able to guide a group of recruits towards a new food source without paying attention to the chemical trail leading to another source. However, it has to be noted that within colonies, the individual behavioural series of foragers are quite diverse: some lay a continuous trail to the nest, some mark only some points in a dotted pattern, and others return rapidly to the nest without laying trails and perform a complex of activating actions inside the nest²³. In addition, categorizing ants as exhibiting either “mass recruitment” or “leader-based recruitment” is an over-simplification, as a range of strategies of recruitment can be observed in a colony, for example depending on the colony size or the moment of observation during a foraging bout²². For example, *Tetramorium* spp shift from “leader-based recruitment” (group recruitment) to a trail recruitment when the number of foragers involved in the recruitment increases^{15,24}.

Numerous parameters influencing collective choice have been studied in social insects, including nest-source distance²⁵, the quality and nature of sources^{20,26} or even effect of geometry on path choice^{27–33} with a main focus on the maximization of foraging gains; however, there is little direct, empirical evidence to show that animals select routes that minimize costs. Indeed, the parameters that characterize landforms, the relief (used as synonymous of elevation in this paper), has been largely neglected, even though they can affect the ants’ foraging decision to exploit resources in the tree canopy, such as aphids³⁴, or resources at the floor level. It is already known that leaf-cutter ants such as *Atta* and *Acromyrmex* spp., are likely to learn a new trail³⁵ or adapt their load transport³⁶ and walking speed^{37,38} according to the physical characteristics of a foraging trail. While it can be equivocal³⁹, it has been suggested that inclines could be more energetically costly than walking on a flat surface (See Introduction in ref. 40), even for insects^{41,42}, resulting from an increase in biomechanical constraints⁴³. In a route-selection experiment using foraging wood ants, it was shown that the route was primarily determined by energetic cost (estimated indirectly from the vertical height traversed), although the journey time was also a factor⁶. Moreover, it is not common for two well-known ant species to be tested in strictly the same experimental setup, and this can be a good starting point for discussions about general or observed species-specific behaviours/strategies.

Our study aims to characterize the collective responses of *L. niger* and *Myrmica rubra* resulting from recruitment competition in binary choice experiments. Firstly, we focused on investigating the effect of food source accessibility, that is having to walk on descending or ascending same-length branches towards identical food sources, on the collective choice of the colony. The gross benefit of both food resources is equal, but we emphasize that the latter maximizes foraging efficiency, as gravity acts on the forager’s load^{38,44} and makes a descending slope when travelling back to the nest easier to cross than an ascending one. Thus, the net energy intake (described as the food resource benefits minus the cost of retrieving it) of an ascending branch leading to a food source could be more profitable, and this branch should therefore be preferentially used by both *M. rubra* and *L. niger* when both food sources are simultaneously available. Undoubtedly, foraging does generally incur costs, and balancing these costs against potential losses from a path to a food source is essential for effective foraging.

Our second aim is thus to evaluate to what extent these colonies were able to not get stuck in suboptimal decisions by balancing the cost/benefit ratio: the flexibility of a foraging workforce will be tested by first introducing only the down food source (at the end of a descending branch), and the second one (at the end of an ascending branch) will be available incidentally (after recruitment to the down food source has initiated). Based on past studies about the flexibility of collective choices in both *Lasius*¹⁵ and *Myrmica*²⁰, we assumed that in case of differential introduction of food sources, *L. niger* recruits should be trapped, despite the lower benefit, by the already established trail towards the down food source, while *M. rubra* should be able to reallocate their workforce towards the ascending and energetically efficient path.

Results

Foraging activity at the colony level and collective choice. The experimental condition had no effect on the overall effort of food collection (see Data Collection and Analysis for definition); regardless of the conditions the foragers globally spent the same amount of time on food sources whether we consider the case of *M. rubra* (Fig. 1, KW, $K = 0.20$, $P = 0.99$) or *L. niger* (Fig. 1, KW, $K = 2.8$, $P = 0.99$). The cumulative number of *M. rubra* was approximately 7 times greater than the number of *L. niger* at a food source (4802 ± 2000 and 644 ± 371 , respectively); this was mainly due to the four-fold longer mean time spent by a forager of *M. rubra* at a food source (321 ± 146 sec, $N = 63$) compared to *L. niger* (75 ± 20 sec, $N = 70$) (see below, individual-level behaviour section). As the cumulative number of ants at the two food sources was not different for the conditions *DH* and *HD* (See Fig. 1), for clarity, we pooled them together (*DH*) for the upcoming results of the *M. rubra* and *L. niger* experiments.

Concerning the collective choice of food source, in the control conditions (*DD* and *HH*) *M. rubra* showed no choice of food source in 7/14 experiments and *L. niger* in 4/13. A significant choice of a food source was highlighted in 7/14 experiments for *M. rubra* and in 9/13 replicates for *L. niger* but these choices were randomly distributed between left and right food source. Figure 2A represents the percentage of experiments characterized by a given % of foragers at the right food source in control conditions (*DD* and *HH* pooled). For both *M. rubra* and *L. niger*, a peak appeared at approximately 50%, suggesting that in the majority of experiments, approximately half of the total number of foragers randomly chose the right or left food source.

In the *DH* and *HD* conditions, we observed a clear preference for the high food source in both *M. rubra* (15/18) and *L. niger* (13/14) (Table 1). Approximately 60% of the experiments were characterized by more than 75% of the ants choosing the high food source (Fig. 2B).

In the *D* → *H* condition, a majority of choices at the end of first 20 min (when only the down food source was introduced) were significantly oriented towards the down food source (*M. rubra*: 9/10, *L. niger*: 9/11). Of the 9/10 experiments for *M. rubra* and 9/11 for *L. niger*, 55% (5/9) and 88% (8/9) switched to the high food source after its introduction, respectively. During the first 20 min, the majority of foragers exploited the down food source (less than 50% exploiting the high food source) in all experiments, while at the end of 2 h, the majority of foragers of

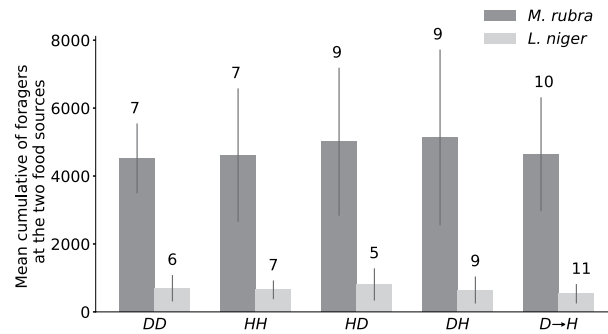

Figure 1. Cumulative number of foragers at the two food sources for 2 h in each condition. Mean and standard deviation; numbers above bars = number of replicates. DD = Down-Down, control condition, two descending paths to food sources. HH = High-High, control condition, two ascending paths to food sources. HD = High-Down, experimental condition, left path ascending to food source and right path descending to food source. DH = Down-High, experimental condition, left path descending to food source and right path ascending to food source. D → H = Down → High, experimental condition, only down food source available at the end of left path during the first 20 min of experiment before incidentally introduction of the high food source at the end of the right branch.

Species	DH		D → H 20 min		D → H 120 min	
	Down	High	Down	High	Down	High
<i>M. rubra</i>	2/18	15/18	9/10	0/10	2/10	5/10
<i>L. niger</i>	0/14	13/14	9/11	0/11	1/11	8/11

Table 1. Food source preference of each experiment for both species in DH and D → H conditions. Number of experiments with significant choices versus total number of experiments (binomial test with $P < 0.05$). In DH condition, both species strongly exploit preferentially the high food source. In D → H, while both species exploit the down food source until 20 min (as the high one is only available after 20 min (D → H 20 min)), at the end of experiment, respectively 5/10 (*M. rubra*) and 8/11 (*L. niger*) colonies preferentially exploit the high food source (D → H 120 min).

Species	DD		HH		DH	
	Left	Right	Left	Right	Down	High
<i>M. rubra</i>	5/7	2/7	2/7	5/7	9/18	8/18
<i>L. niger</i>	3/7	4/7	3/6	3/6	3/14	11/14

Table 2. First food source discovered in the DD, HH and DH conditions.

all colonies exploited the high food source (Fig. 2C). For both the DD and HH control conditions and the DH and HD conditions, no bias towards the left or right food source was highlighted.

Individual-level behaviour. *M. rubra* showed no preference for the first discovered source in the DH condition (Table 2, high: 9/18, down: 8/18; in one experiment, two foragers simultaneously discovered both food sources), while *L. niger* preferentially discovered the high food source (11/14). The time needed to discover the first source was 132 ± 81 sec, 119 ± 66 sec and 134 ± 138 sec, respectively, in the DH, HH and DD conditions for *M. rubra* and 75 ± 70 sec, 64 ± 47 sec and 123 ± 209 sec for *L. niger*.

The experimental condition did not affect the time of first source discovery (see Fig. 3) for *M. rubra* (KW, $K = 0.18$, $P = 0.91$) or for *L. niger* (KW, $K = 0.89$, $P = 0.64$). Moreover, the delay between the discovery of the first and second food source was short, below 120 sec for approximately 80% of the experiments in both studied species. The time spent at a food source was not affected by the experimental condition in either species, regardless of focusing on the winning or losing food source (*M. rubra*: $K = 15.39$, $P = 0.0088$; *L. niger*: $K = 6.60$, $P = 0.25$).

As the preference of both species to exploit the high food source was very clear, we were interested in determining whether individuals showed different travel speeds on the ascending and descending arms, in both nest-to-food source travel and the reverse. In both species, this travel speed was very similar in all conditions (see Table 3; *L. niger*: between 8.1 ± 1.7 sec and 8.5 ± 1.8 sec; *M. rubra*: between 19.3 ± 7 sec and 23.8 ± 7.3 sec) and showed no significant difference (KW, $K = 2.84$; $P = 0.41$) among the different experimental conditions. Having established that branch slope had no effect on the travel speed of foragers, we then examined the behaviour of ants arriving at the Y-maze and facing an ascendant or descendant branch. Considering the DH condition, the proportion of U-turns in the exploration phase in the Nest → Source direction was significantly lower when

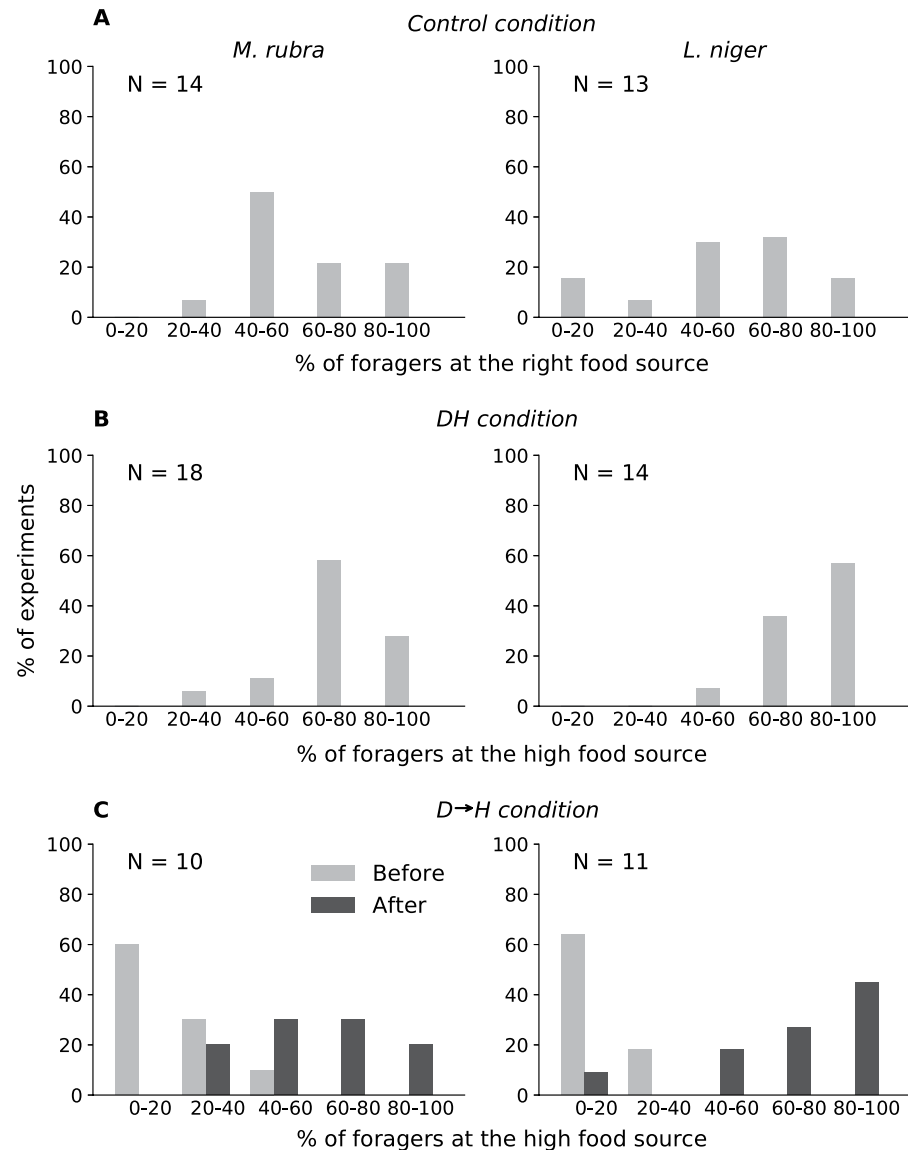

Figure 2. Strength of choice towards a food source. Percentage of experiments against percentage of total foragers present at the high food source for each experimental condition and species. For the $D \rightarrow H$ condition, as in Table 1, we separated the results into two phases, before and after the introduction of the second food source.

ants faced the ascendant branch (4%; $N = 157$) than the descendant branch (45%; $N = 94$) in *L. niger* (Table 4; two-sample binomial test, $P < 0.0001$). Values were similar in *M. rubra*: 7% ($N = 145$) of U-turns towards the ascending branch and 52% ($N = 73$) towards the descending branch (Table 4; two-sample binomial test, $P < 0.0001$). During the phase of exploration in the $D \rightarrow H$ condition, the results were similar for both species: the U-turn rate was approximately 10% ($N = 154$) towards the ascending branch and rose to 46% ($N = 140$) towards the descending branch in *L. niger* (Table 4; two-sample binomial test, $P < 0.0001$), while it was 10% ($N = 63$) towards the ascending branch and rose to 48% ($N = 80$) towards the descending branch in *M. rubra* (Table 4; two-sample binomial test, $P < 0.0001$). Even more surprising were the results of the U-turns in phase of recruitment in the $D \rightarrow H$ condition: even if a pheromone trail led *L. niger* foragers towards the down food source for approximately 20 mins, as it was the only one available (a few moments after having introduced sucrose in the high food source), we observed an interestingly high U-turn rate on the descending branch, approximately 41% ($N = 75$), while it was very low and significantly different towards the ascending branch, 3% ($N = 234$) (Table 4; two-sample binomial test, $P < 0.0001$). Observations were similar for *M. rubra* in the $D \rightarrow H$ condition, with a U-turn rate of 41% ($N = 49$) towards the down food source for approximately 20 mins, while it was only approximately 3% ($N = 73$) towards the ascending branch. In the DD control condition during the exploration phase,

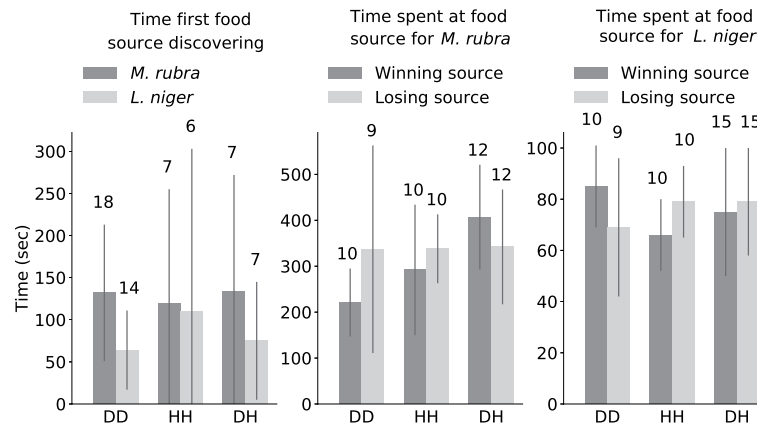

Figure 3. Discovery of and time spent at food sources. Mean and standard deviation; numbers above bars = N.

	Nest → High source	Nest → Down source	Nest → High source	Nest → Down source
<i>L. niger</i>	8.2 ± 2 (30)	8.1 ± 1.7 (30)	8.5 ± 1.8 (30)	8.8 ± 1.4 (30)
<i>M. rubra</i>	19.3 ± 7 (30)	22.5 ± 6.9 (30)	21.75 ± 6.6 (30)	23.8 ± 7.3 (30)

Table 3. Travel speed on the ascendant and descendant branches. The time (in sec) required to cross a branch was measured in the DH condition. Time needed to cross a branch was measured between points (2) and (3) for the ascending branch and between (4) and (5) for the descending one (see 4).

	Exploration		Recruitment	
	High source	Down source	High source	Down source
<i>L. niger</i>				
Down - High	4% (157)	45% (94)	—	—
Down → High	10% (154)	46% (140)	3% (234)	41% (75)
	Winning source	Loosing source	Winning source	Loosing source
Down - Down	67% (101)	68% (100)	40% (171)	60% (67)
High - High	3% (105)	5% (40)	3% (174)	5% (83)
<i>M. rubra</i>				
Down - High	7% (145)	52% (73)	—	—
Down → High	10% (63)	48% (80)	3% (73)	41% (49)
	Winning source	Loosing source	Winning source	Loosing source
Down - Down	51% (206)	46% (184)	45% (180)	41% (162)
High - High	6% (119)	7% (72)	1% (154)	0% (45)

Table 4. U-turn rates on ascendant and descendant branches towards the food sources in different conditions. The U-turn rate was measured in all experimental conditions for the two studied species. For the Down-Down and High-High control conditions, values were counted for both left and right sources and classified as “winning” and “losing” sources.

the U-turn rate was high and not significantly different between the left and right branches in *L. niger*, with a U-turn rate of 68% (N = 100) towards the losing source and 67% (N = 101) towards the winning one (Table 4; two-sample binomial test, P = 1). Surprisingly, the results were very similar in the recruitment phase; the U-turn rate only slightly decreased compared with the phase of exploration and remained particularly high on the losing branch (60%; N = 67) as well as on the winning one (40%; N = 171) and did not significantly differ between the winning and losing branches (Table 4; two-sample binomial test, P = 0.057). The U-turn rate for the winning branch was significantly different between the exploration and recruitment phase (67% and 40%, respectively; two-sample binomial test, P = 0.01), while no difference appeared for the losing branch (68% and 60%, respectively; two-sample binomial test, P = 0.53). The results were similar for *M. rubra* during the phase of exploration, with no significant difference in the U-turn rate towards the losing branch (46%; N = 184) and the winning one (51%; N = 206) (Table 4; two-sample binomial test, P = 0.68). During the phase of recruitment, the U-turn rate differed only slightly and not significantly (two-sample binomial test, P > 0.05 for each branch for the two phases observed): 45% (N = 180) of U-turns towards the winning source and 41% (N = 162) towards the losing one,

and no significant difference appeared between the two branches (Table 4; two-sample binomial test, $P = 0.68$). In the *HH* control condition, a very low U-turn rate was observed for both the winning and losing sources in the exploration and recruitment phases in *L. niger* as well as *M. rubra* (see Table 4).

Discussion

In agreement with our predictions, our experiments showed that when facing a Y-maze with one ascending and one descending branch, both leading to the same quality food source (1 M sucrose), ants of *M. rubra* and *L. niger* clearly preferred to exploit the food source at the end of the ascending branch (in approximately 90% of the experiments). Indeed, in the asymmetrical condition (*HD*), colonies of both species could easily discriminate between the two branches, focusing their foraging effort on the highest food source along the ascending slope in almost all experiments, allowing us to qualify the ascending one as the preferred path or and the descending one as the non-preferred path. We also showed that in this context, both species were able to provide evidence of flexibility, as they reallocated their foraging workforce from the descending branch to the ascending one when incidentally introduced in 72% of experiments. The highest food source was introduced 20 min after the lowest one, as preliminary work showed a maximum presence at food sources occurring approximately 20–30 min, which is and not long enough to completely fill up the food stock at the intranidal level, as foraging activity started to decline only after approximately 60 to 90 min.

The results of our investigations regarding the ability of both species to reallocate the colony's foraging effort from a well-established trail on a non-preferred path to a new preferred path leading to a new food source are not consistent with certain results of past studies. Indeed, it has been shown that if a poor food source is already being exploited, *L. niger* cannot shift its foraging activity to a more rewarding source presented subsequently^{15,45}, while *M. sabuleti* is capable of switching, even when the difference in quality is not so great²⁰. Our experiments were conducted with two food sources of equal concentrations of sucrose, with the only difference being an ascending or descending branch to a food source. The observed shift in food source for both species was quite surprising, as it revealed that a range of parameters are taken into account in collective choice in ants and that modifying only one of them (here the “slope” of the path) could radically change the previously known collective response of ants.

It appeared that in the symmetrical conditions of *DD* and *HH*, colonies of both species were able to exploit the two sources evenly, and approximately 60% of the experiments randomly led to the choice of one source (symmetry breaking). Among the 60% of experiments, a comparison of *HH* and *DD* showed no significant difference in the level of symmetry breaking. In addition, the total amount of food retrieved by foragers was not significantly greater in *HH* than in the *DD* condition.

A past study on *L. niger* showed that if two equally concentrated sources of sucrose were simultaneously presented, colonies focused on one of them¹⁵. This strongly asymmetrical pattern of foraging among food sources is caused by symmetry breaking. The non-linearity of individual choice behaviour in response to the strength of signals for different trails determines asymmetry in foraging^{46,47}. In addition, it has been shown that the degree of non-linearity is a key element in determining the level of asymmetry exhibited by foraging social insects and can be influenced by several parameters, particularly pheromone quantity, a factor dependent on forager number (i.e., colony size)^{48,49}. It is clear that symmetry breaking can either be enhanced or mostly avoided through the modification of individual responses to recruitment stimuli and that the number of foragers changes the effects of the relative non-linearity of the choice⁴⁹. Therefore, it has been shown that small colony size (like our experimental colonies) can cause low levels of asymmetry^{48,50} and may facilitate the switch in paths observed in the $D \rightarrow H$ condition. Larger colony size produces a stronger asymmetry between the choices. It should also be the case in our *HD* experiments. However, despite this stronger asymmetry, the flexibility (shift from down to high food source) is still expected in $D \rightarrow H$ condition. Indeed, the strong individual preference for the ascending path compared to the descending one, observed for both species, must allow the flexibility independently from the colony size.

Additionally, it was shown that pheromone deposition towards a high-quality food source was higher than towards a low one^{5,44}. Previous studies provided evidence that symmetry breaking between two food sources was notably influenced by resource quality^{51,52}. In the case of two trails leading to high-quality food sources, both trails should be strongly marked while when two identical low-quality resources are available, individuals will mark a trail weakly or at the same level as ants that have not fed⁵³. This phenomenon promotes high symmetry breaking when facing two low-quality sources, whereas when food quality was high, enhanced pheromone deposition on both branches caused a smaller relative difference in paths and weaker symmetry breaking, consistent with trail choice following Weber's law^{54,55}. For a very low-quality sources and therefore very weak trail laying, it is intuitive to observe a weak symmetry breaking or a lack of asymmetry⁴⁸. Our results in the symmetrical experiments did not reveal this kind of collective decision making. No difference in symmetry breaking occurred between the two non-preferred branches (*DD* condition) and the two preferred branches (*HH* condition).

Considering the well-known modulation of pheromone deposition in relation to food quality^{5,53} (but not quantity⁵⁶) and its consequences for recruitment intensity, we could expect more significant food collection when ants faced two preferred resources (like the *HH* condition) compared to two non-preferred ones (like the *DD* condition). However, our experimental results did not support this hypothesis, and foraging efficiency did not seem to be affected, as ants did not forage less when facing two non-preferred paths rather than two preferred paths.

To go one step further in understanding collective choice in the case of symmetrical and asymmetrical branches, we investigated the behaviour of foragers at the individual level. The relief of the branches seemed to be a determining factor leading to a clear collective choice in the case of asymmetrical *DH* condition in both studied species, but no information was available here to discuss the impact of this factor on the modulation of pheromone deposition at the individual level. In addition, although previous work showed the effect of gravity

on forager movement⁵¹ and travel speed^{36, 40, 57}, we were not able to highlight an effect of slope (ascending or descending) or nutritional status (empty or full crop) on the average moving speed as no difference was revealed whether on back or forth travel on either branch; the average speed remained constant.

In the *DH* condition, within the first few minutes of the experiments and well before any pheromone deposition^{10, 58}, the foragers show a preference for the ascending branch. At this stage, trail pheromones can be ruled out as the cause of this preference. We therefore investigated the behaviour of foragers arriving at the Y-maze during the first minutes for all conditions. An alternative mechanism for path selection, for which we found strong support, is U-turning behaviour. In the *DH* and *D* → *H* conditions, far more U-turns were performed by foragers facing a descending slope during the period of exploration (approximately 48%) than when facing an ascending slope (approximately 8%). Ants on their first nestward trip performed more U-turns on the descending path and were more likely to switch paths if they initially entered the descending path. It is perhaps not surprising that U-turns play a key role in path selection due to perceived path use, as they have been shown to play a key role in several collective decision mechanisms in ants^{10, 44, 59, 60}. Although one information source may begin the decision-making process, other information sources may cause a decision to be maintained. In the *DH* condition, the initialization of colony-level path choice appeared to be based on individual preference via the U-turning mechanism. This former branch choice was then amplified by two other mechanisms: The first is pheromone deposition, which began a positive feedback cycle, with more ants choosing the ascending path because it had higher trail pheromone levels and therefore depositing more pheromones on this path⁶¹. The second mechanism that was likely to amplify the initial path choice pattern was route memory⁶², as it is well known that ants that took a particular path and were rewarded are likely to take the same path in the future^{63–65}.

However, these mechanisms could not explain the observed switch in foraging activity in both species when the highest food source was introduced incidentally (*D* → *H* condition). The U-turn rate measured during the period of recruitment in both species supported the phenomenon of the switch of sources: Indeed, even if the pheromone trail was strong in the *D* → *H* condition towards the down food source at 20 min (as it was the only food source available during the first 20 min of the experiment), the U-turn rate of foragers facing the branch towards the down food source was higher (approximately 41%) than the U-turn rate of foragers facing the ascending branch (approximately 2%). The results of the U-turn rates in the *DD* and *HH* conditions in both species also confirmed the individual preference for the ascending path. Indeed, in *DD*, the U-turn rate was high and equal between the two descending branches during both the exploration and recruitment phases. In contrast, the U-turn rate in the *HH* condition were surprisingly low in both the exploration and recruitment phases. These results suggest that ants could use different cues during food recruitment and not only the single signal of a pheromone trail, allowing ants to not get stuck in a sub-optimal solution in cases of a stronger pheromone trail towards a poorer food source. Undoubtedly, there are many ways for ant colonies to achieve flexibility in their recruitment^{20, 66–68} and different signals are often used to modulate recruitment (e.g., invitation behaviour and/or multi-component trail pheromones^{69–72}). Substantial differences in the U-turn rate when facing ascending or descending paths seems here to play a central role in the flexibility of collective decision. This is supported by preliminary work on a theoretical model where the parameter of U-turns allows the colony to switch or not (in prep.). U-turns are already known to contribute to collective choice and trail strength in ants^{44, 73}, but the mechanisms underlying the phenomenon of source switching still require further investigations, notably concerning the potential link between U-turn behaviour in relation to slopes and the modulation of pheromone deposition.

What are the ultimate reasons for the preference of ants to exploit the highest food source? The first hypothesis of energy savings is not so straightforward, as a recent study does not support this hypothesis. In their study, they highlighted that energy expenditure per unit distance was minimal on horizontal ground (slope of 0 deg) and significantly increased with an increasing gradient both on an ascending and a descending slope in leaf-cutter ants, *Acromyrmex octospinosus*⁴⁰. This was clearly intriguing as, in our experiments, both species clearly preferred the ascending slope. The second hypothesis is an ecological hypothesis. *L. niger* feeds on the honeydew of aphids, such as *Tuberolachnus salignus*⁷⁴, *Aphis fabae*⁷⁵ or *Metopeurum fuscoviride*⁷⁶, which occur on the branches of trees while its nests are at the ground level. *M. rubra*, despite being myrmecochorous^{77, 78} and carnivorous⁷⁹, also consumes sugar sources⁸⁰, such as extra-floral nectar or honeydew⁸¹ on trees and bushes. The validation of the ecological importance of these laboratory results and hypotheses obviously needs field experiments.

Collective choices are largely based on the competition between positive feedbacks⁴⁷. Each of them is characterized by its own rate of amplification which depends on behavioural modulation related to food characteristics⁵¹ or environmental/physical constraints^{66, 82}. However these constraints (e.g. distance nest-food) may also affect the rate of recruitment without any behavioural modulation. Here we show another environmental variable that affects the collective decision: the relief. Moreover negative feedback acting upstream of the recruitments (such as satiety) or being a by-product of the foraging activity (such as food exhaustion) are also involved. These negative feedbacks can prevent the symmetry-breaking or facilitate the flexibility of collective response. The increase of the complexity of the recruitment mechanisms (multiple pheromones^{66, 68}, leadership²⁴) leading to an increase in the number of feedbacks also facilitate this flexibility. However, in our case such supplemental feedbacks and complexity do not seem necessary to produce flexibility.

Few studies have been conducted on land shape and its influence on foraging behaviour^{57, 83}. Further investigations will be needed to determine how the relief affects the response of large colonies or the importance of the relief of a path to a food source compared with food source quality in the collective choice of ants by combining both determining factors into a single experiment, for example, by introducing a poor food source (0.1 M) at the end of an ascending branch and a rich one (1 M) at the end of descending branch. Our work was a first step towards better understanding the effect of relief of the environment on food source preference in ants and confirmed the large range of parameters taken into account in the collective choice of ants.

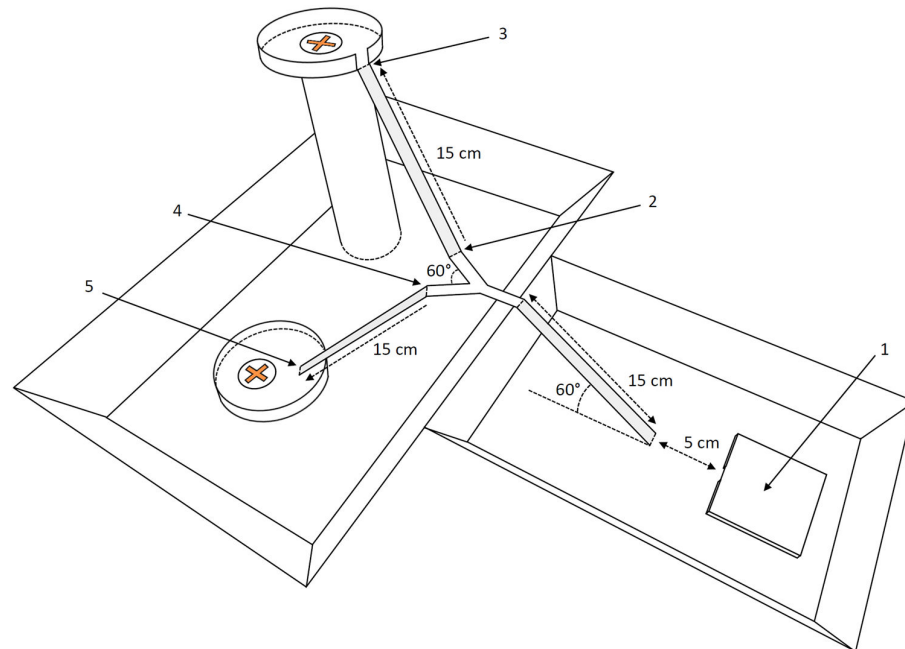

Figure 4. HD experimental setup. The nest (1) and its unique entry (2) facing the first branch of 15 cm leading to the T-maze with ascending and descending branches (HD setup shown). A syrup feeder (1 M sucrose) was placed on a platform at the end of either the ascending or descending branch of the maze. The number of ants was counted at each food source, and U-turns were measured at point (2) of the ascending branch and (4) for the descending one.

Methods

Study species. From ten large mother colonies of the black garden ant, *L. niger* (collected in Brussels, Belgium, Sept. 2015), and the red ant, *M. rubra* (Collected in Falisolle, Belgium, Sept. 2015), we created ten queenless and broodless subcolonies of 100 randomly chosen workers of each species (*L. niger* = L100; *M. rubra* = M100). An mature colony of *L. niger* can contain more than 5000 individuals. But due to the physical characteristics (number of chambers, number of nest holes) of the colonies not all the individuals forage in the same area. Moreover, young colonies contain only a few dozens and later few hundred workers. Colonies of around 100 individuals exhibit efficient trail recruitment⁴⁹. The mature colonies of *Myrmica rubra* are smaller (e.g. the size of 60% of the colonies is less than 1000 individuals)⁸⁴. Therefore, one hundred workers is a consistent number for both species. Colonies were maintained in plastic boxes (26 × 16 × 5 cm high) coated with Fluon[®] and contained a square glass nest (8 × 8 × 0.2 cm high) with a unique 3 mm wide entry. Colonies had access to water and a sucrose solution (0.3 M) ad libitum and were maintained at 21 °C ± 1 C and 60% ± 5 relative humidity with a constant photo-period of 12 hr per day. Before each experiment, we starved the colonies for 4 days to enhance food collection. Each colony was randomly tested in four of the five conditions with a 7 -day break between two consecutive trials.

Experimental Design. Each colony was introduced to the experimental setup 30 min before a trial in a closed environment with blank walls and lighted with homogenous diffused light. After 4 days of starvation, the ants were provided access to two food sources of 1 M sucrose first through a rising slope (15 cm long and 10 cm high, see (1) in Fig. 4) introduced 5 cm from the nest. This first slope led to an asymmetric Y-maze with two same-sized branches separated by a 60 angle. Liquid sucrose was introduced to a circular plastic cup placed in the centre of an 8 cm diameter Petri dish at the end of each branch. The two food sources strictly contained strictly the same concentration (1 M) and volume (3 ml) of liquid sucrose.

We tested five different experimental conditions:

- **Down-High Simultaneous (DH):** Two food sources that ants were freely available to exploit were simultaneously introduced. Each branch was characterized by its slope: the right branch was ascending (15 cm long by 10 cm high), leading to the upper food source, while the left one was descending (15 cm long by 10 cm down), leading to the lower food source (*L. niger*: N = 9, *M. rubra*: N = 9).
- **High-Down Simultaneous (HD):** This condition mirrors that of DH: the right branch ascending to a food source and the left one descending (*L. niger*: N = 9, *M. rubra*: N = 9).
- **Down-High Lag (D → H):** The aim of this condition was to test the ability of the ants to reallocate the forager workforce towards a new food source when it was introduced 20 min after the first one. At the beginning of the experiment, ants had access to both branches, but only the down food source was filled with liquid

sucrose, and ants started to exploit it. After 20 min, the high food source was filled (*L. niger*: N = 7, *M. rubra*: N = 7).

Two symmetrical conditions were also tested:

- High-High Simultaneous (HH): In this condition, the two branches of the Y-maze were ascending and the two food sources were simultaneously introduced (*L. niger*: N = 6, *M. rubra*: N = 7).
- Down-Down Simultaneous (DD): In this condition, the two branches of the Y-Maze were descending and the two food sources were also introduced simultaneously (*L. niger*: N = 7, *M. rubra*: N = 7).

Data Collection and Analysis. Video data were recorded using a Sony DMC-GH4-R mounted with a 12 mm lens capturing 25 frames/s at the definition of 4180 × 2160p. We investigated the ants' behaviour at two levels:

(i) The individual level: We manually measured the time spent by foragers feeding on each of the two food sources, the time needed to cross a branch (Fig. 4) (between (2) and (3) for the ascending branch and between (4) and (5) for the descending one, distance = 15 cm), and the number of U-turns (i.e., ants returning to where they came from without exceeding half of the branch instead of continuing their path) on each branch in both the Nest → Source and Source → Nest direction. The time needed to cross branches and the U-turn rate were measured in all experimental conditions, during the first 5 min of experiments with *L. niger* and the first 10 min for *M. rubra*. This first period of observation was called the “exploration” phase, as few or no pheromone trails had been deposited on each branch because no or only a few foragers had gone back to the nest after having exploited the food source at the beginning of the experiment. U-turns were also measured in all conditions (except *DH*), respectively, for 20 to 25 min for *L. niger* and for 20 to 30 min for *M. rubra*. This was named the “recruitment” phase, as it corresponded to the average peak of foraging activity (maximum number of foragers simultaneously exploiting food sources) in our experiments. U-turns in the *DH* condition were not measured during “recruitment”, as choice occurred rapidly towards one source in this asymmetrical setup and almost no ants used the second branch. The measurement period for *M. rubra* was twice as long as for *L. niger* due to the slower speed of travel and the longer time spent at food sources in *M. rubra*; a longer period of observation was requested to achieve the same sample size.

(ii) The collective level: An open-source tracking software (USE Tracker: <http://usetracker.org/>) was used to automatically estimate the number of ants feeding at each food source in each frame of the video. We assumed that an immobile ant with its head and antennae above the liquid sucrose was collecting food. Thus, the time spent by each forager at a food source was used as a proxy for the amount of food collected. From these data we generated the cumulative number of ants at each food source, defined as the overall effort of food collection. Because of the variability in the detected number of entities in each frame, we averaged this number over a range of 10 sec (see Supplementary Figs S1–S4 for details on the ant tracking procedure). We applied a binomial test on the cumulative number of presences at each food source at the end of the experiments to determine significant difference between relative exploitation of both food sources. For the D → H, this test was also applied to determine the choice 20 min after experiment began. Henceforth, a significant choice oriented first towards the lower food source for 20 min then significantly towards the highest food source at the end of the experiment was considered to be a “switch”. Thus, the recorded parameters were the number of ants simultaneously present on each food source during the entire experiment as well as the time of maximum simultaneous presences and the moment when a choice occurred (last crossing of the two curves). The time of first discovery of each food source was also manually recorded. Filming began when the bridge was placed in front of the nest and ended 2 hr later.

Automated processing of all experiments was performed with Python 3.5.1, statistical analyses were conducted with SciPy 0.17.0, and visualization of the data sets was done with Matplotlib 1.5.1. Our data were not normally distributed. We used a linear model to test correlation. The multiple comparison Kruskal-Wallis test coupled to Dunn's post hoc comparison of pairs was used to compare conditions. The Mann-Whitney U-test was used in cases where we had only two groups to compare. As advocated by Oron and Hoff⁸⁵ when data set needs a tie correction and parametric assumption is violated, we used permutation Kruskal-Wallis tests to analyse nested effects in our hierarchical design. We checked the homogeneity of colonies' responses by carrying out Kruskal-Wallis permutation tests that compared observed data distributions with randomised data distributions (N = 1000). Concerning relative exploitation of the two food sources, colonies displayed similar collective behaviour (permutation Kruskal-Wallis tests: *M. rubra*: H = 0.77, P = 0.83; *L. niger*: H = 0.70, P = 0.78). The differences were considered to be significant at $P < 0.05$ for all tests.

References

1. Pasteels, J. M., Deneubourg, J.-L. & Goss, S. Self-organization mechanisms in ant societies (I): trail recruitment to newly discovered food sources. In *From individual to collective behavior in social insects*, 177–196 (Birkhauser, 1987).
2. Camazine, S., Sneyd, J., Jenkins, M. J. & Murray, J. D. A Mathematical Model of Self-organized Pattern Formation on the Combs of Honeybee Colonies. *J. Theo. Biol.* **147**, 553–571 (1990).
3. Seeley, T. D., Camazine, S. & Sneyd, J. Collective decision-making in honey bees: How colonies choose among nectar sources. *Behav. Ecol. Sociobiol.* **28**, 277–290 (1991).
4. Seeley, T. D. *The Wisdom of the Hive: The Social Physiology of Honey Bee Colonies* (Harvard University Press, 1995).
5. Beckers, R., Deneubourg, J.-L. & Goss, S. Modulation of trail laying in the ant *Lasius niger* (Hymenoptera: Formicidae) and its role in the collective selection of a food source. *J. Insect Behav.* **6**, 751–759 (1993).
6. Denny, A. J., Wright, J. & Grief, B. Foraging efficiency in the wood ant, *Formica rufa*: is time of the essence in trail following? *Anim. Behav.* **62**, 139–146 (2001).
7. von Frish, K. *The Dance Language and Orientation of Bees* (Harvard University Press, Cambridge, 1967).

8. Farina, W. M., Grüter, C. & Arenas, A. Olfactory Information Transfer During Recruitment in Honey Bees. In *Honeybee Neurobiology and Behavior*, 211–226 (Springer, 2012).
9. Möglich, M. & Hölldobler, B. Social carrying behavior and division of labor during best moving in ants. *Psyche* **81**, 219–236 (1974).
10. Beckers, R., Deneubourg, J.-L. & Goss, S. Trail laying behaviour during food recruitment in the ant *Lasius niger* (L.). *Insectes Soc.* **72**, 39–59 (1992).
11. Dussutour, A. & Nicolis, S. C. Flexibility in collective decision-making by ant colonies: Tracking food across space and time. *Chaos, Solitons and Fractals* **50**, 32–38 (2013).
12. Czaczkes, T. J., Grüter, C. & Ratnieks, F. L. Trail Pheromones: An Integrative View of Their Role in Social Insect Colony Organization. *Annual Review Entomol.* **60**, 581–599 (2015).
13. James, F. A. & Traniello, S. K. R. Trail and Territorial Communication in Social Insects. *Chem. Ecol. Insects* pp 241–286 (1995).
14. Ratnieks, F. L. W. Biomimicry: Further Insights from Ant Colonies? In *Bio-Inspired Computing and Communication: First Workshop on Bio-Inspired Design of Networks*, 58–66 (Springer, 2008).
15. Beckers, R., Deneubourg, J.-L., Goss, S. & Pasteels, J. M. Collective decision making through food recruitment. *Insectes Soc.* **37**, 258–267 (1990).
16. Latty, T. & Beekman, M. Keeping track of changes: the performance of ant colonies in dynamic environments. *Anim. Behav.* **85**, 637–643 (2013).
17. Verhaeghe, J.-C. Food recruitment in *Tetramorium impurum* (Hymenoptera: Formicidae). *Insectes Soc.* **29**, 67–85 (1982).
18. Cammaerts, M.-C. Recrutement d'ouvrières vers une source d'eau pure ou sucrée chez la fourmi *Myrmica rubra* L. (Formicidae). *Biol. Behav.* **2**, 287–308 (1977).
19. Breed, M. D., Fewell, J. H., Moore, A. J. & Williams, K. R. Graded recruitment in a ponerine ant. *Behav. Ecol. Sociobiol.* **20**, 407–411 (1987).
20. de Biseau, J.-C., Deneubourg, J.-L. & Pasteels, J. M. Collective flexibility during mass recruitment in the ant *Myrmica sabuleti* (Hymenoptera: Formicidae). *Psyche* **98**, 323–336 (1991).
21. de Biseau, J.-C., Deneubourg, J.-L. & Pasteels, J. M. Mechanisms of food recruitment in the ant *Myrmica sabuleti*: an experimental and theoretical approach. In *Biology and Evolution of Social Insects*, 359–367 (Leuven University Press, 1992).
22. Fedoseeva, E. B. A technological approach to the description of group foraging in the ant *Myrmica rubra*. *Entomol. Review* **95**, 984–999 (2015).
23. Dlussky, G., Voltsit, O. & Sulkhanov, A. Group Foraging in Ants of the Genus *Myrmica*. *Zoology* **57**, 65–77 (1978).
24. de Biseau, J.-C., Schuiten, M., Pasteels, J. M. & Deneubourg, J. Respective contributions of leader and trail during recruitment to food in *Tetramorium bicarinatum* (Hymenoptera: Formicidae). *Insectes Soc.* **41**, 241–254 (1994).
25. Devigne, C. & Detrain, C. How does food distance influence foraging in the ant *Lasius niger*: The importance of home-range marking. *Insectes Soc.* **53**, 46–55 (2006).
26. de Biseau, J.-C. & Pasteels, J. M. Response thresholds to recruitment signals and the regulation of foraging intensity in the ant *Myrmica sabuleti* (Hymenoptera, Formicidae). *Behav. Proc.* **48**, 137–148 (2000).
27. Grüter, C., Maitre, D., Blakey, A., Cole, R. & Ratnieks, F. L. Collective decision making in a heterogeneous environment: *Lasius niger* colonies preferentially forage at easy to learn locations. *Anim. Behav.* **104**, 189–195 (2015).
28. Jackson, D. E., Holcombe, M. & Ratnieks, F. L. W. Trail geometry gives polarity to ant foraging networks. *Nature* **432**, 907–909 (2004).
29. Gerbier, G., Garnier, S., Rieu, C., Theraulaz, G. & Fourcassié, V. Are ants sensitive to the geometry of tunnel bifurcation? *Anim. Cogn.* **11**, 637–642 (2008).
30. Forster, A. *et al.* Effect of trail bifurcation asymmetry and pheromone presence or absence on trail choice by *Lasius niger* ants. *Ethology* **120**, 768–775 (2014).
31. Czaczkes, T. J., Grüter, C., Ellis, L., Wood, E. & Ratnieks, F. L. W. Ant foraging on complex trails: route learning and the role of trail pheromones in *Lasius niger*. *J. Exp. Biol.* **4**, 188–197 (2013).
32. Dussutour, A., Deneubourg, J.-L. & Fourcassié, V. Amplification of individual preferences in a social context: the case of wall-following in ants. *Proc. R. Soc. Lond. B Biol. Sci.* **272**, 705–714 (2005).
33. Jander, R. Arboreal search in ants: Search on branches (Hymenoptera: Formicidae). *J. Insect Behav.* **3**, 515–527 (1990).
34. Maillieux, A.-C., Deneubourg, J.-L. & Detrain, C. How do ants assess food volume? *Anim. Behav.* **59**, 1061–1069 (2000).
35. Ribeiro, P. L., Helene, A. F., Xavier, G., Navas, C. & Ribeiro, F. L. Ants can learn to forage on one-way trails. *PLoS One* **4**, 1–7 (2009).
36. Norton, V., Stevens-Wood, B. & Harris, W. E. Flexibility of Individual Load-mass Selection in Relation to Foraging Trail Gradient in the Leaf-cutter Ant *Acromyrmex octospinosus*. *J. Insect Behav.* **27**, 370–384 (2014).
37. Seidl, T. & Wehner, R. Walking on inclines: how do desert ants monitor slope and step length. *Front. Zool.* **5**, 8 (2008).
38. Lewis, O. T., Martin, M. & Czaczkes, T. J. Effects of trail gradient on leaf tissue transport and load size selection in leaf-cutter ants. *Behav. Ecol.* **19**, 805–809 (2008).
39. Lipp, A., Wolf, H. & Lehmann, F. O. Walking on inclines: energetics of locomotion in the ant *Camponotus*. *J. Exp. Biol.* **208**, 707–719 (2005).
40. Holt, N. C. & Askew, G. N. Locomotion on a slope in leaf-cutter ants: metabolic energy use, behavioural adaptations and the implications for route selection on hilly terrain. *J. Exp. Biol.* **215**, 2545–50 (2012).
41. Richard Taylor, C. & Caldwell, S. L. & Rowntree, V. Running Up and Down Hills: Some Consequences of Size. *Science* **178**, 1096–1097 (1972).
42. Full, R. J. & Tullis, A. Energetics of ascent: insects on inclines. *J. Exp. Biol.* **149**, 307–317 (1990).
43. Moll, K., Roces, F. & Federle, W. Foraging grass-cutting ants (*Atta vollenweideri*) maintain stability by balancing their loads with controlled head movements. *J. Comp. Physiol. A: Neuroethol., Sens., Neur., Behav. Physiol.* **196**, 471–480 (2010).
44. Reid, C. R., Latty, T. & Beekman, M. Making a trail: informed Argentine ants lead colony to the best food by U-turning coupled with enhanced pheromone laying. *Anim. Behav.* **84**, 1579–1587 (2012).
45. Deneubourg, J.-L. & Goss, S. Collective patterns and decision making. *Ethol. Ecol. Evol.* 295–311 (1989).
46. Camazine, S. *et al.* *Self-Organization in Biological Systems* (Princeton University Press, Princeton, 2001), princeton.edu.
47. Detrain, C. & Deneubourg, J.-L. Collective Decision-Making and Foraging Patterns in Ants and Honeybees. *Adv. Insect Physiol.* **35**, 123–173 (2008).
48. Lanan, M. C., Dornhaus, A., Jones, E. I., Waser, A. & Bronstein, J. L. The trail less traveled: individual decision-making and its effect on group behavior. *PLoS One* **7**, e47976 (2012).
49. Maillieux, A.-C., Deneubourg, J.-L. & Detrain, C. How does colony growth influence communication in ants? *Insectes Soc.* **50**, 24–31 (2003).
50. Deneubourg, J.-L., Aron, S., Goss, S., Pasteels, J. M. & Duerink, G. Random Behaviour, Amplification Processes and Number of Participants: How They Contribute To the Foraging Properties of Ants. *Physica* **22**, 176–186 (1986).
51. Price, R. I., Grüter, C., Hughes, W. O. H. & Evison, S. E. F. Symmetry breaking in mass-recruiting ants: extent of foraging biases depends on resource quality. *Behav. Ecol. Sociobiol.* **70**, 1813–1820 (2016).
52. Portha, S., Deneubourg, J.-L. & Detrain, C. Self-organized asymmetries in ant foraging: a functional response to food type and colony needs. *Behav. Ecol. Sociobiol.* **13**, 776–781 (2002).
53. Jackson, D. E. & Châline, N. Modulation of pheromone trail strength with food quality in Pharaoh's ant, *Monomorium pharaonis*. *Anim. Behav.* **74**, 463–470 (2007).

54. Thienen, W. V., Metzler, D., Choe, D. H. & Witte, V. Pheromone communication in ants: A detailed analysis of concentration-dependent decisions in three species. *Behav. Ecol. Sociobiol.* **68**, 1611–1627 (2014).
55. Deco, G., Scarano, L. & Soto-Faraco, S. Weber's Law in Decision Making: Integrating Behavioral Data in Humans with a Neurophysiological Model. *J. Neuro.* **27**, 11192–11200 (2007).
56. Maillieux, A.-C., Deneubourg, J.-L. & Detrain, C. Regulation of ants' foraging to resource productivity. *Proc. R. Soc. Lond. B Biol. Sci.* **270**, 1609–16 (2003).
57. Freeman, B. M. & Chaves-Campos, J. Branch Width and Height Influence the Incorporation of Branches into Foraging Trails and Travel Speed in Leafcutter Ants *Atta cephalotes* (L.) (Hymenoptera: Formicidae). *Neotrop. Entomol.* **258–264** (2016).
58. Maillieux, A.-C., Detrain, C. & Deneubourg, J.-L. Starvation drives a threshold triggering communication. *J. Exp. Biol.* **209**, 4224–9 (2006).
59. Dussutour, A., Nicolis, S. C., Deneubourg, J.-L. & Fourcassié, V. Collective decisions in ants when foraging under crowded conditions. *Behav. Ecol. Sociobiol.* **61**, 17–30 (2006).
60. Czaczkes, T. J., Franz, S., Witte, V. & Heinze, J. Perception of collective path use affects path selection in ants. *Anim. Behav.* **99**, 15–24 (2015).
61. Sumpter, D. J. T. & Beekman, M. From nonlinearity to optimality: pheromone trail foraging by ants. *Anim. Behav.* **66**, 273–280 (2003).
62. Czaczkes, T. J., Salmane, A. K., Klampfleuthner, F. A. M. & Heinze, J. Private information alone can trigger trapping of ant colonies in local feeding optima. *J. Exp. Biol.* **219**, 744–51 (2016).
63. Aron, S., Pasteels, J. M. & Deneubourg, J.-L. Trail-laying behavior during exploratory recruitment in the Argentine ant, *Iridomyrmex humilis*. *Biol. Behav.* **14**, 207–217 (1989).
64. Grüter, C., Czaczkes, T. J. & Ratnieks, F. L. W. Decision making in ant foragers (*Lasius niger*) facing conflicting private and social information. *Behav. Ecol. Sociobiol.* **65**, 141–148 (2011).
65. Harrison, J., Fewell, J., Stiller, T. & Breed, M. D. Effects of experience on use of orientation cues in the giant tropical ant. *Anim. Behav.* **37**, 869–871 (1988).
66. Dussutour, A., Beekman, M., Nicolis, S. C. & Meyer, B. Noise improves collective decision-making by ants in dynamic environments. *Proc. R. Soc. Lond. B Biol. Sci.* **276**, 4353–4361 (2009).
67. Czaczkes, T. J. How to not get stuck-Negative feedback due to crowding maintains flexibility in ant foraging. *J. Theo. Biol.* **360**, 172–180 (2014).
68. Robinson, E. J. H., Jackson, D. E., Holcombe, M. & Ratnieks, F. L. W. Insect communication: 'no entry' signal in ant foraging. *Nature* **438**, 442 (2005).
69. Cammaerts-Tricot, M.-C. & Verhaeghe, J.-C. Ontogenesis of trail pheromone production and trail following behaviour in the workers of *Myrmica rubra* L. (Formicidae). *Insectes Soc.* **3**, 275–282 (1974).
70. Hölldobler, B. The cloacal gland, a new pheromone gland in ants. *Naturwissenschaften* **69**, 186–187 (1982).
71. Hölldobler, B. Communication, raiding behavior and prey storage in *Ceraphys* (Hymenoptera: Formicidae). *Psyche* **89**, 3–23 (1982).
72. Vander Meer, R. K., Lofgren, C. S. & Alvarez, F. M. The orientation inducer pheromone of the fire ant *Solenopsis invicta*. *Physiol. Entomol.* **15**, 483–488 (1990).
73. Beckers, R., Deneubourg, J.-L. & Goss, S. Trails and U-turns in the Selection of a Path by the Ant *Lasius niger*. *J. Theo. Biol.* **159**, 397–415 (1992).
74. Mitter, T. The excretion of honey-dew by *Tuberolachnus salignus* (Gmelin) (Homoptera, Aphididae). *Proc. R. Entom. S. Lond.* **33**, 49–55 (1958).
75. Klingauf, F. Feeding, adaptation and excretion. In *World Crop Pests: Aphids. Their Biology, Natural Enemies and Control*, 225–253 (Elsevier, 1987).
76. Völkl, W., Woodring, J., Fischer, M., Lorenz, M. W. & Hoffmann, K. H. Ant-aphid mutualisms: the impact of honeydew production and honeydew sugar composition on ant preferences. *Oecologia* **118**, 483–491 (1999).
77. Bulow-Olsen, A. Diplochory in *Viola*: A Possible Relation between Seed Dispersal and Soil Seed Bank. *Am. Mid Nat.* **112**, 251–260 (1984).
78. Bologna, A. & Detrain, C. Steep decline and cessation in seed dispersal by *Myrmica rubra* ants. *PLoS One* **10**, 1–18 (2015).
79. Le Roux, A. M., Le Roux, G. & Thibout, E. Food experience on the predatory behavior of the ant *Myrmica rubra* towards a specialist moth, *Acrolepiosis assectella*. *J. Chem. Ecol.* **28**, 2307–2314 (2002).
80. Schmidt, A. Geschmackphysiologische Untersuchungen an Ameisen. *Z Vgl Physiol.* **25** (1938).
81. Seifert, B. *Ameisen, bestimmen beobachten* (Naturbuch Verlag, 1996).
82. Grüter, C. *et al.* Negative feedback enables fast and flexible collective decision-making in ants. *PLoS One* **7**, e44501 (2012).
83. Gibb, H., Andersson, J. & Johansson, T. Foraging loads of red wood ants: *Formica aquilonia* (Hymenoptera: Formicidae) in relation to tree characteristics and stand age. *PeerJ* **4**, e2049 (2016).
84. Elmes, G. W. Observations on the Density of Queens in Natural Colonies of *Myrmica rubra* L. (Hymenoptera: Formicidae). *J. Anim. Ecol.* **42**, 761–771 (1973).
85. Oron, A. P. & Hoff, P. D. Kruskal-Wallis and Friedman type tests for nested effects in hierarchical designs. *Working Paper no. 68. In: Center for Statistics and the Social Sciences University of Washington* (2006).

Acknowledgements

O.B. was financed by a PhD grant from Fonds pour la Formation à la Recherche dans l'Industrie et dans l'Agriculture (FRIA). J.D. is Research Director from the Belgian National Fund for Scientific Research (F.N.R.S).

Author Contributions

J.D., O.B. and N.L. conceived the experiments, N.L. and O.B. conducted the experiment, O.B. analysed the results. O.B. wrote the main manuscript. All authors reviewed the manuscript.

Additional Information

Supplementary information accompanies this paper at doi:10.1038/s41598-017-08592-9

Competing Interests: The authors declare that they have no competing interests.

Publisher's note: Springer Nature remains neutral with regard to jurisdictional claims in published maps and institutional affiliations.



Open Access This article is licensed under a Creative Commons Attribution 4.0 International License, which permits use, sharing, adaptation, distribution and reproduction in any medium or format, as long as you give appropriate credit to the original author(s) and the source, provide a link to the Creative Commons license, and indicate if changes were made. The images or other third party material in this article are included in the article's Creative Commons license, unless indicated otherwise in a credit line to the material. If material is not included in the article's Creative Commons license and your intended use is not permitted by statutory regulation or exceeds the permitted use, you will need to obtain permission directly from the copyright holder. To view a copy of this license, visit <http://creativecommons.org/licenses/by/4.0/>.

© The Author(s) 2017

Supplementary Material

S1. Automatic counting of ants feeding at a food source.

Initial processing of the data using USETracker software, ants were detected by background subtraction algorithm on each frame (25 frames/sec) of the 2 hr movies of the experimental setup (Figure S1 B). Numerical output for each frame is the total number of pixels detected at each food source, corresponding to feeding ants. Values collected on each frame were averaged on a 10 seconds basis to reduce the effect of noise in the total number of detected pixel, $P_{detected}(t)$ = mean number of pixels detected in 250 consecutive frames (10 sec x 25 frames/sec). We calculated the parameter $Size$ = mean size in pixels of a single detected ant for both species (as *M. rubra* is larger than *L. niger*) at each food source (high and down). Indeed the camera was vertically placed above the setup and the high food source was nearest to camera than the down food source. Therefore a forager occupied a greater surface on the movie when it was at the high food than when it was at the down food source (Figure S2). We then estimated the number of ants at each food source at each time step of 10 sec, $N_{mean}(t)$, during 2 hr of experiment, by dividing the mean number of detected pixels during 10 secs by the mean size of a single detected ant: $N_{mean}(t) = P_{detected}(t) / Size$. The accuracy of estimation by the USETracker was then assessed by manually counting the number of ants simultaneously feeding at the food source every minute during the 2 h of an experiment (Figure S3). The coefficient of correlation was around 0.99. and we can see only few times during the 2 h of experiment where the manually counted value and the automatic estimation from the USETracker software were different (never over 1 point).

Once the accuracy of the USETracker was validated, we generated the cumulative number of ants at each food source with the data from USETracker for all the experiments (e.g., Figure S4, S5, S6).



Figure S1. Ants of *L. niger* feeding at a food source are automatically detected by USETracker software. **A** Input frame. **B** Processing frame. **C** Output frame.

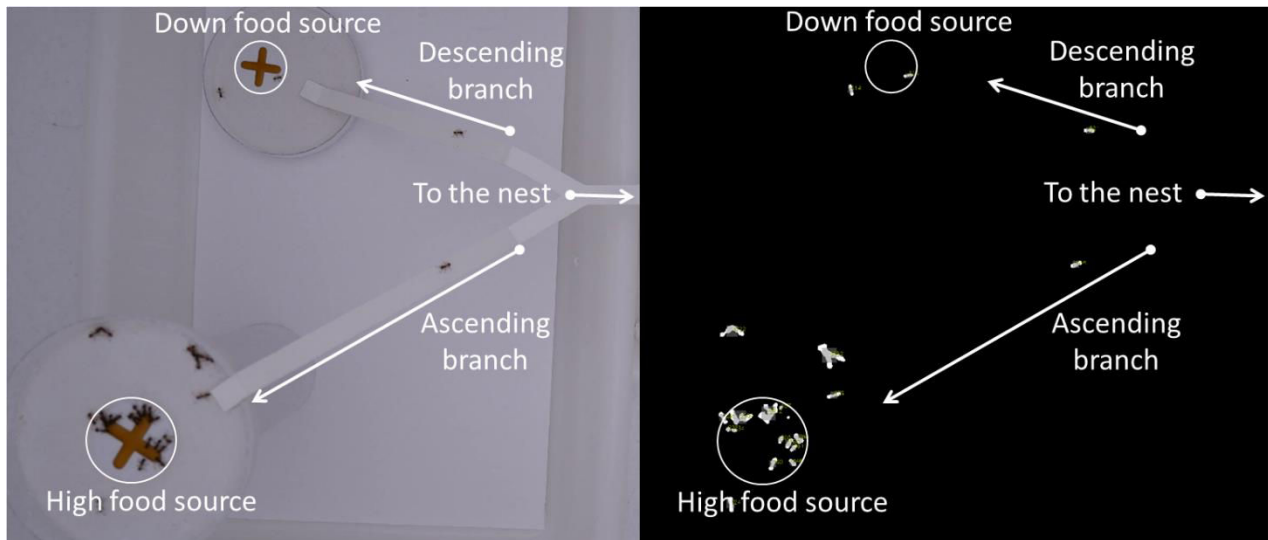

Figure S2. Ants of *M. rubra* of a *HD* experiment feeding at the high and down food sources from **A** a screenshot of the movie and **B** same frame processed by USETracker.

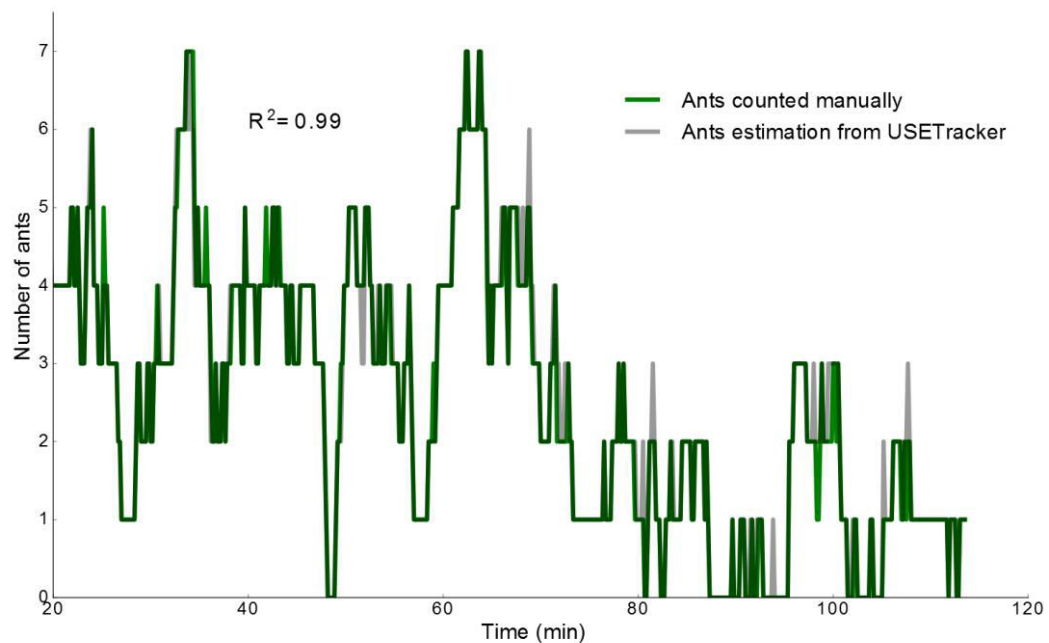

Figure S3. Instantaneous number of ants of *L. niger* of a *HD* experiment feeding at a food source from manual counting (green line, timestep = 1 min) and automatically counted by USETracker (grey line, timestep = 10 sec) during 2 h of an experiment.

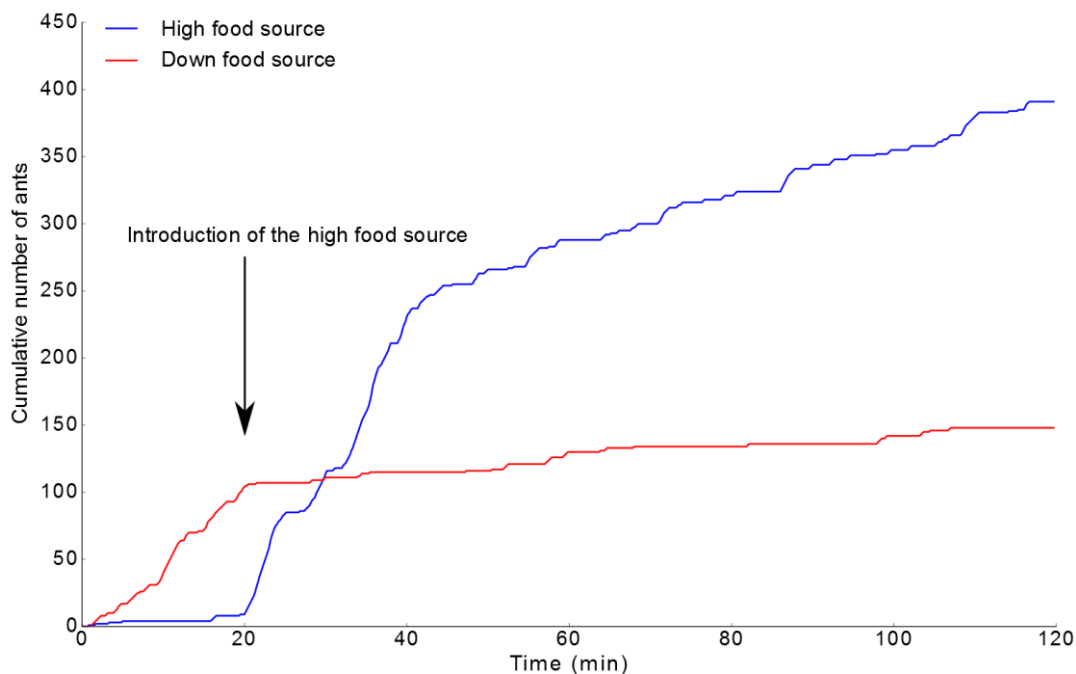

Figure S4. Example of cumulative number of ants of *M. rubra* of a *High* \rightarrow *Down* experiment feeding at the high and the down food source automatically estimated by USETracker during 2h. The high food source was introduced at 20 min. The fast and important exploitation of the high food source from 20 min is clearly apparent. These two curves illustrate a switch of food source exploitation during the experiment (see Methods and Results sections for more explication on this result).

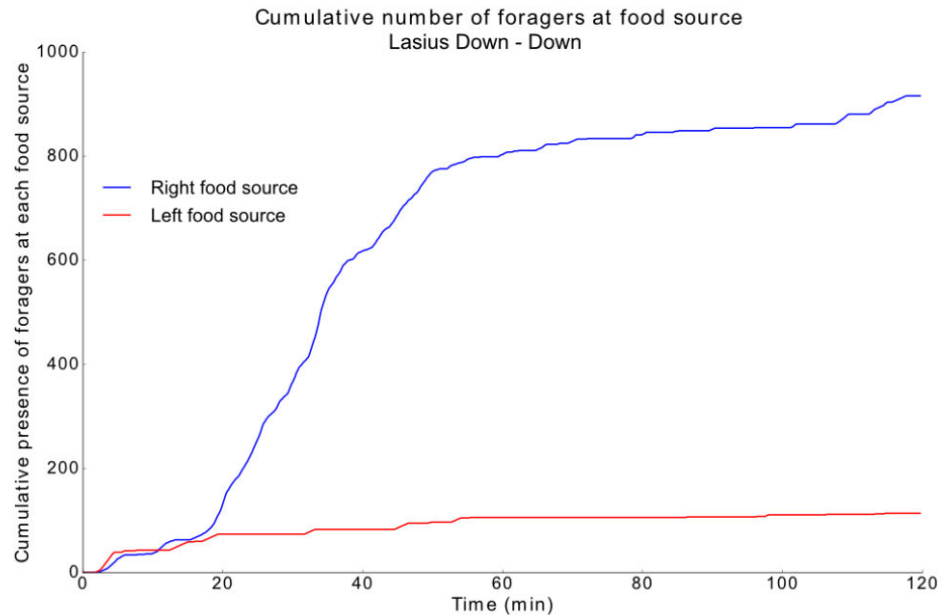

Figure S5. Exemple of cumulative number of ants of *L. niger* of a *Down - Down* experiment feeding at the left and the right food source automatically estimated by USETracker during 2h. The two food sources were simultaneously introduced at the beginning of the experiment. A first phase can be identified, with the arrival of the scouts at food until 20 min before recruitment occurred after 20 min with numerous simultaneous arrivals of new foragers to food source. These two curves illustrate a symmetry breaking between the two symmetrical branches.

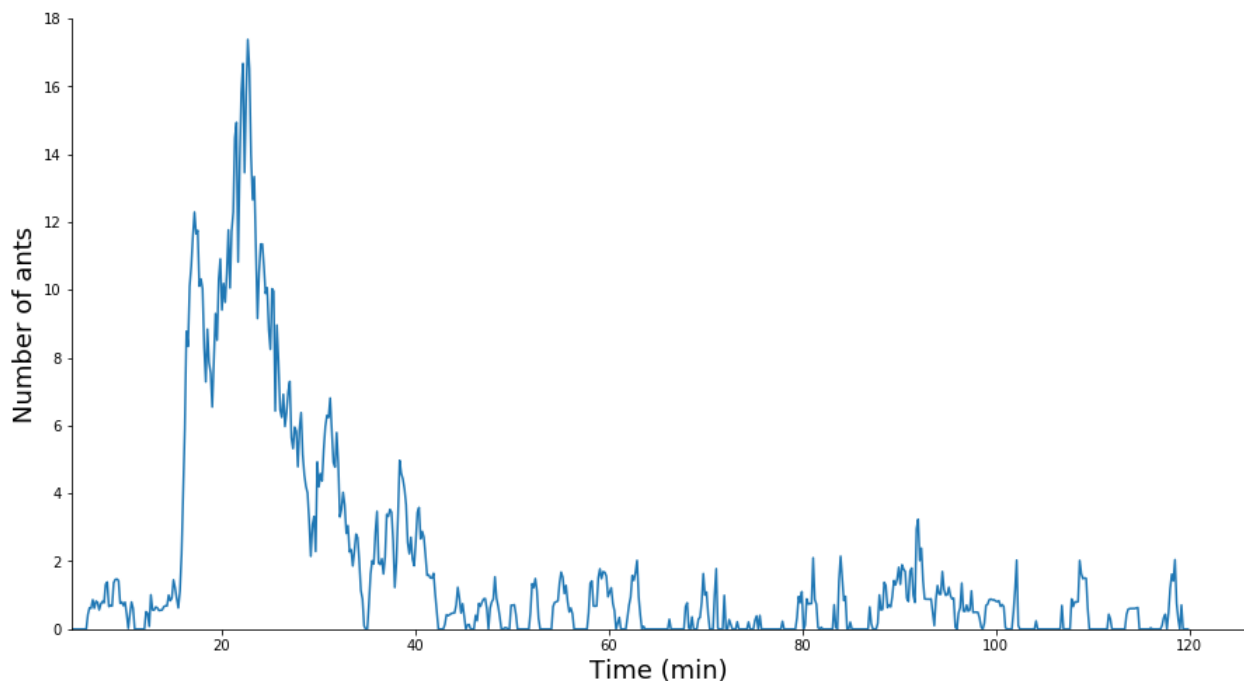

Figure S6. Total number of foragers simultaneously feeding at the two food sources during 2 hours in a colony of 100 ants of *L. niger* in a *DH* experiment. The effect of recruitment lead to an important flow of foragers at food sources around 15 min, with a peak of foraging activity around 25 min before colony satiation and a decreasing number of foragers feeding at food sources happened around 40 min. The duration of experiment was chosen to allow the colony to achieve satiety.

Chapitre 2

Same length, different shapes: Ants collectively choose a straight foraging path over a bent one

Publié : **Bles, O.**, Boehly, T., Deneubourg, J.-L. & Nicolis, S. C. Same length, different shapes: ants collectively choose a straight foraging path over a bent one. *Biology letters* **14**, 20180070 (2018)

<https://doi.org/10.1098/rsbl.2018.0070>

BIOLOGY LETTERS

rsbl.royalsocietypublishing.org

Research



Cite this article: Bles O, Boehly T, Deneubourg J-L, Nicolis SC. 2018 Same length, different shapes: ants collectively choose a straight foraging path over a bent one. *Biol. Lett.* **14**: 20180070.
<http://dx.doi.org/10.1098/rsbl.2018.0070>

Received: 30 January 2018
Accepted: 23 February 2018

Subject Areas:
behaviour

Keywords:
collective decision-making, ant, orientation, exploration, recruitment

Author for correspondence:
Olivier Bles
e-mail: olivier.bles@ulb.ac.be

Electronic supplementary material is available online at <https://dx.doi.org/10.6084/m9.figshare.c.4024462>.

THE ROYAL SOCIETY
PUBLISHING

Animal behaviour

Same length, different shapes: ants collectively choose a straight foraging path over a bent one

Olivier Bles, Thibault Boehly, Jean-Louis Deneubourg and Stamatios C. Nicolis

Center for Nonlinear Phenomena and Complex Systems, Université libre de Bruxelles, Bruxelles, Belgium

OB, 0000-0003-3851-7681; J-LD, 0000-0003-1531-1293; SCN, 0000-0002-7118-5298

In social insects, exploration is fundamental for the discovery of food resources and determines decision-making. We investigated how the interplay between the physical characteristics of the paths leading to food sources and the way it impacts the behaviour of individual ants affects their collective decisions. Colonies of different sizes of *Lasius niger* had access to two equal food sources through two paths of equal length but of different geometries: one was straight between the nest and the food source, and the other involved an abrupt change of direction at the midway point (135°). Both food sources were discovered simultaneously, but the food source at the end of the straight path was preferentially exploited by ants. Based on experimental and theoretical results, we show that a significantly shorter duration of nestbound travel on the straight path, which rapidly leads to a stronger pheromone trail, is at the origin of this preference.

1. Introduction

In the presence of several food sources, many social insects are able to focus their foraging effort towards a particular one [1], especially if they differ in supply [2,3] or if the characteristics of the paths leading to the food sources are different [4,5] (see electronic supplementary material, table S1 for a more exhaustive review). When exploring their environment, ants collect information that will affect their individual behaviour and the collective choice of the colony. Circuitous outbound paths of foraging journeys are integrated into straight inbound vectors, allowing exploring ants to return to their nest along the shortest route. This phenomenon, known as path integration [6], incorporates—and is complemented by—the use of external references, such as light from the sky or objects on the ground. The question arises, therefore, to what extent this system is robust to navigational traps and errors [7,8], particularly how the orientation and the ability to return to the nest are affected by various environmental conditions. It has already been shown that the successful foragers' return rates positively influence the outgoing flow of foragers [9,10] but the link between the nestbound travel durations and the resulting collective decision-making is poorly understood. In this paper, we investigate the collective choice of ants in a binary choice set-up in which individuals could follow two equal length paths leading to two identical food sources (figure 1*a*). The difference between paths was that one was straight, while the other involved an abrupt change in direction (135° angle) at the midway point. We assumed that this geometrical difference affects individual ant behaviour (foodbound and nestbound trips) and, therefore, the resulting collective choice. Prior hypotheses were that increasing colony size would: (i) lead to a transition from a no choice or a small preference for the straight branch to a systematic collective choice of the straight branch (amplifying the effect of path integration)

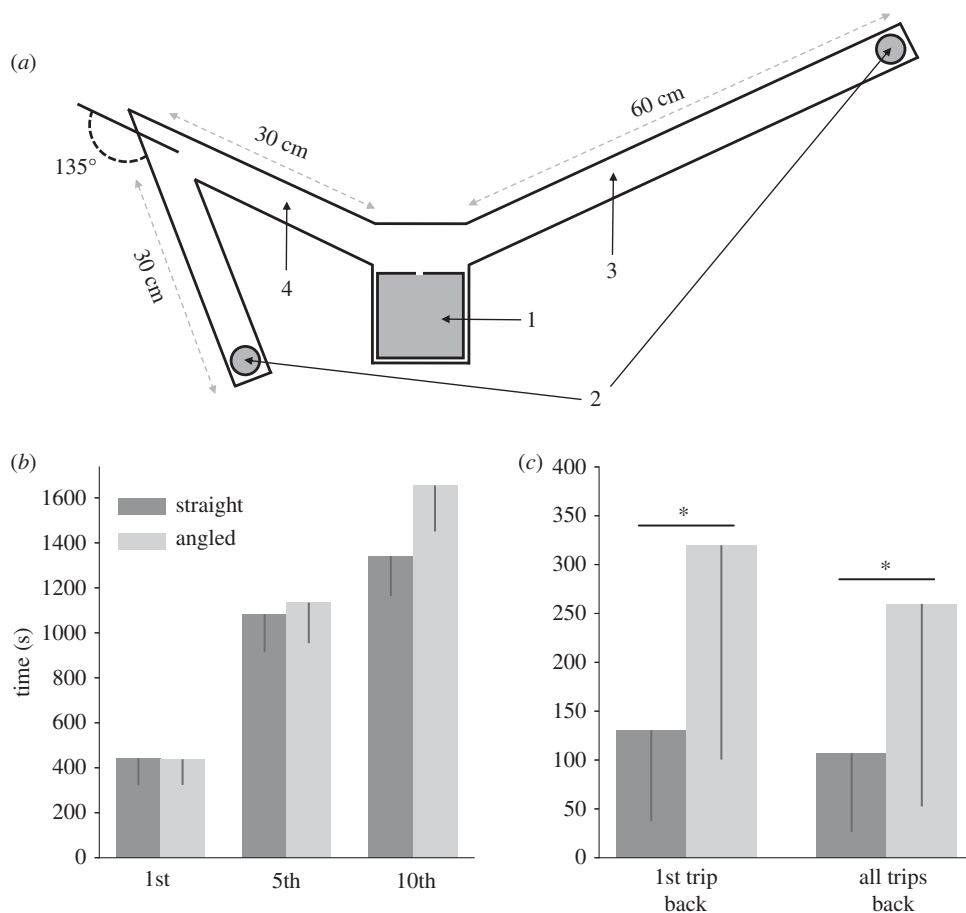

Figure 1. (a) Experimental set-up with (1) the nest and (2) two equal quality food sources equidistant from the nest at the end of the (3) straight and (4) bent paths. (b) Time needed for the 1st, 5th and 10th individuals to discover each food source and (c) the duration of travel back to the nest on each path (* $p < 0.001$).

and (ii) decrease the food-discovery time and increase the food-consumption level. Based on our observations, we then build a mathematical model of ants' recruitment to investigate the link between the geometry of the paths to food sources and the behaviour at the colony level.

2. Material and methods

(a) Experimental set-up and procedure

Two large mother colonies of the black garden ant *Lasius niger* (collected in Brussels, Belgium, September 2014) were each divided into queenless and broodless subcolonies of 50, 100, 200 and 500 individuals, for a total of eight experimental groups. Each subcolony was kept in a plastic box ($260 \times 160 \times 50$ mm) containing a square glass nest ($100 \times 100 \times 2$ mm) and ad libitum water and sucrose solution (1 M). After 2 days of starvation, ants had access for 1 h to the binary choice set-up where a 1 M sucrose food source was placed at the end of each path (figure 1a). Each colony was tested three times ($N = 24$), and six experiments were removed from the analysis, as no ants explored the branches. The food-discovery times of the two branches were compared (Mann–Whitney rank) by measuring the time needed for the 1st, 5th and 10th individual to reach each food source. Additionally, in three experiments with colonies of 100 individuals, we recorded the entire duration of all nestbound trips performed over the course of the experiment (101 individuals performing, $N = 132$ trips). We looked at the effect of colony size on the time of food source discovery and compared the mean times of return to the nest for consecutive travels of each tracked individual (Kruskal–Wallis H -test

coupled to a Dunn's post hoc comparison of pairs). The collective choice of food source by the colony was determined by counting the number of ants feeding at each food source during the whole experiment. An individual was considered to be feeding at a food source if its head was positioned above the sucrose for at least 5 s. A one-sided binomial test was used to determine whether the colony allocated significantly more than 50% of its foraging force towards a path.

(b) Model description

The model is described in figure 2a (see also the electronic supplementary material, model section). Here, R is a reservoir containing individuals that may explore the environment with a probability ϕ . Once out, individuals X choose the branch i ($i = 1, 2$) with a probability f_i depending on the concentration of pheromone on each branch (c_1, c_2). Individuals on branch i , X_i , reach the food source i with a probability α . Individuals at the food source Y_i return to branch i and drop a pheromone unit with a probability γ_i (which contributes to increase c_i). The probabilities α and γ_i correspond to the inverse of time needed to reach the source and time to return to the nest, respectively. The pheromone disappears at a rate μ .

3. Results

(a) Exploration activity and travel back to the nest

The comparison of the times needed for the 1st, 5th and 10th individual to reach the food sources showed no significant difference between branches (figure 1b, Mann–Whitney

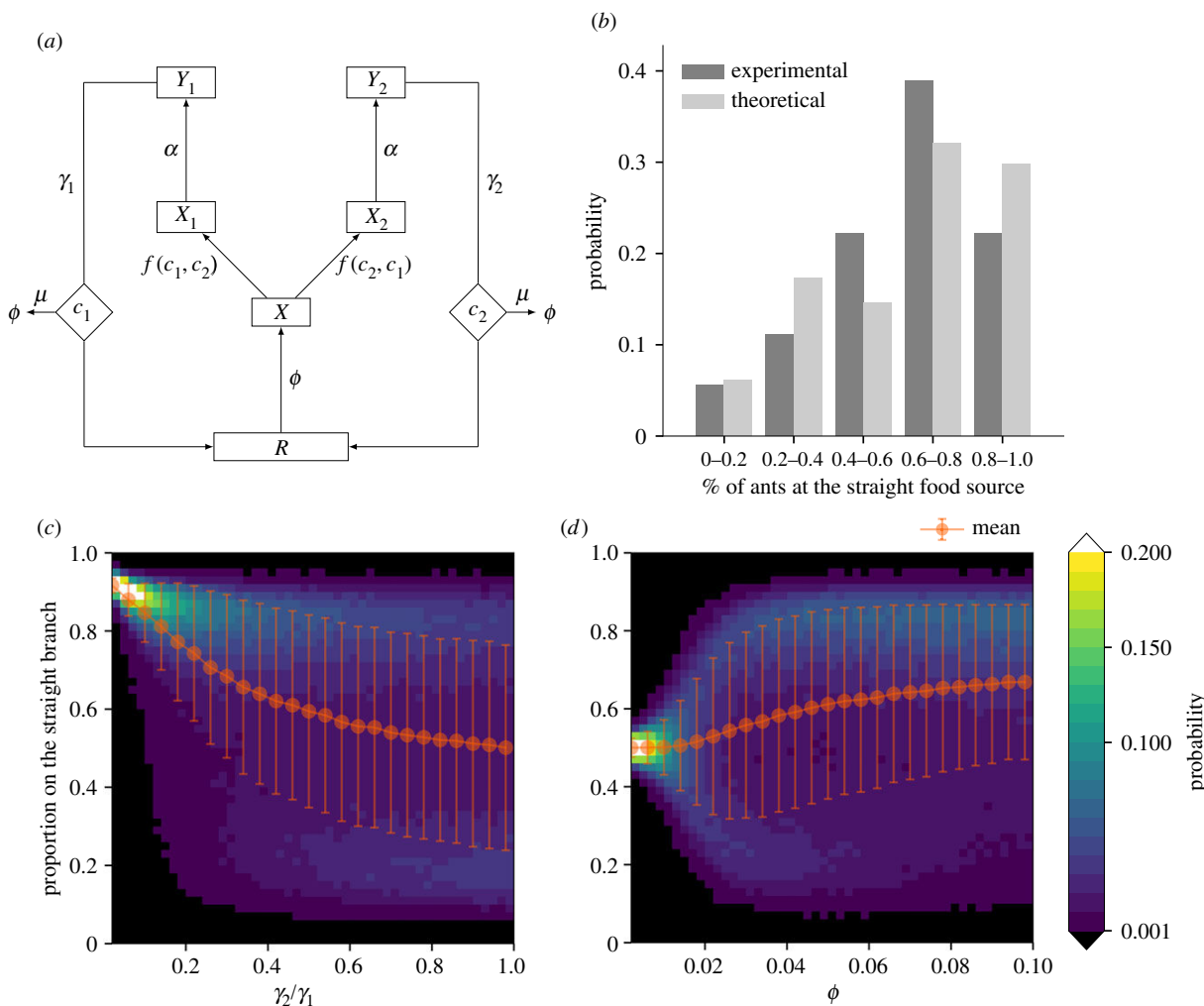

Figure 2. (a) Scheme of the model. (b) Comparison of experimental and theoretical proportion of ants at the food source at the end of the straight path. (c,d) Probability distributions, mean and standard deviation of the proportion of individuals on the straight branch as a function of (c) the ratio γ_2/γ_1 , where $\gamma_1 = 1/107$, $\phi = 0.058 \text{ s}^{-1}$; (d) ϕ , where $\gamma_1 = 1/107$, $\gamma_2 = 1/260$. Other parameter values are given in electronic supplementary material, figure S5; number of simulations = 10 000 and number of steps of each simulation = 3600. (Online version in colour.)

U-test, 1st: $U = 154.0$, $p = 0.406$; 5th: $U = 144.0$, $p = 0.390$; 10th: $U = 122.0$, $p = 0.157$), and the colony size had no impact on these times, regardless of the branch shape (Kruskal–Wallis *H*-test, $\chi^2 = 2.9$, $p = 0.407$). The duration of the first nestbound trip from the end of the bent branch was significantly longer than that from the end of the straight branch (figure 1c, $319.83 \pm 219.44 \text{ s}$, $N = 12$ and 130.45 ± 92.98 , $N = 71$, respectively; Mann–Whitney *U*-test: $U = 153.5$, $p = 0.0002$). A similar result was observed for all nestbound trips (figure 1c, $259.82 \pm 207.30 \text{ s}$, $N = 17$ and $107.18 \pm 80.68 \text{ s}$, $N = 115$, respectively; Mann–Whitney *U*-test: $U = 368.0$, $p < 0.00001$).

(b) Relative exploitation of food source and collective choice

No colonial and no colony size effects were observed at the individual or at the collective level (see electronic supplementary material, S1 and figures S1 and S2). A significant food source choice occurred in 16 of 18 experiments in which ants explored their environment (see electronic supplementary material, table S2). The food source at the end of the straight branch was significantly more exploited, with an

average proportion of $75.38 \pm 9.23\%$ of the ants, in 12 of 16 trials (binomial test, $p = 0.038$). The comparison between experimental and theoretical distributions of the proportion of individuals on the straight branch shows no difference (figure 2b, Kolmogorov–Smirnov test, $D = 0.14$, $p = 0.86$). Figure 2c,d displays the theoretical probability distributions of selecting the straight branch as a function of the ratio γ_2/γ_1 and ϕ , respectively. For an increasing γ_2/γ_1 , the simulations predict a transition from a systematic selection of the straight branch to an equal frequency of selection of each branch. When increasing ϕ , the simulations predict a transition from a systematic equal exploitation to an equal frequency of selection of each branch, followed by a transition to a systematic selection of the straight branch.

4. Discussion

Several studies have focused on the effect of the geometrical characteristics of foraging paths on the individual behaviour and collective choices of ants (see electronic supplementary material, table S1). We showed that in a set-up where two food sources are accessible via a straight and a bent branch

of equal length, a colony preferentially exploits the resource at the end of the straight branch. This collective response is not due to any bias in the outgoing movement patterns of ants, as no difference was found in the time needed to reach each food source during exploration. In contrast, the duration of nestbound trips via the bent path was approximately 2.5 times longer than that via the straight path, favouring the rate of pheromone deposition on the straight path.

During their foraging trips, bees and ants keep track of their location using path integration and their memory, allowing them to return directly to the nest [11,12]. In our experiments this phenomenon led the ants to go rapidly from the food source to the nest on the straight branch, independently of the colony size. By contrast, the nestbound durations were longer on the bent branch, resulting from a possible conflict between the direction imposed by the set-up and the one given by path integration and memory. The model that integrates equal foodbound durations and different nestbound durations is in agreement with the experimental results. It supports the hypothesis that the selection of the straight branch is derived from competition between the two trails, which is enhanced by a shorter nestbound travel time via the straight branch. This difference is likely the result of path integration and individual memory [13].

The difference between trip durations plays a similar role in the case where ants are faced with food patches at different distances from the nest [14]. However, in this case, the collective preference results from a different and simple mechanism linking trip duration and distance. Other experiments have shown that the geometrical differences directly

affect the individual preferences. For example, ants preferentially follow the path that deviates less from their original direction [4,5,15], and those returning to the nest are more sensitive to the geometry of the bifurcations [4,16] than naive ants exploring an unmarked environment [17].

The absence of any colony size effect on exploration activity, foodbound flow and choice intensity revealed by our experiments suggests that a pool of foragers is equally effective in small or large colonies. On the other hand, the Monte Carlo simulations allow different exploitation patterns for different flows which, in their turn, are related to the colony size. It would, therefore, be interesting to undertake further experiments with a wider range of colony sizes or a longer starvation period to test the robustness of these predictions. Finally, as far as path integration is concerned, trajectories of returning ants and their relationship with foodbound duration should be analysed.

Data accessibility. All data can be found in the electronic supplementary material. Dryad: <https://dx.doi.org/10.5061/dryad.1f24f> [18].

Authors' contributions. J.-L.D. and O.B. conceived the experiments; T.B. conducted the experiments; O.B. analysed the results and wrote the manuscript; S.C.N. conceived and analysed the model. All the authors contributed to writing the paper. All authors gave final approval for publication and agree to be held accountable for the content herein.

Competing interests. The authors declare no competing interests.

Funding. O.B. was financed by a PhD grant from FRIA (Fonds pour la Recherche dans l'Industrie et dans l'Agriculture).

Acknowledgement. We thank the two referees for their helpful comments on the manuscript.

References

- Beckers R, Deneubourg J-L, Goss S, Pasteels JM. 1990 Collective decision making through food recruitment. *Insectes Soc.* **37**, 258–267. (doi:10.1007/BF02224053)
- Reid CR, Latty T, Beekman M. 2012 Making a trail: informed Argentine ants lead colony to the best food by U-turning coupled with enhanced pheromone laying. *Anim. Behav.* **84**, 1579–1587. (doi:10.1016/j.anbehav.2012.09.036)
- Sumpter DJT, Beekman M. 2003 From nonlinearity to optimality: pheromone trail foraging by ants. *Anim. Behav.* **66**, 273–280. (doi:10.1006/anbe.2003.2224)
- Gerbier G, Garnier S, Rieu C, Theraulaz G, Fourcassié V. 2008 Are ants sensitive to the geometry of tunnel bifurcation? *Anim. Cogn.* **11**, 637–642. (doi:10.1007/s10071-008-0153-4)
- Forster A, Czaczkes TJ, Warner E, Woodall T, Martin E, Ratnieks FLW. 2014 Effect of trail bifurcation asymmetry and pheromone presence or absence on trail choice by *Lasius niger* ants. *Ethology* **120**, 768–775. (doi:10.1111/eth.12248)
- Wehner R, Srinivasan MV. 2003 Path integration in insects. In *The neurobiology of spatial behaviour* (ed. KJ Jeffery), pp. 9–30. Oxford, UK: Oxford University Press.
- Andel D, Wehner R. 2004 Path integration in desert ants, *Cataglyphis*: how to make a homing ant run away from home. *Proc. R. Soc. Lond. B* **271**, 1485–1489. (doi:10.1098/rspb.2004.2749)
- Muller M, Wehner R. 1988 Path integration in desert ants, *Cataglyphis fortis*. *Proc. Natl Acad. Sci. USA* **85**, 5287–5290. (doi:10.1073/pnas.85.14.5287)
- Udiani O, Pinter-Wollman N, Kang Y. 2014 Identifying robustness in the regulation of foraging of ant colonies using an interaction based model with backward bifurcation. *J. Theor. Biol.* **1904**, 1–24. (doi:10.1016/j.jtbi.2014.11.026)
- Pinter-Wollman N, Bala A, Merrell A, Queirolo J, Stumpe MC, Holmes S, Gordon DM. 2013 Harvester ants use interactions to regulate forager activation and availability. *Anim. Behav.* **86**, 197–207. (doi:10.1016/j.anbehav.2013.05.012)
- Collett TS, Collett M. 2002 Memory use in insect visual navigation. *Nat. Rev. Neurosci.* **3**, 542–552. (doi:10.1038/nrn872)
- Harkness RD, Maroudas NG. 1985 Central place foraging by an ant (*Cataglyphis bicolor* Fab.): a model of searching. *Anim. Behav.* **33**, 916–928. (doi:10.1016/S0003-3472(85)80026-9)
- Czaczkes TJ, Salmane AK, Klampfleuthner FAM, Heinze J. 2016 Private information alone can trigger trapping of ant colonies in local feeding optima. *J. Exp. Biol.* **219**, 744–751. (doi:10.1242/jeb.131847)
- Dussutour A, Beekman M, Nicolis SC, Meyer B. 2009 Noise improves collective decision-making by ants in dynamic environments. *Proc. R. Soc. B* **276**, 4353–4361. (doi:10.1098/rspb.2009.1235)
- Vittori K, Talbot G, Gautrais J, Fourcassié V, Araújo AFR, Theraulaz G. 2006 Path efficiency of ant foraging trails in an artificial network. *J. Theor. Biol.* **239**, 507–515. (doi:10.1016/j.jtbi.2005.08.017)
- Jackson DE, Holcombe M, Ratnieks FLW. 2004 Trail geometry gives polarity to ant foraging networks. *Nature* **432**, 907–909. (doi:10.1038/nature03105)
- Jander R. 1990 Arboreal search in ants: search on branches (Hymenoptera: Formicidae). *J. Insect Behav.* **3**, 515–527. (doi:10.1007/BF01052015)
- Bles O, Boehly T, Deneubourg JL, Nicolis S. 2018 Data from: Same length, different shapes: ants collectively choose a straight foraging path over a bent one. Dryad Digital Repository. (doi:10.5061/dryad.1f24f)

Supplementary Material

S.1 Literature review

Publication title	Authors and year	Summary / Main results
Amplification of individual preferences in a social context: the case of wall-following in ants (Dussutour et al., 2005)	Dussutour & al. 2005	Two symmetrical paths (two branches of a bridge) to food sources, one without wall and one with wall: ants collectively chose the branch of the bridge with the wall.
Effect of the land area elevation on the collective choice in ants (Bles et al., 2017)	Bles & al. 2017	Strong preference for ascending path to food source over the descending one in both <i>Lasius niger</i> and <i>Myrmica rubra</i> , even if the descending path was introduced first.
Collective decision making in a heterogeneous environment: <i>Lasius niger</i> colonies preferentially forage at easy to learn locations (Grüter et al., 2015b)	Grüter & al. 2015	Repeated turns (right-right or left-left) to food source are chosen over alternate turns (right-left or left-right), a preference involving memory.
Path efficiency of ant foraging trails in an artificial network (Vittori et al., 2006b)	Vittori & al. 2006	When facing asymmetrical bifurcation, ants show preference for the branch that deviates less from their current route.
Are ants sensitive to the geometry of tunnel bifurcation? (Gerbier et al., 2008b)	Gerbier & al. 2008	The choice of an ant at a tunnel bifurcation depends more on the presence/absence of a trail pheromone than on the geometry of the bifurcation itself
Preference for straight-line paths in recruitment trail formation of the Argentine ant, <i>Linepithema humile</i> (Yates and Nonacs, 2016)	Yates & Nonacs. 2016	In an artificial grid containing a number of possible routes (differing only in the number of turns that the ants had to make) to a food source, the ants preferred the shortest routes and significantly favoured the path with the fewest turns.
Effect of trail bifurcation asymmetry and pheromone presence or absence on trail choice by <i>Lasius niger</i> ants (Forster et al., 2014)	Forster & al. 2014	Ants preferentially follow the branch deviating least from straight, and this effect increases as asymmetry increases. However, when pheromone is only present on one branch, the graded effect of asymmetry disappears.
Ant foraging on complex trails: route learning and the role of trail pheromones in <i>Lasius niger</i> (Czaczkes et al., 2013)	Czaczkes & al. 2013	Route learning was slower and errors greater on alternating (e.g. left–right) versus repeating (e.g. left–left) routes to food source (30% vs 3%) but errors decrease by 30% when pheromone trail was present.
Foraging efficiency in the wood ant, <i>Formica rufa</i> : is time of the essence in trail following? (Denny et al., 2001)	Denny & al. 2001	Ants tend to use the shortest route whenever possible. When equal in distance, vertical deviations were preferred over horizontal detours, probably because this represents a reduced risk in terms of navigation errors
Shape and efficiency of wood ant foraging networks. (Buhl et al., 2009)	Buhl & al. 2009	The shape of the foraging trail networks of 11 connected nests maximizes efficiency by minimizing both the total length (i.e., total amount of trail) and the route factor (i.e., average distance between nest and foraging site).

Table S1. Review of some works in which the experimental set-ups involve paths to food sources in ants with different physical characteristics.

S2. Material and methods

Two mother colonies were used to create two sets of colonies of equal sizes (50, 100, 200, 500), leading to eight different experimental colonies, each one of which was tested three times. Statistical tests (Mann-Whitney rank test) between the two mother colonies were applied to check for any personality effect of the colony. The results of these tests for all the experiments coming from each mother colony are listed below:

- Total number of ants counted at both the food sources: $U=29.0$, $p = 0.166$
- Time needed for the first ant to reach a food source: $U=36.0$, $p = 0.362$
- Time needed for 5th ants to reach a food source: $U=31.0$, $p = 0.213$
- Time needed for 10th ants to reach a food source: $U=27.0$, $p = 0.126$

Moreover, the food source at the end of the straight branch was preferred in seven out of nine experiments in one colony and in five out of nine in the second colony. The level of asymmetry was similar between both colonies (Mann-Whitney rank test, $U=25.0$, $p = 0.093$). Therefore, no colonial effect occurred in our experiments.

S.3 Experimental results

The mean flow of ants was calculated as the total number of ants counted at both food sources during the entire experiment divided by the duration of the experiment (3600 sec). High inter-colony variation in the mean flow of foragers arriving at the food sources led to no effect of the colony size on the total number of ants exploiting the food sources (Figure S1). The distribution of the mean flow of foragers arriving at the food sources for each experiment shows no difference with a Gaussian distribution (Figure S2, Kolmogorov-Smirnov test, $D=0.22$, $p=0.27$), confirming the absence of effect of colony size on the mean flow of ants in our experiments. Colony size had no effect on the level of food collection (total number of ants counted at both the food sources or flow of ants arriving at both the food source). This could be due to a coupled effect of (1) the relatively low level of starvation [2 days] to which colonies exhibit different responses [reviewed in (Mailleux et al., 2010b)(Gottlieb et al., 2013)] and (2) the fact that smaller colonies can compensate for their reduced work force by being more efficient. For example, per-worker productivity is higher in smaller than in larger colonies (Kramer et al., 2014).

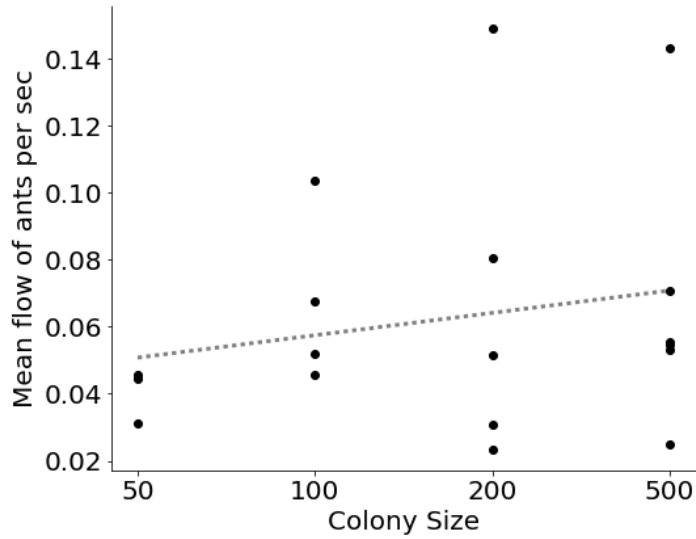

Figure S1. Mean flow of ants arriving at both the food sources, for each experiment, as a function of the colony size. There is no correlation between the colony size and the mean flow of ants at food sources (Linear Regression: $r^2=0.04$, $p=0.414$)

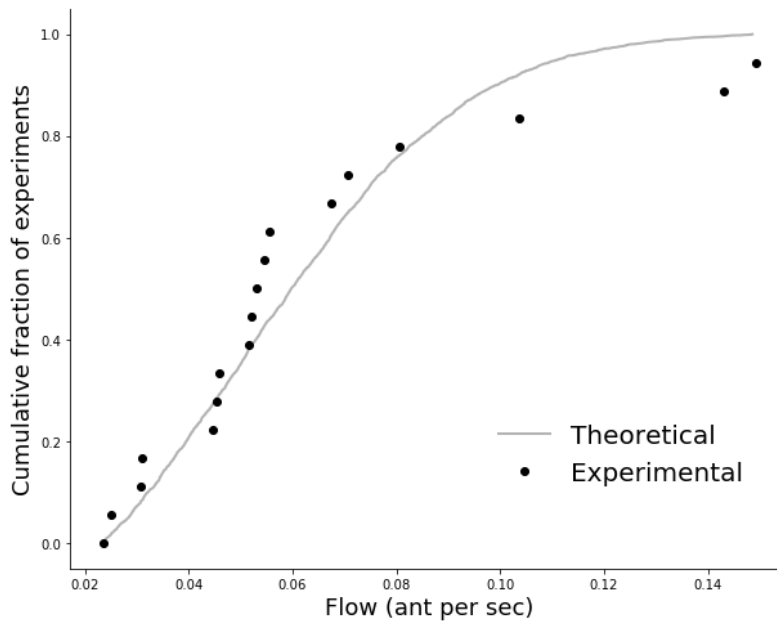

Figure S2. Cumulated survival curve of the mean flow of foragers arriving at the food sources for each experiment. *Theoretical* = Random sampling from a Gaussian distribution, N=5000 (the minimum, maximum, mean and standard deviation of the distribution were adjusted with values from the experimental distribution of flow of ants from all the experiments). Kolmogorov-Smirnov test for the comparison of the theoretical and experimental distribution: D=0.22, p=0.27.

Experiment	Colony Size	No. of ants counted		Binomial Test
		Straight	Angled	
1	50	105	53	**
2	200	41	168	**
3	500	377	128	**
4	500	75	14	**
5	100	122	12	**
6	200	26	56	**
7	500	139	46	**
8	200	52	58	-
9	500	111	25	**
10	100	185	50	**
11	50	57	49	-
12	100	212	129	**
13	200	239	291	*
14	500	143	57	**
15	200	72	114	**
16	500	150	99	**
17	100	156	31	**
18	50	95	31	**

*: $p < 0,05$; **: $p < 0,01$; -: $p > 0,05$

Table S2. Summary of the total number of ants counted at each food source for each experiment and results of the binomial test.

S.4 Model description and analysis

Schematically, the model is viewed as a succession of the following steps (see also the figure 2.A in the main manuscript)

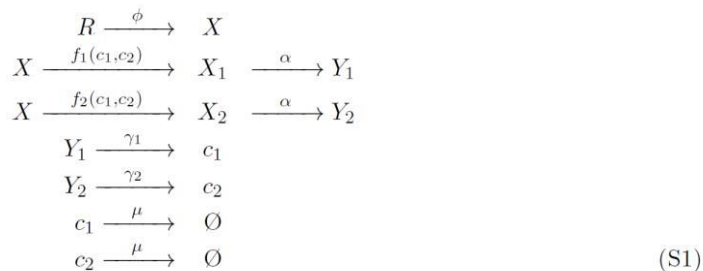

Here R is a reservoir containing individuals which explore the environment with a probability equal to ϕ . Once out, individuals X choose either the branch 1 or 2 with a probability equal to $f_1(c_1, c_2)$ or $f_2(c_1, c_2) = 1 - f_1(c_1, c_2)$ respectively. Individuals on branch 1 (2) X_1 (X_2) will reach eventually the food source 1 (2) with a probability α , which corresponds to the inverse of time needed to cross the branches. Individuals at the food source 1 (2) Y_1 (Y_2), return to the branch 1 (2) and drop a quantity of pheromone c_1 (c_2), with a probability γ_1 (γ_2) corresponding to the inverse of times needed to return to the nest. Finally, the pheromone disappears by evaporation/adsorption at a rate μ . The functions $f_1(c_1, c_2)$ and $f_2(c_2, c_1)$ are classical choice functions that depend on the relative pheromone concentrations on both branches and are written as (Deneubourg et al., 1990) :

$$\begin{aligned}
f_1(c_1, c_2) &= \frac{(k + c_1)^2}{(k + c_1)^2 + (k + c_2)^2} \\
f_2(c_1, c_2) &= 1 - f_1(c_1, c_2) = \frac{(k + c_2)^2}{(k + c_1)^2 + (k + c_2)^2}
\end{aligned} \tag{S2}$$

The rate equations corresponding to scheme (S1) can then be written as

$$\frac{dX_1}{dt} = \phi \frac{(k + c_1)^2}{(k + c_1)^2 + (k + c_2)^2} - \alpha X_1 \quad (\text{S3a})$$

$$\frac{dX_2}{dt} = \phi \frac{(k + c_2)^2}{(k + c_1)^2 + (k + c_2)^2} - \alpha X_2 \quad (\text{S3b})$$

$$\frac{dY_1}{dt} = \alpha X_1 - \gamma_1 Y_1 \quad (\text{S3c})$$

$$\frac{dY_2}{dt} = \alpha X_2 - \gamma_2 Y_2 \quad (\text{S3d})$$

$$\frac{dc_1}{dt} = \gamma_1 Y_1 - \mu c_1 \quad (\text{S3e})$$

$$\frac{dc_2}{dt} = \gamma_2 Y_2 - \mu c_2 \quad (\text{S3f})$$

At the stationary state, the right hand sides of the six equations are set equal to 0. Combining then eqs. (S3c)-(S3f), one obtains

Substituting eqs. (S4) into eqs. (S3a)-(S3b) at the stationary state yields

$$\begin{aligned} Y_1 &= \frac{\alpha}{\gamma_1} X_1 & Y_2 &= \frac{\alpha}{\gamma_2} X_2 \\ c_1 &= \frac{\alpha}{\mu} X_1 & c_2 &= \frac{\alpha}{\mu} X_2 \end{aligned} \quad (\text{S4})$$

$$\phi \frac{\left(k + \frac{\alpha}{\mu} X_1\right)^2}{\left(k + \frac{\alpha}{\mu} X_1\right)^2 + \left(k + \frac{\alpha}{\mu} X_2\right)^2} - \alpha X_1 = 0 \quad (\text{S5a})$$

$$\phi \frac{\left(k + \frac{\alpha}{\mu} X_2\right)^2}{\left(k + \frac{\alpha}{\mu} X_1\right)^2 + \left(k + \frac{\alpha}{\mu} X_2\right)^2} - \alpha X_2 = 0 \quad (\text{S5b})$$

Adding and dividing eqs (S5a)-(S5b), respectively we obtain

$$\phi - \alpha(X_1 + X_2) \Rightarrow X_2 = \frac{\phi}{\alpha} - X_1 = 0 \quad (\text{S5c})$$

$$\frac{\left(k + \frac{\alpha}{\mu}X_1\right)^2}{\left(k + \frac{\alpha}{\mu}X_2\right)^2} = \frac{X_1}{X_2} \quad (\text{S5d})$$

or

$$k^2(X_2 - X_1) - \frac{\alpha^2}{\mu^2}X_1X_2(X_2 - X_1) = 0 \quad (\text{S5e})$$

This equation has two solutions :

$$X_1 = X_2 \quad (\text{S5f})$$

$$X_1 = \frac{k^2\mu^2}{\alpha^2X_2} \quad (\text{S5g})$$

Substituting finally eqs. (S5f)-(S5g) in eq. (S5b), we have

$$X_1 = X_2 = \frac{\phi}{\alpha} \quad (\text{S6a})$$

$$\begin{aligned} 0 &= \alpha X_1^2 - \phi X_1 + \frac{k^2\mu^2}{\alpha} \Rightarrow \\ X_1 &= \frac{1}{2\alpha}\phi \pm \frac{1}{2\alpha}\sqrt{\phi^2 - 4k^2\mu^2} \\ X_2 &= \frac{1}{2\alpha}\phi \mp \frac{1}{2\alpha}\sqrt{\phi^2 - 4k^2\mu^2} \end{aligned} \quad (\text{S6b})$$

and

which, surprisingly, do not depend on the parameters γ_1 and γ_2 . In other words, at the steady states, individuals on branches 1 and 2 going to the food sources 1 and 2 do not depend on the time travelled from the sources to the nest. Figure S3 shows the bifurcation diagram of the steady-states

of $X_1/(X_1 + X_2)$ as a function of the parameter ϕ . One notices that for a small value of the parameter the traffic on the branches is homogenous while above a critical value of ϕ it becomes inhomogeneous, with most of the individuals being on branch 1 or 2. This proportion increases as ϕ is increasing.

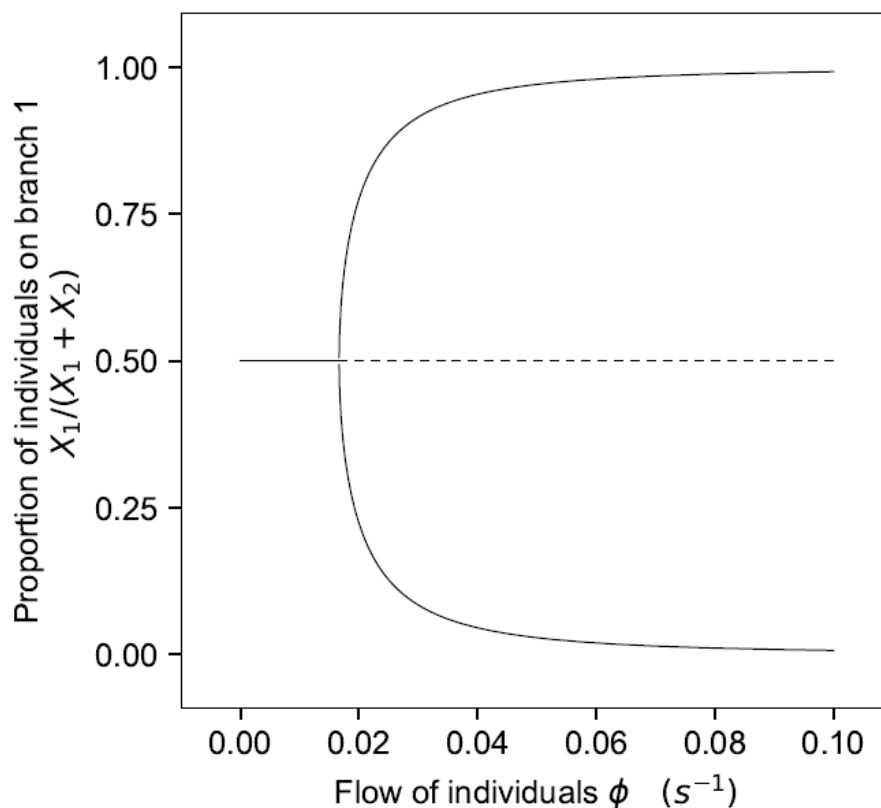

Figure S3. Bifurcation diagram of the steady-states of $X_1/(X_1 + X_2)$ as a function of ϕ (see eqs. (S6a)-(S6b)). Full and dashed lines correspond to stable and unstable solutions respectively. Parameter values are $\alpha = 1/250$, $k = 20$ and $\mu = 1/2400$.

Although the model predicts that no asymmetry will be observed at the steady states that are eventually reached, long transients where asymmetry effects subsist are observed. We developed Monte Carlo simulations of the model in order to study the role of the fluctuations and of these transients. Here, each process described by scheme (S1) is viewed as probabilistic.

A. Comparison of the model output with the experimental results

Figure 2B in the main text displays the probability histogram of the proportion of individuals on the straight branch as a result of 10000 Monte Carlo realisations for parameter values estimated from the experiments. As seen the experimental and theoretical distributions are remarkably similar (Kolmogorov-Smirnov test, $D=0.14$, $p=0.86$).

B. Sensitivity analysis

Figures 2 C-D in the main text display the probability distributions along with the mean and the standard deviation of the variable of interest as a function of the ratio γ_2/γ_1 (c) and of the individual flow ϕ (d). As seen, for a small value of the ratio γ_2/γ_1 , a narrow and high probability peak is observed for a large proportion of individuals on the straight branch. As γ_2/γ_1 increases, the peak is displaced to slightly lower values of the proportion and becomes wider. From a particular value of the ratio and onwards, a small peak of probability appears for a low proportion of individuals on the straight branch coexisting with the more pronounced one situated at large values. The importance of the lower peak is gradually increasing as the ratio keeps increasing, the opposite being true for the higher peak until $\gamma_2/\gamma_1 = 1$, where the two peaks have the same height. As for the mean, it switches from a high value of the proportion with a very small variance, to a value of 0.5 with a large variance, signalling the presence of two equal probability peaks. Concerning the dependence on ϕ (Figure 2D), the probability distribution shows a very narrow peak at a value of 0.5 for small values of ϕ , in agreement with the mean field formulation. As ϕ increases, the homogeneity suddenly disappears, and two probability peaks appear. At some point, the higher peak (i.e. at the larger value of the proportion) takes over until, for large values of ϕ , the lower peak becomes negligible. At the level of the mean value, the proportion is 0.5 for small values of the flow and is then increasing until a plateau is reached. Figures 2C-D in the main manuscript provide an interesting prediction and open the way to future tests for validating our hypothesis that the asymmetry of the geometry of the experimental setup is affecting only the return travels from the source to the nest. More unexpectedly, the results on transient behaviours revealed by our experiments are to be contrasted with the mean field model (S3a)-(S3f) which predicts an equal probability to select the straight or the angled branch.

Chapitre 3

A spatiotemporal analysis of the food dissemination process and the trophallactic network in the ant *Lasius niger*

Joffrey Planckaert¹, Stamatios C. Nicolis¹, Jean-Louis Deneubourg¹, Cédric Sueur² and Olivier Bles^{1*}

¹Center for Nonlinear Phenomena and Complex Systems (Cenoli) - CP 231, Université libre de Bruxelles (ULB), Campus Plaine, Boulevard du Triomphe, Building NO - level 5, B-1050 Bruxelles, Belgium

²Université de Strasbourg, CNRS, IPHC, UMR 7178, Strasbourg, France

[*olivier.bles@ulb.ac.be](mailto:olivier.bles@ulb.ac.be)

Soumis dans *Scientific Reports*.

Abstract

Intranidal food dissemination through trophallactic exchanges is a fundamental issue in social insect colonies, but the underlying mechanisms of food dissemination are far from clear. We develop a framework to investigate the spatiotemporal dynamics of the trophallactic network in starved *Lasius niger* ant colonies. Thanks to individual labelling and tracking methods, the individual and caste (foragers or non-foragers) level contributions and their role (donor / recipient) as well as the spatial locations of the trophallactic interactions in the nest, are recorded. At the colony level, while we highlight a strong heterogeneity of the individual participation in trophallactic activity, the trophallactic network is not different from a random network. We show that the trophallactic behaviour of the two castes is markedly different at both spatial and social levels. A key result is that the foragers not only harvest food but also play a major role in the food dissemination. Moreover, our analysis reveals interindividual differences within both castes, with this heterogeneity being more marked within non-foragers. We discuss our results in light of the division of work, network theory and collective food management in insect societies.

Introduction

Eusociality is one of the most complex and integrated forms of social life, implying coordination in broodcare behaviour, overlapping generations and polytheism (i.e., the existence of fertile and non-fertile castes). Moreover, division of work also occurs within the non-fertile caste ¹ and relies on different factors (e.g., age, morphology, genetics or individual experiences) and on their interplay (e.g., ²). Eusociality implies colony-level coordination through information sharing and exchanges of material and food at the individual level. Food retrieving and food dissemination through the colony implies division of work between a small fraction of the colony (the foragers) that leaves the nest to explore the environment, harvests food and brings it back to the nest while the rest of the colony (the non-foragers) stays inside the nest. Upon returning to the nest after having retrieved food, the foragers share their crop contents through trophallactic interactions (mouth-to-mouth exchanges) with nestmates that are in turn able to share the food. These food exchanges are modulated by colony needs and the level of satiation ^{3,4}.

Trophallactic events are not only a way of delivering food to the colony members that do not feed at the food source ¹ but also a way of diffusing information (such as nutritional needs at the individual and colony levels) and biological material (such as symbionts and hormones) ⁵. Starved ants inside the nest beg for food from their neighbours, who in turn, are able or not to satisfy these requests. These behaviours result in “chains of demand” that lead to the emergence of the trophallactic cascade from laden individuals to starved individuals, according to a continuum of load ⁶⁻⁸. Such a pattern of food dissemination involving consecutive transfers of material from one individual to another is assumed to be more efficient and results in a more homogeneous distribution than direct transfers from only the original donors ⁹.

Moreover, divergences could emerge concerning the information held by the different castes: while the foragers hold information about the food availability, the non-foragers hold information about the colony needs and food store level, e.g., ^{6,10,11}. Therefore, numerous exchanges and communications occur between forager and non-forager individuals, particularly at the interface between the nest and the environment ^{12,13}, which regulates the food flow that enters the nest to meet the colony needs. In ants, these regulations are the by-product of the interaction between gradually satiated non-foragers and foragers. Increasing the crop contents of

non-foragers slows the rate of food transfers from foragers to non-foragers, which in turn modulates the decision of the forager to leave the nest ³. This mechanism of food flow regulation cannot be generalised to other social insects. For example, wasp and honeybee foragers acquire information about the balance between the collection and processing capacity of the colony from the delay to find a transfer partner ¹⁴⁻¹⁷. If a honeybee forager finds an unloading partner quickly ¹⁶⁻¹⁹ or has many receivers during unloading ²⁰⁻²², it is more likely to perform a waggle dance to recruit more foragers to her food source. If on the other hand, a forager experiences a longer delay to unload food, it will trigger an additional receiver by performing a tremble dance ¹⁶.

In addition, the unloading behaviour of the donor is also modulated by the colony state. In starved colonies, a single donor transfers almost all its crop content to approximately 100 workers, while in fed colonies, the donor only transfers less than a third of its crop content, but its food reaches approximately the same number of ants ²³. Furthermore, colony size, division of work and spatial occupation patterns as well as interactions among these factors affect food sharing behaviours and the dynamics of information flow ^{9,24-27}. Thus, food collection and distribution behaviours do not simply result from hunger responses at the individual level but rather result from a complex interplay between the nutritional needs at the colony level and the decisions of individuals.

Despite the central role of the trophallactic interactions in the regulation of food flow in social insects, the way the chains of demand and the spatial organisation of food transfers within the colony are established are still largely ignored ²⁸⁻³¹. Most of the works on this subject have focused on the food flow dissemination inside the nest ^{32,33} and the quantity received by different castes ³⁴ but have ignored the individuality and identity of the trophallactic partners ⁷. The role and modulation of individual trophallactic activities have only been recently investigated in ants ^{3,35,36}.

In this context, we investigated the dynamics of intranidal food accumulation, the individual and caste-level contributions to the food dissemination process and the social and spatial characteristics of the trophallactic networks in colonies of *Lasius niger*. Individuals were classified into functional categories / castes based on whether they visited the food source, even once, (foragers) or did not (non-foragers). We recorded the spatial positions in addition to the identities of the donors and the receivers of all the oral food exchanges inside the nest; from this

data, we built the resulting trophallactic networks at the colony level. More specifically, we evaluated to what extent the characteristics of the food dissemination process, such as the individual and caste-level allocation of the trophallactic activity as well as the properties of the trophallactic network in the experimental colonies, differ from the theoretical networks (randomised). Finally, we established the spatial distributions of the trophallactic exchanges at the intra- and inter-caste levels and as a function of the distance to the nest entrance.

Methods and Materials

Ant colony set-up

From five large mother colonies (>1000 ants) of *Lasius niger* (collected in Brussels, Belgium, autumn 2016), we created five queenless and broodless subcolonies of at least 50 randomly chosen workers. The ants were individually labelled with ArucoColor tags (<https://sites.google.com/site/usetrackerac/>), allowing automatic identification of the ants. Each tag was stuck to the abdomen and had a side length of 0.8 mm, weighed 0.1 mg (corresponding to less than 5% of the average mass of an adult worker or less than 10% of the amount of food a worker carries³⁷) and was printed on waterproof paper at a resolution of 1200 dpi. The tags were hand-cut using a scalpel and a steel ruler as guide. Following a 5-min acclimatisation period, the labelling was not observed to impede the ants' behaviours, movements or interactions. Each subcolony was introduced to the experimental set-up between 15 to 18 days prior to the first experiment; each set-up was composed of a one-chamber nest (56 x 41 x 2 mm) covered by a glass window. This acclimation period was long enough to stabilise the task repartition between individuals. A single access portal (4 x 3 x 2 mm) lead to the foraging area (61 x 49 x mm) containing a 0.3 M sucrose solution and water *ad libitum* (Fig. S1). The walls of the foraging area were covered in Fluon® to prevent the ants from escaping. The subcolonies were kept at 22 ±3°C and 60 ±5% relative humidity, with a 12:12 h constant photoperiod.

Data collection

After 4 days of starvation, we introduced 3 mL of 1 M sucrose solution. The ants were filmed for 90 mins, starting 30 mins before the food source introduction. Each colony was tested once. The

video data were recorded using a Panasonic® Lumix DMC-GH4-R mounted with a 30 mm Olympus® ED lens capturing 25 frames/s at the definition of 4180*2160 p. We discriminated foragers (Fs) from non-foragers (NFs). An individual was considered as a forager if it spent at least 5 consecutive seconds feeding at the food source during the experiment. Additionally, at each minute, we conducted a scan-sampling³⁸ of all the trophallactic interactions inside the nest, identifying the donor, the receiver and the X and Y spatial positions of the trophallactic events (contact point of the mandibles of both ants). A trophallactic event was recorded when ants engaged in mandible-to-mandible contact for greater than 5 s. The directionality of the food flow and the role of the donor and the receiver were determined by the characteristic body posture and the mandible positions^{32,39}(see also Fig. S2). A trophallactic event involving the same individuals on two or several consecutive scans was considered as a single trophallactic event of 2 or several min lengths. As a strong correlation was observed between the total time spent during trophallactic events and the number of trophallactic events (Fig. S3, Spearman, $R^2=0.69$, $p < 0.01$ in each case), we focused on the number of trophallactic events (a proxy for the amount of food transferred) for all the analyses.

Statistical and social network analysis

We checked the homogeneity of the mean number of trophallactic events in the colonies (as well as the mean number of trophallactic events where food was given and received by foragers and non-foragers) by carrying out a two-sided Kruskal-Wallis one-way analysis of variance (hereafter “KW”). The Mann-Whitney (hereafter “MW”) test was used to compare the mean number of trophallactic events (given/receive) between foragers and non-foragers. The experimental distributions of the number of trophallactic events between castes were compared using a Kolmogorov-Smirnov (hereafter “KS”) test. The complete trophallactic network of each subcolony was built (e.g., Fig. 1). In this representation, each node corresponds to individuals, and an edge represents trophallactic events directed from the donor to the receiver.

We performed weighted and directed analyses. Our network analyses were performed at both the individual level and functional category (forager/non-forager) level. We calculated the degree centrality, eigenvector centrality, betweenness centrality and closeness centrality of each individual. Degree centrality is based on individuals’ number connections and can be seen as a general measure of how social an individual is⁴⁰. The betweenness is an estimator of how

important an individual ant is for promoting connectivity across the entire colony and is measured by the number of times an individual acts as a bridge along the shortest path between two other ants ⁴¹. The closeness is based on the shortest paths from an individual to every other individual; the more central an ant is, the lower its total distance is from all other ants ⁴⁰. The eigenvector is a value accounting for the centrality of a node's neighbours ⁴². The clustering coefficient determines the existence of “communities” in a network, such as node pairs with many more edges between them than other node pairs ⁴³.

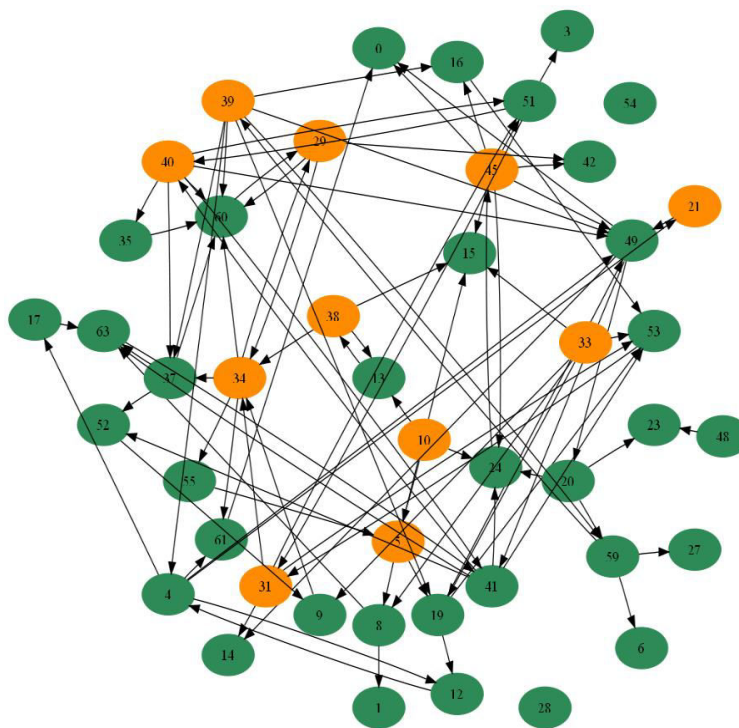

Figure 1. Example of an aggregated trophallactic network. Node = individual, directed black arrow = trophallactic exchange from the donor to the receiver. Orange = foragers, green = non-foragers.

At the global level, the efficiency of the trophallactic network, defined as the multiplicative inverse of the shortest path distance between all pairs of nodes, was calculated. The heterogeneity of the distribution of the trophallactic activity among all the workers of each experiment (N=5) was evaluated using the Lorenz curve and the Gini coefficient. Such a curve displays the share of trophallactic activity (Y axis) accounted for by the top x% of workers (sorted by the number of trophallactic events performed per individual) in the colony. A perfectly equitable distribution of foraging activity would correspond to the line $Y=X$. The Gini

coefficient is known as the ratio between the area below the experimental Lorenz curve and the triangular area below the perfect equality case $Y=X$ and provides a measure of the degree of inequality in the distribution of trophallactic activity, ranging from 0 (perfect equality) to 1 (perfect inequality).

To estimate whether the observed Gini coefficient values and the social network metrics experimentally measured were different from those under random expectations, each empirical network was compared against an ensemble of $N=1000$ randomised networks created by randomly rewiring all the edges between all the nodes, destroying all the features of the original network (Full Random network=FR)⁴⁴. The experimental proportion of each type of trophallactic couple (F->F, F->NF, NF->F and NF->NF) was compared with the ones generated by the FR (these were only based on the relative proportion of the Fs and NFs workers).

To evaluate whether the temporal structure of the trophallactic network facilitated spreading, the empirical network was compared against an ensemble of $N=1000$ temporally randomised networks. This ensemble was created by randomising the original trophallactic events with a randomly permuted times (RP) reference model⁴⁴, which shuffled the times among the original trophallactic contacts. Temporal randomisation destroys temporal correlation but maintains all other features, including the number of trophallactic events and nodes and the topology of the original network leading to the creation of a temporally randomised network. To assess the effect of network temporal structure on the spreading speed, we compared the time when 50% of the ants performed their first trophallactic events in the empirical network and the theoretical corresponding one.

To evaluate the spatial distribution of the trophallactic events at the individual level, we calculated the spatial position of the gravity centre of the polygon resulting from all the trophallactic events for each individual. Then, still at the individual level, we measured the average distance of each trophallactic event from this gravity centre and compared it between all the foragers and non-foragers.

A Z-test (hereafter "ZT") was then performed to evaluate the significance of the differences between the observed and random metrics from the FR and RP reference networks. To estimate the density and the spatial location of ant aggregates inside the nest, we divided the nest area into 30 cells of equal area (9.33×8.22 , equivalent to two ants length) in which the number of ants was

automatically counted and accumulated by the USETracker software every 10 mins over the duration of the experiment. All analyses were conducted with Python 3.6 with the NetworkX.2.1, PyGraphviz 1.4, NumPy 1.14, SciPy 1.0.0 and Matplotlib 2.2 packages. The threshold for significance was set at $p < 0.05$.

Results

Global results

The subcolonies (N=5) were composed of 53.4 \pm 5.2 ants of which 44.2 \pm 1.6 ants were active trophallactic participants (participated in at least one trophallactic event) and performed a total of 99.0 \pm 17.4 trophallactic interactions. A summary of the trophallactic activity at the colony and caste levels is given in Table 1 (see also Table S1). The colonies were homogeneous in terms of trophallactic activity/network parameters and caste composition. Therefore, for clarity, we merged and averaged the experimental results of the 5 colonies in the rest of the paper (Table S2).

		Foragers	Non-foragers	Mann-Whitney
Number of individuals		12.2 (1.9)	41.2 (5.9)	$p=0.006$ ($U=0.0$)
Number of trophallactic events	Total per colony	77.4 (22.7)	120.6 (16.5)	$p=0.001$ ($U=8.0$)
	as donors	60.2 (15.2)	38.8 (8.9)	$p=0.02$ ($U=2.5$)
	as recipients	17.2 (8.0)	81.8 (9.7)	$p=0.006$ ($U=0.0$)
	Mean per colony	6.3 (2.9)	2.9 (2.7)	$p<1.10^{-5}$ ($U=0.0$)
	as donors	4.9 (2.7)	0.9 (1.4)	$p<1.10^{-5}$ ($U=1194.0$)
	as recipients	1.4 (1.4)	2.0 (1.8)	$p=0.012$ ($U=5113.0$)
Social network metrics	Betweenness	0.06 (0.06)	0.03 (0.04)	$p<1.10^{-5}$ ($U=2319.0$)
	Closeness	0.33 (0.23)	0.3 (0.34)	$p=0.001$ ($U=3049.0$)
	Eigenvector	0.15 (0.09)	0.11 (0.07)	$p<2.10^{-5}$ ($U=2324.0$)
	Clustering	0.11 (0.15)	0.09(0.20)	$p=0.001$ ($U=3653.5$)

Table 1. Details of the trophallactic activity and social network metrics per colony and caste. Values = mean from experiments (N=5), parentheses = s.d. See Table S1 for more details.

Individual trophallactic activity and global pattern of exchanges between foragers and non-foragers:

The population of ants that had not yet been involved in a trophallactic event (naïve ants) decreased exponentially as a function of time with a mean time equal to 35 mins (Fig. 2.A, Spearman , $R^2=0.996$, $p<0.001$). This suggests that the individual probability of joining the trophallactic network was constant. This decrease was faster in the experimental network than in the RP networks, which were temporally randomised (Fig. 2.B, ZT, $p<0.001$ in each case, see also Fig. S4). In each experiment, the Lorenz curves showed a strong heterogeneity in the distribution of the trophallactic activity within the ants: ~ 20% of the total population performed more than 60% of the trophallactic events (Fig. 3.A). This heterogeneity was more marked than the theoretical heterogeneity obtained from purely random exchanges, such as in the FR networks, even when we discarded the data from the inactive ants (Fig. 3.A). In every experiment, the Gini coefficient was significantly larger than the one resulting from purely random exchanges (Fig. 3.B, ZT, $p < 0.04$ in each case, see also Fig. S5). There was a strong heterogeneity in the number of partners of trophallactic events and a linear correlation between the number of trophallactic partners and the number of trophallactic events performed (Fig. 3.C, $R^2=0.92$, $p<0.05$). Most of the individuals performed only one or two trophallactic events during an experiment (Fig. 3.C), and there was no correlation between the number of times an individual was the donor or the receiver of trophallactic events (Fig. S6). The number of times each trophallactic pair met did not differ from a FR network distribution (Fig. 3.D, ZT, $Z=0.03$, $p= 0.38$).

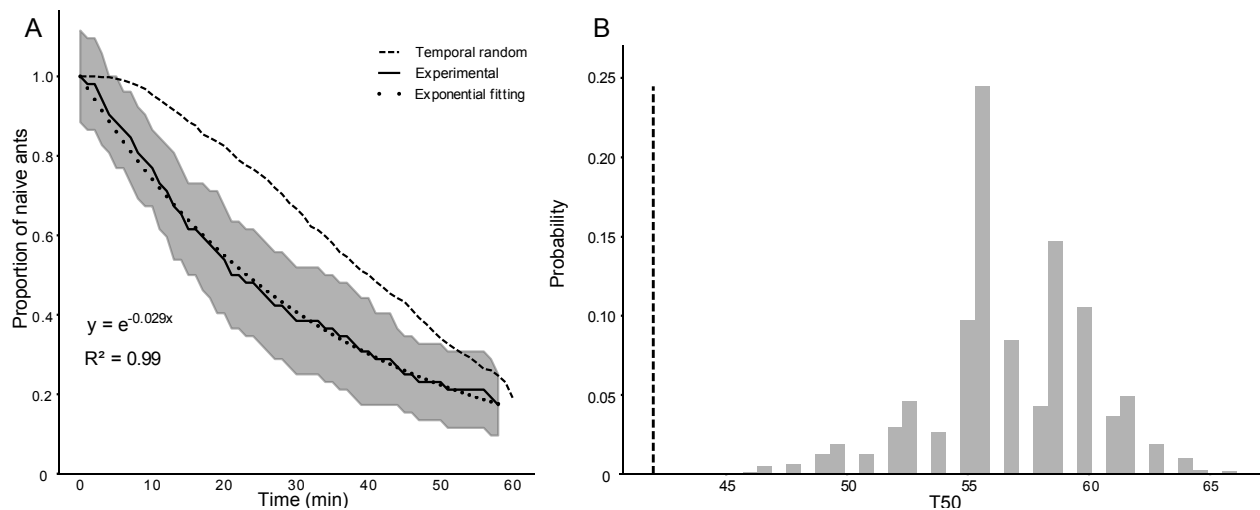

Figure 2.A. Survival curves of the proportion of the naïve ants (that still had not performed any trophallactic events) in the experimental networks (full black line = mean from experiments, grey area = standard deviation, N=5 experiments) and in the RP reference networks (temporal randomisation, dashed black line, mean from N=1000 for each experiment). Dotted black line = exponential fitting. **B.** Example from one experiment: empirical (vertical dotted line) and theoretical distributions (grey bar, from 1000 RP reference networks) of the T_{50} for the half of the population that performed at least one trophallactic exchange, ZT: $Z=-4.51$, $p < 0.0001$. See Fig. S4 for details of the other experiments.

Intracaste distributions and characteristics of the trophallactic activity:

The experimental proportions of given and received trophallactic exchanges between both foragers and non-foragers were different from the theoretical proportions resulting from the FR networks, taking into account the proportions of foragers and non-foragers (Fig. 4. Chi²: $p < 1.10 \cdot 10^{-4}$). The experimental Gini coefficients of both given (Fig. 5.A) and received trophallactic events (Fig. 5.B) among the non-foragers were significantly different from the distribution of the Gini coefficient in the FR networks (ZT, $p=0.028$ and $p=0.022$, respectively). Regarding the foragers, the Gini coefficient tended to be different between the experimental and randomised networks (ZT, $p=0.067$ and $p=0.073$, respectively; see Figs. 5.C-D for details).

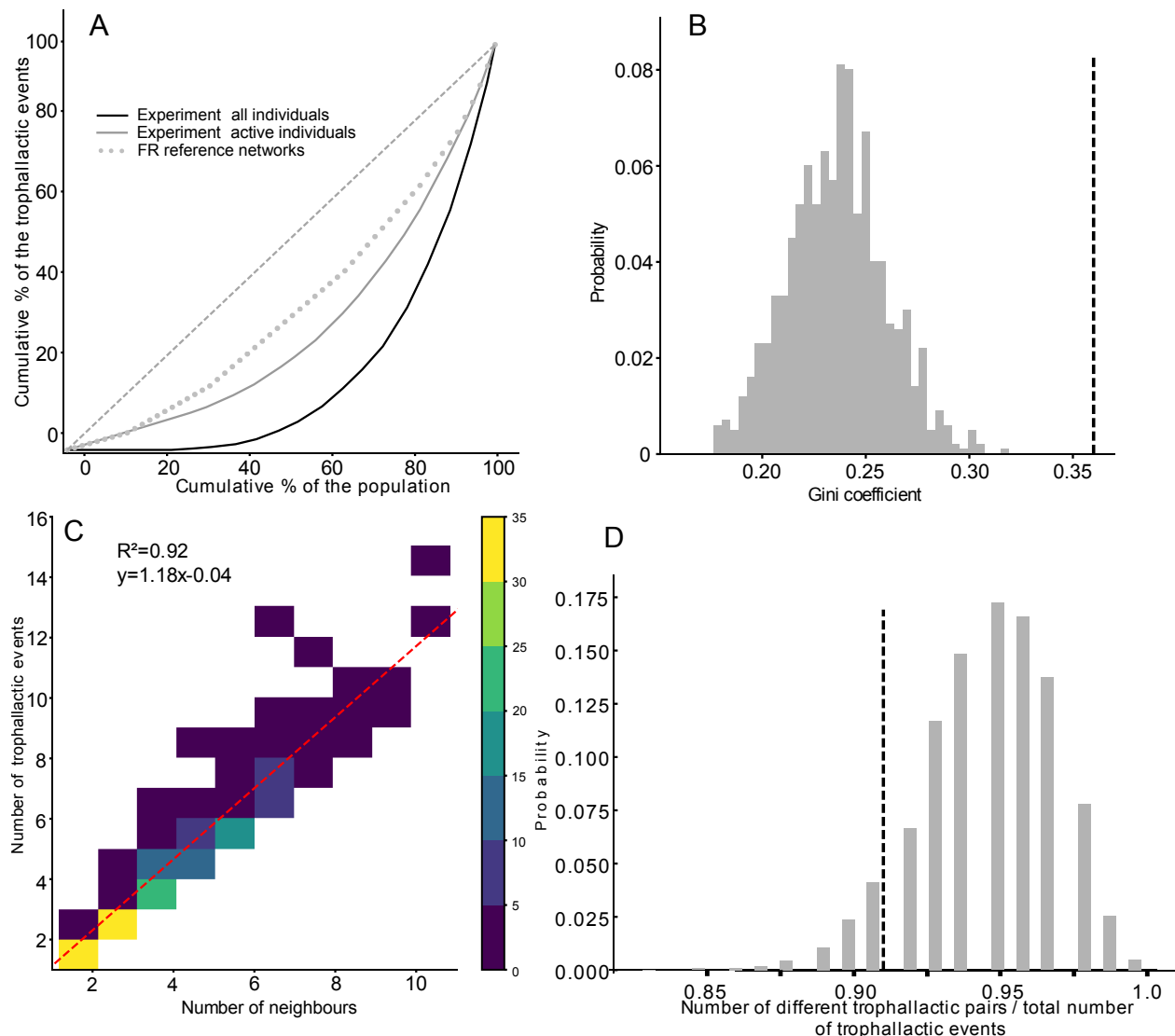

Figure 3.A. Mean Lorenz curves showing the cumulative percentage of all trophallactic events (y axis) vs. the percentage of the population (x axis, sorted by the number of trophallactic events performed per trial per each worker), when considering all the colony members (active and inactive, black line) or only the individuals having performed at least one trophallactic event (active, grey line). The grey dotted line represents the distribution activity from the FR network. **B.** Distribution of the Gini coefficient measured in N=1000 FR reference networks (grey bars) and the experimentally measured value of all active ants (vertical dashed line) in one experiment. See also Fig. S6. **C.** Correlation between the number of trophallactic events and the number of neighbours, for each individual. The colour bar indicates the number of individuals. **D.** Ratio between the total number of trophallactic pairs and the total number of trophallactic interactions. Vertical dashed line = mean experimental ratio (N=5). Grey bars = theoretical distribution from FR reference networks (N=1000).

A larger portion of the non-foragers did not participate in any trophallactic events compared to the foragers, and the distributions of the total number of trophallactic events of foragers and non-foragers were different (Fig. 6.A., KS; $p < 0.0001$). The distributions of the given (received) trophallactic events of foragers and non-foragers were different (similar) (Fig. 6.B., KS; $p < 0.0001$; Fig. 6.C., KS; $p = 0.1632$). The number of trophallactic events given was correlated to the number of visits to the food source; on average, after a visit at the food source, a forager participated in two trophallactic events (Fig. S6.A), and the later a forager visited the food source for the first time the fewer times she would subsequently visit it (Fig. S7.B). Additionally, the later a forager (non-forager) commenced her first trophallactic event, the fewer times she would give (receive) food through a trophallactic interaction (Figs. S7.C-D). The analysis of the balance of the trophallactic events (given minus received) of each individual revealed that the foragers gave food through more trophallactic events than they received while the non-foragers received more food than they gave (Fig. 6.D-E, KS, $p < 1.10^{-5}$).

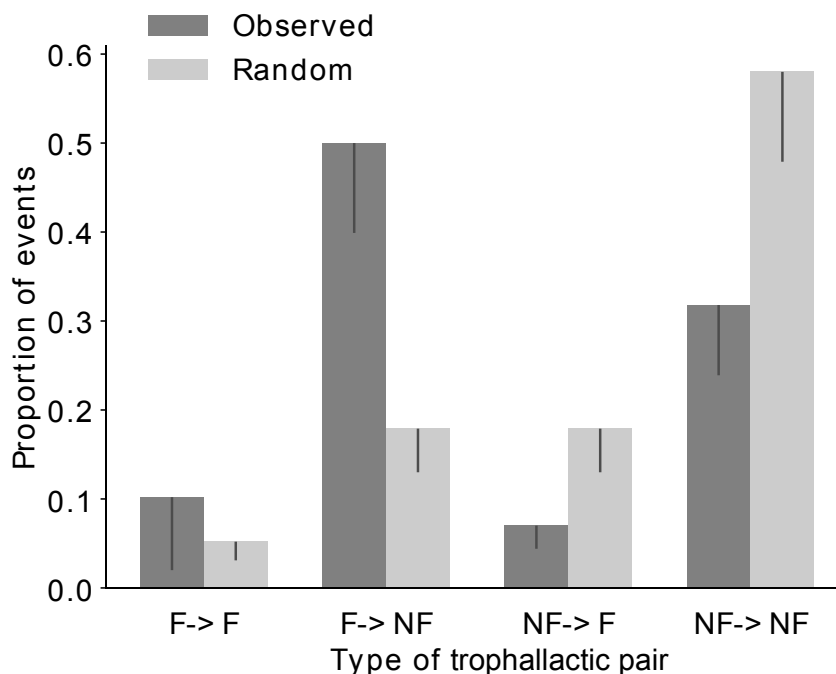

Figure 4. Comparison of the theoretical distribution of the trophallactic events based on a homogenous repartition of the trophallactic events between all the ants with observed distributions.

Social network analysis and dynamics of food dissemination:

The foragers had higher betweenness, closeness, eigenvector and clustering coefficients than non-foragers (Table 1, MW; $p < 0.002$ in each case). At the colony level, none of these parameters nor the efficiency parameter differed from the ones measured in the randomised FR networks (Figs. S8-12, ZT, $p > 0.5$ in each case). The T_{50} of the first given trophallactic events of foragers (41.6 \pm 1.8 min) was significantly lower than the T_{50} of the first given trophallactic events of the non-foragers (66.0 \pm 6.7 min, MW; $p = 0.0058$, Fig. S13.A). This difference is still relevant for the T_{75} (MW; $p = 0.0059$) and T_{95} (MW; $p = 0.01$). The T_{50} of the first received trophallactic events of the foragers (45.0 \pm 1.7 min) was also significantly lower than the T_{50} of the non-foragers (57.0 \pm 3.7 min, MW; $p = 0.0056$, Fig. S13.B). This difference was not relevant when considering the T_{75} and T_{95} (MW, $p > 0.264$ in each case).

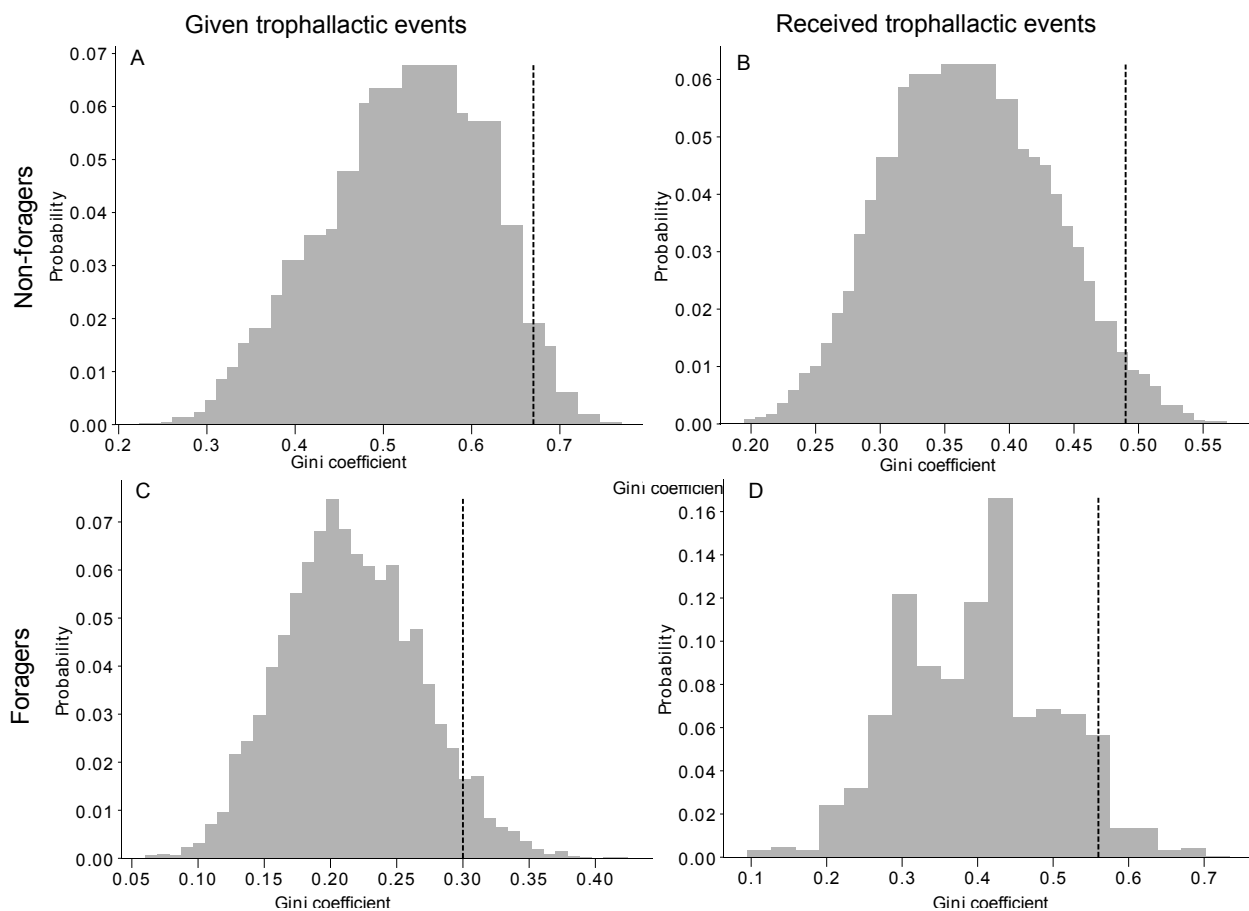

Figure 5. Mean observed (vertical dotted line, $N=5$) and theoretical distribution (grey bar, $N=5 \times 1000$) of the Gini coefficient of the trophallactic events given (Fig. 6.A, ZT, $Z=1.91$, $p=0.028$) and received (Fig. 6.B, ZT, $Z=2.00$, $p=0.022$) by the non-foragers and the trophallactic events given (Fig. 6.C, ZT, $Z=1.49$, $p=0.067$) and received (Fig. 6.D, ZT, $Z=1.45$, $p=0.073$) by the foragers.

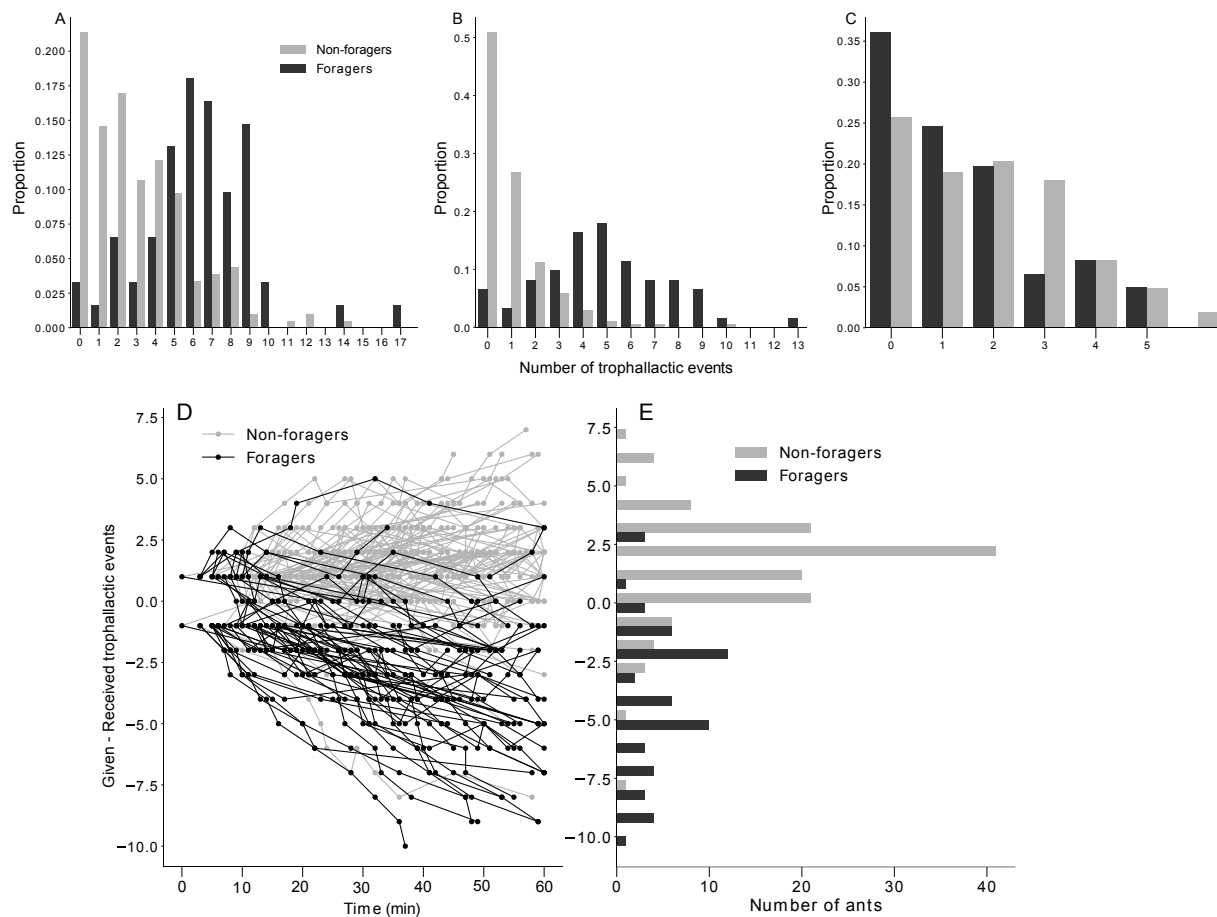

Figure 6. Distribution of the number of trophallactic events done within non-foragers (NF) and foragers (F). **A.** All the trophallactic events. **B.** Given trophallactic events. **C.** Received trophallactic events. **D.** Dynamical trophallactic events statement of each individual (Received=+1, Given=-1). **E.** Distribution of the final statement of non-foragers and foragers, KS, $D=0.76$, $p < 1.10^{-5}$.

Analysis of the spatial distribution of the trophallactic events:

Trophallactic events inside the nest were non-homogeneously spatially distributed (Fig. S14, ZT; $p < 0.0002$). The spatial locations of the trophallactic events and aggregates of ants were significantly correlated (Fig. S15). The foragers gave 33.2% (100/301) of their trophallactic events in the foreground part of the nest (the half the nest next to the nest entrance), a percentage significantly higher than that of the non-foragers (17.8%, 42/236, χ^2 , $p = 0.0074$). The mean distance of the trophallactic events performed by an ant to the gravity centre of the polygon resulting from the spatial position of all its trophallactic interactions (see material and method section) of the foragers (1.49 \pm 0.58 cm) was significantly larger than that of all the non-foragers

(1.01±0.65 cm) (Fig. 7.A, MW; $p=1.2 \cdot 10^{-6}$) and that of the non-foragers that gave and received food (MW, $p=0.00021$; Fig. 7.B). This last mean distance (1.13 ± 0.66 cm) was significantly larger than the mean distance of the non-foragers that only received food (Fig. 7.C, only receive = 0.71 ± 0.53 cm, MW; $p=7.4 \cdot 10^{-4}$). Between the first 10 mins and the last 10 mins of the experiments, the distance to the nest entrance where trophallactic events occurred increased (from 2,75 cm to 3,25 cm for the foragers; from 3 cm to 3.5 cm for the non-foragers) (Fig. 7.D).

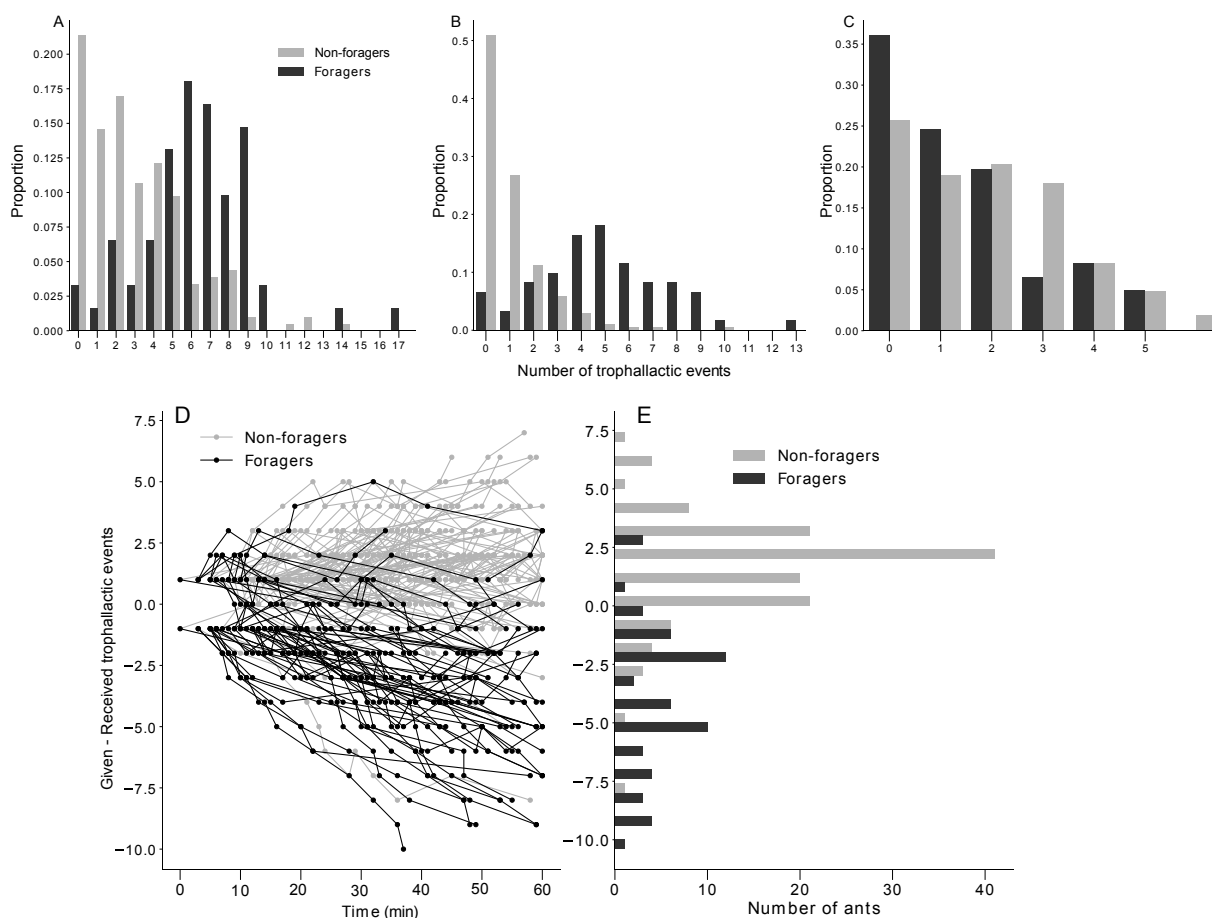

Figure 6. Distribution of the number of trophallactic events done within non-foragers (NF) and foragers (F). **A.** All the trophallactic events. **B.** Given trophallactic events. **C.** Received trophallactic events. **D.** Dynamical trophallactic events statement of each individual (Received=+1, Given=-1). **E.** Distribution of the final statement of non-foragers and foragers, KS, $D=0.76$, $p < 1.10^{-5}$.

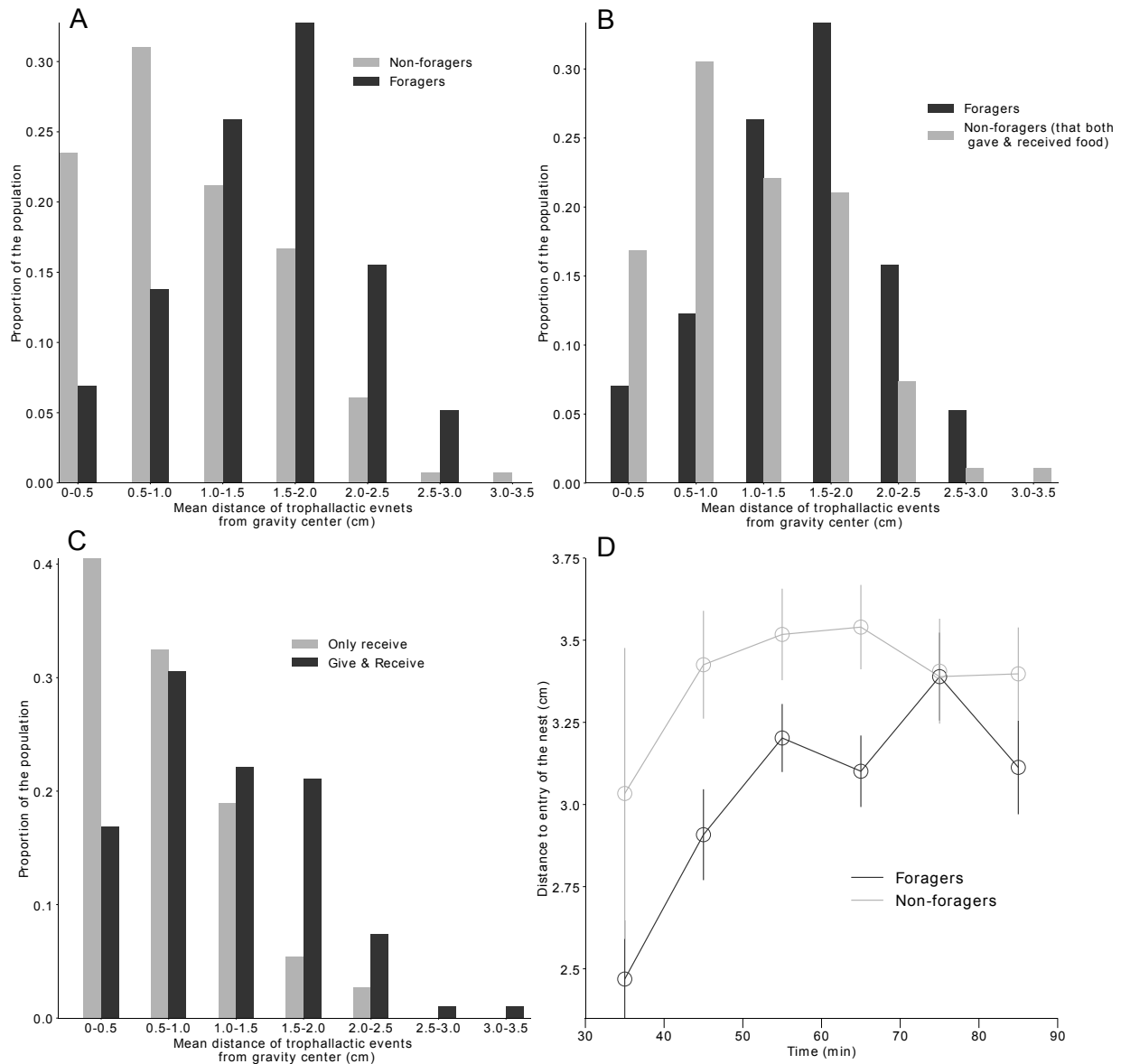

Figure 7.A. Distribution of the mean distance of each trophallactic event from the gravity center of all the trophallactic interactions per ant. **B.** Distribution of the mean distance of trophallactic events from the gravity center of non-foragers considering whether they only received or gave and received food during trophallactic events. **C.** Distribution of the mean distance of trophallactic events from the gravity center for foragers and non-foragers who gave food in at least one trophallactic event. **D.** Distribution of the distances of the trophallactic events initiated relative to the entrance of the nest over time.

Discussion

In this study, we quantitatively analysed the dynamics and the network of food dissemination in colonies of *L. niger* provided with a food source (1 M sucrose solution) after 4 days of starvation. The experimental food spreading rate inside the nest here reflected by the involvement rate of individuals in trophallactic activity is approximately 50% faster than in a temporally randomised network, as has also been observed in honeybee colonies ⁴⁵.

At the colony level, the observed heterogeneity of the trophallactic activity among all individuals is in accordance with most of the literature on the activity distribution among eusocial insect workers ⁴⁶⁻⁵⁰. Additionally, at the individual level, no link was established between the number of given and received trophallactic events. The linear relationship between the number of trophallactic partners and the number of trophallactic events per individual suggests that there are no privileged pairs, with most of the pairs being observed once. Moreover, the comparison between experimental pairs and the ones resulting from theoretical simulations revealed that these pairs are randomly created. This last result supports the hypothesis that the rules governing the pair formations are not at the origin of the difference between the food spreading rate in the observed and randomised networks. Therefore, the individuals inside the nest seem to be anonymous for their conspecifics ⁵¹ and interact opportunistically without apparent individual recognition. The well-known spatial fidelity in ants ²⁶ could have led to privileged trophallactic partners, even in the absence of individual recognition, a phenomenon that did not occur in our experiments. These random encounters are likely to contribute to the resilience of the trophallactic network ⁴⁵.

Several differences were observed between the trophallactic activity of the castes of foragers and non-foragers, although this classification only results from the rough criteria of at least feeding once at the sucrose source. The first noticeable difference, supported by our experimental and theoretical results, concerned the individual rate of donation, which was higher for foragers than for non-foragers. However, the food acquisition rate was quite similar between the castes. At the intracaste level, the Gini coefficient showed that the distribution of the number of given and received trophallactic events performed by the non-foragers tended to be more heterogenous than the ones resulting from the randomised networks. The corresponding distributions for the

foragers tended to present the same level of heterogeneity. On average, a forager visiting the food source subsequently performed two trophallactic events. The linear correlation between the number of visits and the time of the first visit to the food source as well as the correlation between the number of trophallactic events and the time of the first trophallactic event of the foragers showed a constant rate of foraging and trophallactic activity. These results support the hypothesis that the forager probability of leaving the nest was the determining factor underlying the heterogeneity of the trophallactic activity among the foragers. Similarly, the trophallactic activity of the non-foragers and the heterogeneity between them was determined by the time of their first trophallactic interaction.

The trophallactic network and the global dynamics of the food exchanges were the result of the interactions between castes and idiosyncratic individuals. In this network, the foragers showed a higher trophallactic activity (number of trophallactic events per individual), exchanged food faster and had larger network indexes (betweenness, closeness and eigenvector coefficients) than did the non-foragers. These results show that the foragers not only brought the food into the nest but also occupied a central position in the network; therefore, they were the major actors in food dissemination within the nest. Foragers represented 20% of the population, while they performed more than 60% of interactions as donors. Approximately 50% of the trophallactic interactions occurred between foragers and non-foragers, but only 30% of the food exchanges occurred within the non-foragers. Despite the major role of the foragers and the heterogeneity in the trophallactic activity, the high level of randomness in the trophallactic pair formation may prevent highlighting any differences between the empirical network indexes and those characterising random networks. In addition to the social position of individuals within the trophallactic network, we were also interested in how trophallactic interactions are spatially distributed. We revealed a correlation between the spatial location of the trophallactic events and ant aggregates, suggesting a dependency between the spatial pattern of the ants and the trophallactic network. This correlation could result from the interplay between two different spatial behaviours specific to the foragers and non-foragers: the non-foragers tended to be gregarious, while the foragers displayed more exploratory behaviour. The foragers' mean distance of the trophallactic events to their gravity centre was longer than that of the non-foragers that gave food at least one time, which, in turn, is longer than that of non-foragers that only received food. This finding is in accord with another result: the foragers that brought food

back to the nest acted donors more frequently at locations close to the nest entrance than did the non-foragers. After 30 mins of food collection, both foragers and non-foragers performed their trophallactic interactions in the same area, far from the nest entrance. This is in agreement with previous studies showing a similar evolution of the spatial distribution of trophallactic interactions along with colony satiation ^{3,36}.

In this paper, we developed a methodological and analytical framework of food dissemination processes in ant colonies. Through the quantification of trophallactic activity and the resulting network of food exchanges inside the nest, we have gained insights into how food retrieval is organised at the individual, caste and colony levels. The “rough” classification of foragers / non-foragers, based on at least one visit to the food source, proved to be relevant because it highlighted differences in the food-exchange behaviours between these two groups inside the nest. Similarly, the time of the first visit to the food source or the time of the first trophallactic interaction turned out to be a determining factor at the origin of the heterogeneity of the trophallactic activity. At the spatial level, the occupancy patterns differed between the non-foragers and the foragers, the latter displaying larger food area distributions. We also showed that the trophallactic exchanges were correlated with the spatial positions of the ant aggregates that could facilitate trophallactic pair formations ⁴. Moreover, at the colony level, we found no difference between the empirical and randomised trophallactic networks, indicating the absence of marked social structure. The random character of the empirical network could be at the basis of a robust food dissemination process. However, it is important to note that our results could be due to our experimental setup which utilised a one-chamber nest and one 1 M sucrose food source in addition to colonies composed of a small group of workers with no queen and no brood. To test the robustness of our results, further experiments taking into account these parameters are needed. Additionally, key questions concerning the consistencies of the individual and colonial patterns of trophallactic activity and their relationships remain open and should be clarified through successive trials ^{46,52}. Finally, theoretical investigations could shed light on the still unclear relationship between the spatial behaviour of individuals and the subsequent food dissemination dynamics ⁵³.

Supplementary Information

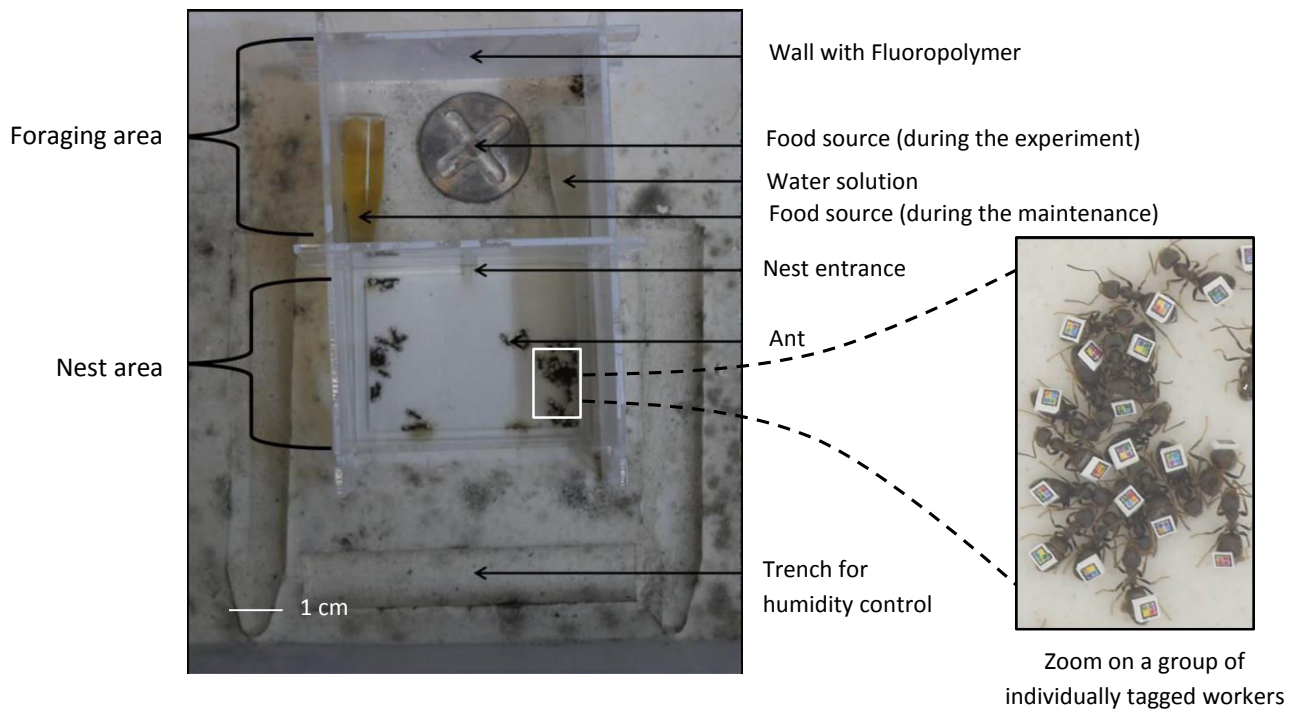

Figure S1. Top view of the experimental setup.

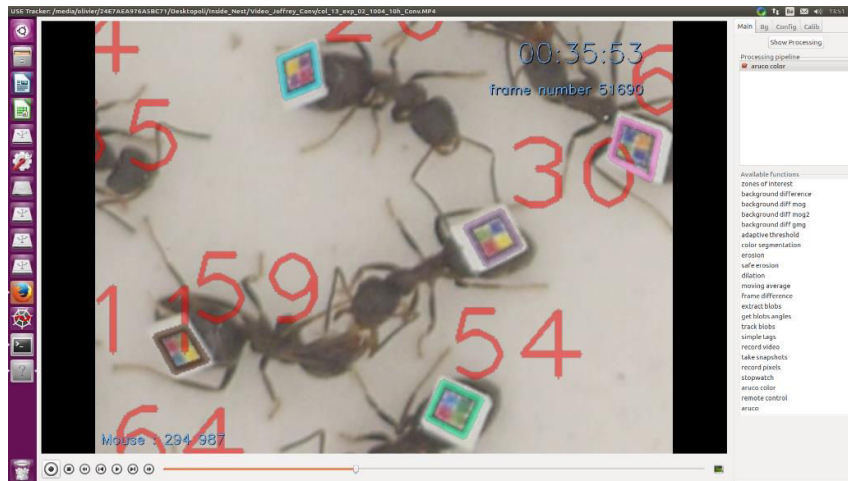

Figure S2. Screen capture for the tracking software USETracker illustrating the individual 50 receiving food from the individual 30. The individual 30 opened his mandibles and displays a droplet of sucrose solution between them while the individual 59 turns and moves forward his head to receive it.

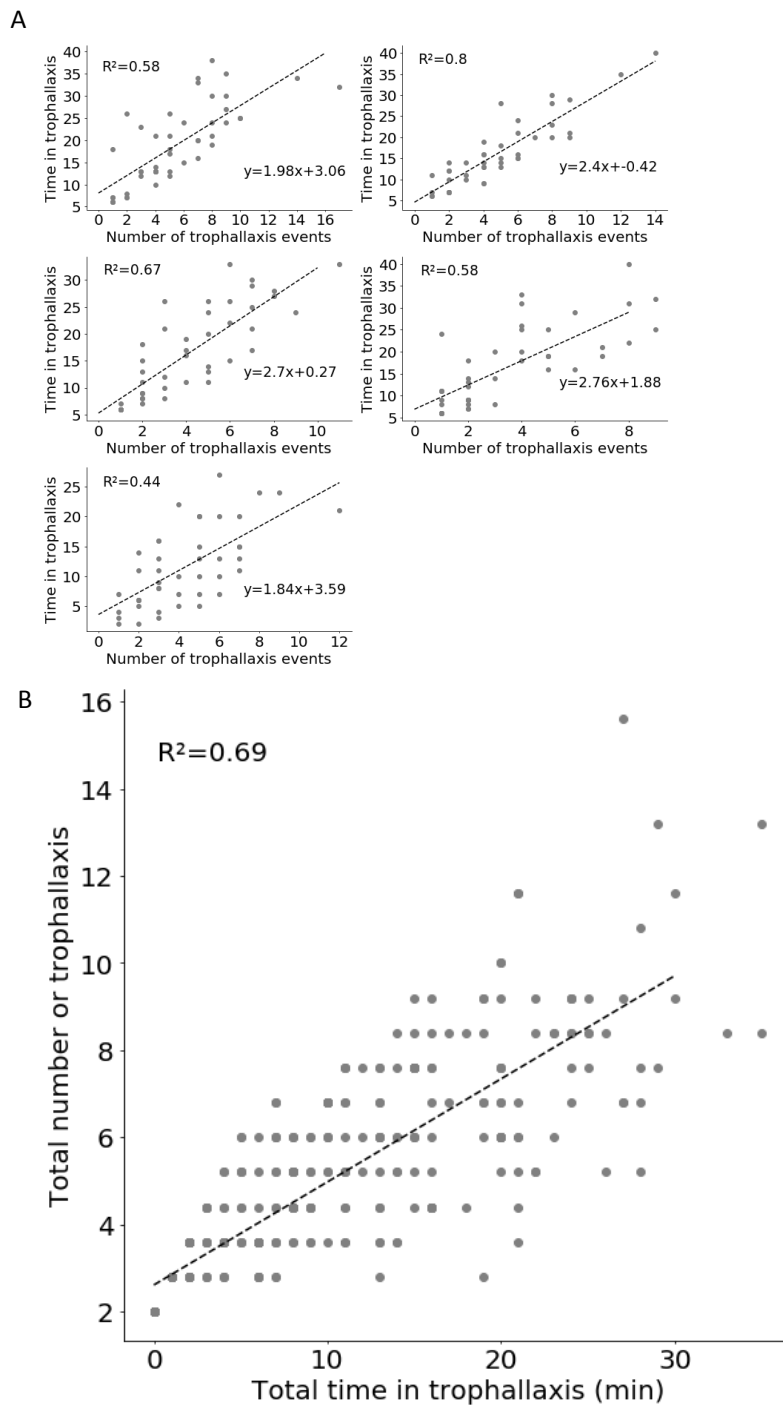

Figure S3. Correlation between the number of trophallactic events and the time spent in trophallactic interactions. **A.** For each subcolony **B.** Mean from the five subcolonies merged.

Subcolonies	1	2	3	4	5
Total number of ants	58	45	50	57	57
Number of active ants	47	43	43	44	44
Number of foragers	14	11	14	9	13
Number of non foragers	44	34	36	48	44
Number of initiator	35	34	28	27	34
Number of recipients	41	40	36	35	40
Total number of trophallactic events	129	104	90	77	95
Trophallactic event given by foragers	89	52	62	47	51
Mean trophallactic event given by F	6.36	4.73	4.77	5.22	4.25
Standard deviation of trophallactic events given by foragers	3.22	2	2.26	2.62	1.69
Trophallactic event given by foragers	40	52	28	30	44
Mean trophallactic event given by F	1.21	1.62	0.93	0.86	1.38
Standard deviation of trophallactic events given by foragers	1.49	2.01	1.18	0.96	1.41
Statistic Mann-whitney trophallactic events given between foragers and non foragers	26	43	39.5	32.5	31.5
<i>p-value</i> Mann-whitney trophallactic events given between foragers and non foragers	0	0.00008	0.00001	0.00008	0.00001
Trophallactic event received by foragers	32	16	13	8	17
Mean trophallactic received given by F	2.29	1.45	1	0.89	1.42
Standard deviation of trophallactic events received by foragers	2.02	1.08	1.11	1.1	1.19
Trophallactic event received by foragers	97	88	77	69	78
Mean trophallactic received gave by F	2.94	2.75	2.57	1.97	2.44
Standard deviation of trophallactic received given by foragers	1.61	1.94	1.8	1.46	1.32
Statistic Mann-whitney trophallactic events received between foragers and non foragers	190.5	97	82.5	88.5	109
<i>p-value</i> Mann-whitney trophallactic events received between foragers and non foragers	0.17245	0.01222	0.00124	0.02032	0.01271
Mean of the degree for foragers	0.19	0.15	0.14	0.14	0.13
Standard deviation of foragers degree	0.07	0.05	0.05	0.06	0.04
Mean of non foragers degree	0.09	0.1	0.08	0.07	0.09
Standard deviation of the degree for non foragers	0.05	0.07	0.05	0.04	0.06
Statistic of Mann Whitney for the degree between foragers and non foragers	62.5	94	89.5	49.5	90
<i>p-value</i> of Mann Whitney for the degree between foragers and non foragers	0.00004	0.01104	0.00253	0.00073	0.00344
Mean of the betweenness for foragers	0.06	0.06	0.06	0.1	0.06
Standard deviation of foragers betweenness	0.04	0.05	0.03	0.08	0.04
Mean of non foragers betweenness	0.02	0.04	0.03	0.03	0.03
Standard deviation of the betweenness for non foragers	0.03	0.05	0.04	0.05	0.05

Statistic of Mann Whitney for the betweenness between foragers and non foragers	95	118	88.5	70.5	101
<i>p-value</i> of Mann Whitney for the betweenness between foragers and non foragers	0.0008	0.05437	0.0025	0.00495	0.00847
Mean of the closeness for foragers	0.35	0.28	0.35	0.46	0.34
Standard deviation of foragers closeness	0.11	0.05	0.16	0.24	0.07
Mean of non foragers closeness	0.29	0.21	0.33	0.38	0.28
Standard deviation of the closeness for non foragers	0.34	0.23	0.38	0.4	0.31
Statistic of Mann Whitney for the closeness between foragers and non foragers	142.5	78	147	132.5	95
<i>p-value</i> of Mann Whitney for the closeness between foragers and non foragers	0.01944	0.0032	0.09947	0.23063	0.00525
Mean of the eigenvector for foragers	0.18	0.15	0.18	0.2	0.18
Standard deviation of foragers eigenvector	0.08	0.08	0.06	0.1	0.06
Mean of non foragers eigenvector	0.1	0.12	0.11	0.1	0.11
Standard deviation of the eigenvector for non foragers	0.07	0.09	0.07	0.07	0.07
Statistic of Mann Whitney for the eigenvector between foragers and non foragers	104	128	92	65	73
<i>p-value</i> of Mann Whitney for the eigenvector between foragers and non foragers	0.00163	0.09305	0.00336	0.00371	0.0009

Table S1. Overview of the different characteristics of the five colonies.

Indices	Kruskall-Wallis	
	<i>H</i>	<i>p</i>
Degree	0.70	0.95
Out Degree	1.80	0.77
In Degree	0.66	0.95
Betweenness	9.10	0.06
Closeness	4.0	0.41
Eigenvector	0.93	0.91
	Chi-square	
	χ^2	<i>p</i>
Ratio F/NF	2.4	0.64

Table S2. Homogeneity of trophallactic networks characteristics and castes.

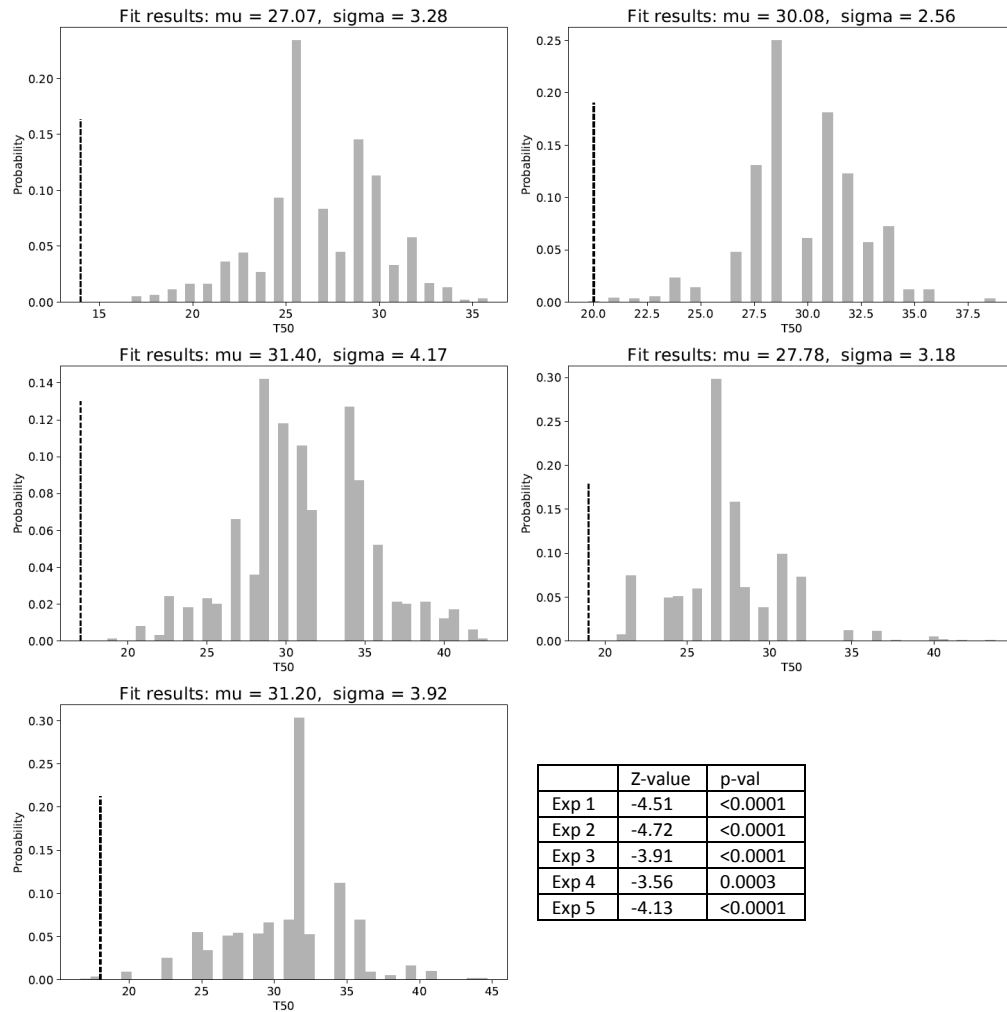

Figure S4. T_{50} needed to half the population performed at least one trophallactic event in each experiment (vertical dashed line) and in the corresponding randomized network (grey bar, $N=1000$). Table shows the statistical values of the Z-Test comparing each experimental value to the distributions of the randomized ones for in each colony.

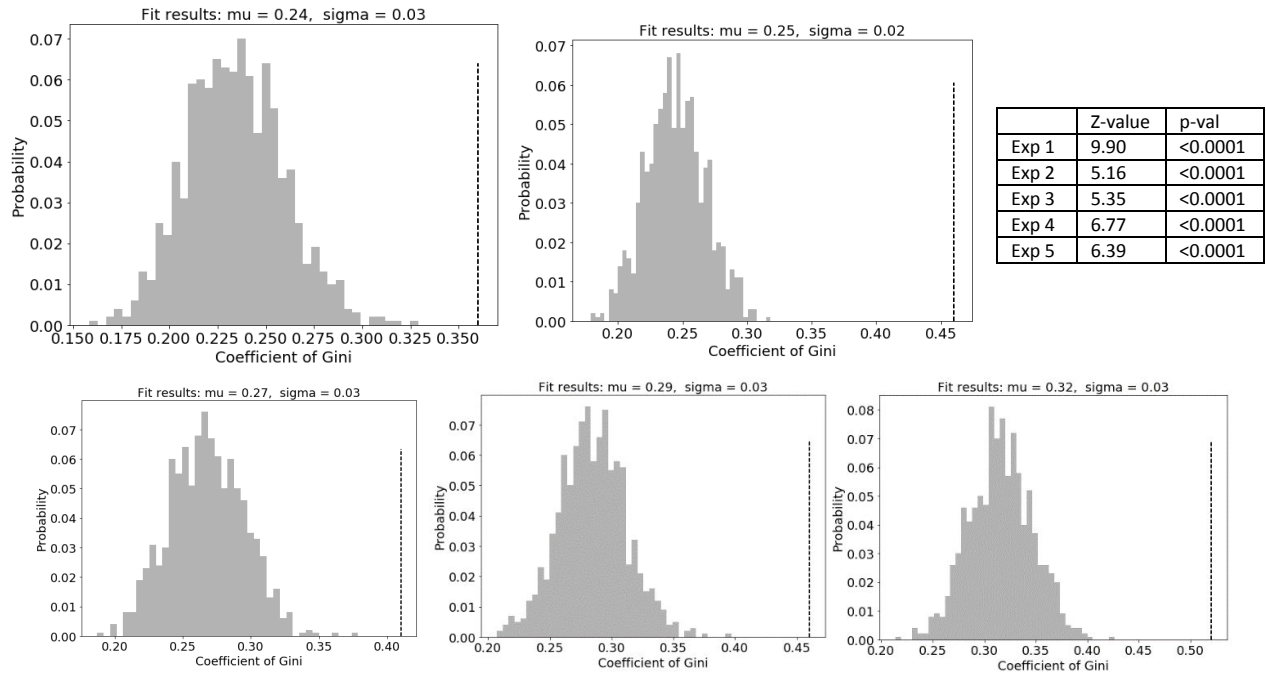

Figure S5. Gini coefficient experimentally measured value of all active ants (vertical dotted line) and the distribution from the FR randomized networks (grey bars, N=1000) for each colony. Table shows the statistical values of the Z-Test comparing each experimental value to the distribution of the randomized one for in each colony.

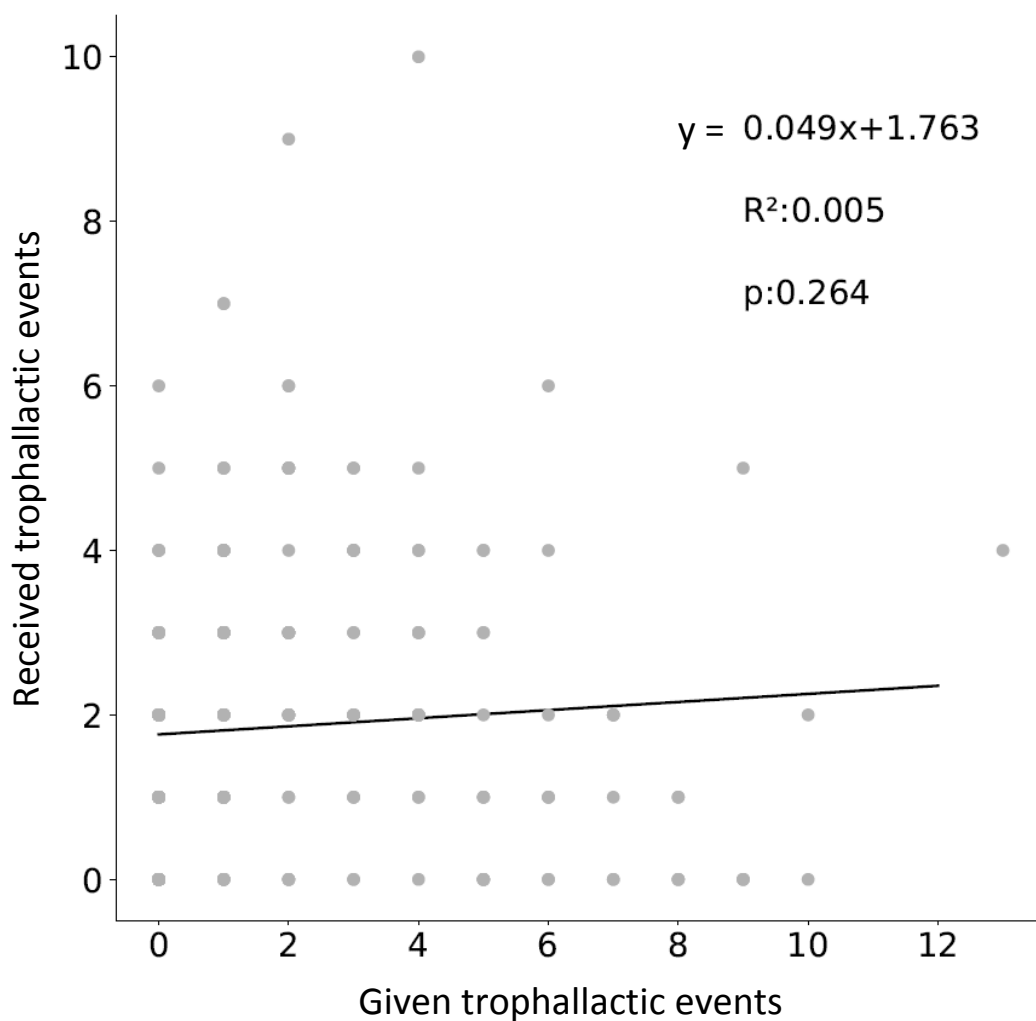

Figure S6. Correlation between the number of given and received trophallactic interactions per individual.

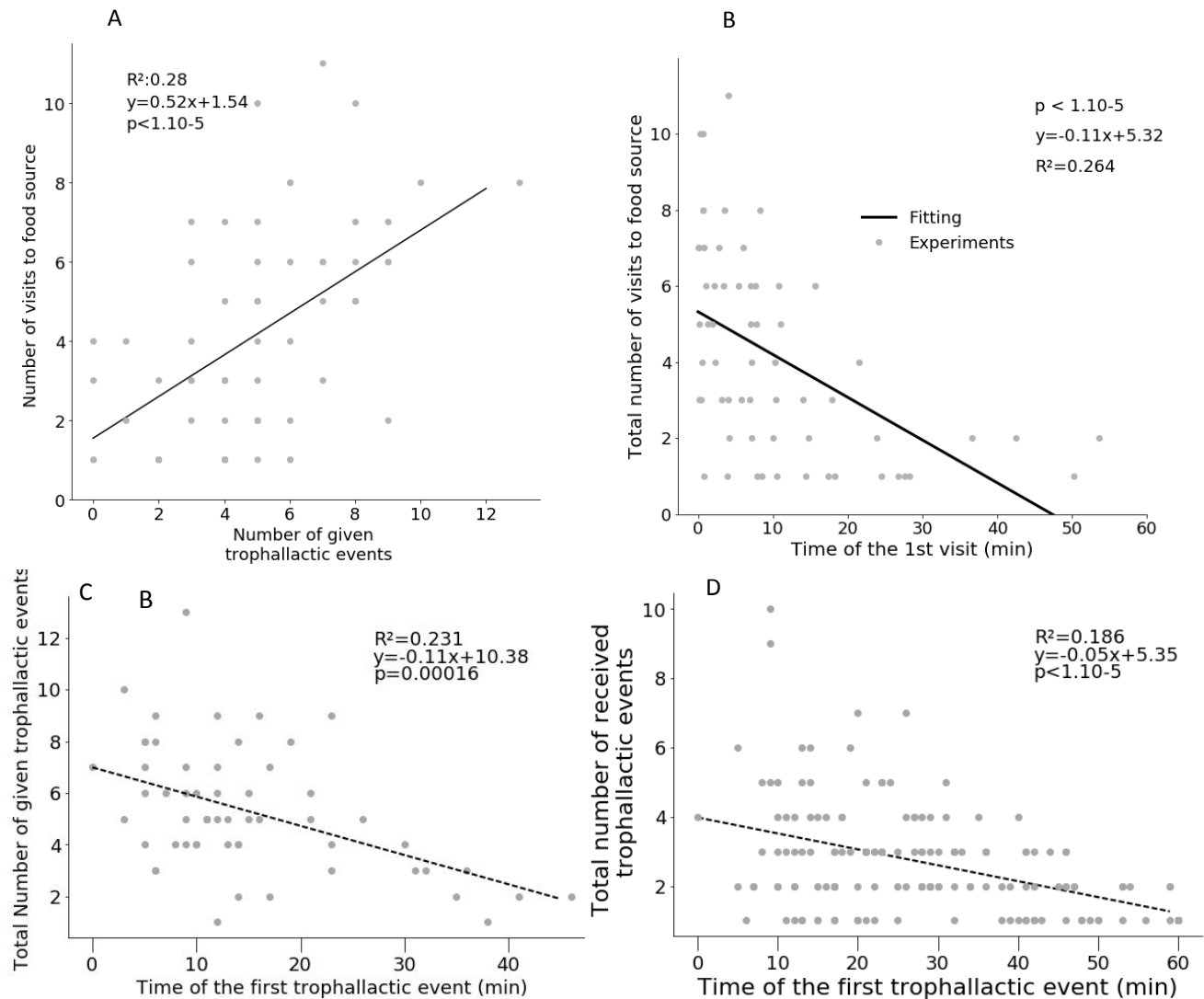

Figure S7.A. Correlation between the number of visits to the food source and the number of given trophallactic events. **B.** Correlation between the time of the 1st visit to food source and the total number of visit to food source. **C.** Correlation between the total number of given trophallactic events per forager and the time it performed its first trophallactic exchange. **D.** Correlation between the total number of received trophallactic events per non forager and the time it performed its first trophallactic exchange.

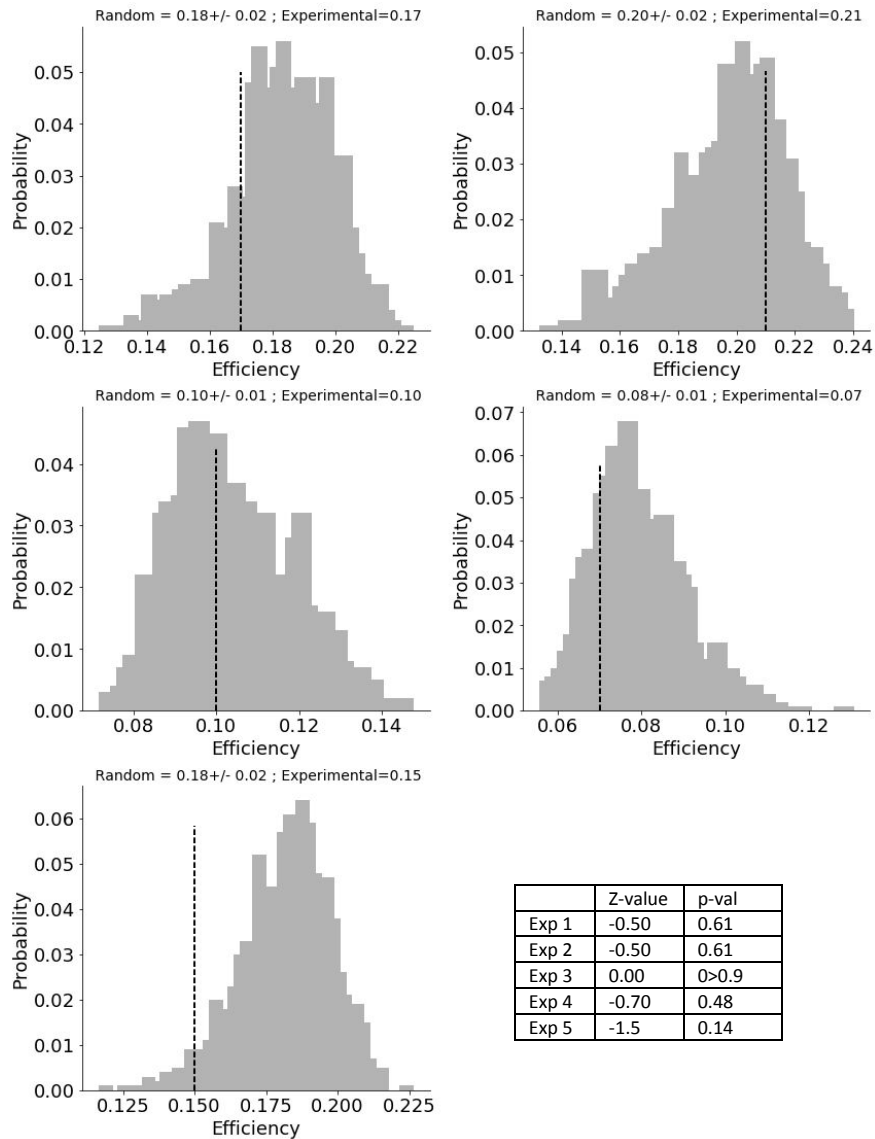

Figure S8. Efficiency coefficient experimentally measured (vertical dotted line) and the distribution from FR randomized networks (grey bars, N=1000) for each colony. Table shows the statistical values of the Z-Test comparing each experimental value to the distribution of the randomized one for in each colony.

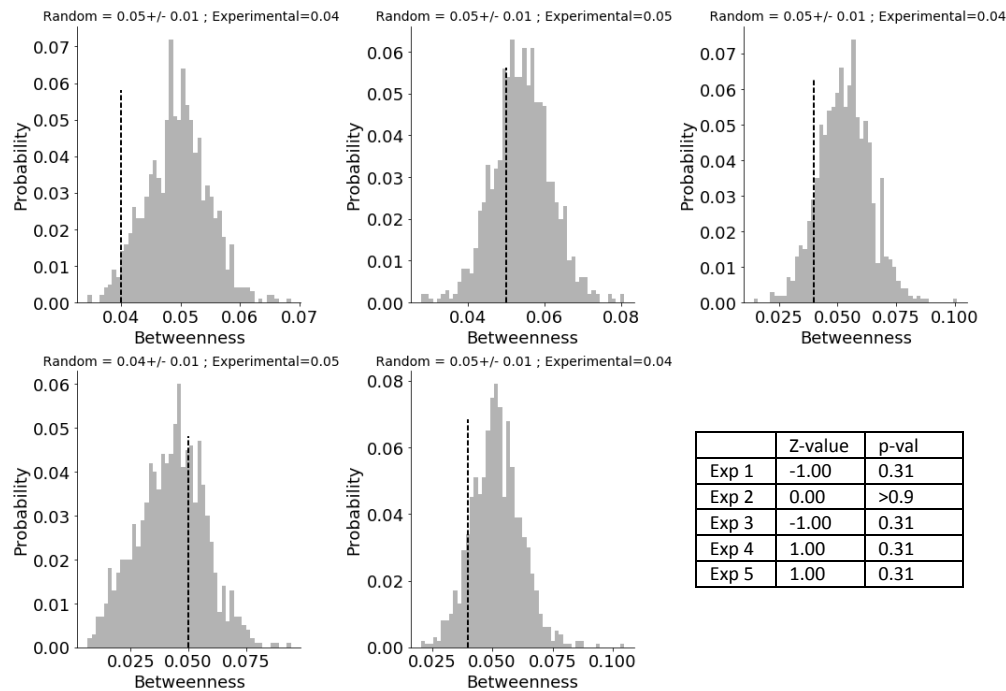

Figure S9. Betweenness coefficient experimentally measured (vertical dotted line) and the distribution from FR randomized networks (grey bars, N=1000) for each colony. Table shows the statistical values of the Z-Test comparing each experimental value to the distribution of the randomized one for in each colony.

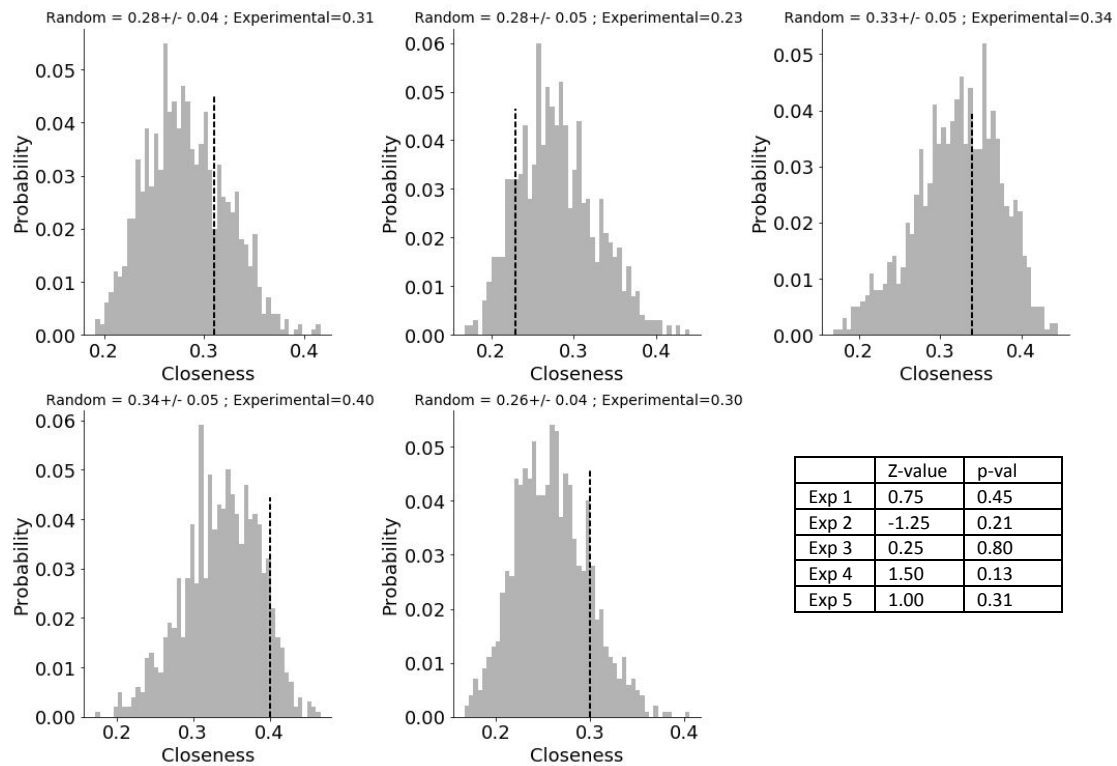

Figure S10. Closeness coefficient experimentally measured (vertical dotted line) and the distribution from FR randomized networks (grey bars, N=1000) for

each colony. Table shows the statistical values of the Z-Test comparing each experimental value to the distribution of the randomized one for in each colony.

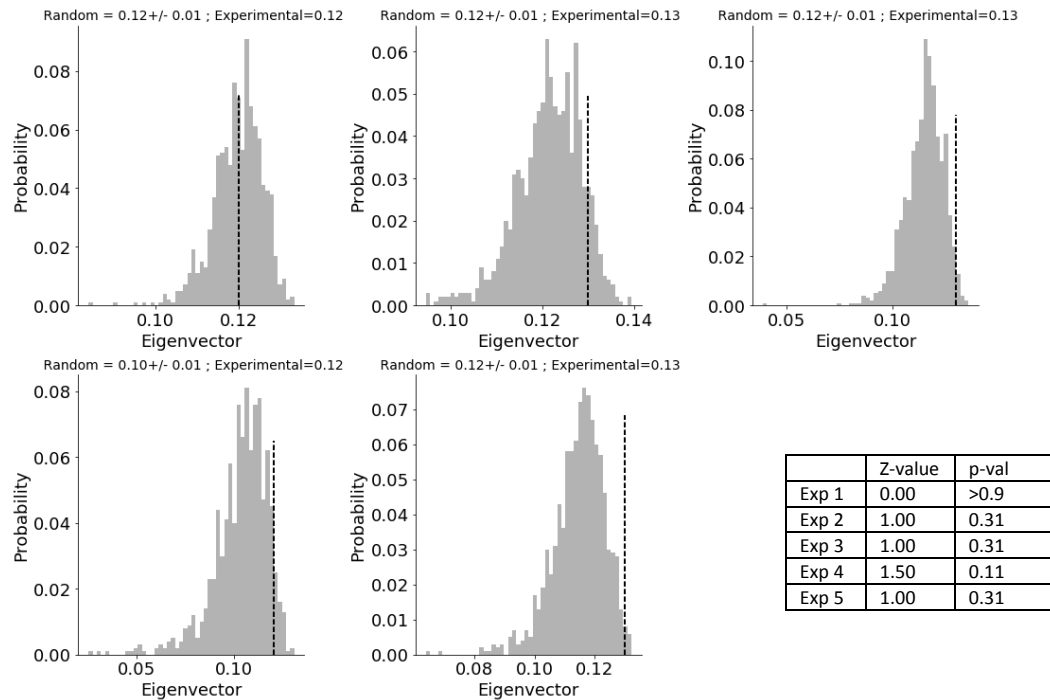

Figure S11. Eigenvector coefficient experimentally measured (vertical dotted line) and the distribution from FR randomized networks (grey bars, N=1000) for each colony. Table shows the statistical values of the Z-Test comparing each experimental value to the distribution of the randomized one for in each colony.

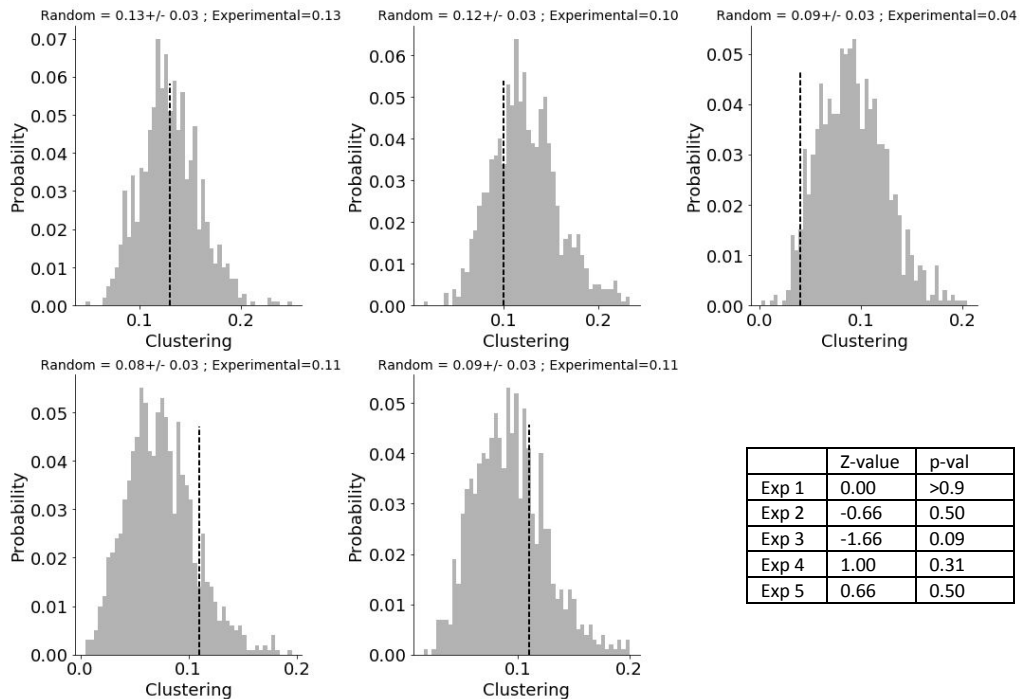

Figure S12. Clustering coefficient experimentally measured (vertical dotted line) and the distribution from FR randomized networks (grey bars, N=1000) for each colony. Table shows the statistical values of the Z-Test comparing each experimental value to the distribution of the randomized one for in each colony.

Chapitre 4

A data-driven simulation of the trophallactic network and intranidal food flow dissemination in ants.

Olivier Bles^{1*}, Jean-Louis Deneubourg¹, Cédric Sueur² and Stamatios C. Nicolis¹

1. Center for Nonlinear Phenomena and Complex Systems (Cenoli) - CP 231, Université libre de Bruxelles (ULB), Campus Plaine, Boulevard du Triomphe, Building NO - level 5, B-1050 Bruxelles, Belgium ; 2. Université de Strasbourg, CNRS, IPHC, UMR 7178, Strasbourg, France

*Corresponding author: olivier.bles@ulb.ac.be

Keywords: Food exchange, Interindividual difference, Interacting agents, Distribution, Starvation, *Lasius niger*

Soumis dans *American Naturalist*.

Abstract

Food collection and intranidal food distribution through trophallactic exchanges are fundamental issues in eusocial insects. However, the behavioural rules underlying the regulation and the dynamics of food intake and the resulting networks of exchanges are poorly understood. In this study, we provide new insights into the behavioural rules underlying the structure of trophallactic networks and food dissemination dynamics within the colony. We build a simple data-driven model to investigate the processes of food accumulation/dissemination inside the nest, both at the individual and collective levels. We establish the links between the interindividual heterogeneity of the trophallactic behaviours, the food flow dynamics and network of trophallactic events. Despite the relative simplicity of the model, its outcomes share similarities with a wide range of observed patterns of food exchanges in ants.

1. Introduction

Insect societies may be seen as social networks whose structure is shaped by individual (nodes) behaviours and interactions (edges) between individuals. While different networks (colonies) may allocate the same total amount of time to a task (such as brood care or food collection), the time investment or the efficiency could be quite different between nodes (Dornhaus et al., 2012; Tenczar et al., 2014). The topology of social networks drives information transmission (Aplin et al., 2014; Atton et al., 2014), food stock building (Sendova-Franks et al., 2010) and influences a range of collective outcomes, such as the transmission of parasites and pathogens (Hamede et al., 2009; VanderWaal et al., 2014). Food stock building in social insects involves networks of food sharing interactions through trophallactic events (mouth-to-mouth exchanges), during which not only food is transferred (LeBoeuf, 2017). A small fraction of the workers (the foragers) collect the food that is distributed to the nonforaging part of the colony, which in turn disseminates the food (Howard and Tschinkel, 1981; Pinter-Wollman et al., 2013). A chain of demands, whose origins are principally the larvae and the queen, fine-tunes the foraging activity to the colony's needs (Cassill et al., 1998; Dussutour and Simpson, 2008). No single worker has a comprehensive understanding of the nutritional status of the whole colony. Instead, colony-level nutritional regulation is an emergent property resulting from numerous individual behaviours (e.g., foraging and disseminating) modulated by local information (such as individual crop content (Seeley, 1989)). In such a process, the interindividual variability of the responses may affect the collective outcomes and performance of the colony (Adler and Gordon, 1992; Delgado et al., 2018; Pamminger et al., 2014; Robinson et al., 2008).

Many studies have focused on interindividual variability in searching behaviour and in food collection efforts (e.g., in honeybees (Spaethe and Weidenmüller, 2002; Tenczar et al., 2014), bumblebees (Crall et al., 2018), and ants (Beverly et al., 2009; Campos et al., 2016; Dornhaus, 2008; Pask et al., 2017; Robinson et al., 2008)). However, the intertwining of the interindividual heterogeneity with the food dissemination activity and the division of work and the resulting trophallactic networks at the intranidal level remain far less studied. Some empirical works revealed the colony-level dynamics of food sharing and accumulation as well as the negative feedbacks that regulate the food flow entering the nest (Buczowski and Bennett, 2009; Buffin et al., 2012, 2009a). The absence of individual identification in such studies limits the inquiries

between the level of workers' contributions and colony food management. The recent technological improvement in automating individual identification (Crall et al., 2018; Gernat et al., 2017; Greenwald et al., 2018; Mersch et al., 2013) allows better investigations of the individual behaviours involved in food exchanges. A first study analysing the whole trophallactic network showed a spatial re-organisation of worker positions in the presence of starvation, accelerating the food stock recovery (Sendova-Franks et al., 2010). Other studies focused on the individual behavioural rules regulating the food exchanges (Bonavita-cougourdan and Gavioli, 1981; Greenwald et al., 2015, 2018), refuting some classical assumptions about this phenomenon which was commonly viewed as a deterministic process (Buffin et al., 2009b; Cassill and Tschinkel, 1999; Gregson et al., 2003; Sendova-Franks et al., 2010). In particular, the authors showed that 1) the donor does not deliver its entire crop load, nor does the recipient fill up to its crop capacity; 2) the food flow during a trophallactic event can be bidirectional; and 3) foragers are able to leave the nest even if their crops are not completely empty.

Moreover, a high level of variability is observed in the amount of food transferred during a trophallactic exchange for the crop contents of a given recipient as well as in the crop load of the foragers exiting the nest (Greenwald et al., 2018). These variabilities prevent any clear conclusions about the relationships between the crop content and the nest-leaving behaviour or the amount of food transferred during an exchange. The consequences of this stochasticity on food flow dynamics and food spreading speed are not straightforward to assess empirically and are therefore overlooked (Gräwer et al., 2017).

In the context of foraging activity, a widely accepted behavioural categorisation distinguishes the individuals visiting, even once, the food source and bringing the food back to the nest (foragers) and the individuals staying inside the nest (non-foragers). However, the link between this categorisation and the respective contributions of each caste (foragers vs. non-foragers) in intranidal food dissemination and the characteristics of the trophallactic network are far from clear. How intra-caste variability in food exchange behaviour affects food dissemination within the context of the trophallactic network is also poorly understood.

In this study, we attempt to fill this gap by developing a data-driven model of trophallactic networks that implements interindividual variability and division of labour. This model is based on empirical data collected from the food exchange process in colonies of the ants *Lasius niger*

[see section 2.2]. Our goal is to identify the minimal set of rules governing the trophallactic and foraging behaviours and to capture the main features of the food exchange process of our experimental ant colonies. The model includes four activities: departure from the nest, food collection, travel back to the nest and food exchange (donation/reception).

While some levels of variability are often expected to enhance foraging success (Campos et al., 2016), here we explore the effects of two levels of variability of the trophallactic behaviour on the food spreading:

- (i) resulting from the existence of forager- and non-forager-specific behaviours. We will first assume that non-forager and forager trophallactic behaviours are identical and will thus consider one behavioural caste (OC). We will next explore the case where a differentiation of non-forager and forager trophallactic behaviours occurs after the first visit of the foragers at the food source and will thus consider two behavioural castes (TEC).
- (ii) occurring within castes. In this case, individuals of each caste have a probability of performing a trophallactic event drawn from a particular distribution. Three common probability distributions will be tested, namely, the delta distribution, uniform distribution and exponential distribution.

In section 2, we formulate the main model and its different versions; section 3 is devoted to the analyses of the model and its comparison with experiments. Finally, in section 4, we discuss the biological relevance of the model predictions, particularly the link between the interindividual variability and the participation of each ant in collective food management.

2. Materials and Methods

2.1 Model description

To capture the essence of food collection and storage dynamics as well as intranidal trophallactic network properties in *L. niger*, we developed an agent-based model. A general overview and the relationship of the main variables of the model is given in Figure 1. At the beginning of each simulation ($t=0$), the colony only contains non-forager individuals *NFs* with a crop content equal to zero, $[Q_i(0) = 0]$. The food source access is unrestricted, and the quantity of food is unlimited. At each timestep t , every non-forager in the nest, selected in a random order, can leave the nest

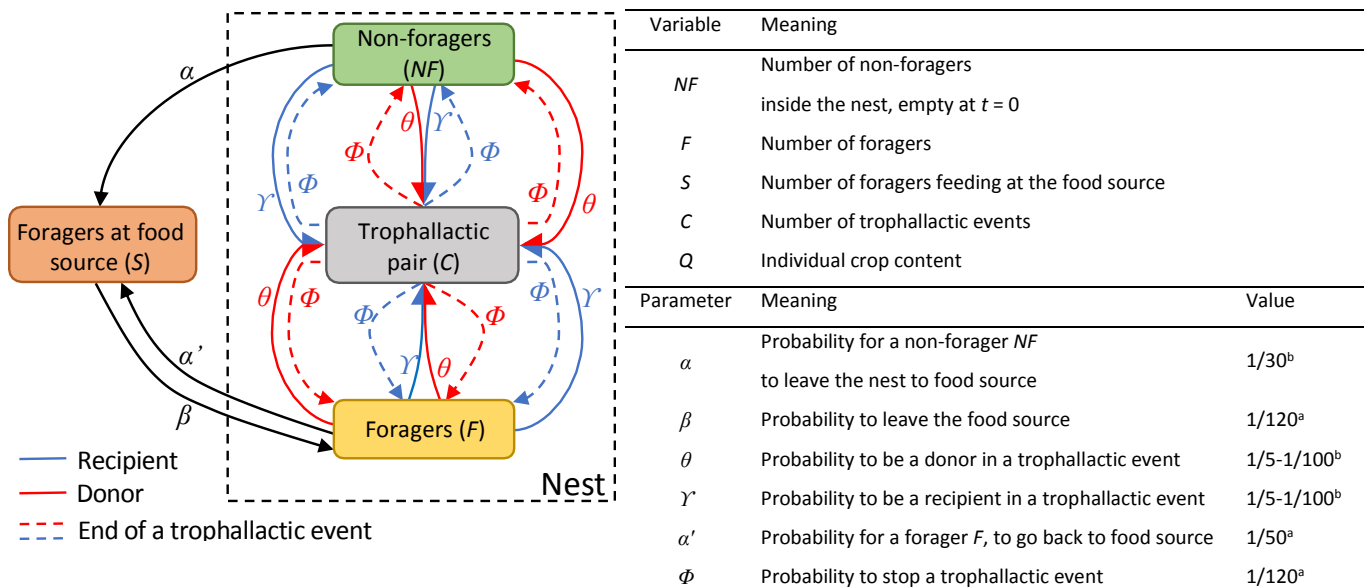

Figure 1: Flow diagram of the model, variables and parameters. The square boxes representing the states of individuals (NF , F , S , C). Black arrows are state-transition rates; coloured arrows represent the formation of a trophallactic pair, the red one being the donor and the blue one the receiver. On the right part of the figure, variables and parameters are defined and value of parameters implemented are indicated. ^aParameters estimated from the experiments presented in the material and methods section or derived from the literature (Mailleux et al., 2010, 2006). ^bParameters estimated by fitting on the experiments.

and start to feed at the food source with a probability per time unit α , which is the inverse of the mean time spent before leaving the nest. Each individual visiting the food source at least once is considered to be a forager F for the rest of the simulations. After a time spent at the food source, the foragers F_s , containing an amount of food Q proportional to the time spent feeding, go back to the nest with a probability β , corresponding to the inverse of this time.

At each timestep t , every individual i ($i=F, NF$) in the nest can randomly exchange food respectively, as donor or receiver, with a probability θ_i or γ_i , which are increasing/decreasing functions that depend in a sigmoidal way on the current crop content Q_i (Greenwald et al., 2015, 2018):

$$\theta_i = \frac{\theta_i(0) \cdot Q_i^n}{k^n + Q_i^n} \quad (1)$$

$$\gamma_i = \frac{\gamma_i(0) \cdot k^n}{k^n + Q_i^n} \quad (2)$$

where k is a threshold value of the amount of food carried and n controls the steepness of the functions. A high value of n leads to a rapid decreasing (increasing) probability to accept (give) food when the value of Q_i , the amount of food carried by the individual i , approaches the value of k . The probability that two individuals exchange food depends on the product of their individual interaction probabilities. Furthermore, the food flow is directional from the donor to the receiver and cannot be reversed during a single trophallactic event. The probability Φ for a trophallactic pair to be separated is equal and constant for both individuals; however, when the donor is empty, the trophallactic event is stopped. For simplicity, we imposed that the quantity of food exchanged is proportional to the duration of the trophallactic event (Greenwald et al., 2015). The individual maximal carrying capacity is not imposed but results from the product of the individual probability θ or γ to give or to receive food and the probability Φ to separate a trophallactic pair. The probability of leaving the nest also decreases with the crop content Q :

$$\alpha_i = \frac{\alpha_i(0) \cdot k^n}{k^n + Q_i^n} \quad (3)$$

with $\alpha_i(0)$ representing the maximum probability of leaving (when $Q=0$). After the first visit to the food source, this maximum probability $\alpha'_i(0)$ increases ($\alpha'_i(0) > \alpha_i(0)$). The literature suggests only a weak link between the crop content and the probability of food exchange or the probability to leave the nest (a wide range of the probability to exchange food or to leave the nest is observed for a given crop content (Greenwald et al., 2015, 2018)); therefore, we fixed the values of n and k as follows: $n = 2$ (smooth increasing/decreasing of the probability to give/receive with an increasing crop content) and $k = 120$ (which corresponds to the mean quantity of food exchanged during one trophallactic event, see section 2.2 for details on experimental procedure). Given these parameter values, individuals leave the nest with variable crop content, according to experiments from (Greenwald et al., 2018).

We compared the dynamics of food dissemination at the intranidal level and the properties of trophallactic networks in two versions of the model which differed only in their assumptions concerning the individual probability of giving or receiving food through a trophallactic event between foragers and non-foragers:

A. In the first version, we made a one-caste assumption (OC version). All individuals of the colony were indistinguishable in terms of their probabilities to give and receive food through a trophallactic event ($\theta_F = \theta_{NF}$ and $Y_F = Y_{NF}$, respectively).

B. In the second version of the model, we made a two emergent castes assumption (TEC version); at the beginning of the simulation, all the individuals are non-foragers *NFs*. When a non-forager *NF* leaves the nest to go to the food source, it becomes a forager *F* and, having new information about the food availability, now behaviourally differs from the non-foragers *NFs* in terms of the probabilities to give and receive food through a trophallactic event ($\theta_F \neq \theta_{NF}$ and $Y_F \neq Y_{NF}$, respectively).

In both versions of the model, we tested three hypotheses entailing an increasing level of interindividual variability in the probability θ_i to give and Y_i to receive food: (i) Delta probability, we tested a delta probability distribution where all the individuals have the same intrinsic probability to exchange food; (ii) Uniform probability, we tested a uniform distribution of the probability θ_i to give and Y_i to receive food between the individuals with a standard deviation, respectively, equal to the mean probabilities of θ_i and Y_i ; and (iii) Exponential distribution, we tested for the effect of individual variation in trophallaxis probability on the food flow entering the nest and the individual inequality in trophallactic activity since ants vary in their probability to give/receive food following a decreasing exponential law [$f(x) = \varepsilon \cdot e^{\left(\frac{-x}{\varepsilon}\right)}$, with ε equal to θ or Y]. In (i), (ii) and (iii) the intrinsic individual probabilities of giving and receiving food through a trophallactic event are attributed at the beginning of each simulation and do not change over time in the one-caste (OC) version of the model. In the two-castes (TEC) version, the individual threshold is updated to a forager (*F*) value after the ant visits the food source for the 1st time. These two values, before and after the 1st visit to the food source, are not correlated.

2.2 Summary of the behavioural experiments

From five large mother colonies (>1000 ants) of *L. niger* (collected in Brussels, Belgium, autumn 2016), we created five queenless and broodless subcolonies of 50 randomly chosen workers. Ants were individually labelled with an ArucoColor tag (<https://sites.google.com/site/usetrackerac/>) allowing automatic identification of ants. Each tag was stuck onto the abdomen, had a side length

of 0.8 mm, weighed 0.1 mg (corresponding to less than 5% of the average mass of an adult worker or less than 10% of the amount of food a worker carries (Mailleux et al., 2000)) and was printed on waterproof paper at a resolution of 1200 dpi. The tags were hand-cut using a scalpel and a steel ruler as guide. Following a 5-min acclimatisation period, the labelling was not observed to impede the ants' behaviours, movement or interactions. Each subcolony was introduced in the experimental setup between 15 to 18 days prior to the first experiment; the setup was composed of a one-chamber nest (56 x 41 x 2 mm) covered by a glass window. This duration was long enough to stabilise the task repartition among individuals. A single access route (4 x 3 x 2 mm) leads to the foraging area (61 x 49 x mm) containing a 0.3 M sucrose solution and water *ad libitum*. The walls of the foraging area were covered in Fluon® to prevent the ants from escaping. The subcolonies were kept at $22 \pm 3^\circ\text{C}$ and $60 \pm 5\%$ relative humidity, with a 12:12 h constant photoperiod. After 4 days of starvation, we introduced 3 mL of a 1 M sucrose solution. The ants were filmed for 90 min, starting 30 min before food source introduction. Each colony was tested once. The video data were recorded using a Panasonic® Lumix DMC-GH4-R mounted with a 30 mm Olympus® ED lens capturing 25 frames/s at the definition of 4180*2160 p. We discriminated foragers (*Fs*) from non-foragers (*NFs*). An individual was considered a forager if it spent at least 5 consecutive seconds feeding at the food source during the experiment. Each minute, we performed a scan-sampling (Altmann, 1974) of all the trophallactic interactions, identifying the donor, the receiver and the X and Y spatial positions of the trophallactic event (contact point of the mandibles of both ants). A trophallactic event was recorded when ants engaged in mandible-to-mandible contact for greater than 5 s. The directionality of food flow and the role of the donor and the receiver were determined by the characteristic body posture and the mandible position (Cassill and Tschinkel, 1999; Greenwald et al., 2015). A trophallactic event involving the same individuals on two or several consecutive scans was considered as a single trophallactic event of 2 or several min lengths. Raw empirical data are available in the supplementary material. A complete description of the results is presented in Planckaert et al. (subm.).

2.3 Model calibration and comparison of the model output with the experimental results

The model was calibrated with values of parameters derived from the experiments (see section 2.2), and the parameters given in Figure 1 and Table 1 so that the model reproduces the following experimental results: 1. the mean number of foragers; 2. the mean number of trophallactic events; and 3. the proportions of the 4 different types of trophallactic pairs ($F \rightarrow NF$; $F \rightarrow$; $NF \rightarrow$; $NF \rightarrow F$). Therefore, the simulations were run for 3600 timesteps (with each timestep equal to 1 s) with 53 individuals, corresponding to the duration of the experiment and the mean size of the experimental colonies. Simulations were repeated 1000 times. For each simulation, the start/end time of each trophallactic event, as well as the identity and role of each individual in the trophallactic pairs (the donor/receiver) were extracted. The complete trophallactic network of each simulation (N=1000) and each experiment (N=5) was built, allowing us to analyse and compare the food dissemination dynamics, the properties of the networks of food exchanges and the participation of individuals in the trophallactic events. Classical tools of social network analysis in animal societies (Wey et al., 2008) were also used to characterise the global properties of each trophallactic network as well as the role of each individual in the network (see section 2.4 for details on data analysis). The survival curve of the 1st arrival to the food source in the experiments is well fitted by a power law distribution of $\alpha_i(0)$, the individual probability to leave the nest in the model (Figure S1). This suggests that few individuals have a high probability of visiting the food source, and most of them have a low probability.

We evaluate the goodness-of-fit of these three outputs between the experiments and both versions of the model (OC and TEC), each tested with the three distributions (delta, uniform, exponential) of the probability $\theta_i(0)$ to give and $\gamma_i(0)$ to receive food through a trophallactic event. Only the version of the model (OC or TEC) that best met this first “selection filter” was considered for more detailed analysis [section 3.2 and the following]. A local sensitivity analysis of the selected parameter values is provided (Figure S6).

Table 1: The upper part of the table shows the parameters values of the two versions of the model and three distributions. Only the parameters that vary between models are shown. The lower part of the table shows the main experimental and the theoretical results of the foraging activity. See the text for further explanation.

Parameters	One caste (OC)			Two emergent castes (TEC)			
	Equal	Uniform	Exp.	Equal	Uniform	Exp.	
θ_F	1/11	1/10	1/6	1/10	1/11	1/9	
θ_W				1/33	1/32	1/23	
γ_F	1/60	1/50	1/56	1/11	1/9	1/9	
γ_W				1/38	1/28	1/27	
Results	Experiments (mean+/-s.d)						
Number of trophallactic events	99.0+/-17.4	100.1	98.7	100.5	101.0	99.5	98.7
Number of foragers	12.2+/-1.9	12.2	12.6	12.2	12.3	12.4	12.5

2.4 Statistical and social network analysis

A Mann-Whitney U test (MW) was used to compare the theoretical and experimental numbers of each type of trophallactic pair ($F \rightarrow NF$; $F \rightarrow F$; $NF \rightarrow NF$; $NF \rightarrow F$; Figures 2, S3 and Table S1). A Kolmogorov-Smirnov test (KS) was used to analyse the deviation between the theoretical and the experimental distributions of the number of trophallactic events among the colony members (Figures 3, S4.A-C and S5) and the cumulative number of trophallactic events (Figures 4.A and S4.D-F). To quantify the degree of inequality in trophallactic activity among the workers, we plotted the cumulative distribution of total trophallactic events performed in each trial in the form of a Lorenz curve (Tenczar et al., 2014) (Figures 4.B and S4.G-I). Such a curve displays the share of trophallactic activity (Y axis) accounted for by x% of the workers (sorted by the number of trophallactic events per individual) in the colony. A perfectly equitable distribution of foraging activity would correspond to the line $Y=X$. The Gini coefficient (Figures 4.C and S4.J-L) is known as the ratio between the area below the experimental Lorenz curve and the triangular area below the perfect equality case $Y=X$ and provides a measure of the degree of inequality in the distribution of trophallactic activity, ranging from 0 (perfect equality) to 1 (perfect inequality). Social network analysis was performed on both the theoretical and experimental results. The nodes correspond to individuals (Figure S2, red = foragers; green = non-foragers), and the edges

represent trophallactic events directed from the donor to the receiver. We performed weighed and directed analyses. Social network analyses were performed at both the individual level and the functional category (foragers/non-foragers) level. The length of the edge conveys no information. At the individual level, we calculated the betweenness, the closeness and the clustering coefficients of each individual. Betweenness centrality (Figures 5.C and S4.S-U) is an estimate of how important an individual ant is to the promotion of connectivity across the entire colony and this value measured by the number of times an individual acts as a bridge along the shortest path between two other ants (Dell et al., 2014). Closeness centrality (Figures 5.B and S4.P-R) is based on the distance (measured by shortest paths) from an individual to every other individual in the colony; the more central an ant is, the lower its total distance is from all the other ants (Wey et al., 2008). The clustering coefficient (Figures 5.D and S4.V-X) allows us to determine the existence of “communities” in a network, such as node pairs with many more edges between them than with other ones (Saramäki et al., 2007). To assess the effect of network structure on food spreading speed, we measured the efficiency (Figures 5.A and S4.M-O), defined as the multiplicative inverse of the shortest path distance between all pairs of nodes (Buhl et al., 2004; Latora and Marchiori, 2001). Concerning the food spreading speed, we compared the mean theoretical T_{50} and experimental T_{50} (time when half the trophallactic events were realised, Figures S4.Y- α). To statistically quantify whether experimental values were different from the simulations (concerning the T_{50} , the Gini coefficient and the social networks metrics: betweenness, closeness clustering, and efficiency coefficients), we used Z-tests (ZT) to compare the experimental mean ($N=5$) to the corresponding theoretical mean (200 mean scores from 5 randomly selected simulations among 1000 simulations). A Kruskal-Wallis (KW) analysis revealed that the degree (KW, $H=0.70$, $p>0.95$), out-degree (KW, $H=1.83$, $p=0.77$), in-degree (KW, $H=0.66$, $p>0.95$), betweenness (KW, $H=9.10$, $p=0.06$), closeness (KW, $H=3.98$, $p=0.41$) and eigenvector (KW, $H=0.93$, $p=0.91$) distributions among colony members were homogeneous between the five experiments; therefore, we merged and averaged the experimental results for the calibration of the model and for the comparison between the experimental and theoretical results. The level of significance was set at $p<0.05$. All simulations were conducted on Python 3.6; all the analyses were performed with NetworkX 2.1, PyGraphviz 1.4, NumPy 1.14, SciPy 1.0.0 and Matplotlib 2.2.2.

3. Results

3.1 Evaluation of the quality of the calibration of the models

The values of the probability θ to give and γ to receive a food through a trophallactic event that best fit the experimental outputs are presented in Table 1. Both model versions (OC and TEC) closely reproduced the empirically measured number of trophallactic events while respecting the number of foragers, although they were not explicitly imposed at the beginning of the simulation. This result is independent of the distribution (delta, uniform, exponential) of the individual probability to give/receive that was implemented (Table 1).

We then determined to what extent each type of trophallactic pair ($F \rightarrow F$, $F \rightarrow NF$, $NF \rightarrow F$, $NF \rightarrow NF$) contributes to the total number of trophallactic events. The OC version, whatever the distribution implemented, systematically reproduced the proportion of each type of trophallactic pair ($F \rightarrow F$, $F \rightarrow NF$, $NF \rightarrow F$, $NF \rightarrow NF$) with a lower accuracy than did the TEC version (Figures 2, S3 and Table S1): the OC version, whatever the distribution, significantly overrated the number of $NF \rightarrow NF$ exchanges and underestimated the number of $F \rightarrow F$ exchanges (MW: $p < 0.05$ in each case, see also Figure S3 and Table S1 for details on statistical analysis), while the TEC version, whatever the distribution, reproduced the number of each type of trophallactic pairs (MW, $p > 0.2$ in each case, see Figures 2, S3 and Table S1 for details on statistical analysis).

As the OC version failed to reproduce the experimentally observed proportions of each type of trophallactic pair, in the rest of the paper, we will focus on the TEC version.

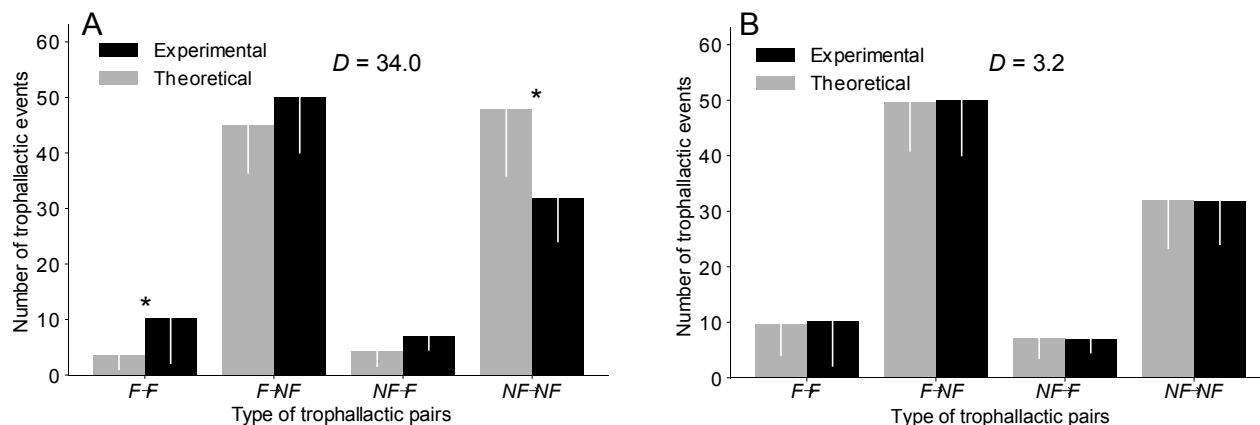

Figure 2: Comparison of the number of each type of trophallactic pairs between the experiments and the simulations implemented with a Delta distribution in the OC version (A) and in the TEC version (B). * = MW with a $p < 0,05$. Error bar = standard deviation. D = Sum of the difference of the number of trophallactic pairs of each type ($F \rightarrow F$, $F \rightarrow NF$, $NF \rightarrow F$, $NF \rightarrow NF$) between the experiments and the simulations. See Figure S3 for the Uniform and Exponential distributions and Table S1 for details.

3.2 Individual contributions to food dispersion / accumulation

After investigating the trophallactic activity at the colony level, we analysed the way each ant participated in trophallactic exchanges. Our main interest was to understand whether interindividual variability in trophallactic activity was required to fine-tune the experimental distribution of trophallactic activity/contribution to food dissemination. Figure 3.A and Figures S4.A-C show the distribution of the number of trophallactic events executed by all the ants, both at the theoretical and experimental levels. While a KS test indicated a significant improvement of the fitting along with an increasing level of interindividual variability implemented in the model (exponential > uniform > delta), only the TEC exponential version was not significantly different from the experiments. Note that the model (with the delta and uniform distributions) always underestimates the proportion of inactive individuals (Figures S4.A-B).

We then focused on the distribution of the number of trophallactic events at a finer scale: the numbers of trophallactic events as donors and receivers, respectively, by the foragers and by the non-foragers (Figures 3B-E, S5 and Table S2). Only the TEC exponential model was not different from the experimental distribution of the trophallactic activity for each category (KS, $p > 0.21$ in each case, see Table S2 for details on statistical analysis).

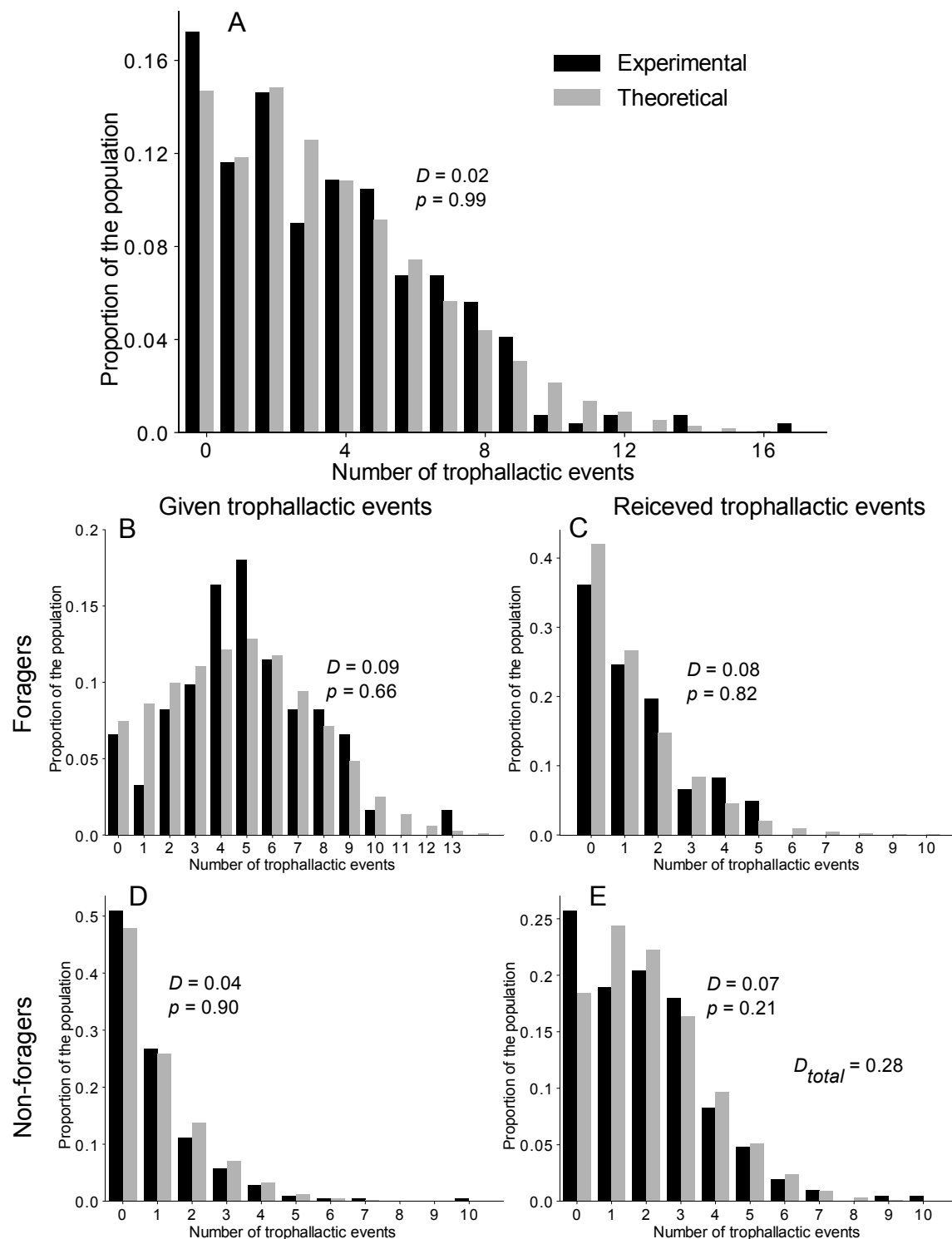

Figure 3: Theoretical and experimental distribution of the number of trophallactic events. A, Distribution of all the trophallactic events at the colony-level. B, C, Respectively, given and received trophallactic events performed by the foragers. D, E, Respectively, given and received trophallactic events performed by the non-foragers. Theoretical = TEC Exponential model. D and p on figures = statistical values from KS test. D_{Total} = sum of the KS distance (D) from the comparison of distribution in B-E. See Figure S5 and Table S2 for details on statistical analysis of other versions of the model.

3.3 Food spreading, heterogeneity and social network analysis

No difference was found between the dynamics of food accumulation in the simulations and experiments in the three versions of the model (KS: $p > 0.95$ in all cases, see also Figures 4.A and S4.D-F for details on statistical analysis). Concerning the spreading speed of food, a Z-test indicated no significant difference between the experimental and theoretical T_{50} (time required to reach 50% of the total number of trophallactic events) of the TEC model, regardless of the distribution implemented (Figures S4.Y- α). The next step consisted of testing the ability of our model to reproduce the experimentally observed interindividual heterogeneity in the food spreading activity, with the majority of the trophallactic events performed by a relatively small number of ants. We statistically quantified the heterogeneity in food spreading activity between the simulations and experiments using the Lorenz curve and Gini coefficient (Figures 4.B-C and S4.G-L). Only the TEC exponential model produced a heterogeneity of the food spreading activity as high as that observed in the experiments (ZT: $Z = -0.9$; $p = 0.39$). We then investigated the characteristics of the trophallactic networks to determine if the structure of the empirical networks facilitated food spreading compared with the simulations. Again, only the efficiency of the trophallactic networks resulting from the TEC exponential model was not significantly different from the empirically measured efficiency (ZT; $Z = -0.9$, $p = 0.38$; Figures 5.A and S4.M-

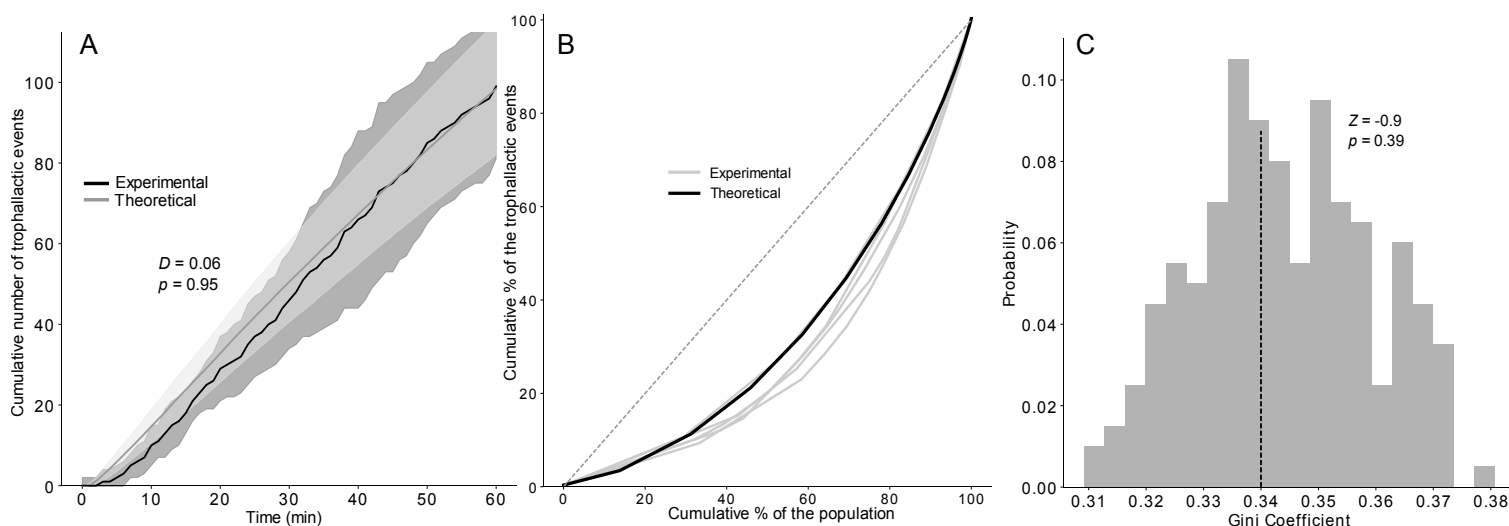

Figure 4: A, Cumulative number of trophallactic events after 1h of experiments or 3600 timesteps from 1000 simulations of the TEC Exponential model and from the experiments (N=5) compared with a KS (D and p -val). Dashed lines represent the time when 50% of the trophallactic events were realized, both in the model and the experiments. Shaded area = standard deviation. B, Lorenz curves showing the cumulative proportions of trophallactic events (y axis) vs. the individual rank (x axis, sorted by the number of trophallactic events performed by each individual), from the simulations (black curve, N=1000) and from the experiments (grey curves, N=5). C, Distribution of the Gini coefficient from the simulations (grey bars, N=1000) and mean from the experiments (dashed lines, N=5) compared with a Z-test (Z -value and p -val).

O). Concerning the closeness, betweenness and clustering coefficients, no significant differences were observed between the three distributions (delta, uniform, exponential) in the TEC model and the experiments (ZT; $p > 0.05$; Figures 5.B-D and S4.P-X). Nevertheless, increasing the theoretical interindividual variability (delta > uniform > exponential) leads to a higher accordance between theoretical and experimental results for these three coefficients.

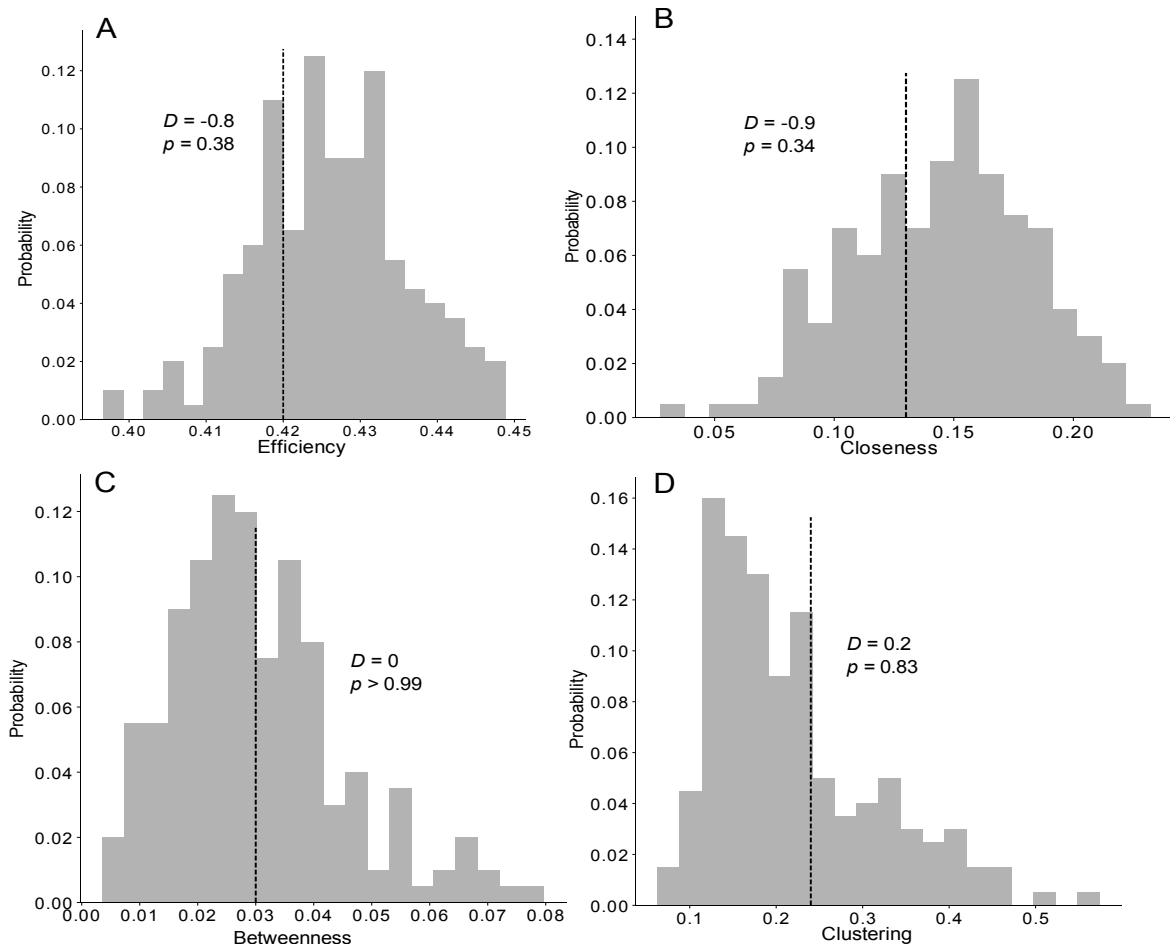

Figure 5: Distribution of the efficiency (A), closeness (B), betweenness (C) and clustering (D) coefficients measured in the networks of the TEC Exponential model (grey bars, $N=1000$) and the mean measured from experiments (vertical dashed line, $N=5$) compared with a Z-test (Z -value and p -val). See also Figures S4.M-X.

4. Discussion

We developed and analysed an agent-based model to investigate the mechanisms underlying the intranidal food spreading in ant nests based on trophallactic exchanges between the colony members. The keystone hypothesis was that no division of labour is a priori at work as far as trophallactic exchange is concerned. Rather, the trophallactic processes lead to chains of exchanges based on random encounters of potential partners.

Two versions of the model were tested (OC and TEC, see section 2.1), each of which was implemented with three types of probability distributions of giving/receiving food in a trophallactic event (delta, uniform, exponential). Both versions, regardless of the probability distribution implemented, fit some of the main outcomes of the experiments: the number of foragers and the number of trophallactic events (Table 1). In contrast, only the TEC version (irrespective of the distribution implemented) was able to reproduce the observed pattern of trophallactic exchanges between the foragers and non-foragers (Table 1, Figure 2 and Figure S3).

Based on the Kolmogorov-Smirnov distance (the supremum of the set of distances between the theoretical and experimental distributions), the TEC exponential model best captured the individual and collective patterns of the food spreading and, in particular, the interindividual heterogeneity in the trophallactic activity (Figure 4, S5 and Table S2).

We showed that a behavioural shift in the probability to give/receive food as a forager in the TEC version of the model and a right-skewed (exponential) distribution of the probability to give/receive food among all colony members (Table S3) are sufficient to reproduce the trophallactic networks.

The Gini coefficient revealed that the empirical interindividual level of heterogeneity in participation in food dissemination activity, both in foragers and non-foragers, was only generated by the TEC exponential model (Figures S4.J-L). Here, few ants were highly engaged in trophallactic interactions, which is a common property of many observed networks (Albert and Barabasi, 2002; Crall et al., 2018; Naug, 2008; Sendova-Franks et al., 2010). This interindividual variability is often considered important as far as resilience is concerned (Naug, 2008), even though the removal of the most engaged nodes can severely disrupt the system (Barabasi, 2002).

Classical metrics of social network analysis were also compared between theory and experiment to assess the role of the underlying network structure and, in particular, whether a non-random mixing of individuals would be at the origin of a structural organisation or if distinct patterns could play a role in the regulation of food collection through colony feedback coupled to individual behaviour. The TEC model, regardless of the distribution of the probabilities, fitted the experimental individual betweenness, closeness and eigenvector values even for the TEC delta model (Figures S4.M-X). For this latter model, the distribution of the probability of leaving the nest for the first time, which is the only source of variability, introduced a slight level of heterogeneity in the number of trophallactic events that was enough to generate the properties of the experimental networks.

The efficiency of experimental networks was only generated by the TEC exponential model, as the TEC delta and TEC uniform models displayed a lower efficiency. All versions of the model assumed random encounters between ants: if the potential donor (receiver) accepts to give (receive) a trophallactic exchange occurred. This simple hypothesis was sufficient to generate the experimental efficiency of the trophallactic network. One could have assumed mechanisms of avoidance/attractiveness between partners that had already exchanged food (Goyret and Farina, 2005; Grüter et al., 2013). However, our results suggest that no specific trophallactic pairs occur except those resulting from the interindividual variability in the probability to participate in a trophallactic exchange. Therefore, the food accumulated by ants originates from a large number of randomly encountered nestmates that had regurgitated the food previously received. Indeed, the model and the experiments showed that approximately 40% of the given food is given by the non-foragers. The efficiency coefficient is a measure of the effectiveness of the diffusion of information/food. This metric assumes a network of individuals with identical needs in which the efficiency is maximal as soon as all the individuals are connected together. This situation may be far from that of real colonies of social insects, in which the needs may be different between individuals (Dussutour and Simpson, 2009) and the diffusion of food must satisfy the individual needs. Thus, the effectiveness of food dissemination in the colony, based on the measure of classical efficiency, suggests an under-optimal connectivity of the observed network.

Increasing the interindividual variability of the probability to give/receive food in a trophallactic event, keeping the mean probability constant (i.e., increasing the standard deviation of the

uniform distribution), leads to a lower number of exchanges / speed of food accumulation in the nest for a given time-window (Figure S6). Our theoretical results are consistent with a previous theoretical work (Nicolis et al., 2003) investigating the relationship between division of labour (trail-laying behaviour) and efficiency of food recruitment and the subsequent role of positive feedbacks. These results deviate from the general agreement of the importance of division of labour in social insects (Hölldobler and Wilson, 1990; Oster and Wilson, 1978) and from recent experimental results establishing a link between within-group behavioural variation and task efficiency (e.g., (Pruitt and Riechert, 2011)(Modlmeier et al., 2012)). However, we must keep in mind that our model (and that of (Nicolis et al., 2003)) does not take into account various ecological and physiological constraints that are omnipresent in such systems and affect the efficiency of the processes.

Other model limitations may have affected the goodness-of-fit of our results. Most obviously, our model does not capture any effect of the intranidal spatial organisation/occupation (Heyman et al., 2016; Pinter-Wollman et al., 2011) on the dynamics of food collection and dissemination in the colony, which are known to be linked to task (Mersch et al., 2013) and to affect collective response (Crall et al., 2018). A recent stochastic spatial model that neglects interindividual differences but shares some of our hypotheses provides useful insights into the role of space during food dissemination (Gräwer et al., 2017). Note that although the spatial segregation of specialised individuals is thought to optimise performance in social insects (Pamminger et al., 2014; Tofts, 1993), our model is still consistent with experiments.

In summary, we investigated the effect of interindividual variation (delta, uniform, and exponential distributions) of homogeneous (OC) or heterogeneous (TEC) colony models on the trophallactic networks and food spreading dynamics. The agreement between the theoretical and empirical data validates the right-skewed behavioural rules used in the model. This analysis succeeds in accounting for the characteristics of the empirically observed trophallactic networks, without evoking behavioural rules other than a right-skewed distribution of food dissemination effort, modulated by the individual crop load. These two hypotheses are in agreement with some recent empirical work (Greenwald et al., 2018). Hence, the observed networks of trophallactic events of ant colonies do not seem to rely on complex behavioural rules involving the transfer of various types of information during the food exchange or the ability to count the number of

trophallactic events executed. The presence of heterogeneity in the food dissemination effort in a more complex social context, including a queen and larvae that increase the gradient of division of work and the heterogeneity in nutritional needs among the colony members (Cassill, 2003; Dussutour and Simpson, 2009), still requires further investigation. Among these future experimental and theoretical investigations, priority should be given to the way the colony size affects the global dynamics of food exchanges and the resulting trophallactic network. Furthermore, the phenomenological character of our model prevents any conclusion about the origin of the observed behavioural variability: is it an outcome or an underlying driver of behavioural/network interactions? These challenging questions require further theoretical and experimental investigations and are of major interest to clarify the link between genetics, individual experience and social structure.

Supplementary Material

Figure S1. Experimental and theoretical survival curves of the time of the first visit to food source for each foraging ant. Power law, Exponential, Uniform and Delta, qualify the distribution of the individual probability to leave the nest for the first time. T=0 corresponds to the beginning of the simulation. Log Rank Test: Delta: $\text{stat}=8.97$, $p=0.003$; Uniform: $\text{stat}=7.83$, $p=0.005$; Exponential: $\text{stat}=7.57$, $p=0.005$; Power law: $\text{stat}=1.47$, $p=0.224$.

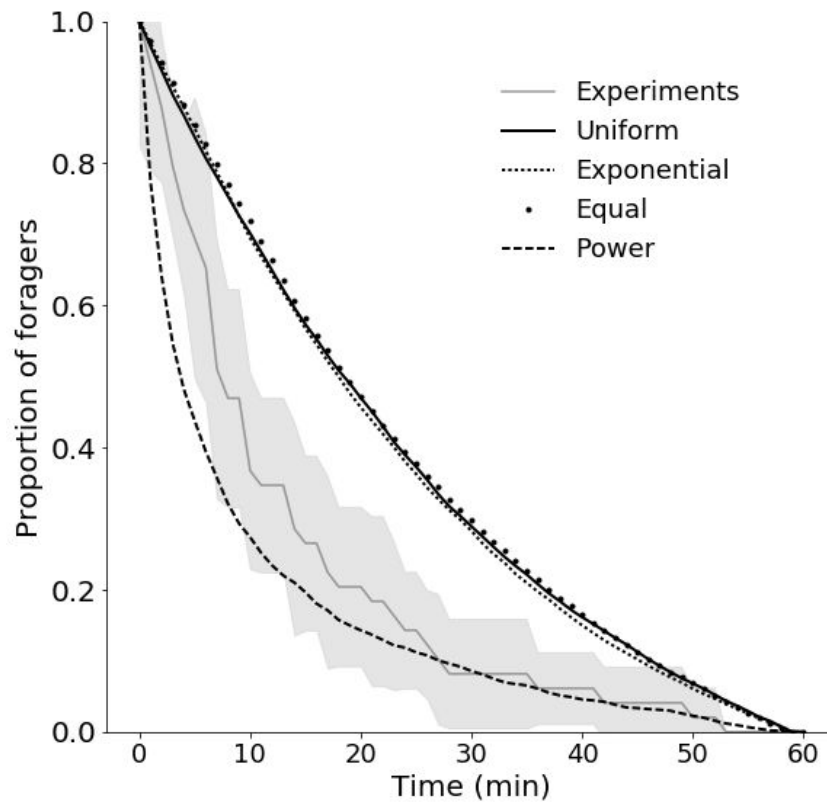

Figure S2.A. Example of a temporal network resulting from a simulation of the TEC Exponential model. Each vertical line represents an ant, arrow represents the trophallaxis, from the donor to the receiver. **B.** Cumulated trophallaxis network of the colony. Node labels represents ants' identities. Red circle = foragers, green circle = non-foragers. Edges are directed from donor to receiver. The spatial position is not relevant.

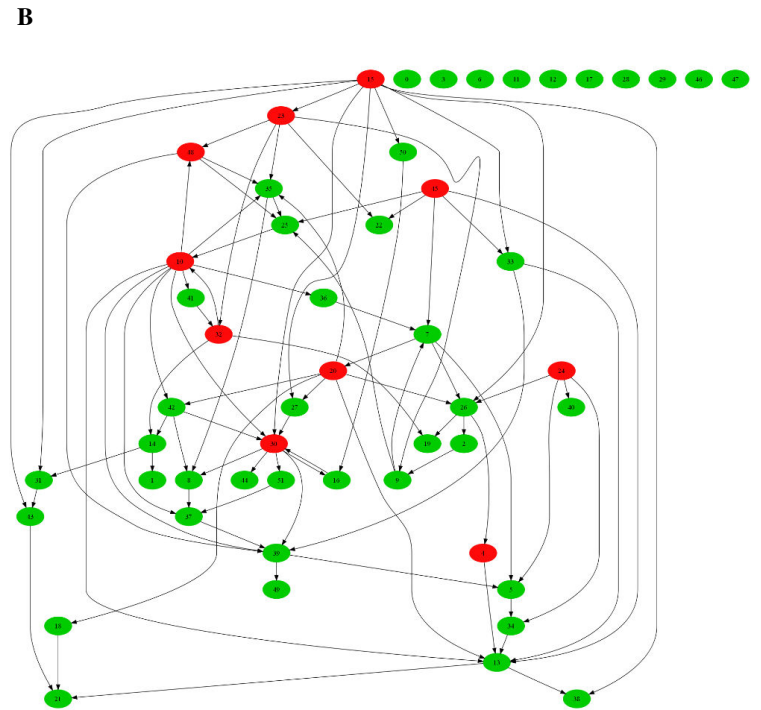
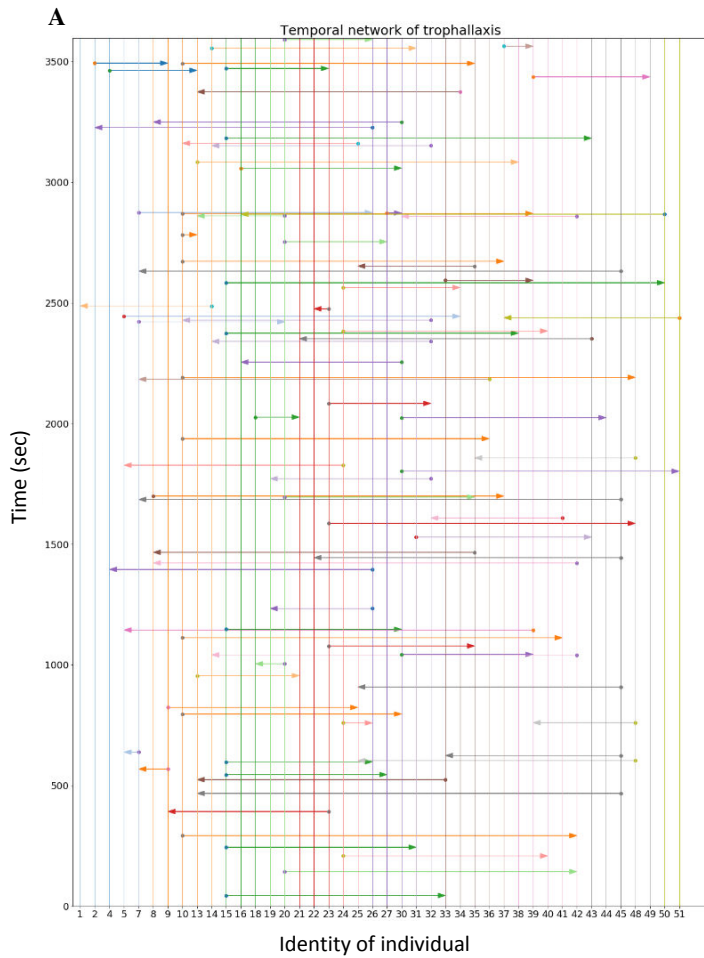

Figure S3. Comparison of the experimental and the theoretical number of couples of trophallaxis of each type. F stands for foragers and NF for non-foragers. Error bar = standard deviation. D = Sum of the difference of the number of couples of trophallaxis of each type between the experiments and the simulations.

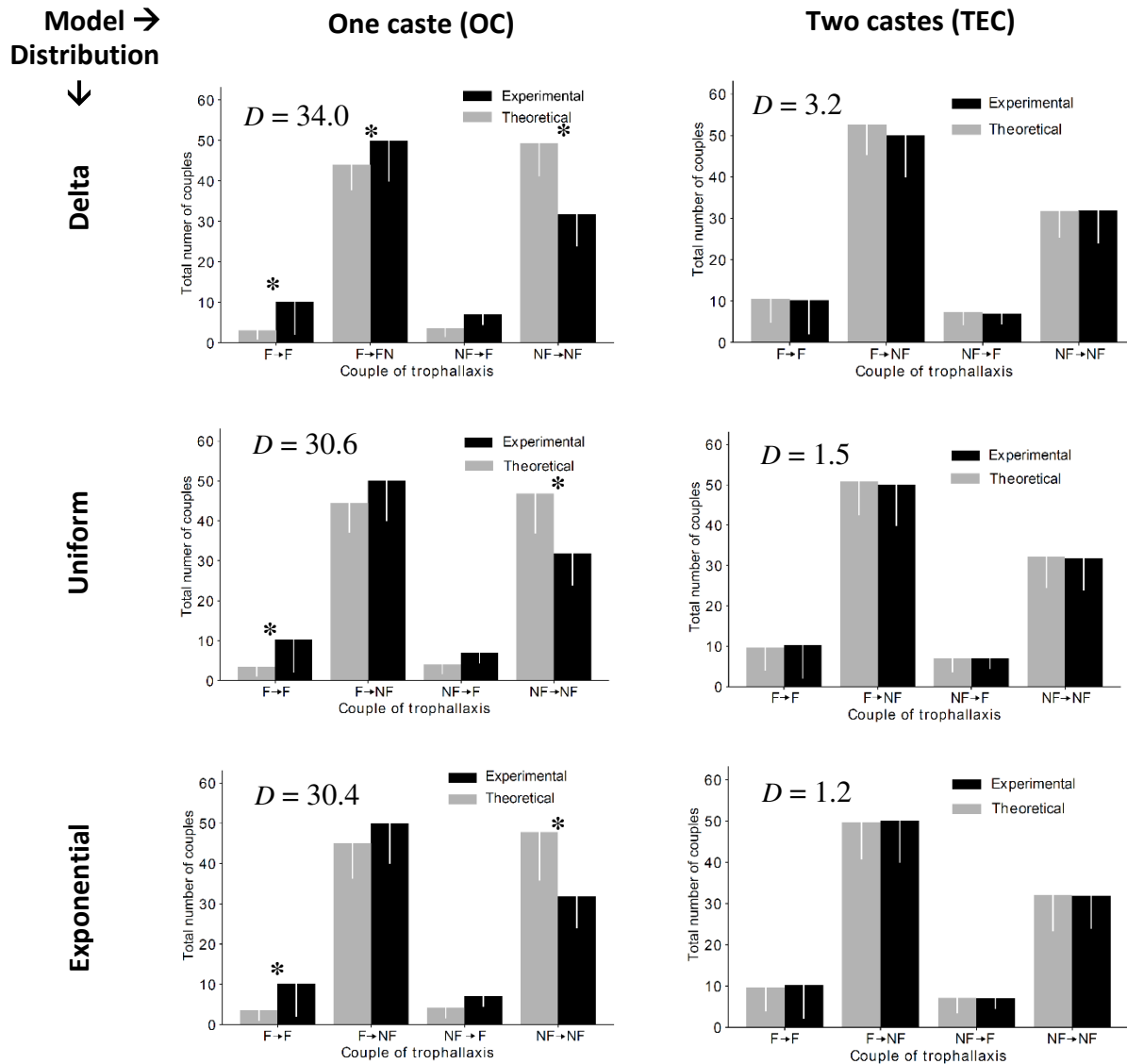

Table S1: Number of trophallactic pairs of each type from the experiments and from the simulation. Mean +/-s.d and results of MW test (U and p) of the comparison between the experiments and the simulations (see also Figure 1 and S3). $N = 5$ for the experiments and 1000 for the simulations.

Experimental values		F→F	F→NF	NF→F	NF→NF
		10.2+/-8.2	50.0+/-10.1	7.0+/-2.6	31.8+/-7.9
One caste model (OC)	Delta	3.1+/-2.2 $U=200.0, p=0.0005$	44.1+/-6.3 $U=653.0, p=0.033$	3.6+/-2.1 $U=784.0, p=0.075$	49.4+/-8.2 $U=98.0, p=0.0002$
	Uniform	3.5+/-2.4 $U=236, p=0.0009$	44.5+/-7.4 $U=764.0, p=0.067$	4.0+/-2.3 $U=766.0, p=0.068$	47.0+/-10.0 $U=168.0, p=0.0004$
	Exponential	3.6+/-2.0 $U=336.5, p=0.0025$	45.0+/-7.7 $U=1009.0, p=0.229$	4.2+/-2.6 $U=1043.0, p=0.261$	47.8+/-11.4 $U=221.5, p=0.0007$
	Delta	10.5+/-5.7 $U=1183.0, p=0.418$	52.5+/-7.3 $U=1125.0, p=0.470$	7.3+/-3.1 $U=844.0, p=0.104$	31.7+/-6.4 $U=1243.0, p=0.492$
Two castes model (TEC)	Uniform	9.7+/-5.8 $U=1078.0, p=0.299$	50.8+/-8.2 $U=1089.0, p=0.310$	7.0+/-3.3 $U=875.0, p=0.123$	32.0+/-7.6 $U=1248.0, p=0.498$
	Exponential	9.7+/-0.2 $U=1209.0, p=0.450$	49.6+/-8.8 $U=1065.0, p=0.285$	7.1+/-3.7 $U=1000.0, p=0.220$	32.0+/-8.8 $U=1170.0, p=0.403$

Table S2: Summary of the KS test applied to the three distributions implemented in the TEC model. The KS test is independently applied to test for a difference in the number of trophallactic events, given and receive, by the foragers and the non-foragers, between the experiments and each version of the model. D_{Total} = sum of each of the four KS distance (D) from KS test on F_{Give} , $F_{Receive}$, NF_{Give} , $NF_{Receive}$.

	F_{Give}		$F_{Receive}$		NF_{Give}		$NF_{Receive}$		D_{Total}
	D	p	D	p	D	p	D	p	
Delta	0.10	0.52	0.09	0.71	0.17	<1.e-6	0.22	<1.10-9	0.58
Uniform	0.04	0.99	0.07	0.91	0.08	0.07	0.13	<1.10-3	0.33
Exponential	0.09	0.66	0.08	0.82	0.04	0.90	0.07	0.21	0.28

Figure S4.A-C. Theoretical and experimental distributions of the total number of trophallaxis per individual compared using a KS test. See also Figure 2. **D-F.** Cumulative number of trophallaxis after 1h of experiments or 3600 timesteps from 1000 simulations. **G-I** Lorenz curves showing the cumulative proportion of trophallaxis vs. the individual rank, sorted by the number of trophallaxis realised by each individual. **J-a.** Distributions of the Gini, efficiency, closeness, betweenness, clustering coefficients and T_{50} (grey bar, N=1000 simulations). Vertical dashed line = experimental mean (N=5). See Section 2.5 for details on statistics.

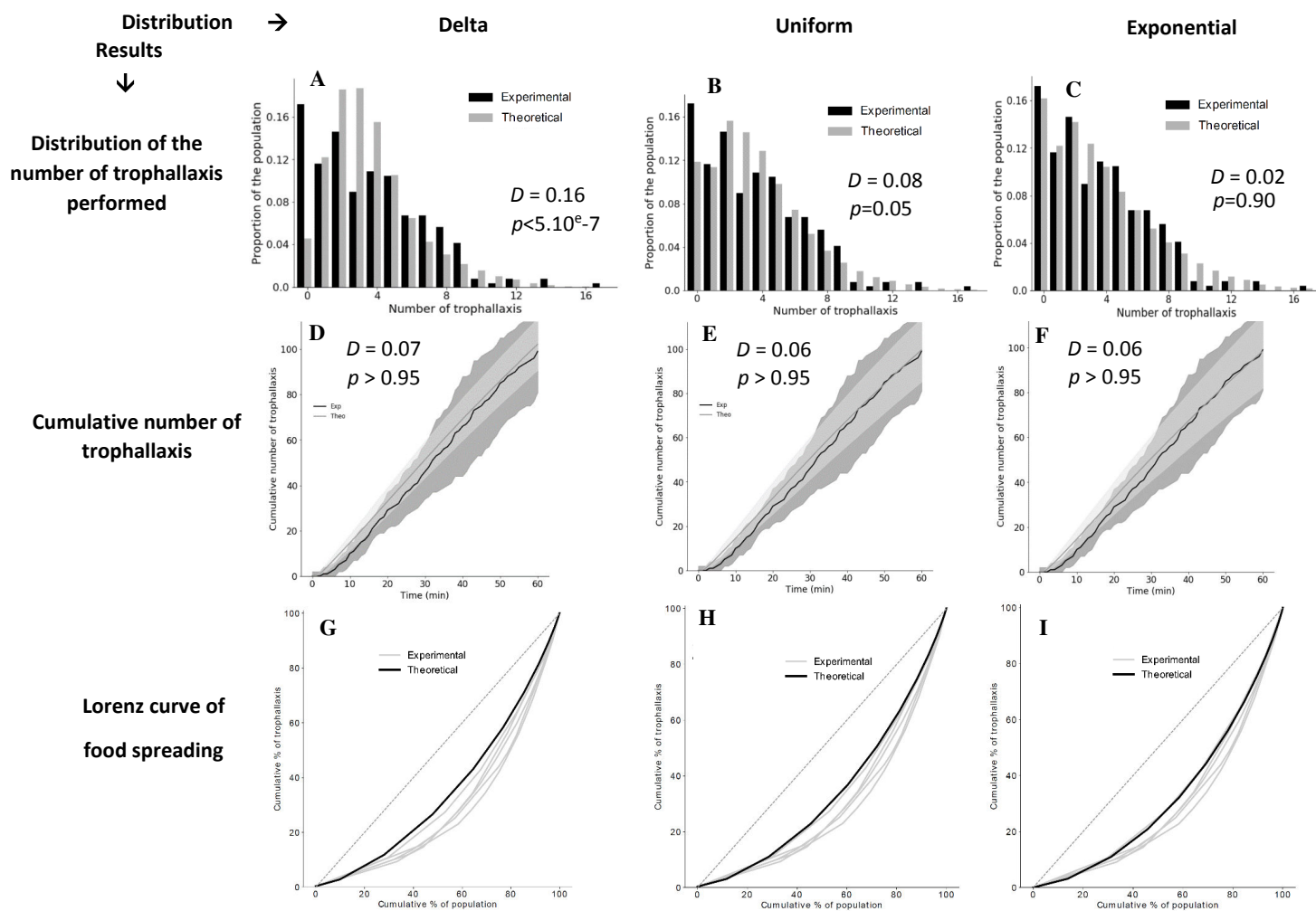

Distribution →
 Results
 ↓
 Gini coefficient

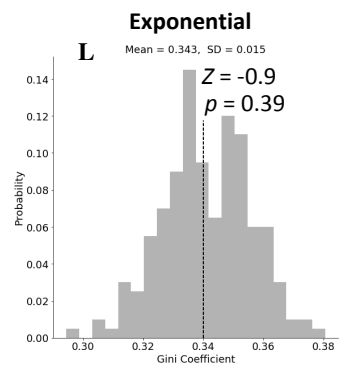
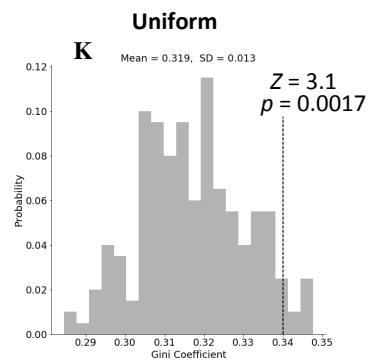
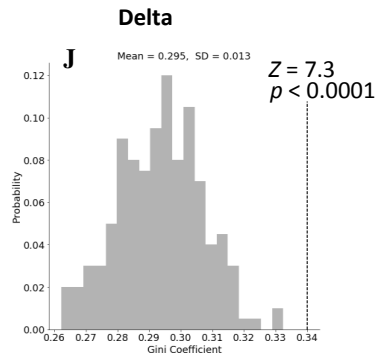

Efficiency

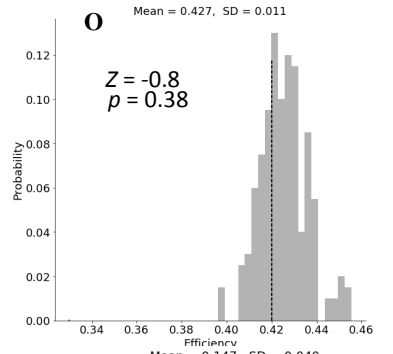
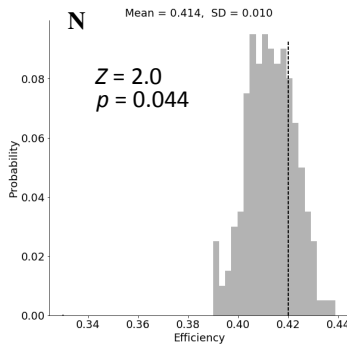
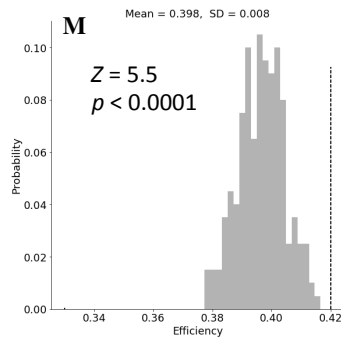

Closeness

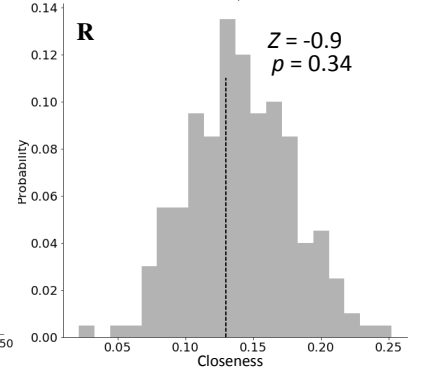
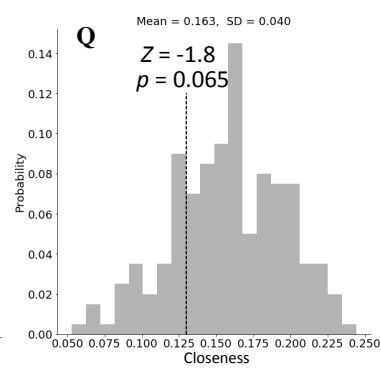
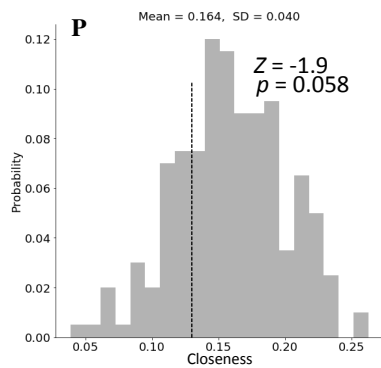

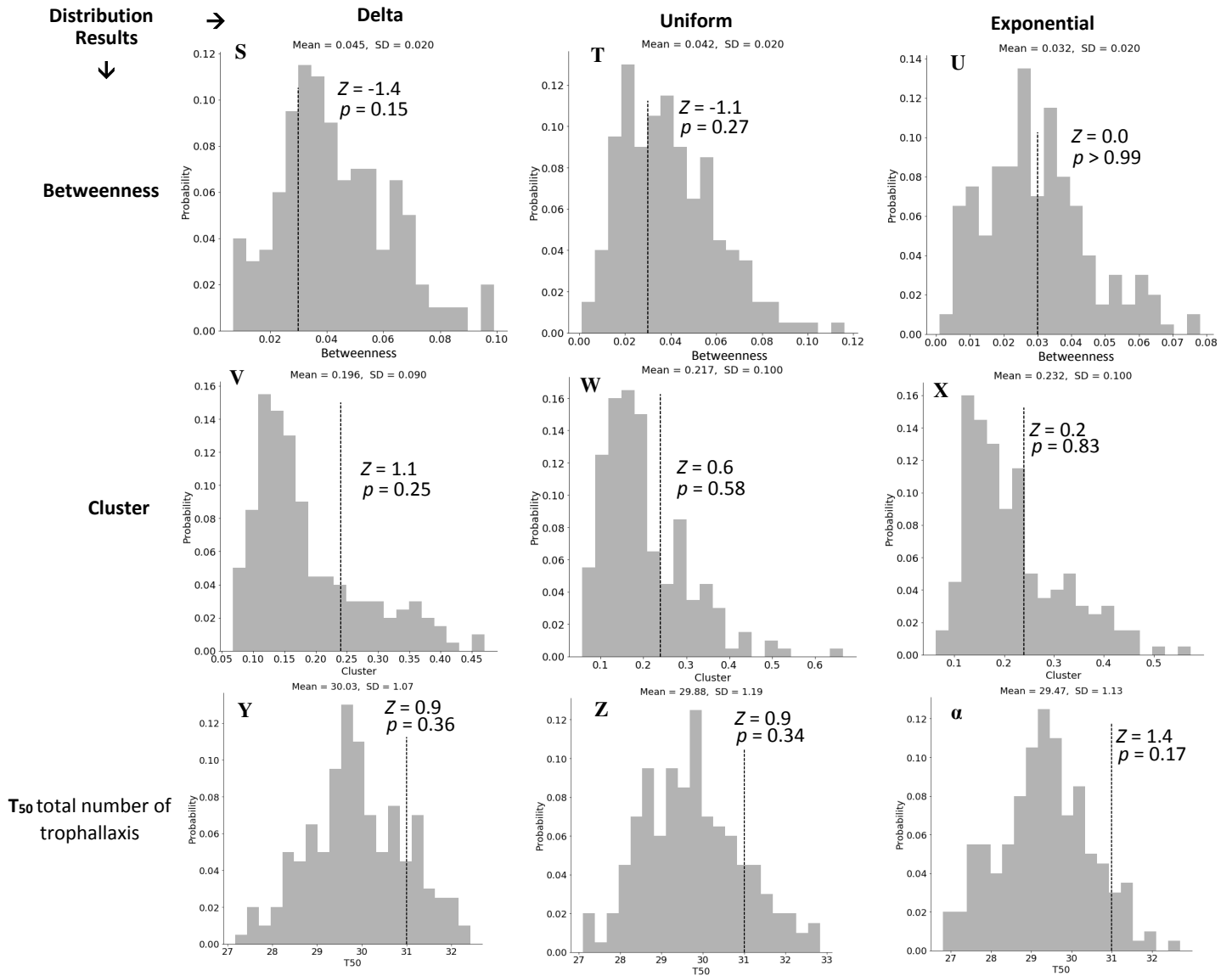
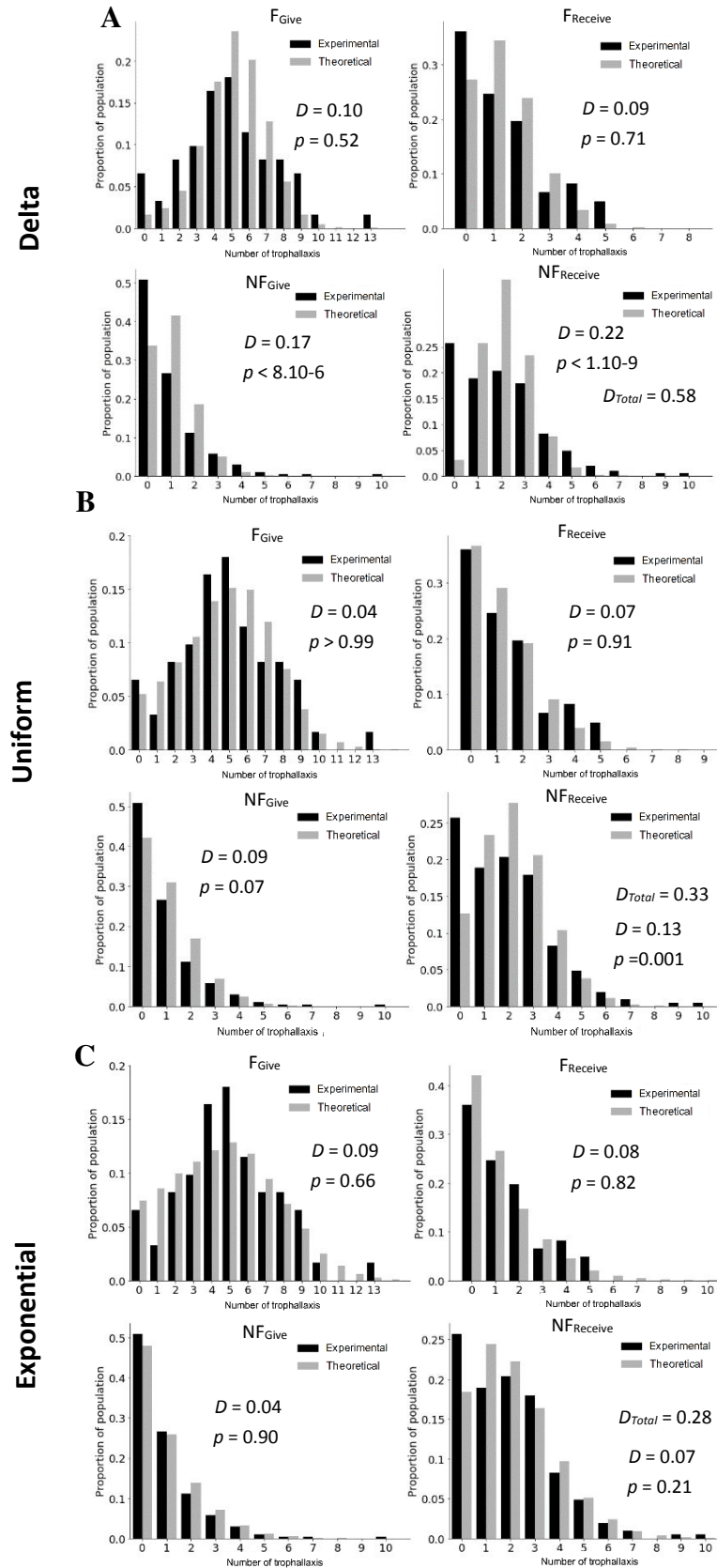

Figure S5. Distribution of the number of trophallaxis given and received, both by the foragers and the non-foragers, as a result of the TEC Delta (A), the TEC Uniform (B) and TEC Exponential (C) models. See also Figure 4 and Table S2.



Chapitre 5

Food dissemination in ants: Robustness of the trophallactic network against resource quality.

Publié : **Bles, O.**, Deneubourg, J.-L. & Nicolis, S. C. Food dissemination in ants: Robustness of the trophallactic network against resource quality. *Journal of Experimental Biology* (2018)

<https://doi.org/10.1242/jeb.192492>

SHORT COMMUNICATION

Food dissemination in ants: robustness of the trophallactic network against resource quality

Olivier Bles*, Jean-Louis Deneubourg and Stamatios C. Nicolis

ABSTRACT

Insect societies are often composed of many individuals, achieving collective decisions that depend on environmental and colonial characteristics. For example, ants are able to focus their foraging effort on the most rewarding food source. While this phenomenon is well known, the link between the food source quality and the intranidal food dissemination networks and its dynamics has been neglected. Here, we analysed the global dynamics of food dissemination in *Camponotus cruentatus* workers, after feeding on a low (0.1 mol l^{-1}) or on a high (1 mol l^{-1}) sucrose concentration food source. We also analysed the trophallaxis activity at the individual level and built the complete network of trophallaxis. The results reveal that the dynamics of food dissemination and the structure of the trophallaxis network are robust and independent of the food concentration. We discuss these results in the light of recent advances in the study of efficiency in food management in ants.

KEY WORDS: *Camponotus cruentatus*, Foraging, Sucrose concentration

INTRODUCTION

Social insects, and ants in particular, live in large and complex societies. Information sharing and the presence of feedback loops between workers (Schafer et al., 2006) allow for a collective exploitation of the best quality food source (e.g. Beckers et al., 1993) while coping with the colony needs (Portha et al., 2002; Sorensen et al., 1985). The individual and collective feeding behaviour in ants is influenced by the food source characteristics such as the sucrose concentration (Beckers et al., 1992; Cassill, 2003; Josens et al., 1998; Price et al., 2016; Reid et al., 2012) and the nature of the food (Markin, 1970; Sorensen et al., 1981; Sorensen and Vinson, 1981), as well as by the level of starvation of the colony (Josens and Roces, 2000). However, the way in which these parameters impact food dissemination inside the colony and, in particular, the individual patterns of trophallaxis exchange, their dynamics and the structure of the associated networks, have been largely overlooked (Cassill, 2003; Greenwald et al., 2015, 2018; Sendova-Franks et al., 2010). Yet, different parameters, such as starvation, affect these dynamics and networks, facilitating food recruitment, which speeds up the dynamics of food accumulation and dissemination at the intranidal level (Buffin et al., 2012; Maillieux et al., 2010; Sendova-Franks et al., 2010). At low or intermediate

starvation level, the crop is still partially laden (Cassill and Tschinkel, 1999b) and the propensity of ants to recruit and to exchange food increases with food concentration (Cassill, 2003). Moreover, this propensity also increases with starvation level (Cassill, 2003; Maillieux et al., 2011) and leads to a large total number of trophallactic events and to a fast food dissemination through the nest (Buffin et al., 2012; Sendova-Franks et al., 2010). This increase in speed is partially due to reorganization of the intranidal process of food spreading, such as a higher proportion of ants that are both donors and receivers when highly starved compared with satiated. In addition, fluid intake rate and crop filling increase with starvation (Josens and Roces, 2000) and food of a lower quality is enough to stimulate the foragers to collect food (Mayor et al., 1987; Mc Cabe et al., 2006). Some nutrients that are ignored by foragers at low levels of starvation are collected and distributed within colonies after a lengthy period of starvation (Chong et al., 2002). This reveals a lower food quality acceptability threshold of highly starved ants. During trophallaxis, the ant receiving food contacts the donor's head and mouth with its forelegs. At low levels of deprivation, this rate of contact and the probability that receivers accept trophallaxis increases with food concentration. This effect of food concentration is not observed at high levels of starvation (Mc Cabe et al., 2006). Therefore, we hypothesized that after a long starvation duration, the total number and the structure of the networks of trophallaxis, the dynamics of food accumulation and the heterogeneity (distribution) of the trophallactic activity among individuals (Cassill, 2003; Sendova-Franks et al., 2010) should be similar regardless of food concentration. To test this hypothesis and to provide a baseline model, we compared the food dissemination activity for two food sources differing in their sucrose concentration (0.1 versus 1 mol l^{-1}) in highly starved (5 days) groups of *Camponotus cruentatus* workers.

MATERIALS AND METHODS

Experimental setup and procedure

From five large mother colonies of the ant *Camponotus cruentatus* (Latreille 1802) (collected in Rochefort du Gard, France, September 2016), we created 10 subcolonies of 25 randomly picked individuals, kept in a plastic box ($175 \times 125 \times 50 \text{ mm}$) containing a circular nest ($95 \times 6 \text{ mm}$), with access to water and sucrose solution (0.3 mol l^{-1}). All subcolonies were maintained in a controlled environment, with a temperature of $21 \pm 1^\circ\text{C}$, a relative humidity of $60 \pm 5\%$ and a constant 12 h/12 h photoperiod. Ants were individually labelled with an Aruco tag (<https://sites.google.com/site/usetrackerac/>) allowing automatic identification of ants. Each tag was attached to the abdomen, had a side length of 1.25 mm and weighed less than 1% of the average mass of the ant. After 5 days of starvation, ants had access to a 0.1 mol l^{-1} (low concentration) or 1 mol l^{-1} (high concentration) sucrose solution feeder placed 40 mm from the nest entrance (Fig. S1A) and were filmed for a period of 120 min. Each colony was randomly tested three times at low and high concentration ($N=60$), with a 5 day break between the two trials.

Center for Nonlinear Phenomena and Complex Systems, Université libre de Bruxelles, 1050 Bruxelles, Belgium.

*Author for correspondence (olivier.bles@ulb.ac.be)

 O.B., 0000-0003-3851-7681; J.-L.D., 0000-0003-1531-1293; S.C.N., 0000-0002-7118-5298

Received 17 September 2018; Accepted 18 October 2018

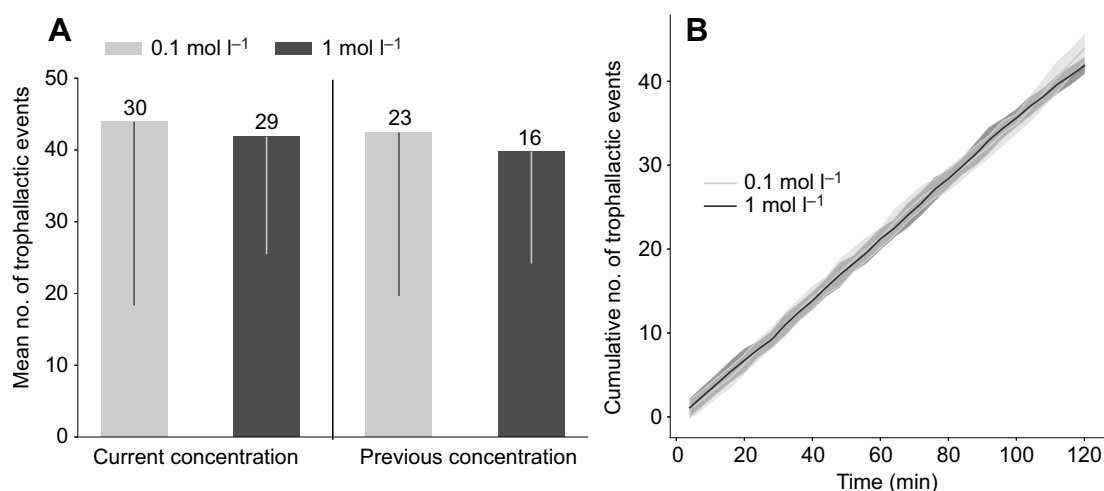

Fig. 1. Mean and cumulative number of trophallactic events. (A) Comparison of the total number of trophallactic events at high (1 mol l⁻¹) and low (0.1 mol l⁻¹) food source concentration. ‘Current concentration’ indicates the number of trophallactic events counted in the experiment (N_i) irrespective of the food source concentration of the previous experiment (N_{i-1}). ‘Previous concentration’ indicates the number of trophallactic events counted in the experiment (N_i) given a food source concentration of the past experiment (N_{i-1}), irrespective of the food concentration of the current experiment (N_i). Numbers above bars indicate the number of experiments; lines inside bars are s.d. (Mann–Whitney U -test: $P > 0.33$ in each case). (B) Cumulative number of trophallactic events (mean \pm s.d.) at both high and low food concentration. A Kolmogorov–Smirnov test indicates an absence of difference in the dynamics of trophallaxis ($P = 0.94$).

Statistical analysis

Experiments were filmed using Panasonic GH4 cameras at a resolution of 4K. Based on snapshots taken every 4 min, in each experiment, we manually counted the number of trophallactic events. Using this footage, trophallactic events and the respective role of both partners (donor or receiver), were identified on the basis of body posture and the mandible position (Cassill and Tschinkel, 1999a; Greenwald et al., 2015; see also Fig. S1B). A Mann–Whitney U -test (MW) and a Kolmogorov–Smirnov test (KS) were respectively used to compare the total (Fig. 1A) and the temporal cumulative number of trophallactic events (Fig. 1B) between all experiments at high versus low food source concentration. Additionally, in a sample of four colonies, each tested once at high and low concentration, we recorded the identity of the donor and the receiver of each trophallactic event in the nest based on body posture and the position of the mandibles (Greenwald et al., 2015). The complete trophallaxis network was then built (see Fig. S2). Each node corresponds to one ant having performed at least one trophallactic event. Pairs of distinct nodes were connected with a directed and weighted edge, from the donor to the receiver. We calculated the ‘betweenness’, the closeness, the eigenvector and the clustering coefficient of each node of the network. Betweenness is an estimate of how important an individual ant is for promoting connectivity across the entire colony and is measured by the number of times an individual acts as a bridge along the shortest path between two other ants (Dell et al., 2014). Closeness is based on the shortest paths from an individual to every other individual: the more central an ant is, the lower its total distance from all other ants (Wey et al., 2008). The eigenvector is a value accounting for the centrality of a node’s neighbours (Butts, 2008). The clustering coefficient determines the existence of ‘communities’ in a network, such as nodes with many more edges between these nodes than with the others (Saramäki et al., 2007). To test for an effect of food concentration on the structure of the trophallaxis network and on the distribution of the trophallaxis activity, for each metric, we applied a Kruskal–Wallis test (KW) of homogeneity on the $N = 8$ (4×2) experiments (Table 1). If the KW indicated an inhomogeneity ($P < 0.05$), we compared the two

distributions (respectively for 0.1 and 1 mol l⁻¹), for each colony, with a MW.

We statistically evaluated the heterogeneity of the distribution of the trophallaxis activity among all the workers of each of $N = 8$ experiments, using the Lorenz curve (Fig. 2; Fig. S3A) and the Gini coefficient (Fig. S3B). The Lorenz curve displays the share of trophallaxis activity (Y -axis) accounted for by $X\%$ of workers (sorted by the number of trophallactic events per individual) in the colony. A perfectly equitable distribution of foraging activity would correspond to the line $Y = X$. The Gini coefficient is known as the ratio between the area below the experimental Lorenz curve and the triangular area below the perfect equality case $Y = X$, and provides a measure of the degree of inequality in the distribution of trophallaxis activity, ranging from 0 (perfect equality) to 1 (perfect inequality).

To estimate whether the observed Gini coefficients and the social network metrics were different from random expectation, we compared each empirical network against two ensembles of $N = 1000$ randomized networks we created by (1) randomly rewiring all edges between all nodes, destroying all features of the original network (full random network, FR); (2) rewiring the edges of the original network while maintaining the distribution of the number of trophallactic events (given/received) by each individual (degree random network, DR) (Holme and Saramäki, 2012). We then performed a Z-test (ZT) to evaluate the significance of the differences between the observed and random metrics. All analysis was conducted in Python 3.6 with

Table 1. Comparison of the homogeneity of network parameters between the eight individually analysed experiments

Colony	H	P
Trophallaxis	5.4	0.61
Betweenness	3.0	0.88
Eigenvector	2.1	0.95
Closeness	42.0	<0.0001
Clustering	10.2	0.18

Results of Kruskal–Wallis tests on the metrics of trophallactic events for $N = 8$ experiments [4 colonies \times (1 trial with high quality food + 1 trial with low quality food)].

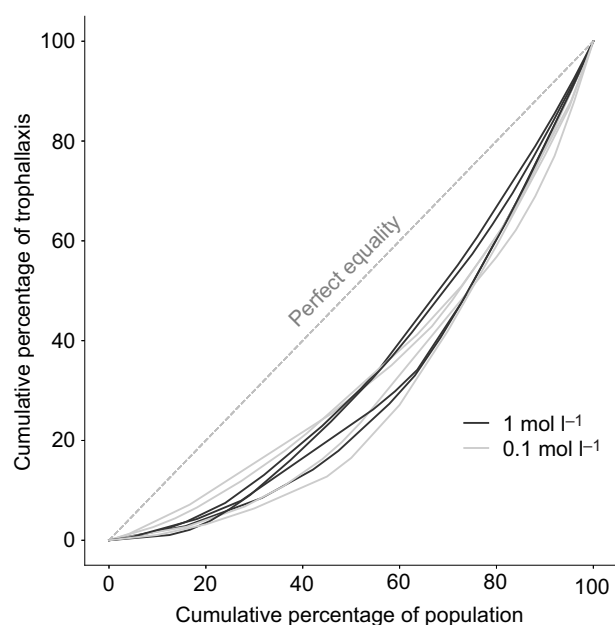

Fig. 2. Distribution of trophallaxis activity. Lorenz curves showing the cumulative percentage of all trophallactic events (Y-axis) performed by the X% of workers (sorted by the number of trophallactic events per individual) for each experiment ($N=8$) and food source quality.

NetworkX 2.1, PyGraphViz 1.4, Numpy 1.14, Scipy 1.0.0 and Matplotlib 2.2.2 packages.

RESULTS AND DISCUSSION

The total number of trophallactic events observed (Fig. 1A, MW: $P>0.33$ in each case) and the dynamics of food accumulation (Fig. 1B, KS, $D=0.07$, $P=1.0$) were independent of the current and the previous (whatever the current concentration) food source concentration.

The proportion of ants involved in trophallaxis activity was independent of the food concentration: $\sim 90\%$ of ants performed at least one trophallactic event and $\sim 70\%$ of ants gave and received food in each experiment (Fisher exact test, $P>0.40$ in each case). All eight experiments were homogeneous in terms of the distribution of the number of trophallactic events individually performed and of social network metrics of each individual (Table 1, KW, $P>0.05$), showing a robustness of the food dissemination and trophallaxis network against food concentration. The closeness was, however, significantly different between the high and low food concentration in two colonies, but without a clear trend, as closeness was higher at high concentration in one of the colonies and at low concentration in the other (MW: $P<0.05$). All trials, regardless of food concentration, had a significant skew in the distribution of the trophallaxis activity: 25% of the workers accounted for more than 50% of the total number of trophallactic events over the course of each experiment (Fig. 2). The observed Gini coefficients were systematically higher than the corresponding theoretical ones obtained from the FR networks (Fig. S3A,B; ZT: $P<0.0001$). The comparison of each experimentally measured social network metric revealed a significant difference from the corresponding FR network (Figs S4, S5; ZT: $P<0.05$), except for the clustering coefficient of two experiments at 1 mol l^{-1} . Finally, no difference occurred between experimentally measured metrics and those from DR networks (Figs S4, S5; ZT: $P>0.05$), except for the closeness coefficient of an experiment and the eigenvector coefficient of two experiments. The highlighted heterogeneity of the trophallaxis activity seems therefore to be the main factor shaping the trophallaxis network as the experimental

networks were not different from the theoretical DR ones. Crop content modulates the individual trophallaxis rate (Greenwald et al., 2018) but we observed a skew in the total number of trophallactic events performed by each ant. This suggests that a high proportion of ants that receive food in a quantity that exceeds their individual nutritional need redistribute it. Therefore, trophallaxis allows them not only to meet their individual needs but also to contribute to food dissemination throughout the colony (Quevillon et al., 2014). Division of labour is assumed to be based on a distribution of the threshold responses among the workers (Pinter-Wollman et al., 2012). In contrast, starvation lowers thresholds (Mailleux et al., 2011) and potentially allows for identical responses to very different food concentrations. Despite this phenomenon, our results suggest that interindividual differences in activity are still maintained.

Our study is, to our knowledge, the first one concerned with the effects of food source concentration on food dissemination activity in ants. Foraging and recruitment processes are affected by food concentration (Cassill, 2003; Josens et al., 1998; Mailleux et al., 2006; Reid et al., 2012). However, our results suggest that the food dissemination network and dynamics depend mainly on the nutritional needs rather than on the concentration of food for long starvation durations (at least for the two different concentrations tested here). This is in agreement with the literature showing that insects consume a large range of food types/quality when starved (Jackson et al., 1998; Mayor et al., 1987; Scharf, 2016). Note that this study concerns subgroups of workers and that further experiments are needed to generalize our results by testing more natural ant colonies (in the presence of queen and brood).

Further investigations are also required to link the mechanisms underlying the observed interindividual variability in trophallaxis activity, colony needs and food dissemination. For example, testing the effect of shorter starvation durations would be important as less hungry individuals with non-empty crop content (Greenwald et al., 2018) exchange only highly energy-rich food and ignore food at low concentration (Cassill, 2003). In contrast, the starvation duration we tested could have led to a high level of excitation that may prevent any effect of food concentration on the dynamics and the structure of the intranidal trophallaxis network.

Acknowledgements

We thank two anonymous referees for their helpful comments.

Competing interests

The authors declare no competing or financial interests.

Author contributions

Conceptualization: O.B.; Methodology: O.B., S.C.N.; Validation: O.B., J.-L.D., S.C.N.; Formal analysis: O.B., S.C.N.; Resources: O.B.; Data curation: O.B.; Writing - original draft: O.B., J.-L.D., S.C.N.; Writing - review & editing: O.B., J.-L.D., S.C.N.; Visualization: O.B.; Supervision: S.C.N.; Project administration: S.C.N.; Funding acquisition: O.B.

Funding

O.B. was financed by a PhD grant from Fonds pour la Recherche dans l'Industrie et dans l'Agriculture and a grant from the Van Buuren Fund.

Data availability

Data are available from the Dryad Digital Repository (Bles et al., 2018): [dryad.r29th82](https://doi.org/10.1002/dryad.r29th82)

Supplementary information

Supplementary information available online at <http://jeb.biologists.org/lookup/doi/10.1242/jeb.192492.supplemental>

References

Beckers, R., Deneubourg, J.-L. and Goss, S. (1992). Trails and U-turns in the selection of a path by the ant *Lasius niger*. *J. Theor. Biol.* **159**, 397-415.

- Beckers, R., Deneubourg, J.-L. and Goss, S.** (1993). Modulation of trail laying in the ant *Lasius niger* (Hymenoptera: Formicidae) and its role in the collective selection of a food source. *J. Insect Behav.* **6**, 751-759.
- Bles, O., Deneubourg, J. and Nicolis, S. C.** (2018). Data from: Food dissemination in ants: robustness of the trophallactic network against resource quality. *Dryad Digital Repository*.
- Buffin, A., Goldman, S. and Deneubourg, J. L.** (2012). Collective regulatory stock management and spatiotemporal dynamics of the food flow in ants. *FASEB J.* **26**, 2725-2733.
- Butts, C. T.** (2008). Social network analysis: a methodological introduction. *Asian J. Soc. Psychol.* **11**, 13-41.
- Cassill, D.** (2003). Rules of supply and demand regulate recruitment to food in an ant society. *Behav. Ecol. Sociobiol.* **54**, 441-450.
- Cassill, D. L. and Tschinkel, W. R.** (1999a). Regulation of diet in the fire ant, *Solenopsis invicta*. *J. Insect Behav.* **12**, 307-328.
- Cassill, D. L. and Tschinkel, W. R.** (1999b). Task selection by workers of the fire ant *Solenopsis invicta*. *Behav. Ecol. Sociobiol.* **45**, 301-310.
- Chong, A., Chong, N. L., Yap, H. H. and Lee, C. Y.** (2002). Effects of starvation on nutrient distribution in the pharaoh ant, *Monomorium pharaonis* (Hymenoptera: Formicidae) workers and various larval stages. Proceedings of the 4th International Conference on Urban Pests. Charleston, SC, USA. 7-10 July 2002, 121-128.
- Dell, A. I., Bender, J. A., Branson, K., Couzin, I. D., de Polavieja, G. G., Noldus, L. P. J. J., Pérez-Escudero, A., Perona, P., Straw, A. D., Wikelski, M. et al.** (2014). Automated image-based tracking and its application in ecology. *Trends Ecol. Evol.* **29**, 417-428.
- Greenwald, E., Segre, E. and Feinerman, O.** (2015). Ant trophallactic networks: simultaneous measurement of interaction patterns and food dissemination. *Sci. Rep.* **5**, 12496.
- Greenwald, E. E., Baltiansky, L. and Feinerman, O.** (2018). Individual crop loads provide local control for collective food intake in ant colonies. *eLife* **7**, e31730.
- Holme, P. and Saramäki, J.** (2012). Temporal networks. *Phys. Rep.* **519**, 97-125.
- Jackson, R. R., Li, D., Barrion, A. T. and Edwards, G. B.** (1998). Prey-capture techniques and prey preferences of nine species of ant-eating jumping spiders (Araneae: Salticidae) from the Philippines. *New Zeal. J. Zool.* **25**, 249-272.
- Josens, R. B. and Roces, F.** (2000). Foraging in the ant *Camponotus mus*: nectar-intake rate and crop filling depend on colony starvation. *J. Insect Physiol.* **46**, 1103-1110.
- Josens, R. B., Farina, W. M. and Roces, F.** (1998). Nectar feeding by the ant *Camponotus mus*: intake rate and crop filling as a function of sucrose concentration. *J. Insect Physiol.* **44**, 579-585.
- Mailleux, A.-C., Detrain, C. and Deneubourg, J.-L.** (2006). Starvation drives a threshold triggering communication. *J. Exp. Biol.* **209**, 4224-4229.
- Mailleux, A.-C., Sempo, G., Depickère, S., Detrain, C. and Deneubourg, J. L.** (2010). How does starvation affect spatial organization within nests in *Lasius niger*? *Insectes Soc.* **58**, 219-225.
- Mailleux, A.-C., Buffin, A., Detrain, C. and Deneubourg, J.-L.** (2011). Recruitment in starved nests: the role of direct and indirect interactions between scouts and nestmates in the ant *Lasius niger*. *Insectes Soc.* **58**, 559-567.
- Markin, G. P.** (1970). Food distribution within laboratory colonies of the Argentine ant, *Tridomyrmex humilis* (Mayr). *Insectes Soc.* **17**, 127-158.
- Mayor, K. L., Aracena, J. M. and Bell, W. J.** (1987). Search duration of *Drosophila melanogaster* on Homogeneous sucrose patches: relative effects of starvation period, sucrose concentration and patch size. *J. Ethol.* **5**, 67-74.
- Mc Cabe, S., Farina, W. M. and Josens, R. B.** (2006). Antennation of nectar-receivers encodes colony needs and food-source profitability in the ant *Camponotus mus*. *Insectes Soc.* **53**, 356-361.
- Pinter-Wollman, N., Hubler, J., Holley, J.-A., Franks, N. R. and Dornhaus, A.** (2012). How is activity distributed among and within tasks in *Temnothorax* ants? *Behav. Ecol. Sociobiol.* **66**, 1407-1420.
- Portha, S., Deneubourg, J.-L. and Detrain, C.** (2002). Self-organized asymmetries in ant foraging: a functional response to food type and colony needs. *Behav. Ecol. Sociobiol.* **13**, 776-781.
- Price, R. I. A., Grüter, C., Hughes, W. O. H. and Evison, S. E. F.** (2016). Symmetry breaking in mass-recruiting ants: extent of foraging biases depends on resource quality. *Behav. Ecol. Sociobiol.* **70**, 1813-1820.
- Quevillon, L. E., Hanks, E. M., Bansal, S. and Hughes, D. P.** (2014). Social, spatial, and temporal organization in a complex insect society. *Sci. Rep.* **5**, 1-11.
- Reid, C. R., Latty, T. and Beekman, M.** (2012). Making a trail: informed Argentine ants lead colony to the best food by U-turning coupled with enhanced pheromone laying. *Anim. Behav.* **84**, 1579-1587.
- Saramäki, J., Kivelä, M., Onnela, J.-P., Kaski, K. and Kertész, J.** (2007). Generalizations of the clustering coefficient to weighted complex networks. *Phys. Rev. E Stat. Nonlinear, Soft Matter Phys.* **75**, 2-5.
- Schafer, R. J., Holmes, S. and Gordon, D. M.** (2006). Forager activation and food availability in harvester ants. *Anim. Behav.* **71**, 815-822.
- Scharf, I.** (2016). The multifaceted effects of starvation on arthropod behaviour. *Anim. Behav.* **119**, 37-48.
- Sendova-Franks, A. B., Hayward, R. K., Wulf, B., Klimek, T., James, R., Planqué, R., Britton, N. F. and Franks, N. R.** (2010). Emergency networking: famine relief in ant colonies. *Anim. Behav.* **79**, 473-485.
- Sorensen, A. A. and Vinson, S. B.** (1981). Quantitative food distribution studies within Laboratory colonies of the imported fire ant, *Solenopsis invicta* Buren. *Insectes Soc.* **28**, 129-160.
- Sorensen, A. A., Mirenda, J. T. and Vinson, S. B.** (1981). Food exchange and distribution by three functional worker groups of the imported fire ant *Solenopsis invicta* Buren. *Insectes Soc.* **28**, 383-394.
- Sorensen, A. A., Busch, T. M. and Vinson, S. B.** (1985). Control of food influx by temporal subcastes in the fire ant, *Solenopsis invicta*. *Behav. Ecol. Sociobiol.* **17**, 191-198.
- Wey, T., Blumstein, D. T., Shen, W. and Jordán, F.** (2008). Social network analysis of animal behaviour: a promising tool for the study of sociality. *Anim. Behav.* **75**, 333-344.

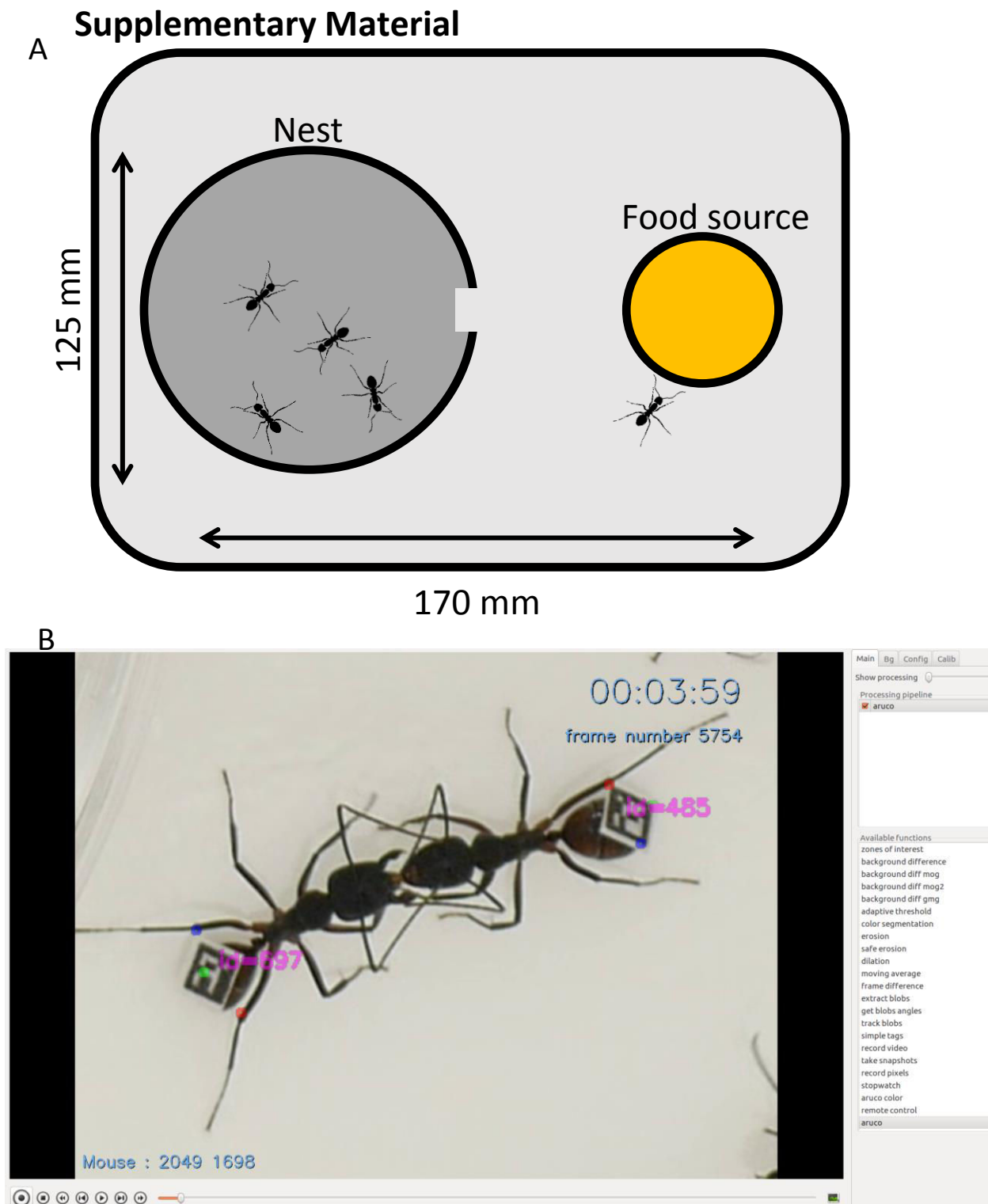

Figure S1.A Experimental setup: A circular plastic nest of 95 mm diameter with a unique entrance of 4mm wide and the food source placed at 40mm of the nest entrance. **B.** Screen capture from an experiment in which the relative position/aperture of the mandibles allow us to affirm that the ant 697 gives liquid sucrose to the ant 485 through a trophallactic exchange.

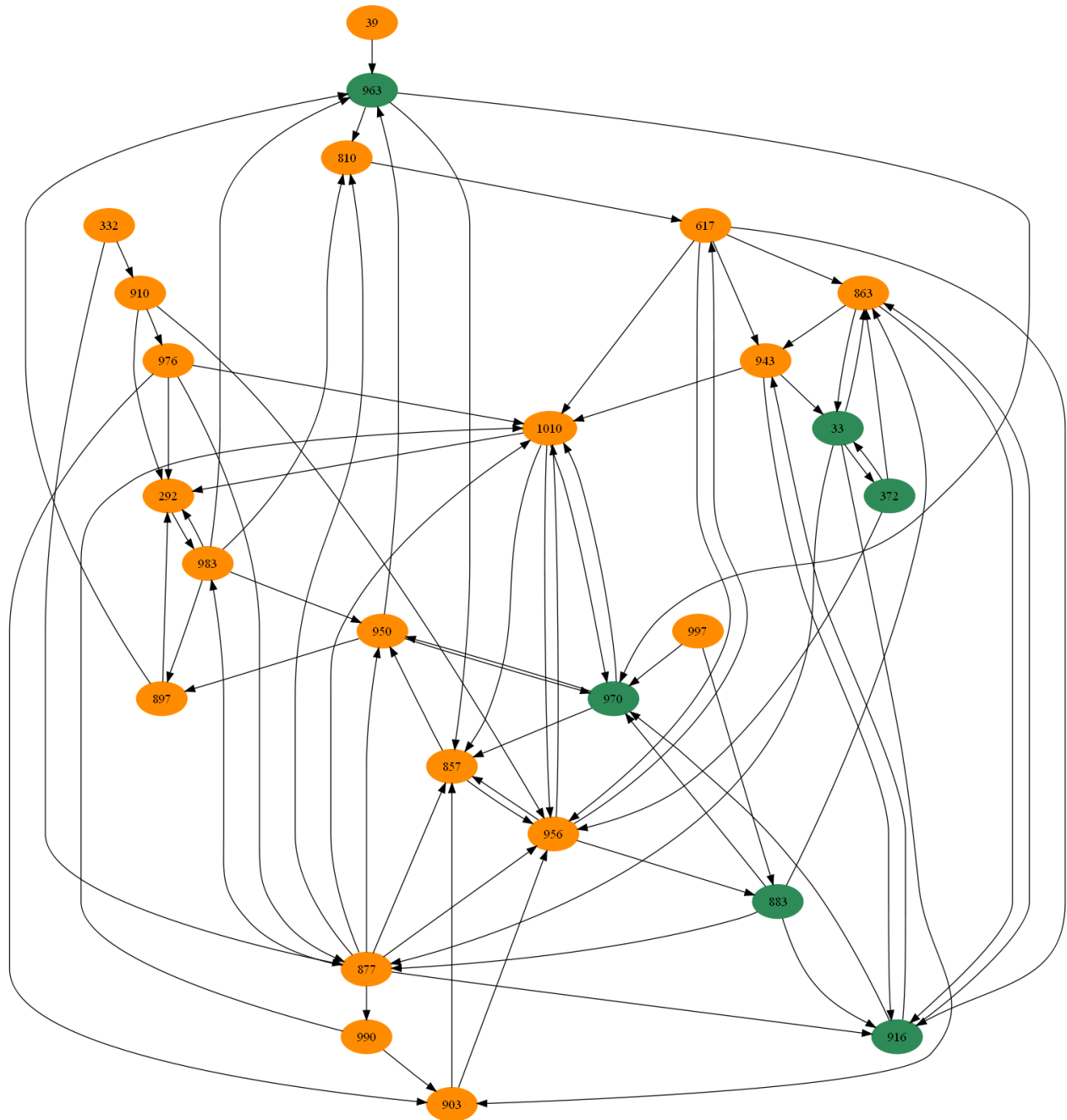

Figure S2. Example of a trophallactic network generated by an experiment where the nodes (circles) represent the workers (orange = foragers, green = intranidal workers) having performed at least one trophallactic exchange. Black arrows represent the trophallactic events oriented from the donor to the receiver.

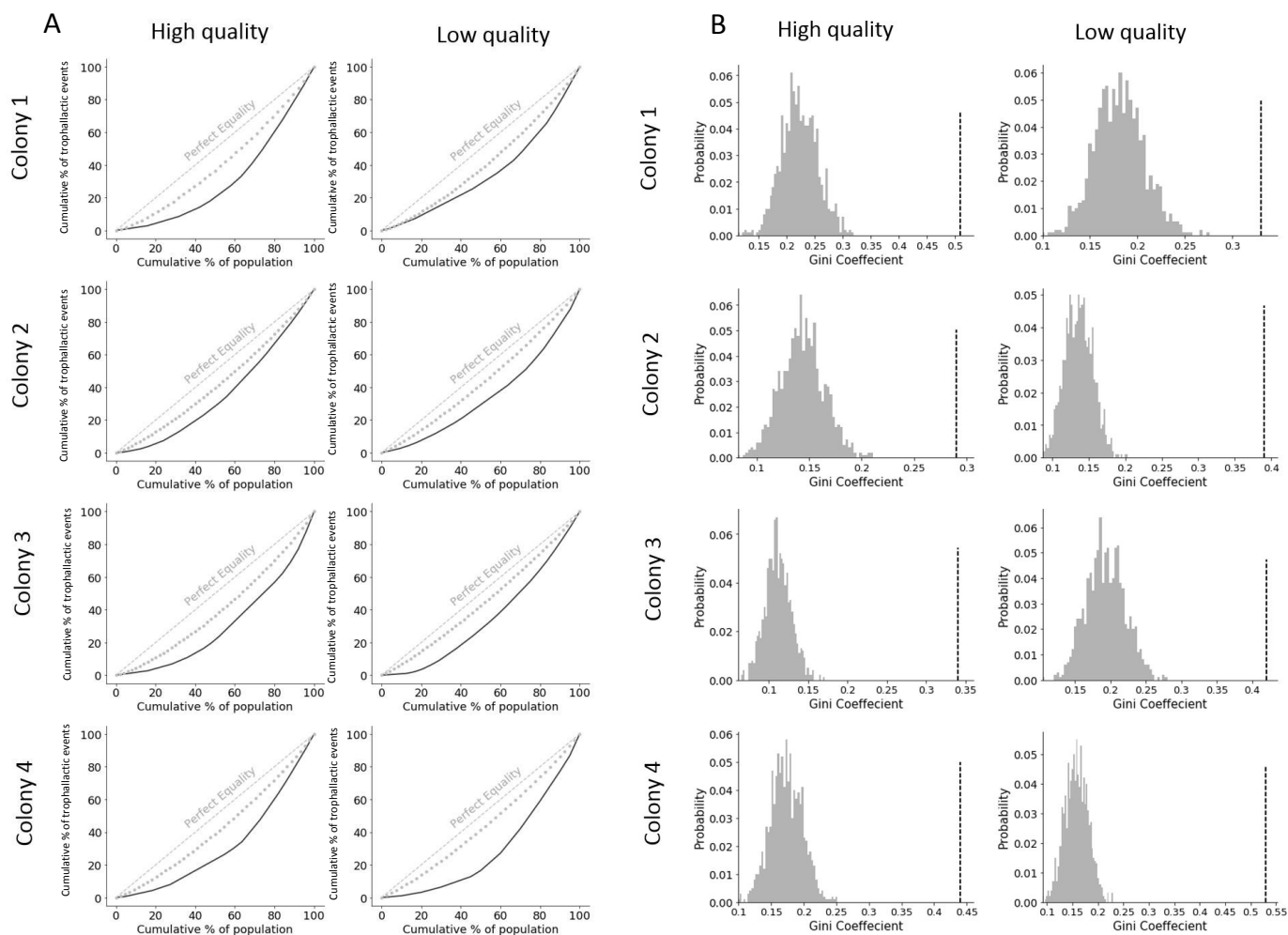

Figure S3. **A** Lorenz curves showing the cumulative percentage of all trophallactic events (y axis) vs. the percentage of the population (x axis, sorted by the number of trophallactic events performed per trial per each worker) for each experiment (black line) and from the trophallactic activity of the 1000 FR randomized reference networks (grey dots). See also Fig.2. **B**. Distribution of the Gini coefficient (grey histogram), measured in each of the 1000 FR networks, for each experiment (N=8). Vertical black dotted line indicates the experimental Gini coefficient in each experiment. Z-Test comparison of the theoretical and experimental values gave a $p < 0.0001$ in each case.

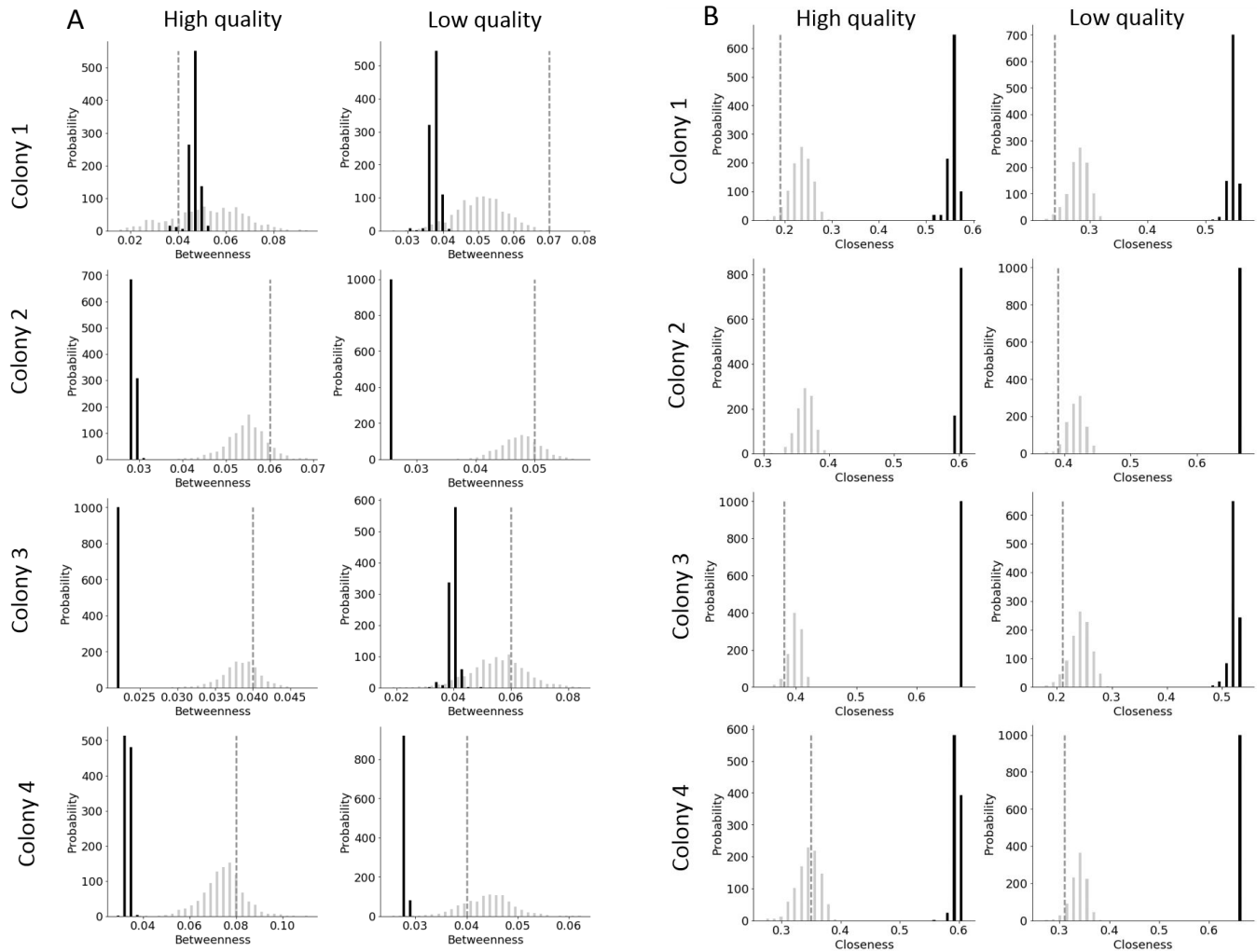

Figure S4. **A** Distribution of the betweenness coefficient, measured in each of the 1000 FR (black histogram) or DR (grey histogram) networks, for each experiment (N=8). Vertical grey dotted line indicates the experimental betweenness coefficient in each experiment. **B.** As in Figure S4.A but for the closeness coefficient.

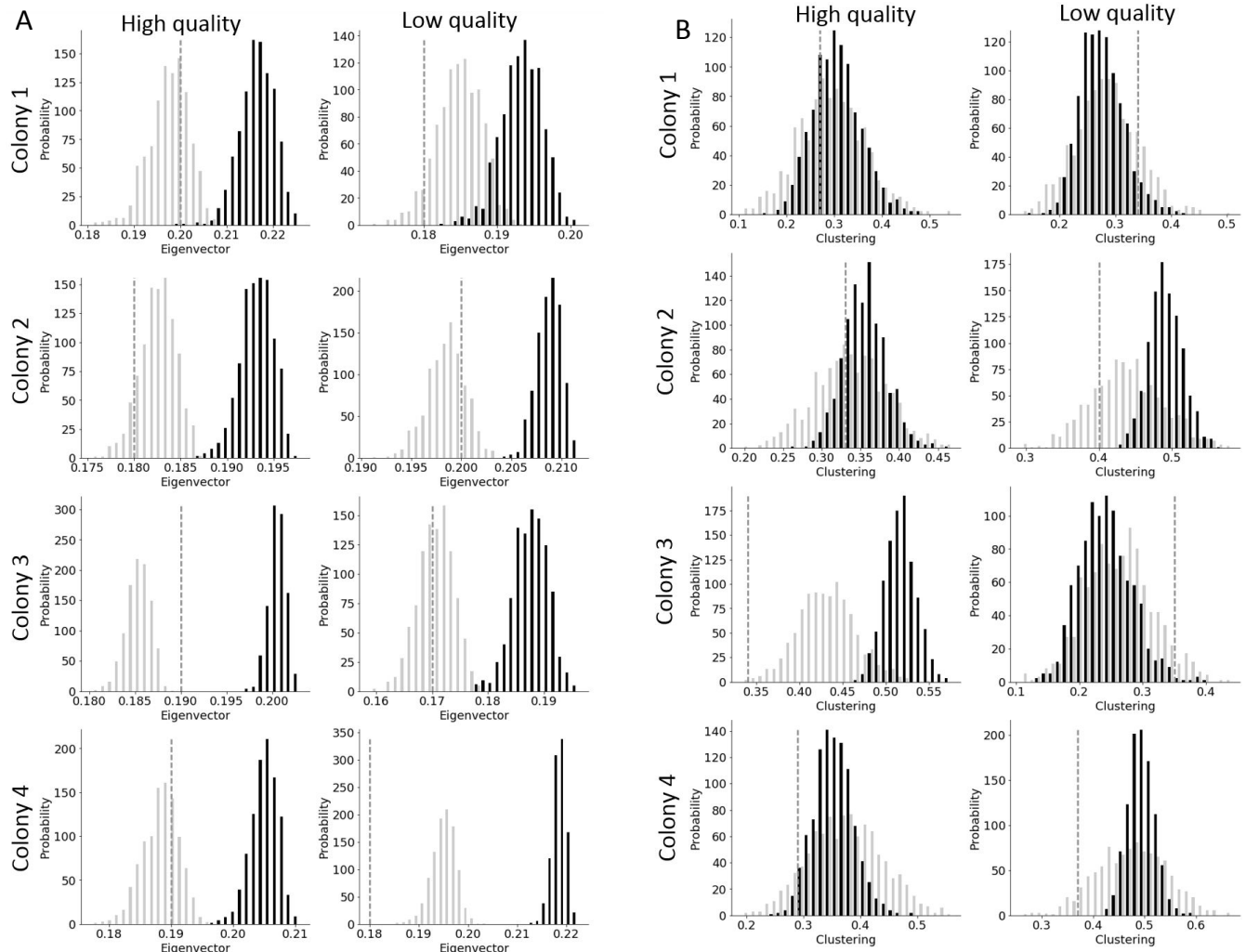

Figure S5. A As in Fig.S4.A but for the eigenvector coefficient. B. As in Figure S4.A but for the clustering coefficient.

Discussion générale

1. Vue générale de la these

Au cours de ce travail de thèse ont été développés et exploités des outils théoriques (simulations) et expérimentaux (notamment de tracking) d'investigation des mécanismes sous-jacents de la gestion/exploitation collective des ressources alimentaires et de la constitution des stocks de nourriture au sein d'une colonie de fourmis. Ces outils ont été employés de façon complémentaire, dans une perspective d'élaboration d'un cadre général d'analyse à plusieurs échelles, notamment individuelle et collective, de phénomènes émergents au sein des sociétés d'insectes. Tout au long des différents axes abordés au cours de cette thèse, la caractérisation des phénomènes observés au niveau collectif - aussi bien en termes d'exploitation/choix collectif de sources de nourriture à l'extérieur du nid que de son accumulation/formation des stocks au sein du nid - a été menée en parallèle de la détermination/analyse des mécanismes et choix comportementaux à l'œuvre à l'échelle individuelle et de leurs interactions. Aussi, il a été choisi de travailler sur 3 espèces de fourmis à la biologie et au comportement connus et variés afin de tester la robustesse et le degré de généralisation imputable aux phénomènes biologiques décrits et des mécanismes qui les soutiennent, au-delà du cadre spécifique. Sont abordés dans un 1^{er} temps les liens entre les caractéristiques de l'environnement externes au nid, notamment en termes de topographie et de géométrie, et l'exploitation collective de source de nourriture, notions traitées dans les deux 1ers chapitres. Est traité ensuite le phénomène de dissémination collective de la nourriture par échanges trophallactiques au niveau intranidal, analysé dans le 3^{ème} chapitre à travers le prisme des réseaux qui en découlent et de la division du travail. Cette approche expérimentale est complétée par une approche théorique de modélisation fortement basée sur ces expériences et ayant permis d'approfondir l'analyse des liens entre les descriptions en réseau ou en densité d'unités de la colonie et son activité. Enfin au cours du dernier chapitre l'enjeu a été de déterminer dans quelle mesure les descriptions des dynamiques et réseaux d'échanges de nourriture dans le nid sont affectés par les caractéristiques de l'environnement et plus particulièrement par la qualité (énergétique) de la ressource alimentaire. Ainsi, ce travail, par son approche couplant modélisation fonctionnelle & expérimentation, se veut également être une synthèse et une intégration de

l'essentiel des connaissances actuelles des lois régissant la gestion collective des ressources alimentaires chez la fourmi dont il s'agit au cours de ce chapitre de démêler le contenu afin d'une part d'en résumer les enjeux et d'autre part d'en discuter les limites et perspectives.

2. Influence de paramètres environnementaux sur les choix collectifs de ressources alimentaires chez la fourmi

2.1 Résumé des résultats concernant l'effet de la topographie et de la géométrie de l'environnement sur les choix d'exploitations de sources alimentaires :

Les insectes sociaux ont fait (et font toujours) l'objet de nombreux travaux dans le contexte de l'étude des phénomènes collectifs, notamment de décisions collectives dès qu'il s'agit, dans le cadre de dispositif de choix binaires par exemple, d'exploiter l'une parmi plusieurs ressources de qualité variables (s'agissant de nids/abris e.g., (Franks et al., 2003) ou de nourriture, e.g., (Beckers et al., 1990)). En effet, les mécanismes à l'œuvre au sein de ces sociétés (décrits au cours de l'introduction), basés sur une organisation décentralisée et des boucles de rétroaction principalement positives, conduisent dans la majorité des cas à l'émergence d'un consensus à l'échelle de la colonie, occupant/exploitant rapidement et uniquement la ressource la plus favorable. Ces processus n'impliquent pas de comparaison directe des différentes ressources par un ou plusieurs individus bien informés, e.g., (Robinson et al., 2014). Ce phénomène de consensus émerge également dans le contexte de ressources de qualité identiques, l'activité se focalisant aléatoirement sur l'une ou l'autre des ressources. Ainsi les colonies de *L. niger* empruntent un seul de deux chemins identiques conduisant à une source de nourriture (Deneubourg and Goss, 1989) aussi bien que d'autres espèces de fourmis à recrutement de masse qui exploitent une seule de deux ou plusieurs sources de nourriture de qualité identique (Sumpter and Beekman, 2003), selon le phénomène de brisure de symétrie. Les facteurs de l'environnement abiotiques interviennent également dans ces phénomènes collectifs, tel que la distance séparant le nid des sources de nourriture par exemple, conduisant à une exploitation de la source la plus proche du nid (Deneubourg et al., 1990). Nos travaux s'inscrivent dans ce contexte du lien entre les propriétés de l'environnement physique et les choix de sources, dans le but, d'une part de discriminer finement les sensibilités des fourmis aux propriétés de leur environnement et leurs influences sur les choix collectifs et d'autre part de déterminer les mécanismes à l'œuvre dans ces phénomènes. Cependant,

dans nos expériences de choix collectifs présentées dans les chapitres 1 et 2, les sources de nourritures sont identiques en termes de qualité (concentration en sucre et taille) et de distance les séparant du nid. Les facteurs de variations concernent la topographie (chapitre 1) et la géométrie (chapitre 2) de l'environnement entre le nid et les sources. Dans le 1^{er} chapitre, il a été montré que des colonies de deux espèces de fourmis, *L. niger* et *M. rubra*, confrontées à un dispositif de choix binaires présentant deux chemins différant uniquement par leur inclinaison, l'un ascendant, l'autre descendant et conduisant à des sources de nourriture identiques, ont une très nette préférence (90% des expériences) pour le chemin ascendant lorsque les deux sources de nourritures sont introduites simultanément. Aussi, et de façon d'autant plus surprenante, cela s'avère également être le cas lorsque la source de nourriture à l'extrémité de la branche ascendante est introduite 20 minutes après celle à l'extrémité de la branche descendante (accessible dès le début de l'expérience). En effet, il est observé une flexibilité au niveau collectif, avec une réallocation de l'exploitation depuis la source à l'extrémité de la branche descendante lors des 20 premières minutes, vers la source à l'extrémité de la branche du haut après son introduction, dans plus de 70% des cas et ce malgré une piste de phéromone déjà bien établie ou du moins après un nombre important d'aller-retours de fourrageuses vers la source du bas. Le deuxième chapitre explore l'impact de la géométrie du chemin entre nid et source sur le choix de la source exploitée. Bien que les deux sources se trouvent à la même distance absolue du nid, l'un des chemins y mène de façon rectiligne tandis que le second implique un angle de 135° à mi-parcours du chemin vers la source. Dans ce contexte, les colonies de *L. niger* exploitent significativement plus la source à l'extrémité du chemin rectiligne que du chemin coudé.

Nous sommes également parvenus à démontrer que les mécanismes à l'œuvre dans l'émergence des comportements collectifs, respectivement dans les deux types de dispositif, sont fondamentalement différents. Dans l'expérience de variation de l'inclinaison des chemins (Chapitre 1), les effets de l'inclinaison sur le comportement individuel sont nettement observables dès la phase d'exploration chez les deux espèces étudiées (bien que cela ne se manifeste pas de la même façon à une échelle d'analyse plus fine, cf. le paragraphe traitant du comportement d'exploration dans la discussion) avec forte propension des exploratrices à effectuer des demi-tours lorsqu'elles sont confrontées à un chemin descendant (aux alentours de 50%) alors qu'elle n'est que de 3 à 10% face à un chemin ascendant. Cependant, les vitesses de déplacement, sur la pente ascendante ou descendante, lors du trajet aller (individu vide) ou retour (individu chargé), sont

strictement identiques. Dans l'expérience où est étudié l'effet de la géométrie (coude) des chemins (Chapitre 2), l'exploration des deux branches (la découverte des deux sources) est similaire mais une différence apparaît au niveau du temps nécessaire pour effectuer le trajet de retour de la source jusqu'au nid : le temps est significativement plus long sur la branche coudée que sur la branche rectiligne.

2.2 Analyse des comportements individuels lors de l'exploration de l'environnement et des trajets de retour au nid :

Dans l'expérience concernant la topographie de l'environnement, la 1^{ère} source découverte est plus fréquemment celle située à l'extrémité du chemin ascendant chez *L. niger* quand aucune préférence n'apparaît chez *M. rubra*. Dans le cas des chemins coudés ou rectilignes, *L. niger* ne découvre préférentiellement aucune des deux sources. Ce constat est intéressant à double-titre dans la mesure où, d'une part la découverte de la source chez *L. niger* semble être affecté par la topographie de l'environnement mais non par la géométrie (au moins dans notre cas) tandis qu'elle semble indépendante de la topographie chez *M. rubra*. La durée de l'affamement est similaire dans les différentes expériences et pour les deux espèces testées. Chez les insectes sociaux, il a été montré que l'affamement, entre autre, affecte l'exploration de l'environnement, augmente le nombre d'exploratrices et la fréquence des sorties du nid (Mailleux et al., 2010b). Les différences de comportement d'exploration en fonction du dispositif expérimental que nous observons chez *L. niger* ne sont pas imputables à l'affamement, dans la mesure où les durées d'affamement sont similaires entre les expériences. L'augmentation de la motivation à explorer l'environnement avec l'affamement chez *L. niger* ne semble pas suffisante pour surpasser l'effet de la topographie sur la propension à explorer. L'absence de préférence en termes de découverte de source chez *M. rubra* malgré la différence marquée entre les deux chemins au niveau des demi-tours peut s'expliquer par le nombre d'exploratrices, plus important chez *M. rubra* que chez *L. niger*. Un nombre important d'exploratrices peut, dans ce type de système dynamique/stochastique, masquer l'effet des demi-tours sur la découverte de la source, d'autant plus que l'on s'intéresse ici à un événement unique (l'arrivée de la 1^{ère} exploratrice à la source). Une hypothèse écologique pourrait également être avancée à ce niveau : certains travaux montrent un lien entre les capacités d'exploration et la « précision » de la niche écologique d'une espèce, incluant le spectre alimentaire. De façon assez

logique, plus cette dernière est restreinte plus l'aversion à l'exploration ou à la « nouveauté » est marquée (Greenberg, 1990a, 1990b). Or *M. rubra* (alimentation de type détritivore, carnivore mais également miellat de puceron) est plus généraliste que *L. niger* dont l'alimentation est plus spécifique et essentiellement restreinte à l'exploitation de miellat de puceron que l'on trouve à la cime des arbres, une différence qui pourrait influencer le comportement exploratoire des deux espèces.

Il est cependant intéressant de noter que dans le cas des expériences contrôles, c'est-à-dire lorsque les deux chemins sont orientés vers le haut ou les deux orientés vers le bas, le temps de 1^{ère} découverte (de la 1^{ère} des deux sources) entre les deux conditions, n'est pas significativement différent, respectivement pour les deux espèces, et ce malgré les différences en termes de demi-tours. Ce résultat suggère que lorsqu'une exploratrice effectue un demi-tour face à un chemin descendant, le retour au nid n'est pas privilégié, malgré un angle moins marqué vers le chemin menant au nid par rapport à celui menant à la seconde source (cf. schéma du setup chapitre 2). Au contraire, l'exploration pourrait être stimulée (probablement par effet de synergie avec l'affamement) et le taux de demi-tour de ce même individu, face à une seconde pente, serait également diminué. Le fait qu'après un 1^{er} demi-tour un individu ne retourne pas au nid malgré un angle moins marqué envers ce chemin suggère que les exploratrices ont tendance à s'éloigner du nid.

La littérature montre chez la fourmi une préférence pour les chemins déviant le moins de sa trajectoire en cours lors du trajet de retour au nid, ce qui n'est pas le cas lors l'exploration (Yates and Nonacs, 2016). En absence d'hétérogénéité dans le plan (tel que des pentes), l'activité d'exploration chez *L. niger* est aléatoire, permettant de prospecter sur une importante surface et conduisant à une découverte indifférenciée des deux sources, un résultat également en accord avec la littérature (Jander, 1990). Cependant le comportement lors du trajet de retour au nid, après la découverte/exploitation d'une source de nourriture est modifié. En effet, la trajectoire lorsqu'il s'agit de retourner au nid chargé de nourriture est, selon la littérature, la plus rectiligne possible (Cammaert and Cammaerts, 1987; Jander, 1990). Ce comportement couplé au phénomène d'« intégration de chemin » permettant de « mémoriser » la position du nid dans l'espace notamment chez la fourmi (e.g.,(Collett and Collett, 2000)), serait à l'origine d'un temps de retour supérieur dans la branche coudée par rapport à la branche rectiligne. Les individus à l'extrémité de la branche

coudée seraient alors, au moins momentanément, piégé par le dispositif, empêchant un retour direct au nid : la durée du retour au nid est alors plus longue dans la mesure où les individus chargés seraient moins enclins à « s'éloigner » du nid, une trajectoire cependant indispensable pour rejoindre le nid dans ce dispositif. Le dépôt de piste plus rapide sur le chemin rectiligne conduit, par effet de rétroactions positives, à un emballement du recrutement vers cette source, ainsi préférentiellement exploitée.

2.3 Analyse de la récolte et hypothèses sous-jacentes aux choix de sources.

Malgré une nette préférence pour la source à l'extrémité du chemin ascendant, il est intéressant de noter que l'effort de récolte (approximé dans nos expériences par la cumulative du temps passé à la source par l'ensemble des individus, cf. matériel et méthodes du chapitre 1) sur l'ensemble de l'expérience, est indépendant de la condition, conditions contrôles comprises (deux sources vers le bas ou deux sources vers le haut). Ainsi, la quantité totale de nourriture apportée au nid ne semble pas affectée par la topographie mais est adaptée à l'état des stocks de la colonie (Buffin et al., 2009; Sendova-Franks et al., 2010).

Le mécanisme de demi-tour différentiel face à une pente ascendante/descendante couplé aux effets de renforcements par dépôt de pistes est suffisant pour expliquer la préférence pour la branche ascendante dans la condition asymétrique. L'origine de cette préférence pourrait résider dans l'avantage en termes énergétiques que représente le fait de descendre la branche avec l'abdomen rempli après un passage à la source plutôt que de remonter une pente. Cependant cet effet pourrait s'avérer complexe et présente des effets non-intuitifs. En effet, la dépense énergétique est minimal lors d'un déplacement horizontal et augmente lors d'un déplacement sur une pente, indépendamment de son inclinaison (ascendante ou descendante) (Holt and Askew, 2012). De plus certains travaux montrent que le coût énergétique d'un trajet de fourragement ne représente que 0.1 à 1% du gain énergétique de la nourriture apportée au nid lors de ce même trajet (Fewell, 1988; Weier and Feener, 1995), laissant supposer que le facteur énergétique n'est pas déterminant dans le choix du chemin emprunté lors de la récolte, malgré une augmentation des dépenses d'un facteur 2 à 3 de lors d'un trajet effectué sur une pente de 45° ou 90° (Full and Tullis, 1990). Cependant cette idée ne fait pas consensus dans la littérature, dans la mesure où certains travaux avancent une

hypothèse diamétralement opposée: plusieurs espèces de fourmis, notamment les fourmis champignonnières, quittent le nid avec une charge importante de nourriture liquide, supposée être une réserve de « carburant » consommée lors du trajet de fourragement, une hypothèse avancée sous le nom de « lunchbox hypothesis » (Rytter and Shik, 2016). La préférence pour un chemin ascendant a également été observé chez *Formica rufa*, lorsqu'un chemin horizontal de même longueur est également disponible (Denny et al., 2001). Cependant, si la longueur du chemin vertical est 2 ou 3 fois plus importante que le chemin horizontal, ce dernier sera largement plus emprunté. Les fourmis privilégient le chemin le plus court/rapide et lorsque les deux options sont équivalentes en termes de longueur, le chemin vertical est préféré, les auteurs invoquant l'hypothèse d'une diminution du risque d'erreur navigationnelle sur le chemin vertical. De plus, une modulation de la vitesse de déplacement est possible. Certains auteurs observent une vitesse réduite sur la branche verticale par rapport à la vitesse de déplacement à l'horizontal, permettant de conserver un taux métabolique constant et de contrebalancer l'augmentation des coûts de déplacement sur un chemin vertical (Holt and Askew, 2012). Ainsi l'efficacité énergétique des trajets source-nid dominerait, dans une certaine mesure (cf. quand la longueur absolue des deux chemins est identique tandis que si le trajet vertical est plus long que l'horizontal, ce schéma n'est plus valable) l'efficacité temporelle. Cependant nos mesures de vitesse ne montrent aucune différence entre les déplacements sur les branches, ascendantes ou descendantes, à l'aller comme au retour et ce chez les deux espèces. La longueur des branches (relativement courte) ou l'inclinaison des branches (45° donc deux fois inférieure à un angle droit) sont probablement impliquées dans ce résultat. Enfin les résultats du chapitre 2 ainsi que la littérature (e.g., (Gerbier et al., 2008)) soulignent la préférence pour un chemin rectiligne lors du retour au nid, or le chemin horizontal intègre deux angles (droits) supplémentaires par rapport au chemin vertical (figures in (Denny et al., 2001)), un paramètre intervenant potentiellement dans le choix de piste de retour. En effet lorsqu'une piste intègre des angles de faibles valeurs celle-ci est préférée à une piste incluant des angles plus importants (Gerbier et al., 2008).

2.4 Ouverture : Flexibilité, exploitation de sources et propriétés de l'environnement.

De nombreux facteurs biotiques, largement étudiés, tels que la distribution spatiale et l'abondance des sources alimentaires, la présence de compétiteurs ou prédateurs, influencent l'activité de récolte de nourriture chez la fourmi (Hölldobler and Wilson, 1990). Les facteurs abiotiques y jouent également un rôle important mais ont été investigués de façon très asymétrique : quand l'effet de la distance a été l'objet de nombreuses études, avec des apports majeurs bien au-delà des considérations strictement biologiques (Dorigo et al., 2006), l'influence de paramètres « secondaires » demeure bien moins connue. Les caractéristiques de l'environnement peuvent intervenir dans les choix collectifs des insectes sociaux via différents mécanismes. Ainsi les propriétés physiques du substrat peuvent indirectement affecter les choix collectifs en modifiant le niveau de perception de la piste chimique (Detrain et al., 2001; Jeanson et al., 2003) sans impliquer de changements comportementaux. Nos expériences montrent qu'un effet plus direct de l'environnement, en accord avec la littérature (Marsh, 1985) peut également intervenir, par modulation du comportement au niveau individuel. Nos deux espèces testées montrent, dans le cas des pentes, une flexibilité collective dans la mesure où l'activité d'exploitation de source est réallouée vers le chemin ascendant malgré son introduction secondaire. Cette flexibilité est particulièrement surprenante, surtout chez *L. niger*, une espèce dont il a été montré que le système de recrutement défavorise toute forme de flexibilité/réallocation vers une source plus profitable lorsqu'une source moins intéressante est en déjà en cours d'exploitation (Beckers et al., 1990), contrairement aux *Myrmica*, capable de réallocation (de Biseau et al., 1991). Ces résultats vont ainsi l'encontre de la littérature concernant la flexibilité des comportements collectifs chez *Lasius* et chez d'autres espèces à recrutement de masse, flexibilité qui repose dans notre cas sur la modulation des demi-tours. Les dispositifs expérimentaux utilisés au cours de nos travaux ont ainsi permis de révéler d'importantes similarités au niveau des choix collectifs d'exploitation de source de nourriture chez deux espèces de fourmis aux caractéristiques écologiques distinctes. De plus ces dispositifs nous ont permis de montrer l'importance des caractéristiques secondaires des piste en plus de leur longueur, telles que la linéarité ou l'inclinaison, dans les choix collectifs. Cependant, dans ce dernier cas, les raisons ultimes de la préférence pour une piste ascendante et la capacité des deux espèces étudiées, à réallouer leur activité sont encore peu claires et appellent à des investigations expérimentales supplémentaires, afin de tester aussi l'hypothèse énergétique par

rapport à l'hypothèse écologique. Il s'agirait notamment de tester la robustesse de cette préférence pour une pente ascendante à une échelle plus large, notamment chez une espèce par exemple exclusivement sous-terrainne, tel que *Lasius flavus*, se nourrissant de miellat de pucerons de racine et dont rien ne laisse supposer une attirance vers une source de nourriture sur la végétation ou même au niveau de la canopée. De même, il s'agirait d'augmenter l'intérêt énergétique de la source sur la branche descendante, en y introduisant une nourriture plus riche que sur la branche ascendante ou en multipliant la longueur de la branche ascendante, afin de jouer sur l'attraction relative des deux branches. Ces expériences permettraient d'explorer le rôle de facteurs ayant des effets antagonistes et leur intégration dans les choix collectifs. Peu d'études ont été consacrées à ces questions. Dans le chapitre 2, notre dispositif expérimental, particulièrement simple, a permis de révéler le caractère potentiellement sous-optimal, (retardement du retour des individus de la source jusqu'au nid), du phénomène d'intégration de chemin pourtant fondamental à l'orientation lors du retour au nid chez un certain nombre d'espèces de fourmis (Wehner and Srinivasan, 2003). *L. niger* ne piste pas lors de l'exploration et dès lors se base sur l'intégration de chemin et la mémoire lors du retour au nid, ce qui n'est pas le cas d'autres espèces, comme *Linepithema humile* qu'il conviendrait de tester dans notre dispositif et qui ne devrait pas montrer de préférence pour le chemin rectiligne. Également, dans nos expériences, les 2 sources de nourritures sont identiques or il serait intéressant de tester dans quelle mesure l'effet de l'intégration du chemin empêcherait l'exploitation d'une source de nourriture plus riche à l'extrémité de la branche coudée conduisant à un choix collectif clairement sous-optimal en termes énergétiques. Certains travaux montrent également un lien entre l'activité d'exploration et des paramètres intranidiaux, tels que la qualité du nid (Doran et al., 2016) ou le degré d'affamement (Mailleux et al., 2010b). Dans ce dernier cas, l'affamement augmente, au niveau individuel, la motivation des exploratrices à quitter le nid. Dès lors, il serait intéressant de tester si cette motivation accrue à explorer l'environnement, en augmentant la durée d'affamement avant l'expérience (3-4 → 8 jours par exemple) pourrait conduire, notamment dans le cas de *L. niger*, à une absence de préférence pour la branche ascendante lors de l'exploration ou au contraire accentuerait cette préférence.

Un bon nombre d'espèces de fourmis montrent des capacités de mémorisation des repères présents sur le chemin entre le nid et la source améliorant les capacités d'orientations (Czaczkes et al., 2013). Ceci n'a pas été étudié dans le cadre de nos expériences dans la mesure où l'environnement visuel est intégralement homogène. De futures expérimentations dans un dispositif identique à celui

présenté dans le chapitre 2 mais intégrant des repères visuels pour les fourmis permettraient d'évaluer le poids relatif de la mémoire visuel par rapport à l'intégration de chemin ou « homing vector » (piégeant les fourmis à la source dans notre dispositif).

Enfin, dans ces expériences, bien que les choix soient marqués et concordants, ils ne sont pour autant pas systématiques. Certaines fourrageuses exploitent la source/solution alternative, voir dans une certaine proportion des expériences les choix collectifs s'orientent vers la solution généralement la moins préférée. Ces comportements s'expliquent certainement par la stochasticité caractéristique de ces systèmes complexes et la variabilité interindividuelle, cette dernière modulant la sensibilité des individus aux propriétés des chemins. Cette stochasticité et variabilité associées aux renforcements positifs peuvent alors conduire à l'exploitation de la source ou du chemin le moins « rentable ». Ces comportements stochastiques présentent cependant des avantages dans la mesure où ils apparaissent comme une réponse adaptée à la découverte de nouvelle source de nourriture dans un environnement imprédictible dont l'exploitation, plus ou moins optimale, va dépendre de la balance entre les processus d'amplification et l'effet des conditions environnementales (Deneubourg et al., 1986; Dussutour et al., 2009).

2.5 Limite des expérimentations en conditions artificielles.

La réalisation des expériences en laboratoire permet un contrôle total des conditions expérimentales et maximise la standardisation des expériences dont les résultats sont d'autant plus robustes. A cela s'ajoute la possibilité de décorréler artificiellement des facteurs qui en situation naturelle peuvent être corrélés. Le dispositif expérimental employé au cours des chapitres 1 et 2, communément appelé « dispositif de choix binaire » dans la littérature, permet de mettre en évidence l'émergence de phénomènes collectifs sans intervention de la part de l'expérimentateur au cours de l'expérience, ce qui en fait une méthode particulièrement peu invasive. Également les ouvrières sont totalement libres de déplacement à travers l'intégralité du dispositif, sans aucune forme de contrainte ou motivation suscitée par l'expérimentateur en dehors de l'affamement préalable. Un certain nombre de facteurs, comme déjà abondamment signalés, peuvent être à l'origine de biais dans les choix comportementaux, au niveau individuel ou collectif, tels qu'une attraction/répulsion par rapport au type de substrat employé sur les chemins entre le nid et les sources ou le degré des angles au niveau des bifurcations (Garnier et al., 2009) et doivent être minutieusement pris en compte aussi bien lors

de l'élaboration du dispositif que lors des analyses. De plus il a été montré, au cours d'expériences en laboratoire et dans des conditions standardisées, que la saison influence la physiologie chez la fourmi et la colonie avec un effet sur les préférences alimentaires, ainsi variables au cours de l'année (Cook et al., 2016). L'accumulation de lipides est favorisée à l'automne quand les carbohydrates le sont en été. Aussi il a été montré que les conditions de laboratoire (température et humidité constantes et nourriture *ad libidum*, absence de prédation) augmentent jusqu'à 800% la longévité des ouvrières, altérant profondément le taux de mortalité naturel et la dynamique des populations de la colonie avec de potentielles répercussions au niveau comportemental voir une inhibition du développement de la colonie (Kwapich and Tschinkel, 2015; Rueppell and Kirkman, 2005). Ainsi l'interprétation des résultats issus d'expériences en laboratoire, en termes de fourragement, division du travail pourrait être largement biaisée. Enfin les « colonies » constituées en laboratoire présentent un important niveau d'artificialité dans le sens où celles-ci sont composées d'un sous-échantillon d'individus aléatoirement prélevés au sein d'une plus massive colonie-mère et ne comprennent souvent ni reine ni couvain, ne semblant pas pouvoir être considéré comme une « colonie ». Cependant de nombreux travaux montre que des organisations spatiales et temporelles, des divisions du travail et de la plasticité émergent au sein de ces groupes artificiels, les propriétés classiquement attribuées aux colonies « naturelles » (e.g. (Dolezal et al., 2012; Ulrich et al., 2018)).

3. Réseaux et division du travail dans le contexte de la diffusion de nourriture dans le nid

Au cours des chapitres 3, 4 et 5 ont été étudiés les dynamiques et réseaux de distribution de nourriture au niveau intranidal chez deux espèces de fourmis, *L. niger* et *C. cruentatus*. Les méthodes théoriques et expérimentales employées/développées au cours de ces travaux ont permis de mettre en lien les hétérogénéités comportementales au niveau individuel avec les dynamiques et réseaux de distributions au niveau colonial, de tester la robustesse de ces réseaux et dynamiques aussi bien par des conditions expérimentales différentes que par des procédés théoriques de randomisation. Bien que cette problématique des ressources alimentaires au sein des sociétés d'insectes soit étudiée depuis plusieurs décennies, certains aspects fondamentaux de ces

phénomènes collectifs ont été peu étudiés jusqu'à présent, notamment les variabilités interindividuelles ainsi que les liens avec la division du travail et les caractéristiques des réseaux. Ces problématiques sont ici abordées sous un angle pluridisciplinaire et novateur via l'étude des réseaux de trophallaxies permettant de quantifier/valider les lois sous-jacentes à la gestion collective des ressources alimentaires, essentielles à la compréhension des mécanismes et organisations à l'œuvre au sein des sociétés d'insectes.

3.1 Dynamique des trophallaxies

La dynamique des trophallaxies au niveau intranidal a été analysée dans les chapitres 3 et 5, respectivement après une période d'affamement de 4 jours chez *L. niger* et 5 jours chez *C. cruentatus*. Les répliques des expériences respectivement au sein des deux espèces révèlent une dynamique et un nombre total de trophallaxies très similaires, suggérant une robustesse dans le phénomène de récolte et distribution de nourriture après un affamement marqué. Bien qu'un léger ralentissement dans la cumulative des échanges soit observé sur la fin des expériences, ces dynamiques sont essentiellement linéaires au cours de nos expériences, ce qui a première vue, semble s'écarter des descriptions logistiques de ce phénomène de constitution des stocks de nourriture dans la colonie par trophallaxies (Buffin et al., 2009; Greenwald et al., 2018; Sendova-Franks et al., 2010). Cependant plusieurs facteurs/contraintes propres à nos expériences peuvent être à l'origine de ces divergences. Le faible emballement de type exponentiel observé dans le nombre de trophallaxies au début des expériences peut être expliqué par la taille relativement peu importante des colonies employées (25 à 55 individus) entravant le phénomène de recrutement par piste de phéromone jusqu'à la source. De plus les contraintes techniques et méthodologiques ont conduit à l'emploi de dispositifs expérimentaux de taille réduite, avec une source de nourriture particulièrement proche du nid, qui associés à un affamement important stimulant la sortie du nid des ouvrières (Mailleux et al., 2010a), favorisent les découvertes spontanées entravant également l'effet de la piste. Enfin l'absence de plateau dans la cumulative des trophallaxies observées dans nos expériences est très probablement due à la durée d'observation limitée à 1h après l'introduction de la source de nourriture quand elle dépasse les 3h dans d'autres travaux (Buffin et al., 2009; Greenwald et al., 2018). Aussi les cumulatives lors de la 1^{ère} heure d'expérience dans ces travaux présentent un caractère linéaire au même titre que nos observations, caractéristique d'une quantité de nourriture accumulée non-encore suffisamment important pour entraîner une diminution du flux

alimentaire entrant dans le nid et une diminution de la probabilité d'échange de nourriture entre individus. Nos travaux couvrent donc la phase de récolte et d'accumulation de la nourriture au cours de laquelle les effets des feedbacks négatifs (saturation de la colonie) ne sont pas encore nettement observables sur la distribution de la nourriture.

3.2 Approches expérimentale et théorique des réseaux de trophallaxies et des répartitions du travail :

La comparaison de la structure des réseaux de trophallaxies expérimentaux chez *C. cruentatus* (chapitres 5) ne révèle aucune différence avec des réseaux générés aléatoirement en respectant la distribution du nombre de trophallaxies données/reçues de chacun des nœuds (individus). Cette génération conduit à des réseaux au sein desquels la distribution des degrés des nœuds (mesurée par le coefficient de Gini) est conservée mais la topologie du réseau est détruite : l'identité des individus impliqués dans une interaction est attribuée de façon aléatoire. Au contraire, si la méthode de randomisation des réseaux est plus « destructive » (ne sont conservés que le nombre de nœuds et le nombre total de trophallaxies au niveau de la colonie), en réattribuant aléatoirement chacune des trophallaxies entre chacun des nœuds (autrement dit en supprimant tous les attributs des réseaux expérimentaux), une différence apparaît entre les valeurs des indices des réseaux théoriques aléatoires et des réseaux expérimentaux. Dans ce dernier cas le coefficient de Gini est systématiquement plus élevé dans les expériences, témoignant d'une hétérogénéité significative dans la répartition de l'activité de distribution de nourriture dans le nid entre chacun des membres de la colonie. Les résultats des chapitres 3 et 4, concernant respectivement l'étude/la construction des réseaux de trophallaxies expérimentaux chez *L. niger* et leur reproduction par simulation, sont également en accord avec ce constat dans la mesure où seuls les réseaux issus des simulations implémentées avec une distribution exponentielle des probabilités individuelles d'échanges génèrent des réseaux en tous points identiques à l'observation. De plus, au cours du chapitre 5 il a été montré que la structure des réseaux de distribution de nourriture après une longue période d'affamement n'est pas affectée par la qualité de la nourriture chez *C. cruentatus*. Ce dernier résultat concorde avec la littérature et nos hypothèses suggérant qu'en état de satiété ou de faible affamement seule une nourriture de haute qualité peut engendrer un comportement de récolte et distribution de nourriture tandis qu'après une période d'affamement plus longue, les seuils de réponses individuels à la nourriture sont abaissés et deviennent indépendant de l'intérêt énergétique (et sans doute physiologique) de la nourriture (Josens, 2018; Mc Cabe et al., 2006). Au niveau

collectif cela se traduit par une dynamique de récolte et un réseau de distributions similaires pour des nourritures de qualité variable (chapitre 5) suggérant une résilience des structures fondamentales de l'organisation sociale face à la variabilité des ressources, un résultat en accord avec la littérature (Feigenbaum and Naug, 2010). Cette robustesse n'est probablement pas à écarter d'une forme d'immunité organisationnelle potentiellement à l'œuvre dans les colonies, limitant le risque de propagation d'agents infectieux ou de substances toxiques parmi les ouvrières et ce indépendamment de l'état d'affaiblissement ou de la disponibilité des ressources (Quevillon et al., 2014; Sendova-Franks et al., 2010; Stroeymeyt et al., 2018). Ce compromis entre dispersion de nourriture et limitation de la diffusion d'agent infectieux au niveau de la colonie nécessite de plus amples investigations dans la mesure où il existe une multitude de stratégies de la part des agents infectieux avec des effets variables sur les ouvrières infectées, tel qu'une augmentation de l'affaiblissement (Romano et al., 2018; Schmid-Hempel, 1998; Sueur et al., 2018), suggérant des liens potentiels d'une part entre le statut nutritionnel de l'individu et son état d'infection d'autres part entre le niveau des stocks de la colonie et la diffusion de la maladie. L'établissement des structures et organisations des réseaux de distribution de nourriture au sein de différentes espèces et avec des procédures expérimentales similaires aux nôtres fournit un cadre général pertinent pour des études fonctionnelles concernant la diffusion de maladies au sein des sociétés d'insectes. Les descriptions théoriques des trophallaxies abordées par notre modèle (chapitre 4) comportent nombre de proximités et de liens avec ces questions épidémiologiques bien que certains aspects fondamentaux divergent. Quand la diffusion de nourriture est « conservative », c'est-à-dire qu'un individu ayant donné une certaine quantité de nourriture n'en dispose plus, aucune nourriture n'est créée au cours des échanges, ce qui n'est pas le cas pour un pathogène : sa transmission à un receveur n'implique pas sa disparition chez l'individu « donneur ». De plus la transmission de pathogènes implique des processus binaires (infecté/non-infecté) quand il s'agit d'échanges continus pour la nourriture. Cependant ces questions liées à la transmission de pathogènes au sein des sociétés d'insectes sont à aborder par simulations. Notre modèle se prête aisément à la modification/adaptation des hypothèses sociales/comportementales et temporelles qui sont également à compléter par l'intégration de notions spatiales, potentiellement fondamentales dans les dynamiques de diffusion de pathogènes.

Bien que nos colonies expérimentales soient exemptes de reine et couvain, des facteurs affectant la récolte de nourriture (Cassill et al., 1998; Loke and Lee, 2006; Sorensen et al., 1983), nos

résultats présentent un certain degré de robustesse. En effet, les larves consomment essentiellement des protéines (Portha et al., 2004) et leur impact sur les processus de distribution du sucre devrait être mineur, de plus la présence de reine ne semble avoir que peu d'effet sur les interactions dans la colonie (Quevillon et al., 2014). Malgré tout, l'objectif a été de dégager les principes fondamentaux et d'établir les bases de l'analyse des réseaux de trophallaxies, au sein d'un groupe homogène en termes d'état (affamement) et de besoins (ouvrières) nutritionnels. Pour cela, ces questions ont été investiguées au sein du module de base d'une colonie de fourmis, un groupe d'ouvrières. La validation des hypothèses et résultats avancés au cours de ces travaux nécessitent évidemment la conduite d'expérimentations et de simulations supplémentaires, notamment au sein de colonies complètes et plus naturelles, intégrant toutes les castes. L'intégration d'une variance des statuts et besoins nutritionnels dans les simulations est à envisager. Les prédictions générées par le modèle peuvent être par la suite quantitativement confrontées à des résultats expérimentaux intégrant ces variances. Les comparaisons des réseaux de trophallaxies expérimentaux de *L. niger* et *C. cruentatus* avec des réseaux aléatoires (chapitres 3 et 5) ou des réseaux issus des simulations (chapitres 4) montrent une nette hétérogénéité interindividuelle dans le niveau de participation à l'activité de dissémination de la nourriture dans le nid, et ce au sein des deux espèces. Pour la seconde fois au cours de cette thèse, il nous a été permis de mettre en évidence quantitativement des similarités comportementales au niveau interspécifique (cf. Chapitre 1), ici dans le cadre de l'activité de trophallaxie, suggérant une robustesse, au sein de la famille des formicidés, des phénomènes étudiés au cours de cette thèse. Pour autant, dès lors que cette hétérogénéité en termes de participation aux trophallaxies est introduite dans les simulations (distribution exponentielle des probabilités) ou dans la génération de réseaux « aléatoires », alors ces derniers ne se montrent pas différents des réseaux expérimentaux, suggérant l'absence de liens privilégiés entre certains individus au cours de la constitution des stocks de nourriture. L'allocation des tâches est un processus hautement dynamique au sein des sociétés d'insectes, de sorte que le nombre d'individus exécutant une tâche s'adapte aux besoins de la colonie concernant cette tâche (Gordon, 2003). De nombreux facteurs interviennent ou au moins sont liés à ce processus d'allocation des tâches au niveau individuel, de l'âge/expérience (Pinter-Wollman et al., 2012) à la localisation spatiale (Crall et al., 2018) en passant par la physiologie (Robinson et al., 2008). Chaque individu percevant un stimuli pour une tâche devrait y répondre de façon adaptée, cependant, de façon générale, il est observé que l'intensité de la réponse est hautement variable et dépend du seuil de réponse interne

(Theraulaz et al., 2008). Ce seuil est abaissé par l'affaînement, conduisant à l'acceptation de nourriture indépendamment de sa qualité lors d'un affaînement important (cf. chapitre 5, ce qui n'est pas le cas lors d'un faible affaînement : voir (Cassill, 2003) mais ne semble pour autant pas s'homogénéiser à travers l'ensemble de la colonie dans la mesure où le niveau d'hétérogénéité dans la participation à l'activité de dissémination de nourriture est systématiquement observé et similaire dans chacune des expériences et ce indépendamment de l'espèce considérée (*L. niger* & *C. cruentatus*). Ce résultat n'est pas tout à fait en accord avec « l'effet Stalingrad » tel que nommé dans la littérature, supposant qu'après un affaînement important, la réponse à certains stimuli, notamment alimentaires, présentant une importante valeur marginale, deviendrait inconditionnelle et ne tiendrait plus compte de certains paramètres tels que la risque de prédation, l'intérêt de la ressource ou encore les différences interindividuelles (Brown and Kotler, 2004).

Ainsi, dans nos expériences, tout se passe comme si les individus présentaient une variabilité de seuil de réponse, dans notre cas de don/réception de nourriture, que l'affaînement tend à abaisser tout en maintenant les différences interindividuelles. En d'autres termes il n'y pas d'homogénéisation des réponses au sein du groupe. Bien que la division du travail soit énormément étudiée depuis des décennies et selon différentes approches, peu d'études se sont intéressées à la façon dont le travail est réparti, parmi les membres de la colonie, au sein d'une même tâche (Tenczar et al., 2014). Nos résultats montrent que l'implication au sein de la tâche de distribution de nourriture n'est pas homogène parmi les fourrageuses : la quantité de travail réalisé par deux fourrageuses peut être extrêmement différente. Le modèle développé et analysé au cours du chapitre 4 est intégralement basé sur les données expérimentales concernant les dynamiques et réseaux de trophallaxies chez *L. niger* récoltées dans le 3^{ème} chapitre. Les simulations du modèle montrent que cette distribution très hétérogène (distribution exponentielle) de l'activité d'échange de nourriture conduit à l'émergence d'un réseau de diffusion de nourriture plus efficient que si la colonie était parfaitement homogène (distribution delta) ou peu hétérogène (distribution uniforme).

3.3 Modèle et simulations

Au niveau théorique, peu d'aspects du fourragement ont été étudiés au sein des sociétés d'insectes. Souvent les modèles négligent les spécificités individuelles ou se concentrent sur l'activité de récolte de nourriture et les choix de sources sans intégrer les dynamiques de dissémination et

d'accumulation par trophallaxies dans le nid, processus pourtant fondamentaux dans les régulations de la récolte. En effet les travaux théoriques investiguant la notion de trophallaxie sont particulièrement peu nombreux. Certains travaux expérimentaux s'intéressent à l'accumulation de ressources au niveau global (e.g.,(Buffin et al., 2012; Sendova-Franks et al., 2010)) et y apportant une description phénoménologique du flux de nourriture dans le nid sans intégrer les échanges au niveau individuel et les lois s'exerçant à ce niveau. De nombreux modèles s'intéressent à la diffusion de l'information dans la colonie, par interactions directes ou indirectes (Blonder and Dornhaus, 2011; Pinter-Wollman et al., 2011; Richardson and Goroehowski, 2015; Waters and Fewell, 2012), et à ses implications biologiques. Une seule étude s'est intéressée aux interactions trophallactiques proprement dites sans que ce modèle n'intègre pour autant de paramètres ayant un réel sens biologique (Gräwer et al., 2017). Le travail théorique mené au cours de cette thèse répond à l'absence d'un modèle fondamental et de simulations complètes et réalistes, en capturant les règles à la base des processus d'échanges dans le nid. Notre modèle intégrant un nombre très limité de paramètres et des hypothèses biologiquement pertinentes concernant la trophallaxie, dépasse les multiples limites décrites précédemment et reproduit l'intégralité des attributs du processus de diffusion de nourriture observé dans nos expériences. C'est le cœur même de la notion « d'échange » qui a été étudié dans ce travail, notamment en quantifiant les règles comportementales à l'œuvre lors des interactions entre individus donneurs et receveurs. Pour rappel, le modèle fait intervenir des agents ou entités (les ouvrières) possédant une probabilité de quitter le nid pour se rendre à la source de nourriture et une capacité limitée d'accumuler de la nourriture non-explicitement implémentée. Cette régulation résulte de la modulation de quitter le nid ou d'effectuer un échange en fonction de la charge. L'espace est ignoré. A chaque instant, chaque individu est interrogé, des couples sont formés aléatoirement et un échange a lieu lorsqu'un des deux partenaires accepte de donner et l'autre de recevoir. Ces acceptations déterminées par les fonctions de probabilités. La durée de l'interaction est probabiliste avec une valeur moyenne basée sur des données expérimentales. Ces interrogations sont répétées à chaque pas de temps (seconde) sur une durée d'une heure. Le modèle décrit ainsi dans les termes les plus simples les processus proximaux/locaux à l'œuvre dans la distribution de nourriture à travers la colonie, basée sur des rencontres et des échanges probabilistes et en dehors de tout contrôle central ou d'un quelconque objectif que se fixe la colonie.

Nos résultats concernant la dynamique des échanges et la structure des réseaux, sont en accord au moins d'un point de vue qualitatif, avec la littérature sur les réseaux de trophallaxies (Gernat et al., 2017; Greenwald et al., 2015, 2018; Quevillon et al., 2014; Sendova-Franks et al., 2010). Une adaptation de la valeur des paramètres implémentés dans le modèle devrait pouvoir satisfaire l'aspect quantitatif également. Ainsi, notre modèle reproduit le schéma classique au cours duquel une fourrageuse, de retour de la source peut donner de la nourriture à plusieurs congénères avec une seule charge de nourriture, ces dernières peuvent alors également redistribuer la nourriture précédemment acquise participant ainsi à l'émergence d'un réseau de trophallaxies à travers le nid, réseau dont les individus sont les nœuds et les trophallaxies les liens entre ces nœuds. Les travaux théoriques développés au cours de cette thèse (chapitre 4) ont permis d'aborder un large spectre de problématiques liées à la gestion collective des ressources alimentaires au sein des colonies de fourmis, de la notion de division du travail entre ouvrières fourrageuses et non-fourrageuses, à la répartition du travail au niveau intracaste tout en les intégrant à la dynamique temporelle des échanges et à la structure des réseaux qui en découlent. En effet le modèle rend précisément compte de l'échelle temporelle à laquelle se déroule les événements de trophallaxies au niveau expérimental et de leur évolution en fonction de l'arrivée de nourriture ou de l'augmentation du niveau de saturation, des aspects rarement investis jusqu'à présent, aussi bien au niveau théorique qu'expérimental. De plus, les hétérogénéités interindividuelles en termes de participation aux échanges, largement observées à travers nos expériences, ont été capturées et finement quantifiées par le modèle et nos analyses, notamment par l'emploi de diverses et robustes méthodes de randomisations. L'originalité de notre travail réside notamment dans le développement et l'utilisation de méthodes expérimentales et théoriques d'études des comportements individuels et collectifs et de leurs liens. De plus ces deux méthodes complémentaires ont été l'objet de confrontations/comparaisons à différentes échelles, d'une grande précision et abordant des problématiques variées autour de la gestion collective des ressources alimentaires dans un système décentralisé, une démarche bien trop rare dans la littérature sur le sujet se réduisant à des travaux expérimentaux (Greenwald et al., 2015; Sendova-Franks et al., 2010) ou à des modélisations aux fondements biologiques très limités (Gräwer et al., 2017). Ceci a permis de déterminer et d'établir dans quelle mesure les dynamiques de récoltes au niveau collectif (Buffin et al., 2012, 2009) émergent des comportements individuels et de caractériser ceux-ci. Ces investigations sont à poursuivre sur des échelles de temps plus longues, au-delà du cadre d'une seule période de récolte,

intégrant l'épuisement des ressources au sein de la colonie ainsi que réorganisations notamment spatiales, opérant dans la colonie sur une période de plusieurs jours. En effet les dynamiques de consommation des ressources restent grandement méconnues, en particulier chez les espèces consommatrices de nourriture liquide stockés dans l'abdomen des individus. L'épuisement des ressources est-il homogène ou hétérogène à travers la colonie ? Des redistributions/échanges permettent-ils une homogénéisation des stocks ou au contraire certains individus se retrouvent fortement affamés et constituent un signal de l'épuisement en cours des stocks ? Ceci permettrait également d'aborder les dynamiques de récolte et distribution au cours de plusieurs évènements successifs et en fonction de l'état des stocks, d'évaluer la pertinence de l'emploi de termes tels que des « couples oscillateurs » et « périodicité » quand il s'agit de qualifier les évolutions spatiales et temporelles, notamment de la mise en activité synchronisée ou non des ouvrières internes et externes au nid (Boi et al., 1999). Ces travaux à « moyen terme » sont pour le moment inexistantes au niveau théorique et marginaux au niveau expérimental (Mailleux et al., 2010c), l'essentiel des travaux étant mené sur des périodes d'une à trois heures seulement, une durée non-suffisante à l'observation de phénomènes résultant de l'épuisement des stocks.

3.4 Limites des analyses de réseaux

Les outils que fournit la théorie des graphes ont été largement employés au cours des 3 derniers chapitres de cette thèse et ce afin de décrire et quantifier les réseaux de trophallaxies observés dans les sociétés de fourmis, dans un contexte de division du travail au sein d'un système décentralisé. Ces systèmes sont caractérisés notamment par leurs dynamiques, les comportements y sont modulés en fonction des besoins, la division du travail peut y être émergente et de nombreux facteurs (boucles de rétroactions, seuil de réponse, etc.) interviennent dans les processus de régulation et d'attributions des tâches au sein de la colonie. Ces réseaux offrent une vision intéressante des échanges dans la mesure où un aperçu complet des trophallaxies (liens) entre les individus (nœuds) est disponible et de nombreux paramètres y sont mesurables, rendant compte de potentiels patterns d'interactions/organisations imperceptibles via d'autres méthodes d'analyses.

Une partie de nos analyses se sont concentrées ici sur des réseaux dits « agrégés », c'est-à-dire au sein desquels la notion de temps est négligée de telle sorte que le déroulement temporel des évènements n'est pas pris en compte dans ces réseaux. Le réseau représente donc l'ensemble des trophallaxies cumulées à l'issue de la période d'observation et c'est sur celui-ci que les mesures

sont effectuées. Celles-ci présentent de nombreux intérêts pour évaluer les structures du réseau, des positions particulières des individus (attribuables ou non à la caste) fluidifiant les interactions/la circulation de la nourriture ou au contraire en ralentissant la dynamique (Waters and Fewell, 2012). Cependant rien n'est proposé concernant le caractère dynamique et émergent du réseau ni de l'ordre dans lequel les interactions se déroulent. Ainsi lorsque les réseaux expérimentaux sont comparés aux réseaux des simulations (chapitre 4) ou encore aux réseaux « randomisés » (chapitres 3 et 5), ce sont leurs structures « finales » qui sont comparées mais les divergences éventuelles au niveau des dynamiques sont ignorées. De plus les simulations ignorent les liens potentiels entre la charge respective des deux partenaires et la durée des trophallaxies (Blonder et al., 2012; Greenwald et al., 2018).

D'autres problèmes plus généraux se posent dans l'utilisation de la théorie des graphes dans l'étude du comportement animal. Aussi les indices issus de cette théorie n'ont pas pour origine des problématiques d'ordres biologiques et bien que dans une certaine mesure ces indices se révèlent pertinents, ce constat n'est pas systématique. En effet, l'efficacité évaluée « l'efficacité » de la structure d'un réseau en se référant à la diffusion maximale d'une information (nourriture dans notre cas) en minimisant le nombre de contact. L'hypothèse sous-jacente est donc celle de besoins strictement équivalents pour chacun des nœuds. Or il est clairement établi qu'au sein de la colonie les besoins entre individus sont variables et hétérogènes. Une mesure expérimentale de l'efficacité du réseau pourrait alors apparaître comme largement sous-optimale quand bien même les besoins de chacun des individus au sein de la colonie seraient entièrement satisfaits. L'emploi des indices de réseaux dans notre contexte offre cependant la possibilité de disséquer l'organisation et la structure des échanges de nourritures, de quantifier les comportements/positions au niveau individuel et au niveau de la caste dans la colonie. Signalons que de nombreuses discussions sont en cours au sein des groupes de spécialistes des réseaux, visant à mieux intégrer ces outils au sein d'analyses dynamiques (spatiales et temporelles) afin de mieux valoriser leurs rôles et contributions (Blonder and Dornhaus, 2011; Pinter-Wollman et al., 2013).

4. Conclusions générales et ouvertures

Au cours des différentes expérimentations menées dans cette thèse ressort le constat global qu'un nombre restreint d'ouvrières joue un rôle clé dans les décisions collectives (choix de source) et au sein des patterns au niveau collectif (distribution de la nourriture dans le nid). En effet, le choix de source est largement déterminé par les premières fourrageuses quittant le nid et la majorité de l'activité de distribution de la nourriture au niveau intranidal (~60% des échanges) repose sur une minorité d'individu (~20% de la population) et ce en accord avec la littérature (e.g., (Buffin et al., 2009; Sendova-Franks et al., 2010)). De façon assez surprenante, dans nos expériences, ce constat est valable même après un affamement important (Chapitre 5) n'aboutissant malgré tout pas à une homogénéisation des comportements. Il s'agirait cependant d'étendre ces analyses sur plusieurs périodes d'observations successives afin de déterminer la stabilité et le degré de cette hétérogénéité interindividuelle dans l'activité de trophallaxie entre individus. Chez les insectes sociaux la division du travail et la réalisation des tâches sont des phénomènes hautement flexibles et continus, non dichotomiques ou discrets hormis éventuellement chez les espèces à polymorphisme de castes. Chez ces dernières, ne représentant que 15% des genres de fourmis (Kaspari and Byrne, 1995) (phénomène totalement absent chez les abeilles et guêpes), la tâche est associée à des adaptations morphologiques s'accompagnant d'une spécialisation (consistance dans la réalisation de la tâche) et d'une efficacité variable dans les différentes tâches : chez les fourmis champignonnistes les « majors » seront plus efficaces dans le découpage de feuilles que dans le soin au couvain quand il s'agit de l'inverse pour les « minors ». Cependant l'association entre polymorphisme et spécialisation ou efficacité n'est pas systématique, suggérant la conservation d'un programme comportemental varié au niveau intercaste (Gordon et al., 2018; Leitner et al., 2018). Chez les insectes sociaux « monomorphes », une variabilité interindividuelle au niveau l'efficacité de réalisation de la tâche est observée mais ne prédit pas la spécialisation pour cette tâche, de même aucune corrélation des performances relatives à travers différentes tâches n'est constatée (Dornhaus, 2008). Des résultats préliminaires concernant la stabilité temporelle ou la répétabilité des comportements, qu'il s'agirait d'approfondir, sont présentés dans le chapitre annexe 2. Ces résultats suggèrent, du moins dans nos conditions, une absence de consistance dans la participation individuelle aux trophallaxies au niveau individuel chez *C. cruentatus* au cours de six observations successives dans les mêmes conditions, espacées d'une semaine chacune. Ainsi, la participation à

la tâche en cours ne semble pas prévisible sur base du niveau de participation au cours l'expérience précédente. Cependant, bien que le comportement individuel présente une importante imprédictibilité, au niveau collectif, le niveau d'hétérogénéité est particulièrement stable sur plusieurs observations successives. Des résultats similaires concernant la variabilité ont été observés chez le bourdon lorsque l'activité de ventilation est mesurée (Garrison et al., 2018) mais vraisemblablement pas chez l'abeille, dont certains individus montre un niveau d'activité stable sur trois observations successives (George and Brockmann, 2018). Par ailleurs, certains travaux montrent qu'une partie de la population présentent une corrélation dans le niveau de participation (différent de la notion d'efficacité) dans différentes tâches, certains performant une importante partie de chacune des tâches et étant alors globalement plus actifs que le reste de la population quand d'autres sont fortement impliqués dans une seule tâche ou encore globalement peu impliqués dans toutes les tâches (Charbonneau and Dornhaus, 2015; Pinter-Wollman et al., 2012). Ces différents résultats ne sont pas incompatibles avec les modèles classiques de seuil dans la mesure où la distribution des seuils propres à chacune des tâches peut montrer un profil très différent entre individus. Ainsi être actif dans une tâche n'empêche pas l'implication dans d'autres tâches. De nombreuses études se sont intéressées à la variabilité interindividuelle et aux liens entre ces hétérogénéités et l'émergence des patterns et comportements collectifs (e.g., (Jandt et al., 2014; Modlmeier et al., 2012; Pruitt and Riechert, 2011; Sih et al., 2012; Trillmich et al., 2018)) sans pour autant clairement déterminer les mécanismes à la base de ces variabilités inter- et intra-individuelles. Ainsi ces différences dans les seuils de réponse à la tâche peuvent être la résultante de facteurs génétiques, épigénétiques, physiologiques, d'histoire individuelle/expérience, de feedbacks au niveau du groupe ou encore de processus stochastiques. Chacun de ces facteurs pourrait potentiellement moduler les réponses comportementales des individus. Les liens entre épigénétique et comportement sont de plus en plus établis. Les récentes avancées méthodologiques et technologiques ont permis des travaux d'une grande précision, rendant compte de la plasticité comportementale liée aux modulations de l'expression des gènes (Herb et al., 2012; Lucas et al., 2017; Matsunami et al., 2018; Simola et al., 2016). Il a été montré qu'une régulation, à l'échelle de l'heure, de l'expression de certains gènes, en particulier liés au fourragement (Ingram et al., 2016). L'hypothèse d'une origine génétiquement déterminée du seuil de réponse (Page et al., 1999) semble devoir être relativisée dans la mesure où une étude menée sur des ouvrières d'une espèce de fourmi clonale (*Strumigenys membranifera*), strictement identiques d'un point de vue génétique,

montre des différences interindividuelles dans le seuil de réponse à une solution sucrée ainsi qu'une variabilité intraindividuelle lors d'observations successives. La détermination des seuils de réponses à la nourriture et de leur flexibilité, à l'origine de la variabilité interindividuelle et des patterns d'allocations des tâches, peut également reposer sur des caractéristiques de la colonie : l'état des stocks au niveau individuel et colonial (Cassill, 2003; Greenwald et al., 2018) aussi bien que sur les interactions sociales directes ou indirectes (Chen and Meyer, 2018; Gordon and Mehdiabadi, 1999). Ainsi les régulations de la division du travail et des patterns d'allocation des tâches permettent une adaptation fine de l'effort de récolte et distribution de nourriture (Sendova-Franks et al., 2010). La détermination des facteurs à l'origine des hétérogénéités observées nécessite des expérimentations dans un contexte plus large que celui de l'activité de trophallaxie et la gestion des ressources alimentaires. La régulation de l'activité de fourragement chez la fourmi est un processus complexe et des investigations théoriques et expérimentales supplémentaires sont nécessaires à l'établissement des liens entre les seuils de réponses, les différences interindividuelles, la variabilité de l'environnement et la stabilité de la réponse de la colonie en termes de constitution des stocks de nourriture. Enfin il s'agirait également de compléter les approches « traditionnelles » essentiellement concentrées sur le court-terme au sein de colonies réduites/artificielles par des expérimentations sur la régulation des dynamiques de récolte et des processus de distribution de nourriture sur le long à très long terme (passage de la saison hivernale) au sein de colonies plus naturelles, disposant de sources variées de nourriture capables de satisfaire les différents besoins nutritionnels de l'ensemble des membres/castes de la colonie.

Sur un plan théorique, ces complications et complexités posent également de nombreuses questions. Si nous avons insisté sur le rôle des feedbacks positifs et des amplifications dans les activités de choix et de fourragement, ceux-ci sont présentes dans nombre d'autres activités coloniales (par exemple défense, construction, mouvements entre différentes parties du nid). Se pose dès lors la question du rôle de ces différentes amplifications et leur compétition dans la dynamique globale de la colonie. Nous avons longuement discuté le rôle de la distribution des seuils de réponses dans la dynamique globale de distribution de nourriture. L'intégration de ces seuils dans ces dynamiques globales n'est guère étudiée et les synergies entre la distribution des seuils et les amplifications restent largement ignorées. En d'autres termes, il s'agirait d'approfondir des questions partiellement abordées dans le chapitre 4 (modélisation) : quel est l'impact d'une

distribution de seuils dans une dynamique d'amplification et les différences entre une telle situation et celle où l'amplification implique des individus identiques ?

Pour rester dans ce cadre théorique, notre approche a largement ignoré –mais pas totalement- le rôle de l'espace notamment dans l'analyse des réseaux. Les interactions entre fourmis incluent dans une situation où interviennent de nombreux paramètres (état de satiété, distribution des tâches...) à une organisation spatiale, par exemple un ensemble d'agrégats d'ouvrières dans le nid. Divers modèles ont contribué à établir les liens entre les comportements individuels et les patterns collectifs. Les réseaux qui peuvent être mis en évidence contribuent également à établir le lien entre individus et organisation coloniale. Se pose la question de la synthèse des deux approches et en termes d'analyse à la fois fonctionnelle et de mécanismes : les réseaux contribuent-ils à l'émergence des structures spatiales où au contraire sont-ils de simples indicateurs, mais des indicateurs très utiles, des interactions et des structures qui émergent ?

Les variabilités et hétérogénéités interindividuelles confèrent à ces organisations de fortes capacités d'adaptabilité, réactivité et de résilience face à des perturbations internes (ex.: perte de membres de la colonie) ou à des changements environnementaux (Crall et al., 2018; Tenczar et al., 2014). Cette flexibilité comportementales conduit à des réorganisations et réallocations des tâches adaptées aux besoins de la colonie et en minimisent les effets délétères (Modlmeier et al., 2012; Pinter-Wollman et al., 2012; Sendova-Franks et al., 2010). Il conviendrait cependant d'intégrer ces problématiques dans le contexte des profondes modifications que l'environnement subit actuellement. Les systèmes de communications au sein de ces sociétés reposent en effet sur divers mécanismes, notamment chimiques (phéromones, hydrocarbures cuticulaires), dont l'efficacité et la flexibilité pourraient être très limitées lors de changements environnementaux, notamment en cas de perte de diversité des ressources alimentaires (influençant le profil cuticulaire des individus (e.g., (van Zweden and d'Ettorre, 2010), de changement de température qui, par exemple, peut affecter la durée de vie des pistes de fourragement (en vertu de la loi d'Arrhenius) ou de l'humidité. Ainsi la perturbation de la communication chimique entre ouvrières pourrait altérer la reconnaissance des intrus ou la stabilité de l'identité coloniale, les interactions sociales et plus globalement la cohésion de la colonie jusqu'à en entraîner l'éventuel effondrement. De plus les phénomènes de réorganisations des castes pourraient également montrer leurs limites, en particulier dans le cas des espèces polymorphes, montrant un moindre degré de flexibilité. La perte de la

diversité des ressources alimentaires pourrait être une source de stress pour la colonie dans la mesure où les besoins spécifiques des différentes castes (Cassill and Tschinkel, 1999; Dussutour and Simpson, 2009) ne sauraient plus être satisfaits, avec probablement des conséquences en termes de survie, aussi bien des adultes que du couvain. Également la menace de maladies, pathogènes et autres parasites des colonies pourrait être aggravée, et leurs disséminations facilitées par une augmentation de la température et de l'humidité (Hughes et al., 2002), dans une mesure au-delà de laquelle les défenses immunitaires de la colonie (e.g.,(Leclerc and Detrain, 2017) pourraient alors se montrer inefficaces. A l'heure où des modifications environnementales et leurs impacts sont déjà sérieusement à l'œuvre sur les espèces (voir par exemple (Archis et al., 2018) ou (Gallé, 2017) attestant un déclin des populations de *L. niger* dans certaines régions), ces diverses considérations nécessitent clairement la prise en compte des facteurs environnementaux et écologiques dans les futures travaux concernant un meilleure compréhension des liens entre comportements individuels et collectifs au sein des sociétés d'insectes. En particulier, la détermination des stratégies de récolte et distribution de nourriture, des mécanismes qui les soutiennent ces processus et de leur flexibilité/résilience face à des changements multiples et abruptes de l'environnement sont primordiales au développement et à la prise de mesures adaptées en termes de conservation/prévention de la perte de ces espèces et de leur diversité.

Annexe 1

Fiducial marks tracking for animal behaviour analysis

In preparation : Antoine, J., Bles, O., Planckaert, J. & Campo, A. Fiducial marks tracking for animal behaviour analysis. *In prep. (Scientific Reports)*

Abstract:

Fiducial markers are very useful to locate and identify objects, and are used in different domains such as augmented and virtual reality, robot navigation, supermarkets and transports. We propose a new colored marker that can be easily implemented and adapted to any size, as well as an algorithm to generate dictionaries. With its higher information density than currently existing markers, our marker can be scaled down to less than a millimetre, and is therefore much less intrusive, allowing for new or more specific applications. We developed a detection algorithm that locates and identifies the markers, and a tracking algorithm which is run afterwards in order to improve accuracy. All three algorithms were implemented in useTracker, an open-source tracking software designed to help recording and analysing movies of scientific experiments.

Keywords: fiducial, markers, ethology, tracking, useTracker

Abbreviations :	HSV	Hue Saturation Value
	VR	Virtual Reality
	AR	Augmented Reality
	FPS	Frames Per Second
	VGA	Video Graphics Array
	RFID	Radio Frequency IDentification
	LED	Light Emitting Diode
	HVS	Human Visual System

1. Introduction

1.1 Context

Ethology is the study of animal behaviours and organisation from a biological perspective. It allows to understand how social animals such as ants work together to form a society, in a similar fashion to us humans. Ethologists have been studying all these behaviours for decades, and for a long time their observations were manual and tedious. With the advent of computers in the 80's and 90's, new methods began to emerge. First, assisting ones, helping researchers to obtain results more easily, and in a second time automated data gathering with systems like Ethovision (Noldus, Spink, and Tegelenbosch, 2001). Automated observation has multiple advantages compared to manual: first, they are more reliable since the algorithm does not change with time, they are not prone to fatigue. Moreover, humans have unconscious bias, because they often know what they want to prove. Computers can also suffer from biases, but at least they are consistent and repeatable. Another important asset is that they are considerably faster than humans. Quantitative measurements such as position or speed are also more precise when measured by a tracking algorithm than inaccurate human estimations. Finally, automated observation comes in very handy when the observed scene alternates between slow and sudden changes.

During the last two decades, with the evolution of processing power and computer science, video multi-tracking became a trending topic (Mersch, Crespi, and Keller, 2013). Because animals interact with each other and can move quickly or even hide in their environment, it is a difficult task. Multiple individuals are often merged during detection, and therefore considered as one animal. Another difficulty is detecting each individual's identity and retaining it throughout the video sequence, which is made especially challenging by occlusions and crossings. A crossing is a merge-and-split process, illustrated in Figure 1.1, during which two or more individuals collide with each other (red circle). It is probably the most famous problem in automated detection.

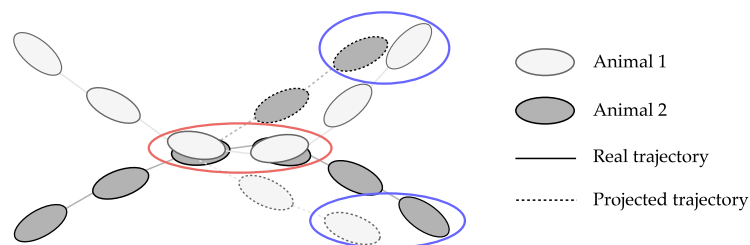

FIGURE 1.1: Crossing problem illustration

Crossings can be very difficult to resolve, especially when the animals follow unpredictable behaviours. A common way to mitigate the problem is to analyse previous movement vectors and extrapolate them. The resulting projected paths are represented with dotted lines in Figure 1.1. However, this can lead to assignment errors when the animals abruptly change direction. Such an error is represented by the blue circle, where one can see that the projected trajectory of Animal 2 overlaps with the actual trajectory of Animal 1. In that case, Animal 1 will be identified as Animal 2, and vice versa. This problem

cannot be resolved unless the colliding animals possess unique features allowing to recognise them, like a different shape or color for instance.

To be able to properly track and identify individuals of a population despite the problems presented previously, a comparison metric is required. As already stated, such a metric can be size, shape, texture or color. However, since observed populations are very often constituted of the same species, and therefore very similar individuals, differences among them are difficult to find – and depend on the species – making recognition very complex (Pérez-Escudero et al., 2014). Markers offer a solution to this problem; there are two kinds of them: active and passive. The two most known active markers are LEDs and RFID systems. LEDs are wired to a control unit, and have different flashing frequencies and/or colors, which allows to easily differentiate them. However, this system suffers from mechanical constraints due to the wiring, the need for a control unit and the limitation of the number of markers due to the stroboscopic timing (Figuroa, Leite, and Barros, 2003). RFID systems usually include two devices: a mobile tag equipped with an antenna and a chip, and a reader that consists of an antenna and a transceiver (Al-Ali et al., 2008). Such systems can be scaled down to a millimeter and sometimes even less. However, they only provide an indication about whether a specific tag is in reach of a reader, and lack precise position information. Because of these reasons, as well as active markers being more expensive, our focus will go to passive markers. Pasting personalised markers on each individual will make them unique, allowing the system to identify them.

1.2 Fiducial markers

A fiducial marker is a unique pattern identifiable by a computer vision algorithm. In scientific articles, they are often used for Augmented Reality (AR) and Virtual Reality (VR) applications (Thomas et al., 2000; Zhou, Duh, and Billingham, 2008) or robot navigation (Johansson and Balkenius, 2007). Figure 1.2 illustrates two use cases of fiducial markers. The left image shows a person wearing a virtual reality mask within a room in which markers were printed. The mask identifies these markers and analyses their pose in order to deduce its own position and orientation in the room. The right image represents the workflow of an AR application. In the top row, the phone uses its camera to locate and extract a marker from the environment. In the bottom row, it estimates the marker's pose so as to understand the environment's relief. It is then able to superimpose a virtual 3D object on the real scene, and display the augmented scene on its screen. Fiducial markers are also found in the everyday world: they are mostly used to identify products in supermarkets and transport companies, and are called barcodes (Figure 1.3(a)). QR codes (Figure 1.3(b)), which are a more recent evolution of classical barcodes, allow to access information such as websites, addresses or contacts easily by being scanned with a smartphone. This evolution was made possible by the exponential growth of smartphones and especially the constant improvement of their cameras.

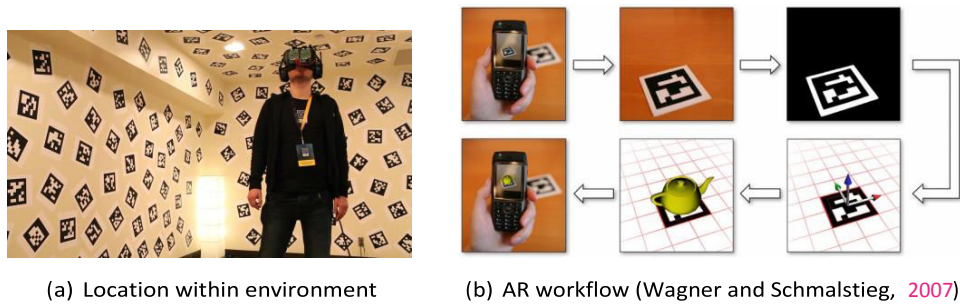

FIGURE 1.2: Examples of fiducial markers applications in VR and AR

There are two kinds of fiducials: black and white and colored ones. The former are the most described in scientific literature and the most used. This is partially due to historic reasons: a few years ago, computer resources were much less developed, and processing was easier with binary images. Printing costs were also more expensive for color. These restrictions have become obsolete nowadays, and we will see that black and white markers are somewhat limited compared to their chromatic counterparts.

1.2.1 Black and white markers

The first markers were developed in the early 1950's, and are used everywhere nowadays: barcodes. They represent data with parallel lines with varying widths and spaces between them, and are therefore considered to be one-dimensional. In the 90's, 2D barcodes began to emerge, allowing to increase the quantity of information stored by unit of area. The most famous one today is the QR code, used in commercial tracking applications as well as smartphone applications. Kato and Billinghurst (1999) were among the first ones to develop 2D monochromatic fiducials, thus establishing what is now the most common format: a payload surrounded by a squared black border and printed on a white background. In their implementation, called ARToolkit (Figure 1.3(f)), the payload is a character, a letter for example. This has two drawbacks, the first one being that decoding the character is a slow operation due to the numerous operations required. The second one is that character generation is difficult, because each character must be approximately orthogonal to the others. Fiala (2005) enhanced ARToolkit's markers by replacing the analog character with a grid of 6×6 , calling them ARTag (Figure 1.3(g)). This binarization resulted in improved identification, verification and library size. However, as the marker's size is fixed, it is not adapted to all kinds of situations. Olson (2011) developed a marker called AprilTag, nearly-identical to ARTag but open-source and documented. Wang and Olson (2016) proposed a revised version called AprilTag2 a few years later, for increased speed and accuracy (Figure 1.3(h)). All these systems have been widely used during the last decade, mostly for AR applications, because they allow to detect the environment easily. Today, Aruco (Figure 1.3(i)) seems to be the most frequent marker, even implemented in computer vision libraries by default like OpenCV. Developed by Garrido-Jurado et al. (2014), this marker is quite similar to ARTag, but includes a more efficient error correction. Its second great advantage is its modularity: one can design markers of a specific size for a given use case.

Other designs have been proposed, like RuneTag (Bergamasco et al., 2011; Figure 1.3(c)), which consists of dots arranged in a circular fashion, Intersense (Naimark and Foxlin, 2002; Figure 1.3(d)), which are circles containing geometric shape, or even reactIVision (Bencina and Kaltenbrunner, 2005; Figure 1.3(e)), which uses topological structures and hierarchy.

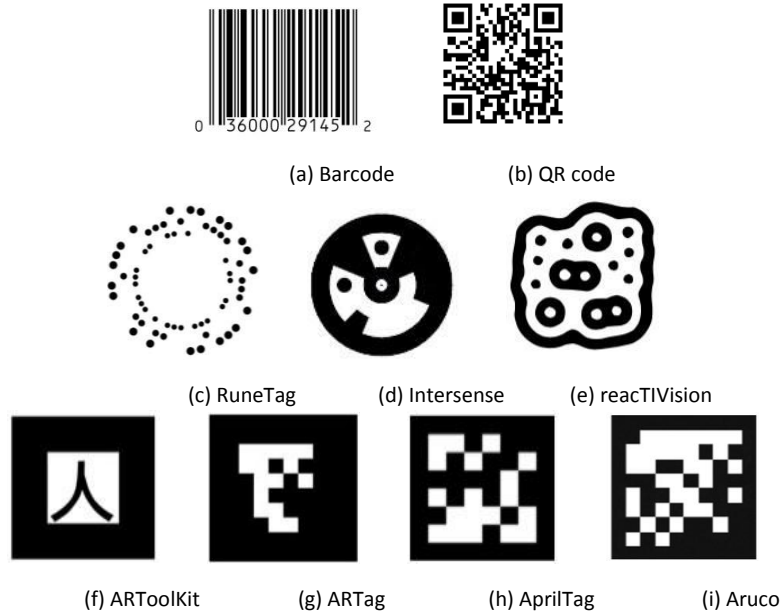

FIGURE 1.3: Existing black and white fiducials

1.2.2 Colored markers

While monochromatic markers are easy to create, the number of markers that can be generated is limited. Colored markers offer a higher information density, allowing to reduce marker size, which is a critical factor in some applications. For a configuration similar to the markers of the last row in Figure 1.3, the maximum theoretical number of markers of size N ($n = N \times N$ components) is 2^n for monochromatic and C^n for a marker constituted of C colors. The exponential gain when switching to color is then

$$G = \left(\frac{C}{2}\right)^n \quad (1.1)$$

For a conservative size of $N = 4$ (AprilTag: $N = 6$, Aruco: $N = 8$ in Figure 1.3), switching from black and white to 8 colors allows to generate $G = 4^{16} = 4294967296$ times more markers! Another advantage of colored markers is that depending on the background environment, they can be easier to detect with color segmentation for example. Finally, nowadays the vast majority of cameras works with colors, so it just seems logic to use them to their full capacity. Gu, Takaki, and Ishii (2012) track multiple objects at an impressive rate of 2000fps using 16-bins color histograms on a FPGA. However, the images are relatively small (512 by 512 pixels), and because of the nature of a histogram, two markers can not have the same set of colors. This already reduces the number of available tags. Also, lightning conditions must be perfectly controlled and identical to those present during training. Finally, they only experiment their implementation with 16 objects, which is far

behind our needs. Bagherinia and Manduchi (2013) developed pie-shaped markers to be detected by mobile phones to help guide blind people. They are consequently not real fiducials as they do not contain information (they can be placed next to barcodes containing a message for example). Their diameter is 15cm and they consist of 4 equal sectors. An interesting aspect of their article is the study of the effect of viewpoint on a surface. They chose 25 different types of paper, took photos from different angles and then analysed the data to determine the nature of each surface: Lambertian or specular. However, they only test their detection algorithm with one marker in the scene, at a VGA resolution of 640 by 480 pixels and at only a few FPS. Gu et al. (2013) also introduced a pie-shaped marker (Figure 1.4(b)), consisting of 5 sectors. To define the beginning of the colors sequence, the first sector is twice as big as the other ones. This is useful to directly determine the orientation, but on the other hand it reduces the number of components. The illumination problem is also present here, and on top of that no error correction is implemented, thus limiting either the detection accuracy or the number of colors available (more colors means they are closer to each other in a given colorspace, and therefore a higher risk of confusing two colors). Liu et al. (2013) use triangular markers offering a strong adaptability to lightning, but they state that their method does not work well with small markers, without further explanation (Figure 1.4(c)).

More recently, Walters and Manja (2016) developed ChromaTag, an enhanced version of AprilTag with colors (Figure 1.4(d)). Their article is very limited though, as they neither present any results nor quantify any measures. Their detection is based on the CIE $L^*a^*b^*$ color space, which represents colors closely to how the human visual system perceives and processes them. Microsoft also developed a tag, the Microsoft Tag (Figure 1.4(a)), using triangles of 4 different colors, but very few information is available since it was discontinued in 2015. Tags were created and stored on a Microsoft's server, and a specific application was necessary to identify them, leaving no freedom to the users. They are High Capacity Color Barcodes, with up to 3 500 alphabetical characters per square inch (BBC News, 2007).

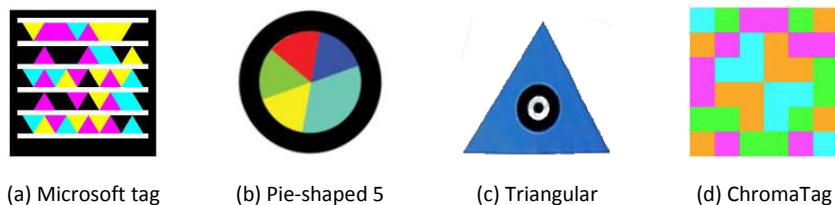



FIGURE 1.4: Existing colored fiducials

1.2.3 Markers comparison

Figure 1.5 provides a brief summary of the presented markers.

Marker	Color	Scalable	High information density	Easily implementable
AprilTag				✓

ARTag					✓
ARToolKit			✓		✓
Aruco			✓		✓
Barcode					
ChromaTag		✓		✓	✓
Intersense					
Microsoft tag		✓	✓	✓	
Pie-shaped		✓	✓		✓
QR code					✓
reacTIVision			✓		
RuneTag			✓		
Triangular		✓			✓
Ours		✓	✓	✓	✓

FIGURE 1.5: Table comparing the presented markers

None of the existing fiducials are suited for carrying a lot of information within tiny sizes. The majority of studied markers measure at least a few centimetres and are detected via low resolution cameras. The only ones that could be reduced are monochromatic, like Aruco. Colored ones' structures are not optimal for a shrinking process, which would therefore greatly alter detection's quality. Our contribution is to present a new colored fiducial

- with increased information density
- with reduced size

- at low cost
- easily implementable • open source and use the full potential of modern cameras.

Its first application is to detect and track populations of tiny animals moving rapidly. It is however not limited to ethology, and can be used in other domains, such as AR and VR, or even robotics. Their advantage is their size, which makes them non-intrusive. Let's imagine a setup where a robot must manipulate small objects, our markers could help identifying and differentiating relevant objects of the scene.

In the following, part 2 explains how we defined our markers as well as an algorithm to generate dictionaries of markers; part 3 then presents an algorithm that detects and identifies the previously created markers. After that, part 4 adds a tracking algorithm in order to improve the detection results, which are then compared and discussed in part 5. Finally, part 6 draws some conclusions on the presented work.

2. Markers creation

2.1 Marker shape

Here, the first objective is to create and implement a set of fiducial color markers. Each marker must be unique, distinguishable from every other markers in the set, and invariant with regard to rotation. These 3 properties combined will allow to identify each individual of a population as well as their position and orientation. The first aspect to consider when creating a set of fiducial markers is their shape. As discussed in [section 1.2](#), different shapes exist, the most common being squares, circles and triangles. Compared to squares, triangles have approximately twice less surface area, resulting in fewer information. Moreover, Liu et al. (2013) have encountered difficulties when reducing the size of their markers. The comparison will therefore focus on squares and circles.

A square has inscribed and circumscribed circles, as represented in [Figure 2.1](#). Let R be the side of the square, its surface is then equal to R^2 . The inscribed circle has a radius of $R/2$, which means its surface is equal to $\pi R^2/4$. The circumscribed circle has a radius of $\sqrt{2}/2R$, resulting in a surface of $\pi R^2/2$. The inscribed and circumscribed circles represent respectively 78.5% and 157% of the square's surface, giving an advantage to the latter. We must remember that the printed size of the marker can be of the order of the millimeter, and that cutting circular shapes manually at that scale is extremely difficult. Since we aim at designing low cost and easily implementable markers, the square shape has an advantage, reinforced by the fact that with small printed sizes, the center of a pie-shaped marker will very likely be smudged. This means that the surface is not used optimally, contrary to a square. Consequently, we opted for squared markers.

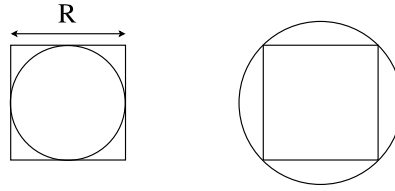

FIGURE 2.1: Square with its inscribed (left) and circumscribed (right) circles

2.2 Marker size

When designing a set of markers, three factors must be considered: camera resolution coupled with the distance to the scene (denoted D , in pixels/mm), the size S of printed markers (in mm), and the number of components N^2 of a marker. In order to filter noise, we want each component to contain at least 50 pixels (squares of 7 by 7 pixels). Equation 2.1 allows to determine one factor by fixing the others.

$$\frac{D \times S}{N} = 7 \text{ pixels/component} \quad (2.1)$$

For example, if we want to print 1mm side markers with 4 components, we must have a camera resolution $D = 7 \times \frac{2}{1} = 14 \text{ pixels/mm}$. From (2.1), we derive the relation

$$D \propto \frac{N}{S} \quad (2.2)$$

which indicates that resolution is proportional to the number of components along one dimension, and inversely proportional to the printed size. This is intuitively logic: when the markers' size decreases, camera must be either brought closer to the scene or upgraded to a higher resolution. Also, for a given printed size, the more components in a marker, the smaller they are, and the same relationship with camera resolution occurs.

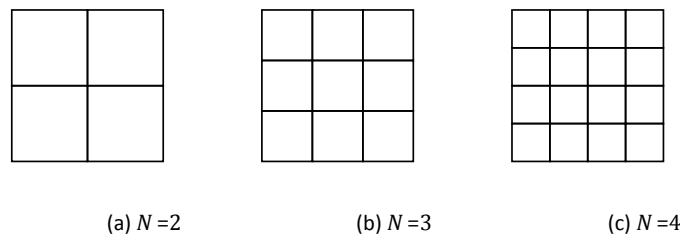

FIGURE 2.2: Markers with fixed size S and different N values

2.3 Colors differentiation

The third aspect to consider is the choice of colors, which must be easily discriminated from one another. In order to generate large numbers of markers, the number of colors C must be as high as possible. On the other hand, when C increases, the distance between colors is reduced, resulting in lower distinguishability. To illustrate this, consider a single-channel color space where 0 is black and 1 is white (see Figure 2.3). If $C = 3$, each color will be distant from its neighbour(s) by $\Delta = 0.5$, and the maximal rectifiable error is

$\frac{\Delta}{2} = 0.25$. If $C = 10$, now $\Delta = 0.1$, and the error margin is 0.05. This reduces the capacity to correct errors by a factor of 5.

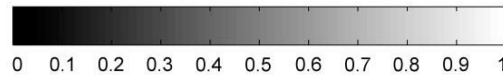

FIGURE 2.3: Grayscale

We considered the problem using the HSV color space (see [Figure 2.4](#)). It is constituted of three channels: hue, which represents color; saturation, which indicates how saturated a color is; and value, which represents light intensity. Since we are studying which colors to use, hue is the only parameter to analyse. We set both saturation and value to their maximum, in order to obtain dazzling colors. Given the darkness of the insects that will be tracked, their saturation and value are often quite low, allowing to discriminate the markers more easily.

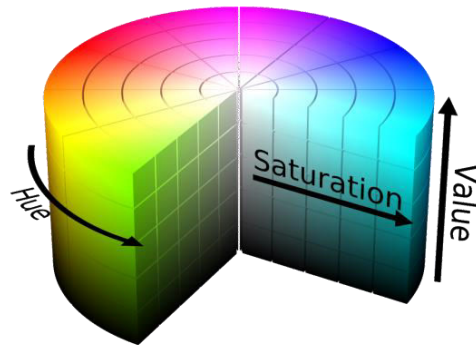

FIGURE 2.4: Representation of the HSV color space

2.3.1 Spectrum analysis

In order to obtain the spectrum perceived by the camera, a palette of colors with hues ranging from 0° to 360° with a step of 10° was generated. The corresponding 36 colors of the spectrum are illustrated in [Figure 2.5](#).



FIGURE 2.5: Complete discrete spectrum (36 colors)

Three videos with different lightning conditions were recorded and analysed. Each calibration board consists of 8 rows of 36 color spots, as can be seen on [Figure 2.6](#). Note

the ruler at the bottom of the picture: a color component is smaller than 1mm. We first calculated an average HSV triplet, which will be referred to as sample, for each color spot, based on all its pixels. A distribution of samples was then calculated for each color.

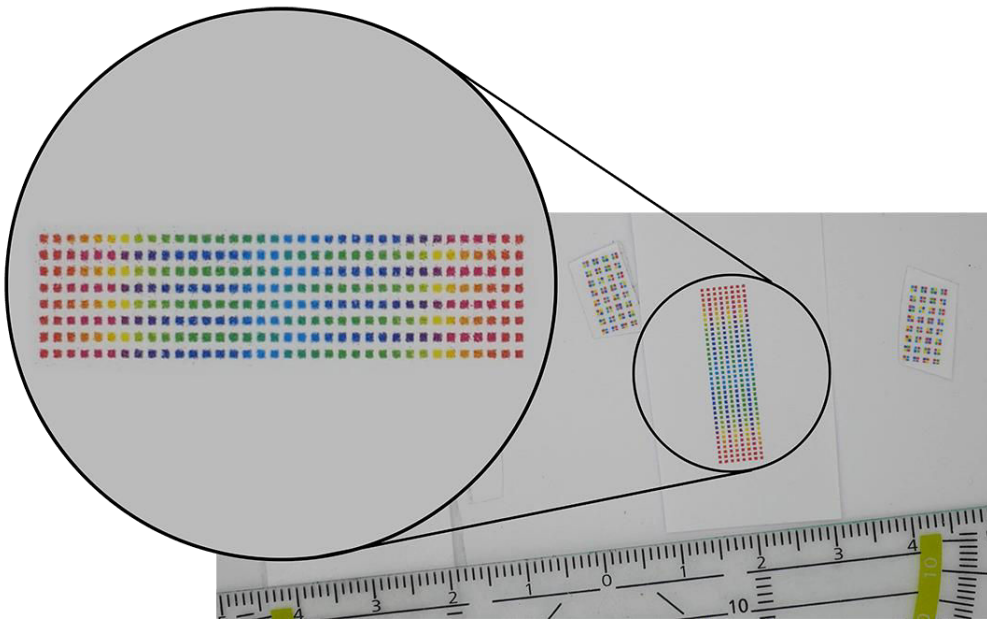

FIGURE 2.6: Zoom on a calibration board used for spectrum analysis

The results, displayed on [Figure 2.7](#), show that only the hue component is relevant, because it is the only one that is quasi linear. Moreover, saturation and value vary considerably upon different lightning conditions, and thus do not help discriminate colors.

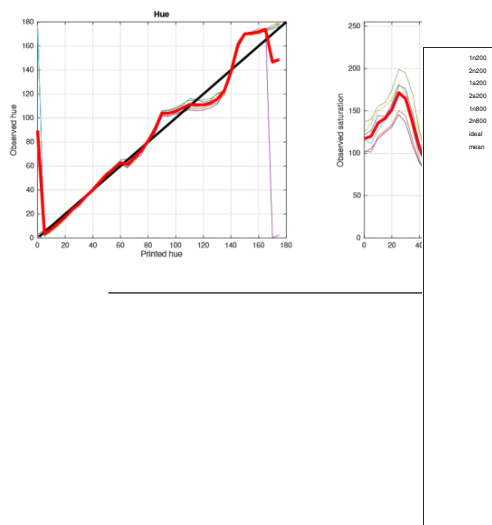

FIGURE 2.7: HSV observed for each of the 36 printed colors. The axis represents the printed hue, and the y-axis the observed hue (left), saturation (center) and value (right).

Even though hue stays constant from one lightning to another, [Figure 2.8](#) shows that it is not perfectly linear (the thick red line is the average hue of the 48 spots for each color and the black line is the ideal linear function $y = x$). The first thing to notice is that the extremities of the spectrum are badly represented. This is due to the circularity of the hue: 0° and 360° represent the same color, red (see [Figure 2.9](#)). In OpenCV, hue is represented in the interval $[0;180)$ instead of the classical $[0;360)$. Unless indicated, the first notation will be used henceforth.

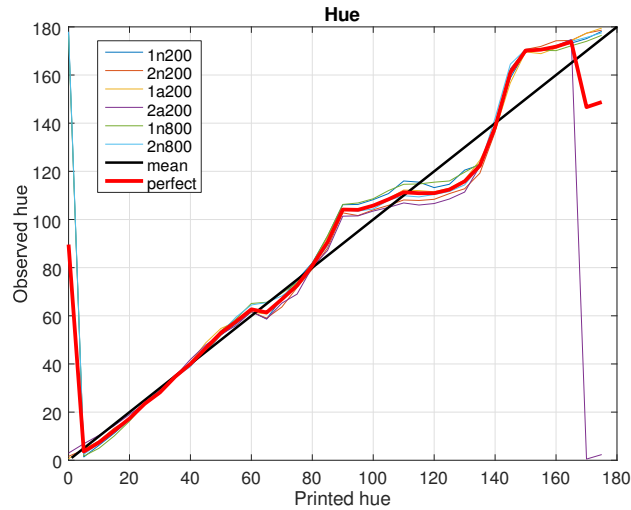

FIGURE 2.8: Hue observed for each of the 36 printed colors. The x and y-axis represent the printed and observed hues respectively.

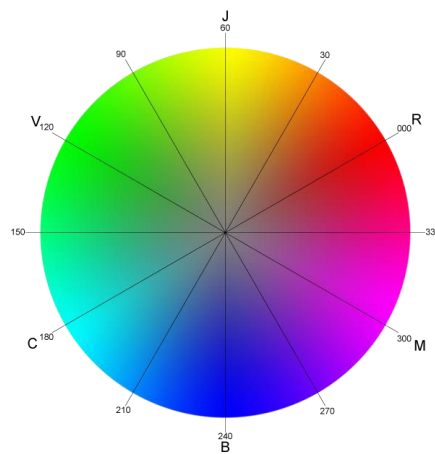

FIGURE 2.9: Hue wheel (Source: Sylveno [CC BY-SA 3.0]) [[Hue wheel](#)]

The second irregularity observable in Figure 2.8 is the plateau around 110, which spans from 90 to 130. All the printed hues inside that interval are perceived by the camera closer than they should be. Moreover, it is the only portion of the curve that vary slightly according to lightning conditions. This plateau can arise from the printer and/or the camera CMOS sensor, and will almost always happen unless the complete printer-camera chain is calibrated.

2.3.2 Thorough analysis

We selected random frames of a video and extracted a distribution of pixels for each color. As a result, we obtained more than 500 000 samples associated to color IDs between 0 and 35. For each color, we rejected 1% on each side to remove outliers, and then box-plotted the results which appear in Figure 2.10(a). Like previously, the end of the spectrum seems to be chaotic, but again it is due to hue's circularity. Unfortunately, scientific literature about circular box plots is very scarce. Abuzaid, Mohamed, and Hussin (2012) proposed a structure, based on the work of Fisher (1995), but never released any source code. We therefore represented the intervals of each color in Figure 2.11, which helps understand the circularity of the hue.

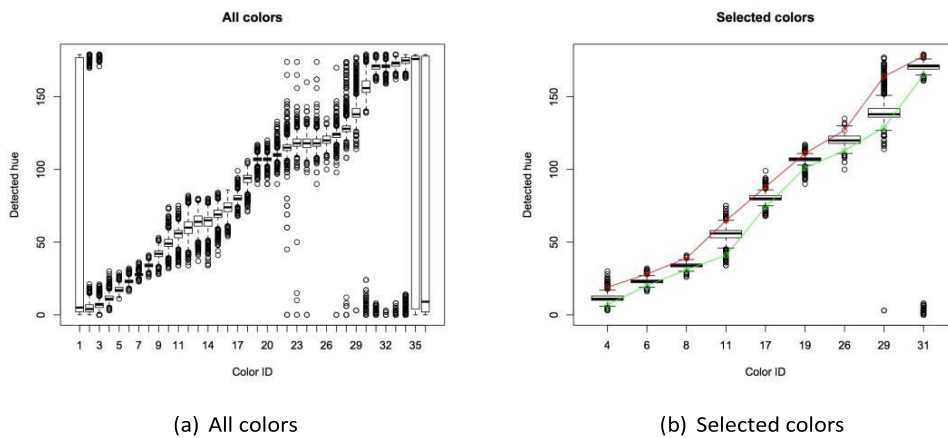

FIGURE 2.10: Box plots of colors hues

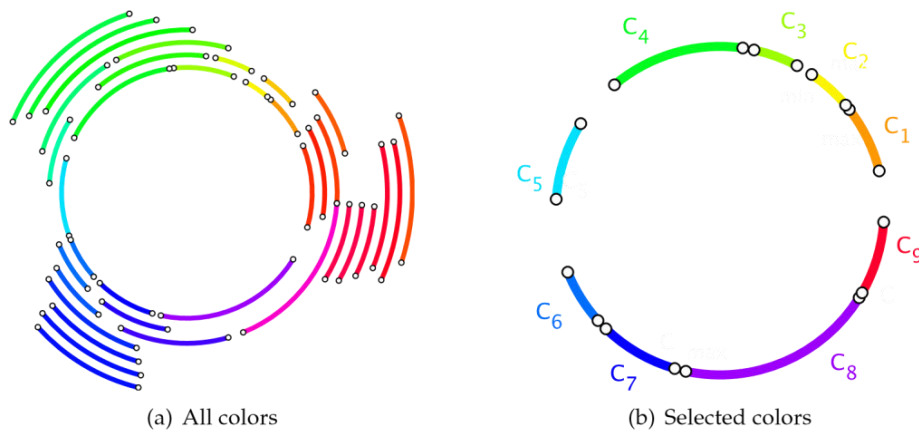

FIGURE 2.11: Circular box plots (alternative representation of the classical box plots, which do not display hue's circularity)

Our objective is now to select the maximum independent set (MIS): the set containing the most non-overlapping colors. This is known as the circular-arc scheduling problem, which can be resolved in $O(n^2)$ (Gupta, Lee, and Leung, 1982), and more recently in $O(n \log n)$ or $O(n)$ depending on whether the arcs' endpoints are sorted or not (Zheng, 1996).

In order to reduce the circular-arc scheduling problem, we must first linearise the circular data so as to exploit the unweighted greedy interval scheduling problem (Moshkovitz and Tidor, 2012). To do that, an appropriate breakpoint must be found so as to keep the optimality of the solution. To guarantee such a breakpoint, the linearisation must be applied with every endpoint, and the best solution will be kept. The procedure is detailed in algorithm 1, and the MIS of colors obtained is displayed in Figures 2.10(b) and 2.11(b) as well as in Table 2.1.

Color ID	4	6	8	11	17	19	26	29	31
Printed hue	15	25	35	50	80	90	125	140	150
Minimum hue	7	20	31	41	74	101	113	129	165
Maximum hue	19	28	39	65	88	111	127	164	178
Median hue	11	23	34	56	80	107	120	138	171

TABLE 2.1: Final set of colors

Algorithm 1: Unweighted circular-arc scheduling problem

```

S ← ∅; // Initialise solutions
D ← ∅; // Initialize distances for ai(xi,yi) ∈ S do
  L ← linearised input wrt to xi;
  remove all arcs from L whose endpoints surround xi; sort
  L wrt to y; d ← 0;
  sol ← ai; lim ←
  yi; for ak ∈ L
  do
    if xk > lim then
      sol.append(ak);
      d ← d + xk - lim
      lim ← yk;
    end end
  S.append(sol);

```

```

    D.append(d); end
max_colors ← maximal length of S;
max_dist ← 0;
MIS ← 0; for
    if length(sol) = max_colors and distance(sol) > max_dist then
        solution = sol;
        max_dist = distance(sol);
    end
end
sol ∈ S do

```

2.4 Border

A border has two purposes: create a distinction between the marker and the background, which can have similar colors in some cases; and allow to detect and extract the exact shape of the marker, which proves to be difficult when it is tilted. A monochromatic border is sufficient when its color is different from the background's and the marker's. In the other case, it gets confused with either one of them, and does not fulfill its role. A black and white border yields a better contrast, because at least one color is different from the background. The other purpose is to extract the marker's shape as precisely as possible. [Figure 2.12](#) illustrates how saturation-based segmentation does not allow a precise shape extraction and misses some markers.

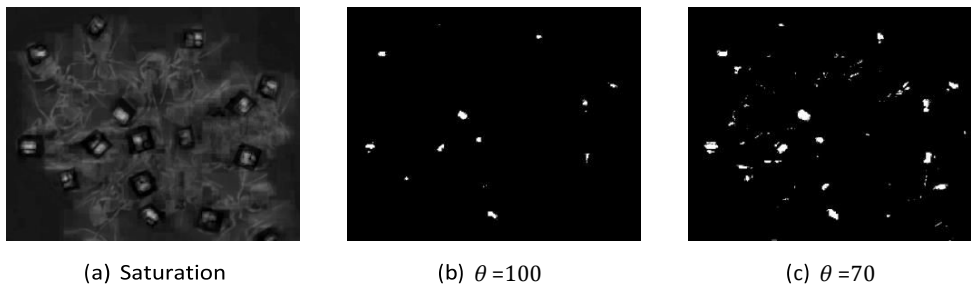

FIGURE 2.12: Saturation of an image, with different thresholds applied. It is not sufficient to extract the precise shape of a marker.

Without a correctly matching shape, identification will very likely be affected. [Figure 2.13](#) shows an example of a poorly extracted shape compared with a good one. In the first case, identification will fail since two colors are missing.

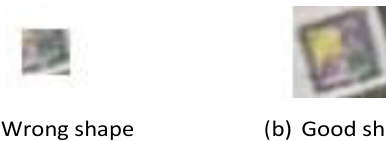

FIGURE 2.13: Example of a shape extraction

Border size should be kept as narrow as possible, in order to maximise the size of color components which carry the actual information; but large enough to be detected with a high confidence. Owen, Xiao, and Middlin (2002) studied how wide a border should be, and

concluded that it must be at least 2.83 pixels wide (the diagonal between two pixels, $2\sqrt{2}$), so we define the border width to 3 pixels.

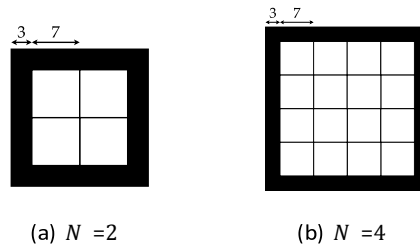

FIGURE 2.14: Illustration of the border with markers of different N

2.5 Generation

Now that the shape, size and colors are fixed, the next step is to generate a dictionary of valid markers. Garrido-Jurado et al. (2014) presented an open source method which is interesting for dealing with distances of any type. It exploits automated exploration for building dictionaries that satisfy some requirements. In this section, we will adapt their method to our colored markers.

2.5.1 Notations

Color components indices

Markers are constituted of N^2 color components. Their colors are represented by a number between 0 and $C - 1$, where C is the number of colors available. Components' indices start at 0 from the top left, and are incremented within each column, as illustrated in Figure 2.15 with a marker of size $N = 4$.

0	4	8	12
1	5	9	13
2	6	10	14
3	7	11	15

FIGURE 2.15: Illustration of the color components' indices

Rotations

Since we designed our marker to be rotation invariant, the only thing to take in consideration is the color sequence order, not its beginning: 1234 is the same marker than 2413, 4321 and 3142. Figure 2.16 shows an example of a marker of size $N = 2$ and its rotations. Note that rotations will always be considered as clockwise if not specified.

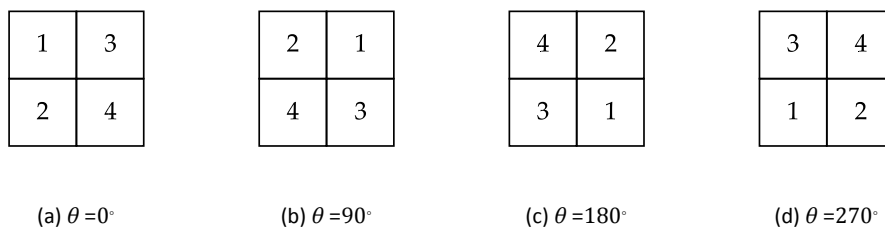

FIGURE 2.16: Illustration of a marker and its 3 rotations

Minimal adjacency

The adjacency is defined as being the distance between two adjacent colors. The distance is the shortest distance between two colors, and is equal to at most $\lfloor \frac{C}{2} \rfloor$ (see Figure 2.17(b)). For instance, the distance between colors 2 and 9 is not 7 but 2. For simplicity, let us consider the

marker 1437, whose adjacencies are illustrated in Figure 2.17(a), and are equal to 3, 3, 4 and 2. Its minimal adjacency α is then equal to 2, which is the minimal value. This can trivially be generalised to any size N .

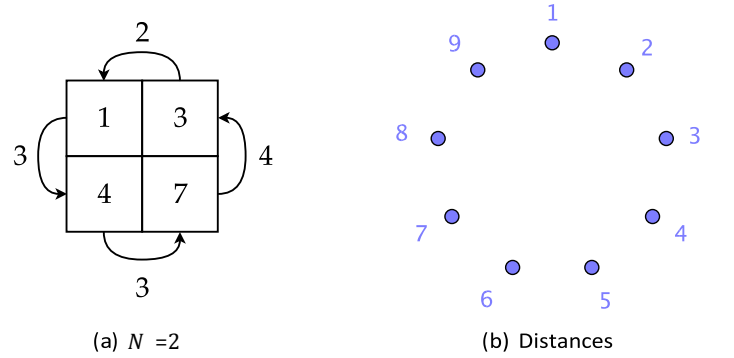

FIGURE 2.17: Adjacencies of a marker of size $N=2$

Distance between two markers

The distance between two markers is defined as being the minimal distance between the first one and all the rotations of the second one:

$$D(m_i, m_j) = \min_{k \in \{0,1,2,3\}} \left(\sum_l^N |m_i(l) - R_k(m_j(l))| \right) \quad (2.3)$$

where R_k is an operator which rotates a marker $k \times 90^\circ$ clockwise.

Self-distance

The self-distance of a marker, which is the distance to itself, is therefore given by:

$$S(m_i) = D(m_i, m_i) \quad (2.4)$$

Distance of a marker to a dictionary

The distance of a marker to a dictionary \mathcal{D} is the distance between the marker and its closest counterpart in the dictionary:

$$D(m_i, \mathcal{D}) = \min_{m_j \in \mathcal{D}} (D(m_i, m_j)) \quad (2.5)$$

2.5.2 Dictionary generation

A dictionary \mathcal{D} is characterised by its size n , the minimal adjacency of its markers α and the distance τ between its two closest markers. Markers are randomly generated, but before being added to \mathcal{D} , they must satisfy three conditions:

- they must respect the minimal adjacency α

- their self-distance must be greater or equal to τ
- their distance to the dictionary must be greater or equal to τ

2.5.3 Algorithm overview

Our algorithm is an adaptation of Aruco ([algorithm 2](#)) for colored markers. We want to generate a dictionary of markers D , where the distance between each marker is greater or equal to τ . As defined in [section 2.3](#), a marker is a sequence of 4 colors. Markers are generated randomly, and if they respect the previous condition, they are added to the dictionary. The process stops either when the dictionary has the desired size or when τ decreases under a given value.

Algorithm 2: Dictionary generation

```

D ← ∅;      // Reset dictionary
τ ← τ0; // Initialize target distance
n ← 0;      // Reset fails
count

while D has not desired size do
  Generate new marker  $m$ ;
  if distance of  $m$  to  $D$  ≥ τ then
    D ← D ∪  $m$ ;           // Add to dictionary
    n ← 0;
  else
    n ← n + 1;
    if n = Ψ then
      // if n = maxFails, reset n and decrease τ
      n ← 0;
      τ ← τ - 1;
    end
  end
  if τ < τmin then
    break;
  end
end

```

2.6 Error correction

According to Garrido-Jurado et al. (2014), we are assured to detect and correct an error of $\lceil (\hat{\tau} - 1)/2 \rceil$. For instance, it is necessary to have $\hat{\tau} \geq 3$ to correct at least one error with 100% confidence. The dictionary size depends largely on $\hat{\tau}$: the higher its value, the less markers will be generated. It also depends on N : increasing the number of color components dramatically increases the number of generated markers. [Table 2.2](#) represents the best sizes we could achieve over 50 generations, with $\Psi = 500000$. With $N = 2$, the highest number of errors that

3. Marker detection

3.1 Detection algorithm

This part focus on the detection and tracking of the markers previously created. Indeed, the sole purpose of these markers is to be pasted on individuals of a population so that they can be detected and tracked thanks to a camera. In the long term, ethologists will implement algorithms based on the detection data to extract certain social behaviours and statistics concerning given populations. In the meanwhile, this chapter will focus on the technical aspects of detection.

We developed two methods for detecting the markers: a first one based on the HSV color space, and another one based on the CIE L*a*b* color space (henceforth mentioned as Lab). Both methods will be presented and then compared, to understand which one was implemented in the end.

Here is a brief summary of the algorithm:

- color segmentation
- contours detection
- contours filtering
- approximation of each contour as a 4-side polygon
- division of each polygon into 4 sub-polygons
- calculation of the average hue of each sub-polygon
- search for a correspondance in the dictionary

3.1.1 Segmentation

The first step is to extract the useful information from the video frames. Color segmentation is a method that performs extraction simply, efficiently and faster than many other extraction methods such as edge detection.

HSV color space

The most straight-forward color segmentation consists in just detecting the color markers in the image. As explained in subsection 2.3.1, a marker's color is defined by a HSV triplet, whose hue is in the interval [0;180] while its saturation and value are both set to their maximum: 255. Since all colors need to be detected, all hues must be considered, so saturation and value are the determining factors of the segmentation.

Figure 2.7 shows that saturation oscillates between 40 and 200 and value between 75 and 175. However, if we choose these values for segmentation, false positives appear, due to the low saturation threshold. The latter can be increased, since a marker is constituted of four colors, with at least two different ones. This means that saturation' lower threshold can be set to 60 (the second minimum of saturation's plot) without risking to miss a marker. This trick allows to eliminate false positives dramatically, while being assured to detect at least 2 colors of each marker (in the worst case).

Because there are commonly no background objects with high saturation or value, the upper thresholds can be set to maximum, giving us the following thresholds:

Component	Low threshold	High threshold
Hue	0	180
Saturation	60	255
Value	80	255

TABLE 3.1: Segmentation thresholds (method 1)

When the segmentation is done, a binary image with little white spots is obtained. The white spots correspond to the color spots present in each markers. As markers need to be treated as a whole, and not each spot separately, the white spots need to be put together so they are considered as one entity. To do so, a closing is operated on the binary image. A closing is a morphological operation which consists in applying a dilation followed by an erosion:

$$A \bullet B \triangleq (A \oplus B) \ominus B \quad (3.1)$$

where A and B are respectively the binary image and the structuring element, and \oplus and \ominus are the dilation and erosion transformations.

The results of this method are far from perfect as can be seen on Figure 3.1. First, dark colors like purple are not detected. Second, tilted markers have a reduced saturation resulting in a poor detection. Markers contours are not well detected (they do not correspond to the actual shape), and average hues (subsection 3.3.1) are calculated on wrong portions of the image. Another problem with this method is that false positive rate is still high, because stains on the floor and ants' legs have saturation values close to those of the markers. This can clearly be identified in Figure 3.1(c), where real markers are green and everything else is false positive.

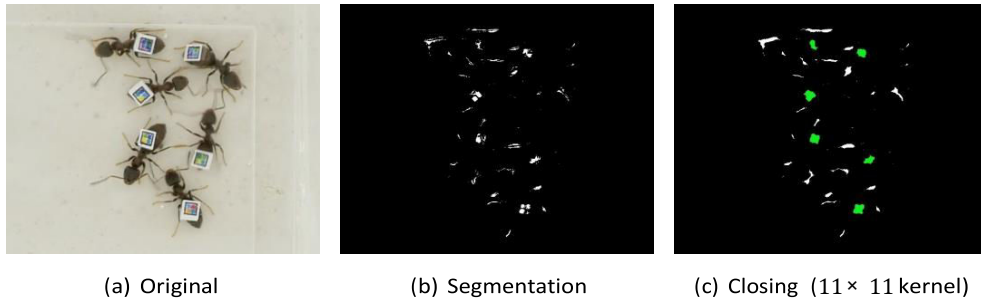

FIGURE 3.1: Segmentation results in HSV (method 1)

In order to obtain well defined contours, another method consists in detecting the markers' borders instead of their color components. Obviously, thresholds of Table 3.1 need to be adapted. Since detection now focuses on black borders, segmentation must extract the low part of the spectrum instead of the high one. In the HSV domain, black is defined by value only (see Figure 2.4). The only parameter to find is the high value threshold. Due to the camera's imperfect color perception, the upper value found is 170, and not a low one as one would expect. The threshold for this second method are given in Table 3.2, and results are shown in Figure 3.2.

Component	Low threshold	High threshold
Hue	0	180
Saturation	0	255
Value	0	170

TABLE 3.2: Segmentation thresholds (method 2)

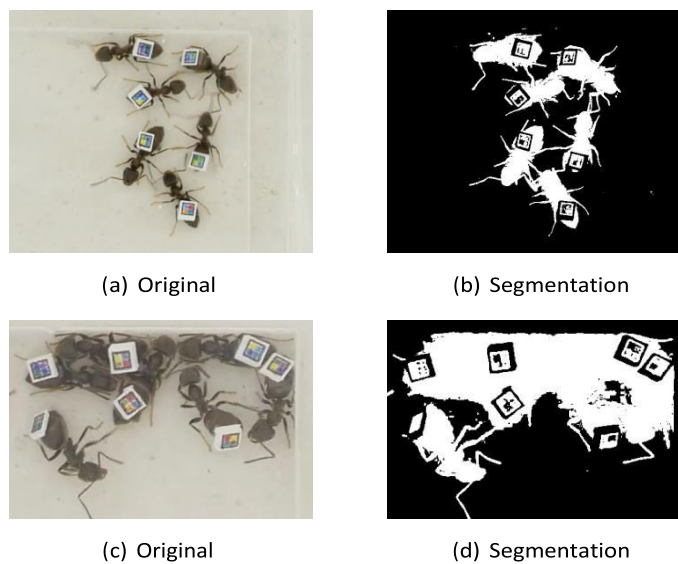

FIGURE 3.2: Segmentation results in HSV (method 2)

Lab color space

Another possibility to extract markers is to use the Lab color space. It is designed to approximate the human visual system, and is constituted of three channels:

- L represents the lightness (0 being black and 1 being white)
- a represents the position between green and red
- b represents the position between blue and yellow

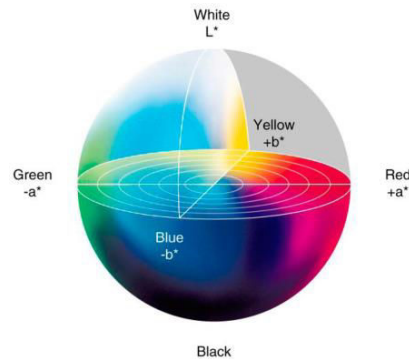

FIGURE 3.3: CIE L*a*b* color space

The method is based on the assumption that natural backgrounds have very few harsh transitions between red and green or blue and yellow, contrary to markers. This translates to high gradients in the a and b channels (Walters and Manja, 2016). Therefore, a Canny edge detection (Canny, 1986) is processed on these two channels and the results are fused together using the OR operator. The resulting binary image is then closed using Equation 3.1 and the result is shown in Figure 3.4. This method, like the first one, focuses on the color components of the marker. However, it provides much less false positives because gradients in a/b channels are much less frequent than objects with high saturations or values.

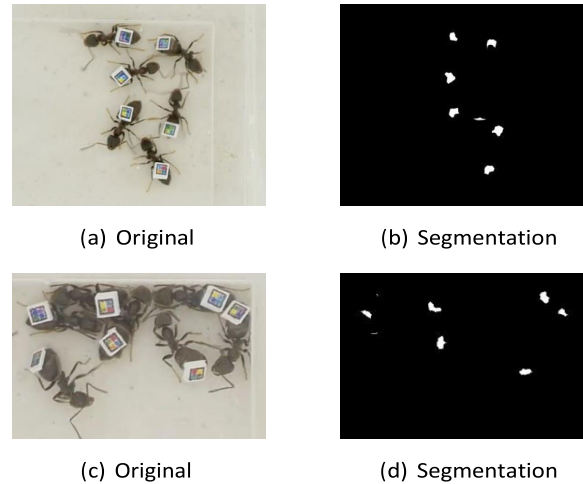

FIGURE 3.4: Segmentation results in Lab

Comparison

For simplicity concerns, we will henceforth refer to the segmentation methods by their order of presentation. [Figure 3.5](#) shows that the last two methods clearly give the best results. Note that the image presented is only a tiny portion of the whole area so that results can be legibly observed. Method 1 finds the six markers present in the image, but also returns a huge amount of false positives. Method 2's goal is to find marker's shape by looking for black borders. Since the ants are black shaded, their shapes are also returned. This is why the border is black and white, so that the white border surrounding the black one allows to discriminate between the ants and the actual markers borders. With this method, markers appear clearly as white squares within black ones, thus allowing to detect their corners easily. Finally, method 3 returns the six markers, as well as a false positive. This is much less than method 1, and so it avoids to process useless information in the next steps of the detection algorithm. We will henceforth only consider methods 2 and 3.

Their processing times were analysed, and [Figure 3.6](#) shows that while both methods are linear, method 2 is faster than method 3 by a factor of between 10 and 25, depending on the image size (the larger the image, the smaller the ratio). Regarding detection performance, method 3 outperforms method 2 in finding only the relevant locations, but on the other hand the contours returned do not match precisely the markers' shapes.

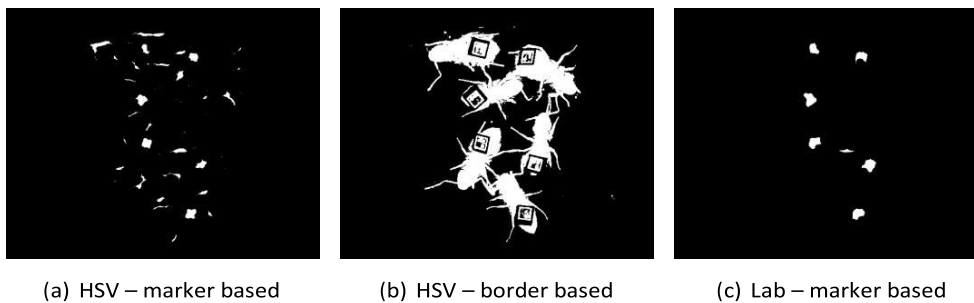

FIGURE 3.5: Comparison of the different segmentations

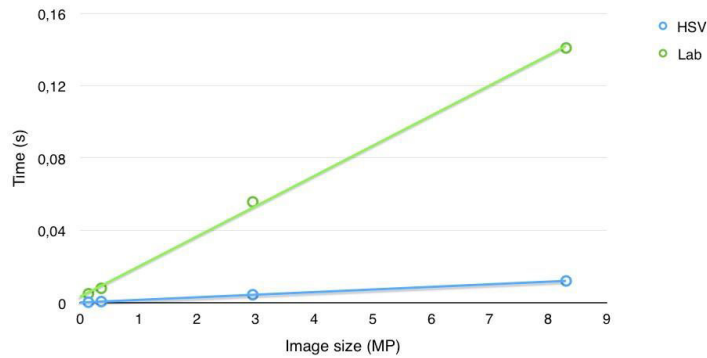

FIGURE 3.6: Segmentation processing times averaged over 100 runs

3.1.2 Contours detection

Once segmentation is done, a binary image is obtained, with all the useful elements in white. [Figure 3.5](#) shows that the binary image is completely different depending on the segmentation method used: method 2 returns an image with much more details than method 3, which only returns the markers positions (and some false positives). That means that in terms of extraction, method 3 is more efficient at only returning the relevant information.

From that segmented image, contours are extracted using [Suzuki and be, 1985]. On a tiny portion of the whole image, containing 6 ants, more than 200 contours are found with method 2, whereas only 7 are found with method 3. This clearly underlines the extraction efficiency of the latter. However, after processing contours so as to eliminate the ones either too small or too large, method 2 returns 11 contours, which is much more reasonable, and brings it back to the comparison (see [Table 3.3](#) for measurements regarding an entire frame). The removal of some contours based on their size is required because segmentation might have included unwanted elements. [Figure 3.7](#) shows the results of both methods on two different images, each contour being colored with a unique hue.

From the images, a trend appears: contours are better extracted from the segmentation method 2. First, markers' shapes are precisely extracted with method 2, while method 3 only extract approximate blobs. Secondly, tilted markers, who suffer from color degradation, have a lower probability of being detected with method 3 since it is based on markers' colors. False positives depend on the background: if there are other objects with rapidly changing colors or generally high saturation, method 3 will return more noise. On the other hand, if the background is uniform, method 2 returns more false positives.

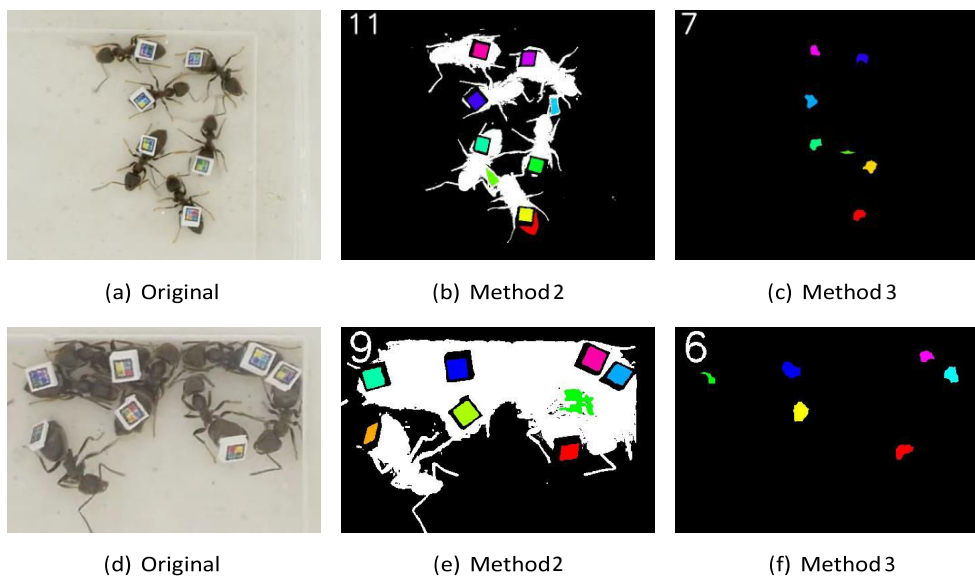

FIGURE 3.7: Contours extraction

Deeper search in Lab color space

The approximate shapes delivered by method 3 are not satisfying enough. Therefore, another search must be executed to find the exact borders of each marker. Since the method uses the Lab space, the only channel containing such information is L. The implementation is the following:

- for each contour detected in the a/b channels, define a surrounding window
- perform a Canny edge detection on the L channel for each window
- find contours using the binary image obtained
- for each contour, define an enclosing rectangle R with minimal surface
- find the convex hull and polygon approximation P of each contour (see subsection 3.1.3)
- if P has exactly 4 sides and the surface ratio $\frac{P_R}{R} > 0.75$, then the contour corresponds to a marker

Figure 3.8 shows 2 examples of the deeper search on two different markers. The first one is clearly detected; however the second one is not. This is due to the occlusion between the ant's leg and the marker's border. It is very well distinguishable on the Canny edge detection image, where the marker does not have a regular rectangular shape, but an open one with a "rolling arm".

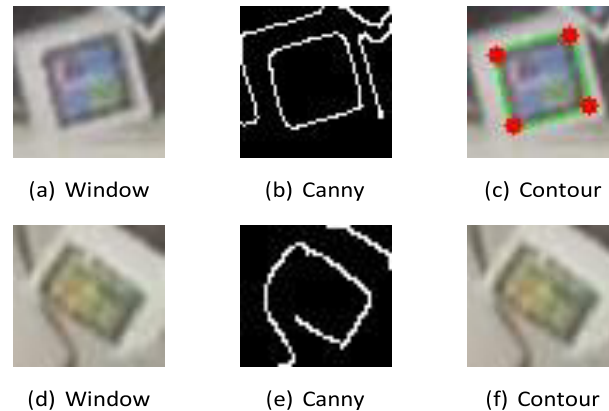

FIGURE 3.8: Deeper search illustrated with 2 markers

3.1.3 Convex hull and polygon approximation

The previous step extracted contours of the segmented elements. Even after filtering the contours based on their size, some false positives still persist, because they are in the right size interval. In order to further filter these leftovers, we begin by calculating each contour's convex hull using [Sklansky, 1982]'s algorithm. This step allows to close contours that were not perfectly detected. The convex hull of a set of points S is the smallest convex set containing S . It can be visualised by the shape of an elastic band when stretching it around a set of nails and then releasing it (De Berg et al., 2000), as illustrated on Figure 3.9. The convex hull is then approximated by a polygon using the Ramer-Douglas-Peucker algorithm (Ramer, 1972; Douglas and Peucker, 1973). All the resulting polygons that do not have exactly four sides are eliminated, thus assuring that all contours have the right shape.

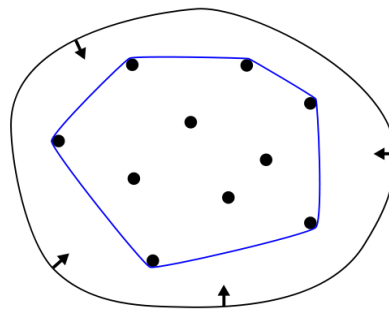

FIGURE 3.9: Illustration of the convex hull

3.1.4 Histogram filtering

After the previous filters, virtually all blobs left are markers. However, some noise having the right size and shape still persists. This is why a last filter based on color is applied. Figure 3.10 shows an example of a valid marker and a false positive: it is obvious that they have drastically different color distributions. The former will have a more equalized hue histogram, whereas the latter will have a distinguishable peak, as can be observed in Figure 3.11. An analysis of the average peak height of both valid and false markers over 200 frames returned the following values: $0.08 \in [0.01;0.16]$ for a valid marker and $0.31 \in$

[0.23;0.68] for a false positive. A threshold of 0.2 was defined, above which the blob is flagged as noise. This last filter allows to eliminate the remaining false positives, thus completing the filtering cascade. [Table 3.3](#) represents the number of blobs after each step of the filtering cascade. The numbers were obtained by averaging over 200 images containing 57 ants.

	Initially	Size filter	Shape filter	Color filter
Method 2	1359	76	57	53
Method 3	61	/	33	/

TABLE 3.3: Number of contours at each step of the processing



(a) Marker



(b) False positive

FIGURE 3.10: Examples of blobs left after size and shape filters

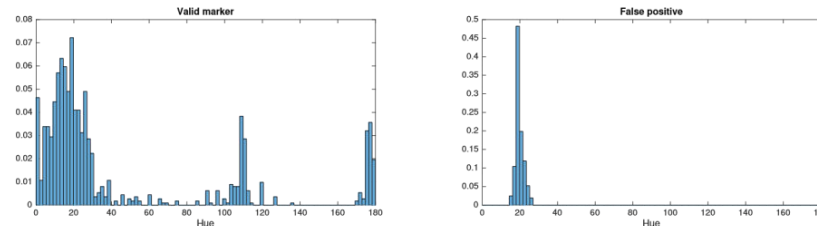

FIGURE 3.11: Hue histograms of valid marker and false positive

3.1.5 Comparison of HSV and Lab methods

[Figure 3.12](#) sums up the previous subsections by comparing both methods. The only advantage of the one using Lab space is that it extracts markers more efficiently at first. However, after filtering the contours, method 2 clearly gets the upper hand. Indeed, it is intrinsically faster (see [Figure 3.6](#)) and detects more markers (see [Table 3.3](#)). It must be noted though that some markers are not detected. On the sequence of 200 frames analysed (see [Table 3.3](#)), an average of 53 ants were detected out of 57, which represents a detection rate of 93% for method 2. Method 3 obtains a much lower score with 58%. Therefore, the only utility of method 3 is to complement method 2, using the fact that an undetected markers in the HSV color space has a non-zero probability of being detected in the Lab space.

		Method 2 (HSV)	Method 3 (Lab)
Initial detection	Accuracy		
	Speed		
	Shape		

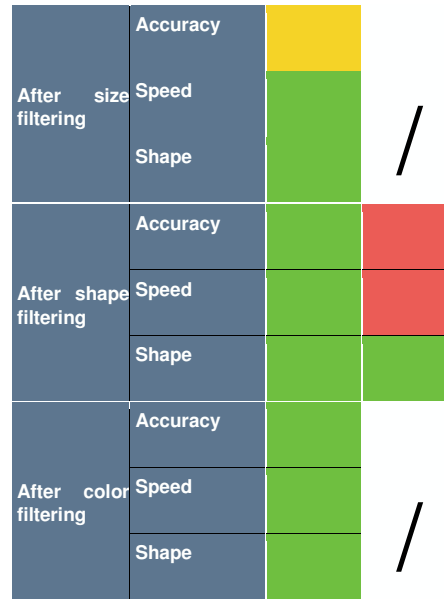

FIGURE 3.12: Summary of contours detection

3.1.6 Division into sub-polygons

At this point, we have the contours of each marker present in the image. The next step is to divide each marker into N^2 areas, each of which will then be averaged based on its hue. The division is fairly simple when in possession of the four corners coordinates. The first step is to divide each side of the polygon in N equal parts, and then connect them accordingly to create sub-polygons. Figure 3.13 illustrates the process for a marker of size $N = 2$.

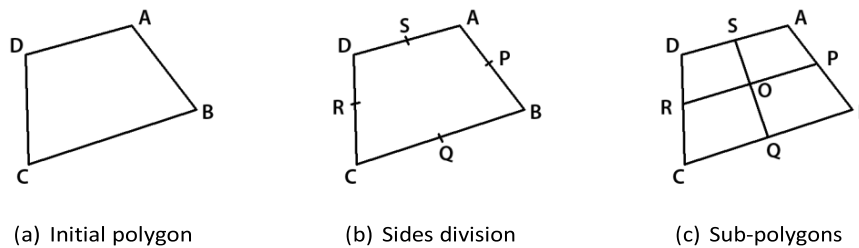

FIGURE 3.13: Polygon subdivision process

3.2 Decoding

3.2.1 Calculation of the average hue

Once the sub-polygons are obtained, their average hue must be calculated. This consists in considering all pixel inside a sub-polygon, and taking their average. This seems simple, but in our case it is not a basic average, due to the circularity of the hue component (see Figure 2.9). Therefore, hues are considered as angles of trigonometric circle of radius 1 instead of basic integer values, and we calculate a vectorial average.

Vectorial average

Since we will work with the trigonometric circle, the first step is to convert our hue from $[0^\circ;180^\circ)$ back to $[0^\circ;360^\circ)$. Each hue must then be transformed from an angle to a normalised vector. We know from basic trigonometry that the vector's x and y components are given respectively by the cosine and sine of the angle:

$$(x_h, y_h) = \left(\cos \left(\frac{h\pi}{180} \right); \sin \left(\frac{h\pi}{180} \right) \right) \quad (3.2)$$

All pixels hues are transformed into vectors which are summed.

$$\sum_h^N (x_h, y_h) = (x_h, y_h) \quad (3.3)$$

To obtain the average hue, we then have to convert the sum of all vectors back to an angle, which is done by calculating the arctangent:

$$h = \text{atan2}(y, x) \cdot \frac{180}{\pi} \quad (3.4)$$

where h is the hue in the interval $[0;360^\circ)$. To recover our original hue, h must be divided by 2. Figure 3.14 shows an example of a vectorial average between the hues 15 and 175. Both hues are converted to unitary vectors which are then summed: $\vec{d} = \vec{u} + \vec{v}$. The resulting vector's angle gives a hue of 5, whereas a normal average would give 95.

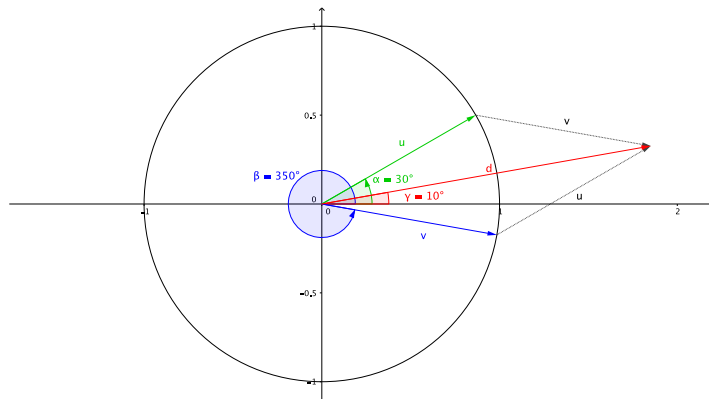

FIGURE 3.14: Illustration of the vectorial mean

3.2.2 Identification

The last part of the algorithm is identification. It consists in looking in the dictionary to find a correspondance between the calculated hues and a marker. There are basically two methods to do so:

- quantise each hue as a color, and then look in the dictionary for the same color sequence
- calculate an euclidian distance between the four hues and each marker of the dictionary

The advantage of the second method is that it guarantees to always find a match, but not necessarily the right one.

Method 1: categorising hues

The first method begins by categorising each hue as a color by determining in which interval it fits (see Table 2.1). The result is a sequence of color IDs, which is exactly how markers are stored in the dictionary. The sequence is then compared to every markers of the dictionary for a match, by making sure to consider the four possible rotations. If no match is found, the closest marker is kept. This allows to correct errors, but chances of correction greatly decrease when the distance error is larger than one (see section 2.7) because two markers can be at the same distance of the sequence, making it impossible to choose between the two.

Method 2: euclidian distance

This method does not quantise hues to obtain color IDs. Instead, it calculates the euclidian distance (3.5) between the calculated hues and the markers median hues (see Table 2.1), also taking into account the four rotations. In the end, the detected marker is associated to the one from the dictionary with the smallest distance d .

$$d(a, b) = \sqrt{\sum_{i=1}^{N^2} (a_i - b_i)^2} \quad (3.5)$$

where a and b are the markers of size N between which the distance is calculated.

4. Tracking

Even after designing robust markers, some errors can still persist during detection. They can be caused by different phenomenons, illustrated at [Figure 4.1](#):

- an ant is moving too fast and appears blurry
- an ant becomes hidden under another object
- an ant is tilted, resulting in a marker's normal vector being virtually perpendicular to the camera's field of view
- lightning conditions may vary depending on the objects present within the scene

In order to alleviate these errors, a tracking algorithm can be implemented, using detection data to resolve some issues.



FIGURE 4.1: Common phenomenons causing detection errors

4.1 Analysis of the problem

There are two ways to implement the tracking algorithm:

- live, at the same time than detection
- a posteriori, when the data from all the frames is known

Obviously, the second one is more accurate, since it evaluates each frame knowing what happened before and after. It can therefore produce more precise extrapolations than its live counterpart. On the other hand, the live one, as its name indicates, has the advantage of processing data in real time. We decided to emphasise accuracy, leaving the live algorithm for a future work.

4.1.1 Assumptions

Before elaborating the algorithm itself, the context must be described and some assumptions must be made. Since the tracked objects are animals, and in our case ants, it is logic to assume a spatiotemporal continuity. Indeed, a given ant cannot teleport from one side of the arena to the other in one frame. A maximum speed must be set, which depends on the animal, the size of the arena, the distance of the camera to the arena, and the camera's resolution. In our case, it was set to 100pixels/frame experimentally.

The second assumption is that errors are considered to be random and not systematic. This means that errors cannot be predicted and adjusted, they are not constant. Also, we assume that a marker will be accurately detected most of the time, and that there is no way to predict which markers will suffer from identification errors.

4.1.2 Resolvable cases

Considering the model described here above, let's focus on the errors that can be corrected.

Missing blob

The first case that can be corrected is when a blob is not detected during a frame or even successive frames. Since each blob's past and future is known thanks to the detection process, a missing blob can be extrapolated. Figure 4.2 illustrates this case, where a given marker was detected in frames t , $t + 2$ and $t + 5$. Its positions in intermediate frames can be recovered (dashed lines) by extrapolating between known frames (solid lines).

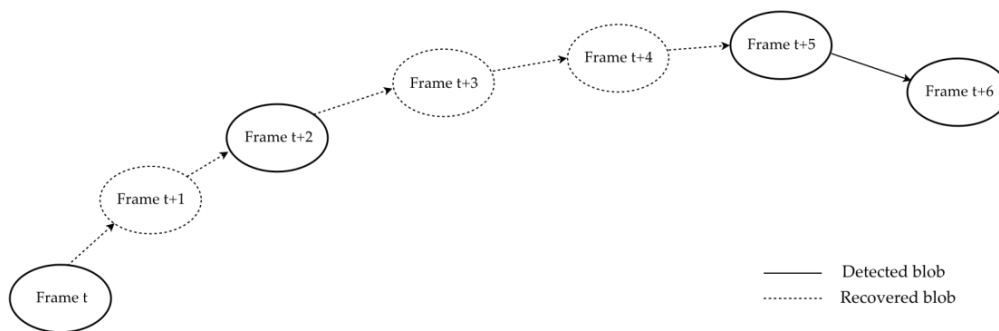

FIGURE 4.2: Extrapolation example

Wrong assignment

Sometimes, a marker will be detected but assigned the wrong tag ID. The a posteriori algorithm will considerably stabilise fluctuating tag IDs by looking at the overall ID distribution for a given marker, and choose the one with the most occurrences. This correction is very efficient if the second assumption of subsection 4.1.1 is right.

However, if the marker was assigned mistakenly more than accurately, correction will still stabilise the result, but to the wrong tag ID. Figure 4.3 shows examples of tag ID distributions. Each graph represents the distribution of a given blob during 200 frames. Distribution (a) can very easily determine the blob's tag. The second distribution also has a clear winner, but we can already see that another tag was assigned approximately 20% of the time. Finally, distribution (c) shows that this blob was assigned two tags for virtually the same number of frames, making the correction highly uncertain.

We therefore introduce a confidence attribute that takes into account both the frequency of the tag and its distance with the second most frequent one. Frequency f is the number of occurrences of the most frequent tag divided by the number of frames where the blob was detected. The inter-distance ratio r is defined as

$$r = 1 - \frac{n_2}{n_1} \quad (4.1)$$

where n_1 and n_2 are the occurrences of the most frequent and second most frequent tags. Confidence is then defined as the geometric average of f and r (so as to penalise low values), and allows to evaluate the reliability of an assignment: the distributions of Figure 4.3 have respective confidences of 98%, 57% and 12%. For the first two, f and r are nearly identical, but the last distribution has a high frequency $f = 50\%$ and a very low $r = 0.03$. This is where the confidence attribute justifies its existence, allowing to determine the assignment's reliability.

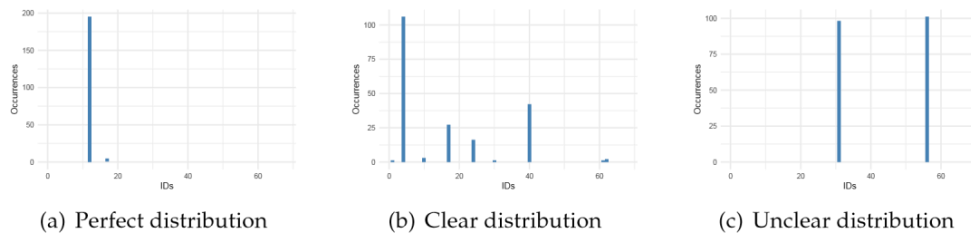

FIGURE 4.3: Examples of tag ID distributions

4.1.3 Unresolvable cases

Never-detected blobs

If during the whole span of the video, a blob is not detected at least once, since the algorithm uses detection's data, it will not be able to recover it.

Switching tag near another blob

It is not rare that a marker is assigned two different tags in successive frames. Most of the time, the algorithm will be able to correct the switch by analysing the marker's past and future assignments. However, there are some cases where the algorithm will simply fail to correct properly, and even mistake two different blobs. Figure 4.4 illustrates such a case where two blobs are next to each other. The numbers represent the identified ID. Blob 1 is represented in yellow and Blob 2 in green. At $t = 0$, both are detected correctly. At $t = 1$, 1 is detected as 3, and 2 is detected as 1. Moreover, 2 comes close to 1's previous position, reinforcing the algorithm's belief that it actually is blob 1 (it has the same tag and a position close to it). It will therefore assign blob 1 as blob 2, and vice versa, as indicated in the rightmost frame.

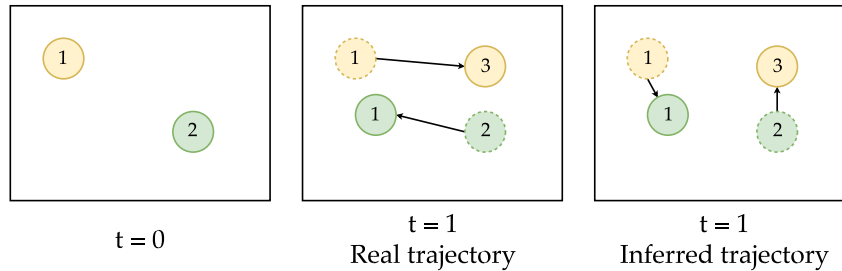

FIGURE 4.4: Wrong assignment

4.2 A posteriori algorithm

4.2.1 Notations

blob an entity representing a given animal, containing its position at each frame and a dictionary with every tag encountered and their occurrences.

candidate a detected marker in the current frame, described by its position and tag, which must be assigned to a blob.

4.2.2 Algorithm

The algorithm is constituted of two successive passes: the first one assigns at each frame all the detected markers to corresponding blobs. The second one uses the blobs resulting from first pass to determine their most likely tag ID and fill holes in their trajectories.

First pass

- initialise vector of blobs B with blobs present in frame 0
- for each frame $f > 0$:
 - for each candidate:
 - * look for the 5 closest blobs
 - * if one of the 5 has in its tag history a higher number of occurrences of the candidate's ID, add the candidate to the concerned blob's waiting list

- * otherwise, add the candidate to the closest blob's waiting list – for each blob:
 - * look at its waiting list, if it's empty then go to next blob
 - * if it is not empty, add the candidate with the ID that is most frequent in the blob's dictionary
 - * if all IDs are new to the blob, add the closest candidate
 - * add the remaining candidates to another global waiting list, and remove them from the blob's one
 - for each candidate in the global waiting list:
 - * add it to the closest blob if it has not been assigned a candidate yet
 - * otherwise, create a new blob in B
 - for all blobs that were not added a candidate, add an artificial point (0,0)

Algorithm 3: Tracking – First pass

```

B ← ∅; // Initialise blobs at frame 0 w(bi) ← ∅; // Initialise each blob's waiting list
W ← ∅; // Initialise global waiting list file ← readcsv; // Open CSV file from
detection while file not empty do
C ← readline; // Extract candidate
  Get 5 closest blobs bi; if C.tag
  ∈ D(bi) then add C to bi's
  waiting list;
  else
  add C to b0's waiting list; // Add to the closest blob
  end
  if f = f + 1 then for b ∈ B do
    if W(b) not empty then add candidate with tag most frequent in D(b), or
    the closest to b; add the remaining candidates to W;
    end
  end for c ∈ W do
    if size(closest blob) ≥ f then add
    c to closest blob;
    else create new blob in B;
    end end for b ∈ B do
    if size(b) < f then add (0;0) to
    b's positions;
    end reset w(bi)
  end
end
and W; end
end

```

Second pass

- for each blob
 - identify it with the most frequent tag in its history – if
 - there are holes in its trajectory (artificial points)

- * if the hole is bounded by real points (the blob was detected before and after), calculate the intermediate position(s) by averaging surrounding ones
- * if the hole has no real points afterwards (the blob was not detected for the remaining of the video), extrapolate using its last known positions

4.2.3. Limitations

The presented algorithm stabilises the detection's results. However, it encounters some limitations, which are explained hereafter.

First, initialisation is a complex task, because there is a non-zero probability that some markers were not detected during the first frame. Consequently, since the vector of blobs is created at frame 0, its length may not be large enough to contain all the markers in the arena. An idea would be to provide the algorithm with the number of markers in the video. However, this raises two other problems: the first one is more a constraint than a problem, as it requires to manually count the markers, making sure that none were hidden during the first frames. The other problem is that even when the algorithm knows how many markers it is supposed to look for, if some are missing from the first frame, how will it know which ones in the following frames are new markers and which were already there in previous frames? A solution that is guaranteed to work is initialising on a frame where all the markers were correctly detected. However, such a frame may not exist, and as already stated, this requires a human intervention which can be fastidious.

Another limitation, which does not come from the algorithm itself but from the assumption made in subsection 4.1.1, is that noise cannot be filtered. This is because an animal can be hidden most of the time, with some short appearances. This behaviour is very similar to that of noise, where a false positive can be detected from time to time, making it impossible to discriminate one from the other.

5. Discussion

5.1 Results

5.1.1 Experimental setup

The experimental setup used to analyse populations of ants is illustrated at [Figure 5.1](#). A Panasonic Lumix GH4 with a M.Zuiko Digital ED 30mm f/3.5 lens is pointed downwards, 23cm above the animals. The latter are positioned in a box with 2 compartments: the nest and a zone with water and food (see [Figure 5.2](#)). The camera and the animals are placed in a closed environment with white walls and diffuse light. A dictionary of 65 markers of size $N = 2$ was created, and the markers pasted on a colony of ants. The markers measure 0.75mm without the white border. Our setup provides a resolution of 36pixels/mm,

resulting in markers of 27 pixels. Each component contains $9 \times 9 = 81$ pixels, satisfying Equation 2.1. They were printed on white paper with an inkjet HP color printer and hand-cut.



FIGURE 5.1: Photo of the setup used to film the ants

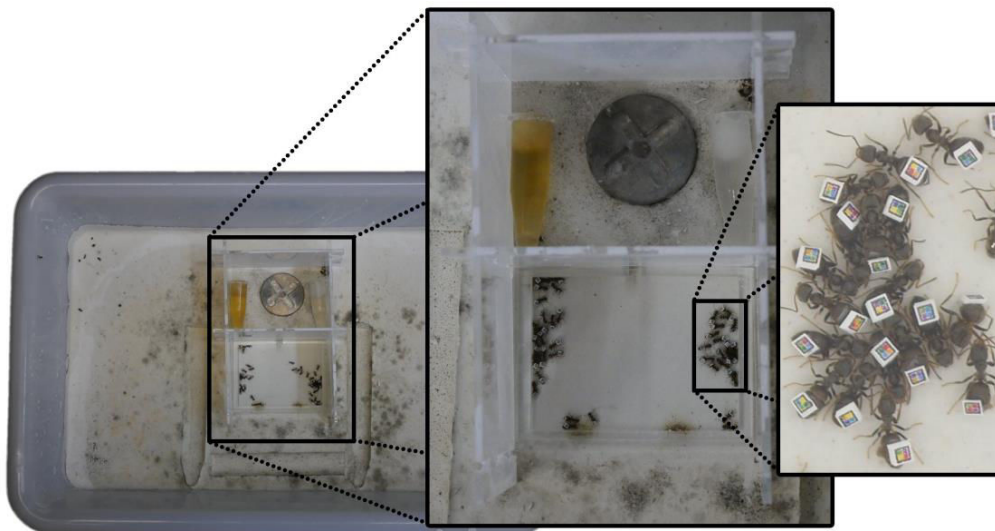

FIGURE 5.2: Ants environment at different zoom levels

FIGURE 5.3: Set of markers at different zoom levels

5.1.2 Notations

Before we present the results, let us introduce some notions:

M = number of markers

N = number of objects detected

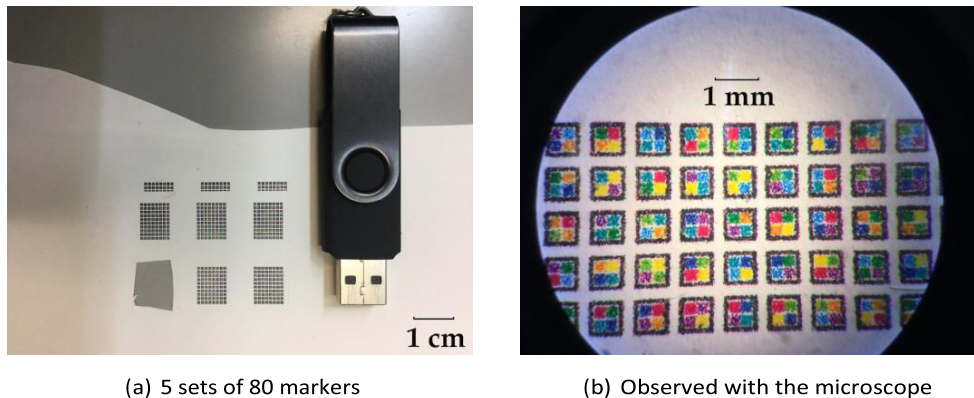

(a) 5 sets of 80 markers

(b) Observed with the microscope

L = number of markers detected

K = number of markers correctly identified

Accuracy

The accuracy A represents the identification performance, that is the proportion of detected markers that were correctly identified:

$$A = \frac{K}{L} \quad (5.1)$$

False positive rate

The false positive rate FP represents the number of objects that were detected as markers while they are not.

$$FP = \frac{N - L}{N} \quad (5.2)$$

False negative rate

The false positive rate FN represents the number of markers that were not detected.

$$FN = \frac{M - L}{M} \quad (5.3)$$

5.1.3 Preliminary note

We realised after the experiments that our maximum independent set algorithm was not optimal. We managed to correct it, but it was too late and therefore the results presented in the following subsections were obtained with a non-optimal set of colors. This means that our method can potentially achieve better results without even modifying it. The set of colors used during the experiments is listed in [Table 5.1](#).

Color ID	5	7	9	13	18	19	26	29	34
Printed hue	20	30	40	60	85	90	125	140	165
Minimum hue	14	25	34	49	82	101	113	129	168
Maximum hue	24	31	48	77	100	111	127	164	7
Median hue	17	28	42	64	94	107	120	138	175

TABLE 5.1: Final set of colors

5.1.4 Identification

The results presented hereafter were obtained by analysing 8 random frames of a video and taking the average. The video contained 44 markers of size $N = 2$, from a dictionary of $\tau^{\wedge} = 3$. [Figure 5.4](#) shows the accuracy of the two identification methods presented in subsection 3.2.2. The second one, which uses an euclidian distance, achieves better results, with an average of 87% accuracy compared to 81% for method 1. This is because it always returns a tag ID, even when errors occurred, while the first method only retrieves an ID when it found a match in the dictionary or it managed to correct an error. Since in that case $\tau^{\wedge} = 3$, only an error of 1 is guaranteed to be corrected, which explains the poorer results.

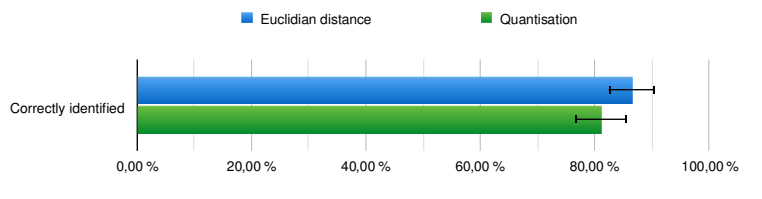

FIGURE 5.4: Accuracy of both identification methods: quantisation (green) and euclidian distance (blue)

5.1.5 Detection and tracking

The results were obtained by analysing 8 random frames of a video, and taking the average. The video contained 57 markers of size $N = 2$, from a dictionary of $\tau^{\wedge} = 3$. [Figure 5.5](#) shows the accuracy, and the false positive and negative rates of detection (blue) and tracking (green), as well as their Clopper-Pearson interval (Clopper and Pearson, 1934). It appears that tracking improves detection's performance in all three domains: accuracy increases

from 85% to 91%, false negative rate decreases from 8% to 6%, and false positive rate also decreases from 3% to 1.5%. Figure 5.6 shows the detailed results for each analysed frame.

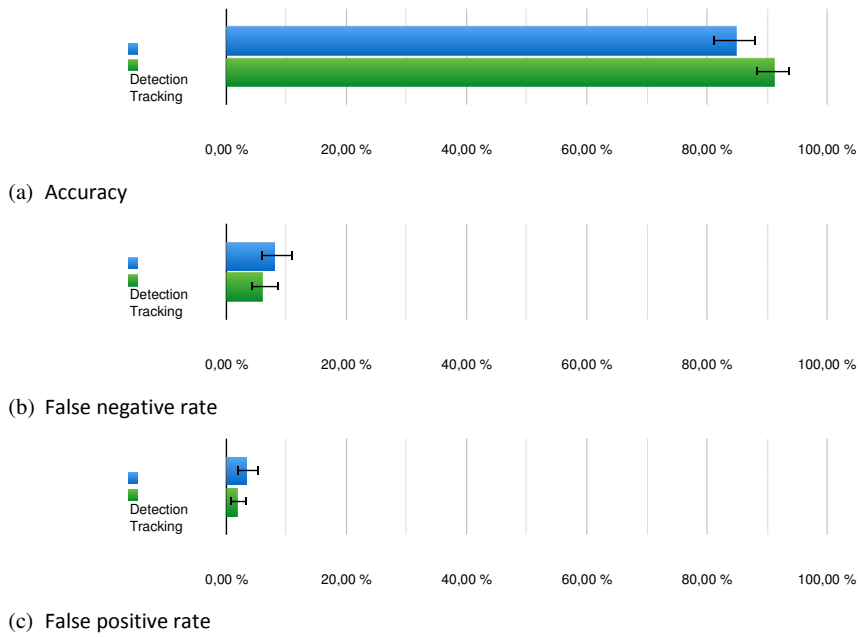
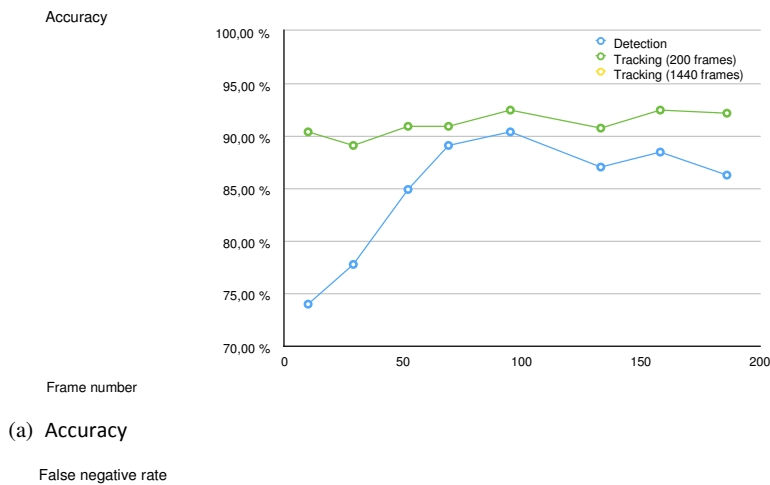

FIGURE 5.5: Average results over 8 random frames

A bit more than 5% of detected markers are not correctly identified. Our first observations suggest that the identification errors are not linked to specific markers. However, only 2 short videos were analysed, so more material should be thoroughly investigated in the future to better understand what causes these errors.



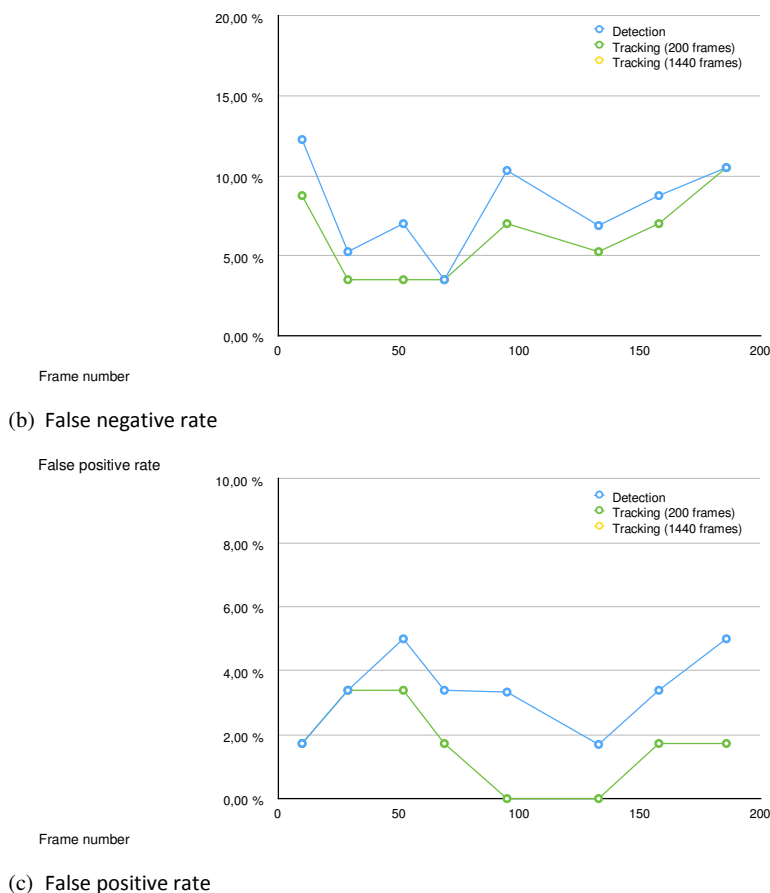

FIGURE 5.6: Comparison results of detection and tracking

5.1.6 Limitations

Blurry artefacts

One of the problems encountered is blurry markers due to fast moving animals. We implemented a tracking algorithm to counter this effect, but it would be even better to completely eliminate it, to increase the amount of available data. We investigated to understand whether the blur is entirely due to the shutter speed or if the compression algorithms of the camera, namely H.264-AVC, also plays a role.

H. 264-AVC is a video compression algorithm, which uses temporal prediction and motion compensation, among other techniques, to reduce file size (Draft, 2003). Inter-frame prediction coding consists in finding local motion vectors between two successive frames and compensate for that motion, so that only prediction errors can be encoded, hence considerably reducing the amount of information (Wiegand et al., 2003). H.264 also uses block coding on each frame. Since each frame of the video is divided in blocks of 8×8 or 4×4 which are coded individually regardless of the possible correlation between neighbouring blocks, a phenomenon called *blocking artefacts* occurs (Unterweger, 2012). It results in visible edges at block borders, which are equidistant thus forming a regular

pattern that can easily be spotted by the Human Visual System (HVS) as not belonging to the actual image (Wu and Rao, 2005).

To remove the blocking artifacts, deblocking filters, which induce blurring artifacts, can be implemented (Unterweger, 2012). Experiments have shown that blurring artifacts are less disturbing than blocking artifacts (Wiegand et al., 2003), hence H.264 uses such filters in order to improve the image quality from a human perspective. Quantisation can also result in blurring when the quantisation parameter is large. This is due to the removal of high frequency components which yields a low-pass behavior. The HVS is less sensitive to high frequencies than low ones (Wu and Rao, 2005), so H.264 uses coarse quantisation, and therefore introduces blurring artifacts. On top of that, the standard does not provide built-in filters to reduce these artifacts (Unterweger, 2012).

H.264 introduces some blur, but the most important source is exposure time. Blur appears when the image changes during recording, because its movement is faster than the exposure of the camera. In order to remove it, shutter speed must be increased. The problem when reducing exposure is that less light is captured, and the scene becomes darker, reducing visibility. The ISO setting allows to counter that decreased brightness, but introduces some noise during the process. We therefore cannot increase it too much without losing precious information. Another setting that can brighten the image is increasing the aperture, but we already use our lens's maximal aperture, $f/3.5$. There are lenses that reach wider apertures, but their cost grows very rapidly and a wider aperture results in a shallower depth of field, hence restraining the variety of experiments.

5.2. Futurework

5.2 Future work

Our algorithm's results are already very satisfying, but they are not perfect. Hereafter we propose some ideas that could reduce these errors or improve the possibilities of our work.

5.2.1 Lightning invariance

We evaluated our algorithm's performance in a controlled environment with fixed lightning conditions. While in many cases such a setup can be elaborated, there might be some times where a changing environment must be studied. Since our markers rely on color detection, changing conditions affect the algorithm's quality considerably. Taking into account lightning would make our algorithm more robust and allow more researchers to use it.

Color correction

A first method to reduce the influence of lightning conditions is color correction. The most common implementation is to add two reference colors on the marker. Lee and Woo (2009) adopt a structure with a black and white border similar to ours, and calculate a transform based on how the borders are perceived. They begin by extracting both borders' pixels R_b and R_w , and then build a Gaussian model for both colors: $N(m_b, \sigma_b)$ and $N(m_w, \sigma_w)$. They define B^e and W^e as

$$B^e = m_b + \Gamma \sigma_b \quad (5.4)$$

$$W^e = m_w + \Gamma \sigma_w \quad (5.5)$$

and then find the scaling vector $\Gamma(\gamma_R, \gamma_G, \gamma_B)$ that minimises the cost of the mapping of B^e to $(0,0,0)$ and W^e to $(255,255,255)$. Since this is done locally for each marker, this method can correct different lightning conditions within a scene. However, both borders need to be clearly identified to perform the correction, which is rarely the case when studying moving animals, especially when they are black and the background is bright.

Wang and Manduchi (2010) add two reference colors to their markers, whose characteristics under varying lightning conditions are assumed to be known by means of training data. Unfortunately, in addition to requiring a training set, this method needs place on the marker to add reference colors. For the moment, this is contradictory with our goal to minimise as much as possible the size of the markers, but with higher camera resolution, it could be implemented in the future.

Color constancy

Color constancy is a characteristic of the human visual system which allows us to perceive colors relatively independently of the illumination conditions. The effect was first described by Land and McCann (1971) as Retinex theory, and broadened a few years later: Land (1977). It is illustrated by Figure 5.7, where the squares A and B , while having the exact same color, are perceived as completely different colors by our brain.

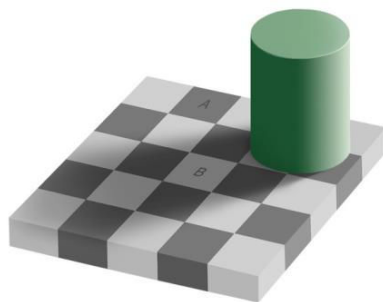

FIGURE 5.7: Color constancy illustration

Briefly summarised, Retinex theory states that an image's intensity can be separated in two components: reflectance and illuminance. The former is color dependant and the latter is illumination dependant. Land noticed that color constancy is achieved thanks to edges. Therefore, by looking at gradients in an image, one can distinguish reflectance (sharp edges) from illuminance (slowly varying gradients). More recently, Morel, Petro, and Sbert (2009) implemented an enhanced version called *Contrast Retinex*. Their results look impressive, as illustrated in Figure 5.8.

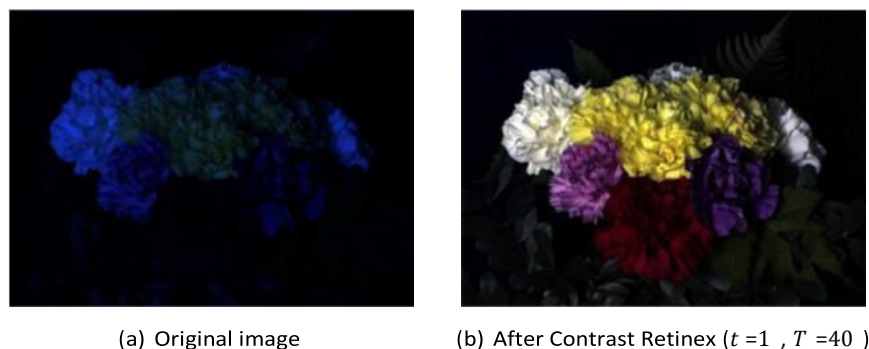

FIGURE 5.8: Contrast Retinex (Morel, Petro, and Sbert, 2009)

Optimal paper

Another method to reduce illumination's influence is to use paper as close as possible from being Lambertian. For the moment, we use basic paper to print our markers, but some other types might have weaker specular reflection components. A simple research could help understand what paper is optimal by taking photos of different kinds from different angles, like Bagherinia and Manduchi (2013). Under a perfect Lambertian model, the color for a given paper must be independent of the viewpoint. In our case, this would greatly reduce the problems encountered with tilted markers.

5.2.2 Tweak camera parameters

To avoid having to deal with blurry elements during detection, the frame rate or shutter speed could be improved. The former might not be necessary, because 25 frames per second are enough to track most animals' trajectories. Also, a higher frame rate means heavier videos, which is something to be avoided especially when filming in 4K. Shutter speed is therefore the parameter to modify in order to remove blur.

By default, with our setup's lightning conditions, which are already quite bright, shutter speed is set to a fiftieth of a second (1/50). We did some tests, increasing the speed to 1/320, and while the blurry blobs were reduced, image intensity rapidly dropped – making detection much less reliable – even when increasing ISO to 400 and EV correction to its maximum (+3). Pushing the ISO even higher results in dramatical quality loss, and the aperture is already maximal. The only factor left to play with is illumination, which is fixed by the setup. Further work could focus on pursuing investigations regarding shutter speed, and/or modifying or rebuilding another setup with more powerful lights.

5.2.3 Performance improvement

Due to the restricted planning of the thesis, we always focused on having a fullyfunctioning algorithm rather than a performant one. Therefore, the first step to improve its performance should be code optimisation. Next, a GPU implementation could be studied, to see if our algorithm could benefit from it. If this is the case, performance would be greatly improved, allowing to run detection and tracking in real-time. This could bring new opportunities to ethologists, such as implementing robots interacting with the studied animals according to their behaviours.

5.2.4 Orientation improvement

For the moment, orientation is calculated based on the marker's orientation. It works well, but it requires that markers be pasted perfectly onto the animals, which can be a difficult task when manipulating tiny insects. As a consequence, when a marker is badly pasted (see [Figure 5.9](#)), the corresponding insect's orientation is offset by a constant factor, depending on the angle at which the marker was pasted. To overcome this limitation, we could use the trajectory information, and make the assumption that most of the time animals moves forward and not laterally like crabs. This assumption allows to deduce the marker's orientation compared to the ant's, and correct the offset.

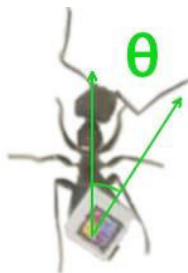

FIGURE 5.9: Illustration of the orientation offset

6. Conclusion

We proposed a new colored fiducial marker, that can be easily implemented at low cost, and that can be adapted to virtually any size. We described a method to select the optimal number of colors based on the number of desired markers and their distinguishability. We also described an algorithm that allows to create dictionaries of markers, giving high flexibility to the user which can choose the number of markers, their size, and the set of colors. They can then simply be printed on white paper with a regular inkjet printer, making them available to the higher number of people.

We developed a detection algorithm that locates the markers more than 90% of the time and identifies them with a reasonable accuracy of 86%. About half of the cases where they are not detected are not due to a deficiency in the algorithm but to a hidden marker, either because another object is above it or the animal wearing it is on its side. For that reason, we also implemented a tracking algorithm, that tracks blobs on top of detecting markers, so that animals with temporarily hidden marker can still be detected. The tracking also corrects the results by assuring spatio-temporal coherence and tag probability, thus increasing detection to 95% and accuracy to 92%. While these results already offer a precious help to ethologists for their studies, they are perfectible. We therefore presented different paths for improving our results. One must keep in mind though that the equipment used for the experiments was very basic: a 4K camera with a low-end lens, and markers printed on classical white paper.

Overall, we fulfilled our objectives, which were to create a cheap, adaptable, highdensity marker available to everyone. Moreover, we implemented our algorithms into useTracker, an open-source tracking software designed to help recording and analysing movies of

scientific experiments, available on [Github](#). This approach will most certainly widen the range of ethological experiments accessible to scientists all around the world.

Appendix A

Dictionary used for experiments

Figure A.1 shows the dictionary generated for the experiments. It is constituted of 65 markers of size $N = 2$. They are classified horizontally, the rows representing the tens and columns units. For instance, marker 21 is located on the third row, second column (the first index is 0).

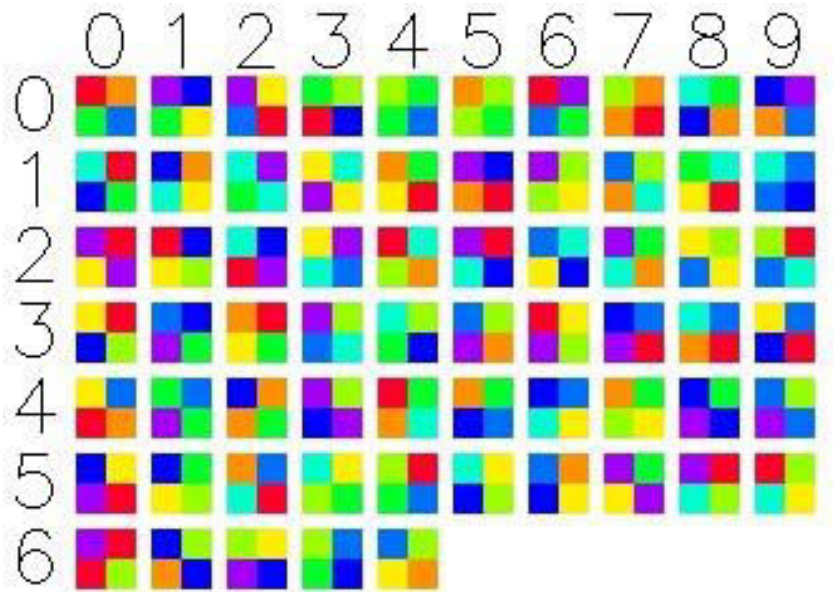

FIGURE A.1: Dictionary

References

- Abuzaid, Ali H, Ibrahim B Mohamed, and Abdul G Hussin (2012). "Boxplot for circular variables". In: *Computational Statistics*, pp. 1–12.
- Al-Ali, AR et al. (2008). "Mobile RFID tracking system". In: *Information and Communication Technologies: From Theory to Applications, 2008. ICTTA 2008. 3rd International Conference on*. IEEE, pp. 1–4.
- Bagherinia, Homayoun and Roberto Manduchi (2013). "Robust real-time detection of multi-color markers on a cell phone". In: *Journal of real-time image processing* 8.2, pp. 207–223.
- BBC News (2007). *Colour barcode system to hit DVDs*. Retrieved from <http://news.bbc.co.uk/2/hi/technology/6570871.stm> on May 29, 2017.
- Bencina, Ross and Martin Kaltenbrunner (2005). "The design and evolution of fiducials for the reactivation system". In: *Proc. 3rd International Conference on Generative Systems in the Electronic Arts*.
- Bergamasco, Filippo et al. (2011). "Rune-tag: A high accuracy fiducial marker with strong occlusion resilience". In: *Computer Vision and Pattern Recognition (CVPR), 2011 IEEE Conference on*. IEEE, pp. 113–120.
- Canny, John (1986). "A computational approach to edge detection". In: *IEEE Transactions on pattern analysis and machine intelligence* 6, pp. 679–698.
- Clopper, Charles J and Egon S Pearson (1934). "The use of confidence or fiducial limits illustrated in the case of the binomial". In: *Biometrika* 26.4, pp. 404–413.
- De Berg, Mark et al. (2000). "Computational geometry". In: *Computational geometry*. Springer, pp. 1–17.
- Douglas, David H and Thomas K Peucker (1973). "Algorithms for the reduction of the number of points required to represent a digitized line or its caricature". In: *Cartographica: The International Journal for Geographic Information and Geovisualization* 10.2, pp. 112–122.
- Draft, ITUT (2003). "recommendation and final draft international standard of joint video specification (ITU-T Rec. H. 264| ISO/IEC 14496-10 AVC)". In: *Joint Video Team (JVT) of ISO/IEC MPEG and ITU-T VCEG, JVTG050* 33.
- Fiala, Mark (2005). "ARTag, a fiducial marker system using digital techniques". In: *Computer Vision and Pattern Recognition, 2005. CVPR 2005. IEEE Computer Society Conference on*. Vol. 2. IEEE, pp. 590–596.
- Figuroa, Pascual J, Neucimar J Leite, and Ricardo ML Barros (2003). "A flexible software for tracking of markers used in human motion analysis". In: *Computer methods and programs in biomedicine* 72.2, pp. 155–165.
- Fisher, Nicholas I (1995). *Statistical analysis of circular data*. Cambridge University Press.
- Garrido-Jurado, S. et al. (2014). "Automatic generation and detection of highly reliable fiducial markers under occlusion". In: *Pattern Recognition* 47.6, pp. 2280 –

2292. ISSN: 0031-3203. DOI: <http://dx.doi.org/10.1016/j.patcog.2014.01.005>. URL: <http://www.sciencedirect.com/science/article/pii/S0031320314000235>.

- Gu, Qingyi, Takeshi Takaki, and Idaku Ishii (2012). "2000 fps multi-object tracking based on color histogram". In: *SPIE Photonics Europe*. International Society for Optics and Photonics, 84370E–84370E.
- Gu, Qingyi et al. (2013). "Fast tracking system for multi-colored pie-shaped markers". In: *International Journal of Optomechatronics* 7.3, pp. 160–180.
- Gupta, U. I., D. T. Lee, and J. Y.-T. Leung (1982). "Efficient algorithms for interval graphs and circular-arc graphs". In: *Networks* 12.4, pp. 459–467. ISSN: 1097-0037.
DOI: [10.1002/net.3230120410](https://doi.org/10.1002/net.3230120410). URL: <http://dx.doi.org/10.1002/net.3230120410>.
- Johansson, Birger and Christian Balkenius (2007). "A multi-robot system for anticipatory experiments". In: *LUCS Minor* 11.
- Kato, Hirokazu and Mark Billinghurst (1999). "Marker tracking and hmd calibration for a video-based augmented reality conferencing system". In: *Augmented Reality, 1999.(IWAR'99) Proceedings. 2nd IEEE and ACM International Workshop on*. IEEE, pp. 85–94.
- Land, Edwin H and John J McCann (1971). "Lightness and retinex theory". In: *Josa* 61.1, pp. 1–11.
- Land, Edwin H et al. (1977). *The retinex theory of color vision*. Citeseer.
- Lee, Wonwoo and Woontack Woo (2009). "Real-time color correction for markerbased augmented reality applications". In: *International Workshop on Ubiquitous Virtual Reality*, pp. 32–25.
- Liu, Jiamin et al. (2013). "Real Time Tracking Method by Using Color Markers". In: *Virtual Reality and Visualization (ICVRV), 2013 International Conference on*. IEEE, pp. 106–111.
- Mersch, Danielle P, Alessandro Crespi, and Laurent Keller (2013). "Tracking individuals shows spatial fidelity is a key regulator of ant social organization". In: *Science* 340.6136, pp. 1090–1093.
- Morel, Jean-Michel, Ana B Petro, and Catalina Sbert (2009). "Fast implementation of color constancy algorithms". In: *IS&T/SPIE Electronic Imaging*. International Society for Optics and Photonics, pp. 724106–724106.
- Moshkovitz, Dana and Bruce Tidor (2012). *Design and Analysis of Algorithms*. Massachusetts Institute of Technology: MIT OpenCourseWare, <https://ocw.mit.edu>. License: Creative Commons BY-NC-SA.
- Naimark, Leonid and Eric Foxlin (2002). "Circular data matrix fiducial system and robust image processing for a wearable vision-inertial self-tracker". In: *Mixed and Augmented Reality, 2002. ISMAR 2002. Proceedings. International Symposium on*. IEEE, pp. 27–36.
- Noldus, Lucas P. J. J., Andrew J. Spink, and Ruud A. J. Tegelenbosch (2001). "EthoVision: A versatile video tracking system for automation of behavioral experiments". In: *Behavior Research Methods*,

- Instruments, & Computers* 33.3, pp. 398–414. ISSN: 1532-5970. DOI: [10.3758/BF03195394](https://doi.org/10.3758/BF03195394). URL: <http://dx.doi.org/10.3758/BF03195394>.
- Olson, Edwin (2011). “AprilTag: A robust and flexible visual fiducial system”. In: *Proceedings of the IEEE International Conference on Robotics and Automation (ICRA)*. IEEE, pp. 3400–3407.
- Owen, Charles B, Fan Xiao, and Paul Middlin (2002). “What is the best fiducial?” In: *Augmented Reality Toolkit, The First IEEE International Workshop*. IEEE, 8–pp.
- Pérez-Escudero, Alfonso et al. (2014). “idTracker: tracking individuals in a group by automatic identification of unmarked animals”. In: *Nature methods* 11.7, pp. 743–748.
-
- Ramer, Urs (1972). “An iterative procedure for the polygonal approximation of plane curves”. In: *Computer graphics and image processing* 1.3, pp. 244–256.
- Sklansky, Jack (1982). “Finding the convex hull of a simple polygon”. In: *Pattern Recognition Letters* 1.2, pp. 79–83.
- Suzuki, Satoshi and Keiichi Abe (1985). “Topological structural analysis of digitized binary images by border following”. In: *Computer Vision, Graphics, and Image Processing* 30.1, pp. 32–46. ISSN: 0734-189X. DOI: [http://dx.doi.org/10.1016/0734-189X\(85\)90016-7](http://dx.doi.org/10.1016/0734-189X(85)90016-7). URL: [//www.sciencedirect.com/science/article/pii/0734189X85900167](http://www.sciencedirect.com/science/article/pii/0734189X85900167).
- Sylveno. *Hue wheel*. Retrieved from https://commons.wikimedia.org/wiki/File:3AColor_wheel_with_degree.png on April 18, 2017.
- Thomas, Bruce et al. (2000). “ARQuake: An outdoor/indoor augmented reality first person application”. In: *Wearable computers, the fourth international symposium on*. IEEE, pp. 139–146.
- Unterwiesing, Andreas (2012). “Compression artifacts in modern video coding and state-of-the-art means of compensation”. In: *Multimedia Networking and Coding*, p. 28.
- Wagner, Daniel and Dieter Schmalstieg (2007). *Artoolkitplus for pose tracking on mobile devices*. na.
- Walters, Austin and Bhargava Manja (2016). “ChromaTag-A Colored Fiducial Marker”.
- Wang, Fan and Roberto Manduchi (2010). “Color-constant information embedding”. In: *European Conference on Computer Vision*. Springer, pp. 13–26.
- Wang, John and Edwin Olson (2016). “AprilTag 2: Efficient and robust fiducial detection”. In: *Proceedings of the IEEE/RSJ International Conference on Intelligent Robots and Systems (IROS)*.
- Wiegand, Thomas et al. (2003). “Overview of the H. 264/AVC video coding standard”. In: *IEEE Transactions on circuits and systems for video technology* 13.7, pp. 560–576.
- Wu, Hong Ren and Kamisetty Ramamohan Rao (2005). *Digital video image quality and perceptual coding*. CRC press.

Zheng, Si-Qing (1996). "Maximum independent sets of circular-arc graphs: Simplified algorithm and proofs". In: *Networks* 28.1, pp. 15–19.

Zhou, Feng, Henry Been-Lirn Duh, and Mark Billinghurst (2008). "Trends in Augmented Reality Tracking, Interaction and Display: A Review of Ten Years of ISMAR". In: *Proceedings of the 7th IEEE/ACM International Symposium on Mixed and Augmented Reality*. ISMAR '08. Washington, DC, USA: IEEE Computer Society, pp. 193–202. ISBN: 978-1-4244-2840-3. DOI: [10.1109/ISMAR.2008.4637362](https://doi.org/10.1109/ISMAR.2008.4637362).
URL: <http://dx.doi.org/10.1109/ISMAR.2008.4637362>.

Annexe 2

Colony-level but no individual-level consistency of the trophallactic activity in the ant *Camponotus cruentatus*

In preparation : Bles, O. & Deneubourg, J.-L. Colony-level but no individual-level consistency of the foraging activity in the ant *Camponotus cruentatus*. *In prep. (Animal Behaviour)*

Abstract

Insect societies are compound of numerous individuals, achieving collective performance, such as nest building, food collection or caring for young. Far from being homogeneous, individuals show behavioural variation among group, impacting collective outcomes. Variation may occur both in the performance of the task (/involvement in a task) and in the consistency with which they perform each task. Here we present an analysis of the inter- and intra-individual behavioral variability and the consistency of this trait in the task of food dissemination, specifically the number of trophallactic interactions they performed. In a colony of the ant *Camponotus cruentatus*, we counted the number of trophallactic exchanges each individual performed during 2h after 5 days of starvations, also we evaluated the social position of each individual in the resulting trophallactic network. The process was repeated 6 times. We show a high level a heterogeneity of the trophallactic activity among individuals within a trial but no consistency of the performance over trials. We discuss this results in terms of colony-level strategy of task allocation and the mechanisms underlying the observed behavioural variability.

1. Introduction

Social insects live in large and complex societies in which division of work occurred between reproductive and non-reproductive individuals (Hölldobler and Wilson, 1990) as well as between non-reproductives, this daily tasks allocation process among colony members depends on many factors that have been largely investigated (e.g. (Fournier et al., 2008; Helanterä and Ratnieks, 2008; Robinson, 1992)). At a finer scale, it has been observed that within-task workload was not homogeneously distributed among individuals (Charbonneau and Dornhaus, 2015a; Crall et al., 2018; Tenczar et al., 2014): few individuals perform most of the work while most perform only little. Individuals aren't equally engaged in task realization, even at the intra-caste level. Specialisations of individuals has been hypothesised to be linked to better task performance, especially in the case of morphological adaptations (Spaethe and Weidenmüller, 2002), but empirical observations don't systematically found correlation between specialisation and efficiency (Dornhaus, 2008). While individuals show flexibility in task performance, according to local interactions and colony labor demands (Tenczar et al., 2014), it doesn't prevent the observations of behavioural consistency (e.g. (Beverly et al., 2009)).

In ants, empirical evidence/quantification for the pattern of workload allocation of the task of food dissemination at the intranidal level (Sendova-Franks et al., 2010), is scarce and even absent if we interesting in the temporal consistency of the individual engagement level over days/trials. Recent works revealed the mechanisms regulating the dynamic of food collection and dissemination at the colony-level, based on the individual rules of exchanges, dictated by the crop content (Greenwald et al., 2015, 2018). While this study is relevant to link the rules acting on individual behaviour and colony-level food intake dynamic, the distribution of the trophallaxis activity between individuals and its potential consistency, remain poorly understood.

Here we have experimentally investigated the level of inter-individual variability in the trophallactic activity in the ants *Camponotus cruentatus*, by counting the number of trophallactic exchange each individual performed over a temporal window of 2h after the introduction of a food source. We also analyzed the temporal consistency, both at the individual and colony-level, of this pattern of workload allocation and the individual social position in the trophallactic network, over 6 replicates of the experiment.

2. Material and Methods

A. Experimental setup and procedure

From a large mother colony of the ant *Camponotus cruentatus* (collected in Rochefort du Gard, France, Sept. 2016), we created a subcolony of 30 randomly picked up individuals, kept in a plastic box (175*125*50mm) containing a circle nest (95*6mm) and ad libitum water and sucrose solution, at a $21^{\circ}\text{C}\pm 1$, $60\%\pm 5$ relative humidity with a constant photo-period of 12h per day. Ants were individually labelled with an Arucolor tag (<http://usetracker.org/>) allowing automatical identification of ants. Individual tag was stucked on the abdomen, had a side length of 1.25 mm, corresponding to less than 1% of the average mass of the ant. After 5 days of starvation, ants had access to sucrose syrup feeder placed at 40mm of the nest entrance (Fig. S1) and were filmed during 120 mins. The colony was tested six times with a 7-day break between two trials.

B. Analysis

Based on the body posture and the mandibles position (Cassill and Tschinkel, 1999a)(Greenwald et al., 2015), we recorded the identity of the donor and the recipient of each trophallaxis exchange in the nest. The complete trophallaxis network of each trial was build (e.g Figure S2) and the classicals metrics of social network analysis in animal societies ([41], see also the Supplementary for details) were measured, on each individual, in each trial. To quantify the degree of inequality in trophallaxis activity among the workers, we plotted the cumulative distribution of total trophallaxis, performed in each trial, in the form of a Lorenz curve (Figure 1.A and Figure S3.A) and computed the resulting Gini coefficient (Figure 1.B and Figure S3.B), a measure of the degree of inequality in the distribution of trophallaxis activity. To estimate whether the observed Gini coefficients values were higher than random expectation, for each trial, we generated 10000 simulations in which we randomly distributed all the trophallaxis among all the workers and computed the average Gini coefficient on the randomly generated distribution of trophallaxis.

To analyze the individual consistency of the position/rank within the group, over all trials, we used the Kendall's coefficient of concordance (W) (Kendall, 1938) of each individually measured metric and compared it with the "Kendall Random Distribution" (KRD) as explained in (Planas-sitja et al., 2015). We performed a Z-test to test the significance differences between, on one side, the

observed W coefficient and the corresponding KRD (Planas-sitja et al., 2015) and, on the other hand, between the observed and random Gini coefficient (see Supplementary for details on methods).

3. Results

A. Distribution of the trophallaxis activity in each trial.

Analyzing individual trophallaxis activity revealed that all trials had a significant skew in the distribution of the trophallaxis activity (define as the number of trophallaxis performed): few workers appeared to be much more active than the rest of the population. Approximately 25% of the workers accounted for more than 50% of the total number of trophallaxis over the course of each experiment (Figure 1A and Figure S7.A). This occurred in all the six trials. We statistically evaluated the observed heterogeneity in the distribution of the trophallaxis activity, among all the workers, using the Gini coefficient, for which values ranging from 0 (perfect equality) to 1 (perfect inequality). Observed Gini coefficients were higher than simulated randomization of trophallaxis activity, in each trial (Figure 1B and Figure S7.B and Table 1, Z-Test: $p < 0.0001$ for each trial).

B. Consistency of the trophallaxis activity and social position

We found no trial-to-trial consistency in the rank of each worker for all the parameters experimentally measured. The experimentally measured Kendall's coefficient of concordance (W), evaluating the consistency of the rank of each individual over all trials, for each parameters, was not different from the "Kendall Random Distribution" of rank obtained after the procedure of random attribution of rank (e.g. Figure 2 for the number of trophallaxis, Z-test: $p > 0.05$, see also Table 1, Table S2-S5 and Figure S4-S7 for the other parameters. The measure of consistency was applied to all the workers having performed at least one trophallaxis, respectively, in 3 (N=29), 4 (N=25), 5 (N=19) and 6 (N=12) over 6 trials, the absence of consistency was systematically observed, whatever the number participation over the 6 trials.

4. Discussion

To the best of our knowledge, we provided the first quantitative study of the individual-level and colony-level behavioural consistency of the trophallaxis activity in ants, intra- and inter- replicates. We have shown that, in each trial, the distribution of the trophallaxis activity among individuals of the ant *Camponotus cruentatus*, during the task of food dissemination, is right-skewed: the majority of the trophallaxis was performed by a minority of individuals (Figure 1, Figure S3). However, we found no consistency of the individual performance/rank/behavioural traits over trial-to-trial observations, whether concerning the number of trophallaxis performed or the position in the trophallaxis network (Figure 2, Figure S4-S7). Previous work showed that in social insects, the foraging activity or the effort of food collection was not homogeneously distributed among the colony members (Crall et al., 2018; Klein et al., 2017; Tenczar et al., 2014). However, only little attention have been paid to the inter-individual variation in the task of intranidal food dissemination, through trophallaxis, particularly in ants (Sendova-Franks et al., 2010), when even no study investigates the consistency of this behavioural traits over days. Our observation was quite surprising as, at the colony-level, we systematically found a significant skew in the distribution of the trophallaxis activity, while, at the individual-level, no persistence of the level of activity/rank over trials/time, has been revealed, despite the continuous gradient of size of individuals, that may impact task performance (Spaethe and Weidenmüller, 2002). The observed absence of individual consistency in the number of trophallaxis performed could be the reflect of the variation of the nutritional status over time and raises the question of how starvation affect the food store/crop content at the individual-level, a factor regulating collective food intake (Greenwald et al., 2018). Do the satiation level decreased homogeneously/inhomogeneously within colony members?

The apparent complexity of the structure of the trophallaxis network, in which the position of each individual varied over time, could hide relevant food dissemination strategies, based on local interaction/individual experience, we have not capture in our set of experiments and that do not require any behavioural consistency. To date, behavioural consistency in task performance is a complex phenomenon, that still not achieve consensus, as some authors revealing a certain level of consistency of task performance in the ants (Pinter-Wollman et al., 2012), while we and others (Dornhaus, 2008) don't. Also, the food dissemination activity, per se, may not be considered as other tasks, such as nest building or brood care, because while it displays collective regulation

(Buffin et al., 2012), it is a distributed process that have to match the nutritional needs of all the colony members. Therefore, variations in individual nutritional needs over time may prevent any behavioural consistency in the trophallaxis performance.

keywords |

Behavioural consistency, ant, trophallaxis, foraging, network

figure/table legends |

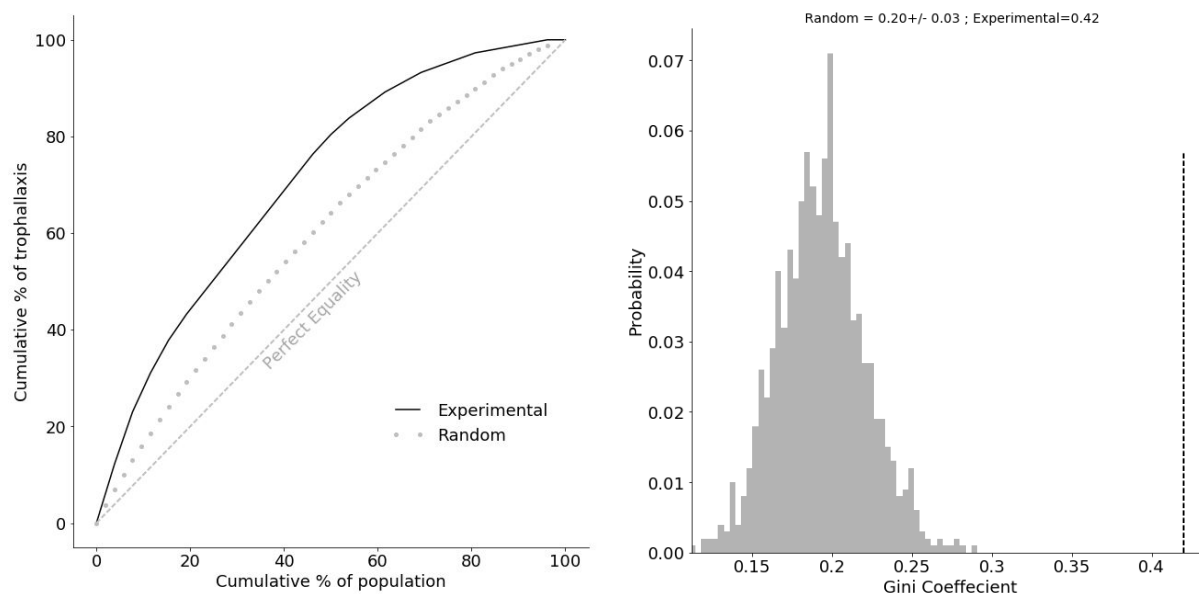

Figure 1.A. Lorenz curves showing cumulative proportion of all trophallaxis (y axis) vs. trophallaxis rank (x axis, sorted by the number of trophallaxis performed per trial per each worker) in one trial. **B.** Distribution of the Gini coefficient of the trophallaxis activity for the 10000 random distributions of number of trophallaxis performed per worker (grey histogram). Vertical black dotted line indicates the Gini coefficient in each trial. See also Table 1 and Figure S7.

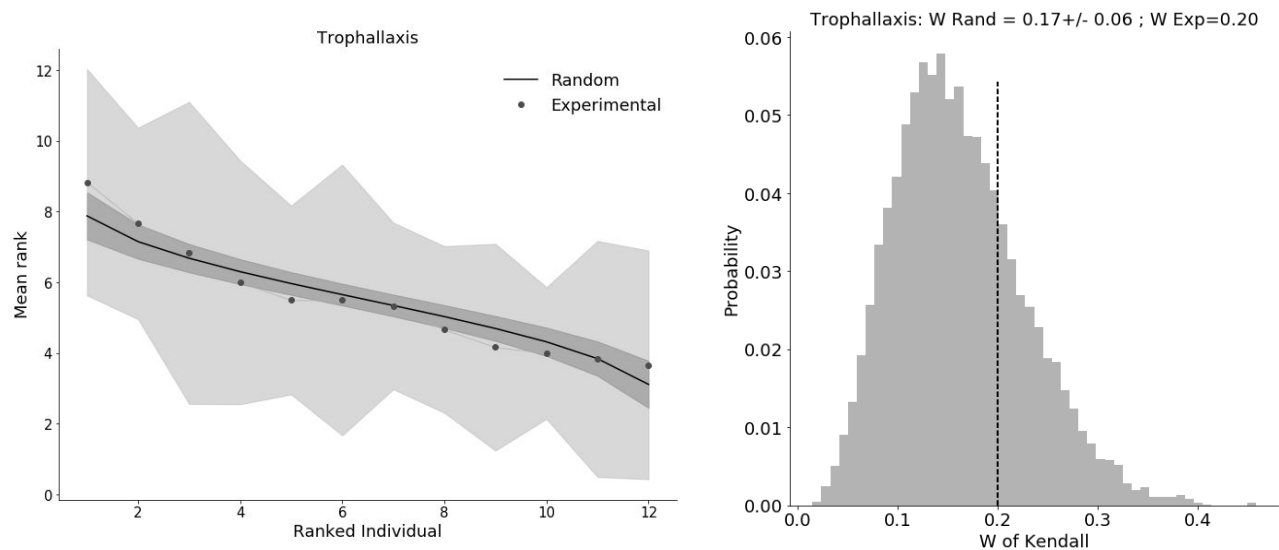

Figure 2. Experimental and random mean rank of the trophallaxis performed per all workers, (N=12) that performed at least one trophallaxis in 6 over 6 trials, sorted in descending order from the highest to lowest mean individual rank. B. Distribution of the W of Kendall, evaluating the consistency, over the 6 trials, in the individual rank, based on the number of trophallaxis performed, from 10000 random distributions of ranks (grey histogram) and the experimentally measured W of Kendall (vertical black dotted line). See also

Metric	W of Kendall		Z-Test	
	Experimental	Random	Z	pval
Trophallaxis	0.20	0.17+/-0.06	0.50	0.31
Degree	0.20	0.17+/-0.06	0.50	0.31
Betweenness	0.16	0.17+/-0.06	-0.17	0.57
Closeness	0.25	0.17+/-0.07	1.14	0.13
Eigenvector	0.10	0.17+/-0.07	-1.00	0.84
Cluster	0.22	0.17+/-0.06	0.83	0.20

Table 1. Experimental Gini coefficients of each trial vs. simulations in which observed foraging activity is randomly distributed across either all ants within the colony. Results of Z-Test to quantify the difference between the $Gini_{Experimental}$ and the $Gini_{Random}$. See also Figure 1 and Figure S3.

Trial	Gini coefficient		Z-Test	
	Experimental	Random	Z	pval
1	0.42	0.19+/-0.03	7.67	<0.0001
2	0.34	0.11+/-0.02	11.50	<0.0001
3	0.35	0.13+/-0.02	11.00	<0.0001
4	0.35	0.15+/-0.02	10.00	<0.0001
5	0.24	0.12+/-0.02	6.00	<0.0001
6	0.38	0.18+/-0.03	6.67	<0.0001

Table 2. Mean experimental W of Kendall of the consistency of the rank of each individual (N=12) having performed at least on trophallaxis in 6 over 6 trials for all metrics measured vs. simulations in which observed foraging activity is randomly distributed across either all ants within the colony. Results of Z-Test to quantify the difference between the $W_{Experimental}$ and the W_{Random} . See also Figure 2 and Figure S4-S7.

Supplementary Material

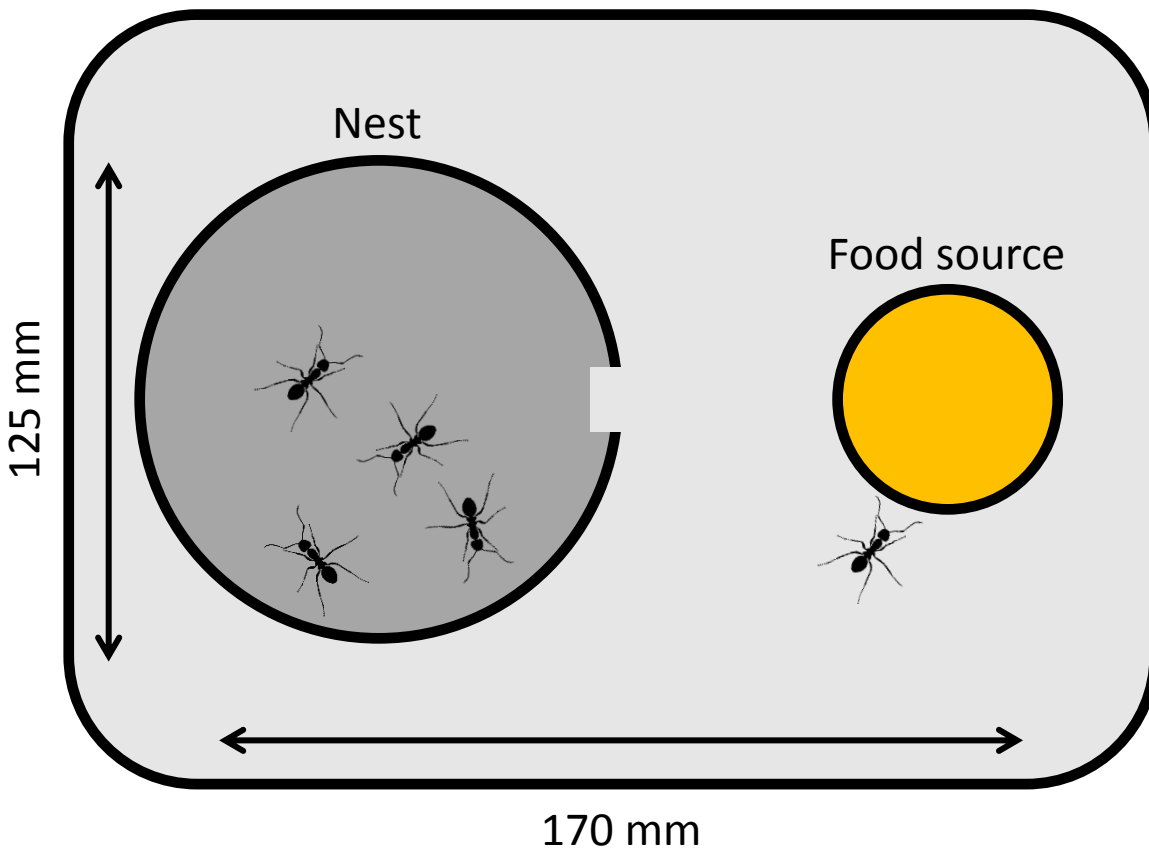

Figure S1. Experimental setup: A circular plastic nest of 95 mm diameter with a unique entrance of 4mm wide and the food source placed at 40mm of the nest entrance .

S.1 Supplementary Material and Methods

A. Quantification of the inequality of trophallaxis activity: Lorenz curves and Gini Coefficient

In each trial, we respectively counted 74, 143, 121, 111, 156 and 79 trophallaxis performed by 26,25, 25,26,27 and 25 individuals of the colony. To quantify the degree of inequality in trophallaxis activity among the workers, we plotted the cumulative distribution of total trophallaxis, performed in each trial, in the form of a Lorenz curve (Figure 1.A and Figure S7.A). Such a curve displays the share of trophallaxis activity (Y axis) accounted for by the top x% of workers (sorted

by the number of trophallaxis performed per individual) in the colony. A perfectly equitable distribution of foraging activity would correspond to the line $Y=X$. The ratio of the area over the line $Y=X$, is known as the Gini coefficient. This value between the Lorenz curve and the line $Y=X$ to the triangular area provides a measure of the degree of inequality in the distribution of trophallaxis activity, ranging from 0 (perfect equality) to 1 (perfect inequality). To estimate whether the observed Gini coefficients values were higher than random expectation, for each trial, we generated 10000 simulations in which we randomly distributed all the trophallaxis among all the workers and computed the average Gini coefficient on the randomly generated distribution of trophallaxis.

To analyze the individual consistency of the position/rank within the group, over all trials, we used the Kendall's coefficient of concordance (W) (Kendall, 1938) of each individually measured metric. This test compares the stability of rank position for each individual within trials and provides the W coefficient, which ranges from 0 (no concordance of ranks) to 1 (complete concordance). Because a general qualitative significance threshold is not available for the consistency of workers behaviour over trials, we compared the observed W coefficients with the "Kendall Random Distribution" (KRD) as explained in (Planas-sitja et al., 2015). The KRD is the theoretical distribution of W coefficients for random rank orders of the same number of individuals and repetitions ($N = 10000$). We performed a Z-test to test the significance differences between, on one side, the observed W coefficient and the corresponding KRD (Planas-sitja et al., 2015)(Zar, 1998) and, on the other hand, between the observed and random Gini coefficient.

B. Social network analysis

We constructed a network from the trophallaxis in each of the 6 trials (e.g Figure S2). Each node in such a network corresponds to one ant. Pairs of distinct nodes (i, j) were connected with a directed edge, from the donor to the receiver of food. At the individual-level, we calculated the, degree centrality, the betweenness, the closeness, the eigenvector and the cluster degree of each individual. Degree centrality is based on individuals' number of connections and can be seen as a general measure of how social an individual is (Wey et al., 2008). The betweenness is an estimator of how important an individual ant is to promoting connectivity across the entire colony and is measured by the number of times an individual act as a bridge along the shortest path between two other ants (Dell et al., 2014). The closeness is based on the distance (measured by shortest paths)

from an individual to every other individual in the colony: the more central an ant is, the lower its total distance is from all other ants (Wey et al., 2008). The clustering coefficient tends to determine the existence of “communities” in a network, such as nodes with much more edges between these nodes than with the others (Saramäki et al., 2007). 1 individual died over the course of all the trials and was removed from analysis. All simulations were conducted on Python 3.6; all the analysis were realized with NetworkX 2.1, PyGraphViz 1.4, Numpy 1.14, Scipy 1.0.0 and MathPlotLib 2.2.2.

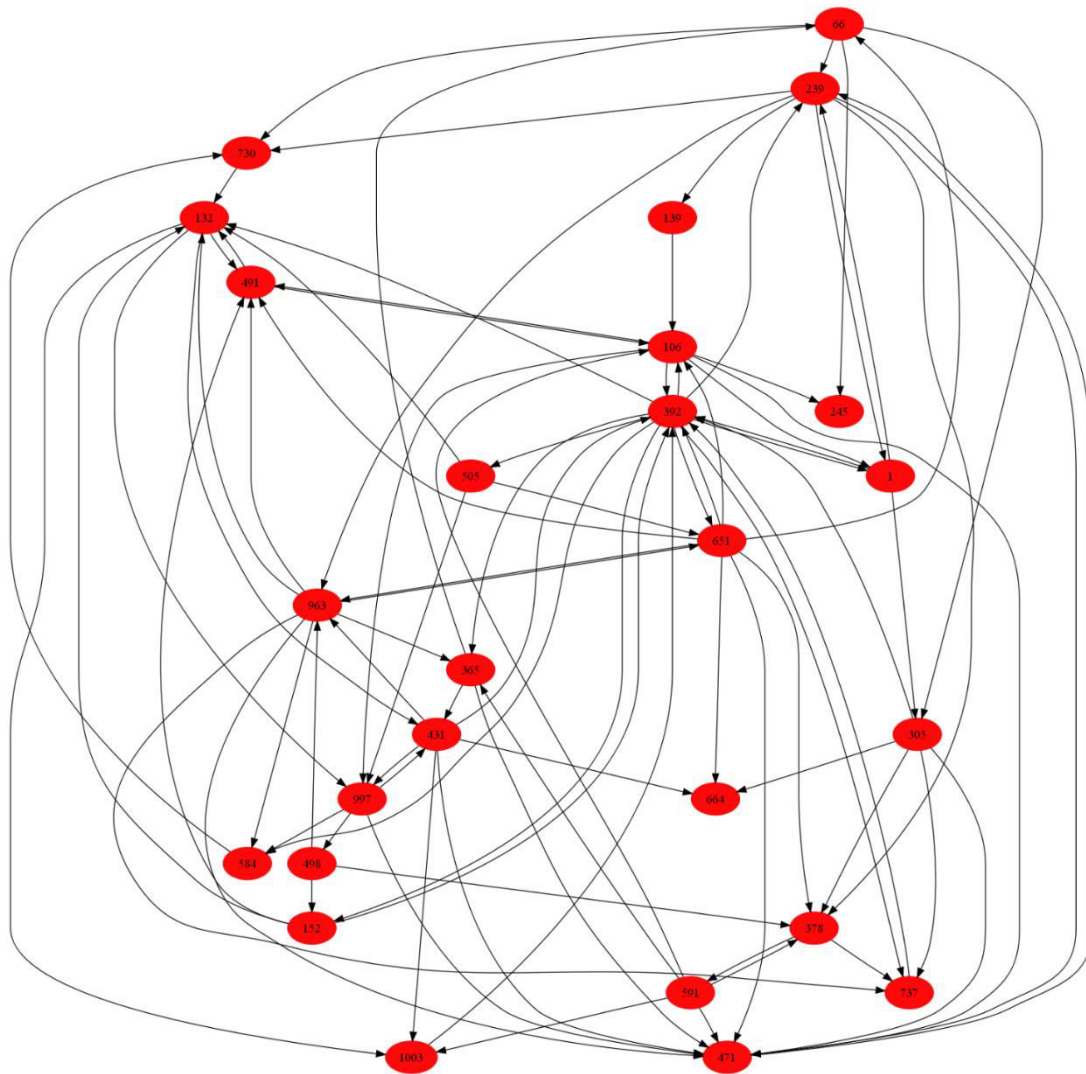

Figure S2. Example of a trophallaxis network of a trial. Are represented all the workers (red circle) with at least one trophallaxis performed. Black arrows represent the trophallaxis oriented from the donor to the receiver.

Experiment	Gini coefficient		Z-Test	
	Experimental	Random	Z	pval
1	0.42	0.19+/-0.03	7.67	<0.0001
2	0.34	0.11+/-0.02	11.50	<0.0001
3	0.35	0.13+/-0.02	11.00	<0.0001
4	0.35	0.15+/-0.02	10.00	<0.0001
5	0.24	0.12+/-0.02	6.00	<0.0001
6	0.38	0.18+/-0.03	6.67	<0.0001

Table S1. Experimental Gini coefficients of each trial vs. simulations in which observed foraging activity is randomly distributed across either all ants within the colony. Results of Z-Test to quantify the difference between the $Gini_{Experimental}$ and the $Gini_{Random}$. See also Figure S3.

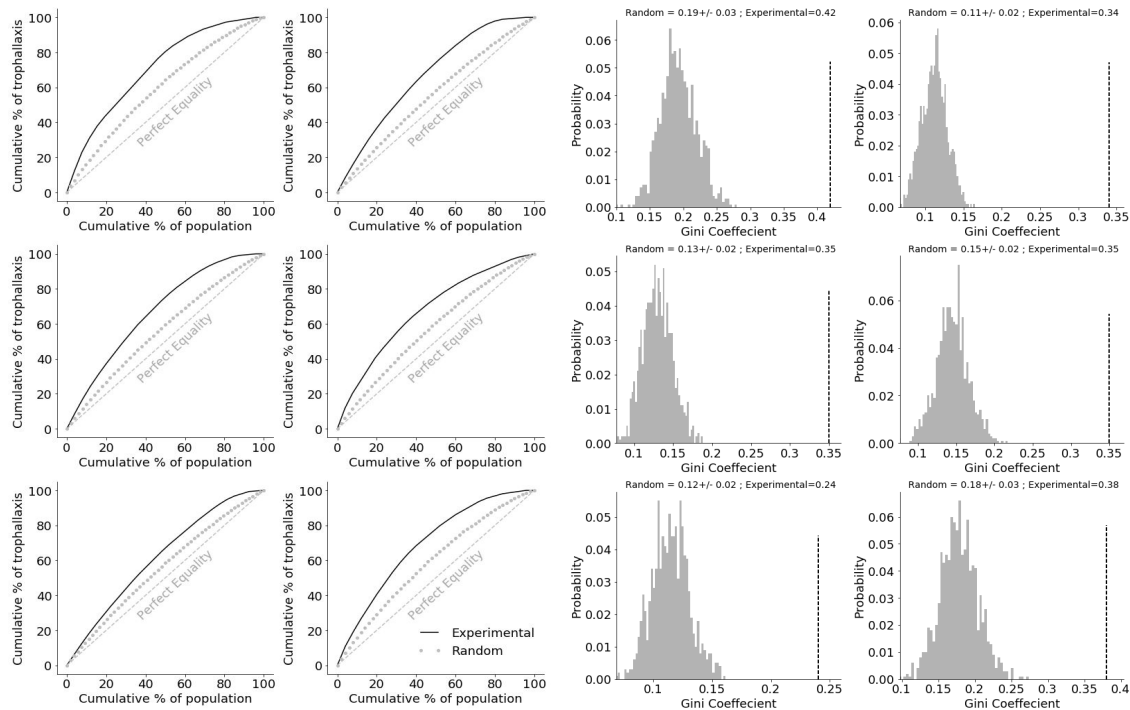

Figure S3.A. Lorenz curves showing cumulative proportion of all trophallaxis (y axis) vs. trophallaxis rank (x axis, sorted by the number of trophallaxis performed per trial per each worker) for each trial. **B.** Distribution of the Gini coefficient of the trophallaxis activity for the 10000 random distributions of number of trophallaxis performed per worker (grey histogram). Vertical black dotted line indicates the Gini coefficient in each trial. See also Table S1.

	W		Z-Test	
	Exp	Rand	Z	pval
Trophallaxis	0.21	0.40+/-0.10	-1.90	0.97
Degree	0.22	0.40+/-0.10	-1.80	0.96
Betweenness	0.24	0.40+/-0.10	-1.60	0.94
Closeness	0.25	0.40+/-0.10	-1.50	0.93
Eigenvector	0.21	0.40+/-0.10	-1.90	0.97
Cluster	0.25	0.40+/-0.10	-1.50	0.93

Table S2. Mean experimental W of Kendall of the consistency of the rank of each individual (N=29) having performed at least on trophallaxis in 3 over 6 trials for all metrics measured vs. simulations in which observed foraging activity is randomly distributed across either all ants within the colony. Results of Z-Test to quantify the difference between the $W_{\text{Experimental}}$ and the W_{Random} . See also Figure S4.

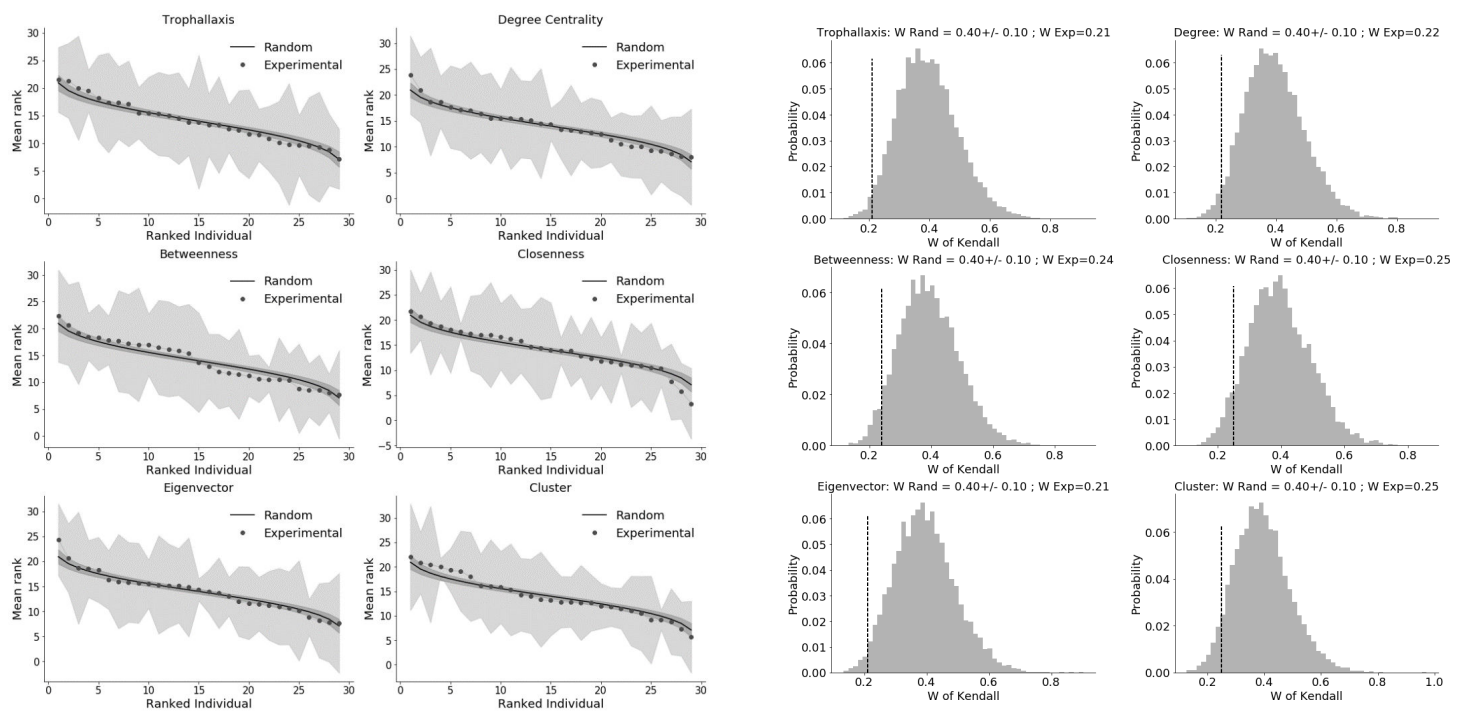

Figure S4.A. Experimental and random mean rank (of all workers, N=29, that performed at least one trophallaxis in 3 over 6 trials) of workers, for each metric, sorted in descending order from the highest to lowest mean individual rank. **B.** Distribution of the W of Kendall of each metric, from 10000 random distributions of ranks (grey histogram) and the experimentally measured W of Kendall (vertical black dotted line). See also Table S2.

	W		Z-Test	
	Exp	Rand	Z	pval
Trophallaxis	0.23	0.35+/-0.09	-1.33	0.91
Degree	0.18	0.35+/-0.09	-1.89	0.97
Betweenness	0.23	0.35+/-0.09	-1.33	0.91
Closeness	0.27	0.35+/-0.09	-0.89	0.81
Eigenvector	0.18	0.35+/-0.09	-1.89	0.97
Cluster	0.24	0.35+/-0.09	-1.22	0.89

Table S3. Mean experimental W of Kendall of the consistency of the rank of each individual (N=25) having performed at least on trophallaxis in 4 over 6 trials for all metrics measured vs. simulations in which observed foraging activity is randomly distributed across either all ants within the colony. Results of Z-Test to quantify the difference between the $W_{\text{Experimental}}$ and the W_{Random} . See also Figure S5.

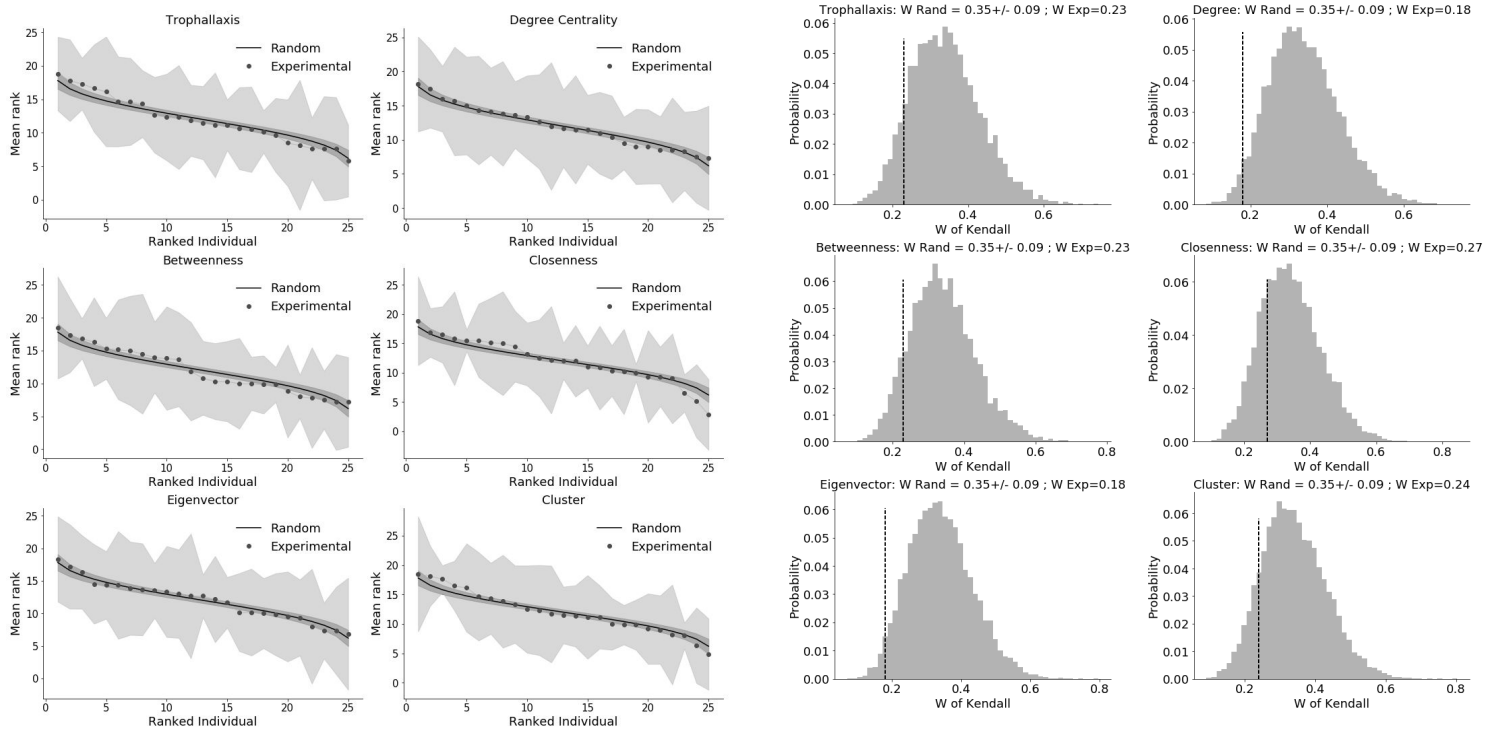

Figure S5.A. Experimental and random mean rank (of all workers, N=25, that performed at least one trophallaxis in 4 over 6 trials) of workers, for each metric, sorted in descending order from the highest to lowest mean individual rank. **B.** Distribution of the W of Kendall of each metric, from 10000 random distributions of ranks (grey histogram) and the experimentally measured W of Kendall (vertical black dotted line). See also Table S3.

	W		Z-Test	
	Exp	Rand	Z	pval
Trophallaxis	0.21	0.26+/-0.08	-0.63	0.73
Degree	0.17	0.26+/-0.08	-1.13	0.87
Betweenness	0.17	0.26+/-0.08	-1.13	0.87
Closeness	0.23	0.26+/-0.08	-0.38	0.65
Eigenvector	0.15	0.26+/-0.08	-1.38	0.92
Cluster	0.17	0.26+/-0.08	-1.13	0.87

Table S4. Mean experimental W of Kendall of the consistency of the rank of each individual (N=19) having performed at least on trophallaxis in 5 over 6 trials for all metrics measured vs. simulations in which observed foraging activity is randomly distributed across either all ants within the colony. Results of Z-Test to quantify the difference between the $W_{\text{Experimental}}$ and the W_{Random} . See also Figure S6.

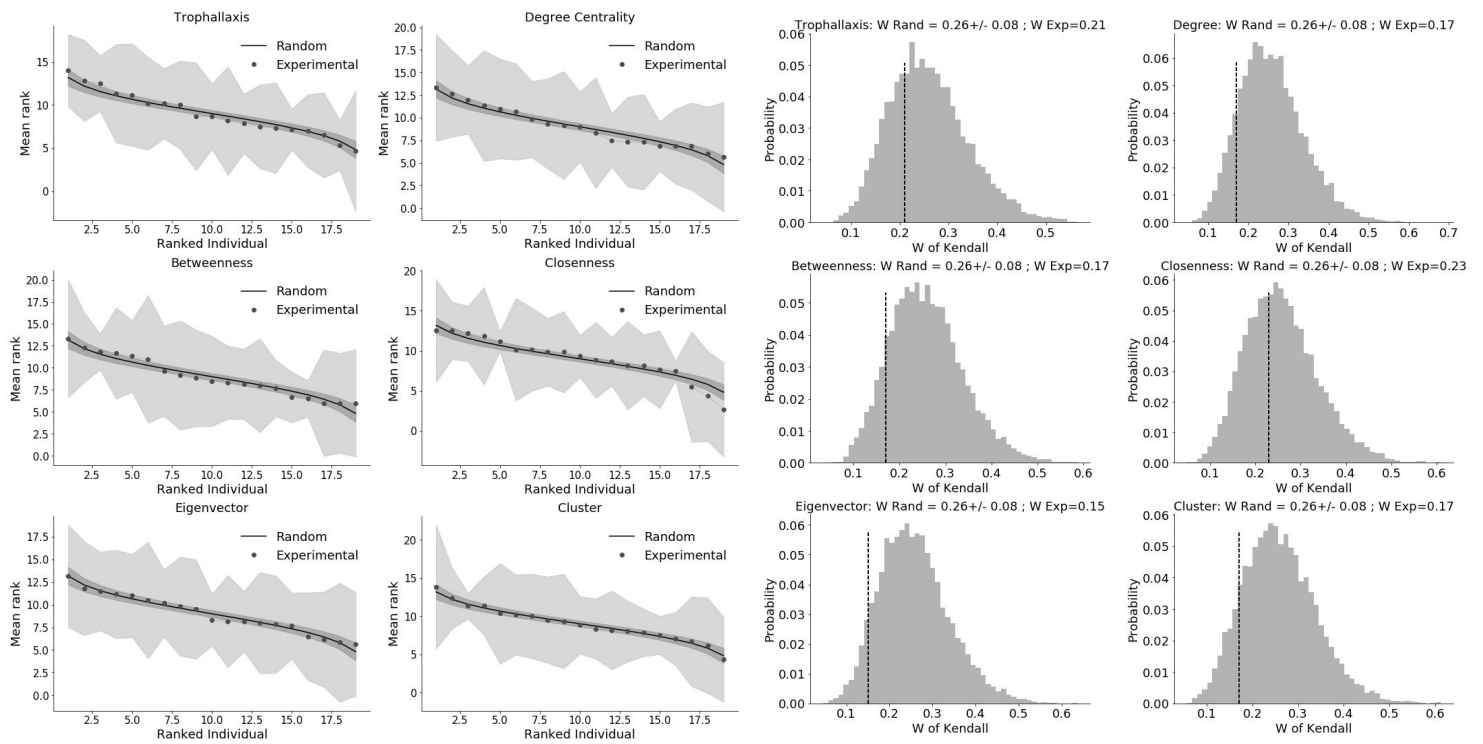

Figure S6.A. Experimental and random mean rank (of all workers, N=19, that performed at least one trophallaxis in 5 over 6 trials) of workers, for each metric, sorted in descending order from the highest to lowest mean individual rank. **B.** Distribution of the W of Kendall of each metric, from 10000 random distributions of ranks (grey histogram) and the experimentally measured W of Kendall (vertical black dotted line). See also Table S4.

	W		Z-Test	
	Exp	Rand	Z	pval
Trophallaxis	0.20	0.17+/-0.06	0.50	0.31
Degree	0.20	0.17+/-0.06	0.50	0.31
Betweenness	0.16	0.17+/-0.06	-0.17	0.57
Closeness	0.25	0.17+/-0.07	1.14	0.13
Eigenvector	0.10	0.17+/-0.07	-1.00	0.84
Cluster	0.22	0.17+/-0.06	0.83	0.20

Table S5. Mean experimental W of Kendall of the consistency of the rank of each individual (N=12) having performed at least on trophallaxis in 6 over 6 trials for all metrics measured vs. simulations in which observed foraging activity is randomly distributed across either all ants within the colony. Results of Z-Test to quantify the difference between the $W_{\text{Experimental}}$ and the W_{Random} . See also Figure S7.

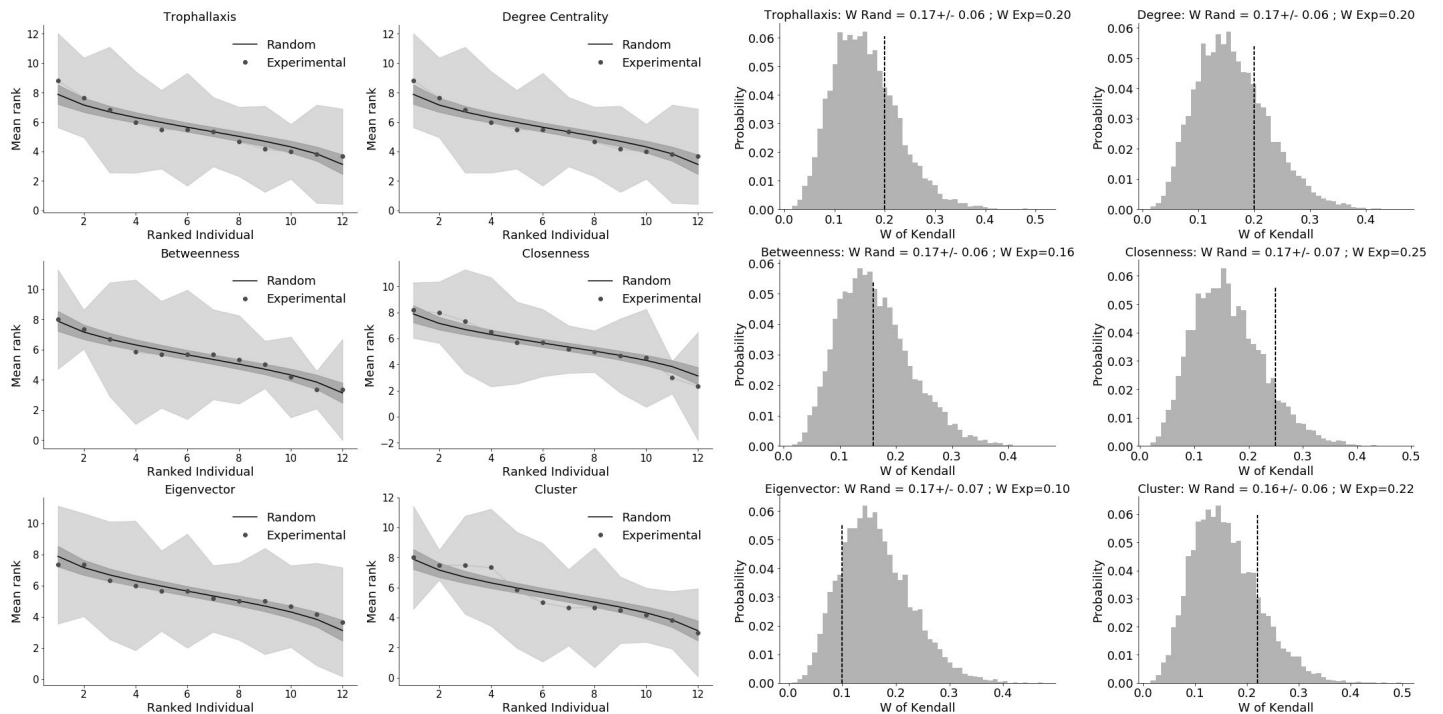

Figure S7.A. Experimental and random mean rank (of all workers, N=12, that performed at least one trophallaxis in 6 over 6 trials) of workers, for each metric, sorted in descending order from the highest to lowest mean individual rank. **B.** Distribution of the W of Kendall of each metric, from 10000 random distributions of ranks (grey histogram) and the experimentally measured W of Kendall (vertical black dotted line). See also Table S5.

References

- Adler, F.R., Gordon, D.M.**, 1992. Information Collection and Spread by Networks of Patrolling Ants. *The American naturalist* **140**, 373–400.
- Albert, R., Barabasi, A.-L.**, 2002. Statistical Mechanics of Complex Networks. *Reviews of Modern Physics* **74**, 47–97.
- Altmann, J.**, 1974. Observational Study of Behavior: Sampling Methods. *Behaviour* **49**, 227–266.
- Anderson, C., Ratnieks, F.L.W.**, 2000. Task partitioning in insect societies: novel situations. *Insectes Sociaux* **47**, 198–199.
- Anderson, C., Ratnieks, F.L.W.**, 1999. Worker allocation in insect societies: coordination of nectar foragers and nectar receivers in honey bee (*Apis mellifera*) colonies. *Behavioral Ecology and Sociobiology* **46**, 73–81.
- Aplin, L.M., Farine, D.R., Mann, R.P., Sheldon, B.C., B, P.R.S.**, 2014. Individual-level personality influences social foraging and collective behaviour in wild birds. *Proc. R. Soc. Lond. B Biol. Sci.* **281**, 20141016.
- Archis, J.N., Akcali, C., Stuart, B.L., Kikuchi, D., Chunco, A.J.**, 2018. Is the future already here? The impact of climate change on the distribution of the eastern coral snake (*Micrurus fulvius*).
- Atton, N., Galef, B.J., Hoppitt, W., Webster, M.M., Laland, K.N.**, 2014. Familiarity affects social network structure and discovery of prey patch locations in foraging stickleback shoals. *Proceedings. Biological sciences* **281**, 20140579.
- Barabasi, A.-L.**, 2002. *Linked: The New Science of Networks*, Perseus. ed. Cambridge, MA.
- Beckers, R., Deneubourg, J.-L., Goss, S.**, 1993. Modulation of trail laying in the ant *Lasius niger* (Hymenoptera: Formicidae) and its role in the collective selection of a food source. *Journal of Insect Behavior* **6**, 751–759.
- Beckers, R., Deneubourg, J.-L., Goss, S., Pasteels, J.M.**, 1990. Collective decision making through food recruitment. *Insectes Sociaux* **37**, 258–267.
- Bernt, K., Walker, W.**, 2007. Human milk as a carrier of biochemical messages. *Acta Paediatrica* **88**, 27–41.
- Bestmann, H., Kern, F., Schafer, D., Witschel, M.C.**, 1992. 3,4-Dihydroisocoumarins, a New Class of Ant Trail Pheromones. *Angewandte Chemie, International* **31**, 795–796.
- Bestmann, H.J., Ubler, E., Hölldobler, B.**, 1997. First Biosynthetic Studies on Trail Pheromones in Ants. *Angewandte Chemie, International* **36**, 377–380.
- Beverly, B.D., McLendon, H., Nacu, S., Holmes, S., Gordon, D.M.**, 2009. How site fidelity leads to individual differences in the foraging activity of harvester ants. *Behavioral Ecology* **20**, 633–638.
- Bles, O., Deneubourg, J.-L., Nicolis, S.C.**, 2018. Food dissemination in ants: Robustness of the trophallactic network against resource quality. *Journal of Experimental Biology*.
- Blonder, B., Dornhaus, A.**, 2011. Time-ordered networks reveal limitations to information flow in ant colonies. *PloS one* **6**, e20298–e20298.
- Blonder, B., Wey, T.W., Dornhaus, A., James, R., Sih, A.**, 2012. Temporal dynamics and network

- analysis (Review). *Methods in Ecology and Evolution* **3**, 958–972.
- Boi, S., Couzin, I.D., Buono, N. Del, Franks, N.R., Britton, N.F.**, 1999. Coupled oscillators and activity waves in ant colonies. *Proceedings of the Royal Society B: Biological Sciences* **266**, 371.
- Bonavita-cougourdan, A., Gavioli, M.**, 1981. LES INVERSIONS DU SENS DU FLUX ALIMENTAIRE AU COURS D'UN MEME CONTACT ENTRE DEUX OUVRIERES CHEZ LA FOURMI CAMPONOTUS VAGUS SCOP (HYMENOPTERA, FORMICIDAE). *Insectes Sociaux* **28**, 321–340.
- Boulay, R., Hefetz, A., Soroker, V., Lenoir, A.**, 2000. Camponotus fellah colony integration: worker individuality necessitates frequent hydrocarbon exchanges. *Animal Behaviour* **59**, 1127–1133.
- Brian, M. V, Abbott, A.**, 1977. THE CONTROL OF FOOD FLOW IN A SOCIETY OF THE ANT. *Animal behaviour* **25**, 1047–1055.
- Brown, J.S., Kotler, B.P.**, 2004. Hazardous duty pay and the foraging cost of predation. *Ecology Letters* **7**, 999–1014.
- Buczowski, G., Bennett, G.**, 2009. The influence of forager number and colony size on food distribution in the odorous house ant, *Tapinoma sessile*. *Insectes Sociaux* **56**, 185–192.
- Buffin, A., Denis, D., Van Simaey, G., Goldman, S., Deneubourg, J.-L.**, 2009. Feeding and stocking up: radio-labelled food reveals exchange patterns in ants. *PloS one* **4**, e5919–e5919.
- Buffin, A., Goldman, S., Deneubourg, J.L.**, 2012. Collective regulatory stock management and spatiotemporal dynamics of the food flow in ants. *FASEB* **26**, 2725–2733.
- Buhl, J., Gautrais, J., Solé, R. V, Kuntz, P., Valverde, S., Deneubourg, J.-L., Theraulaz, G.**, 2004. Efficiency and robustness in ant networks of galleries. *THE EUROPEAN PHYSICAL JOURNAL B* **129**, 123–129.
- Butts, C.T.**, 2008. Social network analysis: A methodological introduction. *Asian Journal Of Social Psychology* **11**, 13–41.
- Camazine, S., Deneubourg, J.-L., Franks, N.R., Sneyd, J., Theraulaz, G., Bonabeau, E.**, 2001. *Self-Organization in Biological Systems.*, Princeton. ed. Princeton University Press.
- Cammaert, R., Cammaerts, M.C.**, 1987. Nest topology, nestmate recognition, territorial marking and homing in the ant *Manica rubida* (Hymenoptera, Formicidae). *Biology of behaviour* **12**, 65–81.
- Campos, D., Bartumeus, F., Mendez, V., Andrade, J.S., Espadaler, X.**, 2016. Variability in individual activity bursts improves ant foraging success. *Interface*.
- Cassill, D.L.**, 2003. Rules of supply and demand regulate recruitment to food in an ant society. *Behavioral Ecology and Sociobiology* **54**, 441–450.
- Cassill, D.L., Stuy, A., Buck, R.G.**, 1998. Emergent Properties of Food Distribution Among Fire Ant Larvae. *Journal of Theoretical Biology* **195**, 371–381.
- Cassill, D.L., Tschinkel, W.R.**, 1999a. Regulation of Diet in the Fire Ant , *Solenopsis invicta*. *Journal of Insect Behavior* **12**, 307–328.
- Cassill, D.L., Tschinkel, W.R.**, 1999b. Information flow during social feeding in ant societies, in: *Information Processing in Social Insects*. Basel.
- Cassill, D.L., Tschinkel, W.R.**, 1995. Allocation of liquid food to larvae via trophallaxis in colonies of the fire ant, *Solenopsis invicta* . *Animal Behaviour* **50**, 801–813.

- Chadab, R.**, 1979. Early Warning Cues for Social Wasps Attacked by Army Ants. *Psyche* (New York) **86**, 115–123.
- Chandra, V., Fetter-Pruneda, I., Oxley, P.R., Ritger, A.L., McKenzie, S.K., Libbrecht, R., Kronauer, D.J.C.**, 2018. Social regulation of insulin signaling and the evolution of eusociality in ants. *Science* **2**, 398–402.
- Charbonneau, D., Dornhaus, A.**, 2015a. Workers ‘specialized’ on inactivity: Behavioral consistency of inactive workers and their role in task allocation. *Behavioral Ecology and Sociobiology* **69**, 1459–1472.
- Charbonneau, D., Dornhaus, A.**, 2015b. When doing nothing is something . How task allocation strategies compromise between flexibility , efficiency , and inactive agents. *Journal of Bioeconomics*.
- Chen, R., Meyer, B.**, 2018. A computational model of task allocation in social insects – ecology and interactions alone can drive specialisation. *bioRxiv* 1–30.
- Collett, M., Collett, T.S.**, 2000. How do insects use path integration for their navigation? *Biological Cybernetics* **83**, 245–259.
- Collignon, B., Deneubourg, J.L., Detrain, C.**, 2012. Leader-based and self-organized communication: modelling group-mass recruitment in ants. *Journal of theoretical biology* **313**, 79–86.
- Cook, S.C., Eubanks, M.D., Gold, R.E., Behmer, S.T.**, 2016. Summer and fall ants have different physiological responses to food macronutrient content. *Journal of Insect Physiology* **87**, 35–44.
- Crall, J.D., Gravish, N., Mountcastle, A.M., Combes, S.A.**, 2015. BEEtag: A Low-Cost, Image-Based Tracking System for the Study of Animal Behavior and Locomotion. *PloS one* **10**.
- Crall, J.D., Gravish, N., Mountcastle, A.M., Kocher, S.D., Oppenheimer, R.L., Pierce, N.E., Combes, S.A.**, 2018. Spatial fidelity of workers predicts collective response to disturbance in a social insect. *Nature Communications* **9**, 1201.
- Czaczkes, T.J., Grüter, C., Ellis, L., Wood, E., Ratnieks, F.L.W.**, 2013. Ant foraging on complex trails: route learning and the role of trail pheromones in *Lasius niger*. *J. Exp. Biol.* **4**, 188–197.
- Czaczkes, T.J., Grüter, C., Ratnieks, F.L.W.**, 2015. Trail Pheromones: An Integrative View of Their Role in Social Insect Colony Organization. *Annual Review Entomol.* **60**, 581–599.
- Czaczkes, T.J., Salmane, A.K., Klampfleuthner, F.A.M., Heinze, J.**, 2016. Private information alone can trigger trapping of ant colonies in local feeding optima. *Journal of Experimental Biology* **219**, 744–751.
- David Morgan, E.**, 2009. Trail pheromones of ants. *Physiological Entomology* **34**, 1–17.
- Davidson, J.D., Gordon, D.M.**, 2017. Spatial organization and interactions of harvester ants during foraging activity. *Journal of The Royal Society Interface* **14**.
- de Biseau, J.-C., Deneubourg, J.-L., Pasteels, J.M.**, 1991. Collective flexibility during mass recruitment in the ant *Myrmica sabuleti* (Hymenoptera : Formicidae). *Psyche* **98**, 323–336.
- De Marco, R.J.**, 2006. How bees tune their dancing according to their colony’s nectar influx: re-examining the role of the food-receivers’ “eagerness”. *The Journal of experimental biology* **209**, 421–32.
- Delgado, M., Miranda, M., Alvarez, S.J., Gurarie, E., Fagan, W.F., Penteriani, V., Virgilio, A.**

- Morales, J.M., Sj, A., Gurarie, E., Wf, F., Delgado, M.,** 2018. The importance of individual variation in the dynamics of animal collective movements. *Philosophical Transaction Royal Society B* **373**.
- Dell, A.I., Bender, J.A., Branson, K., Couzin, I.D., de Polavieja, G.G., Noldus, L.P.J.J., P??rez-Escudero, A., Perona, P., Straw, A.D., Wikelski, M., Brose, U.,** 2014. Automated image-based tracking and its application in ecology. *Trends in Ecology and Evolution* **29**, 417–428.
- Deneubourg, J.-L., Aron, S., Goss, S., Pasteels, J.M.,** 1990. The Self-Organizing Exploratory Pattern of the Argentine Ant. *Journal of Insect Behavior* **3**, 159–168.
- Deneubourg, J.-L., Aron, S., Goss, S., Pasteels, J.M., Duerink, G.,** 1986. Random Behaviour, Amplification Processes and Number of Participants : How They Contribute To the Foraging Properties of Ants. *Physica* **22**, 176–186.
- Deneubourg, J.-L., Goss, S.,** 1989. Collective patterns and decision making. *Ethol. Ecol. Evol.* 295–311.
- Denny, A.J., Wright, J., Grief, B.,** 2001. Foraging efficiency in the wood ant, *Formica rufa*: is time of the essence in trail following? *Animal Behaviour* **62**, 139–146.
- Dethier, V., Gelperin, A.,** 1967. Hyperphagia in the Blowfly. *J. Exp. Biol* **47**, 191–200.
- Detrain, C., Deneubourg, J.-L.,** 2008. Collective Decision-Making and Foraging Patterns in Ants and Honeybees. *Adv. Insect Physiol.* **35**, 123–173.
- Detrain, C., Deneubourg, J.-L., Pasteels, J.M.,** 1999. Decision-making in foraging by social insects.pdf. *Information Processing in Social Insects*.
- Detrain, C., Natan, C., Deneubourg, J.L.,** 2001. The influence of the physical environment on the self-organised foraging patterns of ants. *Naturwissenschaften* **88**, 171–174.
- Devigne, C., Detrain, C.,** 2006. How does food distance influence foraging in the ant *Lasius niger*: The importance of home-range marking. *Insectes Soc.* **53**, 46–55.
- Diez, L., Lejeune, P., Detrain, C.,** 2014. Keep the nest clean: survival advantages of corpse removal in ants. *Biology letters* **10**, 20140306--20140306-.
- Dolezal, A.G., Brent, C.S., Holldobler, B., Amdam, G. V.,** 2012. Worker division of labor and endocrine physiology are associated in the harvester ant, *Pogonomyrmex californicus* . *Journal of Experimental Biology* **215**, 454–460.
- Doran, C., Stumpe, M.C., Sendova-franks, A., Franks, N.R., Doran, C.,** 2016. Exploration adjustment by ant colonies *Sub. Royal Society Open Science* **3**, 150533.
- Dorigo, M., Birattari, M., Stützle, T.,** 2006. Ant Colony Optimization. *IEEE Computational Intelligence Magazine* 28–39.
- Dornhaus, A.,** 2008. Specialization does not predict individual efficiency in an ant. *PLoS Biology* **6**, 2368–2375.
- Dornhaus, A., Holley, J.A., Franks, N.R.,** 2009. Larger colonies do not have more specialized workers in the ant *Temnothorax albigennis*. *Behavioral Ecology* **20**, 922–929.
- Dornhaus, A., Powell, S., Bengston, S.,** 2012. Group size and its effects on collective organization. *Annual review of entomology* **57**, 123–141.
- Dussutour, A., Beekman, M., Nicolis, S.C., Meyer, B.,** 2009a. Noise improves collective decision-making by ants in dynamic environments. *Proceedings of the Royal Society B* **276**, 4353–4361.

- Dussutour, A., Nicolis, S.C., Shephard, G., Beekman, M., Sumpter, D.J.T.**, 2009b. The role of multiple pheromones in food recruitment by ants. *J. Exp. Biol.* **212**, 2337–2348.
- Dussutour, A., Simpson, S.J.**, 2009. Communal nutrition in ants. *Current biology : CB* **19**, 740–744.
- Dussutour, A., Simpson, S.J.**, 2008a. Description of a simple synthetic diet for studying nutritional responses in ants. *Insectes Sociaux* **55**, 329–333.
- Dussutour, A., Simpson, S.J.**, 2008b. Carbohydrate regulation in relation to colony growth in ants 2224–2232.
- Engel, V., Fischer, M.K., Wäckers, F.L., Völkl, W.**, 2001. Interactions between extrafloral nectaries, aphids and ants: are there competition effects between plant and homopteran sugar sources? *Oecologia* **129**, 577–584.
- Evershed, R.P., Morgan, E.D., Cammaerts, M.C.**, 1981. Identification of the trail pheromone of the ant *Myrmica rubra* L., and related species. *Naturwissenschaften* **68**, 374–376.
- Eyer, M., Greco, M.K., Neumann, J.L.P., Dietemann, V.**, 2015. No spatial patterns for early nectar storage in honey bee colonies. *Insectes Sociaux* **63**, 51–59.
- Farina, W.M.**, 1996. Food-exchange by foragers in the hive - a means of communication among honey bees? *Behavioral Ecology and Sociobiology* **38**, 59–64.
- Feigenbaum, C., Naug, D.**, 2010. The influence of social hunger on food distribution and its implications for disease transmission in a honeybee colony. *Insectes Sociaux* **57**, 217–222.
- Fewell, J.H.**, 1988. Energetic and time costs of foraging in harvester ants, *Pogonomyrmex occidentalis*. *Behavioral Ecology and Sociobiology* **22**, 401–408.
- Fournier, D., Battaille, G., Timmermans, I., Aron, S.**, 2008. Genetic diversity, worker size polymorphism and division of labour in the polyandrous ant *Cataglyphis cursor*. *Animal Behaviour* **75**, 151–158.
- Frank, E.T., Höhle, P.O., Linsenmair, K.E.**, 2018. Time-optimized path choice in the termite-hunting ant *Megaponera analis*. *The Journal of Experimental Biology* **221**, jeb174854.
- Franks, N.R.**, 1989. Thermoregulation in army ant bivouacs. *Physiological Entomology* **14**, 397–404.
- Franks, N.R., Mallon, E.B., Bray, H.E., Hamilton, M.J., Mischler, T.C.**, 2003. Strategies for choosing between alternatives with different attributes: Exemplified by house-hunting ants. *Animal Behaviour* **65**, 215–223.
- Freud, S.**, 1930. *Civilization and Its Discontents*. Internationaler Psychoanalytischer Verlag Wien.
- Full, R.J., Tullis, A.**, 1990. Energetics of ascent: insects on inclines. *J. Exp. Biol.* **149**, 307–317.
- Gallé, L.**, 2017. Climate change impoverishes and homogenizes ants' community structure : a long term study **18**, 128–136.
- Garnier, S., Gautrais, J., Theraulaz, G.**, 2007. The biological principles of swarm intelligence. *Swarm Intelligence* **1**, 3–31.
- Garnier, S., Guérécheau, A., Combe, M., Fourcassié, V., Theraulaz, G.**, 2009. Path selection and foraging efficiency in Argentine ant transport networks. *Behavioral Ecology and Sociobiology* **63**, 1167–1179.
- Garrison, L.K., Kleineidam, C.J., Weidenmüller, A.**, 2018. Behavioral flexibility promotes collective

- consistency in a social insect. *Scientific Reports* **8**, 15836.
- George, E.A., Brockmann, A.**, 2018. Regulation of individual differences in recruitment behaviour within honey bee foraging groups 0–3.
- Gerbier, G., Garnier, S., Rieu, C., Theraulaz, G., Fourcassié, V.**, 2008. Are ants sensitive to the geometry of tunnel bifurcation? *Anim. Cogn.* **11**, 637–642.
- Gernat, T., Rao, V.D., Middendorf, M., Dankowicz, H., Goldenfeld, N., Robinson, G.E.**, 2018. Automated monitoring of behavior reveals bursty interaction patterns and rapid spreading dynamics in honeybee social networks. *Proceedings of the National Academy of Sciences of the United States of America*.
- Gernat, T., Rao, V.D., Middendorf, M., Dankowicz, H., Goldenfeld, N., Robinson, G.E., Holme, P., Naug, D., Sokolowski, M.B.**, 2017. Automated monitoring of behavior reveals bursty interaction patterns and rapid spreading dynamics in honeybee social networks. *Proc. Natl. Acad. Sci. USA* 1–6.
- Goldenberg, S.Z., Douglas-Hamilton, I., Wittemyer, G.**, 2016. Vertical Transmission of Social Roles Drives Resilience to Poaching in Elephant Networks. *Current Biology* **26**, 75–79.
- Goodman, W., Granger, N.A.**, 2009. The Juveniles Hormones, in: *Insect Development : Morphogenesis, Molting and Metamorphosis*. Academic, p. 305.
- Gordon, D.M.**, 2003. The Organization of Work in Social Insect Colonies 43–46.
- Gordon, D.M.**, 2002. The regulation of foraging activity in red harvester ant colonies. *The American naturalist* **159**, 509–18.
- Gordon, D.M., Guetz, A., Greene, M.J., Holmes, S.**, 2011. Colony variation in the collective regulation of foraging by harvester ants. *Behavioral ecology : official journal of the International Society for Behavioral Ecology* **22**, 429–435.
- Gordon, D.M., Holmes, S., Nacu, S.**, 2007. The short-term regulation of foraging in harvester ants. *Behavioral Ecology* **19**, 217–222.
- Gordon, D.M., Mehdiabadi, N.J.**, 1999. Encounter rate and task allocation in harvester ants. *Behavioral Ecology and Sociobiology* **45**, 370–377.
- Gordon, D.M., Moreau, M., Fourcassié, V., Traniello, J.F.A.**, 2018. Limited size-related variation in behavioral performance among workers of the exceptionally polymorphic ant *Pheidole rhea*. *Insectes Sociaux* **0**, 0.
- Goss, S., Deneuborg, J.L., Pasteels, J.M.**, 1989. Self-organized shortcuts in the Argentine ant. *Naturwissenschaften* **76**, 579–581.
- Gould, S.J., Vrba, E.S.**, 1982. Exaptation-A Missing Term in the Science of Form. *Paleobiology Society* **8**, 4–15.
- Goyret, J., Farina, W.M.**, 2005. Non-random nectar unloading interactions between foragers and their receivers in the honeybee hive. *Naturwissenschaften* **92**, 440–443.
- Gräwer, J., Ronellenfitch, H., Mazza, M.G., Katifori, E.**, 2017. Trophallaxis-inspired model for distributed transport between randomly interacting agents. *Physical Review E* **96**, 1–16.
- Greenberg, R.**, 1990a. Ecological plasticity, neophobia and resource use in birds.pdf. *Studies in Avian Biology* 431–437.
- Greenberg, R.**, 1990b. Feeding neophobia and ecological plasticity: a test of the hypothesis with captive

- sparrows. *Animal Behaviour* **39**, 375–379.
- Greenwald, E., Segre, E., Feinerman, O.**, 2015. Ant trophallactic networks: simultaneous measurement of interaction patterns and food dissemination. *Scientific Reports* **5**, 12496.
- Greenwald, E.E., Baltiansky, L., Feinerman, O.**, 2018. Individual crop loads provide local control for collective food intake in ant colonies. *eLife* **7**:e31730.
- Gregson, A.M., Hart, A.G., Holcombe, M., Ratnieks, F.L.W.**, 2003. Partial nectar loads as a cause of multiple nectar transfer in the honey bee (*Apis mellifera*): a simulation model. *Journal of Theoretical Biology* **222**, 1–8.
- Grüter, C., Acosta, L.E., Farina, W.M.**, 2006. Propagation of olfactory information within the honeybee hive. *Behavioral Ecology and Sociobiology* **60**, 707–715.
- Grüter, C., Farina, W.M.**, 2009. The honeybee waggle dance: can we follow the steps? *Trends in Ecology & Evolution* **24**, 242–247.
- Grüter, C., Farina, W.M.**, 2007. Nectar distribution and its relation to food quality in honeybee (*Apis mellifera*) colonies. *Insectes Sociaux* **54**, 87–94.
- Grüter, C., Schürch, R., Farina, W.M.**, 2013. Task-partitioning in insect societies: Non-random direct material transfers affect both colony efficiency and information flow. *Journal of theoretical biology* **327**, 23–33.
- Gwadz, R.W.**, 1969. Regulation of blood meal size in the mosquito. *Journal of Insect Physiology* **15**, 2039–2044.
- Hamede, R.K., Bashford, J., McCallum, H., Jones, M.**, 2009. Contact networks in a wild Tasmanian devil (*Sarcophilus harrisii*) population: using social network analysis to reveal seasonal variability in social behaviour and its implications for transmission of devil facial tumour disease. *Ecology Letters* **12**, 1147–1157.
- Hansen, M.J., Schaerf, T.M., Ward, A.J.W.**, 2015. The influence of nutritional state on individual and group movement behaviour in shoals of crimson-spotted rainbowfish (*Melanotaenia duboulayi*). *Behavioral Ecology and Sociobiology* **17**, 1713–1722.
- Hefetz, A., Grozinger, C.M.**, 2016. Hormonal Regulation of Behavioral and Phenotypic Plasticity in Bumblebees. *Hormones, Brain and Behavior: Third Edition* **2**, 453–464.
- Helanterä, H., Ratnieks, F.L.W.**, 2008. Geometry explains the benefits of division of labour in a leafcutter ant. *Proceedings. Biological sciences* **275**, 1255–60.
- Herb, B.R., Wolschin, F., Hansen, K.D., Aryee, M.J., Langmead, B., Irizarry, R., Amdam, G. V., Feinberg, A.P.**, 2012. Reversible switching between epigenetic states in honeybee behavioral subcastes. *Nature Neuroscience* **15**, 1371–1373.
- Heyman, Y., Hefetz, A., Shental, N., Feinerman, O.**, 2016. Ants regulate colony spatial organization using multiple chemical road signs. *Nature Communications* **8**, 15414.
- Holland, J.**, 1998. *Emergence: From Chaos to Order*. Addison-Wesley Helix Books.
- Hölldobler, B., Wilson, E.O.**, 1990. *The ants*. Springer-Verlag, Berlin, Heidelberg.
- Holme, P., Introduction, I., Neural, G.**, 2012. Temporal Networks. *Physics Reports* **519**, 97–125.
- Holt, N.C., Askew, G.N.**, 2012. Locomotion on a slope in leaf-cutter ants: metabolic energy use, behavioural adaptations and the implications for route selection on hilly terrain. *J. Exp. Biol.* **215**,

2545–2550.

- Howard, D.F., Tschinkel, W.R.**, 1981. The flow of food in colonies of the fire ant, *Solenopsis invicta*: a multifactorial study. *Physiol. Entomol.* **6**, 297–306.
- Huang, Z.Y., Robinson, G.E.**, 1996. Regulation of honey bee division of labor by colony age demography. *Behavioral Ecology and Sociobiology* **39**, 147–158.
- Hughes, W.O.H., Eilenberg, J., Boomsma, J.J.**, 2002. Trade-offs in group living: Transmission and disease resistance in leaf-cutting ants. *Proceedings of the Royal Society B: Biological Sciences* **269**, 1811–1819.
- Ingram, K.K., Gordon, D.M., Friedman, D.A., Greene, M., Kahler, J., Peteru, S.**, 2016. Context-dependent expression of the foraging gene in field colonies of ants: The interacting roles of age, environment and task. *Proceedings of the Royal Society B: Biological Sciences* **283**.
- Jander, R.**, 1990. Arboreal search in ants: Search on branches (Hymenoptera: Formicidae). *Journal of Insect Behavior* **3**, 515–527.
- Jandt, J.M., Bengston, S., Pinter-Wollman, N., Pruitt, J.N., Raine, N.E., Dornhaus, A., Sih, A.**, 2014. Behavioural syndromes and social insects: personality at multiple levels. *Biological reviews of the Cambridge Philosophical Society* **89**, 48–67.
- Jeanne L, R.**, 1996. Regulation of nest construction behaviour in *Polybia occidentalis*. *Animal Behaviour* **52**, 473–488.
- Jeanne, R.L.**, 1986. THE EVOLUTION OF THE ORGANIZATION OF WORK IN SOCIAL INSECTS. *Monitore Zoologico Italiano - Italian Journal of Zoology* **20**, 119–133.
- Jeanson, R., Ratnieks, F.L.W., Deneubourg, J.L.**, 2003. Pheromone trail decay rates on different substrates in the pharaoh's ant, *Monomorium pharaonis*. *Physiological Entomology* **28**, 192–198.
- Josens, R.**, 2018. Individual size as determinant of sugar responsiveness in ants 1–9.
- Judd, T.M., Fasnacht, M.P.**, 2007. Distribution of micronutrients in social insects: a test in the termite *Reticulitermes flavipes* (Isoptera: Rhinotermitidae) and the ant *Myrmica punctiventris* (Hymenoptera: Formicidae). *Ann. Entomol. Soc. Am.* **100**, 893–899.
- Kaspari, M., Byrne, M.M.**, 1995. Caste allocation in litter *Pheidole*: lessons from plant defense theory. *Behavioral Ecology and Sociobiology* **37**, 255–263.
- Kendall, A.M.G.**, 1938. A New Measure of Rank Correlation. *Oxford Journals* **30**, 81–93.
- Kern, F., Klein, R.W., Janssen, E., Bestmann, H.J., Attygalle, A.B., Schäfer, D., Maschwitz, U.**, 1997. Mellein, a trail pheromone component of the ant *Lasius fuliginosus*. *Journal of Chemical Ecology* **23**, 779–792.
- Klein, S., Pasquaretta, C., Barron, A.B., Devaud, J.**, 2017. Inter-individual variability in the foraging behaviour of traplining bumblebees. *Scientific Reports* 1–12.
- Kolmes, S.A., Sommeijer, M.J.**, 2010. A Quantitative Analysis of Behavioral Specialization among Worker Stingless Bees (*Melipona favosa* F.) Performing Hive Duties (Hymenoptera, Apidae) Author(s): Steven A. Kolmes and Marinus J. Sommeijer Source: *Journal of the Kansas Entomological Society* **65**, 421–430.
- Kramer, B.H., Van Doorn, G.S., Weissing, F.J., Pen, I.**, 2016. Lifespan divergence between social insect castes: Challenges and opportunities for evolutionary theories of aging. *Current Opinion in*

- Insect Science **16**, 76–80.
- Krause, J., Seebacher, F.**, 2018. Collective Behaviour : Physiology Determines Position. *Current Biology* **28**, R351–R354.
- Kropotkin, P.**, 1902. Mutual Aid: A Factor of Evolution.
- Kwapich, C.L., Tschinkel, W.R.**, 2015. Limited flexibility and unusual longevity shape forager allocation in the Florida harvester ant (*Pogonomyrmex badius*). *Behavioral Ecology and Sociobiology* **70**, 221–235.
- Kwapich, C.L., Tschinkel, W.R.**, 2013. Demography, demand, death, and the seasonal allocation of labor in the Florida harvester ant (*Pogonomyrmex badius*). *Behavioral Ecology and Sociobiology* **67**, 2011–2027.
- Laloux, F.**, 2014. Reinventing Organizations. Nelson Parker.
- Lanan, M.C., Rodrigues, P.A.P., Agellon, A., Jansma, P., Wheeler, D.E.**, 2016. A bacterial filter protects and structures the gut microbiome of an insect. *The ISME Journal* **10**, 1866–1876.
- Lang, C., Menzel, F.**, 2011. *Lasius niger* ants discriminate aphids based on their cuticular hydrocarbons. *Animal Behaviour* **82**, 1245–1254.
- Latora, V., Marchiori, M.**, 2001. Efficient behavior of small-world networks. *Physical Review Letters* **87**, 198701–198704.
- LeBoeuf, A.C.**, 2017. Trophallaxis. *Current Biology* **27**, R1299–R1300.
- LeBoeuf, A.C., Cohan, A.B., Stoffel, C., Brent, C.S., Waridel, P., Privman, E., Keller, L., Benton, R.**, 2018. Molecular evolution of juvenile hormone esterase-like proteins in a socially exchanged fluid. *bioRxiv* 337568.
- Leboeuf, A.C., Waridel, P., Brent, C.S., Gonövalves, A.N., Menin, L., Ortiz, D., Riba-Grognuz, O., Koto, A., Soares, Z.G., Privman, E., Miska, E.A., Benton, R., Keller, L.**, 2016. Oral transfer of chemical cues, growth proteins and hormones in social insects. *eLife* **5**, 1–27.
- Leclerc, J.B., Detrain, C.**, 2017. Loss of attraction for social cues leads to fungal-infected *Myrmica rubra* ants withdrawing from the nest. *Animal Behaviour* **129**, 133–141.
- Leitner, N., Charbonneau, D., Gronenberg, W., Dornhaus, A.**, 2018. Peripheral sensory organs vary among ant workers but variation does not predict division of labor. *Behavioural Processes* **158**, 137–143.
- Lindauer, M.**, 1954. Temperaturregulierung und Wasserhaushalt im Bienenstaat. *Zeitschrift für Angewandte Entomologie* **36**, 108–112.
- Lindauer, M.**, 1949. Über die Einwirkung von Duft- und Geschmacksstoffen sowie anderer Faktoren auf die Tänze der Bienen. *Zeitschrift für Vergleichende Physiologie* **31**, 348–412.
- Loke, P., Lee, C.**, 2006. Effects of Colony Compositions and Food Type on Foraging Behavior of *Monomorium orientis* (Hymenoptera : Formicidae). *Sociobiology* **46**, 595–602.
- Lucas, E.R., Romiguier, J., Keller, L.**, 2017. Gene expression is more strongly influenced by age than caste in the ant *Lasius niger*. *Molecular Ecology* **26**, 5058–5073.
- Lucchetti, M.A., Kilchenmann, V., Glauser, G., Praz, C., Kast, C.**, 2018. Nursing protects honeybee larvae from secondary metabolites of pollen.

- Ma, R., Villar, G., Grozinger, C.M., Rangel, J.**, 2018. Larval pheromones act as colony-wide regulators of collective foraging behavior in honeybees. *Behavioral Ecology* **29**, 1132–1141.
- Mailleux, A.-C., Buffin, A., Detrain, C., Deneubourg, J.-L.**, 2011. Recruitment in starved nests: the role of direct and indirect interactions between scouts and nestmates in the ant *Lasius niger*. *Insectes Sociaux* **58**, 559–567.
- Mailleux, A.-C., Buffin, A., Detrain, C., Deneubourg, J.-L.**, 2010a. Recruiter or recruit: who boosts the recruitment in starved nests in mass foraging ants? *Animal Behaviour* **79**, 31–35.
- Mailleux, A.-C., Deneubourg, J.-L., Detrain, C.**, 2003. Regulation of ants' foraging to resource productivity. *Proceedings. Biological sciences / The Royal Society* **270**, 1609–1616.
- Mailleux, A.-C., Deneubourg, J.-L., Detrain, C.**, 2000. How do ants assess food volume? *Animal Behaviour* **59**, 1061–1069.
- Mailleux, A.-C., Detrain, C., Deneubourg, J.-L.**, 2006. Starvation drives a threshold triggering communication. *The Journal of Experimental Biology* **209**, 4224–4229.
- Mailleux, A.-C., Devigne, C., Deneubourg, J.-L., Detrain, C.**, 2010b. Impact of Starvation on *Lasius niger* ' Exploration. *Ethology* **116**, 248–256.
- Mailleux, A.-C., Sempo, G., Depickère, S., Detrain, C., Deneubourg, J.L.**, 2010c. How does starvation affect spatial organization within nests in *Lasius niger* ? *Insectes Sociaux* **58**, 219–225.
- Malcolm, J.R., Marten, K.**, 1982. Natural selection and the communal rearing of pups in African wild dogs (*Lycaon pictus*). *Behavioral Ecology and Sociobiology* **10**, 1–13.
- Mark L. Winston**, 1987. *The Biology of the Honey Bee*. Harvard University Press, Cambridge, MA.
- Markin, G.P.**, 1970. Food distribution within laboratory colonies of the argentine ant, *Tridomyrmex Humilis* . *Insectes Sociaux* **17**, 127–158.
- Marsh, A.C.**, 1985. Microclimatic factors influencing foraging patterns and success of the thermophilic desert ant, *Ocymyrmex barbiger*. *Insectes Sociaux* **32**, 286–296.
- Matsunami, M., Nozawa, M., Suzuki, R., Toga, K., Masuoka, Y., Yamaguchi, K., Maekawa, K., Shigenobu, S., Miura, T.**, 2018. Caste-specific microRNA expression in termites: insights into soldier differentiation. *Insect Molecular Biology* 1–13.
- Mc Cabe, S., Farina, W.M., Josens, R.B.**, 2006. Antennation of nectar-receivers encodes colony needs and food-source profitability in the ant *Camponotus mus*. *Insectes Sociaux* **53**, 356–361.
- Mersch, D.P., Crespi, A., Keller, L.**, 2013. Tracking individuals shows spatial fidelity is a key regulator of ant social organization. (Supplementary). *Science (New York, N.Y.)* **340**, 1090–1093.
- Mersch, D.P., Eckmann, J.-P., Crespi, A., Keller, L.**, 2018. Synchronised brood transport by ants occurs without communication. *bioRxiv* 364273.
- Mlot, N.J., Tovey, C.A., Hu, D.L.**, 2011. Fire ants self-assemble into waterproof rafts to survive floods. *Proceedings of the National Academy of Sciences* **108**, 7669–7673.
- Modlmeier, a. P., Liebmann, J.E., Foitzik, S.**, 2012. Diverse societies are more productive: a lesson from ants. *Proceedings of the Royal Society B: Biological Sciences* **279**, 2142–2150.
- Naug, D.**, 2008. Structure of the social network and its influence on transmission dynamics in a honeybee colony. *Behavioral Ecology and Sociobiology* **62**, 1719–1725.

- Neupert, S., Hornung, M., Millar, J.G., Kleineidam, C.J.**, 2018. Learning distinct chemical labels of nestmates in ants. *Frontiers in Behavioral Neuroscience* **12**, 191.
- Nicolis, S.C., Detrain, C., Demolin, D., Deneubourg, J.L.**, 2003. Optimality of collective choices: a stochastic approach. *Bulletin of mathematical biology* **65**, 795–808.
- Offenberg, J.**, 2001. Balancing between mutualism and exploitation: the symbiotic interaction between *Lasius* ants and aphids. *Behavioral Ecology and Sociobiology* **49**, 304–310.
- Oster, G.F., Wilson, E.O.**, 1978. Caste and ecology in the social insects. *Monographs in population biology* **12**, 1–352.
- Pacala, S.W., Gordon, D.M., Godfray, H.C.J.**, 1996. Effects of social group size on information transfer and task allocation. *Evolutionary Ecology* **10**, 127–165.
- Page, R.E., Erber, J., Fondrk, M.K.**, 1999. The effect of genotype on response thresholds to sucrose and foraging behavior of honey bees (*Apis mellifera*). *Journal of Comparative Physiology* **182**, 489–500.
- Page, R.E.J., Stuart, R.J.**, 1991. Genetic Component to Division of Labor Among Workers of a Leptothoracine Ant. *Naturwissenschaften* **78**, 375–377.
- Pamminger, T., Foitzik, S., Kaufmann, K.C., Schützler, N., Menzel, F.**, 2014. Worker personality and its association with spatially structured division of labor. *PloS one* **9**, e79616–e79616.
- Pask, G.M., Slone, J.D., Millar, J.G., Das, P., Moreira, J.A., Zhou, X., Bello, J., Berger, S.L., Bonasio, R., Desplan, C., Reinberg, D., Liebig, J., Zwiebel, L.J., Ray, A.**, 2017. Specialized odorant receptors in social insects that detect cuticular hydrocarbon cues and candidate pheromones. *Nature Communications* **8**, 297.
- Pasteels, J.M., Deneubourg, J.-L., Goss, S.**, 1987. Self-organization mechanisms in ant societies (I): trail recruitment to newly discovered food sources., in: Pasteels, J.M., Deneubourg, J.L. (Eds.), *From Individual to Collective Behavior in Social Insects*. *Experientia Supplementum*, Vol. 54. Birkhäuser Verlag, Bâle, pp. 155–175.
- Pinter-Wollman, N.**, 2015. Persistent variation in spatial behavior affects the structure and function of interaction networks. *Current Zoology* **61**, 98–106.
- Pinter-Wollman, N., Bala, A., Merrell, A., Queirolo, J., Stumpe, M.C., Holmes, S., Gordon, D.M.**, 2013. Harvester ants use interactions to regulate forager activation and availability. *Animal behaviour* **86**, 197–207.
- Pinter-Wollman, N., Hobson, E. a., Smith, J.E., Edelman, a. J., Shizuka, D., de Silva, S., Waters, J.S., Prager, S.D., Sasaki, T., Wittemyer, G., Fewell, J., McDonald, D.B.**, 2013. The dynamics of animal social networks: analytical, conceptual, and theoretical advances. *Behavioral Ecology*.
- Pinter-Wollman, N., Hubler, J., Holley, J., Franks, N.R., Dornhaus, A.**, 2012. How is activity distributed among and within tasks in *Temnothorax* ants? *Behav Ecol Sociobiol* 1407–1420.
- Pinter-Wollman, N., Wollman, R., Guetz, A., Holmes, S., Gordon, D.M.**, 2011. The effect of individual variation on the structure and function of interaction networks in harvester ants. *Journal of The Royal Society Interface* **8**, 1562–1573.
- Planas-sitja, I., Deneubourg, J.-L., Gibon, C., Sempo, G.**, 2015. Group personality during collective decision-making : a multi-level approach. *Proceedings of the Royal Society B* **282**.
- Portha, S., Deneubourg, J.-L., Detrain, C.**, 2004. How food type and brood influence foraging decisions of *Lasius niger* scouts. *Animal Behaviour* **68**, 115–122.

- Portha, S., Deneubourg, J.-L., Detrain, C.**, 2002. Self-organized asymmetries in ant foraging : a functional response to food type and colony needs. *Behavioral Ecology and Sociobiology* **13**, 776–781.
- Powell, J.E., Martinson, V.G., Urban-Mead, K., Moran, N.A.**, 2014. Routes of acquisition of the gut microbiota of the honey bee *Apis mellifera*. *Applied and Environmental Microbiology* **80**, 7378–7387.
- Prabhakar, B., Dektar, K.N., Gordon, D.M.**, 2012a. The regulation of ant colony foraging activity without spatial information. *PLoS computational biology* **8**, e1002670–e1002670.
- Prabhakar, B., Dektar, K.N., Gordon, D.M.**, 2012b. Anternet: The regulation of harvester ant foraging and Internet congestion control. 2012 50th Annual Allerton Conference on Communication, Control, and Computing, Allerton 2012 1355–1359.
- Pruitt, J.N., Riechert, S.E.**, 2011. How within-group behavioural variation and task efficiency enhance fitness in a social group. *Proc. R. Soc. B* **278**, 1209–1215.
- Puga-Gonzalez, I., Sosa, S., Sueur, C.**, 2018. Social style and resilience of macaques' networks, a theoretical investigation. *Primates*.
- Quevillon, L.E., Hanks, E.M., Bansal, S., Hughes, D.P.**, 2014. Social , spatial , and temporal organization in a complex insect society. *Scientific Reports* **5**, 1–11.
- Richardson, T.O., Gorochoowski, T.E.**, 2015. Beyond contact-based transmission networks: the role of spatial coincidence. *Journal of The Royal Society Interface* **12**, 20150705.
- Robinson, E.J.H., Feinerman, O., Franks, N.R.**, 2014. How collective comparisons emerge without individual comparisons of the options. *Proceedings of the Royal Society B: Biological Sciences* **281**.
- Robinson, E.J.H., Jackson, D.E., Holcombe, M., Ratnieks, F.L.W.**, 2005. Insect communication: “no entry” signal in ant foraging. *Nature* **438**, 442.
- Robinson, E.J.H., Richardson, T.O., Sendova-Franks, A.B., Feinerman, O., Franks, N.R.**, 2008. Radio tagging reveals the roles of corpulence, experience and social information in ant decision making. *Behavioral Ecology and Sociobiology* **63**, 627–636.
- Robinson, G.E.**, 1992. Regulation of division of labor in insect societies. *Annual review of entomology* **37**, 637–665.
- Romano, V., Shen, M., Pansanel, J., MacIntosh, A.J.J., Sueur, C.**, 2018. Social transmission in networks: global efficiency peaks with intermediate levels of modularity. *Behavioral Ecology and Sociobiology* **72**, 154.
- Rueppell, O., Kirkman, R.W.**, 2005. Extraordinary starvation resistance in *Temnothorax rugatulus* (Hymenoptera, Formicidae) colonies: Demography and adaptive behavior. *Insectes Sociaux* **52**, 282–290.
- Rytter, W., Shik, J.Z.**, 2016. Liquid foraging behaviour in leafcutting ants: the lunchbox hypothesis. *Animal Behaviour* **117**, 179–186.
- Saramäki, J., Kivelä, M., Onnela, J.P., Kaski, K., Kertész, J.**, 2007. Generalizations of the clustering coefficient to weighted complex networks. *Physical Review E - Statistical, Nonlinear, and Soft Matter Physics* **75**, 2–5.
- Sarkies, P., Miska, E.A.**, 2013. Is there social RNA? *Science* **341**, 467–468.

- Schafer, R.J., Holmes, S., Gordon, D.M.**, 2006. Forager activation and food availability in harvester ants. *Animal Behaviour* **71**, 815–822.
- Schmid-Hempel, P.**, 1998. *Parasites in Social Insects*. Princeton University Press.
- Schmid-Hempel, P.**, 1991. The Ergonomics of Worker Behavior in Social Hymenoptera. *Advances in the Study of Behavior* **20**, 87–134.
- Schülke, O., Bhagavatula, J., Vigilant, L., Ostner, J.**, 2010. Social bonds enhance reproductive success in male macaques. *Current Biology* **20**, 2207–2210.
- Seeley, T., Camazine, S., Sneyd, J.**, 1991. Collective decision-making in honey bees: how colonies choose among nectar sources. *Behavioral Ecology and Sociobiology* **28**, 277–290.
- Seeley, T.D.**, 1995. *The Wisdom of the Hive : The Social Physiology of Honey Bee Colonies*. Harvard University Press.
- Seeley, T.D.**, 1989. Social foraging in honey bees: how nectar foragers assess their colony's nutritional status. *Behavioral Ecology and Sociobiology* **24**, 181–199.
- Seeley, T.D., Tovey, C.A.**, 1994. Why search time to find a food-storer bee accurately indicates the relative rates of nectar collecting and nectar processing in honey bee colonies. *Animal Behaviour* **47**, 311–316.
- Sendova-Franks, A.B., Hayward, R.K., Wulf, B., Klimek, T., James, R., Planqué, R., Britton, N.F., Franks, N.R.**, 2010. Emergency networking: famine relief in ant colonies. *Animal Behaviour* **79**, 473–485.
- Shaffer, Z., Sasaki, T., Pratt, S.C.**, 2013. Linear recruitment leads to allocation and flexibility in collective foraging by ants. *Animal Behaviour* **86**, 967–975.
- Sih, A., Cote, J., Evans, M., Fogarty, S., Pruitt, J.**, 2012. Ecological implications of behavioural syndromes. *Ecology Letters* **15**, 278–289.
- Silk, J.B., Beehner, J.C., Bergman, T.J., Crockford, C., Engh, A.L., Moscovice, L.R., Wittig, R.M., Seyfarth, R.M., Cheney, D.L.**, 2010. Strong and consistent social bonds enhance the longevity of female baboons. *Current Biology* **20**, 1359–1361.
- Silva-Junior, E.A., Ruzzini, A.C., Paludo, C.R., Nascimento, F.S., Currie, C.R., Clardy, J., Pupo, M.T.**, 2018. Pyrazines from bacteria and ants: Convergent chemistry within an ecological niche. *Scientific Reports* **8**, 4–10.
- Simola, D.F., Graham, R.J., Brady, C.M., Enzmann, B.L., Desplan, C., Ray, A., Zwiebel, L.J., Bonasio, R., Reinberg, D., Liebig, J., Berger, S.L.**, 2016. Epigenetic (re)programming of caste-specific behavior in the ant *Camponotus floridanus*. *Science* **351**, aac6633–aac6633.
- Solomon, N.**, 2016. «L'avidité scalpel du XIX e siècle» : la métaphore du vivant chez Balzac 1–8.
- Sorensen, A.A., Busch, T.M., Vinson, S.B.**, 1985. Control of food influx by temporal subcastes in the fire ant, *Solenopsis invicta*. *Behavioral Ecology and Sociobiology* **17**, 191–198.
- Sorensen, A.A., Kamas, R.S., Vinson, S.B.**, 1983. The influence of oral secretions from larvae on levels of proteinases in colony members of *Solenopsis invicta* Buren (Hymenoptera: Formicidae). *Journal of Insect Physiology* **29**, 163–168.
- Sorensen, A.A., Vinson, S.B.**, 1981. Quantitative food distribution studies within Laboratory colonies of the imported fire ant, *Solenopsis invicta* Buren. *Insectes Sociaux* **28**, 129–160.

- Spaethe, J., Weidenmüller, A.**, 2002. Size variation and foraging rate in bumblebees (*Bombus terrestris*). *Insectes Sociaux* **49**, 142–146.
- Stoffolano, J.G., Haselton, A.T.**, 2013. The Adult Dipteran Crop: A Unique and Overlooked Organ. *Annual Review of Entomology* **58**, 205–225.
- Stroeymeyt, N., Grasse, A. V, Crespi, A., Mersch, D.P., Cremer, S., Keller, L.**, 2018. Social network plasticity decreases disease transmission in a eusocial insect **945**, 941–945.
- Sudd, J.H.**, 1967. *An Introduction to the Behaviour of Ants*. Edward Arnold, London.
- Sueur, C. (Ed.)**, 2015. *Analyse des réseaux sociaux appliquée à l’Ethologie et à l’Ecologie*, Editions M. ed. Paris.
- Sueur, C., Romano, V., Sosa, S., Puga-Gonzalez, I.**, 2018. Mechanisms of network evolution: a focus on socioecological factors, intermediary mechanisms, and selection pressures. *Primates*.
- Sumner, S., Bell, E., Taylor, D.**, 2018. A molecular concept of caste in insect societies. *Current Opinion in Insect Science* **25**, 42–50.
- Sumpter, D.J.T., Beekman, M.**, 2003. From nonlinearity to optimality: pheromone trail foraging by ants. *Animal Behaviour* **66**, 273–280.
- Sumpter, D.J.T., Pratt, S.C.**, 2009. Quorum responses and consensus decision making. *Philosophical Transactions of the Royal Society B: Biological Sciences* **364**, 743–753.
- Tenczar, P., Lutz, C.C., Rao, V.D., Goldenfeld, N., Robinson, G.E.**, 2014. Automated monitoring reveals extreme interindividual variation and plasticity in honeybee foraging activity levels. *Animal Behaviour* **95**, 41–48.
- Theraulaz, G., Bonabeau, E., Deneubourg, J.**, 2008. Response threshold reinforcement and division of labour in insect societies **265**, 327–332.
- Theraulaz, G., Bonabeau, E., Nicolis, S.C., Solé, R. V, Fourcassié, V., Blanco, S., Fournier, R., Joly, J.-L., Fernández, P., Grimal, A., Dalle, P., Deneubourg, J.-L.**, 2002. Spatial patterns in ant colonies. *Proceedings of the National Academy of Sciences of the United States of America* **99**, 9645–9649.
- Tofts, C.**, 1993. Algorithms for task allocation in ants. (A study of temporal polyethism: Theory). *Bulletin of mathematical biology* **55**, 891–918.
- Toth, A.L.**, 2005. Nutritional status influences socially regulated foraging ontogeny in honey bees. *Journal of Experimental Biology* **208**, 4641–4649.
- Trible, W., Kronauer, D.J.C.**, 2017. Caste development and evolution in ants: it’s all about size. *The Journal of Experimental Biology* **220**, 53–62.
- Trillmich, F., Müller, T., Müller, C.**, 2018. Understanding the evolution of personality requires the study of mechanisms behind the development and life history of personality traits. *Biology Letters* **14**, 20170740.
- Tschinkel, W.R., Hanley, N.**, 2017. Vertical organization of the division of labor within nests of the Florida harvester ant, *Pogonomyrmex badius*. *PLOS ONE* **12**, e0188630.
- Udiani, O., Pinter-Wollman, N.**, 2014. Identifying robustness in the regulation of foraging of ant colonies using an interaction based model with backward bifurcation. *Journal of Theoretical Biology* **1904**, 1–24.

- Ulrich, Y., Saragosti, J., Tokita, C.K., Tarnita, C.E., Kronauer, D.J.C.**, 2018. Fitness benefits and emergent division of labour at the onset of group living. *Nature*.
- Valentini, G., Hamann, H., Dorigo, M.**, 2015. Efficient Decision-Making in a Self-Organizing Robot Swarm : On the Speed Versus Accuracy Trade-Off 1305–1314.
- van Zweden, J.S., d’Ettorre, P.**, 2010. Nestmate recognition in social insects and the role of hydrocarbons. *Insect Hydrocarbons Biology, Biochemistry, and Chemical Ecology* 222–243.
- VanderWaal, K.L., Atwill, E.R., Isbell, L.A., McCowan, B.**, 2014. Linking social and pathogen transmission networks using microbial genetics in giraffe (*Giraffa camelopardalis*). *Journal of Animal Ecology* **83**, 406–414.
- Wainelboim, A.J., Farina, W.M.**, 2000. Trophallaxis in filled-crop honeybees (*Apis mellifera* L.): food-loading time affects unloading behaviour. *Naturwissenschaften* **87**, 280–282.
- Wallis, D.I.**, 2018. Food-Sharing Behaviour of the Ants *Formica sanguinea* and *Formica fusca*. *Behaviour* **17**, 17–47.
- Waters, J.S., Fewell, J.H.**, 2012. Information processing in social insect networks. *PloS one* **7**, e40337–e40337.
- Wehner, R., Srinivasan, M.V.**, 2003. Path integration in insects., in: Jeffery, K.J. (Ed.), *The Neurobiology of Spatial Behaviour*. Oxford University Press, pp. 9–30.
- Weier, J.A., Feener, D.H.**, 1995. Foraging in the seed-harvester ant genus *Pogonomyrmex*: are energy costs important? *Behavioral Ecology and Sociobiology* **36**, 291–300.
- Wey, T., Blumstein, D.T., Shen, W., Jordán, F.**, 2008. Social network analysis of animal behaviour: a promising tool for the study of sociality. *Animal Behaviour* **75**, 333–344.
- Wilkinson, G.S.**, 1984. Reciprocal food sharing in the vampire bat. *Nature* **308**, 181–184.
- Wilson, E., Eisner, T.**, 1952. The morphology of the proventriculus of a Formicine ant. *Psyche* **59**, 47–60.
- Wilson, E.O.**, 1971. *The insect societies*. Cambridge, Massachusetts, USA, Harvard University Press.
- Wilson, E.O.**, 1962. Chemical communication among workers of the fire ant *Solenopsis saevissima*. *Animal Behaviour* **10**, 148–158.
- Wilson, E.O., Eisner, T.**, 1957. Quantitative studies of liquid food transmission in ants. *Insectes Sociaux* **4**, 157–166.
- Yates, A.A., Nonacs, P.**, 2016. Preference for straight-line paths in recruitment trail formation of the Argentine ant, *Linepithema humile*. *Insectes Soc.* **63**, 1–5.
- Zar, J.H.**, 1998. *Biostatistical Analysis*. Prentice Hall.

Approche théorique et expérimentale du choix de source et de la gestion collective des ressources alimentaires chez la fourmi

Au cours de ce travail de thèse ont été développés des outils théoriques (simulation) et expérimentaux (tracking) d'investigation des mécanismes sous-jacents aussi bien aux phénomènes de choix collectifs d'exploitation de sources de nourriture qu'à la gestion collective de cette dernière lors de la constitution des stocks de nourriture au sein d'une colonie de fourmis. Un premier volet de mon travail a concerné l'influence des caractéristiques physiques de l'environnement extérieur à la colonie sur les choix collectifs des fourmis en termes d'exploitation de ressources alimentaires. A la sortie du nid, les fourmis montrent une nette préférence pour un chemin ascendant plutôt que descendant vers des sources de nourriture pourtant identiques. Ce choix s'explique notamment par un mécanisme de demi-tour au niveau individuel face à une pente descendante dont l'effet est renforcé par des feedbacks positifs inhérents au phénomène de recrutement. Les capacités d'orientation et d'intégration du parcours entre le nid et la source de nourriture ont également été testées. Un chemin menant du nid à la source de nourriture selon une trajectoire parfaitement rectiligne est largement plus emprunté qu'un chemin impliquant un angle (135°) à mi-parcours bien que la distance absolue entre le nid et les deux sources de nourriture soit identique. Ce choix est expliqué par des durées de trajets de retour au nid plus longues sur le chemin avec un angle que celles sur le chemin rectiligne, conséquence de désaccords entre la direction à emprunter pour retourner au nid et le phénomène d'intégration de chemin observé chez les fourmis. Un second volet de ma thèse a été consacré à l'étude des dynamiques et régulations à l'œuvre au sein des phénomènes de dissémination collective et d'accumulation de nourriture au niveau intranidal. Ces questions ont été abordées par des méthodes d'analyses complémentaires mêlant des approches théoriques et expérimentales ayant permis d'établir les liens entre les hétérogénéités comportementales au niveau individuel et les résultantes de ces comportements au niveau collectif. Le marquage individuel des fourmis à l'aide d'une méthodologie également développée au cours de cette thèse, a permis la construction du réseau de trophallaxies au sein de deux espèces de fourmis. Malgré des différences au niveau biologique, celles-ci présentent des similarités comportementales : chacune montre une nette hétérogénéité interindividuelle dans le niveau de participation à l'activité de dissémination de la nourriture dans le nid. Des simulations basées sur les données expérimentales montrent que ces hétérogénéités individuelles conduisent à l'émergence d'un réseau de diffusion de nourriture plus efficace que si la colonie était parfaitement homogène. De plus, il a été montré que la structure des réseaux de distribution de nourriture après une longue période d'affamement n'est pas affectée par la qualité de la nourriture, suggérant une résilience des structures fondamentales de l'organisation sociale face à la variabilité des ressources. Ainsi ce travail, par son approche complémentaire entre modélisation fonctionnelle et expérimentation se veut également être une synthèse et une intégration de l'essentiel des connaissances actuelles des lois régissant la gestion collective des ressources alimentaires chez les fourmis.

