



**HAL**  
open science

# Synthesis of trifluoromethylated nitrogen-containing heterocycles

Alexandra Feraldi-Xypolia

► **To cite this version:**

Alexandra Feraldi-Xypolia. Synthesis of trifluoromethylated nitrogen-containing heterocycles. Organic chemistry. Université Pierre et Marie Curie - Paris VI, 2017. English. NNT : 2017PA066444 . tel-02343172

**HAL Id: tel-02343172**

**<https://theses.hal.science/tel-02343172>**

Submitted on 2 Nov 2019

**HAL** is a multi-disciplinary open access archive for the deposit and dissemination of scientific research documents, whether they are published or not. The documents may come from teaching and research institutions in France or abroad, or from public or private research centers.

L'archive ouverte pluridisciplinaire **HAL**, est destinée au dépôt et à la diffusion de documents scientifiques de niveau recherche, publiés ou non, émanant des établissements d'enseignement et de recherche français ou étrangers, des laboratoires publics ou privés.

# Université Pierre et Marie Curie

Ecole doctorale : Chimie Moléculaire ED 406

*Laboratoire de Chimie Organique de l'ESPCI Paris*

## **Synthesis of trifluoromethylated nitrogen-containing heterocycles**

Par Alexandra Feraldi-Xypolia

Thèse de doctorat de Chimie Organique

Dirigée par Pr. Janine Cossy

Présentée et soutenue publiquement le 31 octobre 2017

Devant un jury composé de :

Pr. Janine Cossy	Professeur	Directrice de thèse
Dr. Emmanuel Magnier	Directeur de Recherche	Rapporteur
Dr. Julien Pytkowicz	Maître de Conférences	Rapporteur
Dr. Alejandro Perez-Luna	Directeur de Recherche	Examineur
Dr. Domingo Gomez-Pardo	Maître de Conférences	Membre invité



# Acknowledgements

Firstly I would like to sincerely thank Dr. Emmanuel Magnier, Dr. Julien Pytkowicz and Dr. Alejandro Perez-Luna for accepting to review my thesis and be part of my jury.

I am truly grateful to my PhD director, Prof. Janine Cossy for giving me the opportunity to work in this laboratory. Over the past three years, you have trusted me with this work, you have afforded me great freedom to explore the project, always offering useful advice and suggestions.

I would also want to thank Dr. Domingo Gomez-Pardo, for his support and his patience during these three years. Thank you for your guidance, your optimism and for always being available in case of a problem.

I would then like to thank the DGP team:

First the oldest member of the group: Gael! Thank you for being patient with me, for answering all my questions and of course for having shared your project with me.

Thomas! Thank you for welcoming me in the lab, for showing me around and for allowing me to work next to you for three years. Also thank you for being there for me, whenever I asked for your help either to correct my reports, be there when I used  $\text{Br}_2$  or just when I needed to talk. Lastly, thank you (or not) for kindly making fun of my accent (English and French), and for teaching me all these french expressions (which I have already forgotten).

Thank you Sarah, the only girl in the lab when I arrived. It has been a pleasure working with you, laughing with you and of course sharing numerous reagents ( $\text{Tf}_2\text{O}$ , proton sponge,  $\text{TMSCF}_3$ ) for three years!!

Zeina, thank you for always being in a good mood and for always finding the time to make new playlists. Also thank you for feeding me from time to time with all these chocolates you have in your drawer. Good luck for next year!

Guillaume, the new arrival in our group! Although we worked together for only a year, it was a pleasure to have you as my "work neighbour". Thank you for all the discussions we had, for all the times I've complained to you (and there were a lot!!!!) and of course for all the (weird) french words you had to explain to me over the year.

Of course I could not forget "le petit Gregory"! His love for grapefruits and ducks, as well as his animated drawings, always made my day!



Johan a “half-member” of the team, thank you for all your advice and suggestions and for the time you took to help me each time.

I should also thank all former members of the DGP group who I had the pleasure to meet: Qi, Alexandre, Simon et Thomas.

I would also like to thank all the other members of the lab:

First of all, the permanent members: Christophe thank you for all the chemistry-concerning conversations we had during these three years, which encouraged me (almost) every time. Stellios the only greek person in the lab apart from me, thank you for all the times you offered to help me. I also thank Veronique, who welcomed me in her lab during the first months of my PhD! Amandine thank you for always giving me good advice and of course for organizing all the conferences. Thomas, I think a thank you is not enough for the times you helped me with my NMR spectra and for always finding time to repair the GC/MS machine!! Andrei, thank you for your advice and for handling the solvent orders.

Thank you to “les Meyers”: Ernouf for all the cat-concerning conversations, Boiss, for being in a good mood and of course Florence for all her delicacy and subtlety, being the only girl in this manly group! Also thank you Alexandre, Aziz and Khalil, the new members of the team.

Next I want to thank the group of Stellios: Morgan.. I really don’t know whether to say thank you or not.. For your (black) humour, for all the mean things we said together (and laughed about them) and most importantly for all the times you made me say “iiiiiouuu”!!! Thank you, it was fun! I will not forget Marllon, one of THE most stylish people I have ever met, good luck for the future, and of course Tao who came from far way and has managed to integrate perfectly into the group.

I would also like to thank les “Guérinots”: Baptiste, THE most energetic person I have ever met. Laurine, THE most effective person I have ever met, our conversations about trips and holidays were a nice break to our lab routine. Of course, Etienne thank you for the 1,5 years we had lunch together, for all our conversations and more importantly for saying ouuuuuuu every time you saw me!! Thibault and Morgan, I am grateful for all the advice you gave me, It was so nice meeting you, Claire another cat owner in the lab good luck on your PhD.

Last but not least, I thank the “Bellosta” group: Julien for always being so calm and “zen” and for showing me around when I worked in his lab, Tatiana and Pierrick it was a pleasure to meet you both and hope you are doing well.

A special thank you to Isabelle, Hélène and Arthur for all the administrative and IT help. It would have been impossible to manage all this without you.

I will not forget to thank all the former members of the lab, who I had the chance to meet: Simon, Erica, Paolo, Amandine, Laurent, Baba, Jérémy, Damien, Elodie, Romaine, Jean-Philippe, Cyril, Johan, Kévin, Nisha, Mélanie, Pierre-Antoine et Parth. I hope I didn't forget anyone.

Thank you to all my friends in Paris: Sabrina, Fabiana, I had the pleasure to meet you during the M2 and I am grateful for all the moments we spent together. Alexis, Cédric, Simon and Brendan. I will miss our "apéro" listening kiss.gr that did me good for these three years. Guillaume, Adrien, Ali, Florian, Sonia, Christian, Doriane, Paul, Lucie, Céline, Sébastien, Paulin, Marlène and Paul, thank you for all the "soirées" we had, all the birthdays we celebrated and for all the good times he had!!

The biggest thank you should go to Guillaume, who had the courage and the patience to put up with me, during three years and especially these last months. Thank you for believing in me even when I didn't.

I should also thank my friends in Greece. Antigoni, Nora, Alexandra, Mairi, Eleni, Georgia and JP, we did not see each other often during these years but I always consider you my best friends.

Last but not least, I would like to thank my family: especially my parents and my sister who always supported me in what I did even from far away. Thank you for giving me the chance to come to Paris and do my PhD, for encouraging me and of course for always asking questions and trying to understand what I do.



# Table of Contents

Abbreviations.....	12
Résumé .....	16
General Introduction.....	42
<b>CHAPTER 1: Fluorine in medicinal chemistry .....</b>	<b>46</b>
<b>1. Introduction .....</b>	<b>48</b>
<b>2. Fluorine properties and its influence on the chemical and physico-chemical properties of molecules.....</b>	<b>48</b>
2.1. C–F bond generalities .....	48
2.2. Influence of a fluorine atom on the pKa .....	49
2.3. Influence of a fluorine atom on the lipophilicity of molecules.....	50
2.4. Influence of a fluorine atom on the metabolic stability and bioavailability of molecules.....	50
2.5. Influence of a fluorine atom on molecular conformation.....	51
<b>3. Biologically active CF<sub>3</sub>-containing molecules.....</b>	<b>53</b>
<b>CHAPTER 2: Synthesis of 2-substituted, 2-(trifluoromethyl) pyrrolidines and 2-substituted, 2-(trifluoromethyl) piperidines .....</b>	<b>58</b>
<b>1. Generalities, Biological activity and synthesis of pyrrolidines and piperidines .....</b>	<b>60</b>
1.1. Generalities .....	60
1.2. Biological activity of 2-substituted, 2-(trifluoromethyl) pyrrolidines .....	60
1.3. Biological activity of 2-substituted, 2-(trifluoromethyl) piperidines .....	63

<b>1.4. Main synthetic methods to access 2-substituted, 2-(trifluoromethyl)pyrrolidines and 2-substituted, 2-(trifluoromethyl)piperidines.....</b>	<b>66</b>
1.4.1. Synthetic methods to access 2-substituted, 2-(trifluoromethyl)piperidines .....	66
1.4.2. Synthetic methods to access 2-substituted, 2-(trifluoromethyl)pyrrolidines.....	69
<b>2. Context of the study and objective .....</b>	<b>75</b>
<b>3. Regioselective ring-opening of 2-(trifluoromethyl) aziridinium intermediates.....</b>	<b>77</b>
3.1.1. Formation of an aziridinium under acidic conditions.....	77
3.1.2. Formation of an aziridinium by N-alkylation.....	81
<b>4. Results and discussion .....</b>	<b>84</b>
4.1.1. Synthesis of 2-substituted, 2-(trifluoromethyl)pyrrolidines .....	84
4.1.1.1. Synthesis of the starting material .....	84
4.1.1.2. Optimization of the conditions for the ring contraction.....	85
4.1.1.3. Scope of the reaction .....	89
4.1.1.4. Use of a chiral nucleophile: Chirality transfer .....	93
4.1.1.1. Comparison of the reactivity of 3-hydroxy-3-(trifluoromethyl)piperidine with 3-hydroxy-3-methylpiperidine .....	95
4.1.2. Synthesis of 2-substituted, 2-(trifluoromethyl)piperidines.....	96
4.1.2.1. Synthesis of the starting material .....	96
4.1.2.2. Scope of the ring contraction process.....	98
4.1.2.3. Comparison of the reactivity of 3-hydroxy-3-(trifluoromethyl)azepane with 3-hydroxy-3-methylazepane.....	103
<b>5. Conclusion.....</b>	<b>105</b>
 <b>CHAPTER 2: Experimental Part .....</b>	 <b>106</b>
<b>1. General experimental methods .....</b>	<b>108</b>

<b>2. Synthesis and spectroscopic data of N-benzyl-3-hydroxy-3-(trifluoromethyl)piperidine (1) .....</b>	<b>109</b>
<b>3. Synthesis and spectroscopic data of 2-substituted, 2-(trifluoromethyl)pyrrolidines .....</b>	<b>111</b>
<b>4. Synthesis and spectroscopic data of N-benzyl-3-hydroxy-3-methylpiperidine (37).....</b>	<b>128</b>
<b>5. Synthesis and spectroscopic data of N-benzyl-3-fluoro-3-methyl piperidine (43) .....</b>	<b>130</b>
<b>6. Synthesis and spectroscopic data of N-benzyl-3-hydroxy-3-(trifluoromethyl)azepane (44) .....</b>	<b>131</b>
<b>7. Synthesis and spectroscopic data of 2-substituted, 2-(trifluoromethyl)piperidines.....</b>	<b>137</b>
<b>8. Synthesis and spectroscopic data of N-benzyl-3-hydroxy-3-methylazepane (77) .....</b>	<b>153</b>
<b>9. Synthesis and spectroscopic data of N-benzyl-3-fluoro-3-methylpiperidine (83) .....</b>	<b>155</b>
<b>CHAPTER 3: Synthesis of 6-(trifluoromethyl)pyridazines by a [2+1]/[3+2]-cycloaddition sequence .....</b>	<b>156</b>
<b>1. Structure, biological activity and synthesis of pyridazines .....</b>	<b>158</b>
<b>1.1. Structure'.....</b>	<b>158</b>
<b>1.2. Biological activity.....</b>	<b>158</b>
<b>1.3. Main synthetic methods to access pyridazines .....</b>	<b>162</b>
<b>1.4. Main synthetic methods to access <math>\alpha</math>-(trifluoromethyl) pyridazines and derivatives .....</b>	<b>163</b>

1.4.1. Pyridazines possessing one CF <sub>3</sub> group.....	164
1.4.1.1. Condensation of hydrazine with carbonyl compounds.....	164
1.4.1.2. Intramolecular diaza-Wittig reaction .....	173
1.4.2. Pyridazines possessing two CF <sub>3</sub> groups.....	174
1.4.2.1. Condensation of hydrazine with carbonyl compounds.....	174
1.4.2.2. Intramolecular diaza-Wittig reaction .....	175
1.4.2.3. Diels-Alder reaction with inverse electron demand involving tetrazines .....	175
<b>2. Context of the study and objective .....</b>	<b>185</b>
<b>3. Results and discussion .....</b>	<b>189</b>
<b>3.1. Synthesis of the starting materials .....</b>	<b>189</b>
<b>3.2. Synthesis of <math>\alpha</math>-(trifluoromethyl)pyridazines.....</b>	<b>192</b>
3.2.1. Optimization of the reaction conditions .....	192
3.2.2. Scope of the reaction .....	194
3.2.2.1. Terminal alkynes substituted by an aryl group .....	194
3.2.2.2. Terminal alkynes substituted by heterocycles .....	201
3.2.2.3. Terminal alkynes substituted by alkyl groups .....	203
3.2.3. Other fluorinated diazo compounds .....	205
<b>3.3. Post-functionalization at the C4 position .....</b>	<b>207</b>
3.3.1. Reactivity of 4-fluoropyridazines with nucleophiles .....	207
3.3.2. Variation of the substituent at the C3 position.....	209
3.3.3. Variation of the substituent at the C6 position.....	211
<b>4. Conclusion.....</b>	<b>212</b>
<b>CHAPTER 3: Experimental Part .....</b>	<b>214</b>
<b>1. General experimental methods .....</b>	<b>216</b>
<b>2. Synthesis and experimental data of terminal alkynes.....</b>	<b>217</b>

<b>3. General procedures for the [2+1]/[3+2]-cycloaddition sequence .....</b>	<b>229</b>
<b>4. Synthesis and spectroscopic data of 6-(trifluoromethyl)pyridazines .....</b>	<b>230</b>
<b>5. Synthesis and spectroscopic data of 4-fluoro-3-phenyl-6- (perfluoroethyl)pyridazine (71) .....</b>	<b>248</b>
<b>6. Synthesis and spectroscopic data of 4-fluoro-3-phenyl-6- (difluoromethyl)pyridazine (72) .....</b>	<b>249</b>
<b>7. Post-functionalization of 6-(trifluoromethyl) pyridazines: Synthesis and spectroscopic data of pyridazines 73–89 .....</b>	<b>250</b>
<b>General Conclusion .....</b>	<b>262</b>
<b>Bibliography .....</b>	<b>266</b>





# Abbreviations

Å	: angström
Ac	: acetyl
<i>al.</i>	: <i>alius</i>
Ar	: aryl
BBN	: borabicyclo[3.3.1]nonane
Bn	: benzyl
Boc	: <i>tert</i> -butoxycarbonyl
b.p.	: boiling point
<i>c</i>	: concentration
CAN	: ceric ammonium nitrate
cat.	: catalytic
Cbz	: carboxybenzyl
CTSK	: Cathepsin K
Cy	: cyclohexyl
Δ	: heat
d	: day
DABCO	: 1,4-diazabicyclo[2.2.2]octane
DAST	: diethylaminosulfur trifluoride
DBU	: 1,8-diazabicyclo[5.4.0]undec-7-ene
DGAT	: diacylglycerol acyltransferase
DIAD	: diisopropyl azodicarboxylate
DMAP	: 4-dimethylaminopyridine
DMF	: dimethylformamide
DMP	: Dess-Martin periodinane
DMSO	: dimethyl sulfoxide
DNA	: deoxyribonucleic acid
dr	: diastereoisomeric ratio
EC <sub>50</sub>	: half maximal effective concentration
ee	: enantiomeric excess
e.g.	: <i>exempli gratia</i>
eq	: equation
equiv	: equivalent
Et	: ethyl
EtOAc	: ethyl acetate
F	: oral bioavailability
FDA	: Food and Drug Administration
GC/MS	: gas chromatography-mass spectrometry
<i>gem</i>	: geminal
GnRH	: Gonadotropin Releasing Hormone
GP	: <a href="#">groupement protecteur</a>
h	: hour
HIV	: human immunodeficiency virus
HOMO	: highest occupied molecular orbital
HRMS	: high resolution mass spectrometry
IC <sub>50</sub>	: half maximal inhibitory concentration
<i>i</i> Pr	: isopropyl
Im	: imidazole
IR	: infrared

<i>J</i>	: coupling constant
<i>j</i>	: <a href="#">jours</a>
JAK	: Janus kinase
LAH	: lithium aluminium hydride
LDA	: lithium diisopropylamide
LG	: leaving group
LUMO	: lowest unoccupied molecular orbital
<i>m</i>	: <i>meta</i>
M	: molar (mol/L)
Me	: methyl
MIF	: Melanocyte-inhibiting factor
min	: minute
Mp	: melting point
Ms	: mesyl
mTORC1	: mammalian target of rapamycin complex 1
MW	: microwave
<i>n</i> -Bu	: butyl
n.d.	: not defined
NMO	: <i>N</i> -methylmorpholine <i>N</i> -oxide
NMR	: Nuclear Magnetic Resonance spectroscopy
Nu	: nucleophile
<i>o</i>	: <i>ortho</i>
OTf	: triflate
Ox	: oxidation
<i>p</i>	: <i>para</i>
<i>P</i>	: partition coefficient
PE	: petroleum ether
PG	: protecting group
Ph	: phenyl
ppm	: parts per million
quant	: quantitative
R	: undefined group
( <i>R</i> )	: <i>Rectus</i>
RCM	: Ring-closing metathesis
Red	: reduction
Rf	: fluorine-containing group
<a href="#">Rdt</a>	: <a href="#">rendement</a>
rt	: room temperature
( <i>S</i> )	: <i>Sinister</i>
<i>s</i> -Bu	: <i>sec</i> -butyl
SFC	: Supercritical Fluid Chromatography
$S_NAr$	: Nucleophilic Aromatic Substitution
$\tau_c$	: conversion
<a href="#">ta</a>	: <a href="#">température ambiante</a>
TASF	: tris(dimethylamino)sulfonium difluorotrimethylsilicate
TBAOAc	: tetrabutylammonium acetate
TBABr	: tetrabutylammonium bromide
TBACl	: tetrabutylammonium chloride
TBACN	: tetrabutylammonium cyanide
TBAF	: tetrabutylammonium fluoride
TBS	: <i>tert</i> -butyldimethylsilyl
<i>t</i> -Bu	: <i>tert</i> -butyl

TFA	: trifluoroacetic acid
TFAA	: trifluoroacetic anhydride
TFDA	: trimethylsilyl 2-(fluorosulfonyl)-2,2-difluoroacetate
Tf <sub>2</sub> O	: triflic anhydride
THF	: tetrahydrofurane
TLC	: Thin Layer Chromatography
TMS	: trimethylsilyl
TMV	: Tobacco Mosaic Virus
TNT	: 2,4,6-trinitrotoluene
Ts	: tosyl
UV	: ultraviolet



## **Résumé**



Ce manuscrit est divisé en trois chapitres.

Le **premier chapitre** présente l'intérêt du fluor en chimie médicinale. Son influence sur les propriétés chimiques et physico-chimiques des molécules sera discutée.

Le **deuxième chapitre** présente la réaction de contraction de cycle de (trifluorométhyl)pipéridines ainsi que de (trifluorométhyl)azépanes *via* un intermédiaire aziridinium, afin d'obtenir des 2-(trifluorométhyl)pyrrolidines (Schéma 1, éq 1) et des 2-(trifluorométhyl)pipéridines fonctionnalisées (Schéma 1, éq 2).



Schéma 1

Le **troisième chapitre** présente une séquence de cycloadditions [2+1]/[3+2] impliquant un alcyne terminal, un difluorocarbène et le (trifluorométhyl)diazométhane, afin d'obtenir des 4-fluoro-6-(trifluorométhyl)pyridazines substituées en position C3 (Schéma 2).

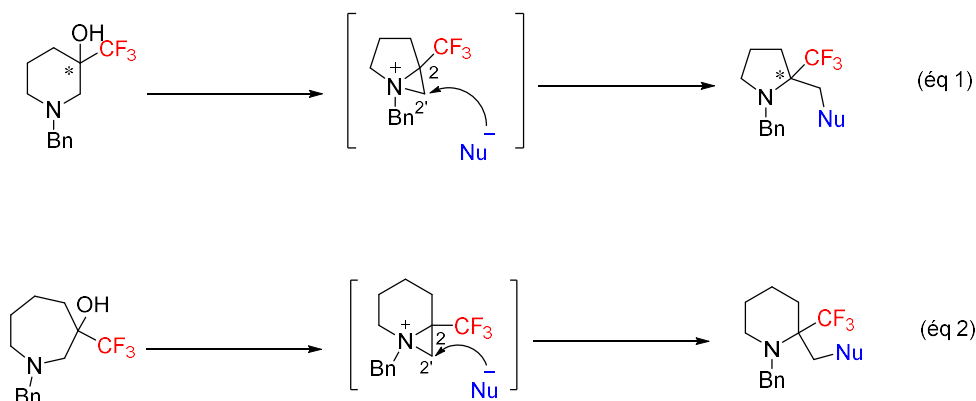

Schéma 2

Ces pyridazines ont ensuite été fonctionnalisées en position C4 par une substitution nucléophile aromatique ( $S_NAr$ ) pour conduire aux pyridazines 3,4,6-substituées (Schéma 3).



Schéma 3

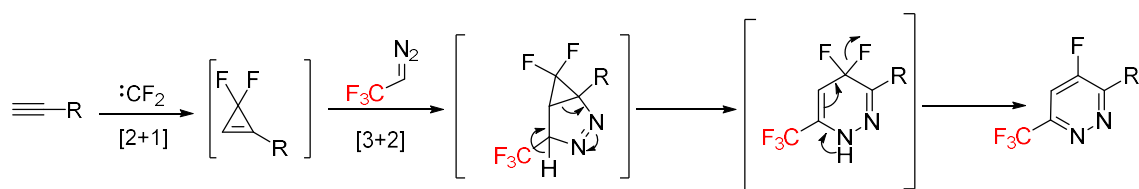

## Chapitre 1 : Le fluor en chimie médicinale

L'atome de fluor est un atome petit possédant un rayon de Van der Waals de 1.47 Å, intermédiaire entre celui de l'hydrogène et celui de l'oxygène, tout en étant proche de celui de l'oxygène. Le fluor étant l'élément le plus électronégatif de la classification périodique, induit la polarisation de la liaison C–F avec une charge négative partielle sur l'atome de fluor et une charge positive partielle sur l'atome de carbone, ce qui confère à la liaison C–F un caractère ionique significatif. Ainsi, la liaison C–F est courte (1.40 Å) et forte (l'énergie de liaison est de 105 kcal/mol) (Tableau 1).

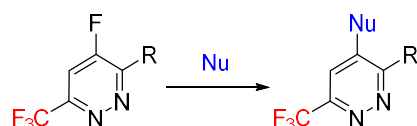
Atome (A)	H	F	O	N	C	Cl	Br
Rayon Van der Waals (Å)	1.20	1.47	1.52	1.55	1.70	1.75	1.85
Electronégativité de Pauling	2.1	4.0	3.5	3.0	2.5	3.2	2.8
Longueur de la liaison C–A (Å)	1.09	1.40	1.43	1.47	1.54	1.77	1.97
Force de la liaison C–A (kcal/mol)	98	105	84	70	83	77	66

**Tableau 1**

Une autre propriété qui dérive de l'électronégativité élevée du fluor, est que ses trois paires d'électrons libres sont fortement attirées par le noyau ce qui rend cet atome relativement inerte. D'autre part, une orbitale antiliante  $\sigma^*$  de faible énergie, orientée dans le plan de la liaison C–F, peut accepter les électrons d'un groupement donneur proche, tel qu'une paire d'électrons libres ou les électrons d'une liaison  $\sigma$ .

Le remplacement d'une liaison C–H par une liaison C–F est très utilisé en chimie médicinale, car si l'introduction d'un atome de fluor, ne modifie pas la taille de la molécule, en revanche, électroniquement parlant, ce remplacement n'est pas négligeable et peut avoir une influence sur la stabilité métabolique, sur les interactions protéine-ligand et sur les propriétés physico-chimiques telles que le pKa ou la lipophilie des molécules.

## Chapitre 2 : Contraction de cycle : synthèse de 2-(trifluorométhyl)pyrrolidines et de 2-(trifluorométhyl)pipéridines fonctionnalisées

Les pyrrolidines et les pipéridines sont des cycles azotés à cinq et six chaînons respectivement, qui appartiennent à la famille des amines cycliques secondaires. Les motifs pyrrolidine et pipéridine sont présents dans de nombreux alcaloïdes possédant des activités biologiques intéressantes. De plus, ils représentent des motifs que nous pouvons retrouver dans certains médicaments présents sur le marché.

Du fait des propriétés intéressantes du fluor, nous nous sommes intéressés à la synthèse des  $\alpha$ -(trifluorométhyl)pyrrolidines et  $\alpha$ -(trifluorométhyl)pipéridines **A** par contraction de cycle, à partir de (trifluorométhyl)pipéridines et de (trifluorométhyl)azépanes **C** respectivement *via* des intermédiaires aziridiniums **B**. Nous supposons que dû à la présence du groupement CF<sub>3</sub>, l'attaque d'un nucléophile devrait se faire de manière régiosélective sur la position C2' de l'aziridinium **B** pour conduire au produit de contraction de cycle **A** (Schéma 4).

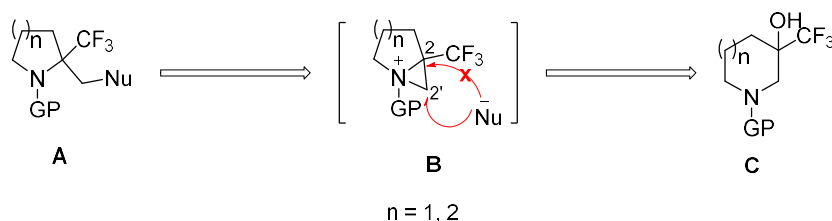

**Schéma 4**

A) Synthèse de 2-(trifluorométhyl)pyrrolidines, 2-substituées

Dans un premier temps, nous avons étudié la réaction de contraction de cycle de 3-hydroxy-3-(trifluorométhyl)pipéridine **C**<sub>1</sub> pour obtenir des  $\alpha$ -(trifluorométhyl)pyrrolidines **A**<sub>1</sub> (Schéma 5).

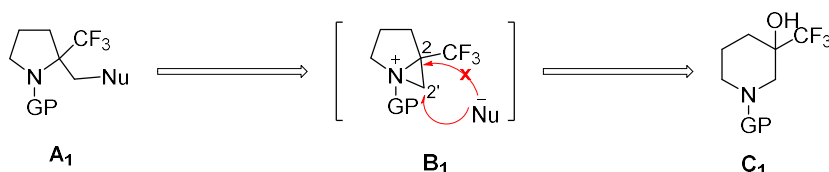

**Schéma 5**

La pipéridine **3** a été facilement obtenue à partir de la *N*-Boc-pipéridin-3-one **1**. Lorsque la pipéridinone **1** a été soumise à une réaction de trifluorométhylation en présence du réactif de Ruppert-Prakash (TMSCF<sub>3</sub>), la (trifluorométhyl)pipéridine **2** a été obtenue avec 77% de rendement. La déprotection de l'amine de **2** en présence d'acide trifluoroacétique (TFA), suivie de la protection par un groupement benzyle (BnBr, K<sub>2</sub>CO<sub>3</sub>, TBAI) a permis la formation de la *N*-benzyl-3-hydroxy-3-(trifluorométhyl)pipéridine **3** avec un rendement quantitatif pour les 2 étapes (Schéma 6). Signalons que le remplacement du groupement Boc par un groupement benzyle est nécessaire pour permettre, grâce à l'assistance anchimérique de l'azote, la formation de l'aziridinium intermédiaire **B**<sub>1</sub> après activation de l'alcool tertiaire.

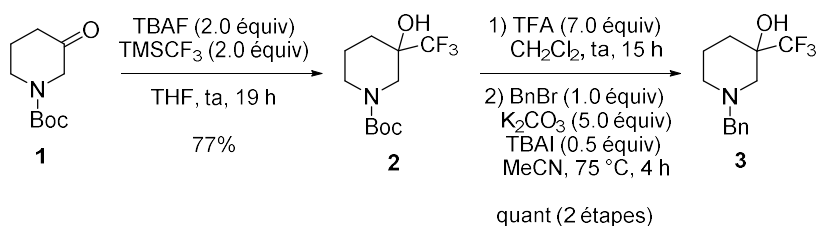

### Schéma 6

Afin d'étudier si la formation de l'aziridinium ainsi que la contraction de la pipéridine **3** était possible, la réactivité de la pipéridine **3** a d'abord été examinée avec du chlorure de thionyle ( $\text{SOCl}_2$ ) dans du  $\text{CH}_2\text{Cl}_2$  en présence d'un excès de triéthylamine ( $\text{Et}_3\text{N}$ ). Cependant, dans ces conditions, le produit désiré **4a** n'a pas été obtenu (Tableau 2, entrée 1). La pipéridine **3** a ensuite été mise en réaction avec de la  $\text{Et}_3\text{N}$  (4.0 équiv) et du chlorure de méthane sulfonyle ( $\text{MsCl}$ ) (3.1 équiv), et dans ces nouvelles conditions, la pyrrolidine chlorée **4a** a été isolée avec néanmoins un rendement faible de 7% et une conversion de 10% de **3** (Tableau 2, entrée 2). Etant donné la faible réactivité de l'alcool tertiaire du composé **3**, cet alcool a été activé par un mélange de triphénylphosphine et de diiode en présence d'imidazole. Le composé souhaité **4b** a été isolé avec un rendement de 25% pour une conversion totale de **3** (Tableau 2, entrée 3). Suite à ce résultat, le composé **3** a été traité par un réactif électrophile plus puissant, à savoir le trifluorure de diéthylaminosulfure (DAST). Le produit fluoré de contraction de cycle **4c** a été obtenu avec un rendement de 71% (Tableau 2, entrée 4). Après avoir vérifié que la contraction de cycle de la (trifluorométhyl)pipéridine **3** était possible, il nous restait à trouver un mode d'activation de **3** compatible avec l'utilisation d'autres nucléophiles comme des amines, des alcools et dérivés, ainsi que des nucléophiles carbonés. Pour cela, la pipéridine **3** a été traitée par de l'anhydride triflique ( $\text{Tf}_2\text{O}$ ) en présence de l'éponge à proton **D** au reflux de  $\text{CH}_2\text{Cl}_2$ . Après 5 h de réaction, de la benzylamine a été ajoutée au milieu réactionnel et dans ces conditions, la pyrrolidine désirée **4d** a été isolée avec un rendement de 75% (Tableau 2, entrée 5).

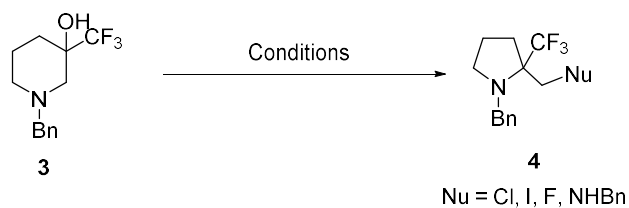

Entrée	Conditions	Nucléophile	Conversion de 3 (%)	Rdt 4 (%)
1	SOCl <sub>2</sub> (1.3 équiv), Et <sub>3</sub> N (4.0 équiv) CH <sub>2</sub> Cl <sub>2</sub>	Cl <sup>-</sup>	–	<b>4a</b> (0%)
2	MsCl (3.1 équiv), Et <sub>3</sub> N (4.0 équiv) CH <sub>2</sub> Cl <sub>2</sub>	Cl <sup>-</sup>	10	<b>4a</b> (7%)
3	PPh <sub>3</sub> (1.5 équiv), Imidazole (2.0 équiv) I <sub>2</sub> (1.5 équiv), THF	I <sup>-</sup>	100	<b>4b</b> (25%)
4	DAST (1.4 équiv) THF	F <sup>-</sup>	100	<b>4c</b> (71%)
5	Tf <sub>2</sub> O (1.5 équiv) Eponge à proton <b>D</b> (2.0 équiv) BnNH <sub>2</sub> (2.5 équiv), CH <sub>2</sub> Cl <sub>2</sub>	BnNH <sub>2</sub>	100	<b>4d</b> (75%)

**Tableau 2**

L'obtention de la pyrrolidine **4d** en fin de réaction, peut s'expliquer par la formation successive des intermédiaires **5** et **6**. Lorsque la pipéridine **3** est traitée par le Tf<sub>2</sub>O, le triflate **5** formé est déplacé par l'atome d'azote de la pipéridine **5**, grâce à une assistance anchimérique et provoque la formation de l'aziridinium intermédiaire **6**. Le nucléophile ajouté dans le milieu peut alors attaquer régiosélectivement cet aziridinium **6** en position C2' pour conduire à la pyrrolidine **4e** (Schéma 7). Signalons que le rôle de l'éponge à proton **D** est de piéger les protons présents dans le milieu réactionnel, afin que le doublet de l'azote reste disponible pour réaliser une attaque nucléophile intramoléculaire et transformer l'intermédiaire **5** en aziridinium **6**.



Schéma 7

Après avoir établi les conditions optimales pour la contraction de cycle de la pipéridine **3**, d'autres nucléophiles ont été impliqués dans la réaction afin d'établir le champ d'application de cette réaction de contraction de cycle. Lorsque l'aniline a été utilisée comme nucléophile, la pyrrolidine **7** a été obtenue avec 71% de rendement. L'utilisation des amines secondaires telles que la *N*-méthylaniline, la diéthylamine, la diallylamine, la dibenzylamine et la morpholine, ont permis d'isoler les pyrrolidines correspondantes **8–12** avec des rendements compris entre 60% et 83% (Schéma 8).

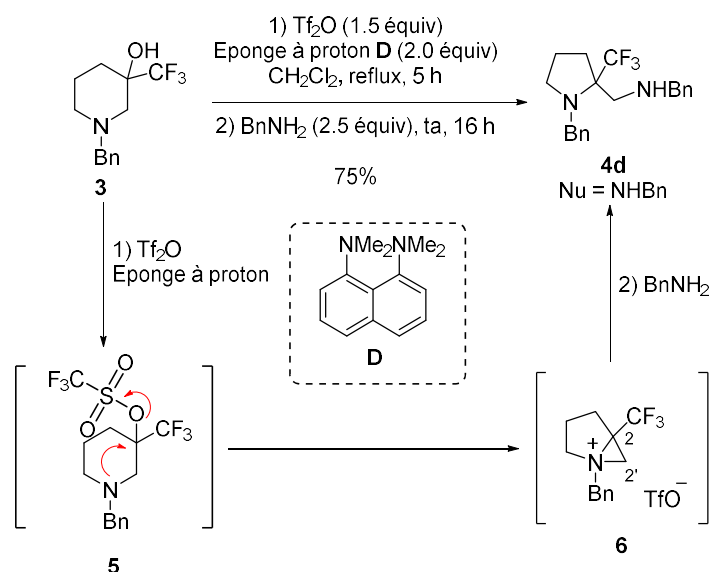

Schéma 8

Suite à ces résultats, l'utilisation de nucléophiles oxygénés a été envisagée. Lorsque des alcools et des alcoolates ont été utilisés, les produits de contraction de cycle **13–19** ont été isolés avec des rendements moyens à bons (51%–77%). Soulignons que l'eau peut être également utilisée comme nucléophile, pour conduire à la pyrrolidine **17** avec 61% de rendement. De plus, le phénolate de sodium ainsi que l'acétate de tétrabutylammonium permettent aussi la formation des produits de contraction de cycle **18** (75%) et **19** (72%) (Schéma 9).

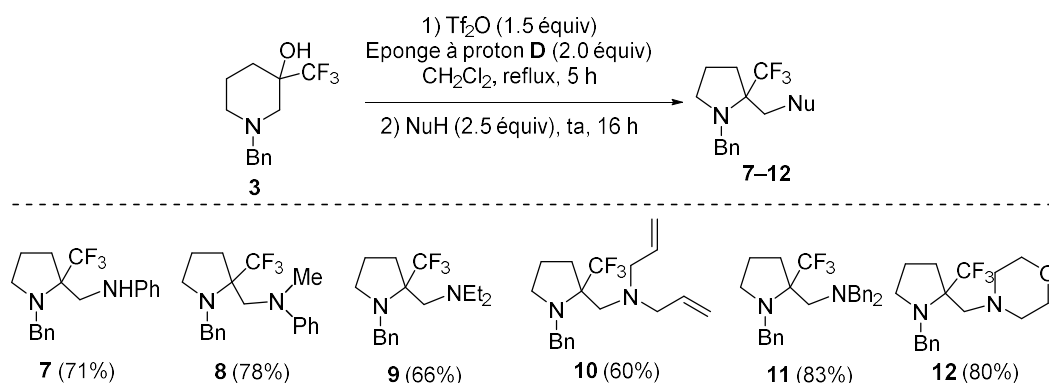
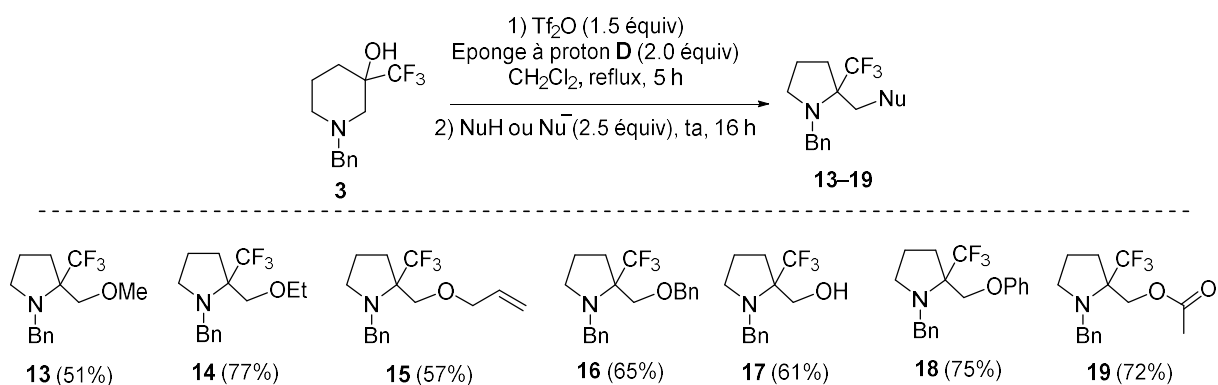

**Schéma 9**

Des nucléophiles soufrés, sous forme de thiols ou de thiolates, peuvent également être engagés dans cette réaction de contraction et les pyrrolidines **20–22** ont été obtenues avec des bons rendements. De plus, lorsque la pipéridine **3** a été traitée par de l'anhydride triflique, en présence de l'éponge à proton **D**, suivi par l'addition du fluorure ou chlorure de tétrabutylammonium, les pyrrolidines **23** et **24** ont été isolées avec des rendements de 30% et 49% respectivement. Enfin, l'addition des nucléophiles carbonés est possible. Lorsqu'un cyanure ou l'anion du malonate de méthyle ont été utilisés comme nucléophiles, les pyrrolidines **25** et **26** ont été isolées avec des bons rendements (Schéma 10).

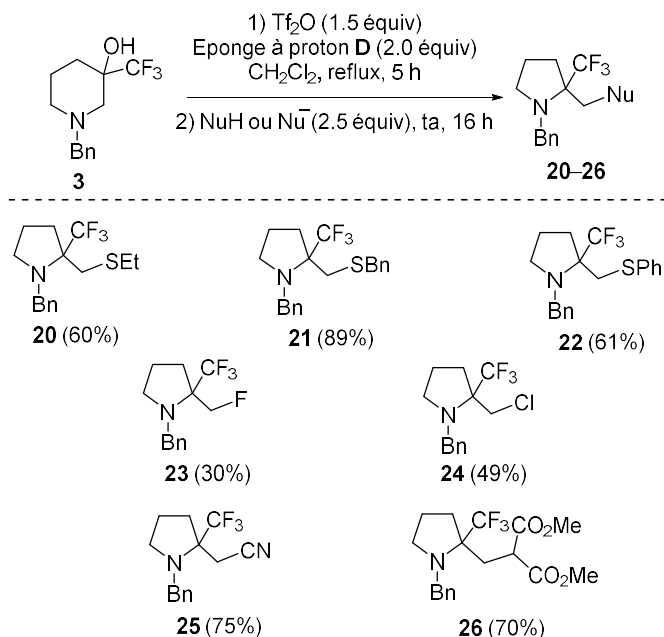

**Schéma 10**

Après avoir étudié le champ d'application de la contraction de cycle de la pipéridine **3** avec divers nucléophiles, nous avons voulu déterminer si au cours de cette réaction, un transfert de chiralité était possible. Pour cela, les deux énantiomères de **3** ont été séparés par SFC (Supercritical Fluid

Chromatography) et ils ont ensuite été traités par de l'anhydride triflique en présence de l'éponge à proton **D**. Après 5 h au reflux du CH<sub>2</sub>Cl<sub>2</sub>, du méthanol a été ajouté au milieu réactionnel. Les composés (+)-**13** et (-)-**13** ont été obtenus avec des pouvoirs rotatoires opposés, indiquant un transfert de chiralité pendant la contraction de cycle. Cependant, la détermination des excès énantiomériques de (+)-**13** et (-)-**13** n'a pas été possible, une autre méthode a donc dû être mise au point pour vérifier ce transfert de chiralité.

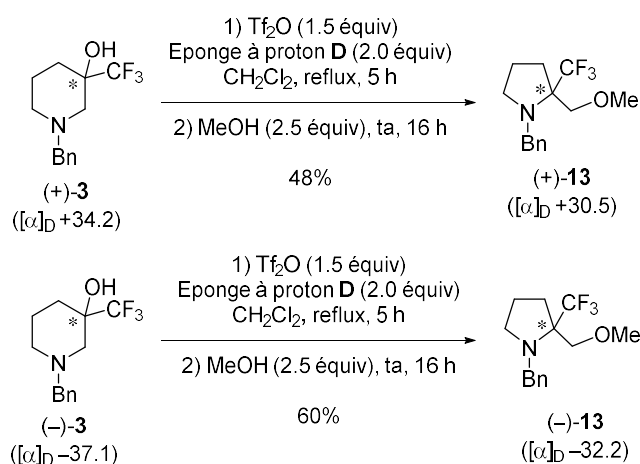

**Schéma 11**

Ainsi, dans un premier temps, la pipéridine **3** a été traitée par de l'anhydride triflique, en présence de l'éponge à proton **D**, suivi par l'addition d'une amine chirale comme nucléophile, la (*S*)-α-méthylbenzylamine. Dans ce cas, la pyrrolidine **27** a été obtenue sous la forme d'un mélange de diastéréoisomères dans un rapport 1:1 (Schéma 12).

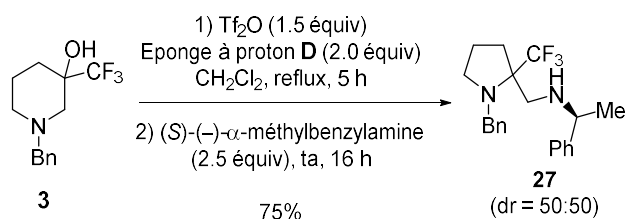

**Schéma 12**

Chacun des deux énantiomères de **3** a été traité dans les mêmes conditions (Tf<sub>2</sub>O/éponge à proton **D**/(*S*)-α-méthylbenzylamine) pour conduire cette fois-ci aux pyrrolidines **27a** et **27b** avec une diastéréosélectivité supérieure à 95>5 pour chaque composé (Schéma 13). Ce résultat, confirme que la contraction de cycle de pipéridines en pyrrolidines procède *via* un transfert total de chiralité.



Schéma 13

Afin de connaître l'influence du groupement  $\text{CF}_3$  sur le processus de contraction de cycle, la pipéridine **28**, substituée en position C3 par un groupement méthyle à la place du groupement trifluorométhyle, a été traitée par  $\text{Tf}_2\text{O}$ /éponge à proton **D**, suivi de l'ajout du fluorure de tétrabutylammonium. Le composé **30** a été obtenu avec un rendement de 36% tandis que le produit attendu de contraction **29** n'a pas été observé. Cela confirme donc l'hypothèse selon laquelle, le groupement  $\text{CF}_3$  agit comme un groupement directeur qui oriente le réarrangement de l'aziridinium intermédiaire vers le produit de contraction de cycle (Schéma 14).

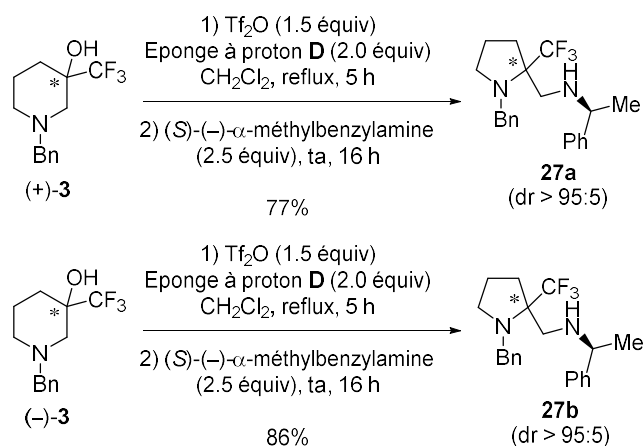

Schéma 14

### B) Synthèse de 2-(trifluorométhyl)pipéridines, 2-substituées

Suite à ces travaux, nous avons voulu appliquer les conditions précédemment développées ( $\text{Tf}_2\text{O}$ /éponge à proton **D**/nucléophile) au 3,3-hydroxy-(trifluorométhyl)azépane **C<sub>2</sub>** afin d'accéder à des  $\alpha$ -(trifluorométhyl)pipéridines **A<sub>2</sub>** (Schéma 15).

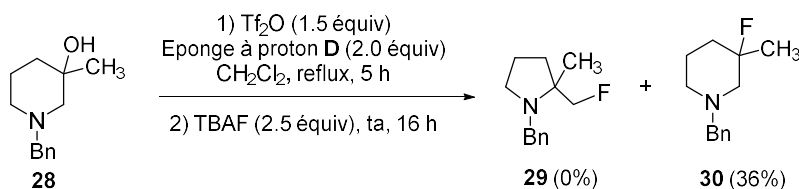

Schéma 15

Le *N*-benzylazépane **39** a été synthétisé à partir du chloroacétaldéhyde **31** en 9 étapes. Le chloroacétaldéhyde **31** a été mis en réaction avec de la poudre d'indium et du bromure d'allyle dans



l'eau pour donner, après 3 h, le composé **32** avec 80% de rendement. Le composé **32**, a ensuite été mis en réaction avec de l'allylamine pour former l'amino-alcool **33** avec un rendement de 96%, puis cet amino-alcool a été protégé par un groupement Boc pour conduire au composé **34** avec un rendement de 93%. Après la métathèse cyclisante de **34** en présence du catalyseur de Grubbs de première génération (Grubbs-I), l'azépane **35** a été obtenu avec 69% de rendement. Cet azépane a ensuite été hydrogéné en présence d'une quantité catalytique de PtO<sub>2</sub> dans l'éthanol, pour donner le produit réduit **36** avec un rendement quantitatif. L'oxydation du composé **36** en présence du réactif de Dess-Martin, a permis la formation de l'azépanone **37** (86% de rendement). Après trifluorométhylation de **37** pendant 5 jours, à l'aide du TMSCF<sub>3</sub>, le (trifluorométhyl)azépane **38** a été isolé avec 93% de rendement. Les deux dernières étapes de la synthèse de **39** consistent en la déprotection de la fonction amine de **38** suivie de sa protection par un groupement benzyle, pour conduire au 3,3-hydroxy-(trifluorométhyl)azépane **39** (85%, 2 étapes) (Schéma 16).

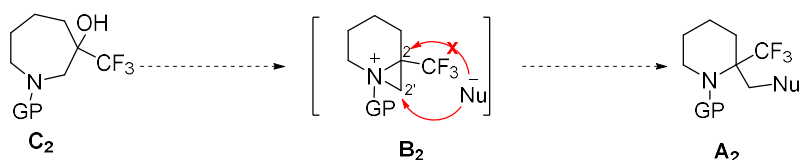

Schéma 16

Ayant synthétisé le substrat de départ **39**, ce dernier a été traité par de l'anhydride triflique, en présence de l'éponge à proton **D** au reflux du CH<sub>2</sub>Cl<sub>2</sub> et après 5 h, différents nucléophiles ont été ajoutés au milieu réactionnel. Lorsque des amines primaires comme la benzylamine ou l'aniline ont été utilisées, les pipéridines **40** et **41** ont été isolées respectivement avec un rendement de 62% et

un rendement quantitatif. De plus, les  $\alpha$ -(trifluorométhyl)pipéridines **42–45** ont été obtenues avec de très bons rendements, lorsque des amines secondaires, telles que la diéthylamine, la diallylamine, la benzylamine et la morpholine, ont été utilisées comme nucléophiles (Schéma 17).

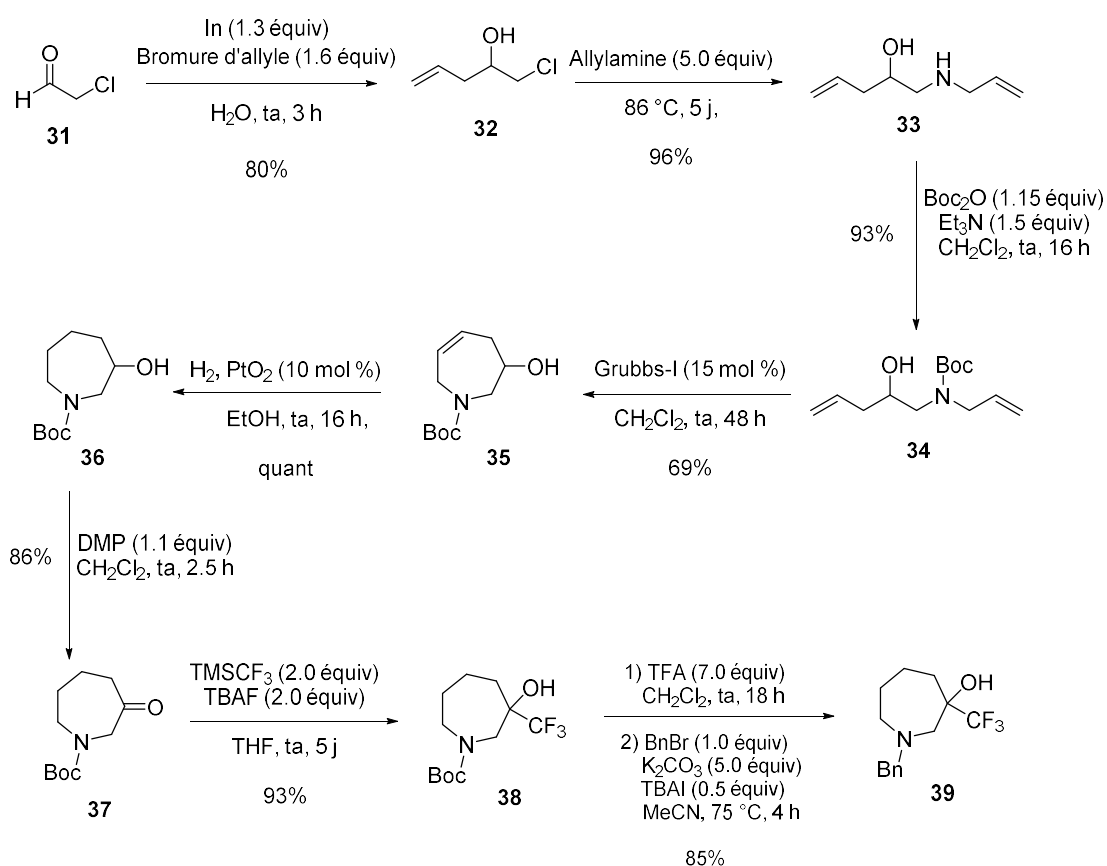
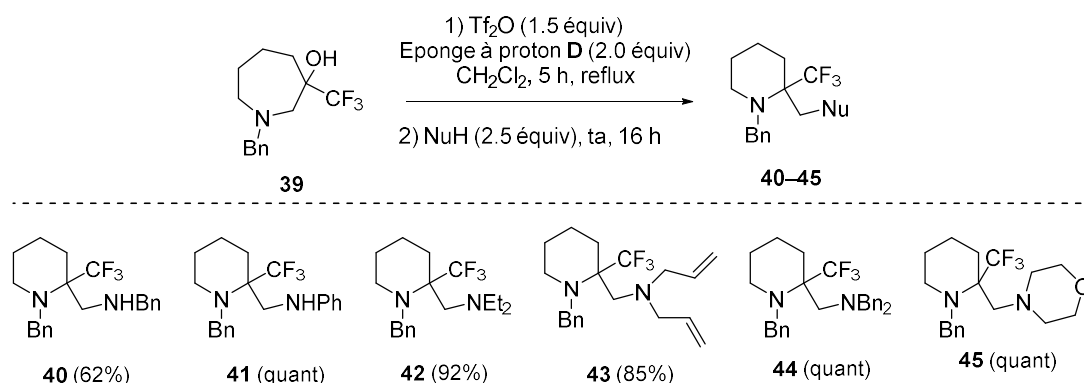

**Schéma 17**

Après avoir étudié la réactivité de l'aziridinium **B**<sub>2</sub> vis-à-vis de nucléophiles azotés, des nucléophiles oxygénés, sous forme d'alcools ou d'alcoolates, ont été examinés. Ainsi, les pipéridines **46–52** ont été synthétisées avec de très bons rendements (82%–quant). Soulignons que les meilleurs résultats ont été obtenus lorsque le nucléophile est sous la forme d'alcoolate ( $\text{PhO}^-$ ) et d'acétate ( $\text{AcO}^-$ ) puisque les pipéridines **51** et **52** ont été isolées avec des rendements quantitatifs (Schéma 18).

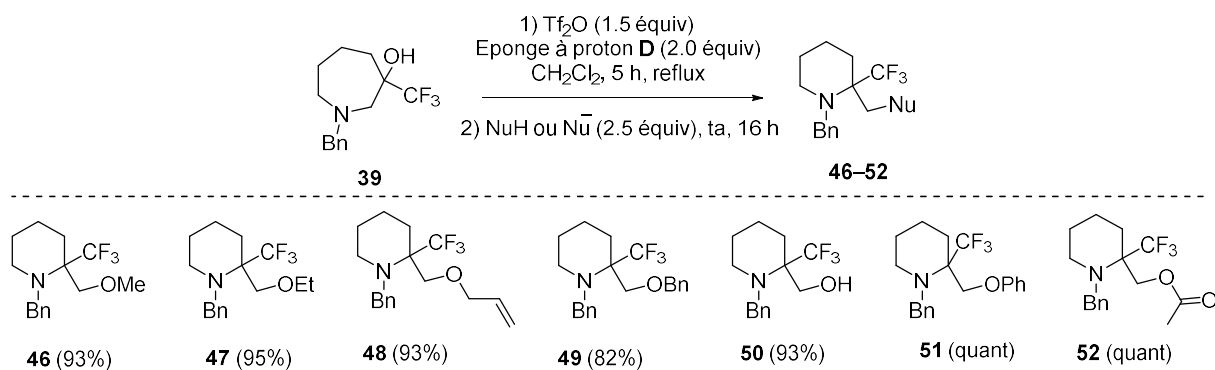

**Schéma 18**

Deux nucléophiles soufrés sous la forme de thiolates ont été utilisés pour réaliser la contraction de cycle. Les  $\alpha$ -(trifluorométhyl)pipéridines désirées **53** et **54** ont été isolées avec des bons rendements. Les sels d'halogénures tels que le fluorure, le chlorure, le bromure et l'iodure de tétrabutylammonium ont aussi été utilisés, afin d'obtenir les pipéridines halogénées **55–58** avec des rendements allant de 69% à 89%. De plus, les pipéridines **59** et **60** ont été isolées avec des rendements excellents, lorsque le cyanure ou l'anion du malonate de méthyle ont été impliqués dans le processus de contraction de cycle. Signalons que le traitement de l'azépane **39**, par l'anhydride triflique, suivi de l'addition du borohydrure de sodium, a permis l'obtention du composé **61** avec 73% de rendement (Schéma 19).

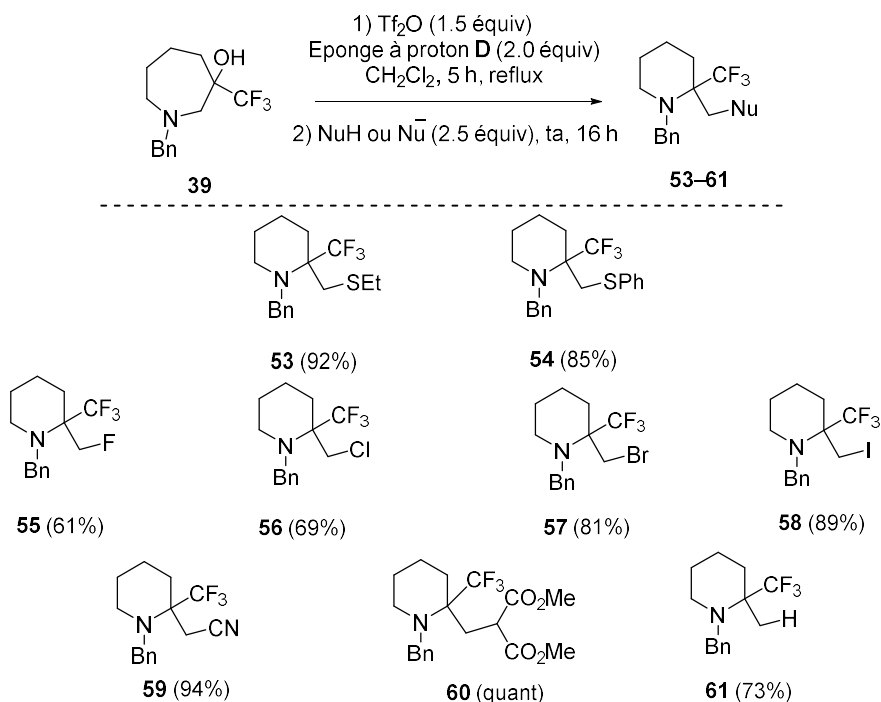

**Schéma 19**

Il est intéressant de noter que la fluorométhyl-pipéridine **55** a été obtenue avec un rendement amélioré de 71% *versus* 61% lorsque l'azépane **39** a été traité par du DAST dans le THF (Schéma 20 *versus* Schéma 18).

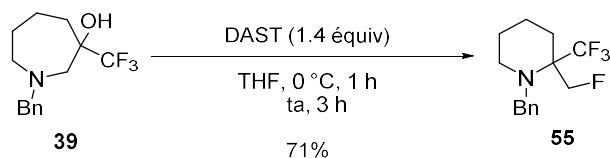

**Schéma 20**

La synthèse d' $\alpha$ -(trifluorométhyl)pipéridines substituées par un groupement alkyle a ensuite été envisagée. Pour cela, le (trifluorométhyl)azépane **39** a été traité par Tf<sub>2</sub>O/éponge à proton **D**, suivi de l'addition d'un organocupromagnésien. Le composé désiré **62** a été obtenu avec 50% de rendement. Parallèlement à la formation de **62**, la formation du composé **56** a été observée par analyse GC/MS, indiquant une réaction entre l'ion chlorure de l'organocupromagnésien et l'aziridinium intermédiaire (Schéma 21).

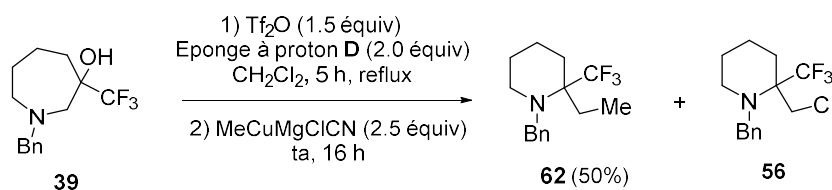

**Schéma 21**

Afin d'étudier l'influence du groupement CF<sub>3</sub> sur la régiosélectivité de la réaction, nous avons remplacé le groupement CF<sub>3</sub> de l'azépane **39**, par un groupement CH<sub>3</sub>, comme nous l'avons fait pour la contraction de la pipéridine **3**. Lors du traitement de l'azépane **63** par Tf<sub>2</sub>O/éponge à proton **D** suivi par l'addition de fluorure de tétrabutylammonium, la pipéridine **64** n'a pas été observée. Le seul produit isolé a été l'azépane **65** (31%), confirmant encore une fois le rôle important du CF<sub>3</sub> comme groupement directeur pendant la contraction de cycle (Schéma 22).

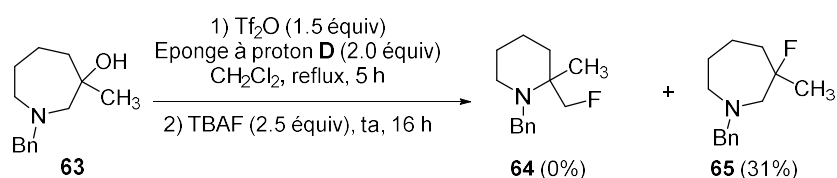

**Schéma 22**

Pour résumer, la synthèse d' $\alpha$ -(trifluorométhyl)pyrrolidines et d' $\alpha$ -(trifluorométhyl)pipéridines, possédant un centre quaternaire en position C2, a été réalisée par contraction de cycle de pipéridines et d'azépanes trifluorométhylées. La réaction est compatible avec une variété de nucléophiles tels que des amines, des alcools, des halogènes ou mêmes des nucléophiles soufrés et carbonés. De plus, il a été démontré que les contractions de cycle s'effectuaient *via* un transfert de chiralité. Enfin, notre hypothèse selon laquelle le pôle d'attaque du nucléophile sur l'intermédiaire bicyclique aziridinium était dirigé par le groupement trifluorométhyle a été validée.

### **Chapitre 3 : Synthèse d' $\alpha$ -(trifluorométhyl)pyridazines par une séquence de cycloadditions**

#### **[2+1]/[3+2]**

Les pyridazines sont des hétérocycles aromatiques à six chaînons comportant deux atomes d'azote adjacents. Depuis leur découverte dans certains produits naturels ainsi qu'à la lumière des activités biologiques variées que ces produits possèdent, un grand intérêt synthétique pour le motif pyridazine est apparu ces dernières années. Au vu de l'importance pour le noyau pyridazine ainsi que les bénéfices apportés par le fluor en chimie médicinale, la mise au point d'une méthode de synthèse d' $\alpha$ -(trifluorométhyl)pyridazines est donc intéressante.

En se basant sur des travaux précédemment effectués au laboratoire, nous avons envisagé d'accéder aux 6-(trifluorométhyl)pyridazines **I** par une séquence de cycloadditions [2+1]/[3+2] impliquant un alcyne terminal, un difluorocarbène et un composé diazo. En effet, le difluorocyclopropène **F** pourrait être formé lorsque l'alcyne **E** serait mis en réaction avec le difluorocarbène. Ce difluorocyclopropène, pourrait ensuite réagir avec le (trifluorométhyl)diazométhane pour conduire à une cyclopropanopyrazoline **G**. Suite au réarrangement de **G** suivie d'une aromatisation de **H**, les (trifluorométhyl)pyridazines **I** pourraient être obtenues (Schéma 23).



Schéma 23

Le (trifluorométhyl)diazométhane **67**, peut être formé à partir du chlorure de la trifluoroéthylamine **66**, en présence du nitrite de sodium dans un mélange  $\text{CH}_2\text{Cl}_2/\text{H}_2\text{O}$  à  $0^\circ\text{C}$ . De l'acide nitreux ( $\text{HNO}_2$ ), généré *in situ*, réagit avec la trifluoroéthylamine **66** pour former l'intermédiaire nitroso qui, après une déshydratation, conduit au (trifluorométhyl)diazométhane **67** (Schéma 24).

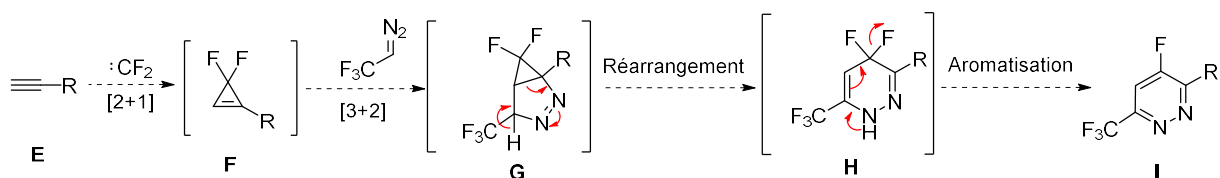

Schéma 24

Afin de vérifier si la réaction de cycloaddition entre un alcyne, un difluorocarbène et le (trifluorométhyl)diazométhane serait possible, le phénylacétylène a été mis en réaction avec le réactif de Ruppert-Prakash ( $\text{TMSCF}_3$ ) et d'iodure de sodium ( $\text{NaI}$ ) dans le THF à  $110^\circ\text{C}$  pendant 2 h. Dans ces conditions, l'ion iodure attaque le silicium du  $\text{TMSCF}_3$  pour former l'anion  $\text{CF}_3^-$ , qui grâce à la haute température, peut se décomposer en ion  $\text{F}^-$  et en difluorocarbène. Une fois le difluorocarbène formé, celui-ci peut subir une cycloaddition [2+1] en présence de phénylacétylène, afin de former un difluorocyclopropène. En présence du (trifluorométhyl)diazométhane (0.6 M dans le  $\text{CH}_2\text{Cl}_2$ ), ce difluorocyclopropène peut subir une deuxième cycloaddition [3+2] pour mener à la pyridazine désirée **68** avec 87% de rendement (Schéma 25).



L'étude du champ d'application de la séquence de cycloadditions [2+1]/[3+2] a été ensuite réalisée sur des alcynes terminaux, substitués par des groupements aryles possédant des groupements riches en électrons. Lorsque le noyau aromatique porte un substituant électro-donneur en position *ortho* ou *para*, les pyridazines correspondantes **69–71** ont été isolées avec de très bons rendements (73%–83%). La pyridazine **72**, fonctionnalisée par un noyau benzénique tri-substitué, a été isolée avec un bon rendement de 76%. Cependant, la pyridazine **73**, dont le noyau aromatique est substitué par un groupement *N,N*-diméthylaniline, n'a pas été obtenue, probablement à cause d'une incompatibilité entre le caractère nucléophile de l'azote de l'aniline et le caractère électrophile du difluorocarbène. Signalons qu'un alcyne terminal substitué par un groupement naphtyle peut aussi être engagé dans la séquence de cycloadditions pour donner la (trifluorométhyl)pyridazine **74** avec 79% de rendement. (Schéma 26).

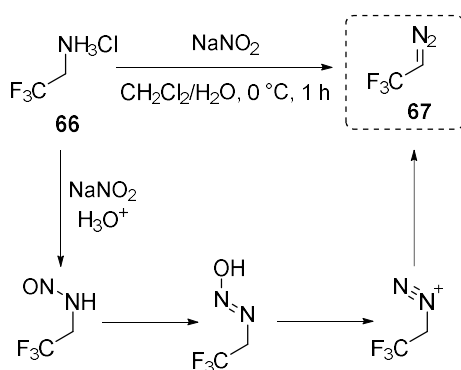
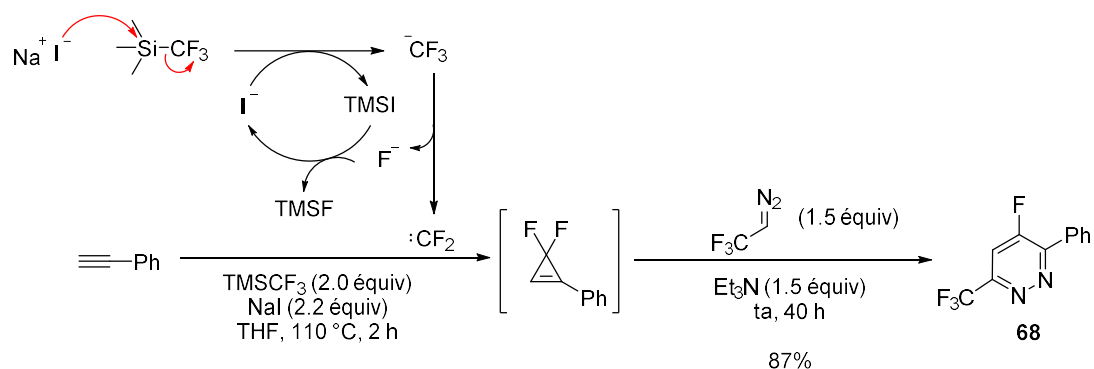
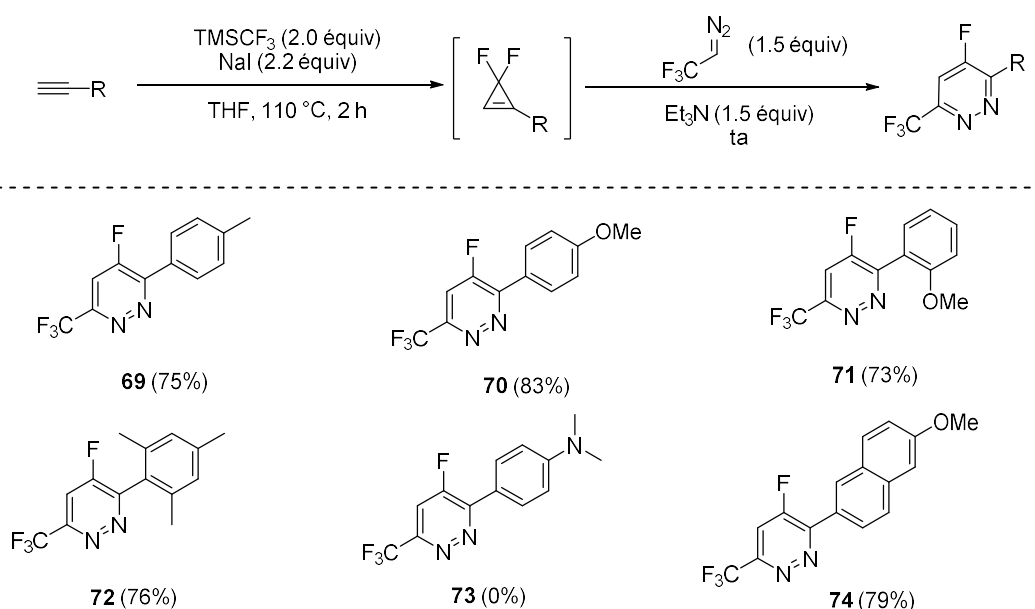

Nous nous sommes par la suite intéressés à des alcynes terminaux portant des aryles qui possèdent des groupements électro-attracteurs. Lorsque le groupement aryle est substitué par un groupement  $\text{CF}_3$  en position *ortho*, ou un groupement ester en position *mé*ta et *para*, les pyridazines **75**, **76** et **77** ont été isolées avec des bons rendements de 66% à 76%. Cependant, la présence d'un groupement phosphonate, ainsi qu'un groupement nitro sur le noyau aromatique a conduit aux pyridazines **78** et **79** avec des rendements plus faibles de 27% et 34% respectivement. Des aryles substitués par des halogènes peuvent aussi être engagés dans la séquence de cycloadditions [2+1]/[3+2], puisque les pyridazines **80**, **81** et **82** ont été formées avec des rendements qui varient de moyens à bons (Schéma 27).

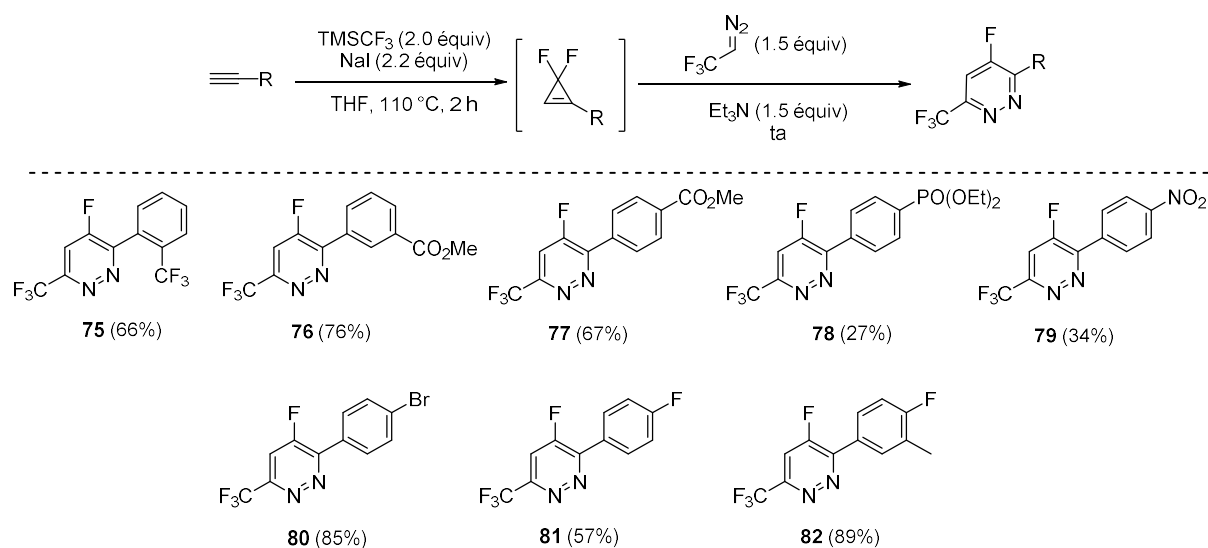

**Schéma 27**

Devant les faibles rendements des pyridazines **78** et **79**, un autre protocole a été mis en place afin d'accéder à ces composés avec des meilleurs rendements. Ainsi, le difluorocarbène peut être généré par réaction du fluorosulfonyldifluoroacétate de triméthylsilyle (TFDA) avec du fluorure de sodium (NaF) dans le diglyme à 120 °C. En effet, le TFDA est décomposé en difluorocarbène à 120 °C par une quantité catalytique de NaF, générant un équivalent de TMSF, du  $\text{CO}_2$ , du  $\text{SO}_2$  ainsi qu'un ion  $\text{F}^-$ . Il s'agit donc d'un procédé qui ne génère pas de nucléophiles tels que  $\text{CF}_3^-$  ou l'ion  $\text{I}^-$  dans le milieu réactionnel (Schéma 28).



Schéma 28

Après traitement des alcynes possédant des groupements aryles appauvris en électrons, avec du TFDA en présence de NaF dans le diglyme, les pyridazines correspondantes ont toutefois été obtenues avec des rendements similaires à ceux obtenus avec le protocole  $\text{TMSCF}_3/\text{NaI}$ . Seule la pyridazine **79**, possédant un aryle avec un groupement nitro en position *para*, a été isolée avec un rendement supérieur de 56% *versus* 34% obtenu avec  $\text{TMSCF}_3/\text{NaI}$ . De plus, la pyridazine **83**, possédant un aryle substitué par un cyanure en position *mé*ta a été obtenue avec 60% de rendement (Schéma 29).

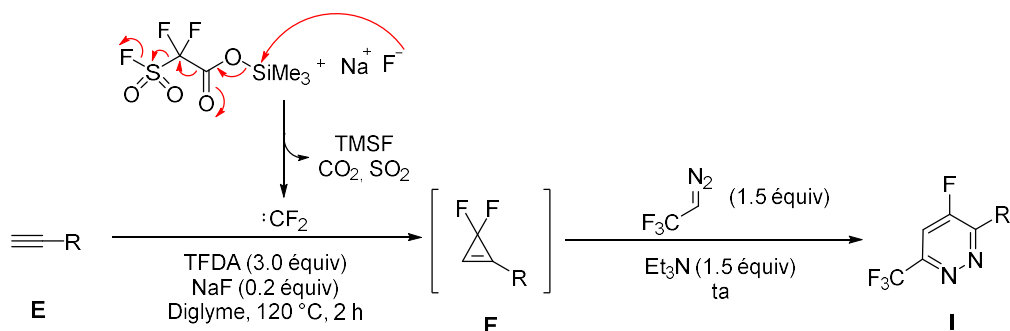

Schéma 29

Après avoir étudié la réactivité de divers alcynes terminaux substitués par des aryles dans la séquence de cycloadditions  $[2+1]/[3+2]$ , la réactivité d'alcynes terminaux substitués par des hétérocycles aromatiques a été examinée. Plus précisément, des alcynes substitués par une pyridine, un thiophène ainsi qu'un groupement benzoxazole ont été traités dans les deux conditions réactionnelles ( $\text{TMSCF}_3/\text{NaI}$  ou/et TFDA/NaF), et les pyridazines **84–88** ont été isolées avec des rendements qui varient de faibles à très bons. Signalons que dans le cas des pyridazines **84** et **86**, l'utilisation du protocole TFDA/NaF a mené à la dégradation du produit (Schéma 30).



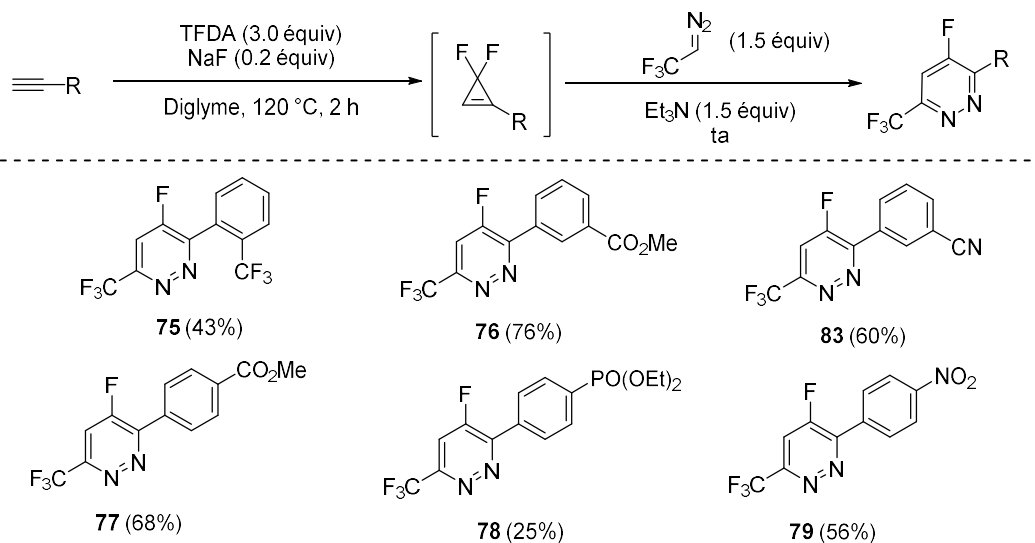
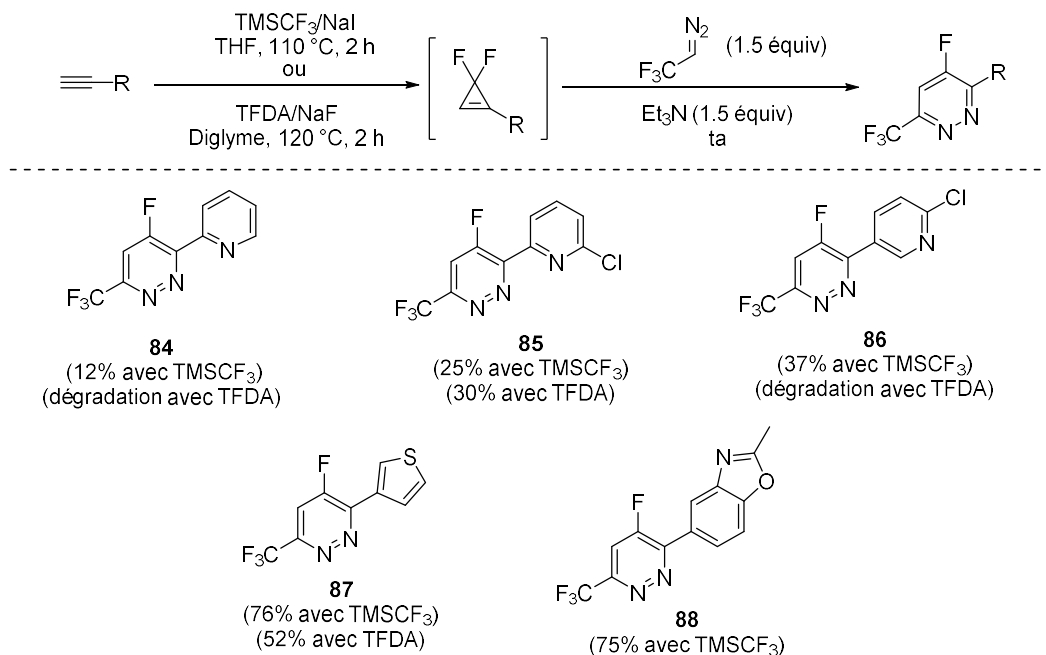

**Schéma 30**

La réactivité des alcynes terminaux substitués par des groupements alkyles a été également étudiée. Les pyridazines **89–91**, possédant des groupements alkyles en position C3, ont été obtenues avec des rendements plus modestes de 20%–39% comparés à ceux obtenus avec des alcynes substitués par des groupements aryles (Schéma 31).

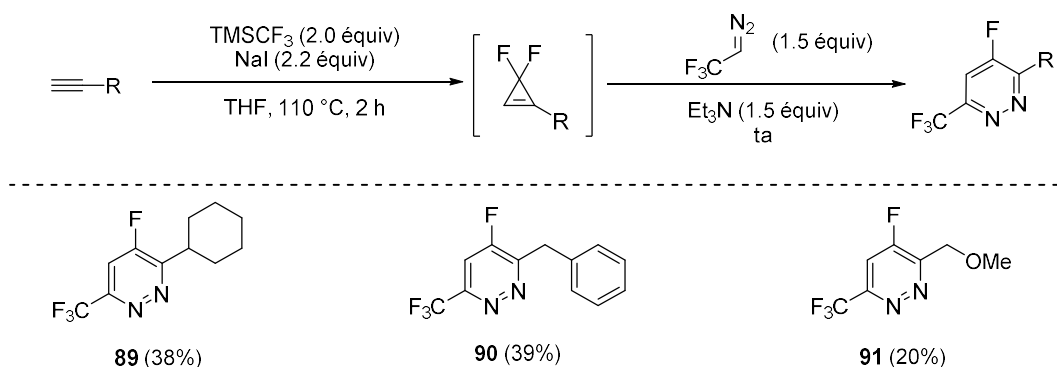

**Schéma 31**

Des alcynes terminaux substitués par des chaînes alkyles portant une fonction amine protégée ont ensuite été engagés dans la séquence de cycloadditions [2+1]/[3+2]. Ainsi, les pyridazines **92** et **93**, possédant des groupements phthalimides, ont été obtenues avec des rendements modestes en appliquant les deux protocoles. Enfin, la pyridazine **94** a aussi été isolée avec un rendement de 64% (TMSCF<sub>3</sub>/NaI) et 36% (TFDA/NaF) (Schéma 32).

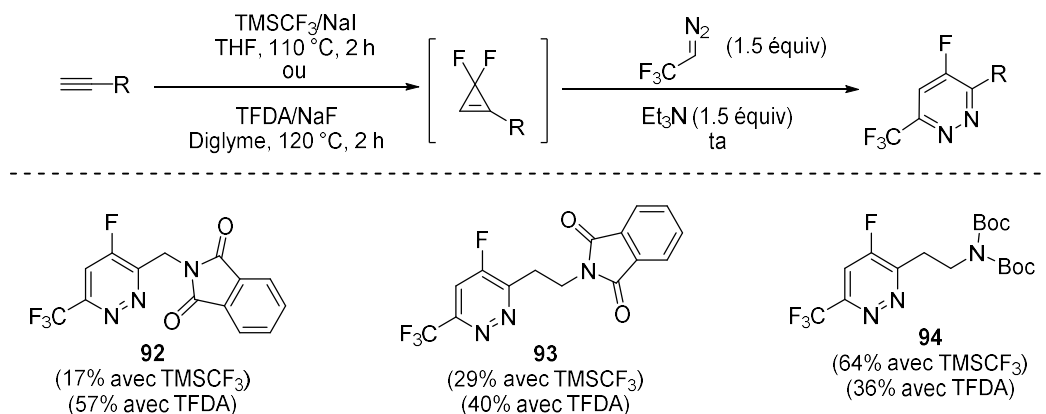

**Schéma 32**

Afin d'élargir cette séquence de cycloadditions à la synthèse de pyridazines substituées en position C6 par différents groupements fluorés, d'autres composés diazo ont été préparés et utilisés. Le (pentafluoroéthyl)diazométhane a été préparé dans le laboratoire de façon similaire au (trifluorométhyl)diazométhane, et il a pu être engagé dans la réaction de cycloaddition [3+2], pour conduire à la pyridazine **95** avec 71% de rendement (Schéma 33).

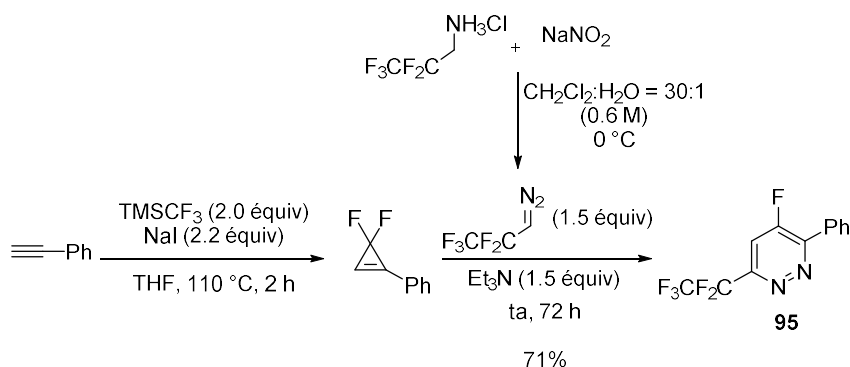

**Schéma 33**

De la même manière, lorsque le (difluorométhyl)diazométhane, préparé à partir de la difluoroéthylamine et du nitrite de *tert*-butyle, a été mis en réaction avec le difluorocyclopropène obtenu par cycloaddition [2+1] du difluorocarbène sur le phénylacétylène, la fluoropyridazine **96** a été isolée avec un rendement modeste de 44% (Schéma 34).



Schéma 34

La séquence de cycloadditions [2+1]/[3+2] est donc une méthode générale et efficace, qui permet de synthétiser des pyridazines **J** possédant différents substituants en positions C3 et C6. Toutefois, la substitution en position C4 reste limitée au fluor. Comme les halogéno-pyridazines peuvent être impliquées dans des substitutions nucléophiles aromatiques ( $S_NAr$ ), le déplacement de l'atome de fluor en cette position par différents nucléophiles a été envisagé, afin d'obtenir une diversité de pyridazines 3,4,6-fonctionnalisées **K** (Schéma 35).

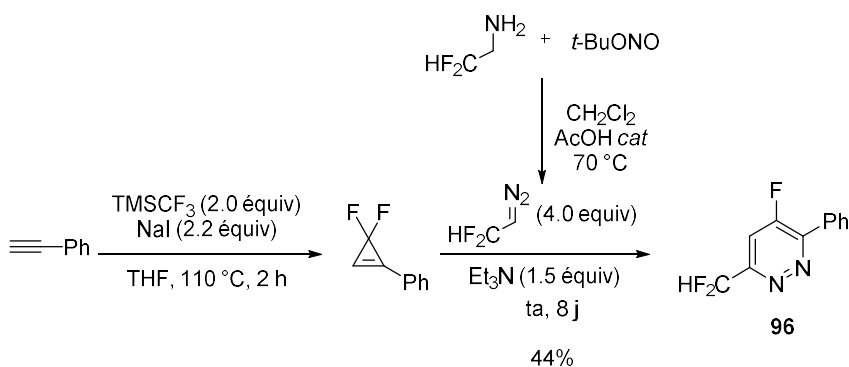

Schéma 35

Ainsi, lorsque la pyridazine **68** a été traitée par la benzylamine dans l'acétonitrile, la pyridazine désirée **97** a été isolée avec 83% de rendement. D'autres nucléophiles ont été utilisés et il est apparu que les amines, les alcools et les composés soufrés sont des nucléophiles capables de substituer l'atome de fluor, pour accéder aux pyridazines **98–102** avec de très bons rendements. L'anion du malonate de méthyle a aussi permis de déplacer sélectivement l'atome de fluor, et la pyridazine **103** a été isolée avec 92% de rendement. Enfin les pyridazines **104** et **105**, substituées respectivement par un groupement nitrométhane et un groupement méthyle en position C4, ont été obtenues avec des rendements plus faibles de 52% et 12% (Schéma 36).

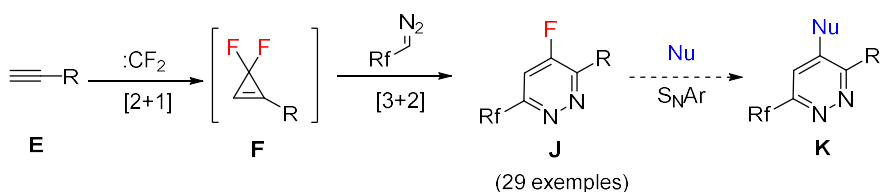
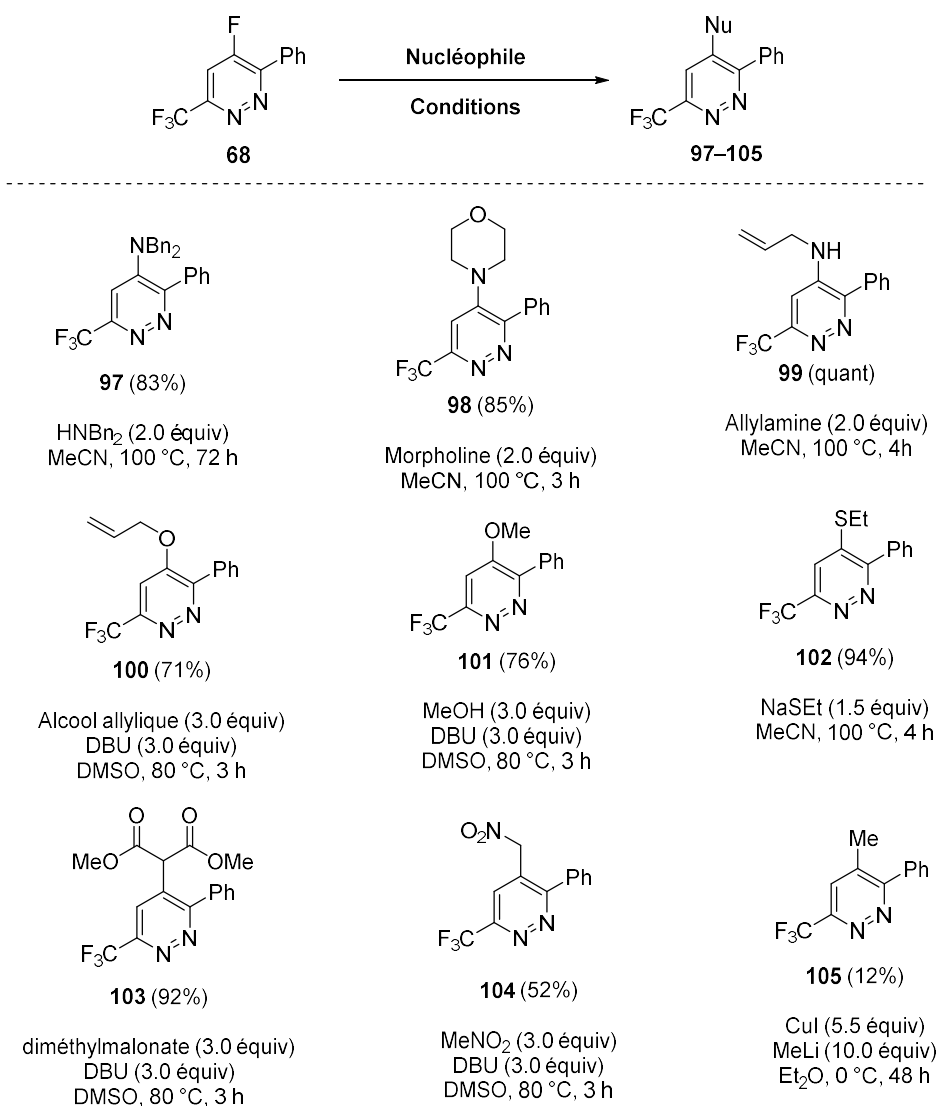

### Schéma 36

Après avoir examiné la réactivité de la pyridazine **68** vis-à-vis de différents nucléophiles, l'influence du substituant en position C3 sur la S<sub>N</sub>Ar a été examinée. Pour cela, la réactivité des pyridazines possédant des aryles électro-appauvris ainsi que des aryles électro-enrichis a été étudiée en utilisant comme nucléophile la morpholine. Lorsque la pyridazine **81** substituée par un aryle possédant un atome de fluor en position *para* a été testée, le composé attendu **106** a été obtenu avec un rendement quantitatif. La pyridazine **77** substituée par un aryle en C3 portant un groupement mésomère-attracteur en *para* (ester de méthyle) en C3 a conduit au produit **107** avec 82% de rendement. Enfin, lorsque le substituant en C3 est un aryle possédant un groupement méthoxy en position *para* ou *ortho*, les pyridazines **108** et **109** ont été obtenues avec des rendements bons à excellents (Schéma 37). Il semble donc que les propriétés électroniques du substituant en position C3 de la pyridazine n'influencent que légèrement la réaction S<sub>N</sub>Ar.

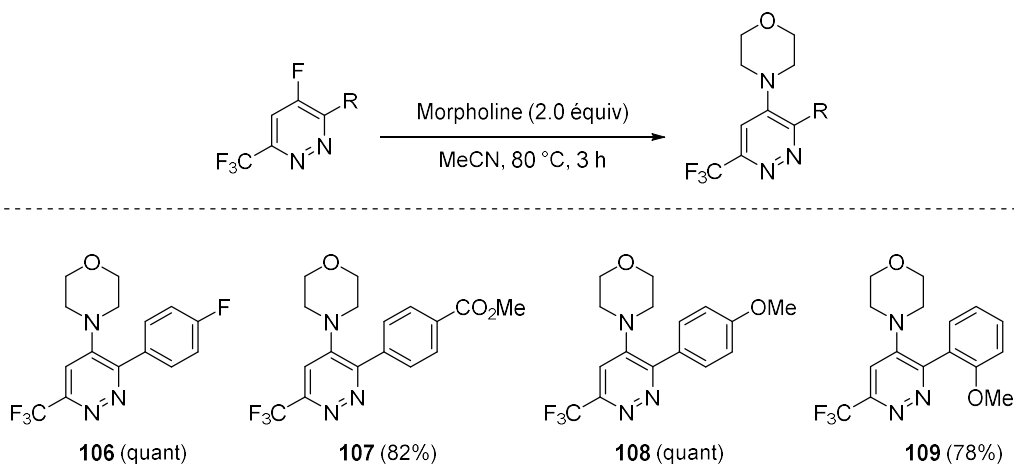

**Schéma 37**

L'influence du substituant en position C6 vis-à-vis de la  $S_NAr$  a également été examinée. Ainsi, lorsque la pyridazine **95**, substituée par un groupement pentafluoroéthyle en position C6, a été traitée par l'allylamine ainsi que par l'éthanethiolate de sodium, les pyridazines **110** et **111** ont été isolées avec des rendements respectifs de 90% et 84% (Schéma 38).

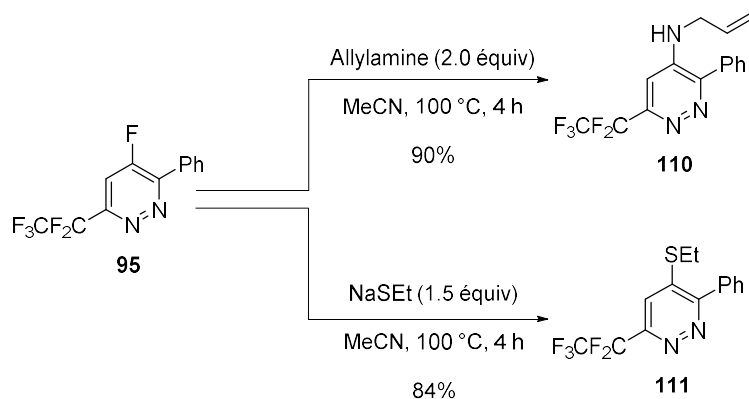

**Schéma 38**

De façon similaire, le traitement de la pyridazine **96**, possédant un groupement difluorométhyle en position C6, par l'allylamine et l'éthanethiolate de sodium, a conduit respectivement aux pyridazines **112** et **113** avec des rendements de 92% et 87% (Schéma 39).

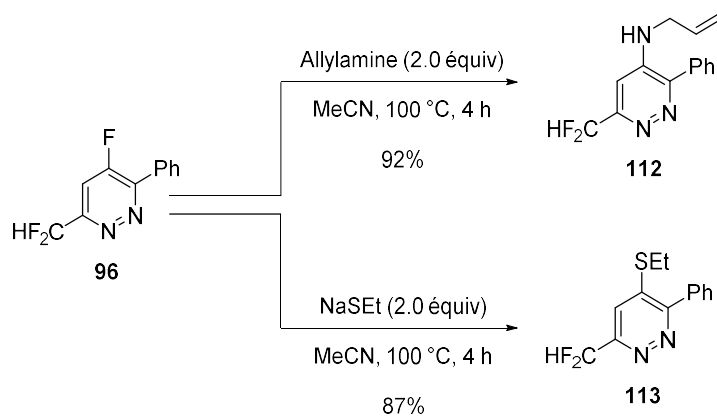

**Schéma 39**

Pour conclure, nous avons montré que des alcynes terminaux peuvent être engagés dans une séquence de cycloadditions [2+1]/[3+2] avec un difluorocarbène et par la suite avec un composé diazo, afin d'accéder à des pyridazines possédant un atome de fluor en position C4. Grâce à une substitution nucléophile aromatique, ces pyridazines peuvent être ensuite fonctionnalisées en position C4, ce qui permet d'accéder à une diversité de 3,4,6-pyridazines tri-substituées.



# **General Introduction**





Our quality of life is closely linked to the discovery of new drugs and biologically active molecules. Among others, heterocycles represent an important family for the pharmaceutical and agrochemical industry, with 70% of pharmaceuticals and agrochemicals containing a heterocyclic motif.<sup>1</sup> Indeed, the insertion of such motif in a drug candidate can not only influence its physico-chemical properties but can also act as a bioisoster of other heterocycles.

However, the development of such bioactive molecules, which have no secondary effects for humans is often complicated. In order to modulate the physico-chemical and pharmacokinetical properties of a compound, medicinal chemists have turned their attention to the introduction of one or more fluorine atoms. This modification allows the improvement of a variety of properties such as a molecules lipophilicity, selectivity or bioavailability.

Consequently, the research for novel synthetic methods, which would allow access to fluorinated heterocycles, is imperative. Our work is focused on this purpose.

This manuscript is divided in three chapters.

The **first chapter** deals with fluorine in medicinal chemistry. The influence of fluorine on molecules chemical and physico-chemical properties will be discussed.

The **second chapter** is devoted to the ring contraction of (trifluoromethyl)piperidines and (trifluoromethyl)azepanes *via* an aziridinium intermediate to obtain 2-substituted, 2-(trifluoromethyl)pyrrolidines (eq 1) and 2-substituted, 2-(trifluoromethyl)piperidines (eq 2) respectively. Bibliographic data concerning the chemistry of 2-substituted, 2-(trifluoromethyl)pyrrolidines and 2-substituted, 2-(trifluoromethyl)piperidines will be presented.

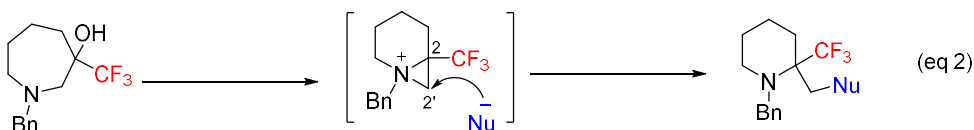
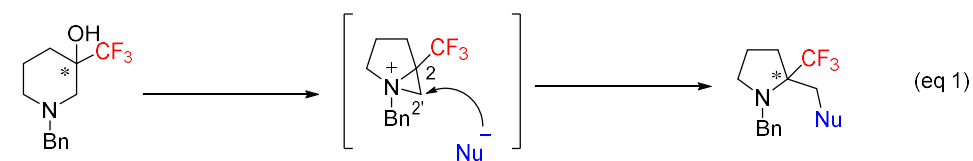

<sup>1</sup> *Bioactive Heterocyclic Compound Classes : Pharmaceuticals and Agrochemicals*; Lamberth, C.; Dinges, J., Eds.; Wiley-VCH : Weinheim, **2012**.

The **third chapter** deals with the synthesis of  $\alpha$ -(trifluoromethyl)pyridazines by a [2+1]/[3+2]-cycloaddition sequence between a terminal alkyne, a difluorocarbene and (trifluoromethyl)diazomethane.

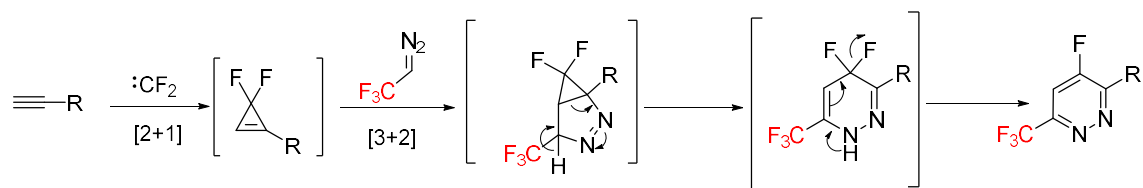

These (trifluoromethyl)pyridazines could be further functionalized at the C4 position to lead to a diversity of 3,4,6-substituted pyridazines.

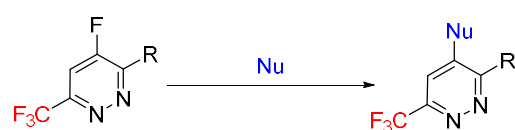

Bibliographic data concerning the chemistry of  $\alpha$ -(trifluoromethyl)pyridazines will be presented.

The molecules, figures, schemes and tables will be numbered according to their order of apparition in the manuscript. For the presentation of bibliographic data, the number of each molecule will be preceded by **L2** (for chapter 2) and **L3** (for chapter 3). For the presentation of our results, the molecules will be numbered starting from **1** for each chapter.

# **CHAPTER 1**

## **Fluorine in medicinal chemistry**



# 1. Introduction

Since the isolation of fluorine in 1886 by Henri Moissan, who was awarded the Nobel Prize in 1906, fluorinated compounds have opened new opportunities due to their interesting properties. Indeed, before 1950, the idea that the incorporation of a fluorine atom in a natural compound could have a beneficial effect on its biological properties was inconceivable, especially given that the first fluorinated natural product was toxic (Figure 1).<sup>2</sup>

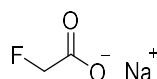

Sodium fluoroacetate

Figure 1

However, since 1955 and after the approval of the first fluorine-containing drug, around 150 fluorinated molecules have reached the market. Indeed, to date around 25% of all marketed drugs contain a fluorine atom.<sup>3</sup>

## 2. Fluorine properties and its influence on the chemical and physico-chemical properties of molecules

### 2.1. C–F bond generalities

Fluorine is a small atom with a Van der Waals radius close to the Van der Waals radius of oxygen (Table 1).<sup>4</sup> It is the most electronegative element in the periodic table, and as a result, the C–F bond is highly polarized, with the fluorine atom bearing the partial negative charge and the carbon atom bearing the partial positive charge.<sup>4,5</sup> Due to the attraction between these two charges, the C–F bond has a less covalent and a more significant ionic character, it is very short and very strong (105 kcal/mol).

---

<sup>2</sup> a) Marais, J. S. C. *Onderstepoort J. Vet. Sci. Anim. Ind.* **1943**, *18*, 203–206; b) Marais, J. S. C. *Onderstepoort J. Vet. Sci. Anim. Ind.* **1944**, *20*, 67–73.

<sup>3</sup> Fried, J.; Sabo, E. F. *J. Am. Chem. Soc.* **1954**, *76*, 1455–1456.

<sup>4</sup> Hunter, L. *Beilstein J. Org. Chem.* **2010**, *6*, doi : 10.3762/bjoc.6.38.

<sup>5</sup> O'Hagan, D. *Chem. Soc. Rev.* **2008**, *37*, 308–319.

Atom (A)	H	F	O	N	C	Cl	Br
Van der Waals radius (Å)	1.20	1.47	1.52	1.55	1.70	1.75	1.85
Pauling electronegativity	2.1	4.0	3.5	3.0	2.5	3.2	2.8
Length of the C–A bond (Å)	1.09	1.40	1.43	1.47	1.54	1.77	1.97
Strength of the C–A bond (kcal/mol)	98	105	84	70	83	77	66

**Table 1**

Another consequence of the high electronegativity of the fluorine atom, is that its three lone pairs are strongly attracted by the nucleus, making this atom inert and unreactive. The high polarization of the C–F bond, can also result in a low-energy  $\sigma^*$  antibonding orbital, located behind the carbon atom in the plane of the C–F bond (Figure 2). This orbital, can accept the electrons of a nearby electron-donating group such as a  $\sigma$  bond or a lone pair.<sup>4,5</sup> The importance of these orbitals will be discussed in Section 2.5.

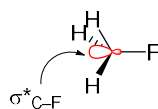

**Figure 2**

Even if the replacement of a C–H or a C–OH by a C–F bond does not influence the size of the molecule, it can surely induce modifications in properties such as the pKa, the lipophilicity or the conformation of a molecule.

## 2.2. Influence of a fluorine atom on the pKa

Due to the high electronegativity of the fluorine atom, the modulation of the pKa of proximal functional groups can be achieved, depending on the number of fluorine atoms, as well as their position in the molecule. For example, the replacement of a hydrogen atom by one fluorine atom in acetic acid, can lead to a decrease of the pKa by 2.2 units, while the replacement of three hydrogens by three fluorine atoms, can induce a decrease of 4.6 units (Figure 3).<sup>6</sup>



**Figure 3**

<sup>6</sup> Böhm, H. -J.; Banner, D.; Bendels, S.; Kansy, M.; Kuhn, B.; Müller, K.; Obst-Sander, U.; Stahl, M. *ChemBioChem* **2004**, *5*, 637–643.

Similarly, the basicity of ethylamine decreases linearly due to the presence of one, two and three fluorine atoms (Figure 4).<sup>7</sup>



Figure 4

### 2.3. Influence of a fluorine atom on the lipophilicity of molecules

For a drug candidate to cross the membrane, it has to be sufficiently lipophilic. At the same time, high lipophilicity can often result in reduced solubility, which can then lead to several undesired properties for the compound, such as incomplete absorption after administration. To find a balance between lipophilicity and minimal polarity, fluorine is often used as a modulator.

The lipophilicity of the drugs is normally measured as the logarithmic partition coefficient ( $\log P$ ) between *n*-octanol and water, the higher the  $\log P$  is, the higher is the lipophilicity of the compound.<sup>8</sup> When a fluorine atom is proximal to an amino group, the amine is less protonated and exists mostly in its neutral form, due to the decreased basicity of the amino group, caused by the presence of fluorine. This implies that the concentration of the compound is increased in octanol. Therefore by increasing the  $\log P$ , the lipophilicity of the fluorinated compound is also increased compared to the non-fluorinated one.<sup>9</sup>

### 2.4. Influence of a fluorine atom on the metabolic stability and bioavailability of molecules

A recurring problem in medicinal chemistry, is the oxidation and the metabolism of a drug prior to its elimination, by enzymes such as cytochrome P450 monooxygenases. In order to prevent this oxidation, the metabolically labile sites can be blocked with a fluorine substituent.<sup>8</sup> Due to the strength of the C–F bond and its oxidative stability, this bond is highly stable towards chemical and metabolic transformations.

An example of the influence of fluorine on drugs metabolic stability, is illustrated in Figure 5. Blockage of the metabolically labile sites of SCH-48461 by the incorporation of a fluorine atom, can prevent the oxidation of the phenyl ring and the dealkylation of the methoxy group, leading to the discovery of the cholesterol-absorption inhibitor ezetimibe, which is 400 times more potent than SCH-48461.

<sup>7</sup> Gillis, E. P.; Eastman, K. J.; Hill, M. D.; Donnelly, D. J.; Meanwell, N. A. *J. Med. Chem.* **2015**, *58*, 8315–8359.

<sup>8</sup> Purser, S.; Moore, P. R.; Swallow, S.; Gouverneur, V. *Chem. Soc. Rev.* **2008**, *37*, 320–330.

<sup>9</sup> Reddy, V. P. *in Organofluorine Compounds in Biology and Medicine*, Elsevier: Oxford, UK, **2015**.



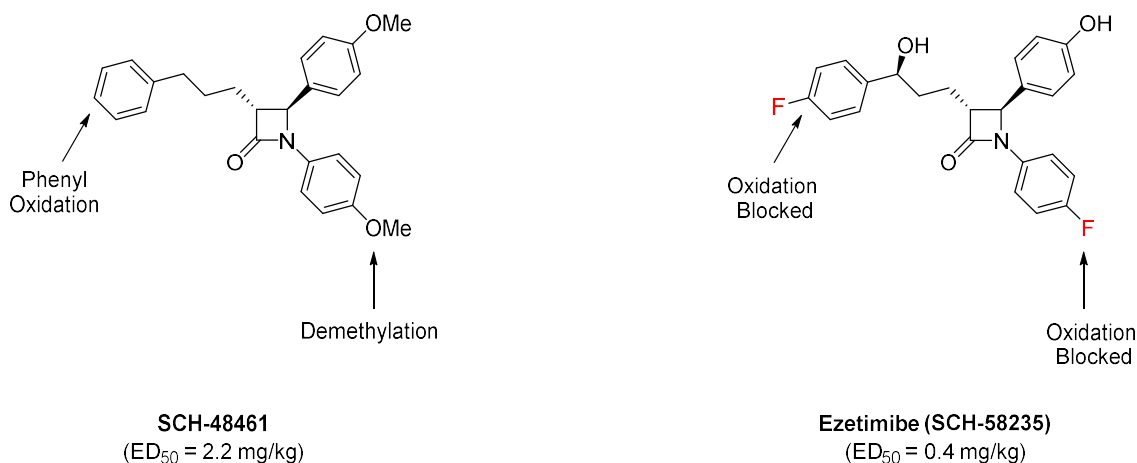

**Figure 5**

In addition, by modulating the lipophilicity and the metabolic stability of a drug, one can influence its absorption as well as its distribution. Indeed, due to the fact that the enzymes active site has a low polarity, the more lipophilic the drug candidate is, the higher its effective concentration is in the active site. As a result, smaller doses are required for an optimal efficacy.<sup>9</sup>

## 2.5. Influence of a fluorine atom on molecular conformation

Due to its small size and high electronegativity, a fluorine atom plays an important role on the conformation of a molecule. Indeed, the C–F bond can not only interact with its environment through electrostatic (dipole-dipole and charge-dipole) interactions, but due to its low-energy C–F  $\sigma^*$  antibonding orbital, it can also participate in a hyperconjugation effect. However, given its high electronegativity, which holds strongly its three lone pairs, fluorine is only a poor donor and hydrogen bonding acceptor unlike oxygen or nitrogen. The participation of fluorine in such interactions (dipole-dipole, charge-dipole, hyperconjugation) might contribute to an enhanced affinity of fluorine-containing compounds with an enzyme active site.

### A) Dipole-dipole interactions

The ionic nature of the C–F bond, confers to this bond a high dipolar moment, which is responsible for any electrostatic interactions. For example, Müller *et al.* studied the spatial conformation of fluorine containing drugs in their protein targets, and proved the existence of an interaction between the fluorine atom and the amide carbon of the protein receptor as it is shown in Figure 6a.<sup>6,10</sup>

Another example indicating the influence of fluorine on the conformation of a molecule is illustrated in Figure 6b, where in  $\alpha$ -fluorocarbonyls, the C–F bond is aligned antiparallel to the C=O bond, with

<sup>10</sup> Müller, K.; Faeh, C.; Diederich, F. *Science* **2007**, *317*, 1881–1886.

the C–F dipole opposed to the carbonyl dipole. It is worth mentioning, that this effect decreases with the decrease of the dipole moment of the carbonyl group.<sup>5</sup>

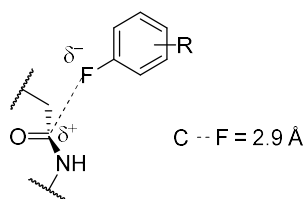

Figure 6a

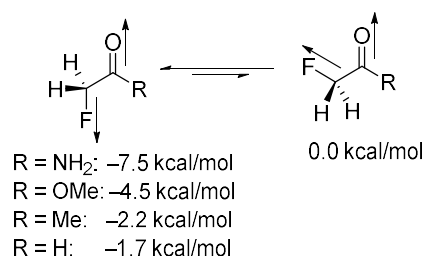

Figure 6b

Figure 6

### B) Charge-dipole interactions

Electrostatic interactions, associated with the C–F bond, become stronger when a neighboring group bears a formal charge. In 2005, Snyder *et al.* studied the family of 3-fluoropiperidines, and observed the preferential axial disposition of the fluorine in each compound, due to a charge-dipole interaction (Figure 7).<sup>11</sup>

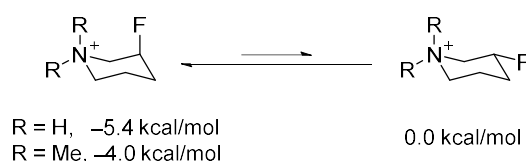

Figure 7

Furthermore, these interactions were also observed in the case of the 2-fluoroethylammonium and the protonated 2-fluoroethanol, where the *gauche* conformation is privileged (Figure 8). This enhanced *gauche* effect, can be attributed to the increased polarization of the C–N<sup>+</sup> or the C–O<sup>+</sup> bond due to the nitrogen or the oxygen positive charge, and to an interaction between the partially negative fluorine atom and the formally positively-charged nitrogen or oxygen atom.<sup>12</sup> It is worth mentioning, that intramolecular F–H interactions probably contribute to this stability, although the magnitude of this contribution is not clear. The *gauche* conformation is also preferred when X is a pyridine, even though the system cannot accommodate hydrogen bonding.<sup>13</sup> The fact that the *gauche* conformation is favored even when hydrogen bonding is not possible, proves that charge-dipole interaction is more important than any hydrogen bonding.

<sup>11</sup> Sun, A.; Lankin, D. C.; Hardcastle, K.; Snyder, J. P. *Chem. Eur. J.* **2005**, *11*, 1579–1591.

<sup>12</sup> Briggs, C. R. S.; Allen, M. J.; O'Hagan, D.; Tozer, D. J.; Slawin, A. M. Z.; Goeta, A. E.; Howard, J. A. K. *Org. Biomol. Chem.* **2004**, *2*, 732–740.

<sup>13</sup> Gooseman, N. E. J.; O'Hagan, D.; Peach, M. J. G.; Slawin, A. M. Z.; Tozer, D. J.; Young, R. J. *Angew. Chem. Int. Ed.* **2007**, *46*, 5904–5908.

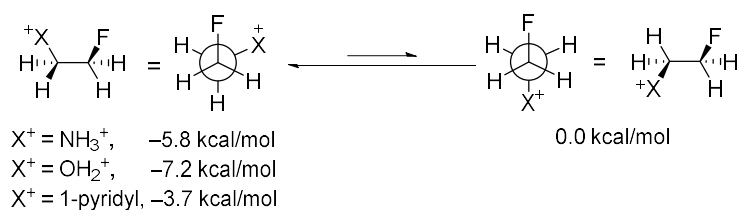

**Figure 8**

### C) Hyperconjugation effect

The hyperconjugation effect, which is observed in the case of fluorine-containing molecules, is closely related to its low-energy  $\sigma^*$  antibonding orbital. For example, for 1,2-difluoroethane there are two possible conformers (*gauche* and *anti*) (Figure 9).<sup>4,5</sup> Although one might predict that the *anti* conformation is privileged due to the repulsion of the two fluorine atoms, surprisingly, it is the *gauche* conformation that is favored. Indeed, in the *gauche* conformer, the two  $\sigma^*_{\text{C-F}}$  orbitals receive electrons in the form of electron rich bonds (C–H bond), thus stabilizing the conformation, whereas in the *anti* conformation, each  $\sigma^*_{\text{C-F}}$  orbital is aligned with an adjacent electron-deficient C–F bond. As a result in the case of the *anti* conformation, the hyperconjugation cannot occur.

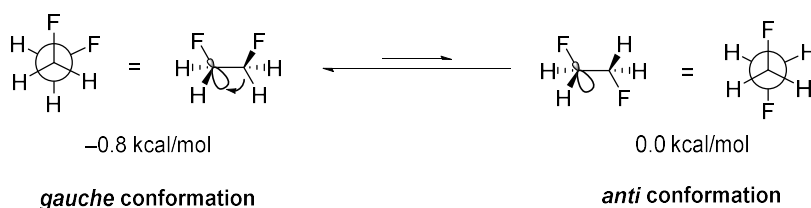

**Figure 9**

## 3. Biologically active $\text{CF}_3$ -containing molecules

Among a variety of fluorinated groups, the trifluoromethyl group has received much attention over the last decades.<sup>7,14</sup> In 1928, Lehmann was the first to report that compounds containing a trifluoromethyl group, have interesting biological activities. More specifically, he found that *m*-nitrobenzotrifluoride and *m*-trifluoromethylbenzoic acid, were potent stimulants and that *m*-aminobenzotrifluoride had a narcotic effect, the three of them affecting the central nervous system of frogs (Figure 10).<sup>15</sup>

<sup>14</sup> a) Wang, J.; Sánchez-Roselló, M.; Aceña, J. L.; del Pozo, D.; Sorochinsky, A. E.; Fustero, S.; Soloshonok, V. A.; Liu, H. *Chem. Rev.* **2014**, *114*, 2432–2506; b) Zhou, Y.; Wang, J.; Gu, Z.; Wang, S.; Zhu, W.; Aceña, J. L.; Soloshonok, V. A.; Izawa, K.; Liu, H. *Chem. Rev.* **2016**, *116*, 422–518.

<sup>15</sup> Lehmann, F. *Arch. Exp. Path. Pharmacol.* **1928**, *130*, 250–255.

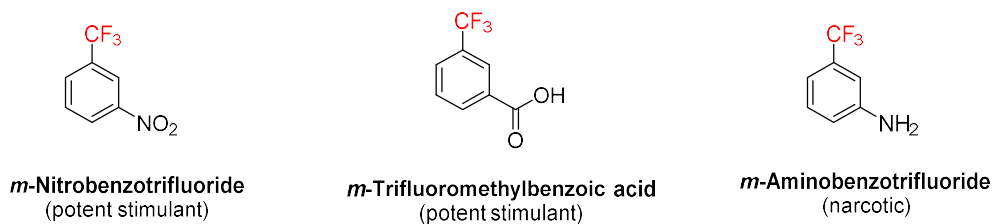

**Figure 10**

It was not until the 1950's that the trifluoromethyl group was widely recognized as a substituent of distinctive properties.<sup>16</sup> In 1987, the antidepressant fluoxetine, more commonly known as Prozac®, was approved by the Food and Drug Administration (FDA) and became the most prescribed antidepressant drug worldwide (Figure 11).<sup>8</sup>

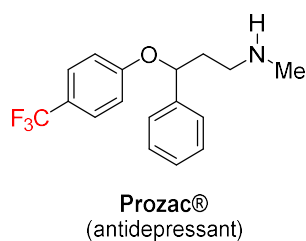
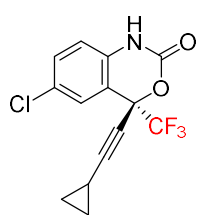

**Figure 11**

Since then, a large number of trifluoromethylated drugs were approved by the FDA, some of them being in the top 200 of the most successful drugs on the market and each of them treating a different type of disease. For example efavirenz, sold under the name Sustiva® and Stocrin®, is used to treat and prevent HIV/AIDS and sitagliptin, marketed under the trade name Januvia® is an antihyperglycemic drug. Other examples include celecoxib, an anti-inflammatory drug, nilotinib used for the treatment of chronic myelogenous leukemia, and siponimod which is an investigational drug used to treat multiple sclerosis (Figure 12).<sup>17</sup>

<sup>16</sup> a) Heidelberger, C.; Chaudhuri, N. K.; Danneberg, P.; Mooren, D.; Griesbach, L.; Duschinsky, R.; Schnitzer, R. *J. Nature* **1957**, *179*, 663–666; b) Yale, H. L. *J. Med. Pharm. Chem.* **1959**, *1*, 121–133.

<sup>17</sup> Zhu, W.; Wang, J.; Wang, S.; Gu, Z.; Aceña, J. L.; Izawa, K.; Liu, H.; Soloshonok, V. A. *J. Fluorine Chem.* **2014**, *167*, 37–54.



**Efavirenz**  
(anti-HIV)

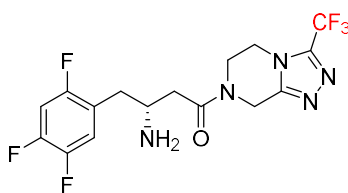

**Sitagliptin**  
(anti-diabetic)

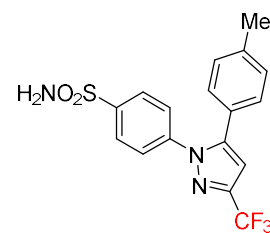

**Celecoxib**  
(nonsteroidal non-inflammatory)

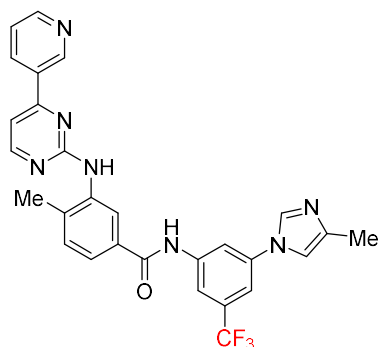

**Nilotinib**  
(chronic myelogenous leukemia treatment)

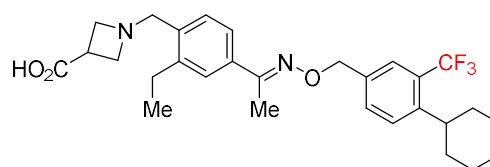

**Siponimod**  
(multiple sclerosis treatment)

**Figure 12**

Therefore, the introduction of fluorine-containing groups into bioactive molecules, resulted in a positive effect for the compounds, such as rendering them more selective or potent. Indeed, the trifluoromethyl group can be used as a bioisoster for an ethyl group, an isopropyl group or even a carbonyl.<sup>10,18</sup>

For instance, in an inhibitor of cathepsin K I, a trifluoroethylamino group was introduced as an amide isoster (Figure 13).<sup>19</sup> It is worth mentioning, that cathepsin K (CTSK) is a lysosomal cysteine protease which might be the enzyme responsible for the degradation of type I collagen. Therefore, CTSK inhibitor I might be effective for the treatment of osteoporosis. Replacement, of the C=O bond by a C–CF<sub>3</sub> bond, led to a more potent and more selective inhibitor II towards cathepsin K, without influencing the basicity of the amide.

<sup>18</sup> Hangmann, W. K. *J. Med. Chem.* **2008**, *51*, 4359–4369.

<sup>19</sup> Black, W. C.; Bayly, C. I.; Davis, D. E.; Desmarais, S.; Falgueyret, J.-P.; Léger, S.; Li, C. S.; Massé, F.; McKay, D. J.; Palmer, J. T.; Percival, M. D.; Robichaud, J.; Tsou, N.; Zamboni, R. *Bioorg. Med. Chem. Lett.* **2005**, *15*, 4741–4744.

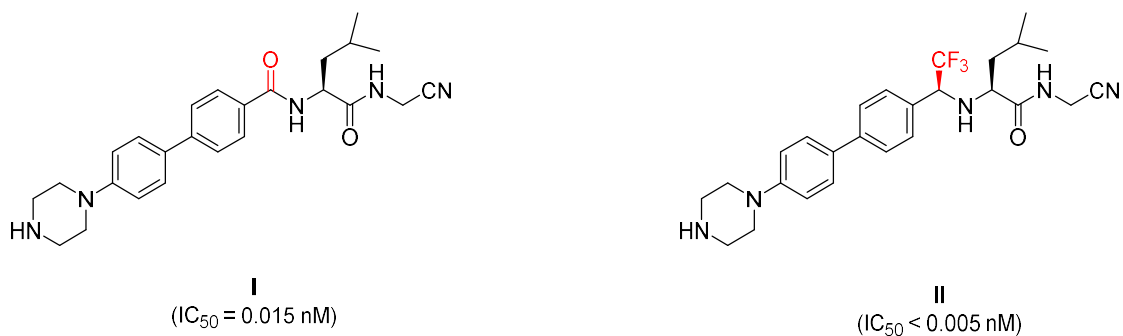

**Figure 13**

Another example demonstrating the importance of the trifluoromethyl group, is illustrated in Figure 14. Piperidine **III** is an antagonist of the gonadotropin releasing hormone (GnRH), which is a peptide released by the hypothalamus. GnRH can activate its own receptor, that causes the release of luteinizing hormone, therefore regulating gonadal steroid hormone production. As a result, GnRH is implicated in several hormone diseases such as prostate cancer, and its suppression by an inhibitor is the key for the treatment of these disorders. By introducing a  $CF_3$  group at the  $\alpha$  position of the piperidine and in spite of a small reduction of the inhibition, piperidine **IV** showed an increased oral bioavailability in dogs.<sup>20</sup>

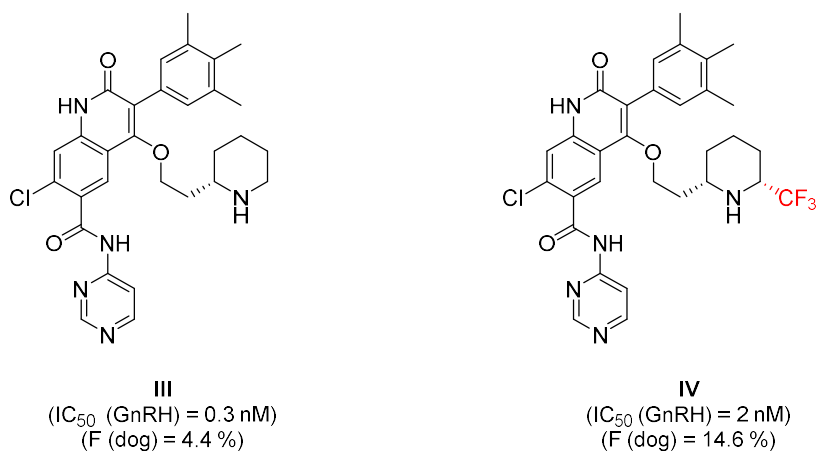

**Figure 14**

Thus, the introduction of a  $CF_3$  group into biologically active molecules, can have a significant impact on drug development due to the fluorine impact on chemical and physico-chemical properties. Given that for a large number of biologically active molecules, a  $CF_3$  group is present on saturated or unsaturated heterocycles, we have focused on the development of synthetic methods to obtain trifluoromethylated heterocycles.

<sup>20</sup> Jiang, J.; DeVita, R. J.; Goulet, M. T.; Wyvratt, M. J.; Lo, J. -L.; Ren, N.; Yudkovitz, J. B.; Cui, J.; Yang, Y. T.; Cheng, K.; Rohrer, S. P. *Bioorg. Med. Chem. Lett.* **2004**, *14*, 1795–1798.



## **CHAPTER 2**

**Ring contraction:**

**Synthesis of 2-substituted,  
2-(trifluoromethyl) pyrrolidines and  
2-substituted, 2-(trifluoromethyl)  
piperidines**





# 1. Generalities, Biological activity and synthesis of pyrrolidines and piperidines

## 1.1. Generalities

Pyrrolidines and piperidines belong to the family of cyclic secondary amines and can also be classified as saturated heterocycles. Pyrrolidines are 5-membered rings containing one nitrogen atom, and piperidines are 6-membered rings also containing one nitrogen atom (Figure 15).



Figure 15

Both heterocycles can be found in numerous natural and non-natural compounds, presenting a diversity of biological activities, with both of them being in the top 10 of the most frequently used ring systems in FDA approved small molecule drugs.<sup>21</sup> As an evidence of their importance it may be noted that by the end of the year 2000, there were over 12.000 compounds possessing a piperidine or a pyrrolidine core, mentioned in clinical or preclinical studies.<sup>22</sup> Due to the interesting properties induced by a fluorine atom or by a CF<sub>3</sub> group, we became interested in the synthesis of pyrrolidines and piperidines containing a CF<sub>3</sub> group at the C2 position.

## 1.2. Biological activity of 2-substituted, 2-(trifluoromethyl) pyrrolidines

As already mentioned, pyrrolidine alkaloids are enormously ubiquitous in a variety of natural and non-natural compounds. There are around 80 pyrrolidine alkaloids known, which are mainly extracted from plants belonging to the *Colanaceae*, *Convolvulaceae* and *Erythroxylaceae* families.

In 1889, Carl Liebermann was one of the first to isolate one of the most simple pyrrolidine alkaloids, hygrine, along with a related compound called cuscohygrine, both found in coca leaves (Figure 16).<sup>23</sup>

<sup>21</sup> Taylor, R. D.; MacCoss, M.; Lawson, A. D. G. *J. Med. Chem.* **2014**, *57*, 5845–5859.

<sup>22</sup> Watson, P. S.; Jiang, B.; Scott, B. *Org. Lett.* **2000**, *2*, 3679–3681.

<sup>23</sup> Pictet, A. in *The vegetable alkaloids. With particular to their chemical constitution*, New York : J. Wiley & sons **1904**.



**Figure 16**

Other simple and well-known pyrrolidine alkaloids, are the amino acids proline and hydroxyproline, both isolated in 1901 by Hermann Emil Louis Fischer from casein (Figure 17).<sup>24</sup> One of the simplest alkaloids, proline, can be used as a precursor for the synthesis of more complex alkaloids.<sup>25</sup>



**Figure 17**

Since then, a large number of natural products and drugs containing a pyrrolidine ring has been discovered, all of them endowed with a variety of biological activities and pharmacological behaviors and some of them are illustrated in Figure 18.<sup>26</sup> For example, kaitocephalin<sup>27</sup> is a glutamate receptor antagonist, that may be useful for the treatment of neurological disorders such as Alzheimer's disease. Radicamine A,<sup>28</sup> which was isolated from a plant mainly found in China, Korea and Japan, presents a potential inhibitory activity against  $\alpha$ -glucosidases, closely linked to diabetes. In addition, spirotryptostatin A,<sup>29</sup> isolated from the *Aspergillus fumigatus* fungus, is a potent anti-cancer drug due to its anti-mitotic properties. Other examples, include marketed drugs such as captopril (hypertension treatment), which was later replaced by enalapril due to its undesired side-effects, and ramipril which is used for the treatment of high blood pressure and congestive heart failure.

<sup>24</sup> Plimmer R. H. A. In *Monographs on biochemistry; The chemical constitution of the proteins, Part I. Analysis* (2nd ed.), R.H.A. Plimmer & F.G. Hopkins, Eds.; London: Longmans, Green and Co. **1908**.

<sup>25</sup> Bhat, C.; Tilve, S. G. *RSC Adv.* **2014**, *4*, 5405–5452.

<sup>26</sup> Kumar, A.; Gupta, G.; Srivastava, S. J. *Comb. Chem.* **2010**, *12*, 458–462.

<sup>27</sup> Shin-ya, K.; Kim, J.-S.; Furihata, K.; Hayakawa, Y.; Seto, H. *Tetrahedron Lett.* **1997**, *38*, 7079–7082.

<sup>28</sup> a) Shibano, M.; Tsukamoto, D.; Masuda, A.; Tanaka, Y.; Kusano, G. *Chem. Pharm. Bull.* **2001**, *49*, 1362–1365;

b) Shibano, M.; Tsukamoto, D.; Kusano, G. *Heterocycles* **2002**, *57*, 1539–1553.

<sup>29</sup> Edmondson, S.; Danishefsky, S. J.; Sepp-Lorenzino, L.; Rosen, N. *J. Am. Chem. Soc.* **1999**, *121*, 2147–2155.

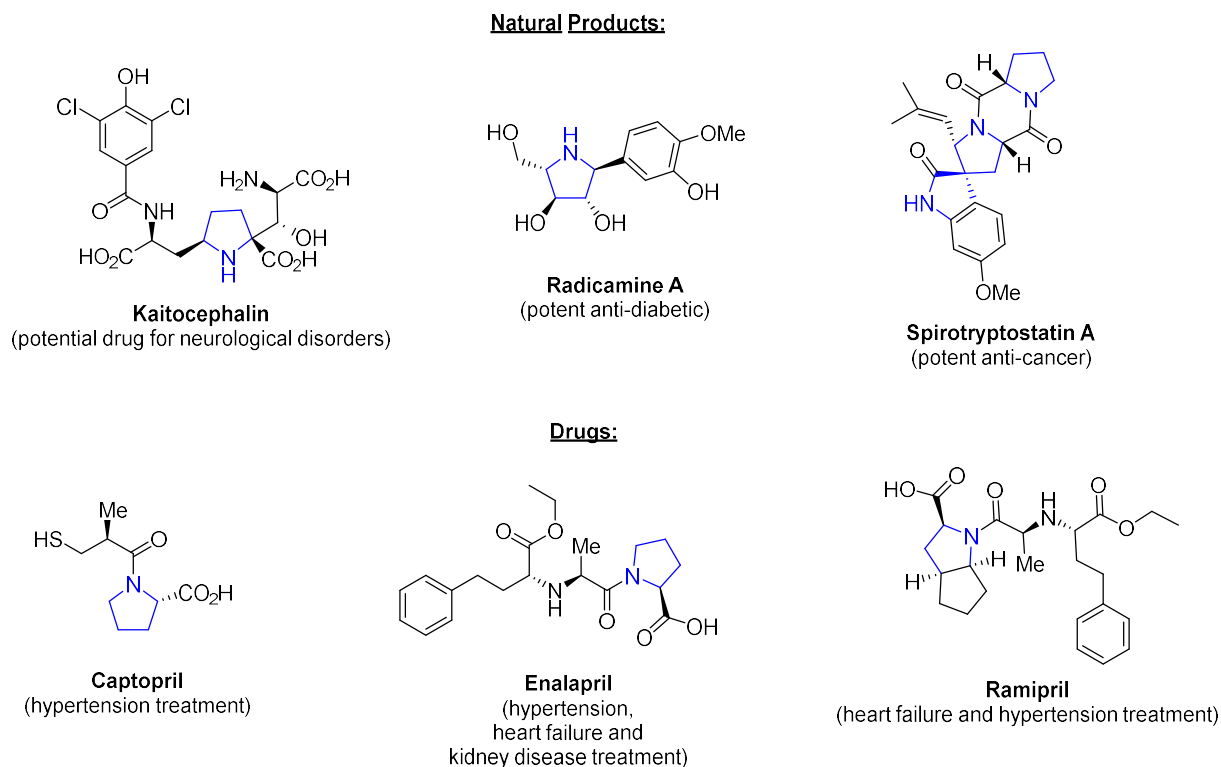

**Figure 18**

Given the great abundance of pyrrolidines in natural alkaloids as well as pharmaceuticals, their trifluoromethylated analogues represent potential biologically interesting compounds.

Fluoroquinolones have been used as antibacterial agents in anti-infective chemotherapy. However, their frequent clinical use has rendered them ineffective towards the quinolone and methicillin-resistant *Staphylococcus aureus*. It has been reported that the introduction of a CF<sub>3</sub> group onto the pyrrolidine **A**, increases their potency towards *Staphylococcus aureus*, while maintaining low side effects (Figure 19).<sup>30</sup>

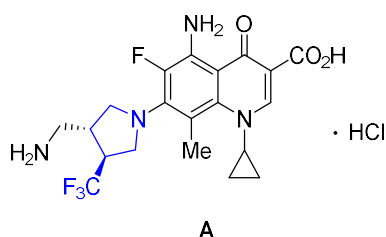

**Figure 19**

Another example that demonstrates the influence of the CF<sub>3</sub> group on the biological profile of a pyrrolidinic compound, is illustrated in Figure 20. MIF-1, a melanocyte-stimulating hormone release

<sup>30</sup> Fukui, H.; Shibata, T.; Naito, T.; Nakano, J.; Maejima, T.; Senda, H.; Iwatani, W.; Tatsumi, Y.; Suda, M.; Arika, T. *Bioorg. Med. Chem. Lett.* **1998**, *8*, 2833–2838.

inhibiting factor, is an endogenous brain peptide, that is able to modulate dopaminergic neurotransmission *in vitro* and *in vivo*. It is therefore considered to be an encouraging agent for the treatment of several brain disorders such as Parkinson's disease or depression. In a series of *in vivo* acute pain experiments on rat model, Brigaud *et al.* showed that, while MIF-1 had no effect, its  $\alpha$ -(trifluoromethyl) analogue CF<sub>3</sub>-(MIF-1) improved the compounds biological activity, exhibiting a significant analgesic effect.<sup>31</sup>

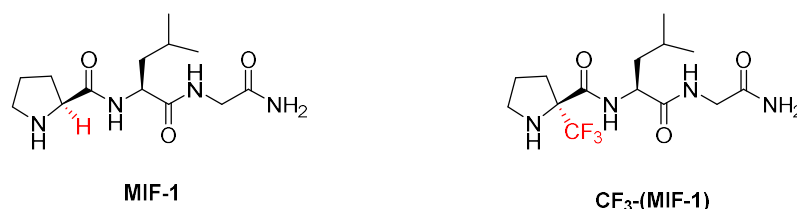

Figure 20

### 1.3. Biological activity of 2-substituted, 2-(trifluoromethyl) piperidines

The piperidine ring is an important structural feature, present in many natural products and pharmaceuticals. Their structure can vary from very simple alkaloids to more complicated ones. One of the simplest piperidine-containing natural products, is the poisonous alkaloid coniine isolated from the poison Hemlock (*Conium maculatum*), along with (-)- $\beta$ -conhydrine. They both cause muscular paralysis leading to death (Figure 21).<sup>32</sup>



Figure 21

Other piperidine alkaloids, include (-)-allosedamine and lobeline, both isolated from *Lobelia inflata* (also known as Indian tobacco). The first one is used for the treatment of respiratory illnesses such as asthma, bronchitis and pneumonia,<sup>33</sup> and the second one has been used as a substitution therapy for tobacco smoking cessation and is reported to have many nicotine-like effects, including

<sup>31</sup> Jlalia, I.; Lensen, N.; Chaume, G.; Dzhambazova, E.; Astasidi, L.; Hadjiolova, R.; Bocheva, A.; Brigaud, T. *Eur. J. Med. Chem.* **2013**, *62*, 122–129.

<sup>32</sup> Felpin, F. -X. ; Lebreton, J. *Eur. J. Org. Chem.* **2003**, 3693–3712.

<sup>33</sup> Wieland, H.; Koschara, W.; Dane, E.; Renz, J.; Schwarze, W.; Linde, W. *Liebigs Ann. Chem.* **1939**, *540*, 103–156.

cardiovascular and central nervous effects.<sup>34</sup> A third example includes micropine,<sup>35</sup> isolated from *Microcos philippinensis*, a plant whose ethanol extracts show antimicrobial activity (Figure 22).

As far as pharmaceutically active piperidine-containing molecules are concerned, among others we can cite naratriptan, which is a triptan drug marketed by GlaxoSmithKline and is used for the treatment of migraine headaches. Ritalin, also called methylphenidate, is a drug owned by Novartis and used for the treatment of attention deficit hyperactivity disorder (ADHD) and narcolepsy. We can also cite miglitol, an oral anti-diabetic drug, that inhibits the ability of the patient to break down complex carbohydrates into glucose (Figure 22).<sup>36</sup>

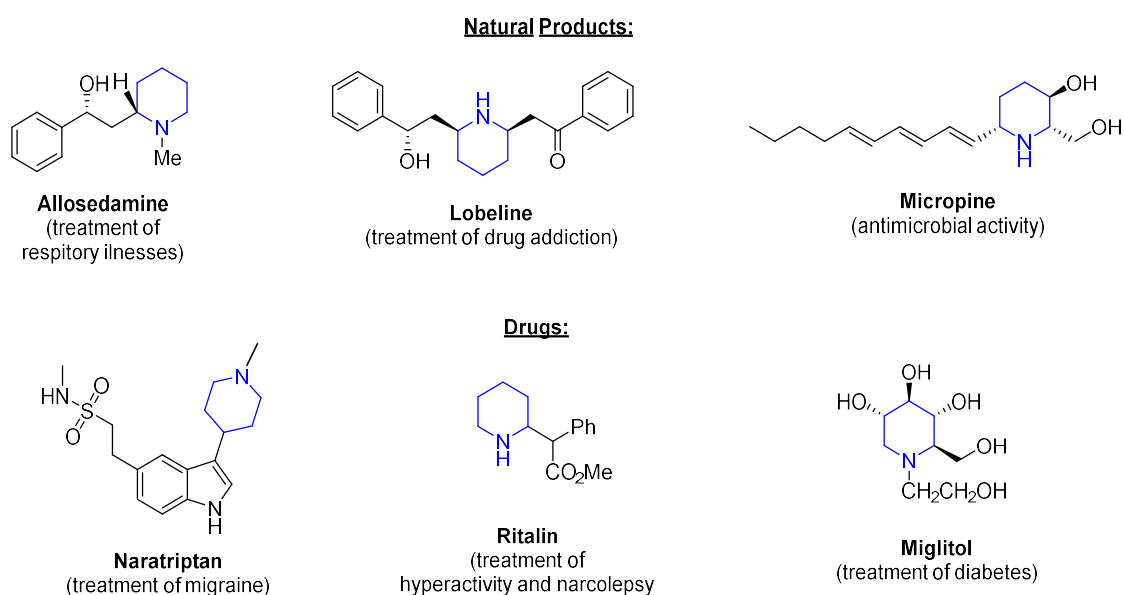

**Figure 22**

Taking into account the importance of the presence of a piperidine ring in biologically active compounds, whether it is natural alkaloids or pharmaceutical drugs, it is logical, that their trifluoromethylated analogues were also studied.

Indeed, some examples of biologically active piperidines containing a CF<sub>3</sub> group have been reported. For instance, mTORC1 is a protein complex that controls protein synthesis and therefore the mTORC1 inhibitor, containing a  $\alpha$ -(trifluoromethyl)piperidine, can modulate the cellular proliferation (Figure 23).<sup>37</sup>

<sup>34</sup> Wieland, H. *Ber. Dtsch. Chem. Ges.* **1921**, *54*, 1784–1788.

<sup>35</sup> Aguinaldo, A. M.; Read, R. W. *Phytochemistry* **1990**, *29*, 2309–2313.

<sup>36</sup> a) Dragutan, I.; Dragutan, V.; Démonceau, A. *RSC Adv.* **2012**, *2*, 719–736; b) Zhang, S.; Cha, L.; Li, L.; Hu, Y.; Li, Y.; Zha, Z.; Wang, Z. *J. Org. Chem.* **2016**, *81*, 3177–3187.

<sup>37</sup> Aay, N.; Blazey, C. M.; Bowles, O. J.; Bussenius, J.; Curtis, J. K.; Defina, S. C.; Dubenko, L.; Harris, J. R.; Jackson-Ugueto, E. E.; Kim, A. I.; Manalo, J. -C. L.; Pack, M.; Peto, C. J.; Rice, K. D.; Tsang, T. H.; Wang, L. **2010** (WO 2010138490).

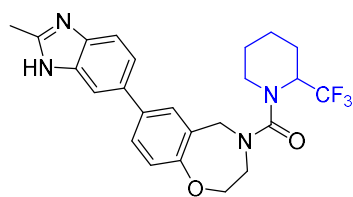

mTORC1 inhibitor

**Figure 23**

$\alpha$ -Trifluoromethylated piperidines can also have an inhibitory effect towards Janus kinases 1 (JAK 1) and 2 (JAK 2), which are implicated in the proliferation and survival of the cells. As a result, these inhibitors, could eventually be used for the treatment of asthma, cancer or even rheumatoid arthritis (Figure 24).<sup>38</sup>

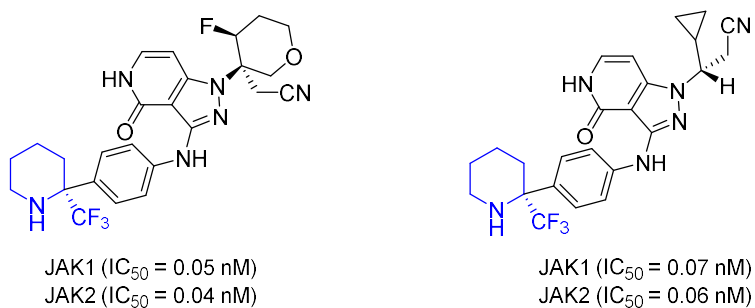

Janus kinases inhibitors

**Figure 24**

<sup>38</sup> a) Childers, M. L.; Fuller, P.; Guerin, D.; Katz, J. D.; Pu, Q.; Scott, M. E.; Thompson, C. F.; Martinez, M.; Falcone, D.; Torres, L.; Deng, Y.; Kuruklasuriya, R.; Zeng, H.; Bai, Y.; Kong, N.; Liu, Y.; Zheng, Z. **2014** (WO 2014146491); b) Dinsmore, C.; Fuller, P.; Guerin, D.; Katz, J. D.; Thompson, C. F.; Falcone, D.; Deng, W.; Torres, L.; Zeng, H.; Bai, Y.; Fu, J.; Kong, N.; Liu, Y.; Zheng, Z. **2014** (WO 2014146493).

## 1.4. Main synthetic methods to access 2-substituted, 2-(trifluoromethyl)pyrrolidines and 2-substituted, 2-(trifluoromethyl)piperidines

Several synthetic methods have been reported in the literature, to obtain  $\alpha$ -(trifluoromethyl)pyrrolidines and  $\alpha$ -(trifluoromethyl)piperidines. As our goal is to synthesize 2-(trifluoromethyl)pyrrolidines and 2-(trifluoromethyl)piperidines possessing a quaternary center at the C2 position, we will only focus on methods developed to obtain 2-substituted, 2-(trifluoromethyl)pyrrolidines and 2-substituted, 2-(trifluoromethyl)piperidines (Figure 25).



Figure 25

Recently, a review was published by our laboratory, presenting the synthetic methods used to access substituted  $\alpha$ -(trifluoromethyl)piperidines.<sup>39</sup> These methods were also applied to the synthesis of substituted  $\alpha$ -(trifluoromethyl)pyrrolidines. Therefore, we will first summarize these methods which can be found in the recently-published review and we will then present in detail the synthetic methods reported to access only 2-substituted, 2-(trifluoromethyl)pyrrolidines.

### 1.4.1. Synthetic methods to access 2-substituted, 2-(trifluoromethyl)piperidines

The most common method to access 2-substituted, 2-(trifluoromethyl)piperidines **B** is from (trifluoromethyl)imines **C**. Nenajdenko *et al.* showed that these imines, which could be formed from the corresponding lactams, reacted with a variety of nucleophiles to afford the desired (trifluoromethyl)piperidines **B**.<sup>40</sup> Alternatively, piperidines **B**, could be accessed from imines **D**. Indeed, imines **D**, which were obtained from the corresponding lactams, could react with the

<sup>39</sup> Riouton, S.; Gomez Pardo, D.; Cossy, J. *Molecules* **2017**, *22*, 483–505.

<sup>40</sup> a) Gulevich, A. V.; Shevchenko, N. E.; Balenkova, E. S.; Röschenhaler, G. -V.; Nenajdenko, V. G. *Synlett* **2009**, 403–406; b) Odinets, I. L.; Artyushin, O. I.; Lyssenko, K. A.; Shevchenko, N. E.; Nenajdenko, V. G.; Röschenhaler, G. -V. *J. Fluorine Chem.* **2009**, *130*, 662–666; c) Shevchenko, N. E.; Balenkova, E. S.; Röschenhaler, G. -V.; Nenajdenko, V. G. *Synthesis* **2010**, 120–126; d) Shmatova, O. I.; Nenajdenko, V. G. *Eur. J. Org. Chem.* **2013**, 6397–6403; e) Shmatova, O. I.; Shevchenko, N. E.; Balenkova, E. S.; Röschenhaler, G. -V.; Nenajdenko, V. G. *Eur. J. Org. Chem.* **2013**, 3049–3058; f) Shmatova, O. I.; Shevchenko, N. E.; Balenkova, E. S.; Röschenhaler, G. -V.; Nenajdenko, V. G. *Mendeleev Commun.* **2013**, *23*, 92–93; g) Shevchenko, N. E.; Shmatova, O. I.; Balenkova, E. S.; Röschenhaler, G. -V.; Nenajdenko, V. G. *Eur. J. Org. Chem.* **2013**, 2237–2245; h) Shmatova, O. I.; Khrustalev, V. N.; Nenajdenko, V. G. *Org. Lett.* **2016**, *18*, 4494–4497.



Ruppert-Prakash reagent (TMSCF<sub>3</sub>), to form  $\alpha$ -(trifluoromethyl)piperidines **B**.<sup>41</sup> Access to 2-substituted, 2-(trifluoromethyl)piperidines **B**, has also been achieved by the electrophilic-induced cyclization of aminoalkynes **E**. In 2011, Hammond *et al.* reported that the reaction of aminoalkynes **E** with TMSCF<sub>3</sub> in the presence of a silver salt, could lead to the cyclized products **B**.<sup>42</sup> (Trifluoromethyl)piperidines **B**, were also obtained by ring-expansion of aziridines **F**. De Kimpe *et al.*, showed that when the aziridine **F** was activated by a tosyl group (R=tosyl), a nucleophile could attack this aziridine at the less substituted position, inducing the ring-opening of **F**, followed by a ring-closure leading to the 6-membered ring **B**.<sup>43</sup> In addition, ring-closing metathesis (RCM) is a very common and effective method to obtain  $\alpha$ -(trifluoromethyl)piperidines **B** and it was a method mainly developed by the groups of Osipov and Dixneuf. The most common starting materials are dienes **G**, which in the presence of a variety of catalysts such as Grubbs-I, Grubbs-II, Hoveyda-II or even other ruthenium-allenylidene catalysts were able to afford the desired unsaturated piperidines **B**.<sup>44</sup> Furthermore, the ring-closing metathesis of 1,6-enynes **H** and 1,7-enynes **I**, in the presence of ruthenium catalysts, led to a variety of substituted piperidines **B**.<sup>45</sup> Polyfunctionalized (trifluoromethyl)piperidine derivatives **B** could also be synthesized from highly electrophilic imines **K** and 1,3-dienes **J** by an aza-Diels Alder reaction.<sup>46,36b</sup> In order for the cycloaddition reaction to occur, the imines used as dienophiles must be activated either by an electron-withdrawing group or by a Lewis acid (Scheme 1).

---

<sup>41</sup> a) Shevchenko, N. E.; Vlasov, K.; Nenajdenko, V. G.; Röschenthaler, G. -V. *Tetrahedron* **2011**, *67*, 69–74; b) Levin, V. V.; Dilman, A. D.; Belyakov, P. A.; Struchkova, M. I.; Tartakovsky, V. A. *Eur. J. Org. Chem.* **2008**, 5226–5230.

<sup>42</sup> Han, J.; Xu, B.; Hammond, G. B. *Org. Lett.* **2011**, *13*, 3450–3453.

<sup>43</sup> Dolfen, J.; Kenis, S.; Van Hecke, K.; De Kimpe, N.; D'hooghe, M. *Chem. Eur. J.* **2014**, *20*, 10650–10653.

<sup>44</sup> a) Osipov, S. N.; Bruneau, C.; Picquet, M.; Kolomiets, A. F.; Dixneuf, P. H. *Chem. Commun.* **1998**, 2053–2054; b) Osipov, S. N.; Artyushin, O. I.; Kolomiets, A. F.; Bruneau, C.; Picquet, M.; Dixneuf, P. H. *Eur. J. Org. Chem.* **2001**, 3891–3897; c) Osipov, S. N.; Artyushin, O. I.; Kolomiets, A. F.; Bruneau, C.; Dixneuf, P. H. *Synlett* **2000**, 1031–1033; d) Osipov, S. N.; Kobel'kova, N. M.; Shchetnikov, G. T.; Kolomiets, A. F.; Bruneau, C.; Dixneuf, P. H. *Synlett* **2001**, 621–622; e) Vorobyeva, D. V.; Mailyan, A. K.; Peregudov, A. S.; Karimova, N. M.; Vasilyeva, T. P.; Bushmarinov, I. S.; Bruneau, C.; Dixneuf, P. H.; Osipov, S. N. *Tetrahedron* **2011**, *67*, 3524–3532.

<sup>45</sup> a) Mailyan, A. K.; Krylov, I. M.; Bruneau, C.; Dixneuf, P. H.; Osipov, S. N. *Eur. J. Org. Chem.* **2013**, 5353–5363; b) Eckert, M.; Monnier, F.; Shchetnikov, G. T.; Titanyuk, I. D.; Osipov, S. N.; Toupet, L.; Dérien, S.; Dixneuf, P. H. *Org. Lett.* **2005**, *7*, 3741–3743.

<sup>46</sup> Kobel'kova, N. M.; Osipov, S. N.; Kolomiets, A. F. *Russ. Chem. Bull., Int. Ed.* **2002**, *51*, 1298–1302.

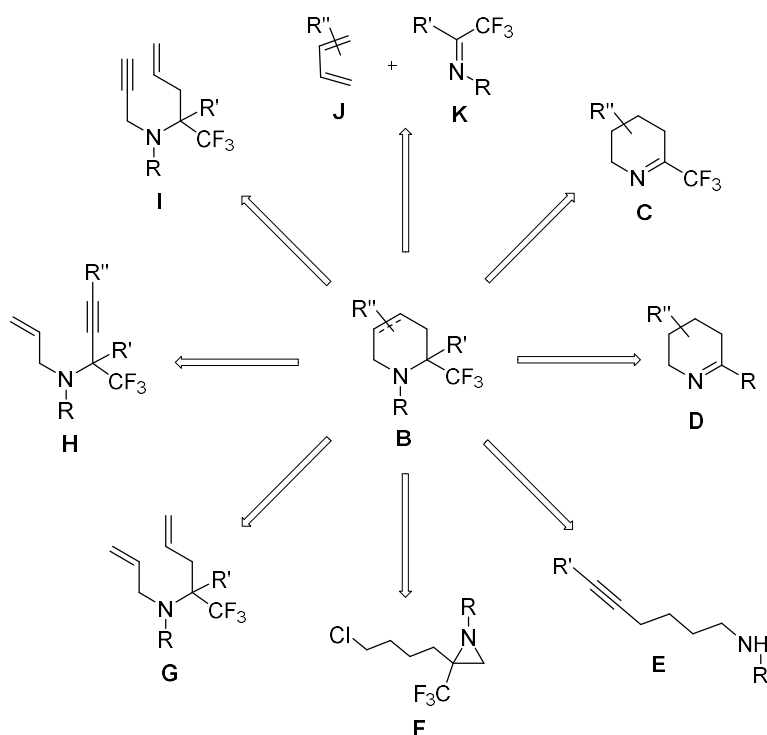

**Scheme 1**

In addition to the above methods, two more particular synthetic routes exist, allowing the formation of 2-substituted, 2-(trifluoromethyl)piperidines of type **B**. In 2012, Fustero *et al.* reported the one-pot iodocyclization of oxazinone **L2.1**, followed by a [1,2]-shift of the CF<sub>3</sub> group of the intermediate **L2.2** to afford (trifluoromethyl)lactone **L2.4**, which could then be transformed to a variety of  $\alpha$ -(trifluoromethyl)pipecolic acid derivatives **L2.5** (Scheme 2).<sup>47</sup>

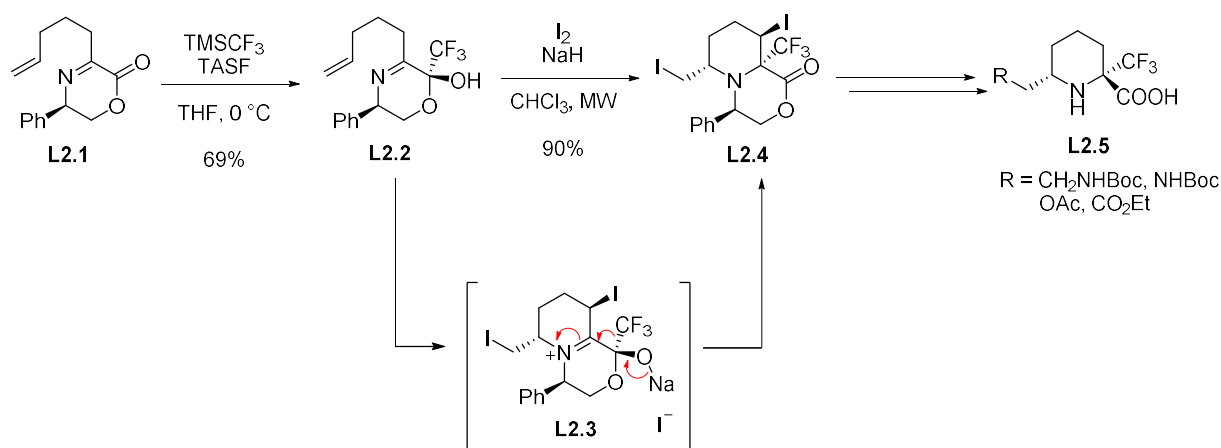

**Scheme 2**

<sup>47</sup> a) Fustero, S.; Albert, L.; Aceña, J. L.; Sanz-Cervera, J. F.; Asensio, A. *Org. Lett.* **2008**, *10*, 605–608; b) Fustero, S.; Albert, L.; Mateu, N.; Chiva, G.; Miró, J.; González, J.; Aceña, J. L. *Chem. Eur. J.* **2012**, *18*, 3753–3764.

In 2016, multi-substituted  $\alpha$ -(trifluoromethyl)piperidines **L2.11** were obtained *via* a one-pot, multicomponent reaction between isoxazole **L2.6**, ketoester **L2.7**, ammonium acetate and aryl aldehydes **L2.8**. According to the proposed mechanism, isoxazole **L2.6** could undergo a Michael addition in the presence of the enolized ketoester **L2.7**, to form intermediate **L2.9**. Then, the product obtained from the condensation of aldehyde **L2.8** with ammonium acetate, could react with **L2.9** to obtain compound **L2.10**, which after an intramolecular cyclization led to the desired spiropiperidines **L2.11** (Scheme 3).<sup>48</sup>

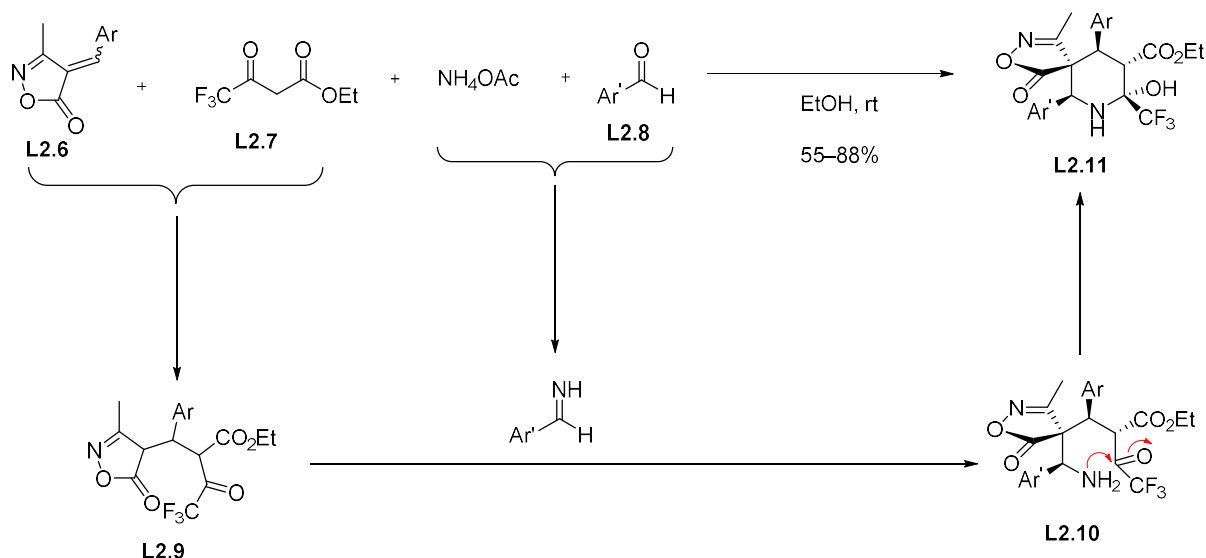

Scheme 3

#### 1.4.2. Synthetic methods to access 2-substituted, 2-(trifluoromethyl)pyrrolidines

The majority of the synthetic routes mentioned above, have been used to access 2-substituted, 2-(trifluoromethyl)pyrrolidines **L**. Therefore treatment of (trifluoromethyl)imines **M** with different nucleophiles,<sup>40</sup> or treatment of imines **N** with  $\text{TMSCF}_3$ ,<sup>41a,49</sup> led to a variety of functionalized pyrrolidines **L**. Moreover, the electrophilic-induced cyclization of aminoalkynes **O** was successfully applied to the synthesis of (trifluoromethyl)pyrrolidines **L** in the presence of a silver salt.<sup>42</sup> The regioselective ring-opening of aziridines **P**, followed by a ring-closure, also allowed the formation of pyrrolidines **L**.<sup>43</sup> Similarly, the optically pure aziridine **Q**, could be opened in the presence of the dimethyl malonate anion, to afford a ring-opening product which after an intramolecular nucleophilic

<sup>48</sup> Shi, W.; Wang, Y.; Zhu, Y.; Zhang, M.; Song, L.; Deng, H. *Synthesis* **2016**, *48*, 3527–3536.

<sup>49</sup> a) Levin, V. V.; Kozlov, M. A.; Dilman, A. D.; Belyakov, P. A.; Struchkova, M. I.; Tartakovsky, V. A. *Russ. Chem. Bull., Int. Ed.* **2009**, *58*, 484–486; b) Huang, W.; Ni, C.; Zhao, Y.; Zhang, W.; Dilman, A. D.; Hu, J. *Tetrahedron* **2012**, *68*, 5137–5144.

substitution, led to the optically active pyrrolidine derivative **L**.<sup>50</sup> In addition, (trifluoromethyl)pyrrolidines **L** were also obtained by the ring-closing metathesis of dienes **R**,<sup>44a,b</sup> as well as enynes **S**<sup>51</sup> and **T**<sup>45b</sup> in the presence of Grubbs-I catalyst or other ruthenium allenylidene complexes (Scheme 4).

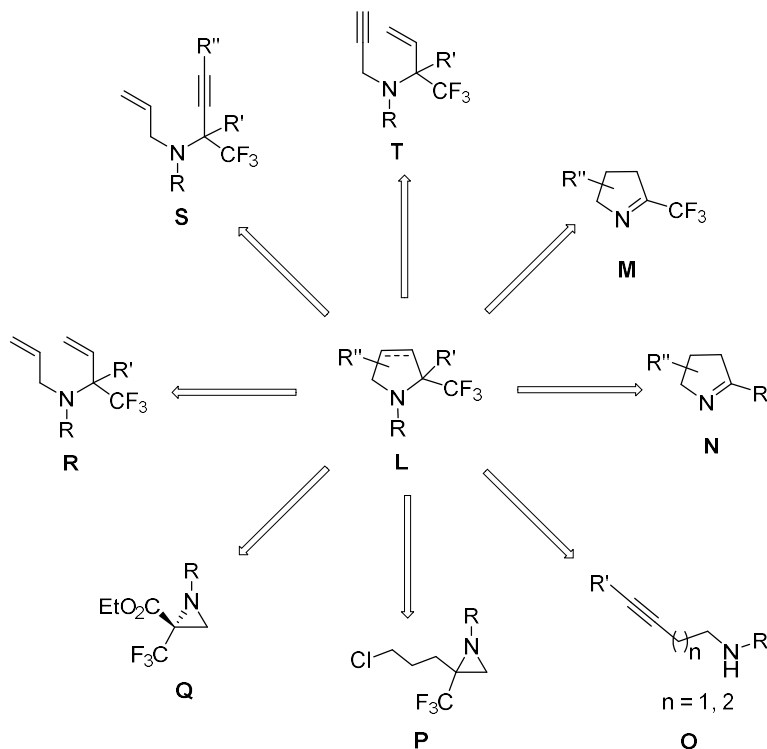

**Scheme 4**

In addition to the methods reported above, some other methods exist, to access 2-substituted, 2-(trifluoromethyl)pyrrolidine derivatives **L**, mostly by cyclization.

In 1996, the  $\alpha$ -(trifluoromethyl)pyroglutamic acid **L2.17** was synthesized from the (trifluoromethyl)imine **L2.12**. The addition of an organomagnesium reagent on **L2.12**, followed by the oxidation of the double bond, afforded compound **L2.14**. After saponification of **L2.14**, followed by a deprotection and a cyclization, the  $\alpha$ -(trifluoromethyl)pyroglutamic acid **L2.17** was isolated (Scheme 5).<sup>52</sup>

<sup>50</sup> Katagiri, T.; Katayama, Y.; Taeda, M.; Ohshima, T.; Iguchi, N.; Uneyama, K. *J. Org. Chem.* **2011**, *76*, 9305–9311.

<sup>51</sup> Sémeril, D.; Le Notre, J.; Bruneau, C.; Dixneuf, P. H.; Kolomiets, A. F.; Osipov, S. N. *New J. Chem.* **2001**, *25*, 16–18.

<sup>52</sup> Kokschi, B.; Ullmann, D.; Jakubke, H. -D.; Burger, K. *J. Fluorine Chem.* **1996**, *80*, 53–57.



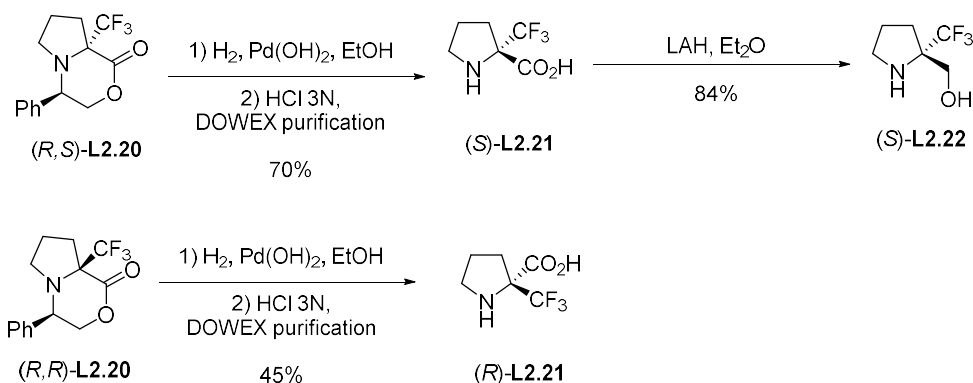

**Scheme 7**

Alternatively, when the diastereomeric mixture of **L2.19a** and **L2.19b** was oxidized by the Jones reagent, a cyclization took place to afford the bicyclic lactams  $(R,S)\text{-L2.23}$  and  $(R,R)\text{-L2.23}$  in 61% and 20% yield respectively, conveniently separated by silica gel chromatography. After saponification of the lactone of  $(R,S)\text{-L2.23}$  and  $(R,R)\text{-L2.23}$  with LiOH and cleavage of the benzylic bond using Li/NH<sub>3</sub>,  $\alpha$ -(trifluoromethyl)pyroglutamic acids  $(S)\text{-L2.24}$  and  $(R)\text{-L2.24}$  were isolated in 49% and 69% yield respectively (Scheme 8).<sup>54</sup>

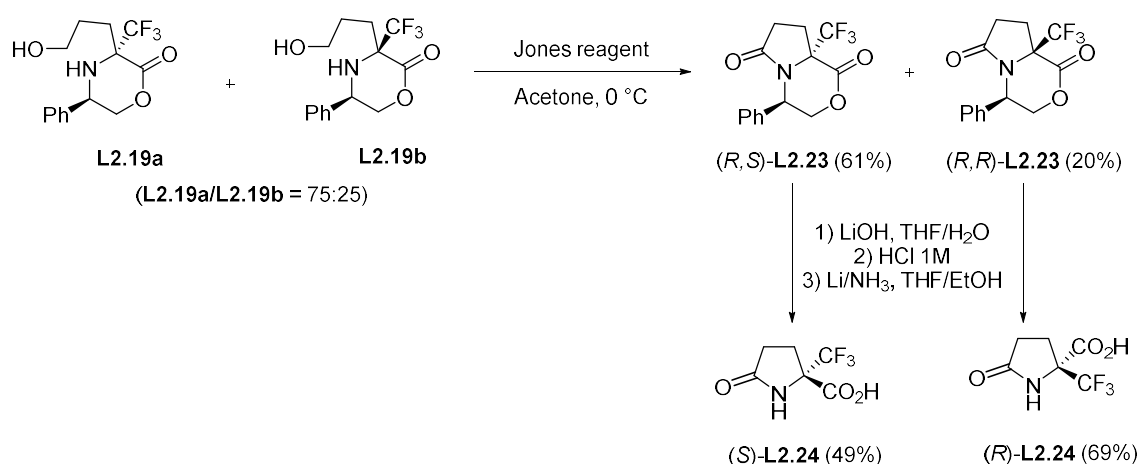

**Scheme 8**

Brigaud *et al.* reported an alternative pathway to access  $\alpha$ -(trifluoromethyl)proline derivatives by an iodocyclization of the morpholinone mixture **L2.18** induced by I<sub>2</sub>. After the dehydroiodination of **L2.25**, compounds  $(R,S)\text{-L2.26}$  and  $(R,R)\text{-L2.26}$  were obtained. At this stage  $(R,S)\text{-L2.26}$  and  $(R,R)\text{-L2.26}$  were easily separated by silica gel chromatography (Scheme 9).<sup>55</sup>

<sup>54</sup> Chaume, G.; Van Severen M. -C.; Ricard, L.; Brigaud, T. *J. Fluorine Chem.* **2008**, *129*, 1104–1109.

<sup>55</sup> Caupène, C.; Chaume, G.; Ricard, L.; Brigaud, T. *Org. Lett.* **2009**, *11*, 209–212.

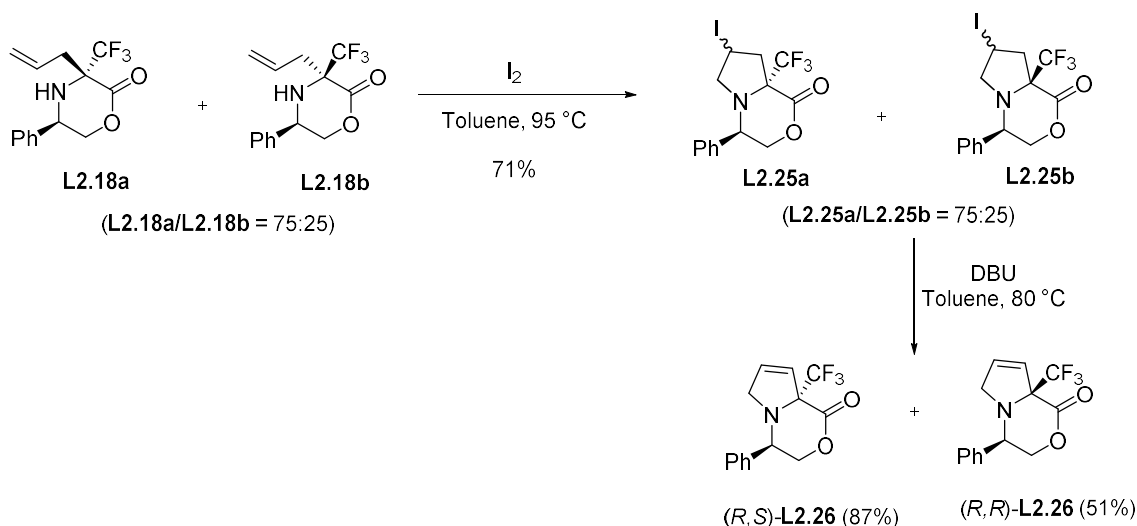

**Scheme 9**

Dihydroxylation of *(R,S)*-**L2.26** and *(R,R)*-**L2.26** followed by cleavage of the chiral auxiliary, led to  $\alpha$ -(trifluoromethyl)dihydroxyprolines *(S)*-**L2.27** and *(R)*-**L2.27** in 68% and 73% yield respectively (Scheme 10). The dihydroxylation afforded the two compounds with complete diastereoselectivity in favour of the compounds possessing the two hydroxyl groups in a *trans* relationship with the CF<sub>3</sub> group, indicating that the CF<sub>3</sub> moiety directs the dihydroxylation and not the chiral auxiliary.<sup>55</sup>

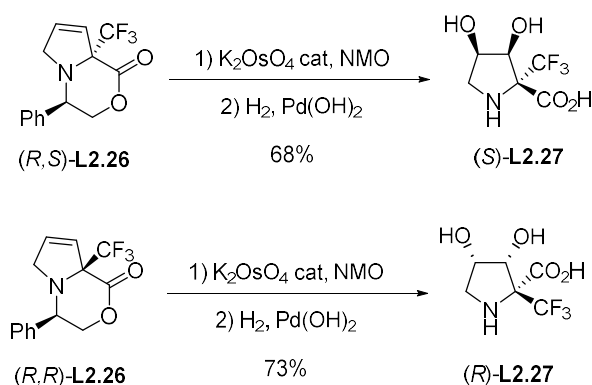

**Scheme 10**

In 2013, Zhang *et al.* reported an alternative synthetic route to access (trifluoromethyl)proline *(R)*-**L2.21** by the enantioselective alkynylation of imine **L2.28** catalyzed by the complex zinc/ligand **L\***. The obtained acetylenic compound **L2.29** was hydrogenated (H<sub>2</sub>, Pd/C), and the TBS group was then cleaved, to afford **L2.30**. This compound was cyclized after treatment with mesyl chloride, to give the protected *(R)*-proline **L2.31**. Deprotection of the amine led to the (trifluoromethyl)proline *(R)*-**L2.21** in 66% yield (Scheme 11).<sup>56</sup>

<sup>56</sup> Huang, G.; Yin, Z.; Zhang, X. *Chem. Eur. J.* **2013**, *19*, 11992–11998.

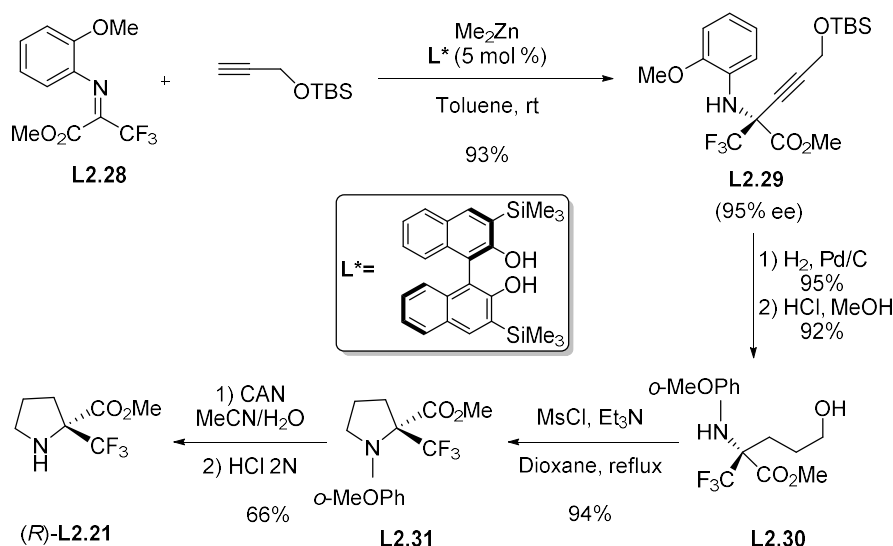

In 2013 Osipov *et al.* reported the intramolecular cyclization of homopropargylamines **L2.32a** and **L2.32b**, to access the  $\alpha$ -CF<sub>3</sub>-dehydroproline derivatives **L2.34a** and **L2.34b**.<sup>57</sup> When the *N*-Boc-protected homopropargylamines **L2.32a** were treated with TFA, a mixture of the deprotected compound **L2.33a** and the cyclized product **L2.34a** was obtained, which after treatment with the silver salt Ag(OTf), gave the dehydroprolines **L2.34a**, possessing a quaternary center at the C2 substituted by an ester and a CF<sub>3</sub> group (Scheme 12, eq 1). However, when the *N*-Cbz-protected propargylamino-phosphonates **L2.32b**, were treated with a mixture of TFA/TsOH, the deprotected amines **L2.33b** were not observed. In this case, a spontaneous cyclization took place, to afford dehydroprolines **L2.34b**, while the addition of a silver salt was not necessary. This reaction therefore represents the first example of an intramolecular cyclization of amines containing a propargyl group without the use of a metal as an activator (Scheme 12, eq 2).

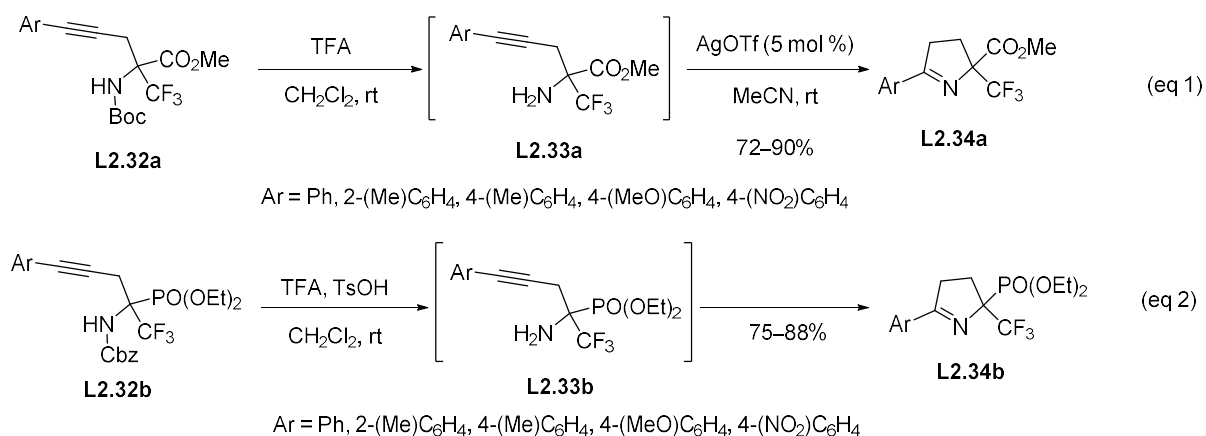

<sup>57</sup> Zotova, M. A.; Vasil'eva, T. P.; Osipov, S. N. *Russ. Chem. Bull., Int. Ed.* **2013**, *62*, 792–796.



## 2. Context of the study and objective

Over the past few years, due to the increasing interest in (trifluoromethyl)pyrrolidines and (trifluoromethyl)piperidines in medicinal chemistry, we became interested in developing synthetic methods to obtain functionalized  $\alpha$ -(trifluoromethyl)pyrrolidines and  $\alpha$ -(trifluoromethyl)piperidines.

In our laboratory, the ring expansion of prolinols **L2.35** to piperidines **L2.37**, via a bicyclic aziridinium intermediate **L2.36**, was reported.<sup>58</sup> Although the reaction is stereoselective, in some cases a mixture of 6-membered rings **L2.37** and 5-membered rings **L2.38** was obtained (Scheme 13).

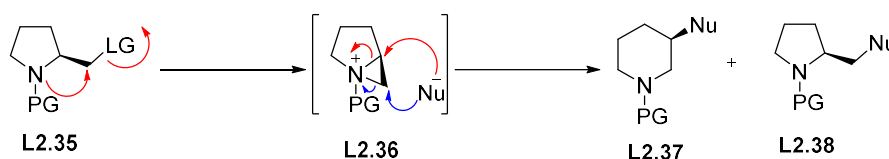

Scheme 13

More recently, it has been shown that the presence of a  $\text{CF}_3$  group on the proline derivative **L2.39**, allowed the exclusive formation of the  $\alpha$ -(trifluoromethyl)piperidines **L2.41** via the aziridinium intermediate **L2.40** (Scheme 14).<sup>59</sup>

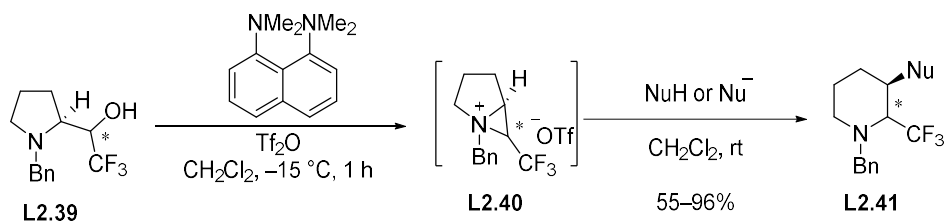

Scheme 14

Based on the reactivity of **L2.39**, it seems that the  $\text{CF}_3$  group is responsible for the regioselective attack of the nucleophile on the aziridinium intermediate (see Section 3). Thus, we envisioned to access 2-substituted-2-(trifluoromethyl)pyrrolidines ( $n=1$ ) and 2-substituted-2-(trifluoromethyl)piperidines ( $n=2$ ) **I** by the ring contraction of hydroxypiperidines ( $n=1$ ) and hydroxyazepanes ( $n=2$ ) **III** respectively, as the presence of  $\text{CF}_3$  group could eventually direct the attack of the nucleophile only at the C2' of the aziridinium intermediate **II** (Scheme 15).

<sup>58</sup> a) Cossy, J.; Gomez Pardo, D. *Chemtracts* **2002**, *15*, 579–605; b) Cossy, J.; Gomez Pardo, D.; Dumas, C.; Mirguet, O.; Déchamps, I.; Métro, T. -X.; Burger, B.; Roudeau, R.; Appenzeller, J.; Cochi, A. *Chirality* **2009**, *21*, 850–856; c) Gomez Pardo, D.; Cossy, J. *Chem. Eur. J.* **2014**, *20*, 4516–4525 and references therein.

<sup>59</sup> Rioton, S.; Orliac, A.; Antoun, Z.; Bidault, R.; Gomez Pardo, D.; Cossy, J. *Org. Lett.* **2015**, *17*, 2916–2919.

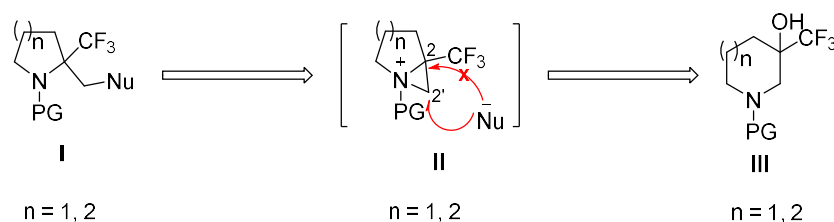

**Scheme 15**

It is worth mentioning that examples of ring contractions are scarce in the literature.<sup>60</sup> Nevertheless, one example of ring contraction *via* an aziridinium intermediate was reported in 2000 by the group of De Kimpe. When piperidines **L2.42**, were treated with boron tribromide ( $\text{BBr}_3$ ), intermediate **L2.43** possessing a good leaving group at the C3 position, was formed. Due to the nitrogen anchimeric assistance, the aziridinium intermediate **L2.44** was formed, to afford after the attack of a bromide anion, pyrrolidines **L2.45** in moderate to good yields. However, along with the ring contracted products **L2.45**, piperidines **L2.46** were formed, probably after the demethylation of the methoxy group of **L2.42** by  $\text{BBr}_3$ , or by sodium hydroxide-induced rearrangement of pyrrolidines **L2.45** *via* the intermediate aziridinium **L2.44** (Scheme 16).<sup>61</sup>

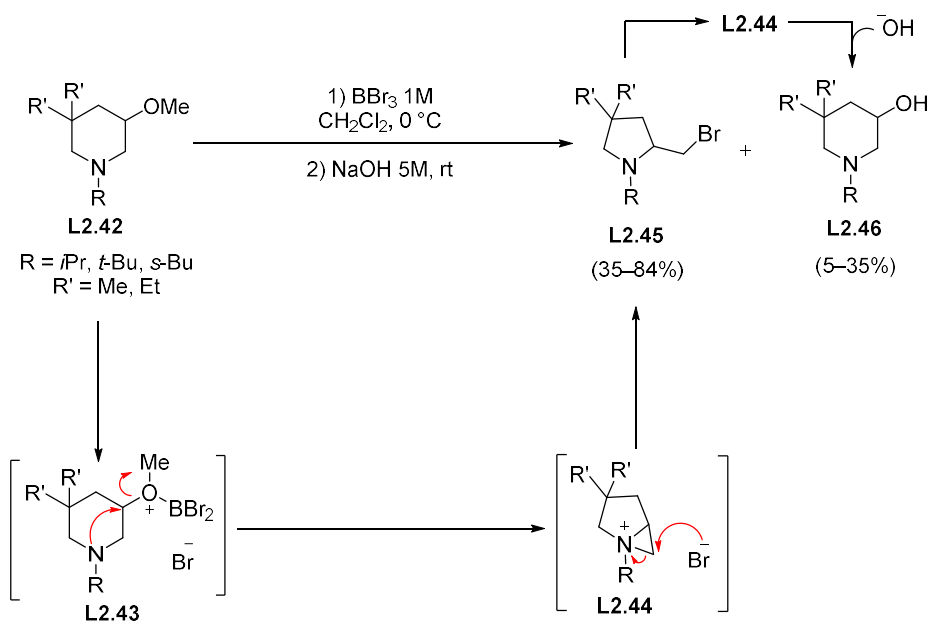

**Scheme 16**

<sup>60</sup> a) Duhamel, L.; Poirier, J. M. *Tetrahedron Lett.* **1976**, 2437–2440; b) Duhamel, P.; Kotera, M. *J. Org. Chem.* **1982**, *47*, 1688–1691; c) Donati, D.; Fusi, S.; Macripo, M. A.; Ponticelli, F. *J. Heterocycl. Chem.* **1987**, *24*, 481–483; d) Plaquevent, J. -C.; Chichaoui, I. *Bull. Soc. Chim. Fr.* **1996**, *133*, 369–379.

<sup>61</sup> Abbaspour Tehrani, K.; Van Syngel, K.; Boelens, M.; Contreras, J.; De Kimpe, N.; Knight, D. W. *Tetrahedron Lett.* **2000**, *41*, 2507–2510.

Before we start discussing our results, we will briefly present the regioselective ring-opening of the 2-(trifluoromethyl)aziridines *via* the formation of an aziridinium intermediate. This regioselective attack can be induced due to the presence of the CF<sub>3</sub> group on the aziridinium.

### 3. Regioselective ring-opening of 2-(trifluoromethyl) aziridinium intermediates

The regioselective ring-opening of 2-(trifluoromethyl)aziridines **IV**, has been the subject of many publications. However, (trifluoromethyl)aziridines whose nitrogen is substituted by an alkyl group, are unreactive towards nucleophilic attack, therefore their prior activation is necessary. Here, we will report the aziridines ring-opening *via* an aziridinium intermediate which can be formed either by activation under acidic conditions (R'=H) or by activation by *N*-alkylation (R'=alkyl). The nucleophilic attack is regioselective at the C3 position of **V**, possibly due to a steric effect as well as an electrostatic repulsion between the nucleophile and the CF<sub>3</sub> group at the C2 position (Scheme 17).

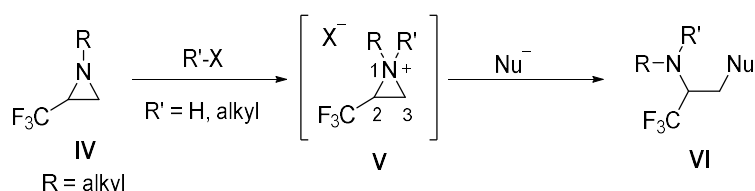

Scheme 17

#### 3.1.1. Formation of an aziridinium under acidic conditions

In 1997, Karimova *et al.* reported the activation of aziridine **L2.47**, by a variety of strong acids (NuH), to afford the aziridinium intermediate **L2.48** which, after attack of the counter-ion (Nu<sup>-</sup>) at the C3 position, led to a regioselective ring-cleavage and the formation of α-(trifluoromethyl)amines **L2.49** (Scheme 18).<sup>62</sup> It is worth mentioning, that treatment of aziridines **L2.47** with a strong acid is necessary, otherwise these aziridines remain unreactive towards nucleophiles. This lack of reactivity is probably due to the presence of the CF<sub>3</sub> group, which decreases the aziridines basicity (by two units) compared to the non-fluorinated aziridines, rendering the protonation more difficult.

<sup>62</sup> Karimova, N. M.; Teplenicheva, Y. L.; Kolomiets, A. F.; Folkin, A. V. *Russ. Chem. Bull.* **1997**, *46*, 1136–1139.

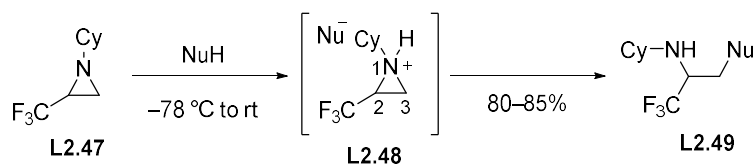

**Scheme 18**

Two years later, Katagiri *et al.* reported the acid-promoted ring-opening of *N*-benzyl-aziridine **L2.50**, with a variety of nucleophiles. Indeed, the optically active aziridine **L2.50** was activated in the presence of sulfuric or trifluoromethanesulfonic acid, to form the corresponding aziridiniums **L2.51a** and **L2.51b** respectively, which in the presence of different nucleophiles, gave the  $\alpha$ -(trifluoromethyl)amines **L2.52**, in good yields and with good enantiomeric excess (Scheme 19).<sup>63</sup> Interestingly, when aziridine **L2.50** was treated with PhSH, without the presence of a strong acid, the ring-opening product **L2.52** was isolated in a lower yield of 40%, along with 50% recovery of **L2.50**. Another interesting point, is that nitrogen-containing nucleophiles, could not promote the ring-opening of aziridines, due to the nitrogen protonation under these acidic conditions.

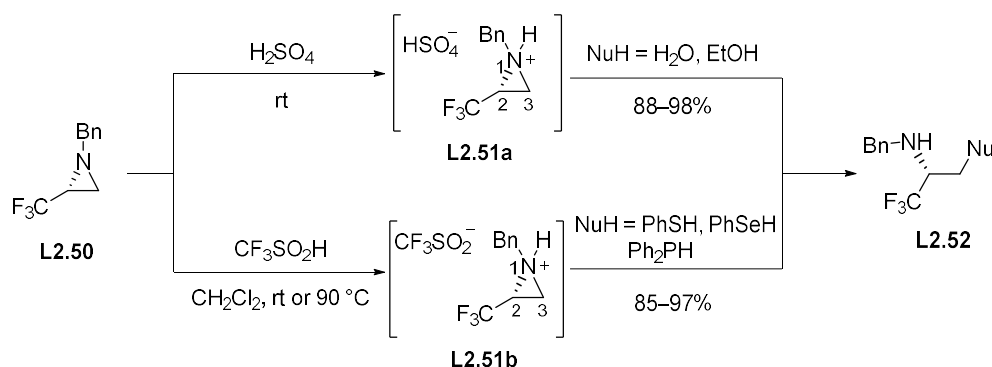

**Scheme 19**

The regioselective ring-opening of other enantiopure aziridines was studied. For example, when the optically pure *trans*-aziridine **L2.53** was activated by trifluoroacetic acid, the aziridinium intermediate **L2.54** was formed. The regioselective and stereoselective attack of the counter-ion on the aziridinium **L2.54** at the C3 position, allowed the ring-opening and therefore the access to the *anti*-(trifluoromethyl)amine **L2.55** (Scheme 20).<sup>64</sup>

<sup>63</sup> Katagiri, T.; Takahashi, M.; Fujiwara, Y.; Ihara, H.; Uneyama, K. *J. Org. Chem.* **1999**, *64*, 7323–7329.

<sup>64</sup> Davoli, P.; Forni, A.; Franciosi, C.; Moretti, I.; Prati, F. *Tetrahedron: Asymmetry* **1999**, *10*, 2361–2371.

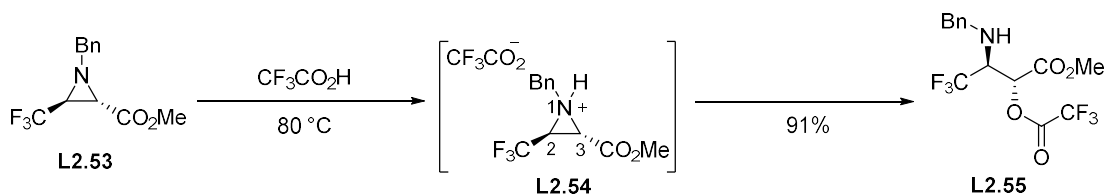

**Scheme 20**

Furthermore, (trifluoromethyl)aziridines **L2.56** can be either activated by a strong acid (HCl or  $\text{CF}_3\text{CO}_2\text{H}$ ) to form the aziridinium salt **L2.57a**, where the resulting counter-ion can then serve as a nucleophile, or activated by  $\text{CF}_3\text{SO}_2\text{H}$  to form the aziridinium **L2.57b** which can then be attacked by an external nucleophile. In both cases, the corresponding amines **L2.58** were obtained in moderate to excellent yields. The authors highlighted that the attack took place at the C3 position, indicating that the presence of the  $\text{CF}_3$  group and not the presence of the ester group, is responsible for the regioselective and diastereoselective ring-opening of the aziridinium (Scheme 21).<sup>65</sup>

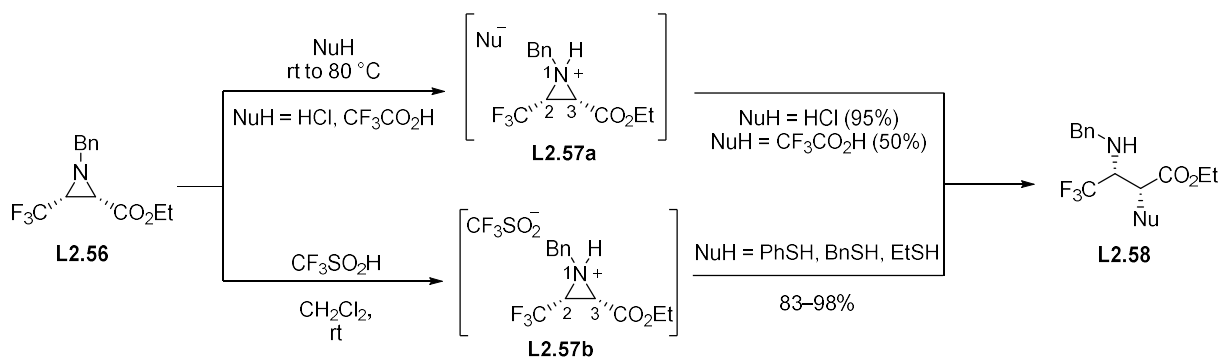

**Scheme 21**

In 2014, De Kimpe and D'hooghe reported the acid-promoted regio- and stereoselective ring-opening of *cis*- and *trans*-(trifluoromethyl)aziridines **L2.59a** and **L2.59b**, to afford a range of  $\alpha$ -(trifluoromethyl)amines **L2.61a** and **L2.61b** via the corresponding aziridinium intermediates **L2.60a** and **L2.60b**. After the activation of the aziridines **L2.59a** and **L2.59b** with sulfuric acid, and after treatment with water and methanol, the regioselective ring-opening of the aziridiniums **L2.60a** and **L2.60b** took place (Scheme 22).<sup>66</sup> The *syn*- and *anti*-products were obtained in good to excellent yields from the *cis*- and *trans*-aziridines respectively.

<sup>65</sup> Crousse, B.; Narizuka, S.; Bonnet-Delpon, D.; Bégué, J. -P. *Synlett* **2001**, 679–681.

<sup>66</sup> Moens, M.; De Kimpe, N.; D'hooghe, M. *J. Org. Chem.* **2014**, *79*, 5558–5568.

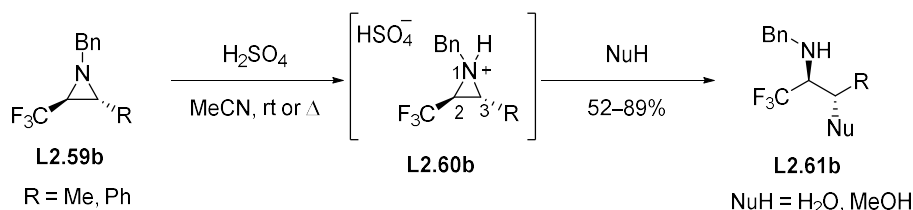
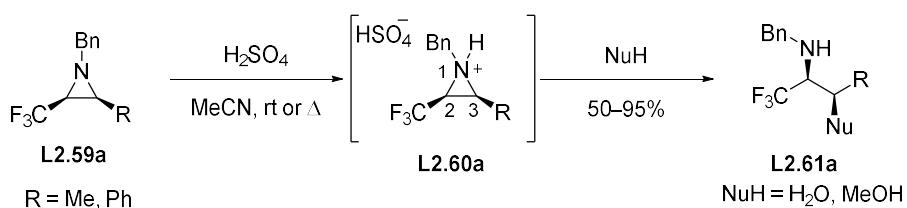

**Scheme 22**

It is worth mentioning that when bromic acid was utilized, the activation of aziridines **L2.59a** and **L2.59b** occurred by HBr itself, and the ring-opened products **L2.63a** and **L2.63b**, were obtained in good yields without the addition of sulfuric acid, after the attack of the bromine anion to the C3 position of the aziridinium **L2.62a** and **L2.62b** (Scheme 23).

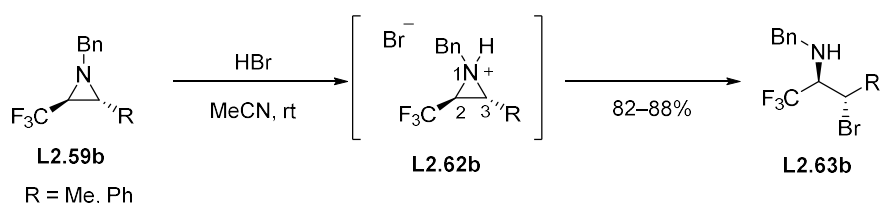
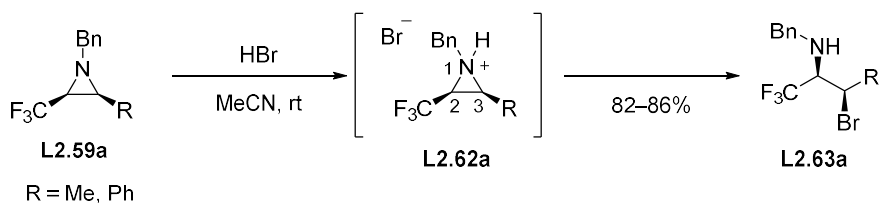

**Scheme 23**

Interestingly, when the enantiopure aziridine **L2.64**, substituted by a phenyl and a CF<sub>3</sub> group at the C2 position, was treated with a mixture of perchloric acid and water, two products were formed. The first one **L2.66**, obtained in 78% yield, is the result of the attack of the nucleophile to the aziridinium **L2.65** at C3 and the second one **L2.67**, obtained in 3% yield, corresponds to the attack of the nucleophile at the benzylic C2 position of the aziridinium intermediate **L2.65** (Scheme 24).<sup>67</sup> It is worth

<sup>67</sup> Grellepois, F.; Nonnenmacher, J.; Lachaud, F.; Portella, C. *Org. Biomol. Chem.* **2011**, *9*, 1160–1168.

noting, that when the *N*-benzyl group was replaced by a *N*-tosyl group, the amino alcohol **L2.67** was the only isolated product.

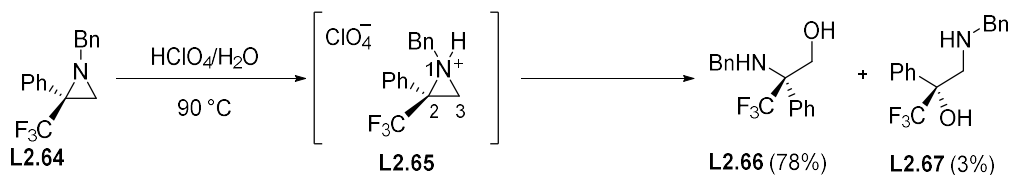

Scheme 24

### 3.1.2. Formation of an aziridinium by *N*-alkylation

An alternative method to activate an aziridine is by alkylation of the nitrogen, to form an aziridinium intermediate. Katagiri *et al.* reported in 1999 the successful *N*-methylation of (trifluoromethyl)aziridine **L2.50** using the Meerwein's reagent ( $\text{Me}_3\text{OBF}_4$ ), to obtain the aziridinium **L2.68**. In order for an external nucleophile to attack the aziridinium **L2.68**, the presence of a non-reactive counter-ion ( $\text{BF}_4^-$ ) is necessary. In the presence of different nucleophiles, the aziridinium **L2.68** underwent a regioselective attack of the nucleophile at C3, to afford a variety of  $\alpha$ -(trifluoromethyl)amines **L2.69** (Scheme 25).<sup>63</sup> It should be noted that under these conditions, the ring-opening of aziridines by carbanions as well as amines, is possible. This ring-opening, was not possible by the acid-promoted ring-opening of aziridines (see Section 3.1.1.).

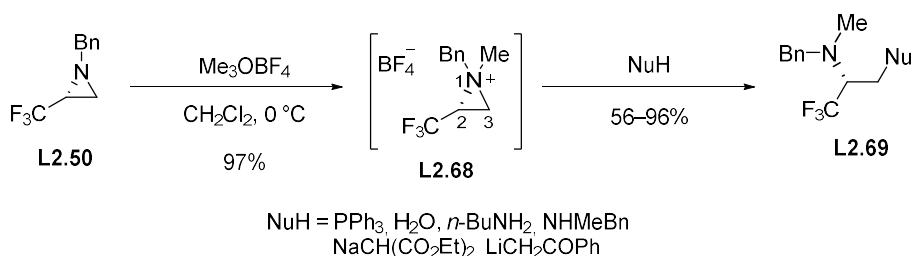

Scheme 25

Due to the difficulty to cleave the *N*-methyl group, the authors have also examined the *N*-allylation of aziridine **L2.50**. Treatment of the aziridine **L2.50** with allyl iodide in the presence of  $\text{AgBF}_4$ , led to the formation of the activated aziridinium **L2.70**, which after the addition of *n*-butylamine, afforded the ring-opened product **L2.71** in a regioselective manner (Scheme 26).<sup>63</sup>

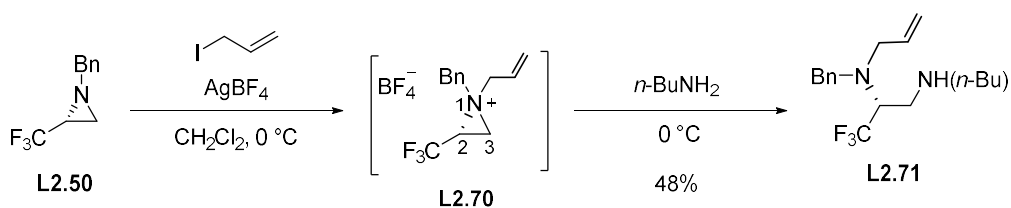

Scheme 26

Furthermore, primary  $\beta$ -iodoamines **L2.74** were obtained in very good yields, from aziridines **L2.72**. Treatment of aziridines **L2.72** with methyl iodide or benzyl iodide, afforded the aziridiniums **L2.73**, which, in the presence of iodide as a counter-ion, resulted in the regioselective attack of the anion at the C3 position and the formation of 2-iodo-1-(trifluoromethyl)amines **L2.74** (Scheme 27).<sup>68</sup> It is worth mentioning that when alkyl iodides were used for the ring-opening of non-activated alkylaziridines, the attack of the nucleophile, took place at the substituted aziridine carbon C2, under thermodynamic conditions.<sup>69</sup> This indicates that due to the electron-withdrawing nature of the CF<sub>3</sub> group, the recyclization of **L2.74** towards the aziridinium **L2.73** was not possible, pointing out that the reaction proceeds under kinetic control.

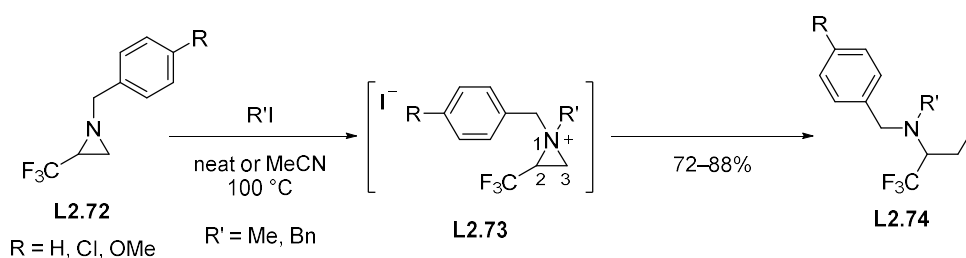

**Scheme 27**

The group of De Kimpe and D'hooghe reported the regioselective and stereoselective ring-opening of *cis*- and *trans*-aziridines **L2.59a** and **L2.59b** by *N*-methylation of the aziridines in the presence of Me<sub>3</sub>OBF<sub>4</sub>. When the aziridiniums **L2.75a** and **L2.75b** were treated with thiophenol or benzylamine, the corresponding ring-opened products **L2.76a** and **L2.76b**, were obtained in poor to moderate yields. When thiophenol was used, one unexpected side-product was also isolated, the corresponding non-methylated amines **L2.77a** and **L2.77b** (Scheme 28).<sup>66</sup> The authors do not propose any explanation for the formation of **L2.77a** and **L2.77b**.

<sup>68</sup> Kenis, S.; D'hooghe, M.; Verniest, G.; Nguyen, V. D.; Thi, T. A.; Van Nguyen, T.; De Kimpe, N. *J. Org. Biomol. Chem.* **2011**, *9*, 7217–7223.

<sup>69</sup> D'hooghe, M.; Catak, S.; Stankovic, S.; Waroquier, M.; Kim, Y.; Ha, H. -J.; Van Speybroeck, V.; De Kimpe, N. *Eur. J. Org. Chem.* **2010**, 4920–4931.



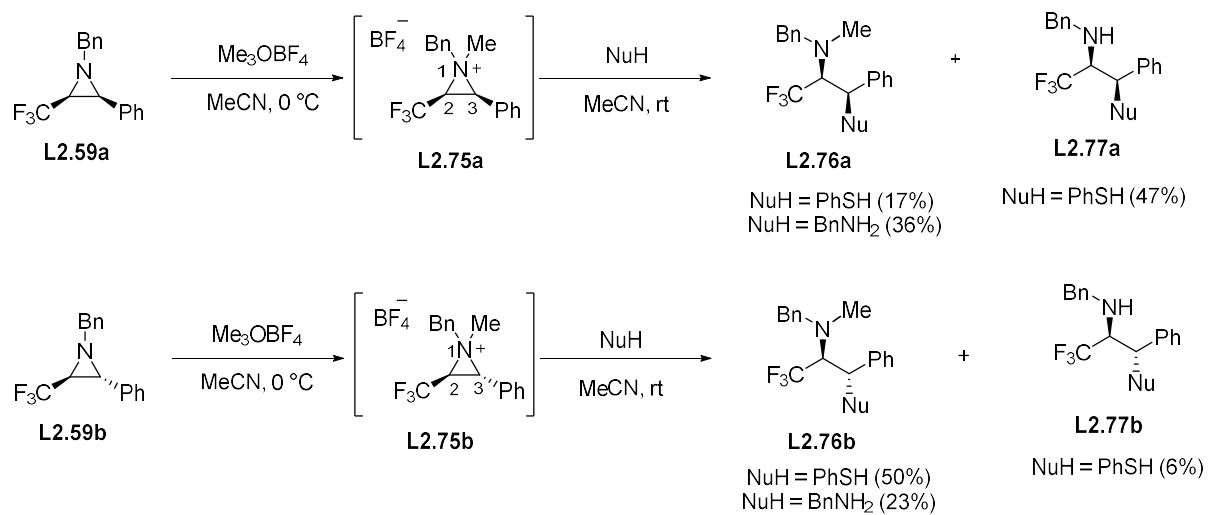

**Scheme 28**

In summary, the presence of a CF<sub>3</sub> group can influence the regioselectivity of the ring-opening of an aziridinium intermediate, by directing the attack of the nucleophile, to the carbon which does not possess the trifluoromethyl group.

## 4. Results and discussion

As previously mentioned, our goal is to access 2-substituted, 2-(trifluoromethyl)pyrrolidines ( $n=1$ ) and 2-substituted, 2-(trifluoromethyl)piperidines ( $n=2$ ) **I** by inducing a ring contraction of 3-hydroxy-3-(trifluoromethyl)piperidine ( $n=1$ ) and 3-hydroxy-3-(trifluoromethyl)azepane ( $n=2$ ) **III** via a bicyclic aziridinium intermediate **II**. This goal is based on the hypothesis that a  $\text{CF}_3$  group at the C2 position of intermediate **II**, would be responsible for the regioselective attack of the nucleophile at the C2' position of the aziridinium **II** (Scheme 29).

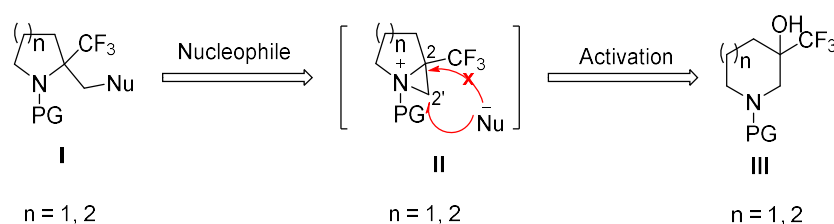

**Scheme 29**

At first, we started by studying the ring contraction of 3-hydroxy-piperidine **III** to  $\alpha$ -(trifluoromethyl)pyrrolidines **I** ( $n=1$ ), and we then expanded our study to the synthesis of  $\alpha$ -(trifluoromethyl)piperidines **I** ( $n=2$ ).

### 4.1.1. Synthesis of 2-substituted, 2-(trifluoromethyl)pyrrolidines

#### 4.1.1.1. Synthesis of the starting material

The synthesis of *N*-benzyl-3-hydroxy-3-(trifluoromethyl)piperidine **1**, was envisioned from the commercially available *N*-Boc-piperidin-3-one **3**. After the trifluoromethylation of piperidone **3**, (trifluoromethyl)piperidine **2** should be obtained, and the replacement of a *N*-Boc by a *N*-benzyl group, would lead to the desired *N*-benzyl-3-hydroxy-3-(trifluoromethyl)piperidine **1** (Scheme 30). It is worth noting that the replacement of the Boc group by a benzyl group is necessary, as the nitrogen has to be nucleophilic enough to form an aziridinium intermediate **II**.

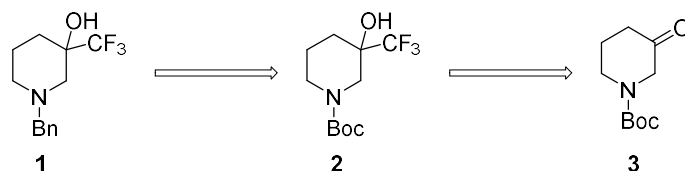

**Scheme 30**

The trifluoromethylation of *N*-Boc-piperidone **3** was carried out with the Ruppert-Prakash reagent, trimethyl(trifluoromethyl)silane ( $\text{TMSCF}_3$ ), in the presence of a stoichiometric amount of tetrabutylammonium fluoride (TBAF) as a fluorine source (THF, rt, 19 h), to afford

3-hydroxy-piperidine **2** in 77% yield. The next step consists of the deprotection of the *N*-Boc group with an excess of trifluoroacetic acid (TFA, 7.0 equiv) and treatment of the resulting ammonium salt with benzyl bromide under basic conditions ( $K_2CO_3$ , TBAI) to access the desired *N*-benzyl-3-hydroxy-3-(trifluoromethyl)piperidine **1** in a quantitative yield for the 2 steps (Scheme 31).

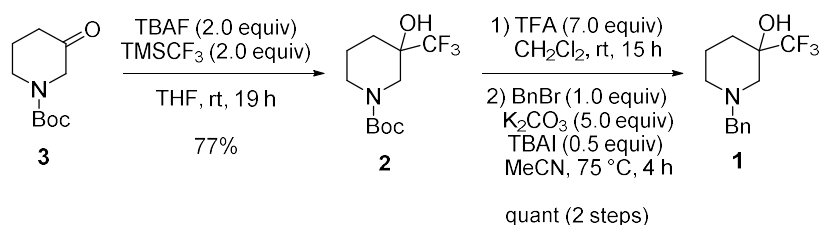

**Scheme 31**

#### 4.1.1.2. Optimization of the conditions for the ring contraction

Having the (trifluoromethyl)piperidine **1** in hand, this latter was treated with thionyl chloride in the presence of triethylamine ( $Et_3N$ ) in dichloromethane ( $CH_2Cl_2$ ), however under these conditions, the desired pyrrolidine **4** was not observed (Scheme 32).

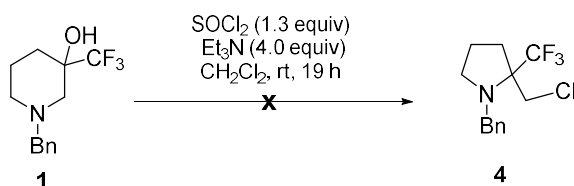

**Scheme 32**

On the contrary, when piperidine **1** was treated with mesyl chloride and  $Et_3N$ , the conversion of **1** was low (10%), but the ring contraction product **4** was isolated in a 7% yield. The formation of **4** can be explained by the formation of intermediate **5** which led to aziridinium **6**, due to the anchimeric assistance of the nitrogen. The chlorine anion present in the reaction mixture, can attack the aziridinium **6** at the C2' position to afford (trifluoromethyl)pyrrolidine **4** (Scheme 33).

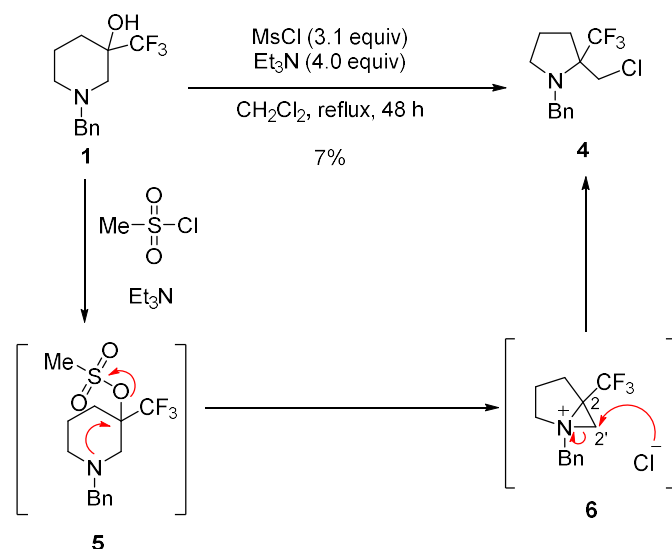

**Scheme 33**

Due to the low yield and the poor reactivity of the tertiary alcohol of **1** towards mesyl chloride, the activation of the alcohol was achieved with a mixture of triphenylphosphine and iodine in the presence of imidazole. After the formation of intermediate **7** and due to the anchimeric assistance of the nitrogen, the aziridinium intermediate **8** was formed, which after the attack of the iodine anion to the C2' position, led to the desired iodomethyl-pyrrolidine **9** in 25% yield and a total conversion of **1** (Scheme 34).

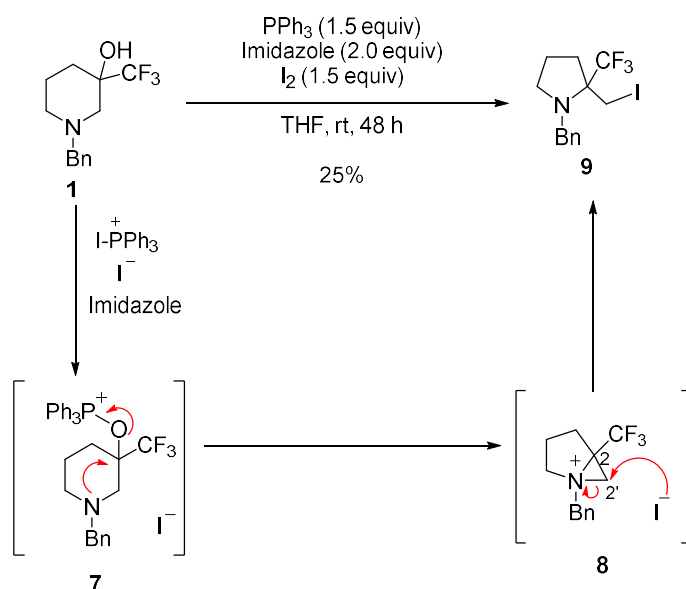

**Scheme 34**

A more powerful electrophilic activator, such as diethylaminosulfur trifluoride (DAST) was then utilized to activate the tertiary alcohol of **1**. By using DAST, the fluorinated pyrrolidine **12**,

corresponding to the ring contracted product, was selectively obtained in a good yield of 71%. The formation of pyrrolidine **12** is the result of the attack of a fluorine anion coming from DAST, to the aziridinium intermediate **11** (Scheme 35).

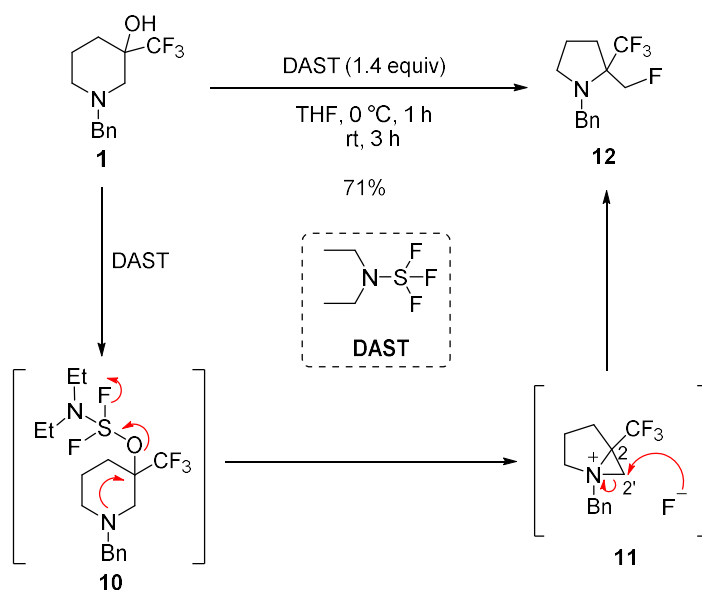

**Scheme 35**

The DAST reagent, allowed us to verify that the ring contraction of *N*-benzyl-3-hydroxy-3-(trifluoromethyl)piperidine **1** is an efficient process when the appropriate activator of the hydroxy group is used. In addition, the reaction proved to be regioselective given that the attack takes place only at the C2' position. However, the inconvenience of the DAST reagent is that other external nucleophiles cannot be used and in consequence the access to a diversity of substituted (trifluoromethyl)pyrrolidines is impossible. As a result, alternative reaction conditions allowing the activation of the hydroxy group by other electrophilic reagents must be found, in order to introduce nucleophiles different from a fluorine atom on the (trifluoromethyl)pyrrolidines.

In 2011, Charette *et al.* reported the formation of a bicyclic aziridinium intermediate **L2.80**, starting from prolinol **L2.78**, when this latter was treated with triflic anhydride (Tf<sub>2</sub>O), in the presence of proton sponge (1,8-bis(dimethylamino)naphthalene) **VII** in CH<sub>2</sub>Cl<sub>2</sub>. After the addition of different nucleophiles, piperidines **L2.81** were obtained in good to excellent yields (Scheme 36).<sup>70</sup>

<sup>70</sup> Jarvis, S. B. D.; Charette, A. B. *Org. Lett.* **2011**, *13*, 3830–3833.

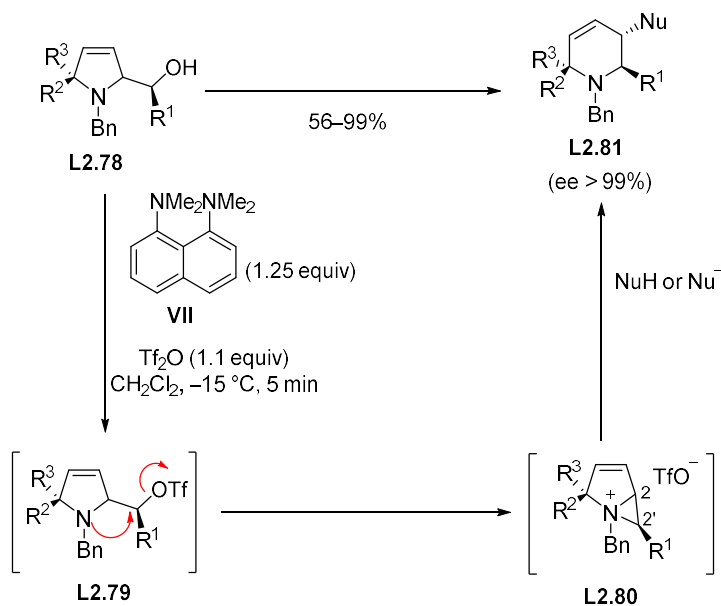

Thus, when 3-hydroxy-piperidine **1** was treated with triflic anhydride (1.5 equiv), in the presence of the proton sponge **VII** (2.0 equiv) in  $\text{CH}_2\text{Cl}_2$  at reflux, and after 5 h, benzylamine (2.5 equiv) was added to the reaction mixture, the ring contraction product, pyrrolidine **15** was isolated in 75% yield. This product is the result of the regioselective nucleophilic attack of the benzylamine to the aziridinium intermediate **14** (Scheme 37).

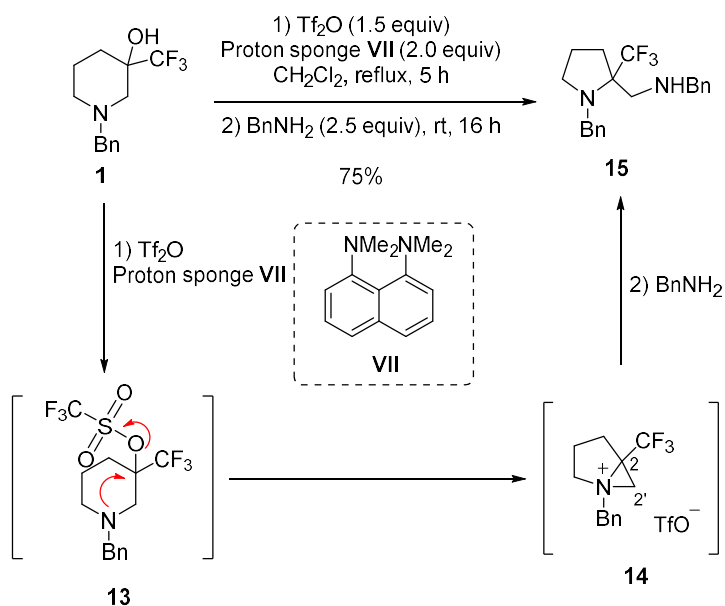

As these conditions, successfully led to the desired pyrrolidine **15** and as they may allow the use of different nucleophiles, the scope of this reaction was then studied.

#### 4.1.1.3. Scope of the reaction

Utilizing the conditions previously developed (Tf<sub>2</sub>O/Proton sponge VII/nucleophile), different primary and secondary amines were examined as nucleophiles. By adding aniline to the reaction mixture, the desired compound **16** was isolated in 71% yield (Table 2, entry 2). Five secondary amines were also tested, such as methylphenylamine, diethylamine, diallylamine, dibenzylamine and morpholine. In each case, the ring contraction products **17–21** were obtained in good yields (Table 2, entries 3–7). The best results were obtained with dibenzylamine and morpholine, where the 2-(trifluoromethyl)pyrrolidines **20** and **21** were isolated in 83% and 80% yield respectively (Table 2, entries 6 and 7). It is worth mentioning that when ammonia was involved in the ring contraction process, compound **23** was formed instead of the desired pyrrolidine **22** (Table 2, entry 8).<sup>71</sup> This product is the result of the addition of the amine to the aziridinium **14**, which is followed by a second nucleophilic attack of the formed amino-pyrrolidine **22** on a second aziridinium intermediate **14**.

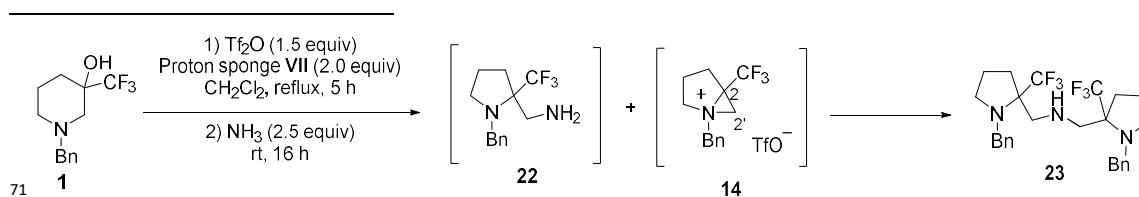

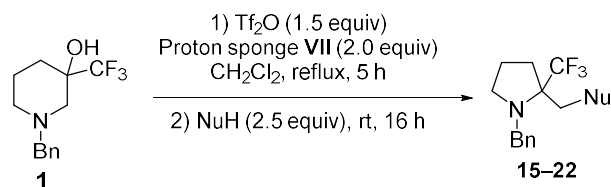

Entry	NuH	Product	Yield (%)
1	BnNH <sub>2</sub>		75
2	PhNH <sub>2</sub>		71
3	NHMePh		78
4	HNEt <sub>2</sub>		66
5			60
6	Bn <sub>2</sub> NH		83
7			80
8	NH <sub>3</sub>		0

**Table 2**

Furthermore, pyrrolidines **24–30** were obtained in good yields when oxygenated nucleophiles were used. By using methanol and ethanol, the desired products **24** and **25** were isolated in 51% and 77% yield respectively (Table 3, entries 1 and 2). When allyl and benzyl alcohol were utilized, piperidine **1** was transformed to the corresponding pyrrolidines **26** and **27**, in 57% and 65% yield respectively (Table 3, entries 3 and 4). Even water can be used as a nucleophile, leading to prolinol **28** in 61% yield,



although 14.0 equiv of H<sub>2</sub>O were required (Table 3, entry 5). In addition, when piperidine **1** was treated with an oxygenated anion such as sodium phenolate and tetrabutylammonium acetate, the desired pyrrolidines **29** and **30** were isolated in 75% and 72% yield respectively (Table 3, entries 6 and 7).

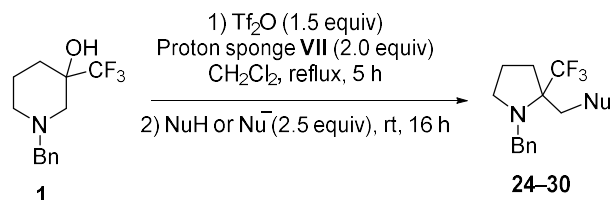

Entry	NuH	Product	Yield (%)
1	MeOH		51
2	EtOH		77
3			57
4	BnOH		65
5 <sup>a</sup>	H <sub>2</sub> O		61
6	PhONa		75
7	TBAOAc		72

a) 14.0 equiv of water were used.

**Table 3**

Other nucleophiles, such as sulfur-containing nucleophiles can undergo the ring contraction, either in the form of thiols or thiolates. Even if sodium ethanethiolate was able to induce the ring-opening of the aziridinium to produce **31** in 60% yield, thiols, which are soft nucleophiles were also able to

produce the ring contraction products, given that pyrrolidine **31** was obtained in 54% yield when ethanethiol was used as a nucleophile. (Table 4, entry 1). Pyrrolidines **32** and **33**, were isolated in 89% and 61% yield when benzyl thiol and thiophenol were utilized respectively (Table 4, entries 2 and 3).

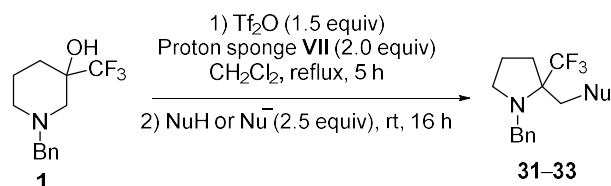

Entry	NuH	Product	Yield (%)
1	EtSNa	 <b>31</b>	60
	EtSH		54
2	BnSH	 <b>32</b>	89
3	PhSH	 <b>33</b>	61

**Table 4**

Piperidine **1** was also transformed to the corresponding fluoromethyl- and chloromethyl-pyrrolidines **12** and **4** in moderate yields (30–49%), after the addition of tetrabutylammonium fluoride and tetrabutylammonium chloride respectively (Scheme 38). It is worth noting that fluoromethyl-pyrrolidine **12** was obtained in a better yield of 71% when piperidine **1** was treated with DAST (see Scheme 35).

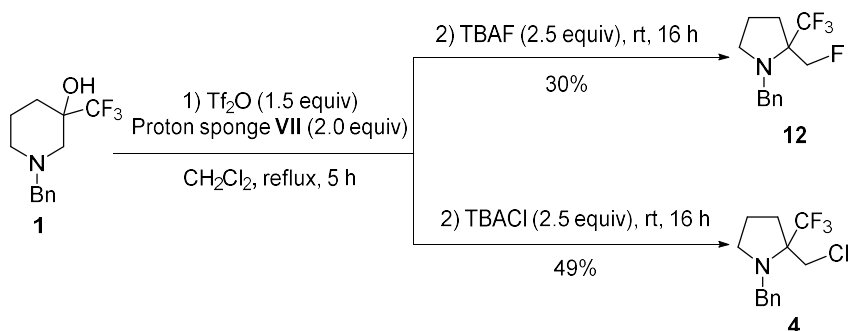

**Scheme 38**

Carbanions can also induce successfully the ring contraction. When piperidine **1** was treated with tetrabutylammonium cyanide and sodium dimethylmalonate, (trifluoromethyl)pyrrolidines **34** and **35** were isolated in 75% and 70% yield respectively (Scheme 39).

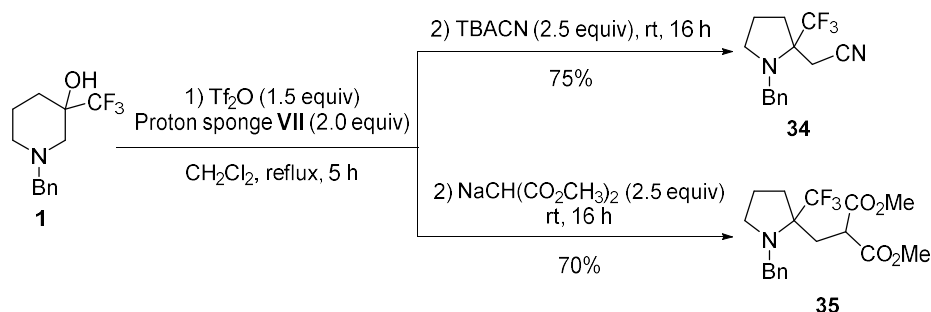

**Scheme 39**

#### 4.1.1.4. Use of a chiral nucleophile: Chirality transfer

Our next objective was to define whether a chirality transfer was induced or not, during the ring contraction process. Consequently, the two enantiomers of **1** were separated by Supercritical Fluid Chromatography (SFC). The two enantio-enriched piperidines (+)-**1** and (–)-**1**, were treated with triflic anhydride, in the presence of the proton sponge **VII** and methanol. Compounds (+)-**24** and (–)-**24**, were obtained in moderate yields and with opposite optical rotations, which could mean that the chirality was transferred during the reaction. However, the determination of the enantiomeric excess of (+)-**24** and (–)-**24** by SFC was not possible, implying that another way had to be found, to prove the chirality transfer (Scheme 40).

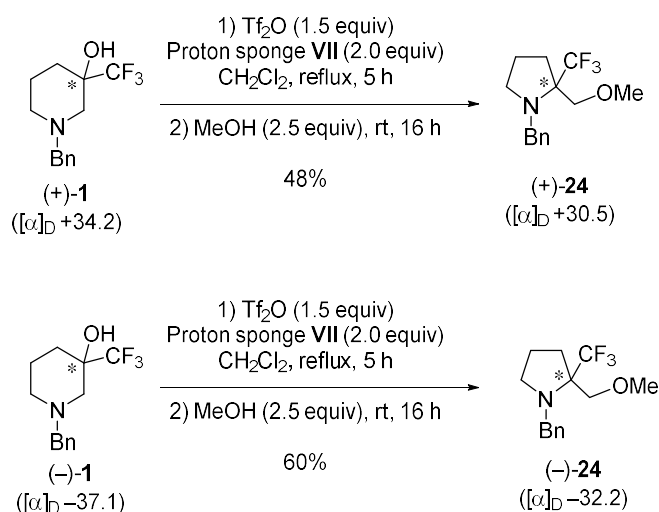

**Scheme 40**

Therefore the racemic piperidine ( $\pm$ )-**1** was treated with triflic anhydride and the proton sponge **VII**, using a chiral amine, (*S*)-(-)- $\alpha$ -methylbenzylamine as a nucleophile. The desired pyrrolidine **36** was obtained in 75% yield as a mixture of two diastereoisomers (dr=50:50) (Scheme 41).

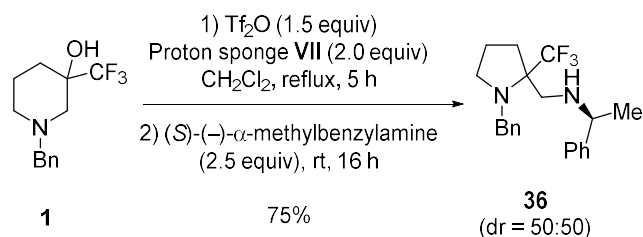

**Scheme 41**

The two enantio-enriched piperidines (+)-**1** and (-)-**1** were then treated with the conditions developed above ( $\text{Tf}_2\text{O}$ /proton sponge **VII**/(*S*)-(-)- $\alpha$ -methylbenzylamine), to afford the ring contraction products **36a** and **36b** in good yields and with diastereoselectivities superior to 95:5 in both cases (Scheme 42). This latter experiment, indicates that the ring contraction of piperidine (+)-**1** and (-)-**1** proceeds with a chirality transfer.

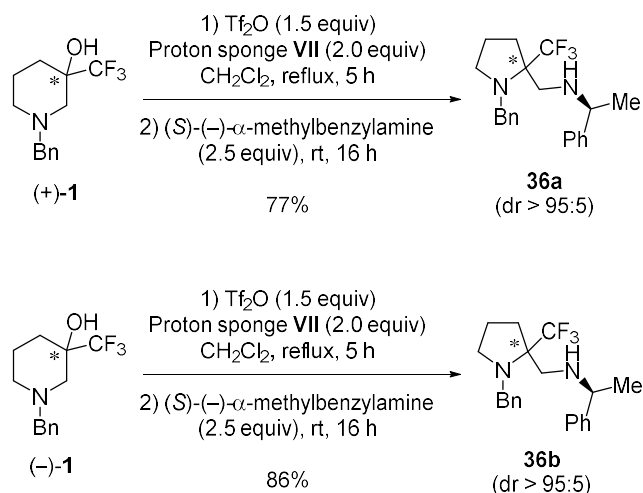

**Scheme 42**

#### 4.1.1.1. Comparison of the reactivity of 3-hydroxy-3-(trifluoromethyl)piperidine with 3-hydroxy-3-methylpiperidine

To study the influence of the  $\text{CF}_3$  group on the ring contraction process, the *N*-benzyl-3-hydroxy-3-methylpiperidine **37** was prepared and its reactivity under the conditions developed previously ( $\text{Tf}_2\text{O}$ /proton sponge **VII**/nucleophile) was studied. The attack of the nucleophile on the aziridinium **38**, can either take place at the C2 position to produce the ring-expansion product **39** (route a), or at the C2' position to produce the ring contraction product **40** (route b) (Scheme 43).

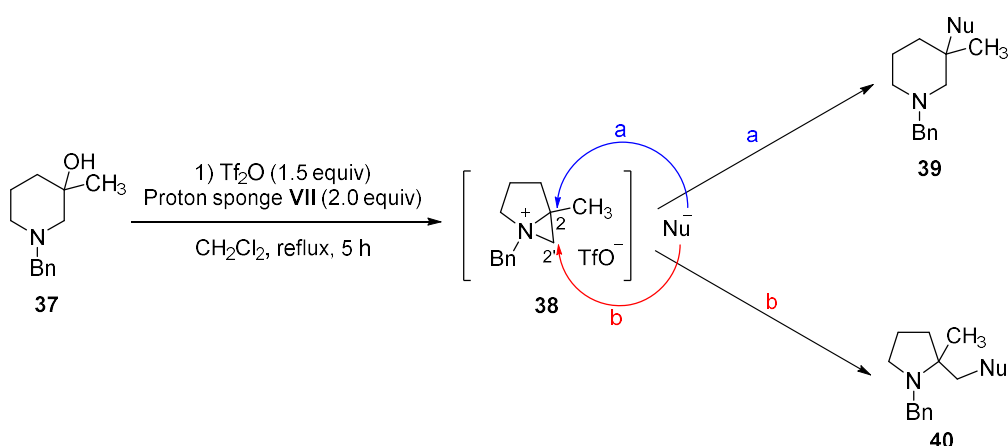

Scheme 43

Piperidine **37** was synthesized by addition of methylmagnesium bromide to piperidone **1** (THF, rt, 16 h). The *N*-Boc-3-hydroxy-3-methylpiperidine **41** was isolated in 50% yield, which after a deprotection/protection sequence (TFA/ $\text{CH}_2\text{Cl}_2$  then  $\text{BnBr}/\text{K}_2\text{CO}_3/\text{TBAI}/\text{MeCN}$ ) led to the desired 3-hydroxy-piperidine **37** in 78% yield (for the two steps) (Scheme 44).

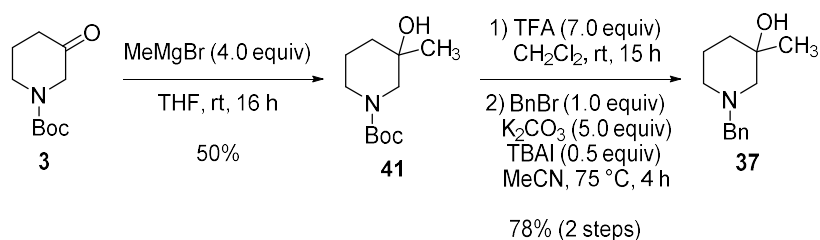

Scheme 44

Piperidine **37**, was then treated with triflic anhydride in the presence of the proton sponge **VII** and after 5 h at reflux, TBAF was added to the reaction mixture. Under these conditions, only the 6-membered ring **43** was observed (Scheme 45), indicating that without the  $\text{CF}_3$  group, the attack

takes place at the C2 position of the aziridinium **38**.<sup>72</sup> Therefore, this last experiment confirms the role of the CF<sub>3</sub> group as a directing group for the regioselective attack of the nucleophile at the C2' position of the aziridinium, allowing a ring contraction process *versus* a ring-expansion.

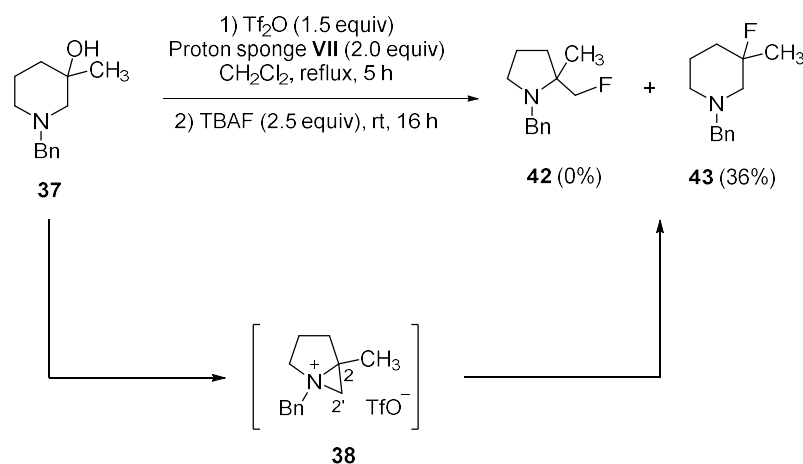

Scheme 45

#### 4.1.2. Synthesis of 2-substituted, 2-(trifluoromethyl)piperidines

Having demonstrated that the ring contraction of piperidine **1** was possible and that the corresponding  $\alpha$ -(trifluoromethyl)pyrrolidines can be obtained, our next goal was to apply the previously developed conditions (Tf<sub>2</sub>O/proton sponge VII/nucleophile) to (trifluoromethyl)azepane **III**, in order to access  $\alpha$ -(trifluoromethyl)piperidines **I** *via* a similar aziridinium intermediate **II** (Scheme 46).

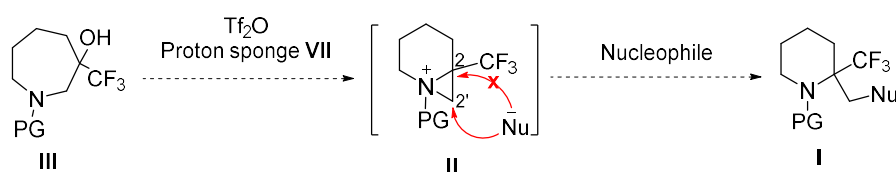

Scheme 46

##### 4.1.2.1. Synthesis of the starting material

The synthesis of *N*-benzyl-3-hydroxy-3-(trifluoromethyl)azepane **44** was envisioned from the hydroxy-azepane **45**, which would be formed after a ring-closing metathesis applied to the unsaturated aminoalcohol **46**. Compound **46** would be obtained from the commercially available

<sup>72</sup> Anxionnat, B.; Robert, B.; George, P.; Ricci, G.; Perrin, M. -A.; Gomez Pardo, D.; Cossy, J. *J. Org. Chem.* **2012**, *77*, 6087–6099.

chloroacetaldehyde **47**, by addition of an allyl metal, followed by treatment with allylamine (Scheme 47).<sup>73</sup>

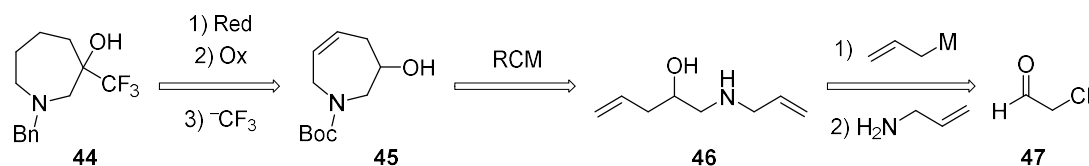

**Scheme 47**

After treatment of chloroacetaldehyde **47** with allyl bromide, in the presence of indium in  $\text{H}_2\text{O}$ , compound **48** was formed in 80% yield and was then reacted with allylamine, to give after 5 days at  $86\text{ }^\circ\text{C}$ , the unsaturated aminoalcohol **46** in 96% yield. Compound **46** was then protected with a Boc group to give the *N*-Boc-protected aminoalcohol **49**, which after a ring-closing metathesis in the presence of 15 mol % of Grubbs-I catalyst, afforded azepane **45** in 69% yield. Hydrogenation of the double bond ( $\text{H}_2/\text{platinum oxide (PtO}_2\text{)}$ ), followed by oxidation with the Dess-Martin periodinane, led to azepanone **51** in an overall yield of 86%. Trifluoromethylation of **51** with  $\text{TMSCF}_3$  and TBAF and finally replacement of the *N*-Boc by a *N*-benzyl group, afforded the desired (trifluoromethyl)azepane **44** (Scheme 48).

<sup>73</sup> Prokopiou, P. A.; Browning, C.; Buckley, J. M.; Clark, K. L.; Fechner, L.; Gore, P. M.; Hancock, A. P.; Hodgson, S. T.; Holmes, D. S.; Kranz, M.; Looker, B. E.; Morriss, K. M. L.; Parton, D. L.; Russell, L. J.; Slack, R. J.; Sollis, S. L.; Vile, S.; Watts, C. J. *J. Med. Chem.* **2011**, *54*, 2183–2195.

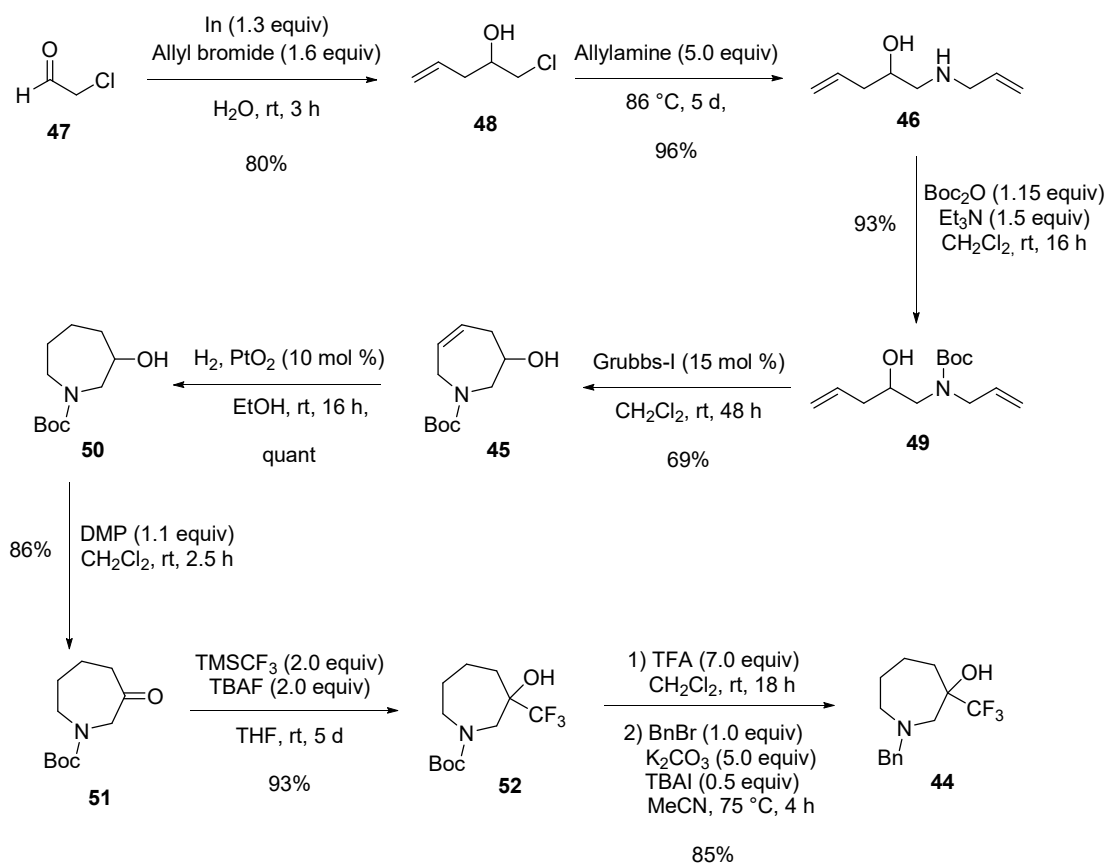

**Scheme 48**

#### 4.1.2.2. Scope of the ring contraction process

Having the 3-hydroxy-3-(trifluoromethyl)azepane **44** in hand, the ring contraction conditions previously developed (Tf<sub>2</sub>O/proton sponge **VII**/nucleophile) were applied to this azepane, in order to access the corresponding  $\alpha$ -(trifluoromethyl)piperidines. The reaction was successful and no further optimization was needed, as the corresponding piperidines were obtained in very good to excellent yields.

Primary amines such as benzylamine and aniline, produced the corresponding piperidines **54** and **55** in very good to excellent yields from azepane **44** (Table 5, entries 1 and 2). When secondary amines such as diethylamine and diallylamine were used, even better yields in the piperidines were obtained as the desired compounds **56** and **57** were isolated in 92% and 85% yield respectively (Table 5, entries 3 and 4). By utilizing dibenzylamine and morpholine, piperidines **58** and **59** were afforded in quantitative yields (Table 5, entries 5 and 6).



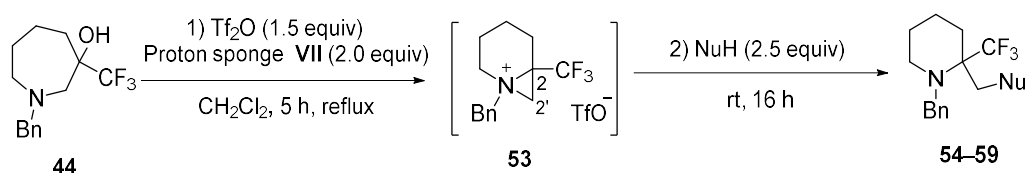

Entry	NuH	Product	Yield (%)
1	BnNH <sub>2</sub>		62
2	PhNH <sub>2</sub>		quant
3	HNEt <sub>2</sub>		92
4			85
5	Bn <sub>2</sub> NH		quant
6			quant

**Table 5**

Several oxygenated nucleophiles were also tested. When methanol and ethanol were used, the corresponding substituted piperidines **60** and **61**, were isolated in 93% and 95% yield respectively (Table 6, entries 1 and 2), while allyl alcohol and benzyl alcohol led to piperidines **62** and **63** in 93% and 82% yield respectively (Table 6, entries 3 and 4). Treatment of **44** with H<sub>2</sub>O, led to compound **64** in 93% yield (Table 6, entry 5). Moreover, piperidines **65** and **66** were obtained in quantitative yields, when charged nucleophiles such as phenolate and acetate were added to the reaction media (Table 6, entries 6 and 7).

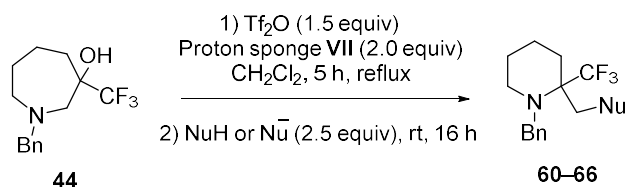

Entry	NuH	Product	Yield (%)
1	MeOH		93
-----			
2	EtOH		95
-----			
3			93
-----			
4	BnOH		82
-----			
5	H <sub>2</sub> O		93
-----			
6	PhONa		quant
-----			
7	TBAOAc		quant

**Table 6**

Furthermore, treatment of azepane **44** with Tf<sub>2</sub>O in the presence of the proton sponge **VII**, followed by the addition of reagents such as sodium ethanethiolate and sodium thiophenolate, led to piperidines **67** (92%) and **68** (85%) (Scheme 49).

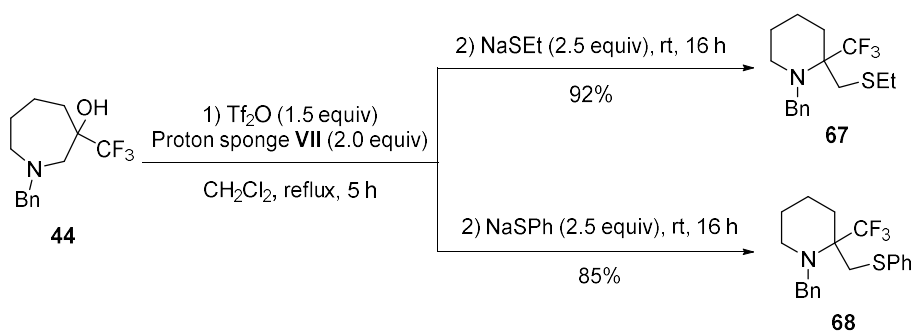

**Scheme 49**

2-Methylhalogen piperidines were also obtained when tetrabutylammonium fluoride, chloride, bromide and iodide were added to the reaction media. The corresponding 2-substituted, 2-(trifluoromethyl)piperidines **69–72** were afforded in good to very good yields from 61%–89% (Scheme 50).

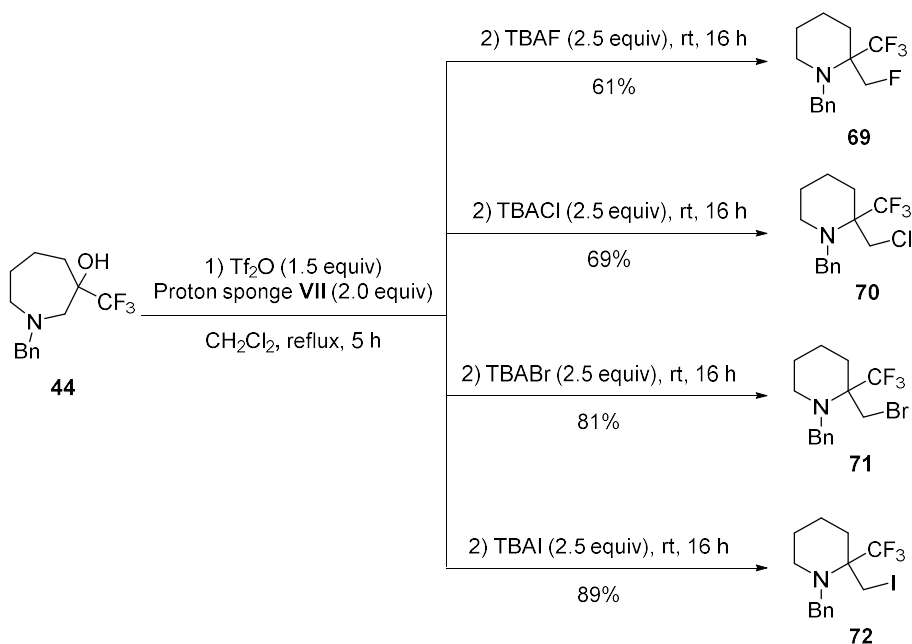

**Scheme 50**

It is interesting to mention, that when azepane **44** was treated with DAST in THF, the fluoromethyl-piperidine **69** was obtained in a better yield than by using  $\text{Tf}_2\text{O}$ /proton sponge **VII**/TBAF (71% versus 61%) (Scheme 50 and Scheme 51).

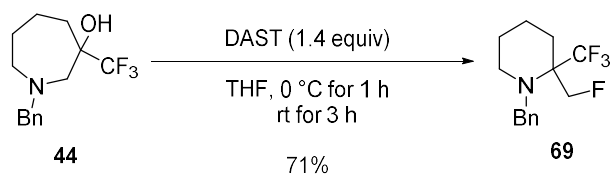

**Scheme 51**

In addition, azepane **44** was transformed to (trifluoromethyl)piperidines **73** and **74** in excellent yields, by using a cyanide (94%) and a malonate anion (quantitative yield) (Scheme 52).

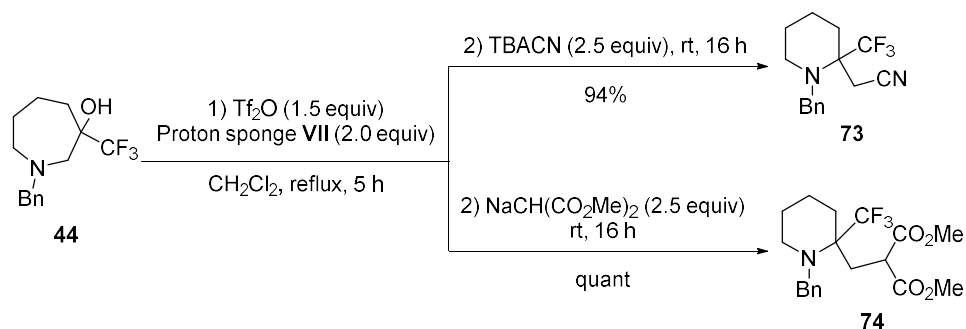

Scheme 52

The addition of a methyl group to the aziridinium **53** to produce **75** (Scheme 53) was then considered. Therefore, azepane **44** was treated with triflic anhydride, in the presence of the proton sponge **VII** and then methyllithium was added to the reaction media. Under these conditions, only traces of the desired product **75** were detected by GC/MS analysis of the crude mixture, as well as the chlorinated piperidine **70** as the major product (Scheme 53). This result indicates that a reaction between methyllithium and dichloromethane takes place, by releasing a chlorine anion, which attacks the aziridinium. To avoid this secondary reaction, methylcyanocuprate was prepared from methyllithium and copper cyanide in THF, and then added to the reaction mixture. Here again, only traces of piperidine **75** were detected by GC/MS analysis, while piperidine **70** was still detected as the major product. Finally, the replacement of the organocuprolithium complex by organocupromagnesium chloride, afforded the desired piperidine **75** in 50% yield. It is worth noting that the presence of the undesired compound **70** was detected, although this latter was not isolated (Scheme 53).

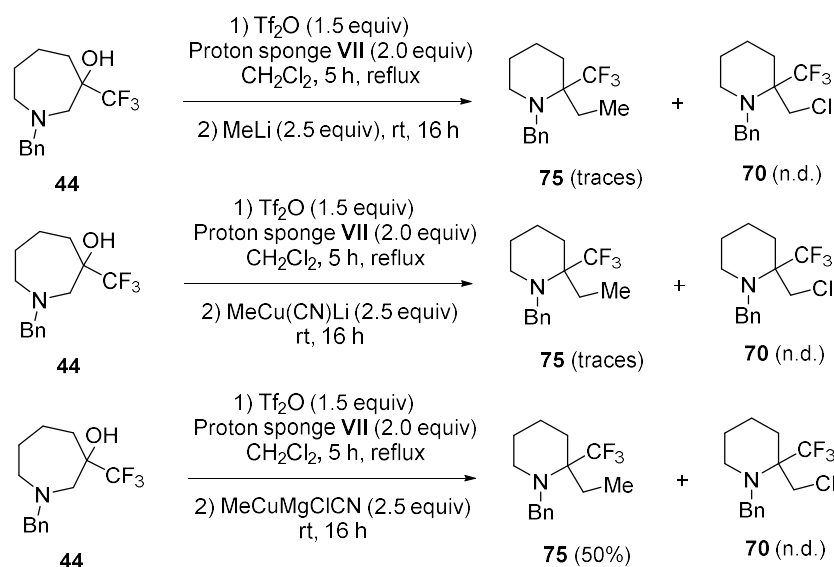

Scheme 53

Interestingly, when sodium borohydride was utilized as a hydride source, the ring contraction product **76** was successfully obtained in 73% yield (Scheme 54).

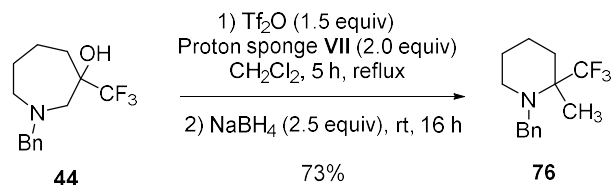

**Scheme 54**

#### 4.1.2.3. Comparison of the reactivity of 3-hydroxy-3-(trifluoromethyl)azepane with 3-hydroxy-3-methylazepane

As for the transformation of (trifluoromethyl)piperidines to (trifluoromethyl)pyrrolidines, the replacement of the  $\text{CF}_3$  group of azepane **44** by a methyl group, was achieved to verify the regioselectivity of the attack of a nucleophile on the aziridinium intermediate. Therefore, the synthesis of 3-hydroxy-3-methylazepane **77** was envisaged, to establish whether the attack of the nucleophile would take place at the C2 or the C2' position of the aziridinium intermediate **78** (route a versus route b) (Scheme 55).

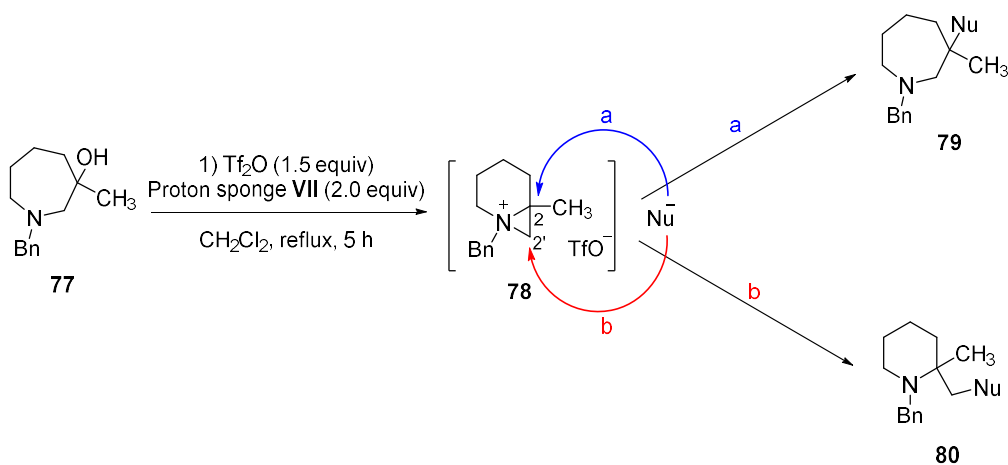

**Scheme 55**

Azepane **77** was obtained from azepanone **51**, previously synthesized (see Scheme 48). Treatment of **51** with methylmagnesium bromide in THF, afforded the *N*-Boc-azepane **81** in 72% yield. Treatment of azepane **81** with trifluoroacetic acid, led to the deprotected ammonium salt, which was then treated with benzyl bromide, in the presence of potassium carbonate and tetrabutylammonium iodide. The desired azepane **77** was isolated with a quantitative yield (Scheme 56).

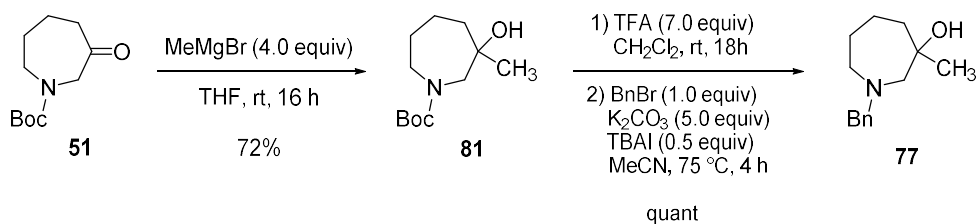

**Scheme 56**

After treatment of azepane **77** with triflic anhydride, proton sponge **VII** and tetrabutylammonium fluoride, the ring contraction product **82** was not isolated, but compound **83** was obtained instead. This latter, results from the attack of the nucleophile at the C2 position of the aziridinium intermediate **78** (Scheme 57).<sup>72</sup> As before, we can deduce that the presence of the CF<sub>3</sub> group on the azepane, is important and necessary for the regioselective attack of the nucleophile on the aziridinium at the C2' position, to afford only the ring contraction products.

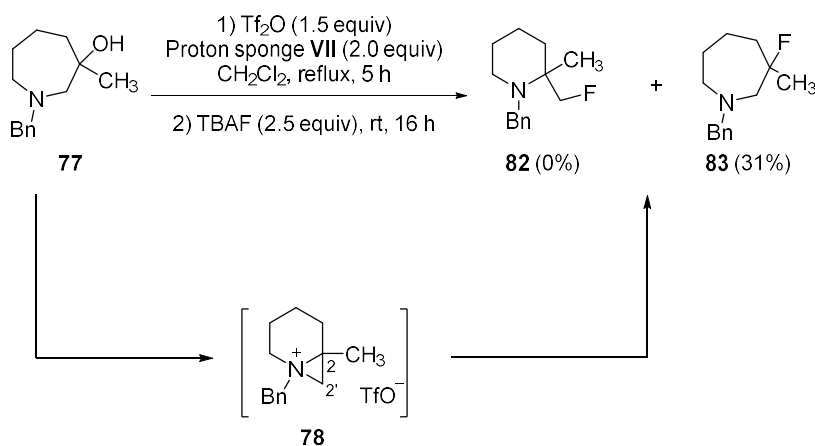

**Scheme 57**

## 5. Conclusion

The ring contraction of 3-hydroxy-3-(trifluoromethyl)piperidine **1** and 3-hydroxy-3-(trifluoromethyl)azepane **44** was accomplished, to afford the corresponding pyrrolidines<sup>74</sup> **15–36** and piperidines **54–76** respectively, possessing a quaternary center at the C2 position. A variety of nucleophiles such as amines, alcohols, thiols, carbanions and halides, can be used to obtain a diversity of 2-substituted, 2-(trifluoromethyl)pyrrolidines and 2-substituted, 2-(trifluoromethyl)piperidines in good to excellent yields (Scheme 58).

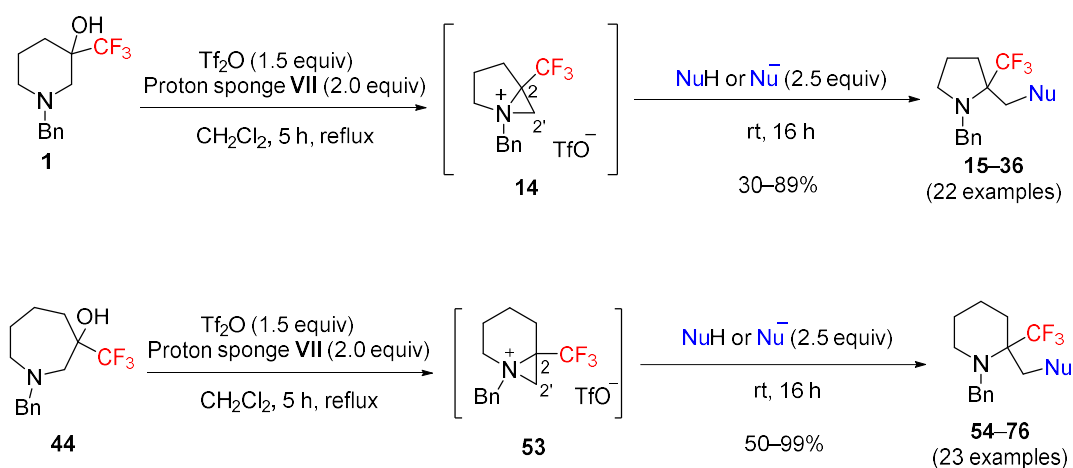

**Scheme 58**

It was also demonstrated that the role of the  $\text{CF}_3$  group was crucial for the regioselectivity of the reaction. Our hypothesis according to which, the  $\text{CF}_3$  acts as a directing group to afford uniquely the ring contraction products, is therefore validated.

Finally, it is important to mention that the chirality transfer during the ring contraction was confirmed, proving that enantio-enriched pyrrolidines and piperidines can be obtained.

<sup>74</sup> Feraldi-Xypolia, A.; Gomez Pardo, D.; Cossy, J. *Chem. Eur. J.* **2015**, *21*, 12876–12880.

**CHAPTER 2**  
**Experimental Part**





# 1. General experimental methods

All reactions were carried out under an argon atmosphere unless otherwise specified. Flasks were oven-dried at 120 °C and cooled down under argon prior to use. Without any specification, all commercially available products were used directly without any purification. THF and Et<sub>2</sub>O were distilled over sodium/benzophenone and Et<sub>3</sub>N and CH<sub>2</sub>Cl<sub>2</sub> were distilled over CaH<sub>2</sub> before their use. MeCN and DMSO were bought dry from Aldrich and used as received. All others reagents were used as obtained from Aldrich, without further purification unless otherwise specified.

Purification by flash column chromatography was carried out by using silica gel (pore size 60 Å, 230 mesh). TLC were performed on silica gel plate (Merck 60F<sub>254</sub>) and visualized either with a UV lamp (254 nm) or by treatment with an aqueous potassium permanganate solution (KMnO<sub>4</sub>/K<sub>2</sub>CO<sub>3</sub>/AcOH) and subsequent heating.

Melting points (Mp) were recorded using a Wagner & Munz Kofler bench and a Büchi Melting Point M-560 apparatus with open capillaries.

<sup>1</sup>H NMR spectra were recorded on a Bruker AVANCE 400 at 400 MHz and data are reported as follows: chemical shift in ppm, with the solvent as internal standard (CDCl<sub>3</sub>, δ 7.26 ppm, DMSO-d<sub>6</sub>, δ 2.50 ppm). The multiplicity and shape of signals are designated by the following abbreviations: s = singlet, d = doublet, t = triplet, q = quadruplet, m = multiplet, br = broad, app = apparent. Coupling constants *J* were measured in Hertz.

<sup>13</sup>C NMR spectra were recorded on a Bruker AVANCE 400 at 100 MHz and data are reported as follows: chemical shift in ppm, with the solvent as internal standard (CDCl<sub>3</sub>, δ 77.16 ppm, DMSO-d<sub>6</sub>, δ 39.52 ppm). The multiplicity and shape of signals are designated by the following abbreviations: s = singlet, d = doublet, t = triplet, q = quadruplet, br = broad, m = multiplet. Coupling constants *J* were measured in Hertz.

Infrared (IR) were recorded with a Bruker TENSORTM 27 (IRFT), wave-numbers are indicated in cm<sup>-1</sup>.

Mass spectra with electronic impact (MS-EI) were recorded from a Shimadzu GCMS-QP 2010S.

High Resolution Mass Spectra (HRMS) were performed by the Centre Regional de Microanalyse (Université Pierre et Marie Curie, Paris VI, France).

Optical rotations were measured with a Perkin Elmer 343 polarimeter in a 10-cm cell. The concentrations indicated are in g/100 mL.

## 2. Synthesis and spectroscopic data of *N*-benzyl-3-hydroxy-3-(trifluoromethyl)piperidine (1)

*tert*-Butyl 3-trifluoromethyl-3-hydroxypiperidin-1-carboxylate (2)<sup>75</sup>

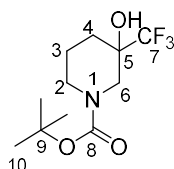

To a stirred solution of *N*-Boc-3-piperidone **3** (2.0 g, 9.74 mmol, 1.0 equiv) in THF (40 mL) at 0 °C was added TMSCF<sub>3</sub> (2.94 mL, 19.47 mmol, 2.0 equiv). A solution of TBAF (1.0 M in THF, 19.5 mL, 19.47 mmol, 2.0 equiv) was added dropwise and the resulting mixture was stirred at rt for 19 h. The solution was quenched with an aqueous and saturated solution of NH<sub>4</sub>Cl (40 mL) and stirred for another 20 min. The solution was then concentrated under reduced pressure and diluted in CH<sub>2</sub>Cl<sub>2</sub>. The organic layer was separated and washed with H<sub>2</sub>O (twice), dried over anhydrous MgSO<sub>4</sub>, filtered and concentrated under reduced pressure. The crude mixture was purified by flash chromatography (EtOAc/PE=10:90 to 20:80) to afford **2** (2.03 g, 7.52 mmol, 77%) as a white solid.

**IR (neat):** 3407, 2978, 1740, 1672, 1432, 1368, 1278, 1247, 1145, 1045, 1010 cm<sup>-1</sup>.

**<sup>1</sup>H NMR (DMSO-d<sub>6</sub>, 400 MHz at 122 °C):** δ 5.48 (br s, OH), 3.69 (d, *J* = 13.2 Hz, 1H, H<sub>6</sub>), 3.68 (m, 1H, H<sub>2</sub>), 3.27 (d, *J* = 13.5 Hz, 1H, H<sub>6</sub>), 3.03 (m, 1H, H<sub>2</sub>), 1.80–1.73 (m, 3H, H<sub>3</sub> and H<sub>4</sub>), 1.55 (m, 1H, H<sub>4</sub>), 1.44 (s, 9H, H<sub>10</sub>).

**<sup>13</sup>C NMR (DMSO-d<sub>6</sub>, 400 MHz at 122 °C):** δ 153.7 (C, C<sub>8</sub>), 125.8 (C, q, *J* = 286.5 Hz, C<sub>7</sub>), 78.3 (CH<sub>2</sub>, C<sub>6</sub>), 69.3 (C, q, *J* = 26.6 Hz, C<sub>5</sub>), 46.6 (C, C<sub>9</sub>), 42.3 (CH<sub>2</sub>, C<sub>2</sub>), 28.3 (CH<sub>2</sub>, C<sub>4</sub>), 27.5 (3xCH<sub>3</sub>, C<sub>10</sub>), 18.8 (CH<sub>2</sub>, C<sub>3</sub>).

**MS *m/z* (relative intensity):** 269 (M<sup>+</sup>, 0.7), 210 (2), 196 (10), 85 (8), 57 (100).

<sup>75</sup> Ryu, J. H.; Kim, S. A.; Ryu, K. H.; Kim, J. S.; Kim, N. H.; Han, H. Y.; Kim, Y. H.; Youn, W. -N.; Lee, Y. -J.; Son, H. J.; Lee, B. -Y.; Park, S. H.; Lee, J. -Y.; Lee, H. J.; Jung, H. C.; Shin, Y. A.; Lee, J. A.; Lee, B. R.; Sa, J. H. **2011** (WO 2011/139107).

### **N-Benzyl-3-hydroxy-3-(trifluoromethyl)piperidine (1)**

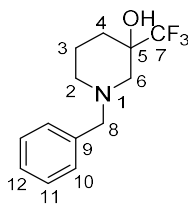

To a stirred solution of *tert*-butyl 3-trifluoromethyl-3-hydroxypiperidin-1-carboxylate **2** (2.03 g, 7.52 mmol, 1.0 equiv) in CH<sub>2</sub>Cl<sub>2</sub> (42 mL) at rt was added TFA (3.91 mL, 52.64 mmol, 7.0 equiv). The reaction mixture was stirred at rt for 15 h and then concentrated under reduced pressure.

To a stirred solution of the crude material previously obtained in MeCN (77 mL) at rt were added successively BnBr (0.90 mL, 7.52 mmol, 1.0 equiv), K<sub>2</sub>CO<sub>3</sub> (5.2 g, 37.6 mmol, 5.0 equiv) and TBAI (1.39 g, 3.76 mmol, 0.5 equiv). The reaction mixture was heated at 75 °C for 4 h and then allowed to cool to rt. The reaction mixture was quenched with H<sub>2</sub>O and extracted with CH<sub>2</sub>Cl<sub>2</sub> (twice). The organic layer was dried over anhydrous MgSO<sub>4</sub>, filtered and concentrated under reduced pressure. The crude mixture was purified by flash chromatography (EtOAc/PE=10:90) to afford **1** (1.93 g, 7.44 mmol, quant) as a colorless oil.

**IR (neat):** 3458, 3030, 2953, 2817, 1496, 1454, 1368, 1284, 1181, 1149, 1103, 1029, 1009, 943 cm<sup>-1</sup>.

**<sup>1</sup>H NMR (CDCl<sub>3</sub>, 400 MHz):** δ 7.35–7.23 (m, 5H, H<sub>10</sub>, H<sub>11</sub> and H<sub>12</sub>), 3.55 (s, 2H, H<sub>8</sub>), 3.47 (br s, OH), 2.86–2.83 (m, 2H, H<sub>2</sub> and H<sub>6</sub>), 2.20 (d, *J* = 11.2 Hz, 1H, H<sub>6</sub>), 1.97 (m, 1H, H<sub>2</sub>), 1.86–1.79 (m, 2H, H<sub>3</sub> and H<sub>4</sub>), 1.62 (m, 1H, H<sub>3</sub>), 1.48 (m, 1H, H<sub>4</sub>).

**<sup>13</sup>C NMR (CDCl<sub>3</sub>, 100 MHz):** δ 137.3 (C, C<sub>9</sub>), 129.1 (2xCH, C<sub>10</sub> or C<sub>11</sub>), 128.6 (2xCH, C<sub>10</sub> or C<sub>11</sub>), 127.6 (CH, C<sub>12</sub>), 125.5 (C, q, *J* = 282.4 Hz, C<sub>7</sub>), 71.3 (C, q, *J* = 28.6 Hz, C<sub>5</sub>), 62.7 (CH<sub>2</sub>, C<sub>8</sub>), 57.1 (CH<sub>2</sub>, d<sub>app</sub>, *J* = 2.0 Hz, C<sub>6</sub>), 52.9 (CH<sub>2</sub>, C<sub>2</sub>), 28.2 (CH<sub>2</sub>, C<sub>4</sub>), 20.3 (CH<sub>2</sub>, C<sub>3</sub>).

**MS *m/z* (relative intensity):** 259 (M<sup>+</sup>, 20), 182 (14), 168 (23), 146 (17), 134 (12), 91 (100), 65 (12).

**HRMS:** calcd for C<sub>13</sub>H<sub>17</sub>F<sub>3</sub>NO (M+H<sup>+</sup>): 260.1257. Found 260.1260.

Separation of the two enantiomers by SFC: RegisPack 4.4\*250 mm, 5μm, Pressure=137 bar, CO<sub>2</sub>/MeOH=95:5, Flow rate=40 mL/min, UV=210 nm, t<sub>R</sub>=1.8 min and t<sub>R</sub>=2.8 min.

### 3. Synthesis and spectroscopic data of 2-substituted, 2-(trifluoromethyl) pyrrolidines

#### General Protocol for the synthesis of 2-(trifluoromethyl)pyrrolidines

To a stirred solution of *N*-benzyl-3-hydroxy-3-(trifluoromethyl)piperidine **1** (1.0 equiv) and proton sponge **VII** (2.0 equiv) in CH<sub>2</sub>Cl<sub>2</sub> (0.047 M) at -15°C was added triflic anhydride (1.5 equiv). After 5 h of stirring at reflux, the solution was cooled to rt, the nucleophile (2.5 equiv) was added and the reaction mixture was stirred at rt for 16 h. The reaction mixture was diluted with H<sub>2</sub>O, extracted with CH<sub>2</sub>Cl<sub>2</sub> and the combined extracts were dried over anhydrous Na<sub>2</sub>SO<sub>4</sub>, filtered and concentrated under reduced pressure. The crude mixture was purified by flash chromatography.

#### ***N*-Benzyl-2-chloromethyl-2-(trifluoromethyl)pyrrolidine (4)**

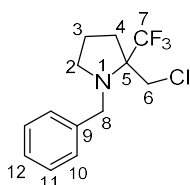

1) Following the general protocol: **1** (100 mg, 0.39 mmol, 1.0 equiv), proton sponge (165.3 mg, 0.77 mmol, 2.0 equiv), triflic anhydride (96 μL, 0.58 mmol, 1.5 equiv). Nucleophile = tetrabutylammonium chloride (268 mg, 0.96 mmol, 2.5 equiv). The crude mixture was purified by flash chromatography (PE=100%) to afford **4** (53 mg, 0.19 mmol, 49%) as colorless oil.

2) To a stirred solution of *N*-benzyl-3-hydroxy-3-(trifluoromethyl)piperidine **1** (250 mg, 0.96 mmol, 1.0 equiv) in CH<sub>2</sub>Cl<sub>2</sub> (6 mL) at 0 °C were added Et<sub>3</sub>N (0.54 mL, 3.9 mmol, 4.0 equiv) and MsCl (0.23 mL, 2.9 mmol, 3.1 equiv). The resulting mixture was stirred at reflux for 48 h. The reaction mixture was quenched with a H<sub>2</sub>O, extracted with CH<sub>2</sub>Cl<sub>2</sub> and the combined organic phases were dried over anhydrous Na<sub>2</sub>SO<sub>4</sub>, filtered and concentrated under reduced pressure. The crude mixture was purified by flash chromatography (PE=100%) to afford **4** (20 mg, 0.07 mmol, 7%) as a colorless oil.

**IR (neat):** 2922, 2852, 1719, 1457, 1409, 1375, 1261, 1097, 1042, 1018 cm<sup>-1</sup>.

**<sup>1</sup>H NMR (CDCl<sub>3</sub>, 400 MHz):** δ 7.35–7.21 (m, 5H, H<sub>10</sub>, H<sub>11</sub> and H<sub>12</sub>), 4.02 (d, *J* = 16.8 Hz, 1H, H<sub>8</sub>), 3.98 (d, *J* = 14.4 Hz, 1H, H<sub>8</sub>), 3.92 (d, *J* = 11.9 Hz, 1H, H<sub>6</sub>), 3.75 (d, *J* = 11.9 Hz, 1H, H<sub>6</sub>), 2.82 (t<sub>app</sub>, *J* = 6.5 Hz, 2H, H<sub>2</sub>), 2.30 (m, 1H, H<sub>4</sub>), 2.19 (m, 1H, H<sub>4</sub>), 1.84–1.77 (m, 2H, H<sub>3</sub>).

**<sup>13</sup>C NMR (CDCl<sub>3</sub>, 100 MHz):** δ 140.0 (C, C<sub>9</sub>), 128.5 (2xCH, C<sub>10</sub> or C<sub>11</sub>), 128.1 (2xCH, C<sub>10</sub> or C<sub>11</sub>), 127.5 (C, q, *J* = 289.8 Hz, C<sub>7</sub>), 127.1 (CH, C<sub>12</sub>), 68.6 (C, q, *J* = 24.5 Hz, C<sub>5</sub>), 52.4 (CH<sub>2</sub>, C<sub>2</sub>), 52.2 (CH<sub>2</sub>, C<sub>8</sub>), 45.1 (CH<sub>2</sub>, C<sub>6</sub>), 31.4 (CH<sub>2</sub>, C<sub>4</sub>), 22.6 (CH<sub>2</sub>, C<sub>3</sub>).

**MS *m/z* (relative intensity):** 279 (M<sup>+</sup>, 0.5), 277 (M<sup>+</sup>, 2), 228 (12), 208 (7), 91 (100), 65 (9).

**HRMS:** calcd for C<sub>13</sub>H<sub>16</sub>ClF<sub>3</sub>N (M+H<sup>+</sup>): 278.0918, and 280.0888. Found 278.0920 and 280.0889.

### ***N*-Benzyl-2-iodomethyl-2-(trifluoromethyl)pyrrolidine (9)**

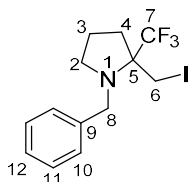

To a stirred solution of *N*-benzyl-3-hydroxy-3-(trifluoromethyl)piperidine **1** (141 mg, 0.54 mmol, 1.0 equiv) in THF (3 mL) at rt, were added PPh<sub>3</sub> (214 mg, 0.82 mmol, 1.5 equiv), imidazole (74 mg, 1.09 mmol, 2.0 equiv) and I<sub>2</sub> (207 mg, 0.82 mmol, 1.5 equiv). The resulting mixture was stirred at rt for 48 h. The reaction mixture was diluted in CHCl<sub>3</sub>, and the organic phase was washed with H<sub>2</sub>O and brine, dried over anhydrous Na<sub>2</sub>SO<sub>4</sub>, filtered and concentrated under reduced pressure. The crude mixture was purified by flash chromatography (PE=100%) to afford **9** (51 mg, 0.14 mmol, 25%) as a colorless oil.

**IR (neat):** 3029, 2924, 2852, 1495, 1455, 1372, 1277, 1141, 1101, 1029 cm<sup>-1</sup>.

**<sup>1</sup>H NMR (CDCl<sub>3</sub>, 400 MHz):** δ 7.37–7.20 (m, 5H, H<sub>10</sub>, H<sub>11</sub> and H<sub>12</sub>), 4.05 (d, 1H, *J* = 13.9 Hz, H<sub>8</sub>), 3.78 (d, 1H, *J* = 13.8 Hz, H<sub>8</sub>), 3.59 (dm, 1H, *J* = 11.2 Hz, H<sub>6</sub>), 3.46 (dm, 1H, *J* = 11.2 Hz, H<sub>6</sub>), 2.89 (m, 1H, H<sub>2</sub>), 2.75 (m, 1H, H<sub>2</sub>), 2.22–2.09 (m, 2H, H<sub>4</sub>), 1.78–1.76 (m, 2H, H<sub>3</sub>).

**<sup>13</sup>C NMR (CDCl<sub>3</sub>, 100 MHz):** δ 139.5 (C, C<sub>9</sub>), 128.3 (2xCH, C<sub>10</sub> or C<sub>11</sub>), 128.2 (2xCH, C<sub>10</sub> or C<sub>11</sub>), 126.9 (CH, C<sub>12</sub>), 128.4 (C, q, *J* = 292.1 Hz, C<sub>7</sub>), 67.1 (C, q, *J* = 24.2 Hz, C<sub>5</sub>), 51.6 (CH<sub>2</sub>, C<sub>8</sub>), 51.3 (CH<sub>2</sub>, C<sub>2</sub>), 34.5 (CH<sub>2</sub>, C<sub>4</sub>), 22.0 (CH<sub>2</sub>, C<sub>3</sub>) 8.5 (CH<sub>2</sub>, C<sub>6</sub>).

**MS *m/z* (relative intensity):** 369 (M<sup>+</sup>, 3), 300 (18), 228 (15), 173 (10), 91 (100), 65 (11).

### ***N*-Benzyl-2-fluoromethyl-2-(trifluoromethyl)pyrrolidine (12)**

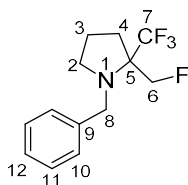

**1) Following the general protocol:** **1** (100 mg, 0.39 mmol, 1.0 equiv), proton sponge (165.3 mg, 0.77 mmol, 2.0 equiv), triflic anhydride (96 μL, 0.58 mmol, 1.5 equiv). Nucleophile = tetrabutylammonium

fluoride (1.0 M in THF, 261 mg, 0.96 mmol, 2.5 equiv). The crude mixture was purified by flash chromatography (Pentane=100%) to afford **12** (30 mg, 0.11 mmol, 30%) as colorless oil.

2) To a stirred solution of *N*-benzyl-3-hydroxy-3-(trifluoromethyl)piperidine **1** (100 mg, 0.39 mmol, 1.0 equiv) in THF (4 mL) at 0 °C was added DAST (66 μL, 0.54 mmol, 1.4 equiv). The resulting mixture was stirred at 0 °C for 1 h and at rt for 3 h. The reaction mixture was quenched with a saturated aqueous solution of Na<sub>2</sub>CO<sub>3</sub>, extracted with EtOAc and the combined organic phases were dried over anhydrous Na<sub>2</sub>SO<sub>4</sub>, filtered and concentrated under reduced pressure. The crude mixture was purified by flash chromatography (PE=100% to EtOAc/PE=5:95) to afford **12** (71 mg, 0.27 mmol, 71%) as a colorless oil.

**IR (neat):** 2956, 2923, 2853, 1727, 1456, 1187, 1145, 1030, 944 cm<sup>-1</sup>.

**<sup>1</sup>H NMR (CDCl<sub>3</sub>, 400 MHz):** δ 7.34–7.24 (m, 5H, H<sub>10</sub>, H<sub>11</sub> and H<sub>12</sub>), 4.69 (dd, *J* = 43.4 and 9.9 Hz, 1H, H<sub>6</sub>), 4.58 (dd, *J* = 41.9 and 9.9 Hz, 1H, H<sub>6</sub>), 4.15 (d, *J* = 13.5 Hz, 1H, H<sub>8</sub>), 3.84 (d, *J* = 13.5 Hz, 1H, H<sub>8</sub>), 2.84 (m, 1H, H<sub>2</sub>), 2.64 (dd, *J* = 15.3 and 7.9 Hz, 1H, H<sub>2</sub>), 2.20 (m, 1H, H<sub>4</sub>), 2.01 (m, 1H, H<sub>4</sub>), 1.83–1.73 (m, 2H, H<sub>3</sub>).

**<sup>13</sup>C NMR (CDCl<sub>3</sub>, 100 MHz):** δ 140.1 (C, C<sub>9</sub>), 128.4 (2xCH, C<sub>10</sub> or C<sub>11</sub>), 128.2 (2xCH, C<sub>10</sub> or C<sub>11</sub>), 127.2 (C, dq, *J* = 287.4 and 7.5 Hz, C<sub>7</sub>), 127.1 (CH, C<sub>12</sub>), 82.5 (CH<sub>2</sub>, d, *J* = 178.6 Hz, C<sub>6</sub>), 67.3 (C, dq, *J* = 25.1 and 18.6 Hz, C<sub>5</sub>), 53.3 (CH<sub>2</sub>, C<sub>8</sub>), 52.7 (CH<sub>2</sub>, C<sub>2</sub>), 30.7 (CH<sub>2</sub>, C<sub>4</sub>), 22.8 (CH<sub>2</sub>, C<sub>3</sub>).

**MS *m/z* (relative intensity):** 261 (M<sup>+</sup>, 3), 228 (6), 192 (8), 170 (3), 91 (100), 65 (10).

**HRMS:** calcd for C<sub>13</sub>H<sub>16</sub>F<sub>4</sub>N (M+H<sup>+</sup>): 262.1213. Found 262.1215.

#### ***N*-Benzyl-2-[[*N*-benzylamino]methyl]-2-(trifluoromethyl)pyrrolidine (**15**)**

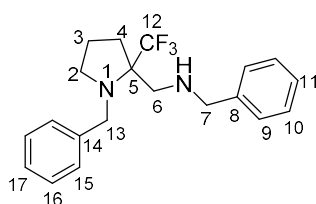

Following the general protocol: **1** (100 mg, 0.39 mmol, 1.0 equiv), proton sponge (165.3 mg, 0.77 mmol, 2.0 equiv), triflic anhydride (96 μL, 0.58 mmol, 1.5 equiv). Nucleophile = benzylamine (105 μL, 0.96 mmol, 2.5 equiv). The crude mixture was purified by flash chromatography (PE=100% to EtOAc/PE=1:99) to afford **15** (101 mg, 0.29 mmol, 75%) as a yellow oil.

**IR (neat):** 3028, 2922, 2822, 1495, 1453, 1371, 1286, 1142, 1101, 1028, 922 cm<sup>-1</sup>.

**<sup>1</sup>H NMR (CDCl<sub>3</sub>, 400 MHz):** δ 7.32–7.22 (m, 10H, H<sub>ar</sub>), 3.94 (d, *J* = 13.7 Hz, 1H, H<sub>13</sub>), 3.84 (s, 2H, H<sub>7</sub>), 3.72 (d, *J* = 13.7 Hz, 1H, H<sub>13</sub>), 2.95 (d<sub>app</sub>, *J* = 11.9 Hz, 1H, H<sub>6</sub>), 2.81–2.69 (m, 3H, H<sub>2</sub> and H<sub>6</sub>), 2.38 (m, 1H, H<sub>4</sub>), 2.06 (m, 1H, H<sub>4</sub>), 1.88 (br s, NH), 1.76–1.73 (m, 2H, H<sub>3</sub>).

**<sup>13</sup>C NMR (CDCl<sub>3</sub>, 100 MHz):** δ 140.3 (C, C<sub>8</sub> or C<sub>14</sub>), 140.1 (C, C<sub>8</sub> or C<sub>14</sub>), 128.5 (2xCH, C<sub>ar</sub>), 128.5 (C, q, *J* = 291.1 Hz, C<sub>12</sub>), 128.4 (2xCH, C<sub>ar</sub>), 128.1 (2xCH, C<sub>ar</sub>), 128.1 (2xCH, C<sub>ar</sub>), 127.1 (CH, C<sub>11</sub> or C<sub>17</sub>), 126.9 (CH, C<sub>11</sub> or C<sub>17</sub>), 68.3 (C, q, *J* = 23.0 Hz, C<sub>5</sub>), 54.2 (CH<sub>2</sub>, C<sub>7</sub>), 52.0 (CH<sub>2</sub>, C<sub>2</sub> or C<sub>13</sub>), 52.0 (CH<sub>2</sub>, C<sub>2</sub> or C<sub>13</sub>), 48.3 (CH<sub>2</sub>, C<sub>6</sub>), 30.6 (CH<sub>2</sub>, C<sub>4</sub>), 22.4 (CH<sub>2</sub>, C<sub>3</sub>).

**HRMS:** calcd for C<sub>20</sub>H<sub>24</sub>F<sub>3</sub>N<sub>2</sub> (M+H<sup>+</sup>): 349.1886. Found 349.1885.

### ***N*-Benzyl-2-[[*N*-phenyl]amino]methyl]-2-(trifluoromethyl)pyrrolidine (**16**)**

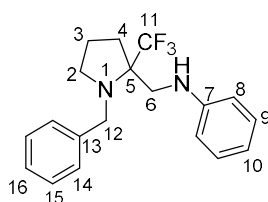

Following the general protocol: **1** (100 mg, 0.39 mmol, 1.0 equiv), proton sponge (165.3 mg, 0.77 mmol, 2.0 equiv), triflic anhydride (96 μL, 0.58 mmol, 1.5 equiv). Nucleophile = aniline (88 μL, 0.96 mmol, 2.5 equiv). The crude mixture was purified by flash chromatography (EtOAc/PE=2:98) to afford **16** (92 mg, 0.27 mmol, 71%) as a yellow oil.

**IR (neat):** 3029, 2923, 2821, 1599, 1506, 1453, 1380, 1269, 1230, 1133, 1097, 1030, 990, 950 cm<sup>-1</sup>.

**<sup>1</sup>H NMR (CDCl<sub>3</sub>, 400 MHz):** δ 7.33–7.18 (m, 7H, H<sub>ar</sub>), 6.76–6.65 (m, 3H, H<sub>8</sub> and H<sub>10</sub>), 4.25 (br s, NH), 4.06 (d, *J* = 13.4 Hz, 1H, H<sub>12</sub>), 3.62 (dd<sub>app</sub>, *J* = 13.4 and 1.9 Hz, 1H, H<sub>12</sub>), 3.36 (t<sub>app</sub>, *J* = 13.1 Hz, 2H, H<sub>6</sub>), 2.96 (m, 1H, H<sub>2</sub>), 2.76 (m, 1H, H<sub>2</sub>), 2.23–2.12 (m, 2H, H<sub>4</sub>), 1.83–1.72 (m, 2H, H<sub>3</sub>).

**<sup>13</sup>C NMR (CDCl<sub>3</sub>, 100 MHz):** δ 148.3 (C, C<sub>7</sub> or C<sub>13</sub>), 139.4 (C, C<sub>7</sub> or C<sub>13</sub>), 129.5 (2xCH, C<sub>ar</sub>), 128.6 (2xCH, C<sub>ar</sub>), 128.5 (C, q, *J* = 292.9 Hz, C<sub>11</sub>), 128.5 (2xCH, C<sub>ar</sub>), 127.3 (CH, C<sub>16</sub>), 117.9 (CH, C<sub>10</sub>), 113.2 (2xCH, C<sub>8</sub>), 68.4 (C, q, *J* = 22.9 Hz, C<sub>5</sub>), 51.9 (CH<sub>2</sub>, C<sub>12</sub>), 51.4 (CH<sub>2</sub>, C<sub>2</sub>), 42.4 (CH<sub>2</sub>, C<sub>6</sub>), 30.5 (CH<sub>2</sub>, C<sub>4</sub>), 21.8 (CH<sub>2</sub>, C<sub>3</sub>).

**MS *m/z* (relative intensity):** 334 (M<sup>+</sup>, 0.9), 228 (13), 209 (6), 105 (13), 91 (100), 77 (17), 65 (12), 50 (3).

**HRMS:** calcd for C<sub>19</sub>H<sub>22</sub>F<sub>3</sub>N<sub>2</sub> (M+H<sup>+</sup>): 335.1730. Found 335.1729.



### ***N*-Benzyl-2-[[*N*-benzyl-*N*-methyl]amino]methyl]-2-(trifluoromethyl)pyrrolidine (**17**)**

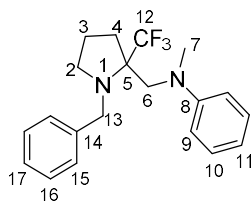

Following the general protocol: **1** (100 mg, 0.39 mmol, 1.0 equiv), proton sponge (165.3 mg, 0.77 mmol, 2.0 equiv), triflic anhydride (96  $\mu$ L, 0.58 mmol, 1.5 equiv). Nucleophile = methylaniline (107  $\mu$ L, 0.96 mmol, 2.5 equiv). The crude mixture was purified by flash chromatography (Et<sub>2</sub>O/PE=1:99) to afford **17** (105 mg, 0.30 mmol, 78%) as a yellow oil.

**IR (neat):** 3028, 2924, 2821, 1599, 1506, 1453, 1380, 1268, 1230, 1133, 1097, 1030, 990, 950  $\text{cm}^{-1}$ .

**<sup>1</sup>H NMR (CDCl<sub>3</sub>, 400 MHz):**  $\delta$  7.33–7.22 (m, 7H, H<sub>ar</sub>), 6.77–6.72 (m, 3H, H<sub>9</sub> and H<sub>11</sub>), 4.29 (d,  $J$  = 13.6 Hz, 1H, H<sub>13</sub>), 3.71 (d<sub>app</sub>,  $J$  = 15.9 Hz, 2H, H<sub>6</sub> and H<sub>13</sub>), 3.56 (d,  $J$  = 15.9 Hz, 1H, H<sub>6</sub>), 3.09 (s, 3H, H<sub>7</sub>), 2.91 (m, 1H, H<sub>2</sub>), 2.60 (q<sub>app</sub>,  $J$  = 8.2 Hz, 1H, H<sub>2</sub>), 2.12–1.97 (m, 2H, H<sub>4</sub>), 1.73–1.60 (m, 2H, H<sub>3</sub>).

**<sup>13</sup>C NMR (CDCl<sub>3</sub>, 100 MHz):**  $\delta$  150.5 (C, C<sub>8</sub> or C<sub>14</sub>), 139.5 (C, C<sub>8</sub> or C<sub>14</sub>), 129.3 (2xCH, C<sub>ar</sub>), 128.9 (C, q,  $J$  = 295.4 Hz, C<sub>12</sub>), 128.5 (2xCH, C<sub>ar</sub>), 128.3 (2xCH, C<sub>ar</sub>), 127.1 (CH, C<sub>17</sub>), 116.8 (CH, C<sub>11</sub>), 112.1 (2xCH, C<sub>9</sub>), 70.2 (C, q,  $J$  = 21.1 Hz, C<sub>5</sub>), 52.6 (CH<sub>2</sub>, C<sub>6</sub>), 52.3 (CH<sub>2</sub>, C<sub>13</sub>), 51.1 (CH<sub>2</sub>, C<sub>2</sub>), 40.5 (CH<sub>3</sub>, C<sub>7</sub>), 29.6 (CH<sub>2</sub>, C<sub>4</sub>), 22.1 (CH<sub>2</sub>, C<sub>3</sub>).

**MS  $m/z$  (relative intensity):** 348 (M<sup>+</sup>, 0.7), 228 (8), 227 (9), 120 (63), 91 (100), 77 (8), 65 (15).

**HRMS:** calcd for C<sub>20</sub>H<sub>24</sub>F<sub>3</sub>N<sub>2</sub> (M+H<sup>+</sup>): 349.1886. Found 349.1888.

### ***N*-Benzyl-2-[[*N,N*-diethyl]amino]methyl]-2-(trifluoromethyl)pyrrolidine (**18**)**

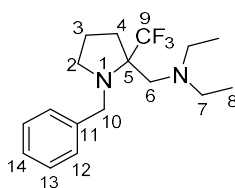

Following the general protocol: **1** (100 mg, 0.39 mmol, 1.0 equiv), proton sponge (165.3 mg, 0.77 mmol, 2.0 equiv), triflic anhydride (96  $\mu$ L, 0.58 mmol, 1.5 equiv). Nucleophile = diethylamine (100  $\mu$ L, 0.96 mmol, 2.5 equiv). The crude mixture was purified by flash chromatography (EtOAc/PE=2:98) to afford **18** (80 mg, 0.25 mmol, 66%) as a colorless oil.

**IR (neat):** 2968, 2811, 1496, 1455, 1373, 1278, 1135, 1102, 1067, 1029, 958  $\text{cm}^{-1}$ .

**<sup>1</sup>H NMR (CDCl<sub>3</sub>, 400 MHz):** δ 7.30–7.22 (m, 5H, H<sub>12</sub>, H<sub>13</sub> and H<sub>14</sub>), 4.16 (d, *J* = 13.8 Hz, 1H, H<sub>10</sub>), 3.70 (dq, *J* = 13.9 and 1.9 Hz, 1H, H<sub>10</sub>), 2.83 (m, 1H, H<sub>2</sub>), 2.78–2.70 (m, 3H, H<sub>6</sub> and H<sub>7</sub>), 2.63–2.57 (m, 4H, H<sub>2</sub>, H<sub>6</sub> and H<sub>7</sub>), 2.37 (m, 1H, H<sub>4</sub>), 1.97 (m, 1H, H<sub>4</sub>), 1.76–1.72 (m, 2H, H<sub>3</sub>), 1.00 (t, *J* = 7.1 Hz, 6H, H<sub>8</sub>).

**<sup>13</sup>C NMR (CDCl<sub>3</sub>, 100 MHz):** δ 140.3 (C, C<sub>11</sub>), 129.1 (C, q, *J* = 295.0 Hz, C<sub>9</sub>), 128.4 (2xCH, C<sub>12</sub> or C<sub>13</sub>), 128.2 (2xCH, C<sub>12</sub> or C<sub>13</sub>), 126.8 (CH, C<sub>14</sub>), 69.4 (C, q, *J* = 20.7 Hz, C<sub>5</sub>), 53.6 (CH<sub>2</sub>, C<sub>6</sub>), 52.4 (CH<sub>2</sub>, C<sub>10</sub>), 51.5 (CH<sub>2</sub>, C<sub>2</sub>), 48.5 (2xCH<sub>2</sub>, C<sub>7</sub>), 30.3 (CH<sub>2</sub>, C<sub>4</sub>), 22.2 (CH<sub>2</sub>, C<sub>3</sub>), 11.9 (2xCH<sub>3</sub>, C<sub>8</sub>).

**MS *m/z* (relative intensity):** 314 (M<sup>+</sup>, 0.1), 227 (10), 91 (76), 86 (100), 65 (12), 58 (7).

**HRMS:** calcd for C<sub>17</sub>H<sub>26</sub>F<sub>3</sub>N<sub>2</sub> (M+H<sup>+</sup>): 315.2043. Found 315.2043.

***N*-Benzyl-2-[[*N,N*-diallyl]amino]methyl]-2-(trifluoromethyl)pyrrolidine (**19**)**

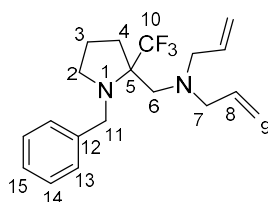

Following the general protocol: **1** (71 mg, 0.27 mmol, 1.0 equiv), proton sponge (117.4 mg, 0.55 mmol, 2.0 equiv), triflic anhydride (68 μL, 0.41 mmol, 1.5 equiv). Nucleophile = diallylamine (84 μL, 0.68 mmol, 2.5 equiv). The crude mixture was purified by flash chromatography (EtOAc/PE=1:99) to afford **19** (56 mg, 0.17 mmol, 60%) as a colorless oil.

**IR (neat):** 3077, 2977, 2814, 1643, 1496, 1454, 1376, 1282, 1137, 1100, 995, 919 cm<sup>-1</sup>.

**<sup>1</sup>H NMR (CDCl<sub>3</sub>, 400 MHz):** δ 7.29–7.21 (m, 5H, H<sub>13</sub>, H<sub>14</sub> and H<sub>15</sub>), 5.90–5.80 (m, 2H, H<sub>8</sub>), 5.17–5.11 (m, 4H, H<sub>9</sub>), 4.15 (d, *J* = 13.8 Hz, 1H, H<sub>11</sub>), 3.68 (d, *J* = 13.8 Hz, 1H, H<sub>11</sub>), 3.43 (dd, *J* = 14.3 and 4.7 Hz, 2H, H<sub>7</sub>), 3.09 (dd, *J* = 12.0 and 4.0 Hz, 2H, H<sub>7</sub>), 2.82 (m, 1H, H<sub>2</sub>), 2.77 (d, *J* = 16.0 Hz, 1H, H<sub>6</sub>), 2.72 (d, *J* = 16.0 Hz, 1H, H<sub>6</sub>), 2.60 (q<sub>app</sub>, *J* = 7.9 Hz, 1H, H<sub>2</sub>), 2.39 (m, 1H, H<sub>4</sub>), 2.00 (m, 1H, H<sub>4</sub>), 1.75–1.71 (m, 2H, H<sub>3</sub>).

**<sup>13</sup>C NMR (CDCl<sub>3</sub>, 100 MHz):** δ 140.0 (C, C<sub>12</sub>), 135.9 (2xCH, C<sub>8</sub>), 128.9 (C, q, *J* = 294.2 Hz, C<sub>10</sub>), 128.4 (2xCH, C<sub>13</sub> or C<sub>14</sub>), 128.2 (2xCH, C<sub>13</sub> or C<sub>14</sub>), 126.9 (CH, C<sub>15</sub>), 117.4 (2xCH<sub>2</sub>, C<sub>9</sub>), 69.4 (C, q, *J* = 21.0 Hz, C<sub>5</sub>), 58.5 (2xCH<sub>2</sub>, C<sub>7</sub>), 52.8 (CH<sub>2</sub>, C<sub>6</sub>), 52.3 (CH<sub>2</sub>, C<sub>11</sub>), 51.4 (CH<sub>2</sub>, C<sub>2</sub>), 30.4 (CH<sub>2</sub>, C<sub>4</sub>), 22.2 (CH<sub>2</sub>, C<sub>3</sub>).

**MS *m/z* (relative intensity):** 338 (M<sup>+</sup>, 0.04), 225 (8), 110 (100), 91 (97), 81 (3), 65 (15).

**HRMS:** calcd for C<sub>19</sub>H<sub>26</sub>F<sub>3</sub>N<sub>2</sub> (M+H<sup>+</sup>): 339.2043. Found 339.2041.

### ***N*-Benzyl-2-[[*N,N*-dibenzyl]amino]methyl]-2-(trifluoromethyl)pyrrolidine (**20**)**

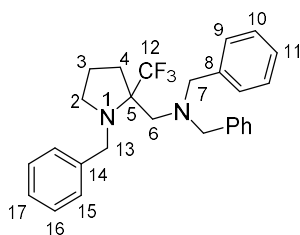

Following the general protocol: **1** (79 mg, 0.31 mmol, 1.0 equiv), proton sponge (131.1 mg, 0.6 mmol, 2.0 equiv), triflic anhydride (76  $\mu$ L, 0.46 mmol, 1.5 equiv). Nucleophile = dibenzylamine (0.15 mL, 0.16 mmol, 2.5 equiv). The crude mixture was purified by flash chromatography (EtOAc/PE=2:98 to 10:90) to afford **20** (111 mg, 0.25 mmol, 83%) as a white solid.

**Mp:** 68–71 °C

**IR (neat):** 3031, 2922, 2848, 2361, 1159, 1119, 1099, 752  $\text{cm}^{-1}$ .

**$^1\text{H}$  NMR ( $\text{CDCl}_3$ , 400 MHz):**  $\delta$  7.38–7.19 (m, 15H,  $H_{ar}$ ), 4.11 (d,  $J = 12.0$  Hz, 1H,  $H_6$ ), 4.10 (d,  $J = 12.0$  Hz, 2H,  $H_7$ ), 3.64 (d,  $J = 13.7$  Hz, 1H,  $H_6$ ), 3.43 (d,  $J = 13.7$  Hz, 2H,  $H_7$ ), 2.86–2.77 (m, 3H,  $H_2$  and  $H_{13}$ ), 2.57 (m, 1H,  $H_2$ ), 2.47 (m, 1H,  $H_4$ ), 1.88 (m, 1H,  $H_4$ ), 1.74–1.69 (m, 2H,  $H_3$ ).

**$^{13}\text{C}$  NMR ( $\text{CDCl}_3$ , 100 MHz):**  $\delta$  139.8 (C,  $C_{14}$ ), 139.5 (2x C,  $C_8$ ), 129.1 (4x CH,  $C_{ar}$ ), 128.8 (C, q,  $J = 294.8$  Hz,  $C_{12}$ ), 128.4 (4x CH,  $C_{ar}$ ), 128.4 (2x CH,  $C_{ar}$ ), 128.3 (2x CH,  $C_{ar}$ ), 127.1 (2x CH,  $C_{ar}$ ), 126.9 (CH,  $C_{ar}$ ), 69.4 (C, q,  $J = 21.3$  Hz,  $C_5$ ), 60.2 (2x  $\text{CH}_2$ ,  $C_7$ ), 52.6 ( $\text{CH}_2$ ,  $C_{13}$ ), 52.3 ( $\text{CH}_2$ ,  $C_6$ ), 51.3 ( $\text{CH}_2$ ,  $C_2$ ), 29.9 ( $\text{CH}_2$ ,  $C_4$ ), 22.2 ( $\text{CH}_2$ ,  $C_3$ ).

**MS  $m/z$  (relative intensity):** 347 ( $M^+ - \text{Bn}^+$ , 0.3), 210 (59), 181 (4), 91 (100), 65 (7).

**HRMS:** calcd for  $\text{C}_{27}\text{H}_{30}\text{F}_3\text{N}_2$  ( $M+H^+$ ): 439.2356. Found 439.2359.

### ***N*-Benzyl-2-[(morpholino)methyl]-2-(trifluoromethyl)pyrrolidine (**21**)**

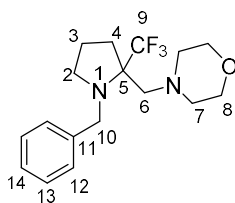

Following the general protocol: **1** (100 mg, 0.39 mmol, 1.0 equiv), proton sponge (165.3 mg, 0.77 mmol, 2.0 equiv), triflic anhydride (96  $\mu$ L, 0.58 mmol, 1.5 equiv). Nucleophile = morpholine (85  $\mu$ L, 0.96 mmol, 2.5 equiv). The crude mixture was purified by flash chromatography (EtOAc/PE=5:95 to 10:90) to afford **21** (101 mg, 0.31 mmol, 80%) as a brown oil.

**IR (neat):** 2957, 2851, 2808, 1496, 1455, 1397, 1371, 1287, 1135, 1118, 1036, 967  $\text{cm}^{-1}$ .

**<sup>1</sup>H NMR (CDCl<sub>3</sub>, 400 MHz):** δ 7.37–7.21 (m, 5H, H<sub>12</sub>, H<sub>13</sub> and H<sub>14</sub>), 4.14 (d, *J* = 13.8 Hz, 1H, H<sub>10</sub>), 3.74 (dq, *J* = 13.8 and 1.8 Hz, 1H, H<sub>10</sub>), 3.68 (t<sub>app</sub>, *J* = 4.6 Hz, 4H, H<sub>8</sub>), 2.80–2.69 (m, 4H, H<sub>2</sub>, H<sub>6</sub> and H<sub>7</sub>), 2.66–2.50 (m, 4H, H<sub>2</sub>, H<sub>6</sub> and H<sub>7</sub>), 2.27 (m, 1H, H<sub>4</sub>), 2.07 (m, 1H, H<sub>4</sub>), 1.79–1.72 (m, 2H, H<sub>3</sub>).

**<sup>13</sup>C NMR (CDCl<sub>3</sub>, 100 MHz):** δ 140.1 (C, C<sub>11</sub>), 128.7 (C, q, *J* = 293.6 Hz, C<sub>9</sub>), 128.4 (2xCH, C<sub>12</sub> or C<sub>13</sub>), 128.2 (2xCH, C<sub>12</sub> or C<sub>13</sub>), 126.9 (CH, C<sub>14</sub>), 68.8 (C, q, *J* = 21.6 Hz, C<sub>5</sub>), 67.4 (2xCH<sub>2</sub>, C<sub>8</sub>), 58.7 (CH<sub>2</sub>, C<sub>6</sub>), 55.9 (2xCH<sub>2</sub>, C<sub>7</sub>), 52.5 (CH<sub>2</sub>, C<sub>10</sub>), 51.6 (CH<sub>2</sub>, C<sub>2</sub>), 30.9 (CH<sub>2</sub>, C<sub>4</sub>), 22.3 (CH<sub>2</sub>, C<sub>3</sub>).

**MS *m/z* (relative intensity):** 328 (M<sup>+</sup>, 0.2), 228 (8), 100 (100), 91 (54), 65 (5).

**HRMS:** calcd for C<sub>17</sub>H<sub>24</sub>F<sub>3</sub>N<sub>2</sub>O (M+H<sup>+</sup>): 329.1835. Found 329.1837.

### ***N*-Benzyl-2-methoxymethyl-2-(trifluoromethyl)pyrrolidine (**24**)**

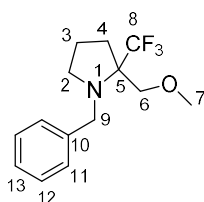

Following the general protocol: **1** (100 mg, 0.39 mmol, 1.0 equiv), proton sponge (165.3 mg, 0.77 mmol, 2.0 equiv), triflic anhydride (96 μL, 0.58 mmol, 1.5 equiv). Nucleophile = methanol (39 μL, 0.96 mmol, 2.5 equiv). The crude mixture was purified by flash chromatography (EtOAc/PE=2:98) to afford **24** (53.6 mg, 0.20 mmol, 51%) as a colorless oil.

**IR (neat):** 2893, 2816, 1495, 1453, 1366, 1331, 1139, 1102, 1030 cm<sup>-1</sup>.

**<sup>1</sup>H NMR (CDCl<sub>3</sub>, 400 MHz):** δ 7.30–7.16 (m, 5H, H<sub>11</sub>, H<sub>12</sub> and H<sub>13</sub>), 4.11 (d, *J* = 13.7 Hz, 1H, H<sub>9</sub>), 3.74 (d, *J* = 13.7 Hz, 1H, H<sub>9</sub>), 3.67 (d, *J* = 9.8 Hz, 1H, H<sub>6</sub>), 3.52 (d, *J* = 9.8 Hz, 1H, H<sub>6</sub>), 3.38 (s, 3H, H<sub>7</sub>), 2.77 (td<sub>app</sub>, *J* = 7.4 and 2.9 Hz, 1H, H<sub>2</sub>), 2.58 (dd, *J* = 15.5 and 8.0 Hz, 1H, H<sub>2</sub>), 2.10–2.07 (m, 2H, H<sub>4</sub>), 1.74–1.67 (m, 2H, H<sub>3</sub>).

**<sup>13</sup>C NMR (CDCl<sub>3</sub>, 100 MHz):** δ 140.8 (C, C<sub>10</sub>), 128.3 (2xCH, C<sub>11</sub> or C<sub>12</sub>), 128.2 (2xCH, C<sub>11</sub> or C<sub>12</sub>), 127.8 (C, q, *J* = 287.1 Hz, C<sub>8</sub>), 126.8 (CH, C<sub>13</sub>), 72.5 (CH<sub>2</sub>, C<sub>6</sub>), 67.7 (C, q, *J* = 24.5 Hz, C<sub>5</sub>), 59.6 (CH<sub>3</sub>, C<sub>7</sub>), 53.3 (CH<sub>2</sub>, C<sub>9</sub>), 53.1 (CH<sub>2</sub>, C<sub>2</sub>), 31.0 (CH<sub>2</sub>, C<sub>4</sub>), 23.0 (CH<sub>2</sub>, C<sub>3</sub>).

**MS *m/z* (relative intensity):** 273 (M<sup>+</sup>, 1), 228 (24), 91 (100), 65 (9).

**HRMS:** calcd for C<sub>14</sub>H<sub>19</sub>F<sub>3</sub>NO (M+H<sup>+</sup>): 274.1413. Found 274.1416.

### **N-Benzyl-2-ethoxymethyl-2-(trifluoromethyl)pyrrolidine (25)**

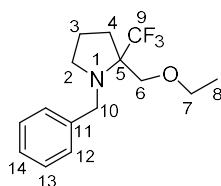

Following the general protocol: **1** (100 mg, 0.39 mmol, 1.0 equiv), proton sponge (165.3 mg, 0.77 mmol, 2.0 equiv), triflic anhydride (96  $\mu$ L, 0.58 mmol, 1.5 equiv). Nucleophile = ethanol (56  $\mu$ L, 0.96 mmol, 2.5 equiv). The crude mixture was purified by flash chromatography (EtOAc/PE=2:98) to afford **25** (85.6 mg, 0.30 mmol, 77%) as a colorless oil.

**IR (neat)**: 2976, 2875, 1495, 1454, 1379, 1360, 1139, 1122, 1103, 1030, 949  $\text{cm}^{-1}$ .

**$^1\text{H NMR}$  ( $\text{CDCl}_3$ , 400 MHz)**:  $\delta$  7.34–7.21 (m, 5H,  $\text{H}_{12}$ ,  $\text{H}_{13}$  and  $\text{H}_{14}$ ), 4.16 (d,  $J = 13.6$  Hz, 1H,  $\text{H}_{10}$ ), 3.77 (d,  $J = 13.9$  Hz, 1H,  $\text{H}_{10}$ ), 3.74 (d,  $J = 9.6$  Hz, 1H,  $\text{H}_6$ ), 3.59–3.51 (m, 3H,  $\text{H}_6$  and  $\text{H}_7$ ), 2.81 (td<sub>app</sub>,  $J = 7.4$  and 2.9 Hz, 1H,  $\text{H}_2$ ), 2.63 (dd,  $J = 15.1$  and 8.2 Hz, 1H,  $\text{H}_2$ ), 2.15–2.11 (m, 2H,  $\text{H}_4$ ), 1.77–1.70 (m, 2H,  $\text{H}_3$ ), 1.24 (t,  $J = 7.0$  Hz, 3H,  $\text{H}_8$ ).

**$^{13}\text{C NMR}$  ( $\text{CDCl}_3$ , 100 MHz)**:  $\delta$  141.0 (C,  $\text{C}_{11}$ ), 128.3 (2xCH,  $\text{C}_{12}$  or  $\text{C}_{13}$ ), 128.2 (2xCH,  $\text{C}_{12}$  or  $\text{C}_{13}$ ), 127.8 (C, q,  $J = 286.9$  Hz,  $\text{C}_9$ ), 126.8 (CH,  $\text{C}_{14}$ ), 70.0 ( $\text{CH}_2$ ,  $\text{C}_6$ ), 67.8 (C, q,  $J = 24.4$  Hz,  $\text{C}_5$ ), 67.2 ( $\text{CH}_2$ ,  $\text{C}_7$ ), 53.3 ( $\text{CH}_2$ ,  $\text{C}_{10}$ ), 53.2 ( $\text{CH}_2$ ,  $\text{C}_2$ ), 31.1 ( $\text{CH}_2$ ,  $\text{C}_4$ ), 23.0 ( $\text{CH}_2$ ,  $\text{C}_3$ ), 15.4 ( $\text{CH}_3$ ,  $\text{C}_8$ ).

**MS  $m/z$  (relative intensity)**: 287 ( $\text{M}^{+}$ , 0.5), 228 (17), 91 (100), 65 (7).

**HRMS**: calcd for  $\text{C}_{15}\text{H}_{21}\text{F}_3\text{NO}$  ( $\text{M}+\text{H}^+$ ): 288.1570. Found 288.1572.

### **N-Benzyl-2-[(prop-2-en-1-yloxy)methyl]-2-(trifluoromethyl)pyrrolidine (26)**

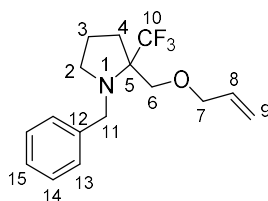

Following the general protocol: **1** (100 mg, 0.39 mmol, 1.0 equiv), proton sponge (165.3 mg, 0.77 mmol, 2.0 equiv), triflic anhydride (96  $\mu$ L, 0.58 mmol, 1.5 equiv). Nucleophile = allyl alcohol (66  $\mu$ L, 0.96 mmol, 2.5 equiv). The crude mixture was purified by flash chromatography (PE=100% to EtOAc/PE=1:99) to afford **26** (66 mg, 0.22 mmol, 57%) as a colorless oil.

**IR (neat)**: 2833, 1495, 1454, 1366, 1330, 1139, 1090, 1020, 989, 926  $\text{cm}^{-1}$ .

**$^1\text{H NMR}$  ( $\text{CDCl}_3$ , 400 MHz)**:  $\delta$  7.34–7.19 (m, 5H,  $\text{H}_{13}$ ,  $\text{H}_{14}$  and  $\text{H}_{15}$ ), 5.92 (m, 1H,  $\text{H}_8$ ), 5.32 (dq<sub>app</sub>,  $J = 17.2$  and 1.7 Hz, 1H,  $\text{H}_9$ ), 5.21 (dq<sub>app</sub>,  $J = 10.5$  and 1.5 Hz, 1H,  $\text{H}_9$ ), 4.15 (d,  $J = 13.7$  Hz, 1H,  $\text{H}_{11}$ ), 4.06–4.04

(m, 2H, H<sub>7</sub>), 3.78 (d, *J* = 12.4 Hz, 1H, H<sub>11</sub>), 3.75 (d, *J* = 9.6 Hz, 1H, H<sub>6</sub>), 3.60 (d, *J* = 9.8 Hz, 1H, H<sub>6</sub>), 2.82 (m, 1H, H<sub>2</sub>), 2.63 (dd, *J* = 15.3 and 8.4 Hz, 1H, H<sub>2</sub>), 2.14–2.12 (m, 2H, H<sub>4</sub>), 1.78–1.71 (m, 2H, H<sub>3</sub>).

**<sup>13</sup>C NMR (CDCl<sub>3</sub>, 100 MHz):** δ 140.8 (C, C<sub>12</sub>), 134.6 (CH, C<sub>8</sub>), 128.3 (2xCH, C<sub>13</sub> or C<sub>14</sub>), 128.2 (2xCH, C<sub>13</sub> or C<sub>14</sub>), 127.8 (C, q, *J* = 287.5 Hz, C<sub>10</sub>), 126.8 (CH, C<sub>15</sub>), 117.2 (CH<sub>2</sub>, C<sub>9</sub>), 72.6 (CH<sub>2</sub>, C<sub>7</sub>), 69.8 (CH<sub>2</sub>, C<sub>6</sub>), 67.8 (C, q, *J* = 24.6 Hz, C<sub>5</sub>), 53.4 (CH<sub>2</sub>, C<sub>11</sub>), 53.1 (CH<sub>2</sub>, C<sub>2</sub>), 31.2 (CH<sub>2</sub>, C<sub>4</sub>), 23.0 (CH<sub>2</sub>, C<sub>3</sub>).

**MS *m/z* (relative intensity):** 299 (M<sup>+</sup>, 0.6), 228 (21), 91 (100), 65 (8).

**HRMS:** calcd for C<sub>16</sub>H<sub>21</sub>F<sub>3</sub>NO (M+H<sup>+</sup>): 300.1570. Found 300.1570.

### ***N*-Benzyl-2-[(benzyloxy)methyl]-2-(trifluoromethyl)pyrrolidine (27)**

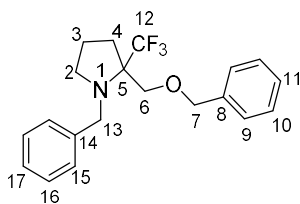

Following the general protocol: **1** (79 mg, 0.30 mmol, 1.0 equiv), proton sponge (130.6 mg, 0.61 mmol, 2.0 equiv), triflic anhydride (76 μL, 0.46 mmol, 1.5 equiv). Nucleophile = benzyl alcohol (79 μL, 0.76 mmol, 2.5 equiv). The crude mixture was purified by flash chromatography (EtOAc/PE=1:99) to afford **27** (69 mg, 0.20 mmol, 65%) as a colorless oil.

**IR (neat):** 3030, 2874, 1496, 1454, 1366, 1330, 1139, 1096, 1028, 926 cm<sup>-1</sup>.

**<sup>1</sup>H NMR (CDCl<sub>3</sub>, 400 MHz):** δ 7.38–7.21 (m, 10H, H<sub>ar</sub>), 4.62 (d, *J* = 11.8 Hz, 1H, H<sub>7</sub>), 4.57 (d, *J* = 12.1 Hz, 1H, H<sub>7</sub>), 4.15 (d, *J* = 13.6 Hz, 1H, H<sub>13</sub>), 3.79 (d, *J* = 9.9 Hz, 1H, H<sub>6</sub>), 3.78 (d, *J* = 13.1 Hz, 1H, H<sub>13</sub>), 3.64 (d, *J* = 9.9 Hz, 1H, H<sub>6</sub>), 2.83 (td<sub>app</sub>, *J* = 7.4 and 3.0 Hz, 1H, H<sub>2</sub>), 2.65 (q<sub>app</sub>, *J* = 8.0 Hz, 1H, H<sub>2</sub>), 2.16–2.13 (m, 2H, H<sub>4</sub>), 1.78–1.72 (m, 2H, H<sub>3</sub>).

**<sup>13</sup>C NMR (CDCl<sub>3</sub>, 100 MHz):** δ 140.8 (C, C<sub>8</sub> or C<sub>14</sub>), 138.1 (C, C<sub>8</sub> or C<sub>14</sub>), 128.6 (2xCH, C<sub>ar</sub>), 128.3 (2xCH, C<sub>ar</sub>), 128.2 (2xCH, C<sub>ar</sub>), 127.9 (CH, C<sub>11</sub> or C<sub>17</sub>), 127.7 (C, q, *J* = 286.8 Hz, C<sub>12</sub>), 127.6 (2xCH, C<sub>ar</sub>), 126.8 (CH, C<sub>11</sub> or C<sub>17</sub>), 73.7 (CH<sub>2</sub>, C<sub>7</sub>), 69.9 (CH<sub>2</sub>, C<sub>6</sub>), 67.9 (C, q, *J* = 24.6 Hz, C<sub>5</sub>), 53.4 (CH<sub>2</sub>, C<sub>13</sub>), 53.2 (CH<sub>2</sub>, C<sub>2</sub>), 31.2 (CH<sub>2</sub>, C<sub>4</sub>), 23.0 (CH<sub>2</sub>, C<sub>3</sub>).

**MS *m/z* (relative intensity):** 349 (M<sup>+</sup>, 0.1), 243 (3), 228 (20), 91 (100), 77 (5), 65 (9).

**HRMS:** calcd for C<sub>20</sub>H<sub>23</sub>F<sub>3</sub>NO (M+H<sup>+</sup>): 350.1726. Found 350.1727.

### **N-Benzyl-2-[(hydroxy)methyl]-2-(trifluoromethyl)pyrrolidine (28)**

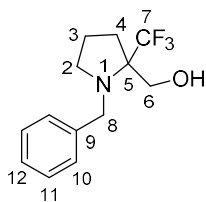

Following the general protocol: **1** (100 mg, 0.39 mmol, 1.0 equiv), proton sponge (165.3 mg, 0.77 mmol, 2.0 equiv), triflic anhydride (96  $\mu$ L, 0.58 mmol, 1.5 equiv). Nucleophile = H<sub>2</sub>O (0.1 mL, 5.55 mmol, 14.0 equiv). The crude mixture was purified by flash chromatography (EtOAc/PE=5:95 to 10:90) to afford **28** (62 mg, 0.24 mmol, 61%) as a brown oil.

**IR (neat)**: 3445, 3030, 2927, 2852, 1496, 1454, 1366, 1287, 1138, 1109, 1058, 943  $\text{cm}^{-1}$ .

**<sup>1</sup>H NMR (CDCl<sub>3</sub>, 400 MHz)**:  $\delta$  7.35–7.25 (m, 5H, H<sub>10</sub>, H<sub>11</sub> and H<sub>12</sub>), 4.09 (d,  $J$  = 13.3 Hz, 1H, H<sub>8</sub>), 3.84 (d,  $J$  = 10.9 Hz, 1H, H<sub>6</sub>), 3.68 (dq,  $J$  = 13.3 and 1.8 Hz, 1H, H<sub>8</sub>), 3.61 (m, 1H, H<sub>6</sub>), 2.90 (m, 1H, H<sub>2</sub>), 2.75 (q<sub>app</sub>,  $J$  = 17.3 Hz, 1H, H<sub>2</sub>), 2.53 (br s, OH), 2.19–2.15 (m, 2H, H<sub>4</sub>), 1.80 (m, 1H, H<sub>3</sub>), 1.71 (m, 1H, H<sub>3</sub>).

**<sup>13</sup>C NMR (CDCl<sub>3</sub>, 100 MHz)**:  $\delta$  139.3 (C, C<sub>9</sub>), 128.7 (2xCH, C<sub>10</sub> or C<sub>11</sub>), 128.5 (2xCH, C<sub>10</sub> or C<sub>11</sub>), 128.0 (C, q,  $J$  = 291.6 Hz, C<sub>7</sub>), 127.4 (CH, C<sub>12</sub>), 69.2 (C, q,  $J$  = 23.3 Hz, C<sub>5</sub>), 59.5 (CH<sub>2</sub>, C<sub>6</sub>), 52.2 (CH<sub>2</sub>, C<sub>8</sub>), 51.9 (CH<sub>2</sub>, C<sub>2</sub>), 30.1 (CH<sub>2</sub>, C<sub>4</sub>), 22.1 (CH<sub>2</sub>, C<sub>3</sub>).

**MS  $m/z$  (relative intensity)**: 259 (M<sup>+</sup>, 0.6), 228 (17), 91 (100), 65 (8).

**HRMS**: calcd for C<sub>13</sub>H<sub>17</sub>F<sub>3</sub>NO (M+H<sup>+</sup>): 260.1257. Found 260.1260.

### **N-Benzyl-2-phenoxyethyl-2-(trifluoromethyl)pyrrolidine (29)**

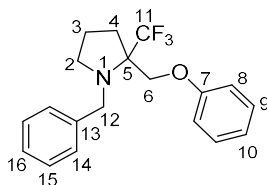

Following the general protocol: **1** (100 mg, 0.39 mmol, 1.0 equiv), proton sponge (165.3 mg, 0.77 mmol, 2.0 equiv), triflic anhydride (96  $\mu$ L, 0.58 mmol, 1.5 equiv). Nucleophile = sodium phenoxy trihydrate (164.1 mg, 0.96 mmol, 2.5 equiv). The crude mixture was purified by flash chromatography (EtOAc/PE=2:98) to afford **29** (98 mg, 0.29 mmol, 75%) as a colorless oil.

**IR (neat)**: 3030, 2955, 2814, 1600, 1589, 1497, 1474, 1455, 1367, 1331, 1288, 1238, 1139, 1077, 1055, 947  $\text{cm}^{-1}$ .

**<sup>1</sup>H NMR (CDCl<sub>3</sub>, 400 MHz):** δ 7.34–7.19 (m, 7H, H<sub>ar</sub>), 7.01–6.94 (m, 3H, H<sub>8</sub> and H<sub>10</sub>), 4.29 (d, *J* = 9.6 Hz, 1H, H<sub>6</sub>), 4.18 (d, *J* = 13.7 Hz, 1H H<sub>12</sub>), 4.13 (d, *J* = 9.8 Hz, 1H, H<sub>6</sub>), 3.80 (d, *J* = 13.6 Hz, 1H, H<sub>12</sub>), 2.89 (m, 1H, H<sub>2</sub>), 2.78 (q<sub>app</sub>, *J* = 7.8 Hz, 1H, H<sub>2</sub>), 2.25–2.23 (m, 2H, H<sub>4</sub>), 1.87–1.81 (m, 2H, H<sub>3</sub>).

**<sup>13</sup>C NMR (CDCl<sub>3</sub>, 100 MHz):** δ 158.5 (C, C<sub>13</sub>), 140.5 (C, C<sub>7</sub>), 129.7 (2xCH, C<sub>ar</sub>), 128.4 (2xCH, C<sub>ar</sub>), 128.1 (2xCH, C<sub>ar</sub>), 127.6 (C, q, *J* = 286.8 Hz, C<sub>11</sub>), 126.9 (CH, C<sub>16</sub>), 121.5 (CH, C<sub>10</sub>), 114.7 (2xCH, C<sub>8</sub>), 67.7 (C, q, *J* = 25.0 Hz, C<sub>5</sub>), 67.5 (CH<sub>2</sub>, C<sub>6</sub>), 53.3 (CH<sub>2</sub>, C<sub>2</sub> or C<sub>12</sub>), 53.3 (CH<sub>2</sub>, C<sub>2</sub> or C<sub>12</sub>), 31.3 (CH<sub>2</sub>, C<sub>4</sub>), 23.1 (CH<sub>2</sub>, C<sub>3</sub>).

**MS *m/z* (relative intensity):** 335 (M<sup>+</sup>, 0.3), 228 (22), 91 (100), 77 (5), 65 (8).

**HRMS:** calcd for C<sub>19</sub>H<sub>21</sub>F<sub>3</sub>NO (M+H<sup>+</sup>): 336.1570. Found 336.1569.

### ***N*-Benzyl-2-[(acetyl)methyl]-2-(trifluoromethyl)pyrrolidine (30)**

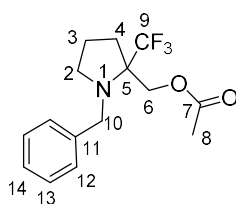

Following the general protocol: **1** (100 mg, 0.39 mmol, 1.0 equiv), proton sponge (165.3 mg, 0.77 mmol, 2.0 equiv), triflic anhydride (96 μL, 0.58 mmol, 1.5 equiv). Nucleophile = tetrabutylammonium acetate (290.7 mg, 0.96 mmol, 2.5 equiv). The crude mixture was purified by flash chromatography (EtOAc/PE=5:95 to 10:90) to afford **30** (84 mg, 0.28 mmol, 72%) as a yellow oil.

**IR (neat):** 3030, 2973, 2813, 1749, 1496, 1454, 1367, 1226, 1141, 1050, 955, 907 cm<sup>-1</sup>.

**<sup>1</sup>H NMR (CDCl<sub>3</sub>, 400 MHz):** δ 7.31–7.22 (m, 5H, H<sub>12</sub>, H<sub>13</sub> and H<sub>14</sub>), 4.39 (d, *J* = 11.8 Hz, 1H, H<sub>6</sub>), 4.32 (d, *J* = 11.8 Hz, 1H, H<sub>6</sub>), 4.06 (d, *J* = 13.6 Hz, 1H, H<sub>10</sub>), 3.81 (d, *J* = 13.6 Hz, 1H, H<sub>10</sub>), 2.82 (m, 1H, H<sub>2</sub>), 2.67 (q<sub>app</sub>, *J* = 7.5 Hz, 1H, H<sub>2</sub>), 2.21 (m, 1H, H<sub>3</sub>), 2.13 (s, 3H, H<sub>8</sub>), 1.99 (m, 1H, H<sub>3</sub>), 1.82–1.74 (m, 2H, H<sub>4</sub>).

**<sup>13</sup>C NMR (CDCl<sub>3</sub>, 100 MHz):** δ 170.7 (C, C<sub>7</sub>), 140.0 (C, C<sub>11</sub>), 128.4 (2xCH, C<sub>12</sub> or C<sub>13</sub>), 128.1 (2xCH, C<sub>12</sub> or C<sub>13</sub>), 127.5 (C, q, *J* = 288.3 Hz, C<sub>9</sub>), 127.0 (CH, C<sub>14</sub>), 67.0 (C, q, *J* = 24.9 Hz, C<sub>5</sub>), 63.4 (CH<sub>2</sub>, C<sub>6</sub>), 53.0 (CH<sub>2</sub>, C<sub>10</sub>), 52.5 (CH<sub>2</sub>, C<sub>2</sub>), 31.4 (CH<sub>2</sub>, C<sub>4</sub>), 22.7 (CH<sub>2</sub>, C<sub>3</sub>), 21.0 (CH<sub>3</sub>, C<sub>8</sub>).

**MS *m/z* (relative intensity):** 301 (M<sup>+</sup>, 1), 228 (25), 91 (100), 65 (8).

**HRMS:** calcd for C<sub>15</sub>H<sub>19</sub>F<sub>3</sub>NO<sub>2</sub> (M+H<sup>+</sup>): 302.1362. Found 302.1364.



### **N-Benzyl-2-[(ethylsulfanyl)methyl]-2-(trifluoromethyl)pyrrolidine (31)**

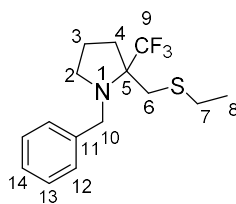

1) Following the general protocol: **1** (100 mg, 0.39 mmol, 1.0 equiv), proton sponge (165.3 mg, 0.77 mmol, 2.0 equiv), triflic anhydride (96  $\mu$ L, 0.58 mmol, 1.5 equiv). Nucleophile = sodium ethanethiolate (81.1 mg, 0.96 mmol, 2.5 equiv). The crude mixture was purified by flash chromatography (EtOAc/PE=1:99) to afford **31** (70 mg, 0.23 mmol, 60%) as a colorless oil.

2) Following the general protocol: **1** (100 mg, 0.39 mmol, 1.0 equiv), proton sponge (165.3 mg, 0.77 mmol, 2.0 equiv), triflic anhydride (96  $\mu$ L, 0.58 mmol, 1.5 equiv). Nucleophile = ethyl mercaptan (72  $\mu$ L, 0.96 mmol, 2.5 equiv). The crude mixture was purified by flash chromatography (EtOAc/PE=1:99) to afford **31** (64 mg, 0.21 mmol, 54%) as a colorless oil.

**IR (neat):** 2968, 2928, 2831, 1495, 1454, 1373, 1330, 1315, 1266, 1137, 1100, 1075, 1029, 943  $\text{cm}^{-1}$ .

**$^1\text{H}$  NMR ( $\text{CDCl}_3$ , 400 MHz):**  $\delta$  7.38–7.36 (m, 2H,  $\text{H}_{\text{ar}}$ ), 7.32–7.28 (m, 2H,  $\text{H}_{\text{ar}}$ ), 7.25–7.20 (m, 1H,  $\text{H}_{\text{ar}}$ ), 4.00 (d,  $J = 13.6$  Hz, 1H,  $\text{H}_{10}$ ), 3.84 (d,  $J = 13.6$  Hz, 1H,  $\text{H}_{10}$ ), 3.27 (d,  $J = 12.9$  Hz, 1H,  $\text{H}_6$ ), 2.77–2.71 (m, 2H,  $\text{H}_2$ ), 2.73 (d,  $J = 12.6$  Hz, 1H,  $\text{H}_6$ ), 2.59 (q,  $J = 8.0$  Hz, 2H,  $\text{H}_7$ ), 2.33 (m, 1H,  $\text{H}_4$ ), 2.15 (m, 1H,  $\text{H}_4$ ), 1.82–1.75 (m, 2H,  $\text{H}_3$ ), 1.30 (t,  $J = 7.4$  Hz, 3H,  $\text{H}_8$ ).

**$^{13}\text{C}$  NMR ( $\text{CDCl}_3$ , 100 MHz):**  $\delta$  140.2 (C,  $\text{C}_{11}$ ), 128.3 (2xCH,  $\text{C}_{12}$  or  $\text{C}_{13}$ ), 128.3 (C, q,  $J = 291.6$  Hz,  $\text{C}_9$ ), 128.2 (2xCH,  $\text{C}_{12}$  or  $\text{C}_{13}$ ), 126.9 (CH,  $\text{C}_{14}$ ), 68.0 (q,  $J = 23.8$  Hz,  $\text{C}_5$ ), 52.3 ( $\text{CH}_2$ ,  $\text{C}_{10}$ ), 51.9 ( $\text{CH}_2$ ,  $\text{C}_2$ ), 35.2 ( $\text{CH}_2$ ,  $\text{C}_6$ ), 31.7 ( $\text{CH}_2$ ,  $\text{C}_4$ ), 27.9 ( $\text{CH}_2$ ,  $\text{C}_7$ ), 22.4 ( $\text{CH}_2$ ,  $\text{C}_3$ ), 15.1 ( $\text{CH}_3$ ,  $\text{C}_8$ ).

**MS  $m/z$  (relative intensity):** 303 ( $\text{M}^+$ , 0.1), 228 (22), 91 (100), 65 (7).

**HRMS:** calcd for  $\text{C}_{15}\text{H}_{21}\text{F}_3\text{NS}$  ( $\text{M}+\text{H}^+$ ): 304.1341. Found 304.1342.

### **N-Benzyl-2-[(benzylsulfanyl)methyl]-2-(trifluoromethyl)pyrrolidine (32)**

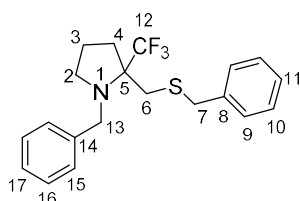

Following the general protocol: **1** (100 mg, 0.39 mmol, 1.0 equiv), proton sponge (165.3 mg, 0.77 mmol, 2.0 equiv), triflic anhydride (96  $\mu$ L, 0.58 mmol, 1.5 equiv). Nucleophile = benzyl mercaptan

(113  $\mu\text{L}$ , 0.96 mmol, 2.5 equiv). The crude mixture was purified by flash chromatography (PE=100%) to afford **32** (126 mg, 0.34 mmol, 89%) as a colorless oil.

**IR (neat):** 3063, 3028, 2954, 2821, 1602, 1494, 1454, 1369, 1315, 1257, 1145, 1100, 1073, 1029, 997, 944  $\text{cm}^{-1}$ .

**$^1\text{H}$  NMR ( $\text{CDCl}_3$ , 400 MHz):**  $\delta$  7.36–7.22 (m, 10H,  $H_{\text{ar}}$ ), 3.94 (d,  $J = 13.7$  Hz, 1H,  $H_{13}$ ), 3.74 (s, 2H,  $H_7$ ), 3.73 (d,  $J = 16.0$  Hz, 1H,  $H_{13}$ ), 3.15 (d,  $J = 12.7$  Hz, 1H,  $H_6$ ), 2.76–2.65 (m, 3H,  $H_2$  and  $H_6$ ) 2.16 (m, 1H,  $H_4$ ), 2.05 (m, 1H,  $H_4$ ), 1.77–1.70 (m, 2H,  $H_3$ ).

**$^{13}\text{C}$  NMR ( $\text{CDCl}_3$ , 100 MHz):**  $\delta$  140.1 (C,  $C_8$  or  $C_{14}$ ), 138.2 (C,  $C_8$  or  $C_{14}$ ), 129.0 (2xCH,  $C_{\text{ar}}$ ), 128.7 (2xCH,  $C_{\text{ar}}$ ), 128.3 (2xCH,  $C_{\text{ar}}$ ), 128.3 (2xCH,  $C_{\text{ar}}$ ), 128.2 (C, q,  $J = 291.8$  Hz,  $C_{12}$ ), 127.3 (CH,  $C_{11}$  or  $C_{17}$ ), 126.9 (CH,  $C_{11}$  or  $C_{17}$ ), 67.9 (C, q,  $J = 23.9$  Hz,  $C_5$ ), 52.2 ( $\text{CH}_2$ ,  $C_{13}$ ), 51.8 ( $\text{CH}_2$ ,  $C_2$ ), 37.9 ( $\text{CH}_2$ ,  $C_7$ ), 34.6 ( $\text{CH}_2$ ,  $C_6$ ), 31.7 ( $\text{CH}_2$ ,  $C_4$ ), 22.3 ( $\text{CH}_2$ ,  $C_3$ ).

**MS  $m/z$  (relative intensity):** 365 ( $M^+$ , 0.5), 228 (42), 91 (100), 65 (10).

**HRMS:** calcd for  $\text{C}_{20}\text{H}_{23}\text{F}_3\text{NS}$  ( $M+H^+$ ): 366.1498. Found 366.1499.

### **N-Benzyl-2-[(phenylsulfonyl)methyl]-2-(trifluoromethyl)pyrrolidine (**33**)**

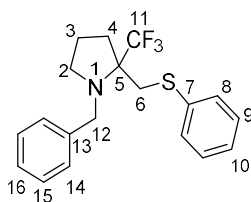

Following the general protocol: **1** (100 mg, 0.39 mmol, 1.0 equiv), proton sponge (165.3 mg, 0.77 mmol, 2.0 equiv), triflic anhydride (96  $\mu\text{L}$ , 0.58 mmol, 1.5 equiv). Nucleophile = sodium thiophenolate (127 mg, 0.96 mmol, 2.5 equiv). The crude mixture was purified by flash chromatography (PE=100%) to afford **33** (83 mg, 0.24 mmol, 61%) as a colorless oil.

**IR (neat):** 3062, 3028, 2955, 2834, 1584, 1495, 1480, 1454, 1438, 1372, 1314, 1252, 1137, 1100, 1026, 997, 943  $\text{cm}^{-1}$ .

**$^1\text{H}$  NMR ( $\text{CDCl}_3$ , 400 MHz):**  $\delta$  7.40–7.18 (m, 10H,  $H_{\text{ar}}$ ), 4.07 (d,  $J = 13.6$  Hz, 1H,  $H_{12}$ ), 3.80 (dd<sub>app</sub>,  $J = 13.6$  and 1.4 Hz, 1H,  $H_{12}$ ), 3.67 (d,  $J = 12.6$  Hz, 1H,  $H_6$ ), 3.21 (d,  $J = 12.6$  Hz, 1H,  $H_6$ ), 2.85 (m, 1H,  $H_2$ ), 2.75 (q<sub>app</sub>,  $J = 7.2$  Hz, 1H,  $H_2$ ), 2.38 (m, 1H,  $H_4$ ), 2.19 (m, 1H,  $H_4$ ), 1.85–1.78 (m, 2H,  $H_3$ ).

**$^{13}\text{C}$  NMR ( $\text{CDCl}_3$ , 100 MHz):**  $\delta$  139.9 (C,  $C_7$  or  $C_{13}$ ), 137.2 (C,  $C_7$  or  $C_{13}$ ), 129.5 (2xCH,  $C_{\text{ar}}$ ), 129.2 (2xCH,  $C_{\text{ar}}$ ), 128.4 (2xCH,  $C_{\text{ar}}$ ), 128.3 (2xCH,  $C_{\text{ar}}$ ), 128.2 (C, q,  $J = 292.4$  Hz, 1C,  $C_{11}$ ), 127.0 (CH,  $C_{10}$  or  $C_{16}$ ), 126.4 (CH,  $C_{10}$  or  $C_{16}$ ), 68.1 (C, q,  $J = 23.8$  Hz,  $C_5$ ), 52.3 ( $\text{CH}_2$ ,  $C_{12}$ ), 51.7 ( $\text{CH}_2$ ,  $C_2$ ), 37.5 ( $\text{CH}_2$ ,  $C_6$ ), 31.8 ( $\text{CH}_2$ ,  $C_4$ ), 22.4 ( $\text{CH}_2$ ,  $C_3$ ).

**MS  $m/z$  (relative intensity):** 351 ( $M^+$ , 0.3), 228 (43), 123 (2), 91 (100), 77 (3), 65 (9).

**HRMS:** calcd for C<sub>19</sub>H<sub>21</sub>F<sub>3</sub>NS (M+H<sup>+</sup>): 352.1341. Found 352.1341.

**N-Benzyl-2-cyanomethyl-2-(trifluoromethyl)pyrrolidine (34)**

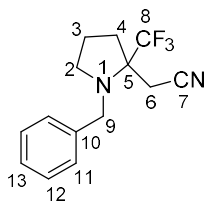

Following the general protocol: **1** (100 mg, 0.39 mmol, 1.0 equiv), proton sponge (165.3 mg, 0.77 mmol, 2.0 equiv), triflic anhydride (96  $\mu$ L, 0.58 mmol, 1.5 equiv). Nucleophile = tetrabutylammonium cyanide (273 mg, 0.96 mmol, 2.5 equiv). The crude mixture was purified by flash chromatography (EtOAc/PE=4:96) to afford **34** (78 mg, 0.29 mmol, 75%) as a yellow oil.

**IR (neat):** 3031, 2962, 2839, 2359, 2252, 1454, 1373, 1349, 1278, 1141, 1105, 1076, 1029, 979, 914 cm<sup>-1</sup>.

**<sup>1</sup>H NMR (CDCl<sub>3</sub>, 400 MHz):**  $\delta$  7.37–7.23 (m, 5H, H<sub>11</sub>, H<sub>12</sub> and H<sub>13</sub>), 4.03 (d,  $J$  = 13.5 Hz, 1H, H<sub>9</sub>), 3.86 (d,  $J$  = 13.5 Hz, 1H, H<sub>9</sub>), 2.89 (m, 1H, H<sub>2</sub>), 2.89 (d,  $J$  = 16.0 Hz, 1H, H<sub>6</sub>), 2.76 (m, 1H, H<sub>2</sub>), 2.74 (d,  $J$  = 16.0 Hz, 1H, H<sub>6</sub>), 2.36 (m, 1H, H<sub>4</sub>), 2.20 (m, 1H, H<sub>4</sub>), 1.93–1.84 (m, 2H, H<sub>3</sub>).

**<sup>13</sup>C NMR (CDCl<sub>3</sub>, 100 MHz):**  $\delta$  138.8 (C, C<sub>10</sub>), 128.5 (2xCH, C<sub>11</sub> or C<sub>12</sub>), 128.0 (2xCH, C<sub>11</sub> or C<sub>12</sub>), 127.3 (CH, C<sub>13</sub>), 127.1 (C, q,  $J$  = 290.6 Hz, C<sub>8</sub>), 116.4 (C, C<sub>7</sub>), 66.2 (C, q,  $J$  = 25.6 Hz, C<sub>5</sub>), 52.0 (CH<sub>2</sub>, C<sub>9</sub>), 51.6 (CH<sub>2</sub>, C<sub>2</sub>), 33.4 (CH<sub>2</sub>, C<sub>4</sub>), 22.2 (CH<sub>2</sub>, C<sub>6</sub>), 22.0 (CH<sub>2</sub>, C<sub>3</sub>).

**MS  $m/z$  (relative intensity):** 268 (M<sup>+</sup>, 1), 228 (8), 199 (3), 91 (100), 65 (11), 54 (5).

**HRMS:** calcd for C<sub>14</sub>H<sub>16</sub>F<sub>3</sub>N<sub>2</sub> (M+H<sup>+</sup>): 269.1260. Found 269.1259.

**N-Benzyl-2-[(1,3-dimethyl-propanedioate)methyl]-2-(trifluoromethyl)pyrrolidine (35)**

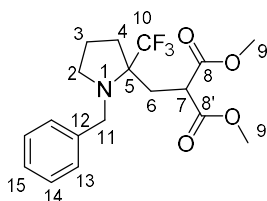

Following the general protocol: **1** (100 mg, 0.39 mmol, 1.0 equiv), proton sponge (165.3 mg, 0.77 mmol, 2.0 equiv), triflic anhydride (96  $\mu$ L, 0.58 mmol, 1.5 equiv). Nucleophile = sodium dimethylmalonate. The crude mixture was purified by flash chromatography (EtOAc/PE=10:90) to afford **35** (101 mg, 0.27 mmol, 70%) as a yellow oil.

For the sodium dimethylmalonate: To a stirred suspension of NaH (60% wt oil dispersion, 40 mg, 1.00 mg, 2.6 equiv) in THF (3 mL) at  $-15^{\circ}\text{C}$  was added dropwise dimethylmalonate (0.35 mL, 1.35 mmol, 3.5 equiv) and the solution was stirred at rt for 30 min.

**IR (neat):** 2956, 2845, 1736, 1455, 1436, 1366, 1268, 1137 1104, 1038  $\text{cm}^{-1}$ .

**$^1\text{H}$  NMR ( $\text{CDCl}_3$ , 400 MHz):**  $\delta$  7.32–7.22 (m, 5H,  $\text{H}_{13}$ ,  $\text{H}_{14}$  and  $\text{H}_{15}$ ), 4.10 (d,  $J = 13.5$  Hz, 1H,  $\text{H}_{11}$ ), 3.78 (s, 3H,  $\text{H}_9$  or  $\text{H}_{9'}$ ), 3.77 (m, 1H,  $\text{H}_7$ ), 3.68 (s, 3H,  $\text{H}_9$  or  $\text{H}_{9'}$ ), 3.57 (dq,  $J = 13.5$  and 2.3 Hz, 1H,  $\text{H}_{11}$ ), 2.86 (m, 1H,  $\text{H}_2$ ), 2.64–2.59 (m, 2H,  $\text{H}_2$  and  $\text{H}_6$ ), 2.38 (dd,  $J = 15.0$  Hz and 6.1 Hz, 1H,  $\text{H}_6$ ), 2.13 (m, 1H,  $\text{H}_4$ ), 1.82–1.66 (m, 3H,  $\text{H}_3$  and  $\text{H}_4$ ).

**$^{13}\text{C}$  NMR ( $\text{CDCl}_3$ , 100 MHz):**  $\delta$  170.6 (C,  $\text{C}_8$  or  $\text{C}_{8'}$ ), 170.2 (C,  $\text{C}_8$  or  $\text{C}_{8'}$ ), 139.4 (C,  $\text{C}_{12}$ ), 128.6 (C, q,  $J = 294.3$  Hz,  $\text{C}_{10}$ ), 128.4 (2xCH,  $\text{C}_{13}$  or  $\text{C}_{14}$ ), 128.3 (2xCH,  $\text{C}_{13}$  or  $\text{C}_{14}$ ), 127.0 (CH,  $\text{C}_{15}$ ), 67.6 (C, q,  $J = 23.2$  Hz,  $\text{C}_5$ ), 53.1 ( $\text{CH}_3$ ,  $\text{C}_9$  or  $\text{C}_{9'}$ ), 53.0 ( $\text{CH}_3$ ,  $\text{C}_9$  or  $\text{C}_{9'}$ ), 51.9 ( $\text{CH}_2$ ,  $\text{C}_{11}$ ), 51.1 ( $\text{CH}_2$ ,  $\text{C}_2$ ), 46.7 (CH,  $\text{C}_7$ ), 31.2 ( $\text{CH}_2$ ,  $\text{C}_4$ ), 29.2 ( $\text{CH}_2$ ,  $\text{C}_6$ ), 21.9 ( $\text{CH}_2$ ,  $\text{C}_3$ ).

**MS  $m/z$  (relative intensity):** 373 ( $\text{M}^+$ , 1), 304 (24), 242 (7), 228 (10), 91 (100), 65 (7).

**HRMS:** calcd for  $\text{C}_{18}\text{H}_{23}\text{F}_3\text{NO}_4$  ( $\text{M}+\text{H}^+$ ): 374.1574. Found 374.1581.

**(+)-*N*-Benzyl-2-[[*(S)*-*N*-(1-methylbenzyl)amino]methyl]-2-(trifluoromethyl)pyrrolidine (+)-(36a)**

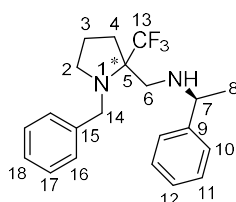

Following the general protocol: (+)-**1** (28 mg, 0.11 mmol, 1.0 equiv), proton sponge (46.3 mg, 0.22 mmol, 2.0 equiv), triflic anhydride (27  $\mu\text{L}$ , 0.16 mmol, 1.5 equiv). Nucleophile = (*S*)-(-)- $\alpha$ -methylbenzylamine (34  $\mu\text{L}$ , 0.27 mmol, 2.5 equiv). The crude mixture was purified by flash chromatography (EtOAc/Pentane=2:98) to afford **36a** (30 mg, 0.08 mmol, 77%) as a yellow oil.

**IR (neat):** 3028, 2966, 2925, 2835, 1494, 1453, 1370, 1285, 1131, 1103, 1076, 1028  $\text{cm}^{-1}$ .

**$[\alpha]_{\text{D}}^{20}$**  +26 ( $c$  0.8,  $\text{CHCl}_3$ )

**$^1\text{H}$  NMR ( $\text{CDCl}_3$ , 400 MHz):**  $\delta$  7.28–7.19 (m, 10H,  $\text{H}_{\text{ar}}$ ), 3.85 (d,  $J = 13.9$  Hz, 1H,  $\text{H}_{14}$ ), 3.74–3.66 (m, 2H,  $\text{H}_7$  and  $\text{H}_{14}$ ), 2.78–2.68 (m, 4H,  $\text{H}_2$  and  $\text{H}_6$ ), 2.39 (m, 1H,  $\text{H}_4$ ), 2.08 (m, 1H,  $\text{H}_4$ ), 1.78–1.69 (m, 2H,  $\text{H}_3$ ), 1.63 (br s, NH), 1.37 (d,  $J = 6.6$  Hz, 3H,  $\text{H}_8$ ).

**$^{13}\text{C}$  NMR ( $\text{CDCl}_3$ , 100 MHz):**  $\delta$  146.0 (C,  $\text{C}_9$  or  $\text{C}_{15}$ ), 140.2 (C,  $\text{C}_9$  or  $\text{C}_{15}$ ), 128.7 (C, q,  $J = 291.6$  Hz,  $\text{C}_{13}$ ), 128.6 (2xCH,  $\text{C}_{\text{ar}}$ ), 128.4 (2xCH,  $\text{C}_{\text{ar}}$ ), 128.0 (2xCH,  $\text{C}_{\text{ar}}$ ), 127.1 (CH,  $\text{C}_{12}$  or  $\text{C}_{18}$ ), 126.9 (CH,  $\text{C}_{12}$  or  $\text{C}_{18}$ ), 126.6 (2xCH,  $\text{C}_{\text{ar}}$ ), 68.3 (C, q,  $J = 23.0$  Hz,  $\text{C}_5$ ), 59.0 (CH,  $\text{C}_7$ ), 52.0 ( $\text{CH}_2$ ,  $\text{C}_2$  or  $\text{C}_{14}$ ), 51.9 ( $\text{CH}_2$ ,  $\text{C}_2$  or  $\text{C}_{14}$ ), 47.1 ( $\text{CH}_2$ ,  $\text{C}_6$ ), 30.6 ( $\text{CH}_2$ ,  $\text{C}_4$ ), 24.1 ( $\text{CH}_3$ ,  $\text{C}_8$ ), 22.4 ( $\text{CH}_2$ ,  $\text{C}_3$ ).

**MS *m/z* (relative intensity):** 362 ( $M^{+}$ , 0.05), 228 (6), 209 (38), 208 (24), 134 (10), 105 (62), 91 (100), 79 (7), 77 (7), 65 (10), 51 (3).

**HRMS:** calcd for  $C_{21}H_{26}F_3N_2$  ( $M+H^+$ ): 363.2043. Found: 363.2044.

**(-)-*N*-Benzyl-2-[(*S*)-*N*-(1-methylbenzyl)amino]methyl]-2-(trifluoromethyl)pyrrolidine (-)-**(36b)****

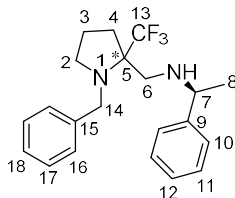

Following the general protocol: (-)-**1** (56 mg, 0.22 mmol, 1.0 equiv), proton sponge (91.8 mg, 0.43 mmol, 2.0 equiv), triflic anhydride (53  $\mu$ L, 0.32 mmol, 1.5 equiv). Nucleophile = (*S*)-(-)- $\alpha$ -methylbenzylamine (68  $\mu$ L, 0.54 mmol, 2.5 equiv). The crude mixture was purified by flash chromatography (EtOAc/Pentane=2:98) to afford **36b** (68 mg, 0.19 mmol, 86%) as a yellow oil.

**IR (neat):** 3028, 2960, 2924, 2833, 1494, 1453, 1370, 1285, 1148, 1131, 1104, 1075, 1028, 964  $cm^{-1}$ .

**$[\alpha]_D^{20}$**  -38 (*c* 1.0,  $CHCl_3$ )

**$^1H$  NMR ( $CDCl_3$ , 400 MHz):**  $\delta$  7.36–7.21 (m, 10H,  $H_{ar}$ ), 4.06 (d,  $J = 13.8$  Hz, 1H,  $H_{14}$ ), 3.76–3.71 (m, 2H,  $H_7$  and  $H_{14}$ ), 2.90 (m, 1H,  $H_2$ ), 2.80 (d,  $J = 11.7$  Hz, 1H,  $H_6$ ), 2.73 (m, 1H,  $H_2$ ), 2.54 (d,  $J = 11.7$  Hz, 1H,  $H_6$ ), 2.40 (m, 1H,  $H_4$ ), 2.01 (m, 1H,  $H_4$ ), 1.79–1.76 (m, 2H,  $H_3$ ), 1.62 (br s, NH), 1.36 (d,  $J = 6.6$  Hz, 3H,  $H_8$ ).

**$^{13}C$  NMR ( $CDCl_3$ , 100 MHz):**  $\delta$  145.8 (C,  $C_9$  or  $C_{15}$ ), 140.3 (C,  $C_9$  or  $C_{15}$ ), 128.6 (4xCH,  $C_{ar}$ ), 128.6 (C, q,  $J = 292.8$  Hz,  $C_{13}$ ), 128.1 (2xCH,  $C_{ar}$ ), 127.1 (CH,  $C_{12}$  or  $C_{18}$ ), 127.0 (CH,  $C_{12}$  or  $C_{18}$ ), 126.7 (2xCH,  $C_{ar}$ ), 68.4 (C, q,  $J = 23.0$  Hz,  $C_5$ ), 59.0 (CH,  $C_7$ ), 52.0 (2xCH<sub>2</sub>,  $C_2$  and  $C_{14}$ ), 47.0 (CH<sub>2</sub>,  $C_6$ ), 30.5 (CH<sub>2</sub>,  $C_4$ ), 25.6 (CH<sub>3</sub>,  $C_8$ ), 22.3 (CH<sub>2</sub>,  $C_3$ ).

**MS *m/z* (relative intensity):** 362 ( $M^{+}$ , 0.04), 228 (8), 209 (49), 208 (29), 134 (12), 105 (69), 91 (100), 79 (8), 77 (8), 65 (10), 51 (3).

**HRMS:** calcd for  $C_{21}H_{26}F_3N_2$  ( $M+H^+$ ): 363.2043. Found: 363.2045.

## 4. Synthesis and spectroscopic data of *N*-benzyl-3-hydroxy-3-methylpiperidine (37)

*tert*-Butyl 3-methyl-3-hydroxypiperidin-1-carboxylate (41)<sup>76</sup>

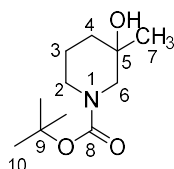

To a stirred solution of *N*-Boc-3-piperidone **3** (1.48 g, 7.43 mmol, 1.0 equiv) in THF (37 mL) at 0 °C was added MeMgBr (3.0 M in Et<sub>2</sub>O, 9.9 mL, 29.7 mmol, 4.0 equiv) and the resulting mixture was stirred at rt for 16 h. The solution was quenched with an aqueous and saturated solution of NH<sub>4</sub>Cl and extracted with EtOAc (twice). The organic layer was then dried over anhydrous MgSO<sub>4</sub>, filtered and concentrated under reduced pressure. The crude mixture was purified by flash chromatography (Et<sub>2</sub>O/PE=30:70) to afford **41** (800 mg, 3.72 mmol, 50%) as a colorless oil.

**IR (neat):** 3393, 2930, 1684, 1422, 1365, 1274, 1247, 1158, 1049, 1025, 1001 cm<sup>-1</sup>.

**<sup>1</sup>H NMR (DMSO-d<sub>6</sub>, 400 MHz at 122 °C):** δ 3.81 (br s, OH), 3.32–3.22 (m, 2H, H<sub>2</sub>), 3.19 (d, *J* = 12.8 Hz, 1H, H<sub>6</sub>), 3.13 (d, *J* = 12.9 Hz, 1H, H<sub>6</sub>), 1.67 (m, 1H, H<sub>3</sub>), 1.54–1.50 (m, 2H, H<sub>4</sub>), 1.38 (m, 1H, H<sub>3</sub>), 1.42 (s, 9H, H<sub>10</sub>), 1.11 (s, 3H, H<sub>7</sub>).

**<sup>13</sup>C NMR (DMSO-d<sub>6</sub>, 400 MHz at 122 °C):** δ 153.8 (C, C<sub>8</sub>), 77.6 (C, C<sub>9</sub>), 66.2 (C, C<sub>5</sub>), 54.2 (CH<sub>2</sub>, C<sub>6</sub>), 42.9 (CH<sub>2</sub>, C<sub>2</sub>), 37.2 (CH<sub>2</sub>, C<sub>4</sub>), 27.6 (3xCH<sub>3</sub>, C<sub>10</sub>), 25.4 (CH<sub>3</sub>, C<sub>7</sub>), 21.1 (CH<sub>2</sub>, C<sub>3</sub>).

**MS *m/z* (relative intensity):** 215 (M<sup>+</sup>, 2), 159 (9), 142 (7), 101 (9), 85 (8), 58 (8), 57 (100), 56 (5).

***N*-Benzyl-3-hydroxy-3-methylpiperidine (37)**

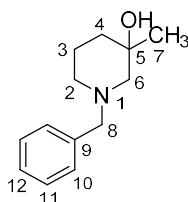

To a stirred solution of *tert*-butyl 3-methyl-3-hydroxypiperidin-1-carboxylate **41** (607 mg, 2.82 mmol, 1.0 equiv) in CH<sub>2</sub>Cl<sub>2</sub> (16 mL) at rt, was added TFA (1.47 mL, 19.74 mmol, 7.0 equiv). The reaction mixture was stirred at rt for 15 h and then concentrated under reduced pressure.

<sup>76</sup> Wenthur, C. J.; Morrison, R.; Felts, A. S.; Smith, K. A.; Engers, J. L.; Byers, F. W.; Daniels, J. S.; Emmitte, K. A.; Conn, P. J.; Lindsley, C. W. *J. Med. Chem.* **2013**, *56*, 5208–5212.

To a stirred solution of the crude material previously obtained in MeCN (29 mL) at rt were added successively BnBr (0.34 mL, 2.82 mmol, 1.0 equiv), K<sub>2</sub>CO<sub>3</sub> (1.9 g, 14.1 mmol, 5.0 equiv) and TBAI (0.52 mg, 1.41 mmol, 0.5 equiv). The reaction mixture was heated at 75 °C for 4 h and then allowed to cool to rt. The reaction mixture was quenched with H<sub>2</sub>O and extracted with CH<sub>2</sub>Cl<sub>2</sub> (twice). The organic layer was dried over anhydrous MgSO<sub>4</sub>, filtered and concentrated under reduced pressure. The crude mixture was purified by flash chromatography (EtOAc/PE=50:50) to afford **37** (452 mg, 2.02 mmol, 78%) as a colorless oil.

**IR (neat):** 3447, 2931, 2798, 1495, 1452, 1366, 1289, 1206, 1135, 1076, 1040, 968 cm<sup>-1</sup>.

**<sup>1</sup>H NMR (CDCl<sub>3</sub>, 400 MHz):** δ 7.34–7.25 (m, 5H, H<sub>10</sub>, H<sub>11</sub> and H<sub>12</sub>), 3.52 (s, 2H, H<sub>8</sub>), 3.33 (br s, OH), 2.79 (d, *J* = 10.7 Hz, 1H, H<sub>2</sub>), 2.59 (d, *J* = 10.9 Hz, 1H, H<sub>6</sub>), 1.95 (d, *J* = 11.0 Hz, 1H, H<sub>6</sub>), 1.89 (dd, *J* = 11.3 and 2.4 Hz, 1H, H<sub>2</sub>), 1.77 (m, 1H, H<sub>3</sub>), 1.62 (dd, *J* = 13.1 and 2.2 Hz, 1H, H<sub>4</sub>), 1.52 (m, 1H, H<sub>3</sub>), 1.24 (m, 1H, H<sub>4</sub>), 1.14 (s, 3H, H<sub>7</sub>).

**<sup>13</sup>C NMR (CDCl<sub>3</sub>, 100 MHz):** δ 138.3 (C, C<sub>9</sub>), 129.1 (2xCH, C<sub>10</sub> or C<sub>11</sub>), 128.4 (2xCH, C<sub>10</sub> or C<sub>11</sub>), 127.3 (CH, C<sub>12</sub>), 67.9 (C, C<sub>5</sub>), 65.1 (CH<sub>2</sub>, C<sub>6</sub>), 62.9 (CH<sub>2</sub>, C<sub>8</sub>), 53.2 (CH<sub>2</sub>, C<sub>2</sub>), 36.6 (CH<sub>2</sub>, C<sub>4</sub>), 26.5 (CH<sub>3</sub>, C<sub>7</sub>), 22.0 (CH<sub>2</sub>, C<sub>3</sub>).

**MS *m/z* (relative intensity):** 205 (M<sup>+</sup>, 10), 147 (5), 146 (6), 134 (65), 114 (11), 92 (9), 91 (100), 85 (14), 65 (10).

**HRMS:** calcd for C<sub>13</sub>H<sub>20</sub>NO (M+H<sup>+</sup>): 206.1539. Found 206.1542.

## 5. Synthesis and spectroscopic data of *N*-benzyl-3-fluoro-3-methyl piperidine (**43**)

### *N*-Benzyl-3-fluoro-3-methylpiperidine (**43**)

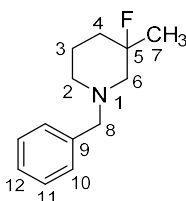

Following the general protocol: *N*-benzyl-3-hydroxy-3-methylpiperidine **37** (50 mg, 0.24 mmol, 1.0 equiv), proton sponge (104 mg, 0.49 mmol, 2.0 equiv), triflic anhydride (61  $\mu$ L, 0.37 mmol, 1.5 equiv). Nucleophile = tetrabutylammonium fluoride (1.0 M in THF, 0.61 mL, 0.61 mmol, 2.5 equiv). The crude mixture was purified by flash chromatography (EtOAc/PE=5:95 and 10:90) to afford **43** (18 mg, 0.09 mmol, 36%) as a yellow oil.

**IR (neat):** 2935, 2859, 2801, 1732, 1679, 1604, 1495, 1453, 1376, 1304, 1284, 1204, 1166, 1130, 1028, 920, 881  $\text{cm}^{-1}$ .

**$^1\text{H}$  NMR ( $\text{CDCl}_3$ , 400 MHz):**  $\delta$  7.33–7.23 (m, 5H,  $\text{H}_{10}$ ,  $\text{H}_{11}$  and  $\text{H}_{12}$ ), 3.55 (s, 2H,  $\text{H}_8$ ), 2.65–2.53 (m, 2H,  $\text{H}_2$  and  $\text{H}_6$ ), 2.27–2.17 (m, 2H,  $\text{H}_2$  and  $\text{H}_6$ ), 1.85–1.76 (m, 2H,  $\text{H}_3$  and  $\text{H}_4$ ), 1.57–1.45 (m, 2H,  $\text{H}_3$  and  $\text{H}_4$ ), 1.34 (d,  $J = 21.7$  Hz, 3H,  $\text{H}_7$ ).

**$^{13}\text{C}$  NMR ( $\text{CDCl}_3$ , 100 MHz):**  $\delta$  138.1 (C,  $\text{C}_9$ ), 129.2 (2xCH,  $\text{C}_{10}$  or  $\text{C}_{11}$ ), 128.3 (2xCH,  $\text{C}_{10}$  or  $\text{C}_{11}$ ), 127.1 (CH,  $\text{C}_{12}$ ), 92.7 (C, d,  $J = 169.7$  Hz,  $\text{C}_5$ ), 62.9 ( $\text{CH}_2$ ,  $\text{C}_8$ ), 62.0 ( $\text{CH}_2$ , d,  $J = 22.9$  Hz,  $\text{C}_6$ ), 53.0 ( $\text{CH}_2$ ,  $\text{C}_2$ ), 35.4 ( $\text{CH}_2$ , d,  $J = 22.4$  Hz,  $\text{C}_4$ ), 25.2 ( $\text{CH}_3$ , d,  $J = 24.1$  Hz,  $\text{C}_7$ ), 22.3 ( $\text{CH}_2$ , d,  $J = 4.7$  Hz,  $\text{C}_3$ ).

**MS  $m/z$  (relative intensity):** 207 ( $\text{M}^+$ , 24), 206 (17), 146 (8), 134 (9), 130 (34), 116 (39), 92 (15), 91 (100), 65 (14).

**HRMS:** calcd for  $\text{C}_{13}\text{H}_{19}\text{FN}$  ( $\text{M}+\text{H}^+$ ): 208.1496. Found 208.1497.



## 6. Synthesis and spectroscopic data of N-benzyl-3-hydroxy-3-(trifluoromethyl)azepane (44)

### 1-Chloropent-4-en-2-ol (48)<sup>77</sup>

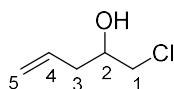

A solution of allyl bromide (5.48 mL, 63 mmol, 1.6 equiv) and In (5.88 g, 51.2 mmol, 1.3 equiv) in H<sub>2</sub>O (99 mL) was stirred for 15 min and then 2-chloroacetaldehyde **47** (5 mL, 39.4 mmol, 1.0 equiv) was added to the gray heterogeneous mixture. After 3 h at rt, the reaction mixture was extracted with Et<sub>2</sub>O and the combined extracts were washed with brine, dried over anhydrous Na<sub>2</sub>SO<sub>4</sub>, filtered and concentrated under reduced pressure to afford **48** (3.7 g, 30.9 mmol, 80%) as a colorless oil.

**IR (neat):** 3382, 3079, 2956, 2917, 1642, 1432, 1047, 996, 919 cm<sup>-1</sup>.

**<sup>1</sup>H NMR (CDCl<sub>3</sub>, 400 MHz):** δ 5.81 (ddt, *J* = 17.3, 10.2 and 7.1 Hz, 1H, H<sub>4</sub>), 5.18–5.11 (m, 2H, H<sub>5</sub>), 3.88 (m, 1H, H<sub>2</sub>), 3.61 (dd, *J* = 11.2 and 4.0 Hz, 1H, H<sub>1</sub>), 3.51 (d, *J* = 11.2 and 6.3 Hz, 1H, H<sub>1</sub>), 3.29 (br s, OH), 2.39–2.31 (m, 2H, H<sub>3</sub>).

**<sup>13</sup>C NMR (CDCl<sub>3</sub>, 100 MHz):** δ 133.3 (CH, C<sub>4</sub>), 118.2 (CH<sub>2</sub>, C<sub>5</sub>), 70.5 (CH, C<sub>2</sub>), 49.0 (CH<sub>2</sub>, C<sub>1</sub>), 38.5 (CH<sub>2</sub>, C<sub>3</sub>).

### N-(Allylamino)pent-7-en-5-ol (46)<sup>73</sup>

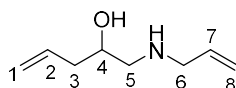

1-chloropent-4-en-2-ol **48** (3.73 g, 30.9 mmol, 1.0 equiv) was treated with allylamine (11.6 mL, 154 mmol, 5.0 equiv) and the reaction mixture was stirred at 86 °C for 5 days. The solution was concentrated under reduced pressure to remove the excess of allylamine. The crude mixture was purified by flash chromatography (MeOH/CH<sub>2</sub>Cl<sub>2</sub>=2:98 and 10:90) to afford **46** (4.2 g, 29.4 mmol, 96%) as an orange oil.

**IR (neat):** 3301, 3076, 2978, 2911, 2825, 1642, 1441, 1341, 1078, 993, 913 cm<sup>-1</sup>.

**<sup>1</sup>H NMR (CDCl<sub>3</sub>, 400 MHz):** δ 5.97–5.79 (m, 2H, H<sub>2</sub> and H<sub>7</sub>), 5.28–5.07 (m, 4H, H<sub>1</sub> and H<sub>8</sub>), 4.38 (s, 2H, OH and NH), 3.85 (m, 1H, H<sub>4</sub>), 3.37–3.35 (m, 2H, H<sub>6</sub>), 2.78 (dd, *J* = 12.2 and 3.0 Hz, 1H, H<sub>5</sub>), 2.59 (dd, *J* = 12.2 and 9.5 Hz, 1H, H<sub>5</sub>), 2.27–2.23 (m, 2H, H<sub>3</sub>).

<sup>77</sup> Jaber, J. J.; Mitsui, K.; Rychnovsky, S. D. *J. Org. Chem.* **2001**, *66*, 4679–4686.

**<sup>13</sup>C NMR (CDCl<sub>3</sub>, 100 MHz):** δ 134.4 (CH, C<sub>2</sub> or C<sub>7</sub>), 134.3 (CH, C<sub>2</sub> or C<sub>7</sub>), 118.2 (CH<sub>2</sub>, C<sub>1</sub> or C<sub>8</sub>), 117.6 (CH<sub>2</sub>, C<sub>1</sub> or C<sub>8</sub>), 68.3 (CH, C<sub>4</sub>), 53.5 (CH<sub>2</sub>, C<sub>5</sub>), 51.6 (CH<sub>2</sub>, C<sub>6</sub>), 39.8 (CH<sub>2</sub>, C<sub>3</sub>).

***tert*-Butyl allyl(2-hydroxypent-4-en-1-yl)carbamate (**49**)<sup>73</sup>**

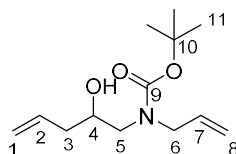

To a stirred solution of *N*-(allylamino)pent-7-en-5-ol **46** (1.2 g, 8.5 mmol, 1.0 equiv) in CH<sub>2</sub>Cl<sub>2</sub> (16.3 mL) was added Et<sub>3</sub>N (1.77 mL, 12.7 mmol, 1.5 equiv) and Boc<sub>2</sub>O (2.09 mL, 9.77 mmol, 1.15 equiv) and the reaction mixture was stirred at rt for 16 h. The reaction mixture was evaporated under reduced pressure, diluted in EtOAc and treated with HCl 1M and extracted with EtOAc. The combined extracts were dried over Na<sub>2</sub>SO<sub>4</sub>, filtered and concentrated under reduced pressure. The crude mixture was purified by flash chromatography (EtOAc/PE=15:85 and 20:80) to afford **49** (1.9 g, 7.9 mmol, 93%) as a colorless oil.

**IR (neat):** 3433, 3079, 2978, 2931, 2248, 1669, 1461, 1409, 1366, 1247, 1168, 1097, 993, 913 cm<sup>-1</sup>.

**<sup>1</sup>H NMR (CDCl<sub>3</sub>, 400 MHz):** δ 5.89–5.75 (m, 2H, H<sub>2</sub> and H<sub>7</sub>), 5.14–5.09 (m, 4H, H<sub>1</sub> and H<sub>8</sub>), 3.85 (m 3H, H<sub>4</sub> and H<sub>6</sub>), 3.55 (s, 1H, OH), 3.25 (m, 2H, H<sub>5</sub>), 2.24–2.22 (m, 2H, H<sub>3</sub>), 1.46 (s, 9H, H<sub>11</sub>).

**<sup>13</sup>C NMR (CDCl<sub>3</sub>, 100 MHz):** δ 157.4 (C, C<sub>9</sub>), 134.4 (CH, C<sub>2</sub> or C<sub>7</sub>), 133.9 (CH, C<sub>2</sub> or C<sub>7</sub>), 117.8 (CH<sub>2</sub>, C<sub>1</sub> or C<sub>8</sub>), 116.4 (CH<sub>2</sub>, C<sub>1</sub> or C<sub>8</sub>), 80.3 (C, C<sub>10</sub>), 70.9 (CH, C<sub>4</sub>), 53.0 (CH<sub>2</sub>, C<sub>5</sub>), 51.6 (CH<sub>2</sub>, C<sub>6</sub>), 39.8 (CH<sub>2</sub>, C<sub>3</sub>), 28.4 (3xCH<sub>3</sub>, C<sub>11</sub>).

***tert*-Butyl 3-hydroxy-2,3,4,7-tetrahydro-1H-azepine-1-carboxylate (**45**)<sup>73</sup>**

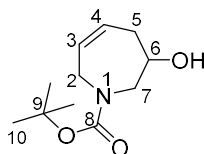

To a stirred solution of *tert*-butyl allyl(2-hydroxypent-4-en-1-yl)carbamate **49** (4.7 g, 19.5 mmol, 1.0 equiv) in CH<sub>2</sub>Cl<sub>2</sub> (106 mL) was added Grubbs-I catalyst (2.48 g, 2.92 mmol, 15 mol %) and the reaction mixture was stirred for 48 h at rt and concentrated under reduced pressure. The crude mixture was purified by flash chromatography (EtOAc/PE=25:75) to afford **45** (2.86 g, 13.4 mmol, 69%) as a brown oil.

**IR (neat):** 3428, 2976, 2930, 1668, 1415, 1366, 1246, 1161, 1057, 880 cm<sup>-1</sup>.

**<sup>1</sup>H NMR (CDCl<sub>3</sub>, 400 MHz) mixture of rotamers:** δ 5.74–5.64 (m, 2H, H<sub>3</sub> and H<sub>4</sub>), 4.14 (d<sub>app</sub>, *J* = 17.5 Hz, 1H, H<sub>2</sub>), 4.01 (m, 1H, H<sub>6</sub>), 3.77 (d<sub>app</sub>, *J* = 16.7 Hz, 2H, H<sub>2</sub> and H<sub>7</sub>), 3.60 (m, 1H, H<sub>7</sub>), 2.38 (m, 2H, H<sub>5</sub>), 1.47 (s, 9H, H<sub>10</sub>).

**<sup>13</sup>C NMR (CDCl<sub>3</sub>, 100 MHz) mixture of rotamers:** δ 156.8 (C, C<sub>8</sub>), 155.3 (C, C<sub>8</sub>'), 130.0 (CH, C<sub>3</sub>' or C<sub>4</sub>'), 129.4 (CH, C<sub>3</sub> or C<sub>4</sub>), 126.3 (CH, C<sub>3</sub> or C<sub>4</sub>), 125.9 (CH, C<sub>3</sub>' or C<sub>4</sub>'), 80.3 (C, C<sub>9</sub>), 70.0 (CH, C<sub>6</sub>), 69.4 (CH, C<sub>6</sub>'), 54.3 (CH<sub>2</sub>, C<sub>7</sub>), 54.1 (CH<sub>2</sub>, C<sub>7</sub>'), 48.2 (CH<sub>2</sub>, C<sub>2</sub>), 47.2 (CH<sub>2</sub>, C<sub>2</sub>'), 34.4 (CH<sub>2</sub>, C<sub>5</sub>), 33.8 (CH<sub>2</sub>, C<sub>5</sub>'), 28.4 (3xCH<sub>3</sub>, C<sub>10</sub>).

**MS *m/z* (relative intensity):** 213 (M<sup>+</sup>, 0.05), 157 (6), 139 (11), 11 (5), 94 (11), 83 (5), 68 (10), 57 (100), 55 (18).

***tert*-Butyl 3-(hydroxy)azepane-1-carboxylate (**50**)<sup>73</sup>**

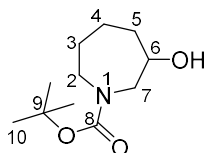

To a stirred solution of *tert*-Butyl 3-hydroxy-2,3,4,7-tetrahydro-1H-azepine-1-carboxylate **45** (2.86 g, 13.4 mmol, 1.4 equiv) in EtOH (224 mL) was added PtO<sub>2</sub> (305 mg, 1.34 mmol, 10 mol %) and the reaction mixture was stirred under H<sub>2</sub> atmosphere for 16 h. The solution was then filtered over Celite, washed with EtOAc and concentrated under reduced pressure to afford **50** (2.84 g, 13.2 mmol, quant) as a brown oil.

**IR (neat):** 3425, 2975, 2929, 2863, 1692, 1666, 1478, 1415, 1365, 1250, 1160, 1053 cm<sup>-1</sup>.

**<sup>1</sup>H NMR (CDCl<sub>3</sub>, 400 MHz) mixture of rotamers:** δ 3.94 (m, 1H, H<sub>6</sub>), 3.68–3.56 (m, 2H, H<sub>2</sub> and H<sub>7</sub>), 3.37 (dd, *J* = 14.8 and 4.2 Hz, 1H, H<sub>7</sub>), 3.10 (m, 1H, H<sub>2</sub>), 1.88 (m, 1H, H<sub>5</sub>), 1.78–1.64 (m, 3H, H<sub>3</sub> and H<sub>4</sub>), 1.50 (m, 1H, H<sub>5</sub>), 1.47 (s, 9H, H<sub>10</sub>), 1.35 (m, 1H, H<sub>4</sub>).

**<sup>13</sup>C NMR (DMSO-d<sub>6</sub>, 400 MHz) mixture of rotamers:** δ 154.7 (C, C<sub>8</sub>), 154.4 (C, C<sub>8</sub>'), 78.3 (C, C<sub>9</sub>), 78.2 (C, C<sub>9</sub>'), 68.8 (CH, C<sub>6</sub>), 53.3 (CH<sub>2</sub>, C<sub>7</sub>), 53.0 (CH<sub>2</sub>, C<sub>7</sub>'), 47.1 (CH<sub>2</sub>, C<sub>2</sub>), 46.8 (CH<sub>2</sub>, C<sub>2</sub>'), 36.2 (CH<sub>2</sub>, C<sub>5</sub>), 35.6 (CH<sub>2</sub>, C<sub>5</sub>'), 28.1 (3xCH<sub>3</sub>, C<sub>10</sub>), 27.3 (CH<sub>2</sub>, C<sub>3</sub>), 27.3 (CH<sub>2</sub>, C<sub>3</sub>'), 20.8 (CH<sub>2</sub>, C<sub>4</sub>), 20.6 (CH<sub>2</sub>, C<sub>4</sub>').

**MS *m/z* (relative intensity):** 215 (M<sup>+</sup>, 0.49), 159 (5), 141 (16), 114 (6), 84 (7), 70 (22), 57 (100).

### ***tert*-Butyl 3-oxoazepane-1-carboxylate (**51**)<sup>78</sup>**

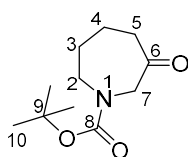

To a solution of *tert*-butyl 3-(hydroxy)azepane-1-carboxylate **50** (2.24 g, 10.4 mmol, 1.0 equiv) in CH<sub>2</sub>Cl<sub>2</sub> (52 mL) was added Dess-Martin periodinane (4.85 g, 3.56 mL, 11.4 mmol, 1.1 equiv) and the reaction mixture was stirred at rt for 2.5 h. The mixture was then quenched with a saturated aqueous solution of Na<sub>2</sub>S<sub>2</sub>O<sub>3</sub>, followed by an aqueous solution of NaOH 1M. The resulting mixture was extracted with CH<sub>2</sub>Cl<sub>2</sub>, dried over Na<sub>2</sub>SO<sub>4</sub>, filtered and concentrated under reduced pressure. The crude product was purified by flash chromatography (Et<sub>2</sub>O/PE=20:80 to 30:70) to give **51** (1.9 g, 8.91 mmol, 86%) as a colorless oil.

**IR (neat):** 2975, 2933, 2864, 1700, 1458, 1415, 1366, 1251, 1158, 1094, 889 cm<sup>-1</sup>.

**<sup>1</sup>H NMR (CDCl<sub>3</sub>, 400 MHz) mixture of rotamers:** δ 4.03 (m, 2H, H<sub>7</sub>), 3.96 (m, 2H, H<sub>7</sub>'), 3.45 (m, 2H, H<sub>2</sub>), 3.38 (m, 2H, H<sub>2</sub>'), 2.53 (dd, *J* = 7.6 and 4.1 Hz, 2H, H<sub>5</sub>), 1.85–1.72 (m, 4H, H<sub>3</sub> and H<sub>4</sub>), 1.51 (s, 9H, H<sub>10</sub>), 1.46 (s, 9H, H<sub>10</sub>').

**<sup>13</sup>C NMR (CDCl<sub>3</sub>, 400 MHz) mixture of rotamers:** δ 212.2 (C, C<sub>6</sub>), 155.2 (C, C<sub>8</sub>), 154.3 (C, C<sub>8</sub>'), 80.5 (C, C<sub>9</sub>), 80.3 (C, C<sub>9</sub>'), 58.5 (CH<sub>2</sub>, C<sub>7</sub>), 57.7 (CH<sub>2</sub>, C<sub>7</sub>'), 49.9 (CH<sub>2</sub>, C<sub>2</sub>), 49.7 (CH<sub>2</sub>, C<sub>2</sub>'), 42.8 (CH<sub>2</sub>, C<sub>5</sub>), 42.5 (CH<sub>2</sub>, C<sub>5</sub>'), 29.2 (CH<sub>2</sub>, C<sub>3</sub>), 28.3 (CH<sub>2</sub>, C<sub>3</sub>'), 28.4 (3xCH<sub>3</sub>, C<sub>10</sub>), 28.3 (3xCH<sub>3</sub>, C<sub>10</sub>'), 23.9 (CH<sub>2</sub>, C<sub>4</sub>), 23.7 (CH<sub>2</sub>, C<sub>4</sub>').

**MS *m/z* (relative intensity):** 213 (M<sup>+</sup>, 2.7), 157 (9), 140 (7), 113 (5), 84 (32), 70 (4), 57 (100).

### ***tert*-Butyl 3-hydroxy-3-(trifluoromethyl)azepane-1-carboxylate (**52**)**

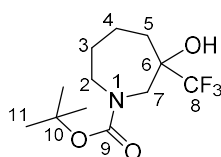

To a stirred solution of *tert*-butyl 3-oxoazepane-1-carboxylate **51** (1.54 g, 7.22 mmol, 1.0 equiv) in THF (30 mL) at 0 °C was added TMSCF<sub>3</sub> (2.16 mL, 14.44 mmol, 2.0 equiv). A solution of TBAF (1.0 M in THF, 14.44 mL, 14.44 mmol, 2.0 equiv) was added dropwise and the resulting mixture was stirred at rt for 5 days. The solution was quenched with an aqueous and saturated solution of NH<sub>4</sub>Cl and stirred for another 20 min. The solution was then concentrated under reduced pressure and diluted in CH<sub>2</sub>Cl<sub>2</sub>. The organic layer was separated and washed with H<sub>2</sub>O (twice), dried over anhydrous MgSO<sub>4</sub>,

<sup>78</sup> Mangion, I. K.; Nwamba, I. K.; Shevlin, M.; Huffman, M. A. *Org. Lett.* **2009**, *11*, 3566–3569.

filtered and concentrated under reduced pressure. The crude mixture was purified by flash chromatography (EtOAc/PE=5:95) to afford **52** (1.90 g, 6.71 mmol, 93%) as a colorless oil.

**IR (neat):** 3392, 2935, 1659, 1423, 1368, 1287, 1152, 1119, 868  $\text{cm}^{-1}$ .

**$^1\text{H}$  NMR ( $\text{CDCl}_3$ , 400 MHz):**  $\delta$  4.91 (br s, OH), 4.21 (d,  $J$  = 15.0 Hz, 1H, H<sub>7</sub>), 3.84 (m, 1H, H<sub>2</sub>), 3.07 (d,  $J$  = 15.0 Hz, 1H, H<sub>7</sub>), 2.99 (d,  $J$  = 13.5 and 5.9 Hz, 1H, H<sub>2</sub>), 1.94–1.53 (m, 6H, H<sub>3</sub>, H<sub>4</sub> and H<sub>5</sub>), 1.48 (s, 9H, H<sub>11</sub>).

**$^{13}\text{C}$  NMR ( $\text{CDCl}_3$ , 400 MHz):**  $\delta$  159.0 (C, C<sub>9</sub>), 126.1 (C, q,  $J$  = 286.4 Hz, C<sub>8</sub>), 81.4 (C, C<sub>10</sub>), 76.7 (C, q,  $J$  = 26.3 Hz, C<sub>6</sub>), 49.5 (CH<sub>2</sub>, C<sub>7</sub>), 47.7 (CH<sub>2</sub>, C<sub>2</sub>), 34.1 (CH<sub>2</sub>, C<sub>3</sub> or C<sub>4</sub> or C<sub>5</sub>), 28.4 (3xCH<sub>3</sub>, C<sub>11</sub>), 28.3 (CH<sub>2</sub>, C<sub>3</sub> or C<sub>4</sub> or C<sub>5</sub>), 20.1 (CH<sub>2</sub>, C<sub>3</sub> or C<sub>4</sub> or C<sub>5</sub>).

**MS  $m/z$  (relative intensity):** 283 ( $\text{M}^+$ , 0.19), 228 (4), 210 (5), 182 (5), 70 (19), 57 (100).

**HRMS:** calcd for  $\text{C}_{12}\text{H}_{20}\text{F}_3\text{NO}_3\text{Na}$  ( $\text{M}+\text{Na}^+$ ): 306.1288. Found 306.1288.

#### ***N*-Benzyl-3-hydroxy-3-(trifluoromethyl)azepane (**44**)**

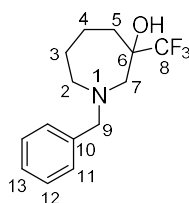

To a stirred solution of *tert*-butyl 3-hydroxy-3-(trifluoromethyl)azepane-1-carboxylate **52** (1.9 g, 6.71 mmol, 1.0 equiv) in  $\text{CH}_2\text{Cl}_2$  (37 mL) at rt, was added TFA (3.49 mL, 46.95 mmol, 7.0 equiv). The reaction mixture was stirred at rt for 18 h and then concentrated under reduced pressure.

To a stirred solution of the crude material previously obtained in MeCN (68 mL) at rt were added successively BnBr (0.80 mL, 6.71 mmol, 1.0 equiv),  $\text{K}_2\text{CO}_3$  (4.6 g, 33.5 mmol, 5.0 equiv) and TBAI (1.24 g, 3.35 mmol, 0.5 equiv). The reaction mixture was heated at 75 °C for 4 h and then allowed to cool to rt. The reaction mixture was quenched with  $\text{H}_2\text{O}$  and extracted with  $\text{CH}_2\text{Cl}_2$  (twice). The organic layer was dried over anhydrous  $\text{MgSO}_4$ , filtered and concentrated under reduced pressure. The crude mixture was purified by flash chromatography (EtOAc/PE=5:95) to afford **44** (1.56 g, 5.71 mmol, 85%) as a colorless oil.

**IR (neat):** 3296, 3030, 2935, 2867, 1453, 1258, 1185, 1151, 1117, 1092, 982  $\text{cm}^{-1}$ .

**$^1\text{H}$  NMR ( $\text{CDCl}_3$ , 400 MHz):**  $\delta$  7.36–7.24 (m, 5H, H<sub>11</sub>, H<sub>12</sub> and H<sub>13</sub>), 3.79 (br s, OH), 3.78 (d,  $J$  = 13.0 Hz, 1H, H<sub>9</sub>), 3.73 (d,  $J$  = 13.0 Hz, 1H, H<sub>9</sub>), 2.84 (s, 2H, H<sub>7</sub>), 2.80 (m, 1H, H<sub>2</sub>), 2.49 (m, 1H, H<sub>2</sub>), 1.92–1.81 (m, 2H, H<sub>3</sub> and H<sub>5</sub>), 1.71–1.47 (m, 4H, H<sub>3</sub>, H<sub>4</sub> and H<sub>5</sub>).

**<sup>13</sup>C NMR (CDCl<sub>3</sub>, 100 MHz):** δ 137.9 (C, C<sub>10</sub>), 129.2 (2xCH, C<sub>11</sub> or C<sub>12</sub>), 128.7 (2xCH, C<sub>11</sub> or C<sub>12</sub>), 127.8 (CH, C<sub>13</sub>), 126.4 (C, q, *J* = 283.7 Hz, C<sub>8</sub>), 72.9 (C, q, *J* = 26.8 Hz, C<sub>6</sub>), 63.9 (CH<sub>2</sub>, C<sub>9</sub>), 54.7 (CH<sub>2</sub>, C<sub>2</sub>), 54.2 (CH<sub>2</sub>, d<sub>app</sub>, *J* = 2.1 Hz, C<sub>7</sub>), 34.7 (CH<sub>2</sub>, C<sub>5</sub>), 27.3 (CH<sub>2</sub>, C<sub>3</sub>), 20.7 (CH<sub>2</sub>, C<sub>4</sub>).

**MS *m/z* (relative intensity):** 273 (M<sup>+</sup>, 18), 182 (6), 160 (20), 146 (5), 134 (6), 91 (100), 84 (16), 70 (12), 65 (18).

**HRMS:** calcd for C<sub>14</sub>H<sub>19</sub>F<sub>3</sub>NO (M+H<sup>+</sup>): 274.1413. Found 274.1415.

## 7. Synthesis and spectroscopic data of 2-substituted, 2-(trifluoromethyl)piperidines

### General Protocol for the synthesis of 2-(trifluoromethyl)piperidines

To a stirred solution of *N*-benzyl-3-hydroxy-3-(trifluoromethyl)azepane **44** (1.0 equiv) and proton sponge **VII** (2.0 equiv) in CH<sub>2</sub>Cl<sub>2</sub> (0.047 M) at -15 °C, was added triflic anhydride (1.5 equiv). After 5 h of stirring at reflux, the solution was cooled to rt, the nucleophile (2.5 equiv) was added and the reaction mixture was stirred at rt for 16 h. The reaction mixture was diluted with H<sub>2</sub>O, extracted with CH<sub>2</sub>Cl<sub>2</sub> and the combined extracts were dried over anhydrous Na<sub>2</sub>SO<sub>4</sub>, filtered and concentrated under reduced pressure. The crude mixture was purified by flash chromatography.

### ***N*-Benzyl-2-[[*N*-benzylamino]methyl]-2-(trifluoromethyl)piperidine (**54**)**

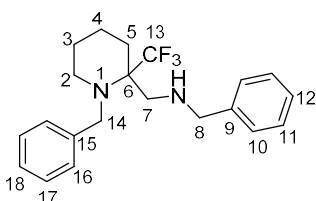

Following the general protocol: **44** (150 mg, 0.55 mmol, 1.0 equiv), proton sponge (235.2 mg, 1.10 mmol, 2.0 equiv) and triflic anhydride (0.14 mL, 0.82 mmol, 1.5 equiv). Nucleophile = benzylamine (151 μL, 1.37 mmol, 2.5 equiv). The crude mixture was purified by flash chromatography (Et<sub>2</sub>O/PE=10:90) to afford **54** (123 mg, 0.34 mmol, 62%) as a yellow oil.

**IR (neat):** 3028, 2935, 2851, 1453, 1240, 1116 cm<sup>-1</sup>.

**<sup>1</sup>H NMR (CDCl<sub>3</sub>, 400 MHz):** δ 7.33–7.12 (m, 10H, H<sub>ar</sub>), 4.13 (d, *J* = 15.4 Hz, 1H, H<sub>14</sub>), 3.76 (d, *J* = 13.4 Hz, 1H, H<sub>8</sub>), 3.70 (d, *J* = 13.4 Hz, 1H, H<sub>8</sub>), 3.46 (dd<sub>app</sub>, *J* = 15.5 and 2.2 Hz, 1H, H<sub>14</sub>), 2.95 (d, *J* = 11.9 Hz, 1H, H<sub>7</sub>), 2.69–2.65 (m, 2H, H<sub>2</sub>), 2.57 (d, *J* = 12.0 Hz, 1H, H<sub>7</sub>), 2.32 (m, 1H, H<sub>5</sub>), 1.89 (m, 1H, H<sub>5</sub>), 1.72–1.51 (m, 4H, H<sub>3</sub> and H<sub>4</sub>).

**<sup>13</sup>C NMR (CDCl<sub>3</sub>, 100 MHz):** δ 140.2 (CH, C<sub>9</sub> or C<sub>15</sub>), 140.1 (C, C<sub>9</sub> or C<sub>15</sub>), 129.4 (C, q, *J* = 299.3 Hz, C<sub>13</sub>), 128.7 (2xCH, C<sub>ar</sub>), 128.4 (2xCH, C<sub>ar</sub>), 128.1 (2xCH, C<sub>ar</sub>), 127.3 (2xCH, C<sub>ar</sub>), 127.0 (CH, C<sub>12</sub> or C<sub>18</sub>), 126.9 (CH, C<sub>12</sub> or C<sub>18</sub>), 62.4 (C, q, *J* = 20.5 Hz, C<sub>6</sub>), 54.2 (CH<sub>2</sub>, C<sub>8</sub>), 53.3 (CH<sub>2</sub>, C<sub>14</sub>), 49.9 (CH<sub>2</sub>, C<sub>7</sub>), 46.7 (CH<sub>2</sub>, C<sub>2</sub>), 28.7 (CH<sub>2</sub>, C<sub>5</sub>), 25.3 (CH<sub>2</sub>, C<sub>3</sub>), 20.4 (CH<sub>2</sub>, C<sub>4</sub>).

**MS *m/z* (relative intensity):** 362 (M<sup>+</sup>, 0.03), 242 (10), 223 (21), 222 (17), 120 (9), 91 (100), 65 (9).

**HRMS:** calcd for C<sub>21</sub>H<sub>26</sub>F<sub>3</sub>N<sub>2</sub> (M+H<sup>+</sup>): 363.2043. Found 363.2042.

### ***N*-Benzyl-2-[[*N*-phenyl]amino]methyl]-2-(trifluoromethyl)piperidine (55)**

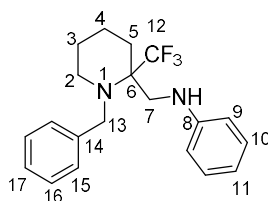

Following the general protocol: **44** (81.6 mg, 0.30 mmol, 1.0 equiv), proton sponge (128 mg, 0.60 mmol, 2.0 equiv) and triflic anhydride (74  $\mu$ L, 0.45 mmol, 1.5 equiv). Nucleophile = aniline (68  $\mu$ L, 0.75 mmol, 2.5 equiv). The crude mixture was purified by flash chromatography (EtOAc/PE=1:99) to afford **55** (103 mg, 0.30 mmol, quant) as a colorless oil.

**IR (neat)**: 3395, 3026, 2947, 2851, 1604, 1504, 1120, 1072  $\text{cm}^{-1}$ .

**$^1\text{H}$  NMR ( $\text{CDCl}_3$ , 400 MHz)**:  $\delta$  7.35–7.13 (m, 7H,  $H_{\text{ar}}$ ), 6.70–6.56 (m, 3H,  $H_9$  and  $H_{11}$ ), 4.43 (br s, NH), 4.20 (d,  $J = 14.8$  Hz, 1H,  $H_{13}$ ), 3.47 ( $d_{\text{app}}$ ,  $J = 13.3$  Hz, 2H,  $H_7$  and  $H_{13}$ ), 3.13 (m, 1H,  $H_7$ ), 2.81 (m, 1H,  $H_2$ ), 2.71 (m, 1H,  $H_2$ ), 2.11 (m, 1H,  $H_5$ ), 1.96 ( $d_{\text{app}}$ ,  $J = 14.5$  Hz, 1H,  $H_5$ ), 1.71–1.49 (m, 4H,  $H_3$  and  $H_4$ ).

**$^{13}\text{C}$  NMR ( $\text{CDCl}_3$ , 100 MHz)**:  $\delta$  148.1 (C,  $C_8$ ), 139.4 (C,  $C_{14}$ ), 129.4 (2xCH,  $C_{\text{ar}}$ ), 129.1 (C, q,  $J = 299.8$  Hz,  $C_{12}$ ), 128.7 (2xCH,  $C_{\text{ar}}$ ), 127.8 (2xCH,  $C_{\text{ar}}$ ), 127.1 (CH,  $C_{17}$ ), 117.6 (CH,  $C_{11}$ ), 112.8 (2xCH,  $C_9$ ), 62.4 (C, q,  $J = 21.1$  Hz,  $C_6$ ), 53.6 ( $\text{CH}_2$ ,  $C_{13}$ ), 46.2 ( $\text{CH}_2$ ,  $C_2$ ), 44.7 ( $\text{CH}_2$ ,  $C_7$ ), 29.0 ( $\text{CH}_2$ ,  $C_5$ ), 25.2 ( $\text{CH}_2$ ,  $C_3$ ), 20.4 ( $\text{CH}_2$ ,  $C_4$ ).

**MS  $m/z$  (relative intensity)**: 348 ( $\text{M}^{+\bullet}$ , 1), 242 (25), 222 (4), 106 (17), 91 (100), 77 (11), 65 (8), 51 (4).

**HRMS**: calcd for  $\text{C}_{20}\text{H}_{24}\text{F}_3\text{N}_2$  ( $\text{M}+\text{H}^+$ ): 349.1886. Found 349.1886.

### ***N*-Benzyl-2-[[*N,N*-diethyl]amino]methyl]-2-(trifluoromethyl)piperidine (56)**

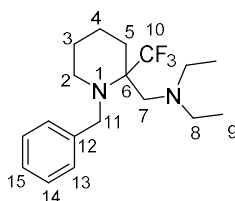

Following the general protocol: **44** (72 mg, 0.26 mmol, 1.0 equiv), proton sponge (112.9 mg, 0.53 mmol, 2.0 equiv) and triflic anhydride (66  $\mu$ L, 0.40 mmol, 1.5 equiv). Nucleophile = diethylamine (68  $\mu$ L, 0.66 mmol, 2.5 equiv). The crude mixture was purified by flash chromatography (EtOAc/PE=2:98) to afford **56** (80 mg, 0.24 mmol, 92%) as a colorless oil.

**IR (neat)**: 2967, 2875, 1453, 1239, 1135, 1114, 1066  $\text{cm}^{-1}$ .



**<sup>1</sup>H NMR (CDCl<sub>3</sub>, 400 MHz):** δ 7.34–7.20 (m, 5H, H<sub>13</sub>, H<sub>14</sub> and H<sub>15</sub>), 4.29 (d, *J* = 15.1 Hz, 1H, H<sub>11</sub>), 3.51 (dd<sub>app</sub>, *J* = 15.1 and 1.8 Hz, 1H, H<sub>11</sub>), 2.83–2.55 (m, 8H, H<sub>2</sub>, H<sub>7</sub> and H<sub>8</sub>), 1.99–1.97 (m, 2H, H<sub>5</sub>), 1.60–1.52 (m, 4H, H<sub>3</sub> and H<sub>4</sub>), 0.96 (t, *J* = 7.1 Hz, 6H, H<sub>9</sub>).

**<sup>13</sup>C NMR (CDCl<sub>3</sub>, 100 MHz):** δ 140.7 (C, C<sub>12</sub>), 129.8 (C, q, *J* = 299.4 Hz, C<sub>10</sub>), 128.3 (2xCH, C<sub>13</sub> or C<sub>14</sub>), 127.7 (2xCH, C<sub>13</sub> or C<sub>14</sub>), 126.7 (CH, C<sub>15</sub>), 63.4 (C, q, *J* = 18.9 Hz, C<sub>6</sub>), 56.3 (CH<sub>2</sub>, C<sub>7</sub>), 54.3 (CH<sub>2</sub>, C<sub>11</sub>), 48.0 (2xCH<sub>2</sub>, C<sub>8</sub>), 47.4 (CH<sub>2</sub>, C<sub>2</sub>), 29.3 (CH<sub>2</sub>, C<sub>5</sub>), 25.5 (CH<sub>2</sub>, C<sub>3</sub>), 20.2 (CH<sub>2</sub>, C<sub>4</sub>), 11.5 (2xCH<sub>3</sub>, C<sub>9</sub>).

**MS *m/z* (relative intensity):** 328 (M<sup>+</sup>, 0.01), 242 (1), 91 (27), 86 (100), 65 (12), 58 (7).

**HRMS:** calcd for C<sub>18</sub>H<sub>28</sub>F<sub>3</sub>N<sub>2</sub> (M+H<sup>+</sup>): 329.2199. Found 329.2198.

### ***N*-Benzyl-2-[[*N,N*-diallyl]amino]methyl]-2-(trifluoromethyl)piperidine (**57**)**

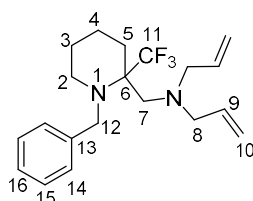

Following the general protocol: **44** (90 mg, 0.33 mmol, 1.0 equiv), proton sponge (141.1 mg, 0.66 mmol, 2.0 equiv) and triflic anhydride (82 μL, 0.49 mmol, 1.5 equiv). Nucleophile = diallylamine (101 μL, 0.82 mmol, 2.5 equiv). The crude mixture was purified by flash chromatography (EtOAc/PE=1:99) to afford **57** (99 mg, 0.28 mmol, 85%) as a colorless oil.

**IR (neat):** 2931, 2854, 1453, 1236, 1156, 1135, 1115, 918 cm<sup>-1</sup>.

**<sup>1</sup>H NMR (CDCl<sub>3</sub>, 400 MHz):** δ 7.32–7.18 (m, 5H, H<sub>14</sub>, H<sub>15</sub> and H<sub>16</sub>), 5.89–5.79 (m, 2H, H<sub>9</sub>), 5.13–5.09 (m, 4H, H<sub>10</sub>), 4.26 (d, *J* = 15.1 Hz, 1H, H<sub>12</sub>), 3.52 (d, *J* = 15.1 Hz, 1H, H<sub>12</sub>), 3.29 (dd, *J* = 14.5 and 6.0 Hz, 2H, H<sub>8</sub>), 3.12 (dd, *J* = 14.5 and 6.7 Hz, 2H, H<sub>8</sub>), 2.87 (d, *J* = 16.1 Hz, 1H, H<sub>7</sub>), 2.84 (d, *J* = 15.6 Hz, 1H, H<sub>7</sub>), 2.62–2.59 (m, 2H, H<sub>2</sub>), 2.01–1.98 (m, 2H, H<sub>5</sub>), 1.60–1.43 (m, 4H, H<sub>3</sub> and H<sub>4</sub>).

**<sup>13</sup>C NMR (CDCl<sub>3</sub>, 100 MHz):** δ 140.4 (C, C<sub>13</sub>), 135.7 (2xCH, C<sub>9</sub>), 129.6 (C, q, *J* = 299.1 Hz, C<sub>11</sub>), 128.4 (2xCH, C<sub>14</sub> or C<sub>15</sub>), 127.7 (2xCH, C<sub>14</sub> or C<sub>15</sub>), 126.7 (CH, C<sub>16</sub>), 117.4 (2xCH<sub>2</sub>, C<sub>10</sub>), 63.5 (C, q, *J* = 19.1 Hz, C<sub>6</sub>), 58.2 (2xCH<sub>2</sub>, C<sub>8</sub>), 55.3 (CH<sub>2</sub>, C<sub>7</sub>), 54.3 (CH<sub>2</sub>, C<sub>12</sub>), 47.3 (CH<sub>2</sub>, C<sub>2</sub>), 29.4 (CH<sub>2</sub>, C<sub>5</sub>), 25.5 (CH<sub>2</sub>, C<sub>3</sub>), 20.2 (CH<sub>2</sub>, C<sub>4</sub>).

**MS *m/z* (relative intensity):** 352 (M<sup>+</sup>, 0.01), 242 (2), 110 (100), 91 (49), 81 (3), 65 (6).

**HRMS:** calcd for C<sub>20</sub>H<sub>28</sub>F<sub>3</sub>N<sub>2</sub> (M+H<sup>+</sup>): 353.2199. Found 353.2199.

### ***N*-Benzyl-2-[[*N,N*-dibenzylamino]methyl]-2-(trifluoromethyl)piperidine (**58**)**

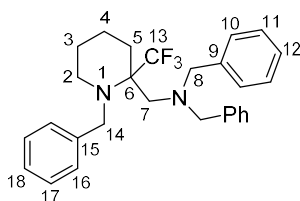

Following the general protocol: **44** (85 mg, 0.31 mmol, 1.0 equiv), proton sponge (133.3 mg, 0.62 mmol, 2.0 equiv) and triflic anhydride (77  $\mu$ L, 0.47 mmol, 1.5 equiv). Nucleophile = dibenzylamine (0.15 mL, 0.78 mmol, 2.5 equiv). The crude mixture was purified by flash chromatography (PE=100%) to afford **58** (141 mg, 0.31 mmol, quant) as a yellow oil.

**IR (neat):** 3028, 2935, 2852, 1452, 1388, 1133, 1107, 1099  $\text{cm}^{-1}$ .

**$^1\text{H}$  NMR ( $\text{CDCl}_3$ , 400 MHz):**  $\delta$  7.36–7.15 (m, 15H,  $H_{ar}$ ), 4.31 (d,  $J = 15.0$  Hz, 1H,  $H_{14}$ ), 3.92 (d,  $J = 13.9$  Hz, 2H,  $H_8$ ), 3.52 (d,  $J = 15.7$  Hz, 1H,  $H_{14}$ ), 3.48 (d,  $J = 13.9$  Hz, 2H,  $H_8$ ), 2.97 (d,  $J = 14.7$  Hz, 1H,  $H_7$ ), 2.88 (d,  $J = 14.7$  Hz, 1H,  $H_7$ ), 2.64–2.56 (m, 2H,  $H_2$ ), 2.12 (m, 1H,  $H_5$ ), 1.79 (m, 1H,  $H_5$ ), 1.54–1.42 (m, 4H,  $H_3$  and  $H_4$ ).

**$^{13}\text{C}$  NMR ( $\text{CDCl}_3$ , 100 MHz):**  $\delta$  140.1 (C,  $C_{15}$ ), 139.3 (2x C,  $C_9$ ), 129.2 (4x CH,  $C_{ar}$ ), 129.5 (C, q,  $J = 299.4$  Hz,  $C_{13}$ ), 128.4 (2x CH,  $C_{ar}$ ), 128.4 (4x CH,  $C_{ar}$ ), 127.7 (2x CH,  $C_{ar}$ ), 127.1 (2x CH,  $C_{ar}$ ), 126.7 (CH,  $C_{ar}$ ), 63.7 (C, q,  $J = 19.3$  Hz,  $C_6$ ), 59.7 (2x  $\text{CH}_2$ ,  $C_8$ ), 54.5 ( $\text{CH}_2$ ,  $C_7$  or  $C_{14}$ ), 54.3 ( $\text{CH}_2$ ,  $C_7$  or  $C_{14}$ ), 47.5 ( $\text{CH}_2$ ,  $C_2$ ), 29.1 ( $\text{CH}_2$ ,  $C_5$ ), 25.5 ( $\text{CH}_2$ ,  $C_3$ ), 20.1 ( $\text{CH}_2$ ,  $C_4$ ).

**MS  $m/z$  (relative intensity):** 451 ( $M^+ - H^+$ , 0.01), 210 (60), 181 (4), 91 (100), 65 (6).

**HRMS:** calcd for  $\text{C}_{28}\text{H}_{32}\text{F}_3\text{N}_2$  ( $M+H^+$ ): 453.2512. Found 453.2514.

### ***N*-Benzyl-2-[(morpholino)methyl]-2-(trifluoromethyl)piperidine (**59**)**

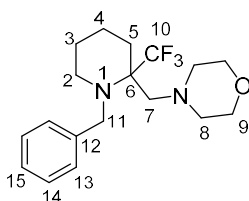

Following the general protocol: **44** (102 mg, 0.37 mmol, 1.0 equiv), proton sponge (160.0 mg, 0.75 mmol, 2.0 equiv) and triflic anhydride (93  $\mu$ L, 0.56 mmol, 1.5 equiv). Nucleophile = morpholine (82  $\mu$ L, 0.93 mmol, 2.5 equiv). The crude mixture was purified by flash chromatography (EtOAc/PE=5:95) to afford **59** (128 mg, 0.37 mmol, quant) as a yellow oil.

**IR (neat):** 2953, 2852, 2807, 1454, 1290, 1135, 1109, 1070  $\text{cm}^{-1}$ .

**<sup>1</sup>H NMR (CDCl<sub>3</sub>, 400 MHz):** δ 7.32–7.17 (m, 5H, H<sub>13</sub>, H<sub>14</sub> and H<sub>15</sub>), 4.24 (d, *J* = 15.1 Hz, 1H, H<sub>11</sub>), 3.67–3.60 (m, 4H, H<sub>9</sub>), 3.53 (d, *J* = 15.1 Hz, 1H, H<sub>11</sub>), 2.71 (d, *J* = 14.8 Hz, 1H, H<sub>7</sub>), 2.66 (d, *J* = 14.7 Hz, 1H, H<sub>7</sub>), 2.61–2.50 (m, 6H, H<sub>2</sub> and H<sub>8</sub>), 2.04 (m, 1H, H<sub>5</sub>), 1.89 (m, 1H, H<sub>5</sub>), 1.59–1.42 (m, 4H, H<sub>3</sub> and H<sub>4</sub>).

**<sup>13</sup>C NMR (CDCl<sub>3</sub>, 100 MHz):** δ 140.4 (C, C<sub>12</sub>), 129.4 (C, q, *J* = 298.7 Hz, C<sub>10</sub>), 128.3 (2xCH, C<sub>13</sub> or C<sub>14</sub>), 127.5 (2xCH, C<sub>13</sub> or C<sub>14</sub>), 126.7 (CH, C<sub>15</sub>), 67.3 (2xCH<sub>2</sub>, C<sub>9</sub>), 63.0 (C, q, *J* = 19.5 Hz, C<sub>6</sub>), 60.5 (CH<sub>2</sub>, C<sub>7</sub>), 55.9 (2xCH<sub>2</sub>, C<sub>8</sub>), 54.2 (CH<sub>2</sub>, C<sub>11</sub>), 47.1 (CH<sub>2</sub>, C<sub>2</sub>), 29.5 (CH<sub>2</sub>, C<sub>5</sub>), 25.3 (CH<sub>2</sub>, C<sub>3</sub>), 20.1 (CH<sub>2</sub>, C<sub>4</sub>).

**MS *m/z* (relative intensity):** 342 (M<sup>+</sup>, 0.02), 242 (12), 100 (100), 91 (78), 65 (8), 56 (8).

**HRMS:** calcd for C<sub>18</sub>H<sub>26</sub>F<sub>3</sub>N<sub>2</sub>O (M+H<sup>+</sup>): 343.1992. Found 343.1988.

***N*-Benzyl-2-methoxymethyl-2-(trifluoromethyl)piperidine (60)**

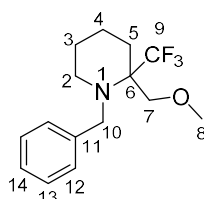

Following the general protocol: **44** (78 mg, 0.29 mmol, 1.0 equiv), proton sponge (122.3 mg, 0.57 mmol, 2.0 equiv) and triflic anhydride (71 μL, 0.43 mmol, 1.5 equiv). Nucleophile = methanol (29 μL, 0.71 mmol, 2.5 equiv). The crude mixture was purified by flash chromatography (EtOAc/PE=2:98) to afford **60** (76 mg, 0.26 mmol, 93%) as a colorless oil.

**IR (neat):** 2929, 2853, 1453, 1243, 1163, 1120, 1082, 1028, 955 cm<sup>-1</sup>.

**<sup>1</sup>H NMR (CDCl<sub>3</sub>, 400 MHz):** δ 7.29–7.15 (m, 5H, H<sub>12</sub>, H<sub>13</sub> and H<sub>14</sub>), 4.12 (d, *J* = 14.7 Hz, 1H, H<sub>10</sub>), 3.59 (d, *J* = 9.8 Hz, 1H, H<sub>7</sub>), 3.48 (d, *J* = 9.9 Hz, 1H, H<sub>7</sub>), 3.48 (d, *J* = 14.4 Hz, 1H, H<sub>10</sub>), 3.29 (s, 3H, H<sub>8</sub>), 2.60 (m, 1H, H<sub>2</sub>), 2.50 (m, 1H, H<sub>2</sub>), 2.91 (dtd<sub>app</sub>, *J* = 14.1, 4.3 and 1.1 Hz, 1H, H<sub>5</sub>), 1.77 (m, 1H, H<sub>5</sub>), 1.57–1.35 (m, 4H, H<sub>3</sub> and H<sub>4</sub>).

**<sup>13</sup>C NMR (CDCl<sub>3</sub>, 100 MHz):** δ 141.0 (C, C<sub>11</sub>), 129.0 (C, q, *J* = 298.1 Hz, C<sub>9</sub>), 128.3 (2xCH, C<sub>12</sub> or C<sub>13</sub>), 128.1 (2xCH, C<sub>12</sub> or C<sub>13</sub>), 126.8 (CH, C<sub>14</sub>), 74.0 (CH<sub>2</sub>, C<sub>7</sub>), 62.3 (C, q, *J* = 21.0 Hz, C<sub>6</sub>), 59.7 (CH<sub>3</sub>, C<sub>8</sub>), 54.7 (CH<sub>2</sub>, C<sub>10</sub>), 46.7 (CH<sub>2</sub>, C<sub>2</sub>), 28.8 (CH<sub>2</sub>, C<sub>5</sub>), 25.2 (CH<sub>2</sub>, C<sub>4</sub>), 20.0 (CH<sub>2</sub>, C<sub>3</sub>).

**MS *m/z* (relative intensity):** 287 (M<sup>+</sup>, 0.17), 252 (18), 91 (100), 65 (9).

**HRMS:** calcd for C<sub>15</sub>H<sub>21</sub>F<sub>3</sub>NO (M+H<sup>+</sup>): 288.1570. Found 288.1572.

### ***N*-Benzyl-2-ethoxymethyl-2-(trifluoromethyl)piperidine (61)**

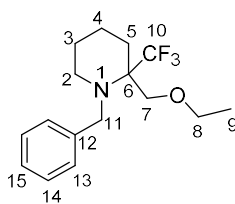

Following the general protocol: **44** (102 mg, 0.37 mmol, 1.0 equiv), proton sponge (160.0 mg, 0.75 mmol, 2.0 equiv) and triflic anhydride (93  $\mu$ L, 0.56 mmol, 1.5 equiv). Nucleophile = ethanol (54  $\mu$ L, 0.93 mmol, 2.5 equiv). The crude mixture was purified by flash chromatography (EtOAc/PE=2:98) to afford **61** (107 mg, 0.36 mmol, 95%) as a yellow oil.

**IR (neat):** 2936, 2876, 1453, 1370, 1165, 1121, 1029  $\text{cm}^{-1}$ .

**$^1\text{H}$  NMR ( $\text{CDCl}_3$ , 400 MHz):**  $\delta$  7.38–7.20 (m, 5H, H<sub>13</sub>, H<sub>14</sub> and H<sub>15</sub>), 4.20 (d,  $J$  = 14.8 Hz, 1H, H<sub>11</sub>), 3.69 (d,  $J$  = 9.9 Hz, 1H, H<sub>7</sub>), 3.57 (d,  $J$  = 9.8 Hz, 1H, H<sub>7</sub>), 3.58–3.45 (m, 3H, H<sub>8</sub> and H<sub>11</sub>), 2.67 (m, 1H, H<sub>2</sub>), 2.57 (m, 1H, H<sub>2</sub>), 1.98 (dt,  $J$  = 14.1 and 4.3 Hz, 1H, H<sub>5</sub>), 1.86 (m, 1H, H<sub>5</sub>), 1.63–1.59 (m, 2H, H<sub>4</sub>), 1.52–1.42 (m, 2H, H<sub>3</sub>), 1.19 (t,  $J$  = 7.0 Hz, 3H, H<sub>9</sub>).

**$^{13}\text{C}$  NMR ( $\text{CDCl}_3$ , 100 MHz):**  $\delta$  141.1 (C, C<sub>12</sub>), 129.1 (C, q,  $J$  = 298.2 Hz, C<sub>10</sub>), 128.3 (2xCH, C<sub>13</sub> or C<sub>14</sub>), 128.1 (2xCH, C<sub>13</sub> or C<sub>14</sub>), 126.7 (CH, C<sub>15</sub>), 71.6 (CH<sub>2</sub>, C<sub>7</sub>), 67.3 (CH<sub>2</sub>, C<sub>8</sub>), 62.3 (C, q,  $J$  = 20.8 Hz, C<sub>6</sub>), 54.6 (CH<sub>2</sub>, C<sub>11</sub>), 46.7 (CH<sub>2</sub>, C<sub>2</sub>), 28.9 (CH<sub>2</sub>, C<sub>5</sub>), 25.3 (CH<sub>2</sub>, C<sub>3</sub>), 20.1 (CH<sub>2</sub>, C<sub>4</sub>), 15.1 (CH<sub>3</sub>, C<sub>9</sub>).

**MS  $m/z$  (relative intensity):** 301 ( $\text{M}^+$ , 0.24), 242 (23), 91 (100), 65 (8).

**HRMS:** calcd for C<sub>16</sub>H<sub>23</sub>F<sub>3</sub>NO ( $\text{M}+\text{H}^+$ ): 302.1726. Found 302.1726.

### ***N*-Benzyl-2-[(prop-2-en-1-yloxy)methyl]-2-(trifluoromethyl)piperidine (62)**

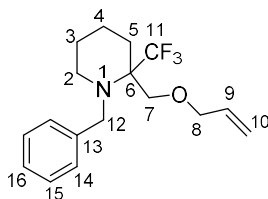

Following the general protocol: **44** (91.6 mg, 0.34 mmol, 1.0 equiv), proton sponge (143.7 mg, 0.67 mmol, 2.0 equiv) and triflic anhydride (83  $\mu$ L, 0.50 mmol, 1.5 equiv). Nucleophile = allylic alcohol (57  $\mu$ L, 0.84 mmol, 2.5 equiv). The crude mixture was purified by flash chromatography (EtOAc/PE=1:99) to afford **62** (98 mg, 0.31 mmol, 93%) as a yellow oil.

**IR (neat):** 2939, 2853, 1452, 1165, 1122, 1092, 993, 926  $\text{cm}^{-1}$ .

**$^1\text{H}$  NMR ( $\text{CDCl}_3$ , 400 MHz):**  $\delta$  7.37–7.20 (m, 5H, H<sub>14</sub>, H<sub>15</sub> and H<sub>16</sub>), 5.86 (m, 1H, H<sub>9</sub>), 5.28 (dd,  $J$  = 17.2 and 1.6 Hz, 1H, H<sub>10</sub>), 5.17 (dd,  $J$  = 10.4 and 1.2 Hz, 1H, H<sub>10</sub>), 4.18 (d,  $J$  = 14.8 Hz, 1H, H<sub>12</sub>), 3.98 (dd,  $J$  =

5.5 and 1.2 Hz, 2H, H<sub>8</sub>), 3.69 (d, *J* = 9.9 Hz, 1H, H<sub>7</sub>), 3.60 (d, *J* = 10.0 Hz, 1H, H<sub>7</sub>), 3.56 (d, *J* = 15.0 Hz, 1H, H<sub>12</sub>), 2.67 (m, 1H, H<sub>2</sub>), 2.57 (m, 1H, H<sub>2</sub>), 2.00 (dt, *J* = 14.0 and 4.2 Hz, 1H, H<sub>5</sub>), 1.87 (m, 1H, H<sub>5</sub>), 1.63–1.59 (m, 2H, H<sub>4</sub>), 1.54–1.42 (m, 2H, H<sub>3</sub>).

**<sup>13</sup>C NMR (CDCl<sub>3</sub>, 100 MHz):** δ 141.0 (C, C<sub>13</sub>), 134.5 (CH, C<sub>9</sub>), 129.0 (C, q, *J* = 298.0 Hz, C<sub>11</sub>), 128.3 (2xCH, C<sub>14</sub> or C<sub>15</sub>), 128.1 (2xCH, C<sub>14</sub> or C<sub>15</sub>), 127.5 (CH, C<sub>16</sub>), 117.3 (CH<sub>2</sub>, C<sub>10</sub>), 72.7 (CH<sub>2</sub>, C<sub>8</sub>), 71.2 (CH<sub>2</sub>, C<sub>7</sub>), 62.4 (C, q, *J* = 20.9 Hz, C<sub>6</sub>), 54.7 (CH<sub>2</sub>, C<sub>12</sub>), 46.7 (CH<sub>2</sub>, C<sub>2</sub>), 28.9 (CH<sub>2</sub>, C<sub>5</sub>), 25.2 (CH<sub>2</sub>, C<sub>3</sub>), 20.0 (CH<sub>2</sub>, C<sub>4</sub>).

**MS *m/z* (relative intensity):** 313 (M<sup>+</sup>, 0.6), 242 (28), 91 (100), 65 (7).

**HRMS:** calcd for C<sub>17</sub>H<sub>23</sub>F<sub>3</sub>NO (M+H<sup>+</sup>): 314.1726. Found 314.1725.

### ***N*-Benzyl-2-[(benzyloxy)methyl]-2-(trifluoromethyl)piperidine (63)**

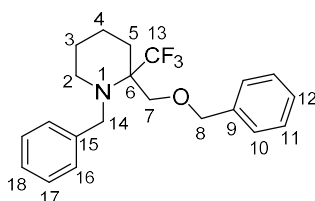

Following the general protocol: **44** (89.7 mg, 0.33 mmol, 1.0 equiv), proton sponge (140.7 mg, 0.66 mmol, 2.0 equiv) and triflic anhydride (82 μL, 0.49 mmol, 1.5 equiv). Nucleophile = benzyl alcohol (85 μL, 0.82 mmol, 2.5 equiv). The crude mixture was purified by flash chromatography (EtOAc/PE=1:99) to afford **63** (98 mg, 0.27 mmol, 82%) as a colorless oil.

**IR (neat):** 2938, 2854, 1453, 1366, 1121, 1094, 1028 cm<sup>-1</sup>.

**<sup>1</sup>H NMR (CDCl<sub>3</sub>, 400 MHz):** δ 7.35–7.18 (m, 10H, H<sub>ar</sub>), 4.52 (s, 2H, H<sub>8</sub>), 4.17 (d, *J* = 14.8 Hz, 1H, H<sub>14</sub>), 3.71 (d, *J* = 9.7 Hz, 1H, H<sub>7</sub>), 3.63 (d, *J* = 9.8 Hz, 1H, H<sub>7</sub>), 3.57 (d, *J* = 14.8 Hz, 1H, H<sub>14</sub>), 2.67 (m, 1H, H<sub>2</sub>), 2.56 (m, 1H, H<sub>2</sub>), 2.01 (dt, *J* = 13.4 and 4.1 Hz, 1H, H<sub>5</sub>), 1.90 (m, 1H, H<sub>5</sub>), 1.62–1.58 (m, 2H, H<sub>4</sub>), 1.53–1.42 (m, 2H, H<sub>3</sub>).

**<sup>13</sup>C NMR (CDCl<sub>3</sub>, 100 MHz):** δ 140.9 (C, C<sub>9</sub> or C<sub>15</sub>), 138.0 (C, C<sub>9</sub> or C<sub>15</sub>), 129.0 (C, q, *J* = 298.3 Hz, C<sub>13</sub>), 128.5 (2xCH, C<sub>ar</sub>), 128.3 (2xCH, C<sub>ar</sub>), 128.1 (2xCH, C<sub>ar</sub>), 127.7 (CH, C<sub>12</sub> or C<sub>18</sub>), 127.6 (2xCH, C<sub>ar</sub>), 126.8 (CH, C<sub>12</sub> or C<sub>18</sub>), 73.8 (CH<sub>2</sub>, C<sub>8</sub>), 71.4 (CH<sub>2</sub>, C<sub>7</sub>), 62.4 (C, q, *J* = 21.0 Hz, C<sub>6</sub>), 54.7 (CH<sub>2</sub>, C<sub>14</sub>), 46.7 (CH<sub>2</sub>, C<sub>2</sub>), 28.9 (CH<sub>2</sub>, C<sub>5</sub>), 25.2 (CH<sub>2</sub>, C<sub>3</sub>), 20.0 (CH<sub>2</sub>, C<sub>4</sub>).

**MS *m/z* (relative intensity):** 363 (M<sup>+</sup>, 0.3), 242 (35), 91 (100), 65 (9).

**HRMS:** calcd for C<sub>21</sub>H<sub>25</sub>F<sub>3</sub>NO (M+H<sup>+</sup>): 364.1883. Found 364.1881.

### **N-Benzyl-2-[(hydroxy)methyl]-2-(trifluoromethyl)piperidine (64)**

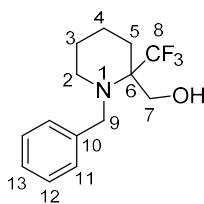

Following the general protocol: **44** (68.7 mg, 0.25 mmol, 1.0 equiv), proton sponge (107.7 mg, 0.50 mmol, 2.0 equiv) and triflic anhydride (63  $\mu$ L, 0.38 mmol, 1.5 equiv). Nucleophile = H<sub>2</sub>O (11  $\mu$ L, 0.63 mmol, 2.5 equiv). The crude mixture was purified by flash chromatography (EtOAc/PE=5:95) to afford **64** (64 mg, 0.23 mmol, 93%) as a yellow oil.

**IR (neat):** 3448, 3030, 2948, 2853, 1453, 1138, 1116, 1082  $\text{cm}^{-1}$ .

**<sup>1</sup>H NMR (CDCl<sub>3</sub>, 400 MHz):**  $\delta$  7.35–7.24 (m, 5H, H<sub>11</sub>, H<sub>12</sub> and H<sub>13</sub>), 4.27 (d,  $J$  = 14.5 Hz, 1H, H<sub>9</sub>), 3.98 (d,  $J$  = 10.9 Hz, 1H, H<sub>7</sub>), 3.45–3.37 (m, 2H, H<sub>7</sub> and H<sub>9</sub>), 2.79 (m, 1H, H<sub>2</sub>), 2.68 (m, 2H, H<sub>2</sub> and OH), 2.01–1.96 (m, 2H, H<sub>5</sub>), 1.64–1.59 (m, 3H, H<sub>3</sub> and H<sub>4</sub>), 1.42 (m, 1H, H<sub>3</sub>).

**<sup>13</sup>C NMR (CDCl<sub>3</sub>, 100 MHz):**  $\delta$  139.2 (C, C<sub>10</sub>), 128.8 (2xCH, C<sub>11</sub> or C<sub>12</sub>), 128.7 (C, q,  $J$  = 297.0 Hz, C<sub>8</sub>), 128.1 (2xCH, C<sub>11</sub> or C<sub>12</sub>), 127.3 (CH, C<sub>13</sub>), 63.2 (C, q,  $J$  = 21.2 Hz, C<sub>6</sub>), 60.9 (CH<sub>2</sub>, C<sub>7</sub>), 53.9 (CH<sub>2</sub>, C<sub>9</sub>), 46.5 (CH<sub>2</sub>, C<sub>2</sub>), 28.1 (CH<sub>2</sub>, C<sub>5</sub>), 25.2 (CH<sub>2</sub>, C<sub>3</sub>), 20.2 (CH<sub>2</sub>, C<sub>4</sub>).

**MS  $m/z$  (relative intensity):** 273 (M<sup>+</sup>, 0.1), 242 (19), 91 (100), 65 (6).

**HRMS:** calcd for C<sub>14</sub>H<sub>19</sub>F<sub>3</sub>NO (M+H<sup>+</sup>): 274.1413. Found 274.1416.

### **N-Benzyl-2-(phoxymethyl)-2-(trifluoromethyl)piperidine (65)**

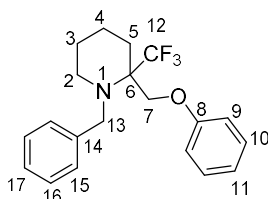

Following the general protocol: **44** (68.1 mg, 0.25 mmol, 1.0 equiv), proton sponge (107 mg, 0.50 mmol, 2.0 equiv) and triflic anhydride (62  $\mu$ L, 0.37 mmol, 1.5 equiv). Nucleophile = sodium phenoxy trihydrate (106 mg, 0.62 mmol, 2.5 equiv). The crude mixture was purified by flash chromatography (EtO<sub>2</sub>/PE=1:99) to afford **65** (87 mg, 0.25 mmol, quant) as a colorless oil.

**IR (neat):** 3030, 2943, 2852, 1601, 1497, 1236, 1122  $\text{cm}^{-1}$ .

**<sup>1</sup>H NMR (CDCl<sub>3</sub>, 400 MHz):**  $\delta$  7.39–7.20 (m, 7H, H<sub>ar</sub>), 6.97–6.91 (m, 3H, H<sub>9</sub> and H<sub>11</sub>), 4.21 (d,  $J$  = 9.3 Hz, 1H, H<sub>7</sub>), 4.18 (d,  $J$  = 13.3 Hz, 1H, H<sub>13</sub>), 4.12 (d,  $J$  = 9.7 Hz, 1H, H<sub>7</sub>), 3.64 (dd<sub>app</sub>,  $J$  = 14.7 and 1.2 Hz, 1H,

H<sub>13</sub>), 2.73 (m, 1H, H<sub>2</sub>), 2.64 (m, 1H, H<sub>2</sub>), 2.11 (dt, *J* = 14.1 and 4.0 Hz, 1H, H<sub>5</sub>), 2.00 (m, 1H, H<sub>5</sub>), 1.69–1.65 (m, 2H, H<sub>4</sub>), 1.58–1.47 (m, 2H, H<sub>3</sub>).

**<sup>13</sup>C NMR (CDCl<sub>3</sub>, 100 MHz):** δ 158.7 (C, C<sub>8</sub>), 140.6 (C, C<sub>14</sub>), 129.6 (2xCH, C<sub>ar</sub>), 128.8 (C, q, *J* = 297.9 Hz, C<sub>12</sub>), 128.4 (2xCH, C<sub>ar</sub>), 128.1 (2xCH, C<sub>ar</sub>), 126.9 (CH, C<sub>17</sub>), 121.4 (CH, C<sub>11</sub>), 114.9 (2xCH, C<sub>9</sub>), 68.6 (CH<sub>2</sub>, C<sub>7</sub>), 62.4 (C, q, *J* = 21.3 Hz, C<sub>6</sub>), 54.7 (CH<sub>2</sub>, C<sub>13</sub>), 46.7 (CH<sub>2</sub>, C<sub>2</sub>), 28.9 (CH<sub>2</sub>, C<sub>5</sub>), 25.2 (CH<sub>2</sub>, C<sub>3</sub>), 20.0 (CH<sub>2</sub>, C<sub>4</sub>).

**MS *m/z* (relative intensity):** 349 (M<sup>+</sup>, 0.16), 242 (29), 91 (100), 77 (5), 65 (6).

**HRMS:** calcd for C<sub>20</sub>H<sub>23</sub>F<sub>3</sub>NO (M+H<sup>+</sup>): 350.1726. Found 350.1723.

### ***N*-Benzyl-2[(acetyl)methyl]-2-(trifluoromethyl)piperidine (66)**

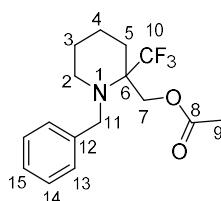

Following the general protocol: **46** (84.8 mg, 0.31 mmol, 1.0 equiv), proton sponge (133 mg, 0.62 mmol, 2.0 equiv) and triflic anhydride (77 μL, 0.47 mmol, 1.5 equiv). Nucleophile = tetrabutylammonium acetate (234 mg, 0.78 mmol, 2.5 equiv). The crude mixture was purified by flash chromatography (EtOAc/PE=2:98) to afford **66** (98 mg, 0.31 mmol, quant) as a colorless oil.

**IR (neat):** 2944, 2853, 1748, 1453, 1337, 1225, 1122, 1046 cm<sup>-1</sup>.

**<sup>1</sup>H NMR (CDCl<sub>3</sub>, 400 MHz):** δ 7.33–7.21 (m, 5H, H<sub>13</sub>, H<sub>14</sub> and H<sub>15</sub>), 4.41 (d, *J* = 11.8 Hz, 1H, H<sub>7</sub>), 4.30 (d, *J* = 11.8 Hz, 1H, H<sub>7</sub>), 4.11 (d, *J* = 14.9 Hz, 1H, H<sub>11</sub>), 3.62 (d, *J* = 14.9 Hz, 1H, H<sub>11</sub>), 2.69 (m, 1H, H<sub>2</sub>), 2.60 (m, 1H, H<sub>2</sub>), 2.07 (s, 3H, H<sub>9</sub>), 2.02 (dt, *J* = 13.8 and 4.4 Hz, 1H, H<sub>5</sub>), 1.80 (m, 1H, H<sub>5</sub>), 1.64–1.48 (m, 4H, H<sub>3</sub> and H<sub>4</sub>).

**<sup>13</sup>C NMR (CDCl<sub>3</sub>, 100 MHz):** δ 170.6 (C, C<sub>8</sub>), 140.2 (C, C<sub>12</sub>), 128.3 (2xCH, C<sub>13</sub> or C<sub>14</sub>), 127.7 (2xCH, C<sub>13</sub> or C<sub>14</sub>), 128.5 (C, q, *J* = 297.7 Hz, C<sub>10</sub>), 126.9 (CH, C<sub>15</sub>), 63.8 (CH<sub>2</sub>, C<sub>7</sub>), 61.7 (C, q, *J* = 21.6 Hz, C<sub>6</sub>), 54.4 (CH<sub>2</sub>, C<sub>11</sub>), 46.6 (CH<sub>2</sub>, C<sub>2</sub>), 28.7 (CH<sub>2</sub>, C<sub>5</sub>), 25.1 (CH<sub>2</sub>, C<sub>3</sub>), 20.9 (CH<sub>3</sub>, C<sub>9</sub>), 19.8 (CH<sub>2</sub>, C<sub>4</sub>).

**MS *m/z* (relative intensity):** 315 (M<sup>+</sup>, 0.5), 242 (20), 91 (100), 65 (7).

**HRMS:** calcd for C<sub>16</sub>H<sub>21</sub>F<sub>3</sub>NO<sub>2</sub> (M+H<sup>+</sup>): 316.1519. Found 316.1515.

### **N-Benzyl-2-[(ethylsulfanyl)methyl]-2-(trifluoromethyl)piperidine (67)**

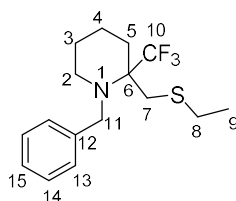

Following the general protocol: **44** (88 mg, 0.32 mmol, 1.0 equiv), proton sponge (138. mg, 0.64 mmol, 2.0 equiv) and triflic anhydride (80  $\mu$ L, 0.48 mmol, 1.5 equiv). Nucleophile = sodium ethanethiolate (75.2 mg, 0.81 mmol, 2.5 equiv). The crude mixture was purified by flash chromatography (EtOAc/PE=1:99 and 2:98) to afford **67** (94 mg, 0.30 mmol, 92%) as a colorless oil.

**IR (neat):** 2932, 2852, 1453, 1233, 1140, 1114  $\text{cm}^{-1}$ .

**$^1\text{H}$  NMR ( $\text{CDCl}_3$ , 400 MHz):**  $\delta$  7.38–7.12 (m, 5H,  $\text{H}_{13}$ ,  $\text{H}_{14}$  and  $\text{H}_{15}$ ), 4.15 (d,  $J = 14.2$  Hz, 1H,  $\text{H}_{11}$ ), 3.36 (dd<sub>app</sub>,  $J = 14.1$  and 2.6 Hz, 1H,  $\text{H}_{11}$ ), 3.30 (d,  $J = 12.7$  Hz, 1H,  $\text{H}_7$ ), 2.49–2.39 (m, 5H,  $\text{H}_2$ ,  $\text{H}_7$  and  $\text{H}_8$ ), 2.20 (m, 1H,  $\text{H}_5$ ), 1.80 (dt,  $J = 14.2$  and 4.0 Hz, 1H,  $\text{H}_5$ ), 1.58–1.54 (m, 2H,  $\text{H}_4$ ), 1.45–1.34 (m, 2H,  $\text{H}_3$ ), 1.16 (td<sub>app</sub>,  $J = 7.3$  and 0.7 Hz, 3H,  $\text{H}_9$ ).

**$^{13}\text{C}$  NMR ( $\text{CDCl}_3$ , 100 MHz):**  $\delta$  140.1 (C,  $\text{C}_{12}$ ), 129.2 (C, q,  $J = 300.2$  Hz,  $\text{C}_{10}$ ), 128.4 (2xCH,  $\text{C}_{13}$  or  $\text{C}_{14}$ ), 128.3 (2xCH,  $\text{C}_{13}$  or  $\text{C}_{14}$ ), 126.8 (CH,  $\text{C}_{15}$ ), 62.3 (C, q,  $J = 20.6$  Hz,  $\text{C}_6$ ), 54.2 ( $\text{CH}_2$ ,  $\text{C}_{11}$ ), 45.9 ( $\text{CH}_2$ ,  $\text{C}_2$ ), 36.8 ( $\text{CH}_2$ ,  $\text{C}_7$ ), 29.6 ( $\text{CH}_2$ ,  $\text{C}_5$ ), 27.4 ( $\text{CH}_2$ ,  $\text{C}_8$ ), 25.1 ( $\text{CH}_2$ ,  $\text{C}_3$ ), 20.4 ( $\text{CH}_2$ ,  $\text{C}_4$ ), 14.9 ( $\text{CH}_3$ ,  $\text{C}_9$ ).

**MS  $m/z$  (relative intensity):** 317 ( $\text{M}^+$ , 0.02), 242 (19), 91 (100), 65 (7).

**HRMS:** calcd for  $\text{C}_{16}\text{H}_{23}\text{F}_3\text{NS}$  ( $\text{M}+\text{H}^+$ ): 318.1498. Found 318.1496.

### **N-Benzyl-2-[(phenylsulfanyl)methyl]-2-(trifluoromethyl)piperidine (68)**

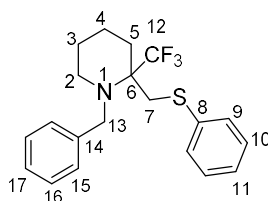

Following the general protocol: **44** (79.5 mg, 0.29 mmol, 1.0 equiv), proton sponge (125 mg, 0.58 mmol, 2.0 equiv) and triflic anhydride (72  $\mu$ L, 0.44 mmol, 1.5 equiv). Nucleophile = sodium thiophenolate (127 mg, 0.73 mmol, 2.5 equiv). The crude mixture was purified by flash chromatography (PE=100%) to afford **68** (90 mg, 0.25 mmol, 85%) as a colorless oil.

**IR (neat):** 3061, 2945, 2851, 1584, 1453, 1139, 1114  $\text{cm}^{-1}$ .



**<sup>1</sup>H NMR (CDCl<sub>3</sub>, 400 MHz):** δ 7.50–7.14 (m, 10H, H<sub>ar</sub>), 4.31 (d, *J* = 14.2 Hz, 1H, H<sub>13</sub>), 3.79 (dd<sub>app</sub>, *J* = 12.3 and 2.3 Hz, 1H, H<sub>7</sub>), 3.49 (dd<sub>app</sub>, *J* = 14.2 and 2.5 Hz, 1H, H<sub>13</sub>), 2.94 (d, *J* = 12.3 Hz, 1H, H<sub>7</sub>), 2.67–2.53 (m, 2H, H<sub>2</sub>), 2.38 (m, 1H, H<sub>5</sub>), 1.95 (d<sub>app</sub>, *J* = 14.2 Hz, 1H, H<sub>5</sub>), 1.65–1.48 (m, 4H, H<sub>3</sub> and H<sub>4</sub>).

**<sup>13</sup>C NMR (CDCl<sub>3</sub>, 100 MHz):** δ 139.8 (C, C<sub>8</sub> or C<sub>14</sub>), 137.3 (C, C<sub>8</sub> or C<sub>14</sub>), 129.6 (2xCH, C<sub>ar</sub>), 129.1 (2xCH, C<sub>ar</sub>), 129.1 (C, q, *J* = 300.2 Hz, C<sub>12</sub>), 128.5 (2xCH, C<sub>ar</sub>), 128.3 (2xCH, C<sub>ar</sub>), 126.9 (CH, C<sub>11</sub> or C<sub>17</sub>), 126.3 (CH, C<sub>11</sub> or C<sub>17</sub>), 62.4 (C, q, *J* = 20.9 Hz, C<sub>6</sub>), 54.3 (CH<sub>2</sub>, C<sub>13</sub>), 46.0 (CH<sub>2</sub>, C<sub>2</sub>), 39.2 (CH<sub>2</sub>, C<sub>7</sub>), 29.8 (CH<sub>2</sub>, C<sub>5</sub>), 25.1 (CH<sub>2</sub>, C<sub>3</sub>), 20.5 (CH<sub>2</sub>, C<sub>4</sub>).

**MS *m/z* (relative intensity):** 365 (M<sup>+</sup>, 0.04), 242 (31), 123 (2), 91 (100), 65 (7).

**HRMS:** calcd for C<sub>20</sub>H<sub>23</sub>F<sub>3</sub>N<sub>2</sub>S (M+H<sup>+</sup>): 366.1498. Found 366.1497.

### ***N*-Benzyl-2-fluoromethyl-2-(trifluoromethyl)piperidine (69)**

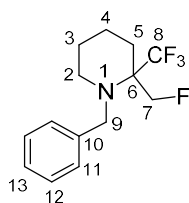

1) Following the general protocol: **44** (80.1 mg, 0.29 mmol, 1.0 equiv), proton sponge (126 mg, 0.59 mmol, 2.0 equiv) and triflic anhydride (73 μL, 0.44 mmol, 1.5 equiv). Nucleophile = tetrabutylammonium fluoride (1.0 M in THF, 0.73 mL, 0.73 mmol, 2.5 equiv). The crude mixture was purified by flash chromatography (Pentane=100%) to afford **69** (49 mg, 0.18 mmol, 61%) as colorless oil.

2) To a stirred solution of *N*-benzyl-3-hydroxy-3-(trifluoromethyl)azepane **44** (152 mg, 0.55 mmol, 1.0 equiv) in THF (6 mL) at 0 °C was added DAST (95 μL, 0.78 mmol, 1.4 equiv). The resulting mixture was stirred at 0 °C for 1 h and at rt for 3 h. The reaction mixture was quenched with a saturated aqueous solution of Na<sub>2</sub>CO<sub>3</sub>, extracted with EtOAc and the combined extracts were dried over anhydrous Na<sub>2</sub>SO<sub>4</sub>, filtered and concentrated under reduced pressure. The crude mixture was purified by flash chromatography (PE=100%) to afford **69** (109 mg, 0.40 mmol, 71%) as a colorless oil.

**IR (neat):** 2949, 2854, 1453, 1166, 1145, 1223 cm<sup>-1</sup>.

**<sup>1</sup>H NMR (CDCl<sub>3</sub>, 400 MHz):** δ 7.34–7.23 (m, 5H, H<sub>11</sub>, H<sub>12</sub> and H<sub>13</sub>), 4.60 (d, *J* = 47.2 Hz, 2H, H<sub>7</sub>), 4.16 (d, *J* = 14.9 Hz, 1H, H<sub>9</sub>), 3.63 (d<sub>app</sub>, *J* = 14.9 and 1.5 Hz, 1H, H<sub>9</sub>), 2.67–2.57 (m, 2H, H<sub>2</sub>), 2.04 (m, 1H, H<sub>5</sub>), 1.75–1.43 (m, 5H, H<sub>3</sub>, H<sub>4</sub> and H<sub>5</sub>).

**<sup>13</sup>C NMR (CDCl<sub>3</sub>, 100 MHz):** δ 140.3 (C, C<sub>10</sub>), 128.5 (2xCH, C<sub>11</sub> or C<sub>12</sub>), 128.4 (C, qd, *J* = 297.6 and 1.7 Hz, C<sub>8</sub>), 127.9 (2xCH, C<sub>11</sub> or C<sub>12</sub>), 127.0 (CH, C<sub>13</sub>), 84.3 (CH<sub>2</sub>, dq, *J* = 181.4 and 2.2 Hz, C<sub>7</sub>), 61.9 (C, dq, *J* = 21.7 and 17.0 Hz, C<sub>6</sub>), 55.0 (CH<sub>2</sub>, C<sub>9</sub>), 46.7 (CH<sub>2</sub>, C<sub>2</sub>), 28.0 (CH<sub>2</sub>, C<sub>5</sub>), 25.1 (CH<sub>2</sub>, C<sub>3</sub>), 19.7 (CH<sub>2</sub>, C<sub>4</sub>).

**MS *m/z* (relative intensity):** 275 ( $M^{+}$ , 3.7), 242 (9), 206 (15), 91 (100), 65 (8), 55 (3).

**HRMS:** calcd for  $C_{14}H_{18}F_4N$  ( $M+H^{+}$ ): 276.1370. Found 276.1371.

#### ***N*-Benzyl-2-chloromethyl-2-(trifluoromethyl)piperidine (70)**

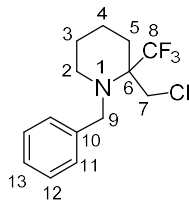

Following the general protocol: **44** (80.5 mg, 0.29 mmol, 1.0 equiv), proton sponge (129 mg, 0.59 mmol, 2.0 equiv) and triflic anhydride (73  $\mu$ L, 0.44 mmol, 1.5 equiv). Nucleophile = tetrabutylammonium chloride (215.4 mg, 0.74 mmol, 2.5 equiv). The crude mixture was purified by flash chromatography (PE=100%) to afford **70** (59 mg, 0.20 mmol, 69%) as colorless oil.

**IR (neat):** 2947, 2853, 1453, 1142, 1117  $cm^{-1}$ .

**$^1H$  NMR ( $CDCl_3$ , 400 MHz):**  $\delta$  7.42–7.22 (m, 5H,  $H_{11}$ ,  $H_{12}$  and  $H_{13}$ ), 4.09 (d,  $J$  = 14.4 Hz, 1H,  $H_9$ ), 3.95 (d,  $J$  = 12.1 Hz, 1H,  $H_7$ ), 3.61 (d,  $J$  = 12.1 Hz, 1H,  $H_7$ ), 3.52 (dq,  $J$  = 14.5 and 2.2 Hz, 1H,  $H_9$ ), 2.66–2.61 (m, 2H,  $H_2$ ), 2.07 (m, 1H,  $H_5$ ), 1.93 (dtd<sub>app</sub>,  $J$  = 14.2, 4.1 and 1.4 Hz, 1H,  $H_5$ ), 1.69–1.61 (m, 2H,  $H_4$ ), 1.58–1.45 (m, 2H,  $H_3$ ).

**$^{13}C$  NMR ( $CDCl_3$ , 100 MHz):**  $\delta$  139.8 (C,  $C_{10}$ ), 128.6 (C, q,  $J$  = 299.5 Hz,  $C_8$ ), 128.4 (2xCH,  $C_{11}$  or  $C_{12}$ ), 128.3 (2xCH,  $C_{11}$  or  $C_{12}$ ), 127.0 (CH,  $C_{13}$ ), 62.9 (C, q,  $J$  = 21.2 Hz,  $C_6$ ), 54.0 ( $CH_2$ ,  $C_9$ ), 46.2 ( $CH_2$ ,  $C_2$ ), 45.0 ( $CH_2$ ,  $C_7$ ), 28.6 ( $CH_2$ ,  $C_5$ ), 25.0 ( $CH_2$ ,  $C_3$ ), 20.0 ( $CH_2$ ,  $C_4$ ).

**MS *m/z* (relative intensity):** 293 ( $M^{+}$ , 0.4), 291( $M^{+}$ , 1.3), 242 (19), 222 (10), 208 (7), 91 (100), 65 (10).

**HRMS:** calcd for  $C_{14}H_{18}ClF_3N$  ( $M+H^{+}$ ): 292.1074 and 294.1043. Found 292.1076 and 294.1045.

#### ***N*-Benzyl-2-bromomethyl-2-(trifluoromethyl)piperidine (71)**

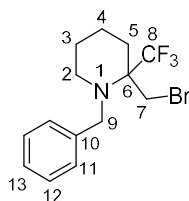

Following the general protocol: **44** (251 mg, 0.92 mmol, 1.0 equiv), proton sponge (393.6 mg, 1.84 mmol, 2.0 equiv) and triflic anhydride (229  $\mu$ L, 1.38 mmol, 1.5 equiv). Nucleophile = tetrabutylammonium bromide (740.2 mg, 2.30 mmol, 2.5 equiv). The crude mixture was purified by flash chromatography (PE=100%) to afford **71** (250 mg, 0.74 mmol, 81%) as colorless oil.

**IR (neat):** 2946, 2853, 1453, 1141, 1070  $\text{cm}^{-1}$ .

**$^1\text{H NMR}$  ( $\text{CDCl}_3$ , 400 MHz):**  $\delta$  7.45–7.23 (m, 5H,  $\text{H}_{11}$ ,  $\text{H}_{12}$  and  $\text{H}_{13}$ ), 4.07 (d,  $J = 14.4$  Hz, 1H,  $\text{H}_9$ ), 3.85 (d,  $J = 11.5$  Hz, 1H,  $\text{H}_7$ ), 3.52 (m, 1H,  $\text{H}_9$ ), 3.48 (d,  $J = 11.5$  Hz, 1H,  $\text{H}_7$ ), 2.65–2.62 (m, 2H,  $\text{H}_2$ ), 2.09 (m, 1H,  $\text{H}_5$ ), 1.92 (dtd<sub>app</sub>,  $J = 14.1$ , 4.1 and 1.3 Hz, 1H,  $\text{H}_5$ ), 1.69–1.62 (m, 2H,  $\text{H}_4$ ), 1.58–1.47 (m, 2H,  $\text{H}_3$ ).

**$^{13}\text{C NMR}$  ( $\text{CDCl}_3$ , 100 MHz):**  $\delta$  139.6 (C,  $\text{C}_{10}$ ), 128.4 (2xCH,  $\text{C}_{11}$  or  $\text{C}_{12}$ ), 128.3 (2xCH,  $\text{C}_{11}$  or  $\text{C}_{12}$ ), 127.8 (C, q,  $J = 299.8$  Hz,  $\text{C}_8$ ), 127.0 (CH,  $\text{C}_{13}$ ), 62.2 (C, q,  $J = 21.1$  Hz,  $\text{C}_6$ ), 54.0 ( $\text{CH}_2$ ,  $\text{C}_9$ ), 46.1 ( $\text{CH}_2$ ,  $\text{C}_2$ ), 34.2 ( $\text{CH}_2$ ,  $\text{C}_7$ ), 29.7 ( $\text{CH}_2$ ,  $\text{C}_5$ ), 25.0 ( $\text{CH}_2$ ,  $\text{C}_3$ ), 20.0 ( $\text{CH}_2$ ,  $\text{C}_4$ ).

**MS  $m/z$  (relative intensity):** 337 ( $\text{M}^+$ , 0.7), 335 ( $\text{M}^+$ , 0.7), 268 (8), 266 (8), 242 (12), 91 (100), 65 (8).

**HRMS:** calcd for  $\text{C}_{14}\text{H}_{18}\text{BrF}_3\text{N}$  ( $\text{M}+\text{H}^+$ ): 336.0569 and 338.0549. Found 336.0572 and 338.0546.

### ***N*-Benzyl-2-iodomethyl-2-(trifluoromethyl)piperidine (**72**)**

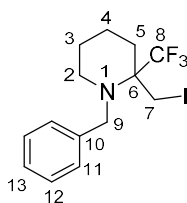

Following the general protocol: **44** (107.6 mg, 0.39 mmol, 1.0 equiv), proton sponge (168.8 mg, 0.79 mmol, 2.0 equiv) and triflic anhydride (98  $\mu\text{L}$ , 0.59 mmol, 1.5 equiv). Nucleophile = tetrabutylammonium iodide (363.6 mg, 0.98 mmol, 2.5 equiv). The crude mixture was purified by flash chromatography (PE=100%) to afford **72** (135 mg, 0.35 mmol, 89%) as colorless oil.

**IR (neat):** 2944, 2853, 1450, 1139, 1112, 1064  $\text{cm}^{-1}$ .

**$^1\text{H NMR}$  ( $\text{CDCl}_3$ , 400 MHz):**  $\delta$  7.49–7.20 (m, 5H,  $\text{H}_{11}$ ,  $\text{H}_{12}$  and  $\text{H}_{13}$ ), 4.02 (d,  $J = 14.3$  Hz, 1H,  $\text{H}_9$ ), 3.72 (d,  $J = 11.4$  Hz, 1H,  $\text{H}_7$ ), 3.47 (dq,  $J = 14.3$  and 2.5 Hz, 1H,  $\text{H}_9$ ), 3.33 (d,  $J = 11.4$  Hz, 1H,  $\text{H}_7$ ), 2.63–2.58 (m, 2H,  $\text{H}_2$ ), 2.00 (m, 1H,  $\text{H}_5$ ), 1.89 (dtd<sub>app</sub>,  $J = 14.2$ , 3.8 and 0.9 Hz, 1H,  $\text{H}_5$ ), 1.70–1.46 (m, 4H,  $\text{H}_3$  and  $\text{H}_4$ ).

**$^{13}\text{C NMR}$  ( $\text{CDCl}_3$ , 100 MHz):**  $\delta$  139.2 (C,  $\text{C}_{10}$ ), 128.5 (2xCH,  $\text{C}_{11}$  or  $\text{C}_{12}$ ), 128.3 (2xCH,  $\text{C}_{11}$  or  $\text{C}_{12}$ ), 127.0 (CH,  $\text{C}_{13}$ ), 125.7 (C, q,  $J = 300.6$  Hz,  $\text{C}_8$ ), 61.1 (C, q,  $J = 20.9$  Hz,  $\text{C}_6$ ), 53.9 ( $\text{CH}_2$ ,  $\text{C}_9$ ), 46.0 ( $\text{CH}_2$ ,  $\text{C}_2$ ), 31.9 ( $\text{CH}_2$ ,  $\text{C}_5$ ), 25.0 ( $\text{CH}_2$ ,  $\text{C}_3$ ), 20.1 ( $\text{CH}_2$ ,  $\text{C}_4$ ), 10.3 ( $\text{CH}_2$ ,  $\text{C}_7$ ).

**MS  $m/z$  (relative intensity):** 383( $\text{M}^+$ , 1.9), 314 (28), 256 (3), 242 (19), 187 (10), 186 (11), 91 (100), 65 (14).

**HRMS:** calcd for  $\text{C}_{14}\text{H}_{18}\text{F}_3\text{IN}$  ( $\text{M}+\text{H}^+$ ): 384.0431. Found 384.0439.

### **N-Benzyl-2-cyanomethyl-2-(trifluoromethyl)piperidine (73)**

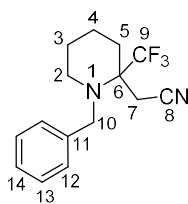

Following the general protocol: **44** (94 mg, 0.34 mmol, 1.0 equiv), proton sponge (147.4 mg, 0.69 mmol, 2.0 equiv) and triflic anhydride (86  $\mu$ L, 0.52 mmol, 1.5 equiv). Nucleophile = tetrabutylammonium cyanide (231 mg, 0.86 mmol, 2.5 equiv). The crude mixture was purified by flash chromatography (EtOAc/PE=5:95) to afford **73** (92 mg, 0.32 mmol, 94%) as a yellow oil.

**IR (neat):** 2951, 2853, 1453, 1240, 1142, 1117  $\text{cm}^{-1}$ .

**$^1\text{H}$  NMR ( $\text{CDCl}_3$ , 400 MHz):**  $\delta$  7.44–7.22 (m, 5H, H<sub>12</sub>, H<sub>13</sub> and H<sub>14</sub>), 4.12 (d,  $J$  = 14.4 Hz, 1H, H<sub>10</sub>), 3.50 (dq,  $J$  = 14.4 and 2.2 Hz, 1H, H<sub>10</sub>), 3.06 (d,  $J$  = 17.2 Hz, 1H, H<sub>7</sub>), 2.64 (d,  $J$  = 17.2 Hz, 1H, H<sub>7</sub>), 2.67–2.56 (m, 2H, H<sub>2</sub>), 2.11 (dtd<sub>app</sub>,  $J$  = 14.1, 3.8 and 1.4 Hz, 1H, H<sub>5</sub>), 2.00 (m, 1H, H<sub>5</sub>), 1.69–1.51 (m, 4H, H<sub>3</sub> and H<sub>4</sub>).

**$^{13}\text{C}$  NMR ( $\text{CDCl}_3$ , 100 MHz):**  $\delta$  138.9 (C, C<sub>11</sub>), 128.6 (2xCH, C<sub>12</sub> or C<sub>13</sub>), 128.2 (2xCH, C<sub>12</sub> or C<sub>13</sub>), 128.0 (C, q,  $J$  = 298.7 Hz, C<sub>9</sub>), 127.3 (CH, C<sub>14</sub>), 116.0 (C, C<sub>8</sub>), 60.9 (C, q,  $J$  = 22.2 Hz, C<sub>6</sub>), 54.4 (CH<sub>2</sub>, C<sub>10</sub>), 46.3 (CH<sub>2</sub>, C<sub>2</sub>), 31.4 (CH<sub>2</sub>, C<sub>5</sub>), 24.8 (CH<sub>2</sub>, C<sub>7</sub>), 24.4 (CH<sub>2</sub>, C<sub>3</sub>), 20.1 (CH<sub>2</sub>, C<sub>4</sub>).

**MS  $m/z$  (relative intensity):** 282 ( $\text{M}^{+\bullet}$ , 1.6), 242 (14), 213 (7), 91 (100), 65 (10), 54 (3).

**HRMS:** calcd for C<sub>15</sub>H<sub>18</sub>F<sub>3</sub>N<sub>2</sub> ( $\text{M}+\text{H}^+$ ): 283.1417. Found 283.1419.

### **N-Benzyl-2-[(1,3-dimethyl-propanedioate)methyl]-2-(trifluoromethyl)piperidine (74)**

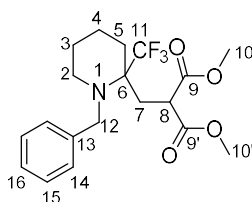

Following the general protocol: **44** (81.3 mg, 0.30 mmol, 1.0 equiv), proton sponge (127.5 mg, 0.60 mmol, 2.0 equiv) and triflic anhydride (74  $\mu$ L, 0.45 mmol, 1.5 equiv). Nucleophile = sodium dimethylmalonate. The crude mixture was purified by flash chromatography (Et<sub>2</sub>O/PE=10:90) to afford **74** (115 mg, 0.30 mmol, quant) as a colorless oil.

For the sodium dimethylmalonate: To a stirred suspension of NaH (60% wt oil dispersion, 31 mg, 0.77 mmol, 2.6 equiv) in THF (3 mL) at  $-15$   $^{\circ}\text{C}$  was added dropwise dimethylmalonate (0.12 mL, 1.04 mmol, 3.5 equiv) and the reaction mixture was stirred at rt for 30 min.

**IR (neat):** 2954, 2852, 1736, 1436, 1237, 1140, 1115  $\text{cm}^{-1}$ .

**$^1\text{H}$  NMR ( $\text{CDCl}_3$ , 400 MHz):**  $\delta$  7.31–7.19 (m, 5H,  $\text{H}_{14}$ ,  $\text{H}_{15}$  and  $\text{H}_{16}$ ), 4.25 (d,  $J = 15.2$  Hz, 1H,  $\text{H}_{12}$ ), 3.95 (dd,  $J = 6.2$  and 3.2 Hz, 1H,  $\text{H}_8$ ), 3.78 (s, 3H,  $\text{H}_{10}$  or  $\text{H}_{10'}$ ), 3.45 (s, 3H,  $\text{H}_{10}$  or  $\text{H}_{10'}$ ), 3.44 (dd,  $J = 15.1$  and 2.4 Hz, 1H,  $\text{H}_{12}$ ), 2.81 (dd,  $J = 15.5$  and 3.2 Hz, 1H,  $\text{H}_7$ ), 2.70 (m, 1H,  $\text{H}_2$ ), 2.61 (m, 1H,  $\text{H}_2$ ), 2.20 (dd,  $J = 15.6$  Hz and 6.3 Hz, 1H,  $\text{H}_7$ ), 1.90 (dd,  $J = 14.1$  Hz and 2.1 Hz, 1H,  $\text{H}_5$ ), 1.60–1.43 (m, 5H,  $\text{H}_3$ ,  $\text{H}_4$  and  $\text{H}_5$ ).

**$^{13}\text{C}$  NMR ( $\text{CDCl}_3$ , 100 MHz):**  $\delta$  170.8 (C,  $\text{C}_9$  or  $\text{C}_{9'}$ ), 169.9 (C,  $\text{C}_9$  or  $\text{C}_{9'}$ ), 139.6 (C,  $\text{C}_{13}$ ), 129.2 (C, q,  $J = 299.6$  Hz,  $\text{C}_{11}$ ), 128.4 (2xCH,  $\text{C}_{14}$  or  $\text{C}_{15}$ ), 127.3 (2xCH,  $\text{C}_{14}$  or  $\text{C}_{15}$ ), 126.6 (CH,  $\text{C}_{16}$ ), 62.1 (C, q,  $J = 21.0$  Hz,  $\text{C}_6$ ), 53.8 ( $\text{CH}_2$ ,  $\text{C}_{12}$ ), 53.0 ( $\text{CH}_3$ ,  $\text{C}_{10}$  or  $\text{C}_{10'}$ ), 52.8 ( $\text{CH}_3$ ,  $\text{C}_{10}$  or  $\text{C}_{10'}$ ), 46.5 ( $\text{CH}_2$ ,  $\text{C}_2$ ), 46.0 (CH,  $\text{C}_8$ ), 30.9 ( $\text{CH}_2$ ,  $\text{C}_7$ ), 30.2 ( $\text{CH}_2$ ,  $\text{C}_5$ ), 25.1 ( $\text{CH}_2$ ,  $\text{C}_3$ ), 20.2 ( $\text{CH}_2$ ,  $\text{C}_4$ ).

**MS  $m/z$  (relative intensity):** 387 ( $\text{M}^{+}$ , 1.8), 318 (34), 242 (11), 91 (100), 65 (6), 55 (4).

**HRMS:** calcd for  $\text{C}_{19}\text{H}_{25}\text{F}_3\text{NO}_4$  ( $\text{M}+\text{H}^+$ ): 388.1730. Found 388.1730.

### ***N*-Benzyl-2-ethyl-2-(trifluoromethyl)piperidine (75)**

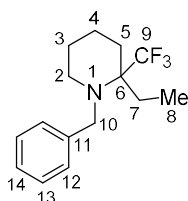

Following the general protocol: **44** (70.8 mg, 0.26 mmol, 1.0 equiv), proton sponge (111 mg, 0.52 mmol, 2.0 equiv) and triflic anhydride (64  $\mu\text{L}$ , 0.39 mmol, 1.5 equiv); the organocuprate was added. The crude mixture was purified by flash chromatography (PE=100%) to afford **75** (35 mg, 0.13 mmol, 50%) as a colorless oil.

To a stirred solution of coppercarbonitrile (93.7 mg, 1.04 mmol, 4.0 equiv) in THF (9.95 mL) at  $-78^\circ\text{C}$  under Ar atmosphere, was added methylmagnesium chloride (3 M, 0.43 mL, 1.3 mmol, 5.0 equiv) and the reaction mixture was stirred at rt for 1h.

**IR (neat):** 2945, 2852, 1453, 1243, 1132, 1117  $\text{cm}^{-1}$ .

**$^1\text{H}$  NMR ( $\text{CDCl}_3$ , 400 MHz):**  $\delta$  7.35–7.20 (m, 5H,  $\text{H}_{12}$ ,  $\text{H}_{13}$  and  $\text{H}_{14}$ ), 4.16 (d,  $J = 15.2$  Hz, 1H,  $\text{H}_{10}$ ), 3.48 (dd<sub>app</sub>,  $J = 15.2$  and 2.4 Hz, 1H,  $\text{H}_{10}$ ), 2.64–2.59 (m, 2H,  $\text{H}_2$ ), 1.96 (dq,  $J = 15.0$  and 7.5 Hz, 1H,  $\text{H}_7$ ), 1.84–1.45 (m, 7H,  $\text{H}_3$ ,  $\text{H}_4$ ,  $\text{H}_5$  and  $\text{H}_7$ ), 0.98 (t,  $J = 7.5$  Hz, 3H,  $\text{H}_8$ ).

**$^{13}\text{C}$  NMR ( $\text{CDCl}_3$ , 100 MHz):**  $\delta$  140.6 (C,  $\text{C}_{11}$ ), 130.1 (C, q,  $J = 299.7$  Hz,  $\text{C}_9$ ), 128.4 (2xCH,  $\text{C}_{12}$  or  $\text{C}_{13}$ ), 127.7 (2xCH,  $\text{C}_{12}$  or  $\text{C}_{13}$ ), 126.7 (CH,  $\text{C}_{14}$ ), 61.8 (C, q,  $J = 20.2$  Hz,  $\text{C}_6$ ), 53.7 ( $\text{CH}_2$ ,  $\text{C}_{10}$ ), 46.3 ( $\text{CH}_2$ ,  $\text{C}_2$ ), 29.0 ( $\text{CH}_2$ ,  $\text{C}_5$ ), 25.5 ( $\text{CH}_2$ ,  $\text{C}_3$  or  $\text{C}_7$ ), 25.3 ( $\text{CH}_2$ ,  $\text{C}_3$  or  $\text{C}_7$ ), 20.5 ( $\text{CH}_2$ ,  $\text{C}_4$ ), 7.3 ( $\text{CH}_3$ ,  $\text{C}_8$ ).

**MS  $m/z$  (relative intensity):** 272 ( $\text{M}^{+}$ , 1.2), 242 (6), 202 (23), 91 (100), 65 (8), 55 (3).

**HRMS:** calcd for  $\text{C}_{15}\text{H}_{21}\text{F}_3\text{N}$  ( $\text{M}+\text{H}^+$ ): 272.1620. Found 272.1622.

### **N-Benzyl-2-methyl-2-(trifluoromethyl)piperidine (76)**

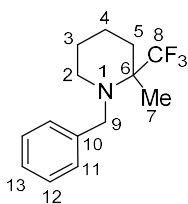

Following the general protocol: **44** (153 mg, 0.56 mmol, 1.0 equiv), proton sponge (240 mg, 1.12 mmol, 2.0 equiv) and triflic anhydride (139  $\mu$ L, 0.84 mmol, 1.5 equiv). Nucleophile = sodium borohydride (53 mg, 1.4 mmol, 2.5 equiv). The crude mixture was purified by flash chromatography (PE=100%) to afford **76** (105 mg, 0.41 mmol, 73%) as a colorless oil.

**IR (neat):** 2942, 2852, 1454, 1382, 1310, 1251, 1160, 1136, 1121, 1088, 957  $\text{cm}^{-1}$ .

**$^1\text{H}$  NMR ( $\text{CDCl}_3$ , 400 MHz):**  $\delta$  7.34–7.19 (m, 5H,  $\text{H}_{11}$ ,  $\text{H}_{12}$  and  $\text{H}_{13}$ ), 4.06 (d,  $J = 14.8$  Hz, 1H,  $\text{H}_9$ ), 3.54 (dd,  $J = 14.8$  and 1.5 Hz, 1H,  $\text{H}_9$ ), 2.65 (m, 1H,  $\text{H}_2$ ), 2.49 (m, 1H,  $\text{H}_2$ ), 1.99 (m, 1H,  $\text{H}_5$ ), 1.62–1.42 (m, 5H,  $\text{H}_3$ ,  $\text{H}_4$ , and  $\text{H}_5$ ), 1.34 (d,  $J = 0.8$  Hz, 3H,  $\text{H}_7$ ).

**$^{13}\text{C}$  NMR ( $\text{CDCl}_3$ , 100 MHz):**  $\delta$  141.1 (C,  $\text{C}_{10}$ ), 129.6 (C, q,  $J = 296.5$  Hz,  $\text{C}_8$ ), 128.4 (2xCH,  $\text{C}_{11}$  or  $\text{C}_{12}$ ), 127.9 (2xCH,  $\text{C}_{11}$  or  $\text{C}_{12}$ ), 126.8 (CH,  $\text{C}_{13}$ ), 59.3 (C, q,  $J = 21.8$  Hz,  $\text{C}_6$ ), 54.4 ( $\text{CH}_2$ ,  $\text{C}_9$ ), 46.6 ( $\text{CH}_2$ ,  $\text{C}_2$ ), 34.0 ( $\text{CH}_2$ ,  $\text{C}_5$ ), 25.7 ( $\text{CH}_2$ ,  $\text{C}_3$ ), 20.9 ( $\text{CH}_2$ ,  $\text{C}_4$ ), 20.6 ( $\text{CH}_3$ ,  $\text{C}_7$ ).

**MS  $m/z$  (relative intensity):** 257 ( $\text{M}^+$ , 5.9), 189 (10), 188 (70), 91 (100), 65 (14), 55 (6).

**HRMS:** calcd for  $\text{C}_{14}\text{H}_{19}\text{F}_3\text{N}$  ( $\text{M}+\text{H}^+$ ): 258.1464. Found 258.1462.

## 8. Synthesis and spectroscopic data of *N*-benzyl-3-hydroxy-3-methylazepane (77)

### *tert*-Butyl 3-hydroxy-3-methylazepane-1-carboxylate (81)

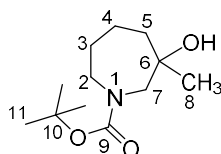

To a stirred solution of *tert*-butyl 3-oxoazepane-1-carboxylate **51** (303 mg, 1.42 mmol, 1.0 equiv) in THF (7.1 mL) at 0 °C was added MeMgBr (3.0 M in Et<sub>2</sub>O, 1.89 mL, 5.68 mmol, 4.0 equiv) and the resulting mixture was stirred at rt for 16 h. The solution was quenched with an aqueous and saturated solution of NH<sub>4</sub>Cl and extracted with EtOAc. The organic layers were then dried over anhydrous MgSO<sub>4</sub>, filtered and concentrated under reduced pressure. The crude mixture was purified by flash chromatography (Et<sub>2</sub>O/PE=30:70) to afford **81** (234 mg, 1.01 mmol, 72%) as a yellow oil.

**IR (neat):** 3445, 2973, 2929, 1664, 1479, 1416, 1366, 1282, 1159, 1118, 869 cm<sup>-1</sup>.

**<sup>1</sup>H NMR (CDCl<sub>3</sub>, 400 MHz):** δ 4.11 (br s, OH), 3.92–3.84 (m, 2H, H<sub>2</sub> and H<sub>7</sub>), 2.87–2.79 (m, 2H, H<sub>2</sub> and H<sub>7</sub>), 1.73–1.68 (m, 2H, H<sub>3</sub> or H<sub>4</sub>), 1.64–1.62 (m, 2H, H<sub>5</sub>), 1.48 (s, 9H, H<sub>11</sub>), 1.43–1.26 (m, 2H, H<sub>3</sub> or H<sub>4</sub>), 1.18 (s, 3H, H<sub>8</sub>).

**<sup>13</sup>C NMR (CDCl<sub>3</sub>, 400 MHz):** δ 158.2 (C, C<sub>9</sub>), 80.3 (C, C<sub>10</sub>), 74.5 (C, C<sub>6</sub>), 58.6 (CH<sub>2</sub>, C<sub>7</sub>), 49.6 (CH<sub>2</sub>, C<sub>2</sub>), 42.3 (CH<sub>2</sub>, C<sub>5</sub>), 29.4 (CH<sub>2</sub>, C<sub>3</sub> or C<sub>4</sub>), 28.5 (3xCH<sub>3</sub>, C<sub>11</sub>), 27.5 (CH<sub>3</sub>, C<sub>8</sub>), 21.9 (CH<sub>2</sub>, C<sub>3</sub> or C<sub>4</sub>).

**MS *m/z* (relative intensity):** 229 (M<sup>+</sup>, 1.5), 173 (9), 156 (8), 114 (7), 99 (18), 88 (10), 86 (22), 70 (7), 59 (15), 57 (100).

**HRMS:** calcd for C<sub>12</sub>H<sub>23</sub>NO<sub>3</sub>Na (M+Na<sup>+</sup>): 252.1570. Found 252.1572.

### *N*-Benzyl-3-hydroxy-3-methylazepane (77)

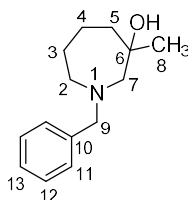

To a stirred solution of *tert*-butyl 3-hydroxy-3-methylazepane-1-carboxylate **81** (224 mg, 0.98 mmol, 1.0 equiv) in CH<sub>2</sub>Cl<sub>2</sub> (5.4 mL) at rt was added TFA (0.51 mL, 6.84 mmol, 7.0 equiv). The reaction mixture was stirred at rt for 18 h and then concentrated under reduced pressure.

To a stirred solution of the crude material previously obtained in MeCN (10 mL) at rt were added successively BnBr (0.12 mL, 0.98 mmol, 1.0 equiv), K<sub>2</sub>CO<sub>3</sub> (675 mg, 4.88 mmol, 5.0 equiv) and TBAI (180 mg, 0.49 mmol, 0.5 equiv). The reaction mixture was heated at 75 °C for 4 h and then allowed to cool to rt. The reaction mixture was quenched with H<sub>2</sub>O and extracted with CH<sub>2</sub>Cl<sub>2</sub> (twice). The organic layer was dried over anhydrous MgSO<sub>4</sub>, filtered and concentrated under reduced pressure. The crude mixture was purified by flash chromatography (Et<sub>2</sub>O/PE=40:60) to afford **77** (212 mg, 0.97 mmol, quant) as a colorless oil.

**IR (neat):** 3421, 3028, 2925, 2860, 1495, 1452, 1391, 1369, 1300, 1200, 1127, 1109, 1074, 969 cm<sup>-1</sup>.

**<sup>1</sup>H NMR (CDCl<sub>3</sub>, 400 MHz):** δ 7.36–7.26 (m, 5H, H<sub>11</sub>, H<sub>12</sub> and H<sub>13</sub>), 3.76 (d, *J* = 13.0 Hz, 1H, H<sub>9</sub>), 3.69 (d, *J* = 13.0 Hz, 1H, H<sub>9</sub>), 2.75–2.67 (m, 2H, H<sub>2</sub> and H<sub>7</sub>), 2.49–2.41 (m, 2H, H<sub>2</sub> and H<sub>7</sub>), 1.81 (m, 1H, H<sub>3</sub>), 1.70 (m, 1H, H<sub>5</sub>), 1.49 (m, 3H, H<sub>3</sub> and H<sub>4</sub>), 1.29 (m, 1H, H<sub>5</sub>), 1.12 (s, 3H, H<sub>8</sub>).

**<sup>13</sup>C NMR (CDCl<sub>3</sub>, 100 MHz):** δ 139.1 (C, C<sub>10</sub>), 129.1 (2xCH, C<sub>11</sub> or C<sub>12</sub>), 128.5 (2xCH, C<sub>11</sub> or C<sub>12</sub>), 127.4 (CH, C<sub>13</sub>), 69.9 (C, C<sub>6</sub>), 64.5 (CH<sub>2</sub>, C<sub>9</sub>), 63.2 (CH<sub>2</sub>, C<sub>7</sub>), 53.9 (CH<sub>2</sub>, C<sub>2</sub>), 43.9 (CH<sub>2</sub>, C<sub>5</sub>), 28.2 (CH<sub>2</sub>, C<sub>3</sub>), 27.7 (CH<sub>3</sub>, C<sub>8</sub>), 21.0 (CH<sub>2</sub>, C<sub>4</sub>).

**MS *m/z* (relative intensity):** 219 (M<sup>+</sup>, 7), 176 (7), 160 (11), 146 (2), 134 (69), 129 (11), 120 (10), 99 (7), 91 (100), 70 (7), 65 (12), 55 (11).

**HRMS:** calcd for C<sub>14</sub>H<sub>22</sub>NO (M+H<sup>+</sup>): 220.1696. Found 220.1698.



## 9. Synthesis and spectroscopic data of N-benzyl-3-fluoro-3-methylpiperidine (**83**)

### *N*-Benzyl-2-fluoro-2-methylazepane (**83**)

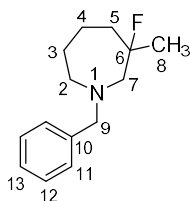

Following the general protocol: *N*-benzyl-3-hydroxy-3-methylazepane **77** (85 mg, 0.39 mmol, 1.0 equiv), proton sponge (166 mg, 0.78 mmol, 2.0 equiv) and triflic anhydride (96  $\mu$ L, 0.59 mmol, 1.5 equiv). Nucleophile = tetrabutylammonium fluoride (1.0 M in THF, 0.97 mL, 0.97 mmol, 2.5 equiv). The crude mixture was purified by flash chromatography (EtOAc/PE=5:95 and 10:90) to afford **83** (27 mg, 0.12 mmol, 31%) as a yellow oil.

**IR (neat):** 2931, 2862, 1494, 1375, 1350, 1263, 1228, 1188, 1117, 1042, 1029, 965, 910  $\text{cm}^{-1}$ .

**$^1\text{H}$  NMR ( $\text{CDCl}_3$ , 400 MHz):**  $\delta$  7.35–7.21 (m, 5H,  $\text{H}_{11}$ ,  $\text{H}_{12}$  and  $\text{H}_{13}$ ), 3.71 (d,  $J = 13.5$  Hz, 1H,  $\text{H}_9$ ), 3.66 (d,  $J = 13.5$  Hz, 1H,  $\text{H}_9$ ), 2.87 (m, 1H,  $\text{H}_7$ ), 2.73–2.59 (m, 3H,  $\text{H}_2$  and  $\text{H}_7$ ), 1.98 (m, 1H,  $\text{H}_5$ ), 1.86–1.64 (m, 3H,  $\text{H}_3$ ,  $\text{H}_4$ , and  $\text{H}_5$ ), 1.58 (m, 1H,  $\text{H}_3$ ), 1.42 (m, 1H,  $\text{H}_4$ ), 1.25 (d,  $J = 21.7$  Hz, 3H,  $\text{H}_8$ ).

**$^{13}\text{C}$  NMR ( $\text{CDCl}_3$ , 100 MHz):**  $\delta$  139.9 (C,  $\text{C}_{10}$ ), 129.0 (2xCH,  $\text{C}_{11}$  or  $\text{C}_{12}$ ), 128.3 (2xCH,  $\text{C}_{11}$  or  $\text{C}_{12}$ ), 127.1 (CH,  $\text{C}_{13}$ ), 98.3 (C, d,  $J = 166.4$  Hz,  $\text{C}_6$ ), 65.4 ( $\text{CH}_2$ , d,  $J = 28.9$  Hz,  $\text{C}_7$ ), 63.9 ( $\text{CH}_2$ ,  $\text{C}_9$ ), 57.5 ( $\text{CH}_2$ ,  $\text{C}_2$ ), 40.0 ( $\text{CH}_2$ , d,  $J = 23.4$  Hz,  $\text{C}_5$ ), 30.8 ( $\text{CH}_2$ ,  $\text{C}_3$ ), 26.6 ( $\text{CH}_3$ , d,  $J = 25.0$  Hz,  $\text{C}_8$ ), 21.8 ( $\text{CH}_2$ , d,  $J = 6.0$  Hz,  $\text{C}_4$ ).

**MS  $m/z$  (relative intensity):** 221 ( $\text{M}^+$ , 28), 220 (11), 174 (8), 160 (33), 146 (11), 144 (11), 135 (18), 130 (25), 91 (100), 84 (15), 70 (10), 65 (16), 55 (9).

**HRMS:** calcd for  $\text{C}_{14}\text{H}_{21}\text{FN}$  ( $\text{M}+\text{H}^+$ ): 222.1653. Found 222.1653.

**CHAPTER 3**  
**Synthesis of**  
**6-(trifluoromethyl)pyridazines by a**  
**[2+1]/[3+2]-cycloaddition sequence**



# 1. Structure, biological activity and synthesis of pyridazines

## 1.1. Structure<sup>79,80</sup>

Pyridazines (1,2-diazines) are aromatic six-membered heterocycles, containing two  $sp^2$  hybridized adjacent nitrogen atoms. They belong to the family of diazines along with pyrimidines (1,3-diazines) and pyrazines (1,4-diazines). Pyridazines are planar molecules with a slightly distorted hexagonal geometry, whose bond lengths are similar to those of benzene (1.39 Å). Although pyridazines are aromatic compounds, their resonance energy (100 kJ/mol) is considerably lower than the resonance energy of benzene (150 kJ/mol) and pyridine (117 kJ/mol) and thus, their aromaticity is lower (Figure 26).



Pyridazine

Figure 26

Due to the nitrogen inductive effect, pyridazines are electron-deficient compounds with a partially positive charge on the carbon atoms and a partially negative charge on the nitrogen atoms. Pyridazines are also molecules of low basicity with a  $pK_a$  of 2.3, which is lower than the  $pK_a$  of pyridine ( $pK_a=5.2$ ) and are therefore not easily protonated.

Two resonance structures contribute to the structure of pyridazine. According to calculations, structure **B** contributes more to the resonance hybrid than structure **A**, as the N-N bond has a significant single bond character (Figure 27).

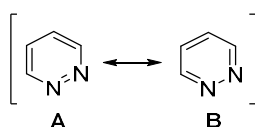

Figure 27

## 1.2. Biological activity

Until now, only nine natural compounds, containing a pyridazine ring, are reported in the literature, presenting a variety of biological activities (Figure 28). For example, pyridazomycin, which was the first pyridazine-containing natural product, was isolated from *Streptomyces violaceoniger* in 1988,

<sup>79</sup> Cabal, M. -P. Six-Membered Heterocycles: 1,2-, 1,3-, 1,4-Diazines and Related Systems. In *Modern Heterocyclic Chemistry, Vol. 2*; Alvarez-Builla, J.; Vaquero, J. J.; Barluenga, J., Eds.; Wiley-VCH: Weinheim, **2011**, 1683–1776.

<sup>80</sup> Haider, N.; Holzer, W. In *Product Class 8: Pyridazines, Science of Synthesis*, **2004**, 16, 125–249.

and has shown antifungal and antibiotic properties<sup>81</sup> while liguducimine A, isolated from the plant *Ligularia duciformis*, has antitussive properties.<sup>82</sup> In addition, cinnoline 4849F, isolated in 2007, has shown some cytotoxic activity towards human breast cancer and ovarian cancer cells<sup>83</sup> (Figure 28).

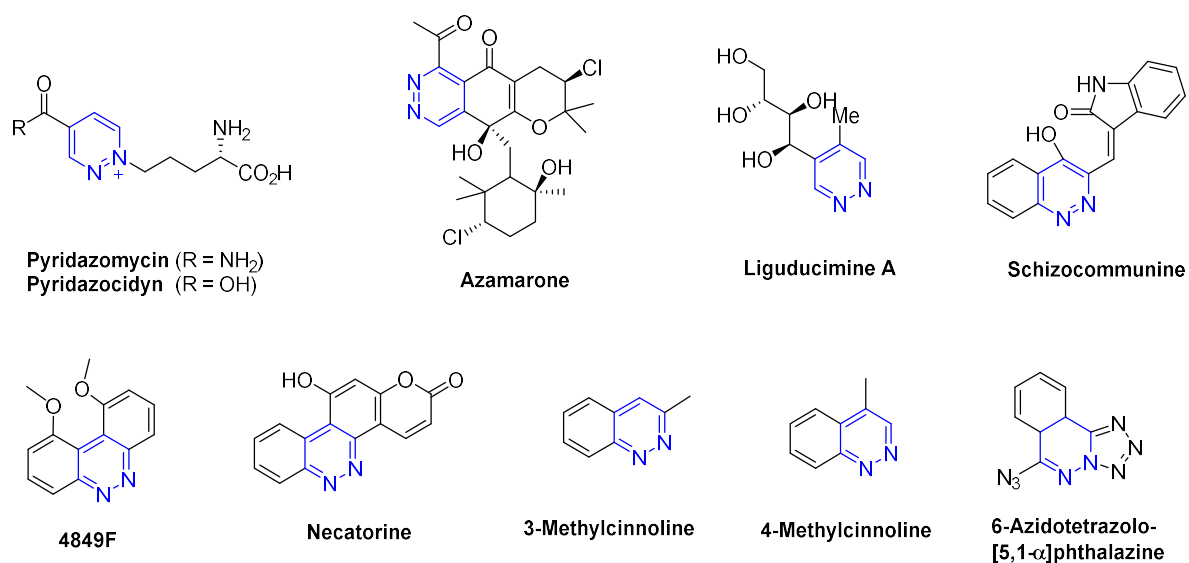

**Figure 28**

For a long time, pyridazines have been considered as dangerous heterocycles due to the potential toxicity of the hydrazine motif present on the pyridazine ring and, until 1950, only two drugs possessing a pyridazine moiety were on the market: hydralazine which is a vasodilator and sulfamethoxypyridazine which is an antibacterial agent (Figure 29).<sup>84</sup>

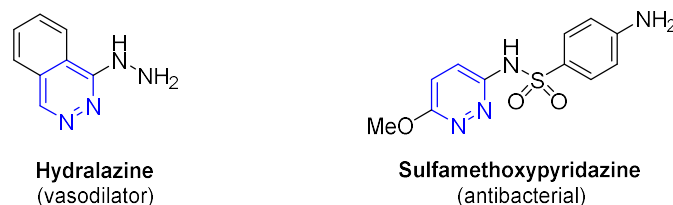

**Figure 29**

However, over the last years, pyridazines have been considered as privileged structures<sup>84</sup> and one of the “most developable” heteroaromatic rings for drug design according to GlaxoSmithKline researchers.<sup>85</sup> Therefore, the increasing interest in pyridazine-containing compounds, has led to the

<sup>81</sup> Grote, R.; Chen, Y.; Zeeck, A.; Chen, Z.; Zaehner, H.; Mischnick-Luebbecke, P.; Koenig, W. A. *J. Antibiot.* **1988**, *41*, 595–601.

<sup>82</sup> Zhang, C. -F.; Wang, Q.; Zhang, M. *J. Asian Nat. Prod. Res.* **2009**, *11*, 339–344.

<sup>83</sup> Wang, K.; Guo, L.; Zou, Y.; Li, Y.; Wu, J. *J. Antibiot.* **2007**, *60*, 325–327.

<sup>84</sup> Wermuth, C. G. *Med. Chem. Commun.* **2011**, *2*, 935–941.

<sup>85</sup> Ritchie, T. J.; Macdonald, S. J. F.; Peace, S.; Pickett, S. D.; Luscombe, C. N. *Med. Chem. Commun.* **2012**, *3*, 1062–1069.

development of minaprine which is an antidepressant drug, SR 41378, a potent candidate for the treatment of seizures, and pyridate which is a herbicide (Figure 30).

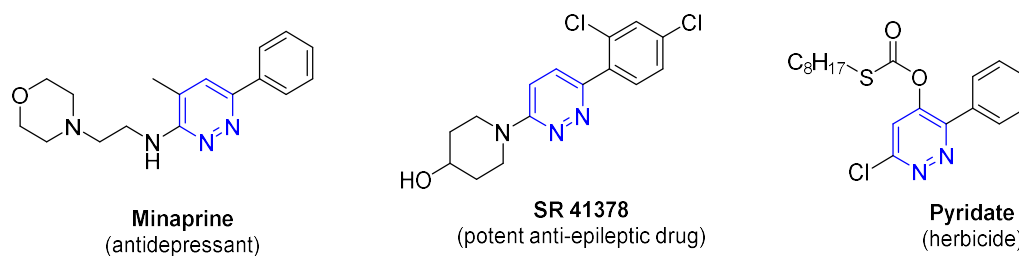

**Figure 30**

Nowadays, numerous synthetic biologically-active pyridazines, with various therapeutic properties, are developed. For example, compound **I** was found to have an inhibitory activity towards picornavirus, a virus that is responsible for several human diseases such as acute hepatitis, myocarditis and poliomyelitis.<sup>86</sup> Compound **II**, seems to show an inhibitory activity towards acyl CoA: Diacylglycerol AcylTransferase (DGAT1), an enzyme that catalyzes the formation of triglycerides. With the discovery of compound **II**, it seems that the formation of triglycerides could be modulated, offering a treatment for numerous diseases such as type II diabetes and obesity<sup>87</sup> (Figure 31).

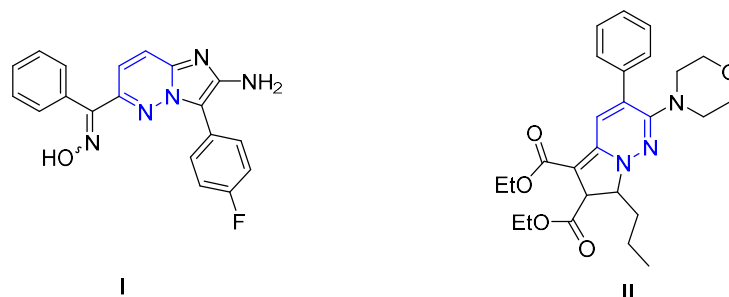

**Figure 31**

Due to the increasing interest in pyridazine derivatives over the last years, as well as an interest in introducing fluorine atoms in molecules as mentioned before, the development of trifluoromethylated pyridazines has become increasingly popular.

A first example demonstrating the importance of (trifluoromethyl)pyridazines, is illustrated in Figure 32. Due to the lack of efficient drugs and/or with low side-effects, a new class of agents e.g. triple reuptake inhibitors, has been developed to inhibit serotonin, norepinephrine, and dopamine transporters. This inhibition provokes an increase in the extracellular concentration of these

<sup>86</sup> Hamdouchi, C.; Sanchez-Martinez, C.; Gruber, J.; Del Prado, M.; Lopez, J.; Rubio, A.; Heinz, B. A. *J. Med. Chem.* **2003**, *46*, 4333–4341.

<sup>87</sup> Fox, B. M.; Iio, K.; Li, K.; Choi, R.; Inaba, T.; Jackson, S.; Sagawa, S.; Shan, B.; Tanaka, M.; Yoshida, A.; Kayser, F. *Bioorg. Med. Chem. Lett.* **2010**, *20*, 6030–6033.

transporters and therefore an increase in the neurotransmission. Thus, these agents can be used for the treatment of depression. For example, BMS-911278, possessing a (trifluoromethyl)pyridazine ring, was presented as a potent triple reuptake inhibitor which could possibly treat depression.<sup>88</sup>

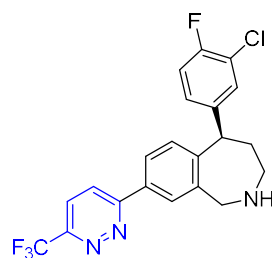

BMS-911278

Figure 32

Another example indicating the importance of (trifluoromethyl)pyridazines is illustrated in Figure 33. In an attempt to develop new anti-HIV agents, due to the increasing resistance to already marketed drugs, a series of functionalized  $\alpha$ -(trifluoromethyl)pyridazinones has been recently synthesized. The pyridazinone ring can act as a bioisoster of the pyrimidinone ring of raltegravir, an antiretroviral drug that targets integrase, an HIV-enzyme which integrates viral DNA into the host cell genome. Among a variety of synthesized pyridazinones, compounds III and IV exhibited high anti-HIV activity, while compound V and raltegravir showed a similar *in-vitro* and *in-vivo* anti-viral activity against the tobacco mosaic virus (TMV).<sup>89</sup>

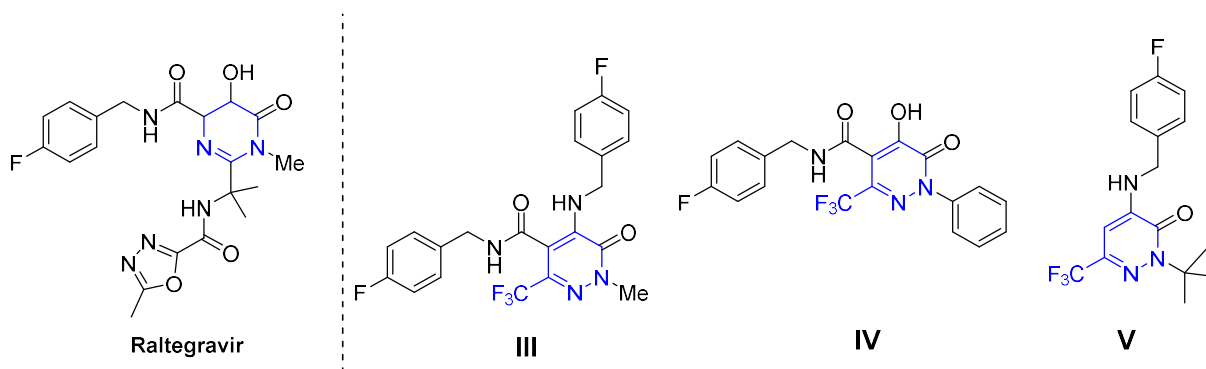

Figure 33

<sup>88</sup> Molino, B. F.; Liu, S.; Sambandam, A.; Guzzo, P. R.; Hu, M.; Zha, C.; Nacro, K.; Manning, D. D.; Isherwood, M. L.; Fleming, K. N.; Cui, W.; Olson, R. E. **2007** (US2007/0021408 A1).

<sup>89</sup> Wang, Z.; Wang, M.; Yao, X.; Li, Y.; Tan, J.; Wang, L.; Qiao, W.; Geng, Y.; Liu, Y.; Wang, Q. *Eur. J. Med. Chem.* **2012**, *54*, 33–41.

### 1.3. Main synthetic methods to access pyridazines

The first pyridazine synthesis was reported in 1886 by Emil Fischer.<sup>90</sup> However, it is not until the 1950's that the synthesis and reactivity of pyridazines were studied. Nowadays, numerous methods exist to access the pyridazine ring. Among them, we can cite:

- the condensation of hydrazine with 1,4-diketones (route a)
- a Diels-Alder/retro Diels-Alder reaction between tetrazines and alkynes (route b)
- a [1,3]-dipolar cycloaddition between a cyclopropene and a diazo compound (route c)
- the ring-contraction of diazepines (route d) (Scheme 59).

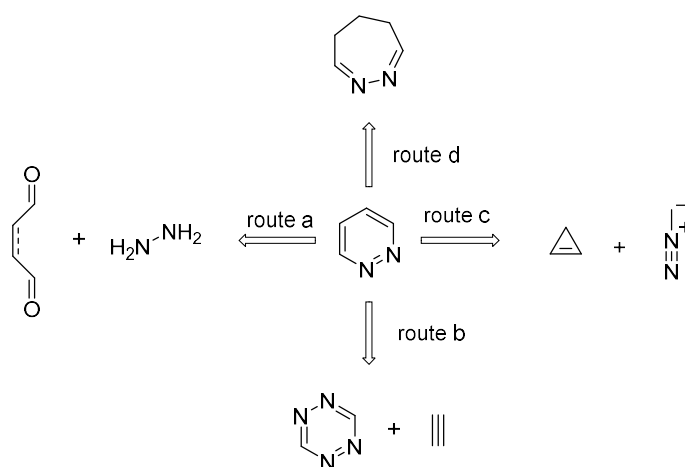

**Scheme 59**

As our goal was to access pyridazines possessing a  $\text{CF}_3$  group to the  $\alpha$  position of one of the two nitrogens, we will focus only on the synthetic methods developed to obtain  $\alpha$ -(trifluoromethyl)pyridazines as well as their derivatives. It should be mentioned that we have decided to number the pyridazine atoms as indicated in Figure 34, whatever the substituents on the pyridazine ring.

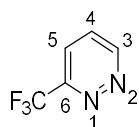

$\alpha$ -(Trifluoromethyl)pyridazine

**Figure 34**

<sup>90</sup> Fischer, E. *Justus Liebigs Ann. Chem.* **1886**, 236, 126–151.



## 1.4. Main synthetic methods to access $\alpha$ -(trifluoromethyl)pyridazines and derivatives

One of the first synthesis of a  $\alpha$ -(trifluoromethyl)pyridazine, was reported by Kobayashi *et al.* in 1980.<sup>91</sup> When triazolone **L3.1** was activated with triphenylphosphine, intermediate **L3.3** was formed. This intermediate could then react with cyclopropene **L3.2** to afford intermediate **L3.4** which, after the release of triphenylphosphine oxide, produced the polycyclic compound **L3.5** possessing four CF<sub>3</sub> groups (38% yield) (Scheme 60).

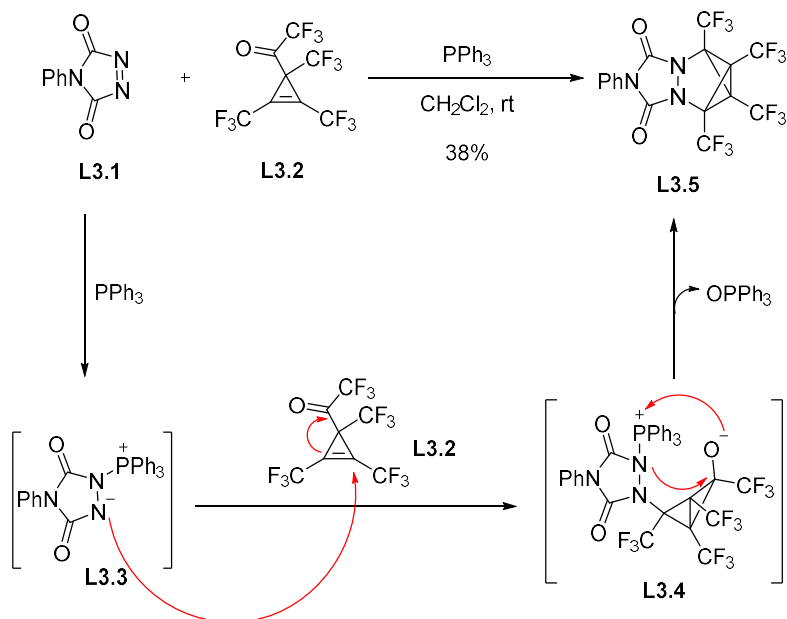

Scheme 60

Treatment of **L3.5** with ammonia in ether, followed by treatment with dinitrogen tetroxide (N<sub>2</sub>O<sub>4</sub>), led to the tetrakis-(trifluoromethyl)pyridazine **L3.7** (Scheme 61).

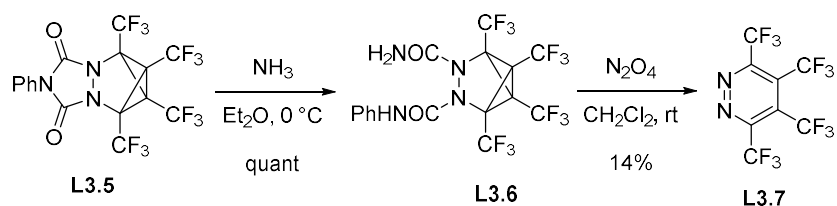

Scheme 61

Beside the method presented above, a few synthetic methods are reported, to access specifically  $\alpha$ -(trifluoromethyl)pyridazines and their derivatives. We have divided these methods according to the

<sup>91</sup> Kobayashi, Y.; Nakano, T.; Shirahashi, K.; Takeda, A.; Kumadaki, I. *Tetrahedron Lett.* **1980**, *21*, 4615–4618.

number of CF<sub>3</sub> groups present on the pyridazine ring (one or two) and then according to the reaction type.

### 1.4.1. Pyridazines possessing one CF<sub>3</sub> group

Pyridazines possessing one CF<sub>3</sub> group can be obtained either by:

- the condensation of hydrazine with a carbonyl compound or
- a Staudinger/intramolecular diaza-Wittig sequence.

#### 1.4.1.1. Condensation of hydrazine with carbonyl compounds

Condensation of hydrazine with a variety of carbonyl compounds is a typical method to access  $\alpha$ -(trifluoromethyl)pyridazines. Generally, the mechanism involves the reaction of hydrazine with a dicarbonyl compound **C**, to afford intermediate **D** by elimination of one molecule of H<sub>2</sub>O. Reaction of the second nitrogen of the hydrazine with the second carbonyl group and elimination of another molecule of H<sub>2</sub>O, leads to the desired pyridazines **E** (Scheme 62).

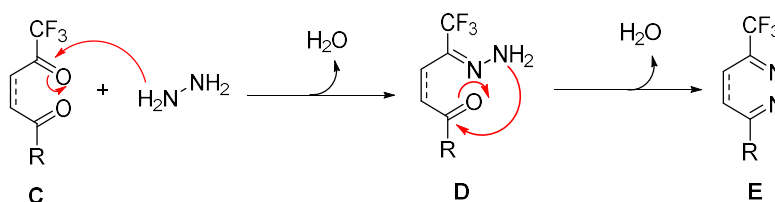

Scheme 62

In 1993, Takahashi *et al.* reported the synthesis of (trifluoromethyl)pyridazines **L3.12a** and **L3.12b** from compound **L3.8** and hydrazine. Indeed, condensation of **L3.8** with hydrazine gave access to hydrazone **L3.9** (85% yield), which after reaction with dibenzoyl **L3.10** in the presence of *p*-toluenesulfonic acid, afforded azine **L3.11** in 75% yield. Azine **L3.11** was then converted to pyridazine **L3.12a** (15%) after treatment with LDA, and to pyridazine **L3.12b** (58%) when treated with sodium methoxide due to the release of a hydroxy anion during the condensation step (Scheme 63).<sup>92</sup>

<sup>92</sup> Takahashi, M.; Kotashima, H.; Saitoh, T. *Heterocycles* **1993**, 35, 909–914.



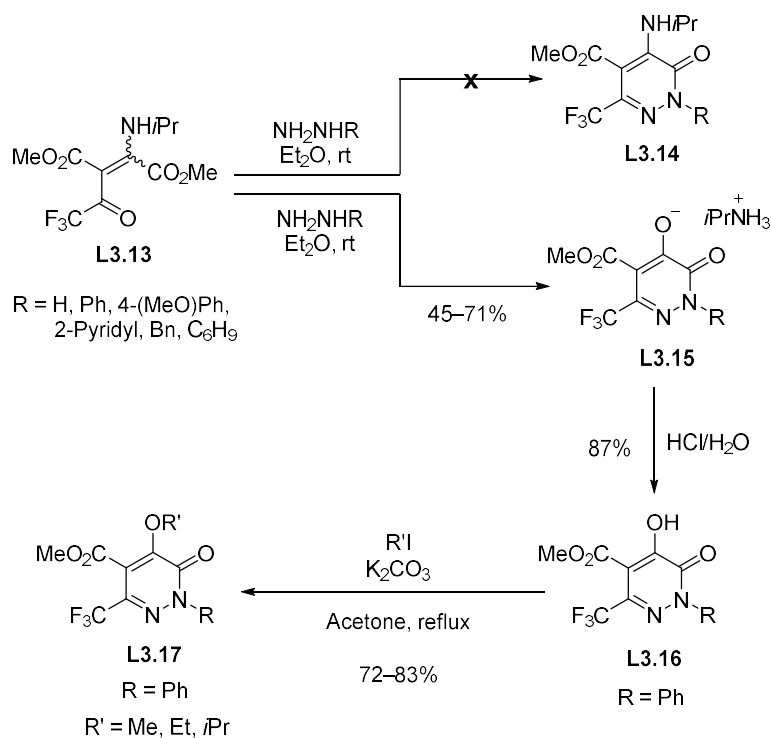

**Scheme 64**

To explain the formation of **L3.15**, a mechanism was proposed by the authors, where the carbonyl that possesses the  $\text{CF}_3$  group in **L3.13** was attacked by an alkyl or an aryl hydrazine, to form intermediate **L3.18** which could then undergo a cyclization. Due to the elimination of methanol, intermediate **L3.19** is formed, and two possible mechanisms can be envisioned to access **L3.15**. The first one involves the elimination of  $\text{H}_2\text{O}$  from intermediate **L3.19**, which could then attack the enamino ester functionality to form compound **L3.20** (Scheme 65). The second mechanism, involves a concerted rearrangement of the allylic alcohol to access **L3.20**. Elimination of *isopropylamine* could then lead to compound **L3.21**, which after an irreversible acido-basic reaction, led to the highly substituted (trifluoromethyl)pyridazinone derivatives **L3.15** (Scheme 65).

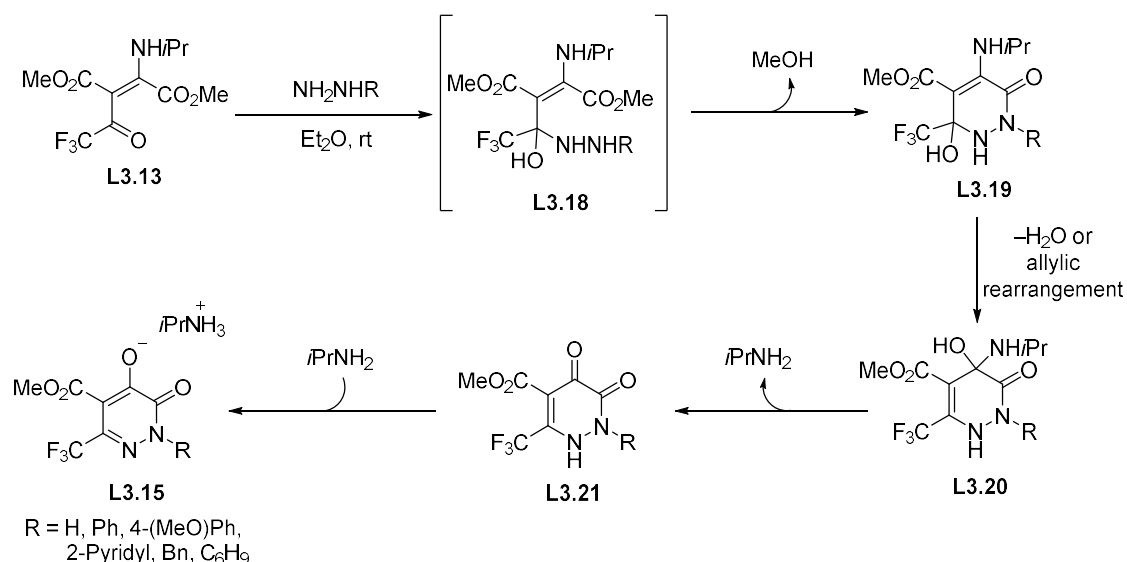

In 2012, this method was applied to the synthesis of a diversity of pyridazinones **L3.22**, following the same procedure as illustrated in Scheme 64.<sup>93</sup> These pyridazinones could be further functionalized by the addition of neat 4-fluorobenzylamine, to give a diversity of 6-(trifluoromethyl)pyridazinones **L3.23** which after treatment under acidic conditions led to pyridazinones **L3.24** (Scheme 66).<sup>89</sup>

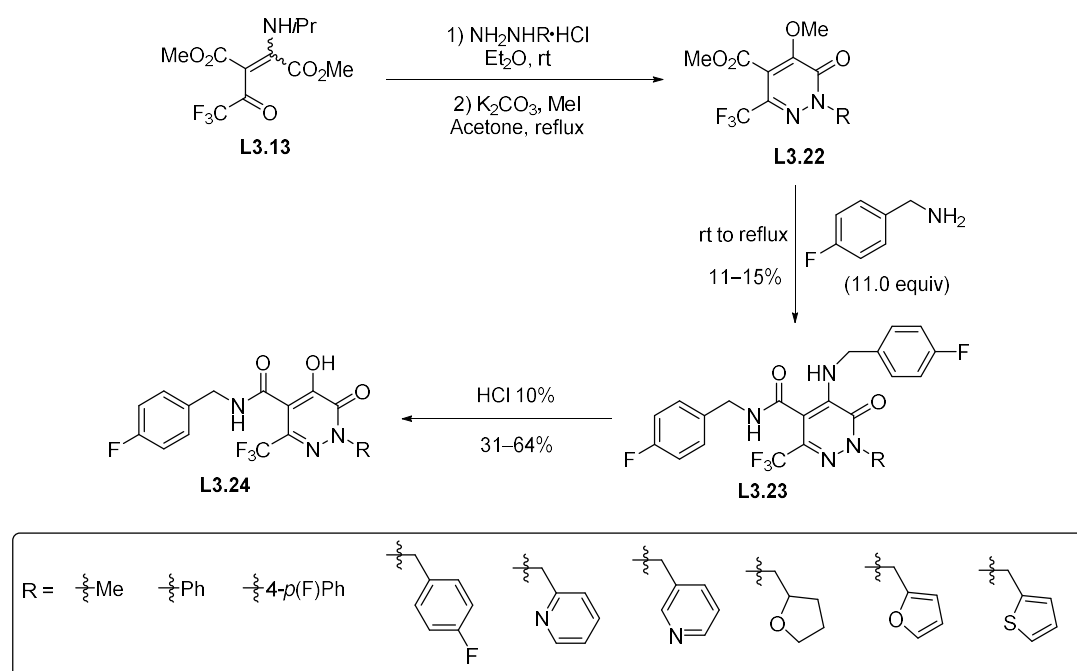

The formation of (trifluoromethyl)pyridazinones **L3.24**, can be rationalized by the formation of intermediate **L3.25** after treatment of pyridazinones **L3.23** under acidic conditions. An allylic rearrangement can then take place to produce **L3.26**, which after elimination of benzylamine, leads to pyridazinones **L3.24** (Scheme 67).

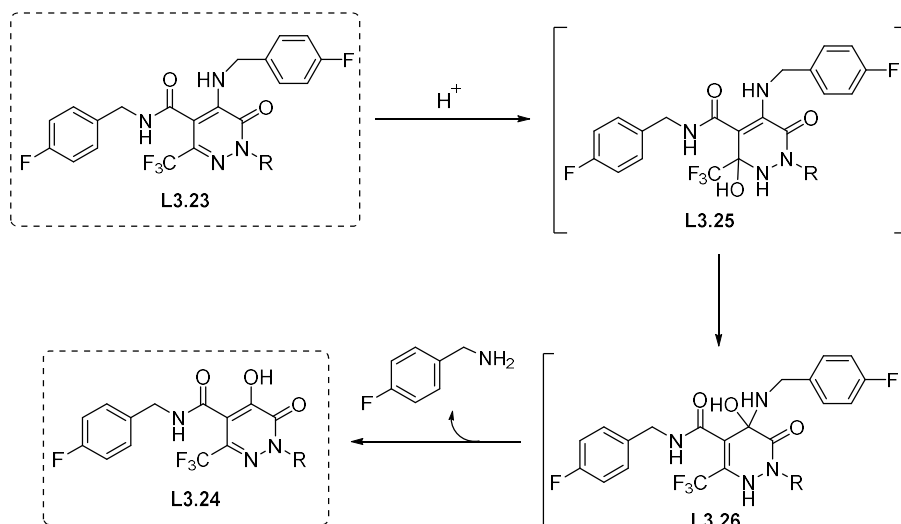

**Scheme 67**

Furthermore, when R is an *isopropyl* group, treatment of **L3.22** with neat 4-fluorobenzylamine, led to pyridazinone derivatives **L3.27** in 39% yield, and treatment of **L3.27** with HCl afforded (trifluoromethyl)pyridazinone **L3.28** in 26% yield (Scheme 68).<sup>89</sup>

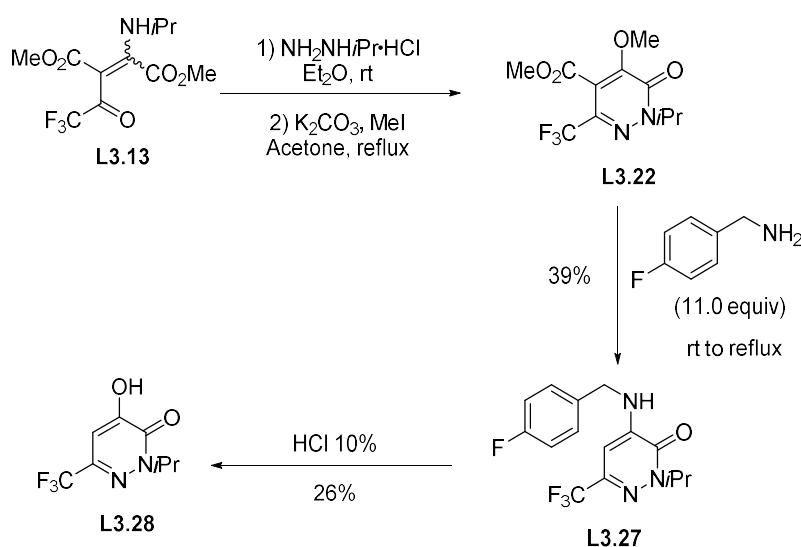

**Scheme 68**

Therefore, to explain the formation of **L3.27** and **L3.28** from **L3.22**, another mechanism was envisaged. Treatment of pyridazinone **L3.22** with neat 4-fluorobenzylamine, afforded the decarboxylated compound **L3.27**, which after treatment with 10% HCl, gave intermediate **L3.29**. The allylic rearrangement of **L3.29** followed by the elimination of a benzylamino group, led to pyridazinones **L3.28** (Scheme 69).

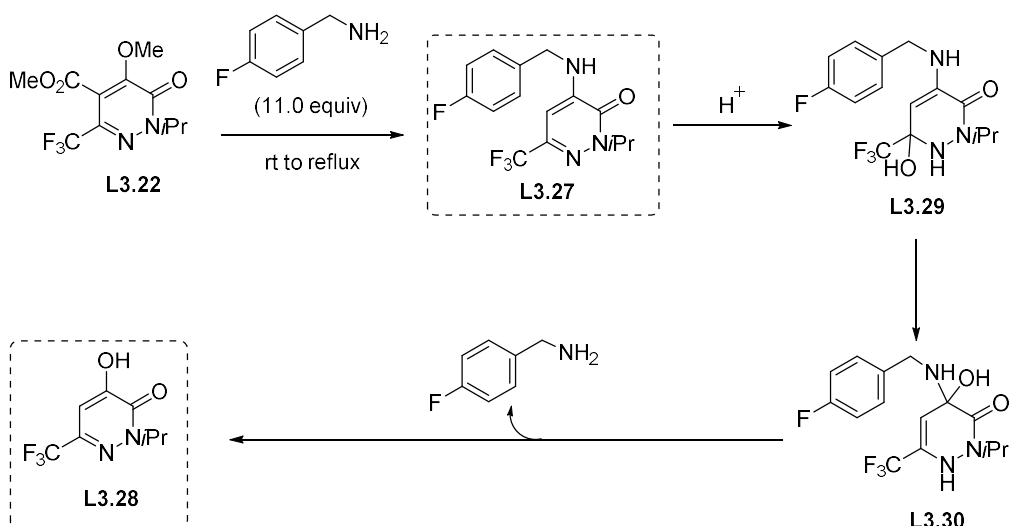

**Scheme 69**

In 2009, the synthesis of (trifluoromethyl)pyridazinones **L3.34** was reported by the condensation of hydrazine derivatives with ketoester **L3.31**, under acidic conditions. After protonation of **L3.31** with *p*-toluenesulfonic acid, intermediate **L3.32** was attacked by the hydrazine derivatives to form intermediates **L3.33**. A condensation can then take place to afford compounds **L3.34** in very good yields (80%–94%) (Scheme 70). It is worth noting that the 1 to 1 ratio of ketoester **L3.31** and hydrazine derivatives is important for the completion of the reaction. When this ratio is 1 to 2, the cyclization of **L3.33** does not take place. The same result was obtained when the hydrazine is substituted by an aromatic ring possessing electron-withdrawing groups, such as two nitro groups, given that the reaction stops after the formation of compound **L3.33** independently of the ratio of ketoester **L3.31** and hydrazine derivatives.<sup>95</sup>

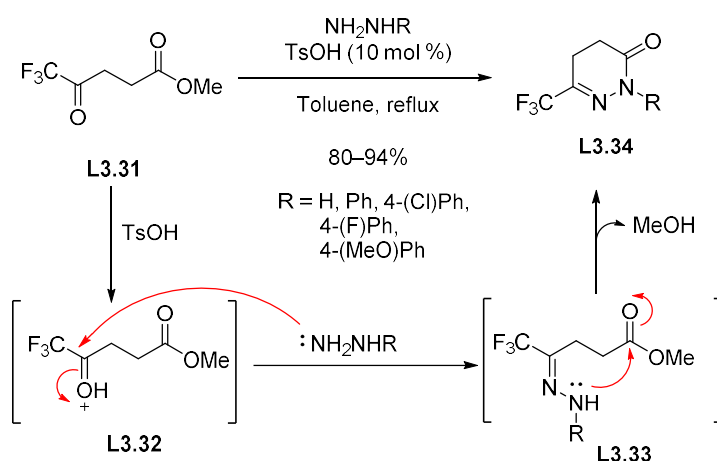

**Scheme 70**

<sup>95</sup> Wan, W.; Hou, J.; Jiang, H.; Wang, Y.; Zhu, S.; Deng, H.; Hao, J. *Tetrahedron* **2009**, *65*, 4212–4219.

It is worth mentioning that oxidation of **L3.34** (R=H), led to the (trifluoromethyl)pyridazinone **L3.35** in 95% yield (Scheme 71).

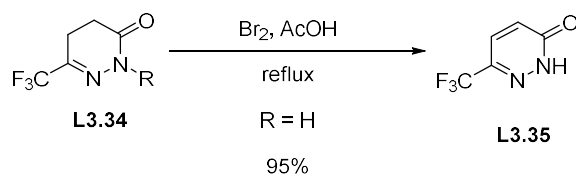

**Scheme 71**

More recently, the synthesis of (trifluoromethyl)pyridazines **L3.39** and **L3.40** was reported starting from chromones **L3.36** and 2,3-diaminobenzene or 2,3-diaminopyridine **L3.37a** or 2,3-diaminonaphthalene **L3.37b**. When the condensation of 2,3-diaminobenzene or 2,3-diaminopyridine **L3.37a** or 2,3-diaminonaphthalene **L3.37b** with chromones **L3.36** took place under acidic conditions, the chromone ring was opened to produce respectively quinoxalines **L3.38a** and **L3.38b**.<sup>96</sup> Treatment of quinoxalines **L3.38a** with hydrazine led to (trifluoromethyl)pyridazines **L3.39**, while treatment of quinoxalines **L3.38b** with hydrazine afforded **L3.40** in moderate to good yields (Scheme 72).<sup>97</sup>

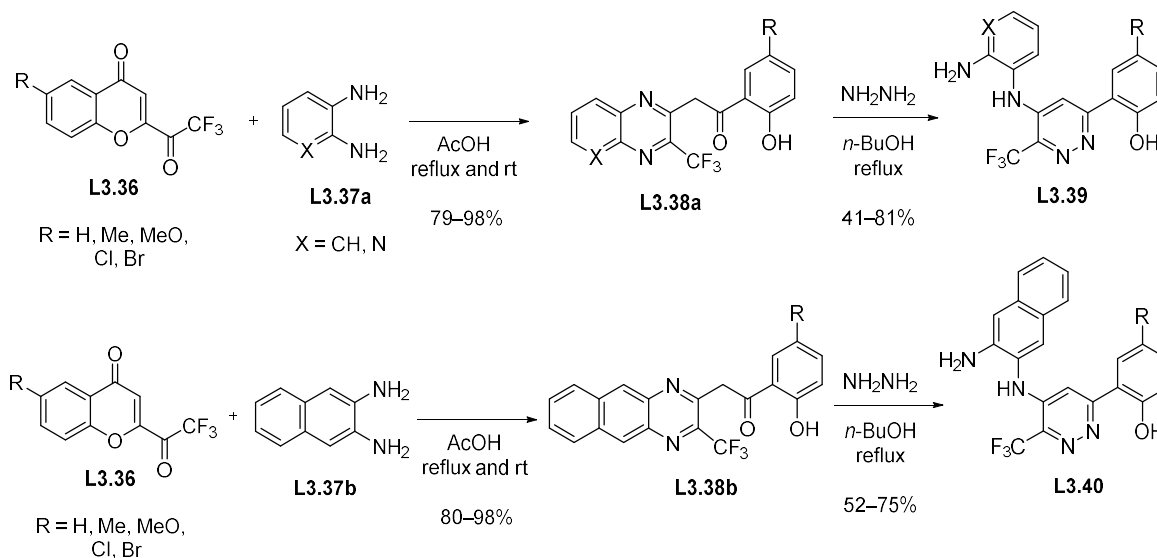

**Scheme 72**

The formation of **L3.39** and **L3.40** can be explained by the attack of hydrazine on the carbonyl group of **L3.38** to produce the intermediate compound **L3.41**. After the attack of the second amino group of the hydrazine on the carbon bearing the CF<sub>3</sub> group, intermediate **L3.42** is formed. The amination of

<sup>96</sup> Irgashev, R. A.; Safrygin, A. V.; Ezhikova, M. A.; Kodess, M. I. Rösenthaler, G. -V.; Sosnovskikh, V. Y. *Tetrahedron* **2015**, *71*, 1822–1830.

<sup>97</sup> Sosnovskikh, V. Y.; Safrygin, A. V.; Irgashev, R. A.; Ezhikova, M. A.; Kodess, M. I. *RSC Adv.* **2016**, *6*, 30056–30069.



**L3.42** is then cleaved to afford **L3.43**, which after a [1,3]-hydride shift, leads to the desired (trifluoromethyl)pyridazines **L3.39** and **L3.40** (Scheme 73).

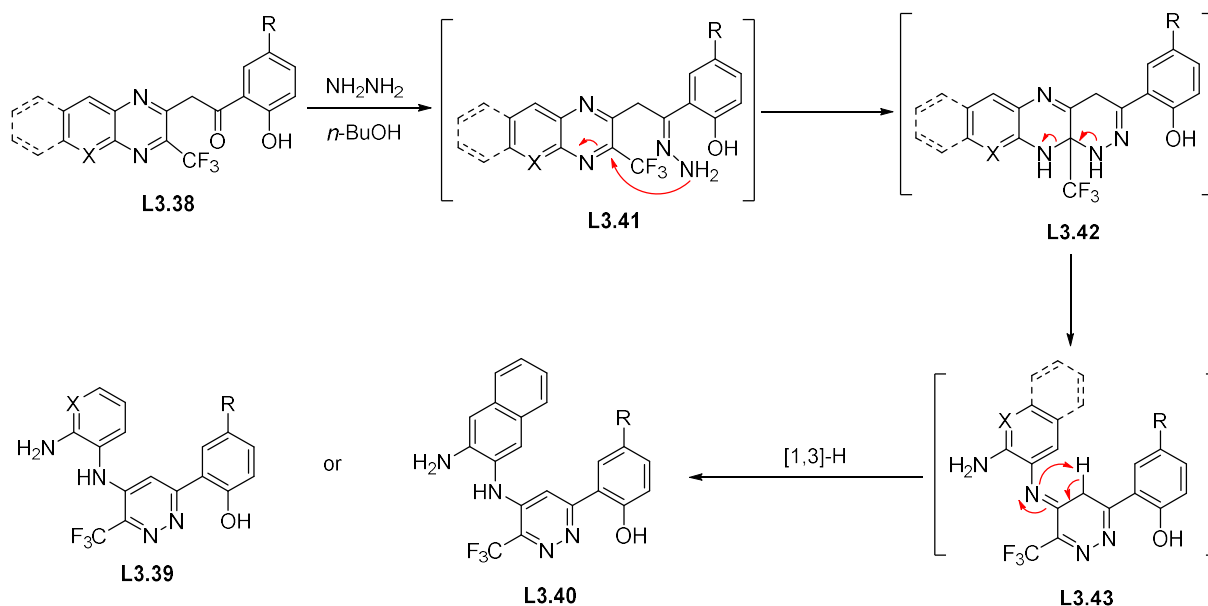

**Scheme 73**

Similarly, (trifluoromethyl)pyridazines **L3.46** and **L3.47** were produced in good yields from **L3.45a** and **L3.45b** respectively, after treatment of these latter with hydrazine under acidic conditions. It is worth noting that quinoxalines **L3.45a** and **L3.45b** were obtained from (trifluoromethyl)furanones **L3.44** when these latter reacted respectively with 2,3-diaminobenzene **L3.37a** or 2,3-diaminonaphthalene **L3.37b** (Scheme 74).<sup>98</sup>

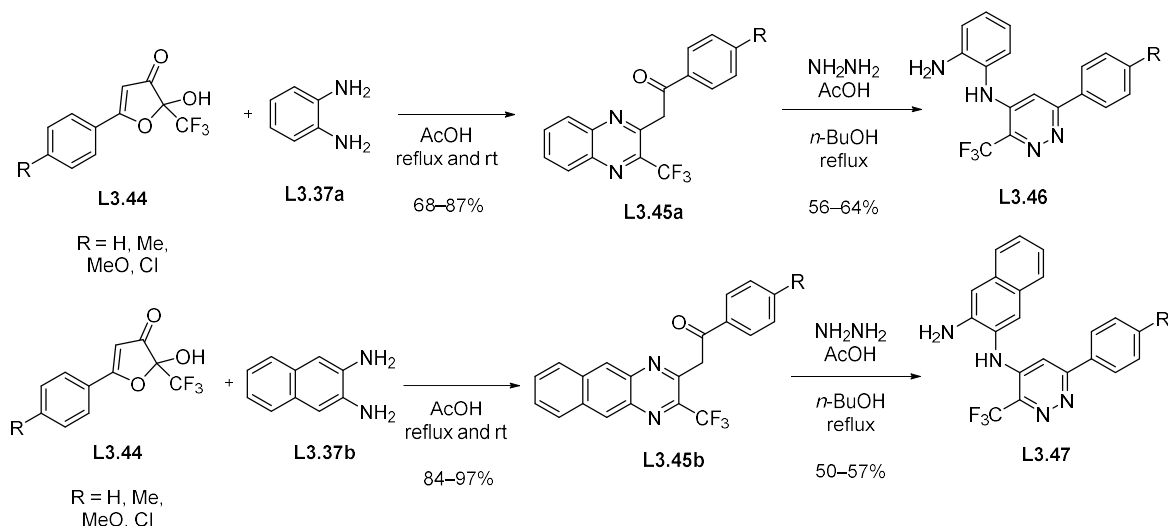

**Scheme 74**

<sup>98</sup> Safrygin, A. V.; Irgashev, R. A.; Slepukhin, P. A.; Röschenthaler, G. -V.; Sosnovskikh, V. Y. *Tetrahedron* **2015**, *71*, 8535–8543.

Alternatively, when R is a hydrogen, (trifluoromethyl)furanone **L3.44** can directly react with hydrazine in acetic acid, to form a tautomeric mixture of pyridazinone derivative **L3.48a** and pyridazine **L3.48b** in favor of **L3.48a** (Scheme 75).<sup>98</sup>

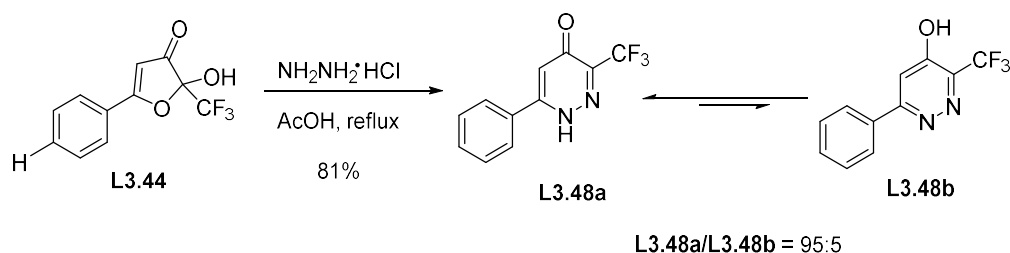

**Scheme 75**

Recently, the group of Zhan<sup>99</sup> reported the synthesis of (trifluoromethyl)dihydropyridazine **L3.52** starting from trifluoroacetaldehyde **L3.49**. Indeed after condensation of trifluoroacetaldehyde **L3.49** with phenylhydrazine, hydrazone **L3.50** was formed which after a condensation with 3-bromo-1-propynyl-benzene led to the propargylic hydrazone **L3.51**. The silver-catalyzed tandem sigmatropic rearrangement/[1,3]-hydride shift/ $6\pi$ -aza electrocyclization of hydrazone **L3.51**, allowed the formation of **L3.52**. Dihydropyridazine **L3.52** could then be transformed to (trifluoromethyl)pyridazinone **L3.53** after treatment with selenium oxide (Scheme 76).

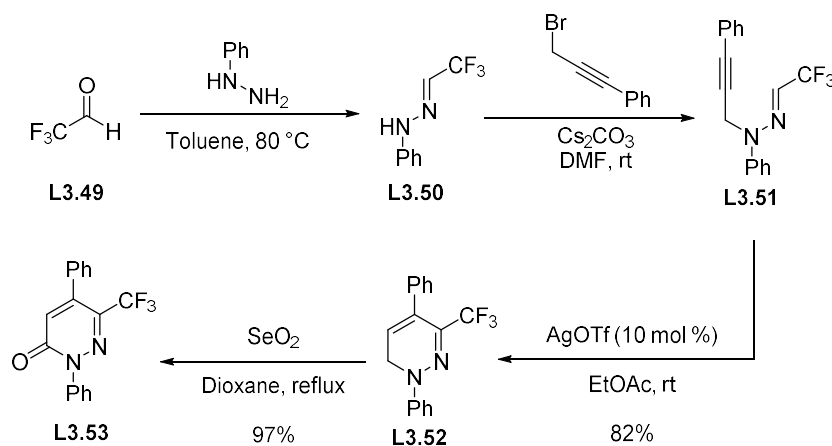

**Scheme 76**

The formation of **L3.52** can be explained by the activation of the triple bond of the propargylic hydrazone **L3.51** with silver triflate, that induces a *6-endo-dig* cyclization to afford intermediate **L3.55**. Decomposition of **L3.55** leads to the allenic intermediate **L3.56** with regeneration of the silver

<sup>99</sup> Ding, Z. -C.; Ju, L. -C.; Yang, Y.; An, X. -M.; Zhou, Y. -B.; Li, R. -H.; Tang, H. -T.; Ding, C. -K.; Zhan, Z. -P. *J. Org. Chem.* **2016**, *81*, 3936–3941.

catalyst. A [1,3]-hydrogen shift then takes place to allow the formation of **L3.57**, which after a 6 $\pi$ -aza electrocyclization leads to dihydropyridazine **L3.52**<sup>100</sup> (Scheme 77).

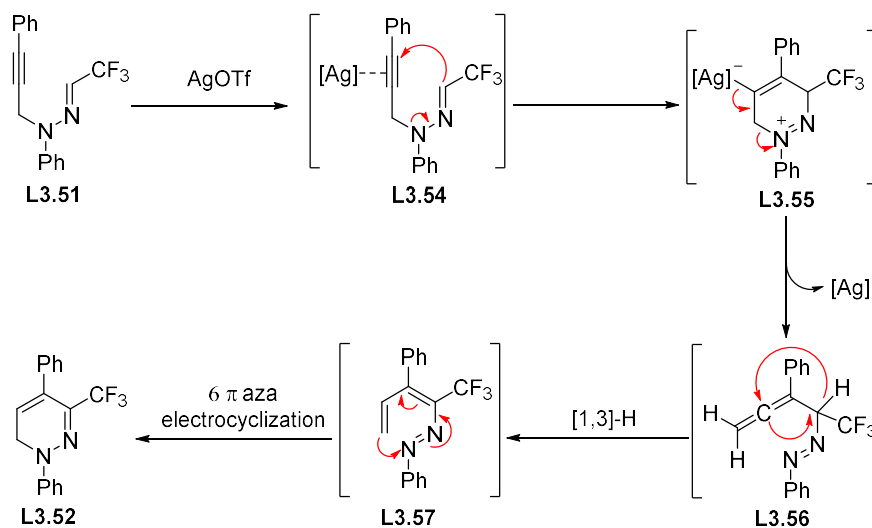

**Scheme 77**

#### 1.4.1.2. Intramolecular diaza-Wittig reaction

Another synthetic route to access  $\alpha$ -(trifluoromethyl)pyridazines involves the intramolecular diaza-Wittig reaction of phosphazines. In this nitrogen version of the Wittig-reaction, a diazo compound **F** reacts with a nucleophilic phosphorus reagent ( $\text{PR}_3$ ) according to a Staudinger reaction, to form a N-P ylide intermediate **G**, called iminophosphorane. In the presence of a carbonyl group, this iminophosphorane **G** undergoes an intramolecular diaza-Wittig reaction to afford the pyridazine derivative **I** via the oxophosphetane intermediate **H** (Scheme 78).

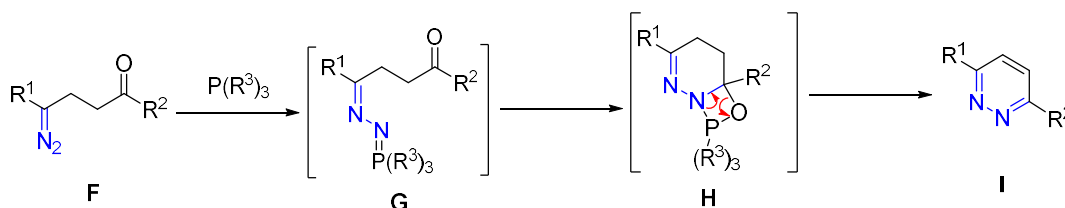

**Scheme 78**

One example of the diaza-Wittig reaction is reported in the literature, for the synthesis of pyridazines possessing one  $\text{CF}_3$  group. In 2014, the synthesis of (trifluoromethyl)pyridazines **L3.63** from (trifluoromethyl)diazomethane and carbonates **L3.58**, in a one-pot synthesis was reported. The first step involved a Morita-Baylis-Hillman reaction between the (trifluoromethyl)diazomethane and carbonate **L3.58**, in the presence of DABCO (1,4-diazabicyclo[2.2.2]octane) as a Lewis base, to form

<sup>100</sup> The authors underline that when AgOTf was replaced by  $\text{Rh}(\text{Oct})_4$ , the [1,3]-shift could not take place and therefore a pyrazole derivative was obtained instead of the pyridazine derivative.

the allylic diazo compound **L3.59**. In the presence of tri-*n*-butylphosphine, **L3.59** was transformed to the iminophosphorane intermediate **L3.60**, which then underwent a diaza-Wittig reaction and a subsequent aromatization, affording the highly substituted pyridazines **L3.63** (Scheme 79).<sup>101</sup>

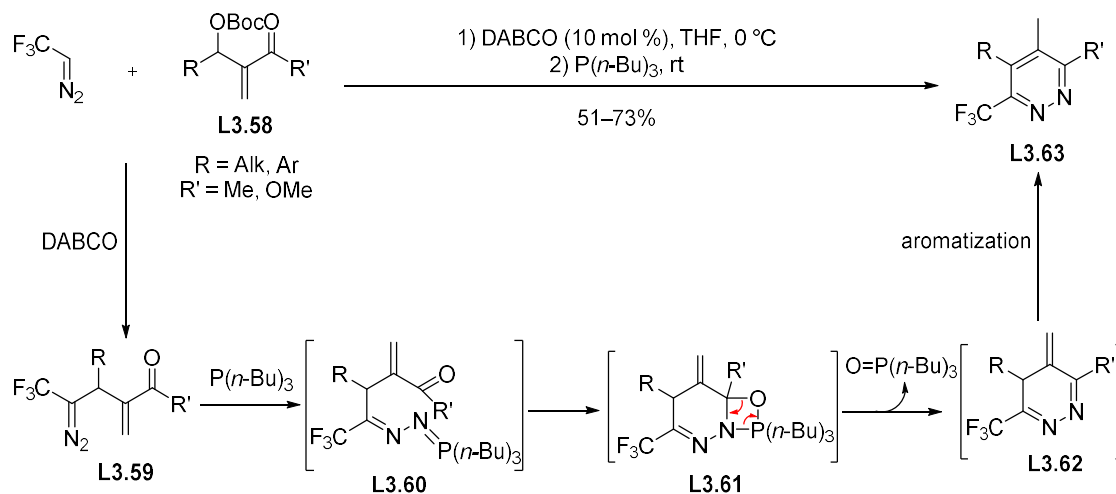

**Scheme 79**

### 1.4.2. Pyridazines possessing two CF<sub>3</sub> groups

Pyridazines possessing two CF<sub>3</sub> groups can be accessed by:

- the condensation of hydrazine with a carbonyl compound,
- a Staudinger/intramolecular diaza-Wittig sequence,
- a Diels-Alder reaction with inverse electron demand/retro Diels-Alder reaction between a bis-(trifluoromethyl)tetrazine and an alkene.

#### 1.4.2.1. Condensation of hydrazine with carbonyl compounds

In 1985, Tamborski *et al.* reported the condensation of hydrazine with diketone **L3.64** in pyridine, to afford the bis-(trifluoromethyl)pyridazine **L3.66**, insisting on the fact that the expected intermediate **L3.65** was not observed but instead product **L3.66** was isolated in 73% yield (Scheme 80).<sup>102</sup>

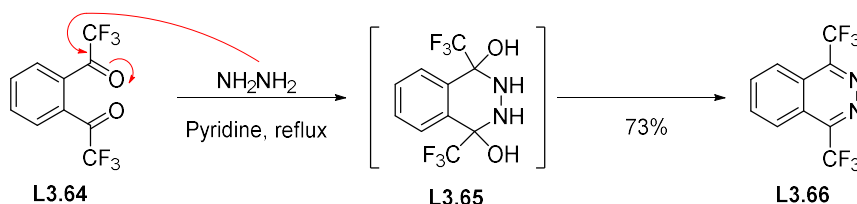

**Scheme 80**

<sup>101</sup> Mao, H.; Lin, A.; Tang, Z.; Hu, H.; Zhu, C.; Cheng, Y. *Chem. Eur. J.* **2014**, *20*, 2454–2458.

<sup>102</sup> Tamborski, C.; Prabhu, U. D. G.; Eapen, K. C. *J. Fluorine Chem.* **1985**, *28*, 139–150.

#### 1.4.2.2. Intramolecular diaza-Wittig reaction

In 2011, the synthesis of bis-(trifluoromethyl)pyridazines **L3.72** was reported by using a diaza-Wittig reaction. When diazo-oxo-trifluorobutanoates **L3.67** reacted with the dicarbonyl compound **L3.68**, in the presence of tris(dimethylamino)phosphine, the desired tetrasubstituted bis-(trifluoromethyl)pyridazines **L3.72** were isolated. In this process, diazoketoesters **L3.67** underwent a Staudinger reaction in the presence of tris(dimethylamino)phosphine, to form phosphazines **L3.69** in excellent yields (up to 97%). A diaza-Wittig reaction then took place when **L3.69** was treated with ketoester **L3.68**, to produce intermediate **L3.70**, which released tris(dimethylamino)phosphine oxide to afford compound **L3.71**. An intramolecular condensation of **L3.71** led to the desired bis-(trifluoromethyl)pyridazines **L3.72** in 44% (R=Me) and 50% (R=Et) yield (Scheme 81).<sup>103</sup> It is worth mentioning that when the reaction was carried out in the presence of triphenylphosphine instead of tris(dimethylamino)phosphine, the pyridazines were obtained in moderate yields. These moderate yields can be explained by the presence of H<sub>2</sub>O released during the intramolecular condensation, which can hydrolyze the diazoketoesters **L3.67** and phosphazines **L3.69** (Ph instead of NMe<sub>2</sub>). In addition, these moderate yields can also come from the dissociation of phosphazines **L3.69** into the initial diazoketoesters **L3.67** and triphenylphosphine.

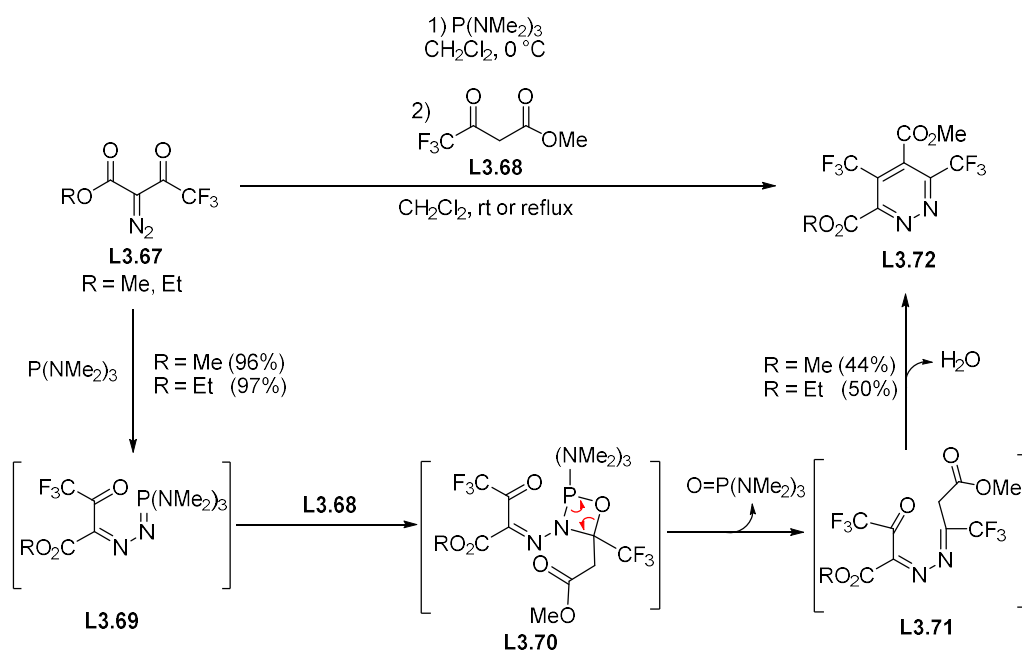

Scheme 81

#### 1.4.2.3. Diels-Alder reaction with inverse electron demand involving tetrazines

The inverse electron demand Diels-Alder reaction of a tetrazine with a dienophile, followed by a retro Diels-Alder reaction, releasing N<sub>2</sub>, represents one of the most common methods to obtain

<sup>103</sup> Supurgibekov, M. B.; Yanyuk, N. S.; Nikolaev, V. A. *Russ. J. Org. Chem.* **2011**, *47*, 1252–1255.

bis-(trifluoromethyl)pyridazines as well as their derivatives. This reaction, under orbital control (LUMO<sub>diene</sub>/HOMO<sub>dienophile</sub>), is favored by the presence of electron-withdrawing groups on the tetrazine and electron-donating groups on the dienophile. Therefore, an extremely electron-poor diene such as bis-(trifluoromethyl)tetrazine **L3.73** is an excellent substrate for this reaction. Generally, after a [4+2]-cycloaddition between tetrazine **L3.73** and an alkene, intermediate **J** is formed which after the release of N<sub>2</sub> by a retro-Diels Alder reaction can lead to compound **K**. After oxidation of **K**, the desired bis-(trifluoromethyl)pyridazines **L** are obtained (Scheme 82).

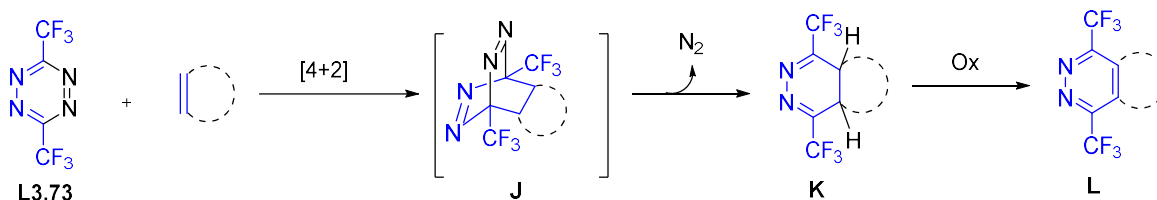

Scheme 82

At this point, it is important to mention that this reaction was mostly used for the synthesis of pyridazines polycyclic derivatives and it was not until recently, that it was applied to the synthesis of monocyclic bis-(trifluoromethyl)pyridazines.

In 1987, a Diels-Alder reaction with inverse electron demand was reported by the group of Seitz. When tetrazine **L3.73** reacted with benzene derivatives **L3.74** under high temperature, the Diels-Alder adducts **L3.75** were formed. The elimination of N<sub>2</sub>, along with an oxidation by air, led to the bicyclic bis-(trifluoromethyl)pyridazine derivatives **L3.77** in moderate to good yields (Scheme 83).<sup>104</sup>

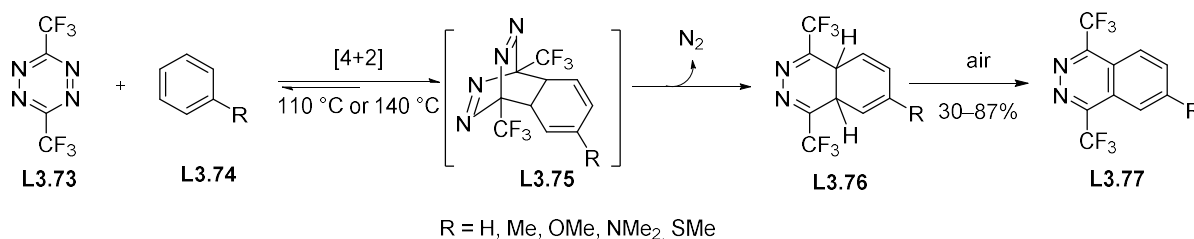

Scheme 83

The same group applied this method to access a diversity of bis-(trifluoromethyl)pyridazine derivatives.<sup>105</sup> For example, an inverse electron demand Diels-Alder reaction using  $\pi$ -system

<sup>104</sup> Seitz, G.; Hoferichter, R.; Mohr, R. *Angew. Chem. Int. Ed. Engl.* **1987**, *26*, 332–334.

<sup>105</sup> a) Seitz, G.; Mohr, R. *Chem.-Ztg.* **1987**, *111*, 81–82; b) Hoferichter, R.; Seitz, G.; Wassmuth, H. *Chem. Ber.* **1989**, *122*, 711–714; c) Seitz, G.; Hoferichter, R.; Mohr, R. *Arch. Pharm.* **1989**, *322*, 415–417; d) Seitz, G.; Wassmuth, H. *Arch. Pharm.* **1990**, *323*, 89–91; e) Baumann, L.; Kampchen, T.; Seitz, G. *Chem. Ber.* **1992**, *125*, 171–176; f) Hoferichter, R.; Seitz, G. *Liebigs Ann. Chem.* **1992**, 1153–1158; g) Reimers, U.; Seitz, G. *J. Prakt. Chem.* **1993**, *335*, 152–156; h) Richter, M.; Seitz, G. *Arch. Pharm.* **1993**, *326*, 427–428; i) Hoferichter, R.; Reimers,

dienophiles displaying valence tautomerism was reported in 1995.<sup>105k</sup> More specifically, when tetrazine **L3.73** reacted with the tautomeric system cyclooctatetraene **L3.78**/bicyclo[4.2.0]octatriene **L3.79**, the non-isolable cycloadduct **L3.80** was formed. Elimination of N<sub>2</sub>, afforded **L3.81** which rapidly tautomerized to the more stable compound **L3.82** (Scheme 84). The authors pointed out that the equilibrium cyclooctatetraene **L3.78**/bicyclo[4.2.0]octatriene **L3.79** is constant in refluxing dichloromethane (b.p.=39.6 °C), therefore it is the cyclooctatetraene **L3.78** that acts as the dienophile rather than the bicyclo[4.2.0]octatriene **L3.79**. They also specified that even if the formation of the tautomers **L3.83** and **L3.84** can be envisaged, chromatographic and spectroscopic analysis did not reveal the presence of such intermediates.

However, during the Diels-Alder reaction, the side product **L3.85** was isolated in 5% yield, indicating that a small amount of **L3.83** can react with another molecule of tetrazine **L3.73** to form the cycloadduct **L3.85**. Oxidation with silver oxide, promotes a [2+2]-cycloreversion to afford pyridazines **L3.86** (61%) and **L3.87** (64%) (Scheme 84).

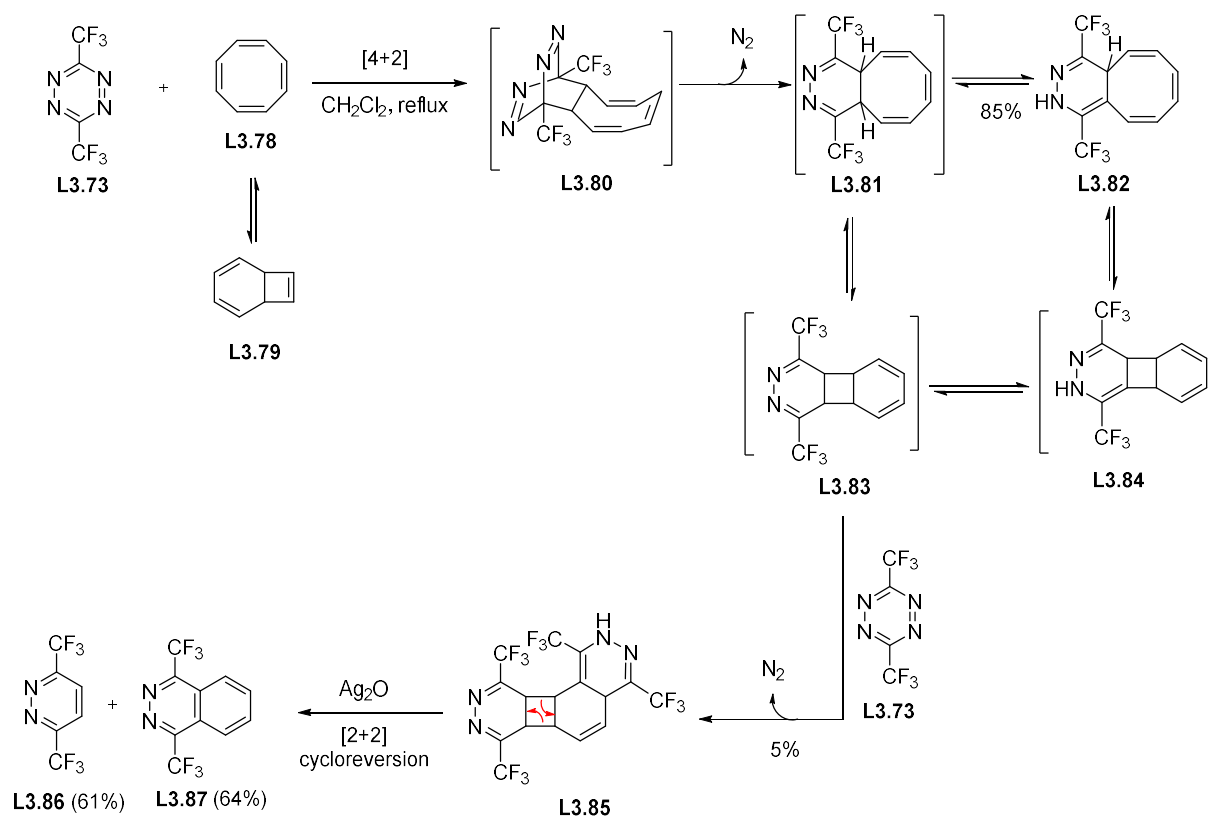

**Scheme 84**

U.; Seitz, G. *Arch. Pharm.* **1993**, *326*, 29–32; j) Frenzen, G.; Massa, W.; Reimers, U.; Seitz, G. *Chem. Ber.* **1993**, *126*, 441–445; k) Baumann, L.; Folkerts, A.; Imming, P.; Klindert, T.; Massa, W.; Seitz, G.; Wocadlo, S. *Liebigs Ann.* **1995**, 661–666; l) Klindert, T.; Seitz, G. *Synth. Comm.* **1996**, *26*, 2587–2596; m) Klindert, T.; Stroetmann, I.; Seitz, G.; Hofner, G.; Wanner, K. T.; Frenzen, G.; Eckhoff, B. *Arch. Pharm. Pharm. Med. Chem.* **1997**, *330*, 163–168; n) Klindert, T.; Von Hagel, P.; Baumann, L.; Seitz, G. *J. Prakt. Chem.* **1997**, *339*, 623–632.

Another example of a Diels-Alder reaction with inverse electron demand was reported, using the valence tautomeric dienophile e.g. cycloheptatriene **L3.88**/norcaradiene **L3.89** (Scheme 85). Although cycloheptatriene **L3.88** is the thermodynamically more stable system, when the molecule is substituted by an electron-withdrawing group the equilibrium is shifted towards norcaradiene **L3.89**.

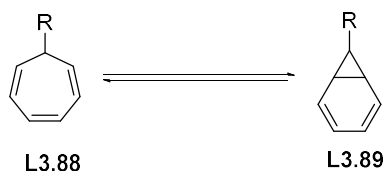

Scheme 85

Therefore, when R is an electron-withdrawing group such as a cyano group or an ester group, the equilibrium is shifted towards the bicyclic tautomer **L3.89**. When tetrazine **L3.73** reacted with norcaradiene **L3.89**, and after the release of N<sub>2</sub>, compounds **L3.91** were formed *via* intermediate **L3.90**. The tricyclic compound **L3.91** was quickly tautomerized to the more stable **L3.92** which, after oxidation, led to the desired pyridazines **L3.93** (Scheme 86).<sup>105e</sup>

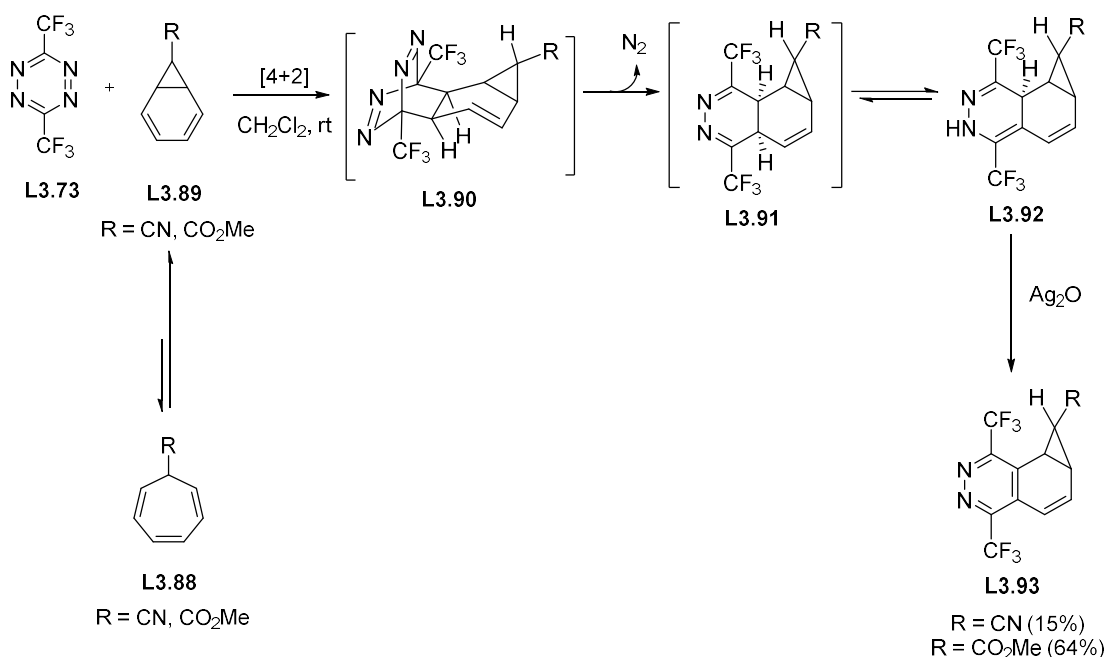

Scheme 86

However, when R is an electron-donating group, both cycloheptatriene **L3.88** and norcaradiene **L3.89** reacted with tetrazine **L3.73** to form the corresponding pyridazines **L3.96** as the major product (29%–67%) and **L3.97** as the minor product (2%–22%) (Scheme 87).<sup>105e</sup>



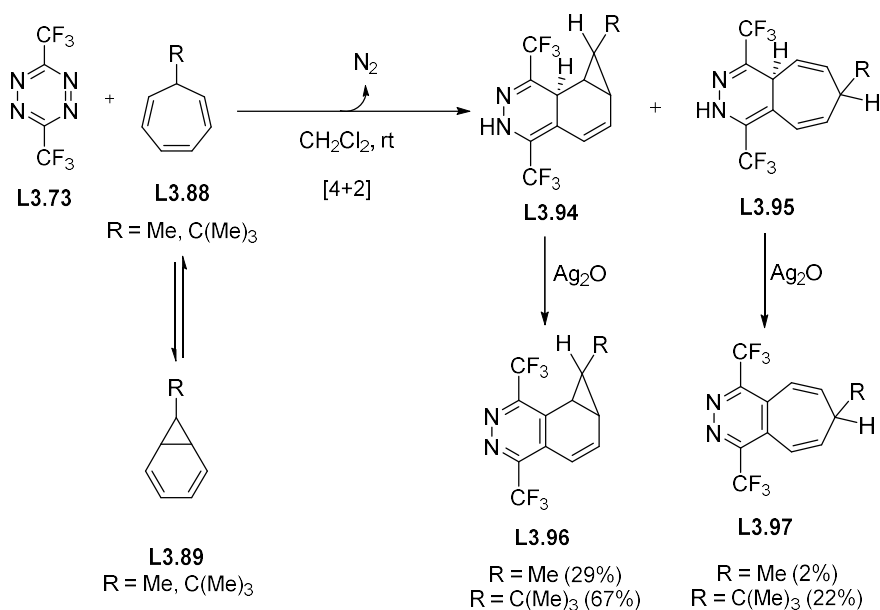

**Scheme 87**

Haider *et al.*,<sup>106</sup> worked on the synthesis of bis-(trifluoromethyl)pyridazine derivatives by an inverse electron-demand (LUMO<sub>diene</sub>-controlled) Diels-Alder reaction. In 1994, these authors reported the synthesis of the tricyclic (trifluoromethyl)pyridazine derivative **L3.100**, starting from an indole derivative and tetrazine **L3.73**. More specifically, when indole **L3.98**, possessing a leaving group at the C3 position, reacted with tetrazine **L3.73**, intermediate **L3.99** was formed and after aromatization by elimination of MeSH, bis-(trifluoromethyl)pyridazine **L3.100** was isolated in 58% yield. It is interesting to mention that when the *N*-protected indole **L3.101** (obtained after treatment of indole **L3.98** with *n*-BuLi and mesyl chloride), was treated with tetrazine **L3.73**, the cycloaddition reaction failed and **L3.102** was not formed (Scheme 88).

<sup>106</sup> Haider, N.; Wanko, R. *Heterocycles* **1994**, *38*, 1805–1811.

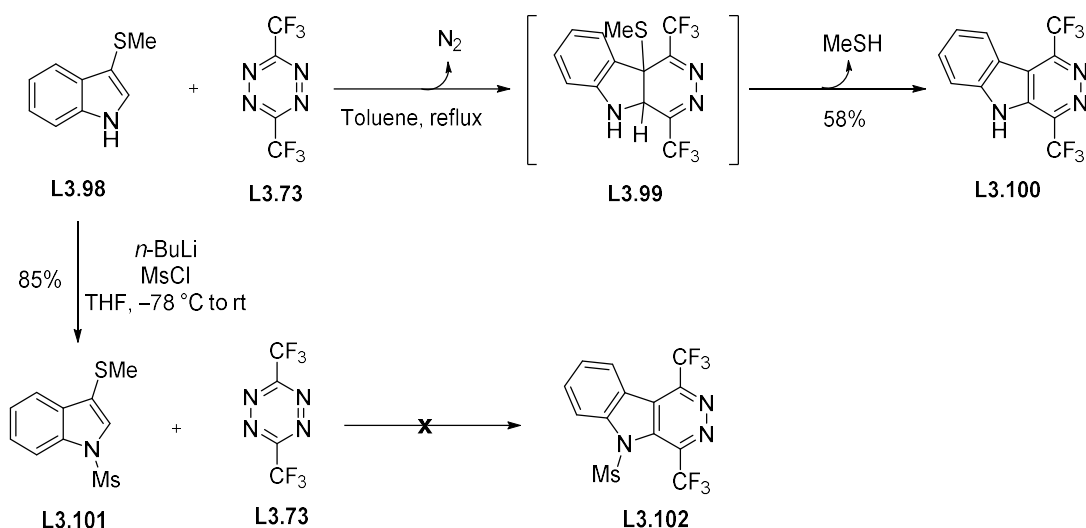

Scheme 88

However, when indole **L3.103**, possessing a *N*-mesyl group, without a leaving group at the C3 position, was treated in refluxing toluene, a ring-opening took place slowly to produce the substituted bis-(trifluoromethyl)pyridazine **L3.105** instead of the expected aromatization compound **L3.102**, showing that, in this case the ring-opening step is more favorable than the aromatization of the indole as **L3.102** was not formed (Scheme 89).<sup>106</sup>

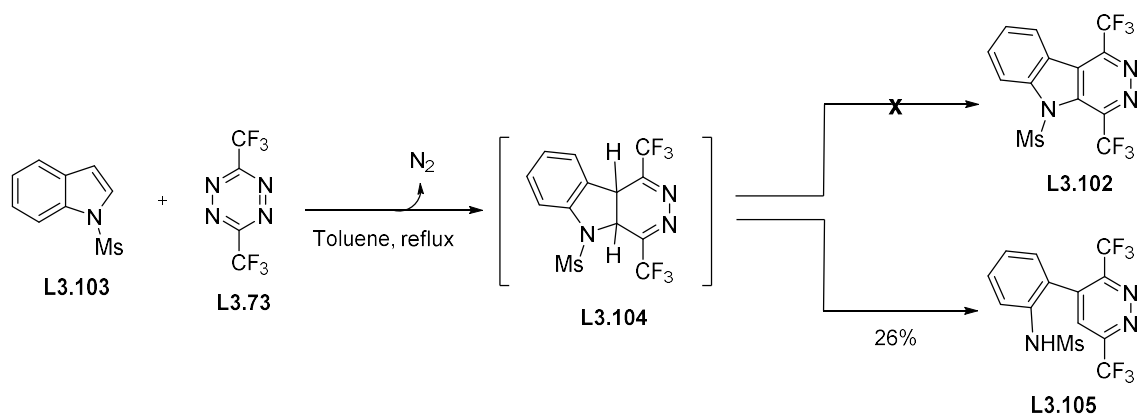

Scheme 89

An unexpected double inverse electron demand Diels-Alder reaction was reported in 1999, when dienamine **L3.106** reacted with 2.0 equiv of tetrazine **L3.73**, as two unexpected monocyclic cycloadducts, **L3.107** and **L3.108** were obtained in 38% and 44% yield respectively (Scheme 90).<sup>107</sup>

<sup>107</sup> Kotschy, A.; Novak, Z.; Vincze, Z.; Smith, D. M.; Hajos, G. *Tetrahedron Lett.* **1999**, *40*, 6313–6316.

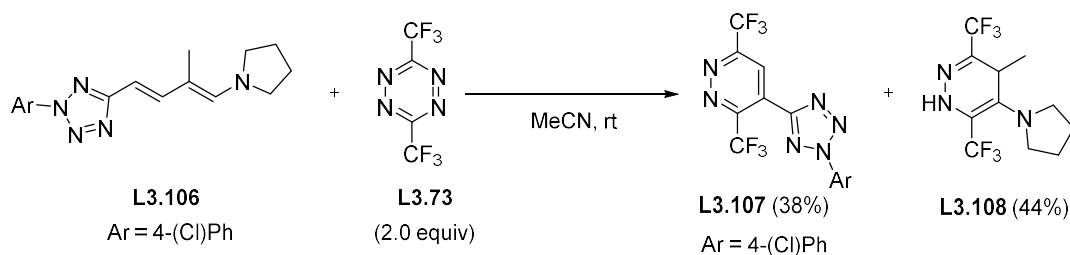

**Scheme 90**

It is worth mentioning that 2.0 equiv of tetrazine **L3.73** were necessary for the consumption of dienamine **L3.106**. Therefore, according to the authors, as one of the two double bonds of dienamine **L3.106** is trisubstituted, tetrazine **L3.73** reacted only with the disubstituted double bond to form intermediate **L3.110**, while intermediate **L3.109** was not formed. Reaction of the remaining enamine in **L3.110** with a second equivalent of tetrazine **L3.73**, led to the bis-dihydropyridazine intermediate **L3.111** which after disproportionation gave pyridazine derivatives **L3.107** and **L3.108** (Scheme 91).<sup>107</sup>

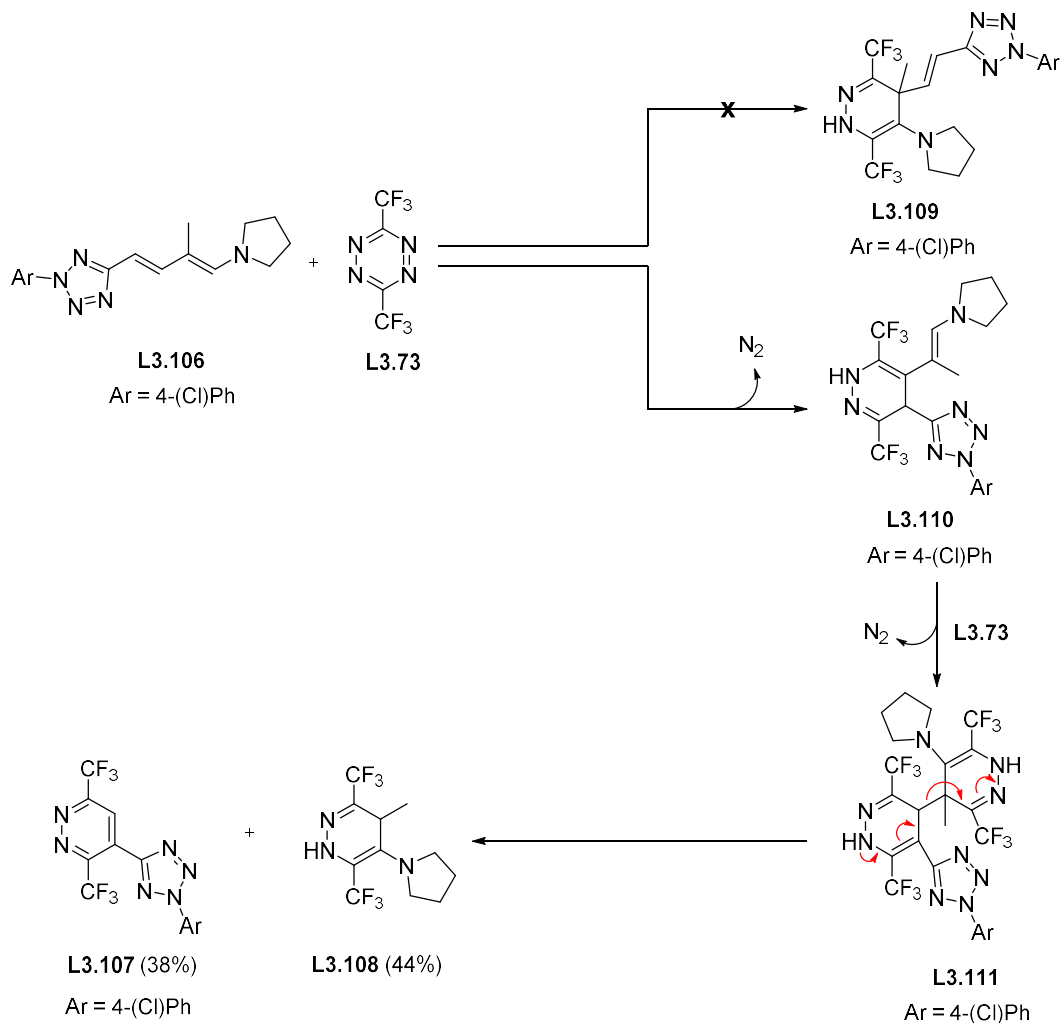

**Scheme 91**

Over the years, the Diels-Alder reaction with inverse electron demand, has found application in the synthesis of substituted pyridazines and derivatives, which could act as a bioisoster of other heteroaromatic rings.

For example, the group of Seitz, has envisioned to replace the pyridine ring of (-)-anabasine, which is a tobacco alkaloid with potential agonist activity towards nicotinic acetylcholine receptors, by a bis-(trifluoromethyl)pyridazine to access compound **L3.115** and study its biological activity. Consequently, enol ether **L3.112** was used as an electron-rich dienophile which reacted with tetrazine **L3.73** to form the Diels-Alder intermediate **L3.113**. After elimination of N<sub>2</sub> and methanol, pyridazine derivative **L3.114** was formed and after deprotection of the amine (TFA, CH<sub>2</sub>Cl<sub>2</sub>), the desired enantioenriched compound **L3.115** was isolated in 84% yield (Scheme 92).<sup>108</sup>

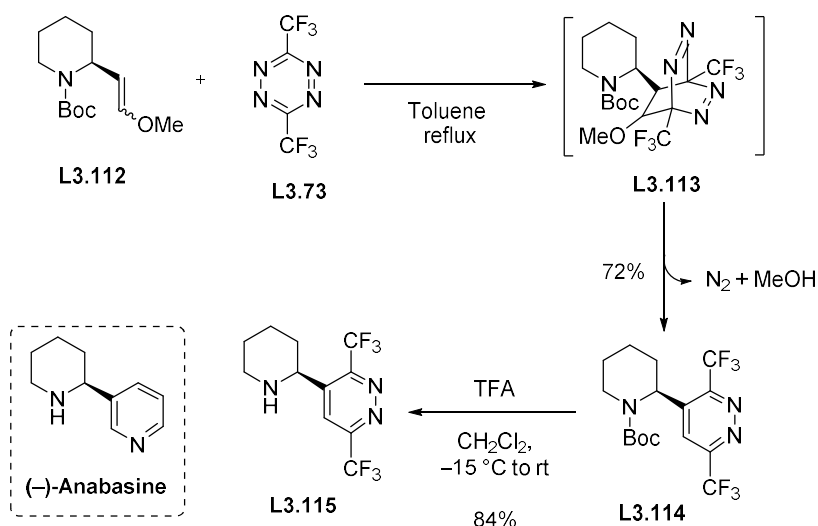

**Scheme 92**

Similarly, the replacement of the 1-chloropyridine substituent of epibatidine, an analgesic agent, by a bis-(trifluoromethyl)pyridazine moiety was envisioned, to access the pyridazine-containing compound **L3.118**. The Diels-Alder reaction between the electron-rich dienophile **L3.116** and the electron-poor diene **L3.73**, gave cycloadduct **L3.117** in 88% yield according to a mechanism similar to the one reported in Scheme 92. Deprotection of the amine using trimethylsilyl iodide and methanol, afforded compound **L3.118** (Scheme 93).<sup>109</sup>

<sup>108</sup> Stahl, A.; Seitz, G.; Schulz, K. *Tetrahedron* **2002**, *58*, 1343–1354.

<sup>109</sup> Che, D.; Wegge, T.; Stubbs, M. T.; Seitz, G.; Meier, H.; Methfessel, C. *J. Med. Chem.* **2001**, *44*, 47–57.

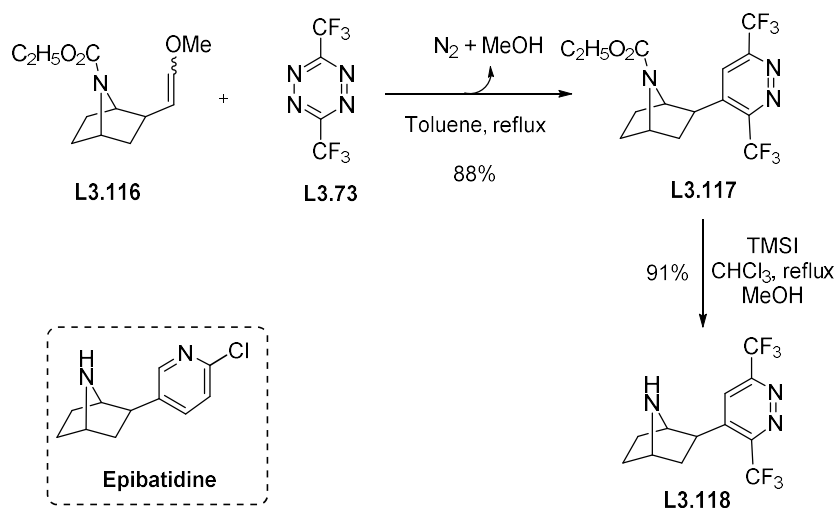

**Scheme 93**

Norferruginine is another potent agonist of nicotinic acetylcholine receptors which could be used potentially for the treatment of several central nervous system diseases. A series of compounds, bioisoteric of norferruginine, were therefore synthesized and studied, and the bis-(trifluoromethyl)pyridazine derivative **L3.123** was one of them. After treatment of tropanone **L3.119** with morpholine and *p*-toluenesulfonic acid, enamine **L3.120** was obtained. The enamine **L3.120** underwent a successful Diels-Alder reaction with inverse electron demand in the presence of tetrazine **L3.73**, to afford the polycyclic compound **L3.121** in 93% yield. Further treatment of **L3.121** with *p*-toluenesulfonic acid, led to an aromatization step and to compound **L3.122**, which could then be deprotected to access bis-(trifluoromethyl)pyridazine derivative **L3.123** (Scheme 94).<sup>110</sup>

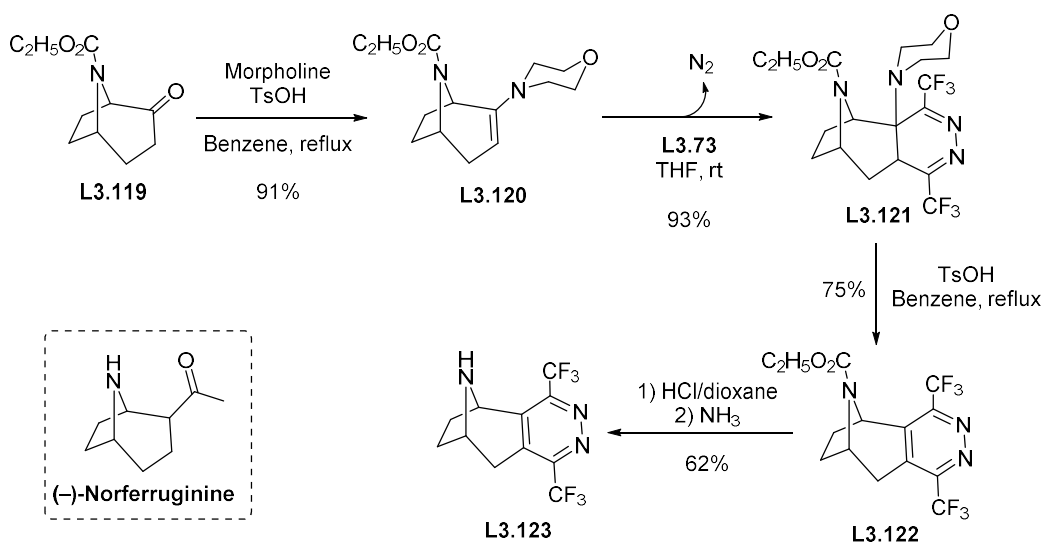

**Scheme 94**

<sup>110</sup> Gündisch, D.; Kämpchen, T.; Schwarz, S.; Seitz, G.; Siegl, J.; Wegge, T. *Bioorg. Med. Chem.* **2002**, *10*, 1–9.

Furocoumarins are photoreactive molecules that can covalently link to DNA. Cross-linking problems are common during the furocoumarins mode of action, and could be limited and eventually eliminated by the insertion of nitrogen-containing rings in the furocoumarin system, that would improve the interactions with DNA. Therefore, the group of Uriarte,<sup>111</sup> reported the synthesis of bis-(trifluoromethyl)pyridazine-containing furocoumarins, which could eventually limit cross-linking problems. For example **L3.127** can be obtained by an inverse electron demand Diels-Alder reaction between tetrazine **L3.73** and the enolized form of furocoumarin **L3.124**, **L3.125**. The reaction proceeded smoothly, to afford after elimination of H<sub>2</sub>O and N<sub>2</sub>, the desired polycyclic compound **L3.127** in 54% yield (Scheme 95).<sup>111b</sup>

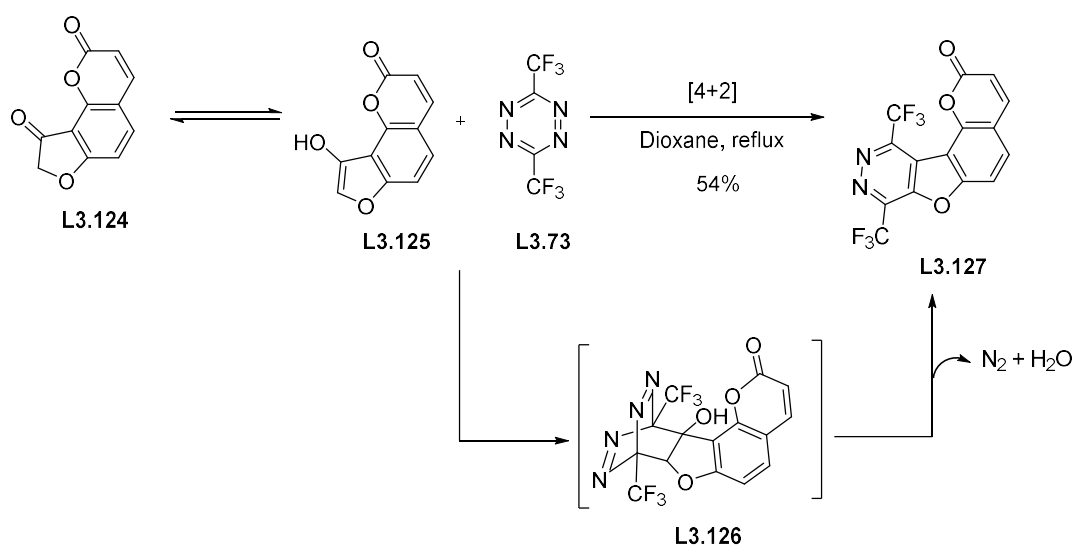

Scheme 95

Therefore, the Diels-Alder reaction with inverse electron demand of the electron-poor tetrazine **L3.73** with a variety of electron-rich dienophiles, constitutes an important method to access pyridazines substituted by two CF<sub>3</sub> groups at the α position of each nitrogen.

<sup>111</sup> a) Gonzalez-Gomez, J. C.; Dedola, T.; Santana, L.; Uriarte, E.; Begala, M.; Copez, D.; Podda, G. *J. Heterocycl. Chem.* **2000**, *37*, 907–910; b) Gonzalez-Gomez, J. C.; Santana, L.; Uriarte, E. *Synthesis* **2002**, 43–46; c) Gonzalez, J. C.; Lobo-Antunes, J.; Pérez-Lourido, P.; Santana, L.; Uriarte, E. *Synthesis* **2002**, 475–478.

## 2. Context of the study and objective

Over the years, the pyridazine core has been present in several commercial drugs and drug candidates (see Section 1.2). In addition, the biological significance of pyridazines trifluoromethylated analogues has recently become a new trend, therefore the search for new efficient methods for the synthesis of (trifluoromethyl)pyridazines has become a challenge.

Recently, a [2+1]/[3+2]-cycloaddition sequence was developed in our laboratory, involving an alkyne **L3.128**, a difluorocarbene source and a diazo compound, to access fluoropyridazines **L3.132** possessing an ester group at the C6 position. More specifically, in the presence of a difluorocarbene, alkynes **L3.128** underwent a [2+1]-cycloaddition to form 3,3-difluorocyclopropenes **L3.129**. These cyclopropenes then underwent a [3+2]-cycloaddition in the presence of an alkyl diazoacetate to afford cyclopropanopyrazolines **L3.130**. Ring-expansion of **L3.130** led to the dihydropyridazines **L3.131**, which after aromatization, afforded the desired pyridazines **L3.132** (Scheme 96).<sup>112</sup>

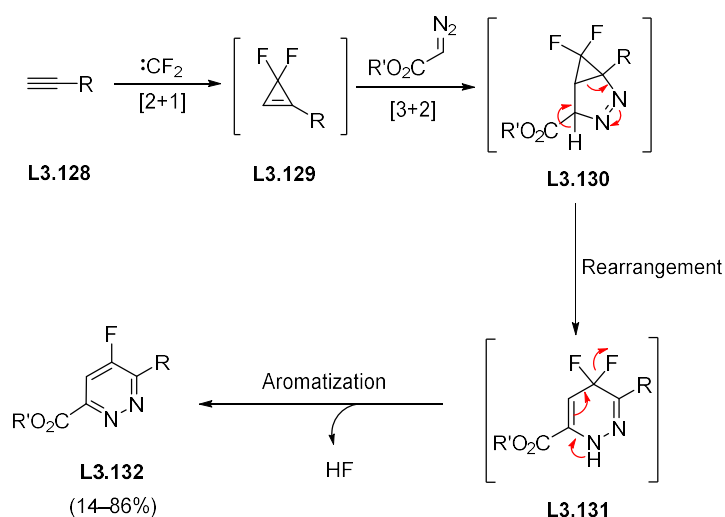

Pyridazines **L3.132** were further functionalized by a nucleophilic aromatic substitution ( $S_NAr$ ), to afford a diversity of highly substituted pyridazines **L3.133** (Scheme 97).

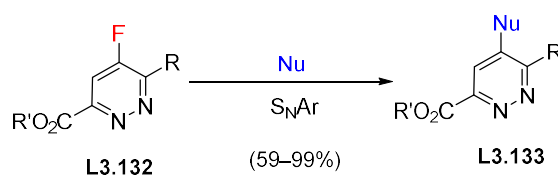

<sup>112</sup> Tran, G.; Gomez Pardo, D.; Tsuchiya, T.; Hillebrand, S.; Vors, J. -P.; Cossy, J. *Org. Lett.* **2015**, *17*, 3414–3417.

Our goal was to replace the commercially available diazoacetate compounds by the non-commercially available (trifluoromethyl)diazomethane, to access 6-(trifluoromethyl)pyridazines **O**. As this method is limited to pyridazines possessing a fluorine substituent at the C4 position, the replacement of the fluorine atom by other nucleophiles using a nucleophilic aromatic substitution ( $S_NAr$ ) was envisaged to access 3,4,6-functionalized pyridazines **P** (Scheme 98).

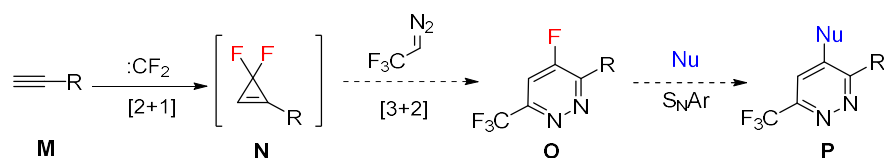

**Scheme 98**

Before the presentation of our results, we will briefly describe the properties of (trifluoromethyl)diazomethane, along with its preparation and its use in organic chemistry.

(Trifluoromethyl)diazomethane is a yellow gas, first reported by Gilman and Jones in 1943.<sup>113</sup> The boiling point of this diazo compound is 13 °C. In addition, (trifluoromethyl)diazomethane is suspected to be toxic and is considered to be an explosive molecule, with 50–100% of the energy released by the same weight of TNT.<sup>114</sup> Two resonance structures contribute to its structure and properties (Scheme 99).



**Scheme 99**

(Trifluoromethyl)diazomethane **L3.138** can be prepared by the diazotization of the commercially available 2,2,2-trifluoroethylamine hydrochloride **L3.134** with sodium nitrite ( $\text{NaNO}_2$ ) in  $\text{H}_2\text{O}$ , with or without the presence of an acid.  $\text{HNO}_2$  is the active agent formed *in situ* that carries out the diazotization. Therefore, the reaction of  $\text{HNO}_2$  with trifluoroethylamine **L3.134** leads to the *N*-nitroso intermediate **L3.135**, which after dehydration, affords the diazonium intermediate **L3.137**. Elimination of the acidic proton leads to (trifluoromethyl)diazomethane **L3.138** (Scheme 100).

<sup>113</sup> Gilman, H.; Jones, R. G. *J. Am. Chem. Soc.* **1943**, *65*, 1458–1460.

<sup>114</sup> Fields, R.; Tomlinson, J. P. *J. Fluorine Chem.* **1979**, *13*, 147–158.



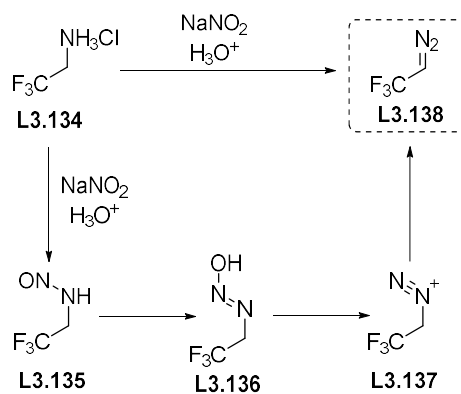

**Scheme 100**

Recently, Carreira *et al.* reported the successful formation of (trifluoromethyl)diazomethane **L3.138** from trifluoroethylamine hydrochloride **L3.134** in a mixture of CH<sub>2</sub>Cl<sub>2</sub>/H<sub>2</sub>O (30:1) (Scheme 101).<sup>115</sup>

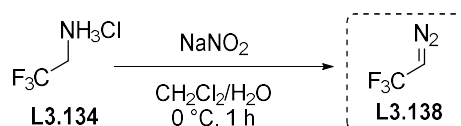

**Scheme 101**

Despite its toxicity and explosiveness, (trifluoromethyl)diazomethane **L3.138** has emerged as a useful reagent as it can be involved in:

- the cyclopropanation and cyclopropenation of alkenes and alkynes in the presence of an appropriate metal to produce respectively (trifluoromethyl)cyclopropanes and (trifluoromethyl)cyclopropenes,
- a [1,3]-dipolar cycloaddition of alkynes and alkenes, to afford (trifluoromethyl)pyrazoles and (trifluoromethyl)pyrazolines respectively,
- the homologation of aliphatic aldehydes and cyclic ketones in the presence of a Lewis Acid to access (trifluoromethyl)ketones (Scheme 102).

<sup>115</sup> Morandi, B.; Carreira, E. M. *Angew. Chem. Int. Ed.* **2011**, *50*, 9085–9088.



### 3. Results and discussion

For our part, we were interested in the synthesis of pyridazines **O**, possessing a CF<sub>3</sub> group at the C6 position. We envisaged to form these pyridazines by the [2+1]-cycloaddition of difluorocarbene with terminal alkynes **M**, followed a [3+2]-cycloaddition between the formed difluorocyclopropene intermediates **N** and (trifluoromethyl)diazomethane (Scheme 103).

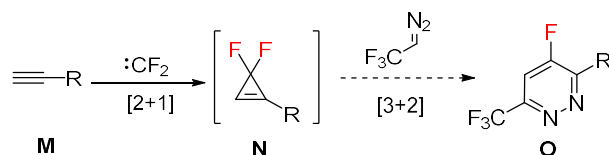

Scheme 103

We therefore initiated our study by synthesizing the starting materials e.g. different terminal alkynes, which would be used for the scope of the reaction.

#### 3.1. Synthesis of the starting materials

As most of the terminal alkynes are either very expensive or not commercially available, their preparation is necessary. Most of these alkynes were easily accessible by a Sonogashira cross-coupling reaction between an aryl halide and trimethylsilylacetylene using  $\text{PdCl}_2(\text{PPh}_3)_2$  (5–10 mol %),  $\text{CuI}$  (5–10 mol %) and  $\text{Et}_3\text{N}$  (3.0 equiv) in THF, followed by the cleavage of the trimethylsilyl group by treatment with  $\text{K}_2\text{CO}_3$  in MeOH. The results are summarized in Table 7. Terminal alkynes **6** and **7**, possessing an aromatic ring substituted by a nitro group or an ester at the *para*-position, were isolated in 76% and 57% yield respectively from the corresponding aryl iodides **1** and **2** (Table 7, entries 1 and 2). The Sonogashira cross-coupling of trimethylsilylacetylene with bromo-pyridines **3** and **4**, followed by the cleavage of the TMS group, led to the desired alkynes **8** and **9** in 61% and 53% yield respectively (Table 7, entries 3 and 4). Treatment of 5-bromo-2-methylbenzoxazole **5** with trimethylsilylacetylene under the Sonogashira cross-coupling conditions, gave the corresponding alkyne **10** in 87% yield (Table 7, entry 5).

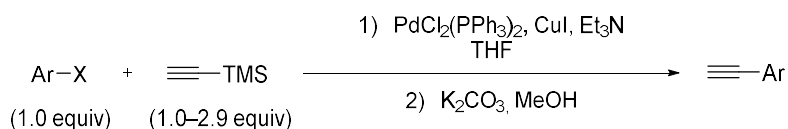

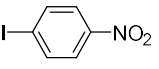
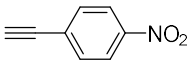
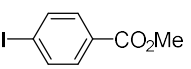
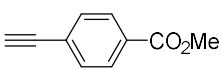
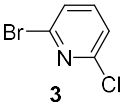
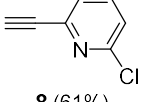
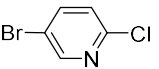
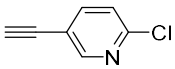
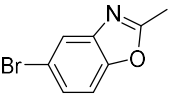
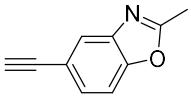
Entry	Ar-X	Conditions	≡-Ar
1	 <b>1</b>	1) PdCl <sub>2</sub> (PPh <sub>3</sub> ) <sub>2</sub> (5 mol %) CuI (5 mol %), Et <sub>3</sub> N (3.0 equiv) THF, rt, 2 h 2) K <sub>2</sub> CO <sub>3</sub> (0.1 equiv), MeOH, rt, 2 h	 <b>6</b> (76%)
2	 <b>2</b>	1) PdCl <sub>2</sub> (PPh <sub>3</sub> ) <sub>2</sub> (5 mol %) CuI (5 mol %), Et <sub>3</sub> N (3.0 equiv) THF, rt, 2 h 2) K <sub>2</sub> CO <sub>3</sub> (3.0 equiv), MeOH, rt, 1 h	 <b>7</b> (57%)
3	 <b>3</b>	1) PdCl <sub>2</sub> (PPh <sub>3</sub> ) <sub>2</sub> (5 mol %) CuI (5 mol %), Et <sub>3</sub> N (3.0 equiv) THF, rt, 2 h 2) K <sub>2</sub> CO <sub>3</sub> (0.1 equiv), MeOH, rt, 2 h	 <b>8</b> (61%)
4	 <b>4</b>	1) PdCl <sub>2</sub> (PPh <sub>3</sub> ) <sub>2</sub> (5 mol %) CuI (5 mol %), Et <sub>3</sub> N (3.0 equiv) THF, 90 °C, 2 h 2) K <sub>2</sub> CO <sub>3</sub> (0.1 equiv), MeOH, rt, 30 min	 <b>9</b> (53%)
5	 <b>5</b>	1) PdCl <sub>2</sub> (PPh <sub>3</sub> ) <sub>2</sub> (10 mol %) CuI (10 mol %), Et <sub>3</sub> N (3.0 equiv) THF, rt, 2 h 2) K <sub>2</sub> CO <sub>3</sub> (3.0 equiv), MeOH, rt, 4 h	 <b>10</b> (87%)

**Table 7**

Alkyne **12**, possessing an aryl group substituted by a phosphonate at the *para*-position, was synthesized from the aryl iodide **11**. The Sonogashira coupling of **11** with trimethylsilylacetylene, followed by a second coupling catalyzed by palladium (0) was used to introduce a diethyl phosphite substituent [Pd(PPh<sub>3</sub>)<sub>4</sub> (5 mol %), PPh<sub>3</sub> (0.5 mol %) and Et<sub>3</sub>N in toluene at 110 °C for 4 h]. After the cleavage of the TMS group (TBAF in THF at 0 °C for 2 h), the terminal alkyne **12** was isolated with an overall yield of 71% (Scheme 104).

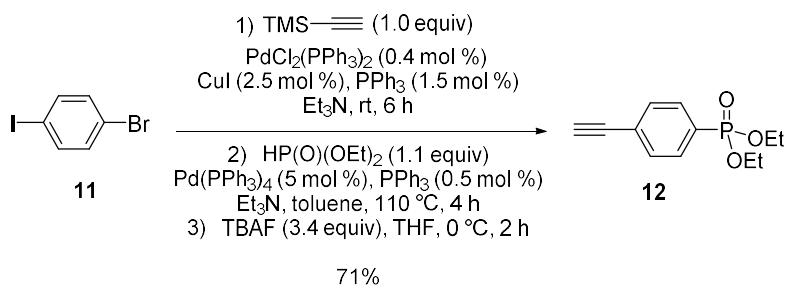

**Scheme 104**

Alkyne **14**, possessing an aromatic ring substituted by a methyl ester at the *meta*-position, was easily obtained from 3-ethynylbenzoic acid **13**. When alkyne **13** was treated with methyl iodide (1.6 equiv) in the presence of K<sub>2</sub>CO<sub>3</sub> (1.5 equiv), in DMF at rt for 16 h, alkyne **14** was isolated in 90% yield (Scheme 105).

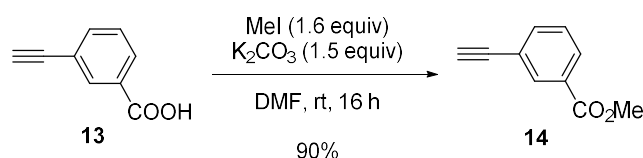

**Scheme 105**

To access propargylamino derivatives, a Mitsunobu reaction was carried out. Thus, *N*-propargyl phthalimide **17** was synthesized in 87% yield from propargylic alcohol **15** and phthalimide **16**, using PPh<sub>3</sub> and DIAD (Scheme 106).

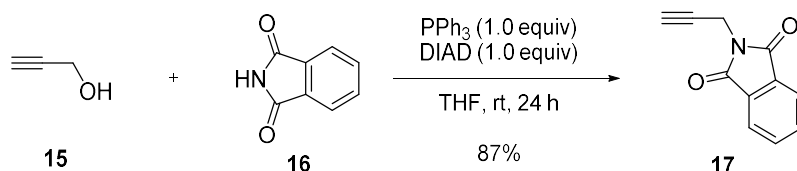

**Scheme 106**

By using the same Mitsunobu conditions (PPh<sub>3</sub>, DIAD), *N*-homopropargyl phthalimide **19** was isolated in 91% yield, starting from homopropargylic alcohol **18** and phthalimide **16**. After treatment of **19** with hydrazine (EtOH, reflux, 1 h) followed by treatment with Boc<sub>2</sub>O (2.5 equiv), DMAP (1.0 equiv) and Et<sub>3</sub>N (3.0 equiv), the protected homopropargylamine **20** was formed. Given that our goal was to obtain alkyne **21**, the monoprotected alkyne **20** was not isolated but directly treated with Boc<sub>2</sub>O in the presence of DMAP, to afford the desired alkyne **21** in 20% yield from **19** (Scheme 107).

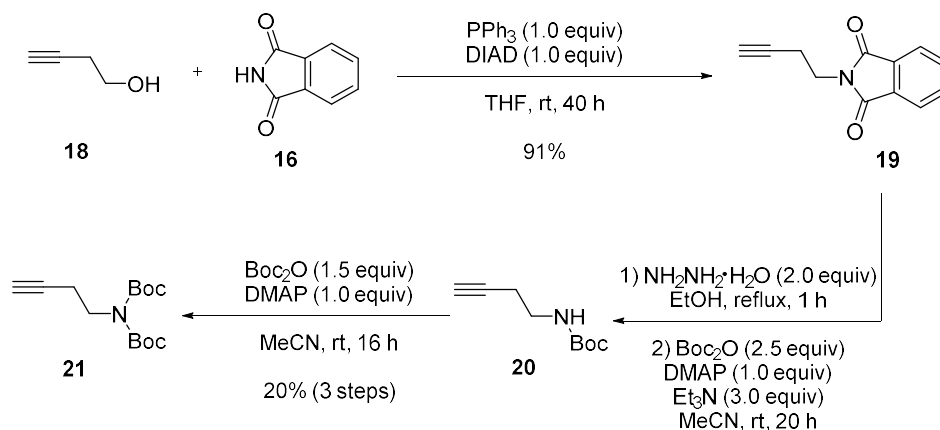

Scheme 107

## 3.2. Synthesis of $\alpha$ -(trifluoromethyl)pyridazines

### 3.2.1. Optimization of the reaction conditions

To access  $\alpha$ -(trifluoromethyl)pyridazines, the optimization of the reaction conditions was carried out with phenylacetylene **22**. To form the difluorocyclopropene **23** from **22**, the difluorocarbene was generated according to the reaction conditions reported by Hu and Prakash *et al.* (TMSCF<sub>3</sub>, NaI, THF, 110 °C, 2 h).<sup>116</sup> When the Ruppert-Prakash reagent (TMSCF<sub>3</sub>) was treated with sodium iodide, the CF<sub>3</sub> anion was generated, and under high temperature (110 °C), the difluorocarbene was formed along with a fluorine anion. A [2+1]-cycloaddition could then take place, between the difluorocarbene and phenylacetylene **22**, to produce the difluorocyclopropene **23**. This compound was not isolated, but was directly treated with (trifluoromethyl)diazomethane. This latter, was generated by using the conditions developed by Carreira *et al.*<sup>115</sup> Thus, when 2,2,2-trifluoroethylamine hydrochloride (2.05 equiv) was treated with sodium nitrite (2.4 equiv), in a mixture of 0.3 M CH<sub>2</sub>Cl<sub>2</sub>/H<sub>2</sub>O (30:1) at 0 °C for 1 h, (trifluoromethyl)diazomethane was formed. This solution was then cooled to –78 °C and transferred to the difluorocyclopropene solution. After 46 h at rt, the desired (trifluoromethyl)pyridazine **24** was obtained in 78% yield (Scheme 108).

<sup>116</sup> Wang, F.; Luo, T.; Hu, J.; Wang, Y.; Krishnan, H. S.; Jog, P. V.; Ganesh, S. K.; Prakash, G. K. S.; Olah, G. A. *Angew. Chem. Int. Ed.* **2011**, *50*, 7153–7157.

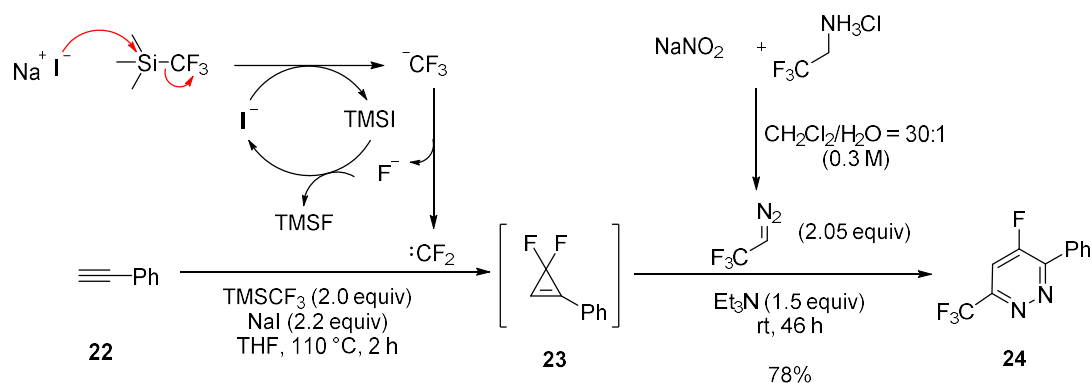

**Scheme 108**

To optimize the reaction conditions, we first decided to carry out the [3+2]-cycloaddition at 80 °C instead of rt in order to decrease the reaction time. However at 80 °C, the corresponding pyridazine **24** was only obtained in 66% yield, while the reaction time remained the same (46 h) (Table 8, entry 2 *versus* entry 1). As the yield in **24** was better at rt than at 80 °C, we then turned our attention to the influence of the concentration of the diazo compound (2.05 equiv) on the yield of **24**. Instead of 0.3 M solution, a 0.6 M solution of (trifluoromethyl)diazomethane in CH<sub>2</sub>Cl<sub>2</sub>/H<sub>2</sub>O (30:1) was used. Under these conditions, pyridazine **24** was still obtained in a moderate yield of 60% after 40 h (Table 8, entry 3). When 1.5 equiv of (trifluoromethyl)diazomethane were used instead of 2.05 equiv, at a concentration of 0.6 M in CH<sub>2</sub>Cl<sub>2</sub>/H<sub>2</sub>O (30:1), the desired compound **24** was isolated in 87% yield after 40 h at rt (Table 8, entry 4).

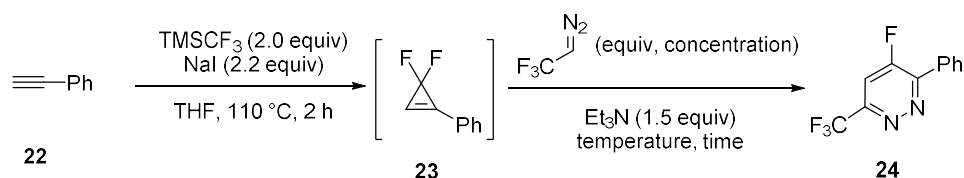

Entry	Equiv	Concentration (M)	Temperature (°C)	Time (h)	Yield (%)
1	2.05	0.3	rt	46	78
2	2.05	0.3	80	46	66
3	2.05	0.6	rt	40	60
4	1.5	0.6	rt	40	87

**Table 8**

Therefore, the best conditions to access pyridazine **24** from phenylacetylene **22** are 1.5 equiv of (trifluoromethyl)diazomethane at a concentration of 0.6 M in CH<sub>2</sub>Cl<sub>2</sub>/H<sub>2</sub>O (30:1) at rt. The desired

pyridazine **24** was isolated in 87% yield from phenylacetylene **22** after a [2+1]/[3+2]-cycloaddition sequence utilizing TMSCF<sub>3</sub> and NaI in THF at 110 °C for 2 h, followed by the addition of 0.6 M solution of (trifluoromethyl)diazomethane in CH<sub>2</sub>Cl<sub>2</sub> at rt.

### 3.2.2. Scope of the reaction

#### 3.2.2.1. Terminal alkynes substituted by an aryl group

To study the scope of the reaction, we first examined the reactivity of terminal alkynes possessing aromatic rings substituted by electron-donating groups. When alkyne **25**, possessing an aromatic group substituted by a methyl group at the *para*-position, was engaged in the cycloaddition sequence, the corresponding compound **31** was isolated in 75% yield although the reaction time was long (6 days) (Table 9, entry 2). The reaction time was increased to 3 weeks, when the terminal alkyne was substituted by an aromatic ring possessing a *p*-MeO or a *o*-MeO group, however, the cycloadducts **32** and **33** were respectively isolated in good yields of 83% and 73% (Table 9, entries 3 and 4). When the alkyne possessed a trisubstituted aryl group such as in **28**, this latter underwent the cycloaddition sequence successfully, leading to (trifluoromethyl)pyridazine **34** in 76% yield (Table 9, entry 5). It is worth noting that it took one month as well as 2.0 equiv of (trifluoromethyl)diazomethane to obtain a total conversion of the difluorocyclopropene. Nevertheless, when the same reaction was carried out at 55 °C, pyridazine **34** was obtained in 83% yield after 12 days (see footnote b). On the contrary, when 4-ethynyl-*N,N*-dimethylaniline **29** was engaged in the cycloaddition sequence, neither product **35** nor the difluorocyclopropene were observed (Table 9, entry 6). A possible explanation might be that the nucleophilic character of the dimethylaniline (pK<sub>a</sub>=5.2), can interact with the electrophilic difluorocarbene leading to the deactivation of the difluorocarbene and to the degradation of the product. Furthermore, when alkyne **30**, substituted with a methoxy naphthalene, was involved in the [2+1]/[3+2]-cycloaddition sequence, pyridazine **36** was formed in a good yield of 79% after 40 h (Table 9, entry 7).



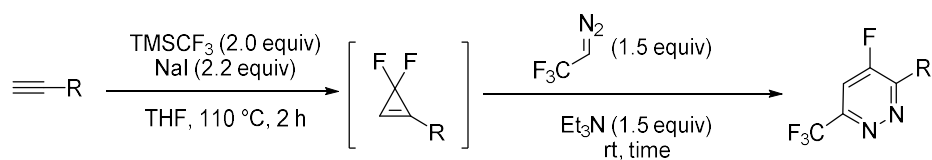

Entry	≡-R	Time	Product (%)
1		40 h	 24 (87%)
2		6 d	 31 (75%)
3		3 weeks	 32 (83%)
4		15 d	 33 (73%)
5 <sup>a,b</sup>		1 month	 34 (76%)
6		—	 35 (0%)
7		40 h	 36 (79%)

a) 2.0 equiv of (trifluoromethyl)diazomethane were necessary for a total conversion of the cyclopropene.

b) When the reaction was carried out at 55 °C, the reaction time decreased in 12 days and the product was obtained in 83% yield.

**Table 9**

The reactivity of terminal alkynes substituted by aryl groups possessing electron-withdrawing substituents was then examined. We noticed that the reaction times were in most cases shorter than the reaction times required for alkynes possessing aryl groups substituted with electron-donating

substituents. When 1-ethynyl-2-trifluoromethylbenzene **37** was treated with  $\text{TMSCF}_3/\text{NaI}$  in THF at 110 °C for 2 h, followed by the addition of (trifluoromethyl)diazomethane in  $\text{CH}_2\text{Cl}_2$ , pyridazine **41** was formed in 66% yield after 48 h (Table 10, entry 1). Alkynes **14** and **7**, possessing an ester group at the *meta*- and *para*-position of the aromatic ring respectively, were transformed to (trifluoromethyl)pyridazines **42** and **43** in good yields, 76% and 67% respectively (Table 10, entries 2 and 3). A decrease in the yield of pyridazines was observed when alkynes **12** and **6**, substituted by an aryl possessing a *p*- $\text{PO}(\text{OEt})_2$  or a *p*- $\text{NO}_2$  group underwent the [2+1]/[3+2]-cycloaddition sequence, as the corresponding pyridazines **44** and **45** were isolated in low yields, 27% and 34% respectively (Table 10, entries 4 and 5). It is worth noting that the presence of a weak electron-withdrawing substituent such as a bromine or a fluorine atom at the *para*-position of the aromatic ring, allowed an increase in the yield of pyridazines, as **46** and **47** were isolated in 85% and 57% yield respectively. However, longer reaction times of 5 to 7 days were necessary for the complete conversion of the difluorocyclopropene intermediate (Table 10, entries 6 and 7). Alkyne **40**, possessing an aromatic ring substituted by a fluorine atom and a methyl group, afforded pyridazine **48** in a very good yield of 89% after 72 h of reaction (Table 10, entry 8).

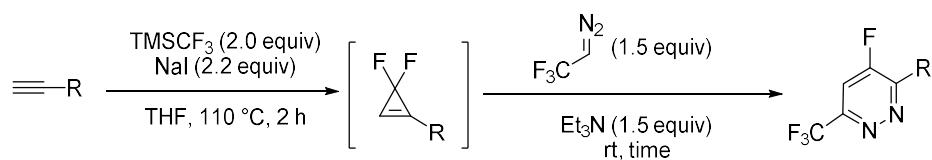

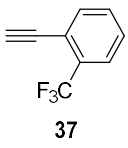
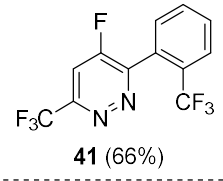
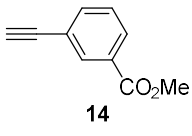
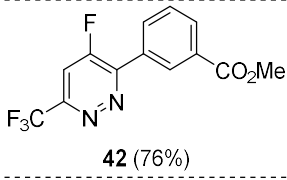
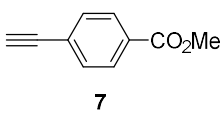
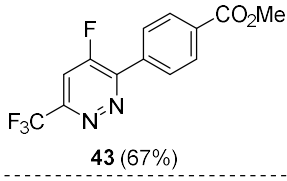
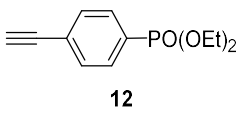
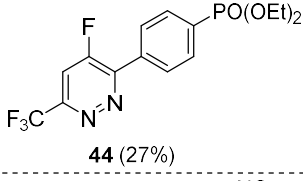
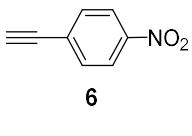
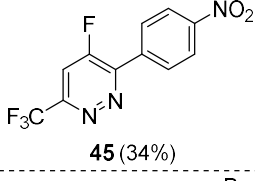
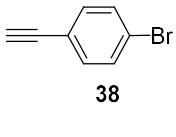
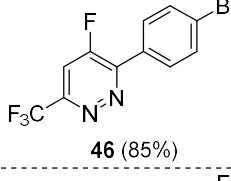
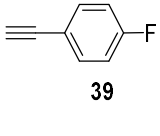
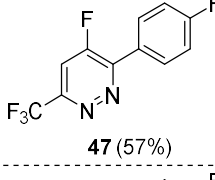
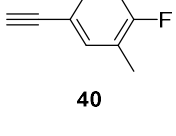
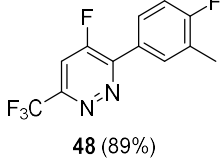
Entry	≡-R	Time	Product (%)
1		48 h	 41 (66%)
2		72 h	 42 (76%)
3		24 h	 43 (67%)
4		48 h	 44 (27%)
5 <sup>a</sup>		24 h	 45 (34%)
6		7 d	 46 (85%)
7		5 d	 47 (57%)
8		72 h	 48 (89%)

a) 2.0 more equiv of TMSCF<sub>3</sub> were necessary for a total conversion of the alkyne.

Table 10

In summary, terminal alkynes possessing aromatic rings substituted by electron-donating groups and terminal alkynes possessing aromatic rings substituted by electron-withdrawing groups, underwent the [2+1]/[3+2]-cycloaddition sequence successfully, to produce 6-(trifluoromethyl)pyridazines. In the case of alkynes possessing an aryl group substituted by electron-donating groups, long reaction times were required for the total conversion of difluorocyclopropenes to the corresponding pyridazines. In the case of alkynes possessing an aryl group substituted by an electron-withdrawing group, lower yields than those obtained with alkynes substituted by an aryl possessing electron-donating groups, were observed. The presence of electron-withdrawing substituents on the aryl group can be detrimental to the yields of difluorocyclopropenes, as these latter can be prone to a nucleophilic attack by the anions present in the reaction mixture ( $\text{CF}_3^-$  and  $\text{I}^-$ ) when treated with the Hu and Prakash conditions. To solve this problem, another source of difluorocarbene was envisaged, based on the work of Chen *et al.*<sup>117</sup> Thus,  $\text{TMSCF}_3$  was replaced by trimethylsilyl fluorosulfonyldifluoroacetate (TFDA) and  $\text{NaI}$  by a catalytic amount of  $\text{NaF}$ . After the attack of the fluorine to the trimethylsilyl group of TFDA, a difluorocarbene is formed, along with  $\text{CO}_2$ ,  $\text{SO}_2$  and fluorine. This fluorine can then attack another molecule of TFDA, in consequence a catalytic amount of  $\text{NaF}$  is necessary (Scheme 109). For the formation of the difluorocarbene using TFDA, a slow addition of this latter in the reaction media at high temperature is needed, therefore the reaction was carried out in diglyme (b.p.=162 °C) at 120 °C.

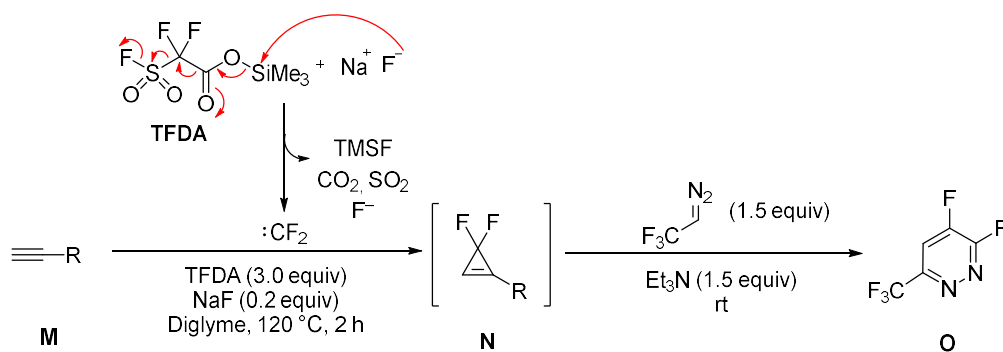

**Scheme 109**

As these conditions do not involve the presence of strong nucleophiles in the reaction mixture, terminal alkynes substituted by an aryl group possessing an electron-withdrawing substituent could lead to the corresponding pyridazines in higher yields than those obtained previously with  $\text{TMSCF}_3/\text{NaI}$  (see Table 10). However, when 1-ethynyl-2-trifluoromethylbenzene **37** was treated with TFDA, in the presence of a catalytic amount of  $\text{NaF}$  in diglyme at 120 °C, followed by the addition of (trifluoromethyl)diazomethane in  $\text{CH}_2\text{Cl}_2$ , pyridazine **41** was obtained in a lower yield of 43% than the

<sup>117</sup> a) Tian, F.; Kruger, V.; Bautista, O.; Duan, J. -X.; Li, A. -R.; Dolbier, Jr. W. R.; Chen, Q. -Y. *Org. Lett.* **2000**, *2*, 563–564; b) Xu, W.; Chen, Q. -Y. *J. Org. Chem.* **2002**, *67*, 9421–9427.

yield obtained with  $\text{TMSCF}_3/\text{NaI}$  (66%) (Table 11, entry 1). Furthermore, when treated with TFDA, alkynes **14** and **7**, led to pyridazines **42** and **43** in 76% and 68% yield, which means that no improvement in the yields was observed whatever the method used (Table 11, entries 2 and 3). Yields in **44** were similar when using  $\text{TMSCF}_3/\text{NaI}$  and TFDA/NaF as alkyne **12** was transformed to pyridazine **44** in 25% yield (*versus* 27% yield with  $\text{TMSCF}_3/\text{NaI}$ ) (Table 11, entry 4). However, when alkyne **6**, possessing an aromatic ring substituted by a *p*- $\text{NO}_2$  group, underwent the [2+1]/[3+2]-cycloaddition sequence using TFDA/NaF, pyridazine **45** was obtained in 56% yield which is higher than the 34% yield obtained with  $\text{TMSCF}_3/\text{NaI}$  (Table 11, entry 5). When alkyne **49**, substituted by an aromatic ring possessing a cyano group at the *meta*-position, was engaged in the cycloaddition sequence, the corresponding product **50** was obtained in a good yield of 60% (Table 11, entry 6). It is worth mentioning, that although in most cases the yields remained low, the reaction times were slightly improved when the TFDA/NaF procedure was used compared to the  $\text{TMSCF}_3/\text{NaI}$  procedure.

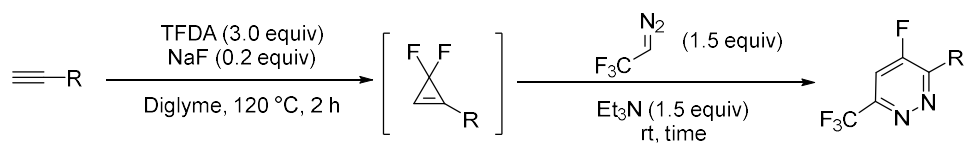

Entry	≡-R	Time	Product (%)
1		16 h	 41 (43%)
2		16 h	 42 (76%)
3 <sup>a</sup>		24 h	 43 (68%)
4 <sup>a</sup>		16 h	 44 (25%)
5		16 h	 45 (56%)
6 <sup>a</sup>		16 h	 50 (60%)

a) 2.0 more equiv of TFDA were necessary for a total conversion of the alkyne.

**Table 11**

The same observations were made when alkyne **27**, possessing an aromatic ring substituted by an electron-donating group, was submitted to the TFDA procedure. Although the corresponding pyridazine **33** was obtained in a slightly lower yield compared to the one obtained with the TMSCF<sub>3</sub> procedure (68% *versus* 73%), the reaction time was significantly improved from 15 days to 4 days (Scheme 110).

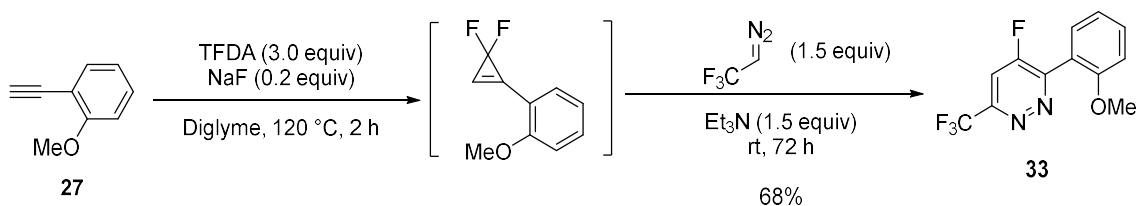

**Scheme 110**

Therefore, compared to the  $\text{TMSCF}_3/\text{NaI}$  procedure, although the TFDA procedure was not able to improve the yields in pyridazines from alkynes possessing an aryl group substituted by electron-withdrawing groups, it remains a useful method to access pyridazines from alkynes substituted by aryl groups with electron-withdrawing or electron-donating substituents, as the [2+1]/[3+2]-cycloaddition products were obtained in shorter reaction times compared to the reaction times needed for the  $\text{TMSCF}_3$  procedure.

### 3.2.2.2. Terminal alkynes substituted by heterocycles

Terminal alkynes substituted by heteroaromatic rings were also involved in the [2+1]/[3+2]-cycloaddition sequence. When 2-ethynylpyridine **51** was submitted to the  $\text{TMSCF}_3$  procedure ( $\text{TMSCF}_3/\text{NaI}$ , THF, 110 °C, 2 h), pyridazine **53** was obtained in a low yield of 12%, possibly due to the nucleophilicity of the pyridine nitrogen ( $\text{pK}_a=5.25$ ) which can react with the difluorocarbene. When the same alkyne was submitted to the TFDA procedure (TFDA/NaF, diglyme, 120 °C, 2 h), only the degradation of the starting material was observed (Table 12, entry 1). However, when 2-chloro-6-ethynylpyridine **8** was treated with the system  $\text{TMSCF}_3/\text{NaI}$ , the corresponding (trifluoromethyl)pyridazine **54** was isolated in a 25% yield, possibly due to a decrease in the nucleophilic character of the nitrogen of the pyridine. It is worth mentioning that treatment of 2-chloro-6-ethynylpyridine **8** with the TFDA/NaF system, gave pyridazine **54** in 30% yield (Table 12, entry 2). In addition, treatment of 2-chloro-5-ethynylpyridazine **9** with  $\text{TMSCF}_3/\text{NaI}$  led to the cycloaddition product **55** in 37% yield, while its treatment with TFDA/NaF led to the degradation of **9** (Table 12, entry 3). The cycloaddition sequence applied to 3-ethynylthiophene **52**, using the two procedures, led to pyridazine **56** in 76% yield when  $\text{TMSCF}_3/\text{NaI}$  was used and in 52% when TFDA/NaF was utilized (Table 12, entry 4). Treatment of alkyne **10**, substituted by a benzoxazole group, with  $\text{TMSCF}_3/\text{NaI}$ , followed by the addition of (trifluoromethyl)diazomethane in  $\text{CH}_2\text{Cl}_2$ , afforded pyridazine **57** in 75% yield (Table 12, entry 5).

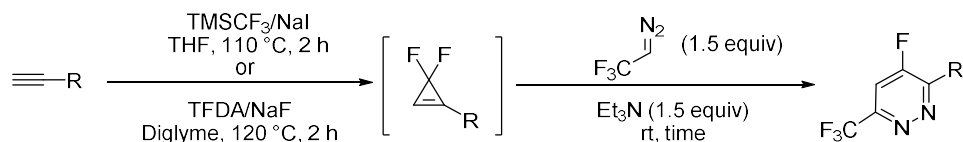

Entry	≡-R	Conditions	Time	Product (%)
1 <sup>a</sup>		TMSCF <sub>3</sub> TFDA	24 h —	 <b>53</b> (12% with TMSCF <sub>3</sub> ) (degradation with TFDA)
2 <sup>b,c</sup>		TMSCF <sub>3</sub> TFDA	40 h 16 h	 <b>54</b> (25% with TMSCF <sub>3</sub> ) (30% with TFDA)
3 <sup>d</sup>		TMSCF <sub>3</sub> TFDA	48 h —	 <b>55</b> (37% with TMSCF <sub>3</sub> ) (degradation with TFDA)
4		TMSCF <sub>3</sub> TFDA	72 h 24 h	 <b>56</b> (76% with TMSCF <sub>3</sub> ) (52% with TFDA)
5 <sup>b</sup>		TMSCF <sub>3</sub>	48 h	 <b>57</b> (75%)

a) 1.0 more equiv of TMSCF<sub>3</sub> was necessary for a total conversion of the alkyne.

b) 2.0 more equiv of TMSCF<sub>3</sub> were necessary for a total conversion of the alkyne.

c) 2.0 more equiv of TFDA were necessary for a total conversion of the alkyne.

d) 4.0 more equiv of TMSCF<sub>3</sub> were necessary for a total conversion of the alkyne.

**Table 12**

It is worth mentioning that when 2-chloro-6-ethynylpyridine **8** was treated with TMSCF<sub>3</sub>, beside pyridazine **54**, the presence of two more products was observed by GC/MS analysis, compounds **58** and **59**. Compound **58** could be the result of the deprotonation of alkyne **8** by the CF<sub>3</sub> anion generated in the reaction media followed by a trimethylsilylation of **60**. In the case of compound **59**, this latter



could be formed either by attack of the difluorocarbene on **58**, or by deprotonation of the difluorocyclopropene **61** followed by a trimethylsilylation (Scheme 111).

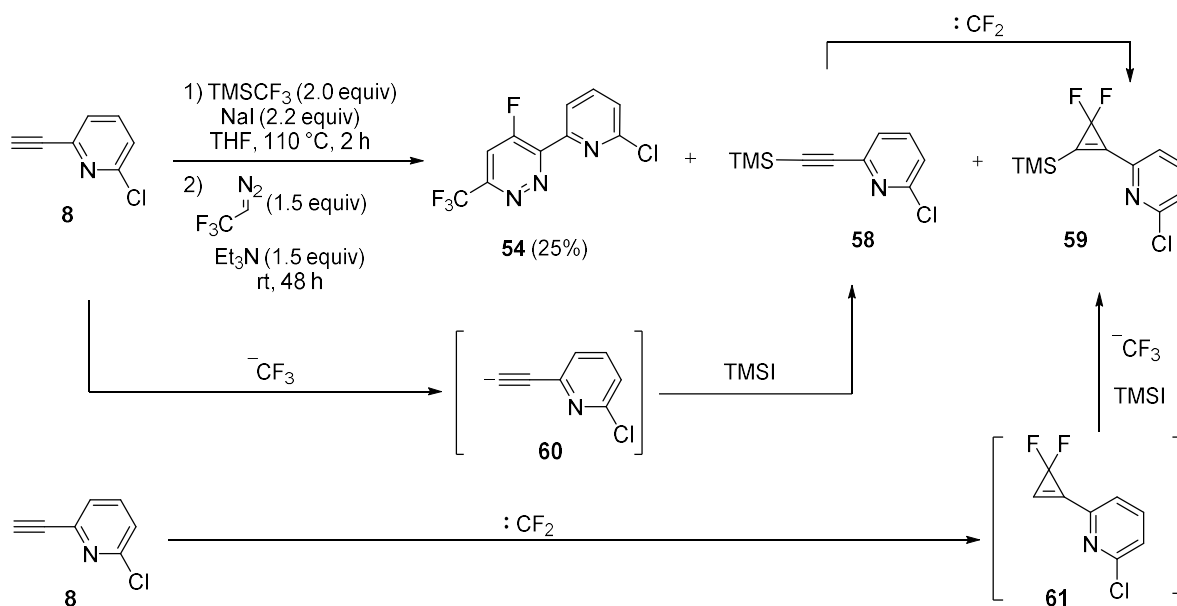

**Scheme 111**

### 3.2.2.3. Terminal alkynes substituted by alkyl groups

To further expand the scope of the reaction, terminal alkynes substituted by alkyl groups were engaged in the [2+1]/[3+2]-cycloaddition sequence. Treatment of alkynes **62–64** with  $\text{TMSCF}_3/\text{NaI}$ , followed by treatment with (trifluoromethyl)diazomethane in  $\text{CH}_2\text{Cl}_2$ , allowed the formation of the corresponding pyridazines **65–67**, although in moderate yields. For example, alkyne **62**, substituted by a cyclohexyl group, gave the desired pyridazine **65** in 38% yield after 12 days (Table 13, entry 1). Alkynes **63** and **64**, substituted by a benzyl or a methoxymethyl group, were transformed to the corresponding cycloadducts **66** and **67** in 39% and 20% yield respectively (Table 13, entries 2 and 3).

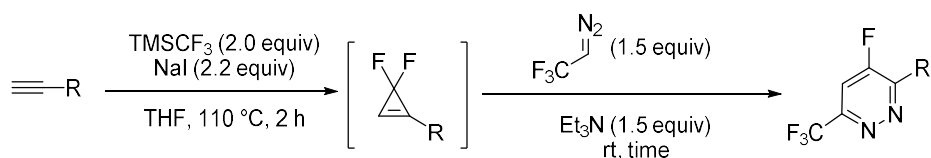

Entry	≡-R	Time	Product (%)
1	 62	12 d	 65 (38%)
2	 63	20 d	 66 (39%)
3	 64	72 h	 67 (20%)

**Table 13**

Alkynes substituted by alkyl chains with protected nitrogen groups, were also involved in the [2+1]/[3+2]-cycloaddition sequence, by using both procedures,  $\text{TMSCF}_3/\text{NaI}$  and  $\text{TFDA}/\text{NaF}$ . When *N*-propargyl phthalimide **17** was treated with  $\text{TMSCF}_3/\text{NaI}$  in THF, at 110 °C for 2 h, followed by the addition of (trifluoromethyl)diazomethane, (trifluoromethyl)pyridazine **68** was isolated in 17% yield after 48 h. The yield in **68**, as well as the reaction time were improved, when  $\text{TMSCF}_3/\text{NaI}$  was replaced by  $\text{TFDA}/\text{NaF}$ , as the (trifluoromethyl)pyridazine was isolated in 57% yield after 16 h (Table 14, entry 1). Similarly, treatment of *N*-homopropargyl phthalimide **19** with the  $\text{TMSCF}_3/\text{NaI}$  system, led to pyridazine **69** in 29% yield after 48 h, whereas treatment of **19** with the  $\text{TFDA}/\text{NaF}$  system afforded **69** in 40% yield after 16 h (Table 14, entry 2). This improvement of the reaction time when using the  $\text{TFDA}/\text{NaF}$  procedure, was also observed in the case of alkyne **21**. However, for this compound, a higher yield in pyridazine **70** was obtained with the  $\text{TMSCF}_3$  procedure than with the  $\text{TFDA}$  procedure (Table 14, entry 3).

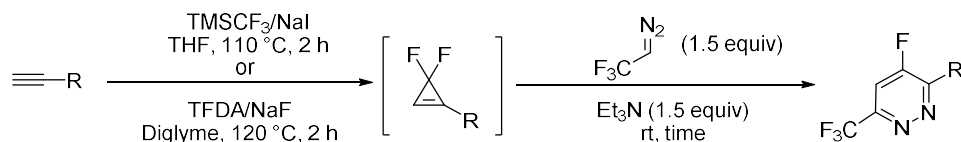

Entry	≡-R	Conditions	Time	Product (%)
1 <sup>a,b</sup>		TMSCF <sub>3</sub> TFDA	48 h 16 h	 68 (17% with TMSCF <sub>3</sub> ) (57% with TFDA)
2 <sup>a</sup>		TMSCF <sub>3</sub> TFDA	48 h 16 h	 69 (29% with TMSCF <sub>3</sub> ) (40% with TFDA)
3 <sup>c</sup>		TMSCF <sub>3</sub> TFDA	40 h 16 h	 70 (64% with TMSCF <sub>3</sub> ) (36% with TFDA)

a) 2.0 more equiv of TMSCF<sub>3</sub> were necessary for a total conversion of the alkyne.

b) 3.0 more equiv of TFDA were necessary for a total conversion of the alkyne.

c) 1.0 more equiv of TMSCF<sub>3</sub> were necessary for a total conversion of the alkyne.

**Table 14**

Thus, the reaction scope could be expanded not only to alkynes substituted by aromatic rings possessing electron-donating and electron-withdrawing groups but also to alkynes substituted by heterocycles and alkyl groups. Even though problems were encountered when a basic nitrogen is present on the heterocyclic rings, a variety of (trifluoromethyl)pyridazines were obtained, with the TMSCF<sub>3</sub>/NaI and/or the TFDA/NaF procedure.

### 3.2.3. Other fluorinated diazo compounds

To increase the diversity of substituted pyridazines possessing different fluorinated groups at the C6 position, other non-commercially available fluorinated diazo compounds were prepared and involved in the [2+1]/[3+2]-cycloaddition sequence.

When 1.5 equiv of (pentafluoroethyl)diazomethane, prepared according to the literature<sup>118</sup> from 2,2,3,3,3-pentafluoropropanamine hydrochloride and sodium nitrite (NaNO<sub>2</sub>), reacted with

<sup>118</sup> a) Mykhailiuk, P. K. *Chem. Eur. J.* **2014**, *20*, 4942–4947; b) Mykhailiuk, P. K. *Beilstein J. Org. Chem.* **2015**, *11*, 16–24; c) Mykhailiuk, P. K.; Ishchenko, A. Y.; Stepanenko, V.; Cossy, J. *Eur. J. Org. Chem.* **2016**, 5485–5493.

difluorocyclopropene **23**, the cycloaddition product **71** was isolated in 71% yield (Scheme 112). It should be mentioned that difluorocyclopropene **23** was formed after a [2+1]-cycloaddition between the difluorocarbene generated from  $\text{TMSCF}_3/\text{NaI}$  and phenylacetylene **22**.

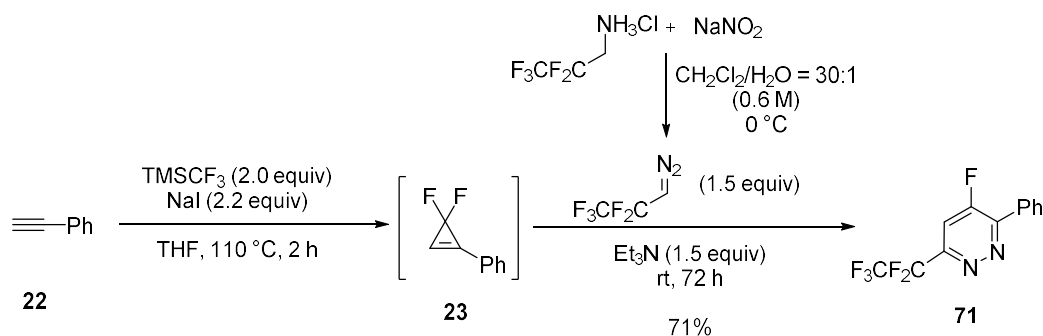

**Scheme 112**

In addition, the (difluoromethyl)diazomethane was prepared according to the literature,<sup>119</sup> starting from 2,2-difluoroethylamine and *tert*-butyl nitrite in  $\text{CH}_2\text{Cl}_2$ , in the presence of a catalytic amount of acetic acid. It is worth noting that heating the reaction mixture at 70 °C for 10 min was necessary to form the (difluoromethyl)diazomethane. When 2.0 equiv of this diazo compound were added to the difluorocyclopropene **23**, the desired pyridazine **72** was obtained in a low yield of 13% and only 65% conversion of **23** was observed after 9 days (Scheme 113).

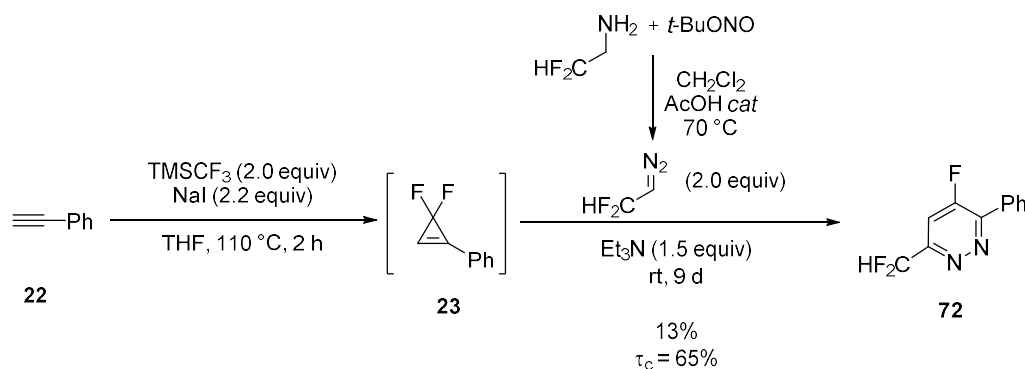

**Scheme 113**

To achieve a total conversion of **23** as well as to obtain a higher yield in **72**, 4.0 equiv of (difluoromethyl)diazomethane were necessary to carry out the [3+2]-cycloaddition. Under these conditions, the corresponding pyridazine **72** was isolated with an improved yield of 44% after 8 days (Scheme 114).

<sup>119</sup> a) Mykhailiuk, P. K. *Angew. Chem. Int.* **2015**, *54*, 6558–6561; b) Li, J.; Yu, X. -L.; Cossy, J.; Lv, S. -Y.; Zhang, H. -L.; Su, F.; Mykhailiuk, P. K.; Wu, Y. *Eur. J. Org. Chem.* **2017**, 266–270.

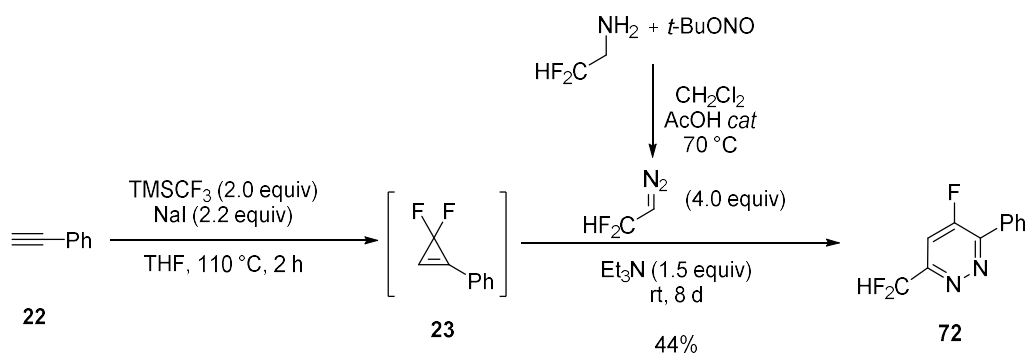

Scheme 114

In summary, the [2+1]/[3+2]-cycloaddition sequence can be carried out not only with (trifluoromethyl)diazomethane, but also with other fluorinated diazo compounds, allowing the access to a variety of fluorinated pyridazines.

### 3.3. Post-functionalization at the C4 position

$\alpha$ -(Trifluoromethyl)pyridazines **O'** were easily accessed by a [2+1]/[3+2]-cycloaddition sequence between terminal alkynes **M**, a difluorocarbene source and a diazo compound. Although this cycloaddition sequence is a convenient method to introduce a variety of substituents at the C3 and C6 position, the substituent at the C4 position remains always a fluorine atom. To access a diversity of pyridazines **P'**, functionalized at the C4 position, we took advantage of the presence of the fluorine atom to introduce other substituents. As fluoropyridazines can be ideal substrates for a nucleophilic aromatic substitution ( $S_NAr$ ), this reaction was chosen to functionalize these pyridazines at the C4 position (Scheme 115).

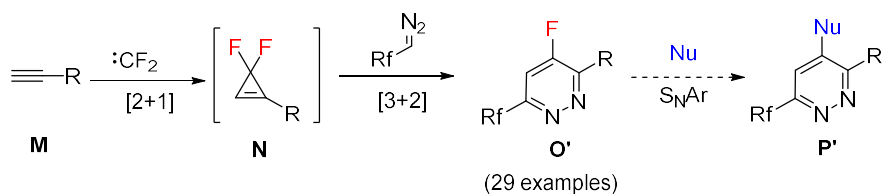

Scheme 115

#### 3.3.1. Reactivity of 4-fluoropyridazines with nucleophiles

Pyridazine **24**, substituted by a phenyl group at the C3 position, was chosen as a model substrate, to study the nucleophilic aromatic substitution. The fluorine atom can be easily replaced by different nucleophiles and the results are reported in Table 15. When pyridazine **24** reacted with a secondary amine such as morpholine or dibenzylamine in acetonitrile at 100 °C, the corresponding pyridazines **73** and **74**, were obtained in 85% and 83% yield respectively (Table 15, entries 1 and 2). When a primary amine was used as the nucleophile such as allylamine, the desired compound **75** was isolated

in a quantitative yield (Table 15, entry 3). Treatment of pyridazine **24** with sodium methoxide in acetonitrile, led to pyridazine **76** in 69% yield (Table 15, entry 4). Interestingly, pyridazine **76** was obtained in a higher yield of 76% when **24** was treated with methanol in the presence of DBU in DMSO (Table 15, entry 5). When the allyl alcohol was used as a nucleophile, the corresponding pyridazine **77** was isolated in 71% yield (Table 15, entry 6). In addition, sulfur containing nucleophiles can be used such as sodium ethanethiolate, leading to pyridazine **78** in 94% yield (Table 15, entry 7). By using carbon nucleophiles such as a malonate anion, the corresponding product **79** was obtained with an excellent yield (92%) (Table 15, entry 8) however, when a nitromethane anion or a cuprate were used, the desired pyridazines **80** and **81** were isolated in low yields of 52% and 12% respectively (Table 15, entries 9 and 10).

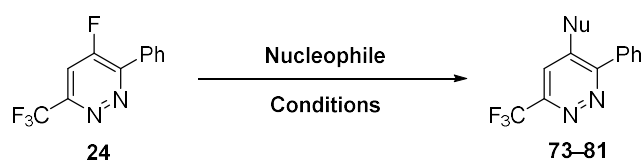

Entry	Nucleophile	Conditions	Product (%)
1	 (2.0 equiv)	MeCN, 100 °C, 3 h	 <b>73</b> (85%)
2	HNBn <sub>2</sub> (2.0 equiv)	MeCN, 100 °C, 72 h	 <b>74</b> (83%)
3	 (2.0 equiv)	MeCN, 100 °C, 4 h	 <b>75</b> (quant)
4	MeONa (3.0 equiv)	MeCN, 100 °C, 48 h	 <b>76</b> (69%)
5	MeOH (3.0 equiv)	DBU (3.0 equiv) DMSO, 80 °C, 3 h	 <b>76</b> (76%)

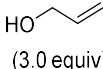
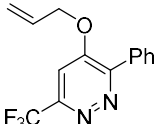
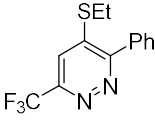
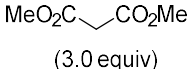
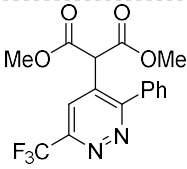
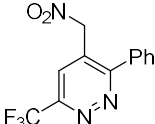
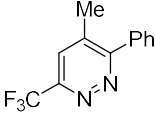
6	 (3.0 equiv)	DBU (3.0 equiv) DMSO, 80 °C, 3 h	 <b>77</b> (71%)
7	NaSEt (1.5 equiv)	MeCN, 100 °C, 4 h	 <b>78</b> (94%)
8	 (3.0 equiv)	DBU (3.0 equiv) DMSO, 80 °C, 3 h	 <b>79</b> (92%)
9	MeNO <sub>2</sub> (3.0 equiv)	DBU (3.0 equiv) DMSO, 80 °C, 3 h	 <b>80</b> (52%)
10	CuI (5.5 equiv) MeLi (10.0 equiv)	Et <sub>2</sub> O, 0 °C, 48 h	 <b>81</b> (12%)

**Table 15**

Pyridazine **24** is an excellent substrate for an S<sub>N</sub>Ar reaction, allowing the introduction of different nucleophiles such as amines, alkoxy and sulfur derivatives as well as carbanions, to access highly functionalized pyridazines.

### 3.3.2. Variation of the substituent at the C3 position

The influence of the substituent at the C3 position of the (trifluoromethyl)pyridazines was investigated on the nucleophilic aromatic substitution, using morpholine as a nucleophile. As reported previously, when pyridazine **24**, substituted by a simple phenyl group at the C3 position was treated with morpholine in acetonitrile, the S<sub>N</sub>Ar product **73** was obtained in 85% yield (Table 16, entry 1). The replacement of the phenyl ring at C3 by 4-fluorobenzene (the fluorine atom being a weak electron-withdrawing group), led to the corresponding  $\alpha$ -(trifluoromethyl)pyridazine **82** in an excellent yield (quant) (Table 16, entry 2). Treatment of pyridazine **43**, possessing an aromatic ring substituted by a *p*-CO<sub>2</sub>Me group, led to the desired compound **83** in a good yield of 82% (Table 16, entry 3). In addition, when pyridazine **32**, substituted by an aromatic ring possessing an electron-donating group at the *para*-position, was submitted to the same conditions, pyridazine **84** was isolated in a quantitative yield (Table 16, entry 4). Replacement of the *p*-OMe by *o*-OMe

substituent, induced a slight decrease of the yield as pyridazine **85** was obtained in 78% yield instead of a quantitative yield (Table 16, entry 5).

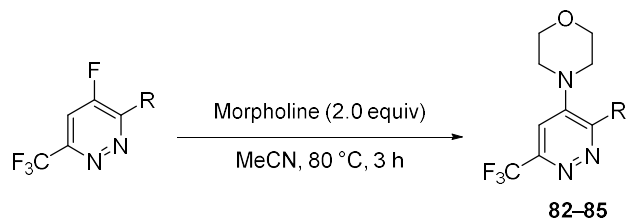

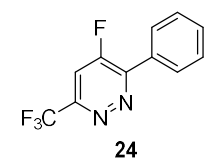
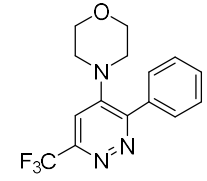
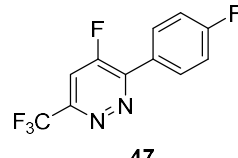
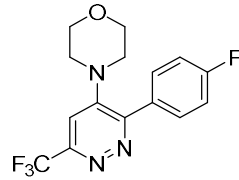
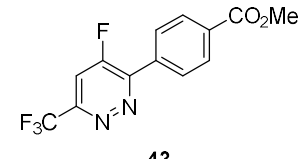
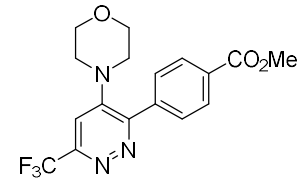
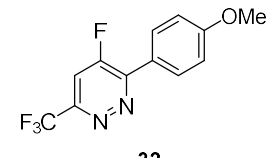
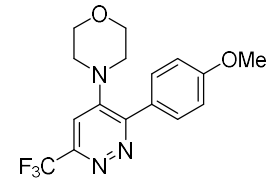
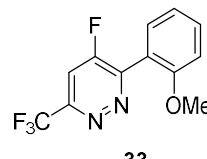
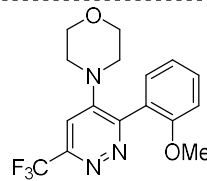
Entry	Substrate	Product (%)
1 <sup>a</sup>	 <b>24</b>	 <b>73 (85%)</b>
2	 <b>47</b>	 <b>82 (quant)</b>
3	 <b>43</b>	 <b>83 (82%)</b>
4	 <b>32</b>	 <b>84 (quant)</b>
5	 <b>33</b>	 <b>85 (78%)</b>

a) The reaction was carried out at 100 °C.

**Table 16**

From the obtained results, we notice that all the products resulting from the  $\text{S}_{\text{N}}\text{Ar}$  were obtained in very good to excellent yields independently of the nature and the position of the substituent at the C3 position of the  $\alpha$ -(trifluoromethyl)pyridazines. However, the best yields were obtained when the



aromatic ring is substituted by an electron-donating or a weak electron-withdrawing group at the *para*-position, indicating a small influence of the stereoelectronic effects of the substituents of the aromatic ring on the  $S_NAr$  reaction.

### 3.3.3. Variation of the substituent at the C6 position

The  $S_NAr$  was also carried out with 4-fluoro-pyridazines **71** and **72**, substituted by different fluorinated groups at the C6 position. When pyridazine **71**, substituted by a pentafluoroethyl group at the C6 position, was treated with allylamine and sodium ethanethiolate in acetonitrile at 100 °C, pyridazines **86** and **87** were isolated in 90% and 84% yield respectively (Scheme 116).

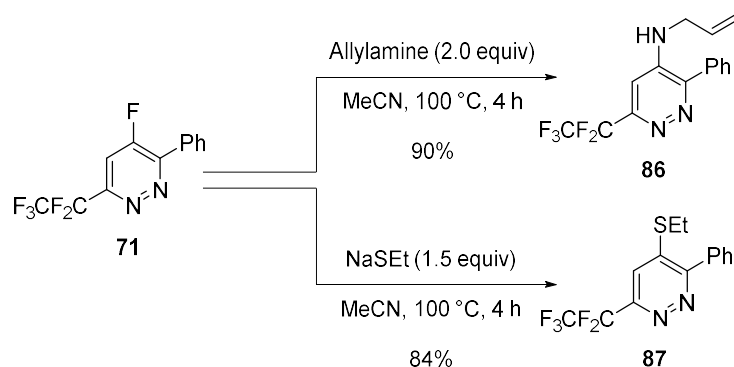

Scheme 116

The nucleophilic aromatic substitution applied to the 4-fluoro-pyridazine **72** also proceeded uneventfully when this pyridazine was treated with allylamine and sodium ethanethiolate, as the desired products **88** and **89** were obtained in very good yields of 92% and 87% respectively (Scheme 117).

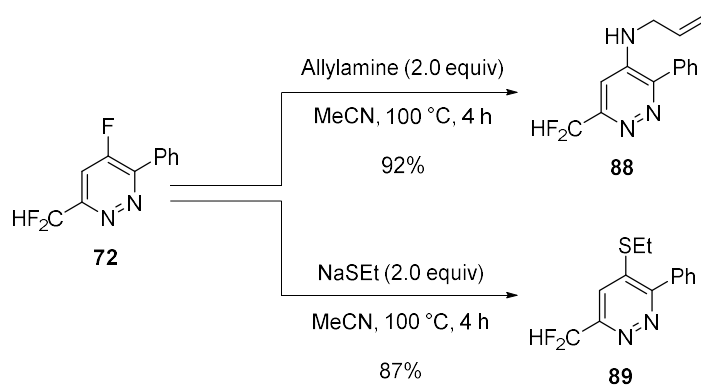

Scheme 117

## 4. Conclusion

During this work, a variety of fluorinated pyridazines **O'** were synthesized by using a [2+1]/[3+2]-cycloaddition sequence between a terminal alkyne **M**, a difluorocarbene and a diazo compound. Indeed, after the [2+1]-cycloaddition of the alkynes **M** with a difluorocarbene, the difluorocyclopropenes **N** were formed, which after a [3+2]-cycloaddition with a diazo compound afforded intermediates **Q**. After a rearrangement and an aromatization step, pyridazines **O'** were obtained in 12%–89% yield (Scheme 118).<sup>120</sup>

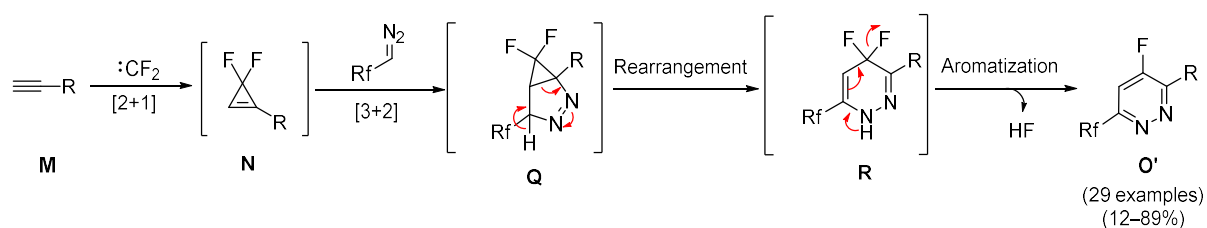

**Scheme 118**

Moreover, pyridazines **O'**, could be further functionalized by a nucleophilic aromatic substitution ( $\text{S}_{\text{N}}\text{Ar}$ ), which rapidly and efficiently led to pyridazines **P'** in 12%–99% yield, with no significant influence of the substituents at the C3 and C6 positions (Scheme 119).

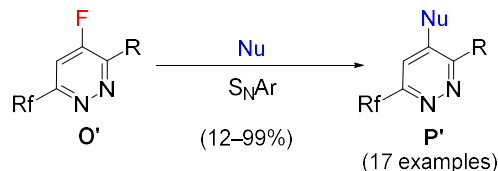

**Scheme 119**

It is worth mentioning that during my PhD, a Master student (Gregory Fredj) worked on the synthesis of pyridazines **S**, possessing a hydrogen in the place of the  $\text{CF}_3$  group. When (trifluoromethyl)diazomethane was replaced by (trimethylsilyl)diazomethane, fluoropyridazines **S** were obtained. These fluoropyridazines could also be functionalized at the C4 position, when treated with different nucleophiles, to access a variety of 3,4-substituted pyridazines **T** (Scheme 120).<sup>120</sup>

<sup>120</sup> Feraldi-Xypolia, A.; Fredj, G.; Tran, G.; Tsuchiya, T.; Vors, J. -P.; Mykhailiuk, P.; Gomez Pardo, D.; Cossy, J. *Asian J. Org. Chem.* **2017**, *6*, 927–935.

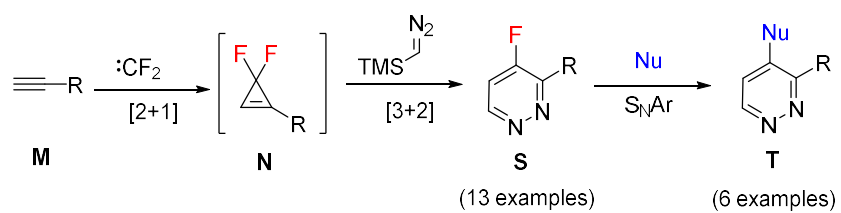

**Scheme 120**

Due to this efficient approach, a diversity of substituted 6-(trifluoromethyl)pyridazines can be obtained and can potentially lead to interesting biologically active compounds.

**CHAPTER 3**  
**Experimental Part**



# 1. General experimental methods

All reactions were carried out under an argon atmosphere unless otherwise specified. Flasks were oven-dried at 120 °C and cooled down under argon prior to use. THF and Et<sub>2</sub>O were distilled over sodium/benzophenone. Et<sub>3</sub>N, CH<sub>2</sub>Cl<sub>2</sub> and diglyme were distilled over CaH<sub>2</sub>. NaI and NaF were dried at 120 °C for 24 h and cooled down under Ar atmosphere. MeCN and DMSO were bought dry from Aldrich and used as received. All others reagents were used as obtained from Aldrich without further purification unless otherwise specified.

Purification by flash column chromatography was carried out by using silica gel (pore size 60 Å, 230 mesh). TLC were performed on silica gel plate (Merck 60F<sub>254</sub>) and visualized either with a UV lamp (254 nm) or by treatment with an aqueous potassium permanganate solution (KMnO<sub>4</sub>/K<sub>2</sub>CO<sub>3</sub>/AcOH) and subsequent heating.

Melting points (Mp) were recorded using a Wagner & Munz Kofler bench and a Büchi Melting Point M-560 apparatus with open capillaries.

<sup>1</sup>H NMR spectra were recorded on a Bruker AVANCE 400 at 400 MHz and data are reported as follows: chemical shift in ppm, with the solvent as internal standard (CDCl<sub>3</sub>, δ 7.26 ppm). The multiplicity and shape of signals are designated by the following abbreviations: s = singlet, d = doublet, t = triplet, q = quadruplet, m = multiplet, br = broad, app = apparent. Coupling constants *J* were measured in Hertz.

<sup>13</sup>C NMR spectra were recorded on a Bruker AVANCE 400 at 100 MHz and data are reported as follows: chemical shift in ppm, with the solvent as internal standard (CDCl<sub>3</sub>, δ 77.16 ppm). The multiplicity and shape of signals are designated by the following abbreviations: s = singlet, d = doublet, t = triplet, q = quadruplet, br = broad, m = multiplet. Coupling constants *J* were measured in Hertz.

Infrared (IR) were recorded with a Bruker TENSORTM 27 (IRFT), wave-numbers are indicated in cm<sup>-1</sup>.

Mass spectra with electronic impact (MS-EI) were recorded from a Shimadzu GCMS-QP 2010S.

High Resolution Mass Spectra (HRMS) were performed by the Centre Regional de Microanalyse (Université Pierre et Marie Curie, Paris VI, France).

## 2. Synthesis and experimental data of terminal alkynes

### 1-Ethynyl-4-nitrobenzene (**6**)<sup>121</sup>

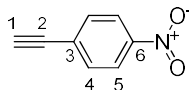

In a pressure vial were introduced the 1-iodo-4-nitrobenzene **1** (1.00 g, 4.0 mmol, 1.0 equiv), CuI (38.7 mg, 0.20 mmol, 5 mol %) and PdCl<sub>2</sub>(PPh<sub>3</sub>)<sub>2</sub> (141.5 mg, 0.20 mmol, 5 mol %). The vial was flushed with argon and dry and degassed THF (10 mL) was added, followed by Et<sub>3</sub>N (1.7 mL, 3.1 mmol, 3.0 equiv) and ethynyltrimethylsilane (0.7 mL, 4.89 mmol, 1.2 equiv). The mixture was then sealed with a teflon-lined cap and stirred at rt for 2 h. The reaction mixture was filtered over a thin bed of silica gel (AcOEt washings), then an aqueous saturated NaHCO<sub>3</sub> solution was added to the filtrate and the aqueous phase was extracted twice with AcOEt. The combined organic phases were washed with brine, dried over Na<sub>2</sub>SO<sub>4</sub> and concentrated under reduced pressure. The product was directly engaged without purification and MeOH (15 mL) and K<sub>2</sub>CO<sub>3</sub> (650 mg, 0.36 mmol, 0.1 equiv) were added. The resulting suspension was stirred under air at rt for 2 h. The reaction mixture was then concentrated under reduced pressure, an aqueous saturated NaHCO<sub>3</sub> solution was added and the aqueous phase was extracted three times with AcOEt. The combined organic phases were dried over Na<sub>2</sub>SO<sub>4</sub> and concentrated under reduced pressure. The crude mixture was purified by flash chromatography (Et<sub>2</sub>O/PE=5:95) to afford **6** (304 mg, 2.21 mmol, 76%) as a beige solid.

**Mp:** 148 °C.

**IR (neat):** 3254, 1594, 1509, 1351, 1311, 1288, 1107 cm<sup>-1</sup>.

**<sup>1</sup>H NMR (CDCl<sub>3</sub>, 400 MHz):** δ 8.20 (d, *J* = 8.9 Hz, 2H, H<sub>5</sub>), 7.64 (d, *J* = 9.0 Hz, 2H, H<sub>4</sub>), 3.36 (s, 1H, H<sub>1</sub>).

**<sup>13</sup>C NMR (CDCl<sub>3</sub>, 100 MHz):** δ 17.7 (C, C<sub>3</sub>), 133.1 (CH, C<sub>5</sub>), 129.1 (C, C<sub>6</sub>), 123.7 (CH, C<sub>4</sub>), 82.5 (C, C<sub>2</sub>), 81.6 (CH, C<sub>1</sub>).

**MS *m/z* (relative intensity):** 147 (M<sup>+</sup>, 100), 117 (52), 101 (84), 89 (41), 75 (92), 74 (32), 63 (16), 51 (43), 50 (18).

<sup>121</sup> Schmidt, B.; Riemer, M.; Schilde, U. *Eur. J. Org. Chem.* **2015**, 7602–7611.

### Methyl 4-ethynylbenzoate (**7**)<sup>122</sup>

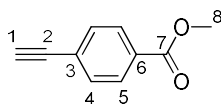

In a pressure vial were introduced the methyl 4-iodobenzoate **2** (1.36 g, 5.19 mmol, 1.0 equiv), CuI (50 mg, 0.26 mmol, 5 mol %) and PdCl<sub>2</sub>(PPh<sub>3</sub>)<sub>2</sub> (183 mg, 0.26 mmol, 5 mol %). The vial was flushed with argon and dry and degassed THF (13 mL) was added, followed by Et<sub>3</sub>N (1.6 g, 2.2 mL, 15.8 mmol, 3.0 equiv) and ethynyltrimethylsilane (621 mg, 0.9 mL, 6.32 mmol, 1.2 equiv). The mixture was then sealed with a teflon-lined cap and stirred at rt for 2 h. The reaction mixture was filtered over a thin bed of silica gel (AcOEt washings), then an aqueous saturated NaHCO<sub>3</sub> solution was added to the filtrate and the aqueous phase was extracted twice with AcOEt. The combined organic phases were washed with brine, dried over Na<sub>2</sub>SO<sub>4</sub> and concentrated under reduced pressure. The crude mixture was purified by flash chromatography (AcOEt/PE=2:98) to afford the desired product (1.20 g, 5.16 mmol, quant) as a white solid.

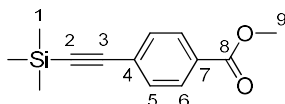

### Methyl 4-[2-(trimethylsilyl)ethynyl]benzoate<sup>122</sup>

**Mp:** 57 °C.

**IR (neat):** 2956, 1719, 1604, 1441, 1406, 1274, 1248, 1172, 1108, 1018, 840 cm<sup>-1</sup>.

**<sup>1</sup>H NMR (CDCl<sub>3</sub>, 400 MHz):** δ 7.97 (d, *J* = 8.6 Hz, 2H, H<sub>6</sub>), 7.52 (d, *J* = 8.6 Hz, 2H, H<sub>5</sub>), 3.91 (s, 3H, H<sub>9</sub>), 0.26 (s, 9H, H<sub>1</sub>).

**<sup>13</sup>C NMR (CDCl<sub>3</sub>, 100 MHz):** δ 166.7 (C, C<sub>8</sub>), 132.0 (2xCH, C<sub>6</sub>), 129.8 (C, C<sub>4</sub>), 129.5 (2xCH, C<sub>5</sub>), 127.9 (C, C<sub>7</sub>), 104.2 (C, C<sub>2</sub>), 97.8 (C, C<sub>3</sub>), 52.4 (CH<sub>3</sub>, C<sub>9</sub>), 0.0 (3xCH<sub>3</sub>, C<sub>1</sub>).

**MS *m/z* (relative intensity):** 232 (M<sup>+</sup>, 20), 218 (18), 217 (100), 201 (5), 158 (5), 143 (7), 93 (9), 86 (5), 79 (8).

To a solution of methyl 4-[2-(trimethylsilyl)ethynyl]benzoate (1.2 g, 5.16 mmol, 1.0 equiv) in MeOH (10 mL) was added K<sub>2</sub>CO<sub>3</sub> (2.1 g, 15.49 mmol, 3.0 equiv) in one portion. The resulting suspension was stirred under air at rt for 1 h. The reaction mixture was then concentrated under reduced pressure, an aqueous saturated NaHCO<sub>3</sub> solution was added and the aqueous phase was extracted three times with AcOEt. The combined organic phases were dried over Na<sub>2</sub>SO<sub>4</sub> and concentrated under reduced

<sup>122</sup> Pearson, A. J.; Kim, J. B. *Tetrahedron Lett.* **2003**, *44*, 8525–8527.



pressure. The crude mixture was purified by flash chromatography (Et<sub>2</sub>O/PE=5:95) to afford the desired product **7** (468 mg, 2.92 mmol, 57%) as a white solid.

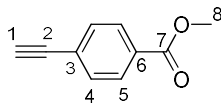

### Methyl 4-ethynylbenzoate (**7**)

**Mp:** 94 °C.

**IR (neat):** 3241, 1702, 1607, 1434, 1403, 1310, 1278, 1193, 1175, 1109, 1017, 959 cm<sup>-1</sup>.

**<sup>1</sup>H NMR (CDCl<sub>3</sub>, 400 MHz):** δ 7.99 (d, *J* = 8.7 Hz, 2H, H<sub>5</sub>), 7.55 (d, *J* = 8.6 Hz, 2H, H<sub>4</sub>), 3.92 (s, 3H, H<sub>8</sub>), 3.23 (s, 1H, H<sub>1</sub>).

**<sup>13</sup>C NMR (CDCl<sub>3</sub>, 100 MHz):** δ 166.5 (C, C<sub>7</sub>), 132.2 (2xCH, C<sub>5</sub>), 130.2 (C, C<sub>3</sub>), 129.6 (2xCH, C<sub>4</sub>), 126.9 (C, C<sub>6</sub>), 82.9 (CH, C<sub>1</sub>), 80.2 (C, C<sub>2</sub>), 52.4 (CH<sub>3</sub>, C<sub>8</sub>).

**MS *m/z* (relative intensity):** 160 (M<sup>+</sup>, 46), 130 (10), 129 (100), 101 (49), 75 (20), 74 (8), 51 (10), 50 (5).

### 2-Chloro-6-ethynylpyridine (**8**)<sup>112</sup>

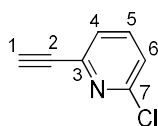

In a pressure vial were introduced 6-bromo-2-chloropyridine **3** (361 mg, 1.9 mmol, 1.0 equiv), CuI (18.1 mg, 0.09 mmol, 5 mol %) and PdCl<sub>2</sub>(PPh<sub>3</sub>)<sub>2</sub> (66.1 mg, 0.09 mmol, 5 mol %). The vial was flushed with argon and dry and degassed THF (4.4 mL) was added, followed by Et<sub>3</sub>N (0.8 mL, 5.7 mmol, 3.0 equiv) and ethynyltrimethylsilane (222 mg, 0.32 mL, 2.26 mmol, 1.2 equiv). The mixture was then sealed with a teflon-lined cap and stirred at rt for 2 h. The reaction mixture was filtered over a thin bed of silica gel (AcOEt washings), then an aqueous saturated NaHCO<sub>3</sub> solution was added to the filtrate and the aqueous phase was extracted twice with AcOEt. The combined organic phases were washed with brine, dried over Na<sub>2</sub>SO<sub>4</sub> and concentrated under reduced pressure. The crude mixture was purified by flash chromatography (AcOEt/PE=2:98) to afford the desired product (355 mg, 1.69 mmol, 90%) as a brown solid.

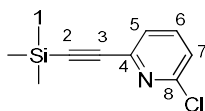

### 2-Chloro-6-[(trimethylsilyl)ethynyl]pyridine<sup>112</sup>

**Mp:** 48 °C.

**IR (neat):** 2960, 1569, 1555, 1429, 1250, 1158, 1140 cm<sup>-1</sup>.

**<sup>1</sup>H NMR (CDCl<sub>3</sub>, 400 MHz):** δ 7.60 (m, 1H, H<sub>6</sub>), 7.37 (dd, *J* = 7.6 and 0.9 Hz, 1H, H<sub>7</sub>), 7.26 (dd, *J* = 8.0 and 0.9 Hz, 1H, H<sub>5</sub>), 0.26 (s, 9H, H<sub>1</sub>).

**<sup>13</sup>C NMR (CDCl<sub>3</sub>, 100 MHz):** δ 151.3 (C, C<sub>8</sub>), 143.2 (C, C<sub>4</sub>), 138.7 (CH, C<sub>6</sub>), 126.0 (CH, C<sub>7</sub>), 124.1 (CH, C<sub>5</sub>), 102.4 (C, C<sub>3</sub>), 96.8 (C, C<sub>2</sub>), 0.29 (3xCH<sub>3</sub>, C<sub>1</sub>).

**MS *m/z* (relative intensity):** 210 (M<sup>+</sup>, 8), 208 (M<sup>+</sup>, 16), 196 (33), 194 (100), 166 (4), 164 (5), 97 (7), 79 (17), 65 (8), 63 (16).

To a solution of 2-chloro-6-[(trimethylsilyl)ethynyl]pyridine (355 mg, 1.69 mmol, 1.0 equiv) in MeOH (3.6 mL) was added K<sub>2</sub>CO<sub>3</sub> (23.7 mg, 0.17 mmol, 0.1 equiv) in one portion. The resulting suspension was stirred under air at rt for 2 h. The reaction mixture was then concentrated under reduced pressure, an aqueous saturated NaHCO<sub>3</sub> solution was added and the aqueous phase was extracted three times with AcOEt. The combined organic phases were dried over Na<sub>2</sub>SO<sub>4</sub> and concentrated under reduced pressure. The crude mixture was purified by flash chromatography (Et<sub>2</sub>O/PE=5:95) to afford **8** (159 mg, 1.16 mmol, 68%) as a white solid.

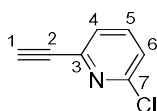

### 2-Chloro-6-pyridine (**8**)

**Mp:** 37 °C.

**IR (neat):** 3295, 1573, 1428, 1159, 1136, 987 cm<sup>-1</sup>.

**<sup>1</sup>H NMR (CDCl<sub>3</sub>, 400 MHz):** δ 7.64 (t<sub>app</sub>, *J* = 7.6 Hz, 1H, H<sub>5</sub>), 7.41 (d, *J* = 7.6 Hz, 1H, H<sub>6</sub>), 7.32 (d, *J* = 8.0 Hz, 1H, H<sub>4</sub>), 3.21 (s, 1H, H<sub>1</sub>).

**<sup>13</sup>C NMR (CDCl<sub>3</sub>, 100 MHz):** δ 151.5 (C, C<sub>7</sub>), 142.4 (C, C<sub>3</sub>), 138.9 (CH, C<sub>5</sub>), 126.1 (CH, C<sub>6</sub>), 124.6 (CH, C<sub>4</sub>), 81.6 (C, C<sub>2</sub>), 78.7 (CH, C<sub>1</sub>).

**MS *m/z* (relative intensity):** 139 (M<sup>+</sup>, 33), 137 (M<sup>+</sup>, 100), 102 (77), 74 (10), 62(4), 51 (23), 50 (24).

## 2-Chloro-5-ethynylpyridine (9)<sup>112</sup>

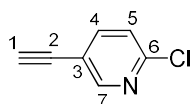

In a pressure vial were introduced 5-bromo-2-chloropyridine **4** (1.0 g, 5.2 mmol, 1.0 equiv), CuI (50 mg, 0.26 mmol, 5 mol %) and PdCl<sub>2</sub>(PPh<sub>3</sub>)<sub>2</sub> (183 mg, 0.26 mmol, 5 mol %). The vial was flushed with argon and dry and degassed THF (13 mL) was added, followed by Et<sub>3</sub>N (1.6 g, 2.2 mL, 15.8 mmol, 3.0 equiv) and ethynyltrimethylsilane (614 mg, 0.89 mL, 6.25 mmol, 1.2 equiv). The mixture was then sealed with a teflon-lined cap and heated in a Biotage Initiator microwave oven at 90 °C for 2 h. The reaction mixture was cooled down to rt, filtered over a thin bed of silica gel (AcOEt washings), then an aqueous saturated NaHCO<sub>3</sub> solution was added to the filtrate and the aqueous phase was extracted twice with AcOEt. The combined organic phases were washed with brine, dried over Na<sub>2</sub>SO<sub>4</sub> and concentrated under reduced pressure. The crude mixture was purified by flash chromatography (PE=100% and Et<sub>2</sub>O/PE=2:98) to afford the desired product (790 mg, 3.77 mmol, 72%) as a white solid.

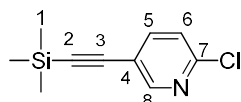

## 2-Chloro-5-[(trimethylsilyl)ethynyl]pyridine<sup>123</sup>

**Mp:** 58 °C.

**IR (neat):** 2961, 1579, 1548, 1454, 1356, 1251, 1226, 1133, 1106, 1021 cm<sup>-1</sup>.

**<sup>1</sup>H NMR (CDCl<sub>3</sub>, 400 MHz):** δ 8.18 (dd, *J* = 2.3 and 0.7 Hz, 1H, H<sub>8</sub>), 7.41 (dd, *J* = 8.3 and 2.4 Hz, 1H, H<sub>5</sub>), 6.99 (dd, *J* = 8.3 and 0.7 Hz, 1H, H<sub>6</sub>), 0.00 (s, 9H, H<sub>1</sub>).

**<sup>13</sup>C NMR (CDCl<sub>3</sub>, 100 MHz):** δ 152.1 (CH, C<sub>8</sub>), 150.3 (C, C<sub>7</sub>), 141.0 (CH, C<sub>5</sub>), 123.5 (CH, C<sub>6</sub>), 118.9 (C, C<sub>4</sub>), 99.9 (C, C<sub>2</sub> or C<sub>3</sub>), 99.3 (C, C<sub>2</sub> or C<sub>3</sub>), 0.5 (3xCH<sub>3</sub>, C<sub>1</sub>).

**MS *m/z* (relative intensity):** 211 (M<sup>+</sup>, 7), 209 (M<sup>+</sup>, 19), 196 (35), 194 (100), 166 (5), 164 (5), 89 (7), 80 (15), 63 (11).

To a solution of 2-chloro-5-[(trimethylsilyl)ethynyl]pyridine (600 mg, 2.86 mmol, 1.0 equiv) in MeOH (6 mL) was added K<sub>2</sub>CO<sub>3</sub> (39 mg, 0.29 mmol, 0.1 equiv) in one portion. The resulting suspension was stirred under air at rt for 30 min. The reaction mixture was then concentrated under reduced pressure, an aqueous saturated NaHCO<sub>3</sub> solution was added and the aqueous phase was extracted three times with AcOEt. The combined organic phases were dried over Na<sub>2</sub>SO<sub>4</sub> and concentrated

<sup>123</sup> Hapuarachchige, S.; Montano, G.; Ramesh, C.; Rodriguez, D.; Henson, L. H.; Williams, C. C.; Kadavakkollu, S.; Johnson, D. L.; Shuster, C. B.; Arterburn, J. B. *J. Am. Chem. Soc.* **2011**, *133*, 6780–6790.

under reduced pressure. The crude mixture was purified by flash chromatography (Et<sub>2</sub>O/PE=5:95) to afford the desired product **9** (290 mg, 2.11 mmol, 74%) as a white solid.

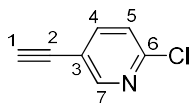

### 2-Chloro-5-ethynylpyridine (**9**)

**Mp:** 84 °C.

**IR (neat):** 3209, 1577, 1550, 1451, 1352, 1287, 1105, 1158, 1021 cm<sup>-1</sup>.

**<sup>1</sup>H NMR (CDCl<sub>3</sub>, 400 MHz):** δ 8.50 (br d, *J* = 2.3 Hz, 1H, H<sub>7</sub>), 7.72 (dd, *J* = 8.3 and 2.3 Hz, 1H, H<sub>4</sub>), 7.31 (dd, *J* = 8.3 and 0.7 Hz, 1H, H<sub>5</sub>), 3.27 (s, 1H, H<sub>1</sub>).

**<sup>13</sup>C NMR (CDCl<sub>3</sub>, 100 MHz):** δ 152.8 (CH, C<sub>7</sub>), 151.3 (C, C<sub>6</sub>), 141.6 (CH, C<sub>4</sub>), 124.0 (CH, C<sub>5</sub>), 118.3 (C, C<sub>3</sub>), 81.9 (C, C<sub>2</sub>), 79.2 (CH, C<sub>1</sub>).

**MS *m/z* (relative intensity):** 139 (M<sup>+</sup>, 32), 137 (M<sup>+</sup>, 100), 102 (62), 76 (8), 75 (28), 74 (14), 51 (10), 50 (17).

### 5-Ethynyl-2-methyl-1,3-benzoxazole (**10**)<sup>112</sup>

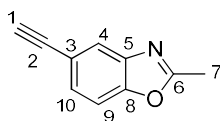

In a pressure vial were introduced 5-bromo-2-methyl-1,3-benzoxazole **5** (1.0 g, 4.72 mmol, 1.0 equiv), CuI (89.8 mg, 0.47 mmol, 10 mol %) and PdCl<sub>2</sub>(PPh<sub>3</sub>)<sub>2</sub> (331 mg, 0.47 mmol, 10 mol %). The vial was flushed with argon and dry and degassed THF (12 mL) was added, followed by Et<sub>3</sub>N (2.0 mL, 14.2 mmol, 3.0 equiv) and trimethylsilylacetylene (2.0 mL, 13.7 mmol, 2.9 equiv). The mixture was then sealed with a teflon-lined cap and stirred at rt for 2 h. The reaction mixture was filtered over a thin bed of silica gel (AcOEt washings), then an aqueous saturated NaHCO<sub>3</sub> solution was added to the filtrate and the aqueous phase was extracted twice with AcOEt. The combined organic phases were washed with brine, dried over Na<sub>2</sub>SO<sub>4</sub> and concentrated under reduced pressure. The product was directly engaged without purification and MeOH (11 mL) and K<sub>2</sub>CO<sub>3</sub> (1.96 g, 14.15 mmol, 3.0 equiv) were added. The resulting suspension was stirred under air at rt for 4 h. The reaction mixture was then concentrated under reduced pressure, an aqueous saturated NaHCO<sub>3</sub> solution was added and the aqueous phase was extracted three times with AcOEt. The combined organic phases were dried over Na<sub>2</sub>SO<sub>4</sub> and concentrated under reduced pressure. The crude product was purified by flash column chromatography (Et<sub>2</sub>O/PE=10:90) to give **10** (645 mg, 4.10 mmol, 87%) as a brown solid.

**Mp:** 71 °C.

**IR (neat):** 3291, 2108, 1623, 1575, 1469, 1428, 1382, 1260, 1180 cm<sup>-1</sup>.

**<sup>1</sup>H NMR (CDCl<sub>3</sub>, 400 MHz):** δ 7.79 (s, 1H, H<sub>4</sub>), 7.45–7.39 (m, 2H, H<sub>9</sub> and H<sub>10</sub>), 3.06 (s, 1H, H<sub>1</sub>), 2.64 (s, 3H, H<sub>7</sub>).

**<sup>13</sup>C NMR (CDCl<sub>3</sub>, 100 MHz):** δ 165.1 (C, C<sub>6</sub>), 151.3 (C, C<sub>8</sub>), 141.7 (C, C<sub>5</sub>), 129.0 (CH, C<sub>10</sub>), 123.5 (CH, C<sub>4</sub>), 118.2 (C, C<sub>3</sub>), 110.4 (CH, C<sub>9</sub>), 83.5 (CH, C<sub>1</sub>), 76.6 (C, C<sub>2</sub>), 14.6 (CH<sub>3</sub>, C<sub>7</sub>).

**MS *m/z* (relative intensity):** 157 (M<sup>+</sup>, 100), 128 (9), 116 (8), 102 (16), 88 (38), 87 (12), 79 (6), 62 (31).

#### Diethyl (4-ethynylphenyl)phosphonate (**12**)<sup>124</sup>

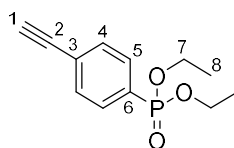

1-Bromo-4-iodobenzene **11** (2.00 g, 7.07 mmol, 1.0 equiv), CuI (34 mg, 0.18 mmol, 2.5 mol %), PdCl<sub>2</sub>(PPh<sub>3</sub>)<sub>2</sub> (20 mg, 0.028 mmol, 0.4 mol %), and PPh<sub>3</sub> (28 mg, 0.11 mmol, 1.5 mol %) were introduced in a round bottom flask, which was then flushed with argon. Et<sub>3</sub>N (23 mL) was then added, the resulting solution was stirred at rt for 10 min, and trimethylsilylacetylene (1.00 mL, 7.07 mmol, 1.0 equiv) was then added. The resulting solution was stirred at rt for 6 h, before being filtered over a glass frit. The filtrate was concentrated under reduced pressure to give a yellow oil, which was then filtered over a short pad of silica gel (PE washings). The filtrate was concentrated under reduced pressure to give the desired product (1.8 g, 7.1 mmol, quant) as a white solid.

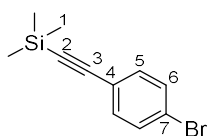

#### [(4-Bromophenyl)ethynyl]trimethylsilane<sup>125</sup>

**Mp:** 58 °C.

**IR (neat):** 2959, 1486, 1394, 1250, 1214, 1071, 1011 cm<sup>-1</sup>.

**<sup>1</sup>H NMR (CDCl<sub>3</sub>, 400 MHz):** δ 7.44–7.38 (m, 2H, H<sub>6</sub>), 7.33–7.26 (m, 2H, H<sub>5</sub>), 0.24 (s, 9H, H<sub>1</sub>).

**<sup>13</sup>C NMR (CDCl<sub>3</sub>, 100 MHz):** δ 133.5 (CH, C<sub>5</sub>), 131.6 (CH, C<sub>6</sub>), 122.9 (C, C<sub>4</sub> or C<sub>7</sub>), 122.3 (C, C<sub>4</sub> or C<sub>7</sub>), 104.0 (C, C<sub>3</sub>), 95.5 (C, C<sub>2</sub>), 0.0 (3xCH<sub>3</sub>, C<sub>1</sub>).

<sup>124</sup> Onouchi, H.; Maeda, K.; Yashima, E. *J. Am. Chem. Soc.* **2001**, *123*, 7441–7442.

<sup>125</sup> Shigeta, M.; Watanabe, J.; Konishi, G. *Tetrahedron* **2013**, *54*, 1761–1764.

**MS *m/z* (relative intensity):** 254 ( $M^{+}$ , 22), 252 ( $M^{+}$ , 22), 239 (100), 237 (100), 220 (14), 209 (5), 207 (6), 158 (4), 119 (9), 118 (9), 109 (3), 107 (4), 79 (10).

In a pressure vial were weighted [(4-bromophenyl)ethynyl]trimethylsilane (1.2 g, 4.7 mmol, 1.0 equiv), Pd(PPh<sub>3</sub>)<sub>4</sub> (274 mg, 0.24 mmol, 5 mol %) and PPh<sub>3</sub> (6.2 mg, 0.024 mmol, 0.5 mol %). The vial was flushed with argon, then dry toluene (25 mL) was added, followed by Et<sub>3</sub>N (0.72 mL, 5.2 mmol, 1.1 equiv). The vial was sealed with a teflon-lined cap, the reaction mixture was stirred at 110 °C for 5 min, then diethyl phosphite (0.78 mL, 5.7 mmol, 1.2 equiv) was added through the septum. The reaction mixture was then stirred at 110 °C for 4 h. An aqueous saturated NaHCO<sub>3</sub> solution was added to the reaction mixture, and the aqueous phase was extracted 2 times with EtOAc. The combined organic phases were dried over anhydrous Na<sub>2</sub>SO<sub>4</sub>, filtered and concentrated under reduced pressure to give a black oil. The crude mixture was purified by flash chromatography (AcOEt/PE=50:50) to give the desired product (1.19 g, 3.80 mmol, 81%) as a pale yellow oil.

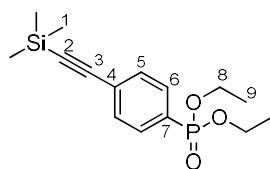

**Diethyl {4-[(trimethylsilyl)ethynyl]phenyl}phosphonate<sup>124</sup>**

**IR (neat):** 2981, 1560, 1392, 1249, 1128, 1051, 1019, 964 cm<sup>-1</sup>.

**<sup>1</sup>H NMR (CDCl<sub>3</sub>, 400 MHz):** δ 7.75–7.70 (m, 2H, H<sub>6</sub>), 7.54–7.51 (m, 2H, H<sub>5</sub>), 4.15–4.02 (m, 4H, H<sub>8</sub>), 1.30 (t, *J* = 7.1 Hz, 6H, H<sub>9</sub>), 0.25 (d, *J* = 3.4 Hz, 9H, H<sub>1</sub>).

**<sup>13</sup>C NMR (CDCl<sub>3</sub>, 100 MHz):** δ 131.9 (2xCH, d, *J* = 15.2 Hz, C<sub>5</sub>), 131.7 (2xCH, d, *J* = 10.0 Hz, C<sub>6</sub>), 128.4 (C, d, *J* = 189.0 Hz, C<sub>7</sub>), 127.4 (C, d, *J* = 3.4 Hz, C<sub>4</sub>), 104.0 (C, C<sub>3</sub>), 97.6 (C, C<sub>2</sub>), 62.3 (2xCH<sub>2</sub>, d, *J* = 5.4 Hz, C<sub>8</sub>), 16.4 (2xCH<sub>3</sub>, d, *J* = 6.4 Hz, C<sub>9</sub>), 0.0 (3xCH<sub>3</sub>, C<sub>1</sub>).

**MS *m/z* (relative intensity):** 310 ( $M^{+}$ , 21), 296 (19), 295 (100), 282 (18), 267 (28), 237 (8), 221 (36), 158 (9), 120 (15).

To a solution of diethyl {4-[(trimethylsilyl)ethynyl]phenyl}phosphonate (1.18 g, 3.8 mmol, 1.0 equiv) in THF (59 mL) was added TBAF (1.0 M in THF, 13.0 mL, 3.4 mmol, 3.4 equiv). The resulting solution was stirred at 0 °C for 2 h. This solution was then filtered over a short pad of silica gel (EtOAc washings), and the filtrate was concentrated under reduced pressure to give an orange oil. The crude mixture was purified by flash chromatography (AcOEt/PE=50:50) to afford **12** (799 mg, 3.35 mmol, 88%) as a yellow oil.

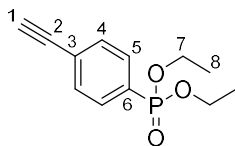

### Diethyl (4-ethynylphenyl)phosphonate (**12**)

**IR (neat):** 3200, 2983, 1560, 1392, 1240, 1125, 1049, 1016, 962  $\text{cm}^{-1}$ .

**$^1\text{H}$  NMR (400 MHz,  $\text{CDCl}_3$ ):**  $\delta$  7.80–7.74 (m, 2H,  $\text{H}_5$ ), 7.59–7.56 (m, 2H,  $\text{H}_4$ ), 4.19–4.05 (m, 4H,  $\text{H}_7$ ), 3.22 (s, 1H,  $\text{H}_1$ ), 1.32 (td,  $J = 7.1$  and  $0.6$  Hz, 6H,  $\text{H}_8$ ).

**$^{13}\text{C}$  NMR ( $\text{CDCl}_3$ , 100 MHz):**  $\delta$  132.1 (2xCH, d,  $J = 15.2$  Hz,  $\text{C}_4$ ), 131.8 (2xCH, d,  $J = 10.0$  Hz,  $\text{C}_5$ ), 129.0 (C, d,  $J = 189.1$  Hz,  $\text{C}_6$ ), 126.4 (C, d,  $J = 3.5$  Hz,  $\text{C}_3$ ), 82.7 (C, d,  $J = 1.5$  Hz,  $\text{C}_2$ ), 79.9 (CH,  $\text{C}_1$ ), 62.4 (2xCH<sub>2</sub>, d,  $J = 5.4$  Hz,  $\text{C}_7$ ), 16.4 (2xCH<sub>3</sub>, d,  $J = 6.4$  Hz,  $\text{C}_8$ ).

**MS  $m/z$  (relative intensity):** 238 ( $\text{M}^{+\bullet}$ , 23), 210 (19), 183 (13), 182 (100), 166 (31), 165 (39), 129 (46), 128 (14), 118 (43), 102 (53), 101 (37), 89 (8), 75 (27), 65 (8), 51 (12).

### Methyl 3-ethynylbenzoate (**14**)<sup>126</sup>

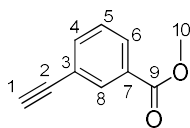

To a solution of 3-ethynylbenzoic acid **13** (927 mg, 6.34 mmol, 1.0 equiv) in DMF (30 mL), were added  $\text{K}_2\text{CO}_3$  (1.3 g, 9.41 mmol, 1.5 equiv) and MeI (1.5 g, 0.64 mL, 10.2 mmol, 1.6 equiv). The solution was stirred at rt for 16 h. The reaction mixture was then filtrated and concentrated under reduced pressure and an aqueous saturated  $\text{NaHCO}_3$  solution was added. The aqueous phase was extracted three times with  $\text{Et}_2\text{O}$ . The combined organic phases were dried over  $\text{Na}_2\text{SO}_4$  and concentrated under reduced pressure. The crude mixture was purified by flash chromatography ( $\text{Et}_2\text{O}/\text{PE}=20:80$ ) to afford **14** (910 mg, 5.68 mmol, 90%) as a yellow pale solid.

**Mp:** 54 °C.

**IR (neat):** 3255, 1714, 1598, 1581, 1482, 1432, 1293, 1273, 1195, 1100, 1079, 969  $\text{cm}^{-1}$ .

**$^1\text{H}$  NMR ( $\text{CDCl}_3$ , 400 MHz):**  $\delta$  8.14 ( $t_{\text{app}}$ ,  $J = 1.4$  Hz, 1H,  $\text{H}_8$ ), 7.98 ( $dt_{\text{app}}$ ,  $J = 7.9$  and  $1.4$  Hz, 1H,  $\text{H}_6$ ), 7.64 ( $dt_{\text{app}}$ ,  $J = 7.7$  and  $1.4$  Hz, 1H,  $\text{H}_4$ ), 7.37 ( $t_{\text{app}}$ ,  $J = 7.8$  Hz, 1H,  $\text{H}_5$ ), 3.90 (s, 3H,  $\text{H}_{10}$ ), 3.17 (s, 1H,  $\text{H}_1$ ).

**$^{13}\text{C}$  NMR ( $\text{CDCl}_3$ , 100 MHz):**  $\delta$  166.1 (C,  $\text{C}_9$ ), 136.1 (CH,  $\text{C}_4$ ), 133.1 (CH,  $\text{C}_8$ ), 130.4 (C,  $\text{C}_7$ ), 129.7 (CH,  $\text{C}_6$ ), 128.4 (CH,  $\text{C}_5$ ), 122.5 (C,  $\text{C}_3$ ), 82.5 (CH,  $\text{C}_1$ ), 78.3 (C,  $\text{C}_2$ ), 52.2 (CH<sub>3</sub>,  $\text{C}_{10}$ ).

<sup>126</sup> Gao, M.; Duan, L.; Luo, J.; Zhang, L.; Lu, X.; Zhang, Y.; Zhang, Z.; Tu, Z.; Xu, Y.; Ren, X.; Ding, K. *J. Med. Chem.* **2013**, *56*, 3281–3295.

**MS  $m/z$  (relative intensity):** 160 ( $M^{+}$ , 58), 130 (10), 129 (100), 102 (6), 101 (63), 75 (25), 74 (12), 51 (13), 50 (6).

***N*-Propargyl phthalimide (**17**)<sup>112</sup>**

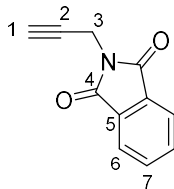

To a solution of  $PPh_3$  (3.27 g, 12.5 mmol, 1.0 equiv) and phthalimide **16** (1.84 g, 12.5 mmol, 1.0 equiv) in dry THF (63 mL) were added neat 3-propyn-1-ol **15** (0.74 mL, 12.5 mmol, 1.0 equiv), followed by neat diisopropyl azodicarboxylate (2.6 mL, 12.5 mmol, 1.0 equiv). The resulting solution was stirred at rt for 24 h. After concentration under reduced pressure, purification by flash chromatography ( $CH_2Cl_2/PE=50:50$ ) led to **17** (2.0 g, 10.8 mmol, 87%) as a white solid.

**Mp:** 150 °C.

**IR (neat):** 3293, 2966, 1770, 1706, 1470, 1429, 1396, 1353, 1327, 1190, 1120, 950  $cm^{-1}$ .

**$^1H$  NMR (400 MHz,  $CDCl_3$ ):**  $\delta$  7.90–7.88 (m, 2H,  $H_6$  or  $H_7$ ), 7.76–7.74 (m, 2H,  $H_6$  or  $H_7$ ), 4.46 (d,  $J = 2.5$  Hz, 2H,  $H_3$ ), 2.23 (t,  $J = 2.5$  Hz, 1H,  $H_1$ ).

**$^{13}C$  NMR ( $CDCl_3$ , 100 MHz):**  $\delta$  167.1 (2xC,  $C_4$ ), 134.4 (2xCH,  $C_6$  or  $C_7$ ), 132.1 (2xC,  $C_5$ ), 123.7 (2xCH,  $C_6$  or  $C_7$ ), 77.3 (C,  $C_2$ ), 71.6 (CH,  $C_1$ ), 27.1 ( $CH_2$ ,  $C_3$ ).

**MS  $m/z$  (relative intensity):** 185 ( $M^{+}$ , 100), 157 (70), 156 (26), 129 (29), 104 (33), 102 (41), 76 (63), 50 (32).

***N*-Homopropargyl phthalimide (**19**)<sup>127</sup>**

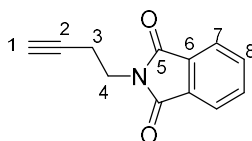

To a solution of  $PPh_3$  (5.23 g, 20.0 mmol, 1.0 equiv) and phthalimide **16** (2.94 g, 20.0 mmol, 1.0 equiv) in dry THF (100 mL) were added neat 3-butyne-1-ol **18** (1.50 mL, 20.0 mmol, 1.0 equiv), followed by neat diisopropyl azodicarboxylate (4.0 mL, 20.2 mmol, 1.0 equiv). The resulting solution was stirred at rt for 40 h. After concentration under reduced pressure, purification by flash chromatography ( $CH_2Cl_2/PE=50:50$ ) led to **19** (3.6 g, 18.1 mmol, 91%) as a white solid.

<sup>127</sup> Iyer, S.; Liebeskind, L. S. *J. Am. Chem. Soc.* **1987**, *109*, 2759–2770.



**Mp:** 136 °C.

**IR (neat):** 3251, 2924, 1765, 1698, 1468, 1427, 1399, 1370, 1336, 1248, 1190, 1115, 995, 868 cm<sup>-1</sup>.

**<sup>1</sup>H NMR (400 MHz, CDCl<sub>3</sub>):** δ 7.87–7.84 (m, 2H, H<sub>7</sub>), 7.76–7.72 (m, 2H, H<sub>8</sub>), 3.89 (t, *J* = 7.1 Hz, 2H, H<sub>4</sub>), 2.62 (td, *J* = 7.1 and 2.7 Hz, 2H, H<sub>3</sub>), 1.98 (t, *J* = 2.7 Hz, 1H, H<sub>1</sub>).

**<sup>13</sup>C NMR (CDCl<sub>3</sub>, 100 MHz):** δ 168.1 (2xC, C<sub>5</sub>), 134.1 (2xCH, C<sub>7</sub>), 132.0 (2xC, C<sub>6</sub>), 123.4 (2xCH, C<sub>8</sub>), 80.4 (C, C<sub>2</sub>), 70.4 (CH, C<sub>1</sub>), 36.6 (CH<sub>2</sub>, C<sub>4</sub>), 18.4 (CH<sub>2</sub>, C<sub>3</sub>).

**MS *m/z* (relative intensity):** 199 (M<sup>+</sup>, 28), 160 (100), 133 (21), 104 (12), 77 (20), 50 (9).

***N,N*-Bis[(*tert*-butoxy)carbonyl]-*N*-(but-3-yn-1-yl)carbamate (**21**)<sup>112</sup>**

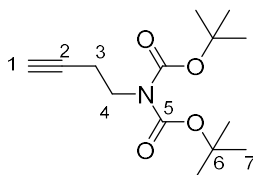

To a solution of *N*-homopropargyl phthalimide **19** (3.14 g, 15.8 mmol, 1.0 equiv) in absolute ethanol (70 mL) was added hydrazine hydrate (1.20 mL, 31.5 mmol, 2.0 equiv) and the solution was refluxed for 1 h. The resulting suspension was poured onto 20 mL of a 1 M aqueous solution of HCl, and filtered over a fritted glass. The filtrate was concentrated under reduced pressure to give a yellow solid.

This solid was suspended in MeCN (7 mL), and Boc<sub>2</sub>O (8.4 mL, 39.4 mmol, 2.5 equiv) was added, followed by Et<sub>3</sub>N (6.60 mL, 47.3 mmol, 3.0 equiv) and DMAP (1.93 g, 15.8 mmol, 1.0 equiv). The resulting suspension was stirred at rt for 20 h. An aqueous saturated solution of NaHCO<sub>3</sub> was added, followed by AcOEt. The aqueous phase was extracted twice with AcOEt. The combined organic phases were washed once with an aqueous 0.5 M HCl solution, twice with H<sub>2</sub>O, once with brine, dried over Na<sub>2</sub>SO<sub>4</sub>, and concentrated under reduced pressure to afford a white solid (1.9 g). GCMS analysis showed that the solid was not **21** but the monoprotected product **20**.

To a solution of this crude solid (1.90 g, 11.2 mmol, 1.0 equiv) in MeCN (6 mL) was added Boc<sub>2</sub>O (3.60 g, 16.9 mmol, 1.5 equiv), followed by DMAP (1.37 g, 11.2 mmol, 1.0 equiv). The resulting solution was stirred at rt for 16 h. After concentration under reduced pressure, purification by flash column chromatography on silica gel (Et<sub>2</sub>O/PE=20:80) led to **21** (840 mg, 3.11 mmol, 20% yield) as a white solid.

**Mp:** 57 °C.

**IR (neat):** 3285, 2981, 1733, 1696, 1393, 1368, 1347, 1280, 1142, 1110.

**<sup>1</sup>H NMR (CDCl<sub>3</sub>, 400 MHz):** δ 3.77 (t, *J* = 7.3 Hz, 2H, H<sub>4</sub>), 2.47 (td, *J* = 6.7 and 2.7 Hz, 2H, H<sub>3</sub>), 1.95 (td, *J* = 2.6 and 1.4 Hz, 1H, H<sub>1</sub>), 1.51 (s, 18H, H<sub>7</sub>).

**<sup>13</sup>C NMR (CDCl<sub>3</sub>, 100 MHz):** δ 152.4 (2xC, C<sub>5</sub>), 82.6 (2xC, C<sub>6</sub>), 81.2 (C, C<sub>2</sub>), 69.8 (CH, C<sub>1</sub>), 44.9 (CH<sub>2</sub>, C<sub>4</sub>), 28.2 (6xCH<sub>3</sub>, C<sub>7</sub>), 18.9 (CH<sub>2</sub>, C<sub>3</sub>).

### 3. General procedures for the [2+1]/[3+2]-cycloaddition sequence

#### Procedure A: TMSCF<sub>3</sub> as the carbene CF<sub>2</sub> source.

In an oven-dried vial were introduced NaI (2.2 equiv) and the alkyne (1.0 equiv). The vial was then flushed with argon, and THF ( $c = 0.375$  M) was added, followed by the addition of neat TMSCF<sub>3</sub> (2.0 equiv). The vial was then immersed in a pre-heated oil bath at 110 °C. Vigorous stirring was then applied for 2 h and completion of the reaction was monitored by TLC or GC/MS. If necessary, supplementary amounts of TMSCF<sub>3</sub> were added until complete consumption of the alkyne. The reaction mixture was allowed to cool down to rt and to this solution was added Et<sub>3</sub>N (1.5 equiv), followed by the addition of (trifluoromethyl)diazomethane (0.6 M in CH<sub>2</sub>Cl<sub>2</sub>, 1.5 equiv). The resulting solution was stirred at rt under argon, until complete consumption of the *gem*-difluorocyclopropene, as assessed by TLC or GC/MS. The reaction mixture was then carefully concentrated under reduced pressure and purified by flash column chromatography on silica gel.

#### Procedure B: TFDA as the carbene CF<sub>2</sub> source.

In an oven-dried vial were introduced NaF (0.2 equiv) and the alkyne (1.0 equiv). The vial was then flushed with argon and diglyme ( $c = 2.0$  M) was added. The reaction mixture was then heated in a pre-equilibrated oil bath at 120 °C and neat TFDA (3.0 equiv) was added dropwise over 1 h using a syringe pump. At the end of the addition, the reaction mixture was stirred for 1 h and completion of the reaction was assessed by TLC or GC/MS. The reaction mixture was allowed to cool down to rt and to this solution was added Et<sub>3</sub>N (1.5 equiv), followed by the addition of (trifluoromethyl)diazomethane (0.6 M in CH<sub>2</sub>Cl<sub>2</sub>, 1.5 equiv). The resulting solution was stirred, under argon until complete consumption of the *gem*-difluorocyclopropene, as assessed by TLC or GC/MS. The reaction mixture was then carefully concentrated under reduced pressure and purified by flash column chromatography on silica gel.

#### Formation of (trifluoromethyl)diazomethane in CH<sub>2</sub>Cl<sub>2</sub>

In an oven-dried vial were introduced 2,2,2-trifluoroethylamine hydrochloride (1.5 equiv compared to the alkyne) and NaNO<sub>2</sub> (1.8 equiv compared to the alkyne). The vial was then flushed with argon, CH<sub>2</sub>Cl<sub>2</sub> ( $c = 0.6$  M) and H<sub>2</sub>O (CH<sub>2</sub>Cl<sub>2</sub>/H<sub>2</sub>O=30:1) were added and the solution was stirred at 0 °C for 1 h and at -78 °C for 10 min. The solution was then added to the difluorocyclopropene solution *via* a syringe.

## 4. Synthesis and spectroscopic data of 6-(trifluoromethyl)pyridazines

### 4-Fluoro-3-phenyl-6-(trifluoromethyl)pyridazine (24)

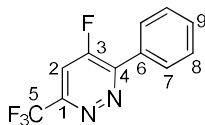

Prepared according to procedure **A** from phenylacetylene **22** (70 mg, 0.69 mmol, 1.0 equiv). After the addition of (trifluoromethyl)diazomethane, 40 h were necessary to reach complete consumption of the *gem*-difluorocyclopropene. The crude mixture was purified by flash chromatography (AcOEt/PE=2:98) to afford **24** (145 mg, 0.60 mmol, 87%) as a light yellow solid.

**Mp:** 75 °C.

**IR (neat):** 3081, 2928, 2856, 1598, 1555, 1453, 1407, 1320, 1296, 1248, 1145, 1078, 1036 942 cm<sup>-1</sup>.

**<sup>1</sup>H NMR (CDCl<sub>3</sub>, 400 MHz):** δ 8.08–8.05 (m, 2H, H<sub>7</sub>), 7.63 (d, *J* = 10.5 Hz, 1H, H<sub>2</sub>), 7.56–7.52 (m, 3H, H<sub>8</sub> and H<sub>9</sub>).

**<sup>13</sup>C NMR (CDCl<sub>3</sub>, 100 MHz):** δ 160.4 (C, d, *J* = 281.5 Hz, C<sub>3</sub>), 153.6 (C, d, *J* = 4.7 Hz, C<sub>4</sub>), 151.9 (C, qd, *J* = 35.6 and 3.3 Hz, C<sub>1</sub>), 131.4 (CH, C<sub>9</sub>), 130.9 (C, d, *J* = 4.7 Hz, C<sub>6</sub>), 129.4 (2xCH, d, *J* = 5.2 Hz, C<sub>7</sub>), 129.0 (2xCH, C<sub>8</sub>), 120.8 (C, qd, *J* = 274.6 and 2.8 Hz, C<sub>5</sub>), 111.8 (CH, dq, *J* = 18.1 and 2.4 Hz, C<sub>2</sub>).

**<sup>19</sup>F NMR (CDCl<sub>3</sub>, 470 MHz):** δ –66.7 (s, F, CF<sub>3</sub>), –113.5 (s, 1F, F).

**MS *m/z* (relative intensity):** 242 (M<sup>+</sup>, 100), 214 (22), 213 (17), 195 (13), 170 (10), 164 (24), 120 (34), 102 (14).

**HRMS:** calcd for C<sub>11</sub>H<sub>7</sub>F<sub>4</sub>N<sub>2</sub> (M+H<sup>+</sup>): 243.0540. Found 243.0542.

### 4-Fluoro-3-(*p*-tolyl)-6-(trifluoromethyl)pyridazine (31)

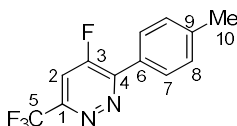

Prepared according to procedure **A** from 4-ethynyltoluene **25** (60 mg, 0.52 mmol, 1.0 equiv). After the addition of (trifluoromethyl)diazomethane, 6 days were necessary to reach complete consumption of the *gem*-difluorocyclopropene. The crude mixture was purified by flash chromatography (AcOEt/PE=2:98) to afford **31** (99 mg, 0.39 mmol, 75%) as a light yellow solid.

**Mp:** 86 °C.

**IR (neat):** 3050, 2927, 1587, 1427, 1393, 1317, 1295, 1267, 1251, 1151, 1080, 943  $\text{cm}^{-1}$ .

**$^1\text{H}$  NMR ( $\text{CDCl}_3$ , 400 MHz):**  $\delta$  7.99 (dd,  $J$  = 8.3 and 1.8 Hz, 2H,  $\text{H}_7$ ), 7.59 (d,  $J$  = 10.7 Hz, 1H,  $\text{H}_2$ ), 7.35 (br d,  $J$  = 8.0 Hz, 2H,  $\text{H}_8$ ), 2.44 (s, 3H,  $\text{H}_{10}$ ).

**$^{13}\text{C}$  NMR ( $\text{CDCl}_3$ , 100 MHz):**  $\delta$  160.4 (C, d,  $J$  = 281.2 Hz,  $\text{C}_3$ ), 153.6 (C, d,  $J$  = 5.1 Hz,  $\text{C}_4$ ), 151.6 (C, qd,  $J$  = 35.6 and 3.3 Hz,  $\text{C}_1$ ), 142.0 (C,  $\text{C}_9$ ), 129.8 (2xCH,  $\text{C}_8$ ), 129.3 (2xCH, d,  $J$  = 5.5 Hz,  $\text{C}_7$ ), 128.1 (C, d,  $J$  = 4.8 Hz,  $\text{C}_6$ ), 120.8 (C, qd,  $J$  = 274.4 and 2.7 Hz,  $\text{C}_5$ ), 111.6 (CH, dq,  $J$  = 18.2 and 2.4 Hz,  $\text{C}_2$ ), 21.5 ( $\text{CH}_3$ ,  $\text{C}_{10}$ ).

**MS  $m/z$  (relative intensity):** 256 ( $\text{M}^{++}$ , 100), 228 (14), 213 (4), 177 (4), 159 (8), 134 (13), 133 (30), 115 (11), 107 (4).

**HRMS:** calcd for  $\text{C}_{12}\text{H}_9\text{F}_4\text{N}_2$  ( $\text{M}+\text{H}^+$ ): 257.0696. Found 257.0696.

#### 4-Fluoro-3-(4-methoxyphenyl)-6-(trifluoromethyl)pyridazine (32)

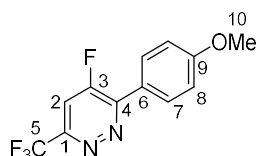

Prepared according to procedure **A** from 4-ethynylanisole **26** (70 mg, 0.53 mmol, 1.0 equiv). After the addition of (trifluoromethyl)diazomethane, 3 weeks were necessary to reach complete consumption of the *gem*-difluorocyclopropene. The crude mixture was purified by flash chromatography ( $\text{AcOEt/PE}$ =5:95) to afford **32** (120 mg, 0.44 mmol, 83%) as a light yellow oil.

**IR (neat):** 2847, 1656, 1592, 1511, 1463, 1433, 1397, 1315, 1253, 1172, 1149, 1078, 1030, 980, 940  $\text{cm}^{-1}$ .

**$^1\text{H}$  NMR ( $\text{CDCl}_3$ , 400 MHz):**  $\delta$  8.12–8.09 (m, 2H,  $\text{H}_7$ ), 7.58 (d,  $J$  = 10.9 Hz, 1H,  $\text{H}_2$ ), 7.07–7.03 (m, 2H,  $\text{H}_8$ ), 3.88 (s, 3H,  $\text{H}_{10}$ ).

**$^{13}\text{C}$  NMR ( $\text{CDCl}_3$ , 100 MHz):**  $\delta$  162.3 (C,  $\text{C}_9$ ), 160.1 (C, d,  $J$  = 280.8 Hz,  $\text{C}_3$ ), 153.1 (C, d,  $J$  = 4.2 Hz,  $\text{C}_4$ ), 151.1 (C, qd,  $J$  = 35.5 and 3.3 Hz,  $\text{C}_1$ ), 131.1 (2xCH, d,  $J$  = 6.0 Hz,  $\text{C}_7$ ), 123.3 (C, d,  $J$  = 5.0 Hz,  $\text{C}_6$ ), 120.9 (C, qd,  $J$  = 274.6 and 2.8 Hz,  $\text{C}_5$ ), 114.5 (2xCH,  $\text{C}_8$ ), 111.5 (CH, dq,  $J$  = 18.2 and 2.4 Hz,  $\text{C}_2$ ), 55.5 ( $\text{CH}_3$ ,  $\text{C}_{10}$ ).

**MS  $m/z$  (relative intensity):** 272 ( $\text{M}^{++}$ , 100), 244 (26), 200 (16), 201 (15), 151 (16), 150 (22), 135 (11), 132 (11), 107 (13).

**HRMS:** calcd for  $\text{C}_{12}\text{H}_9\text{F}_4\text{N}_2\text{O}$  ( $\text{M}+\text{H}^+$ ): 273.0646. Found 273.0648.

#### 4-Fluoro-3-(2-methoxyphenyl)-6-(trifluoromethyl)pyridazine (33)

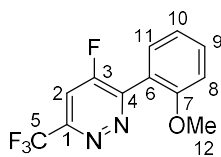

Prepared according to procedure A from 2-ethynylanisole **27** (70 mg, 0.53 mmol, 1.0 equiv). After the addition of (trifluoromethyl)diazomethane, 15 days were necessary to reach complete consumption of the *gem*-difluorocyclopropene. The crude mixture was purified by flash chromatography (AcOEt/PE=5:95) to afford **33** (105 mg, 0.39 mmol, 73%) as a yellow oil.

Prepared according to procedure B from 2-ethynylanisole **27** (65 mg, 0.49 mmol, 1.0 equiv). After the addition of (trifluoromethyl)diazomethane, 72 h were necessary to reach complete consumption of the *gem*-difluorocyclopropene. The crude mixture was purified by flash chromatography (Et<sub>2</sub>O/PE=15:85) to afford **33** (91 mg, 0.33 mmol, 68%) as a yellow oil.

**IR (neat):** 2944, 1604, 1496, 1464, 1438, 1408, 1261, 1238, 1146, 1075, 1047, 1024, 1010, 942 cm<sup>-1</sup>.

**<sup>1</sup>H NMR (CDCl<sub>3</sub>, 400 MHz):** δ 7.60–7.57 (m, 2H, H<sub>2</sub> and H<sub>11</sub>), 7.53 (ddd, *J* = 8.4, 7.5 and 1.7 Hz, 1H, H<sub>9</sub>), 7.13 (td<sub>app</sub>, *J* = 7.5 and 0.9 Hz, 1H, H<sub>10</sub>), 7.05 (d, *J* = 8.4 Hz, 1H, H<sub>8</sub>), 3.83 (s, 3H, H<sub>12</sub>).

**<sup>13</sup>C NMR (CDCl<sub>3</sub>, 100 MHz):** δ 160.7 (C, d, *J* = 280.8 Hz, C<sub>3</sub>), 157.6 (C, C<sub>7</sub>), 154.1 (C, d, *J* = 10.3 Hz, C<sub>4</sub>), 152.3 (C, qd, *J* = 35.5 and 3.5 Hz, C<sub>1</sub>), 132.5 (CH, C<sub>9</sub>), 131.4 (CH, C<sub>11</sub>), 121.1 (CH, C<sub>10</sub>), 120.9 (C, qd, *J* = 274.7 and 2.9 Hz, C<sub>5</sub>), 120.6 (C, d, *J* = 3.6 Hz, C<sub>6</sub>), 111.3 (CH, C<sub>8</sub>), 110.7 (CH, dq, *J* = 17.5 and 2.2 Hz, C<sub>2</sub>), 55.7 (CH<sub>3</sub>, C<sub>12</sub>).

**MS *m/z* (relative intensity):** 272 (M<sup>+</sup>, 99), 253 (61), 244 (53), 213 (21), 203 (100), 164 (30), 154 (32), 151 (34), 120 (29), 107 (43).

**HRMS:** calcd for C<sub>12</sub>H<sub>9</sub>F<sub>4</sub>N<sub>2</sub>O (M+H<sup>+</sup>): 273.0646. Found 273.0649.

#### 4-Fluoro-3-mesityl-6-(trifluoromethyl)pyridazine (34)

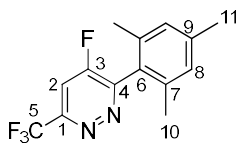

Prepared according to procedure A from 2-ethynyl-1,3,5-trimethylbenzene **28** (70 mg, 0.49 mmol, 1.0 equiv). After the addition of (trifluoromethyl)diazomethane (2.0 equiv), 1 month was necessary to reach complete consumption of the *gem*-difluorocyclopropene. The crude mixture was purified by flash chromatography (AcOEt/PE=2:98) to afford **34** (105 mg, 0.37 mmol, 76%) as an orange solid.

**Mp:** 95 °C.

**IR (neat):** 1613, 1550, 1446, 1401, 1279, 1246, 1148, 1069, 1010, 954, 934 cm<sup>-1</sup>.

**<sup>1</sup>H NMR (CDCl<sub>3</sub>, 400 MHz):** δ 7.64 (d, *J* = 8.4 Hz, 1H, H<sub>2</sub>), 7.02 (s, 2H, H<sub>8</sub>), 2.36 (s, 3H, H<sub>11</sub>), 2.03 (s, 6H, H<sub>10</sub>).

**<sup>13</sup>C NMR (CDCl<sub>3</sub>, 100 MHz):** δ 160.2 (C, d, *J* = 276.8 Hz, C<sub>3</sub>), 156.7 (C, d, *J* = 11.3 Hz, C<sub>4</sub>), 152.5 (C, qd, *J* = 35.6 and 3.0 Hz, C<sub>1</sub>), 140.1 (C, C<sub>9</sub>), 136.7 (2xC, C<sub>7</sub>), 128.9 (2xCH, C<sub>8</sub>), 127.2 (C, d, *J* = 2.7 Hz, C<sub>6</sub>), 120.8 (C, qd, *J* = 274.9 and 3.0 Hz, C<sub>5</sub>), 110.9 (CH, dq, *J* = 17.6 and 2.3 Hz, C<sub>2</sub>), 21.2 (CH<sub>3</sub>, C<sub>11</sub>), 19.8 (2xCH<sub>3</sub>, C<sub>10</sub>).

**MS *m/z* (relative intensity):** 284 (M<sup>+</sup>, 33), 283 (10), 269 (25), 267 (16), 265 (100), 250 (11), 215 (25), 200 (9), 171 (6), 146 (19), 133 (7), 115 (9), 77 (10).

**HRMS:** calcd for C<sub>14</sub>H<sub>13</sub>F<sub>4</sub>N<sub>2</sub> (M+H<sup>+</sup>): 285.1009. Found 285.1009.

#### 4-Fluoro-3-(6-methoxynaphthalene)-6-(trifluoromethyl)pyridazine (36)

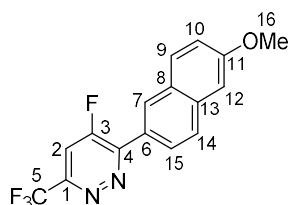

Prepared according to procedure A from 2-ethynyl-6-methoxynaphthalene **30** (100 mg, 0.55 mmol, 1.0 equiv). After the addition of (trifluoromethyl)diazomethane, 40 h were necessary to reach complete consumption of the *gem*-difluorocyclopropene. The crude mixture was purified by flash chromatography (AcOEt/PE=4:96 and 6:94) to afford **36** (139 mg, 0.43 mmol, 79%) as a yellow solid.

**Mp:** 119 °C.

**IR (neat):** 1629, 1487, 1426, 1386, 1255, 1203, 1164, 1076, 904 cm<sup>-1</sup>.

**<sup>1</sup>H NMR (CDCl<sub>3</sub>, 400 MHz):** δ 8.48 (s, 1H, H<sub>7</sub>), 8.15 (dt<sub>app</sub>, *J* = 8.7 and 1.7 Hz, 1H, H<sub>15</sub>), 7.82 (d, *J* = 7.2 Hz, 1H, H<sub>9</sub> or H<sub>14</sub>), 7.80 (d, *J* = 7.4 Hz, 1H, H<sub>9</sub> or H<sub>14</sub>), 7.55 (d, *J* = 10.9 Hz, 1H, H<sub>2</sub>), 7.17 (dd, *J* = 8.9 and 2.5 Hz, 1H, H<sub>10</sub>), 7.12 (d<sub>app</sub>, *J* = 2.4 Hz, 1H, H<sub>12</sub>), 3.91 (s, 3H, H<sub>16</sub>).

**<sup>13</sup>C NMR (CDCl<sub>3</sub>, 100 MHz):** δ 160.5 (C, d, *J* = 281.5 Hz, C<sub>3</sub>), 159.5 (C, C<sub>11</sub>), 153.4 (C, d, *J* = 4.3 Hz, C<sub>4</sub>), 151.3 (C, qd, *J* = 35.4 and 3.3 Hz, C<sub>1</sub>), 136.1 (C, C<sub>6</sub>), 130.8 (CH, C<sub>10</sub> or C<sub>14</sub>), 130.1 (CH, d, *J* = 7.3 Hz, C<sub>7</sub>), 128.4 (C, C<sub>13</sub>), 127.6 (CH, C<sub>10</sub> or C<sub>14</sub>), 126.0 (CH, d, *J* = 4.4 Hz, C<sub>15</sub>), 126.0 (C, d, *J* = 4.9 Hz, C<sub>8</sub>), 120.8 (C, qd, *J* = 274.4 and 2.6 Hz, C<sub>5</sub>), 119.8 (CH, C<sub>9</sub>), 111.6 (CH, dq, *J* = 18.3 and 2.4 Hz, C<sub>2</sub>), 105.7 (CH, C<sub>12</sub>), 55.4 (CH<sub>3</sub>, C<sub>16</sub>).

**MS *m/z* (relative intensity):** 322 (M<sup>+</sup>, 100), 294 (7), 279 (16), 251 (21), 250 (11), 201 (9), 200 (11), 157 (23), 147 (5).

**HRMS:** calcd for C<sub>16</sub>H<sub>11</sub>F<sub>4</sub>N<sub>2</sub>O (M+H<sup>+</sup>): 323.0802. Found 323.0804.

#### 4-Fluoro-3-[2-(trifluoromethyl)phenyl]-6-(trifluoromethyl)pyridazine (41)

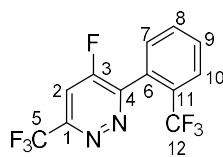

Prepared according to procedure A from 1-ethynyl-2-(trifluoromethyl)benzene **37** (70 mg, 0.41 mmol, 1.0 equiv). After the addition of (trifluoromethyl)diazomethane, 48 h were necessary to reach complete consumption of the *gem*-difluorocyclopropene. The crude mixture was purified by flash chromatography (Et<sub>2</sub>O/PE=10:90) to afford **41** (84 mg, 0.27 mmol, 66%) as a yellow oil.

Prepared according to procedure B from 1-ethynyl-2-(trifluoromethyl)benzene **37** (80 mg, 0.47 mmol, 1.0 equiv). After the addition of (trifluoromethyl)diazomethane, 16 h were necessary to reach complete consumption of the *gem*-difluorocyclopropene. The crude mixture was purified by flash chromatography (Et<sub>2</sub>O/PE=10:90) to afford **41** (66 mg, 0.20 mmol, 43%) as a yellow oil.

**IR (neat):** 1413, 1315, 1281, 1167, 1132, 1087, 1059, 1036, 942 cm<sup>-1</sup>.

**<sup>1</sup>H NMR (CDCl<sub>3</sub>, 400 MHz):** δ 7.88 (m, 1H, H<sub>10</sub>), 7.77–7.71 (m, 2H, H<sub>8</sub> and H<sub>9</sub>), 7.68 (d, *J* = 8.4 Hz, 1H, H<sub>2</sub>), 7.51 (m, 1H, H<sub>7</sub>).

**<sup>13</sup>C NMR (CDCl<sub>3</sub>, 100 MHz):** δ 160.2 (C, d, *J* = 279.7 Hz, C<sub>3</sub>), 154.9 (C, d, *J* = 10.8 Hz, C<sub>4</sub>), 153.3 (C, qd, *J* = 35.8 and 3.1 Hz, C<sub>1</sub>), 132.2 (CH, C<sub>9</sub>), 131.5 (CH, C<sub>7</sub>), 130.9 (CH, C<sub>8</sub>), 129.7 (C, q, *J* = 31.5 Hz, C<sub>11</sub>), 129.2 (C, m, C<sub>6</sub>), 127.2 (CH, q, *J* = 4.7 Hz, C<sub>10</sub>), 123.7 (C, q, *J* = 273.8 Hz, C<sub>12</sub>), 120.7 (C, qd, *J* = 275.1 and 3.0 Hz, C<sub>5</sub>), 111.0 (CH, dq, *J* = 17.1 and 2.4 Hz, C<sub>2</sub>).

**MS *m/z* (relative intensity):** 310 (M<sup>+</sup>, 100), 291 (11), 263 (9), 232 (30), 213 (89), 193 (14), 187 (14), 182 (11), 169 (24), 138 (6), 75 (12), 69 (13).

HRMS: calcd for C<sub>12</sub>H<sub>6</sub>F<sub>7</sub>N<sub>2</sub> (M+H<sup>+</sup>): 311.0414. Found 311.0415.

#### 4-Fluoro-3-(3-carbomethoxyphenyl)-6-(trifluoromethyl)pyridazine (42)

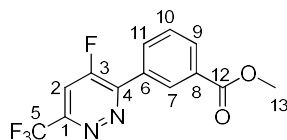

Prepared according to procedure A from methyl 3-ethynylbenzoate **14** (70 mg, 0.44 mmol, 1.0 equiv). After the addition of (trifluoromethyl)diazomethane, 72 h were necessary to reach complete consumption of the *gem*-difluorocyclopropene. The crude mixture was purified by flash chromatography (Et<sub>2</sub>O/PE=15:85) to afford **42** (100 mg, 0.33 mmol, 76%) as a white solid.



Prepared according to procedure **B** from methyl 3-ethynylbenzoate **14** (60 mg, 0.37 mmol, 1.0 equiv). After the addition of (trifluoromethyl)diazomethane, 16 h were necessary to reach complete consumption of the *gem*-difluorocyclopropene. The crude mixture was purified by flash chromatography (Et<sub>2</sub>O/PE=15:85) to afford **42** (85 mg, 0.28 mmol, 76%) as a white solid.

**Mp:** 130 °C.

**IR (neat):** 3076, 2924, 2853, 1721, 1593, 1450, 1412, 1396, 1299, 1242, 1180, 1163, 1138, 1082, 972, 932 cm<sup>-1</sup>.

**<sup>1</sup>H NMR (CDCl<sub>3</sub>, 400 MHz):** δ 8.76 (dd, *J* = 3.1 and 1.6 Hz, 1H, H<sub>7</sub>), 8.31 (ddd, *J* = 7.9, 3.0 and 1.5 Hz, 1H, H<sub>11</sub>), 8.25 (dt<sub>app</sub>, *J* = 7.8 and 1.4 Hz, 1H, H<sub>9</sub>), 7.71 (d, *J* = 10.5 Hz, 1H, H<sub>2</sub>), 7.67 (td<sub>app</sub>, *J* = 7.9 and 1.4 Hz, 1H, H<sub>10</sub>), 3.97 (s, 3H, H<sub>13</sub>).

**<sup>13</sup>C NMR (CDCl<sub>3</sub>, 100 MHz):** δ 166.3 (C, C<sub>12</sub>), 160.6 (C, d, *J* = 281.9 Hz, C<sub>3</sub>), 152.8 (C, d, *J* = 5.4 Hz, C<sub>4</sub>), 152.3 (C, qd, *J* = 35.8 and 3.3 Hz, C<sub>1</sub>), 133.6 (CH, d, *J* = 4.7 Hz, C<sub>11</sub>), 132.3 (CH, C<sub>10</sub>), 131.3 (C, d, *J* = 4.7 Hz, C<sub>6</sub>), 131.2 (C, C<sub>8</sub>), 130.6 (CH, d, *J* = 5.9 Hz, C<sub>7</sub>), 129.3 (CH, C<sub>9</sub>), 120.7 (C, qd, *J* = 274.7 and 2.7 Hz, C<sub>5</sub>), 112.0 (CH, dq, *J* = 17.9 and 2.4 Hz, C<sub>2</sub>), 52.5 (CH<sub>3</sub>, C<sub>13</sub>).

**MS *m/z* (relative intensity):** 300 (M<sup>+</sup>, 47), 270 (15), 269 (100), 242 (85), 241 (68), 193 (9), 144 (16), 135 (8), 119 (6), 111 (8), 95 (8), 75 (6), 69 (7).

**HRMS:** calcd for C<sub>13</sub>H<sub>9</sub>F<sub>4</sub>N<sub>2</sub>O<sub>2</sub> (M+H<sup>+</sup>): 301.0595. Found 301.0596.

#### 4-Fluoro-3-(4-carbomethoxyphenyl)-6-(trifluoromethyl)pyridazine (**43**)

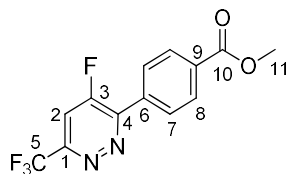

Prepared according to procedure **A** from methyl 3-ethynylbenzoate **7** (70 mg, 0.44 mmol, 1.0 equiv). After the addition of (trifluoromethyl)diazomethane, 24 h were necessary to reach complete consumption of the *gem*-difluorocyclopropene. The crude mixture was purified by flash chromatography (Et<sub>2</sub>O/PE=15:85) to afford **43** (88 mg, 0.29 mmol, 67%) as a yellow solid.

Prepared according to procedure **B** from methyl 4-ethynylbenzoate **7** (90 mg, 0.56 mmol, 1.0 equiv). Supplementary amounts of TFDA (0.22 mL, 2.0 equiv) were necessary to reach complete consumption of the alkyne. After the addition of (trifluoromethyl)diazomethane, 24 h were necessary to reach complete consumption of the *gem*-difluorocyclopropene. The crude mixture was purified by flash chromatography (Et<sub>2</sub>O/PE=15:85) to afford **43** (115 mg, 0.38 mmol, 68%) as a yellow solid.

**Mp:** 121 °C.

**IR (neat):** 1723, 1602, 1552, 1425, 1395, 1278, 1261, 1145, 1109, 1077, 1012, 945 cm<sup>-1</sup>.

**<sup>1</sup>H NMR (CDCl<sub>3</sub>, 400 MHz):** δ 8.23–8.16 (m, 4H, H<sub>7</sub> and H<sub>8</sub>), 7.71 (d, *J* = 10.5 Hz, 1H, H<sub>2</sub>), 3.98 (s, 3H, H<sub>11</sub>).

**<sup>13</sup>C NMR (CDCl<sub>3</sub>, 100 MHz):** δ 166.3 (C, C<sub>10</sub>), 160.7 (C, d, *J* = 282.3 Hz, C<sub>3</sub>), 152.7 (C, d, *J* = 5.1 Hz, C<sub>4</sub>), 152.4 (C, qd, *J* = 35.6 and 3.4 Hz, C<sub>1</sub>), 134.9 (C, d, *J* = 4.8 Hz, C<sub>6</sub>), 132.6 (C, C<sub>9</sub>), 130.1 (2xCH, C<sub>8</sub>), 129.4 (2xCH, d, *J* = 5.3 Hz, C<sub>7</sub>), 120.7 (C, qd, *J* = 274.6 and 2.7 Hz, C<sub>5</sub>), 112.0 (CH, dq, *J* = 18.0 and 2.4 Hz, C<sub>2</sub>), 52.5 (CH<sub>3</sub>, C<sub>11</sub>).

**MS *m/z* (relative intensity):** 300 (M<sup>+</sup>, 36), 269 (100), 241 (42), 193 (9), 144 (20), 119 (11), 99 (11), 75 (12), 69 (13).

**HRMS:** calcd for C<sub>13</sub>H<sub>9</sub>F<sub>4</sub>N<sub>2</sub>O<sub>2</sub> (M+H<sup>+</sup>): 301.0595. Found 301.0596.

#### 4-Fluoro-3-[4-(diethoxyphosphoryl)phenyl]-6-(trifluoromethyl)pyridazine (44)

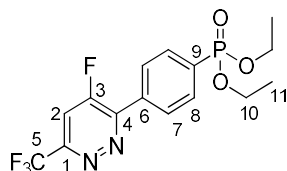

Prepared according to procedure A from diethyl (4-ethynylphenyl)phosphonate **12** (80 mg, 0.34 mmol, 1.0 equiv). After the addition of (trifluoromethyl)diazomethane, 48 h were necessary to reach complete consumption of the *gem*-difluorocyclopropene. The crude mixture was purified by flash chromatography (MeOH/CH<sub>2</sub>Cl<sub>2</sub>=2:98) to afford **44** (34 mg, 0.09 mmol, 27%) as a colorless oil.

Prepared according to procedure B from diethyl (4-ethynylphenyl)phosphonate **12** (90 mg, 0.38 mmol, 1.0 equiv). Supplementary amounts of TFDA (0.15 mL, 2.0 equiv) were necessary to reach complete consumption of the alkyne. After the addition of (trifluoromethyl)diazomethane, 16 h were necessary to reach complete consumption of the *gem*-difluorocyclopropene. The crude mixture was purified by flash chromatography (Et<sub>2</sub>O=100%) to afford **44** (36 mg, 0.10 mmol, 25%) as a colorless oil.

**IR (neat):** 2927, 1421, 1389, 1314, 1252, 1175, 1156, 1078, 1053, 1024, 967, 943 cm<sup>-1</sup>.

**<sup>1</sup>H NMR (CDCl<sub>3</sub>, 400 MHz):** δ 8.23–8.19 (m, 2H, H<sub>8</sub>), 8.05–8.00 (m, 2H, H<sub>7</sub>), 7.71 (d, *J* = 10.4 Hz, 1H, H<sub>2</sub>), 4.25–4.12 (m, 4H, H<sub>10</sub>), 1.37 (td, *J* = 7.1 and 0.4 Hz, 6H, H<sub>11</sub>).

**<sup>13</sup>C NMR (CDCl<sub>3</sub>, 100 MHz):** δ 160.7 (C, d, *J* = 282.3 Hz, C<sub>3</sub>), 152.8 (C, d, *J* = 6.3 Hz, C<sub>4</sub>), 152.6 (C, qd, *J* = 36.0 and 3.5 Hz, C<sub>1</sub>), 134.6 (C, m, C<sub>6</sub>), 132.4 (2xCH, d, *J* = 10.0 Hz, C<sub>8</sub>), 131.8 (C, d, *J* = 187.9 Hz, C<sub>9</sub>), 129.4 (2xCH, dd, *J* = 14.9 and 5.2 Hz, C<sub>7</sub>), 120.7 (C, qd, *J* = 274.6 and 2.9 Hz, C<sub>5</sub>), 112.1 (CH, dq, *J* = 17.9 and 2.3 Hz, C<sub>2</sub>), 62.6 (2xCH<sub>2</sub>, d, *J* = 5.5 Hz, C<sub>10</sub>), 16.5 (2xCH<sub>3</sub>, d, *J* = 6.4 Hz, C<sub>11</sub>).

**MS *m/z* (relative intensity):** 378 ( $M^{+}$ , 20), 350 (14), 349 (11), 322 (100), 305 (40), 269 (51), 258 (26), 242 (49), 193 (12), 144 (15), 136 (6), 120 (7), 99 (7), 81 (8), 65 (18).

**HRMS:** calcd for  $C_{15}H_{15}F_4N_2O_3PNa$  ( $M+Na^{+}$ ): 401.0649. Found 401.0649.

#### 4-Fluoro-3-(4-nitrophenyl)-6-(trifluoromethyl)pyridazine (45)

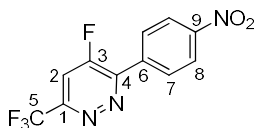

Prepared according to procedure A from 1-ethynyl-4-nitrobenzene **6** (60 mg, 0.41 mmol, 1.0 equiv). Supplementary amounts of  $TMSCF_3$  (0.13 mL, 2.0 equiv) were necessary to reach complete consumption of the alkyne. After the addition of (trifluoromethyl)diazomethane, 24 h were necessary to reach complete consumption of the *gem*-difluorocyclopropene. The crude mixture was purified by flash chromatography ( $Et_2O/PE=15:85$ ) to afford **45** (40 mg, 0.14 mmol, 34%) as a light yellow solid.

Prepared according to procedure B from 1-ethynyl-4-nitrobenzene **6** (60 mg, 0.41 mmol, 1.0 equiv). After the addition of (trifluoromethyl)diazomethane, 16 h were necessary to reach complete consumption of the *gem*-difluorocyclopropene. The crude mixture was purified by flash chromatography ( $Et_2O/PE=15:85$ ) to afford **45** (66 mg, 0.23 mmol, 56%) as a light yellow solid.

**Mp:** 126 °C.

**IR (neat):** 2922, 1604, 1520, 1430, 1392, 1349, 1304, 1252, 1148, 1080, 943  $cm^{-1}$ .

**$^1H$  NMR ( $CDCl_3$ , 400 MHz):**  $\delta$  8.44–8.41 (m, 2H,  $H_8$ ), 8.35–8.32 (m, 2H,  $H_7$ ), 7.78 (d,  $J = 10.5$  Hz, 1H,  $H_2$ ).

**$^{13}C$  NMR ( $CDCl_3$ , 100 MHz):**  $\delta$  160.8 (C, d,  $J = 282.9$  Hz,  $C_3$ ), 153.0 (C, qd,  $J = 36.0$  and 3.6 Hz,  $C_1$ ), 151.6 (C, d,  $J = 4.7$  Hz,  $C_4$ ), 149.5 (C,  $C_9$ ), 136.7 (C, d,  $J = 4.9$  Hz,  $C_6$ ), 130.6 (2xCH, d,  $J = 5.5$  Hz,  $C_7$ ), 124.2 (2xCH,  $C_8$ ), 120.5 (C, qd,  $J = 275.1$  and 2.9 Hz,  $C_5$ ), 112.3 (CH, dq,  $J = 17.8$  and 2.4 Hz,  $C_2$ ).

**MS *m/z* (relative intensity):** 287 ( $M^{+}$ , 100), 257 (15), 241 (49), 229 (16), 193 (20), 151 (23), 144 (32), 99 (12), 75 (13), 69 (15).

**HRMS:** calcd for  $C_{11}H_6F_4N_3O_2$  ( $M+H^{+}$ ): 288.0391. Found 288.0390.

#### 4-Fluoro-3-(4-bromophenyl)-6-(trifluoromethyl)pyridazine (46)

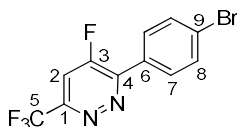

Prepared according to procedure A from 1-ethynyl-4-bromobenzene **38** (70 mg, 0.39 mmol, 1.0 equiv). After the addition of (trifluoromethyl)diazomethane, 7 days were necessary to reach

complete consumption of the *gem*-difluorocyclopropene. The crude mixture was purified by flash chromatography (AcOEt/PE=2:98) to afford **46** (105 mg, 0.33 mmol, 85%) as a white solid.

**Mp:** 106 °C.

**IR (neat):** 2971, 1591, 1423, 1386, 1308, 1286, 1253, 1155, 1080, 1009, 943 cm<sup>-1</sup>.

**<sup>1</sup>H NMR (CDCl<sub>3</sub>, 400 MHz):** δ 8.01–7.98 (m, 2H, H<sub>7</sub>), 7.92–7.69 (m, 2H, H<sub>8</sub>), 7.65 (d, *J* = 10.6 Hz, 1H, H<sub>2</sub>).

**<sup>13</sup>C NMR (CDCl<sub>3</sub>, 100 MHz):** δ 160.4 (C, d, *J* = 281.8 Hz, C<sub>3</sub>), 152.7 (C, d, *J* = 4.5 Hz, C<sub>4</sub>), 152.2 (C, qd, *J* = 35.7 and 3.3 Hz, C<sub>1</sub>), 132.4 (2xCH, C<sub>8</sub>), 130.9 (2xCH, d, *J* = 5.6 Hz, C<sub>7</sub>), 129.8 (C, d, *J* = 4.9 Hz, C<sub>6</sub>), 126.5 (C, C<sub>9</sub>), 120.7 (C, qd, *J* = 274.7 and 2.9 Hz, C<sub>5</sub>), 111.9 (CH, dq, *J* = 18.0 and 2.4 Hz, C<sub>2</sub>).

**MS *m/z* (relative intensity):** 322 (M<sup>+</sup>, 98), 320 (M<sup>+</sup>, 100), 294 (17), 292 (17), 248 (9), 250 (9), 213 (34), 144 (18), 119 (22), 99 (17), 75 (16), 69 (10).

**HRMS:** calcd for C<sub>11</sub>H<sub>6</sub>BrF<sub>4</sub>N<sub>2</sub> (M+H<sup>+</sup>): 320.9645 and 322.9625. Found 320.9646 and 322.9625.

#### 4-Fluoro-3-(4-fluorophenyl)-6-(trifluoromethyl)pyridazine (47)

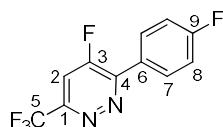

Prepared according to procedure **A** from 1-ethynyl-4-fluorobenzene **39** (60 mg, 0.50 mmol, 1.0 equiv). After the addition of (trifluoromethyl)diazomethane, 5 days were necessary to reach complete consumption of the *gem*-difluorocyclopropene. The crude mixture was purified by flash chromatography (AcOEt/PE=5:95) to afford **47** (74 mg, 0.28 mmol, 57%) as a yellow solid.

**Mp:** 102 °C.

**IR (neat):** 3084, 2927, 1603, 1511, 1421, 1392, 1310, 1298, 1274, 1255, 1234, 1170, 1143, 1102, 1079, 944 cm<sup>-1</sup>.

**<sup>1</sup>H NMR (CDCl<sub>3</sub>, 400 MHz):** δ 8.17–8.12 (m, 2H, H<sub>7</sub>), 7.65 (d, *J* = 10.7 Hz, 1H, H<sub>2</sub>), 7.28–7.23 (m, 2H, H<sub>8</sub>).

**<sup>13</sup>C NMR (CDCl<sub>3</sub>, 100 MHz):** δ 164.8 (C, d, *J* = 253.8 Hz, C<sub>3</sub> or C<sub>9</sub>), 160.4 (C, d, *J* = 281.3 Hz, C<sub>3</sub> or C<sub>9</sub>), 152.6 (C, d, *J* = 5.0 Hz, C<sub>4</sub>), 152.0 (C, qd, *J* = 35.7 and 3.3 Hz, C<sub>1</sub>), 131.7 (2xCH, dd, *J* = 8.8 and 5.7 Hz, C<sub>7</sub>), 127.1 (C, dd, *J* = 4.7 and 3.5 Hz, C<sub>6</sub>), 120.6 (C, qd, *J* = 274.6 and 2.8 Hz, C<sub>5</sub>), 116.4 (2xCH, d, *J* = 21.9 Hz, C<sub>8</sub>), 111.9 (CH, dq, *J* = 18.1 and 2.4 Hz, C<sub>2</sub>).

**MS *m/z* (relative intensity):** 260 (M<sup>+</sup>, 100), 232 (21), 213 (12), 188 (10), 182 (17), 138 (34), 120 (13), 75 (8), 69 (7).

**HRMS:** calcd for C<sub>11</sub>H<sub>6</sub>F<sub>5</sub>N<sub>2</sub> (M+H<sup>+</sup>): 261.0446. Found 261.0444.

#### 4-Fluoro-3-(4-fluoro-3-methylphenyl)-6-(trifluoromethyl)pyridazine (48)

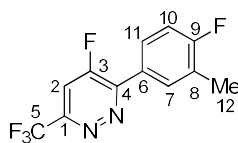

Prepared according to procedure **A** from 4-ethynyl-1-fluoro-2-methylbenzene **40** (60 mg, 0.45 mmol, 1.0 equiv). After the addition of (trifluoromethyl)diazomethane, 72 h were necessary to reach complete consumption of the *gem*-difluorocyclopropene. The crude mixture was purified by flash chromatography (AcOEt/PE=2:98) to afford **48** (111 mg, 0.40 mmol, 89%) as a yellow oil.

**IR (neat):** 1592, 1504, 1414, 1380, 1307, 1255, 1235, 1146, 1080, 1037, 949  $\text{cm}^{-1}$ .

**$^1\text{H}$  NMR ( $\text{CDCl}_3$ , 400 MHz):**  $\delta$  7.99 (br d,  $J = 7.3$  Hz, 1H,  $\text{H}_7$ ), 7.93–7.89 (m, 1H,  $\text{H}_{11}$ ), 7.63 (d,  $J = 10.7$  Hz, 1H,  $\text{H}_2$ ), 7.17 ( $t_{\text{app}}$ ,  $J = 8.9$  Hz, 1H,  $\text{H}_{10}$ ), 2.37 (d,  $J = 1.9$  Hz, 3H,  $\text{H}_{12}$ ).

**$^{13}\text{C}$  NMR ( $\text{CDCl}_3$ , 100 MHz):**  $\delta$  163.4 (C, d,  $J = 251.6$  Hz,  $\text{C}_9$ ), 160.3 (C, d,  $J = 281.2$  Hz,  $\text{C}_3$ ), 152.8 (C, d,  $J = 4.9$  Hz,  $\text{C}_4$ ), 151.8 (C, qd,  $J = 35.6$  and 3.2 Hz,  $\text{C}_1$ ), 132.9 (CH,  $t_{\text{app}}$ ,  $J = 5.3$  Hz,  $\text{C}_7$ ), 129.0 (CH, dd,  $J = 8.9$  and 6.2 Hz,  $\text{C}_{11}$ ), 126.8 (C, dd,  $J = 4.5$  and 3.9 Hz,  $\text{C}_6$ ), 126.1 (C, d,  $J = 17.8$  Hz,  $\text{C}_8$ ), 120.8 (C, qd,  $J = 274.6$  and 2.8 Hz,  $\text{C}_5$ ), 115.8 (CH, d,  $J = 23.0$  Hz,  $\text{C}_{10}$ ), 111.8 (CH, dq,  $J = 18.2$  and 2.4 Hz,  $\text{C}_2$ ), 14.7 ( $\text{CH}_3$ , d,  $J = 3.4$  Hz,  $\text{C}_{12}$ ).

**MS  $m/z$  (relative intensity):** 274 ( $\text{M}^{+}$ , 100), 246 (20), 202 (10), 177 (11), 152 (17), 151 (33), 133 (15), 134 (11), 83 (5), 57 (5).

**HRMS:** calcd for  $\text{C}_{12}\text{H}_8\text{F}_5\text{N}_2$  ( $\text{M}+\text{H}^+$ ): 275.0602. Found 275.0603.

#### 4-Fluoro-3-(3-benzonitrile)-6-(trifluoromethyl)pyridazine (50)

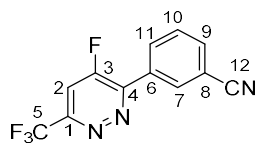

Prepared according to procedure **B** from 3-ethynyl-benzonitrile **49** (60 mg, 0.47 mmol, 1.0 equiv). Supplementary amounts of TFDA (0.19 mL, 2.0 equiv) were necessary to reach complete consumption of the alkyne. After the addition of (trifluoromethyl)diazomethane, 16 h were necessary to reach complete consumption of the *gem*-difluorocyclopropene. The crude mixture was purified by flash chromatography (Et<sub>2</sub>O/PE=30:70) to afford **50** (76 mg, 0.28 mmol, 60%) as a white solid.

**Mp:** 85 °C.

**IR (neat):** 2233, 1595, 1557, 1416, 1441, 1393, 1299, 1254, 1145, 1082, 948  $\text{cm}^{-1}$ .

**<sup>1</sup>H NMR (CDCl<sub>3</sub>, 400 MHz):** δ 8.32–8.28 (m, 2H, H<sub>7</sub> and H<sub>11</sub>), 7.79 (m, 1H, H<sub>9</sub>), 7.67 (d, *J* = 10.5 Hz, 1H, H<sub>2</sub>), 7.65 (td<sub>app</sub>, *J* = 7.8 and 0.7 Hz, 1H, H<sub>10</sub>).

**<sup>13</sup>C NMR (CDCl<sub>3</sub>, 100 MHz):** δ 160.7 (C, d, *J* = 282.3 Hz, C<sub>3</sub>), 152.9 (C, qd, *J* = 35.8 and 3.4 Hz, C<sub>1</sub>), 151.5 (C, d, *J* = 4.7 Hz, C<sub>4</sub>), 134.7 (CH, C<sub>9</sub>), 133.5 (CH, d, *J* = 5.2 Hz, C<sub>7</sub> or C<sub>11</sub>), 132.9 (CH, d, *J* = 5.9 Hz, C<sub>7</sub> or C<sub>11</sub>), 132.3 (C, d, *J* = 4.8 Hz, C<sub>6</sub>), 130.2 (CH, C<sub>10</sub>), 120.6 (C, qd, *J* = 275.0 and 3.0 Hz, C<sub>5</sub>), 118.0 (C, C<sub>12</sub>), 113.7 (C, C<sub>8</sub>), 112.3 (CH, dq, *J* = 17.9 and 2.4 Hz, C<sub>2</sub>).

**MS *m/z* (relative intensity):** 267 (M<sup>+</sup>, 100), 239 (20), 238 (17), 220 (14), 189 (28), 145 (23), 127 (9), 118 (9), 75 (12), 69 (9).

**HRMS:** calcd for C<sub>12</sub>H<sub>5</sub>F<sub>4</sub>N<sub>3</sub>Na (M+Na<sup>+</sup>): 290.0312. Found 290.0313.

#### 4-Fluoro-3-(6-pyridin-2-yl)-6-(trifluoromethyl)pyridazine (53)

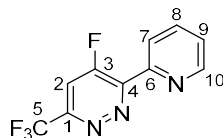

Prepared according to procedure A from 6-ethynylpyridine **51** (80 mg, 0.78 mmol, 1.0 equiv). Supplementary amounts of TMSCF<sub>3</sub> (0.11 mL, 1.0 equiv) were necessary to reach complete consumption of the alkyne. After the addition of (trifluoromethyl)diazomethane, 24 h were necessary to reach complete consumption of the *gem*-difluorocyclopropene. The crude mixture was purified by flash chromatography (AcOEt/PE=25:75) to afford **53** (22 mg, 0.09 mmol, 12%) as a brown oil.

**IR (neat):** 3061, 2926, 2855, 1723, 1590, 1474, 1443, 1409, 1304, 1256, 1178, 1154, 1085, 946 cm<sup>-1</sup>.

**<sup>1</sup>H NMR (CDCl<sub>3</sub>, 400 MHz):** δ 8.83 (br d, *J* = 4.7 Hz, 1H, H<sub>10</sub>), 8.30 (dd, *J* = 7.9 and 0.6 Hz, 1H, H<sub>7</sub>), 7.97 (td<sub>app</sub>, *J* = 7.8 and 1.8 Hz, 1H, H<sub>8</sub>), 7.71 (d, *J* = 10.0 Hz, 1H, H<sub>2</sub>), 7.51 (m, 1H, H<sub>9</sub>).

**<sup>13</sup>C NMR (CDCl<sub>3</sub>, 100 MHz):** δ 161.2 (C, d, *J* = 287.5 Hz, C<sub>3</sub>), 153.0 (C, qd, *J* = 35.6 and 3.9 Hz, C<sub>1</sub>), 152.9 (C, d, *J* = 3.8 Hz, C<sub>4</sub>), 151.2 (C, d, *J* = 6.4 Hz, C<sub>6</sub>), 149.9 (CH, C<sub>10</sub>), 137.4 (CH, C<sub>8</sub>), 125.4 (CH, C<sub>9</sub>), 124.7 (CH, C<sub>7</sub>), 120.7 (C, qd, *J* = 274.8 and 2.7 Hz, C<sub>5</sub>), 112.6 (CH, dq, *J* = 17.4 and 2.4 Hz, C<sub>2</sub>).

**MS *m/z* (relative intensity):** 243 (M<sup>+</sup>, 100), 196 (8), 165 (20), 146 (15), 94 (9), 78 (10), 51 (11).

**HRMS:** calcd for C<sub>10</sub>H<sub>5</sub>F<sub>4</sub>N<sub>3</sub>Na (M+Na<sup>+</sup>): 266.0312. Found 266.0334.

#### 4-Fluoro-3-(6-chloropyridin-2-yl)-6-(trifluoromethyl)pyridazine (54)

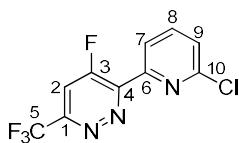

Prepared according to procedure **A** from 2-chloro-6-ethynylpyridine **8** (70 mg, 0.51 mmol, 1.0 equiv). Supplementary amounts of  $\text{TMSCF}_3$  (0.15 mL, 2.0 equiv) were necessary to reach complete consumption of the alkyne. After the addition of (trifluoromethyl)diazomethane, 40 h were necessary to reach complete consumption of the *gem*-difluorocyclopropene. The crude mixture was purified by flash chromatography (AcOEt/PE=10:90) to afford **54** (35 mg, 0.13 mmol, 25%) as a yellow solid.

Prepared according to procedure **B** from 2-chloro-6-ethynylpyridine **8** (100 mg, 0.73 mmol, 1.0 equiv). Supplementary amounts of TFDA (0.29 mL, 2.0 equiv) were necessary to reach complete consumption of the alkyne. After the addition of (trifluoromethyl)diazomethane, 16 h were necessary to reach complete consumption of the *gem*-difluorocyclopropene. The crude mixture was purified by flash chromatography ( $\text{Et}_2\text{O}/\text{PE}=15:85$ ) to afford **54** (60 mg, 0.22 mmol, 30%) as a yellow solid.

**Mp:** 125 °C.

**IR (neat):** 3085, 1592, 1580, 1568, 1410, 1389, 1268, 1173, 1158, 1136, 1091, 1081, 987, 950  $\text{cm}^{-1}$ .

**$^1\text{H}$  NMR ( $\text{CDCl}_3$ , 400 MHz):**  $\delta$  8.25 (br d,  $J = 7.7$  Hz, 1H,  $\text{H}_7$ ), 7.94 ( $t_{\text{app}}$ ,  $J = 7.9$  Hz, 1H,  $\text{H}_8$ ), 7.73 (d,  $J = 9.8$  Hz, 1H,  $\text{H}_2$ ), 7.65 (dd,  $J = 8.0$  and 0.8 Hz, 1H,  $\text{H}_9$ ).

**$^{13}\text{C}$  NMR ( $\text{CDCl}_3$ , 100 MHz):**  $\delta$  161.1 (C, d,  $J = 288.9$  Hz,  $\text{C}_3$ ), 153.3 (C, qd,  $J = 35.7$  and 3.7 Hz,  $\text{C}_1$ ), 151.6 (C, d,  $J = 2.1$  Hz,  $\text{C}_4$ ), 151.4 (C,  $\text{C}_{10}$ ), 151.3 (C, d,  $J = 6.2$  Hz,  $\text{C}_6$ ), 139.9 (CH,  $\text{C}_8$ ), 126.4 (CH,  $\text{C}_9$ ), 123.1 (CH,  $\text{C}_7$ ), 120.6 (C, qd,  $J = 275.0$  and 2.5 Hz,  $\text{C}_5$ ), 112.8 (CH, dq,  $J = 17.1$  and 2.4 Hz,  $\text{C}_2$ ).

**MS  $m/z$  (relative intensity):** 279 ( $\text{M}^{++}$ , 30), 277 ( $\text{M}^{++}$ , 100), 242 (7), 230 (8), 214 (32), 194 (26), 164 (8), 155 (8), 145 (8), 120 (17), 112 (7), 100 (7), 76 (12), 69 (13), 50 (7).

**HRMS:** calcd for  $\text{C}_{10}\text{H}_4\text{ClF}_4\text{N}_3\text{Na}$  ( $\text{M}+\text{Na}^+$ ): 299.9922 and 301.9893. Found 299.9923 and 301.9892.

#### 4-Fluoro-3-(6-chloropyridin-3-yl)-6-(trifluoromethyl)pyridazine (55)

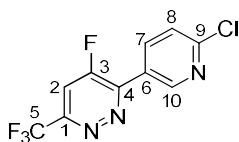

Prepared according to procedure **A** from 2-chloro-5-ethynylpyridine **9** (70 mg, 0.51 mmol, 1.0 equiv). Supplementary amounts of  $\text{TMSCF}_3$  (0.30 mL, 4.0 equiv) were necessary to reach complete consumption of the alkyne. After the addition of (trifluoromethyl)diazomethane, 48 h were necessary

to reach complete consumption of the *gem*-difluorocyclopropene. The crude mixture was purified by flash chromatography (AcOEt/PE=10:90) to afford **55** (52 mg, 0.19 mmol, 37%) as an orange solid.

**Mp:** 112 °C.

**IR (neat):** 1586, 1546, 1468, 1423, 1411, 1367, 1281, 1259, 1238, 1174, 1142, 1110, 1081, 1005, 942 cm<sup>-1</sup>.

**<sup>1</sup>H NMR (CDCl<sub>3</sub>, 400 MHz):** δ 9.13 (m, 1H, H<sub>10</sub>), 8.47 (ddd, *J* = 8.4, 2.5 and 1.1 Hz, 1H, H<sub>7</sub>), 7.74 (d, *J* = 10.5 Hz, 1H, H<sub>2</sub>), 7.58 (dd, *J* = 8.4 and 0.7 Hz, 1H, H<sub>8</sub>).

**<sup>13</sup>C NMR (CDCl<sub>3</sub>, 100 MHz):** δ 160.6 (C, d, *J* = 282.2 Hz, C<sub>3</sub>), 154.6 (C, d, *J* = 1.0 Hz, C<sub>9</sub>), 152.8 (C, qd, *J* = 36.0 and 3.3 Hz, C<sub>1</sub>), 150.4 (C, d, *J* = 5.4 Hz, C<sub>4</sub>), 150.1 (CH, d, *J* = 8.4 Hz, C<sub>10</sub>), 139.1 (CH, d, *J* = 4.4 Hz, C<sub>7</sub>), 126.2 (C, d, *J* = 5.3 Hz, C<sub>6</sub>), 125.0 (CH, C<sub>8</sub>), 120.6 (C, qd, *J* = 274.8 and 2.8 Hz, C<sub>5</sub>), 112.2 (CH, dq, *J* = 17.6 and 2.4 Hz, C<sub>2</sub>).

**MS *m/z* (relative intensity):** 279 (M<sup>+</sup>, 34), 277 (M<sup>+</sup>, 100), 242 (9), 214 (15), 194 (14), 155 (15), 120 (20), 93 (9), 69 (14).

**HRMS:** calcd for C<sub>10</sub>H<sub>5</sub>ClF<sub>4</sub>N<sub>3</sub> (M+H<sup>+</sup>): 278.0103 and 280.0073. Found 278.0105 and 280.0073.

#### 4-Fluoro-3-(2-thiophen-3-yl)-6-(trifluoromethyl)pyridazine (56)

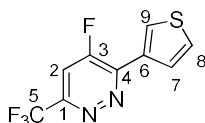

Prepared according to procedure A from 3-ethynylthiophene **52** (60 mg, 0.55 mmol, 1.0 equiv). After the addition of (trifluoromethyl)diazomethane, 72 h were necessary to reach complete consumption of the *gem*-difluorocyclopropene. The crude mixture was purified by flash chromatography (Et<sub>2</sub>O/PE=3:97) to afford **56** (104 mg, 0.42 mmol, 76%) as a yellow solid.

Prepared according to procedure B from 3-ethynylthiophene **52** (60 mg, 0.55 mmol, 1.0 equiv). After the addition of (trifluoromethyl)diazomethane, 24 h were necessary to reach complete consumption of the *gem*-difluorocyclopropene. The crude mixture was purified by flash chromatography (Et<sub>2</sub>O/PE=3:97) to afford **56** (72 mg, 0.29 mmol, 52%) as a yellow solid.

**Mp:** 76 °C.

**IR (neat):** 1602, 1560, 1522, 1435, 1422, 1357, 1267, 1193, 1148, 1116, 1075, 1034, 950 cm<sup>-1</sup>.

**<sup>1</sup>H NMR (CDCl<sub>3</sub>, 400 MHz):** δ 8.30 (m, 1H, H<sub>9</sub>), 8.02 (dt<sub>app</sub>, *J* = 5.2 and 1.3 Hz, 1H, H<sub>7</sub>), 7.61 (d, *J* = 10.9 Hz, 1H, H<sub>2</sub>), 7.50 (ddd, *J* = 5.2, 3.0 and 0.4 Hz, 1H, H<sub>8</sub>).

**<sup>13</sup>C NMR (CDCl<sub>3</sub>, 100 MHz):** δ 159.9 (C, d, *J* = 281.1 Hz, C<sub>3</sub>), 151.5 (C, qd, *J* = 35.6 and 3.3 Hz, C<sub>1</sub>), 149.8 (C, d, *J* = 5.3 Hz, C<sub>4</sub>), 132.8 (C, d, *J* = 5.4 Hz, C<sub>6</sub>), 130.5 (CH, d, *J* = 10.3 Hz, C<sub>9</sub>), 127.5 (CH, d, *J* = 3.8 Hz,



C<sub>7</sub>), 126.7 (CH, d, *J* = 0.9 Hz, C<sub>8</sub>), 121.2 (C, qd, *J* = 274.5 and 3.0 Hz, C<sub>5</sub>), 111.5 (CH, dq, *J* = 17.7 and 2.4 Hz, C<sub>2</sub>),

**MS *m/z* (relative intensity):** 248 (M<sup>+</sup>, 100), 220 (16), 201 (17), 176 (9), 170 (14), 157 (3), 126 (29), 108 (11), 107 (8), 81 (9), 69 (17).

**HRMS:** calcd for C<sub>9</sub>H<sub>5</sub>F<sub>4</sub>N<sub>2</sub>S (M+H<sup>+</sup>): 249.0104. Found 249.0103.

#### 4-Fluoro-3-(2-methylbenzo[d]oxazole)-6-(trifluoromethyl)pyridazine (57)

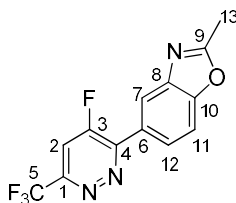

Prepared according to procedure **A** from 5-ethynyl-2-methyl-1,3-benzoxazole **10** (70 mg, 0.45 mmol, 1.0 equiv). Supplementary amounts of TMSCF<sub>3</sub> (0.13 mL, 2.0 equiv) were necessary to reach complete consumption of the alkyne. After the addition of (trifluoromethyl)diazomethane, 48 h were necessary to reach complete consumption of the *gem*-difluorocyclopropene. The crude mixture was purified by flash chromatography (CH<sub>2</sub>Cl<sub>2</sub>/Et<sub>2</sub>O=2:98) to afford **57** (99 mg, 0.33 mmol, 75%) as a light yellow solid.

**Mp:** 151 °C.

**IR (neat):** 2922, 1594, 1402, 1382, 1333, 1269, 1254, 1139, 1071, 947 cm<sup>-1</sup>.

**<sup>1</sup>H NMR (CDCl<sub>3</sub>, 400 MHz):** δ 8.37 (t<sub>app</sub>, *J* = 1.5 Hz, 1H, H<sub>7</sub>), 8.11 (dt<sub>app</sub>, *J* = 8.6 and 1.5 Hz, 1H, H<sub>12</sub>), 7.68 (d, *J* = 10.6 Hz, 1H, H<sub>2</sub>), 7.65 (dd, *J* = 8.6 and 0.4 Hz, 1H, H<sub>11</sub>), 2.70 (s, 3H, H<sub>13</sub>).

**<sup>13</sup>C NMR (CDCl<sub>3</sub>, 100 MHz):** δ 165.4 (C, C<sub>9</sub>), 160.4 (C, d, *J* = 281.3 Hz, C<sub>3</sub>), 153.4 (C, d, *J* = 4.7 Hz, C<sub>4</sub>), 152.9 (C, C<sub>10</sub>), 151.8 (C, qd, *J* = 35.7 and 3.4 Hz, C<sub>1</sub>), 142.2 (C, C<sub>8</sub>), 127.1 (C, d, *J* = 4.8 Hz, C<sub>6</sub>), 126.2 (CH, d, *J* = 4.6 Hz, C<sub>12</sub>), 121.1 (CH, d, *J* = 6.6 Hz, C<sub>7</sub>), 120.7 (C, qd, *J* = 274.6 and 2.8 Hz, C<sub>5</sub>), 111.8 (CH, dq, *J* = 18.2 and 2.4 Hz, C<sub>2</sub>), 111.0 (CH, C<sub>11</sub>), 14.6 (CH<sub>3</sub>, C<sub>13</sub>).

**MS *m/z* (relative intensity):** 297 (M<sup>+</sup>, 100), 269 (13), 225 (12), 200 (26), 175 (18), 157 (7), 150 (7), 106 (14), 81 (7), 63 (6).

**HRMS:** calcd for C<sub>13</sub>H<sub>8</sub>F<sub>4</sub>N<sub>3</sub>O (M+H<sup>+</sup>): 298.0598. Found 298.0598.

#### 4-Fluoro-3-cyclohexyl-6-(trifluoromethyl)pyridazine (65)

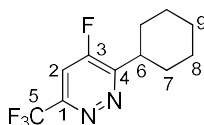

Prepared according to procedure **A** from cyclohexylacetylene **62** (60 mg, 0.55 mmol, 1.0 equiv). After the addition of (trifluoromethyl)diazomethane, 12 days were necessary to reach complete

consumption of the *gem*-difluorocyclopropene. The crude mixture was purified by flash chromatography (AcOEt/PE=2:98) to afford **65** (53 mg, 0.21 mmol, 38%) as a yellow oil.

**IR (neat):** 2933, 2857, 1604, 1554, 1451, 1411, 1370, 1319, 1284, 1242, 1182, 1151, 1060, 950  $\text{cm}^{-1}$ .

**$^1\text{H}$  NMR ( $\text{CDCl}_3$ , 400 MHz):**  $\delta$  7.38 (d,  $J = 9.4$  Hz, 1H,  $\text{H}_2$ ), 3.18 (m, 1H,  $\text{H}_6$ ), 1.89–1.72 (m, 7H,  $\text{H}_7$ ,  $\text{H}_8$  and  $\text{H}_9$ ), 1.45–1.23 (m, 3H,  $\text{H}_8$  and  $\text{H}_9$ ).

**$^{13}\text{C}$  NMR ( $\text{CDCl}_3$ , 100 MHz):**  $\delta$  161.4 (C, d,  $J = 9.2$  Hz,  $\text{C}_4$ ), 160.4 (C, d,  $J = 277.8$  Hz,  $\text{C}_3$ ), 151.8 (C, qd,  $J = 35.2$  and  $3.2$  Hz,  $\text{C}_1$ ), 120.9 (C, qd,  $J = 274.7$  and  $3.1$  Hz,  $\text{C}_5$ ), 110.3 (CH, dq,  $J = 17.5$  and  $2.4$  Hz,  $\text{C}_2$ ), 39.2 (C, d,  $J = 2.1$  Hz,  $\text{C}_6$ ), 31.0 (2x $\text{CH}_2$ ,  $\text{C}_7$ ), 26.4 (2x $\text{CH}_2$ ,  $\text{C}_8$ ), 25.8 ( $\text{CH}_2$ ,  $\text{C}_9$ ).

**MS  $m/z$  (relative intensity):** 248 ( $\text{M}^{+}$ , 6), 233 (8), 219 (20), 207 (15), 193 (100), 180 (86), 145 (9), 95 (6), 81 (6), 67 (6).

**HRMS:** calcd for  $\text{C}_{11}\text{H}_{13}\text{F}_4\text{N}_2$  ( $\text{M}+\text{H}^+$ ): 249.1009. Found 249.1009.

#### 4-Fluoro-3-benzyl-6-(trifluoromethyl)pyridazine (66)

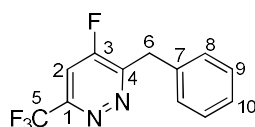

Prepared according to procedure A from 3-phenyl-1-propyne **63** (60 mg, 0.52 mmol, 1.0 equiv). After the addition of (trifluoromethyl)diazomethane, 20 days were necessary to reach complete consumption of the *gem*-difluorocyclopropene. The crude mixture was purified by flash chromatography (AcOEt/PE=2:98) to afford **66** (51 mg, 0.20 mmol, 39%) as a light yellow oil.

**IR (neat):** 3066, 1602, 1559, 1496, 1455, 1415, 1304, 1281, 1242, 1183, 1144, 1056, 956  $\text{cm}^{-1}$ .

**$^1\text{H}$  NMR ( $\text{CDCl}_3$ , 400 MHz):**  $\delta$  7.46 (d,  $J = 9.0$  Hz, 1H,  $\text{H}_2$ ), 7.36–7.22 (m, 5H,  $\text{H}_8$ ,  $\text{H}_9$  and  $\text{H}_{10}$ ), 4.49 (d,  $J = 1.9$  Hz, 2H,  $\text{H}_6$ ).

**$^{13}\text{C}$  NMR ( $\text{CDCl}_3$ , 100 MHz):**  $\delta$  160.8 (C, d,  $J = 278.9$  Hz,  $\text{C}_3$ ), 156.9 (C, d,  $J = 9.5$  Hz,  $\text{C}_4$ ), 152.5 (C, qd,  $J = 35.7$  and  $3.2$  Hz,  $\text{C}_1$ ), 135.8 (C,  $\text{C}_7$ ), 129.2 (2xCH,  $\text{C}_8$  or  $\text{C}_9$ ), 129.0 (2xCH,  $\text{C}_8$  or  $\text{C}_9$ ), 127.5 (CH,  $\text{C}_{10}$ ), 120.7 (C, qd,  $J = 274.9$  and  $3.1$  Hz,  $\text{C}_5$ ), 110.9 (CH, dq,  $J = 16.4$  and  $2.4$  Hz,  $\text{C}_2$ ), 36.8 ( $\text{CH}_2$ , d,  $J = 1.9$  Hz,  $\text{C}_6$ ).

**MS  $m/z$  (relative intensity):** 256 ( $\text{M}^{+}$ , 31), 255 (100), 235 (10), 215 (5), 133 (8), 118 (5), 91 (9), 65 (6), 51 (6).

**HRMS:** calcd for  $\text{C}_{12}\text{H}_9\text{F}_4\text{N}_2$  ( $\text{M}+\text{H}^+$ ): 257.0696. Found 257.0695.

#### 4-Fluoro-3-methoxymethyl-6-(trifluoromethyl)pyridazine (67)

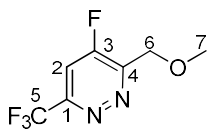

Prepared according to procedure A from methyl propargyl ether **64** (60 mg, 0.86 mmol, 1.0 equiv). After the addition of (trifluoromethyl)diazomethane, 72 h were necessary to reach complete consumption of the *gem*-difluorocyclopropene. The crude mixture was purified by flash chromatography (AcOEt/PE=20:80) to afford **67** (36 mg, 0.17 mmol, 20%) as a brown solid.

**Mp:** 54 °C.

**IR (neat):** 2931, 1608, 1561, 1423, 1306, 1252, 1172, 1144, 1101, 1061, 997, 950 cm<sup>-1</sup>.

**<sup>1</sup>H NMR (CDCl<sub>3</sub>, 400 MHz):** δ 7.60 (d, *J* = 8.9 Hz, 1H, H<sub>2</sub>), 4.95 (d, *J* = 1.3 Hz, 2H, H<sub>6</sub>), 3.52 (s, 3H, H<sub>7</sub>).

**<sup>13</sup>C NMR (CDCl<sub>3</sub>, 100 MHz):** δ 161.6 (C, d, *J* = 281.4 Hz, C<sub>3</sub>), 153.5 (C, d, *J* = 9.5 Hz, C<sub>4</sub>), 153.7 (C, q<sub>app</sub>, *J* = 33.8 Hz, C<sub>1</sub>), 120.6 (C, qd, *J* = 275.2 and 3.1 Hz, C<sub>5</sub>), 111.3 (CH, dq, *J* = 16.0 and 1.9 Hz, C<sub>2</sub>), 69.0 (CH<sub>2</sub>, br s, C<sub>6</sub>), 59.4 (CH<sub>3</sub>, C<sub>7</sub>).

**MS *m/z* (relative intensity):** 180 (M<sup>+</sup>-CH<sub>2</sub>O, 100), 132 (29), 101 (24), 81 (6), 75 (8), 69 (11), 63 (10), 57 (6).

**HRMS:** calcd for C<sub>7</sub>H<sub>7</sub>F<sub>4</sub>N<sub>2</sub>O (M+H<sup>+</sup>): 211.0489. Found 211.0642.

#### 4-Fluoro-3-[(1,3-dioxoisindolin-2-yl)methyl]-6-(trifluoromethyl)pyridazine (68)

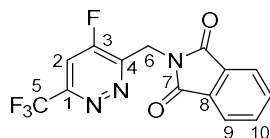

Prepared according to procedure A from *N*-propargyl phthalimide **17** (100 mg, 0.54 mmol, 1.0 equiv). Supplementary amounts of TMSF<sub>3</sub> (0.16 mL, 2.0 equiv) were necessary to reach complete consumption of the alkyne. After the addition of (trifluoromethyl)diazomethane, 48 h were necessary to reach complete consumption of the *gem*-difluorocyclopropene. The crude mixture was purified by flash chromatography (AcOEt/PE=20:80) to afford **68** (30 mg, 0.09 mmol, 17%) as a white solid.

Prepared according to procedure B from *N*-propargyl phthalimide **17** (100 mg, 0.54 mmol, 1.0 equiv). Supplementary amounts of TFDA (0.32 mL, 3.0 equiv) were necessary to reach complete consumption of the alkyne. After the addition of (trifluoromethyl)diazomethane, 16 h were necessary to reach complete consumption of the *gem*-difluorocyclopropene. The crude mixture was purified by flash chromatography (AcOEt/PE=20:80) to afford **68** (100 mg, 0.31 mmol, 57%) as a white solid.

**Mp:** 138 °C.

**IR (neat):** 2927, 1776, 1720, 1607, 1411, 1394, 1365, 1281, 1189, 1167, 1113, 1057, 947, 905 cm<sup>-1</sup>.

**<sup>1</sup>H NMR (CDCl<sub>3</sub>, 400 MHz):** δ 7.91–7.87 (m, 2H, H<sub>9</sub> or H<sub>10</sub>), 7.79–7.75 (m, 2H, H<sub>9</sub> or H<sub>10</sub>), 7.60 (d, *J* = 9.1 Hz, 1H, H<sub>2</sub>), 5.34 (s, 2H, H<sub>6</sub>).

**<sup>13</sup>C NMR (CDCl<sub>3</sub>, 100 MHz):** δ 167.7 (2xC, C<sub>7</sub>), 160.5 (C, d, *J* = 279.9 Hz, C<sub>3</sub>), 153.4 (C, qd, *J* = 35.9 and 2.9 Hz, C<sub>1</sub>), 160.0 (C, d, *J* = 9.8 Hz, C<sub>4</sub>), 134.4 (2xCH, C<sub>9</sub> or C<sub>10</sub>), 132.1 (2xC, C<sub>8</sub>), 123.8 (2xCH, C<sub>9</sub> or C<sub>10</sub>), 120.5 (C, qd, *J* = 275.0 and 3.0 Hz, C<sub>5</sub>), 110.8 (CH, dq, *J* = 15.5 and 2.3 Hz, C<sub>2</sub>), 36.1 (CH<sub>2</sub>, C<sub>6</sub>).

**MS *m/z* (relative intensity):** 325 (M<sup>+</sup>, 100), 213 (12), 212 (82), 161 (81), 133 (11), 105 (13), 104 (78), 77 (25), 76 (49), 75 (11), 50 (18).

**HRMS:** calcd for C<sub>14</sub>H<sub>7</sub>F<sub>4</sub>N<sub>3</sub>NaO<sub>2</sub> (M+Na<sup>+</sup>): 348.0367. Found 348.0366.

#### 4-Fluoro-3-[2-(1,3-dioxisoindolin-2-yl)ethyl]-6-(trifluoromethyl)pyridazine (69)

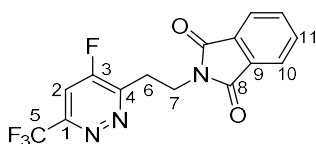

Prepared according to procedure A from *N*-homopropargyl phthalimide **19** (100 mg, 0.50 mmol, 1.0 equiv). Supplementary amounts of TMSCF<sub>3</sub> (0.15 mL, 2.0 equiv) were necessary to reach complete consumption of the alkyne. After the addition of (trifluoromethyl)diazomethane, 48 h were necessary to reach complete consumption of the *gem*-difluorocyclopropene. The crude mixture was purified by flash chromatography (AcOEt/PE=20:80) to afford **69** (50 mg, 0.15 mmol, 29%) as a pale yellow solid.

Prepared according to procedure B from *N*-homopropargyl phthalimide **19** (100 mg, 0.50 mmol, 1.0 equiv). After the addition of (trifluoromethyl)diazomethane, 16 h were necessary to reach complete consumption of the *gem*-difluorocyclopropene. The crude mixture was purified by flash chromatography (AcOEt/PE=20:80) to afford **69** (68 mg, 0.20 mmol, 40%) as a pale yellow solid.

**Mp:** 143 °C.

**IR (neat):** 2925, 2854, 1720, 1700, 1430, 1410, 1304, 1250, 1171, 1153, 1132, 1058, 997, 948 cm<sup>-1</sup>.

**<sup>1</sup>H NMR (CDCl<sub>3</sub>, 400 MHz):** δ 7.81–7.79 (m, 2H, H<sub>10</sub> or H<sub>11</sub>), 7.74–7.71 (m, 2H, H<sub>10</sub> or H<sub>11</sub>), 7.52 (d, *J* = 9.0 Hz, 1H, H<sub>2</sub>), 4.25 (t, *J* = 6.7 Hz, 2H, H<sub>7</sub>), 3.54 (td, *J* = 6.7 and 1.4 Hz, 2H, H<sub>6</sub>).

**<sup>13</sup>C NMR (CDCl<sub>3</sub>, 100 MHz):** δ 168.1 (2xC, C<sub>8</sub>), 161.2 (C, d, *J* = 278.4 Hz, C<sub>3</sub>), 155.0 (C, d, *J* = 10.4 Hz, C<sub>4</sub>), 152.6 (C, qd, *J* = 35.4 and 3.0 Hz, C<sub>1</sub>), 134.3 (2xCH, C<sub>10</sub> or C<sub>11</sub>), 131.9 (2xC, C<sub>9</sub>), 123.5 (2xCH, C<sub>10</sub> or C<sub>11</sub>), 120.7 (C, qd, *J* = 274.8 and 3.0 Hz, C<sub>5</sub>), 110.4 (CH, dq, *J* = 16.4 and 2.4 Hz, C<sub>2</sub>), 35.7 (CH<sub>2</sub>, C<sub>7</sub>), 29.5 (CH<sub>2</sub>, d, *J* = 2.0 Hz, C<sub>6</sub>).

**MS *m/z* (relative intensity):** 339 ( $M^{+}$ , 49), 252 (7), 192 (16), 175 (14), 161 (11), 160 (100), 133 (17), 105 (16), 104 (25), 77 (26), 76 (19), 50 (7).

**HRMS:** calcd for  $C_{15}H_9F_4N_3NaO_2$  ( $M+Na^{+}$ ): 362.0523. Found 362.0529.

**4-Fluoro-3-(2-{bis[(*tert*-butoxy)carbonyl]amino}ethyl)-6-(trifluoromethyl)pyridazine (70)**

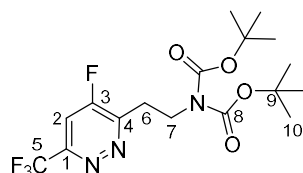

Prepared according to procedure **A** from *N,N*-bis[(*tert*-butoxy)carbonyl]-*N*-(but-3-yn-1-yl)carbamate **21** (106 mg, 0.39 mmol, 1.0 equiv). Supplementary amounts of  $TMSCF_3$  (0.06 mL, 1.0 equiv) were necessary to reach complete consumption of the alkyne. After the addition of (trifluoromethyl)diazomethane, 40 h were necessary to reach complete consumption of the *gem*-difluorocyclopropene. The crude mixture was purified by flash chromatography (AcOEt/PE=5:95) to afford **70** (102 mg, 0.25 mmol, 64%) as a yellow oil.

Prepared according to procedure **B** from *N,N*-bis[(*tert*-butoxy)carbonyl]-*N*-(but-3-yn-1-yl)carbamate **21** (100 mg, 0.37 mmol, 1.0 equiv). After the addition of (trifluoromethyl)diazomethane, 16 h were necessary to reach complete consumption of the *gem*-difluorocyclopropene. The crude mixture was purified by flash chromatography (AcOEt/PE=5:95) to afford **70** (55 mg, 0.13 mmol, 36%) as a yellow oil.

**IR (neat):** 2982, 1790, 1731, 1692, 1415, 1398, 1367, 1346, 1316, 1232, 1129, 1106, 1059, 963  $cm^{-1}$ .

**$^1H$  NMR ( $CDCl_3$ , 400 MHz):**  $\delta$  7.50 (d,  $J = 9.0$  Hz, 1H,  $H_2$ ), 4.11 (t,  $J = 6.6$  Hz, 2H,  $H_7$ ), 3.46 (td,  $J = 6.5$  and 1.6 Hz, 2H,  $H_6$ ), 1.44 (s, 18H,  $H_{10}$ ).

**$^{13}C$  NMR ( $CDCl_3$ , 100 MHz):**  $\delta$  161.3 (C, d,  $J = 278.1$  Hz,  $C_3$ ), 155.8 (C, d,  $J = 10.2$  Hz,  $C_4$ ), 152.3 (2xC,  $C_8$ ), 152.3 (C, qd,  $J = 35.5$  and 3.1 Hz,  $C_1$ ), 120.7 (C, qd,  $J = 274.6$  and 3.1 Hz,  $C_5$ ), 110.0 (CH, dq,  $J = 16.6$  and 2.4 Hz,  $C_2$ ), 82.9 (2xC,  $C_9$ ), 44.2 ( $CH_2$ ,  $C_7$ ), 29.9 ( $CH_2$ , d,  $J = 2.1$  Hz,  $C_6$ ), 28.0 (6x $CH_3$ ,  $C_{10}$ ).

**HRMS:** calcd for  $C_{17}H_{23}F_4N_3NaO_4$  ( $M+Na^{+}$ ): 432.1517. Found 432.1536.

## 5. Synthesis and spectroscopic data of 4-fluoro-3-phenyl-6-(perfluoroethyl)pyridazine (71)

### 4-Fluoro-3-phenyl-6-(perfluoroethyl)pyridazine (71)

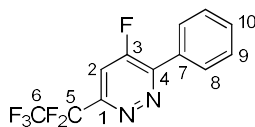

Formation of (pentafluoroethyl)diazomethane *in situ*: In an oven-dried vial were introduced 2,2,3,3,3-pentafluoropropan-1-amine hydrochloride (1.5 equiv compared to the alkyne) and NaNO<sub>2</sub> (1.8 equiv compared to the alkyne). The vial was then flushed with argon, CH<sub>2</sub>Cl<sub>2</sub> (*c* = 0.6 M) and H<sub>2</sub>O (CH<sub>2</sub>Cl<sub>2</sub>/H<sub>2</sub>O=30:1) were added. The reaction was then stirred at 0 °C for 1 h and at –78 °C for 10 min. The solution was then added to the difluorocyclopropene solution *via* a syringe.

Prepared according to procedure A from phenylacetylene **22** (70 mg, 0.69 mmol, 1.0 equiv). After the addition of (pentafluoroethyl)diazomethane, 72 h were necessary to reach complete consumption of the *gem*-difluorocyclopropene. The crude mixture was purified by flash chromatography (AcOEt/PE=2:98) to afford **71** (142 mg, 0.48 mmol, 71%) as a light yellow solid.

**Mp**: 52 °C.

**IR (neat)**: 1591, 1550, 1411, 1393, 1334, 1320, 1194, 1145, 1099, 1040, 1019, 906 cm<sup>-1</sup>.

**<sup>1</sup>H NMR (CDCl<sub>3</sub>, 400 MHz)**: δ 8.13–8.10 (m, 2H, H<sub>8</sub>), 7.66 (d, *J* = 10.7 Hz, 1H, H<sub>2</sub>), 7.59–7.54 (m, 3H, H<sub>9</sub> and H<sub>10</sub>).

**<sup>13</sup>C NMR (CDCl<sub>3</sub>, 100 MHz)**: δ 160.5 (C, d, *J* = 281.8 Hz, C<sub>3</sub>), 153.6 (C, d, *J* = 5.2 Hz, C<sub>4</sub>), 151.7 (C, td, *J* = 26.3 and 3.1 Hz, C<sub>1</sub>), 131.6 (CH, C<sub>10</sub>), 130.9 (C, d, *J* = 4.8 Hz, C<sub>7</sub>), 129.5 (2xCH, d, *J* = 5.3 Hz, C<sub>8</sub>), 129.1 (2xCH, C<sub>9</sub>), 118.7 (C, qt, *J* = 286.5 and 36.5 Hz, C<sub>6</sub>), 113.0 (CH, dt, *J* = 18.1 and 4.1 Hz, C<sub>2</sub>), 110.7 (C, tqd, *J* = 255.0, 39.0 and 2.0 Hz, C<sub>5</sub>).

**MS *m/z* (relative intensity)**: 292 (M<sup>+</sup>, 100), 273 (5), 245 (2), 195 (74), 175 (12), 169 (6), 151 (6), 125 (5), 120 (22), 100 (5), 98 (6), 75 (10), 69 (5), 51 (9).

**HRMS**: calcd for C<sub>12</sub>H<sub>6</sub>F<sub>6</sub>N<sub>2</sub>Na (M+Na<sup>+</sup>): 315.0327. Found 315.0328.

## 6. Synthesis and spectroscopic data of 4-fluoro-3-phenyl-6-(difluoromethyl)pyridazine (72)

### 4-Fluoro-3-phenyl-6-(difluoromethyl)pyridazine (72)

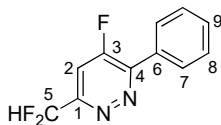

Formation of (difluoromethyl)diazomethane *in situ*: In an oven-dried vial was introduced 2,2-difluoroethan-1-amine (4.0 equiv compared to the alkyne) and  $\text{CH}_2\text{Cl}_2$  ( $c = 0.6 \text{ M}$ ) was added. *t*-BuONO (4.8 equiv compared to the alkyne) and AcOH (0.8 equiv compared to the alkyne) were added. The reaction was then stirred at  $70^\circ\text{C}$  for 10 min and was then allowed to cool down to rt. The solution was then added to the difluorocyclopropene solution *via* a syringe.

Prepared according to procedure A from phenylacetylene **22** (50 mg, 0.49 mmol, 1.0 equiv). After the addition of (difluoromethyl)diazomethane, 8 days were necessary to reach complete consumption of the *gem*-difluorocyclopropene. The crude mixture was purified by flash chromatography (AcOEt/PE=3:97) to afford **72** (48 mg, 0.21 mmol, 44%) as a yellow oil.

**IR (neat)**: 3065, 1601, 1551, 1399, 1350, 1166, 1087, 1051, 990, 898  $\text{cm}^{-1}$ .

**$^1\text{H}$  NMR ( $\text{CDCl}_3$ , 400 MHz)**:  $\delta$  8.09–8.06 (m, 2H, H<sub>7</sub>), 7.61 (d,  $J = 10.6 \text{ Hz}$ , 1H, H<sub>2</sub>), 7.59–7.55 (m, 3H, H<sub>8</sub> and H<sub>9</sub>), 7.01 (td,  $J = 54.4$  and  $1.4 \text{ Hz}$ , 1H, H<sub>5</sub>).

**$^{13}\text{C}$  NMR ( $\text{CDCl}_3$ , 100 MHz)**:  $\delta$  160.9 (C, d,  $J = 280.6 \text{ Hz}$ , C<sub>3</sub>), 156.4 (C, td,  $J = 27.6$  and  $3.2 \text{ Hz}$ , C<sub>1</sub>), 153.4 (C, d,  $J = 5.8 \text{ Hz}$ , C<sub>4</sub>), 131.3 (C, d,  $J = 4.6 \text{ Hz}$ , C<sub>6</sub>), 131.2 (CH, C<sub>9</sub>), 129.4 (2xCH, d,  $J = 5.0 \text{ Hz}$ , C<sub>7</sub>), 129.0 (2xCH, C<sub>8</sub>), 112.8 (C, td,  $J = 240.9$  and  $1.4 \text{ Hz}$ , C<sub>5</sub>), 111.1 (CH, dt,  $J = 16.9$  and  $2.0 \text{ Hz}$ , C<sub>2</sub>).

**MS  $m/z$  (relative intensity)**: 224 ( $\text{M}^+$ , 100), 195 (43), 177 (11), 175 (7), 151 (8), 146 (31), 125 (7), 120 (22), 102 (6), 94 (7), 75 (8), 51 (16).

**HRMS**: calcd for  $\text{C}_{11}\text{H}_7\text{F}_3\text{N}_2\text{Na}$  ( $\text{M}+\text{Na}^+$ ): 247.0454. Found 247.0454.

## 7. Post-functionalization of 6-(trifluoromethyl) pyridazines: Synthesis and spectroscopic data of pyridazines 73–89

### 4-Morpholino-3-phenyl-6-(trifluoromethyl)pyridazine (73)

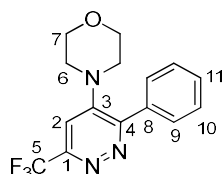

To a stirred solution of 4-fluoro-3-phenyl-6-(trifluoromethyl)pyridazine **24** (50 mg, 0.21 mmol, 1.0 equiv) in MeCN (0.2 mL) was added morpholine (0.036 mL, 0.41 mmol, 2.0 equiv) and the reaction mixture was stirred at 100 °C for 3 h. The reaction mixture was concentrated under reduced pressure. The crude mixture was purified by flash chromatography (AcOEt/PE=30:70) to afford **73** (54 mg, 0.17 mmol, 85%) as a white solid.

**Mp:** 149 °C.

**IR (neat):** 2960, 2859, 1582, 1568, 1426, 1374, 1313, 1291, 1274, 1253, 1179, 1133, 1098, 1071, 1055, 1010, 968 cm<sup>-1</sup>.

**<sup>1</sup>H NMR (CDCl<sub>3</sub>, 400 MHz):** δ 7.88–7.86 (m, 2H, H<sub>9</sub> or H<sub>10</sub>), 7.50–7.46 (m, 3H, H<sub>9</sub> or H<sub>10</sub> and H<sub>11</sub>), 7.16 (s, 1H, H<sub>2</sub>), 3.67–3.70 (m, 4H, H<sub>7</sub>), 3.06–3.03 (m, 4H, H<sub>6</sub>).

**<sup>13</sup>C NMR (CDCl<sub>3</sub>, 100 MHz):** δ 155.7 (C, C<sub>3</sub>), 150.2 (C, q, *J* = 33.8 Hz, C<sub>1</sub>), 149.2 (C, C<sub>4</sub>), 137.0 (C, C<sub>8</sub>), 130.0 (CH, C<sub>11</sub>), 129.0 (2xCH, C<sub>9</sub> or C<sub>10</sub>), 128.0 (2xCH, C<sub>9</sub> or C<sub>10</sub>), 121.7 (C, q, *J* = 274.9 Hz, C<sub>5</sub>), 109.6 (CH, q, *J* = 2.2 Hz, C<sub>2</sub>), 65.9 (2xCH<sub>2</sub>, C<sub>7</sub>), 49.3 (2xCH<sub>2</sub>, C<sub>6</sub>).

**MS *m/z* (relative intensity):** 309 (M<sup>+</sup>, 100), 308 (50), 282 (22), 251 (41), 250 (77), 202 (18), 182 (34), 155 (9), 126 (14), 102 (23), 86 (17), 77 (14).

**HRMS:** calcd for C<sub>15</sub>H<sub>15</sub>F<sub>3</sub>N<sub>3</sub>O (M+H<sup>+</sup>): 310.1162. Found 310.1161.

### 4-Dibenzylamino-3-phenyl-6-(trifluoromethyl)pyridazine (74)

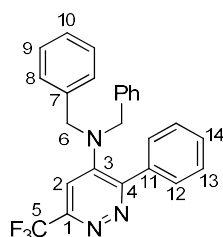

To a stirred solution of 4-fluoro-3-phenyl-6-(trifluoromethyl)pyridazine **24** (50 mg, 0.21 mmol, 1.0 equiv) in MeCN (0.2 mL) was added *N,N*-dibenzylamine (0.080 mL, 0.41 mmol, 2.0 equiv) and the



reaction mixture was stirred at 100 °C for 72 h. The reaction mixture was concentrated under reduced pressure. The crude mixture was purified by flash chromatography (AcOEt/PE=15:85) to afford **74** (72 mg, 0.17 mmol, 83%) as a white solid.

**Mp:** 127 °C.

**IR (neat):** 1564, 1495, 1452, 1418, 1358, 1288, 1176, 1140, 1102, 1028, 1011, 953 908 cm<sup>-1</sup>.

**<sup>1</sup>H NMR (CDCl<sub>3</sub>, 400 MHz):** δ 7.85–7.82 (m, 2H, H<sub>12</sub> or H<sub>13</sub>), 7.52–7.44 (m, 3H, H<sub>12</sub> or H<sub>13</sub> and H<sub>14</sub>), 7.32–7.24 (m, 6H, H<sub>9</sub> and H<sub>10</sub>), 7.11 (s, 1H, H<sub>2</sub>), 7.03–7.01 (m, 4H, H<sub>8</sub>), 4.18 (s, 4H, H<sub>6</sub>).

**<sup>13</sup>C NMR (CDCl<sub>3</sub>, 100 MHz):** δ 155.6 (C, C<sub>3</sub>), 149.7 (C, q, *J* = 33.5 Hz, C<sub>1</sub>), 148.2 (C, C<sub>4</sub>), 137.7 (C, C<sub>11</sub>), 135.6 (2xC, C<sub>7</sub>), 129.6 (CH, C<sub>14</sub>), 129.1 (2xCH, C<sub>12</sub> or C<sub>13</sub>), 128.9 (4xCH, C<sub>8</sub> or C<sub>9</sub>), 128.3 (2xCH, C<sub>12</sub> or C<sub>13</sub>), 128.1 (2xCH, C<sub>10</sub>), 128.1 (4xCH, C<sub>8</sub> or C<sub>9</sub>), 121.7 (C, q, *J* = 274.9 Hz, C<sub>5</sub>), 110.9 (CH, q, *J* = 2.6 Hz, C<sub>2</sub>), 54.7 (2xCH<sub>2</sub>, C<sub>6</sub>).

**MS *m/z* (relative intensity):** 419 (M<sup>+</sup>, 15), 418 (8), 328 (18), 250 (6), 126 (1), 92 (9), 91 (100), 65 (11).

**HRMS:** calcd for C<sub>25</sub>H<sub>21</sub>F<sub>3</sub>N<sub>3</sub> (M+H<sup>+</sup>): 420.1682. Found 420.1681.

#### 4-Allylamino-3-phenyl-6-(trifluoromethyl)pyridazine (**75**)

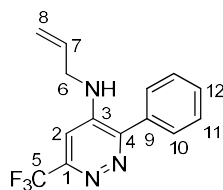

To a stirred solution of 4-fluoro-3-phenyl-6-(trifluoromethyl)pyridazine **24** (60 mg, 0.25 mmol, 1.0 equiv) in MeCN (0.24 mL) was added allylamine (0.037 mL, 0.50 mmol, 2.0 equiv) and the reaction mixture was stirred at 100 °C for 4 h. The reaction mixture was concentrated under reduced pressure. The crude mixture was purified by flash chromatography (AcOEt/PE=20:80) to afford **75** (70 mg, 0.25 mmol, quant) as a white solid.

**Mp:** 132 °C.

**IR (neat):** 3267, 1590, 1548, 1507, 1427, 1387, 1290, 1180, 1142, 1096, 1011, 929 cm<sup>-1</sup>.

**<sup>1</sup>H NMR (CDCl<sub>3</sub>, 400 MHz):** δ 7.53–7.51 (m, 2H, H<sub>10</sub> or H<sub>11</sub>), 7.45–7.40 (m, 3H, H<sub>10</sub> or H<sub>11</sub> and H<sub>12</sub>), 6.73 (s, 1H, H<sub>2</sub>), 5.74 (m, 1H, H<sub>7</sub>), 5.20–5.13 (m, 3H, NH and H<sub>8</sub>), 3.79–3.76 (m, 2H, H<sub>6</sub>).

**<sup>13</sup>C NMR (CDCl<sub>3</sub>, 100 MHz):** δ 152.2 (C, C<sub>3</sub>), 150.2 (C, q, *J* = 33.3 Hz, C<sub>1</sub>), 144.1 (C, C<sub>4</sub>), 133.9 (C, C<sub>9</sub>), 131.8 (CH, C<sub>7</sub>), 130.0 (CH, C<sub>12</sub>), 129.5 (2xCH, C<sub>10</sub> or C<sub>11</sub>), 128.7 (2xCH, C<sub>10</sub> or C<sub>11</sub>), 121.8 (C, q, *J* = 274.8 Hz, C<sub>5</sub>), 117.0 (CH<sub>2</sub>, C<sub>8</sub>), 101.8 (CH, q, *J* = 2.6 Hz, C<sub>2</sub>), 44.9 (CH<sub>2</sub>, C<sub>6</sub>).

**MS *m/z* (relative intensity):** 279 (M<sup>+</sup>, 92), 278 (100), 251 (21), 237 (13), 202 (22), 183 (37), 126 (10), 115 (8), 102 (21), 89 (16), 77 (16), 56 (24).

**HRMS:** calcd for C<sub>14</sub>H<sub>13</sub>F<sub>3</sub>N<sub>3</sub> (M+H<sup>+</sup>): 280.1056. Found 280.1055.

#### 4-Methoxy-3-phenyl-6-(trifluoromethyl)pyridazine (76)

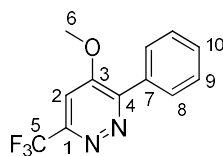

1) To a stirred solution of 4-fluoro-3-phenyl-6-(trifluoromethyl)pyridazine **24** (50 mg, 0.21 mmol, 1.0 equiv) in MeCN (0.2 mL) was added sodium methoxide (33.5 mg, 0.62 mmol, 3.0 equiv) and the reaction mixture was stirred at 100 °C for 48 h. The reaction mixture was then concentrated under reduced pressure. The crude mixture was purified by flash chromatography (AcOEt/PE=20:80) to afford **76** (36 mg, 0.14 mmol, 69%) as a pale brown oil.

2) To a stirred solution of 4-fluoro-3-phenyl-6-(trifluoromethyl)pyridazine **24** (50 mg, 0.21 mmol, 1.0 equiv) in DMSO (0.2 mL) was added MeOH (0.025 mL, 0.62 mmol, 3.0 equiv) and DBU (0.093 mL, 0.62 mmol, 3.0 equiv) and the reaction mixture was stirred at 80 °C for 3 h. An aqueous saturated NH<sub>4</sub>Cl solution was added to the mixture and the aqueous phase was extracted with AcOEt. The combined organic phases were dried over Na<sub>2</sub>SO<sub>4</sub> and concentrated under reduced pressure. The crude mixture was purified by flash chromatography (AcOEt/PE=20:80) to afford **76** (40 mg, 0.16 mmol, 76%) as a pale brown oil.

**IR (neat):** 2927, 1586, 1571, 1468, 1388, 1321, 1297, 1265, 1178, 1139, 1091, 1021, 918 cm<sup>-1</sup>.

**<sup>1</sup>H NMR (CDCl<sub>3</sub>, 400 MHz):** δ 7.90–7.87 (m, 2H, H<sub>8</sub> or H<sub>9</sub>), 7.42–7.40 (m, 3H, H<sub>8</sub> or H<sub>9</sub> and H<sub>10</sub>), 7.18 (s, 1H, H<sub>2</sub>), 3.93 (s, 3H, H<sub>6</sub>).

**<sup>13</sup>C NMR (CDCl<sub>3</sub>, 100 MHz):** δ 157.1 (C, C<sub>3</sub>), 154.9 (C, C<sub>4</sub>), 151.0 (C, q, *J* = 34.3 Hz, C<sub>1</sub>), 133.3 (C, C<sub>7</sub>), 130.3 (CH, C<sub>10</sub>), 129.8 (2xCH, C<sub>8</sub> or C<sub>9</sub>), 128.4 (2xCH, C<sub>8</sub> or C<sub>9</sub>), 121.4 (C, q, *J* = 274.8 Hz, C<sub>5</sub>), 104.9 (CH, q, *J* = 2.4 Hz, C<sub>2</sub>), 56.1 (CH<sub>3</sub>, C<sub>6</sub>).

**MS *m/z* (relative intensity):** 254 (M<sup>+</sup>, 46), 253 (100), 225 (5), 205 (6), 183 (9), 133 (14), 102 (26), 89 (23), 77 (8), 69 (8), 63 (10), 51 (7).

**HRMS:** calcd for C<sub>12</sub>H<sub>10</sub>F<sub>3</sub>N<sub>2</sub>O (M+H<sup>+</sup>): 255.0740. Found 255.0738.

#### 4-Allyloxy-3-phenyl-6-(trifluoromethyl)pyridazine (77)

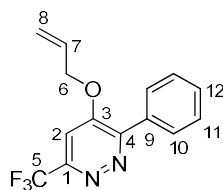

To a stirred solution of 4-fluoro-3-phenyl-6-(trifluoromethyl)pyridazine **24** (50 mg, 0.21 mmol, 1.0 equiv) in DMSO (0.2 mL) was added allylic alcohol (0.042 mL, 0.62 mmol, 3.0 equiv) and DBU (0.093 mL, 0.62 mmol, 3.0 equiv) and the reaction mixture was stirred at 80 °C for 3 h. An aqueous saturated NH<sub>4</sub>Cl solution was added to the mixture and the aqueous phase was extracted with AcOEt. The combined organic phases were dried over Na<sub>2</sub>SO<sub>4</sub> and concentrated under reduced pressure. The crude mixture was purified by flash chromatography (AcOEt/PE=10:90) to afford **77** (41 mg, 0.15 mmol, 71%) as a colorless oil.

**IR (neat):** 1584, 1409, 1357, 1321, 1267, 1178, 1140, 1092, 1014, 988, 926 cm<sup>-1</sup>.

**<sup>1</sup>H NMR (CDCl<sub>3</sub>, 400 MHz):** δ 8.02–7.99 (m, 2H, H<sub>10</sub> or H<sub>11</sub>), 7.52–7.48 (m, 3H, H<sub>10</sub> or H<sub>11</sub> and H<sub>12</sub>), 7.25 (s, 1H, H<sub>2</sub>), 6.02 (m, 1H, H<sub>7</sub>), 5.47–5.39 (m, 2H, H<sub>8</sub>), 4.76 (dt<sub>app</sub>, *J* = 5.1 and 1.5 Hz, 2H, H<sub>6</sub>).

**<sup>13</sup>C NMR (CDCl<sub>3</sub>, 100 MHz):** δ 156.0 (C, C<sub>3</sub>), 155.0 (C, C<sub>4</sub>), 150.9 (C, q, *J* = 34.3 Hz, C<sub>1</sub>), 133.3 (C, C<sub>9</sub>), 130.3 (CH, C<sub>7</sub>), 130.2 (CH, C<sub>12</sub>), 129.9 (2xCH, C<sub>10</sub> or C<sub>11</sub>), 128.4 (2xCH, C<sub>10</sub> or C<sub>11</sub>), 121.4 (C, q, *J* = 274.9 Hz, C<sub>5</sub>), 119.8 (CH<sub>2</sub>, C<sub>8</sub>), 105.9 (CH, q, *J* = 2.4 Hz, C<sub>2</sub>), 69.8 (CH<sub>2</sub>, C<sub>6</sub>).

**MS *m/z* (relative intensity):** 280 (M<sup>+</sup>, 100), 279 (90), 251 (95), 249 (63), 239 (24), 224 (35), 203 (10), 196 (18), 170 (9), 144 (10), 142 (10), 133 (12), 128 (17), 126 (20), 115 (16), 108 (99), 102 (42), 89 (27), 77 (36), 69 (78), 63 (33), 51 (22).

**HRMS:** calcd for C<sub>14</sub>H<sub>12</sub>F<sub>3</sub>N<sub>2</sub>O (M+H<sup>+</sup>): 281.0896. Found 281.0893.

#### 4-Ethylthio-3-phenyl-6-(trifluoromethyl)pyridazine (78)

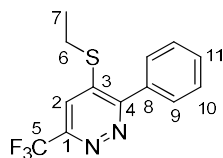

To a stirred solution of 4-fluoro-3-phenyl-6-(trifluoromethyl)pyridazine **24** (50 mg, 0.207 mmol, 1.0 equiv) in MeCN (0.2 mL) was added sodium ethanethiolate (28.9 mg, 0.31 mmol, 1.5 equiv) and the reaction mixture was stirred at 100 °C for 4 h. An aqueous saturated NaHCO<sub>3</sub> solution was added to the mixture and the aqueous phase was extracted with AcOEt. The combined organic phases were dried over Na<sub>2</sub>SO<sub>4</sub> and concentrated under reduced pressure. The crude mixture was purified by flash chromatography (AcOEt/PE=10:90) to afford **78** (55 mg, 0.19 mmol, 94%) as a yellow oil.

**IR (neat):** 3061, 2932, 1551, 1447, 1353, 1315, 1292, 1255, 1177, 1139, 1110, 1073, 1009, 1034 cm<sup>-1</sup>.

**<sup>1</sup>H NMR (CDCl<sub>3</sub>, 400 MHz):** δ 7.71–7.69 (m, 2H, H<sub>9</sub> or H<sub>10</sub>), 7.53–7.51 (m, 4H, H<sub>2</sub>, H<sub>9</sub> or H<sub>10</sub> and H<sub>11</sub>), 2.99 (q, *J* = 7.4 Hz, 2H, H<sub>6</sub>), 1.39 (t, *J* = 7.4 Hz, 3H, H<sub>7</sub>).

**<sup>13</sup>C NMR (CDCl<sub>3</sub>, 100 MHz):** δ 161.0 (C, C<sub>3</sub>), 149.1 (C, q, *J* = 34.2 Hz, C<sub>1</sub>), 144.6 (C, C<sub>4</sub>), 135.3 (C, C<sub>8</sub>), 130.3 (CH, C<sub>11</sub>), 129.1 (2xCH, C<sub>9</sub> or C<sub>10</sub>), 128.6 (2xCH, C<sub>9</sub> or C<sub>10</sub>), 121.6 (C, q, *J* = 274.9 Hz, C<sub>5</sub>), 117.8 (CH, q, *J* = 2.3 Hz, C<sub>2</sub>), 25.6 (CH<sub>2</sub>, C<sub>6</sub>), 12.5 (CH<sub>3</sub>, C<sub>7</sub>).

**MS *m/z* (relative intensity):** 284 (M<sup>+</sup>, 36), 255 (100), 207 (28), 183 (6), 158 (5), 134 (18), 126 (9), 120 (12), 89 (9), 77 (7), 69 (7).

**HRMS:** calcd for C<sub>13</sub>H<sub>12</sub>F<sub>3</sub>N<sub>2</sub>S (M+H<sup>+</sup>): 285.0668. Found 285.0671.

#### 4-Dimethyl malonate-3-phenyl-6-(trifluoromethyl)pyridazine (79)

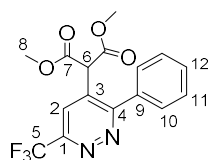

To a stirred solution of 4-fluoro-3-phenyl-6-(trifluoromethyl)pyridazine **24** (50 mg, 0.207 mmol, 1.0 equiv) in DMSO (0.5 mL) was added dimethyl malonate (0.071 mL, 0.62 mmol, 3.0 equiv) and DBU (0.093 mL, 0.62 mmol, 3.0 equiv) and the reaction mixture was stirred at 80 °C for 3 h. An aqueous saturated NH<sub>4</sub>Cl solution was added to the mixture and the aqueous phase was extracted with AcOEt. The combined organic phases were dried over Na<sub>2</sub>SO<sub>4</sub> and concentrated under reduced pressure. The crude mixture was purified by flash chromatography (AcOEt/PE=20:80) to afford **79** (67 mg, 0.19 mmol, 92%) as a white solid.

**Mp:** 118 °C.

**IR (neat):** 2959, 2850, 1739, 1437, 1392, 1263, 1218, 1193, 1144, 1083, 1017, 913 cm<sup>-1</sup>.

**<sup>1</sup>H NMR (CDCl<sub>3</sub>, 400 MHz):** δ 8.11 (s, 1H, H<sub>2</sub>), 7.49 (br s, 5H, H<sub>10</sub>, H<sub>11</sub> and H<sub>12</sub>), 4.91 (s, 1H, H<sub>6</sub>), 3.71 (s, 6H, H<sub>8</sub>).

**<sup>13</sup>C NMR (CDCl<sub>3</sub>, 100 MHz):** δ 166.6 (2xC, C<sub>7</sub>), 163.8 (C, C<sub>4</sub>), 150.4 (C, q, *J* = 34.9 Hz, C<sub>1</sub>), 134.7 (C, C<sub>3</sub> or C<sub>9</sub>), 132.2 (C, C<sub>3</sub> or C<sub>9</sub>), 130.2 (CH, C<sub>12</sub>), 129.5 (2xCH, C<sub>10</sub> or C<sub>11</sub>), 129.1 (2xCH, C<sub>10</sub> or C<sub>11</sub>), 125.1 (CH, q, *J* = 2.4 Hz, C<sub>2</sub>), 121.5 (C, q, *J* = 274.6 Hz, C<sub>5</sub>), 53.9 (2xCH<sub>3</sub>, C<sub>8</sub>), 52.7 (CH, C<sub>6</sub>).

**HRMS:** calcd for C<sub>16</sub>H<sub>14</sub>F<sub>3</sub>N<sub>2</sub>O<sub>4</sub> (M+H<sup>+</sup>): 355.0900. Found 355.0900.

#### 4-Nitromethyl-3-phenyl-6-(trifluoromethyl)pyridazine (80)

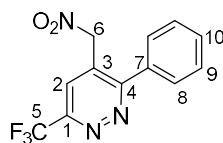

To a stirred solution of 4-fluoro-3-phenyl-6-(trifluoromethyl)pyridazine **24** (150 mg, 0.62 mmol, 1.0 equiv) in DMSO (1.8 mL) was added nitromethane (0.1 mL, 1.89 mmol, 3.0 equiv) and DBU (0.28 mL, 1.89 mmol, 3.0 equiv) and the reaction mixture was stirred at 80 °C for 3 h. An aqueous saturated NH<sub>4</sub>Cl solution was added to the mixture and the aqueous phase was extracted with CH<sub>2</sub>Cl<sub>2</sub>. The combined organic phases were dried over Na<sub>2</sub>SO<sub>4</sub> and concentrated in vacuo. The crude mixture was purified by flash chromatography (MeOH/CH<sub>2</sub>Cl<sub>2</sub>=2:98) to afford **80** (91 mg, 0.32 mmol, 52%) as a yellow oil.

**IR (neat):** 2925, 2854, 1561, 1398, 1364, 1292, 1266, 1194, 1148, 1085, 1036, 1015, 908 cm<sup>-1</sup>.

**<sup>1</sup>H NMR (CDCl<sub>3</sub>, 400 MHz):** δ 7.93 (br s, 1H, H<sub>2</sub>), 7.52–7.42 (m, 5H, H<sub>8</sub>, H<sub>9</sub> or H<sub>10</sub>), 5.54 (s, 2H, H<sub>6</sub>).

**<sup>13</sup>C NMR (CDCl<sub>3</sub>, 100 MHz):** δ 163.8 (C, C<sub>4</sub>), 150.9 (C, q, *J* = 35.6 Hz, C<sub>1</sub>), 134.0 (C, C<sub>3</sub> or C<sub>7</sub>), 130.8 (CH, C<sub>10</sub>), 129.4 (2xCH, C<sub>8</sub> or C<sub>9</sub>), 129.2 (2xCH, C<sub>8</sub> or C<sub>9</sub>), 128.3 (C, C<sub>3</sub> or C<sub>7</sub>), 125.9 (CH, q, *J* = 2.4 Hz, C<sub>2</sub>), 121.2 (C, q, *J* = 274.7 Hz, C<sub>5</sub>), 75.3 (CH<sub>2</sub>, C<sub>6</sub>).

**MS *m/z* (relative intensity):** 283 (M<sup>+</sup>, 28), 237 (100), 217 (8), 188 (64), 168 (20), 159 (12), 139 (19), 115 (18), 89 (14), 77 (15), 69 (14), 51 (12).

**HRMS:** calcd for C<sub>12</sub>H<sub>8</sub>F<sub>3</sub>N<sub>3</sub>O<sub>2</sub>Na (M+Na<sup>+</sup>): 306.0461. Found 306.0462.

#### 4-Methyl-3-phenyl-6-(trifluoromethyl)pyridazine (81)

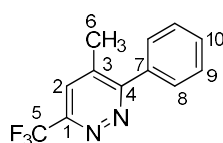

To a stirred solution of CuI (433 mg, 2.27 mmol, 5.5 equiv) in Et<sub>2</sub>O (7.1 mL) at –30 °C was added dropwise MeLi (2.58 mL, 4.13 mmol, 10.0 equiv, 1.6 M in Et<sub>2</sub>O) and the reaction mixture was stirred at –30 °C for 5 min. A solution of 4-fluoro-3-phenyl-6-(trifluoromethyl)pyridazine **24** (100 mg, 0.41 mmol, 1.0 equiv) in Et<sub>2</sub>O (3.6 mL) was added to the mixture and the solution was stirred at 0 °C for 48 h. An aqueous saturated NH<sub>4</sub>Cl solution was added to the mixture and the aqueous phase was extracted with Et<sub>2</sub>O. The combined organic phases were dried over Na<sub>2</sub>SO<sub>4</sub> and concentrated under reduced pressure. The crude mixture was purified by flash chromatography (AcOEt/PE=5:95 and 10:90) to afford **81** (12 mg, 0.05 mmol, 12%) as a yellow oil.

**IR (neat):** 2920, 1448, 1397, 1318, 1293, 1269, 1197, 1169, 1128, 1092, 761, 702  $\text{cm}^{-1}$ .

**$^1\text{H}$  NMR ( $\text{CDCl}_3$ , 400 MHz):**  $\delta$  7.71 (q,  $J = 0.8$  Hz, 1H,  $\text{H}_2$ ), 7.63–7.61 (m, 2H,  $\text{H}_8$  or  $\text{H}_9$ ), 7.55–7.53 (m, 3H,  $\text{H}_8$  or  $\text{H}_9$  and  $\text{H}_{10}$ ), 2.49 (d,  $J = 0.7$  Hz, 3H,  $\text{H}_6$ ).

**$^{13}\text{C}$  NMR ( $\text{CDCl}_3$ , 100 MHz):**  $\delta$  164.3 (C,  $\text{C}_4$ ), 150.1 (C, q,  $J = 34.6$  Hz,  $\text{C}_1$ ), 137.5 (C,  $\text{C}_3$  or  $\text{C}_7$ ), 136.0 (C,  $\text{C}_3$  or  $\text{C}_7$ ), 129.8 (CH,  $\text{C}_{10}$ ), 129.4 (2xCH,  $\text{C}_8$  or  $\text{C}_9$ ), 128.8 (2xCH,  $\text{C}_8$  or  $\text{C}_9$ ), 125.5 (CH, q,  $J = 2.2$  Hz,  $\text{C}_2$ ), 121.7 (C, q,  $J = 274.4$  Hz,  $\text{C}_5$ ), 20.1 ( $\text{CH}_3$ ,  $\text{C}_6$ ).

**MS  $m/z$  (relative intensity):** 238 ( $\text{M}^+$ , 35), 237 (100), 188 (8), 170 (6), 116 (30), 115 (95), 89 (8), 63 (18), 51 (22).

**HRMS:** calcd for  $\text{C}_{12}\text{H}_9\text{F}_3\text{N}_2\text{Na}$  ( $\text{M}+\text{Na}^+$ ): 261.0610. Found 261.0608.

#### 4-Morpholino-3-(4-fluorophenyl)-6-(trifluoromethyl)pyridazine (**82**)

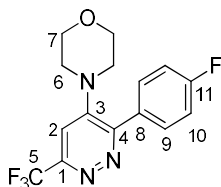

To a stirred solution of 4-fluoro-3-(4-fluoro-phenyl)-6-(trifluoromethyl)pyridazine **47** (50 mg, 0.19 mmol, 1.0 equiv) in MeCN (0.19 mL) was added morpholine (0.034 mL, 0.38 mmol, 2.0 equiv) and the reaction mixture was stirred at 80 °C for 3 h. The reaction mixture was concentrated under reduced pressure. The crude mixture was purified by flash chromatography ( $\text{Et}_2\text{O}/\text{PE}=20:80$  and 30:70) to afford **82** (62 mg, 0.19 mmol, quant) as a white solid.

**Mp:** 166 °C.

**IR (neat):** 2960, 2858, 1602, 1570, 1508, 1433, 1402, 1320, 1299, 1228, 1134, 1117, 1054, 970  $\text{cm}^{-1}$ .

**$^1\text{H}$  NMR ( $\text{CDCl}_3$ , 400 MHz):**  $\delta$  7.94–7.90 (m, 2H,  $\text{H}_9$ ), 7.22–7.17 (m, 3H,  $\text{H}_2$  and  $\text{H}_{10}$ ), 3.73–3.70 (m, 4H,  $\text{H}_7$ ), 3.06–3.03 (m, 4H,  $\text{H}_6$ ).

**$^{13}\text{C}$  NMR ( $\text{CDCl}_3$ , 100 MHz):**  $\delta$  163.7 (C, d,  $J = 250.6$  Hz,  $\text{C}_{11}$ ), 154.8 (C,  $\text{C}_3$ ), 150.3 (C, q,  $J = 33.8$  Hz,  $\text{C}_1$ ), 149.2 (C,  $\text{C}_4$ ), 133.0 (C, d,  $J = 3.4$  Hz,  $\text{C}_8$ ), 130.1 (2xCH, d,  $J = 8.3$  Hz,  $\text{C}_9$ ), 121.6 (C, q,  $J = 274.9$  Hz,  $\text{C}_5$ ), 116.1 (2xCH, d,  $J = 21.7$  Hz,  $\text{C}_{10}$ ), 109.9 (CH, q,  $J = 2.4$  Hz,  $\text{C}_2$ ), 65.9 (2x $\text{CH}_2$ ,  $\text{C}_7$ ), 49.3 (2x $\text{CH}_2$ ,  $\text{C}_6$ ).

**MS  $m/z$  (relative intensity):** 327 ( $\text{M}^+$ , 100), 296 (81), 282 (9), 269 (35), 268 (67), 220 (12), 201 (12), 200 (28), 162 (7), 144 (13), 120 (17), 86 (15), 75 (5), 57 (9).

**HRMS:** calcd for  $\text{C}_{15}\text{H}_{14}\text{F}_4\text{N}_3\text{O}$  ( $\text{M}+\text{H}^+$ ): 328.1068. Found 328.1068.

#### 4-Morpholino-3-(4-carbomethoxyphenyl)-6-(trifluoromethyl)pyridazine (83)

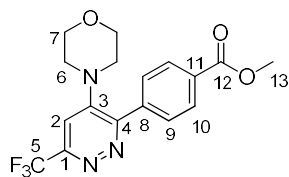

To a stirred solution of 4-fluoro-3-(4-methylbenzoate)-6-(trifluoromethyl)pyridazine **43** (50 mg, 0.17 mmol, 1.0 equiv) in MeCN (0.16 mL) was added morpholine (0.029 mL, 0.33 mmol, 2.0 equiv) and the reaction mixture was stirred at 80 °C for 3 h. The reaction mixture was concentrated under reduced pressure. The crude mixture was purified by flash chromatography (Et<sub>2</sub>O/PE=70:30) to afford **83** (50 mg, 0.14 mmol, 82%) as a white solid.

**Mp:** 186 °C.

**IR (neat):** 2956, 2856, 1719, 1578, 1564, 1434, 1402, 1275, 1179, 1135, 1113, 1009, 969, 911 cm<sup>-1</sup>.

**<sup>1</sup>H NMR (CDCl<sub>3</sub>, 400 MHz):** δ 8.19–8.17 (m, 2H, H<sub>10</sub>), 8.00–7.98 (m, 2H, H<sub>9</sub>), 7.20 (s, 1H, H<sub>2</sub>), 3.97 (s, 3H, H<sub>13</sub>), 3.71–3.69 (m, 4H, H<sub>7</sub>), 3.06–3.04 (m, 4H, H<sub>6</sub>).

**<sup>13</sup>C NMR (CDCl<sub>3</sub>, 100 MHz):** δ 166.5 (C, C<sub>12</sub>), 154.7 (C, C<sub>3</sub>), 150.6 (C, q, *J* = 33.9 Hz, C<sub>1</sub>), 149.3 (C, C<sub>4</sub>), 141.3 (C, C<sub>11</sub>), 131.5 (C, C<sub>8</sub>), 130.3 (2xCH, C<sub>10</sub>), 128.1 (2xCH, C<sub>9</sub>), 121.6 (C, q, *J* = 274.9 Hz, C<sub>5</sub>), 109.9 (CH, q, *J* = 2.4 Hz, C<sub>2</sub>), 65.9 (2xCH<sub>2</sub>, C<sub>7</sub>), 52.5 (CH<sub>3</sub>, C<sub>13</sub>), 49.5 (2xCH<sub>2</sub>, C<sub>6</sub>).

**MS *m/z* (relative intensity):** 367 (M<sup>+</sup>, 100), 352 (14), 336 (17), 309 (37), 308 (62), 250 (31), 240 (18), 202 (12), 139 (17), 125 (24), 86 (14), 59 (20).

**HRMS:** calcd for C<sub>17</sub>H<sub>17</sub>F<sub>3</sub>N<sub>3</sub>O<sub>3</sub> (M+H<sup>+</sup>): 368.1217. Found 368.1216.

#### 4-Morpholino-3-(4-methoxyphenyl)-6-(trifluoromethyl)pyridazine (84)

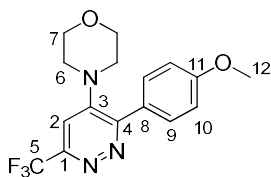

To a stirred solution of 4-fluoro-3-(4-methoxyphenyl)-6-(trifluoromethyl)pyridazine **32** (55 mg, 0.20 mmol, 1.0 equiv) in MeCN (0.20 mL) was added morpholine (0.036 mL, 0.40 mmol, 2.0 equiv) and the reaction mixture was stirred at 80 °C for 3 h. The reaction mixture was concentrated under reduced pressure. The crude mixture was purified by flash chromatography (AcOEt/PE=35:65) to afford **84** (70 mg, 0.20 mmol, quant) as a pale yellow solid.

**Mp:** 119 °C.

**IR (neat):** 2863, 1431, 1300, 1252, 1174, 1135, 1113, 1035, 1001, 968, 905, 724 cm<sup>-1</sup>.

**<sup>1</sup>H NMR (CDCl<sub>3</sub>, 400 MHz):** δ 7.80 (d, *J* = 8.9 Hz, 2H, H<sub>9</sub>), 7.05 (s, 1H, H<sub>2</sub>), 6.93 (d, *J* = 8.9 Hz, 2H, H<sub>10</sub>), 3.79 (s, 3H, H<sub>12</sub>), 3.65–3.62 (m, 4H, H<sub>7</sub>), 2.97–2.94 (m, 4H, H<sub>6</sub>).

**<sup>13</sup>C NMR (CDCl<sub>3</sub>, 100 MHz):** δ 161.0 (C, C<sub>11</sub>), 155.4 (C, C<sub>3</sub>), 149.8 (C, q, *J* = 33.6 Hz, C<sub>1</sub>), 149.1 (C, C<sub>4</sub>), 129.5 (2xCH, C<sub>9</sub>), 129.1 (C, C<sub>8</sub>), 121.7 (C, q, *J* = 274.7 Hz, C<sub>5</sub>), 114.3 (2xCH, C<sub>10</sub>), 109.7 (CH, q, *J* = 2.2 Hz, C<sub>2</sub>), 66.0 (2xCH<sub>2</sub>, C<sub>7</sub>), 55.4 (CH<sub>3</sub>, C<sub>12</sub>), 49.2 (2xCH<sub>2</sub>, C<sub>6</sub>).

**MS *m/z* (relative intensity):** 339 (M<sup>+</sup>, 100), 338 (60), 324 (22), 308 (29), 296 (17), 281 (20), 280 (35), 266 (10), 250 (11), 238 (11), 213 (12), 144 (9), 132 (11), 113 (6), 89 (10), 86 (24).

**HRMS:** calcd for C<sub>16</sub>H<sub>16</sub>F<sub>3</sub>N<sub>3</sub>O<sub>2</sub>Na (M+Na<sup>+</sup>): 362.1087. Found 362.1086.

#### 4-Morpholino-3-(2-methoxyphenyl)-6-(trifluoromethyl)pyridazine (85)

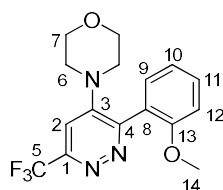

To a stirred solution of 4-fluoro-3-(2-methoxyphenyl)-6-(trifluoromethyl)pyridazine **33** (72 mg, 0.26 mmol, 1.0 equiv) in MeCN (0.26 mL) was added morpholine (0.047 mL, 0.53 mmol, 2.0 equiv) and the reaction mixture was stirred at 80 °C for 3 h. The reaction mixture was concentrated under reduced pressure. The crude mixture was purified by flash chromatography (AcOEt/PE=35:65) to afford **85** (70 mg, 0.21 mmol, 78%) as a white mousse.

**IR (neat):** 2856, 1576, 1493, 1460, 1434, 1321, 1295, 1259, 1179, 1135, 1117, 1051, 1024, 1007, 970, 910 cm<sup>-1</sup>.

**<sup>1</sup>H NMR (CDCl<sub>3</sub>, 400 MHz):** δ 7.48–7.42 (m, 2H, H<sub>9</sub> and H<sub>11</sub>), 7.09 (m, 1H, H<sub>10</sub>), 7.09 (br s, 1H, H<sub>2</sub>), 7.00 (d, *J* = 8.3 Hz, 1H, H<sub>12</sub>), 3.80 (s, 3H, H<sub>14</sub>), 3.57 (t, *J* = 4.8 Hz, 4H, H<sub>7</sub>), 3.05 (br s, 4H, H<sub>6</sub>).

**<sup>13</sup>C NMR (CDCl<sub>3</sub>, 100 MHz):** δ 156.5 (C, C<sub>13</sub>), 154.1 (C, C<sub>3</sub>), 150.1 (C, q, *J* = 33.4 Hz, C<sub>1</sub>), 149.1 (C, C<sub>4</sub>), 131.1 (CH, C<sub>11</sub>), 130.5 (CH, C<sub>9</sub>), 126.7 (C, C<sub>8</sub>), 121.8 (C, q, *J* = 274.8 Hz, C<sub>5</sub>), 121.3 (CH, C<sub>10</sub>), 111.3 (CH, C<sub>12</sub>), 108.6 (CH, q, *J* = 2.5 Hz, C<sub>2</sub>), 66.2 (2xCH<sub>2</sub>, C<sub>7</sub>), 55.6 (CH<sub>3</sub>, C<sub>14</sub>), 48.5 (2xCH<sub>2</sub>, C<sub>6</sub>).

**MS *m/z* (relative intensity):** 339 (M<sup>+</sup>, 71), 308 (16), 280 (13), 266 (10), 253 (100), 225 (10), 219 (10), 182 (9), 155 (8), 131 (9), 118 (12), 102 (13), 91 (18), 86 (48), 77 (10), 57 (12).

**HRMS:** calcd for C<sub>16</sub>H<sub>17</sub>F<sub>3</sub>N<sub>3</sub>O<sub>2</sub> (M+H<sup>+</sup>): 340.1267. Found 340.1266.



#### 4-Allylamino-3-phenyl-6-(pentafluoroethyl)pyridazine (86)

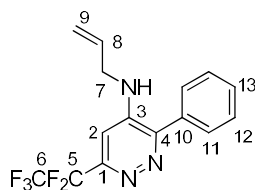

To a stirred solution of 4-fluoro-3-phenyl-6-(pentafluoroethyl)pyridazine **71** (75 mg, 0.26 mmol, 1.0 equiv) in MeCN (0.25 mL) was added allylamine (0.038 mL, 0.51 mmol, 2.0 equiv) and the reaction mixture was stirred at 100 °C for 4 h. The reaction mixture was concentrated under reduced pressure. The crude mixture was purified by flash chromatography (AcOEt/PE=20:80) to afford product **86** (76 mg, 0.23 mmol, 90%) as a white solid.

**Mp:** 99 °C.

**IR (neat):** 1586, 1507, 1450, 1417, 1385, 1333, 1203, 1149, 1103, 1075, 1008, 997, 906 cm<sup>-1</sup>.

**<sup>1</sup>H NMR (CDCl<sub>3</sub>, 400 MHz):** δ 7.63–7.61 (m, 2H, H<sub>11</sub> or H<sub>12</sub>), 7.54–7.48 (m, 3H, H<sub>11</sub> or H<sub>12</sub> and H<sub>13</sub>), 6.83 (s, 1H, H<sub>2</sub>), 5.82 (m, 1H, H<sub>8</sub>), 5.30–5.21 (m, 3H, NH and H<sub>9</sub>), 3.87–3.84 (m, 2H, H<sub>7</sub>).

**<sup>13</sup>C NMR (CDCl<sub>3</sub>, 100 MHz):** δ 152.0 (C, C<sub>3</sub>), 149.7 (C, t, *J* = 24.5 Hz, C<sub>1</sub>), 143.9 (C, C<sub>4</sub>), 133.8 (C, C<sub>10</sub>), 131.7 (CH, C<sub>8</sub>), 130.0 (CH, C<sub>13</sub>), 129.5 (2xCH, C<sub>11</sub> or C<sub>12</sub>), 128.7 (2xCH, C<sub>11</sub> or C<sub>12</sub>), 118.9 (C, qt, *J* = 286.7 and 37.1 Hz, C<sub>6</sub>), 117.9 (CH<sub>2</sub>, C<sub>9</sub>), 111.4 (C, tq, *J* = 255.7 and 38.6 Hz, C<sub>5</sub>), 103.0 (CH, t, *J* = 4.5 Hz, C<sub>2</sub>), 44.9 (CH<sub>2</sub>, C<sub>7</sub>).

**MS *m/z* (relative intensity):** 329 (M<sup>+</sup>, 87), 328 (100), 301 (22), 287 (14), 252 (27), 233 (7), 183 (30), 141 (7), 126 (10), 102 (20), 89 (18), 77 (15), 56 (24).

**HRMS:** calcd for C<sub>15</sub>H<sub>13</sub>F<sub>5</sub>N<sub>3</sub> (M+H<sup>+</sup>): 330.1024. Found 330.1023.

#### 4-Ethylthio-3-phenyl-6-(pentafluoroethyl)pyridazine (87)

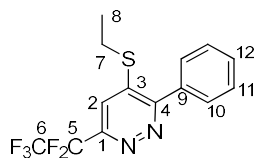

To a stirred solution of 4-fluoro-3-phenyl-6-(pentafluoroethyl)pyridazine **71** (60 mg, 0.21 mmol, 1.0 equiv) in MeCN (0.20 mL) was added sodium ethanethiolate (29 mg, 0.31 mmol, 1.5 equiv) and the reaction mixture was stirred at 100 °C for 4 h. The reaction mixture was concentrated under reduced pressure. The crude mixture was purified by flash chromatography (AcOEt/PE=5:95) to afford **87** (58 mg, 0.17 mmol, 84%) as a yellow oil.

**IR (neat):** 2934, 1549, 1446, 1403, 1329, 1311, 1199, 1152, 1113, 1092, 1013, 993  $\text{cm}^{-1}$ .

**$^1\text{H}$  NMR ( $\text{CDCl}_3$ , 400 MHz):**  $\delta$  7.66–7.64 (m, 2H,  $\text{H}_{10}$  or  $\text{H}_{11}$ ), 7.45–7.43 (m, 4H,  $\text{H}_2$ ,  $\text{H}_{10}$  or  $\text{H}_{11}$  and  $\text{H}_{12}$ ), 2.91 (q,  $J = 7.4$  Hz, 2H,  $\text{H}_7$ ), 1.31 (t,  $J = 7.4$  Hz, 3H,  $\text{H}_8$ ).

**$^{13}\text{C}$  NMR ( $\text{CDCl}_3$ , 100 MHz):**  $\delta$  160.9 (C,  $\text{C}_3$ ), 148.8 (C, t,  $J = 25.3$  Hz,  $\text{C}_1$ ), 144.4 (C,  $\text{C}_4$ ), 135.2 (C,  $\text{C}_9$ ), 130.4 (CH,  $\text{C}_{12}$ ), 129.2 (2xCH,  $\text{C}_{10}$  or  $\text{C}_{11}$ ), 128.6 (2xCH,  $\text{C}_{10}$  or  $\text{C}_{11}$ ), 119.0 (CH, t,  $J = 4.1$  Hz,  $\text{C}_2$ ), 118.8 (C, qt,  $J = 286.8$  and 36.9 Hz,  $\text{C}_6$ ), 111.4 (C, tq,  $J = 256.3$  and 39.1 Hz,  $\text{C}_5$ ), 25.6 ( $\text{CH}_2$ ,  $\text{C}_7$ ), 12.5 ( $\text{CH}_3$ ,  $\text{C}_8$ ).

**MS  $m/z$  (relative intensity):** 334 ( $\text{M}^+$ , 34), 305 (100), 257 (7), 236 (5), 234 (5), 207 (9), 158 (8), 134 (20), 126 (8), 121 (15), 89 (8).

**HRMS:** calcd for  $\text{C}_{14}\text{H}_{12}\text{F}_5\text{N}_2\text{S}$  ( $\text{M}+\text{H}^+$ ): 335.0636. Found 335.0638.

### 5-Allylamino-3-phenyl-6-(difluoromethyl)pyridazine (88)

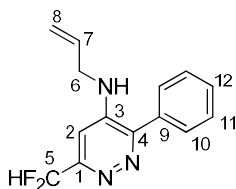

To a stirred solution of 4-fluoro-3-phenyl-6-(difluoromethyl)pyridazine **72** (26 mg, 0.12 mmol, 1.0 equiv) in MeCN (0.11 mL) was added allylamine (0.017 mL, 0.23 mmol, 2.0 equiv) and the reaction mixture was stirred at 100 °C for 4 h. The reaction mixture was concentrated under reduced pressure. The crude mixture was purified by flash chromatography (AcOEt/PE=40:60) to afford **88** (28 mg, 0.11 mmol, 92%) as a white solid.

**Mp:** 127 °C.

**IR (neat):** 3248, 1585, 1546, 1504, 1424, 1357, 1299, 1240, 1193, 1148, 1085, 1035, 1008, 995, 920  $\text{cm}^{-1}$ .

**$^1\text{H}$  NMR ( $\text{CDCl}_3$ , 400 MHz):**  $\delta$  7.64–7.61 (m, 2H,  $\text{H}_{10}$  or  $\text{H}_{11}$ ), 7.56–7.50 (m, 3H,  $\text{H}_{10}$  or  $\text{H}_{11}$  and  $\text{H}_{12}$ ), 6.83 (s, 1H,  $\text{H}_2$ ), 6.79 (t,  $J = 55.0$  Hz, 1H,  $\text{H}_5$ ), 5.84 (m, 1H,  $\text{H}_7$ ), 5.26–5.22 (m, 2H,  $\text{H}_8$ ), 5.08 (br s, NH), 3.87–3.83 (m, 2H,  $\text{H}_6$ ).

**$^{13}\text{C}$  NMR ( $\text{CDCl}_3$ , 100 MHz):**  $\delta$  154.3 (C, t,  $J = 26.0$  Hz,  $\text{C}_1$ ), 152.2 (C,  $\text{C}_3$ ), 144.2 (C,  $\text{C}_4$ ), 134.3 (C,  $\text{C}_9$ ), 132.0 (CH,  $\text{C}_7$ ), 129.9 (CH,  $\text{C}_{12}$ ), 129.5 (2xCH,  $\text{C}_{10}$  or  $\text{C}_{11}$ ), 128.7 (2xCH,  $\text{C}_{10}$  or  $\text{C}_{11}$ ), 117.8 ( $\text{CH}_2$ ,  $\text{C}_8$ ), 114.1 (CH, t,  $J = 240.2$  Hz,  $\text{C}_5$ ), 101.3 (CH, t,  $J = 2.0$  Hz,  $\text{C}_2$ ), 44.9 ( $\text{CH}_2$ ,  $\text{C}_6$ ).

**MS  $m/z$  (relative intensity):** 261 ( $\text{M}^+$ , 100), 260 (98), 233 (17), 219 (11), 184 (29), 183 (40), 165 (5), 126 (8), 115 (10), 102 (18), 89 (15), 77 (14), 63 (6), 56 (17), 51 (11).

**HRMS:** calcd for  $\text{C}_{14}\text{H}_{14}\text{F}_2\text{N}_3$  ( $\text{M}+\text{H}^+$ ): 262.1150. Found 262.1148.

#### 4-Ethylthio-3-phenyl-6-(difluoromethyl)pyridazine (89)

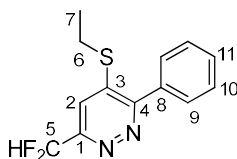

To a stirred solution of 4-fluoro-3-phenyl-6-(difluoromethyl)pyridazine **72** (26 mg, 0.12 mmol, 1.0 equiv) in MeCN (0.11 mL) was added sodium ethanethiolate (16 mg, 0.14 mmol, 2.0 equiv) and the reaction mixture was stirred at 100 °C for 4 h. The reaction mixture was concentrated under reduced pressure. The crude mixture was purified by flash chromatography (AcOEt/PE=5:95) to afford **80** (27 mg, 0.10 mmol, 87%) as a white solid.

**Mp:** 107 °C.

**IR (neat):** 2932, 1553, 1520, 1493, 1443, 1364, 1344, 1262, 1145, 1106, 1070, 1021, 1010, 918, 891  $\text{cm}^{-1}$ .

**$^1\text{H}$  NMR ( $\text{CDCl}_3$ , 400 MHz):**  $\delta$  7.71–7.68 (m, 2H,  $\text{H}_9$  or  $\text{H}_{10}$ ), 7.53–7.50 (m, 4H,  $\text{H}_2$ ,  $\text{H}_9$  or  $\text{H}_{10}$  and  $\text{H}_{11}$ ), 6.92 (t,  $J = 54.7$  Hz, 1H,  $\text{H}_5$ ), 2.99 (q,  $J = 7.4$  Hz, 2H,  $\text{H}_6$ ), 1.39 (t,  $J = 7.4$  Hz, 3H,  $\text{H}_7$ ).

**$^{13}\text{C}$  NMR ( $\text{CDCl}_3$ , 100 MHz):**  $\delta$  160.8 (C,  $\text{C}_3$ ), 153.0 (C, t,  $J = 26.8$  Hz,  $\text{C}_1$ ), 144.4 (C,  $\text{C}_4$ ), 135.6 (C,  $\text{C}_8$ ), 130.1 (CH,  $\text{C}_{11}$ ), 129.2 (2xCH,  $\text{C}_9$  or  $\text{C}_{10}$ ), 128.6 (2xCH,  $\text{C}_9$  or  $\text{C}_{10}$ ), 117.6 (CH, t,  $J = 1.7$  Hz,  $\text{C}_2$ ), 113.9 (CH, t,  $J = 240.5$  Hz,  $\text{C}_5$ ), 25.5 ( $\text{CH}_2$ ,  $\text{C}_6$ ), 12.6 ( $\text{CH}_3$ ,  $\text{C}_7$ ).

**MS  $m/z$  (relative intensity):** 266 ( $\text{M}^+$ , 39), 237 (100), 189 (24), 158 (5), 134 (16), 121 (11), 89 (7), 77 (6), 51 (7).

**HRMS:** calcd for  $\text{C}_{13}\text{H}_{13}\text{F}_2\text{N}_2\text{S}$  ( $\text{M}+\text{H}^+$ ): 267.0762. Found 267.0760.

## **General Conclusion**



The aim of this project was to access three different families of nitrogen-containing heterocycles: pyrrolidines, piperidines and pyridazines, all of them possessing a CF<sub>3</sub> group at the α position to the nitrogen.

During the first part of this work, the synthesis of 2-substituted, 2-(trifluoromethyl)pyrrolidines was achieved by the ring contraction of 3-hydroxy-3-(trifluoromethyl)piperidine. Indeed, under the right conditions (triflic anhydride/proton sponge/nucleophile), the hydroxy group of the (trifluoromethyl)piperidine can be activated, to form an aziridinium intermediate. Due to the presence of the CF<sub>3</sub> group at the C2 position of the aziridinium, a nucleophile can attack regioselectively at the C2' position to afford the ring contraction products, the 2-substituted, 2-(trifluoromethyl)pyrrolidines in moderate to very good yields.

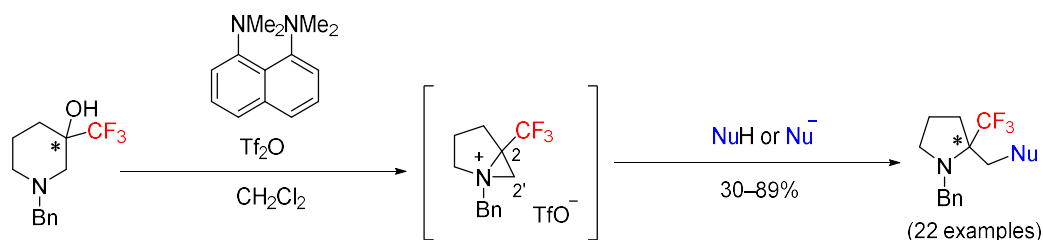

This method was then applied to the 3-hydroxy-3-(trifluoromethyl)azepane, in order to access 2-substituted, 2-(trifluoromethyl)piperidines *via* a similar aziridinium intermediate. The ring contraction products were successfully obtained in good to excellent yields.

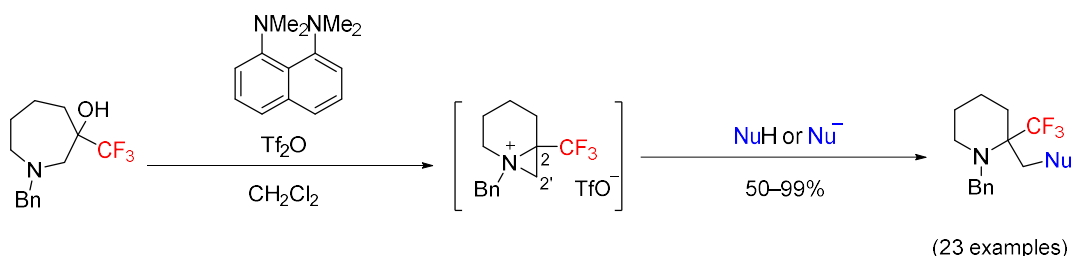

The presence of the CF<sub>3</sub> group proved to be crucial for the success of the ring contraction, and the reaction proceeds with a chirality transfer.

The second part of this work was dedicated to the synthesis of α-(trifluoromethyl)pyridazines by a [2+1]/[3+2]-cycloaddition sequence between a terminal alkyne, a difluorocarbene and a diazo compound. After reaction of the alkyne with the difluorocarbene, a difluorocyclopropene was formed by a [2+1]-cycloaddition. This difluorocyclopropene underwent a [3+2]-cycloaddition in the presence of (trifluoromethyl)diazomethane to afford a cyclopropanopyrazoline, which after a rearrangement and an aromatization step, led to the desired 6-(trifluoromethyl)pyridazines. (Trifluoromethyl)diazomethane could be replaced by other fluorinated diazo compounds to allow access to different fluorinated pyridazines.

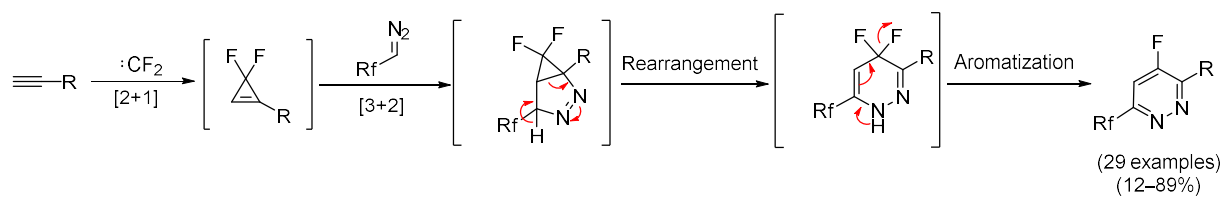

Finally, due to the presence of fluorine at the C4 position, these pyridazines could be further functionalized by a nucleophilic aromatic substitution ( $S_NAr$ ), to afford a variety of 3,4,6-trisubstituted pyridazines.

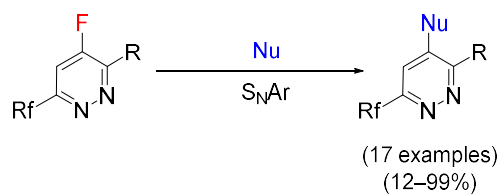

## **Bibliography**





- (1) *Bioactive Heterocyclic Compound Classes : Pharmaceuticals and Agrochemicals*; Lamberth, C.; Dinges, J., Eds.; Wiley-VCH : Weinheim, **2012**.
- (2) a) Marais, J. S. C. *Onderstepoort J. Vet. Sci. Anim. Ind.* **1943**, *18*, 203–206; b) Marais, J. S. C. *Onderstepoort J. Vet. Sci. Anim. Ind.* **1944**, *20*, 67–73.
- (3) Fried, J.; Sabo, E. F. *J. Am. Chem. Soc.* **1954**, *76*, 1455–1456.
- (4) Hunter, L. *Beilstein J. Org. Chem.* **2010**, *6*, doi : 10.3762/bjoc.6.38.
- (5) O’Hagan, D. *Chem. Soc. Rev.* **2008**, *37*, 308–319.
- (6) Böhm, H. -J.; Banner, D.; Bendels, S.; Kansy, M.; Kuhn, B.; Müller, K.; Obst-Sander, U.; Stahl, M. *ChemBioChem* **2004**, *5*, 637–643.
- (7) Gillis, E. P.; Eastman, K. J.; Hill, M. D.; Donnelly, D. J.; Meanwell, N. A. *J. Med. Chem.* **2015**, *58*, 8315–8359.
- (8) Purser, S.; Moore, P. R.; Swallow, S.; Gouverneur, V. *Chem. Soc. Rev.* **2008**, *37*, 320–330.
- (9) Reddy, V. P. *in Organofluorine Compounds in Biology and Medicine*, Elsevier: Oxford, UK, **2015**.
- (10) Müller, K.; Faeh, C.; Diederich, F. *Science* **2007**, *317*, 1881–1886.
- (11) Sun, A.; Lankin, D. C.; Hardcastle, K.; Snyder, J. P. *Chem. Eur. J.* **2005**, *11*, 1579–1591.
- (12) Briggs, C. R. S.; Allen, M. J.; O’Hagan, D.; Tozer, D. J.; Slawin, A. M. Z.; Goeta, A. E.; Howard, J. A. K. *Org. Biomol. Chem.* **2004**, *2*, 732–740.
- (13) Gooseman, N. E. J.; O’Hagan, D.; Peach, M. J. G.; Slawin, A. M. Z.; Tozer, D. J.; Young, R. J. *Angew. Chem. Int. Ed.* **2007**, *46*, 5904–5908.
- (14) a) Wang, J.; Sánchez-Roselló, M.; Aceña, J. L.; del Pozo, D.; Sorochinsky, A. E.; Fustero, S.; Soloshonok, V. A.; Liu, H. *Chem. Rev.* **2014**, *114*, 2432–2506; b) Zhou, Y.; Wang, J.; Gu, Z.; Wang, S.; Zhu, W.; Aceña, J. L.; Soloshonok, V. A.; Izawa, K.; Liu, H. *Chem. Rev.* **2016**, *116*, 422–518.
- (15) Lehmann, F. *Arch. Exp. Path. Pharmacol.* **1928**, *130*, 250–255.
- (16) a) Heidelberger, C.; Chaudhuri, N. K.; Danneberg, P.; Mooren, D.; Griesbach, L.; Duschinsky, R.; Schnitzer, R. J. *Nature* **1957**, *179*, 663–666 ; b) Yale, H. L. *J. Med. Pharm. Chem.* **1959**, *1*, 121–133.
- (17) Zhu, W.; Wang, J.; Wang, S.; Gu, Z.; Aceña, J. L.; Izawa, K.; Liu, H.; Soloshonok, V. A. *J. Fluorine Chem.* **2014**, *167*, 37–54.
- (18) Hangmann, W. K. *J. Med. Chem.* **2008**, *51*, 4359–4369.
- (19) Black, W. C.; Bayly, C. I.; Davis, D. E.; Desmarais, S.; Falgueyret, J.-P.; Léger, S.; Li, C. S.; Massé, F.; McKay, D. J.; Palmer, J. T.; Percival, M. D.; Robichaud, J.; Tsou, N.; Zamboni, R. *Bioorg. Med. Chem. Lett.* **2005**, *15*, 4741–4744.

- (20) Jiang, J.; DeVita, R. J.; Goulet, M. T.; Wyvratt, M. J.; Lo, J. -L.; Ren, N.; Yudkovitz, J. B.; Cui, J.; Yang, Y. T.; Cheng, K.; Rohrer, S. P. *Bioorg. Med. Chem. Lett.* **2004**, *14*, 1795–1798.
- (21) Taylor, R. D.; MacCoss, M.; Lawson, A. D. G. *J. Med. Chem.* **2014**, *57*, 5845–5859.
- (22) Watson, P. S.; Jiang, B.; Scott, B. *Org. Lett.* **2000**, *2*, 3679–3681.
- (23) Pictet, A. in *The vegetable alkaloids. With particular to their chemical constitution*, New York: J. Wiley & sons **1904**.
- (24) *Plimmer R. H. A. In Monographs on biochemistry; The chemical constitution of the proteins, Part I. Analysis (2nd ed.), R.H.A. Plimmer & F.G. Hopkins, Eds.; London: Longmans, Green and Co. 1908.*
- (25) Bhat, C.; Tilve, S. G. *RSC Adv.* **2014**, *4*, 5405–5452.
- (26) Kumar, A.; Gupta, G.; Srivastava, S. *J. Comb. Chem.* **2010**, *12*, 458–462.
- (27) Shin-ya, K.; Kim, J.-S.; Furihata, K.; Hayakawa, Y.; Seto, H. *Tetrahedron Lett.* **1997**, *38*, 7079–7082.
- (28) a) Shibano, M.; Tsukamoto, D.; Masuda, A.; Tanaka, Y.; Kusano, G. *Chem. Pharm. Bull.* **2001**, *49*, 1362–1365; b) Shibano, M.; Tsukamoto, D.; Kusano, G. *Heterocycles* **2002**, *57*, 1539–1553.
- (29) Edmondson, S.; Danishefsky, S. J.; Sepp-Lorenzino, L.; Rosen, N. *J. Am. Chem. Soc.* **1999**, *121*, 2147–2155.
- (30) Fukui, H.; Shibata, T.; Naito, T.; Nakano, J.; Maejima, T.; Senda, H.; Iwatani, W.; Tatsumi, Y.; Suda, M.; Arika, T. *Bioorg. Med. Chem. Lett.* **1998**, *8*, 2833–2838.
- (31) Jlalía, I.; Lensen, N.; Chaume, G.; Dzhambazova, E.; Astasidi, L.; Hadjiolova, R.; Bocheva, A.; Brigaud, T. *Eur. J. Med. Chem.* **2013**, *62*, 122–129.
- (32) Felpin, F. -X. ; Lebreton, J. *Eur. J. Org. Chem.* **2003**, 3693–3712.
- (33) Wieland, H.; Koschara, W.; Dane, E.; Renz, J.; Schwarze, W.; Linde, W. *Liebigs Ann. Chem.* **1939**, *540*, 103–156.
- (34) Wieland, H. *Ber. Dtsch. Chem. Ges.* **1921**, *54*, 1784–1788.
- (35) Aguinaldo, A. M.; Read, R. W. *Phytochemistry* **1990**, *29*, 2309–2313.
- (36) a) Dragutan, I.; Dragutan, V.; Demonceau, A. *RSC Adv.* **2012**, *2*, 719–736; b) Zhang, S.; Cha, L.; Li, L.; Hu, Y.; Li, Y.; Zha, Z.; Wang, Z. *J. Org. Chem.* **2016**, *81*, 3177–3187.
- (37) Aay, N.; Blazey, C. M.; Bowles, O. J.; Bussenius, J.; Curtis, J. K.; Defina, S. C.; Dubenko, L.; Harris, J. R.; Jackson- Ugueto, E. E.; Kim, A. I.; Manalo, J. -C. L.; Pack, M.; Peto, C. J.; Rice, K. D.; Tsang, T. H.; Wang, L. **2010** (WO 2010138490).
- (38) a) Childers, M. L.; Fuller, P.; Guerin, D.; Katz, J. D.; Pu, Q.; Scott, M. E.; Thompson, C. F.; Martinez, M.; Falcone, D.; Torres, L.; Deng, Y.; Kuruklasuriya, R.; Zeng, H.; Bai, Y.; Kong, N.; Liu, Y.; Zheng, Z. **2014** (WO 2014146491); b) Dinsmore, C.; Fuller, P.; Guerin, D.; Katz, J. D.;

- Thompson, C. F.; Falcone, D.; Deng, W.; Torres, L.; Zeng, H.; Bai, Y.; Fu, J.; Kong, N.; Liu, Y.; Zheng, Z. **2014** (WO 2014146493).
- (39) Rioton, S.; Gomez Pardo, D.; Cossy, J. *Molecules* **2017**, *22*, 483–505.
- (40) a) Gulevich, A. V.; Shevchenko, N. E.; Balenkova, E. S.; Röschenthaler, G. -V.; Nenajdenko, V. G. *Synlett* **2009**, 403–406; b) Odinets, I. L.; Artyushin, O. I.; Lyssenko, K. A.; Shevchenko, N. E.; Nenajdenko, V. G.; Röschenthaler, G. -V. *J. Fluorine Chem.* **2009**, *130*, 662–666; c) Shevchenko, N. E.; Balenkova, E. S.; Röschenthaler, G. -V.; Nenajdenko, V. G. *Synthesis* **2010**, 120–126; d) Shmatova, O. I.; Nenajdenko, V. G. *Eur. J. Org. Chem.* **2013**, 6397–6403; e) Shmatova, O. I.; Shevchenko, N. E.; Balenkova, E. S.; Röschenthaler, G. -V.; Nenajdenko, V. G. *Eur. J. Org. Chem.* **2013**, 3049–3058; f) Shmatova, O. I.; Shevchenko, N. E.; Balenkova, E. S.; Röschenthaler, G. -V.; Nenajdenko, V. G. *Mendeleev Commun.* **2013**, *23*, 92–93; g) Shevchenko, N. E.; Shmatova, O. I.; Balenkova, E. S.; Röschenthaler, G. -V.; Nenajdenko, V. G. *Eur. J. Org. Chem.* **2013**, 2237–2245; h) Shmatova, O. I.; Khrustalev, V. N.; Nenajdenko, V. G. *Org. Lett.* **2016**, *18*, 4494–4497.
- (41) a) Shevchenko, N. E.; Vlasov, K.; Nenajdenko, V. G.; Röschenthaler, G. -V. *Tetrahedron* **2011**, *67*, 69–74; b) Levin, V. V.; Dilman, A. D.; Belyakov, P. A.; Struchkova, M. I.; Tartakovsky, V. A. *Eur. J. Org. Chem.* **2008**, 5226–5230.
- (42) Han, J.; Xu, B.; Hammond, G. B. *Org. Lett.* **2011**, *13*, 3450–3453.
- (43) Dolfen, J.; Kenis, S.; Van Hecke, K.; De Kimpe, N.; D’hooghe, M. *Chem. Eur. J.* **2014**, *20*, 10650–10653.
- (44) a) Osipov, S. N.; Bruneau, C.; Picquet, M.; Kolomiets, A. F.; Dixneuf, P. H. *Chem. Commun.* **1998**, 2053–2054; b) Osipov, S. N.; Artyushin, O. I.; Kolomiets, A. F.; Bruneau, C.; Picquet, M.; Dixneuf, P. H. *Eur. J. Org. Chem.* **2001**, 3891–3897; c) Osipov, S. N.; Artyushin, O. I.; Kolomiets, A. F.; Bruneau, C.; Dixneuf, P. H. *Synlett* **2000**, 1031–1033; d) Osipov, S. N.; Kobel’kova, N. M.; Shchetnikov, G. T.; Kolomiets, A. F.; Bruneau, C.; Dixneuf, P. H. *Synlett* **2001**, 621–622; e) Vorobyeva, D. V.; Mailyan, A. K.; Peregodov, A. S.; Karimova, N. M.; Vasilyeva, T. P.; Bushmarinov, I. S.; Bruneau, C.; Dixneuf, P. H.; Osipov, S. N. *Tetrahedron* **2011**, *67*, 3524–3532.
- (45) a) Mailyan, A. K.; Krylov, I. M.; Bruneau, C.; Dixneuf, P. H.; Osipov, S. N. *Eur. J. Org. Chem.* **2013**, 5353–5363; b) Eckert, M.; Monnier, F.; Shchetnikov, G. T.; Titanyuk, I. D.; Osipov, S. N.; Toupet, L.; Dérien, S.; Dixneuf, P. H. *Org. Lett.* **2005**, *7*, 3741–3743.
- (46) Kobel’kova, N. M.; Osipov, S. N.; Kolomiets, A. F. *Russ. Chem. Bull., Int. Ed.* **2002**, *51*, 1298–1302.
- (47) a) Fustero, S.; Albert, L.; Aceña, J. L.; Sanz-Cervera, J. F.; Asensio, A. *Org. Lett.* **2008**, *10*, 605–608; b) Fustero, S.; Albert, L.; Mateu, N.; Chiva, G.; Miró, J.; González, J.; Aceña, J. L. *Chem. Eur. J.* **2012**, *18*, 3753–3764.
- (48) Shi, W.; Wang, Y.; Zhu, Y.; Zhang, M.; Song, L.; Deng, H. *Synthesis* **2016**, *48*, 3527–3536.
- (49) a) Levin, V. V.; Kozlov, M. A.; Dilman, A. D.; Belyakov, P. A.; Struchkova, M. I.; Tartakovsky, V. A. *Russ. Chem. Bull., Int. Ed.* **2009**, *58*, 484–486; b) Huang, W.; Ni, C.; Zhao, Y.; Zhang, W.; Dilman, A. D.; Hu, J. *Tetrahedron* **2012**, *68*, 5137–5144.

- (50) Katagiri, T.; Katayama, Y.; Taeda, M.; Ohshima, T.; Iguchi, N.; Uneyama, K. *J. Org. Chem.* **2011**, *76*, 9305–9311.
- (51) Sémeril, D.; Le Notre, J.; Bruneau, C.; Dixneuf, P. H.; Kolomiets, A. F.; Osipov, S. N. *New J. Chem.* **2001**, *25*, 16–18.
- (52) Kokschi, B.; Ullmann, D.; Jakubke, H. -D.; Burger, K. *J. Fluorine Chem.* **1996**, *80*, 53–57.
- (53) Chaume, G.; Van Severen M. -C.; Marinkovic, S.; Brigaud, T. *Org. Lett.* **2006**, *8*, 6123–6126.
- (54) Chaume, G.; Van Severen M. -C.; Ricard, L.; Brigaud, T. *J. Fluorine Chem.* **2008**, *129*, 1104–1109.
- (55) Caupène, C.; Chaume, G.; Ricard, L.; Brigaud, T. *Org. Lett.* **2009**, *11*, 209–212.
- (56) Huang, G.; Yin, Z.; Zhang, X. *Chem. Eur. J.* **2013**, *19*, 11992–11998.
- (57) Zotova, M. A.; Vasil'eva, T. P.; Osipov, S. N. *Russ. Chem. Bull., Int. Ed.* **2013**, *62*, 792–796.
- (58) a) Cossy, J.; Gomez Pardo, D. *Chemtracts* **2002**, *15*, 579–605; b) Cossy, J.; Gomez Pardo, D.; Dumas, C.; Mirguet, O.; Déchamps, I.; Métro, T. -X.; Burger, B.; Roudeau, R.; Appenzeller, J.; Cochi, A. *Chirality* **2009**, *21*, 850–856; c) Gomez Pardo, D.; Cossy, J. *Chem. Eur. J.* **2014**, *20*, 4516–4525 and references therein.
- (59) Rioton, S.; Orliac, A.; Antoun, Z.; Bidault, R.; Gomez Pardo, D.; Cossy, J. *Org. Lett.* **2015**, *17*, 2916–2919.
- (60) a) Duhamel, L.; Poirier, J. M. *Tetrahedron Lett.* **1976**, 2437–2440; b) Duhamel, P.; Kotera, M. *J. Org. Chem.* **1982**, *47*, 1688–1691; c) Donati, D.; Fusi, S.; Macripo, M. A.; Ponticelli, F. *J. Heterocycl. Chem.* **1987**, *24*, 481–483; d) Plaquevent, J. -C.; Chichaoui, I. *Bull. Soc. Chim. Fr.* **1996**, *133*, 369–379.
- (61) Abbaspour Tehrani, K.; Van Syngel, K.; Boelens, M.; Contreras, J.; De Kimpe, N.; Knight, D. W. *Tetrahedron Lett.* **2000**, *41*, 2507–2510.
- (62) Karimova, N. M.; Teplenicheva, Y. L.; Kolomiets, A. F.; Folkin, A. V. *Russ. Chem. Bull.* **1997**, *46*, 1136–1139.
- (63) Katagiri, T.; Takahashi, M.; Fujiwara, Y.; Ihara, H.; Uneyama, K. *J. Org. Chem.* **1999**, *64*, 7323–7329.
- (64) Davoli, P.; Forni, A.; Franciosi, C.; Moretti, I.; Prati, F. *Tetrahedron: Assymetry* **1999**, *10*, 2361–2371.
- (65) Crousse, B.; Narizuka, S.; Bonnet-Delpon, D.; Bégué, J. -P. *Synlett* **2001**, 679–681.
- (66) Moens, M.; De Kimpe, N.; D'hooghe, M. *J. Org. Chem.* **2014**, *79*, 5558–5568.
- (67) Grellepois, F.; Nonnenmacher, J.; Lachaud, F.; Portella, C. *Org. Biomol. Chem.* **2011**, *9*, 1160–1168.
- (68) Kenis, S.; D'hooghe, M.; Verniest, G.; Nguyen, V. D.; Thi, T. A.; Van Nguyen, T.; De Kimpe, N. *J. Org. Biomol. Chem.* **2011**, *9*, 7217–7223.

(69) D'hooghe, M.; Catak, S.; Stankovic, S.; Waroquier, M.; Kim, Y.; Ha, H. -J.; Van Speybroeck, V.; De Kimpe, N. *Eur. J. Org. Chem.* **2010**, 4920–4931.

(70) Jarvis, S. B. D.; Charette, A. B. *Org. Lett.* **2011**, *13*, 3830–3833.

(71)

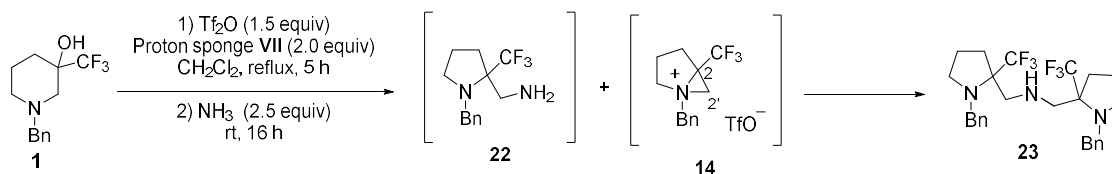

(72) Anxionnat, B.; Robert, B.; George, P.; Ricci, G.; Perrin, M. -A.; Gomez Pardo, D.; Cossy, J. *J. Org. Chem.* **2012**, *77*, 6087–6099.

(73) Prokopiou, P. A.; Browning, C.; Buckley, J. M.; Clark, K. L.; Fechner, L.; Gore, P. M.; Hancock, A. P.; Hodgson, S. T.; Holmes, D. S.; Kranz, M.; Looker, B. E.; Morriss, K. M. L.; Parton, D. L.; Russell, L. J.; Slack, R. J.; Sollis, S. L.; Vile, S.; Watts, C. J. *J. Med. Chem.* **2011**, *54*, 2183–2195.

(74) Feraldi-Xypolia, A.; Gomez Pardo, D.; Cossy, J. *Chem. Eur. J.* **2015**, *21*, 12876–12880.

(75) Ryu, J. H.; Kim, S. A.; Ryu, K. H.; Kim, J. S.; Kim, N. H.; Han, H. Y.; Kim, Y. H.; Youn, W. -N.; Lee, Y. -J.; Son, H. J.; Lee, B. -Y.; Park, S. H.; Lee, J. -Y.; Lee, H. J.; Jung, H. C.; Shin, Y. A.; Lee, J. A.; Lee, B. R.; Sa, J. H. **2011** (WO 2011/139107).

(76) Wenthur, C. J.; Morrison, R.; Felts, A. S.; Smith, K. A.; Engers, J. L.; Byers, F. W.; Daniels, J. S.; Emmitte, K. A.; Conn, P. J.; Lindsley, C. W. *J. Med. Chem.* **2013**, *56*, 5208–5212.

(77) Jaber, J. J.; Mitsui, K.; Rychnovsky, S. D. *J. Org. Chem.* **2001**, *66*, 4679–4686.

(78) Mangion, I. K.; Nwamba, I. K.; Shevlin, M.; Huffman, M. A. *Org. Lett.* **2009**, *11*, 3566–3569.

(79) Cabal, M. -P. Six-Membered Heterocycles: 1,2-, 1,3-, 1,4-Diazines and Related Systems. In *Modern Heterocyclic Chemistry, Vol. 2*; Alvarez-Builla, J.; Vaquero, J. J.; Barluenga, J., Eds.; Wiley-VCH: Weinheim, **2011**, 1683–1776.

(80) Haider, N.; Holzer, W. In *Product Class 8: Pyridazines, Science of Synthesis*, **2004**, *16*, 125–249.

(81) Grote, R.; Chen, Y.; Zeeck, A.; Chen, Z.; Zaehner, H.; Mischnick-Luebbecke, P.; Koenig, W. A. *J. Antibiot.* **1988**, *41*, 595–601.

(82) Zhang, C. -F.; Wang, Q.; Zhang, M. *J. Asian Nat. Prod. Res.* **2009**, *11*, 339–344.

(83) Wang, K.; Guo, L.; Zou, Y.; Li, Y.; Wu, J. *J. Antibiot.* **2007**, *60*, 325–327.

(84) Wermuth, C. G. *Med. Chem. Commun.* **2011**, *2*, 935–941.

(85) Ritchie, T. J.; Macdonald, S. J. F.; Peace, S.; Pickett, S. D.; Luscombe, C. N. *Med. Chem. Commun.* **2012**, *3*, 1062–1069.

(86) Hamdouchi, C.; Sanchez-Martinez, C.; Gruber, J.; Del Prado, M.; Lopez, J.; Rubio, A.; Heinz, B. A. *J. Med. Chem.* **2003**, *46*, 4333–4341.

- (87) Fox, B. M.; Iio, K.; Li, K.; Choi, R.; Inaba, T.; Jackson, S.; Sagawa, S.; Shan, B.; Tanaka, M.; Yoshida, A.; Kayser, F. *Bioorg. Med. Chem. Lett.* **2010**, *20*, 6030–6033.
- (88) Molino, B. F.; Liu, S.; Sambandam, A.; Guzzo, P. R.; Hu, M.; Zha, C.; Nacro, K.; Manning, D. D.; Isherwood, M. L.; Fleming, K. N.; Cui, W.; Olson, R. E. **2007** (US2007/0021408 A1).
- (89) Wang, Z.; Wang, M.; Yao, X.; Li, Y.; Tan, J.; Wang, L.; Qiao, W.; Geng, Y.; Liu, Y.; Wang, Q. *Eur. J. Med. Chem.* **2012**, *54*, 33–41.
- (90) Fischer, E. *Justus Liebigs Ann. Chem.* **1886**, *236*, 126–151.
- (91) Kobayashi, Y.; Nakano, T.; Shirahashi, K.; Takeda, A.; Kumadaki, I. *Tetrahedron Lett.* **1980**, *21*, 4615–4618.
- (92) Takahashi, M.; Kotashima, H.; Saitoh, T. *Heterocycles* **1993**, *35*, 909–914.
- (93) Hegde, S. G.; Jones, C. R. *J. Heterocycl. Chem.* **1993**, *30*, 1501–1508.
- (94) a) Huisgen, R.; Herbig, K.; Siegl, A.; Huber, H. *Chem. Ber.* **1966**, *99*, 2526–2545; b) Domschke, G. *Z. Chem.* **1976**, *16*, 13–14.
- (95) Wan, W.; Hou, J.; Jiang, H.; Wang, Y.; Zhu, S.; Deng, H.; Hao, J. *Tetrahedron* **2009**, *65*, 4212–4219.
- (96) Irgashev, R. A.; Safrygin, A. V.; Ezhikova, M. A.; Kodess, M. I. Röschenthaler, G. -V.; Sosnovskikh, V. Y. *Tetrahedron* **2015**, *71*, 1822–1830.
- (97) Sosnovskikh, V. Y.; Safrygin, A. V.; Irgashev, R. A.; Ezhikova, M. A.; Kodess, M. I. *RSC Adv.* **2016**, *6*, 30056–30069.
- (98) Safrygin, A. V.; Irgashev, R. A.; Slepukhin, P. A.; Röschenthaler, G. -V.; Sosnovskikh, V. Y. *Tetrahedron* **2015**, *71*, 8535–8543.
- (99) Ding, Z. -C.; Ju, L. -C.; Yang, Y.; An, X. -M.; Zhou, Y. -B.; Li, R. -H.; Tang, H. -T.; Ding, C. -K.; Zhan, Z. -P. *J. Org. Chem.* **2016**, *81*, 3936–3941.
- (100) The authors underline that when AgOTf was replaced by Rh(Oct)<sub>4</sub>, the [1,3]-shift could not take place and therefore a pyrazole derivative was obtained instead of the pyridazine derivative.
- (101) Mao, H.; Lin, A.; Tang, Z.; Hu, H.; Zhu, C.; Cheng, Y. *Chem. Eur. J.* **2014**, *20*, 2454–2458.
- (102) Tamborski, C.; Prabhu, U. D. G.; Eapen, K. C. *J. Fluorine Chem.* **1985**, *28*, 139–150.
- (103) Supurgibekov, M. B.; Yanyuk, N. S.; Nikolaev, V. A. *Russ. J. Org. Chem.* **2011**, *47*, 1252–1255.
- (104) Seitz, G.; Hoferichter, R.; Mohr, R. *Angew. Chem. Int. Ed. Engl.* **1987**, *26*, 332–334.
- (105) a) Seitz, G.; Mohr, R. *Chem.-Ztg.* **1987**, *111*, 81–82; b) Hoferichter, R.; Seitz, G.; Wassmuth, H. *Chem. Ber.* **1989**, *122*, 711–714; c) Seitz, G.; Hoferichter, R.; Mohr, R. *Arch. Pharm.* **1989**, *322*, 415–417; d) Seitz, G.; Wassmuth, H. *Arch. Pharm.* **1990**, *323*, 89–91; e) Baumann, L.; Kampchen, T.; Seitz, G. *Chem. Ber.* **1992**, *125*, 171–176; f) Hoferichter, R.; Seitz, G. *Liebigs Ann. Chem.* **1992**, 1153–1158; g) Reimers, U.; Seitz, G. *J. Prakt. Chem.* **1993**, *335*, 152–156; h)

- Richter, M.; Seitz, G. *Arch. Pharm.* **1993**, *326*, 427–428; i) Hoferichter, R.; Reimers, U.; Seitz, G. *Arch. Pharm.* **1993**, *326*, 29–32; j) Frenzen, G.; Massa, W.; Reimers, U.; Seitz, G. *Chem. Ber.* **1993**, *126*, 441–445; k) Baumann, L.; Folkerts, A.; Imming, P.; Klindert, T.; Massa, W.; Seitz, G.; Wocadlo, S. *Liebigs Ann.* **1995**, 661–666; l) Klindert, T.; Seitz, G. *Synth. Comm.* **1996**, *26*, 2587–2596; m) Klindert, T.; Stroetmann, I.; Seitz, G.; Hofner, G.; Wanner, K. T.; Frenzen, G.; Eckhoff, B. *Arch. Pharm. Pharm. Med. Chem.* **1997**, *330*, 163–168; n) Klindert, T.; Von Hagel, P.; Baumann, L.; Seitz, G. *J. Prakt. Chem.* **1997**, *339*, 623–632.
- (106) Haider, N.; Wanko, R. *Heterocycles* **1994**, *38*, 1805–1811.
- (107) Kotschy, A.; Novak, Z.; Vincze, Z.; Smith, D. M.; Hajos, G. *Tetrahedron Lett.* **1999**, *40*, 6313–6316.
- (108) Stehl, A.; Seitz, G.; Schulz, K. *Tetrahedron* **2002**, *58*, 1343–1354.
- (109) Che, D.; Wegge, T.; Stubbs, M. T.; Seitz, G.; Meier, H.; Methfessel, C. *J. Med. Chem.* **2001**, *44*, 47–57.
- (110) Gündisch, D.; Kämpchen, T.; Schwarz, S.; Seitz, G.; Siegl, J.; Wegge, T. *Bioorg. Med. Chem.* **2002**, *10*, 1–9.
- (111) a) Gonzalez-Gomez, J. C.; Dedola, T.; Santana, L.; Uriarte, E.; Begala, M.; Copez, D.; Podda, G. *J. Heterocycl. Chem.* **2000**, *37*, 907–910; b) Gonzalez-Gomez, J. C.; Santana, L.; Uriarte, E. *Synthesis* **2002**, 43–46; c) Gonzalez, J. C.; Lobo-Antunes, J.; Pérez-Lourido, P.; Santana, L.; Uriarte, E. *Synthesis* **2002**, 475–478.
- (112) Tran, G.; Gomez Pardo, D.; Tsuchiya, T.; Hillebrand, S.; Vors, J. -P.; Cossy, J. *Org. Lett.* **2015**, *17*, 3414–3417.
- (113) Gilman, H.; Jones, R. G. *J. Am. Chem. Soc.* **1943**, *65*, 1458–1460.
- (114) Fields, R.; Tomlinson, J. P. *J. Fluorine Chem.* **1979**, *13*, 147–158.
- (115) Morandi, B.; Carreira, E. M. *Angew. Chem. Int. Ed.* **2011**, *50*, 9085–9088.
- (116) Wang, F.; Luo, T.; Hu, J.; Wang, Y.; Krishnan, H. S.; Jog, P. V.; Ganesh, S. K.; Prakash, G. K. S.; Olah, G. A. *Angew. Chem. Int. Ed.* **2011**, *50*, 7153–7157.
- (117) a) Tian, F.; Kruger, V.; Bautista, O.; Duan, J. -X.; Li, A. -R.; Dolbier, Jr. W. R.; Chen, Q. -Y. *Org. Lett.* **2000**, *2*, 563–564; b) Xu, W.; Chen, Q. -Y. *J. Org. Chem.* **2002**, *67*, 9421–9427.
- (118) a) Mykhailiuk, P. K. *Chem. Eur. J.* **2014**, *20*, 4942–4947; b) Mykhailiuk, P. K. *Beilstein J. Org. Chem.* **2015**, *11*, 16–24; c) Mykhailiuk, P. K.; Ishchenko, A. Y.; Stepanenko, V.; Cossy, J. *Eur. J. Org. Chem.* **2016**, 5485–5493.
- (119) a) Mykhailiuk, P. K. *Angew. Chem. Int.* **2015**, *54*, 6558–6561; b) Li, J.; Yu, X. -L.; Cossy, J.; Lv, S. -Y.; Zhang, H. -L.; Su, F.; Mykhailiuk, P. K.; Wu, Y. *Eur. J. Org. Chem.* **2017**, 266–270.
- (120) Feraldi-Xypolia, A.; Fredj, G.; Tran, G.; Tsuchiya, T.; Vors, J. -P.; Mykhailiuk, P.; Gomez Pardo, D.; Cossy, J. *Asian J. Org. Chem.* **2017**, *6*, 925–935.
- (121) Schmidt, B.; Riemer, M.; Schilde, U. *Eur. J. Org. Chem.* **2015**, 7602–7611.



- (122) Pearson, A. J.; Kim, J. B. *Tetrahedron Lett.* **2003**, *44*, 8525–8527.
- (123) Hapuarachchige, S.; Montano, G.; Ramesh, C.; Rodriguez, D.; Henson, L. H.; Williams, C. C.; Kadavakkollu, S.; Johnson, D. L.; Shuster, C. B.; Arterburn, J. B. *J. Am. Chem. Soc.* **2011**, *133*, 6780–6790.
- (124) Onouchi, H.; Maeda, K.; Yashima, E. *J. Am. Chem. Soc.* **2001**, *123*, 7441–7442.
- (125) Shigeta, M.; Watanabe, J.; Konishi, G. *Tetrahedron* **2013**, *54*, 1761–1764.
- (126) Gao, M.; Duan, L.; Luo, J.; Zhang, L.; Lu, X.; Zhang, Y.; Zhang, Z.; Tu, Z.; Xu, Y.; Ren, X.; Ding, K. *J. Med. Chem.* **2013**, *56*, 3281–3295.
- (127) Iyer, S.; Liebeskind, L. S. *J. Am. Chem. Soc.* **1987**, *109*, 2759–2770.



## Synthesis of trifluoromethylated nitrogen-containing heterocycles

L'introduction d'un atome de fluor sur un composé organique peut avoir une influence importante sur les propriétés chimiques et physico-chimiques de ce composé, ainsi que sur son activité biologique. Par ailleurs, les hétérocycles représentent une famille de composés intéressante pour l'industrie pharmaceutique et agrochimique avec 70% de nouvelles molécules bioactifs possédant un motif hétérocyclique. Ainsi, le développement des méthodes de synthèse permettant la formation des hétérocycles trifluorométhylés, représente un défi en chimie organique.

Dans le cadre de nos travaux, nous avons dans un premier temps développé une méthode afin d'accéder aux  $\alpha$ -(trifluorométhyl)pyrrolidines et  $\alpha$ -(trifluorométhyl)pipéridines substituées, par contraction de cycle de (trifluorométhyl)pipéridines et (trifluorométhyl)azépanes respectivement *via* un intermédiaire aziridinium. L'attaque régiosélective du nucléophile sur l'aziridinium est induite par le groupement  $\text{CF}_3$  présent sur cet intermédiaire.

Dans un deuxième temps, nous avons développé une séquence de cycloadditions [2+1]/[3+2] entre un alcyne terminal, un difluorocarbène et le (trifluorométhyl)diazométhane, afin d'accéder aux  $\alpha$ -(trifluorométhyl)pyridazines fonctionnalisées.

**Mots clés:** contraction de cycle,  $\alpha$ -(trifluorométhyl)pyrrolidines,  $\alpha$ -(trifluorométhyl)pipéridines, aziridinium, cycloaddition,  $\alpha$ -(trifluorométhyl)pyridazines.

The introduction of a fluorine atom in an organic compound can have major impact on the compounds chemical and physico-chemical properties, therefore influencing its biological activity. Moreover, heterocycles represent an important class of compounds for the pharmaceutical and agrochemical industry, given that 70% of the biologically-active molecules possess a heterocyclic moiety. Therefore, the development of synthetic methods which allow access to trifluoromethylated heterocycles represent a challenge in organic chemistry. The work presented in this manuscript is focused on the synthesis of nitrogen containing heterocycles possessing a  $\text{CF}_3$  group at the  $\alpha$  position to the nitrogen. More specifically, a variety of substituted  $\alpha$ -(trifluoromethyl)pyrrolidines and substituted  $\alpha$ -(trifluoromethyl)piperidines were obtained by the ring contraction of (trifluoromethyl)piperidines and (trifluoromethyl)azepanes respectively *via* an aziridinium intermediate. The regioselective attack of the nucleophile on the aziridinium is induced by the  $\text{CF}_3$  group present on the intermediate. Furthermore, a diversity of functionalized  $\alpha$ -(trifluoromethyl)pyridazines were obtained by a [2+1]/[3+2]-cycloaddition sequence between a terminal alkyne, a difluorocarbene and (trifluoromethyl)diazomethane.

**Key words:** ring contraction,  $\alpha$ -(trifluoromethyl)pyrrolidines,  $\alpha$ -(trifluoromethyl)piperidines, aziridinium, cycloaddition,  $\alpha$ -(trifluoromethyl)pyridazines.