



**HAL**  
open science

# Biogeochemical functioning and trajectories of French territorial agricultural systems: carbon, nitrogen and phosphorus fluxes (1852-2014)

Julia Le Noë

► **To cite this version:**

Julia Le Noë. Biogeochemical functioning and trajectories of French territorial agricultural systems: carbon, nitrogen and phosphorus fluxes (1852-2014). Biodiversity and Ecology. Sorbonne Université, 2018. English. NNT: 2018SORUS159 . tel-02355318

**HAL Id: tel-02355318**

**<https://theses.hal.science/tel-02355318v1>**

Submitted on 8 Nov 2019

**HAL** is a multi-disciplinary open access archive for the deposit and dissemination of scientific research documents, whether they are published or not. The documents may come from teaching and research institutions in France or abroad, or from public or private research centers.

L'archive ouverte pluridisciplinaire **HAL**, est destinée au dépôt et à la diffusion de documents scientifiques de niveau recherche, publiés ou non, émanant des établissements d'enseignement et de recherche français ou étrangers, des laboratoires publics ou privés.

# Sorbonne Université

Spécialité : Sciences de l'environnement

Ecole doctorale 398 : Géosciences, Ressources Naturelles et Environnement

*UMR Métis/ 7619*

## **Biogeochemical functioning and trajectories of French territorial agricultural systems**

*Carbon, Nitrogen and Phosphorus Fluxes (1852-2014)*

Julia Le Noë

Thèse de doctorat de Sciences de l'Environnement

Dirigée par Josette Garnier et Gilles Billen

Présentée et soutenue publiquement le 24/09/2018

Devant un jury composé de :

Mme Josette Garnier	DR CNRS (Paris)	Co-directrice de thèse
M. Gilles Billen	DR CNRS (Paris)	Co-directeur de thèse
Mme Sabine Barles	Pr Panthéon-Sorbonne (Paris)	Rapporteure
M. Thomas Nesme	Pr Ecole Nat. Sup. d'Agronomie (Bordeaux)	Rapporteur
Mme Simone Gingrich	Mag. Dr. Institute of Social Ecology (Vienne)	Examinatrice
M. Petros Chatzimpiros	MC Paris-Diderot (Paris)	Examineur
M. François Baudin	Pr Sorbonne Université (Paris)	Examineur
M. Luis Lassaletta	Dr. Polytechnic University (Madrid)	Invité



Except where otherwise noted, this work is licensed under  
<http://creativecommons.org/licenses/by-nc-nd/3.0/>



**Biogeochemical functioning and trajectories  
of French territorial agricultural systems:  
Carbon, Nitrogen and Phosphorus Fluxes  
(1852-2014)**



## Remerciements

Nous sommes le mardi 17 juillet 2018 et voilà que ma thèse est sur le point d'être achevée. C'est le moment des remerciements auxquels j'ai tant pensé pendant ces trois années. J'y ai pensé souvent car c'est à mille reprises que je me suis sentie pleine de gratitude envers tou.te.s celles et ceux qui m'entouraient. Peut-être aussi parce que je n'ai pas souvent l'occasion d'adresser de vrais longs remerciements sans risquer de manquer de pudeur. Ces trois années de doctorat sont sans aucun doute mes plus belles années de formation scientifique et elles m'en ont d'ailleurs paru dix plutôt que trois tant ce furent de riches années. J'entends souvent dire que « le temps passe vite » mais s'il y a bien une belle chose que j'ai pu apprendre au cours de ces années de thèse c'est justement que le temps dont on s'empare est un temps qui ne passe pas, il est au contraire un temps qui s'épaissit, un temps qui devient spécifique et non plus abstrait comme les chiffres du cadran d'une montre sont abstraits.

A ce titre, mes premiers remerciements vont à Josette Garnier et Gilles Billen qui ont été pour moi des modèles dont j'ai tenté de suivre les traces. Bien sûr je les remercie pour leur immense patience à mon égard, pour avoir su me mettre le pied à l'étrier au début de ma thèse puis pour m'avoir laissé la liberté d'explorer des voies qui n'étaient pas envisagées au commencement de la thèse. Cette thèse qui porte principalement sur le fonctionnement actuel et passé des systèmes de production agricole en France avait d'abord été pensée pour être une thèse explorant uniquement des scénarios à partir de l'analyse de l'actuel. Si j'ai finalement étudié le passé avant de porter mon regard vers l'avenir c'est grâce aux discussions enthousiastes que j'ai eues avec Gilles et Josette et dans lesquelles le sujet prenait réellement vie. Je n'aurais jamais pu écrire ce que j'ai écrit, ni faire ce que j'ai fait sans l'émulation humaine et scientifique qu'il y a pu avoir en amont. Je crois que les idées ne surgissent pas de la raison pure - du moins pas dans mon cas -, elles naissent bien plutôt de la joie qui a presque toujours une saveur d'amitié, agrémentée çà et là d'admiration, de curiosité et d'envie. Mais je deviens abstraite en disant cela et il y a des choses bien concrètes, matérielles, et même laborieuses, que je tiens aussi à mentionner. D'abord je les remercie de m'avoir aidée à trouver mon stage de master 2 à Madrid, sous la tutelle bienveillante d'Alberto Sanz-Cobeña. Je les remercie d'avoir soutenu ma candidature à l'école doctorale en juin 2015 et de m'avoir aidée à préparer l'audition. Je les remercie pour tous les colloques auxquels j'ai pu participer : Afterres 2050 à Toulouse en mai 2016, le colloque des doctorant.e.s en écologie territoriale et industrielle à Troyes en mars 2017, le RMT Spycé à Dijon en octobre 2017 et le N symposium à Rennes en juin 2018. Je remercie en particulier Gilles pour son aide précieuse dans la collecte de certaines données nécessaires à ce travail. Je remercie spécialement Josette pour un conseil qui m'a particulièrement marqué « ce que tu écriras seras à la hauteur de ce que tu auras lu ». Josette m'a dit cette phrase au début de ma thèse, nul doute que cela m'a aidée à persévérer au cours de certaines lectures rudes. Je les remercie encore pour leurs conseils pour préparer l'après thèse, pour avoir su comprendre et rassurer mes doutes et mes peurs. Je les remercie pour toutes leurs relectures attentives de mon manuscrit de thèse qui n'aurait sans doute pas pu être fini à temps sans la rapidité avec laquelle ils l'ont relu et corrigé, ainsi que pour toutes leurs autres relectures, que ce soit pour de simples résumés ou pour des articles plus longs. Enfin je leur suis sincèrement reconnaissante pour tous les échanges chaleureux qui ont contribué à créer un univers de travail stimulant et agréable.

Dans cet univers de travail il y a d'autres personnes que je souhaite également remercier. Je pense d'abord à mes « co-bureaux » Audrey Marescaux, Mélanie Raimonet et Philippe Riboust, avec toutefois une pensée particulière pour Audrey avec qui j'ai réalisé la totalité de ces trois années de thèse et qui m'a bien souvent aidée dans les multiples problèmes informatiques (niveau 1.0) que je rencontrais et dans d'autres problèmes de la vie. Je ne saurais pas non plus oublier Fabien Esculier qui m'a donné la

première opportunité d'écrire un article pour une revue internationale ainsi que pour tous les moments d'amitié partagés. Je remercie également Nicolas Roux à qui mon destin est probablement lié : après nous être rencontré.e.s grâce au judo en 2011, nous nous sommes miraculeusement retrouvé.e.s en 2017 alors qu'il revenait de quatre années d'étude au Japon, cette fois-ci dans le contexte des études afin de réaliser un stage de trois mois avec Gilles, Josette et moi-même et nous nous retrouverons à nouveau à Vienne l'an prochain, lui pour réaliser son doctorat et moi un post-doc. Je remercie Vincent Thieu pour sa bonne humeur matinale qui m'a bien souvent été contagieuse. Je remercie Marie Sylvestre, Sylvain Thiéry, Antsiva Ramarson, et Paul Passy pour tous les moments conviviaux que nous avons passés pendant les pauses déjeuners. J'adresse mes sincères remerciements à Anùn Martinez, Abdel Azougui, Sébastien Bosc et Benjamin Mercier pour leur aide sur le terrain et dans le laboratoire et sans laquelle le chapitre III de cette thèse aurait difficilement pu être écrit. Je remercie tou.te.s celles et ceux qui m'ont donné les conseils dont j'avais besoin pour la poursuite après la thèse, bien sûr de nouveau Gilles et Josette, mais aussi Pierre Ribstein, Fabienne Petit et Sabine Barles pour leur sagacité rassérénante. Enfin, je remercie toute l'équipe de METIS pour son accueil chaleureux et convivial et pour toutes les journées scientifiques qui participent de la richesse de la vie du laboratoire

L'univers scientifique étant vaste, mes remerciements dépassent les frontières de METIS et celles de la France pour s'adresser à Alberto Sanz-Cobeña et Luis Lassaletta, tous les deux membres *del equipo de los sueños* ou *dream team*. Les agradezco mucho por todo sus apoyos, tanto por el trabajo científico como por sus calurosa acogida cuando me fui a estudiar en España. I hope I will be soon capable to also express my warm thanks in german to Simone Gingrich and the other members of the Institute of Social Ecology in Vienna for accepting me as a future Post-Doctoral fellow in their team and for their kind welcome at the Kick-off meeting of the HEFT project. Je remercie également Bruno Ventelou, économiste directeur de recherche au CNRS et vieil ami, pour m'avoir encouragée à poursuivre en thèse quand je doutais encore et qui m'en a sans doute convaincue.

Je remercie Claire Chenu, Bruno Mary et François Baudin d'avoir accepté de participer à mon comité de suivi de thèse et pour leurs nombreux conseils qui m'ont aidés à améliorer la qualité et la rigueur de cette thèse. Je remercie Sabine Barles, Thomas Nesmes, Petros Chatzimpiros, Simone Gingrich et François Baudin pour avoir accepté d'être les membres du jury de thèse et plus particulièrement Sabine Barles et Thomas Nesmes qui ont bien voulu être les deux rapporteurs du jury.

On oublie peut-être trop souvent tou.te.s les enseignant.e.s du primaire et du secondaire qui sont à la base de toute formation et sans qui les études supérieures ne seraient accessibles à pratiquement personne. Ici, je souhaite adresser une mention spéciale à Madame Contoux et Monsieur Benzekri, enseignant.es en Science de la Vie et de la Terre et en Mathématiques au Lycée Montesquieu d'Herblay où j'ai réalisé mes études secondaires. A Madame Contoux pour nous avoir enseigné la rigueur nécessaire aux démonstrations d'une science où l'exception est la règle et pour son introduction philosophico-scientifique à la variable temps que j'ai toujours gardée en mémoire, reprenant les mots de Saint-Augustin : « Qu'est-ce donc que le temps ? Si personne ne me le demande, je le sais bien ; mais si on me le demande, et que j'entreprenne de l'expliquer, je trouve que je l'ignore ». Merci de nous avoir enseigné le doute qui est bien plus beau et plus riche que la certitude et qui est sans doute la meilleure voie vers la connaissance du monde. A Monsieur Benzekri, bien que je n'aie jamais été une élève très brillante en mathématiques, je voudrais adresser mes profonds remerciements pour m'avoir communiqué une certaine admiration pour la « beauté des maths » (et je reprends ici ses propres termes) qui m'a permis de saisir la part d'imagination et d'invention inhérente à toutes tentatives d'appréhension objective du réel, la part d'émotion et de singulier au rationnel et à l'universel. Je les remercie tou.te.s

les deux pour les modèles de rigueur et de déontologie qu'ils ont représenté pendant mon année de préparation au bac.

Trois années de thèse ce sont évidemment trois années de vie qui lui sont indissociablement liées. Ainsi, à côté des expériences d'extraction du phosphore labile des sols, à côté des calculs de bilan azoté sur les terres arables de 1852 à 2014, et à côté des lectures sur la dynamique du carbone dans les sols, il y a eu la COP 21, la mobilisation contre la loi travail, l'élection de Donald Trump aux Etats-Unis puis celle d'Emmanuel Macron en France, le Brexit des Britanniques, les ordonnances Macron, la déferlante MeToo en France et dans plein d'autres pays du monde, la loi asile et immigration, la mobilisation contre la loi ORE et la grève de la SNCF pour le maintien du statut de cheminot.e. Comme tout le monde j'ai vécu ces événements. Je ne les ai pas vécus seule car j'ai autant cherché à les comprendre qu'à les affronter et cela implique de se lier aux autres, à celles et ceux qui se sentent des intérêts et un idéal commun à défendre. Ici je tiens à exprimer toute ma reconnaissance et ma camaraderie au comité de mobilisation de Jussieu ainsi qu'au collectif féministe révolutionnaire grâce auquel j'ai découvert un autre visage de la politique que celui auquel j'avais été habituée depuis toujours à voir à la télévision ou à entendre à la radio. J'ai compris ce que pouvait être la politique au sens noble du terme : s'organiser collectivement dans des conditions qu'on n'a pas choisies pour tenter de bâtir un monde plus juste et plus libre. Ou pour le dire autrement une éthique qui se forge perpétuellement dans l'action et dans le rapport à l'altérité, c'est-à-dire l'inverse à la fois de principes moraux abstraits et à la fois du pragmatisme cynique consistant à dire que « la fin justifie les moyens ». Ce fut aussi un apprentissage qui d'une certaine manière embrassa celui que je faisais dans les salles du laboratoire.

Mais l'altérité ce n'est pas qu'un concept, ce sont aussi des personnes qui me sont chères, en tant que camarades et en tant qu'ami.e.s. Je fais parfois le choix de la sobriété, pensant que trop en dire c'est ne rien dire, pensant aussi qu'en taisant mes affections je les préserve et que les mots sont de toute façon trop étroits pour contenir la largesse et la précision, la complexité et la simplicité qu'on aimerait y mettre. Mais c'est aussi trop facile car c'est ne prendre aucun risque. Je commencerai donc par remercier Aurore, Louise et Sandro pour m'avoir littéralement portée au monde politique mais aussi pour leur douceur et leur intensité de vie. Je remercie Sandro pour m'avoir aidée avec sa nonchalante délicatesse à m'intégrer quand il était encore le seul que je connaissais ainsi que pour tous les moments de complicité que nous avons passés. Je le remercie d'avoir été un coéquipier de choc pendant toute cette année de mobilisation à Jussieu. Je remercie Louise pour sa capacité à mettre les autres en avant quand c'est souvent elle qui comprend les choses avant tout le monde, je sais que j'en ai bénéficié à de nombreuses reprises. A ce titre je la remercie d'être la plus grande philosophe que je connaisse : celle pour qui il me semble que la philosophie est un mode de vie cohérent avec la pensée. Je remercie Aurore pour sa capacité à créer du sens, à faire de la vie un théâtre et elle sait sans doute à quel point le théâtre est tout sauf un divertissement pour moi. Plus simplement, je la remercie pour toutes les fois où je peux compter sur elle, toutes les fois où elle relit et amende mes interventions et toutes les fois où elle m'encourage.

Je remercie aussi Mar, Yohann, Alix, Paul, Seb, Jordy, Manue, Auriane, Elo et Liza pour les toutes les soirées, manif et assemblées générales que nous passons ensemble et qui font que la vie est une fête. Je remercie spécialement Yohann, Manue et Auriane pour les soirées belotte et méga brunch où j'ai toujours l'impression de me retrouver hors du temps, comme si tout à coup nous étions des enfants en colonie de vacances. Je remercie aussi Yohann pour sa relecture de l'introduction qui m'a fait plaisir autant qu'elle m'a aidée.



Je remercie également Fred pour sa joie et sa simplicité, pour ses mots rassurants et la possibilité de l'infini qu'il fait exister dans l'interconnaissance qu'il promet par la discussion et l'écoute attentive. Je le remercie de m'aider à savoir observer pour saisir l'existence pratique avant les idées préétablies, parce qu'il permet ainsi d'ouvrir le champ des possibles. Je remercie Nicolas pour son amitié infaillible depuis des années, pour les mercredis piscine et pour les soirées théâtre qui apportaient un peu de fantaisie et de rêve dans le quotidien. Je le remercie d'avoir été, sans qu'il ne l'ait jamais su, mon modèle pendant toute ma troisième année de licence. Je crois que j'aurais peut-être décroché de mes études scientifiques si je ne l'avais pas rencontré à ce moment-là et qu'il n'avait pas alors représenté pour moi l'enthousiasme et la curiosité que je peinais à regagner.

Je remercie mes amies de toujours Pauline, Daphné, Laïs, Maud, Lola et Madeleine parce qu'elles forment ce fil continu entre les époques de la vie. Je remercie Maud d'avoir été une colocataire hors-pair pendant deux ans et une amie depuis 25 ans, pour sa sensibilité littéraire qu'elle me fait partager et son intérêt pour mon sujet de thèse dont je lui ai bien souvent parlé. Je remercie Pauline d'être mon Jiminy Cricket depuis la seconde, celle à qui je peux tout raconter et sur qui je peux toujours compter. Je remercie Daphné pour la fraîcheur de notre amitié, pour les moments de rigolade que nous passons et qui sont un bol d'air frais dans les moments parfois un peu fatigants de la vie. Je remercie Laïs pour sa loyauté sans pareil et parce que je la retrouve chaque fois comme si l'on s'était quitté la veille.

Pour finir, mes plus tendres remerciements vont à ma famille dont le soutien inconditionnel à toutes les épreuves de la thèse et de la vie m'a été indispensable. Je remercie mes quatre grands-parents : Michel, Françoise, Michel et Jocelyne pour leur tendresse et leur intérêt pour mon travail. Je remercie mes frères et sœurs, Marius, Victoria et Lola. Je remercie Marius pour sa sensibilité esthétique, qu'elle soit simplement vestimentaire ou qu'elle porte sur l'appréciation d'une situation et qui me sert bien souvent de boussole sans qu'il le sache toujours. Je remercie Victoria d'être le meilleur public de mes blagues, d'être depuis qu'elle est née mon modèle de générosité et de simplicité. Je remercie Lola d'avoir été ma plus grande complice de bêtises, de jeu et de sport. Parce que même quand je ne lui dis rien elle me devine toujours aussi vite. Enfin je remercie mes parents, Emmanuelle et Olivier pour tout leur amour. Ici les mots deviennent réellement trop faibles alors je dirai simplement que l'on ne peut sans doute ni aimer, ni sourire, ni persévérer dans le travail, le sport et les relations affectives quand on n'a pas reçu tout cela soi-même. J'espère que je saurai perpétuer aussi longtemps et aussi intensément que possible ces sentiments que je leur dois car c'est eux qui me les ont donnés depuis toujours.

## Abstract

Resource management in agriculture is a permanent challenge as it implies to produce enough food to feed people while preserving terrestrial and aquatic environments from pollution and loss of fertility for next generations. In this context, this work investigates agricultural systems from the angle of nitrogen (N), phosphorus (P) and carbon (C) biogeochemical fluxes in French regions from 1852 to 2014, following a socio-metabolic approach stressing out the underlying logic behind these material fluxes. To that end, the GRAFS approach (Generalized Representation of Agro-Food Systems) was extended to C and developed for long term analysis. GRAFS is a generic biogeochemical accounting method describing agro-food system of a given region, by quantifying nutrient fluxes between cropland, permanent grassland, livestock, humans, and the surrounding environment.

Results brought out by this research highlight the systemic relation between production pattern and N and P balances, and changes in soil organic C stocks in agricultural soil of French regions. Intensive specialized agricultural systems generate high environmental losses and resource consumption per unit of agricultural surface and present largely open nutrient cycles due to substantial trade flows. Conversely, integrated crop and livestock farming have more limited N and P consumption and lead to lower air and water contamination.

Long-term analysis shows that these patterns have not always existed; only after the Second World War, under the pressure of strong interventionist policies, some French regions specialized into crop or livestock farming, increasing their integration into the international market. Particularly, the period from the 1950's to the 1980's was marked by a concomitant acceleration in crops yields, livestock production and use of mineral fertilizers. This resulted in increased N and P balances over cropland and grassland and growing C inputs to cropland, causing important losses of N to the hydrosphere and atmosphere, together with the accumulation of P and C stocks in cropland soils. However, C accumulation resulting from increased crop production was permitted by the increased recourse to mineral fertilizers and agricultural machinery which consumes fossil-fuel energy. Therefore, C storage in cropland appeared to be a side-effect of the shift from an energy metabolism based on solar energy to one based on fossil-fuel combustion. Overall, trajectory analysis made clear that deep structural changes of the agro-food system, beyond the mere optimization of agricultural practices, are necessary to further reduce the environmental imprint of agricultural production.

The value of a historical perspective also lies in an improved ability to embrace the future. To illustrate this, the results were used as a basis for exploring two prospective scenarios for the future of French agriculture. The first one pursues the opening and specialization characterizing the long-term evolution of the last 50 years of most French agricultural regions, while the second assumes a shift towards more autonomy at the farm and regional scales, a reconnection of crop and livestock farming and a more frugal human diet. The former, even complying with regulations regarding reasoned fertilization, would result in considerable environmental burdens. The latter alternative scenario would meet the future national food demand while still exporting substantial amount of cereals to the international market, and would significantly reduce losses to the environment.

**Key words:** nitrogen, phosphorus and carbon cycling; agro-food system; socio-ecological metabolism; long-term; trajectories; sustainability.

## Résumé

La gestion des ressources en agriculture doit faire face à un double enjeu : produire de la nourriture tout en préservant les écosystèmes. Dans ce contexte, le travail réalisé décrit les systèmes de production agricole en termes de flux biogéochimiques d'azote (N), de phosphore (P) et de carbone (C) dans les territoires français de 1852 à 2014 suivant une approche socio-écologique permettant d'appréhender les logiques qui les gouvernent. Dans ce but, l'approche GRAFS (Generalized Representation of Agro Food Systems) a été étendue au C et développée pour permettre l'analyse sur la longue durée. GRAFS est un modèle générique de comptabilité biogéochimique qui décrit le système agricole d'un territoire en termes de flux de nutriments entre les terres arables, les prairies permanentes, le bétail, la population humaine et les écosystèmes environnants.

Les résultats obtenus mettent en lumière à l'échelle des territoires français le lien systémique entre structures de production, bilans N et P et variations des stocks de C organique dans les sols agricoles. Les systèmes agricoles intensifs et spécialisés engendrent les pertes environnementales et les consommations de ressources par unité de surface agricole les plus considérables et accentuent l'ouverture des cycles d'N et de P. A l'inverse, les territoires de polyculture-élevage ont des consommations en N et P moindres, atténuant les pertes vers l'atmosphère et l'hydrosphère.

L'analyse sur la longue durée révèle que c'est seulement après la seconde guerre mondiale, sous la pression de politiques volontaristes, que certaines régions françaises se sont spécialisées dans la grande culture ou, à partir des années 1980, dans l'élevage intensif, renforçant leur intégration aux marchés internationaux. En particulier, la période des années 1950 à 1980 est marquée par l'accélération concomitante des rendements des cultures végétales, de la densité de cheptel et de l'usage des fertilisants minéraux. Les conséquences ont été une augmentation des bilans N et P des sols agricoles ainsi que l'accroissement des apports de C aux terres arables, causant des pertes considérables d'N vers l'hydrosphère et l'atmosphère et l'augmentation des stocks de P et de C dans les sols. Néanmoins, l'accumulation du C résultant de l'augmentation de la production végétale n'a été rendue possible que par le recours accru aux fertilisants minéraux et au machinisme agricole consommant des énergies fossiles. Ainsi, le stockage du C dans les sols représente un effet secondaire du passage d'un métabolisme énergétique dépendant de l'énergie solaire à un métabolisme fondé sur la combustion d'énergie fossile. Ces analyses indiquent clairement que, bien au-delà de la simple optimisation des pratiques et techniques agricoles, des changements structuraux profonds des systèmes de production sont nécessaires pour réduire l'empreinte environnementale de l'agriculture française.

L'intérêt d'une approche historique réside aussi dans sa capacité à embrasser l'avenir. Pour illustrer ce point, les résultats précédents ont été utilisés comme base pour l'exploration de deux scénarios prospectifs du futur de l'agriculture française. Le premier scénario poursuit la tendance à l'ouverture et à la spécialisation qui caractérisent de nombreux territoires français depuis les 50 dernières années, tandis que le second suppose une transition vers une plus grande autonomie à l'échelle des fermes et des territoires, une reconnexion de l'élevage et des cultures et un régime alimentaire plus frugal, où la portion de protéines animales est réduite à 40%. Le premier scénario, même s'il se conforme aux normes réglementaires de la fertilisation raisonnée, conduirait à augmenter encore davantage les nuisances environnementales. En revanche, le scénario alternatif permettrait de répondre à la demande alimentaire nationale tout en conservant une quantité substantielle de production végétale disponible à l'exportation et permettrait de réduire significativement les pertes environnementales.

**Mots clés:** cycles de l'azote, du phosphore et du carbone ; système agro-alimentaire; métabolisme socio-écologique; long terme; trajectoires; soutenabilité.

# Contents

## **Introduction.**

<b>Agriculture and the nutrient metabolism of socio-ecosystems</b>	<b>1</b>
1. Agriculture and societies : a brief overview	3
2. Socio-ecological metabolism: a materialistic view of Nature/Society interactions	8
3. Biogeochemical cycles of N, P and C and the role of agriculture at the global scale	11
4. Objectives and structure of the thesis	21

## **Chapitre I. 25**

### **The Generalized Representation of Agro-Food System (GRAFS approach)**

1. Concepts and application of the GRAFS approach	27
2. Human population and consumption	30
3. Livestock metabolism	35
4. N and P Inputs to cropland and permanent grassland	45
5. Vegetal production, N and P balances and humified C inputs	53
6. Feed trade and allocation of agricultural production	60
7. Formalization of the GRAFS calculations and uncertainty estimation	62
8. Conclusion	64

## **Chapitre II. 65**

### **Characterization of current French regional agro-food systems**

1. Introduction	66
2. Methods	70
3. Characterization of regional agro-food systems	77
4. N fluxes associated to agricultural commodity trade	95
5. Imprint of Megacities on their food supplying areas: the case of Paris Megacity	104
6. Conclusion: toward more sustainability in the agro-food-trade system	112

## **Chapter III. 115**

### **P management in cropping systems of the Paris Basin: from farm to regional scale**

1. Introduction	117
2. Material and methods	119
3. Field Scale Analysis	126
4. Regional scale analysis	129
5. Interrelation of P cycling at nested scales	131
6. Conclusion	135

## **Chapter IV**

### **Long-term socioecological trajectories of agro-food systems revealed by N and P flows in French regions from 1852 to 2014 137**

1. Introduction	139
2. Regional features revealed by the GRAFS approach	141
3. Trajectories of agro-food systems	147
4. Socio-economic & political mechanisms behind regional biogeochemical trajectories	156

5. Conclusion

**Chapter V.**

**Drivers of long-term carbon dynamics in French cropland 163**

1. Introduction	165
2. Material and methods	166
3. Results	171
4. Discussion	180
5. Conclusion	186

**General Discussion:**

**From past trajectories to scenarios: a prospective discussion for French agrofood systems 187**

1. Introduction	189
2. The storylines of the scenarios	191
3. Translation of the storylines into a coherent GRAFS description	194
4. The GRAFS description of the scenarios	200
5. The role of scenario for reality	206
6. Conclusion	207

**General Conclusion 209**

1. A brief overview of the work carried out	211
2. The relationships between science, policy and society	212
3. Towards an emancipatory environmental science?	213

**References 217**

**List of figures 251**

**List of tables 255**





# **Introduction**

**Agriculture and the nutrient metabolism of socio-ecosystems**





# 1. Agriculture and societies : a brief overview

**Agriculture** can be broadly defined as land use planning to optimize solar energy flux for the photosynthesis of edible plants for human and domestic animals. This ability of human society to adapt the environment to their use has been referred as to “**Human Appropriation of Net Primary Production**” (HANPP) with HANPP being defined as the difference between potential NPP ( $NPP_0$ ) and NPP after harvest ( $NPP_t$ ) (Haberl et al., 2007). From there, human societies since the Neolithic have shaped their livelihood conditions. Considering that agriculture is also supported by soil and depends on climate conditions, one can say that it emerges from the interaction between human society and biophysical environment. However, humans cannot change Nature without changing themselves. Evidence to this assertion is that the more Net Primary Production (NPP) human society can appropriate, the larger population can be sustained. But increased HANPP and demography can lead to the deterioration of reproduction conditions such as soil fertility, leading to the advent of a new agrarian system with new land use planning, tools and agricultural practices (Mazoyer, 1977). The relationship between nature and society is therefore dialectic with agriculture being at the interface of this relationship. It is also closely linked to the co-evolution of humans with nature all along historical times, so that agriculture should also be considered as a historical process.

Understanding agriculture as a historical process implies to conceive **agrarian systems** that have succeeded to each other. This in turn entails to see agricultural practices, land use planning, soil management and peasant labor as a whole and to consider criteria to gather similar production systems as belonging to a certain type of agrarian systems. The concept of agrarian systems also enables to distinguish different mode of agriculture and thus to apprehend a vast range of different systems. Following Mazoyer and Roudart (1997), agrarian systems should be decomposed into two sub-systems: the cultivated ecosystem on the one hand, and the social productive system on the other hand. Understanding agriculture under the prism of agrarian system provides a theoretical framework for further knowledge. It does not preclude the need for investigating singular cases located in time and space, which are real object of knowledge. Rather the observation of singular past and present agricultural systems at various scales is a necessary condition to consider agrarian system, and conversely observations of singular cases can be built on theoretical knowledge. This analytical framework should prevent to get lost in the complexity of reality.

## 1.1. A brief history of agrarian systems

Such a historical description of agrarian systems has been proposed by Mazoyer and Roudart (1998) in *A History of World Agricultures*. Based on their work, five main agrarian systems can be identified in Western Europe from the Neolithic to nowadays: slash-and-burn system in the Neolithic, biennial rotation with fallow and pastoral livestock in the Antiquity, triennial rotation with fallow and livestock breeding in the Middle-Age, integrated crops and livestock system without fallow from the 17<sup>th</sup> to the 19<sup>th</sup> century and motorized and mineral

agriculture from the 20<sup>th</sup> century. A brief overview of these agrarian systems is useful for our purpose, for providing more concrete substance to the above.

Slash-and-burn systems are characterized by a long rotation of ca 30 years in wooded area. After clearing and burning of vegetation, cultivation took place for two to four years, with crop growth being sustained by the nutrients present in the soil and in the ashes. After that time, yields drop and the cultivated area is abandoned to forest regrowth for several decades, ensuring fertility recovery. Thanks to deep roots forest explores a large volume of soil. Nutrients extracted from the below-ground are stored in above-ground biomass which again will provide soil organic matter and release nutrients to topsoil once burned. This type of agrarian system requires large surface of forest with less than 10% of cultivated area. The sustainable population density is limited to ca 15-20 inhabitants per km<sup>2</sup>. The social organization is typically composed of “families” which operate as auto-sufficient production entities. However, if population density increases, then the rotation accelerates, leading to the extension of culture at the expense of forest, which impairs the restoration of soil fertility. In this context, slash-and-burn system is likely to move toward a new agrarian system.

In Greek antiquity, a new land use system of biennial rotation with fallow associated to pastoral livestock was made possible by new land use and tools, mainly the spade (imported from Mesopotamia) and the hoe which enables to plough the soil and improve the harvest. The production of such work tools, however, involves a higher division of labor which happened in Mediterranean region only from the Iron Age in around 800 before J.-C. In this system, the fertility of the *ager* (the cultivated area) was sustained through the transfer of fertility from the *saltus* (pasture land) via livestock who spent all day grazing in the *saltus* and was parked by night in the *ager*, providing manure to soil. However, this way of manuring generates much loss because dejections can be lost on the paths and nutrients can be lixiviated. Consequently, this agrarian system necessitates a large share of *saltus* to manure a small share of *ager*. In this context, shortage and famine were frequent and sustainable population density is not much higher than in the slash-and-burn system. The chronic livelihood crisis characteristic of the agrarian systems of Mediterranean Antiquity have been suggested as one of the main driver of the development of military city because conquests enabled to extend the cultivated area but also to enslave. As slaves have no family to feed, an increase in slave stock improved labor productivity.

In around year 1000, the use of a range of tools spread in relation with the development of steel industry in the northern and temperate parts of Europe. Steel industry was able to supply more iron and of better quality used to make scythes. The use of this tool was essential to the agricultural revolution in the Middle-Age as it promoted the harvesting of hay which, together with the development of barns, enabled more animals to survive winter. Increased livestock density is obviously correlated to increased manure which in turn boosts crop yield. As manure has prolonged effects on land fertility, peasants could afford to switch from biennial to a triennial rotation. Furthermore, animal did not only contribute to sustain soil fertility but also to increase labor productivity through the development of animal traction namely for ploughing. All these changes strengthened the association of crops and livestock breeding. With increased

crop and livestock production, population more than tripled in northern Europe between year 1000 and 1300. In this context of population growth, a small but a larger fraction of population than previously has been able to dedicate to non-agricultural activity. Higher labor division led to the emergence of a new class of workers: the merchants who would have had tremendous importance in trade expansion and the progressive commodification of food production which were particularly clear in the great fairs. However, by the 14<sup>th</sup> century, the ecological limits of this system were reached: as the population kept rising, shortage and famine were again more common. Weakened population was more vulnerable to disease while Europe entered in a war period; all of this could explain the demographic fall between the 14<sup>th</sup> and 16<sup>th</sup> centuries.

From the 17<sup>th</sup> century, improved management of agriculture emerged first in Flanders and England before spreading through in the rest of Europe in the 18<sup>th</sup> and 19<sup>th</sup> centuries. In triennial rotation, peasants began to replace fallow by fodder crops including temporary legume grassland (clover, sainfoin, ray-grass...) and which provided N fertilization through biological fixation. By the end of this new agricultural revolution, cropland produced as much grass and fodder as pasture and permanent grassland. As a result, livestock density, manure and crop productions almost doubled which further strengthened the association of livestock and crop production. By the beginning of the 20<sup>th</sup> century, in regions where this revolution occurred, shortage and famine disappeared, food supply improved, population density increased and, for the first time of History, peasants supplied food to a majority of non-peasants population, working in the industry and services. Agricultural revolution had released hands available for industrial labor but at the same time the industrial revolution fostered labor productivity in the agricultural sector through the production of more robust animal-traction machine (reversible plough, mower, tedder, etc) and other machinery (threshing machine, cream separator, sorter). These new machines made it possible to double the land surface cultivated per peasant, provided, however, that they could invest for this new farm equipment.

The latest agricultural revolution which occurred globally over the course of the long 20<sup>th</sup> century is characterized by a complete reversal of the previous paradigm of a relatively autonomous peasant society with respect to the encompassing society (Mendras, 1967). Industry is now supplying the agricultural sector with tractors, mineral fertilizers, pesticide treatments, concentrated feed, selected varieties of plant and animal species which enabled to increase labor productivity, crop yields and livestock production. In Europe, this transformation of agrarian systems has been favored by the protectionist measures of the common agricultural policy (CAP) from 1962 to 1992 and by subsidies supporting the modernization of farms. The development of new distribution channel and transport network increased competition which led to the elimination of the least competitive farms and to the further integration of agriculture to the market economy. As a consequence, the supply chain downstream had a stronger grip on agricultural production, bending farmer to the market requirements. Furthermore, the historical association of crops and livestock production has been made obsolete by the generalization of mineral fertilization which favored strong specialization of agricultural production in many regions. Although big farmers benefitted from and were sometimes actor of this change, many other impoverished or simply left the sector. The rural exodus which occurred in occidental Europe from the mid-19<sup>th</sup> century to nowadays brought the share of the agricultural sector in

labor force as low as 2 to 4% of labor (<https://donnees.banquemondiale.org/indicateur>). The resulting tremendous increase of crop and livestock production is a major determinant of the demographic boom which led to the tripling of the world population since the mid-20<sup>th</sup> century. The reverse of the medal of increase food production was, however, widespread air and water pollution resulting from excess mineral fertilization or over-concentration of livestock in landless production, mostly from the 1970's. Agricultural green revolution has also been shown to be one of the drivers of increasing atmospheric CO<sub>2</sub> seasonal amplitude (Zeng et al., 2014). Coming back to the original point, the spread of these changes at the global level, though uneven, resulted in HANPP of 23.8% of potential NPP (Haberl et al., 2007) in year 2000 with biomass harvest and land-use induced productivity changes contributing together to 93% of this total.

## **1.2. Agriculture at the interface of social and biophysical sphere**

Far from providing a Malthusian view of the demographic issue, the preceding brief overview of the History of agrarian systems in Europe shows that demography has not been restricted in the past by ecological limits but rather has depended on the capacity of the society to manage the production of agrarian systems. Even so, demographic shifts are not only of a quantitative nature but also result in important restructuring of labor division -whether be it at local, national or global scale-, and in transformation of terrestrial ecosystems to supply a growing population. Furthermore, seeing agriculture as a historical process especially throws light on the interrelation between agricultural and industrial sectors. Every revolution in agrarian systems appears to have occurred simultaneously with a revolution in the craft or industrial sector. These revolutions were therefore parts of a same process of general transformation in social relationships and Society-Nature relations (Moore, 2014). The future of food security will therefore depend both on the sustainability of land planning and agricultural practices but also on how social relationships can reconfigure in order to shift production in line with social and vital requirements of world population. Figure 0.1 synthesizes schematically this view of agriculture as emerging from the interaction between social and biophysical spheres.

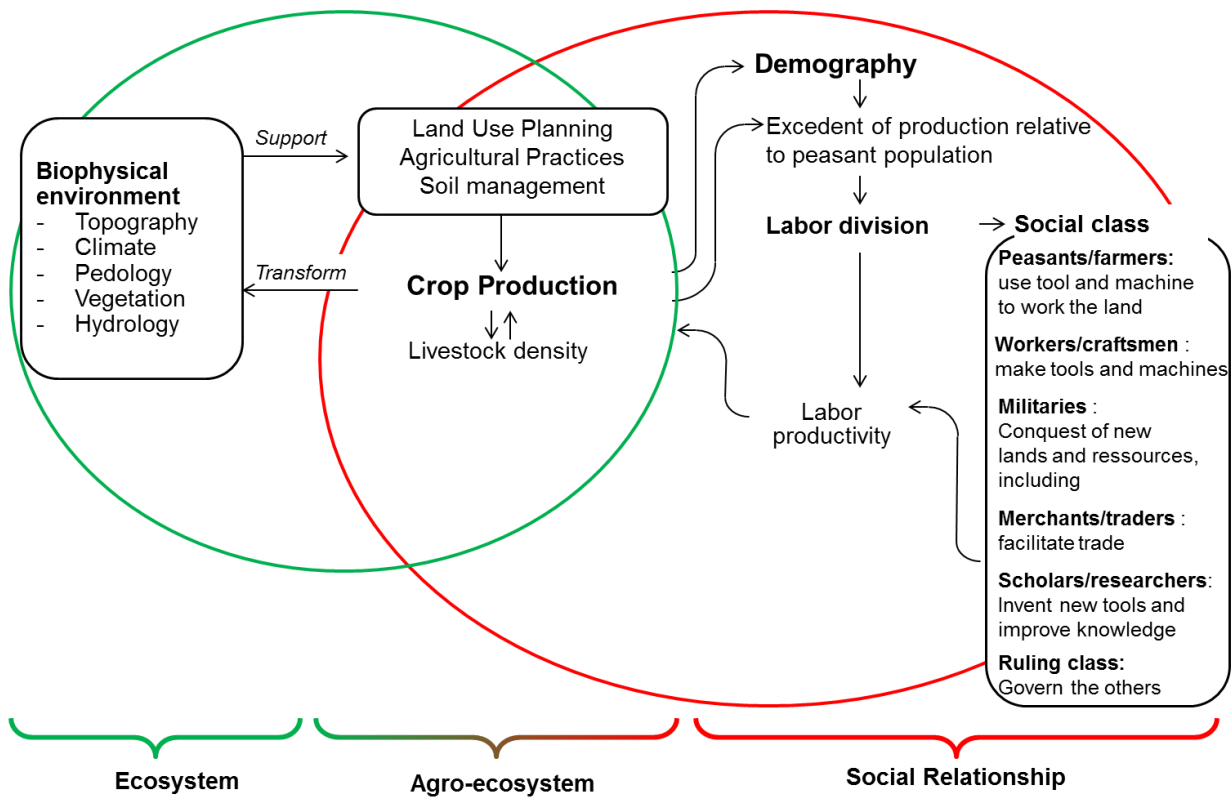

**Figure 0.1** Schematic representation of agriculture as an emblematic interface of the social and biophysical spheres.

## 2. Socio-ecological metabolism: a materialistic view of Nature/Society interactions

The dialectic view of the relationships between society and nature calls into question the very concepts of nature and society since they appear to be interwoven in a dense material and energy flux network. This view transcends the great ontological division between natural sciences dealing with the study of regularities that characterized the biophysical world on the one hand, and social sciences which study the conventional construction and historical rules properly human. In its wake, this great division implicitly excludes humans from nature and considers nature as an ahistorical entity which could be known from universal laws (Charbonnier, 2013). It might be conceded this dual representation is quite caricatural since in early time of sociology Durkheim (1912) insisted on the fact that: « Whether the society is a specific reality, it is, however, not an empire in an empire; it is a part of Nature, it is its highest expression”. Nevertheless, the fragmentation of knowledge in distinct academic fields had often led to confuse practical processes of compartmentalization of knowledge with real ontological separation (Charbonnier, 2013). The point here is not to demolish all conceptual boundaries but rather to consider their importance and to choose the right ones. Certainly, the methodology and conceptual framework can differ according to the specificity of the object of studies. For our purpose, the conceptual categories proposed by Vernadsky (1926) could also fit to understand agricultural systems; he distinguished five spheres of reality: the lithosphere, the biosphere, the atmosphere, the technosphere and the noosphere (sphere of mind). Its four firsts categories belong to what we previously defined as the biophysical sphere; the technosphere, yet, establish the link between the noosphere and other spheres. The technosphere and noosphere can be seen from a social perspective as quite specific to human society which led to reconsider the relevance of the Society/Nature couple. For our purpose, it seems that, the standpoint of the unit of society and natural environment makes sense only if its construction is explicated and, from this point of view, the distinction between natural environment and society is not just pure rhetoric. For this reason, the framework of socio-ecological metabolism is appropriate to study agricultural systems as emerging from the interaction between biophysical environment and human society.

### 2.1. Socio-ecological metabolism

The conceptual framework of socio-ecological metabolism has recently experienced strong interest in the scientific community, from philosophy and sociology (Fisher-Kowalski, 1998; Foster, 2000; Barles, 2014; Moore, 2014) to ecological and agronomical sciences (Krausmann, 2004; Gingrich et al., 2007; Niedertschneider et al., 2016; Güldner and Krausmann, 2017). The concept of social metabolism has, however, a longer history and dates back from Marx (1867) who stated that: “*The labor-process [...] is human action with a view to the production of use-values, appropriation of natural substances to human requirements; it is the necessary condition for effecting exchange of matter between man and Nature; it is the everlasting Nature-imposed conditions of human existence, and therefore independent of every social phase of that existence, or rather is common to every such phase*” (cited after Fisher-Kowalski, 1998).

The concept of metabolism (*stoffwechsel*) applied to society may be taken as a mere metaphor; however, it is more than that. It is actually an extension of the cellular and organism metabolism as understood in biology. One may wonder whether such an extension is relevant and whether it is not diluting the real meaning of metabolism by scaling-up its boundaries. This question can be precisely answered by re-examining the classical conception of metabolism in biology: the metabolism is all the reactions, i.e., energy and material fluxes and transformations that allow organisms to grow and reproduce, maintain their structures, and respond to their environments. But how would human metabolism be maintained and reproduced without, for instance, agricultural production and hospital, two sectors mobilizing important material and energy fluxes, in our modern societies? This question highlights two major points. First, human metabolisms are collectively sustained by specific modes of appropriation of nature. Secondly, this metabolism is a historical process because, in agreement with Godelier (1986) saying that: « *Human being have a history because they transform nature* », and as mentioned in the previous section, agriculture in a given time and place (but obviously hospital too) results from the long history of human society with its biophysical environment. This latter point has been widely investigated by socio-ecological scientists with, among others, Fisher-Kowalski and Haberl (2007) who described accelerations in history as socio-metabolic transitions. The shift from one regime to another is combined with an increasing colonization of nature, namely its management and transformation in order to maximize its utility to respond to social and vital requirements.

## 2.2. Methodological approaches to socio-ecological metabolism

In an article defining theoretical foundations for long-term socio-ecological research, Haberl et al. (2006) defines the methodology of socio-ecological metabolism accounting: « *The principal measures of socio-ecological metabolism are physical entities, i.e., stocks and flows of materials and energy that are important characteristics of both ecosystems and industrial and social systems* ». Therefore Material Flows Analysis (MFA), Substance Flows Analysis (SFA) (Barles, 2014) and Energy Flows Analysis (Gingrich, 2018) are privileged scientific tools for socio-ecological systems, including agricultural systems. MFA, SFA and EFA imply to account for physical and chemical processes mediating material transformation whether it is intentionally shaped by human societies (e.g., C fluxes through crops harvest, N and P fertilizers inputs to cropland) or whether it constitutes an uncontrolled material flux (e.g. CO<sub>2</sub> emitted from plant residues decomposition, nitrate lixiviation). Besides, the originality of biophysical analysis in the current debates on sustainability is that it reveals economy under its material aspect. It also enable to discuss on what is technically and ecologically feasible with current available techniques, land use planning and productive force.

All these approaches raise at least two crucial methodological issues: the choice of the unit and the delimitation of the system perimeter. Indeed, numerous studies dealing with the socio-ecological metabolism of agricultural systems have identified differently the flows and compartments of agricultural systems and, depending on the problem considered, have chosen different units. For instance Billen et al. (2013a) studied the current N cascade from the



agrofood system to surface water from a sample of watersheds to the world whereas Lassaletta et al. (2014c) and Guzman et al. (2017) accounted for N fluxes from 1961 to 2009 and agroecological EROI fluxes from 1900 to 2008 respectively within agro-food system at the national scale in Spain. All studies pointed out a richer diet in animal protein as a main driver of agricultural specialization and increased dependency from feed importation for the common period under study (1961-2008), however different unit choice also led to emphasize different aspects of change in agro-food systems. Lassaletta et al. (2014c) revealed an increased openness of N cycle resulting in important N export to hydro system whereas Guzman et al. (2017) stressed out that loss in agroecosystem EROI reflected the deterioration of soil due to higher erosion rates, decrease in soil organic matter, salinization and the overexploitation of water resources and loss of agrarian biodiversity.

Besides, the accounting can never be exhaustive and completely accurate, and leads to the so-called observer bias. Results and interpretations should thus reflect simultaneously real aspects of the object study as well as methodological choices. Consequently, data availability and quality as well as coherency of flux allocation hypotheses are key determinants of the robustness of the method developed.

### **2.3. Trade-off between food production and environmental impact**

The choice of unit to analyze agricultural system should try to best reflect the dual nature of fluxes within agroecosystems. In this respect, resource management in agricultural systems is particularly relevant since it is a matter of producing enough food to feed people now while preserving the conditions of maintenance of terrestrial and coastal environments from pollution and loss of fertility for next generation. The trade-off between food production and environmental impacts is reflected in the duality of elements such as nitrogen (N), phosphorus (P), and carbon (C). They are essential for plant growth and soil fertility but with harmful effects for the environment when resulting in eutrophication (O'Higgins & Glibert 2014; Passy et al., 2013) or when emitted to the atmosphere as greenhouse gases (GHG, Martikainen 1985; Rodrigues Soares et al., 2012) or other compounds, considered as a major environmental risk to human health. For these reasons analyzing agricultural systems from the angle of main nutrient fluxes is particularly relevant as it integrates a socio-ecological metabolism approach to a biogeochemical vision. This implied, however, to have a good knowledge of biogeochemical cycles of nutrients studied both in agroecosystems and, more generally, on earth in order to better understand what is at stake.

### **3. Biogeochemical cycles of N, P and C and the role of agriculture at the global scale**

#### **3.1. Biogeochemistry: history of a new scientific discipline**

The term biogeochemistry was first used in 1923 by Vladimir I. Vernadsky in the article “A plea for the establishment of a biogeochemical laboratory” (Lapo, 2001), essentially motivated by the perception of the unitive biogeochemical process by which the biosphere maintains itself. This thesis was deepened in Vernadsky’s best known writing: *The Biosphere* published in 1926 which unified biology and geology in one place: the so-called *Biosphere* and, by doing so, fully established the field of biogeochemistry. For Vernadsky: “*The study of solar radiation effects on terrestrial processes allow us to envision, in a first approximation, the biosphere, in an accurate and scientific way, as both a terrestrial and cosmic mechanism [...because by its very essence it...] can be considered as a region of earth crust occupied by transformers changing cosmic radiations in terrestrial energy, whether electrical, chemical, mechanical or heat energy* » (The Biosphere, 1926). Actually, radiative energy is transformed in the first instance in chemical energy through the photosynthesis which then become available for other living organisms and then can be transformed in other forms of energy. The shape of biogeochemical cycles on earth is thus closely related to the coevolution of living organisms and the composition of environmental compartments in which they evolve (atmosphere, hydrosphere and lithosphere/soil). However, with the exception of oxygen, the main elements indispensable to life (C, H, O, N, P, and S) do not correspond to the most abundant element that constitutes the terrestrial and oceanic crust since oxygen, siliceous, aluminum, iron, calcium, magnesium and sodium represent 97% of their total mass (Valero Delgado, 2008 cited after Esculier, 2018). As a consequence, the biosphere largely operates in loop and the recycling of life element along the trophic chain is a fundamental regulatory mechanism of life on earth. Although H, O and S are essential to plant growth, like any other life form, I focused only on the case of N, P and C within the framework of this PhD. The reasons for this choice shall be clearer in what follows. Let us now recall the major characteristics of N, P and C cycles on Earth and, more specifically, in agroecosystems.

#### ***Nitrogen cycling***

Representing ca. 0.2-0.3 % of phytomass (Smil, 2000), nitrogen is an essential element of ADN, ARN and amino acids (the building blocks of proteins). It is an indispensable element of vegetal production which can be taken up from soil as soluble ions of ammonium ( $\text{NH}_4^+$ ) and nitrate ( $\text{NO}_3^-$ ). However, most of the N on Earth is under the form of  $\text{N}_2$ , an inert gas accounting for ca. 78% of air. In the absence of anthropogenic influence, this gas can only be converted into reactive forms through biological fixation that only some bacteria can achieve, mostly in symbiosis with leguminous plants (Follet, 2008). Over the long course of agriculture history, N has been made available almost only through rice and leguminous cultivation and then internally recycled within agroecosystem. Evolution of ecosystems and agroecosystems has been shaped in this context of structuring N scarcity which involved limited vegetal production

and high biodiversity. Hence, in 1890 global anthropogenic N fixation amounted to ca. 15 Tg yr<sup>-1</sup> or 13% of global terrestrial N fixation (Galloway and Cowling, 2002). However, this has had to change soon and scientific discoveries did play an important role, as summarized in the following.

Nitrogen was already known since the late 18th century through the work of several chemists, Scheele (1742-1786), Rutherford (1749-1819), Lavoisier (1743-1794) and finally named as ‘nitrogene’ by Chaptal (1756-1832). The role of N in crop production was first recognized by Boussingault (1802-1887). Afterwards, the discovery near the end of the 19th century by Hellriegel (1831-1895) and Wilfarth (1853-1904) of biological N fixation, a process by which microbial communities convert the non-reactive atmospheric N<sub>2</sub> into a reactive nitrogen forms (like ammonium or amino acids) has probably inspired the German scientist Fritz Haber who first performed the nitrogen fixation in laboratory conditions. In 1913, Carl Bosch developed an industrial application of this process: the Haber-Bosch process. The rapid expansion of this process, first designed to produce explosives then used in the fertilizer industry, made it possible to tremendously increase crop production, one of the factor that enable population growth. However, this also led to a considerable acceleration and opening of the N cycle. As illustrated in Figure 0.2, the tremendous anthropogenic introduction of N exceeded the planetary boundary for a ‘safe operating space for humanity’ as defined by Rockström et al. (2009) by the beginning of the 1960’s. In 1990, the rate of anthropogenic introduction of reactive forms of N into the environment through industrial fixation, traffic and energy production and expansion of N<sub>2</sub> fixing legumes crops amounted to ca. 140 TgN yr<sup>-1</sup>, reaching the same rate as natural N<sub>2</sub> fixing processes (Galloway and Cowling, 2002).

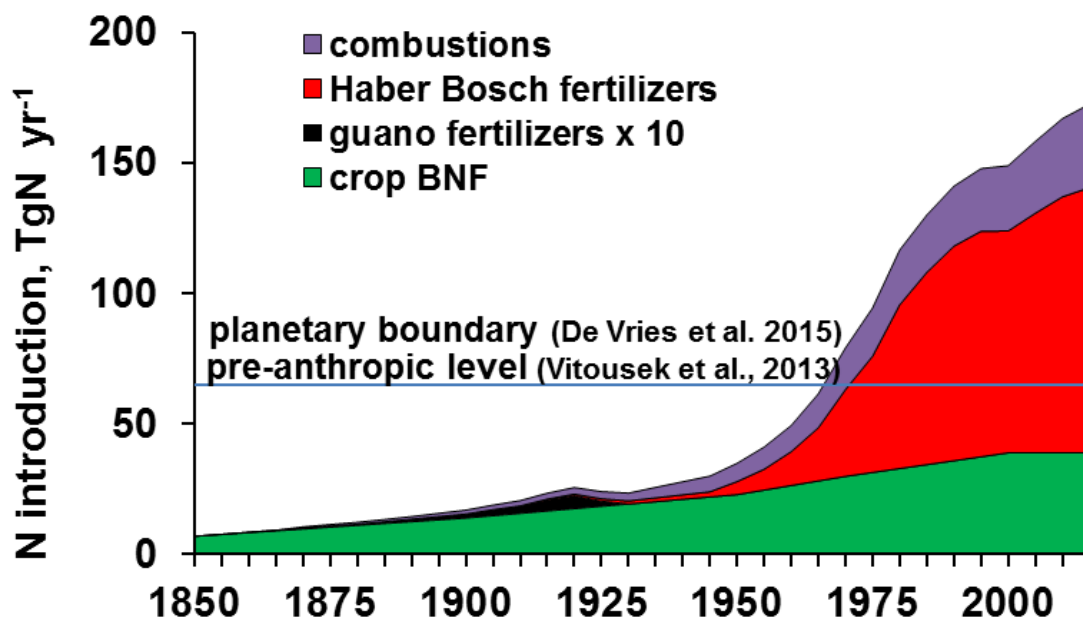

**Figure 0.2** Global introduction of reactive nitrogen from 1850 to 2015, based on a data compilation from several sources (FaoStat, 2018; Lotka, 1924; Herridge et al., 2008; Vitousek et al., 2013; Bouwman et al., 2013; Fowler et al., 2013; Galloway et al., 2003)

Once in a reactive form, N is likely to undergo various transformations (e.g., mineralization, immobilization, nitrification, and denitrification). Denitrification is the only stage allowing N return to the atmospheric pool and closing the N cycle loop (Robertson and Groffman, 2015). Thus, considering the total N stock on earth as constant, the same quantity of N<sub>2</sub> gas fixed has to be stored in oceans, sediments, soils, and biomass or returned to the atmosphere as NH<sub>3</sub>, N<sub>2</sub>O, NO<sub>x</sub> or N<sub>2</sub> via volatilization, nitrification or denitrification. Such equilibrium between fixation of N reactive forms and reconversion to N<sub>2</sub> is not occurring anymore. As a consequence reactive N fixed is accumulating in the environment (Galloway et al., 1995). Because of its strong mobility in the environment, the result has been an increase of the N contamination of atmosphere and hydrosphere, with serious environmental and public health effects (Sutton et al., 2011), a phenomenon known as the ‘N cascade in the environment’ (Galloway and Cowling, 2002).

Agriculture is the most important sector where environmental losses of N are occurring. It is therefore of primary importance to understand the disturbance of N cycle in agricultural systems. As a matter of facts, croplands cover 12% of the Earth’s land surface and N fertilizers are applied to agricultural fields at highly variable rates across the different crop and geographical areas but generally about 100-700 kgN ha<sup>-1</sup> yr<sup>-1</sup> (Foley et al., 2011). The Nitrogen Use Efficiency (NUE) of cropping system, defined as the ratio between N incorporated into harvested products and the total input of N to the soil, has been shown to have decreased at the global scale from 68% in 1960 to 47% in 2009 (Lassaletta et al., 2014b). Low NUE at the plot or the farm scales negatively affects agronomical performance and is economically detrimental for farmers (Rodrigues Soares et al., 2012). However considering the whole production-processing-consumption chain, the overall NUE in 1990 was only about 10% with global 14% NUE for crop production and 4% NUE for meat and dairy production. The reactive N that does not enter human mouth is distributed in the environment and has both beneficial and detrimental impact. Losses of N to the environment (i.e., the part of N application to cropland that does not reach human mouth) include gaseous emission of NH<sub>3</sub>, N<sub>2</sub>O and NO<sub>x</sub>, transfer to hydrosystem through runoff, erosion and lixiviation of different form of reactive N but mostly NO<sub>3</sub><sup>-</sup> and accumulation in soil and biomass under inorganic and organic form. At the global scale, fixation of reactive N forms in the environment have increased from 29 TgN yr<sup>-1</sup> (before industrial revolution) to 107 TgN yr<sup>-1</sup> in 1990 (Galloway et al., 1995). Such a strong disturbance of the global N cycle raises question about the different impacts caused by reactive N accumulation in the environment and the subsequent N cascade it engenders.

On a global scale, NH<sub>3</sub> is emitted to the atmosphere at a rate of 10 TgN yr<sup>-1</sup> and 32 TgN yr<sup>-1</sup> from fertilized lands and animal wastes, respectively, as a result of urea hydrolysis and direct volatilization of ammonium based fertilizers (Galloway et al., 1995). In Europe, intensive agriculture is estimated to produce around 90% of NH<sub>3</sub> emissions (CORINAIR, 2007; Boyer et al., 2002). Wind transport of NH<sub>3</sub>, and its subsequent reactions in the atmosphere lead to a redistribution of N and disturbance of ecosystems that may be located far away from the emission source. In aquatic ecosystems, atmospheric N deposition can generate acidification. If acidification is persistent, species at the bottom of food web are shifted and often simplified in favor of acid-tolerant macrophytes and phytoplankton. Impacts can reach higher trophic

level, including zooplankton, benthic invertebrates, amphibians and birds (Erisman et al., 2013). N deposition also disturbs forest ecosystem by diminishing the degree of N limitation of forest growth, therefore altering forest community composition by changing plant-soil interactions, and opening forest N cycle (Nadelhoffer, 2001). N enrichment can result in increased forest productivity but also engender biodiversity losses (Erisman et al., 2013). Besides encompassing environmental hazards, ammonia emissions also include health risks since it is an air pollutant contributing to the formation of fine particulate matter (PM<sub>2.5</sub>) (Hristov, 2011; Erisman et al., 2007). Indeed, NH<sub>3</sub> emitted to the atmosphere readily reacts with sulphate (SO<sub>4</sub><sup>2-</sup>) and nitrate (NO<sub>3</sub><sup>-</sup>) to form particles (Ansari and Pandis, 1998). The primary human health concerns are irritation and corrosion of the eyes, skin, and respiratory tract (Parod, 2014).

Agricultural activities are responsible for 70% of N<sub>2</sub>O anthropogenic annual emissions (Mosier et al., 2001; Janzen et al., 1998) and about 35% of the global emissions (Isermann, 1994). In the context of climate change, those emissions are a huge issue since N<sub>2</sub>O is a long lasting greenhouse gas accounting for 7% of the current anthropogenic greenhouse effect (Duxbury 1994) and with a Global Warming Potential (GWP) ca. 300 times higher than CO<sub>2</sub>. However, when accounting for the net effect of the major interaction between reactive N on climate change, Erisman et al. (2011) estimated an overall small net cooling effect of -0.24 W.m<sup>-2</sup> but with high uncertainties ranging from -0.5 to +0.2 W.m<sup>-2</sup>. This is mainly due to the fact that increased biomass production owing to N enrichment has enhanced CO<sub>2</sub> uptake by plants for photosynthesis. Increased N<sub>2</sub>O also depletes ozone (O<sub>3</sub>) in the stratosphere, a compound that protects the biosphere from harmful ultraviolet (UV) radiation, by oxidizing into nitrogen oxides (NO) in the stratosphere (Crutzen 1981).

Most anthropogenic NO<sub>x</sub> emissions derive from agricultural activities and fossil fuel burning. In the atmosphere, NO<sub>x</sub> contributes to increase tropospheric O<sub>3</sub>, smog, P.M. and aerosols. As a by-product of NO<sub>x</sub> emissions, O<sub>3</sub> can have detrimental effects on crops cultivation when it is absorbed via stomatal pores because O<sub>3</sub> damages cell walls and membranes which affect photosynthesis efficiency and, in some cases, can even lead to cell death. Consequently O<sub>3</sub> negatively impacts yields on a global scale. In Europe, relative yield losses due to O<sub>3</sub> exposure are estimated at ca. 5%, 4%, 5% and 27% for wheat, rice, maize and soybeans respectively (Erisman et al., 2013).

Inputs of reactive N to freshwater and coastal ecosystems through runoff, erosion and lixiviation are likely to entail water contamination both for human, animals and plants health, and hence for aquatic ecosystems. However, losses of reactive N to aquatic ecosystems mostly concern NO<sub>3</sub><sup>-</sup> because it is negatively charged and poorly retained in soils which preferentially exchange anions with respect to cation due to the overall negative charge of clay in soils. As a consequence when NO<sub>3</sub><sup>-</sup> is applied to agricultural soils or when other mineral N inputs undergo nitrification, most of the NO<sub>3</sub><sup>-</sup> surplus is likely to be lixiviated to ground water. Nitrate drained to rivers, lakes or estuaries can cause degradation of surface water quality, resulting in eutrophication, hypoxia and important perturbation of trophic chains (Di and Cameron, 2002). More details on the eutrophication process and its environmental damages are provided in the

next section because P is more often the most limiting nutrients in freshwater bodies. High concentrations of  $\text{NO}_3^-$  in drinking water can also have adverse effects on human health, in terms of cancers (Weyer et al., 2001) although harmful effects are mainly known for children less than 1 year. For human health protection, the World Health Organization (WHO) has set drinking water standards, imposing a maximum concentration of  $50 \text{ mg NO}_3^- \text{ L}^{-1}$  (WHO, 1984). High concentrations of  $\text{NO}_3^-$  can also be toxic to animals and generate methemoglobinemia and e.g. abortions in cattle (Di and Cameron, 2002).

Lastly, enrichment in reactive N in terrestrial ecosystem, including agroecosystems is likely to engender a decline in species richness with species characteristics of oligotrophy and mesotrophic habitats being competed by nitrophilous and acid-tolerant species. Graminoids adapted to high levels of nutrients are the main beneficiary of increase while lichens and other fungi are among the most impacted species (Erisman et al., 2013). N impacts on soil biodiversity may diminish crop resilience to pests and increase ecosystem vulnerability to change. As a consequence, ecosystems may decrease their capacity to generate ecosystem services for human societies (Folke et al., 2004).

### ***Phosphorus cycling***

Phosphorus is present in the four main universal molecules of life: deoxyribonucleic acid (DNA), ribonucleic acid (RNA), adenosine triphosphate (ATP) and adenosine diphosphate (ADP). Therefore, although P abundance in phytomass is only 0.005% (Smil, 2000), the fixation of C through photosynthesis, it “would be a fruitless tour of force if it were not followed by the phosphorylation of sugar produced” (Deevey, 1970). Phosphorus is also a main constituent of bones and teeth. Contrary to N, it has no significant gaseous form and its global geological cycling operates therefore on very long time-scale (ca.  $10^7$ - $10^8$  years, Smil, 2000). Long geological P cycling can be broken down in four main stages: (i) tectonic uplift and the subsequent exposition of phosphate rocks (mainly apatite) to the forces of weathering; (ii) Physical erosion and chemical weathering of bedrocks contribute to pedogenesis and provide dissolved and particulate P to lake and oceans; (iii) erosion and runoff redistribute P in the watershed and ultimately transport P from soil to water stream; (iv) P associated with mineral or organic matter is transported to the ocean and undergoes sedimentation and burial in sediments. The cycling goes on with the uplift of sediments into the weathering regime (Ruttenberg, 2014). Contrary to N, P cycling is mostly controlled by physical and chemical reactions, mostly sorption, desorption, dissolution and precipitation (Walker and Syers, 1976), which is partly due to the fact that P has no significant gaseous form (Smil, 2000).

Alongside this long geological P cycling, a much shorter cycling takes place in the plant-soil system of ca.  $10^{-2}$ - $10^0$  year (Smil, 2000). This cycling is regulated through myriads of reactions moving P from soil to plant and from inorganic to organic forms. Living organisms play an important role in the P cycling. Bacteria are significant contributors to apatite dissolution in later stages of pedogenesis through acid release. Mycorrhizal association with root plants facilitate P uptake: it increases the physical exploration of soil through effectively enhanced

rhizosphere volume, thus increasing desorption of less mobile P ions *via* root exudates. Microorganisms and small animals also largely contribute to mineralization of organic P in soil thus enabling its recycling within the plant-soil system (Frossard et al., 1995). However physical and chemical reactions might be even more important key drivers of P cycling in the plant-soil systems. Soil pH, ferric oxide and hydroxide abundance, calcium and aluminum contents and, more generally, soil texture are determinant for sorption/desorption and precipitation/dissolution of P in soils (Frossard et al., 1995; Walker et al., 1976).

Although Carl Sprengel already showed that P was indispensable to plant growth in 1828 (Ulrich and Frossard, 2014), the recognition of P importance for crop cultivation was truly highlighted in 1840 by the theory of nutrient limitation in plant productivity developed by von Liebig (1803-1873) which stressed out the P was likely to be a limiting factor of crop production. In France it had only limited response because French agronomists argued that the main issue for plant growth was about N; this error was to be recognized only by the end of the 19<sup>th</sup> century (Boulaine, 2006). The understanding of P importance for cultivated crops together with soil exhaustion in some cropland area certainly triggered the search for new sources of P which truly started with the exploitation of guano in islands of the Peruvian coast (Ulrich and Frossard, 2014). However, as guano resources were limited they soon became exhausted and guano mining only lasted from 1840 to 1880 (Cordell et al., 2009). Phosphate mining from apatite deposit started in North Carolina in the late 1860's but Florida extraction became dominant in 1988. The discovery of huge P deposits in Morocco in 1914 which started to be extracted from 1921 increased even more resources abundance. After WWII the most sizeable P minable discoveries occurred in China and Jordan. In 2000 thirty countries were extracting P (Smil, 2000) and 90% of global demand for P regarded food production, around 148 million tons of phosphates rock per year (Cordell et al., 2009).

The extraction of P from deposits and the invention of the Haber-Bosch process were two main determinant of the tremendous increase of crop yield from the second part of 20<sup>th</sup> century which made it possible to feed a growing population. However, from there, agriculture also had the primary responsibility for the global perturbation of N and P cycles on Earth (Rockström et al., 2009). Indeed, the phenomenal raise in P extraction led to an almost tripling of global terrestrial P fluxes and even more significant changes in P stocks of freshwater and terrestrial ecosystems from preindustrial times to beginning of the 21<sup>th</sup> century (Bennett et al., 2001). Figure 0.3 illustrates this phenomenal increase of global P introduction resulting from extraction of fossil P. However, cumulative P budgets on world agricultural land have been very uneven with the two extreme being for Africa and North Europe, with respectively 85 kgP ha<sup>-1</sup> yr<sup>-1</sup> and 910 kgP ha<sup>-1</sup> yr<sup>-1</sup> of cumulative P budget from 1965 to 2007 (calculated from data provided by Sattari et al., 2012). As most P is sorbed onto soil particle, the consequence is much contrasted P legacies in agricultural soil mainly reflecting recent historical mineral fertilization. Thus, in country such as France with considerable recent past P fertilization, the anthropogenic P fixed in soil since 1948 has been estimated to contribute to 84% of today's food production (Ringeval et al., 2014). Discrepancies in P budgets were even more marked on 0.5° grid cell resolution with lowest P budget reaching -39 kgP ha<sup>-1</sup> yr<sup>-1</sup> while highest P budget achieved more than 800 kgP ha<sup>-1</sup> yr<sup>-1</sup> in year 2000. Area with the highest P budget were generally characterized by low P use

efficiency (PUE), where PUE is defined as total crop dry-matter production per unit of P applied (MacDonald et al., 2011).

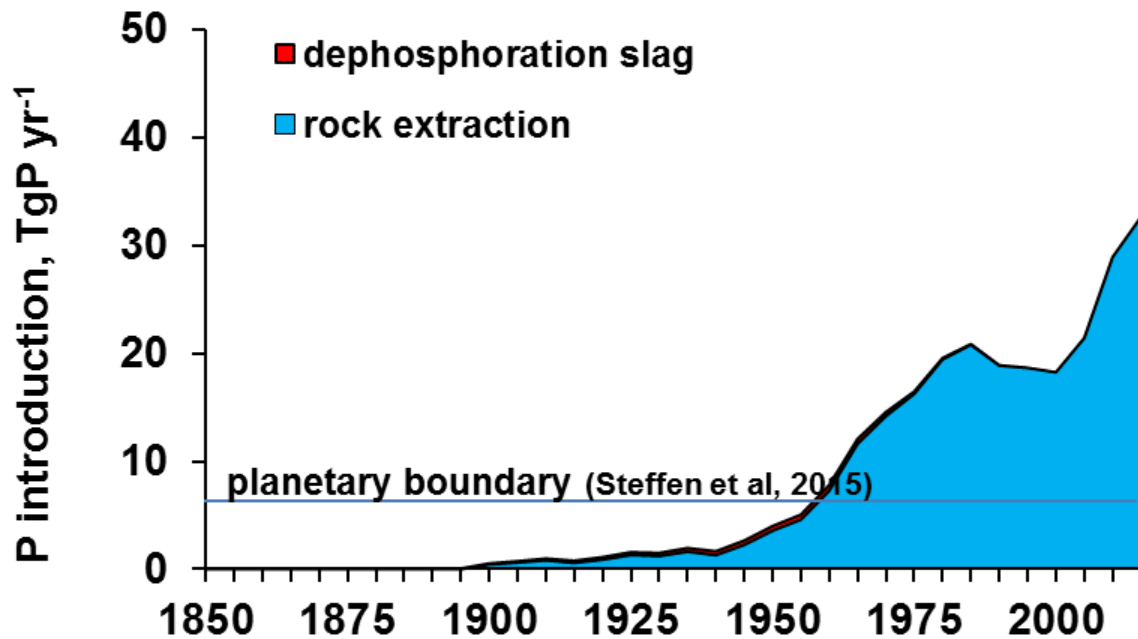

**Figure 0.3** Global introduction of phosphorus resulting from fossil P extraction from 1850 to 2015, based on a data compilation from several sources (Jasinski, 2008; IFA, <https://www.ifastat.org/databases/plant-nutrition>)

A major environmental impact of increased P budget on agricultural land is the consequential increase of P fluxes to water stream and coastal ecosystems which almost triple over the course of the last two centuries leading to important eutrophication of lake, riverine and estuarine ecosystems (Bennett et al., 2001). Advanced stages of eutrophication are marked by blooms of cyanobacteria, potential toxic algae, and others non palatable algae. Decomposition of these phytomass creates hypoxic or anoxic conditions in water bodies, alter the resources for drinking water production and causes serious health hazards to humans and livestock (Smil, 2000). Furthermore, important P legacy are likely to continue impairing water quality even where P inputs have been strongly reduced (Jarvie et al., 2013). In fact, while accumulation of P due to huge fertilization rate can build in a few decades, the physical and biogeochemical cascades of P along the continuum from soils to river within the watershed may last for much longer time, entailing significant and sometimes discouraging time-lag between best management practices (such as reduced P fertilization or implementation of grass strips) and water quality improvements (Sharpley et al., 2014).

To conclude with P cycling, recent reassessment of P reserves revealed that huge P deposit may still be available for the future with 80% of it being localized in Morocco (Elser and Bennett, 2011). Therefore, contrary to the alert launched by Cordell et al. (2009) who estimated that a P peak may occur in 2030, the biggest issues with P are certainly more its economical profitability (Mew, 2016; Ulrich and Frossard, 2014), its quality (Smil, 2000), the pollution of water stream it may generate even decades after excess use of P (Sharpley et al., 2014), its uneven access to



poor counties (Mew, 2015) and, more generally, its global “broken biogeochemical cycle” (Bennett et al., 2011; Rockström et al., 2009) rather than its scarcity.

### *Carbon cycling*

Because of its preeminent contribution to climate change, global C cycling has been a burning issue for several decades. Back in 1957, Roger Revelle and Hans Suess already alerted on a global scale “experiment” in which human societies were “returning to the atmosphere and oceans the concentrated organic carbon stored in sedimentary rocks over hundreds of millions of years”. The emission of CO<sub>2</sub> from coal, oil and natural gas - which constitute the geological reservoir of C – to the atmosphere is part of the vast planetary C cycling in which C circulate between different large reservoirs and undergoes numerous biogeochemical transformations. The four main reservoirs that can be identified are in ascending order: (i) the atmosphere; (ii) terrestrial ecosystems; (iii) deep geological burial and (iv) oceans.

Geological burials are part of a very long C cycle and, without anthropic exploitation, fluxes of C from this reservoir to the atmosphere would probably be near zero. Emissions of C from this reservoir therefore interfere with the other components of the global C cycle. C emissions through the burning of fossil fuels were estimated to have grown at a rate of 4.3% per year from 1860 to 1973 (with exception during the great depression and world wars). The oil embargo in 1973 halted growth but emissions have grown again since 1980 (Post et al., 1990). In 2008, concentration of atmospheric CO<sub>2</sub> has increased to a level 30% higher than before industrial area (Gruber and Galloway, 2008). This rising CO<sub>2</sub> concentration in the atmosphere mostly resulted from the cumulated CO<sub>2</sub> emissions from fossil fuel burning and land-use change (Figure 0.4). Although the atmosphere is the smallest pool of C, it plays a major role in the global C cycle as it represents the main conduit between the other pools. CO<sub>2</sub> is exchanged rapidly across the sea-air interface, resulting in an approximate equilibrium between the partial pressures of CO<sub>2</sub> in the atmosphere and in the surface ocean water. Therefore, increase atmospheric CO<sub>2</sub> entails ocean acidification which threatens key marine organisms such as corals and plankton which may have more difficulties to maintain their external calcium carbonate skeletons, thus disrupting the whole marine food web (Orr et al., 2005). However CO<sub>2</sub> diffusion to the oceans is also captured through photosynthesis: autotrophic marine organisms uptake dissolved CO<sub>2</sub> and a fraction of the substance created through primary production sink to deeper ocean in the form of faecal pellets and dead organisms where part of the C is buried in organic or inorganic forms. This transport mechanism from sea surface to deep oceans is called biological pumping (Post et al., 1990). On terrestrial ecosystems, C is fixed in organic form through photosynthesis. Phytomass and other autotrophic organisms, together with heterotrophic microorganisms, are the first link in the terrestrial food web and provide, directly or indirectly, energy to the rest of living organisms which retransforms part of the organic C into atmospheric CO<sub>2</sub>. As soils receive most of the dead organic matter, soil respiration have a major role on CO<sub>2</sub> return to the atmosphere. The difference between C inputs and outputs to soil is crucial to determine whether they behave as a sink or a source of C. This

C sequestration represents a potential to either enhance or mitigate the effects of climate change through increase CO<sub>2</sub> concentration in the atmosphere (Schlesinger, 2000).

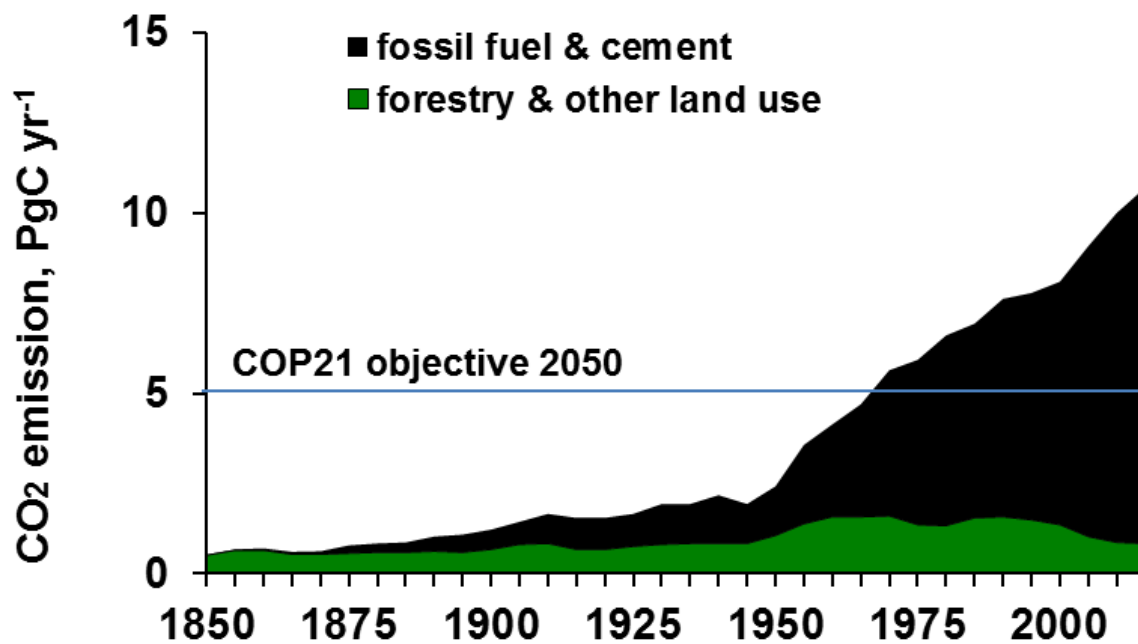

**Figure 0.4** Cumulated CO<sub>2</sub> emissions at the global level from 1850 to 2015, based on data provided by IPCC (2014)

In this context, the understanding of the mechanisms that govern C absorption by and release from soils is a major challenge. The average residence time of C in surface soils is about 30 years (Shlesinger, 2000), however, the concept of organic C pool in soils enables to discretize different organic C pool based on their turn-over time and therefore to provide a quantitative comprehension of C dynamic in soil. Traditionally, three pools at least are distinguished: fresh inputs to soil, an active pool of C with turn-over time between 10 and 100 years and a passive pool of C with turn-over time over 100 years (Von Lützow et al., 2008). However, the identification of organic C pool with different turn-over times in soil raises two main methodological issues: (i) the choice of criteria to distinguish these pools and (ii) the methodology developed to isolate each of these pools. The different methodological choices underlie different visions of the mechanisms involved in C stabilization in soils. Kléber and Johnsson (2010) presented a state of the art of the great scientific dilemma on the process involved in organic matter stabilization. On the one hand, there is the view that the intrinsic chemical properties of organic matter molecules confer them their degree of resistance to biodegradation. Clearly, fresh inputs of C present a gradient in lability from cellulose to lignin. The observation of soil profile indicates yet that even pieces of wood vanish into soil litter, leaving room to an organic amorphous and dark phase, the so-called humus. On the other hand, there is the idea that soil structure and association with minerals are controlling C stabilization in soils. This hypothesis was illustrated in different articles which isolated different size and/or density categories of aggregate and revealed that the smallest and heaviest the aggregates were, the older were the organic matter (e.g., Salvo et al., 2014; Puget et al., 2000; Besnard et al.,

1996; Six et al., 1998; Post and Kwon, 2000). Results from these studies indicated the higher degree of inaccessibility of organic matter to living organisms when it is physically protected by occlusion and suggests that sorption of organic matter onto clay mineral surfaces is an important mechanism of organic matter protection. Recently, this second vision has triumphed and it is now largely accepted that molecular structure alone does not control soil organic matter stability, rather, physical protection and sorption onto mineral clay particles determine the accessibility of soil organic C to micro-organisms (Schmidt et al., 2011; Lehmann and Kléber, 2015). A possible reconciliation of these two views has been however suggested by Von Lützow (2008) who considered that the chemical properties of organic matter might be determinant in the first stage of C stabilization, i.e., for fresh inputs to soils while physical protection and sorption onto clay minerals would become preeminent factor for further stabilization of organic matter in soils.

Overall, it is clear that soil organic C is a crucial element in the terrestrial C cycling. Soil management, especially agricultural soil, will therefore have an impact on soil C dynamic. Eglin et al. (2010) performed a meta-analysis of land-use change influences on soil organic C. The study stressed out the preeminence of deforestation (responsible for the emission of 1.4 Pg of C between 2000 and 2008 at the global scale) and intensive crop cultivation in enhanced mineralization rates of soil organic C resulting in CO<sub>2</sub> release from soils. However, the fate of soil organic C in newly deforested area converted to grassland or cropland also varied greatly according to the agricultural practices subsequently implemented. Intensive cropping may thus deplete most of the organic C stocks in less than 30 years while best management practices have the potential to maintain soil organic C content to its initial level. In agricultural soils, increased soil organic C stocks may be achieving either through increase C inputs or through reduce C outputs. However, most of the time, it is more likely and effective to increase inputs rather than diminish outputs (Chenu et al., 2014). Therefore, implementation of cover crops, intermediate crops and grass strips (Pellerin et al., 2013), residues left to soils, conversion of cropland to pasture (Guo and Grifford, 2002) increased green manure and recycling of human and animal excretions (Powlson et al., 2012) are measures which could increase soil organic C sequestration.

Other factors also come into play in the perturbation of C cycle by agriculture such as, increased livestock production resulting in important emission of methane (CH<sub>4</sub>) a greenhouse gas, with global warming potentials of 25-28 (Eckard et al., 2010). Overall, agriculture produces ~10%–12% of total global anthropogenic greenhouse gas emissions, contributing ~50% and ~60% of all anthropogenic methane (CH<sub>4</sub>) (Smith et al., 2007). The use of fossil-fuel, directly (e.g., tractor) or indirectly (e.g., to synthesize fertilizers), for agriculture production are also part of the global C balance (Gingrich et al., 2007; Erb et al., 2008).

## 4. Objectives and structure of the thesis

Consideration to large context in all the above was, to my view, a useful step to better understand the piece of the broader jigsaw I worked on during my three years of PhD thesis. I will now move on to the specific problematics of the thesis.

My aim is to revisit the long term trajectory of agro-food systems in light of a biogeochemical analysis of their metabolism, in order to grasp the issues at stakes for their transition towards more sustainability. To that goal I focused on one country: France, in a limited time period: from 1852 to 2014 and on three nutrients essential to agricultural production: N, P and C, following a biogeochemical perspective in a conceptual framework of socio-ecological metabolism. The systemic approach developed within the framework of this thesis aims at linking the biogeochemical functioning of agro-food systems to the environmental and agronomical sustainability challenges already mentioned, based on the coupled assessment of N, P and C cycling.

To this end a first step has been to lay solid methodological grounds material flow analysis of agro-food systems. Billen et al. (2014) and Garnier et al. (2014) developed a biogeochemical vision to trace the circulation of N through five main conceptual compartments of agricultural systems in a given geographical area: cropland, permanent grassland, livestock, local population and hydro system. This method, named as General Representation of Agro-Food System (GRAFS), presents the advantage of providing a systemic view of agro-food system from a biogeochemical perspective which can be implemented at various spatial and time scales. A P approach of the water-agro-food system was also developed (Garnier et al., 2015). Starting from the principles of the GRAFS approach, we extended the methodology to C and improved its accuracy based on an extensive literature survey. **This constitutes the first chapter of the thesis.**

For analyzing agro-food systems, the case of France is of particular interest because it is a major agricultural country. Over recent years, France held a strategic position in the world for cereal production as the second largest world exporter and the seventh world producer (FAO, <http://faostat3.fao.org/home/E>). The importance of food and feed trade and its impact on nutrient biogeochemical cycle is therefore crucial to understand the current functioning of agro-food systems. The place of French agriculture in the world results from the organization of the different regional agro-food systems which compose it. As suggested by several studies, the regional scale is well suited for studying socio-ecosystems through quantitative and qualitative analysis of material or nutrient flows (Buclet et al., 2015). Studying the diversity of regional agro-food systems should therefore enable to identify environmental and agronomical performances with regard to N, P and C cycling related to their structural organization. Production systems are responding to consumption demand, production and consumption should thus be seen as the two sides of the same coin. Questioning the environmental imprint of urban consumer enables to reverse the perspective and to fully analyze the drivers and environmental impacts of current agro-food systems. **The second chapter aims to build up a**

**comprehensive picture of current French regional agro-food systems which accounts for production systems, inter-regional trade and consumption of food in urban areas.**

The regional analysis of N, P and C fluxes within agro-food systems may however conceal concrete fieldwork practices which are likely to vary even within a regional unit. Regional analysis should not preclude the need for local investigations because regional agro-food system also emerges from the sum of agricultural practices at the farm scale. Consideration for interwoven scales triggers the question of what kind of links exists between agro-food system at the regional level and agricultural practices at the farm level. A multi-scale analysis was performed for N management in organic and conventional commercial farms of the Paris Basin and at the territorial level by Anglade (2015a). The analysis of individual farms can provide a more concrete and nuanced picture of the farmer's choices and constraints in the context of organic and conventional cropping systems of the Paris Basin. A similar approach applied to P would enable to address the specific issues related to this element. Indeed, while there is an increasing interest in organic farming due to its good environmental performance, organic cropping systems are yet suspected of generating negative P budgets, which questions their ability to provide sustainable P management. The design of agricultural systems at a broader scale also largely influences the shape of the P cycle and the possibility of its recycling to cropland. Investigating the sustainability issue related to P management at various scales implies to look for indicators of farming practices and soil status that could be defined both at the farm scale and at the regional scale. **The third chapter tries to answer these questions by providing a multi-scale analysis of P management in cropping system of the Paris Basin.**

France had not always been an agricultural powerhouse. It is not before the 1960's that the great modernization of French agriculture have completely reshaped both the agricultural landscape and agricultural activity, in the scope of a large political project of 'modernization' supported by the French state and the European Economic Community (EEC), together with agricultural organizations. From a biogeochemical point of view, however, transformations of agro-food systems started long before with the use of mineral fertilizers and the increasing openness of regional systems with the development of rail network impelled by the Freycinet plan (1878) which made it possible to open-up the country-side. For these reasons, the period from 1852 to 2014 was studied here. The mid-19<sup>th</sup> century corresponds to the very beginning of mineral fertilization in France (Boulaine, 2006) and of agriculture industrialization. All these transformations, however, unevenly affected the different French regions (Duby and Wallon, 1978, 1993) which reinforces the relevance to address the issue of biogeochemical trajectories at the regional scale. Thus, the understanding of current regional agro-food systems therefore involves questioning the historical trajectories from which they arise: what paths have led to the French regional agro-food systems as we know it today? How different regional evolutions have affected agronomic and environmental performances of agriculture with regard to N, P and C? Furthermore, studying historical trajectories enables to grasp issues related to biogeochemical legacy such as the accumulation or depletion of P stocks in agricultural stocks. Such a vision should also enable to better consider future sustainable management by considering already existing reserves in soils while accounting for the need of environmental justice with regard to other territories that may not have benefitted from the same build-up of

soil reserves. **Chapter 4 tries to find elements of responses to these questions by assessing long-term trajectories of regional agro-food system as revealed by N and P fluxes.**

The case of C was treated in a separate chapter, as it is not a nutrient supplied to soil just like N and P. In the context of climate change and of the 4‰ (<http://www.4p1000.org/>) impelled just after the COP 21 by the French minister of Agriculture, the main issue with regard to C is the dynamic evolution of C stocks over the same historical period (1852-2014). **Chapter 5 seeks to assess long-term soil organic carbon dynamics in cropland and to identify the main drivers of C sequestration.**

Finally, the overall vision of past and current biogeochemical functioning of French regional agro-food systems should enable to **open a broader discussion on the possible future for agriculture in France.** Sustainability issues could then consider the specific challenges related to the biogeochemistry of N, P and C but also the fact that any future evolution will be a historical process prolonging or disrupting the current trends which themselves result from a long history. However, future of agriculture cannot be investigated just as past because it will involve choices and we can provide hypotheses and imagine possible scenarios. For this reason, we wanted to adopt a non-prescriptive scientific approach presenting a panel of possible futures but also an approach that could be easily appropriated so that future choices won't be only in the hand of 'experts' or 'policy makers' but may be as much as possible a collective choice involving every person concerned with food production, consumption and preservation of agroecosystems.



# **Chapter I**

## **The Generalized Representation of Agro-Food System (GRAFS approach):**

**Development of a methodological framework for the assessment of the N, P, C biogeochemical functioning of past and present agro-food systems**

*Most of the work carried out in the present study is based on a biogeochemical accounting method called GRAFS. We here present the general concepts behind this approach, and the detailed procedures and hypotheses for the estimation of the various fluxes characterizing the functioning of the agro-food systems.*





# 1. Concepts and application of the GRAFS approach

## 1.1. The GRAFS Representation scheme

The GRAFS approach (Generalized Representation of Agro-Food Systems, Billen et al., 2014) is a generic biogeochemical accounting method for describing the agro-food system of a given territory, from the farm to the global scale, through the quantification of nutrient fluxes between cropland, permanent grassland, livestock, humans and the natural environment (Figure 1.1). It has been first designed by Billen et al. (2014) for N and used by Garnier et al. (2015) for P. For the purpose of this thesis, the GRAFS approach has been refined and extended to C and further developed in order to better document nutrient fluxes within French regional agro-food systems over a long historical period of time, beginning in 1852 with the first national agricultural statistical data.

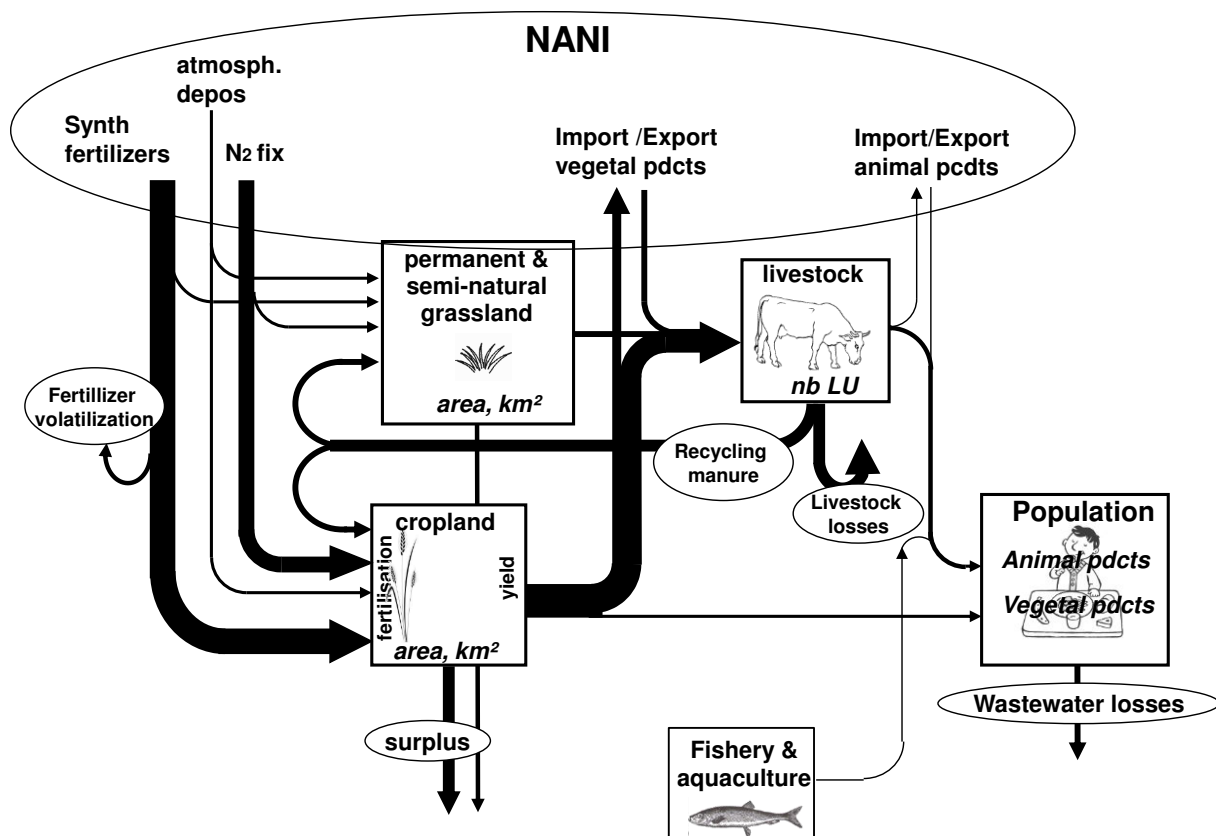

**Figure 1.1** Principles of the GRAFS representation, as illustrated by N fluxes. NANI refers to Net Anthropogenic Nitrogen Inputs.

From the GRAFS perspective, cropping systems are considered to convert nutrient inputs (such as fertilizers, manure, symbiotic N fixation, and atmospheric deposition) into harvestable vegetal products. Crop products can be used (i) to meet the vegetal protein requirements of human nutrition, (ii) to be exported or (iii) to feed livestock, to the extent that they are not fed by grazing on permanent and semi-natural grassland, or by imported feedstuffs. The difference

between nutrient inputs and outputs informs on the nutrient balances of either crop or grassland soils.

The efficiency of feed and grazing conversion into consumable animal proteins (meat, milk and eggs) determines the amount of excreted N, a part of which can be recycled into cropland as manure, making cropland fertility partly dependent on transfers from permanent grassland. The fishery and aquaculture sector also provides animal proteins for human nutrition, but is considered as a separate system for the sake of simplicity. Nutrient losses to the environment occur at each stage of the chain, particularly through leaching and volatilization from cropland, loss from animal excreta and waste from food processing and, finally, from human excretion. Storage in the soil pool is also a possible fate for nutrients.

The GRAFS representation enables one to draw direct links between different aspects of the agro-food system, e.g., the link between livestock breeding, grassland areas, and forage crops and the link between fertilization of cropland and grassland and environmental nutrient losses. GRAFS also provides some key indicators for analyzing agro-food systems from both the environmental and agronomic perspectives.

The GRAFS approach enables to differentiate between at least three sub-systems: (i) the arable system which account for inputs, outputs and balance from arable land; (ii) the agricultural system which accounts for the nutrients fluxes circulating between livestock, permanent grassland and arable land; and (iii) the agro-food which encompass all the GRAFS and where the population. In the rest of this manuscript this three terms are used depending on the perimeter considered.

## **1.2. GRAFS implementation to current and past French agro-food systems**

The GRAFS model is based on the collection and compilation of empirical data, mainly agricultural production and human diet, and theoretical assumptions on the allocation of nutrients flows from one compartment to another. Below we provide the details of the data used and the underlying hypothesis for establishing the GRAFS model of France at the regional scale.

In order to grasp the historical perspective, 22 dates have been chosen since the beginning of the existence of official and comprehensive agricultural statistics, namely: 1852, 1885, 1906, 1929, 1946, 1955, 1965, 1970, 1974, 1978, 1981, 1985, 1989, 1993, 1997, 2000, 2004, 2006, 2008, 2010, 2012 and 2014.

Spatially, our analysis aims at describing the agro-food system at the sub-national scale, in order to put in evidence the regional variability of the systems. Administrative division of regions (Nuts 2) or departments (Nuts 3) are not always relevant from a perspective of biogeochemical functioning of agro-food system. However, most agricultural statistics are provided at this scale.

Administrative division of regions changed a lot over the period studied and for the sake of consistency it is preferable not to change spatial entities. By contrast, departmental divisions kept quite constant over the period studied but French departments are very numerous and the choice of this spatial unit would thus have the inconvenience of getting lost in the vast amount of results. An intermediate solution has been adopted: the 95 French ‘department’ (Nuts 3) are aggregated into 33 homogeneous agricultural regions. Clustering of departments is based on geographical proximity and similarity of agricultural systems in 2006. Criteria retained to assess similarity of agricultural systems are: (i) the N autotrophy/heterotrophy ratio, which translates the dependency for food and feed supply and is calculated from food and feed trade data provided by Sitram (see below) and; (ii) the share of permanent grassland in the Utilized Agricultural Area (UAA) reflecting the intensity of livestock production (see Figure 1.2).

**N-Autotrophy –N-Heterotrophy**

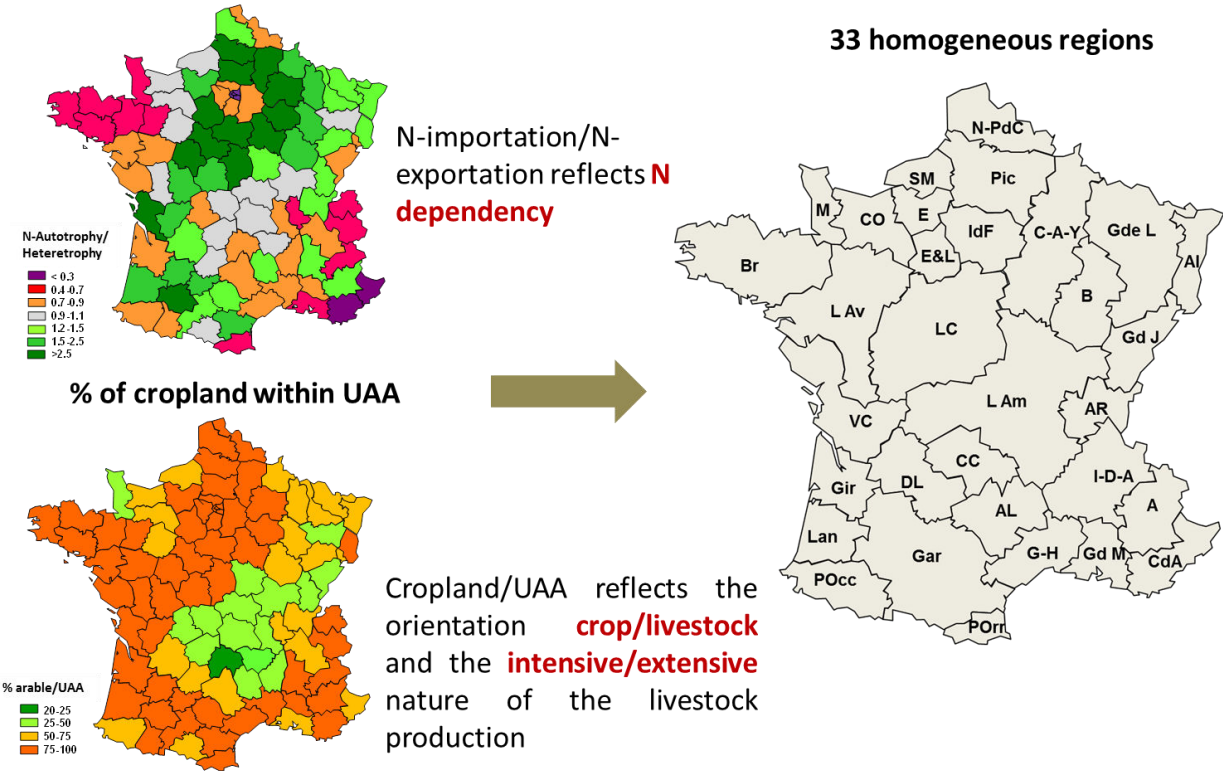

**Figure 1.2** Construction of the 33 French agricultural regions based on their geographical proximity and the similarity of their land-use system and dependency regarding N provisioning. A: Alpes; Al: Alsace; AL: Aveyron-Lozère; AR: Ain-Rhône; B: Bourgogne; Br: Bretagne; C-A-Y: Champagne-Ardenne-Yonne; CC: Cantal-Corrèze; CdA: Côte d’Azur; CO: Calvados-Orne; DL: Dordogne-Lot; E: Eure; E&L: Eure-et-Loire; Gar: Garonne; Gd J: Grand Jura; Gd M: Grand Marseille; Gde L: Grande Lorraine; G-H: Gard-Hérault; Gir: Gironde; I-D-A: Isère-Drôme-Ardèche; IdF: Ile de France; L Am: Loire Amont; L Av: Loire Aval; Lan: Landes; LC: Loire Centrale; M: Manche; N-PdC: Nord Pas-de-Calais; Pic: Picardie; Pocc: Pyrénées Occidentales; POr: Pyrénées Orientales; S: Savoie; VC: Vendée-Charentes.

## 2. Human population and consumption

### 2.1. Total and urban population

Total population figures at the “département” (Nuts 3) level are provided by the French National Institute for Statistics and Economic Studies (INSEE, 2017) for the census years, every 5 years from 1852 to 2014. These data are interpolated to the selected years.

The urban population, defined according to a criterion of continuity of building areas and population density, is also provided by INSEE at the national level. Two studies (Loua, 1880 and Nicot, 2005) allowed estimating these at the regional level (Figure 1.3).

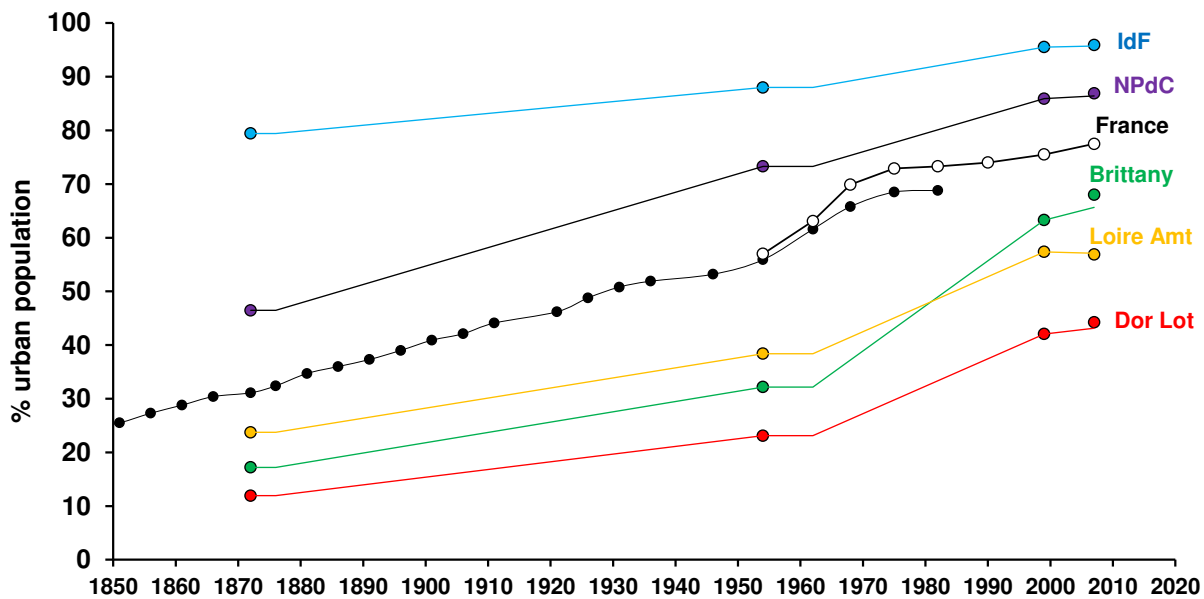

**Figure 1.3** Urban population (in % total population) in France and in a sample of French agricultural territories. IdF: Ile-de-France; NPdC: Nord Pas-de-Calais; Loire Amt: Loire Amont; Dor Lot: Dordogne-Lot.

### 2.2. Human diet

In order to account for local population requirements, changes in the human diet in France over the last two centuries need to be investigated. **For the last 50 years**, the apparent food consumption, which included discarded and wasted parts at the retail and domestic levels, is provided by the estimate of the available food commodities calculated by INSEE (2017) from the analysis of national accounts. For this period we ignored all regional differences in consumption patterns, shown to be rather limited by the surveys of the French Food Safety Agency (AFSSA, 2009). The conversion coefficients used to translate consumption figures expressed in fresh weight of each food item into N, P and C comes from a compilation of data from different databases including CIQUAL (<https://pro.anses.fr/tableciqua/>), Diet Grail (<http://dietgrail.com>) and USDA (<http://ndb.nal.usda.gov>) (Table 1.1). Whereas P content is provided as such in the databases, N has been calculated from protein content using a factor of

6.25 gProtein gN<sup>-1</sup>, and C content was calculated using the average stoichiometry of protein (53%C), fat (70%C), and carbohydrates (44%C).

More detailed inquiries on dietary habits in France (INCA2, 2009) also provide figures of effective ingestion. The difference between apparent and net consumption figures provides an estimate of waste generation (Table 1.2).

**Table 1.1** Conversion into nitrogen (N), phosphorus (P), and carbon (C) of the food items considered in the INSEE nomenclature of human food consumption (in gN, gP, or gC per 100g of foodstuff).

Food item	Kcal g <sup>-1</sup>	gC 100 g <sup>-1</sup>	gN 100 g <sup>-1</sup>	gP 100 g <sup>-1</sup>
Durum wheat semolina	3.60	39.81	2.02	0.14
Wheat flour	3.43	37.97	2.02	0.13
Rice	3.64	39.75	1.15	0.14
Crispbread	2.74	31.90	1.36	0.10
Cakes and spice bread	4.78	48.97	1.08	0.14
Baby cereals	3.88	42.36	1.59	0.39
Instant deserts	3.42	34.47	0.89	0.11
Pasta	3.67	41.31	2.11	0.22
Bread	2.74	31.90	1.36	0.10
Potatoes	0.77	8.92	0.33	0.06
Fresh vegetables	0.30	3.65	0.18	0.03
Deep-frozen vegetables	0.30	3.65	0.18	0.03
Dry vegetables	0.97	14.47	1.23	0.11
Canned vegetables	0.30	4.18	0.24	0.03
Citrus fruits	0.49	6.16	0.10	0.02
Other fresh fruits	0.49	6.16	0.10	0.02
Deep-frozen fruits	0.49	6.16	0.10	0.02
Dry fruits	4.15	42.31	1.79	0.26
Syrup fruits	0.49	6.16	0.10	0.02
Jam and jelly	2.36	26.73	0.03	0.01
Fruit compote	0.49	6.16	0.10	0.02
Fresh pork	1.51	16.40	3.25	0.21
Ham	2.51	23.54	2.82	0.19
Other delicatessen and canned meat	2.51	23.54	2.82	0.19
Tripe products	1.51	16.40	3.25	0.21
Beef	1.51	16.40	3.25	0.21
Veal	1.51	16.40	3.25	0.21
Lamb	1.51	16.40	3.25	0.21
Horse	1.51	16.40	3.25	0.21
Poultry meat	1.51	16.40	3.25	0.21
Deep-frozen meat products	1.51	16.40	3.25	0.21
Rabbit and game	1.51	16.40	3.25	0.21
Eggs	1.43	13.62	2.01	0.20
Fish, shellfish, and crustaceans	0.98	11.47	2.88	0.21
Deep-frozen fish and seafood	0.98	11.47	2.88	0.21
Canned fish	0.98	11.47	2.88	0.21
Liquid milk	0.49	5.24	0.61	0.09
Fresh cream	0.81	8.40	0.73	0.10
Yogurt	0.81	8.40	0.73	0.10
Milk deserts	0.81	8.40	0.73	0.10
Fresh cheese	0.81	8.40	0.73	0.10

Matured cheese	3.21	29.62	3.44	0.39
Butter	7.12	55.48	0.16	0.03
Oil	8.88	68.51	0.00	0.00
Margarine	5.28	40.40	0.00	0.05
Sugar	2.97	33.27	0.09	0.01
Chocolate	5.14	50.42	1.06	0.17
Candies	2.97	33.27	0.09	0.01
Chocolate candies	5.14	50.42	1.06	0.17
Honey	2.97	33.27	0.09	0.01
Ice cream	2.04	20.51	0.50	0.09
Wines	0.65	0.92	0.03	0.01
Beer	0.65	0.92	0.03	0.01
Cider	0.65	0.92	0.03	0.01
Sodas	0.41	4.53	0.06	0.01
Fruit juice	0.49	6.16	0.10	0.02
Coffee	3.80	43.40	2.41	0.20
Tea	3.80	43.40	2.41	0.20
Herbal teas	2.74	22.30	3.25	0.39

The reconstitution of the former consumption patterns at the end of the **19th and the first half of the 20th century** is based on the work by Toutain (1971), who described the changes in the French diet from 1780 to 1960 in terms of calories and proteins. Toutain's estimations converted into  $\text{kgN cap}^{-1} \text{yr}^{-1}$   $\text{kgP cap}^{-1} \text{yr}^{-1}$   $\text{kgC cap}^{-1} \text{yr}^{-1}$  can then be related to the trend for the most recent period. However, this author provided data at the national level, whereas several studies (Philippe, 1961; Barles, 2007) showed that the consumption pattern of the Paris region during this period clearly differed from the rest of France for animal proteins. Thus, Chatzimpiros (2011) evaluated Paris's consumption of meat and milk to be about 30% higher than the national average until 1890, when consumption at the national and Parisian levels converged. We applied this correction for 1852 and 1885. Figure 1.4 gathers the available data.

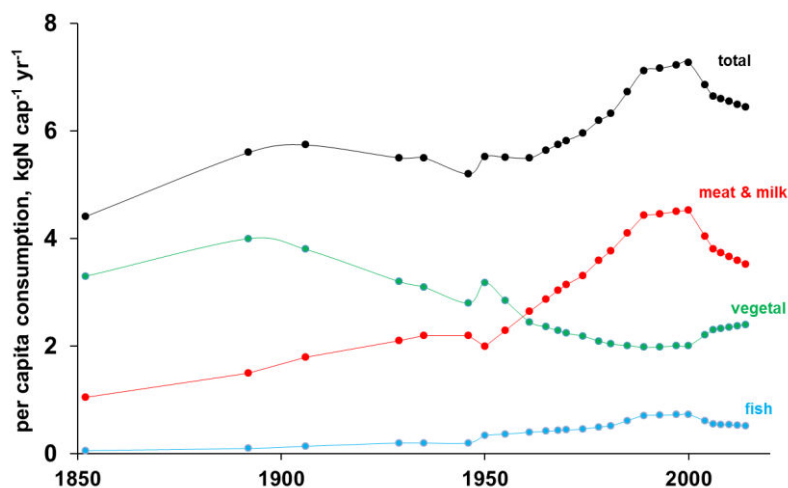

**Figure 1.4** Estimation of per capita food consumption rate in France and Paris, according to several sources, including Toutain (1971), Chatzimpiros (2011), INSEE and FAO.

The conversion coefficients used to translate consumption of each food item into N, P and C are those presented in Table 1.1. Based on these coefficients and on the evolution of human diet, Table 1.2 summarizes the evolution of the human diet in France from 1852 to 2014.

**Table 1.2** *Per capita consumption of vegetal and animal products (excluding fish)*

	<b>Total</b>			<b>Total</b>			<b>Total</b>		
	<b>Vegetal</b>	<b>Animal</b>		<b>Vegetal</b>	<b>Animal</b>		<b>Vegetal</b>	<b>Animal</b>	
	<b>kgN.cap<sup>-1</sup>.yr<sup>-1</sup></b>			<b>kgP.cap<sup>-1</sup>.yr<sup>-1</sup></b>			<b>kgC.cap<sup>-1</sup>.yr<sup>-1</sup></b>		
<b>2014</b>	6.44	2.40	3.52	0.56	0.26	0.30	113.76	85.68	28.09
<b>2012</b>	6.49	2.38	3.59	0.56	0.25	0.31	113.43	84.78	28.64
<b>2010</b>	6.55	2.35	3.66	0.57	0.25	0.32	113.09	83.89	29.20
<b>2008</b>	6.60	2.33	3.73	0.57	0.25	0.32	112.76	83.00	29.76
<b>2006</b>	6.65	2.30	3.80	0.57	0.25	0.33	112.43	82.11	30.32
<b>2004</b>	6.86	2.20	4.04	0.59	0.24	0.35	110.92	78.65	32.26
<b>2000</b>	7.27	2.01	4.53	0.61	0.21	0.39	107.90	71.75	36.14
<b>1997</b>	7.23	2.00	4.50	0.60	0.21	0.39	107.39	71.46	35.93
<b>1993</b>	7.16	1.99	4.46	0.60	0.21	0.39	106.52	70.97	35.56
<b>1989</b>	7.12	1.98	4.43	0.59	0.21	0.38	106.03	70.68	35.35
<b>1985</b>	6.73	2.01	4.10	0.57	0.21	0.35	104.47	71.75	32.71
<b>1981</b>	6.33	2.04	3.77	0.54	0.22	0.33	102.90	72.82	30.08
<b>1978</b>	6.19	2.09	3.60	0.54	0.22	0.31	103.48	74.77	28.71
<b>1974</b>	5.95	2.19	3.31	0.52	0.23	0.29	104.46	78.08	26.38
<b>1970</b>	5.82	2.24	3.14	0.51	0.24	0.27	105.02	79.96	25.05
<b>1968</b>	5.75	2.29	3.03	0.51	0.24	0.26	105.81	81.63	24.19
<b>1965</b>	5.64	2.36	2.87	0.50	0.25	0.25	107.01	84.13	22.88
<b>1961</b>	5.50	2.45	2.65	0.49	0.26	0.23	108.60	87.46	21.14
<b>1955</b>	5.51	2.85	2.30	0.50	0.30	0.20	120.07	101.75	18.32
<b>1950</b>	5.52	3.18	2.00	0.51	0.34	0.17	129.62	113.66	15.96
<b>1946</b>	5.20	2.80	2.20	0.49	0.30	0.19	117.51	99.95	17.55
<b>1935</b>	5.50	3.10	2.20	0.52	0.33	0.19	128.22	110.66	17.55
<b>1929</b>	5.50	3.20	2.10	0.52	0.34	0.18	130.99	114.23	16.76
<b>1906</b>	5.74	3.80	1.80	0.56	0.41	0.16	150.01	135.65	14.36
<b>1892</b>	5.60	4.00	1.50	0.56	0.43	0.13	154.76	142.79	11.97
<b>1852</b>	4.41	3.30	1.05	0.44	0.35	0.09	126.18	117.80	8.38



### 2.3. Number and size of farms

One important socio-economic feature for characterizing agriculture is the number and average size of farms in a given territory. A farm is currently defined as an agricultural production unit with independent management and comptability, above a certain size, production or number of livestock. In historical times, the number of very small (<1ha) farms is quite important and may blur some trends in the overall evolution of the agricultural system. For instance Houée (1972) reported that farms smaller than 1 ha counted for 38% of the total number in France in 1882 (Fig. 1.5), while representing only 2% of the total agricultural area. From 1955 on, farms smaller than 1ha becomes negligible in the total number. We therefore decided to consider only the number of farms larger than 1ha, and to define the average size of farms by dividing the total agricultural area of a region by this number of farms. It is important to note that this average farm size might be quite different from the median size, because of the skewed size distribution of farm areas.

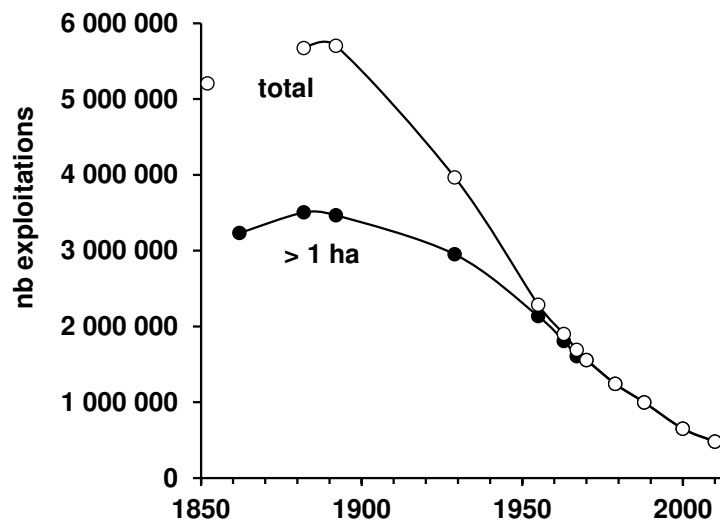

**Figure 1.5** Evolution of the number of farms (total and >1ha) in France from 1852 to 2010. (Data from Houée, 1972, and RGA, Agreste).

Data on the number of farms by size classes at the department level were not available in the *Statistiques Annuelles de la Production Agricole*, which was our main source for calculating agro-system metabolism. These data are provided:

- \* in the *Recensements Généraux de l'Agriculture* (RGA) since 1955.
- \* in the *Statistiques Agricoles de la France* of 1929
- \* in the *Enquête décennale sur l'Agriculture* of 1892
- \* in the *Statistiques Agricoles* of 1852 (providing the number of owners cultivating their land, the number of farmers paying a rent, the number of *métayers* giving a part of the harvest to the owner, the number of farms cultivated by a *régisseur* or a *maître valet*)

Values have been linearly interpolated between the documented dates.

### 3. Livestock metabolism

#### 3.1. Edible and nonedible animal production

Agricultural statistics regarding carcass and dairy production are provided in mass unit by Agreste (2017) for the 1970-2014 period and by non-digitized official registers (available from Gallica.bnf.fr) for the 1852-1965 period.

**Milk production** is calculated in terms of N, P and C content from production data in hL yr<sup>-1</sup>, taking into account the elemental composition provided in Table 1.3. For eggs, an average weight of 50 g is considered.

**Table 1.3** N, P and C content of milk and eggs (Sources: USDA; <http://ndb.nal.usda.gov>)

	%N (kgN 100 L <sup>-1</sup> )	%P (kgP 100 L <sup>-1</sup> )	%C (kgC 100 L <sup>-1</sup> )
Cow milk	0.53	0.091	5.48
Goat milk	0.94	0.135	8.7
Sheep milk	0.94	0.135	8.7
	%N (gN.100 g <sup>-1</sup> )	%P (gP.100 g <sup>-1</sup> )	%C (gC.100 g <sup>-1</sup> )
Eggs	1.79	0.19	13

To calculate **meat production** from carcass weight, a complete budget of slaughtering and cutting has to be established, taking into account the N, P and C content of each animal fraction (Table 1.4). The edible fraction is considered to be made of boneless meat, half the offal and half the grease. Note that the high P content of bones leads to a very different proportion of edible and nonedible fractions in terms of P, N and C. We considered that there was no temporal evolution in the N, P and C contents of animal organs.

**Table 1.4** Balance sheet of slaughtering and cutting. N, P, and C contents in the different fractions of edible and unedible animal products. The edible production is considered to be constituted only of boneless meat, half of the offal, and half of the fat from the carcass. \*Kg of edible product.100 kg carcass<sup>-1</sup> is calculated as: % total carcass in live weight × 100/ %edible product in live weight. \*\*Kg of nonedible product.100 kg carcass<sup>-1</sup> is derived by subtraction as: kg of live weight in carcass – kg of edible product in carcass. (Sources: Benhalima et al., 2015; CIQUAL ; USDA <http://ndb.nal.usda.gov>; Mello et al., 1978).

**a. Bovines**

	% live weight	kg.100 kg carcass <sup>-1</sup>	kgN.100 kg fraction <sup>-1</sup>	kgN.100 kg carcass <sup>-1</sup>	kgP.100 kg fraction <sup>-1</sup>	kgP.100 kg carcass <sup>-1</sup>	kgC.100 kg fraction <sup>-1</sup>	kgC.100 kg carcass <sup>-1</sup>
<b>Removed fraction</b>								
Skin	8	15	5.28	0.81	0.33	0.051	35.4	5.4
Blood	4	8	2.4	0.19	0.007	0.001	27	2.1
Entrails	25	48	0.5	0.24	0.067	0.032	7.8	3.8
Head, feet	3	6	6	0.35	0.18	0.010	31	1.8
Offal	3	6	2.9	0.17	0.31	0.018	14.4	0.8
Grease	5	9	0.3	0.03	0.15	0.014	66.7	6.4
Total removed	48	92		1.78		0.13		20.3
<b>Carcass</b>								
Boneless meat	36	69	3.13	2.17	0.2	0.138	13.7	9.5
Bones	10	19	5.5	1.06	6	1.15	49.4	9.5
Fat cut	6	12	0.3	0.03	0.15	0.017	66.7	7.7
Total carcass	52	100		3.26		1.31		26.7
<b>Live weight</b>	100	192						
<b>Edible</b>	40.5	78*		2.3		0.156		13.7
<b>Nonedible</b>	59.5	114**		2.77		1.28		33.2

**b. Pigs**

	%live weight	kg.100kg carcass <sup>-1</sup>	kgN.100kg fraction <sup>-1</sup>	kgN.100kg carcass <sup>-1</sup>	kgP.100kg fraction <sup>-1</sup>	kgP.100kg carcass <sup>-1</sup>	kgC.100kg fraction <sup>-1</sup>	kgC.100kg carcass <sup>-1</sup>
<b>Removed fraction</b>								
Skin	8	12	5.28	0.81	0.33	0.038	35.4	2.8
Blood	3.4	5	2.4	0.19	0.007	0.0003	27	0.9
Entrails	10	14	0.5	0.24	0.067	0.010	7.8	0.8
Head, feet	3	4	6	0.35	0.18	0.008	33.2	1.0
Offal	2.5	4	2.9	0.17	0.18	0.006	11.9	0.3
Grease	3.1	4	0.75	0.03	0.15	0.007	58.2	1.8
Total removed	30	43		1.19		0.07		7.63
<b>Carcass</b>								
Boneless meat	55	79	3.5	2.75	0.23	0.181	13	7.2
Bones	10	14	5.5	0.79	6	0.86	49.4	4.9
Fat cut	5	7	0.75	0.05	0.15	0.011	58.2	2.9
Total carcass	70	100		3.59		1.05		15
<b>Live weight</b>	100	143						
<b>Edible</b>	58.8	84*		2.83		0.189		8.75
<b>Nonedible</b>	41.2	59**		1.95		0.93		13.87

### c. Goats and sheep

	% live weight	kg.100kg carcass <sup>-1</sup>	kgN.100kg fraction <sup>-1</sup>	kgN.100kg carcass <sup>-1</sup>	kgP.100kg fraction <sup>-1</sup>	kgP.100kg carcass <sup>-1</sup>	kgC.100kg fraction <sup>-1</sup>	kgC.100kg carcass <sup>-1</sup>
<b>Removed fraction</b>								
Skin	8	15	5.28	0.81	0.33	0.038	35.4	5.4
Blood	4	8	2.4	0.19	0.007	0.0003	27	2.1
Entrails	25	48	0.5	0.24	0.067	0.010	7.8	3.8
Head, feet	3	6	6	0.35	0.18	0.008	29.3	1.7
Offal	3	6	2.9	0.17	0.18	0.006	12.4	0.7
Grease	5	9	0.75	0.03	0.15	0.007	37.8	3.6
Total removed	48	92		1.78		0.12		17.3
<b>Carcass</b>								
Boneless meat	39	75	2.7	2.03	0.19	0.143	13.7	10.3
Bones	8	15	5.5	0.85	6	0.92	49.4	7.6
Fat cut	5	10	0.3	0.03	0.15	0.014	37.8	3.6
Total carcass	52	100		2.9		1.08		21.5
<b>Live weight</b>	100	192						
<i>Edible</i>	43	83*		2.12		0.158		12.45
<i>Nonedible</i>	67	110**		2.56		1.047		26.37

### d. Poultry

	% live weight	kg.100kg carcass <sup>-1</sup>	kgN.100kg fraction <sup>-1</sup>	kgN.100kg carcass <sup>-1</sup>	kgP.100kg fraction <sup>-1</sup>	kgP.100kg carcass <sup>-1</sup>	kgC.100kg fraction <sup>-1</sup>	kgC.100kg carcass <sup>-1</sup>
<b>Removed fraction</b>								
Skin	10	14	5.28	0.81	0.11	0.016	36.1	5.2
Blood	3.4	5	2.4	0.19	0.007	0.0003	27	1.3
Entrails	8	12	0.5	0.24	0.067	0.008	7.8	0.9
Head, feet	3	4	6	0.35	0.18	0.008	31.2	1.3
Offal	2.5	4	2.9	0.17	0.22	0.008	11.5	0.4
Grease	3.1	4	0.32	0.03	0.15	0.007	31	1.4
Total removed	30	43		1.31		0.05		10.5
<b>Carcass</b>								
Boneless meat	47	67	3	2.0	0.19	0.128	12.1	8.1
Bones	20	29	5.5	1.57	6	1.71	49.4	14.1
Fat cut	3	4	0.3	0.01	0.15	0.006	72.9	3.1
Total carcass	70	100		3.6		1.85		25.4
<b>Live weight</b>	100	143						
<i>Edible</i>	49.7	71*		2.1		0.13		9.89
<i>Nonedible</i>	50.3	72**		2.8		1.76		25.95

For some dates (before 1929), only the number of heads are available in the statistics. Meat production is therefore calculated from head numbers using regional carcass production to head ratios from the year 1929.

The carcass weight production provided by agricultural statistics corresponds to the production of the region's slaughter houses rather than the production of the livestock grown in the region itself. For some regions, particularly Ile-de-France, this leads to a considerable overestimation of local production because of the import of living animals to slaughterhouses located close to large city centers. The problem is particularly acute before 1929 because live animals were still slaughtered in the Paris regions rather than imported as meat. This bias is corrected by taking into account the meat consumption of the Paris region and the % origin of Paris region meat supply, known from other studies (Billen et al., 2012b).

### 3.2. Excretion

Excretion in N is calculated from the number of head of each animal category using excretion coefficients (in kgN head<sup>-1</sup> yr<sup>-1</sup>) reconstituted on the basis of those established for the current situation, (CGDD, 2013) which we assume to be applicable for the 2000-2014 period. **Total excretion in N** is calculated from livestock numbers using emission factors specific to each age class of each animal category (Tables 1.5 to 1.9). The **livestock unit (LU)** is a reference unit that facilitates the aggregation of livestock from various species and ages established on the basis of the nutritional or feed requirement of each type of animal. The reference unit used is the grazing equivalent of one adult dairy cow producing 3000 kg of milk annually (Eurostat, 2016). However, since the performance of livestock evolves over time and varies regionally, the definitions of LU are many and changing. In previous work on N environmental contamination, N-LU was defined on the basis of the amount of N released as excreta (CORPEN, 1999; Sebillotte, 1994). Here, we adopt this approach, defining **LU** as the number of animals excreting 85 kgN yr<sup>-1</sup> (Billen et al., 2014; Lassaletta et al., 2016). Excretion in terms of C is calculated using C/N ratios reported in Table 1.5 while P excretion is estimated as the difference between P ingestion and P production in edible and inedible livestock and dairy production. More details regarding P excretion are provided in section 4.3.

For N, the historical reconstitution of excretion factors is based on the following:

- (i) Data on excreta and manure production available from observations reported since the mid-19th and early 20th centuries (Bertin, 1856; Girardin, 1864; Gueymard, 1868; Gros, 1957; Noirfalise, 1974);
- (ii) The changes in the average weight of slaughtered animals, provided for some years at the regional scale in agricultural statistics.

Although the nomenclature of age class and animal categories varied across the period studied, for the sake of consistency we used the current nomenclature (2000-2014) for each year of the survey and simply reallocated the figures provided for former categories to the current ones.

### 3.2.1. Bovine species

The excretion coefficients used for the 2000–2014 are gathered in table 1.5.

**Table 1.5** Current (2000-2014) N excretion factors for different bovine classes (compilation of various sources, including: CORPEN, 1999; MEEM, 2010; CITEPA, 2013; UNIFA, 2016). Corresponding livestock unit and C/N ratios of excreted material (source: MEEM, 2010 corrected by Soltner, 2005).

Livestock type	kgN head <sup>-1</sup> yr <sup>-1</sup>	C/N excr	LU head <sup>-1</sup>
Milking cows	113	10.3	1.33
Suckler cows	100	10.3	1.18
Heifer for milking herd renewal over 2 yrs old	60	10.3	0.71
Heifer for suckler cows renewal over 2 yrs old	60	10.3	0.71
Heifer for slaughter over 2 yrs old	60	10.3	0.71
Males of milking type over 2 yrs old	91	10.3	1.07
Males of butcher type over 2 yrs old	91	10.3	1.07
Heifer for milking herd renewal betw 1 and 2 yrs old	52	10.3	0.61
Heifer for suckler cows renewal betw 1 and 2 yrs old	52	10.3	0.61
Heifer for slaughter between 1 and 2 yrs old	52	10.3	0.61
Males of milking type between 1 and 2 yrs old	74	10.3	0.87
Males of butcher type between 1 and 2 yrs old	74	10.3	0.87
Veal calves	6	10.3	0.07
Other females under 1 yr	20	10.3	0.24
Other males under 1 yr	12	10.3	0.14

For the 1970's, Noirfalise (1974) provides lower figures: 90 kgN head<sup>-1</sup> yr<sup>-1</sup> for a milking cow. According to Gros (1957), manure production of a milking cow staying in the stable was 12 tons yr<sup>-1</sup>, i.e., 41 kgN head<sup>-1</sup> yr<sup>-1</sup> in the 1950's. Taking into account 30% loss through volatilization and an input of litter straw of 1 ton head<sup>-1</sup> yr<sup>-1</sup>, the excretion of a milking cow in 1950 can be estimated at 57 kgN head<sup>-1</sup> yr<sup>-1</sup>. Figures available in the 19<sup>th</sup> century sources do not differ a great deal from the latter data: 41–63 kgN head<sup>-1</sup> yr<sup>-1</sup> for a milking cow.

The time variations suggested by these data are represented in Figure 1.6a. It shows a slow increase until 1950, then a rapid increase reaching a plateau in 2000–2015. The following Gaussian relationship fits well these data:

$$\text{Excr (kgN head}^{-1} \text{ yr}^{-1}) = 45 + 0.05 \cdot (t - 1850) + 65 \cdot \exp(- (t - 2010)^2 / 40^2) \quad (1)$$

With t in years

On the other hand, the variations of the carcass weight of slaughtered bovine species since the middle of the 19<sup>th</sup> century is provided by agricultural statistics (Figure 1.6b). These figures are difficult to interpret, because they reflect not only the size of the adult animals, but also the average age at slaughter, which can be assumed to have decreased over the period, mitigating the trend towards an increase in the adult weight. These figures are nevertheless useful because they reveal and quantify regional differences, and hence regionalize the above data, which mostly concern the northern half of France. The deviation from the national average of bovine carcass weight is shown in Figure 1.6c for the years 1852, 1929 and 1981. In 1852, carcass weights are clearly higher than the national average in northern France and lower in many southern or central regions. These differences vanish in more recent periods.

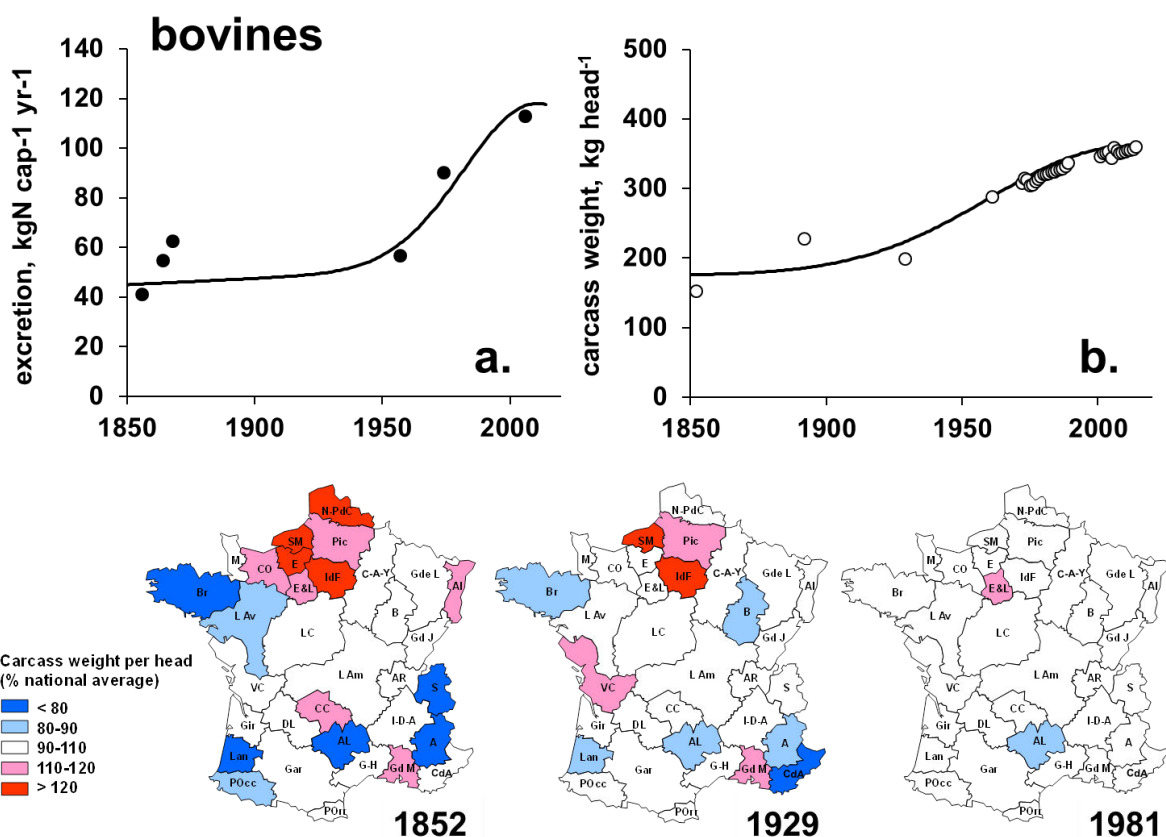

**Figure 1.6** *a.* Time variation of N excretion by a standard milking cow in the North of France; *b.* Evolution of the carcass weight of slaughtered bovines (national average); *c.* Deviation from national average of bovine carcass weight in 1852, 1929 and 1981.

From these data, the excretion coefficient values were calculated for each region and interpolated between the dates throughout the 1852–2000 period.

### 3.2.2. Porcine species

Excretion coefficients for porcine species used for the 2000–2014 period are shown in Table 1.6.

**Table 1.6** Current N excretion factors for different porcine classes (compilation of various sources, including: CORPEN, 1999; MEEM, 2010; CITEPA, 2013; UNIFA, 2016). Corresponding livestock unit and C/N ratios of excreted material (source: MEEM, 2010 corrected by Soltner, 2005).

Livestock type	kgN head <sup>-1</sup> yr <sup>-1</sup>	C/N excr	LU head <sup>-1</sup>
Piglets	3.8	4.5	0.05
young pigs between 20 and 50 kg	3.8	4.5	0.05
Sows over 50 kg	22	4.5	0.26
Boars over 50 kg	22	4.5	0.26
fattening pigs over 50 kg	12	4.5	0.15

Historical values of excretion per head are gathered in Figure 1.7a. They show a linear increasing trend, obeying the relation (2):

$$\text{Excr (kgN cap}^{-1} \text{ yr}^{-1}) = 7.25 + 0.032 (t-1850) \quad (2)$$

With t in years

The chronicle of average carcass weight of pigs confirms this linear increase (Figure 1.7b). Regional variations were significant until the 1980s (Figure 1.7c). The geographical trend is opposite to the trend for cattle, with higher carcass weight in the southern part of France than in the North.

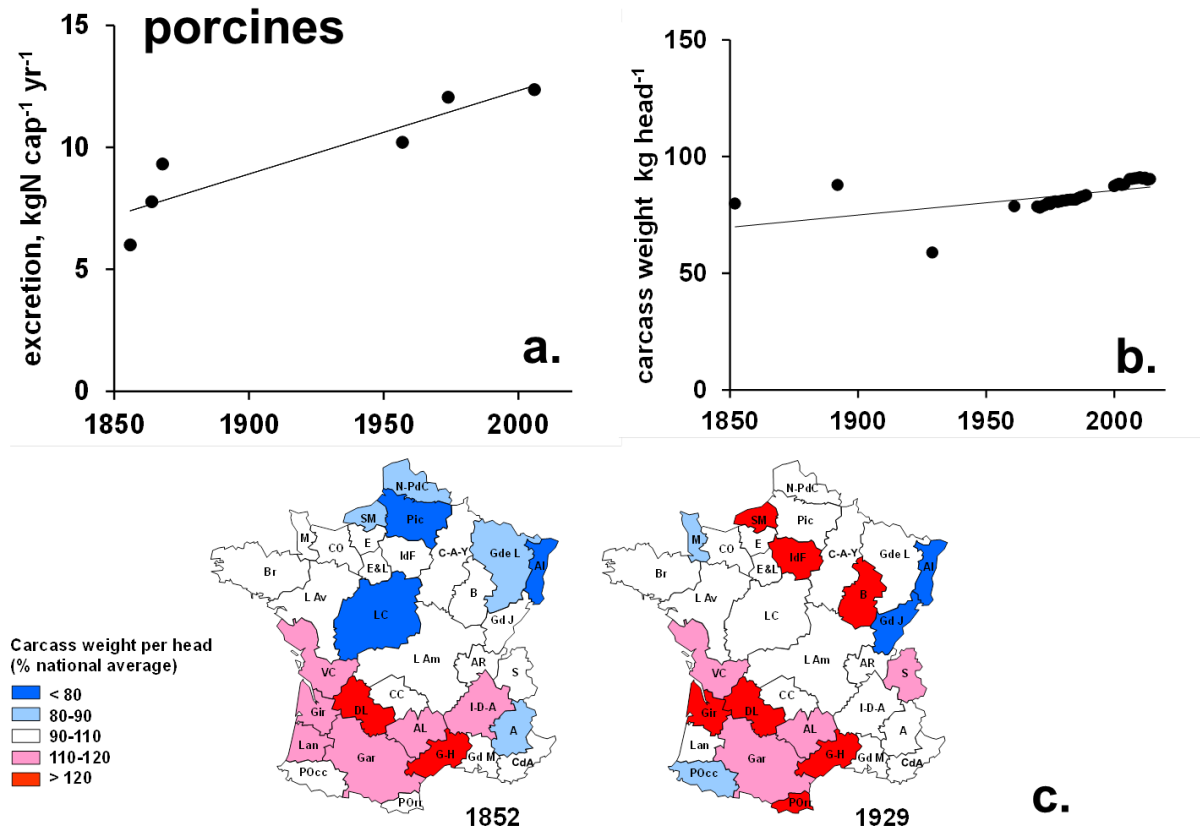

**Figure 1.7 a.** Time variation of N excretion by a standard pig weighing approximately 60 kg live weight in northern France; **b.** Changes in the carcass weight of slaughtered pigs (national average); **c.** Deviation from national average of pig carcass weight in 1852 and 1929.

From these data, the excretion coefficient values were calculated for each region and interpolated between dates throughout the 1852–2000 period.



### 3.2.3. *Ovine and caprine species*

The excretion coefficients for ovine and caprine species used for the 2000–2014 period are shown in Table 1.7.

**Table 1.7** Current N excretion factors for different caprine and ovine classes (compilation of various sources, including: CORPEN, 1999; MEEM, 2010; CITEPA, 2013; UNIFA, 2016). Corresponding livestock unit and C/N ratios of excreted material (source: MEEM, 2010 corrected by Soltner, 2005).

Livestock type	kgN head <sup>-1</sup> yr <sup>-1</sup>	C/N excr	LU head <sup>-1</sup>
kid goats	7	6.7	0.08
female goats	14	6.7	0.17
Other caprines (including male goats)	14	6.7	0.16
ewe lambs	6.5	6.7	0.08
Sheep	14	6.7	0.17
other ovines (incl. rams)	5.8	6.7	0.07

The historical values available are gathered in Figure 1.8. They show an increasing trend similar to that observed for ovine species. The sigmoid relationship (3) fits the data.

$$\text{Excr (kgN head}^{-1} \text{ yr}^{-1}) = 4 + 0.02 \cdot (t - 1850) + 9 \cdot \exp\left(-\frac{(t - 2020)^2}{45^2}\right) \quad (3)$$

With t in years

The same sigmoid relationship is used for both ovine and caprine because we did not find equivalent data for caprine.

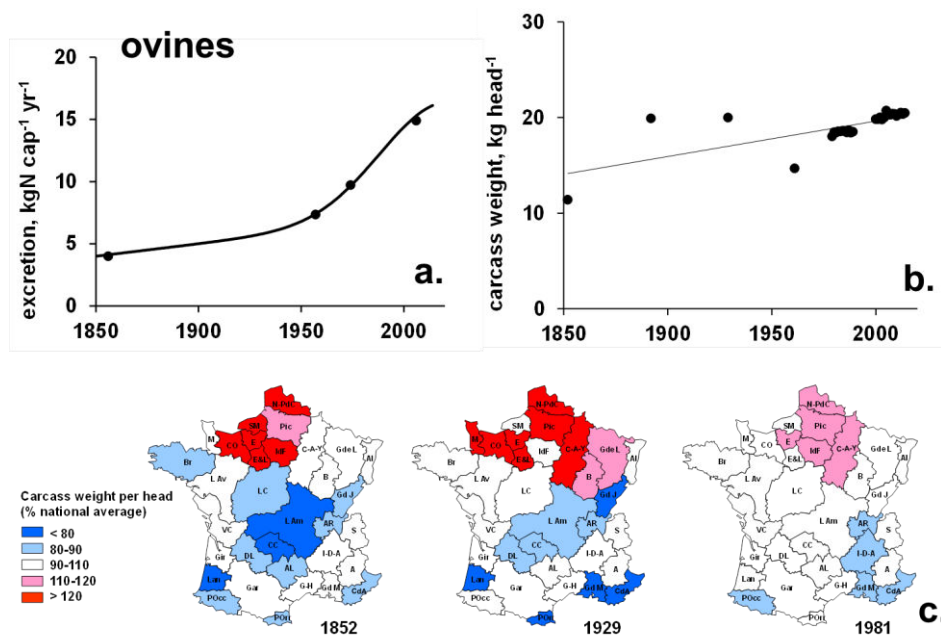

**Figure 1.8** a. Time variation of N excretion by a standard pig weighing about 60 kg live weight in northern France; b. Changes in the carcass weight of slaughtered pigs (national average); c. Deviation from national average of pig carcass weight in 1852, 1929 and 1981.

Similar to what is observed for bovine species, the average carcass weight of ovine species evolved only slightly during the 1850–2000 period (Figure 1.8b). Inter-regional variations are significant, however (Figure 1.8c).

From these data, the excretion coefficient values were calculated for each region and interpolated between dates throughout the 1852–2000 period.

**3.2.4. Equine species**

The excretion coefficients used for the 2000–2014 period are shown in Table 1.8.

**Table 1.8** Current N excretion factors for different equine classes (compilation of various sources, including: CORPEN 1999; MEEM, 2010; CITEPA, 2013; UNIFA, 2016). Corresponding livestock unit and C/N ratios of excreted material (source: MEEM, 2010 corrected by Soltner, 2005).

Livestock type	kgN head <sup>-1</sup> yr <sup>-1</sup>	C/N excr	LU head <sup>-1</sup>
Horses	120	10.3	1.42
Donkey & Mules	40	10.3	0.47

The historical values available are gathered in Figure 1.9. The following linear relationship (4) with time fits the data.

$$\text{Excr (t) (kgN cap}^{-1} \text{ yr}^{-1}) = 74 + 0.295*(t-1850) \quad (4)$$

With t in years

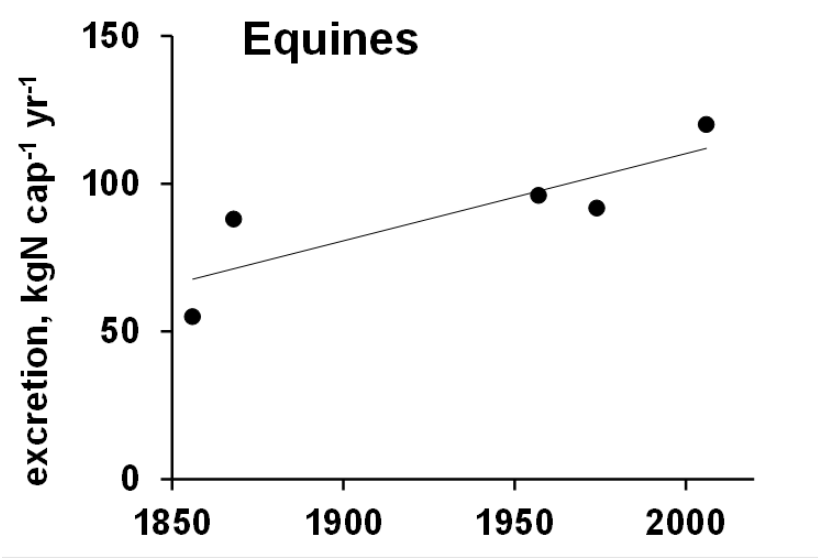

**Figure 1.9** Available data for adult horse excretion over the 1850–2014 period.

Because of a lack of data, we have ignored possible inter-regional variations. From these data, excretion coefficients were calculated by interpolation throughout the 1852–2000 period.

### 3.2.5. Poultry species

As no historical values were available for poultry species, the same excretion coefficients are used for the whole 1852-2014 period (Table 1.9)

**Table 1.9** N excretion factors for different poultry classes (compilation of various sources, including CORPEN, 1999; MEEM, 2010; CITEPA, 2013; UNIFA, 2016). Corresponding livestock unit and C/N ratios of excreted material (source: MEEM, 2010 corrected by Soltner, 2005).

Livestock type	kgN head <sup>-1</sup> yr <sup>-1</sup>	C/N excr	LU head <sup>-1</sup>
Laying hens for hatching eggs	0.7	5.8	0.008
Laying hens for consumption eggs	0.7		0.008
young hens	0.3		0.004
Chickens	0.3		0.004
Duck for 'foie gras'	0.6		0.007
Ducks for roasting	0.6		0.007
Turkeys	1.0		0.012
Geese	1.5		0.017
Guinea fowls	0.3		0.004
Quails	0.2		0.002
mother rabbits	1.0		0.011

### 3.3. Ingestion

**Ingestion in terms of N** is defined as the sum of excretion (before gaseous losses) and total production (including nonedible parts) lost at the slaughter and cutting stages.

**In terms of P**, the calculations are slightly different. Before 1946, N flows dedicated to livestock feeding were simply translated in terms of P, using the N/P ratios of grass and feed crops. Total P excretion was subsequently calculated as the difference between total P ingestion and production. After 1946, our calculation takes into account the possible use of P feed additives (Meschy and Ramirez-Perez, 2005; Soltner, 2008). A survey by Agreste (2014) provided figures on the use of phosphate minerals as raw materials for animal feedstuffs for the 1979–2012 period at the national level. As feed additives concerned mainly poultry and porcine species bred in France (Sauvant, 2004), we estimated the use of mineral P as feed additives in each region *pro rata* their contribution to total national poultry and pig breeding. For the years between 1946 and 1979, the values were linearly interpolated assuming zero mineral P additives in 1946. Based on these assumptions, livestock P ingestion after 1946 was established as the sum of N ingestion converted into P and mineral P additives. P excretion was then calculated as the difference between total P ingestion and production.

**Regarding C**, since a large part of the C ingested is emitted as CO<sub>2</sub> through respiration, the amount of C ingested is calculated from the corresponding N figure by applying the C/N ratio in animal feed, specific for each agricultural region (see below). The difference between C ingested on the one hand and the sum of C excreted and contained in livestock and dairy production on the other hand, provides an estimation of the C lost by respiration and eructation.

## 4. N and P Inputs to cropland and permanent grassland

### 4.1. Mineral fertilizers

Application rates of **N and P mineral fertilizers** to agricultural land were taken from Unifa (2016) (Union des Industries de la Fertilisation) at the “département” scale from 1970 to 2014. A percentage of N embedded in mineral fertilizers is lost through ammonia volatilization depending on the form of fertilizers. N volatilization coefficients from mineral fertilizer application on a regional scale (NUTS 2) were taken from CGDD (2013). For the 1929–1965 period, the application rate of N and P fertilizers was provided at the “département” scale by annual agricultural statistics (available from *Gallica.bnf.fr*). Prior to 1929, fertilization data did not appear in annual agricultural statistics and were obtained at the national level from the compilation of various sources including Pluvinage (1912) and Duby and Wallon (1993). At that time, most of the mineral fertilization was practiced in the Paris Basin region (Duby and Wallon, 1993). Therefore, we assumed that roughly three-quarters of N and P mineral fertilizers used in France in 1885 and 1906 were evenly distributed over arable land of the Paris Basin region, the remainder being evenly spread over arable land of the other French regions. Given the low value of mineral fertilizer used at that time, the uncertainty on this estimation cannot significantly affect our estimate of total N and P inputs to agricultural land.

To assess the distribution of total fertilizer use among crop- and grasslands, we used regional data available from special surveys on grassland fertilization carried out by Agreste (Enquêtes Pratiques, 2011) in 1958, 1982, 1998 and 2011. No mineral fertilization of grassland was considered prior to 1955 (Richard, 1951).

### 4.2. Atmospheric deposition

#### 4.2.1. Current atmospheric N deposition at the scale of agricultural regions

Atmospheric N deposition (as oxidized and reduced species, under wet and dry forms) is provided by the results of the EMEP model at the resolution of a 50×50-km grid over the whole of Europe since 1980 ([http://www.emep.int/mscw/mscw\\_ydata.html](http://www.emep.int/mscw/mscw_ydata.html)). These data are the result of a transport and deposition model fed by national inventories of the sources of atmospheric pollution and validated with measurements of deposition. We integrated these values at the scale of the French agricultural regions and used them directly for the 1980–2014 period. These data generally show a gradual decrease in most regions, except in those with high livestock densities, such as Brittany (Figure 1.10).

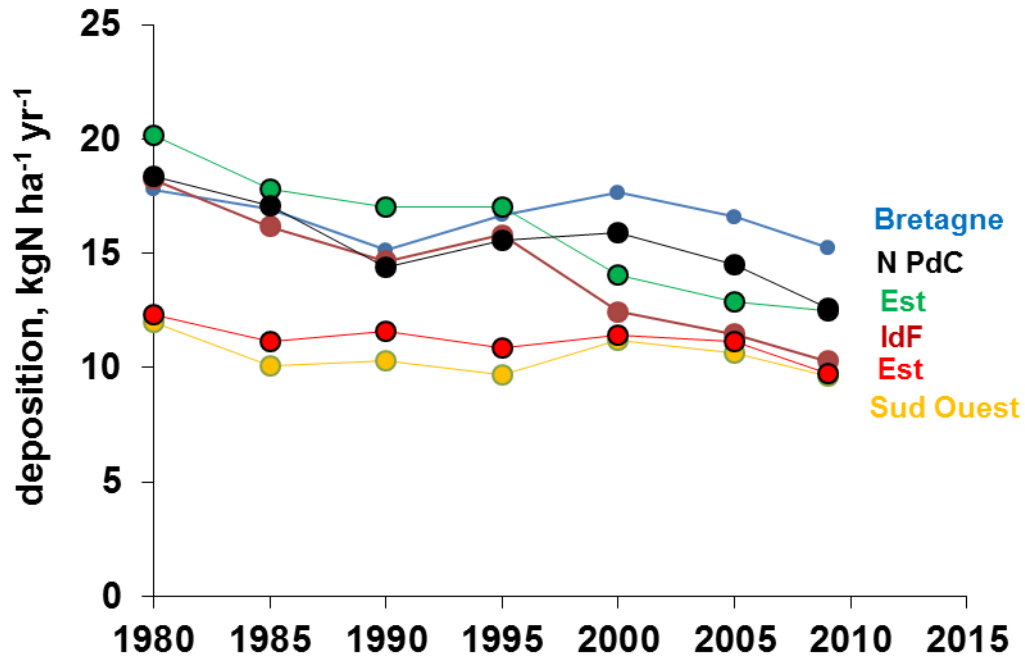

**Figure 1.10** Atmospheric total N deposition in a number of French agricultural regions since 1980 (data from EMEP).

Inter-regional variability is largely explained by differences in livestock density (expressed in LU per km<sup>2</sup> territory, not per agricultural area), as shown in Figure 1.11. The extrapolation to zero livestock provides a background value of 10 kgN ha<sup>-1</sup> yr<sup>-1</sup>, which accounts for about 60% of the maximum deposition rate observed. This background value reflects atmospheric deposition related to other sources than local livestock, probably mainly traffic and industry, including in remote regions.

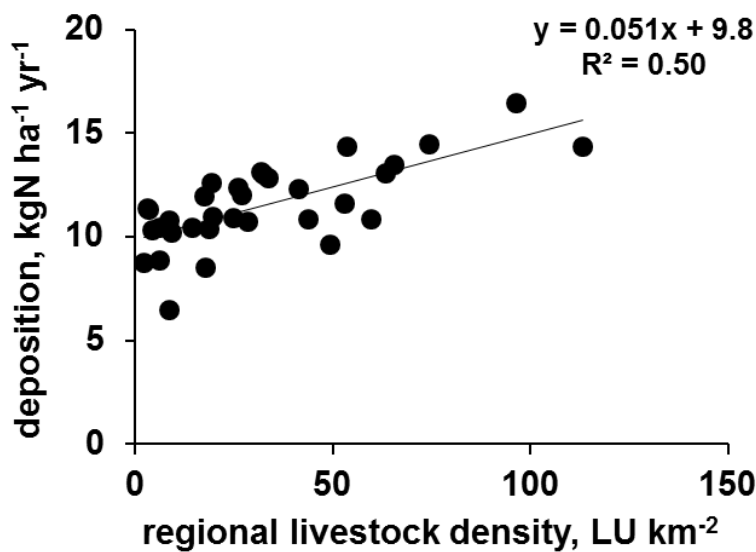

**Figure 1.11** Relationship between atmospheric N deposition and livestock density for agricultural regions in France in 2006.

#### 4.2.2. Long term record of atmospheric deposition

A few long-term records of atmospheric deposition have been published in the literature (Figure 1.12a) Data collected in Rothamsted (UK), cited by Ruoho-Airola et al. (2012), show a slow progression between 1850 and 1950, then a tremendous increase until 1980. Data for the Baltic Sea (Ruoho-Airola et al., 2012) show the same type of variation, with a strong decrease after the 1980s. Asman et al. (1988) gathered the data on emissions sources of  $\text{NH}_x$  for European countries since 1870 and used a long-distance transport/deposition model to calculate atmospheric deposition. Data for France are also shown in Figure 1.12a). Based on these data, we suggest the relative variations of background N deposition as represented in Figure 1.12b).

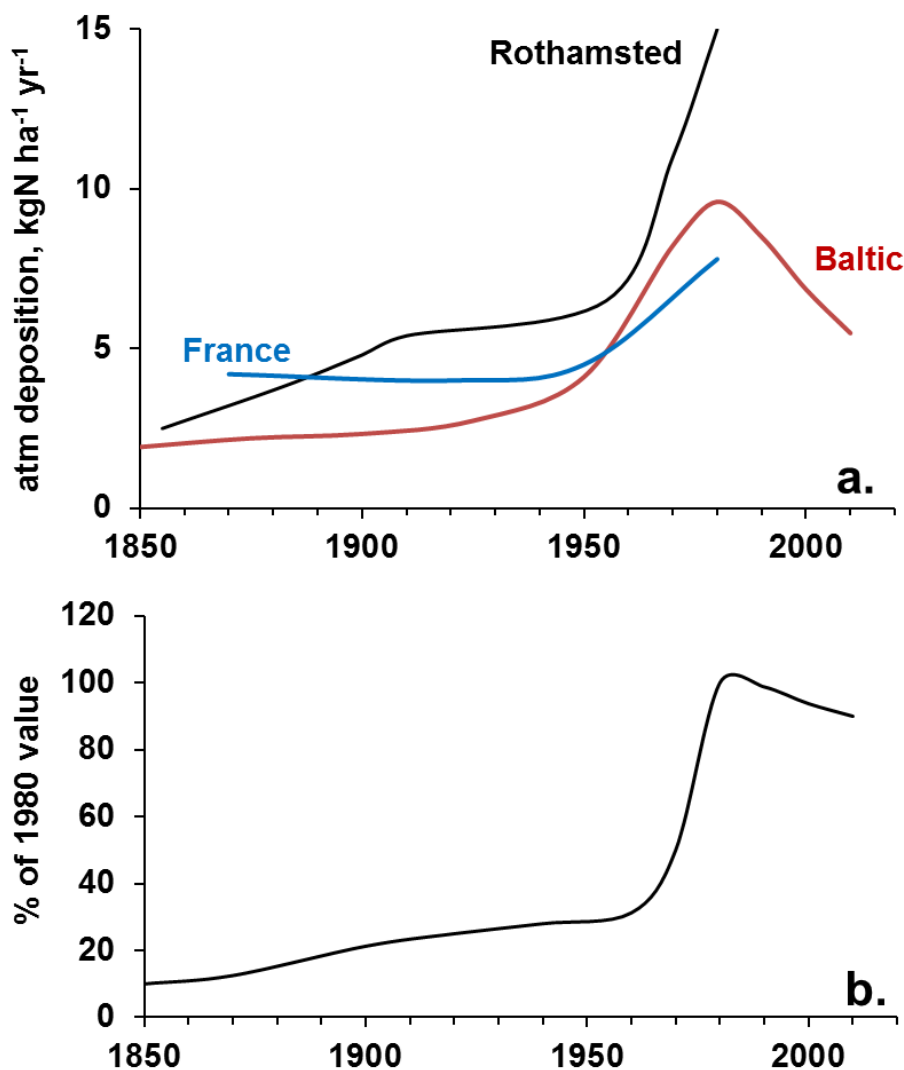

**Figure 1.12 a.** Long-term evolution of N deposition for Rothamsted, the Baltic Sea (Ruoho-Airola et al., 2012) and France (Asman et al., 1988); **b.** Suggested relative variations of N deposition for France (% of 1980 value, constructed by superimposition of the composite data of Figure 1.12a)

#### 4.2.3. Procedure for estimating historical atmospheric deposition

For the 1980–2014 period, the model results from the EMEP model are considered. For 1980, a background deposition rate is calculated for each region by subtracting the calculated contribution of livestock from the EMEP value (5), based on the relation illustrated in Figure 1.12:

$$\text{livestock-related deposition} = 0.05 \text{ kgN ha}^{-1} \text{ yr}^{-1} * \text{livestock density} \quad (5)$$

With livestock density in in LU/km<sup>2</sup>

It is then considered that the background deposition varies with time according to the ideal curve shown in Figure 1.12b, as a percentage of the 1980 value. The contribution of livestock calculated for the corresponding year is then added to this background deposition.

#### 4.2.4. Phosphorus deposition

Very few data on P deposition have been published. The values cited for Northern Europe are in the range of 0.05–0.4 kgP ha<sup>-1</sup> yr<sup>-1</sup> (Ruoho-Airola et al., 2012). The value reported for the Seine basin by Némery and Garnier (2007) (0.4 kgP ha<sup>-1</sup> yr<sup>-1</sup>) is in the higher part of this range. We found no data to estimate the changes in P deposition over time. Ruoho-Airola et al. (2012) considers half the current rate in the middle of the 19<sup>th</sup> century, without a clear rationale. In view of the very small contribution of P deposition to the overall P budget of soils, we used the value determined by Némery and Garnier (2007) throughout the 1850–2014 period.

### 4.3. Symbiotic N fixation

**Symbiotic N<sub>2</sub> fixation** was estimated according to the relationships linking N fixation to yields (Y, ktN ha<sup>-1</sup> yr<sup>-1</sup>) for forage (6) and grain legumes (7) as established by Anglade et al. (2015a) and simplified by Lassaletta et al. (2014b):

$$\text{Symbiotic fixation} = 1.47 * Y \text{ (forage legumes)} \quad (6)$$

$$= 1.23 * Y \text{ (grain legumes)} \quad (7)$$

For permanent grassland, we assumed legumes to be responsible for 25% of the total production based on the range from 40% to 10% of leguminous plants in grassland provided by Agreste (Enquête Pratiques culturales, 2006).

### 4.4. Seeds

N and P inputs through seeds were estimated as a variable percentage of N and P in harvest. For the most recent period, a simple calculation based on the recommended density of cereal seedlings (Chamber of Agriculture of the Manche “département” (<http://www.chambre-agriculture-50.fr/cultures/cereales/semis-des-cereales/>) and the average yield of cereal throughout the 2000–2014 period (Agreste, 2017) suggested that seeds account for about 2% of the harvested grain for cereal. For potatoes, this figure was estimated at 5.6% by Agreste (2017). For 1960 and 1900, Toutain (1971) estimated that seeds accounted for 8 and 17% of

the harvested cereals, respectively, while 10% of the potatoes harvested were considered as “not for sale” in 1900. We therefore used these figures as the seed/harvest ratios from 1852 to 1900 and the values were then interpolated linearly across the 1900–1990 period, assuming that prior to 1900 and after 1990 the seed/harvest ratios remained constant. For all roots and tubers we used the seed/harvest ratio of potato and for all oleaginous, proteaginous and dry vegetables, we used the seed/harvest ratio of cereals. Seed inputs for other crops were not investigated.

## 4.5. Manure inputs

### 4.5.1. Manure inputs for the 1990-2014 period

N, P and C inputs to cropland and permanent grassland through manure depends on the time spent by the animals on grassland (direct excretion) versus indoors and on the type of management for manure collected indoors. An estimate of the time spent on grassland is provided in the ‘NOPOLU-volet agricole’ report, established for the Ministry of the Environment (MEEM, 2010), which also documents the type of excretion management for the fraction collected indoors (farmyard manure or slurry) for each type of livestock and each region (see the example of the Auvergne region in Table 1.10).

**Table 1.10** Time spent on grassland and indoors and mode of excretion management for different livestock classes. The example of the Auvergne region (other regions available in *Nopolu-volet Agricole report, MEEM, 2010*)

Livestock class	% time spent on grassland	% time spent indoors	% manure	% slurry
Dairy cows	42.5	57.5	60	40
Meat bovines	67	33	90	10
Mixed bovines	53	47	70	30
Sheep and goats	53	47	100	0
Pigs	0	100	20	80
Poultry	0	100	10	90 (droppings)

In the case of N, a certain percentage of the N embedded in the excreted manure is lost by direct volatilization in the form of ammonia depending on manure management (farmyard manure, slurry, or direct excretion while grazing). Data on manure management practices for each animal category at the department level (NUTS 3) as well as volatilization coefficients from manure, slurry, and direct excretion at different stages (indoors, storage, and spreading on fields) are taken from MEEM (2010). Similarly, emission factors are available in the same study for losses through denitrification (as N<sub>2</sub> and N<sub>2</sub>O), which represent much lower values. Table 1.11 provides the emission factors for losses as ammonia during storage and application according to the type of livestock and excrement management. These volatilization coefficients are considered to be valid for the whole period studied.



**Table 1.11** Losses, (in %N yr<sup>-1</sup>) by NH<sub>3</sub> volatilization during management and application of livestock excrements (MEEM, 2010).

Livestock class	% Lost indoors	% Lost in storage	% Lost at application	% Lost at direct excretion
<b>Dairy cows</b>				
Manure	25	5	10	10
Slurry	25	5	20	
<b>Meat bovines</b>				
Manure	25	5	10	10
Slurry	25	5	20	
<b>Mixed bovines</b>				
Manure	25	5	10	10
Slurry	25	5	20	
<b>Sheep and goats</b>				
Manure	25	5	10	10
Slurry	25	5	20	
<b>Pigs</b>				
Manure	24	0	10	10
Slurry	25	5	20	
<b>Poultry</b>				
Manure	30	15	10	60
Droppings	30	15	20	

No loss either at application or in storage is considered for P, so that the amount of P to be distributed on cropland and grassland is equal to the total P embedded in excretion.

Regarding C, the situation is again more complex given both the loss of C through mineralization during storage and the addition of C through the incorporation of litter into manure. Therefore, the amount of C contained in the manure applied is estimated from the calculated N amounts in the different types of managed excrements using the C/N ratio of the different types of managed excrements presented in Table 1.12. The difference between C content in excreta and C content after manure and slurry processing indicates losses owing to mineralization.

**Table 1.12** C/N ratio of livestock manure types (sources: Soltner, 2005; MEEM, 2010)

Livestock types	Manure	Slurry	Direct excretion
All bovines	18.7	7.7	10.3
Sheep	11.7	-	10.8
Goats	11.7	-	10.8
Pigs	22.8	4.4	-
Poultry	9.2	5.8	-
Equine	18.7	7.7	10.3

For each type of animal and each region, the available amount of livestock excrement remaining after losses is allocated between grassland and cropland according to the following rules:

(1) Direct excretion during grazing is allocated to both permanent and temporary grassland (the latter being part of cropland) *pro rata* to their respective surface area.

(2) Managed manure is allocated to both permanent grassland and cropland *pro rata* to their respective surface areas.

#### ***4.5.2. Manure inputs for the 1852-1990 period***

For the 1852-1990 period, we did not find equivalent data on excretion management. Although it is plausible to consider that gaseous emission coefficients remain valid for the whole period, by contrast it is likely that management of livestock excretion have changed over the period. Hence, four hypotheses can be made to estimate the regional evolution of excretion management:

- 1- The period from 1852 to 1950 does not undergo important change in livestock manure management which can be considered homogeneous over this period.
- 2- Before 1950 all excretions indoor are transformed into manure, therefore, slurry is not considered.
- 3- All excretions indoor are brought to cropland. Excretion outdoor is distributed between permanent grassland and temporary grassland *pro rata* to their respective surface areas.
- 4- For the 1950-1990 period, excretion management for each animal category at the regional scale is estimated based on linear interpolation from 1950 to 1990.

Given these assumptions, a key distribution of livestock manure between cropland and permanent grassland needs to be established for each animal category for the 1852-1950 period. This can be proposed based on qualitative historical documents (Duby, 1993; Risse, 2003):

#### ***Bovines***

Bovines are among the animal whose main interests for the agriculture were the manure and traction force they provided for peasants. They were the “necessary evil” that Lavoisier spoke about (Risse, 2003). Therefore, bovine manure was certainly precious and peasants could probably not afford to lose it in grassland. Depending on climatic conditions the following distribution key can be proposed:

Temperate regions: Winter lasts at least 3 months (ca. 90 days). The rest of the year bovine can be assumed to spend at least half time indoors (night) or on cropland (field work). Therefore, the % of excretion on cropland corresponds to  $(90+138)/365 \times 100$  or 62%.

Cold regions: Winter lasts at least 4 months (ca. 120 days). The rest of the year bovine can be assumed to spend at least half time indoors (night) or on cropland (field work). Therefore, the % of excretion on cropland corresponds to  $(120 + 123)/365 \times 100$  or 66%.

Cold mountainous regions: Winter lasts at least 5 months (ca. 150 days). The rest of the year bovine can be assumed to spend at least half time indoors (night) or on cropland (field work). Therefore, the % of excretion on cropland corresponds to  $(150 + 108)/365 \times 100$  or 70%.

Warm regions: Winter lasts about 2 months (ca. 60 days). The rest of the year bovine can be assumed to spend at least half time indoors (night) or on cropland (field work). Therefore, the % of excretion on cropland corresponds to  $(60 + 151)/365 \times 100$  or 48%.

As *equines* fulfill a similar function in pre-motorized agriculture, it is assumed that equine manure management is the same as that estimated for bovines.

### *Ovines and caprines*

Penning and transhumance are common practices of the ovine and caprine herd management. Therefore, in mountainous regions and regions of Provence, it can be considered that ovine spent about 4 months in transhumance. The rest of the year they can be assumed to spend one third of the time in meadows and grassland and two-third of the time indoors or in penning on cropland where they contribute to direct fertilization. For mountainous regions this corresponds to about 44% of excretion to cropland. For lowland regions where transhumance is unlikely, this corresponds to about 67% of excretion to cropland.

### *Porcines*

We found very few information about porcine herd management. However, Risse (2003) mentioned that pigs “feed on anything”; this includes unavoidable food waste (e.g., peeling), acorns, grass and crops. As porcine manure was also probably precious, it can reasonably be assumed that pigs spent most of their time in the pigsty. We therefore assumed that about 65% of pig manure was brought to cropland.

Because of the lack of quantitative data, all these assumptions are subject to considerable uncertainties. We tried to account for these uncertainties by providing statistical analyses which are explained in section 7.2.

## **4.6. Human excreta inputs**

N, P and C inputs to cropland through recycling of **human excreta** was calculated based on an estimated rate of human waste recycling, differing for urban and rural populations, and varying regionally and throughout the whole period. For the 19<sup>th</sup> and early 20<sup>th</sup> centuries these rates were based on a thorough examination of the historical literature on human waste management, distinguishing between regions where human excreta was used “the Flemish way,” i.e., with storage of urine and feces in cesspools and direct spreading on agricultural land, and regions where human excreta were either not recycled at all or processed with low-efficiency treatments (see e.g., Paulet 1853; Liger, 1875; Girardin, 1876; Barles, 2005). The details can be found in Esculier (2018).

For recent periods, the recycling rates were estimated through the analysis of the performance of the wastewater management systems and their rate of collection, treatment and sludge recycling (Esculier et al., 2018, based on e.g., National surveys of INSEE and the Ministry in charge of sanitation, Goubert, 1984; Bellanger, 2010).

## 5. Vegetal production, N and P balances and humified C inputs to cropland and permanent grassland

### 5.1. N and P harvested

Crop- and grassland production are the mass harvested or grazed in wet weight or dry weight depending on the product, provided by annual agricultural statistics (Agreste, 2017 for the 1970-2014 periods, and non-digitized official registers available from *Gallica.bnf.fr* for the 1852-1965 period). The conversion of vegetal production from mass unit to ktN yr<sup>-1</sup> and ktP yr<sup>-1</sup> is based on coefficients for 36 different types of vegetal products gathered by Lassaletta et al. (2014a, Suppl Mat, compiling FAO data) and presented in Table 1.13. N and P contents in harvested or grazed products are considered constant over the course of the period investigated. Although this assumption may introduce some bias in the results, the lack of data on historical evolution of crop N and P content makes it difficult to account for such changes.

**Table 1.13** N, P, and C content of the main crops expressed (in % N and P in the untransformed harvested product) (sources: for N and P contents: Lassaletta et al. 2014a, Suppl Mat, compiling FAO data)

Crops	%N	%P
<b>Cereals</b>		
Wheat	1.95	0.33
Rye	1.76	0.33
Barley	1.76	0.33
Oat	2.08	0.33
Grain maize	1.52	0.25
Rice	1.07	0.11
Other cereals	1.8	0.33
Straw	0.5	0.056
<b>Oil crops</b>		
Rapeseed	3.5	0.4
Sunflower	1.96	0.33
Soybean	6	0.61
Other oil crops	3.5	0.5
<b>Protein crops</b>		
Horse beans and faba beans	3.6	0.1
Peas	3.6	0.34
Other protein crops	3.6	0.3
<b>Roots and tubers</b>		
Sugar beet	0.208	0.0405
Potatoes	0.256	0.025
Other roots	0.23	0.023
<b>Fruits and vegetables</b>		
Green peas	0.5	0.035
Dry beans	1.5	0.15
Green beans	0.5	0.05
Dry vegetables	3.6	0.34
Dry fruits	2	0.39

Squash and melons	0.18	0.03
Cabbage	0.36	0.075
Leaves vegetables	0.22	0.075
Fruits	0.1	0.025
Olives	0.67	0.07
Citrus	0.18	0.01
<b>Textile crops</b>		
Hemp	0.35	0.035
Flax	0.35	0.035
<b>Fodder and meadows</b>		
Forage maize	1	0.18
Forage cabbages	0.36	0.075
Alfalfa and clover	2.8	0.225
Non-legume temporary meadow	1.25	0.18
Natural meadow	2	0.2

## 5.2. N and P balances in cropland and grassland

The N balance is defined as the sum of N inputs through mineral fertilizers, manure after  $\text{NH}_3$  volatilization, symbiotic fixation by legumes, sludge, seeds and atmospheric deposition, minus N output through crop harvesting. The N balance on arable land represents a potential loss to the environment, either as  $\text{N}_2$ ,  $\text{N}_2\text{O}$  and  $\text{NO}$  emissions or as N leaching (Benoit et al., 2015); part of the N balance can also be stored in the SOM pool. By contrast, below a threshold of about  $100 \text{ kgN ha}^{-1} \text{ yr}^{-1}$ , the N balance in grassland is mostly stored or denitrified instead of being leached to groundwater (Billen et al., 2011).

Similarly, the annual soil P balance was calculated considering P inputs through mineral fertilizers, manure, sludge, seeds, and atmospheric deposition, and P output through harvest. Contrary to N, P leaching is generally low because phosphate anions are strongly sorbed onto soil particles and tend to precipitate with  $\text{Ca}^{2+}$  cations. Most of the time erosion is the dominant loss process (Kronvang et al., 2007). Therefore, in a first approximation, we considered positive P balances to indicate potential P accumulation in soils (with possible subsequent P losses through erosion), while negative P balances reveal net P removal from the soil pool (Bouwman et al., 2013; Garnier et al., 2015).

## 5.3. Net Primary Production (NPP) and harvested C

In order to estimate cropland NPP for the different types of crops considered in GRAFS, we used the harvested production reported by Agreste (2017) for the period 1970–2014 and by non-digitized official registers (available from *Gallica.bnf.fr*) for earlier periods, and applied the approach reported by Bolinder et al. (2007) to derive NPP. Briefly, Bolinder’s approach considers four plant parts: the harvested product, the above-ground residues, the root residues, and the extra-root residues. Because of significant uncertainties regarding below-ground

biomass production, we modified this approach slightly. First, we did not account for extra-root residues inputs regarding the very large uncertainty concerning exudate production. Second, and more importantly, we modified the calculation of root biomass production because Bolinder considered a fixed shoot–root ratio, while recent studies show that root C inputs are independent of above-ground production and can be better estimated using a constant crop-specific value (Taghizadeh-Toosi et al., 2016; Hirte et al., 2017; Hu et al., 2018). To estimate this constant below-ground production, we first used the crop relative C allocation coefficients provided by Bolinder et al. (2007) to calculate root biomass production for each crop in each region over the whole study period. We subsequently derived an average root dry biomass per hectare specific to each crop for each region. Finally, the NPP in each region was calculated over the whole study period by using (1) the crop-specific relative C allocation coefficients to estimate above-ground production and (2) the calculated root biomass production, applying the following equation (8-10):

$$NPP_{i,j} = S_{i,j} \times [Y_{i,j} \times (1 - W_i) \times 0.44/HI_i + 0.40 \times Y_{ri,j} \times (1 - \beta_i^h)] \quad (8)$$

$NPP_{i,j}$  denotes the NPP in region  $j$  of crop  $i$  in tons of C;  $S_{i,j}$  is the surface dedicated to crop  $i$ ;  $Y_{i,j}$  is the yield of the crop in tons fresh weight;  $W_i$  is the crop moisture content at harvest; 0.44 is the carbon content in dry matter of harvested product and above ground residues;  $HI_i$  is the crop harvest index; 0.4 is the carbon content in dry matter of root;  $Y_{ri,j}$  is the calculated coefficient of root biomass production for crop  $i$  in region  $j$  in tons dry weight per hectare and  $\beta_i^h$  is a coefficient relative to root distribution (Fan et al., 2016) which enables to account for root residues down to depth  $h$ . For cereals  $HI$  is calculated as a linear function of crop yield ( $Y$ ) following the Fan method (Fan et al., 2016) with the intercept and the slope being specific for each cereal species (see equation 9 and table 1.15). For all other crops,  $HI$  is calculated as the ratio of relative C allocation in above-ground residue ( $C_{a-g}$ ) to the sum of relative C allocation in harvested crop ( $C_h$ ) and above-ground residues (see equation 10). Relative C allocation in the different parts of plants is provided in table 1.16.

$$HI_{cereal} = a \times Y + b \quad (9)$$

$$HI_{other\ crops} = \frac{C_{a-g}}{C_{a-g} + C_h} \quad (10)$$

**Table 1.15** Coefficients  $a$  (slope) and  $b$  (intercept) for the calculation of  $HI$  of different cereals (Fan et al., 2016)

	Slope a	Intercept b
<b>Wheat</b>	0.015	0.344
<b>Barley</b>	0.028	0.373
<b>Oat</b>	0.029	0.357
<b>Grain maize</b>	0.015	0.369

**Table 1.16** Moisture content (derived from Preston, 2012), coefficients of C relative allocation in harvested, above-ground residue and below-ground residues (adapted from Bolinder et al., 2007 and Justes et al., 2009), coefficients of relative deep-rootedness in the 30 cm of topsoil (calculated from Fan et al., 2016 as  $1-\beta^{30}$ ) and calculated coefficient of root dry biomass production in the top 30 cm (figures into bracket indicate the variation around around the national average).

Crops	%Humidity	Allocation to			Share of root in the top 30 cm of soil	Root dry biomass prod in top 30 cm
		Harvested product	Above-ground residue	Root		
<b>Cereals</b>						
Wheat	15	0.4	0.42	0.11	0.71	565 (±110)
Rye	15	0.4	0.42	0.11	0.71	448 (±95)
Barley	15	0.44	0.42	0.08	0.84	370 (±68)
Oat	15	0.33	0.29	0.23	0.85	1313 (±273)
Grain maize	15	0.43	0.36	0.13	0.77	765 (±103)
Rice	15	0.4	0.41	0.12	0.79	415 (±588)
Other cereals	15	0.4	0.41	0.12	0.79	541 (±105)
<b>Oleaginous</b>						
Rapeseed	13	0.16	0.6	0.14	0.92	1207 (±190)
Sunflower	13	0.26	0.53	0.13	0.89	190 (±58)
Soybean	5	0.25	0.52	0.14	0.85	130 (±35)
Other oil crops	13	0.22	0.55	0.13	0.89	150 (±158)
<b>Proteaginous</b>						
Horse & faba beans	15	0.39	0.34	0.17	0.7	510 (±168)
Peas	15	0.45	0.34	0.13	0.68	763 (±530)
Other protein crops	15	0.42	0.34	0.15	0.69	566 (±160)
<b>Roots</b>						
Sugar beet	80	0.59	0.15	0.16	0.76	1567 (±128)
Potatoes	80	0.83	0.15	0.02	0.76	71 (±15)
Other roots	80	0.67	0.15	0.11	0.76	887 (±300)
<b>Fruits and vegetables</b>						
Green peas	90	0.42	0.34	0.15	0.69	114 (±43)
Dry beans	15	0.42	0.34	0.15	0.69	671 (±230)
Green beans	90	0.42	0.34	0.15	0.69	195 (±40)
Dry vegetables	15	0.42	0.34	0.15	0.69	320 (±100)
Dry fruits	15	0.42	0.34	0.15	0.69	415 (±130)
Squash and melons	85	0.42	0.08	0.3	0.76	900 (±15)
Cabbage	90	0.42	0.08	0.3	0.76	4280 (±1550)
Leaves vegetables	90	0.42	0.08	0.3	0.76	1087 (±387)
Fruits	85	0.42	0.08	0.3	0.76	1881 (±583)
Olives	85	0.42	0.08	0.3	0.76	183 (±35)
Citrus	85	0.42	0.08	0.3	0.76	900 (±11)
<b>Fiber plants</b>						
Hemp	25	0.42	0.08	0.3	0.76	565 (±110)

Flax	25	0.42	0.08	0.3	0.76	565 ( $\pm$ 110)
<b>Fodder, grassland and weeds</b>						
Forage maize	70	0.76	0.03	0.13	0.77	765 ( $\pm$ 103)
Forage cabbages	70	0.42	0.08	0.3	0.76	4280 ( $\pm$ 1550)
Alfalfa and clover	5	0.48	0.07	0.27	0.71	2239 ( $\pm$ 273)
Non-legume temporary meadow	5	0.42	0.08	0.3	0.76	2716 ( $\pm$ 598)
Natural meadow	5	0.45	0.08	0.29	0.74	1661 ( $\pm$ 573)
Weed	0	0.45	0.08	0.29	0.74	1661 ( $\pm$ 573)

Dry biomass production of weeds in historical periods was also taken into account in cropland NPP using data of modern weed production without pesticide. To that end a literature survey was undertaken in order to estimate ratios of weed dry biomass production per unit of harvested crop production (Table 1.17). Relative standard errors of these ratios varied a lot from 45% for peas to 278% for potatoes. According to Tilman et al. (2002) and to the World Health Organization (1990) weed eradication by herbicides began in the 1940's and had broadened and strengthened by the beginning of the 1980's in France. Therefore, we assumed weed dry biomass production for the period prior to 1940 from the ratios summarized in Table 1.17. After 1980 we assumed ratios of weed dry biomass production per unit of harvested crop dropped to 1% for all crops. Values of ratio between 1940 and 1980 were linearly interpolated.

**Table 1.17** Ratios of weed dry biomass production per unit of harvested crop production in field studies without pesticide for different types of in temperate (marked by +) and Mediterranean (marked by \*) climate

Crops	Average ratio (%)	Relative standard error (%)	References	Number of data
Wheat	15	118	Cosser et al. (1997) <sup>+</sup> ; Rasmussen (2004) <sup>+</sup>	29
Cabbage	1.8	122	Hoyt and Walgenbach (1995) <sup>+</sup>	2
Squash	113	111	Ilnicki and Enache (1992) <sup>+</sup>	3
Corn	51	136	Ilnicki and Enache (1992) <sup>+</sup> ; Poudel et al. (2002) <sup>*</sup>	4
Onion	105	64	Vecin Jimenez and Güzman (1997) <sup>*</sup>	2
Barley	55	60	Mohler and Liebman (1987) <sup>+</sup>	6
Peas	233	45	Mohler and Liebman (1987) <sup>+</sup>	6
Potatoes	53	278	Vangessel and Renner (1990) <sup>+</sup> ; Conley et al. (2001) <sup>+</sup> ; Boydston and Vaughn (2002) <sup>+</sup>	33
Soybean	119	138	Ilnicki and Enache (1992) <sup>+</sup>	2
Tomatoes	10	149	Poudel et al. (2002) <sup>*</sup> ; Vecin Jimenez et Güzman (1997) <sup>*</sup> ; Clark et al. (1999) <sup>*</sup>	10



## 5.4. Humified C inputs to cropland and grassland

Above-ground and below-ground annual plant residue inputs to cropland and permanent grassland are calculated as NPP minus harvested crops and straw exportation reported in agricultural production statistics. For permanent grassland we assume that the reported herbaceous production corresponds to grass mowed or grazed by cattle.

However, only a fraction of fresh material input to soil remains in the soil after 1 year. This corresponds to the humified C input (called ‘efficient C input’ by Sleutel et al., 2006, 2007). Humified C inputs from plant residue inputs are calculated using humification coefficients specific to plant and above-ground or below-ground inputs as recommended by Clivot et al. (2018) and Justes et al. (2009). Regarding C inputs from weeds to arable land in historical periods, we consider, by lack of more detailed information, that about half the weed biomass production was fed by cattle and the corresponding C inputs are already accounted through manure. Humified C inputs from weeds are thus calculated as half their NPP multiplied by the same humification coefficient as for grass. Other soil C inputs included manure and urban sludges. Humification rates of these inputs are taken from Clivot et al. (2018) and Justes et al. (2009) as well as Bertora et al. (2009). Table 1.18 and 1.19 summarize the humification coefficients used for manure inputs crop residue inputs respectively.

Contrary to N and P balances, humified C inputs to cropland and permanent grassland do not provide a complete C budget since C mineralization from soil humus are not accounted. The GRAFS approach alone does not provide an estimation of these fluxes. However, the coupling of the GRAFS approach with a model of soil C budget enables to simulate the dynamic of soil organic C (SOC). Such an assessment has been performed in chapter V where the model coupling is explained.

**Table 1.18** *Humification coefficients of animal excretion (based on data provided by Bertora et al., 2009 and Justes et al., 2009)*

	<b>Humification coefficient (yr-1)</b>
<b>Bovine manure</b>	0.52
<b>Bovine slurry</b>	0.15
<b>Ovine and caprine manure</b>	0.61
<b>Porcine manure</b>	0.53
<b>Porcine slurry</b>	0.15
<b>Poultry slurry</b>	0.15
<b>Horse manure</b>	0.52
<b>Other manure</b>	0.46
<b>Direct grazing excretion</b>	0.26

**Table 1.19** Humification coefficients of the 36 crops considered in the GRAFS approach (using data provided by Clivot et al., 2018 and Justes et al., 2009)

	Humification coefficient, yr <sup>-1</sup>	
	aerial	Root
<b>Cereals</b>		
Wheat	0.217	0.4
Rye	0.217	0.4
Barley	0.222	0.4
Oat	0.222	0.4
Grain maize	0.233	0.4
Rice	0.220	0.4
Other cereals	0.220	0.4
<b>Oleaginous</b>		
Rapeseed	0.227	0.4
Sunflower	0.251	0.4
Soybean	0.276	0.4
Other oil crops	0.251	0.4
<b>Proteaginous</b>		
Horse beans and faba beans	0.276	0.4
Peas	0.276	0.4
Other protein crops	0.315	0.4
<b>Roots</b>		
Sugar beet	0.238	0.4
Potatoes	0.289	0.4
Other roots	0.276	0.4
<b>Fruits and vegetables</b>		
Green peas	0.276	0.4
Dry beans	0.276	0.4
Green beans	0.276	0.4
Dry vegetables	0.276	0.4
Dry fruits	0.255	0.4
Squash and melons	0.255	0.4
Cabbage	0.255	0.4
Leafy vegetables	0.255	0.4
Fruits	0.255	0.4
Olives	0.255	0.4
Citrus	0.255	0.4
<b>Fiber plants</b>		
Hemp	0.255	0.4
Flax	0.233	0.4
<b>Fodder, grassland and weeds</b>		
Forage maize	0.255	0.4
Forage cabbages	0.257	0.4
Alfalfa and clover	0.238	0.4
Non-legume temporary meadow	0.248	0.4
Natural meadow	0.248	0.4
Weed	0.248	0.4

## 6. Feed trade and allocation of agricultural production

### 6.1. Feed trade data

For the 1981–2014 period, the net import of animal feed was obtained from the complete matrix of animal feed exchanged between the 33 French agricultural regions from the analysis of the SitraM database on commodity transport of the French Ministry of the Environment (<http://www.statistiques.developpement-durable.gouv.fr/sources-methodes/>), using the methodology of Silvestre et al. (2015). For the 1961–1981 period, we used the data on feed import at the national scale provided by the FAO (2017). We assumed that the distribution of imported feed from abroad between the 33 French agricultural regions during this latter period followed the same pattern as in 1981, the earliest date documented in SitraM. Before 1961, we considered imported feed to be insignificant, based on the very low volume of imported feed at the national level reported by FAO (2017) at the beginning of the 1960s.

### 6.2. Internal flows and extra-regional exchanges

For the sake of consistency, allocation of the vegetal production was first set for N flows and then translated into P and C, based on P/N and C/N ratios of crop- and grassland production. These ratios differed across time period and regions depending on the dominant crop production and the relative importance of grassland.

During the whole period studied, livestock was assumed to be first fed by use of local grassland production, either as silage or by direct grazing.

**Before 1960**, we considered that, if the livestock N requirement was not met by grass ingestion, then the remaining animal needs were completed at the expense of local cropland production, excluding wheat, which was considered preferentially dedicated to human consumption, but including harvested straw that was provided in agricultural statistics. If local cropland production was not enough, then we assumed that livestock was fed by other local sources, such as organic domestic waste or grazing on marginal lands.

**After 1960**, since we were able to collect data on feed imports (see section 6.1), we used a slightly different allocation scheme. If livestock ingestion from grassland was not sufficient to meet requirements, then the net import of animal feed was assumed to complete the livestock N requirement. If these two sources did not satisfy total ingestion, then the remaining animal needs were considered to be completed by local cropland production not already dedicated to the local human population. If the sum of local grass, imported feed and local crop production ingested by livestock did not match total ingestion, then we assumed the error came from our estimate of imported feed, which we considered as the less reliable values and thus adjusted to close the budget.

Before 1946, N flows dedicated to livestock feeding were simply translated in terms of P and C. After 1946, the use of P feed additives was taken into account as described above (§ 4.3).

The allocation of arable production between the local human population, livestock production and export to other French or foreign regions was established according to the following ranking rules: wheat production was first dedicated to meet the local human demand. If local livestock production required crop production, then it was used to satisfy these needs. Finally, the excess of crop production over human and livestock needs was exported out of the region. By contrast, if the local crop was insufficient to meet the local demand the gap was filled by importation from other regions. Similarly, livestock production was first allocated to satisfy local population requirement. The excess of livestock production was exported out of the region. By contrast, if the livestock production was insufficient to meet the local demand the gap was filled by importation from other regions.

For the current period, the coherency of this procedure could be checked by comparing the calculated fluxes of import or export to or from each region with the fluxes recorded in the SitraM database for the year 2006. Net imports deduced from the budget calculation and from the SitraM database are reasonably well correlated (Figure 1.13).

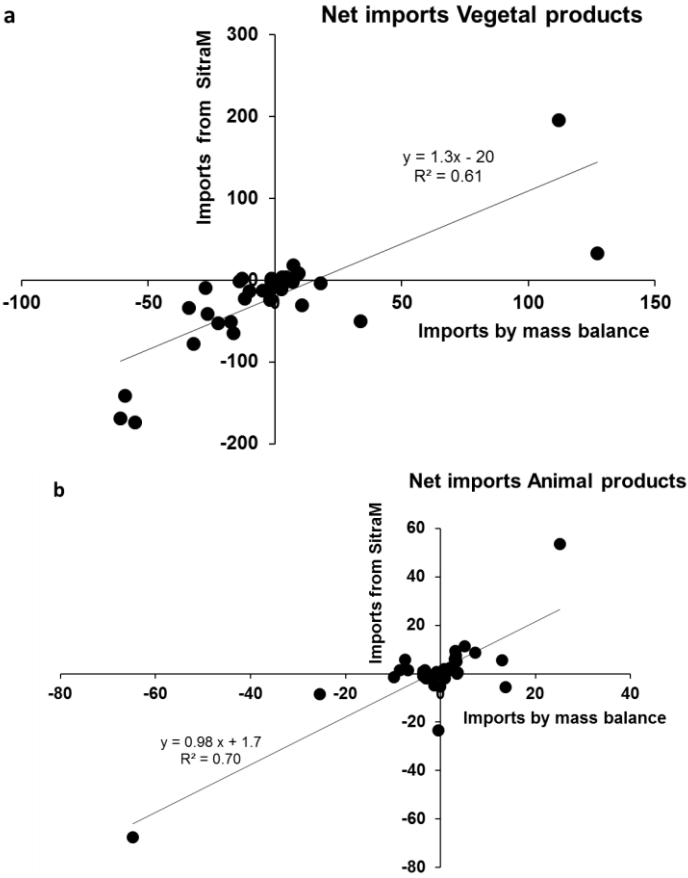

**Figure 1.13** Net imports of vegetal (a) and animal (b) products provided by SitraM plotted against net import inferred from the mass balance for the year 2006.

## 7. Formalization of the GRAFS calculations and uncertainty estimation

The systematic application of the conversion and calculation procedures described above to 33 regions in France, using statistical data for 22 dates, required to accurately formalize an ensemble of spreadsheets, convenient for data collection and processing.

Among the data processing, an important aspect is the estimation of the uncertainty associated to the calculated variables.

### 7.1. The GRAFS *xlsx* workbook

The GRAFS workbook, which forms the basic biogeochemical accounting tool used in this study, is composed of two worksheets for each year (Figure 1.14).

The first sheet, called **pvar**, gathers

- (1) The basic values of the primary data, extracted from agricultural statistical sources for each region considered.
- (2) The parameters values used for conversion of these basic data into derived variables.
- (3) Derived variables calculated from (1) and (2) for each region.
- (4) An estimate of the uncertainty on the basic data and on the parameters is mentioned.

The second sheet is the **GRAFS** worksheet *sensu stricto*. It contains the calculated stocks and fluxes involved in the GRAFS representation of the agro-food system of each regions for the year considered. The GRAFS worksheet is linked to the corresponding pvar sheet. (Figure 1.14).

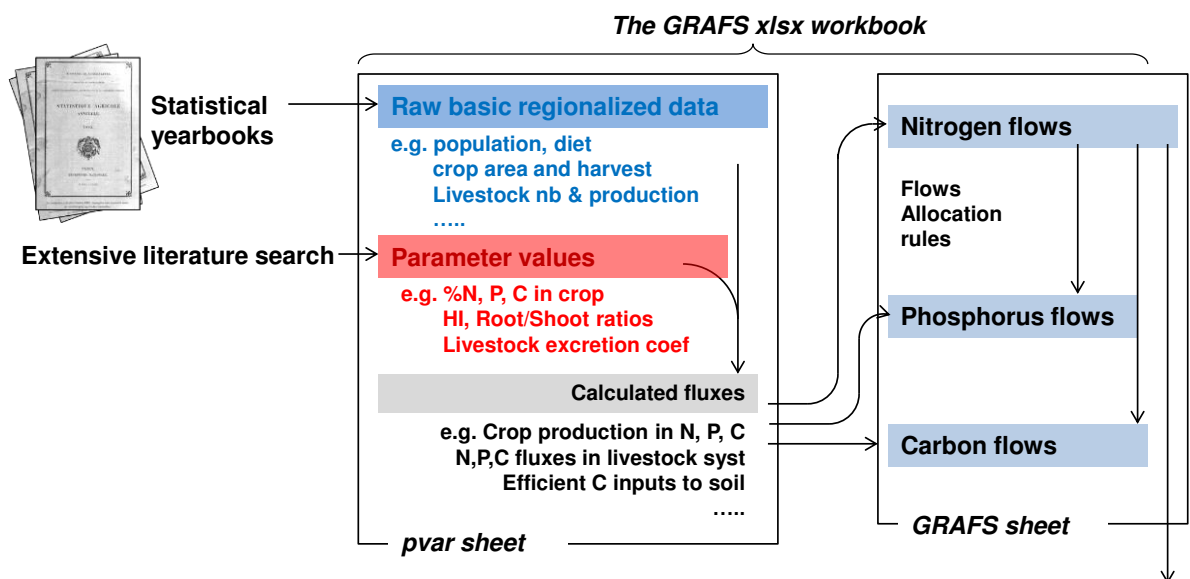

Figure 1.14 Organization of the GRAFS workbook

## 7.2. Uncertainty calculations

As discussed by Oenema et al. (2003), uncertainties in the model results may originate both from structural uncertainties about the construction of the model itself and from operational uncertainties in the data and parameters. Structural uncertainties concern the rules for allocating nutrients flows between arable land, grassland, livestock and human population pools. As an example, the simplifying assumptions in the GRAFS approach regarding the order of preference for allocating arable crop production to local human consumption or livestock feeding make logical sense but would require empirical investigation, and might be a source of bias in our results. For instance, the part of the arable crop production allocated to local human population or livestock could be possibly exported, and local human population or livestock could be fed with more imported vegetal products than estimated with the GRAFS approach. It is rather difficult to quantitatively assess this kind of uncertainty.

On the other hand, to assess operational uncertainties, we used the Monte Carlo method to generate random samples of values for each primary data (such as animal production in kton carcass or atmospheric deposition) and each parameter (such as %N of each crop or animal product), considering their own level of uncertainty. We considered that primary data such as surface area, crop and animal production figures, originating from official agricultural census are known within a confidence interval of 1, 5 and 15% respectively; data from other sources with 5 to 20% uncertainty. Accuracy of the parameters was estimated between 10 and 30% depending on the source of information. Model intermediate variables (such as vegetal or animal production in N, P or C) and outputs (such as N or P balances) were computed in accordance to the Monte Carlo simulation of the primary data (Loucks, 2005). We thus generated a distribution of the main variables and outputs of the model by bootstrapping the Monte Carlo simulation with replacement (1000 replicates). The uncertainty for each variable and parameter were given by the standard error of the mean of the 1000 replicates. All statistical analyses were performed using Microsoft Excel and associated VBA macros.

## 8. Conclusion

The GRAFS method explained in this chapter provides the grounds for the biogeochemical accounting which is the basic methodology of this thesis. With respect to the previous versions (Billen et al., 2014; Garnier et al., 2015), several improvements were brought. Firstly, considerable efforts have been dedicated to ensure the best coherency between N, P and C flux accounting. Several new parameters have been taken into account, such as manure management and losses by volatilization or the distinction between edible and non-edible animal production. Then, the GRAFS worksheet has been adapted to historical sources of data. Several new indicators, can now be easily derived, as will be described in the next chapters. Finally, the structure of the worksheets has been reshaped in order to make it easier to use for systematic series of data, as well as for uncertainty calculation.

Nevertheless, like any representation of reality, the GRAFS approach remains a reductionist view of the complexity of agro-food systems, privileging nutrient flux analysis at the expense of other aspects.

## Chapter II

### **Characterization of current French regional agro-food systems: Agricultural production, trade and consumption**

*This chapter is based on three articles published in Science of the Total Environment (Le Noë et al., 2017), Cahiers Agricultures (Le Noë et al., 2016) and Journal of Hydrology (Esculier, Le Noë et al., 2018). The GRAFS approach was slightly modified from the publication of the first article in 2017 and the publication of a second and a third articles based on the GRAFS approach in 2018 (see Chapter III and IV of this manuscript). Consequently, I used the most recent version of the GRAFS approach (presented in chapter I) to update the data initially published in STOTEN and Journal of Hydrology. These changes have only a minor influence on some previously published numerical values, and did not alter the overall trends reported.*





# 1. Introduction

France is a major agricultural power in Europe. Its highly productive agricultural sector generates a national trade balance surplus owing to its large market export (Desriers, 2007). These agronomic and economic performances are, however, balanced by important environmental impacts with among other, greenhouse gases (GHG) emission, nitrogen (N) leaching and phosphorus losses via runoff to riverine and coastal ecosystems generating eutrophication and hypoxia (Howarth et al., 1996).

This trade-off between food production and ecosystems preservation can be objectify through indicators of environment and agronomic performances at different levels. At the farm scale, performances mostly depend on farming practices. However, our aim is to assess the performances at the integrative scale of the whole functioning of *agro-food systems* at the regional and macro-regional levels, for capturing the whole path required for food to get to our tables. This broad definition leads *agro-food system* to be a polysemous concept used in numerous different academic fields such as human geography, agronomy, ecology and economy. The definition of agro-food system mostly depends on the perimeter considered. It may include the entire upstream industrial sector that provides agriculture with fertilizers, pesticides and machines, the channel distribution that commercializes the production but also the institutional structures that provide a legal framework for the functioning of the agro-food system. There is no absolute definition of agro-food system but rather different uses of the concept according to the issue raised that justify the choice of a given perimeter. Within the framework of this chapter, the main focus is on N, P and C fluxes related to agro-food systems functioning in France at the regional level. Consequently assessing the overall functioning of agro-food systems under the prism of N, P and C circulation implies to account for all direct N, P and C fluxes involved in crop, grass and livestock production, the subsequent redistribution of food and feed in areas of consumption and the unintended nutrient losses occurring at different stage of their circulation from production to consumption. For our purpose, agro-food systems should thus be seen from the double perspective of production and consumption, these two sides of the same coin being joined by agricultural commodity trade. In the context of global biogeochemical disruption (Steffen et al., 2015), the definition of such a perimeter for agro-food systems makes it possible to raise the issue of nutrient fluxes circularity by accounting for both agricultural specialization but although the division between rural areas of production and urban areas of consumption.

Several approaches have been developed for evaluating environmental and agronomic performances of agricultural systems at different scales, from local to global. At the farm scale, nutrient balances have been used as a tool for management of soil fertility and assessment of environmental imprint with different accounting procedures from farm gate to system budgets (Watson and Atkinson, 1999; Watson et al., 2002). Humus balance is also a commonly used method to predict soil organic matter (SOM) shifts from an agronomic perspective (Hénin and Dupuis, 1941; Quenum et al., 2014). On a regional scale, several approaches have been developed with various objectives, but generally focusing on one single nutrient (e.g., Nesme,

2015; Garnier et al., 2016). At national and global levels, several methodologies have been developed to account for nutrient cycling in agro-food systems with different objectives, giving rise to an extensive literature (e.g., Senthilkumar et al., 2011, 2014; Garnier et al., 2015).

However, most of these approaches only account for the environmental and agronomic performances generated at the production level without considering the link between production and consumption area. Furthermore, with the increasing specialization of agriculture, production areas themselves increasingly rely on other distant regions. This is particularly true for region specialized in livestock production which imports a significant share of animal feed from foreign regions (Billen et al., 2014). Better understanding these interdependencies requires a spatially-explicit assessment of nutrient fluxes embedded in food and feed trade. This kind of approach has already been proposed to examine the agro-alimentary interdependencies between 12 macro-regions at the global scale based on the systematic investigation of the FAO database (Billen et al., 2014). The implementation of this approach at the national scale is paradoxically more difficult because of lack of data on intra-national food and feed trade. In the case of France however, trade of agricultural goods are collated since at least three decades in the SitraM database established by corporate services in charge of transport management. The analysis of this database can provide a complete description of nutrient fluxes embedded in food and feed trade between French regions. Such an investigation would throw light on the interconnection of the different regional agricultural systems and on the provisioning of highly urbanized area which are characterized by the externalization of most of the material and energy flows necessary to sustain their life.

As a consequence, the functioning of cities depends on various areas and ecosystems located outside their boundaries. The industrial era has increased this dependence and remoteness to the point that the urban environmental impact is greater in these supply areas than in the city itself (Barles, 2015). Therefore, as suggested by other studies (e.g., Billen et al., 2012a), the sustainability of city should be seen in relation with their supplying area. More than other cities, megacities are characterized by their huge need for material and energy (Kennedy et al., 2015), among which food is of utmost importance for the life of their inhabitants. Megacities are not just bigger than most cities: their large and diverse populations, their spatial extension, the amount and diversity of activities that characterize them, the complexity of their functioning make the organization of megacities' metabolism particularly delicate, including for food supply. This has a strong impact on biogeochemical cycles because megacities play a major role in nutrients flows and depend on them. Some studies have provided an overview of urban metabolism through substance flow analysis regarding N or P (Svirejeva-Hopkins et al., 2011; Færge et al., 2001; Forkes, 2007; Barles, 2007). Others have focused on the urban 'food-print' and show the relevance of a spatialized approach (Billen et al., 2009, 2012a, b, c; Chatzimpiros and Barles, 2013).

In this chapter we focused on the case of Paris Megacity to better understand the role of megacities in determining the shape of nutrient fluxes in agro-food system. The case of Paris Megacity can be seen as a generic case study of megacities but its location within the Seine River basin also makes it a case of particular interest. Indeed, Paris Megacity is located 220 km

upstream from the estuary where the small size Seine River flows into the Seine Bight, as well as into the contiguous North-West Channel and Southern Bight of the North Sea, and is responsible for the development of harmful algal blooms causing severe damage to fish and shellfish populations (Lancelot et al., 2007; Passy et al., 2013, 2016). The Seine River basin has therefore been classified as a sensitive area subject to eutrophication in the sense of the 1991 Urban Waste Water Treatment (UWWT) Directive (European Council Directive 91/271/EEC). The 2015 Seine River basin management plan aims at reaching good ecological potential for 2021, including reduction of N and P concentrations. Moreover, the 1992 Oslo-Paris convention required the Seine River basin to halve its N and P fluxes to the sea between 1985 and 1995. The target on P has been reached, but the fluxes of N show an opposite trend of +1% per year over the last 30 years (AESN, 2013; Romero et al., 2016).

Overall, the objective of this chapter is therefore to develop a systemic vision of the structure of regional agro-food systems in France by examining at the same time production, trade and consumption patterns and the connections between them. To reach that goal, production patterns are first analyzed based on the GRAFS methodology described in chapter I in order to capture the **main characteristic of French regional agro-food systems** in 2006. Applying the GRAFS approach at the regional scale enables to draw a particular picture for each regional unit and show the diversity of the agro-food systems co-existing at the national level. Based on this first analysis, a **typology** is developed in order to objectify main types of agro-food system and to further systematize the analysis of their agronomic and environmental performances. **Performances** are evaluated in terms of N and P exogenous inputs, N balance, NH<sub>3</sub> volatilization, P balance and humified C inputs to cropland and grassland soil. **Food and feed trade** is then analyzed based on the SitraM database using the Amstram software (Silvestre, 2015), in order to highlight the contribution of trade to the opening of nutrient cycles and to examine the commercial exchanges between the different regional units. This analysis of trade fluxes will be only carried out in terms of N fluxes, because the corresponding fluxes in P or C are essentially parallel and their analysis lead to the same conclusions. Finally the **N and P imprints of Paris Megacity's food supply** are estimated by attributing a fraction of the environmental imprint of each regional agro-food systems pro rata to the share of its agricultural production dedicated to Paris Megacity provisioning. We therefore characterize the imprint of Paris Megacity by the magnitude of the flows of N and P resources required to sustain its food supply. We also determine the spatial distribution of these flows. Carbon is not accounted as a resource because the main input of C considered here is the atmospheric CO<sub>2</sub> uptake by photosynthesis.

## 2. Methods

The GRAFS approach was applied to each regional unit presented in chapter I. The base year of the data set used in the GRAFS model is 2006, for the sake of comparison with the data assembled on interregional trade throughout France. Analyzing the trends of several important indicators of agricultural production over the last few decades shows that 2006 is reasonably representative of the 2000–2013 period (Figure 2.1a–c).

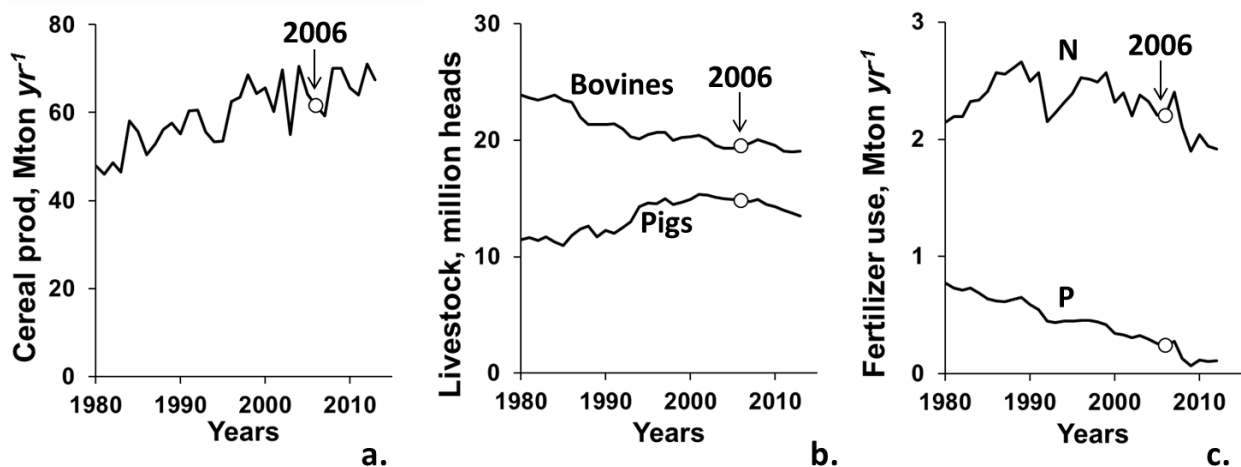

**Figure 2.1** Evolution of: **a.** total cereal production (mega-tons  $\text{yr}^{-1}$ ), **b.** number of livestock ( $10^6$  head  $\text{yr}^{-1}$ ) and, **c.** N and P synthetic (mega-tons N and P  $\text{yr}^{-1}$ ) fertilizers for the 1980–2013 period in France.

### 2.1. Imprint of crop and livestock production

Once assembled into a coherent representation of the agro-food system, the GRAFS data can be used to assess the agronomical and environmental performances associated with a given production pattern, in terms of the resources required and the environmental nutrient losses.

From a regional perspective (the scale of agricultural areas as described in chapter I and in line with the definition provided by Buclet et al., 2015), the **environmental imprint** of agricultural production was expressed *pro rata to the surface* of crop- and grassland, i.e., in kgN and kgP per hectare and per year. To assess the N and P resources and the losses attributable to regional production, not only those associated with direct inputs (synthetic fertilizers, N symbiotic fixation, atmospheric deposition, sludge) must be accounted for, but also those related to the fraction of imported feed ending up as manure applied on cropland and grassland. The latter are referred as *new* N and P in manure. To calculate this, the manure fraction derived from local crop and grass ingestion by livestock was excluded from the calculation, given that it represents internally recycled nutrients.

With regard to **agronomic performance**, resources consumed and nutrients lost to the hydrosphere and atmosphere were expressed **per unit of vegetal or animal production**. This requires partitioning resource consumption and environmental losses between animal and vegetal production, respectively. Yet, this distinction is not straightforward because these two types of agricultural production are interconnected in all the agricultural areas. Part of the cropland production is dedicated to feeding cattle, while part of the manure excreted ends up on cropland.

Two components of total vegetal production (TVP, ktN yr<sup>-1</sup>) can be considered: that locally consumed by humans or exported outside the region (HVP, ktN yr<sup>-1</sup>) and that used locally as feed for livestock (LVP, ktN yr<sup>-1</sup>). The latter is accounted for in the animal production imprint. However, a fraction of it is recycled as manure and used as a resource for total vegetal production. This fraction corresponds in a way to regenerated vegetal production (RegVP, ktN yr<sup>-1</sup>), which is estimated as the amount of manure applied to cropland (ManICL, ktN yr<sup>-1</sup>) multiplied by the share of local cropland production (LVP, ktN yr<sup>-1</sup>) in total livestock ingestion (LIng, ktN yr<sup>-1</sup>) (see equation 1). This fraction has to be deducted from total production for estimating the new vegetal production (NewVP, ktN yr<sup>-1</sup>) sustained by external (or new) nutrient resources (see equation 2).

$$\text{RegVP} = \text{ManICL} \times \text{LVP} / \text{LIng} \quad (1)$$

$$\text{NewVP} = \text{TVP} - \text{RegVP} \quad (2)$$

It is therefore possible to allocate to cropland production the new nutrient resources originating from permanent grassland fertilization and from import of feed brought to cropland through manure application. The amount of manure input corresponding to new inputs of nutrients is defined in equation (3). Accounting for the new manure inputs (NewManCL, ktN yr<sup>-1</sup>) makes it possible to fully track the origin of new nutrients that ultimately contribute to cropland fertilization, including nutrient inputs originally applied on grassland and imported feed for livestock breeding.

$$\text{NewManCL} = \text{ManICL} (1 - \text{ManICL}/\text{LIng}) \quad (3)$$

Finally, the imprint of animal production is calculated by subtracting the vegetal production imprint from the total imprint of agricultural production. For the sake of simplicity however, all surpluses generated on grassland and all losses of nutrient during manure management are considered to be attributed to animal production. Table 2.1 summarizes the relationships used for calculating the components of N imprint of vegetal and animal production. A similar approach is used for the P imprint.

**Table 2.1** Calculation of the elements of vegetal and animal productions (for N imprint). Abbreviations used for the equation are detailed below the table.

Resource consumption	Attributable to vegetal production	Attributable to animal production
Cropland area (ha)	$SCL * HVP / TVP$	$SCL * LVP / TVP$
Grassland area (ha)	-	$SGr$
Synth fertilizer applied to cropland (ktN yr <sup>-1</sup> )	$FsynthCL * HVP / NewVP$	$FsynthCL * (1-HVP/ NewVP)$
Symbiot fix to cropland (ktN yr <sup>-1</sup> )	$FsymbCL * HVP / NewVP$	$FsymbCL * (1-HVP/ NewVP)$
Synth fertilizer applied to grassland (ktN yr <sup>-1</sup> )	$FsynthGr/(FsynthGr+FsymbGr+FeedImp) * (ManCL-RegPV) * HVP/NewVP$	$FsynthGr - FsynthGr_{veg prod}$
Symbiot fixation to grassland (ktN yr <sup>-1</sup> )	$FsymbGr/(FsynthGr+FsymbGr+FeedImp) * (ManCL-RegPV) * HVP/NewVP$	$FsymbGr - F_{symbGr_{veg prod}}$
Feed Imports (ktN yr <sup>-1</sup> )	$FeedImp/(FsynthGr+FsymbGr+FeedImp) * (ManCL-RegPV) * HVP/NewVP$	$FeedImp - FeedImp_{veg prod}$
<b>Pollution</b>		
Cropland balance (ktN yr <sup>-1</sup> )	$SplCL * HVP/NewVP$	$SplAr * (1 - HVP/NewVP)$
Grassland balance (ktN yr <sup>-1</sup> )	-	$SplGr$
NH <sub>3</sub> volatilization (ktN yr <sup>-1</sup> )	-	$VolNH_3$

Abbreviations: **FeedImp**: imported feed (ktN yr<sup>-1</sup>); **FeedImp<sub>veg prod</sub>**: feed import originally dedicated to livestock breeding that actually contributed to cropland fertilization through manure inputs derived from imported feed ingestion (ktN yr<sup>-1</sup>); **FsymbCL**: N symbiotic fixation to cropland (ktN yr<sup>-1</sup>); **FsymbGr**: N symbiotic fixation to grassland (ktN yr<sup>-1</sup>); **FsymbGr<sub>veg prod</sub>**: N symbiotic fixation originally on grassland that actually contributed to cropland fertilization through manure inputs derived from grass ingestion (ktN yr<sup>-1</sup>); **FsynthCL**: synthetic fertilizers to cropland (ktN yr<sup>-1</sup>); **FsynthGr**: synthetic fertilizers to grassland (ktN yr<sup>-1</sup>); **FsynthGr<sub>veg prod</sub>**: synthetic fertilizers originally applied on grassland that actually contributed to cropland fertilization through manure inputs derived from grass ingestion (ktN yr<sup>-1</sup>); **HVP**: vegetal production dedicated to human consumption or exported (ktN yr<sup>-1</sup>); **LVP**: vegetal production dedicated to local livestock (ktN yr<sup>-1</sup>); **ManImp**: manure input to cropland (ktN yr<sup>-1</sup>); **NewVP**: new vegetal production (vegetal production derived from non-recycled resources within the regional agro-food system) (ktN yr<sup>-1</sup>); **RegPV**: regenerated vegetal production (vegetal production derived from recycled resources within the regional agro-food system) (ktN yr<sup>-1</sup>); **SCL**: surface of cropland (ha); **SGr**: surface of grassland (ha); **SplCL**: balance on cropland (ktN yr<sup>-1</sup>); **SplGr**: balance on grassland (ktN yr<sup>-1</sup>); **TVP**: total vegetal production (ktN yr<sup>-1</sup>); **VolNH<sub>3</sub>**: ammonia volatilization (ktN yr<sup>-1</sup>).

## 2.2. N fluxes embedded in food and feed interregional trade

The trade exchange of agricultural goods between French departments (NUTS3) is obtained from the French database SitraM (Système d'Information sur le Transport des Marchandises; <http://www.statistiques.developpement-durable.gouv.fr/sources-methodes/>). It annually identifies the transport of 50 categories of agricultural goods between French departments by roads, railways and navigable waterways, as well as exchanges with foreign countries (customs database) since 1974. For each of these modes of transportation, food and feed trade are reported in monetary and raw mass terms. The place of unloading and the last place of loading are indicated. Automated software has been developed by Silvestre et al. (2015) for the analysis of these data.

The principle of this software is as follows: the SitraM database can be seen as a set of matrices [F(d,o)] relative to each products, indicating transport fluxes between the last place of loading

(origin, o) which can be a French department or a foreign country, and the place of destination (d). Each matrix initially includes a total of 306 lines and columns (95 French Departments and 211 countries). Internal transport fluxes  $F(i,i)$  are not accounted in the SitraM database but are replaced by internal agricultural production provided by the Agreste database for French departments and by the FAO database for other countries. This enables to integrate local production for each of the food items considered. The resulting matrix is referred as  $[F^*(d,o)]$ . Values in tons are subsequently translated in N unit based on coefficient compiled by Lassaletta et al. (2014a) and already mentioned in chapter I. For the analysis of food and feed trade, we hypothesized that the relative distribution of origins in the final consumption of each region is identical to that of the sum of importations and internal production of the region considered, even though a significant part of what is imported is re-exported. This “perfect mixing” hypothesis ignores the possible preference for certain provenances, including local ones, in the whole offer delivered to a given region. This hypothesis is necessary only for the calculation of product origin at the second order (see equation 4), i.e. for accounting for the origin preceding the last loading: the flux  $I_2$  imported to department  $a$  from each origin  $i$  is given as the sum of contributions of this origin in all incoming flux of all origins:

$$I_2(a, i) = \sum_{k \neq a} (F^*(a, k) \times r_1(k, i)), \quad (4)$$

where  $r_1(k, i)$  represents the fraction of each origin  $i$  in incoming flux to department  $k$  (equation 5):

$$r_1(k, i) = \frac{F^*(k, i)}{\sum_j F^*(k, j)}, \quad (5)$$

Most of the time, results at the second order are not fundamentally different from those obtained at the first order, which alleviates the bias of the perfect mixing hypothesis.

Using N as a generic unit to express trade flows makes it possible to gather several food items within a more general category. Therefore, among the 50 agricultural goods reported in the SitraM database, we distinguished here 5 different categories:

- Cereals, including: wheat, spelt, meslin, barley, oat, rice, rye, and grain maize;
- Fruits and vegetables, including: potatoes, sugar beet, dry legumes, hops, other fresh or frozen legumes, citruses, other fruits and fresh nuts, frozen or dried fruits, processed and canned fruits, preserved or processed vegetables and vegetable-based products;
- Animal feed, including: straw, hay, cereal husks, oil seed crops, oleaginous almonds, crabs and residues of vegetable oils, other animal feed, wastes from the food industries;
- Meat, including: fresh, refrigerated and frozen meat, dried, salted and smoked meat, preparation and processed meat;
- Dairy products, including: fresh milk and fresh cream, butter, cheese, eggs, other dairy products.



The 95 French departments are grouped in agricultural regions as defined in section 2 of chapter I. For the sake of simplicity, foreign countries, aside from close countries that are most involved in food and feed trade with French departments (Belgium, Luxembourg, Netherlands, Germany, United Kingdom, Italy, Spain, Portugal), were grouped by subcontinent (other European countries, North America, Central America, Latin America, New Zealand and Australia, Maghreb and Middle East, sub-Saharan Africa, Asia). For each of the 5 agricultural commodity categories a matrix (57×57) of raw importations from French regions to any French and foreign regions was established thanks to the Amstram software (Silvestre et al., 2015). Each matrix was subsequently transposed, giving a matrix of exportations. The subtraction of the transposed matrix (exportation) from the original matrix (importation) provides the matrix of net fluxes for each of the seven categories. This latter matrix is used to examine N fluxes embedded in food and feed trade.

## **2.3. Calculation of N and P imprint of Paris Megacity food supply**

### **2.3.1. *Spatial frame***

The urban agglomeration of Paris is ranked the 25<sup>th</sup> largest city in the world (United Nations, 2014). It is the largest city of the European Union and, with a population of more than 10 million inhabitants, it is classified as a megacity. The definition of a city remains controversial and the setting of its boundaries can vary greatly depending on the definition adopted. In this chapter, we choose to follow the French National Institute of Economic Statistics and Studies' (INSEE, [www.insee.fr](http://www.insee.fr)) definition of the urban unit. The main characteristic of a urban unit is that the distance between two inhabited buildings does not exceed 200 m. In this sense, Paris Megacity is composed of 412 municipalities totaling 10,550,350 inhabitants in the official 2012 census and has a density of 3700 cap.km<sup>-2</sup> (INSEE). Following Esculier et al. (2018), the term Paris Megacity is used in this chapter to refer to the Paris urban unit. Paris Megacity should be thus distinguished from three other perimeters that are also commonly used to define Paris, illustrated in Table 2.2 and Figure 2.2: (i) the Paris city center. This is the core municipality of Paris Megacity representing 21% of its population. It is one of the densest city centers in the world with more than 21000 cap.km<sup>-2</sup> (INSEE); (ii) the Paris urban area. The INSEE definition adds to the Paris urban unit the municipalities where at least 40% of the residents and working population work in the Paris urban unit. Paris Megacity accounts for 85% of the population of the Paris urban area and is five times denser; (iii) the Ile-de-France region. This is the administrative region in which Paris Megacity is included. Its population is about the same as the Paris urban area, but their respective perimeters differ slightly.

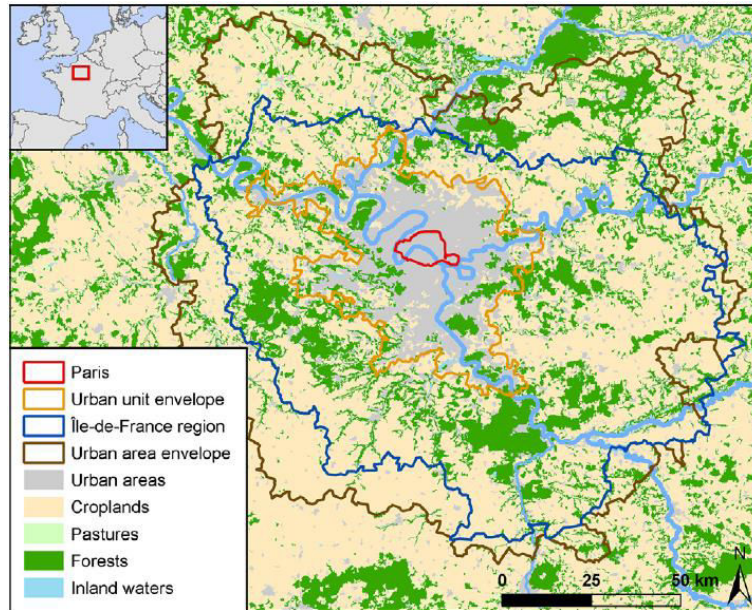

**Figure 2.2** The perimeters of the Paris city center, urban unit, urban area and Ile-de- France administrative region. The background shows the main types of land use (from European Environment Agency, 2013)

**Table 2.2** Population and density of Paris: city center, urban unit, urban area and Ile-de- France administrative region (data: INSEE, year 2012).

		Paris city center	Paris urban unit	Paris urban area	Ile-de-France region
	Units				
<b>Population</b>	cap	2 240 621	10 550 350	12 341 418	11 898 502
<b>% of Paris Megacity</b>		21%	100%	117%	113%
<b>Population density</b>	cap.km <sup>-2</sup>	21 258	3 709	719	991

This chapter describes the metabolism of people who are actually inside Paris Megacity and the results are expressed in yearly averaged figures. Data from the population census, commuting patterns, tourism and business trips have been gathered from studies conducted by French public institutions (INSEE, authorities in charge of economy and tourism, Institut d'Aménagement et d'Urbanisme de la Région Ile-de-France). They have been used to obtain the yearly average instantaneous number of people actually eating: dwellers temporarily out of the city for holidays or work have been deducted *pro rata temporis*; nondwellers coming to the city for tourism or work have been added *pro rata temporis*.

### 2.3.2. The agro-food system that feed Paris Megacity

Evaluating the environmental imprint of Paris Megacity over its food supplying areas requires (i) quantifying Paris Megacity's consumption; (ii) identifying the areas supplying food to Paris Megacity; (iii) evaluating agricultural production and environmental losses from agriculture for each area contributing to the food supply of Paris Megacity and (iv) calculating the environmental imprint of Paris Megacity as the fraction of the environmental losses attributable to food supply of Paris Megacity in each contributing area.

From the SITRAM data presented in section 2.2, the relative contribution of each agricultural region to the total Ile-de-France food supply was calculated, separately for vegetal and animal proteins. We assumed that there was no significant typological difference between Paris Megacity's food supply and Ile-de-France's food supply; therefore, the food supply of Paris Megacity was deduced by simple application of population ratios.

### ***2.3.3. Evaluation of Ile-de-France's environmental imprint over its supply areas***

The relative contribution to the total import to Ile-de-France of either vegetal or animal proteins, as calculated from the SitraM database, was used as an index for calculating the imprint in terms of agricultural area in each region, by considering their main orientation into either crop or livestock supply to Paris Megacity. The environmental imprint of Ile-de-France was calculated only over regions that contribute to more than 1% of Ile-de-France vegetal or animal supply.

We thus defined the **imprint of crop production** (defined in section 2.1) of a given region as the total resource consumption and environmental losses attributable to the portion of crop dedicated to vegetal food supply to Ile-de France. Conversely, the **imprint of meat and milk production** (also defined in section 2.1) was calculated by considering all resources and pollution associated with livestock farming dedicated to animal food supply to Ile-de France.

In some cases, animal husbandry is based on imported feed such as soybean or oil seed cakes. As a consequence, N and P imports embedded in animal feed need to be accounted for in Ile-de-France's environmental imprint. Accordingly, the environmental imprint of these regions attributable to Ile-de-France animal protein supply was calculated taking into account the share of vegetal production imported to the regions supplying Paris Megacity with meat and milk products.

Uncertainties were calculated for the indicators of environmental and agronomic performances of agricultural systems and for the Paris Megacity environmental imprint following the Monte Carlo analysis explained in section 7.2 of chapter I (see results in the following section 3).

### 3. Characterization of regional agro-food systems

The GRAFS analysis provides a comprehensive picture of the N, P, and C fluxes across the agro-food system of each of the 33 regions considered in France in 2006. The interconnection of these fluxes is represented at the scale of all of France for N, P, and C (Figure 2.3a–c). These data can be used to highlight various aspects of the biogeochemical functioning of the agro-food system, including soil nutrient budgets and their environmental consequences.

#### 3.1. Soil nutrient balances

##### 3.1.1. Nitrogen

N balance in cropland (after N-NH<sub>3</sub> volatilization had occurred) ranged from 9.8 ( $\pm 1.3$ ) to 148 ( $\pm 16$ ) kgN ha<sup>-1</sup> yr<sup>-1</sup>, showing the large variability in N use across the 33 French agricultural regions (Figure 2.4a). Empirical data demonstrate that N balance in cropland is a robust indicator of N losses, mostly through lixiviation, which generally accounts for 30–80% of losses (Billen et al., 2013b; Anglade, 2015a), leading to ground- and surface water contamination and coastal eutrophication (Passy et al., 2016). Generally the highest N balance over cropland was found in regions with high livestock density (e.g., Brittany, Cantal-Corrèze, and Loire Aval). Regions showing high N inputs and high crop production, such as Picardy, Loire Centrale, and Eure, did not show very high balance values. However, some regions with high crop production such as Champagne-Ardennes-Yonne presented high N balance due to excessive N mineral fertilizers inputs to cropland.

Nitrogen balance for grassland ranged from 8.3 ( $\pm 0.8$ ) to 133 ( $\pm 27$ ) kgN ha<sup>-1</sup> yr<sup>-1</sup> (Figure 2.4b), but unlike in cropland, N balance in grassland does not result in high leaching below a threshold of about 100 kgN ha<sup>-1</sup> yr<sup>-1</sup> (Billen et al., 2013b). Accordingly, the balance observed in grassland might not be necessarily viewed as indicating a negative environmental impact. In some cases it is indeed likely to increase the SOM level. High balance on grassland generally reflects a mismatch between grazing intensity and grassland surface areas, leading to over fertilization of N from animal excretion in excess over grass production (e.g., in Brittany).

Ammonia emission is the second leading pathway of environmental N losses from agricultural areas (Figure 2.4c). Ammonia volatilization owing to synthetic fertilizer application in regions dominated by crops, and to animal excretion depending on livestock density, was counted together, although the proportion of both emission pathways greatly differed between regions. Ammonia losses from N synthetic fertilizer volatilization reached 75% of emissions in Ile-de-France, while 95% originated from manure management in Brittany. However, it is notable that the highest NH<sub>3</sub> emissions rose from regions with important livestock density and where animal excretion is stored and transformed into manure or slurry. NH<sub>3</sub> emissions thus primarily reflected manure management and livestock density.

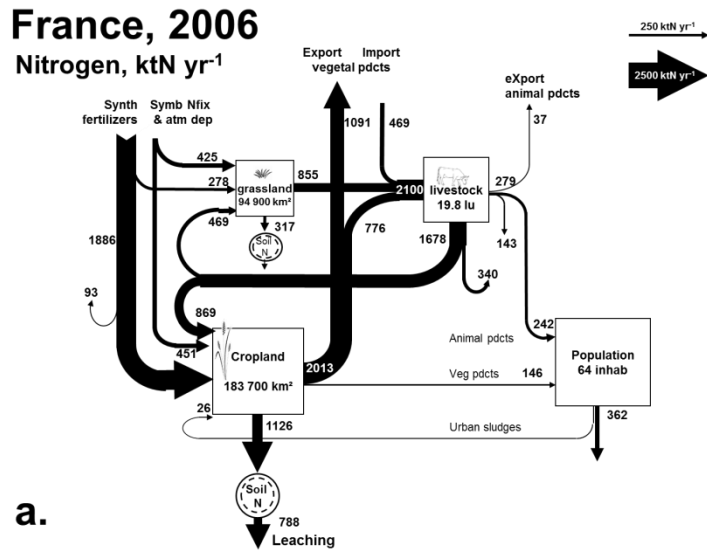

a.

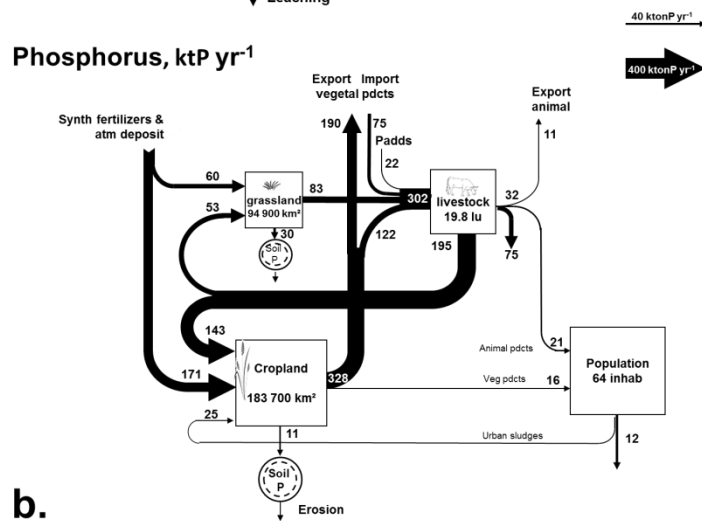

b.

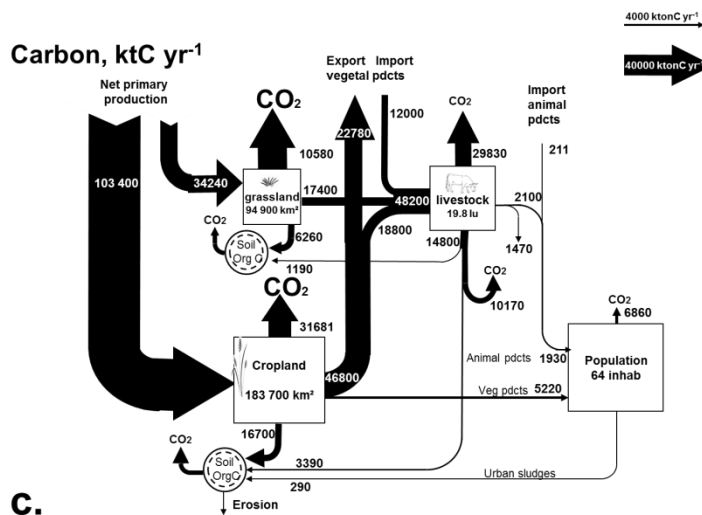

c.

**Figure 2.3** Representation of: **a.** nitrogen; **b.** phosphorus and; **c.** carbon fluxes, expressed in  $kt\ yr^{-1}$  at the national scale for France in 2006. Squares represent transformation processes occurring in the corresponding environmental compartments. The width of black arrows are proportional to the intensity of the fluxes involved in these processes. Circles represent storage pools of N, P or C in the soil compartments; the dotted circle figures the initial state, the solid circle the final stage.

### 3.1.2. Phosphorus

On cropland, the P balance ranged from  $-8.9 (\pm 3.0)$  to  $+41 (\pm 6.6)$  kgP ha<sup>-1</sup> yr<sup>-1</sup>, showing large disparities between regions (Figure 2.4d). Extreme P balance values resulted from an imbalance between P inputs to cropland and P uptake by crop. In the case of P-removing regions (e.g., in regions located in the Paris basin), the imbalance resulted from very intensive crop production with inputs of P fertilizers lower than the requirements of crop growth in the last decades. As discussed by Senthilkumar et al. (2011) and Garnier et al. (2015), this is not yet accompanied by crop growth limitation owing to the legacy of huge accumulated stocks of P resulting from past excessive P fertilization. The rate of P application to cropland in these regions has indeed been reduced by a factor of 3.5 since the 1970s (Unifa, 2016, see also chapter III). By contrast, regions presenting the highest P accumulation in cropland (e.g., Cantal-Corrèze) should be attributed to the very high inputs of P on cropland through manure application of an important herd size that is not absorbed by crops. However, Brittany, with a high livestock density, presented only medium P balance on cropland. This is probably due to the low mineral fertilizer rate in this region ( $5.3 \pm 0.5$  kgP ha<sup>-1</sup> yr<sup>-1</sup>) and high crop export. Very high P accumulation rates (together with high N balance) were also observed in regions such as Aveyron-Lozère, Gard-Hérault and Grand Marseille with intermediate level of fertilization, but in large excess over the requirements of a rather low crop production, which could be due to the Mediterranean unfavorable climate for crop production of these regions (Figure 2.3e).

**N Balance: cropland**

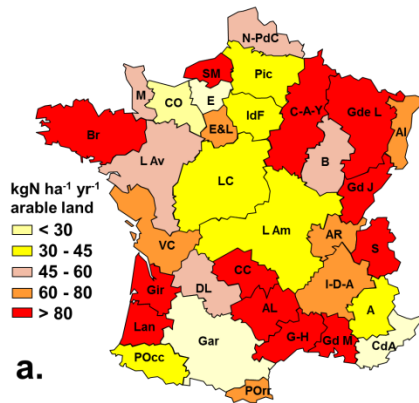

**N Balance: grassland**

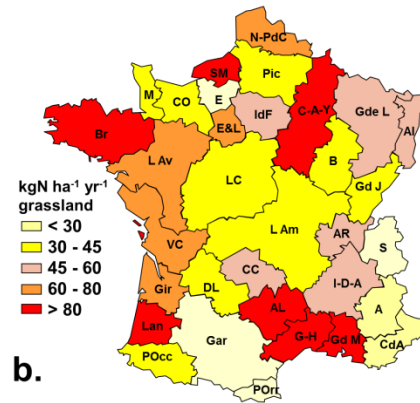

**NH<sub>3</sub> emission: total agricultural area**

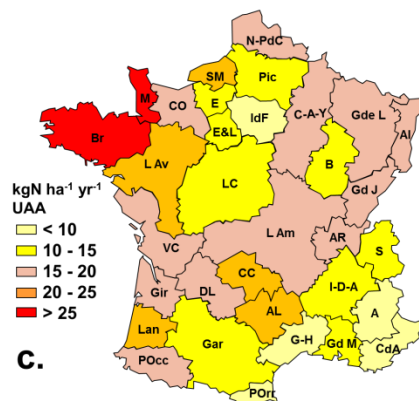

**P balance: cropland**

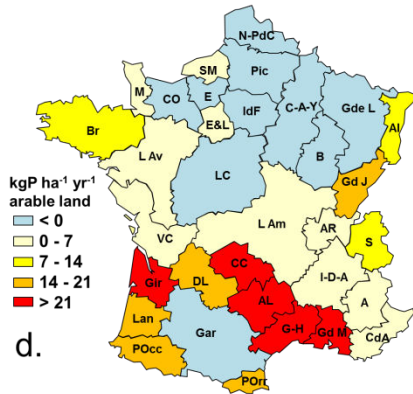

**P balance: grassland**

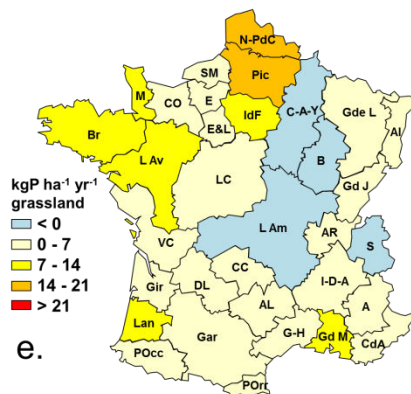

**Humified C input: cropland**

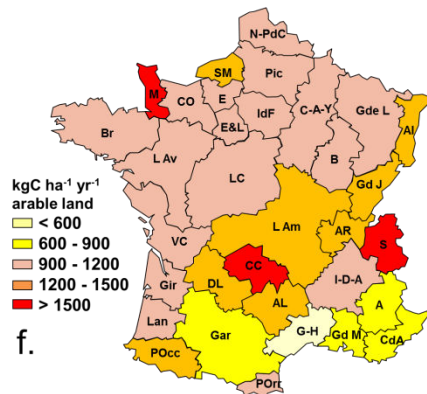

**Humified C input: grassland**

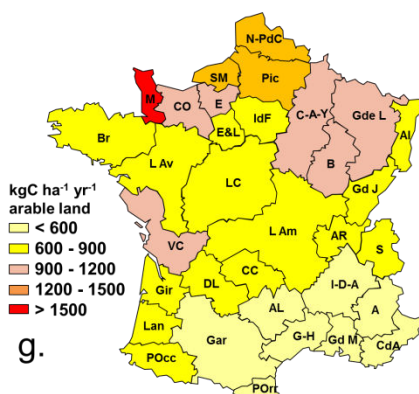

**Figure 2.4** Distribution across the 33 French agricultural areas of: **a.** N balance in cropland (kgN ha<sup>-1</sup> yr<sup>-1</sup>); **b.** N balance in grassland (kgN ha<sup>-1</sup> yr<sup>-1</sup>); **c.** NH<sub>3</sub> emissions from utilized agricultural area accounting for NH<sub>3</sub> emissions derived from livestock manure and synthetic fertilizer spreading (kgN ha<sup>-1</sup> yr<sup>-1</sup>); **d.** P balance in cropland (kgP ha<sup>-1</sup> yr<sup>-1</sup>); **e.** P balance in grassland (kgP ha<sup>-1</sup> yr<sup>-1</sup>); **f.** Humified OC inputs to cropland (kgC ha<sup>-1</sup> yr<sup>-1</sup>); **g.** Humified OC inputs to grassland (kgC ha<sup>-1</sup> yr<sup>-1</sup>). A: Alpes; Al: Alsace; AL: Aveyron-Lozère; AR: Ain-Rhône; B: Bourgogne; Br: Bretagne; C-A-Y: Champagne-Ardenne-Yonne; CC: Cantal-Corrèze; CdA: Côte d'Azur; CO: Calvados-Orne; DL: Dordogne-Lot; E: Eure; E&L: Eure-et-Loire; Gar: Garonne; Gd J: Grand Jura; Gd M: Grand Marseille; Gde L: Grande Lorraine; G-H: Gard-Hérault; Gir: Gironde; I-D-A: Isère-Drôme-Ardèche; IdF: Ile de France; L Am: Loire Amont; L Av: Loire Aval; Lan: Landes; LC: Loire Centrale; M: Manche; N-PdC: Nord Pas-de-Calais; Pic: Picardie; Pocc: Pyrénées Occidentales; PO: Pyrénées Orientales; S: Savoie; VC: Vendée-Charentes.

The phosphorus balance in grassland, with much lower variability, ranged from -3.2 (± 2.7) to 15.5 (± 3.2) kgP ha<sup>-1</sup> yr<sup>-1</sup>. It is notable that Picardy and Nord Pas-de-Calais showed the highest positive P balance in grassland, whereas their P balance in cropland was among the lowest (Figure 2.4d and e). This result could reflect an artifact due to the very small grassland areas of these regions (less than 15%). The remaining regions, with the most positive P balance, were often characterized by high livestock density; therefore P accumulation on grassland was mostly due to an excess of P inputs through direct excretion, which would also be in excess if recycled

on cropland due to high livestock density. This is in accordance with the study reported by Sharpley et al. (2007), who reported that regional specialization patterns and intensification of livestock production led to reduced opportunities for P recycling over the surrounding cropland. The transfer of fertility from grassland to cropland (Ohm et al., 2015; Barataud et al., 2015; Sattatri et al., 2016) can be illustrated here at the regional scale where P accumulation on cropland is higher than on grassland with a similar fertilizer input (e.g., Loire Amont, Alsace, and Cantal-Corrèze). This probably resulted from higher export of P through cattle grazing than P inputs through direct excretion, implying a P transfer from grassland to cropland through manure application. In some case (e.g., Loire Amont) this could even lead to P depletion in permanent grassland.

### **3.1.3. Carbon**

A large number of studies indicate that SOC content at steady state is controlled by humified OC inputs (Jenkinson and Rayner, 1977; Kong et al., 2005; Sleutel et al., 2006, 2007; Vitro et al., 2012; Chenu et al., 2014), although humus mineralization is also dependent on climatic conditions as well as the soil's biophysical features and management (Stockmann et al., 2013). However, the quite recent emergence of a soil C saturation concept as a limit above which SOC can become saturated (Stewart et al., 2007) has led to re-examining the paradigm that prevailed before, e.g., a linearity between C input levels and C stocks at steady state (as first proposed by Jenny, 1941), implying that SOC content could continuously increase with increasing humified OC inputs. Since concepts such as “maximum C sequestration” or “effective stabilization capacity” are still under debate (Six et al., 2002; Stewart et al., 2007; Schmidt et al., 2011), we considered humified OC inputs to be a good proxy for potential additional storage assuming that croplands are, in most cases, far from their C saturation limit and have not yet reached their steady state. This assumption is in line with the results from the Rothamsted long-term experiment, which showed that even after 150 years of identical agricultural practices; soil C stocks have not yet reached a steady state (Jenkinson and Rayner, 1977; Poulton et al., 2018).

Humified carbon inputs mainly depend on the type of crop roots and residues returning to the soils, crop productivity, and manure management. Consequently, regions with substantial manure spreading over cropland but average crop production (e.g., Loire Amont, Cantal-Corrèze) had the highest scores of humified C inputs (Figure 2.4f). Regions with intermediate humified C inputs to cropland were mostly characterized by low manure supply and high crop productivity (e.g., Ile-de-France, Loire Centrale, Eure) or, conversely intermediate crop productivity and high manure supply (e.g., Brittany, Loire Aval). A recent study by Tosser et al. (2014) reported a positive progression of SOC stocks in croplands in France over the 1990–2010 period; this supports the idea that cropping systems keep accumulating C in France. If this remains true at the regional scale, regions with the highest humified OC inputs are likely to increase their SOC stocks. At the national level, humified C inputs derived from crop residues for example were on average four times as large as inputs derived from animal excretion. However, animal excretion varied much more (82% variation coefficient around the mean value) than humified C inputs (18% variation). This indicates that humified crop residue inputs to the SOM pool are crucial, but the quantity and quality of animal excretion management are



also very influential for potential C storage improvement, as highlighted by Vleeshouwers and Verhagen (2002) and Kong et al. (2005).

Humified C inputs on grassland were on average lower than on cropland (Figure 2.4g). This is coherent with the fact that grassland productivity is lower than crop productivity ( $1.8 (\pm 0.15)$  against  $2.5 (\pm 0.17)$  tC ha<sup>-1</sup> yr<sup>-1</sup> for grassland and cropland respectively at the national level). In the case of grassland, humified C inputs mainly reflected the grassland productivity; indeed, humified C inputs derived from plant residues accounted, on average, for 83% of the total humified inputs.

### **3.2. A typology of production patterns**

The GRAFS approach could provide as many monographs as regions considered. To systemize the analysis of our results and to obtain an objective assessment of the 33 French regions, we chose here to aggregate these regions according to similarities in their production pattern which should enable to characterize distinct types of agricultural system rather than specific French regions. This typology corresponds to an algorithm that filters various results provided by the GRAFS analysis and subsequently defines each region as belonging to an agricultural system type from the angle of nutrient fluxes. The choice of criteria and thresholds is necessarily somewhat arbitrary, minimized by a thorough analysis of the raw results, which was partly performed in section 3.1 above. Specialization and intensification are the two main features captured through the GRAFS approach. Therefore, we have built our typology based on the degree of specialization, openness or self-reliance and inter-connections between crop, grassland and livestock breeding.

Biogeochemical criteria thus refer to nutrient fluxes or fluxes ratio. The ratio between arable crop production and livestock excretion was used as an indicator of the dominance of crop production over livestock breeding. The share of manure in arable land fertilization and the proportion of local arable production in livestock feeding were both used as indicators of the connection between crop and livestock farming. The proportion of grass in livestock feeding was taken as an indicator of the connection between grassland production and livestock production. Finally, the livestock density and the share of imported feed in livestock feeding were considered as indicative of the specialization in livestock production and the dependence of livestock production on feed supply. The typology was established based on N production and fertilization data, but the subsequent analysis can also account for P and C fluxes in each of the different types of region defined. The decision tree accordingly represents the differentiation logic, criteria and thresholds used (Figure 2.5).

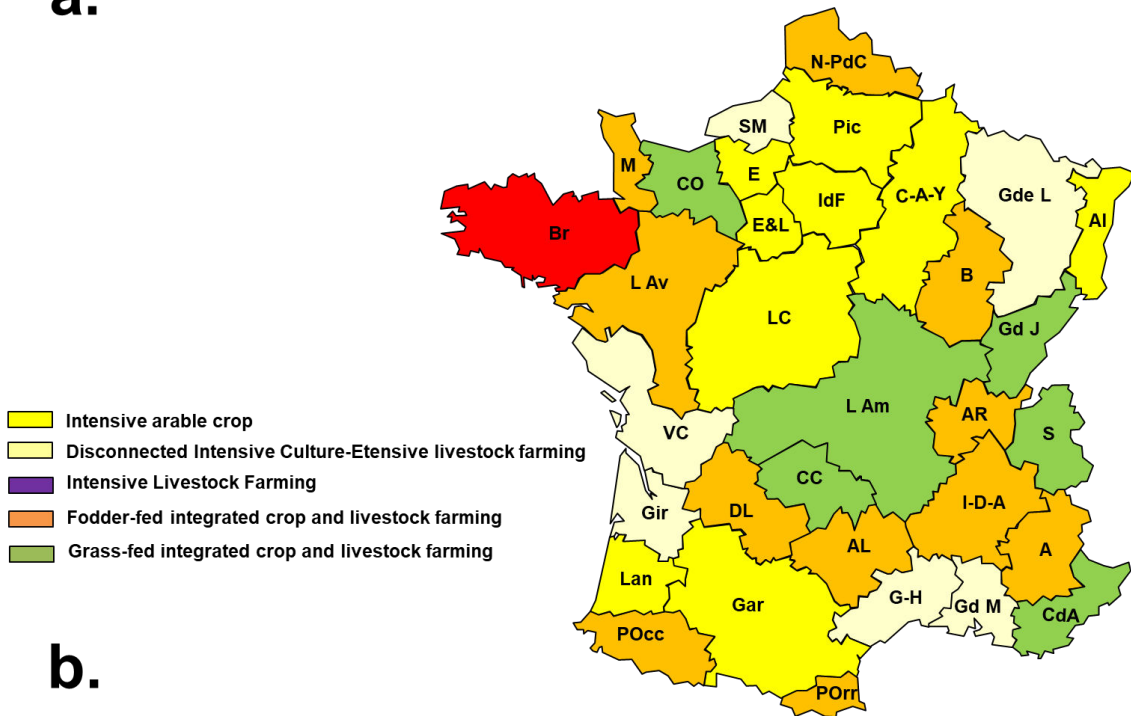
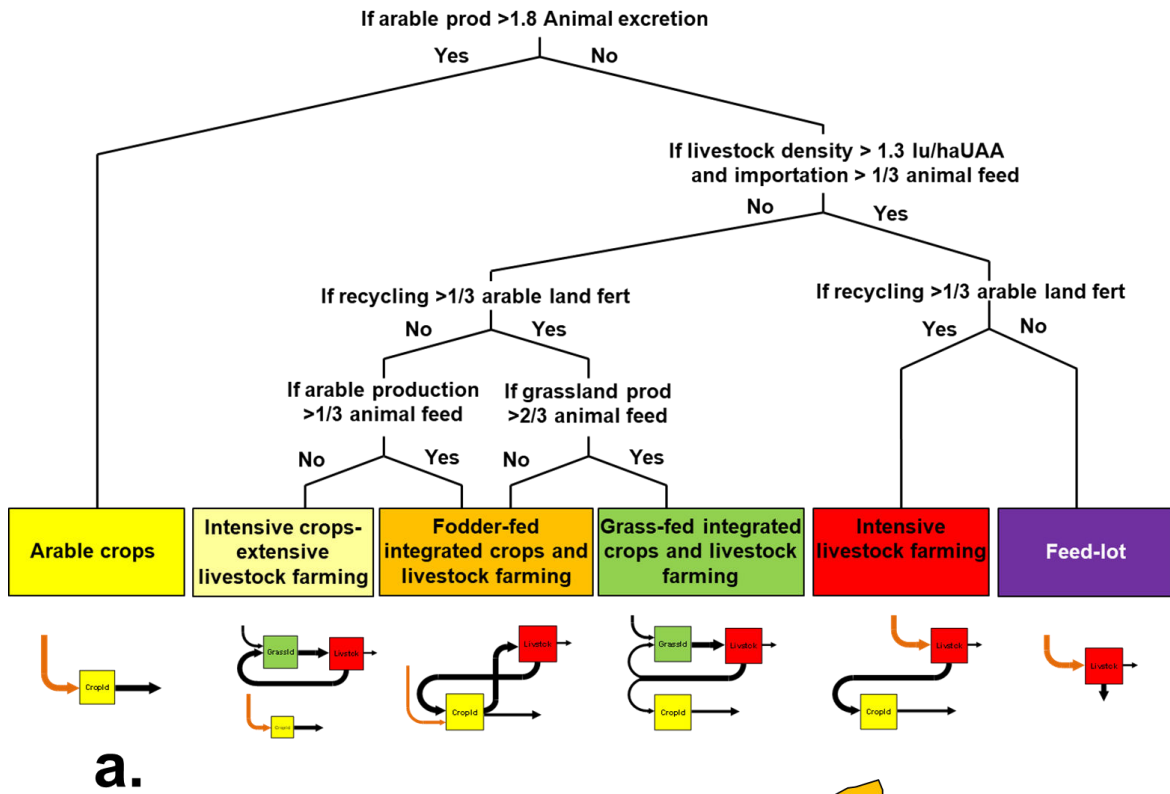

**Figure 2.5 a.** Decision tree representing the elaboration of a typology of the main representative agricultural systems in France. **b.** Spatial distribution of the five main representative agricultural systems as defined according to the criteria set out in Figure 2.4a.

The agricultural system types can be literally defined as follows:

- (i) “Intensive arable crop” systems are characterized by the dominance of arable crop production over livestock breeding;
- (ii) “Intensive livestock farming” systems are characterized by high livestock density and dependence on feed import. However, the connection between arable and livestock production exists in this system through the high proportion of manure in arable land fertilization.
- (iii) By contrast, “Grass-fed integrated crop and livestock farming” systems are defined by the connection between livestock, grass and crop production through the double criteria of a large share of grass in livestock feeding and a significant contribution of manure to arable land fertilization.
- (iv) Systems defined as “Fodder-fed integrated crop and livestock farming” are characterized by the connection between livestock and arable production through either the significant contribution of manure in arable land fertilization and/or the high proportion of local arable production in livestock feeding. However, the share of grass in livestock feeding is of lesser importance compared to systems defined as grass-fed integrated crops and livestock farming.
- (v) Systems defined as “Disconnected intensive cropping and extensive livestock farming” systems are characterized by the connection between livestock and grassland production owing to the significant proportion of grass in livestock feeding, while the link between livestock and arable land production is weak, since manure plays only a minor role in arable land fertilization and local arable land production contributes only marginally to livestock feeding. Consequently, arable land is mainly fertilized by mineral fertilizers, which justify the first term “intensive crops” for this type of system.
- (vi) Lastly, “Feed-Lot” represent an ideal case of battery breeding where there is almost no cropland or grassland and consequently, all animal feed are imported from abroad. We never observed this type of system in France, however, it may exist in other region of the globe (e.g., in the USA).

Our typology of agricultural production patterns based on N fluxes can be compared with the one by Ryschawy et al. (2015) who proposed an original typology of animal breeding practices based on the analysis of ecosystem services with a similar scale resolution in France. The five regions grouped together in their study superimposed rather well onto the types of regions we defined in the present study, suggesting that production patterns we defined on a biogeochemical basis could be linked with certain ecosystem services as described by these authors.

Figure 2.6 provides a representation of the functioning of agro-food system of each of the different type of agricultural system defined in this typology. It shows that regions characterized by an “intensive arable land” system or “intensive livestock farming” patterns represent two extremes of agricultural specialization. Both are very productive and a significant part of their production is available for exportation. The so-called “intensive livestock farming” areas showed important excess of livestock production with a surplus of 70 ( $\pm 9.0$ ) ktN yr<sup>-1</sup> of edible products. However, these “intensive livestock farming” regions required much more in vegetal products (216 ( $\pm 23$ ) ktN yr<sup>-1</sup>), mainly from South American countries. Conversely, the “intensive arable land” regions together produced massive amounts of vegetal products in excess of their

local requirements for human and livestock ( $656_{(\pm 24)}$  ktN yr<sup>-1</sup> or 63% of total vegetal production), but required a high quantity of animal products (shortfall of  $55_{(\pm 4.5)}$  ktN yr<sup>-1</sup> of food products or 60% of total edible animal protein required). Regions defined as “disconnected intensive cropping-extensive livestock farming” systems constituted an intermediate type: just as “arable land” systems these regions had an excess vegetal production but required importation from other regions to sustain their local requirements for animal proteins. However, specialization was less marked since these excess in production represented by only 30% of the total vegetal production while requirement of animal proteins from outside accounted for also 30% of local need. Finally, regions of “fodder-fed integrated crop and livestock farming” and “grass-fed integrated crop and livestock farming” systems can be distinguished by a lower degree of specialization: their vegetal and animal production meet the local need for human livestock with a rather small surplus available for exportation. Besides, excess production of vegetal products confirmed their autonomy for livestock production which is coherent with the criteria used in for the establishment of the typology.

**Intensive arable land regions, 2006**

**Nitrogen, kgN haUAA<sup>-1</sup> yr<sup>-1</sup>**

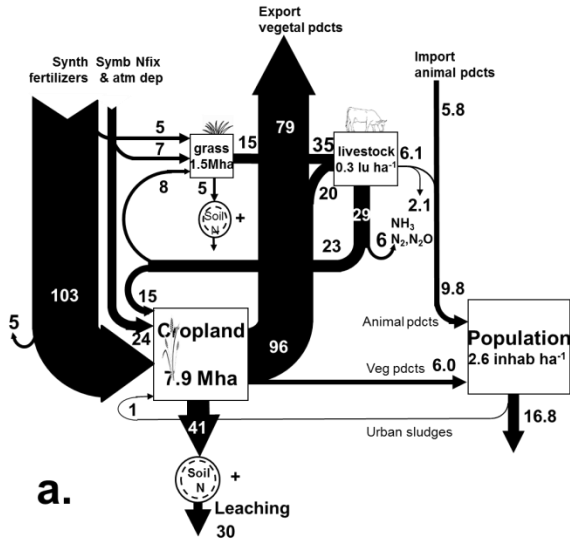

**Intensive livestock Farming regions, 2006**

5 kgN ha<sup>-1</sup> yr<sup>-1</sup>

50 kgN ha<sup>-1</sup> yr<sup>-1</sup>

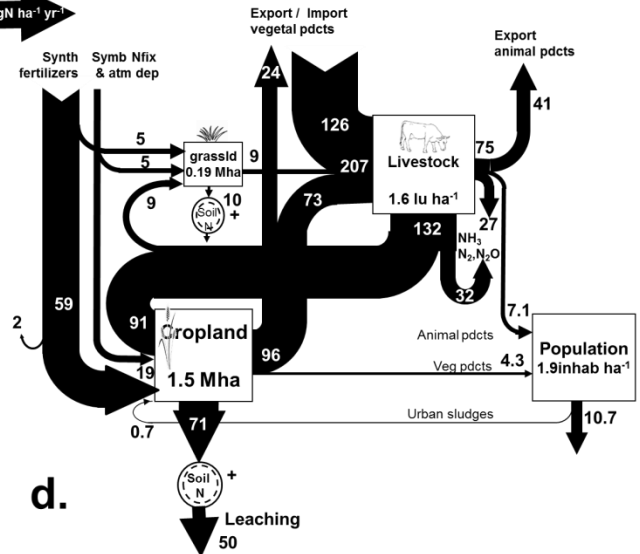

**Phosphorus, kgP haUAA<sup>-1</sup> yr<sup>-1</sup>**

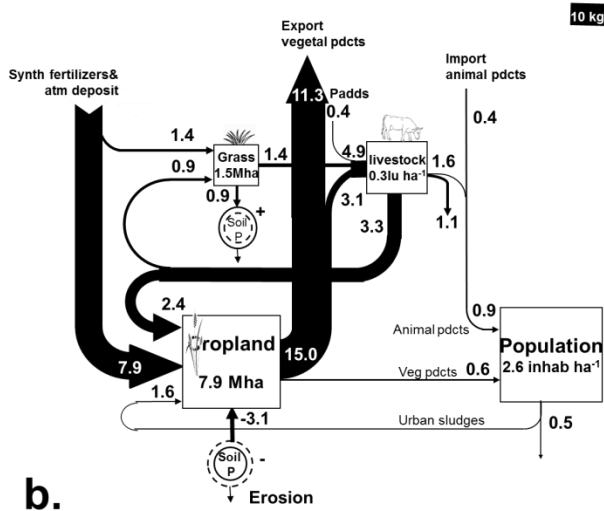

1 kgP ha<sup>-1</sup> yr<sup>-1</sup>

10 kgP ha<sup>-1</sup> yr<sup>-1</sup>

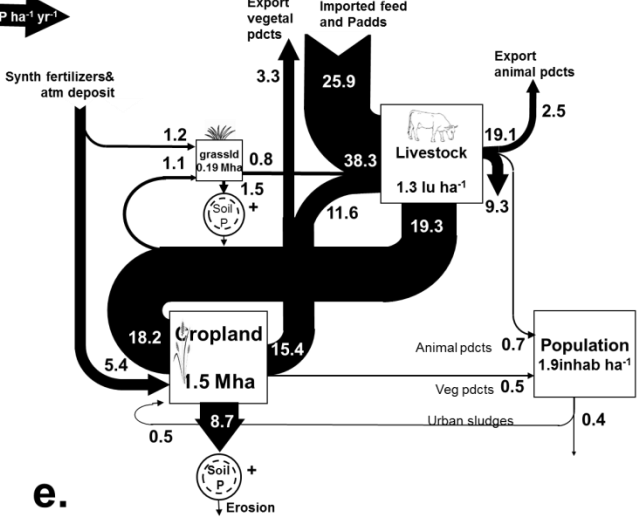

**Carbon, kgC haUAA<sup>-1</sup> yr<sup>-1</sup>**

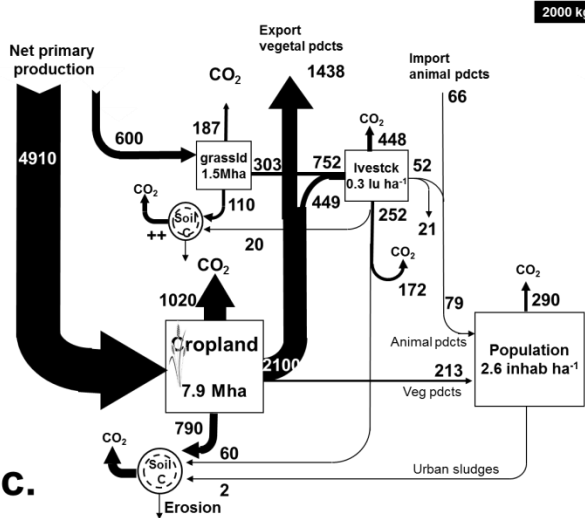

200 kgC ha<sup>-1</sup> yr<sup>-1</sup>

2000 kgC ha<sup>-1</sup> yr<sup>-1</sup>

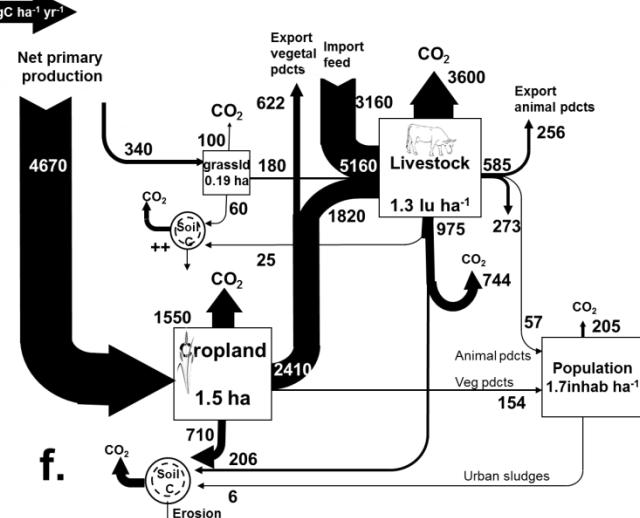

**Intensive integrated crop and livestock farming regions, 2006**

**Extensive integrated crop and livestock farming regions, 2006**

**Nitrogen, kgN haUAA<sup>-1</sup> yr<sup>-1</sup>**

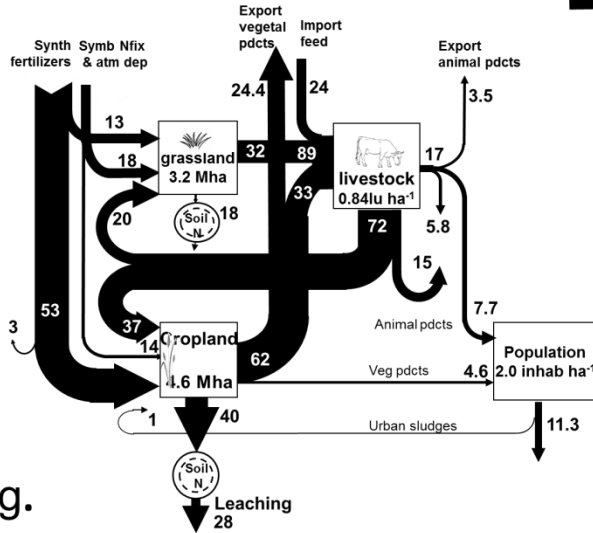

**g.**

5 kgN ha<sup>-1</sup> yr<sup>-1</sup>  
50 kgN ha<sup>-1</sup> yr<sup>-1</sup>

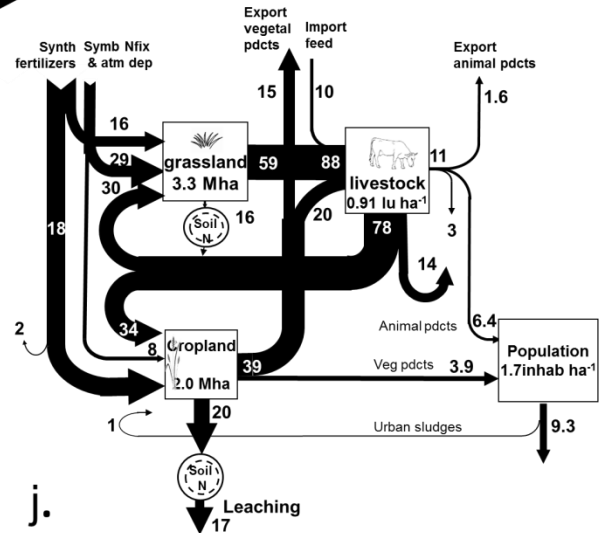

**j.**

**Phosphorus, kgP haUAA<sup>-1</sup> yr<sup>-1</sup>**

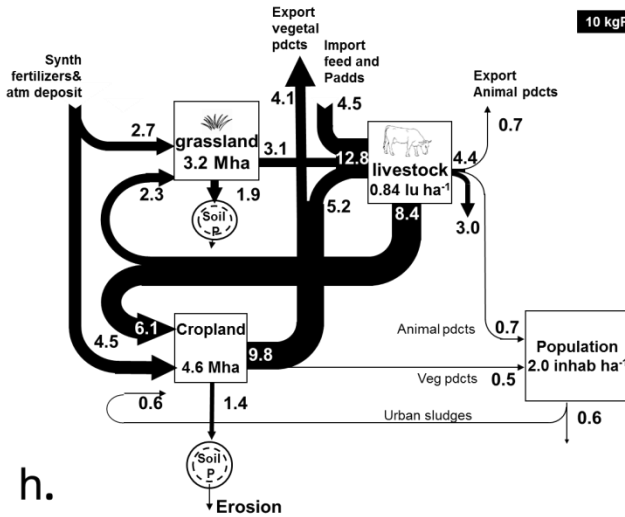

**h.**

1 kgP ha<sup>-1</sup> yr<sup>-1</sup>  
10 kgP ha<sup>-1</sup> yr<sup>-1</sup>

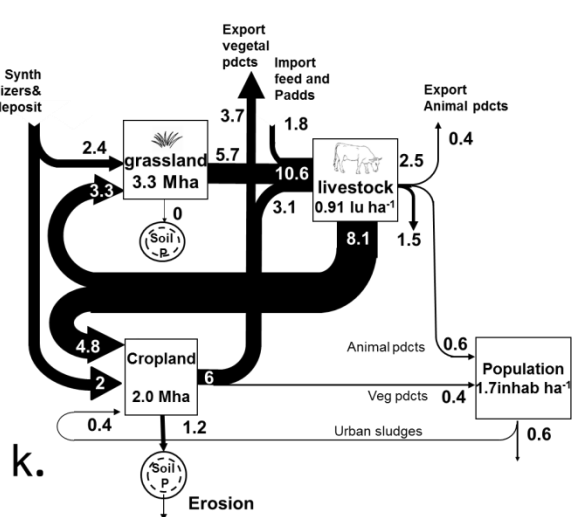

**k.**

**Carbon, kgC haUAA<sup>-1</sup> yr<sup>-1</sup>**

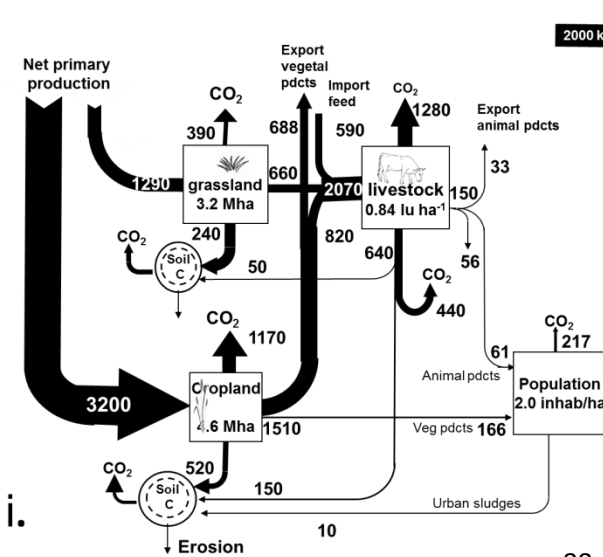

**i.**

200 kgC ha<sup>-1</sup> yr<sup>-1</sup>  
2000 kgC ha<sup>-1</sup> yr<sup>-1</sup>

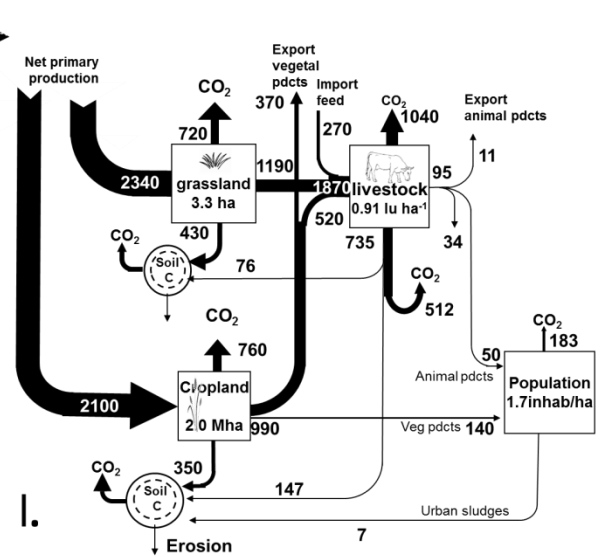

**l.**

**Disconnected intensive crop-extensive livestock farming system regions, 2006**  
 Nitrogen, kgN.haUAA<sup>-1</sup>.yr<sup>-1</sup>

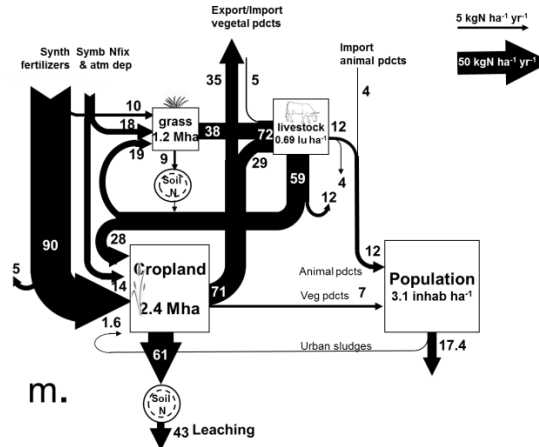

**Phosphorus, kgP haUAA<sup>-1</sup> yr<sup>-1</sup>**

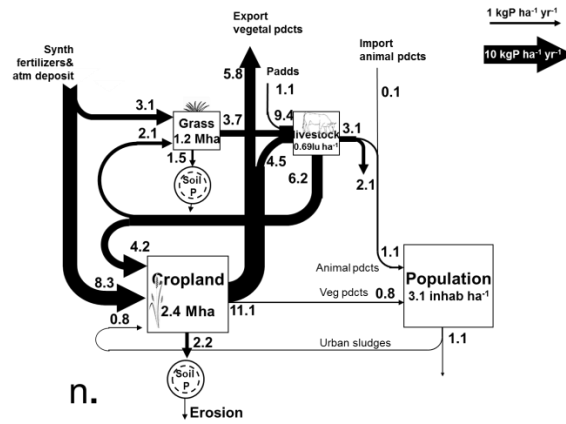

**Carbon, kgC haUAA<sup>-1</sup> yr<sup>-1</sup>**

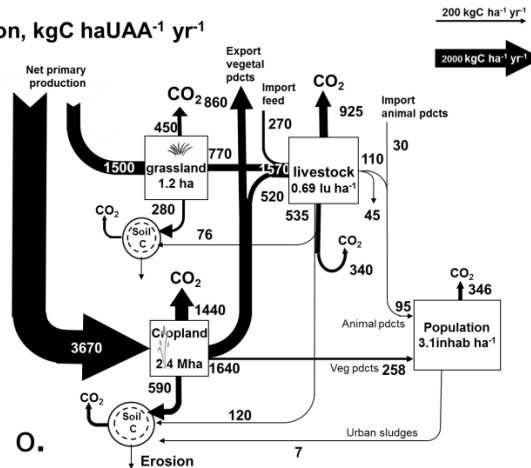

**Figure 2.6** Representation, in 2006, of the N, P, and C fluxes across the agro-food system, expressed in kg per ha of utilizable agricultural area of (a, b, c) the “intensive arable land” system region, (d, e, f) the “intensive livestock farming” system, (g, h, i) the “fodder-fed integrated crop and livestock farming” system, (j, k, l) the “grass-fed integrated crop and livestock farming” system, (m, n, o) the “disconnected intensive crop-extensive livestock farming” system. Squares represent transformation processes occurring in the corresponding environmental compartments. The width or black arrows are proportional to the intensity of the fluxes involved in these processes. Circles represent storage pools of N, P or C in the soil compartments; the dotted circle figures the initial state, the solid circle the final stage.



### 3.3. Environmental and agronomical performances of production patterns

#### 3.3.1. Environmental performance

The production patterns observed in the five typological regions were also associated with differing environmental effects in terms of the N and P resources mobilized, with P primarily stored in the soil and N mainly lost to the atmosphere and the hydrosphere. Table 2.3 illustrates the value of these environmental indicators expressed per hectare of cropland and grassland, inferring the environmental performance from a regional perspective. Looking first at the environmental imprint for crop production, it appears that regions included in the “intensive arable land” and “disconnected intensive crop-extensive livestock farming” system types were by far the largest consumers of mineral N and P fertilizers. In the “intensive crops-extensive livestock farming” system, the high inputs of mineral fertilizer were not compensated by output through crop harvested and, as a consequence, led to the highest N surplus with  $87.3 (\pm 9.9)$  kgN ha<sup>-1</sup> cropland yr<sup>-1</sup> but to small positive P budgets ( $3.2 (\pm 1.4)$  kgP ha<sup>-1</sup> cropland yr<sup>-1</sup>) since other type of inputs remained limited. The small contribution of *new* N and P inputs through manure (as defined in section 2.1) in this type of system confirmed that livestock was mainly fed by locally grown crops and grass. The large quantity of synthetic fertilizers in the intensive arable land types came from the almost total lack of organic inputs combined with the high demand for N and P to support the high productivity of cropland, leading to intermediate N balance and negative P budget ( $49.1 (\pm 9.7)$  kgN ha<sup>-1</sup> cropland yr<sup>-1</sup> and  $-3.6 (\pm 1.4)$  kgP ha<sup>-1</sup> cropland yr<sup>-1</sup>). The negative P budget in cropland indicates that some regions with this production pattern have begun to mine their soil P reserve, still substantial.

The opposite pattern occurred in “intensive livestock farming” systems where the use of mineral fertilizers over cropland was among the lowest, but the *new* N and P inputs through manure application were the highest. Lower crop production, however, led to an imbalance between total N and P inputs and outputs, resulting in high N and P balances ( $80.1 (\pm 11.8)$  kgN ha<sup>-1</sup> cropland yr<sup>-1</sup> and  $9.9 (\pm 4.4)$  kgP ha<sup>-1</sup> cropland yr<sup>-1</sup>).

Both fodder-fed and grass-fed “integrated crop and livestock farming” systems presented intermediate trends, since these types of region had intermediate N and P inputs and balances over cropland, although the “grass-fed integrated crop and livestock farming” clearly showed the best environmental performances. It is remarkable that mineral fertilizers remained the largest input from outside of the system (about 70% of exogenous N and P inputs in both systems, i.e. excluding inputs through recycled manure). However, when accounting for internal manure recycling, manure contributed to 58% and 37% of N fertilization and 66% and 54% of P fertilization in grass-fed and fodder-fed “integrated crop and livestock farming” systems respectively

The environmental imprint regarding grassland production followed similar trends to that described above for cropland. The main difference was the far larger contribution of symbiotic N fixation to new N inputs to grassland soil (between 13 and 34% of the total N inputs,

excluding inputs through recycled manure) than for cropland (between 2 and 9% of the total N inputs).

Overall, this analysis revealed that, from a regional point of view, specialized agricultural systems (either cropping or livestock farming systems) were clearly associated with the highest environmental losses and resource consumption, whereas the “integrated crop and livestock farming” systems were characterized by lower N and P consumptions leading to moderate N and P balance. These findings are in good agreement with the several studies by Lassaletta et al. (2014 a, b, c, d) and Anglade et al. (2015a), revealing that the increasing specialization of the agricultural systems’ production on global and sometimes national or sub-national scales (as in Spain, or the North of France) has led to a complete reshaping of the N cycle as well as increased water pollution and GHG emissions.

**Table 2.3** Environmental indicators expressed per unit of agricultural surface within each of the five main agricultural systems in France. Numbers in parenthesis indicate uncertainties

	Intensive arable land	Grass-fed integrated crops and livestock farming	Fodder-fed integrated crops and livestock farming	Disconnected Intensive culture - extensive livestock	Intensive livestock farming
<b>Nitrogen</b>					
N mineral fertilizers to cropland (kgN ha <sup>-1</sup> yr <sup>-1</sup> )	116 (± 4.6)	43.0 (± 1.7)	84.4 (± 3.4)	129 (± 5.0)	64.0 (± 2.9)
N fixation to cropland (kgN ha <sup>-1</sup> yr <sup>-1</sup> )	14.0 (± 1.9)	7.1 (± 1.0)	8.8 (± 1.4)	7.0 (± 1.1)	2.77 (± 0.3)
New N manure to cropland (kgN ha <sup>-1</sup> yr <sup>-1</sup> )	0.32 (± 0.7)	9.4 (± 2.5)	17.9 (± 4.5)	3.0 (± 0.7)	61.5 (± 15.5)
N mineral fertilizers to grassland (kgN ha <sup>-1</sup> yr <sup>-1</sup> )	28.6 (± 2.2)	26.3 (± 2.0)	32.3 (± 2.5)	28.1 (± 2.1)	46.6 (± 3.6)
N fixation to grassland (kgN ha <sup>-1</sup> yr <sup>-1</sup> )	34.2 (± 6.8)	34.5 (± 6.8)	28.6 (± 5.7)	40.8 (± 8.1)	28.2 (± 5.6)
New N manure to grassland (kgN ha <sup>-1</sup> yr <sup>-1</sup> )	0.78 (± 0.19)	5.4 (± 1.5)	9.8 (± 2.8)	3.1 (± 0.8)	50.8 (± 4.8)
N balance in cropland (kgN ha <sup>-1</sup> yr <sup>-1</sup> )	49.1 (± 9.7)	51.6 (± 12.2)	67.9 (± 9.4)	87.3 (± 9.9)	80.1 (± 11.8)
N balance in grassland (kgN ha <sup>-1</sup> yr <sup>-1</sup> )	30.2 (± 13.3)	26.4 (± 13.5)	42.4 (± 11.9)	25.7 (± 15.3)	99.4 (± 17.4)
NH <sub>3</sub> emission from total UAA (kgN ha <sup>-1</sup> yr <sup>-1</sup> )	12.2 (± 0.9)	15.7 (± 2.0)	17.7 (± 1.8)	17.1 (± 1.6)	34.4 (± 4.3)
<b>Phosphorus</b>					
P mineral fertilizers to cropland (kgP ha <sup>-1</sup> yr <sup>-1</sup> )	8.6 (± 0.3)	4.8 (± 0.2)	7.1 (± 0.3)	11.8 (± 0.5)	5.3 (± 0.2)
P mineral fertilizers to grassland (kgP ha <sup>-1</sup> yr <sup>-1</sup> )	8.4 (± 0.7)	3.5 (± 0.3)	5.9 (± 0.5)	8.7 (± 0.8)	10.6 (± 0.9)
New P manure to cropland (kgP ha <sup>-1</sup> yr <sup>-1</sup> )	0.23 (± 0.05)	2.2 (± 0.5)	3.7 (± 0.9)	0.82 (± 0.18)	13.2 (± 4.4)
New P manure to grassland (kgP ha <sup>-1</sup> yr <sup>-1</sup> )	0.08 (± 0.02)	1.5 (± 0.4)	1.1 (± 0.3)	0.33 (± 0.07)	0.75 (± 0.29)
P balance in cropland (kgP ha <sup>-1</sup> yr <sup>-1</sup> )	-3.6 (± 1.4)	2.9 (± 2.6)	2.4 (± 1.5)	3.2 (± 1.4)	9.9 (± 4.4)
P balance in grassland (kgP ha <sup>-1</sup> yr <sup>-1</sup> )	5.4 (± 1.7)	-0.06 (± 1.4)	4.2 (± 1.4)	4.5 (± 1.8)	13.0 (± 3.1)
<b>Carbon</b>					
Humified C inputs to cropland (kgC ha <sup>-1</sup> yr <sup>-1</sup> )	1030 (± 108)	1360 (± 150)	1160 (± 120)	1050 (± 123)	1040 (± 116)
Humified C inputs to grassland (kgC ha <sup>-1</sup> yr <sup>-1</sup> )	817 (± 183)	824 (± 185)	700 (± 150)	796 (± 160)	793 (± 158)

### 3.3.2. Agronomical performance

The environmental performance indicators discussed above can be put into perspective for agronomical performance evaluation by expressing them per unit of vegetal and animal production, which reflects the nutrient use efficiency of the production process. Table 2.4 illustrates the resources and the environmental cost per unit of vegetal and animal production, respectively, thus indicating the agro-environmental performance.

On the whole, the production of one unit of vegetal product used up to 1.5–4.5 times less N and P input than one unit of animal product. Similarly, vegetal production generated N and P balances up to five times less than one unit of animal product (Table 2.4). By comparing the agronomic performance of the different types of production pattern for their vegetal production, it appears that nutrient requirement was the lowest for “arable land” systems, e.g., 1.65 ( $\pm 0.07$ ) kgN required per kgN of vegetal products and 0.77 ( $\pm 0.11$ ) kgP per kgP of vegetal products. This corresponds to NUE of 68% ( $\pm 6$ ) and PUE of 129% ( $\pm 12$ ). The particularly low requirement of P per unit of vegetal product may reflect the negative P balance for cropland in this typological region (Figure 2.5d above). Low requirement of P was physically possible probably because of the utilization of a huge P legacy resulting from intensive fertilizer application over the past few decades (Figure 2.1c) (Rowe et al., 2016; Sattari et al., 2012). For “disconnected intensive crop-extensive livestock farming” regions, the lower NUE resulted from the excess rate of fertilization in these regions. For the “intensive livestock farming” regions, low NUE of cropping systems could be explained, to a certain extent, by the high stocking size generating excessive N inputs through manure application on cropland.

Regional nutrient requirement for animal production was lower for “intensive livestock farming” systems with 2.27 ( $\pm 0.50$ ) kgN and 1.36 ( $\pm 0.16$ ) kgP of new resources required per unit of N and P of animal product, respectively. This corresponds to NUE of 42% ( $\pm 5$ ) and PUE of 74% ( $\pm 9$ ). By contrast, “grass-fed integrated crop and livestock farming” systems had higher nutrient requirement for N with 4.86 ( $\pm 0.96$ ) kgN.kgN<sup>-1</sup> but similar P requirement with 1.33 ( $\pm 0.47$ ) kgP.kgP<sup>-1</sup> of animal products, respectively. This corresponds to NUE of 22% ( $\pm 5$ ) and PUE of 76% ( $\pm 8$ ) (Table 2.4). In “intensive livestock farming” systems, with a high animal production rate per hectare (75.1 ( $\pm 7.2$ ) kgN ha UAA<sup>-1</sup> yr<sup>-1</sup> or 38.4 ( $\pm 3.1$ ) kgP ha UAA<sup>-1</sup> yr<sup>-1</sup>), the high NUE was partly due to a high proportion of monogastric animals with a much higher conversion coefficient of vegetal into animal proteins compared to ruminants (conversion coefficients were 0.23 ( $\pm 0.01$ ) vs 0.08 ( $\pm 0.00$ ), respectively, for “intensive livestock farming” and “grass-fed integrated crop and livestock farming” systems). The highest N and P balances in cropland per unit of animal production were found in regions of fodder-fed and grass-fed “integrated crops and livestock farming” and “intensive crop-extensive livestock farming” systems. Finally, while looking at N balances in grassland generated per unit of animal production, “grass-fed integrated crop and livestock farming” regions presented the strongest impact followed by “fodder-fed integrated crop and livestock farming” while “intensive livestock farming” regions presented the lowest N balance on grassland (Table 2.4). This ranking actually mainly reflects the time spent on grassland and the resulting inputs of animal excreta.

**Table 2.4** Environmental indicators expressed per unit of animal or vegetal product within each of the five main agricultural systems in France and nutrient use efficiency for vegetal and animal production. Numbers in parenthesis indicate uncertainties.

	Intensive arable land	Grass-fed integrated crops and livestock farming	Fodder-fed integrated crops and livestock farming	Intensive culture - Extensive livestock	Intensive livestock farming
<b>Nitrogen</b>					
Mineral fertilizer					
kgN kgN <sup>-1</sup> vegetal product	1.2 (± 0.1)	0.78 (± 0.10)	1.1 (± 0.1)	1.5 (± 0.1)	0.88 (± 0.13)
kgN kgN <sup>-1</sup> animal product	2.3 (± 0.4)	1.7 (± 0.5)	1.9 (± 0.4)	2.7 (± 0.4)	0.45 (± 0.14)
Symbiotic fixation					
kgN kgN <sup>-1</sup> vegetal product	0.32 (± 0.3)	0.63 (± 0.09)	0.41 (± 0.05)	0.39 (± 0.05)	0.31 (± 0.05)
kgN kgN <sup>-1</sup> animal product	1.1 (± 0.2)	2.3 (± 0.4)	1.1 (± 0.1)	1.3 (± 0.2)	0.18 (± 0.2)
N inputs invested for imported feed					
kgN kgN <sup>-1</sup> vegetal product	0.13 (± 0.03)	1.7 (± 0.5)	2.8 (± 0.6)	0.48 (± 0.11)	1.0 (± 0.2)
kgN kgN <sup>-1</sup> animal product	0.08 (± 0.06)	0.86 (± 0.26)	1.2 (± 0.6)	0.32 (± 0.08)	1.64 (± 0.32)
N balance in cropland					
kgN kgN <sup>-1</sup> vegetal product	0.39 (± 0.10)	0.27 (± 0.13)	0.32 (± 0.10)	0.55 (± 0.10)	0.36 (± 0.15)
kgN kgN <sup>-1</sup> animal product	0.77 (± 0.25)	1.1 (± 0.5)	1.5 (± 0.3)	1.6 (± 0.4)	0.88 (± 0.16)
N balance in grassland					
kgN kgN <sup>-1</sup> animal product	0.78 (± 0.34)	1.5 (± 0.8)	1.0 (± 0.3)	0.71 (± 0.42)	0.15 (± 0.03)
N volatilization UAA					
kgN kgN <sup>-1</sup> animal product	1.0 (± 0.1)	1.4 (± 0.1)	0.85 (± 0.05)	0.96 (± 0.06)	0.43 (± 0.03)
Overall N use efficiency of vegetal production (%)	67.6 (± 6.1)	65.8 (± 7.0)	60.5 (± 5.2)	51.8 (± 4.9)	44.7 (± 4.3)
Overall N use efficiency of animal production (%)	28.6 (± 4.4)	20.1 (± 4.6)	23.4 (± 2.9)	23.8 (± 3.4)	41.7 (± 5.4)
<b>Phosphorus</b>					
Mineral fertilizer					
kgP kgP <sup>-1</sup> vegetal product	0.76 (± 0.08)	0.88 (± 0.26)	0.72 (± 0.16)	1.1 (± 0.1)	0.66 (± 0.21)
kgP kgP <sup>-1</sup> animal product	1.1 (± 0.1)	0.91 (± 0.31)	1.0 (± 0.2)	1.6 (± 0.2)	0.21 (± 0.06)
P inputs invested for imported feed					
kgP kgP <sup>-1</sup> vegetal product	0.01 (± 0.003)	0.25 (± 0.12)	0.29 (± 0.12)	0.06 (± 0.02)	1.2 (± 0.4)
kgP kgP <sup>-1</sup> animal product	0.13 (± 0.03)	0.40 (± 0.16)	0.70 (± 0.11)	0.25 (± 0.05)	1.0 (± 0.1)
P balance in cropland					
kgP kgP <sup>-1</sup> vegetal product	-0.23 (± 0.08)	0.13 (± 0.14)	0.01 (± 0.06)	0.14 (± 0.10)	0.89 (± 0.44)
kgP kgP <sup>-1</sup> animal product	-0.29 (± 0.08)	0.31 (± 0.24)	0.30 (± 0.14)	0.36 (± 0.12)	0.28 (± 0.12)
P balance in grassland					
kgP kgP <sup>-1</sup> animal product	0.56 (± 0.19)	-0.01 (± 0.35)	0.40 (± 0.14)	0.49 (± 0.21)	0.07 (± 0.02)
Overall P use efficiency of vegetal production (%)	129 (± 12)	88 (± 9)	99 (± 10)	88 (± 9)	53 (± 7)
Overall P use efficiency of animal production (%)	78 (± 9)	76 (± 8)	58 (± 7)	54 (± 7)	74 (± 9)

Overall, results presented in this section suggest an inverse relationship between environmental and agronomic performances of agricultural systems. This anti-symmetry between the environmental footprint per area unit versus per agricultural production unit has already been highlighted by Chatzimpiros and Barles (2013), who stressed that high productivity at individual animal and crop levels in specialized intensive systems is often associated with high nutrient loss over the whole agricultural system. The improvement of crop yields generally involves heavy fertilization with lower NUE (Tilman et al., 2002), while intensive livestock farming give rise to an overconcentration of livestock, resulting in a high amount of manure excretion with a low opportunity for recycling in the agricultural system. To sum up, applying the GRAFS approach revealed the systemic impacts of production patterns on environmental and agronomic performances at the regional level.

## **4. N fluxes associated to agricultural commodity trade: a consequence of regional specialization**

The interconnection of the regional agricultural systems studied in section 3 can be now investigated in order to shed light on the relation between production and trade patterns. We made the choice of analyzing commercial fluxes of agricultural commodities in terms of N because of the structuring role of this element in the biogeochemical functioning of agro-food systems. However, the N:P:C stoichiometry of each agricultural product would enable to translate N fluxes embedded in trade in terms of P and C fluxes, which would result in trade fluxes about 10 times lower for P and 10 times larger for C.

### **4.1. Implication of the different agricultural regions in agricultural commodity trade**

Raw trade fluxes are defined here by cumulating absolute value of imports and exports of all agricultural commodities for each region and then dividing by two this total in order to avoid double counting of fluxes between regions. Analyzing raw fluxes of inter-regional and international agricultural commodities trade revealed a quite contrasted contribution of the different French regions: 80% of trade fluxes indeed involved only 45% of regions (Figure 2.7a).

The ratio of raw trade fluxes to total agricultural production of each region (Figure 2.7b) provides an indicator of the degree of openness of their agro-food system. There is a sharp contrast between, on the one hand, regions of the Atlantic seaboard, Mediterranean regions and highly populated regions (such as Ile-de-France, Ain-Rhône and Alsace) and on the other hand, regions of the East and the Center of the country that remain much less involved in agricultural commodity trade. At the national level, N fluxes embedded in agricultural trade are 1.6 times the total agricultural production (in ton N).

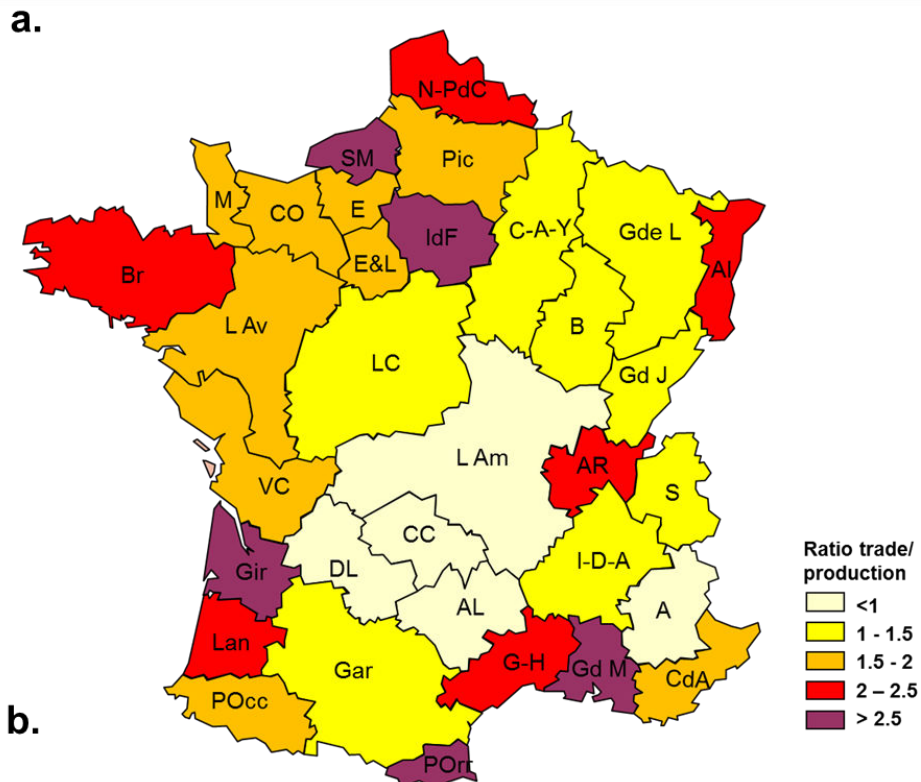
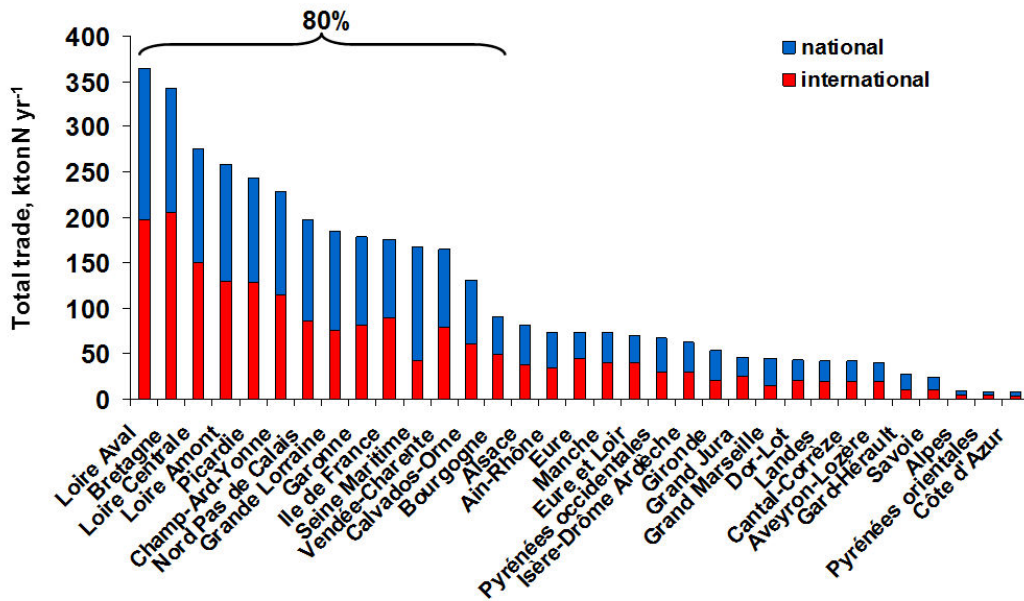
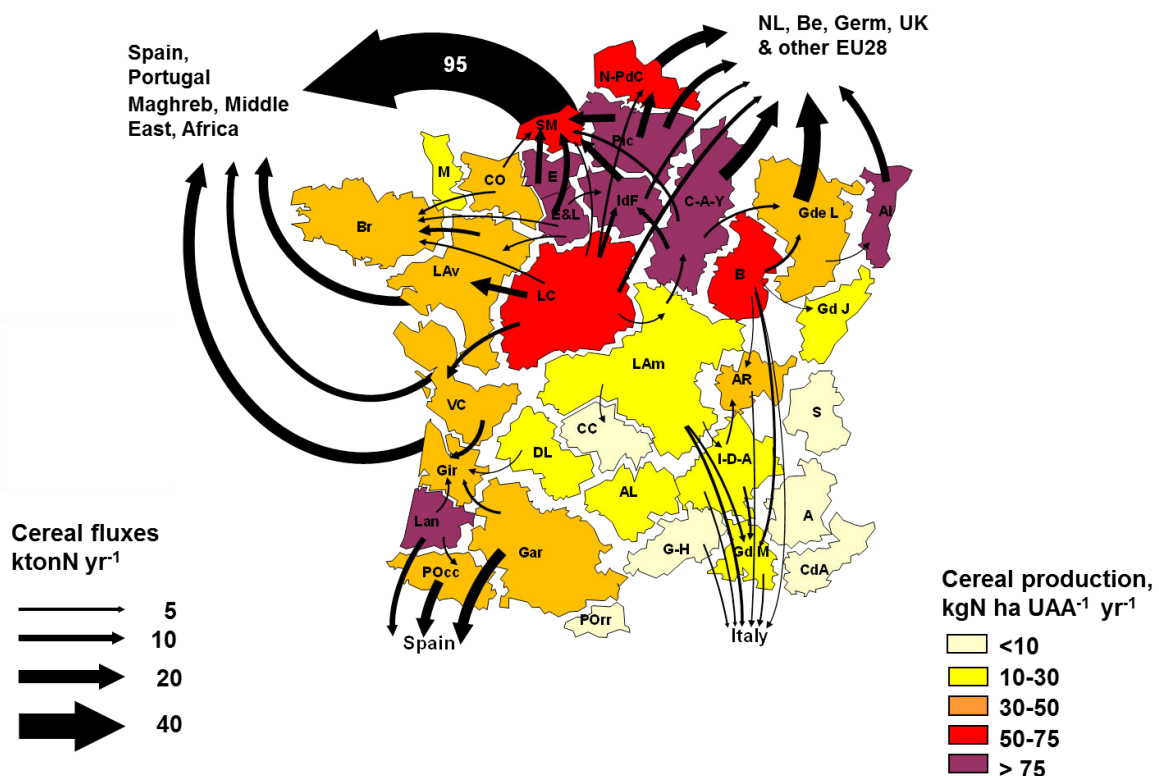

**Figure 2.7** *a.* Inter-regional and international exchanges of nitrogen in agricultural commodities for the different groupings of French departments. *b.* Spatial distribution of the ratio between long distance trade and local production (crop and forage). A: Alpes; Al: Alsace; AL: Aveyron-Lozère; AR: Ain-Rhône; B: Bourgogne; Br: Bretagne; C-A-Y: Champagne-Ardenne-Yonne; CC: Cantal-Corrèze; CdA: Côte d'Azur; CO: Calvados-Orne; DL: Dordogne-Lot; E: Eure; E&L: Eure-et-Loire; Gar: Garonne; Gd J: Grand Jura; Gd M: Grand Marseille; Gde L: Grande Lorraine; G-H: Gard-Hérault; Gir: Gironde; I-D-A: Isère-Drôme-Ardèche; IdF: Ile de France; L Am: Loire Amont; L Av: Loire Aval; Lan: Landes; LC: Loire Centrale; M: Manche; N-PdC: Nord Pas-de-Calais; Pic: Picardie; Pocc: Pyrénées Occidentales; POr: Pyrénées Orientales; S: Savoie; VC: Vendée-Charentes.

## 4.2. Net N fluxes embedded in the different types of agricultural commodities

In 2006, cereal exports from France were 44 times higher than imports: 252 ktN yr<sup>-1</sup> were exported, mainly to Maghreb and the Middle East, northern Europe, the Iberian Peninsula and Italy, compared to a production of 879 ktN yr<sup>-1</sup> in 2006. Most of these exports took place from sea harbors (Rouen, Dunkerque, Saint-Nazaire, La Rochelle, Bordeaux, Marseille) or river ports (Metz) to which cereal fluxes from cereal-growing plains of the Paris Basin converged (Figure 2.8). These latter regions are those characterized as “arable land” systems (Figure 2.5b).

### Cereals

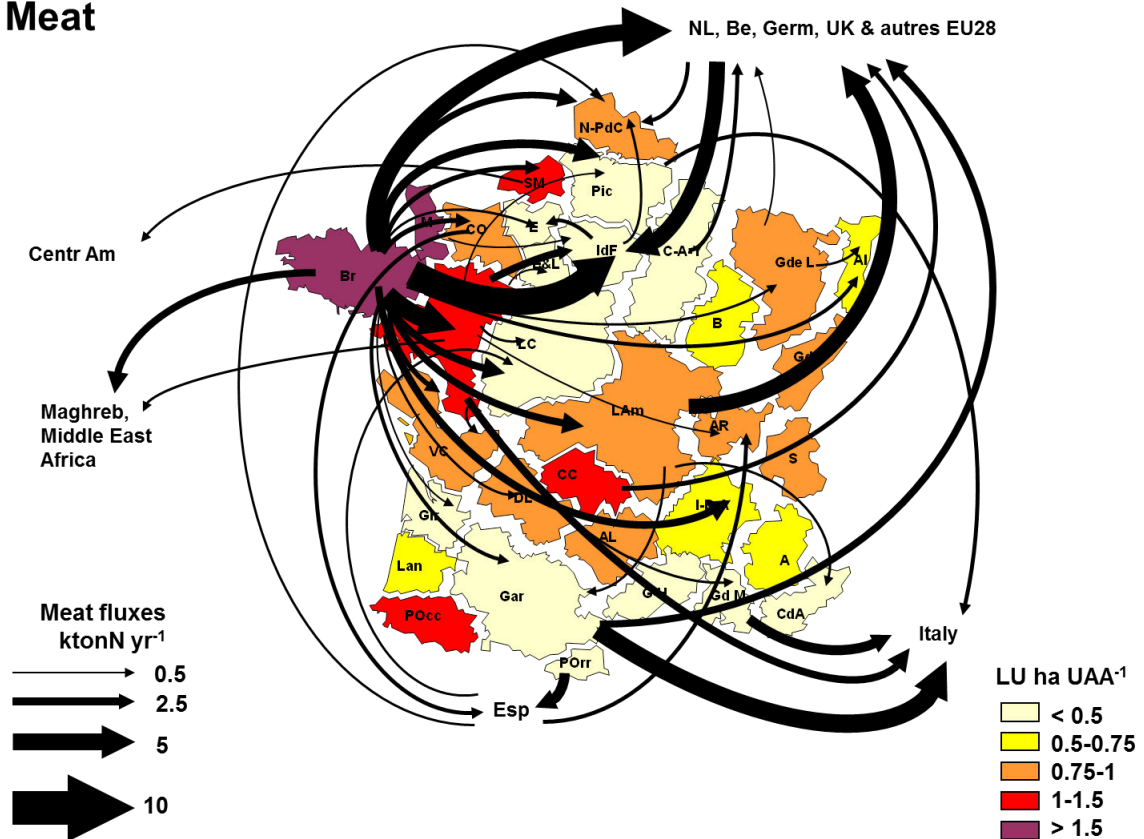

**Figure 2.8** Main net fluxes of cereals exchanged between agricultural regions. Unless explicitly indicated, the width of the arrows is proportional to the flux intensity. Cereal production per unit of total agricultural surface is indicated by a color scale.

Regarding trade fluxes of meat, Figure 2.9 clearly reveals the leading role of Brittany that supplied almost all French regions as well as international market, with Ile-de-France, Loire Aval and northern Europe, being the main destination areas. Brittany exported 52 ktN yr<sup>-1</sup> of meat with a total production of 99 ktN yr<sup>-1</sup> in 2006. This trade pattern is coherent with the definition of Brittany as “intensive livestock farming” (Figure 2.5b). The Ile-de-France region, with a high population density and food production pattern of « intensive arable land » type (Figure 2.5b) was the largest importer of meat.



## Meat



**Figure 2.9** Main net fluxes of meats exchanged between agricultural regions. Unless explicitly indicated, the width of the arrows is proportional to the flux intensity. Livestock unit per hectare of total agricultural is indicated by a color scale.

Overall, France was a net exporter of dairy product, with 23 ktN yr<sup>-1</sup> being exported abroad, out of a total production of 139 ktN yr<sup>-1</sup>. However, inter-regional fluxes dominated with the Manche and Brittany regions being the largest suppliers to other French regions while the Ile-de-France region concentrated flows from the center, the east and the west of France (Figure 2.10). The case of Manche is of particular interest because it was characterized as an “intensive integrated crop and livestock farming” system (Figure 2.5b) but its trade pattern revealed a specialization in dairy products, which can be counterintuitive. This means that this region was, at the same time, almost autonomous for its agricultural production (livestock was fed for more than 85% with local grass and crop production while manure contributed to 65% and 45% of crop and grassland fertilization respectively), with a significant herd (1.5 LU ha UAA<sup>-1</sup>) specialized in dairy production, as shown by its low exportation of meat products (Figure 2.9) but high exportation of dairy products (Figure 2.10). Such a food and trade pattern can be explained by the relatively low population density (85 inhab km<sup>-2</sup>) which makes it easy to produce enough food for local population, and by the high share of permanent grasslands in the UAA (54 %) which precludes the need for animal importation while allowing significant livestock density.





## Fruits and vegetables

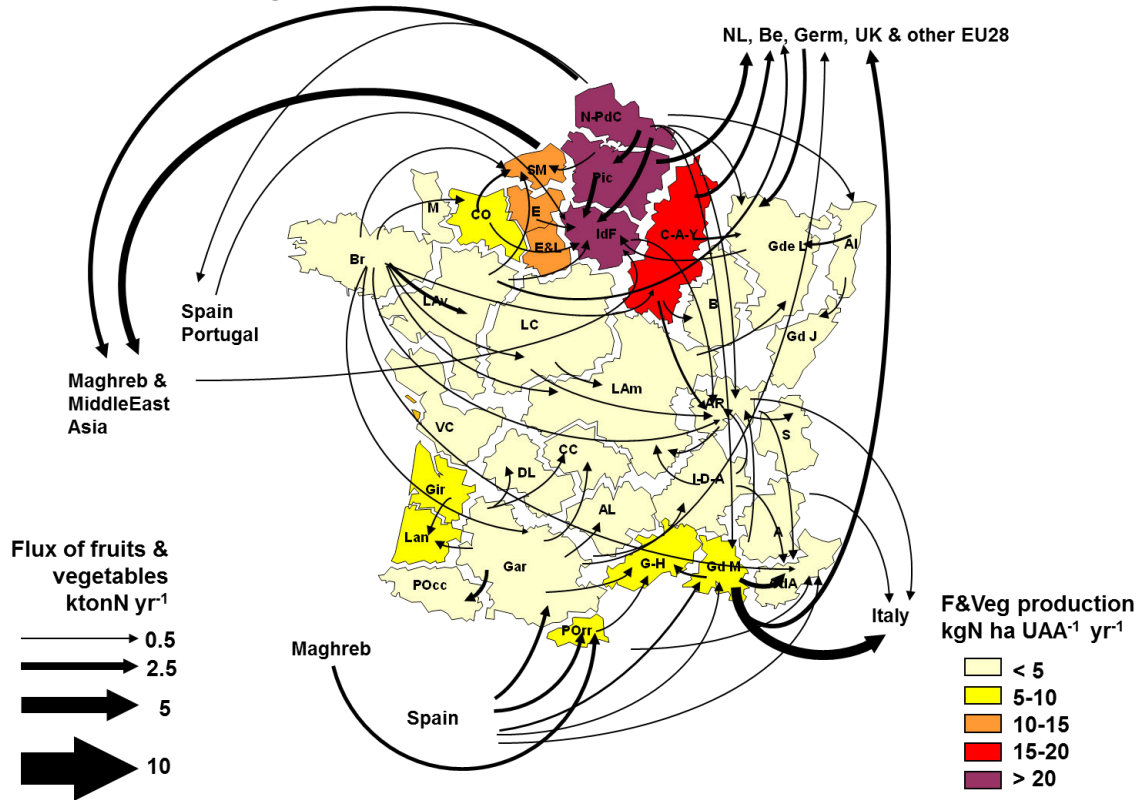

**Figure 2.12** Main net fluxes of fruits and vegetables exchanged between agricultural regions. Unless explicitly indicated, the width of the arrows is proportional to the flux intensity. Fruits and vegetables production per unit of total agricultural surface is indicated by a color scale.

### 4.3. Identification of main trade patterns

The sum of all N fluxes embedded in agricultural good trade provides a synthetic view of inter-regional and international exchanges. Overall, France was a net exporter in terms of proteins, as it imported  $284 \text{ ktN yr}^{-1}$  of animal feed but exported  $390 \text{ ktN yr}^{-1}$ , in the form of cereals, meat and dairy products, fruits and vegetables. According to their net balance of total N protein trade, regions can be characterized as net importer (or heterotroph following the definition proposed by Billen et al., 2010), net exporter (autotroph) or balanced (Figure 2.13). Net importer regions were either regions with high LU density relying on livestock feed imports (e.g., Brittany and Loire Aval) or region densely populated (e.g., Ile-de-France, Ain-Rhône, Grand Marseille, Gironde). Large exporter of proteins concentrated in the Paris Basin for which production pattern was defined as “intensive arable land” system (Figure 2.5b).



**The North-East of France** (Alsace, Grande Lorraine, Bourgogne, Jura and, to a lesser extent, Champagne-Ardenne-Yonne) differs from this large area: it is characterized by large exportation of cereals to northern Europe. Importations are much lower although livestock production is sometimes significant and relies much less on importation.

**The Rhône valley** structures the exchanges within regions of a South-East quarter of France. Densely populated, Lyon and Marseille represent centers of consumption; they are supplied by diverse regions but mostly by neighboring regions (45 % of importations to Ain-Rhône, Grand Marseille and Côte d'Azur). The area is a minor exporter of meat and fruits products to foreign countries, mainly Spain and Italy. Although trade patterns seem to be determined by population density and geographical factors, the relative self-sufficiency and low exportation are also coherent with the food patterns of the regions identified as “integrated crop and livestock farming” and “disconnected intensive crop-extensive livestock farming” (Figure 2.5b)

**The South-West area** running from Vendée-Charente to Garonne is characterized by significant mutual exchanges, but also by an active role in international trade with exportation of meat and maize to the Iberian Peninsula, which is in line with the dominance of “intensive crop-extensive livestock farming” and “intensive arable land” systems in this area (Figure 2.5b). Surprisingly importations of soybean from Latin America are also important but might be re-exported after processing.

Lastly, **the center of France** (Loire Amont, Cantal-Corrèze, Dor-Lot, Aveyron-Lozère) steers clear of exchanges, including with neighboring regions. The low population density, the mountainous geography and the dominance of food production patterns defined as “grass-fed integrated crop and livestock farming” are consistent with this trade pattern.

Overall, the analysis of trade pattern reveals the importance of trade in the N mobility, thus adding a component to the N cascade in the environment. Results provided by sections 3 and 4 revealed that the more regional agricultural systems are specialized, the more they are involved in agricultural commodity trade. Similarly, the more densely regions are populated, the more they are involved in agricultural commodity trade. Therefore, two types of spatial specializations are key determinants of N fluxes embedded in agricultural trade: rural *versus* urban area and specialization in livestock *versus* crop production. Consequently, the openness of nutrient cycles in agricultural systems is not only resulting from agricultural practices (e.g., mineral fertilization) but is also the consequence of the structural characteristics of agro-food systems at different scale (regional, national and international). In some French regions, the integration of agricultural production to international market highlights the lack of functional complementarity between neighboring regions which precludes closing nutrient cycle at the local or regional scales. The case of France also shows that specialization and interdependency found at the regional level are practically a homothety of what had already been observed between macro-regions at the international level (Lassaletta et al., 2014a; Billen et al., 2014).

## **5. Imprint of Megacities on their food supplying areas: the case of Paris Megacity**

The key role of population density in the trade of agricultural products and therefore in nutrient fluxes in agro-food systems prompts switching from a perspective of agricultural production to a perspective of food consumption. The question concerning the impact of urban area on agro-food system may be stated as follows: how is the segregation between rural productive areas and urban consumer areas reflected in terms of environmental imprint over supplying areas? To answer this question we take here as an example the case of Paris Megacity which represents a paroxysmal case of densely populated urban area.

### **5.1. The agro-food system supplying Paris Megacity**

The analysis of the transport matrix concerning the 33 French agricultural regions and foreign countries reveals strong spatial segregation between regions supplying vegetal or animal products to Paris Megacity.

Five regions provided 80% of the Paris Megacity supply of vegetal proteins in 2006, namely Ile-de-France, Champagne-Ardennes-Yonne, Loire Centrale, Picardie and Eure-et-Loir. Those regions are highly specialized in field crop production (Figure 2.5b) and their production of animal proteins is negligible. In view of their spatial distribution around Paris Megacity (Figure 2.14), the whole area is hereafter called the “Central Paris Basin” and classified as an “intensive arable land” area (Figure 2.5b).

The animal protein supply is much more dispersed: 19 French regions contributed more than 1% each and together supply 55% of Paris Megacity animal proteins. On the one hand, three of these regions – Bretagne, Loire Aval and Manche – accounted for 32% of the Paris Megacity animal protein supply. They are characterized by high livestock density (1.6, 1.5 and 1.1 LU ha UAA<sup>-1</sup> for Brittany, Loire Aval and Manche respectively), which, in the case of Brittany, depends on massive imports of animal feed from South America (Figure 2.11). As those regions are spatially distributed in western France (Figure 2.14), the whole area is hereafter called the “Great West” and is classified as an “intensive livestock farming” area, although only Brittany was strictly defined as such in the typology of Figure 2.5a. Regarding imports of feed to the Great West region from South America, they represented 67% of the 302 ktN yr<sup>-1</sup> imported to France. These imports are essential to support cattle breeding in the Great West, which satisfies about one-third of Paris Megacity animal protein requirement; hence South America took a significant, yet indirect, part in the food supplying area of Paris Megacity that we define hereafter as a “soybean cultivation” area.

On the other hand, the 16 remaining regions represented 23% of the animal food supply. They are much less specialized in one or another type of production, but they occupy a larger agricultural area; in addition, the proportion of permanent grassland is largely equivalent to that of arable land. For the sake of simplicity, in this section, we referred to the regions previously

defined as fodder-fed and grass-fed “integrated crop and livestock farming” and “intensive crop-extensive livestock farming” only as “mixed crop and livestock farming”. We call the “Great East” an area formed by six regions (Loire Amont, Grande Lorraine, Cantal-Corrèze, Ain-Rhône, Isère-Drôme-Ardèche and Bourgogne), which supply 13% of Paris Megacity animal food.

Furthermore, various foreign countries contribute to the animal food supply (Figure 2.14). Their local environmental imprint is not directly calculated because of the lack of information regarding the functioning of the agro-food system and the uncertainties regarding their N and P environmental losses. Yet based on literature data (Billen et al., 2014) foreign countries were classified as being close to the “intensive livestock farming” or “mixed crop and livestock farming” systems. This allows us to estimate the share of animal proteins provided by “intensive livestock farming” regions or “mixed crop and livestock farming” regions (Figure 2.14).

In summary, our analysis reveals four distinct typical areas contributing to the Paris Megacity food supply, each with its own agricultural system/orientation. These regions are (i) the **Central Paris Basin**, specialized in crop farming; (ii) the **Great West** with intensive livestock farming, strongly dependent on soybean cultivation in **South American countries** as feed suppliers; and (iii) the **Great East** with mixed crop and livestock farming. To gain better insight into the agricultural metabolism of each of the four types of territory supplying Paris Megacity, we established the full GRAFS diagram of N and P flows across their agricultural systems (Figure 2.15a–h).



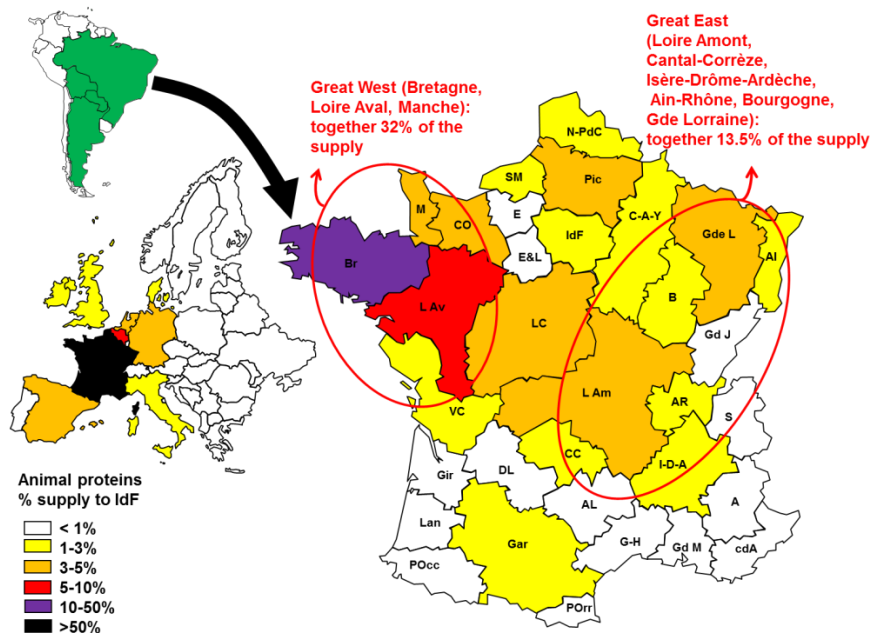

**Supply of animal proteins**

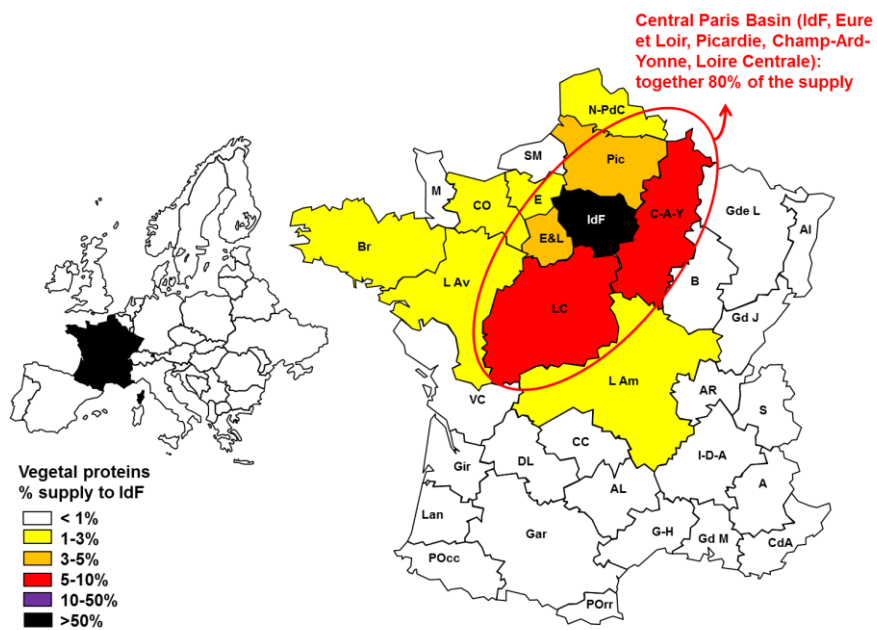

**Supply of vegetal proteins**

**Figure 2.14** Contribution of different agricultural regions to the supply of animal and vegetal proteins to Paris Megacity (calculated from trade statistic, see section 2.2 above). South American soy exporting countries represent important feed suppliers to the intensive livestock farming systems of the Great West.



## 5.2. Environmental imprint of Paris Megacity food supply

As stated above, the imprint of Paris Megacity food consumption in each supplying area is defined as the resources consumed and the environmental nutrient losses, which are attributable to the food supply of Paris Megacity. Table 2.5 summarizes the calculated imprints over the four main supplying areas which contribute 62% of the total protein supply of Paris Megacity. Overall, this agricultural area is estimated at about 2.5 million ha of which approximately one-third are grassland areas, almost all located in the mixed crop and livestock farming area. When these absolute numbers are reduced to the population of Paris Megacity, it appears that 0.22 ha is required for this part of the food supply per inhabitant (62%). Of these, only 0.012 ha, or about 5%, is dedicated to the supply of vegetal proteins, the remaining being mostly devoted to meat and milk production. The total environmental N imprint of these agricultural activities within these areas can be characterized by their soil N balance, estimated to 139 ( $\pm 32$ ) ktN yr<sup>-1</sup> with about one-fourth of this balance in grassland, and by their NH<sub>3</sub> volatilization, amounting to 39 ( $\pm 4.1$ ) ktN yr<sup>-1</sup>.

**Table 2.5** Estimation of the environmental imprint of Paris Megacity over its main supplying areas.

	Category	Central Paris Basin	Great west	South America	Great East and similar*	Total
<b>Surface, ha</b>	<b>Cropland</b>	120 000 ( $\pm 18\ 200$ )	530 000 ( $\pm 92\ 400$ )	270 000 ( $\pm 42\ 000$ )	380 000 ( $\pm 110\ 000$ )	1 300 000 ( $\pm 190\ 000$ )
	<b>Grassland</b>	-	135 000 ( $\pm 21\ 000$ )	-	1 000 000 ( $\pm 150\ 000$ )	1 135 000 ( $\pm 175\ 000$ )
<b>N Fertilizers, ktN yr<sup>-1</sup></b>	<b>Cropland</b>	16 ( $\pm 2.5$ )	12 ( $\pm 4.7$ )	16 ( $\pm 2.6$ )	34 ( $\pm 9.7$ )	78 ( $\pm 13$ )
	<b>Grassland</b>	0.18 ( $\pm 0.04$ )	4.6 ( $\pm 0.9$ )	-	18.5 ( $\pm 3.9$ )	23 ( $\pm 4.8$ )
<b>Feed Import, ktN yr<sup>-1</sup></b>	<b>Livestock</b>	4.8 ( $\pm 1.6$ )	33 ( $\pm 8.1$ )	-	10.0 ( $\pm 2.5$ )	48 ( $\pm 12$ )
	<b>Livestock</b>	-	13 ( $\pm 2.0$ )	-	26 ( $\pm 4.0$ )	39 ( $\pm 4.1$ )
<b>NH<sub>3</sub> emission, ktN yr<sup>-1</sup></b>	<b>Cropland</b>	5.8 ( $\pm 1.6$ )	14 ( $\pm 5.8$ )	18 ( $\pm 5.0$ )	25 ( $\pm 9.2$ )	63 ( $\pm 22$ )
	<b>Grassland</b>	-	8.8 ( $\pm 2.9$ )	-	28 ( $\pm 12.9$ )	37 ( $\pm 16$ )
<b>N balance, KtN yr<sup>-1</sup></b>	<b>Cropland</b>	1.7 ( $\pm 0.47$ )	1.2 ( $\pm 0.48$ )	7.8 ( $\pm 2.1$ )	3.5 ( $\pm 1.0$ )	14 ( $\pm 1.3$ )
	<b>Grassland</b>	0.05 ( $\pm 0.01$ )	0.74 ( $\pm 0.15$ )	-	3.4 ( $\pm 0.82$ )	4.2 ( $\pm 0.95$ )
<b>P fertilizers, ktP yr<sup>-1</sup></b>	<b>Cropland</b>	-0.31 ( $\pm 0.39$ )	1.3 ( $\pm 0.91$ )	0.70 ( $\pm 0.86$ )	0.89 ( $\pm 0.93$ )	2.6 ( $\pm 1.3$ )
	<b>Grassland</b>	-	0.71 ( $\pm 0.36$ )	-	2.1 ( $\pm 1.5$ )	2.8 ( $\pm 1.8$ )
<b>P balance, ktP yr<sup>-1</sup></b>	<b>Livestock</b>	-	5.1 ( $\pm 1.1$ )	-	1.4 ( $\pm 0.45$ )	6.5 ( $\pm 1.5$ )
	<b>Livestock</b>	-	1.2 ( $\pm 0.37$ )	-	0.48 ( $\pm 0.15$ )	1.7 ( $\pm 0.51$ )

\*All French” integrated crop and livestock farming” and “intensive crop-extensive livestock farming” regions contributing more than 1% of the animal food supply of Paris Megacity.

More specifically, it appears that the mixed crop and livestock farming area is the most costly in terms of the surface required to feed Paris as well as of N and P fertilizers and N balance on arable land. However, as pointed in sections 3 and 4, this area is almost self-sufficient since it requires low net imports of feed from other regions to sustain its livestock production. In contrast, the intensive livestock farming area imports a substantial amount of feed from South America, making these two areas part of a same system. With this in mind, it appears that the environmental imprint of Paris Megacity is not so different for both systems and is higher in

terms of P balance on arable lands compared to the intensive livestock farming/soybean cultivation regions.

To summarize, Figure 2.16 shows the main fluxes of N and P resources mobilized and/or lost to the environment attributable to the animal and vegetal food supply of one inhabitant in Paris Megacity (Esculier, 2018; Esculier et al., 2018). With the environmental imprint of Paris Megacity becoming less and less significant on the urban area itself, Paris Megacity has nearly completely externalized the environmental imprint of human metabolism on agricultural lands. It makes it largely invisible for urban dwellers, seldom conscious that pollution in South America or in the Great West is directly related to their consumption of food.

When looking only at the absolute figures, the imprint of the vegetal product supply to one inhabitant in Paris Megacity is much lower than the impact of the intensive livestock farming coupled with its South American feed supplier's area, which is itself similar to that of the integrated crop and livestock farming areas. However, when compared with the corresponding surface area involved, the figures of nutrient losses per hectare show a different picture, where the large mixed crop and livestock farming areas are characterized by much more diluted losses than the intensive livestock farming area and even than the specialized crop farming area, with lower impact on hydrosystems. Accordingly, although the environmental imprint of Paris Megacity appears to be strong on the mixed crop and livestock farming system, it is most probable that the dilution of the calculated values over a large surface area leads to the least impact on the surrounding agro-ecosystem. This is in line with results presented in section 3.3 where we observed better environmental performances in regions defined as “integrated crop and livestock farming” systems.

kgN cap<sup>-1</sup> yr<sup>-1</sup>

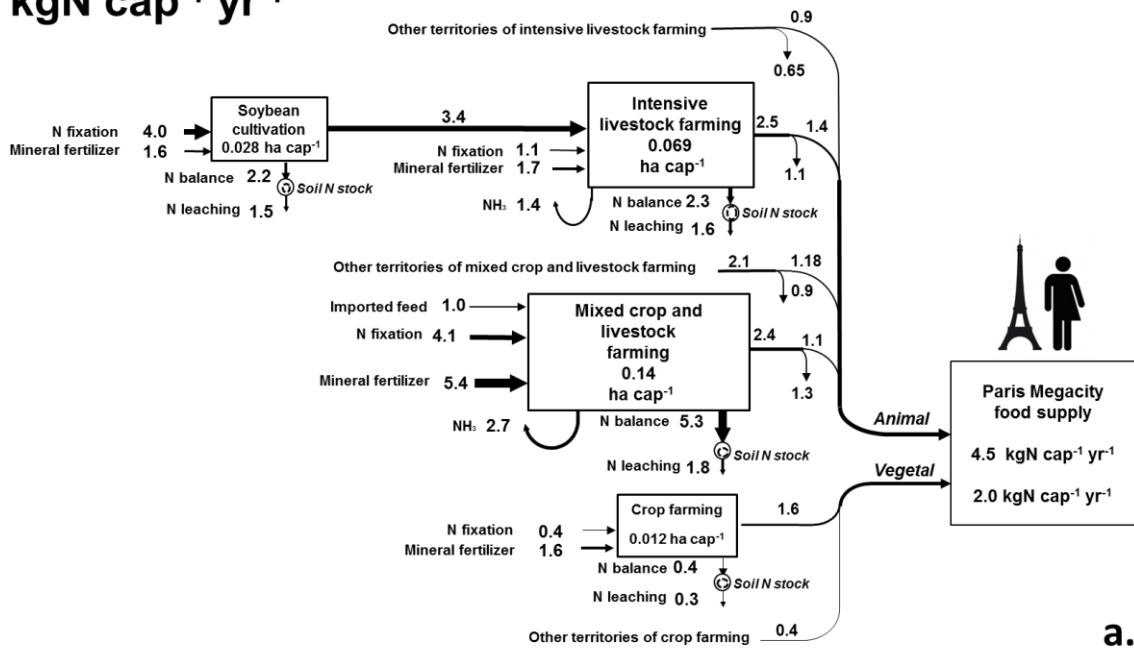

kgP cap<sup>-1</sup> yr<sup>-1</sup>

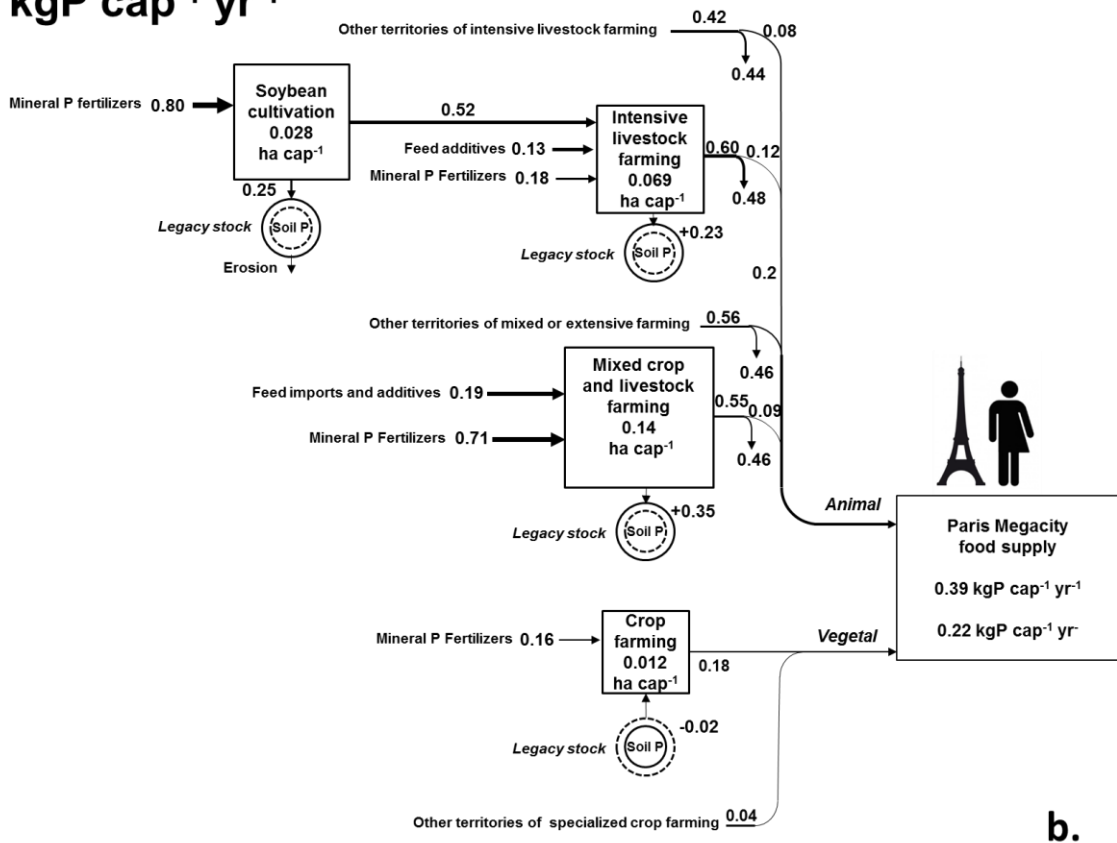

**Figure 2.16** Flows of: **a.** nitrogen and; **b.** phosphorus which can be attributed to the food supply of one inhabitant of Paris Megacity in the different agricultural areas involved. The flows are expressed in kgN or kgP per capita and per year (in Esculier et al., 2018; Esculier, 2018).

Analyzing the imprint of Paris Megacity for its food supply suggests that Human metabolism is a key element around which the whole agro-food system is organized since ingestion of food is one of the core, vital drivers of sustaining human life. The intensity of the megacity's socioecological regime depends enormously on the human diet. Two-thirds of the ingested N and P come from animal products, but they account for more than 90% of N and P agricultural inputs and 95% of surfaces dedicated to food production. Furthermore, compared to the needs of N ingestion of  $3.3 \text{ kgN cap}^{-1} \text{ yr}^{-1}$  (WHO, 2007), Paris Megacity's mean diet currently contains 150% of this level. This difference between the healthy diets recommended by the WHO and the actual diet of Parisian (and French people in general) indicates that the demand for food largely exceeds the vital needs.

In light of the overall results of this chapter, this raises the question of whether consumption is determining the shape of agro-food system metabolism (including production, trade and consumption), or are the food production patterns the main drivers. Although it might be answered that each subsystems (production, trade and consumption) are all the cogs of the same agro-food system, logic suggests, however, that it is first necessary to produce food to consume it as a second step. In other words, if the offer meets the basic demand, the demand remains subject to increase in response to increasing offer. Besides, in the case of the French agro-food system where some of the regional agricultural systems are massive, extremely performing, capable to provide as much animal protein as desired and where the transport system allows connecting distant areas, the consumption can be as massive and as meat-oriented as is permitted. If it is true that the vital requirements of human metabolism sets a minimum level of production, in the current French context where less than 5% of assets are in the agricultural sector, it is clear that food production goes well beyond the needs of farmer's metabolism and rather serves the metabolism of society as a whole. Therefore the human metabolism of Parisians appears to be a consequence of the agro-food system by which it is sustained rather than a cause; consequently it should not be regarded as a static entity determining the production objectives, but rather as a dynamic one largely shaped by the productive system.

## 6. Conclusion: toward more sustainability in the agro-food-trade system

This chapter shows that there is considerable room for improvement in increasing sustainability of agro-food system while minimizing the biogeochemical imprint of megacities such as Paris. Analyzing simultaneously food production, trade and consumption patterns highlighted the interlinkages between the different components of the agro-food systems.

The French agro-food system is a composite of very different agricultural systems at the regional level with the more specialized having the highest environmental imprint in terms of N and P. These results highlight the systemic impacts of production patterns on environmental performances. It is clear, therefore, that deep structural changes of the agro-food system, beyond the mere optimization of agricultural practices, are necessary to further reduce the environmental imprint of agricultural production. In line with findings from other studies (Lemaire et al., 2014; Bonaudo et al., 2014; Garnier et al., 2016; Billen et al., 2016), our results suggest that inverting the specialization trend and reconnecting crop and livestock farming is likely to be the best options for reducing agricultural nutrient pollution. Besides, analyzing N fluxes embedded in trade of agricultural commodities stressed the significant interdependency existing between the most specialized agricultural systems as well as between rural producing areas and urban consuming areas. It also emphasized the role of trade in opening nutrient cycles. Last but not least, taking a consumption perspective pointed out the high environmental losses externalized by Paris Megacity and the opening of nutrient cycles induced by the linear pattern of production – trade – consumption – excretion with no way back to agricultural land.

This chapter also showed that the agronomic and environmental imprints are by far larger for animal than for vegetal production, although these imprints also depend on the regional food production patterns. This is illustrated by our finding that the largest imprint of Paris Megacity food supply is related to livestock breeding rather than to vegetal production. This implies that any reduction of the proportion of animal products in the human diet, as advocated by the 2009 Barsac declaration (<http://www.nine-esf.org/barsac-declaration>), would have a tremendous lever effect on the agricultural imprint. Lowering the total quantity of ingested proteins is also not only possible but recommended by French health authorities (Haut Comité de la Santé Publique, 2000). It would trigger a decrease in the intensity of the imprint of Paris Megacity on agricultural land. Exploring scenarios, several studies at the regional and global scale have demonstrated that a reduction in animal protein in the diet, while reconnecting crop and livestock production, would clearly reduce ground and surface water nitrate contamination, major changes that are compatible with organic farming (Billen et al., 2015; Garnier et al., 2016; Lassaletta et al., 2016; Anglade et al., 2017).

However, even with these possible improvements of agro-food system sustainability, the separation between rural and urban area is challenging for the circularity of fluxes. Esculier et al. (2018) have shown that current sewer system and considerable food waste in Paris Megacity preclude the closing of nutrient cycles while generating important N and P losses to

hydrosystems. Therefore, the necessity of closing nutrient cycle questions the sustainability of highly urbanized area such as Paris Megacity but also the sustainability of the technical infrastructures of human excreta and organic waste management. This issue has been addressed by Esculier (2018) who demonstrated that a complete overhaul in toilet and sewage systems together with a reduction in the perimeter of food supplying areas would be necessary to close the loop of nutrient cycles.

On the whole, this chapter enables to identify the main levers that should be activated to reach more sustainability in agro-food systems: human diet, structure of regional agricultural systems and human excretion management. We suggest that such major changes in agro-food systems could only arise from a political willing at the national or even international level. Which type of group of persons and how such a political willing could be carried on remain an open question here since the results brought out by this chapter do not allow providing a final decision to this question. However, our analysis suggest that the main efforts should be first placed at the production level as it seems to be the cogs likely to induce the biggest changes in the wheel of agro-food systems.

Nevertheless, it has to be kept in mind that our approach based on N, P and, to a lesser extent, C fluxes is necessarily limited in its findings. Describing agro-food systems solely through nutrients flows leaves aside many other aspects of these systems: water consumption, greenhouse gas emissions, energy requirements and sanitary issues are also constitutive of the metabolism sustaining food production, trade and consumption. The snapshot approach used in this chapter and the focus on biophysical dimensions do not allow directly accounting for the economic and political logics that shape nutrient fluxes in agro-food systems. Furthermore the regional perspective used here places emphasis on the importance of structural organization of agro-food system on environmental and agronomic performances but leaves aside the agricultural practices which should also be investigated for specific cases at the farm level. Linking structure to practices at various scales is the purpose of the next chapter.





## **Chapter III**

### **Phosphorus management in cropping systems of the Paris Basin: from farm to regional scale**

*The farm scale is the one at which day to day decisions are taken regarding agricultural practices. Taking the example of phosphorus fertilization, we here examine how these decisions may be linked to regional structural characteristics and heritages from the past.*

*This Chapter is based on the publication “Phosphorus management in cropping systems of the Paris Basin: from farm to regional scale” by Le Noë et al. (2018) in Journal of Environmental Management.*



# 1. Introduction

In agricultural systems, the export of the harvested biomass production inexorably leads to the depletion of soil phosphorus (P) reserves if those outputs are not compensated by new inputs to the soil. Historically, manure and other organic inputs enabled farmers to maintain soil fertility and to close the P loop at the local or regional scale (Mazoyer and Roudart, 1997), with rock alteration being sufficient to compensate for the inevitable losses of P through soil erosion. This changed at the turn of the 20<sup>th</sup> century with the discovery of P mines and the concomitant development of the mineral fertilizer industry. In countries having benefited from these advances, the consequence was a complete overhaul of P management in agricultural systems, shifting from a quite closed cycle at the farm or regional scale to a largely open P cycle at the international scale (Cordell et al., 2009; Ashley et al., 2011; Ulrich and Frossard, 2014). The increasing specialization of agriculture led to the spatial segregation of animal and vegetal production and the tripling of the global P flux to the biosphere compared to the preindustrial level (McDonald et al., 2012). However, the current access to mined P resources and the P legacy in soil inherited from past fertilization vary widely from one country to another (McDonald et al., 2011) and phosphate deposits are limited, nonrenewable and unevenly distributed across the globe (Cordell et al., 2009; Elser and Bennett, 2011). Moreover, not all the P reserve in soil is useful for plant growth: only the P in the soil solution and the P that can be easily desorbed from particles are available for plants. Phosphorus is certainly indispensable to crops, but an excess of P can also be detrimental to the surrounding water ecosystems. Many studies have reported severe cases of eutrophication attributable to the erosion and run-off of soils over-enriched in P (Garnier et al., 1995, 2005; Carpenter et al., 1998; Sharpley et al., 2014). The sustainable management of P in agriculture is therefore a complex issue requiring that agricultural practices, the structure of agro-food systems and the impact on the environment be elucidated.

In organic farming (OF), the use of chemical fertilizers is prohibited (Regulation No 834/2007 of the European Commission) and P fertilization is only based on organic inputs (e.g., crop residue, manure), or untreated phosphate rocks. Without external input, P management in OF is therefore likely to diminish P inputs and losses but may also decrease the soil P content. In many respects, OF has been proved to lessen the impacts on the environment when compared with conventional farming (CF) by increasing soil organic matter content and reducing nitrate leaching (Tuomisto et al., 2012; Benoit et al., 2014, 2016), enhancing soil biodiversity (Bengtsson et al., 2005) and improving manure recycling (Pimentel et al., 2005). However, the sustainability of OF with regard to P management is still under debate. Oehl et al. (2002) observed an adequate level of available P after 21 years of organic cropping systems, whereas Morel et al. (2006) detected a decrease of P availability in OF systems in France. Recently, several reviews (Rowe et al., 2016; Withers et al., 2015) have examined the P management issue from a holistic perspective. For instance, the 5R strategy (Re-align P inputs, Reduce P losses, Recycle P in bioresources, Recover P in wastes, and Redefine P in food systems) proposed by Withers et al. (2015) embraces aspects from the technical management of P resources on fields including management of the P soil legacy, to the redesign of P use in society and agro-food systems while Rowe et al. (2016) outlined how the biophysical, management and

behavioral factors should be taken into account in order to better utilize the soil legacy P as part of a more sustainable management

The analysis and assessment of P management are more often addressed from a system perspective at the global (McDonald et al., 2011) or national and regional (Hansrud et al., 2016 in Norway; Garnier et al., 2015 in France and Viet-Nam) levels, while a narrower technical perspective is generally adopted at the farm or field level (Oehl et al., 2002; Messiga et al., 2010). Yet, multiscale analyses of P management combining field study with regional analysis are needed to provide an assessment of the relative impacts of agricultural practices and structural features of agro-food systems. This implies selecting indicators of farming practices and soil status that could be linked at the farm scale and then extrapolated at the regional scale. The soil P budget is a meaningful indicator of agricultural practices because it reflects the potential accumulation or depletion of P in soil (Oenema et al., 2003) while plant-available soil P content is a commonly used soil status indicator (Bai et al., 2013). Several protocols for assessing plant-available soil P content have been proposed to assess both risks of deficiency for plant growth and losses to the environment. This includes isotopic dilution (Fardeau et al., 1985), resin extraction (Amer et al., 1955) and numerous chemical extraction as illustrated by Neyroud and Lisher (2003) among which the Olsen, Bray and Mehlich extraction. Blake et al. (2003) have shown that change in soil-available P is positively and linearly correlated to P budget and similarly, a case study performed by Messiga et al. (2010) revealed that soil-available P is positively and linearly correlated to cumulated P budget.

The aim of this chapter is therefore to assess the relative influence on P management of (i) agricultural practices (including organic and conventional farming) and (ii) the structure of agro-food systems, by analyzing the P budget and soil-available P in contrasted cropping systems (farm scale) and agro-food systems (regional scale). To this end, we addressed the issue of P sustainability in OF and CF by comparing P budgets and soil-available P status of 14 cropping systems in commercial crop farms of a participative network in the Paris Basin region (<http://www.eauetbio.org/experiences-locales/umpc-cnrs-ephe-abac/>). This approach was then up-scaled to the regional level using the Generalized Representation of the Agro-Food System (GRAFS) methodology as presented in chapter I. Specifying the relative influence of the components involved in the P cycle will make it possible to identify the main levers to be activated to reach sustainable P management within the specific ecological context of French regions, and more specifically in the Paris Basin region.

## 2. Material and methods

### 2.1. Field scale

#### 2.1.1. *Site location and description of the participative network of farms*

In this chapter, the same agricultural systems as described by Benoit et al. (2016) are studied. This corresponded to 14 cropping systems in 12 commercial farms of which six were organic farming (OF) and eight conventional farming (CF) systems. All these farms in the network have been monitored since 2013 for soil physical and chemical properties such as texture, bulk density, total C, N and P contents. Aside from lack of agrochemical products and chemical fertilizer, the OF systems studied also differed from CF systems in the nature and duration of their rotations (7–9 years), which includes at least 2 years of forage legume. In contrast, the CF rotations lasted 2–4 years and were mainly composed of cash crops, with wheat being the predominant crop.

All organic and conventional systems are located across four areas with distinct soil and climate conditions: (i) the Oise *département* (EU Nuts 3 administrative unit); (ii) the northeast of the Seine-et-Marne *département* (Paris region); (iii) the southeast of the Seine-et-Marne *département* and (iv) the Yonne *département*. Mean annual temperatures and rainfall are 9.7°C and 697 mm, 11.3°C and 676 mm, 10.7°C and 880 mm for the first, second and third, and fourth areas, respectively (Météo France weather station of Saint Quentin, Melun and Cruzy). A map of the Seine Basin watershed and location of the organic and conventional participative farms is provided in Figure 3.1. All areas are encompassed within the Paris Basin, a geological unit with a very typical structure of concentric sedimentary rocks piling from the Triassic to the Miocene period, overlaid by a silt layer of a variable thickness (Meybeck et al., 1998). The loess layer confers a fine grain size to the soil of the Paris Basin, which makes it one of the most fertile in the world. The Oise area is characterized by a chalky substratum covered with a fine layer of silt loam soil; both areas of the Seine-et-Marne department have a deep loamy soil with hydromorphic conditions, while the Yonne department is characterized by a limestone soil (Benoit et al., 2016).

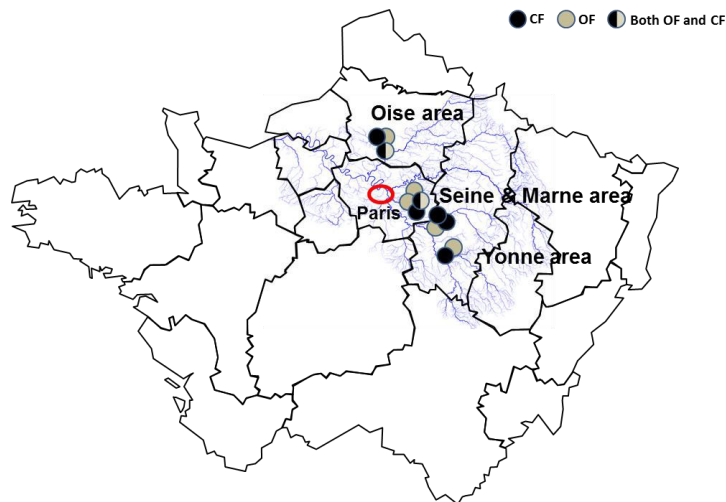

**Figure 3.1** Map of the Seine Basin watershed and location of the organic and conventional participative farms. Black circles indicate conventional farms, grey circles indicate organic farms and black and grey circles indicate farms with both organic and conventional cropping systems (after Benoit et al., 2016).

The Paris Basin has substantial agricultural activity with 60 % of the utilized agricultural area (UAA) being arable land, mostly specialized in cash crop production with wheat covering almost half the arable land (29 % of the UAA). In the Paris Basin, OF occupies less than 2 % of the UAA, compared to 4.9 % for the national mean in 2012 (Agence Bio, 2017).

### 2.1.2. P budget over the cropping system at the farm scale

The P budget over the whole rotation of each cropping system was estimated as the difference between P inputs through mineral and organic fertilizers and P outputs through harvested crops (Figure 3.2). In the previous study by Benoit et al. (2016), surveys on agricultural practices between 2013 and 2015, a 2-year period, were conducted. Surveys included fertilizer inputs, crop rotation, crop yields, tillage, straw management and presence or lack of catch crops. Data from these surveys are aggregated to reconstruct an average crop rotation of the investigated plots and fertilizer input in each cropping system (Table 3.1).

The mean P output from the whole rotation was calculated as the sum of the frequency of occurrence (from 0 to 1) of each type of crop in the rotation multiplied by its mean yield (in  $\text{kton ha}^{-1} \text{yr}^{-1}$ ) and by its P content ( $\text{kgP kg}^{-1}$  of product). Phosphorus content in each crop was taken from Garnier et al. (2015). The frequency of occurrence of one given crop in the rotation was taken as the number of occurrences of this crop in the whole rotation during the 2-year period divided by the number of plots cultivated during the same period. This procedure accounts for all crops and plots cultivated during this 2-year period and takes full advantage of the surveys carried out, given the lack of a long-term chronicle. Similarly, mean P input to the rotation was calculated as the sum of the input frequency (from 0 to 1) of each type of fertilizer applied during the 2-year observation period multiplied by the mean supply rate (in  $\text{kton ha}^{-1} \text{yr}^{-1}$ ) and P content ( $\text{kgP kg}^{-1}$  of fertilizer). Phosphorus contents in each type of organic fertilizer were taken from diverse sources (Martel et al., 2013; MEEM, 2002; Huber and Schaub, 2011).

**Table 3.1** Description of conventional (CF) and organic (OF) cropping systems of the participative network (from Benoit et al., 2014 and Benoit et al., 2016)

	Location	soil texture and orgC content(upper 30 cm)				Main crop in rotation (frequency in the rotation**)	Nbs of plots	Average P inputs	Average P output
		%clay	%silt	%sand	%org C			kgP ha yr <sup>-1</sup>	kgP ha yr <sup>-1</sup>
CF1*	Seine et Marne	21	67	12	1.06	wheat (40 %), spring faba bean (20 %), sugar beet (40 %)	2	7	28
CF2	Seine et Marne	21	65	14	1.16	wheat (56 %), spring faba bean (11 %), spring maize (33 %)	2	0	22
CF3	Seine et Marne	22	74	5	1.12	wheat (42 %), sugar beet (25 %), spring maize (33 %)	3	9	20
CF4	Seine et Marne	20	68	12	0.95	wheat (42 %), rapeseed (17 %), spring maize (17 %), winter barley (8 %)	3	6	24
CF5	Seine et Marne	21	65	14	1.06	wheat (42 %), rapeseed (25 %), sugar beet (17 %), winter barley (17 %)	4	7	22
CF6*	Oise	24	67	9	1.88	wheat (58 %), rapeseed (8 %), peas (17 %), spring flax (17 %)	3	0	27
CF7	Oise	21	72	7	0.79	wheat (33 %), sugar beet (33 %), peas (8 %), oat (17 %), barley (8 %)	3	4	21
CF8	Yonne	20	58	22	0.95	wheat (38 %), barley (19 %), rapeseed (19 %), oat (19 %), maize (6 %)	4	4	23
OF1*	Seine et Marne	21	68	11	1.14	alfalfa (30%), wheat (30%), flax (15 %), faba beans (5%), green bean (15 %), spelt (5 %)	6	15	17
OF2	Seine et Marne	19	76	5	1.14	alfalfa (20 %), wheat (39 %), triticale (11 %), flax (8 %), faba bean (8 %), lentils (6 %), oat (6 %)	8	16	18
OF3	Seine et Marne	18	66	16	0.95	Winter Sainfoin (17 %), wheat (30 %), triticale (9 %), winter trefoil (13 %), faba beans (9 %), spring lentils (13 %), spring potatoe (4 %), alfalfa (4 %)	6	4	13
OF4	Yonne	19	54	27	1.18	alfalfa (29 %), wheat (29 %), spring faba bean (8 %), lentils (4 %), spelt (4 %), triticale (4 %), barley (4 %), oat (4 %), soya (4 %), sunflower (4 %), rye (4 %)	6	0	9
OF5	Oise	24	67	9	1.3	alfalfa (9 %), wheat 31 %, spring faba bean (14 %), spelt (6 %), spring vegetable (9 %), lentils (6 %), spring maize (9 %), oat (6 %)	9	0	13
OF6*	Oise	24	67	9	1.88	alfalfa (38 %), wheat (29 %), triticale (13 %), spring maize (13 %), spelt (6 %), oat (6 %)	3	0	13

\* Note 1: OF 1 and CF 1 correspond to the same farm but encompass both organic and conventional cropping systems. This is also the case for OF 6 and CF 6.

\*\* Note 2: Crops representing at least 4% of the rotation are provided.



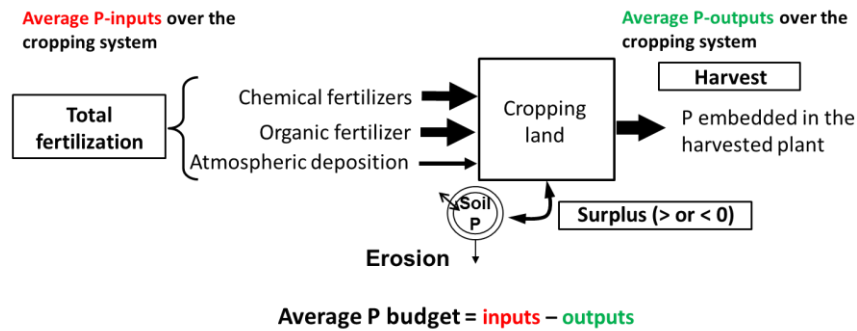

**Figure 3.2** Principles of the calculation of the mean soil P budget over the cropping system for each commercial farm

### 2.1.3. Sampling and laboratory analysis of total soil phosphorus

Soil samples were collected between October and December 2015 at every plot of the participative network with an auger at 0–30 cm deep in triplicate and pooled together into one sample. Samples were transported to the laboratory in capped 200-mL flasks and then stored at 4°C prior to further analysis. Fresh soils were weighed (30 g) and oven-dried at 105°C until constant weight to determine moisture content. All extractions of total and available P were performed after freeze-drying and grinding of the soil samples. Total soil P content was measured by the calcination of 0.85 g of soil at 550°C for 20 h and subsequent extraction of 0.75 g of calcined soil by 30 mL of 1 M HCl for 18 h (Némery et al., 2005).

### 2.1.4. Determination of soil-available P

Soil-available P is theoretically defined as the stocks of P in soil that can be used by plants over their development period. The available P at any given moment is the sum of the dissolved inorganic phosphate (DIP) in soil solution and of the P sorbed onto soil particles labile enough to replenish the soil solution when the DIP concentration gradient increases. However, moving from theoretical concept to practical quantification of soil-available P is quite difficult. Measured values of available P for the same soil have been found to vary as much as a hundredfold depending on the nature of the extraction solution (Neyroud and Lisher, 2003). Such variations provide evidence of soil P lability gradients and stress the decisive nature of methodological choices. In this chapter, the extraction of available P using the Olsen method (Olsen, 1954) was chosen because it has been shown to extract very few forms of recalcitrant P (Fardeau et al., 1988). It is also one of the most widely used methods in the world and in France, which helps for comparison with other studies reported in the scientific literature. Furthermore, the Olsen method has been chosen by the French Committee for Study and Development of Reasoned Fertilization (COMIFER, 1995) to establish upper and lower reference thresholds of P status in the various arable soils of France and for different crop types. For a given crop in a given soil, the upper Olsen P threshold indicates the limit above which fertilization can be skipped, whereas the lower Olsen P threshold indicates the limit below which fertilization should be strengthened. Soil-available P measured by the Olsen method is referred to as Olsen P in the rest of this chapter.

However, this type of method by simple chemical extraction does not account for the soil–plant system complexity (Morel et al., 2011). The DIP content in the soil solution is governed by

multiple sorption/desorption, precipitation/dissolution and immobilization/mineralization reactions with varying kinetics (Fardeau et al., 1985; Morel and Fardeau, 1991; Pellerin et al., 2009). To account for these processes, we measured the soil-available P using anion-exchange resins. This method is based on ligand exchange ( $\text{HCO}_3^-$ ) by resin and better mimics the physical and chemical conditions in the rhizosphere. Several studies (Gunary and Sutton, 1967; Bache and Rogers, 1970; Metwally et al., 1975; Kadeba and Boyle, 1978; Bache and Ireland, 1980) have shown that resins provided better correlations with P uptake by plants than other methods based on chemical extraction. Schneider and Morel (2000) found that measurements of soil-available P by resin were very similar, if not identical, to those using the isotope dilution method with  $^{32}\text{P}$ . Soil-available P measured using the resin method is referred to as resin P in the rest of this chapter.

#### 2.1.5. Laboratory analysis of available P using the Olsen and resin methods

The measurement protocol of Olsen P was adapted from Olsen (1954) and Fardeau et al. (1988) and optimized through several tests. A 2 g sample of ground and lyophilized soil was shaken with 40 mL of  $\text{NaHCO}_3$  solution (0.5 M) for 5 h and then centrifuged at 10,000 rpm before analysis of phosphate ions in the supernatant by spectrophotometry (Gallery, Thermo Scientific<sup>TM</sup> Gallery<sup>TM</sup>). For each soil sample the measurement was taken in quadruplicate.

The resin P measurement protocol was adapted from several studies (Bache and Ireland, 1980; Lajtha et al., 1999; Schneider and Morel, 2000). Several tests were performed for optimization of the soil: solution ratio, the duration of the phosphate sorption by resin, as well as the nature and concentration of the extraction solution. Briefly, resin strips (Product 55164 2S, BDH Laboratory Supplies, Poole, UK) measuring  $2 \times 2.5$  cm charged with hydrogen carbonate anions ( $\text{HCO}_3^-$ ) were introduced in small containers with 2 g of ground and lyophilized soil and 20 mL of distilled water and shaken during successive periods of 3, 13, 27, 48 and 72 h. Cumulatively, this corresponded to a one week period. After each shaking period, resins were eluted twice in 10 mL of 0.5 M NaCl solution for 20 min in order to release phosphate ions. Both eluting solutions were pooled together and analyzed for phosphate ion concentration by spectrophotometry (Gallery, Thermo Scientific<sup>TM</sup> Gallery<sup>TM</sup>). Resin P values measured at five time steps indicate the kinetic desorption of phosphate ions in the soil solution. All experimental values were fitted using Equation (1), assuming an exponential decrease of phosphate ion diffusion from the solid to the liquid phase, with two characteristic times, 24 h and 10 days, respectively:

$$P_1 \times (1 - \exp^{-t/10.42}) + P_2 \times (1 - \exp^{-t/240.2}) \quad (1)$$

where  $P_1$  ( $\text{mgP kg}^{-1}$  of dry soil) is a very labile stock of P with 90 % released in less than 24 h;  $P_2$  ( $\text{mgP kg}^{-1}$  of dry soil) is a less labile stock of P with 90 % released in less than 240 h;  $t$  is the cumulative incubation time, in hours. A typical example of P desorption by the resin method is provided in Figure 3.3.

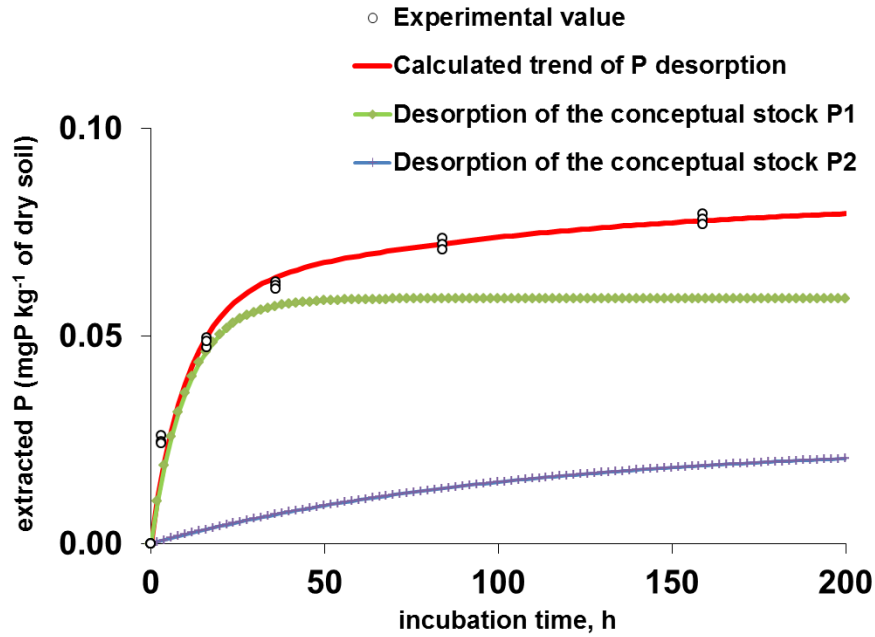

**Figure 3.3** Kinetics of phosphate desorption from the soil by anion exchange against hydrogen carbonate. The equation for the desorption curve is:  $P_1 \times (1 - \exp^{-t/10.4}) + P_2 \times (1 - \exp^{-t/104.2})$ , with  $P_1$  the stock of P available within 24 h and  $P_2$  the stock of P available within 240 h. The results from a surface soil from an organic cropping system in Seine-et-Marne are provided as an example.

### 2.1.6. Total and available phosphorus stocks

Stocks of total, Olsen and resin P over the first 30 cm of soil were calculated by multiplying the measured values of total P, Olsen P and resin P content ( $\text{kgP kg}^{-1}$  of dry soil) by the mass of dry soil (kg) in the first 30 cm of 1 ha ( $3000 \text{ m}^3$ ). For each commercial farm, this mass of dry soil was calculated from the bulk density ( $\text{ton.m}^{-3}$ ) of dry soil provided by Benoit et al. (2016).

## 2.2. Regional scale

### 2.2.1. Soil Olsen P

Median Olsen P contents in the topsoil (0–30 cm) of arable land for the 2004–2014 period were provided at the township level by the study of Gouny et al. (2016), who gathered several thousands of soil analysis available in the French arable topsoil data base (Infosol). We have averaged these data at the scale of our 33 agricultural regions. The full procedure is detailed by Eveillard et al. (2016).

### 2.2.2. P budget over arable land at the regional scale for the 2004–2014 period

The GRAFS approach presented in chapter I was used to calculate the P budget over cropland at the regional scale. The P budget over arable land was calculated as the sum of P embedded in mineral fertilizer, manure and atmospheric deposition inputs minus the P outputs through harvest. Phosphorus is a generally immobile element in soil given that it is strongly sorbed onto soil particles, and phosphate anions tend to precipitate with  $\text{Ca}^{2+}$  cations. Although,

some studies documented significant dissolved P leaching, enhanced by high concentration of bioavailable P levels in agricultural soils (Sharpley, 1993, Sharpley et al., 2000), these losses are generally low with respect to the inputs, and erosion of the containing P particles is most of the time the dominant loss process (Kronvang et al., 2007). Therefore, in first approximation, positive P budgets indicate accumulation of P in soil in the absence of significant P losses by erosion, whereas negative P budgets indicate a decrease in the soil P stock. We calculated mean P budgets over cropland for the 2004–2014 and 1970–1981 periods using mineral fertilizer rates, livestock numbers, vegetal and animal production in the years 2004, 2006, 2008, 2010, 2012 and 2014 and for the years 1970, 1974, 1978, 1981, respectively.

### **2.3. Statistical analysis**

Concerning total P, Olsen P and resin P stocks, all data and data sets of P stocks grouped by pedoclimatic area were first tested for distribution comparison between OF and CF systems using the Mann–Whitney test (using Rstudio version 3.3.2). The same statistical test was then applied to the different P stocks integrated over the rotation cycle of the whole farms for distribution comparison between OF and CF systems. When the sample size was above  $n = 30$ , correlation tests were performed using a Student *t*-test. For smaller sample sizes we applied a Kendall test.

For the P budget at the regional scale, we used the Monte Carlo method to generate random samples of values for each primary datum (such as yield or fertilizer rate) and each coefficient (such as % P in each type of vegetal product or fertilizer), from their own relative uncertainty (see section 7.2 chapter I). At the regional scales, the bootstrap procedure revealed an exponentially decreasing relative standard error of the P budget. We found the highest and lowest relative standard error for the Ile-de-France region in the 2004-2014 period, amounting 66% of the P budget and the Savoie region in the 1970-1981 period, 2.9 % of the P budget.

### 3. Field Scale Analysis

A total of 62 soil samples from 14 cropping systems were analyzed for total P, Olsen P and resin P content. Soil-available P contents measured by the Olsen and resin methods were correlated (Figure 3.4a,  $R=0.69$ ,  $p\text{-value}=3.7e-07$ ). The resin method provided information on the kinetics of P release, whereas the Olsen measurement helped assess whether the minimal threshold of available P had been met. The kinetic curves revealed that 60 % ( $\pm 17$ ) of P was released during the first 24 h. This matched the relative amount of P extracted by the Olsen method in 5 h. Clearly, this finding indicates that the available P measured by the two methods corresponds to the same stocks of available P, with the Olsen P stock being more labile than the total resin P stock. The P extracted by the resin method provided an estimation of the P available within 10 days (Figure 3.2). As the peak of P uptake by plants lasts for about 15–20 days (Gahooni et al., 1997; Rubio et al., 1997), the pool of available P measured by the resin method is likely to be closer to the effectively available P pool than when measured using the Olsen method. In the remainder of this chapter, we consider the resin P as the effectively available P for plants and refer to the Olsen P for assessing the need for strengthened or reduced P fertilization according to the COMIFER (1995) recommendations. Olsen P and total P contents were also correlated (Figure 3.4b,  $R=0.45$ ,  $p\text{-value}=9.8e-05$ ), with Olsen P corresponding to about 6 % of total P content. The correlation coefficient was even lower between resin P and total P (data not shown,  $R = 0.34$ ,  $p\text{-value} = 0.007$ ). Although the amount of available P is built on total soil P, these rather low correlations suggest that other factors also govern the available P content in soils.

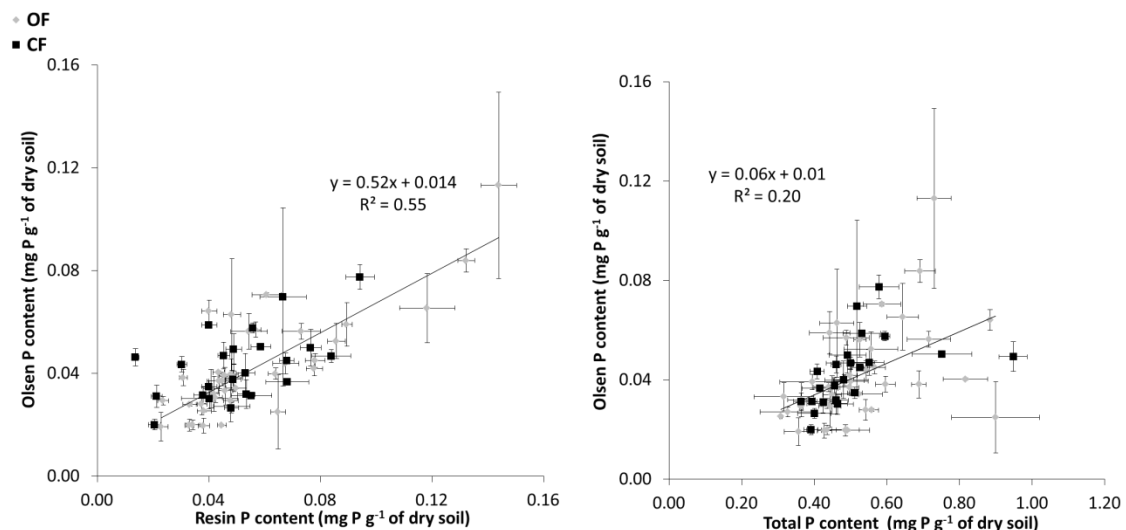

**Figure 3.4** Relationship between **a.** available P ( $\text{mg P g}^{-1}$  of dry soil) measured using Olsen versus resin anion exchange methods ( $n = 62$ ); **b.** available P ( $\text{mg P g}^{-1}$  of dry soil) measured using Olsen versus total P ( $n = 62$ ).

Contents of total and available P in soil varied considerably over our soil samples, from 0.31 to 0.95  $\text{mgP g}^{-1}$  of dry soil for total P, from 0.019 to 0.11  $\text{mgP g}^{-1}$  for Olsen P and from 0.009 to 0.18  $\text{mgP g}^{-1}$  for resin P. For Olsen P contents, 13 out of 23 and 19 out of 40 cultivated plots

within CF and OF systems, respectively, were above  $0.039 \text{ mgP.g}^{-1}$  of dry soil, the recommended threshold above which it is possible to skip P fertilization for demanding crops in the Paris Basin (COMIFER, 1995). In contrast, only one and seven cultivated plots within the CF and OF systems, respectively, had Olsen P contents under  $0.026 \text{ mgP kg}^{-1}$  of dry soil, the limit below which P fertilization must be strengthened for demanding crops in the Paris Basin (COMIFER, 1995). However, mean Olsen P contents were almost identical in the OF and CF systems ( $0.043$  and  $0.042 \text{ mgP kg}^{-1}$  of dry soil, respectively). Statistical analysis found no significant differences of Olsen P content between the OF and CF systems ( $W = 490$ ,  $p$ -value =  $0.55$ ). This was also the case when Olsen P data were grouped by pedoclimatic area. Regarding resin P, the results showed that mean available P was higher for OF than CF ( $0.062$  and  $0.054 \text{ mgP.kg}^{-1}$ ), but these means were not significantly different ( $W = 493$ ,  $p$ -value =  $0.77$ ). Stocks of total and available P over the top 30 cm of soil were calculated from the measurements of total P, Olsen P and resin P at the field scale and integrated over the whole rotation. No significant difference in P stocks could be found between the OF and CF systems ( $W = 34, 18, 26.5$  and  $p$ -value =  $0.23, 0.49$  and  $0.80$  for total P, Olsen P and resin P, respectively).

Surprisingly, we found that P budgets were slightly but significantly higher in OF than in CF ( $W = 46$ ,  $p$ -value =  $0.003$ ) (Figure 3.5). In the OF systems, the P budgets were almost always the least negative because of lower P exportation through harvest. Also, the two highest rates of P inputs over crop rotation occurred in the OF systems, including horse and poultry manure, compost, bone meal and vinasse. By contrast, P inputs in CF when applicable were in mineral form, but also as cow/chicken manure or digestates.

Figure 3.5 simultaneously displays the mean P budget ( $\text{kgP ha}^{-1} \text{ yr}^{-1}$ ) over each of the 14 cropping systems versus: (a) the stock of available P within 10 days as measured using the resin method; (b) the stock of available P as measured with Olsen P and (c) the stock of total P. We found no direct relationship between any of the measured stocks of P and the P budgets over the whole farm rotation ( $T = 58, 44$  and  $58$  and  $p$ -value =  $0.27, 0.91$  and  $0.39$  for the correlation between the P budgets and total P, Olsen P and resin P, respectively). This suggests that the P budget over the whole farm rotation cannot explain the differences in P stocks in soils among farms. The stock of available P measured with the resin method ranged from  $189$  to  $445 \text{ kgP ha}^{-1}$  in the top 30 cm of the soil profile in the OF systems and from  $149$  to  $286 \text{ kgP ha}^{-1}$  in the CF systems. The reason for the higher available P stocks in the OF systems stems from the lower harvest export over the rotation in these systems. Measurements of mean resin, Olsen and total P stocks in each cropping systems are detailed in Table 3.2

**Table 3.2** Measurement of available (Olsen and resin) and total P stocks in the 30 cm depth in 14 cropping systems of the Paris Basin. Figures into brackets indicate the standard deviation.

	Location	Mean stock of resin P available within 10 days	Mean stock of Olsen P	Mean stock of total P
		kg P ha <sup>-1</sup> yr <sup>-1</sup>	kg P ha <sup>-1</sup> yr <sup>-1</sup>	kg P ha <sup>-1</sup> yr <sup>-1</sup>
CF1*	Seine et Marne	271 (± 0)	176 (± 0)	1910 (± 0)
CF2	Seine et Marne	149 (± 68)	151 (± 12)	2149 (± 284)
CF3	Seine et Marne	257 (± 192)	249 (± 61)	2262 (± 135)
CF4	Seine et Marne	254 (± 106)	171 (± 51)	2020 (± 308)
CF5	Seine et Marne	189 (± 60)	207 (± 11)	2202 (± 465)
CF6*	Oise	259 (± 24)	224 (± 47)	2775 (± 684)
CF7	Oise	286 (± 141)	662 (± 14)	3168 (± 1056)
CF8	Yonne	272 (± 41)	34 (± 8)	2042 (± 282)
OF1*	Seine et Marne	445 (± 270)	55 (± 33)	2548 (± 760)
OF2	Seine et Marne	303 (± 86)	188 (± 46)	2144 (± 375)
OF3	Seine et Marne	270 (± 35)	211 (± 65)	2261 (± 301)
OF4	Yonne	235 (± 41)	149 (± 62)	2470 (± 920)
OF5	Oise	232 (± 158)	170 (± 103)	2290 (± 572)
OF6*	Oise	189 (± 23)	44 (± 18)	3480 (± 795)

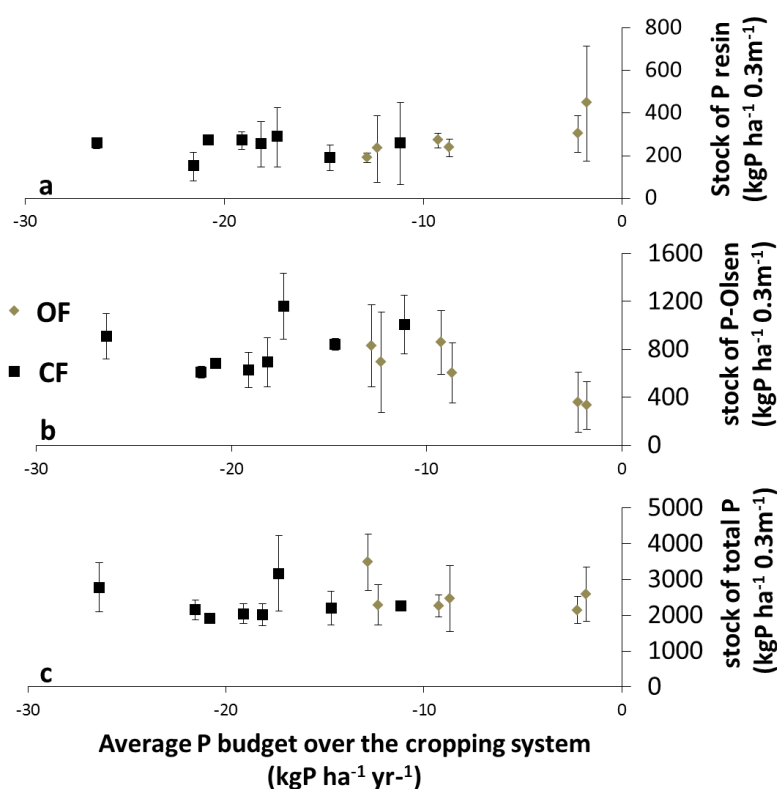

**Figure 3.5** Mean P budgets (kgP ha<sup>-1</sup> yr<sup>-1</sup>) over the 14 cropping systems on the basis of the studied plots **a.** stocks of available P within 10 days (kgP ha<sup>-1</sup> in the top 30 cm of the soil profile) measured using resin anion exchange; **b.** stocks of available P (kgP ha<sup>-1</sup> in the top 30 cm) measured using the Olsen method; **c.** stocks of total P (kgP.ha<sup>-1</sup> in the top 30 cm) measured using ignition and extraction with HCl 1 M.

## 4. Regional scale analysis

Mean P budgets over French regions for the 1970–1981 period ranged from 3.1 ( $\pm 1.7$ ) to 68 ( $\pm 6.7$ ) kgP ha<sup>-1</sup> yr<sup>-1</sup> (Figure 3.6a). Positive P budgets occurred everywhere in France because of very high rates of chemical fertilizer application at that time (Fig. 3.6d). We identified two types of agricultural production pattern generating high P budgets. First, regions with very intensive crop production combined with high rates of chemical fertilizer application (e.g., Ile-de-France and Eure-et-Loir with respectively 53.1 ( $\pm 5.4$ ) and 29.9 ( $\pm 3.1$ ) kgP ha<sup>-1</sup> yr<sup>-1</sup>) showed high P budgets. Second, regions with significant livestock production had both high rates of manure and chemical fertilizer application (e.g., Vendée-Charente and Manche with respectively 49.5 ( $\pm 4.5$ ), and 30.1 ( $\pm 3.3$ ) kgP ha<sup>-1</sup> yr<sup>-1</sup>), generating very positive P budgets. A few regions with low crop production sometimes revealed surprisingly high rates of chemical fertilizers leading to huge P budgets (e.g., Grand Marseille and Côte d'Azur with respectively 51.4 ( $\pm 5.2$ ) and 30.7 ( $\pm 3.1$ ) kgP ha<sup>-1</sup> yr<sup>-1</sup>): this might be due to a misestimating of the redistribution of mineral fertilizer between grassland and arable land in these regions.

Mean P budgets over regions in France for the 2004–2014 period showed large disparities between regions, ranging from -10.3 ( $\pm 1.5$ ) to +30.5 ( $\pm 3.1$ ) kgP ha<sup>-1</sup> yr<sup>-1</sup> (Figure 3.6b). Moderate P budgets occurred in regions with a discrepancy between livestock numbers and cropland area. For instance in Brittany, intensive and specialized livestock breeding led to huge excrement production that had to be applied on arable land exceeding crop needs. Rather high P accumulations were also observed in regions with intermediate herd size but very small arable land surfaces, resulting in apparent overfertilization (e.g., Cantal-Corrèze, Aveyron-Lozère). The highest P balance occurred in Grand Marseille but this probably resulted from a misestimating of chemical fertilizers rates in this region as indicated above. By contrast, negative P budgets occurred in regions characterized by intensive and specialized cropping systems with little or no recycling of livestock excrement. This was particularly true in the case of the regions located in the Paris Basin that presented the most negative P budgets. In these regions, inputs of mineral P fertilization (between 3.2 ( $\pm 1.8$ ) and 13.8 ( $\pm 2.0$ ) kgP ha<sup>-1</sup> yr<sup>-1</sup>) did not compensate for the very high P exportations through harvest.

The results indicate that P budgets in the 1970–1981 period were much higher than current ones, reflecting much higher fertilizer application rates at that time (Figure 3.6d). Chemical P fertilizer accounted for more than 50 % of total P fertilization in all regions in the 1970–1981 period. By comparison, in the 2004–2014 period, P chemical fertilization accounted for more than 50 % in only 12 regions out of 33. In the Ile-de-France, Eure, Eure-et-Loir and Picardy regions, P budgets were very positive in the 1970–1981 period (53.1 ( $\pm 4.9$ ), 29.7 ( $\pm 2.7$ ), 29.9 ( $\pm 2.4$ ) and 26.5 ( $\pm 2.5$ ) kgP ha<sup>-1</sup> yr<sup>-1</sup>, respectively) but shifted to negative values in the 2004–2014 period (-3.4 ( $\pm 1.5$ ), -10.1 ( $\pm 1.3$ ), -0.9 ( $\pm 0.6$ ) and -10.2 ( $\pm 1.1$ ) kgP ha<sup>-1</sup> yr<sup>-1</sup>, respectively).

Regarding Olsen P content in French regions in 2004–2014 (Figure 3.6c), the highest values were found in the north part of the country (including the Ile-de-France region) and Brittany, but were still substantial in a large part of the country. No apparent relationship between the P budget and the Olsen P content in soil could be found ( $R = -0.25$ ,  $p$ -value = 0.157) for the 200



4–2014 period. Despite negative P budgets for the Ile-de-France region, the P soil status remained high.

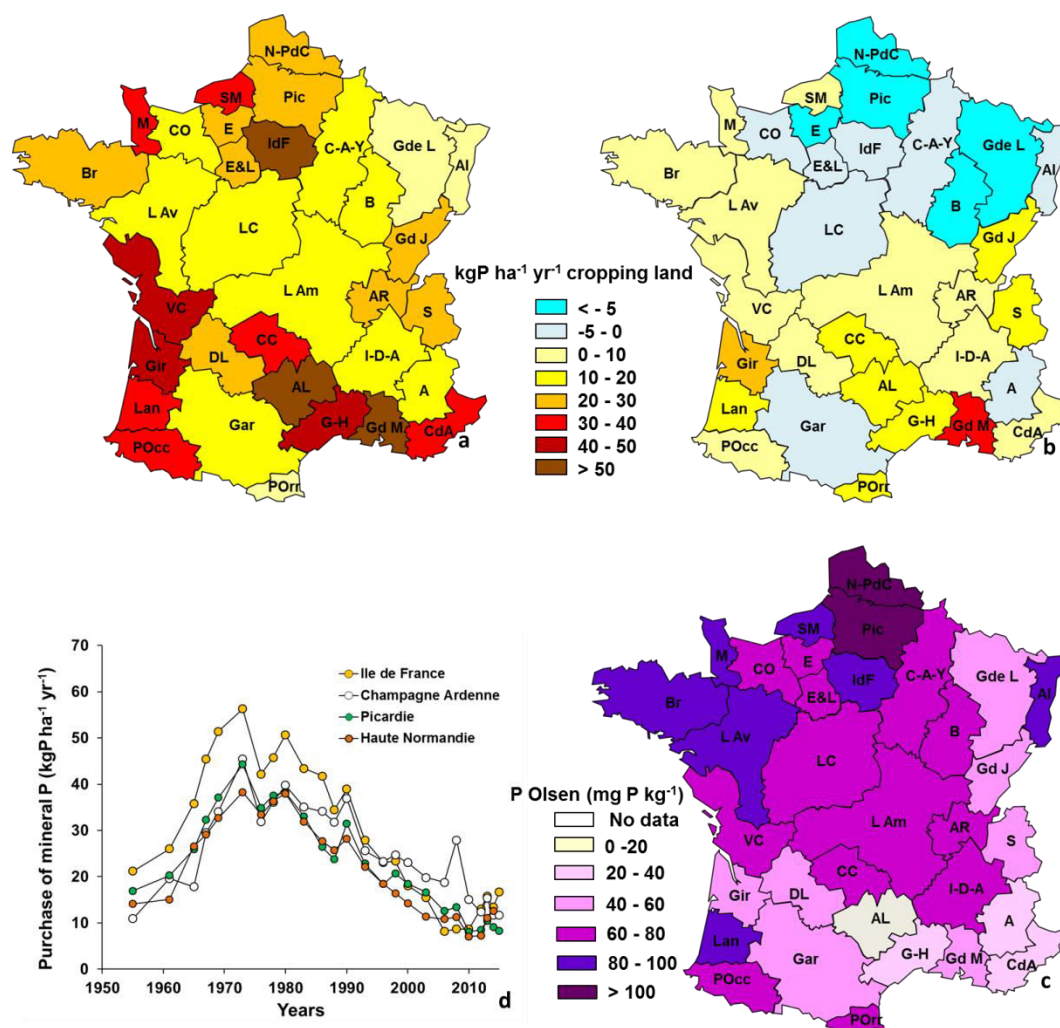

**Figure 3.6** Distribution across the 33 French agricultural areas of: **a.** mean **P budget** in cropland over the 1970–1981 period ( $\text{kgP ha}^{-1} \text{yr}^{-1}$ ); **b.** mean **P budget** in cropland over the 2004–2014 period ( $\text{kgP ha}^{-1} \text{yr}^{-1}$ ); **c.** mean **Olsen-P** in cropland over the 2005–2014 period ( $\text{mg P kg}^{-1}$ ); **d.** changes in **P fertilization rates** in the four main regions of the Paris Basin over the 1955–2015 period. A: Alpes; Al: Alsace; AL: Aveyron-Lozère; AR: Ain-Rhône; B: Bourgogne; Br: Bretagne; C-A-Y: Champagne-Ardennes-Yonne; CC: Cantal-Corrèze; CdA: Côte d’Azur; CO: Calvados-Orne; DL: Dordogne-Lot; E: Eure; E&L: Eure-et-Loire; Gar: Garonne; Gd J: Grand Jura; Gd M: Grand Marseille; Gde L: Grande Lorraine; G-H: Gard-Hérault; Gir: Gironde; I-D-A: Isère-Drôme-Ardèche; IdF: Ile de France; L Am: Loire Amont; L Av: Loire Aval; Lan: Landes; LC: Loire Centrale; M: Manche; N-PdC: Nord Pas-de-Calais; Pic: Picardie; Pocc: Pyrénées Occidentales; POr: Pyrénées Orientales; S: Savoie; VC: Vendée-Charentes.

## 5. Interrelation of P cycling at nested scales

Moving from the field to the regional scale can account for the structural effects of the agro-food-system. This upscaling, however, leads to a loss of accuracy regarding the cropping system, the P budget and the soil P status. The two scales are therefore complementary and require a comparable approach. The need for indicators of farming practices and soil status that could be linked at the farm scale and then extrapolated at the regional scale is the guiding thread throughout the following discussion.

### 5.1. Soil-available P from the farm to the regional scale

Soil-available P has been functionally defined here as the amount of phosphate ions extracted by anion exchange resin or by 0.5 M NaHCO<sub>3</sub>. This definition of available P is still controversial because it cannot account for the organic P pool, whose significance is still underestimated (Plassard et al., 2015). In OF the importance of this pool could be even greater because organic inputs are predominant. Moreover, the correlation we found between Olsen P and total P and between resin P and total P suggest that the stock of total soil P may sustain the stock of available P, assuming these relationships remain constant over time. If this was true, it implies that crop production may be sustained without P input to soils with high P stocks. This assumption is in line with other studies that also found a positive correlation between total P and Olsen P (Bai et al., 2013) or demonstrated that some unavailable P may indeed be available in deficient P conditions (Blake et al., 2003). The definition of available P is therefore a tricky issue and we must acknowledge that our approach is restrictive. The available P we estimated here is only soil-related; it accounts for neither crop specificity (Holford, 1997) nor rhizosphere and microbial interactions (Li et al., 2007). Furthermore the measurements from the topsoil horizon may have missed some downwards transport of P retained in the subsoil or leached to groundwater (Blake et al., 2003; Sharpley et al., 2014).

The use of two different methods underlines that the estimation of available P is highly dependent on the method. The Olsen method underestimated the soil-available P content by 40 % compared to the resin method (Figure 3.4a). This result is in accordance with the study by Paris et al. (2004), which showed that Olsen P may underestimate the amount of P available for plants in P-enriched soils. For this reason and because the resin method shows better repeatability, provides kinetic information and better mimics the physical and chemical conditions in the rhizosphere, we argue that this method gives a more realistic estimate of the effectively available P for plants. However, the correlation we found between the two methods (Figure 3.4a) supports the notion that the Olsen method also provides a meaningful estimation of available P.

The results from this chapter have demonstrated that Olsen P and resin P are not significantly different in the organic and conventional cropping systems of the Paris Basin region. This is in line with the study by Van Den Bossche and Hofman (2005), which reported no significant difference in available P between OF and CF systems in Flanders. By contrast, other studies systematically found significantly lower Olsen P content in OF than CF systems (Morel et al.,

2006 for cropping systems in the Southwest and Centre of France; Gosling and Shepherd, 2005 in southern England). These contradictions suggest that other factors than OF versus CF practices prevail to explain differences in soil P status. In what follows, we try to find an explanation for these divergent conclusions.

A possible explanation for the lack of a significant difference in soil-available P between OF and CF is that soil-available P is related to P budgets and not to the conventional or organic nature of cropping systems. Also we did not consider the whole real rotation, but only the investigated plots, despite chosen as representative. However considering that the P budget can reasonably be seen as representative for the last 4–9 years, depending on the crop rotation period, one might have expected that mean available P would reflect the P budget. However, we found no direct relationship between mean soil-available P (resin P and Olsen P) and the P budget over the whole rotation. In a similar study, Nesme et al. (2012) did not find a clear relationship between soil-available P and P budgets in a participative network of both stockless and animal farms in the southwest of France. At the farm scale, variations in soil-available P are therefore unexplained by our calculated P budgets. A possible reason for this is that current fertilization practices, crop rotations and the resulting P budgets over the considered rotations are too recent to have impacted soil-available P. Therefore, we assume that the differences of available P observed among plots and farms resulted from different soil P legacy built through the succession of agricultural systems over the past few decades, although a chronicle of past budgets in our farm network would be necessary to confirm this hypothesis. Fortunately, the regional analysis provides us a historical perspective of changes in P budgets and is therefore complementary to the farm-scale analysis.

At the regional scale, the occurrence of very high Olsen P contents despite negative P budgets in the Paris Basin regions could be explained by the quite recent shift from very high P budgets over cropland (Figure 3.6a) to much lower or moderate P budgets (Figure 3.6b) in the last decade. Assuming that mean P budgets in 1970–1981, a decade quite representative for the fertilization regime of the 1965–1990 period (Figure 3.6d), could be taken as the mean P budgets for the longer 1965–1990 period, we can roughly estimate that P accumulation in arable land in these regions has reached a value of P stocks that may be as high as 900 kgP ha<sup>-1</sup>. This suggests that the current Olsen P content in soils may be better explained by the accumulation of P resulting from cumulated P budgets across the last 50 years than by current budget values. In line with other recent studies (Sattari et al., 2012; Sharpley et al., 2014; Hanserud et al., 2016), our analysis strongly supports that the fertilization history over the last five decades and the resulting P legacy are the main drivers of current available P in soils at the regional level. This may be why we could not find any relationship between current P budgets and Olsen P contents at both scales however; the lack of relationship may also result from uncertainties regarding both P budgets estimation and Olsen P measurements. Current crop productions are thus probably sustained by P legacy built over the past few decades. However, as several studies found a close and direct relationship between the P budget and the rate of change in Olsen P (Hua et al., 2016; Shen et al., 2014; Messiga et al., 2012; Blake et al., 2003), the current negative P budgets at the farm and regional levels in the Paris Basin could take their toll in the coming years if this trend remains constant over the next few decades. According to Rowe et al. (2016)

legacy P can generally support constant crop yield on many different types of arable and grassland soils for period of up to 10 years or more. Nevertheless the time which legacy P can sustain crop without significant declining yield have been reported to vary from more than 25 years for alfalfa, potato, rye, sugar, beet, barley rotations on a Luvic Phaeozem in Germany (Gransee and Merbach, 2000) to 4 years for corn, soybean rotation on a fine loamy soil in the Iowa, USA (Dodd and Mallarino, 2005).

## **5.2. P budget from the farm to the regional scale**

In this chapter, we found negative P budgets for the two years analyzed farms and significantly lower P budgets in CF than OF. This was mainly due to lower harvest export over the rotation in the OF systems. This finding contradicts earlier results reported by Oehl et al. (2002), i.e., respectively positive and negative P budget for CF and OF (and biodynamic) differing only by the nature and quantity of P inputs, whereas crop rotations were the same in all experimental fields. Although their study provided valuable information on the influence of distinct P fertilization regimes, commercial OF and CF practices are more complex than controlled field experiments. Not only the nature and application rate of P fertilizers differed between OF and CF, but also the crop rotation and export by harvest. Furthermore, the diversity of agricultural practices at the farm scale has been illustrated by several case studies of commercial OF showing both positive and negative P budgets (Berry et al., 2003; Nesme et al., 2012). Here again, the fact that our results are counterintuitive highlights the need for a better understanding of local situations and the diversity of farming practices.

While OF systems are often presented as sustainable alternatives to CF systems, their current operation might depend on the by-products of the CF practices since they are the dominant system (Rigby and Caceres, 2001). Therefore, the sustainability of agricultural practices needs to be put into perspective and assessed in light of agricultural systems at a broader scale. From this perspective, it is worth noting that P budgets in the regions of the Paris Basin were always negative, which is coherent with our observations for the farms. The consistency of P budgets on the farm and regional scales suggests that P management in cropping systems is not solely linked to organic versus conventional agricultural practices. In our farm network, both organic and conventional cropping systems had low P inputs. This suggests that the sign of P budgets in the farms of our network is conditioned by the production pattern rather than by the organic or conventional nature of the cropping system. Production patterns in the farms studied mirror what we observed at the regional level, suggesting that individual P budgets are determined, at least in part, by the regional agro-food system. The term “agro-food system” should be understood here as the combination of fertilization practices, orientation and level of agricultural production specialization, dependency on imports and export orientation, as defined by Billen et al. (2014). At the regional scale, these features determine the environmental and agronomic performance of agro-food systems such as nutrient budgets, environmental losses and nutrient use efficiency. However, the variations of P budgets observed among farms reflect the influence of agricultural practices and crop rotations. This shows that regional analysis does not preclude the need for local investigations. Rather, in this study, the analysis

of individual farms provides a more concrete and nuanced picture of the farmer's choices and constraints.

At the regional scale, our estimations of current P budgets are consistent with those reported by Senthilkumar et al. (2012) for French regions. In both studies, P budgets at the regional level for the 2004–2014 period clearly indicate that the structure of the agro-food system has a systemic impact on the P cycling. This is generally true for most nutrients, as underlined by several studies (Moraine et al., 2017; Bonaudo et al., 2014; Dumont et al., 2013), e.g., the way animals are incorporated within agro-ecosystems both at farm and regional levels is a determining factor to improve farming-system metabolism and particularly nutrients recycling. In this chapter, regions combining high or intermediate herd size (between 0.7 and 1.6 LU ha UAA<sup>-1</sup>) with low cropland surfaces relatively to the UAA generally have the highest P budgets (e.g., Aveyron-Lozère, Cantal-Corrèze), whereas specialized cropping systems have the smallest and often negative P budgets (e.g., Ile-de-France, Picardie). Moderate P balance occurred in regions with high or intermediate herd size (e.g., Loire Amont and Brittany). Estimations of P budgets for the 2004–2014 period are somewhat lower than our previous estimates for 2006 alone (see Chapter II), reflecting the currently still decreasing trend in the P budget in most French regions due to a continued reduction in mineral P fertilization rates.

### **5.3. Implication for future P management**

In the future, agriculture will have to deal with two major challenges: an increasing demand for food must be met while preserving resources for future generations. In this context, increasing P recycling and PUE will be a step toward implementing sustainable agriculture. Considering the important soil P legacy inherited from the past in many regions of France, including the Paris Basin, will improve PUE by forgoing the P fertilization when possible. Furthermore, the mining of soil P reserves by crops can be desirable in many situations where excess P in soils is likely to engender eutrophication of the surrounding water ecosystems. Looking further ahead, the depletion of both mining resources and soil P reserves is inevitable. The structure of agro-food systems therefore needs to be redesigned on local, regional and global scales in order to better close the P loop. Accordingly, we advocate that the evaluation and implementation of sustainable P management in the agro-ecosystem will require further enhancement of scientific knowledge regarding the interrelation of P cycling at nested scales.

## 6. Conclusion

In this chapter, we implemented a multi-scale approach to analyze the relative impact of agricultural practices at the level of the individual farm and the production structural pattern at the regional level. Switching back and forth between local and regional scales enables to attain broader knowledge of the dynamics of P cycling by linking agricultural practices in farms to structure of agro-food system at the regional level. Indeed, the consistency of P budgets on farms and at the regional scale suggests that P management in cropping systems is not solely linked to the organic versus conventional agricultural practices. The shift of the focal point from the field scale to the regional scale highlights the importance of the structure of agro-food systems as the main driver of the P budget. At the farm level, we found that organic farming practices would not be a threat in themselves to soil P status and that the current P budget would not be related to soil P status. In the Paris Basin, both regional and farm analyses reveal negative P budgets, indicating that P reserves are being mined. Past analysis of P budgets revealed that this is made possible by huge P stocks in soils inherited from past decades of fertilization, which sustains the current high productivity of cropping systems in this area. We conclude that the specialization of agricultural systems result in soil P legacy due to cumulated positive P budgets across the last 50–60 years, and is responsible of current soil P status. Therefore, future sustainable nutrient management requires an environmental historical perspective of regional agro-food system trajectories. This is the subject of the next chapter.



# Chapter IV

## Long-term socioecological trajectories of agro-food systems revealed by N and P flows in French regions from 1852 to 2014

*We here apply the GRAFS approach explained in Chapter I to retrace the long term evolution of the French regional agricultural systems since the middle of the 19<sup>th</sup> century. We will show that the changing structure of N and P flows within these systems allows distinguishing diverse trajectories followed by the different regions. Based on current literature we interpret these trajectories in terms of socio-ecological metabolism.*

*This chapter is mostly based on the following paper: Le Noë J, Billen G, Esculier F & Garnier J. (2018) Long-term socioecological trajectories of agro-food systems revealed by N and P flows in French regions from 1852 to 2014. *Agr Ecosyst Env.* 265: 132-143. <https://doi.org/10.1016/j.jenvman.2017.09.039>*





# 1. Introduction

The transition from organic fertilization toward mineral-based fertilization was initially made possible by two historical discoveries: (i) the existence of phosphate deposits, in the form of guano in Peru first, and as phosphorus rock in Florida and Morocco thereafter (Clark and Foster, 2009; Pluvinage, 1912) and (ii) the invention of the Haber-Bosh process in 1913 (Smil, 2001). By the end of the 19<sup>th</sup> century, the use of these exogenous fertilizers appeared as a response to the problem of soil exhaustion due to nutrient limitation, which had already raised concerns among scientists (e.g., Liebig) as early as 1840 (Foster, 2000). It also made it possible to better integrate agriculture into the market economy as yields increased with these new means of fertilization, while the need for closing the nutrient loop locally became less stringent. In many places, this implied the progressive specialization of agricultural systems over the course of the 20<sup>th</sup> century in order to remain competitive and maximize profits (Mazoyer and Roudart, 1998). In return, decoupling animal and vegetal production resulted in ever-increasing trade flows of agricultural products (Lassaletta et al., 2014a).

In this context, a number of recent studies have focused on the socioecological metabolism of agro-food systems, applying material, nutrients or energy flow analysis approaches from local to global scales (Güldner and Krausmann, 2017; Güzman et al., 2017; Garnier et al., 2015; 2016; Soto et al., 2016; Billen et al., 2012c). Analyses of socioecological metabolism conducted within a long-term perspective can shed light on the interrelation between human and natural history in the evolution of agro-ecosystems. Material and energy flows embedded in the functioning of agro-food systems are shaped by the human activities of harvest, processing and consumption of biomass, but are also mediated by complex and dynamic natural processes such as ammonia volatilization, nitrate leaching and P sorption. Therefore, as stated by Gizicki-Neudlinger et al. (2017), agricultural systems, perhaps more than any other human activity, need to be considered as *“historical phenomenon[a] at the intersection of economy and ecology, as a hybrid between nature and culture.”*

However, to our knowledge few studies within this perspective have examined the case of France, with the exception of the recent articles of Harchaoui and Chatzimpiros (2017), which analyzed the transformation of livestock breeding and its consequences over land use and agricultural trade in France over the 1961–2010 period. Yet, the national scale adopted in their study is blind to regional disparities and to the structural link between livestock breeding, arable land and grassland production. The case of France is noteworthy because this country is currently one of the main agricultural powers in Europe, the first exporter of cereals in 2014 (FAO, 2017), although the modernization of French agriculture had long lagged behind other Western European countries such as the United Kingdom, The Netherlands, Belgium and Germany (Ruttan, 1978). The late modernization of agriculture in France has been studied in great depth by historians (Jollivet, 2007; Duby and Wallon, 1993; Muller, 1984; Ruttan, 1978; Duby and Wallon, 1978) who highlighted the political and economic reasons for this delay. Nevertheless, the consequences of the particular evolution of French agriculture in terms of N and P cycles and environmental and agronomic performance are still lacking in the analysis.

This chapter explores the co-evolution of the different patterns of agro-food systems in terms of N and P cycles in their historical context, applying the Generalized Representation of Agro-Food System (GRAFS) presented in chapter I.

Studying the trajectories of agro-food systems from the perspective of N and P flows is an original prism for such analysis because at the same time it provides information on their degree of openness, their agronomic and environmental performance in terms of N and P use efficiency (NUE and PUE, i.e. the fraction of all N and P inputs to soil that is effectively harvested), and the N and P balances. What are the trajectories that have led to the current agro-food systems at the regional scale? What were the main drivers of these trajectories? What are the environmental consequences? What are the legacies from the previous history on the current state of the system? Answering these questions contributes responding to the general challenge for future sustainable agricultural production because (i) lessons can be drawn from the past given that traditional agricultural systems relied mainly on nutrient recycling at the farm and regional scale and (ii) designing future patterns of production will require accounting for the effect of agriculture development based on soil fertility, particularly P.

We therefore studied the period from 1852 to 2014. The mid-19<sup>th</sup> century corresponds to the very beginning of mineral fertilization in France (Boulaine, 2006) and also to the beginning of the Napoleonian Second Empire and the documentation of regular and detailed agricultural statistics. In this chapter, some concrete findings regarding the evolution of agro-food system for three typical and contrasted French regions are first analyzed in order to capture the main characteristic of these systems. Based on the typology developed in section 3 of chapter II, we then investigate the evolution of agricultural systems toward the different types identified and the consequences of these evolutions in terms of N and P fluxes; some interpretations regarding the drivers of these evolutions are proposed based on a literature analyse.

## 2. Regional features revealed by the GRAFS approach

### 2.1. Changes in the overall metabolism of three typical regions

The temporal evolution of N flows in agro-food systems is shown for three typical but contrasted French regions: Picardy, Brittany and Loire Amont (Figure 4.1).

**In 1852**, all three regions were characterized by self-sufficiency for crop, grass and livestock production, which was just enough to fulfill the local human demand. The only exogenous inputs to arable land and grassland were symbiotic N fixation and atmospheric deposition, and total inputs were close to balance with N output through harvest. Consequently N balance over arable land was very low ( $5 (\pm 7)$ ,  $1 \pm 5$  and  $1 (\pm 3)$  kgN ha<sup>-1</sup> yr<sup>-1</sup> for Picardy, Loire Amont and Brittany, respectively), while the P balance was almost balanced in Brittany and Loire Amont but slightly negative over arable land in Picardy ( $-2 (\pm 1)$  kgP ha<sup>-1</sup> yr<sup>-1</sup>), indicating that soil P was being mined at a time when P inputs to soil were low, which challenged the sustainability of the agro-food system. Mining in soil fertility around the mid-19<sup>th</sup> century has also been reported in other studies (Güldner and Krausmann, 2017).

The cases of Picardy and Loire Amont, regions that already had a significant exceedent of crop and livestock production with respect to their local livestock and human population requirements, would suggest that these products already had the status of a commodity. This hypothesis would be particularly relevant for Picardy, where the additional production was likely exported to the nearby Paris food market, leading to a negative P balance. Brittany showed complete self-subsistence since no products had to be imported or exported. Nevertheless, although some differences can be observed, the overall similarity between agro-food systems is striking.

**Over one century later**, the situation had drastically changed. The GRAFS of the three regions considered in 1970 (Figure 4.1) showed contrasted production patterns, although the common features of the evolution of these agro-food systems can be found in the increased recourse to both N and P mineral fertilizers and the overall intensification of internal and external nutrient flows. This happened concomitantly with a sharp decrease in the contribution of symbiotic N fixation to overall inputs (Figure 4.2). This stressed out the preeminent role that legume crops had in the previous periods, when they provided both direct fertilization to cropland and indirect fertilization through manure input by fed livestock.

*In Picardy*, arable crop production doubled while livestock density and the local human population levelled off, generating an increased crop surplus with more than 80% of the production being available for exportation. Simultaneously, N and P balance over arable land rose significantly, reaching  $57 (\pm 8)$  kgN ha<sup>-1</sup> yr<sup>-1</sup> and  $46 (\pm 1)$  kgP ha<sup>-1</sup> yr<sup>-1</sup>, respectively. The apparent specialization in crop production in Picardy was accompanied by a significant decrease of NUE and PUE from  $85 (\pm 13)\%$  and  $160 (\pm 29)\%$  in 1852 to  $66 (\pm 4)\%$  and  $27 (\pm 2)\%$  in 1970, respectively.

*In Brittany*, the complementarity between livestock, arable land and grassland continued to be effective since animal excretion and N symbiotic fixation still made up more than 60 ( $\pm 3$ )% of arable land fertilization, while livestock were mainly fed from arable land and grassland. However, imported feed was already needed to meet the requirement of increasing livestock. The agro-food system therefore turned from a complete self-sustaining regime in 1852 to a clear system of interdependence for both vegetal and animal production. The consequences of these changes in terms of environmental and agronomic performance was an increase in N and P balances over arable land, reaching 29 ( $\pm 11$ ) kgN ha<sup>-1</sup> yr<sup>-1</sup> and 37 ( $\pm 3$ ) kgP ha<sup>-1</sup> yr<sup>-1</sup> and the concomitant drop in NUE and PUE from 96 ( $\pm 16$ )% and 118 ( $\pm 26$ )% in 1852 to 81 ( $\pm 7$ )% and 35 ( $\pm 3$ )% in 1970, respectively.

The case of *Loire Amont* in 1970 showed much smaller changes compared to the situation of 1852. The recycling of N within the agro-food system continued to make up most arable land and grassland fertilization together with N symbiotic fixation, while livestock production was still self-reliant. Paradoxically, this region showed relatively low environmental and agronomic performance since N and P balances over arable land reached 77 ( $\pm 10$ ) kgN ha<sup>-1</sup> yr<sup>-1</sup> and 39 ( $\pm 3$ ) kgP ha<sup>-1</sup> yr<sup>-1</sup>, while NUE and PUE decreased from 89 ( $\pm 15$ )% and 118 ( $\pm 35$ )% in 1852 to 49 ( $\pm 4$ )% and 21 ( $\pm 2$ )% in 1970, respectively.

**Finally, the GRAFS for 2010** confirmed the trends observed in the 1970s, namely the increased specialization in crop and livestock farming for Picardy and Brittany, respectively, and the continued integrated crop and livestock farming in Loire Amont. In Picardy, grassland was less than 15 ( $\pm 0.4$ )% of the utilized agricultural area (UAA) and N mineral fertilizer contributed 73 ( $\pm 2$ )% to total fertilization of arable land. The case of Brittany is particularly striking in that the agro-food system was almost entirely dedicated to livestock production, with 77 ( $\pm 3$ )% of the arable production used for livestock ingestion and more than 55 ( $\pm 3$ )% of animal feed being imported. Moreover, although Loire Amont was still characterized by apparently integrated crop and livestock farming, the livestock production was henceforth dependent on imported feed.

Overall, the evolution of these agro-food systems can be analyzed as three aspects of the same process: the progressive expansion of a “metabolic rift” (Foster, 2013) mostly captured, in this chapter, through the rising openness of N and P cycles with increasing dependence on external inputs and a growing share of the production being exported.

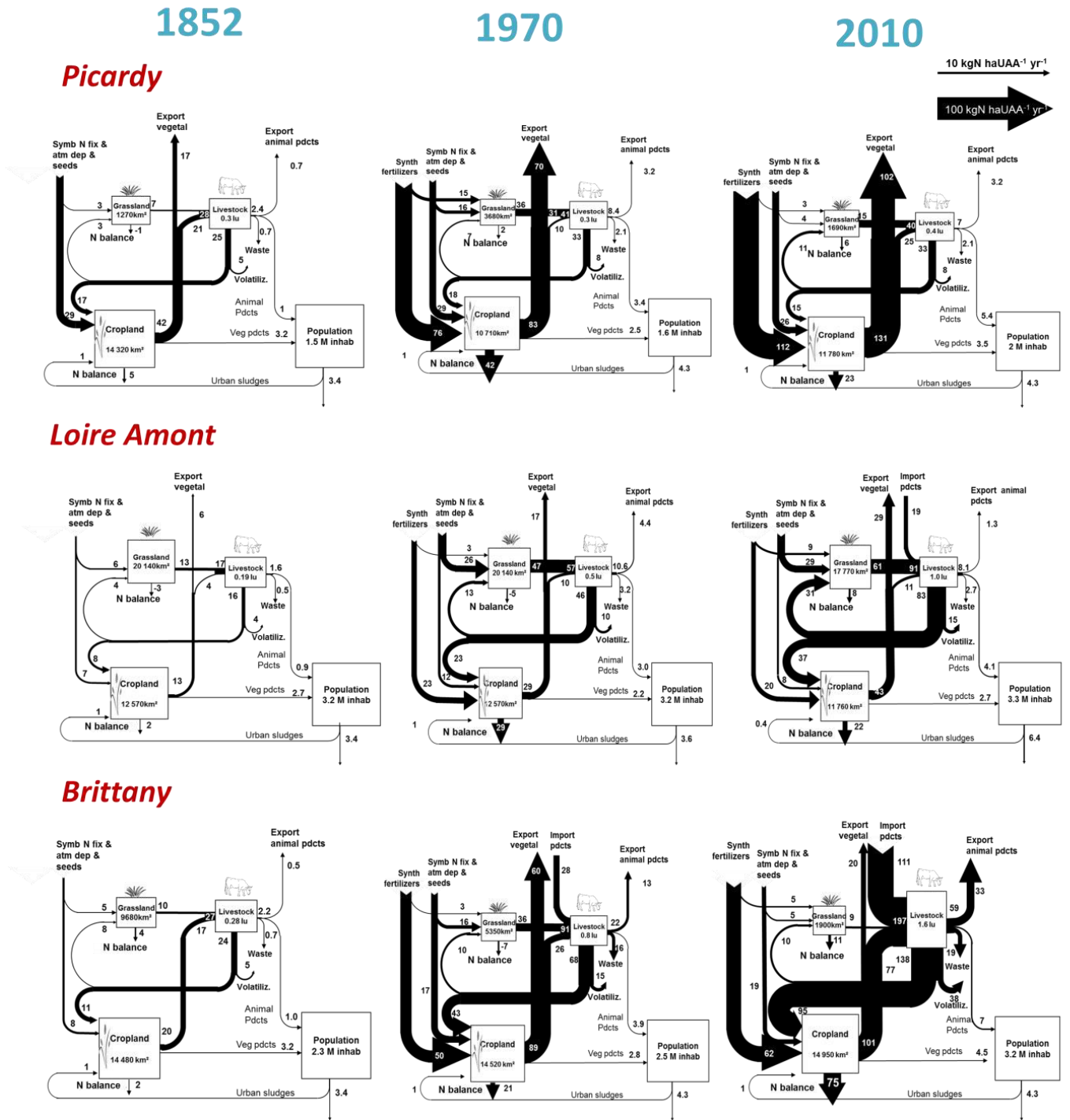

**Figure 4.1** GRAFS-based N flows for Picardy, Loire-Amont and Brittany in 1852, 1970 and 2010.

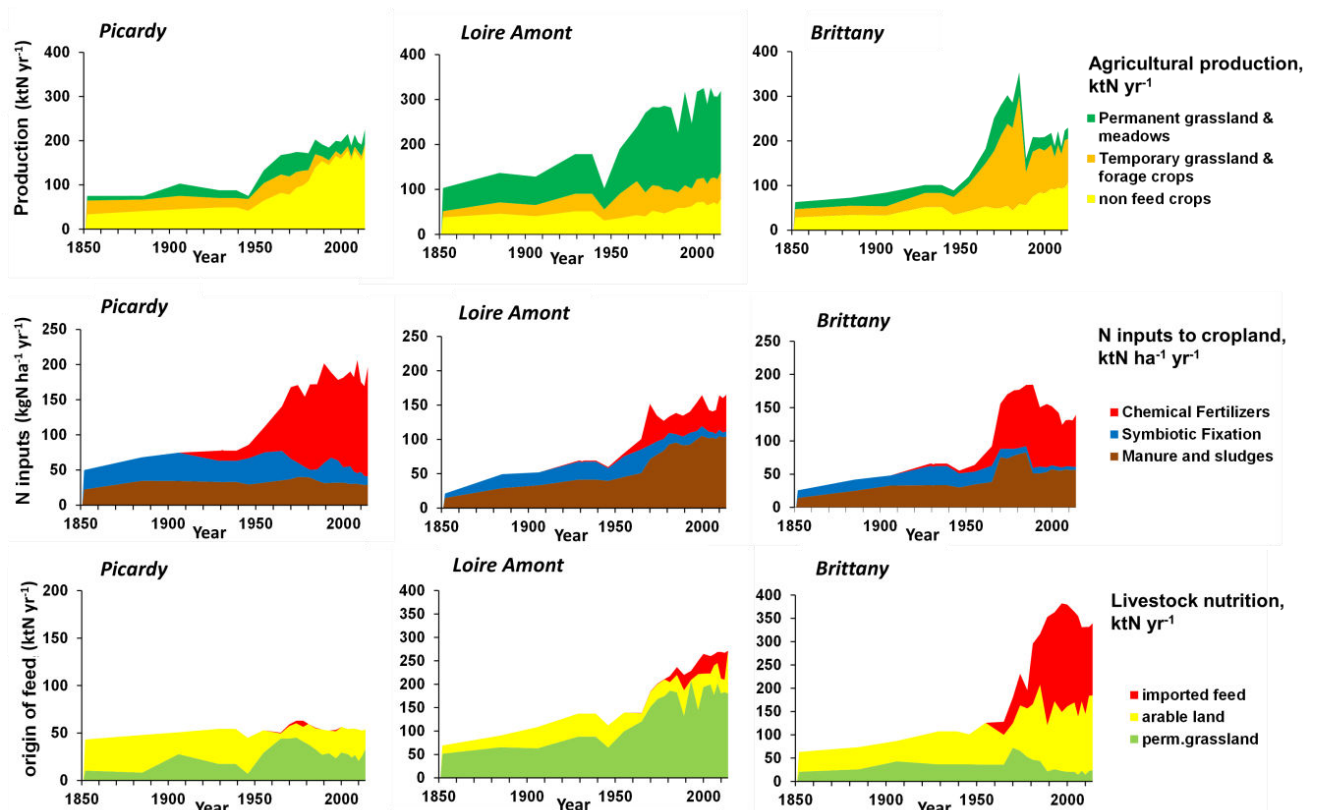

**Figure 4.2** Features of the agricultural systems of Picardy, Loire Amont and Brittany over time. a. Agricultural production; b. type of N fertilization; c. origin of livestock feed

## 2.2. Historical legacy of phosphorus

Long-term accumulation (or depletion) of P in arable land, calculated by summing up annual P balances of cropland over the whole period covered, revealed both similar and contrasted patterns in Picardy, Loire Amont and Brittany (Figure 4.3). In all cases the late 19<sup>th</sup> and early 20<sup>th</sup> centuries were characterized by the continuous mining of P reserves, indicating that inputs could not compensate for output. This trend was clearly reversed after WWII when a substantial P stock had accumulated until the 1990s. Yet for the recent period, due to a large reduction in mineral fertilizers, Picardy again showed a net mining of the cumulated P balance, while it plateaued for Loire Amont. By contrast, Brittany continued to accumulate P in arable land. Again, this particularity can be explained by the huge amount of P inputs through animal excretion due to the concentration of livestock breeding in the region. For the case of Brittany, P inputs through manure originated, to a large extent, from feed import from South America (see section 4 of chapter II). Our estimations of P balances over arable land for these three regions were in accordance with two other studies on France, which also indicated a sharp rise of P in arable land at the turn of the 1960s (Ringeval et al., 2014) and their relative stagnation in the last two decades (Senthilkumar et al., 2012).

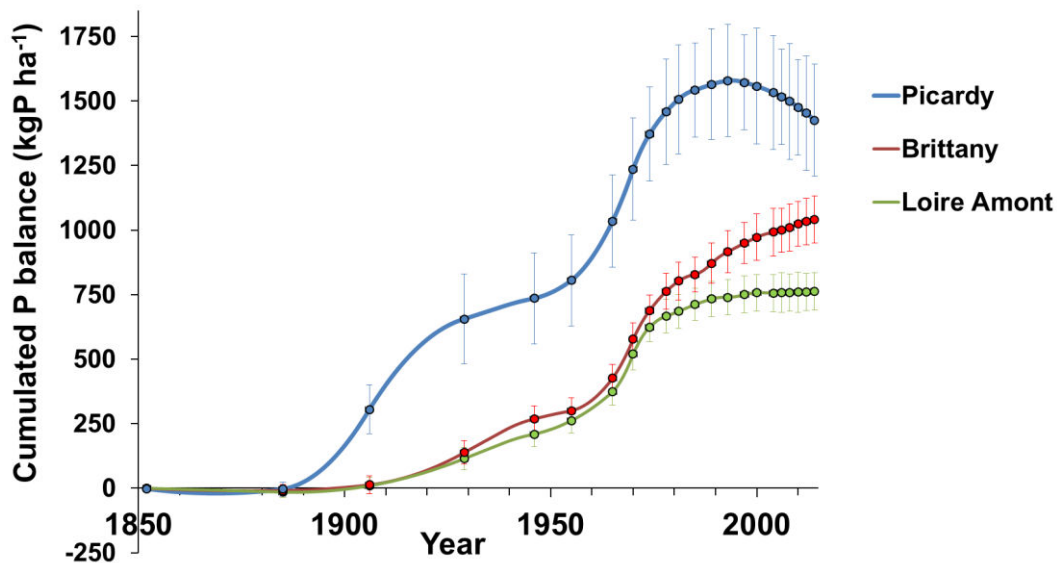
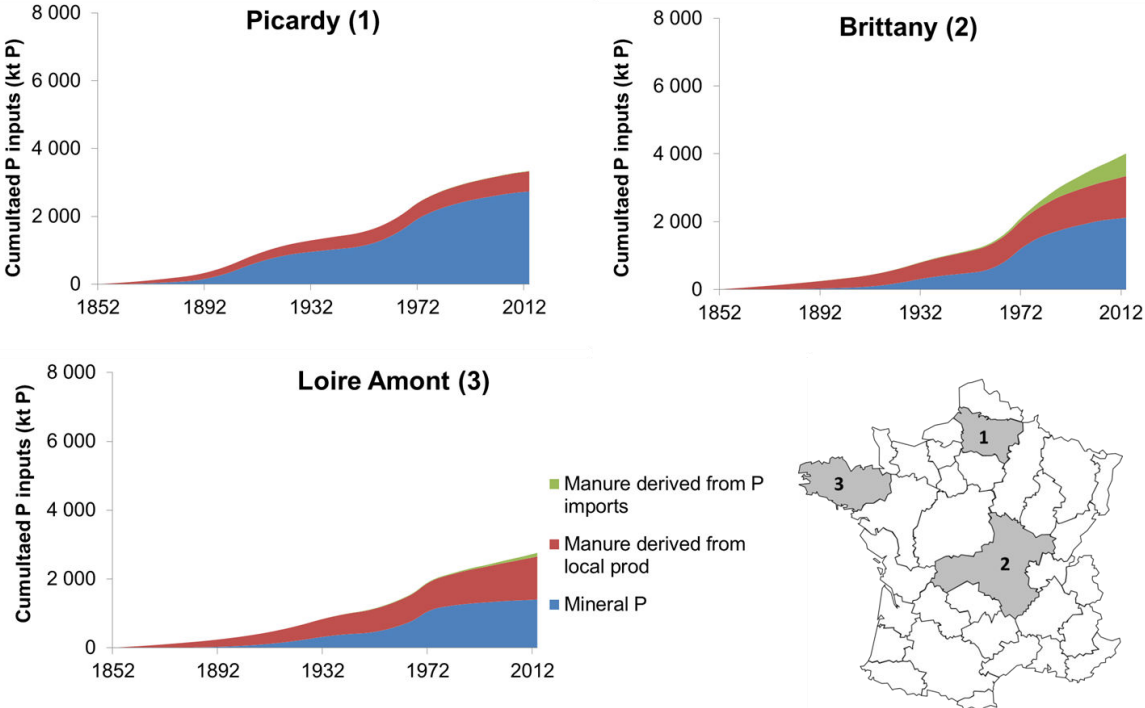

**Figure 4.3** Cumulated P balance over arable land in the course of the 1852–2014 period in Brittany, Loire Amont and Picardy. Error bars provide uncertainties as calculated by the Monte Carlo analysis.

Our results highlighted that, according to their specific trajectories, French regions have constituted their own P legacy, deriving from three main sources: (i) a transfer of fertility from the local permanent grassland, (ii) the importation of mineral fertilizers mainly from foreign mining resources and (iii) a transfer of fertility from arable land of feed-exporting regions. In the future, although anthropogenic P accumulated in agricultural soil should contribute to sustaining plant growth for some years (Ringeval et al., 2014), a possible shortage of P (Cordell et al., 2009) could threaten the ecological maintenance of agricultural soil. Regions that benefited from high P fertilization rates in the past will thus take advantage of their past legacy in the future, whereas regions that have historically exported nutrients could suffer from the unpaid cost of ecological soil degradation. Such historically unequal exchanges have been defined as ecological debt by several authors (Roberts and Parks, 2009, Clark and Foster, 2009). A concise definition of this notion was provided by Martinez-Alier (2002): “*The first cause of ecological debt is ecologically unequal exchange, or the fact that exports of raw materials and other products from relatively poor countries are sold at prices that do not include compensation for local or global externalities. Ecologically unequal exchange is responsible for the following components of ecological debt: the (unpaid) costs of reproduction or maintenance or sustainable management of the renewable resources that have been exported: for instance, the nutrients incorporated in agricultural products*”. The case of P accumulation in arable land clearly falls into this definition of an ecological debt. As revealed by Figure 4.4, the composition of cumulated P inputs to arable land could be very different, implying different type of ecological debt for P. In 2014, in Picardy, mineral fertilizer largely dominated the cumulated P inputs; in Loire Amont, cumulated P inputs was divided in two equivalent fractions: mineral fertilizer and a transfer of P from local grassland while in Brittany, mineral fertilizer represented the largest share of inputs but manure derived from imports amounted



17% of the cumulated P inputs. This evaluation of current P stocks in soils contributes to historicize them by highlighting that cumulated P budgets and their composition are determined by the trajectories of regional agro-food systems.



**Figure 4.4** Cumulated P inputs in the course of the 1852–2014 period in Picardy, Brittany and Loire Amont.

### 3. Trajectories of agro-food systems

To systemize the analysis of our results and to obtain an objective assessment of the trajectories of the 33 French regions, we used the same typology as that described in section 3.2 of chapter II. As used, criteria gather regions with a homogeneous production pattern; the internal variability among regions belonging to the same type is sometimes concealed. For instance, in 1929, the average yield of arable land, a parameter that was not included in our typology, reached  $50 (\pm 15)$  and  $54 (\pm 9)$   $\text{kgN ha}^{-1} \text{ yr}^{-1}$  in regions of Grass-fed and Fodder-fed integrated crops and livestock farming, respectively. In 1989, the average yield of arable land of the different categories of regions was  $130 (\pm 15)$   $\text{kgN ha}^{-1} \text{ yr}^{-1}$  for Intensive arable crops,  $97 (\pm 23)$   $\text{kgN ha}^{-1} \text{ yr}^{-1}$ , and  $97 (\pm 21)$   $\text{kgN ha}^{-1} \text{ yr}^{-1}$  for Grass-fed and Fodder-fed integrated crops and livestock farming, and  $81 (\pm 38)$   $\text{kgN ha}^{-1} \text{ yr}^{-1}$  for Disconnected intensive crops-extensive livestock farming. The variability of individual regional values around the mean emphasizes the need for a dual approach: at the regional level to describe specific trajectories and at the national level to analyze the overall evolution of production patterns toward specialization or continued integrated crops and livestock. In the next section we do not discuss the variability within each type of region but provide uncertainty values as calculated by the Monte Carlo procedure (see section 7.2 of chapter I).

In view of the above, we can now trace the evolution the agricultural system of the 33 regions in France toward specialization or continued integrated crop and livestock farming (Figures 4.5a–4.5d and 4.6). Putting the changes captured within their political and socio-economic context should allow us to identify the drivers of these changes together with their impact on N and P fluxes in agricultural systems.

#### 3.1. The dominance of integrated crop-livestock farming: 1852–1906

Integrated crop and livestock farming was the rule everywhere during the late 19<sup>th</sup> century (Figure 4.6), because fertilization mainly relied on manure recycling and symbiotic N fixation. Therefore, the progressive intensification of production with increasing yields occurring during this period (Figure 4.5b) was only driven by an increase of livestock density with the increase in forage crops and grassland. The agricultural system in this period therefore fully obeyed the well-established paradigm that crop production can only be improved by increasing manure resources (Krausmann, 2004). At the farm scale, diversification of production was also the best suited way to cope with pests, disease and weather and ensure the subsistence of the farm while multiplying possible outlets. As long as other technical possibilities remained limited, integrating crop and livestock was inherent in farming systems (Antoine and Herment, 2016). The visible shift from Fodder-fed integrated crop and livestock farming to Grass-fed integrated crop and livestock farming systems between 1852 and 1906 (Figure 4.6) also reflects the increase in grassland area as a corollary of the growing importance of livestock breeding activities. The integrated crop and livestock farming model was also well adapted to respond to a growing demand for animal protein whose distribution became physically possible with the development and extension of the railway network (Freycinet plan in 1878). Consequently,

animal production, which had long been a “necessary evil” (cf. Lavoisier 1791) started to become a marketable product. The expansion of the railway in the late 19<sup>th</sup> century also engendered the emergence of a national market for food products by opening up isolated rural regions. As a consequence, price differentials between regions lessened: for instance, the maximum difference among “départements” in the price of wheat shifted from 70% in the mid-19<sup>th</sup> century to less than 10% in 1913 (Duby and Wallon, 1993).

The slow increase in productivity of French agriculture, essentially driven by an increase in manure production rather than by the recourse to industrial fertilizers, contrasted with the development of agriculture in England and Germany during this period (Duby and Wallon, 1993; Muller, 1984). Duby and Wallon (1978) interpreted this delay in French agriculture to result from the structure of agriculture in France at these times that was well adapted to the needs of a national economy that matched the place France held in the world economy. Until the end of WWII the economic power of France in global capitalism arose mostly from its financial role as an international banking power. According to Duby and Wallon (1993), with their savings, peasants contributed almost one-third of the surplus money that could be appropriated through the banking channel and invested in the industrial sector and, above all, invested abroad as loans. For this reason, there was no political will in France to enhance labor productivity by mechanization or other forms of modernization, since this would have resulted in an increased rural exodus and a shift of peasant savings to investments. Accordingly, French population was predominantly rural (between 74 and 58% of the metropolitan France from 1852 to 1906) and the average size of farms remained quite small over the period with ca. 5.9 to 8.6 ha UAA per farm (Figure 4.5c). The protectionist measures implemented by the French Minister of Agriculture Jules Méline between 1884 and 1892 and until the beginning of WWI offered a sort of artificial prosperity to farmers, who were ensured outlets for their production without improving labor productivity through mechanical and chemical modernization; instead, farmers could fulfil their dream of purchasing land (Duby and Wallon, 1993). The limited rate of fertilization induced by this slow modernization resulted in very high NUE and PUE, a low N balance and a slightly negative P balance (Figure 4.5d and e), indicating that the intensification of agricultural production led to loss of soil fertility, with only quite limited inputs of exogenous fertilizers.

The results could provide the impression of uniformity in the agricultural production pattern in the 1852–1906 period. However, some areas within a region, such as the Rennes Basin in Brittany, were already in a process of specialization in the sense that their local production was already dedicated to exportation (Cocaud, 2016), while others remained behind this movement. In total, the perspective adopted in this chapter revealed that, despite a possible patchwork of farming, the overall regional structure of agricultural systems led to similar biogeochemical patterns.

### 3.2. Timid beginning of crop specialization: 1907–1946

For the same reasons as those explained in section 3.1, and in spite of the major crises of WWI and 1929, the inter-war period continued to be characterized by the near homogeneity of integrated crop and livestock farming. Self-subsistence was still perceived as the best protection against poverty and integrated crops and livestock farming thus remained the best-suited system. This assumption can be confirmed by the figures of on-farm consumption in 1938: 30% of the pork meat, 30% of the dairy products, 40% of the eggs, 20% of the wine and 10% of the wheat harvest were consumed on the farm (Duby and Wallon, 1978). Nevertheless, the very beginning of regional specialization in crop production around the Ile-de-France region was already visible (Figure 4.5). Following Von Thünen's theory, the specialization in cash crop production in this area should be attributed to the closeness of Paris; however, other factors such as proximity to the Seine River or the establishment of a complex commercial network also explain the geography of specialization (Antoine and Herment, 2016).

During this period, N mineral fertilization clearly rose in regions specialized in Intensive arable crops, shifting from almost zero at the end of WWI to  $9.9 (\pm 0.9) \text{ kgN ha}^{-1} \text{ yr}^{-1}$  in 1929 and then  $14 (\pm 1.2) \text{ kgN ha}^{-1} \text{ yr}^{-1}$  in 1946. By contrast, in regions of integrated crops and livestock farming, N mineral fertilization rose more slowly. Between 1929 and 1946, the rates of N mineral fertilizer over arable land shifted from  $4 (\pm 0.4) \text{ kgN ha}^{-1} \text{ yr}^{-1}$  and  $8.5 (\pm 0.8) \text{ kgN ha}^{-1} \text{ yr}^{-1}$  to  $5.5 (\pm 0.6) \text{ kgN ha}^{-1} \text{ yr}^{-1}$  and  $6.7 (\pm 0.7) \text{ kgN ha}^{-1} \text{ yr}^{-1}$  in regions of Grass-fed and Fodder-fed integrated crops and livestock farming, respectively. Regarding P, rates of mineral fertilization increased considerably between 1906 and 1929 but then slightly decreased between 1929 and 1946, probably due to the economic difficulties arising from the economic crisis and WWII ( $8.7 (\pm 0.7)$ ,  $8.5 (\pm 0.7)$  and  $9.2 (\pm 0.8) \text{ kgP ha}^{-1} \text{ yr}^{-1}$  in 1929 and  $7.5 (\pm 0.6)$ ,  $7.1 (\pm 0.6)$  and  $6.3 (\pm 0.5) \text{ kgP ha}^{-1} \text{ yr}^{-1}$  in 1946 for Intensive arable crops, Grass-fed and Fodder-fed integrated crops and livestock farming systems, respectively). Although it was limited, the progress in the use of mineral fertilizers during the inter-war periods has been mainly attributed to the popularization of new technical possibilities provided by industry and national syndicates for mineral fertilizers, such as the propaganda created in 1920 (Duby and Wallon, 1978). Furthermore, modernization was triggered after WWI resulting from the losses of millions of peasants killed in combat in WWI; increasing the productivity of agricultural labor was therefore a necessity. However, the role of the state remained limited to the creation of the national Grain Board in 1936 by the Front Populaire, allowing farmers to be involved in the fixation of wheat prices. In the absence of national policy, the investment in new technical equipment remained low and more than two-thirds of peasant debts still involved land acquisition. The average size of farms almost double, increasing from 5.9, 7.4 and 6.5 in 1929 to 12.4, 10.6 and 9.9 ha UAA in 1946 in Intensive arable crops, Grass-fed and Fodder-fed integrated crop and livestock farming systems respectively. However these average sizes of farms remained quite small, reflecting the technical limits to run a farm by a family.

In spite of the development of mineral fertilizer, arable crop yields stagnated, although disparities between the different types of agricultural systems showed better performance in

regions of Intensive arable crop with average yields of  $67 \pm 4$ ,  $47 \pm 3$  and  $51 \pm 3$  kgN ha<sup>-1</sup> yr<sup>-1</sup> for Intensive arable crops, Grass-fed and Fodder-fed integrated crops and livestock farming systems, respectively (Figure 4.5a). The combination of stagnant yield and little progress in terms of N fertilization resulted in a progressive increase in N balance over arable land, but this remained quite low (Figure 4.4d). Similarly, the slight decline in P mineral fertilization between 1929 and 1946 led to reduced, but still positive, P balances for cropland in all types of regions.

Interestingly, regions that specialized were also among those identified by Bonnin et al. (2014) as presenting the greatest loss of wheat genetic diversity, promoted by intensification and integration of crop production to market. However, the study of these authors showed that other regions had already been concerned by losses in wheat genetic diversity since 1912, mainly the Paris basin and the northwest quadrant. It is therefore possible that regions such as Picardie, Eure and Champagne-Ardenne-Yonne were already on the path toward arable crop intensification, as will be confirmed in the next section.

### **3.3. The expansion of crop specialization and the great acceleration: 1947–1978**

The three decades following WWII were marked by the expansion of Intensive arable crop system around the Paris Basin and the development of a new type of agricultural system defined in our typology as Disconnected intensive crops-extensive livestock farming. The use of synthetic fertilizer started to increase from the end of WWII and exploded at the beginning of the 1960s, generating high N and P balances over arable land (Figure 4.5d and e) and grassland. This trend was not specific to France: similar patterns also occurred in other European countries (Bouwman et al., 2017). The degree of openness of N and P cycles strongly depended on the type of agricultural system. Regions of Intensive arable crops exported most of their vegetal production and relied almost completely on N and P mineral fertilizers to compensate for export through harvest. Regions of Disconnected intensive crops-extensive livestock farming relied mainly on N and P mineral fertilizer for arable land production but retained significant livestock farming where animals were mainly fed on permanent grassland. In this type of region, the complementarity between arable land, grassland and livestock production was giving way to a disconnection of animal and crop production. Along with the expansion of agricultural specialization, regions defined as Grass-fed or Fodder-fed integrated crop and livestock farming still existed, with strongly interlinked N and P flows between arable land, grassland and livestock production, but were characterized by an intensification of both arable land and livestock production (Figure 4.5a and b) and an increased use of mineral fertilizer, particularly P. Therefore, although specialization only concerned crop production, intensification of arable production was occurring everywhere with increased yield. Densification of livestock production was also characteristic of this period, except for regions specialized in crop production (Figure 4.5b). As a consequence, N and P balances rose sharply from the beginning of the 1960s in all types of region, resulting in a rapid decrease in NUE and PUE.

These far-reaching changes in the intensity and nature of N and P fluxes in the different types of agricultural systems in French regions have to be linked to their historical background. In the post-WWII context, France was completely devastated and almost everything had to be rebuilt. Consequently, France had to live on credit and its commercial balance was in strong deficit. By comparison with previous periods, the economic situation of France in the world economy had completely changed (Duby and Wallon, 1978). A voluntarist policy was thus implemented to find a new acceptable place for the French economy within Europe, implying an enormous increase in agricultural production, in order not only to meet domestic demand, but also to become a net exporter on the international agricultural market (Jollivet, 2007). The Monnet Plan (1945) followed by the Marshall Plan (1947) thus explicitly aimed at improving labor productivity in agriculture in order to export food products, accelerate the rural exodus and free labor for employment in industry, as well as making agriculture an important outlet for the chemical and machinery industrial sectors (Duby and Wallon, 1978). To reach that goal, the French government implemented a strong policy of popularization and education in the countryside and developed new land ownership legislation that favored the development of the medium-sized farm, eliminating the smallest and least competitive landowners while avoiding the concentration of land in the hands of non-farmers, which would have led to the development of wage-earning in the agricultural sector (Duby and Wallon, 1978). As a consequence, the average size of farms increased from 33, 15, 12 and 5 ha in 1955 to 42, 25, 22 and 18 ha UAA in 1978 for Intensive arable crops, Disconnected intensive crops-extensive livestock farming, Grass-fed and Fodder-fed integrated crops and livestock farming systems respectively. The implementation of the European common market in 1957 fostered the modernization of agriculture by protecting internal European markets with custom barriers. Later on, the implementation of the Common Agricultural Policy beginning in 1962 ensured that farms adopted modernization to remain viable by providing them outlets for food products at guaranteed prices (Bureau and Thoyer, 2014). However, the project of agriculture modernization was not only led by the French state and the European Economic Community (EEC) but also by agricultural organizations themselves such as the *Centre d'Etude Techniques Agricoles* (CETA, Center for agricultural technical studies), *Groupe de Vulgarisation Agricole* (GVA, Group of Agricultural Vulgarization) and the *Jeunesse Agricole Catholique* (JAC, Catholic Agricultural Youth) (Gerbaux and Muller, 1984). These changes clearly turned peasants into entrepreneurs (Jollivet, 2007). This was however not accepted by all of them and in the 1970's other organizations emerged such as the *Confédération nationale des syndicats de travailleurs paysans* (CNSTP, National Union of Peasant Workers) which struggled against productivism and for the union of peasants and workers, with the emblematic fight for the Larzac from 1970 to 1981.

Overall, modernization of agriculture in France was stimulated through propaganda and economic incentives but was constrained by laws restricting and regulating access to land, reinforcing the competition between farmers who had to modernize to survive. This fierce competition combined with modernization is probably the main factor explaining the expansion of crop specialization during the 1946–1981 period (Jollivet, 2007). Machines, fertilization and herbicides were first designed for arable land to facilitate crop specialization. Furthermore, cereals producers were the main beneficiaries of the French government and European subsidies

through price setting of wheat and export subsidies (Bureau and Thoyer, 2014). This is consistent with the larger expansion of average size of farms in Intensive arable crops systems where farmers were the most propelled to modernize. Therefore, the great acceleration in crop specialization, the increasing openness of N and P fluxes in agricultural systems and the dependency on external inputs were driven by economic interests and by the political commitment of the French government and the Common Agriculture Policy.

### **3.4.Livestock specialization and the rational use of fertilizers: 1979–2014**

The most recent period from 1978 onwards was characterized by the continuous development of Intensive arable crop systems together with the emergence of a new type of agricultural system, i.e., “Intensive livestock farming” (see Figure 4.6). At the same time, regions defined as Disconnected intensive crops-extensive livestock farming declined, either as a result of a lower rate of mineral fertilizer (which gave greater weight to manure recycling on arable land and grassland and therefore led to classify this type of region into integrated crop and livestock farming system), or because they turned into specialized arable crop system. The 1980’s marked the beginning of Intensive livestock farming in the west of France. Poultry and pig breeding were the most emblematic of this new form of industrial breeding, which were nothing else than factories converting vegetal proteins into animal proteins (Duby and Wallon, 1978). The average size of farms kept rising in all types of agricultural regions, with however significant differences between regions (Figure 5.c). The smallest average size of farms was in Intensive livestock farming systems with 45 ha UAA in the 2004-2014 period, which is consistent with the low surface requirement for intensive animal breeding where most feed is imported from abroad. By contrast the Intensive arable crops kept being characterized by the largest average size of farms with 63 ha UAA in the 2004-2014 period. The consequences of increased specialization in terms of N and P fluxes were an increased dependence upon feed import and a structural excess of N and P inputs to arable land and grassland through manure application, generating high N and P balances, although moderate mineral fertilization has reduced these balances over the last two decades (Figure 4.4e).

Indeed, this period also showed a clear inversion in the trends of mineral fertilization. At the same time, arable yields kept rising, although at a slower rate than in the previous period. As a consequence, the N and P balances on arable land steadily decreased. In regions of Intensive arable crops, P balances have even become increasingly negative over the two last decades. As pointed out in the previous chapter, this could probably be achieved without loss in crop yield due to the huge soil P legacy built up between 1960 and 1980. This decreasing trend is taking place in all types of regions and started by the end of the 1970s. It coincided with the second oil crisis, which generated a peak in energy prices and therefore in the price of N and P fertilizers (Mew, 2016). With the 2007–2008 food crisis, phosphate rock and fertilizer prices increased by 700% in 14 months (Cordell et al., 2009), probably contributing to reinforcing the decline in P mineral fertilizer use. After the 2000s the decline in N and P mineral fertilizer use might also be attributed to the implementation of agro-environmental measures introduced at the European level through a series of successive European directives gathered within the Water

Framework Directive in 2000 (Bureau and Thoyer, 2014). The consequences of these changes were the increase of NUE and PUE in every type of regions except Intensive livestock farming regions.

Summarizing the changes during this period, regional specialization strengthened while N and P inputs through mineral fertilizers decreased but the ever-growing dependence for both inputs and outlets, increased the openness of N and P cycles. On the economic side, policies progressively shifted from interventionism and support to production to give way to greater liberalism by lowering and sometimes eliminating customs barriers. The Common Agricultural Policy stopped linking its subsidies to the volume of production, which instead became indexed on the surface area farmed and the herd size. The aim was to incite farmers to adapt to international competition (Bureau and Thoyer, 2014) which subsequently reinforced these specialized production patterns and fully integrated agriculture into the market economy.



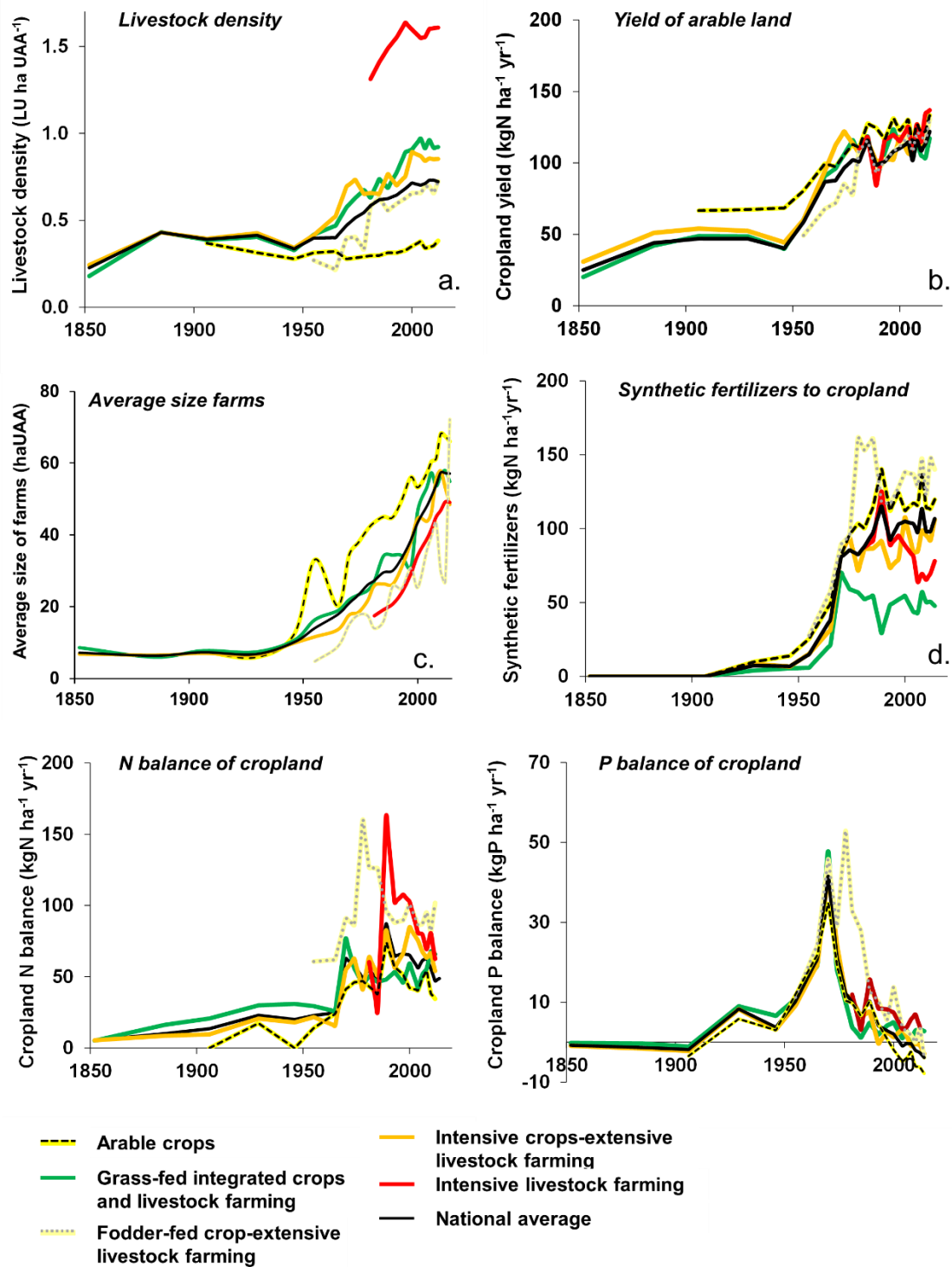

**Figure 4.5** Evolution in the five different types of regions considered for France over the 1852–2014 period. **a.** Livestock density (LU haUAA<sup>-1</sup>); **b.** yield of arable land (kgN ha<sup>-1</sup> yr<sup>-1</sup>); **c.** Average size of farms (based on a calculation of the number of farms of more than 1 ha over the UAA of each regions, except for 1852 where farms of less than 1 ha were a significant share of the UAA and were accounted in the total of farms) (haUAA); **d.** rate of N synthetic fertilizer application over arable cropland (kgN ha<sup>-1</sup> yr<sup>-1</sup>); **e.** N balance of arable land (kgN ha<sup>-1</sup> yr<sup>-1</sup>); **f.** P balance of arable land (kgP ha<sup>-1</sup> yr<sup>-1</sup>).

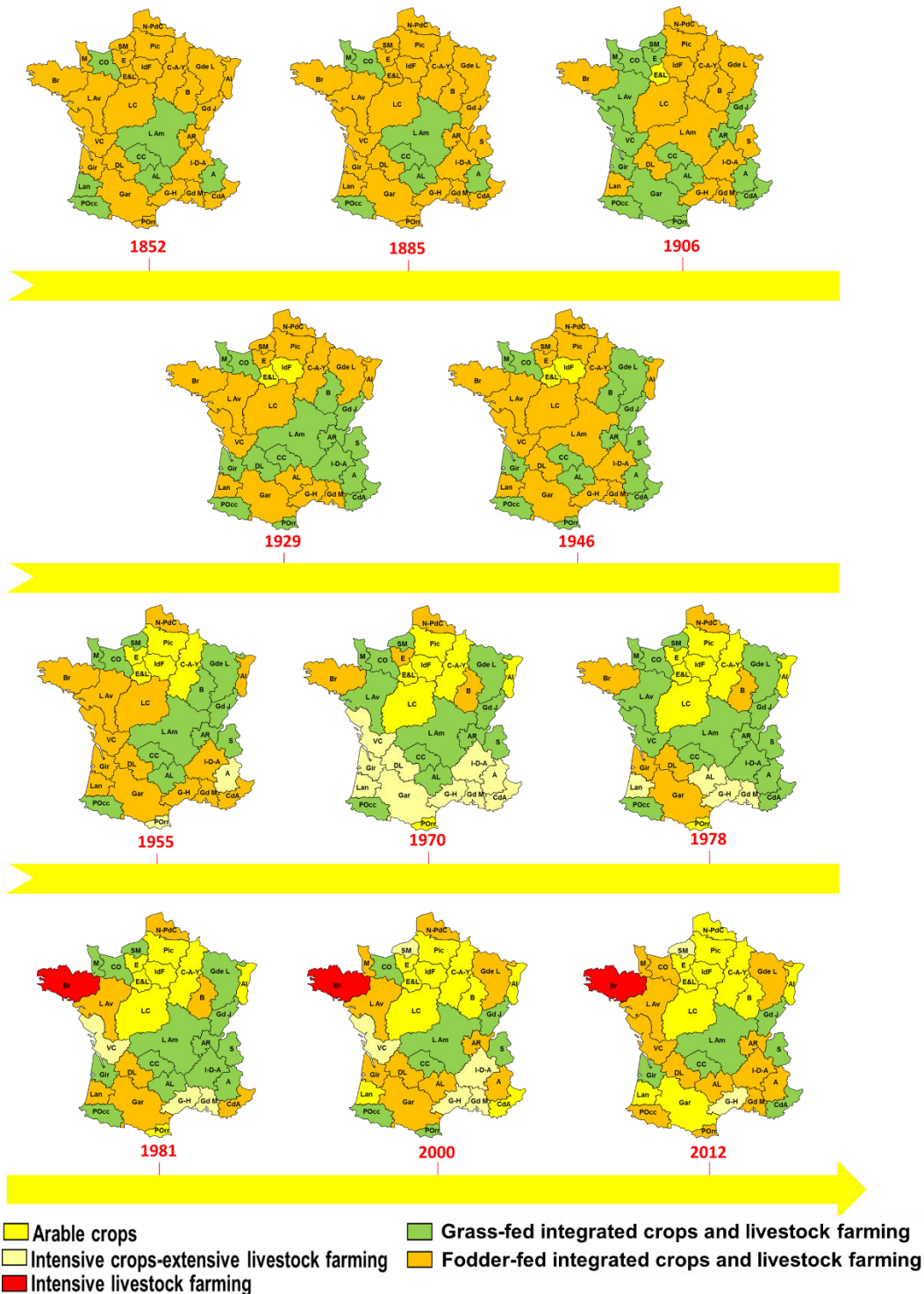

**Figure 4.6** Chronology of the different types of agricultural regions in France over the 1852–2014 period. A: Alpes; Al: Alsace; AL: Aveyron-Lozère; AR: Ain-Rhône; B: Bourgogne; Br: Bretagne; C-A-Y: Champagne-Ardennes-Yonne; CC: Cantal-Corrèze; CdA: Côte d’Azur; CO: Calvados-Orne; DL: Dordogne-Lot; E: Eure; E&L: Eure-et-Loire; Gar: Garonne; Gd J: Grand Jura; Gd M: Grand Marseille; Gde L: Grande Lorraine; G-H: Gard-Hérault; Gir: Gironde; I-D-A: Isère-Drôme-Ardèche; IdF: Ile de France; L Am: Loire Amont; L Av: Loire Aval; Lan: Landes; LC: Loire Centrale; M: Manche; N-PdC: Nord Pas-de-Calais; Pic: Picardie; Pocc: Pyrénées Occidentales; POR: Pyrénées Orientales; S: Savoie; VC: Vendée-Charentes.

## 4. Socio-economic and political mechanisms behind the regional biogeochemical trajectories

The major results brought by the above application of the GRAFS approach to the long-term evolution of agricultural production in the regions of France can be summarized as follows.

In the mid-19<sup>th</sup> century, the production patterns of regional agricultural systems were quite homogeneous. Integrated crop and livestock farming systems were the rule everywhere and manure recycling was the main source of agricultural land fertilization. However, at the beginning of the 20<sup>th</sup> century, the sustainability of this farming system began to be jeopardized by the mining of soil nutrient stocks, especially P. Over the course of the 20<sup>th</sup> century, this situation shifted toward more contrasted production patterns, particularly after the WWII: modernization of agriculture contributed to the emergence of specialized cereal cropping systems in the most fertile plains of the North of France, exporting a large fraction of their cereal production, and decreasing their connection to livestock. The significant rupture after 1946, which accentuated the openness of regional agricultural system, was promoted by the increased recourse to mineral fertilizers and the subsequent separation of crop and animal production in regions on a path to specialization. The consequences for N and P cycles varied, depending on the specific trajectory of each region. Overall, regions of Intensive arable crops revealed the highest degree of openness through crop exportation, while the region of Intensive livestock farming was characterized by a growing reliance on feed importation and over-fertilization of arable land through manure inputs. However, all regions, including those which remained belonging to the Grass-fed and Fodder-fed integrated crop and livestock farming system, intensified their production during the second half of the 20<sup>th</sup> century by increasing rates of mineral fertilizer inputs. As a result, arable yield rose, as did the N and P balances. The rise of fertilizer prices together with the implementation of agro-environmental measures over the last two decades resulted in the lowering of N and P balances, the latter being even negative in regions specialized in crop production. However, as long as the agricultural system remains specialized, possible changes through improved fertilization are to be limited by the inefficiency of nutrient recycling at the regional level.

Although regional agricultural systems followed quite different trajectories, they all display a general trend toward increasing production available for exportation and increasing reliance upon extra-territorial resources. This became particularly true since the end of WWII. This opening (in terms of impossibility of closing nutrient loops) and loss of autonomy (in terms of dependence on exogenous resources) characterizes what has been designated as a “metabolic rift” by J.B. Foster (2013). In section 3 above we examined the national political and economic context which fostered the evolution of French regional agricultural systems. However, some questions remain open: how were these transformations of agricultural production made possible at the individual level of the farm? At this level, which mechanisms explained the ever-rising production excess of agricultural products? How can the mode of production at nested scales be related to the growing metabolic rift in agriculture in France?

#### 4.1. Applicability of the concept of metabolic rift in the Marxist theory to agriculture

According to Foster (2013), his developed concept of metabolic rift for characterizing the development of specialized, open cycle agriculture, dates back to the critique of “Large-scale Industry and Agriculture” in Karl Marx’ Capital (1867):

*“Capitalist production collects the population together in great centers, and causes the urban population to achieve an ever-growing preponderance. This has two results. On the one hand it concentrates the historical motive force of society; on the other hand, it disturbs the metabolic interaction between man and the earth, i.e., it prevents the return to the soil of its constitutive elements consumed by man in the form of food and clothing; hence it hinders the operation of eternal natural condition for the lasting fertility of the soil (...). But by destroying the circumstances surrounding that metabolism (...) it compels its systematic restoration as a regulative law of social production, and in a form adequate to the full development of the human race (...). All progress in capitalist agriculture is a progress in the art, not only of robbing the worker, but of robbing the soil; all progress in increasing the fertility of the soil for a given time is a progress toward ruining the more long-lasting sources of that fertility” (Cited after Foster, 2013)*

According to this critic by Marx, the metabolic rift is generated by the capitalist mode of production in agriculture and by the process of concentration of population in large cities distant from their feeding hinterland.

The difficulty in accepting this simple explanation lies in the fact that the definition of capitalist mode of production did never apply to agricultural production during the period studied in France. A current broad definition of capitalism lies in relations of production based on private property leading to the separation between capital (which can be financial, i.e. financial assets, or economic, i.e. means of production) and the labor forces (workers). As workforces has been progressively separated from the means of production over the course of a long historical process from the mid-19<sup>th</sup> to now, workers need to sell their labor power against wages to the capital owners. Thanks to their wages, workers can buy the goods they do not produce themselves. However, in the capitalist system, workers only perceive a fraction of their labor since part of the gains (the so-called profit) goes to the employer. Furthermore labor itself is a commodity since workers must sell their workforce to their employer and are in competition with other workers on the labor market.

In France the mode of production in agriculture does not fit this definition of capitalism because, since the French revolution, the vast majority of peasants and farmers owned their land or at least rented it (Dubey and Wallon, 1978, 1993). *Strico sensu*, farmers are thus not part of the proletariat. From the mid-19<sup>th</sup> century to the end of WWII a reason to this must be found in the voluntary policies implemented in order to favor the access to land property. As observed by Augé-Laribé by the beginnings of the 1880’s, on the one hand, “*the technical superiority of the*

*big exploitation was not incontestable enough to crush the resistance that peasant parcels stubbornly opposed to the concentration of land”, on the other hand “at the moment where democratic ideas, if not socialist, were already circulating in the villages, it was wisdom, prudence and wit to gather proprietary of all size in a coherent group and to maintain individual property as an intangible principle, divine for right men, revolutionary for the radicals” (cited after Servolin, 1977).*

## **4.2. The coexistence of specialized cropping farms and integrated crop and livestock farms**

However, after WWII, the technical conditions for massive increase in labor productivity in vegetal production existed: mechanization of all productive operation, high-yield variety of plants, mineral fertilization enabling to skip manure fertilization, simplification of the rotations, and the use of pesticides. As already observed this enabled an ever-specialization in crop production (Figure 4.6) together with a growing intensification in several regions (Figure 4.5a and b). Owing to the recourse of these new industrial products, farmers which got specialized in crop cultivation were capable to make profit often equivalent, if not superior, to the average profit rate in the agricultural sector, and become more and more characterized as market enterprises (Servolin, 1977). However, these high profit rates cannot be attributed to an elevated relative plus-value since much of these market oriented farmers succeeded in increasing their capital by performing themselves the productive work and almost without waged labor (Servolin, 1977). As a consequence, although the average size of farm increased, it kept being small enough for a couple or a family to run the farm with modern production technique (Figure 4.5c). It therefore corresponds to a type of mercantile capitalist mode of production and not to an industrial one since there was no or few labor division within the exploitation. On the other hand, as illustrated in Figure 4.6, animal breeding kept being organized according to the traditional integrated mixed crop and livestock farming systems with average sizes of farms smaller than in Intensive arable crops systems. Therefore, as observed by Servolin (1977), smallholding peasants conserved the exclusivity of animal breeding (Servolin, 1977). By contrast to big farmers, small peasants could only remunerate themselves in order to maintain their own subsistence and to reproduce the conditions of their labor. This was particularly true in the 1960's and the 1970's when peasants were willing to accept very hard conditions of labor and to sell the fruits of their labor to prices lower than their real values, which enabled them to keep being competitive on the market (Servolin, 1977). Here was the basis for the co-existence between small and big exploitations which translated at the regional scale into the coexistence of specialized cropping systems and integrated crops and livestock farming systems (Figure 4.6).

One could wonder why no trend appeared to concentrate land property and to establish wage-earning in animal production. A first reason to this must be found in the high land prices resulting from the fierce competition between farmers to acquire a piece of land so that land represents a sterile capital for the non-exploiting owner. Nevertheless, although this assertion was still true until the end of the 70's, things started to change from the beginning of the 1980's

on, as land rental increased (de Cirseno, 1988; Courleux, 2011). Consequently tenant farming became more important in the last four decades but this was partly resulting from the demographic shifts with an increased proportion of retired farmers compared to younger assets who rented their land (Courleux, 2011). Since the beginning of the 21<sup>st</sup> century, wage-earning in the agricultural sector increased but still represented less than 1/3 of the hours worked (Cahuzac and Détang-Dessendre, 2012).

### 4.3. Specialization as a support of market economy

Smallholding peasant having survived, it is now necessary to examine how they adapted to economy exigencies and how this mode of production was affected by its integration in the economy. Classically, the peasant smallholdings can be categorized as small market production systems (or *petite production marchande*), because of two major characteristics: (1) the worker is owner of all the means of production, the process of production is organized by him/herself and according to its workmanship (or *métier*). The fruit of its labor totally belong to him/herself; (2) the aim of the production is neither the growth of the capital nor the profit, but the subsistence of the worker and its family, and the reproduction of the means of production necessary to insure it. Therefore, the sale of its products and the purchase for its subsistence and means of production are performed according to the simple exchange: the producer exchanges the fruits of its labor against useful objects of equal value; money only plays the role of a pure mean of circulation (Servolin, 1977). However, agricultural production is not isolated from the rest of the economy. As soon as the direct producer requires the merchant to sell its production, this latter will take part of the value of the product to make gains.

Over the course of the 19<sup>th</sup> and the beginning of the 20<sup>th</sup> century, the industry progressed and increasingly replaced craft that used to produce non-agricultural goods. At the beginning of the 20<sup>th</sup> century, these changes in the configuration of rural economies already pushed peasants to more and more buy non-agricultural goods with money to capitalist merchants and producers whose prices depended on the national or even international market. Consequently, they had to increase their production for the market. This can be illustrated here by the increasing crop yield and livestock density in Fodder-fed and Grass-fed integrated crops and livestock farming (Figure 4.5a and b), a symptom that peasants smallholding were pushed to produce more to have an increased food surplus to sell on the market as also indicated by de Cirseno (1988). To that end, peasants and farmers had to adopt new techniques and to improve their means of production. Therefore, although technical investments mostly concerned the Paris Basin and the North until the end of WWII (Duby and Wallon, 1978), this phenomenon extended to the entire agricultural sector in the second part of the 20<sup>th</sup> century (Servolin, 1977; de Cirseno, 1988; Boinon, 2011). This required the adoption of scientific modes of production and an increased use of industrial means of production which could only be financed by the credit. However, these methods can only be applied efficiently if peasants own a minimum surface of production which led them to purchase or rent new lands (de Cirseno, 1988; Boinon, 2011). However, over the course of this second mid of the 20<sup>th</sup> century, in many cases, peasants could not purchase the equipment necessary to practice the traditional integrated mixed crop and livestock farming (Servolin, 1977) and they had to specialize into one type of livestock breeding

or into crop cultivation (Figure 4.6). This double necessity to specialize and to enlarge the surface of production is illustrated by the growing average size of farms after WWII, which grew even more rapidly and substantially in regions of Intensive arable crops system (Figure 5.c). However, this movement toward increasing average size of farms was also visible in Grass-fed and Fodder-fed integrated crops and livestock farming systems. Accordingly, in order to keep ownership of their labor conditions, peasants were more and more losing the real property of their means of production due to their indebtedness (Servolin, 1977; de Cirseno, 1988). The major consequences for the agricultural sector were (i) the continuous decrease of the value of agricultural goods (ii) the rural exodus and the ever-decreasing of agricultural assets in France (Servolin, 1977; de Cirseno, 1988; Boinon, 2011).

These trends were reinforced by the CAP reform after 1992 and the subsequent deregulation of agricultural market which further accentuated the integration of agricultural production into the market economy (Kroll and Pouch, 2012). These evolutions strongly impacted the production mode of peasant smallholding; the decision to produce and how to produce was less and less that of the peasant but rather increasingly involved the agro-alimentary industries (Rastoin, 2000), which kept controlling the labor conditions and gains of smallholding peasants (Servolin, 1977; de Cirseno, 1988).

Overall, the analysis of the evolutions of agricultural mode of production and their impacts on peasant constraints is coherent with our biogeochemical analysis at the regional level where we observed increase specialization and intensification of the production with growing food surplus in many regions. Therefore, the growing metabolic rift in French region, contrary to what was supposed by Marx, is not resulting from the shift from peasant smallholding to capitalist mode of production in agriculture but rather from the enlargement and intensification of the peasant smallholding which had to produce more and more for the market. Both economic power relation and national or supra-national policies fostered these changes toward increase absorption of agriculture to the capitalist economy. Such an absorption into capitalist relations of production has also been shown for various other non-industrial activities such as craft, where producers are neither salaries nor capitalists but have to sell their product on the market (e.g., Gerry, 1980).

## **5. Conclusion**

This chapter demonstrated the value of adopting a long-term perspective to articulate a vision of how production pattern changed and environmental and agronomic performances are related. The analysis of these changes in light of their political and economic contexts, based on the existing literature, showed that changes in production patterns as well as their consequences on N and P flows and agro-environmental performances should be mostly attributed to external factors related to political choices and modes of insertion within the market economy, rather than to mechanisms endogenous to agricultural production itself. Material flow analysis was shown to be a way to capture both the biophysical processes governing agricultural production and its impact on natural resources and the environment. At the same time, analyzing social, economic and political processes, allowed to illustrate how these processes evolve. A holistic approach linking the materiality of agricultural production to its political and economic logic helped understanding past changes for a vision of possible transformations of agro-food systems in the future. More generally, this chapter stressed out the artificiality of the distinction between “natural” and “anthropic” fluxes and the need for linking quantitative and qualitative approaches. Hence, this chapter should also be an incentive for further interdisciplinary collaboration at least in the fields of economic and political sciences, agronomy and environmental sustainability.





# Chapter V

## Drivers of long-term carbon dynamics in French cropland

*Soil organic carbon is an important environmental compartment with long residence time, the size of which is dependent on the long term history of agricultural practices. In this chapter we make use of the detailed data base discussed in the preceding chapter regarding the evolution of regional agriculture since the middle of the 19<sup>th</sup> century, to reconstruct the long term dynamics of cropland organic carbon pool, and discuss it the context of the so called 4‰ initiative.*

*This chapter is extracted from the paper: Le Noë J, Billen G, Mary B and Garnier J. Drivers of long-term carbon dynamics in French cropland, submitted in July 2018 to Global Change Biology.*



# 1. Introduction

Carbon (C) storage in arable soil is a key feature of both fertility and greenhouse gas balance and was recently promoted through the 4‰ initiative (<http://www.4p1000.org/>; Minasny et al., 2017) aiming at improving farming practices so as to increase soil C sequestration as a way to offset anthropogenic CO<sub>2</sub> emission. The balance between fresh organic matter inputs and mineralization of soil C defines soil as a sink or source of C. This balance results from complex soil processes depending on many variables at the field scale such as pedo-climatic conditions (Kätterer et al., 1998; Saffih and Mary, 2008; Milesi Delaye et al., 2013; Stockmann et al., 2013), soil aggregation (Six et al., 2000; Puget et al., 2000; Haynes, 2000; Bronick and Lal, 2004), micro-organism activities (Anderson and Domsch, 1989; Sparling, 1992; Six et al., 2006; Miltner et al., 2012), land-use change (Conant et al., 2001; Lal et al., 2004; Stockmann et al., 2013), as well as the nature and quantity of C inputs (Campbell et al. 1991; Kong et al., 2005; Poeplau and Don, 2012; Autret et al., 2016). Recent studies (Sleutel et al., 2006; Bertora et al., 2009; Virto et al., 2012; Autret et al., 2016; Poulton et al., 2018) have shown that, among all these factors, the quantity and nature of C inputs are the most determinant for the storage or release of soil C in the absence of land-use change. The nature and quantity of C inputs to cropland are themselves determined by crop rotation (Campbell et al., 1991; Autret et al., 2016), crop productivity, and manure application (Jenkinson et al., 1977; Sleutel et al., 2007). This, in turn, depends on agricultural practices such as tillage (Virto et al., 2012), irrigation, and fertilization (Burney et al., 2010; Mueller et al., 2012), which are driven by the structural organization of agricultural production at various spatial scales (Gingrich et al., 2015; Aguilera et al., 2018). Agricultural production must indeed be considered an important economic sector, conditioning in the first instance the development of all other sectors while its structural characteristics are in turn affected by its integration into the market economy (Erb et al., 2008; Krausmann et al., 2012).

In this context, an analysis of the C storage trend in agricultural soil by taking a historical and regional perspective is needed. To our knowledge, only one study (Aguilera et al., 2018) has focused on the interrelation between C storage in agricultural soil and the socioecological metabolism of agro-food systems. This study was conducted for Spain at the national scale for the period 1900–2008, considering Spain as a model for Mediterranean countries. The authors reported that the history of Spanish agriculture has been marked by the long period of isolationism under the fascist regime (1936–1978), which strongly impacted crop productivity and net primary production (NPP) and consequently the C inputs into soils. The case of French regions, having a wide range of climates, agricultural management practices, and food production trajectories, is of particular interest with respect to soil C storage. In addition, France can be considered a model for temperate countries, with the exception of South-East France, which experiences a Mediterranean climate.

The aim of this chapter is to assess the evolution of C stocks in cropland in the 33 French territories defined in section 1.2 of chapter I over the period 1852–2014. To this end, we coupled the GRAFS model (see chapter I) to the AMG model (Saffih-Hdadi and Mary, 2008; Milesi

Delaye, 2013; Clivot et al., 2018). We also seek to answer three related questions: (1) How did the soil organic C (SOC) in cropland change over the studied period? (2) Which were the main levers responsible for the observed trends of cropland SOC? (3) Given the current trends, would the objective of a 4‰ yr<sup>-1</sup> accumulation rate of C in cropland soil be achievable?

## **2. Material and Methods**

### **2.1. Principles of the method**

Coupling the GRAFS approach with the AMG model enables us to derive a direct link between the structure of agro-food systems, dominant crops cultivated, pedo-climatic conditions, and the soil C dynamics in cropland (Figure 5.1). We applied the GRAFS approach to the 33 regions defined in section 1.2 of chapter I for 22 dates from 1852 to 2014, to estimate NPP and humified C inputs (see section 6.2 and 6.4 of chapter I) and interpolated the humified C inputs between the two closest documented dates. Therefore, here we only provide a synthetic description of the main hypotheses and data sources used to establish mineralization rates of labile C in soil, and SOC changes during the period by coupling the two models. This chapter focusses on cropland (including temporary grasslands that are part of crop rotations) for which the AMG model was initially developed and calibrated. However, we also calculated the evolution of SOC in permanent grassland in order to account for the possible shift in SOC related to the conversion of permanent grassland into cropland.

## GRAFS description of regional agro-food system 1852-2014

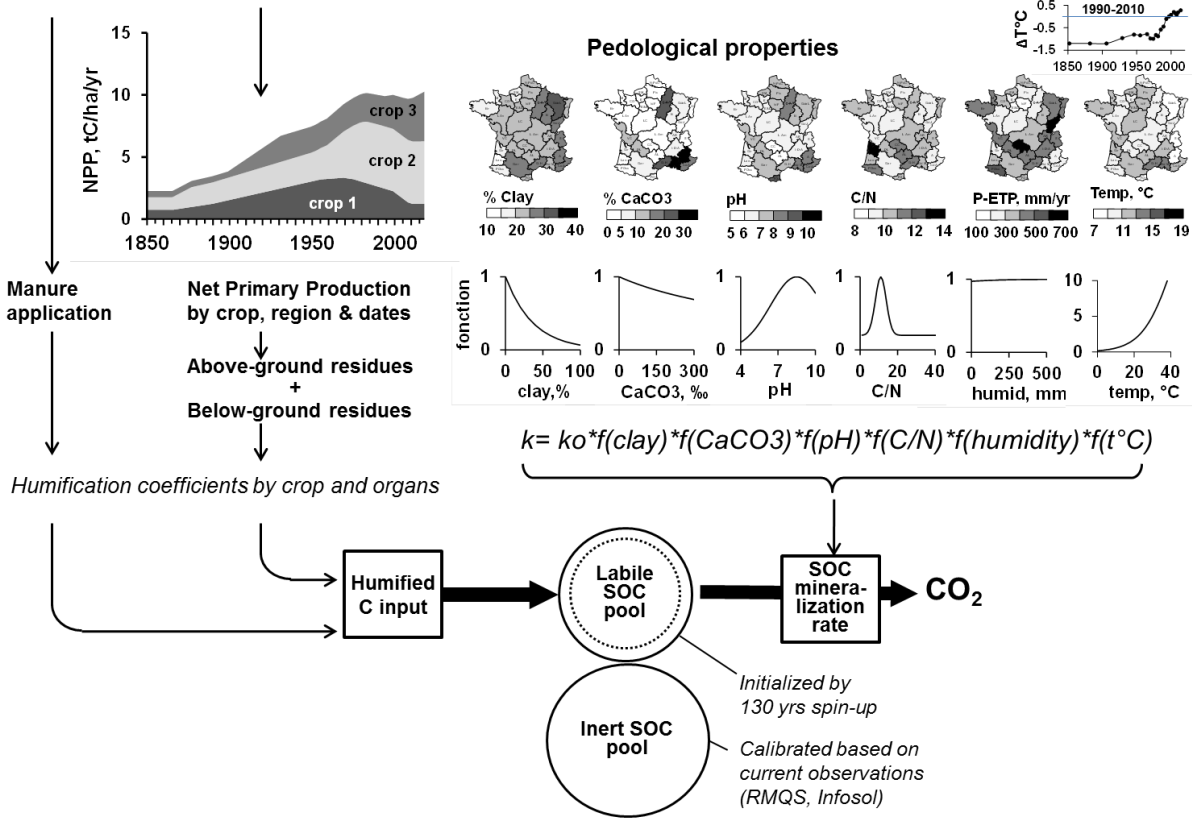

**Figure 5.1** Coupling of the GRAFS and AMG models. The AMG model considers three pools of C: fresh organic C inputs as well as soil labile organic C and inert soil organic C. Humified C inputs to the soil are estimated from the GRAFS considering three main types of inputs: manure, above-ground residues, and below-ground residues. The balance between annual humified C input and output via labile SOC mineralization drives the change in total SOC pool of cropland in the absence of land-use change.

## 2.2. Mineralization of labile C

Mineralization coefficients ( $k$ ) of labile C stocks were calculated according to Clivot et al. (2017) using the following equation:

$$k = k_o \times f_1(C) \times f_2(\text{CaCO}_3) \times f_3(T) \times f_4(\text{pH}) \times f_5(H) \times f_6(C/N)$$

where  $C$  is the % average clay content;  $\text{CaCO}_3$  is the carbonate content in  $\text{g.kg}^{-1}$ ;  $T$  is the temperature in  $^\circ\text{C}$ ;  $H$  is the humidity defined as rainfall – potential evapotranspiration + irrigation (all in  $\text{mm/yr}$ );  $C/N$  the carbon to nitrogen ratio of bulk soil organic matter in  $\text{gC/gN}$ .

with

$$f_1(C) = e^{-a\left(\frac{C}{100}\right)}, \text{ where } a = 2.72 \text{ (g kg}^{-1}\text{)}^{-1}$$

$$f_2(\text{CaCO}_3) = \frac{1}{1 + c_m \text{CaCO}_3} \text{ where, } c_m = 1.5 \times 10^{-3} \text{ (g kg}^{-1}\text{)}^{-1}$$

$$\begin{cases} f_3(T) = \frac{a_T}{1+b_T e^{(-c_T \times T)}} & \text{If } T > 0 \\ f_3(T) = 0 & \text{If } T \leq 0 \end{cases}$$

Where,  $b_T = (a_T - 1)e^{(c_T \times T_{ref})}$ ;  $a_T = 25$ ;  $c_T = 0.12$  ( $^{\circ}\text{C}^{-1}$ ) and  $T_{ref} = 15$  ( $^{\circ}\text{C}$ )

$f_4(H) = 1/(1 + a_H e^{[-b_H \times (R - PET + irrigation)]/1000})$  where,  $a_H = 3 \times 10^{-2}$   $\text{mm}^{-1}$ ;  $b_H = 5.247$   $^{\circ}\text{C}^{-1}$ ;

$f_5(pH) = e^{-a_{pH} \times (pH - pH_c)^2}$  where,  $a_{pH} = 0.112$  and  $pH_c = 8.5$

$f_6\left(\frac{C}{N}\right) = 0.8e^{-a_{CN}\left(\frac{C}{N} - CN_c\right)^2} + 0.2$  where,  $a_{CN} = 0.06$ ;  $CN_c = 11$

These functions were initially calibrated for long testing periods in field studies with varying climate conditions typical of the diverse French regions. In this chapter, except for temperature, we used these functions to estimate average mineralization rates of labile C in cropland and grassland soils at the regional level from the corresponding regional average value of the soil variables (see below), which is an approximation due to the non-linearity of the functions.

Average clay content in arable land and permanent grassland was calculated by superimposing GIS layers of land use (CORINNE LandCover, [www.data.gouv.fr/fr/datasets/](http://www.data.gouv.fr/fr/datasets/)), French ‘départements’ (Nuts 3), and clay content in the 20-cm topsoil (European Soil Data Center, Ballabio et al. 2016). Clay content in arable land and permanent grassland for each region was subsequently calculated as the average clay content of each departments included in a given territory weighted by surfaces of cropland and permanent grassland. The estimated values of clay content were considered constant over the whole study period.

Because of the highly non-linear character of the  $f_3(T)$  function, its annual mean value was calculated for each ‘département’ as:  $f_3(T) = \sum_i^n f_3(T_i)/365$ , where  $T_i$  is the daily mean temperature and  $i$  is the julian day. The average day by day variations of  $T_i$  was calculated from daily temperature data at the ‘département’ level from 1990 to 2010, taken from the MESAN database (Raimonet et al. 2017) over a grid of 12 x 12 km. In order to take into account the effect of climate change over the 1852-2014 period, we superimposed to the latter data a temperature shift calculated for each region and each year as the annual mean temperature deviation from the 1990-2010 average, obtained from long term annual mean data per department available from 1950 to 2014 (E-OBS, [www.ecad.eu/download/ensembles/download.php](http://www.ecad.eu/download/ensembles/download.php)) and completed by the national data of Moisselin (2002) for the period from 1850 to 1950. The reconstituted temperature variations, and the corresponding  $f_3(T)$  values across the 1852-2014 period, are illustrated in Figure 5.2.

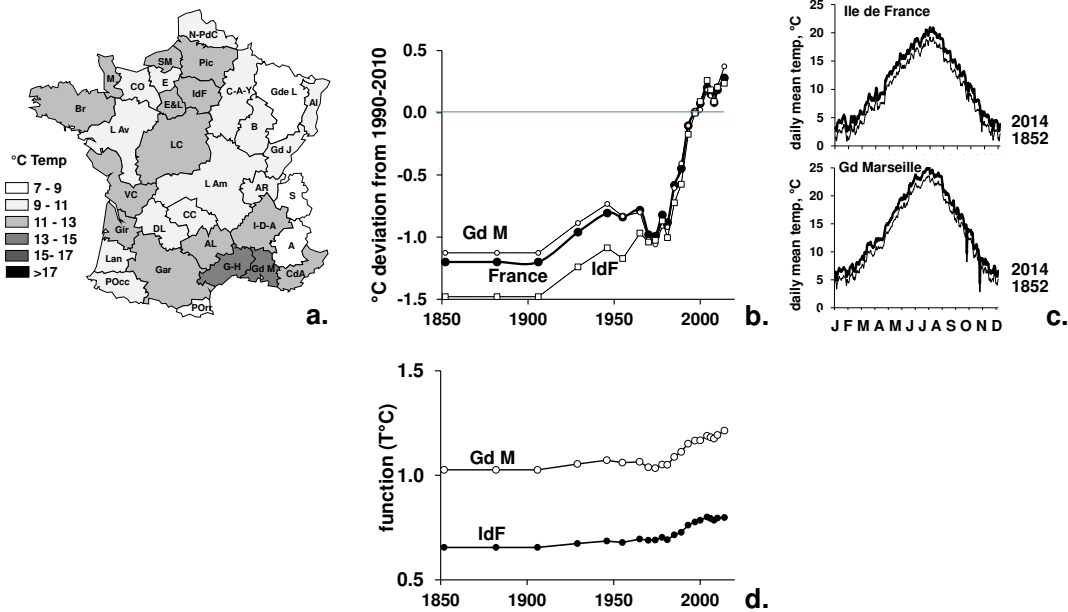

**Figure 5.2** *a.* Distribution of mean annual temperature (1990-2010) across French regions. *b.* mean annual temperature deviation from the 1990-2010 average since 1852, for Ile de France (IdF), Gd Marseille (GdM) and whole of France. *c.* Annual variations of temperature in Ile de France and Grand Marseille in 1852 and 2014. *d.* Long term variations of the annual value of the temperature function of mineralization coefficient in Ile de France and Gd Marseille regions.

In the AMG model, soil humidity was estimated from:  $R - PET + \text{irrigation}$ . Here, we used the data of runoff for the last two decades at the ‘département’ scale derived from specific volume flow rates provided by the HYDRO data bank ([hydro.eaufrance.fr/](http://hydro.eaufrance.fr/)). We used these values for the whole study period for both cropland and permanent grassland.

Carbonate content, C/N ratio, and pH in the 30-cm topsoil were estimated from the data provided by the French National Institute of Agronomy (INRA) and collected by the Network of Measurements and Quality of Soil (RMQS). This network has been implemented by INRA, which centralizes numerous analyses of soil measurements at the department (Nuts 3) scale. Carbon losses through erosion could also represent an output of C from cropland but were not accounted for in this study. Changes of SOC stocks due to erosion are difficult to evaluate because erosion is likely to engender both output through losses and input through redeposition. Integrating all C fluxes for European Union agricultural soils, Lugato et al. (2016) calculated that the net effect of erosion on agricultural soils can be either positive or negative on the overall soil C balance.

### 2.3. Changes in soil organic carbon

Changes in labile C stocks in the 30-cm topsoil of cropland and grassland of each territory were calculated by incrementation on an annual time-step. Labile C stocks were initialized by a spin-up calculation assuming constant rates of humified C inputs during a period of 130 years prior to 1852. The land-use change that may have occurred from permanent grassland to



cropland was accounted for from 1852 to 2014 if, for a given year, permanent grassland lost surfaces while arable land gained surfaces, considering the conversion from one to the other as the smallest absolute surface change. The process was iterated each year and stocks of labile C in permanent grassland and arable land for year  $n+1$  was thus calculated as:

$$C_{\text{Lab GL } n+1} = (C_{\text{Lab GL } n} + \sum_j I_{j \text{ GL}} \times h_j - k_{\text{GL}} \times C_{\text{Lab GL } n}) \times \frac{1}{1 + \varepsilon_1} + (C_{\text{Lab AL } n}) \times \frac{\varepsilon_1}{1 + \varepsilon_1}$$

$$C_{\text{Lab AL } n+1} = (C_{\text{Lab AL } n} + \sum_j I_{j \text{ AL}} \times h_j - k_{\text{AL}} \times C_{\text{Lab AL } n}) \times \frac{1}{1 + \varepsilon_2} + (C_{\text{Lab GL } n}) \times \frac{\varepsilon_2}{1 + \varepsilon_2}$$

$C_{\text{Lab GL}}$  and  $C_{\text{Lab AL}}$  denote the stocks of labile C (in tC ha<sup>-1</sup>) in permanent grassland and arable land, respectively.  $k_{\text{GL}}$  and  $k_{\text{AL}}$  refer to the mineralization rate of labile C in permanent grassland and arable grassland, respectively (in yr<sup>-1</sup>).  $I_{j \text{ GL}}$  and  $I_{j \text{ AL}}$  are inputs of crop residue (or manure)  $j$  to permanent grassland and arable land, respectively (in tC ha<sup>-1</sup> yr<sup>-1</sup>).  $h_j$  is the humification rate of residue  $j$  (in yr<sup>-1</sup>).  $\varepsilon_1$  is the fraction of grassland in year  $n+1$  that was under arable land in the previous year  $n$  and is calculated as the minimum value of absolute surface change of arable land and permanent grassland between years  $n+1$  and  $n$  divided by permanent grassland area in year  $n+1$ . Conversely,  $\varepsilon_2$  corresponds to the fraction of arable land in year  $n+1$  that has been converted from permanent grassland in year  $n$  and is calculated as the minimum value of absolute surface change of arable land and permanent grassland between years  $n+1$  and  $n$ , divided by arable land area in year  $n+1$ . The values of  $\varepsilon$  are generally close to zero, and reach a few percent only during limited periods in specific regions.  $\varepsilon$  values thus introduce only a second-order correction during these periods, provided the organic content is significantly different between grassland and cropland.

According to the hypotheses of the AMG model, stocks of inert C in the 30-cm topsoil are considered remaining constant and identical in crop and grassland of the same pedoclimatic region. Stocks of inert C were estimated for 2014 by subtracting the calculated stocks of labile C from the observed total stocks of C in arable land. These total stocks of C in cropland and grassland were obtained from the RMQS database mentioned earlier, and aggregated at the territorial level.

## 2.4. Uncertainties

Uncertainties were estimated applying the Monte Carlo method to generate random samples of values for humified C inputs to cropland, current SOC stocks in the 30-cm topsoil, and for each variable of the mineralization coefficient, considering their own level of uncertainty, which can differ over the time period covered by the study (see section 7.2 of chapter I).

A sensitivity analysis was also performed to test the effect of modifying key parameters on the results. The tested parameters were weed biomass (one exploration with no weed), manure input (one exploration with no manure), temperature (one exploration assuming constant T value since 1852), root–shoot ratio (one exploration with constant root–shoot ratio instead of fixed root C biomass production per hectare), and land-use change (one exploration without

considering land-use change). To evaluate the importance of each parameter, the analysis was performed at the territorial level and at the national scale by pooling together all territories.

### 3. Results

#### 3.1. Changes in net primary production

Overall, cropland NPP ( $\text{t C ha}^{-1} \text{ yr}^{-1}$ ) increased in all regions until the beginning of the 1980s. Contrary to the observation of Aguilera et al. (2018) for Spain, we found a rather limited contribution of weeds to cropland NPP, representing 4.2%, 2.5%, and 0.1% in 1852, 1955, and 2014, respectively. Figure 5.3 shows the evolution of NPP in six typical French territories characterized by contrasted pedo-climatic conditions and agricultural trajectories: Eure-et-Loire, Manche, Brittany, Loire Amont, and Aveyron-Lozère.

Cropland NPP ranged from 0.6 to 2.5  $\text{t C ha}^{-1} \text{ yr}^{-1}$  in 1852, 1.2 to 4.2  $\text{t C ha}^{-1} \text{ yr}^{-1}$  in 1955, 1.4 to 9.2  $\text{t C ha}^{-1} \text{ yr}^{-1}$  in 1981, and 2.5 to 7.4  $\text{t C ha}^{-1} \text{ yr}^{-1}$  in 2014, reflecting the large disparity in yields between the different French regions. NPP increased slightly in all regions from 1852 to the beginning of the 1950s with, however, a small decrease during the Second World War (Figure 5.3). Crop rotations were dominated by cereals, temporary grassland and fodder in all regions, but in some regions such as Nord Pas-de-Calais, Picardie, and Ile-de-France, roots and tubers also occupied a significant share.

A sharp growth in NPP occurred in the following 30 years (1950–1980), reaching a peak in some regions in the 1980s. This coincided with an increased reliance on N and P mineral fertilizers (Figure 5.5e, f), which boosted productivity. Crop rotations diversified with roots and tubers being given more place in almost all regions and the emergence of oleaginous and proteaginous crops. However, in most regions, the NPP of crop rotations remained dominated by cereals (e.g., Eure-et-Loire and Landes) or temporary grassland and fodder (e.g., Manche, Brittany, Aveyron-Lozère). In the regions where temporary grassland and fodder became the main crops, livestock density increased too (Figure 5.4b).

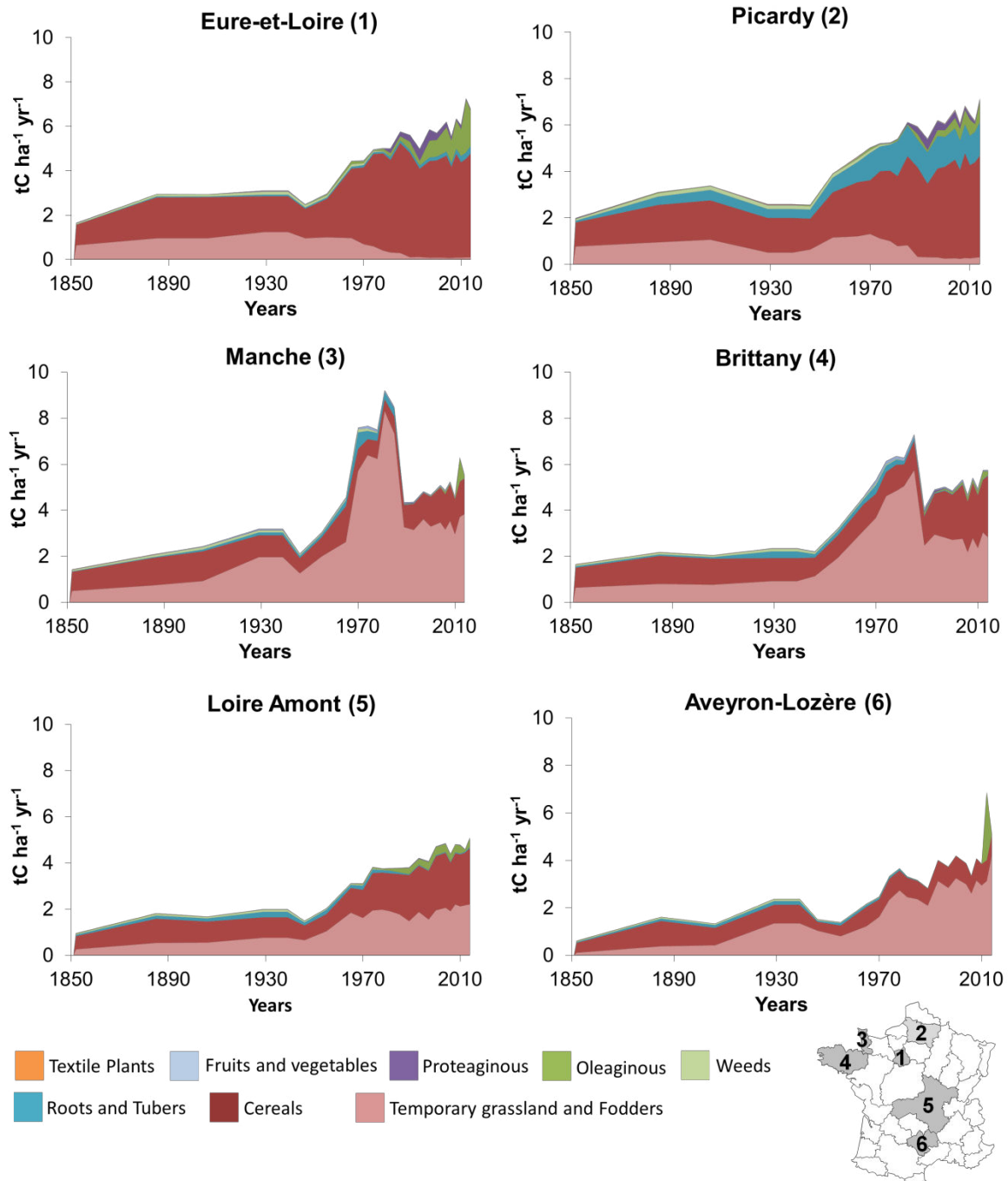

**Figure 5.3** Changes in cropland NPP from 1852 to 2014 in six typical French territories: *Eure-et-Loire*, *Picardy*, *Manche*, *Brittany*, *Loire Amont*, and *Aveyron-Lozère*, distinguishing NPP for eight crop categories.

From the 1980s to 2014, there were contrasting trends in cropland NPP: Some territories presented stagnating NPP (e.g., Loire Amont, see Figure 5.3); some showed decreasing NPP (e.g., Manche and Brittany) while others still had increasing NPP (e.g., Eure-et-Loire, Aveyron-Lozère). At the scale of France, the dominant trend for the last period was stagnating NPP, indicating that productivity of cropland tended to level off. The main characteristic of the last 30 years is the regression of temporary grassland and fodder NPP in almost all territories, including those where livestock density was still increasing, occasionally reaching very high values (e.g., Brittany and Manche). This was often accompanied by an increased feed

importation from abroad in several regions (Figure 5.5a). Brittany and Loire Aval represent emblematic examples of this type of trajectory. The same trend was also visible at the scale of France. However, territories such as Eure-et-Loire and Picardy also presented a decrease in temporary grassland and fodder NPP, together with the virtual elimination of livestock production (Figure 5.4b) and an ever-increasing NPP in cereals, roots, and tubers. Some territories did not show any decrease, neither in temporary grassland and fodder NPP nor in livestock density (e.g., Loire Amont see Figure 5.3 and 5.4b). This type of territory was previously described in chapter II and IV as an integrated crops and livestock farming system with better nutrient recycling at the territorial level.

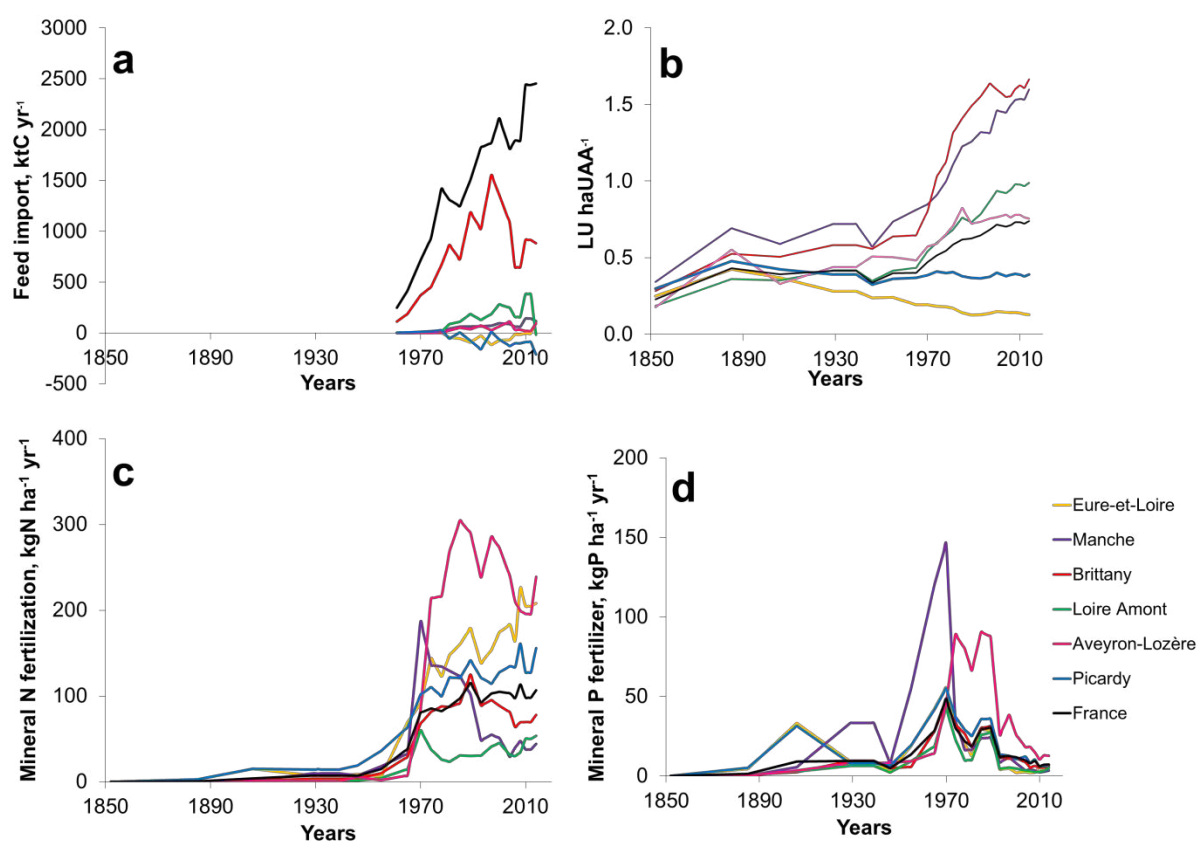
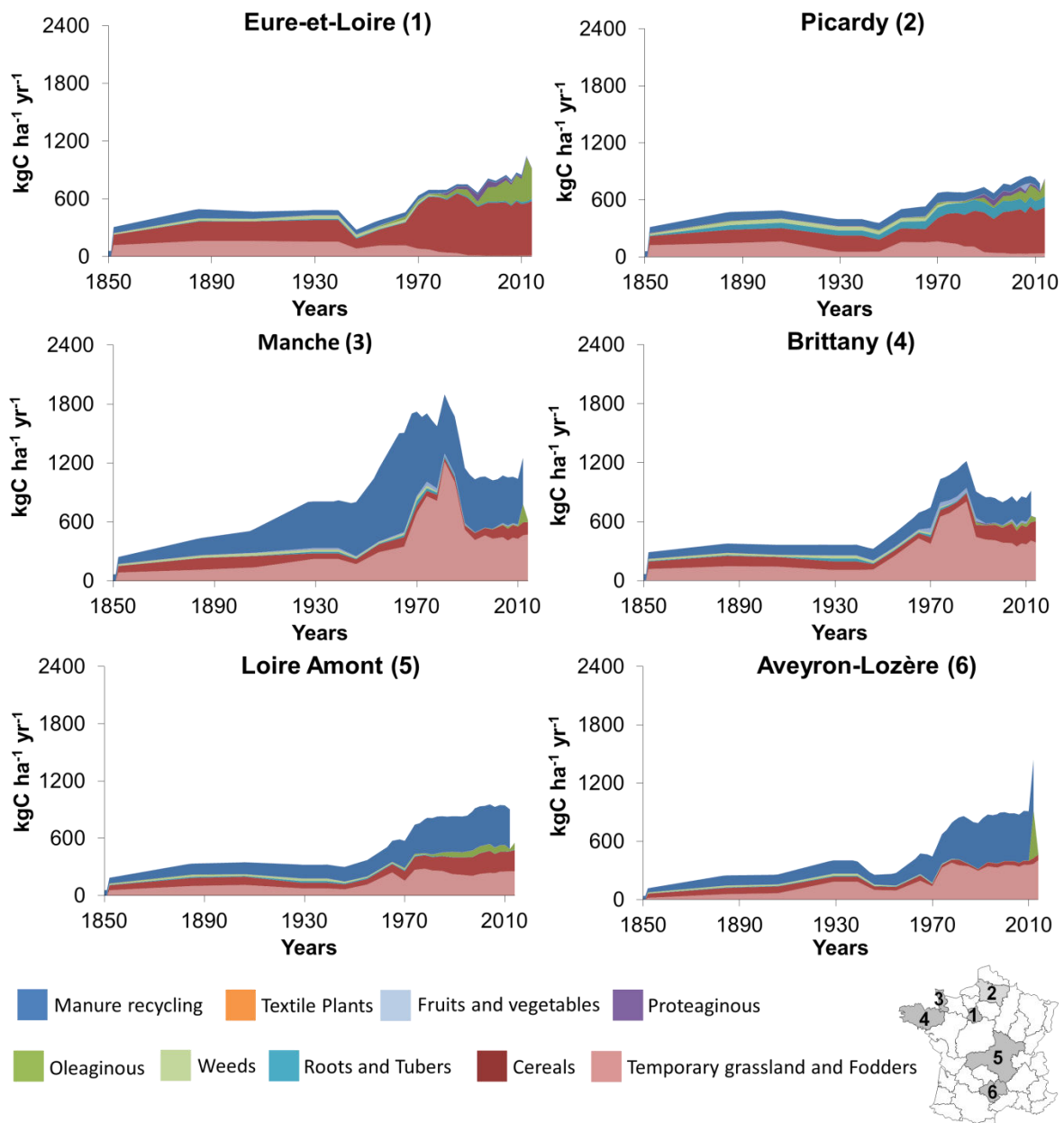

**Figure 5.4** Evolution of: **a** feed importation from abroad; **b** livestock density; **c** rates of mineral N fertilization to cropland; **d** rates of mineral P fertilization to cropland from 1852 to 2014 in France and for six typical French territories: Eure-et-Loire, Manche, Brittany, Loire Amont, Aveyron-Lozère, and Picardy. Data were taken from different sources: Agreste, 2017 and Gallica.bnf.fr for livestock density and N and P fertilization prior to 1970; Unifa, 2016 for N and P fertilization from 1970 to 2014; SitraM, 2016 and FAO, 2017 for feed importation.

### 3.2. Evolution of humified C inputs

Inputs of humified C to cropland ( $\text{kg C ha}^{-1} \text{ yr}^{-1}$ ) ranged from 100 to 400 in 1852, 250 to 1,100 in 1955, 330 to 1,900 in 1981, and 390 to 1,500  $\text{kg C ha}^{-1} \text{ yr}^{-1}$  in 2014 (Figure 5.5). The changes in humified C inputs to cropland basically followed those of NPP, since in three quarters of territories the contribution of humified C inputs through manure was less than 28%, 39%, and 35% in 1852, 1955, and 2014, respectively, with some exceptions as in Cantal-Corrèze where manure represented 59%, 60%, and 61% of total humified C inputs in 1852, 1955, and 2014, respectively. Overall, the relative importance of manure decreased over the period of 1955–2014 (Figure 5.5) although absolute inputs increased concomitantly with livestock density (Figure 5.4b), reflecting the fact that crop productivity increased faster than manure application in this period.

As for NPP, humified C inputs to cropland rose slowly from 1852 to the beginning of the 1950s. From 1950 to 1980, C inputs increased sharply, whereas in the last period, from 1980 to present, the trajectory of the regions were different, following that of cropland NPP, which was the main driver of humified C inputs. In most regions where temporary grassland and fodder NPP decreased while livestock density and importation of feed were still growing, the rise of humified C input to cropland through manure did not compensate the decline of the inputs through temporary grassland and fodder (e.g., Brittany, Loire Aval, and Manche). In territories where temporary grassland and fodders were replaced by roots and tubers and cereals, humified C inputs to cropland slightly increased or stagnated, being mainly impacted by productivity improvements (e.g., Eure-et-Loire, Picardy, Nord Pas-de-Calais). When livestock density kept rising without a reduction in temporary grassland and fodder NPP, humified C inputs to cropland were still increasing, following the increase in manure input (e.g., Aveyron-Lozère, Loire Amont).



**Figure 5.5** Evolution of humified C inputs to cropland from 1852 to 2014 in six typical French territories: Eure-et-Loire, Picardy, Manche, Brittany, Loire Amont, and Aveyron-Lozère. Nine categories of inputs are distinguished.

### 3.3. Changes of SOC in cropland

At the territorial scale, changes of SOC in cropland on a per hectare basis followed the evolution of NPP and the subsequent humified C inputs to cropland (Figure 5.6). Therefore, SOC dynamics were mostly determined by the amount of humified C inputs to cropland, with crop residue inputs being the main driver. However, in some regions manure input to cropland was also an important factor of SOC dynamics in soil and could explain up to 58% of the labile SOC pool changes (as in the case of Cantal-Corrèze) over the whole study period.

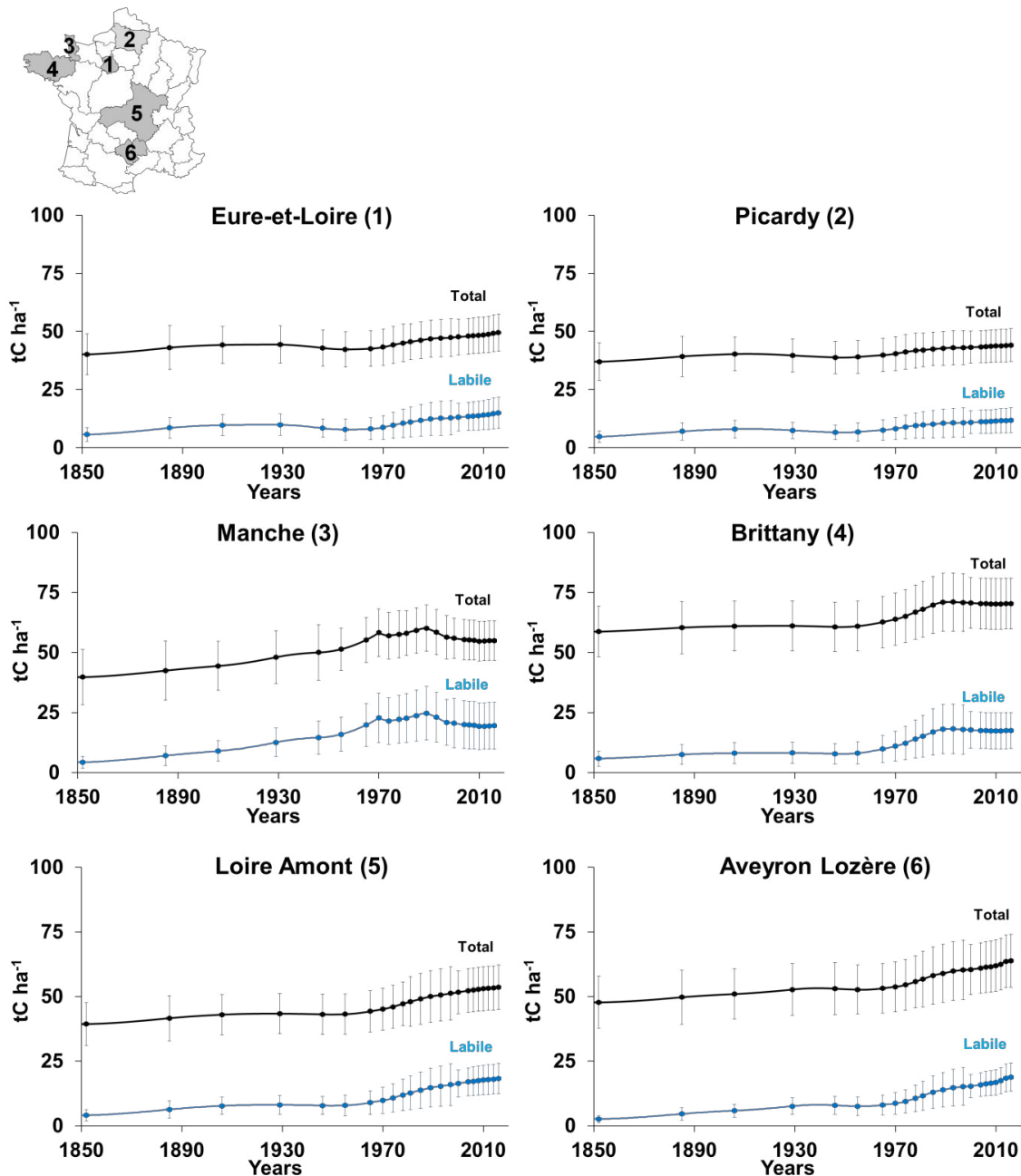

**Figure 5.6** Evolution of labile and total SOC stocks in the topsoil of cropland (0–30 cm) from 1852 to 2014 in six typical French territories: Eure-et-Loire, Picardy, Manche, Brittany, Loire Amont, and Aveyron-Lozère. Error bars indicate uncertainties as calculated with the Monte Carlo analysis.

At the national scale, the rate of C storage in the upper 30-cm cropland soil showed both large regional and temporal variability, as illustrated in Figure 5.7. In the period 1885–1900, most regions revealed a relative rate of C storage of around 1–2‰ per year (Figure 5.7a), which is in agreement with the slow yield increase of that period. The period from 1955 to 1970 is characterized by a stronger increase of the relative rate of C storage in cropland, exceeding 2‰ per year in most French regions (Figure 5.7b) and reaching values over 4‰ per year in several regions (e.g., Manche and Calvados-Orne). In a context of rapid yield growth and increased livestock density, these figures are not surprising. By comparison, Poulton et al. (2018) also found significant rates of relative net C storage in the few decades following increased mineral fertilization on experimental plots (around 4–7‰ per year). In the period 2000–2014, net storage at a relative rate of 0–2‰ per year is observed in the areas of specialized cropping systems in the Paris and Aquitaine basins and in the Alsace Plain. However, cropland SOC stocks decreased in the western part of France at a rate of  $-1.5‰ \text{ yr}^{-1}$ , while mountainous regions with integrated crop and livestock farming systems showed the highest relative rates of SOC storage in cropland (around 2–4‰ per year) (Figure 5.7c).

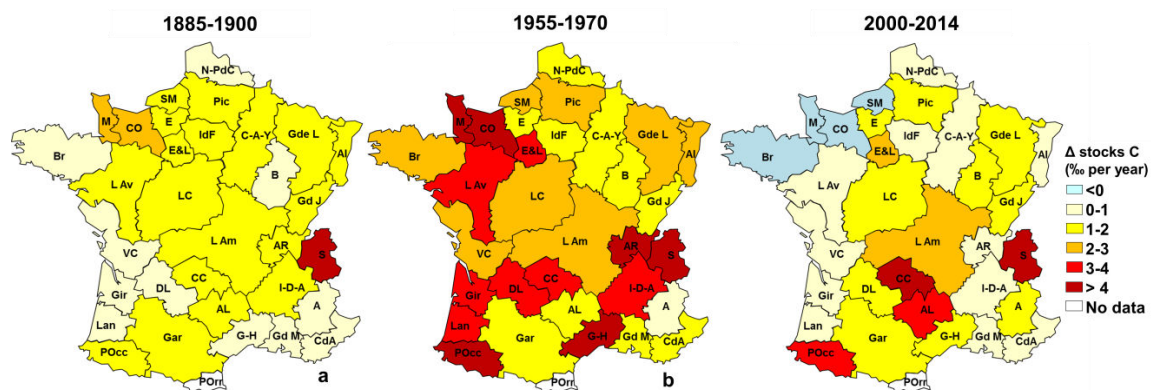

**Figure 5.7** Maps of relative rates of change in SOC stocks in the topsoil of cropland (0–30 cm) in French territories during the periods **a.** 1885–1900, **b.** 1955–1970, and **c.** 2000–2014. A: Alpes; Al: Alsace; AL: Aveyron-Lozère; AR: Ain-Rhône; B: Bourgogne; Br: Bretagne; C-A-Y: Champagne-Ardenne-Yonne; CC: Cantal-Corrèze; CdA: Côte d’Azur; CO: Calvados-Orne; DL: Dordogne-Lot; E: Eure; E&L: Eure-et-Loire; Gar: Garonne; Gd J: Grand Jura; Gd M: Grand Marseille; Gde L: Grande Lorraine; G-H: Gard-Hérault; Gir: Gironde; I-D-A: Isère-Drôme-Ardèche; IdF: Ile de France; L Am: Loire Amont; L Av: Loire Aval; Lan: Landes; LC: Loire Centrale; M: Manche; N-PdC: Nord Pas-de-Calais; Pic: Picardie; Pocc: Pyrénées Occidentales; POr: Pyrénées Orientales; S: Savoie; VC: Vendée-Charentes.

At the national level, cropland SOC stock on a per hectare basis increased gradually from 1852 to 2014 with a concomitant reduction in cropland surfaces. Consequently, total SOC stock in Mt C in the 30-cm topsoil of French cropland was lower in 2014 than in 1852, although the difference is not significant (Table 5.1). Interestingly, a sharp decrease in total stock occurred from 1852 to 1906 because the drop in cropland area was not compensated by the increased C storage in cropland soils. Total SOC stock in cropland thus reached a minimum around the year



1900. This trend toward declining SOC stocks (Mt C) in cropland was, however, reversed due to a slight increase in cropland area until 1929 and then remained constant while NPP and C inputs were continually rising at the national level.

**Table 5.1.** Total SOC stocks in cropland in France (national scale) in 1855, 1900, 1955, 1980, and 2014

	Cropland		
	SOC stock t C ha <sup>-1</sup>	SOC stock Mt C	Area Mha
<b>1852</b>	42 ± 8.0	1100 ± 230	26 ± 2.6
<b>1906</b>	45 ± 7.9	760 ± 140	17 ± 1.7
<b>1955</b>	45 ± 7.8	850 ± 140	19 ± 1.0
<b>1990</b>	51 ± 8.6	900 ± 150	18 ± 0.9
<b>2014</b>	52 ± 8.1	930 ± 150	18 ± 0.9

### 3.4. Uncertainties

Uncertainties regarding stocks of labile C on a per hectare basis at the end of the model simulation (2014) provide a good approximation of the overall reliability of the numerical results of our study. These uncertainties were estimated on average at 31% but ranged from 13% in Alpes to 49% in Gironde. This indicates that values of labile SOC stocks estimated should be considered with caution.

Operational uncertainties in the data and parameters can be estimated through statistical analysis. However, the impact of structural uncertainties concerning the design and hypothesis of the model itself can be more difficult to assess quantitatively. Here the sensitivity analysis performed enabled us to assess the significance of certain variables and key hypotheses (see Table 5.2). At the national level, our analysis indicates that manure inputs to cropland explain 24% of the labile SOC pool changes from 1852 to 2014. Contrary to the findings of Aguilera et al. (2018), we found that humified C inputs through weeds played only a minor role in the SOC evolution over the whole study period. According to sensitivity analysis, it explained only 3.7% of labile SOC changes between 1852 and 2014 at the national level. Conversion of permanent grassland to cropland had only minor influence on changes in labile SOC stocks since land-use changes explained 3.4% of SOC stock changes since 1852 at the national level. However, at the territorial level, the conversion from permanent grassland to cropland had an effect on current cropland labile SOC stocks (per hectare basis) ranging from almost 0 in Ile-de-France to 14% in Manche (when compared with the test in which land-use change was not taken into account). The sensitivity analysis revealed that accounting for change in temperature led to 11% lower labile SOC pool at the national level in 2014 when compared with the exploration assuming annual average temperature of 1852 in each region to be constant over the whole study period (Table 5.2). This also reveals the specific impact of temperature on the mineralization of labile SOC expected with climate change. Lastly, a labile SOC pool would have been 17% higher in 2014 and 27% lower in 1852 if we had used a fixed root–shoot ratio

instead of a constant but crop-specific root biomass production. Therefore, the hypothesis regarding root biomass production significantly impacted the simulated evolution of a labile SOC pool over the whole study period.

**Table 5.2** *Relative change (expressed in %) in total SOC stocks in France (national scale) with respect to the current standard simulation when using one of the five alternative explorations (no weeds, no manure, constant temperature since 1852, no land-use change and fixed shoot–root ratio) in 1852, 1906, 1955, 1990, and 2014 (Positive values means that the standard simulation of SOC stock is higher than the tested ones)*

	Current/No weed %	Manure application/No manure %	Evolutionary temp/Constant temp %	Land use change/No land use change %	Constant shoot- root/Fixed shoot- root %
<b>1852</b>	5.6	24.3	-0.1	-0.1	26.7
<b>1906</b>	5.8	26.6	0.4	0.4	21.2
<b>1955</b>	5.9	29.5	-3.4	0.0	6.6
<b>1990</b>	1.2	24.4	-4.3	-2.1	-12.7
<b>2014</b>	0.5	24.4	-10.9	-1.6	-16.5

## 4. Discussion

### 4.1. The AMG model and the concept of soil C saturation

Operational uncertainties in the data and parameters have been estimated through statistical analysis. However, structural uncertainties remain concerning the design and hypothesis of the model itself and are more difficult to quantitatively assess. They thus require a qualitative discussion about the relevance of the model in light of the current knowledge on the mechanisms involved in SOC dynamic.

Recently, in several studies, the concept of C saturation in soil has emerged, indicating that the capacity of soil to accumulate C could be limited by its clay content (Hassink, 1997; Six et al. 2002; Stewart et al. 2007). This concept was qualified by Stewart et al. (2007) as “effective storage capacity” under a given scenario of soil management. In this chapter, we did not account for any saturation capacity and estimated that SOC would linearly respond to increase C inputs. This might not be true and improvement in C modelling accounting for such saturation effect could lead us to reconsider our results. However, the notion of “carbon saturation deficit” (Angers et al. 2011), corollary of the saturation concept, was also sharply criticized as, in its current definition, it does not allow to reliably quantify the potential of C storage in soil (Barré et al. 2017). Furthermore, a recent meta-analysis on SOC dynamic over long-time period (more than 160 years) revealed that even with huge manure inputs ( $35\text{ t ha}^{-1}\text{ yr}^{-1}$ ), SOC kept increasing in some experimental plots after more than a hundred of year and no saturation capacity could be observed (Poulton et al. 2018).

Besides, some of the known soil properties and mechanisms that are involved in SOC changes were not accounted in the GRAFS-AMG model. This clearly constitutes a limitation to the findings of our study. For instance, by coupling nano-scale secondary ion mass spectrometry and isotopic tracing, Vogel et al. (2014) demonstrated that fresh inputs of C preferentially attached to pre-existing organo-mineral clusters, thus providing evidence that clay-size surfaces contributed only to a limited extent to C sequestration whereas in our model mineralization, coefficient of SOC is considered a strongly decreasing function of soil clay content. Miltner et al. (2012) showed that microbial biomass was a significant source of SOC and stressed out the role of microbial turnover as the main processor of C in soil, thus playing a key role in SOC dynamic while Fontaine et al. (2011) stressed out the importance of fungi as a predominant actor of C sequestration in nutrient limited environment. This was corroborated by Kirkby et al. (2013) who showed that microbial biomass-C and the fine fraction of SOC were significantly correlated following straw enriched with nutrient inputs to soil, thus providing additional evidences that microbial action contribute substantially to the accumulation of stable C in soils. The AMG model does not account for any microbial pool, and more generally is based on a simplified and semi-empirical representation of the complex processes involved in soil organic matter dynamics. However, Saffih-Hdadi and Mary (2008) reported that the AMG model simulating the level of SOC stocks provides results similar to those more sophisticated model considering a microbial pool.

Furthermore, statistical analysis revealed that operational uncertainties were relatively high. However, to our knowledge, there has been no previous attempt to investigate SOC dynamic at the regional scale over the long run which makes it possible to broaden the understanding of its drivers at the territorial scale.

## **4.2. Value of a historical and systemic approach**

Our results emphasize that cropland NPP and, to a lesser extent, manure application are the two key determinants of humified C inputs to soils and therefore the main drivers of SOC change on a per hectare basis. This is in line with other studies that highlighted the predominant influence of C inputs on SOC change (e.g., Saffih and Mary, 2008; Virto et al., 2012; Chenu et al., 2014). However, understanding the causes of changes in NPP and manure application requires a systemic and historical perspective that goes beyond pure agronomical determinism. Distinguishing three historical periods can help to identify the changes in agricultural systems that affected NPP and C input to cropland.

In the first period from 1852 to 1950, cropland NPP rose slowly. In most regions, livestock density and NPP evolved in parallel and it can be assumed that the increase in NPP relied on extra-manure inputs. The increase in livestock density was facilitated by an increased share of fodder and temporary grassland in cropland rotation. Such patterns in the evolution of agricultural production have also been identified in other countries for the nineteenth century and the first half of the twentieth century (e.g., Krausmann et al., 2004). In France, these evolutions were promoted by the growing share of animal protein in human diet (Toutain, 1971), which was permitted by the development of the railway network from 1878 impelled by the Ministry of Public Works (Freyciney Plan), leading to the opening up of the country-side by the end of the nineteenth century (Duby and Wallon, 1993). However, the rural world in France was kept largely on the margins of the capitalist economy because the agricultural sector was still poorly integrated in machine industries and because agricultural production was protected from foreign competition by customs barriers implemented from the end of the nineteenth century (see also chapter IV). This explains why, although yields improved, these enhancements remained weak at that time.

In the second period from 1950 to 1980, cropland NPP rose sharply in all French territories leading to SOC accumulation in soils. This was mainly attributable to an increased use of N and P mineral fertilizer after World War II. With the exception of Ile-de-France, Eure, and Grand Marseille, all regions experienced an increase in temporary grassland and fodder NPP, including those with stagnating or even decreasing livestock density (e.g., Picardy and Loire Centrale). Temporary grassland and fodder became the predominant crops in regions with the highest rise in livestock density (e.g., Brittany, Loire Aval, Aveyron-Lozère, and Cantal-Corrèze). This indicates that livestock production was still mostly supported by local crop production. Additional production of temporary grassland and fodder in territories where livestock density did not increase suggests that regional specialization also contributed toward

sustaining growing livestock in other regions. However, the national net importation of animal feed from abroad increased from 0.25 to 1.31 Mt C yr<sup>-1</sup> between 1961 and 1981, which implies that livestock density was also promoted by a higher specialization of agricultural production at the international level. This is in line with other studies that emphasized the preeminent role of agricultural trade (Billen et al., 2014; Lassaletta et al., 2014a; Soto et al., 2016; Gonzalez de Molina et al., 2017) and the shift from an organic and solar-based energy system to a mineral and fossil-dependent system at the turn of the 1960s (Krausmann et al., 2008; Carmo et al., 2017; Niedertschneider et al., 2017); this led to the transformation of agricultural systems at various scales from local to global over the course of the last six decades. These trends toward increased regional specialization, crop productivity, mineral fertilizer application rates, livestock density, and feed trade should not be considered as spontaneous rural dynamics. They took place, in their early stage, in the very special context of the Cold War and the "Glorious Thirties" with a strong economic growth, the development of mass consumption, and the technological innovation race in the Western capitalist block. As previously discussed in chapter IV, the boost of agricultural productivity was an active state policy fostered at the European and international level through the Monnet (1945) and Marshall (1947) plans (Duby and Wallon, 1978) and supported by a fringe of the new generation of farmers, which took active part in the modernization of agriculture and its increased connection with upstream (fertilizer and machine) and downstream (distribution channel) production chains of what was to become the agro-alimentary industry (Muller, 1984; Duby and Wallon, 1978).

A third period from 1980 to 2014 can be identified with the clear emergence of diverging trends in terms of NPP, C inputs to soils, and SOC change. The common feature of this period for almost all regions was the drastic diminution in temporary grassland and fodder NPP. First, in regions with important livestock density such as Brittany, Loire Aval, and Manche this loss in NPP was not fully compensated by other crops and the increase in inputs of manure did not offset the diminution of humified C inputs from temporary grassland and fodder. As a consequence, SOC stocks in cropland started to gradually decline. Specifically in Brittany and Loire Aval where this occurred together with a fall in permanent grassland area and production, livestock nutrition relied increasingly on feed imports from foreign countries, mainly from Latin America (see chapter II). These structural characteristics of the agricultural system of these regions can thus be seen as being responsible for cropland becoming a source of C emission to the atmosphere. The case of Manche, however, is different since permanent grassland production could provide a significant share of animal feed; therefore, importation remained low. The diminishing temporary grassland and fodder NPP that led to the huge simulated loss in cropland SOC in Manche after 1980 appears to be the result of a de-intensification of cropland production (as seen from the reduction in mineral fertilization rate). Second, in stockless regions such as Picardy and Eure-et-Loire, where the reduction of temporary grassland and fodder NPP was concomitant with increased cereals, roots, and tuber NPP, an ever-decreasing livestock density and the growing importation of animal feed at the national level may have challenged the outlet of local fodder production owing to the lack of local demand and the concurrence of foreign imports on the national market. In these regions, SOC stocks were stagnating. A third type of trajectory occurred in regions that had rising livestock density, constant or growing temporary grassland and fodder NPP, low importation

of animal feed, and increasing or stagnating SOC stocks. Most of these regions could be characterized as integrated crop and livestock farming systems (see chapter II and IV). Changes observed in this period occurred in the context of French and European policy voluntarism being considerably diminished, with the lowering of custom barriers, giving way to more liberal governance (Bureau and Thoyer, 2014). While the previous period (1950–1980) had promoted modernization and specialization of agricultural production by the protection of the European market and an active policy of direct aid to increase production, the gradual weakening of this policy reinforced what was able to begin: openness and specialization. This trend of exacerbated specialization of regional agricultural production has also been observed in Spain with adverse effect on the energy return on investment (Guzman et al., 2017), increased greenhouse gas emissions (Lassaletta et al., 2014d), and loss of food sovereignty (Soto et al., 2016). All these changes occurred in the new global historical context following the fall of the communist bloc; the interventionist policies characterizing the former period became obsolete and left the field open to a hegemonic neoliberalism, as made clear in the Washington Consensus in 1990 (Plihon, 2012).

Our analysis thus highlights the need for a systemic and historical approach to better understand the chain of causalities determining the changes in SOC stocks, as illustrated in the simplified representation of Figure 5.8.

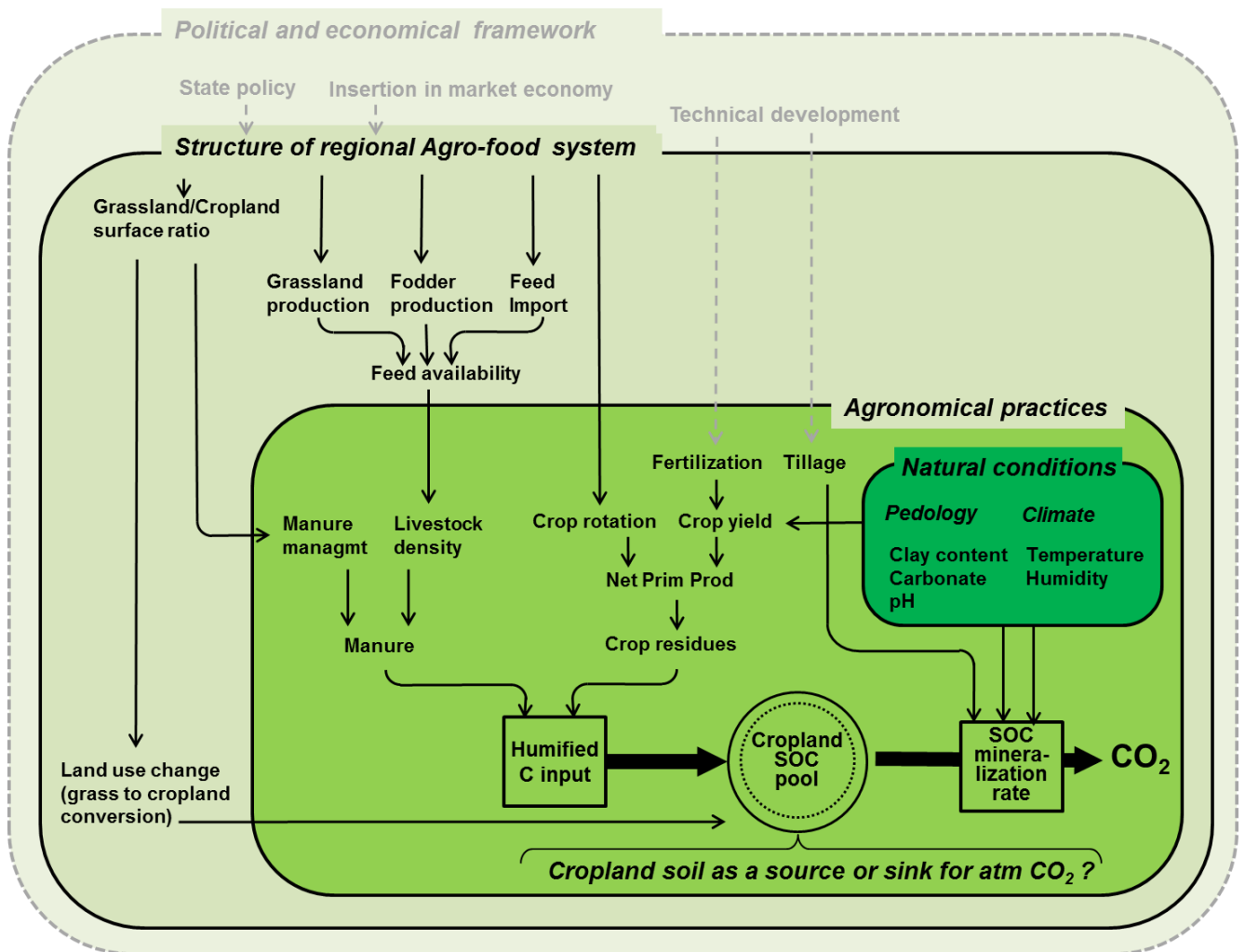

**Figure 5.8** Simplified representation of the chain of causalities involved in changes of SOC stocks of cropland. The political and economic frameworks are represented in light green and their influences are in dashed lines since a detailed analysis of their role is beyond the scope of this study.

### 4.3. Realism and significance of the 4‰ objective

The value of a historical perspective also lies in an improved ability to embrace the future. Based on our results and in the context of the 4‰ initiative, the question can be raised of the realism of this objective. Our first estimations showed that, when pooling all territories together at the national level, the rate of C storage in cropland currently leveled off at around 1‰ per year, although regional disparities were found to be important (Figure 5.7c). Therefore, in most regions, the 4‰ objective could only be achieved by a considerable increase in C inputs. A recent study performed at INRA (Pellerin et al., 2013) examined possible measures that could increase C inputs and storage. Among these opportunities were: (1) the introduction of cover crops and buffer strips in cropping systems; (2) agroforestry development; and (3) increasing the duration of temporary grassland. Our results indicate that management practices are

intrinsically linked to the structure of agricultural systems at the regional scale (Figure 5.8). Accordingly, our results also suggest that increasing C inputs to cropland through residues from fodder and temporary grassland production, and increasing manure application, hence decreasing N and P mineral fertilizers owing to enhanced nutrients recycling, would enhance C storage.

However, the increasing rate of C storage in agricultural soil to 4‰ yr<sup>-1</sup> should be compared with the whole C budget of current agricultural system production. In this regard, the C stored in cropland soil through increased NPP in French regions over the course of the period 1852–2014 should be seen as a side effect of increasing reliance on fossil fuel that provided direct (e.g. tractor) or indirect (fertilizer manufacture) energy to foster NPP. This phenomenon has already been described by several authors as a “fossil-fuel-powered carbon sink” (Gingrich et al, 2007; Erb et al, 2007). Following this view, the increase in SOC in croplands of French regions during 1852–2014 would be only one aspect of the transition from an agrarian to a highly industrialized socioecological regime (Fisher-Kowalski and Haberl, 2007) with a shift from a territory-dependent and solar-based energy system to an extra-territorial, fossil-fuel-based energy system. In the case of France, direct fossil fuel consumption by tractors and building heating represents 5.0 Mtoe yr<sup>-1</sup> (Mt oil equivalent yr<sup>-1</sup>) while indirect consumption, including fertilizer production, amounts to 5.4 Mtoe yr<sup>-1</sup> (Doublet, 2011). If we consider a conversion factor of 0.85 t C toe<sup>-1</sup>, the C emission due to technical energy consumption of the agricultural sector in France reaches a value as high as 8.8 Mt C yr<sup>-1</sup>. Therefore, our estimation of total SOC storage in the 30-cm top layer of about 1.7 Mt C yr<sup>-1</sup> (average of the last 20 years for French cropland) is more than fivefold lower than the current rate of CO<sub>2</sub> emission by the agricultural sector alone.

Such an analysis contradicts the statement of Lal (2016) in a recent article: *“The 4 per thousand proposal should be more about the concept than any specific number. The concept that soils and agriculture are solutions to the global issue of Climate change, food insecurity and environmental pollution, is a major shift of historical significance.”* Although we may agree with the 4‰ concept, we are not convinced by such possible compensatory remedial measures, which could only be a temporary stopgap of climate change as underlined by several authors (Sommer and Bossio, 2014; Lassaletta and Aguilera, 2015; Baveye et al, 2018, Poulton et al, 2018).



## 5. Conclusion

This chapter stressed that in most French regions, cropland SOC stocks per unit of area have increased from 1852 to 2014, although a decrease was observed in some regions during the last 30 years. These changes mostly depended on NPP and the subsequent C inputs to soil. This was determined by livestock density, crop rotation, use of mineral fertilizers, and labor productivity. Different patterns of agricultural production could be identified across time and space within a general great increase of NPP from 1950 to 1980. In this period, changes toward intensification and specialization were permitted by an increased reliance on fossil fuel energy for fertilizer production and agricultural mechanization but also contributed to the global emission of CO<sub>2</sub> and climate perturbation. The technical and structural evolution of French territories toward agriculture intensification and specialization during this period responded to national and international political will and economic interests. This transition period was characterized in all regions by a significant increase of SOC stocks in cropland. During the most recent decades, the different trajectories followed by regional agricultural systems in France resulted in either a reduction or a stabilization of cropland SOC stocks. C sequestration in soil is far from compensating the direct and indirect CO<sub>2</sub> emissions by the agricultural sector.

In the short term, land-use planning increasing permanent grassland surface and sustainable agricultural practices favoring increased C inputs to soil could enable additional C sequestration in agricultural soil, while reducing C energy output. Therefore, in the medium and long term the sustainability of agricultural production with regard to C emission mitigation will also depend on how social relationships can reconfigure the agro-food system according to the well-being and environmental requirements of the human population. Overall, this showed the importance of the socio-ecological logic that shapes, directly or indirectly, the evolution of the major quantitative variables involved in C sequestration or release from cropland.

# **General Discussion**

## **From past trajectories to scenarios: a prospective discussion for French agro-food systems**

*In this discussion the GRAFS approach is used in a prospective way for elaborating two contrasted scenarios of the future French agro-food system at the horizon of the next 30 to 40 years, and for evaluating their agronomical and environmental performances.*

*The discussion relies on the following paper*

*Billen G, Le Noë J, Garnier J. (2018). Two contrasted future scenarios for the French agro-food system. Science of the Total Environment 637-638: 695-705.*

*An original evaluation of the dynamics of soil organic carbon in the two scenarios, using the methodology developed in chapter V has been added.*



# 1. Introduction

In the previous chapters, the functioning of French regional agro-food systems has been characterized following a systemic, historical and biogeochemical perspective. The increasing openness and specialization of agro-food systems was shown to be responsible for the accumulation of P stocks in cropland soil and huge N balance over cropland and grassland while the increase in cropland NPP and livestock density were identified as important drivers of C storage in cropland which actually represented a side-effect of the shift of the agricultural sector from a solar-based energy producer to a fossil-fuel consumer with the subsequent C emissions to the atmosphere being far above the current level of C storage. The increasing share of animal protein in the French diet, the spatial segregation between livestock and vegetal production and between rural and urban area, the shift of cropping techniques from mostly organic to mineral farming were the main structural drivers of the evolution of N, P and C fluxes and stocks variation in regional agro-food systems. In the context of global and climate changes, these evolutions of the interaction between societies and the environment in agricultural systems challenged the sustainability of our way of life and way of production. The work performed in this thesis emphasized the intertwining social and biophysical determinisms that drove these transformations. Therefore, as for the past and present, challenges regarding the sustainability of future agro-food system should also be considered through the prism of socio-ecological metabolism.

When dealing with the future, however, we are facing a major epistemological issue. According to a completely deterministic view of both human and natural History, the future could be known just as the past, i.e., as far as we are able to modelling the systems studied. Such a vision of history is the one described in the famous metaphor of the Devil of Laplace (Bergson, 1905), according to which if all the variables of a given system were known at a certain initial time, all the subsequent states of the system should be predictable. This scientific vision is fundamentally opposed to the one which considered an irreducible part of unpredictability, which is at the roots of quantum mechanics. In environmental sciences, the possibility of unpredictability lies in the fact that the future course of events does not only arise from the necessity of bio-physical constraints, but also from the conflict between different human willing with different interests and different desires for future, the results of which cannot *a priori* be determined.

This doubt regarding the ability to predict pushes to first adopt a reflective stance regarding our scientific research. If environmental science cannot predict the future, nor can it decide for the future. Consequently our scientific approach should be a non-prescriptive one. Designing future scenarios for agro-food systems is based on our current knowledge of the biogeochemistry of nutrient fluxes in agro-food systems but it is also part of our imagination, i.e. the way we are extrapolating to the future past and current trajectories, speculating about some ruptures or continuities. Such a scientific approach mixing facts with imagination may seem paradoxical because it recognizes the part of subjectivity within the scientific work.

In view of these reflections and based on our analysis in the previous chapters, we explore in this last chapter the ultimate outcome of a number of opposite trends co-existing in the current situation, leading to two contrasted sets of storylines, each qualitatively describing what the French agro-food system could be at the horizon of 3–4 decades. We then use the GRAFS methodology to translate these storylines into a coherent and quantitative description of N, P and C fluxes throughout the system at the regional scale. We thus further enrich the GRAFS methodology in order to use it as a tool for scenario elaboration, regarding demography and human diet, cropping systems and connection to livestock systems. The detailed descriptions of the two scenarios obtained are used to assess their agronomic performances, their capacity to meet the food requirements of the French population and their position in international exchanges, as well as their environmental imprint in terms of nutrient cycling, resource requirements and carbon sequestration/emission.

## 2. The storylines of the scenarios

Two contrasted scenarios of the future French agro-food system were elaborated, aiming at discern within the present dynamics of the system, a number of trends, currently contradicting each other, and to explore the trajectory that could be followed if these trends were pushed to their extreme. The following storylines therefore mix facts about certain trends that can be perceived in the current French agro-food system and fictions about how they may evolve at the 2040–2050 horizon.

### 2.1. Pursuit of past trend towards opening and specialization: the O/S scenario.

As shown in chapter IV and V, one of the most striking trends in the development of French agriculture over the last 60 years is its increasing integration into international markets. Export of French cereals has regularly increased since the 1960's, while import of feed, mainly soybean from South America, has increased fivefold. This has gone hand in hand with the specialization, in stockless crop farming of the most fertile lowland regions, such as the Paris and Aquitaine Basins and the Alsace Plain, while the Great West regions specialized in intensive livestock farming (see chapters II and IV). Large harbor and land transport infrastructures have been established and are still projected, extending the harbor hinterland to remote grain-producing areas (Duszynski, 2013; Haropa, 2014). Support for this globalization of French agriculture was recurrently re-affirmed in political declarations at the national level, as illustrated by the declaration of former French president N. Sarkozy in 2009 “*We need to rebuild a policy and maritime ambition for France, around emerging issues (...) of a globalized world that breathes through international trade*” and his successor F. Hollande in 2012: “*Our agriculture has a major role to play in the supply of agricultural commodities and in the balance of world markets. (...) France must help feed the population of the planet.*” This view of French agricultural development driven by exportation was shared by the majority farmers' union (FNSEA) as well as by the largest farming cooperatives, many of which have maintained international positions in some key food sectors (Tereos Group for sugar, Avril Group for oils, etc.). Agrofuels and green chemistry also offer similar development perspectives (Ministère de l'Agriculture, 2012). In the O/S scenario, these trends of opening and specialization of cropping systems are assumed to intensify. Regarding animal production, the milk sector is opening to international trade mostly through the mass production and export of milk powder, the demand for which continues to rise as it has over the last five decades (Bureau and Thoyer, 2014). The economic profitability of this industrialized production requires large farms concentrating thousands of animals, fed in the barn with imported feed.

Strong environmental regulations have been enacted, however, to limit the pollution generated by these agricultural activities. In areas defined as vulnerable to nitrate contamination, farmers were constrained to limit the soil N balance below a value of 50 kgN ha<sup>-1</sup> yr<sup>-1</sup>, and to strictly optimize N and P fertilization by following provisional calculations formulas established by COMIFER ([www.comifer.asso.fr/](http://www.comifer.asso.fr/)). On the other hand, the maximum allowed animal density

was limited by the capacity of crop or grassland areas to absorb the effluents produced and managed (typically 170 kgN ha<sup>-1</sup> yr<sup>-1</sup>), unless a treatment unit would be installed. Although these regulations were often felt too restrictive by farmers, we have considered they will still be observed in the future.

Regarding the local food demand in France, no significant change occurred in the average diet, but the share of animal products in total protein consumption continued to be linked to economic indicators such as revenue at the individual scale (Le Nechet et al., 2006) or GDP at the national scale (Billen et al., 2013a), and kept increasing. The great distribution sector increased its capacity to capture most of the added value of the domestic food supply chain, maintaining low prices to farmers and promoting processed food rather than raw products.

## 2.2. Changing towards autonomy, reconnection and a demitarian diet: the A/R/D scenario

Following repeated crises and scandals in the food sector such as the mad cow crisis from 1986 to 2004, the chicken contamination with dioxin in 1999, the discovery of horse meat in pure beef lasagna in 2013, the Fipronil egg scandal in 2017, of bacteriological contamination of milk powder in 2018 (Le Monde, 2017), a consumer and citizen movement has developed, aiming at taking control of the food supply. Multiple initiatives have flourished such as community-supported agriculture, shared gardens and in general, an increased demand for products from organic agriculture, guaranteeing the absence of pesticide residues (Figure 6.1).

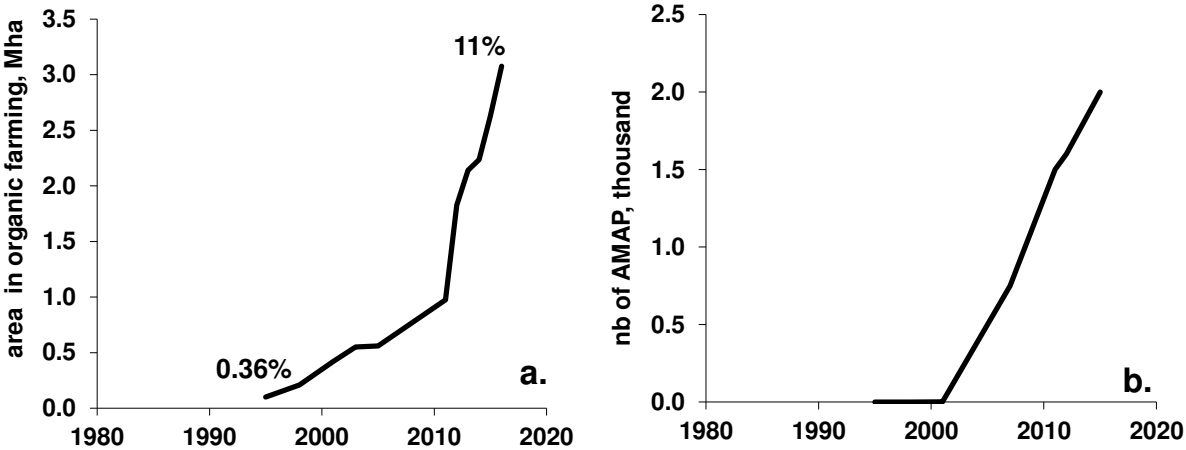

**Figure 6.1 a.** Trends in the area of organic farming in France (data from Agence Bio, ([www.agencebio.org/](http://www.agencebio.org/))). Figures on the curve refer to the fraction of total agricultural area. **b.** Number of community-supported agriculture (AMAP) contracts in France (data from [www.miramap.org/](http://www.miramap.org/).)

While these trends were still minor in the early 2000's, in this A/R/D scenario, these movements are assumed to increase rapidly in terms of audience and the scope of their claims, from mainly

health-based issues in the beginning, evolving into radical social movements, up to the point of constituting a real driver of change in the agro-food sector.

Together with growing concerns regarding health issues related to pesticides, the instability of market prices of fertilizers and agricultural products (Mew, 2016; Timmer, 2008) may also be a strong incentive to switch to organic practices. Long and diversified organic rotations, with a large proportion of forage legumes, have the potential to allow farmers to wean off their dependence on mineral fertilizers and pesticides (Crowder et al., 2010). Furthermore, local coupling with animal farming provided the best output for forage production, as in the examples described by Garnier et al. (2016) and Anglade et al. (2017). In this way, the specialized cropping regions are assumed to evolve toward more diversified integrated crop and livestock farming patterns in the A/R/D scenario.

At the same time, we assumed that animal protein in the diet was gradually reduced to half its current value, in accordance with the recommendations of environmentalists (<http://www.nine-esf.org/node/281/index.html>) as well as nutritionists (Maillot et al., 2011). As a whole, the number of livestock decreased considerably at the national scale but was much more evenly distributed among the different regions, so that it could rely on grass and local forage production instead of imported feedstuff.



### 3. Translation of the storylines into a coherent GRAFS description

The above storylines provide two contrasting qualitative pictures of possible future French agro-food systems. The GRAFS approach makes it possible to translate them into quantitative descriptions to test their coherence and assess their environmental imprint. It requires, however, a number of quantitative hypotheses, which are discussed hereafter.

#### 3.1. Demography

Population projections at the 2040 horizon are provided by INSEE ([www.insee.fr/fr/statistiques/2529884](http://www.insee.fr/fr/statistiques/2529884)) (Figure 6.2.b). We used their high estimate for the O/S scenario. The INSEE projection indicates a population increase in the west and south of France, while the demographic rate of growth in the north and northeastern regions would be much lower. For the Paris region, already by far the most populated region of the country (Figure 6.3.a), INSEE predicts an increase of 2.2 million inhabitants by 2040. For the A/R/D scenario, we redistributed one million inhabitants from Ile-de-France to neighboring regions including the north and northeastern regions with weak demography (Figure 6.2c).

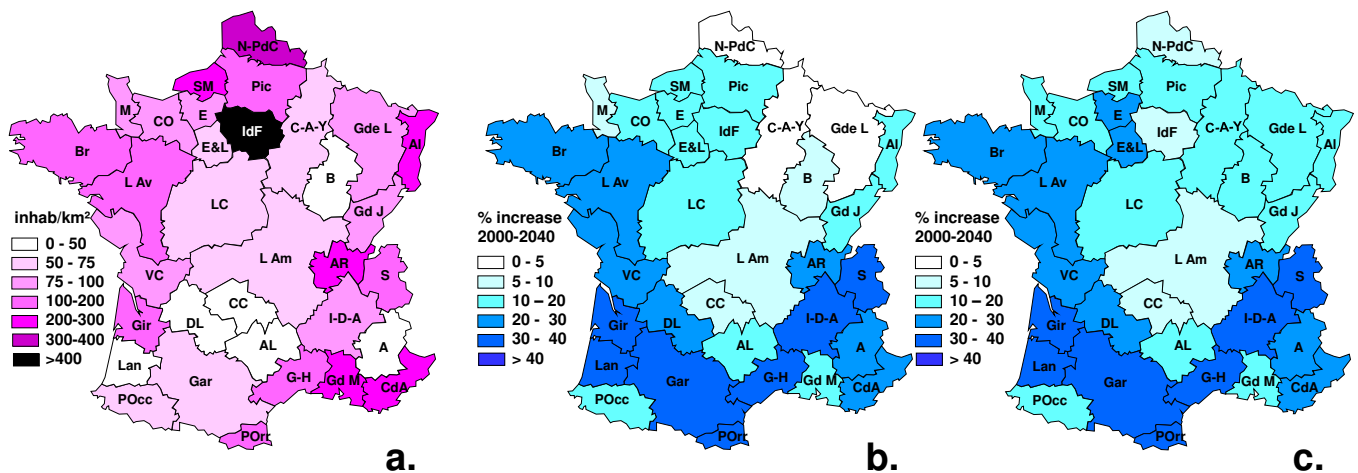
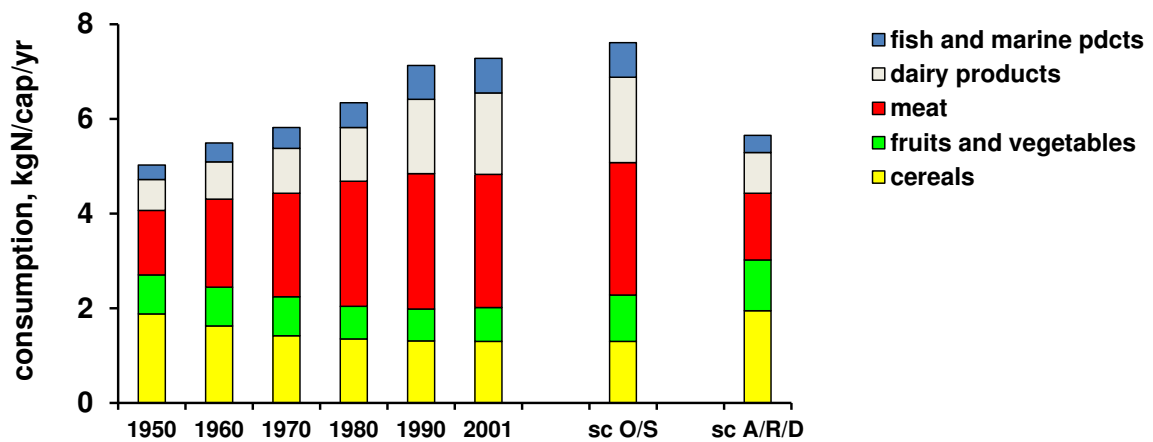

**Figure 6.2** a. Current (2010) distribution of the population density in France. b. % annual increase over the 2010–2040 period according to INSEE (high hypothesis). c. % annual increase over the 2010–2040 period with the hypothesis of a voluntarist policy for a more equilibrated population distribution between the Paris region and the northeastern rural areas. A: Alpes; Al: Alsace; AL: Aveyron-Lozère; AR: Ain-Rhône; B: Bourgogne; Br: Bretagne; C-A-Y: Champagne-Ardenne-Yonne; CC: Cantal-Corrèze; CdA: Côte d’Azur; CO: Calvados-Orne; DL: Dordogne-Lot; E: Eure; E&L: Eure-et-Loire; Gar: Garonne; Gd J: Grand Jura; Gd M: Grand Marseille; Gde L: Grande Lorraine; G-H: Gard-Hérault; Gir: Gironde; I-D-A: Isère-Drôme-Ardèche; IdF: Ile de France; L Am: Loire Amont; L Av: Loire Aval; Lan: Landes; LC: Loire Centrale; M: Manche; N-PdC: Nord Pas-de-Calais; Pic: Picardie; Pocc: Pyrénées Occidentales; POr: Pyrénées Orientales; S: Savoie; VC: Vendée-Charentes.

Population development goes along with an increase in urban, built-up areas, which we assumed to be mostly subtracted from agricultural land. To calculate this land use change, we evaluated, in each region, the new built-up areas corresponding to the population increase, and to be subtracted from cropland, according to the following relationship, established from empirical data by Couturier et al. (2017), between built-up areas (Surb, ha) and population density (popdens, inhab km<sup>-2</sup>) at the Nuts3 scale:

$$\text{Surb} = 1475 * \text{popdens}^{(-0.6)}. \quad (1)$$

The food demand of the population is calculated for each scenario according to the corresponding average diet shown in Figure 6.3 for the last 50 years for both scenarios.



**Figure 6.3** Trends in the composition of the human diet in France. (The figures correspond to apparent consumption rather than net ingestion, i.e., they include waste at the final stages of domestic consumption) (data from INSEE, 2010). The human diet in the Opening/Specialization scenario reflects an increase in the consumption of animal products. The human diet in the Autonomous/Reconnected/Demitarian scenario replaces half of the animal proteins with vegetal proteins and avoids half of the waste at the consumer stage.

### 3.2. Cropping systems

The Opening/Specialization scenario assumes the reinforcement of the currently observed specialization of agricultural regions as described in chapter IV, with no major changes in the cropping systems. Because of strict environmental regulations, the rate of chemical fertilization is adjusted up to a cropland N soil balance of 50 kgN ha<sup>-1</sup> yr<sup>-1</sup>. The corresponding yield is calculated assuming that the same Yield (Y, kgN ha<sup>-1</sup> yr<sup>-1</sup>) versus total N soil inputs (F, kgN ha<sup>-1</sup> yr<sup>-1</sup>) relationship holds true, averaged over the whole rotation cycle, for current and future cropping systems in each region. This Y vs F relationship can be expressed by a single parameter hyperbolic function (Lassaletta et al., 2014b; Anglade et al., 2015b):

$$Y = Y_{\max} F / (F + Y_{\max}) \quad (2)$$

The value of  $Y_{max}$  varies according to pedoclimatic context of each region (Figure 6.4a), but the relationship (1) applies to crop rotation in use in organic farming as well as to conventional rotations (Figure 6.4b), as shown by a compilation of enquiries available in different French agricultural regions.

For organic farming systems in the A/R/D scenario, a dominant crop rotation is assumed for each region (Table 6.1), characterized by a frequency of forage and grain legumes, and the corresponding yield of these legume crops (considered independent on the N fertilization rate). The total N soil input to the entire crop rotation can therefore be evaluated (taking into account regional livestock numbers; see below), and the yield of the non-legume crops can be calculated. In the A/R/D scenario, a systematic use of cover crop has been assumed for organic farming practices, representing an additional input of dry organic matter of between  $\text{tonDM ha}^{-1} \text{yr}^{-1}$  (Constantin et al., 2010; Juste, 2012), assuming that 70% of cropland would be concerned by cover crop.

Similarly, the production of permanent grassland systems is calculated from the total of N input and the current  $Y_{max}$  value for grassland, considering the current rate of symbiotic atmospheric N fixation.

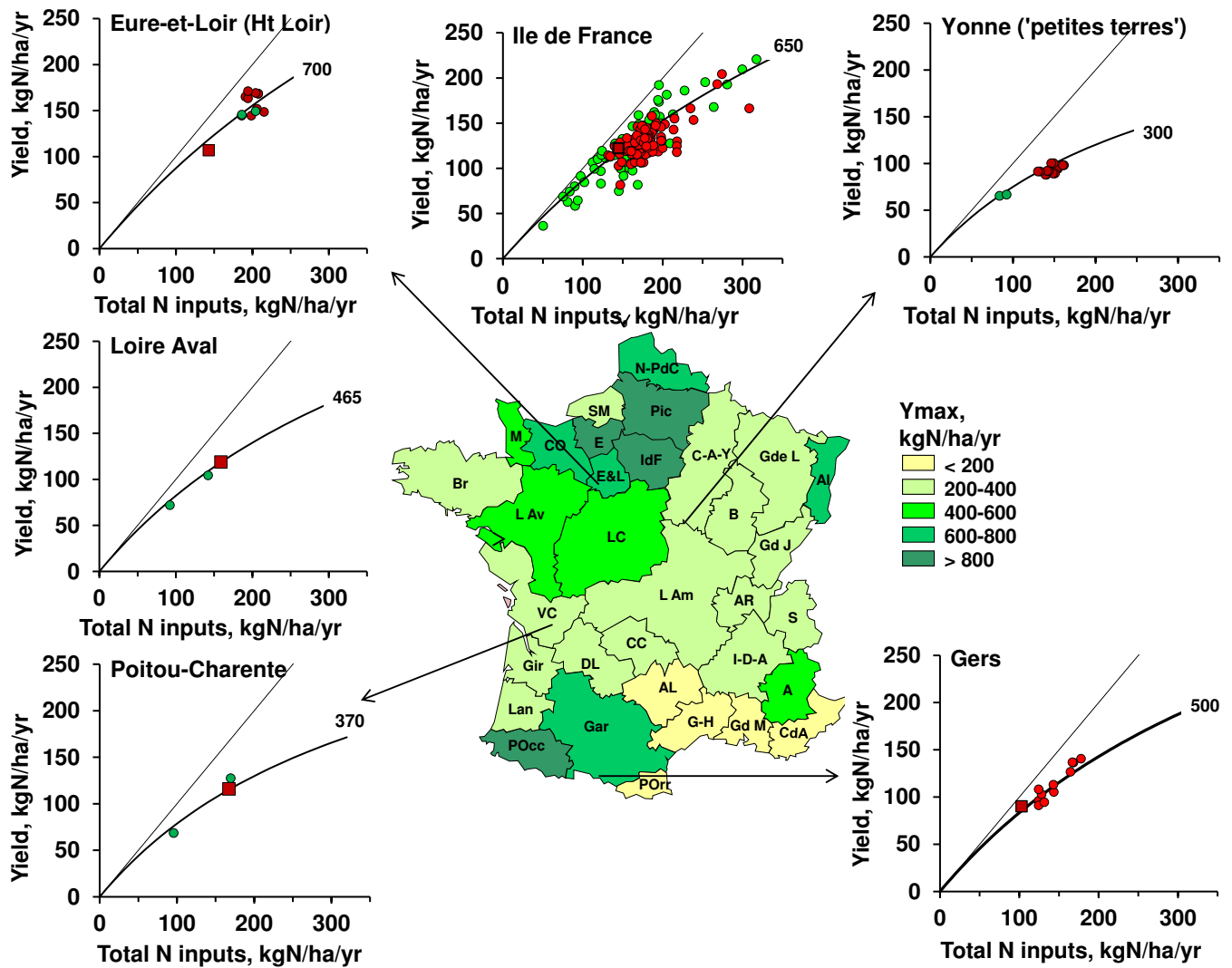

**Figure 6.4** Current distribution of the parameter  $Y_{max}$ , characterizing the  $Y$  vs  $F$  relationship of cropping systems in each region. Examples of  $Y$  vs  $F$  relationship for conventional (red points) and organic (green points) cropping systems. Yields (y axis) refer to the average yield over the crop rotation. Total N inputs (x axis) represent the average input of N (as mineral fertilizers, manure, symbiotic fixation and atmospheric deposition) to the soil, again over the whole rotation cycle. The data show that the same  $Y_{max}$  holds for both organic and conventional systems in the same pedoclimatic context (see Anglade et al., 2015a,b for Ile de France; and for the other regions green circles are from ITAB, 2011 and red squares are data from the GRAFS analysis of the different agricultural regions).

**Table 6.1** Dominant crop rotation considered for organic farming in the different regions in the A/R/D scenario, and current yield of fodder and grain legumes involved. (sources: Anglade et al., 2015b; LeMaitre, pers. comm.; ITAB, 2011; Doltra, 2015, EC DG ENV, 2010). Alf : alfalfa ; W : winter weat ; Cer : other cereal ; other: other non legume and non cereal crop; GrLeg: grain legume; Soy: Soybean; Sunfl: sunflower; Mai: maize; Clo: clover; Vet: vetch; Pot: potatoes; PT: temporary grassland)

Typical Crop succession	Frequency cereals	Legumes	Frequency legumes	Reference yield legume (kgN ha <sup>-1</sup> yr <sup>-1</sup> )
<b>Paris basin (IdF, Picardy, Eure, Champ-Ard, ...)</b>	0.5	Alf	0.25	250–300
Alf, Alf, W, Cer2, other, GrLeg, W, Cer3		GrLeg	0.125	50–100
<b>Normandy (Calvados, Manche)</b>				
Clo,Clo,Mai,W,GLeg,W,Cer	0.5	Clo	0.2	250
		GrLeg	0.2	95
<b>Nord-Pas de Calais</b>				
Luz, Pot, W, GLeg, W, Cer	0.5	Luz	0.17	280
		GLeg	0.17	80
<b>Grande Lorraine</b>				
PT, PT, W, Cer/GrLeg, W, Cer	0.58	PT	0.33	180
		GrLeg	0.08	73
<b>Alsace</b>				
Alf,Alf,W,Cer,Cer, Soy, Soy, Mai, Cer	0.44	Alf	0.22	80
		Soy	0.22	290
<b>Britanny</b>				
Clo,Clo,Mai,W,Cer,GrLeg,W,Cer	0.5	Clo	0.25	180
		GrLeg	0.125	100
<b>Vendée-Charente</b>				
Soy,W,Mai,GrLeg,W,Mai	0.33	Soy & GrLeg	0.33	80
<b>Loire Aval</b>				
Clo,Clo,Mai,GrLeg,W,other	0.17	Clo	0.33	200
		GrLeg	0.17	75
<b>Loire Centrale</b>				
Alf,Alf,W,Cer,GrLeg,W,Cer	0.57	Alf	0.29	210
		GrLeg	0.14	85
<b>Loire Amont</b>				
Alf,Alf,Alf,W,Cer,Sunfl,GrLeg,Mai,Sunfl,Cer	0.3	Alf	0.3	260
		GrLeg	0.1	55
<b>Grand Jura</b>				
Alf,Alf,W,Cer,GrLeg,W,Cer,Mai	0.44	Alf	0.33	180
		GrLeg	0.11	60
<b>Savoie</b>				
Al,Alf,Alf,W,Cer,Sunfl,GrLeg,W,Cer	0.44	Alf	0.33	170
		GrLeg	0.11	60
<b>Ain-Rhone</b>				
Alf,Alf,Mai,GrLeg,W,Cer, Mai	0.29	Alf	0.14	255
		GrLeg	0.29	72
<b>Alpes</b>				
Alf,Alf,Alf,W,Cer,Sunfl,W,Cerl	0.44	Alf	0.33	190
		GrLeg	0.11	27
<b>Isère-Drome-Ardèche</b>				
Alf,Alf,W,Cer,Sunfl	0.4	Alf	0.4	130
<b>Aveyron-Lozère</b>				
W,Sunfl,GrLeg	0.33	GrLeg	0.33	43
<b>Garonne, PyrOcc</b>				
Soy,Sunfl,Cer	0.33	Soy	0.33	55

<b>Gironde, Landes, Dor-Lot</b>				
Soy,Mai,Cer,GrLeg	0.25	Soy & GrLeg	0.5	63
<b>Cantal-Corrèze</b>				
Alf,Alf,Alf,W,Cer,Sunfl,GrLeg,Mai,Sunfl,Cer	0.3	Alf GrLeg	0.3 0.1	80 40
<b>GdMarseille, Cote d'Azur,Gard-Hérault, PyrOr</b>				
W,Sunfl,GrLeg	0.33	GrLeg	0.33	7-27

### 3.3. Livestock distribution

The reinforcement of regional specialization of the agricultural regions in France in the O/S scenario would lead the regions of the central Paris basin, Nord-Pas-de-Calais, Alsace, Gironde, Landes and the regions of the extreme southeast to become completely devoid of livestock and grassland. Elsewhere, the livestock density would increase up to a density of 2 LU ha<sup>-1</sup> (livestock units per hectare agricultural area), the maximum allowed by European Nitrate Directive (91/676/CEE), with the same species composition as today. Feed is imported in case of insufficient local forage resources.

In the A/R/D scenario, all regions are considered as integrated crop and livestock farming areas, and livestock densities are adjusted to the availability of the forage resources of each region (no import of feed is allowed), with, however, an upper limit corresponding to a maximum cropland soil balance of 50 kgN ha<sup>-1</sup> yr<sup>-1</sup>. The livestock species composition is kept identical to the current one for the regions currently characterized by integrated crop and livestock farming. For the other regions, we applied the specific composition of Grande Lorraine and Dordogne-Lot regions to the north and south of France, respectively. Grassland areas are adjusted to cover at least one-third of the livestock ration but cannot decrease below their current value.

## 4. The GRAFS description of the scenarios

The above storylines and hypotheses, summarized in Table 6.2, serve as input data for the GRAFS model based on a current reference situation corresponding to the average fluxes over the 2004–2014 period. Small routines, developed as Macros appended to the GRAFS Excel files, allow adjusting mineral fertilizer rates or livestock density in each region for the O/S and A/R/D scenarios, respectively, following the respective constraints. Here we discuss the resulting description of the nutrient fluxes in both scenarios.

**Table 6.2** *Main features of the O/S and A/R/D scenarios*

<b>Opening/Specilization</b>	<b>Autonomy/Reconnection/Demitarian diet</b>
<b>Population</b>	
INSEE 2040 projection (elevated hyp)	Idem with redistribution of 1M additional inhabitants in Paris toward the eastern
<b>Human diet</b>	
Increased meat and milk consumption	Demitarian diet
6.85 kgN cap <sup>-1</sup> yr <sup>-1</sup> total proteins	5.56 kgN cap <sup>-1</sup> yr <sup>-1</sup> total proteins
4.6 kgN cap <sup>-1</sup> yr <sup>-1</sup> animal prot (excl fish)	1.93 kgN cap <sup>-1</sup> yr <sup>-1</sup> animal prot (excl fish)
<b>Agricultural area (AA)</b>	
Total AA reduced by urban sprawl	Total AA identical to the current one.
No perm. grassland in crop farming areas	Perm. grassland area: (1) never lower that current level; (2) adjusted to provide at least 30% of livestock feed.
Same proportion to AA elsewhere	
<b>Mineral N Fertilization to cropland</b>	
Adjusted to maximize production up to a maximum N surplus of 50 kgN ha <sup>-1</sup> yr <sup>-1</sup> .	Zero mineral fertilization
<b>Livestock</b>	
Crop farming regions: zero	For all regions:
Livestock farming regions: 2.1 LU ha UAA <sup>-1</sup>	min 0.5 LU ha UAA <sup>-1</sup>
	maximum compatible with
	(1) No forage import
	(2) 30% share of perm. grassland to feed
	(3) N surplus < 40 kgN ha <sup>-1</sup> yr <sup>-1</sup>

### 4.1. Major N fluxes at the national scale

The results of the scenarios at the scale of the whole of France in terms of production and consumption of protein nitrogen are compared with the reference figures of the current situation (Table 6.3).

In the O/S scenario, cropland production would increase by 15%, potentially doubling cereal exports, in conformity with the explicit goal of this scenario. The number of livestock would also considerably increase, allowing a quite significant rise in animal product exports. The share of grassland in livestock nutrition would drop by one-third of its current value, and imported feed would become dominant in animal nutrition as is already the case in some French regions

(see chapter II and IV) and some European countries (Lassaletta et al., 2014a, c). This requires four times more import of feed from abroad, changing the status of France from a net exporter of N agricultural products ( $\sim 100$  ktN yr<sup>-1</sup>) into a net importer ( $\sim 600$  ktN yr<sup>-1</sup>).

**Table 6.3** Production figures and other features of the French agro-food system in the current reference situation and in the two scenarios for 2040. Lines or cells marked with an \* corresponds to hypothesis of the scenarios. The others result from the GRAFS calculations.

		2004–2014 Reference	2040 Opening Specialization	2040 Autonomy Reconnection Demitarian diet
<b>Population</b> *	Mhab	62	75	75
Consumption vegetal proteins*	ktN yr <sup>-1</sup>	145	169	273
Consumption animal prot (excl fish)*	ktN yr <sup>-1</sup>	232	330	135
<b>Agricultural area</b>	Mha	28	27	28
<i>% permanent grassland</i>	%	34	29	36
<b>Permanent grassland production</b>	ktN yr <sup>-1</sup>	829	1093	633
<b>Cropland production</b>	ktN yr <sup>-1</sup>	2192	2508	1770
Cereal production	ktN yr <sup>-1</sup>	1218	1412	440
Forage production	ktN yr <sup>-1</sup>	831	837	1180
Net cereals import (+) / export (-)	ktN yr <sup>-1</sup>	-540	-1089	-222
<b>Livestock</b>	M LU	19	37	12
Meat and milk production	ktN yr <sup>-1</sup>	261	383	138
Meat and milk import (+)/ export (-)	ktN yr <sup>-1</sup>	-29	-53	-3
Livestock ingestion	ktN yr <sup>-1</sup>	1955	3731	1224
<i>Perm grassland grazing</i>	%	42	29	45
<i>Local cropland product Ingestion</i>	%	35	26	55
<i>Imported feed ingestion</i>	%	23	45	0*
<b>Net feed import (+) / export (-)</b>	ktN yr <sup>-1</sup>	+438	+1687	0*

In the A/R/D scenario, in spite of the lack of use of mineral N fertilizers and pesticides, cropland production would decrease by less than 20%. Owing to the reduction of livestock, this would not prevent a surplus of crop products with respect to the internal demand, available for export or other uses, such as energy production through methanation. In particular, about 220 ktN yr<sup>-1</sup> of cereals can be exported, accounting for 40% of the currently exported amount. Livestock nutrition would be entirely based on local grassland and cropland products (including 10% cereals), without any feed import. Nevertheless, this extensive animal production would fulfill the requirements of the 75 million demitarian inhabitants. Only a small quantity of high-quality and added-value products, such as AOC (registered designation of origin) cheese would be exported on the international market.

## 4.2. Inter-regional exchanges



Because of the concentration of population in a few large urban centers, several regions are not and will probably never be self-sufficient in terms of food. Based on the analysis of transport statistics, we provided in section 4 of chapter II a matrix of the major fluxes of inter-regional exchanges of agricultural products in 2006 for France (Figure 6.5). To draw a similar picture for the two scenarios (Figure 6.5), we assumed that the probability of exchange of a particular product between two regions is inversely proportional to the distance between them and proportional to their respective supply potential and demand, thus considering an optimal spatial match between regional supply and demand. Besides international export of agricultural commodities, the long-distance international and inter-regional transport fluxes required to meet the local demand for food and feed amount 1400 ktN yr<sup>-1</sup> in the current situation; they increase to 1890 ktN yr<sup>-1</sup> in the O/S scenario, and drops to only 94 ktN yr<sup>-1</sup> in the A/R/D scenario.

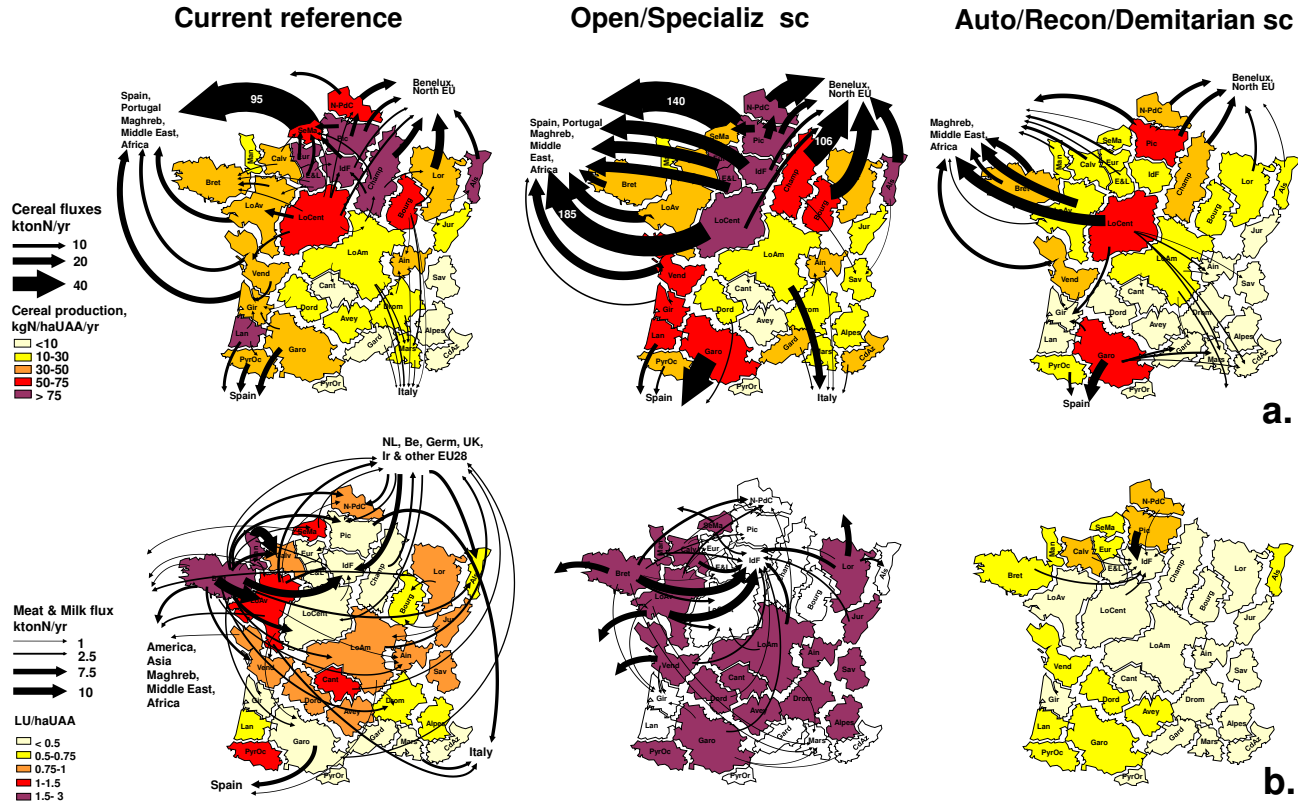

**Figure 6.5** Inter-regional and international fluxes of cereals **a.** and animal products **b.** in the 2006 French Agro-food system (left), as revealed by transport surveys (see chapter II), as well as in the Opening/Specialization scenario (center), and in the Autonomy/Reconnection/Demitarian scenario (right), calculated based on proximity and availability. LU: Livestock unit; UAA: utilized agricultural area.

### 4.3. Agronomical and environmental performances

Several indicators of environmental performance can be calculated from the GRAFS representation of the scenarios. To provide only a few examples, we focus here first on the amount of external resources required by the agro-food system, with industrial fertilizers in the lead. Then we assess the risk of water resource contamination through N leaching. Finally, we examine the consequences in terms of orgC status of cropland and the overall CO<sub>2</sub> emission budget.

#### ***4.3.1. N and P mineral fertilizer use***

In the reference 2004-2014 period, the French agro-food system used 1890 ktonN yr<sup>-1</sup> of nitrogen mineral fertilizers applied over cropland and 67 ktonN yr<sup>-1</sup> over permanent grassland. In the O/S scenario, the figures would be quite similar (1870 and 72 ktonN yr<sup>-1</sup>, respectively, on cropland and grassland), while mineral N fertilization would be inexistent by hypothesis in the A/R/D scenario. Regarding phosphorus fertilizers, 145 ktonP yr<sup>-1</sup> were applied in the recent reference period over cropland and 90 ktonP yr<sup>-1</sup> over permanent grassland. As shown in chapter III and IV, these figures correspond to an unbalanced and often deficit P fertilization made possible by the existence of a considerable P legacy stored in agricultural soils during the 1960's–1990's. Ensuring an equilibrated soil P balance in the O/S scenario would require applying 170 ktonP yr<sup>-1</sup> over cropland in the regions specialized in crop farming, while a large excess of soil P input would be applied in livestock farming regions. In the A/R/D scenario, the exogenous P requirements for equilibrating the soil P balance would be 55 ktonP yr<sup>-1</sup> on cropland and 12 ktonP yr<sup>-1</sup> on grassland. About half of this P amount corresponds to the P contained in domestic wastewater; its possible recycling has not been considered in these two scenarios, beyond the current level of urban sludge application on cropland. The other half corresponds to the P content of exported vegetal production, mostly as cereal.

#### ***4.3.2. Nitrogen leaching***

Cropland N soil surplus, an indicator of nitrate leaching to ground- and surface water, is another major aspect of environmental performance (Figure 6.6a). Taking into account the long-term average infiltration water depth in each region and assuming the surplus-nitrate leaching relationship discussed in Anglade et al. (2017), the nitrate concentration in groundwater recharge can be calculated (Figure 6.6b) and compared with the WHO drinking water standard of 11 mgN/l (i.e., 50 mgNO<sub>3</sub> l<sup>-1</sup>) and the recommended value of 5.6 mgN l<sup>-1</sup> by European standards ([http://www.eau-seine-normandie.fr/mediatheque/flipbook\\_sdage/](http://www.eau-seine-normandie.fr/mediatheque/flipbook_sdage/)). Clearly, only in the A/R/D scenario would agriculture be compatible with good-quality drinking water production in most regions, even though the O/S scenario has been established in compliance with current French and European regulations regarding reasoned fertilization and livestock densities.

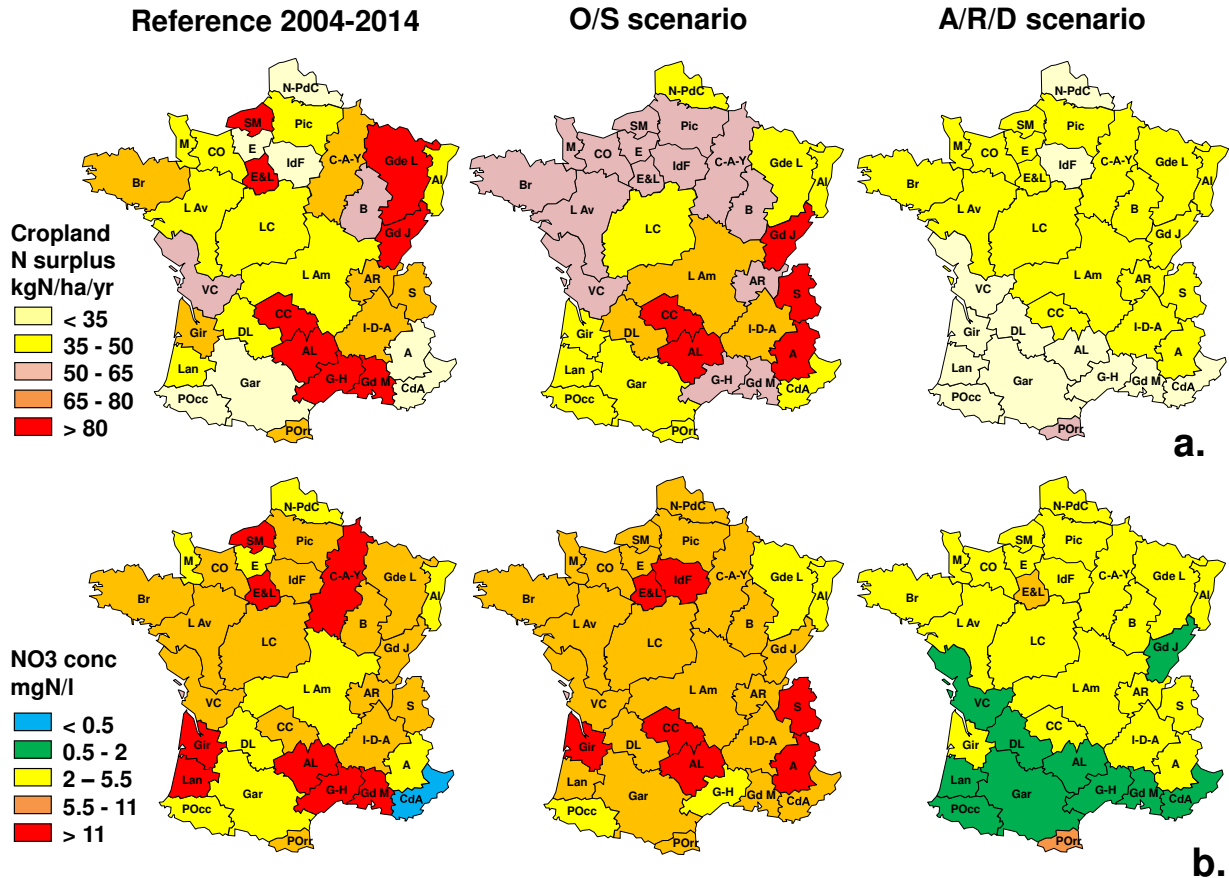

**Figure 6.6** Cropland N surplus **a.** and nitrate concentration in groundwater recharge **b.** calculated for the reference situation and the two scenarios.

#### 4.3.3. Humified carbon input to cropland and CO<sub>2</sub> emission budget

According to the procedure described in Chapter V, the coupling of the GRAFS description of the two scenarios to the AMG models enables to calculate the dynamics of organic carbon in arable land, assuming a gradual implementation of the scenarios starting from 2015 to 2050, following a linear trajectory, as well as an average temperature increase of 1.5 °C by 2050 in the continuity of the increase observed since the last decades (see chapter V). Moreover, we have considered the same rate of direct CO<sub>2</sub> emission through agricultural mechanical work and building heating as in the current French agriculture (115 kgC-CO<sub>2</sub> ha UAA<sup>-1</sup> yr<sup>-1</sup> and 53 kgC-CO<sub>2</sub> LU<sup>-1</sup>) as well as the same CO<sub>2</sub> emission associated to mineral fertilizer manufacture (1.3 tC-CO<sub>2</sub> tN<sup>-1</sup> fertilizer and 0.7 tC-CO<sub>2</sub> tP<sup>-1</sup> fertilizer) (calculated based on figures provided for France in 2006 by Doublet, 2017). For imported feed, we based our estimations on the figures provided by Aguilera (2015) and used the value of 100 kgC-CO<sub>2</sub> ton<sup>-1</sup> feed imported, accounting for both production and transport and assuming an average distance of travel of 5000 km of which 300 km by road and the rest by ship. Carbon accumulation or release from permanent grassland soil was not included in the C balance due to lack of an adapted C dynamic modelling in permanent grassland. Future investigations accounting for the all land-use in agriculture could enable to improve the accuracy of the trends simulated here.

These preliminary results revealed that in the O/S scenario, increased humified C inputs through manure and crops residues led to a build-up in cropland C stocks of 2.5 MtC yr<sup>-1</sup> over the period from 2035 to 2050. However, improved manure and residue inputs are permitted by substantial recourse to mineral N fertilizer (in crop specialized region) and imported feed (in livestock farming regions). In this scenario, carbon emissions due to consumption of fossil fuel for agriculture energy requirement would reach 14 MtC yr<sup>-1</sup>. About 45% of these C emissions would be caused by production and transport of imported feed.

By contrast, in the A/R/D scenario, although humified C inputs increased due to a higher share of temporary grassland and the implementation of cover crops, these changes would not be enough to offset enhanced C mineralization rates provoked by temperature rise. As a consequence, average C losses from cropland would reach -0.8 MtC yr<sup>-1</sup> over the period from 2035 to 2050. However, in the absence of mineral N fertilizer and an almost self-sufficiency for livestock production, C emissions induced by direct and indirect energy consumption for agriculture consumption would be much lower, reaching only 4 MtC yr<sup>-1</sup>. Overall, the C emission budget would be much lower in the A/R/D than in the O/S scenario (4.8 versus 11.5 MtC yr<sup>-1</sup> respectively). Figure 6.7 represent the effects of each scenario on the C emission budgets in agriculture for each region.

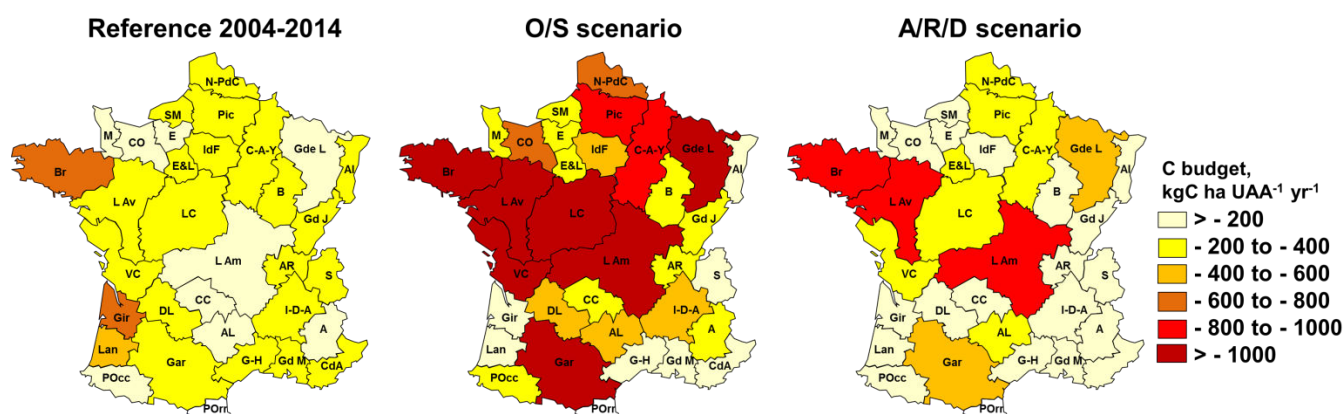

**Figure 6.7** C budget of agricultural production for the reference situation and the two scenarios, accounting for C storage in arable land and C emissions generated by agricultural mechanical work and building heating, N and P mineral fertilizers, production and transport of imported feed.

## 5. The role of scenario for reality

As mentioned above, the purpose of any prospective work is not to predict the future, but rather to produce a panel of visions of what it could be, if some of the current trends were pushed to their logical limits. As stated by Découflé (1980), “*a good scenario is by definition unacceptable. It is there to provoke the people to whom it is presented, to force them to question the hypotheses chosen. A scenario is made to be challenged and, once rejected, to feed another of its own remains.*” Nevertheless, it should not only nourish further scenarios, but also make citizens and policy makers react because it reveals the range of open possibilities, which is shown to be much wider than often presented by mainstream thinking as the ineluctable productivist business-as-usual future (Fouilleux et al., 2017). To provoke reactions implies to think about the potential driving belts of these scenarios to ensure the largest possible appropriation. Therefore, a bottom-up perspective for this work, and particularly this last chapter on possible scenario for agro-food systems in France, is greatly needed to keep consistent with that goal. To that end different paths could be explored: (1) the creation of free or open-source software enabling to anyone to use the GRAFS approach to imagine future scenario for agro-food systems; (2) the vulgarization of our approach in newspaper or social network; (3) the greater access to teaching in the university.

However, it is clear that any changes towards more sustainability will be a collective work. The research performed here is only a small building block to this edifice and we are not the first ones to design future scenario. During the last decade several prospective studies have been published exploring scenarios of a possible future for agro-food systems at the global scale. Among them Billen et al. (2015) and Erb et al. (2016) both explored the range of possibilities of feeding the projected 2050 world population by varying agricultural intensification, livestock feed composition and human diet, and demonstrated that a vast range of options exists for feeding the world, without expanding the global agricultural area. As also underlined by Kastner et al. (2012), the human diet (more specifically the fraction of livestock products in total protein ingestion) appeared as the strongest determinant of the “option space.” Lassaletta et al. (2016) and Muller et al. (2017) further showed that organic agriculture, if combined with structural measures including reduction of food wastage and animal product consumption would make it possible to meet the requirements of the current world population with much less pollution, and less long-distance trade, hence a higher degree of food sovereignty. Using the economic and biophysical model MagPIE, Schmitz et al. (2012) concluded that extension of food trade liberalization would increase trade fluxes, reduce global agriculture production costs, but substantially increase environmental damage and GHG emissions compared with a scenario with the current level of trade tariff. The role of trade was also addressed by Kastner et al. (2014), who concluded that the potential to reduce land demand by closing yield gaps with available production techniques is substantially larger than the hypothetical land savings achieved through international trade. The former strategy would also help poor importing regions to increase their self-sufficiency in terms of crop products, making them less vulnerable to global market fluctuations.

## 6. Conclusion

This last chapter developed a prospective approach for translating the storylines of two contrasted scenarios of the future French agro-food system into a quantitative description in terms of nutrient fluxes at the regional scale. For its application to prospective scenarios, we have added to the GRAFS methodology the capacity of translating a narrative description of a hypothetical future into a set of quantitative constraints, making it possible to establish a coherent and quantitative picture of the corresponding system at regional scales. One basic hypothesis making this translation possible is that of the regional invariance of the yield/fertilization relationship at the crop succession level. The empirical evidence presented in this chapter fully justifies this hypothesis. It enables making predictions about agricultural production for hypothetical farming systems, given the total rate of N soil input, even in the absence of detailed agronomical references.

On the whole, these results show that the future of the French agro-food system will depend on the tradeoffs between two diametrically opposed trends : (i) a centrifugal trend promoting opening of agricultural production to international markets with specialization in activities presenting comparative advantages and economies of scale, and (ii) a centripetal trend developing innovative forms of relocation of agricultural production and food consumption, creating new links between actors at the regional scale for a better closure of nutrient cycles.

A major conclusion of this chapter is the feasibility, in terms of nutrient fluxes, of an agro-food system based on (i) autonomy with respect to industrial fertilizers and imported feed, (ii) reconnection of crop and livestock farming and (iii) a diet with reduced animal protein, as in the A/R/D scenario. Such a scenario applied to France is in line with some of the global scenarios privileging food sovereignty and organic farming techniques (Kastner et al., 2012, 2014; Pradhan et al., 2014; Billen et al., 2015; Erb et al., 2016; Lassaletta et al., 2016; Muller et al., 2017). Indeed, none of those scenarios predicts full self-sufficiency of all world regions at the 2050 horizon, making a certain amount of international trade of agricultural goods and a certain degree of openness of local economies unavoidable. In that respect it is notable that our extreme A/R/D scenario for France would allow net cereal exports at more than two-thirds of the current level, while no imports of feed would be necessary. On the contrary, the O/S scenario, because of its reliance on imported feed, would bring France from a net exporter to a net importer of agricultural goods.



# **General Conclusion**





## 1. A brief overview of the work carried out

Throughout the six chapters of this thesis, we have shown how the structure of agro-food systems and agricultural practices shaped nutrient fluxes at various scales. We developed the GRAFS approach as a biogeochemical accounting method able to summarize the major fluxes which define the socio-ecological metabolism of agro-food systems. Examining the long-term trajectories of these systems, from 1852 to 2014 highlights the imbrication between the vegetal and animal production, the opening of nutrient cycles, the regional biophysical features and the national historical context. Yet the analysis of the evolution of the biogeochemical fluxes in agro-food systems in light of the national and international economic and political contexts provided us an environmental long term view of these systems. Such a prism of analysis reconciles the “human” and “natural” histories which are seen through the “environment” emerging from the interaction of both. Our focus on N, P and C fluxes and stocks linked to agricultural production made it possible to identify different period in the trajectory of agro-food systems with the most striking changes occurring from 1950 to the 1980’s, a period almost coinciding with the Glorious Thirties (Fourastié, 1979). This period was marked by a concomitant acceleration in crops yields, livestock production, uses of mineral fertilizer together with an increasing specialization of several regions into crop production and, at the turn of the 1980’s, into livestock production. This resulted in increased N and P balances over cropland and grassland and growing C inputs to cropland, causing important losses of N to the hydrosphere and atmosphere and the accumulation of P and C stocks in cropland. However, the accumulation of C in cropland was reversed in regions specialized in livestock production in the last two decades. Furthermore, C accumulation resulting from increased crop production, and concomitant root and above-ground residue inputs, was permitted by the increased recourse to mineral fertilizers and agricultural machinery which consumes fossil-fuel energy. Therefore, C storage in cropland appeared to be a side-effect of the shift from an energy metabolism based on solar energy to one based on fossil-fuel combustion.

Lastly, when addressing the challenges of future sustainable agro-food systems in terms of nutrients fluxes, our GRAFS approach showed that reconnection of livestock and crop production at the regional scale and a shift from the current diet to a demitarian diet would enable to feed the French population while still maintaining a significant share of cereal production available for exportation at the horizon 2040-2050. In such a scenario, agriculture would also be compatible with good-quality drinking water production in most regions and the CO<sub>2</sub> emission budgets would be much lower due to a decrease of energy consumption for agricultural production. By contrast a scenario reinforcing the trend toward opening and specialization of agro-food systems would lead to increased dependence for animal feed and N and P mineral fertilizer and would further increase the CO<sub>2</sub> emission budgets related to agricultural production. Besides, even if current regulations regarding reasoned fertilization and livestock density are respected in our scenario of opening and specialization, this would not be sufficient to ensure good water quality in most regions, thus suggesting that deep structural changes in agro-food systems are necessary to reconcile agriculture and water quality.

At the term of this work, because of the major issues it raised regarding the environmental sustainability of the current French agro-food systems, regarding the decisive choices standing in front of us which will determine the viability of our environment and our planet, it is difficult to avoid some basic reflexive questioning on the role of science in politics and society, on the kind of knowledge we want to produce, as well as on the place of the scientist in social transformation processes.

## **2. The relationships between science, policy and society**

The relationships between science, policy and society have changed a lot from the middle of the 20<sup>th</sup> century (Bonneuil, 2004). During the period of the Glorious Thirties, in exactly the same way as the French State followed a voluntarist policy of modernization of agriculture, several public Research Institutes were created or developed with the aim of producing the knowledge required for the technical development of the country. Following the creation of the CNRS in 1939 dedicated to basic research, the creation of the French Atomic Energy Commission (CEA) in 1945 and of the National Institute for Agronomic Research (INRA) in 1946 are both emblematic of this willing to provide France with an ambitious innovation policy capable to permeate and boost various sectors of the economy. Consequently, from 1958 to 1968, Research and Innovation increased its share of the State budget from 2.45 % to 6.2 %. The links between the state, the public research and the public or private companies became more tightened, leading to the reinforcement of a technocratic regime, which was especially the case for the agricultural sector (Muller, 1984).

After the events of May 68 and, even more, after the oil crisis, budgetary allocation for public research became more rigorous. A period of politicization among research institutions emerged through a posture of ‘critical research’ or ‘specific intellectual’ (Bonneuil, 2004), questioning the role of researchers in society as well as the link between technical progress, economic growth and human well-being. However, the period of the 1980’s was marked by the comeback of the state in scientific institutions and the subsequent reinforcement of the vision of scientists as ‘experts’.

At the turn of the 21<sup>st</sup> century, Bonneuil (2004) stressed out the increasing hold of private company such as Monsanto on the research agenda. However, he also identified the growing implication in the research and innovation area, of « laypersons», that are neither scientists nor professional technicians. Therefore, along with the increasing importance of market logic in the production and regulation of scientific knowledge, there is also the emergence of a “civic” mode of production and regulation. While in the period preceding the 1980’s the choices regarding research and innovation had been limited to the triangle formed by researchers, policy-makers and entrepreneur’s, the emergence of a “civic” mode of production in the last three decades was fostered by the involvement of new actors such as patient associations, practitioners, users, activists and workers in the co-production of research and its diffusion in virtual or real forums (Bonneuil, 2004, Madelrieux, 2017, Compagnone et al, 2018). The involvement of these

“laypersons” in the co-production and diffusion of knowledge represents an empowerment of citizens by science which can promote an ascending ecological transition rather than a descending one where decisions are taken by policy-makers and entrepreneur’s (Madelrieux, 2017). However, this trend toward a greater involvement of citizens remains limited (Bonneuil, 2004) because many barriers (lack of time, social inequalities regarding the appropriation of scientific knowledge, lack of funding for public research) still impede a larger involvement of citizens in science.

Our conviction is that any changes towards more environmental and social sustainability will require a collective work for providing scientific knowledge useful for future choices regarding our common future, exchanging this knowledge beyond the sphere of research and management, making its appropriation by a large number of people easier.

### **3. Towards an emancipatory environmental science?**

Erik Olin Wright (2010) proposed the concept of an “emancipatory social science”. For him, the world “science” stresses the importance of starting from the analysis of real facts. The world “social” ingrained this science at the scale of society where the problems of individuals are not isolated from the rest of the world but are rather conceived as related to the political and economic balance of forces. Lastly the world “emancipatory”, identifies in the production of such knowledge a goal of eliminating the oppressions and creating the conditions favoring human fulfilment. According to Wright, such an “emancipatory social science” must be assigned three fundamental tasks: (1) to elaborate a systematic critic of the world as it is; (2) to imagine viable alternative; (3) to understand the barriers faced by any project of social transformation but also its possibilities and dilemma.

Here, we believe that this concept can be adapted to an “emancipatory environmental science” applied to regional agro-food systems. If the word “social” is replaced by the word “environmental”, it means that the type of facts we tried to understand are related to the interaction between societies and their biophysical environment. Therefore, environmental issues are placed at the level of socio-ecological metabolism at embedded scales. In the present case, the notion of “emancipation” is applied to the possibility of undergoing an agro-ecological transition toward more sustainability. However, the idea of a transition relates to the transformation of society interactions with their environment, which is a political issue because it involves choices while science only try to understand or discover facts or laws for which we do not have choice. As stated above (Chapter VI), we are aware of the rather subjective approach of designing scenarios for future agro-food systems and, as experts; we preferred to remain in a non-prescriptive posture. Thus, following the Weberian vision of the relation between science and politic (Weber, 1959), our research regarding the challenge for future sustainable agro-food system must be separated from policy but is produced with a view of being useful. Therefore, the question is: to whom could it be useful and how? This type of research could be useful to any persons and collective body of persons concerned by climate

change, food sovereignty, and air and water pollution who could be involved in the decision regarding their common future. Consequently, in order to fulfill the requirements of an “emancipatory” science, we should reflect on the possibility of our research to be appropriated as largely as possible.

Therefore, following Gonzalez de Molina (2014) we agree to say that “it is the actions of citizens, turned into social processes, that can and should realize the necessary changes for exiting the crisis and building a new metabolic configuration” but we would also add that scientists may help to that goal by conceiving transmittable and appropriable knowledge favoring an ascending transition toward more sustainability in agro-food systems and, more generally, in socio-ecological systems. A major issue for future research is probably to federate all these researches with the aim of bringing together different scientific tools and approaches from various disciplinary backgrounds. Such a project would be a collective work but requires a common vision of our role as scientists in the ecological transition: a non-prescriptive but also non-neutral role, accounting for the current balance of forces that we are part of.

To conclude, the theoretical framework of socio-ecological metabolism that was adopted in this thesis provides a coherent integration of various aspects of a same reality, i.e., agro-food system trajectories and their possible futures. More broadly, it emphasizes that a double emancipation, social and ecological, is required for creating new metabolic modalities for a genuinely sustainable society.

# References



AESN, 2013. Etat des lieux du bassin de la Seine et des cours d'eau côtiers normands. *Agence de l'eau Seine Normandie. Préfecture de Région Ile-de-France*. 329 pp.

Afssa, 2009. Enquête Individuelle Nationale des consommations Alimentaires (INCA 2). Rapport. <https://www.anses.fr/fr/system/files/PASER-Ra-INCA2.pdf>. Consulted 15 sept 2016.

Agence Bio, 2017. <http://www.agencebio.org/la-bio-dans-les-regions>. Consulted 08/10/2017

Agreste, 2006. La statistique agricole. Ministère de l'Agriculture, de l'Agro-Alimentaire et de la Forêt. <http://agreste.agriculture.gouv.fr/la-statistique-agricole/> Consulted 15 sept 2016.

Agreste, 2011. Enquêtes Pratiques, available at : <http://agreste.agriculture.gouv.fr/enquetes/pratiques-culturelles/grandes-cultures-prairies/>

Agreste, 2014. Les matières premières de l'alimentation animale en 2012. Agreste Chiffres et Données Agroalimentaire n° 181. Ministère de l'Agriculture.

Agreste, 2017. La statistique agricole. Ministère de l'Agriculture, de l'Agro-Alimentaire et de la Forêt. <http://agreste.agriculture.gouv.fr/la-statistique-agricole/> Cited 15 november 2017.

Aguilera, E., Guzman, G. I., Alvaro-Fuentes, J., Infante-Amate, J., Garcia-Ruiz, R., Carranza-Gallego, G., Soto, D., Gonzalez de Molina, M., 2018. A historical perspective on soil organic carbon in Mediterranean cropland (Spain, 1900-2008). *Science of the Total Environment*. 621, 634-648. DOI : [org/10.1016/j.scitotenv.2017.11.243](https://doi.org/10.1016/j.scitotenv.2017.11.243)

Amer, F., Bouldin, D. R., Black, C. A., Duke, F. R., 1955. Characterization of soil phosphorus by anion exchange resin adsorption and P 32-equilibration. *Plant Soil* 6, 391-408.

Anderson, T.-H., Domsch, K.H., 1989. Ratios of microbial carbon to total organic carbon in arable soils. *Soil Biology and Biochemistry*, 21, 471-479. DOI: [org/10.1016/0038-0717\(89\)90117-X](https://doi.org/10.1016/0038-0717(89)90117-X)

Angers, D., Arrouays, D., Saby, N., Walter, C., 2011. Estimating and mapping the carbon saturation deficit of French agricultural topsoils. *Soil Use and Management* 27, 448-452.

Anglade, J., 2015a. Agriculture biologique, qualité de l'eau et gouvernance. Ph-D Thesis Univ. Paris 6 (UPMC), ED " Géosciences et Ressources Naturelles". 295 pp.

Anglade, J., Billen, G., Garnier, J., 2015b. Relationships for estimating N<sub>2</sub> fixation in legumes: incidence for N balances of legume-based cropping systems in Europe. *Ecosphere* 6(3):37. DOI: [10.1890/ES1400353.1](https://doi.org/10.1890/ES1400353.1)



Anglade J, Billen, G., Garnier, J., 2017. Reconquérir la qualité de l'eau en régions de grande culture : agriculture biologique et reconnexion avec l'élevage. *Fourrages*. 231, 257-268.

Ansari, A., Pandis, S., 1998. Response of inorganic PM to precursor concentrations. *Environmental Science and Technology*, 32, 2706–2714.

Antoine, A., Herment, L., 2016. Specialisation in rural history: towards a definition, in: Antoine, A., (Ed), *Agricultural specialisation and rural patterns of development*. Brepols, Turnhout, Belgium. DOI: 10.1484/M.RURHE-EB.5.112259

Ashley, K., Cordell, D., Mavinic, D., 2011. A brief history of phosphorus: from the philosopher's stone to nutrient recovery and reuse. *Chemosphere*, 84, 737-746. DOI: 10.1016/j.chemosphere.2011.03.001

Asman, W.A.H., Drukker, B. Janssen A.J., 1988. Modelled historical concentrations and deposition of ammonia and ammonium in Europe. *Atmospheric Environment*, 22: 725-735.

Autret, B., Mary, B., Chenu, C., Balabane, M., Girardin, C., Bertrand, M., Grandeau, G., Beaudoin, N., 2016. Alternative arable cropping systems: A key to increase soil organic carbon storage? Results from a 16 year field experiment. *Agriculture, Ecosystems & Environment*, 232, 150-164. DOI : org/10.1016/j.agee.2016.07.008

Bache, B., Rogers, N., 1970. Soil phosphate values in relation to phosphate supply to plants from some Nigerian soils. *Journal of Agricultural Science*. 74, 383–390.

Bache, B., Ireland, C., 1980. Desorption of phosphate from soils using anion exchange resins. *Journal of Soil Science*. 31, 297–306. DOI: 10.1111/j.1365-2389.1980.tb02082.x

Bai, Z., Li, H., Yang, X., Zhou, B., Shi, X., Wang, B., Li, D., Shen, J., Chen, Q., Qin, W., 2013. The critical soil P levels for crop yield, soil fertility and environmental safety in different soil types. *Plant Soil*. 372, 27–37. DOI: 10.1007/s11104-013-1696-y

Ballabio, C., Panagos, P., Monatanarella, L., 2016. Mapping topsoil physical properties at European scale using the LUCAS database. *Geoderma*, 261, 110-123. DOI: org/10.1016/j.geoderma.2015.07.006

Barataud, F., Foissy, D., Fiorelli, J.-L., Beaudoin, N., Billen, G., 2015. Conversion of a Conventional to an Organic Mixed Dairy Farming System: Consequences in Terms of N Fluxes. *Agroecology and Sustainable Food Systems*, 39, 978-1002. DOI: 10.1080/21683565.2015.1067940

Barles, S., 2005. L'invention des déchets urbains: France 1790-1970, Champ Vallon, Seyssel Ain.

Barles, S., 2007. Feeding the city: food consumption and flow of nitrogen, Paris, 1801-1914. *Science of the Total Environment*. 375: 48–58. DOI : 10.1016/j.scitotenv.2006.12.003.

Barles, S., 2014. L'écologie territoriale et les enjeux de la dématérialisation des sociétés : l'apport de l'analyse des flux de matières. *Développement durable & territoires*, 5, 1.

Barles, S., 2015. The Main Characteristics of Urban Socio-Ecological Trajectories: Paris (France) from the 18th to the 20th Century. *Ecological Economics*, 118, 177-185

Barré, P., Angers, A.A., Basile-Doelsche, I., Bispo, A. Cécillon, L., Chenu, C., Chevallier, T., Derrien, D., Eglin, T.K., Pellerin, S., 2017. Ideas and perspectives: Can we use the soil carbon saturation deficit to quantitatively assess the soil carbon storage potential, or should we explore other strategies? *Biogeosciences*. DOI: 10.5194/bg-2017-395

Baveye, P., Berthelin, J., Tessier, D., Lemaire, G., 2018. The “4 per 1000” initiative: A credibility issue for the soil science community? *Geoderma*, 309 (Supplement C), 118-123. DOI: 10.1016/j.geoderma.2017.05.005

Bellanger, E., 2010. Assainir l'agglomération parisienne. Histoire d'une politique interdépartementale de l'assainissement (XIXe-XXe siècles) avec la collaboration d'Éléonore PINEAU, Éditions de L'Atelier, Paris.

Bengtsson, J., Ahnström, J., Weibull, A., 2005. The effects of organic agriculture on biodiversity and abundance: a meta-analysis. *Journal of Applied Ecology*. 42, 261–269. DOI: 10.1111/j.1365-2664.2005.01005.x

Benhalima, M., Billen, G., Bortzmeyer, M., Scarsi, F., Fosse, J. , 2015. Analyse du système agro-alimentaire de la région Nord-Pas-de-Calais et ses enjeux sur l'eau. *Collection « Études et documents »* Commissariat Général au Développement Durable n° 125. 48pp. <http://www.developpement-durable.gouv.fr/IMG/pdf/ED125.pdf>. Cited 15 sept 2016.

Bennett, E. M., Carpenter, S. R., Caraco, N. F., 2001. Human impact on erodable phosphorus and eutrophication : A global perspective. *BioScience*, 51, 227-234. DOI : org/10.1641/0006-3568(2001)051[0227:HIOEPA]2.0.CO;2

Benoit, M., Garnier, J., Anglade, J., Billen, G., 2014. Nitrate leaching from organic and conventional arable crop farms in the Seine Basin (France). *Nutr. Cycl. Agroecosystems* 100, 285–299. DOI: 10.1007/s10705-014-9650-9

Benoit, M., Garnier, J., Billen, G., Tournebize, J., Gréhan, E., Bruno, M., 2015. Nitrous oxide emissions and nitrate leaching in an organic and a conventional cropping system (Seine basin,

France). *Agriculture, Ecosystem and Environment*. 213, 131-141. DOI : 10.1016/j.agee.2015.07.030.

Benoit, M., Garnier, J., Beaudoin, N., Billen, G., 2016. A participative network of organic and conventional crop farms in the Seine Basin (France) for evaluating nitrate leaching and yield performance. *Agricultural Systems*. 148, 105–113. DOI: 10.1016/j.agsy.2016.07.005

Bergson, 1905, L'évolution créatrice. PUF, Collection Quadrige, Paris. 375 pp

Berry, P., Stockdale, E., Sylvester-Bradley, R., Philipps, L., Smith, K., Lord, E., Watson, C., Fortune, S., 2003. N, P and K budgets for crop rotations on nine organic farms in the UK. *Soil Use and Management*. 19, 112–118.

Bertin, A. 1856. Du fumier, de la culture et du bétail, en vue du fumier. Carette-Bondessein, imprimeur-libraire, Valognes

Bertora C., Zavattaro. L., Sacco, D., Monaco, S., Grignani, C., 2009. Soil organic matter and losses in manured maize-based forage systems. *European Journal of Agronomy* 30:117-186

Besnard, E., Chenu, C., Balesdent, J., Puget, P., Arrouays, D., 1996. Fate of particulate organic matter in soil aggregates during cultivation. *European Journal of Soil Science*, 47, 495-503.

Billen, G., Barles, S., Garnier, J., Rouillard, J., Benoit, P., 2009. The food-print of Paris: long-term reconstruction of the nitrogen flows imported into the city from its rural hinterland. *Regional Environment Change*, 9, 13–24. DOI: 10.1007/s10113-008-0051-y

Billen, G., Garnier, J., Barles, S., 2012a. History of the urban environmental imprint: introduction to a multidisciplinary approach to the long term relationships between Western cities and their hinterland. *Regional Environmental Change*, 12, 249-254.

Billen, G., Garnier, J., Silvestre, M., Thieu, V., Barles, S., Chatzimpiros, P., 2012b. Localising the nitrogen imprint of Paris food supply: the potential of organic farming and changes in human diet. *Biogeosciences*, 9, 607–616.

Billen, G., Barles, S., Chatzimpiros, P., Garnier, J., 2012c. Grain, meat and vegetables to feed Paris: where did and do they come from? Localising Paris food supply areas from the eighteenth to the twenty-first century. *Regional Environmental Change*, 12, 325-336.

Billen, G., Garnier J., Lassaletta, L., 2013a. The nitrogen cascade from agricultural soils to the sea: modelling nitrogen transfers at regional watersheds and global scales. *Philosophical Transactions of the Royal Society B* 368, 20130123

Billen, G., Garnier, J., Benoît, M., 2013b. La cascade de l'azote dans les territoires de grande culture du Nord de la France. *Cahiers Agricultures*, 22, 272-81. DOI: 10.1684/agr.2013.0640.

- Billen G., Lassaletta L., Garnier J., 2014. A biogeochemical view of the global agro-food system: Nitrogen flows associated with protein production, consumption and trade. *Global Food Security* 209–219. DOI: 10.1016/j.gfs.2014.08.003.
- Billen G, Lassaletta L, Garnier, J., 2015. A vast range of opportunities for feeding the world in 2050: trade-off between diet, N contamination and international trade. *Environmental Research. Letters*. 10: 025001 doi:10.1088/1748-9326/10/2/025001
- Billen, G., Le Noë, J., Lassaletta, L., Thieu, V., Anglade, J., Petit, L., Garnier, J., 2016. Et si la France passait au régime « Bio, Local et Demitarrien » ? Un scénario radical d'autonomie protéique et azotée de l'agriculture et de l'élevage, et de sobriété alimentaire. DEMETER 2017. *Club-Demeter*, Paris.
- Blake, L., Johnston, A., Poulton, P., Goulding, K., 2003. Changes in soil phosphorus fractions following positive and negative phosphorus balances for long periods. *Plant and Soil*. 254, 245–261. DOI: 10.1023/A:1025544817872
- Boinon, J.P., 2011. Les politiques foncières agricoles en France depuis 1945. *Economie et Statistique*, 444-445, 19-37. DOI: 10.3406/estat.2011.9641.
- Bolinder, M.A., Janzen, H.H., Gregorich, E.G., Angers, D.A., VandenBygaart, A.J., 2007. An approach for estimating net primary productivity and annual carbon inputs to soil for common agricultural crops in Canada. *Agriculture, Ecosystems & Environment*, 118, 29-42. DOI : org/10.1016/j.agee.2006.05.013
- Bonaudo, T., Bendahan, A. B., Sabatier, R., Ryschawy, J., Bellon, S., Leger, F., Magda, D. and Tichit, M., 2014. Agroecological principles for the redesign of integrated crop–livestock systems. *European Journal of Agronomy*, 57 43–51.
- Bonneuil, C., 2005, Les transformations des rapports entre sciences et sociétés en France depuis la Seconde Guerre mondiale : un essai de synthèse. *Actes du colloque Sciences, Médias et Société, ENS, Paris*. pp 15-40.  
[http://science.societe.free.fr/documents/pdf/actes\\_colloque\\_ENS\\_sciences\\_medias\\_et\\_societe.pdf#page=19](http://science.societe.free.fr/documents/pdf/actes_colloque_ENS_sciences_medias_et_societe.pdf#page=19)
- Bonnin, I., Bonneuil, C., Goffaux, R., Montalent, P., 2014. Explaining the decrease in the genetic diversity of wheat in France over the 20th century. *Agriculture, Ecosystems and Environment*, 195, 183-192.
- Bossche, A., Neve, S. de, Hofman, G., 2005. Soil phosphorus status of organic farming in Flanders: an overview and comparison with the conventional management. *Soil Use and Management*. 21, 415–421. DOI: 10.1079/SUM2005355

- Boulaine, J., 2006. Histoire de la fertilisation phosphatée 1762–1914. *Etude et Gestion des Sols*, 13, 129-137.
- Bouwman, A.F., Beusen, A.H.W., Lassaletta, L., van Apeldoorn, D.F., van Grinsven, H.J.M., Zhang, J., Ittersum van, M.K., 2017. Lessons from temporal and spatial patterns in global use of N and P fertilizer on cropland. *Scientific Reports*, 7, 40366. DOI: 10.1038/srep40366.
- Bouwman, L., Goldewijk, K.K., Van Der Hoek, K.W., Beusen, A.H.W., Van Vuuren, D. P., Willems, J., Rufino, M.C., Stehfest, E., 2013. Exploring global changes in nitrogen and phosphorus cycles in agriculture induced by livestock production over the 1900–2050 period. *Proceedings of the National Academy of Sciences of the USA*. 20882-20887.
- Boydston, R.A., and Vaughn, S.F., 2002. Alternative weed management systems control weeds in potato (*Solanum tuberosum*). *Weed Technology*, 16, 23-8.
- Boyer E.W., Goodale C.L., Jaworsk N.A., Howarth R.W., 2002. Anthropogenic nitrogen sources and relationships to riverine nitrogen export in the northeastern USA. *Biogeochemistry*, 57, 137–169.
- Bronick, C.J., Lal, R., 2004. Soil structure and management: a review. *Geoderma*. 124, 3-22. DOI : org/10.1016/j.geoderma.2004.03.005
- Buclet, N., Barles, S., Cerceau, J., Herbelin, A., 2015. L'écologie territoriale entre l'analyse de métabolisme et jeux d'acteurs. In N. Buclet (Ed.), *Essai d'écologie territoriale L'exemple d'Aussois en Savoie* (first ed.), CNRS, Paris (2015).
- Bureau, J.-C., Thoyer, S., 2014. La politique agricole commune. *La Découverte*, Paris.
- Burney, J.A., Davis, S.J., Lobell, D.B., 2010. Greenhouse gas mitigation by agricultural intensification. *Proceedings of the National Academy of Sciences*, 107, 12052-12057. DOI : org/10.1073/pnas.0914216107
- Cahuzac, E., Détang-Dessendre, C., 2012. Le salariat agricole. Une part croissante dans l'emploi des exploitations mais une précarité des statuts. *Economie rurale*, 323, 82-92. DOI : 10.4000/economierurale.3050
- Campbell, C.A., Biederberck, V.O., Zenter, R.P., Lafond, G.P., 1991. Effect of crop rotation and cultural practices on soil organic matter, microbial biomass and respiration in a thin Black Chernozem. *Canadian Journal of Soil Sciences*, 71, 363-376.
- Carmo, M., Garia-Ruiz, R., Ferreira, M.I., Domingos, T., 2017. The N-P-K soil nutrient balance of Portuguese cropland in the 1950s: The transition from organic to chemical fertilization. *Scientific Reports*, 7, 8111. DOI:10.1038/s41598-017-08118-3

Carpenter, S.R., Caraco, N.F., Correll, D.L., Howarth, R.W., Sharpley, A.N., Smith, V.H., 1998. Nonpoint pollution of surface waters with phosphorus and nitrogen. *Ecological Applications*, 8, 559–568. DOI: 10.1890/1051-0761(1998)008[0559:NPOSWW]2.0.CO;2

CGDD, 2013. NOPOLU-Agri. Outil de spatialisation des pressions de l'agriculture. Méthodologie et résultats pour les surplus d'azote et les émissions des gaz à effet de serre Campagne 2010-2011 Document de travail n°14. Commissariat général au développement durable - Service de l'observation et des statistiques. Available at: [http://www.statistiques.developpement-durable.gouv.fr/fileadmin/documents/Produits\\_editoriaux/Publications/Documents\\_de\\_travail/2013/doc-travail-14-nopolu-09-2013.pdf](http://www.statistiques.developpement-durable.gouv.fr/fileadmin/documents/Produits_editoriaux/Publications/Documents_de_travail/2013/doc-travail-14-nopolu-09-2013.pdf). Cited Sept 2016.

Charbonnier, P., 2013. La nature est-elle un fait social comme les autres : les rapports collectifs à l'environnement à la lumière de l'anthropologie. *Cahiers philosophiques*, 132, 75-95. doi:10.3917/caph.132.0075.

Chatzimpiros, P., 2011. Les empreintes environnementales de l'approvisionnement alimentaire : Paris, ses viandes et lait, XIXe-XXIe siècles. PhD thesis Architecture, aménagement de l'espace. Université Paris-Est, 2011. <NNT : 2011PEST1135>. <pastel-00834837>

Chatzimpiros, P., Barles, S., 2013. Nitrogen food-print: N use related to meat and dairy consumption in France. *Biogeosciences*, 10:471-481.

Chenu, C., Klumpp, K., Bispo, A., Angers, D., Colnenne, C., Metay, A., 2014. Stocker du carbone dans les sols agricoles : évaluation de leviers d'action pour la France. *Innovations Agronomiques*, 37, 23-37.

CIQUAL : Composition nutritionnelle des Aliments, Anses. Available at: <https://pro.anses.fr/tableciqua/> Cited Sept 2016

CITEPA, 2013. OMINEA, Organisation et Méthodes des Inventaires Nationaux des Emissions Atmosphériques en France"10<sup>e</sup> edition. <http://www.citepa.org/fr/> Cited Sept 2016.

Clark, S.M., Horwarth, W.R., Shennan, C., Scaow, K.M., Lantni, W.T., Ferris, H., 1999. Nitrogen, weeds and water as yield-limiting factors in conventional, low-input, and organic tomato systems. *Agriculture, Ecosystems and Environment*, 73, 257-270.

Clark, B., Foster, J. B., 2009. Ecological Imperialism and the global metabolic rift, unequal exchange and the guano/nitrates trade. *International Journal of Comparative Sociology*, 50, 311-334.

Clivot, H., Mary, B., Valé, M., Cohan, J.-P., Champolivier, L., Proux, F., Laurent, F., Justes, E., 2017. Quantifying in situ and modeling net nitrogen mineralization from soil organic matter

in arable cropping systems. *Soil Biology & Biochemistry*, 111, 44-59. Doi : [org/10.1016/j.soilbio.2017.03.010](https://doi.org/10.1016/j.soilbio.2017.03.010)

Clivot, H., Duparque, A., Dinh, J.L., Mouny, J.C, et al., 2018. Modeling soil organic carbon evolution in long-term arable experiments with AMG model. *Geoderma*, submitted.

Cocaud, M., 2016. A early form of specialized agriculture in Western France, in: Antoine, A., (Ed), *Agricultural specialisation and rural patterns of development*. Brepols, Turnhout, Belgium. DOI: 10.1484/M.RURHE-EB.5.112261

COMIFER, 1995. Aide au diagnostic et à la prescription de la fertilisation phosphatée et potassique des grandes cultures. Comité français d'étude et de développement de la fertilisation raisonnée, Paris. Available at <http://www.comifer.asso.fr/index.php/fr/publications/les-brochures.html>.

Compagnone, C., Lamine, C., Dupré, L., 2010. La production et la circulation des connaissances en agriculture interrogées par l'agro-écologie. *Revue d'anthropologie des connaissances*, 12, 111-138. DOI : 10.3917/rac.039.0111.

Conant, R.T., Paustian, K., Elliot, E.T., 2001. Grassland management and conversion into grassland: effects on soil carbon. *Ecological Applications*, 11, 343-355.

Conley, S.P., Binning, L.K., Connell, T.R., 2001. Effect of cultivar, row spacing, and weed management on weed biomass, potato yield and net crop value. *American Journal of Potato Research*, 78, 31-37.

Constantin, J., Mary, B., Laurent, F., Aubrion, G., Fontaine, A., Kerveillant, P., Beaudoin, N. (2010). Effects of catch crops, no till and reduced nitrogen fertilization on nitrogen leaching and balance in three long-term experiments. *Agriculture, Ecosystems and Environment* 135, 268-278.

Cordell, D., Drangert, J.-O., White, S., 2009. The story of phosphorus: global food security and food for thought. *Global Environmental Change*, 19, 292–305. DOI: 10.1016/j.gloenvcha.2008.10.009

CORINAIR, 2007. <http://reports.eea.europa.eu/EMEPCORINAIR5/en/B1090vs2.pdf>.

CORPEN, 1999. Estimation des flux d'azote, de phosphore et de potassium associés aux vaches laitières et à leur système fourrager. CORPEN, «Groupe Alimentation » Sous groupe « Vaches laitières ». 18 p.

Cosser, N.D., Gooding, M.J., Thompson, A.J., Froud-Williams, R.J., 1997. Competitive ability and tolerance of organically grown wheat cultivars to natural weed infestations. *Annals of Applied Biology*, 130, 523-535.

Courleux, F., 2011. Augmentation des terres en location : échec ou réussite de la politique foncière. *Economie et statistiques*, 444-445, 39-53. DOI : 10.3406/estat.2011.9642

Couturier C., Charru M., Doublet S., Pointereau P., 2017. Le scénario Afterres 2050. Solagro. [www.afterres2050.solagro.org](http://www.afterres2050.solagro.org)

Crowder D.W., Northfield T. D., Strand M. R., Snyder W. E., 2010. Organic agriculture promotes evenness and natural pest control. *Nature*. 09183 doi:10.1038

Crutzen P.J., 1981. Atmospheric chemical processes of the oxides of nitrogen, including nitrous oxide. In: Delwiche, C.C. (Ed.), *Denitrification, Nitrification and Nitrous Oxide*. John Wiley & Sons, New York, pp. 17–44.

De Cirsenois, C., 1988. De l'origine et du rôle de la politique foncière agricole. *Économie rurale*. N°184-186. In : *Un siècle d'histoire française agricole*. pp. 85-91. DOI: 10.3406/ecoru.1988.3895

Découflé C., 1980. La prospective. PUF, Paris, France.

Deevey, E.S., 1970. Mineral cycles. *Scientific American*, 223, 148–58.

Desriers, M., 2007. L'agriculture française depuis cinquante ans : des petites exploitations familiales aux droits à paiement unique. *Agreste Cahiers n° 2*. Accessible en ligne à l'adresse : <http://agreste.agriculture.gouv.fr/IMG/pdf/articles07072A1.pdf>.

Di, H., Cameron, K., 2002. Nitrate leaching in temperate agroecosystems: sources, factors and mitigating strategies. *Nutrient Cycling in Agroecosystems*, 64, 237-256. DOI: [org/10.1023/A:1021471531188](http://dx.doi.org/10.1023/A:1021471531188).

Diet Grail. Quest for an ideal diet. Phosphorus content of foods; Protein content of foods. Available at: <http://dietgrail.com>. Cited Sept. 2016

Direction Générale de la Santé, 2012. Abandons de captages utilisés pour la production d'eau destinée à la consommation humaine. Bilan Février 2012, secrétariat d'Etat chargé de la santé.

Dodd, J.R., Mallarino A.P., 2005. Soil-test phosphorus and crop grain yield responses to long-term phosphorus fertilization for corn-soybeans rotations. *Soil Science Society of America Journal*. 69, 1118-1128.

Doublet, S., 2011. CLIMAGRI : bilan énergies et GES des territoires ruraux, la ferme France en 2006 et 4 scénarios pour 2030. Rapport ADEME. Available at : <http://www.ademe.fr/sites/default/files/assets/documents/climagri-la-ferme-france-en-2006-et-4-scenarios-pour-2030.pdf>



- Duby, G., Wallon, A., 1978. Histoire de la France rurale, tome IV Depuis 1914, Seuil, Paris.
- Duby, G., Wallon, A., 1993. Histoire de la France rurale, tome III De 1789 à 1914, Seuil, Paris.
- Dumont, B., Fortun-Lamothe, L., Jouven, M., Thomas, M., Tichit, M., 2013. Prospects from agroecology and industrial ecology for animal production in the 21st century. *Animal*, 7, 1028-1043. DOI: 10.1017/S1751731112002418
- Durkheim, E., 1979 [1960] Les formes élémentaires de la vie religieuse, PUF, Paris.
- Duxbury J.M., 1994. The significance of agricultural sources of greenhouse gases. *Fertilizer Research*. 38, 151–163.
- Eckard, R.J., Graiger, C., de Klein, C.A.M., 2010. Options for the abatement of methane and nitrous oxide from ruminant production: A review. *Livestock Science*, 130, 47-56. DOI: org/10.1016/j.livsci.2010.02.010
- Eglin, T., Ciais, P., Piao, S. L., Barré, P., Bellassen, V., Cadule, P., Chenu, C., Gasser, T., Koven, C., Reichstein, M. and Smith, P., 2010. Historical and future perspectives of global soil carbon response to climate and land-use changes. *Tellus B*, 62, 700-718. doi:10.1111/j.1600-0889.2010.00499.x
- Elser, J., Bennett, E., 2011. Phosphorus cycle: a broken biogeochemical cycle. *Nature* 478, 29–31. DOI: 10.1038/478029a.
- EMEP, 2006. Available at: [http://www.emep.int/mscw/mscw\\_data.html](http://www.emep.int/mscw/mscw_data.html) Cited Sept 2016
- Erb K.-H., Haberl H., Krausmann F., 2007. The fossil fuel-powered carbon sink. Carbon flows and Austria's energetic metabolism in a long-term perspective. In M. Fischer-Kowalski, H. Haberl (Eds.), *Socioecological transitions and global change*, Edward Elgar, Cheltenham (2007), pp. 60-82
- Erb, K.-H., Gingrich, S., Krausmann, F., Haberl, H., 2008. Industrialization, fossil fuels, and the transformation of land use. *Journal of Industrial Ecology*, 12, 686-703. DOI: org/10.1111/j.1530-9290.2008.00076.x
- Erb K.-H., Lauk C., Kastner T., Mayer A., Theurl M.C., Haberl H., 2016. Exploring the biophysical option space for feeding the world without deforestation *Nature Communications*. 7 11382
- Erismann, J.W., Bleeker, A., Galloway, J., Sutton, M.S., 2007. Reduced nitrogen in ecology and the environment. *Environmental Pollution*, 150, 140–149.

Erisman, J.W., Galloway, J.N., Seitzinger, S., Bleeker, A., Butterbach-Bahl, K., 2011. Reactive nitrogen in the environment and its effect on climate change. *Current Opinion in Environmental sustainability*, 3, 281-290. DOI: [org/10.1016/j.cosust.2011.08.012](https://doi.org/10.1016/j.cosust.2011.08.012)

Erisman, J.W., Galloway, J.N., Seitzinger, S., Bleeker, A., Dise, N.B., Petrescu, A.M.R., Leach, A.M., de Vries, W., 2013. Consequences of human modification of the global nitrogen cycle. *Philosophical Transactions of the Royal Society B*, 368, 20130116. DOI: [10.1098/rstb.2013.0116](https://doi.org/10.1098/rstb.2013.0116)

Esculier, F., 2018. Le système alimentation/excrétion des territoires urbains : régimes et transitions socio-écologiques. Thèse Université de Paris Est.

Esculier, F., Le Noë, J., Barles, S., Billen, G., Créno, B., Garnier, J., Lesavre, J., Petit, L., Tabuchi, J.-P., 2018. The biogeochemical imprint of human metabolism in Paris Megacity: a regionalized analysis of a water-agro-food system. *Journal of Hydrology*. DOI [10.1016/j.jhydrol.2018.02.043](https://doi.org/10.1016/j.jhydrol.2018.02.043)

Eveillard, P., Saby, N., Gouny, L., Denoroy, P., Foucaud Lemercier, B., 2016. Effect on soil nutrient status of input/output balances for phosphate and potassium in France. *Proceedings - International Fertiliser Society* (791), 25 p. <http://prodinra.inra.fr/record/391316>

Færgé, J., Magid, J., Frits, W. T., Vries, P. DE., 2001. Urban nutrient balance for Bangkok. *Ecological Modelling* 139, 63-74.

Fan, J., McConkey, B., Wang, H., Janzen, H., 2016. Root distribution by depth for temperate agricultural crop. *Field Crops Research*, 189, 68-74. DOI: [org/10.1016/j.fcr.2016.02.013](https://doi.org/10.1016/j.fcr.2016.02.013)

FAOstat, 2017, Food and Agriculture Organization of the United Nations. available at : <http://faostat.fao.org/site/291/default.aspx> Cited 15 oct 2017.

Fardeau, J.-C., Morel, C., Jappé, J., 1985. Cinétique d'échange des ions phosphate dans les systèmes sol-solution: vérification expérimentale de l'équation théorique. *Comptes Rendus Séances Académie des Sciences. Sér. 3 Sciences de la Vie*. 300, 371–376.

Fardeau, J.-C., Morel, C., Boniface, R., 1988. Pourquoi choisir la méthode Olsen pour estimer le phosphore «assimilable» des sols? *Agronomie* 8, 577–584.

Fischer-Kowalski, M., 1998. Society's Metabolism The intellectual History of Material Flow Analysis, Part I, 1860-1970, 2, 1.

Fisher-Kowalski, M., Haberl, H., 2007. Conceptualizing, observing and comparing socioecological transitions. In *Socioecological transitions and global change: Trajectories of social metabolism and land use*, Edited by M. Fischer-Kowalski and H. Haberl. Cheltenham , UK : Edward Elgar , pp . 1 – 30.

Foley, J.A., Ramankutty, N., Brauman, K.A., Cassidy E.S., Gerber, J.S., Johnston, M., Mueller, N.D., O’Connell, C., Ray, D.K., West, P.C., Balzer, C., Bennett, E.M., Carpenter, S.R., Hill, J., Monfreda, C., Polasky, S., Rockstrom, J., Sheehan, J., Siebert, S., Tilman, D., Zaks, D.P.M., 2011. Solutions for a cultivated planet. *Nature*. 478, 337–342.

Folke, C., Carpenter, S., Wilker, B., Scheffer, M., Elmqvist, T., Gunderson, L., Holling, C.S., 2004. Regime shifts, resilience and biodiversity in ecosystem management. *Annual Review of Ecology, Evolution and Systematics*, 35, 557-81. doi: 10.1146/annurev.ecolsys.35.021103.105711

Follet, R., 2008 Transformation and Transport Processes of Nitrogen in Agricultural Systems, Published in Nitrogen in the Environment: Sources, Problems, and Management, Second edition, ed. J. L. Hatfield & R. F. Follett (Amsterdam, Boston, et al.: Academic Press/Elsevier).

Fontaine, S., Henault, C., Aamor, A., Bdioui, N., Bloor, J.M.G., Maire, V., Mary, B., Revaillo, S., Maron, P.A., 2011. Fungi mediate long term sequestration of carbon and nitrogen in soil through their priming effect. *Soil Biology and Biochemistry*, 43, 86-96. DOI: org/10.1016/j.soilbio.2010.09.017

Forkes, F., 2007. Nitrogen balance for the urban food metabolism of Toronto, Canada , *Resources, Conservation and Recycling*, 52, 74-94.

Foster, J.B., 2000. Marx’s ecology: Materialism and Nature. *Monthly Review Press*, New York.

Foster, J.B., 2013. Marx and the rift in the Universal Metabolism of Nature. *Monthly review*, 6, 1-19.

Fouilleux E., Bricas N., Alpha A., 2017. ‘Feeding 9 billion people’: global food security debates and the productionist trap, *Journal of European Public Policy*, 24:1658-1677, DOI: 10.1080/13501763.2017.1334084

Fourastié, J., 1979. Les Trente Glorieuses ou la revolution invisible, *Fayard*. Paris.

Frossard, E., Brossard, M., Hedley, M.J., Metherell, A., 1995. Reactions controlling the cycling of P in soils. In : Tiessen H. (ed.) Phosphorus in the global environment : transfers, cycles and management. Chichester : J. Wiley, (54), 107-137. ISBN 0-471-95691

Gahoonia, T.S., Nielsen, N.E., 1997. Variation in root hairs of barley cultivars doubled soil phosphorus uptake. *Euphytica*. 98, 177–182. DOI: 10.1023/A:1003113131989

Galloway J.N., and Cowling E.B., 2002. Reactive nitrogen and the world: 200 years of change. *Ambio*, 31, 64-71. DOI: org/10.1579/0044-7447-31.2.64

- Galloway, J.N., Schlesinger, W.H., Levy, H., Michaels, A., Scnhoor, J.L., 1995. Nitrogen fixation: anthropogenic enhancement-environmental response. *Global Biogeochemical Cycles*, 9, 235-252. DOI : org/10.1029/95GB00158
- Garnier, J., Billen, G., Coste, M., 1995. Seasonal succession of diatoms and Chlorophyceae in the drainage network of the Seine River: observation and modeling. *Limnology and Oceanography*. 40, 750–765. DOI: 10.4319/lo.1995.40.4.0750
- Garnier, J., Némery, J., Billen, G., Théry, S., 2005. Nutrient dynamics and control of eutrophication in the Marne River system: modelling the role of exchangeable phosphorus. *Journal of Hydrology*. 304, 397–412. DOI: 10.1016/j.jhydrol.2004.07.040
- Garnier, J., Billen, G., Vilain, G., Benoit, M., Passy, P., Tallec, G., Tournebize, J., Anglade, J., Billy, C., Ansart, P., Azoufui, A., Sebilo, M., Kao, C., 2014. Curative vs. preventive management of nitrogen transfers in rural areas: Lessons from the case of the Orgeval watershed (Seine River basin, France). *Journal of Environmental Management*, 144, 125-134. DOI : org/10.1016/j.jenvman.2014.04.030
- Garnier, J., Lassaletta, L., Billen, G., Romero, E., Grizzetti, B., Némery, J., Le, T.P.Q., Pistocchi, C., Aissa-Grouz, N., Luu, T.N.M., 2015. Phosphorus budget in the water-agro-food system at nested scales in two contrasted regions of the world (ASEAN-8 and EU-27). *Global Biogeochemical Cycles*, 29, 1348–1368. DOI: 10.1002/2015GB005147.
- Garnier, J., Anglade, J., Benoit, M., Billen, G., Puech, T., Ramarson, A., Passy, P., Silvestre, M., Lassaletta, L., Trommenschlager, J.-M., Schott, C., Tallec, G., 2016. Reconnecting crop and cattle farming to reduce nitrogen losses to river water of an intensive agricultural catchment (Seine basin, France): past, present and future. *Environmental Science and Policy*, 63, 76-90. DOI: 10.1016/j.envsci.2016.04.019
- Gerbaux, F., Muller, P., 1984. La naissance du développement agricole en France. *Economie rurale*, 159, 17-22. DOI : 10.3406/ecoru.1984.3019
- Gerry, C., 1980. Petite production marchande ou « salariat déguisé » ? Quelques réflexions. *Tiers-Monde*, 82, 387-403. DOI: 10.3406/tiers.1980.4230
- Gingrich, S., Cunfer, G., Aguilera, E., 2018. Agroecosystem energy transitions: exploring the energy-land nexus in the course of industrialization. *Regional Environmental Change*, 18, 929-936. DOI: org/10.1007/s10113-018-1322-x
- Gingrich, S., Erb, K.-H., Krausmann, F., Gaube, V., Haberl, H., 2007. Long-term dynamics of terrestrial carbon stocks in Austria: a comprehensive assessment of the time period from 1830 to 2000. *Regional Environmental Change*, 7, 37-47. DOI: 10.1007/s10113-007-0024-6

Gingrich, S., Niedertscheider, M., Kastner, T., Haberl, H., Cosor, G., Krausmann, F., Kuemmerle, T., Müller, D., Reith-Musel, A., Rudbeck Jepsen, M., Vadineanu, A., Erb, K., 2015. Exploring long-term trends in land use change and aboveground human appropriation of net primary production in nine European countries. *Land Use Policy*, 47, 426-438. DOI: [org/10.1016/j.landusepol.2015.04.027](https://doi.org/10.1016/j.landusepol.2015.04.027)

Girardin, J., 1876. Des fumiers et autres engrais animaux, seventh ed. Garnier frères, Paris. Available at: <http://catalogue.bnf.fr/ark:/12148/cb305108417>

Gizicki-Neudlinger, M., Gingrich, S., Güldner, D., Krausmann, F., Tello, E., 2017. Land, food and labour in pre-industrial agro-ecosystems: a socio-ecological perspective on early 19<sup>th</sup> century seigneurial systems. *Historia Agraria*, 71, 37-78.

Godelier, M., 1986. The Mental and the material: Thought, Economy and Society, London: Blackwell Verso

Gonzalez de Molina, M., Toledo, V.M., 2014, The Social Metabolism, A socio-Ecological Theory of Historical Change. Springer Cham Heidelberg New York Dordrecht London. ISSN 2211-9027. DOI 10.1007/978-3-319-06358-4

Gonzalez de Molina, M., Soto Fernandez, D., Infante-Amate, J., Aguilera, E., Vila Traver, J., Guzman, G.I., 2017. Decoupling food from land: The evolution of Spanish agriculture from 1960 to 2010. *Sustainability*, 9, 2348. DOI: [org/10.3390/su9122348](https://doi.org/10.3390/su9122348)

Gosling, P., Shepherd, M., 2005. Long-term changes in soil fertility in organic arable farming systems in England, with particular reference to phosphorus and potassium. *Agriculture, Ecosystems and Environment*. 105, 425–432. DOI: [10.1016/j.agee.2004.03.007](https://doi.org/10.1016/j.agee.2004.03.007)

Goubert, J.P., 1984. La France s'équipe. Les réseaux d'eau et d'assainissement. 1850-1950. *Les Annales de la recherche urbaine*. 23 (1), 47-53.

Gouny, L., Saby, N., Lemercier, B., Eveillard, P., Denoroy, P., 2016. Status and evolution of P, K, and Mg content in french arable topsoil data. *Pangaea*. DOI:10.1594/PANGAEA.865249

Granssee, A., Merbach, W., 2000. Phosphorus dynamics in a long-term P fertilization trial on Luvic Phaeozem at Hall. *Journal of Plant Nutrition and Soil Science*. 163, 353-357.

Gros, A., 1957. Guide pratique de la fertilisation. La Maison Rustique, Paris.

Gruber, N., Galloway, J.N., 2008. An Earth-system perspective of the global nitrogen cycle. *Nature*, 451, 293-296. DOI: [10.1038/nature06592](https://doi.org/10.1038/nature06592)

Gueymard, E. 1868. Recueil d'analyses chimiques à l'usage de l'agriculture moderne. Imprimerie de Prudhomme, Grenoble.

Güldner, D., Krausmann, F., 2017. Nutrient Recycling and Soil Fertility Management in the Course of the Industrial Transition of Traditional, Organic Agriculture: The case of Bruck Estate, (1787-1906). *Agriculture, Ecosystems and Environment*. 249, 80:90

Gunary, D., Sutton, C., 1967. Soil factors affecting plant uptake of phosphate. *Journal of Soil Science*. 18, 167–173. DOI: 10.1111/j.1365-2389.1967.tb01497.x

Guo L. B., Gifford R. M., 2002. Soil carbon stocks and land use change: A meta analysis. *Global Change Biology*, 8, 345-360. DOI: org/10.1046/j.1354-1013.2002.00486.x

Gúzman, G. I., González de Molina, M., Soto Fernandez, D., Infante-Amate, J., Aguilera, E., 2017. Spanish agriculture from 1900 to 2008: a long-term perspective on agroecosystem energy from an agroecological approach. *Regional Environmental Change*, DOI: 10.1007/s10113-017-1136-2

Haberl, H., Winiwarter, V., Andersson, K., Ayres, R.U., Boones, C., Castillo, A., Cunfer, G., Fisher-Kowalski, M., Freudenburg, W.R., Furman, E., Kaufmann, R., Krausmann, F., Langthaler, E., Lotze-Campen, H., Mirtl, M., REdman, C.L., Reenberge, A., Wardell, A., Warr, B., Zechmeister, H., 2006. From LTER to LTSE: Conceptualizing the socioeconomic dimension of long-term socioecological research. *Ecology and Society*, 11 13

Haberl, H., Erb, K.-H., Krausmann, F., Gaube, V., Bondeau, A., Plutzer, C., Gingrich, S., Fisher-Kowalski, M., 2007. Quantifying and mapping the human appropriation of net primary production in earth's terrestrial ecosystems. *Proceeding of the National Academy of Sciences*, 104, 1294-12947. DOI: 10.1073/pnas.0704243104

Hanserud, O.S., Brod, E., Øgaard, A.F., Müller, D.B., Brattebø, H., 2016. A multi-regional soil phosphorus balance for exploring secondary fertilizer potential: the case of Norway. *Nutrient Cycles in Agroecosystems* 104, 307–320. DOI: 10.1007/s10705-015-9721-6

Harchaoui, S., Chatzimpiros, P., 2017. Reconstructing production efficiency, land use and trade for livestock systems in historical perspective. The case of France, 1961-2010. *Land Use Policy*, 67, 378-386. DOI: 10.1016/j.landusepol.2017.05.028.

Haropa, 2014 Projet stratégique 2015-2020. Paris.

Hassink, J., 1997. The capacity of soils to preserve organic C and N by their association with clay and silt particles. *Plant and Soil*, 191, 77-87.

Haut Comité de la Santé Publique, 2000. Pour une politique nutritionnelle de santé publique en France. ENSP, Rennes. ISBN : 2-85952-629-3.275 pp.

Haynes, R.J., 2000. Interactions between soil organic matter status, cropping history, method of quantification and sample pretreatment and their effects on measured aggregate stability. *Biology and Fertility of Soils*, 30, 270-275.

Hénin, S., Dupuis, M., 1945. Essai de bilan de la matière organique du sol. *Annales Agronomiques*, 15, 17–29.

Hirstov A.N., 2011. Technical note: Contribution of ammonia emitted from livestock to atmospheric fine particulate matter (PM<sub>2.5</sub>) in the United States. *Journal of Dairy Science*, 94 (6), 3130–3136.

Holford, I., 1997. Soil phosphorus: its measurement, and its uptake by plants. *Soil Research*, 35, 227–240.

Houée, P., 1972. Les étapes du développement rural. Tome I : La lente évolution des campagnes françaises 1815 à 1950. Editions ouvrières. Paris.

Howarth, R.W., Billen, G., Swaney, D., Townsend, A., Jaworski, N., Lajtha, K., Downing, J.A., Elmgren, R., Caraco, N., Jordan, T., Berendse, F., Freney, J., Kudeyarov, V., Murdoch, P., Zhao-Liang, Z., 1996. Regional nitrogen budgets and riverine N & P fluxes for the drainages to the North Atlantic Ocean: Natural and human influences. *Biogeochemistry*, 35: 75-139.

Hoyt, G.D., et Walgenbach, J.F., 1995. Pest evaluation in sustainable cabbage production systems. *Horticultural Science*, 30, 1046-1048.

Hu, T., Sorensen, P., Wahlström, E.M., Chirinda, N., Sharif, B., Li, X., Olesen, J.E., 2018. Root biomass in cereals, catch crops and weeds can be reliably estimated without considering aboveground biomass. *Agriculture, Ecosystems and Environment*, 251, 141-148.

Hua, K., Zhang, W., Guo, Z., Wang, D., Oenema, O., 2016. Evaluating crop response and environmental impact of the accumulation of phosphorus due to long-term manuring of vertisol soil in northern China. *Agriculture, Ecosystems and Environment*, 219, 101–110. DOI: 10.1016/j.agee.2015.12.008

Huber, G., Schaub, C., 2011. Guide des fertilisants azotés utilisables en bio. Chambre d'Agriculture du Bas-Rhin. Available at [http://www.bas-rhin.chambagri.fr/fileadmin/documents/Environnement-Innovation/AB/Guide\\_des\\_fertilisants\\_azotes\\_bio\\_CA67.pdf](http://www.bas-rhin.chambagri.fr/fileadmin/documents/Environnement-Innovation/AB/Guide_des_fertilisants_azotes_bio_CA67.pdf)

Ilnicki, R.D., and Enache, A.J., 1992. Subterranean clover living mulch: an alternative method of weed control. *Biotic Diversity in Agroecosystems*, 40, 249-264.

INSEE, 2001. Annuaire statistique de la France. INSEE, Paris. Available at <http://social-sante.gouv.fr/IMG/pdf/conso.pdf> Cited 15 sept 2016

INSEE, 2017. Institut National de la Statistique et des Etudes Economiques. [www.insee.fr/fr/statistiques/](http://www.insee.fr/fr/statistiques/)

Isermann K., 1994. Agriculture's share in the emission of trace gases affecting the climate and some cause-oriented proposals for sufficiently reducing this share. *Environmental Pollution*, 83, 95-111.

ITAB (2011) Rotations en grandes cultures biologiques sans élevage. Réseau expérimental RotAB. [www.itab.asso.fr/downloads/rotab/rotab-broch-fertilite.pdf](http://www.itab.asso.fr/downloads/rotab/rotab-broch-fertilite.pdf)

Janzen H.H., Desjardins R.L., Asselin J.M.R., Grace B., 1998. The Health of Our Air– toward Sustainable Agriculture in Canada. Publ.1981/E. Research Branch, Agriculture and Agricultural Food Canada, Ottawa, ON.

Jarvie, H.P., Sharpley, A.N., Spears, B., Buda, A.R., May, L., Kleinman, J.A., 2013. Water quality remediation faces unprecedented challenges from “legacy phosphorus”. *Environmental Science & Technology*, 47, 8997-8998. DOI: [org/10.1021/es403160a](https://doi.org/10.1021/es403160a)

Jenkinson, D.S., Rayner, J.F., 1977. The turnover of soil organic matter in some of the Rothamsted classical experiment. *Soil Science*, 123, 298-305.

Jenny, H., 1941. Factors of soil formation. McGraw-Hill Book Comp. Inc., New-York and London.

Jollivet, M., 2007. La grande transformation de l'agriculture française sous l'œil du sociologue. *Économie rurale*, 300, 26-29. DOI: [10.4000/economierurale.2098](https://doi.org/10.4000/economierurale.2098)

Justes, E., Mary, B., Nicolardot, B., 2009. Quantifying and modelling C and N mineralization kinetics of catch crop residues in soil: parameterization of the residue decomposition module of STICS model for mature and non-mature residues. *Plant and Soil*, 325, 171-185.

Justes E., Beaudoin N., Bertuzzi P., Charles R., Constantin J., Dürr C., Hermon C., Joannon A., Le Bas C., Mary B., Mignolet C., Montfort F., Ruiz L., Sarthou J.P., Souchère V., Tournebize J., 2012. Réduire les fuites de nitrate au moyen de cultures intermédiaires : conséquences sur les bilans d'eau et d'azote, autres services écosystémiques. Rapport d'étude, INRA (France). Chapitre 10.

Kadeba, O., Boyle, J., 1978. Evaluation of phosphorus in forest soils: comparison of phosphorus uptake, extraction method and soil properties. *Plant and Soil*, 49, 285–297.

Kastner T., Rivas M. J. I., Koch W., Nonhebel S. 2012. Global changes in diets and the consequences for land requirements for food. *Proceedings of the National Academy of Sciences of the USA*, 109 6868–72.



Kastner T., Erb K.-H., Haberl H., 2014. Rapid growth in agricultural trade: effects on global area efficiency and the role of management. *Environmental Research Letters*, 9 034015

Kätterer, T., Reichstein, M., Andrén, O., Lomander, A., 1998. Temperature dependence of organic matter decomposition: a critical review using literature data analyzed with different models. *Biology and Fertility of Soils*, 27, 258-262.

Kennedy, C., Pincetl, S., Bunje, P., 2011. The study of urban metabolism and its applications to urban planning and design. *Environmental Pollution*, 159, 1965-1973.

Kirkby, C.A., Richardson, A.E., Wade, L.J., Batten, G.D., Blanchard, C., Kirkegaard, J.A., 2013. Carbon-nutrient stoichiometry to increase soil carbon sequestration. *Soil Biology and Biochemistry*, 60, 77-86. DOI : org/10.1016/j.soilbio.2013.01.011

Kleber, M., Johnson M. G., 2010. Advances in understanding the molecular structure of soil organic matter : implications for interactions in the environment. *Advances in Agronomy*, 106, 77-142. DOI : org/10.1016/S0065-2113(10)06003-7

Kong, A.Y.Y., Six, J., Bryant, D.C., Ford, Denison, R., van Kessel, C., 2005. The Relationship between Carbon Input, Aggregation, and Soil Organic Carbon Stabilization in Sustainable Cropping Systems. *Soil Sciences Society of America Journal*, 69, 1078–1085.

Krausmann, F., 2004, Milk, Manure and Muscle Power. Livestock and the Transformation of Preindustrial Agriculture in Central Europe. *Human Ecology*, 32, 735-772. DOI : 10.1007/s10745-004-6834-y.

Krausmann F., Schandl, H., Sieferle, R.P., 2008. Socio-ecological regime transitions in Austria and the United Kingdom. *Ecological Economics*, 65, 187-201. DOI : org/10.1016/j.ecolecon.2007.06.009

Krausmann, F., Gingrich, S., Haberl, H., Erb, K.-H., Musel, A., Kastner, T., Kohlheb, NO., Niedertscheider, M., Schwarzmüller, E., 2012. Long-term trajectories of the human appropriation of net primary production: lessons from six national case studies. *Ecological Economics*, 77, 129-138. DOI: org/10.1016/j.ecolecon.2012.02.019

Kroll, J.-C., Pouch, T., 2012. Régulation versus Dérégulation des marchés agricoles : la construction sociale d'un clivage économique. *L'Homme & la société*, 183-184, 181-206. DOI: 10.3917/lhs.183.0181.

Kronvang, B., Vagstad, N., Behrendt, H., Bøgestrand, J., Larsen, S. E., 2007. Phosphorus losses at the catchment scale within Europe: an overview. *Soil Use and Management*, 23, 104-116. DOI: 10.1111/j.1475-2743.2007.00113.x

Lal, R., 2004. Soil carbon sequestration to mitigate climate change. *Geoderma*, 123, 1-22. DOI:10.1016/j.geoderma.2004.01.032

Lal, R., 2016. Beyond COP21: Potential and challenges of the “4 per Thousand” initiative. *Journal of Soil and Water Conservation*, 71, 1. DOI:10.2489/jswc.71.1.20A

Lancelot, C., Gypens, N., Billen, G., Garnier, J., Roubex, V., 2007. Testing an integrated river–ocean mathematical tool for linking marine eutrophication to land use: The Phaeocystis-dominated Belgian coastal zone (Southern North Sea) over the past 50 years. *Journal of Marine System*, 64, 216-228.

Lapo, A.V., 2001. Vladimir, I. Vernadsky (1863-1945), founder of the biosphere concept. *International Microbiology*, 4, 47-49. DOI: org/10.1007/s101230100008

Lassaletta, L., Billen, G., Grizzetti, B., Garnier, J., Leach, A.M., Galloway, J.N., 2014a. Food and feed trade as a driver in the global nitrogen cycle: 50-year trends. *Biogeochemistry*, 118:225–241. DOI: 10.1007/s10533-013-9923-

Lassaletta L., Billen G., Grizzetti B., Anglade J., Garnier J., 2014b. 50 year trends in nitrogen use efficiency of world cropping systems: the relationship between yield and nitrogen input to cropland. *Environmental Research Letters*. 9. DOI:10.1088/1748-9326/9/10/105011

Lassaletta, L., Billen, G., Romero, E., Garnier, J., Aguilera, E., 2014c. How changes in diet and trade patterns have shaped the N cycle at the national scale: Spain (1961-2009). *Regional Environmental Change*, 14, 784-797.

Lassaletta, L., Aguilera, E., Sanz-Cobena, A., Pardo, G., Billen, G., Garnier, J., Grizzetti, B., 2014d. Leakage of nitrous oxide emissions within the Spanish agro-food system in 1961-2009. *Mitigation and Adaptation Strategies for Global Change* 7:21-975. DOI 10.1007/s11027-014-9569-0.

Lassaletta, L., Aguilera, E., 2015. Soil carbon sequestration is a climate stabilization wedge: Comments on Sommer and Bossio (2014). *Journal of Environmental Management*, 153, 48-49.

Lassaletta, L., Billen, G., Garnier, J., Bouwman, L., Velazquez, E., Mueller, N.D., Gerber, J.S., 2016. Nitrogen use in the global food system: Historical trends and future trajectories of agronomic performance, pollution, trade, and dietary demand. *Environmental Research Letters*, 11, 095007. DOI:10.1088/1748-9326/11/9/095007

Lajtha, K., Driscoll, C., Jarrell, W., Elliott, E., 1999. Soil phosphorus: characterization and total element analysis. *Standard Soil Methods Long-Term Ecological Research*, Oxf. Univ. Press N. Y. 115–142.

Le Monde, 2017. [http://www.lemonde.fr/planete/article/2017/08/11/le-scandale-alimentaire-scenario-a-repetition-de-l-agroalimentation-mondialisee\\_5171473\\_3244.html](http://www.lemonde.fr/planete/article/2017/08/11/le-scandale-alimentaire-scenario-a-repetition-de-l-agroalimentation-mondialisee_5171473_3244.html)

Le Nechet R., Michaud M., Legrain P., Hirschler J., Pas N., Chauvin S., Lafont M., 2006. 2020 : Que mangerons-nous ? Enjeux pour les productions agricoles Normandes. Chambre d'Agriculture de Normandie.

Lehmann, J., Kléber, M., 2015. The contentious nature of soil organic matter. *Nature*, 528, 60-68. DOI: 10.1038/nature16069

Lemaire, G., Franzluebbers, A., Carvalho, P.C.F., Dedieu, B., 2014. Integrated crop–livestock systems: Strategies to achieve synergy between agricultural production and environmental quality. *Agriculture, Ecosystems and Environment*, 190, 4-8.

Li, L., Li, S.-M., Sun, J.-H., Zhou, L.-L., Bao, X.-G., Zhang, H.-G., Zhang, F.-S., 2007. Diversity enhances agricultural productivity via rhizosphere phosphorus facilitation on phosphorus-deficient soils. *Proceedings of the National Academy of Science*, 104, 11192–11196.

Liger, F., 1875. Dictionnaire historique et pratique de la voierie, de la construction, de la police municipale et de la contiguïté : fosses d'aisances, latrines, urinoirs et vidanges, Baudry, Paris.

Loua, T., 1880. La population rural en France. *Journal de la Société statistique de Paris*. 21 : 175-182. [http://www.numdam.org/item?id=JSFS\\_1880\\_21\\_1750](http://www.numdam.org/item?id=JSFS_1880_21_1750)

Loucks, D., Van Beek, E., Stedinger, J., Dijkman, J., Villars, M. (2005). Model sensitivity and uncertainty analysis. *Water Resource and System Planning Management*, 255–290.

Lugato, E., Paustian, K., Panagos, P., Jones, A., Borrelli, P., 2016. Quantifying the erosion effect on current carbon budget of European agricultural soils at high spatial resolution. *Global Change Biology*, DOI: 10.1111/gcb.13198

MacDonald, G.K., Bennett, E.M., Potter, P.A., Ramankutty, N., 2011. Agronomic phosphorus imbalances across the world's croplands. *Proceeding of the National Academy of Sciences*, 108, 3086–3091. DOI: 10.1073/pnas.1010808108

MacDonald, G.K., Bennett, E.M., Taranu, Z.E., 2012. The influence of time, soil characteristics, and land-use history on soil phosphorus legacies: a global meta-analysis. *Global Change Biology*, 18, 1904–1917. DOI: 10.1111/j.1365-2486.2012.02653.x

Madelrieux, Sophie, Nicolas Buclet, Philippe Lescoat, et Marc Moraine. 2017. « Écologie et économie des interactions entre filières agricoles et territoire: quels concepts et cadre d'analyse ? » *Cahiers Agricultures*, 26 (2): 24001. doi:10.1051/cagri/2017013.

Maillot M., Issa C., Vieux F., Lairon D., Darmon N., 2011. The shortest way to reach nutritional goals is to adopt Mediterranean food choices: evidence from computer-generated personalized diets. *American Journal of Clinical Nutrition*, 94: 1127–1137.

Martel, S., Desmeules, X., Landry, C., Lavallée, S., Paré, M., Tremblay, F., 2013. Valeur Fertilisante des Digestats de Méthanisation. Agrinova. Available at [https://www.irda.qc.ca/assets/documents/Publications/documents/martel-et-al-2013\\_fiche\\_digestats\\_methanisation.pdf](https://www.irda.qc.ca/assets/documents/Publications/documents/martel-et-al-2013_fiche_digestats_methanisation.pdf)

Martikainen, P.J., 1985. Nitrous oxide emission associated with autotrophic ammonium oxidation in acid coniferous forest soil. *Applied and Environmental Microbiology*, 50, 1519–1525.

Marx, K., 1867/1961. Capital 1. London.

Mazoyer, M., 1977. Evolution et différenciation des systèmes agricoles d'exploitation de la nature. *Journal d'agriculture traditionnelle et de botanique appliquée*, 24, 267-275.

Mazoyer, M., Roudart, L., 1997. Pourquoi une théorie des systèmes agraires? *Cahiers Agricultures*, 6, 591-595.

Mazoyer, M., Roudart, L., 1998. Histoire des agricultures du monde. Du Néolithique à la crise contemporaine, Seuil, Paris.

MEEM, 2010. NOPOLU-volet Agricole. Guide Méthodologique. Commissariat général au développement durable. Service de l'Observation et des Statistiques.

Mello, FC., Field, RA., Riley, ML., 1978. Effect of age and anatomical location on composition bovine bone. *Journal of Food Science*, 43 :677-679.

Mendras, H., 1967. La Fin des Paysans. Innovations et changement dans l'agriculture français. Paris, SEDEIS.

Meschy, F., Ramirez-Perez, A., 2005. Evolutions récentes des recommandations d'apport en phosphore pour les ruminants. *INRA Productions Animales* 18: 175-182.

Messiga, A., Ziadi, N., Plénet, D., Parent, L., Morel, C., 2010. Long-term changes in soil phosphorus status related to P budgets under maize monoculture and mineral P fertilization. *Soil Use and Management*, 26, 354–364. DOI: 10.1111/j.1475-2743.2010.00287.x

- Messiga, A.J., Ziadi, N., Bélanger, G., Morel, C., 2012. Process-based mass-balance modeling of soil phosphorus availability in a grassland fertilized with N and P. *Nutrient Cycles in Agroecosystems*, 92, 273–287. DOI: 10.1007/s10705-012-9489-x
- Metwally, A., Hamdy, H., El-Baz, S., 1975. Evaluation of various parameters for available phosphorus in alluvial and calcareous soils of Egypt. *Journal of Plant Nutrition and Soil Science*. 138, 595–604.
- Mew, M.C., 2016. Phosphate rock costs, prices and resources interaction. *Science of the Total Environment*. 542, 1008–1012. DOI: 10.1016/j.scitotenv.2015.08.045
- Meybeck, M., de Marsily, G., Fustec, E., 1998 (eds). La Seine en son bassin. Fonctionnement écologique d'un système fluvial anthropisé. Elsevier, 749 pp.
- Milesi Delaye L.A., Irizar, A.B., Andriulo, A.E., Mary, B., 2013. Effects of continuous agriculture of grassland soils of the rolling pampa on soil organic carbon and nitrogen. *Applied and Environmental Soil Science*, DOI: org/10.1155/2013/487865
- Miltner, A., Bombach, P., Schmidt-Brücken, B., Kästner, M., 2012. SOM genesis: microbial biomass as a significant source. *Biogeochemistry*, 111, 41-55. DOI: 10.1007/s10533-011-9658-z
- Minasny, B., Malone, B.P., McBratney, A.B., Angers, D.A., Arrouays, D., Chambers, A., Chaplot, V., Zueng-Sang, C., Cheng, K., Das, B.S., Field, D.J., Gimona, A., Hedley, C.B., Young Hong, S., Mandal, B., Marchant, B.P., Martin, M., McConkey, B.G., Leatitia Mulder, V., O'Rourke, S., Richer-de-Forges, A.C., Odeh, I., Padarian, J., Paustian, K., Pan, G., Poggio, L., Savin, I., Stolbovoy, V., Stockmann, U., Sulaemen, Tsui C.-C., Vagen, T.-G., van Wesemael, B., Winowiecki, L., 2017. Soil carbon 4 per mille. *Geoderma*, 292, 59–86. DOI: org/10.1016/j.geoderma.2017.01.002
- Ministère de l'Agriculture, de l'Agro-alimentaire et de la Forêt, (2012). Panorama des industries agroalimentaires. Editions 2012 <http://www.agroalimentaire-lr.com/sites/aria.choosit.eu>
- Mohler, C.L., and Liebman, M., 1987. Weed productivity and composition in sole crops and intercrops of barley and field pea. *Journal of Applied Ecology*, 24, 685-699.
- Moisselin, J.M., Schneider, M., Canellas C., Mestre, O., 2002. Les changements climatiques en France au XXe siècle. Étude des longues séries homogénéisées de données de température et de précipitations. *La Météorologie*, 38, 45-56.
- Moore, J.W., 2014. The end of the road? Agricultural revolutions in the capitalist world-ecology, 1450-2010. *Journal of Agrarian Change*, 10, 389-413. DOI: org/10.1111/j.1471-0366.2010.00276.x

Moraine, M., Duru, M., Therond, O., 2017. A social-ecological framework for analyzing and designing integrated crop–livestock systems from farm to territory levels. *Renewable Agricultural and Food Systems*, 32, 43–56. DOI: 10.1017/S1742170515000526

Morel, C., Fardeau, J., 1991. Phosphorus bioavailability of fertilizers: a predictive laboratory method for its evaluation. *Nutrient Cycles in Agroecosystems*, 28, 1–9. DOI: 10.1007/BF01048850

Morel, C., Le Clech, B., Linères, M., Pellerin, S., 2006. Gare à la baisse de la biodisponibilité du phosphore. *Alternatives Agricultures*, 79, 21–23.

Morel, C., Butler, F., Castillon, P., Champolivier, L., Denoroy, P., Duval, R., Hanocq, D., Kouassi, A.S., Kvarnström, E., Messiga, A., 2011. Gestion à long terme de la dynamique du phosphore dans les sols cultivés. 10èmes Rencontres Fertil. Raison. L'analyse Terre GEMAS COMIFER Reims 23.

Mosier A.R., 2001. Exchange of gaseous nitrogen compounds between terrestrial systems and the atmosphere. pp. 291-309. In R.F Follett and J. Hatfield (eds) Nitrogen in the environment: sources problems and solutions. Elsevier Science Publishers. The Netherlands. 520 pp.

Mueller, N. D., Gerber, J.S., Johnston, M., Ray, D.K., Ramankutty, N., Foley, J.A., 2012. Closing yield gaps through nutrient and water management. *Nature*, 254, 490. DOI: 10.1038/nature11420

Muller, P., 1984. Le technocrate et le paysan: Les lois d'orientation agricole de 1960-1962 et la modernisation de l'agriculture française 1945-1984. Ed. L'Harmattan, Paris.

Muller A., Schader C., El-Hage Scialabba N., Brüggemann J., Isensee A., Erb K.-H., Smith P., Klocke P., Leiber F., Stolze M., Niggli U., 2017. Strategies for feeding the world more sustainably with organic agriculture. *Nature Communications*, 8:1290. DOI: 10.1038/s41467-017-01410-w

Nadelhoffer K.J., 2001. The Impacts of Nitrogen Deposition on Forest Ecosystems, Published in Nitrogen in the Environment: Sources, Problems, and Management, Eds. J. L. Hatfield & R. F. Follett (Amsterdam, Boston, et al.: Academic Press/Elsevier).

Némery, J., Garnier, J., Morel, C., 2005. Phosphorus budget in the Marne Watershed (France): urban vs. diffuse sources, dissolved vs. particulate forms. *Biogeochemistry*, 72, 35–66.

Némery, J., Garnier, J., 2007. Origin and fate of phosphorus in the Seine watershed (France): Agricultural and hydrographic P budgets. *Journal of Geophysical Research*, 112, G03012, doi:10.1029/2006JG000331

Nesme, T., Toublant, M., Mollier, A., Morel, C., Pellerin, S., 2012. Assessing phosphorus management among organic farming systems: a farm input, output and budget analysis in southwestern France. *Nutrient Cycling In Agroecosystems*, 92, 225–236. DOI: 10.1007/s10705-012-9486-0

Nesme, T., 2015. Agriculture et cycles biogéochimiques globaux: analyse des transformations des cycles de l'azote et du phosphore à des échelles spatiales larges, du territoire à la planète. Mémoire d'habilitation à diriger des recherches de l'Université de Bordeaux-2016". *Agronomie, Environnement et Sociétés*, 6, 149-150.

Neyroud, J., Lischer, P., 2003. Do different methods used to estimate soil phosphorus availability across Europe give comparable results? *Journal of Plant Nutrition and Soil Science*, 166, 422–431. DOI: 10.1002/jpln.200321152

Nicot, B.H., 2005. Urbain-rural : de quoi parle-t-on ? *Sirius- Université Paris XII*.

Niedertscheider, M., Kastner, T., Fetzel, T., Haberl, H., Kroisleitner, C., Plutzer, C., Erb, K.H., 2016. Mapping and analyzing cropland use intensity from a NPP perspective. *Environmental Research Letters*, 11, 014008. DOI : 10.1088/1748-9326/11/1/014008.

Niedertscheider M., Tasser, E., Patek, M., Rüdiger, J., Tappeiner, U., Erb, K., 2017. Influence of land-use intensification on vegetation C-stocks in an alpine valley from 1865 to 2003. *Ecosystems*, 20, 1391-1406. DOI: 10.1007/s10021-017-0120-5.

Noirfalise, A., 1974. Conséquences écologiques de l'application des techniques modernes de production en agriculture. *Informations Internes sur l'Agriculture*, Commission des Communautés Européennes. N°137.

O'Higgins, T.G., Gilbert, A.J., 2014. Embedding ecosystem services into the marine strategy framework directive: illustrated by eutrophication in the North Sea. *Estuarine Coastal and Shelf Science*, 140, 146-152. DOI: org/10.1016/j.ecss.2013.10.005

Oehl, F., Oberson, A., Tagmann, H., Besson, J., Dubois, D., Mäder, P., Roth, H.-R., Frossard, E., 2002. Phosphorus budget and phosphorus availability in soils under organic and conventional farming. *Nutrient Cycles in Agroecosystems*, 62, 25–35. DOI: 10.1023/A:1015195023724

Oenema, O., Kros, H., de Vries, W., 2003. Approaches and uncertainties in nutrient budgets: implications for nutrient management and environmental policies. *European Journal of Agronomy*, 20:3-16

Ohm, M., Schüler, M., Fyströ, G., Paulsen, H.M., 2015. Redistribution of soil phosphorus from grassland to cropland in an organic dairy farm. *Applied Agriculture and Forestry Research*, 65, 193-204.

Olsen, S.R., 1954. Estimation of available phosphorus in soils by extraction with sodium bicarbonate. United States Department of Agriculture; Washington.

Orr, J.C., Fabry, V.J., Aumont, O., Bopp, L., Doney, S.C., Feely, R.A., Gnanandesikan, A., Gruber, N., Ishida, A., Joos, F., Key, R.M., Lindsay, K., Maier-Reimer, E., Matear, R., Monfray, P., Mouchet, A., Najjar, R.G., Plattner, G.-K., Rodgers, K.B., Sabien, C.L., Sarmiento, J.L., Schlitzer, R., Slater, R.D., Tetterdell, I.J., Weirig, M.F., Yamanak, Y., Yool, A., 2005. Anthropogenic ocean acidification over the twenty-first century and its impact on calcifying organisms. *Nature*, 437, 681-686. DOI: 10.1038/nature04095.

Paris, P., Gavazzi, C., Tabaglio, V., 2004. Rate of soil P decline due to crop uptake. Long-term curves of depletion. *Agriculture Mediterranean*, 134, 236–245.

Parod, R.J., 2014. Ammonia. In *Encyclopedia of Toxicology (Third Edition)*, pp 206-208.

Passy, P., Gypens, N., Billen, G., Garnier, J., Thieu, V., Rousseau, V., Callens, J., Parent, J.-Y., Lancelot, C., 2013. A model reconstruction of riverine nutrient fluxes and eutrophication in the Belgian Coastal Zone since 1984. *Journal of Marine Systems*, 128, 106-122. DOI: org/10.1016/j.jmarsys.2013.05.005

Passy, P., Le Gendre, R., Garnier, J., Cugier, P., Callens, J., Paris, F., Billen, G., Riou, P., Romero, E., 2016. Eutrophication modelling chain for improved management strategies to prevent algal blooms in the Bay of Seine. *Marine Ecology Progress Series*, 543, 107-125

Paulet, M., 1853. L'Engrais humain. Histoire des applications de ce produit à l'agriculture, aux arts industriels, avec description des plus anciens procédés de vidanges et des nouvelles réformes dans l'intérêt de l'hygiène, Comptoir des imprimeurs-unis, Veuve Comon, Paris.

Pellerin S., Bamière L., Angers D., Béline, F., Benoît, M., Butault, J.-P., Chenu, C., Colnenne-David, C., de Cara, S., Delame, N., Doreau, M., Dupraz, P., Faverin, P., Garcia-Launay, F., Hassouna, M., Hénault, C., Jeuffroy, M.-H., Klumpp, K., Metay, Moran, D., Recous, S., Samson, E., Savini, I., Pardon, L., 2013. Contribution de l'agriculture française à la réduction des émissions de gaz à effet de serre. Potentiel d'atténuation et coût de dix actions techniques. Synthèse du rapport d'étude. INRA, p. 92

Philippe, R., 1961. Une opération pilote : l'étude du ravitaillement de Paris au temps de Lavoisier. *Annales. Economies, Sociétés, Civilisations*. 16 (3), 564-568.

Pimentel, D., Hepperly, P., Hanson, J., Doubs, D., Seidel, R., 2005. Environmental, energetic, and economic comparisons of organic and conventional farming systems. *BioScience*, 55, 573–582. DOI: 10.1641/0006-3568(2005)055[0573:EEAECO]2.0.CO2



Plassard, C., Robin, A., Le Cadre, E., Marsden, C., Trap, J., Herrmann, L., Waithaisong, K., Lesueur, D., Blanchard, E., Chapuis-Lardy, L., 2015. Améliorer la biodisponibilité du phosphore: comment valoriser les compétences des plantes et les mécanismes biologiques du sol? *Innovations Agronomiques*, 43, 115–138.

Plihon, D., 2012. Le nouveau capitalisme. 4th Ed. La Découverte, Paris

Pluvillage, C., 1912. Industrie et commerce des engrais et des anticryptogamiques et insecticides, Baillière et fils, Paris.

Poeplau, C., Don, A., 2012. Carbon sequestration in agricultural soils via cultivation of cover crops – A meta-analysis. *Agriculture, Ecosystems and Environment*, 200, 33-41. DOI : org/10.1016/j.agee.2014.10.024

Post, W.M., Peng, T.-H., Emanuel, W.R., King, A.W., Dale, V.H., DeAngelis, D.L., 1990. The global carbon cycle. *American Scientist*, 78- 310-326.

Post, W.M., Kwon, K.C., 2000. Soil carbon sequestration and land-use change processes and potential. *Global Change Biology*, 6, 317-327.

Poudel, DD., Horwath, W.R., Lanini, W.T., Temple, S.R., van Bruggen, A.H.C., 2002. Comparison of soil N availability and leaching potential, crop yields and weeds in organic, low input and conventional farming systems in northern California. *Agriculture, Ecosystems and Environment*, 90, 125-137.

Poulton, P., Johnston, J., Macdonald, A., White, R., Powlson, D., 2018. Major limitations to achieving "4 per 1000" increases in soil organic carbon stock in temperate regions: Evidence from long-term experiments at Rothamsted Research, United Kingdom. *Global Change Biology*, 1-22. DOI: 10.1111/gcb.14066

Powlson, D.S., Bhogal, A., Chambers, B.J., Coleman, K., Macdonald, A.J., Goulding, K.W.T., Whitmore, A.P., 2002. The potential to increase soil carbon stocks through reduced tillage or organic material in England and Wales: A case study. *Agriculture, Ecosystems and Environment*, 146, 23-33. DOI: 10.1016/j.agee.2011.10.004

Pradhan P., Lüdeke M.K.B., Reusser D.E., Kropp J.P., 2014. Food Self-Sufficiency across Scales: How Local Can We Go? *Environmental Science and Technology*, 48, 9463–9470 dx.doi.org/10.1021/es5005939

Preston, R.L., 2012. Feed composition tables. *Beef Magazine*, Mar-2012

Puget, P., Chenu, C., Balesdent, J., 2000. Dynamics of soil organic matter associated with particle-size fractions of water-stable aggregates. *European Journal of Soil Science*, 51, 595-605.

Quenum, M., Giroux, M., Royer, R., 2004. Étude sur le bilan humique des sols dans des systèmes culturaux sous prairies et sous cultures commerciales selon les modes de fertilisation. *Agrosol*, 15, 57-71.

Raimonet, M., Oudin, L., Thieu, V., Silvestre, M., Vautard, R., Rabouille, C., Le Moigne, P., 2017. Evaluation of gridded meteorological datasets for hydrological modeling. *American Meteorological Society*, DOI: org/10.1175/JHM-D-17-0018.1

Rasmussen, I.A., 2004. The effect of sowing date, stale seedbed, row width and mechanical weed control on weeds and yields of organic winter wheat. *Weed Research*, 44, 12-20.

Rastoin, J.-L., 2000. Une brève histoire de l'industrie alimentaire. *Economie rurale*, 255-256, 61-71. DOI: 10.3406/ecoru.2000.5157.

Richard, M., 1951. *Physionomie de la fertilisation en France*. Paris: La Maison rustique, ed.  
Ringeval, B., Nowak, B., Nesme, T., Delmas, M., Pellerin, S., 2014. Contribution of anthropogenic phosphorus to agricultural soil fertility and food production. *Global Biogeochemical Cycles*, 28, 743-756. DOI: org/10.1002/2014GB004842

Ringeval, B., Nowak, B., Nesme, T., Delmas, M., Pellerin, S., 2014. Contribution of anthropogenic phosphorus to agricultural soil fertility and food production. *Global Biogeochemical Cycles*, 28, 743-756. DOI: 10.1002/2014GB004842.

Rigby, D., Cáceres, D., 2001. Organic farming and the sustainability of agricultural systems. *Agricultural Systems*. 68, 21–40. DOI: 10.1016/S0308-521X(00)00060-3

Risse, J., 2003. *Histoire de l'Élevage en France*. L'Harmattan, Paris.

Roberts, J. R., Parks, B.C., 2009. Ecologically Unequal Exchange, ecological Debt, and climate Justice. *International Journal of Comparative Sociology*, 50, 385-409.

Robertson, G.P., Groffman P.M., 2015. Nitrogen transformations. pp 421-446 in E. A. Paul, editor. *Soil microbiology, ecology and biochemistry*. Fourth edition. Academic Press, Burlington, Massachusetts, USA.

Rockström, J., Steffen, W., Noone, K., Persson, A., Chapin, F.S., Lambin, E.F., Lenton, T.M., Scheffer, M., Folke, C., Schellnhuber, H.J., Nykvist, B., de Wit, C.A., Hughes, T., van der Leeuw, S., Rodhe, H., Sörlin, S., Snyder, P.K., Costanza, R., Svedin, U., Falkenmark, M., Karlberg, L., Corell, R.W., Fabry, V.J., Hansen, J., Walker, B., Liverman, D., Richardson, K., Crutzen, Foley, J.A., 2009. A safe operating space for humanity. *Nature*, 461, 472-475. DOI : 10.1038/461472a

Rodrigues Soares, J., Cantarella, H., de Campos Menegale, M.L., 2012. Ammonia volatilization losses from surface-applied urea with urease and nitrification inhibitors. *Soil Biology & Biochemistry*, 52, 82-89.

Romero, E., Le Gendre, R., Garnier, J., Billen, G., Fisson, C., Silvestre, M., Riou, Ph., 2016. Long-term water quality in the lower Seine: lessons learned over 4 decades of monitoring. *Environmental Science and Policy*, 58: 141–154.

Rowe, H., Withers, P.J.A., Baas, P., Chan, N.I., Doody, D., Holiman, J., Jacobs, B., Li, H., MacDonald, G.K., McDowell, R., Sharpley, A.N., Shen, J., Taheri, W., Wallenstein, M., Weintraub, M.N., 2016. Integrating legacy soil phosphorus into sustainable nutrient management strategies for future food, bioenergy and water security. *Nutrient Cycling in Agroecosystems*, 104, 393-412.

Rubio, G., Oosterheld, M., Alvarez, C.R., Lavado, R.S., 1997. Mechanisms for the increase in phosphorus uptake of waterlogged plants: soil phosphorus availability, root morphology and uptake kinetics. *Oecologia*, 112, 150–155. DOI: 10.1007/s004420050294

Ruoho-Airola, T., Eilola, K., Savchuk, O.P., Parviainen, M., Tarvainen, V., 2012. Atmospheric Nutrient Input to the Baltic Sea from 1850 to 2006: A Reconstruction from Modeling Results and Historical Data. *Ambio*, 41: 549–557

Ruttan, V., 1978. Structural Retardation and the Modernization of French Agriculture: A Skeptical View. *The Journal of Economic History*, 38, 714-728. DOI: 10.1017/S0022050700082632

Ruttenberg, K.C., 2014. The global phosphorus cycle. *Treatise on Geochemistry*. 2<sup>nd</sup> Edition, Elsevier Ltd, 499-558.

Ryschawy, J., Tichit, M., Bertrand, S., Allaire, G., Plantureux, S., Aznar, O., Perrot, C., Guinot, C., Josien, E., Lasseur, J., Aubert, C., Tchakérian, E., Disenhaus, C., 2015. Comment évaluer les services rendus par l'élevage ? Une première approche méthodologique sur le cas de la France. *INRA Production Animales*, 28, 23-38.

Saffih-Hdadi K. and Mary B., 2008. Modeling consequences of straw residues export on soil organic carbon. *Soil Biology & Biochemistry*, 40, 594-607

Salvo, L., Hernandez, J., Ernst, O., 2014. Soil organic carbon dynamics under different tillage systems in rotations with perennial pastures. *Soil & Tillage Research*, 135, 41-18. DOI : org/10.1016/j.still.2013.08.014

Sarkozy, N., 2009. Déclaration sur la politique maritime de la France, Le Havre le 16 juillet 2009. <http://discours.vie-publique.fr/notices/097002118.html>

Sattari, S.Z., Bouwman, A.F., Giller, K.E., van Ittersum, M.K., 2012. Residual soil phosphorus as the missing piece in the global phosphorus crisis puzzle. *Proceedings of National Academy of Sciences*, 109, 6348–6353.

Sattari, S.Z., Bouwman, A.F., Martinez Rodriguez, R., Beusen, A.H.W., van Ittersum, M.K., 2016. Negative global phosphorus budgets challenge sustainable intensification of grassland. *Nature Communications*, 7.

Sauvant, D., 2004. Principes généraux de l'alimentation animale. Institut National Agronomique Paris-Grignon, Paris.

Schlesinger, W.H., Andrews, J.A., 2000. Soil respiration and the global carbon cycle. *Biogeochemistry*, 48, 7-20.

Schneider, A., Morel, C., 2000. Relationship between the isotopically exchangeable and resin-extractable phosphate of deficient to heavily fertilized soil. *European Journal of Soil Sciences*. 51, 709–715. DOI: 10.1046/j.1365-2389.2000.00351.x

Schmidt, M.W., Torn, M.S., Abiven, S., Dittmar, T., Guggenberger, G., Janssens, I.A., Kléber, M., Kögel-Knabner, I., Lehmann, J., Manning, D.A.C., Nannipieri, P., Rasse, D.P., Weiner, S., Trumbore, S.E., 2011. Persistence of soil organic matter as an ecosystem property. *Nature*, 478, 49–56. DOI: 10.1038/nature10386

Schmitz C., Biewald A., Lotze-Campen H., Popp A., Dietrich J.P., Bodirsky B., Krause M., Weindl I., 2012. Trading more food: Implications for land use, greenhouse gas emissions, and the food system. *Global Environmental Change*, 22:189-209. doi:10.1016/j.gloenvcha.2011.09.013

Sebillotte, J., 1994. Qualité de l'environnement et pollution azotée de l'eau. Quelles procédures pour le développement agricole ? in *Études et Recherches des Systèmes Agraires et Développement*. Ed INRA, INRA, Paris, pp. 277-285. doi:10.1111/j.1365-2621.1978.tb02391.x

Senthilkumar, K., Nesme, T., Mollier, A., Pellerin, S., 2012. Regional-scale phosphorus flows and budgets within France: the importance of agricultural production systems. *Nutrient Cycling in Agroecosystems*, 92, 145–159. DOI: 10.1007/s10705-011-9478-5.

Senthilkumar, K., Mollier, A., Delmas, M., Pellerin, S., Nesme, T., 2014. Phosphorus recovery and recycling from waste: An appraisal based on a French case study. *Resources, Conservation and Recycling*, 87, 97–108.

Servolin, C., 1977. L'absorption de l'agriculture dans le mode de production capitaliste. In Tavernier et al., *L'univers politique des paysans dans la France contemporaines*, Presse de Sciences Po (P.F.N.S.P.) "Académiques", pp 41-77.

Sharpley, A.N., Herron, S., Daniel, T., 2007. Overcoming the challenges of phosphorus-based management in poultry farming. *Journal of Soil and Water Conservation*, 62, 375–89.

Sharpley, A. N., Daniel, T. C., Edwards, D. R., 1993. Phosphorus movement in the landscape. *Journal of Production in Agriculture*, 6, 492-500. DOI: 10.2134/jpa1993.0492

Sharpley, A., Tunney, H., 2000. Phosphorus research strategies to meet agricultural and environmental challenges of the 21st century. *Journal of Environmental Quality*, 29, 176-181. DOI: 10.2134/jeq2000.00472425002900010022x

Sharpley, A., Jarvie, H.P., Buda, A., May, L., Spears, B., Kleinman, P., 2014. Phosphorus legacy: overcoming the effects of past management practices to mitigate future water quality Impairment. *Journal of Environmental Quality*, 42, 1308-1326. DOI:10.2134/jeq2013.03.0098

Shen, P., Xu, M., Zhang, H., Yang, X., Huang, S., Zhang, S., He, X., 2014. Long-term response of soil Olsen P and organic C to the depletion or addition of chemical and organic fertilizers. *Catena*, 118, 20–27. DOI: 10.1016/j.catena.2014.01.020

Silvestre, M., Billen, G., Garnier, J., 2015. Évaluation de la provenance des marchandises consommées par un territoire : AmstraM, une application de webmapping basée sur les statistiques de transport et de production. In: Junqua G, Brullot S, eds. *Écologie industrielle et territoriale : COLEIT 2012*. Paris: Presses des Mines, pp. 361–370.

SitraM, 2006. Système d'Information sur le Transport des Marchandises. Ministère de l'Ecologie et du Développement durable. <http://www.statistiques.developpement-durable.gouv.fr/sources-methodes/> cited 15 sept 2016.

Six, J., Elliott, E.T., Paustian, K., Doran, J.W., 1998. Aggregation and soil organic matter accumulation in cultivated and native grassland soils. *Soil Science Society of America Journal*, 62, 1367-1377.

Six, J., Elliott, E.T., Paustian, K., 2000. Soil macroaggregate formation: a mechanism for C sequestration under no-tillage agriculture. *Soil Biology & Biochemistry*, 32, 2099-2103.

Six, J., Conant, R.T., Paul, E.A., Paustian, E.A., 2002. Stabilization mechanisms of soil organic matter: Implications for C-saturation of soils. *Plant and Soil*, 241, 155-176.

Six, J., Frey, S.D., Thiet, R.K., Batten, K.M., 2006. Bacterial and Fungal Contributions to Carbon Sequestration in Agroecosystems. *Soil Science Society America Journal*. 70, 555-569, DOI: 10.2136/sssaj2004.0347

Sleutel, S., De Neve, S., Singier, B., Hofman, G., 2006. Organic C levels in intensively managed arable soils – long-term regional trends and characterization of fractions. *Soil Use and Management*, 22, 188–196.

Sleutel, S., De Neve, S., Hofman, G., 2007. Assessing causes of recent organic carbon losses from cropland soils by means of regional-scaled input balances for the case of Flanders (Belgium). *Nutrient Cycling in Agroecosystems*, 78,265–278.

Smil, V., 2000. Phosphorus in the environment: Natural flows and human interferences. *Annual Review of Ecology, Evolution and Systematics*, 25, 53-88.

Smil, V., 2001. *Enriching the Earth: Fritz Haber, Carl Bosch and the Transformation of World Food Production*, MIT Press, Cambridge, Massachusetts.

Smith, P., Martino, D., Cai, Z., Gwary, D., Janzen, H., Kumar, P., McCarl, B., Ogle, S., O'Mara, F., Rice, C., Scholes, B., Sirotenko, O., Howden, M., McAllister, T., Pan, G., Romanenkov, V., Schneider, U., Towprayoon, S., 2007. Policy and Technological constraints to implementation of greenhouse gas mitigation options in agriculture. *Agriculture, Ecosystems and Environment*, 118, 6-28.

Soltner, D., 2005. *Les Bases de la Production Végétales*. 24th edn. Sciences et Techniques Agricoles. Bressuire

Soltner, D., 2008. *Alimentation des Animaux Domestiques*. 22th edn. Sciences et Techniques Agricoles, Bressuire.

Sommer, R., Bossio, D., 2014. Dynamics and climate change mitigation potential of soil organic carbon sequestration. *Journal of Environmental Management*, 144, 83-87.

Soto, D., Infante-Amate, J., Guzman, G. I., Cid, A., Aguilera, E., Garcia, R., de Molina, M. G., 2016. The social metabolism of biomass in Spain, 1900-2008: From food to feed-oriented changes in the agro-ecosystems. *Ecological Economics*, 128, 130-138. DOI : 10.1016/j.ecolecon.2016.04.017.

Sparling, G.P., 1992. Ratio of microbial biomass carbon to soil organic carbon as a sensitive indicator of changes in soil organic matter. *Australian Journal of Soil Research*, 302, 195-207.

Stewart, C., Paustian, K., Richard, T., Plante, A.F., Six, J., 2007. Soil carbon saturation: concept, evidence and evaluation. *Biogeochemistry*, 86, 19–31.

Stockmann, U., Adams, M.A., Crawford, J.W., Field, D.J., Henakaarchchi, N., Jenkins, M., Minasny, B., McBratney, A.B., de Remy de Courcelles, V., Singh, K., Wheeler, I., Abbott, L., Angers, D.A., Baldock, J., Bird, M., Brookes, P.C., Chenu, C., Jastrow, J.D., Lal, R., Lehmann, J., O'Donnell, A.G., Parton, W.J., Whitehead, D., Zimmermann, M., 2013. The knowns, known

unknowns and unknowns of sequestration of soil organic carbon. *Agriculture, Ecosystems and Environment*, 164, 80–99. DOI: [org/10.1016/j.agee.2012.10.001](https://doi.org/10.1016/j.agee.2012.10.001)

Sutton M., Howard C., Erisman J.W., Billen G., Bleeker A., Grennfelt P., van Grinsven H., Grizeeti B., 2011. The European Nitrogen Assessment: sources, effects and policy perspectives. Cambridge University Press. 601 pp.

Svirejeva-Hopkins, A., Reis, S., Magid, J., Nardoto, G. B., Barles, S., Bouwman, A.F. Erzi, I., Kousoulidou, M., Howard, C.M., Sutton, M.A., 2011. Nitrogen flows and fate in urban landscape. In Sutton MA et al. The European Nitrogen Assessment. Chapter 12 pp. 249-270. Cambridge University Press.

Taghizadeh-Toosi, A., Christensen, B.T., Glendining, M., Olesen, J.E., 2016. Consolidating soil carbon turnover models by improved estimates of belowground carbon input. *Scientific Reports*. 6, 32568. DOI : [10.1038/srep32568](https://doi.org/10.1038/srep32568).

Tilman, D., Cassman, K.G., Matson, P.A., Naylor, R., Polasky, S., 2002. Agricultural sustainability and intensive production practices. *Nature*, 418, 671–677.

Tosser, V., Eglin, T., Bardy, M., Besson, A., Martin, M., 2014. Evaluation des stocks de carbone organique des sols cultivés de France. *Etude et Gestion des Sols*, 21, 7-23.

Toutain, J.C., 1971. La consommation alimentaire en France de 1789 à 1964. *Economie et Société*, 5, 1909-2049.

Tuomisto, H.L., Hodge, I., Riordan, P., Macdonald, D.W., 2012. Does organic farming reduce environmental impacts?—A meta-analysis of European research. *Journal of Environmental Management*, 112, 309–320. DOI: [10.1016/j.jenvman.2012.08.018](https://doi.org/10.1016/j.jenvman.2012.08.018)

Ulrich, A.E., and Frossard, E., 2014. On the history of a reoccurring concept: Phosphorus scarcity. *Science of the Total Environment*, 490, 694-707. DOI: [10.1016/j.scitotenv.2014.04.050](https://doi.org/10.1016/j.scitotenv.2014.04.050)

Unifa, 2016. Union des Industries de la fertilisation. La Fertilisation en France <http://www.unifa.fr/le-marche-en-chiffres/la-fertilisation-en-france.html>. Cited 15 sept 2016.

USDA, 2016. United States Department of Agriculture. Food Composition Databases (<http://ndb.nal.usda.gov>). Cited Sept 2016.

Valero Delgado, A., 2008. *Exergy evolution of the mineral capital on Earth*. Thèse de doctorat. University of Zaragoza. Vernadsky, V.I., 1926. The Biosphere, Seuil, mars 2012. ISBN 2-84134-041-4.

Vangessel, M.J., and Renner, K.A., 1990. Effect of soil type, hilling time, and weed interference on potato (*Solanum tuberosum*) development and yield. *Weed Technology*, 4, 299-305.

Vecin Jimenez et Gùzman. Determinacion del periodico critico de competencia de la flora arvense en dos cultivos hortícolas.

[http://www.agroecologia.net/recursos/publicaciones/publicaciones-online/2000/IV%20congreso%20cordoba/plagas/periodo\\_critico.html](http://www.agroecologia.net/recursos/publicaciones/publicaciones-online/2000/IV%20congreso%20cordoba/plagas/periodo_critico.html)

Virto, I., Barré, P., Burlot, A., Chenu, C., 2012. Carbon input differences as the main factor explaining the variability in soil organic C storage in no-tilled compared to inversion tilled agrosystems. *Biogeochemistry*, 108, 17–26. DOI: 10.1007/s10533-011-9600-4

Vleeshouwers, L.M., Verhagen, A., 2002. Carbon emission and sequestration by agricultural land use: a model study for Europe. *Global Change Biology*, 8, 519–530.

Vogel, C., Muelle, S.W., Höschen, C., Buegger, F., Heister, K., Schulz, S., Schloter, M., Kögel-Knabner, I., 2014. Submicron structures provide preferential spots for carbon and nitrogen sequestration in soils. *Nature*, 2947, DOI: 10.1038/ncomms3947

Von Lützow, M., Kögel-Knabner, I., Ludwig, B., Matzner, E., Flessa, H., Ekschmitt, K., Guggenberger, G., Marschner, B., Kalbitz, K., 2008 Stabilization of organic matter in four temperate soils: Development and application of a conceptual model . *Journal of Plant Nutrition and Soil Science*, 171, 111-124.

Walker, T.W., Syers, J.K., 1976. The fate of phosphorus during pedogenesis. *Geoderma*, 15, 1-19.

Watson, C.A., Atkinson, D., 1999. Using nitrogen budgets to indicate nitrogen use efficiency and losses from whole farm systems: a comparison of three methodological approaches. *Nutrient Cycling in Agroecosystems*, 53, 259–267.

Watson, C.A., Bengtsson, H., Ebbesvik, M., Loes, A.-K., Myrbeck, A., Salomon, E., Schroder, J., Stockdale, E.A., 2002. A review of farm-scale nutrient budgets for organic farms as a tool for management of soil fertility. *Soil Use and Management*, 18, 264-273.

Weber, M., 1959. *Le savant et le politique*, PLON, Paris, ISBN 2-264-00209-3

Weyer, P. J., Cerhan, J.R., Kross, B.C., Hallberg, G.R., Kantamneni, J., Breuer, G., Jones, M.P., Zheng, W., Lynch, C.F., 2001. Municipal Drinking Water Nitrate Level and Cancer Risk in Older Women: The Iowa Women's Health Study. *Epidemiology*, 12, 327-38. <http://www.jstor.org/stable/3703710>.

World Health Organization (WHO), 2007. *Public Water Supply and Access to Improved Water Sources*. World Health Organization, Geneva.



World Health Organization (WHO), 1990. Public Health Impacts of Pesticides Used in Agriculture (WHO in collaboration with the United Nations Environment Programme, Geneva.

World Health Organization (WHO), 2007. Food and Agriculture Organisation, United Nations University (Eds.). Protein and amino acid requirements in human nutrition: report of a joint WHO/FAO/UNU Expert

Withers, P.J., van Dijk, K.C., Neset, T.-S.S., Nesme, T., Oenema, O., Rubæk, G.H., Schoumans, O.F., Smit, B., Pellerin, S., 2015. Stewardship to tackle global phosphorus inefficiency: the case of Europe. *Ambio* 44, 193–206. DOI: 10.1007/s13280-014-0614-8.

Wright, E.O., 2010. Utopies Réelles. Paris, La Découverte.

Zeng, N., Zhao, F., Collatz, G.J., Kalnay, E., Salawitch, R.J., West, T.O., Guanter, L., 2014. Agricultural green revolution as a driver of increasing atmospheric CO<sub>2</sub> seasonal amplitude. *Nature*, 515, 394-397. DOI: 10.1038/nature13893

## List of Figures

<b>Figure 0.1</b> Schematic representation of agriculture as an emblematic interface of the social and biophysical spheres	7
<b>Figure 0.2</b> Global introduction of reactive nitrogen from 1850 to 2015	12
<b>Figure 0.3</b> Global introduction of phosphorus resulting from fossil P extraction from 1850 to 2015	17
<b>Figure 0.4</b> Cumulated CO <sub>2</sub> emissions at the global level from 1850 to 2015	19
<b>Figure 1.1</b> Principles of the GRAFS representation, as illustrated by N fluxes	27
<b>Figure 1.2</b> Construction of the 33 French agricultural regions based on their geographical proximity and the similarity of their land-use system and dependency regarding N provisioning	29
<b>Figure 1.3</b> Urban population (in % total population) in France and in a sample of French agricultural territories	30
<b>Figure 1.4</b> Estimation of per capita food consumption rate in France and Paris	32
<b>Figure 1.5</b> Evolution of the number of farms (total and >1ha) in France from 1852 to 2010	34
<b>Figure 1.6 a.</b> Time variation of N excretion by a standard milking cow in the North of France. <b>b.</b> Evolution of the carcass weight of slaughtered bovines (national average). <b>c.</b> Deviation from national average of bovine carcass weight in 1852, 1929 and 1981	40
<b>Figure 1.7 a.</b> Time variation of N excretion by a standard pig weighing approximately 60 kg live weight in northern France. <b>b.</b> Changes in the carcass weight of slaughtered pigs (national average). <b>c.</b> Deviation from national average of pig carcass weight in 1852 and 1929	41
<b>Figure 1.8 a.</b> Time variation of N excretion by a standard pig weighing about 60 kg live weight in northern France. <b>b.</b> Changes in the carcass weight of slaughtered pigs (national average). <b>c.</b> Deviation from national average of pig carcass weight in 1852, 1929 and 1981	42
<b>Figure 1.9</b> Available data for adult horse excretion over the 1850–2014 period	43
<b>Figure 1.10</b> Atmospheric total N deposition in a number of French agricultural regions since 1980	46
<b>Figure 1.11</b> Relationship between atmospheric N deposition and livestock density for agricultural regions in France in 2006	46
<b>Figure 1.12 a.</b> Long-term evolution of N deposition for Rothamsted, the Baltic Sea <b>b.</b> Suggested relative variations of N deposition for France	47
<b>Figure 1.13</b> Net imports of vegetal: <b>a.</b> and animal; <b>b.</b> products provided by SitraM plotted against net import inferred from the mass balance for the year 2006	61
<b>Figure 1.14</b> Organization of the GRAFS workbook	62

<b>Figure 2.1</b> Evolution of: <b>a.</b> total cereal production, <b>b.</b> number of livestock and, <b>c.</b> N and P synthetic fertilizers for the 1980–2013 period in France	<b>70</b>
<b>Figure 2.2</b> The perimeters of the Paris city center, urban unit, urban area and Ile-de- France administrative region. The background shows the main types of land use	<b>75</b>
<b>Figure 2.3</b> Representation of nitrogen <b>a.</b> phosphorus <b>b.</b> and carbon <b>c.</b> fluxes, expressed in kt yr <sup>-1</sup> at the national scale for France in 2006	<b>78</b>
<b>Figure 2.4</b> Distribution across the 33 French agricultural areas of <b>a.</b> N balance in cropland; <b>b.</b> N balance in grassland; <b>c.</b> NH <sub>3</sub> emissions from utilized agricultural area accounting for NH <sub>3</sub> emissions derived from livestock manure and synthetic fertilizer spreading ; <b>d.</b> P balance in cropland; <b>e.</b> P balance in grassland; <b>f.</b> Humified OC inputs to cropland; <b>g.</b> Humified OC inputs to grassland	<b>80</b>
<b>Figure 2.5 a.</b> Decision tree representing the elaboration of a typology of the main representative agricultural systems in France. <b>b.</b> Spatial distribution of the five main representative agricultural systems	<b>84</b>
<b>Figure 2.6</b> Representation, in 2006, of the N, P, and C fluxes across the agro-food system, expressed in kg per ha of utilizable agricultural area of ( <b>a, b, c</b> ) the “intensive arable land” system region, ( <b>d, e, f</b> ) the “intensive livestock farming” system, ( <b>g, h, i</b> ) the “intensive integrated crop and livestock farming” system, ( <b>j, k, l</b> ) the “grass-fed integrated crop and livestock farming” system, ( <b>m, n, o</b> ) the “disconnected intensive crop-extensive livestock farming” system	<b>89</b>
<b>Figure 2.7 a.</b> Inter-regional and international exchanges of nitrogen in agricultural commodities for the different groupings of French departments. <b>b.</b> Spatial distribution of the ratio between long distance trade and local production (crop and forage)	<b>96</b>
<b>Figure 2.8</b> Main net fluxes of cereals exchanged between agricultural regions	<b>97</b>
<b>Figure 2.9</b> Main net fluxes of meats exchanged between agricultural regions	<b>98</b>
<b>Figure 2.10</b> Main net fluxes of dairy products exchanged between agricultural regions	<b>99</b>
<b>Figure 2.11</b> Main net fluxes of animal feed exchanged between agricultural regions	<b>100</b>
<b>Figure 2.12</b> Main net fluxes of fruits and vegetables exchanged between agricultural regions	<b>101</b>
<b>Figure 2.13</b> Main net fluxes of total protein nitrogen in agricultural commodities exchanged between agricultural territories	<b>102</b>
<b>Figure 2.14</b> Contribution of different agricultural regions to the supply of animal and vegetal proteins to Paris Megacity	<b>106</b>
<b>Figure 2.15</b> N- and P-GRAFS established for 4 main areas contributing to Paris Megacity food supply: Central Paris Basin ( <b>a and b</b> ), Great East ( <b>c and d</b> ), Great West ( <b>e and f</b> ) and South American soy exporting countries ( <b>g and h</b> )	<b>107</b>
<b>Figure 2.16</b> Flows of: <b>a.</b> nitrogen and <b>b.</b> phosphorus which can be attributed to the food supply of one inhabitant of Paris Megacity in the different agricultural areas involved	<b>110</b>

<b>Figure 3.1</b> Map of the Seine Basin watershed and location of the organic and conventional participative farms	<b>120</b>
<b>Figure 3.2</b> Principles of the calculation of the mean soil P budget over the cropping system for each commercial farm	<b>122</b>
<b>Figure 3.3</b> Kinetics of phosphate desorption from the soil by anion exchange against hydrogen carbonate	<b>124</b>
<b>Figure 3.4</b> Relationship between <b>a.</b> available P measured using Olsen versus resin anion exchange methods; <b>b.</b> available P measured using Olsen versus total P	<b>126</b>
<b>Figure 3.5</b> Mean P budgets over the 14 cropping systems on the basis of the studied plots <b>a.</b> stocks of available P within 10 days measured using resin anion exchange; <b>b.</b> stocks of available P measured using the Olsen method; <b>c.</b> stocks of total P measured using ignition and extraction with HCl 1 M	<b>128</b>
<b>Figure 3.6</b> Distribution across the 33 French agricultural areas of <b>a.</b> mean P budget in cropland over the 1970–1981 period; <b>b.</b> mean P budget in cropland over the 2004–2014 period; <b>c.</b> mean Olsen-P in cropland over the 2005–2014 period; <b>d.</b> changes in P fertilization rates in the four main regions of the Paris Basin over the 1955–2015 period	<b>130</b>
<b>Figure 4.1</b> GRAFS-based N flows for Picardy, Loire-Amont and Brittany in 1852, 1970 and 2010	<b>143</b>
<b>Figure 4.2</b> Features of the agricultural systems of Picardy, Loire Amont and Brittany over time. <b>a.</b> Agricultural production; <b>b.</b> type of N fertilization; <b>c.</b> origin of livestock feed	<b>144</b>
<b>Figure 4.3</b> Cumulated P balance over arable land in the course of the 1852–2014 period in Brittany, Loire Amont and Picardy	<b>145</b>
<b>Figure 4.4</b> Cumulated P inputs in the course of the 1852–2014 period in Picardy, Brittany and Loire Amont	<b>146</b>
<b>Figure 4.5</b> Evolution in the five different types of regions considered for France over the 1852–2014 period. <b>a.</b> Livestock density; <b>b.</b> yield of arable land ; <b>c.</b> Average size of farms <b>d.</b> rate of N synthetic fertilizer application over arable cropland; <b>e.</b> N balance of arable land; <b>f.</b> P balance of arable land	<b>154</b>
<b>Figure 4.6</b> Chronology of the different types of agricultural regions in France over the 1852–2014 period	<b>155</b>
<b>Figure 5.1</b> Coupling of the GRAFS and AMG models	<b>167</b>
<b>Figure 5.2</b> <b>a.</b> Distribution of mean annual temperature (1990-2010) across French regions. <b>b.</b> mean annual temperature deviation from the 1990-2010 average since 1852, for Ile de France (IdF), Gd Marseille (GdM) and whole of France. <b>c.</b> Annual variations of temperature in Ile de France and Grand Marseille in 1852 and 2014. <b>d.</b> Long term variations of the annual value of the temperature function of mineralization coefficient in Ile de France and Gd Marseille regions	<b>169</b>

<b>Figure 5.3</b> Changes in cropland NPP from 1852 to 2014 in six typical French territories: Eure-et-Loire, Picardy, Manche, Brittany, Loire Amont, and Aveyron-Lozère, distinguishing NPP for eight crop categories	<b>172</b>
<b>Figure 5.4</b> Evolution of <b>a</b> feed importation from abroad; <b>b</b> livestock density; <b>c</b> rates of mineral N fertilization to cropland; <b>d</b> rates of mineral P fertilization to cropland from 1852 to 2014 in France and for six typical French territories: Eure-et-Loire, Manche, Brittany, Loire Amont, Aveyron-Lozère, and Picardy	<b>173</b>
<b>Figure 5.5</b> Evolution of humified C inputs to cropland from 1852 to 2014 in six typical French territories: Eure-et-Loire, Picardy, Manche, Brittany, Loire Amont, and Aveyron-Lozère. Nine categories of inputs are distinguished	<b>175</b>
<b>Figure 5.6</b> Evolution of labile and total SOC stocks in the topsoil of cropland (0–30 cm) from 1852 to 2014 in six typical French territories: Eure-et-Loire, Picardy, Manche, Brittany, Loire Amont, and Aveyron-Lozère	<b>176</b>
<b>Figure 5.7</b> Maps of relative rates of change in SOC stocks in the topsoil of cropland (0–30 cm) in French territories during the periods <b>a.</b> 1885–1900, <b>b.</b> 1955–1970, and <b>c.</b> 2000–2014	<b>177</b>
<b>Figure 5.8</b> Simplified representation of the chain of causalities involved in changes of SOC stocks of cropland	<b>184</b>
<b>Figure 6.1 a.</b> Trends in the area of organic farming in France. <b>b.</b> Number of community-supported agriculture (AMAP) contracts in France	<b>192</b>
<b>Figure 6.2 a.</b> Current (2010) distribution of the population density in France. <b>b.</b> % annual increase over the 2010–2040 period according to INSEE (high hypothesis). <b>c.</b> % annual increase over the 2010–2040 period with the hypothesis of a voluntarist policy for a more equilibrated population distribution between the Paris region and the northeastern rural areas	<b>194</b>
<b>Figure 6.3</b> Trends in the composition of the human diet in France	<b>195</b>
<b>Figure 6.4</b> Current distribution of the parameter Ymax, characterizing the Y vs F relationship of cropping systems in each region	<b>197</b>
<b>Figure 6.5</b> Inter-regional and international fluxes of cereals <b>a.</b> and animal products <b>b.</b> in the 2006 French Agro-food system, as revealed by transport surveys, as well as in the Opening/Specialization scenario, and in the Autonomy/Reconnection/Demitarian scenario ), calculated based on proximity and availability	<b>202</b>
<b>Figure 6.6</b> Cropland N surplus <b>a.</b> and nitrate concentration in groundwater recharge <b>b.</b> calculated for the reference situation and the two scenarios	<b>204</b>
<b>Figure 6.7</b> C budget of agricultural production for the reference situation and the two scenarios	<b>205</b>

## List of Tables

<b>Table 1.1</b> Conversion into nitrogen (N), phosphorus (P), and carbon (C) of the food items considered in the INSEE nomenclature of human food consumption	<b>31</b>
<b>Table 1.2</b> Per capita consumption of vegetal and animal products (excluding fish)	<b>33</b>
<b>Table 1.3</b> N, P and C content of milk and eggs	<b>35</b>
<b>Table 1.4</b> Balance sheet of slaughtering and cutting. N, P, and C contents in the different fractions of edible and unedible animal products	<b>36</b>
<b>Table 1.5</b> Current (2000-2014) N excretion factors for different bovine classes	<b>39</b>
<b>Table 1.6</b> Current N excretion factors for different porcine classes	<b>40</b>
<b>Table 1.7</b> Current N excretion factors for different caprine and ovine classes	<b>42</b>
<b>Table 1.8</b> Current N excretion factors for different equine classes	<b>43</b>
<b>Table 1.9</b> N excretion factors for different poultry classes	<b>44</b>
<b>Table 1.10</b> Time spent on grassland and indoors and mode of excretion management for different livestock classes. The example of the Auvergne region	<b>49</b>
<b>Table 1.11</b> Losses by NH <sub>3</sub> volatilization during management and application of livestock excrements	<b>50</b>
<b>Table 1.12</b> C/N ratio of livestock manure types	<b>50</b>
<b>Table 1.13</b> N, P, and C content of the main crops expressed	<b>53</b>
<b>Table 1.14</b> Coefficients a (slope) and b (intercept) for the calculation of HI of different cereals	<b>55</b>
<b>Table 1.15</b> Moisture content, coefficients of C relative allocation in harvested, above-ground residue and below-ground residues, coefficients of relative deep-rootedness in the 30 cm of topsoil and calculated coefficient of root dry biomass production in the top 30 cm	<b>56</b>
<b>Table 1.16</b> Ratios of weed dry biomass production per unit of harvested crop production in field studies without pesticide for different types of in temperate and Mediterranean climate	<b>57</b>
<b>Table 1.17</b> Humification coefficients of animal excretion	<b>58</b>
<b>Table 1.18</b> Humification coefficients of the 36 crops considered in the GRAFS approach	<b>59</b>
<b>Table 2.1</b> Calculation of the elements of vegetal and animal productions (for N imprint)	<b>72</b>
<b>Table 2.2</b> Population and density of Paris: city center, urban unit, urban area and Ile-de-France administrative region	<b>75</b>

<b>Table 2.3</b> Environmental indicators expressed per unit of agricultural surface within each of the five main agricultural systems in France	<b>91</b>
<b>Table 2.4</b> Environmental indicators expressed per unit of animal or vegetal product within each of the five main agricultural systems in France and nutrient use efficiency for vegetal and animal production	<b>94</b>
<b>Table 2.5</b> Estimation of the environmental imprint of Paris Megacity over its main supplying areas	<b>108</b>
<b>Table 3.1</b> Description of conventional (CF) and organic (OF) cropping systems of the participative network	<b>121</b>
<b>Table 3.2</b> Measurement of available (Olsen and resin) and total P stocks in the 30 cm depth in 14 cropping systems of the Paris Basin	<b>128</b>
<b>Table 5.1.</b> Total SOC stocks in cropland in France (national scale) in 1855, 1900, 1955, 1980, and 204	<b>178</b>
<b>Table 5.2</b> Relative change (expressed in %) in total SOC stocks in France (national scale) with respect to the current standard simulation when using one of the five alternative explorations	<b>179</b>
<b>Table 6.1</b> Dominant crop rotation considered for organic farming in the different regions in the A/R/D scenario, and current yield of fodder and grain legumes involved	<b>198</b>
<b>Table 6.2</b> Main features of the O/S and A/R/D scenarios	<b>200</b>
<b>Table 6.3</b> Production figures and other features of the French agro-food system in the current reference situation and in the two scenarios for 2040.	<b>203</b>





## Abstract

Resource management in agriculture is a permanent challenge as it implies to produce enough food to feed people while preserving terrestrial and aquatic environments from pollution and loss of fertility for next generations. In this context, this work investigates agricultural systems from the angle of nitrogen (N), phosphorus (P) and carbon (C) biogeochemical fluxes in French regions from 1852 to 2014, following a socio-metabolic approach stressing out the underlying logic behind these material fluxes. To that end, the GRAFS approach (Generalized Representation of Agro-Food Systems) was extended to C and developed for long term analysis. GRAFS is a generic biogeochemical accounting method describing agro-food system of a given region, by quantifying nutrient fluxes between cropland, permanent grassland, livestock, humans, and the surrounding environment.

Results brought out by this research highlight the systemic relation between production pattern and N and P balances, and changes in soil organic C stocks in agricultural soil of French regions. Intensive specialized agricultural systems generate high environmental losses and resource consumption per unit agricultural surface and present largely open nutrient cycles due to substantial trade flows. Conversely, integrated crop and livestock farming have more limited N and P consumption and lead to lower air and water contamination.

Long-term analysis shows that these patterns have not always existed; only after the Second World War, under the pressure of strong interventionist policies, some French regions specialized into crop or livestock farming, increasing their integration into the international market. Particularly, the period from the 1950's to the 1980's was marked by a concomitant acceleration in crops yields, livestock production and use of mineral fertilizers. This resulted in increased N and P balances over cropland and grassland and growing C inputs to cropland, causing important losses of N to the hydrosphere and atmosphere, together with the accumulation of P and C stocks in cropland soils. However, C accumulation resulting from increased crop production was permitted by the increased recourse to mineral fertilizers and agricultural machinery which consumes fossil-fuel energy. Therefore, C storage in cropland appeared to be a side-effect of the shift from an energy metabolism based on solar energy to one based on fossil-fuel combustion. Overall, trajectory analysis made clear that deep structural changes of the agro-food system, beyond the mere optimization of agricultural practices, are necessary to further reduce the environmental imprint of agricultural production.

The value of a historical perspective also lies in an improved ability to embrace the future. To illustrate this, the results were used as a basis for exploring two prospective scenarios for the future of French agriculture. The first one pursues the opening and specialization characterizing the long-term evolution of the last 50 years of most French agricultural regions, while the second assumes a shift towards more autonomy at the farm and regional scales, a reconnection of crop and livestock farming and a more frugal human diet. The former, even complying with regulations regarding reasoned fertilization, would result in considerable environmental burdens. The latter alternative scenario would meet the future national food demand while still exporting substantial amount of cereals to the international market, and would significantly reduce losses to the environment.