



**HAL**  
open science

# Hinf-Linear Parameter Varying Controllers Order Reduction : Application to semi-active suspension control

Hossni Zebiri

► **To cite this version:**

Hossni Zebiri. Hinf-Linear Parameter Varying Controllers Order Reduction : Application to semi-active suspension control. Other. Université de Haute Alsace - Mulhouse, 2016. English. NNT : 2016MULH7733 . tel-02371267

**HAL Id: tel-02371267**

**<https://theses.hal.science/tel-02371267>**

Submitted on 19 Nov 2019

**HAL** is a multi-disciplinary open access archive for the deposit and dissemination of scientific research documents, whether they are published or not. The documents may come from teaching and research institutions in France or abroad, or from public or private research centers.

L'archive ouverte pluridisciplinaire **HAL**, est destinée au dépôt et à la diffusion de documents scientifiques de niveau recherche, publiés ou non, émanant des établissements d'enseignement et de recherche français ou étrangers, des laboratoires publics ou privés.

ÉCOLE DOCTORALE 269  
MATHÉMATIQUES, SCIENCES DE L'INFORMATION ET DE L'INGÉNIEUR

# THÈSE

pour obtenir le grade de :  
DOCTEUR DE L'UNIVERSITÉ DE HAUTE ALSACE  
Spécialité : Automatique

---

*$\mathcal{H}_\infty$* -Linear Parameter Varying Controllers Order Reduction  
Application to semi-active suspension control

Réduction d'ordre de correcteurs  $\mathcal{H}_\infty$ -linéaires à paramètre variant  
Application à la commande d'une suspension semi-active

---

Présentée par :  
**Hossni ZEBIRI**

Thèse soutenue le 03 Octobre 2016, devant le jury composé de :

<b>Rapporteurs :</b>	- X. Brun	Professeur, INSA Lyon.
	- B. Clément	Professeur, ENSTA Bretagne.
<b>Examineurs :</b>	- E. Caillaud	Professeur, Université de Strasbourg.
	- D. Koenig	Maître de conférences HdR, ESISAR Gr. Grenoble INP.
<b>Invités :</b>	- C. Murea	Maître de conférences HdR, Université Haute-Alsace.
	- C. Roos	Docteur, ONERA Toulouse.
<b>Directeur :</b>	- M. Basset	Professeur, Université Haute-Alsace.
<b>Co-Encadrant :</b>	- B. Mourllion	Maître de conférences, Université Haute-Alsace.



# Contents

List of Figures	vi
List of Tables	vii
Notation and Symbols	ix
Acronyms	xi
Introduction	xiii
Conferences and Publications	xvii
<b>1 Preliminaries and Background</b>	<b>1</b>
Introduction . . . . .	2
1.1 Signal and System Descriptions . . . . .	2
1.1.1 Signal Spaces and Norms . . . . .	2
1.1.2 System Spaces . . . . .	3
1.2 Linear Algebra . . . . .	5
1.2.1 Linear Fractional Transformation . . . . .	5
1.2.2 Hamiltonian Matrix and Riccati Equation . . . . .	6
1.2.3 Polynomial Criterion . . . . .	7
1.2.4 Matrices Vectorisation Operators . . . . .	8
1.3 LTI-systems . . . . .	9
1.3.1 LTI-representaion . . . . .	9
1.3.2 Controllability and Observability . . . . .	10
1.3.3 Norms . . . . .	11
1.3.4 Schur Complement Formula . . . . .	12
1.3.5 Bounded Real Lemma . . . . .	12
1.4 LPV-systems . . . . .	13
1.4.1 LPV-modelling . . . . .	13
1.4.2 LPV-models regarding the Parameter Trajectories . . . . .	14
1.4.3 LPV-models regarding the Parameter Function . . . . .	15
1.4.4 LPV-models regarding the System Representations . . . . .	16
<b>2 <math>\mathcal{H}_\infty</math>-Controller Design</b>	<b>21</b>
Introduction . . . . .	22
2.1 $\mathcal{H}_\infty$ -LTI-Control Design . . . . .	22

---

2.1.1	LTI-Systems Stability . . . . .	22
2.1.2	$\mathcal{H}_\infty$ -LTI-Synthesis . . . . .	25
2.1.3	Robustness Analysis . . . . .	29
2.2	Fixed-Order $\mathcal{H}_\infty$ -Controller Design . . . . .	31
2.2.1	Ankelhed Method . . . . .	32
2.2.2	Apkarian Method [Apkarian et al., 2003] . . . . .	41
2.2.3	Summary and Relationship between Methods . . . . .	45
2.3	LPV-Robust Control Design . . . . .	46
2.3.1	LPV-Stability . . . . .	46
2.3.2	$\mathcal{H}_\infty$ -LPV-synthesis . . . . .	50
	Conclusion . . . . .	52
<b>3</b>	<b><math>\mathcal{H}_\infty</math>-Controller Order Reduction</b>	<b>55</b>
	Introduction . . . . .	57
3.1	Model Order Reduction . . . . .	57
3.1.1	Balancing Procedure . . . . .	58
3.1.2	Balanced Truncation . . . . .	59
3.1.3	Singular Perturbation Approximation . . . . .	60
3.1.4	Frequency Weighted Balanced Truncation . . . . .	62
3.2	$\mathcal{H}_\infty$ -LTI-Controller Order Reduction . . . . .	70
3.2.1	Full Order Controller . . . . .	71
3.2.2	FWBT for Controller Order Reduction . . . . .	72
3.2.3	Order Reduction Procedure . . . . .	73
3.3	$\mathcal{H}_\infty$ -LPV-Controller Order Reduction . . . . .	75
3.3.1	Gramians and Generalised Gramians . . . . .	75
3.3.2	Frequency-Limited Order Reduction by FWBT . . . . .	78
3.3.3	Frequency-Limited Order Reduction by SPA . . . . .	84
	Conclusion . . . . .	85
<b>4</b>	<b>Application to Automotive-suspension Control</b>	<b>87</b>
	Introduction . . . . .	88
4.1	Benchmark Library <i>COMPl<sub>e</sub>ib</i> . . . . .	88
4.1.1	<i>COMPl<sub>e</sub>ib</i> Problems . . . . .	88
4.1.2	Fixed-Order Controller Evaluation . . . . .	89
4.1.3	Fixed-Order vs. Reduced-Order Controllers . . . . .	92
4.2	Quarter Vehicle LTI-Model . . . . .	93
4.2.1	System Modelling . . . . .	93
4.2.2	Performance Specification . . . . .	95
4.2.3	$\mathcal{H}_\infty$ -Controller Design . . . . .	96
4.2.4	Simulation Results and Discussion . . . . .	97

---

4.2.5	Robustness Analysis . . . . .	101
4.2.6	Fixed-Order vs. Reduced-Order Controllers . . . . .	105
4.3	Semi-Active Suspension LPV-Model . . . . .	107
4.3.1	LPV-Model . . . . .	107
4.3.2	$\mathcal{H}_\infty$ -Controller Synthesis . . . . .	110
4.3.3	Numerical Issue . . . . .	112
4.3.4	Results and Discussion . . . . .	112
	Conclusion . . . . .	117
	<b>Conclusion and Perspectives</b>	<b>119</b>
	<b>Bibliography</b>	<b>123</b>
	<b>A Numerical Considerations</b>	<b>133</b>
A.1	Gradient and Hessian . . . . .	133
A.1.1	Gradient computation, [Helmersson, 2009] . . . . .	133
A.1.2	Hessian computation, [Helmersson, 2009] . . . . .	134
A.2	$X, Y$ and $X_a, Y_a$ Searching Algorithms . . . . .	134



# List of Figures

1	Low Order Controller Design . . . . .	xiv
1.1	Linear Fractional Representation LFT . . . . .	5
1.2	LPV-LFT-system . . . . .	18
2.1	Closed-loop for Stability Analysis . . . . .	24
2.2	Lower-LFT for Closed-loop System . . . . .	25
2.3	Augmented System . . . . .	26
2.4	LFT of the uncertain model . . . . .	30
2.5	$\mathcal{H}_\infty$ -Controller Synthesis Methods Comparison . . . . .	45
2.6	Robust Controller . . . . .	46
2.7	LPV-controllers types . . . . .	50
3.1	Controller Order Reduction Scheme [Anderson and Liu, 1989] . . . . .	56
3.2	Flowchart of Model Order Reduction Methods [Antoulas, 2005a] . . . . .	58
3.3	Hankel Singular values . . . . .	62
3.4	Frequency Response of the Building Model. . . . .	63
3.5	$\mathcal{H}_\infty$ -controlled system . . . . .	71
3.6	LFT of the Controller K . . . . .	71
3.7	From Full to Reduced Order $\mathcal{H}_\infty$ -controller . . . . .	72
3.8	Block Diagram Representation of $K_r$ . . . . .	72
3.9	Block Diagram Representation of $Q_r$ . . . . .	73
3.10	FWBT for controller order reduction . . . . .	74
3.11	Closed-loop Scheme . . . . .	75
4.1	Quarter Vehicle Model . . . . .	95
4.2	$\mathcal{H}_\infty$ -control Scheme for the Active Suspension . . . . .	96
4.3	Weighting Functions . . . . .	97
4.4	Bode-diagram of the Transfer Function $Z_s/Z_r$ . . . . .	100
4.5	Bode-diagram of the Transfer Function $Z_{us}/Z_r$ . . . . .	100
4.6	Frequency Response of $Z_r$ to $Z_s$ . . . . .	101
4.7	Frequency Response of $Z_r$ to $Z_{us}$ . . . . .	102
4.8	Time Responses on a bump of 0.01x2 m . . . . .	103
4.9	$\Delta_r(s)$ block . . . . .	103
4.10	Real and fictive uncertainties of $\Delta$ . . . . .	104
4.11	$K_5$ -time and Frequency Analysis with Uncertainties . . . . .	104
4.12	Upper and Lower $\mu$ for Nominal Performance . . . . .	105
4.13	Upper and Lower $\mu$ for Robust Stability . . . . .	105



4.14	Upper and Lower $\mu$ for Robust Performance . . . . .	106
4.15	Upper and Lower $\mu$ for Robust Performance . . . . .	106
4.16	Bode-diagram Magnitude of the Transfers $T_{z_s z_r}$ and $T_{z_{us} z_r}$ . . . . .	107
4.17	Time-response on a Bump of 0.01x2 m . . . . .	108
4.18	Quarter-vehicle Model . . . . .	108
4.19	$\mathcal{H}_\infty$ -control Scheme . . . . .	111
4.20	Bode-diagram Magnitude of the Transfer $T_{z_s z_r}$ . . . . .	114
4.21	Bode-diagram Magnitude of the Transfer $T_{\dot{z}_s z_r}$ . . . . .	115
4.22	Bode-diagram Magnitude of the Transfer $T_{z_{us} z_r}$ . . . . .	115
4.23	Time-response on a Bump of 0.01x2 m . . . . .	116

# List of Tables

4.1	Evaluation and Comparison between Apkarian's and Ankelhed's methods	91
4.2	Comparison between HINFSTRUCT, HIFOO, Apkarian's and Ankelhed's Methods.	93
4.3	$\ T_{zw}\ _\infty$ in Direct and Indirect Low-order Approaches	94
4.4	Parameter Values	95
4.5	Closed-loop Stability of the Reduced-order Controllers (S: stable, U: unstable)	98
4.6	Results from Simulation of $\mathcal{H}_\infty$ -controller Step Response	98
4.7	Closed-loop Stability of Reduced-order Controllers and Error Approximation	99
4.8	Parameter Values	111
4.9	Values of $(\text{rank}[\mathbf{B}(\rho), \mathbf{B}_\Omega(\rho)]/\text{rank}[\mathbf{B}_\Omega(\rho)]; \text{rank}[\mathbf{C}^\top(\rho), \mathbf{C}_\Omega^\top(\rho)]/\text{rank}[\mathbf{C}_\Omega^\top(\rho)])$ for Several Frozen Values of $(\rho_1, \rho_2)$	112
4.10	Values of the $\ T_{zw}(\rho) - \hat{T}_{zw}(\rho)\ _{i,2}$ and the Upper bound for Several Frozen Values of $(\rho_1, \rho_2)$	113



# Notation and Symbols

$\mathbb{R}$	: Fields of real numbers.
$\mathcal{RH}_\infty$	: Set of stable proper rational transfer matrices.
$\rho$	: Parameter varying.
$\dot{\rho}$	: Parameter time derivative.
$\text{vert } \{\Delta\}$	: Set of vertices of a convex polyhedron $\Delta$ .
$\Delta_\rho$	: Set the parameter values, i.e. $\rho \in \Delta_\rho$ .
$V_\rho$	: Set of vertices of $\Delta_\rho$ , i.e. $V_\rho = \text{vert } \{\Delta\}$ .
$\Delta_v$	: Set of the parameter derivative values, i.e. $\dot{\rho} \in \Delta_v$ .
$\omega_i$	: The $i^{\text{th}}$ vertex of a polytope.
$\mathbb{S}_{>0}^n$	: cone of $n \times n$ symmetric positive definite matrices.
$\prec (\preceq), \succ (\succeq)$	: Negative (semi-negative), positive (semi-positive) definite.
$S^*$	: Complex conjugate transpose of $S$ .
$A^{-\top}$	: $(A^{-1})^\top = (A^\top)^{-1}$ , inverse transpose of $A$ .
$\mathbb{1}_n$	: Column vector of dimension $n$ containing one entries.
$\mathcal{R}, \mathcal{O}$	: Reachability and observability Gramians.
$P(\rho), Q(\rho)$	: Generalised reachability and observability Gramians.
$P_\Omega(\rho), Q_\Omega(\rho)$	: Frequency weighted generalised reachability and observability Gramians.
$\sigma_i$	: The $i^{\text{th}}$ generalised Hankel singular value.
$\lambda_i(A)$	: The $i^{\text{th}}$ eigenvalue of $A$ .
$\gamma_i$	: The $i^{\text{th}}$ frequency weighted generalised Hankel singular value.
$\mathcal{L}_2$	: Time domain Lebesgue space = the space of square integrable signals in $\mathbb{R}$ .
$\mathcal{L}_\infty$	: Functions bounded in
$\mathcal{H}_\infty$	: Set of analytic functions.
$\text{trace}(A)$	: Trace of a matrix $A$ .
$\mathfrak{S}(A)$	: Image (or range) space $A$ .
$\ker(A)$	: Kernel (or null ) space $A$ .
$A \otimes B$	: Kronecker product of matrix $A$ and $B$ .
$\text{vec}(A)$	: Vectorisation of matrix $A$ .
$\text{mat}(a)$	: Inverse operator of $\text{vec}$ for a vector $a$ .
$\text{vech}(A)$	: Half-vectorisation of matrix $A \in \mathbb{R}^{n \times n}$ .
$\nabla_x f$	: Gradient of function $f$ .
$\nabla^2 f$	: Hessian of function $f$ .

- $\min(a; b)$  : Smallest of the scalars  $a$  and  $b$ .  
 $\arg \min f$  : Minimising argument of  $f$ .  
 $\text{diag}(A)$  : Diagonal elements of  $A$ .  
 $\mathbf{H}(f(x))$  : Hessian of  $f(x)$ .  
 $\mathbf{H}_\delta(f(x))$  : Approximated Hessian of  $f(x)$ .  
 $D_\perp$  : Orthogonal complement of  $D$ , i.e.  $\begin{bmatrix} D \\ D_\perp \end{bmatrix}$  or  $[ D \ D_\perp ]$  is unitary.  
 $S^\perp$  : Orthogonal complement of subspace  $S$ .

# List of Acronyms

LTI	:	Linear Time Invariant.
LTV	:	Linear Time Variant.
LPV	:	Linear parameter Invariant.
LFT	:	Linear Fractional Transformation.
LMI	:	Linear Matrix Inequality.
BT	:	Balanced Truncation.
FWBT	:	Frequency Weighted Balanced Truncation.
MR	:	Magneto-Rheological.
SPA	:	Singular Perturbation Approximation.
HNA	:	Hankel Norm Approximation.
SISO	:	Single Input Single Output.
MIMO	:	Multiple Input Multiple Output.
SDP	:	Semi-Definite Programming.
MOR	:	Model Order Reduction.
COR	:	Controller Order Reduction.



# Introduction

## Overview

For best productivity and less defaults, industrial systems have to be more and more powerful [Zhou et al., 1996, Antoulas, 2005a, Yousefi, 2007]. Hence, mechatronic systems appear to be increasingly useful. It is well-known that obtaining reasonable mathematical models is fundamental to the analysis and the design of dynamic systems. Nowadays, modelling tools are leading to an increasing fairly complex models. However, simpler models are easier to understand, to maintain and to implement. The process of deriving a low-order model from a high order one is known as Model Order Reduction MOR. From control point of view, another problem is accrued with the significant progress work on robust and optimal control design. This latter has allowed to improve considerably the controlled systems performance. Nevertheless, controllers stabilising high order models and achieving a specified high performance are generally of higher order than the model itself. The complexity of the obtained high-order controllers restricts their real-time operation in embedded systems and increases their implementation costs. Then, the reduction of the controllers order is a needful design step. This gave rise to the so-called Controller Order Reduction COR problem. This approximation step has to preserve the closed-loop stability and the required performance. Generally, three ways can be used to reduce the controllers order [Anderson and Liu, 1989] according to Figure 1:

1. The first approach is to design a reduced-order model directly from the high order system [Yeh et al., 1994, Ly et al., 1985, Gangsaas et al., 1986, Bernstein, 1989, Hyland and Richter, 1990, Fischer and Gutman, 1991]. The main lack of this kind of methods is that the order of the reduced-controller has to be chosen by an ad-hoc way [Goddard, 1995].
2. The second way is to reduce the model using a MOR method [Antoulas, 2005b], and then design a controller for the obtained reduced model. The disadvantage of this indirect method is that the resulting error from reduction process will not be taken into the controller design step. And as a result, the reduced order controller is not guaranteed to stabilise the full order model [Kong, 2012].
3. The third way is to firstly design a full-order controller and then, reduce it while preserving the properties of the closed-loop system.

The proposed work will mainly focus on the third path.



## Contributions Organisation

$\mathcal{H}_\infty$ -Controller order reduction for LTI-systems has been pretty investigated in the last four decades. However, a dearth of survey study exists in this field. In this dissertation, we propose a global review synthesis study that handle every edge of the fundamental scheme in Figure 1 [Zebiri et al., 2013]. Moreover, a real engineering problem derived from an industrial requirements specification is considered to test the effectiveness of the existing methods [Zebiri et al., 2014b]. We also perform a robustness study to evaluate the validity of the methods regarding the possible parameters variation [Zebiri et al., 2014a]. Furthermore, and based on the significant recent researches for LTI-case, we propose a new extension study to the LPV-case. Indeed, from an  $\mathcal{H}_\infty$ -LPV-full-order controller, a reduced order one is derived. This latter is guaranteed stabilising and the closed-loop performance are achieved. The new method allows a better approximation in a limited frequency range. In addition, the approximation error between the original full order and reduced-order closed-loops is guaranteed bounded. Assumptions and the validation domain of the proposed method are carried out. Generalised Gramian framework is explored in order to keep the particular structure of the this order reduction. Finally, the developed LPV-order reduction algorithm is evaluated in an real engineering application. Indeed, an  $\mathcal{H}_\infty$ -LPV-control design is considered for an automotive-suspension system. This evaluation demonstrates that our proposed technique is effective with better performance against an other methods available in the literature [Zebiri et al., 2016b, Zebiri et al., 2016a] .

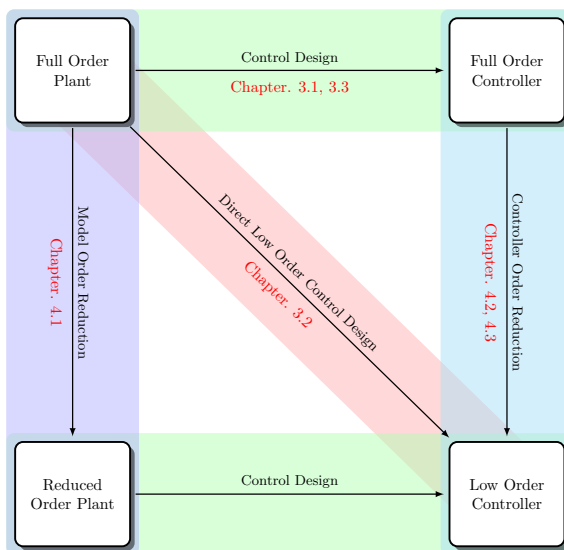

Figure 1: Low Order Controller Design

Then, this thesis is divided into four chapters:

- Chapter 1** presents some backgrounds on control theory. The mathematical framework of the used signals and systems is first introduced. Then, essential linear algebra notions are recalled. From the fact that this thesis deals with continuous LTI and LPV-systems, the two classes are fully highlighted. Indeed, the LTI representation and the associated norms are given. For LPV-systems, a non-exhaustive study on their modelling is given in the end of this chapter.
- Chapter 2** investigates the  $\mathcal{H}_\infty$ -control theory. The continuous LTI case is first considered where both stability and performance constraints can be guaranteed with an  $\mathcal{H}_\infty$ -controller. The  $\mathcal{H}_\infty$ -control problem is presented and the synthesis procedure is given. By stating that this procedure provide controllers with high order, a second low order procedure is studied. In fact, the fixed-order way is presented and existent algorithms are reviewed. Finally, a similar study is done for the LPV-case where stability and control synthesis are discussed. A special attention is given to the LPV-polytopic models.
- Chapter 3** is devoted to a new controller order reduction method to LPV-systems. In this chapter, model order reduction problematic for LTI-systems is first introduced. Methods based on singular value decomposition are highlighted then used in a closed-loop scheme to reduce the  $\mathcal{H}_\infty$ -controllers order. Based on this, an extension to LPV-case is proposed. The obtained  $\mathcal{H}_\infty$ -LPV-controller is guaranteed stable and the approximation error is bounded. In addition, the big advantage of this method is the possibility to perform the order reduction in a chosen limited frequency range.
- Chapter 4** gives a complete evaluation of the studied controller order reduction methods. The *COMPl<sub>e</sub>ib* benchmark library is first considered. The fixed order techniques are evaluated among some control problems of this benchmark. In addition, a comparison with the order reduction way is also performed using the *COMPl<sub>e</sub>ib* library problems. The second evaluation concerns the order reduction of an  $\mathcal{H}_\infty$ -LTI-controller for an active suspension system. The investigated techniques in the previous chapter are implemented and tested. Finally, the developed method for  $\mathcal{H}_\infty$ -LPV-controller order reduction is evaluated on semi-active suspension system. The stability of the reduced order controller is tested and the approximation error is shown bounded. The effectiveness of the method is confirmed by the performance test where the obtained controller deals well with the comfort and the road handling performance requirements.

Conclusive remarks with short outline about possible further developments are given in the **Conclusion and Perspective** section. Finally, some details about the nu-

merical considerations and algorithms for the  $\mathcal{H}_\infty$ -fixed-order synthesis are given in Appendix A.

# Conferences and Publications

## International peer-reviewed journal

Hossni Zebiri, Benjamin Mourllion, and Michel Basset. Frequency limited  $H_\infty$ -controller order reduction for linear parameter varying systems. In *International Journal of Control*,. published 2016, doi:10.1080/00207179.2016.1233482.(Section 3.3, Section 4.3)

Hossni Zebiri, Benjamin Mourllion, and Michel Basset. Frequency weighted singular perturbation for  $LPV - H_\infty$  controller order reduction. In *Journal of The Franklin Institute*,. Under review 2016.(Section 3.3, Section 4.3)

## International peer-reviewed conferences with proceedings

Hossni Zebiri, Benjamin Mourllion, and Michel Basset.  $H_\infty$ -controller order reduction for active suspension system. In *IEEE 13th European Control Conference ECC'14*, Strasbourg, 2014.(Section 3.2, Section 4.2)

Hossni Zebiri, Benjamin Mourllion, and Michel Basset. Order-reduction and mu-analysis of an  $H_\infty$ -controller. Application to active suspension systems. In *12th International symposium on Advanced Vehicle Control*, Tokyo, 2014.(Section 3.2, Section 4.2)

Hossni Zebiri, Benjamin Mourllion, and Michel Basset. Balanced truncation techniques for active suspension reduced-order  $H_\infty$ -controller. In *IFAC Workshop on Advances in Control and Automation Theory for Transportation Applications*, Istanbul, pages 123–128, 2013.(Section 3.2)

## National conferences (without proceedings)

Hossni Zebiri, Benjamin Mourllion, and Michel Basset. Frequency weighted balanced truncation of  $H_\infty$ -controller. Application to active suspensions. In *Journées Automatique et Automobile*. Bordeaux, Octobre 2013.

Hossni Zebiri, Benjamin Mourllion, and Michel Basset. Réduction d'ordre de correcteurs. In *5èmes Journées Doctorales / Journées Nationales MACS*. Strasbourg, Juillet 2013.



# Preliminaries and Background

---

## Contents

---

<b>Introduction</b> . . . . .	<b>2</b>
<b>1.1 Signal and System Descriptions</b> . . . . .	<b>2</b>
1.1.1 Signal Spaces and Norms . . . . .	2
1.1.2 System Spaces . . . . .	3
1.1.2.1 State-Space Realisation . . . . .	4
<b>1.2 Linear Algebra</b> . . . . .	<b>5</b>
1.2.1 Linear Fractional Transformation . . . . .	5
1.2.2 Hamiltonian Matrix and Riccati Equation . . . . .	6
1.2.3 Polynomial Criterion . . . . .	7
1.2.4 Matrices Vectorisation Operators . . . . .	8
<b>1.3 LTI-systems</b> . . . . .	<b>9</b>
1.3.1 LTI-representaion . . . . .	9
1.3.2 Controllability and Observability . . . . .	10
1.3.3 Norms . . . . .	11
1.3.4 Schur Complement Formula . . . . .	12
1.3.5 Bounded Real Lemma . . . . .	12
<b>1.4 LPV-systems</b> . . . . .	<b>13</b>
1.4.1 LPV-modelling . . . . .	13
1.4.2 LPV-models regarding the Parameter Trajectories . . . . .	14
1.4.3 LPV-models regarding the Parameter Function . . . . .	15
1.4.4 LPV-models regarding the System Representations . . . . .	16

---

## Introduction

This chapter presents basic definitions and elementary results in linear algebra and system theory. The treatment of this material is not exhaustive but should be sufficient as a reference for the future chapters.

In Section 1.1, signals and systems spaces are defined. In fact, the several results and methods presented in this dissertation, concern specific system classes. Then, a general framework about the used signals and systems is presented in this section. In addition, general background about norms is then highlighted.

In Section 1.2, essential results on linear algebra are given. Indeed, notions like Linear Fractional Transformation or Hamiltonian matrices are very important for the sequel of this dissertation. Several definitions about matrix manipulation are also given.

In Section 1.3, descriptions for Linear Time Invariant (LTI) systems and their norms are presented. Moreover, important results in control theory are also given.

Thereafter, the Linear Parameter Varying (LPV) systems are introduced in Section 1.4. Some historical facts are shown first. Then, a non exhaustive listing about the existing LPV-models are presented .

## 1.1 Signal and System Descriptions

This section reviews some standard notations and definitions about signals and systems. Essential elements about dynamical systems and theirs representations are recalled. In particular, notions about norms are given.

### 1.1.1 Signal Spaces and Norms

The signal space used in this dissertation is the basic Lebesgue space  $\mathcal{L}_2$  defined as follows

**Definition 1.1.1 ( $\mathcal{L}_2$ -space)** [Lee, 1997] *The space  $\mathcal{L}_2$  is the set of all real, one sided measurable functions  $x: \mathbb{R}_+ \rightarrow \mathbb{R}^n$  ;  $t \mapsto x(t)$  for which  $\|x\|_2 \triangleq \sqrt{\int_0^{+\infty} \|x(t)\|_2^2 dt}$  is finite. The quantity  $\|x\|_2$  is called the  $\mathcal{L}_2$ -norm of  $x$ .*

From this definition, an operator norm can be derived: the so-called *induced*  $\mathcal{L}_2$ -norm is defined as follows

**Definition 1.1.2 (Induced  $\mathcal{L}_2$ -norm)** [Lee, 1997] Given the linear operator  $H: \mathcal{L}_2 \rightarrow \mathcal{L}_2$ , the quantity

$$\|H\|_{i,2} \triangleq \sup_{\substack{x \in \mathcal{L}_2 \\ x \neq 0}} \frac{\|Hx\|_2}{\|x\|_2} = \sup_{\substack{x \in \mathcal{L}_2 \\ \|x\|_2=1}} \|Hx\|_2 \quad (1.1)$$

(if finite) is called the induced  $\mathcal{L}_2$ -norm of  $H$ .

In connection with  $\mathcal{L}_2$ -norm space and their associated norms, the  $\mathcal{L}_\infty$ -norm is given as follows

**Definition 1.1.3 ( $\mathcal{L}_\infty$ -norm)** [Lee, 1997] the set space  $\mathcal{L}_\infty$  is called the set of all real, one-sided, measurable functions  $x: \mathbb{R}_+ \rightarrow \mathbb{R}^n \mid t \mapsto x(t)$  for which  $\|x\|_{\mathcal{L}_\infty} \triangleq \sup_{t \geq 0} \|x(t)\|_2$  is finite.  $\|x\|_{\mathcal{L}_\infty}$  is called the  $\mathcal{L}_\infty$ -norm of  $x$ .

Then, referring to Definition 1.1.2, a similar induced norm for  $\mathcal{L}_\infty$ -space is given as follows.

**Definition 1.1.4 (Induced  $\mathcal{L}_\infty$ -norm)** [Lee, 1997] Given a bounded input, bounded output linear operator  $H: \mathcal{L}_\infty \rightarrow \mathcal{L}_\infty$ , the quantity

$$\|H\|_{i,\infty} \triangleq \sup_{x \in \mathcal{L}_\infty} \frac{\|Hx\|_{\mathcal{L}_\infty}}{\|x\|_{\mathcal{L}_\infty}} = \sup_{\substack{x \in \mathcal{L}_\infty \\ \|x\|_{\mathcal{L}_\infty}=1}} \|Hx\|_{\mathcal{L}_\infty} \quad (1.2)$$

(if finite) is called the induced  $\mathcal{L}_\infty$ -norm of  $H$ .

These various definitions about norms are very useful for Chapter 2 and Chapter 3.

### 1.1.2 System Spaces

In control theory, dynamical systems are mostly modelled and analysed in the context of the behavioural approach, where physical phenomena are described as a set of possible signal trajectories.



**Definition 1.1.5 (Dynamical System)** [*Polderman and Willems, 1991*] A dynamical system  $\mathcal{G}$  is defined as a triple

$$\mathcal{G} = (\mathbb{T}, \mathbb{W}, \mathcal{B}), \quad (1.3)$$

with  $\mathbb{T}$  (often a subset of  $\mathbb{R}$  or  $\mathbb{Z}$ ) called the time-axis,  $\mathbb{W}$  a set called the signal space, and  $\mathcal{B}$  a subset of  $\mathbb{W}^{\mathbb{T}}$  called the behaviour. Then,  $\mathbb{W}^{\mathbb{T}}$  is the standard notation for the set of all maps from  $\mathbb{T}$  to  $\mathbb{W}$ .

Remark that this definition cover a large systems classes like Linear Invariant-Time (LTI) systems [*Polderman and Willems, 1991*], Linear Parameter Varying (LPV) systems 1.4.1, Linear Time Varying LTV-systems [*Bourlès and Marinescu, 2011*] and even Nonlinear (NL) systems [*Khalil, 2000*]. Then, two major properties of dynamical systems namely *linearity* and *time-variance* are defined as follows

**Definition 1.1.6 (Linear Dynamical System)** [*Polderman and Willems, 1991*] A dynamical system  $\mathcal{G}$  is called linear, if  $\mathbb{W}$  is a vector space and  $\mathcal{B}$  is a linear subspace of  $\mathbb{W}^{\mathbb{T}}$ .

For the time invariance property, the following definition is given

**Definition 1.1.7 (Time-Invariant Dynamical System)** [*Polderman and Willems, 1991*] A dynamical system  $\mathcal{G}$  is called time-invariant, if  $\mathbb{T}$  is closed under addition and  $q^{\tau}\mathcal{B} = \mathcal{B}$  for all  $\tau \in \mathbb{T}$ , where  $q$  is the forward time-shift operator,  $q^{\tau}w(t) = w(t + \tau)$ .

A particularly important class of systems which has both of these properties, are the LTI-systems.

### 1.1.2.1 State-Space Realisation

For a linear system  $\Sigma$ , a state-space realisation  $\mathcal{S}$  can be given as

$$\Sigma: \mathcal{S} = \begin{cases} \dot{x}(t) = A(t)x(t) + B(t)u(t) \\ y(t) = C(t)x(t) + D(t)u(t) \\ x(0) = x_0 \end{cases} \quad \forall t \geq 0, \quad (1.4)$$

where the vector  $x(t) \in \mathbb{R}^n$  is the state,  $u(t) \in \mathbb{R}^{n_u}$  is the input and  $y(t) \in \mathbb{R}^{n_y}$  is the output. When  $n_y = n_u = 1$ , the system is Single-Input Single-Output (SISO). It is assumed that  $A: \mathbb{R} \rightarrow \mathbb{R}^{n \times n}$ ,  $B: \mathbb{R} \rightarrow \mathbb{R}^{n \times n_u}$ ,  $C: \mathbb{R} \rightarrow \mathbb{R}^{n_y \times n}$  and  $D: \mathbb{R} \rightarrow \mathbb{R}^{n_y \times n_u}$  are bounded piecewise continuous functions of time. Generally, a solution for state-space realisation is denoted by the so-called *state transition matrix*.

**Definition 1.1.8 (State Transition Matrix)** [Callier and Desoer, 1991] Define  $\Phi : \mathbb{R} \times \mathbb{R} \rightarrow \mathbb{R}^{n \times n}$  as the unique continuous solution to the homogeneous differential equation

$$\frac{\partial}{\partial t} \Phi(t, t_0) = A(t) \Phi(t, t_0) \quad \forall t \geq 0, \quad (1.5)$$

with  $\Phi(t_0, t_0) = I_n$ . The function  $\Phi$  is called the state transition matrix.

This essential notion is used in Section 2.1.

## 1.2 Linear Algebra

This section presents some definitions and useful properties that occur essentially in matrix algebra.

### 1.2.1 Linear Fractional Transformation

Linear fractional transformations (LFTs) provide a useful framework to formulate numerous control problems. They are particularly convenient in  $\mathcal{H}_\infty$ -control and the uncertainty modelling and they are used to provide elementary results regarding feedback interconnections of matrices or systems.

Considering Figure 1.1, the following definition is given:

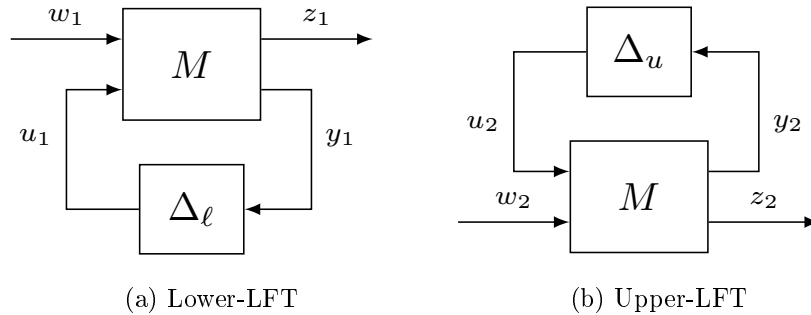

Figure 1.1: Linear Fractional Representation LFT

**Definition 1.2.1** [Zhou et al., 1996] Let  $M$  be a complex matrix partitioned as

$$M = \begin{bmatrix} M_{11} & M_{12} \\ M_{21} & M_{22} \end{bmatrix} \in \mathbb{C}^{(p_1+p_2) \times (q_1+q_2)}, \quad (1.6)$$

and let  $\Delta_\ell \in \mathbb{C}^{q_2 \times p_2}$  and  $\Delta_u \in \mathbb{C}^{q_1 \times p_1}$  be two other complex matrices. Then, assuming that  $(I - M_{22}\Delta_\ell) \neq 0$ , the lower-LFT can be defined with respect to  $\Delta_\ell$  as the map

$$\begin{aligned} \mathcal{F}_\ell(M, \bullet): \mathbb{C}^{q_2 \times p_2} &\rightarrow \mathbb{C}^{p_1 \times q_1} \\ \Delta_\ell &\mapsto \mathcal{F}_\ell(M, \Delta_\ell) \end{aligned}$$

such that

$$\mathcal{F}_\ell(M, \Delta_\ell) \triangleq M_{11} + M_{12}\Delta_\ell(I - M_{22}\Delta_\ell)^{-1}M_{21}. \quad (1.7)$$

Assuming that  $(I - M_{11}\Delta_u)^{-1} \neq 0$ , the upper-LFT can be defined with respect to  $\Delta_u$  as the map

$$\begin{aligned} \mathcal{F}_u(M, \bullet): \mathbb{C}^{q_1 \times p_1} &\rightarrow \mathbb{C}^{p_2 \times q_2} \\ \Delta_u &\mapsto \mathcal{F}_u(M, \Delta_u) \end{aligned}$$

with

$$\mathcal{F}_u(M, \Delta_u) \triangleq M_{22} + M_{21}\Delta_u(I - M_{11}\Delta_u)^{-1}M_{12}. \quad (1.8)$$

In Section 1.4, 2.1 and 2.3, The LFT notion is widely used .

## 1.2.2 Hamiltonian Matrix and Riccati Equation

The so-called Algebraic Riccati Equation (ARE) is more general equation than the well-known Lyapunov equation. Similar to this latter which is used in system analysis, the ARE is most useful in control system synthesis.

**Definition 1.2.2** [Zhou et al., 1996] Let  $A, Q$  and  $R$  be  $n \times n$  real matrices with  $Q$  and  $R$  symmetric. Then an algebraic Riccati equation (ARE) is the following matrix equation

$$A^\top X + XA + XRX + Q = 0. \quad (1.9)$$

where  $X \in \mathbb{R}^{n \times n}$ . This Riccati equation can be rewritten as

$$\begin{bmatrix} X & -I_n \end{bmatrix} H \begin{bmatrix} I_n \\ X \end{bmatrix} = 0 \quad (1.10)$$

with  $H \triangleq \begin{bmatrix} A & R \\ -Q & -A^\top \end{bmatrix}$  is a  $2n \times 2n$  matrix called Hamiltonian matrix.

Then, the following definition is given to introduce the domain *Ric*

**Definition 1.2.3** [*Zhou et al., 1996*] Given  $X$ , the solution of (1.9), let us define

$$\begin{aligned} \text{Ric}: \text{dom}(\text{Ric}) \subset \mathbb{R}^{2n \times 2n} &\rightarrow \mathbb{R}^{n \times n} \\ H &\mapsto X \end{aligned} \quad (1.11)$$

### 1.2.3 Polynomial Criterion

This subsection is given to provide a closeness measure to a rank constraint of matrix. In other words, how a rank constraint of a matrix can be expressed as function of its characteristic polynomial.

**Definition 1.2.4** [*Helmersson, 2009*] The characteristic polynomial of a matrix  $Z \in \mathbb{R}^{n \times n}$  is defined by

$$\det(\lambda I - Z) = \sum_{i=0}^n c_i(Z) \lambda^i, \quad (1.12)$$

where the coefficients,  $c_i(Z)$  are polynomial continuous functions of the elements in  $Z$ . Some known coefficients are given as

$$c_0(Z) = \det(Z), \quad c_{n-1}(Z) = \text{trace}(Z), \quad c_n(Z) = 1.$$

More properties of the characteristic polynomial coefficients of the positive matrix  $Z$  will be presented in following theorem.

**Theorem 1:** [**Helmersson, 2009**]

Let  $Z \in \mathbb{R}^{n \times n}$  be matrix with non-negative real eigenvalues,  $\lambda_i(Z) \geq 0$ , and let  $c_i(-Z)$  be the coefficients of the characteristic polynomial of  $-Z$  as defined in (1.12). Then, the following statements are equivalent if  $n_k < n$ :

- (i)  $c_{n-n_k-1}(-Z) = 0$ .
- (ii)  $\text{rank}(Z) \leq n_k$ .

More specifically, if  $\lambda_i$  are ordered as  $\lambda_1(Z) \geq \lambda_2(Z) \geq \dots \geq \lambda_n(Z) \geq 0$ . Then,

the following relations hold:

$$\frac{1}{n_k + 1} \sum_{n_k+1}^n \lambda_i(Z) \leq \frac{c_{n-n_k-1}(-Z)}{c_{n-n_k}(-Z)} \leq \sum_{n_k+1}^n \lambda_i(Z), \quad (1.13)$$

or equivalently,

$$\frac{c_{n-n_k-1}(-Z)}{c_{n-n_k}(-Z)} \leq \sum_{n_k+1}^n \lambda_i(Z) \leq (n_k + 1) \frac{c_{n-n_k-1}(-Z)}{c_{n-n_k}(-Z)}. \quad (1.14)$$

This theorem is useful and will be used in Chapter 2.

### 1.2.4 Matrices Vectorisation Operators

Operation to transform matrices into equivalent vectors is presented as follows

**Definition 1.2.5** ([Henderson and Searle, 1979, Turkington, 1998])

Let  $X$  be a square matrix

$$X = \begin{bmatrix} x_{11} & x_{12} & \cdots & x_{1n} \\ x_{21} & x_{22} & & \vdots \\ \vdots & & \ddots & \\ x_{n1} & x_{n2} & \cdots & x_{nn} \end{bmatrix}$$

The *vec* of the matrix  $X$  stacks columns of  $X$  one under another in a single column, and its operator inverse is the operator *mat*, i.e.

$$\text{vec}(X) = [x_{11} \ x_{21} \ \cdots \ x_{n1} \ x_{12} \ \cdots \ x_{n2} \ x_{13} \ \cdots \ x_{(n-1)1} \ x_{1n} \ \cdots \ x_{nn}]^T \quad (1.15)$$

$$X = \text{mat}(\text{vec}(X)). \quad (1.16)$$

The *vech* of the symmetric matrix  $X$  stacks columns of  $X$  one under another in a single column starting by a diagonal element of each column.

$$\text{vech}(X) = [x_{11} \ x_{21} \ \cdots \ x_{n1} \ x_{22} \ \cdots \ x_{n2} \ x_{33} \ \cdots \ x_{nn}]^T. \quad (1.17)$$

Let  $\mathcal{D}$  denotes the transformation matrix mapping the *vech* of the symmetric matrix  $X$  into its *vec* representation by this relationship:

$$\text{vec}(X) = \mathcal{D} \text{vech}(X) \quad (1.18)$$

with  $\mathcal{D} \in \mathbb{R}^{n^2 \times \frac{1}{2}n(n+1)}$ . For instance,  $\mathcal{D}$  takes this form for  $n = 3$ ,

$$\left[ \begin{array}{ccc|cc} 1 & 0 & 0 & 0 & 0 \\ 0 & 1 & 0 & 0 & 0 \\ 0 & 0 & 1 & 0 & 0 \\ \hline 0 & 1 & 0 & 0 & 0 \\ 0 & 0 & 0 & 1 & 0 \\ 0 & 0 & 0 & 0 & 1 \\ \hline 0 & 0 & 1 & 0 & 0 \\ 0 & 0 & 0 & 0 & 1 \\ 0 & 0 & 0 & 0 & 1 \end{array} \right]. \quad (1.19)$$

These tools are of big interest and will be used in Section 2.2

### 1.3 LTI-systems

The class of LTI systems is considered to be the collection of the simplest dynamical systems. Systems belonging to this class have been successfully used in enumerable engineering applications to describe or approximate a wide range of physical phenomena.

#### 1.3.1 LTI-representaion

Let  $\Sigma$ , be an LTI-system of order  $n$  with  $n_u$  inputs and  $n_y$  outputs and expressed under the state space realisation  $\mathcal{S}$  given as

$$\Sigma: \mathcal{S} = \begin{cases} \dot{x}(t) = Ax(t) + Bu(t) \\ y(t) = Cx(t) + Du(t) \end{cases} \quad \forall t \geq 0, \quad (1.20)$$

where  $A \in \mathbb{R}^{n \times n}$ ,  $B \in \mathbb{R}^{n \times n_u}$ ,  $C \in \mathbb{R}^{n_y \times n}$  and  $D \in \mathbb{R}^{n_y \times n_u}$ . Then, the state transition matrix defined in (1.5) becomes

$$\Phi(t, t_0) = e^{A(t-t_0)}. \quad (1.21)$$

Moreover, LTI-system can be represented with a *transfer function*. In fact, given  $U$  and  $Y$ , the Laplace transform of  $u$  and  $y$  respectively, the transfer function matrix from the input to the output is defined as  $G(s)$  considering its initial conditions and equilibrium point to be zero. Then, for a complex variable  $s$ ,

$$Y(s) = G(s)U(s). \quad (1.22)$$

Then, from this definition it is easy to get

$$G(s) = C(sI - A)^{-1}B + D. \quad (1.23)$$

In the sequel of this dissertation, the transfer function (1.23) is expressed under the form

$$G \stackrel{s}{=} \left[ \begin{array}{c|c} A & B \\ \hline C & D \end{array} \right]. \quad (1.24)$$

### 1.3.2 Controllability and Observability

In this subsection two very important concepts in linear system theory are given.

**Definition 1.3.1 (Reachability)** *A state  $\bar{x}$  is said to be reachable (from the origin) if, given  $x(0) = 0$ , there exist a finite time interval  $[0, T]$  and an input  $u(t), t \in [0, T]$  such that  $x(T) = \bar{x}$ . If all states are reachable, the system is said to be completely reachable.*

**Definition 1.3.2 (Controllability)** *A state  $x_0$  is said to be controllable if there exists a finite time interval  $[0, T]$  and an input  $u(t), t \in [0, T]$  such that  $x(T) = 0$ . If all states are controllable, then the system is said to be completely controllable.*

Moreover, the dual notion of the Controllability which is the observability is defined as follows.

**Definition 1.3.3 (Observability)** *The LTI-system described by the equations (1.20) or by the pair  $(C, A)$  is said to be observable if, for any  $t_1 > 0$ , the initial state  $x(0) = x_0$  can be determined from the time history of the input  $u(t)$  and the output  $y(t)$  in the interval of  $[0; t_1]$ . Otherwise, the system, or  $(C, A)$ , is said to be unobservable.*

Note that an LTI-system has an infinity number of state space realisations. From all possible realisations, those which have the smallest state dimension are called *minimal*.

**Definition 1.3.4 (Minimal Realisation)** *A state space realisation  $\mathcal{S}$  given in (1.20) is said to be a minimal realisation if the matrix  $A$  has the smallest possible dimension.*

Then, necessary and sufficient conditions to define a minimal realisation are given as follows

**Theorem 2:** [Zhou et al., 1996]

A state space realisation  $\mathcal{S}$  given in (1.20) is minimal if and only if  $(A, B)$  is controllable and  $(C, A)$  is observable.

Finally, the following definition is given to express the conjugate transpose of a transfer function. It will be used thereafter in the next chapters.

**Definition 1.3.5** ([Goddard, 1995]) *The conjugate transpose of the transfer function  $G$  given in (1.23), is denoted*

$$G^\sim \stackrel{s}{=} \left[ \begin{array}{c|c} -A^\top & C^\top \\ \hline -B^\top & D^\top \end{array} \right]. \quad (1.25)$$

*When evaluated on the imaginary axis,  $[G(j\omega)]^* = [G(-j\omega)]^\top = G^\sim(j\omega)$ .*

Note that this notion about minimality is very important in the order reduction procedure. In Section 3.1, 3.2 and 3.3, order reduction methods require the minimality of the high order model.

### 1.3.3 Norms

Results on norms viewed previously for general systems can be fitted for the LTI-systems as follows.

**Definition 1.3.6** ( $\mathcal{H}_\infty$ -norm) *Given the LTI-system  $\Sigma$  represented by its transfer function  $G$  denoted in (1.23). If  $G$  is Hurwitz, then it has a finite  $\mathcal{H}_\infty$ -norm defined as*

$$\|G\|_{\mathcal{H}_\infty} = \sup_{s \in \mathbb{C}_+} \bar{\sigma}(G(s)), \quad (1.26)$$

*where  $\bar{\sigma}(G(s))$  is the largest singular value of  $G(s)$ .*

For sake of simplicity,  $\|\cdot\|_{\mathcal{H}_\infty}$  is denoted by  $\|\cdot\|_\infty$  in the sequel for this dissertation. It is easy to show that  $\|G\|_\infty = \|G\|_{i,2}$  for LTI-systems [Goddard, 1995]. Moreover, the induced  $\mathcal{L}_\infty$ -norm of an LTI-system  $\Sigma$  with the transfer function  $G$  is given by

$$\|G\|_{i,\infty} = \int_0^{+\infty} |g(t)| dt \quad \forall t \geq 0 \quad (1.27)$$



where  $g: \mathbb{R}_+ \rightarrow \mathbb{R}$  is the *impulse response* of  $\Sigma$ . Through the Laplace transform, the transfer function  $G$  is given as

$$G(s) = \int_0^{+\infty} g(t)e^{-st} dt \quad \forall s \in \mathbb{C}. \quad (1.28)$$

### 1.3.4 Schur Complement Formula

The Schur complement formula is a useful notion and will be used in Chapter 2.

#### Lemma 1: [Boyd et al., 1994]

Given the matrices  $R \in \mathbb{S}^n$ ,  $S \in \mathbb{S}^m$  and  $G \in \mathbb{R}^{n \times m}$ , the following conditions are equivalent

1.

$$R \prec 0 \quad \text{and} \quad S - G^T R^{-1} G \prec 0 \quad (1.29)$$

2.

$$\begin{bmatrix} S & G \\ G & R \end{bmatrix} \prec 0 \quad (1.30)$$

where  $\mathbb{S}^n$  (resp.  $\mathbb{S}^m$ ) is a cone of  $n \times n$  (resp.  $m \times m$ ) symmetric matrices.

### 1.3.5 Bounded Real Lemma

In Chapter 2, the  $\mathcal{H}_\infty$ -control problem will be discussed. Then, the so-called Bounded Real Lemma BRL will be of big interest. Indeed, in the BRL,  $\mathcal{H}_\infty$ -norm computation problem can be transferred into a standard Linear Matrix Inequality LMI optimisation formulation.

#### Lemma 2: [Scherer, 1990, Ankelhed et al., 2011]

Consider a continuous-time transfer function  $T(s) = D + C(sI - A)^{-1}B$  of a not necessarily minimal realisation and  $\gamma > 0$ . The following statements are equivalent:

1.  $\|T\|_\infty < \gamma$  and  $A$  is Hurwitz.

2. There exists a symmetric positive definite solution  $P$  (i.e.  $P \in \mathbb{S}_{>0}^n$ ) to the LMI:

$$\begin{bmatrix} A^T P + PA + C^T C & PB + C^T D \\ B^T P + D^T C & D^T D - \gamma^2 I_{n_u} \end{bmatrix} \prec 0. \quad (1.31)$$

The inequality (1.31) can be rewritten as

$$\begin{bmatrix} A^\top P + PA & PB \\ B^\top P & -\gamma^2 I_{n_u} \end{bmatrix} + \begin{bmatrix} C^\top \\ D^\top \end{bmatrix} I_{n_y} \begin{bmatrix} C & D \end{bmatrix} \prec 0. \quad (1.32)$$

Then, multiplying this last inequality by  $\gamma^{-1}$  and let  $P_1 = \gamma^{-1}P$  leads to

$$\begin{bmatrix} A^\top P_1 + P_1 A & P_1 B \\ B^\top P_1 & -\gamma I_{n_u} \end{bmatrix} + \begin{bmatrix} C^\top \\ D^\top \end{bmatrix} \gamma^{-1} I_{n_y} \begin{bmatrix} C & D \end{bmatrix} \prec 0. \quad (1.33)$$

For later purposes, it is useful to reformulate the inequality in (1.33) to become linear in state-space matrices  $A, B, C, D$ . The use of Lemma 1 gives the inequality in (1.33) can be rewritten as

$$\begin{bmatrix} P_1 A + A^\top P_1 & P_1 B & C^\top \\ B^\top P_1 & -\gamma I_{n_u} & D^\top \\ C & D & -\gamma I_{n_y} \end{bmatrix} \prec 0 \quad (1.34)$$

which is an LMI in the matrices  $A, B, C, D$  if the matrix  $P_1$  and  $\gamma$  are given. The inequality (1.31) and (1.34) are equivalent for the solution matrix  $P_1$ . The bounded real lemma is of big interest to obtain the results in Section 2.2.

## 1.4 LPV-systems

LPV system is not a recent notion in control theory. In fact, the LPV-framework is appeared first time in association with the *gain scheduling* notion. Then, the global behaviour of systems is approximated by a set of fixed (frozen) LTI-systems [Shamma and Athans, 1990]. The concept of *frozen* LTI-behaviours is an essential viewpoint on LPV-systems and will be used for semi-active system developed in Chapter 4.

Thereafter, LPV-systems have obtained their own framework structure [Packard and Kantner, 1996]. Then, LPV-systems are defined as a large class of dynamical systems for which the future evolution of the state depends on the current state of the system plus some additional signals called parameters. These parameters act as inputs to the system and shape its internal structure [Briat, 2015].

Hence, in this section the mathematical definition of the LPV-systems is given. Then, according to the mathematical/physical properties or the role and structure of parameters, a non exhaustive classification is suggested.

### 1.4.1 LPV-modelling

Linear Parameter Varying models are representing systems whose dynamics are known functions of varying parameters. LPV-systems are commonly described by the following

the state-space realisation

$$\begin{cases} \dot{x}(t) = A(\rho(t))x(t) + B(\rho(t))u(t) \\ y(t) = C(\rho(t))x(t) + D(\rho(t))u(t) \\ x(0) = x_0 \end{cases} \quad \forall t \geq 0, \quad (1.35)$$

where  $x(t)$ ,  $u(t)$  and  $y(t)$  are the state, the input and the output of the system, respectively. The vector  $\rho(t)$  is the exogenous parameter varying vector which is time dependent.

The state-space representation (1.35) can be written as

$$G(\rho) \stackrel{s}{=} \left[ \begin{array}{c|c} A(\rho) & B(\rho) \\ \hline C(\rho) & D(\rho) \end{array} \right]. \quad (1.36)$$

Since LPV-framework apparition, many representation ways has been given. LPV-models can be classified regarding the mathematical properties or the physical meaning of their parameters. The role of the varying parameters can engender another types of LPV-models. In addition, and from a control point of view, the formulation of the LPV-representation gives a third way to encapsulate the LPV-models. Then, a non-exhaustive list of LPV-classes is proposed as follows

### 1.4.2 LPV-models regarding the Parameter Trajectories

By analysing the types of parameters, a first classification can be given. Then, a variety of LPV-models systems are defined according to their parameters trajectories.

#### LPV-models with Fast Varying Parameters

LPV-systems with arbitrarily fast varying parameters have parameters in a bounded set  $\mathcal{P}_\rho$  defined as

$$\mathcal{P}_\rho = \left\{ \begin{array}{ccc} \rho : \mathbb{R}_+ & \rightarrow & \Delta_\rho \\ t & \mapsto & \rho(t) \end{array} \right\}, \quad (1.37)$$

where  $\Delta_\rho$  is a compact and convex polytope (e.g. a box).

#### LPV-models with Slow Varying Parameters

LPV-systems with slowly varying parameters have parameters in the set  $\mathcal{P}_v$  defined as

$$\mathcal{P}_v = \left\{ \begin{array}{ccc} \rho : \mathbb{R}_+ & \rightarrow & \Delta_\rho \\ t & \mapsto & \rho(t) \end{array} \text{ and } \dot{\rho}(t) \in \Delta_v \quad \forall t \in \mathbb{R}_+ \right\}, \quad (1.38)$$

where  $\Delta_v$  is a convex and compact polyhedron containing 0.

### LPV-models with Piecewise Constant Parameters

LPV-systems with piecewise constant parameters have parameters in the set  $\mathcal{P}_{pc}$  defined as

$$\mathcal{P}_{pc} = \left\{ \begin{array}{l} \rho_i : \mathbb{R}_+ \rightarrow \Delta_\rho \\ t \mapsto \rho_i(t) \end{array} \mid \rho_i \text{ piecewise constant, } i = 1, \dots \right\}. \quad (1.39)$$

### LPV-models Representing Switched Models

Given  $A(\rho) = \sum_{i=1}^N A_i \rho_i$  with  $A_i$  are constant matrices, a switched system, with  $N$  modes can be represented as an LPV-system with parameters in the set  $\mathcal{P}_{ss}$  such as

$$\mathcal{P}_{ss} = \left\{ \begin{array}{l} \rho_i : \mathbb{R}_+ \rightarrow \{0, 1\}^N \\ t \mapsto \rho_i(t) \end{array} \mid \sum_{i=1}^N \rho_i = 1 \right\}, \quad (1.40)$$

where, again, some conditions have to be satisfied in order to obtain solutions at any time.

### LPV-models Representing Periodic Systems

Periodic systems, can be represented as LPV-systems with parameters in the set of  $T$ -periodically varying parameters  $\forall T > 0$

$$\mathcal{P}_T = \left\{ \begin{array}{l} \rho : \mathbb{R}_+ \rightarrow \Delta_\rho \\ t \mapsto \rho(t) \end{array} \mid \rho(t) = \rho(t + T) \right\}. \quad (1.41)$$

#### 1.4.3 LPV-models regarding the Parameter Function

In this second classification, the parameters role is the main criterion to differentiate LPV-models. Then, models can approximate nonlinear dynamics, time-varying parts or, even, introduce extra degrees of freedom to an existent LTI-model.

#### Quasi-LPV Systems

Whenever LPV-systems are considered as an approximation of nonlinear systems, scheduling parameters are function of the system states. This particular type of LPV systems is referred to a *quasi*-LPV systems, sometimes abbreviated as q-LPV systems. As an example, the following scalar nonlinear system

$$\dot{x}(t) = x(t)^2 \quad \forall t > 0, \quad (1.42)$$

can be represented as

$$\dot{x}(t) = \rho(t)x(t) \quad \forall t > 0, \quad (1.43)$$

with  $\rho(t) \triangleq x(t) \in \mathbb{R} \quad \forall t \in \mathbb{R}_+$ .

### LPV-models with Intrinsic Parameters

Parameters can also be used to embed time-varying components in order to use LPV-gain-scheduling techniques for controlling the original system. For instance, the Linear Time-Varying (LTV) system

$$\dot{x}(t) = [-a + b \sin(\omega t)] x(t), \quad \forall t > 0. \quad (1.44)$$

can be represented

$$\dot{x}(t) = [a + b\rho(t)] x(t) \quad \forall t > 0, \quad (1.45)$$

where  $\rho(t) \triangleq \sin(\omega t) \in [-1, 1]$ .

### LPV-models with Artificial Intrinsic Parameters

Extrinsic parameters are mostly involved when design is the underlying objective. These artificial parameters may then be used in the control law in order to shape its structure according to objectives. To illustrate this, let us consider the following LTI system

$$\begin{cases} \dot{x}(t) = x(t) + u(t) \\ y(t) = x(t) \end{cases} \quad \forall t \geq 0, \quad (1.46)$$

where  $x(t) \in \mathbb{R}$  and  $u(t) \in \mathbb{R}$  are the state and the control input, respectively. It is proposed to determine a control law such that

- the output  $y$  tracks a differentiable reference signal  $r$ , and
- the bandwidth of the closed-loop system can be adjusted in real-time.

The control law

$$u(t) = -[1 + \rho(t)] x(t) + \rho(t)r(t), \quad \rho(t) \geq 0, \quad (1.47)$$

where  $\rho$  is an external parameter yields the closed-loop system

$$\dot{x}(t) = -\rho(t) [x(t) - r(t)]. \quad (1.48)$$

#### 1.4.4 LPV-models regarding the System Representations

The LPV-system representations can have many forms. Some formulations are of particular importance when it comes to analysis and synthesis. A big part of LPV-systems can be written under one of the following ways

##### LPV-affine Systems

By an affine LPV-system we mean an LPV-system whose matrices are affine functions of the scheduling parameter. Then, the following definition is given

**Definition 1.4.1** An LPV-system given in (1.36) is said to be affine if the system matrices are represented by

$$\begin{aligned} A(\rho) &= A_0 + \sum_{i=1}^N A_i \rho_i, \\ B(\rho) &= B_0 + \sum_{i=1}^N B_i \rho_i, \\ C(\rho) &= C_0 + \sum_{i=1}^N C_i \rho_i, \\ D(\rho) &= D_0 + \sum_{i=1}^N D_i \rho_i. \end{aligned} \tag{1.49}$$

$\rho_i$  is the  $i^{\text{th}}$  element of  $\rho$  and  $A_i, B_i, C_i, D_i$  are constant matrices.

### LPV-polytopic Systems

The polytopic form gives a convenient framework for representing and analysing LPV-systems (see [Apkarian et al., 1994]). Polytopic systems are expressed as time varying convex combination of LTI-systems. This property can be operated to obtain stability or stabilisation results using convex optimisation techniques.

**Definition 1.4.2** [Poussot-Vassal, 2008] An LPV-system given in (1.36) is said to be polytopic if the system matrices are represented by

$$\begin{aligned} A(\rho) &= \sum_{i=1}^N \alpha_i(\rho) A_i, \\ B(\rho) &= \sum_{i=1}^N \alpha_i(\rho) B_i, \\ C(\rho) &= \sum_{i=1}^N \alpha_i(\rho) C_i, \\ D(\rho) &= \sum_{i=1}^N \alpha_i(\rho) D_i, \end{aligned} \tag{1.50}$$

where  $\sum_{i=1}^N \alpha_i(\rho) = 1$ ,  $\alpha_i(\rho) \geq 0$  and  $A_i, B_i, C_i, D_i$  are constant known matrices (that represent the system evaluated at each vertex).

Then, the LPV-system can be represented by an equivalent polytopic form such that

$$G(\rho) \stackrel{s}{=} \left[ \begin{array}{c|c} A(\rho) & B(\rho) \\ \hline C(\rho) & D(\rho) \end{array} \right] = \sum_{i=1}^N \alpha_i(\rho) \left[ \begin{array}{c|c} A(\omega_i) & B(\omega_i) \\ \hline C(\omega_i) & D(\omega_i) \end{array} \right], \tag{1.51}$$

where  $\omega_i$  are the vertices of the polytope formed by all the extremities of each

varying parameter  $\rho \in \mathcal{P}_\rho$ , and where  $\alpha_i(\rho)$  are defined as,

$$\alpha_i(\rho) = \frac{\prod_{k=1}^{\ell} |\rho_k - \mathfrak{C}(\omega_i)_k|}{\prod_{k=1}^{\ell} (\bar{\rho}_k - \underline{\rho}_k)}, \quad (1.52)$$

where  $\mathfrak{C}(\omega_i)_k$  is the  $k^{\text{th}}$  component of the vector  $\mathfrak{C}(\omega_i)$  defined as,

$$\mathfrak{C}(\omega_i)_k = \{\rho_k : \rho_k = \bar{\rho}_k \text{ if } (\omega_i)_k = \underline{\rho}_k \text{ or } \rho_k = \underline{\rho}_k \text{ otherwise}\}. \quad (1.53)$$

$N = 2^\ell$  is the number of vertices of the polytope formed by  $\ell$  varying parameters.

The polytopic systems are of interest in controller design and implementation. As in this case, the LPV-system is a convex hull of a finite number of LTI-systems, it allows to solve a finite number of LMI problems (see [Gahinet et al., 1996, Scherer, 2004]) to find a global LPV-controller (which is also a convex hull of a finite number of local LTI-controllers).

### LPV-LFT-systems

LPV-systems given under a LFT form are systems expressed as interconnection of two subsystems (Figure 1.2).

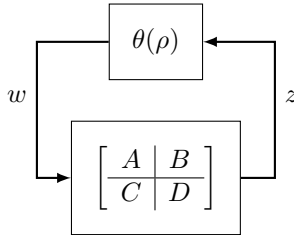

Figure 1.2: LPV-LFT-system

The main idea of this LFT form is to rewrite a complex system under an interaction between a “simple linear system” and “complicated and annoying” one. The first “simple nice part” should have convenient properties such as linearity, time invariance, etc. The other complicated part, contains non-linearities, time varying terms, ect. This formulation has been emphasised in numerous papers. In fact, in [Packard, 1994, Apkarian and Gahinet, 1995] a gain scheduling controllers for LPV-LFT-form systems are proposed. Then, recently in [Scherer, 2001, Scherer, 2012], LPV-controller based on dynamics D-scales is developed.

**Definition 1.4.3** An LPV-system given in (1.36) is said to be in LFT-form, such as the one depicted in Figure 1.2, state-space representation can be expressed as

$$\begin{cases} \dot{x}(t) = Ax(t) + Bw(t) \\ z(t) = Cx(t) + Dw(t) \\ w(t) = \theta(\rho(t))z(t) \end{cases} \quad \forall t \geq 0, \quad (1.54)$$

with  $I - \theta(\rho)D$  is invertible for all  $\rho \in \Delta_\rho$ .

This LFT-form can be rewritten according to the following proposition

**Proposition 2:** [Briat, 2015]

The LPV-LFT-form system given in (1.2) is equivalent to the following LPV-systems

$$\dot{x} = \left[ A - B[I - \theta(\rho)D]^{-1} \theta(\rho)C \right] x \quad (1.55)$$

$$\dot{x} = \left[ A - B\theta(\rho)[I - D\theta(\rho)]^{-1} C \right] x \quad (1.56)$$

In this chapter a non-exhaustive notions were introduced. This choice to focus only on a specific mathematical background is taken in the aim keep the clarity and the readability of the thesis.





# $\mathcal{H}_\infty$ -Controller Design

## Contents

<b>Introduction</b> . . . . .	<b>22</b>
<b>2.1 <math>\mathcal{H}_\infty</math>-LTI-Control Design</b> . . . . .	<b>22</b>
2.1.1 LTI-Systems Stability . . . . .	22
2.1.1.1 Global Asymptotic Stability . . . . .	22
2.1.1.2 Input-Output Stability . . . . .	24
2.1.2 $\mathcal{H}_\infty$ -LTI-Synthesis . . . . .	25
2.1.2.1 $\mathcal{H}_\infty$ -problem Formulation . . . . .	25
2.1.2.2 $\mathcal{H}_\infty$ -problem Resolution . . . . .	26
2.1.3 Robustness Analysis . . . . .	29
<b>2.2 Fixed-Order <math>\mathcal{H}_\infty</math>-Controller Design</b> . . . . .	<b>31</b>
2.2.1 Ankelhed Method . . . . .	32
2.2.1.1 Problem Formulation . . . . .	32
2.2.1.2 $X$ and $Y$ Searching . . . . .	35
2.2.1.3 Recovering the matrix $X_a$ from $X$ and $Y$ . . . . .	39
2.2.1.4 Obtaining the Controller . . . . .	40
2.2.1.5 A General Algorithm for $\mathcal{H}_\infty$ -synthesis . . . . .	40
2.2.2 Apkarian Method [Apkarian et al., 2003] . . . . .	41
2.2.2.1 Problem Formulation . . . . .	41
2.2.2.2 $X_a$ and $Y_a$ Searching . . . . .	42
2.2.3 Summary and Relationship between Methods . . . . .	45
<b>2.3 LPV-Robust Control Design</b> . . . . .	<b>46</b>
2.3.1 LPV-Stability . . . . .	46
2.3.1.1 Quadratic Stability . . . . .	47
2.3.1.2 Robust Stability . . . . .	48
2.3.1.3 Stability of LPV-systems in LFT-Form . . . . .	49
2.3.2 $\mathcal{H}_\infty$ -LPV-synthesis . . . . .	50
<b>Conclusion</b> . . . . .	<b>52</b>

## Introduction

Robustness notion plays an essential role in system and control theory nowadays. The emergence of this notion is basically motivated by the huge demand on performance for new control laws. Optimisation approaches based on  $\mathcal{H}_\infty$  and  $\mathcal{H}_2$  theory appear of a big importance to fit the increasing specified requirements.  $\mathcal{H}_\infty$ -controllers are knowing a big raise last twenty years whether in theoretical development or in practical issue. In addition, the plant dynamics may vary to such an level that a single linear model proves insufficient to capture the essential features of the plant. Then, a series of models describing the plant behaviour at a number of operating points is required. Thus,  $\mathcal{H}_\infty$ -controllers based on LPV-models appeared and seem to be of a great interest. Nevertheless, the controllers stabilising complex models and achieving a specified high performance are generally at least as complex as the model itself. The complexity of the obtained high-order controllers restricts their real-time operation in embedded systems and increases their implementation costs. In fact, low-order controller requires less complicated and more easy available hardware to understand, to maintain and to implement in the real world. In this chapter, the  $\mathcal{H}_\infty$ -control theory is introduced for LTI-systems first. Indeed, after introducing the stability conditions, the LTI- $\mathcal{H}_\infty$ -control design problem is formulated. Then, a survey about the existing methods to design an  $\mathcal{H}_\infty$ -controller is given. Then-after, the  $\mathcal{H}_\infty$  problem is reviewed to design fixed-order controllers in Section 2.2. The extension to the LPV-case is then developed in Section 2.3 and a special interest is allocated to the polytopic models.

## 2.1 $\mathcal{H}_\infty$ -LTI-Control Design

### 2.1.1 LTI-Systems Stability

Stability notion is fundamental for dynamical systems analysis in control theory. At first sight this concept seems to be natural. However, closer examination shows that a multitude of definitions can be given to stability [Lyapunov, 1992, Khalil, 2000, Desoer and Vidyasagar, 2009]. In this Section, a no-exhaustive overview on the question is given. In fact, for stability analysis, there are two fundamental theorems. The first one gives sufficient conditions for asymptotic (exponential) stability. The second one called the *small gain theorem* is the pillar of the input/output stability theory.

#### 2.1.1.1 Global Asymptotic Stability

**General Stability Results** Stability of general systems cannot be analysed by looking at the explicit solutions since they are, most of the time, difficult or even impossible to compute. Lyapunov theory allows to analyse stability implicitly from the expression of the dynamical system through the use of a Lyapunov function.

**Theorem 3: Lyapunov's Stability Theorem [Lyapunov, 1992, Khalil, 2000]**

Let us consider the general dynamical system

$$\begin{cases} \dot{x}(t) &= f(x(t)), \\ x(0) &= x_0, \end{cases} \quad \forall t > 0 \quad (2.1)$$

having  $x^* = 0$  as equilibrium point, i.e.  $f(x^*) = 0$ , let  $D \subset \mathbb{R}^n$  be a domain containing  $x^*$  and  $V: D \rightarrow \mathbb{R}$  be a continuously differentiable function such that

$$\begin{cases} V(x^*) &= 0, \\ V(x) &> 0 \text{ in } D \setminus \{x^*\}, \\ \dot{V}(x) &\leq 0 \text{ in } D. \end{cases} \quad (2.2)$$

Then,  $x^*$  is a stable equilibrium point and  $V$  is called a Lyapunov function for (2.1). Moreover, if

$$\dot{V}(x) < 0 \text{ in } D \setminus \{x^*\} \quad (2.3)$$

then  $x^*$  is an asymptotically stable equilibrium.

**LTI-Systems Case** Whenever LTI-systems are considered, The stability analysis become easier. In fact, necessary and sufficient Lyapunov conditions for stability can be easily stated

**Theorem 4: [Briat, 2015]**

Let us consider the LTI-system  $\Sigma$  with the state-space representation (1.20). Then, the following statements are equivalent

- The system (1.20) is globally asymptotically stable.
- The system (1.20) is globally exponentially stable.
- The matrix  $A$  is Hurwitz, i.e.  $\Re(\lambda_i(A)) < 0$ .
- There exists a matrix  $P \in \mathbb{S}_{>0}^n$  such that the Lyapunov inequality

$$A^\top P + PA \prec 0, \quad (2.4)$$

holds.

- There exist matrices  $P, Q \in \mathbb{S}_{>0}^n$  such that the Lyapunov equation

$$A^\top P + PA + Q = 0, \quad (2.5)$$

holds.

### 2.1.1.2 Input-Output Stability

If you ask anyone to give his own definition of stability, there is a big chance to have this answer: A system is stable if the output signal energy remains bounded for a bounded input signal energy. Mathematically speaking, this approach was derived from the *Operator Theory* [Kato, 1990]. It is noted that first theoretical development on input-output stability notion are relatively recent [Desoer and Vidyasagar, 2009]. In [Vidyasagar, 2002, Chapter 6], a synthetic view about input-output stability is given. Unfortunately, there is no general result that allow a direct input-output stability analysis, except if all system trajectories are computed (Lyapunov approach). Then, this approach is complementary to the previous one and the aim is to make easier the stability analysis of the interconnected systems. Thus, the *Small Gain Theorem* is given as follows

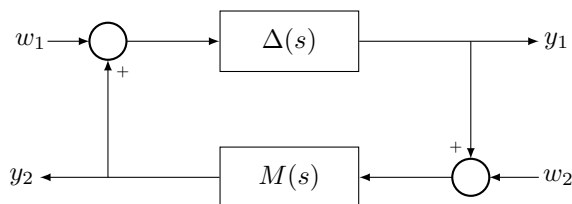

Figure 2.1: Closed-loop for Stability Analysis

#### Theorem 5: Small Gain Theorem [Zhou et al., 1996]

Suppose  $M \in \mathcal{RH}_\infty$  (i.e. with  $M$  a stable transfer matrix) and let  $\gamma > 0$ . Then, the interconnected system shown in Figure 2.1 is well-posed and internally stable for all  $\Delta \in \mathcal{RH}_\infty$  (i.e. stable transfer matrix) with  $\|\Delta\|_\infty < 1/\gamma$  if and only if  $\|M\|_\infty < \gamma$ .

A typical application of this theorem is when considering  $M$  like a known transfer function and  $\Delta$  as a unknown transfer function. Then, small gain theorem is classically used to derive conditions for *Robust Stability* with respect to the uncertainty models (represented by  $\Delta$ ).

2.1.2  $\mathcal{H}_\infty$ -LTI-Synthesis2.1.2.1  $\mathcal{H}_\infty$ -problem Formulation

In control theory, new methodologies in control theory focus on the research of a controller that guarantee both closed-loop stability and performance. Then, such control problem can be formulated under the LFT-scheme in Figure 2.2.

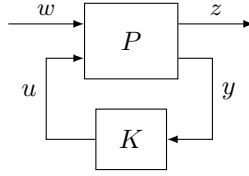

Figure 2.2: Lower-LFT for Closed-loop System

where  $P$  is the transfer function between input vector (exogenous and control signals) and output vector (controlled and measured outputs).

$$\begin{bmatrix} Z \\ Y \end{bmatrix} = \begin{bmatrix} P_{11} & P_{12} \\ P_{21} & P_{22} \end{bmatrix} \begin{bmatrix} W \\ U \end{bmatrix}. \quad (2.6)$$

Then, the goal is to find a controller  $K$  that compensate the influence of exogenous inputs  $w$  on the controlled outputs  $z$  through the information given by the measured signals  $y$ . This objective is achieved when the closed-loop norm of the transfer from  $w$  to  $z$  namely  $T_{zw}$  is minimised. From a mathematical point of view,  $\mathcal{H}_\infty$ -suboptimal problem is to find a controller  $K$  that stabilise the closed-loop system internally and guarantee

$$\|T_{zw}\|_\infty < \gamma. \quad (2.7)$$

where  $\gamma$  is pre-set attenuation level and  $T_{zw}$  is given according to (1.7) as

$$\begin{aligned} T_{zw}(s) &= \mathcal{F}_\ell(P, K)(s) \\ &= P_{11}(s) + P_{12}(s)K(I - P_{22}(s)K(s))^{-1}P_{21}(s). \end{aligned} \quad (2.8)$$

The optimal  $\mathcal{H}_\infty$ -problem corresponds to the minimisation of  $\gamma$ . This minimal value  $\gamma_{\text{opt}}$  can be approximated by dichotomic search algorithm.

In practice, the plant  $P$  consists of the system transfer function  $G$  and weighting functions  $W_i$  and  $W_o$  associated the exogenous input  $w$  and the controlled output  $z$  respectively as shown in Figure 2.3. These weighting functions allow to emphasise some transfers in certain frequency ranges. Then, several frequency templates can be defined as the inverse of the weighting functions. Thus, required performance like disturbance or noise rejection can be expressed threwh  $W_i$  and  $W_o$ .

It is well known that the major drawback of the  $\mathcal{H}_\infty$ -control design is the order of

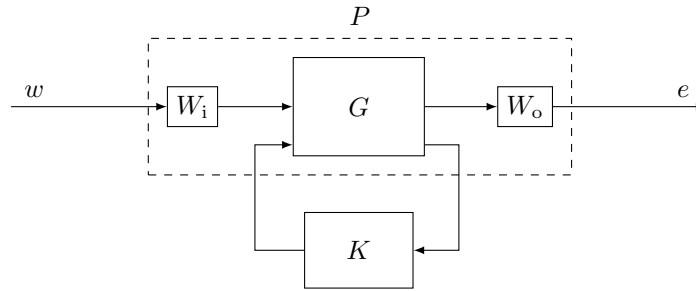

Figure 2.3: Augmented System

obtained controllers which is typically at least of the same order as the plant. Next section presents a solution to the  $\mathcal{H}_\infty$ -problem based on Riccati equations.

### 2.1.2.2 $\mathcal{H}_\infty$ -problem Resolution

Various methods are developed to solve the standard  $\mathcal{H}_\infty$ -control design problem. Among them, two methods are widely used: the first one is based on the resolution of two Riccati equations. The second one deals with some Linear Matrix Inequalities LMIs.

**Riccati-based Solution** One of the common tool to resolve this  $\mathcal{H}_\infty$ -problem is based on the resolution of Riccati equations. Suppose  $K$  is an  $n_K$ -th order controller which stabilises the closed-loop system and the  $n$ -th order generalised plant  $P$  is given by

$$P = \begin{bmatrix} P_{11} & P_{12} \\ P_{21} & P_{22} \end{bmatrix} \stackrel{s}{=} \left[ \begin{array}{c|cc} A & B_1 & B_2 \\ \hline C_1 & D_{11} & D_{12} \\ C_2 & D_{21} & D_{22} \end{array} \right]. \quad (2.9)$$

where  $A \in \mathbb{R}^{n \times n}$ ,  $B_1 \in \mathbb{R}^{n \times n_w}$ ,  $B_2 \in \mathbb{R}^{n \times n_u}$ ,  $C_1 \in \mathbb{R}^{n_z \times n}$ ,  $C_2 \in \mathbb{R}^{n_y \times n}$ ,  $D_{11} \in \mathbb{R}^{n_z \times n_w}$ ,  $D_{12} \in \mathbb{R}^{n_z \times n_u}$ ,  $D_{21} \in \mathbb{R}^{n_y \times n_w}$  and  $D_{22} \in \mathbb{R}^{n_y \times n_u}$ .

The following assumptions are made

- A1:  $(A, B_2)$  is stabilisable and  $(C_2, A)$  is detectable.
- A2:  $D_{12}$  has full column rank and  $D_{21}$  has full row rank.
- A3:  $\begin{bmatrix} A - j\omega I_n & B_2 \\ C_1 & D_{12} \end{bmatrix}$  has full column rank for all  $\omega \in \mathbb{R}$ .
- A4:  $\begin{bmatrix} A - j\omega I_n & B_1 \\ C_2 & D_{21} \end{bmatrix}$  has full row rank for all  $\omega \in \mathbb{R}$ .

$T_{zw}$  is the transfer function from  $w$  to  $z$ , defined as (2.8). According the Youla parametrisation theory [Youla et al., 1976, Vidyasagar, 1985], all rational internally stabilising controllers  $K$  satisfying  $\|\mathcal{F}_\ell(P, K)\|_\infty < \gamma$  are given by  $K(s) = \mathcal{F}_\ell(M_\infty, Q)(s)$  for arbitrary  $Q \in \mathcal{RH}_\infty$  such that  $\|Q\|_\infty < \gamma$ , where

$$M_\infty = \begin{bmatrix} M_{11} & M_{12} \\ M_{21} & M_{22} \end{bmatrix} \stackrel{s}{=} \left[ \begin{array}{c|cc} \hat{A} & \hat{B}_1 & \hat{B}_2 \\ \hline \hat{C}_1 & \hat{D}_{11} & \hat{D}_{12} \\ \hat{C}_2 & \hat{D}_{21} & \hat{D}_{22} \end{array} \right].$$

All relevant parameters  $(\hat{A}, \hat{B}_1, \hat{B}_2, \hat{C}_1, \hat{C}_2, \hat{D}_{11}, \hat{D}_{12}, \hat{D}_{21}, \hat{D}_{22})$  can be found in [Zhou et al., 1996]. For a simple case, where

$$G = \begin{bmatrix} G_{11} & G_{12} \\ G_{21} & G_{22} \end{bmatrix} \stackrel{s}{=} \left[ \begin{array}{c|cc} A & B_1 & B_2 \\ \hline C_1 & 0 & D_{12} \\ C_2 & D_{21} & 0 \end{array} \right].$$

The  $\mathcal{H}_\infty$ -solution involves the following two Hamiltonian matrices:

$$\mathcal{H}_\infty = \begin{bmatrix} A & \gamma^{-2}B_1B_1^\top - B_2B_2^\top \\ -C_1^\top C_1 & -A^\top \end{bmatrix}, \quad \mathcal{J}_\infty = \begin{bmatrix} A^\top & \gamma^{-2}C_1^\top C_1 - C_2^\top C_2 \\ -B_1B_1^\top & -A \end{bmatrix}.$$

**Theorem 6:** [Glover and Doyle, 1988, Zhou et al., 1996]

There exists an admissible controller such that  $\|T_{zw}(s)\| < \gamma$  iff the following three conditions hold

- $\mathcal{H}_\infty \in \text{dom}(\text{Ric})$  and  $X_\infty = \text{Ric}(\mathcal{H}_\infty) \succ 0$ .
- $\mathcal{J}_\infty \in \text{dom}(\text{Ric})$  and  $Y_\infty = \text{Ric}(\mathcal{J}_\infty) \succ 0$ .
- $\rho(X_\infty Y_\infty) < \gamma^2$ .

Moreover, when these conditions hold, one such controller is

$$K \stackrel{s}{=} \left[ \begin{array}{c|c} A_\infty & -Z_\infty L_\infty \\ \hline F_\infty & 0 \end{array} \right] \quad (2.10)$$

where

$$\begin{aligned} A_\infty &= A + \gamma^{-2}B_1B_1^\top X_\infty + B_2F_\infty + Z_\infty L_\infty C_2, \\ F_\infty &= -B_2^\top X_\infty, \\ L_\infty &= -Y_\infty C_2^\top, \\ Z_\infty &= (I - \gamma^2 Y_\infty X_\infty)^{-1}. \end{aligned}$$

Furthermore, the set of all admissible controllers such that  $\|T_{zw}\|$  is given by  $M_\infty$



such that

$$M_\infty = \begin{bmatrix} M_{11} & M_{12} \\ M_{21} & M_{22} \end{bmatrix} \stackrel{s}{=} \left[ \begin{array}{c|cc} A_\infty & -Z_\infty L_\infty & Z_\infty B_2 \\ \hline F_\infty & 0 & I_{n_u} \\ -C_2 & I_{n_y} & 0 \end{array} \right] \quad (2.11)$$

That is,

$$\begin{aligned} K &= \mathcal{F}_\ell(M_\infty, Q) \\ &= M_{11} + M_{12}Q(I - M_{22}Q)^{-1}M_{21}, \end{aligned} \quad (2.12)$$

where  $Q \in \mathcal{RH}_\infty$  and  $\|Q\|_\infty \leq \gamma$ .

Generally speaking,  $Q$  can be chosen to satisfy additional performance objectives. However, how to find such  $Q$  is a challenging problem and still an active research topic. In most cases,  $Q = 0$  is chosen resulting in the so-called central  $\mathcal{H}_\infty$ -controller  $K_c = \mathcal{F}_\ell(M_\infty, 0) = M_{11}$ .

**LMI-based Solution** Alternative to the Riccati-based solution for the  $\mathcal{H}_\infty$ -control problem is the LMI-based approach. In fact, necessary and sufficient conditions for the existence of admissible controllers is expressed in terms of LMIs. Consequently, Assumptions (A2) to (A4) may be omitted. Then, an advantage of this framework is that no rank assumptions are required on  $D_{12}$  and  $D_{21}$  and hence singular problems may be solved using the same machinery.

Furthermore, for the  $\mathcal{H}_\infty$ -optimal problem,  $\gamma_{\text{opt}}$  can be found directly without iterative procedure like in Riccati-based solution.

**Theorem 7: [Gahinet, 1994, Gahinet and Apkarian, 1993]**

Consider the plant of equation (2.9) and make assumption (A1) (Section 2.1.2.2), and let  $\mathcal{N}_R$  and  $\mathcal{N}_S$  denote orthonormal bases of the null spaces of  $(B_2^\top, D_{12}^\top)$  and  $(C_2, D_{21})$  respectively.

There exists a solution to the  $\mathcal{H}_\infty$ -problem if and only if there exist symmetric matrices  $R$  and  $S$  satisfying the following system of LMIs

$$\left[ \begin{array}{c|c} \mathcal{N}_R^\top & 0 \\ \hline 0 & I_{n_w} \end{array} \right] \left[ \begin{array}{cc|c} AR + RA^\top & RC_1^\top & B_1 \\ C_1 R & -\gamma I_{n_z} & D_{11} \\ \hline B_1^\top & D_{11}^\top & -\gamma I_{n_w} \end{array} \right] \left[ \begin{array}{c|c} \mathcal{N}_R & 0 \\ \hline 0 & I_{n_w} \end{array} \right] \prec 0 \quad (2.13)$$

$$\begin{bmatrix} \mathcal{N}_S^\top & 0 \\ 0 & I_{n_z} \end{bmatrix} \left[ \begin{array}{cc|c} AS + SA^\top & SB_1 & C_1^\top \\ B_1^\top S & -\gamma I_{n_w} & D_{11}^\top \\ \hline C_1 & D_{11} & -\gamma I_{n_z} \end{array} \right] \begin{bmatrix} \mathcal{N}_S & 0 \\ 0 & I_{n_z} \end{bmatrix} \prec 0 \quad (2.14)$$

$$\begin{bmatrix} R & I_n \\ I_n & S \end{bmatrix} \succeq 0 \quad (2.15)$$

For a given  $\gamma$ , equations (2.13) to (2.15) are affine in  $R$  and  $S$ , and the set of pairs  $R$  and  $S$  is convex. Methods to construct an admissible  $\mathcal{H}_\infty$ -controller  $K$  given feasible  $R$  and  $S$  can be found in [Gahinet and Apkarian, 1993, Gahinet, 1994].

### 2.1.3 Robustness Analysis

Robustness analysis aims at providing an accurate sensitivity estimation of the several input/output transfers to the variability on the parameters. Various tools can be used to make this analysis. In this study,  $\mu$ -analysis [Zhou and Doyle, 1998, Skogestad and Postlethwaite, 2005] is chosen to study the robustness via the measurement of the *structured singular value*  $\mu$ .

On control design, the main property to check on a closed-loop system is the closed-loop stability. The goal is to keep this stability although the presence of uncertainties on parameters (due to neglected dynamics, ill-identification ...) and is called the *Robust Stability (RS)*. The stability robustness is analysed by measuring the lowest uncertainty that destabilises the system.

The performance of the nominal closed-loop system could also be analysed through the  $\mu$  measurement by neglecting the uncertainties when evaluating  $\mu$ . Then, the margins of the *Nominal Performance (NP)* are obtained.

Finally, the *Robust Performance (RP)* are analysed to check if the system satisfies the performance specifications for the perturbed plant.

Let the transfer matrix  $N$  partitioned as follow (Figure 2.4 ):

$$N = \begin{bmatrix} N_{zv} & N_{zw} \\ N_{ev} & N_{ew} \end{bmatrix}$$

where  $w$  and  $e$  are the exogenous input and the controlled output respectively.  $\Delta_r$  is the uncertain matrix that could contain the model uncertainties, parametric uncertainties, gain uncertainties, phase shifting or the delay on the inputs/outputs of the nominal system.

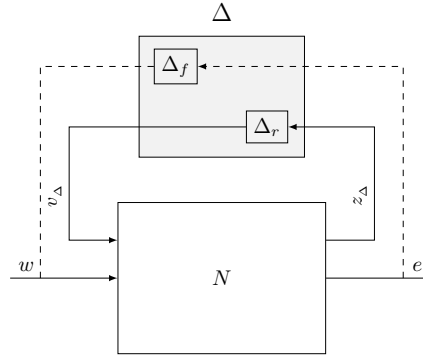

Figure 2.4: LFT of the uncertain model

$\Delta_f$  is a fictive uncertain block that relays the controlled outputs to the exogenous inputs.

Then, the closed loop transfer matrix is:

$$T_{ew} = N_{ew} + N_{ew}\Delta(I - N_{zv})^{-1}N_{zw} \quad (2.16)$$

As we consider structured uncertainties, a  $\mu$ -analysis step is performed to study the robustness:

$N_{ew}$  is the nominal closed-loop transfer matrix. It is used to analyse the *NP* of the system. Note that if  $N_{ew}$  is stable, the instability in (2.16) may only come from  $(I - N_{zv})^{-1}N_{zw}$ . Then, the  $N_{zv}$  is analysed to study the *RS*. By the way, the *RP* is analysed by evaluating the whole  $N$  block.

Consider the set of matrices:  $\underline{\Delta}$  that have the same structure as  $\Delta$  and defined as:

$$\underline{\Delta} : \{\Delta = \text{diag}(\Delta_1, \dots, \Delta_q, \delta_1 I_{r_1}, \dots, \delta_r I_{r_r}, \varepsilon_1 I_{c_1}, \dots, \varepsilon_c I_{c_c})\}$$

where:  $\Delta \in \mathbb{C}^{k \times k}$ ,  $\Delta_i \in \mathbb{C}^{k_i \times k_i}$ ,  $\delta \in \mathbb{R}$ ,  $\varepsilon_i \in \mathbb{C}$ .

Then, the *structured singular value*  $\mu$  of  $N$  through the set  $\underline{\Delta}$  is defined as:

$$\mu_{\underline{\Delta}}(N) = \left( \inf_{\Delta \in \underline{\Delta}} \{\bar{\sigma}(\Delta), \det(I - \Delta N) = 0\} \right)^{-1}$$

**Theorem 8: [Skogestad and Postlethwaite, 2005]**

Assume that the nominal system  $N_{ew}$  and the perturbations  $\Delta$  are stable. Then, the feedback system is stable for all allowed perturbations  $\Delta$  such that

$\|\Delta\|_\infty < 1/\bar{\mu}$  if and only if:

$$\forall \omega \in \mathbb{R}, \mu_{\underline{\Delta}}(N_{zv}(j\omega)) \leq \bar{\mu}$$

For all perturbations, the following rules should be verified  $\forall \omega$ :

$$\begin{aligned} \text{NP} &\iff \bar{\sigma}(N_{ew}(j\omega)) = \mu_{\underline{\Delta}_f}(N_{ew}(j\omega)) < 1 \\ \text{RS} &\iff \bar{\sigma}(N_{zv}(j\omega)) = \mu_{\underline{\Delta}_r}(N_{zv}(j\omega)) < 1 \\ \text{RP} &\iff \bar{\sigma}(N(j\omega)) = \mu_{\underline{\Delta}}(N(j\omega)) < 1 \end{aligned} \quad (2.17)$$

In practice, the structured singular value cannot be calculated explicitly, so that the method consists in finding an upper bound and a lower bound, as closed as possible to  $\mu$ :

$$\mu_{\underline{\Delta}}(N(j\omega)) \in [\mu_{\underline{\Delta}}^{\text{lb}}(N(j\omega)); \mu_{\underline{\Delta}}^{\text{ub}}(N(j\omega))]$$

$\mu_{\underline{\Delta}}^{\text{lb}}(N(j\omega))$ :  $\mu$ -lower bound,

$\mu_{\underline{\Delta}}^{\text{ub}}(N(j\omega))$ :  $\mu$ -upper bound.

## 2.2 Fixed-Order $\mathcal{H}_\infty$ -Controller Design

The  $\mathcal{H}_\infty$ -synthesis is an important tool in robust control design. First techniques are based on solving Riccati equations [Boyd et al., 1994]. Since that, the robust design tools became much easier to use and gained popularity. Thereafter, LMIs were found to be a suitable tool for solving these kinds of problems by using reformulations of the Riccati equations [Gahinet and Apkarian, 1994]. The high requirements for robustness and for disturbance rejection in control design, result controllers of very high order, which complicates implementation. To overcome this drawback, constraint on the maximum order of the controller is set to be lower than the order of the plant. However, the problem is no longer convex and it is then relatively hard to solve. This motivates the development of efficient algorithms that can solve these kinds of problems.

First, let  $P$  be the plant introduced in (2.9) and define  $K$  the linear  $\mathcal{H}_\infty$ -controller denoted by

$$K : \begin{cases} \dot{x}_K(t) &= A_K x_K(t) + B_K y(t) \\ u(t) &= C_K x_K(t) + D_K y(t) \end{cases} \quad \forall t \geq 0, \quad (2.18)$$

where  $x_K(t) \in \mathbb{R}^{n_K}$  is the state vector of the controller. The state-space realisation  $K$  is given as

$$K(s) = D_K + C_K(sI - A_K)^{-1}B_K, \quad (2.19)$$

with  $A_K \in \mathbb{R}^{n_K \times n_K}$ ,  $B_K \in \mathbb{R}^{n_K \times n_y}$ ,  $C_K \in \mathbb{R}^{n_u \times n_K}$ ,  $D_K \in \mathbb{R}^{n_u \times n_y}$ . Then, a (not necessarily minimal) realisation of the closed-loop transfer function from  $w$  to  $z$  is

obtained as (Figure 2.2)

$$T_{zw}(s) = D_{\text{CL}} + C_{\text{CL}}(sI - A_{\text{CL}})^{-1}B_{\text{CL}}, \quad (2.20)$$

where

$$\begin{aligned} A_{\text{CL}} &= \begin{bmatrix} A + B_2 D_K C_2 & B_2 C_K \\ B_K C_2 & A_K \end{bmatrix}, & B_{\text{CL}} &= \begin{bmatrix} B_1 + B_2 D_K D_{21} \\ B_K D_{21} \end{bmatrix}, \\ C_{\text{CL}} &= \begin{bmatrix} C_1 + D_{12} D_K C_2 & D_{12} C_K \end{bmatrix}, & D_{\text{CL}} &= D_{11} + D_{12} D_K D_{21}. \end{aligned}$$

Let define  $\Theta$ , a matrix that contains all controller parameters

$$\Theta = \begin{bmatrix} A_K & B_K \\ C_K & D_K \end{bmatrix} \in \mathbb{R}^{(n_K+n_u) \times (n_K+n_y)}. \quad (2.21)$$

Before introducing the way to design a fixed order controller, the following lemma is useful for afterwards.

**Lemma 3: [Gahinet and Apkarian, 1994]**

Given a symmetric matrix  $\psi \in \mathbb{S}^M$  and two matrices  $\mathcal{P}$  and  $\mathcal{Q}$  composed of  $M$  columns, consider the problem of finding some matrix  $Z$  of compatible dimensions such that

$$\psi + \mathcal{P}^\top Z^\top \mathcal{Q} + \mathcal{Q}^\top Z \mathcal{P} \prec 0 \quad (2.22)$$

Denote by  $W_{\mathcal{P}}$ ,  $W_{\mathcal{Q}}$  any matrices whose columns form bases of the null spaces of  $\mathcal{P}$  and  $\mathcal{Q}$  respectively, i.e.  $W_{\mathcal{P}} = \mathcal{P}_\perp$  and  $W_{\mathcal{Q}} = \mathcal{Q}_\perp$  respectively. Then, (2.22) is solvable for  $Z$  if and only if

$$\begin{cases} W_{\mathcal{P}}^\top \psi W_{\mathcal{P}} \prec 0 \\ W_{\mathcal{Q}}^\top \psi W_{\mathcal{Q}} \prec 0 \end{cases} \quad (2.23)$$

## 2.2.1 Ankelhed Method

The approach proposed by Ankelhed is based on formulating the constraint on the maximum order of the controller as a polynomial (or rational) equation. The problem is then solved by reformulating it as an optimisation problem using a minimisation algorithm.

### 2.2.1.1 Problem Formulation

Let the matrix  $X_a \in \mathbb{S}^{n+n_K}$  and its inverse be partitioned as

$$X_a = \begin{bmatrix} X & X_2 \\ X_2^\top & X_3 \end{bmatrix}, \text{ and } X_a^{-1} = \begin{bmatrix} Y & Y_2 \\ Y_2^\top & Y_3 \end{bmatrix} \quad (2.24)$$

where  $X, Y \in \mathbb{S}_{>0}^n$ . Then, insert  $X_a$  and the closed loop system matrices  $A_{\text{CL}}, B_{\text{CL}}, C_{\text{CL}}, D_{\text{CL}}$  into the inequality in (1.34). After some rearrangements we get the following matrix inequality.

$$\begin{aligned}
 & \underbrace{\begin{bmatrix} XA + A^\top X & A^\top X_2 & XB_1^\top & C_1^\top \\ X_2^\top A & 0 & X_2^\top B_1 & 0 \\ B_1^\top X & B_1^\top X_2 & -\gamma I_{n_z} & D_{11}^\top \\ C_1 & 0 & D_{11} & -\gamma I_{n_w} \end{bmatrix}}_{\Psi_{X_a}} \\
 & + \underbrace{\begin{bmatrix} XB_2 & X_2 \\ X_2^\top B_2 & X_3 \\ 0 & 0 \\ D_{12} & 0 \end{bmatrix}}_P \underbrace{\begin{bmatrix} D_K & C_K \\ B_K & A_K \end{bmatrix}}_F \underbrace{\begin{bmatrix} C_2 & 0 & D_{21} & 0 \\ 0 & I_{n_K} & 0 & 0 \end{bmatrix}}_{Q^\top} \\
 & + \underbrace{\begin{bmatrix} C_2 & 0 & D_{21} & 0 \\ 0 & I_{n_K} & 0 & 0 \end{bmatrix}}_Q \underbrace{\begin{bmatrix} D_K & C_K \\ B_K & A_K \end{bmatrix}}_{F^\top} \underbrace{\begin{bmatrix} XB_2 & X_2 \\ X_2^\top B_2 & X_3 \\ 0 & 0 \\ D_{12} & 0 \end{bmatrix}}_{P^\top} \prec 0
 \end{aligned} \tag{2.25}$$

The matrix inequality in (2.25) is bilinear in the controller variables,  $A_K, B_K, C_K, D_K$  and the matrices  $X, X_2, X_3$ . Then, in order to apply Lemma 3, the orthogonal complements  $W_P$  and  $W_Q$  need to be derived from  $P$  and  $Q$  respectively. Note that  $P$  in (2.25) can be factorised as

$$P = \begin{bmatrix} XB_2 & X_2 \\ X_2^\top B_2 & X_3 \\ 0 & 0 \\ D_{12} & 0 \end{bmatrix} = \left[ \begin{array}{c|c} X_a & 0 \\ \hline 0 & I_{(n_w+n_z)} \end{array} \right] \begin{bmatrix} B_2 & 0 \\ 0 & I_{n_K} \\ 0 & 0 \\ D_{12} & 0 \end{bmatrix} \tag{2.26}$$

and an orthogonal complement  $W_P$  can now be constructed as

$$W_P = \begin{bmatrix} B_2 & 0 \\ 0 & I_{n_K} \\ 0 & 0 \\ D_{21} & 0 \end{bmatrix} \perp \left[ \begin{array}{c|c} X_a^{-1} & 0 \\ \hline 0 & I_{(n_w+n_z)} \end{array} \right]. \tag{2.27}$$

Then, after some rearrangements, the inequality (2.25) is now equivalent to the two LMIs

$$\begin{bmatrix} \mathcal{N}_X^\top & \vdots & 0 \\ \hline 0 & \vdots & I_{n_w} \end{bmatrix} \begin{bmatrix} XA + A^\top X & XB_1 & \vdots & C_1^\top \\ B_1^\top X & -\gamma I_{n_z} & \vdots & D_{11}^\top \\ \hline C_1 & D_{11} & \vdots & -\gamma I_{n_w} \end{bmatrix} \begin{bmatrix} \mathcal{N}_X & \vdots & 0 \\ \hline 0 & \vdots & I_{n_w} \end{bmatrix} \prec 0, \tag{2.28a}$$

$$\begin{bmatrix} \mathcal{N}_Y^\top & 0 \\ 0 & I_{n_z} \end{bmatrix} \left[ \begin{array}{cc|c} AY + YA^\top & YC_1^\top & B_1 \\ C_1Y & -\gamma I_{n_w} & D_{11} \\ \hline B_1^\top & D_{11}^\top & -\gamma I_{n_z} \end{array} \right] \begin{bmatrix} \mathcal{N}_Y & 0 \\ 0 & I_{n_z} \end{bmatrix} \prec 0, \quad (2.28b)$$

where  $\mathcal{N}_X$  and  $\mathcal{N}_Y$  denote orthonormal bases of the null spaces of  $(C_2, D_{21})$  and  $(B_2^\top, D_{12}^\top)$  respectively. Now, the LMIs (2.28) are coupled by the relation of  $X$  and  $Y$  through (2.24), which can be simplified after using the following lemma.

**Lemma 4: [Packard, 1994]**

Suppose  $X, Y \in \mathbb{S}_{>0}^n$  and  $n_K$  being a nonnegative integer. Then, the following statements are equivalent

1. There exist  $X_2, Y_2 \in \mathbb{R}^{n \times n_K}$  and  $X_3, Y_3 \in \mathbb{R}^{n_K \times n_K}$  such that

$$X_a = \begin{bmatrix} X & X_2 \\ X_2^\top & X_3 \end{bmatrix}, \text{ and } X_a^{-1} = \begin{bmatrix} Y & Y_2 \\ Y_2^\top & Y_3 \end{bmatrix}. \quad (2.29)$$

2. The following inequalities hold.

$$\begin{bmatrix} X & I_n \\ I_n & Y \end{bmatrix} \succeq 0 \text{ and } \text{rank} \begin{bmatrix} X & I_n \\ I_n & Y \end{bmatrix} \leq n + n_K. \quad (2.30)$$

Finally, from all previous development, the solvability conditions for the  $\mathcal{H}_\infty$ -problem can be formulated as follows

**Lemma 5**

The problem of finding a linear controller such that the closed-loop system  $T_{zw}$  is stable and such that  $\|T_{zw}\|_\infty < \gamma$ , is solvable if and only if there exist positive defined matrices  $X, Y \in \mathbb{S}_{>0}^n$ , which satisfy

$$\begin{bmatrix} \mathcal{N}_X^\top & 0 \\ 0 & I_{n_w} \end{bmatrix} \left[ \begin{array}{cc|c} XA + A^\top X & XB_1 & C_1^\top \\ B_1^\top X & -\gamma I_{n_z} & D_{11}^\top \\ \hline C_1 & D_{11} & -\gamma I_{n_w} \end{array} \right] \begin{bmatrix} \mathcal{N}_X & 0 \\ 0 & I_{n_w} \end{bmatrix} \prec 0, \quad (2.31a)$$

$$\begin{bmatrix} \mathcal{N}_Y^\top & 0 \\ 0 & I_{n_z} \end{bmatrix} \left[ \begin{array}{cc|c} AY + YA^\top & YC_1^\top & B_1 \\ C_1Y & -\gamma I_{n_w} & D_{11} \\ \hline B_1^\top & D_{11}^\top & -\gamma I_{n_z} \end{array} \right] \begin{bmatrix} \mathcal{N}_Y & 0 \\ 0 & I_{n_z} \end{bmatrix} \prec 0, \quad (2.31b)$$

$$\begin{bmatrix} X & I_n \\ I_n & Y \end{bmatrix} \succeq 0, \quad (2.31c)$$

$$\text{rank}(XY - I_n) \leq n_K, \quad (2.31d)$$

where  $\mathcal{N}_Y$  and  $\mathcal{N}_X$  denote orthonormal bases of the null spaces of  $(B_2^\top, D_{12}^\top)$  and  $(C_2, D_{21})$  respectively

In this formulation, LMIs (2.31a),(2.31b) and (2.31c) replace assumptions **A1** to **A4** in Section 2.1.2.2 for  $\mathcal{H}_\infty$ -controller design. Finally the condition (2.31d) seems to allow the design of  $\mathcal{H}_\infty$ -controllers with lower order. Either the condition (2.31d) is easy to satisfy, however research of fixed-order controller is very difficult to resolve. Indeed, this constrain is not convex. and the problem is bilinear.

### 2.2.1.2 $X$ and $Y$ Searching

It could be desirable to replace the rank constraint in (2.31d) with a smooth function in order to be able to apply gradient methods for optimisation. To do that, the following lemma issued from Theorem 1 is used

#### Lemma 6: [Ankelhed, 2011]

Assume that the inequality

$$\begin{bmatrix} X & I_n \\ I_n & Y \end{bmatrix} \succeq 0 \quad (2.32)$$

holds. Let

$$\begin{aligned} \det(\lambda I - (I - XY)) &= \sum_{i=0}^n c_i(I - XY)\lambda_i \\ &= \lambda^n + c_{n-1}(I - XY)\lambda^{n-1} + \dots + c_1(I - XY)\lambda \\ &\quad + c_0(I - XY), \end{aligned} \quad (2.33)$$

be the characteristic polynomial of  $(I - XY)$  where the functions  $c_i(I - XY)$  are its coefficients. Then the following statements are equivalent if  $n_K < n$ :

1.  $\text{rank}(XY - I) \leq n_K$ .
2.  $c_{n-n_K-1}(I - XY) = 0$ .

Additionally, all coefficients are non-negative, i.e.

$$c_i(I - XY) \geq 0, \quad \forall i. \quad (2.34)$$



Combining Lemma 5 and Lemma 6, the resolvability conditions to find a  $n_K$ -order controller can be given in next theorem.

**Theorem 9: [Ankelhed, 2011]**

The problem of finding an  $\mathcal{H}_\infty$ -controller of order  $n_K < n$  such that the closed loop system  $T_{zw}$  is stable and  $\|T_{zw}\|_\infty < \gamma$  is equivalent to find  $X, Y \in \mathbb{S}_{>0}^n$  which satisfy

$$\begin{bmatrix} \mathcal{N}_X^\top & 0 \\ 0 & I_{n_w} \end{bmatrix} \begin{bmatrix} XA + A^\top X & XB_1 & C_1^\top \\ B_1^\top X & -\gamma I_{n_z} & D_{11}^\top \\ \hline C_1 & D_{11} & -\gamma I_{n_w} \end{bmatrix} \begin{bmatrix} \mathcal{N}_X & 0 \\ 0 & I_{n_w} \end{bmatrix} \prec 0 \quad (2.35a)$$

$$\begin{bmatrix} \mathcal{N}_Y^\top & 0 \\ 0 & I_{n_z} \end{bmatrix} \begin{bmatrix} AY + YA^\top & YC_1^\top & B_1 \\ C_1 Y & -\gamma I_{n_w} & D_{11} \\ \hline B_1^\top & D_{11}^\top & -\gamma I_{n_z} \end{bmatrix} \begin{bmatrix} \mathcal{N}_Y & 0 \\ 0 & I_{n_z} \end{bmatrix} \prec 0 \quad (2.35b)$$

$$\begin{bmatrix} X & I_n \\ I_n & Y \end{bmatrix} \succeq 0 \quad (2.35c)$$

$$\frac{c_{n-n_K-1}(XY - I)}{c_{n-n_K}(XY - I)} = 0 \quad (2.35d)$$

$$c_{n-n_K}(XY - I) \neq 0 \quad (2.35e)$$

Where columns of  $\mathcal{N}_X$  and  $\mathcal{N}_Y$  denote any bases of null spaces of  $(C_2, D_{21})$  and  $(B_2^\top, D_{12}^\top)$  respectively.

**Optimisation Problem** Conditions of Theorem 9 can be reformulated as an optimisation problem of a smooth function. It is recalled that the quotient in (2.35d) is positive if  $XY - I \succeq 0$ . Then, the problem of finding a low-order  $\mathcal{H}_\infty$ -controller can be stated as

$$\begin{aligned} & \text{minimise } \gamma \\ & \text{subject to } \mathbf{q}(X, Y) = 0, \text{ and} \\ & (\gamma, X, Y) \in \mathbb{X} \end{aligned} \quad (2.36)$$

where  $\mathbf{q}(X, Y) = \frac{c_{n-n_K-1}(-Z)}{c_{n-n_K}(-Z)}$ , and  $\mathbb{X}$  is the convex set defined by the LMIs in Theorem 9.

This problem can be formulated in order to be solved using a *Partial Augmented Lagrangian*. Then, the constraint is relaxed and added to the objective function as follows

$$\begin{aligned} & \text{minimise } \lambda + \lambda \mathbf{q}(X, Y) + \frac{\mu}{2} \mathbf{q}^2(X, Y). \\ & \text{subject to } (\gamma, X, Y) \in \mathbb{X}, \end{aligned} \quad (2.37)$$

where  $\lambda$  is a Lagrangian multiplier and  $\mu$  is a penalty multiplier. The augmented Lagrangian method was proposed independently by [Powell, 1969, Hestenes, 1969], this algorithm is well-known in the context of mathematical programming with classical equality and inequality constraints and has well-established convergence properties. The global convergence of this algorithm is proved in [Conn et al., 1991, Noll et al., 2004]. For this Lagrangian equation, the augmentation part is added *partially* by only the equality constraint while the LMIs remain unchanged in order to keep the structure of the problem. The solution to the original problem (2.36) is obtained by iteratively solving an approximation of (2.37) for a sequence of increasing values of  $\mu$ .

Remark

More details on augmented Lagrangian methods can be found in [Bertsekas, 1982, Nocedal and Wright, 2006].

Using notations  $\mathbf{x} = \begin{bmatrix} \text{vech}(X) \\ \text{vech}(Y) \\ \gamma \end{bmatrix}$  and  $\gamma = \mathbf{d}^\top \mathbf{x}$  where  $\mathbf{d}$  is denoted as  $\mathbf{d} = [0 \ \cdots \ 0 \ \cdots \ 0 \ 1]^\top$ , the optimisation problem (2.37) can be rewritten as

$$\begin{aligned} & \text{minimise } \Phi_{\mathbf{q}}(\mathbf{x}, \lambda, \mu) \\ & \text{subject to } \mathbf{x} \in \mathbb{X}, \end{aligned} \quad (2.38)$$

where

$$\Phi_{\mathbf{q}}(\mathbf{x}, \lambda, \mu) = \mathbf{d}^\top \mathbf{x} + \lambda \mathbf{q}(\mathbf{x}) + \frac{\mu}{2} \mathbf{q}^2(\mathbf{x}). \quad (2.39)$$

This reformulation of the original initial problem is also non-convex ( $\mathbf{q}$  is non-convex) and a resolution using a sequence of SDPs is not possible. However,  $\mathbb{X}$  is a convex set which make the problems less difficult to solve.

One possible approach to tackle this problem is to approximately solve (2.38) for a sequence of increasing values of  $\mu_k$  using Newton's method. However, since the optimisation problem in (2.38) still includes constraints, we must make sure that the next point also satisfies the constraints. Then, a *search direction* is computed as follows

**Search Direction Computation** One possible approach is to approximate the objective function  $\Phi_{\mathbf{q}}(\mathbf{x} + d\mathbf{x}, \lambda, \mu)$  by a quadratic function related to the three first terms in the Taylor series around the point  $\mathbf{x}$ . Similarly to what is done in regular Newton methods, we intend to find a step direction  $d\mathbf{x}$  that minimises this second order model, but the difference is that we also require that  $\mathbf{x} + d\mathbf{x} \in \mathbb{X}$ , i.e. that the next point also lies in the feasible set. This problem can be formulated as

$$\begin{aligned} & \arg \min_{d\mathbf{x}} \nabla_{\mathbf{x}} \Phi_{\mathbf{q}}(\mathbf{x}, \lambda, \mu)^\top d\mathbf{x} + \frac{1}{2} d\mathbf{x}^\top \mathbf{H}_\delta(\mathbf{x}, \lambda, \mu) d\mathbf{x} \\ & \text{subject to } \mathbf{x} + d\mathbf{x} \in \mathbb{X}. \end{aligned} \quad (2.40)$$

where  $\nabla_{\mathbf{x}}\Phi_{\mathbf{q}}(\mathbf{x}, \lambda, \mu)$  is the gradient of the objective function  $\Phi_{\mathbf{q}}(\mathbf{x}, \lambda, \mu)$ , and  $\mathbf{H}_\delta(\mathbf{x}, \lambda, \mu)$  is a positive definite approximation of the Hessian of the objective function.

Remark

From now, the problem (2.40) can be solved using Yalmip [Lofberg, 2004] with SDPT3 [Toh et al., 2001].

**Gradient and Hessian of the Objective Function  $\Phi_{\mathbf{q}}$**  [Ankelhed et al., 2011] in order to obtain the gradient and approximation of the Hessian of  $\Phi_{\mathbf{q}}$ , lets differentiate  $\Phi_{\mathbf{q}}(\mathbf{x}, \lambda, \mu)$  with respect to  $\mathbf{x}$ . Then,

$$\nabla_{\mathbf{x}}\Phi_{\mathbf{q}}(\mathbf{x}, \lambda, \mu) = \mathbf{d} + \lambda\nabla_{\mathbf{x}}\mathbf{q}(\mathbf{x}) + \mu\mathbf{q}(\mathbf{x})\nabla_{\mathbf{x}}\mathbf{q}(\mathbf{x})$$

$$\nabla_{\mathbf{xx}}\Phi_{\mathbf{q}}(\mathbf{x}, \lambda, \mu) = (\lambda + \mu\mathbf{q}(\mathbf{x}))\nabla_{\mathbf{xx}}^2\mathbf{q}(\mathbf{x}) + \mu\nabla_{\mathbf{x}}\mathbf{q}(\mathbf{x})\nabla_{\mathbf{x}}^T\mathbf{q}(\mathbf{x})$$

where the gradient  $\nabla_{\mathbf{x}}\mathbf{q}$  and Hessian  $\nabla_{\mathbf{xx}}^2\mathbf{q}$  of the quotient  $\mathbf{q}(\mathbf{x}) = \frac{c_{n-n_K-1}(\mathbf{x})}{c_{n-n_K}(\mathbf{x})}$  are given as follows

$$\begin{aligned}\nabla_{\mathbf{x}}\mathbf{q}(\mathbf{x}) &= \frac{1}{c_{n-n_K-1}}\nabla_{\mathbf{x}}c_{n-n_K-1} - \frac{c_{n-n_K-1}}{c_{n-n_K}^2}\nabla_{\mathbf{x}}c_{n-n_K} \\ \nabla_{\mathbf{xx}}^2\mathbf{q}(\mathbf{x}) &= \frac{1}{c_{n-n_K}}\nabla_{\mathbf{xx}}^2c_{n-n_K-1} - \frac{c_{n-n_K-1}}{c_{n-n_K}^2}\nabla_{\mathbf{xx}}^2c_{n-n_K} + \frac{2c_{n-n_K-1}}{c_{n-n_K}^3}(\nabla_{\mathbf{x}}c_{n-n_K}\nabla_{\mathbf{x}}^Tc_{n-n_K}) \\ &\quad - \frac{1}{c_{n-n_K}^2}(\nabla_{\mathbf{x}}c_{n-n_K-1}\nabla_{\mathbf{x}}^Tc_{n-n_K}) + (\nabla_{\mathbf{x}}c_{n-n_K}\nabla_{\mathbf{x}}^Tc_{n-n_K-1})\end{aligned}$$

Since the constraint function  $\mathbf{q}$  is non-convex, the Hessian is not always positive definite which in turn might lead to that  $\mathbf{H}(\mathbf{x}, \lambda, \mu) = \nabla_{\mathbf{xx}}\Phi_{\mathbf{q}}(\mathbf{x}, \lambda, \mu)$  is not necessarily positive definite, which has to be dealt with. Two common ways are to either use Newton methods in which the Hessian is convexified or to use Trust-region methods where the non-convexity is dealt with by optimising over a limited region in each iteration. The authors of [Apkarian et al., 2003] advice against using Trust-region methods since the complexity of such a method is too large in this case. Therefore, the Hessian  $\nabla_{\mathbf{xx}}\Phi_{\mathbf{q}}(\mathbf{x}, \lambda, \mu)$  could be convexified as follows.

**Hessian Modifications** [Ankelhed et al., 2011] One method which can be used to convexify the exact Hessian  $\nabla_{\mathbf{xx}}\Phi_{\mathbf{q}}(\mathbf{x}, \lambda, \mu)$  is a modified indefinite symmetric factorisation. To carry out this modification, the indefinite symmetric factorisation (LDL decomposition) is given as  $\nabla_{\mathbf{xx}}^{\text{GN}}\Phi_{\mathbf{q}} = P^TLDL^TP$ , where  $L$  is a lower triangular matrix,  $P$  is a permutation matrix and  $D$  is a block diagonal of size  $(1 \times 1)$  or  $(2 \times 2)$ . Then we construct the modification matrix  $D_m$  in order to ensure the positiveness of  $L(D + D_m)L^T$  by following these steps:

1. Compute the eigenvalue decomposition

$$D = Q\bar{D}Q^T. \quad (2.41)$$

2. Then, compute the modification matrix

$$D_m = QEQ^\top. \quad (2.42)$$

The matrix  $E$  is diagonal and is defined by

$$E_{ii} = \begin{cases} 0, & \text{if } \bar{D}_{ii} \geq \delta \\ \delta - \bar{D}_{ii}, & \text{if } \bar{D}_{ii} < \delta \end{cases} \quad i = 1, 2, \dots \quad (2.43)$$

where  $\delta = 10^{-4} \|\nabla_{\mathbf{x}\mathbf{x}}^2 \Phi_{\mathbf{q}}\|_\infty$ , and  $\|A\|_\infty$  denotes the largest row sum of  $A$ . With these notation the matrix  $D_m$  takes the minimal matrix in the Frobenius norm such that  $\delta \leq D + D_m$ .

Remark

1. For gradient and Hessian detailed computation, see Appendix A.1
2. The approach to compute  $X$  and  $Y$  can be summarised as Algorithm 4 in Appendix A.1

### 2.2.1.3 Recovering the matrix $X_a$ from $X$ and $Y$

Assume that we have found  $X, Y \in \mathbb{S}_{>0}^n$  that satisfy (2.31). We now wish to construct  $X_a$  such that 2.24 holds. First note the equality

$$\begin{aligned} X_a^{-1} &= \begin{bmatrix} Y & Y_2 \\ Y_2^\top & Y_3 \end{bmatrix} \\ &= \begin{bmatrix} (X - X_2 X_3^{-1} X_2^\top)^{-1} & -X^{-1} X_2 (X_3 - X_2^\top X^{-1} X_2)^{-1} \\ -X_3^{-1} X_2^\top (X - X_2 X_3^{-1} X_2^\top)^{-1} & (X_3 - X_2^\top X^{-1} X_2)^{-1} \end{bmatrix} \end{aligned} \quad (2.44)$$

which is verified by multiplying the expression in (2.44) by the matrix  $X_a = \begin{bmatrix} X & X_2 \\ X_2^\top & X_3 \end{bmatrix}$  from the left. Equalling the upper left blocks in (2.44), the following equality must hold.

$$X - Y^{-1} = X_2 X_3^{-1} X_2^\top. \quad (2.45)$$

Now we intend to find  $X_2 \in \mathbb{R}^{n \times n_K}$  and  $X_3 \in \mathbb{R}^{n_K \times n_K}$  that satisfy the equality in (2.45). Perform an upper Cholesky factorisation of  $X$  and  $Y$  such that  $X = R_X^\top R_X$  and  $Y = R_Y^\top R_Y$ . Then we have that

$$R_X^\top R_X - R_Y^{-1} R_Y^{-\top} = X_2 X_3^{-1} X_3^\top \quad (2.46)$$

which after multiplication by  $R_Y$  from the left and by  $R_Y^\top$  from the right becomes

$$R_Y R_X^\top R_X - I = R_Y X_2 X_3^{-1} X_3^\top R_Y^\top. \quad (2.47)$$

Then, use a singular value decomposition  $R_Y R_X^\top = U \Sigma V^\top$  to obtain

$$U(\Sigma^2 - I)U^\top = U\Gamma^2U^\top = R_Y X_2 X_3^{-1} X_3^\top R_Y^\top, \quad (2.48)$$

where

$$\Sigma = \begin{bmatrix} \Sigma_{n_K} & 0 \\ 0 & I_{n-n_K} \end{bmatrix}, \quad \Gamma^2 = \Sigma^2 - I_n, \quad \text{and} \quad \Gamma = \begin{bmatrix} \Gamma_{n_K} & 0 \\ 0 & 0 \end{bmatrix}.$$

Let  $T = \Sigma^{-1/2} V^\top R_X$  be the balancing transformation matrix, i.e.  $T^{-\top} X T^{-1} = T Y T^\top = \Sigma$ . Now we can choose

$$X_3 = \Sigma_{n_K} \quad \text{and} \quad X_2 = T^\top \begin{bmatrix} \Gamma_{n_K} \\ 0 \end{bmatrix},$$

which satisfy (2.24) and (2.48).

#### 2.2.1.4 Obtaining the Controller

In the previous section we recovered the matrix variable  $X_a$ . The controller state-space matrices  $A_K$ ,  $B_K$ ,  $C_K$  and  $D_K$  can be obtained by solving the following convex optimisation problem

$$\begin{aligned} & \underset{\beta, A_K, B_K, C_K, D_K}{\text{minimise}} && \beta \\ & \text{subject to} && \Psi_{x_a} + Q^\top F^\top P + P^\top F Q < \beta I. \end{aligned} \quad (2.49)$$

Note that the subject function is the left part of the inequality (2.25). The conditions that validate the solvability of the optimisation problem (2.49) are:

1. The  $\mathcal{H}_\infty$  norm of the closed-loop system must be less than  $\gamma$ ,  $\|T_{zw}\|_\infty < \gamma$  with  $\gamma > 0$ .
2. The value of  $\beta$  must be negative.

#### 2.2.1.5 A General Algorithm for $\mathcal{H}_\infty$ -synthesis

Now we summarise the contents of the proposed approach in an algorithm.

**Algorithm 1** Fixed-Order synthesis

Assume that  $n_K$  and system matrices  $A, B, C, D$  are given.

1. Find  $X, Y \in \mathbb{S}_{>0}^n$  that satisfy (2.31) using Algorithm 1.
2. Recover  $X_a$  from  $X$  and  $Y$  as described in Section 2.2.1.3
3. Solve (2.49) to get the controller system matrices  $A_K, B_K, C_K, D_K$ .

**2.2.2 Apkarian Method [Apkarian et al., 2003]**

The second method can be formulated as follows

**2.2.2.1 Problem Formulation**

Let us introduce

$$\begin{aligned} \hat{A} &= \begin{bmatrix} A & 0_{n_K} \\ 0_{n_K} & 0_{n_K} \end{bmatrix}, \quad \hat{B}_1 = \begin{bmatrix} B_1 \\ 0_{n_K \times n_w} \end{bmatrix}, \quad \hat{B}_2 = \begin{bmatrix} 0_{n \times n_K} & B_2 \\ I_{n_K} & 0_{n_K \times n_u} \end{bmatrix}, \\ \hat{C}_1 &= [C_1 \quad 0_{n_z \times n_K}], \quad \hat{C}_2 = \begin{bmatrix} 0_{n_K \times n} & I_{n_K} \\ C_2 & 0_{n_y \times n_K} \end{bmatrix}, \\ \hat{D}_{12} &= [0_{n_z \times n_K} \quad D_{12}], \quad \hat{D}_{21} = \begin{bmatrix} 0_{n_K \times n_w} \\ D_{21} \end{bmatrix}. \end{aligned} \quad (2.50)$$

Then, the closed-loop matrices  $A_{CL}, B_{CL}, C_{CL}, D_{CL}$  can be written as

$$\begin{aligned} A_{CL} &= \hat{A} + \hat{B}_2 \Theta \hat{C}_2, & B_{CL} &= \hat{B}_1 + \hat{B}_2 \Theta \hat{D}_{21}, \\ C_{CL} &= \hat{C}_1 + \hat{D}_{12} \Theta \hat{C}_2, & D_{CL} &= D_{11} + \hat{D}_{12} \Theta \hat{D}_{21}. \end{aligned} \quad (2.51)$$

Note that (2.50) involves only plant data and that  $A_{CL}, B_{CL}, C_{CL}, D_{CL}$  depend affinely on the controller data  $\Theta$  given in (2.21).

Combining Lemma 2, Lemma 1 and Lemma 3, the following necessary and sufficient conditions for the existence of  $\gamma$ -suboptimal controllers of order  $n_K$  are given.

**Theorem 10: [Gahinet and Apkarian, 1994]**

Consider a proper plant  $P$  of minimal realisation corresponding to the state-space equation (2.9) and assume that  $D_{22} = 0$  and  $(A, B_2, C_2)$  stabilisable and detectable. With the notation (2.50), define

$$P = \begin{bmatrix} \hat{B}_2^T & 0_{(n_K+n_u) \times n_w} & \hat{D}_{12}^T \end{bmatrix}; \quad Q = \begin{bmatrix} \hat{C}_2 & \hat{D}_{21} & 0_{(n_K+n_y) \times n_z} \end{bmatrix}, \quad (2.52)$$

and let  $W_P$  and  $W_Q$  be two matrices whose columns span the null spaces of  $P$  and

Q, respectively. There exists a set of controller of order  $n_K$  if and only if there exists some  $X_a \in \mathbb{S}_{>0}^{n+n_K}$  matrix such that

$$W_P^\top \Upsilon_{X_a} W_P \prec 0; \quad W_Q^\top \Upsilon_{X_a^{-1}} W_Q \prec 0 \quad (2.53)$$

where

$$\Upsilon_{X_a} = \begin{bmatrix} \hat{A}X_a + X_a\hat{A}^\top & X_a\hat{B}_1 & \hat{C}_1^\top \\ \hat{B}_1^\top X_a & -\gamma I_{n_w} & D_{11}^\top \\ \hat{C}_1 & D_{11} & -\gamma I_{n_z} \end{bmatrix}, \quad (2.54)$$

$$\Upsilon_{X_a^{-1}} = \begin{bmatrix} X_a^{-1}\hat{A}^\top + \hat{A}X_a^{-1} & \hat{B}_1 & X_a^{-1}\hat{C}_1^\top \\ \hat{B}_1^\top & -\gamma I_{n_w} & D_{11}^\top \\ \hat{C}_1 X_a^{-1} & D_{11} & -\gamma I_{n_z} \end{bmatrix}. \quad (2.55)$$

Based on the previous theorem, the problem of finding a fixed-order controller of order  $n_K$  is reduced to the following set of conditions: Find two positives definite matrices  $X_a$  and  $Y_a$  such that

$$W_P^\top \begin{bmatrix} \hat{A}X_a + X_a\hat{A}^\top & X_a\hat{B}_1 & \hat{C}_1^\top \\ \hat{B}_1^\top X_a & -\gamma I & D_{11}^\top \\ \hat{C}_1 & D_{11} & -\gamma I \end{bmatrix} W_P \prec 0, \quad (2.56a)$$

$$W_Q^\top \begin{bmatrix} Y_a\hat{A}^\top + \hat{A}Y_a & \hat{B}_1 & Y_a\hat{C}_1^\top \\ \hat{B}_1^\top & -\gamma I & D_{11}^\top \\ \hat{C}_1 Y_a & D_{11} & -\gamma I \end{bmatrix} W_Q \prec 0, \quad (2.56b)$$

$$\begin{bmatrix} X_a & I_{(n+n_K)} \\ I_{(n+n_K)} & Y_a \end{bmatrix} \succ 0. \quad (2.56c)$$

$$X_a Y_a - I_{(n+n_K)} = 0. \quad (2.56d)$$

Without loss of generality, this option helps stabilising algorithms [Apkarian et al., 2003]. Let  $\mathbb{X}_a$  denotes the convex set defined by the three LMIs (2.56a), (2.56b) and (2.56c). The relation (2.56d) is denoted by a non-convex set  $\bar{\mathbb{X}}_a$ .

### 2.2.2.2 $X_a$ and $Y_a$ Searching

To design a  $n_K$  fixed-order controller that stabilises the closed-loop system, we must find an approach to fix the non-convex constraint (2.56d). Using Definition 1.2.5, let us define a vector of decision variables that we search for solving the problem of fixed-order  $\mathcal{H}_\infty$ -controller defined by the set of convex and non-convex constraints  $\mathbb{X}_a, \bar{\mathbb{X}}_a$ :

$$\mathbf{x}_a = [ \text{vech}(X_a)^\top, \text{vech}(Y_a)^\top, \gamma ]^\top. \quad (2.57)$$

**Smooth Optimisation Problem** As mentioned in the previous section,  $\mathbb{X}_a$  represents a convex set which makes the problem somewhat less difficult to solve than a general non-convex problem. The non-convex constraint  $\bar{\mathbb{X}}_a$  given in (2.56d) contains a smooth function, so this yields the problem even more less difficult but is also non-convex. In order to convexify the problem of finding a controller of order  $n_K$ , it is sufficient to define an objective function to minimise. The original problem (2.56) which is formed by convex and non-convex constraints becomes a convex optimisation problem which can be reformulated as

$$\begin{aligned} & \text{minimise } \gamma \\ & \text{subject to } \mathbf{x}_a \in \mathbb{X}_a, \text{ and} \\ & X_a Y_a - I_{(n+n_K)} = 0. \end{aligned} \quad (2.58)$$

As explained in Section 2.2.1.2 and using the PAL, the problem in (2.58) can be reformulated as

$$\begin{aligned} & \underset{\mathbf{x}_a}{\text{minimise}} \Phi_{Ap}(\mathbf{x}_a, \lambda, \mu) \\ & \text{subject to } \mathbf{x}_a \in \mathbb{X}_a \end{aligned} \quad (2.59)$$

where  $\Phi_{Ap}(\mathbf{x}_a, \lambda, \mu)$  is the augmented Lagrangian function defined as

$$\Phi_{Ap}(\mathbf{x}_a, \lambda, \mu) = \gamma + \sum_{i,j} \lambda_{i,j} (X_a Y_a - I_{(n+n_K)})_{i,j} + \frac{\mu}{2} \sum_{i,j} [(X_a Y_a - I_{(n+n_K)})_{i,j}]^2. \quad (2.60)$$

in the matrix form, this objective function can be written as

$$\begin{aligned} \Phi_{Ap}(\mathbf{x}_a, \lambda, \mu) = & \gamma + \text{trace}(\lambda^\top (X_a Y_a - I_{(n+n_K)})) \\ & + \frac{\mu}{2} \text{trace}(X_a Y_a - I_{(n+n_K)})^\top (X_a Y_a - I_{(n+n_K)}) \end{aligned} \quad (2.61)$$

where  $\lambda$  is a Lagrange multiplier matrix and  $\mu$  is a positive penalty.

**Search Direction** As explained in Section 2.2.1.2, a search direction is computed and the problem is be formulated as

$$\begin{aligned} & \arg \min_{d\mathbf{x}} \nabla_{\mathbf{x}_a} \Phi_{Ap}(\mathbf{x}_a, \lambda, \mu)^\top d\mathbf{x}_a + \frac{1}{2} d\mathbf{x}_a^\top \mathbf{H}_\delta(\mathbf{x}_a, \lambda, \mu) d\mathbf{x}_a \\ & \text{subject to } \mathbf{x}_a + d\mathbf{x}_a \in \mathbb{X}_a. \end{aligned} \quad (2.62)$$

Then, the objective function to minimise is formed by the gradient, Hessian of the Lagrangian function and the step direction. The modified Hessian  $\mathbf{H}_\delta(\mathbf{x}_a, \lambda, \mu)$  is obtained after making some changes to the Gauss-Newton approximation of the exact Hessian function as follows



Remark

The problem (2.62) is a conic programming problem that can be solved using Yalmip [Lofberg, 2004] with SDPT3 [Toh et al., 2001] or LMILab [Gahinet, 1994] included in Robust Control Toolbox of Matlab.

**Gradient and Hessian Computation** Before starting to compute the derivatives, first we compute the Jacobian of the function  $e(\mathbf{x}_a) = X_a Y_a - I$ ,

$$J(\mathbf{x}_a) = [ (Y_a \otimes I)\mathcal{D} \quad (I \otimes X_a)\mathcal{D} \quad 0 ] \quad (2.63)$$

where  $\mathcal{D}$  denotes the transformation mapping from vech to its vec representation as shown in Definition 1.2.5. The gradient of the Lagrangian function is given by

$$\nabla_{\mathbf{x}_a} \Phi_{Ap}(\mathbf{x}_a, \lambda, \mu) = \begin{bmatrix} \mathcal{D}^\top \text{vec}(\lambda Y_a) \\ \mathcal{D}^\top \text{vec}(X_a \lambda) \\ 1 \end{bmatrix} + \mu J(\mathbf{x}_a)^\top \text{vec}(X_a Y_a - I). \quad (2.64)$$

Applying the Gauss-Newton approximation method to the Lagrangian function, we obtain

$$\nabla_{\mathbf{x}_a \mathbf{x}_a}^{\text{GN}} \Phi_{Ap}(\mathbf{x}_a, \lambda, \mu) = \begin{bmatrix} 0 & \mathcal{D}^\top (I \otimes \lambda) \mathcal{D} & 0 \\ \mathcal{D}^\top (I \otimes \lambda^\top) \mathcal{D} & 0 & 0 \\ 0 & 0 & 0 \end{bmatrix} + \mu J(\mathbf{x}_a)^\top J(\mathbf{x}_a) \quad (2.65)$$

**Hessian Modifications** In the objective function, the modified Hessian  $\mathbf{H}_\delta(\mathbf{x}_a, \lambda, \mu)$  is obtained after some modification to the Gauss-Newton approximation of the exact Hessian  $\mathbf{H}(\mathbf{x}_a, \lambda, \mu) = \nabla_{\mathbf{x}_a \mathbf{x}_a}^2 \Phi_{Ap}(\mathbf{x}_a, \lambda, \mu)$  in order to ensure the positiveness of the Hessian. This approximation is detailed in Section 2.2.1.2.

Remark

Then to compute  $X_a$  and  $Y_a$ , the Algorithm 5 in Section A.1 is given.

**Controller Synthesis** In order to obtain the controller parameters  $A_K, B_K, C_K, D_K$ , the following convex optimisation must be solve

$$\begin{aligned} & \underset{\beta, A_K, B_K, C_K, D_K}{\text{minimise}} && \beta \\ & \text{subject to} && \Upsilon_{x_a} + \mathbf{Q}^\top \Theta^\top \mathcal{P}_{X_a} + \mathcal{P}_{X_a}^\top \Theta \mathbf{Q} \prec \beta I. \end{aligned} \quad (2.66)$$

The conditions that validate the solvability of the optimisation problem (2.66) are:

1. The  $\mathcal{H}_\infty$ -norm of the closed-loop system must be less than  $\gamma$ ,  $\|T_{zw}\|_\infty < \gamma$  with  $\gamma > 0$ .
2.  $\beta$  must be negative.

## 2.2.3 Summary and Relationship between Methods

If we try to resume various steps for synthesising an  $\mathcal{H}_\infty$  controller of order  $n_k$  in schematic form in order to facilitate understanding methods presented in this report.

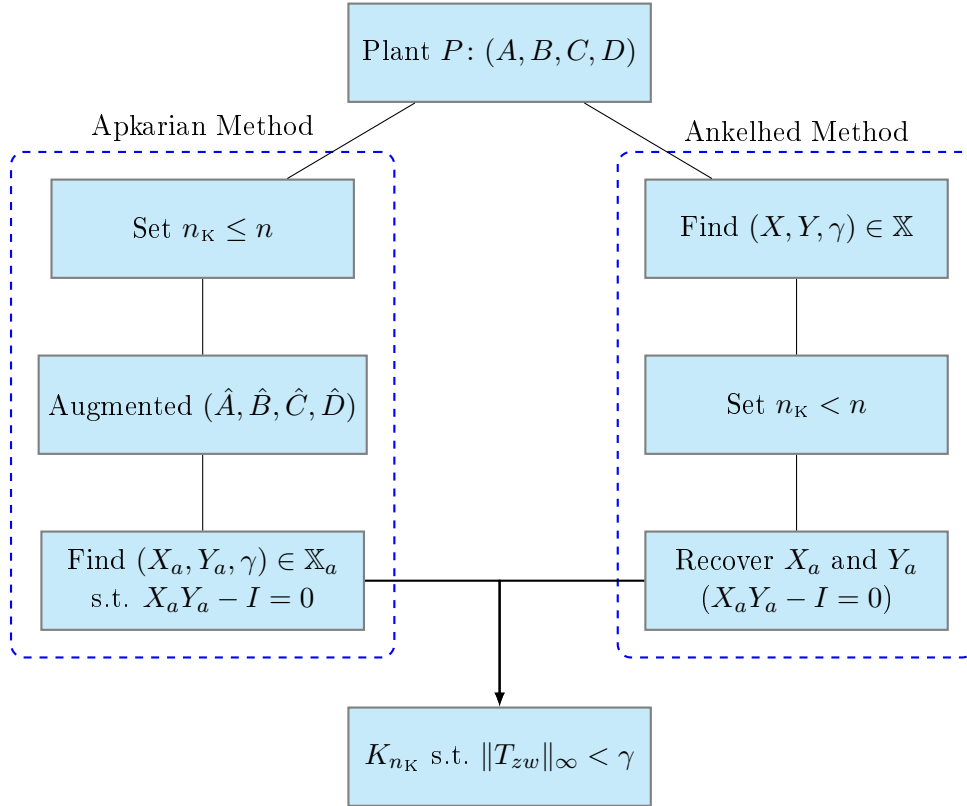
Figure 2.5:  $\mathcal{H}_\infty$ -Controller Synthesis Methods Comparison

## 2.3 LPV-Robust Control Design

The most important contribution of LPV-framework occurs when design is the main purpose. Indeed, LPV-control design, has proven to be successful design methodology in many engineering applications [Shamma and Athans, 1990].

In the beginning, only the *gain scheduling* fashion was used. The basic concept is to linearise NL-systems at different operating points which engender a collection of local LTI controllers. To describe the changes of the operating points, a varying signal is introduced, and the LPV-gain scheduling theory is appeared, giving rise to LPV gain-scheduled controllers (Figure 2.6(a)). LPV gain-scheduling can be seen as an extension of the LTI-robust control theory (Figure 2.6(b)) in which the controller is time-invariant and without adaptation even the uncertainties values are changing. However in the LPV-framework the LPV-controller is updating its values whenever the model changes.

Even if guarantees for overall stability of the designed LPV-controllers have not been

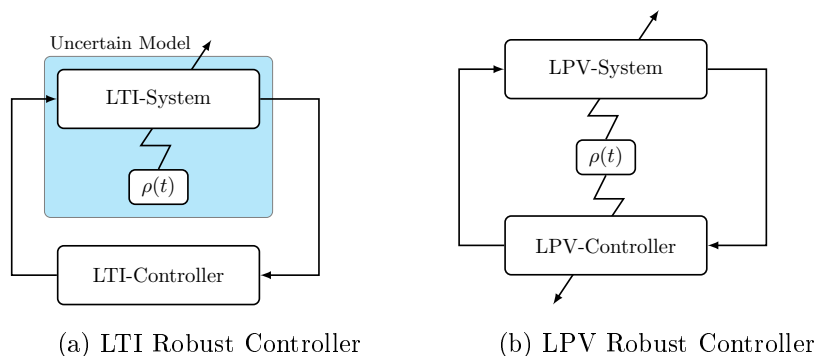

Figure 2.6: Robust Controller

available. The first gain scheduling ideas proposed in [Shamma and Athans, 1990] has drawn a big attention for nonlinear systems control theory. Due to many successful applications of this design methodology, gain-scheduling has become popular in industrial applications. However, the major difficulty at that time, was the lack of general theory for analysing stability of LPV systems and designing LPV-based gain-scheduled control laws.

Nowadays, this problem has been resolved when interpolation based methods seem to guarantee global stability. The suitable framework for controlling LPV systems are emerging from robust control theory, such as  $\mathcal{H}_\infty$ -control, and the use of LMIs.

### 2.3.1 LPV-Stability

Similar to LTI-systems in Section 2.1.1, there exist various stability concepts of LPV systems. Most of them are based on Lyapunov approach. Then, the notions of *quadratic*

*stability* and *robust stability*, along their respective class of Lyapunov functions are introduced in this section. Moreover, the connection with the input/output stability notion can be used when analysing LPV-systems under LFT-form.

### 2.3.1.1 Quadratic Stability

The quadratic stability for LPV-systems does not make distinction between time-invariant parameters, slowly-varying parameters and fast-varying parameters. Therefore, quadratic stability may be very conservative.

**Definition 2.3.1 (Quadratic Stability)** *System (1.35) is said to be quadratically stable if the positive definite quadratic form*

$$V: x \mapsto x^\top P x, \quad P \in \mathbb{S}_{>0}^n \quad (2.67)$$

*is a Lyapunov function for (1.35). A such Lyapunov function is often referred to a common Lyapunov function or a parameter-independent Lyapunov function.*

#### Proposition 10: [Briat, 2015]

The system (1.35) is quadratically stable if and only if there exists a matrix  $P \in \mathbb{S}_{>0}^n$  such that the LMI

$$A^\top(\rho)P + PA(\rho) \prec 0 \quad (2.68)$$

holds for all  $\rho \in \Delta_\rho$ .

**LPV-polytopic Case** Thanks to the fact that LPV-polytopic systems are affine in parameters, their stability could be checked in the same way as the generic LPV-systems.

#### Theorem 11: [Briat, 2015]

The polytopic LPV-systems (1.51) is quadratically stable if there exists a matrix  $P \in \mathbb{S}_{>0}^n$  such that the LMI

$$A_i^\top P + PA_i \prec 0, \quad (2.69)$$

holds for all  $i = 1, \dots, N$ .

### 2.3.1.2 Robust Stability

The robust stability is a stronger notion of the quadratic stability. Unlike the latter one, robust stability makes distinction between constant and time-varying differentiable parameters. Robust stability for LPV-systems also consider information on the parameters variation rates.

#### Theorem 12: [Briat, 2015]

The system (1.35) is robustly stable if there exists a differentiable matrix function  $P: \Delta_\rho \rightarrow \mathbb{S}_{>0}^n$ ;  $\rho \mapsto P(\rho)$  such that the condition

$$A^\top(\rho)P(\rho) + P(\rho)A(\rho) + \sum_{i=1}^s \dot{\rho}_i \frac{\partial P(\rho)}{\partial \rho_i} \prec 0, \quad (2.70)$$

holds for all  $(\rho, \dot{\rho}) \in \Delta_\rho \times \Delta_v$  and where  $\Delta_v \in \mathbb{R}^s$  is the subset of the parameters rates and  $\dot{\rho}_i$  is the  $i$ th element of  $\dot{\rho}$ .

**LPV-polytopic Case** Robust stability deals with parameters variation rate. In the LPV-polytopic case, this rate is included in the term  $\dot{\lambda}$ . But there is no definition for a set that could contain the  $\dot{\lambda}$  trajectories. Then, the assumption that the LPV-systems is approximated with  $N_p$  parameter with known derivative bounds is made.

#### Proposition 12: [Briat, 2015]

Assume that  $\dot{\rho} \in \Delta_v = \text{Co}\{\mathbf{V}_d\}$ ,  $\mathbf{V}_d = \{d_1, \dots, d_N\}$ ,  $N = 2^{N_p}$  and that

$$\rho(t) = \sum_{i=1}^N \lambda(t) v_i,$$

holds with  $\mathbf{V}_v = v_1, \dots, v_N$ . Then, the set of all  $\dot{\lambda}$ 's is given by

$$\dot{\Lambda}_N = \left\{ \left[ \begin{array}{c} \mathbf{V} \\ \mathbb{1}_N^\top \\ 0 \end{array} \right]^+ \left[ \begin{array}{c} \mathbf{D} \\ 0 \\ \mathbb{1}_N^\top \end{array} \right] \xi : \eta \in \Lambda_N \right\} \quad (2.71)$$

where  $\xi(t) \in \Lambda_N$ ,  $\mathbf{V} = [v_1, \dots, v_N]$  and  $\mathbf{D} = [d_1, \dots, d_N]$ . Moreover, the following identity is given

$$\dot{\rho}(t) = \sum_{i=1}^N \xi_i(t) d_i = \sum_{i=1}^N \dot{\lambda}_i(t) v_i. \quad (2.72)$$

based on the latter characterisation of  $\dot{\Lambda}_N$  the following results is given

**Theorem 13**

The polytopic LPV-system given in (1.51) is robustly stable if there exist matrices  $P_i \in \mathbb{S}_{>0}^n$ ,  $i = 1, \dots, N$ , such that the parameter-dependent LMI

$$A(\lambda)^\top P(\lambda) + P(\lambda)A(\lambda) + P(\theta) \prec 0, \quad (2.73)$$

holds for all  $(\lambda, \theta) \in \Lambda_N \times \text{vert}\{\dot{\Lambda}_N\}$  where

$$P(\lambda) = \sum_{i=1}^N \lambda_i P_i \text{ and } A(\lambda) = \sum_{i=1}^N \lambda_i A_i.$$

**2.3.1.3 Stability of LPV-systems in LFT-Form**

Let the system given under the LFT-form (Figure 1.2) with the following state space realisation

$$\begin{cases} \dot{x}(t) = Ax(t) + Bu(t) \\ y(t) = Cx(t) + Du(t) \\ w(t) = \theta(\rho(t))z(t) \end{cases} \quad \forall t \geq 0, \quad (2.74)$$

where  $\theta(\rho)$  is a possibly structured, matrix containing the time-varying parameters. The lower part this LFT-form system is represented as an LTI-model with the following transfer function

$$\mathcal{G}(s) = C(sI - A)^{-1}B + D. \quad (2.75)$$

Given  $\alpha \in \mathcal{L}_2$ , let us consider the multiplication operator  $\Theta_\rho$  defined as

$$\Theta_\rho(\alpha(t)) = \theta(\rho(t))\alpha(t). \quad (2.76)$$

Then, the *small gain theorem* for LPV-systems under LFT-form is stated as the following

**Theorem 14: Small Gain Theorem for LPV-Systems [Briat, 2015]**

Assume that  $\|\Theta_\rho\|_{i,2}$  for all  $\rho \in \mathcal{P}$ , then the LPV-system (2.74) is asymptotically stable if

$$\|\mathcal{G}\|_\infty < 1, \quad (2.77)$$

where  $\mathcal{P}$  is the set parameter trajectories and  $\|\cdot\|_{i,2}$  is the induced  $\mathcal{L}_2$ -norm defined in (1.1).

As mentioned in the LTI-case, the small gain theorem is a very simple tool for stability analysis. In fact, only gains are considered and no information on the phase are needed (unlike the Nyquist test for example). However, it remains very conservative for the LPV-framework. Indeed, information about the interconnected structures are not caught. For example, a simple structure (e.g. block diagonal matrix) of  $\theta(\rho)$ , can not be exploited in the analysis conditions. To tackle this drawback, the *scaled* small-gain notion is introduced. Then, information on the interconnection structure can be captured and the explicit expression of  $\theta(\rho)$  is considered (for more details, see [Packard and Doyle, 1993, Briat, 2015]).

### 2.3.2 $\mathcal{H}_\infty$ -LPV-synthesis

Analysis and control of LPV-systems is directly inherited from robust control theory. The main distinctness is in the fact that the parameters are assumed to be known or measurable in the LPV-framework, whereas they are unknown, by assumption, in robust control theory. The designed LPV-controllers should guarantee both stability and performance for all scheduling parameters in the predefined set. To this end, several control-laws for LPV-systems are developed : by considering the two parameters classes (bounded parameters with bounded derivatives or arbitrary variation rates), two control design categories are then given namely *quadratic* and *robust* stabilisation. On the other hand, the controller representation (static or dynamic) and the controller-input (output-feedback or state-feedback), generates several classes of control strategies. Then, a various combinations of LPV-controllers are obtained and they are highlighted in Figure 2.7

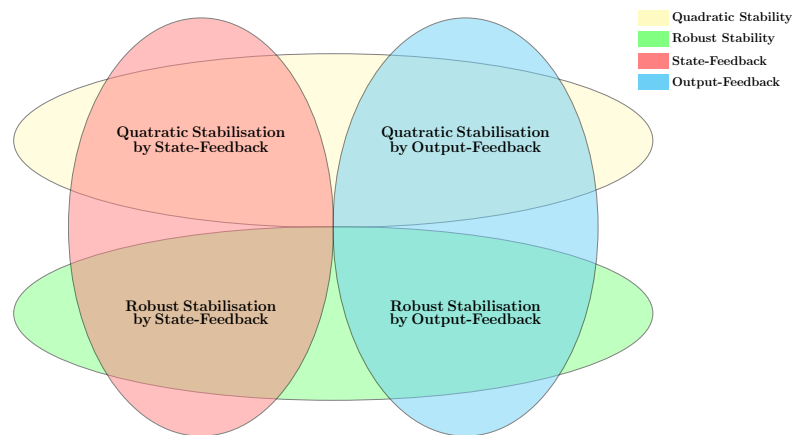

Figure 2.7: LPV-controllers types

In addition, and according to the several LPV-representations mentioned in 1.4.4 (affine, polytopic, etc), a third classification can be given. Details on those controllers are given

in [Briat, 2015] and presented in Appendix A.1.

In this section the quadratic approach with output feedback for polytopic systems is presented.

**Quadratic Stabilisation for LPV-polytopic Systems** Consider a general LPV-system represented under the following state-space realisation

$$\begin{cases} \dot{x}(t) = A(\rho(t))x(t) + B_1(\rho(t))w(t) + B_2(\rho(t))u(t) \\ z(t) = C_1(\rho(t))x(t) + D_{11}(\rho(t))w(t) + D_{12}(\rho(t))u(t) \\ y(t) = C_2(\rho(t))x(t) + D_{21}(\rho(t))w(t) + D_{22}(\rho(t))u(t) \end{cases} \quad \forall t > 0, \quad (2.78)$$

where  $x(t) \in \mathbb{R}^n$ ,  $u(t) \in \mathbb{R}^{n_u}$ ,  $w(t) \in \mathbb{R}^{n_w}$ ,  $z(t) \in \mathbb{R}^{n_z}$ ,  $y(t) \in \mathbb{R}^{n_y}$  are respectively the state, the input, the disturbance vectors, the controlled output and the measured output. The vector  $\rho(t)$  is the exogenous parameter varying vector which is time dependent and  $\Delta_\rho$  is the set of the parameter values, i.e.  $\rho(t) \in \Delta_\rho$ .

Then,

$$\begin{aligned} A: \Delta_\rho &\rightarrow \mathbb{R}^{n \times n}, & B_1: \Delta_\rho &\rightarrow \mathbb{R}^{n \times n_w}, & B_2: \Delta_\rho &\rightarrow \mathbb{R}^{n \times n_u}, \\ C_1: \Delta_\rho &\rightarrow \mathbb{R}^{n_z \times n}, & C_2: \Delta_\rho &\rightarrow \mathbb{R}^{n_y \times n}, & D_{11}: \Delta_\rho &\rightarrow \mathbb{R}^{n_z \times n_w}, \\ D_{12}: \Delta_\rho &\rightarrow \mathbb{R}^{n_z \times n_u}, & D_{21}: \Delta_\rho &\rightarrow \mathbb{R}^{n_y \times n_w} & \text{and } D_{22}: \Delta_\rho &\rightarrow \mathbb{R}^{n_y \times n_u}. \end{aligned}$$

The  $\mathcal{H}_\infty$ -LPV-controller for the LPV-system (2.78) is defined by

$$K(\rho): \begin{cases} \dot{x}_K(t) = A_K(\rho(t))x_K(t) + B_K(\rho(t))y(t) \\ u(t) = C_K(\rho(t))x_K(t) + D_K(\rho(t))y(t) \end{cases} \quad \forall t > 0, \quad (2.79)$$

where  $x_K(t)$ ,  $y(t)$  and  $u(t)$  are respectively the states, the inputs and outputs of the controller  $K(\rho)$ .  $A_K: \Delta_\rho \rightarrow \mathbb{R}^{n \times n}$ ,  $B_K: \Delta_\rho \rightarrow \mathbb{R}^{n \times n_y}$ ,  $C_K: \Delta_\rho \rightarrow \mathbb{R}^{n_u \times n}$  and  $D_K: \Delta_\rho \rightarrow \mathbb{R}^{n_u \times n_y}$ .

The  $\mathcal{H}_\infty$ -LPV-controller synthesis concerns the design of an LPV-global-controller that guarantees both *stability* and *performance* for all parameters variations defined in the set  $\Delta_\rho$ .

To guarantee the closed-loop system quadratic stability and to satisfy  $\mathcal{H}_\infty$ -performance criterion, the approach developed in [Scherer et al., 1997] is used to design the  $\mathcal{H}_\infty$ -LPV-controller. This solution is on the polytopic formulation, and the global  $\mathcal{H}_\infty$ -LPV-controller is a convex combination of local controllers like shown in 1.4.4. Those local controllers are given as follows: by assuming that the system matrices  $B_2$ ,  $D_{12}$ ,  $C_2$  and  $D_{21}$  are parameter independent and  $D_{22} = 0$ . and for a pre-defined real positive scalar  $\gamma$  and a parameter dependent quadruplet matrices  $(\hat{A}_K, \hat{B}_K, \hat{C}_K, \hat{D}_K)$ , there exist two symmetric matrices  $X$  and  $Y$  such that the sufficient condition that solves the



$\mathcal{H}_\infty$ -LPV-problem is given by the following LMIs

$$\begin{bmatrix} A(\omega_i)X + B_2\hat{C}_K(\omega_i) + (*) & & * \\ \hat{A}_K(\omega_i) + A^\top(\omega_i) + C_2^\top\hat{D}_K^\top(\omega_i)B_2^\top & YA(\omega_i) + \hat{B}_K(\omega_i)C_2 + (*) & \\ B_1^\top(\omega_i) + D_{21}^\top\hat{D}_K^\top(\omega_i)B_2^\top & B_1^\top(\omega_i)Y + D_{21}^\top\hat{B}_K^\top(\omega_i) & \dots \\ C_1(\omega_i)X + D_{12}\hat{C}_K(\omega_i) & C_1(\omega_i) + D_{12}\hat{D}_K(\omega_i)C_2 & \end{bmatrix} \quad (2.80)$$

$$\begin{bmatrix} * & * \\ * & * \\ \dots & -\gamma I_{n_u} & * \\ D_{11}(\omega_i) + D_{12}\hat{D}_K(\omega_i)C_2 & -\gamma I_{n_y} \end{bmatrix} \prec 0,$$

$$\begin{bmatrix} X & I \\ I & Y \end{bmatrix} \succ 0, \quad (2.81)$$

where  $\omega_i$  are the vertices of the polytope formed by all the extremities of each varying parameter  $\rho \in \mathcal{P}_\rho$  and terms denoted  $(*)$  are induced by symmetry, for example

$$\begin{bmatrix} M + N + (*) & * \\ K & L \end{bmatrix} = \begin{bmatrix} M + M^\top + N + N^\top & K^\top \\ K & L \end{bmatrix}$$

The controller  $K(\omega_i)$  at vertex  $i$  is then reconstructed as

$$\begin{aligned} D_K(\omega_i) &= \hat{D}_K(\omega_i). \\ C_K(\omega_i) &= (\hat{C}_K(\omega_i) - D_K(\omega_i)C_2X)M^{-\top}. \\ B_K(\omega_i) &= N^{-1}(\hat{B}_K(\omega_i) - YB_2D_K(\omega_i)). \\ A_K(\omega_i) &= N^{-1}(\hat{A}_K(\omega_i) - YA(\omega_i)X - YB_2D_K(\omega_i)C_2X)M^{-\top} \\ &\quad - B_K(\omega_i)C_2XM^{-\top} - N^{-1}YB_2C_K(\omega_i). \end{aligned} \quad (2.82)$$

where  $M$  and  $N$  are defined such that  $MN^\top = I_n - XY$  and which can be solved through a singular value decomposition and a Cholesky factorisation. The final controller  $K(\rho)$  defined in (2.79) is then the convex combination of local controllers (see also [Sato and Peaucelle, 2013]).

## Conclusion

In this chapter the  $\mathcal{H}_\infty$ -control theory for LTI and LPV systems has been presented. The stability issue and the  $\mathcal{H}_\infty$ -synthesis procedure regarding the two system classes have been discussed. The investigation on the resulted  $\mathcal{H}_\infty$ -controllers shows the Achilles heels of this advanced control technique which is the probable high order of the controllers. One evident solution to remedy this drawback is to set this order before

---

the design step. The big flexibility offered by the design method through the LMI tools make the order constraint very easy to incorporate in the basic  $\mathcal{H}_\infty$ -problem. However, the problem become non-convex and by the way the controller is then harder to find. Many approaches are recently developed and summarised in this chapter. As shown in the last Section, convexification step is achieved after many approximation. In addition, the application of these algorithms has more chance to generate numerical difficulties. This fact limits the use and the reliability of this direct path to get a low order controller. This disadvantage come from the fact that the solutions are dependent on the developed numerical solvers. These last are still developing. In the next chapter, The order reduction way to get a low order controller is exterminated. Methods to reduce the order of controllers are presented and could give some alternative to given ones on this chapter. In fact numerical problems are less involved and optimisation problems are avoided.

methods combining model-order reduction and controller synthesis are suggested as more manageable way to get a low order controller.



# $\mathcal{H}_\infty$ -Controller Order Reduction

---

## Contents

---

<b>Introduction</b> . . . . .	<b>57</b>
<b>3.1 Model Order Reduction</b> . . . . .	<b>57</b>
3.1.1 Balancing Procedure . . . . .	58
3.1.2 Balanced Truncation . . . . .	59
3.1.3 Singular Perturbation Approximation . . . . .	60
3.1.4 Frequency Weighted Balanced Truncation . . . . .	62
3.1.4.1 Enns' Method . . . . .	63
3.1.4.2 Lin and Chiu's Method . . . . .	65
3.1.4.3 Varga and Anderson's Method . . . . .	67
3.1.4.4 Wang's et al. Method . . . . .	67
3.1.4.5 Gawronski's et al. Method . . . . .	68
3.1.4.6 Gugercin's et al. Method . . . . .	70
<b>3.2 <math>\mathcal{H}_\infty</math>-LTI-Controller Order Reduction</b> . . . . .	<b>70</b>
3.2.1 Full Order Controller . . . . .	71
3.2.2 FWBT for Controller Order Reduction . . . . .	72
3.2.3 Order Reduction Procedure . . . . .	73
<b>3.3 <math>\mathcal{H}_\infty</math>-LPV-Controller Order Reduction</b> . . . . .	<b>75</b>
3.3.1 Gramians and Generalised Gramians . . . . .	75
3.3.2 Frequency-Limited Order Reduction by FWBT . . . . .	78
3.3.3 Frequency-Limited Order Reduction by SPA . . . . .	84
<b>Conclusion</b> . . . . .	<b>85</b>

---

## Introduction

As shown in Chapter 2, the obtained  $\mathcal{H}_\infty$ -controllers have at least the same order as the plant. Since this latter is built from the physical model and the frequency weighting functions (for performance requirements), the order of plant may be very high. In this case, the full-order controllers may be of limited use in practical applications. In practice, low-order controllers are preferred to high-order controllers as they require less complicated and more easily available hardware to understand, to maintain and to implement in the real world. In the early days, the development in this field has made the order reduction for control a needful design step. In order to achieve these advantages, new methods which yield low order controllers are developing. These methods can be divided into three classes:

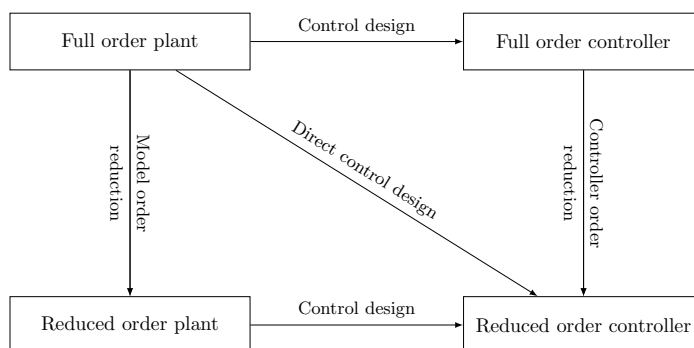

Figure 3.1: Controller Order Reduction Scheme [Anderson and Liu, 1989]

1. The first approach is to design a reduced-order controller directly from the high order system [Yeh et al., 1994, Ly et al., 1985, Gangsaas et al., 1986, Bernstein, 1989, Hyland and Richter, 1990, Fischer and Gutman, 1991]. The main lack of this kind of methods is that the order of the reduced-controller has to be chosen by an ad-hoc way [Goddard, 1995].
2. The second way is to reduce the model using one of the existing open-loop model order reduction methods [Antoulas, 2005b], and then design a controller for the obtained reduced model. The disadvantage of this indirect method is that the resulting error from reduction process will not be taken into the controller design step. And as a result, the reduced order controller is not guaranteed to stabilise the full order model [Kong, 2012].
3. The third way is to firstly design a full-order controller and then, reduce it while preserving the properties of the closed-loop system.

Note that reducing the designed controller for a high order plant is more effective than designing a controller for the reduced plant for many reasons:

- Error might expand when the reduction step is achieved before controller design.
- The plant approximation needs knowledges of the controller while the later has not yet been designed.

Thus, in this dissertation the third way is used to design a low-order controller. In this Chapter, well known methods of model order reduction methods are first reviewed in Section 3.1. Based on this, controller order reduction method for LTI-systems is shown in Section 3.2. Then, an extension to the LPV-systems is developed in Section 3.3.

### 3.1 Model Order Reduction

Model Order Reduction (MOR) is a very active research field in system and control theory. Indeed, it allows the conception of compact systems from an initial complex high order models. Mathematically speaking, the model reduction problem can be formulated as follows: given  $\Sigma$ , the LTI system introduced in (1.20) with the transfer function  $G$  given by  $G(s) = D + C(sI - A)^{-1}B$ , find a reduced order model with the transfer function  $G_r(s)$

$$G_r(s) = D_r + C_r(sI - A_r)^{-1}B_r \quad (3.1)$$

with  $A_r \in \mathbb{R}^{r \times r}$ ,  $B_r \in \mathbb{R}^{r \times n_u}$ ,  $C_r \in \mathbb{R}^{n_y \times r}$ ,  $D_r \in \mathbb{R}^{n_y \times n_u}$  and  $r < n$ , such that the following properties are satisfied

- Approximation error against the initial model is small.
- System stability is preserved.
- Reduction procedure is computationally efficient and reliable.

Various approaches are developed. They deal on the error expression by deleting the less important states or matching some parameters of the original and reduced order systems. These methods can be classified two main categories (Figure 3.2)

1. Eigenvalues decomposition based methods (Modal- and SVD-based techniques)
2. Moment matching methods (Krylov techniques)

These classes are broadly investigated in the literature, However, an attention is given to the first category. Indeed, SVD-based methods are well grounded in theory and are widely used. Among them, the unweighted/weighted balanced truncation approximations and the singular perturbation are the most popular methods. This section reviews

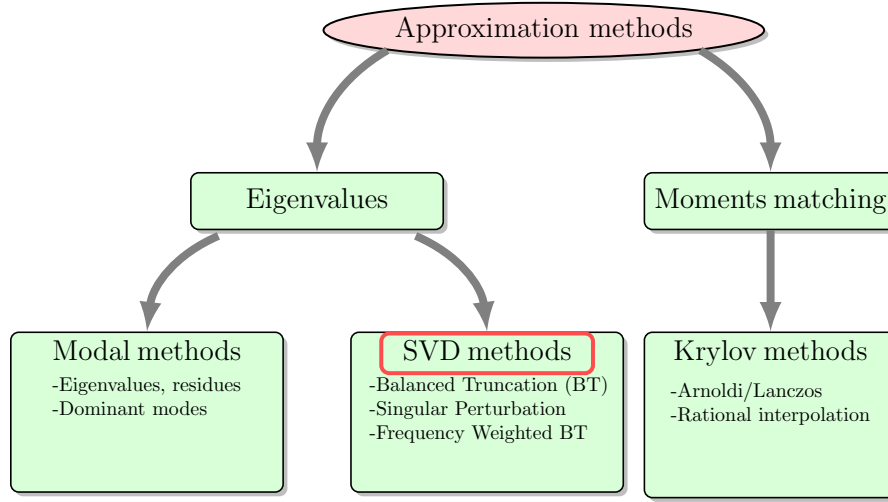

Figure 3.2: Flowchart of Model Order Reduction Methods [Antoulas, 2005a]

them and show their performance and drawbacks in open-loop configuration. Based on this, a controller order reduction in closed loop scheme is performed in the next sections. Before introducing these methods, a balancing step is needed. It helps to split the states into two sets so-called dominant and non-dominant states:

### 3.1.1 Balancing Procedure

Let  $\Sigma$ , be the LTI-system of order  $n$  with  $n_u$  inputs and  $n_y$  outputs given in (1.20) with  $G(s) = C(sI - A)^{-1}B + D$  its transfer function. Then, let us associate to this system the following Lyapunov equations

$$\begin{cases} AW_r + W_r A^\top + BB^\top = 0 \\ A^\top W_o + W_o A + C^\top C = 0. \end{cases} \quad (3.2)$$

If  $\Sigma$  is asymptotically stable ( $Re(\lambda_i(A)) < 0 \forall i$ ) and its state space realisation (1.20) is minimal (i.e. reachable and observable), then (3.2) has two unique definite positive symmetric solutions  $W_r, W_o \in \mathbb{S}_{>0}^n$  called: *reachability Gramian* and *observability Gramian* respectively. The square root of the eigenvalues of the product  $W_r W_o$  gives the so-called *Hankel singular values*, i.e.

$$\sigma_i(G) = \sqrt{\lambda_i(W_r W_o)}. \quad (3.3)$$

**Definition 3.1.1** ([Moore, 1981]) *The reachable, observable and stable LTI-system  $\Sigma$  is called balanced if*

$$W_r = W_o = \text{diag}(\sigma_1 I_{m_1}, \dots, \sigma_q I_{m_q}). \quad (3.4)$$

with  $\sigma_1 > \sigma_2 > \dots > \sigma_q > 0$ ,  $m_i : i = 1, \dots, q$  are the multiplicities of  $\sigma_i$  and  $m_1 + \dots + m_q = n$ .

To balance the system, a basis change matrix  $T$  can be defined so that

$$\begin{cases} \dot{\tilde{x}} = \tilde{A}\tilde{x} + \tilde{B}u \\ y = \tilde{C}\tilde{x} + Du \end{cases} \quad (3.5)$$

with

$$x = T\tilde{x}, \quad \tilde{A} = T^{-1}AT, \quad \tilde{B} = T^{-1}B \quad \text{and} \quad \tilde{C} = CT.$$

In this new basis, Gramians are expressed as

$$\tilde{W}_r = T^{-1}W_r T^{-\top} \quad \text{and} \quad \tilde{W}_o = T^{\top}W_o T. \quad (3.6)$$

Note that Moore & Laub procedure [Moore, 1981] is the historical well-known one to compute the matrix  $T$ . It is given as follows

1. Compute Gramians  $W_r$  and  $W_o$  of a minimal realisation  $(A, B, C, D)$ .
2. Compute  $R$  the Cholesky factor (upper triangular) of  $W_r$ , i.e.  $W_r = RR^{\top}$ .
3. Compute the singular value decomposition:  $R^{\top}W_o R = UW^2U^{\top}$ .
4. Compute the basis change matrix  $T = RUW^{-1/2}$ .

Note that another algorithm based on the use of the Cholesky factors of the two Gramians is given in [Li, 2000].

### 3.1.2 Balanced Truncation

Balanced Truncation BT concept was introduced first by [Mullis and Roberts, 1976]. Then, generalisation for system theory is given in [Moore, 1981]. The main idea is to find another equivalent state space representation where the system states are as reachable as observable. In this new basis, the reduced order model is obtained by states truncating at the desired order. Applied to stable systems, this approach preserves stability with a guaranteed error bound [Pernebo and Silverman, 1982]. For medium order models (dozens of states), this method is very efficient however for very high order model ( $\gg 100$ ), the implementation of the BT seems to be expensive. Indeed, dense matrices factorisation is required, which needs a higher memory capacity.



**Theorem 15: [Pernebo and Silverman, 1982]**

Let  $\mathcal{S}$  be a minimal realisation of the asymptotically stable LTI-system (1.20). It can be expressed under its balanced realisation  $\tilde{\mathcal{S}}$  such as:

$$\tilde{\mathcal{S}}: \left[ \begin{array}{c|c} \begin{bmatrix} A_{11} & A_{12} \\ A_{21} & A_{22} \end{bmatrix} & \begin{bmatrix} B_1 \\ B_1 \end{bmatrix} \\ \hline \begin{bmatrix} C_1 & C_2 \end{bmatrix} & D \end{array} \right] \quad (3.7)$$

with

$$W_r = W_o = \text{diag}(\Sigma_1, \Sigma_2)$$

where

$$\Sigma_1 = \text{diag}(\sigma_1 I_{m_1}, \dots, \sigma_k I_{m_k}) \text{ and } \Sigma_2 = \text{diag}(\sigma_{k+1} I_{m_{k+1}}, \dots, \sigma_q I_{m_q})$$

with:  $\sigma_1 > \sigma_2 > \dots > \sigma_q > 0$ ,  $m_i : i = 1, \dots, q$  are multiplicities of  $\sigma_i$  and  $m_1 + \dots + m_q = n$ .

Then, the reduced order realisation:  $\left[ \begin{array}{c|c} A_r & B_r \\ \hline C_r & D_r \end{array} \right]$ , obtained by truncation is asymptotically stable, minimal and satisfy

$$\|G - G_r\|_\infty \leq 2 \sum_{k+1}^q \sigma_i \quad (3.8)$$

where  $G$  and  $G_r$  are the full and the reduced order model transfer functions respectively. Note that  $r = \sum_{i=1}^k m_i$ .

**Remark**

The presented approach is valid for all stable system with minimal realisation. For unstable systems see [Zhou et al., 1999].

**3.1.3 Singular Perturbation Approximation**

The Singular Perturbation Approximation (SPA) method is an alternative to the truncation technique if the model is stable with minimal realisation and internally balanced. These two methods constitute complementary model order reduction techniques for continuous-time systems, and both of them conserve the stability. Even though, the upper bound for both reduction methods is the same, the BT aims to reach a smaller error at high frequencies and tends to be larger at low frequencies, whereas the reduced order models through SPA method behave otherwise, i.e. the error goes to zero at low

frequencies and tends to enlarge at high frequencies. In SPA method, all balanced states are sorted and divided into the slow and fast modes by representing the smaller Hankel singular values as the fast mode, and the rest as the slow mode. Thus, a reduced-order model can be obtained by setting the derivative of all states corresponding to the fast mode equal to zero.

Let  $\tilde{\mathcal{S}}$  be the balanced realisation of the LTI-system given in (3.7), i.e.

$$\tilde{\mathcal{S}}: \begin{cases} \dot{\tilde{x}}_1(t) &= A_{11}\tilde{x}_1(t) + A_{12}\tilde{x}_2(t) + B_1u(t) \\ \dot{\tilde{x}}_2(t) &= A_{21}\tilde{x}_1(t) + A_{22}\tilde{x}_2(t) + B_2u(t) \\ y(t) &= C_1\tilde{x}_1(t) + C_2\tilde{x}_2(t) + D_ru(t) \end{cases} \quad \forall t \geq 0.$$

Since the system is balanced,  $\tilde{x}_2$  represents states corresponding to smaller HSV, i.e. the fast dynamics of the system. Based on the concept of the SPA method [Liu and Anderson, 1989], the derivative of all states corresponding to  $\tilde{x}_2$  are set to zero. Then, the reduced order model is given by the transfer function  $G_r(s) = C_r(sI - A_r)^{-1}B_r + D_r$  with

$$A_r = A_{11} - A_{12}A_{22}^{-1}A_{21}, \quad (3.9)$$

$$B_r = B_1 - A_{12}A_{22}^{-1}B_2, \quad (3.10)$$

$$C_r = C_1 - C_2A_{22}^{-1}A_{21}, \quad (3.11)$$

$$D_r = D - C_2A_{22}^{-1}B_2 \quad (3.12)$$

and assuming that  $A_{22}$  is invertible.

**Theorem 16: [Glover, 1984]**

Let  $\tilde{\mathcal{S}}$  be the minimal balanced state space representation of the asymptotically stable system given in (3.7). Then, the reduced order model obtained by SPA is asymptotically stable and satisfy

$$\|G - G_r\|_\infty \leq 2 \sum_{i=k+1}^n \sigma_i. \quad (3.13)$$

where  $G$  and  $G_r$  are the full and the reduced order model transfer functions respectively and  $r = \sum_{i=1}^k m_i$

**Example** In order to showing the effectiveness of these approaches, a numerical application to a physical system is given. Then, a building (the Los Angeles University Hospital) with 8 floors each having 3 degrees of freedom is modelled by a state space

form of order 48 [Chahlaoui and Dooren, 2002].

Figure 3.3 shows the model Hankel singular values HSV that/whose can give a first idea about the order of the reduced order model by eliminating the smallest HSV. Remark that the first ten HSV are quite bigger than the rest of the values. Then, when truncating, the first ten states are kept. Figure 3.4 shows the model frequency response, where

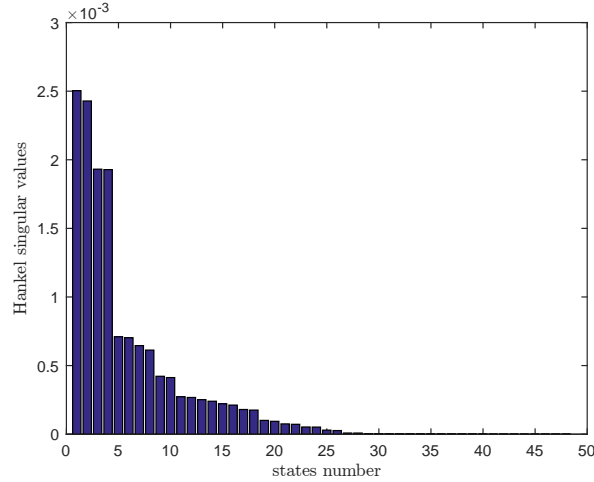

Figure 3.3: Hankel Singular values

the two obtained reduced order models using BT and SPA are compared to the initial model. Note that BT-based method shows good performance in high frequencies but not for the static gain. As expected, the characteristics of both methods are contrary to each other. Indeed, the SPA-reduced order model fits the model in low frequency but not over 10Hz.

### 3.1.4 Frequency Weighted Balanced Truncation

The BT and the SPA approaches are performed with the aim to limit the error between the full-order model and the reduced-order one in the whole frequency range. However, for many applications, a reduction in specific frequency range is more important. To do this, a Frequency Weighted FW technique is given in order to fit the reduction step to a limit frequency range. This idea has been introduced first in [Enns, 1984] where the BT is extended to give birth to the so-called Frequency Weighted Balanced Truncation FWBT. Nevertheless, the stability of the reduced order model is not guaranteed. To tackle this problem, a second variant that guarantee the stability is proposed in [Lin and Chiu, 1990]. However an additional assumption is needed which limit its use. Thereafter, the method is modified in [Sreeram and Anderson, 1995] and [Kim et al., 1995] to introduce an explicit a priori upper bound of the approximation er-

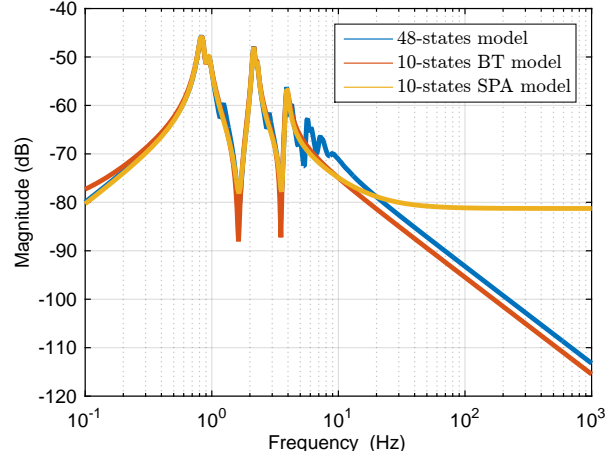

Figure 3.4: Frequency Response of the Building Model.

ror. In [Wang et al., 1999], then in [Varga and Anderson, 2001], a simpler upper bound is given. Moreover, another version that focus on the relative approximation error is proposed in [Zhou, 1995]. All these developed techniques require the determination of an input and output weighting functions which is not an easy task. Thus, the classical version of the FWBT is modified in [Gawronski and Juang, 1990] where a reduced order model in a limited frequency range can be found without setting the input and output weighting functions. However, the stability in this approach is not guaranteed. Recently [Gugercin and Antoulas, 2004] propose an improved version that guarantee the stability with an upper error bound.

#### 3.1.4.1 Enns' Method

The FWBT technique can be achieved by introducing two weighting function  $V$  and  $W$  in input and the output of the system. Then, the desirable approximation error is  $W(G - G_r)V$ .

Let  $\Sigma$  be the square LTI-system and  $G(s) = C(sI - A)^{-1}B + D$  its transfer function. Define  $V(s) = C_V(sI - A_V)^{-1}B_V + D_V$  and  $W(s) = C_W(sI - A_W)^{-1}B_W + D_W$  a stable input and output weighting functions respectively. Then, two augmented systems are given as

$$GV(s) = C_i(sI - A_i^{-1})B_i + D_i, \quad (3.14)$$

$$WG(s) = C_o(sI - A_o^{-1})B_o + D_o, \quad (3.15)$$

where

$$\left[ \begin{array}{c|c} A_i & B_i \\ \hline C_i & D_i \end{array} \right] = \left[ \begin{array}{c|c} \left[ \begin{array}{cc} A & BC_V \\ 0 & A_V \end{array} \right] & \left[ \begin{array}{c} BD_V \\ B_V \end{array} \right] \\ \hline \left[ \begin{array}{cc} C & DC_V \end{array} \right] & DD_V \end{array} \right], \quad (3.16)$$

and

$$\left[ \begin{array}{c|c} A_o & B_o \\ \hline C_o & D_o \end{array} \right] = \left[ \begin{array}{c|c} \left[ \begin{array}{cc} A_W & B_W C \\ 0 & A \end{array} \right] & \left[ \begin{array}{c} B_W D \\ B \end{array} \right] \\ \hline \left[ \begin{array}{cc} C_W & D_W C \end{array} \right] & D_W D \end{array} \right]. \quad (3.17)$$

Then, let  $P_i = \begin{bmatrix} P_{11} & P_{12} \\ P_{12}^\top & P_{22} \end{bmatrix}$  and  $Q_o = \begin{bmatrix} Q_{11} & Q_{12} \\ Q_{12}^\top & Q_{22} \end{bmatrix}$ , be the solutions of following Lyapunov equations

$$\begin{cases} A_i P_i + P_i A_i^\top + B_i B_i^\top & = 0 \\ A_o^\top Q_o + Q_o A_o + C_o^\top C_o & = 0 \end{cases} \quad (3.18)$$

Then, solving (3.18) is equivalent to solve

$$\begin{cases} AP_{11} + P_{11}A^\top + X & = 0 \\ A^\top Q_{22} + Q_{22}A + Y & = 0 \end{cases} \quad (3.19)$$

with

$$X = BC_V P_{12}^\top + P_{12} C_V^\top B^\top + BD_V D_V^\top B^\top \quad (3.20)$$

and

$$Y = C^\top B_W^\top Q_{12} + Q_{12}^\top B_W C + C^\top D_W^\top D_W C. \quad (3.21)$$

The method is based on balancing  $P_{11}$  and  $Q_{22}$ , i.e

$$P_{11} = Q_{22} = \text{diag}(\bar{\sigma}_1 I_{m_1}, \dots, \bar{\sigma}_q I_{m_q}) \quad (3.22)$$

with:  $m_i : i = 1, \dots, q$  are multiplicities of  $\bar{\sigma}_i$  and  $m_1 + \dots + m_q = n$ .  
 $\bar{\sigma}_i$  are the weighted singular values of  $G(s)$ .

In addition, in this basis, the system can be expressed under the following realisation:

$$\tilde{\mathcal{S}} : \left[ \begin{array}{c|c} \left[ \begin{array}{cc} A_{11} & A_{12} \\ \hline A_{21} & A_{22} \end{array} \right] & \left[ \begin{array}{c} B_1 \\ B_2 \end{array} \right] \\ \hline \left[ \begin{array}{cc} C_1 & C_2 \end{array} \right] & D \end{array} \right]. \quad (3.23)$$

Finally,  $\left[ \begin{array}{c|c} A_{11} & B_1 \\ \hline C_1 & D \end{array} \right]$  is the reduced-order system obtained by truncation.

Remark

1. The reduced order model is not guaranteed stable but only when one weighting function is identity, i.e.  $V = I$  or  $W = I$ .
2. It is noted that the equations system (3.19) has semi definite pair of solutions  $P_E$  and  $Q_E$  if  $D$  is not singular ( $D \neq 0$ ). When the system is singular, [Willems, 1972] proposes to replace  $D$  by  $(D + \frac{\varepsilon}{2}I)$  for any  $\varepsilon > 0$ .

Then-after, an upper error bound is expressed in [Kim et al., 1995], but it is very hard to compute it:

**Theorem 17: [Kim et al., 1995]**

Consider the minimal realisation of the asymptotically stable LTI-system given in (1.20). Then, the reduced order model obtained by the FWBT with Enns' method satisfy

$$\|W(G - G_r)V\|_\infty \leq 2 \sum_{i=k+1}^q \sqrt{\bar{\sigma}_k^2 + (\alpha_k + \beta_k)\bar{\sigma}_k^{3/2} + \alpha_k\beta_k\bar{\sigma}_k} \quad (3.24)$$

where  $G_r$  is the reduced order model transfer function and  $\alpha_k, \beta_k$  are  $\mathcal{H}_\infty$ -norms of certain functions dependant on  $W$  and  $V$ . In addition, if  $W = I$  or  $V = I$ , the reduced-order model is guaranteed stable.

Remark

When  $W = V = I$ , relation (3.24) become  $\|(G - G_r)\|_\infty \leq 2 \sum_{i=k+1}^q \sigma_k$  which is the absolute error given on the BT method.

#### 3.1.4.2 Lin and Chiu's Method

Enns' method has been modified in [Lin and Chiu, 1990] in order to conserve the system stability when reducing. Later, this method is modified in [Sreeram and Anderson, 1995] in order to give an upper error bound to the approximation error.

Let  $T_{LC_i} = \begin{bmatrix} I & P_{12}P_{22}^{-1} \\ 0 & I \end{bmatrix}$  and  $T_{LC_o} = \begin{bmatrix} I & -Q_{22}Q_{12} \\ 0 & I \end{bmatrix}$ , two transformations applied to the augmented systems (3.14) and (3.15) respectively. Then, two transformed systems are given as

$$\left[ \begin{array}{c|c} \bar{A}_i & \bar{B}_i \\ \hline \bar{C}_i & \bar{D}_i \end{array} \right] = \left[ \begin{array}{c|c} \begin{bmatrix} A & X_{12} \\ 0 & A_V \end{bmatrix} & \begin{bmatrix} B_{LC} \\ B_V \end{bmatrix} \\ \hline [C & CP_{12}P_{22} + DC_V] & DD_V \end{array} \right] \quad (3.25)$$

and

$$\left[ \begin{array}{c|c} \bar{A}_0 & \bar{B}_0 \\ \hline \bar{C}_0 & \bar{D}_0 \end{array} \right] = \left[ \begin{array}{c|c} \left[ \begin{array}{cc} A_W & Y_{12} \\ 0 & A \end{array} \right] & \left[ \begin{array}{c} B \\ B_W D + Q_{11}^{-1} Q_{12} B \end{array} \right] \\ \hline \left[ \begin{array}{cc} C_{LC} & D_W \end{array} \right] & D_W D \end{array} \right] \quad (3.26)$$

with

$$X_{12} = AP_{12}P_{22}^{-1} + BC_V - P_{12}P_{22}^{-1}A_V, \quad (3.27)$$

$$Y_{12} = Q_{22}^{-1}Q_{12}A + B_W C - A_W Q_{11}^{-1}Q_{12} \quad (3.28)$$

and

$$B_{LC} = BD_V - P_{12}P_{22}^{-1}B_V, \quad (3.29)$$

$$C_{LC} = D_W C - C_W Q_{22}^{-1}Q_{12}. \quad (3.30)$$

Then, transformed reachability and observability Gramians namely  $P_{LC}$  and  $Q_{LC}$  are satisfying the two Lyapunov equations

$$\begin{cases} AP_{LC} + P_{LC}A^\top + B_{LC}B_{LC}^\top = 0 \\ A^\top Q_{LC} + Q_{LC}A + C_{LC}^\top C_{LC} = 0. \end{cases} \quad (3.31)$$

Simultaneous diagonalisation of  $P_{LC}$  and  $Q_{LC}$  gives

$$P_{LC} = Q_{LC} = \text{diag}(\bar{\sigma}_1 I_{m_1}, \dots, \bar{\sigma}_q I_{m_q}). \quad (3.32)$$

The reduced order model is obtained by transforming and partitioning the original system. Assuming no pole-zero cancellations between the weights and the original system, the realisation  $\{A, B_{LC}, C_{LC}\}$  is then minimal and Lin and Chiu's technique yields stable models in the case of double-sided weighting.

**Theorem 18: [Lin and Chiu, 1990, Sreeram and Anderson, 1995]**

Consider the minimal realisation of the asymptotically stable LTI-system given in (1.20). Then, the reduced order model obtained by the Lin and Chiu's FWBT method is stable and satisfy

$$\|W(G - G_r)V\|_\infty \leq 2 \sum_{i=k+1}^q \sqrt{(\bar{\sigma}_k^2 + \alpha_k + \lambda_k)(\bar{\sigma}_k + \beta_k + \omega_k)} \quad (3.33)$$

where  $\alpha_k, \beta_k, \lambda_k$  and  $\omega_k$  are the  $\mathcal{H}_\infty$ -norm of certain functions that depend on  $W$  and  $V$ .

Note that the given upper bound is less easier to compute than the one introduced previously and given by [Kim et al., 1995].

### 3.1.4.3 Varga and Anderson's Method

As shown previously, the assumption that no pole-zero cancellations occur when forming the augmented system limits the applicability of Lin and Chiu's method. A solution to overcome this drawback has been proposed in [Varga and Anderson, 2001]. The idea is to balancing  $P_{VA}$  and  $Q_{VA}$  instead of  $P_{11}$  and  $Q_{22}$  where

$$\begin{cases} P_{VA} &= P_{11} - \alpha^2 P_{12} P_{22}^{-1} P_{12}^T, \\ Q_{VA} &= Q_{22} - \beta^2 Q_{12}^T Q_{11}^{-1} Q_{12}, \end{cases} \quad (3.34)$$

with  $0 \leq \alpha \leq 1$  and  $0 \leq \beta \leq 1$ .

**Remark**

Note that  $\alpha_c = \alpha_o = 0$  corresponds to Enns' method and  $\alpha = \beta = 1$  leads to Lin and Chiu's method.

### 3.1.4.4 Wang's et al. Method

The problem on stability in the case of two sided weighted method viewed in Enns' method, is resolved here. Then, a method has been proposed in [Wang et al., 1999] in order to guarantee that  $X$  and  $Y$  of (3.20) and (3.21) respectively are semi-positive definite matrices. Then, the two Gramians of reachability and observability  $P_{WSL}$  and  $Q_{WSL}$  are obtained by solving the following two Lyapunov equations

$$\begin{cases} AP_{WSL} + P_{WSL}^T + B_{WSL} B_{WSL}^T &= 0 \\ A^T Q_{WSL} + Q_{WSL} A + C_{WSL}^T C_{WSL} &= 0 \end{cases} \quad (3.35)$$

where  $B_{WSL} = U_{WSL} \sqrt{|S_{WSL}|}$  and  $C_{WSL} = \sqrt{|R_{WSL}|} V_{WSL}^T$ . The matrices  $U_{WSL}$ ,  $S_{WSL}$ ,  $V_{WSL}$  and  $R_{WSL}$  are obtained by an eigenvalue decomposition of  $X$  and  $Y$  given in (3.20) and (3.21), i.e.

$$X = U_{WSL} S_{WSL} U_{WSL}^T \quad (3.36)$$

$$Y = V_{WSL} R_{WSL} V_{WSL}^T \quad (3.37)$$

with

$$S_{WSL} = \text{diag}(s_1, s_2, \dots, s_n) \quad (3.38)$$

$$R_{WSL} = \text{diag}(r_1, r_2, \dots, r_n) \quad (3.39)$$

where  $|s_1| \geq |s_2| \geq \dots \geq |s_n| \geq 0$  and  $|r_1| \geq |r_2| \geq \dots \geq |r_n| \geq 0$ .

**Theorem 19:** [Wang et al., 1999]

Given  $G$ , let  $G_r$  be obtained by Wang's et. al frequency weighted balanced trun-



cation as above. Then  $G_r$  is stable. In addition if

$$\text{rank}([B, B_{\text{WSL}}]) = \text{rank}(B_{\text{WSL}}) \quad (3.40)$$

$$\text{rank}([C^\top, C_{\text{WSL}}^\top]) = \text{rank}(C_{\text{WSL}}^\top), \quad (3.41)$$

then  $G_r$  is asymptotically stable and satisfies

$$\|W(G - G_r)V\|_\infty \leq 2\|WL\|_\infty \|KV\|_\infty \sum_{i=r+1}^n \kappa_i \quad (3.42)$$

with

$$L = CV_{\text{WSL}} \text{diag}(|r_1|^{-1/2}, |r_2|^{-1/2}, \dots, |r_{ni}|^{-1/2}, 0, \dots, 0) \quad (3.43)$$

$$K = \text{diag}(|s_1|^{-1/2}, |s_2|^{-1/2}, \dots, |r_{no}|^{-1/2}, 0, \dots, 0)U_{\text{WSL}}^\top B \quad (3.44)$$

where  $ni = \text{rank}(X)$  and  $no = \text{rank}(Y)$ .

### 3.1.4.5 Gawronski's et al. Method

A scheme where the frequency weights are not predefined and approximation is considered in a given frequency interval is introduced in [Gawronski and Juang, 1990].

Let  $P$  and  $Q$  be the reachability and the observability Gramians introduced in (3.2). Using Parseval's relationship it follows that in the frequency domain,  $P$  and  $Q$  are given by

$$P = \frac{1}{2\pi} \int_{-\infty}^{+\infty} H(w)BB^\top H^*(w)dw, \quad (3.45)$$

$$Q = \frac{1}{2\pi} \int_{-\infty}^{+\infty} H^*(w)C^\top CH(w)dw, \quad (3.46)$$

where  $H(w) = (jwI - A)^{-1}$  and  $H^*(w) = (-jwI - A^*)^{-1}$ . For a given frequency band  $\Omega = [\omega_1; \omega_2]$ , the frequency weighted Gramians can be defined as

$$P_\Omega = P(\omega_2) - P(\omega_1) \quad (3.47)$$

$$Q_\Omega = Q(\omega_2) - Q(\omega_1) \quad (3.48)$$

where

$$P(\omega) = \frac{1}{2\pi} \int_{-\omega}^{+\omega} H(w)BB^\top H^*(w)dw, \quad (3.49)$$

$$Q(\omega) = \frac{1}{2\pi} \int_{-\omega}^{+\omega} H^*(w)C^\top CH(w)dw. \quad (3.50)$$

Note that  $P(\omega)$  and  $P(\omega)$  are both positive definite. From the fact that

$$BB^\top = -AP - PA^\top = (j\omega I - A)P + P(j\omega I - A)^*,$$

the weighted reachability Gramian can be expressed as

$$P(\omega) = \frac{1}{2\pi} \int_{-\omega}^{+\omega} [PH^*(w) + H(w)P] dw \quad (3.51)$$

The final equation yields

$$P(w) = PS^*(w) + S(w)P \quad (3.52)$$

where

$$S(\omega) = \frac{1}{2\pi} \int_{-\omega}^{+\omega} H(w)dw = \frac{j}{2\pi} \ln((j\omega I + A)(-j\omega I + A)^{-1}) \quad (3.53)$$

A similar argument leads to

$$Q(w) = S^*(w)Q + QS(w). \quad (3.54)$$

Based on the definitions of  $S(w)$  and  $P$  in (3.53) and (3.45), and from the fact that  $H(\omega_1)H(\omega_2) = H(\omega_2)H(\omega_1)$  for any  $\omega_1, \omega_2 \in \mathbb{R}$ , one obtains

$$\begin{aligned} S(w)P &= \frac{1}{4\pi^2} \int_{-\omega}^{+\omega} \int_{-\infty}^{+\infty} H(w)H(\phi)BB^\top H^*(\phi)d\phi dw \\ &= \frac{1}{2\pi} \int_{-\infty}^{+\infty} H(\phi)S(\omega)BB^\top H^*(\phi)d\phi. \end{aligned} \quad (3.55)$$

Plugging this into (3.51) gives

$$P(w) = PS^*(w) + S(w)P = \frac{1}{2\pi} \int_{-\infty}^{+\infty} H(\phi)W_c(w)H^*(\phi)d\phi. \quad (3.56)$$

where  $W_c(w) = S(w)BB^\top + BB^\top S^*(w)$ . Since  $A$  is asymptotically stable,  $P(w)$  is the solution to the Lyapunov equation

$$AP(w) + P(w)A^\top + W_c(w) = 0 \quad (3.57)$$

Therefore, the frequency weighted Gramian  $P_\Omega$  in (3.47) is obtained by solving

$$AP_\Omega + P_\Omega A^\top + W_c(\Omega) = 0 \quad (3.58)$$

where  $W_c(\Omega) = W_c(\omega_2) - W_c(\omega_1)$ . A similar argument yields

$$A^\top Q_\Omega + Q_\Omega A^\top + W_o(\Omega) = 0 \quad (3.59)$$

where  $W_o(\Omega) = W_o(\omega_2) - W_o(\omega_1)$  and  $W_o(w) = S^*(w)C^T C + C^T C S(w)$ . Therefore  $S(w)$  can be computed whenever a balanced realisation can be computed. Gawronski and Juang's frequency weighted method is obtained by balancing  $P_\Omega$  and  $Q_\Omega$ , i.e. finding a basis so that

$$P_\Omega = Q_\Omega = \text{diag}(\sigma_{n_1} I_{n_1}, \dots, \sigma_{n_q} I_{n_q}) \quad (3.60)$$

where  $n_i$  are the multiplicities of each singular value  $\sigma_{n_i}$  and  $n_1 + \dots + n_q = n$ . Then the reduced order model is obtained by truncation. The advantage of this method is that the construction of input and output weights is avoided by defining the Gramians over the specified frequency range.

Remark

since  $W_c(\Omega)$  and  $W_o(\Omega)$  are not guaranteed to be positive definite, stability of the reduced model cannot be guaranteed.

### 3.1.4.6 Gugercin's et al. Method

In this method, a modification is introduced to Gawronski's method in order to obtain a frequency balancing method which guarantees stability and provides a simple error result.

Given the Lyapunov equation (3.58) and (3.59), let  $W_c(\Omega)$  and  $W_o(\Omega)$  have the following EVD:

$$W_c(\Omega) = M \Lambda M^T = M \text{diag}(\lambda_1, \dots, \lambda_{n_K}) M^T, \quad (3.61)$$

$$W_o(\Omega) = N \Delta N^T = N \text{diag}(\delta_1, \dots, \delta_{n_K}) N^T, \quad (3.62)$$

where  $MM^T = NN^T = I_n$  with  $|\lambda_1| \geq \dots \geq |\lambda_n| \geq 0$  and  $|\delta_1| \geq \dots \geq |\delta_n| \geq 0$ . From the fact that  $W_c(\Omega)$  and  $W_o(\Omega)$  are both symmetric, such decompositions exist. Let  $u \leq n$  and  $v \leq n$  be respectively the ranks of  $W_c(\Omega)$  and  $W_o(\Omega)$ . Based on these definitions, let us define the two quantities:

$$B_G = M \text{diag}(|\lambda_1|^{\frac{1}{2}}, \dots, |\lambda_u|^{\frac{1}{2}}, 0, \dots, 0), \quad (3.63)$$

$$C_G = \text{diag}(|\delta_1|^{\frac{1}{2}}, \dots, |\delta_v|^{\frac{1}{2}}, 0, \dots, 0) N^T. \quad (3.64)$$

## 3.2 $\mathcal{H}_\infty$ -LTI-Controller Order Reduction

Methods proposed in the last section deal with an open-loop order reduction, where only the stability of the model is considered. However, in a closed-loop configuration the stability of the closed-loop must be preserved when reducing. In addition, performance of the reduced order should be kept as close as possible to the original controller performance.

## 3.2.1 Full Order Controller

First, let us recall the standard interconnected closed loop system of the Figure 3.5 where the augmented plant  $P$  is represented as follow:

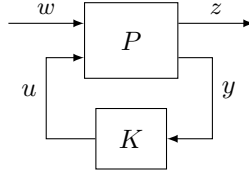
 Figure 3.5:  $\mathcal{H}_\infty$ -controlled system

$$P = \begin{bmatrix} P_{zw} & P_{zu} \\ P_{yw} & P_{yu} \end{bmatrix} \stackrel{s}{=} \left[ \begin{array}{c|cc} A & B_w & B_u \\ \hline C_z & D_{zw} & D_{zu} \\ C_y & D_{yw} & D_{yu} \end{array} \right]. \quad (3.65)$$

Then, finding the stabilising controller  $K$  is equivalent to reduce the  $\mathcal{H}_\infty$ -norm of the transfer  $T_{zw}$  such that:

$$\|T_{zw}\|_\infty = \|\mathcal{F}_\ell(P, K)\|_\infty = \|P_{zw} + P_{zu}K(I - P_{yu})^{-1}P_{yw}\|_\infty \quad (3.66)$$

A general solution for this problem base in Youla parametrisation [Youla et al., 1976, Vidyasagar, 1985] is given in [Zhou et al., 1996] (Fig. 3.6):

$$K = \mathcal{F}_\ell(M, Q) = M_{11} + M_{12}(I - M_{22}Q)^{-1}M_{21}, \quad (3.67)$$

where  $M$  is a fixed transfer function matrix of the form:

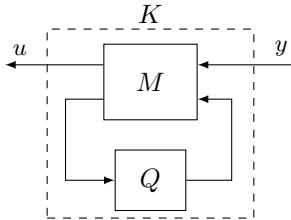

Figure 3.6: LFT of the Controller K

$$M = \begin{bmatrix} M_{11} & M_{12} \\ M_{21} & M_{22} \end{bmatrix} \stackrel{s}{=} \left[ \begin{array}{c|cc} \hat{A} & \hat{B}_1 & \hat{B}_2 \\ \hline \hat{C}_1 & \hat{D}_{11} & \hat{D}_{12} \\ \hat{C}_2 & \hat{D}_{21} & \hat{D}_{22} \end{array} \right]. \quad (3.68)$$

$\hat{D}_{12}$  and  $\hat{D}_{21}$  are invertible, and  $M_{12}^{-1}$  and  $M_{21}^{-1}$  are stable.  $Q$  is a free parameter which should be stable and should satisfy the following inequalities:

$$\begin{cases} Q \in \mathcal{RH}_\infty \\ \|Q\|_\infty < \gamma. \end{cases} \quad (3.69)$$

The solution obtained by setting  $Q = 0$  is called the central controller  $K_c = M_{11}$ . This solution is used in general as  $\mathcal{H}_\infty$ -controller [Zhou et al., 1996, Nagado and Usui, 2009].

### 3.2.2 FWBT for Controller Order Reduction

The problem to be considered here is to find a controller  $K_r$  with a minimal possible order such that the  $\mathcal{H}_\infty$  performance requirement  $\|\mathcal{F}_\ell(G, K_r)\|_\infty \leq \gamma$  is satisfied (Figure 3.7). This is clearly equivalent to finding a  $Q$  so that it satisfies the above constraint and the order of  $K_r$  is reduced. However, directly finding such a  $Q$  has proven to be very difficult.

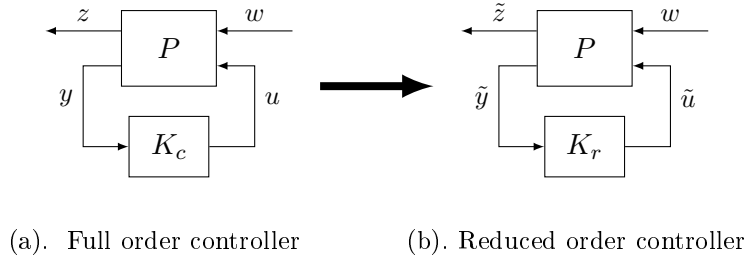

Figure 3.7: From Full to Reduced Order  $\mathcal{H}_\infty$ -controller

Then,  $K_r$  can be presented as (Figure 3.8):

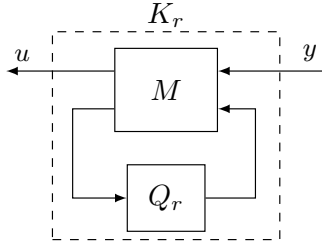

Figure 3.8: Block Diagram Representation of  $K_r$

$$K_r = M_{11} + M_{12}Q_r(I_r - M_{22}Q_r)^{-1}M_{21} \quad (3.70)$$

The reduction error  $\Delta_K$  is defined by  $\Delta_K \triangleq K_r - K_c$ . Then,

$$\Delta_K = M_{12}Q_r(I - M_{22}Q_r)^{-1}M_{21}. \quad (3.71)$$

Based on this:

$$Q_r = (I_r + M_{12}^{-1}\Delta_K M_{21}^{-1}M_{22})^{-1}M_{12}^{-1}\Delta_K M_{21}^{-1} \quad (3.72)$$

Then, finding a low-order- $\mathcal{H}_\infty$ -controller is equivalent to search the stable free parameter  $Q_r$  such that  $\|Q_r\|_\infty < \gamma$ . The expression (3.72) can be represented by the block diagram in Figure 3.9:

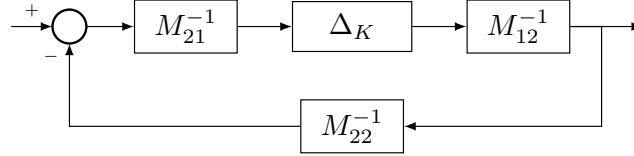

Figure 3.9: Block Diagram Representation of  $Q_r$

Based on the small gain theorem, the closed-loop system is stable if:

$$\|\Delta_K M_{21}^{-1} M_{22} M_{12}^{-1}\|_\infty < 1 \quad (3.73)$$

or

$$\|M_{21}^{-1} M_{22} M_{12}^{-1} \Delta_K\|_\infty < 1 \quad (3.74)$$

Therefore, the above inequality can be interpreted as frequency-weighted model reduction problem given in the previous section w.r.t. the following settings:

$$V = I_r \quad \text{and} \quad W = M_{21}^{-1} M_{22} M_{12}^{-1}$$

or

$$V = M_{21}^{-1} M_{22} M_{12}^{-1} \quad \text{and} \quad W = I_r$$

### 3.2.3 Order Reduction Procedure

By considering the scheme in Figure 3.10, we summarise the contents of this approach in Algorithm 2.

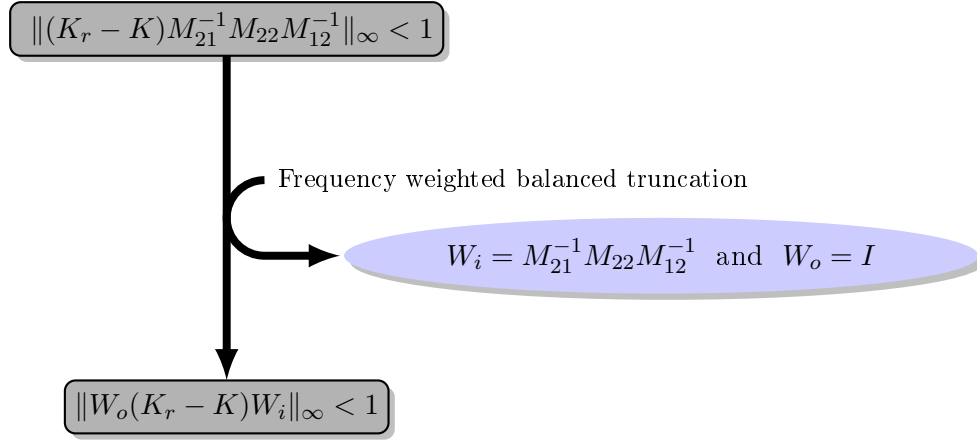

Figure 3.10: FWBT for controller order reduction

---

**Algorithm 2**  $\mathcal{H}_\infty$ -LTI-controller order reduction
 

---

1. Compute the full order controller  $K = M_{11}$  as described in Section 2.1.
  2. Compute  $M_{12}$ ,  $M_{21}$  and  $M_{22}$  given in (2.11).
  3. By considering the Figure 3.10, compute the Gramians  $P_1$  and  $Q_o$  as described in (3.18).
  4. Search a balanced realisation according to the Moore's algorithm giving in Section 3.1.
  5. Truncate the balanced realisation of  $K$  to obtain  $K_r$  at the order  $r$ .
- 

In this section, the balanced truncation method is used to reduce the order of  $\mathcal{H}_\infty$ -LTI-Controller. In fact, the FWBT detailed in Section 3.1 is fitted to the controller order reduction issue. The full order controller is firstly designed as shown in Section 2.1, then the FWBT with its various variants (Enns, Lin and Chiu, Wang, etc.) is used to obtain a stabilising reduced order one. Performance of the used techniques will be checked in Chapter 4

### 3.3 $\mathcal{H}_\infty$ -LPV-Controller Order Reduction

Thanks to their shown good properties, BT method has been proposed to reduce the order of controllers for LTI systems [Liu and Anderson, 1989, Zhou et al., 1995]. The extension of these reduction techniques to LPV-systems is proposed in this section. The idea is to substitute the use of LTI Gramians by using parameter/time varying equivalents [Wood et al., 1996, Sandberg and Rantzer, 2004]. A generalised method with unbounded rate parameter model is given in [El-Zobaidi and Jaimoukha, 1998]. Then-after, an effective BT method for  $\mathcal{H}_\infty$ -LPV-controller order reduction is proposed in [Widowati et al., 2004].

The proposed method adapts the FWBT to reduce the order of an  $\mathcal{H}_\infty$ -LPV controller. For the development of this approach, the generalised Gramian framework is used [Shaker and Wisniewski, 2011]. Then, the closed-loop system represented by  $T_{zw}(\rho)$

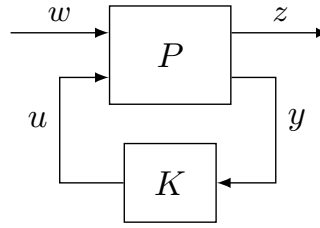

Figure 3.11: Closed-loop Scheme

can be expressed as

$$T_{zw}(\rho) = \left[ \begin{array}{c|c} \mathbf{A}(\rho) & \mathbf{B}(\rho) \\ \hline \mathbf{C}(\rho) & 0 \end{array} \right] \quad (3.75)$$

where

$$\begin{aligned} \mathbf{A}(\rho) &= \begin{bmatrix} A(\rho) + B_2(\rho)D_K(\rho)C_2(\rho) & B_2(\rho)C_K(\rho) \\ B_K(\rho)C_2(\rho) & A_K(\rho) \end{bmatrix}, \\ \mathbf{B}(\rho) &= \begin{bmatrix} B_1(\rho) + B_2(\rho)D_K(\rho)D_K(\rho)D_{21}(\rho) \\ B_K(\rho)D_{21}(\rho) \end{bmatrix} \text{ and} \\ \mathbf{C}(\rho) &= \begin{bmatrix} C_1(\rho) + D_{12}(\rho)D_K(\rho)C_2(\rho) & D_{12}(\rho)C_K(\rho) \end{bmatrix}. \end{aligned}$$

#### 3.3.1 Gramians and Generalised Gramians

The proposed method is based on the FWBT method where the key notions are the so-called *reachability and observability Gramians*.



**Definition 3.3.1 (Gramians)** *Considering the quadratic stable and minimal realisation of the closed-loop LPV-system  $T_{zw}(\rho)$  given in (3.75), Let us define  $\mathcal{R}(\rho)$  and  $\mathcal{O}(\rho)$ , the related reachability and observability Gramians respectively, they are defined as the solution of the two parameter dependent Lyapunov equations*

$$-\sum_{i=1}^s v_i \frac{\partial \mathcal{R}(\rho)}{\partial \rho_i} + \mathbf{A}(\rho)\mathcal{R}(\rho) + \mathcal{R}(\rho)\mathbf{A}^\top(\rho) + \mathbf{B}(\rho)\mathbf{B}^\top(\rho) = 0, \quad (3.76)$$

$$\sum_{i=1}^s v_i \frac{\partial \mathcal{O}(\rho)}{\partial \rho_i} + \mathbf{A}^\top(\rho)\mathcal{O}(\rho) + \mathcal{O}(\rho)\mathbf{A}(\rho) + \mathbf{C}^\top(\rho)\mathbf{C}(\rho) = 0. \quad (3.77)$$

For a given parameter trajectory  $\rho$ , let  $\Phi_\rho(t, 0)$  be the state-transition matrix. Then, the functional  $\mathcal{R}(\rho)$  and  $\mathcal{O}(\rho)$ , respectively the reachability and observability Gramians of the closed-loop LPV-system (3.75), are expressed such that

$$\mathcal{R}(\rho) = \int_{-\infty}^0 \Phi_\rho(0, t)\mathbf{B}(\rho(t))\mathbf{B}^\top(\rho(t))\Phi_\rho^\top(0, t) dt, \quad (3.78)$$

$$\mathcal{O}(\rho) = \int_0^{\infty} \Phi_\rho^\top(t, 0)\mathbf{C}^\top(\rho(t))\mathbf{C}(\rho(t))\Phi_\rho(t, 0) dt. \quad (3.79)$$

**Definition 3.3.2 (Generalised Gramians)** *Let  $\mathbf{P}(\rho)$  and  $\mathbf{Q}(\rho)$  be respectively the generalised reachability and observability Gramians of the quadratic stable and minimal closed-loop LPV-system (3.75) given as*

$$\forall(\rho, v) \in \Delta_\rho \times \Delta_v$$

$$-\sum_{i=1}^s v_i \frac{\partial \mathbf{P}(\rho)}{\partial \rho_i} + \mathbf{A}(\rho)\mathbf{P}(\rho) + \mathbf{P}(\rho)\mathbf{A}^\top(\rho) + \mathbf{B}(\rho)\mathbf{B}^\top(\rho) \prec 0 \quad (3.80)$$

$$\sum_{i=1}^s v_i \frac{\partial \mathbf{Q}(\rho)}{\partial \rho_i} + \mathbf{A}^\top(\rho)\mathbf{Q}(\rho) + \mathbf{Q}(\rho)\mathbf{A}(\rho) + \mathbf{C}^\top(\rho)\mathbf{C}(\rho) \prec 0. \quad (3.81)$$

Indeed, Lyapunov inequalities (rather than Lyapunov equations) are solved to compute generalised Gramians. This linear matrix inequality (LMI) approach to the model reduction problem is particularly useful when some structures need to be preserved in the process of model reduction. Controller reduction is a typical example of this type of problems [Shaker and Wisniewski, 2011]. Note that the physical interpretations of generalised Gramians are similar to ordinary Gramians. Considering  $T_{zw}(\rho)$ ,  $\mathcal{R}(\rho)$  and  $\mathcal{O}(\rho)$ , the following lemma introduces useful results about the relation between Gramians and generalised Gramians.

**Lemma 7**

Let  $T_{zw}(\rho)$  be a minimal state-space realisation of the quadratic stable and minimal closed-loop system defined by (3.75). Then,  $\forall \rho \in \mathcal{P}_\rho$

$$\begin{aligned}\mathcal{R}(\rho) &< \mathbf{P}(\rho(0)) \\ \mathcal{O}(\rho) &< \mathbf{Q}(\rho(0)).\end{aligned}\tag{3.82}$$

where  $\mathcal{R}(\rho)$ ,  $\mathcal{O}(\rho)$ ,  $\mathbf{P}(\rho)$  and  $\mathbf{Q}(\rho)$  are the solutions of (3.78), (3.79), (3.80) and (3.81) respectively.

**Proof:** By multiplying on the left by  $\Phi_\rho(0, t)$  and on the right by  $\Phi_\rho^\top(0, t)$ , the relation (3.80) yields

$$\begin{aligned}-\Phi_\rho(0, t) \sum_{i=1}^s v_i \frac{\partial \mathbf{P}}{\partial \rho_i} \Phi_\rho^\top(0, t) + \Phi_\rho(0, t) \mathbf{A}(\rho(t)) \mathbf{P}(\rho) \Phi_\rho^\top(0, t) + \Phi_\rho(0, t) \mathbf{P}(\rho) \mathbf{A}^\top(\rho(t)) \Phi_\rho^\top(0, t) \\ + \Phi_\rho(0, t) \mathbf{B}(\rho(t)) \mathbf{B}^\top(\rho(t)) \Phi_\rho^\top(0, t) < 0.\end{aligned}\tag{3.83}$$

Using fact that  $\frac{\partial}{\partial t_0} \Phi_\rho(t, t_0) = -\Phi_\rho(t, t_0) \mathbf{A}(\rho(t_0))$ , then (3.83) yields

$$-\frac{d}{dt} \left( \Phi_\rho(0, t) \mathbf{P}(\rho) \Phi_\rho^\top(0, t) \right) + \Phi_\rho(0, t) \mathbf{B}(\rho(t)) \mathbf{B}^\top(\rho(t)) \Phi_\rho^\top(0, t) < 0.\tag{3.84}$$

which on integrating over the semi-infinite time axis  $(-\infty, 0]$  and considering that  $\lim_{t \rightarrow -\infty} \Phi_\rho(0, t) = 0$ , gives

$$\mathbf{P}(\rho(0)) > \underbrace{\int_{-\infty}^0 \Phi_\rho(0, t) \mathbf{B}(\rho(t)) \mathbf{B}^\top(\rho(t)) \Phi_\rho^\top(0, t) dt}_{\mathcal{R}(\rho)}\tag{3.85}$$

Similarly, let us multiply on the right by the closed-loop state-transition matrix  $\Phi_\rho(t, 0)$  and on the left by  $\Phi_\rho^\top(t, 0)$ , the relation (3.81):

$$\begin{aligned}\Phi_\rho^\top(t, 0) \sum_{i=1}^s v_i \frac{\partial \mathbf{Q}}{\partial \rho_i} \Phi_\rho(t, 0) + \Phi_\rho^\top(t, 0) \mathbf{A}^\top(\rho(t)) \mathbf{Q}(\rho) \Phi_\rho(t, 0) + \Phi_\rho^\top(t, 0) \mathbf{Q}(\rho) \mathbf{A}(\rho(t)) \Phi_\rho(t, 0) \\ + \Phi_\rho^\top(t, 0) \mathbf{C}^\top(\rho(t)) \mathbf{C}(\rho(t)) \Phi_\rho(t, 0) < 0\end{aligned}\tag{3.86}$$

Using the fact that  $\frac{\partial}{\partial t} \Phi_\rho(t, 0) = \mathbf{A}(\rho(t)) \Phi_\rho(t, 0)$ , then (3.86) yields

$$\frac{d}{dt} \left( \Phi_\rho^\top(t, 0) \mathbf{Q}(\rho) \Phi_\rho(t, 0) \right) + \Phi_\rho^\top(t, 0) \mathbf{C}^\top(\rho(t)) \mathbf{C}(\rho(t)) \Phi_\rho(t, 0) < 0.\tag{3.87}$$

Integrating the last expression from 0 to  $+\infty$  gives

$$\mathbf{Q}(\rho(0)) \succ \underbrace{\int_0^{+\infty} \Phi_\rho^\top(t, 0) \mathbf{C}^\top(\rho(t)) \mathbf{C}(\rho(t)) \Phi_\rho(t, 0) dt}_{\mathcal{O}(\rho)} \quad (3.88)$$

■

### 3.3.2 Frequency-Limited Order Reduction by FWBT

For a given parameter trajectory  $\rho$ , let consider  $\Phi_\rho(t, 0)$  the state-transition matrix of the closed-loop system (3.75). Then, let us define

$$\begin{aligned} f_\rho(t) &= \Phi_\rho(0, t) \mathbf{B}(\rho(t)) H(-t) \\ g_\rho(t) &= \mathbf{C}(\rho(t)) \Phi_\rho(t, 0) H(t) \end{aligned} \quad \forall t, \quad (3.89)$$

where  $H$  is the heaviside step function.

By considering  $\Omega = [\omega_1 ; \omega_2]$  the frequency range where order-reduction is desired to be better, the following definition is given

**Definition 3.3.3 (Frequency Limited Gramians)** Let  $\mathcal{R}_\Omega(\rho)$  and  $\mathcal{O}_\Omega(\rho)$  two frequency dependent terms defined as

$$\mathcal{R}_\Omega(\rho) = \mathcal{R}_{\omega_2}(\rho) - \mathcal{R}_{\omega_1}(\rho) \quad \text{and} \quad \mathcal{O}_\Omega(\rho) = \mathcal{O}_{\omega_2}(\rho) - \mathcal{O}_{\omega_1}(\rho)$$

where

$$\mathcal{R}_\omega(\rho) = \int_{-\omega}^{+\omega} F_\rho(w) F_\rho^*(w) dw \quad (3.90)$$

$$\mathcal{O}_\omega(\rho) = \int_{-\omega}^{+\omega} G_\rho^*(w) G_\rho(w) dw \quad (3.91)$$

with  $F_\rho$  (resp.  $G_\rho$ ) is the Fourier transform of  $f_\rho$  (resp.  $g_\rho$ ). Then, the functional  $\hat{\mathcal{R}}_\Omega(\rho)$  and  $\hat{\mathcal{O}}_\Omega(\rho)$ , respectively the frequency limited reachability and observability Gramians of the closed-loop LPV-system (3.75), are defined as the solutions of  $\forall(\rho, v) \in \mathbf{\Delta}_\rho \times \mathbf{\Delta}_v$

$$-\sum_{i=1}^s v_i \frac{\partial \hat{\mathcal{R}}_\Omega(\rho)}{\partial \rho_i} + \mathbf{A}(\rho) \hat{\mathcal{R}}_\Omega(\rho) + \hat{\mathcal{R}}_\Omega(\rho) \mathbf{A}^\top(\rho) + \mathcal{R}_\Omega(\rho) = 0 \quad (3.92)$$

$$\sum_{i=1}^s v_i \frac{\partial \hat{\mathcal{O}}_\Omega(\rho)}{\partial \rho_i} + \mathbf{A}^\top(\rho) \hat{\mathcal{O}}_\Omega(\rho) + \hat{\mathcal{O}}_\Omega(\rho) \mathbf{A}(\rho) + \mathcal{O}_\Omega(\rho) = 0. \quad (3.93)$$

The quantities  $\mathcal{R}_\Omega(\rho)$  and  $\mathcal{O}_\Omega(\rho)$  have the following eigenvalues decomposition

$$\mathcal{R}_\Omega(\rho) = U_\Omega(\rho) \text{diag}(\lambda_1(\rho), \dots, \lambda_{n_K}(\rho)) U_\Omega^\top(\rho) \quad (3.94)$$

$$\mathcal{O}_\Omega(\rho) = V_\Omega(\rho) \text{diag}(\delta_1(\rho), \dots, \delta_{n_K}(\rho)) V_\Omega^\top(\rho) \quad (3.95)$$

with  $|\lambda_1| \geq \dots \geq |\lambda_{n_K}| \geq 0$  and  $|\delta_1| \geq \dots \geq |\delta_{n_K}| \geq 0$ . Let  $u_\rho \leq n_K$  and  $v_\rho \leq n_K$  be respectively the ranks of  $\mathcal{R}_\Omega(\rho)$  and  $\mathcal{O}_\Omega(\rho)$ . Based on these definitions, let us define the two quantities:

$$\mathbf{B}_\Omega(\rho) = U_\Omega(\rho) \text{diag}(|\lambda_1(\rho)|^{\frac{1}{2}}, \dots, |\lambda_{u_\rho}(\rho)|^{\frac{1}{2}}, 0, \dots, 0), \text{ and} \quad (3.96)$$

$$\mathbf{C}_\Omega(\rho) = \text{diag}(|\delta_1(\rho)|^{\frac{1}{2}}, \dots, |\delta_{v_\rho}(\rho)|^{\frac{1}{2}}, 0, \dots, 0) V_\Omega^\top(\rho). \quad (3.97)$$

**Definition 3.3.4 (Modified Frequency Limited Generalised Gramians)**

Consider  $K(\rho)$ , the full-order stabilising LPV-controller given in (2.79). Let

$$\hat{\mathbf{P}}_\Omega(\rho) = \begin{bmatrix} \hat{\mathbf{P}}_1(\rho) & 0 \\ 0 & \hat{\mathbf{P}}_2(\rho) \end{bmatrix} \succ 0 \text{ and } \hat{\mathbf{Q}}_\Omega(\rho) = \begin{bmatrix} \hat{\mathbf{Q}}_1(\rho) & 0 \\ 0 & \hat{\mathbf{Q}}_2(\rho) \end{bmatrix} \succ 0 \text{ be the}$$

modified frequency limited reachability and observability Gramians defined as the solutions of the following Lyapunov equations

$$\forall(\rho, v) \in \Delta_\rho \times \Delta_v$$

$$-\sum_{i=1}^s v_i \frac{\partial \hat{\mathbf{P}}_\Omega(\rho)}{\partial \rho_i} + \mathbf{A}(\rho) \hat{\mathbf{P}}_\Omega(\rho) + \hat{\mathbf{P}}_\Omega(\rho) \mathbf{A}^\top(\rho) + \mathbf{B}_\Omega(\rho) \mathbf{B}_\Omega^\top(\rho) = 0 \quad (3.98)$$

$$\sum_{i=1}^s v_i \frac{\partial \hat{\mathbf{Q}}_\Omega(\rho)}{\partial \rho_i} + \mathbf{A}^\top(\rho) \hat{\mathbf{Q}}_\Omega(\rho) + \hat{\mathbf{Q}}_\Omega(\rho) \mathbf{A}(\rho) + \mathbf{C}_\Omega^\top(\rho) \mathbf{C}_\Omega(\rho) = 0. \quad (3.99)$$

For the generalisation, we have the following inequalities:

$$-\sum_{i=1}^s v_i \frac{\partial \mathbf{P}_\Omega(\rho)}{\partial \rho_i} + \mathbf{A}(\rho) \mathbf{P}_\Omega(\rho) + \mathbf{P}_\Omega(\rho) \mathbf{A}^\top(\rho) + \mathbf{B}_\Omega(\rho) \mathbf{B}_\Omega^\top(\rho) \prec 0 \quad (3.100)$$

$$\sum_{i=1}^s v_i \frac{\partial \mathbf{Q}_\Omega(\rho)}{\partial \rho_i} + \mathbf{A}^\top(\rho) \mathbf{Q}_\Omega(\rho) + \mathbf{Q}_\Omega(\rho) \mathbf{A}(\rho) + \mathbf{C}_\Omega^\top(\rho) \mathbf{C}_\Omega(\rho) \prec 0. \quad (3.101)$$

$$\text{with } \mathbf{P}_\Omega(\rho) = \begin{bmatrix} \mathbf{P}_1(\rho) & 0 \\ 0 & \mathbf{P}_2(\rho) \end{bmatrix} \succ 0 \text{ and } \mathbf{Q}_\Omega(\rho) = \begin{bmatrix} \mathbf{Q}_1(\rho) & 0 \\ 0 & \mathbf{Q}_2(\rho) \end{bmatrix} \succ 0.$$

If the block diagonal solutions  $\mathbf{P}_\Omega(\rho)$  and  $\mathbf{Q}_\Omega(\rho)$  exist, then let  $T_1(\rho)$  and  $T_2(\rho)$  be two

nonsingular matrices given such that

$$\begin{aligned} T_1^{-1}(\rho)\mathbf{P}_1(\rho)T_1^{-\top}(\rho) &= T_1^\top(\rho)\mathbf{Q}_1(\rho)T_1(\rho) \\ &= \Sigma_1(\rho) \\ &= \text{diag}(\xi_1(\rho), \dots, \xi_n(\rho)), \end{aligned} \quad (3.102)$$

with  $\xi_1(\rho) \geq \xi_2(\rho) \geq \dots \geq \xi_n(\rho)$ , and

$$\begin{aligned} T_2^{-1}(\rho)\mathbf{P}_2(\rho)T_2^{-\top}(\rho) &= T_2^\top(\rho)\mathbf{Q}_2(\rho)T_2(\rho) \\ &= \Sigma_2(\rho) \\ &= \text{diag}(\underbrace{\gamma_1(\rho), \dots, \gamma_r(\rho)}_{\Sigma_{21}}, \underbrace{\gamma_{r+1}(\rho), \dots, \gamma_{n_K}(\rho)}_{\Sigma_{22}}), \end{aligned} \quad (3.103)$$

with  $\gamma_1(\rho) \geq \gamma_2(\rho) \geq \dots \geq \gamma_r(\rho) > \gamma_{r+1}(\rho) \geq \gamma_{r+2}(\rho) \geq \dots \geq \gamma_{n_K}(\rho)$  are the frequency limited generalised Hankel singular values of  $K(\rho)$  and  $r$  is the desired order for the reduced-order controller. The balanced realisation of  $K(\rho)$  can be written as

$$\tilde{K}(\rho) = \left[ \begin{array}{c|c} T_2^{-1}(\rho)A_K(\rho)T_2(\rho) & T_2^{-1}(\rho)B_K(\rho) \\ \hline C_K(\rho)T_2(\rho) & D_K(\rho) \end{array} \right] = \left[ \begin{array}{c|c} \tilde{A}_K(\rho) & \tilde{B}_K(\rho) \\ \hline \tilde{C}_K(\rho) & \tilde{D}_K(\rho) \end{array} \right]. \quad (3.104)$$

Further,  $\tilde{K}(\rho)$  is partitioned as conformably with  $\Sigma_2(\rho)$  as

$$\tilde{K}(\rho) = \left[ \begin{array}{cc|c} \hat{A}_K(\rho) & \tilde{A}_{K12}(\rho) & \hat{B}_K(\rho) \\ \tilde{A}_{K21}(\rho) & \tilde{A}_{K22}(\rho) & \tilde{B}_{K2}(\rho) \\ \hline \hat{C}_K(\rho) & \tilde{C}_{K2}(\rho) & \hat{D}_K(\rho) \end{array} \right]. \quad (3.105)$$

Finally, a truncation step is performed to obtain a reduced-order controller.

**Definition 3.3.5** *Given the balanced realisation  $\tilde{K}(\rho)$  defined in (3.116), let  $\hat{K}(\rho)$  be the truncated realisation to the  $r$ th order and denoted as follows*

$$\hat{K}(\rho) = \left[ \begin{array}{c|c} \hat{A}_K(\rho) & \hat{B}_K(\rho) \\ \hline \hat{C}_K(\rho) & \hat{D}_K(\rho) \end{array} \right] \quad (3.106)$$

Furthermore, the reduced-order parameter dependent closed-loop system is given as

$$\begin{aligned} \hat{T}_{zw}(\rho) &= \left[ \begin{array}{c|c} \hat{\mathbf{A}}(\rho) & \hat{\mathbf{B}}(\rho) \\ \hline \hat{\mathbf{C}}(\rho) & \hat{\mathbf{D}}(\rho) \end{array} \right] \\ &= \left[ \begin{array}{cc|c} A(\rho) + B_2 \hat{D}_K(\rho) C_2 & B_2 \hat{C}_K(\rho) & B_1(\rho) + B_2 \hat{D}_K(\rho) \hat{D}_K(\rho) D_{21} \\ \hat{B}_K(\rho) C_2 & \hat{A}_K(\rho) & \hat{B}_K(\rho) D_{21} \\ \hline C_1(\rho) + D_{12} \hat{D}_K(\rho) C_2 & D_{12} \hat{C}_K(\rho) & D_{11}(\rho) + D_{12} \hat{D}_K(\rho) D_{21} \end{array} \right]. \end{aligned} \quad (3.107)$$

### Theorem 20

Suppose  $K(\rho)$  is the stabilising parameter dependent controller defined in (2.79) such that the closed-loop transfer  $T_{zw}(\rho)$  defined in (3.75) is minimal, quadratic stable and there exist Lyapunov inequality solutions  $\mathbf{P}_\Omega(\rho)$  and  $\mathbf{Q}_\Omega(\rho)$  such that (3.100) and (3.101) are satisfied. Let  $\hat{K}(\rho)$  be the reduced-order controller defined in (3.106) and obtained by truncation. Then, the closed-loop system with the reduced-order controller  $\hat{T}_{zw}(\rho)$  defined in (3.107) is stable. If in addition

$$\text{rank}[\mathbf{B}(\rho), \mathbf{B}_\Omega(\rho)] = \text{rank}[\mathbf{B}_\Omega(\rho)], \quad (3.108)$$

and

$$\text{rank}[\mathbf{C}^\top(\rho), \mathbf{C}_\Omega^\top(\rho)] = \text{rank}[\mathbf{C}_\Omega^\top(\rho)], \quad (3.109)$$

then,  $\hat{T}_{zw}(\rho)$  is quadratic stable and satisfies

$$\|T_{zw}(\rho) - \hat{T}_{zw}(\rho)\|_{i,2} \leq 2 \|J_B(\rho)\|_\infty \|J_C(\rho)\|_\infty \sum_{i=r+1}^{n_K} \gamma_{i,\rho} \quad (3.110)$$

where  $J_B(\rho) := \text{diag}(|\lambda_1|^{-\frac{1}{2}}(\rho), \dots, |\lambda_{u_\rho}|^{-\frac{1}{2}}(\rho), 0, \dots, 0) U_\Omega(\rho) \mathbf{B}(\rho)$  and  $J_C(\rho) := \mathbf{C}(\rho) V_\Omega(\rho) \text{diag}(|\delta_1|^{-\frac{1}{2}}(\rho), \dots, |\delta_{v_\rho}|^{-\frac{1}{2}}(\rho), 0, \dots, 0)$ ,

**Proof:** The reachability and the observability Gramians given in (3.78),(3.79) can be expressed as

$$\mathcal{R}(\rho) = \int_{-\infty}^{+\infty} f_\rho(\tau) f_\rho^*(\tau) d\tau \quad (3.111)$$

$$\mathcal{O}(\rho) = \int_{-\infty}^{+\infty} g_\rho^*(\tau) g_\rho(\tau) d\tau \quad (3.112)$$

where  $f_\rho(\tau)$  and  $g_\rho(\tau)$  are given in (3.89).

Then, using Parseval relationship, the reachability and the observability Gramians could be expressed as follows

$$\mathcal{R}(\rho) = \frac{1}{2\pi} \int_{-\infty}^{+\infty} F_\rho(w) F_\rho^*(w) dw \quad (3.113)$$

$$\mathcal{O}(\rho) = \frac{1}{2\pi} \int_{-\infty}^{+\infty} G_\rho^*(w) G_\rho(w) dw. \quad (3.114)$$

By considering  $F_\rho$  (resp.  $g_\rho$ ) the Fourier transform of  $f_\rho$  (resp.  $g_\rho$ ), we can define  $\mathcal{R}_\omega(\rho)$  and  $\mathcal{O}_\omega(\rho)$  as the limited reachability and observability Gramians given in (3.91) and (3.91). Then, by setting  $\Omega = [\omega_1; \omega_2]$  the frequency range where approximation is desired to be better. Then, a new modified terms  $\mathcal{R}_\Omega(\rho)$  and  $\mathcal{O}_\Omega(\rho)$  are defined.

Since  $\mathcal{R}_\Omega(\rho)$  and  $\mathcal{O}_\Omega(\rho)$  are not guaranteed to be positive definite, stability of the reduced-order controller is not guaranteed. Then, an idea based on eigenvalues decomposition presented in [Gugercin and Antoulas, 2004] is proposed here to guarantee stability by providing an upper error bound. Indeed, the solution of (3.100) and (3.101) is performed instead of (3.92) and (3.93). In addition, the modified frequency limited Gramians in (3.98) and (3.99) are used instead of the ordinary ones defined in (3.98) and (3.99). In fact, Lemma 7 shows that the generalised Gramians could be an approximation of the ordinary Gramians. The transition to generalised Gramian framework might induce less accurate approximation but the order-reduction error still bounded. Finally the expression of the upper error bound given in (3.110) is found according to this

Let  $\tilde{T}_{zw}(\rho)$  be the frequency limited balanced realisation of the full-order closed-loop system. Then,  $\tilde{T}_{zw}(\rho)$  is defined by

$$\tilde{T}_{zw}(\rho) = \left[ \begin{array}{c|c} \frac{T^{-1}(\rho)\mathbf{A}(\rho)T(\rho)}{\mathbf{C}(\rho)T(\rho)} & T^{-1}(\rho)\mathbf{B}(\rho) \\ \hline & \mathbf{D}(\rho) \end{array} \right] = \left[ \begin{array}{c|c} \left[ \begin{array}{cc} \hat{\mathbf{A}}(\rho) & \tilde{\mathbf{A}}_{12}(\rho) \\ \tilde{\mathbf{A}}_{21}(\rho) & \tilde{\mathbf{A}}_{22}(\rho) \end{array} \right] & \left[ \begin{array}{c} \hat{\mathbf{B}}(\rho) \\ \tilde{\mathbf{B}}_2(\rho) \end{array} \right] \\ \hline \left[ \begin{array}{cc} \hat{\mathbf{C}}(\rho) & \tilde{\mathbf{C}}_2(\rho) \end{array} \right] & \tilde{\mathbf{D}}(\rho) \end{array} \right], \quad (3.115)$$

where  $T(\rho) = \text{diag}(T_1(\rho), T_2(\rho))$ .

By considering the assumptions (3.108) and (3.109), there exist  $J_B(\rho)$  and  $J_C(\rho)$  such that  $\mathbf{B}(\rho) = \mathbf{B}_\Omega(\rho)J_B(\rho)$  and  $\mathbf{C}(\rho) = J_C(\rho)\mathbf{C}_\Omega(\rho)$ . On the other hand, the reduction error is expressed as

$$\begin{aligned} \|T_{zw}(\rho) - \hat{T}_{zw}(\rho)\|_{i,2} &= \|\mathbf{C}(\rho)(sI - \mathbf{A}(\rho))^{-1}\mathbf{B}(\rho) - \hat{\mathbf{C}}(\rho)(sI - \hat{\mathbf{A}}(\rho))^{-1}\hat{\mathbf{B}}(\rho)\|_{i,2} \\ &= \|J_C(\rho) \left[ \mathbf{C}_\Omega(\rho)(sI - \mathbf{A}(\rho))^{-1}\mathbf{B}_\Omega(\rho) - \hat{\mathbf{C}}(\rho)(sI - \hat{\mathbf{A}}(\rho))^{-1}\hat{\mathbf{B}}(\rho) \right] J_B(\rho)\|_{i,2} \\ &\leq 2\|J_B(\rho)\|_\infty \|J_C(\rho)\|_\infty \sum_{i=r+1}^{n_K} \gamma_{i,\rho} \end{aligned}$$

■

Remark

The Assumptions (3.108) and (3.109) mean that there exist  $J_B(\rho)$  and  $J_C(\rho)$  such that  $\mathbf{B}(\rho) = \mathbf{B}_\Omega(\rho)J_B(\rho)$  and  $\mathbf{C}(\rho) = J_C(\rho)\mathbf{C}_\Omega(\rho)$ . In addition, by following the steps in [Anderson and Clements, 1981, Wang et al., 1999, Imran et al., 2014] it was shown that assumptions (3.108) and (3.109) are almost always true. Hence we expect that our approach will apply in most of the cases. Indeed, during our simulations, the assumptions have always been satisfied.

**Algorithm 3**  $\mathcal{H}_\infty$ -LPV-Controller Order Reduction

Considering the LPV-plant described in (2.78) the reduced-order controller can be computed as follows

**Inputs:**  $(A(\rho), B(\rho), C(\rho), D(\rho))$ .

**Outputs:**  $(\hat{A}(\rho), \hat{B}(\rho), \hat{C}(\rho), \hat{D}(\rho))$ .

**Assumptions:**  $(\mathbf{A}(\rho), \mathbf{B}(\rho), \mathbf{C}(\rho), \mathbf{D}(\rho))$  minimal.

**Algorithm:**

1. Compute  $K(\rho)$  the full-order controller according Section 2.3.2.
2. Compute the closed-loop system  $T_{zw}$  given in (3.75).
3. Compute the generalised Gramians  $\mathbf{P}(\rho)$  and  $\mathbf{Q}(\rho)$  solutions of (3.80) and (3.81) respectively.
4. Compute the balanced realisation  $\tilde{K}(\rho)$  of the full-order controller  $K(\rho)$  by:
  - (a) Find  $T_2$ , the basis change matrix according to (3.103). (For instance, Procedure in [Moore et al., 1988] can be used).
  - (b) Compute the balanced realisation  $\tilde{K}(\rho)$  as defined in (3.116).
5. Compute the reduced-order controller  $\hat{K}(\rho)$  from  $\tilde{K}(\rho)$  by truncation.



### 3.3.3 Frequency-Limited Order Reduction by SPA

The balanced realisation of  $K(\rho)$  given in (3.116) can be partitioned as conformably with  $\Sigma_2(\rho)$  as

$$\tilde{K}(\rho) = \left[ \begin{array}{c|c} \left[ \begin{array}{cc} \tilde{A}_{K11}(\rho) & \tilde{A}_{K12}(\rho) \\ \tilde{A}_{K21}(\rho) & \tilde{A}_{K22}(\rho) \end{array} \right] & \left[ \begin{array}{c} \tilde{B}_{K1}(\rho) \\ \tilde{B}_{K2}(\rho) \end{array} \right] \\ \hline \left[ \tilde{C}_{K1}(\rho) & \tilde{C}_{K2}(\rho) \right] & \tilde{D}_K(\rho) \end{array} \right] \quad (3.116)$$

Then, the equation (3.116) can be written as

$$\begin{aligned} \begin{bmatrix} \dot{x}_{K1}(t) \\ \dot{x}_{K2}(t) \end{bmatrix} &= \begin{bmatrix} \tilde{A}_{K11}(\rho) & \tilde{A}_{K12}(\rho) \\ \tilde{A}_{K21}(\rho) & \tilde{A}_{K22}(\rho) \end{bmatrix} \begin{bmatrix} x_{K1}(t) \\ x_{K2}(t) \end{bmatrix} + \begin{bmatrix} \tilde{B}_{K1}(\rho) \\ \tilde{B}_{K2}(\rho) \end{bmatrix} y(t) \\ u(t) &= \begin{bmatrix} \tilde{C}_{K1}(\rho) & \tilde{C}_{K2}(\rho) \end{bmatrix} \begin{bmatrix} x_{K1}(t) \\ x_{K2}(t) \end{bmatrix} + \tilde{D}_K(\rho) y(t) \end{aligned} \quad (3.117)$$

In this balanced realisation, states corresponding to the first smallest singular values represent the fast dynamics of the system (i.e. states that have fast transient dynamics and decay rapidly to certain steady value). based on this concept of SPA method [Oh et al., 1997], the system (3.117) is approximated by setting  $x_{K2} = 0$ . Then (3.117) becomes

$$\begin{cases} \dot{x}_{K1}(t) = \tilde{A}_{K11}(\rho)x_{K1}(t) + \tilde{A}_{K12}(\rho)x_{K2}(t) + \tilde{B}_{K1}(\rho)y(t) \\ 0 = \tilde{A}_{K21}(\rho)x_{K1}(t) + \tilde{A}_{K22}(\rho)x_{K2}(t) + \tilde{B}_{K2}(\rho)y(t) \\ u(t) = \tilde{C}_{K1}(\rho)x_{K1}(t) + \tilde{C}_{K2}(\rho)x_{K2}(t) + \tilde{D}_K(\rho)y(t) \end{cases} \quad (3.118)$$

**Definition 3.3.6** Given the balanced realisation  $\tilde{K}(\rho)$  defined in (3.116), let  $\hat{K}(\rho)$  be the Frequency Weighted Singular Perturbation Approximation FWSPA to the  $r$ th-order and denoted as follows

$$\hat{K}(\rho) = \left[ \begin{array}{c|c} \hat{A}_K(\rho) & \hat{B}_K(\rho) \\ \hline \hat{C}_K(\rho) & \hat{D}_K(\rho) \end{array} \right] \quad (3.119)$$

where

$$\hat{A}_K(\rho) = \tilde{A}_{K11}(\rho) - \tilde{A}_{K12}(\rho)\tilde{A}_{K22}^{-1}(\rho)\tilde{A}_{K21}(\rho), \quad (3.120)$$

$$\hat{B}_K(\rho) = \tilde{B}_{K1}(\rho) - \tilde{A}_{K12}(\rho)\tilde{A}_{K22}^{-1}(\rho)\tilde{B}_{K2}(\rho), \quad (3.121)$$

$$\hat{C}_K(\rho) = \tilde{C}_{K1}(\rho) - \tilde{C}_{K2}(\rho)\tilde{A}_{K22}^{-1}(\rho)\tilde{A}_{K21}(\rho), \quad (3.122)$$

$$\hat{D}_K(\rho) = -\tilde{C}_{K2}(\rho)\tilde{A}_{K22}^{-1}(\rho)\tilde{B}_{K2}(\rho). \quad (3.123)$$

Furthermore, the reduced-order parameter dependent closed-loop system is given as

$$\hat{T}_{zw}(\rho) = \left[ \begin{array}{c|c} \hat{\mathbf{A}}(\rho) & \hat{\mathbf{B}}(\rho) \\ \hline \hat{\mathbf{C}}(\rho) & \hat{\mathbf{D}}(\rho) \end{array} \right] \quad (3.124)$$

$$= \left[ \begin{array}{cc|c} A(\rho) + B_2 \hat{D}_K(\rho) C_2 & B_2 \hat{C}_K(\rho) & B_1(\rho) + B_2 \hat{D}_K(\rho) \hat{D}_K(\rho) D_{21} \\ \hat{B}_K(\rho) C_2 & \hat{A}_K(\rho) & \hat{B}_K(\rho) D_{21} \\ \hline C_1(\rho) + D_{12} \hat{D}_K(\rho) C_2 & D_{12} \hat{C}_K(\rho) & D_{11}(\rho) + D_{12} \hat{D}_K(\rho) D_{21} \end{array} \right]$$

### Theorem 21

Suppose  $K(\rho)$  is the stabilising parameter dependent controller defined in (2.79) such that the closed-loop transfer  $T_{zw}(\rho)$  defined in (3.75) is minimal, quadratic stable and there exist Lyapunov inequality solutions  $\mathbf{P}_\Omega(\rho)$  and  $\mathbf{Q}_\Omega(\rho)$  such that (3.100) and (3.101) are satisfied. Let  $\hat{K}(\rho)$  be the reduced-order controller defined in (3.119). Then, the closed-loop system with the reduced-order controller  $\hat{T}_{zw}(\rho)$  defined in (3.107) is stable. If in addition the assumptions (3.108) and (3.109) are satisfied, then,  $\hat{T}_{zw}(\rho)$  is quadratic stable and satisfies

$$\|T_{zw}(\rho) - \hat{T}_{zw}(\rho)\|_{i,2} \leq 2\|J_B(\rho)\|_\infty \|J_C(\rho)\|_\infty \sum_{i=r+1}^{n_K} \gamma_{i,\rho} \quad (3.125)$$

where  $J_B(\rho) := \text{diag}(|\lambda_1|^{-\frac{1}{2}}(\rho), \dots, |\lambda_{u_\rho}|^{-\frac{1}{2}}(\rho), 0, \dots, 0) U_\Omega(\rho) \mathbf{B}(\rho)$  and  $J_C(\rho) := \mathbf{C}(\rho) V_\Omega(\rho) \text{diag}(|\delta_1|^{-\frac{1}{2}}(\rho), \dots, |\delta_{v_\rho}|^{-\frac{1}{2}}(\rho), 0, \dots, 0)$ ,

**Proof**

similar to the previous proof

## Conclusion

In this chapter, order reduction issue is discussed. The model order-reduction problem is first stated in Section 3.1 where an open-loop configuration is considered. Approaches based on the Singular Value Decomposition SVD are introduced. Specifically, the Balanced Truncation BT and the Singular Perturbation Approximation SPA are both highlighted. After a detailed review on these methods, it is shown that they are more efficient in quite high frequency or rather in low frequency only. Then, a third variant is introduced which performs in a limited specific frequency range. In fact, the

Frequency Weighted Balanced Truncation FWBT allows better order-reduction in a specific frequency range. Thus, the several existing methods that deals with the FWBT are reviewed and discussed while showing their advantages and drawbacks. This study, leads to perform the controller order-reduction in closed-loop scheme in the rest of the chapter.

In Section 3.2, the LTI-case is considered. In fact, after analysing the FWBT methods. It appeared that a link can be established between the  $\mathcal{H}_\infty$ -control synthesis approach and the relative bounded  $\mathcal{H}_\infty$ -relative error in the FWBT technique. Then, a method to reduce the order of an LTI- $\mathcal{H}_\infty$ -controller is derived. Regarding the various variants of the FWBT approach, a comparison between these variants is achieved in the next chapter. Finally, in Section 3.3, a new method is proposed in order to extend the study to the LPV-case. Indeed, the limited frequency BT and SPA are managed to reduce the order of an  $\mathcal{H}_\infty$ -LPV controller. To do this, the generalised Gramian framework is introduced and shown to be of big interest. The obtained reduced-order controller is proven stable and the degradation in the closed-loop performance is guaranteed bounded. An application of the proposed method to reduce the order of a semi-active suspension-controller is given in the next chapter.

# Application to Automotive-suspension Control

---

## Contents

---

<b>Introduction</b> . . . . .	<b>88</b>
<b>4.1 Benchmark Library <math>COMPl_{elib}</math></b> . . . . .	<b>88</b>
4.1.1 $COMPl_{elib}$ Problems . . . . .	88
4.1.2 Fixed-Order Controller Evaluation . . . . .	89
4.1.2.1 Numerical Considerations for Augmented Lagrangian Method . . . . .	89
4.1.2.2 Results and Discussion . . . . .	89
4.1.3 Fixed-Order vs. Reduced-Order Controllers . . . . .	92
<b>4.2 Quarter Vehicle LTI-Model</b> . . . . .	<b>93</b>
4.2.1 System Modelling . . . . .	93
4.2.2 Performance Specification . . . . .	95
4.2.3 $\mathcal{H}_\infty$ -Controller Design . . . . .	96
4.2.4 Simulation Results and Discussion . . . . .	97
4.2.4.1 Frequency Domain Analysis . . . . .	99
4.2.4.2 Time Domain Analysis . . . . .	99
4.2.5 Robustness Analysis . . . . .	101
4.2.6 Fixed-Order vs. Reduced-Order Controllers . . . . .	105
<b>4.3 Semi-Active Suspension LPV-Model</b> . . . . .	<b>107</b>
4.3.1 LPV-Model . . . . .	107
4.3.2 $\mathcal{H}_\infty$ -Controller Synthesis . . . . .	110
4.3.3 Numerical Issue . . . . .	112
4.3.4 Results and Discussion . . . . .	112
<b>Conclusion</b> . . . . .	<b>117</b>

---

## Introduction

In this chapter, the numerical evaluations of the presented methods in Chapter 2 and Chapter 3 are given.

- In Section 4.1, the fixed-order methods studied in Section 2.2 are evaluated on some benchmark examples of the *COMPl<sub>e</sub>ib* library. The evaluation is completed by two other available MATLAB toolboxes namely HIFOO and HINFSTRUT. Finally, a comparison between the fixed-order way and the reduced order one is performed (Figure 3.1).
- In Section 4.2, an  $\mathcal{H}_\infty$ -LTI-control problem is considered. It consists of an active suspension system. The mathematical model is first given. Then, the full-order  $\mathcal{H}_\infty$ -controller is designed. Based on this, the FWBT approach is used to reduce the designed controller order. Numerical simulations are performed and results are analysed in the frequency and the time domain. The evaluation is completed by a comparison with the fixed-order approaches.
- In Section 4.3, the developed method to reduced the order of an  $\mathcal{H}_\infty$ -LPV-controller presented in Section 3.3 is evaluated. A problem of a semi-active suspension control is considered. Then, an LPV-model of a magneto-rheological suspension is first set. Then, a reduced-order controller is obtained from the full-order one. Finally, performance of the reduced-order controller are tested and approximation error evaluated.

### 4.1 Benchmark Library *COMPl<sub>e</sub>ib*

The synthesis of an  $\mathcal{H}_\infty$ -fixed order-controller has been reviewed in Section 2.2. Then, the studied methods are evaluated in this section. First, a description of the benchmark problems library *COMPl<sub>e</sub>ib* is given. Then, the two design methods are tested and compared on the *COMPl<sub>e</sub>ib* examples. In addition, comparison with two other existing toolbox namely HIFOO and HINFSTRUCT is also performed. This evaluation is performed by testing the performance parameter  $\gamma$  and the  $\mathcal{H}_\infty$ -norm of the closed-loop system. Finally, a comparison between the direct fixed-order way and the indirect order-reduction one is performed.

Note that the simulations are performed on a INTEL core *i7* CPU (3.07 GHz) running with MATLAB 2015a.

#### 4.1.1 *COMPl<sub>e</sub>ib* Problems

The evaluation of methods in Section 2.2 is achieved over the benchmark problem library *COMPl<sub>e</sub>ib* (CONstraint Matrix-optimization Problem library), which is presented in

[Leibfritz, 2006]. This library contains systems collected from engineering literature and also pure academic problems. The set of problems includes for instance models of aircraft, helicopters, jet engines and reactors. Higher is the dimension, harder is to solve this problems. The library is easily available from a website<sup>1</sup>.

#### 4.1.2 Fixed-Order Controller Evaluation

In this section, the comparison between the studied methods and their performance is performed on 11 systems. The problems included in *COMPl<sub>e</sub>ib* library are of different order from 4 to 24 states. The systems chosen for the evaluation are: Aircraft models (AC2 and AC5 and AC18), Helicopter models (HE1 and HE3), Jet Engines model (JE3), Euler Bernoulli Beams (EB4), Reduced Order Control (ROC1), Academic test problems (NN11) and mathematical model of position and velocity control for a string of high speed vehicles (IH).

##### 4.1.2.1 Numerical Considerations for Augmented Lagrangian Method

The studied methods in Section 2.2 are based on the augmented Lagrangian approach. Algorithms used to implement these methods are given in Appendix A. For their implementation, some numerical considerations about parameter initialisation are given. The initial penalty parameter has been set to  $\mu^0 = 10^{-3}$  and the multiplier is set to  $\lambda^0 = \mu^0(X_a^0 Y_a^0 - I)$  for the Apkarian's method and  $\lambda^0 = \mu^0 \mathbf{q}(X^0, Y^0)$  for the Ankelhed's method, where  $X_a^0, Y_a^0$  and  $X^0, Y^0$  are solutions of the convex set  $\mathbb{X}, \mathbb{X}_a$  respectively. The parameters  $\rho$  and  $\rho_0$  determine the updating rules for the penalty and multiplier in general tests. They are chosen as  $\rho = 9$  and  $\rho_0 = 0.9$ . However, in other few tests these parameters have to be changed in order to improve the results. Then, the values of these parameters are changed and low values in the case where  $\gamma \ll \|T_{zw}\|_\infty$  are given (remember that our objective is to find  $\|T_{zw}\|_\infty < \gamma$ ). Then, the idea is to slow down the optimisation process to achieve the objective by obtaining  $\|T_{zw}\|_\infty < \gamma$ . This technique is valid for the greater part of tests when  $\gamma \ll \|T_{zw}\|_\infty$ .

##### 4.1.2.2 Results and Discussion

The studied methods are first tested between them on some chosen *COMPl<sub>e</sub>ib* Problems. Then, an extended evaluation against another existing toolboxes is performed. Finally, the general scheme in Figure 3.1 is considered and a comparison between the direct fixed-order control and the controller order reduction is achieved.

**Ankelhed and Apkarian's Methods Comparison** After implementing the two methods, the evaluation results are shown in Table 4.1. To evaluate and to compare

<sup>1</sup>Available from: <http://www.compleib.de/>

methods, we focus our reviews only on results shown in bold in order to simplify explanation and avoid repeating the same remarks. The first column presents the system name, the system order, the number of the control inputs and outputs, and the order of the designed controller. The second and the third columns show the  $\gamma$  and  $\mathcal{H}_\infty$ -norm obtained by each method. **N.P.** means Numerical Problems. The first evaluation is done using the systems HE1 and HE3. Note that similar results are obtained for both methods and for different orders. The evaluation using the system ROC1 shows that the Apkarian's method give slightly better result than the Ankelhed's method. For this test, the Ankelhed's method give worse results in the case  $n_K = 2$  where the objective of the  $\mathcal{H}_\infty$ -synthesis is not achieved (i.e.  $\gamma > \|T_{zw}\|_\infty$ ). However, the evaluation from the system JE3 and for  $n_K = 0$  (static gain) shows that the Ankelhed's method has better results compared to the Apkarian's method which fails with this system.

As conclusion, both methods almost give the same results when synthesising  $\mathcal{H}_\infty$ -controllers for systems of order  $n \leq 20$ . However, in few cases one of them can give better results than the other. When  $20 \leq n \leq 24$ , the Ankelhed's method give better results compared to Apkarian's method. Note that, in some cases, methods do not show any results. This can be explained by the high number of decision variables.

Once the order of the system begins to be higher  $n \geq 24$ , several problems encountered in the algorithm initialisation. In fact, it is even difficult to find a starting point of decision vector  $\mathbf{x}^0$  and  $\mathbf{x}_a^0$  for both methods. This problem can be explained also by the fact that decision vectors  $\mathbf{x}^0$ ,  $\mathbf{x}_a^0$  contain many decision variables, and it is very difficult to solve this problem by one of the existing solvers. Even if a starting point of decision vectors is found, but in optimisation step more numerical problems are encountered. In few words, we can say that studied methods achieve good results for medium order systems. (i.e.  $n \leq 24$ )

**Comparison with Other Existing Methods** In addition of the studied techniques, two numerical toolboxes namely HINFSTRUCT and HIFOO are evaluated

**HINFSTRUCT** is included in the ROBUST CONTROL TOOLBOX of MATLAB and based on [Apkarian and Noll, 2006] work. The method uses subgradient calculus to solve the problem [Clarke, 1990]. First, it minimises the spectral abscissa of the closed-loop system in order to find parameters for a stable controller. Then, these parameters are used as a starting point to minimise the  $\mathcal{H}_\infty$ -norm. HINFSTRUCT is a deterministic technique which does not involve any random elements. However, extra starting points can be randomised upon request.

**HIFOO** (H-Infinity Fixed-Order Optimisation) is a software package that can be run in MATLAB. HIFOO is described in [Burke, 2006], [Gumussoy and Overton., 2008] and [Gumussoy et al., 2009].

Table 4.1: Evaluation and Comparison between Apkarian's and Ankelhed's methods

Sys( $n, n_u, n_y, n_k$ )	Apkarian		Ankelhed	
	$\gamma$	$\ T_{zw}\ _\infty$	$\gamma$	$\ T_{zw}\ _\infty$
HE1(4,2,1,0)	0.19	0.16	0.20	0.18
HE1(4,2,1,1)	0.20	0.17	0.20	0.12
HE1(4,2,1,2)	<b>0.19</b>	<b>0.16</b>	<b>0.22</b>	<b>0.15</b>
HE1(4,2,1,3)	<b>0.19</b>	<b>0.16</b>	<b>0.23</b>	<b>0.16</b>
HE3(8,4,6,0)	<b>0.95</b>	<b>0.92</b>	<b>0.97</b>	<b>0.92</b>
HE3(8,4,6,1)	<b>0.94</b>	<b>0.93</b>	<b>0.91</b>	<b>0.87</b>
HE3(8,4,6,2)	0.95	0.93	0.97	0.89
HE3(8,4,6,3)	0.95	0.94	1.01	0.91
HE3(8,4,6,4)	0.94	0.93	0.97	0.90
ROC1(9,2,2,2)	<b>2.63</b>	<b>2.48</b>	<b>1.34</b>	<b>5.24</b>
ROC1(9,2,2,3)	2.11	1.96	1.28	2.09
ROC1(9,2,2,4)	1.82	1.71	3.46	3.29
ROC1(9,2,2,5)	<b>1.78</b>	<b>1.60</b>	<b>3.45</b>	<b>3.28</b>
ROC1(9,2,2,7)	1.95	1.80	3.42	4.21
NN11(16,3,5,0)	0.10	0.10	0.10	0.10
NN11(16,3,5,1)	0.10	0.10	0.11	0.11
NN11(16,3,5,2)	0.10	0.10	0.11	0.11
NN11(16,3,5,3)	0.10	0.10	0.11	0.10
NN11(16,3,5,4)	0.10	0.10	0.12	0.11
NN11(16,3,5,5)	0.10	0.10	0.41	0.17
JE3(24,3,6,0)	<b>9.10</b>	<b>8.60</b>	<b>5.10</b>	<b>5.10</b>
JE3(24,3,6,3)	<b>N.P</b>	<b>N.P</b>	<b>2.90</b>	<b>2.89</b>



HIFOO first chooses three random starting points to initialise the algorithm. Then, it tries to find stabilising controllers before optimising it locally with respect to the closed-loop  $\mathcal{H}_\infty$ -norm. Both optimisation problems are non-smooth and non-convex. The later optimisation problem can be written as

$$\underset{A_K, B_K, C_K, D_K}{\text{minimise}} \|T_{zw}\|_\infty.$$

When HIFOO has finished the optimisation, the controller with the best  $\mathcal{H}_\infty$ -norm of the three candidates is the output. Due to the randomisation of the initial points and the randomisation in gradient sampling phase, the experiments are not repeatable with the same result each time. In [Gumussoy and Overton., 2008], the authors suggested that HIFOO is evaluated by running it ten times on each problem and choosing the best result. The HIFOO is also shown very well compared to several others methods, and it has also been used several times in different applications.

It is noted that the HINFSTRUCT should be initialised with two extra starting points when comparing its performance with HIFOO, since this last one uses three randomised starting points.

**Results and Discussion** The comparison between studied methods and available toolboxes is giving according to Table 4.2. From the system AC2 and EB4, Note that all methods achieve good results but without forgetting that systems order is between  $4 \leq n \leq 20$ . In general, the examined methods achieve a comparable results in most cases. HIFOO performs well but the best results are obtained by HINFSTRUCT. From the system IH where the orders of the controller are  $n_K = 5$  and  $n_K = 7$ , HINFSTRUCT achieves better results than the other methods. Then, we can say that this method keeps good properties when augmenting the order of the controller. For the controllers obtained from the system JE3, HINFSTRUCT and HIFOO show good performance. However, as said previously, the studied methods encounter numerical problems due to the high number of decision variables when  $n \leq 24$ .

### 4.1.3 Fixed-Order vs. Reduced-Order Controllers

As shown in Section 3.2, there are two different ways to obtain a low order controller even if the model has a high order. These two approaches are evaluated here on some COMPl<sub>e</sub>ib problems. Then, results are presented in Table 4.3. Since all methods in this evaluation attempts to minimise the closed-loop  $\mathcal{H}_\infty$ -norm  $\|T_{zw}\|_\infty$ , this latter is compared at several orders for different examples. The comparison is done with the best results given by each way. Note that, for very low orders, the fixed-order approach deals better and gives a smaller  $\mathcal{H}_\infty$ -norm. However, for medium or higher orders, the order reduction methods gives better results than the fixed-order one. This can be explained

Table 4.2: Comparison between HINFSTRUCT, HIFOO, Apkarian's and Ankelhed's Methods.

Sys( $n, n_u, n_y, n_k$ )	$\ T_{zw}\ _\infty$			
	Apkarian	Ankelhed	HINFSTRUCT	HIFOO
AC2(5,3,3,0)	<b>0.11</b>	<b>0.11</b>	<b>0.11</b>	<b>0.11</b>
AC5(4,2,2,0)	658	660	665	669
AC5(4,2,2,3)	665	662	658	643
EB4(20,1,1,0)	N.P	2.46	2.06	2.06
EB4(20,1,1,3)	<b>1.81</b>	<b>1.80</b>	<b>1.82</b>	<b>1.82</b>
IH(21,11,10,0)	4.45	2.34	1.59	1.90
IH(21,11,10,1)	4.12	1.96	1.80	1.80
IH(21,11,10,3)	3.69	1.97	1.57	1.74
IH(21,11,10,5)	<b>4.01</b>	<b>1.86</b>	<b>1.15</b>	<b>1.69</b>
IH(21,11,10,7)	<b>3.88</b>	<b>1.75</b>	<b>0.79</b>	<b>1.72</b>
JE3(24,3,6,0)	<b>8.6</b>	<b>5.10</b>	<b>5.10</b>	<b>5.10</b>
JE3(24,3,6,3)	<b>N.P</b>	<b>2.89</b>	<b>2.90</b>	<b>2.89</b>

by the fact that, the number of decision variables is increasing when  $n_K$  increases for fixed-order case.

## 4.2 Quarter Vehicle LTI-Model

After having introduced the LTI model, an  $\mathcal{H}_\infty$ -control law is designed with respect to the performance specifications. Once the full-order controller is obtained, the controller order reduction method based on FWBT (Section 3.2) is used to reduce the controller order. The obtained reduced-order controller is first compared with a similar reduced-order one based on the unweighted BT. Then, a comparison between the several variants of the FWBT methods is given according to Section 3.2. Results are discussed in both frequency and time domain. Finally the robustness of the reduced-order controller is analysed by considering uncertainties on the system physical parameters.

### 4.2.1 System Modelling

A quarter-vehicle model (Figure 4.1) can be used to represent the vertical physical behaviour for the suspension system.

Table 4.3:  $\|T_{zw}\|_\infty$  in Direct and Indirect Low-order Approaches

$\text{SYS}(n, n_u, n_y, n_K)$	Fixed-order controller	Reduced-order controller
AC2(5,3,3,0)	1.01	2.16
AC2(5,3,3,1)	0.12	0.43
AC2(5,3,3,2)	0.24	0.21
AC2(5,3,3,3)	0.23	0.22
AC2(5,3,3,4)	0.14	0.14
AC2(5,3,3,5)	N.P	0.14
HE1(4,2,1,0)	0.16	0.55
HE1(4,2,1,1)	0.12	0.15
HE1(4,2,1,2)	0.12	0.08
HE1(4,2,1,3)	0.15	0.08
HE1(4,2,1,4)	N.P	0.07
AC18(10,2,2,0)	N.P	140.33
AC18(10,2,2,1)	N.P	48.28
AC18(10,2,2,2)	N.P	17.80
AC18(10,2,2,3)	2.09	19.74
AC18(10,2,2,4)	2.34	4.51
AC18(10,2,2,5)	2.48	4.99
AC18(10,2,2,6)	3.28	4.98
AC18(10,2,2,7)	13.4	10.30
AC18(10,2,2,8)	13.3	4.31
AC18(10,2,2,9)	13.56	2.01
AC18(10,2,2,10)	N.P.	2.02

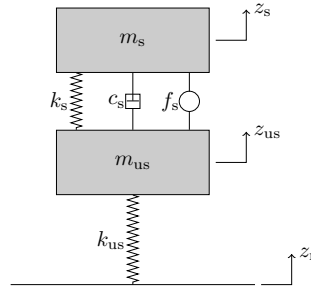

Figure 4.1: Quarter Vehicle Model

The model is then, described by the following motion equations:

$$m_s \ddot{z}_s = k_s(z_{us} - z_s) + c_s(\dot{z}_{us} - \dot{z}_s) + f_s \quad (4.1)$$

$$m_{us} \ddot{z}_{us} = k_s(z_s - z_{us}) + c_s(\dot{z}_s - \dot{z}_{us}) + k_{us}(z_r - z_{us}) - f_s \quad (4.2)$$

The parameters values, chosen accordingly to [Sammier, 2001] are presented in Table 4.4:

Parameter		Value
Sprung mass	$(m_s)$	415 [kg]
Unsprung mass	$(m_{us})$	52 [kg]
Tyre stiffness coefficient	$(k_s)$	270000 [N/m]
Spring stiffness coefficient	$(k_{us})$	22000 [N/m]
Viscous damping coefficient	$(c_s)$	1500 [N.s/m]

Table 4.4: Parameter Values

Then, the system can be expressed by the following state-space representation:

$$\begin{cases} \dot{x} = Ax + B_w w + B_u u \\ y = Cx + Du \end{cases} \quad (4.3)$$

where the states, the disturbance, the input and the measured output signals are respectively :  $x = [z_s \ z_{us} \ \dot{z}_s \ \dot{z}_{us}]^T$ ,  $w = z_r$ ,  $u = f_s$  and  $y = [z_s \ z_{us} \ \ddot{z}_s]^T$  respectively.

### 4.2.2 Performance Specification

The main objective of an active suspension system is to improve the comfort in the vehicle simultaneously to the performance on road handling. The passenger comfort can be improved by isolating the vibrations transmitted from the road surface. It is evaluated

considering the response of the vehicle chassis with excitation coming from the vertical disturbances. According to industrial performance specifications [Sammier, 2001], the main objective is to mitigate the resonance peak in low frequencies without degradation at the high frequencies:

- The maximal gain of the transfer  $Z_{s_{acc}}/Z_r$  should be limited to 2 in the frequency range  $[1; 5]$  Hz, where  $Z_{s_{acc}} = Z_s \cdot s^2$  is the Laplace transform of  $\ddot{z}_s$ .
- The road holding is evaluated from the unsprung mass (wheel) oscillations with respect to the road profile. The maximal gain of the transfer  $Z_{us}/Z_r$  should be 2 in the frequency range  $[1; 15]$  Hz.

### 4.2.3 $\mathcal{H}_\infty$ -Controller Design

The standard  $\mathcal{H}_\infty$ -control problem is formulated according to the Figure 4.2 where the vector of output variables to be regulated is chosen as:  $z = [z_s \ z_{us} \ \ddot{z}_s]^T$ . Then,  $W = z_r$ ,

$$U = u = f_s,$$

$$Z = [u^T W_u^T \quad z^T W_z^T]^T,$$

$$Y = (z_s - z_{us}).$$

The weighting functions are parametrised according to Section 4.2.2 in order to re-

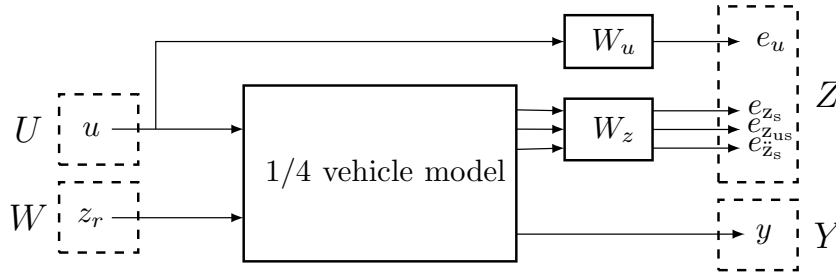

Figure 4.2:  $\mathcal{H}_\infty$ -control Scheme for the Active Suspension

spect the natural invariant points ([Hedrick and Butsuen, 1990, Sammier, 2001]) for the transfer  $Z_s/Z_r$  and  $Z_{us}/Z_r$  in specific frequencies. The weighting function  $W_u$  penalises the control signal for frequencies higher than 20 Hz. The transfer  $Z_s/Z_r$  and  $Z_{us}/Z_r$  are templated by the inverse of  $W_{z_s}$  and  $W_{z_{us}}$  respectively, in order to reduce their gains in the low frequencies ( $[1; 10]$  Hz and  $[5; 15]$  Hz respectively). The weighting function  $W_{z_s}$  is chosen constant. Hence,  $W_z = \text{diag}(W_{z_s}, W_{z_{us}}, W_{z_s})$ .

Note that  $W_{z_s}$  and  $W_{z_{us}}$  are second order filters (for more details see [Sammier, 2001]) which increase the order of the plant. Then, the Figure 4.3 gives the weighting functions frequency representation.

Considering the above specifications, a 14-order  $\mathcal{H}_\infty$ - controller is obtained. It has a high order considering such systems. Then, a reduction step will be of great interest.

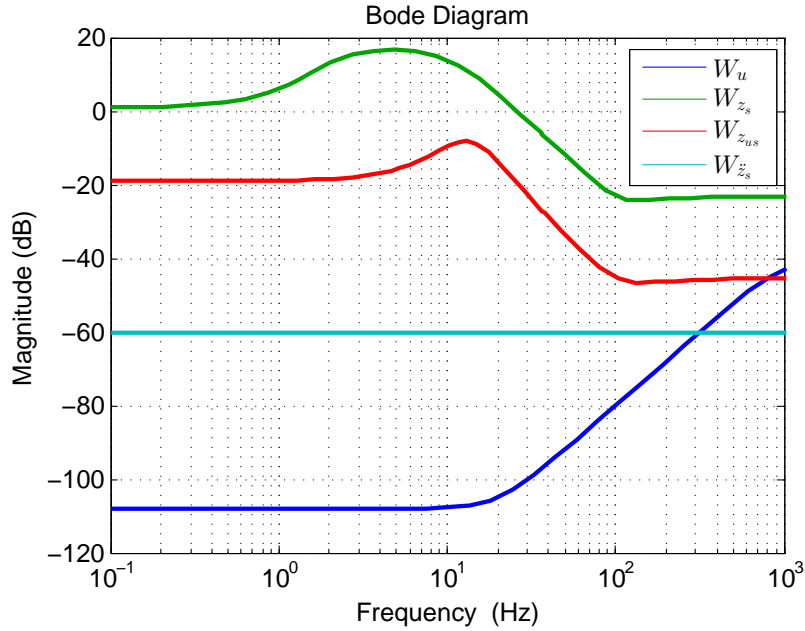

Figure 4.3: Weighting Functions

#### 4.2.4 Simulation Results and Discussion

The simulations are given in this section to evaluate the performance of the reduced-order  $\mathcal{H}_\infty$ -controller. Experiments are performed on a INTEL core *i7* CPU (3.07 GHz) running with MATLAB 2012b.

Then, the following systems are compared:

- Passive suspension system (open-loop).
- Active suspension system based on 14 order  $\mathcal{H}_\infty$ -controller.
- Active suspension system based on reduced 5 order  $\mathcal{H}_\infty$ -controller.

Note that the designed full-order controller is singular. According to Remark 2 (page 65), a small singular perturbation is applied to  $D$  with  $\varepsilon = 0.08$ .

As shown in Section 3.2, method based on the FWBT is used to reduce the order of the LTI-controller. Then, a first evaluation is represented in Table 4.5. where the applied method is compared to the classical BT method that reduces the  $\mathcal{H}_\infty$ -norm of the absolute error  $\Delta_K$ .

Note that, the closed-loop system is unstable below the tenth order for the BT reduced order controller. However, the FWBT method maintains the stability of the closed loop

$n_K$	14	12	10	8	5	4	3	2
BT	S	S	S	U	U	U	U	U
FWBT	S	S	S	S	S	S	U	U

Table 4.5: Closed-loop Stability of the Reduced-order Controllers (S: stable, U: unstable)

at lower order. This first result confirms the choice of this approach.

In Table 4.6. The following indicators are analysed:

- Rising time (step response): The time it takes for the output to first reach 90%, from 10% of its final value, which is usually required to be small.
- Settling time (step response): the time after which the output remains within  $\pm 2\%$  of its final value, which is usually required to be small.
- Storage memory: the memory allocated to the controller.

Simulation results from a step response applied on the full-order ( $K_{14}$ ) and the reduced-order one ( $K_5$ ) are shown. Note that the time-rise for  $K_5$  is 61% rise-time of the one obtained with  $K_{14}$ . The settling-time of  $K_5$  remains close to the  $K_{14}$ . It is shown also that the required memory for the designed reduced-order controller is reduced to less than the half of the memory for the full order which is very interesting when packaging the controller in a simple calculator.

	Rise time		Settling time		Storage memory	
	[ms]	%	[ms]	%	[Bytes]	%
$K_{14}$	5.50	100	2000	95	2586	100
$K_5$	3.4	61	2100	100	1074	41.5

Table 4.6: Results from Simulation of  $\mathcal{H}_\infty$ -controller Step Response

The third evaluation is represented in Table 4.7 where the approximation errors obtained using the several methods are compared. The test on stability of the closed-loop system is also given.

Note that although the FWBT by Enns' method can produce unstable reduced-order controller (closed-loop stability), it yields the lower approximation error. The Lin and Chiu's method already gives a stable reduced-order controller. However, the increased weighted error can affect the frequency behaviour of the stabilising controller. Enns

Controller order	12	8	5	3
Enns	9.5 stable	6.9 unstable	$1.4 \times 10^2$ stable	$2.6 \times 10^2$ unstable
Lin & Chiu	$9 \times 10^7$ stable	$6.9 \times 10^{10}$ stable	$5 \times 10^{10}$ stable	$6.8 \times 10^{10}$ stable
Varga & Anderson	$3 \times 10^6$ unstable	$1.4 \times 10^9$ stable	$2 \times 10^{10}$ unstable	$3.5 \times 10^{10}$ unstable
Wang	$1.5 \times 10^3$ stable	$3.6 \times 10^5$ stable	$9 \times 10^8$ unstable	$7.6 \times 10^9$ unstable

Table 4.7: Closed-loop Stability of Reduced-order Controllers and Error Approximation

and Lin and Chiu's methods are elected to be compared in frequency and time domain for the order 5.

#### 4.2.4.1 Frequency Domain Analysis

In the Figure 4.4, the frequency response magnitude of  $Z_s$  to the road disturbance  $Z_r$  is plotted. Note that the template  $\gamma/W_z$  designed in Section 4.2.2 limits the amplification of this transfer in the frequency range [1; 10] Hz where the human sensitivity to vertical vibrations is important. The other techniques are less effective. Moreover, the reduced-order  $\mathcal{H}_\infty$ -controller by Enns' method is very closed to the full-order one. However, the Lin and Chiu's method amplifies the response in [1; 5] Hz.

Figure 4.5 shows the performance of the full order and the reduced-order controllers with respect to the road holding specifications. The full-order controller and the reduced-order controller by Enns mitigate the frequency response in [8; 14] Hz which is amplified in the passive case. In this frequency range, the maximal gain is reduced to 1.5 which responds to the performance specifications in Section 4.2.2 as shown in Figure 4.7 and Figure 4.6.

#### 4.2.4.2 Time Domain Analysis

For the time domain analysis, the road profile  $Z_r$  is set with a bump of  $0.01 \text{ m} \times 2 \text{ m}$  and the vehicle is travelling with a constant velocity of 30 km/h. The response of the several designed controllers is shown in Figure 4.8. It is observed that the time

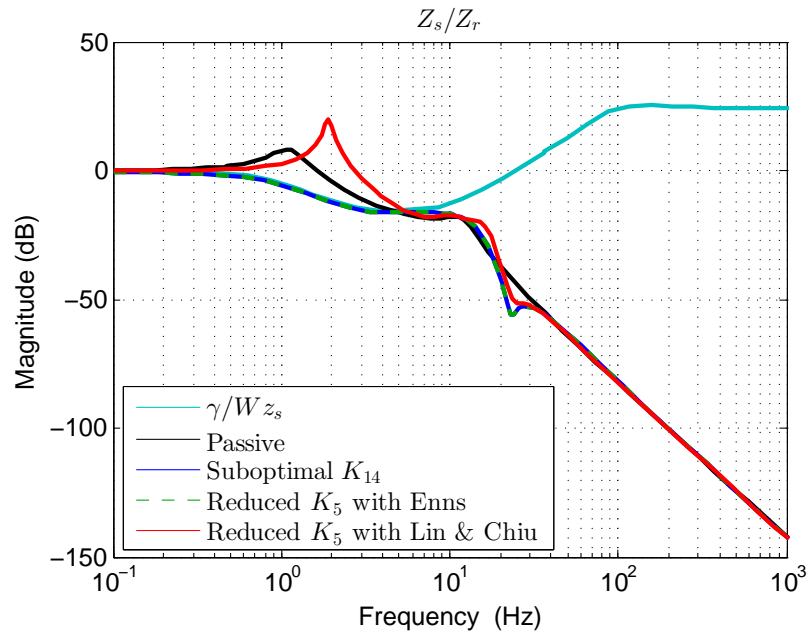
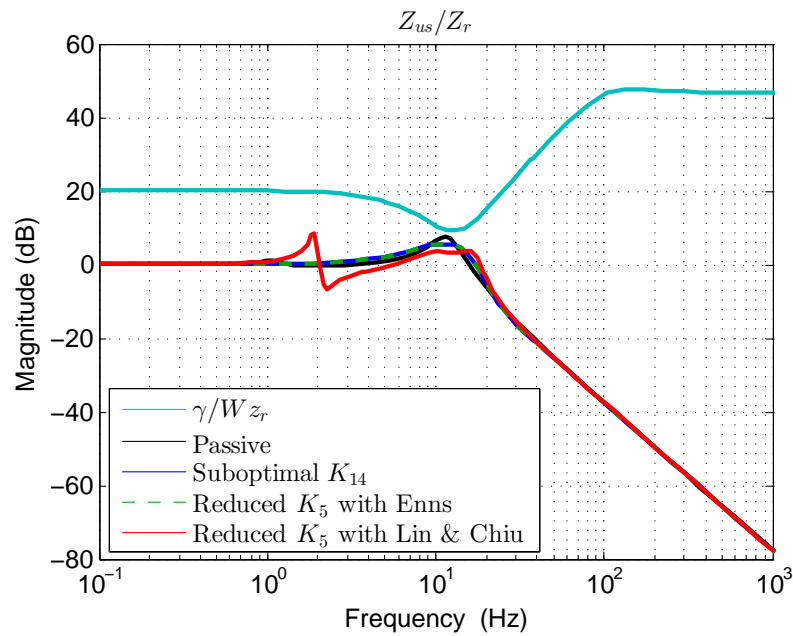

Figure 4.4: Bode-diagram of the Transfer Function  $Z_s/Z_r$ Figure 4.5: Bode-diagram of the Transfer Function  $Z_{us}/Z_r$

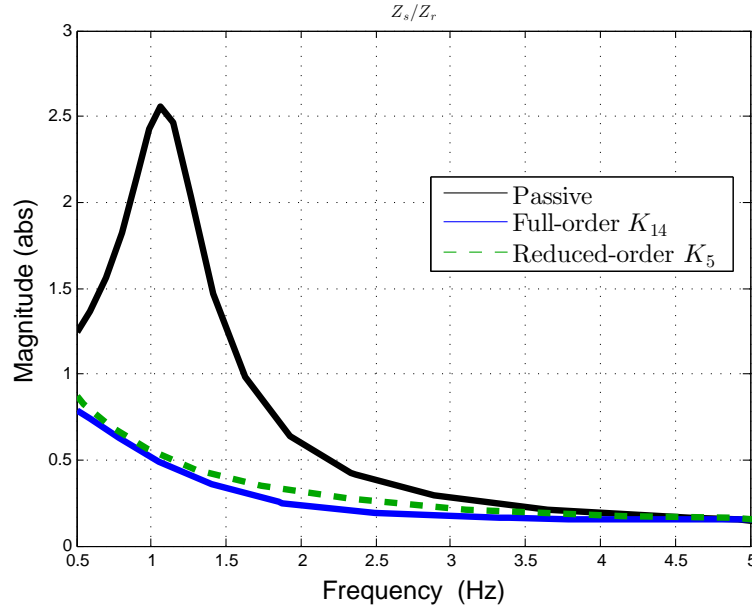
Figure 4.6: Frequency Response of  $Z_r$  to  $Z_s$ 

response confirms the contribution of the  $\mathcal{H}_\infty$ -control design. In fact, the wheel is stabilised rapidly without overtake on the suspension deflection, The most important observation is that reduced-controller by Enns gives similar performance as the full-order controller on the diverse controlled outputs. However, with the Lin and Chiu's method, the controller fails to steer the system correctly, which is an expected result according to the increased weighted error.

#### 4.2.5 Robustness Analysis

Variations on model parameters are considered as follows:

$$\begin{aligned}
 \bar{k} &= k(1 + p_k \delta_k) \\
 \bar{k}_p &= k(1 + p_{kp} \delta_{kp}) \\
 \bar{m}_s &= k(1 + p_s \delta_s) \\
 \bar{m}_{us} &= k(1 + p_{us} \delta_{us})
 \end{aligned}$$

where

$$\begin{aligned}
 \{p_k, p_{kp}, p_s, p_{us}\} &\in [-1; 1], \\
 \{\delta_k, \delta_{kp}, \delta_s, \delta_{us}\} &\in [0; 1].
 \end{aligned}$$

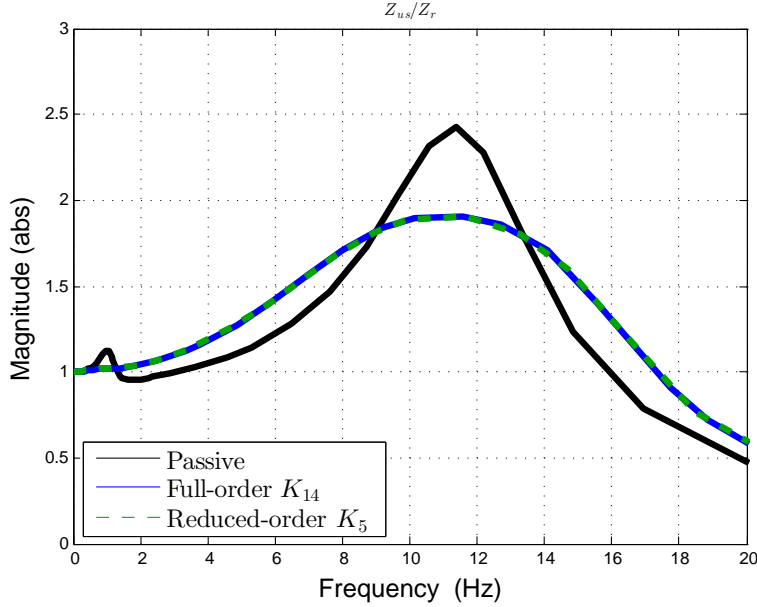
Figure 4.7: Frequency Response of  $Z_r$  to  $Z_{us}$ 

Those parametric uncertainties can be expressed in the block  $\Delta_r = \text{diag}(\delta_s, \delta_{us}, \delta_k, \delta_{kp})$  (Figure 4.9) and are used to analyse the  $RS$ .

For  $NP$  analysis, the input and the output weights  $P_1$  and  $P_0$  respectively, are taken the same as the given ones for performance specification, i.e.  $W_z = \text{diag}(W_{z_s}, W_{z_{us}}, W_{\dot{z}_s})$  for the outputs, but not  $W_u$ . In addition, a normalisation is performed to obtain:

$$\|N_{ew}\|_\infty = \|P_0 H P_1\|_\infty = 1$$

Then, the upper  $\mu$  measurement of the transfer matrix  $N$  (Figure 4.10) determines the admissible interval for the  $RP$ . For the presented example, the uncertain model parameters are initially chosen as follow:  $m_s = 415 \pm 15\%$  kg,  $m_{us} = 15 \pm 15\%$  kg,  $k_s = 22000 \pm 5\%$  N/m, and  $k_{us} = 270000 \pm 5\%$  N/m. A first test is shown in Figure 4.11 where a set of closed-loop systems is generated. It consists of the nominal system with a frequency-dependent amount of uncertainty. The stability margin analysis indicates that the reduced order closed-loop remains stable and tolerates variability in  $k$ ,  $m$  and  $c$ . More consistently, the  $\mu$ -analysis tool is used to get a reliable test on the controller robustness. Then, the  $NP$ ,  $RS$  and  $RP$  problems of the reduced-order closed-loop system are evaluated:

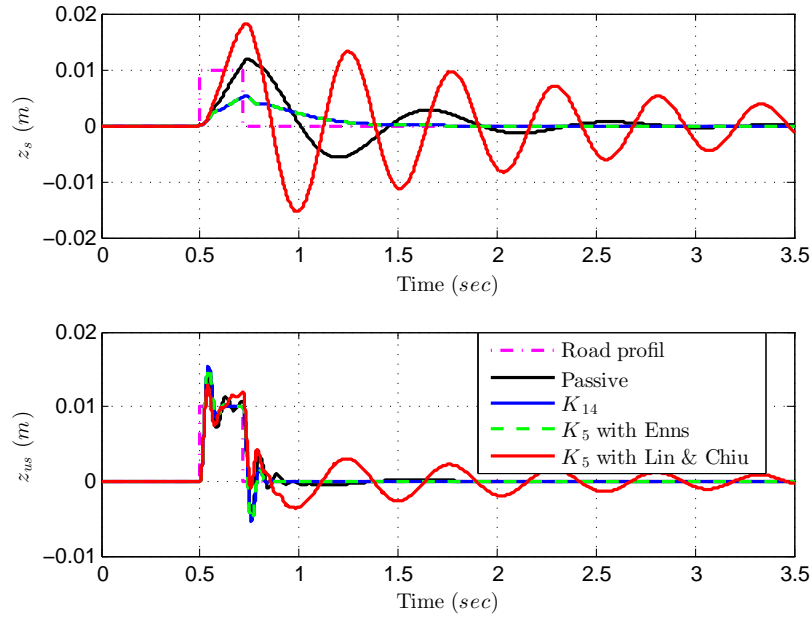

Figure 4.8: Time Responses on a bump of 0.01x2 m

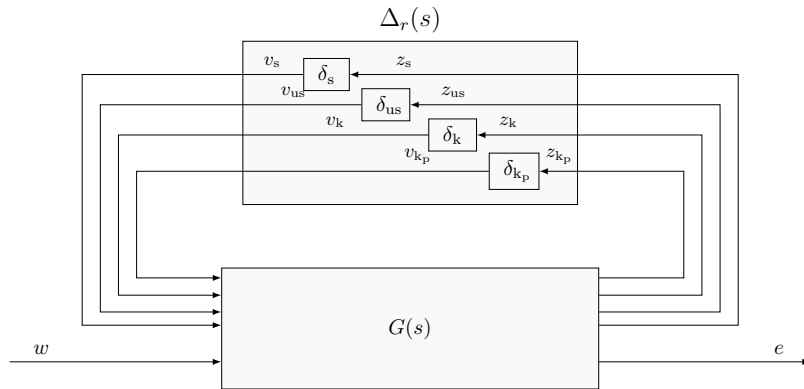
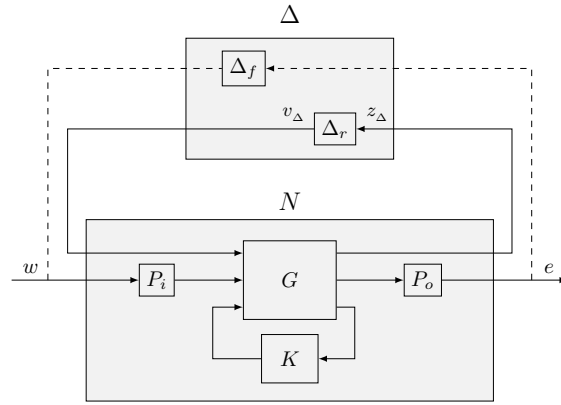
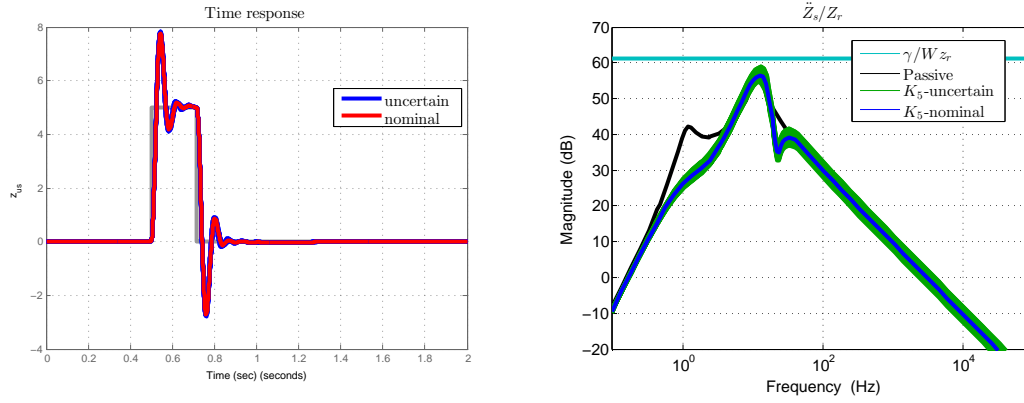

Figure 4.9:  $\Delta_r(s)$  block

**NP:** the nominal performance problem is independent from the chosen uncertainties of the parameters. Figure 4.12 shows that the maximal measurement  $\bar{\mu}$  is lower than 1 which means that nominal performance are reached. This was expected because the nominal performance are the same as the closed-loop performance.

Figure 4.10: Real and fictive uncertainties of  $\Delta$ Figure 4.11:  $K_5$ -time and Frequency Analysis with Uncertainties

**RS:** in Figure 4.13 the maximal value of the  $\mu$  is less than 1 (Max.  $\mu$  of  $RS = 0.28$ ). Consequently, the closed-loop remains stable for larger margins of uncertainties. By dividing by 0.28 the margins for  $RS$  are:  $m_s = 415 \pm 50\%$  kg,  $m_{us} = 52 \pm 50\%$  kg,  $k_s = 22000 \pm 17\%$  N/m and  $k_{us} = 270000 \pm 17\%$  N/m.

**RP:** finally, in Figure 4.14 the maximal  $\mu$  measurement for  $RP$  is upper than 1 (Max.  $\mu$  of  $RS = 1.2$ ), which means that these initial uncertainty margins do not guarantee the stability performance.

Then, a new uncertainty range are redefined as:  $m_s = 415 \pm 10\%$  kg,  $m_{us} = 52 \pm 10\%$  kg,  $k_s = 22000 \pm 4\%$  N/m, and  $k_{us} = 270000 \pm 4\%$  N/m. The new upper  $\mu$  measurement value show that performance robustness are satisfied for these margins (Figure 4.15).

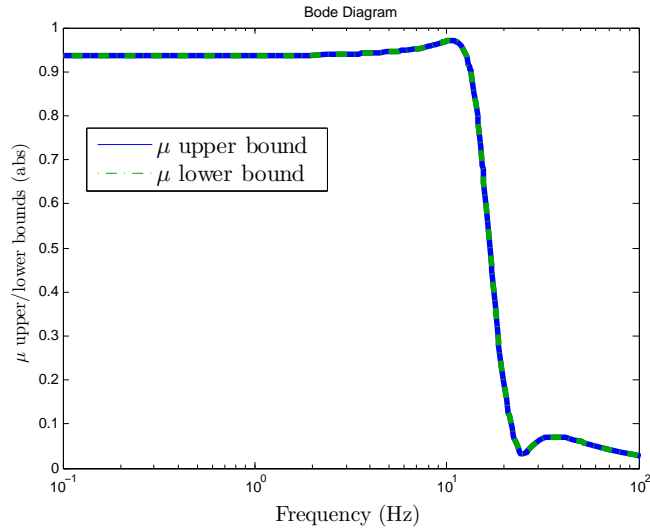
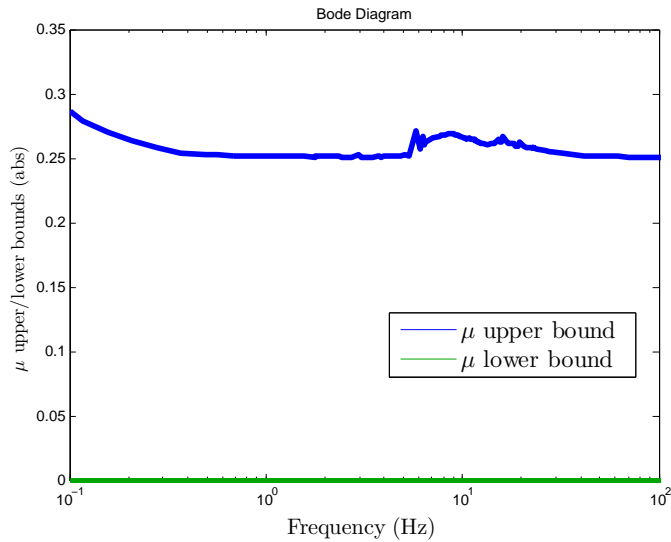
Figure 4.12: Upper and Lower  $\mu$  for Nominal PerformanceFigure 4.13: Upper and Lower  $\mu$  for Robust Stability

#### 4.2.6 Fixed-Order vs. Reduced-Order Controllers

Similar to the previous section where the fixed-order methods have been compared to the reduced-order ones for some *COMPl<sub>e</sub>ib* examples, a comparative analysis is also

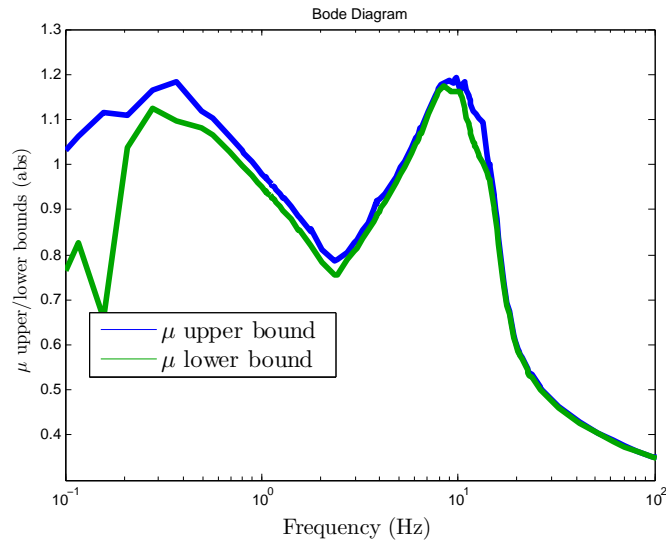
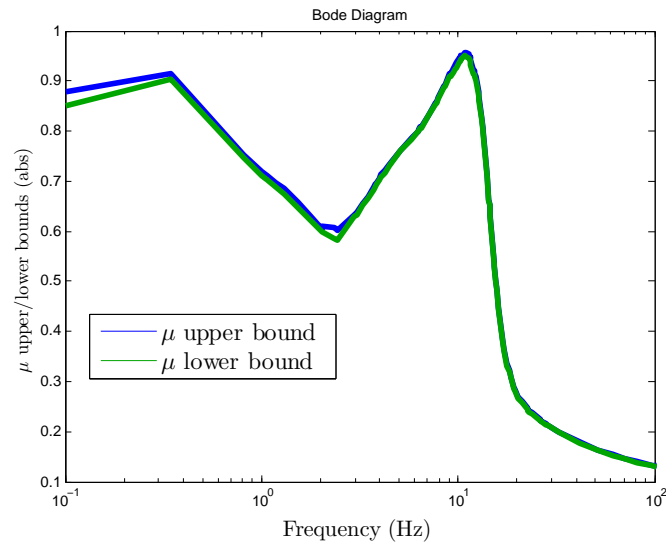
Figure 4.14: Upper and Lower  $\mu$  for Robust PerformanceFigure 4.15: Upper and Lower  $\mu$  for Robust Performance

given here. Then, comparison is done with the best results given by each way. From the fact that, this example gives details about performance specification, then a frequency and time domain analysis can be performed. This allows a better evaluation compared

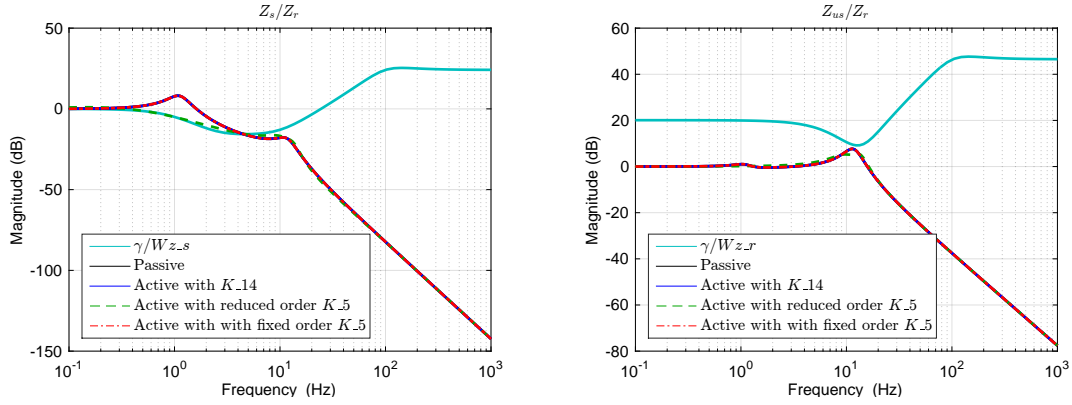

Figure 4.16: Bode-diagram Magnitude of the Transfers  $T_{z_s/z_r}$  and  $T_{z_{us}/z_r}$

to the previous section where just the  $\mathcal{H}_\infty$ -norm errors have been compared. Indeed, Figure 4.16 show the frequency behaviour at order 5. Note that the reduced order controller gives better performance in the frequency and the time domain simulation (Figure 4.17). The fixed-order one has almost the same transfer as the open-loop.

## 4.3 Semi-Active Suspension LPV-Model

### 4.3.1 LPV-Model

In this section, the given method to reduce the LPV-controller is applied on a semi-active automotive suspension presented in [Do et al., 2011]. Actually, when suspension modelling and control are considered, the vertical quarter car model is often used. This model allows to study the vertical behaviour of a vehicle according to the suspension characteristic (passive or controlled). Figure 4.18 shows the so-called vertical quarter car. Then, the dynamical equations of the system are given by

$$\begin{cases} m_s \ddot{z}_s = -k_s z_{\text{def}} - F_{\text{mr}} \\ m_{\text{us}} \ddot{z}_{\text{us}} = k_s z_{\text{def}} + F_{\text{mr}} - k_t (z_{\text{us}} - z_r) \end{cases} \quad (4.4)$$

where  $F_{\text{mr}}$  is the magneto-rheological force generated by the semi active suspension. According to the non-linear model of Guo [Guo et al., 2006],  $F_{\text{mr}}$  can be expressed as follows

$$F_{\text{mr}} = a_2 \left( \dot{z}_{\text{def}} + \frac{v_0}{x_0} z_{\text{def}} \right) + a_1 \tanh \left( a_3 \left( \dot{z}_{\text{def}} + \frac{v_0}{x_0} z_{\text{def}} \right) \right) \quad (4.5)$$

with  $z_{\text{def}} = z_s - z_{\text{us}}$  is the damper deflection (must be measured or estimated) and  $\dot{z}_{\text{def}} = \dot{z}_s - \dot{z}_{\text{us}}$  is the damper velocity. Parameters  $a_2, a_3, v_0$  and  $x_0$  are constant, and  $a_1$  is the controllable force such that  $a_1 \in [a_{1\text{min}}; a_{1\text{max}}]$ .



Figure 4.17: Time-response on a Bump of  $0.01 \times 2$  m

Figure 4.18: Quarter-vehicle Model

By defining

$$\begin{aligned}\rho_1 &= \tanh\left(a_3\left(\dot{z}_{\text{def}} + \frac{v_0}{x_0}z_{\text{def}}\right)\right), \\ c_{\text{mr}} &= a_2, \text{ MR damping coefficient,} \\ k_{\text{mr}} &= a_2\frac{v_0}{x_0}, \text{ MR stiffness coefficient.}\end{aligned}$$

Then, a state-space representation can be given by considering the state vector  $x_s = [z_s \dot{z}_s z_{\text{us}} \dot{z}_{\text{us}}]^\top$  and the exogenous input  $w = z_r$ , as follows

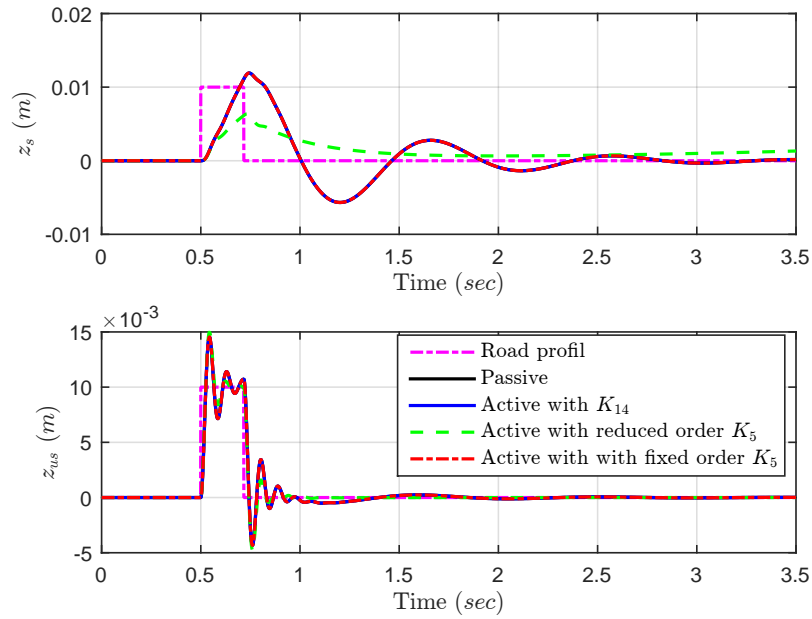
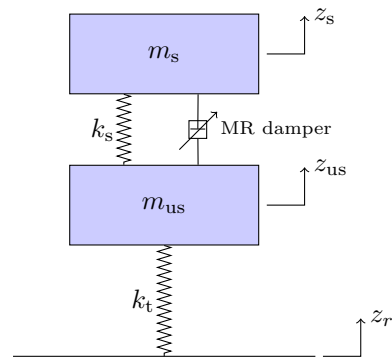
$$\begin{cases} \dot{x}_s = A_s x_s + B_s \rho_1 a_1 + B_{s1} w \\ z = C_{s1} x_s + D_{s1} \rho_1 a_1 \\ y = C_s x_s \end{cases} \quad (4.6)$$

with

$$A_s = \begin{bmatrix} 0 & 1 & 0 & 0 \\ -\frac{k_s+k_{\text{mr}}}{m_s} & -\frac{c_{\text{mr}}}{m_s} & \frac{k_s+k_{\text{mr}}}{m_s} & \frac{c_{\text{mr}}}{m_s} \\ 0 & 0 & 0 & 1 \\ \frac{k_s+k_{\text{mr}}}{m_{\text{us}}} & \frac{c_{\text{mr}}}{m_{\text{us}}} & -\frac{k_s+k_{\text{mr}}+k_t}{m_{\text{us}}} & -\frac{c_{\text{mr}}}{m_{\text{us}}} \end{bmatrix}, B_s = \begin{bmatrix} 0 \\ \frac{-1}{m_s} \\ 0 \\ \frac{1}{m_{\text{us}}} \end{bmatrix}, B_{s1} = \begin{bmatrix} 0 \\ 0 \\ 0 \\ \frac{k_t}{m_{\text{us}}} \end{bmatrix}.$$

The measurement output is  $y = z_s - z_{\text{us}}$ , and the controlled outputs are chosen as  $z = [\ddot{z}_s \quad z_s]^\top$ , respectively the acceleration and the displacement of the sprung mass. Then

$$C_{s1} = \begin{bmatrix} -\frac{k_s+k_{\text{mr}}}{m_s} & -\frac{c_{\text{mr}}}{m_s} & \frac{k_s+k_{\text{mr}}}{m_s} & \frac{c_{\text{mr}}}{m_s} \\ 1 & 0 & 0 & 0 \end{bmatrix}, D_{s1} = \begin{bmatrix} -\frac{1}{m_s} \\ 0 \end{bmatrix}, C_s = [1 \quad 0 \quad -1 \quad 0].$$

However, two constraints must be satisfied

1. The control signal  $a_1$  must be positive (dissipative constraint)
2. The input matrices  $B_s \rho_1$  and  $D_{s1} \rho_1$  must be constant to satisfy the LPV- $\mathcal{H}_\infty$  synthesis assumption.

The passivity problem is solved by defining a new control signal  $u = a_1 - F_0$  where  $F_0$  is the mean value of  $a_1$  ( $F_0 = (a_{1\text{max}} - a_{1\text{min}})/2$ ). Then, the problem of the passivity on  $a_1$  is recast to a simple saturation problem on  $u$  ( $u \in [-F_0; F_0]$ ). With these modifications, (4.7) yields

$$\begin{cases} \dot{x}_s = (A_s + B_{s2} \frac{\rho_1}{C_{s2} x_s} C_{s2}) x_s + B_s \rho_1 u + B_{s1} w \\ z = C_{s1} x_s + D_{s1} \rho_1 u \\ y = C_s x_s \end{cases} \quad (4.7)$$

where

$$B_{s2} = \begin{bmatrix} 0 & -\frac{F_0}{m_s} & 0 & \frac{F_0}{m_{\text{us}}} \end{bmatrix}^\top \text{ and } C_{s2} = \begin{bmatrix} -\frac{a_3 v_0}{x_0} & a_3 & -\frac{a_3 v_0}{x_0} & -a_3 \end{bmatrix}^\top.$$

To overcome the second problem, [Apkarian and Gahinet, 1995] proposes to add a strictly proper filter  $\mathcal{F}$  to make the controlled output matrices independent of the scheduling parameters

$$\mathcal{F} : \begin{bmatrix} \dot{x}_f \\ u \end{bmatrix} = \begin{bmatrix} A_f & B_f \\ C_f & 0 \end{bmatrix} \begin{bmatrix} x_f \\ u_c \end{bmatrix} \quad (4.8)$$

Then, by defining  $\rho_2 = \frac{\rho_1}{C_{s2}x_s}$  and  $x = (x_s \ x_f)^\top$  the system (4.7) can be represented as

$$\begin{cases} \dot{x} = A(\rho_1, \rho_2)x + Bu_c + B_1w \\ z = C_1(\rho_1, \rho_2)x \\ y = Cx \end{cases} \quad (4.9)$$

where

$$A(\rho_1, \rho_2) = \begin{bmatrix} A_s + \rho_2 B_{s2} C_{s2} & \rho_1 B_s C_f \\ 0 & A_f \end{bmatrix}, \quad B = \begin{bmatrix} 0 \\ B_f \end{bmatrix}, \quad B_1 = \begin{bmatrix} B_{s1} \\ 0 \end{bmatrix},$$

$$C_1(\rho_1, \rho_2) = [ C_{s1} \ \rho_1 D_{s1} C_f ] \text{ and } C = [ C_s \ 0 ].$$

### 4.3.2 $\mathcal{H}_\infty$ -Controller Synthesis

By considering the LPV-model (4.9), an  $\mathcal{H}_\infty$ -controller is designed to guarantee the internal closed-loop stability and to satisfy some required performance. In fact, the main objective and challenge of a controlled suspension system is to improve the comfort for car passengers simultaneously to the performance on road holding. The passenger comfort can be improved by isolating the vibrations transmitted from the road surface. Then, the frequency response from the road profile  $z_r$  to the vehicle chassis acceleration  $\ddot{z}_s$  must be kept small in the low frequency range. Then, a weighting function is designed as

$$W_{\ddot{z}_s} = w_{\ddot{z}_s} \frac{s^2 + \xi_{11} w_{11} s + w_{11}^2}{s^2 + 2\xi_{12} w_{12} s + w_{12}^2}$$

Furthermore, the road holding is evaluated from the unsprung mass (wheel) oscillations with respect to the road profile. This transfer should be kept small at high frequencies. Then,  $W_{z_{us}}$  is designed as

$$W_{z_{us}} = w_{z_{us}} \frac{s^2 + \xi_{21} w_{21} s + w_{21}^2}{s^2 + 2\xi_{22} w_{22} s + w_{22}^2}$$

$W_{z_r} = 5 \times 10^{-3}$  is the road profile gain. Finally, the filter introduced in (4.8) is given as:  $\mathcal{F} = \frac{w_f}{s+w_f}$ . It is designed with a large bandwidth to decouple the input and the varying parameters, where

$$w_{\ddot{z}_s} = 1, \quad \xi_{11} = 0.1, \quad \xi_{12} = 1, \quad w_{11} = 2\pi \times 1 \text{ rad.s}^{-1}, \quad w_{12} = 2\pi \times 3 \text{ rad.s}^{-1},$$

$w_{z_{us}} = 10$ ,  $\xi_{21} = 0.3$ ,  $\xi_{22} = 1$ ,  $w_{21} = 2\pi \times 9 \text{ rad.s}^{-1}$ ,  $w_{22} = 2\pi \times 9 \text{ rad.s}^{-1}$ ,  $w_f = 90.34$ . Then, an interconnection between the LPV-model and these weighting functions are presented in Figure 4.19.

Model parameters are obtained by considering experimental data in

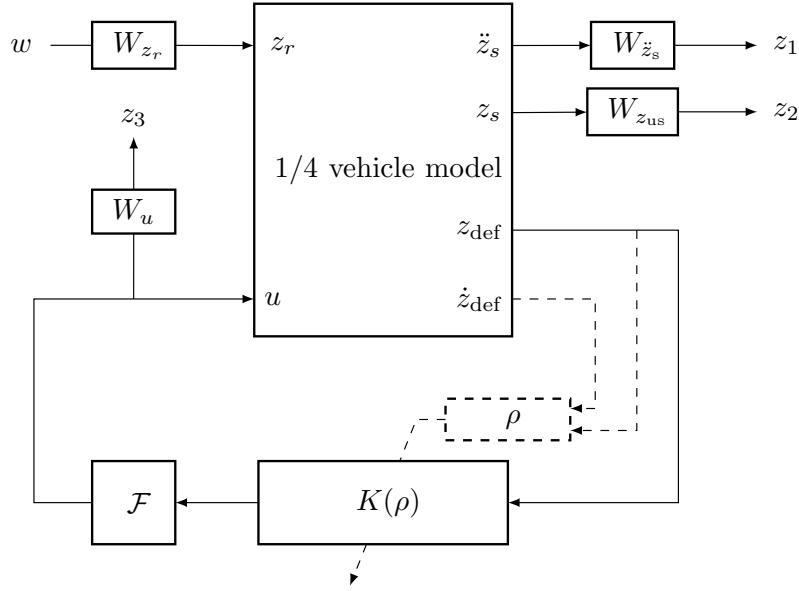

Figure 4.19:  $\mathcal{H}_\infty$ -control Scheme

[Tudon-Martinez et al., 2013] and given as Table 4.8 To carry out a controller

Table 4.8: Parameter Values

Parameter	Value
Sprung mass ( $m_s$ )	470 [kg]
Unsprung mass ( $m_{us}$ )	110 [kg]
Tyre stiffness coefficient ( $k_t$ )	270000 [N/m]
Spring stiffness coefficient ( $k_s$ )	86378 [N/m]

satisfying these objectives, the  $\mathcal{H}_\infty$ -LPV-synthesis is designed by using solution for polytopic systems: it consists in finding a global LPV-controller  $K(\rho_1, \rho_2)$  which is a convex combination of local controllers obtained by solving the LMIs set at each vertex (formed by limits values of the varying parameters). All varying parameters are bounded:  $\rho_1 \in [-1; 1]$ ,  $\rho_2 \in [0; 1]$ .

For more details and explanation on  $\mathcal{H}_\infty$ -LPV-control synthesis, see [Apkarian and Gahinet, 1995, Scherer et al., 1997]. The design method for LPV-systems is used like in [Apkarian et al., 1994].

### 4.3.3 Numerical Issue

The proposed method requests the solution of two Lyapunov inequalities with an infinite number of constraints. These sets of infinite LMIs can be solved by gridding techniques. Then, some approximations must be made by gridding the set  $\Delta_\rho$  with finite number  $L$  of points  $\{\rho_i\}_{i=1}^L$  [Lee, 1997]. Moreover, the infinite variables  $\mathbf{P}_\Omega(\rho)$  and  $\mathbf{Q}_\Omega(\rho)$  in LMIs (3.100),(3.101) are approximated by combinations of scalar basis functions such as

$$\mathbf{P}_\Omega(\rho) = \sum_{j=1}^{N_P} \phi_j(\rho) P_j \succ 0$$

$$\mathbf{Q}_\Omega(\rho) = \sum_{j=1}^{N_Q} \varphi_j(\rho) Q_j \succ 0$$

where  $P_j = P_j^\top, Q_j = Q_j^\top$ . There is a large freedom in the choice of basis functions [Wood, 1995]. For this example, the following choice is made:

$$\{\phi_j\}_{j=1}^{13} = \{\varphi_j\}_{j=1}^{13} = \{1, \rho_1, \rho_2, \rho_1^2, \rho_2^2, \rho_1\rho_2, \rho_1\rho_2^2, \rho_1^2\rho_2, \rho_1^2\rho_2^2, \rho_1^3, \rho_2^3, \rho_1\rho_2^3, \rho_1^3\rho_2\}.$$

The main consequence of this approximation is that the number of LMIs to be solved is finite and is  $2L(2^{s+1} + 1)$  where  $s$  is the number of parameters, i.e.  $s = 2$  and  $L = 13$ . The full-order controller is designed using the procedure developed in [Scherer et al., 1997]. Then, an 8-order controller  $K_{\text{full}}$  is obtained. The proposed method is used to reduce  $K_{\text{full}}$ . Then,  $K_{\text{FWBT}}$  is produced.

To test its effectiveness, a comparison with the method developed in [Widowati et al., 2004] (LPV balanced truncation) namely  $K_{\text{BT}}$ , is performed. The feasibility problems (3.100)(3.101) are convex. Using (MATLAB LMI Control Toolbox), controllers are reduced to the 5th order obtained heuristically by trial-and-error approach. Therefore, a frequency and time analysis are performed.

### 4.3.4 Results and Discussion

The first evaluation is represented in Table 4.9 where first the assumption (3.108) and (3.109) are checked. Note that for 25 frozen values of  $(\rho_1, \rho_2)$ , the rank assumption is satisfied for all these points. This fact confirms Remark 3.3.2 and allows us compute an upper bound. Precisely, Table 4.10 express the upper bounds and  $\mathcal{H}_\infty$ -norm of the error values. These results evince that the upper bound is correctly positioned (the gap is positive). However, we note that this upper bound is not tight to error  $\mathcal{H}_\infty$ -norm.

Table 4.9: Values of  $(\text{rank}[\mathbf{B}(\rho), \mathbf{B}_\Omega(\rho)]/\text{rank}[\mathbf{B}_\Omega(\rho)] ; \text{rank}[\mathbf{C}^\top(\rho), \mathbf{C}_\Omega^\top(\rho)]/\text{rank}[\mathbf{C}_\Omega^\top(\rho)])$  for Several Frozen Values of  $(\rho_1, \rho_2)$

$\rho_1 \backslash \rho_2$	-1.0	-0.5	0.0	0.5	1.0
0	(14/14; 14/14)	(14/14; 14/14)	(14/14; 14/14)	(14/14; 14/14)	(14/14; 14/14)
0.25	(14/14; 14/14)	(13/13; 14/14)	(14/14; 14/14)	(14/14; 14/14)	(14/14; 14/14)
0.5	(11/11; 14/14)	(13/13; 14/14)	(11/11; 14/14)	(12/12; 14/14)	(11/11; 14/14)
0.75	(12/12; 14/14)	(14/14; 14/14)	(14/14; 14/14)	(14/14; 14/14)	(14/14; 14/14)
1.0	(14/14; 14/14)	(14/14; 14/14)	(14/14; 14/14)	(14/14; 14/14)	(14/14; 14/14)

Table 4.10: Values of the  $\|T_{zw}(\rho) - \hat{T}_{zw}(\rho)\|_{i,2}$  and the Upper bound for Several Frozen Values of  $(\rho_1, \rho_2)$

$\rho_1 \backslash \rho_2$	-1.0	-0.5	0.0	0.5	1.0
0.0	$1.36 \leq 5.07$	$1.35 \leq 3.32$	$1.33 \leq 4.08$	$1.31 \leq 3.37$	$1.30 \leq 3.72$
0.25	$0.32 \leq 9.88$	$0.32 \leq 9.93$	$0.32 \leq 10.38$	$0.31 \leq 10.39$	$0.31 \leq 9.80$
0.5	$0.00 \leq 1.79$	$0.00 \leq 0.13$	$0.00 \leq 2.22$	$0.00 \leq 11.81$	$0.00 \leq 2.03$
0.75	$0.31 \leq 9.97$	$0.31 \leq 9.92$	$0.30 \leq 10.58$	$0.30 \leq 9.86$	$0.29 \leq 9.89$
1.5	$1.22 \leq 3.77$	$1.20 \leq 3.04$	$1.19 \leq 4.46$	$1.18 \leq 2.88$	$1.17 \leq 2.90$

### Frequency analysis:

The Bode diagrams at several frozen values of  $\rho_1$  and  $\rho_2$  (25 points) of the three transfer function  $T_{z_s}$ ,  $T_{\ddot{z}_s}$  and  $T_{z_{us}}$  are shown respectively in Figure 4.20, 4.21 and 4.22. In fact, the frequency behaviours of the chassis position  $z_s$  and acceleration  $\ddot{z}_r$  are chosen to be analysed in order to observe the comfort performance regarding the road profile input  $z_r$ . The wheel position signal  $z_{us}$  is also analysed to test the road holding. Then, the weighting functions  $W_{\ddot{z}_s}$  and  $W_{z_s}$  designed in Section 4.3.2, limit the amplification of the previously cited transfers in low frequency range (around [1 ; 10] Hz). In fact, the human sensitivity to vertical vibrations is important in this frequency range [Do et al., 2010]. For this reason, the frequency interval of the proposed frequency limited FWBT method is chosen as [1 ; 8] Hz.

In Figure 4.20, note the reduced-order closed-loop system produced by FWBT approximate well the full-order closed-loop system in the chosen frequency range [1 ; 10] Hz. In this interval, the reduced-order closed-loop system produced by the unweighted BT fails. In fact, an important gap appears a 2 Hz and 3 Hz which is exacted as th BT is known to guarantee good approximation at high frequency. The same comment is given in Figure 4.21 where FWBT fits the full order closed-loop system in all the shown range unlike BT method that miss the peak around 2 (a resonance frequency). These results are more explicit when observing Figure 4.22. Indeed, FWBT gives a good approximation when BT fails (2 Hz and 8 Hz). The other important fact stated by these results, is the sensitivity against the parameters variation. Actually, a dispersion of  $\rho_1$  and  $\rho_2$  values is induced by the reduction step. This degradation is expected since the given application is a qLPV system where  $\rho_1$  and  $\rho_2$  are depending on the

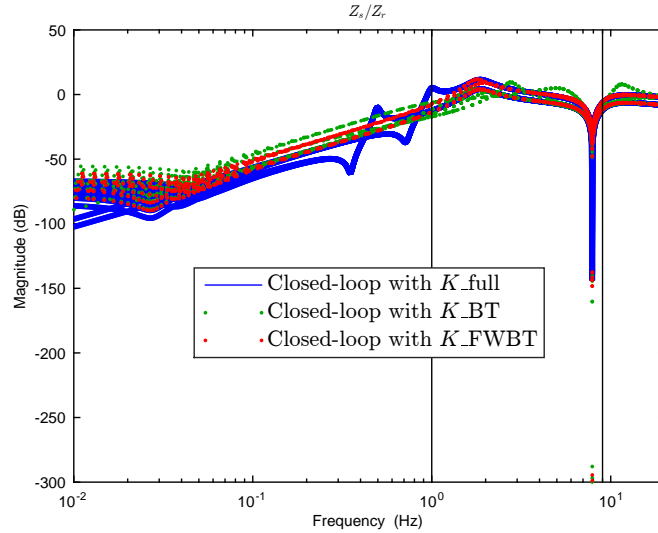

Figure 4.20: Bode-diagram Magnitude of the Transfer  $T_{z_s/z_r}$

state vector. Then, every decrease in the order (states) affects the  $\rho_1$  and  $\rho_2$  values. However, this loss when reducing is under control for two reasons: the first one, the stability of reduced-order closed-loop is preserved and the error is guaranteed limited. The second one is that this dispersion is weak in the required frequency range. Thus, performance are not affected.

**Remark**

As Bode diagram for non-linear systems is not possible, a pseudo-Bode plot is then proposed in [Poussot-Vassal, 2008].

**Time analysis:**

In the time domain, the several controlled suspensions are travelling a bump of 0.01 m  $\times$  2 m for a vehicle speed 8.3 m/s (i.e. 30 km/h). It is observed that the time response confirms the contribution of the FWBT reduction method. In fact, in Figure 4.23, the chassis is stabilised rapidly (1 sec. after the perturbation) without overtake on the suspension unlike the suspension with  $K_{BT}$ . This observation, preserves the required ‘comfort’ performance. Moreover, for  $z_{us}$ , the wheel equipped with a  $K_{FWBT}$ -suspension, keeps almost the same profile of the road although its variations which respects the ‘road handling’ performance. The  $K_{BT}$ -suspension generate an infinite perturbation just after the bump (after 1 sec.). Note also, that temporal test draw two output signals (chassis and wheel positions) regarding the input (the road profile) and by the way there will be just one plot of each transfer besides the several plots in the frequency responses.

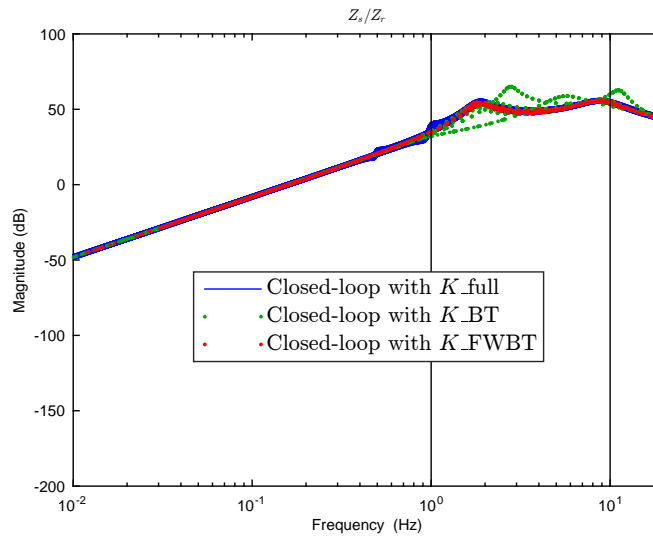
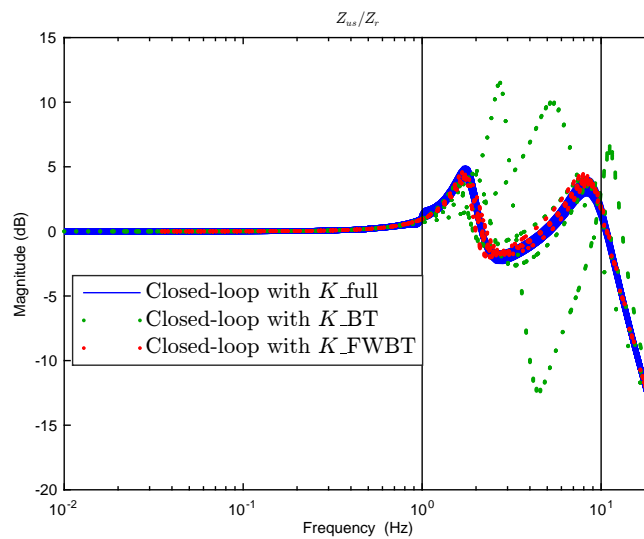
Figure 4.21: Bode-diagram Magnitude of the Transfer  $T_{z_s/z_r}$ Figure 4.22: Bode-diagram Magnitude of the Transfer  $T_{z_{us}/z_r}$ 

## Conclusion

In this chapter, the studied approaches in previous chapters are implemented and evaluated on several engineering problems.

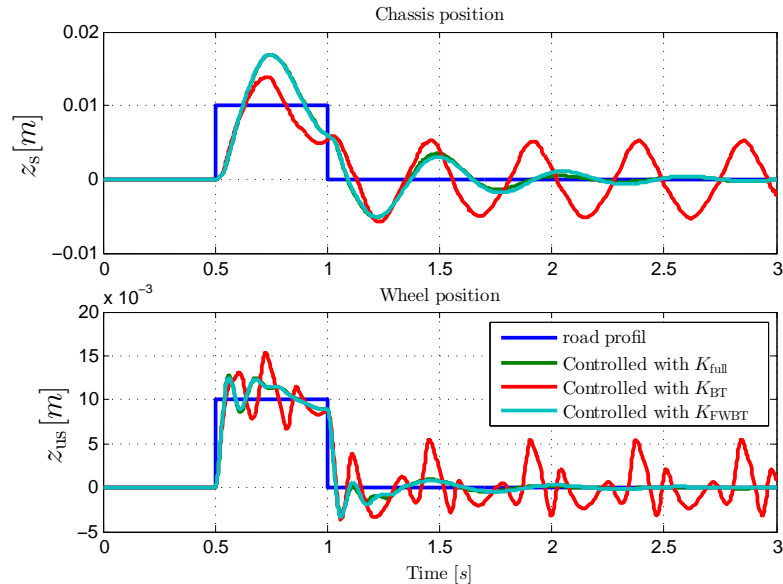

Figure 4.23: Time-response on a Bump of  $0.01 \times 2$  m

The different methods to obtain a fixed-order controller have been first tested: the Apkarian and the Ankelhed's algorithms are implemented and tested on some *COMPl<sub>e</sub>ib* benchmark problems. From the fact that the main objective is to minimise  $\|T_{zw}\|_{\infty}$ , this  $\mathcal{H}_{\infty}$ -norm of the closed-loop system is evaluated for different orders. First analysis, shows similar good results for the two techniques. On the contrary, they failed for some models with quit high order which was expected regarding the big number of decision variables. This evaluation has been completed by an additional comparison with two available MATLAB toolboxes. These latters show a bit better result in most cases. Evaluation on *COMPl<sub>e</sub>ib* benchmark has been finished by a macro test where best results in the direct fixed order way have been compared the ones of the indirect way. As expected, the fixed order way show some numerical problems in many cases unlike the order reduction approach which give a stable results even if the order is big. It has been noted also that the fixed order way give better results than the reduced order approach for very low orders (0 or 1). However for higher orders ( $> 2$ ) reduction the best results are obtained by the reduced order controller.

Thereafter, The indirect way in turn is evaluated. An automotive-suspension with a controlled damper is consider. The system is first represented with an LTI-model. Then, performance specifications have been achieved with a full-order  $\mathcal{H}_{\infty}$ -controller. This latter has been the subject of an order reduction step where the FWBT technique is used. As shown in Section 3.2, various versions have been used to perform the order reduction. Then, these variants are implemented and tested through this system.

The shown results have confirmed their effectiveness and comparable good results have been obtained for each method. In fact, a remarkable gain in time and memory has been observed. Finally, a time and frequency domain analysis have been performed. This evaluation has conformed the effectiveness of the implemented methods, Indeed, the performance specification have been respected even the controller is reduced to one third of its order.

Finally, the most important contribution concerning the  $\mathcal{H}_\infty$ -LPV-controller order reduction, has been validated in the last section. The control of a car magneto-rheological damper is considered. This semi-active suspension system has been written under an LPV-model. Then, an  $\mathcal{H}_\infty$ -LPV-controller has been designed. Thereafter, the developed method has been implemented and a reduced order controller is derived. Similar examination to the previous example is done by performing a time and frequency domain analysis. Subject to bump road profile, the controlled semi-active suspension shows good performance even the controller order is reduced. Unlike the fixed order way, the developed method guarantee an upper bound of the approximation error. This latter has been computed and shown to be always bounded by the introduced upper bound.



# Conclusion and Perspectives

The work presented in this dissertation is related to the  $\mathcal{H}_\infty$ -LPV-controller order reduction. This latter consists of the design of a robust reduced-order LPV-controller for LPV-systems. The order reduction issue has been very fairly investigated, However, the case of LPV-control design is slightly discussed. This thesis focuses primarily on two topics : How to obtain an LPV-reduced-order controller even the high order generated by the classical synthesis and how this reduced order controller can deal with a practical engineering problem (semi-active suspension control). In view of this, The order-reduction topic and the  $\mathcal{H}_\infty$ -synthesis theory have been widely studied in this thesis. This study, has allowed the development of a new method for  $\mathcal{H}_\infty$ -LPV-controller order reduction.

In Chapter 1, Definitions and basic notions on system and control theory have introduced. Mathematical framework has been well detailed and required notions have been detailed. Essential notions in the linear algebra have been first recalled. Then, the interested systems classes namely the LTI and LPV systems, have been described.

In Chapter 2,  $\mathcal{H}_\infty$ -control design has been investigated. Firstly, the LTI-case has been considered. The stability and the performance requirements have been shown guaranteed by the  $\mathcal{H}_\infty$ -controller. The examination of this design methodology has shown its drawback regarding the high order of the resulting synthesised controller. One way to tackle this problem was to set the order when synthesising the controller. This approach has been examined in this chapter. Finally, the LPV-case is considered where the stability and the performance issues have been also treated. The same observation has been stated i.e. the high order of the LPV-controller. Then, reducing this latter has conducted to define the main objective of this thesis.

In Chapter 3, the primary contribution of this thesis has been given. To achieve this latter, The model order-reduction matter has been first introduced and discussed. Methods based on singular value decomposition have been then studied and compared. Their analysis has shown their usefulness for the control order reduction (instead of the model order reduction). Hence, they have been used to obtain  $\mathcal{H}_\infty$ -LTI-reduced-order controllers. This study has completed the main summery scheme on how to get a low-order controllers given in Figure 1. Indeed, comparison work has been planned in the last chapter to evaluate every edge of the scheme for the LTI-case. Inspired by these stated developments of  $\mathcal{H}_\infty$ -LTI-controller order reduction, a new method has been derived to achieve this objective for  $\mathcal{H}_\infty$ -LPV controllers. A big advantage of this approach was to perform the order reduction in oriented limited frequency range.

The obtained reduced-order controller is guaranteed stabilising and the approximation error has been proven bounded.

Finally in Chapter 4, All the treated methods and algorithms have been implemented and evaluated. First, various engineering problems from the *COMPl<sub>e</sub>ib* benchmark library have been considered. The studied algorithms in Section 2.2 have been tested and compared on some of the library examples. This comparison has been extended to other existing MATLAB tools that have the same objective. The evaluation has shown good performance with comparable results for each method. However, considerable numerical resources and some technical troubles have been encountered when applying them. Thereafter, the control of an automotive suspension has been concerned. According the actuator technology, two control laws are derived: an  $\mathcal{H}_\infty$ -LTI controller for an active-suspension and  $\mathcal{H}_\infty$ -LPV-controller for a magneto-rheological semi-active one. For the first one, methods reviewed in Section 3.2 has been evaluated with this system. Performance regarding the passenger comfort and the road handling are tested and results have shown their effectiveness. The frequency and time analysis have shown also their efficacy comparing to the fixed-order methods. Ultimately, the developed  $\mathcal{H}_\infty$ -LPV-controller method with its two variants developed in the Section 3.3 have been evaluated. The several tests of the approximation error and the performance in time and frequency time have shown the contribution of the given order reduction methods.

## Perspectives

Among the presented work, several improvements are proposed

- The  $\mathcal{H}_\infty$ -synthesis for LTI-systems is known to ensure the controller robustness. This latter is investigated in this thesis and a Robustness analysis is performed through the  $\mu$ -analysis tool in Section 2.1 and Section 4.2. Then, the stability and the performance robustness of the reduced-order controllers have been tested. However, no guarantee is ensured by such control approach. Recently, various techniques are developing that guarantee a robustness degree while synthesising the controller. The most known one to achieve this objective is the so-called DK-iteration procedure [Doyle et al., 1987]. It would be interesting if the order-reduction procedure and this controller synthesis would be mixed in order to ensure the robustness even the order-reduction.
- The frequency limited method for LPV-case proposed in Section 3.3 is developed with two variants: the BT way that approximate better in high frequency and the SPA one that approximate error in low frequency. The two variant have tested for medium frequency range. It will be of great interest if the method would be

tested in all the possible cases, e.g. chose a very low frequency and test the BT or chose a very high frequency range and test the SPA.

- It has shown in Section 2.1 that the weighting functions derived from the performance specifications are the primary reason to increase the controller order. Then, the link between the several proposed methods and these weighting functions should be investigated with the aim to limit the order before the  $\mathcal{H}_\infty$ -controller design.
- Almost all the proposed work in this thesis concerns the  $\mathcal{H}_\infty$ -control. An extension to the  $\mathcal{H}_2$ -control seems to be feasible and could give an interesting contribution. Moreover, mixed  $\mathcal{H}_\infty/\mathcal{H}_2$  control design problem could be treated and reduced-order controller procedure for this type of control design would be derived.
- The proposed method in Section 3.3 concerns the order-reduction way for LPV-controllers. Even if research for a such complicated problem, the fixed-order way for  $\mathcal{H}_\infty$ -LPV-controller should be investigated and evaluated.
- Passivity notion is essential in dynamical systems. Unlike the proprieties like stability and performance, this passivity criterion has not been discussed. It would be useful if a study could be conducted in this direction. Some recent contributions are treating this issue [Li et al., 2015, Li and Gao, 2015].
- Even though the design of an  $\mathcal{H}_\infty$ -LPV controller is considered robust against the parameters variation, it is more consistent to consider uncertainties for LPV-systems. This uncertain LPV-controllers would necessary have a higher order, Then, approximating such controllers would be very useful.



# Bibliography

- [Anderson and Liu, 1989] Anderson, B. and Liu, Y. (1989). Controller reduction: concepts and approaches. *IEEE Transactions on Automatic Control*, 34(8):802–812. (Cited on pages v, xiii and 56.)
- [Anderson and Clements, 1981] Anderson, B. D. and Clements, D. J. (1981). Algebraic characterization of fixed modes in decentralized control. *Automatica*, 17(5):703–712. (Cited on page 83.)
- [Ankelhed, 2011] Ankelhed, D. (2011). *On design of low order  $H_\infty$  controllers*. PhD thesis, Linköping University. (Cited on pages 35 and 36.)
- [Ankelhed et al., 2011] Ankelhed, D., Helmersson, A., and Hansson, A. (2011). A partially augmented lagrangian method for low order  $H_\infty$  controller synthesis using rational constraints. In *Decision and Control and European Control Conference (CDC-ECC), 2011 50th IEEE Conference on*, pages 8219–8224. (Cited on pages 12 and 38.)
- [Antoulas, 2005a] Antoulas, A. (2005a). *Approximation of Large-Scale Dynamical Systems*. Society for Industrial and Applied Mathematics. (Cited on pages v, xiii and 58.)
- [Antoulas, 2005b] Antoulas, A. (2005b). A new result on passivity preserving model reduction. *Systems & Control Letters*, 54(4):361–374. (Cited on pages xiii and 56.)
- [Apkarian and Gahinet, 1995] Apkarian, P. and Gahinet, P. (1995). A convex characterization of gain-scheduled  $H_\infty$  controllers. *Automatic Control, IEEE Transactions on*, 40(5):853–864. (Cited on pages 18, 110 and 111.)
- [Apkarian et al., 1994] Apkarian, P., Gahinet, P., and Becker, G. (1994). Self-scheduled  $H_\infty$  linear parameter-varying systems. In *IEEE Transactions on Automatic Control*, pages 856–860. (Cited on pages 17 and 111.)
- [Apkarian and Noll, 2006] Apkarian, P. and Noll, D. (2006). Nonsmooth  $H_\infty$  synthesis. *Automatic Control, IEEE Transactions on*, 51(1):71–86. (Cited on page 90.)
- [Apkarian et al., 2003] Apkarian, P., Noll, D., and Tuan, H. (2003). Fixed order  $H_\infty$  control design via a partially Augmented Lagrangian method. *Robust and Nonlinear Control*, 13:12. (Cited on pages ii, 21, 38, 41 and 42.)
- [Bernstein, 1989] Bernstein, D. (1989). Robust stability and performance via fixed-order dynamic compensation. *SIAM Journal on Control and Optimization*, 27(2):389–406. (Cited on pages xiii and 56.)



- [Bertsekas, 1982] Bertsekas, D. P. (1982). *Constrained Optimization and Lagrange Multiplier Methods*. Academic Press. (Cited on page 37.)
- [Bourlés and Marinescu, 2011] Bourlés, H. and Marinescu, B. (2011). *Linear Time-Varying Systems*. Springer Berlin Heidelberg. (Cited on page 4.)
- [Boyd et al., 1994] Boyd, S., El Ghaoui, L., Feron, E., and Balakrishnan, V. (1994). *Linear Matrix Inequalities in System and Control Theory*, volume 15 of *Studies in Applied Mathematics*. SIAM, Philadelphia, PA. (Cited on pages 12 and 31.)
- [Briat, 2015] Briat, C. (2015). *Linear Parameter-Varying and Time-Delay Systems*. Springer. (Cited on pages 13, 19, 23, 47, 48, 49, 50 and 51.)
- [Burke, 2006] Burke, J.V. Henrion, D. L. A. O. M. (2006). HIFOO - a matlab package for fixed-order controller design and H-infinity optimization. In *Proceedings of the 5th IFAC Symposium on Robust Control Design ROCOND*. (Cited on page 90.)
- [Callier and Desoer, 1991] Callier, F. M. and Desoer, C. A. (1991). *Linear System Theory*. Springer-Verlag New York. (Cited on page 5.)
- [Chahlaoui and Dooren, 2002] Chahlaoui, Y. and Dooren, P. V. (2002). A collection of benchmark examples for model reduction of linear time invariant dynamical systems. In *SLICOT Working Note*. (Cited on page 62.)
- [Clarke, 1990] Clarke, F. (1990). *Optimization and Nonsmooth Analysis*. Classics in Applied Mathematics. Society for Industrial and Applied Mathematics. (Cited on page 90.)
- [Conn et al., 1991] Conn, A., Gould, N. M., and Toint, P. (1991). A globally convergent augmented Lagrangian algorithm for optimization with general constraints and simple bounds. *SIAM Journal on Numerical Analysis*, 28(2):545–572. (Cited on page 37.)
- [Desoer and Vidyasagar, 2009] Desoer, C. and Vidyasagar, M. (2009). *Feedback Systems*. Society for Industrial and Applied Mathematics. (Cited on pages 22 and 24.)
- [Do et al., 2011] Do, A. L., Sename, O., Dugard, L., and Boussaad, S. (2011). Multi-objective optimization by genetic algorithms in  $H_\infty$ /LPV control of semi-active suspension. In *Proceedings of the 18th IFAC World Congress*. (Cited on page 107.)
- [Do et al., 2010] Do, A. L., Spelta, C., Savaresi, S., Sename, O., Dugard, L., and Delvecchio, D. (2010). An LPV control approach for comfort and suspension travel improvements of semi-active suspension systems. In *Decision and Control (CDC), 2010 49th IEEE Conference on*, pages 5560–5565. (Cited on page 113.)

- [Doyle et al., 1987] Doyle, J., Lenz, K., and Packard, A. (1987). *Design Examples Using  $\mu$ -Synthesis: Space Shuttle Lateral Axis FCS During Reentry*, pages 127–154. Springer Berlin Heidelberg, Berlin, Heidelberg. (Cited on page 120.)
- [El-Zobaidi and Jaimoukha, 1998] El-Zobaidi, H. and Jaimoukha, I. (1998). Robust control and model and controller reduction of linear parameter varying systems. In *Decision and Control, 1998. Proceedings of the 37th IEEE Conference on*, volume 3, pages 3015–3020 vol.3. (Cited on page 75.)
- [Enns, 1984] Enns, D. (1984). Model reduction with balanced realizations: An error bound and a frequency weighted generalization. In *Decision and Control, 1984. The 23rd IEEE Conference on*, volume 23, pages 127–132. (Cited on page 62.)
- [Fischer and Gutman, 1991] Fischer, M. and Gutman, S. (1991). Synthesis of fixed-order compensators. *Journal of Optimization Theory and Applications*, 70:333–354. (Cited on pages xiii and 56.)
- [Gahinet, 1994] Gahinet, P. (1994). Explicit controller formulas for LMI-based  $H_\infty$  synthesis. In *American Control Conference, 1994*, volume 3, pages 2396–2400 vol.3. (Cited on pages 28, 29 and 44.)
- [Gahinet and Apkarian, 1993] Gahinet, P. and Apkarian, P. (1993). An lmi-based parametrization of all  $H_\infty$  controllers with applications. In *Decision and Control, 1993., Proceedings of the 32nd IEEE Conference on*, pages 656–661 vol.1. (Cited on pages 28 and 29.)
- [Gahinet and Apkarian, 1994] Gahinet, P. and Apkarian, P. (1994). A linear matrix inequality approach to  $H_\infty$  control. *International Journal of Robust and Nonlinear Control*, 4:421–448. (Cited on pages 31, 32 and 41.)
- [Gahinet et al., 1996] Gahinet, P., Apkarian, P., and Chilali, M. (1996). Affine parameter-dependent lyapunov functions and real parametric uncertainty. *Automatic Control, IEEE Transactions on*, 41(3):436–442. (Cited on page 18.)
- [Gangsaas et al., 1986] Gangsaas, D., Bruce, D., Blight, K. J., and Ly, U. (1986). Application of modern synthesis to aircraft control: Three case studies. In *IEEE Transactions on Automatic Control*, pages 995–1014. (Cited on pages xiii and 56.)
- [Gawronski and Juang, 1990] Gawronski, W. and Juang, J. (1990). Model reduction in limited time and frequency intervals. *International Journal of Systems Science*, 21(2):349–376. (Cited on pages 63 and 68.)
- [Glover, 1984] Glover, K. (1984). All optimal Hankel-norm approximations of linear multivariable systems and their  $L_\infty$  error bounds. *International Journal of Control*, 39(6):1115–1193. (Cited on page 61.)

- [Glover and Doyle, 1988] Glover, K. and Doyle, J. C. (1988). State-space formulae for all stabilizing controllers that satisfy an  $H_\infty$  norm bound and relations to risk sensitivity. *Syst. Control Lett.*, 11(3):167–172. (Cited on page 27.)
- [Goddard, 1995] Goddard, P. J. (1995). *Performance-Preserving Controller Approximation*. PhD thesis, Trinity College Cambridge. (Cited on pages xiii, 11 and 56.)
- [Gugercin and Antoulas, 2004] Gugercin, S. and Antoulas, A. (2004). A survey of model reduction by balanced truncation and some new results. *International Journal of Control*, 77:748–766. (Cited on pages 63 and 82.)
- [Gumussoy et al., 2009] Gumussoy, S., Henrion, D., Millstone, M., and Overton, M. L. (2009). Multiobjective robust control with HIFOO 2.0. In *IFAC Symposium on Robust Control Design (Rocond'09)*. (Cited on page 90.)
- [Gumussoy and Overton., 2008] Gumussoy, S. and Overton., M. (2008). Timings for numerical experiments on benchmark examples for fixed order H-infinity controller design,. (Cited on pages 90 and 92.)
- [Guo et al., 2006] Guo, S., Yang, S., and Pan, C. (2006). Dynamic modeling of magnetorheological damper behaviors. *Journal of Intelligent Material Systems and Structures*, 17(1):3–14. (Cited on page 107.)
- [Hedrick and Butsuen, 1990] Hedrick, J. K. and Butsuen, T. (1990). Invariant properties of automotive suspensions. *Proceedings of The Institution of Mechanical Engineers Part D-journal of Automobile Engineering*, 204:21–27. (Cited on page 96.)
- [Helmersson, 2009] Helmersson, A. (2009). on polynomial coefficients and rank constraints. Technical report, Automatic Control Reglerteknik Linköpings Universitet. (Cited on pages iii, 7, 133 and 134.)
- [Henderson and Searle, 1979] Henderson, H. V. and Searle, S. R. (1979). vec and vech operators for matrices, with some uses in jacobians and multivariate statistics. *The Canadian Journal of Statistics*, 7:65–81. (Cited on page 8.)
- [Hestenes, 1969] Hestenes, M. (1969). Multiplier and gradient methods. *Journal of Optimization Theory and Applications*, 4(5):303–320. (Cited on page 37.)
- [Hyland and Richter, 1990] Hyland, D. and Richter, S. (1990). On direct versus indirect methods for reduced-order controller design. In *IEEE Transactions on Automatic Control*, pages 377–379. (Cited on pages xiii and 56.)
- [Imran et al., 2014] Imran, M., Ghafoor, A., and Sreeram, V. (2014). A frequency weighted model order reduction technique and error bounds. *Automatica*, 50(12):3304–3309. (Cited on page 83.)

- [Kato, 1990] Kato, T. (1990). *Perturbation Theory for Linear Operators*. Springer-Verlag Berlin Heidelberg. (Cited on page 24.)
- [Khalil, 2000] Khalil, H. (2000). *Nonlinear Systems*. Pearson Education. (Cited on pages 4, 22 and 23.)
- [Kim et al., 1995] Kim, S., Anderson, B., and Madieviski, A. (1995). Error bound for transfer function order reduction using frequency weighted balanced truncation. *Syst. Control Lett.*, 24:183–192. (Cited on pages 62, 65 and 66.)
- [Kong, 2012] Kong, L. (2012). *Controller reduction for linear systems*. PhD thesis, Louisiana State University. (Cited on pages xiii and 56.)
- [Lee, 1997] Lee, L. H. (1997). *Identification and Robust Control of Linear Parameter-Varying Systems*. PhD thesis, University of California at Berkeley. (Cited on pages 2, 3 and 112.)
- [Leibfritz, 2006] Leibfritz (2006). *Compleib: Constrained matrix-optimization problem library - a collection*. (Cited on page 89.)
- [Li, 2000] Li, J.-R. (2000). *Model Reduction of Large Linear Systems via Low Rank System Gramians*. PhD thesis, Massachusetts Institute of Technology. Dept. of Mathematics. (Cited on page 59.)
- [Li and Gao, 2015] Li, X. and Gao, H. (2015). Robust frequency-domain constrained feedback design via a two-stage heuristic approach. *IEEE Transactions on Cybernetics*, 45(10):2065–2075. (Cited on page 121.)
- [Li et al., 2015] Li, X., Yu, C., and Gao, H. (2015). Frequency-limited  $H - \infty$  model reduction for positive systems. *Automatic Control, IEEE Transactions on*, 60(4):1093–1098. (Cited on page 121.)
- [Lin and Chiu, 1990] Lin, C. and Chiu, T. (1990). Model reduction via frequency weighted balanced realization. In *American Control Conference*, pages 2069 –2070. (Cited on pages 62, 65 and 66.)
- [Liu and Anderson, 1989] Liu, Y. and Anderson, B. (1989). Singular perturbation approximation of balanced systems. In *Decision and Control, 1989., Proceedings of the 28th IEEE Conference on*, pages 1355–1360 vol.2. (Cited on pages 61 and 75.)
- [Lofberg, 2004] Lofberg, J. (2004). Yalmip: A toolbox for modeling and optimization in matlab. In *Computer Aided Control Systems Design, 2004 IEEE International Symposium on*, pages 284–289. IEEE. (Cited on pages 38 and 44.)

- [Ly et al., 1985] Ly, U.-L., Bryson, A., and Cannon, R. (1985). Design of low-order compensators using parameter optimization. *Automatica*, 21(3):315 – 318. (Cited on pages [xiii](#) and [56](#).)
- [Lyapunov, 1992] Lyapunov, A. (1992). General problem of the stability of motion. (Translated from Russian to French by E. Davaux and from French to English by A. T. Fuller). Taylor and Francis, London. (Cited on pages [22](#) and [23](#).)
- [Moore, 1981] Moore, B. (1981). Principal component analysis in linear systems: Controllability, observability, and model reduction. *IEEE Transactions on Automatic Control*, 26(1):17–32. (Cited on page [59](#).)
- [Moore et al., 1988] Moore, J. B., Telford, A. J., and Ly, U.-L. (1988). Controller reduction methods maintaining performance and robustness. In *Conference on Decision and Control*. (Cited on page [83](#).)
- [Mullis and Roberts, 1976] Mullis, C. and Roberts, R. (1976). Synthesis of minimum roundoff noise fixed point digital filters. *IEEE Transactions on Circuits and Systems*, 23(9):551 – 562. (Cited on page [59](#).)
- [Nagado and Usui, 2009] Nagado, T. and Usui, S. (2009). Controller reduction via frequency weightings considering  $H_\infty$  property preservation. *Electrical Engineering in Japan*, 166(2):63–69. (Cited on page [72](#).)
- [Nocedal and Wright, 2006] Nocedal, J. and Wright, S. J. (2006). *Numerical Optimization*. Springer Series in Operations Research and Financial Engineering. Springer New York. (Cited on page [37](#).)
- [Noll et al., 2004] Noll, D., Toriki, M., and Apkarian, P. (2004). Partially augmented lagrangian method for matrix inequality constraints. *SIAM Journal on Optimization*, 15(1):161–184. (Cited on page [37](#).)
- [Oh et al., 1997] Oh, D. C., Bang, K. H., and Park, H. B. (1997). Controller order reduction using singular perturbation approximation. *Automatica*, 33(6):1203 – 1207. (Cited on page [84](#).)
- [Packard, 1994] Packard, A. (1994). Gain scheduling via linear fractional transformations. *Systems & Control Letters*, 22:79–92. (Cited on pages [18](#) and [34](#).)
- [Packard and Doyle, 1993] Packard, A. and Doyle, J. (1993). The complex structured singular value. *Automatica*, 29(1):71–109. (Cited on page [50](#).)
- [Packard and Kantner, 1996] Packard, A. and Kantner, M. (1996). Gain scheduling the LPV way. In *Decision and Control, 1996., Proceedings of the 35th IEEE Conference on*, volume 4, pages 3938–3941 vol.4. (Cited on page [13](#).)

- [Pernebo and Silverman, 1982] Pernebo, L. and Silverman, L. (1982). Model reduction via balanced state space representations. *IEEE Transactions on Automatic Control*, 27:382–387. (Cited on pages 59 and 60.)
- [Polderman and Willems, 1991] Polderman, J. W. and Willems, J. C. (1991). *Introduction to the Mathematical Theory of Systems and Control*. Springer. (Cited on page 4.)
- [Poussot-Vassal, 2008] Poussot-Vassal, C. (2008). *Robust LPV multivariable Automotive Global Chassis Control*. Theses, Institut National Polytechnique de Grenoble - INPG. (Cited on pages 17 and 114.)
- [Powell, 1969] Powell, M. J. D. (1969). A method for nonlinear constraints in minimization problems. In Fletcher, R., editor, *Optimization*, pages 283–298. Academic Press, New York. (Cited on page 37.)
- [Sammier, 2001] Sammier, D. (2001). *Sur la modélisation et la commande de suspension de véhicules automobiles*. PhD thesis, Institut National Polytechnique de Grenoble - INPG. (Cited on pages 95 and 96.)
- [Sandberg and Rantzer, 2004] Sandberg, H. and Rantzer, A. (2004). Balanced truncation of linear time-varying systems. *Automatic Control, IEEE Transactions on*, 49(2):217–229. (Cited on page 75.)
- [Sato and Peaucelle, 2013] Sato, M. and Peaucelle, D. (2013). Gain-scheduled output-feedback controllers using inexact scheduling parameters for continuous-time {LPV} systems. *Automatica*, 49(4):1019 – 1025. (Cited on page 52.)
- [Scherer, 1990] Scherer, C. (1990). *The Riccati inequality and state-space  $H_\infty$  -optimal control*. PhD thesis, Universität Würzburg, Germany. (Cited on page 12.)
- [Scherer, 2001] Scherer, C. (2001). LPV control and full block multipliers. *Automatica*, 37(3):361 – 375. (Cited on page 18.)
- [Scherer, 2004] Scherer, C. (2004). Robust mixed control and LPV control with full block scaling. Technical report, Delft University of Technology, Mechanical Engineering Systems and Control Group. (Cited on page 18.)
- [Scherer, 2012] Scherer, C. (2012). Gain-scheduled synthesis with dynamic positive real multipliers. In *Decision and Control (CDC), 2012 IEEE 51st Annual Conference on*, pages 6641–6646. (Cited on page 18.)
- [Scherer et al., 1997] Scherer, C., Gahinet, P., and Chilali, M. (1997). Multiobjective output-feedback control via LMI optimization. *Automatic Control, IEEE Transactions on*, 42(7):896–911. (Cited on pages 51, 111 and 112.)

- [Shaker and Wisniewski, 2011] Shaker, H. R. and Wisniewski, R. (2011). Generalized gramian framework for model/controller order reduction of switched systems. *International Journal of Systems Science*, pages 1277–1291. (Cited on pages 75 and 76.)
- [Shamma and Athans, 1990] Shamma, J. and Athans, M. (1990). Analysis of gain scheduled control for nonlinear plants. *Automatic Control, IEEE Transactions on*, 35(8):898–907. (Cited on pages 13 and 46.)
- [Skogestad and Postlethwaite, 2005] Skogestad, S. and Postlethwaite, I. (2005). *Multivariable Feedback Control: Analysis and Design*. John Wiley & Sons. (Cited on pages 29 and 30.)
- [Sreeram and Anderson, 1995] Sreeram, V. and Anderson, B. (1995). Frequency weighted balanced reduction technique: a generalization and an error bound. In *Decision and Control, 1995., Proceedings of the 34th IEEE Conference on*, volume 4, pages 3576 –3581 vol.4. (Cited on pages 62, 65 and 66.)
- [Toh et al., 2001] Toh, K., Todd, M., and Tütüncü, R. (2001). SDPT3 - a Matlab software package for semidefinite programming. *Optimization methods and software*, 11:545–581. (Cited on pages 38 and 44.)
- [Tudon-Martinez et al., 2013] Tudon-Martinez, J. C., Fergani, S., Varrier, S., Sename, O., Dugard, L., Morales-Menendez, R., and Ramirez-Mendoza, R. (2013). Road Adaptive Semi-active Suspension in a Pick-up Truck using an LPV Controller. In *The 7th IFAC international symposium on Advances in Automotive Control (AAC)*, Tokyo, Japan. (Cited on page 111.)
- [Turkington, 1998] Turkington, D. (1998). Handbook of matrices. *Journal of Applied Econometrics*, 13(4):421–423. (Cited on page 8.)
- [Varga and Anderson, 2001] Varga, A. and Anderson, B. (2001). Accuracy enhancing methods for the frequency-weighted balancing related model reduction. In *Decision and Control, 2001. Proceedings of the 40th IEEE Conference on*, volume 4, pages 3659 –3664 vol.4. (Cited on pages 63 and 67.)
- [Vidyasagar, 1985] Vidyasagar, M. (1985). *Control system synthesis : a factorization approach*. Cambridge. (Cited on pages 27 and 71.)
- [Vidyasagar, 2002] Vidyasagar, M. (2002). *Nonlinear Systems Analysis*. Society for Industrial and Applied Mathematics, second edition. (Cited on page 24.)
- [Wang et al., 1999] Wang, G., Sreeram, V., and Liu, W. (1999). A new frequency-weighted balanced truncation method and an error bound. *Automatic Control, IEEE Transactions on*, 44(9):1734 –1737. (Cited on pages 63, 67 and 83.)

- [Widowati et al., 2004] Widowati, W., Riyanto, B., and Saragih, R. (2004). Controller reduction of parameter dependent systems. *ITB Journal of Engineering Science*, 36:43–56. (Cited on pages 75 and 112.)
- [Willems, 1972] Willems, J. (1972). Dissipative dynamical systems part II: Linear systems with quadratic supply rates. *Archive for Rational Mechanics and Analysis*, 45:352–393. (Cited on page 65.)
- [Wood et al., 1996] Wood, G., Goddard, P., and Glover, K. (1996). Approximation of linear parameter-varying systems. In *Decision and Control, 1996., Proceedings of the 35th IEEE Conference on*, volume 1, pages 406–411 vol.1. (Cited on page 75.)
- [Wood, 1995] Wood, G. D. (1995). *Control of Parameter-Dependent Mechanical Systems*. PhD thesis, St Johns College. (Cited on page 112.)
- [Yeh et al., 1994] Yeh, H.-H., Hsu, C., and Banda, S. (1994). Fixed-order  $H_\infty$  compensator design. *International Journal of Robust and Nonlinear Control*, 4(3):363–369. (Cited on pages xiii and 56.)
- [Youla et al., 1976] Youla, D., Jabr, H., and Bongiorno, J. (1976). Modern wiener-hopf design of optimal controllers—part ii: The multivariable case. *IEEE Transactions on Automatic Control*, 21(3):319–338. (Cited on pages 27 and 71.)
- [Yousefi, 2007] Yousefi, A. (2007). *Stabilizing frequency weighted controller reduction approach*. PhD thesis, Technische Universitat Munchen. (Cited on page xiii.)
- [Zebiri et al., 2013] Zebiri, H., Mourllion, B., and Basset, M. (2013). Balanced truncation techniques for active suspension reduced-order  $H_\infty$ -controller. In *IFAC Workshop on Advances in Control and Automation Theory for Transportation Applications-Istanbul*, pages 123–128. (Cited on page xiv.)
- [Zebiri et al., 2014a] Zebiri, H., Mourllion, B., and Basset, M. (2014a).  $H_\infty$ -controller order reduction for active suspension system. In *IEEE 13th European Control Conference ECC'13*, Strasbourg. (Cited on page xiv.)
- [Zebiri et al., 2014b] Zebiri, H., Mourllion, B., and Basset, M. (2014b). Order-reduction and mu-analysis of an  $H_\infty$ -controller. application to active suspension systems. In *12th International symposium on Advanced Vehicle Control*, Tokyo. (Cited on page xiv.)
- [Zebiri et al., 2016a] Zebiri, H., Mourllion, B., and Basset, M. (2016a). Frequency limited  $H_\infty$ -controller order reduction for linear parameter varying systems. *International Journal of Control*. Submitted. (Cited on page xiv.)



- [Zebiri et al., 2016b] Zebiri, H., Mourllion, B., and Basset, M. (2016b). Frequency weighted singular perturbation for  $LPV - H_\infty$  controller order reduction. *Journal of The Franklin Institute*. Submitted. (Cited on page [xiv](#).)
- [Zhou, 1995] Zhou, K. (1995). A comparative study of  $H_\infty$  controller reduction methods. In *American Control Conference, 1995. Proceedings of the*, volume 6, pages 4015–4019. (Cited on page [63](#).)
- [Zhou and Doyle, 1998] Zhou, K. and Doyle, J. (1998). *Essentials of Robust Control*. Prentice Hall international editions. Prentice Hall International. (Cited on page [29](#).)
- [Zhou et al., 1996] Zhou, K., Doyle, J. C., and Glover, K. (1996). *Robust and optimal control*. Prentice-Hall, Inc., Upper Saddle River, NJ, USA. (Cited on pages [xiii](#), [6](#), [7](#), [11](#), [24](#), [27](#), [71](#) and [72](#).)
- [Zhou et al., 1995] Zhou, K., D’Souza, C., and Cloutier, J. R. (1995). Structurally balanced controller order reduction with guaranteed closed loop performance. *Systems & Control Letters*, 24(4):235–242. (Cited on page [75](#).)
- [Zhou et al., 1999] Zhou, K., Salomon, G., and Wu, E. (1999). Balanced realization and model reduction for unstable systems. *International Journal of Robust and Nonlinear Control*, 9(3):183–198. (Cited on page [60](#).)

# Numerical Considerations

---

## A.1 Gradient and Hessian

### A.1.1 Gradient computation, [Helmersson, 2009]

Let  $C_i \in \mathbb{R}^{n \times n}$  and define

$$\begin{aligned}
 C_n &= 0, \\
 C_{n-1} &= I, \\
 C_{n-2} &= Z + c_{n-1}(Z)I, \\
 &\vdots \\
 C_k &= C_{k+1}Z + c_{k+1}(Z)I, \\
 &\vdots \\
 C_0 &= C_1Z + c_1(Z)I
 \end{aligned}$$

These matrices can be computed easily using the coefficients  $c_k$ . The first-order derivatives of a coefficient  $c_k(Z)$  in (1.12) are given by

$$\frac{\partial c_k}{\partial X_{ij}} = \text{trace } C_k E_{ij} Y, \quad (\text{A.1a})$$

$$\frac{\partial c_k}{\partial Y_{ij}} = \text{trace } C_k X E_{ij}, \quad (\text{A.1b})$$

with the matrix  $E_{ij}$  defined as

$$e_{ij} = \begin{cases} e_i e_j^T, & \text{if } i = j, \\ e_i e_j^T + e_j e_i^T, & \text{if } i \neq j \end{cases} \quad (\text{A.2})$$

where  $e_i, e_j \in \mathbb{R}^n$  are the  $i$ th and  $j$ th unit vectors respectively. The expressions in (A.1) can be written in another form using the invariance under cyclic ( $\text{trace}(ABC) = \text{trace}(CAB) = \text{trace}(BCA)$ ). For an example where  $i \neq j$ , we get the following relations

$$\frac{\partial c_k}{\partial X_{ij}} = e_j^T Y C_k e_i + e_i^T Y C_k e_j, \quad (\text{A.3a})$$

$$\frac{\partial c_k}{\partial Y_{ij}} = e_j^T C_k X e_i + e_i^T C_k X e_j, \quad (\text{A.3b})$$

which is equivalent to extract two elements from  $X, Y$  and  $E_{ij}$  and summing them.

### A.1.2 Hessian computation, [Helmerrsson, 2009]

$$\begin{aligned} \frac{\partial^2 c_k}{\partial X_{ij} \partial X_{pq}} &= (\text{trace } C_{x-1} E_{pq} Y)(\text{trace } Z^{x-k-2} E_{ij} Y) - \text{trace } C_{x-1} E_{pq} Y Z^{x-k-2} E_{ij} Y \\ &+ \dots \\ &+ (\text{trace } C_{k+2} E_{pq} Y)(\text{trace } Z E_{ij} Y) - \text{trace } C_{k+2} E_{pq} Y Z E_{ij} Y \\ &+ (\text{trace } C_{k+1} E_{pq} Y)(\text{trace } E_{ij} Y) - \text{trace } C_{k+1} E_{pq} Y E_{ij} Y \end{aligned}$$

$$\begin{aligned} \frac{\partial^2 c_k}{\partial Y_{ij} \partial Y_{pq}} &= (\text{trace } C_{x-1} X E_{pq})(\text{trace } Z^{x-k-2} X E_{ij}) - \text{trace } C_{x-1} X E_{pq} Z^{x-k-2} X E_{ij} \\ &+ \dots \\ &+ (\text{trace } C_{k+2} X E_{pq})(\text{trace } Z X E_{ij}) - \text{trace } C_{k+2} X E_{pq} Z X E_{ij} \\ &+ (\text{trace } C_{k+1} X E_{pq})(\text{trace } X E_{ij}) - \text{trace } C_{k+1} X E_{pq} X E_{ij} \end{aligned}$$

$$\begin{aligned} \frac{\partial^2 c_k}{\partial X_{ij} \partial Y_{pq}} &= (\text{trace } C_{x-1} X E_{pq})(\text{trace } Z^{x-k-2} E_{ij} Y) - \text{trace } C_{x-1} X E_{pq} Z^{x-k-2} E_{ij} Y \\ &+ \dots \\ &+ (\text{trace } C_{k+2} X E_{pq})(\text{trace } Z E_{ij} Y) - \text{trace } C_{k+2} X E_{pq} Z E_{ij} Y \\ &+ (\text{trace } C_{k+1} X E_{pq})(\text{trace } E_{ij} Y) - \text{trace } C_{k+1} X E_{pq} E_{ij} Y \\ &+ \text{trace } C_k E_{ij} E_{pq} \end{aligned}$$

$$\frac{\partial^2 c_k}{\partial Y_{ij} \partial X_{pq}} = \frac{\partial^2 c_k}{\partial X_{ij} \partial Y_{pq}}.$$

## A.2 $X, Y$ and $X_a, Y_a$ Searching Algorithms

**Algorithm 4**  $X$  and  $Y$  searching**1. Initial phase.**

- (a) Find a starting point by solving the convex SDP

$$\begin{aligned} & \underset{\mathbf{x}}{\text{minimise}} \quad \gamma + \text{trace}(X + Y) \\ & \text{subject to} \quad \mathbf{x} \in \mathbb{X} \end{aligned}$$

and denote the  $X^0, Y^0$  matrices associated to this solution. Solving this optimisation problem means, find a solution of minimal norm  $\|XY - I\|_F$  and a low value of  $\gamma$ .

- (b) Define the variable
- $k$
- and set
- $k = 0$
- . Choose starting value for
- $\alpha, \lambda^0, \mu^0, \rho, \rho_0$
- and the tolerance
- $\varepsilon$
- (
- $\rho > 1, 0 < \rho_0 < 1, \alpha = 0.98$
- ).

**2. Optimisation phase:** Set  $k = k + 1$  and let  $d\mathbf{x}_X, d\mathbf{x}_Y \in \mathbb{S}^n, d\mathbf{x}_\gamma \in \mathbb{R}$ 

- (a) Using
- $\lambda = \lambda_{k-1}$
- and
- $\mu = \mu_{k-1}$
- , solve (2.40) for the solution

$$d\mathbf{x} = \left[ \text{vech}(d\mathbf{x}_X) \quad \text{vech}(d\mathbf{x}_Y) \quad d\mathbf{x}_\gamma \right]^T \quad (\text{A.4})$$

- (b) Update variable as

$$X_k = X_{k-1} + \alpha d\mathbf{x}_X, \quad Y_k = Y_{k-1} + \alpha d\mathbf{x}_Y, \quad \gamma_k = \gamma_{k-1} + \alpha d\mathbf{x}_\gamma$$

or equivalently:

$$\mathbf{x}_k = \mathbf{x}_{k-1} + \alpha d\mathbf{x}.$$

**3. Update penalty and multiplier.**

$$\lambda_k = \lambda_{k-1} + \mu_{k-1}(X_k Y_k - I) \quad (\text{A.5})$$

$$\mu_k = \begin{cases} \rho \mu_{k-1}, & \text{if } \mathbf{q}(\mathbf{x}_k) > \rho_0 \mathbf{q}(\mathbf{x}_{k-1}) \\ \mu_{k-1}, & \text{if } \mathbf{q}(\mathbf{x}_k) \leq \rho_0 \mathbf{q}(\mathbf{x}_{k-1}) \end{cases} \quad (\text{A.6})$$

**4. Terminating phase:** If  $\mathbf{q}(\mathbf{x}) > \varepsilon$ , go to the phase 2, else check the following

- If  $\gamma_k < 0.99 \gamma_{k-1}$  for three consequent iterates, it can be that we are near a local optimum. Finish the program.
- Otherwise, the objective function value is still decreasing, hence we continue the optimisation, i.e. go back to phase 2.

**Algorithm 5**  $X_a$  and  $Y_a$  searching**1. Initial phase:**

- (a) Find a starting point by solving the convex SDP

$$\begin{aligned} & \underset{\mathbf{x}_a}{\text{minimise}} \quad \gamma + \text{trace}(X_a + Y_a) \\ & \text{subject to} \quad \mathbf{x}_a \in \mathbb{X}_a \end{aligned}$$

and denote the solution  $X_a^0$  and  $Y_a^0$ . Solving this optimisation problem means, find a solution of low rank and a low value of  $\gamma$ .

- (b) Define the variable
- $k$
- and set
- $k = 0$
- . Choose starting value for
- $\lambda^0, \mu^0, \rho, \rho_0$
- and the tolerance
- $\varepsilon$
- (
- $\rho > 1, 0 < \rho_0 < 1$
- ).

**2. Optimisation phase:** Set  $k = k + 1$  and let  $d\mathbf{x}_{X_a}, d\mathbf{x}_{Y_a} \in \mathbb{S}^n, d\mathbf{x}_\gamma \in \mathbb{R}$ 

- (a) Using
- $\lambda = \lambda_{k-1}$
- and
- $\mu = \mu_{k-1}$
- , solve (2.62) for the solution

$$d\mathbf{x} = \left[ \text{vech}(d\mathbf{x}_{X_a}) \quad \text{vech}(d\mathbf{x}_{Y_a}) \quad d\mathbf{x}_\gamma \right]^\top \quad (\text{A.7})$$

which is the step direction.

- (b) Update variable as

$$X_{a_k} = X_{a_{k-1}} + \alpha d\mathbf{x}_{X_a}, \quad Y_{a_k} = Y_{a_{k-1}} + \alpha d\mathbf{x}_{Y_a}, \quad \gamma_k = \gamma_{k-1} + \alpha d\mathbf{x}_\gamma$$

or equivalently:  $\mathbf{x}_k = \mathbf{x}_{k-1} + \alpha d\mathbf{x}$ , where  $\alpha = 0.98$ .

**3. Update penalty and multiplier**

$$\lambda_k = \lambda_{k-1} + \mu_{k-1}(X_{a_k} Y_{a_k} - I_{n+n_K}) \quad (\text{A.8})$$

$$\mu_k = \begin{cases} \rho\mu_k, & \text{if } \|X_{a_k} Y_{a_k} - I_{n+n_K}\|_F > \rho_0 \|X_{a_{k-1}} Y_{a_{k-1}} - I_{n+n_K}\|_F \\ \mu_k, & \text{if } \|X_{a_k} Y_{a_k} - I_{n+n_K}\|_F \leq \rho_0 \|X_{a_{k-1}} Y_{a_{k-1}} - I_{n+n_K}\|_F \end{cases} \quad (\text{A.9})$$

4. **Stopping test:** In the case where  $\|X_a Y_a - I_{n+n_K}\|_F < \varepsilon$  and the necessary optimality conditions are satisfied then the algorithm stops progress. Otherwise increase the counter  $k$  and go to phase 2.

5. **Terminating phase:** If  $\|X_a Y_a - I_{n+n_K}\|_F < \varepsilon$ , we give the solution  $\mathbf{x}_a$  and try to construct the controller as explained in the next subsection, but if this fails, reduce  $\varepsilon$ , increase  $k$  and go to phase 2.

