



HAL
open science

Investigation de la pathogénèse du syndrome de détresse respiratoire aiguë post-transfusionnel (TRALI) dans un modèle murin

Sofiane Tariket

► To cite this version:

Sofiane Tariket. Investigation de la pathogénèse du syndrome de détresse respiratoire aiguë post-transfusionnel (TRALI) dans un modèle murin. Médecine humaine et pathologie. Université de Lyon, 2017. Français. NNT : 2017LYSES059 . tel-02372517

HAL Id: tel-02372517

<https://theses.hal.science/tel-02372517v1>

Submitted on 20 Nov 2019

HAL is a multi-disciplinary open access archive for the deposit and dissemination of scientific research documents, whether they are published or not. The documents may come from teaching and research institutions in France or abroad, or from public or private research centers.

L'archive ouverte pluridisciplinaire **HAL**, est destinée au dépôt et à la diffusion de documents scientifiques de niveau recherche, publiés ou non, émanant des établissements d'enseignement et de recherche français ou étrangers, des laboratoires publics ou privés.



N° d'ordre NNT : 2017LYSES059

THESE de DOCTORAT DE L'UNIVERSITE DE LYON
opérée au sein de
(Université Jean-Monnet)

Ecole Doctorale N° EDSIS488
(Ecole doctorale Science, Ingénierie, Santé)

Spécialité de doctorat : Biologie Cellulaire et Moléculaire
Discipline : (Biologie, Médecine et Santé)

Soutenue publiquement le 15/12/2017, par :
Sofiane Tariket

**Investigation de la pathogenèse du syndrome
de détresse respiratoire aiguë post-
transfusionnel (TRALI) dans un modèle murin**

Devant le jury composé de :

Pr. BOURLET Thomas	Université Jean-Monnet / GIMAP-EA3064	Président
Dr. OURY Cécile	Université de Liège / Département de cardiologie	Rapporteur
Dr. RITEAU Béatrice	Université d'Aix-Marseille / UMR 1062	Rapporteur
Dr. LEFRANÇAIS Emma	Université de Toulouse III / IPBS	Examinatrice
Pr. GARRAUD Olivier	Université de Lyon / Institut National de la Transfusion Sanguine & GIMAP-EA3064	Co-Directeur de thèse
Dr. COGNASSE Fabrice	Université de Lyon / Etablissement Français du Sang Auvergne-Rhône-Alpes & GIMAP-EA3064	Directeur de thèse



N° d'ordre NNT : 2017LYSES059

THESE de DOCTORAT DE L'UNIVERSITE DE LYON
opérée au sein de
(Université Jean-Monnet)

Ecole Doctorale N° EDSIS488
(Ecole doctorale Science, Ingénierie, Santé)

Spécialité de doctorat : Biologie Cellulaire et Moléculaire
Discipline : (Biologie, Médecine et Santé)

Soutenue publiquement le 15/12/2017, par :
Sofiane Tariket

**Investigation de la pathogenèse du syndrome
de détresse respiratoire aiguë post-
transfusionnel (TRALI) dans un modèle murin**

Devant le jury composé de :

Pr. BOURLET Thomas	Université Jean-Monnet / GIMAP-EA3064	Président
Dr. OURY Cécile	Université de Liège / Département de cardiologie	Rapporteur
Dr. RITEAU Béatrice	Université d'Aix-Marseille / UMR 1062	Rapporteur
Dr. LEFRANÇAIS Emma	Université de Toulouse III / IPBS	Examinatrice
Pr. GARRAUD Olivier	Université de Lyon / Institut National de la Transfusion Sanguine & GIMAP-EA3064	Co-Directeur de thèse
Dr. COGNASSE Fabrice	Université de Lyon / Etablissement Français du Sang Auvergne-Rhône-Alpes & GIMAP-EA3064	Directeur de thèse

La vie, c'est comme une bicyclette, il faut avancer pour ne pas perdre l'équilibre.

Albert Einstein

REMERCIEMENT

En premier lieu, je tiens à remercier les différents membres du jury, Docteur Cécile Oury et Docteur Béatrice Riteau, d'avoir accepté d'évaluer ce travail. Merci également au Docteur Emma Lefrançais pour avoir pris le temps d'examiner mon mémoire de thèse. Merci au Professeur Thomas Bourlet pour la présidence de ce jury et, en particulier, pour son accueil en tant que Directeur au sein du laboratoire GIMAP-EA3064.

Je remercie également l'Établissement Français du Sang Auvergne-Rhône-Alpes pour son soutien financier ainsi que l'ensemble du personnel que j'ai pu côtoyer durant ces 3 années. Je tiens aussi à remercier les donneurs de sang qui, en plus de l'importance de leur don, m'ont permis d'effectuer une partie de mes travaux.

Je tiens en particulier à remercier mon Directeur de thèse, Docteur Fabrice Cognasse, pour toute l'aide, les conseils et le soutien qu'il m'a accordé au cours de ces 3 années. J'ai connu, grâce à vous, un enrichissement fort d'un point de vue scientifique et personnel. Merci également pour les opportunités pour lesquels vous avez œuvré, notamment le stage à Cambridge.

Un sincère Merci à mon Co-Directeur de thèse, Professeur Olivier Garraud, pour votre confiance et votre encadrement des plus enrichissants. Je vous remercie pour la valorisation de mes travaux de thèse et toutes ses heures passées si précieuses que vous m'avez consacré.

Je remercie le Professeur Bruno Pozzetto, Directeur du GIMAP-EA3064 lors de mes débuts de thèse, pour son accueil et son dévouement envers les étudiants. Merci également au Docteur Sandrine Laradi pour son soutien et son aide qu'elle a su me consacrer au cours de mes premiers pas en tant que stagiaire au sein de l'EFS et au cours de ma thèse. Je tiens également à remercier le Docteur Hind Hamzeh-Cognasse pour sa contribution scientifique considérable et sa gentillesse au quotidien. Enfin, je tenais à remercier le Docteur Antoine Prigent, qui a été le précurseur de cette aventure.

J'aimerais aussi remercier le laboratoire NHS Blood and Transplant de Cambridge, qui m'a accueilli pendant presque 2 mois et m'a permis de perfectionner ces travaux de thèse. Merci tout particulièrement au Docteur José Guerrero et au Docteur Cédric Ghevaert, ainsi qu'à toute leur équipe pour leur accueil chaleureux et leur apport scientifique considérable. Merci aussi au laboratoire Plexan, notamment Priscilla et Ghislaine pour votre aide indispensable.

Merci à tous les membres du laboratoire GIMAP-EA3064, qui ont permis faire rimer les mots Travail et Plaisir. Merci à Nico, Fabienne, Blandine, Alex (I^{er}) et Alex (II), Amélie, Perrine, Kiki, Rémi, Eva, Fedy, Jocelyn, Sandrine, Sophie, Alice, Sylvie, Stéphane, Paul, Olivier, Séverine et Benji. Merci pour ces leçons de vie (éducation des enfants et du chat), ces blagues du niveau intellectuel propre au GIMAP et ce si bon et délicieux café (noir mais pas rouge).

Ce travail n'aurait jamais pu être ce qu'il a été sans l'inestimable « Plaquette Team ». Merci à tous ses membres pour le soutien constant et sans faille, d'un point de vue scientifique et personnel. Merci à Charly, grâce à toi j'ai pu me forger une carapace impénétrable face aux attaques à venir.

Merci à Marie-Ange, la gentillesse incarnée, quand tu ne fus pas influencée par ton colocataire de bureau. Merci à mes colocs. Caro, grâce à qui je sais maintenant apprécier les asperges et Adri, qui a été mon gourou de Game of Thrones. Tant de temps passé à vos côtés au laboratoire et même dans le monde. Ce fut un plaisir d'allier Science et amitié. Merci aux membres actuels et passés de Robespierre. Merci à Jocelyne pour la sagesse et la bienveillance que tu incarnes. Merci à Chaker, de si bon conseil, sauf quand il s'agissait de magie. Enfin, je remercie également les « anciens » doctorants Paulin et Kim Anh, et les étudiants de l'EFS.

Merci à mes deux compatriotes d'université, David et Clément. Depuis la licence jusqu'à la thèse nos parcours ont été parallèles.

Un énorme merci à ma belle-famille. Merci Didier, alias « Gogo-Gadjeto », pour ta gentillesse et ta générosité sans fin. Merci à Laurence pour votre douceur et votre bienveillance. Marine, la sœurette, merci pour tous ces bons moments partagés, tous ces délires qui font tellement de bien. Romain, le toulousain, merci (mais pas trop sinon tu vas prendre la grosse tête) pour cette complicité entre pièces rapportées. Merci également à tous les autres qui m'ont apporté tant de joie, Minou, Claude, Michelle, Leïdi, Dany, Coline, Fanny, Lucille, Lucas, Pierre et les autres.

Merci à tous mes amis, mes frères, Toto, Jéré, Clem, Yann, Sylvain, Bobo, Jim, Nini, Mehdi, Hadjou et Flo. Vous avez tous été une force pour moi, une famille, bien plus que des simples amis et je vous en remercie. Je remercie aussi toute ma famille, ma grand-mère, mon grand-père (repose en paix), mes oncles, tantes, cousin, cousines. J'espère que vous serez fière d'accueillir un nouveau docteur parmi vous. Un grand merci en particulier à mes deux sœurs, Assia et Melissa, pour avoir partagé une grande partie de ma vie.

On arrive aux personnes qui me sont le plus chère. Merci Hichem, mon frère. On s'est chamaillé tant de fois, à mon plus grand plaisir. Je me retrouve tant en toi, même tempérament, personnalité et bêtise. Reste comme tu es et garde cette joie de vivre qui fait tant de bien aux gens qui t'entoure.

À ma mère, une vraie guerrière. Tu nous as élevé seule, Hichem et moi. Tu es si forte. Cette réussite t'est entièrement dédiée et, je l'espère, t'apportera fierté et joie. Un merci ne suffira pas à te prouver toute ma reconnaissance, mais je te le dis quand même, Merci.

La femme de ma vie, Manon, Nionion, ma chérie, la maman de Ness. Que dire... Tu es arrivée dans ma vie et tu l'as bouleversée. Tu m'as fait découvrir tant de choses que je n'oublierai jamais. Tu as été mon carburant, ma force. Merci pour tout, ton soutien au cours de cette thèse et ces merveilleux moments gravés en moi pour toujours... Je t'aime

RESUME : La transfusion sanguine permet de sauver des vies et réduit la morbidité pour un grand nombre de maladies et d'affections cliniques, mais elle n'est pas exempte de complications. Un incident néfaste lié à une transfusion, également appelé Effet Indésirable Receveur (EIR), est un incident défavorable survenant chez un patient pendant ou après une transfusion sanguine. Parmi eux, le TRALI est considéré comme l'une des réactions inflammatoires les plus critiques. Cette pathologie se développe généralement dans les 6 heures après transfusion. On en reconnaît deux types, les TRALI immunologiques et les TRALI non-immunologiques. En France, les premiers sont presque entièrement prévenus par une politique de sécurité des produits sanguins, tandis que la fréquence des seconds augmente. La physiopathologie du TRALI reste mal connue. Tandis que certains y accordent une place importante aux plaquettes sanguines du patient transfusé, d'autres les considèrent comme pas réellement impliquées. Le but de ce travail de thèse a été, dans un premier temps, d'investiguer le potentiel inflammatoire des plaquettes sanguines conservées dans les concentrés plaquettaires et l'influence de cette inflammation sur l'endothélium vasculaire général. Ensuite, sera évalué le rôle des plaquettes sanguines de l'organisme, notamment par l'intermédiaire de leurs produits de sécrétion, dans la pathogénie de cette complication transfusionnelle. Pour cela, un ALI (mimant un TRALI) a été déclenché, dans un modèle *in vivo*, par une injection d'anticorps anti-CMH I chez des souris préalablement stimulées avec du LPS. L'ensemble de nos résultats confirme le potentiel inflammatoire des plaquettes sanguines, au sein des concentrés plaquettaires, pouvant probablement assumer l'entière responsabilité du déclenchement d'un TRALI non-immunologique, ainsi qu'un rôle secondaire des plaquettes sanguines de l'organisme, participant activement à l'amplification de la sévérité de la pathologie. Cette thèse s'inscrit dans la continuité logique des études menées, au sein du laboratoire GIMAP-EA3064, investiguant la place des plaquettes sanguines au sein de l'inflammation, ouvrant ainsi de nouvelles perspectives dans la sécurité transfusionnelle.

MOTS CLES : TRALI – Transfusion – Plaquettes – Inflammation – CD40L

Sommaire

Liste des abréviations	1
Liste des figures	5
Introduction générale	7
La plaquette sanguine et le TRALI: de la poche à l'organisme	7
Revue de la littérature	19
Chapitre 1 – La transfusion comme une frappe inflammatoire : connaissances et inconnus	20
Chapitre 2 – Transfusion-Related Acute Lung Injury : l'aspect clinique	31
<i>Section 1 – Caractérisation du TRALI : la terminologie</i>	31
<i>Section 2 – Caractérisation du TRALI : la prévalence</i>	35
<i>Section 3 – Caractérisation du TRALI : la clinique</i>	36
Chapitre 3 – Transfusion-Related Acute Lung Injury : transfusion, plaquettes et modificateurs de la réponse biologique (BRM)	39
Mise à jour bibliographique	52
I – Section - <i>Because their secretory capacity can cause immunological differences</i>	52
II – Section - <i>Several tracks already mentioned in TRALI</i>	54
Chapitre 4 – Le rôle de signalisation du CD40 ligand dans la biologie plaquettaire et dans la transfusion de composants plaquettaires	56
Mise à jour bibliographique	80
I – Section - <i>CD40L and its receptors in inflammatory pathologies</i>	80
Chapitre 5 – Hypothèse de l'atteinte multi-organes au cours d'un TRALI	83
<i>Section 1 – Le pancréas</i>	83
I – Physiopathologie de la pancréatite : <i>les neutrophiles</i>	83
II – Physiopathologie de la pancréatite : <i>l'endothélium vasculaire</i>	85
III – Physiopathologie de la pancréatite : <i>les plaquettes</i>	86
IV – Physiopathologie de la pancréatite : <i>Le couple CD40/CD40L</i>	87
<i>Section 2 – Inflammation intestinale</i>	89
I – Physiopathologie des MICI : <i>les neutrophiles</i>	89
II – Physiopathologie des MICI : <i>l'endothélium vasculaire</i>	89
III – Physiopathologie des MICI : <i>les plaquettes</i>	90
IV – Physiopathologie des MICI : <i>le couple CD40/CD40L</i>	92
<i>Section 3 – Les autres organes</i>	93

I – Les reins	93
II – Le foie	94
Objectifs et problématique	97
Résultats.....	101
Manuscrit I : Modélisation de l'effet des surnageants de concentrés plaquettaires sur les cellules endothéliales: focus sur Endocan/ESM-1.....	103
Manuscrit III : Les plaquettes régulent la sévérité de l'ALI induit expérimentalement par injection de LPS et d'anti-CMH I	139
Manuscrit IV : La neutralisation du complexe protéique CD40/CD40L inhibe le développement d'œdème pulmonaire lésionnel induit dans un modèle murin par injection de lipopolysaccharide et d'anticorps anti-CMH I	165
Manuscrit V : La neutralisation du complexe protéique CD40/CD40L protège les souris de l'atteinte pancréatique induite lors du développement du TRALI.....	199
Discussion et perspectives	223
Conclusion	237
Références	239
Annexes.....	257

Liste des abréviations

βTG : β-thromboglobuline

Ang-1 : Angiogénine-1

ALI : Acute Lung Injury

bFGF : basic Fibroblast Growth Factor

BEACH : Beige and Cheadiak-Higashi

BRM : Biological Response Modifier

Ca⁺⁺ : Calcium

CD : Cluster of Differentiation

CD40L : CD40 Ligand

CD62E : E-Selectin

CD62L : L-Selectin

CD62P : P-Selectin

CINC : Cytokine-Induced Neutrophil Chemoattractant

CMH : Complexe Majeur d'Histocompatibilité

COX-1 : Cyclooxygenase-1

CP : Concentrés Plaquettaires

CRP : C Reactive Protein

DAG : Diacylglycérol

DAMP : Damage-Associated Molecular Pattern

dTRALI : delayed TRALI

EA : Elastase-α1-Antitrypsin

EGF : Epidermal Growth Factor

EIR : Effet Indésirable Receveur

ENA-78 : Epithelial cell-derived Neutrophil-Activating peptide-78

EPCR : Endothelial Protein C Receptor

GM-CSF : Granulocyte Macrophage Colony-Stimulating Factor

GP : Glycoprotein

GPR13 : G-Protein coupled Receptor 13 (fractalkine)

GROα : Growth Regulated Protein α

RCH : Rectocolite Hémorragique

HGF : Hepatocyte Growth Factor

HLA : Human Leukocyte Antigen

HMGB1 : High-Mobility Group Box 1

ICAM-1 : Intercellular Cell Adhesion Molecule-1

IL : Interleukin

IP₃ : Inositol-1,4,5-trisphosphate

JAM-C : Junctional Adhesion Molecule-C

LBA : Lavage Broncho-Alvéolaire

LFA-1 : Lymphocyte Function-Associated antigen-1

LPAM : Lymphocyte Peyer patch Adhesion Molecule

LPS : Lipopolysaccharide

Mac-1 : Macrophage-1 antigen

MadCAM-1 : Mucosal vascular Addressin Cell Adhesion Molecule-1

MC : Maladie de Crohn

MCP-1 : Monocyte Chimoattractant Protein-1

MICI : Maladies inflammatoires chroniques de l'intestin

MIP-2 : Macrophage Inflammatory Protein-2

MMP-9 : Metalloproteinase-9

MPO : Myeloperoxidase

mtDNA : ADN mitochondrial

NBEAL2 : Neurobeachin-like protein 2

NET : Neutrophil Extracellular Traps

NF- κ B : Nuclear Factor- κ B

NLR : Neutrophil-Leukocyte Ratio

oxLDL : oxidized Low-Density Lipoprotein

PAC-1 : Procaspace Activating Compound-1

PAI-1 : Plasminogen Activator Inhibitor-1

PAMP : Pathogen-Associated Molecular Pattern

PAR-4 : Platelet protease-Activated Receptor-4

PF4 : Platelet Factor 4

PIP₂ : Phosphatidylinositol-4,5-bisphosphate

PMN : Polymorphonucléaires

PSL : Produits Sanguins Labiles

pTRALI : possible TRALI

Rac-1 : Ras-related C3 botulinum toxin substrate-1

RNFH : Réaction Fébrile Non-hémolytique

ROS : Dérivé réactif de l'oxygène

S1P : Sphingosine-1-Phosphate

sCD40L : soluble CD40L

SDRA : Syndrome de Détresse Respiratoire

SNAP-23 : Synaptosomal-Associated Protein-23

SNARE : Soluble N-éthylmaleimide-sensitive-factor Attachment protein Receptor

sRAGE : soluble Receptor for Advanced Glycation End-products

TATC : Thrombin-Antithrombin Complex

TGF- β : Transforming Growth Factor- β

Th : Lymphocytes T auxiliaire

TLR : Toll-Like Receptor

TNF- α : Tumor Necrosis Factor- α

TRALI : Transfusion-Related Acute Lung Injury

Tx : Thromboxane

U : Constante inconnue

VAMP-8 : Vesicle-Associated Membrane Protein-8

VCAM-1 : Vascular Cell Adhesion Molecule-1

VEGF-A : Vascular Endothelial Growth Factor-A

vWF : von Willebrand Factor

WD40 : Répétitions en β -transducine

Liste des figures

<i>Tableau 1 : Evolution des cytokines inflammatoires chez les patients TRALI.....</i>	<i>38</i>
<i>Figure 1 : Les définition des différents TRALI, inspiré de [15] et [16]</i>	<i>32</i>
<i>Figure 2 : Premier modèle de seuil, d'après Middelburg et al. [22].....</i>	<i>33</i>
<i>Figure 3 : Deuxième modèle de seuil, d'après Middelburg et al. [22]</i>	<i>34</i>
<i>Figure 4 : Troisième modèle de seuil, inspiré de Middelburg et al. [22].....</i>	<i>35</i>
<i>Figure 5 : Radiographie de poumons d'un patient ayant développé un TRALI, d'après Ilango et al. [37]</i>	<i>37</i>
<i>Figure 6 : Physiopathologie de la pancréatite associée au déclenchement d'une détresse respiratoire</i>	<i>88</i>
<i>Figure 7 : Pathophysiologie des MICI, d'après Neurath et al. [165]</i>	<i>93</i>
<i>Figure 8 : Développement de la thèse</i>	<i>99</i>
<i>Figure 9 : Influence d'endocan sur la transmigration leucocytaire.....</i>	<i>104</i>
<i>Figure 10 : Implication de la protéine NBEAL2 dans le processus d'exocytose des granules-α plaquettaires ..</i>	<i>125</i>

Introduction générale

**La plaquette sanguine et le TRALI: de la poche à
l'organisme**

*Revue soumise pour publication
(Transfusion Clinique et Biologique)*

Platelet and TRALI: from blood component to organism

Sofiane Tariket^{1,2}, Caroline Sut^{1,2}, Olivier Garraud^{1,3}, Fabrice Cognasse^{1,2,*}

¹ Université de Lyon, GIMAP-EA3064, Saint-Etienne, France

² Établissement Français du Sang Rhône-Alpes-Auvergne, Saint-Etienne, France

³ Institut National de la Transfusion Sanguine, Paris, France

*Address for correspondence and reprint requests: Dr. Fabrice Cognasse, PhD-HDR, Etablissement Français du Sang Auvergne-Rhône-Alpes and GIMAP-EA 3064, Université de Saint-Etienne, Etablissement Français du Sang Rhône-Alpes-Auvergne, 25 Boulevard Pasteur, 42100 Saint-Etienne. Telephone: +33 (0) 683975883; Fax: +33 (0) 477421486; E-mail: fabrice.cognasse@efs.sante.fr

Conflict-of-interest disclosure: All other authors declare no competing financial interests.

Running title: Platelets and inflammation

Keywords: TRALI, Platelets, Transfusion, Inflammation, CD40/CD40L

Abstract: Even though used systematically with leukocyte reduction, platelet transfusions still cause adverse reactions in recipients. They include Transfusion-Related Acute Lung Injury (TRALI), respiratory distress that occurs within six hours of the transfusion. The pathophysiology of this transfusion complication brings complex cellular communication into play. The role, particularly inflammatory, played by blood platelets in TRALI pathophysiology has been demonstrated, but is still under debate. Blood platelets play a role in inflammation, particularly via the CD40/CD40L (sCD40L) immunomodulator complex. In this study, we examine in particular the specific involvement of the CD40/CD40L (sCD40L) complex in the inflammatory pathogenesis of TRALI. This molecular complex could be a major target in a TRALI prevention strategy. Improving the conditions in which the platelet concentrates (PC) are prepared and stored would contribute to controlling partly the risks of non-immune TRALI.

1. Transfusion-Related Acute Lung Injury (TRALI)

1.1. Introduction

TRALI is described as the onset of respiratory distress that occurs within six hours of the transfusion. This complication is characterised by the occurrence of bilateral pulmonary oedema, qualified by the observation of a characteristic infiltrate. Several events are considered to be evocative of TRALI, including dyspnoea, tachypnea and hypoxia. Unlike non-lesional fluid overload, TRALI, which is a lesional oedema, is characterised by bilateral pulmonary infiltration, observed by chest X-ray and non-cardiogenic pulmonary oedema, defined by pulmonary blood pressure lower than 18 mm Hg or left arterial hypertension, and by a $\text{PaO}_2/\text{FiO}_2$ ratio less than 300 [1]. In 2015 in France, red blood cells (RBC) concentrates and platelet concentrates (PC), both labile blood products, are the most frequently involved in cases of TRALI with imputability of 1 to 3 (an incidence of approximately 0.2 per 100,000 RBC and 0.3 per 100,000 PC transfused). This transfusion complication represents 0.32% of the serious adverse reactions occurring in recipients (SAR) [2]. Internationally, the impact of TRALI is estimated at 0.08% and 15% of transfused patients [1].

1.2. “Two-hits”

According to current consensus, the pathophysiology of TRALI is described as an inflammatory phenomenon characterised by two successive events or “Two-hits”. The first event, also called priming, results in a pre-activation of the polymorphonuclear (PMN) cells. This initial attack results in a change in the phenotypic profile of the central cells involved in the physiopathology of TRALI, such as endothelial cells, neutrophils and platelets. The expression of adhesion molecules on the surface of these same cells triggers an exacerbation of intercellular communication in a conducive environment, an inflammatory environment. This causes, in particular, increased expression of CD62P (P-Selectin), CD62E (E-Selectin) and ICAM-1 on the surface of endothelial cells and a change of expression notably of PSGL-1 and Mac-1 (called also $\beta 2$ -Integrin and CD11b/CD18) on the surface of neutrophils [3].

The second event is the step causing the induction of TRALI. It can be classified as two types: immune TRALI and non-immune TRALI. In the case of immune TRALI, the cause is mainly the infusion of pathogenic antibodies (more rarely, or even exceptionally, pre-formed antibodies). Three types of antibodies are mostly encountered: anti-HLA-I, anti-HLA II, and anti-HNA (mainly anti-HNA-3A). The mode of action of these antibodies may vary according to their target. Anti-HLA I antibodies, especially anti-HLA-A2, primarily target PMN. This direct activation allows the activation of

neutrophils, and the adhesion and interaction of these antibodies on the surface of endothelial cells. Active neutrophils then migrate into the alveolar space. The uncontrolled production of reactive oxygen (ROS) and protease derivatives causes the development of pulmonary oedema [4]. Anti-HLA II antibodies interact specifically with monocytes and macrophages rather than neutrophils. Excessive production of proinflammatory Biological Response Modifiers (BRM) is essential for the activation and recruitment of neutrophils in the lungs [5]. Finally, anti-HNA antibody, particularly anti-HNA-3a, targets both neutrophils and endothelial cells by adhering directly to the CTL-2 protein (choline transport-like protein 2). The pulmonary attack is on two fronts; the severity of this event is considered to be the most important [6]. One of the hypotheses that we propose is that the severity of immune TRALI could be dependent on the inflammatory condition of the PSL involved and not just the antibodies present (Figure 1 and 2).

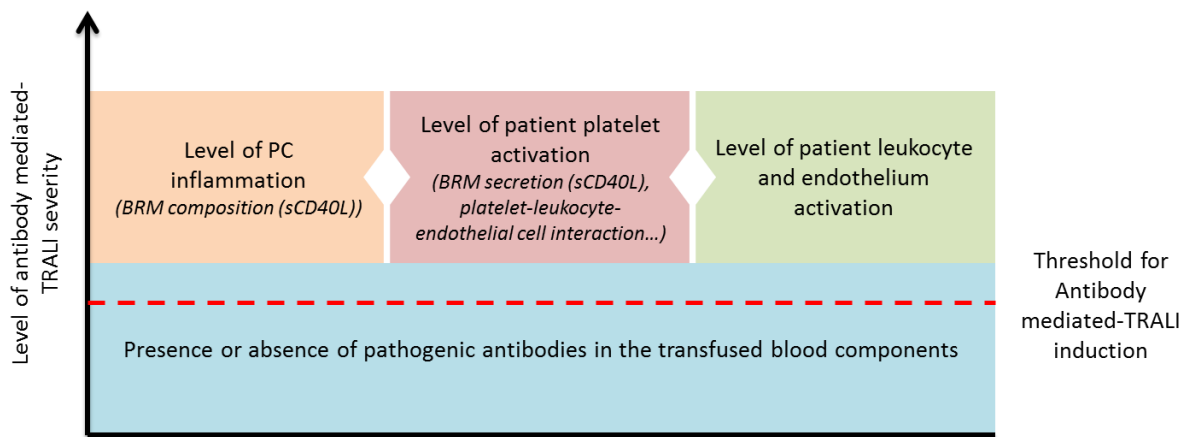

Figure 1: Hypothetical involvement of PC and platelets in the severity of immune TRALI

The immune TRALI trigger is dependent on the combination of anti-leukocyte antibodies, platelet concentrates and other PSL. The hypothesis focuses on the level of severity of immune TRALI dependent on the degree of inflammation of the PC and the degree of activation of the patient's blood platelets. These two parameters are particularly related to the BRM rate, such as sCD40L, secreted by platelets in the PC and/or in the patient. At the same time, the activation state of leukocytes and endothelial cells of the patient are considered in this hypothesis. The level of the activation threshold of immune TRALI could also be decreased according to the inflammatory degree of these three parameters.

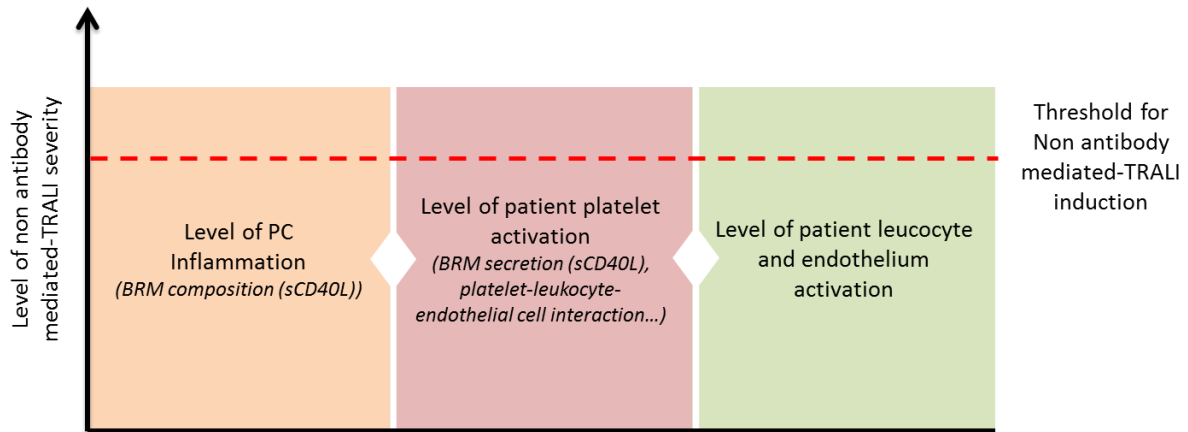

Figure 2: Hypothetical involvement of PC and platelets in triggering and in the severity of non-immune TRALI

The hypothesis is evoked for non-immune TRALI where the trigger is dependent on the degree of inflammation of the PC, the activation state of the patient's platelets and also the degree of activation of the neutrophils and endothelial cells. The severity of TRALI also depends on these three parameters. The first two parameters are particularly related to the BRM rate, such as sCD40L, secreted by platelets in the PC and in the patient.

At the present time, non-immune TRALI is more discussed than immune TRALI in the scientific and medical community. Cases of TRALI without the observation of anti-leukocyte antibodies in patients are emerging [7] as are cases of non-observed TRALI in patients with a pathological past that is conducive to the development of Acute Lung Injury (ALI), transfused with PSL with anti-leukocyte antibodies [8]. A current question is based on the ability, or not, of proinflammatory BRM present in PSL - especially the PC in our research - to trigger TRALI [9]. This is based on the different correlations observed between the increase in the risk of triggering TRALI and the excessive release of proinflammatory BRM depending on the RBC storage time [10] and the PC [11, 12]. However, this theory is controversial, as several studies have shown the inefficiency of older RBC to trigger TRALI [11] and also in volunteers who previously received an injection of LPS (lipopolysaccharide) [13]. Regarding the PC, we are attempting to respond partly to this theory by focusing on the inflammatory impact of the PC on endothelial cells, which are cells central to TRALI. Could this cocktail of cytokines/chemokines bear full responsibility for the outbreak of non-immune TRALI (Figure 2)? Could they also participate in the increase of the severity of immune TRALI (Figures 1)?

2. TRALI and blood platelets: Development of animal models

2.1. Inflammatory role of platelets

In recent years, several controversial studies have addressed the involvement of platelets in the body in TRALI physiopathology. Platelets are recognised as both inflammatory and immune cells [14]. At the present time, their role is debated by the scientific community. Some support a protective impact of platelets in an inflammatory process through a recovery of the endothelial functions [15], while others evoke the contribution of platelets to the activation of inflammation [16]. Other parameters evoke an important role of platelets in inflammation. On their surface, platelets have inflammatory and immune receptors, such as Toll-like receptors (TLR), NLRP3 or SIGLEC [17]. Moreover, in the circulation, several proinflammatory BRM are released by platelets themselves. They have a secretory power that can stimulate and maintain an inflammatory condition in the body. Among these BRM are the proinflammatory soluble factors, such as sCD40L, RANTES and PF4 [3]. Finally, the action of platelets in the inflammatory process is probably through their ability to interact with various cells (immune or not). Platelets interact directly with endothelial cells and different leukocytes through the expression of adhesion molecules on the surface of these cells [18]. The problem described in the literature is the balance between the involvement of platelets in inflammation vs. in haemostasis. Indeed, if platelets are an inflammation stimulus, what is their specific role in TRALI (Figures 1 and 2)? Finally, is their role in haemostasis too important to be able to block their activation at the expense of a haemorrhagic context?

2.2. Investigation of the role of platelets in TRALI: animal models

To respond to this new hypothesis, several inhibition animal models have been developed to study TRALI and its inhibition potential. Anti-platelet treatment, such as Bulsufan[®], an anti-platelet serum, aspirin and 15-Epi-LXA₄, seem conducive to the protection of mice in ALI models [16, 19-22]. Unlike these studies referring to the significant involvement of platelets in this pathology, others demonstrate that platelets are perhaps not central to TRALI. Indeed, in a recent study, mice treated with several platelet antagonists, such as aspirin, Clopidogrel[®] or even JAQ1 (anti-GPVI mAb), nevertheless developed TRALI, accompanied by intense bleeding episodes [23]. All these differences open the field to new studies focusing on the real involvement of platelets in the transfusion complication.

As mentioned in the paragraph above, several studies have defined the significant impact of the platelets during TRALI, notably through their ability to release multiple BRM. Several TRALI and ALI animal models targeting platelet proteins also seemed to be effective for the protection of these syndromes. Indeed, these animal models target soluble immunomodulator factors, such as sCD62P, RANTES, PF4 and β -TG [16, 19, 20, 24, 25]. Among all these proinflammatory soluble factors, one stands out from others: sCD40L, secreted mainly by platelets [26], seems to be a key molecule in the

induction and modulation of TRALI. This molecule allows platelet activation and interaction between platelets and immune system cells via an autocrine, paracrine and endocrine signal. Involvement of the CD40/CD40L complex, including immune cells, participates in the liberation of proinflammatory factors. The CD40/CD40L complex plays a leading role in the maintenance of the permeability of the endothelial wall of the blood capillaries and the expression of adhesion molecules, such as CD62E, ICAM-1 and VCAM-1 [27]. All these physiological elements are central to TRALI pathophysiology. Other parameters can evoke the influence of sCD40L in TRALI, and particularly during non-immune TRALI. Indeed, the release of platelet sCD40L is often correlated with the duration of storage of the pockets of blood products [28]. In an inflammatory and transfusion context such as TRALI, the implication of sCD40L has often been observed [29-31]. In addition, CD40L has already been correlated to the triggering of TRALI [32], although this is not consensual [33], and of ALI [34, 35]. Would the release of sCD40L, notably by platelets, be a risk factor for TRALI whose impact has long been underestimated (Figures 1 and 2)?

3. Ways of exploring the involvement of platelets in TRALI or experimental ALI models

3.1. Our research project

Our investigations involve two directions: i) the influence of platelet secretion products in PC having induced an sAR on endothelial cells, which are central to TRALI, through an *in vitro* model and ii) the impact of these secretions (notably sCD40L) and blood platelets, in the regulation or the amplification of an inflammatory condition with a focus on ALI pathophysiology through an *in vivo* model.

3.2. Inflammatory power of platelet concentrates having induced an sAR

To answer the first hypotheses, we are developing an *in vitro* model to highlight the impact of the platelet BRM present in PC supernatants having induced an sAR, on the ability of endothelial cells to secrete proteins regulating their impermeability, notably by the assessment of Endocan production. Endocan is a protein regulating positively the impermeability of the endothelial cells and therefore it is essential to the preservation of their integrity [36]. We found significant expression of Endocan by endothelial cells that could be seen as a marker of the post-transfusional inflammatory response and could probably be extrapolated in ALI physiopathology (work accepted for publication). It would be interesting to assess the impact of the inflammatory status of these same PC directly on leukocytes, other cells central to ALI. We could test the hypothesis of a trigger and the severity of TRALI dependent on the inflammatory condition of the PC before transfusion (Figure 1 and 2).

3.3. Inflammatory power of blood platelets: Their role in ALI

We developed simultaneously an *in vivo* experimental model to evaluate the inflammatory power of blood platelets. In the first instance, we studied the inflammatory impact of platelet secretion in a murine model of systemically induced inflammation. For this, we used *Nbeal2*^{-/-} mice. This murine model has platelets deficient in α -granules and an inability to produce platelet BRM formed in these same granules, i.e. more than 300 elements [37]. Assessment of the inflammatory response to LPS injection in these mice could highlight the real involvement of platelets in inflammation (*article in editing*).

Moreover, several protocols allow the study of platelet inhibition to evaluate the platelet activation cascades triggered during ALI. We can therefore model the inhibition of certain platelet activation pathways and assess the potential modulation of physiological disturbances observed during ALI, such as vascular permeabilization, pulmonary leukostasis or polymorphonuclear activation (*work in progress*).

In addition to determining the precise role of platelets in ALI, we discuss the role of the CD40/CD40L (sCD40L) immune complex. Our work contributes to the understanding of the role of platelets and associated BRM in the PC during the induction of inflammatory sAR in transfused patients (including TRALI) as well as in the process of preparation and storage of platelet concentrates (*work submitted for publication*).

We postulate that platelets present in the PC and in the patient play an important role in TRALI and post-transfusional inflammatory pathologies (Figures 1 and 2), beyond their haemostatic role. Targeting a platelet product more specifically, such as sCD40L, rather than general platelet inhibition could participate partly in the prevention of cases of TRALI and also other post-transfusional inflammatory reactions, such as multi-organ failure sometimes encountered during transfusion that can cause ALI (*work submitted for publication*).

References

1. Vlaar, A.P. and N.P. Juffermans, **Transfusion-related acute lung injury: a clinical review.** *Lancet*, 2013. **382**(9896): p. 984-94.
2. ANSM, **French Hemovigilance Activity Report 2015.** 2016.
3. Tariket, S., et al., **Transfusion-related acute lung injury: transfusion, platelets and biological response modifiers.** *Expert Rev Hematol*, 2016: p. 1-12.
4. Looney, M.R., et al., **Neutrophils and their Fc gamma receptors are essential in a mouse model of transfusion-related acute lung injury.** *J Clin Invest*, 2006. **116**(6): p. 1615-23.
5. Nishimura, M., et al., **Role of anti-human leucocyte antigen class II alloantibody and monocytes in development of transfusion-related acute lung injury.** *Transfus Med*, 2007. **17**(2): p. 129-34.
6. Storch, E.K., C.D. Hillyer, and B.H. Shaz, **Spotlight on pathogenesis of TRALI: HNA-3a (CTL2) antibodies.** *Blood*, 2014. **124**(12): p. 1868-72.
7. Silliman, C.C., et al., **Transfusion-related acute lung injury: epidemiology and a prospective analysis of etiologic factors.** *Blood*, 2003. **101**(2): p. 454-62.
8. Toy, P., et al., **Recipients of blood from a donor with multiple HLA antibodies: a lookback study of transfusion-related acute lung injury.** *Transfusion*, 2004. **44**(12): p. 1683-8.
9. Peters, A.L., et al., **Pathogenesis of non-antibody mediated transfusion-related acute lung injury from bench to bedside.** *Blood Rev*, 2015. **29**(1): p. 51-61.
10. Tung, J.P., et al., **Age of blood and recipient factors determine the severity of transfusion-related acute lung injury (TRALI).** *Crit Care*, 2012. **16**(1): p. R19.
11. Middelburg, R.A., et al., **Storage time of blood products and transfusion-related acute lung injury.** *Transfusion*, 2012. **52**(3): p. 658-67.
12. Silliman, C.C., et al., **Plasma and lipids from stored platelets cause acute lung injury in an animal model.** *Transfusion*, 2003. **43**(5): p. 633-40.
13. Peters, A.L., et al., **Transfusion of 35-Day Stored RBCs in the Presence of Endotoxemia Does Not Result in Lung Injury in Humans.** *Crit Care Med*, 2016. **44**(6): p. e412-9.
14. Garraud, O. and F. Cognasse, **Are Platelets Cells? And if Yes, are They Immune Cells?** *Front Immunol*, 2015. **6**: p. 70.
15. Gros, A., et al., **Single platelets seal neutrophil-induced vascular breaches via GPVI during immune-complex-mediated inflammation in mice.** *Blood*, 2015. **126**(8): p. 1017-26.
16. Zarbock, A., K. Singbartl, and K. Ley, **Complete reversal of acid-induced acute lung injury by blocking of platelet-neutrophil aggregation.** *J Clin Invest*, 2006. **116**(12): p. 3211-9.
17. Cognasse, F., et al., **The Inflammatory Role of Platelets via Their TLRs and Siglec Receptors.** *Front Immunol*, 2015. **6**: p. 83.
18. Kapur, R., et al., **Nouvelle cuisine: platelets served with inflammation.** *J Immunol*, 2015. **194**(12): p. 5579-87.
19. Grommes, J., et al., **Disruption of platelet-derived chemokine heteromers prevents neutrophil extravasation in acute lung injury.** *Am J Respir Crit Care Med*, 2012. **185**(6): p. 628-36.
20. Looney, M.R., et al., **Platelet depletion and aspirin treatment protect mice in a two-event model of transfusion-related acute lung injury.** *J Clin Invest*, 2009. **119**(11): p. 3450-61.
21. Ortiz-Munoz, G., et al., **Aspirin-triggered 15-epi-lipoxin A4 regulates neutrophil-platelet aggregation and attenuates acute lung injury in mice.** *Blood*, 2014. **124**(17): p. 2625-34.
22. Caudrillier, A. and M.R. Looney, **Platelet-neutrophil interactions as a target for prevention and treatment of transfusion-related acute lung injury.** *Curr Pharm Des*, 2012. **18**(22): p. 3260-6.

23. Hechler, B., et al., **Platelets are dispensable for antibody-mediated transfusion-related acute lung injury in the mouse.** *J Thromb Haemost*, 2016.
24. Yiming, M.T., et al., **Platelets enhance endothelial adhesiveness in high tidal volume ventilation.** *Am J Respir Cell Mol Biol*, 2008. **39**(5): p. 569-75.
25. Bdeir, K., et al., **Platelet-Specific Chemokines Contribute to the Pathogenesis of Acute Lung Injury.** *Am J Respir Cell Mol Biol*, 2017. **56**(2): p. 261-270.
26. Andre, P., et al., **Platelet-derived CD40L: the switch-hitting player of cardiovascular disease.** *Circulation*, 2002. **106**(8): p. 896-9.
27. Aloui, C., et al., **The signaling role of CD40 ligand in platelet biology and in platelet component transfusion.** *Int J Mol Sci*, 2014. **15**(12): p. 22342-64.
28. Cognasse, F., et al., **Release of potential immunomodulatory factors during platelet storage.** *Transfusion*, 2006. **46**(7): p. 1184-9.
29. Phipps, R.P., J. Kaufman, and N. Blumberg, **Platelet derived CD154 (CD40 ligand) and febrile responses to transfusion.** *Lancet*, 2001. **357**(9273): p. 2023-4.
30. Blumberg, N., et al., **An association of soluble CD40 ligand (CD154) with adverse reactions to platelet transfusions.** *Transfusion*, 2006. **46**(10): p. 1813-21.
31. Blumberg, N., et al., **The platelet as an immune cell-CD40 ligand and transfusion immunomodulation.** *Immunol Res*, 2009. **45**(2-3): p. 251-60.
32. Khan, S.Y., et al., **Soluble CD40 ligand accumulates in stored blood components, primes neutrophils through CD40, and is a potential cofactor in the development of transfusion-related acute lung injury.** *Blood*, 2006. **108**(7): p. 2455-62.
33. Toy, P., et al., **Transfusion-related acute lung injury: incidence and risk factors.** *Blood*, 2012. **119**(7): p. 1757-67.
34. Adawi, A., et al., **Blockade of CD40-CD40 ligand interactions protects against radiation-induced pulmonary inflammation and fibrosis.** *Clin Immunol Immunopathol*, 1998. **89**(3): p. 222-30.
35. Adawi, A., et al., **Disruption of the CD40-CD40 ligand system prevents an oxygen-induced respiratory distress syndrome.** *Am J Pathol*, 1998. **152**(3): p. 651-7.
36. Balta, S., et al., **Endocan: A novel inflammatory indicator in cardiovascular disease? Atherosclerosis**, 2015. **243**(1): p. 339-43.
37. Kahr, W.H., et al., **Abnormal megakaryocyte development and platelet function in Nbeal2(-/-) mice.** *Blood*, 2013. **122**(19): p. 3349-58.

Revue de la littérature

Chapitre 1 – La transfusion comme une frappe inflammatoire : connaissances et inconnus



Transfusion as an Inflammation Hit: Knowns and Unknowns

Olivier Garraud^{1,2*}, S. Tariket¹, C. Sut¹, A. Haddad^{1,3}, C. Aloui¹, T. Chakroun^{1,4,5}, S. Laradi^{1,6} and F. Cognasse^{1,6}

¹ Faculty of Medicine of Saint-Etienne, University of Lyon, Saint-Etienne, France, ² Institut National de la Transfusion Sanguine, Paris, France, ³ Hôpital du Sacré-Coeur, Beirut, Lebanon, ⁴ Centre de Transfusion Sanguine, Sousse, Tunisia, ⁵ Faculty of Pharmacy, University of Monastir, Monastir, Tunisia, ⁶ Etablissement Français du Sang Rhône-Alpes-Auvergne, Saint-Etienne, France

OPEN ACCESS

Edited by:

Fulvio D'Acquisto,
Queen Mary University
of London, UK

Reviewed by:

Philippe Saas,
Etablissement Français du Sang
Bourgogne Franche-Comté, France
Angela Ianaro,
University of Naples Federico II, Italy
Philip Norris,
Blood Systems, USA

*Correspondence:

Olivier Garraud
ogarraud@ints.fr

Specialty section:

This article was submitted
to Inflammation,
a section of the journal
Frontiers in Immunology

Received: 31 August 2016

Accepted: 11 November 2016

Published: 29 November 2016

Citation:

Garraud O, Tariket S, Sut C,
Haddad A, Aloui C, Chakroun T,
Laradi S and Cognasse F (2016)
Transfusion as an Inflammation
Hit: Knowns and Unknowns.
Front. Immunol. 7:534.
doi: 10.3389/fimmu.2016.00534

Transfusion of blood cell components is frequent in the therapeutic arsenal; it is globally safe or even very safe. At present, residual clinical manifestations are principally inflammatory in nature. If some rare clinical hazards manifest as acute inflammation symptoms of various origin, most of them linked with conflicting and undesirable biological material accompanying the therapeutic component (infectious pathogen, pathogenic antibody, unwanted antigen, or allergen), the general feature is subtler and less visible, and essentially consists of alloimmunization or febrile non-hemolytic transfusion reaction. The present essay aims to present updates in hematology and immunology that help understand how, when, and why subclinical inflammation underlies alloimmunization and circumstances characteristic of red blood cells and – even more frequently – platelets that contribute inflammatory mediators. Modern transfusion medicine makes sustained efforts to limit such inflammatory hazards; efforts can be successful only if one has a clear view of each element's role.

Keywords: inflammation, transfusion, allergy, blood components, leukocytes, platelets, erythrocytes, alloimmunization

INTRODUCTION

Historically, inflammation was viewed as the compendium of all four stigmas: “*rubor, calor, dolor, and tumor*”; this concept fits well with the theory of humors; bloodletting – and surrogates (e.g., leeches and suction cups) – have long been applied to treat, if not cure, inflammation symptoms. As a matter of fact, iron depletion caused by bloodletting happened to alter bacterial growth and ameliorate certain disease conditions, as already observed by Tissot in 1761 (1). The Hippocratic theory of humors was probably the first to introduce the relationship between blood and inflammation, though using wrong descriptors. In its earliest days, transfusion was clearly associated with acute inflammation, though the connection was not acknowledged as such: indeed, the very first reported serious adverse events (SAEs) of “modern” transfusion in the early twentieth century were dual in nature: first, immune-hematological [i.e., antigen–antibody (ABO)] conflicts, and second, blood-borne and blood-transmitted infections, such as syphilis and malaria (2). Both conditions – presenting as very severe – were later on acknowledged as being dominated by cytokine storms and standing for acute inflammatory reactions (often lethal) (3, 4).

The concept of inflammation has been largely revisited by modern internal medicine; series of autoimmune and auto-inflammatory diseases have thus been acknowledged. No organ-specific disorder is actually beyond the scope of the large clinical inflammation spectrum, since a number of

neurological disorders (5) – as well as many cardiovascular lesions especially the atheroma plaque deposit (6) – are inflammation stigmas. The causality of inflammation in organ-specific lesions is being questioned, but combinations of genetic predisposition, lifelong hygienic habits, other environmental factors, and infectious triggers are commonly evoked. For decades now, clinical inflammation has not been restricted to acute Hippocratic symptoms and is acknowledged to present as more subtle symptoms of varying degrees.

We believe two major achievements have helped reconsider clinical inflammation as it may apply to transfusion medicine and cell, tissue, and organ transplantation. Neither was intended to apply to this discipline; however, the first is the (re)discovery of the danger signal theory, as proposed by P. Matzinger at the NIAID, NIH, in the 1990s, after its seminal conceptualization by E. Metchnikoff at the Pasteur Institute 100 years earlier. This discovery is basic to immunology and helps reframe the reading of immunology (7). The second is the conceptualization of the microbiota's role in immunity – initially presented as governing what Ph Sansonetti (at the Pasteur Institute in Paris) called “war and peace” at the mucosal surfaces. This concept helped show that inflammation spans the whole spectrum, from physiology to pathology (8–10). It has since been suggested that healing (e.g., of tissue attrition or organ lesions) is the ultimate step of inflammation (11, 12).

TRANSFUSION AND INFLAMMATION: FROM BEDSIDE TO BENCH

From the bedside, one can consider two periods in relation to transfusion-related hazards, especially inflammation. The initial period concerns acute symptoms of SAEs: inflammation is observed among other symptoms such as shock. Those accidents were principally reported with reference to their major cause(s): the ABO conflict, transfusion-transmitted bacterial, viral, or parasitic infections, and allergy. In 1983, a novel cause of transfusion-transmitted SAE was described: *transfusion-related acute lung injury* (TRALI) (13–15). Interestingly, this SAE is ascribed to a dual cause: an Ag/Ab conflict – within the human leukocyte antigen (HLA) or, more rarely but more severely, the human neutrophil antigen (HNA) systems – and an inflammatory layer: sepsis, stress, etc. Besides conflicting Abs (when identified, i.e., in two out of every three cases on average), the principal actors are leukocytes recruited or residing in lung capillaries. The TRALI concept prompted a reinvestigation of SAEs in transfusion and acknowledgment of serious inflammatory cases. This is also true for allergy: though one cannot exclude the possibility of pathogenic IgE transfer, it is rather felt that such an occurrence cannot account for one-third of adverse events (AEs) varying in severity (16, 17). Transfusion allergy is, in general, considered to present like allergy, though it is not believed to have a link with atopy or involve allergens or Abs specific to allergens. It is recognized as one of the most frequent inflammatory consequences of transfusion (18).

In summary, despite this is over-simplistic, one may acknowledge that inflammation symptoms manifested by a transfused patient and in relation with the transfusion process has two

principal causes: it is either due to the transfer of pathogenic material collected from the donor or it is due to a conflict between high affinity receptors found on the recipients' cells or plasma molecules and ligands brought by the transfused component.

The majority of AEs in patients receiving blood (recipients) manifest either allergy or febrile non-hemolytic transfusion reactions (FNHTRs), both being clearly inflammatory conditions (19). Leukocytes transferred with blood were ascribed to as the principal causes of TT inflammation. Systematic “leucoreduction” – often inappropriately, but nevertheless officially, termed “leucodepletion” – was proposed at the start of the millenium by many countries or blood transfusion systems. However, leucoreduction has neither been become recommended nor a mandatory practice for mitigating inflammatory responses but is instead used to limit transfusion-transmitted viral risks as many “serious transfusion-associated viruses” are intracellular. Leucoreduction was principally aimed to reduce the risk of transmitting the Creutzfeldt–Jakob prion (20). Veterans of transfusion medicine very well recall the time when every single transfused patient was “shaking and heating,” manifesting common symptoms that were subsequent to the therapy and introduced as such to patients (when patients happened to receive information). Pre-storage leucoreduction was then acknowledged to have largely improved comfort and safety in patients, suggesting a deleterious role for leukocytes (21, 22). When leucoreduction is performed post-storage (e.g., at the bedside, prior to the infusion of the blood component), inflammatory manifestation is intermediate, largely suggesting that not only leukocytes but also their secreted content play a role in the transfusion inflammation pathophysiology (23).

However, as the transfused patient profile changed, more and more recipients benefited from platelet components (PCs). This major change took place more or less at the same time as the implementation of systematic hemovigilance, and it soon became obvious that PCs – though representing no more than 10% of issued blood components – provide between one-quarter to one-half of reported AEs (24). This means that leukocytes were not the only cells associated with transfusion-associated inflammation.

Another population of patients benefiting from frequent transfusion episodes, sickle-cell disease patients, led to an important discovery: first, they manifest complex hemolytic reactions that involve activated complement and present as essentially inflammatory (25) and second, they are subjected to the most frequent rate of alloimmunization among tracked cohorts of transfused patients (26). This prompted specialists to also examine the inflammatory potential of stored erythrocytes.

THE MAJOR IDENTIFIED CAUSES OF TRANSFUSION-ASSOCIATED INFLAMMATION

There is good evidence in favor of an undesirable role for residual leukocytes in transfused patients; blood banks can get rid of such residual leukocytes with a high degree of efficacy by using filtration methods. Leucoreduction is highly recommended by the European Community and the American Association of Blood

Banks with a target of no more than 10^6 residual leukocytes per blood component after filtration (27, 28); most pre-storage methods allow scores of leucoreduction ranging between 2 and 5×10^5 residual leukocytes per component (29). However, clinical observations suggest that other constituents of pre-stored and leucoreduced cellular blood components still lead to some inflammatory manifestations in patients.

To simplify and summarize, pro-inflammatory factors in labile blood components fall into one of the following four categories: (1) infectious pathogens transmitted by blood that cause bacterial sepsis, acute or chronic viral infection, or acute parasitic infection (and often hemolysis); (2) pathogenic, undesirable, Abs (causing hemolysis when encountering target Ags, especially when capable of binding complement; causing TRALI, depending on circumstances or predisposition; causing Reagin-mediated allergy; and causing a number of non-hemolytic situations, now ascribed to FNHTRs); (3) leukocytes and their content, and especially their high loads of pro-inflammatory cytokines, chemokines, and the like, collectively termed *biological response modifiers* (BRMs); and (4) (pro)inflammatory material linked to platelet and erythrocyte pathophysiology, especially when cellular blood components [PCs and packed red blood cell components (pRBCCs)] are stored over time and undergo so-called storage lesions, which consist of extracellular vesicle emission and the freeing of membrane-bound molecules and intracellular content, either iron (erythrocytes) or BRMs (platelets). It is not unusual that extracellular vesicles are called microparticles.

The first two categories are chiefly inflammatory, involving two principal mechanisms: first, the triggering of a cytokine storm, with broad consequences for all systems, exposing the patient to multivisceral failure and severe central neurologic disorders. Second, if erythrocytes are ultimate targets of the Ab or infectious pathogens, there is acute hemolysis with obvious consequences. This essay will not further discuss such cases. Neither will it discuss the specific case of bacterial contamination of PCs, largely related to the storage temperature of $22 \pm 2^\circ\text{C}$; 18.5 severe cases per million PCs delivered are recorded annually according to the latest French hemovigilance records; and one such case happens to be lethal, on average (30).

The latter two categories reveal that inflammation is not only the result of substantial levels of BRMs secreted by leukocytes, platelets, or lysed erythrocytes but also of products secreted as a consequence of cell–cell encounters after the blood component has been transfused. Cell–cell interactions occur mainly between (i) donor transfused cells and recipient circulating cells and (ii) donor transfused cells and recipient vascular endothelium cells. Transfusion is a dynamic process, but it is often regarded as the passive infusion of therapeutic components (31). This view is misleading and a source of errors for the interpretation of transfusion-associated inflammation.

MODELS OF TRANSFUSION-ASSOCIATED INFLAMMATION HIT

This section will address three main issues: (1) how transfusion can act as a stress for the recipient, subsequently triggering an

immune defense; (2) how blood components can present with varying degrees of stress signals, accompanied by pathogenic storage lesions; and (3) how the stage is set for a recipient's adaptive immune response to donor cell Ags. These three points parallel three major aspects of the transfusion process or chain: donor-linked characteristics, additional pathogenic steps during blood component production, and recipient-linked characteristics.

Transfusion as a Stress and Donor-Linked Characteristics Account for Recipients' Inflammatory Symptoms

Transfusion is an unnatural process in the sense that the exchange of body parts between individuals – other than mothers and their embryos or fetuses – is not part of the human evolutionary program. Each individual's blood has potentially unique biological characteristics. Thus, when foreign cellular material, is tentatively grafted into a recipient, the latter identifies it as foreign and potentially dangerous, even when it has a therapeutic purpose. Indeed, many studies have shown that platelets express a large variety of pathogen sensors, promptly engaged by several kinds of the so-called pathogen-associated molecular pattern (molecules) or PAMPs (if stresses are infectious in nature) or damage-associated molecular pattern (molecules) or DAMPs (if stresses are internal, such as Abs). This has been principally found relative to platelets (32, 33), and similar findings have been reported for erythrocytes (34). Furthermore, donor platelets express HLA class I Ags that differ in general from those of recipients. Donor cells are thus likely to be sensed as foreign by recipients' circulating and vessel-lining leukocytes, which are prone to signaling this through a pro-inflammatory response, or by vessel endothelial cells. Experimental data suggest that endothelial cells can also signal the detection of foreign material by mounting a pro-inflammatory response (35–38). In general, though it is still difficult to link with certainty a host's innate inflammatory response with unmanipulated donor cells, the danger theory of innate immunity would largely predict it in transfusion.

Recent data offer newer evidence supporting the hypothesis. First, a large Canadian clinical trial recently reported that age and sex of donors influenced the outcome of transfusion in recipients, more than any other factor (e.g., age of blood or pathology) (39, 40). Although there is now good evidence that there are differences between males and females in pathology and in particular in immune responses to infection or vaccines and inflammation processes, the gender issue has not been specifically addressed satisfactorily in transfusion medicine (41); this is perhaps a path for further investigation.

Our own investigations have shown that donors present great variation in the genes coding for CD40L; CD40L was investigated because platelets are the major purveyors of sCD40L in the body (42), and this BRM influences both innate and adaptive immunity (43). CD40L gene polymorphism was found to influence the presentation of secreted CD40L (44). It has been hypothesized that this genetic characteristic of donors may affect pro-inflammatory secretion of donated platelets in BCs (45, 46). This type of result is plausible as well for other BRMs.

Blood Component Manufacturing and Storage Lesions with Pro-inflammatory Consequences in Recipients

A large body of reviews has documented this topic. We may consider two sets of data for illustrative purposes: one explores the secretory capacity of stored platelets over time or of platelets undergoing stress lesions upon collection, processing, and storage (47–50); the other explores the age of blood – and more precisely, the age of pRBCs – at delivery. Both data sets incorporate diverse readouts: BRMs, oxidants, free iron, and extracellular vesicles (51–54). Despite such extracellular vesicles are reported to carry pro-inflammatory factors (55), some anti-inflammatory properties of extracellular vesicles have been reported (56), suggesting a fine-tune balance of inflammatory responses in relation of extracellular vesicles, likely depending on their sizes (57), origin, and abundance.

To summarize, it is generally reported that longer PC storage is accompanied by greater production of pro-inflammatory cytokines, which make up the majority of anti-inflammatory products (58–62) (Table 1). If leukocytes are still present in the

PCs, leukocyte- and platelet-originating cytokines and other BRMs potentiate each other over time (63). Our own group has reported that there is a direct relationship between (i) the secretion of sCD40L [proved to exert a pathogenic effect in certain recipients, together with companion BRMs OX40L and IL-27 (64, 65)] and the component shelf life; and (ii) between the net amount of sCD40L (alongside potentiating molecules IL-13 or MIP-1 α) and the manifestation of an inflammatory AE in the recipient (62). Similar findings exist for mitochondrial DNA (66–68). In addition, it has also been proposed that the techniques used to obtain PCs influence pro-inflammatory reactions, as these techniques do not expose platelets to the same stress (62, 69). Together, these observations strongly suggest the platelet storage lesions have a role in PC induced inflammation and its balance in transfused patients.

The situation for erythrocytes is even more complex. Substantial experimental evidence suggests that the age of erythrocytes, and the subsequent freeing of iron, is directly responsible for inflammation in experimental models, both *in vivo* and *ex vivo/in vitro* (70–74). Thus far, however, clinical trials have consistently failed to support this hypothesis (75). It should nevertheless be noted

TABLE 1 | Blood product storage and biological response modifier release.

	Packed red blood cell concentrates	Platelet concentrates	Plasma for direct therapeutic use
Usual storage time	42 days	5 days	1 year
Main product transformation	Leucoreduction Irradiation Pediatric preparation Deplasmatisation/washing Volume reduction Cryopreservation Reconstituted blood	Automated cell separation Centrifugation Leucoreduction Platelet additive solutions Occasionally pathogen Reduction or inactivation technology Irradiation Deplasmatisation/washing Cryopreservation Volume reduction	Leucoreduction Freezing/thawing Solvent-detergent Chemical and light pathogen inactivation Lyophilization
Lesion storage	Shape changes from a normal biconcave disk to echinocytes and spherocytes ↑ Ammonium ↑ Free Hb in plasma ↑ K ⁺ from ↓ ATP ↓ 2,3 DPG to <10% of original levels – replenished ↓ Labile proteins, e.g., complement, fibronectin, and coagulation factors ↓ to negligible ↓ Na ⁺ ↓ pH ↓ NADH ↑ Bioactive substances (free Hb, hemin, microvesicles, iron, cytokines, lipids, and enzymes) ↓ S-nitrosohemoglobin (SNO-Hb) bioactivity	Shape changes from discoid to spheroid ↑ Activation (↑ release of granular contents) ↑ Proteolysis Altered platelet surface receptor expression ↑ Platelet aggregates Decreased mean platelet volume (MPV) ↑ Volume and density heterogeneity ↑ Procoagulant activity ↑ Platelet apoptosis ↓ pH, pO ₂ , and glucose ↑ pCO ₂ ↑ Lactate production ↑ Glucose consumption ↓ Calcium ion flux ATP/ADP ratio change ↓ Mitochondrial oxidative respiration ↓ Fibrinogen binding	↑ Proteases ↑ Oxidation of Pro, Arg, Lys, Thr, Glu, or Asp side chains ↑ Cleavage of protein backbone ↑ Incorporation of lipid peroxidation products into Cys, His, or Lys residues ↑ Formation of advanced glycation end products ↑ Lipid peroxidation
Released/increased factor	MPs, IL-8, TNF- α , RANTES, NAP-2, Gro- α , MIP-1 α , SDF-1, ENA-78, TGF- β , ... Microvesicles	EGF, ENA-78, Gro- α , IL-1 β , IL-6, IL-7, IL-8, IL-27, Lyso-PCs, sOX40L, PAI-1, PDGF-AA, PF4, RANTES, sCD40L, TGF- β , TNF- α , VEGF, β -TG, ... Microvesicles Mitochondrial DNA	MPO, ECP, and histamine increase after thawing IL-1 β , IL-4, and IL-10 increase with freeze/thaw cycles MMP-7 increases with the number of freeze/thaw cycles IL-4, IL-12, and TNF- α increase with the number of freeze/thaw cycles ...

that this is extremely difficult to investigate and that further trials are necessary to resolve the matter (76).

Consequences of Inflammation in Recipients: Manifestations of Adaptive Immunity

There are two main consequences of inflammation in blood component recipients. One – alloimmunization to foreign Ags – is rather clear. The other is transfusion-related immune modulation or TRIM. TRIM is a complex occurrence that involves a number of adaptive immune tools, of which suppressive CD8+ T cells, regulatory T (and probably B) cells, anti-idiotypic T cell clones, along with soluble HLA molecules and other supposed mediators (77–79). It must be made clear that, if the main visible consequence of immunization to foreign Ags is alloimmunization, there is a likely strong T cell immunity; however, it seems difficult to catch it up, and the majority of published works focus on Ab production. One may hypothesize that T cell immunity and TRIM rather explain cases where immunization is not productive in terms of Ab formation. Another consequence of TRIM is perhaps the likely depression of immune surveillance with the report of suspected increase of posttransfusion infections (that are quite well documented) and perhaps malignancies or organ dysfunctions (that are to be ascertained) (80–83).

Alloimmunization remains the most frequently reported AE of transfusion. It is often reported in pathologies where extended matching of red cells is difficult to achieve, for people needing repeated transfusions, such as sickle-cell disease or β -thalassemic patients. Indeed, as there are near 350 Ags on erythrocytes, a perfect match is unlikely. Recipient characteristics such as how well one presents HLA are also considered to have a major impact (84). In addition, residual leukocytes are highly potent immunizers (far more commonly in HLA groups than in HNA groups); platelets are also good immunizers in both HLA class I and HPA groups (85). However, it has been demonstrated that residual leukocytes can influence the global immunization score: as shown in experimental models, stringent but incomplete leucoreduction minimizes alloimmunization, while strict leucoreduction reinforces it, supposedly by erasing the TRIM effect (84).

Yet in spite of several attempts to decipher innate immune mechanisms acting as layers of inflammation that fuel Ag presentation, the details of alloimmunization largely remain a mystery (86).

Last, another consequence of inflammation is the reported enhanced erythrocyte phagocytosis by spleen cells. Inflammation created by excess iron and nitric oxide (NO) freeing – perhaps linked with aged erythrocytes – would aggravate anemia instead of correcting it by bringing Hb/O₂ (87). While there is good experimental evidence in favor of this pathophysiology, clinical relevance is not yet ascertained.

FROM BENCH TO BEDSIDE: PATHS TO IMPROVE PATIENTS' SAFETY

Pathophysiological studies of platelets reveal that any exposure to stress may have consequences. Depending on the nature of this

stress, platelets can mobilize predefined patterns of BRMs (88, 89). Indeed, contrary to what we might expect, given that they are anucleate, platelets do not indiscriminately release granule content through an all-or-nothing mechanism but rather exhibit stress-dictated processes (32, 90–93). This may explain why certain patients having received PCs manifest allergic reactions (where δ -granule BRMs predominate) or FNHTR/inflammation (where α -granule BRMs predominate) (Figure 1; Table 2). A readout in the PC leftover is given by the predominance of either IL-13 or MIP-1 α in addition to sCD40L (62). Platelets are extremely reactive cells, and it is almost impossible to not pre-activate them while processing PCs for transfusion purposes. However, it has been made clear that the collection process, i.e., apheresis vs. recovered platelets from whole blood; platelets recovered from platelet-rich plasma vs. from buffy coats; PAS vs. plasma; pathogen reduction/inactivation vs. no additional safety measure; and in the case of apheresis, type of cell separator – and the length of storage are important parameters to control activation (59, 62, 65, 94–97). Despite conflicting data (98), it cannot be ruled out that ABO compatibility vs. identity also affects the outcome of platelet transfusion (99, 100), but probably not by triggering pre-activation. Furthermore, PCs are almost always HLA incompatible, at least for the majority of expressed class I Ags. This has not appeared to be deleterious in terms of clinical outcome – in the PLADO trial (98), for example, but consistent recommendations suggest that refractoriness to platelet transfusion is better addressed with HLA-compatible PCs (97). The HPA case is barely addressed, unless a specific and pathogenic Ab is identified, or in the case of fetal/neonatal maternal incompatibility (101). Serious allergies, allergic reactions, or severe FNHTRs can be addressed – when further PC transfusions are needed – by washing the components. This process is nevertheless tedious as it may itself pre-activate the cells. Alternatively, some teams may absorb pathogenic BRMs on columns when available (102, 103). At present, there are parameters that cannot be controlled (recipients' genetic characteristics and – to a large extent – donors' characteristics) and those that can be partly controlled, i.e., manufacturing, ABO matching, and aging of the PCs (Table 3). Most efforts appear to focus on the last three issues to limit inflammation in recipients. Further investigations are needed to evaluate the actual impact of safety measures in PC recipients and determine whether efforts can be made to propose matching procedures that can calculate the most important factors to limit inflammatory responses in patients.

For pRBCCs, the appropriate strategy may be very simple or very complex. In theory, it should be simple if one considers that the enemy is alloimmunization, which concerns inflammation. To limit the risk of immunization, an improvement of blood group Ag matching would be ideal; however, considering the volume of blood components to be issued to millions of recipients, this is simply not achievable on a routine basis. Efforts are being made to facilitate matching for at-risk recipients, such as those routinely receiving transfusions, though success varies according to specific needs of ethnic groups transfused outside their native region, where erythrocyte Ag group distribution differs from their own. Further, if inflammation fuels alloimmunization, some genetic control of responders vs. non-responders – or more

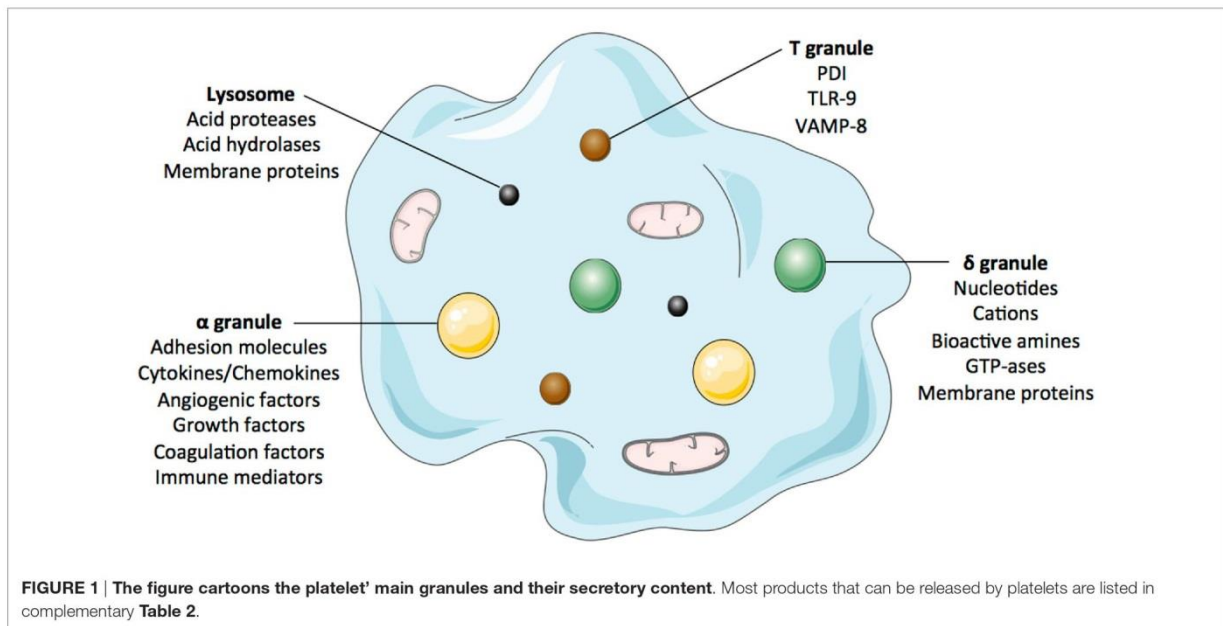

TABLE 2 | Platelet granule main contents.

α granules	δ granules	T granules	Lysosomes
Adhesion molecules αIIbβ3, αVβ3, CD9, fibronectin, GPIIbα, multimerin, osteonectin, PECAM, P-selectin, vitronectin, vWF Cytokines/chemokines β-thromboglobulin, CCL4, CCL17, ENA-78, Gro-α, IL-1, IL-7, IL-8, MCP-1, MCP-3, MIP-1α, NAP-2, PF4, RANTES, sCD40L, SDF-1 Angiogenesis/growth factors ADAM10, ADAMTS13, angiostatin, angiopoietin-1, BDNF, bFGF, BMP-2, BMP-4, BMP-6, CTAP-III, CTGF, EGF, endostatin, HGF, HGR, IGF-1, kininogen, MMP-1, MMP-2, MMP-9, PDGF, TGF-β, thrombospondin, TIMP-1, TIMP-4, VEGF Coagulation factors α ₂ -antiplasmin, α ₂ -antitrypsin, α ₂ -macroglobulin, antithrombin, factor V-VIII-XI-XIII, fibrinogen, PAI-1, plasmin, plasminogen, protease nexin-2, protein S, prothrombin, TFPI Immune mediators β1H globulin, C1 inhibitor, complement factors, factor D, IgA, IgG, IgM, platelet factor H, thymosin-β4 Others Albumine, PDCl	Nucleotides ADP, ATP Cations Calcium, magnesium Bioactive amines Serotonin, histamine GTP-ases rab27a, rab27b Membrane proteins αIIbβ3, CD63, GPIIb, LAMP-1, LAMP-2, P-selectin Others Polyphosphate, pyrophosphate	PDI TLR-9 VAMP-8	Acid proteases Acid phosphatase, arylsulphatase Carboxypeptidase A-B, cathepsin D-E, collagenase, elastase, proline carboxypeptidase Acid hydrolases α-arabinofuranosidase, α-fucosidase, β-fucosidase, α-galactosidase, β-galactosidase, β-glucuronidase, α-mannosidase, α-glucosidase, β-glucosidase, β-N-acetyl-hexosaminidase Membrane proteins CD63, LAMP-1, LAMP-2

ADP, adenosine diphosphate; ATP, adenosine triphosphate; BDNF, brain-derived neurotrophic factor; bFGF, basic fibroblast growth factor; BMP, bone morphogenetic protein; C, complement; CTAP-III, connective tissue-activating peptide III; CTGF, connective tissue growth factor; EGF, epidermal growth factor; HGF, hepatocyte growth factor; HGR, histidine-rich glycoprotein; Ig, immunoglobulin; IGF, insulin-like growth factor; IL, interleukin; LAMP, lysosomal-associated membrane protein; MCP, monocyte chemotactic protein; MIP, macrophage inflammatory protein; MMP, matrix metalloproteinase; NAP, neutrophil-activating protein; PAI, plasminogen activator inhibitor; PDCl, platelet-derived collagenase inhibitor; PDGF, platelet-derived growth factor; PDI, protein disulfide isomerase; PECAM, platelet endothelial cell adhesion molecule; PF, platelet factor; RANTES, regulated on activation normal T cell expressed and secreted; SDF, stromal cell-derived factor; TFPI, tissue factor pathway inhibitor; TGF, transforming growth factor; TIMP, tissue inhibitor of metalloproteinases; TLR, toll-like receptor; VEGF, vascular endothelial growth factor; VAMP, vesicle-associated membrane protein; vWF, von Willebrand factor.

precisely, good vs. bad HLA presenters – seems to prevail: this has been observed for certain blood group Ags and is very likely true for all others (77, 104). The situation is more complex than for platelets because the triggers of inflammation are less clearly identified. The age of blood is a likely but unproven factor, and

the effects of storage lesions and erythrocyte Ag alloimmunization (105). Various teams have provided indirect evidence after examining whether RBC collection can stress RBCs and subsequently stress endothelial cells exposed to such RBCs (at least in *ex vivo/in vitro* models) (106, 107). Here again, until more

TABLE 3 | Examples of preventable and not yet preventable causes of inflammation in transfusion medicine.

	Parameters that can be addressed	Parameters that cannot yet be addressed
Donor-related parameters	<ul style="list-style-type: none"> - So-called irregular antibodies to red blood cells or HLA - Autoantibodies - Potentially: allergens and IgE antibodies to allergens - Infectious pathogens and infectious pathogen-derived material (toxins, residues, superantigens) - ... 	Genetic parameters predisposing to inflammation
Processed component-related parameters	<ul style="list-style-type: none"> - Typically: leukocytes - Microvesicles/microparticles - All types of storage lesions - Age of blood^a - ... 	
Recipient-related parameters	<ul style="list-style-type: none"> - Certain therapies (drugs) 	<ul style="list-style-type: none"> - Genetic parameters that predispose to inflammation - Clinical state (causal disease or treatment being the cause of the transfusion need) - Most therapies, otherwise needed - Preexisting alloimmune Abs, autoimmune Abs - ...
Standard of operation parameters (SOP)	<ul style="list-style-type: none"> - Main blood group matching - Blood component freshness^a 	<ul style="list-style-type: none"> - Fine-tuned blood group matching

^aAge of blood appears to fall into either category as it affects the release of biological response modifiers (storage lesions) and likely sustains TRIM, and it affects the release of, e.g., oxygen (SOP) and the recirculation of cells (and propensity to apoptosis or to be prone to phagocytosis).

direct evidence becomes available, one may heed protocols that minimize stress to donors' RBCs and subsequently to recipients' vascular endothelium. Accordingly, some authors recommend not overexposing cellular blood components to radiation unless absolutely required as this may increase storage lesions (54, 108, 109). Closer examination is needed to determine the extent to which irradiation of BCs favors alloimmunization. Similar caution has been suggested for pathogen inactivation/reduction technologies, but there are conflicting claims in favor of reduction or alloimmunization based on impairment of indirect Ag presentation (84). This too calls for further investigation.

CONCLUSION

Transfusion is an old therapy, though it is not obsolete. In fact, it is quite modern if seen as cell therapy or biotherapy (110). It is very commonly used and is nowadays associated with few nosocomial AEs. Moreover, not all AEs are truly nosocomial as some are in fact linked to characteristics of recipients that can neither be dampened nor counteracted by matching blood components. When transfusion is associated with AEs, most can be related to an inflammatory state, which is either obvious (allergy, FNHTR, hypotension) or ascribed to such a state by current knowledge (alloimmunization). Indeed, transfusion-transmitted infection has become a rarity, and novel means are regularly applied to further minimize their occurrence. Means of decreasing the occurrence of transfusion-associated inflammation have received less attention and care, though they should be our new focus, to help patients, secure resources, and limit indirect costs. Platelet pathophysiology owes a lot to transfusion medicine: many of the major discoveries in this field were made by researchers who, questioning the role of PC transfusion in AEs (and occasionally

SAEs), attempted to solve questions about platelet activation and secretion. This review has not considered the other side of the coin with respect to platelets and their role in the inflammation process. Namely, in addition to being the source of many pro-inflammatory BRMs, platelets also produce healing factors (the terminus of physiological inflammation) that may also be used as therapeutic tools (111).

AUTHOR CONTRIBUTIONS

OG drafted the manuscript; all other contributors contributed illustrations, discussion, and critical review, along with the production of original data supporting the synthesis as a review article.

ACKNOWLEDGMENTS

The authors wish to thank Prof. Bruno Pozzetto, Prof. Thomas Bourlet, Prof. Philippe Berthelot, Dr. Hind Hamzeh-Cognasse, Lyon/Saint-Etienne, and Prof. Saloua Jemni-Yacoub, Monastir, for their excellent input, as well as Charles-Antoine Arthaud, Marie-Ange Eyraud, and Jocelyne Fagan for invaluable technical support. They would also like to express their gratitude to Dr. Julien Berthet, Dr. Sandrine Lafarge, Dr. Kim Ahn Nguyen, and Mr. Adrien Chabert for their excellent work. The authors further acknowledge support from University Jean-Monnet of Saint-Etienne, University of Lyon, Région Rhône-Alpes-Auvergne, Foundation Erasmus Mundus Al-Idrisi, Etablissement Français du Sang Rhône-Alpes-Auvergne, Institut National de la Transfusion Sanguine, Agence Nationale du Médicament et des Produits de Santé, Association Recherche-Tranfusion, and Association Les Amis de Rémi.

REFERENCES

- Garraud O, Tissot JD. Bloodletting for non-medical reasons: what about safety and quality? *Transfus Med* (2015) 25(6):424–5. doi:10.1111/tme.12234
- Alter HJ, Klein HG. The hazards of blood transfusion in historical perspective. *Blood* (2008) 112(7):2617–26. doi:10.1182/blood-2008-07-077370
- Higgins SJ, Kain KC, Liles WC. Immunopathogenesis of falciparum malaria: implications for adjunctive therapy in the management of severe and cerebral malaria. *Expert Rev Anti Infect Ther* (2011) 9(9):803–19. doi:10.1586/eri.11.96
- Sazama K. Transfusion errors: scope of the problem, consequences, and solutions. *Curr Hematol Rep* (2003) 2(6):518–21.
- Shabab T, Khanabali R, Moghadamtousi SZ, Kadir HA, Mohan G. Neuroinflammation pathways: a general review. *Int J Neurosci* (2016) 1–10. doi:10.1080/00207454.2016.1212854
- Gregersen I, Holm S, Dahl TB, Halvorsen B, Aukrust P. A focus on inflammation as a major risk factor for atherosclerotic cardiovascular diseases. *Expert Rev Cardiovasc Ther* (2016) 14(3):391–403. doi:10.1586/14779072.2016.1128828
- Matzinger P. Tolerance, danger and the extended family. *Annu Rev Immunol* (1994) 12:991–1045. doi:10.1146/annurev.iy.12.040194.005015
- Sansonetti PJ. War and peace at the intestinal epithelial surface: an integrated view of bacterial commensalism versus bacterial pathogenicity. *J Pediatr Gastroenterol Nutr* (2008) 46(Suppl 1):E6–7. doi:10.1097/01.mpg.0000313819.96520.27
- Thaiss CA, Zmora N, Levy M, Elinav E. The microbiome and innate immunity. *Nature* (2016) 535(7610):65–74. doi:10.1038/nature18847
- Honda K, Littman DR. The microbiota in adaptive immune homeostasis and disease. *Nature* (2016) 535(7610):75–84. doi:10.1038/nature18848
- Martin P, Nunan R. Cellular and molecular mechanisms of repair in acute and chronic healing. *Br J Dermatol* (2015) 173(2):370–8. doi:10.1111/bjd.13954
- Portou MJ, Baker D, Abraham D, Tsui J. The innate immune system, toll-like receptors and dermal wound healing: a review. *Vascul Pharmacol* (2015) 71:31–6. doi:10.1016/j.vph.2015.02.007
- Popovsky MA, Abel MD, Moore SB. Transfusion-related acute lung injury associated with passive transfer of antileukocyte antibodies. *Am Rev Respir Dis* (1983) 128(1):185–9. doi:10.1164/arrd.1983.128.1.185
- Vlaar AP, Juffermans NP. Transfusion-related acute lung injury: a clinical review. *Lancet* (2013) 382(9896):984–94. doi:10.1016/S0140-6736(12)62197-7
- Tariket S, Sut C, Hamzeh-Cognasse H, Laradi S, Pozzetto B, Garraud O, et al. Transfusion-related acute lung injury: transfusion, platelets and biological response modifiers. *Expert Rev Hematol* (2016) 9(5):497–508. doi:10.1586/17474086.2016.1152177
- Hirayama F. Current understanding of allergic transfusion reactions: incidence, pathogenesis, laboratory tests, prevention and treatment. *Br J Haematol* (2013) 160(4):434–44. doi:10.1111/bjh.12150
- Bolton-Maggs PH, Cohen H. Serious Hazards of Transfusion (SHOT) haemovigilance and progress is improving transfusion safety. *Br J Haematol* (2013) 163(3):303–14. doi:10.1111/bjh.12547
- Hendrickson JE, Hillyer CD. Noninfectious serious hazards of transfusion. *Anesth Analg* (2009) 108(3):759–69. doi:10.1213/ane.0b013e3181930a6e
- Marti-Carvajal AJ, Sola I, Gonzalez LE, Leon de Gonzalez G, Rodriguez-Malagon N. Pharmacological interventions for the prevention of allergic and febrile non-haemolytic transfusion reactions. *Cochrane Database Syst Rev* (2010) 6:CD007539. doi:10.1002/14651858.CD007539.pub2
- Douet JY, Bujdosó R, Andreoletti O. Leukoreduction and blood-borne vCJD transmission risk. *Curr Opin Hematol* (2015) 22(1):36–40. doi:10.1097/MOH.0000000000000101
- Rajesh K, Harsh S, Amarjit K. Effects of prestorage leukoreduction on the rate of febrile nonhemolytic transfusion reactions to red blood cells in a tertiary care hospital. *Ann Med Health Sci Res* (2015) 5(3):185–8. doi:10.4103/2141-9248.157498
- Bassuni WY, Blajchman MA, Al-Moshary MA. Why implement universal leukoreduction? *Hematol Oncol Stem Cell Ther* (2008) 1(2):106–23. doi:10.1016/S1658-3876(08)50042-2
- Pagano MB, Ness PM, Chajewski OS, King KE, Wu Y, Tobian AA. Hypotensive transfusion reactions in the era of prestorage leukoreduction. *Transfusion* (2015) 55(7):1668–74. doi:10.1111/trf.13047
- Politis C, Wiersum JC, Richardson C, Robillard P, Jorgensen J, Renaudier P, et al. The international haemovigilance network database for the surveillance of adverse reactions and events in donors and recipients of blood components: technical issues and results. *Vox Sang* (2016) 111:409–17. doi:10.1111/vox.12447
- Gardner K, Hoppe C, Mijovic A, Thein SL. How we treat delayed haemolytic transfusion reactions in patients with sickle cell disease. *Br J Haematol* (2015) 170(6):745–56. doi:10.1111/bjh.13494
- Yazdanbakhsh K. Mechanisms of sickle cell alloimmunization. *Transfus Clin Biol* (2015) 22(3):178–81. doi:10.1016/j.traci.2015.05.005
- EDQM. *European Directorate for the Quality of Medicines & HealthCare – Guide to the Preparation, Use and Quality Assurance of Blood Components*. 18th ed. Strasbourg: Council of Europe (2015).
- AABB. *Standards for Blood Banks and Transfusion Services*. 25th ed. Washington, DC: AABB (2009).
- Masse M. Universal leukoreduction of cellular and plasma components: process control and performance of the leukoreduction process. *Transfus Clin Biol* (2001) 8(3):297–302. doi:10.1016/S1246-7820(01)00119-7
- Lafeuillade B, Eb F, Ounouhene N, Petermann R, Daurat G, Huygue G, et al. Residual risk and retrospective analysis of transfusion-transmitted bacterial infection reported by the French national hemovigilance network from 2000 to 2008. *Transfusion* (2015) 55(3):636–46. doi:10.1111/trf.12883
- Stolla M, Refaai MA, Heal JM, Spinelli SL, Garraud O, Phipps RP, et al. Platelet transfusion – the new immunology of an old therapy. *Front Immunol* (2015) 6:28. doi:10.3389/fimmu.2015.00028
- Garraud O, Cognasse F. Are platelets cells? And if yes, are they immune cells? *Front Immunol* (2015) 6:article70. doi:10.3389/fimmu.2015.00070
- Cognasse F, Nguyen KA, Damien P, McNicol A, Pozzetto B, Hamzeh-Cognasse H, et al. The inflammatory role of platelets via their TLRs and siglec receptors. *Front Immunol* (2015) 6:article83. doi:10.3389/fimmu.2015.00083
- Mendonca R, Silveira AA, Conran N. Red cell DAMPs and inflammation. *Inflamm Res* (2016) 65(9):665–78. doi:10.1007/s00011-016-0955-9
- Kaplanski G, Farnarier C, Kaplanski S, Porat R, Shapiro L, Bongrand P, et al. Interleukin-1 induces interleukin-8 secretion from endothelial cells by a juxtacrine mechanism. *Blood* (1994) 84(12):4242–8.
- Daub K, Langer H, Seizer P, Stellos K, May AE, Goyal P, et al. Platelets induce differentiation of human CD34+ progenitor cells into foam cells and endothelial cells. *FASEB J* (2006) 20(14):2559–61. doi:10.1096/fj.06-6265fje
- Lovren F, Verma S. Evolving role of microparticles in the pathophysiology of endothelial dysfunction. *Clin Chem* (2013) 59(8):1166–74. doi:10.1373/clinchem.2012.199711
- Xie RF, Hu P, Wang ZC, Yang J, Yang YM, Gao L, et al. Platelet-derived microparticles induce polymorphonuclear leukocyte-mediated damage of human pulmonary microvascular endothelial cells. *Transfusion* (2015) 55(5):1051–7. doi:10.1111/trf.12952
- Chasse M, McIntyre L, English SW, Tinmouth A, Knoll G, Wolfe D, et al. Effect of blood donor characteristics on transfusion outcomes: a systematic review and meta-analysis. *Transfus Med Rev* (2016) 30(2):69–80. doi:10.1016/j.tmr.2016.01.002
- Chasse M, Tinmouth A, English SW, Acker JP, Wilson K, Knoll G, et al. Association of blood donor age and sex with recipient survival after red blood cell transfusion. *JAMA Intern Med* (2016) 176(9):1307–14. doi:10.1001/jamainternmed.2016.3324
- Fischer J, Jung N, Robinson N, Lehmann C. Sex differences in immune responses to infectious diseases. *Infection* (2015) 43(4):399–403. doi:10.1007/s15010-015-0791-9
- Andre P, Nannizzi-Alaimo L, Prasad SK, Phillips DR. Platelet-derived CD40L: the switch-hitting player of cardiovascular disease. *Circulation* (2002) 106(8):896–9. doi:10.1161/01.CIR.0000028962.04520.01
- Aloui C, Prigent A, Sut C, Tariket S, Hamzeh-Cognasse H, Pozzetto B, et al. The signaling role of CD40 ligand in platelet biology and in platelet component transfusion. *Int J Mol Sci* (2014) 15(12):22342–64. doi:10.3390/ijms15122342
- Mälartstig A, Lindahl B, Wallentin L, Siegbahn A. Soluble CD40L levels are regulated by the -3459 A>G polymorphism and predict myocardial infarction and the efficacy of antithrombotic treatment in non-ST elevation acute coronary syndrome. *Arterioscler Thromb Vasc Biol* (2006) 26(7):1667–73. doi:10.1161/01.ATV.0000222908.78873.36
- Aloui C, Sut C, Prigent A, Fagan J, Cognasse F, Granados-Herbepin V, et al. Are polymorphisms of the immunoregulatory factor CD40LG implicated in acute transfusion reactions? *Sci Rep* (2014) 4:7239. doi:10.1038/srep07239

46. Aloui C, Prigent A, Tariket S, Sut C, Fagan J, Cognasse F, et al. Levels of human platelet-derived soluble CD40 ligand depend on haplotypes of CD40LG-CD40-ITGA2. *Sci Rep* (2016) 6:24715. doi:10.1038/srep24715
47. Capocelli KE, Dumont LJ. Novel platelet storage conditions: additive solutions, gas, and cold. *Curr Opin Hematol* (2014) 21(6):491–6. doi:10.1097/MOH.0000000000000081
48. Thon JN, Schubert P, Devine DV. Platelet storage lesion: a new understanding from a proteomic perspective. *Transfus Med Rev* (2008) 22(4):268–79. doi:10.1016/j.tmr.2008.05.004
49. Devine DV, Serrano K. The platelet storage lesion. *Clin Lab Med* (2010) 30(2):475–87. doi:10.1016/j.cl.2010.02.002
50. Ohto H, Nolle KE. Overview on platelet preservation: better controls over storage lesion. *Transfus Apher Sci* (2011) 44(3):321–5. doi:10.1016/j.transci.2011.03.008
51. Hod EA, Spitalnik SL. Stored red blood cell transfusions: iron, inflammation, immunity, and infection. *Transfus Clin Biol* (2012) 19(3):84–9. doi:10.1016/j.traci.2012.04.001
52. Hess JR. Measures of stored red blood cell quality. *Vox Sang* (2014) 107(1):1–9. doi:10.1111/vox.12130
53. Liu C, Liu X, Janes J, Stapley R, Patel RP, Gladwin MT, et al. Mechanism of faster NO scavenging by older stored red blood cells. *Redox Biol* (2014) 2:211–9. doi:10.1016/j.redox.2013.12.014
54. Adams F, Bellairs G, Bird AR, Oguntibeju OO. Biochemical storage lesions occurring in nonirradiated and irradiated red blood cells: a brief review. *Biomed Res Int* (2015) 2015:968302. doi:10.1155/2015/968302
55. Lee H, Zhang D, Zhu Z, Dela Cruz CS, Jin Y. Epithelial cell-derived microvesicles activate macrophages and promote inflammation via microvesicle-containing microRNAs. *Sci Rep* (2016) 6:35250. doi:10.1038/srep35250
56. Burnouf T, Chou ML, Goubran H, Cognasse F, Garraud O, Seghatchian J. An overview of the role of microparticles/microvesicles in blood components: are they clinically beneficial or harmful? *Transfus Apher Sci* (2015) 53(2):137–45. doi:10.1016/j.transci.2015.10.010
57. Boilard E, Duchez AC, Brisson A. The diversity of platelet microparticles. *Curr Opin Hematol* (2015) 22(5):437–44. doi:10.1097/MOH.000000000000166
58. Stack G, Snyder EL. Cytokine generation in stored platelet concentrates. *Transfusion* (1994) 34(1):20–5. doi:10.1046/j.1537-2995.1994.34194098597.x
59. Cognasse F, Boussoulade E, Chavarin P, Acquart S, Fabrigli P, Lamy B, et al. Release of potential immunomodulatory factors during platelet storage. *Transfusion* (2006) 46(7):1184–9. doi:10.1111/j.1537-2995.2006.00869.x
60. Seghatchian J. Platelet storage lesion: an update on the impact of various leukoreduction processes on the biological response modifiers. *Transfus Apher Sci* (2006) 34(1):125–30. doi:10.1016/j.transci.2005.09.026
61. Sahler J, Spinelli S, Phipps R, Blumberg N. CD40 ligand (CD154) involvement in platelet transfusion reactions. *Transfus Clin Biol* (2012) 19(3):98–103. doi:10.1016/j.traci.2012.02.003
62. Nguyen KA, Hamzeh-Cognasse H, Sebban M, Fromont E, Chavarin P, Absi L, et al. A computerized prediction model of hazardous inflammatory platelet transfusion outcomes. *PLoS One* (2014) 9(5):e97082. doi:10.1371/journal.pone.0097082
63. Aloui C, Chakroun T, Prigent A, Jemni-Yacoub S, Cognasse F, Laradi S, et al. Leukocyte cytokines dominate over platelet cytokines overtime in non-leukoreduced platelet components. *Blood Transfus* (2016) 8:1–10. doi:10.2450/2016.0076-16
64. Hamzeh-Cognasse H, Damien P, Nguyen KA, Arthaud CA, Eyraud MA, Chavarin P, et al. Immune-reactive soluble OX40 ligand, soluble CD40 ligand, and interleukin-27 are simultaneously oversecreted in platelet components associated with acute transfusion reactions. *Transfusion* (2014) 54(3):613–25. doi:10.1111/trf.12378
65. Hamzeh-Cognasse H, Laradi S, Osselaer JC, Cognasse F, Garraud O. Amotosalen-HCl-UVA pathogen reduction does not alter poststorage metabolism of soluble CD40 ligand, OX40 ligand and interleukin-27, the cytokines that generally associate with serious adverse events. *Vox Sang* (2015) 108(2):205–7. doi:10.1111/vox.12203
66. Boudreau LH, Duchez AC, Cloutier N, Soulet D, Martin N, Bollinger J, et al. Platelets release mitochondria serving as substrate for bactericidal group IIA-secreted phospholipase A2 to promote inflammation. *Blood* (2014) 124(14):2173–83. doi:10.1182/blood-2014-05-573543
67. Cognasse F, Aloui C, Anh Nguyen K, Hamzeh-Cognasse H, Fagan J, Arthaud CA, et al. Platelet components associated with adverse reactions: predictive value of mitochondrial DNA relative to biological response modifiers. *Transfusion* (2016) 56(2):497–504. doi:10.1111/trf.13373
68. Yasui K, Matsuyama N, Kuroishi A, Tani Y, Furuta RA, Hirayama F. Mitochondrial damage-associated molecular patterns as potential proinflammatory mediators in post-platelet transfusion adverse effects. *Transfusion* (2016) 56(5):1201–12. doi:10.1111/trf.13535
69. Nguyen KA, Chavarin P, Arthaud CA, Cognasse F, Garraud O. Do manual and automated processes with distinct additive solutions affect whole blood-derived platelet components differently? *Blood Transfus* (2013) 11(1):152–3. doi:10.2450/2012.0010-12
70. Godbey EA, Hod EA. The outsider adverse event in transfusion: inflammation. *Presse Med* (2016) 45(7–8 Pt 2):e325–9. doi:10.1016/j.lpm.2016.06.025
71. Spitalnik SL, Francis RO. Red blood cell components: meeting the quantitative and qualitative transfusion needs. *Presse Med* (2016) 45(7–8 Pt 2):e281–8. doi:10.1016/j.lpm.2016.06.019
72. Hod EA, Zhang N, Sokol SA, Wojczyk BS, Francis RO, Ansaldi D, et al. Transfusion of red blood cells after prolonged storage produces harmful effects that are mediated by iron and inflammation. *Blood* (2010) 115(21):4284–92. doi:10.1182/blood-2009-10-245001
73. Zimring JC, Spitalnik SL. Pathobiology of transfusion reactions. *Annu Rev Pathol* (2015) 10:83–110. doi:10.1146/annurev-pathol-012414-040318
74. Gibb DR, Calabro S, Liu D, Tormey CA, Spitalnik SL, Zimring JC, et al. The Nlrp3 inflammasome does not regulate alloimmunization to transfused red blood cells in mice. *EBioMedicine* (2016) 9:77–86. doi:10.1016/j.ebiom.2016.06.008
75. Lacroix J, Hébert PC, Fergusson DA, Tinmouth A, Cook DJ, Marshall JC, et al. Age of transfused blood in critically ill adults. *N Engl J Med* (2015) 372(15):1410–8. doi:10.1056/NEJMoa1500704
76. Garraud O. Do we need [more] clinical trials in transfusion medicine and hemotherapy? *Transfus Apher Sci* (2016) 55(2):262–3. doi:10.1016/j.transci.2016.09.001
77. Bilgin YM, van de Watering LM, Brand A. Clinical effects of leucoreduction of blood transfusions. *Neth J Med* (2011) 69(10):441–50.
78. Refaai MA, Blumberg N. Transfusion immunomodulation from a clinical perspective: an update. *Expert Rev Hematol* (2013) 6(6):653–63. doi:10.1586/17474086.2013.850026
79. Abe Y, Urakami H, Ostanin D, Zibari G, Hayashida T, Kitagawa Y, et al. Induction of Foxp3-expressing regulatory T-cells by donor blood transfusion is required for tolerance to rat liver allografts. *PLoS One* (2009) 4(11):e7840. doi:10.1371/journal.pone.0007840
80. Karrowini W, Vora AN, Dai D, Wojdyla D, Dakik H, Rao SV. Blood transfusion and the risk of acute kidney injury among patients with acute coronary syndrome undergoing percutaneous coronary intervention. *Circ Cardiovasc Interv* (2016) 9(9):e003279. doi:10.1161/CIRCINTERVENTIONS.115.003279
81. Chalfin HJ, Liu JJ, Gandhi N, Feng Z, Johnson D, Netto GJ, et al. Blood transfusion is associated with increased perioperative morbidity and adverse oncologic outcomes in bladder cancer patients receiving neoadjuvant chemotherapy and radical cystectomy. *Ann Surg Oncol* (2016) 23(8):2715–22. doi:10.1245/s10434-016-5193-4
82. Shander A, Lobel GP, Javidroozi M. Transfusion practices and infectious risks. *Expert Rev Hematol* (2016) 9(6):597–605. doi:10.1586/17474086.2016.1164593
83. Muszynski JA, Spinella PC, Cholette JM, Acker JP, Hall MW, Juffermans NP, et al. Transfusion-related immunomodulation: review of the literature and implications for pediatric critical illness. *Transfusion* (2016). doi:10.1111/trf.13855
84. Pavenski K, Freedman J, Semple JW. HLA alloimmunization against platelet transfusions: pathophysiology, significance, prevention and management. *Tissue Antigens* (2012) 79(4):237–45. doi:10.1111/j.1399-0039.2012.01852.x
85. Rozman P. Platelet antigens. The role of human platelet alloantigens (HPA) in blood transfusion and transplantation. *Transpl Immunol* (2002) 10(2–3):165–81. doi:10.1016/S0966-3274(02)00063-1
86. Hod EA, Spitalnik SL. Harmful effects of transfusion of older stored red blood cells: iron and inflammation. *Transfusion* (2011) 51(4):881–5. doi:10.1111/j.1537-2995.2011.03096.x

87. Hendrickson JE, Chadwick TE, Roback JD, Hillyer CD, Zimring JC. Inflammation enhances consumption and presentation of transfused RBC antigens by dendritic cells. *Blood* (2007) 110(7):2736–43. doi:10.1182/blood-2007-03-083105
88. Berthet J, Damien P, Hamzeh-Cognasse H, Pozzetto B, Garraud O, Cognasse F. Toll-like receptor 4 signal transduction in platelets: novel pathways. *Br J Haematol* (2010) 151(1):89–92. doi:10.1111/j.1365-2141.2010.08292.x
89. Berthet J, Damien P, Hamzeh-Cognasse H, Arthaud CA, Eyraud MA, Zeni F, et al. Human platelets can discriminate between various bacterial LPS isoforms via TLR4 signaling and differential cytokine secretion. *Clin Immunol* (2012) 145(3):189–200. doi:10.1016/j.clim.2012.09.004
90. Cognasse F, Garraud O, Pozzetto B, Laradi S, Hamzeh-Cognasse H. How can non-nucleated platelets be so smart? *J Thromb Haemost* (2016) 14(4):794–6. doi:10.1111/jth.13262
91. Mantovani A, Garlanda C. Platelet-macrophage partnership in innate immunity and inflammation. *Nat Immunol* (2013) 14(8):768–70. doi:10.1038/ni.2666
92. Kapur R, Zufferey A, Boilard E, Semple JW. Nouvelle cuisine: platelets served with inflammation. *J Immunol* (2015) 194(12):5579–87. doi:10.4049/jimmunol.1500259
93. Semple JW, Italiano JE Jr, Freedman J. Platelets and the immune continuum. *Nat Rev Immunol* (2011) 11(4):264–74. doi:10.1038/nri2956
94. Cognasse F, Osselaer JC, Payrat JM, Chavarin P, Corash L, Garraud O. Release of immune modulation factors from platelet concentrates during storage after photochemical pathogen inactivation treatment. *Transfusion* (2008) 48(5):809–13. doi:10.1111/j.1537-2995.2008.01655.x
95. Cognasse F, Hamzeh-Cognasse H, Lafarge S, Acquart S, Chavarin P, Courbil R, et al. Donor platelets stored for at least 3 days can elicit activation marker expression by the recipient's blood mononuclear cells: an in vitro study. *Transfusion* (2009) 49(1):91–8. doi:10.1111/j.1537-2995.2008.01931.x
96. Chavarin P, Cognasse F, Argaud C, Vidal M, De Putter C, Boussoulade F, et al. In vitro assessment of apheresis and pooled buffy coat platelet components suspended in plasma and SSP+ photochemically treated with amotosalen and UVA for pathogen inactivation (INTERCEPT Blood System). *Vox Sang* (2011) 100(2):247–9. doi:10.1111/j.1423-0410.2010.01389.x
97. Garraud O, Cognasse F, Tissot JD, Chavarin P, Laperche S, Morel P, et al. Improving platelet transfusion safety: biomedical and technical considerations. *Blood Transfus* (2016) 14(2):109–22. doi:10.2450/2015.0042-15
98. Kaufman RM, Assmann SF, Triulzi DJ, Strauss RG, Ness P, Granger S, et al. Transfusion-related adverse events in the Platelet Dose study. *Transfusion* (2015) 55(1):144–53. doi:10.1111/trf.12791
99. Zaffuto BJ, Conley GW, Connolly GC, Henrichs KF, Francis CW, Heal JM, et al. ABO-immune complex formation and impact on platelet function, red cell structural integrity and haemostasis: an in vitro model of ABO non-identical transfusion. *Vox Sang* (2016) 110(3):219–26. doi:10.1111/vox.12354
100. Blumberg N, Refaai M, Heal J. ABO matching of platelet transfusions – “Start Making Sense”. “As we get older, and stop making sense.” – The Talking Heads (1984). *Blood Transfus* (2015) 13(3):347–50. doi:10.2450/2015.0001-15
101. Brojer E, Husebekk A, Debska M, Uhrynowska M, Guz K, Orzinska A, et al. Fetal/Neonatal alloimmune thrombocytopenia: pathogenesis, diagnostics and prevention. *Arch Immunol Ther Exp (Warsz)* (2016) 64(4):279–90. doi:10.1007/s00005-015-0371-9
102. Cholette JM, Henrichs KF, Alferis GM, Powers KS, Phipps R, Spinelli SL, et al. Washing red blood cells and platelets transfused in cardiac surgery reduces postoperative inflammation and number of transfusions: results of a prospective, randomized, controlled clinical trial. *Pediatr Crit Care Med* (2012) 13(3):290–9. doi:10.1097/PCC.0b013e31822f173c
103. Tanaka S, Hayashi T, Tani Y, Hirayama F. Removal of biological response modifiers associated with platelet transfusion reactions by columns containing adsorption beads. *Transfusion* (2014) 54(7):1790–7. doi:10.1111/trf.12542
104. Alexander PE, Barty R, Fei Y, Vandvik PO, Pai M, Siemieniuk RA, et al. Transfusion of fresher vs older red blood cells in hospitalized patients: a systematic review and meta-analysis. *Blood* (2016) 127(4):400–10. doi:10.1182/blood-2015-09-670950
105. Kormoczi GF, Mayr WR. Responder individuality in red blood cell alloimmunization. *Transfus Med Hemother* (2014) 41(6):446–51. doi:10.1159/000369179
106. Cognasse F, Garraud O, Hamzeh-Cognasse H, Damien P, Nguyen KA, Pozzetto B, et al. Investigative in vitro study about red blood cell concentrate processing and storage. *Am J Respir Crit Care Med* (2013) 187(2):216–7. doi:10.1164/ajrccm.187.2.216
107. Radwanski K, Garraud O, Cognasse F, Hamzeh-Cognasse H, Payrat JM, Min K. The effects of red blood cell preparation method on in vitro markers of red blood cell aging and inflammatory response. *Transfusion* (2013) 53(12):3128–38. doi:10.1111/trf.12143
108. Gehrie EA, Dunbar NM. Modifications to blood components: when to use them and what is the evidence? *Hematol Oncol Clin North Am* (2016) 30(3):653–63. doi:10.1016/j.hoc.2016.01.007
109. Muench MO, Heitman JW, Inglis H, Fomin ME, Marschner S, Goodrich RP, et al. Reduced alloimmunization in mice following repeated transfusion with pathogen-reduced platelets. *Transfusion* (2016) 56(6):1419–29. doi:10.1111/trf.13579
110. Garraud O, Guillevin L. Towards a “Nouvelle Vague” therapy? *Presse Med* (2016) 45(7–8 Pt 2):e243–5. doi:10.1016/j.lpm.2016.06.015
111. Martínez CE, Smith PC, Palma Alvarado VA. The influence of platelet-derived products on angiogenesis and tissue repair: a concise update. *Front Physiol* (2015) 6:290. doi:10.3389/fphys.2015.00290

Conflict of Interest Statement: The authors declare no competing financial interests and no conflicts of interest regarding this study.

The reviewer PS declared a shared affiliation, though no other collaboration, with one of the authors FC to the handling Editor, who ensured that the process nevertheless met the standards of a fair and objective review.

Copyright © 2016 Garraud, Tariket, Sut, Haddad, Aloui, Chakroun, Laradi and Cognasse. This is an open-access article distributed under the terms of the Creative Commons Attribution License (CC BY). The use, distribution or reproduction in other forums is permitted, provided the original author(s) or licensor are credited and that the original publication in this journal is cited, in accordance with accepted academic practice. No use, distribution or reproduction is permitted which does not comply with these terms.

Chapitre 2 – Transfusion-Related Acute Lung Injury : l'aspect clinique

Section 1 – Caractérisation du TRALI : *la terminologie*

Le TRALI (Transfusion-Related Acute Lung Injury) a été depuis ces débuts considéré comme une pathologie occasionnelle mais peut-être sous-déclarée, mais dont la mortalité l'a placé dans les premiers rangs des complications transfusionnelles les plus inquiétantes. Son existence a été pour la première fois évoquée dans les années 1950 [1, 2] et le terme « TRALI » a été utilisé pour la première fois par le Dr Popovsky, dès les années 1980 [3]. On décrit, depuis le début du 20^{ème} siècle, cette pathologie comme une réaction pulmonaire aiguë, l'ALI (Acute Lung Injury), qui se développe dans les 6 heures après transfusion de Produits Sanguins Labiles (PSL) [4]. Cependant, certains investigateurs évoquent des TRALI pouvant se déclarer jusqu'à 72h après la transfusion, parlant ainsi de « delayed TRALI » (dTRALI) (pour TRALI retardé) [5, 6]. Ce TRALI atypique est souvent corrélé avec des cofacteurs pathologiques comme le sepsis ou un traumatisme sévère. La physiopathologie serait liée à des médiateurs bioactifs plutôt que des anticorps anti-leucocytaires, contrairement au TRALI dit classique (*voir revue « Transfusion-related acute lung injury: transfusion, platelets and biological response modifiers »* page 38 [7]). Enfin, ces TRALI présenteraient un taux de mortalité accru (45% *vs.* 10%) [8]. Une dernière catégorie de TRALI est aujourd'hui envisagée, les possibles TRALI (pTRALI). De façon générale, la responsabilité des ALI n'est en aucun cas d'origine transfusionnelle contrairement au TRALI. Lorsque la cause de cette détresse respiratoire ne peut être clairement associée au processus de transfusion, bien que le patient ait connu un épisode transfusionnel, on parle alors de pTRALI [9-12] (Figure 1). Ce dernier terme est, à l'heure actuelle, encore débattu par la communauté transfusionnelle. En effet, certains souhaiteraient un changement de la nomenclature, utilisant le terme de possible syndrome de détresse respiratoire aiguë (SDRA), car le pTRALI évoque, par son nom, une composante transfusionnelle alors qu'il pourrait simplement être dû à un facteur autre que la transfusion elle-même [13, 14].

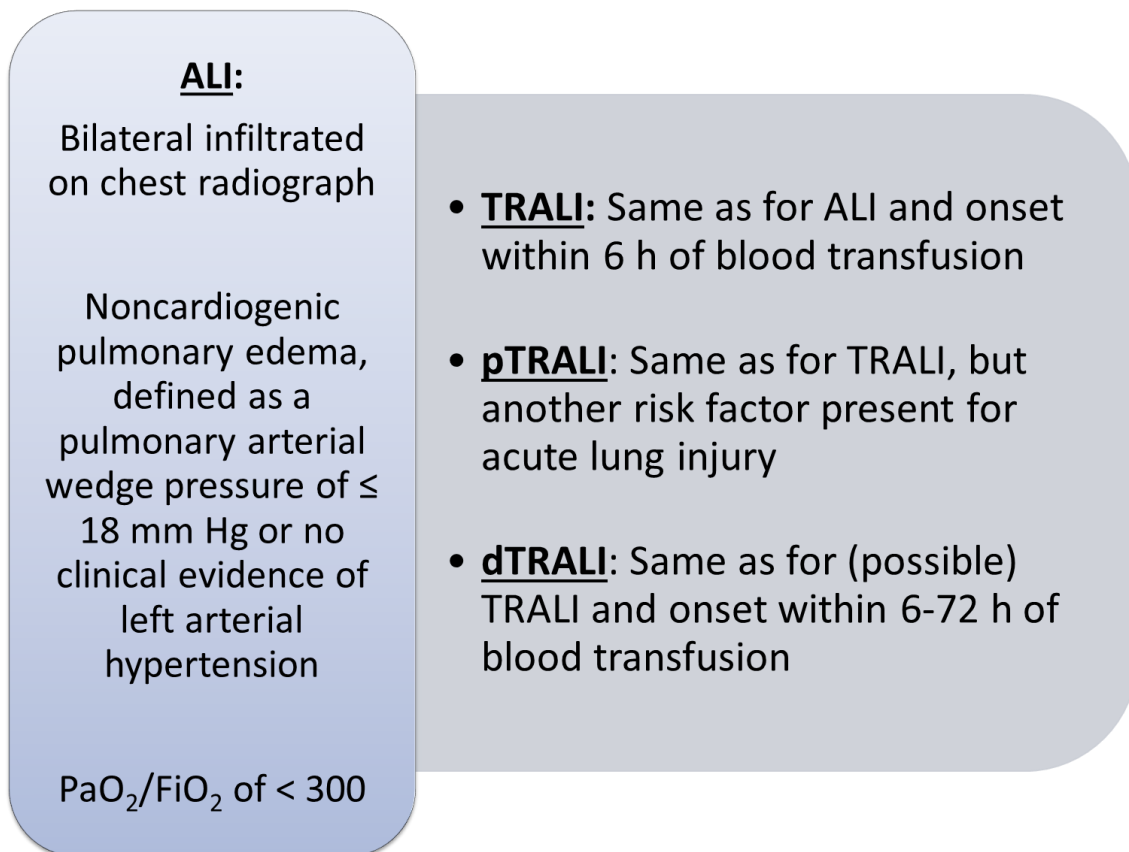

Figure 1 : Les définition des différents TRALI, inspiré de [15] et [16]

Aujourd'hui beaucoup de critères entrent en compte pour la définition du TRALI. La complexité du diagnostic est corrélée à tous les facteurs de risques, propres aux patients, évoqués dans la littérature. On peut, effectivement, citer une multitude de contextes pathologiques et interventionnels médicaux favorables au développement d'un TRALI. Les cancers hématologiques [17, 18], les maladies cardio-vasculaires [17], le sepsis [5, 18, 19], les transfusions massives [18, 20] et la ventilation mécanique [18] sont des facteurs de risques associés au TRALI. Dans un but de simplification du diagnostic du TRALI, plusieurs modèles théoriques, appelés « modèles de seuil », ont alors été élaborés. On compte aujourd'hui trois modèles allant du plus simple au plus complexe. Le premier, proposé en 2007 par Bux et Sachs [21], n'inclut que l'activation des neutrophiles et de l'endothélium (essentiel à l'induction du TRALI –voir revue « *Transfusion-related acute lung injury: transfusion, platelets and biological response modifiers* » page 38 [7]–) induite selon la prédisposition du patient et selon l'impact inflammatoire de la transfusion. Dans ce modèle, une prédisposition importante du patient (par exemple un épisode septique passé sévère) nécessitera un pouvoir inflammatoire des PSL faible, c'est-à-dire avec des concentrations basses d'anticorps anti-leucocytaires et de « Biological Response Modifiers » (BRM) (Figure 2).

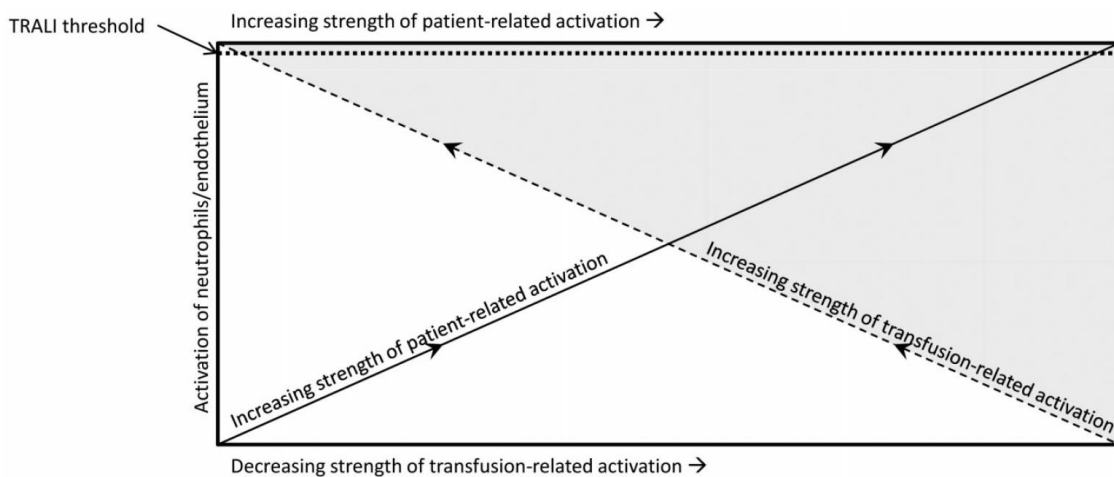

Figure 2 : Premier modèle de seuil, d'après Middelburg *et al.* [22]

Modèle de seuil du déclenchement du TRALI dépendant du niveau de prédisposition du patient transfusé et du pouvoir d'activation des neutrophiles et de l'endothélium par le produit transfusé. Les niveaux d'activation des deux paramètres cités sont compensatoires. Une forte prédisposition du patient (par exemple, un lourd passé pathologique) nécessite un pouvoir inflammatoire faible du produit sanguin transfusé.

Le second modèle, d'abord évoqué en 1999 par Rosendaal dans un modèle de thrombus veineux [23], et, par la suite, rendu applicable au TRALI par Middelburg et Van der Bom en 2014 (Figure 3), utilise un principe plus complexe. Ici, les facteurs de risques sont différenciés selon leur impact sur le niveau d'activation des neutrophiles et de l'endothélium et selon leur répercussion dans le temps. Ces facteurs de risques peuvent être une entité pathologique, telle qu'une pneumonie ou un cancer hématologique, ou une intervention opératoire/médicale, par exemple une chirurgie cardiaque ou un premier épisode transfusionnel. Ces différents facteurs de risques sont, dans ce modèle, juxtaposables, permettant l'élévation du niveau d'activation des neutrophiles et de l'endothélium. Enfin, la transfusion, responsable du « second-hit » du TRALI, permettra l'induction de la pathologie susnommée.

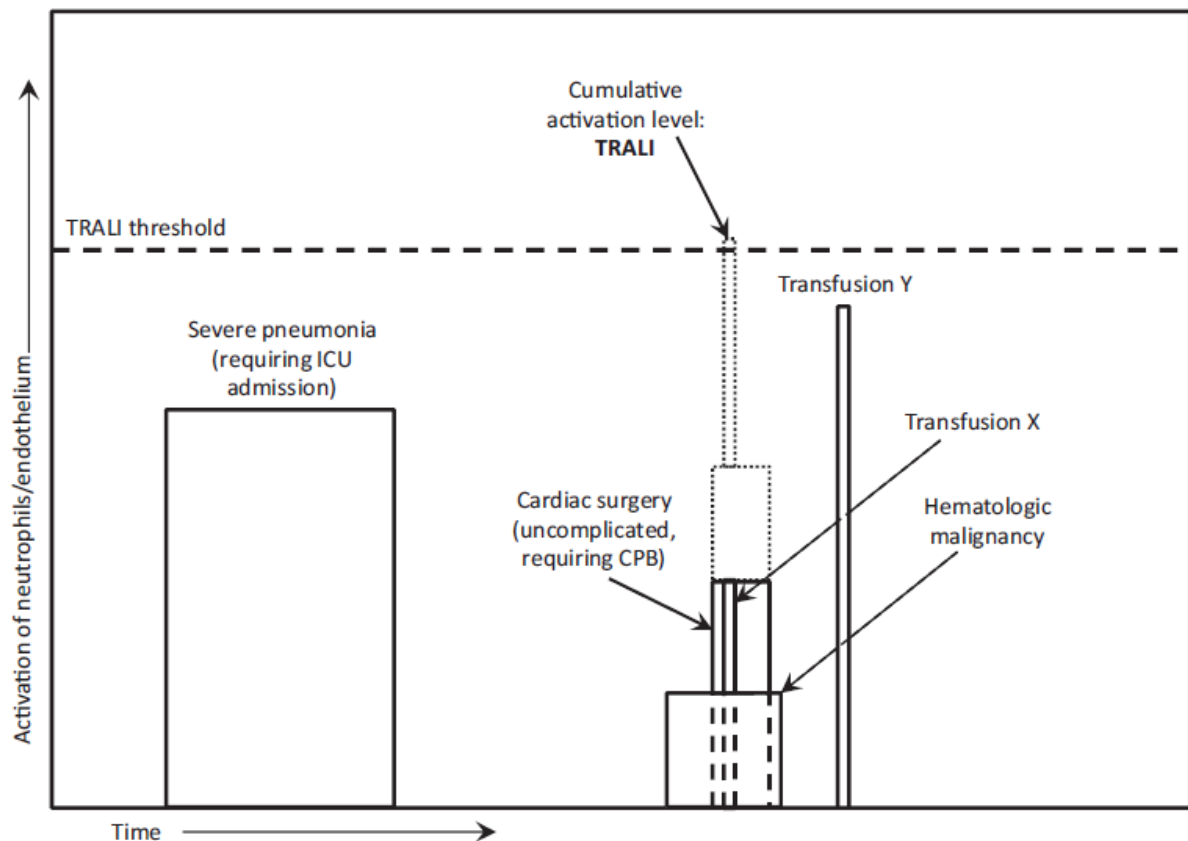

Figure 3 : Deuxième modèle de seuil, d'après Middelburg *et al.* [22]

Modèle de seuil du déclenchement du TRALI dépendant de l'impact de la transfusion et de la pathologie pré-transfusionnelle du patient, en fonction du temps et du niveau d'activation des neutrophiles et de l'endothélium vasculaire. Tous les phénomènes sont juxtaposables. La sommation des différents niveaux d'activation, des neutrophiles et de l'endothélium, doit être suffisamment importante pour dépasser le seuil de déclenchement du TRALI. On voit ici que la transfusion sanguine peut être responsable à la fois du premier et du second évènement (Transfusion X et Y).

Un dernier modèle a été présenté. Inspiré du modèle établi par Rothman, en 1976, dont le but était d'instaurer une logique épidémiologique applicable à toutes les maladies [24], Middelburg et Van der Bom ont présenté un dernier modèle de seuil incluant le paramètre « U » représentant la constante inconnue trop souvent décrite dans les différents cas de TRALI (Figure 4). Ici, on considère la sommation inflammatoire du passé pathologique du patient (cancer hématologique, sévère pneumonie, chirurgie cardiaque...) et de la transfusion non suffisante au déclenchement du TRALI. Rentre alors en jeu la composante inconnue « U » dont l'impact suffira à dépasser le seuil de déclenchement du TRALI. Cette composante peut être génétique, ou simplement due à l'hygiène de vie du patient (consommation de nicotine, d'alcool...).

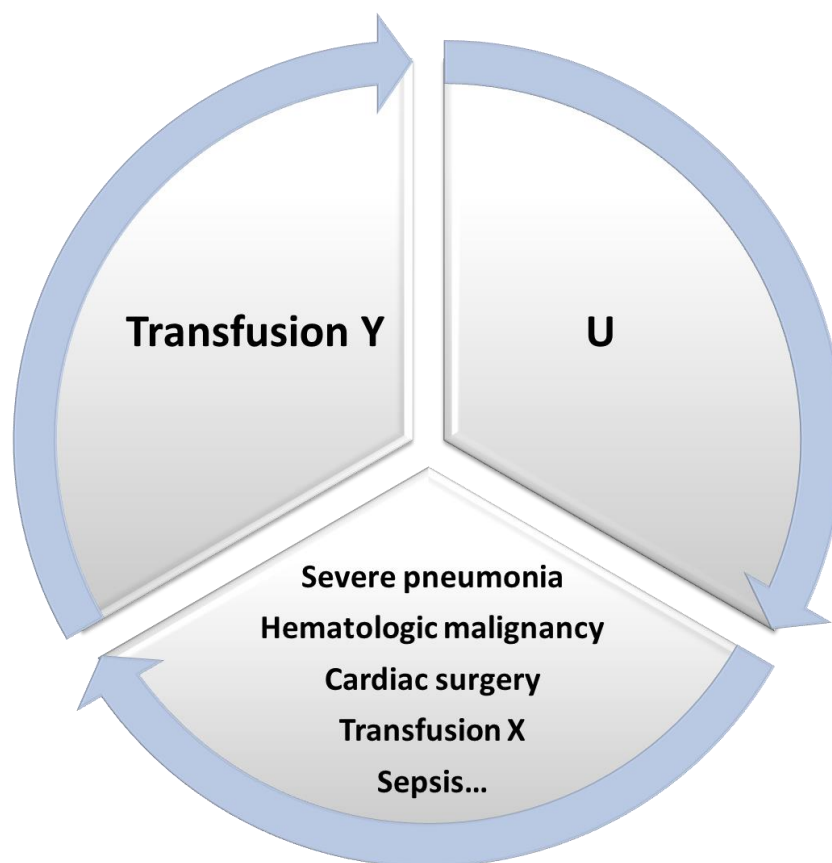

Figure 4 : Troisième modèle de seuil, inspiré de Middelburg *et al.* [22]

Ce modèle représente la part de chaque paramètre sur l'induction du TRALI. Les notions de temps et d'effet sur l'inflammation ne sont pas mentionnées. Cependant, ce modèle inclut la variante inconnue « U », représentant l'influence des caractéristiques propres aux patients.

Finalement, le principal problème rencontré, par le corps médical transfuseur, est l'absence d'un consensus officialisant et simplifiant le diagnostic de ce syndrome. La frontière, entre TRALI et ALI, est actuellement mince, ce qui sous évalue la fréquence du premier.

Section 2 – **Caractérisation du TRALI : la prévalence**

Le TRALI est décrit comme l'une des pathologies inflammatoires dont la mortalité est la plus élevée, mais avec une fréquence observée souvent très faible. Le rapport de l'ISTARE (base de données de la surveillance des Effets Indésirables Receveurs (EIR) associée aux dons de sang et à la transfusion des composés sanguins), publié en 2016 et regroupant des rapports d'hémovigilances de 25 pays entre 2006 et 2012, rapporte une fréquence d'EIR de 77,5 pour 100 000 composés sanguins transfusés. Parmi eux, 25% (soit 19,1 pour 100 000) sont dits

sévères. Parmi ces réactions transfusionnelles, 349 décès ont été répertoriés dont 58% sont attribués à l'atteinte du système respiratoire. Le TRALI serait responsable de 32,76% de ces décès liés au dysfonctionnement respiratoire. Au sein de ce rapport, le TRALI représente 1% de toutes les réactions et environ 4% des réactions dites sévères [25]. Dans des populations de patients transfusés, la fréquence du TRALI observée est très variable, pouvant aller de 0,005% à 15%. Cette valeur dépend de plusieurs facteurs : i) la cohorte étudiée (facteurs de risques plus importants dans une population de patients septiques transfusés par rapport à la population générale des individus transfusés), ii) la période (évolution des processus de préparation des produits sanguins dans le temps –par exemple, instauration de la leucoréduction dès 1998 en France [26]–) et iii) la géolocalisation (la politique transfusionnelle diffère entre les pays). Par exemple, le rapport d'hémovigilance de l'année 2015 de France, publié en 2016, fait référence à 26 cas de TRALI pour 529 204 patients transfusés, soit 0,005% [27]. *A contrario*, dans une population de 150 patients admis en unité de soins intensifs, de 2002 à 2008, pour hémorragie digestive, 22 patients ont déclaré un TRALI, soit 15% [28].

Ces résultats sont très variables et probablement sous-estimés du fait de l'absence d'un réel consensus sur le diagnostic et la terminologie du TRALI et de ses variantes (pTRALI, dTRALI). Certains ALI sont probablement des TRALI, mais faute de preuve pouvant les catégoriser tels quels, ils n'ont pas été catégorisés comme TRALI.

Section 3 – **Caractérisation du TRALI : la clinique**

Le TRALI, sous toutes ses variantes, est caractérisé par différentes manifestations dont les principales sont la dyspnée, la tachypnée et l'hypoxémie. Parallèlement, plusieurs signes peuvent accompagner ces dernières, tels que des rougeurs, une tachycardie, de la fièvre, une hypothermie, une hypotension et, très rarement, une hypertension. Enfin, des infiltrats pulmonaires bilatéraux formés d'opacités alvéolaires cotonneuses plus ou moins confluentes, pouvant aller jusqu'à l'aspect de "poumon blanc" en champ de coton bilatéral sont observables par radiographie thoracique [16] (Figure 5). Une leucoagglutinine, présente chez les donneurs impliqués, est souvent corrélée au développement du TRALI [29]. Une étude comparative entre 89 cas de TRALI et 164 contrôles transfusés sans manifestation d'œdème pulmonaire a montré que le nombre de neutrophiles circulants accroît jusqu'à 48 heures après développement du TRALI [30]. Cependant, une leucopénie transitoire peut être observée dans certains cas de TRALI [31-33]. Cette numération cellulaire est aussi accompagnée d'une relocalisation

pulmonaire des neutrophiles plus importante [34]. Le devenir des plaquettes sanguines semble différent. En effet, plusieurs cas de thrombopénie ont été rapportés dans la littérature et ce jusqu'à 6 heures après le début de la transfusion [35, 36]. De façon plus générale, au sein d'une cohorte de patients transfusés, la chute du compte plaquettaire semble être une conséquence à l'induction du TRALI [30].

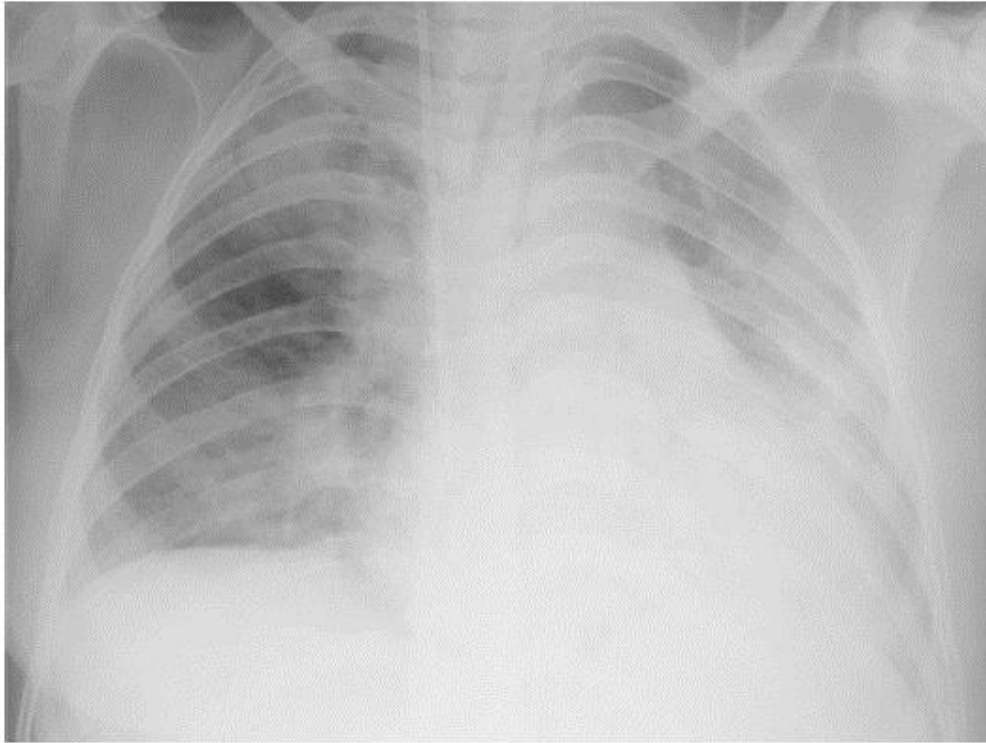

Figure 5 : Radiographie de poumons d'un patient ayant développé un TRALI, d'après Ilango *et al.* [37]

La manifestation d'un état inflammatoire, pré- et posttransfusionnel, chez les patients développant un TRALI est une conséquence quasiment inéluctable. Plusieurs études ont analysé la libération de facteurs solubles pro et/ou anti-inflammatoires circulants et pulmonaires chez des patients ayant déclaré un TRALI (Tableau 1). De façon générale, plusieurs de ces cytokines ont été mises en évidence chez des patients développant un ALI/SDRA, à la fois dans le compartiment pulmonaire, mais également périphérique. Nous pouvons effectivement citer l'IL-1 β , TNF- α (Tumor Necrosis Factor- α), IL-8 ou encore IL-6 [38, 39]. Dans le cas plus précis des TRALI, la concentration des principales cytokines inflammatoires, telles qu'IL-6 [34, 40], IL-8 [30, 34, 40] ou IL-1 β [34, 41] est le plus souvent augmentée, à la fois dans le compartiment vasculaire et pulmonaire. L'augmentation de cytokines anti-inflammatoires a aussi été constatée. C'est le cas d'IL-10 ou d'IL-1RA (antagoniste d'IL-1 β), ce qui évoque l'établissement d'une réponse protectrice de la part de l'organisme, dont le but est de réguler cet excès inflammatoire caractéristique du TRALI [30].

Tableau 1 : Evolution des cytokines inflammatoires chez les patients TRALI

Authors	Populations	Vascular compartment		Pulmonary compartment	Soluble mediators	Vascular compartment		Pulmonary compartment
		Pre-TRALI	Post-TRALI	Post-TRALI		Evolution	Final difference vs. control	Final difference vs. control
Vlaar [34]	Cardiac surgery patients	X	X	X	IL-6	Increase after surgery and don't change after TRALI	No difference	Higher than control
					IL-8	Increase after surgery and decrease after TRALI	No difference	Higher than control
					IL-1 β	No change	No difference	Higher than control
					EA	Increase after surgery and decrease after TRALI	No difference	Higher than control
					TATC	Increase after TRALI	Higher than control	Higher than control
					PAA	Decrease after TRALI	Lower than control	Lower than control
					PAI-1			Higher than control
Looney [30]	Transfused patients	X	X		IL-6	Increase after TRALI	No difference	
					IL-8	Increase after TRALI and pTRALI	Higher than control	
					IL-10	Increase after TRALI and pTRALI	Higher than control	
					IL1-RA	Increase after TRALI	Higher than control	
Müller [41]	Cardiac surgery patients		X	X	sRAGE		No difference	No difference
					HMGB1			No difference
					S100A12			Higher than control but not significant
					IL-1 β			Positively correlated with S100A12 increase
					IL-6			Positively correlated with S100A12 increase
					IL-8			Positively correlated with S100A12 increase
					TNF- α			Positively correlated with S100A12 increase
Roubinian [40]	Transfused patients	X	X		IL-6	Increase after TRALI (2.7 fold increase)	Higher than control (pre-TRALI)	Higher than control (post-TRALI)
					IL-8	No change	Higher than control (pre-TRALI)	Higher than control (post-TRALI)
					IL-10	Increase after TRALI (1.75 fold increase)	No difference	No difference
					TNF- α	No change	No difference	No difference
					GM-CSF	No change	No difference	No difference
Kapur [42]	Transfused orthopedic surgery patients		X		CRP		Higher than control	
Kapur [43]	Transfused patients		X		IL-10		No difference	

Chapitre 3 – Transfusion-Related Acute Lung Injury : transfusion, plaquettes et modificateurs de la réponse biologique (BRM)

Les plaquettes sanguines sont des cellules de l'inflammation [44], bien que la seule fonction qui leur a été longtemps accordée fût un rôle dans l'hémostase et la thrombose. Le but de cette revue est de mettre en évidence le rôle inflammatoire des plaquettes sanguines –celles présentes dans les concentrés plaquettaires et celles présentes dans l'organisme– et leur possible influence dans le développement d'un œdème pulmonaire aiguë transfusionnel, le TRALI. Dans un premier temps, les différentes hypothèses émises sur la physiopathologie du TRALI immunologique vous seront présentés. Ensuite, l'hypothèse reposant sur une induction de « second-hit » du TRALI non immunologique régulée par les BRM secrétés par les plaquettes pendant la conservation des concentrés plaquettaires (CP) sera évoquée. Finalement, le rôle des plaquettes de l'organisme au sein de la physiopathologie des TRALI immunologiques et non-immunologiques sera discuté, en particulier au sein de modèles expérimentaux.

Ce travail de synthèse ayant été publié en 2016, une mise à jour bibliographique figure à la suite de cette revue pour référer de l'avancée des recherches se concentrant sur l'impact i) des médiateurs solubles des concentrés plaquettaires sur l'endothélium vasculaire et iv) des plaquettes sanguines de l'organisme sur le devenir de l'ALI/TRALI.

Erratum « Transfusion-related acute lung injury: transfusion, platelets and biological response modifiers »: ICAM-1 exprimé à la surface de l'endothélium et Mac-1 (β2 intégrine ou CD11b/CD18) exprimé à la surface des neutrophiles.

REVIEW

Transfusion-related acute lung injury: transfusion, platelets and biological response modifiers

Sofiane Tariket^a, Caroline Sut^a, Hind Hamzeh-Cognasse^a, Sandrine Laradi^{a,b}, Bruno Pozzetto^a, Olivier Garraud^{a,c} and Fabrice Cognasse^{a,b}

^aUniversité de Lyon, Saint Etienne, France; ^bEtablissement Français du Sang - Rhône-Alpes-Auvergne, Saint-Etienne, France; ^cINTS - Institut National de la Transfusion Sanguine, Paris, France

ABSTRACT

Transfusion-related acute lung injury (TRALI) may be induced by plasma, platelet concentrates and red blood cell concentrates. The mechanism leading to TRALI is thought to involve two steps. The priming step consists of previous inflammatory pathological conditions or external factors attracting leukocytes to lung vessels and creating conditions favorable for the second step, in which anti-HLA or anti-HNA antibodies or biologically active lipids, usually in transfused blood products, stress leukocytes and inflame lung epithelia. Platelets may be involved in the pathogenesis of TRALI because of their secretory potential and capacity to interact with other immune cells. There is no drug based-prophylaxis, but transfusion strategies are used to mitigate the risk of TRALI.

ARTICLE HISTORY

Received 4 January 2016
Accepted 5 February 2016
Published online
23 February 2016

KEYWORDS

Platelet; inflammation; biological response modifiers; TRALI; transfusion

Background

One of the most serious complications of blood component transfusion is transfusion-related acute lung injury (TRALI) [1], an acute lung injury (ALI) occurring within 6 h of blood product transfusion [2]. TRALI is characterized by pulmonary edema after blood component transfusion, especially after plasma-derived drug injection, and by respiratory distress, including dyspnea, tachypnea, and hypoxemia. Other TRALI symptoms include rigor, tachycardia, fever, hypothermia, and hypotension, with hypertension being rare [3]. Among the risk factors that create conditions favoring TRALI development [4] is a history of inflammatory pathology [5,6], including sepsis. Nevertheless, sepsis can be considered as an inductor of acute respiratory distress syndrome (ARDS); in this case, we refer to an ARDS related to a sepsis and not a TRALI [7]. Several investigations highlighted a more important incidence of TRALI in ICU patients than on healthy subjects [8,9]. Blood components that can trigger TRALI include plasma [2], red blood cell (RBC) concentrates [10,11] and platelet concentrates (PCs) [12]. Differences in the processing and storage of plasma and cellular blood products may alter the hemodynamic characteristics of blood, suggesting that some of these conditions are associated with the development of TRALI [13–15].

The 'Two-hit' model

TRALI can be described as being induced by a 'two-hit' model (Figure 1), first proposed by Van Buren in 1990. The first hit consists of priming, in which polymorphonuclear (PMN) are preactivated [16]. Priming is essential for inducing the expression of adhesion molecules on endothelial cells and

neutrophils. CD62P and CD62E on endothelial cells and PSGL-1 on neutrophils interact with peripheral granulocytes, whereas the expression of other molecules such as β 2-integrin on endothelium and ICAM-1 on neutrophils results in intrapulmonary leukostasis [17,18].

The second event occurs when neutrophils are attracted into the alveolar space and after transfusion of antibodies or blood components. In more than 85% of patients, TRALI episodes are triggered by antibodies, whereas in the remaining patients, TRALI is induced by activator lipids present in stored blood components [22,26]. Pulmonary endothelium may be damaged by oxidation radicals and lysosomal enzymes secreted by priming neutrophils [27]. Pulmonary edema and fluid intrapulmonary infiltration may then cause hypo-oxygenation, which may even be fatal.

Antibody-mediated TRALI

TRALI may be induced by immune incompatibility between reactive antibodies in donor plasma and target antigens on recipient leukocytes. Three main types of antibodies have been described, to human leukocyte antigen (HLA) classes I and II, and human neutrophil alloantigen (HNA) [28,29]. Antibodies to HLA classes I and II have been detected in 59% and 30–56% of donor plasma in patients who developed TRALI, whereas the prevalence of anti-HNA antibodies, to HNA-1, HNA-2, and HNA-3, has been reported to range between 3% and 33% [29]. Anti-HLA class I antibodies target neutrophils, endothelial cells [3,30], and platelets [31]; anti-HLA class II antibodies target monocytes [32] and especially macrophages [33]; and anti-HNA antibodies, primarily anti-HNA-3a [34,35], target neutrophils and endothelial cells [36].

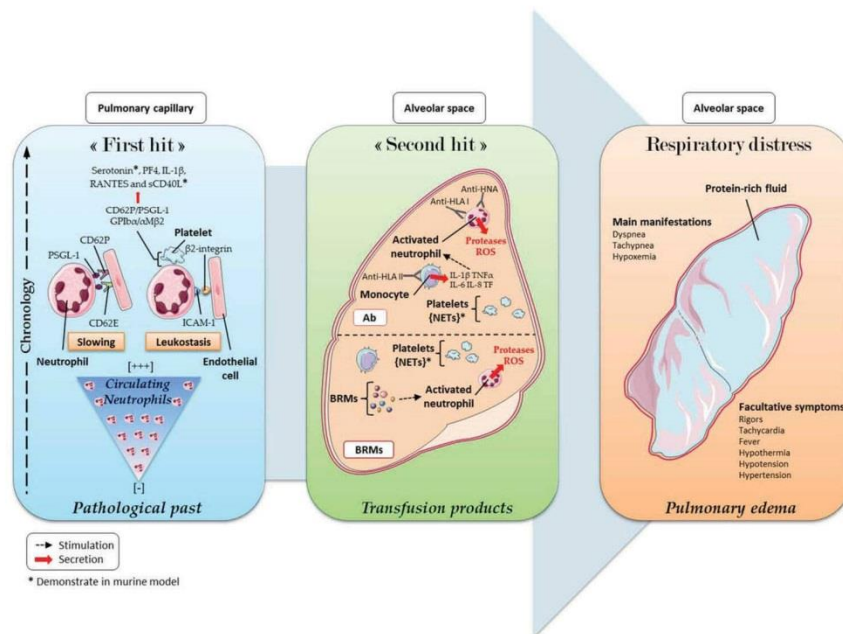

Figure 1. Pathophysiology of “two-event”-mediated TRALI. TRALI is regarded as a “two-hit” model [3]. The first event is pre-activation of polymorphonuclear leukocytes in response to a previous pathology [5]. Adhesion molecules, such as PSGL-1 and ICAM-1 on neutrophils, CD62E, CD62P and β 2-integrin on endothelial cells and CD62P on platelets, are expressed and promote cell-cell interactions [17–21]. These interactions induce neutrophil migration into the alveolar space. The second event is induced by the transfusion of blood products containing factors such as antibodies and/or BRMs [22]. Leukostasis into the alveolar space is accentuated, neutrophils are activated, NETs are formed and pro-inflammatory BRMs and enzymes are secreted [23,24]. Respiratory distress and protein-rich edema fluid are characteristic of TRALI [25].

Abbreviations: BRM, biological response modifier; CD, cluster differentiation; GP, glycoprotein; ICAM, intercellular adhesion molecule; IL, interleukin; NET, neutrophil extracellular trap; PF, platelet factor; PSGL, P-selectin glycoprotein ligand; RANTES, regulated on activation, normal T cell expressed and secreted; ROS, reactive oxygen species.

HLA-A2 (HLA class I) is the HLA antigen most frequently implicated in TRALI, probably because it has allele frequencies of 0.249 in the United States and 0.276 in Europe, as determined by the Allele Frequency Net Database. Expression of HLA-A2 on cell membranes is greater in subjects homozygous than heterozygous for this gene, increasing the interactions of the former with anti-HLA-A2 antibodies [37]. A higher concentration of anti-HLA-A2 antibodies in blood components thus can result in the development of lung injury in HLA-A2 homozygous recipients [38]. This reaction activates the complement system and PMN cells, with the latter being responsible for damage to the endothelium and the induction of ALI [39].

In contrast to anti-HLA class I antibodies, anti-HLA class II antibodies interact with monocytes rather than with neutrophils [40]. This induces the production of proinflammatory biological response modifiers (BRMs), including interleukin (IL)-1 β , tumor necrosis factor (TNF)- α , IL-6, IL-8, and tissue factor (TF), resulting in the secondary activation of neutrophils [3,41].

Anti-HNA-3a antibody induces more severe TRALI than anti-HLA class I and class II antibodies [34,35]. The antigen frequency of HNA-3a in European populations is greater than 89% [42], enabling anti-HNA-3a to act directly on neutrophils and endothelial cells in these subjects. Anti-HNA-3a has been shown to interact directly with choline transporter-like protein 2 (CTL-2) on the endothelial cell surface [43]. TRALI induction with anti-HNA-3a antibody is associated with neutrophil

aggregation and infiltration into the lungs reinforced by serine protease activity [44].

Non-antibody-mediated TRALI

Can TRALI be induced in the absence of antibodies?

Although antibodies to HLA classes I and II and to HNA-3a have been associated with the development of TRALI in most patients, these antibodies are undetectable in some patients. For example, a study of 28 patients with TRALI, each transfused with two units of PCs obtained from apheresis, followed by leukoreduction, found that only seven of these patients were positive for anti-leukocyte antibodies [45]. Antibodies in the other 21 patients may have been present but undetectable, because of the dosing method or their absorption onto lymphocytes or platelets, and other cell types [46]. Triggering antibodies have been detected in up to 89% of patients with TRALI [22]; we can hypothesize that in the other 11%, TRALI may have been triggered by proinflammatory BRMs, an evoked track but still unclear [47].

Can BRMs take over the entire responsibility for TRALI?

An alternative hypothesis for the induction of TRALI has been proposed. According to this hypothesis, TRALI may be induced by an accumulation of proinflammatory mediators (bioactive

lipids or cytokines/chemokines) released by cells during storage or already present in donor blood [3]. Transfusions into naïve recipients of PC or fresh frozen plasma (FFP) from donors whose blood cells (BCs) had been primed for TRALI do not, in general, induce respiratory syndrome. One study reported that 103 patients who underwent transfusions of FFP or PC from implicated donors did not develop TRALI [48]. All of these patients expressed HLA antigen that bound to donor antibodies, with some having already experienced the first hit, caused by a hematologic malignancy, surgery, or infection. These results suggest that the 'two-event' model of TRALI is more complex than initially thought. The second event likely needs, at least in part, a BRM that complements the antibodies.

Many studies have observed correlations between the age of blood components and the incidence of TRALI. For example, the age of RBC concentrates was found to correlate with transfusion risk factors [5]. A comparison of patients with and without TRALI showed that the age of platelet components was higher in the TRALI than in the control group and that the risk of TRALI increased as storage time increased, with relative risks of 5.8 after 4–5 days and 6.8 after 6–7 days [15]. Experiments in a rat model showed that TRALI was induced after transfusions of platelet-rich plasma and apheresis PC [49]. However, TRALI was induced only by platelets that were stored for 5 days, whereas the transfusion of fresh platelets had no effect on lung function in rats. In contrast, the length of storage of RBC concentrates did not differ between control and TRALI groups [15].

The mechanism by which TRALI is induced by blood components with undetectable antibodies is unclear. Actually, it is known that some BRMs can induce adhesion molecule expression on PMNs and chemoattracting conditions, activities more specific of the first hit of TRALI. Nevertheless, the capacity of BRMs to activate directly PMNs, means a release of the microbicidal arsenal by them to initiate the second event of TRALI, remains unclear. A study compares two mouse models of TRALI, an immune model induced by an anti-HNA-2 antibody and a nonimmune model related to platelet-activating factor stimulus, and confirms that these two models are efficient to induce a respiratory distress [50].

Why do platelet components have a high likelihood of causing TRALI?

Platelets secrete a large array of immunomodulating BRMs, depending on their activation profile and storage time. Thus, platelets have been implicated in acute transfusion reactions (ATRs) and TRALI development.

Because their secretory capacity can cause immunological differences

Binding of exogenous activators to membrane-bound proteins on platelets can induce secretion from platelet granules, with different pathways involved in the secretion of different granules. The most abundant granules in platelets are the α -granules, which contain a large number of immunomodulatory cytokines and chemokines, including PF4, β -thromboglobulin,

MIP1- α , and RANTES, which have proinflammatory function [51]. Other granules include dense granules, which store ADP, ATP, calcium, serotonin, pyrophosphate, magnesium, polyphosphate, and, perhaps, histamine; and T-granules, which have been implicated by the expression of TLR9, an immune system receptor, and are activated by the binding of type IV collagen to the platelet surface [52].

Platelets secrete large numbers of immunomodulatory factors, with secretion being dependent on stimulation signals. Platelet surface receptors include immune system receptors, including TLRs 1–7 and 9 [53], Fc receptors recognizing immunoglobulin [54], and CD40 [55]. Platelets also express receptors for thrombin (i.e. PAR1, 3, and 4), ADP (i.e. P2Y₁ and P2Y₁₂), and TxA₂ (i.e. TP- α and TP- β), which, when bound by their respective ligands, promote aggregation and BRM secretion [56]. Finally, platelets can be activated by direct contact with other cells. For example, platelets can interact with neutrophils through CD62P, with B cells via pattern recognition receptors, with T cells via CD40/CD40L complexes and with endothelial cells and erythrocytes through integrin receptors [57]. Depending upon the activation signal, platelets can secrete various proinflammatory factors, with some likely involved in TRALI. These include chemokines that can attract and activate neutrophils and permeabilize the endothelial layer. For example, platelets secrete the chemokines TGF- β , PDGF, VEGF, Ang-1, IL-1, RANTES, MIP-1 α , β -thromboglobulin, Gro- α , ENA-78, MCP-3, PF4, and SDF-1 [58,59], all of which have been implicated in inflammation. Recently, new characteristics are used to describe platelets, cells of immunity and inflammation [60].

Because their BRM secretion patterns change during storage

Storage of blood components can result in the secretion of several proinflammatory BRMs and activator lipids, suggesting that storage may be involved in the pathogenesis of TRALI, although this has not been confirmed [15]. Soluble mediators are also secreted during platelet storage, with different BRMs being regulated in association with the storage of platelet concentrates (Table 1).

sCD40L is often investigated in stored platelets because this protein can directly activate PMNs by interacting with membrane-bound CD40. Several studies have shown that sCD40L levels are increased during platelet storage [12,13,62,71,72]. Some lipids, such as lyso-PCs, which are present in stored platelets, were found to induce TRALI. Lyso-PC concentrations are significantly higher on day 1 than on day 0 of PC storage, remaining high through day 6 [67]. However, Vlaar AP et al. [75] demonstrated that lyso-PCs did not accumulate during the routine storage of prestorage leukoreduced (buffy coat removal) RBCs (LR-RBCs) in SAGM, 42 days at 2–4°C, and did not evidence priming activity using a 30-min neutrophil (PMN) priming assay in which the respiratory burst was measured in the presence of the plasma or plasma fraction of the stored component. However, if plasma was added to the LR-RBCs, then there was a significant increase in lyso-PCs on day 1 that did not increase over the storage interval. In addition, PCs, stored in plasma, did evidence lyso-PC accumulation

Table 1. Changes in BRMs during storage.

BRM	Function	Change	Article
EGF	Mitotic activity	Increases during PCs storage	Tung et al. 2012 [13]
ENA-78	Neutrophil chemotaxis	Increases during PCs storage	Tung et al. 2012 [13]
Gro- α	Neutrophil chemotaxis/mitogenic properties	Increases during PCs storage	Tung et al. 2012 [13]
IL-1 β	Proinflammatory properties	Increases during PCs storage	Stack et al. 1994 [61]
IL-6	Proinflammatory properties	Increases during PCs storage	Cognasse et al. 2006 [62]
		Increases during platelet-rich plasma PCs storage	Wadhwa et al. 1996 [63]
IL-7	Survival/development/homeostasis of cells B, T, and NK.	Increases during PCs storage	Shanwell et al. 2003 [64]
IL-8	Neutrophil chemotaxis	Increases during PCs storage	Apelseth et al. 2006 [65]
		Increases during storage of platelet-rich plasma and buffy coat PCs	Stack et al. 1994 [61]
			Wadhwa et al. 1996 [63]
IL-27	Anti- and proinflammatory properties	Increases during PCs storage	Hamzeh-Cognasse et al. 2014 [66]
Lyso-PCs	Apoptosis	Increases during PCs storage	Maslanka et al. 2012 [67]
MPs	Proinflammatory properties	Increases during PCs storage	Böing et al. 2008 [68]
sOX40L	Proinflammatory properties	Increases during PCs storage	Hamzeh-Cognasse et al. 2014 [66]
PAI-1	Fibrinolysis inhibitor	Increases during apheresis PCs storage	Edvarsen et al. 2001 [69]
PDGF-AA	Cell proliferation	Increases during PCs storage	Cognasse et al. 2006 [62]
PF4	Blood coagulation	Increases during PCs storage	Shanwell et al. 2003 [64]
			Apelseth et al. 2006 [65]
RANTES	Leukocyte chemotaxis	Increases during PCs storage	Shanwell et al. 2003 [64]
			Apelseth et al. 2006 [65]
			Fujihara et al. 1999 [70]
sCD40L	Costimulatory function	Increases during PCs storage	Cognasse et al. 2006 [62]
			Khan et al. 2006 [71]
			Sahler et al. 2012 [72]
			Tung et al. 2012 [13]
			Xie et al. 2014 [12]
			Hamzeh-Cognasse et al. 2014 [66]
			Cognasse et al. 2006 [62]
TGF- β	Cell proliferation	Increases until day 3 and returns to basal level on day 5 during PCs storage	
		Increases during PCs storage	Apelseth et al. 2006 [65]
			Fujihara et al. 1999 [70]
			Wadhwa et al. 1996 [63]
		Increases during storage of platelet-rich plasma, and buffy coat and apheresis PCs	
TNF- α	Proinflammatory properties	Increases during PCs storage	Muylle et al. 1993 [73]
VEGF	Vasculogenesis/angiogenesis	Increases during storage of apheresis and buffy coat PCs	Edvarsen et al. 2001 [69]
		Increases during apheresis PCs storage	Maloney et al. 2014 [74]
β -TG	No definite biological function	Increases during PCs storage	Shanwell et al. 2003 [64]

during routine storage, 7 days at 20–24°C, and the plasma fraction primed the PMN oxidase after 30 min. Also, further studies are necessary to delineate the complete nature of bioactive lipids that accumulate during the routine storage of cellular components, because detection of bioactive lipids from stored cellular blood components seems dependent of *in vitro* method quantification [76].

Some proinflammatory and regulatory BRMs are secreted preferentially during platelet storage. For example, sCD40L and PDGF-AA are significantly increased, beginning on day 4, and IL-6 is increased, starting on day 5. In contrast, the concentration of the anti-inflammatory TGF- β is significantly higher on days 2 and 3 but returns to baseline on day 5, probably because of a modification of functional structure that induces a loss of detectability [62]. Other proinflammatory BRMs, such as RANTES, β -TG, PF4, and IL-7, are positively regulated during platelet storage [64]. Storage of PC also increases the concentrations of RANTES, PF4, and IL-8 significantly; moreover, TGF- β concentration is increased throughout storage, with no reduction after 4 days [65]. In addition, the concentrations of RANTES and TGF- β 1 were found to increase during storage of both filtered and unfiltered platelets [70].

The concentrations of several inflammatory mediators were found to correlate with platelet storage. For example, IL-8 concentrations increase significantly with longer storage time and IL-1 β concentrations are significantly higher in some PCs during storage [61]. Moreover, IL-6, IL-8, and TGF- β concentrations increased during storage of platelet-rich plasma, IL-8 and TGF- β concentrations increased during storage of buffy coat PCs, and TGF- β concentrations increased during storage of apheresis PCs, with all positively correlated with storage time [63]. However, comparative studies are required to determine the effects of different types of platelet preparations (e.g. platelet-rich plasma, buffy coat PCs, and apheresis PCs) on cytokine levels.

More recently, newly discovered BRMs were investigated in stored platelets. For example, the concentrations of sCD40L, EGF, ENA-78, and Gro- α were found to increase during platelet storage [13]. In addition, the concentration of plasminogen activator inhibitor (PAI-1), a component secreted by platelets, was found to depend on the length of PC storage time. PAI-1 concentration in apheresis PCs was found to increase daily for 6 days, whereas VEGF concentrations in buffy coat and apheresis PCs were found to increase daily for 7 days [69]. These results were confirmed by a study showing that VEGF

concentration correlated with the duration of apheresis PC storage, being significantly higher on day 4 than on day 0 [74].

Because some platelet BRMs are correlated with ATRs

As platelets regulate some of the adverse effects of transfusion, studies have focused on platelet BRMs in post-transfusion reactions. Grade 3 ATRs have been associated with twofold increases in sCD40L, IL-27, and sOX40L concentrations, all of which interact with B and T lymphocytes, in transfused platelet components compared with controls [66]. A predictive model, based on platelet BRM concentrations in single-donor apheresis platelet preparations, has been used to estimate the risks of developing an ATR. For example, an sCD40L concentration >289.5 pg/ 10^9 platelets has been associated with risks of (i) febrile non-hemolytic transfusion reactions (FNHTR) if the MIP-1 α concentration is >20.4 pg/ 10^9 platelets and (ii) atypical allergic transfusion reactions (AATR) if the MIP-1 α concentration is <20.4 pg/ 10^9 platelet. The concentration of IL-13, similar to sCD40L, is predictive of ATR. An IL-13 concentration >0 has been associated with risks of (i) FNHTR if the MIP-1 α concentration is >20.4 pg/ 10^9 platelets and (ii) AATR if the MIP-1 α concentration is <20.4 pg/ 10^9 platelets [77].

Platelet mitochondria and mitochondrial DNA (mtDNA) have been found to induce proinflammatory signals in response to platelet production of sPLA2-IIA. Platelet sPLA2-IIA can interact with platelet mitochondrial membranes, hydrolyzing the sn-2 acyl moiety on glycerophospholipids and inducing fatty acid and lysophospholipid production [78]. In addition, sPLA2-IIA was found to interact with extracellular mitochondria, inducing membrane hydrolysis and resulting in the secretion of fatty acids, lysophospholipids, and mtDNA. These extracellular mitochondria interact with neutrophils, with neutrophil activation requiring the presence of sPLA2-IIA. The simultaneous presence of extracellular mitochondria, sPLA2-IIA, and neutrophils induces the formation of neutrophil extracellular traps (NETs), which consist of extracellular fibers from neutrophil DNA composed of histones and antibacterial molecules. Finally, reactive oxygen species (ROS) expression is necessary for membrane denaturation, promoting immediate DNA decondensation under the control of PAD4 [79,80]. Of note, sPLA2 activity is a potential activator of PMNs to promote a release of superoxide and elastase by them [81] and is regulated with ARDS syndrome development [82]. The concentrations of free mitochondria and mitochondria encapsulated in PMPs are significantly increased during PC storage, and mtDNA is significantly more concentrated in PCs implicated in ATRs than in control PCs [83]. mtDNA is normally present in RBCs, FFP, and PCs [84]. We recently reported that mtDNA does not associate with several BRMs, suggesting that the role of mtDNA in PC transfusion-linked inflammation is independent of BRMs and that mtDNA is associated with adverse effects of transfusion [85].

All of these BRMs could be also directly or indirectly implicated in TRALI mechanism, but we cannot extrapolate these results in TRALI because TRALI is neither a severe form nor a consecutive form of other ATRs.

Several reports presented evidence that stored platelets contain immunomodulatory molecules, such as cytokines and chemokines, and secrete them differentially over time during storage before their transfusion. sCD40L in platelet transfusion is a candidate mediator of acute lung injury and other inflammatory conditions [86]. sCD40L accumulates in stored blood components, primes neutrophils through CD40, and is a potential cofactor in the development of TRALI [71]. Of note, we performed coculture of homologous platelets and PBMNCs for 48 h, which is the time required to increase the PBMNC marker of expression *in vitro* and we observed clear effect of platelets on PBMNC pathophysiology [87]. We also showed that platelets are active elements of the immune system that might play a role in balancing the ability of DCs to polarize T-cell responses, therefore making them critical factors in transfusion processes [88]. Finally, there are evidence of *in vitro* binding of IL-27 and sOX40L in ATR-related platelet component to their receptors on B and T cells [89].

Several tracks already mentioned in TRALI

Although platelets contain considerable numbers of BRMs, the secretion of which is dependent on conditions such as storage length and stimuli, the involvement of these BRMs in TRALI remains unclear. Although several studies found that storage time correlated with the development of TRALI, other studies showed no difference in the induction of TRALI between fresh and older blood components. Nevertheless, many BRMs were suspected as being activators and/or modulator of TRALI.

Soluble CD40 ligand (sCD40L), which is mainly secreted by platelets [62,90], can directly activate neutrophils by interacting with membrane CD40 [91]. sCD40L also targets other cells, including monocytes, endothelial cells, and lymphocytes. For example, sCD40L induces monocyte secretion of MIP-2, a chemoattractant for neutrophils [92]. Moreover, a supernatant containing sCD40L has a greater ability to induce the secretion of proinflammatory mediators, such as IL-6, cyclooxygenase-2 (COX-2), and prostaglandin E2, from pulmonary fibroblasts than a supernatant that does not contain sCD40L [93]. However, the direct involvement of sCD40L in the pathogenesis of TRALI remains unclear. Although studies have shown that sCD40L concentrations are higher in PCs associated with TRALI than in control PCs [12,71]. In contrast, inhibitors of sCD40L expression, including ciglitazone, and an inhibitor of CD40/sCD40L interactions were unable to prevent severe TRALI induced by a high concentration of anti-MHC I antibody (4.5 mg/kg) in a murine model [94]. sCD40L may be a key to TRALI prevention, being an essential mediator of interactions among endothelial cells, PMNs, and platelets.

Platelet-microparticle (PMP) formation results from activation induced by several stimuli, including collagen, thrombin, epinephrine, adenosine diphosphate, and the ionophore A23187 [95], and is stimulated by *ex vivo* preparation and storage of blood components used for transfusion [96]. Increased PMP formation has been reported to contribute to the inflammatory activity of platelets in various clinical conditions [97]. The contributions of PMPs to the inflammatory process are well documented. For example, the release of PMPs increases under inflammatory conditions [98]. PMPs upregulate neutrophil

activation [99] and the synthesis of numerous proinflammatory enzymes and active proinflammatory soluble mediators in non-immune and immune cells [100,101]. PMPs contain high levels of amino phospholipids, which are substrates for phospholipase A2 and are thus associated with the production of lysophosphatidic acids that influence the platelet inflammatory process. PMPs support the transcellular transport of arachidonic acid, increasing the expression in endothelial cells of COX-2 and intracellular adhesion molecule (ICAM)-1, which regulate the interface between vascular cells and platelets [102–104]. Moreover, arachidonic acid in PMPs is involved in platelet aggregation and the interactions of platelets with immune and nonimmune cells, including PMNs and endothelial cells, which are essential in ALI [105]. The activation and aggregation of PMPs directly stimulate neutrophils [106]. TF-containing MPs, which are secreted primarily by alveolar epithelial cells, but also by endothelial cells, macrophages, and platelets, are increased in the alveolar space of patients with ALI/ARDS. TF in MPs is a procoagulant factor, which can contribute to fibrin formation in alveolar space, a characteristic of ALI pathogenesis [107].

Vascular endothelial growth factor (VEGF) from platelets can induce endothelial permeability. This characteristic may also have potential for the resolution of TRALI. Although secreted by platelets, VEGF is not present in white BCs lysed in apheresis PCs. VEGF increases the endothelial permeability of isolated rat lungs, as shown by ¹²⁵I-albumin infiltration [74]. Endothelium permeability plays a key role in TRALI pathogenesis, suggesting that factors regulating permeability may be a potential target to prevent TRALI.

Von Willebrand factor (vWF) is a potential target in the treatment of TRALI as it has been associated with anti-HNA-3a antibody-induced TRALI. Anti-HNA-3a antibodies are the most frequently detected anti-HNA antibodies in TRALI patients, with this antigen expressed on neutrophils, monocytes, lymphocytes, platelets, and pulmonary endothelium. HNA-3a antigen is located on CTL-2, a 70–95 kDa glycoprotein coded by the SLC44A2 gene. Anti-HNA-3a antibodies form a complex with vWF, CTL-2, and Mac-1 on neutrophils and induce neutrophil agglutination and ROS production, which are responsible for pulmonary edema in TRALI. Neutrophils expressing HNA-3a are agglutinated by anti-HNA-3a antibodies, together with vWF secreted by platelet α -granules and Weibel–Palade bodies in endothelial cells. This *in vitro* agglutination is in the range of the negative control in patients with type 3 von Willebrand disease (complete absence of vWF production). Moreover, injection of anti-HNA-3a antibodies induced less severe TRALI in vWF^{-/-} than in control mice [108].

Thromboxane A₂ (TXA₂) is produced from arachidonic acid by COX-1 and can induce endothelial permeability. Moreover, TXA₂ has been implicated in ALI [109] and TRALI. Treatment of TRALI patients with aspirin was found to reduce disease severity and mortality, as well as to reduce TXA₂ concentration via inhibition of COX-1 [110]. Platelets seem to be an inexhaustible source of factors that target key actors in TRALI. Products secreted by platelets are involved in endothelium permeabilization, PMN activation, and other steps. Targeting platelets may, therefore, prevent the induction of TRALI, as BRMs from platelets and other cells are involved in TRALI pathogenesis [47]. Even if the mechanism of antibody-mediated TRALI was clearer, the effect of BRMs cannot be reduced.

Platelet directly migrate and cooperate in induction of TRALI

Platelets can migrate into the lungs, express membrane-bound proteins, and secrete proinflammatory BRMs. Moreover, platelets can also be produced directly in the lungs; this phenomenon is referred to as the pulmonary megakaryopoiesis [111]. In several murine models, platelet migration into the alveolar space increased with TRALI development. Microscopic examination showed that platelet migration occurs during the development of TRALI [23] and ALI [109]. Platelet sequestration in the lungs has been observed in patients with ARDS [112], with platelet transmigration into the alveolar space shown to result in thrombocytopenia [23]. Platelets can migrate into the lungs, either alone or complexed with neutrophils.

Platelets can interact directly with neutrophils to promote their activation [113,114]. Several membrane-bound proteins expressed on platelets are involved in the formation of platelet/neutrophil complexes. For example, the interaction between CD62P on platelets and PSGL-1 on neutrophils is responsible for inducing an activation signal [19–21]. This interaction, in turn, induces neutrophils to express Mac-1, which binds GPIIb on platelets [115,116]. In response to this activation cascade, platelets secrete serotonin, PF4, IL-1 β , RANTES, and sCD40L, which enhance neutrophil activation [117,118]. The interaction between platelets and neutrophils is regarded as an important step during TRALI development, as well as being responsible for NET formation. This, in turn, results in associations between nucleic acids and azurophilic granules containing histones, pentraxin, MMP-9, PRP-1, and lactoferrin [119–123]. Lipopolysaccharide (LPS)-induced platelet stimulation via membrane-bound TLR4, for example, during the priming step of TRALI, can induce platelet/neutrophil aggregates and NET formation [124,125]. This pathway indirectly causes positive feedback for platelet activation. Histones present in NETs amplify the production of thrombin, the most effective platelet activator, via TLR2 and TLR4 receptors [126]. Histone binding to the GPIIb-A1 domain on vWF attracts platelets into NETs [127], which have been implicated in the pathogenesis of TRALI [128]. The binding of platelets activated by LPS or thrombin and neutrophils was shown essential for NET formation, with these NETs inducing pulmonary endothelium permeability in the lungs of TRALI mice [24]. NETs, which originally have a protective role against bacterial infections, may, if formed at the wrong time, have significant, sometimes irreversible, consequences by being involved in TRALI.

Examples of experimental models of platelet BRM in acute lung injury

Using of neutralizing antibodies and antagonist/agonist BRMs targeting platelet should be a track to prevent pulmonary edema development. Several mouse models were used to focus on the different steps of TRALI and on ALI induced through direct injury as well as acid, LPS, or mechanical ventilation stimuli (Table 2). Nevertheless, mechanical ventilation and acid stimuli are a direct induction of ALI, whereas the second event of TRALI is an indirect action. Consequently, it is

Table 2. Different mouse models focus on platelet BRMs to prevent TRALI and ALI.

	ALI				TRALI			
	Injury	Mice	Authors	Effect	Injury	Mice	Authors	Effect
Knock-out models	Mechanical ventilation	CD62P ^{-/-}	Yiming et al. 2008 [129]	Inhibition of platelet/endothelial cell communication	LPS and anti-MHC I	TLR4 ^{-/-}	Looney et al. 2009 [23]	Protection against TRALI
	Acid	PSGL ^{-/-}	Looney et al. 2009 [23]	No inhibition of lung injury				
	Acid	CD62P ^{-/-}	Zarbock et al. 2006 [109]	Protection against ALI				
	LPS; acid; CLP	RANTES ^{-/-}	Grommes et al. 2012 [130]	Protection against ALI	LPS and anti-HNA-3a	vWF ^{-/-}	Bayat et al. 2015 [108]	Less severe TRALI development
Neutralizing-antibodies models	Injury	Mice	Authors	Effect	Injury	Mice	Authors	Effect
	Acid	BALB/c	Looney et al. 2009 [23]	Only a weak amelioration of platelet migration	LPS and anti-MHC I	BALB/c	Tong et al. 2015 [131]	Protection against TRALI
	Acid	C57BL/6	Zarbock et al. 2006 [109]	Protection against ALI	LPS and mechanical ventilation	C57BL/6	Guo et al. 2015 [132]	Protection against TRALI
	LPS; acid; CLP	C57BL/6	Grommes et al. 2012 [130]	Protection against ALI				
	Acid	C57BL/6	Zarbock et al. 2006 [109]	Protection against ALI				
Antagonist BRMs models	LPS	C57BL/6	Peng et al. 2006 [133]	Inhibition of ALI development				
Platelet depletion/inhibition models	Injury	Mice	Authors	Effect	Injury	Mice	Authors	Effect
	Acid	C57BL/6	Zarbock et al. 2006 [109]	Protection against ALI	LPS and anti-MHC I	BALB/c	Looney et al. 2009 [23]	Protection against TRALI
	Acid	C57BL/6	Zarbock et al. 2006 [109]	Protection against ALI	LPS and anti-MHC I	BALB/c	Ortiz-Munoz et al. 2014 [134]	Protection against TRALI
	LPS	C57BL/6	Grommes et al. 2012 [130]	Protection against ALI	LPS and anti-MHC I	BALB/c	Caudrillier et al. 2012 [24]	Protection against TRALI
					LPS and anti-MHC I	BALB/c	Looney et al. 2009 [23]	Protection against TRALI

important to consider the difference in a two-hit model of TRALI and some ALI models.

Finally, platelets are monitored in many studies of ALI, induced by various stimuli, as well as by mechanical ventilation, endotoxin, or transfusion. Targeting platelet cytokines and receptors has been shown to block edema development in mice.

These various experimental models targeting platelets provide clues that may result in the prevention or treatment of TRALI. At present, several treatments, like aspirin, remain controversial because of their likely side effects, but actually a study seems to challenge this idea about controversial effect of aspirin [135].

Treatment and transfusion policies

The main symptom of TRALI is respiratory distress and, occasionally, dyspnea, tachypnea, and hypoxemia. There is no treatment for TRALI. The patient can only be monitored, with 70–90% requiring respiratory support [3]. Chest X-rays of lungs with bilateral infiltration show a characteristic white-out appearance. Patients with severe TRALI have been treated with extracorporeal membrane oxygenation, using a circulatory system continuous with, but parallel to, the natural circulatory system, to provide an additional source of oxygen [136].

Leukoreduction of platelet storage lesion was made mandatory in France in 1998. In the United States, however, only approximately 65–70% of the blood supply was leukocyte reduced in 2005 [137]. The implementation of leukoreduction has been to reduce the TRALI rate by 85% for PCs and RBC concentrates and 82% for plasma transfusions [138]. Nevertheless, some other epidemiological studies observed no influence of leukoreduction in TRALI mitigation [139,140].

PCs can be stored in platelet additive solution (PAS), a salt solution that replaces approximately 66% of the plasma used to store platelets. PAS, which has been used in France since 2003, was found to reduce transfusion reactions. Platelets remain relatively unaltered and more stable when stored in glucose-free citrate-acetate-NaCl PAS (PAS2, Baxter Healthcare Corp., Guyancourt, France) than in plasma [141]. Moreover, when magnesium and potassium were added to PAS-III, the concentrations of platelet-derived cytokines during storage were similar to those of platelets stored in plasma [64]. Reduction in the percentage of plasma also reduces the amounts of transfused neutrophil-reactive antibodies that can cause TRALI [142].

Generally, TRALI is induced by anti-HLA class I and class II antibodies, more rarely by anti-HNA antibodies. Female donors are more likely to develop such antibodies [143–145], as a consequence of alloimmunization during pregnancy. Thus, plasma from male donors is preferred. The National Blood Service in the United Kingdom was the first to use this strategy [146]. Some blood services accept plasma from female donors who have not been pregnant or who have not developed detectable anti-HLA and/or HNA antibodies [5,147,148]. Although about 1% of male of donors are carriers of anti-HLA class I and/or anti-HNA antibodies, these antibodies are generally immunoglobulin M, which have a low affinity [149]. This strategy has caused a significant reduction in TRALI risk [2,146,150–152]. At present, there is no treatment or optimal transfusion strategy for TRALI.

Expert commentary

TRALI remains a leading cause of transfusion-related deaths, with a mortality rate reported between 5% and 25%. TRALI is a complicated clinical condition that has undergone *in vivo*, *in vitro*, and *ex vivo* scientific investigation. A two-hit model of TRALI was proposed. The first event involves the pulmonary sequestration of neutrophils (PMNs), in accordance with the original hypothesis that TRALI was caused by anti-PMN antibodies present in donated blood products. The second event involves the introduction of BRMs, which are present in donated blood products. These BRMs include alloantibodies, immunomodulatory factors that accumulate during blood storage (such as sCD40L and/or mtDNA), and lipids.

Ongoing studies should provide a better understanding of the pathogenesis of TRALI and identify donor and recipient risk factors that will lead to measures to prevent this rare, but serious, transfusion complication. *In vitro* future directions should include determinants in the pathophysiology of TRALI and the development and optimization of a relevant *in vitro* model to support extensive investigations of (i) the role of BRMs in TRALI, (ii) pulmonary endothelial injury, (iii) neutrophil function, (iv) platelet function, and (v) patient factors.

Five-year view

Over the last 60 years, knowledge of TRALI has significantly increased, leading to measures that decreased its incidence. TRALI is a serious, potentially life-threatening complication of transfusion therapy. Its frequency and outcomes are based largely on passive reporting systems, suggesting that TRALI is probably underreported and its incidence is higher than published. Coordinated efforts by bench researchers, translational researchers, clinicians, epidemiologists, and blood bank donor centers will be required to understand the pathophysiology of TRALI and further minimize the risk of this potentially fatal complication of transfusion. The pathophysiology of TRALI is multifactorial and remains uncertain. Patients at risk for TRALI are not well characterized, and nonimmune mechanisms are poorly understood.

Molecular and/or personalized treatment medicine is required for patients at high risk of possibly complicated acute inflammatory responses, particularly TRALI. If not yet implementable at a large scale, this may occur in the very near future.

Acknowledgments

The authors wish to thank Charles Antoine Arthaud, Marie Ange Eyraud and Jocelyne Fagand for their invaluable contributions. We would like to thank the medical staff and personnel of Etablissement Français du Sang Auvergne-Loire, Saint-Etienne, France for their technical support throughout our studies.

Financial and competing interests disclosure

This work was supported by grants from the French National Blood Service – EFS (Grant APR), France; the Association for Research in Transfusion (ART), Paris, France; the Agence Nationale de la Sécurité et du Médicament et des produits de santé (ANSM - AAP-2012-011, Reference 2012S055); the “Agence Nationale de la Recherche” (ANR), reference ANR-12-JSV1-0012-01 and the Association “Les Amis de Rémi,” Savigneux, France. The authors have no other relevant affiliations or financial involvement with any organization or entity with a financial interest in or financial conflict with the subject matter or materials discussed in the manuscript apart from those disclosed.

Key issues

- TRALI is a severe pathology characterized by respiratory distress, hypoxia, and bilateral pulmonary infiltrates occurring within 6 h of transfusion.
- A 'two-hit' hypothesis of TRALI has been proposed to explain its pathophysiology.
- The first hit involves specific inflammatory host factors that prime neutrophils.
- The second hit occurs when transfused mediators (i.e. antibodies and/or BRMs) activate neutrophils and damage pulmonary endothelium.
- PCs associated with TRALI induction have higher concentrations of sCD40L and lipids than control PCs.
- Although the 'two-hit' theory is supported by numerous clinical studies, TRALI pathogenesis is not yet completely understood.

References

Papers of special note have been highlighted as:

• of interest

•• of considerable interest

1. Dasararaju R, Marques MB. Adverse effects of transfusion. *Cancer Control: J Moffitt Cancer Center*. 2015;22(1):16–25.
2. Lin Y, Saw CL, Hannach B, et al. Transfusion-related acute lung injury prevention measures and their impact at Canadian Blood Services. *Transfusion*. 2012;52(3):567–574.
3. Vlaar AP, Juffermans NP. Transfusion-related acute lung injury: a clinical review. *Lancet*. 2013;382(9896):984–994.
4. Middelburg RA, van der Bom JG. Transfusion-related acute lung injury not a two-hit, but a multicausal model. *Transfusion*. 2015;55(5):953–960.
- **Complete description of clinical manifestation of TRALI and transfusion policies to limit TRALI emergence.**
5. Toy P, Gajic O, Bacchetti P, et al. Transfusion-related acute lung injury: incidence and risk factors. *Blood*. 2012;119(7):1757–1767.
6. Kapur R, Kim M, Shanmugabhavananthan S, et al. C-reactive protein (CRP) enhances murine antibody-mediated transfusion-related acute lung injury (TRALI). *Blood*. 2015;126(25):2747–2751.
7. Toy P, Bacchetti P, Grimes B, et al. Recipient clinical risk factors predominate in possible transfusion-related acute lung injury. *Transfusion*. 2015;55(5):947–952.
8. Gajic O, Rana R, Winters JL, et al. Transfusion-related acute lung injury in the critically ill: prospective nested case-control study. *Am J Respir Crit Care Med*. 2007;176(9):886–891.
9. Benson AB, Austin GL, Berg M, et al. Transfusion-related acute lung injury in ICU patients admitted with gastrointestinal bleeding. *Intensive Care Med*. 2010;36(10):1710–1717.
10. Maslanka K, Uhrynowska M, Lopacz P, et al. Analysis of leucocyte antibodies, cytokines, lysophospholipids and cell microparticles in blood components implicated in post-transfusion reactions with dyspnoea. *Vox Sanguinis*. 2015;108(1):27–36.
11. Odent-Malaure H, Quainon F, Ruyer-Dumontier P, et al. Transfusion related acute lung injury (TRALI) caused by red blood cell transfusion involving residual plasma anti-HLA antibodies: a report on two cases and general considerations. *Clin Dev Immunol*. 2005;12(4):243–248.
12. Xie RF, Hu P, Li W, et al. The effect of platelet-derived microparticles in stored apheresis platelet concentrates on polymorphonuclear leucocyte respiratory burst. *Vox Sanguinis*. 2014;106(3):234–241.
13. Tung JP, Fraser JF, Nataatmadja M, et al. Age of blood and recipient factors determine the severity of transfusion-related acute lung injury (TRALI). *Crit Care*. 2012;16(1):R19.
14. Silliman CC, Moore EE, Kelher MR, et al. Identification of lipids that accumulate during the routine storage of prestorage leukoreduced red blood cells and cause acute lung injury. *Transfusion*. 2011;51(12):2549–2554.
15. Middelburg RA, Borkent-Raven BA, Janssen MP, et al. Storage time of blood products and transfusion-related acute lung injury. *Transfusion*. 2012;52(3):658–667.
- **This study shows clearly the impact of the age of platelets on TRALI incidence.**
16. Silliman CC. The two-event model of transfusion-related acute lung injury. *Crit Care Med*. 2006;34(5 Suppl):S124–131.
- **This review gives us a complete description of TRALI mechanism.**
17. Doerschuk CM. Mechanisms of leukocyte sequestration in inflamed lungs. *Microcirculation*. 2001;8(2):71–88.
18. Carlos TM, Harlan JM. Leukocyte-endothelial adhesion molecules. *Blood*. 1994;84(7):2068–2101.
19. Piccardoni P, Sideri R, Manarini S, et al. Platelet/polymorphonuclear leukocyte adhesion: a new role for SRC kinases in Mac-1 adhesive function triggered by P-selectin. *Blood*. 2001;98(1):108–116.
20. Moore KL, Patel KD, Bruhl RE, et al. P-selectin glycoprotein ligand-1 mediates rolling of human neutrophils on P-selectin. *J Cell Biol*. 1995;128(4):661–671.
21. Moore KL. Structure and function of P-selectin glycoprotein ligand-1. *Leuk Lymphoma*. 1998;29(1–2):1–15.
22. Muller MC, Van Stein D, Binnekade JM, et al. Low-risk transfusion-related acute lung injury donor strategies and the impact on the onset of transfusion-related acute lung injury: a meta-analysis. *Transfusion*. 2015;55(1):164–175.
23. Looney MR, Nguyen JX, Hu Y, et al. Platelet depletion and aspirin treatment protect mice in a two-event model of transfusion-related acute lung injury. *J Clin Invest*. 2009;119(11):3450–3461.
- **This study elaborates a good mouse model of TRALI to determine the platelet implication in TRALI mechanism.**
24. Caudrillier A, Kessenbrock K, Gilliss BM, et al. Platelets induce neutrophil extracellular traps in transfusion-related acute lung injury. *J Clin Invest*. 2012;122(7):2661–2671.
25. Shaz BH, Stowell SR, Hillyer CD. Transfusion-related acute lung injury: from bedside to bench and back. *Blood*. 2011;117(5):1463–1471.
26. Middelburg RA, Van Stein D, Briet E, et al. The role of donor antibodies in the pathogenesis of transfusion-related acute lung injury: a systematic review. *Transfusion*. 2008;48(10):2167–2176.
27. Fung YL, Silliman CC. The role of neutrophils in the pathogenesis of transfusion-related acute lung injury. *Transfus Med Rev*. 2009;23(4):266–283.
28. Curtis BR, McFarland JG. Mechanisms of transfusion-related acute lung injury (TRALI): anti-leukocyte antibodies. *Crit Care Med*. 2006;34(5(Suppl)):S118–123.
29. Peters AL, Van Stein D, Vlaar AP. Antibody-mediated transfusion-related acute lung injury; from discovery to prevention. *Br J Haematol*. 2015;170(5):597–614.
30. Bux J, Sachs UJ. The pathogenesis of transfusion-related acute lung injury (TRALI). *Br J Haematol*. 2007;136(6):788–799.
31. Cosgrove LJ, Vaughan HA, Tjandra JJ, et al. HLA (class II) antigens on platelets are involved in platelet function. *Immunol Cell Biol*. 1988;66(Pt 1):69–77.
32. Bunbury A, Potoличchio I, Maitra R, et al. Functional analysis of monocyte MHC class II compartments. *FASEB Journal: Official Publication of the Federation of American Societies for Experimental Biology*. 2009;23(1):164–171.
33. Roche PA, Furuta K. The ins and outs of MHC class II-mediated antigen processing and presentation. *Nature reviews. Immunology*. 2015;15(4):203–216.
34. Bux J. Antibody-mediated (immune) transfusion-related acute lung injury. *Vox Sanguinis*. 2011;100(1):122–128.
35. Davoren A, Curtis BR, Shulman IA, et al. TRALI due to granulocyte-agglutinating human neutrophil antigen-3a (5b) alloantibodies in donor plasma: a report of 2 fatalities. *Transfusion*. 2003;43(5):641–645.
36. Storch EK, Hillyer CD, Shaz BH. Spotlight on pathogenesis of TRALI: HNA-3a (CTL2) antibodies. *Blood*. 2014;124(12):1868–1872.

37. Silliman CC, Bercovitz RS, Khan SY, et al. Antibodies to the HLA-A2 antigen prime neutrophils and serve as the second event in an in vitro model of transfusion-related acute lung injury. *Vox Sanguinis*. 2014;107(1):76–82.
38. Kelher MR, Masuno T, Moore EE, et al. Plasma from stored packed red blood cells and MHC class I antibodies causes acute lung injury in a 2-event in vivo rat model. *Blood*. 2009;113(9):2079–2087.
39. Looney MR, Su X, Van Ziffle JA, et al. Neutrophils and their Fc gamma receptors are essential in a mouse model of transfusion-related acute lung injury. *J Clin Invest*. 2006;116(6):1615–1623.
40. Nishimura M, Hashimoto S, Takashi M, et al. Role of anti-human leucocyte antigen class II alloantibody and monocytes in development of transfusion-related acute lung injury. *Transfus Med*. 2007;17(2):129–134.
41. Kopko PM, Paglieroni TG, Popovsky MA, et al. TRALI: correlation of antigen-antibody and monocyte activation in donor-recipient pairs. *Transfusion*. 2003;43(2):177–184.
42. Moritz E, Norcia AM, Cardone JD, et al. Human neutrophil alloantigen systems. *Anais Da Academia Brasileira De Ciencias*. 2009;81(3):559–569.
43. Bayat B, Tjahjono Y, Sydykov A, et al. Anti-human neutrophil antigen-3a induced transfusion-related acute lung injury in mice by direct disturbance of lung endothelial cells. *Arterioscler Thromb Vasc Biol*. 2013;33(11):2538–2548.
44. Berthold T, Schubert N, Muschter S, et al. HNA antibody-mediated neutrophil aggregation is dependent on serine protease activity. *Vox Sang*. 2015;109(4):366–374.
45. Silliman CC, Boshkov LK, Mehdizadehkashi Z, et al. Transfusion-related acute lung injury: epidemiology and a prospective analysis of etiologic factors. *Blood*. 2003;101(2):454–462.
46. Kao KJ, Scornik JC, Riley WJ, et al. Association between HLA phenotype and HLA concentration in plasma or platelets. *Hum Immunol*. 1988;21(2):115–124.
47. Peters AL, Van Hezel ME, Juffermans NP, et al. Pathogenesis of non-antibody mediated transfusion-related acute lung injury from bench to bedside. *Blood Rev*. 2015;29(1):51–61.
48. Toy P, Hollis-Perry KM, Jun J, et al. Recipients of blood from a donor with multiple HLA antibodies: a lookback study of transfusion-related acute lung injury. *Transfusion*. 2004;44(12):1683–1688.
49. Silliman CC, Bjornsen AJ, Wyman TH, et al. Plasma and lipids from stored platelets cause acute lung injury in an animal model. *Transfusion*. 2003;43(5):633–640.
50. Tamarozzi MB, Soares SG, Sa-Nunes A, et al. Comparative analysis of the pathological events involved in immune and non-immune TRALI models. *Vox Sanguinis*. 2012;103(4):309–321.
51. Rendu F, Brohard-Bohn B. The platelet release reaction: granules' constituents, secretion and functions. *Platelets*. 2001;12(5):261–273.
52. Heijnen H, Van Der Sluijs P. Platelet secretory behaviour: as diverse as the granules .. or not?. *J Thromb Haemost*. 2015;13(12):2141–2151.
53. Semple JW, Italiano JE Jr., Freedman J. Platelets and the immune continuum. *Nature reviews. Immunology*. 2011;11(4):264–274.
54. Hasegawa S, Tashiro N, Matsubara T, et al. A comparison of Fc epsilon RI-mediated RANTES release from human platelets between allergic patients and healthy individuals. *Int Arch Allergy Immunol*. 2001;125(Suppl 1):42–47.
55. Lapchak PH, Ioannou A, Kannan L, et al. Platelet-associated CD40/CD154 mediates remote tissue damage after mesenteric ischemia/reperfusion injury. *PLoS One*. 2012;7(2):e32260.
56. Ghoshal K, Bhattacharyya M. Overview of platelet physiology: its hemostatic and nonhemostatic role in disease pathogenesis. *ScientificWorld J*. 2014;2014:781857.
57. Yeaman MR. Platelets: at the nexus of antimicrobial defence. *Nature reviews. Microbiology*. 2014;12(6):426–437.
58. Mantovani A, Garlanda C. Platelet-macrophage partnership in innate immunity and inflammation. *Nat Immunol*. 2013;14(8):768–770.
59. Gawaz M, Vogel S. Platelets in tissue repair: control of apoptosis and interactions with regenerative cells. *Blood*. 2013;122(15):2550–2554.
60. Rondina MT, Garraud O. Emerging evidence for platelets as immune and inflammatory effector cells. *Front Immunol*. 2014;5:653, 1–6.
61. Stack G, Snyder EL. Cytokine generation in stored platelet concentrates. *Transfusion*. 1994;34(1):20–25.
62. Cognasse F, Boussoulade F, Chavarin P, et al. Release of potential immunomodulatory factors during platelet storage. *Transfusion*. 2006;46(7):1184–1189.
- **Interesting study that highlights the inflammatory potential of PCs during storage.**
63. Wadhwa M, Seghatchian MJ, Lubenko A, et al. Cytokine levels in platelet concentrates: quantitation by bioassays and immunoassays. *Br J Haematol*. 1996;93(1):225–234.
64. Shanwell A, Falker C, Gulliksson H. Storage of platelets in additive solutions: the effects of magnesium and potassium on the release of RANTES, beta-thromboglobulin, platelet factor 4 and interleukin-7, during storage. *Vox Sanguinis*. 2003;85(3):206–212.
65. Apelseth TO, Hervig TA, Wentzel-Larsen T, et al. Cytokine accumulation in photochemically treated and gamma-irradiated platelet concentrates during storage. *Transfusion*. 2006;46(5):800–810.
66. Hamzeh-Cognasse H, Damien P, Nguyen KA, et al. Immune-reactive soluble OX40 ligand, soluble CD40 ligand, and interleukin-27 are simultaneously oversecreted in platelet components associated with acute transfusion reactions. *Transfusion*. 2014;54(3):613–625.
67. Maslanka K, Smolenska-Sym G, Michur H, et al. Lysophosphatidylcholines: bioactive lipids generated during storage of blood components. *Arch Immunol Ther Exp (Warsz)*. 2012;60(1):55–60.
68. Boing AN, Hau CM, Sturk A, et al. Platelet microparticles contain active caspase 3. *Platelets*. 2008;19(2):96–103.
69. Edvardsen L, Taaning E, Dreier B, et al. Extracellular accumulation of bioactive substances during preparation and storage of various platelet concentrates. *Am J Hematol*. 2001;67(3):157–162.
70. Fujihara M, Ikebuchi K, Wakamoto S, et al. Effects of filtration and gamma radiation on the accumulation of RANTES and transforming growth factor-beta1 in apheresis platelet concentrates during storage. *Transfusion*. 1999;39(5):498–505.
71. Khan SY, Kelher MR, Heal JM, et al. Soluble CD40 ligand accumulates in stored blood components, primes neutrophils through CD40, and is a potential cofactor in the development of transfusion-related acute lung injury. *Blood*. 2006;108(7):2455–2462.
- **A study well elaborated to focus on CD40/CD40L implication in TRALI pathophysiology.**
72. Sahler J, Spinelli S, Phipps R, et al. CD40 ligand (CD154) involvement in platelet transfusion reactions. *Transfusion Clinique Et Biologique: Journal De La Societe Francaise De Transfusion Sanguine*. 2012;19(3):98–103.
73. Muylle L, Joos M, Wouters E, et al. Increased tumor necrosis factor alpha (TNF alpha), interleukin 1, and interleukin 6 (IL-6) levels in the plasma of stored platelet concentrates: relationship between TNF alpha and IL-6 levels and febrile transfusion reactions. *Transfusion*. 1993;33(3):195–199.
74. Maloney JP, Ambruso DR, Voelkel NF, et al. Platelet vascular endothelial growth factor is a potential mediator of transfusion-related acute lung injury. *J Pulmonary Respiratory Med*. 2014;4:1–7.
75. Vlaar AP, Kulik W, Nieuwland R, et al. Accumulation of bioactive lipids during storage of blood products is not cell but plasma derived and temperature dependent. *Transfusion*. 2011;51(11):2358–2366.
76. Silliman CC, Kelher M, Ambruso DR. Bioactive lipids from stored cellular blood components: in vitro method is crucial for proper interpretation. *Transfusion*. 2012;52(5):1155–1157. author reply 1157–1158
77. Nguyen KA, Hamzeh-Cognasse H, Sebban M, et al. A computerized prediction model of hazardous inflammatory platelet transfusion outcomes. *PLoS One*. 2014;9(5):e97082.
78. Bae JS. Inhibitory effect of orientin on secretory group IIA phospholipase A. *Inflammation*. 2015;38(4):1631–1638.
79. Leshner M, Wang S, Lewis C, et al. PAD4 mediated histone hyperacetylation induces heterochromatin decondensation and chromatin unfolding to form neutrophil extracellular trap-like structures. *Front Immunol*. 2012;3:307.

80. Li P, M L, Lindberg MR, et al. PAD4 is essential for antibacterial innate immunity mediated by neutrophil extracellular traps. *The Journal of Experimental Medicine*. 2010;207(9):1853–1862.
81. Zallen G, Moore EE, Johnson JL, et al. New mechanisms by which secretory phospholipase A2 stimulates neutrophils to provoke the release of cytotoxic agents. *Arch Surg*. 1998;133(11):1229–1233.
82. Kim DK, Fukuda T, Thompson BT, et al. Bronchoalveolar lavage fluid phospholipase A2 activities are increased in human adult respiratory distress syndrome. *Am J Physiol*. 1995;269(1 Pt 1):L109–118.
83. Boudreau LH, Duchez AC, Cloutier N, et al. Platelets release mitochondria serving as substrate for bactericidal group IIA-secreted phospholipase A2 to promote inflammation. *Blood*. 2014;124(14):2173–2183.
84. Lee YL, King MB, Gonzalez RP, et al. Blood transfusion products contain mitochondrial DNA damage-associated molecular patterns: a potential effector of transfusion-related acute lung injury. *J Surg Res*. 2014;191(2):286–289.
85. Cognasse F, Aloui C, Anh Nguyen K, et al. Platelet components associated with adverse reactions: predictive value of mitochondrial DNA relative to biological response modifiers. *Transfusion*. 2016;56(2):497–504.
86. Blumberg N, Spinelli SL, Francis CW, et al. The platelet as an immune cell-CD40 ligand and transfusion immunomodulation. *Immunol Res*. 2009;45(2–3):251–260.
87. Cognasse F, Hamzeh-Cognasse H, Lafarge S, et al. Donor platelets stored for at least 3 days can elicit activation marker expression by the recipient's blood mononuclear cells: an in vitro study. *Transfusion*. 2009;49(1):91–98.
88. Hamzeh-Cognasse H, Cognasse F, Palle S, et al. Direct contact of platelets and their released products exert different effects on human dendritic cell maturation. *BMC Immunol*. 2008;9:54.
89. Hamzeh-Cognasse H, Damien P, Nguyen KA, et al. Immune-reactive soluble OX40 ligand, soluble CD40 ligand, and interleukin-27 are simultaneously oversecreted in platelet components associated with acute transfusion reactions. *Transfusion*. 2014;54(3):613–625.
90. Aloui C, Prigent A, Sut C, et al. The signaling role of CD40 ligand in platelet biology and in platelet component transfusion. *Int J Mol Sci*. 2014;15(12):22342–22364.
91. Jin R, Yu S, Song Z, et al. Soluble CD40 ligand stimulates CD40-dependent activation of the beta2 integrin Mac-1 and protein kinase C zeta (PKCzeta) in neutrophils: implications for neutrophil-platelet interactions and neutrophil oxidative burst. *PLoS One*. 2013;8(6):e64631.
92. Rahman M, Zhang S, Chew M, et al. Platelet-derived CD40L (CD154) mediates neutrophil upregulation of Mac-1 and recruitment in septic lung injury. *Ann Surg*. 2009;250(5):783–790.
93. Kaufman J, Spinelli SL, Schultz E, et al. Release of biologically active CD154 during collection and storage of platelet concentrates prepared for transfusion. *Journal of Thrombosis and Haemostasis: JTH*. 2007;5(4):788–796.
94. Tuinman PR, Gerard MC, Jongsma G, et al. Lack of evidence of CD40 ligand involvement in transfusion-related acute lung injury. *Clin Exp Immunol*. 2011;165(2):278–284.
95. Horstman LL, Ahn YS. Platelet microparticles: a wide-angle perspective. *Crit Rev Oncol Hematol*. 1999;30(2):111–142.
96. Bode AP, Orton SM, Frye MJ, et al. Vesiculation of platelets during in vitro aging. *Blood*. 1991;77(4):887–895.
97. Solum NO. Procoagulant expression in platelets and defects leading to clinical disorders. *Arterioscler Thromb Vasc Biol*. 1999;19(12):2841–2846.
98. Daniel L, Fakhouri F, Joly D, et al. Increase of circulating neutrophil and platelet microparticles during acute vasculitis and hemodialysis. *Kidney Int*. 2006;69(8):1416–1423.
99. Lo SC, Hung CY, Lin DT, et al. Involvement of platelet glycoprotein Ib in platelet microparticle mediated neutrophil activation. *J Biomed Sci*. 2006;13(6):787–796.
100. Boilard E, Nigrovic PA, Larabee K, et al. Platelets amplify inflammation in arthritis via collagen-dependent microparticle production. *Science*. 2010;327(5965):580–583.
101. Nurden AT. Platelets, inflammation and tissue regeneration. *Thromb Haemost*. 2011;105(Suppl 1):S13–33.
102. Xie RF, Hu P, Wang ZC, et al. Platelet-derived microparticles induce polymorphonuclear leukocyte-mediated damage of human pulmonary microvascular endothelial cells. *Transfusion*. 2015;55(5):1051–1057.
103. Zibara K, Chignier E, Covacho C, et al. Modulation of expression of endothelial intercellular adhesion molecule-1, platelet-endothelial cell adhesion molecule-1, and vascular cell adhesion molecule-1 in aortic arch lesions of apolipoprotein E-deficient compared with wild-type mice. *Arterioscler Thromb Vasc Biol*. 2000;20(10):2288–2296.
104. Barry OP, Pratico D, Lawson JA, et al. Transcellular activation of platelets and endothelial cells by bioactive lipids in platelet microparticles. *J Clin Invest*. 1997;99(9):2118–2127.
105. McVey M, Tabuchi A, Kuebler WM. Microparticles and acute lung injury. *American Journal of Physiology. Lung Cellular and Molecular Physiology*. 2012;303(5):L364–381.
106. Jy W, Mao WW, Horstman L, et al. Platelet microparticles bind, activate and aggregate neutrophils in vitro. *Blood Cells Mol Dis*. 1995;21(3):217–231. discussion 231a
107. Bastarache JA, Fremont RD, Kropski JA, et al. Procoagulant alveolar microparticles in the lungs of patients with acute respiratory distress syndrome. *American Journal of Physiology. Lung Cellular and Molecular Physiology*. 2009;297(6):L1035–1041.
108. Bayat B, Tjahjono Y, Berghofer H, et al. Choline transporter-like protein-2: new von Willebrand factor-binding partner involved in antibody-mediated neutrophil activation and transfusion-related acute lung injury. *Arterioscler Thromb Vasc Biol*. 2015;35(7):1616–1622.
109. Zarbock A, Singbartl K, Ley K. Complete reversal of acid-induced acute lung injury by blocking of platelet-neutrophil aggregation. *J Clin Invest*. 2006;116(12):3211–3219.
110. Caudrillier A, Looney MR. Platelet-neutrophil interactions as a target for prevention and treatment of transfusion-related acute lung injury. *Curr Pharm Des*. 2012;18(22):3260–3266.
- **This study reveals clearly the importance of platelet-neutrophil complex in the TRALI pathogenesis.**
111. Weyrich AS, Zimmerman GA. Platelets in lung biology. *Annu Rev Physiol*. 2013;75:569–591.
112. Schneider RC, Zapol WM, Carvalho AC. Platelet consumption and sequestration in severe acute respiratory failure. *Am Rev Respir Dis*. 1980;122(3):445–451.
113. Page C, Pitchford S. Neutrophil and platelet complexes and their relevance to neutrophil recruitment and activation. *Int Immunopharmacol*. 2013;17(4):1176–1184.
114. Li J, Kim K, Barazia A, et al. Platelet-neutrophil interactions under thromboinflammatory conditions. *Cellular and Molecular Life Sciences: CMLS*. 2015;72(14):2627–2643.
115. Ehlers R, Ustinov V, Chen Z, et al. Targeting platelet-leukocyte interactions: identification of the integrin Mac-1 binding site for the platelet counter receptor glycoprotein Ibalpha. *The Journal of Experimental Medicine*. 2003;198(7):1077–1088.
116. Simon DI, Chen Z, Xu H, et al. Platelet glycoprotein Ibalpha is a counterreceptor for the leukocyte integrin Mac-1 (CD11b/CD18). *The Journal of Experimental Medicine*. 2000;192(2):193–204.
117. Duerschmied D, Suidan GL, Demers M, et al. Platelet serotonin promotes the recruitment of neutrophils to sites of acute inflammation in mice. *Blood*. 2013;121(6):1008–1015.
118. Andre P, Nannizzi-Alaimo L, Prasad SK, et al. Platelet-derived CD40L: the switch-hitting player of cardiovascular disease. *Circulation*. 2002;106(8):896–899.
119. Kessenbrock K, Krumbholz M, Schonermarck U, et al. Netting neutrophils in autoimmune small-vessel vasculitis. *Nat Med*. 2009;15(6):623–625.
120. Papayannopoulos V, Metzler KD, Hakkim A, et al. Neutrophil elastase and myeloperoxidase regulate the formation of neutrophil extracellular traps. *J Cell Biol*. 2010;191(3):677–691.
121. Brown GT, McIntyre TM. Lipopolysaccharide signaling without a nucleus: kinase cascades stimulate platelet shedding of proinflammatory IL-1beta-rich microparticles. *J Immunol*. 2011;186(9):5489–5496.

122. Prasad KS, Andre P, He M, et al. Soluble CD40 ligand induces beta3 integrin tyrosine phosphorylation and triggers platelet activation by outside-in signaling. *Proc Natl Acad Sci U S A*. 2003;100(21):12367–12371.
123. Brinkmann V, Reichard U, Goosmann C, et al. Neutrophil extracellular traps kill bacteria. *Science*. 2004;303(5663):1532–1535.
124. Clark SR, Ma AC, Tavener SA, et al. Platelet TLR4 activates neutrophil extracellular traps to ensnare bacteria in septic blood. *Nat Med*. 2007;13(4):463–469.
125. Bruslerud O. Bidirectional crosstalk between platelets and monocytes initiated by Toll-like receptor: an important step in the early defense against fungal infections?. *Platelets*. 2013;24(2):85–97.
126. Semeraro F, Ammolto CT, Morrissey JH, et al. Extracellular histones promote thrombin generation through platelet-dependent mechanisms: involvement of platelet TLR2 and TLR4. *Blood*. 2011;118(7):1952–1961.
127. Ward CM, Tetaz TJ, Andrews RK, et al. Binding of the von Willebrand factor A1 domain to histone. *Thromb Res*. 1997;86(6):469–477.
128. Thomas GM, Carbo C, Curtis BR, et al. Extracellular DNA traps are associated with the pathogenesis of TRALI in humans and mice. *Blood*. 2012;119(26):6335–6343.
129. Yiming MT, Lederer DJ, Sun L, et al. Platelets enhance endothelial adhesiveness in high tidal volume ventilation. *Am J Respir Cell Mol Biol*. 2008;39(5):569–575.
130. Grommes J, Alard JE, Drechsler M, et al. Disruption of platelet-derived chemokine heteromers prevents neutrophil extravasation in acute lung injury. *Am J Respir Crit Care Med*. 2012;185(6):628–636.
131. Tong S, Wang H, Zhang T, et al. Accumulation of CD62P during storage of apheresis platelet concentrates and the role of CD62P in transfusion-related acute lung injury. *Mol Med Rep*. 2015;12(5):7777–7781.
132. Guo Y, Mishra A, Howland E, et al. Platelet-derived Wnt antagonist Dickkopf-1 is implicated in ICAM-1/VCAM-1-mediated neutrophilic acute lung inflammation. *Blood*. 2015;126(19):2220–2229.
133. Peng X, Hassoun PM, Sammani S, et al. Protective effects of sphingosine 1-phosphate in murine endotoxin-induced inflammatory lung injury. *Am J Respir Crit Care Med*. 2004;169(11):1245–1251.
134. Ortiz-Munoz G, Mallavia B, Bins A, et al. Aspirin-triggered 15-epilipoxin A4 regulates neutrophil-platelet aggregation and attenuates acute lung injury in mice. *Blood*. 2014;124(17):2625–2634.
135. Kor DJ, Talmor DS, Banner-Goodspeed VM, et al. Lung injury prevention with aspirin (LIPS-A): a protocol for a multicentre randomised clinical trial in medical patients at high risk of acute lung injury. *BMJ Open*. 2012;2:5.
136. Worsley MH, Sinclair CJ, Campanella C, et al. Non-cardiogenic pulmonary oedema after transfusion with granulocyte antibody containing blood: treatment with extracorporeal membrane oxygenation. *Br J Anaesth*. 1991;67(1):116–119.
137. Bassuni WY, Blajchman MA, Al-Moshary MA. Why implement universal leukoreduction?. *Hematol Oncol Stem Cell Ther*. 2008;1(2):106–123.
138. West FB, Silliman CC. Transfusion-related acute lung injury: advances in understanding the role of proinflammatory mediators in its genesis. *Expert Rev Hematol*. 2013;6(3):265–276.
139. Dzik WH, Anderson JK, O'Neill EM, et al. A prospective, randomized trial of universal WBC reduction. *Transfusion*. 2002;42(9):1114–1122.
140. Watkins TR, Rubenfeld GD, Martin TR, et al. Effects of leukoreduced blood on acute lung injury after trauma: a randomized controlled trial. *Crit Care Med*. 2008;36(5):1493–1499.
141. Wagner T, Vetter A, Dimovic N, et al. Ultrastructural changes and activation differences in platelet concentrates stored in plasma and additive solution. *Transfusion*. 2002;42(6):719–727.
142. Reesink HW, Lee J, Keller A, et al. Measures to prevent transfusion-related acute lung injury (TRALI). *Vox Sang*. 2012;103(3):231–259.
143. Holness L, Knippen MA, Simmons L, et al. Fatalities caused by TRALI. *Transfus Med Rev*. 2004;18(3):184–188.
144. Popovsky MA, Davenport RD. Transfusion-related acute lung injury: femme fatale?. *Transfusion*. 2001;41(3):312–315.
145. Van Stein D, Beckers EA, Sintnicolaas K, et al. Transfusion-related acute lung injury reports in the Netherlands: an observational study. *Transfusion*. 2010;50(1):213–220.
146. Chapman CE, Stainsby D, Jones H, et al. Ten years of hemovigilance reports of transfusion-related acute lung injury in the United Kingdom and the impact of preferential use of male donor plasma. *Transfusion*. 2009;49(3):440–452.
147. Funk MB, Guenay S, Lohmann A, et al. Benefit of transfusion-related acute lung injury risk-minimization measures—German haemovigilance data (2006–2010). *Vox Sanguinis*. 2012;102(4):317–323.
148. Funk MB, Heiden M, Volkers P, et al. Evaluation of risk minimisation measures for blood components - based on reporting rates of transfusion-transmitted reactions (1997–2013). *Transfus Med Hemother*. 2015;42(4):240–246.
149. Triulzi DJ, Kleinman S, Kakaiya RM, et al. The effect of previous pregnancy and transfusion on HLA alloimmunization in blood donors: implications for a transfusion-related acute lung injury risk reduction strategy. *Transfusion*. 2009;49(9):1825–1835.
150. Nakazawa H, Ohnishi H, Okazaki H, et al. Impact of fresh-frozen plasma from male-only donors versus mixed-sex donors on post-operative respiratory function in surgical patients: a prospective case-controlled study. *Transfusion*. 2009;49(11):2434–2441.
151. Vlaar AP, Binnekade JM, Prins D, et al. Risk factors and outcome of transfusion-related acute lung injury in the critically ill: a nested case-control study. *Crit Care Med*. 2010;38(3):771–778.
152. Wright SE, Snowden CP, Athey SC, et al. Acute lung injury after ruptured abdominal aortic aneurysm repair: the effect of excluding donations from females from the production of fresh frozen plasma. *Crit Care Med*. 2008;36(6):1796–1802.

Mise à jour bibliographique

I – Section - *Because their secretory capacity can cause immunological differences*

Les plaquettes des CP sont capables de sécréter un arsenal de médiateurs solubles pouvant ainsi modifier le devenir des cellules de l'inflammation, telles que les leucocytes. Cette libération de BRM peut également agir directement sur l'endothélium vasculaire, élément clé dans la physiopathologie du TRALI, comme vu dans la revue ci-dessus (« *Transfusion-related acute lung injury: transfusion, platelets and biological response modifiers* » page 38 [7]). Les plaquettes secrètent tout un panel de BRM pro-inflammatoires, durant le stockage des concentrés plaquettaires, pouvant induire l'activation des cellules endothéliales et ainsi promouvoir la migration des leucocytes directement à travers cette barrière vasculaire ou, au contraire, renforcer l'intégrité de l'endothélium. Durant le stockage des CP issus d'aphérèse ou de mélange de CP, la concentration en microparticules plaquettaires et en sCD40L est augmentée. Dans un modèle *in vitro*, ces produits induisent une dégradation directe et indirecte (via l'activité des polymorphonucléaires (PMN)) de l'endothélium [45]. La concentration en sCD40L dans les CP est positivement corrélée avec le risque d'induction d'EIR, résultat observé dans une nouvelle étude, menée par notre équipe, avec près de 10 000 échantillons de CP [46]. Une seconde étude a pu démontrer que la stimulation des cellules endothéliales, *in vitro*, avec des surnageants de CP augmentait l'activité inflammatoire de ces dernières, caractérisée notamment par une plus forte libération de médiateurs solubles, tels qu'IL-6, IL-8 ou encore GRO α (Growth Regulated Oncogene α), et aussi par une amélioration de la transmigration des neutrophiles à travers cette barrière endothéliale. Ces effets étaient plus amplifiés lorsque les cellules endothéliales étaient préalablement stimulées avec du lipopolysaccharide (LPS) [47]. Un nouveau facteur soluble secrété directement par les plaquettes et ayant un impact sur l'état d'activation de l'endothélium est actuellement ciblé comme possible inducteur de réactions inflammatoires transfusionnelles, l'ADN mitochondrial (mtDNA), considéré comme un motif moléculaire associé aux dégâts cellulaires (DAMPs). On retrouve dans le cytoplasme des plaquettes quiescentes environ 4 mitochondries ; ces mitochondries peuvent être relocalisées dans les pseudopodes plaquettaires, puis libérées dans le milieu, sous forme libre ou complexées aux microparticules, après stimulation. Une fois libérée, ces mitochondries sont hydrolysées par la phospholipase A₂-IIa (sPLA₂-IIa) ce qui permet la libération de son ADN qui peut alors se fixer directement sur les neutrophiles et promouvoir leur interaction avec la paroi vasculaire [48]. Lors du stockage des CP, la libération de l'ADN mitochondrial est plus importante dans les CP impliqués dans les

EIR, et cela de la même manière que d'autres facteurs pro-inflammatoires, tels que le sCD40L et l'IL13, [49] mais également dans les CP impliqués dans des cas de TRALI humains [50]. L'absence de corrélation entre la concentration d'ADN mitochondrial et des facteurs solubles plaquettaires montre probablement des mécanismes de libération plaquettaire différents après activation [49].

L'ADN mitochondrial a un impact direct sur la perméabilité de l'endothélium. Une étude *in vitro* observe une augmentation de la perméabilité des cellules endothéliales artérielles pulmonaires humaines induite directement par l'ADN mitochondrial ou indirectement via les PMN. En effet, l'ADN mitochondrial permet la fixation des PMN avec les cellules endothéliales, corrélée avec une expression de l'« intercellular adhesion molecule-1 » (ICAM-1) plus importante ainsi qu'une communication améliorée entre ces deux types cellulaires [51]. Ce médiateur de l'inflammation peut également être un stimulus direct aux PMN. De façon *in vitro*, l'ADN mitochondrial et les mitochondries entières ont la capacité d'activer directement les basophiles, les monocytes et les neutrophiles [50]. Les plaquettes sont donc potentiellement capables d'induire un état inflammatoire propice au développement d'un ALI de par leur capacité à sécréter de l'ADN mitochondrial, molécule ayant une influence directe sur l'endothélium vasculaire et les PMN. Plusieurs études ont démontré que l'ADN mitochondrial peut participer à l'induction d'une atteinte pulmonaire dans des modèles murins [52-54]. On observe donc un potentiel d'activation et de dégradation de l'endothélium non négligeable des CP. Cependant, la libération de cytokines/chimiokines plaquettaires pendant le stockage des CP peut également avoir un impact dans le maintien de l'intégrité vasculaire. La concentration en facteurs de croissance dans les concentrés plaquettaires peut être augmentée après une stimulation de ces derniers avec de la thrombine ou du calcium. La conséquence de cette stimulation est une prolifération importante des cellules endothéliales. Cela permet d'envisager un effet important de la transfusion de CP sur le maintien de l'intégrité vasculaire [55, 56].

Les CP sont donc capables d'induire à la fois une activité inflammatoire des cellules endothéliales mais également leur détérioration, accentuant la perméabilité de la paroi vasculaire aux cellules de l'inflammation. L'un des buts de cette thèse est de déterminer l'impact des composés produits lors du stockage des CP, spécialement ceux associés à un EIR, pour tenter de déterminer leur pouvoir inflammatoire. Nous nous intéresserons notamment à la libération d'Endocan par les cellules endothéliales, protéine normalement impliquée dans la sauvegarde de l'imperméabilité de la couche endothéliale mais sa forte libération a souvent été utilisée comme marqueur pathologique [57-63] (*voir manuscrit I*).

II – Section - *Several tracks already mentioned in TRALI*

A l'heure actuelle, l'implication des plaquettes sanguines de l'organisme dans la physiopathologie de l'ALI/TRALI fait débat. L'influence des plaquettes sanguines, plus particulièrement via la production de microparticules, dans des cas d'ALI/SDRA chez l'homme a été récemment évoquée. Les observations étaient différentes au niveau circulant par rapport à l'espace alvéolaire. Une augmentation importante du nombre de microparticules pulmonaires a d'abord été observée chez des patients développant un ALI/SDRA non cardiogénique comparés à des patients présentant un œdème pulmonaire cardiogénique [64]. En revanche, des niveaux circulants plus bas ont été constatés chez des patients avec un ALI/SDRA non cardiogénique comparé à des patients n'ayant pas développé de SDRA mais présentant des facteurs de risques liés à cette pathologie [65]. D'autres études évoquent un rôle pro-inflammatoire plaquettaire capable de promouvoir le développement de l'ALI/SDRA et du TRALI. Chez l'homme, deux méta-analyses ont révélé un effet bénéfique des traitements antiplaquettaires sur le devenir d'ALI/SDRA, notamment par une diminution drastique de la mortalité. Ici, les drogues plaquettaires utilisées étaient l'aspirine, le clopidogrel, la ticlopidine, le cilostazol, le dipyridamole, l'anagrélide et la persantine [66, 67].

L'inhibition de l'expression de certains facteurs plaquettaires, tels que la β -thromboglobuline (β -TG) et le facteur plaquettaire 4 (PF4), dans un modèle murin d'ALI, induit par injection trachéale d'acide chloridrique, semble protectrice face au développement de cette pathologie. Cela était représenté par une diminution du score de l'ALI, des protéines totales détectées dans les lavages broncho-alvéolaires (LBA) et de l'infiltrat au niveau du parenchyme pulmonaire [68]. L'aspirine, qui est un inhibiteur de l'activation plaquettaire ciblant le système COX-1 (Cyclooxygénase-1), prévient entièrement le développement d'un ALI induit par stimulation des voies aérodynamiques avec du LPS dans un modèle murin. A la fois le recrutement pulmonaire des neutrophiles, la formation des « Neutrophil Extracellular Traps » (NET) – phénomène cellulaire caractérisé par une extravasation de la chromatine des neutrophiles dans le milieu extracellulaire [69]– et le développement de l'œdème pulmonaire sont inhibés. Cependant, l'utilisation du tirofiban, antagoniste non peptidique du récepteur GPIIb/IIIa plaquettaire (récepteur du fibrinogène et du facteur de von Willebrand (vWF)), ne semblait pas prévenir les symptômes liés au déclenchement de l'ALI [70]. De plus, dans un modèle murin du TRALI, dont le priming est induit par une injection de LPS et le « second-hit » par transfusion de plaquettes murines en fonction de leur temps de stockage, la pathologie se manifeste avec une sévérité dépendante du temps de stockage des plaquettes [71], démontrant un impact non

négligeable des sécrétions plaquettaires dans l'amplification de la physiopathologie inflammatoire du TRALI expérimental. Finalement, une étude a mis en place plusieurs traitements à base de drogues antiplaquettaires dans un modèle murin du TRALI établi par injection de LPS, par voie intrapéritonéale, 24 heures avant l'injection d'anticorps anti-CMH I (Complexe Majeur d'Histocompatibilité I), par voie intraveineuse. Le but a été d'induire une thrombopénie et d'utiliser des traitements antiplaquettaires à base d'aspirine, de clopidogrel et d'anticorps anti-CD36, préalablement à l'induction de la lésion pulmonaire. Aucun de ces traitements n'a permis l'inhibition du développement de l'œdème pulmonaire. Au contraire, cette étude postule sur un rôle plaquettaire dans le maintien de l'intégrité vasculaire et donc un rôle antagoniste au développement du TRALI [72].

Au regard de débats scientifiques concernant le rôle des plaquettes sanguines de l'hôte dans le développement des œdèmes pulmonaires lésionnels, l'un des objectifs de cette thèse est de comprendre, au mieux, le réel rôle plaquettaire dans l'induction de l'ALI/TRALI (*voir manuscrit III*).

Chapitre 4 – Le rôle de signalisation du CD40 ligand dans la biologie plaquettaire et dans la transfusion de composants plaquettaires

La revue que nous avons écrite (ci-après) permet d'introduire le rôle du complexe CD40/CD40L, et du sCD40L notamment plaquettaire, du point de vue de la transfusion et de l'inflammation. Ce travail de synthèse ayant été publié en 2014, une mise à jour bibliographique est proposée à sa suite, pour contextualiser les hypothèses du rôle de ce complexe immun dans la physiopathologie de l'ALI/TRALI.

Erratum « The signaling role of CD40 ligand in platelet biology and in platelet component transfusion »: Lors de la rédaction de cette revue nous affirmions que « *The role of $\alpha 5\beta 1$ as a receptor for CD40L in $\alpha 5\beta 1$ -expressing-cells has not yet been investigated* ». Cependant, depuis 2015, une étude a investigué le rôle de l' $\alpha IIb\beta 3$ et l' $\alpha 5\beta 1$ plaquettaire dans la capture du sCD40L. L'activation des plaquettes induite par stimulus via le sCD40L est entièrement inhibée lors de la neutralisation de l' $\alpha IIb\beta 3$ et l' $\alpha 5\beta 1$. Bloquer d'autres intégrines plaquettaires telles que l' $\alpha 2\beta 1$ et l' $\alpha V\beta 3$ ne prévient pas l'activation des plaquettes par le sCD40L, prouvant ainsi que les intégrines $\alpha IIb\beta 3$ et $\alpha 5\beta 1$ sont les premières impliquées dans une réponse au stimulus via le sCD40L [73].

Review

The Signaling Role of CD40 Ligand in Platelet Biology and in Platelet Component Transfusion

Chaker Aloui ^{1,2,*}, Antoine Prigent ^{1,2}, Caroline Sut ¹, Sofiane Tariket ¹,
Hind Hamzeh-Cognasse ¹, Bruno Pozzetto ¹, Yolande Richard ^{3,4,5}, Fabrice Cognasse ^{1,2,*},
Sandrine Laradi ^{1,2} and Olivier Garraud ^{1,6}

¹ Immunity of Mucosa and Pathogen Agents Group (GIMAP-EA3064), University of Lyon, Saint-Etienne 42023, France; E-Mails: antoine.prigent@efs.sante.fr (A.P.); caroline-sut@hotmail.fr (C.S.); tariket.sofiane@hotmail.fr (S.T.); hind.hamzeh@univ-st-etienne.fr (H.H.C.); bruno.pozzetto@univ-st-etienne.fr (B.P.); sandrine.laradi@efs.sante.fr (S.L.); ogarraud@ints.fr (O.G.)

² French Blood Establishment, EFS Auvergne-Loire, Saint-Etienne 42023, France

³ INSERMu1016, Institut Cochin, Departement “Infection, Immunity and Inflammation”, Paris 75014, France; E-Mail: Yolande.richard@inserm.fr

⁴ CNRS-UMR8104, Institut Cochin, Paris 75014, France

⁵ Université Paris-Descartes, Sorbonne Paris Cité, Paris 75270, France

⁶ Institut National de Transfusion Sanguine (INTS), Paris 75739, France

* Authors to whom correspondence should be addressed;

E-Mails: fabrice.cognasse@univ-st-etienne.fr (F.C.); chaker.aloui@univ-st-etienne.fr (C.A.);
Tel.: +33-683-975-883 (F.C.); Fax: +33-477-421-486 (F.C.).

Received: 30 October 2014; in revised form: 25 November 2014 / Accepted: 27 November 2014 /

Published: 3 December 2014

Abstract: The CD40 ligand (CD40L) is a transmembrane molecule of crucial interest in cell signaling in innate and adaptive immunity. It is expressed by a variety of cells, but mainly by activated T-lymphocytes and platelets. CD40L may be cleaved into a soluble form (sCD40L) that has a cytokine-like activity. Both forms bind to several receptors, including CD40. This interaction is necessary for the antigen specific immune response. Furthermore, CD40L and sCD40L are involved in inflammation and a panoply of immune related and vascular pathologies. Soluble CD40L is primarily produced by platelets after activation, degranulation and cleavage, which may present a problem for transfusion. Soluble CD40L is involved in adverse transfusion events including transfusion related acute lung injury (TRALI). Although platelet storage

designed for transfusion occurs in sterile conditions, platelets are activated and release sCD40L without known agonists. Recently, proteomic studies identified signaling pathways activated in platelet concentrates. Soluble CD40L is a good candidate for platelet activation in an auto-amplification loop. In this review, we describe the immunomodulatory role of CD40L in physiological and pathological conditions. We will focus on the main signaling pathways activated by CD40L after binding to its different receptors.

Keywords: CD40 ligand; CD40; inflammation; signaling pathways; p38 mitogen-activated protein kinases (MAPK); nuclear factor-KappaB (NF-κB)

1. Introduction

CD40 ligand (CD40L)—otherwise known as CD154—is of particular interest for several reasons. It is easily detectable in plasma; it is essential to immunity at large and central to adaptive immunity, being among the seminal molecules that tether antigen (Ag)-specific T and B-lymphocytes in the synapse; and it is indispensable for the formation of germinal centers (GCs) in lymph nodes [1–4]. CD40L is thus crucial for cell signaling in both adaptive and innate immunity, as it is expressed by a large variety of cells that take a role in immune responses [1,4]. Further, CD40L has genetic and molecular polymorphisms, with pathogenic and pathologic consequences [5]. Intriguingly, its soluble form is principally generated by platelets, and it is responsible for transfusion associated hazards [6–8]. Together, those properties require the attention of pathologists and clinicians, as CD40L is more important in medicine than initially thought.

In this review, we will discuss the role of CD40L and its soluble form (sCD40L) in transfusion hazards. It is associated with high levels of inflammatory molecules such as chemokines, cytokines and biological response modifiers (BRMs) released by platelets during storage. sCD40L is a master pro-inflammatory BRM in transfusion [6–12]. Platelet sCD40L has been largely studied in inflammation and autoimmune disease [3,13–15], but the mechanism for its regulation is just beginning to be unraveled.

2. What Is CD40L?

CD40L is a 33 kDa type II transmembrane protein belonging to the Tumor Necrosis Factor (TNF) superfamily. The CD40L gene (*CD40LG*) encodes a 261 amino acid (AA) protein with a 22 AA cytoplasmic domain, a 24 AA transmembrane (TM) domain, and a 215 AA extracellular domain (Figure 1) [3]. CD40L is constitutively highly expressed by a panoply of hematopoietic and non-hematopoietic cells [1,3,4,16]. CD40L can be further expressed or overexpressed by activated cells, the most characteristic and best studied of which are activated and/or differentiated T cells [4]. Like other members of the TNF family, active CD40L at the cell surface or in its soluble form is composed of homotrimers [17]. This multimeric conformation of CD40L is of crucial importance for effective interaction with CD40 and the subsequent intracellular signaling [18]. Moreover, the

soluble forms of CD40L retain their ability to form trimers, which bind CD40 and deliver biological signals [18]. Membrane bound CD40L can be cleaved at methionine 113 of the extracellular domain and shed as a soluble form [19–21]. The principal isoform (isoform 1) is encoded by 5 exons. The second CD40L isoform (isoform 2) is poorly described (Figure 1). It is a truncated 240 AA protein lacking exon 4 in the *CD40LG* (extracellular domain), and the functional consequence of this is unknown [22]. Of note, membrane bound CD40L is expressed on B cells and dendritic cells (DCs). It is not expressed on non-activated T cells and platelets, but is weakly expressed on non-activated macrophages, neutrophils and endothelial cells [23]. It is highly expressed on activated T cells and platelets from which it can be cleaved as a soluble form, but it is not cleaved from B cells, DCs and macrophages. There is no up-regulation in neutrophils and endothelial cells, regardless of whether they are activated [1,3,4,23].

Figure 1. Scheme of the CD40 ligand gene structure and its different isoforms. Intracellular domain (IC), transmembrane domain (TM), extracellular domain (EC).

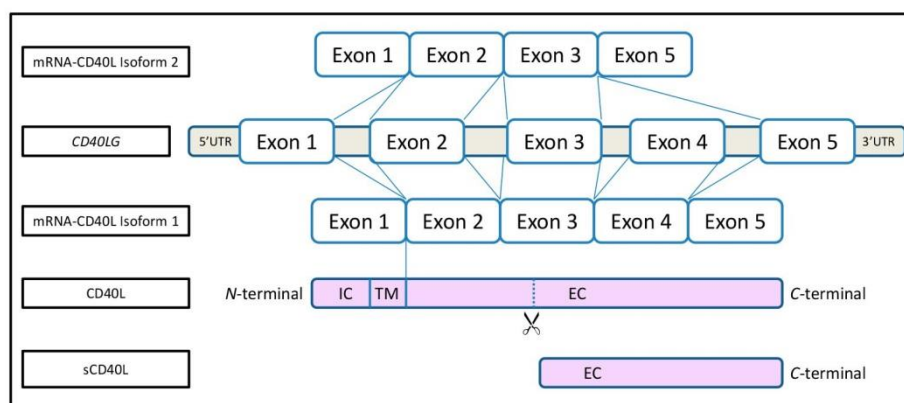

The main receptor for CD40L is CD40, which is constitutively expressed by antigen presenting cells (APCs) such as B cells, macrophages, and DCs [3,4,24]. CD40 is also expressed by platelets [25,26], neutrophils, endothelial cells [23] and T-cells [27–30]. Five distinct isoforms of CD40 are expressed with two isoforms predominating in human and mice [31–33]. Isoform 1 predominates and is membranous, but may be cleaved into a soluble form by a metalloproteinase, ADAM-17 [34]. In contrast, isoform 2 is produced as a soluble form resulting from alternative splicing [35]. It is hypothesized that the soluble forms act as competitive inhibitors for the membranous form, though this remains unclear [36]. Although CD40 is a type I TM protein that can form monomers, dimers and trimers, only the latter form fully activates cells [37–39].

CD40L can also bind to three integrins: the platelet glycoprotein α Ib β 3 (GPIIb/IIIa), otherwise known as receptor for fibrinogen and von Willebrand Factor [40,41]; α 5 β 1 (CD49e/CD29), an integrin that binds to matrix macromolecules and proteinases and thereby stimulates angiogenesis [42–44]; and Mac-1, an integrin (otherwise known as CR3 (Complement Receptor 3), CD11b/CD18, or α M β 2), mainly expressed by neutrophils, natural killer cells and macrophages to trigger a transduction signal and mediate inflammation [45]. The functional interaction of CD40L with α 5 β 1 is independent of its binding to α Ib β 3 and CD40 [43,44]. Interactions between CD40L and α 5 β 1 are not relevant in platelet physiology/physiopathology [45].

3. What Is the Function of CD40L?

The interaction between CD40 and CD40L is essential in the innate and adaptive immune systems, both in physiology and in physiopathology.

3.1. CD40/CD40L in Physiology

First characterized as a major marker on carcinoma cells, CD40 was next shown to be a key molecule shared by endothelial cells and most APCs, including B-cells, monocytes and DCs [46]. Interactions with CD40L are mandatory for the B-cell response to T-dependent Ags [2]. In particular, studies on patients with primary Ab immunodeficiencies targeting CD40 or CD40L have definitively established the requirement of these interactions for GC formation and the generation of memory B-cells and long-lived plasma cells [47]. More recent data on GC reactions and follicular helper T-cells (T_{FH}) show that the polarization of CD4 T-cells into T_{FH} is initiated by contact with DCs at the border of B-cell follicles and maintained by GC B-cells [48]. The expression of BCL6, the master regulator of T_{FH} , is dependent on CD40-CD40L and ICOS-ICOSL interactions outside follicles and within GCs [49]. CD40L-induced CD40 signaling in B-cells is crucial for inducing the expression of BCL6 and Ki67 in GC B-cells, allowing the proliferation of GC B-cells in the dark zone and expression of activation-induced deaminase (AID), a transcription factor required for somatic hypermutation (dark zone) and Ig class switching (light zone). CD40-CD40L interactions are further required for the selection of B-cell clones expressing high affinity BCR that takes place within the GC light zone. In physiological conditions, only selected B-cell clones differentiate into effector B-cells (memory and plasma cells). CD40 is also constitutively expressed by DCs and macrophages, and its triggering induces the expression of other co-stimulatory molecules and the release of cytokines that modulate T- and B-cell responses [24]. CD40 activation on macrophages also induces the release of nitric oxide and reactive oxygen species, contributing to the destruction of intracellular pathogens. Strikingly, CD40-induced CD40L signaling in CD8 T-cells rescues them from the exhaustion observed during chronic viral infections and is important to maintain their poly-functionality [50]. With CD40 being expressed on various B-cell lymphomas and carcinomas (nasopharynx, bladder, cervix, kidney and ovary), there is a renewed interest in CD40/CD40L in the control of tumor growth, leading to the development of new therapeutic strategies [51].

3.2. CD40L and Its Receptors in Inflammatory Pathologies

As already presented, in addition to the classical receptor CD40, CD40L also binds the $\alpha IIb\beta 3$, $\alpha 5\beta 1$, and Mac-1 ($\alpha M\beta 2$) integrins and induces different biological responses. Figure 2 illustrates the pathological role of each dyad interaction.

The CD40-CD40L system is associated with both pro-thrombotic and pro-inflammatory effects. Soluble CD40L contributes to the pathophysiology of atherosclerosis and atherothrombosis [52]. Because of its autocrine, paracrine, and endocrine activities, sCD40L enhances platelet activation, aggregation, and platelet-leukocyte conjugation that may lead to atherothrombosis [13,53,54]. CD40L binding may result in the activation of CD40 expressing cells with interleukin production [23,55].

The interaction of CD40L with CD40 on endothelial and other vascular cells upregulates adhesion molecules such as E-selectin, VCAM-1, ICAM-1 and proinflammatory cytokines such as regulated on activation normal T cell expressed and secreted (RANTES), interleukin (IL)-6, and IL-8 as well as matrix metalloproteinase (MMP)-1, -2, -3, and -9 [56]. Soluble CD40L also stimulates the expression of tissue factor (TF) on monocytes and on endothelial cells [57,58]. After CD40L and CD40 interact on the endothelial surface, thrombomodulin expression is decreased, facilitating thrombin generation [59]. CD40L-CD40 interactions activate endothelial cells via either sCD40L *in vivo* or by a specific antibody to CD40. Membrane-bound CD40L, but not sCD40L, induces the upregulation of pro-inflammatory cytokines and cell adhesion factors in endothelial cells. However, both forms of CD40L activate both classical and alternative NF- κ B pathways [60]. In addition, sCD40L induces endothelial dysfunction with decreased NO synthesis and augmented oxidative stress [61]. These events may further contribute to endothelium injury and accompanying atherogenesis. sCD40L may play a pathogenic role in triggering acute coronary syndromes [54,62]. The involvement of CD40-CD154 interactions in autoimmunity and allo-immunity is also well documented. In fact, many tissue injuries and immune mediated pathologies such as graft allo-rejections involve this signaling pathway [63]. CD40-CD40L interactions play a significant role in the production of auto-antibodies in systemic lupus erythematosus (SLE), rheumatoid arthritis (RA) and other autoimmune diseases. An increased serum level of soluble CD154 was reported in SLE, RA, and Sjogren's disease, in correlation with the relevant auto-antibodies and with the clinical disease activity [14,64].

Figure 2. CD40L and its receptors: the binding of CD40L to CD40, α IIb β 3, α 5 β 1, or Mac-1 (α M β 2) induces different inflammatory pathologies. Systemic lupus erythematosus (SLE), transfusion-related acute lung injury (TRALI), reactive oxygen and nitrogen species (RONS), Myeloperoxidase (MPO).

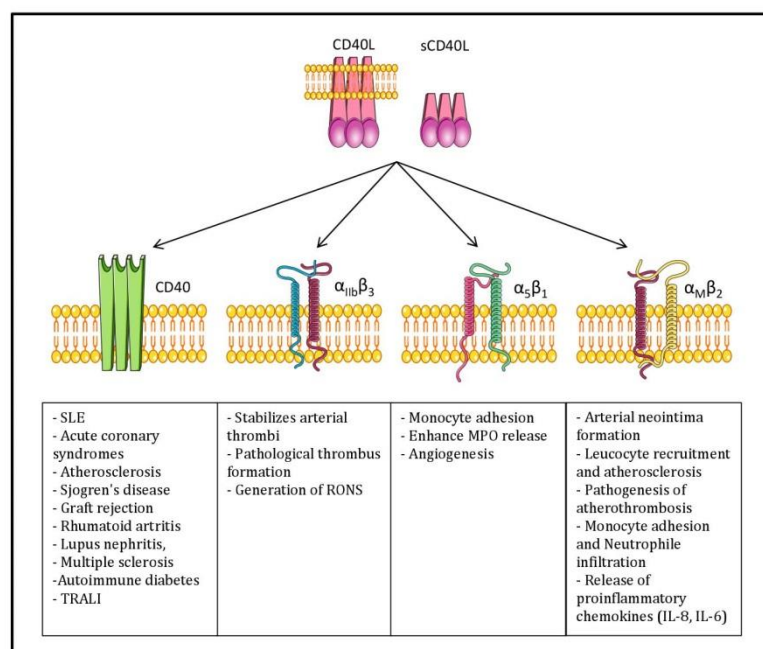

α Ib β 3 integrin was first identified as a receptor for CD40L by André *et al.* [65]. They showed that sCD40L can bind to α Ib β 3 integrin on activated platelets, thereby inducing platelet spreading and promoting platelet aggregation under high shear rates, as well as allowing stability of arterial thrombi [66]. The same group further reported that CD40L is a primary platelet agonist capable of inducing platelet activation, induction of fibrinogen binding and the formation of platelet microparticles by binding to its α Ib β 3 receptor and triggering outside-in signaling [67]. In addition, the engagement of α Ib β 3 by CD40L or other ligands that induce platelet adhesion upregulates CD40L surface exposure on platelets [68], enhancing the interaction of platelets with CD40+ cells, including ECs. Incubation of platelets with recombinant sCD40L led to enhanced P-selectin expression, aggregation, and platelet-leukocyte conjugation. The inhibition of either sCD40L or α Ib β 3 attenuated the generation of reactive oxygen and nitrogen species (RONS) by platelets [69].

Mac-1 is an important mediator of neutrophil and monocyte adhesion to the activated endothelium during inflammation. CD40L ligation to Mac-1 is involved in mediating CD40L/Mac-1-dependent monocyte and neutrophil adhesion and transmigration at the atherosclerotic lesion site, as well as neointimal formation during atherogenesis [42,70]. In transfusion, the sCD40L concentration increases in stored platelets compared to fresh platelets [9,10]. The neutrophil priming ability of stored platelets is significantly higher compared to fresh platelets [71]. Soluble CD40L and CD40-activated-neutrophils are essential to permit the adhesion and migration of neutrophils by Mac-1 secretion. This signal is the main system to recruit neutrophils into pulmonary tissue [72]. CD40+ neutrophils primed by CD40L+ activated platelets and sCD40L are recruited and over-stimulated by IL-6, IL-8 and IL-1 β originating from alveolar macrophages and fibroblasts. In alveolar space, these neutrophils secrete ROS, proteases, PAF and elastase- α 1-antitrypsin complexes that insult the pulmonary parenchyma [73]. In another study using the two-event TRALI mouse model, Hidalgo and colleagues demonstrated an increase in platelet interactions with adherent neutrophils in the systemic circulation [74]. These interactions were dependent on E-selectin expression on the endothelium interacting with E-selectin ligand on neutrophils, which ultimately led to the polarization of Mac-1 on the leading edge of the neutrophils. Circulating platelets interacted with the clustered Mac-1, although the platelet ligand mediating this interaction is not known [74]; could it be CD40L?

The α 5 β 1 integrin is expressed by endothelial cells, smooth muscle cells, monocytes/macrophages and platelets. It is implicated in cell adhesion, migration, and proliferation as well as survival of many cell types. The binding of CD40L to a monocytic cell line expressing α 5 β 1 integrin leads to the phosphorylation of the extracellular signal regulated kinases 1/2 (ERK-1/2) and expression of IL-8 mRNA in these cells [14]. However, unlike fibrinogen and vitronectin which are the natural ligands of α 5 β 1, CD40L binds to the inactive rather than the active form of α 5 β 1. Interestingly, CD40L/ α 5 β 1 interactions do not interfere with the binding of CD40L to CD40, indicating that CD40L can bind simultaneously to both receptors [43].

The role of α 5 β 1 as a receptor for CD40L in α 5 β 1-expressing-cells has not yet been investigated. Hassan *et al.* hypothesized the involvement of the CD40L/ α 5 β 1 dyad in angiogenesis and pathological conditions of the vascular system after the tethering of cells in inflamed tissues such as atherosclerotic lesion sites [75].

4. Platelet CD40L

The discovery in 1998 that platelets preferentially express many copies of CD40L on their surfaces upon activation was surprising because CD40L was thought to characterize immune reactive cells, and platelets were not yet acknowledged to display any immune function [25]. CD40L was then found in platelet cytoplasm [25,65,76,77], and years later more precisely identified as being docked in the platelet α -granules [78] (Figure 3). The discovery that, despite being non-nucleated cells devoid of DNA apart from mitochondrial DNA [79], platelets can retrotranscribe RNA using a spliceosome [80–83] and lead to detectable RNA messages for cytokines, questioned the possibility that CD40L is also produced *de novo* by activated platelets. Recently, some RNA-seq studies did not find CD40L mRNA in platelets [84–87]. This result suggests that a preformed protein is synthesized by megakaryocytes and stored in α -granules before platelet fragmentation [88–90].

Figure 3. Schematic overview of the regulation of platelet CD40L and the role of sCD40L in signaling after binding to platelet CD40 and α IIB β 3 inducing an auto-amplification loop. Synaptosomal-associated protein 23 (SNAP23), mitogen-activated protein kinase (MAPK), nuclear factor kappa B (NF- κ B), protein kinase B (AKT) matrix metalloproteinase-2 (MMP-2), TNF receptor associated factor 2 (TRAF2).

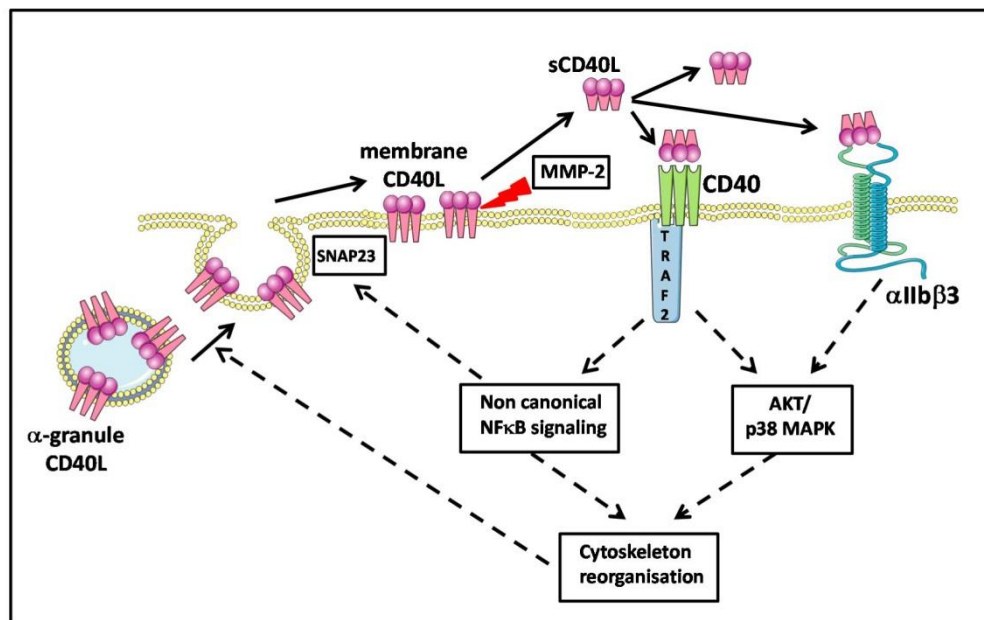

After stimulation by different agonists, platelets undergo a degranulation process via a well characterized mechanism [91], and either export the α -granule molecules to the membrane in a fixed form or secrete them as a soluble form. Granules fuse with the platelet membrane and display their fixed CD40L on the surface. This process occurs within seconds to minutes after stimulation [25]. CD40L is thus expressed on the platelet surface only after activation, and this molecule is identical in terms of structure and physiological function to membrane bound CD40L

expressed in activated T-lymphocytes and other cells. It can notably generate signals for the recruitment and extravasation of leukocytes. It induces, through the engagement of CD40, the secretion of chemokines and the expression of adhesion receptors in endothelial cells [25]. It provides a powerful link between platelets and the immune system: CD40L expressed on activated platelets induces dendritic cell maturation, B-cell isotype switching, and augments CD8+ T-cell responses in both *in vitro* and *in vivo* models [92–95].

Platelets do not maintain CD40L on their surface for long. It is cleaved and released in a soluble form and may also be carried on the surface of microparticle-derived platelets [96]. Platelets are the major source of sCD40L in the circulation [65,97,98]. The normal range of sCD40L in the serum of a healthy adult is estimated at 0.79 to 4.7 ng/mL, by means of immunoassay techniques [99–101].

Of note, platelets constitutively express CD40 on their surfaces, both when resting and upon activation (Figure 3) [25,26,92]. This is surprising, as CD40 has long been considered to characterize APCs. Some sCD40L is reabsorbed on the platelet surface and principally binds CD40, a mechanism of recycling that must not be ignored when discussing platelet physiology and pathology.

5. Platelets, CD40L, and Molecular Signaling

5.1. Platelet Activation in Platelet Components and Molecular Signaling

Platelet activation and the signaling pathways involved in hemostatic conditions are well documented [102–104]. However, there is little information regarding the platelet components (PCs) prepared and processed for transfusion.

Several proteomic studies have investigated platelet changes after either resting (*ex vivo*) conditions or stimulation (*in vitro*) [105,106]. Most have tested activation markers such as shape change, glycolysis, supernatant pH levels, platelet CD62P and CD40L surface expression, reactivity to repeated activation by agonists, secretion of platelet granule products, cytoskeletal reorganization and expression of apoptotic markers [9,107,108]. Most of those studies, as well as the subsequent ones, were carried out with the purpose of improving the platelet physiology in the *ex vivo* conditions that lead to the possibility of storing platelets for a limited number of days and transfusing homologous donor platelets to a recipient patient. The signaling pathways involved in the “spontaneous” activation of platelets in PCs were investigated [105,109,110].

Schubert *et al.* [109] found evidence for a signaling pathway mediating PC storage lesions in which PI3-kinase-dependent Rap1 activation leads to integrin α IIB β 3 activation and platelet degranulation. This pathway involves two principal actors: Rap1, a small GTPase that modulates α IIB β 3 affinity, most likely through effects on the actin cytoskeleton [111], and Talin, an adaptor protein that links α IIB β 3 to the actin cytoskeleton. In hemostasis, this pathway is activated by soluble molecules after binding to different receptors, leading to the activation of the integrin α IIB β 3 [112].

Moreover, several studies identified the activation of the p38 MAPK signaling pathway during the aging of platelets not subjected to added stimulus [105,110], and/or after treatment of platelet concentrates with UV light with the intent of eradicating infectious pathogens. p38 MAPK is more

highly activated after UV exposure, a PI3-kinase-dependent mechanism that involves AKT, VASP and HSP27. AKT thus acts as a substrate for p38 MAPK. HSP27 is a substrate for AKT, and it regulates actin dynamics and degranulation. This confirms the earlier finding that MAPK activation stimulates platelet degranulation and TxA₂ synthesis, which may in turn activate platelets via the TP receptor [113]. After degranulation, soluble factors (ADP, ATP, TxA₂, Ca²⁺ and thrombin) are released and may act quickly to amplify autocrine activation of platelets as well as the activation of surrounding platelets (Figure 4) [88].

Platelets possess a variety of pathogen recognition receptors (PRRs) to sense bacterial and viral moieties and other receptors that could be involved in platelet activation in PCs [114–116]. Activated platelets can, consequently, secrete inflammatory cytokines and chemokines and other biological response modifiers (BRMs), including sCD40L, which could be a good candidate for such autocrine activation loops in platelets (Figures 3 and 4).

Figure 4. Principal signaling pathways inducing platelet activation in platelet components. Phosphoinositide 3-kinase (PI3K), mitogen-activated protein kinase (MAPK), protein kinase B (AKT), Thromboxane A2 (TxA₂), Vasodilator-stimulated phosphoprotein (VASP), Ras-proximate-1 (Rap1), Heat shock protein 27 (HSP27).

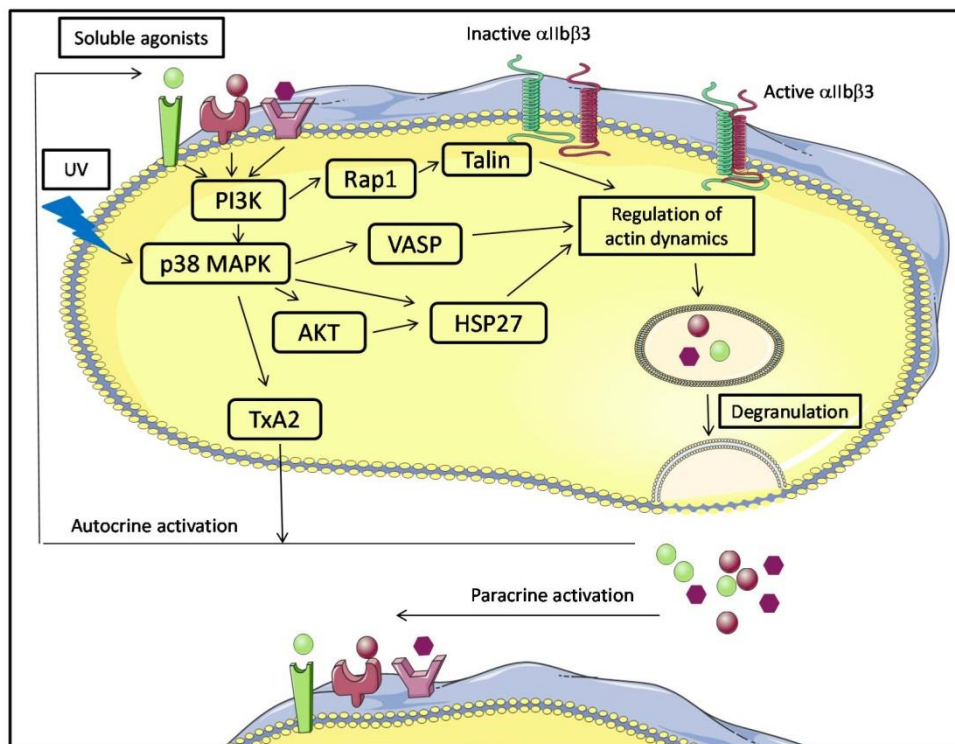

5.2. Platelet Membrane CD40L Regulation and Shedding

As already stated, CD40L was initially thought to be almost absent from the surface of non-activated platelets [117]. It has been recently reported, however, that resting platelets express very low levels of CD40L on their surface but can translocate massive amounts of CD40L to the

surface within minutes of activation. This CD40L can subsequently be cleaved and released as a soluble molecule into the circulation [92,118,119]. Such CD40L would thus be mobilized from the α -granules (Figure 3).

Knowledge regarding CD40L cleavage, either from T-cells or from platelets, remains incomplete. Cleavage from T-cells has been attributed to two types of MMPs. Two other MMPs are also responsible for the cleavage of platelet membrane bound CD40L.

MMPs constitute a large family of more than 25 functionally related endopeptidases mediating the proteolytic cleavage of most matrix proteins, as well as several non-matrix proteins including cytokines, chemokines, adhesion molecules and surface receptors [120]. ADAM10 has been proposed as a candidate MMP for CD40L cleavage and shedding from T-cells [121]. ADAM17 has been shown to be another candidate in an *in vitro* model of Jurkat E6.1 T-cells, where the inhibition of both ADAM10 and ADAM17 nearly completely inhibited CD40L shedding from the cells, suggesting that no other MMP besides ADAM10 and ADAM17 is involved [122]. The mechanisms that cleave activated platelet CD40L appear to be quite different. Not only MMPs but also the integrin α IIB β 3 are mandatory. MMP2 is the best candidate, based on different experimental approaches [123–126]. A novel enzyme has revealed itself as a potential candidate, at least in pathological situations, as demonstrated in a mouse model of sepsis. Here, MMP9 was involved in the shedding of CD40L after platelet-neutrophil interaction. Again, different experimental approaches confirmed a role for MMP9 [127–130].

Interestingly, the enzymatic regulation of CD40L cleavage from CD40L-positive cells appears cell-dependent. Platelets and T-cells use different proteases to cleave sCD40L from their cell surfaces (MMP2/MMP9, and ADAM10/ADAM17, respectively), despite both cell types containing all four identified enzymes. Among the possible explanations are the existence and particularities of the cytoplasmic or granule reservoirs. Those distinct mechanisms have functional consequences on signaling pathways triggered upon CD40L/CD40 activation between these two cell types.

In platelet CD40L cleavage, the need for functional and complete α IIB β 3 remains intriguing [123,131]. For example, Glanzmann thrombocytopenia patients fail to properly release sCD40L upon platelet activation [123].

5.3. Platelet and CD40L Signaling

CD40L production by platelets is an interesting intersection between hemostasis and inflammation. Hemostatic activation of platelets (by ADP, thrombin, collagen, *etc.*) induces inside-out signaling and, consequently, activation of α IIB β 3. This leads to outside-in signaling and degranulation, followed by CD40L expression on the membrane surface. After activation, CD40L is shed and released in an active form that can activate different cell types, including platelets.

Soluble CD40L may activate platelets via two independent receptors, CD40 and α IIB β 3. After sCD40L binding, both receptors activate AKT and enhance platelet p38 MAP kinase phosphorylation. One study showed that this signaling pathway initiates the generation of inflammatory molecules such as reactive oxygen and nitrogen species [69].

Soluble CD40L binding to platelet α IIB β 3 (through its KGD sequence) enhances thrombus formation and induces platelet spreading via outside-in integrin signaling in an auto-amplification

loop [65,67]. This phenomenon also induces the generation of microparticles, especially through phosphorylation of tyrosine-759 in the cytoplasmic domain of the $\beta 3$ chain [67].

Soluble CD40L may also activate platelets via the CD40 receptor, which is present on platelet membranes [25,26]. In this case, the mechanism is outside-in independent. The CD40L/CD40 activation in platelets involves a CD40-dependent TRAF2/Rac1/p38 MAPK signaling pathway and triggers phosphorylation of I κ B α [132,133]. Thus, the sCD40L/CD40 interaction also triggers NF- κ B pathway activation in platelets. In this case, NF- κ B acts as a signaling molecule and not a transcription factor. I κ B phosphorylates SNAP23, a key protein for the fusion of alpha granules and the plasma membrane [134]. IKK β blockade inhibits SNAP 23 phosphorylation and prevents SNARE complex formation (SNARE complex formation reviewed in [90,135,136]) and platelet degranulation [134]. These mechanisms are outlined in Figure 3.

6. CD40L and Platelet Component Transfusion

The sCD40L association with platelets has been popularized because of the description of transfusion hazards [6–12]. Before that, although well published, this association received little consideration. For more than a decade, sCD40L-linked associated hazards also received modest consideration, probably because the attention of transfusiologists focused on preventable hazards, and residual leukocytes were considered to be responsible for all symptoms of inflammation [137]. Transfusion-linked inflammation was not yet acknowledged, but classed as discomfort. Accidents were attributed to other causes, which were sometimes reported as unidentified. Soluble CD40L gained attention when progress was made in the field of hemostasis and thrombosis, which outlined the role of platelets and leukocytes in the formation of atheroma plaque deposition and led to the proposal that cardiovascular disease is inflammatory [16,99,138–143].

Platelets in an inventory are generally stored no longer than 5 days (ranging from 3 to 7 days depending on country regulations). During storage, and without the addition of any stimulus intended to activate them, those so-called “resting” platelets are exposed to a number of stresses, including the process of constituting a PC, exposure to plastics, preservatives and gases, rotation, and changes in temperature [107,144,145]. Platelets are extremely reactive to external signals and are designed to sense external danger. They are equipped with many types of receptors and danger sensors, and they respond to multiple signals [83,116]. Anticoagulant factors and bacterial residues can modify the status of platelets that are believed to be “resting”, but which in fact are lightly stimulated just above physiological steady state [83,116]. As platelets secrete more pro-inflammatory than anti-inflammatory BRMs, they begin to produce or secrete BRMs that are fairly detectable in the PC supernatant by day 3 [9,146]. Soluble CD40L is the most visible cytokine-like BRM which is thus made, and it is produced in amounts that are sufficient to activate CD40+ cells *in vitro*, including B-cells, dendritic cells, and macrophages [146,147]. It is therefore fully bioactive. The longer the PC is stored, the more BRMs are found, apart from some molecules with extremely short half-life [11,12,146]. CD40L has a short half-life outside the α -granule, but its secretion over day 3, for 2 to 4 days, still allows biological function [146]. In general, PC transfusion is safe and accomplishes what it is expected to do: prevent or stop bleeding in the allocated patient/recipient. In approximately 10% of cases, moderate intolerance symptoms are reported, which are referred to

as either febrile non-hemolytic transfusion reactions (FNHTRs) or allergic reactions (in fact, allergic-type reactions) [148]. In 2% of cases, the symptomatology is more severe, and presents more clearly as inflammatory [148]; such cases have been investigated by several groups, and there is a consensus on the responsibility of sCD40L that is found in excess in the PC or in the recipient's plasma [6,7,10–12]. Soluble CD40L does not carry the full responsibility, but it is chiefly to blame [7,11,12]. It is also responsible in part for the physiopathology of a severe transfusion hazard called TRALI (Transfusion-Related Acute Lung Injury) [10], despite one recent publication that disputed this [149]. An open question is why some PCs seem loaded with sCD40L. If platelets in PCs can be over-stimulated by some unexpected event in the process, it probably does not occur in all cases [7,150].

7. Concluding Remarks: Towards Molecular Medicine Based upon CD40L and CD40 Polymorphisms

As the CD40/CD40L molecular tandem is essential in many pathways of physiological but also pathological immune and inflammatory responses, its control is valuable in patient care. We and other groups have worked extensively during the past few years on the involvement of sCD40L in transfusion associated hazards, and we have recently obtained evidence that there are a number of *CD40LG* polymorphisms that may affect the behavior of platelets in a PC processed for the purpose of transfusion [151]. Combined with polymorphisms of *CD40*, this may affect the preferential decrease of inhibitory isoforms of the molecules and the increase of high affinity isoforms. Certain platelet donors may express high levels of sCD40L that are promptly cleaved [11,12,126], and/or certain recipients express high affinity CD40 receptors on both circulating cells and endothelial cells, favoring excess CD40/CD40L reactions and adverse events. Cell signaling through these interactions may prompt those cells to either synthesize or release copious amounts of bioactive BRMS with inflammatory potential. If proven, donor selection and/or patient investigation would allow better matching to prevent such adverse events. Serious adverse events would also benefit from the recent development of biologicals that target either CD40 or CD40L. In fact, Tanaka *et al.* [152,153] have succeeded to remove 80% to 90% of sCD40L in PCs using a column of adsorptive cellulose beads. However, there was a significant decrease in the recovery of platelets after adsorption. In other diseases, blockade of CD40/CD40L was performed using anti-CD40L Abs, but unfortunately these drugs have exhibited potentially adverse interactions with platelets in patients [154].

Molecular or personalized medicine is thus underway for patients presenting with high risk of potentially lethal acute inflammatory responses. If not yet implementable at a large scale, this may be forecast for the very near future.

Acknowledgments

This work was supported by a grant from Erasmus Mundus Al-Idrisi (idri-1100823) and by the “Etablissement Français du Sang Auvergne-Loire”.

Author Contributions

Fabrice Cognasse, Sandrine Laradi and Olivier Garraud designed and supervised this manuscript. Chaker Aloui, Olivier Garraud and Yolande Richard wrote this manuscript. Antoine Prigent, Caroline Sut and Sofiane Tariket participated in the discussion and in the conception of the figures. Hind Hamzeh-Cognasse and Bruno Pozzetto reviewed the manuscript.

Conflicts of Interest

The authors declare no conflict of interest.

References

1. Grewal, I.S.; Flavell, R.A. CD40 and CD154 in cell-mediated immunity. *Annu. Rev. Immunol.* **1998**, *16*, 111–135.
2. Banchereau, J.; Bazan, F.; Blanchard, D.; Brière, F.; Galizzi, J.P.; van Kooten, C.; Liu, Y.J.; Rousset, F.; Saeland, S. The CD40 antigen and its ligand. *Annu. Rev. Immunol.* **1994**, *12*, 881–922.
3. Van Kooten, C.; Banchereau, J. CD40-CD40 ligand. *J. Leukoc. Biol.* **2000**, *67*, 2–17.
4. Elgueta, R.; Benson, M.J.; de Vries, V.C.; Wasiuk, A.; Guo, Y.; Noelle, R.J. Molecular mechanism and function of CD40/CD40L engagement in the immune system. *Immunol. Rev.* **2009**, *229*, 152–172.
5. Malarstig, A.; Lindahl, B.; Wallentin, L.; Siegbahn, A. Soluble CD40L levels are regulated by the -3459 A>G polymorphism and predict myocardial infarction and the efficacy of antithrombotic treatment in non-ST elevation acute coronary syndrome. *Arterioscler. Thromb. Vasc. Biol.* **2006**, *26*, 1667–1673.
6. Phipps, R.P.; Kaufmann, J.; Blumberg, N. Platelet derived CD154 (CD40 ligand) and febrile responses to transfusion. *Lancet* **2001**, *357*, 2023–2024.
7. Blumberg, N.; Gettings, K.F.; Turner, C.; Heal, J.M.; Phipps, R.P. An association of soluble CD40 ligand (CD154) with adverse reactions to platelet transfusions. *Transfusion* **2006**, *46*, 1813–1821.
8. Blumberg, N.; Spinelli, S.L.; Francis, C.W.; Taubman, M.B.; Phipps, R.P. The platelet as an immune cell—CD40 ligand and transfusion immunomodulation. *Immunol. Res.* **2009**, *45*, 251–260.
9. Cognasse, F.; Boussoulade, F.; Chavarin, P.; Acquart, S.; Fabrigli, P.; Lamy, B.; Garraud, O. Release of potential immunomodulatory factors during platelet storage. *Transfusion* **2006**, *46*, 1184–1189.
10. Khan, S.Y.; Kelher, M.R.; Heal, J.M.; Blumberg, N.; Boshkov, L.K.; Phipps, R.; Gettings, K.F.; McLaughlin, N.J.; Silliman, C.C. Soluble CD40 ligand accumulates in stored blood components, primes neutrophils through CD40, and is a potential cofactor in the development of transfusion-related acute lung injury. *Blood* **2006**, *108*, 2455–2462.

11. Hamzeh-Cognasse, H.; Damien, P.; Nguyen, K.A.; Arthaud, C.-A.; Eyraud, M.-A.; Chavarin, P.; Absi, L.; Osselaer, J.-C.; Pozzetto, B.; Cognasse, F.; *et al.* Immune-reactive soluble OX40 ligand, soluble CD40 ligand, and interleukin-27 are simultaneously oversecreted in platelet components associated with acute transfusion reactions. *Transfusion* **2014**, *54*, 613–625.
12. Nguyen, K.A.; Hamzeh-Cognasse, H.; Sebban, M.; Fromont, E.; Chavarin, P.; Absi, L.; Pozzetto, B.; Cognasse, F.; Garraud, O. A computerized prediction model of hazardous inflammatory platelet transfusion outcomes. *PLoS One* **2014**, *9*, e97082.
13. Antoniadou, C.; Bakogiannis, C.; Tousoulis, D.; Antonopoulos, A.S.; Stefanadis, C. The CD40/CD40 ligand system: linking inflammation with atherothrombosis. *J. Am. Coll. Cardiol.* **2009**, *54*, 669–677.
14. Alaaeddine, N.; Hassan, G.S.; Yacoub, D.; Mourad, W. CD154: An immunoinflammatory mediator in systemic lupus erythematosus and rheumatoid arthritis. *Clin. Dev. Immunol.* **2012**, *2012*, doi:10.1155/2012/490148.
15. Dejica, D.I.; Manea, E.M. Costimulatory molecule CD154 in systemic lupus erythematosus and rheumatoid arthritis. Therapeutic perspectives. *Roum. Arch. Microbiol. Immunol.* **2006**, *65*, 66–74.
16. Zhang, B.; Wu, T.; Chen, M.; Zhou, Y.; Yi, D.; Guo, R. The CD40/CD40L system: A new therapeutic target for disease. *Immunol. Lett.* **2013**, *153*, 58–61.
17. Locksley, R.M.; Killeen, N.; Lenardo, M.J. The TNF and TNF receptor superfamilies: Integrating mammalian biology. *Cell* **2001**, *104*, 487–501.
18. Anand, S.X.; Viles-Gonzalez, J.F.; Badimon, J.J.; Cavusoglu, E.; Marmur, J.D. Membrane-associated CD40L and sCD40L in atherothrombotic disease. *Thromb. Haemost.* **2003**, *90*, 377–384.
19. Ludewig, B.; Henn, V.; Schröder, J.M.; Graf, D.; Kroczeck, R.A. Induction, regulation, and function of soluble TRAP (CD40 ligand) during interaction of primary CD4⁺ CD45RA⁺ T cells with dendritic cells. *Eur. J. Immunol.* **1996**, *26*, 3137–3143.
20. Blair, P.J.; Riley, J.L.; Harlan, D.M.; Abe, R.; Tadaki, D.K.; Hoffmann, S.C.; White, L.; Francomano, T.; Perfetto, S.J.; Kirk, A.D.; *et al.* CD40 ligand (CD154) triggers a short-term CD4⁺ T cell activation response that results in secretion of immunomodulatory cytokines and apoptosis. *J. Exp. Med.* **2000**, *191*, 651–660.
21. Graf, D.; Müller, S.; Korthäuer, U.; van Kooten, C.; Weise, C.; Kroczeck, R.A. A soluble form of TRAP (CD40 ligand) is rapidly released after T cell activation. *Eur. J. Immunol.* **1995**, *25*, 1749–1754.
22. Ensembl Genome Browser 77: Homo Sapiens-Summary-Gene: CD40LG (ENSG00000102245). Available Online: http://www.ensembl.org/Homo_sapiens/Gene/Summary?db=core;g=ENSG00000102245;r=X:136648193-136660390 (accessed on 8 October 2014).
23. Lievens, D.; Eijgelaar, W.J.; Biessen, E.A.L.; Daemen, M.J.A.P.; Lutgens, E. The multi-functionality of CD40L and its receptor CD40 in atherosclerosis. *Thromb. Haemost.* **2009**, *102*, 206–214.
24. Ma, D.Y.; Clark, E.A. The role of CD40 and CD154/CD40L in dendritic cells. *Semin. Immunol.* **2009**, *21*, 265–272.

25. Henn, V.; Slupsky, J.R.; Gräfe, M.; Anagnostopoulos, I.; Förster, R.; Müller-Berghaus, G.; Kroczek, R.A. CD40 ligand on activated platelets triggers an inflammatory reaction of endothelial cells. *Nature* **1998**, *391*, 591–594.
26. Inwald, D.P. CD40 is constitutively expressed on platelets and provides a novel mechanism for platelet activation. *Circ. Res.* **2003**, *92*, 1041–1048.
27. Girvin, A.M.; dal Canto, M.C.; Miller, S.D. CD40/CD40L interaction is essential for the induction of EAE in the absence of CD28-mediated co-stimulation. *J. Autoimmun.* **2002**, *18*, 83–94.
28. Baker, R.L.; Wagner, D.H.; Haskins, K. CD40 on NOD CD4 T cells contributes to their activation and pathogenicity. *J. Autoimmun.* **2008**, *31*, 385–392.
29. Vaitaitis, G.M.; Wagner, D.H. High distribution of CD40 and TRAF2 in Th40 T cell rafts leads to preferential survival of this auto-aggressive population in autoimmunity. *PLoS One* **2008**, *3*, e2076.
30. Munroe, M.E. Functional roles for T cell CD40 in infection and autoimmune disease: The role of CD40 in lymphocyte homeostasis. *Semin. Immunol.* **2009**, *21*, 283–288.
31. Tone, M.; Tone, Y.; Fairchild, P.J.; Wykes, M.; Waldmann, H. Regulation of CD40 function by its isoforms generated through alternative splicing. *Proc. Natl. Acad. Sci. USA* **2001**, *98*, 1751–1756.
32. Hou, H.; Obregon, D.; Lou, D.; Ehrhart, J.; Fernandez, F.; Silver, A.; Tan, J. Modulation of neuronal differentiation by CD40 isoforms. *Biochem. Biophys. Res. Commun.* **2008**, *369*, 641–647.
33. Chatzigeorgiou, A.E.; Lembessis, P.E.; Mylona-Karagianni, C.F.; Tsouvalas, E.A.; Diamanti-Kandarakis, E.; Kamper, E.F. CD40 expression and its association with low-grade inflammation in a Greek population of type 1 diabetic juveniles: Evidence for differences in CD40 mRNA isoforms expressed by peripheral blood mononuclear cells. *Exp. Clin. Endocrinol. Diabetes* **2010**, *118*, 38–46.
34. Contin, C.; Pitard, V.; Itai, T.; Nagata, S.; Moreau, J.-F.; Déchanet-Merville, J. Membrane-anchored CD40 is processed by the tumor necrosis factor- α -converting enzyme. Implications for CD40 signaling. *J. Biol. Chem.* **2003**, *278*, 32801–32809.
35. Eshel, D.; Toporik, A.; Efrati, T.; Nakav, S.; Chen, A.; Douvdevani, A. Characterization of natural human antagonistic soluble CD40 isoforms produced through alternative splicing. *Mol. Immunol.* **2008**, *46*, 250–257.
36. Esposito, P.; Rampino, T.; dal Canton, A. Soluble CD40 as a modulator of CD40 pathway. *Immunol. Lett.* **2012**, *147*, 85–86.
37. Reyes-Moreno, C.; Girouard, J.; Lapointe, R.; Darveau, A.; Mourad, W. CD40/CD40 homodimers are required for CD40-induced phosphatidylinositol 3-kinase-dependent expression of B7.2 by human B lymphocytes. *J. Biol. Chem.* **2004**, *279*, 7799–7806.
38. Pullen, S.S.; Labadia, M.E.; Ingraham, R.H.; McWhirter, S.M.; Everdeen, D.S.; Alber, T.; Crute, J.J.; Kehry, M.R. High-affinity interactions of tumor necrosis factor receptor-associated factors (TRAFs) and CD40 require TRAF trimerization and CD40 multimerization. *Biochemistry* **1999**, *38*, 10168–10177.

39. He, X.; Xu, L.; Liu, Y. Enhancement of binding activity of soluble human CD40 to CD40 ligand through incorporation of an isoleucine zipper motif. *Acta Pharmacol. Sin.* **2006**, *27*, 333–338.
40. Fullard, J.F. The role of the platelet glycoprotein IIb/IIIa in thrombosis and haemostasis. *Curr. Pharm. Des.* **2004**, *10*, 1567–1576.
41. Scarborough, R.M.; Rose, J.W.; Hsu, M.A.; Phillips, D.R.; Fried, V.A.; Campbell, A.M.; Nannizzi, L.; Charo, I.F. Barbourin. A GPIIb-IIIa-specific integrin antagonist from the venom of *Sistrurus m. barbouri*. *J. Biol. Chem.* **1991**, *266*, 9359–9362.
42. Zirlik, A.; Maier, C.; Gerdes, N.; MacFarlane, L.; Soosairajah, J.; Bavendiek, U.; Ahrens, I.; Ernst, S.; Bassler, N.; Missiou, A.; *et al.* CD40 ligand mediates inflammation independently of CD40 by interaction with Mac-1. *Circulation* **2007**, *115*, 1571–1580.
43. Léveillé, C.; Bouillon, M.; Guo, W.; Bolduc, J.; Sharif-Askari, E.; el-Fakhry, Y.; Reyes-Moreno, C.; Lapointe, R.; Merhi, Y.; Wilkins, J.A.; *et al.* CD40 ligand binds to alpha5beta1 integrin and triggers cell signaling. *J. Biol. Chem.* **2007**, *282*, 5143–5151.
44. El Fakhry, Y.; Alturaihi, H.; Yacoub, D.; Liu, L.; Guo, W.; Leveillé, C.; Jung, D.; Khzam, L.B.; Merhi, Y.; Wilkins, J.A.; *et al.* Functional interaction of CD154 protein with $\alpha 5\beta 1$ integrin is totally independent from its binding to $\alpha IIb\beta 3$ integrin and CD40 molecules. *J. Biol. Chem.* **2012**, *287*, 18055–18066.
45. Hassan, G.S.; Merhi, Y.; Mourad, W.M. CD154 and its receptors in inflammatory vascular pathologies. *Trends Immunol.* **2009**, *30*, 165–172.
46. Ledbetter, J.A.; Shu, G.; Gallagher, M.; Clark, E.A. Augmentation of normal and malignant B cell proliferation by monoclonal antibody to the B cell-specific antigen BP50 (CDW40). *J. Immunol.* **1987**, *138*, 788–794.
47. Durandy, A.; Kracker, S.; Fischer, A. Primary antibody deficiencies. *Nat. Rev. Immunol.* **2013**, *13*, 519–533.
48. Nutt, S.L.; Tarlinton, D.M. Germinal center B and follicular helper T cells: siblings, cousins or just good friends? *Nat. Immunol.* **2011**, *12*, 472–477.
49. Baumjohann, D.; Preite, S.; Reboldi, A.; Ronchi, F.; Ansel, K.M.; Lanzavecchia, A.; Sallusto, F. Persistent antigen and germinal center B cells sustain T follicular helper cell responses and phenotype. *Immunity* **2013**, *38*, 596–605.
50. Bhadra, R.; Gigley, J.P.; Khan, I.A. Cutting edge: CD40-CD40 ligand pathway plays a critical CD8-intrinsic and -extrinsic role during rescue of exhausted CD8 T cells. *J. Immunol.* **2011**, *187*, 4421–4425.
51. Korniluk, A.; Kemon, H.; Dymicka-Piekarska, V. Multifunctional CD40L: Pro- and anti-neoplastic activity. *Tumour Biol.* **2014**, *35*, 9447–9457.
52. Nagy, B.; Miszti-Blasius, K.; Kerenyi, A.; Clemetson, K.J.; Kappelmayer, J. Potential therapeutic targeting of platelet-mediated cellular interactions in atherosclerosis and inflammation. *Curr. Med. Chem.* **2012**, *19*, 518–531.
53. Prasad, K.S.S.; Andre, P.; Yan, Y.; Phillips, D.R. The platelet CD40L/GP IIb-IIIa axis in atherothrombotic disease. *Curr. Opin. Hematol.* **2003**, *10*, 356–361.
54. Pamukcu, B.; Lip, G.Y.H.; Snezhitskiy, V.; Shantsila, E. The CD40-CD40L system in cardiovascular disease. *Ann. Med.* **2011**, *43*, 331–340.

55. Lievens, D.; Zerneck, A.; Seijkens, T.; Soehnlein, O.; Beckers, L.; Munnix, I.C.A.; Wijnands, E.; Goossens, P.; van Kruchten, R.; Thevissen, L.; *et al.* Platelet CD40L mediates thrombotic and inflammatory processes in atherosclerosis. *Blood* **2010**, *116*, 4317–4327.
56. Nurden, A.T. Platelets, inflammation and tissue regeneration. *Thromb. Haemost.* **2011**, *105* (Suppl. 1), S13–S33.
57. Sanguigni, V.; Ferro, D.; Pignatelli, P.; del Ben, M.; Nadia, T.; Saliola, M.; Sorge, R.; Violi, F. CD40 ligand enhances monocyte tissue factor expression and thrombin generation via oxidative stress in patients with hypercholesterolemia. *J. Am. Coll. Cardiol.* **2005**, *45*, 35–42.
58. Levi, M.; van der Poll, T.; Büller, H.R. Bidirectional relation between inflammation and coagulation. *Circulation* **2004**, *109*, 2698–2704.
59. Miller, D.L.; Yaron, R.; Yellin, M.J. CD40L-CD40 interactions regulate endothelial cell surface tissue factor and thrombomodulin expression. *J. Leukoc. Biol.* **1998**, *63*, 373–379.
60. Chen, Y.; Chen, J.; Xiong, Y.; Da, Q.; Xu, Y.; Jiang, X.; Tang, H. Internalization of CD40 regulates its signal transduction in vascular endothelial cells. *Biochem. Biophys. Res. Commun.* **2006**, *345*, 106–117.
61. Chen, C.; Chai, H.; Wang, X.; Jiang, J.; Jamaluddin, M.S.; Liao, D.; Zhang, Y.; Wang, H.; Bharadwaj, U.; Zhang, S.; *et al.* Soluble CD40 ligand induces endothelial dysfunction in human and porcine coronary artery endothelial cells. *Blood* **2008**, *112*, 3205–3216.
62. Gururajan, P.; Gurumurthy, P.; Nayar, P.; Babu, S.; Sarasabharati, A.; Victor, D.; Cherian, K.M. Increased serum concentrations of Soluble CD40 Ligand as a prognostic marker in patients with Acute Coronary Syndrome. *Indian J. Clin. Biochem.* **2009**, *24*, 229–233.
63. Xu, H.; Zhang, X.; Mannon, R.B.; Kirk, A.D. Platelet-derived or soluble CD154 induces vascularized allograft rejection independent of cell-bound CD154. *J. Clin. Investig.* **2006**, *116*, 769–774.
64. Toubi, E.; Shoenfeld, Y. The role of CD40-CD154 interactions in autoimmunity and the benefit of disrupting this pathway. *Autoimmunity* **2004**, *37*, 457–464.
65. André, P.; Nannizzi-Alaimo, L.; Prasad, S.K.; Phillips, D.R. Platelet-derived CD40L: The switch-hitting player of cardiovascular disease. *Circulation* **2002**, *106*, 896–899.
66. André, P.; Prasad, K.S.S.; Denis, C.V.; He, M.; Papalia, J.M.; Hynes, R.O.; Phillips, D.R.; Wagner, D.D. CD40L stabilizes arterial thrombi by a beta3 integrin-dependent mechanism. *Nat. Med.* **2002**, *8*, 247–252.
67. Prasad, K.S.; Andre, P.; He, M.; Bao, M.; Manganello, J.; Phillips, D.R. Soluble CD40 ligand induces $\beta 3$ integrin tyrosine phosphorylation and triggers platelet activation by outside-in signaling. *Proc. Natl. Acad. Sci. USA* **2003**, *100*, 12367–12371.
68. May, A.E.; Kälsch, T.; Massberg, S.; Herouy, Y.; Schmidt, R.; Gawaz, M. Engagement of glycoprotein IIb/IIIa (α (IIb) $\beta 3$) on platelets upregulates CD40L and triggers CD40L-dependent matrix degradation by endothelial cells. *Circulation* **2002**, *106*, 2111–2117.
69. Chakrabarti, S.; Varghese, S.; Vitseva, O.; Tanriverdi, K.; Freedman, J.E. CD40 ligand influences platelet release of reactive oxygen intermediates. *Arterioscler. Thromb. Vasc. Biol.* **2005**, *25*, 2428–2434.

70. Li, G.; Sanders, J.M.; Bevard, M.H.; Sun, Z.; Chumley, J.W.; Galkina, E.V.; Ley, K.; Sarembock, I.J. CD40 ligand promotes Mac-1 expression, leukocyte recruitment, and neointima formation after vascular injury. *Am. J. Pathol.* **2008**, *172*, 1141–1152.
71. Tung, J.-P.; Fraser, J.F.; Nataatmadja, M.; Colebourne, K.I.; Barnett, A.G.; Glenister, K.M.; Zhou, A.Y.; Wood, P.; Silliman, C.C.; Fung, Y.L. Age of blood and recipient factors determine the severity of transfusion-related acute lung injury (TRALI). *Crit. Care* **2012**, *16*, doi:10.1186/cc11178.
72. Rahman, M.; Zhang, S.; Chew, M.; Ersson, A.; Jeppsson, B.; Thorlacius, H. Platelet-derived CD40L (CD154) mediates neutrophil upregulation of Mac-1 and recruitment in septic lung injury. *Ann. Surg.* **2009**, *250*, 783–790.
73. Vlaar, A.P.J.; Juffermans, N.P. Transfusion-related acute lung injury: a clinical review. *Lancet* **2013**, *382*, 984–994.
74. Hidalgo, A.; Chang, J.; Jang, J.-E.; Peired, A.J.; Chiang, E.Y.; Frenette, P.S. Heterotypic interactions enabled by polarized neutrophil microdomains mediate thromboinflammatory injury. *Nat. Med.* **2009**, *15*, 384–391.
75. Hassan, G.S.; Merhi, Y.; Mourad, W. CD40 ligand: A neo-inflammatory molecule in vascular diseases. *Immunobiology* **2012**, *217*, 521–532.
76. Hermann, A. Platelet CD40 ligand (CD40L)—subcellular localization, regulation of expression, and inhibition by clopidogrel. *Platelets* **2001**, *12*, 74–82.
77. Danese, S.; Sans, M.; Fiocchi, C. The CD40/CD40L costimulatory pathway in inflammatory bowel disease. *Gut* **2004**, *53*, 1035–1043.
78. Charafeddine, A.H.; Kim, E.J.; Maynard, D.M.; Yi, H.; Weaver, T.A.; Gunay-Aygun, M.; Russell, M.; Gahl, W.A.; Kirk, A.D. Platelet-derived CD154: Ultrastructural localization and clinical correlation in organ transplantation. *Am. J. Transplant.* **2012**, *12*, 3143–3151.
79. Doescher, A.; Petershofen, E.K.; Hertenstein, B.; Kraemer, D.; Casper, J.; Schmidt, J.-P.; Müller, T.H. Platelet recovery and survival measured in patients by quantitative polymerase chain reaction of mitochondrial DNA. *Transfusion* **2014**, doi:10.1111/trf.12778.
80. Denis, M.M.; Tolley, N.D.; Bunting, M.; Schwertz, H.; Jiang, H.; Lindemann, S.; Yost, C.C.; Rubner, F.J.; Albertine, K.H.; Swoboda, K.J.; *et al.* Escaping the nuclear confines: Signal-dependent pre-mRNA splicing in anucleate platelets. *Cell* **2005**, *122*, 379–391.
81. Nurden, A.T.; Nurden, P.; Sanchez, M.; Andia, I.; Anitua, E. Platelets and wound healing. *Front. Biosci. J. Virtual Libr.* **2008**, *13*, 3532–3548.
82. Plé, H.; Maltais, M.; Corduan, A.; Rousseau, G.; Madore, F.; Provost, P. Alteration of the platelet transcriptome in chronic kidney disease. *Thromb. Haemost.* **2012**, *108*, 605–615.
83. Garraud, O.; Berthet, J.; Hamzeh-Cognasse, H.; Cognasse, F. Pathogen sensing, subsequent signalling, and signalosome in human platelets. *Thromb. Res.* **2011**, *127*, 283–286.
84. Gnatenko, D.V.; Dunn, J.J.; McCorkle, S.R.; Weissmann, D.; Perrotta, P.L.; Bahou, W.F. Transcript profiling of human platelets using microarray and serial analysis of gene expression. *Blood* **2003**, *101*, 2285–2293.
85. Rowley, J.W.; Oler, A.J.; Tolley, N.D.; Hunter, B.N.; Low, E.N.; Nix, D.A.; Yost, C.C.; Zimmerman, G.A.; Weyrich, A.S. Genome-wide RNA-seq analysis of human and mouse platelet transcriptomes. *Blood* **2011**, *118*, e101–e111.

86. Simon, L.M.; Edelstein, L.C.; Nagalla, S.; Woodley, A.B.; Chen, E.S.; Kong, X.; Ma, L.; Fortina, P.; Kunapuli, S.; Holinstat, M.; *et al.* Human platelet microRNA-mRNA networks associated with age and gender revealed by integrated plateletomics. *Blood* **2014**, *123*, e37–e45.
87. Nagalla, S.; Shaw, C.; Kong, X.; Kondkar, A.A.; Edelstein, L.C.; Ma, L.; Chen, J.; McKnight, G.S.; López, J.A.; Yang, L.; *et al.* Platelet microRNA-mRNA coexpression profiles correlate with platelet reactivity. *Blood* **2011**, *117*, 5189–5197.
88. Flaumenhaft, R. Molecular basis of platelet granule secretion. *Arterioscler. Thromb. Vasc. Biol.* **2003**, *23*, 1152–1160.
89. Rendu, F.; Brohard-Bohn, B. The platelet release reaction: granules' constituents, secretion and functions. *Platelets* **2001**, *12*, 261–273.
90. Blair, P.; Flaumenhaft, R. Platelet α -granules: Basic biology and clinical correlates. *Blood Rev.* **2009**, *23*, 177–189.
91. Jackson, S.P.; Nesbitt, W.S.; Westein, E. Dynamics of platelet thrombus formation. *J. Thromb. Haemost.* **2009**, *7*, 17–20.
92. Henn, V.; Steinbach, S.; Büchner, K.; Presek, P.; Kroczeck, R.A. The inflammatory action of CD40 ligand (CD154) expressed on activated human platelets is temporally limited by coexpressed CD40. *Blood* **2001**, *98*, 1047–1054.
93. Elzey, B.D.; Grant, J.F.; Sinn, H.W.; Nieswandt, B.; Waldschmidt, T.J.; Ratliff, T.L. Cooperation between platelet-derived CD154 and CD4⁺ T cells for enhanced germinal center formation. *J. Leukoc. Biol.* **2005**, *78*, 80–84.
94. Elzey, B.D.; Tian, J.; Jensen, R.J.; Swanson, A.K.; Lees, J.R.; Lentz, S.R.; Stein, C.S.; Nieswandt, B.; Wang, Y.; Davidson, B.L.; *et al.* Platelet-mediated modulation of adaptive immunity. A communication link between innate and adaptive immune compartments. *Immunity* **2003**, *19*, 9–19.
95. Cognasse, F.; Hamzeh-Cognasse, H.; Lafarge, S.; Chavarin, P.; Cogné, M.; Richard, Y.; Garraud, O. Human platelets can activate peripheral blood B cells and increase production of immunoglobulins. *Exp. Hematol.* **2007**, *35*, 1376–1387.
96. Leroyer, A.S.; Rautou, P.-E.; Silvestre, J.-S.; Castier, Y.; Lesèche, G.; Devue, C.; Duriez, M.; Brandes, R.P.; Lutgens, E.; Tedgui, A.; *et al.* CD40 ligand⁺ microparticles from human atherosclerotic plaques stimulate endothelial proliferation and angiogenesis a potential mechanism for intraplaque neovascularization. *J. Am. Coll. Cardiol.* **2008**, *52*, 1302–1311.
97. Danese, S.; Katz, J.A.; Saibeni, S.; Papa, A.; Gasbarrini, A.; Vecchi, M.; Fiocchi, C. Activated platelets are the source of elevated levels of soluble CD40 ligand in the circulation of inflammatory bowel disease patients. *Gut* **2003**, *52*, 1435–1441.
98. Viallard, J.-F.; Solanilla, A.; Gauthier, B.; Contin, C.; Déchanet, J.; Grosset, C.; Moreau, J.-F.; Praloran, V.; Nurden, P.; Pellegrin, J.-L.; *et al.* Increased soluble and platelet-associated CD40 ligand in essential thrombocythemia and reactive thrombocytosis. *Blood* **2002**, *99*, 2612–2614.
99. Chaturvedi, R.; Gupta, M.; Jain, A.; Das, T.; Prashar, S. Soluble CD40 ligand: A novel biomarker in the pathogenesis of periodontal disease. *Clin. Oral Investig.* **2014**, doi:10.1007/s00784-014-1216-3.

100. Galicia López, A.; Olguin Ortega, L.; Saavedra, M.A.; Méndez Cruz, R.; Jimenez Flores, R.; García de la Peña, M. Increased concentrations of soluble CD40 ligand platelet in patients with primary antiphospholipidic syndrome. *Reumatol. Clin.* **2013**, *9*, 216–220.
101. Kim, H.O.; Kim, H.-S.; Youn, J.-C.; Shin, E.-C.; Park, S. Serum cytokine profiles in healthy young and elderly population assessed using multiplexed bead-based immunoassays. *J. Transl. Med.* **2011**, *9*, doi:10.1186/1479-5876-9-113.
102. Li, Z.; Delaney, M.K.; O'Brien, K.A.; Du, X. Signaling during platelet adhesion and activation. *Arterioscler. Thromb. Vasc. Biol.* **2010**, *30*, 2341–2349.
103. Varga-Szabo, D.; Pleines, I.; Nieswandt, B. Cell Adhesion mechanisms in platelets. *Arterioscler. Thromb. Vasc. Biol.* **2008**, *28*, 403–412.
104. Rivera, J.; Lozano, M. L.; Navarro-Núñez, L.; Vicente, V. Platelet receptors and signaling in the dynamics of thrombus formation. *Haematologica* **2009**, *94*, 700–711.
105. Thon, J.N.; Schubert, P.; Devine, D.V. Platelet storage lesion: A new understanding from a proteomic perspective. *Transfus. Med. Rev.* **2008**, *22*, 268–279.
106. Dzieciatkowska, M.; D'Alessandro, A.; Burke, T.A.; Kelher, M.R.; Moore, E.E.; Banerjee, A.; Silliman, C.C.; West, B.F.; Hansen, K.C. Proteomics of apheresis platelet supernatants during routine storage: Gender-related differences. *J. Proteomics* **2014**, *112C*, 190–209.
107. Ohto, H.; Nollet, K.E. Overview on platelet preservation: Better controls over storage lesion. *Transfus. Apher. Sci.* **2011**, *44*, 321–325.
108. Estebanell, E.; Díaz-Ricart, M.; Escolar, G.; Lozano, M.; Mazzara, R.; Ordinas, A. Alterations in cytoskeletal organization and tyrosine phosphorylation in platelet concentrates prepared by the buffy coat method. *Transfusion* **2000**, *40*, 535–542.
109. Schubert, P.; Thon, J.N.; Walsh, G.M.; Chen, C.H.I.; Moore, E.D.; Devine, D.V.; Kast, J. A signaling pathway contributing to platelet storage lesion development: targeting PI3-kinase-dependent Rap1 activation slows storage-induced platelet deterioration. *Transfusion* **2009**, *49*, 1944–1955.
110. Canault, M.; Duerschmied, D.; Brill, A.; Stefanini, L.; Schatzberg, D.; Cifuni, S.M.; Bergmeier, W.; Wagner, D.D. p38 mitogen-activated protein kinase activation during platelet storage: Consequences for platelet recovery and hemostatic function *in vivo*. *Blood* **2010**, *115*, 1835–1842.
111. Escolar, G.; White, J.G. Changes in glycoprotein expression after platelet activation: Differences between *in vitro* and *in vivo* studies. *Thromb. Haemost.* **2000**, *83*, 371–386.
112. Kasirer-Friede, A.; Kahn, M.L.; Shattil, S.J. Platelet integrins and immunoreceptors. *Immunol. Rev.* **2007**, *218*, 247–264.
113. Kageyama, Y.; Doi, T.; Matsushima-Nishiwaki, R.; Iida, Y.; Akamatsu, S.; Kondo, A.; Kuroyanagi, G.; Yamamoto, N.; Mizutani, J.; Otsuka, T.; *et al.* Involvement of Rac in thromboxane A2-induced human platelet activation: Regulation of sCD40 ligand release and PDGF-AB secretion. *Mol. Med. Rep.* **2014**, doi:10.3892/mmr.2014.2143.
114. Panzer, S. Differential response to LPS isotypes induced platelet activation mediated by Toll-like receptor (TLR)-4. *Clin. Immunol.* **2013**, *146*, 13–14.

115. Rivadeneyra, L.; Carestia, A.; Etulain, J.; Pozner, R.G.; Fondevila, C.; Negrotto, S.; Schattner, M. Regulation of platelet responses triggered by Toll-like receptor 2 and 4 ligands is another non-genomic role of nuclear factor- κ B. *Thromb. Res.* **2014**, *133*, 235–243.
116. Berthet, J.; Damien, P.; Hamzeh-Cognasse, H.; Arthaud, C.-A.; Eyraud, M.-A.; Zéni, F.; Pozzetto, B.; McNicol, A.; Garraud, O.; Cognasse, F. Human platelets can discriminate between various bacterial LPS isoforms via TLR4 signaling and differential cytokine secretion. *Clin. Immunol.* **2012**, *145*, 189–200.
117. Otterdal, K.; Pedersen, T.M.; Solum, N.O. Release of soluble CD40 ligand after platelet activation: Studies on the solubilization phase. *Thromb. Res.* **2004**, *114*, 167–177.
118. Jin, Y.; Nonoyama, S.; Morio, T.; Imai, K.; Ochs, H.D.; Mizutani, S. Characterization of soluble CD40 ligand released from human activated platelets. *J. Med. Dent. Sci.* **2001**, *48*, 23–27.
119. Mason, P.J.; Chakrabarti, S.; Albers, A.A.; Rex, S.; Vitseva, O.; Varghese, S.; Freedman, J.E. Plasma, serum, and platelet expression of CD40 ligand in adults with cardiovascular disease. *Am. J. Cardiol.* **2005**, *96*, 1365–1369.
120. Santos-Martínez, M.J.; Medina, C.; Jurasz, P.; Radomski, M.W. Role of metalloproteinases in platelet function. *Thromb. Res.* **2008**, *121*, 535–542.
121. Matthies, K.M.G.; Newman, J.L.; Hodzic, A.; Wingett, D.G. Differential regulation of soluble and membrane CD40L proteins in T cells. *Cell. Immunol.* **2006**, *241*, 47–58.
122. Yacoub, D.; Benslimane, N.; Al-Zoobi, L.; Hassan, G.; Nadiri, A.; Mourad, W. CD154 is released from T-cells by a disintegrin and metalloproteinase domain-containing protein 10 (ADAM10) and ADAM17 in a CD40 protein-dependent manner. *J. Biol. Chem.* **2013**, *288*, 36083–36093.
123. Furman, M.I.; Krueger, L.A.; Linden, M.D.; Barnard, M.R.; Frelinger, A.L.; Michelson, A.D. Release of soluble CD40L from platelets is regulated by glycoprotein IIb/IIIa and actin polymerization. *J. Am. Coll. Cardiol.* **2004**, *43*, 2319–2325.
124. Reinboldt, S.; Wenzel, F.; Rauch, B.H.; Hohlfeld, T.; Grandoch, M.; Fischer, J.W.; Weber, A.-A. Preliminary evidence for a matrix metalloproteinase-2 (MMP-2)-dependent shedding of soluble CD40 ligand (sCD40L) from activated platelets. *Platelets* **2009**, *20*, 441–444.
125. Wenzel, F.; Rox, J.; Reinboldt, S.; Weber, A.A.; Giers, G.; Fischer, J. Release of soluble CD40L by matrix metalloproteinase-2 (MMP-2)-dependent shedding of platelets and its subsequent accumulation in stem cell products of autologous donors. *J. Stem Cells Regen. Med.* **2010**, *6*, 66–67.
126. Choi, W.S.; Jeon, O.H.; Kim, D.S. CD40 ligand shedding is regulated by interaction between matrix metalloproteinase-2 and platelet integrin α (IIb) β (3). *J. Thromb. Haemost.* **2010**, *8*, 1364–1371.
127. Rahman, M.; Roller, J.; Zhang, S.; Syk, I.; Menger, M.D.; Jeppsson, B.; Thorlacius, H. Metalloproteinases regulate CD40L shedding from platelets and pulmonary recruitment of neutrophils in abdominal sepsis. *Inflamm. Res.* **2012**, *61*, 571–579.
128. Rahman, M.; Zhang, S.; Chew, M.; Syk, I.; Jeppsson, B.; Thorlacius, H. Platelet shedding of CD40L is regulated by matrix metalloproteinase-9 in abdominal sepsis. *J. Thromb. Haemost.* **2013**, *11*, 1385–1398.

129. Menchén, L.; Marín-Jiménez, I.; Arias-Salgado, E.G.; Fontela, T.; Hernández-Sampelayo, P.; Rodríguez, M.C.G.; Butta, N.V. Matrix metalloproteinase 9 is involved in Crohn's disease-associated platelet hyperactivation through the release of soluble CD40 ligand. *Gut* **2009**, *58*, 920–928.
130. Fernández Bello, I.; Álvarez, M.T.; López-Longo, F.J.; Arias-Salgado, E.G.; Martín, M.; Jiménez-Yuste, V.; Rodríguez de la Rúa, A.; Butta, N.V. Platelet soluble CD40L and matrix metalloproteinase 9 activity are proinflammatory mediators in Behçet disease patients. *Thromb. Haemost.* **2012**, *107*, 88–98.
131. Nannizzi-Alaimo, L.; Alves, V.L.; Phillips, D.R. Inhibitory effects of glycoprotein IIb/IIIa antagonists and aspirin on the release of soluble CD40 ligand during platelet stimulation. *Circulation* **2003**, *107*, 1123–1128.
132. Yacoub, D.; Hachem, A.; Théorêt, J.-F.; Gillis, M.-A.; Mourad, W.; Merhi, Y. Enhanced levels of soluble CD40 ligand exacerbate platelet aggregation and thrombus formation through a CD40-dependent tumor necrosis factor receptor-associated factor-2/Rac1/p38 mitogen-activated protein kinase signaling pathway. *Arterioscler. Thromb. Vasc. Biol.* **2010**, *30*, 2424–2433.
133. Hachem, A.; Yacoub, D.; Zaid, Y.; Mourad, W.; Merhi, Y. Involvement of nuclear factor κ B in platelet CD40 signaling. *Biochem. Biophys. Res. Commun.* **2012**, *425*, 58–63.
134. Karim, Z.A.; Zhang, J.; Banerjee, M.; Chicka, M.C.; Al Hawas, R.; Hamilton, T.R.; Roche, P.A.; Whiteheart, S.W. I κ B kinase phosphorylation of SNAP-23 controls platelet secretion. *Blood* **2013**, *121*, 4567–4574.
135. Ren, Q.; Ye, S.; Whiteheart, S.W. The platelet release reaction: Just when you thought platelet secretion was simple. *Curr. Opin. Hematol.* **2008**, *15*, 537–541.
136. Broos, K.; Feys, H.B.; de Meyer, S.F.; Vanhoorelbeke, K.; Deckmyn, H. Platelets at work in primary hemostasis. *Blood Rev.* **2011**, *25*, 155–167.
137. Vamvakas, E.C.; Blajchman, M.A. Prestorage *versus* poststorage white cell reduction for the prevention of the deleterious immunomodulatory effects of allogeneic blood transfusion. *Transfus. Med. Rev.* **2000**, *14*, 23–33.
138. Zhang, M.; Lu, S.; Wu, X.; Chen, Y.; Song, X.; Jin, Z.; Li, H.; Zhou, Y.; Chen, F.; Huo, Y. Multimarker approach for the prediction of cardiovascular events in patients with mild to moderate coronary artery lesions. A 3-year follow-up study. *Int. Heart. J.* **2012**, *53*, 85–90.
139. Zhao, W.; Zhang, F.; Li, Z.; Yu, H.; Li, Z.; Gao, W. Soluble CD40 ligand is associated with angiographic severity of coronary artery disease in patients with acute coronary syndrome. *Chin. Med. J.* **2014**, *127*, 2218–2221.
140. Gerdes, S.; Osadtschy, S.; Buhles, N.; Baurecht, H.; Mrowietz, U. Cardiovascular biomarkers in patients with psoriasis. *Exp. Dermatol.* **2014**, *23*, 322–325.
141. Zahn, D.; Petrak, F.; Uhl, I.; Juckel, G.; Neubauer, H.; Hägele, A.-K.; Wiltfang, J.; Herpertz, S. New pathways of increased cardiovascular risk in depression: a pilot study on the association of high-sensitivity C-reactive protein with pro-atherosclerotic markers in patients with depression. *J. Affect. Disord.* **2013**, *146*, 420–425.
142. Ferroni, P.; Riondino, S.; Vazzana, N.; Santoro, N.; Guadagni, F.; Davì, G. Biomarkers of platelet activation in acute coronary syndromes. *Thromb. Haemost.* **2012**, *108*, 1109–1123.

143. Panichi, V.; Scatena, A.; Migliori, M.; Marchetti, V.; Paoletti, S.; Beati, S. Biomarkers of chronic inflammatory state in uremia and cardiovascular disease. *Int. J. Inflamm.* **2012**, *2012*, doi:10.1155/2012/360147.
144. Devine, D.V.; Serrano, K. The platelet storage lesion. *Clin. Lab. Med.* **2010**, *30*, 475–487.
145. Shrivastava, M. The platelet storage lesion. *Transfus. Apher. Sci.* **2009**, *41*, 105–113.
146. Cognasse, F.; Hamzeh-Cognasse, H.; Lafarge, S.; Acquart, S.; Chavarin, P.; Courbil, R.; Fabrigli, P.; Garraud, O. Donor platelets stored for at least 3 days can elicit activation marker expression by the recipient's blood mononuclear cells: An *in vitro* study. *Transfusion* **2009**, *49*, 91–98.
147. Hamzeh-Cognasse, H.; Cognasse, F.; Palle, S.; Chavarin, P.; Olivier, T.; Delézay, O.; Pozzetto, B.; Garraud, O. Direct contact of platelets and their released products exert different effects on human dendritic cell maturation. *BMC Immunol.* **2008**, *9*, doi:10.1186/1471-2172-9-54.
148. National Agency of Security of the Drug and Health Products. Available online: <http://ansm.sante.fr/Mediatheque/Publications/Informations-recentes> (accessed on 2 December 2014).
149. Tuinman, P.R.; Gerards, M.C.; Jongsma, G.; Vlaar, A.P.; Boon, L.; Juffermans, N.P. Lack of evidence of CD40 ligand involvement in transfusion-related acute lung injury. *Clin. Exp. Immunol.* **2011**, *165*, 278–284.
150. Wang, C.; Mody, M.; Herst, R.; Sher, G.; Freedman, J. Flow cytometric analysis of platelet function in stored platelet concentrates. *Transfus. Sci.* **1999**, *20*, 129–139.
151. Aloui, C.; Sut, C.; Prigent, A.; Fagan, J.; Cognasse, F.; Granados-Herbepin, V.; Touraine, R.; Pozzetto, B.; Aouni, M.; Fendri, C.; *et al.* Genotyping of polymorphisms responsible for the regulation of the expression of CD40 ligand in two blood donor populations (Auvergne-Loire, France; Sousse and Monastir, Tunisia). *Transfus. Clin. Biol.* **2013**, *20*, 293–294.
152. Tanaka, S.; Hayashi, T.; Tani, Y.; Hirayama, F. Removal by adsorbent beads of biological response modifiers released from platelets, accumulated during storage, and potentially associated with platelet transfusion reactions. *Transfusion* **2010**, *50*, 1096–1105.
153. Tanaka, S.; Hayashi, T.; Tani, Y.; Hirayama, F. Removal of biological response modifiers associated with platelet transfusion reactions by columns containing adsorption beads. *Transfusion* **2014**, *54*, 1790–1797.
154. Couzin, J. Magnificent obsession. *Science* **2005**, *307*, 1712–1715.

© 2014 by the authors; licensee MDPI, Basel, Switzerland. This article is an open access article distributed under the terms and conditions of the Creative Commons Attribution license (<http://creativecommons.org/licenses/by/4.0/>).

Mise à jour bibliographique

I – Section - *CD40L and its receptors in inflammatory pathologies*

Le CD40L, notamment plaquettaire, participe au déclenchement et au maintien d'un état inflammatoire en agissant sur plusieurs fronts ; directement sur l'endothélium ou sur les leucocytes ou au travers d'un signal auto et paracrine propre aux plaquettes. Dans notre revue « *the signaling role of CD40 ligand in platelet biology and in platelet component transfusion* page 55 [74]», nous signalons que la communication des cellules circulantes avec l'endothélium, via le couple immun CD40/CD40L, participe à un changement d'état d'activation des cellules endothéliales favorable au développement de plusieurs pathologies, notamment inflammatoires, telles que le TRALI. Depuis, de nouvelles études ont investigué le rôle de ce complexe protéique dans la régulation de l'activité vasculaire. La production de médiateurs solubles depuis l'endothélium est aussi dépendante du complexe formé entre le CD40 de l'endothélium et le CD40L membranaire ou soluble des plaquettes. Ainsi, le « monocyte chemoattractant protein-1 » (MCP-1), qui participe à l'amplification de la perméabilité vasculaire et le recrutement des cellules immunitaires et inflammatoires [75], voit sa production augmentée après interaction du CD40 endothélial et du CD40L plaquettaire [76]. Le vWF est lui aussi produit par l'endothélium dépendamment de l'interaction de son CD40 membranaire avec son ligand plaquettaire, le CD40L. Cette interaction régule positivement l'internalisation du calcium par l'endothélium ce qui amplifiera l'exposition du vWF par ces mêmes cellules. La conséquence sera donc la mise en place d'un rétrocontrôle positif amplificateur de l'agrégation plaquettaire à la paroi vasculaire, favorisant la captation et la diapédèse des leucocytes [77]. Le recrutement des globules blancs par l'endothélium vasculaire peut également être favorisé par l'expression de la fractalkine –chémokine transmembranaire–, elle aussi dépendamment de la complexification du CD40 et du CD40L. Les leucocytes positifs en GPR13 (G-Protein Coupled Receptor 13) –récepteur à la fractalkine– pourront alors fixer cette barrière vasculaire [78]. Le CD40L plaquettaire participe également à une augmentation du risque thrombotique en favorisant l'interaction des plaquettes avec l'endothélium et leur agrégation [79-83]. Ces résultats évoquent un impact non négligeable du CD40L plaquettaire dans des complications thrombotiques et inflammatoires.

L'impact du complexe protéique CD40/CD40L n'est pas exclusif aux cellules endothéliales, comme décrit, en 2014, dans notre revue « *the signaling role of CD40 ligand in platelet biology and in platelet component transfusion* page 55 [74] ». Effectivement, ce couple immun impact directement le devenir des leucocytes. La protéine CD40L, notamment plaquettaire, peut fixer le

récepteur « Macrophage-1 antigen » (Mac-1), présent à la surface des neutrophiles, et ainsi initier la migration de ces derniers depuis le compartiment sanguin jusqu'à la zone enflammée. La communication entre ces deux types cellulaires peut directement être établie via le complexe CD40 des neutrophiles et CD40L des plaquettes, ce qui engendra une cascade de signalisant amplifiant l'interaction des neutrophiles avec l'endothélium [84]. L'isoforme soluble du CD40L membranaire plaquettaire amplifie également la communication entre les neutrophiles et les plaquettes, en stimulant l'expression de Mac-1 à la surface des neutrophiles, pour finalement accroître la production de dérivés de l'oxygène, les ROS, depuis ces derniers [85, 86]. Cette interaction préétablie entre les plaquettes et les neutrophiles peut être responsable d'une amplification de la production de sCD40L par les plaquettes et donc auto-promouvoir leur complexification avec les cellules immunes ou non immunes (comme les cellules endothéliales) exprimant le CD40 [87]. Certains évoquent également un rôle inhibiteur de l'intégrine plaquettaire GPIIb/IIIa dans la promotion d'une interaction entre les plaquettes et les leucocytes via, entre autres, l'expression du CD40L plaquettaire [88]. Les plaquettes, qui expriment également le CD40 [89], l'utilisent pour la formation de complexes directement avec d'autres cellules telles que les cellules dendritiques, les monocytes et les neutrophiles. La neutralisation/inhibition de ce récepteur plaquettaire limite la triple communication entre les plaquettes, l'endothélium et les leucocytes, limitant également la transmigration leucocytaire et plaquettaire, à travers la paroi vasculaire [90]. Dans des situations pathologiques, telles que le sepsis dont certains modèles animaux proposent une physiopathologie proche de celle de certains TRALI expérimentaux, l'influence du sCD40L plaquettaire sur les neutrophiles a largement été investiguée. Le clivage du CD40L plaquettaire, contrôlé par l'activité de la métalloprotéinases-9 (MMP-9) [91] et le transducteur de signal « Ras-related C3 botulinum toxin substrate-1 » (Rac-1) [92], amplifie drastiquement l'expression de Mac-1 à la surface des neutrophiles et, par conséquent, leur infiltration pulmonaire [93, 94]. L'utilisation de la simvastatine, capable de réduire significativement les concentrations plasmatiques du sCD40L, confirme l'implication du sCD40L dans la migration des neutrophiles dans les poumons lors d'un sepsis murin induit par ligature et ponction du cæcum [95]. Le même constat a été fait dans d'autres pathologies inflammatoires confirmant une fois de plus une influence considérable du CD40L plaquettaire dans l'activation et le recrutement des leucocytes jusqu'à la zone enflammée [96, 97]. Dans des modèles murins d'ALI, le rôle du couple CD40/CD40L a déjà été évoqué mais sa cascade d'activation n'a jamais été entièrement investiguée. La transcription de l'ARNm du CD40 et son affinité avec le facteur de transcription « Nuclear Factor- κ B » (NF- κ B) sont significativement augmentées lors de l'induction d'un ALI par injection *in vivo* de LPS [98]. L'inhibition du

complexe CD40/CD40L protège du développement de l'ALI dans plusieurs modèles animaux, induit par endotoxémie [99], ischémie-reperfusion [100], hyperventilation [101] ou radiation [102]. Cette protection est associée à une diminution des concentrations protéiques au niveau pulmonaire en TNF- α , IL-1 β et « Macrophage Inflammatory Protein-2 » (MIP-2) ainsi qu'une diminution de l'activité de la MMP-9 et une augmentation de la perméabilité vasculaire. L'influence du complexe CD40/CD40L n'a cependant jamais été réellement prouvée dans le TRALI et même écartée dans un modèle murin « one-hit » de la pathologie [103]. En effet, ce modèle murin utilise une simple injection d'anti-CMH I, inducteur de l'œdème pulmonaire, de 4,5 mg/kg alors que le modèle murin du TRALI, légitimement validé par la communauté scientifique, est celui proposé par le Dr Looney reposant sur l'hypothèse du « two-hit » avec une première injection de LPS suivie d'une seconde injection d'anticorps anti-CMH I à 1 mg/kg [104].

Tous ces résultats sont évocateurs d'une influence du complexe CD40/CD40L sur l'aggravation de l'état inflammatoire induit préalablement par un agent extérieur de stress infectieux ou stérile (comme peut l'être l'acte transfusionnel). Cela nous amène donc à suspecter un rôle important de ce couple immun dans la physiopathologie du TRALI humain.

Chapitre 5 – Hypothèse de l’atteinte multi-organes au cours d’un TRALI

Section 1 – Le pancréas

I – Physiopathologie de la pancréatite : *les neutrophiles*

Tout comme les poumons, le pancréas peut être la cible de réactions inflammatoires pathologiques, on parle alors de pancréatite. Actuellement, la phase aiguë de cette pathologie est la plus connue et son état chronique nécessite une investigation plus approfondie [105]. La pancréatite aiguë est caractérisée par l’apparition d’un œdème pancréatique, d’une nécrose du tissu adipeux, d’une protéolyse pancréatique, d’hémorragies pancréatiques et d’une réaction inflammatoire aiguë [106]. Chez l’homme, l’aspect inflammatoire des pancréatites a été investigué depuis déjà plusieurs années, malgré la diversité de ses causes et donc de sa physiopathologie. La concentration de plusieurs cytokines inflammatoires, telles qu’IL-1 β [107], IL-6 [108, 109], IL-8 [110, 111] ou encore IL-18 [112], a été positivement corrélée en lien avec la caractérisation de différentes pancréatites aiguës ou chroniques.

Plusieurs études expérimentales évoquent un lien étroit entre pancréatite et ALI. Dans un premier temps, l’induction d’une pancréatite aiguë par administration de céruléine ou d’acides aminés, dans plusieurs modèles murins, est corrélée avec une atteinte pulmonaire, caractérisée par une migration des neutrophiles, un infiltrat pulmonaire, une congestion alvéolaire et des phénomènes hémorragiques [113, 114]. Une activité importante des neutrophiles au niveau pulmonaire, caractérisée par une libération excessive de myéloperoxidase (MPO), a aussi plusieurs fois été évoquée suite à l’induction expérimentale d’une pancréatite aiguë [114, 115]. De façon plus générale, l’induction d’une pancréatite aiguë, dans un modèle murin, induit le développement d’un ALI qui se manifeste par des signes d’insuffisance respiratoire, un ratio entre le poids des poumons et du corps important (caractéristique d’un œdème pulmonaire) et enfin un score d’atteinte pulmonaire croissant avec le temps d’exposition à l’inducteur pathologique [116].

Tout comme le TRALI, en particulier, et l’ALI, en général, les neutrophiles semblent jouer un rôle primordial dans l’induction, le maintien et l’aggravation de certaines pancréatites, selon un point de vue expérimental [117, 118]. D’après plusieurs études, la déplétion totale des neutrophiles, notamment par l’utilisation d’un sérum anti-neutrophile, atténue considérablement la sévérité de certaines pancréatites, au sein de plusieurs modèles animaux, et permet également la protection des poumons contre le développement d’un ALI [119-121]. En effet, ici les

neutrophiles sont considérés comme les cellules principalement responsables de cette pathologie. Après induction expérimentale d'une pancréatite, déclenchée par administration d'acides aminés ou de taurocholate, on retrouve une infiltration des neutrophiles significative à la fois dans les poumons, mais surtout dans le pancréas, dépendamment de la production de PF4, selon une étude [122], mais aussi, hypothétiquement, de l'expression accrue de la protéine Mac-1 à la surface des neutrophiles selon d'autres auteurs [123]. Une récente théorie évoque une capacité qu'ont les neutrophiles, dans le cas d'une pancréatite associée à une atteinte pulmonaire déclenchée par des injections successives de céruléine et de LPS, à migrer dans une première zone, le pancréas, puis, après un retour au niveau circulant, d'effectuer une nouvelle migration dans un second tissu, les poumons. Ce mécanisme est appelé « migration transendothéliale inverse » et est régulé par l'expression de la molécule « junctional adhesion molecules C » (JAM-C) [124] (Figure 6). Finalement, cette infiltration tissulaire des neutrophiles est permise par l'expression de plusieurs protéines de surfaces, telles que Mac-1 et la L-sélectine (CD62L) sur les neutrophiles [125], la protéine « lymphocyte function-associated antigen-1 » (LFA-1) sur les leucocytes [126] et ICAM-1 à la surface des cellules endothéliales [127]. La conséquence finale de cette migration tissulaire excessive est la libération des ROS responsable de la dégradation cellulaire [128], elle-même responsable d'un signal paracrine alimentant la nécrose cellulaire pancréatique [129]. Finalement, les neutrophiles semblent aussi participer à la dégradation pancréatique, lors de certaines pancréatites humaines ou expérimentalement induites [130], par la formation des NET, dont le rôle principal est antimicrobien [131]. En effet, tout d'abord la quantité des NET semble augmentée chez les patients atteints de pancréatite, dépendamment de la sévérité. De plus, dans un modèle murin de pancréatite aiguë, l'utilisation de DNase I, inhibiteur de la formation des NET, prévient entièrement le développement de la pancréatite induit par injection rétrograde de taurocholate de sodium à 5% [130]. L'activation des neutrophiles ne participe pas seulement à la migration de ces derniers dans le tissu enflammé, mais permettrait également la dégradation directe de l'endothélium vasculaire [132]. Enfin, le rôle des neutrophiles dans certaines pancréatites semble d'une telle ampleur que certains proposent l'utilisation du ratio entre le nombre des neutrophiles et des leucocytes circulants (appelé NLR) comme marqueur de la pathologie [133]. On retrouve donc, au sein de plusieurs modèles animaux de la pancréatite, une physiopathologie principalement orchestrée par les neutrophiles circulants et migratoires, proposant des caractéristiques similaires à celles observées dans plusieurs ALI également expérimentaux.

II – Physiopathologie de la pancréatite : *l'endothélium vasculaire*

Comme décrit précédemment, l'endothélium participe au recrutement et à la migration des leucocytes, phénomènes souvent observés par le « rolling » des leucocytes, lors de pancréatites expérimentales [134, 135]. Cette barrière endothéliale régule la migration des neutrophiles, notamment via l'expression de JAM-C [124] et d'ICAM-1 [127, 136]. Cependant, certaines études évoquent une protection pulmonaire plutôt que pancréatique quant à la neutralisation de l'expression d'ICAM-1 des cellules endothéliales dans des cas de pancréatite expérimentale associée à des lésions pulmonaires. La neutralisation de la P-sélectine (CD62P) de l'endothélium est, quant à elle, protectrice de l'atteinte pulmonaire mais également de l'atteinte pancréatique [137]. L'utilisation de plusieurs protéines solubles en tant que marqueur de la sévérité de la pathologie, chez l'homme, a été proposée. On peut citer l'ICAM-1 soluble [138], la E-sélectine (CD62E) soluble, l'IL-6 [139], la thombomoduline soluble (sTM) [140], le vWF ou encore la forme soluble du récepteur « endothelial protein C receptor (EPCR) [141], évoquant ainsi une implication des cellules endothéliales dans cette physiopathologie.

Durant le développement d'une pancréatite aiguë murine, induit par l'utilisation de céruléine, les observations microscopiques de la barrière endothéliale montrent un changement de cette dernière, caractérisé par une augmentation de la perméabilité et de l'adhérence des leucocytes [142]. L'apoptose des cellules endothéliales, notamment dans les capillaires pulmonaires, est également augmentée suite à l'administration d'acide taurocholique dans un modèle murin [143] ainsi que leur dégradation, *in vitro*, induite par l'activité des neutrophiles de patients diagnostiqués avec une pancréatite aiguë [132]. La réduction de la densité capillaire dans les zones proches des nécroses pancréatiques a aussi été démontrée [144, 145]. La diminution progressive de l'expression de CD105 et de sa complexification avec le « transforming growth factor- β 1 » (TGF- β 1) et « - β 3 » (TGF- β 3), chez l'homme, évoque une atteinte de la fonction angiogénique de l'endothélium vasculaire, lors d'une pancréatite [146]. La dégradation de l'endothélium vasculaire, suite à l'induction de certaines pancréatites expérimentales, n'est pas exclusive aux zones pancréatiques et/ou pulmonaires mais c'est également le cas de l'endothélium des capillaires intestinaux, dont la perméabilité est également augmentée [147, 148].

Selon plusieurs résultats, observés dans divers modèles expérimentaux de pancréatite, on retrouve une implication des cellules endothéliales en tant que cellules promotrices du recrutement et de la migration des leucocytes dans la zone cible mais également en tant que cible directe de l'activité des leucocytes.

III – Physiopathologie de la pancréatite : *les plaquettes*

Un rôle des plaquettes sanguines dans la physiopathogénie de certaines pancréatites expérimentales a été proposé. Plusieurs modèles murins d'induction d'une pancréatite et de traitements antiplaquettaires ont tenté de mettre en lumière la responsabilité des plaquettes sanguines. Une thrombopénie induite par l'injection d'anticorps anti-GPIIb α prévient le développement de la pancréatite aiguë, induite par injection intrapéritonéale de céruléine, et ce corrélé avec une diminution de l'expression de Mac-1 sur les neutrophiles, de la production de la chimiokine MIP-2 –protéine chimioattractante des neutrophiles– et de l'infiltration des neutrophiles dans le pancréas et donc de la libération de MPO dans ce même tissu [149]. Les plaquettes sanguines participent également par leur capacité à communiquer avec les cellules centrales à la physiopathologie de certains modèles animaux de la pancréatite. Leur activité est significativement augmentée lors de l'induction de la pathologie et est la cause d'une communication accrue avec l'endothélium vasculaire [145, 150, 151]. La formation de complexes entre les neutrophiles et les plaquettes est aussi observée [134]. Cette mécanistique est notamment rendue possible par l'expression du CD62P à la surface des plaquettes permettant leur adhésion à la paroi vasculaire [135] et influençant ainsi la captation et la migration des leucocytes dans le tissu pancréatique [152].

Chez l'homme, les observations du devenir des plaquettes sanguines lors du diagnostic de diverses pancréatites diffèrent. Certains mentionnent une élévation du compte plaquettaire dans un cas précis de pancréatite sévère, durant ses différentes phases de développement, observée sur 20 jours après admission d'urgence en soins intensif [153]. De façon plus générale, la comparaison de patients ayant manifesté une pancréatite œdémateuse biliaire avec des contrôles montre une diminution significative du compte plaquettaire associée à une augmentation de leur volume [154], caractéristique de l'activation des plaquettes [155]. L'augmentation de l'activation plaquettaire est confirmée, par une seconde étude, par la mesure de l'expression du CD62P à la surface des plaquettes sanguines et la production circulante du PF4, dépendamment de la sévérité de la pancréatite. Cependant, le compte plaquettaire évolue dans le sens d'une augmentation lors du développement d'une pancréatite aiguë sévère [156], contrairement à l'étude précédente [154]. Des observations décrites dans une revue rétrospective, impliquant de patients admis à l'hôpital pour pancréatite aiguë entre 2007 et 2011 ont encore été différentes. Ici, le compte plaquettaire ne change pas entre ces patients et leurs contrôles et, contrairement aux études précédentes, le volume plaquettaire moyen diminue avec le développement de la pancréatite aiguë [157].

Même si les scientifiques semblent s'accorder sur un rôle important des plaquettes sanguines pendant une atteinte inflammatoire du pancréas, leur fonction est encore mal comprise.

IV – Physiopathologie de la pancréatite : *Le couple CD40/CD40L*

Le rôle du couple immun CD40/CD40L n'est pas encore entièrement compris dans le cadre des pancréatites. A l'heure actuelle, son implication reste débattue. En 2001, une étude a investigué le rôle du CD40L dans la physiopathogénie de la pancréatite aiguë, induite par administration de céruléine au sein d'un modèle murin. Cette étude se concentre sur le CD40L membranaire des lymphocytes T et le CD40 membranaire des monocytes. Dans un premier temps, l'expression du CD40 au niveau pancréatique et pulmonaire diminuait après injection de l'agent responsable de l'induction de la pancréatite chez les souris sauvages et CD40L^{-/-}. Le développement de la pancréatite aiguë était inhibé lorsque les souris étaient déficientes pour l'expression du CD40L. En effet, il a été observé une diminution de la production d'amylase, de l'infiltrat pancréatique, de la production du MPO pancréatique et de la nécrose des cellules du pancréas, 4h et 12h après induction de la pathologie. L'atteinte pulmonaire, notamment caractérisée par des observations histologiques et la mesure de l'infiltrat pulmonaire, était elle aussi inhibée [158]. Une seconde étude a démontré que le traitement à base de leptine réduit significativement la sévérité de la pancréatite, également induite par injection de céruléine, corrélé avec une diminution de l'expression du CD40 dans les tissus cibles, le pancréas et les poumons [159]. Finalement, une étude *in vitro*, analysant l'impact du CD40 membranaire d'une lignée cellulaire pancréatique et du CD40L membranaire de fibroblastes transfectés dans un conditionnement proche d'une pancréatite, démontre que le complexe CD40/CD40L permet d'amplifier l'activité cellulaire au niveau pancréatique, se manifestant par une libération excessive de médiateurs pro-inflammatoires tels que TNF- α et IL-1 β [160]. Cependant, en 2011, une étude a investigué l'impact d'une déficience en CD40L des cellules sur le développement de la pancréatite aiguë. Les résultats étaient alors différents de ceux évoqués ci-dessus. L'induction de cette pancréatite par injection de taurocholate et de céruléine n'était pas inhibée dans leur modèle murin CD40L^{-/-}. La concentration d'amylase plasmatique, la production du MPO pulmonaire et pancréatique et du MIP-2 pancréatique ainsi que le score histologique, reflétant l'atteinte du pancréas, n'étaient pas diminués chez les souris « knock-out ». Les comptes cellulaires n'étaient, eux aussi, pas impactés. Les souris déficientes en CD40L présentaient un taux plaquettaire identique, une diminution du nombre de polymorphonucléaires et des mononucléaires comparés aux souris contrôles de la pathologie [161]. Chez l'homme, seul des dosages du sCD40L ont été

réalisés et certains proposent l'utilisation de la concentration de cette molécule comme marqueur de prédiction du développement d'une pancréatite sévère [162].

En conclusion, nous constatons une étroite relation entre la pancréatite et l'ALI, démontrée grâce à plusieurs modèles animaux, tous deux orchestrés par une implication significative des neutrophiles, de l'endothélium et des plaquettes sanguines. Nous proposons ainsi un schéma hypothétique de la physiopathologie de la pancréatite associée au développement de l'ALI représenté par la figure 6.

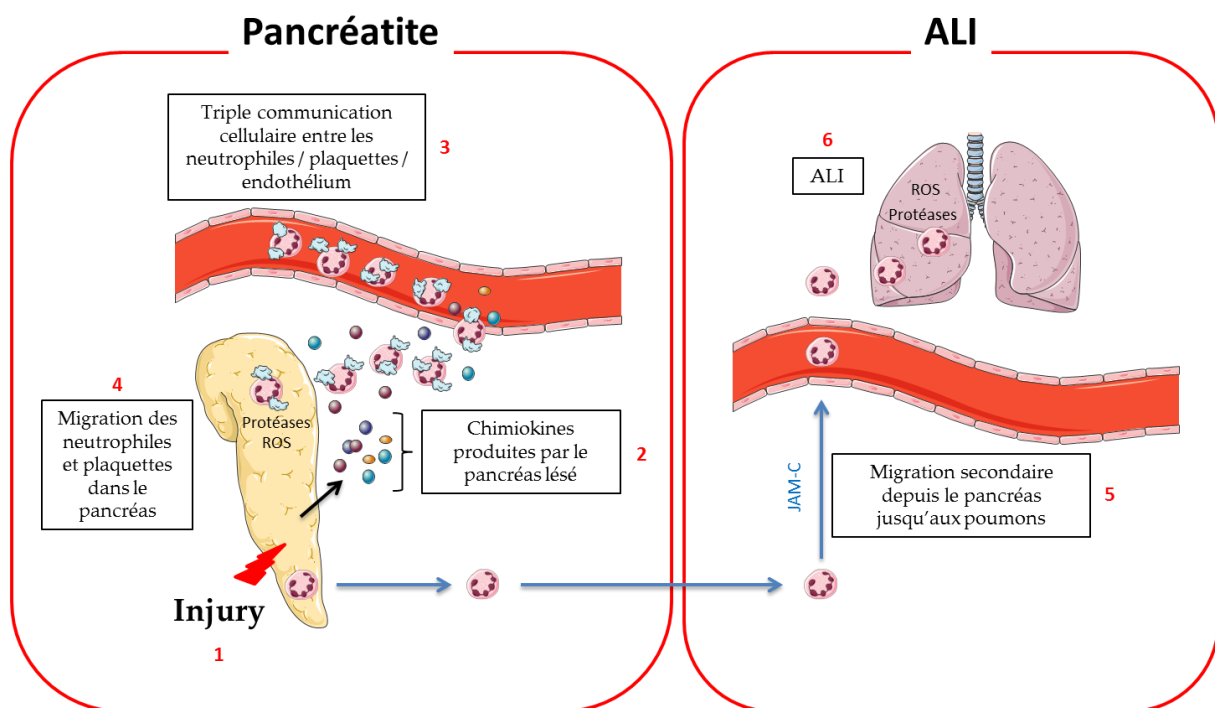

Figure 6 : Physiopathologie de la pancréatite associée au déclenchement d'une détresse respiratoire

Une première agression du pancréas, responsable du développement de la pancréatite, va induire une libération de médiateurs solubles activateurs de l'inflammation et attractifs des neutrophiles. Une communication étroite entre les neutrophiles, les plaquettes circulantes et l'endothélium vasculaire va être établie. L'infiltration excessive des neutrophiles dans le pancréas conclura la dégradation de ce dernier. Dans un second temps, les neutrophiles ayant migré dans le pancréas vont être recrutés dans l'espace alvéolaire. Ce mécanisme est rendu possible par l'expression de JAM-C de la part de l'endothélium qui permet la mise en place de la « migration transendothéliale inverse ». Finalement, ce mécanisme est la cause du développement d'un ALI.

Section 2 – Inflammation intestinale

I – Physiopathologie des MICI : *les neutrophiles*

L'intestin peut également être une cible lors de certaines pathologies inflammatoires et immunitaires d'étiologie multiple et proposant donc une mécanistique complexe. C'est notamment le cas des maladies inflammatoires chroniques de l'intestin (MICI). Dans cette catégorie on retrouve principalement la rectocolite hémorragique (RCH) et la maladie de Crohn (MC) [163]. La physiopathologie actuellement décrite pour les MICI repose principalement sur une dérégulation générale du système immunitaire, notamment via les lymphocytes T auxiliaires Th2 et Th17 pour les RCH et Th1 et Th17 pour les MC. Une infection bactérienne va induire une réponse de l'immunité innée, dans un premier temps, par l'intermédiaire des macrophages et des neutrophiles. Cette réponse primaire sera, ensuite, la cause d'une activation du système immunitaire adaptatif activatrice des lymphocytes T auxiliaires [164, 165] (Figure 7). Le rôle des neutrophiles, pouvant être parmi les premières cellules impliquées suite à l'activation de l'immunité innée lors d'une MICI, est mal connu [163]. Certains ont décrit une activation des neutrophiles, dans des modèles expérimentaux de RCH induit par administration de dextran sulfate sodium (DSS), dépendante de la sécrétion de cytokines et de chimiokines depuis les cellules inflammatoires, telles que le KC –équivalent de l'IL-8 humain–, le MIP-2 ou encore l'« Epithelial-derived Neutrophil-Activating peptide-78 » (ENA-78) [166-168], ou même l'IL-8 chez des patients ayant manifesté une MICI, d'origine diverse [169, 170]. Suite à l'activation des leucocytes, l'expression de molécules d'adhésion à leur surface, par exemple CD11b, Mac-1 et ICAM-2, observée dans des cas de RCH, ou CD11a, CD11c, ICAM-1, et ICAM-3, associée à différents cas de MC, va être augmentée ce qui permettra alors l'établissement d'une communication étroite avec l'endothélium et promouvoir la migration des neutrophiles jusqu'au tissu intestinal [171]. Ce phénomène est à l'initiative de dommages oxydatifs dans la zone intestinale, observée chez des patients diagnostiqués pour des MICI [172], et donc aboutir à une dégradation tissulaire [173]. Enfin, les neutrophiles agissent également via la formation de NET dans ces pathologies, observée chez des patients, reflétant ainsi une activité exagérée et nocive des neutrophiles [174].

II – Physiopathologie des MICI : *l'endothélium vasculaire*

L'atteinte de l'intégralité vasculaire est aussi une clé dans le déclenchement et donc la résolution des MICI [175]. Lors de la manifestation d'une MICI, chez certains patients ou dans différents modèles expérimentaux, l'endothélium vasculaire augmente sa capacité à réagir avec les

leucocytes, caractérisée notamment par la présentation de protéines membranaires, telles qu'ICAM-1 et la « vascular cell adhesion protein-1 » (VCAM-1) capables de former un complexe avec la protéine CD11a/CD18 des leucocytes [176-178] ou encore l'expression de la « mucosal vascular addressin cell adhesion molecule-1 » (MAdCAM-1) qui peut interagir avec la « lymphocyte Peyer patch adhesion molecule » (LPAM ou intégrine $\alpha 4\beta 7$) des leucocytes [179]. L'expression du CD40 membranaire a aussi été observée à la surface de l'endothélium amplifiant ainsi le recrutement des leucocytes. Dans un modèle murin d'inflammation du colon induit par administration de DSS, la déplétion en CD40 et CD40L diminue considérablement le recrutement des leucocytes, mais également des plaquettes sanguines, au niveau de l'intestin enflammé [180]. La perméabilité de l'endothélium vasculaire semble également augmentée lors d'une RCH, après injection d'iodoacetamide et de DSS dans deux modèles animaux distincts, corrélée avec l'augmentation de la dégradation de ce même endothélium, justifiant donc l'amplification du recrutement leucocytaire au niveau intestinal [181]. Enfin, plusieurs marqueurs solubles, produits par l'endothélium, sont augmentés dans le sérum des patients avec des réactions inflammatoires intestinales. On peut notamment citer une augmentation de la concentration soluble du CD62E [182], d'ICAM-1 [182, 183], de VEGF-A, du « basic fibroblast growth factor » (bFGF), de l'endothelin-1 [184], de l'angiogénine [185] ou encore de l'angiopoïétine [186].

III – Physiopathologie des MICI : les plaquettes

Finalement, le rôle des plaquettes sanguines dans les réactions inflammatoires intestinales a largement été investigué [187-190]. Les plaquettes sanguines agissent selon deux fronts. La première approche va dans le sens d'une augmentation de la fonction thrombotique des plaquettes tandis que la seconde approche ira dans le sens d'une activité inflammatoire prépondérante lors de cette pathologie [189]. Ces mécanismes semblent dépendant l'un de l'autre. Dans un premier temps, plusieurs preuves du rôle thrombotique des plaquettes ont été évoquées chez l'homme et dans des modèles murins, après déclaration d'une MICI. Au sein d'une population de patients présentant une RCH, une augmentation de l'expression plaquettaire de l'intégrine $\alpha \beta 2$ GPI a été observée [191]. Cette intégrine est principalement impliquée dans la formation du thrombus [192]. L'augmentation de l'expression de la protéine CD36 a aussi été évoquée chez des patients avec une MICI [193], augmentant ainsi le risque potentiel thrombotique [194, 195]. En effet, le CD36 plaquettaire est sensible aux lipoprotéines à basse densité oxydées (oxLDL). Cette interaction hypersensibilise les plaquettes à l'ADP et promeut donc leur agrégation [196]. L'utilisation d'un modèle murin a démontré que la déficience en

CD36 bloque l'agrégation plaquettaire [197]. De façon globale, le pouvoir d'agrégation plaquettaire est plus élevé dans la population de patients diagnostiqués pour une MICI que dans une population saine [198]. Le risque important d'agrégation lors d'une MICI a aussi été prouvé à l'aide de plusieurs modèles animaux. La production d'IL-6, facteur pro-inflammatoire sécrété par une multitude de cellules, favorise la formation de thrombus orchestrée par les plaquettes sanguines, suite à l'induction expérimentale d'une RCH par administration de DSS [199]. Finalement, ces thrombus peuvent également se former directement dans la circulation lymphatique. En effet, une étude a démontré que l'activation plaquettaire induite lors d'une inflammation intestinale, provoquée par une injection de DSS dans un modèle murin, peut induire la migration des plaquettes sanguines jusqu'au système lymphatique pour inhiber le développement de ce dernier en inhibant la prolifération des cellules endothéliales et la lymphangiogenèse normalement induite par l'inflammation. La conséquence de ce processus réside en un déclin de la capacité de ce système lymphatique à réduire la formation des cellules inflammatoires, qui seront responsables d'une dégradation tissulaire [200].

Le rôle plaquettaire, d'un point de vue inflammatoire, lors de certaines MICI expérimentaux et humains a aussi été investigué. Tout d'abord, la numération plaquettaire semble être souvent augmentée après le diagnostic d'une MICI chez des patients [201-203]. *A contrario*, la présence des plaquettes réticulées est diminuée, reflétant ainsi un déficit dans la thrombopoïèse orchestrée par les mégacaryocytes, car ces plaquettes sont dites immatures et *de novo* [203]. L'état d'activation plaquettaire est lui aussi généralement augmenté suite au déclenchement de certaines pathologies inflammatoires intestinales. L'augmentation de ce paramètre est souvent mesurée par la quantification du CD62P membranaire aux plaquettes sanguines ou soluble [201, 204-207]. Le PF4 peut également être utilisé comme marqueur d'activité plaquettaire, ainsi ce paramètre a été positivement corrélé avec la manifestation d'une RCH chez des patients [208]. Cependant, la mesure du volume plaquettaire moyen, marqueur d'une activité plaquettaire importante [155], est plus souvent diminuée en lien avec les MICI chez l'homme [201-204, 209]. La diminution de ce volume plaquettaire moyen reste, à l'heure actuelle, incomprise, mais certains évoquent la possibilité d'une migration favorisée des plaquettes larges, dans le tissu enflammé, expliquant ainsi le faible volume des plaquettes circulantes [210]. Le niveau de cette activation plaquettaire peut aussi être évalué par la mesure de la production plaquettaire de sCD40L [206, 211-213], production principalement assurée par les plaquettes [89], ou de la thromboxane B₂ (TxB₂) [211]. La conséquence de cette activité plaquettaire excessive est une amplification de l'activation des leucocytes [214], de la communication cellulaire entre les plaquettes et les leucocytes [180, 206, 214-216], de l'expression de molécules d'adhésion à la surface de l'endothélium et de la sécrétion

de molécules chimioattractives des neutrophiles [217], de la migration des leucocytes au niveau de la muqueuse intestinale [207] et enfin de la production de réactifs responsables de lésions tissulaires [214].

Finalement, le rôle immunomodulateur des plaquettes au sein des différentes pathologies inflammatoires intestinales mérite une investigation fondamentale plus approfondie comme, par exemple, l'utilisation de drogues antiplaquettaires, car, à l'heure actuelle, seule une étude, *in vivo*, a tenté de résoudre les complications liées au développement d'une MICI dans un modèle murin avec l'agent clopidogrel. On peut noter un effet protecteur de ce traitement face au développement de la RCH associé à la diminution de l'activité des neutrophiles [218].

IV – Physiopathologie des MICI : le couple CD40/CD40L

Parallèlement à l'activité des plaquettes, l'implication du CD40L, notamment plaquettaire, et de son récepteur le CD40 ont également été étudiés au cours de certaines MICI humains et expérimentaux. Dans un premier temps, l'expression du CD40 membranaire dans les tissus lésés [219, 220] et le CD40L à la surface des plaquettes [212] est sensiblement augmentée après manifestation d'une MICI chez l'homme. Cette même expression est élevée également dans le système vasculaire du côlon proximal et distal suite à l'induction d'une RCH expérimentale associée à l'administration de DSS. L'utilisation de souris déficiente en CD40 et CD40L démontre une protection contre le déclenchement de cette RCH, associée à une réduction de la production de MPO par les neutrophiles et l'interaction des plaquettes avec l'endothélium et les leucocytes, interaction plus dépendante du CD40L que du CD40 [180]. Le couple CD40/CD40L semble également avoir un impact direct sur les cellules endothéliales, dans le cadre des MICI diagnostiquées chez des patients ou au détours d'études *in vitro*, en limitant la production de VEGF, d'IL-8, du « hepatocyte growth factor » (HGF), ainsi que l'expression d'ICAM-1, de VCAM-1 et de l'angiogenèse [217, 220, 221].

En conclusion, Le recrutement des neutrophiles dans la zone enflammée, investigué grâce à des modèles expérimentaux ou observé chez des patients diagnostiqués pour une MICI, sera dépendant d'une mécanistique ciblant l'endothélium vasculaire et les plaquettes sanguines. Un recrutement non contrôlé des neutrophiles pourrait donc participer à l'amplification de la dégradation tissulaire, accentuée par une libération importante des ROS, d'enzymes et la formation de NET. Ces paramètres ont également été évoqués au sein de la physiopathologie de plusieurs modèles animaux du TRALI. Nous pouvons donc émettre l'hypothèse d'une atteinte multi-organes lors d'un TRALI, ciblant notamment l'intestin.

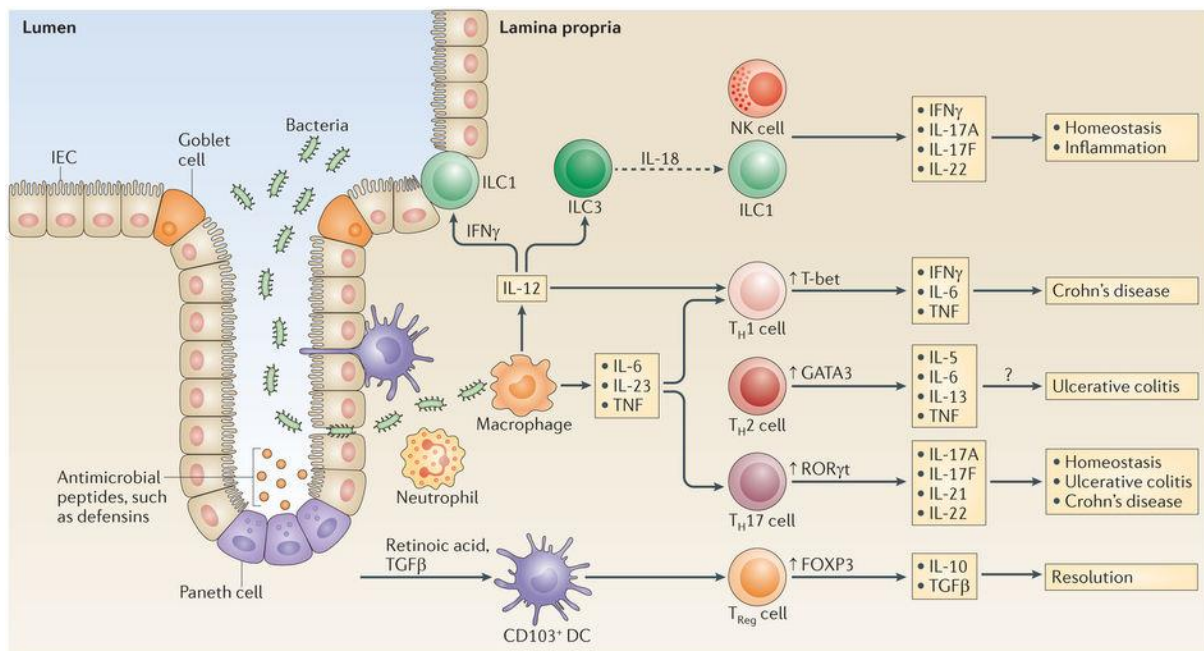

Nature Reviews | Immunology

Figure 7 : Pathophysiologie des MICI, d'après Neurath *et al.* [165]

Suite à une infection bactérienne ciblant la zone intestinale, une première réponse sera établie dont le but est de lutter directement contre le pathogène. Cette réponse innée sera orchestrée par les macrophages et les neutrophiles. Par la suite, à plus long terme, le système adaptatif sera responsable de l'activité inflammatoire excessive dans l'intestin enflammé.

Section 3 – Les autres organes

I – Les reins

D'autres organes peuvent également être sujets à des pathologies inflammatoires régulées par une mécanistique cellulaire présentant plusieurs points communs à celle observée au sein d'ALI expérimentaux. On peut, par exemple, citer l'insuffisance rénale aiguë dont une inflammation excessive semble être l'une des causes principales de cette pathologie [222-224]. Ici, le mécanisme, induit expérimentalement, par exemple par ischémie-reperfusion, réside en une induction non contrôlée d'un état inflammatoire [225]. Un panel de médiateurs solubles sont produits lors de cette pathologie favorisant ainsi l'activation et l'attraction des cellules immunitaires et inflammatoires, on peut notamment citer l'IL-1, l'IL-6, le TNF- α , le MIP-2 ou encore l'IL-8 [226-230]. L'augmentation de la production de composés pro-inflammatoires réside en un accroissement du recrutement, de l'activation et de l'infiltration des neutrophiles jusqu'aux reins enflammés, observé dans des modèles murins [231], mais également chez l'homme [232].

Cette mécanistique est régulée par l'expression de molécules d'adhésion à la surface de l'endothélium, comme ICAM-1 [233], et à la surface des leucocytes, comme LFA-1 [234]. La résultante finale de cette leucostase est une libération des ROS et de protéases au niveau rénal responsable de la dégradation tubulaire. Cela implique donc un rôle important des leucocytes et de l'endothélium dans l'induction et l'amplification de certaines insuffisances rénales aiguës induites expérimentalement. Le rôle des plaquettes sanguines a également été investigué. L'état d'activation de ces cellules est sensiblement augmenté lors de l'induction de cette pathologie, dans différents modèles animaux résultants d'une ischémie-reperfusion ou d'une ligature-ponction caecale, caractérisé par une augmentation de l'expression du CD62P et de la « procaspase activating compound-1 » (PAC-1) membranaire. Cette activation permet l'augmentation de la communication des plaquettes avec les leucocytes, favorisant notamment la formation des NET ainsi que la migration des neutrophiles dans la zone lésée [235-237].

II – Le foie

Plusieurs pathologies inflammatoires peuvent cibler le foie. Pour investiguer la part inflammatoire de ces pathologies, plusieurs modèles animaux d'atteinte du foie ont été utilisés, tels qu'une lésion hépatique induite par ischémie-reperfusion, par endotoxémie et par toxicité à l'alcool, à l'acetaminophène et à l' α -naphthyl-isothiocyanate [238], ainsi que suite à une cholestase obstructive [239]. L'un des principaux paramètres inflammatoires observé, grâce à ces différents modèles expérimentaux, lors d'une atteinte du foie est une infiltration des neutrophiles dans le parenchyme de ce tissu [240], notamment via l'expression de Mac-1 à la surface des neutrophiles [241]. Lors d'une lésion au niveau du foie, les cellules hépatiques peuvent sécréter un panel de cytokines et de chimiokines formant un gradient attractif accentuant la migration des neutrophiles dans ce tissu comme le MIP-2 [242-244], le KC [242, 244], la « cytokine-induced neutrophil chemoattractant » (CINC) [243, 245], l'ENA-78 [246] et, hypothétiquement, MCP-1 –jusqu'à l'ors décrit uniquement comme chemoattractant des monocytes– [247] et des médiateurs solubles activateurs des neutrophiles, tels que le TNF- α [243, 244, 248, 249] et l'IL-1 [244, 249]. La conséquence de cette activation réside en une amplification de la communication cellulaire, notamment entre les neutrophiles et l'endothélium vasculaire. En effet, l'expression de Mac-1 est sensiblement augmentée à la surface des neutrophiles [239, 241, 250-252], ainsi qu'ICAM-1 [250, 253-255] à la membrane des cellules endothéliales, particulièrement dans la zone sinusoidale du foie. Finalement, la production des ROS par les neutrophiles ayant migré sera la résultante caractéristique de l'atteinte du foie et sa dégradation, par exemple lorsqu'elle est induite expérimentalement par ischémie-reperfusion [256]. Les plaquettes participent également à

l'amélioration de l'infiltration des leucocytes, et donc des neutrophiles, lors de certaines atteintes inflammatoires du foie, mais principalement via une exacerbation de la communication avec l'endothélium sinusoidal qui participera à une libération de facteurs attractif des leucocytes [257]. Dans un premier temps, une séquestration plaquettaire a été observée au niveau de l'endothélium sinusoidal lors d'inductions expérimentales d'une hépatite virale [258-261]. Ces plaquettes fixées grâce à l'expression des intégrines GPIIb/IIIa et $\alpha V\beta 3$ va permettre la production de chimiokines attractantes des neutrophiles, par exemple IL-8 et MCP-1 [262]. L'inhibition plaquettaire par l'utilisation du clopidogrel semble protéger les souris d'une atteinte inflammatoire du foie induite par l' α -naphthyl-isothiocyanate, caractérisée notamment par la diminution de l'infiltration des neutrophiles [263]. La migration des leucocytes, dans un modèle murin d'ischémie-reperfusion, est aussi altérée lors de l'inhibition plaquettaire par l'utilisation d'anticorps anti-GPIIb/IIIa, qui est une intégrine, récepteur du fibrinogène et du vWF, et d'anticorps anti-CD62P [264].

Ces phénomènes inflammatoires touchant ces différents organes sont semblables à ceux observés dans différents modèles expérimentaux d'ALI permettant ainsi d'émettre l'hypothèse d'un impact non exclusif aux poumons lors d'un TRALI mais probablement aussi des organes plus profonds, particulièrement le pancréas. Suite à la transfusion des composés sanguins pouvant induire un TRALI, nous émettons l'hypothèse que les poumons seraient la principale cible des anticorps anti-leucocytaires et BRM transfusés ainsi que des premières cellules circulantes activées par ces mêmes réactifs. Les organes plus profonds, tels que le pancréas, seraient donc une cible secondaire dont l'atteinte serait dépendante du pouvoir inflammatoire du « second-hit » du TRALI, la transfusion.

Objectifs et problématique

Actuellement, le TRALI est considéré comme l'une des pathologies transfusionnelles les plus critiques, notamment en termes de mortalité. En France, les TRALI dits immunologiques, provoqués par la présence d'anticorps anti-leucocytaires, tels que les anti-HLA de classe I et II ou les anti-HNA, dans les PSL, sont désormais assez bien prévenus. Cela est notamment dû aux différentes prédispositions prises dans les centres de transfusion consistant en un dépistage amélioré des anticorps anti-leucocytaires, à une régulation importante des donneurs –exclusion des femmes ayant connues un épisode de grossesse récent et étant donc une source importante d'anticorps anti-HLA–, aux changements des processus de préparation des différents PSL –par exemple le remplacement d'une partie du plasma des concentrés plaquettaires par une solution de conservation plaquettaire additive–, etc... Cependant, la seconde catégorie, les TRALI dits non-immunologiques, notamment induits par transfusion de médiateurs solubles pro-inflammatoires, connaissent une croissance numérique non négligeable, malgré le changement de la politique transfusionnelle [265]. De plus, le sous-diagnostic des TRALI non-immunologiques, souvent considérés comme des SDRA, décroît l'occurrence de ces derniers. Mieux comprendre la physiopathologie du TRALI, qu'il soit immunologique ou non, permettrait, à l'avenir de prévenir entièrement son développement. Ces connaissances fondamentales et mécanistiques pourraient être extrapolées à d'autres pathologies inflammatoires, telles que l'ALI, les SDRA, les pathologies transfusionnelles inflammatoires, le sepsis, la pancréatite et autres.

Au cours de cette thèse, nous émettons l'hypothèse que la fonction inflammatoire des plaquettes sanguines des concentrés plaquettaires ou au sein de l'organisme pourrait expliquer, en partie, le développement des TRALI non-immunologiques, en particulier suite aux transfusions des concentrés plaquettaires, mais également, partiellement, la sévérité des TRALI immunologiques. Pour répondre à cette hypothèse nous avons abordé cette problématique selon plusieurs points de vue (figure 8) : i) qu'elle est le réel impact inflammatoire des productions des concentrés plaquettaires sur le devenir de l'intégrité vasculaire, paramètre clé lors du développement du TRALI ? ii) Qu'elle est la place des plaquettes sanguines de l'organisme dans l'induction, le maintien et/ou la régulation de l'inflammation, d'un point de vue général ? iii) et contextualisé dans un modèle murin du TRALI ? iv) qu'elle est l'influence du couple CD40/CD40L, dont le rôle du sCD40L, produit majoritairement par les plaquettes, est agoniste de la forme membranaire, sur la sévérité du TRALI induit immunologiquement dans un modèle murin ? v) et enfin, la place de ce même couple protéique sur l'atteinte multi-organes, si elle existe, lors d'un TRALI ?

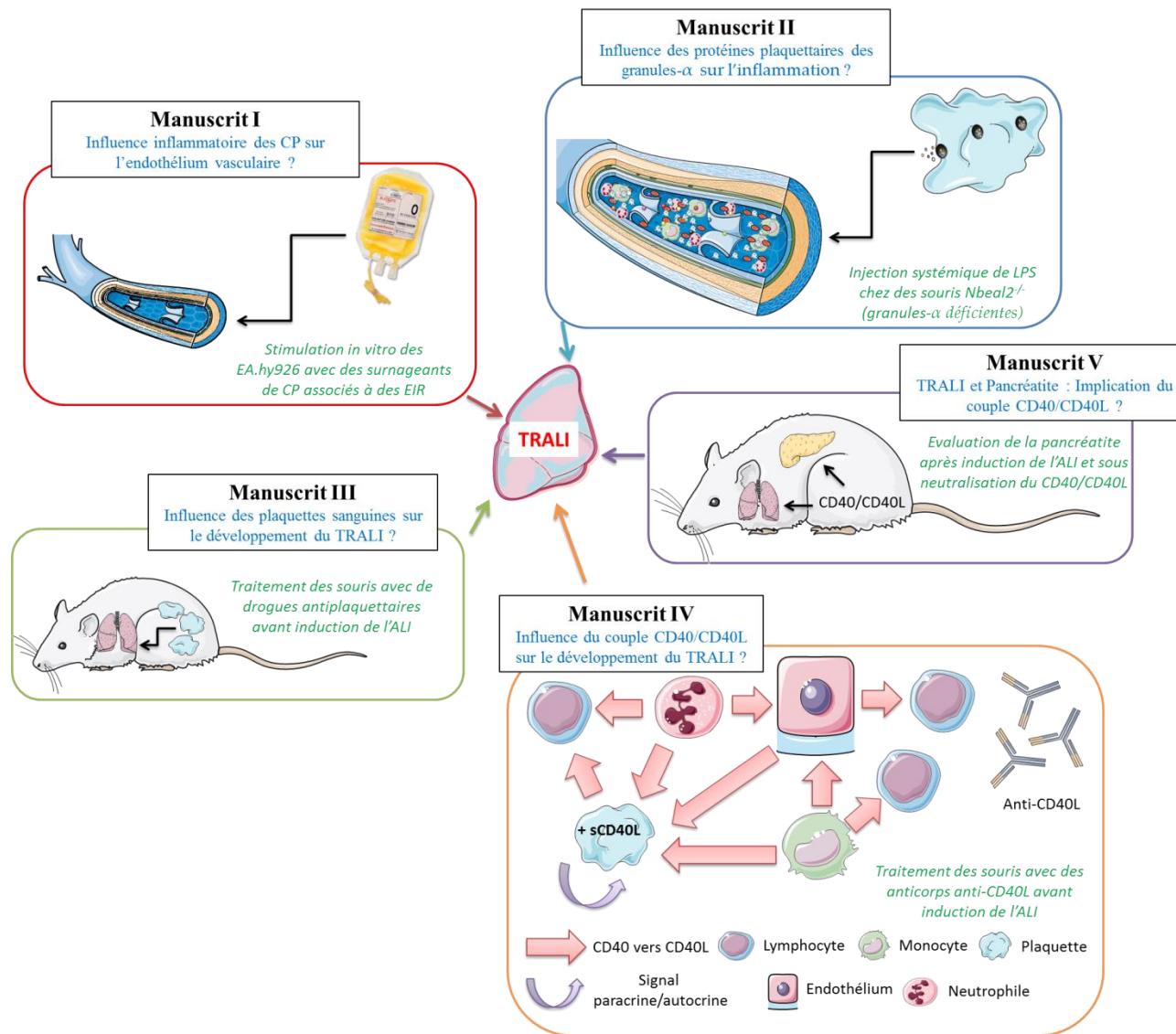

Figure 8 : Développement de la thèse

Résultats

**Manuscrit I : Modélisation de l'effet des surnageants de
concentrés plaquettaires sur les cellules endothéliales:
focus sur Endocan/ESM-1**

*“Modeling the effect of platelet concentrate supernatants on
endothelial cells: focus on Endocan/ESM-1”*

Article sous presse dans « Transfusion »

Endocan est une glycoprotéine exprimée par l'endothélium vasculaire dont le rôle est de maintenir l'intégrité de la paroi vasculaire et en assurer son imperméabilité face aux composés sanguins. Après libération, endocan peut se fixer aux récepteurs leucocytaires des globules blancs préalablement adhérents aux cellules endothéliales par le complexe LFA-1/ICAM-1, limitant ainsi leur transmigration à travers la barrière endothéliale (Figure 9) [266]. Lors de certaines réactions inflammatoires, cet endothélium vasculaire peut être lésé et, par le relâchement de ces jonctions serrées, permettre une leucostase améliorée [59, 60]. La libération d'endocan est donc augmentée dans le but de contrer l'atteinte de l'endothélium vasculaire.

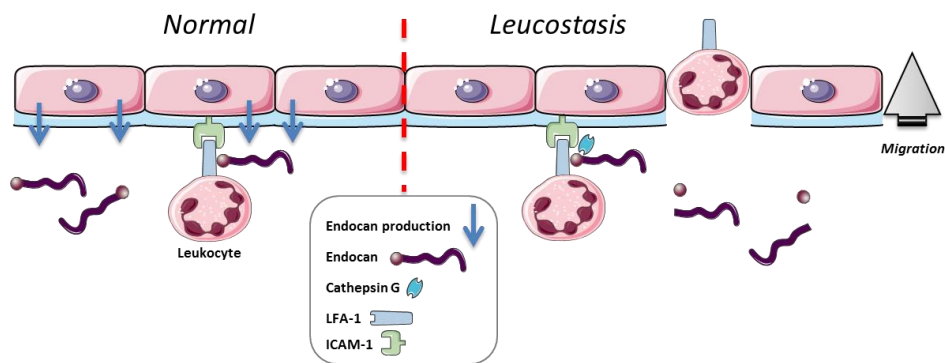

Figure 9 : Influence d'endocan sur la transmigration leucocytaire

Endocan est produit par les cellules endothéliales. Son rôle est de maintenir l'intégrité de la paroi vasculaire. Ainsi, endocan limite l'infiltration des leucocytes dans le tissu adjacent. Son influence peut être limitée de deux principales manières ; soit par une production limitée de la part des cellules endothéliales, soit par l'action de la cathepsine G, produite par les neutrophiles, capable de cliver endocan en plusieurs fragments et inhibant sa fonction première.

Au cours de ce travail de thèse, le but était de mettre en évidence l'influence inflammatoire des composés présents dans les milieux de conservation des concentrés plaquettaires associés au développement de réactions transfusionnelles sur l'endothélium vasculaire et d'évaluer la libération d'endocan depuis ce dernier. Nous avons pu observer une exacerbation de l'état inflammatoire des cellules endothéliales caractérisé par une libération plus importante de médiateurs solubles comme IL-6, mais également endocan, lorsque ces cellules sont stimulées avec des surnageants de CP liés à des réactions transfusionnelles par rapport à des surnageants de CP sans lien pathologique avec le receveur. Cette production endothéliale est corrélée avec une prolifération cellulaire réduite et une apoptose plus accrue. Ainsi, comme pour d'autres pathologies inflammatoires, nous pourrions envisager la mesure de la concentration plasmatique d'endocan comme un marqueur précoce de la lésion inflammatoire de l'endothélium et donc de réactions transfusionnelles inflammatoires.

Modelling the effect of platelet concentrate supernatants on endothelial cells: focus on Endocan/ESM-

1

Sofiane Tariket^{1,2}, Caroline Sut^{1,2}, Charles-Antoine Arthaud¹, Marie-Ange Eyraud¹, Astrid Meneveau¹,
Sandrine Laradi^{1,2}, Hind Hamzeh-Cognasse², Olivier Garraud^{2,3}, Fabrice Cognasse^{1,2}

¹ Etablissement Français du Sang Auvergne-Rhône-Alpes, Saint-Etienne, France

² Université de Lyon, GIMAP-EA3064, Saint Etienne, France

³ Institut National de la Transfusion Sanguine (INTS), Paris, France

*Address for correspondence and reprint requests: Dr. Fabrice Cognasse, PhD, Etablissement Français du Sang Auvergne-Rhône-Alpes and GIMAP-EA 3064, Université de Saint-Etienne. Etablissement Français du Sang Auvergne-Rhône-Alpes, 25 Boulevard Pasteur, 42100 Saint-Etienne. Telephone: +33 (0) 683975883;

Fax: +33 (0) 477421486; E-mail: fabrice.cognasse@efs.sante.fr

Keywords: platelets; ESM-1/Endocan; inflammation; transfusion; serious adverse events

Running title: Platelets and inflammation

The authors declare that they have no conflict of interest.

Word count: 1682; **Abstract:** 243; **References:** 25; **Figures:** 3; **Tables:** 0

Abstract

Background:

Platelets are prone to activation and the release of Biological Response Modifiers (BRMs) under storage conditions. The transfusion inflammatory reaction in the vascular compartment involves endothelial cell activation due to cell-cell interactions and BRMs infused with the blood products. ESM-1/Endocan is a proteoglycan secreted by endothelial cells under the control of proinflammatory cytokines.

Objectives:

We aimed to measure Endocan activity in supernatants of platelet components (PCs), implicated in Serious Adverse Reactions (SARs) or not (no.AR), sampled at different stages during storage.

Materials and Methods:

Platelet function, by quantification of soluble CD62P, and their ability to produce endocan were assessed. Functional testing of PC supernatants was performed on EA.hy926 endothelial cells *in vitro* by exposing them to PC supernatants from each group (no.AR or SARs); EA.hy926 activation was evaluated by their production of IL-6 and Endocan.

Results:

Platelet endocan secretion was not induced in response to platelet surface molecule agonists, and no significant correlation was observed between sCD62P and endocan concentration after platelet activation. However, we observed a significant increase in the secretion of IL-6 and endocan following EA.hy926 activation by all PC supernatants. IL-6 and endocan secretion were significantly higher for cells stimulated with SAR than those stimulated with no.AR PC supernatants, as well as cell apoptosis.

Conclusion:

The correlation between the secretion of endocan and that of IL-6 by endothelial cells suggests that endocan can be used as a predictive marker of inflammation for the quality assessment of transfusion grade platelets.

Introduction

Endocan (also known as endothelial cell-specific molecule-1, ESM-1) is involved in the pathophysiology of pneumonia, acute respiratory distress syndrome, cancer, cardiovascular disease, hypertension, chronic kidney disease, and sepsis.¹⁻⁹ It is a proteoglycan involved in cell adhesion, migration, proliferation, and neovascularization² and is released by damaged vascular endothelium in response to inflammatory cytokines and pro-angiogenic stimuli. Endocan expression appears to be pro-inflammatory, in association with VEGF or TNF- α .^{8,10-12} These properties led us to explore whether there is a possible link between endocan expression and inflammatory platelet components (PCs), as PCs are frequently associated with inflammatory responses in patients.¹³

Biological response modifiers (BRMs), secreted by platelets in PCs during storage, play a role in serious adverse events (SARs) associated with transfusion. Previous reports have shown that transfusion inflammatory reactions in the vascular compartment involves endothelial cell activation and BRMs present in the blood products, particularly those present in platelet components.¹⁴ Identification of variations in the levels of BRM in PCs during the process of preparation and/or storage is therefore seminal to avoid or, at least, limit occurrences of transfusion associated SARs. Investigation of endothelial cell physiology upon exposure to various PC supernatants should aid our understanding of the pathophysiological mechanisms of endothelial cell activation during transfusion associated SARs.

Here, we aimed to decipher the state of endothelial activation *in vitro*, focusing on the secretion of IL-6 and endocan upon exposure to PC supernatants sampled at various times during storage (up to five days), that were or were not involved in transfusion-associated SARs.

Methods

Platelet component preparation

PCs were collected from either single donor by apheresis (SDA) or from whole blood. SDA platelets were collected on cell separators using citrate dextrose-A with Trima Accel™ (Gambro BCT, Lakewood, CO, USA) or MCS™ (Haemonetics™, Braintree, MA, USA). All PCs were automatically resuspended in 35% autologous donor plasma and 65% platelet additive solution (PAS-C; InterSol, Fenwal, la Châtre, France; or SSP1™; MacoPharma, Mouveaux, France).¹³ Whole blood PCs were prepared as pooled buffy coats from five whole blood collections, using the Optipress device with top and bottom separation (Baxter Healthcare Corporation, La Chatre, France) and platelet additive solution (i.e., PAS-C; Fenwal, La Châtre, France; or PAS-E; MacoPharma, Mouveaux, France) with a mean range of 35% residual plasma. Pooled PCs were leukoreduced by filtration.¹⁵ PCs were stored at 22°C ± 2°C with gentle rotation and shaking on a flat agitator (60 rpm) for a maximum of 5 days (after collection was completed) before being issued for transfusion. PC supernatants were collected after centrifugation (1,500 rpm; 10 min) and stored as frozen stocks in aliquots at –80°C. We collected 55% of the supernatants, tested in the present study, from apheresis PCs and 45% from buffy coats. Transfusions were conducted as part of routine care in nearby university clinics; clinic physicians report SARs according to French regulations and laws, ascribing SARs to a pathological category, such as allergic transfusion reaction (ATR), febrile non-haemolytic transfusion reaction (FNHTR), acute haemolytic transfusion reactions (AHTR), etc.¹⁶ Among the PCs associated with SARs, 63% were associated with FNHTRs, 26% with AHTR, and 11% with ATR. Upon occurrence of SAR, clinics agreed to provide a platelet component sample if some was leftover, as part of a collaborative research program. For this study, PC supernatant from clinical transfusions where no adverse reaction was experienced (No.AR), stored for the same period of time and harvested using the same collection processor, were selected to match each reported SAR sample.

Platelet stimulation

Platelet endocan secretion was tested on Platelet-rich plasma (PRP). Peripheral blood was collected from healthy donors in endotoxin-free 3.2% sodium citrate tubes (Vacutainer®, Becton-Dickinson, San Jose, CA). PRP was prepared by centrifuging the blood at 1,500 rpm for 10 min at room temperature. PRP samples were separated and then stimulated with thrombin receptor stimulating peptide (TRAP; 5 µg/ml) or collagen (20 µg/ml) (Sigma Aldrich, Saint-Louis). PRP supernatants were collected after centrifugation (1,500 rpm; 10 min) and stored as frozen stocks in aliquots at –80°C. Platelet membrane protein expression was analysed through flow cytometry after stimulation. Platelets were recognized using FITC-anti-CD41 mAb and membrane CD62P expression was measured using APC-anti-CD62P mAb

(BD Pharmingen, Franklin Lakes, USA). Soluble endocan (Lunginnov, Lille, France) and soluble CD62P (R&D systems, Lille, France) were quantified in PRP supernatants by ELISA, according to the manufacturer's instructions. Absorbance at 450 nm was determined with an ELISA reader (Tecan, Männedorf, Switzerland).

EA.hy926 endothelial cells preparation

Functional testing of cell supernatants on EA.hy926 immortalized endothelial cell lines is a commonly used *in vitro* model for endothelium studies of various processes connected with its functions¹⁷. The human endothelial hybrid cell line EA.hy926 was obtained by fusion of primary umbilical vein endothelial cells with the human lung carcinoma cell line A459/8 (ATCC #CRL-2922). EA.hy926 cells were cultured in Dulbecco's Modified Eagle's Medium (DMEM) High Glucose containing 10% foetal bovine serum, 1% penicillin/streptomycin, 1% non-essential amino acids, and 0.1% ciprofloxacin (Sigma-Aldrich, Saint-Louis) and then incubated at 37°C in a humidified atmosphere in 5% CO₂ until the cell monolayer reached confluence.

Functional testing of PC supernatants on EA.hy926 endothelial cells

The cells were exposed to PC supernatants from each group (no.AR or SARs) for 1, 6 or 24h. Neutral medium was used as a negative control. EA.hy926-cell proliferation was evaluated under PC supernatant stimulation, using an MTT Cell Proliferation Assay kit (ATCC, Manassas, USA). Briefly, after EA.hy926-cell stimulation, MTT reagent was added in each well and incubated for 3 hours. Next, detergent reagent was added in each well for 2 hours. Finally, absorbance was read at 570 nm. Evaluation of cell proliferation was deduced from blank wells. Flow cytometry process was used to evaluate ICAM-1 expression and death cell under PC supernatant stimulation. After stimulation, cells were incubated with FITC-anti-CD105 mAb, PE-anti-ICAM-1 mAb and 7AAD reagent. Finally, EA.hy926-cell activation was evaluated to test for secretion of IL-6 and endocan.¹⁸ Soluble endocan (Lunginnov, Lille, France) and IL-6 (R&D systems, Lille, France) were quantified in EA.hy926 and PC supernatants by ELISA, according to the manufacturer's instructions. Absorbance at 450 nm was determined with an ELISA reader (Tecan, Männedorf, Switzerland).

Statistical tests

Statistical analyses were performed using GraphPad Prism 5 software (Graph ad, La Jolla, USA). One way ANOVA test and Bonferroni post-hoc test were used when Kolmogorov-Smirnov normality test passed. Kruskal-Wallis test and the Dunn's post-hoc test were used when Kolmogorov-Smirnov normality test

failed. Correlations were assessed using Spearman's test. P-values were considered to be significant when < 0.05 for all tests: * < 0.05 ; ** < 0.01 ; *** < 0.001 .

Results

Platelet activation does not induce endocan release

We determined whether normal platelets can release endocan (and sCD62P as a control) following 30-min of stimulation with TRAP or collagen, the canonical agonists of platelet surface molecule engagement. TRAP or collagen platelet activation resulted in a 1.5 and 1.3-fold increase in sCD62P levels, respectively (respectively, $p < 0.001$ and $p < 0.05$) (**Fig. 1A**). There was no significant endocan release after activation of platelets by TRAP or collagen, relative to baseline levels (**Fig. 1B**). There was also no significant correlation between sCD62P and endocan concentrations after platelet activation (**Fig. 1C**). Thus, endocan secretion was not induced in platelets in response to agonists, suggesting that it is not stored inside platelet granules.

Endothelial cells proliferation and activation under supernatants from PCs (no.AR or SAR)

Firstly, EA.hy926 cell proliferation was evaluated after 1, 6 and 24 hours upon PC supernatant stimulation. From 1 hour to 24 hours, there was a moderate decrease in EA.hy926 cell viability and proliferation though still significantly higher under no.AR PC versus SAR PC supernatant stimulation (**Fig. 2A**). To confirm the reduction in cell proliferation, we then evaluated cell apoptotic state, in the same conditions. The rate of 7AAD positive cells, representing cell death, was greatly increased after 6 hours of PC supernatant stimulation. Nevertheless, such results evoked a more significant apoptotic induction of EA.hy926 cells at 24 hours under SAR PC supernatant stimulation than within the no.AR group (**Fig. 2B**). Cell proliferation and cell death were significantly and negatively correlated for each sample (**Fig. 2D**). Finally, ICAM-1 expression increases from 1 hour to 24 hours of stimulation. However, no difference was noted between no.AR and SAR PC supernatant stimulation (**Fig.2E**).

Bioactivity of supernatants from PCs (no.AR or SAR) on endothelial cells and endocan release

We next assessed the bioactivity of supernatants from PCs associated, or not, with SARs using the human endothelial hybrid cell line EA.hy926. IL-6 is a classical activation marker of endothelial cells;¹⁸ Endocan has never been investigated as an endothelial cell activation marker nor been found to be associated with SARs. IL-6 (**Fig. 3A**) and endocan (**Fig. 3B**) secretion were significantly higher for EA.hy926 cells stimulated with SAR than those stimulated with the no.AR PC supernatants. This was true for cells stimulated for 6 or 24 h for IL-6, and 24 h for endocan.¹⁹ Incubation of EA.hy926 cells with PC supernatants for 24 h induced a 1.97 and 3.24-fold increase in IL-6 levels (**Fig. 3A**) and an 8.6 and 10.04-fold increase in endocan levels (**Fig. 3B**) for the no.AR and SAR supernatants, respectively. We, next, investigated the bioactivity of the no.AR and SAR PC supernatants aged 0–3 [0-3[or 3-5 [3-5] days on

EA.hy926 cells by measuring IL-6 and endocan secretion after 6 or 24 h exposure to the supernatant. IL-6 (**Fig. 3C, D**) and endocan (**Fig. 3E, F**) secretion were significantly higher for cells stimulated with SAR than those stimulated with the no.AR PC supernatants, regardless of the time in storage. Nevertheless, no difference was observed depending on SAR type (supplemental data). There was a significant correlation between IL-6 and endocan secretion after 6 (**Fig. 3G**) and 24 h (**Fig. 3H**) of EA.hy926 cell activation. This correlation was higher after 24 h than 6 h ($r = 0.3064$ vs. 0.2444 , respectively).

Discussion

Several BRMs, including cytokines, chemokines, mitochondrial DNA, and soluble glycoproteins, increase during the storage of PCs and are associated with SARs.^{13,20-25} However, the mechanisms by which platelet transfusions induce SARs are complex and not completely understood. We used an *in vitro* model of endothelial cell stimulation to evaluate the participation of endocan secretion in inflammatory transfusion reactions. The main finding was the influence of supernatants from PCs associated with SARs on endocan secretion. We firstly showed that SAR implicated-PCs affected more significantly the endothelial cell proliferation and viability than the no.AR PC supernatants (**Fig 2A, B, C and D**). Nevertheless, endothelial cell activation seemed to be higher after the SAR PC supernatant stimulation, as evidenced by IL-6 enhance production (**Fig. 3A, C and D**); however ICAM-1 expression remain unaffected (**Fig. 2E**). Endocan secretion by endothelial cells significantly correlated with stimulation.⁹ SAR PC supernatants induced the secretion of significantly higher levels of endocan than no.AR PC supernatants. We also observed this difference regardless of storage time.

These results are in agreement with studies of various inflammatory disorders.^{4,6,9,26} Furthermore, LPS injection of human volunteers has been shown to increase the level of endocan after 2 hours.¹ Endocan secretion has also been positively correlated with the secretion of other pro-inflammatory cytokines, such as TNF- α and IL-1 β .²⁶ Endocan is a soluble proteoglycan that is secreted by endothelial cells in response to proinflammatory cytokines, LPS, or angiogenic factors.⁹ Although the role of endocan has not been completely elucidated, several reports have shown that an increase in the production of proinflammatory cytokines by endothelial cells enhances microvascular permeability and modulates leukocyte migration.^{5,27} In a mouse model, endocan drives leukocyte extravasation similar to that observed for certain acute respiratory distress syndromes, such as TRALI.¹² Several studies suggest that endocan levels can predict pathologies such as ARDS,^{3,4} sepsis,⁹ and cancer.^{8,28,29} Supernatants from PCs that led to SARs in patients display pro-inflammatory profiles that can promote endocan and IL-6 secretion by endothelial cells. IL-6 is a proinflammatory marker of endothelial cell activation. However, this inflammatory change seems to be associated with a reduction in cell viability and an increase in cell death rather than proliferation functions. This data are in keeping with findings in TRALI, i.e., an increase vascular permeability due to inflammation driven by several mechanisms,³⁰ of which BRMs, or bacterial moieties, or pathogenic antibodies, or combinations of the above. The correlation between the secretion of endocan and that of IL-6 by endothelial cells suggests that endocan can be used, along with other inflammatory cytokines, as a marker of inflammation, in particular transfusion-associated inflammation. It is likely that the association between endocan and SARs is mediated through endothelial dysfunction.

Future studies are required to investigate the direct relationship between endocan and endothelial function.

Acknowledgements

The authors gratefully acknowledge the blood donors. We would like to thank the medical staff and personnel of the Etablissement Français du Sang Auvergne-Rhone-Alpes, Saint-Etienne, France for their technical support throughout our studies. This work was supported by grants from the French National Blood Service – EFS (Grant APR), France; the Association for Research in Transfusion (ART), Paris, France; the Agence Nationale de la Sécurité et du Médicament et des produits de santé (ANSM - AAP-2012-011, Reference 2012S055); and the Association “Les Amis de Rémi” Savigneux, France.

Authors' contributions

ST, CS, CAA, MAE, and AM performed the experiments and analysed the data.

ST, SL, HHC, OG, and FC conceived and designed the experiments, analysed the data and wrote the paper.

All authors read and approved the final manuscript.

References

1. Cox LA, van Eijk LT, Ramakers BP, Dorresteijn MJ, Gerretsen J, Kox M, Pickkers P. Inflammation-Induced Increases in Plasma Endocan Levels Are Associated With Endothelial Dysfunction in Humans In Vivo. *Shock* 2015.
2. Balta S, Mikhailidis DP, Demirkol S, Ozturk C, Celik T, Iyisoy A. Endocan: A novel inflammatory indicator in cardiovascular disease? *Atherosclerosis* 2015;**243**: 339-43.
3. Orbegozo D, Rahmania L, Irazabal M, Mendoza M, Annoni F, De Backer D, Creteur J, Vincent JL. Endocan as an early biomarker of severity in patients with acute respiratory distress syndrome. *Ann Intensive Care* 2017;**7**: 93.
4. Tang L, Zhao Y, Wang D, Deng W, Li C, Li Q, Huang S, Shu C. Endocan levels in peripheral blood predict outcomes of acute respiratory distress syndrome. *Mediators Inflamm* 2014;**2014**: 625180.
5. Mihajlovic DM, Lendak DF, Brkic SV, Draskovic BG, Mitic GP, Novakov Mikic AS, Cebovic TN. Endocan is useful biomarker of survival and severity in sepsis. *Microvasc Res* 2014;**93**: 92-7.
6. Balta S, Mikhailidis DP, Demirkol S, Ozturk C, Kurtoglu E, Demir M, Celik T, Turker T, Iyisoy A. Endocan--a novel inflammatory indicator in newly diagnosed patients with hypertension: a pilot study. *Angiology* 2014;**65**: 773-7.
7. De Freitas Caires N, Legendre B, Parmentier E, Scherpereel A, Tscopoulos A, Mathieu D, Lassalle P. Identification of a 14 kDa endocan fragment generated by cathepsin G, a novel circulating biomarker in patients with sepsis. *J Pharm Biomed Anal* 2013;**78-79**: 45-51.
8. Rennel E, Mellberg S, Dimberg A, Petersson L, Botling J, Ameer A, Westholm JO, Komorowski J, Lassalle P, Cross MJ, Gerwins P. Endocan is a VEGF-A and PI3K regulated gene with increased expression in human renal cancer. *Exp Cell Res* 2007;**313**: 1285-94.
9. Scherpereel A, Depontieu F, Grigoriu B, Cavestri B, Tscopoulos A, Gentina T, Jourdain M, Pugin J, Tonnel AB, Lassalle P. Endocan, a new endothelial marker in human sepsis. *Crit Care Med* 2006;**34**: 532-7.
10. Roudnicky F, Poyet C, Wild P, Krampitz S, Negrini F, Huggenberger R, Rogler A, Stohr R, Hartmann A, Provenzano M, Otto VI, Detmar M. Endocan is upregulated on tumor vessels in invasive bladder cancer where it mediates VEGF-A-induced angiogenesis. *Cancer Res* 2013;**73**: 1097-106.
11. Bechard D, Gentina T, Delehede M, Scherpereel A, Lyon M, Aumercier M, Vazeux R, Richet C, Degand P, Jude B, Janin A, Fernig DG, Tonnel AB, Lassalle P. Endocan is a novel chondroitin sulfate/dermatan sulfate proteoglycan that promotes hepatocyte growth factor/scatter factor mitogenic activity. *J Biol Chem* 2001;**276**: 48341-9.
12. Rocha SF, Schiller M, Jing D, Li H, Butz S, Vestweber D, Biljes D, Drexler HC, Nieminen-Kelha M, Vajkoczy P, Adams S, Benedito R, Adams RH. Esm1 modulates endothelial tip cell behavior and vascular permeability by enhancing VEGF bioavailability. *Circ Res* 2014;**115**: 581-90.
13. Nguyen KA, Hamzeh-Cognasse H, Sebban M, Fromont E, Chavarin P, Absi L, Pozzetto B, Cognasse F, Garraud O. A computerized prediction model of hazardous inflammatory platelet transfusion outcomes. *PloS one* 2014;**9**: e97082.
14. Baimukanova G, Miyazawa B, Potter DR, Muench MO, Bruhn R, Gibb SL, Spinella PC, Cap AP, Cohen MJ, Pati S. Platelets regulate vascular endothelial stability: assessing the storage lesion and donor variability of apheresis platelets. *Transfusion* 2016;**56 Suppl 1**: S65-75.
15. Nguyen KA, Chavarin P, Arthaud CA, Cognasse F, Garraud O. Do manual and automated processes with distinct additive solutions affect whole blood-derived platelet components differently? *Blood Transfus* 2013;**11**: 152-3.

16. ANSM. French Haemovigilance Activity Report 2015. 2016.
17. Bouis D, Hospers GA, Meijer C, Molema G, Mulder NH. Endothelium in vitro: a review of human vascular endothelial cell lines for blood vessel-related research. *Angiogenesis* 2001;**4**: 91-102.
18. Sut C, Hamzeh-Cognasse H, Laradi S, Bost V, Aubrege C, Acquart S, Vignal M, Boutahar N, Arthaud CA, Ange Eyraud M, Pozzetto B, Tiberghien P, Garraud O, Cognasse F. Properties of donated red blood cell components from patients with hereditary hemochromatosis. *Transfusion* 2017;**57**: 166-77.
19. Mutin M, Dignat-George F, Sampol J. Immunologic phenotype of cultured endothelial cells: quantitative analysis of cell surface molecules. *Tissue antigens* 1997;**50**: 449-58.
20. Hamzeh-Cognasse H, Damien P, Nguyen KA, Arthaud CA, Eyraud MA, Chavarin P, Absi L, Osselaer JC, Pozzetto B, Cognasse F, Garraud O. Immune-reactive soluble OX40 ligand, soluble CD40 ligand, and interleukin-27 are simultaneously oversecreted in platelet components associated with acute transfusion reactions. *Transfusion* 2014 **54**: 613-25.
21. Kaufman J, Spinelli SL, Schultz E, Blumberg N, Phipps RP. Release of biologically active CD154 during collection and storage of platelet concentrates prepared for transfusion. *J Thromb Haemost* 2007;**5**: 788-96.
22. Khan SY, Kelher MR, Heal JM, Blumberg N, Boshkov LK, Phipps R, Gettings KF, McLaughlin NJ, Silliman CC. Soluble CD40 ligand accumulates in stored blood components, primes neutrophils through CD40, and is a potential cofactor in the development of transfusion-related acute lung injury. *Blood* 2006;**108**: 2455-62.
23. Cognasse F, Boussoulade F, Chavarin P, Acquart S, Fabrigli P, Lamy B, Garraud O. Release of potential immunomodulatory factors during platelet storage. *Transfusion* 2006;**46**: 1184-9.
24. Boudreau LH, Duchez AC, Cloutier N, Soulet D, Martin N, Bollinger J, Pare A, Rousseau M, Naika GS, Levesque T, Laflamme C, Marcoux G, Lambeau G, Farndale RW, Pouliot M, Hamzeh-Cognasse H, Cognasse F, Garraud O, Nigrovic PA, Guderley H, Lacroix S, Thibault L, Semple JW, Gelb MH, Boilard E. Platelets release mitochondria serving as substrate for bactericidal group IIA-secreted phospholipase A2 to promote inflammation. *Blood* 2014;**124**: 2173-83.
25. Tung JP, Fraser JF, Nataatmadja M, Colebourne KI, Barnett AG, Glenister KM, Zhou AY, Wood P, Silliman CC, Fung YL. Age of blood and recipient factors determine the severity of transfusion-related acute lung injury (TRALI). *Crit Care* 2012;**16**: R19.
26. Lassalle P, Molet S, Janin A, Heyden JV, Tavernier J, Fiers W, Devos R, Tonnel AB. ESM-1 is a novel human endothelial cell-specific molecule expressed in lung and regulated by cytokines. *J Biol Chem* 1996;**271**: 20458-64.
27. Lee W, Ku SK, Kim SW, Bae JS. Endocan elicits severe vascular inflammatory responses in vitro and in vivo. *J Cell Physiol* 2014;**229**: 620-30.
28. Huang X, Chen C, Wang X, Zhang JY, Ren BH, Ma DW, Xia L, Xu XY, Xu L. Prognostic value of endocan expression in cancers: evidence from meta-analysis. *Onco Targets Ther* 2016;**9**: 6297-304.
29. Seo K, Kitazawa T, Yoshino Y, Koga I, Ota Y. Characteristics of serum endocan levels in infection. *PLoS One* 2015;**10**: e0123358.
30. Tariket S, Sut C, Hamzeh-Cognasse H, Laradi S, Pozzetto B, Garraud O, Cognasse F. Transfusion-related acute lung injury: transfusion, platelets and biological response modifiers. *Expert Rev Hematol* **2016**: 1-12.

Figure 1: sCD62P and endocan secretion following platelet stimulation

Membrane CD62P on platelet and sCD62P production in platelet-rich plasma (PRP) supernatants were respectively determined by flow cytometry and ELISA assay (**A**). The quantity of endocan in PRP supernatants was determined by ELISA assay (**B**). Correlation between the mean of sCD62P and endocan secretion following stimulation was evaluated (**C**). Data are presented as the mean (n = 8). *p < 0.05; **p < 0.01; and ***p < 0.001 represent the difference relative to the unstimulated group.

Figure 2: Endothelial cell activation and proliferation under PC supernatant stimulation

EA.hy926 cell proliferation, using MTT Cell Proliferation Assay (**A**), and EA.hy926 cell apoptosis, using 7AAD DNA fluorescent intercalant (**B**), were evaluated. 7AAD fluorescence was presented under flow cytometry histogram (**C**). Correlation between cell proliferation fold increase and 7AAD positive cells was statistically measured for each sample (n = 237) (**D**). ICAM-1 expression on EA.hy926 cell membrane was evaluated, using flow cytometry analysis (**E**). Data are presented as the mean. Groups were separated into SAR (n = 19) and no.AR (n = 60). *p < 0.05; **p < 0.01; and ***p < 0.001 represent the difference between no.AR and SAR groups.

Figure 3: Secretion of IL-6 and endocan by endothelial cells following stimulation with PC supernatants

The quantity of IL-6 (**A**, **C** and **D**) and endocan (**B**, **E** and **F**) in endothelial cell medium of culture was determined by ELISA assay. Groups were first separated into SAR (n = 19) and no.AR (n = 57) (**A** and **B**). Groups were then formed according to whether or not they were associates with SARs and storage time (**C**, **D**, **E** and **F**); SARs ([0-3[, n = 5; [3-5], n = 14) or no.AR ([0-3[, n = 37; [3-5], n = 20). Correlation between IL-6 and endocan secretion for each sample after 6 (**G**) or 24 h of stimulation (**H**) (n = 76). Data are presented as the mean of fold increase values (**A**, **B**, **C**, **D**, **E** and **F**) and as the direct value of fold increase (**G** and **H**). *p < 0.05; **p < 0.01 and ***p < 0.001 represent the difference relative to no.AR group.

Fig 1.

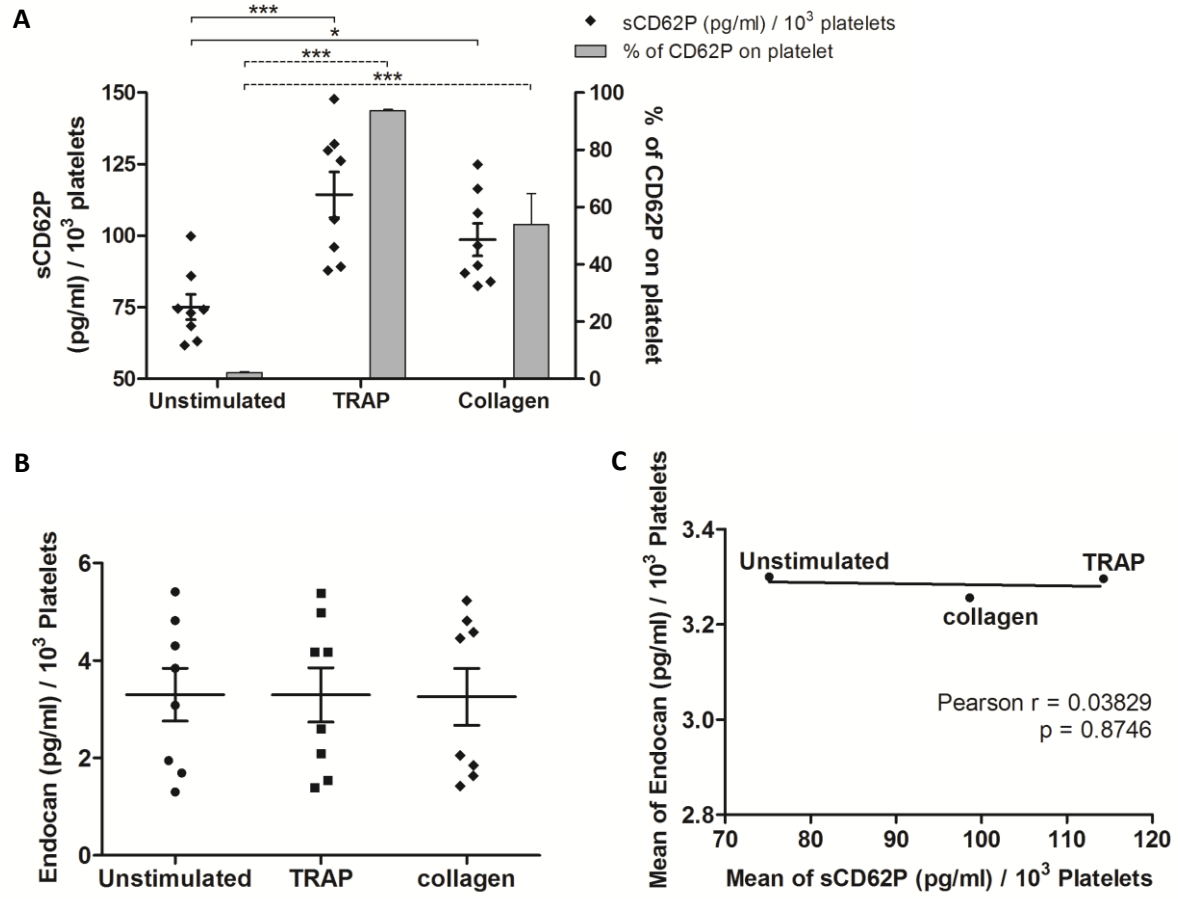

Fig 2.

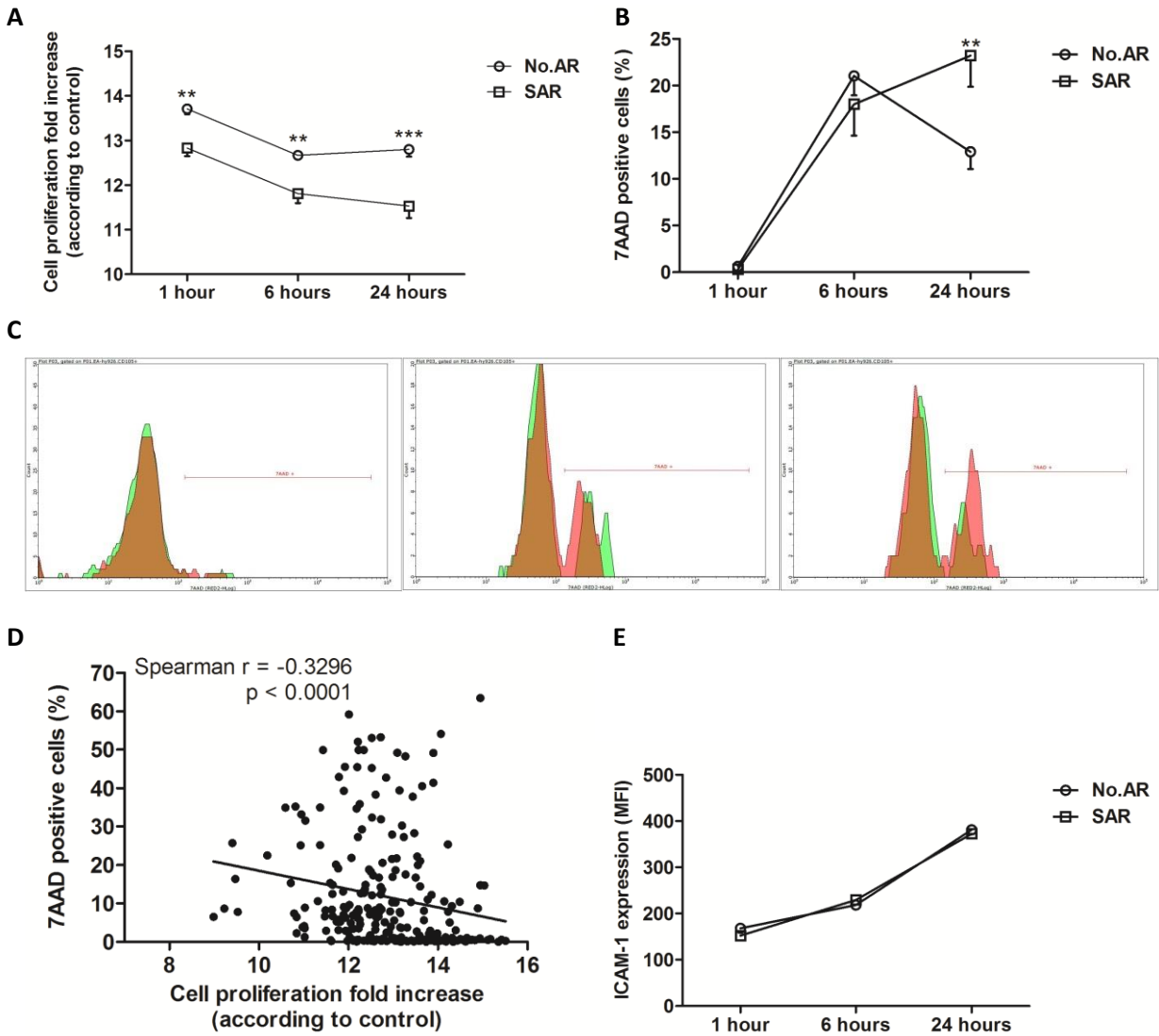
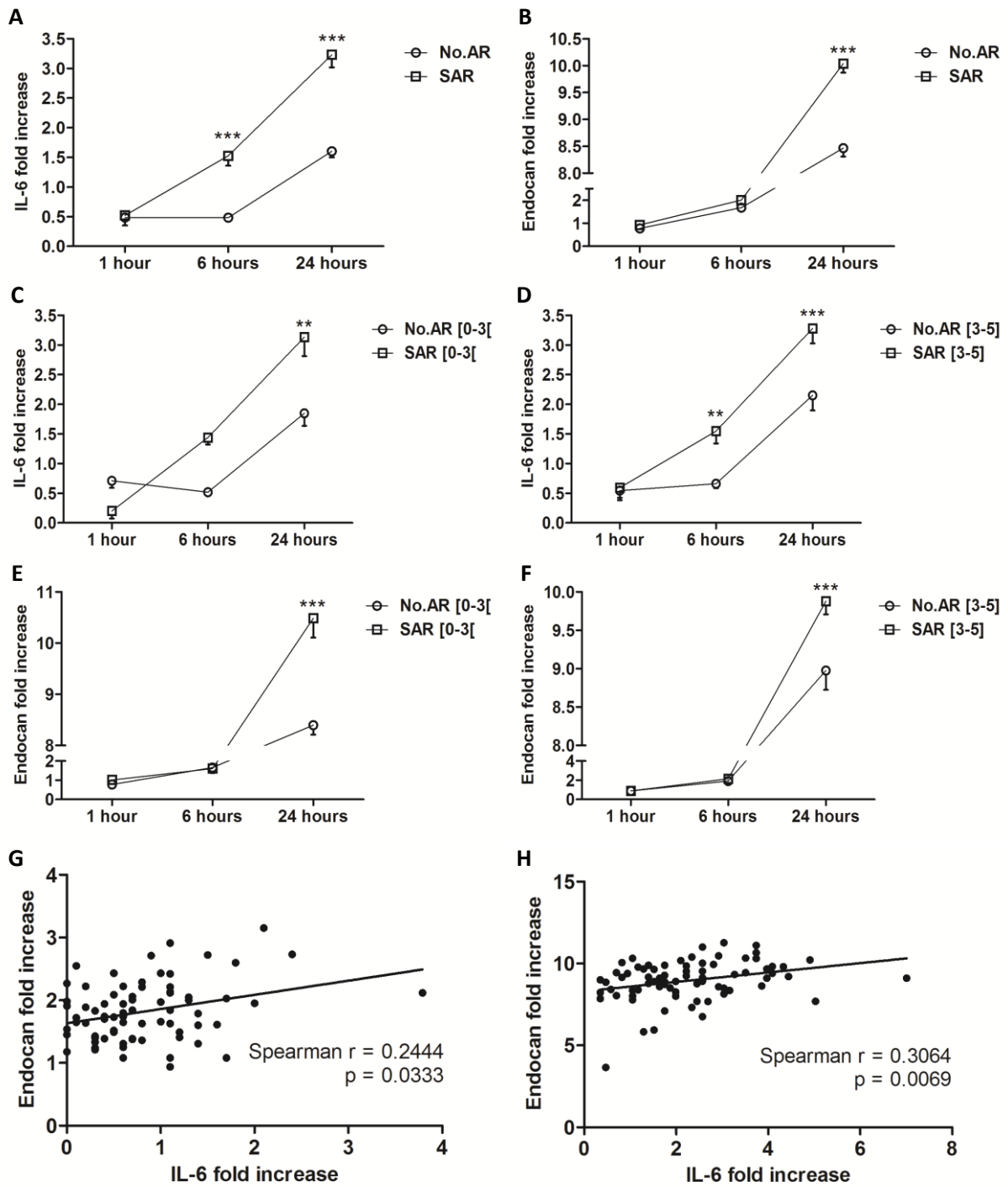

Fig 3.



Supplemental table 1: Secretion of IL-6 and endocan by endothelial cells following stimulation with SAR type-associated PC supernatants

The table represents IL-6 and endocan fold increase expression determined by ELISA assay. Groups were split depending of SAR type, No.AR (n = 57), FNHTR (n = 12), AHTR (n = 5) and ATR (n = 2). *p < 0.05; **p < 0.01 and ***p < 0.001 represent the difference relative to the No.AR group.

	IL-6 (fold increase)			Endocan (fold increase)		
	1 hour	6 hours	24 hours	1 hour	6 hours	24 hours
No.AR (n = 57)	0,49 ± 0,06	0,48 ± 0,04	1,60 ± 0,10	0,78 ± 0,02	1,68 ± 0,05	8,46 ± 0,15
FNHTR (n = 12)	0,35 ± 0,14	1,59 ± 0,24 ***	3,165 ± 0,22 ***	0,88 ± 0,04	2,05 ± 0,19	9,97 ± 0,23 ***
AHTR (n = 5)	0,54 ± 0,41	1,44 ± 0,25 **	3,46 ± 0,65 ***	1,03 ± 0,08	1,87 ± 0,19	10,16 ± 0,34 ***
ATR (n = 2)	1,5 ± 0,90	1,35 ± 0,15	3,04 ± 0,47	0,94 ± 0,08	2,07 ± 0,66	10,18 ± 0,16

***Manuscrit II* : La déficience plaquettaire en granules- α
change la réponse inflammatoire induite par l'injection
systémique de lipopolysaccharide chez les souris**

***“Platelet α -granule deficiency changes the inflammatory response
induced under systemic lipopolysaccharide injection in mice”***

Article soumis dans « Journal of Thrombosis and Haemostasis »

Lors de l'inflammation, les plaquettes sanguines ont la capacité de produire une multitude de médiateurs solubles dont le rôle peut être pro-thrombotique, régulateur de l'activité des cellules voisines, mais également pro-inflammatoire. Ces produits de sécrétion sont stockés dans les granules plaquettaire qui existent sous 3 types, les lysosomes, les granules- δ et les granules- α . La majorité des médiateurs solubles plaquettaire composent les granules- α [267]. Dans ce travail de thèse, nous avons investigué la place des sécrétions plaquettaire dans le maintien, l'amplification et la régulation de l'inflammation en utilisant un modèle de souris *Nbeal2* déficientes. Le processus d'extravasation des granules- α repose sur une mécanistique très complexe. Lors de l'activation plaquettaire, la formation de la phospholipase C induit le clivage de la phosphatidylinositol-4,5-bisphosphate (PIP_2) en inositol-1,4,5-trisphosphate (IP_3) et diacylglycérol (DAG), ce qui va amplifier le signal calcium (Ca^{++}) dépendent [268]. C'est alors que se met en place l'exocytose vésiculaire plaquettaire sous l'influence d'une mécanistique moléculaire complexe : A l'état quiescent, la protéine Sec1 est complexée avec la syntaxine-4, exprimée sur la membrane plaquettaire, inhibant ainsi l'interaction entre les « Soluble N-éthylmaleimide-sensitive-factor Attachment protein REceptor » (SNARE) vésiculaires et membranaires. Sous stimulation, se met alors en place l'amarrage, première étape de l'exocytose. Les vSNARE vésiculaires et les tSNARE membranaires entrent en fusion. C'est plus précisément VAMP-8 à la surface de la vésicule qui se lie au SNAP-23 membranaire. La dernière étape, aussi appelée la fusion, repose sur la séparation de la protéine Sec1 et la syntaxine-4, préalablement complexées, qui permet alors le renforcement de l'interaction entre la « vesicle-associated membrane protein-8 » (VAMP-8) et la « synaptosomal-associated protein-23 » (SNAP-23) et ainsi la fusion finale de la vésicule plaquettaire avec sa membrane [269]. La place du gène *Nbeal2*, dans cette mécanistique, permet de faire l'intermédiaire entre le signal « ON », dépendant de PIP_2 et IP_3 , et la fusion des vésicules à la membrane, dépendante des SNARE (Figure 10). La protéine neurobeachin-like protéin 2, ou NBEAL2, est composée d'une multitude de domaines glycoprotéiques comme les « Beige and Chediak-Higashi » (BEACH) et des répétitions en β -transducine (WD40), qui sont des domaines de la famille des lectines, et plus précisément des concanavaline A (ConA), dont le rôle est de recruter les protéines à la membrane cellulaire, telles que les SNARE [270].

En induisant une déficience du gène *Nbeal2* chez des souris C57BL6, nous avons pu prévenir la fusion des granules- α avec la membrane plaquettaire et donc la libération de ses composés granulaires. La biogenèse des granules- α était également impactée. La réponse inflammatoire, suite à une injection systémique de LPS, présentait un profil différent, lorsqu'il était comparé à celui des souris sauvage. En effet, l'aspect anti-inflammatoire semble

prépondérant lorsque les souris présentent des plaquettes circulantes déficientes en production granulaire- α .

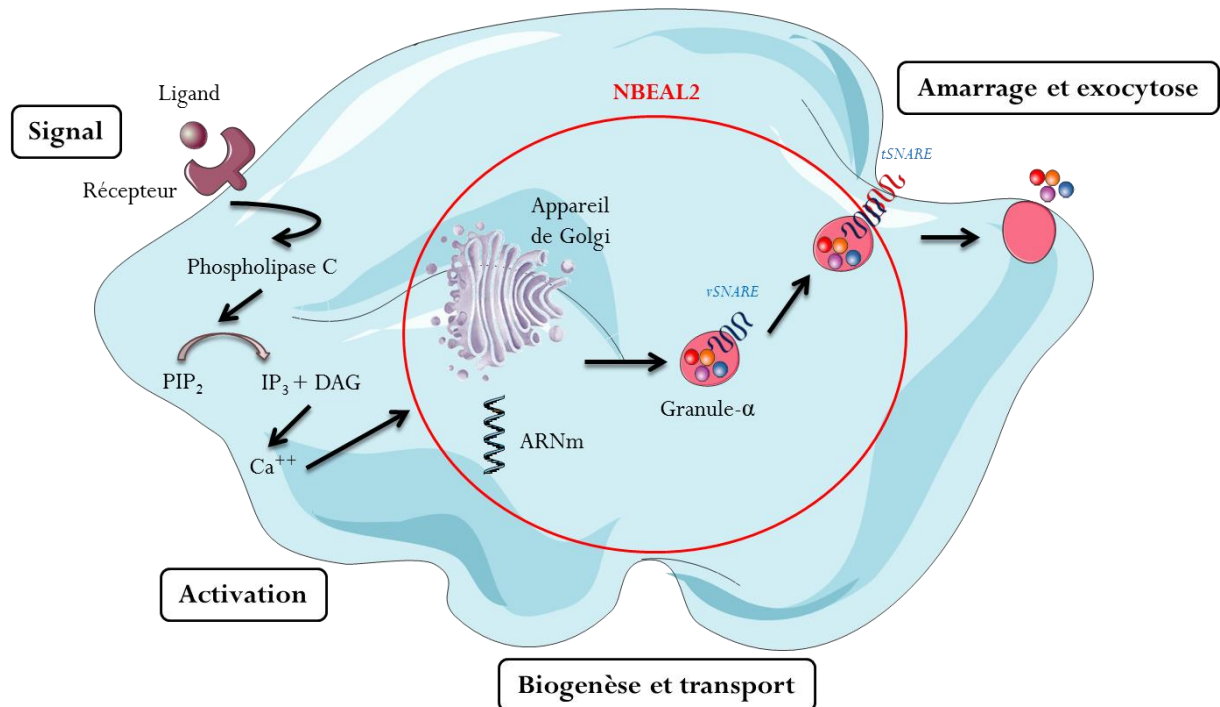

Figure 10 : Implication de la protéine NBEAL2 dans le processus d'exocytose des granules- α plaquettaire

Sous stimulus, après liaison du ligand à son récepteur plaquettaire, une cascade d'activation se met en place. La phospholipase C permet la conversion de la PIP₂ en IP₃ et DAG, ce qui va permettre l'instauration d'un signal d'activation Ca⁺⁺ dépendant. Ce processus induira la biogenèse et le transport des granules- α jusqu'à la membrane plaquettaire. Cette étape est alors régie par une mécanistique dépendante de la protéine NBEAL2 dont le rôle est d'attirer les granules plaquettaire jusqu'à la membrane dépendamment des SNARE vésiculaires et membranaires.

Platelet α -Granules Modulate the Inflammatory Response Under Systemic LPS Injection in Mice

Tariket, S.^{1,2}, Guerrero, J.A.^{3,4}, Garraud, O.^{1,5}, Ghevaert, C.^{3,5}, Cognasse, F.^{1,2}

¹ Université de Lyon, GIMAP-EA3064, Saint-Etienne, France

² Établissement Français du Sang Rhône-Alpes-Auvergne, Saint-Etienne, France

³ Department of Haematology, University of Cambridge and NHS Blood and Transplant, Long Road,
Cambridge, CB2 0PT, UK

⁴ National Health Service Blood and Transplant, Cambridge Biomedical Campus, Cambridge, UK.

⁵ Institut National de la Transfusion Sanguine, Paris, France

***Address for correspondence and reprint requests:** Dr. Fabrice Cognasse, Etablissement Français du Sang, Auvergne-Rhône-Alpes & Université de Lyon, GIMAP-EA3064, Faculté de Médecine, 10 rue de la Marandière - 42270 St Priest en Jarez, France. Tel.: +33 4 77 42 14 67; Fax: +33 4 77 42 14 86;

E-mail address: fabrice.cognasse@univ-st-etienne.fr

Running Title: Platelet inflammation

Key words: Platelets, Inflammation, NBEAL2, Soluble mediators, CD40L

Word count: 1760; **Abstract:** 150; **References:** 28; **Figures:** 3; **Tables:** 1

Abstract

Beyond their role in haemostasis and thrombosis, platelets are also important mediators of inflammation by the release of hundreds of factors stored in their α -granules. Mutations in *Nbeal2* cause gray platelet syndrome (GPS) characterised by the lack of platelet α -granules. This study aims to evaluate the immunological (pro-inflammatory) effects of platelet α -granules using *Nbeal2*^{-/-} mice, the mouse model of GPS. Systemic inflammation was induced by intravenous injection of lipopolysaccharide (LPS). The lack of *Nbeal2* significantly reduced the recruitment of circulating neutrophils and monocytes. The control of inflammation, evaluated by the production of anti-inflammatory cytokines, appeared to be greater in *Nbeal2*^{-/-} mice compared with controls. Conversely, the production of certain inflammatory-soluble mediators known to characterize normal platelet secretion, such as sCD40L, was decreased under experimental inflammation in *Nbeal2*^{-/-} mice. These results show that α -granules play a direct role in platelet-mediated inflammation balance, confirming the need to further investigate platelet-associated inflammatory pathophysiology.

Introduction

Platelets are anucleated secretory cells that circulate in blood and are mostly characterised by their role in haemostasis and thrombosis [1]. However, platelets have also been recognised as mediators of inflammation and immunity [2]. Platelets and their progenitors, megakaryocytes (MKs), express surface receptors that can initiate/propagate inflammatory responses such as "Toll-like" receptor- 4 (TLR-4), TLR-2 and TLR-9 [3] and numerous cytokine and chemokine receptors that are essential in cell migration and communication [4]. Platelets also display sialic acid-binding immunoglobulin-type lectin (Siglec) receptors and specifically Siglec-7, which play a key role in immunity [5].

Platelets contain three main types of granules, including α -granules, δ -granules and lysosomes whose contents are differentially released upon activation [6]. Of the three types, the α -granules are the most abundant, containing hundreds of proteins with diverse biological roles, including inflammation [7]. Therefore, the role of platelets in inflammation is not limited to the expression of the multiple aforementioned receptors that primarily sense pathogens, relying also on inflammatory soluble factors stored in the α -granules and released upon secretion [8], such as CD62P, CD40L, platelet factor 4 (PF4), MIP-1 α , RANTES and IL-1. The majority of soluble factors stored in α -granules are proinflammatory [9], however, many studies also suggest platelets have an anti-inflammatory role. Indeed, higher levels of tumour necrosis factor- α (TNF- α), IL-6 and interferon- γ (IFN- γ) have been observed in sera and plasma in the absence of platelets [10-12]. Furthermore, platelets can regulate the inflammatory response of blood neutrophils by influencing the expression of macrophage receptor-1 (Mac-1) on their surface, notably through platelet integrin GPIb-IX exposure [12]. The balance between the pro- and anti-inflammatory factors stored in the α -granules and the platelet response through the TLR and chemokine receptors should thus determine the overall role of platelets in inflammation.

Gray platelet syndrome (GPS) is a rare platelet bleeding disorder caused by loss of function mutations in *NBEAL2* and characterised by a low platelet count, a lack of platelet α -granules and early myelofibrosis. Deletion of its murine ortholog, *Nbeal2*, recapitulates all major features of GPS. Mouse *Nbeal2*^{-/-} platelets have a significant decrease, or an almost complete absence, in α -granule proteins such as PF4, vWF and P-selectin [13-15] with a potential imbalance of inflammation. In fact, *Nbeal2*^{-/-} mice have increased susceptibility to bacterial and viral infection [16]. The objective was therefore to investigate the effect of platelet α -granule content on the amplification or down-regulation of LPS-induced systemic inflammation in *Nbeal2*^{-/-} mice, to reveal the pro- and anti-inflammatory balance.

Material and methods

Mice

Adult, male, C57BL6 mice between 8 and 13 weeks old were used. For each experiment, a minimum of 6 mice were used. The mice were randomly distributed into different groups (PBS wild type [WT] vs. LPS WT vs. PBS *Nbeal2*^{-/-} vs. LPS *Nbeal2*^{-/-}). This research was performed under the Animals (Scientific Procedures) Act 1986 Amendment Regulations 2012, following an ethical review by the University of Cambridge Animal Welfare and Ethical Review Body (AWERB).

LPS Challenge

Mice were intravenously (*i.v.*) injected with LPS extracted from *Escherichia coli* (0111) (Sigma Aldrich, Saint-Louis, USA) used at 10 mg/kg, or with PBS (control). Mice were monitored for 5 hours. The surviving mice were then euthanized in a carbon dioxide chamber and blood was collected in acid citrate-dextrose (ACD) (Sigma Aldrich, Saint-Louis, USA).

Cell Counting

Blood was collected in ACD solution. Full blood counts were measured using a “scil Vet abc” instrument (scil Vet abc, Montpellier, France). Plasma was obtained by centrifugation and frozen at -80°C until used.

Inflammatory Soluble Factors and Platelet Biological Response Modifiers Immunoassay

The mouse biological response modifier (BRM) magnetic 16-plex kit (IL-1 β , bFGF, IL-10, IL-13, IL-6, IL-12, IL-17, GM-CSF, IL-5, IL-1 α , IFN- γ , TNF- α , IL-2, IP-10, MIG and IL-4) (ThermoFisher, Waltham, USA), magnetic 5-plex kit (KC, MCP-1, MIP-1 α , RANTES and VEGF) and magnetic simplex kit (sCD40L) (Merck Millipore, Billerica, USA) were used according to the manufacturers' instructions. The reading was taken through the Luminex[®] 200[™] (Luminex, Austin, USA).

Statistical Tests

Statistical analyses were performed using GraphPad Prism 5 software (GraphPad, San Diego, USA). P-values were calculated using a 2-tailed unpaired T test, a one-way ANOVA and a Bonferroni post-hoc test when the Kolmogorov-Smirnov normality test was passed. P-values were calculated using a 2-tailed Mann-Whitney test, a Kruskal-Wallis test, a one-way ANOVA and Dunn's post-hoc test when the Kolmogorov-Smirnov normality test failed. A p-value was considered significant when it was < 0.05 for all tests. Using *, [†] and # < 0.05; **, ^{††} and ## < 0.01; ***, ^{†††} and ### < 0.001 symbols.

Results and Discussion

Inflammatory Cell Recruitment Changes Dependent upon NBEAL2 Protein Expression

Firstly, the circulating cell count revealed a significant 3- and 4- fold increase in the neutrophil and monocyte counts respectively, in *Nbeal2*^{-/-} mice compared with control mice. The effect of LPS intravenous injection was then assessed demonstrating that LPS injection significantly increased the number of monocytes and reduced the number of platelets and circulating lymphocytes in both WT and *Nbeal2*^{-/-} mice. Reciprocally, the number of neutrophils significantly increased in WT mice after LPS injection, but not in *Nbeal2*^{-/-} mice (Figure 1, A). The fold change of the cell populations before and after LPS injection revealed a significant increase in the neutrophil and monocyte counts in control animals compared with *Nbeal2*^{-/-} mice (Figure 1, B). These results show that *Nbeal2*^{-/-} mice mobilise leukocytes (neutrophils and monocytes) less efficiently than WT mice following LPS-induced systemic inflammation. A likely explanation for this is that *Nbeal2*^{-/-} mice have a limited capacity for secreting pro-inflammatory mediators capable of synergising at the systemic level. Indeed, it has already been shown that platelets, by the release of a multitude of soluble mediators contained in the α -granules, play an essential role in attracting and capturing leukocytes [9].

An Anti-Inflammatory Pattern is Revealed in *Nbeal2*^{-/-} Mice after LPS Injection

The purpose was to evaluate the influence of platelet secretion on inflammation evaluated through cytokine/chemokine production from inflammatory cells. The concentrations of 15 cytokines/chemokines were therefore measured with pro- and anti-inflammatory function, in WT and *Nbeal2*^{-/-} mice challenged systematically by LPS. Under the baseline condition (*i.e.*, PBS injection), levels of IL-10, an anti-inflammatory BRM [17], were only higher in WT mice compared with *Nbeal2*^{-/-} mice. Systemic LPS injection induced a significant increase in 10 pro-inflammatory soluble factors in both WT and *Nbeal2*^{-/-} mice, including IL-6, IL-12, GM-CSF, IL-5, IL-1 α , IFN- γ , TNF- α , IL-2, IP-10 and MIG. Only the level of IL-17 was significantly higher in *Nbeal2*^{-/-} mice than in control mice under LPS-induced inflammation. With regard to anti-inflammatory BRMs (IL-10 [17], IL-13 and IL-4 [18-20]), higher levels were only observed in *Nbeal2*^{-/-} mice after LPS systemic injection (Figure 2, A and Table 1), which correlated with their fold-increase (Figure 2, B). In summary, under systemic inflammatory conditions, *Nbeal2*^{-/-} mice show a more sustained anti-inflammatory response normally hidden or limited in WT animals. These results could therefore support the possibility that the secretion of platelet α -granule products can change the secretory pattern of inflammatory cells and balance pro- and anti-inflammatory BRMs and, overall, inflammation.

Circulating Blood Cells Compensate for the Decrease in Pro-inflammatory Platelet-released factors in *Nbeal2*^{-/-} Mice, Except for sCD40L.

Under systemic inflammatory conditions, several soluble pro-inflammatory factors are secreted by platelets and other cells such as leukocytes and endothelial cells. For instance, platelets and other blood and vascular cells secrete BRMs such as IL-1 β , KC, MCP-1, MIP-1 α , RANTES, VEGF and sCD40L under physiological conditions and, to a greater degree, upon stimulation. While sustained production of IL-1 β [21], KC [22], MCP-1 [23], MIP-1 α [24], RANTES [23] and VEGF [25] is a common feature of platelets and other cells, sCD40L is mostly secreted by platelets [26]. It was therefore investigated whether the lack of platelet secretion, particularly for these seven soluble factors, could be compensated by other blood cells in *Nbeal2*^{-/-} mice. Concentrations of IL-1 β , KC, MCP-1, MIP-1 α , RANTES and VEGF, measured in blood plasma, were significantly increased after stimulation induced by LPS injection in both wild type and *Nbeal2*^{-/-} mice (Figure 3, A and Table 1). These results indicate that other inflammatory blood cells have a potential compensatory capacity for secretion. However, sCD40L followed a different pattern as observed by a 2.5-fold increase in its levels in PBS-injected *Nbeal2*^{-/-} mice when compared to control animals (Figure 3, A and Table 1). This production may be due to the excessive inflammatory activity of megakaryocytes already observed in *Nbeal2*^{-/-} mice (indeed this is the case for MIP-1 β [13]). Moreover, α -granules are generated in megakaryocytes, but not retained during their maturation; it can therefore be postulated that immature megakaryocytes can secrete sCD40L contained in their α -granules [13]. Lastly, this raised concentration of sCD40L, evidenced in non-stimulated *Nbeal2*^{-/-} mice, is likely to partially explain the high baseline count of circulating neutrophils and monocytes (Figure 1, A). Indeed, CD40L, and its agonist form sCD40L, typically participate in leukocyte recruitment notably by binding leukocyte CD40 and Mac-1 receptors [27]. Under inflammation induced through LPS intravenous injection, sCD40L levels increased in WT mice in contrast to *Nbeal2*^{-/-} mice (Figure 3, B), which seems to correlate with the limitation of neutrophil and monocyte recruitment in control (as shown in Figure 1, B). The secretion of certain platelet BRMs, such as sCD62P, vWF, PF4 and fibrinogen, is indeed reduced in *Nbeal2*^{-/-} mice [13-15], what may contribute to the observed increase in the anti-inflammatory profile of these mice (Figure 2, B).

In summary, platelet α -granule content is implicated in the inflammatory process [9]. In this study, a comparable pro-inflammatory cytokine/chemokine secretion pattern was observed in *Nbeal2*-gene deficiency and wild type conditions, except for sCD40L secretion. Nevertheless, the anti-inflammatory profile was greater when mice lacked α -granules and were stimulated with intravenous LPS. These observations are consistent with a recent study showing that the lack of NBEAL2 protein expression in mice increases their sensitivity to bacterial infection [16]. Furthermore, this mouse model is protected against thrombosis complication [14], and both ourselves and others have proposed that sepsis and coagulation are linked to platelet and neutrophil inflammatory secretion

[28]. In conclusion, this study has expanded knowledge on the fine-tuning role of anti- versus pro-inflammatory functions of platelets via α -granule secretion deficiency, broadening our understanding of systemic inflammation (such as can be caused by sepsis) and how the platelet functions can be balanced, to limit both excess pro-coagulant and pro-inflammatory pathology.

Reference

1. Broos, K., et al., Platelets at work in primary hemostasis. *Blood Rev*, 2011. **25**(4): p. 155-67.
2. Semple, J.W., J.E. Italiano, Jr., and J. Freedman, Platelets and the immune continuum. *Nat Rev Immunol*, 2011. **11**(4): p. 264-74.
3. Cognasse, F., et al., Evidence of Toll-like receptor molecules on human platelets. *Immunol Cell Biol*, 2005. **83**(2): p. 196-8.
4. Cognasse, F., et al., The Inflammatory Role of Platelets via Their TLRs and Siglec Receptors. *Front Immunol*, 2015. **6**: p. 83.
5. Nguyen, K.A., et al., Role of Siglec-7 in apoptosis in human platelets. *PLoS One*, 2014. **9**(9): p. e106239.
6. Heijnen, H. and P. van der Sluijs, Platelet secretory behaviour: as diverse as the granules ... or not? *J Thromb Haemost*, 2015. **13**(12): p. 2141-51.
7. Manne, B.K., S.C. Xiang, and M.T. Rondina, Platelet secretion in inflammatory and infectious diseases. *Platelets*, **2016**: p. 1-10.
8. Maynard, D.M., et al., Proteomic analysis of platelet alpha-granules using mass spectrometry. *J Thromb Haemost*, 2007. **5**(9): p. 1945-55.
9. Thomas, M.R. and R.F. Storey, The role of platelets in inflammation. *Thromb Haemost*, 2015. **114**(3): p. 449-58.
10. Wuescher, L.M., A. Takashima, and R.G. Worth, A novel conditional platelet depletion mouse model reveals the importance of platelets in protection against *Staphylococcus aureus* bacteremia. *J Thromb Haemost*, 2015. **13**(2): p. 303-13.
11. Xiang, B., et al., Platelets protect from septic shock by inhibiting macrophage-dependent inflammation via the cyclooxygenase 1 signalling pathway. *Nat Commun*, 2013. **4**: p. 2657.
12. Corken, A., et al., Platelet glycoprotein Ib-IX as a regulator of systemic inflammation. *Arterioscler Thromb Vasc Biol*, 2014. **34**(5): p. 996-1001.
13. Guerrero, J.A., et al., Gray platelet syndrome: proinflammatory megakaryocytes and alpha-granule loss cause myelofibrosis and confer metastasis resistance in mice. *Blood*, 2014. **124**(24): p. 3624-35.
14. Deppermann, C., et al., Gray platelet syndrome and defective thrombo-inflammation in *Nbeal2*-deficient mice. *J Clin Invest*, 2013.
15. Kahr, W.H., et al., Abnormal megakaryocyte development and platelet function in *Nbeal2*($-/-$) mice. *Blood*, 2013. **122**(19): p. 3349-58.
16. Sowerby, J.M., et al., NBEAL2 is required for neutrophil and NK cell function and pathogen defense. *J Clin Invest*, 2017. **127**(9): p. 3521-3526.
17. Hazlett, L.D., X. Jiang, and S.A. McClellan, IL-10 function, regulation, and in bacterial keratitis. *J Ocul Pharmacol Ther*, 2014. **30**(5): p. 373-80.
18. Hart, P.H., et al., Potential antiinflammatory effects of interleukin 4: suppression of human monocyte tumor necrosis factor alpha, interleukin 1, and prostaglandin E2. *Proc Natl Acad Sci U S A*, 1989. **86**(10): p. 3803-7.
19. Marie, C., et al., Regulation by anti-inflammatory cytokines (IL-4, IL-10, IL-13, TGFbeta) of interleukin-8 production by LPS- and/ or TNFalpha-activated human polymorphonuclear cells. *Mediators Inflamm*, 1996. **5**(5): p. 334-40.
20. Huang, X.L., et al., Role of anti-inflammatory cytokines IL-4 and IL-13 in systemic sclerosis. *Inflamm Res*, 2015. **64**(3-4): p. 151-9.
21. Brown, G.T., et al., Lipopolysaccharide stimulates platelets through an IL-1beta autocrine loop. *J Immunol*, 2013. **191**(10): p. 5196-203.
22. Gear, A.R. and D. Camerini, Platelet chemokines and chemokine receptors: linking hemostasis, inflammation, and host defense. *Microcirculation*, 2003. **10**(3-4): p. 335-50.
23. Gleissner, C.A., P. von Hundelshausen, and K. Ley, Platelet chemokines in vascular disease. *Arterioscler Thromb Vasc Biol*, 2008. **28**(11): p. 1920-7.

24. Menten, P., A. Wuyts, and J. Van Damme, Macrophage inflammatory protein-1. *Cytokine Growth Factor Rev*, 2002. **13**(6): p. 455-81.
25. Mohle, R., et al., Constitutive production and thrombin-induced release of vascular endothelial growth factor by human megakaryocytes and platelets. *Proc Natl Acad Sci U S A*, 1997. **94**(2): p. 663-8.
26. Andre, P., et al., Platelet-derived CD40L: the switch-hitting player of cardiovascular disease. *Circulation*, 2002. **106**(8): p. 896-9.
27. Aloui, C., et al., The Signaling Role of CD40 Ligand in Platelet Biology and in Platelet Component Transfusion. *Int J Mol Sci*, 2014. **15**(12): p. 22342-22364.
28. Rondina, M.T. and O. Garraud, Emerging evidence for platelets as immune and inflammatory effector cells. *Front Immunol*, 2014. **5**: p. 653.

Figures and tables

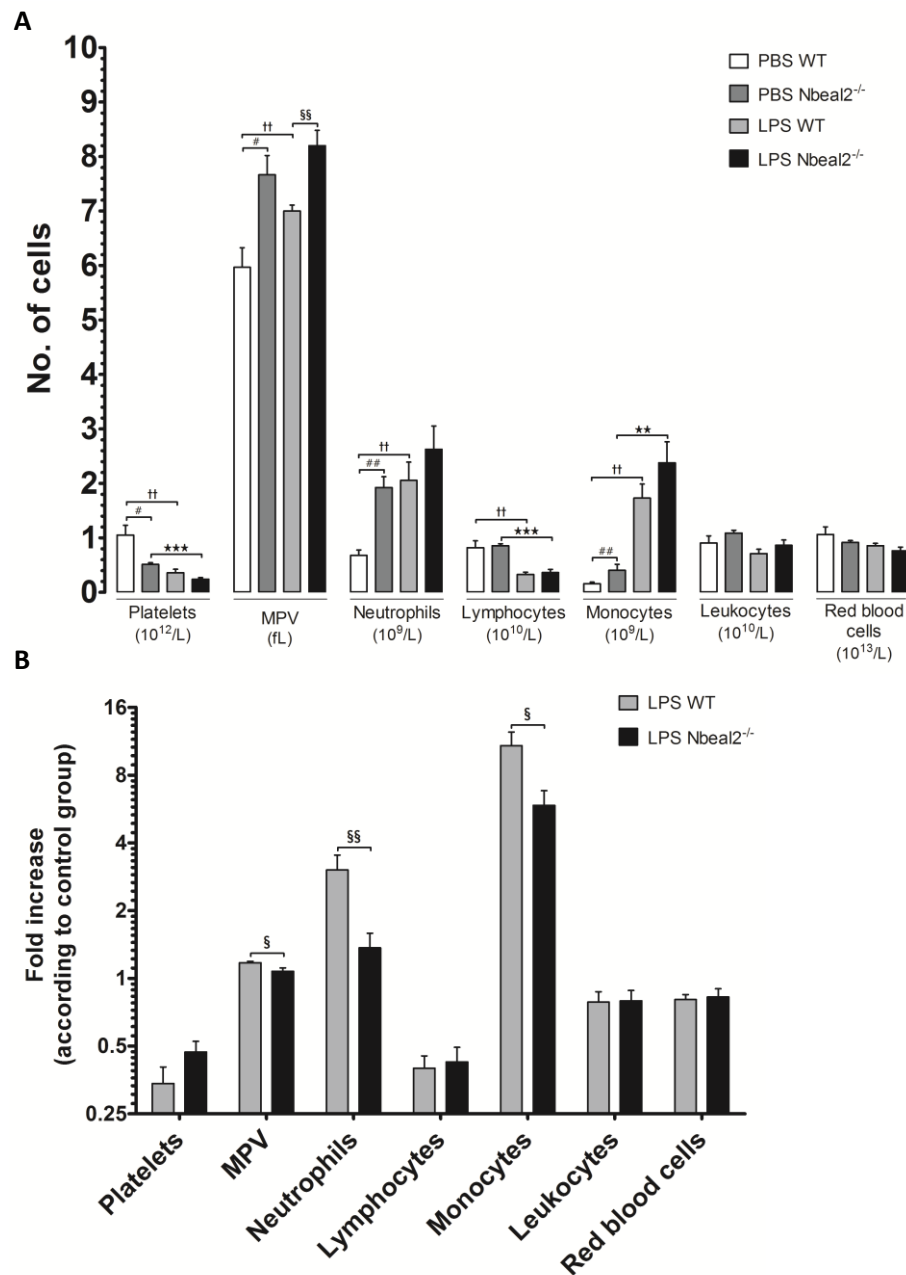
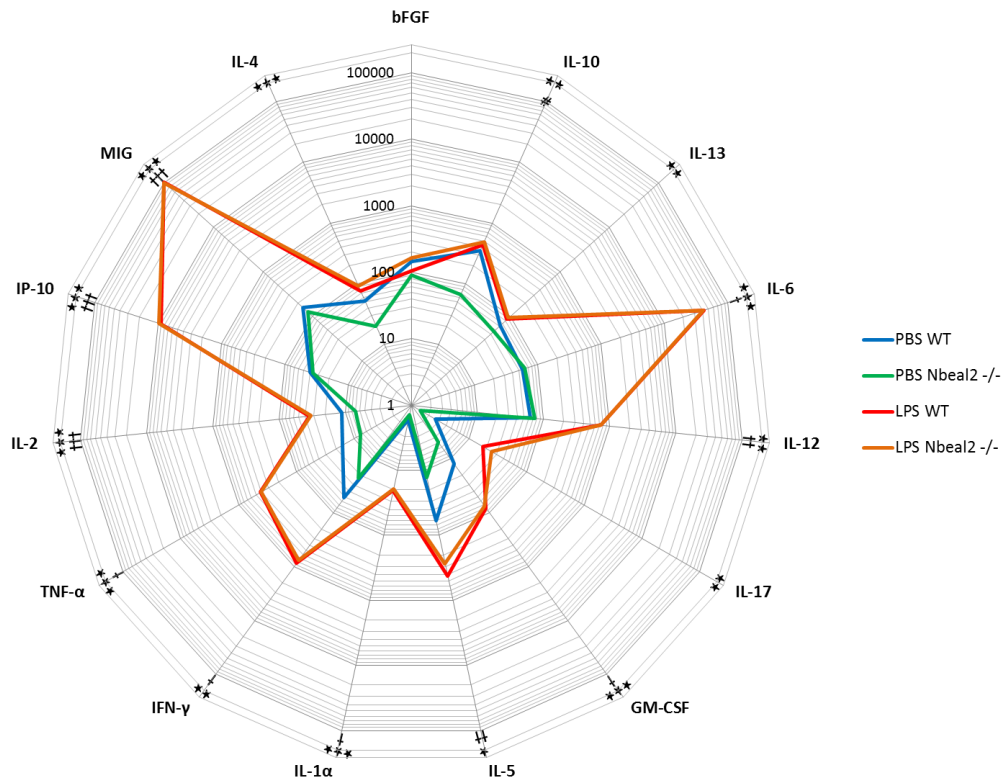

Figure 1: Blood cell parameters evaluation

Blood cell count and mean platelet volume were evaluated for each group of mice (A). The fold increase of cell number after LPS injection, in each condition was represented (B). Data are presented as mean (n = 6 - 9). *p < 0.05; **p < 0.01 and ***p < 0.001 represent differences between *Nbeal2*^{-/-} groups. †p < 0.05; ††p < 0.01 and †††p < 0.001 represent differences between wild type groups. #p < 0.05; ##p < 0.01 and ###p < 0.001 represent differences between PBS groups. §p < 0.05; §§p < 0.01 and §§§p < 0.001 represent differences between LPS groups.

A



B

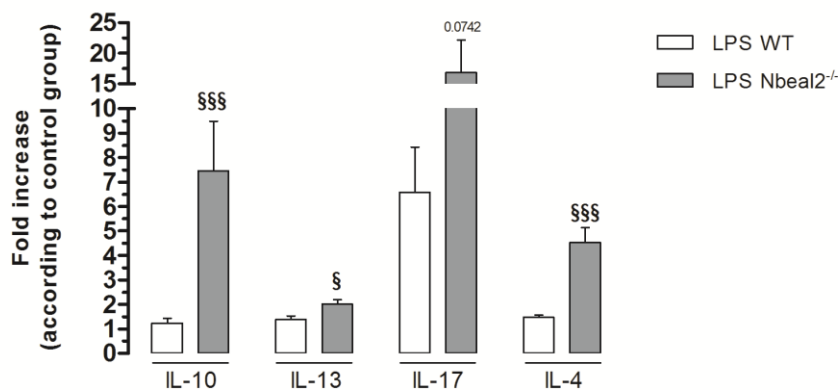

Figure 2: Proinflammatory pattern evaluation of mouse soluble factors

The rate of soluble factors in mouse blood was measured for each group of mice. The unit is pg/ml (A). Difference of fold increase between LPS WT and *Nbeal2*^{-/-} mice, according to the associated mean of control group, for IL-10, IL-13, IL-17 and IL-4 was compared (B). Data are presented as mean (n = 6 - 9). *p < 0.05; **p < 0.01 and ***p < 0.001 represent differences between *Nbeal2*^{-/-} groups. †p < 0.05; ††p < 0.01 and †††p < 0.001 represent differences between wild type groups. #p < 0.05; ##p < 0.01 and ###p < 0.001 represent differences between PBS groups. §p < 0.05; §§p < 0.01 and §§§p < 0.001 represent differences between LPS groups.

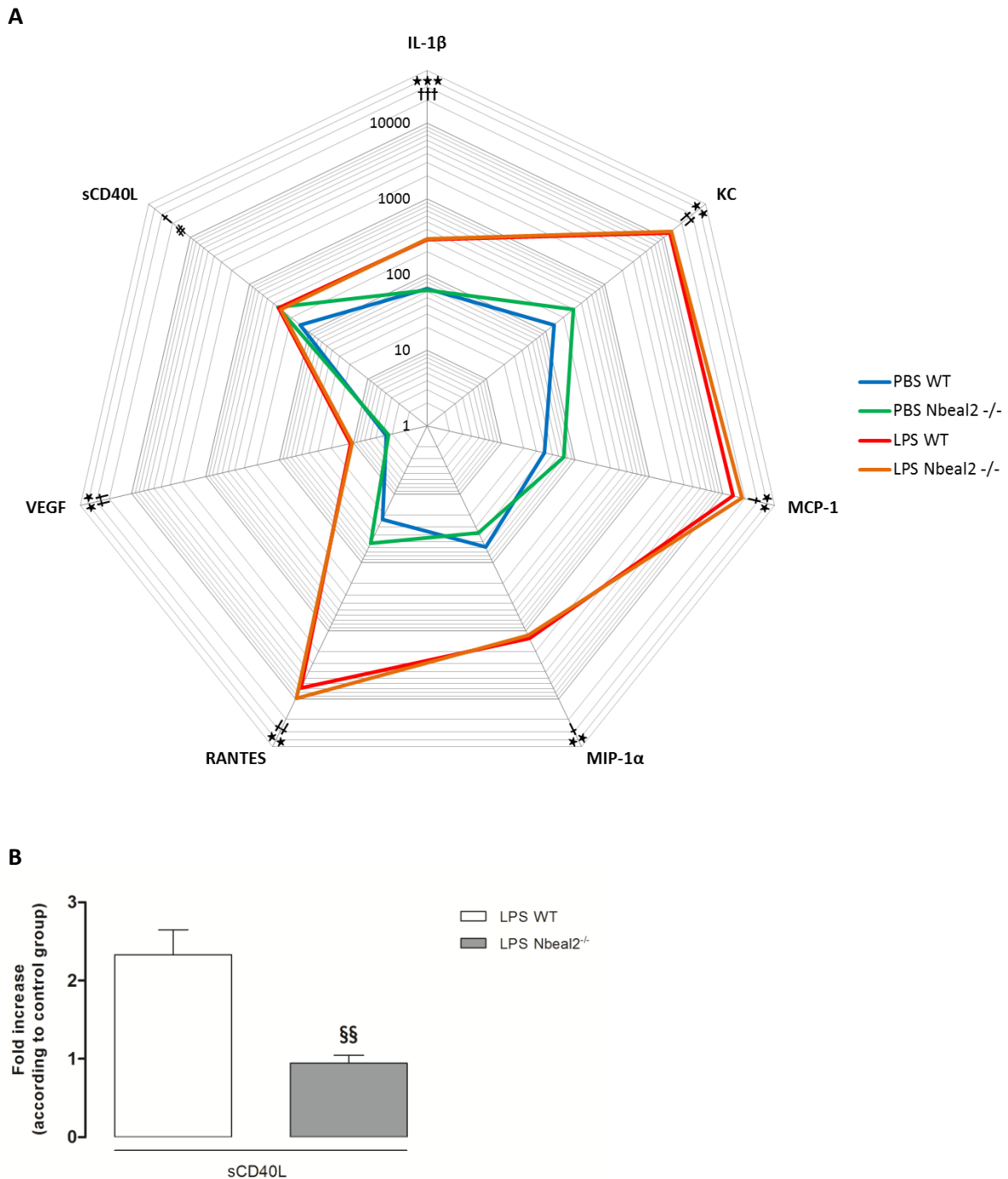

Figure 3: Platelet soluble factors assay

The rate of 6 soluble factors secreted notably from platelet in mouse blood was measured for each group of mice. The unit is pg/ml (A). Difference of fold increase between LPS WT and *Nbeal2*^{-/-} mice, according to the associated mean of control group, for sCD40L was compared (B). Data are presented as mean (n = 6 - 8). *p < 0.05; **p < 0.01 and ***p < 0.001 represent differences between *Nbeal2*^{-/-} groups. †p < 0.05; ††p < 0.01 and †††p < 0.001 represent differences between wild type groups. #p < 0.05; ##p < 0.01 and ###p < 0.001 represent differences between PBS groups. §p < 0.05; §§p < 0.01 and §§§p < 0.001 represent differences between LPS groups.

Table 1: Values representation of the soluble factors evaluations

Values quantification of each soluble factor in plasma was determined through multiplex assay for each group of mice. The unit is pg/ml. Data are presented as mean \pm SEM (n = 6 – 9). *p < 0.05; **p < 0.01 and ***p < 0.001 represent differences between *Nbeal2*^{-/-} groups. †p < 0.05; ††p < 0.01 and †††p < 0.001 represent differences between wild type groups. #p < 0.05; ##p < 0.01 and ###p < 0.001 represent differences between PBS groups. No difference was observed between LPS groups.

	PBS WT	PBS <i>Nbeal2</i> ^{-/-}	LPS WT	LPS <i>Nbeal2</i> ^{-/-}	p-value symbol
<i>bFGF</i>	144.29 \pm 55.04	90.61 \pm 19.93	104.67 \pm 19.75	164.71 \pm 66.61	
<i>IL-1β</i>	64.86 \pm 17.30	62.05 \pm 17.42	290.35 \pm 40.82	293.78 \pm 64.20	*** †††
<i>IL-10</i>	351.20 \pm 185.54	65.74 \pm 24.46	431.90 \pm 142.41	490.79 \pm 293.82	** #
<i>IL-13</i>	61.89 \pm 18.39	45.81 \pm 13.68	85.07 \pm 23.62	91.93 \pm 20.80	**
<i>IL-6</i>	57.50 \pm 20.57	62.66 \pm 57.32	41752.00 \pm 15259.62	41295.70 \pm 19058.35	*** †
<i>IL-12</i>	63.19 \pm 8.98	73.74 \pm 23.88	742.91 \pm 266.31	746.19 \pm 437.51	** ††
<i>IL-17</i>	2.62 \pm 1.65	1.45 \pm 1.10	17.26 \pm 12.22	24.39 \pm 17.05	**
<i>GM-CSF</i>	12.23 \pm 5.47	4.90 \pm 0.31	81.25 \pm 18.74	74.17 \pm 18.57	*** †
<i>IL-5</i>	59.02 \pm 36.87	12.82 \pm 3.37	417.85 \pm 71.15	271.65 \pm 77.84	* ††
<i>IL-1α</i>	1.67 \pm 0.38	1.40 \pm 0.23	20.60 \pm 14.60	19.28 \pm 9.30	*** †
<i>IFN-γ</i>	52.46 \pm 28.58	22.92 \pm 18.98	866.40 \pm 496.46	761.59 \pm 511.26	** †
<i>TNF-α</i>	15.80 \pm 9.77	7.51 \pm 5.66	410.75 \pm 63.25	403.07 \pm 162.51	*** †
<i>IL-2</i>	11.33 \pm 2.81	7.06 \pm 1.86	35.04 \pm 5.67	33.40 \pm 4.27	*** †††
<i>IP-10</i>	39.43 \pm 13.98	36.14 \pm 6.25	8911.97 \pm 2241.85	9673.37 \pm 4528.40	*** †††
<i>MIG</i>	157.17 \pm 30.59	123.60 \pm 38.18	101899.66 \pm 32534.36	100400.95 \pm 35539.99	*** †††
<i>IL-4</i>	51.55 \pm 21.95	20.21 \pm 4.36	75.91 \pm 11.47	91.32 \pm 29.51	***
<i>KC</i>	140.09 \pm 78.44	292.41 \pm 230.32	12455.28 \pm 418.95	13141.09 \pm 2113.74	** ††
<i>MCP-1</i>	38.39 \pm 11.31	70.24 \pm 35.87	13718.63 \pm 2553.77	18277.49 \pm 3738.30	** †
<i>MIP-1α</i>	59.62 \pm 38.13	36.32 \pm 4.31	1279.17 \pm 745.14	1154.02 \pm 500.22	** †
<i>RANTES</i>	23.42 \pm 6.19	52.85 \pm 25.47	6961.41 \pm 4197.66	9727.42 \pm 5734.19	** ††
<i>VEGF</i>	3.60 \pm 0.77	3.38 \pm 0.73	10.90 \pm 3.90	10.36 \pm 2.93	** ††
<i>sCD40L</i>	138.27 \pm 38.84	331.12 \pm 108.81	322,14 \pm 88,72	293.33 \pm 74.19	† #

**Manuscrit III : Les plaquettes régulent la sévérité de l'ALI
induit expérimentalement par injection de LPS et d'anti-
CMH I**

*“Platelets limit the severity of an experimental ALI induced by
injection of LPS and anti-MHC I”*

Etude en cours

Comme vue en introduction, le rôle des plaquettes dans le TRALI est très débattu. Le but de ce travail de thèse est d'apporter plus d'informations aux détours de plusieurs manipulations, *in vivo* et *in vitro*, sur la réelle place de la plaquette sanguine dans la physiopathologie du TRALI. Pour tenter de répondre à cette question, nous avons utilisé un modèle murin de l'ALI induit par injection successive de LPS et d'anticorps anti-CMH I. Le LPS a pour rôle de mimer l'étape du « priming », généralement induit par le passé pathologique du patient développant un TRALI, et les anticorps anti-CMH I ont pour but d'activer les cellules inflammatoires préalablement stimulées avec l'injection du LPS [104]. Différentes drogues antiplaquettaires ont alors été utilisées, telles que des anticorps anti-GPIIb/IIIa ou du ML354 (inhibiteur du récepteur PAR-4 plaquettaire). Des stimulations, *in vitro*, ont permis d'évaluer la réponse plaquettaire sous l'influence des différents stimuli utilisés dans le modèle *in vivo*.

Les résultats présentés ci-dessous ne sont que préliminaires et nécessitent donc des analyses plus approfondies, avant publication. Cependant, un début de réponse peut être envisagé grâce aux premières expériences. En effet, on remarque que l'inhibition ou la déplétion plaquettaire ne prévient pas efficacement le développement du TRALI induit expérimentalement, mais la sévérité de cette pathologie est significativement réduite. Suite à ces résultats, nous envisageons d'investiguer, expérimentalement, le rôle des plaquettes produites directement dans l'interstitium pulmonaire sur la pathogénie du TRALI, cellules qui ne sont pas déplétées lors de l'induction expérimentale de la thrombopénie [271]. De plus, on observe une activation des plaquettes sanguines suite à une stimulation, *in vitro*, combinée avec du LPS et des anticorps anti-CMH I. Dans le but de compléter cette étude, nous prévoyons d'analyser, le plus précisément possible, la cascade d'activation plaquettaire, si elle existe, lors de la fixation des anticorps anti-CMH I sur son antigène internalisé et présenté par les plaquettes [272, 273].

Cette étude est présentée sous forme de publication scientifique bien que les travaux ne soient pas aboutis

Les plaquettes régulent la sévérité de l'ALI induit expérimentalement par injection de LPS et d'anti-CMH I

Sofiane Tariket^{1,2}, Charles-Antoine Arthaud², Marie-Ange Eyraud², Sandrine Laradi^{1,2}, Thomas Bourlet¹, Philippe Berthelot¹, Hind Hamzeh-Cognasse¹, Olivier Garraud^{1,3}, Fabrice Cognasse^{1,2}

¹ Université de Lyon, GIMAP-EA3064, Saint-Etienne, France

² Établissement Français du Sang Rhône-Alpes-Auvergne, Saint-Etienne, France

³ Institut National de Transfusion Sanguine (INTS), Paris, France

Résumé

La lésion pulmonaire aiguë transfusionnelle (TRALI) est une complication rare mais potentiellement grave. La physiopathologie de cette complication n'est pas encore consensuelle pour la communauté scientifique, notamment en ce qui concerne un rôle particulier pour les plaquettes sanguines dans le développement du TRALI. Cette étude a comme principal objectif d'investiguer la participation des plaquettes dans un modèle expérimental murin dans lequel un ALI a été induit par des injections successives de lipopolysaccharide et d'anticorps anti-CMH I. L'injection d'anticorps anti-GPIIb/IIIa, initiateur d'une déplétion plaquettaire, et de ML354, molécule inhibitrice de la voie d'activation du récepteur PAR-4, ont été administrés à des souris BALB/c 30 min avant l'induction de l'ALI. La déplétion plaquettaire induite par anticorps réduit la sévérité de la lésion pulmonaire aiguë, sans néanmoins la prévenir totalement. En revanche, le traitement à base de ML354 n'a montré aucun effet expérimental aux conditions d'utilisation. Enfin, nous avons observé, *in vitro*, une influence directe du LPS couplé aux anticorps anti-CMH I sur l'activation plaquettaire. Ces résultats permettent de consolider les connaissances de la pathogénie du TRALI pour, finalement, en réduire son occurrence par un management personnalisé des patients dits à risque.

Introduction

Le TRALI (Transfusion-Related Acute Lung Injury) est considéré comme l'une des réactions transfusionnelles inflammatoires les plus critiques [1]. On décrit le TRALI selon deux types, en fonction de sa physiopathologie ; le TRALI dit immunologique, dont le déclenchement dépend de la transfusion d'anticorps anti-leucocytaires, tels que les anti-HLA de classe I et II ou les anti-HNA ; et le TRALI dit non-immunologique, dont l'induction est dépendante de la présence de médiateurs solubles pro-inflammatoires en l'absence d'anticorps anti-leucocytaires détectables dans les produits sanguins labiles transfusés [2]. Actuellement, le rôle de l'activité des leucocytes et de l'endothélium vasculaire dans la pathogénie du TRALI n'est pas remis en question [3, 4]. Cependant, le rôle des plaquettes sanguines dans la constitution physiopathologique du TRALI reste encore à définir.

Le TRALI est considéré comme une pathologie transfusionnelle inflammatoire. Il est donc une conséquence d'une hyperactivité de cellules de l'inflammation à l'interface vasculaire et endothéliale pulmonaire [5]. La fonction plaquettaire a été, pendant longtemps, uniquement dédiée à la thrombose et l'hémostase, mais la communauté scientifique s'accorde à lui attribuer une fonction en tant que cellule de l'immunité et de l'inflammation [6]. En effet, les plaquettes sanguines participent à l'inflammation. Elles possèdent un pouvoir sécrétoire pro-inflammatoire non négligeable, notamment par l'exocytose de leurs différents granules [7, 8]. Elles expriment également une multitude de récepteurs sensibles aux signaux de danger comme de nombreuses cellules de l'immunité innée, tels que les « Toll-Like Receptors » (TLR) [9, 10]. Enfin, elles participent activement à l'induction, le maintien, l'amplification [11-13] mais aussi la régulation [14-17] du processus inflammatoire en interagissant directement avec d'autres cellules, notamment les neutrophiles.

Ces fonctions plaquettaires, ainsi décrites, pourraient théoriquement être soit délétères, soit protectrices dans le développement d'un ALI. Pour explorer l'une ou l'autre hypothèse, nous avons reproduit un modèle murin d'œdème lésionnel pulmonaire induit par injection successive de lipopolysaccharide (LPS) et d'anticorps anti-CMH I, équivalent du HLA de classe I chez l'homme, modèle considéré actuellement reproductible et homogène [18], et nous avons cherché à inhiber les plaquettes des souris avant de déclencher l'ALI. Comprendre au mieux la place des plaquettes sanguines dans la physiopathologie d'un ALI visant à modéliser un TRALI pourrait permettre un meilleur management des patients à risques.

Matériels et méthodes

Approbation de l'étude

L'utilisation des animaux a été autorisée par le Comité d'éthique du Ministère de l'Enseignement supérieur et de la Recherche (numéro d'agrément : CU14N11).

Souris

Des souris mâles BALB/c sauvages (8-12 semaines) ont été fournies par Charles River (Charles River, Wilmington, USA). Les expériences ont utilisé ≥ 8 souris par groupe.

Expérimentation animale

Des souris mâles H2K^d BALB/c ont été pré-stimulées par injection intrapéritonéale (*ip*) de lipopolysaccharide (LPS; 0.1 mg/kg, extrait d'*Escherichia Coli* 0111; InvivoGen, San Diego, USA), 24 heures avant l'injection intraveineuse (*iv*) d'anticorps anti-CMH I monoclonaux (mAb 34-1-2s, 1 mg/kg, H2K^d, IgG2a, κ), ou de contrôle isotypique IgG2a, κ (eBioscience, San Diego, USA). Les souris ont été traitées, par voie intraveineuse, avec un anticorps anti-GPIb α polyclonal (pAb anti-GPIb α , 2 mg/kg, IgG) ou son contrôle isotypique IgG (Abcam, Cambridge, USA), ou par voie intrapéritonéale, avec du ML354 (1-Methyl-5-nitro-3-phenyl-1*H*-indole-2-methanol, 4 mg/kg) (Tocris, Lille, France) ou du DMSO (1%) (Sigma Aldrich, Saint-Louis, USA), 30 min avant injection des anticorps anti-CMH I ou de l'anticorps contrôle (**Figure 1**). Une solution contenant de la kétamine (100 mg / kg) et de la xylazine (10 mg / kg) a été administrée lorsque les souris paraissaient moribondes ou après 2 heures. Les poumons des souris ont été recueillis et placés dans du paraformaldéhyde à 4% (Sigma Aldrich, Saint-Louis, USA) pendant la nuit.

Développement de l'ALI et évaluation de l'œdème pulmonaire lésionnel

La température des souris a été mesurée à l'aide d'une sonde rectale et d'un thermomètre numérique (Bioseb, Pinellas Park, USA), avant injection de l'anti-CMH I puis toutes les 10 min pendant 2 h ou jusqu'au sacrifice des souris. Les taux de survie des souris ont été évalués sur les 2 heures de l'expérimentation. L'ALI a été évalué en utilisant un score du comportement des souris et un score de lésion pulmonaire macroscopique (**Tableaux 1 et 2**). Le rapport poids des poumons/poids du corps a été calculé. Les lavages bronchoalvéolaires (LBA) ont été obtenus par cathétérisation de la trachée. Un lavage a été effectué en utilisant une injection de 1 ml de PBS froid. Les cellules des LBA ont été centrifugées à 491 g pendant 10 minutes et remises en suspension dans du PBS. Les plaquettes des LBA ont été énumérées en utilisant un analyseur hématologique MS4[®] (Melet Schloesing Laboratoires, Osny, France). La concentration en protéines totales dans les LBA a

été évaluée par le dosage de Bradford. Le nombre de cellules dans le sang périphérique et le volume plaquettaire moyen (MPV) ont été déterminés par le MS4®. La ponction intracardiaque a été réalisée avec une aiguille de calibre 25G et une solution de citrate-dextrose anticoagulante (ACD) (Sigma Aldrich, Saint-Louis, USA). Les injections dans veine caudale ont été réalisées à l'aide d'une aiguille de calibre 30G.

Sections pulmonaires

Les poumons ont été incorporés dans du composé OCT (CML, Nemours, France) et placés sur l'azote liquide pour induire une solidification rapide. Des coupes de 8 µm ont été préparées à l'aide d'un microtome cryostat (Leica Microsystem, Nanterre, France).

H&E staining and immunohistochemistry

L'épaisseur pulmonaire et l'accumulation de fluide périvasculaire ont été évaluées après coloration H&E. Pour l'immunohistochimie, l'activité endogène de la peroxydase a été bloquée par une première incubation avec 0,3% d'H₂O₂. Un sérum d'albumine bovine (BSA, 3%) (Sigma-Aldrich, Saint Louis, USA) a été utilisé pour prévenir une hybridation aspécifique des anticorps. Les coupes de poumons ont été incubées 1 h avec des anticorps anti-CD41 monoclonaux (MWRReg30, 2.5 µg/ml) ou des anticorps anti-Ly6G monoclonaux (1A8, 5 µg/ml; BD Biosciences, Franklin Lakes, USA). Ensuite, ces coupes ont été incubées avec des anticorps secondaires anti-rat monoclonaux biotinylés (G15-337, 5 µg/ml; BD Biosciences, Franklin Lakes, USA) pendant 30 min, suivi par une incubation avec de la streptavidine pré-diluée et du 3, 3'-Diaminobenzidine. Finalement, les coupes histologiques pulmonaires ont été colorées par des bains successifs dans de l'hématoxyline, de l'alcool (95%, 100%) et du xylène (Sigma-Aldrich, Saint Louis, USA). Les observations ont été faites avec un microscope Nikon Eclipse Ti-S, une caméra Nikon DS-R12 et un logiciel Nikon NIS-Elements (Nikon, Champigny sur Marne, France). Les images ont été traitées avec le logiciel Image J [19].

Evaluation de l'activation plaquettaire ex vivo

Du sang a été récupéré sur 20 souris. Après centrifugation à 100 g pendant 8 min, le PRP (Platelet-Rich Plasma) a été récupéré. Tous les PRP ont alors été « poolés » et stimulés pendant 1 h sous différentes conditions ; non stimulées (PBS), exposées à l'anti-CMH I (1 µg ; 2.5 µg ; 25 µg), au LPS (1 µg ; 2.5 µg ; 12.5 µg), à l'anti-CMH I et au LPS (respectivement, 25 µg ; 2.5 µg) et à un agoniste au récepteur PAR-4 (AYPGKF ; 10 µg) (Sigma Aldrich, Saint-Louis, USA). Les PRP ont finalement été centrifugés à 491 g pendant 10 min pour récupérer les surnageants. Des dosages des concentrations du PF4 ont été réalisés (Mouse CXCL4/PF4 DuoSet ELISA, R&D Systems, Minneapolis, USA) selon les instructions du fabricant.

Evaluation de l'agrégation plaquettaire ex vivo

Les PRP ont été récupérés sur 20 souris et « poolés » de la même manière que décrite au-dessus. L'agrégation plaquettaire a été évaluée, à l'aide de l'agrégomètre plaquettaire TA-4V (Stago, Asnières sur seine, France), sous différents stimuli ; non stimulée (PBS) ; stimulée par l'anti-CMH I (25 µg), le LPS (2.5 µg ; 12.5 µg), l'anti-CMH I et le LPS (respectivement, 25 µg ; 2.5 µg) et l'agoniste au récepteur PAR-4 (AYPGKF ; 10 µg).

Analyses statistiques

Les analyses statistiques ont été effectuées à l'aide du logiciel GraphPad Prism 5 (Graph ad, San Diego, USA). Une analyse statistique de type ANOVA avec correction de Bonferroni post-hoc a été utilisée pour comparer plus de deux groupes de données avec une distribution normale. Le test de Kruskal-Wallis et les tests post-hoc de Dunn ont été appliqués pour des comparaisons entre des données non distribuées normalement. Les scores de l'ALI et la température ont été statistiquement analysés en utilisant une analyse de variance bidirectionnelle. Les valeurs de P <0,05 étaient considérées comme significatives.

Résultats

La déplétion plaquettaire limite la sévérité de l'œdème pulmonaire lésionnel induit par injection d'anti-CMH I

Dans un premier temps, le but de ce travail est d'évaluer, par l'utilisation de drogues antiplaquettaires, la fonction des plaquettes au sein de la mécanistique de l'ALI. Le modèle murin utilisé repose sur deux injections successives de LPS et d'anticorps anti-CMH I, séparées de 24 heures. Les souris contrôles n'auront connu qu'une simple injection de LPS, par voie péritonéale. Enfin, les souris traitées ont subi une injection, par voie intraveineuse, d'anticorps anti-GPIb α , pour induire une déplétion plaquettaire 30 minutes avant l'induction de l'ALI (**Figure 1, A**). Finalement, les souris ont été suivies pendant 2 heures. Les premiers résultats démontrent une protection contre le développement de l'ALI, suite à l'utilisation des anticorps anti-GPIb α . En effet, nous pouvons constater une réduction de la mortalité, d'environ 90% chez les souris modèles de l'ALI contre 40% après déplétion plaquettaire (**Figure 2, A**). La température, qui est utilisée comme un marqueur du choc pathologique, ne montre, cependant, aucune amélioration. Les souris, à la fois du groupe ALI mais également du groupe traité, présentent une chute de la température jusqu'à 6°C à partir de 30 minutes (**Figure 2, B**). Finalement, l'évaluation du score pathologique de l'ALI (**Tableau 1**) et de celui reflétant l'état macroscopique des poumons (**Tableau 2**) évoque une amélioration significative de l'état général des souris. Cependant, ces deux scores restent significativement plus élevés chez les souris traitées avec des anticorps anti-GPIb α par rapport au groupe des souris contrôles [LPS] (**Figure 2, C et D**). L'analyse spécifique du développement de l'œdème pulmonaire, évalué par le ratio du poids des poumons et des souris et de la concentration en protéines totales dans les LBA, démontre une sévérité moindre lorsque les souris sont préalablement injectées avec un anticorps anti-GPIb α . En revanche, ces deux paramètres restent significativement plus importants dans le groupe des souris [LPS + anti-CMH I + anti-GPIb α] par rapport aux contrôles [LPS] (**Figure 3, A et B**). Finalement, ce traitement ne prévient pas entièrement le développement de la lésion pulmonaire, observée par une infiltration pulmonaire importante évalué par coloration H&E (**Figure 3, C**).

La déplétion plaquettaire augmente le compte des plaquettes au niveau pulmonaire mais réduit celui des neutrophiles.

L'analyse du compte cellulaire montre que les souris ayant subi une injection préalable d'anticorps anti-GPIb α présente le taux le plus faible de plaquettes circulantes, en moyenne $167,5 \cdot 10^6/\mu\text{l}$ pour le groupe [LPS + anti-CMH I + anti-GPIb α], $285,9 \cdot 10^6/\mu\text{l}$ pour le groupe [LPS + anti-CMH I] et $639 \cdot 10^6/\mu\text{l}$ pour le groupe [LPS]. Cependant, le taux de leucocytes circulants, en particulier les neutrophiles, ne semble pas impacté par l'induction de l'ALI après déplétion plaquettaire (**Figure 4, A**). L'activation

des plaquettes, au niveau périphérique et dans les LBA, est similaire entre les groupes [LPS + anti-CMH I] et [LPS + anti-CMH I + anti-GPIb α] (**Figure 4, B et D**). Le taux de plaquettes détecté dans les LBA est significativement plus important dans le groupe [LPS + anti-CMH I + anti-GPIb α] par rapport au groupe [LPS + anti-CMH I], lui-même proposant une infiltration plaquettaire significativement augmentée comparée aux souris contrôle (**Figure 4, C**). Ces résultats sont confirmés par l'analyse immunohistologique des plaquettes (CD41) dans les tissus pulmonaires (**Figure 4, E**). Cette même technique démontre une légère réduction de la migration des neutrophiles (Ly6G) dans l'interstitium pulmonaire lors de la déplétion des plaquettes circulantes des souris (**Figure 4, F**).

La voie d'activation des plaquettes n'est pas dépendante du récepteur PAR-4

Les souris ont été préalablement traitées avec une injection, par voie intrapéritonéale, de ML354 (inhibiteur du récepteur PAR-4), 30 min avant l'induction expérimentale de la lésion pulmonaire, provoquée par l'administration d'anticorps anti-CMH I (**Figure 1, B**). Aucun effet significatif n'a été constaté, suite à cette inhibition, ni sur la survie (**Figure 5, A**), la température (**Figure 5, B**), le score pathologique (**Figure 5, C**) et de l'atteinte pulmonaire (**Figure 5, D**), le développement de l'œdème pulmonaire (**Figure 6**) ou la numération et activation cellulaire au niveau périphérique et des LBA (**Figure 7**).

Les plaquettes sanguines sont sensibles au LPS, et au stimulus combiné du LPS et des anti-CMH I

Les plaquettes circulantes de souris, n'ayant connu aucun stimulus, ont été récupérées, sous forme de PRP, et stimulées avec plusieurs réactifs testant l'activation et l'agrégation plaquettaire. Nous avons observé une augmentation significative de la production de PF4, marqueur de l'activité des plaquettes [15], et de l'agrégation plaquettaire après stimulation avec un agoniste du récepteur PAR-4 (AYPGKF). La stimulation des plaquettes avec des concentrations importantes en LPS (12.5 μ g) induit une libération importante de PF4, similaire à la stimulation avec AYPGKF. Enfin, la combinaison des stimuli LPS et anti-CMH I, aux concentrations suboptimales, a également augmenté la concentration de PF4 libérée par les plaquettes (**Figure 8, A**). En revanche, seule la stimulation avec l'agoniste au récepteur PAR-4 a permis une augmentation de l'agrégation plaquettaire (**Figure 8, B**).

Discussion

La participation des plaquettes sanguines de l'individu dans la genèse d'un TRALI est encore très débattue. Pendant que certains évoquent un rôle non négligeable des plaquettes du patient au sein de la pathogénie de cet œdème lésionnel pulmonaire transfusionnel [20-24], certains les considèrent comme facultatives, voire inutiles [25, 26]. Au cours de cette étude, nous avons évalué l'activité plaquettaire dans la physiopathologie d'un ALI expérimental mimant le TRALI, en apportant un traitement antiplaquettaire ; le modèle murin de l'ALI était induit par injection d'anticorps anti-CMH I à des souris préalablement prédisposées par une injection de LPS.

Nous avons objectivé une inhibition limitée du développement de l'ALI (**Figures 2 et 3**), après l'injection d'anticorps anti-GPIIb/IIIa, résultat intermédiaire entre les études démontrant une protection totale lors de la déplétion plaquettaire [23] et celles observant une absence de prévention de la lésion pulmonaire [25]. La protection totale, d'abord observée en 2009 [23], peut être justifiée par l'utilisation d'un sérum antiplaquettaire ayant probablement eu un impact sur les leucocytes. Une autre étude [25], ayant induit une thrombopénie sévère chez des souris génétiquement modifiées, rapporte une mort importante des souris probablement en lien avec un syndrome hémorragique induit et pas nécessairement la conséquence de l'ALI. Notre étude rapporte également une augmentation importante du nombre de plaquettes dans les LBA et l'interstitium pulmonaire (**Figure 4, C et E**), avec une moyenne de leur volume faible (**Figure 4, D**), après la déplétion des plaquettes circulantes. Ces derniers résultats peuvent probablement s'expliquer, en partie, par la thrombopoïèse plaquettaire pulmonaire décrite récemment [27], qui pourrait être, hypothétiquement, compensatoire de la thrombopénie induite en participant à la synthèse de nouvelles plaquettes. Ces résultats peuvent alors justifier la limite de protection lors de la déplétion des plaquettes circulantes. En effet, notre étude propose une sévérité limitée, mais pas entièrement résolue, tandis que deux premières études n'observaient aucun changement, lors de l'induction de l'ALI suite à la déplétion plaquettaire [25, 26]. Aucune preuve n'a été apportée, dans ces précédentes études, sur l'inhibition des plaquettes nouvellement synthétisées dans l'interstitium pulmonaire. Nous émettons ainsi l'hypothèse que l'activité des plaquettes sanguines présentes et produites dans les poumons peut prendre le relais de celle des plaquettes périphériques déplétées, lors d'un ALI.

Finalement, nous avons tenté de déterminer les cascades d'activation des plaquettes sanguines lors de l'induction expérimentale de l'ALI. Dans un premier temps, nous n'observions aucune protection contre le développement de l'ALI après inhibition du récepteur PAR-4 (**Figure 5, 6 et 7**). Cependant, nous pouvons constater que les plaquettes sont sensibles à de fort taux de LPS seul, prouvé par une libération augmentée de PF4, ou à une combinaison de LPS et d'anti-CMH I à des dosages proches de

ceux utilisés dans notre modèle murin de l'ALI (**Figure 8, A**). Cependant, ces différents stimuli ne semblent pas impacter leur pouvoir d'agrégation (**Figure 8, B**). Ainsi, grâce à ces résultats, nous pouvons noter que les plaquettes circulantes sont également une cible des stimuli utilisés dans notre modèle murin pathologique. L'effet agoniste observé lors de la stimulation au LPS peut s'expliquer par le fait que les plaquettes expriment différents TLR à leur surface, notamment le TLR4 [10]. En revanche, de nouvelles investigations ont besoin d'être menées pour comprendre quel effet pourrait avoir les anticorps anti-leucocytaires directement sur les plaquettes, car ces dernières ont la capacité d'internaliser le CMH I, produit par les autres cellules immunitaires, et ensuite l'exprimer à leur surface [28, 29]. Finalement, cette étude pourrait apporter une compréhension significative concernant la physiopathologie du TRALI et, ainsi, permettre un management personnalisé des patients transfusés à risques.

Références :

1. ANSM, **French Haemovigilance Activity Report 2015**. 2016.
2. Alvarez, P., et al., **Transfusion-Related Acute Lung Injured (TRALI): Current Concepts**. *Open Respir Med J*, 2015. **9**: p. 92-6.
3. Peters, A.L., D. Van Stein, and A.P. Vlaar, **Antibody-mediated transfusion-related acute lung injury; from discovery to prevention**. *Br J Haematol*, 2015.
4. Peters, A.L., et al., **Pathogenesis of non-antibody mediated transfusion-related acute lung injury from bench to bedside**. *Blood Rev*, 2015. **29**(1): p. 51-61.
5. Vlaar, A.P. and N.P. Juffermans, **Transfusion-related acute lung injury: a clinical review**. *Lancet*, 2013. **382**(9896): p. 984-94.
6. Garraud, O. and F. Cognasse, **Are Platelets Cells? And if Yes, are They Immune Cells?** *Front Immunol*, 2015. **6**: p. 70.
7. Garraud, O., et al., **Transfusion as an Inflammation Hit: Knowns and Unknowns**. *Front Immunol*, 2016. **7**: p. 534.
8. Manne, B.K., S.C. Xiang, and M.T. Rondina, **Platelet secretion in inflammatory and infectious diseases**. *Platelets*, 2016: p. 1-10.
9. Cognasse, F., et al., **The Inflammatory Role of Platelets via Their TLRs and Siglec Receptors**. *Front Immunol*, 2015. **6**: p. 83.
10. Cognasse, F., et al., **Lipopolysaccharide induces sCD40L release through human platelets TLR4, but not TLR2 and TLR9**. *Intensive Care Med*, 2007. **33**(2): p. 382-4.
11. Middleton, E.A., A.S. Weyrich, and G.A. Zimmerman, **Platelets in Pulmonary Immune Responses and Inflammatory Lung Diseases**. *Physiol Rev*, 2016. **96**(4): p. 1211-59.
12. Thomas, M.R. and R.F. Storey, **The role of platelets in inflammation**. *Thromb Haemost*, 2015. **114**(3): p. 449-58.
13. Kapur, R., et al., **Nouvelle cuisine: platelets served with inflammation**. *J Immunol*, 2015. **194**(12): p. 5579-87.
14. Boulaftali, Y., et al., **Platelet ITAM signaling is critical for vascular integrity in inflammation**. *J Clin Invest*, 2013. **123**(2): p. 908-16.
15. de Stoppelaar, S.F., et al., **Thrombocytopenia impairs host defense in gram-negative pneumonia-derived sepsis in mice**. *Blood*, 2014. **124**(25): p. 3781-90.
16. Goerge, T., et al., **Inflammation induces hemorrhage in thrombocytopenia**. *Blood*, 2008. **111**(10): p. 4958-64.
17. Gros, A., et al., **Single platelets seal neutrophil-induced vascular breaches via GPVI during immune-complex-mediated inflammation in mice**. *Blood*, 2015. **126**(8): p. 1017-26.
18. Looney, M.R., et al., **Neutrophils and their Fc gamma receptors are essential in a mouse model of transfusion-related acute lung injury**. *J Clin Invest*, 2006. **116**(6): p. 1615-23.
19. Schneider, C.A., W.S. Rasband, and K.W. Eliceiri, **NIH Image to ImageJ: 25 years of image analysis**. *Nat Methods*, 2012. **9**(7): p. 671-5.
20. Ortiz-Munoz, G., et al., **Aspirin-triggered 15-epi-lipoxin A4 regulates neutrophil-platelet aggregation and attenuates acute lung injury in mice**. *Blood*, 2014. **124**(17): p. 2625-34.
21. Caudrillier, A. and M.R. Looney, **Platelet-neutrophil interactions as a target for prevention and treatment of transfusion-related acute lung injury**. *Curr Pharm Des*, 2012. **18**(22): p. 3260-6.
22. Caudrillier, A., et al., **Platelets induce neutrophil extracellular traps in transfusion-related acute lung injury**. *J Clin Invest*, 2012. **122**(7): p. 2661-71.
23. Looney, M.R., et al., **Platelet depletion and aspirin treatment protect mice in a two-event model of transfusion-related acute lung injury**. *J Clin Invest*, 2009. **119**(11): p. 3450-61.
24. Tong, S., et al., **Accumulation of CD62P during storage of apheresis platelet concentrates and the role of CD62P in transfusion-related acute lung injury**. *Mol Med Rep*, 2015.
25. Hechler, B., et al., **Platelets are dispensable for antibody-mediated transfusion-related acute lung injury in the mouse**. *J Thromb Haemost*, 2016.

26. Strait, R.T., et al., **MHC class I-specific antibody binding to nonhematopoietic cells drives complement activation to induce transfusion-related acute lung injury in mice.** J Exp Med, 2011. **208**(12): p. 2525-44.
27. Lefrancais, E., et al., **The lung is a site of platelet biogenesis and a reservoir for haematopoietic progenitors.** Nature, 2017. **544**(7648): p. 105-109.
28. Zufferey, A., et al., **Characterization of the platelet granule proteome: evidence of the presence of MHC1 in alpha-granules.** J Proteomics, 2014. **101**: p. 130-40.
29. Semple, J.W., J.E. Italiano, Jr., and J. Freedman, **Platelets and the immune continuum.** Nat Rev Immunol, 2011. **11**(4): p. 264-74.

Tableaux

Tableau 1 : Evaluation du comportement des souris

<i>Paramètre</i>	<i>ID animale</i>	<i>Score</i>
Apparence	Normal	1
	Manque général de toilettage	2
	Piloérection, décharges oculaires et nasales fraîches	3
	Piloérection, courbure	4
	Au-dessus et les yeux à moitié fermés	5
Comportement naturel	Normal	0
	Changements mineurs	1
	Moins mobile et isolé, mais alerte	2
	Agité ou très calme, pas alerte	3
Etat d'hydratation	Normal	0
	Test de pincement cutané anormal	5
Signe clinique	Fréquence respiratoire normale	0
	Légers changements, fréquence seulement augmentée	1
	Augmentation de la fréquence avec respiration abdominale	2
	Diminution de la fréquence avec respiration abdominale	2
	Respiration abdominale marquée et cyanose	3
Comportement provoqué	Normal	0
	Dépression mineure ou réponse exagérée	1
	Changement modéré du comportement attendu	2
	Très faible et précomateuse	3
Total		0-19

Tableau 2 : Evaluation de la dégradation macroscopique des poumons

<i>Score atteinte poumons</i>	<i>Observations</i>
1	Entièrement rose et Sec
2	Très peu de taches (10 % ≤ X ≤ 30 %) et Sec
3	Quelques taches sombres (30 % < X ≤ 50 %) et peu humide
4	Beaucoup de taches sombre (50 % < X ≤ 75 %) et humide
5	Presque entièrement sombre (X > 75 %) et très humide

Figures

Figure 1 : Evaluation des symptômes des souris

Le protocole expérimental, *in vivo*, est présenté ici. Les souris sont préalablement stimulées avec une injection intrapéritonéale de LPS, à 0.1 mg/kg, 24 heures avec l'induction de l'ALI par injection intraveineuse d'anticorps anti-CMH I. Les souris sont traitées soit avec des anticorps anti-GPIIb α à 2 mg/kg, responsable de la déplétion plaquettaire **(A)**, soit avec le ML354 à 4 mg/kg, inhibiteur de la voie d'activation PAR-4 **(B)**. Les souris sont suivies pendant 2 h.

Figure 2 : Evaluation des symptômes des souris après déplétion plaquettaire

Les courbes de survie **(A)**, la température rectale **(B)**, le score du changement comportemental des souris (/19) **(C)** et le score de l'atteinte macroscopique des poumons (/5) **(D)** ont été mesurés. Les valeurs sont représentées en moyenne \pm SEM (n = 16 – 25). *p < 0.05, **p < 0.01, et ***p < 0.001 représentent les différences entre les groupes [LPS] et [LPS + anti-CMH I] ; † p < 0.05, †† p < 0.01, et ††† p < 0.001 représentent les différences entre les groupes [LPS + anti-CMH I] et [LPS + anti-CMH I + anti-GPIIb α] ; and $^{\#}$ p < 0.05, $^{\#\#}$ p < 0.01, et $^{\#\#\#}$ p < 0.001 représentent les différences entre les groupes [LPS] et [LPS + anti-MHC I + anti- GPIIb α].

Figure 3 : Caractérisation de l'œdème pulmonaire après déplétion plaquettaire

Le ratio entre le poids des poumons et des souris **(A)** et la concentration en protéines totales dans les LBA **(B)** ont été mesurés. La microarchitecture pulmonaire est présentée après coloration H&E pour chaque groupe de souris (Grossissement original x400). Barre d'échelle, 50 μ m **(C)**. Les valeurs sont représentées en moyenne \pm SEM (n = 8 – 15). *p < 0.05, **p < 0.01, et ***p < 0.001 représentent les différences entre les groupes [LPS] et [LPS + anti-CMH I] ; † p < 0.05, †† p < 0.01, et ††† p < 0.001 représentent les différences entre les groupes [LPS + anti-CMH I] et [LPS + anti-CMH I + anti-GPIIb α] ; and $^{\#}$ p < 0.05, $^{\#\#}$ p < 0.01, et $^{\#\#\#}$ p < 0.001 représentent les différences entre les groupes [LPS] et [LPS + anti-MHC I + anti- GPIIb α].

Figure 4 : Evaluation cellulaire après déplétion plaquettaire

L'évaluation du compte cellulaire, au niveau périphérique, pour les plaquettes, les leucocytes, les neutrophiles et les monocytes a été réalisé **(A)**. Le volume plaquettaire moyen a été évalué pour les plaquettes circulantes **(B)**. La numération plaquettaire a été réalisée dans les LBA **(C)**. Le volume plaquettaire moyen a été évalué pour les plaquettes pulmonaires **(D)**. Les valeurs sont représentées en moyenne \pm SEM (n = 8 – 25). *p < 0.05, **p < 0.01, et ***p < 0.001 représentent les différences entre les groupes [LPS] et [LPS + anti-CMH I] ; † p < 0.05, †† p < 0.01, et ††† p < 0.001 représentent les

différences entre les groupes [LPS + anti-CMH I] et [LPS + anti-CMH I + anti-GPIb α] ; and [#]p < 0.05, ^{##}p < 0.01, et ^{###}p < 0.001 représentent les différences entre les groupes [LPS] et [LPS + anti-MHC I + anti-GPIb α]. La coloration immunohistochimique de l'interstitium pulmonaire a été utilisée pour mesurer l'infiltration plaquettaire (**E**) et des neutrophiles (**F**) (Grossissement original x400). Barre d'échelle, 50 μ m.

Figure 5 : Evaluation des symptômes des souris après inhibition du récepteur PAR-4

Les courbes de survie (**A**), la température rectale (**B**), le score du changement comportemental des souris (/19) (**C**) et le score de l'atteinte macroscopique des poumons (/5) (**D**) ont été mesurés. Les valeurs sont représentées en moyenne \pm SEM (n = 15 – 25). *p < 0.05, **p < 0.01, et ***p < 0.001 représentent les différences entre les groupes [LPS] et [LPS + anti-CMH I] ; [†]p < 0.05, ^{††}p < 0.01, et ^{†††}p < 0.001 représentent les différences entre les groupes [LPS + anti-CMH I] et [LPS + anti-CMH I + ML354] ; and [#]p < 0.05, ^{##}p < 0.01, et ^{###}p < 0.001 représentent les différences entre les groupes [LPS] et [LPS + anti-MHC I + ML354].

Figure 6 : Caractérisation de l'œdème pulmonaire après inhibition du récepteur PAR-4

Le ratio entre le poids des poumons et des souris (**A**) et la concentration en protéines totales dans les LBA (**B**) ont été mesurés. La microarchitecture pulmonaire est présentée après coloration H&E pour chaque groupe de souris (Grossissement original x400). Barre d'échelle, 50 μ m (**C**). Les valeurs sont représentées en moyenne \pm SEM (n = 8). *p < 0.05, **p < 0.01, et ***p < 0.001 représentent les différences entre les groupes [LPS] et [LPS + anti-CMH I] ; and [#]p < 0.05, ^{##}p < 0.01, et ^{###}p < 0.001 représentent les différences entre les groupes [LPS] et [LPS + anti-MHC I + ML354].

Figure 7 : Evaluation cellulaire après inhibition du récepteur PAR-4

L'évaluation du compte cellulaire, au niveau périphérique, pour les plaquettes, les leucocytes, les neutrophiles et les monocytes a été réalisé (**A**). Le volume plaquettaire moyen a été évalué pour les plaquettes circulantes (**B**). La numération plaquettaire a été réalisée dans les LBA (**C**). Le volume plaquettaire moyen a été évalué pour les plaquettes pulmonaires (**D**). Les valeurs sont représentées en moyenne \pm SEM (n = 8 – 25). *p < 0.05, **p < 0.01, et ***p < 0.001 représentent les différences entre les groupes [LPS] et [LPS + anti-CMH I] ; and [#]p < 0.05, ^{##}p < 0.01, et ^{###}p < 0.001 représentent les différences entre les groupes [LPS] et [LPS + anti-MHC I + ML354].

Figure 8: Activité plaquettaire sous différents stimuli

L'activation des plaquettes, isolées dans les PRP, a été évaluée par la mesure de la concentration du PF4 (A) et l'agrégation plaquettaire (B) sous différents stimuli. Les valeurs sont représentées en

moyenne \pm SEM (n = 5 – 10). *p < 0.05, **p < 0.01, et ***p < 0.001 représentent les différences par rapport au groupe non stimulé (NS).

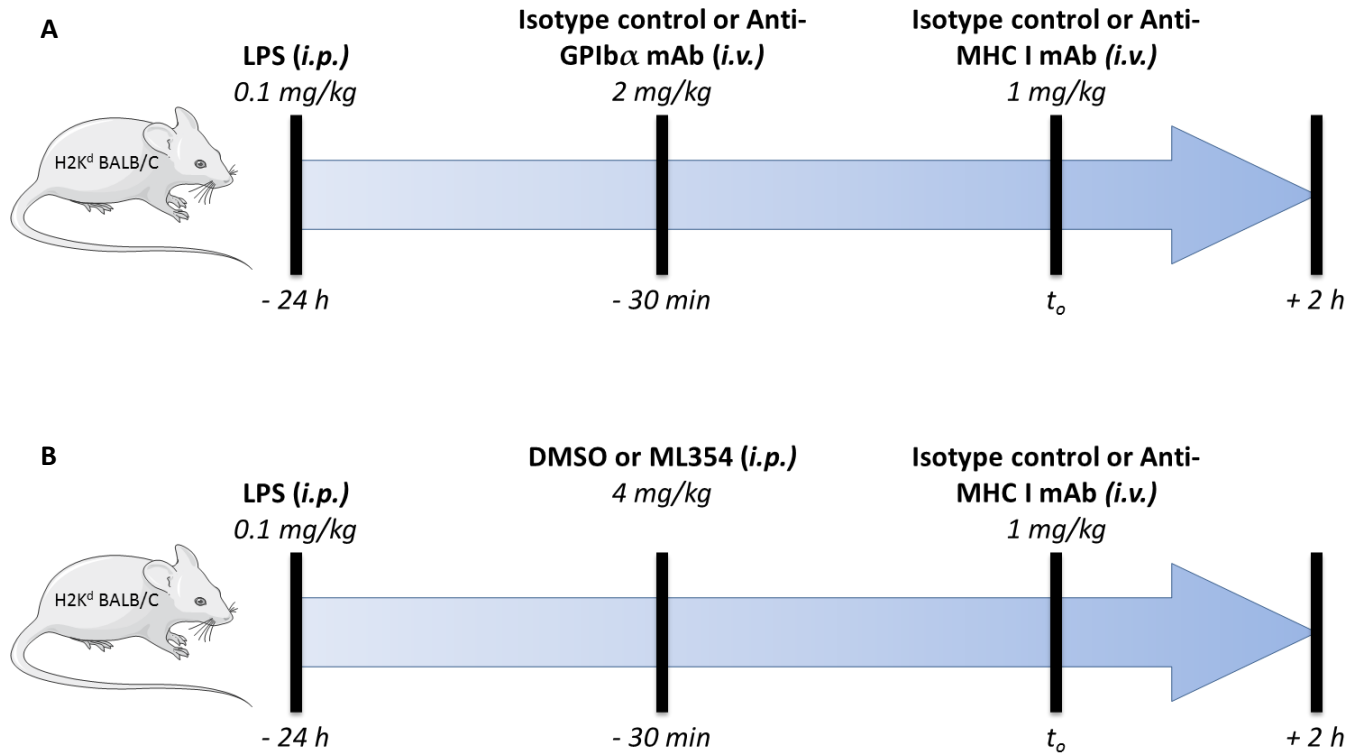

Figure 1 : Evaluation des symptômes des souris

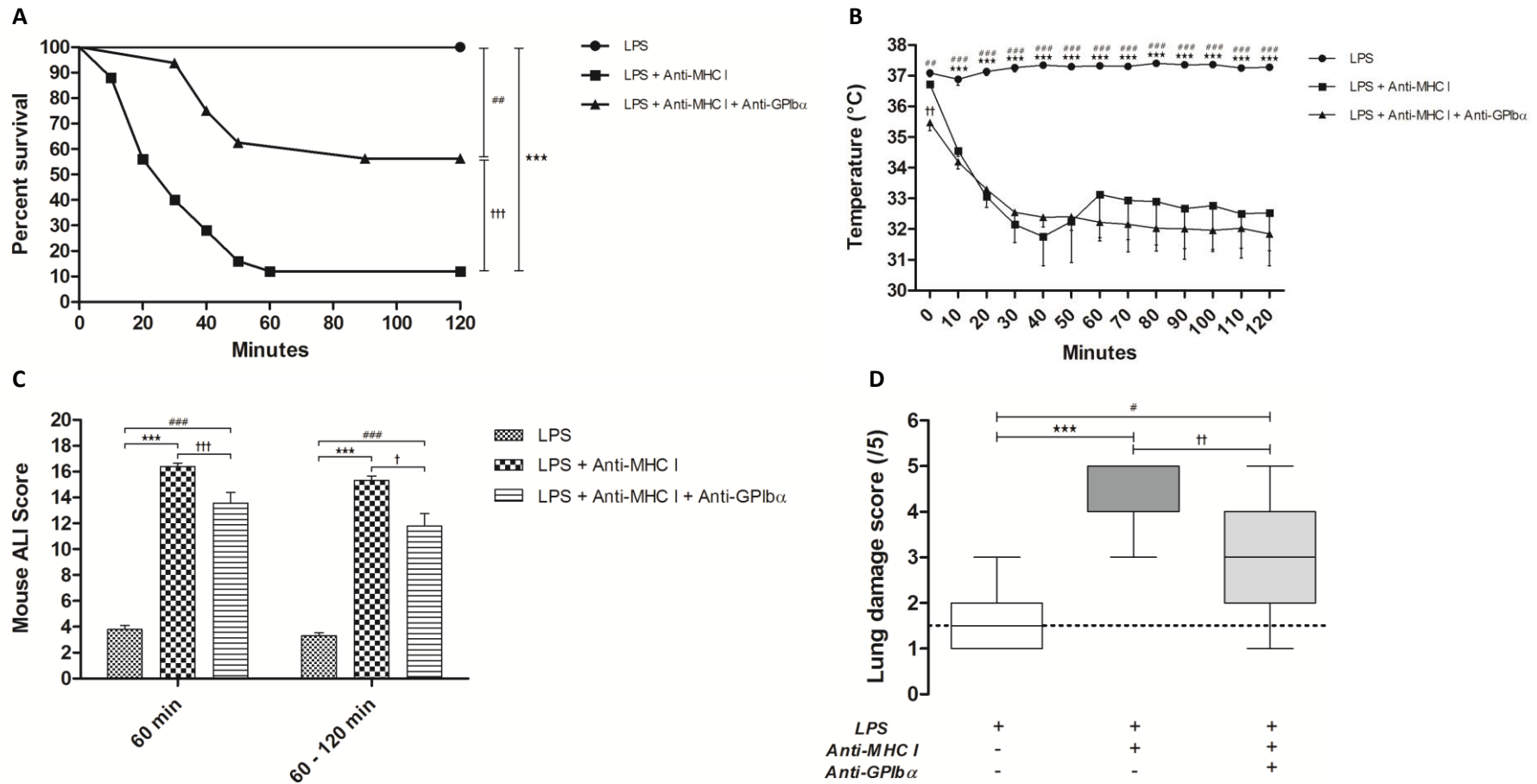

Figure 2 : Evaluation des symptômes des souris après déplétion plaquettaire

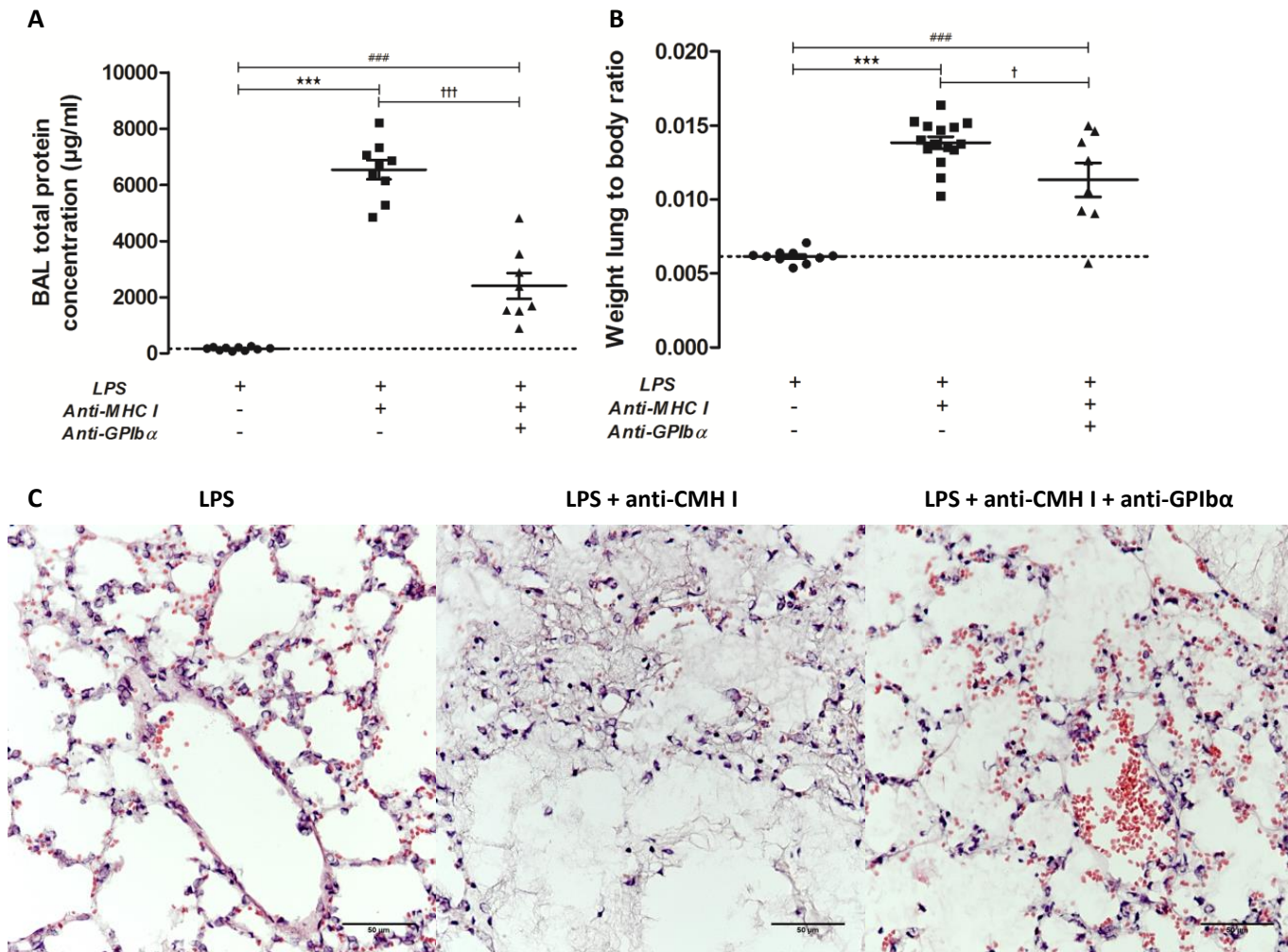

Figure 3 : Caractérisation de l'œdème pulmonaire après déplétion plaquettaire

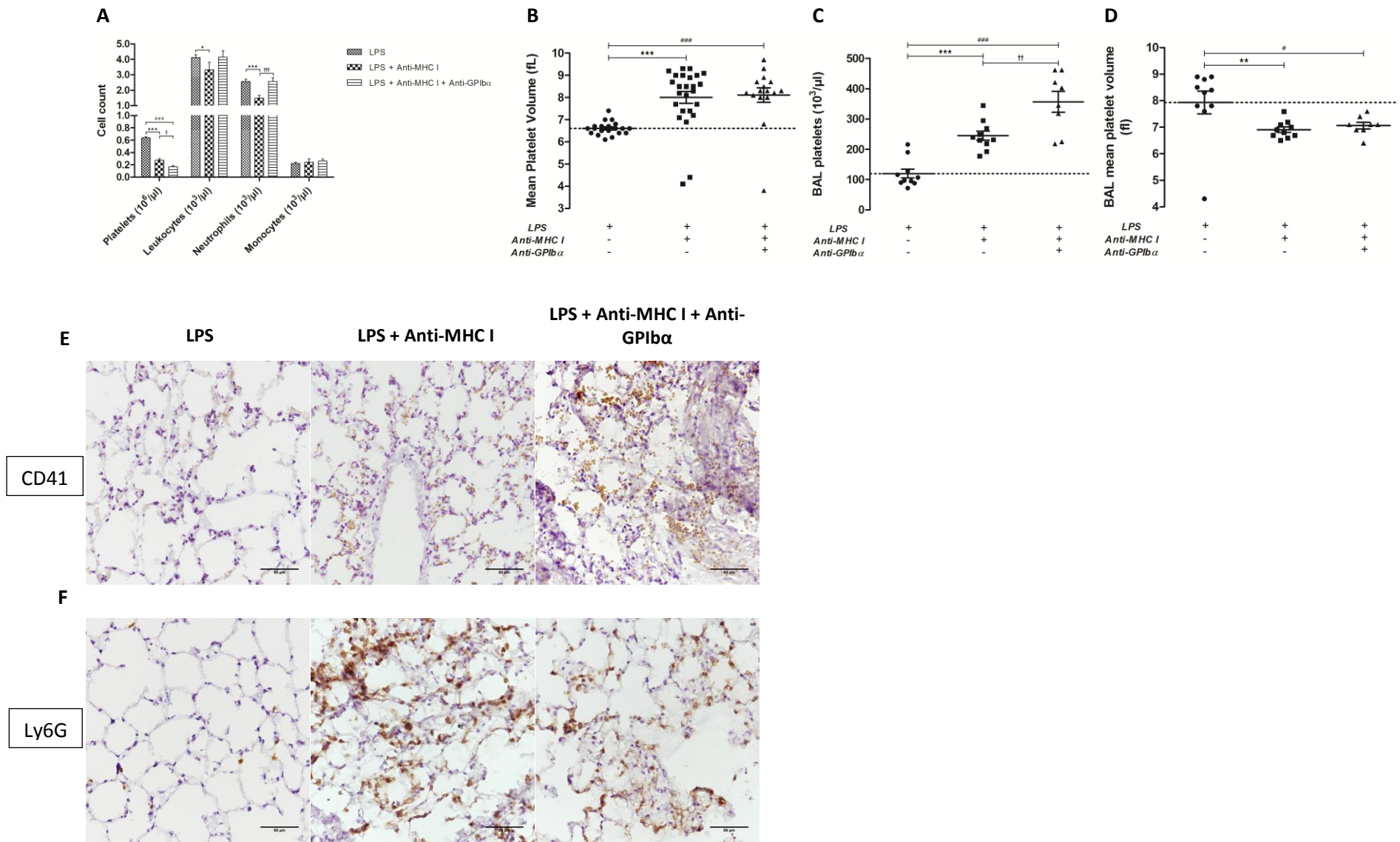

Figure 4 : Evaluation cellulaire après déplétion plaquettaire

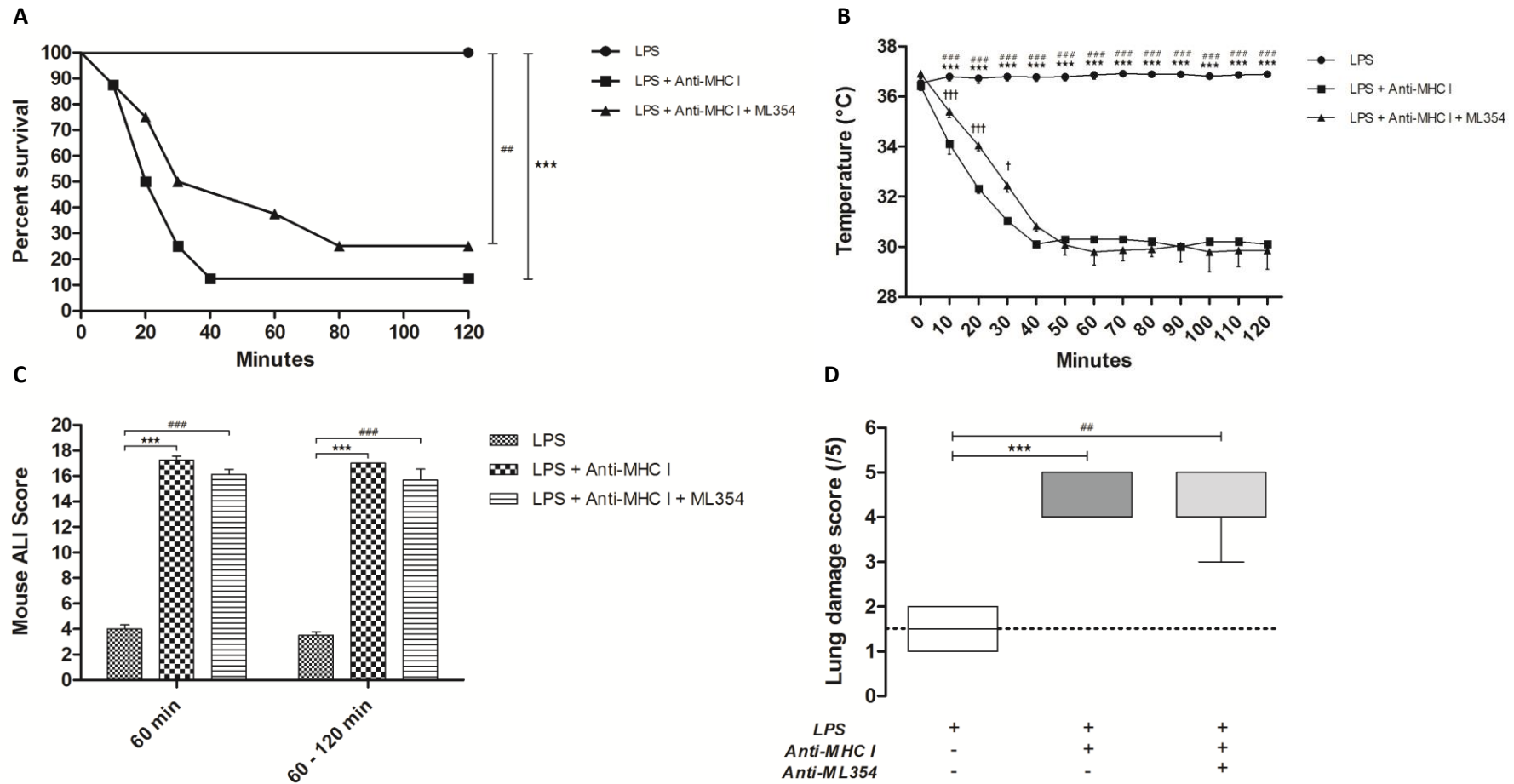

Figure 5 : Evaluation des symptômes des souris après inhibition du récepteur PAR-4

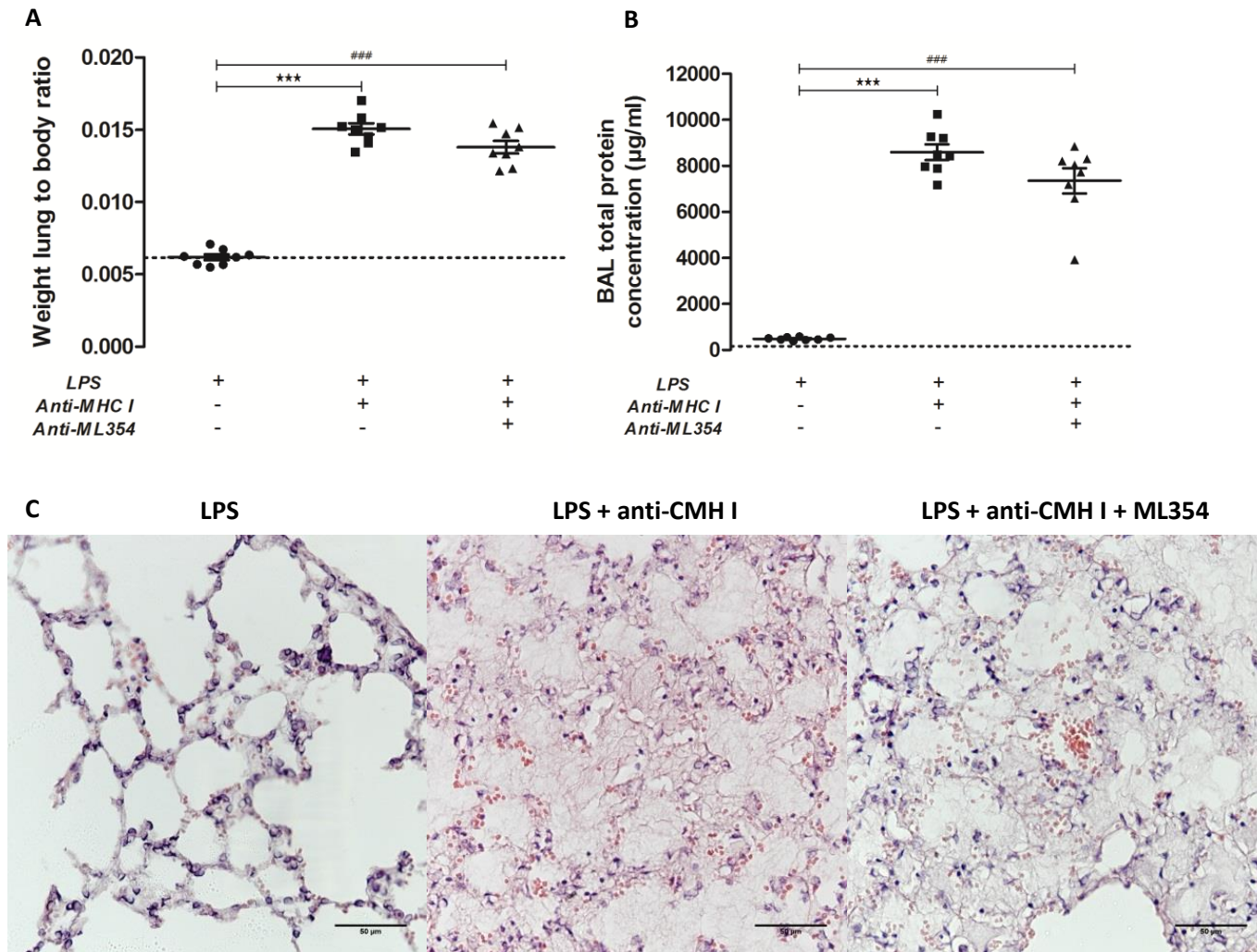

Figure 6 : Caractérisation de l'œdème pulmonaire après inhibition du récepteur PAR-4

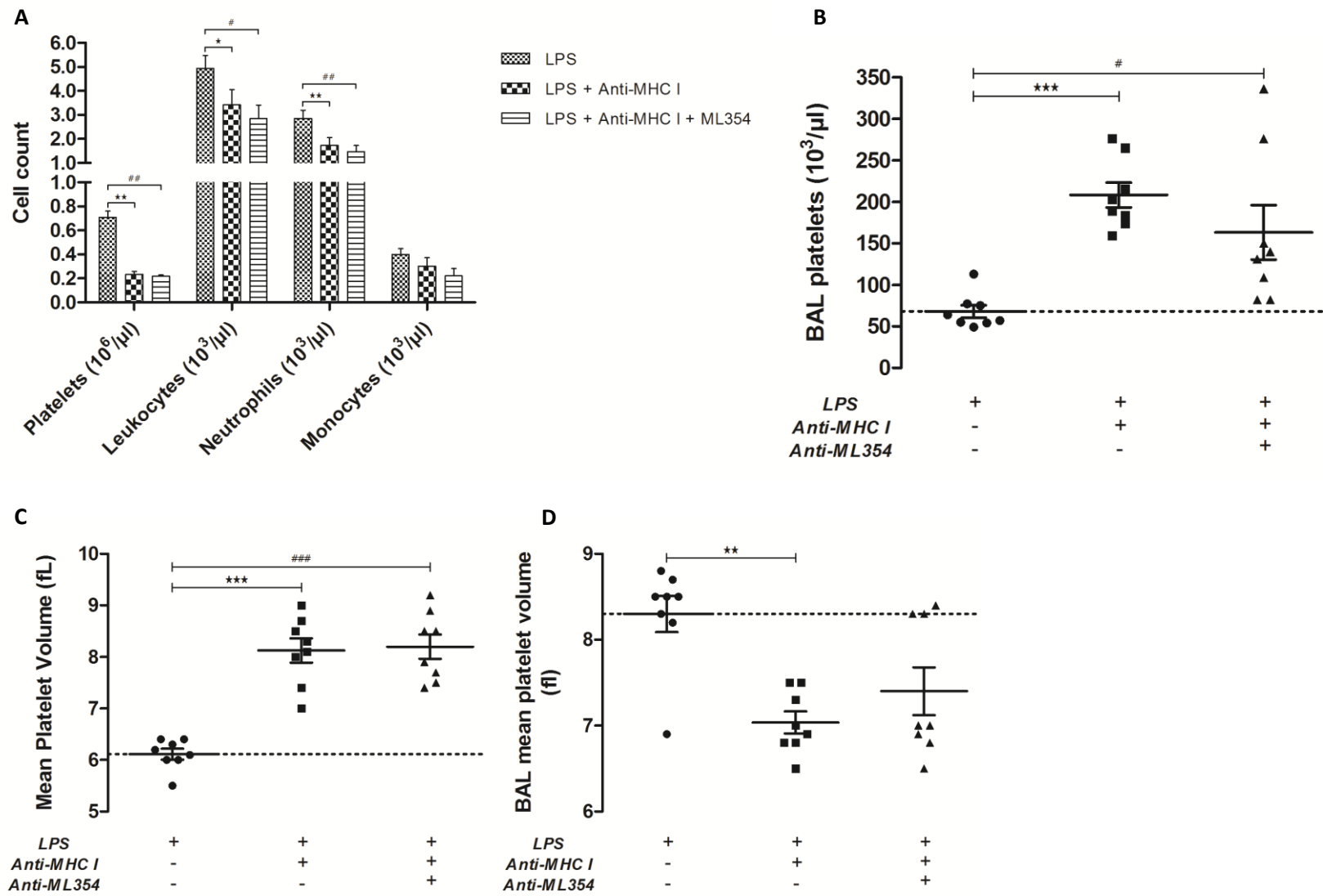

Figure 7 : Evaluation cellulaire après inhibition du récepteur PAR-4

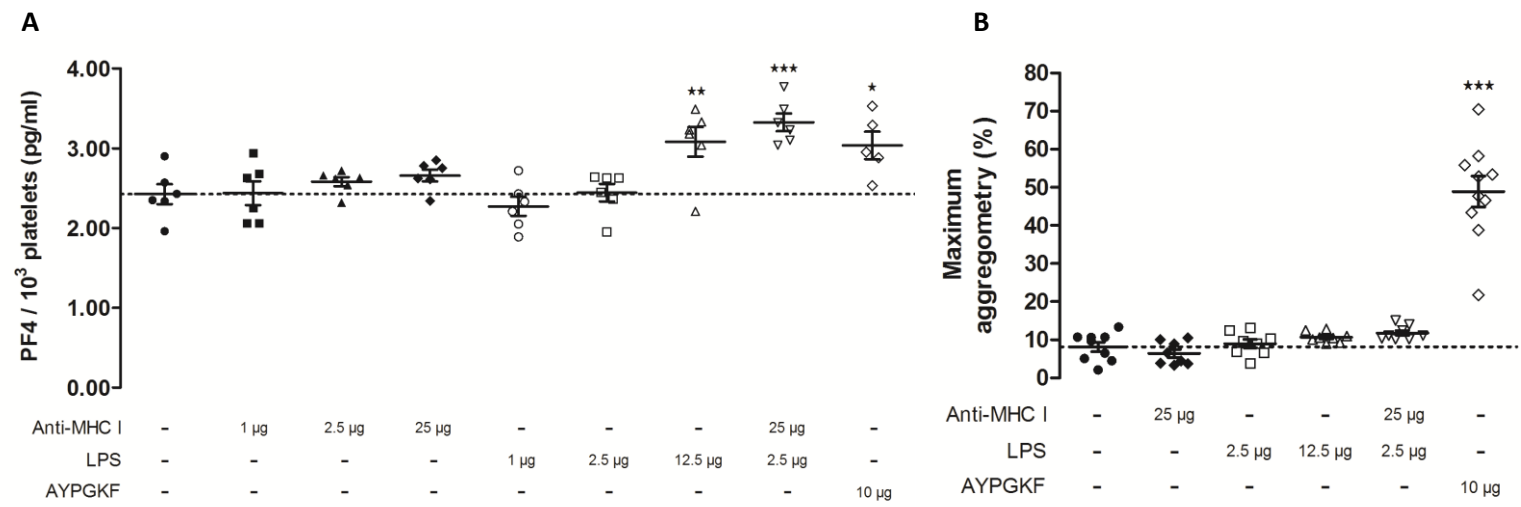
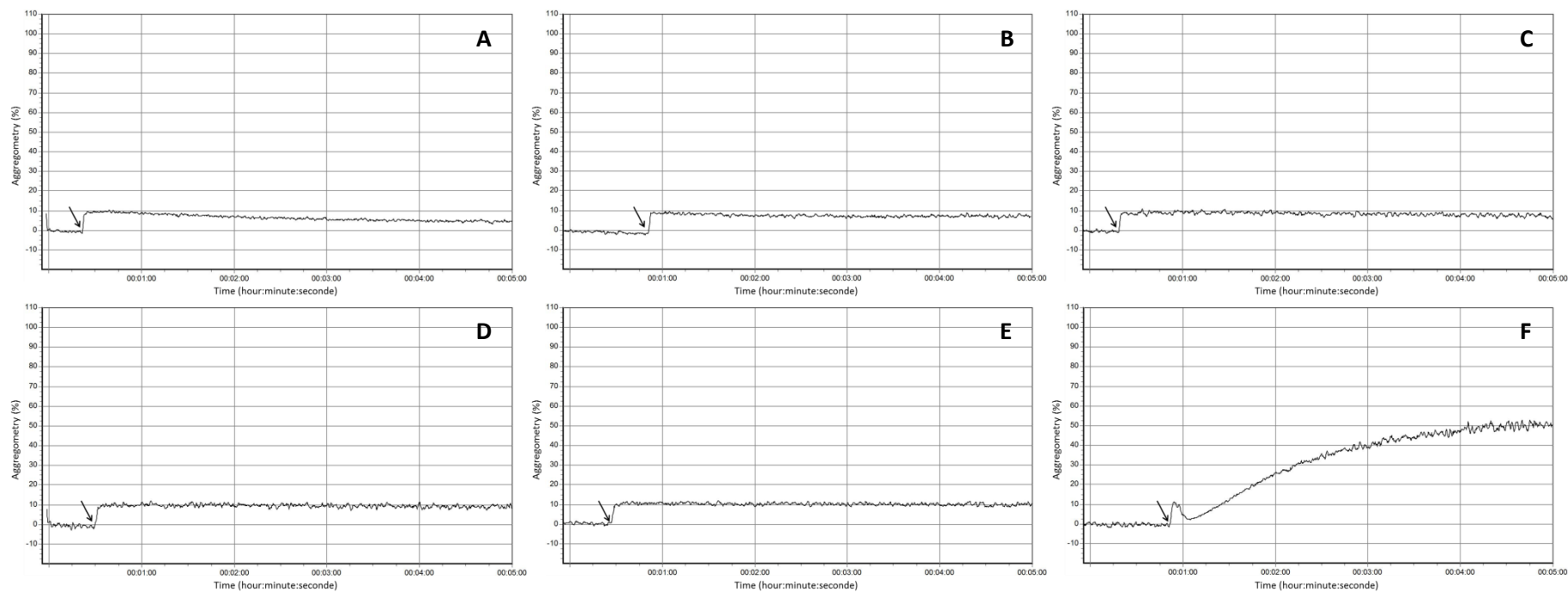

Figure 8: Activité plaquettaire sous différents stimuli

Supplemental figure 1 : Agrégation plaquettaire



Représentation des profils d'agrégation en fonction des stimulations. Chaque profil représente un échantillon caractéristique de chaque stimulation ; NS (A), anti-CMH I - 25 µg (B), LPS - 2.5 µg (C), LPS - 12.5 µg (D), anti-CMH I - 25 µg + LPS - 2.5 µg (E), PAR-4 - 10 µg (F).

**Manuscrit IV : La neutralisation du complexe protéique
CD40/CD40L inhibe le développement d'œdème
pulmonaire lésionnel induit dans un modèle murin par
injection de lipopolysaccharide et d'anticorps anti-CMH I**

***“The neutralization of CD40/CD40L complex inhibits Acute Lung
Injury development in a mouse model induced through
lipopolysaccharide and anti-MHC I mAb injection”***

Article soumis dans « Critical Care »

Comme vu précédemment, le TRALI propose une pathogénie très complexe mettant en jeu diverses cellules de l'inflammation, telles que les neutrophiles, les plaquettes et les cellules endothéliales [104, 274-276]. Certains évoquent même l'implication d'autres cellules, c'est le cas des monocytes [277] ou des macrophages pulmonaires [278]. Même si aucun consensus actuel n'a validé les vraies cellules impliquées (neutrophiles *vs* monocytes *vs* macrophages pulmonaires *vs* plaquettes sanguines), un point commun existe entre toutes ces cellules, l'implication du complexe protéique CD40/CD40L. Les plaquettes sanguines, par la production d'environ 95% du CD40L soluble, agoniste à la forme membranaire, sont au cœur d'une physiopathologie dépendant du couple CD40/CD40L [89]. Ce couple immun participe activement à l'établissement de l'immunité innée, adaptative et, de façon plus générale, de l'inflammation [74]. En ciblant ce complexe protéique, nous avons donc émis l'hypothèse d'une inhibition de l'ALI, induit dans un modèle murin par des injections successives de LPS et d'anticorps anti-CMH I.

Plutôt que l'activation cellulaire, c'est la migration des neutrophiles et des plaquettes sanguines, depuis le compartiment vasculaire jusqu'à l'espace alvéolaire qui a été ciblée. En effet, dans le compartiment sanguin, l'inflammation n'est pas limitée, sous traitement à base d'anticorps anti-CD40L neutralisant, mais l'activité des neutrophiles et des plaquettes au niveau pulmonaire est sensiblement réduite. L'inhibition du couple CD40/CD40L semble, au cours de cette étude, avoir également un impact sur les monocytes, paramètre qui mériterait une investigation plus approfondie. Cette étude met en avant un rôle trop longtemps sous-estimé du complexe protéique CD40/CD40L dans la physiopathologie du TRALI.

The CD40L/CD40 pathway is central in Acute Lung Injury physiopathology: evidence in an experimental mouse model of transfusion-related acute lung injury

Sofiane Tariket,^{1,2} Hind Hamzeh-Cognasse,¹ Charles-Antoine Arthaud,² Thomas Bourlet,¹ Philippe Berthelot,¹ Sandrine Laradi,^{1,2} Olivier Garraud,^{1,3} and Fabrice Cognasse^{1,2}

¹Université de Lyon, GIMAP-EA3064, Saint-Etienne, France; ²Établissement Français du Sang Auvergne-Rhône-Alpes, Saint-Etienne, France; ³Institut National de la Transfusion Sanguine, Paris, France

Address for correspondence and reprint requests:

Dr. F. Cognasse (PhD), Université de Lyon, GIMAP-EA3064, Faculté de Médecine, 10 rue de la Marandière - 42270 St Priest en Jarez France. Tel.: +33 4 77 42 14 67; Fax: +33 4 77 42 14 86; E-mail address: fabrice.cognasse@univ-st-etienne.fr

Short Title: Role for CD40/CD40L in immune acute lung injury

Text word count: 4153

Abstract word count: 213

References: 52

Figures: 6

Tables: 1

Abstract

Platelet transfusions can cause adverse reactions in their recipients, including transfusion-related acute lung injury (TRALI), a type of respiratory distress that occurs within 6 h of transfusion. The pathophysiology of TRALI depends on a number of signaling pathways and the role played by blood platelets remains controversial. Platelets are important in inflammation, particularly via the immunomodulator complex CD40/CD40L. Here, we studied the specific function of the CD40/CD40L complex in regulating an experimental ALI model that mimics TRALI. A mouse model of immune ALI was triggered by injection of LPS and an anti-MHC I antibody, and the effect of injection of a neutralizing anti-CD40L antibody before induction of ALI investigated. The characteristics of ALI were decreased body temperature, pulmonary lesions, and immune cell infiltration into the alveolar space. Pulmonary infiltration was evaluated by blood counts of specific immune cells and their detection in lung sections. Inhibition of the CD40/CD40L immunomodulator complex significantly reduced cellular communication and the development of pulmonary edema. Hence, our results indicate that targeting of the CD40/CD40L complex could be an important method to prevent ALI/TRALI. We conclude that improvement of the conditions under which platelet concentrates are prepared and stored would assist in control of the risk of TRALI and may provide the clinical safety and effectiveness of platelet transfusion.

Introduction

There are two main etiologies of respiratory distress in transfusion. The first is transfusion associated circulatory overload (TACO), which is characterized by hydrostatic pulmonary edema and increased left arterial pressure. Conversely, the development of permeability pulmonary edema, accompanied by hypotension, indicates transfusion related acute lung Injury (TRALI), including mild or atypical forms, referred to as possible-TRALI (pTRALI) [1]. The incidence of typical TRALI can be greatly reduced by the removal of plasma-rich blood components, which include anti-MHC class I or class II [2]. Moreover, the substitution of platelet concentrate (PC) plasma with platelet additive solution also led to a marked reduction in inflammatory complications in general, and TRALI in particular [3]. Nevertheless, cases of pTRALI and TRALI continue to be reported, since this pathology appears to be affected not only by the transfusion product, but also by patient characteristics [4].

A “two-hit” model has been proposed for the classical form of TRALI [5], whereby inflammatory conditions present in some transfused recipients strongly predispose them to the development of pathology, resulting in changes to the phenotypes of inflammatory cells, such as neutrophils, platelets, and endothelial cells [6, 7]; this is the priming event. The second hit results from transfusion of anti-leukocyte antibodies [8] and/or soluble mediators [9] present in blood. A mouse model was proposed, in 2009, to mimic the hypothesis of the “two-hit” pathophysiology of human TRALI [10]. This experimental TRALI is based on a first injection of LPS, to reproduce the priming step, followed by an intravenous injection of anti-MHC I mAb, to induce pulmonary edema.

CD40 is a membrane protein found on many immune and inflammatory cells, and CD40 ligand (CD40L) is also expressed on the surface of various immune cells [11]. Soluble CD40L (sCD40L) is an agonist of CD40L, 95% of which is secreted by platelets [12]; it is derived either from alternative mRNA splicing of *CD40L* or after cleavage of the CD40L protein by MMP2 [13]. The interaction between CD40 and CD40L is central to numerous innate and adaptive immune functions [14], and to many pathologies [15]; the CD40/CD40L complex is considered pro-inflammatory [13] and sCD40L appears to impact transfusion reactions and to accumulate with time in storage, particularly in PC [16-19].

Several factors justify interest in sCD40L in the context of TRALI. First, from a transfusion perspective, sCD40L levels correlate with PC storage time [20, 21]. Blumberg *et al.* demonstrated that transfusion, febrile, and allergic reactions were significantly correlated with high levels of sCD40L in PC [22]. Nevertheless, the role of the CD40/CD40L complex in TRALI is controversial. Some reports unequivocally indicate its involvement [23] while others deny such claims [24]. Second, this molecular complex, which is pivotal in both innate and adaptive immunity [13], is often implicated in

other forms of ALI, such as sepsis [25-28]. Such pathology depends on: (i) the formation of a cellular tri-complexes of neutrophils, endothelial cells, and platelets; (ii) transmigration of neutrophils and platelets into the alveolar space; and (iii) pulmonary complications [29]. Further, significant levels of sCD40L are observed in TRALI-implicated PCs and in the plasma of 67% of TRALI patients post-reaction [23]. Finally, in three animal models of ALI, induced by hyperventilation [30], radiation [31], or following endotoxemia [32], pathophysiology appeared to be CD40/CD40L dependent.

Given the severity of TRALI and the continued use of transfusions for severely affected patients, risk reduction strategies targeting key molecules, including serum sCD40L, represent a potential route to improvement of this condition. Here we investigated sCD40L as a therapeutic target in a mouse “two-hit” acute lung injury (ALI)/TRALI model. We identified a central role for CD40/CD40L in both intercellular communication and the migration of polymorphonuclear cells into the alveolar space, a phenomenon key to the induction of TRALI. Further, we demonstrate that inhibition of CD40/CD40L was effective in preventing pulmonary edema.

Materials and methods

Study approval

Animal use was by the authorization of the Ethics Committee of the French Ministry of Higher Education and Research (approval number: CU14N11).

Mice

Male BALB/c wild-type mice (8–12 weeks old) were purchased from Charles River (Charles River, Wilmington, USA). Experiments used ≥ 4 mice per group. Experimental groups were: PBS [baseline]; LPS [control]; LPS + Anti-MHC I mAb [ALI model]; LPS + Anti-MHC I mAb + neutralizing anti-CD40L mAb [treated mice]; and LPS + Anti-CD40L mAb [treatment control].

Animal experiments

Male H2K^d BALB/c mice were primed by intraperitoneal (*i.p.*) injection of lipopolysaccharide (LPS, 0.1 mg/kg, extracted from *Escherichia Coli* 0111; InvivoGen, San Diego, USA), 24 h before challenge with intravenous (*i.v.*) anti-MHC I monoclonal antibody (mAb 34-1-2s; 1 mg/kg; H2K^d; IgG2a, κ) or IgG2a, κ isotype control (eBM2a) (eBioscience, San Diego, USA). Mice in the treatment group were intravenously administered with 4 mg/kg anti-CD40L mAb (MR1) or IgG3, κ Isotype control (E36-239) (BD Pharmingen, Franklin Lakes, USA) 30 min prior to challenge with anti-MHC I mAb or isotype control (Figure S1). Ketamine (100 mg/kg) and xylazine (10 mg/kg) were administered when mice appeared moribund or after 2 h. After death, mouse lungs were collected and placed in 4% paraformaldehyde (Sigma Aldrich, Saint-Louis, USA) overnight.

TRALI development and edema evaluation

Mouse temperatures were measured using a rectal probe and digital thermometer (Bioseb, Pinellas Park, USA), prior to anti-MHC I injection and then every 10 min for 2 h, or until death. Mouse survival rates were evaluated for 2 h and at 48 h following treatment. First set of mice were used to calculate wet lung to body weight ratio. Other set of mice were used to obtain bronchial lavage fluid (BAL) through a tracheotomy with a 25-gauge catheter before the pneumonectomy. Lavage was conducted using a 1 ml injection of cold PBS flushed back three times. BAL cells were centrifuged at 491 g for 10 min and resuspended in PBS. BAL platelets were enumerated using an MS4™ Hematology Analyzer (Melet Schloesing Laboratoires, Osny, France). BAL total proteins were evaluated by Bradford assay. Peripheral-blood cell number and MPV were determined using the MS4™. Intracardiac puncture was conducted with a 25-gauge needle and anticoagulant citrate-dextrose solution (Sigma Aldrich, Saint-

Louis, USA). Tail vein injections used a 30-gauge needle. Plasma samples were collected and stored.

The BAL platelet ratio was calculated as follows: $\left(\frac{BAL_{platelets}}{BAL_{platelets} + Blood_{platelets}} \right) \times 100$

Lung sections

Lungs, for which no BAL has been performed, were embedded in OCT compound (CML, Nemours, France), placed over liquid nitrogen to induce rapid solidification. For hematoxylin and eosin (H&E) staining (Sigma-Aldrich, Saint Louis, USA), immunohistochemistry, and immunofluorescence, 8 μ m sections were prepared using a cryostat microtome (Leica Microsystem, Nanterre, France).

H&E staining and immunohistochemistry

Pulmonary cellular exudate area was evaluated through stereological assessment, as previously described [33], after H&E staining. For immunohistochemistry, endogenous peroxidase activity was blocked with 0.3% H₂O₂. Bovine serum albumin (BSA, 3%) (Sigma-Aldrich, Saint Louis, USA) was used to block nonspecific hybridization, sections were incubated for 1 h with anti-CD41 mAb (MWRReg30, 2.5 μ g/ml) or anti-Ly6G mAb (1A8, 5 μ g/ml; BD Biosciences, Franklin Lakes, USA). Sections were then incubated with biotinylated secondary anti-rat mAb (G15-337, 5 μ g/ml; BD Biosciences, Franklin Lakes, USA) for 30 min, followed by pre-diluted streptavidin and 3, 3'-Diaminobenzidine. Sections were counterstained by successive immersion in hematoxylin, alcohol (95%, 100%) and xylene (Sigma-Aldrich, Saint Louis, USA). Observations were made with a Nikon Eclipse Ti-S microscope, Nikon DS-R12 camera and Nikon NIS-Elements software (Nikon, Champigny sur Marne, France). Images were processed with Image J software [34].

Immunoassays

MPO and PF4 (Mouse Myeloperoxidase DuoSet ELISA and Mouse CXCL4/PF4 DuoSet ELISA, R&D Systems, Minneapolis, USA) were measured in plasma and BAL according to the manufacturer's instructions. Plasma IL-6, MIP-2 (Mouse IL-6 DuoSet ELISA and Mouse CXCL2/MIP-2 DuoSet ELISA R&D Systems, Minneapolis, USA), and sCD40L (Mouse TH17 Magnetic Bead Panel Multiplex Assay, Merck Millipore, Billerica, USA) were measured according to manufacturer's instructions. NETs were evaluated in mouse plasma by ELISA as previously described [35]. Values for soluble NET formation are expressed as percentage increase in absorbance above control, calculated as follows:

$$\left(\frac{(OD_x - OD_{blank})}{OD_{blank}} \right) \times 100$$

Neutrophil-platelet aggregate (NPA) assay

Immediately following whole blood collection, flow cytometry was used to evaluate NPA formation. PE-anti-CD45 mAb (30-F11) and APC-anti-Ly6G mAb (1A8) (BD Biosciences, Franklin Lakes, USA) were used to identify neutrophils. FITC-anti-CD41 mAb (MWRReg30) was used to identify platelets among the CD45/Ly6G neutrophil population; a positive FITC signal in this population was considered to indicate NPA. Analysis was performed using FACSCANTO II (BD Biosciences, Franklin Lakes, USA) and FlowJo™ software (FlowJo, Ashland, USA).

Phenotypic characterization of neutrophils

Neutrophils were identified in whole blood using PE-anti-CD45 mAb (30-F11) and APC-anti-Ly-6G mAb (1A8). Neutrophil surface Mac-1 (CD18) and CD40 were identified with FITC-anti-CD18 mAb (M18/2) and Pacific Blue™-anti-CD40 mAb (3/23) (BioLegend, San Diego, USA). Flow cytometry and software analysis were as described above.

Immunofluorescence assays

Pulmonary-interstitial co-localization of platelets and neutrophils was by direct immunofluorescence. Pulmonary sections were blocked with 10% BSA and incubated with anti-CD41 mAb (MWRReg30, 1 µg/ml; Abcam, Cambridge, USA) and anti-Ly6G mAb (1A8, 5 µg/ml) simultaneously for 1 h in a humidified chamber. Next, secondary Alexa fluor™ 488-anti-rabbit mAb (2 µg/ml) and Cy5™-anti-rat mAb (5 µg/ml; Abcam, Cambridge, USA) were added for 1 h. Nuclei were stained with 4', 6-diamidino-2-phenylindole (DAPI). Images and overlay were treated with Image J software [34].

Statistical analyses

Statistical analyses were performed using GraphPad Prism 5 software (Graph ad, San Diego, USA). Unpaired Student's t-tests were used for comparisons between two groups if the data were normally distributed (as determined by Kolmogorov-Smirnov test), with Mann Whitney tests applied for non-normally distributed data. ANOVA with post-hoc Bonferroni correction was used for comparisons among more than two groups of data with normal distribution, with the Kruskal-Wallis and Dunn's post-hoc tests applied for comparisons among non-normally distributed data. Temperature and mouse ALI scores over 48 h were calculated using two-way analysis of variance. Correlations were by Spearman's test. P-values < 0.05 were considered significant.

Results

Anti-CD40L monoclonal antibody prevented pulmonary edema in the TRALI mouse model

Injection of anti-MHC I (H2k^d) mAb in Balb/c mice, conditioned by prior (24 h) LPS injection, resulted in mortality of 60% of animals within 2 h. LPS injection alone had no effect on mortality at 2 h. Treatment with anti-CD40L neutralizing antibody 30 min prior to anti-MHC I injection completely prevented mortality at 2 h (Figure 1A). Mice in the [LPS + anti-MHC I] group, which mimicked TRALI, were hypothermic, with rectal temperatures approximately 8°C below those of both [PBS] and [LPS] control group mice. Injection of anti-CD40L neutralizing antibody, 30 min before anti-MHC I antibody, maintained normothermia. The mean temperature reduction in [LPS + anti-MHC I + anti-CD40L] mice was $\leq -3^{\circ}\text{C}$ between 20–50 min, and in the last hour the difference was $< -2^{\circ}\text{C}$ and not significantly different from controls (Figure 1B). Transfusion ALIs, particularly ALI lesions, are characterized by pulmonary edema. Pulmonary edema was more pronounced in the [LPS + anti-MHC I] group than in [LPS] control group. The injection of anti-MHC I after priming with LPS induced a dramatic deterioration of the lungs, as visualized by their violet color and moist appearance, suggestive of pulmonary infiltration (Figure 1C). In contrast, the general appearance of the lungs in [LPS + anti-MHC I + anti-CD40L] mice was equivalent to that of [LPS] controls (Figure 1C). Significant increases were observed in wet lung mass/body mass ratio and total protein in bronchoalveolar lavage (BAL) in [LPS + anti-MHC I] mice compared with [LPS] controls ($p < 0.001$), while treatment with intravenous anti-CD40L significantly reduced these two parameters (Figure 1D–E). H&E staining of the pulmonary interstitium revealed pulmonary infiltration, evidenced by pulmonary cellular exudate, in [LPS + anti-MHC I] mice, while the pulmonary parenchyma of [LPS] controls and [LPS + anti-MHC I + anti-CD40L] treated mice showed no evidence of infiltration (Figure 1F; quantified in Figure 1G). These results suggest that prophylactic injection of anti-CD40L neutralizing antibodies could prevent pulmonary edema triggered by treatment with LPS and anti-MHC I and consequently the development of ALI in this model of TRALI.

Anti-CD40L reduces lung infiltration by circulating leukocytes and platelets

Levels of circulating platelets were slightly reduced after LPS injection, and subsequent anti-MHC I injection significantly exacerbated this thrombocytopenia ($p < 0.001$). Administration of anti-CD40L prior to anti-MHC I injection significantly limited the severity of the thrombocytopenia ($p < 0.05$), although platelet levels remained significantly lower compared with untreated controls ($p < 0.001$) (Figure 2A). LPS injection alone produced a modest increase in platelets in BAL. After anti-MHC I lesional induction, the BAL platelet level increased by approximately 2.6 times on average as compared to the [LPS] control group. Prior Injection of anti-CD40L, significantly reduced the platelet

infiltrate ($p < 0.01$) (Figure 2B). Circulating levels of leukocytes, particularly neutrophils, increased significantly following LPS injection ($p < 0.05$), and subsequent treatment with anti-MHC I normalized the number of neutrophils; moreover, injection of anti-CD40L did not alter baseline neutrophil levels observed in ALI mice. LPS injection induced a significant elevation in monocytes ($p < 0.05$), which was maintained following injection of anti-MHC I antibodies ($p < 0.01$); however, levels decreased on injection with the anti-CD40L antibody, returning to basal levels (PBS control) (Figure 2C).

In parallel, examination of the pulmonary parenchyma showed a greater infiltration of platelets and neutrophils in [LPS] mice than in the [PBS] control group. The addition of anti-MHC I amplified the infiltration whereas the injection of anti-CD40L [LPS + anti-MHC I + anti-CD40L] decreased and normalized levels of platelets (Figure 2D) and neutrophils (Figure 2E). Platelet proportion in BAL samples, considered partly migratory, were increased in [LPS + anti-MHC I] mice compared with [LPS] control and [LPS + anti-MHC I + anti-CD40L] treated groups, and were significantly higher in [LPS + anti-MHC I + anti-CD40L] group (41.34%) compared with [LPS] mice (17.74%) ($p < 0.001$) (Figure 2F). Blood platelet numbers were significantly and negatively correlated with BAL platelet levels ($p < 0.0001$ and Pearson $r = -0.6339$) (Figure 2G). Hence, injection of anti-CD40L antibody considerably affected platelet and leukocyte levels in the pulmonary parenchyma, possibly because of cellular migration/relocation coupled with pulmonary thrombopoiesis [36].

Anti-CD40L antibody limits neutrophil and platelet activation induced by LPS and anti-MHC I antibody to a limited extent in blood and sustainably in lungs

The levels of activated neutrophils and platelets were evaluated by measuring myeloperoxidase (MPO) [37] and platelet factor-4 (PF4) [38], respectively. Concentrations of MPO (Figure 3A) and PF4 (Figure 3B) were considerably increased in [LPS + anti-MHC I] mice compared with [LPS] controls in both plasma and BAL. Anti-CD40L reduced levels of PF4 in the blood and of PF4 and MPO in BAL, 1.9-, 33-, and 3.5-fold, respectively (Figure 3A–B). Mean platelet volume (MPV), a characteristic of platelet activation [39], was evaluated to assess the pathophysiological involvement of platelets in ALI. An increase in MPV in [LPS + anti-MHC I] versus [LPS] mice was observed in blood, but not BAL, where basal MPV was high. Anti-CD40L antibodies neutralized MPV increases in the blood, with levels equivalent to those observed after treatment with LPS alone; however, anti-CD40L antibody treatment also led to a further increase in MPV in the lungs compared with [LPS + anti-MHC I] mice (Figure 3C). To confirm BAL platelet activation in [LPS + anti-MHC I] mice, the concentration of thromboxane B₂ (TxB₂) was measured. The levels of TxB₂ in [LPS + anti-MHC I] mice were elevated compared with both control [LPS] and [LPS + anti-MHC I + anti-CD40L] mice (Figure 3D), consistent with the results of PF4 assessment (Figure 3B). TxB₂ was only measured in BAL, because the sampling

method precluded its measurement in blood. Hence, our results indicate that platelet activation is reduced by anti-CD40L, in both blood and lungs. In contrast, neutrophil activation was apparently irreversible in the blood, despite the inhibition of the CD40/CD40L immune complex (sCD40L).

Effect of anti-CD40L on levels of NPA in blood and lung: importance of Mac-1

Levels of NPA formation were evaluated in this model of ALI, since their presence is a pathogenic risk factor for both sepsis and ALI [40]. After LPS injection, levels of NPA relative to the neutrophil population were 3%, and injection of anti-MHC I [LPS + anti-MHC I] and anti-CD40L [LPS + anti-MHC I + anti-CD40L] antibodies led to significant decreases ($p < 0.001$), to approximately 35% and 11%, respectively. Furthermore, NPA level was significantly reduced in neutralizing anti-CD40L treated mice compared to anti-MHC I induced ALI mice ($p < 0.01$) (Figure 4A). Neutrophil extracellular traps (NETs), comprised of platelets and neutrophils [35], were also evaluated. NETosis is particularly increased in the presence of gram-negative bacteria or LPS [41]. NETs were considerably reduced in blood from [LPS + anti-MHC I + anti-CD40L] compared with [LPS + anti-MHC I] mice (Figure 4B). Moreover, levels of neutrophil surface Macrophage-1 antigen (Mac-1) and CD40 were examined following treatment with anti-CD40L antibody. The mean fluorescence index (MFI) for Mac-1 differed considerably among groups and was 1.4 and 2 times higher in [LPS + anti-MHC I] mice compared with [LPS] and [LPS + anti-MHC I + antiCD40L] mice, respectively. Similarly, levels of CD40 were significantly higher in [LPS + anti-MHC I] mice ($p < 0.05$) (Figure 4C). A positive and significant correlation was observed between Mac-1 and CD40 expression (Pearson $r = 0.7463$ and $p = 0.0002$; Figure 4D). Immunofluorescence detection of platelets (CD41) and neutrophils (Ly6G) indicated higher levels of their co-localization in the interstitium in [LPS + anti-MHC I] compared with [LPS] and [LPS + anti-MHC I + anti-CD40L] mice (Figure 4E). These observations were consistent with the observed reduction in platelet and neutrophil infiltration following treatment with anti-CD40L antibodies (Figure 2D–E).

The pulmonary inflammation created by LPS and anti-MHC I injection resolves after 48 h, following parenteral injection of anti-CD40L

In this model of ALI, local/regional inflammation was evaluated by measurement of IL-6 and macrophage inflammatory protein 2 (MIP-2) in plasma from the different groups of mice. Both IL-6 and MIP-2 increased by approximately 2- and 3-fold, respectively, compared with controls after LPS and anti-MHC I administration and injection of anti-CD40L did not influence their levels (Figure 5A–B; Table 1). sCD40L levels in plasma were altered by injection of anti-CD40L in [LPS +anti-MHC I] mice (Figure 5C; Table 1). Inflammation was evaluated 48 h after challenge with anti-MHC I in [LPS + anti-MHC I + anti-CD40L] mice, in comparison with 'baseline' mice (injected with PBS). The aim was to

evaluate whether recovery could be considered complete, *i.e.* equivalent to the basal levels measured in mice that have never undergone an inflammatory stimulus. [LPS + anti-MHC I] mice were not included in this experiment because they were too affected and sacrificed in agreement with the ethic committee (approval number: CU14N11). At 48 h follow-up, [LPS + anti-MHC I + anti-CD40L] mice all survived (Figure S6), whereas only 40% of [LPS + anti-MHCI] mice survived after 2 h (Figure 1A). In [LPS + anti-MHC I + anti-CD40L] mice, platelet (Figure 6A), total leukocyte (Figure 6C), and monocyte (Figure 6E) counts returned to baseline after 48 h in blood, as did the platelet count in BAL (Figure 6B). The difference in neutrophil counts persisted, with significantly fewer circulating neutrophils relative to [PBS] mice ($p < 0.01$) (Figure 6D). Using these same mice, we re-evaluated levels of IL-6, MIP-2, and MPO. Despite a two-fold increase in MPO levels in [LPS + anti-MHC I + anti-CD40L] compared with [PBS] mice at 48 h, the increases in these three cytokines tended to recede after 2 h (Figure 6F–H). In conclusion, in the short term anti-CD40L antibody did not appear to resolve the inflammation induced by anti-MHC I antibody; however, 48 h after anti-MHC I antibody injection, inhibition of CD40/CD40L complex formation appeared to almost completely resolve the consequences of anti-MHC I antibody administration.

Discussion

The incidence of immune post-transfusional, particularly lesional, respiratory distress has decreased because of improved selection of donors and donations; however, the increase occurrence of non-immune TRALI after transfusions of blood components [42], which contains few pathogenic mediators, highlights the need to better understand ALIs. Moreover, lesional edema and overload take various forms, particularly in patients subject to critical (intensive) care protocols. For improved management of these patients, a better model of lesion pathophysiology is required.

To develop a preventive treatment for TRALI, we used a mouse model to determine the role of the CD40/CD40L complex in ALI/TRALI pathophysiology. Anti-CD40L reduced pulmonary edema (Figures 1), platelet activation in blood and infiltrated tissues (Figure 3B–D), cellular pulmonary relocation (Figure 2D–E, 4E) and neutrophil activity in the lungs (Figure 3A). Anti-CD40L also appeared to limit intercellular communication, particularly between neutrophils and platelets, evidenced by decreases in NPA formation and NETs (Figure 4A–B), which correlated with low Mac-1 expression on neutrophils (Figure 4C). Follow-up of treated mice showed almost complete recovery following CD40/CD40L inhibition (Figure 6). The main limitation of this treatment was that inflammation wasn't prevented following the injection of anti-CD40L (Figures 2A–C, 5).

Our data suggest a protective role of neutralizing anti-CD40L mAb to prevent pulmonary edema formation. These findings do not accord with previous observation investigating the influence of CD40/CD40L complex in a “one-hit” mouse model of TRALI. Treatments with ciglitazone and neutralizing anti-CD40L do not prevent TRALI development in mice [24]. Nevertheless, the used mouse model was different than the one used in our study, considered as the reference mouse model of TRALI [10]. Effectively, the used mouse model consisted to a “one-hit” model of TRALI with a single anti-MHC I injection at 4.5 mg/kg, whereas we used a “two-hit” mouse model more representative of the recognized “two-hit” hypothesis of human TRALI [8]. This difference may explain the absence of protection against the development of TRALI observed in our study during the inhibition of the CD40/CD40L interaction.

Our data suggest that anti-CD40L mAb inhibits neutrophil migration, rather than activating or regulating inflammation in ALI/TRALI in mice. These results are consistent with reports demonstrating the direct impact of antibodies on CD40/CD40L complex inhibition, via Mac-1 on the neutrophil surface [28, 43, 44]. Mac-1 is directly involved in neutrophil migration [45], cellular interactions between neutrophils and platelets via the Mac-1/GPIb α complex [46], and communication between neutrophils and endothelial cells [44, 45]. The interaction between platelets and neutrophils may be responsible for amplified platelet sCD40L production, promoting complex

formation [47]. Platelet-secreted sCD40L induces chemokine release by endothelial cells, promoting neutrophil attachment and migration in the alveolar space, conditioned by TRALI [48]. sCD40L also influences platelet activation and migration into the alveolar space. Since platelets are an important source of sCD40L and CD40 membrane protein [12], autocrine and paracrine positive feedback would be expected to amplify platelet and (indirectly) neutrophil transmigration, during TRALI onset. Indeed, the involvement of platelets in TRALI has previously been postulated [10, 49]. Neutrophil migration from the blood to the lungs may be dependent on platelet activation, since the close communication between these two cell types enhances neutrophil migration [35, 50]. Notably, the lungs are a significant source of thrombopoiesis in mice, similar to the bone marrow [36]. The changes in BAL platelet levels observed in this study are consistent with both ALI/TRALI-related platelet and neutrophil migration and compensatory pulmonary thrombopoiesis due to ALI-induced thrombocytopenia. In support of this hypothesis, MPV, a platelet activation marker [39], decreased in BAL of mice injected with anti-MHC I (Figure 3C). This may be due to high levels of pulmonary production of new platelets, which would be less likely to be activated and, therefore, lower in volume (Figure S4).

The main limitations of this study are: lack of direct visualization of platelet and neutrophil relocation from the vasculature to the lung parenchyma; lack of direct measurement of communication between neutrophils and endothelial cells, a key parameter in the extravasation of neutrophils to the alveolar space [45]; and lack of distinction between platelets recruited from the periphery and those produced locally, in the lungs. Our study did not explore monocytes in depth, only their numbers; although a previous study demonstrated that 34-1-2s anti-MHC I antibody can directly activate this cell type [51]. ALI, and TRALI in particular, likely involves various cell types in addition to neutrophils. Our study shows a regulation of neutrophil and platelet activity under neutralizing anti-CD40L mAb, but this treatment may also prevent other inflammatory cell activity participating in TRALI development. Indeed, several studies mentioned other cells, with the capacity to expose CD40 and/or CD40L on their surface, implicated in some experimental TRALI pathophysiology, like dendritic cells [37], T regulatory lymphocytes [37], pulmonary macrophages [52] and monocytes [51].

Our data address the reversibility of several events that are considered characteristic of ALI and TRALI during lesion development (second hit); however, we anticipate that better understanding of patient risk factors and the first-hit of TRALI could suggest prophylactic and curative treatments. Identification of patients at risk for ALI will enable preemptive personalized treatments, facilitating both improved patient management and cost reduction. Overall, our data indicate that improvement of the conditions under which platelet concentrates are prepared and stored to reduce sCD40L levels could help to control of the risk of TRALI.

Author contributions

ST, FC and OG devised the study hypothesis and wrote the manuscript. ST and FC designed the protocol and trained personnel. ST and CAA collected samples, performed the experiments and statistical analyses. SL and HHC participated in all steps of the process and reviewed the manuscript.

Conflicts of Interest

None of the authors declare any conflicts of interest.

Acknowledgments

We are grateful to MA Eyraud and Astrid Meneveaux for their contributions to the original data. We would also like to thank the facility technical staff of the University of Saint-Etienne PLEXAN. This work was supported by grants from the French Blood Establishment (Grant APR), France; the Agence Nationale de la Sécurité et du Médicament et des Produits de Santé (ANSM - AAP-2012-011, Reference 2012S055); the Academic Research Community-1 of the Auvergne-Rhône-Alpes Region; the French “Agence Nationale de la Recherche” (ANR-12-JSV1-0012-01); and the Association “Les Amis de Rémi” Savigneux, France.

References

1. Roubinian NH, Looney MR, Keating S, Kor DJ, Lowell CA, Gajic O, Hubmayr R, Gropper M, Koenigsberg M, Wilson GA et al: **Differentiating pulmonary transfusion reactions using recipient and transfusion factors**. *Transfusion* 2017.
2. P'Ng S S, Hughes AS, Cooney JP: **A case report of transfusion-related acute lung injury during plasma exchange therapy for thrombotic thrombocytopenia purpura**. *Therapeutic apheresis and dialysis : official peer-reviewed journal of the International Society for Apheresis, the Japanese Society for Apheresis, the Japanese Society for Dialysis Therapy* 2008, **12**(1):78-81.
3. Dunbar NM: **Current options for transfusion-related acute lung injury risk mitigation in platelet transfusions**. *Current opinion in hematology* 2015, **22**(6):554-558.
4. Vlaar AP, Juffermans NP: **Transfusion-related acute lung injury: a clinical review**. *Lancet* 2013, **382**(9896):984-994.
5. Silliman CC: **The two-event model of transfusion-related acute lung injury**. *Critical care medicine* 2006, **34**(5 Suppl):S124-131.
6. Middelburg RA, van der Bom JG: **Transfusion-related acute lung injury not a two-hit, but a multicausal model**. *Transfusion* 2014.
7. Doerschuk CM: **Mechanisms of leukocyte sequestration in inflamed lungs**. *Microcirculation* 2001, **8**(2):71-88.
8. Peters AL, Van Stein D, Vlaar AP: **Antibody-mediated transfusion-related acute lung injury; from discovery to prevention**. *British journal of haematology* 2015.
9. West FB, Silliman CC: **Transfusion-related acute lung injury: advances in understanding the role of proinflammatory mediators in its genesis**. *Expert review of hematology* 2013, **6**(3):265-276.
10. Looney MR, Nguyen JX, Hu Y, Van Ziffle JA, Lowell CA, Matthay MA: **Platelet depletion and aspirin treatment protect mice in a two-event model of transfusion-related acute lung injury**. *The Journal of clinical investigation* 2009, **119**(11):3450-3461.
11. van Kooten C, Banchereau J: **CD40-CD40 ligand**. *Journal of leukocyte biology* 2000, **67**(1):2-17.
12. Andre P, Nannizzi-Alaimo L, Prasad SK, Phillips DR: **Platelet-derived CD40L: the switch-hitting player of cardiovascular disease**. *Circulation* 2002, **106**(8):896-899.
13. Aloui C, Prigent A, Sut C, Tariket S, Hamzeh-Cognasse H, Pozzetto B, Richard Y, Cognasse F, Laradi S, Garraud O: **The signaling role of CD40 ligand in platelet biology and in platelet component transfusion**. *International journal of molecular sciences* 2014, **15**(12):22342-22364.
14. Elgueta R, Benson MJ, de Vries VC, Wasiuk A, Guo Y, Noelle RJ: **Molecular mechanism and function of CD40/CD40L engagement in the immune system**. *Immunological reviews* 2009, **229**(1):152-172.
15. Zhang B, Wu T, Chen M, Zhou Y, Yi D, Guo R: **The CD40/CD40L system: a new therapeutic target for disease**. *Immunology letters* 2013, **153**(1-2):58-61.
16. Tariket S, Sut C, Hamzeh-Cognasse H, Laradi S, Pozzetto B, Garraud O, Cognasse F: **Transfusion-related acute lung injury: transfusion, platelets and biological response modifiers**. *Expert review of hematology* 2016:1-12.
17. Hamzeh-Cognasse H, Damien P, Nguyen KA, Arthaud CA, Eyraud MA, Chavarin P, Absi L, Osselaer JC, Pozzetto B, Cognasse F et al: **Immune-reactive soluble OX40 ligand, soluble CD40 ligand, and interleukin-27 are simultaneously oversecreted in platelet components associated with acute transfusion reactions**. *Transfusion* 2014, **54**(3):613-625.
18. Cognasse F, Payrat JM, Corash L, Osselaer JC, Garraud O: **Platelet components associated with acute transfusion reactions: the role of platelet-derived soluble CD40 ligand**. *Blood* 2008, **112**(12):4779-4780; author reply 4780-4771.

19. Sahler J, Spinelli S, Phipps R, Blumberg N: **CD40 ligand (CD154) involvement in platelet transfusion reactions**. *Transfusion clinique et biologique : journal de la Societe francaise de transfusion sanguine* 2012, **19**(3):98-103.
20. Cognasse F, Boussoulade F, Chavarin P, Acquart S, Fabrigli P, Lamy B, Garraud O: **Release of potential immunomodulatory factors during platelet storage**. *Transfusion* 2006, **46**(7):1184-1189.
21. Kaufman J, Spinelli SL, Schultz E, Blumberg N, Phipps RP: **Release of biologically active CD154 during collection and storage of platelet concentrates prepared for transfusion**. *Journal of thrombosis and haemostasis : JTH* 2007, **5**(4):788-796.
22. Blumberg N, Gettings KF, Turner C, Heal JM, Phipps RP: **An association of soluble CD40 ligand (CD154) with adverse reactions to platelet transfusions**. *Transfusion* 2006, **46**(10):1813-1821.
23. Khan SY, Kelher MR, Heal JM, Blumberg N, Boshkov LK, Phipps R, Gettings KF, McLaughlin NJ, Silliman CC: **Soluble CD40 ligand accumulates in stored blood components, primes neutrophils through CD40, and is a potential cofactor in the development of transfusion-related acute lung injury**. *Blood* 2006, **108**(7):2455-2462.
24. Tuinman PR, Gerards MC, Jongsma G, Vlaar AP, Boon L, Juffermans NP: **Lack of evidence of CD40 ligand involvement in transfusion-related acute lung injury**. *Clinical and experimental immunology* 2011, **165**(2):278-284.
25. Lorente L, Martin MM, Varo N, Borreguero-Leon JM, Sole-Violan J, Blanquer J, Labarta L, Diaz C, Jimenez A, Pastor E et al: **Association between serum soluble CD40 ligand levels and mortality in patients with severe sepsis**. *Critical care* 2011, **15**(2):R97.
26. Tuinman PR, Juffermans NP: **Soluble CD40 ligand, a mediator of sepsis or of transfusion-related adverse effects?** *Critical care* 2011, **15**(3):429; author reply 429.
27. Rahman M, Roller J, Zhang S, Syk I, Menger MD, Jeppsson B, Thorlacius H: **Metalloproteinases regulate CD40L shedding from platelets and pulmonary recruitment of neutrophils in abdominal sepsis**. *Inflammation research : official journal of the European Histamine Research Society [et al]* 2012, **61**(6):571-579.
28. Rahman M, Zhang S, Chew M, Ersson A, Jeppsson B, Thorlacius H: **Platelet-derived CD40L (CD154) mediates neutrophil upregulation of Mac-1 and recruitment in septic lung injury**. *Annals of surgery* 2009, **250**(5):783-790.
29. de Stoppelaar SF, van 't Veer C, van der Poll T: **The role of platelets in sepsis**. *Thrombosis and haemostasis* 2014, **112**(4):666-677.
30. Adawi A, Zhang Y, Baggs R, Finkelstein J, Phipps RP: **Disruption of the CD40-CD40 ligand system prevents an oxygen-induced respiratory distress syndrome**. *The American journal of pathology* 1998, **152**(3):651-657.
31. Adawi A, Zhang Y, Baggs R, Rubin P, Williams J, Finkelstein J, Phipps RP: **Blockade of CD40-CD40 ligand interactions protects against radiation-induced pulmonary inflammation and fibrosis**. *Clinical immunology and immunopathology* 1998, **89**(3):222-230.
32. Hashimoto N, Kawabe T, Imaizumi K, Hara T, Okamoto M, Kojima K, Shimokata K, Hasegawa Y: **CD40 plays a crucial role in lipopolysaccharide-induced acute lung injury**. *American journal of respiratory cell and molecular biology* 2004, **30**(6):808-815.
33. Vasilescu DM, Klinge C, Knudsen L, Yin L, Wang G, Weibel ER, Ochs M, Hoffman EA: **Stereological assessment of mouse lung parenchyma via nondestructive, multiscale micro-CT imaging validated by light microscopic histology**. *Journal of applied physiology* 2013, **114**(6):716-724.
34. Schneider CA, Rasband WS, Eliceiri KW: **NIH Image to ImageJ: 25 years of image analysis**. *Nature methods* 2012, **9**(7):671-675.
35. Caudrillier A, Kessenbrock K, Gilliss BM, Nguyen JX, Marques MB, Monestier M, Toy P, Werb Z, Looney MR: **Platelets induce neutrophil extracellular traps in transfusion-related acute lung injury**. *The Journal of clinical investigation* 2012, **122**(7):2661-2671.

36. Lefrancais E, Ortiz-Munoz G, Cadrillier A, Mallavia B, Liu F, Sayah DM, Thornton EE, Headley MB, David T, Coughlin SR et al: **The lung is a site of platelet biogenesis and a reservoir for haematopoietic progenitors.** *Nature* 2017, **544**(7648):105-109.
37. Kapur R, Kim M, Aslam R, McVey MJ, Tabuchi A, Luo A, Liu J, Li Y, Shanmugabhavanathan S, Speck ER et al: **T regulatory cells and dendritic cells protect against transfusion-related acute lung injury via IL-10.** *Blood* 2017, **129**(18):2557-2569.
38. de Stoppelaar SF, van 't Veer C, Claushuis TA, Albersen BJ, Roelofs JJ, van der Poll T: **Thrombocytopenia impairs host defense in gram-negative pneumonia-derived sepsis in mice.** *Blood* 2014, **124**(25):3781-3790.
39. Park Y, Schoene N, Harris W: **Mean platelet volume as an indicator of platelet activation: methodological issues.** *Platelets* 2002, **13**(5-6):301-306.
40. Wang X, Qin W, Sun B: **New strategy for sepsis: Targeting a key role of platelet-neutrophil interaction.** *Burns & trauma* 2014, **2**(3):114-120.
41. Garraud O, Hamzeh-Cognasse H, Pozzetto B, Cavaillon JM, Cognasse F: **Bench-to-bedside review: Platelets and active immune functions - new clues for immunopathology?** *Critical care* 2013, **17**(4):236.
42. Andreu G, Boudjedir K, Muller JY, Pouchol E, Ozier Y, Fevre G, Gautreau C, Quaranta JF, Drouet C, Rieux C et al: **Analysis of Transfusion-Related Acute Lung Injury and Possible Transfusion-Related Acute Lung Injury Reported to the French Hemovigilance Network From 2007 to 2013.** *Transfusion medicine reviews* 2017.
43. Jin R, Yu S, Song Z, Zhu X, Wang C, Yan J, Wu F, Nanda A, Granger DN, Li G: **Soluble CD40 ligand stimulates CD40-dependent activation of the beta2 integrin Mac-1 and protein kinase C zeta (PKCzeta) in neutrophils: implications for neutrophil-platelet interactions and neutrophil oxidative burst.** *PloS one* 2013, **8**(6):e64631.
44. Li G, Sanders JM, Bevard MH, Sun Z, Chumley JW, Galkina EV, Ley K, Sarembock IJ: **CD40 ligand promotes Mac-1 expression, leukocyte recruitment, and neointima formation after vascular injury.** *The American journal of pathology* 2008, **172**(4):1141-1152.
45. Zuchtriegel G, Uhl B, Pühr-Westerheide D, Pornbacher M, Lauber K, Krombach F, Reichel CA: **Platelets Guide Leukocytes to Their Sites of Extravasation.** *PLoS biology* 2016, **14**(5):e1002459.
46. Andrews RK, Berndt MC: **Microparticles facilitate neutrophil/platelet crosstalk.** *Blood* 2008, **112**(6):2174-2175.
47. Vanichakarn P, Blair P, Wu C, Freedman JE, Chakrabarti S: **Neutrophil CD40 enhances platelet-mediated inflammation.** *Thrombosis research* 2008, **122**(3):346-358.
48. Henn V, Slupsky JR, Grafe M, Anagnostopoulos I, Forster R, Muller-Berghaus G, Kroczeck RA: **CD40 ligand on activated platelets triggers an inflammatory reaction of endothelial cells.** *Nature* 1998, **391**(6667):591-594.
49. Ortiz-Munoz G, Mallavia B, Bins A, Headley M, Krummel MF, Looney MR: **Aspirin-triggered 15-epi-lipoxin A4 regulates neutrophil-platelet aggregation and attenuates acute lung injury in mice.** *Blood* 2014, **124**(17):2625-2634.
50. Cadrillier A, Looney MR: **Platelet-neutrophil interactions as a target for prevention and treatment of transfusion-related acute lung injury.** *Current pharmaceutical design* 2012, **18**(22):3260-3266.
51. McKenzie CG, Kim M, Singh TK, Milev Y, Freedman J, Semple JW: **Peripheral blood monocyte-derived chemokine blockade prevents murine transfusion-related acute lung injury (TRALI).** *Blood* 2014, **123**(22):3496-3503.
52. Strait RT, Hicks W, Barasa N, Mahler A, Khodoun M, Kohl J, Stringer K, Witte D, Van Rooijen N, Susskind BM et al: **MHC class I-specific antibody binding to nonhematopoietic cells drives complement activation to induce transfusion-related acute lung injury in mice.** *The Journal of experimental medicine* 2011, **208**(12):2525-2544.

Table 1. Inflammatory cytokine levels in treated and untreated TRALI mouse models and controls

IL-6, MIP-2, and sCD40L levels were determined in plasma by ELISA for each group of mice. Data are presented as means \pm SEM (n = 4–10). **p < 0.01 and ***p < 0.001 indicate significant differences compared with the [LPS] group. ###p < 0.001 indicates a significant difference compared with the [LPS + anti-MHC I + anti-CD40L] group.

Experimental group	Plasma IL-6 (pg/ml)	Plasma MIP-2 (pg/ml)	Plasma sCD40L (pg/ml)
PBS	22.92 \pm 0.38	29.64 \pm 0.49	144.38 \pm 0.72
LPS	26.80 \pm 1.72	32.00 \pm 1.81	162.95 \pm 1.03
LPS + Anti-MHC I	58.26 \pm 9.43***	97.25 \pm 22.48**	365.03 \pm 2.15***###
LPS + Anti-MHC I + Anti-CD40L	47.58 \pm 5.52**	91.75 \pm 23.86**	223.75 \pm 5.82
LPS + Anti-CD40L	28.71 \pm 1.717	36.43 \pm 2.59	157.10 \pm 1.60

Figure Legends

Figure 1. Evaluation of ALI development. Survival curves (A) and rectal temperatures (B) were measured for each experimental group. The general appearance of the lungs (C) is represented for each group of mice. Wet lung to body weight ratio (D) and BAL total protein concentration (E) were measured for each group of mice. Lung microarchitecture is presented after H&E staining (F) for each group of mice (Original magnification x400). Scale bar, 50 μ m. Pulmonary cellular exudate area was measured in ratio to the microscopic field (G). Data are presented as means \pm SEM (n = 4–10). *p < 0.05, **p < 0.01, and ***p < 0.001 indicate differences between the [LPS] and [LPS + anti-MHC I] groups; †p < 0.05, ††p < 0.01, and †††p < 0.001 indicate differences between the [LPS] and [LPS + anti-MHC I + anti-CD40L] groups; and #p < 0.05, ##p < 0.01, and ###p < 0.001 indicate differences between the [LPS + anti-MHC I] and [LPS + anti-MHC I + anti-CD40L] groups.

Figure 2. Evaluation of cell migration. Numbers of platelets in peripheral blood (A) and BAL (B), and of leukocytes, neutrophils, and monocytes in peripheral blood (C) were measured for each group of mice. Immunohistochemistry staining characteristic of platelet (CD41) (D) and neutrophil (Ly6G) (E) infiltration in the lungs are presented for each mouse group (Original magnification x400). Scale bar, 50 μ m. Blood and BAL platelet proportions are presented for each group of mice (F). Data are presented as means (n = 4–10). §p < 0.05, §§p < 0.01, and §§§p < 0.001 indicate differences between the [PBS] and [LPS] groups; *p < 0.05, **p < 0.01, and ***p < 0.001 indicate differences between the [LPS] and [LPS + anti-MHC I] groups; †p < 0.05, ††p < 0.01, and †††p < 0.001 indicate differences between the [LPS] and [LPS + anti-MHC I + anti-CD40L] groups; and #p < 0.05, ##p < 0.01, and ###p < 0.001 indicate differences between the [LPS + anti-MHC I] and [LPS + anti-MHC I + anti-CD40L] groups.. Correlation between blood and BAL platelet levels (G) was evaluated for all mice (n = 38). Spearman's correlation and the coefficient of determination are represented by r and r², respectively, and p < 0.05 was considered statistically significant.

Figure 3. Evaluation of neutrophil and platelet activation. Quantification of MPO (A) and PF4 (B) in both plasma and BAL. MPV, in whole blood and BAL (C), was determined by MS4® analysis for each group of mice. TxB₂ in BAL (D) was evaluated by ELISA for each group of mice. Data are presented as means \pm SEM (n = 4–10). *p < 0.05, **p < 0.01, and ***p < 0.001 indicate differences between the [LPS] and [LPS + anti-MHC I] groups; †p < 0.05, ††p < 0.01, and †††p < 0.001 indicate differences between the [LPS] and [LPS + anti-MHC I + anti-CD40L] groups; and #p < 0.05, ##p < 0.01, and ###p < 0.001 indicate differences between the [LPS + anti-MHC I] and [LPS + anti-MHC I + anti-CD40L] groups.

Figure 4. Evaluation of neutrophil and platelet interaction. The proportion of blood NPA in neutrophil populations (A) was determined by flow cytometric analysis for each group of mice. The

percent NET increase in blood (B) was evaluated by immunoassay for each mouse group. Mac-1 and CD40 MFI values for circulating neutrophils (C) are presented for each mouse group. Data are presented as means \pm SEM (n = 2–9). *p < 0.05, **p < 0.01, and ***p < 0.001 indicate differences between the [LPS] and [LPS + anti-MHC I] groups; and #p < 0.05, ##p < 0.01, and ###p < 0.001 indicate differences between the [LPS + anti-MHC I] and [LPS + anti-MHC I + anti-CD40L] groups.. Correlation between Mac-1 and CD40 expression (D) was tested using data from all mice. Data are presented as MFI values for each mouse (n = 19). Spearman's correlation and the coefficient of determination are indicated by r and r², respectively, and p < 0.05 was considered statistically significant. Immunofluorescence was used to evaluate co-localization of neutrophils and platelets in the pulmonary interstitium (E) for each group of mice. DAPI (blue, laser exposition 100ms/14V), Alexa fluor[®] 488 (green, laser exposition 1s/31.4V), and Cy5[®] (red, laser exposition 30s/64V), represent nuclei, CD41 and Ly6G, respectively. Overlays were applied using these fluorescence signals (Original magnification x600). Scale bar = 20 μ m.

Figure 5. Evaluation of inflammation 2 h after treatment. Levels of IL-6 (A), MIP-2 (B), and sCD40L (C) in plasma were evaluated by immunoassay for each group of mice. Data are presented as means (n = 4–10). *p < 0.05, **p < 0.01, and ***p < 0.001 indicate differences between the [LPS] and [LPS + anti-MHC I] groups; †p < 0.05, ††p < 0.01, and †††p < 0.001 indicate differences between the [LPS] and [LPS + anti-MHC I + anti-CD40L] groups; and #p < 0.05, ##p < 0.01, and ###p < 0.001 indicate differences between the [LPS + anti-MHC I] and [LPS + anti-MHC I + anti-CD40L] groups.

Figure 6. Changes in mouse status 48 h after treatment. Blood (A) and BAL (B) platelets, blood leukocytes (C), neutrophils (D), and monocytes (E) were compared between [PBS] and [LPS + anti-MHC I + anti-CD40L] groups at 2 h and evaluated in other [PBS] and [LPS + anti-MHC I + anti-CD40L] mice after 48 h. Plasma IL-6 (F), MIP-2 (G), and MPO (H) were compared between [PBS] and [LPS + anti-MHC I + anti-CD40L] mice after 2 h and evaluated in other [PBS] and [LPS + anti-MHC I + anti-CD40L] mice after 48 h by immunoassay. Data are presented as means (n = 4–10). *p < 0.05, **p < 0.01, and ***p < 0.001.

Figure 1

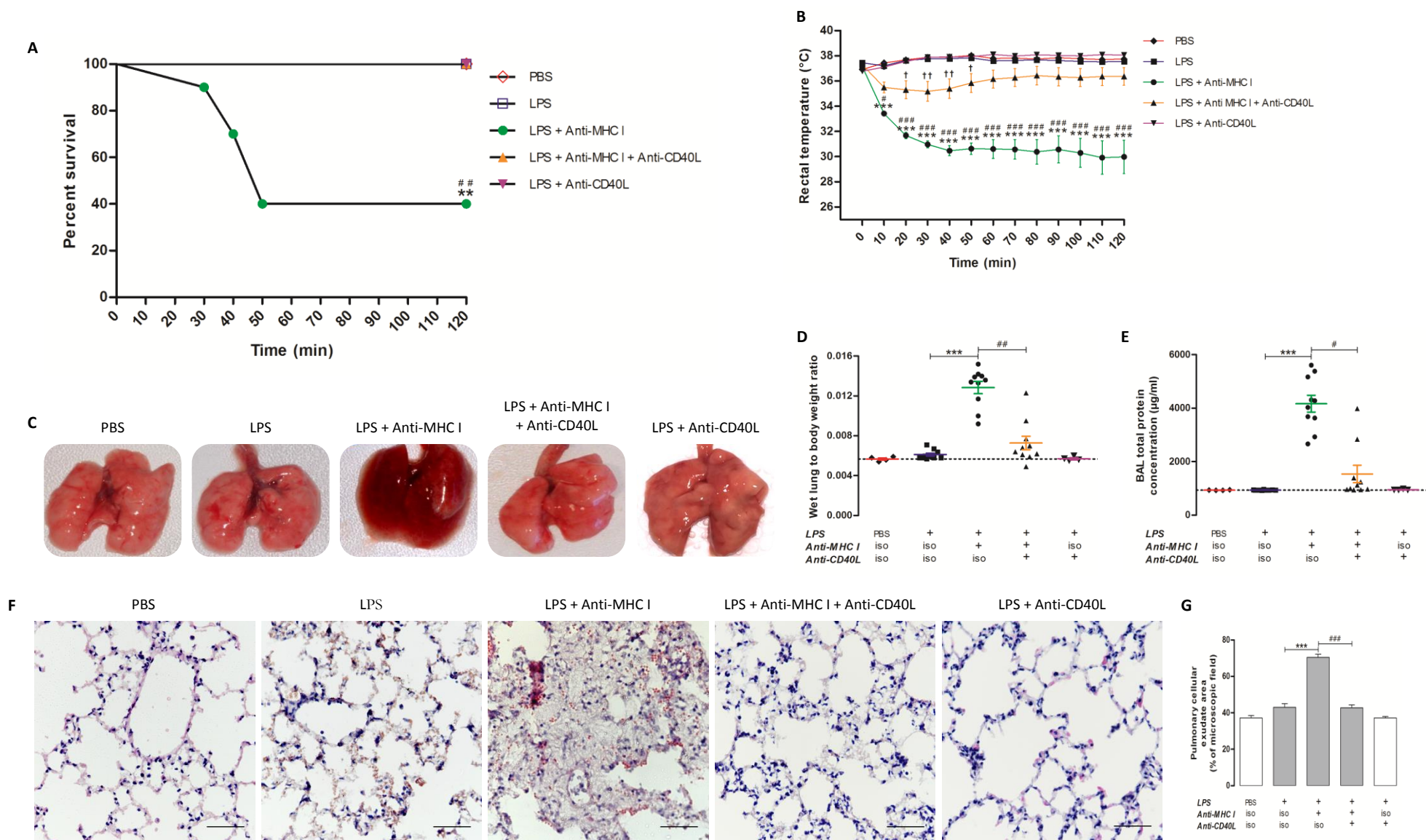

Figure 2

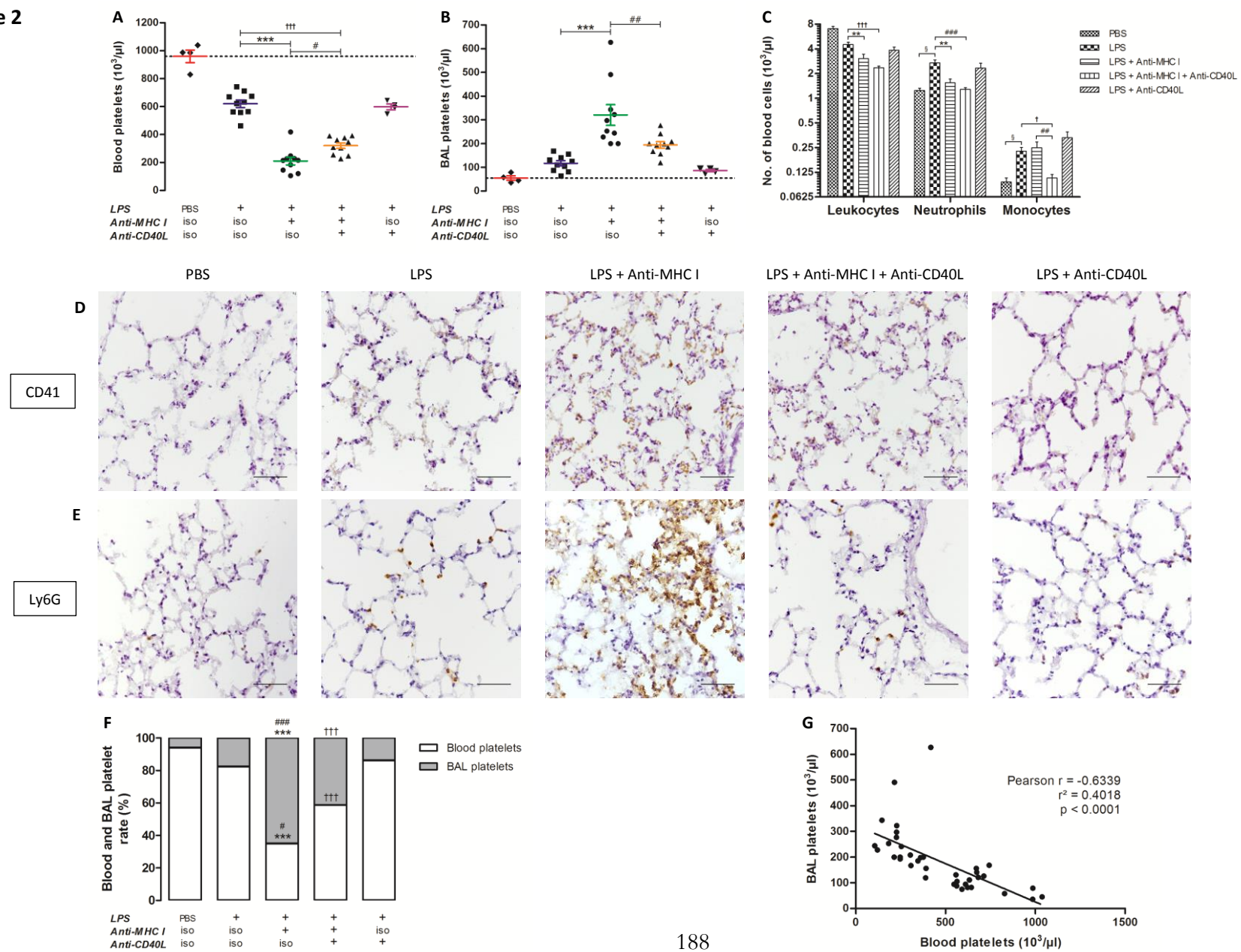

Figure 3

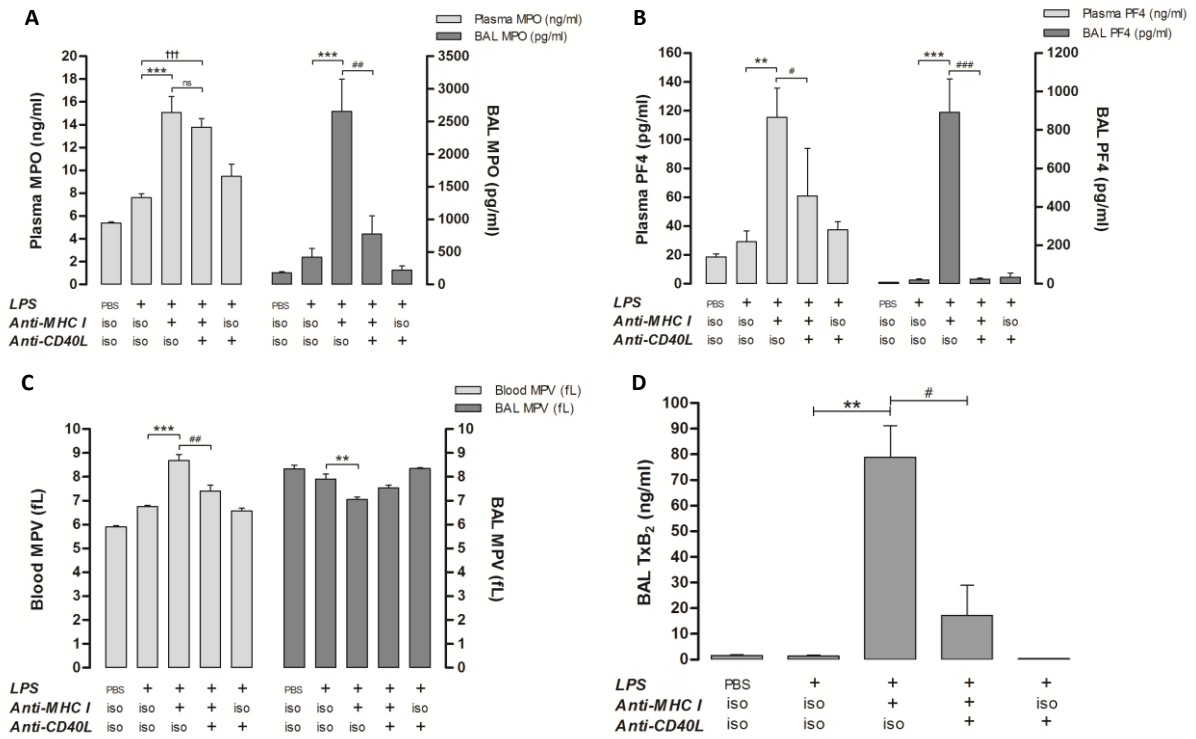
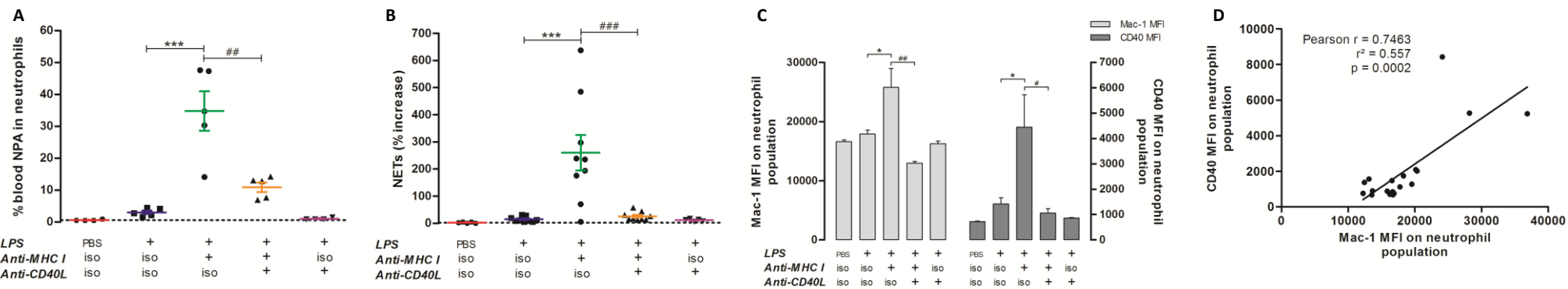

Figure 4



E

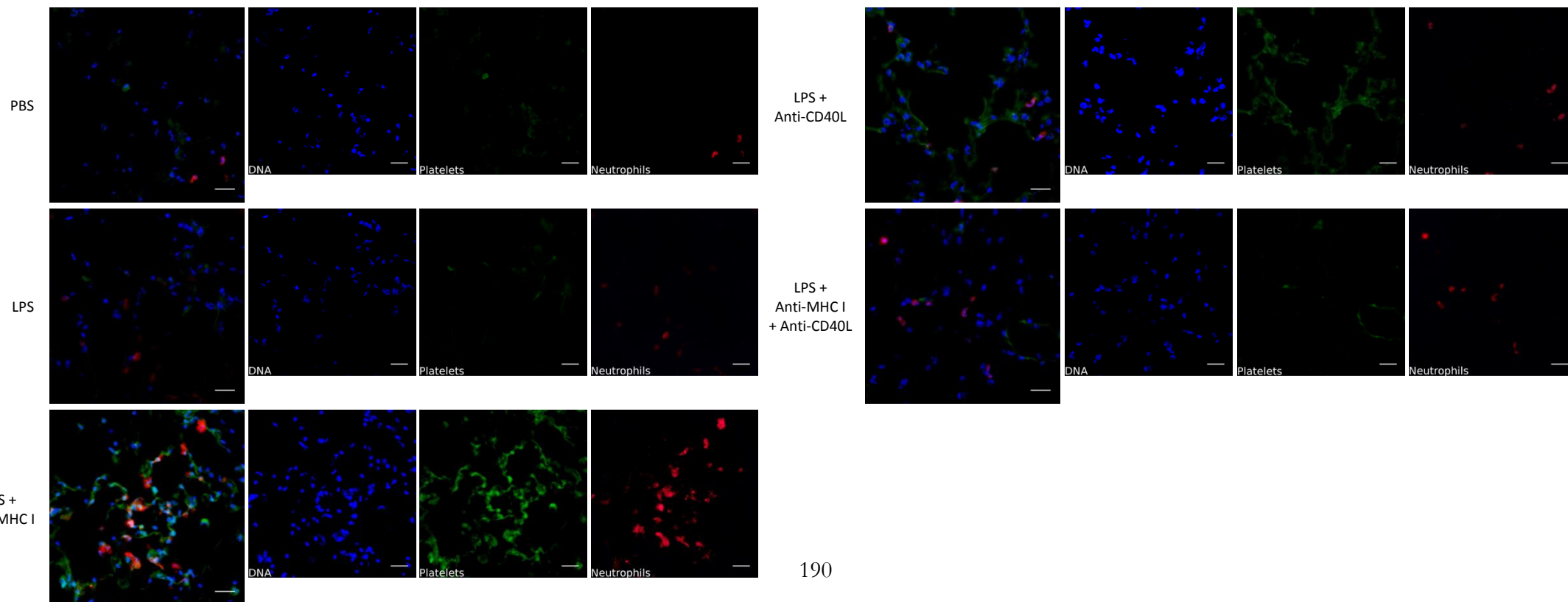

Figure 5

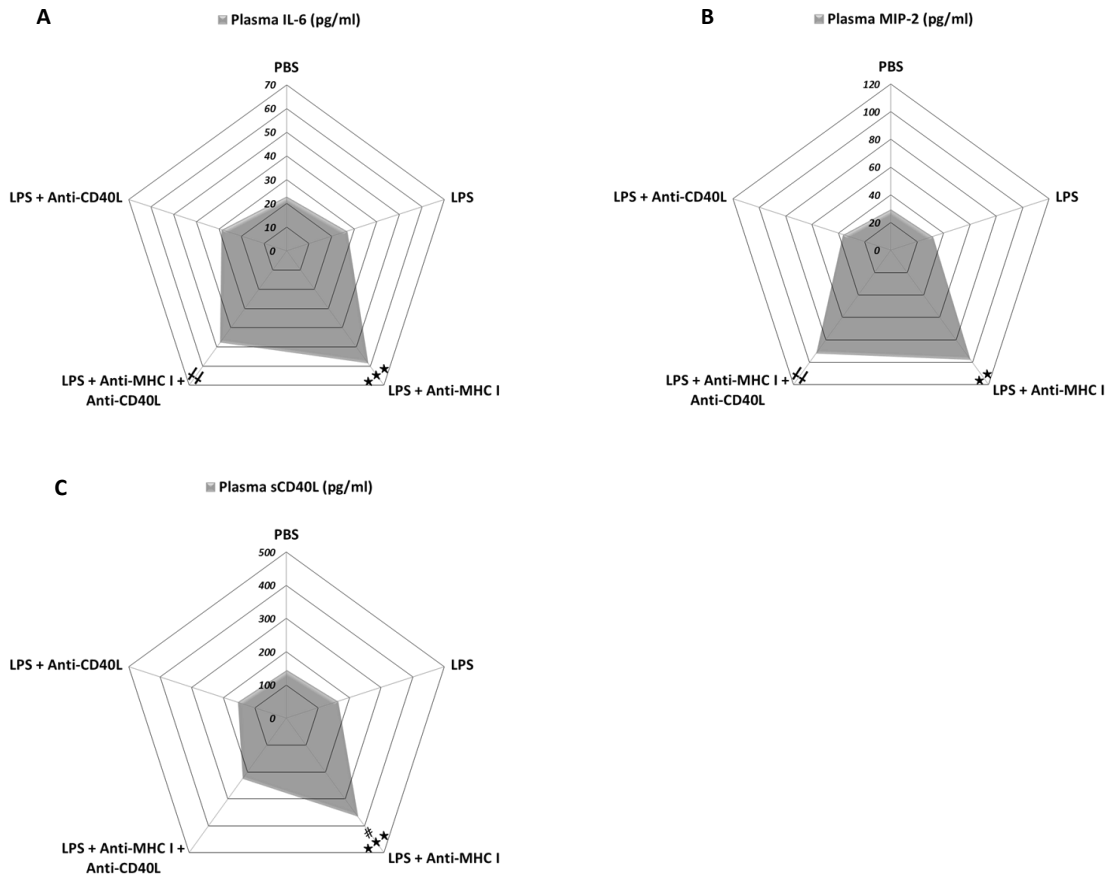
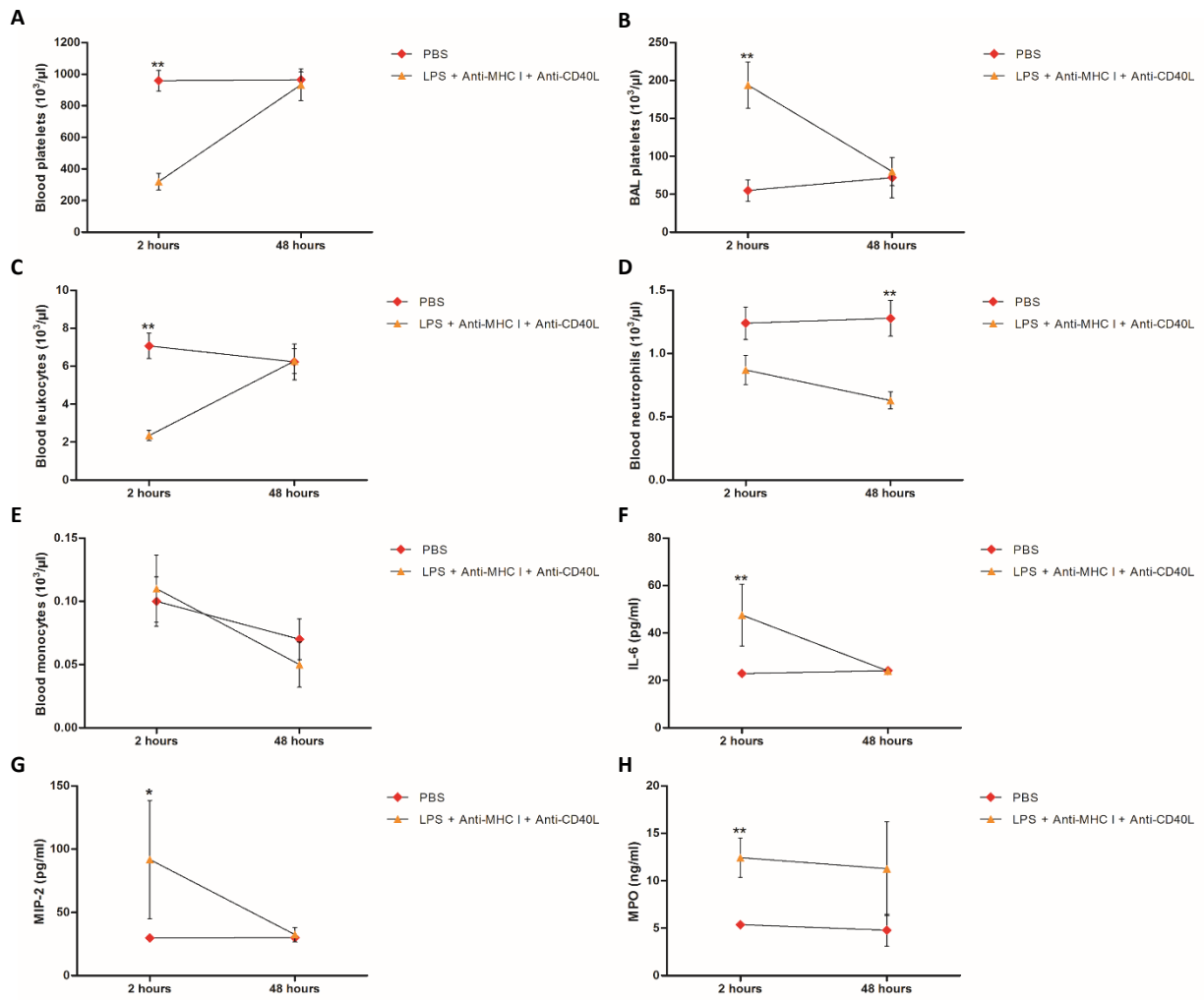

Figure 6



Supplemental data

Figures

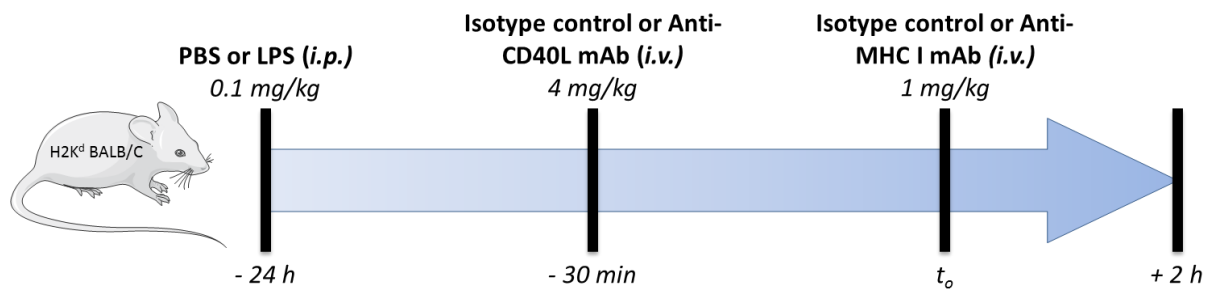

Figure S1: TRALI experimentation

The different injections performed during the TRALI mouse study are presented. PBS or LPS (at 0.1 mg/kg) was injected, intraperitoneally, 24 hours before isotype control or anti-MHC I mAb (at 1 mg/kg) intravenous injection. The injection of isotype control or neutralizing anti-CD40L mAb (at 4 mg/kg) was performed, intravenously, 30 minutes prior to isotype control or anti-MHC I mAb intravenous administration.

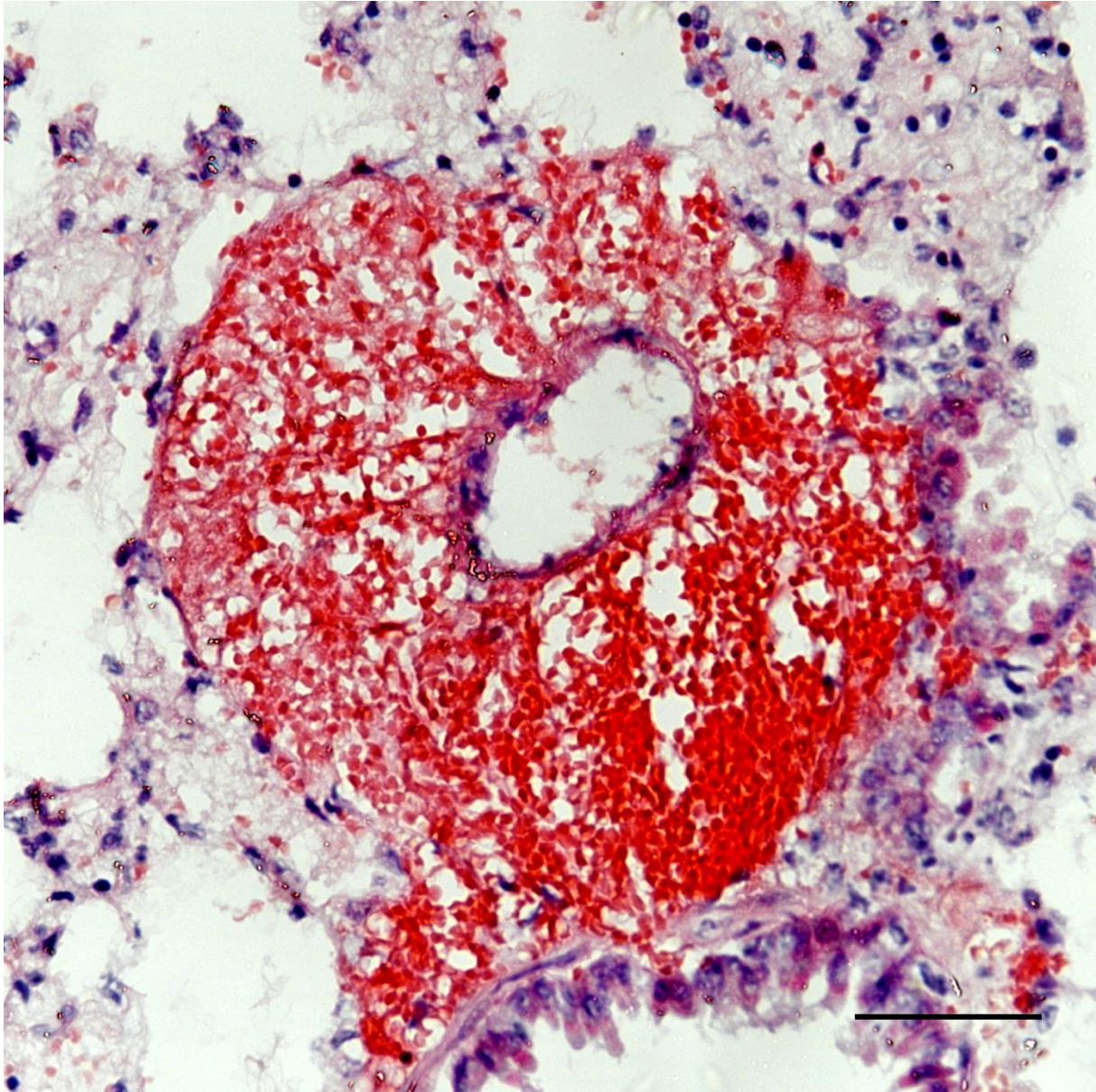

Figure S2: Pulmonary hemorrhage

Pulmonary hemorrhage was observed, after H&E staining, exclusively in the [LPS + Anti-MHC I] group. Red blood cells were infiltrated in the lung interstitium, around the pulmonary artery (observation x400). Scale bar = 50 μ m.

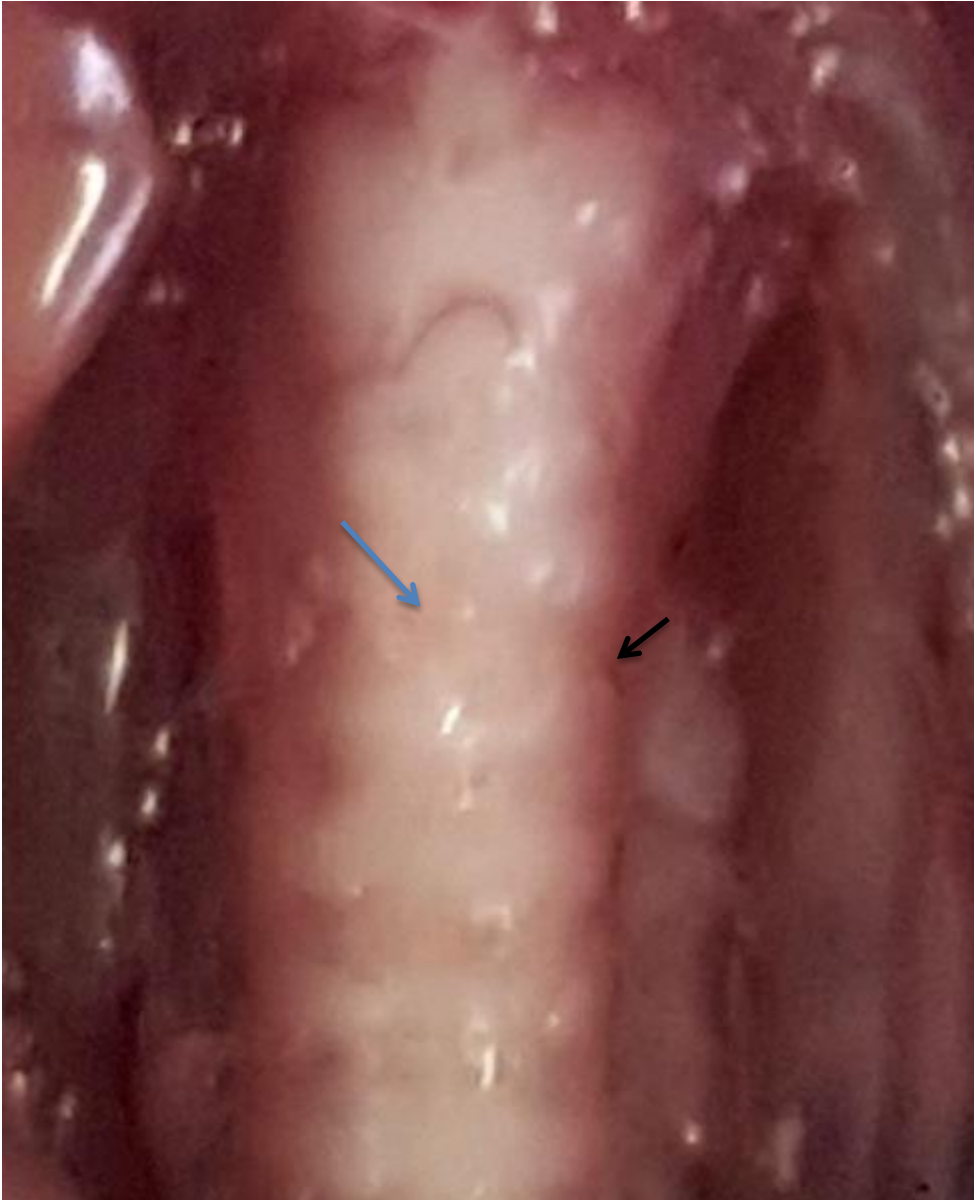

Figure S3: Fluid excretion

In more than 95 % of [LPS + anti-MHC I] mice, fluid was found directly in the trachea whereas this phenomenon was observed only exceptionally (< 1 %) in the [LPS + anti-MHC I + anti-CD40L] group. The black area indicates the trachea, and the blue area indicates fluid.

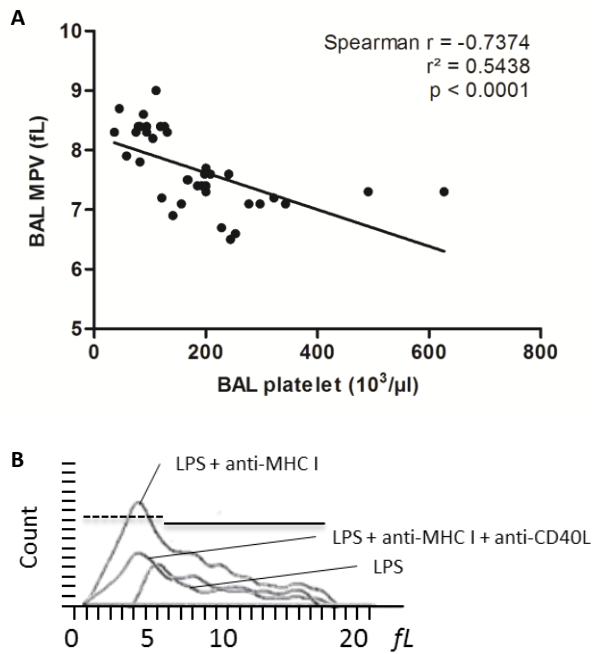

Figure S4: BAL MPV evaluation

Correlation was tested between BAL platelet count and BAL MPV, including all mice ($n = 38$). Spearman's correlation and the coefficient of determination are represented respectively by r and r^2 symbols and $p < 0.05$ is considered statistically significant. BAL platelet count and BAL MPV are significantly and negatively correlated ($p < 0.0001$ and $r = -0.7374$) (**A**). An overlay of a BAL [LPS], [LPS + anti-MHC I] and [LPS + anti-MHC I + anti-CD40L] mouse MS4[®] platelet histogram is represented. We hypothesize that the dotted line represents *de novo* platelets and the full line is characteristic of migrated and activated platelets. In this histogram, [LPS] mouse MPV is 8.4 fL, [LPS + anti-MHC I] mouse MPV is 6.7 fL and [LPS + anti-MHC I + anti-CD40L] mouse MPV is 7.5 fL (**B**). These results show that *de novo* platelets from the lungs presumably compensate for peripheral blood thrombocytopenia, particularly in the [LPS + anti-MHC I] mice and to a lesser extent, due to the limited but persistent thrombocytopenia, in the [LPS + anti-MHC I + anti-CD40L] mice.

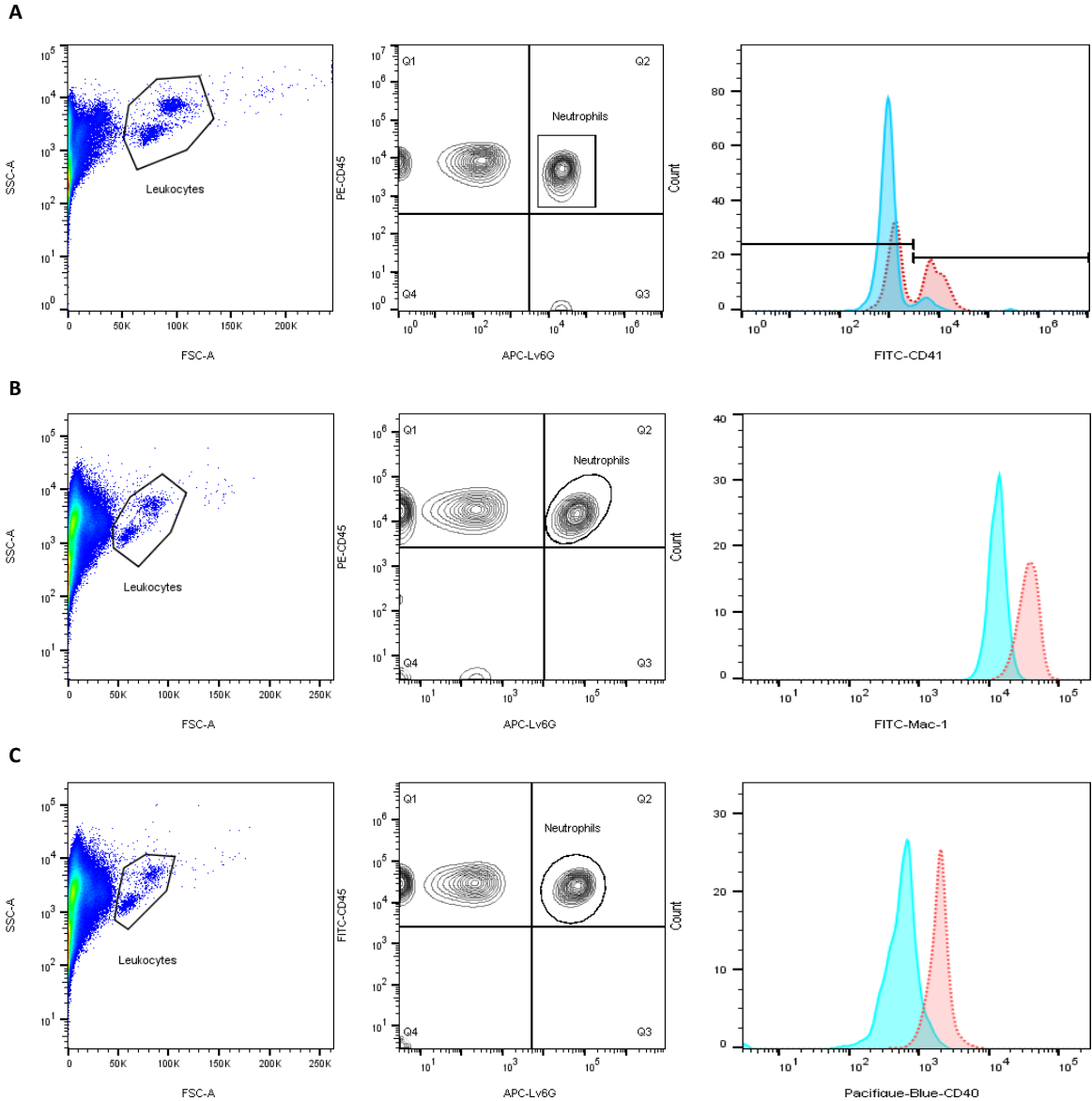

Figure S5: NPA, Mac-1 and CD40 cytometry process

The cytometry process is presented. NPA frequency was evaluated directly in the CD45+/Ly6G+ neutrophil population via a FITC-anti-CD41 mAb fluorescence signal (A). Mac-1 MFI was evaluated directly in the CD45+/Ly6G+ neutrophil population via a FITC-anti-Mac-1 mAb fluorescence signal (B). CD40 MFI was evaluated directly in the CD45+/Ly6G+ neutrophil population via a Pacific BlueTM-anti-CD40 mAb fluorescence signal (C). The red spectrum represented a [LPS + anti-MHC I] mouse and the blue spectrum represents a [LPS + anti-MHC I + anti-CD40L] mouse.

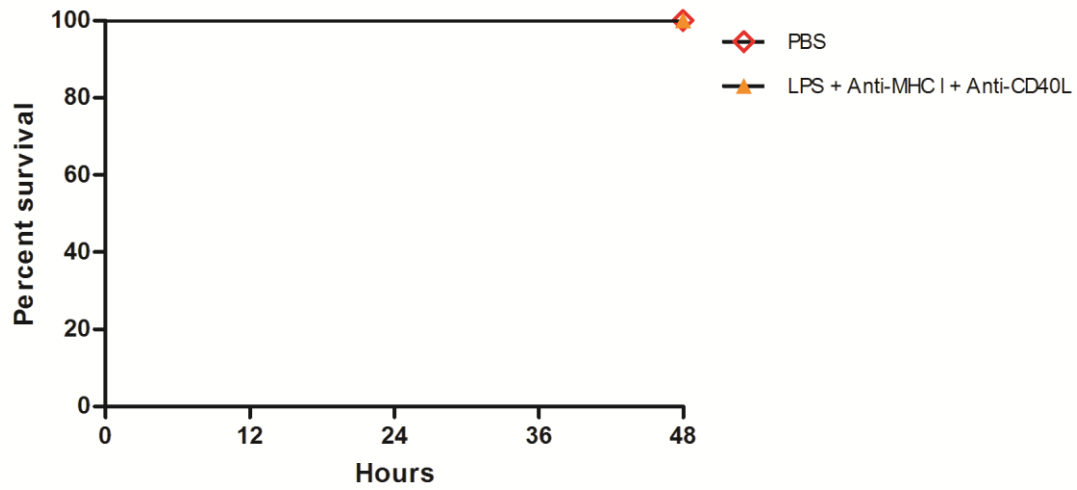

Figure S6: Survival rate after 48 hours

The mortality percentage is represented for the [PBS] and [LPS + anti-MHC I + anti-CD40L] groups over 48 hours. No survival difference was observed between these two groups after 48 hours.

**Manuscrit V : La neutralisation du complexe protéique
CD40/CD40L protège les souris de l'atteinte pancréatique
induite lors du développement du TRALI**

***“The inhibition of CD40/CD40L complex protects mice against
TRALI-induced pancreas degradation”***

Article soumis dans « Respiratory Research »

Le TRALI est considéré comme l'une des réactions transfusionnelles avec la mortalité la plus élevée [27]. Cette pathologie est caractérisée par une atteinte pulmonaire sévère justifiant ce fort taux de mortalité. La pathogénie du TRALI se rapproche de celle de plusieurs pathologies inflammatoires, telles que la pancréatite ou encore les pathologies inflammatoires de l'intestin. La physiopathologie du TRALI repose sur l'activation de plusieurs cellules de l'inflammation initiant la migration, dans l'espace alvéolaire, de ces mêmes cellules [16]. Lors de la pancréatite une mécanistique similaire, orchestrée par la migration des neutrophiles dans le tissu lésé, peut-être observée [279]. Nous émettons l'hypothèse que lors de l'induction du TRALI, des organes plus profonds, tels que le pancréas, peuvent être une cible secondaire. Parce que les deux pathogénies, celle de la pancréatite et du TRALI, sont étroitement liées, nous émettons également l'hypothèse d'une implication du couple protéique CD40/CD40L dans l'amplification de la pancréatite induite suite au développement d'un TRALI (implication préalablement démontrée dans le manuscrit IV de ce travail de thèse).

En utilisant, ici, un modèle animal de l'ALI, induit par injection successive de LPS et d'anticorps anti-CMH I, et un traitement préventif à base d'anticorps anti-CD40L, nous avons pu démontrer que l'atteinte pancréatique, observée dans notre modèle pathologique, est sensiblement prévenue lors de l'inhibition du complexe immunitaire CD40/CD40L.

Inhibition of the CD40/CD40L complex protects mice against TRALI-induced pancreas degradation

Sofiane Tariket^{1,2}, Charles-Antoine Arthaud², Sandrine Laradi^{1,2}, Thomas Bourlet¹, Philippe Berthelot¹, Hind Hamzeh-Cognasse¹, Olivier Garraud^{1,3}, Fabrice Cognasse^{1,2}

¹ Université de Lyon, GIMAP-EA3064, Saint-Etienne, France

² Établissement Français du Sang Rhône-Alpes-Auvergne, Saint-Etienne, France

³ Institut National de Transfusion Sanguine (INTS), Paris, France

*Address for correspondence and reprint requests: Dr Fabrice Cognasse, PhD, Etablissement Français du Sang Auvergne-Rhône-Alpes and GIMAP-EA 3064, Université de Saint-Etienne. Etablissement Français du Sang Auvergne-Rhône-Alpes, 25 Boulevard Pasteur, 42100 Saint-Etienne. Telephone: +33 (0) 683975883; Fax: +33 (0) 477421486; E-mail: fabrice.cognasse@efs.sante.fr

Keywords: TRALI, CD40/CD40L, pancreas, lung, inflammation

Running title: TRALI and pancreas

The authors declare that they have no conflicts of interest.

Word count: 2,368; **Abstract:** 182; **References:** 61; **Figures:** 5; **Tables:** 0; **Supplemental figure:** 0;

Supplemental table: 4

ABSTRACT:

Acute lung injury is a severe complication of transfusion. In a previous study, we saw that inhibition of the CD40/CD40L complex allowed restoration of ALI lesions in an experimental mouse model. This study focused on pancreas-associated injury development during experimental ALI pathogenesis and its limitation through CD40/CD40L complex inhibition. An ALI mouse model was established through intraperitoneal lipopolysaccharide and intravenous anti-MHC I mAb injection. Pre-emption of lesions was achieved with intravenous injection of neutralizing anti-CD40L mAb, 30 minutes prior to the trigger, i.e., anti-MHC I mAb, administration. Histology and immunoassay analyses were used to evaluate pancreas lesions. ALI development induced significant degradation of the lungs and pancreas and was associated with pancreas lesions. Different scores were established showing more severe injury to the pancreas in TRALI conditions; however injury was significantly reduced through CD40/CD40L complex inhibition. This study supports the idea that several organs are exposed during ALI development, and particularly when such experimental ALI aims at mimicking transfusion-associated ALI (TRALI); nevertheless, preventive treatment inhibiting CD40/CD40L (sCD40L) complex formation provides protection from lung disease and also disease of other organs, like pancreas.

Abbreviations:

TRALI: Transfusion-Related Acute Lung Injury

INTRODUCTION

Transfusion-related acute lung injury (TRALI) is acute lung injury (ALI) that occasionally occurs within 6 hours of blood component transfusion. Development of pulmonary edema is associated with dyspnea, tachypnea and hypoxia (1). The consequences of this respiratory risk are significant. TRALI is associated with a high mortality rate (16.5%), reported between 2007 and 2008, according to French Hemovigilance (ANSM) (2). TRALI is generally considered to be the result of a “two-hit” mechanism (3). An inflammatory condition in the patient as well as severe disease induces pre-activation of polymorphonuclear cells that are prone to migrate to the lung epithelium (4). This step results in exacerbation of membrane molecule adhesion expression on several cell types such as neutrophils, platelets and endothelial cells (5). The second event is triggered by anti-leukocyte antibodies and/or biological response modifiers (BRMs) present in the transfused blood component(s). Antibodies may be anti-HLA class I and II or anti-HNA (6). These different agents lead to PMN activation and migration in the alveolar space, aided by an increase in microvascular permeability (7). The reference TRALI mouse model used in this study was proposed by Looney *et al.* The principle is based on mouse priming with intraperitoneal injection of lipopolysaccharides (LPS) 24 hours prior to the challenge intravenous anti-MHC I mAb injection (8). The LPS injection provokes an inflammatory state in mice but without direct induction of ALI development, contrary to alternate LPS-induced ALI mouse models (9, 10).

Under inflammatory conditions, particularly in ALI, there is exacerbation of communications between circulating neutrophils and endothelial cells with expression of adhesion molecules such as E-selectin, P-selectin and ICAM1 on endothelial cells and PSGL-1, L-selectin, Mac-1 on neutrophils (11). This phenomenon is not exclusive to the lung capillary endothelium. Pancreas (12, 13), gut (14, 15), liver (16) and also kidney (17) can be the targets of inflammatory injury, as shown in several experimental mouse models, and are adhesion molecule expression-dependent which can be associated with inflammatory cell infiltration in inflamed tissue. These pathophysiological features evoke a narrow border between lung involvement, observed during ALI, and multi-organ injury.

Neutrophil transmigration, determining the severity of ALI and pancreatitis pathogenesis, seems to be regulated through CD40/CD40L intercommunication (18-20). The interaction between CD40 and CD40L plays a proinflammatory role alongside involvement of costimulation in the innate and adaptive immune system; it is dysregulated in certain types of cancer (21) and autoimmune diseases (22). CD40 is predominant on the antigen-presenting cell surface. CD40L is expressed on the membrane of different immune cells. However, the soluble and agonist form of CD40L is secreted in 95% of cases by platelets (23). This immune mediator seems to be significantly involved in

transfusion reaction as it is regulated during platelet concentrate storage (24). The CD40/CD40L protein complex has been, for a long time, a way of resolving ALI as experimentally tested in many mouse models (25-27). We recently provided evidence of neutralization of the CD40/CD40L complex to protect mice from ALI development (article submitted for publication).

This study reports on pancreas dysfunction during ALI pathogenesis and on the involvement of the CD40/CD40L immune complex. We hypothesized that using preventive injection of neutralizing anti-CD40L mAb in a mouse model of ALI, both lung and associated organ (i.e., pancreas) degradation would be limited, offering interesting avenues for furthering understanding of transfusion-associated pathophysiology and for managing high-risk patients.

MATERIALS AND METHODS

Study approval

The animals were authorized for handling by the Ethics Committee and the French Ministry of Higher Education and Research (approval number: CU14N11).

Mice

Male BALB/c WT mice were purchased from Charles River (Charles River, Wilmington, USA). All experiments were conducted using mice between 8- and 12-weeks-old. For each experiment, a minimum of 4 mice was used. The mice were randomly divided into different groups (PBS [baseline] vs. LPS [study control] vs. LPS + Anti-MHC I mAb [ALI model] vs. LPS + Anti-MHC I mAb + neutralizing anti-CD40L mAb [treated mice] vs. LPS + Anti-CD40L mAb [treatment control]).

Animal experimentation

Male H2K^d BALB/C mice were primed with *i.p.* LPS injection, extracted from *Escherichia Coli* (0111) (InvivoGen, San Diego, USA), at 0.1 mg/kg 24 hours prior to challenge with *i.v.* anti-MHC I mAb (34-1-2s) (H2K^d; IgG2a, κ) or IgG2a, κ isotype control (eBM2a) (eBioscience, San Diego, USA) injection at 1 mg/kg. Mice were pretreated, 30 minutes prior to challenge with anti-MHC I mAb or IgG2a, κ isotype control, with intravenous anti-CD40L mAb (MR1) or IgG3, κ Isotype control (E36-239) (BD Pharmingen, Franklin Lakes, USA) administration at 4 mg/kg (**Figure 1**). Intracardiac puncture was performed using a 25-gauge sterile needle and 100 μl of ACD anticoagulant (Sigma Aldrich, Saint-Louis, USA). The tail vein injections were performed using a 30-gauge sterile needle. Anaesthesia combined intraperitoneal ketamine (100 mg/kg) and xylazine (10 mg/kg) administration when mice appeared moribund or after 2 hours. After death, BAL was performed by cannulating the trachea with a 25-gauge catheter and using a 1 ml injection of cold PBS flushed back three times. The lungs and pancreas of the mice were collected and placed in 4% paraformaldehyde (Sigma Aldrich, Saint-Louis, USA) overnight.

Pulmonary edema evaluation

Rectal temperature was measured with a rectal probe and a digital thermometer (Bioseb, Pinellas Park, USA), once prior to anti-MHC I mAb injection and then every 10 minutes for 2 hours or until death. Mouse survival rate was evaluated over 2 hours. Extravascular lung water was measured using lung to body weight ratio. The BAL was centrifuged at 491 g for 10 minutes. On the BAL supernatant, the Bradford technique was used to test total proteins in the lungs. Plasma samples were collected and stored after centrifugation at 491 g for 10 minutes.

Pancreatitis evaluation

A histological score was used to evaluate development of pancreatitis, as previously described (28). Briefly, pancreatic edema, necrosis, hemorrhage and leukocyte infiltration were evaluated by microscopic observation. The score was determined between 0, representing no parameter observation, and 4, representing maximal severity. The pancreatitis histological score criteria were shown in **supplemental tables 1-4**. Finally, pancreatic lipase and amylase (CliniSciences, Nanterre, France) were measured in plasma according to the manufacturer's instructions to evaluate pancreas injury.

Inclusions and sections

The pancreas and lungs were collected and placed in paraformaldehyde at 4% for 24 hours. They were then embalmed in OCT (CML, Nemours, France). The cryomolds of OCT were placed over liquid nitrogen to induce rapid OCT solidification. The OCT cryomolds were stored at -80°C. 8 µm sections were produced using the cryostat microtome (Leica Microsystem, Nanterre, France). Lungs and pancreas sections were stained according to the H&E protocol (Sigma-Aldrich, Saint Louis). Microscopic observations were carried out using the Nikon DS-R12 camera and Nikon NIS-Elements software (Nikon, Tokyo, Japan).

Statistic tests

Statistical analyses were performed using GraphPad Prism 5 software (Graph ad, San Diego, USA). ANOVA with post-hoc Bonferroni correction was used for comparisons among more than two groups of data with normal distribution, with the Kruskal-Wallis and Dunn's post-hoc tests applied for comparisons among non-normally distributed data. Temperature and mouse ALI scores over 48 h were calculated using two-way analysis of variance. P-values < 0.05 were considered significant.

RESULTS

Successive injection of LPS and anti-MHC I antibodies induces ALI development in mice

Initially, we observed a drastic decrease in the survival rate of mice that developed ALI (30%), which was not observed in the [PBS] and [LPS] groups (**Figure 2, A**). Rectal temperature measurement in the mice, a characteristic of pathological shock, demonstrated a severe and rapid decrease following injection of the anti-MHC I antibodies in the mice primed with LPS. The drop in temperature occurred from the first 20 minutes to reach around 30°C after 40 minutes and until the end of the experiment. No significant temperature loss was measured in the [PBS] and [LPS] mice (**Figure 2, B**). Development of pulmonary edema was evaluated according to two parameters; the ratio between the weight of the lungs and the mice and total protein concentration in the BAL. These two tests were significantly increased in [LPS + anti-MHC I] mice compared to [PBS] and [LPS] mice ($p < 0.001$) (**Figure 2, C and D**). Finally, H&E staining confirmed the increase in pulmonary infiltration in mice mimicking TRALI compared to the two control groups (**Figure 2, E**).

Pancreas is one of the secondary targets in a mouse model of ALI

Histological evaluation of pancreatitis, by H&E staining, showed significant tissue degradation in LPS-primed mice injected with anti-MHC I antibodies compared to mice without anti-MHC I antibody injection (**Figure 3, A**). These findings are correlated with histological pancreatitis scores, characterized by an increase in pancreatic edema (**Figure 3, B**), necrosis (**Figure 3, C**) and hemorrhage amplification (**Figure 3, D**). However, pancreas leukocyte infiltration is slightly increased during development of ALI, significant only compared to the [PBS] group (**Figure 3, E**). Plasma pancreatic lipase and amylase release was significantly increased after anti-MHC I antibody injection ([PBS], $p < 0.01$, [LPS], $p < 0.001$) (**Figure 3, F and G**).

Neutralizing anti-CD40L mAb injection protects mice from experimental ALI development

Firstly, we observed inhibition of ALI development following injection of neutralizing anti-CD40L antibodies, 30 minutes before administration of anti-MHC I antibodies. The survival rate dropped to 25% after the 2-hour experiment. In the group of mice treated with neutralizing anti-CD40L antibodies, we found a maximum rate of 100% (**Figure 4, A**). Rectal temperature was also used as a marker of pathological shock. While the mice in the [LPS + anti-MHC I] group exhibited a drop in temperature to around 29°C after 2 hours, injection of neutralizing anti-CD40L antibodies prevented this drop. In fact, body temperature was significantly higher at each interval compared to the [LPS + anti-MHC I] mice. A decrease of around 2°C was observed in the first 80 minutes followed by a return to normal levels ($> 36^\circ\text{C}$) in the last hour (**Figure 4, B**). Preventive injection of neutralizing anti-CD40L antibodies significantly limits the increase, normally observed in the case of anti-MHC I injection-

induced-ALI, in the lung to body weight ratio and total protein concentration in the BAL (**Figure 4, C and D**). These results are confirmed by evaluation of pulmonary infiltration after H&E staining of lung sections (**Figure 4, E**).

Pancreas injury, during experimental ALI, is prevented with neutralizing anti-CD40L mAb treatment

Firstly, histological analysis of the pancreas showed increased injury associated with ALI development in mice (**Figure 5, A**). Pancreatic edema, necrosis and hemorrhage were significantly more severe in the [LPS + anti-MHC I] group than in the treated mice ($p < 0.05$) (**Figure 5, B, C and D**). However, leukocyte infiltration is equivalent between the two groups, justified by weak detection of leucocytes in the pancreas following the successive injection of LPS and anti-MHC I antibodies in mice mimicking TRALI (**Figure 5, E**). Evaluation of pancreatic dysfunction, characterized by significant release of pancreatic lipase and amylase in the plasma, suggests inhibition of ALI induced-pancreatitis following injection of neutralizing anti-CD40L antibodies (**Figure 5, F and G**).

DISCUSSION

To some extent, this model aims to reproduce TRALI experimentally. Indeed, this model relies on circulating inflammatory cell activation by a bacterial mediator, LPS, i.e., the initiator, and the formation of an immune complex using anti-MHC I antibodies, i.e., the trigger. This activation regulates migration of leukocytes from the blood compartment to the alveolar space, a key parameter of TRALI. This study describes, for the first time, multiple organ damage in an animal model of ALI induced by LPS and anti-MHC I antibody injection

Histological evaluation of pancreatic lesions and the measurement of plasma soluble markers, reflecting degradation of the tissue, suggested multiple organ injury occurred in this murine model of ALI (**Figure 4 and 5**). In this model, development of the pathology is dependent on hyper-activation of the inflammatory state of the mice (29). Moreover, such an inflammatory response is observed in other pathologies, notably during pancreatitis (30, 31). Indeed, during acute pancreatitis, migration of neutrophils into the pancreatic tissue is amplified (12, 32-34). Migration involves several adhesion molecules expressed on the neutrophil surface, such as Mac-1, CD62L or LFA-1 (35, 36). Pancreatic leukostasis is also dependent on the activity of the endothelium which, during exacerbated inflammation, expresses ICAM-1 and JAM-C on its surface, which can then bind to neutrophils and cause them to transmigrate (37-39). Similarly to TRALI, platelets appear to play a significant role in the induction of pancreatitis. Several observations indicate increased platelet activity in the above-mentioned pathology (40-42). They also participate in neutrophil activation, migration and complex formation with themselves (43, 44). Therefore, pancreatitis appears to share certain pathophysiological features similar to that of ALI/TRALI. Some findings, indeed, evoke a narrow frontier between pancreatitis and ALI (45-48).

Secondly, we were able to demonstrate overall protection of the lungs following CD40/CD40L immune complex inhibition (**Figures 2 and 3**). We investigated the role of this immune complex, CD40/CD40L, because, within transfusion reactions, sCD40L is involved due to its increased concentration during storage of platelet components (49, 50) and its direct impact in febrile and allergic transfusion reactions (51). The interaction between CD40L and its ligand, CD40, plays a seminal role in cellular communication, especially between platelets, neutrophils and endothelial cells (52). Under the influence of this protein complex, neutrophils significantly increased the expression of Mac-1, a membrane protein involved in cellular communication and neutrophil leukostasis (18-20, 53). In different conditions, the CD40/CD40L protein complex contributes to vascular dysfunction (54), to the expression of adhesion molecules (55-57), to the production of inflammatory soluble mediators (55, 58-60), to leukocyte and platelet adhesion to the vascular wall

(20, 52, 61, 62) and, lastly, to the migration of these attached cells. By blocking some of these mechanisms, development of ALI is therefore inhibited, thus protecting the lungs from the induction of respiratory distress and the pancreas from acute pancreatitis.

These results suggest multiple organ injury in ALI/TRALI, at least under experimental conditions, which may explain morbidity and even mortality. Pulmonary insult is still the main consequence and often the cause of patient death; however a multi-organ target would decrease the chances of patient survival. Other organs such as the intestine, liver or kidneys deserve further investigation during ALI. This investigation confirms that ALI/TRALI can either be prevented or reversed; it also provides interesting clues as to understanding of the hyper inflammation state induced in pancreatitis and possible therapeutic avenues.

Acknowledgements

The authors extend their thanks to the personnel at PLEXAN for their technical support on the animal models throughout our studies. This work was supported by grants from the Association “Les Amis de Rémi.”, the “Agence Nationale de la Recherche” (ANR), reference ANR-12-JSV1-0012-01. and the French National Agency for Medicines and Health Products Safety (ANSM - AAP-2012-011, Reference 2012S055).

REFERENCES

1. Vlaar AP, Juffermans NP. **Transfusion-related acute lung injury: a clinical review.** *Lancet* 2013; **382**: 984-994.
2. Ozier Y, Muller JY, Mertes PM, Renaudier P, Aguilon P, Canivet N, Fabrigli P, Rebibo D, Tazerout M, Trophilme C, Willaert B, Cالداني C. **Transfusion-related acute lung injury: reports to the French Hemovigilance Network 2007 through 2008.** *Transfusion* 2011; **51**: 2102-2110.
3. Silliman CC. **The two-event model of transfusion-related acute lung injury.** *Critical care medicine* 2006; **34**: S124-131.
4. Middelburg RA, van der Bom JG. **Transfusion-related acute lung injury not a two-hit, but a multicausal model.** *Transfusion* 2014.
5. Doerschuk CM. **Mechanisms of leukocyte sequestration in inflamed lungs.** *Microcirculation* 2001; **8**: 71-88.
6. Peters AL, Van Stein D, Vlaar AP. **Antibody-mediated transfusion-related acute lung injury; from discovery to prevention.** *British journal of haematology* 2015.
7. Alvarez P, Carrasco R, Romero-Dapueto C, Castillo RL. **Transfusion-Related Acute Lung Injured (TRALI): Current Concepts.** *The open respiratory medicine journal* 2015; **9**: 92-96.
8. Looney MR, Nguyen JX, Hu Y, Van Ziffle JA, Lowell CA, Matthay MA. **Platelet depletion and aspirin treatment protect mice in a two-event model of transfusion-related acute lung injury.** *The Journal of clinical investigation* 2009; **119**: 3450-3461.
9. Xu W, Zhu Y, Ning Y, Dong Y, Huang H, Zhang W, Sun Q, Li Q. **Nogo-B protects mice against lipopolysaccharide-induced acute lung injury.** *Scientific reports* 2015; **5**: 12061.
10. Sakaguchi R, Chikuma S, Shichita T, Morita R, Sekiya T, Ouyang W, Ueda T, Seki H, Morisaki H, Yoshimura A. **Innate-like function of memory Th17 cells for enhancing endotoxin-induced acute lung inflammation through IL-22.** *International immunology* 2015.
11. Kolaczowska E, Kubes P. **Neutrophil recruitment and function in health and inflammation.** *Nature reviews Immunology* 2013; **13**: 159-175.
12. Wetterholm E, Linders J, Merza M, Regner S, Thorlacius H. **Platelet-derived CXCL4 regulates neutrophil infiltration and tissue damage in severe acute pancreatitis.** *Translational research : the journal of laboratory and clinical medicine* 2016.
13. Merza M, Hartman H, Rahman M, Hwaiz R, Zhang E, Renstrom E, Luo L, Morgelin M, Regner S, Thorlacius H. **Neutrophil Extracellular Traps Induce Trypsin Activation, Inflammation, and Tissue Damage in Mice With Severe Acute Pancreatitis.** *Gastroenterology* 2015; **149**: 1920-1931 e1928.
14. Huang E, Liu R, Lu Z, Liu J, Liu X, Zhang D, Chu Y. **NKT cells mediate the recruitment of neutrophils by stimulating epithelial chemokine secretion during colitis.** *Biochemical and biophysical research communications* 2016; **474**: 252-258.
15. Sumagin R, Brazil JC, Nava P, Nishio H, Alam A, Luissint AC, Weber DA, Neish AS, Nusrat A, Parkos CA. **Neutrophil interactions with epithelial-expressed ICAM-1 enhances intestinal mucosal wound healing.** *Mucosal immunology* 2016.
16. Zhang J, Xu P, Song P, Wang H, Zhang Y, Hu Q, Wang G, Zhang S, Yu Q, Billiar TR, Wang C, Zhang J. **CCL2-CCR2 signaling promotes hepatic ischemia/reperfusion injury.** *The Journal of surgical research* 2016; **202**: 352-362.
17. Dagher PC, Hato T, Mang HE, Plotkin Z, Richardson QV, Massad M, Mai E, Kuehl SE, Graham P, Kumar R, Sutton TA. **Inhibition of Toll-Like Receptor 4 Signaling Mitigates Microvascular**

- Loss but Not Fibrosis in a Model of Ischemic Acute Kidney Injury.** International journal of molecular sciences 2016; **17**.
18. Rahman M, Zhang S, Chew M, Ersson A, Jeppsson B, Thorlacius H. **Platelet-derived CD40L (CD154) mediates neutrophil upregulation of Mac-1 and recruitment in septic lung injury.** Annals of surgery 2009; **250**: 783-790.
 19. Jin R, Yu S, Song Z, Zhu X, Wang C, Yan J, Wu F, Nanda A, Granger DN, Li G. **Soluble CD40 ligand stimulates CD40-dependent activation of the beta2 integrin Mac-1 and protein kinase C zeta (PKCzeta) in neutrophils: implications for neutrophil-platelet interactions and neutrophil oxidative burst.** PloS one 2013; **8**: e64631.
 20. Li G, Sanders JM, Bevard MH, Sun Z, Chumley JW, Galkina EV, Ley K, Sarembock IJ. **CD40 ligand promotes Mac-1 expression, leukocyte recruitment, and neointima formation after vascular injury.** The American journal of pathology 2008; **172**: 1141-1152.
 21. Hassan SB, Sorensen JF, Olsen BN, Pedersen AE. **Anti-CD40-mediated cancer immunotherapy: an update of recent and ongoing clinical trials.** Immunopharmacology and immunotoxicology 2014; **36**: 96-104.
 22. van Kooten C, Banchereau J. **CD40-CD40 ligand.** Journal of leukocyte biology 2000; **67**: 2-17.
 23. Andre P, Nannizzi-Alaimo L, Prasad SK, Phillips DR. **Platelet-derived CD40L: the switch-hitting player of cardiovascular disease.** Circulation 2002; **106**: 896-899.
 24. Tariket S, Sut C, Hamzeh-Cognasse H, Laradi S, Pozzetto B, Garraud O, Cognasse F. **Transfusion-related acute lung injury: transfusion, platelets and biological response modifiers.** Expert review of hematology 2016; **1-12**.
 25. Adawi A, Zhang Y, Baggs R, Rubin P, Williams J, Finkelstein J, Phipps RP. **Blockade of CD40-CD40 ligand interactions protects against radiation-induced pulmonary inflammation and fibrosis.** Clinical immunology and immunopathology 1998; **89**: 222-230.
 26. Adawi A, Zhang Y, Baggs R, Finkelstein J, Phipps RP. **Disruption of the CD40-CD40 ligand system prevents an oxygen-induced respiratory distress syndrome.** The American journal of pathology 1998; **152**: 651-657.
 27. Hashimoto N, Kawabe T, Imaizumi K, Hara T, Okamoto M, Kojima K, Shimokata K, Hasegawa Y. **CD40 plays a crucial role in lipopolysaccharide-induced acute lung injury.** American journal of respiratory cell and molecular biology 2004; **30**: 808-815.
 28. Schmidt J, Rattner DW, Lewandrowski K, Compton CC, Mandavilli U, Knoefel WT, Warshaw AL. **A better model of acute pancreatitis for evaluating therapy.** Annals of surgery 1992; **215**: 44-56.
 29. Looney MR, Su X, Van Ziffle JA, Lowell CA, Matthay MA. **Neutrophils and their Fc gamma receptors are essential in a mouse model of transfusion-related acute lung injury.** The Journal of clinical investigation 2006; **116**: 1615-1623.
 30. Manohar M, Verma AK, Venkateshaiah SU, Sanders NL, Mishra A. **Pathogenic mechanisms of pancreatitis.** World journal of gastrointestinal pharmacology and therapeutics 2017; **8**: 10-25.
 31. Dumnicka P, Maduzia D, Ceranowicz P, Olszanecki R, Drozd R, Kusnierz-Cabala B. **The Interplay between Inflammation, Coagulation and Endothelial Injury in the Early Phase of Acute Pancreatitis: Clinical Implications.** International journal of molecular sciences 2017; **18**.
 32. Pandol SJ, Saluja AK, Imrie CW, Banks PA. **Acute pancreatitis: bench to the bedside.** Gastroenterology 2007; **132**: 1127-1151.
 33. Yang ZW, Meng XX, Xu P. **Central role of neutrophil in the pathogenesis of severe acute pancreatitis.** Journal of cellular and molecular medicine 2015; **19**: 2513-2520.

34. Yu C, Merza M, Luo L, Thorlaciuc H. **Inhibition of Ras signalling reduces neutrophil infiltration and tissue damage in severe acute pancreatitis.** European journal of pharmacology 2015; **746**: 245-251.
35. Hartwig W, Jimenez RE, Fernandez-del Castillo C, Kelliher A, Jones R, Warshaw AL. **Expression of the adhesion molecules Mac-1 and L-selectin on neutrophils in acute pancreatitis is protease- and complement-dependent.** Annals of surgery 2001; **233**: 371-378.
36. Awla D, Abdulla A, Zhang S, Roller J, Menger MD, Regner S, Thorlaciuc H. **Lymphocyte function antigen-1 regulates neutrophil recruitment and tissue damage in acute pancreatitis.** British journal of pharmacology 2011; **163**: 413-423.
37. Frossard JL, Saluja A, Bhagat L, Lee HS, Bhatia M, Hofbauer B, Steer ML. **The role of intercellular adhesion molecule 1 and neutrophils in acute pancreatitis and pancreatitis-associated lung injury.** Gastroenterology 1999; **116**: 694-701.
38. Hartwig W, Werner J, Warshaw AL, Antoniu B, Castillo CF, Gebhard MM, Uhl W, Buchler MW. **Membrane-bound ICAM-1 is upregulated by trypsin and contributes to leukocyte migration in acute pancreatitis.** American journal of physiology Gastrointestinal and liver physiology 2004; **287**: G1194-1199.
39. Wu D, Zeng Y, Fan Y, Wu J, Mulatibieke T, Ni J, Yu G, Wan R, Wang X, Hu G. **Reverse-migrated neutrophils regulated by JAM-C are involved in acute pancreatitis-associated lung injury.** Scientific reports 2016; **6**: 20545.
40. Hackert T, Pfeil D, Hartwig W, Fritz S, Schneider L, Gebhard MM, Buchler MW, Werner J. **Platelet function in acute experimental pancreatitis.** Journal of gastrointestinal surgery : official journal of the Society for Surgery of the Alimentary Tract 2007; **11**: 439-444.
41. Hackert T, Pfeil D, Hartwig W, Gebhard MM, Buchler MW, Werner J. **Platelet function in acute experimental pancreatitis induced by ischaemia-reperfusion.** The British journal of surgery 2005; **92**: 724-728.
42. Uhlmann D, Lauer H, Serr F, Ludwig S, Tannapfel A, Fiedler M, Hauss J, Witzigmann H. **Pathophysiological role of platelets in acute experimental pancreatitis: influence of endothelin A receptor blockade.** Cell and tissue research 2007; **327**: 485-492.
43. Abdulla A, Awla D, Hartman H, Rahman M, Jeppsson B, Regner S, Thorlaciuc H. **Role of platelets in experimental acute pancreatitis.** The British journal of surgery 2011; **98**: 93-103.
44. Abdulla A, Awla D, Hartman H, Weiber H, Jeppsson B, Regner S, Thorlaciuc H. **Platelets regulate P-selectin expression and leukocyte rolling in inflamed venules of the pancreas.** European journal of pharmacology 2012; **682**: 153-160.
45. Lu G, Tong Z, Ding Y, Liu J, Pan Y, Gao L, Tu J, Wang Y, Liu G, Li W. **Aspirin Protects against Acinar Cells Necrosis in Severe Acute Pancreatitis in Mice.** BioMed research international 2016; **2016**: 6089430.
46. Qiao YY, Liu XQ, Xu CQ, Zhang Z, Xu HW. **Interleukin-22 ameliorates acute severe pancreatitis-associated lung injury in mice.** World journal of gastroenterology : WJG 2016; **22**: 5023-5032.
47. Bonjoch L, Casas V, Carrascal M, Closa D. **Involvement of exosomes in lung inflammation associated with experimental acute pancreatitis.** The Journal of pathology 2016; **240**: 235-245.
48. Wang F, Lu F, Huang H, Huang M, Luo T. **Ultrastructural changes in the pulmonary mechanical barriers in a rat model of severe acute pancreatitis-associated acute lung injury.** Ultrastructural pathology 2016; **40**: 33-42.

49. Cognasse F, Boussoulade F, Chavarin P, Acquart S, Fabrigli P, Lamy B, Garraud O. **Release of potential immunomodulatory factors during platelet storage.** *Transfusion* 2006; **46**: 1184-1189.
50. Kaufman J, Spinelli SL, Schultz E, Blumberg N, Phipps RP. **Release of biologically active CD154 during collection and storage of platelet concentrates prepared for transfusion.** *Journal of thrombosis and haemostasis : JTH* 2007; **5**: 788-796.
51. Blumberg N, Gettings KF, Turner C, Heal JM, Phipps RP. **An association of soluble CD40 ligand (CD154) with adverse reactions to platelet transfusions.** *Transfusion* 2006; **46**: 1813-1821.
52. Zuchtriegel G, Uhl B, Pühr-Westerheide D, Pornbacher M, Lauber K, Krombach F, Reichel CA. **Platelets Guide Leukocytes to Their Sites of Extravasation.** *PLoS biology* 2016; **14**: e1002459.
53. Rahman M, Roller J, Zhang S, Syk I, Menger MD, Jeppsson B, Thorlacius H. **Metalloproteinases regulate CD40L shedding from platelets and pulmonary recruitment of neutrophils in abdominal sepsis.** *Inflammation research : official journal of the European Histamine Research Society [et al]* 2012; **61**: 571-579.
54. Hausding M, Jurk K, Daub S, Kroller-Schon S, Stein J, Schwenk M, Oelze M, Mikhed Y, Kerafrod JG, Kossmann S, Jansen T, Schulz E, Wenzel P, Reske-Kunz AB, Becker C, Munzel T, Grabbe S, Daiber A. **CD40L contributes to angiotensin II-induced pro-thrombotic state, vascular inflammation, oxidative stress and endothelial dysfunction.** *Basic research in cardiology* 2013; **108**: 386.
55. Greene JA, Portillo JA, Lopez Corcino Y, Subauste CS. **CD40-TRAF Signaling Upregulates CX3CL1 and TNF-alpha in Human Aortic Endothelial Cells but Not in Retinal Endothelial Cells.** *PLoS one* 2015; **10**: e0144133.
56. Hollenbaugh D, Mischel-Petty N, Edwards CP, Simon JC, Denfeld RW, Kiener PA, Aruffo A. **Expression of functional CD40 by vascular endothelial cells.** *The Journal of experimental medicine* 1995; **182**: 33-40.
57. Karmann K, Hughes CC, Schechner J, Fanslow WC, Pober JS. **CD40 on human endothelial cells: inducibility by cytokines and functional regulation of adhesion molecule expression.** *Proceedings of the National Academy of Sciences of the United States of America* 1995; **92**: 4342-4346.
58. Omari KM, Chui R, Dorovini-Zis K. **Induction of beta-chemokine secretion by human brain microvessel endothelial cells via CD40/CD40L interactions.** *Journal of neuroimmunology* 2004; **146**: 203-208.
59. Pluvinet R, Olivar R, Krupinski J, Herrero-Fresneda I, Luque A, Torras J, Cruzado JM, Grinyo JM, Sumoy L, Aran JM. **CD40: an upstream master switch for endothelial cell activation uncovered by RNAi-coupled transcriptional profiling.** *Blood* 2008; **112**: 3624-3637.
60. Chakrabarti S, Blair P, Freedman JE. **CD40-40L signaling in vascular inflammation.** *The Journal of biological chemistry* 2007; **282**: 18307-18317.
61. Yacoub D, Hachem A, Theoret JF, Gillis MA, Mourad W, Merhi Y. **Enhanced levels of soluble CD40 ligand exacerbate platelet aggregation and thrombus formation through a CD40-dependent tumor necrosis factor receptor-associated factor-2/Rac1/p38 mitogen-activated protein kinase signaling pathway.** *Arteriosclerosis, thrombosis, and vascular biology* 2010; **30**: 2424-2433.
62. Aloui C, Prigent A, Sut C, Tariket S, Hamzeh-Cognasse H, Pozzetto B, Richard Y, Cognasse F, Laradi S, Garraud O. **The Signaling Role of CD40 Ligand in Platelet Biology and in Platelet Component Transfusion.** *International journal of molecular sciences* 2014; **15**: 22342-22364.

FIGURE AND TABLE

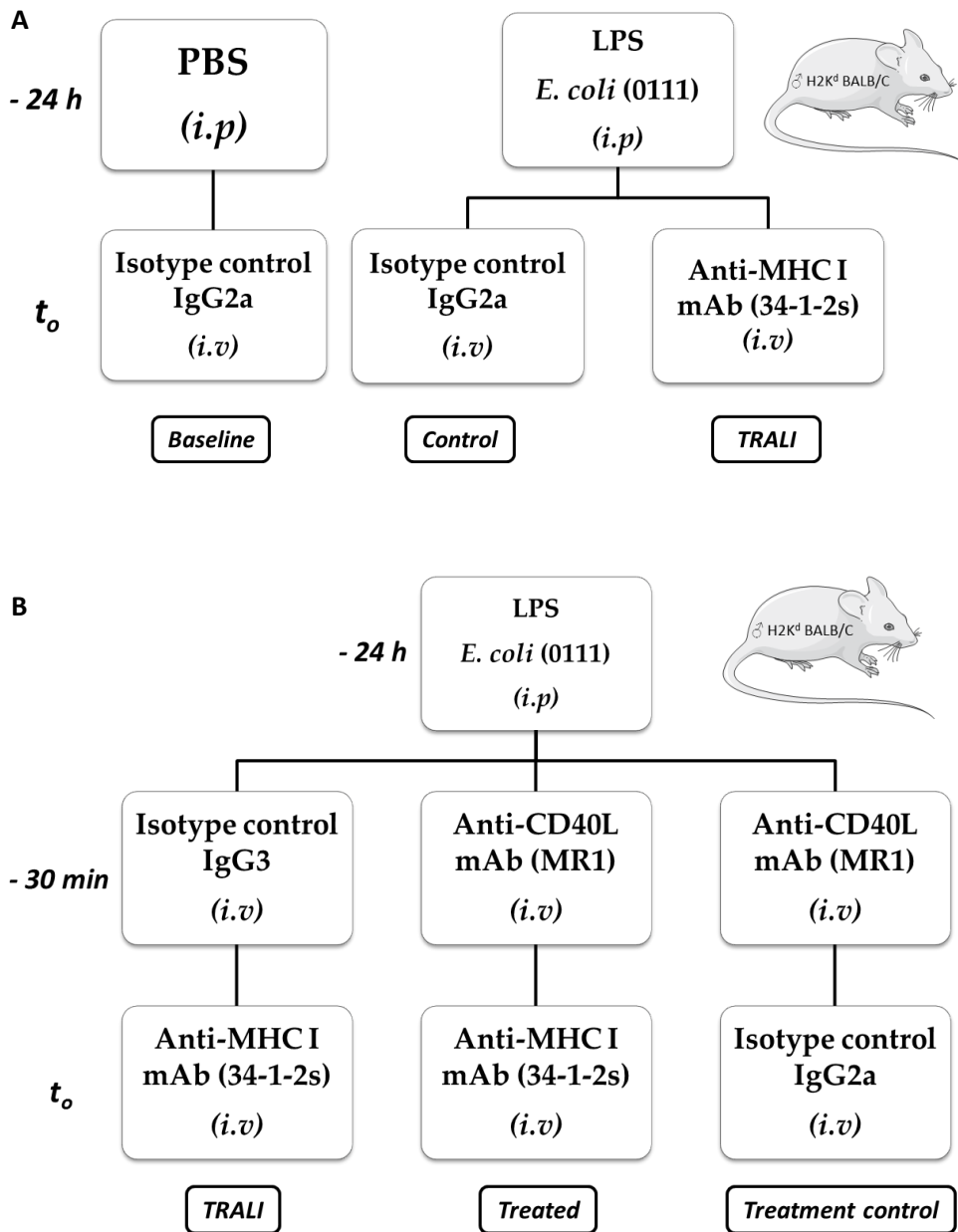

Figure 1: Experimental plan

The acute lung injury experiment involved successive injections of intraperitoneal LPS (*E. coli* 0111) at 0.1 mg/kg and intravenous anti-MHC I mAb (34-1-2s) at 1 mg/kg. Mice were followed-up for 2 hours after anti-MHC I mAb injection (**A**). Experimental treatment firstly involved intraperitoneal injection of LPS (*E. coli* 0111) at 0.1 mg/kg followed by neutralizing anti-CD40L mAb (MR1) intravenous injection at 4 mg/kg, 30 minutes prior to intravenous anti-MHC I mAb (34-1-2s) at 1 mg/kg. Mice were followed-up for 2 hours after anti-MHC I mAb injection (**B**).

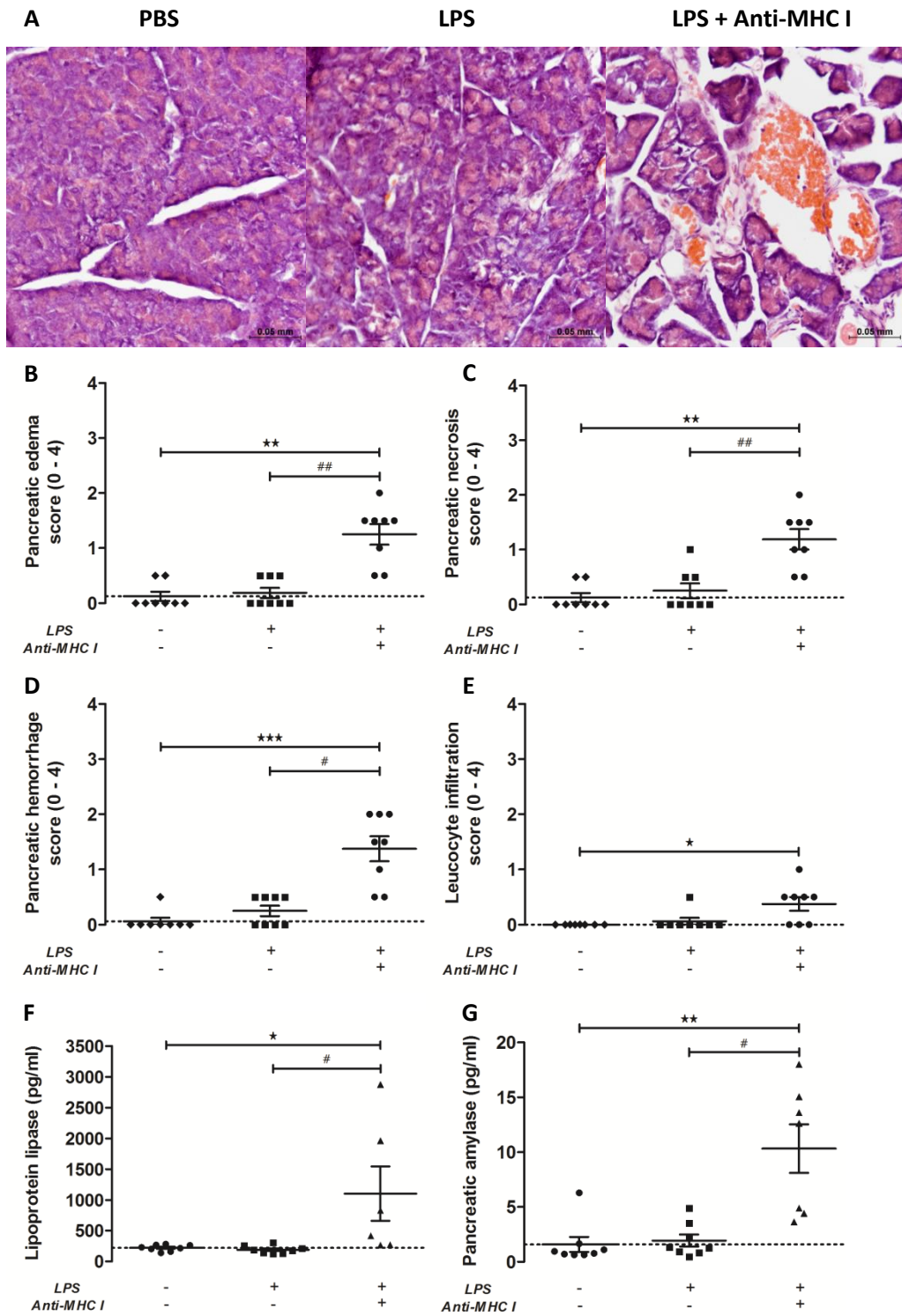

Figure 3: Anti-MHC I mAb injection induces pancreatitis development

Pancreatic microarchitecture is represented through H&E staining (observation x400) (A). Scale bar: 50 μ m. Pancreatic edema (B), necrosis (C), hemorrhage (D) and leukocyte infiltration (E) were determined through pancreatic histological score criteria. Immunoassay of plasma pancreatic lipoprotein lipase (F) and amylase (G) was performed to evaluate pancreatic dysfunction. Data are given as the mean \pm SEM (n = 6 - 8). *p < 0.05; **p < 0.01 and ***p < 0.001 represent differences between [PBS] and [LPS + anti-MHC I] groups. #p < 0.05; ##p < 0.01 and ###p < 0.001 represent differences between [LPS] and [LPS + anti-MHC I] groups.

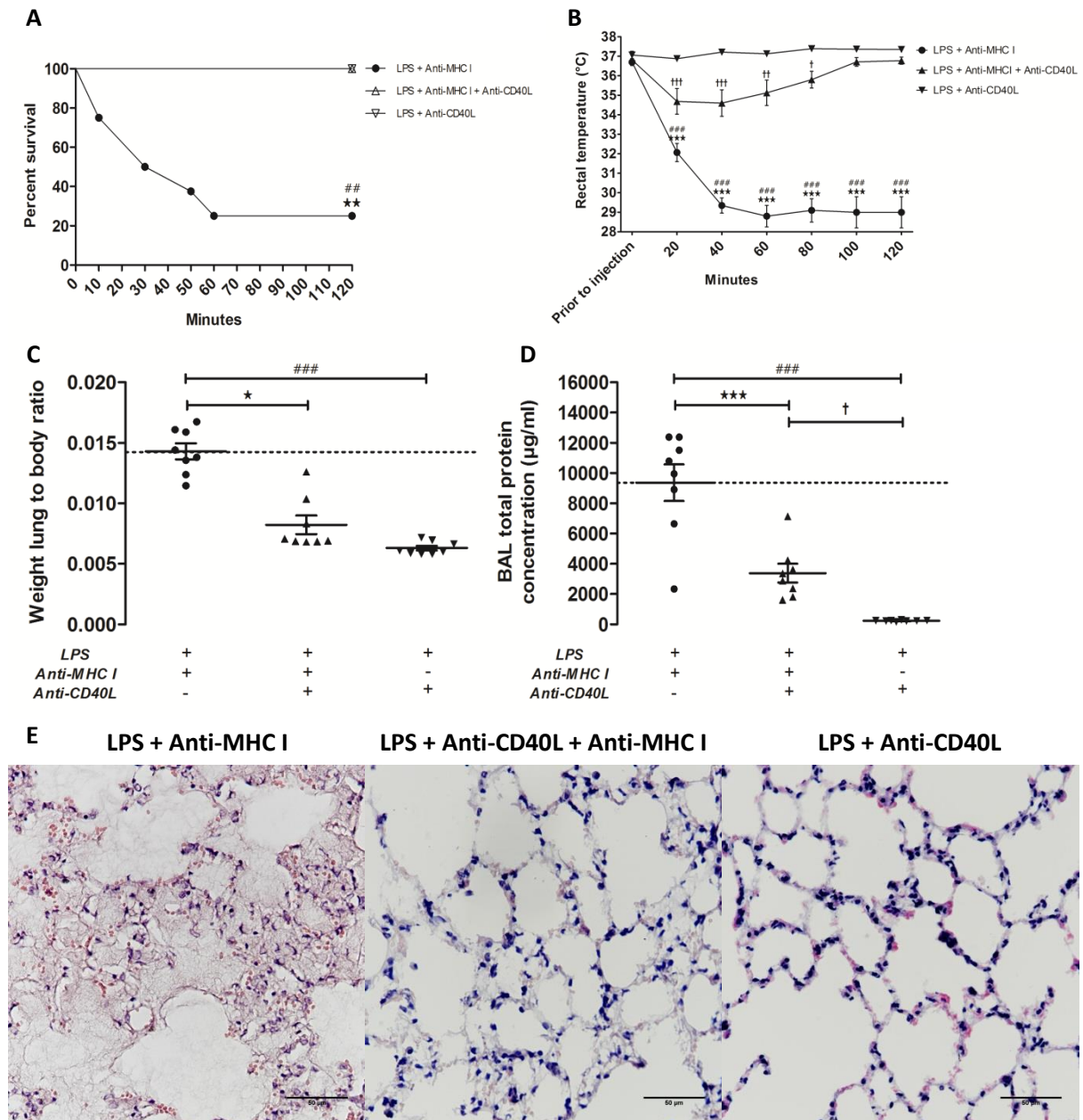

Figure 4: Anti-CD40L mAb injection protects from ALI development

Survival curve (A) and rectal temperature (B) were measured for each group of mice. Wet lung to dry lung ratio (C) and BAL protein concentration (D) were evaluated to represent pulmonary edema development. Data are presented as mean \pm SEM (n = 8). *p < 0.05; **p < 0.01 and ***p < 0.001 represent differences between [LPS + anti-MHC I] and [LPS + Anti-MHC I + Anti-CD40L] groups. #p < 0.05; ###p < 0.01 and ####p < 0.001 represent differences between [LPS + anti-MHC I] and [LPS + Anti-CD40L] groups. †p < 0.05; ††p < 0.01 and †††p < 0.001 represent differences between [LPS + anti-MHC I + Anti-CD40L] and [LPS + Anti-CD40L] groups. Lung microarchitecture was observed after H&E staining (observation x400) (E). Scale bar: 50 μ m.

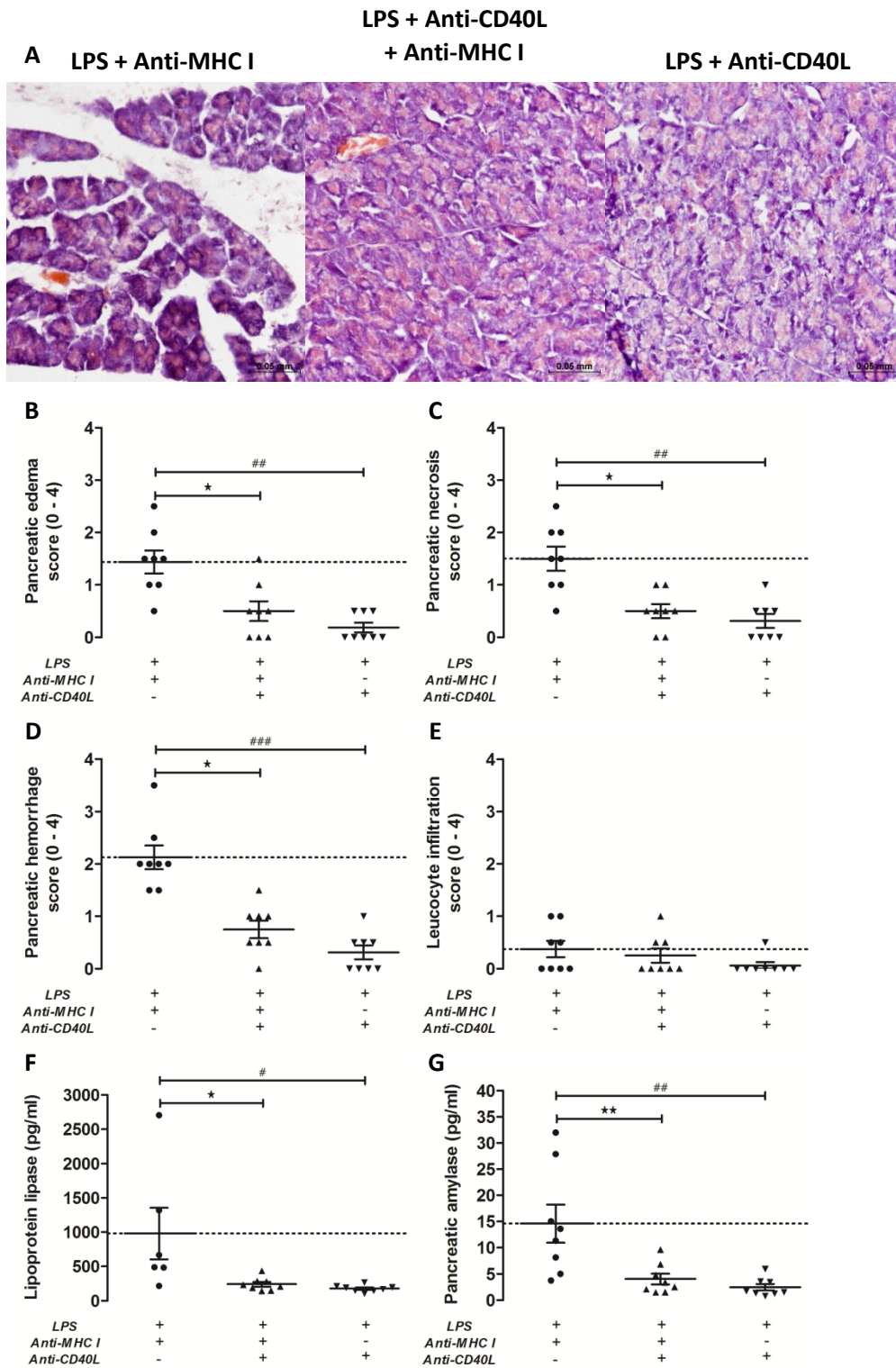

Figure 5: Anti-CD40L mAb injection protects from ALI development

Pancreatic microarchitecture is represented through H&E staining (observation x400) (A). Scale bar: 50 μ m. Pancreatic edema (B), necrosis (C), hemorrhage (D) and leukocyte infiltration (E) were determined through pancreatic histological score criteria. Immunoassay of plasma pancreatic lipoprotein lipase (F) and amylase (G) was performed to evaluate pancreatic dysfunction. Data are given as the mean \pm SEM (n = 6 - 8). *p < 0.05; **p < 0.01 and ***p < 0.001 represent differences between [LPS + anti-MHC I] and [LPS + Anti-MHC I + Anti-CD40L] groups. #p < 0.05; ##p < 0.01 and ###p < 0.001 represent differences between [LPS + anti-MHC I] and [LPS + Anti-CD40L] groups.

SUPPLEMENTAL DATA

Supplemental table 1: Pancreatic edema score

<i>Edema</i>	
0	Absent
0.5	Focal expansion of interlobar septae
1	Diffuse expansion of interlobar septae
1.5	Same as 1 + focal expansion of interlobular septae
2	Same as 1 + diffuse expansion of interlobular septae
2.5	Same as 2 + focal expansion of interacinar septae
3	Same as 2 + diffuse expansion of interacinar septae
3.5	Same as 3 + focal expansion of intercellular spaces
4	Same as 3 + diffuse expansion of intercellular spaces

Supplemental table 2: Pancreatic necrosis score

<i>Acinar necrosis</i>	
0	Absent
0.5	Focal occurrence of 1-4 necrotic cells/HPF
1	Diffuse occurrence of 1-4 necrotic cells/HPF
1.5	Same as 1 + focal occurrence of 5-10 necrotic cells/HPF
2	Diffuse occurrence of 5-10 necrotic cells/HPF
2.5	Same as 2 + focal occurrence of 11-16 necrotic cells/HPF
3	Diffuse occurrence of 1 1-16 necrotic cells/HPF (foci of confluent necrosis)
3.5	Same as 3 + focal occurrence of > 16 necrotic cells/HPF
4	> 16 necrotic cells/HPF (Extensive confluent necrosis)

Supplemental table 3: Pancreatic hemorrhage score

<i>Hemorrhage and fat necrosis</i>	
0	Absent
0.5	1 focus
1	2 foci
1.5	3 foci
2	4 foci
2.5	5 foci
3	6 foci
3.5	7 foci
4	8 foci

Supplemental table 4: Pancreatic leukocyte infiltration score

<i>Inflammation and perivascular infiltrate</i>	
0	0-1 intralobular or perivascular leukocytes/ HPF
0.5	2-5 intralobular or perivascular leukocytes/ HPF
1	6-10 intralobular or perivascular leukocytes/ HPF
1.5	11-15 intralobular or perivascular leukocytes/ HPF
2	16-20 intralobular or perivascular leukocytes/ HPF
2.5	21-25 intralobular or perivascular leukocytes/ HPF
3	26-30 intralobular or perivascular leukocytes/ HPF
3.5	>30 leukocytes/HPF or focal microabscesses
4	>35 leukocytes/HPF or confluent microabscesses

Discussion et perspectives

Lors de la transfusion sanguine, plusieurs types de réactions peuvent survenir chez le receveur. On parle alors d'effets indésirables receveurs ou EIR [280]. Parmi ces différentes réactions, 4 sont considérées comme inflammatoires aiguës ou subaiguës, c'est le cas des réactions fébriles non-hémolytiques (RFNH), des réactions allergiques, des hypotensions et des TRALI [281]. D'après le dernier rapport d'hémovigilance de France, ces réactions représentent 43,95% des EIR déclarés en 2015, indépendamment du type de produit transfusé. Les plaquettes sanguines jouent un rôle prépondérant lors du déclenchement et le devenir de ces complications transfusionnelles, selon deux points de vue : i) depuis les concentrés plaquettaires, où elles ont la capacité de produire une multitude de médiateurs solubles inflammatoires, ii) et directement au sein de l'organisme, où elles participeront activement à l'activation, le maintien et l'amplification de l'état inflammatoire induit lors de ces pathologies. Ce travail de thèse est construit au regard de ces deux points de vue. Tout d'abord nous voulons évaluer le potentiel inflammatoire des concentrés plaquettaires, ayant induit un EIR ou non, sur l'un des principaux types cellulaires protagonistes lors de l'inflammation, l'endothélium vasculaire. Puis, par une approche *in vivo*, nous avons voulu investiguer l'influence des plaquettes sanguines au sein de l'organisme sur le développement de l'inflammation, tout d'abord dans un contexte général, lors d'une inflammation induite par voie systémique, puis dans un cas particulier, celui du TRALI.

les CP peuvent être impliqués dans le déclenchement de ces différentes réactions transfusionnelles inflammatoires [27]. Les RFNH résultent d'une activation des cellules inflammatoires orchestrée par la présence d'anticorps anti-leucocytaires et de médiateurs solubles pro-inflammatoires [282]. Ces médiateurs solubles peuvent aussi être responsables de l'induction des réactions allergiques transfusionnelles lorsqu'ils se fixent sur les cellules cibles que sont les mastocytes ou les basophiles, on parle alors de voie indépendante des allergènes [283]. La physiopathologie des réactions transfusionnelles hypotensives est mal connue. A l'heure actuelle, l'origine du déclenchement de cette complication est accordée aux médiateurs solubles présents dans les PSL, et en particulier à la bradykinine [284]. Enfin, le TRALI est considéré comme la réaction transfusionnelle inflammatoire la plus sévère, mais aussi la plus rare. Cette pathologie peut être induite par des anticorps anti-leucocytaires, c'est le cas des TRALI immunologiques, mais aussi par des médiateurs solubles présents dans les PSL, on parle alors de TRALI non-immunologique [285, 286]. Les CP sont donc des coupables tout désignés. En effet, la multitude de médiateurs solubles secrétés pendant le stockage de ces PSL peut-être responsable du déclenchement de ces différents EIR. On retrouve des BRM pouvant activer directement les leucocytes, tels qu'IL-1 β , IL-7, IL-8, RANTES, ENA-78 mais également des médiateurs solubles ciblant l'endothélium vasculaire, par exemple IL-6, les microparticules plaquettaires, TNF- α , le

facteur de croissance épidermique (EGF), sCD40L ou encore VEGF [7]. Notre équipe a même déjà démontré que la prédisposition génétique de certains donneurs de sang, notamment la présence de certains polymorphismes dans la région promotrice du gène CD40L, pouvait amplifier le niveau d'expression de la protéine [287]. Ainsi, certains PSL seraient plus susceptibles d'induire un EIR inflammatoire que d'autres. L'inflammation est souvent décrite vis-à-vis des leucocytes mais l'endothélium vasculaire est lui aussi un protagoniste non négligeable. Ce dernier est une cible privilégiée des BRM retrouvés dans les CP. C'est pourquoi, au cours de cette thèse, nous avons voulu évaluer le potentiel inflammatoire des productions des CP sur les cellules endothéliales, cellules cibles lors des EIR.

Peu d'études ont déjà évalué le potentiel des sécrétions des CP à activer l'endothélium. Une première étude a démontré, *in vitro*, que les composés présents dans les surnageants des CP, « poolés » ou issues d'aphérèse, agissent sur la production de médiateurs solubles de la part des cellules endothéliales et favorisent la migration des leucocytes à travers cette dernière [47]. Une seconde équipe, par l'utilisation de modèles *in vitro* et *in vivo*, a observé que les plaquettes humaines conservées 5 jours ont un potentiel protecteur contre l'induction de la perméabilité vasculaire moindre par rapport aux plaquettes stockées seulement 1 jour, à 22 ou 4°C [288, 289]. Nous apportons donc un point de vue original par l'évaluation de l'impact des médiateurs solubles présents dans les surnageants des CP, ayant induit un EIR ou non et en fonction du temps de stockage, sur le devenir inflammatoire des cellules endothéliales. Nous avons, en effet, pu démontrer que les CP ayant induit un EIR présentent un potentiel inflammatoire plus important que leurs contrôles. L'impact direct sur les cellules endothéliales, caractérisé par une production massive d'endocan et d'IL-6, peut-être corrélé avec les différentes réactions inflammatoires transfusionnelles et en particulier avec le TRALI dont l'atteinte de l'endothélium vasculaire est le paramètre clé lors de l'induction de cette pathologie [290]. En effet, lors du TRALI, la perméabilité vasculaire induite sera un paramètre inéluctable quant à la migration des leucocytes dans l'espace alvéolaire et donc au développement de l'œdème pulmonaire [16]. C'est la raison pour laquelle nous nous sommes intéressés à la production d'endocan par les cellules endothéliales. Effectivement, endocan participe au maintien de l'intégrité vasculaire. Il a un rôle protecteur pour l'endothélium vasculaire contre une agression liée à l'inflammation. Endocan présente une activité anti-inflammatoire. En effet, il est inhibiteur de la cascade d'activation endothéliale dépendamment de l'intégrine leucocytaire, LFA-1 [291]. En empêchant l'entrée des leucocytes dans les tissus interstitiels, endocan réduit l'inflammation, est serait donc un inhibiteur potentiel du TRALI. Sa sécrétion est positivement corrélée avec le développement de nombreuses pathologies inflammatoires, telles que la pneumonie, le SDRA, les cancers, les

maladies cardiovasculaires, les maladies chroniques rénales et le sepsis [59-63, 292-295]. La libération excessive d'endocan peut donc être considérée comme un signal d'alerte lors d'un choc pathologique, référant à une tentative de défense de l'endothélium vasculaire à l'encontre d'un signal de stress inflammatoire. Au cours de notre première étude, nous avons démontré que les productions des CP impliqués dans les EIR ont un impact néfaste sur le devenir de l'endothélium. La réponse inflammatoire est augmentée, démontré par une sécrétion endothéliale accrue d'IL-6. Cependant, ce changement inflammatoire semble être associé à une réduction de la viabilité cellulaire et à une augmentation de la mort cellulaire plutôt que des fonctions pro-angiogéniques. Cette réponse cellulaire est corrélée avec une importante libération du facteur de maintien de l'intégrité vasculaire qu'est endocan. Endocan peut donc être utilisé comme un marqueur prédictif du développement d'une pathologie inflammatoire après transfusion sanguine, notamment lors d'un TRALI, évoquant ainsi un signal d'alerte référant de l'atteinte de l'endothélium vasculaire. Ces résultats font suite aux premières études publiées par notre équipe caractérisant le profil inflammatoire des CP ayant induit un EIR. En effet, on retrouve des productions excessives de plusieurs cytokines pro-inflammatoires dans ces CP pouvant justifier le développement d'EIR inflammatoires, par exemple sCD40L, IL-13, MIP-1 α , Ox40L ou encore IL-27 [46, 296, 297]. Suite à notre étude, il serait alors intéressant d'évaluer l'impact des CP impliqués dans des EIR directement sur les populations leucocytaires, apportant un point de vue sur l'inflammation plus complet. Il faut également limiter l'extrapolation de nos résultats sur les cas de TRALI, car dans nos échantillons, aucun surnageant de CP n'était associé à un cas de lésion pulmonaire aiguë.

Le rôle des plaquettes sanguines dans les pathologies inflammatoires transfusionnelles n'est pas seulement exclusif aux différents produits sanguins labiles, mais peut également concerner les plaquettes sanguines présentes chez les receveurs des PSL. Pendant longtemps, le rôle physiologique plaquettaire a été limité à la thrombose et l'hémostase. Cependant, depuis quelques années, la communauté scientifique s'accorde à donner une nouvelle fonction aux plaquettes sanguines en tant que cellules de l'inflammation [298]. Les plaquettes sanguines présentent un panel de récepteurs de l'inflammation, capable de capter les signaux d'agression extérieure et être ainsi au premier front de l'inflammation. En effet, ces cellules expriment des « toll-like receptors » (TLR) à leur surface, mais également de façon intracellulaire, ce qui les rends sensibles aux motifs moléculaires associés aux pathogènes, les PAMP [273, 299, 300]. Sont référencés, aussi, plusieurs récepteurs aux compléments et aux immunoglobulines [301]. Les plaquettes sanguines sont, de plus, activables par des stimuli protéiques divers. Nous pouvons, par exemple, citer les récepteurs IL-1R et IL-8R [302]. Une fois activées, les plaquettes sanguines

produisent, via leurs différents granules, un cocktail de cytokines/chimiokines stimulant les différentes cellules de l'inflammation [267]. Ce cocktail comprend des chimiokines et des cytokines ciblant les monocytes (PF4, RANTES, MIP-1 α , CD40L...) mais également les neutrophiles (PF4, NAP-2, GRO- α , ENA-78, CD40L...) [44]. Malgré ces différentes compétences cellulaires énumérées, l'indécision persiste quant à leur réelle implication au sein d'un processus inflammatoire : sont-elles régulatrices ou promotrices de l'inflammation ? Ou n'ont-elles qu'un rôle exclusivement antihémorragique ?

Plusieurs travaux évoquent des preuves d'un rôle plaquettaire limitant la réponse inflammatoire des différentes cellules impliquées. La perméabilisation de l'endothélium vasculaire est considérée comme une étape souvent inéluctable lors d'une inflammation excessive, notamment observée lors de TRALI expérimentaux [7]. Depuis les années 1990, les plaquettes ont été caractérisées comme cellules préservatrices de l'intégrité vasculaire, et donc limitant la fuite et la migration des cellules inflammatoires dans les tissus ciblés [303-309]. La transfusion de plaquettes issues de souris sauvages à des souris thrombopéniques, sous pathologies inflammatoires induites, limite l'hémorragie liée à l'inflammation et restaure l'intégrité de l'endothélium vasculaire [310-313]. Certains évoquent même une réparation plaquettaire des brèches endothéliales induites par les neutrophiles [313]. Cette fonction protectrice est appelée thrombose inflammatoire plaquettaire. Elle est notamment supportée par une production de facteurs stabilisateurs de l'intégrité vasculaire tels que la sphingosine-1-phosphate (S1P) [314, 315] ou l'angiopoïétine-1 (Ang-1) [316]. Ce rôle régulateur ne fait pas l'unanimité. En effet, notamment dans des contextes inflammatoires pulmonaires, plusieurs preuves évoquant une contribution certaine des plaquettes quant à l'amplification de la perméabilité des capillaires sanguins émergent [317-321]. La thrombopénie induite a souvent été corrélée à une amélioration de l'intégrité de la paroi vasculaire, limitant ainsi la diapédèse, dans plusieurs modèles pathologiques murins comme le sepsis [322, 323], l'ALI [104, 323] et même le TRALI [104]. Nous avons préalablement cité certains médiateurs solubles sécrétés par les plaquettes pouvant accroître l'imperméabilité vasculaire, notamment S1P et Ang-1, mais les plaquettes contiennent, au sein de leurs granules, d'autres médiateurs solubles dont le rôle est opposé aux derniers nommés. C'est le cas de l'histamine [324], la thromboxane A₂ (TxA₂) [323] ou l'IL-1 β [325]. Les plaquettes peuvent également participer de façon indirecte à la dégradation des cellules endothéliales dans un contexte inflammatoire. Les productions plaquettaires peuvent stimuler l'activité délétère des leucocytes, notamment les neutrophiles, sur l'endothélium vasculaire [326]. Cela nous amène à évoquer un second point de vue renforçant l'hypothèse que les plaquettes

participent à l'amplification de l'inflammation et ont donc un rôle néfaste dans certaines pathologies inflammatoires.

Le second point de vue susnommé est l'interaction et l'influence directe des plaquettes sanguines sur d'autres cellules de l'inflammation, les leucocytes. Cette communication étroite entre les plaquettes et les leucocytes circulants est régie selon plusieurs mécanismes moléculaires. L'un des plus investigués est le couple protéique CD62P/PSGL-1 [84, 327]. Cette interaction cellulaire est plus secondairement dépendante des couples CD40L/CD40 et GPIIb/IIIa/Mac-1 [84, 328]. Le recrutement cellulaire est bidirectionnel, c'est-à-dire que les leucocytes adhérant à l'endothélium peuvent recruter les plaquettes sanguines circulantes [329-332], comme les plaquettes sanguines fixées à la paroi vasculaire peuvent elles aussi participer au recrutement des leucocytes [333-336]. Ces complexes cellulaires ont été observés directement dans la circulation sanguine générale lors de pathologies inflammatoires humaines [337-341] et murines [323, 342], mais également dans les capillaires sanguins des organes enflammés ou dans des zones tissulaires, par exemple les poumons [343, 344]. Les conséquences d'une communication étroite entre les plaquettes et les différents leucocytes circulants se manifestent par une expression accrue de molécules d'adhésion à la surface de ces derniers facilitant ainsi leur transmigration [84, 335, 345-348], notamment jusqu'à l'espace alvéolaire lors de TRALI expérimentaux [7], mais également par une dégranulation leucocytaire, par la production des ROS et par une modification de l'activité vasculaire [44]. Finalement, les plaquettes sanguines interagissent avec les neutrophiles et participent ainsi à la NETose, phénomène essentiel lors de la mise en place d'une réponse antibactérienne de l'organisme. Ce mécanisme est caractérisé par une libération de la chromatine nucléaire décondensée dans l'espace extracellulaire couplée à des agents antimicrobiens [131, 349]. Cependant, lors de certaines pathologies inflammatoires, une NETose non régulée peut contribuer au développement de complications pulmonaires, notamment observées dans le cas de TRALI expérimentaux [275].

Le but de notre second manuscrit de ce travail de thèse était d'investiguer la place des plaquettes sanguines, au vu de leur production de BRM, dans un contexte inflammatoire. Plus particulièrement, évaluer l'impact des productions plaquettaires contenues dans les granules- α , *in vivo*, sur le maintien, la régulation et/ou l'amplification de l'inflammation induite par injection systémique de LPS. Pour cela, nous avons utilisé un modèle transgénique de souris déficientes pour le gène *Nbeal2*. Cette manipulation génétique réduit significativement la biogenèse des granules- α tout en changeant l'aspect plaquettaire, présentant un profil plus volumineux, et en réduisant leur compte circulant [350]. En limitant la sécrétion plaquettaire, dans l'absolu, aucune

différence n'a pu être observée à propos du compte des cellules inflammatoires, ainsi que dans les concentrations cytokiniques/chimiokines finales. Cela a déjà été observé dans une première étude, dont le modèle animal proposait une inhibition de la biogenèse à la fois de granules- α mais également des granules- δ plaquettaires. Cette étude évoquait alors un effet prépondérant des productions plaquettaires sur le processus hémostatique et thrombotique plutôt qu'inflammatoire [351]. C'est, cependant, le profil d'évolution qui a été affecté. En effet, en limitant la production plaquettaire nous avons pu observer un impact direct sur la mise en place d'une réponse anti-inflammatoire plus importante. Le recrutement des leucocytes, spécialement les neutrophiles et les monocytes, était limité, la production de cytokines anti-inflammatoires, comme IL-10, IL-4 et IL-13, était amplifiée et la sécrétion de certains médiateurs solubles pro-inflammatoires était inhibée, c'était le cas du sCD40L. Ces principales différences sont plutôt dues à des taux importants basaux observés. Cependant, ces résultats ne peuvent pas entièrement être attribués à l'absence des granules- α plaquettaires car, en effet, les souris *Nbeal2^{-/-}* présentent également une atteinte granulaire des autres cellules, telles que les neutrophiles et les cellules NK [352]. En conclusion, cette étude démontre que les plaquettes sanguines participeraient activement, tout en étant sur un plan secondaire, au maintien et à l'amplification de l'inflammation, dans un contexte inflammatoire induit, plutôt que dans la résolution de cet état. De futurs travaux de recherche, notamment au sein d'un modèle murin ciblant exclusivement les granules plaquettaires, pourraient apporter une réelle réponse sur le rôle des plaquettes sanguines dans l'inflammation. Finalement, dans un contexte pathologique inflammatoire, comme le TRALI, on peut émettre l'hypothèse que les plaquettes sanguines participent activement à l'augmentation de la sévérité de cette pathologie, mais reste secondaire au regard des autres cellules centrales que sont les leucocytes et les cellules endothéliales.

Certaines équipes ont déjà tenté de répondre à cette question : quel est le rôle des plaquettes sanguines lors du développement du TRALI ? Comme cité auparavant, des éléments de réponses doivent être apportés selon plusieurs points de vue : i) le rôle des plaquettes conservées dans les produits sanguins labiles, ii) et le rôle inflammatoire de ces mêmes plaquettes via leur interaction avec l'endothélium et les leucocytes, leur production protéique, leur migration pulmonaire ou encore leur biogénèse pulmonaire. A l'heure actuelle, plusieurs études démontrent un potentiel inflammatoire des CP suffisant pour être responsable du « second-hit » du TRALI non-immunologique. Certains ont d'abord évalué, *in vitro*, l'influence directe des CP, en fonction du temps de stockage, sur l'activité des PMN. Les CP stockés 5 jours présentent un impact direct sur le métabolisme oxydatif des neutrophiles, phénomène extrapolable au TRALI [353]. Une partie des médiateurs solubles présents dans ces CP a déjà été ciblée comme potentiellement

responsable de cette activité des neutrophiles. En effet, la production massive de microparticules plaquettaires et de sCD40L serait en partie responsable [86, 354]. L'implication du VEGF plaquettaire a aussi été évoquée, mais son implication serait au détriment de l'imperméabilité vasculaire, plutôt que pour l'activation directe des PMN [355]. Finalement, de façon plus concrète, de nombreux modèles animaux ont démontré que les CP âgés et leur production plasmatique peuvent endosser l'entière responsabilité du « second-hit » du TRALI [71, 356-358]. Ces résultats, en corrélation avec notre première étude démontrant l'impact inflammatoire des CP impliqués dans des réactions transfusionnelles, prouvent que les plaquettes transfusées présentent un potentiel pro-inflammatoire non négligeable et sont, probablement, à l'origine du déclenchement de certains TRALI non-immunologiques.

L'investigation du rôle des productions plaquettaires dans les PSL en tant qu'inducteurs potentiel d'une partie des TRALI non-immunologiques nécessite encore des études plus approfondies, mais, à l'heure actuelle, peu de doute persiste. Le second champ d'investigation se concentrant sur une influence, directe ou indirecte, des plaquettes de l'organisme au sein de la physiopathologie du TRALI est plus débattu. Pour répondre de la façon la plus précise possible à cette interrogation, plusieurs thérapies antiplaquettaires ont alors été rapportées dans la littérature. Les premiers à réellement proposer des preuves d'une implication active des plaquettes sanguines dans la pathogenèse du TRALI expérimental sont Looney *et al.* en 2009 [104]. Au sein de cette étude, l'induction de la lésion pulmonaire a été réalisée par une double injection de LPS et d'anticorps anti-CMH I, l'équivalent murin du HLA I humain responsable de la majorité des TRALI jusqu'alors déclarés [285]. Ce modèle animal est devenu le modèle animal référence du TRALI, malgré ces limites. Cette équipe a donc été la première à avoir observé une chute du compte plaquettaire lors de l'induction expérimentale du TRALI associée avec une migration accentuée des plaquettes sanguines dans l'espace alvéolaire. L'utilisation d'un sérum antiplaquettaire et d'aspirine, dont le rôle est, entre autres, inhibiteur de l'activation plaquettaire [359], a alors démontré une protection contre le développement de ce même TRALI, caractérisé par une survie maximale et une infiltration pulmonaire limitée [104]. Suite à cela, plusieurs études ont alors consolidé ces preuves, en utilisant le même modèle animal. L'aspirine, mais également son produit final, la 15-epi-lipoxine, connue pour avoir un rôle direct sur les plaquettes sanguines [359], semblent réduire efficacement la sévérité de l'ALI expérimentalement induit par l'administration intratrachéale de LPS [343]. La principale limite de ce traitement est qu'il n'a pas une influence exclusive aux plaquettes mais également sur l'endothélium vasculaire [360]. L'inhibition des protéines membranaires plaquettaires semble également être une piste de résolution du TRALI. C'est le cas du CD62P, dont la neutralisation protège les souris d'un

développement du TRALI induit par des injections systémiques de LPS et d'anti-CMH I [361]. Cette molécule, comme l'intégrine GPIIb/IIIa ou encore le CD40L, semble participer à la formation de complexe entre les plaquettes et les neutrophiles, participant ainsi à l'amplification de la transmigration de ces derniers [84]. Certains proposent que la modulation de la communication neutro-plaquettaire soit une piste thérapeutique pour la prévention du TRALI [274, 275]. Chez l'homme, peu d'investigations ont réellement été menées en ce qui concerne la place des plaquettes dans la physiopathologie du TRALI. Cependant, sans de réelles preuves scientifiques, une étude évoque la possibilité d'une induction retardée du TRALI par des anticorps spécifiquement dirigés contre les plaquettes sanguines. En effet, dans un rapport de cas, une patiente aurait déclaré un TRALI retardé, associé à de forts taux d'anticorps inhibiteurs de l'activité plaquettaire dans son sérum et à la présence d'anticorps anti-leucocytaires. Les auteurs concluent que l'inhibition plaquettaire, chez cette patiente, aurait retardé le développement du TRALI, évoquant ainsi un rôle plaquettaire dans l'amplification du niveau d'activation des leucocytes. Leur hypothèse repose sur une accentuation de l'activité des leucocytes, particulièrement des neutrophiles, suite à la libération de médiateurs solubles plaquettaires, tels qu'IL-8 et ENA-78, inhibée chez cette patiente [362]. Enfin, une découverte récente permet d'envisager une fonction pulmonaire des plaquettes probablement sous-estimée. Effectivement, une étude a démontré qu'il existe une thrombopoïèse pulmonaire murine, responsable de la formation de plus de 50% des plaquettes circulantes [271]. Cette découverte permet d'envisager une participation des plaquettes au sein des pathologies pulmonaires. A l'encontre de toutes ses études, plusieurs preuves émergent quant à une implication inexistante des plaquettes dans la physiopathologie de l'ALI induit dans le même modèle murin cité au-dessus, c'est-à-dire par injection successive de LPS et d'anti-CMH I. En effet, la déplétion des plaquettes sanguines, induite génétiquement ou par injection d'anticorps, ainsi que l'inhibition de l'activité plaquettaire, notamment par l'utilisation d'aspirine, de clopidogrel ou d'anticorps anti-CD36, protéine membranaire des plaquettes participant à leur fonction thrombotique [363], ne préviennent pas le développement de l'ALI [278] et manifeste un état hémorragique délétère [72].

Au cours de cette thèse de sciences de la vie et de la santé, nous avons souhaité répondre en partie à cette interrogation (*manuscrit III*). Notre étude apporte un début de réponse à ce débat. L'inhibition de l'activité plaquettaire, en fixant le récepteur « platelet protease-activated receptor-4 » (PAR-4) par injection intrapéritonéale de ML354, n'a en aucun cas apportée des preuves d'une amélioration de l'état des souris après induction de la lésion pulmonaire. Cependant, la déplétion presque totale des plaquettes circulantes, réalisée par une injection préemptive d'anticorps anti-GPIIb/IIIa, n'est pas suffisante à prévenir systématiquement le

développement de l'œdème pulmonaire induit par la double injection de LPS et d'anticorps anti-CMH I, mais en a réduit significativement sa sévérité. Afin d'approfondir notre démarche, nous avons également évalué l'impact des stimuli utilisés dans notre modèle *in vivo* d'induction de l'ALI, c'est-à-dire le modèle « double-hit » par injection de LPS et d'anticorps anti-CMH I, directement sur les plaquettes de souris non préalablement stimulées, dans un modèle *in vitro*. Le LPS utilisé à une dose supérieure de celle administrée dans notre modèle *in vivo* de l'ALI semble avoir un effet sur l'activité plaquettaire, notamment sur la production de médiateurs solubles, tels que le PF4, plutôt que sur l'agrégation de ces dernières. La combinaison de LPS et d'anti-CMH I, à des concentrations n'ayant aucun impact seul sur l'activation des plaquettes, a également influencé la sécrétion du PF4 plaquettaire. En revanche, même à des doses significativement plus élevées que celle utilisée dans notre modèle murin du TRALI, les anticorps anti-CMH I seuls n'ont jamais favorisé l'activation des plaquettes, dans notre modèle *in vitro*. Il est connu que les plaquettes peuvent présenter à leur surface des fragments de l'antigène CMH de classe I, mais ces résidus moléculaires ne sont pas produits, *de novo*, par les plaquettes. En effet, c'est au travers d'un processus d'internalisation des antigènes CMH I, préalablement produits par d'autres cellules de l'immunité dans le plasma, que les plaquettes sanguines sont capables d'exhiber cette protéine [273, 364-366]. La fixation des anticorps anti-CMH I directement sur sa cible plaquettaire n'a donc sûrement aucun impact suffisamment important pour induire une cascade d'activation des plaquettes. Aussi, nos résultats ne semblent pas prendre clairement parti pour une implication directe des plaquettes dans la physiopathologie du TRALI, ni pour leur exclusion. En effet, nos premiers travaux sont en emphases avec une participation des plaquettes sanguines plutôt dans l'augmentation du degré de sévérité de ce TRALI expérimental, précédemment décrit, plutôt qu'une pathogénie entièrement dépendante d'une contribution plaquettaire. Enfin, l'utilisation de notre modèle de souris thrombopénique, déplétion induite par injection d'anticorps anti-GPIIb/IIIa, évoque des résultats en faveur de la thrombopoïèse pulmonaire, déjà décrite dans une étude récemment publiée [271]. En effet, nous observons une augmentation importante du nombre de plaquettes présentes dans les lavages bronchoalvéolaires et l'interstitium pulmonaire chez les souris avec une thrombopénie induite de façon préemptive à l'induction de la lésion pulmonaire. Ces observations semblent évocatrices d'une thrombopoïèse pulmonaire compensatrice de la thrombopénie périphérique induite expérimentalement. Ce phénomène physiologique peut sûrement, à lui seul, justifier l'absence de protection observée dans plusieurs modèles murins de l'ALI après induction de la thrombopénie [72, 278]. Notre étude, valorisée dans le manuscrit III, nécessite des compléments d'information et un approfondissement certain. À l'avenir, nous envisageons de mieux caractériser les plaquettes produites directement dans l'interstitium

pulmonaire pour tenter d'élaborer un nouveau modèle animal de l'ALI/TRALI ciblant en particulier les plaquettes issues de la thrombopoïèse pulmonaire et ainsi apporter un regard innovant sur l'implication des plaquettes dans cette physiopathologie.

Les plaquettes sanguines semblent avoir un rôle très complexe lors de certains processus inflammatoires. Comme cité préalablement, elles possèdent un potentiel de sécrétion et d'expression protéique pouvant agir sur plusieurs fronts. Elles participent au maintien de l'intégrité vasculaire [303-309], mais peuvent également amplifier les réactions inflammatoires pathologiques [104, 322, 323]. En conséquence, nous avons émis l'hypothèse que cibler un produit plaquettaire, au rôle pléiotropique, serait une voie à envisager plutôt qu'une inhibition plaquettaire totale. Nous avons donc choisi de cibler le couple protéique CD40/CD40L pour plusieurs raisons : les plaquettes sanguines sont responsables de la production de plus de 95% du CD40L soluble (sCD40L) dans le plasma, dont la fonction est agoniste à la forme membranaire [89]. L'implication du couple protéique CD40/CD40L a été démontrée dans plusieurs modèles murins de l'ALI [99-102]. Des taux importants de sCD40L ont été corrélés avec le déclenchement de plusieurs pathologies transfusionnelles [367-370]. Enfin, ce complexe immun participe à la communication intercellulaire entre l'endothélium vasculaire, les leucocytes et les plaquettes sanguines [84]. En 2011, une première étude a investigué le rôle du couple CD40/CD40L dans la physiopathologie d'un TRALI expérimental et n'a pu démontrer aucune amélioration de l'état des souris lors de la neutralisation de ce complexe protéique par l'utilisation d'anticorps anti-CD40L et de ciglitazone, inhibant l'expression du CD40L plaquettaire [371]. La principale limite de cette étude était l'utilisation d'un modèle murin peu représentatif de l'hypothèse validée du « two-hit » du TRALI humain. En effet, ce modèle repose sur une simple injection d'anticorps anti-CMH I à 4,5 mg/kg responsable de la lésion pulmonaire [103]. De plus, l'utilisation d'une telle concentration dans notre modèle murin reposant sur l'hypothèse de la double frappe (LPS et anti-CMH I) réduit considérablement la survie des souris. Lors de la validation du modèle murin du « two-hit », Looney *et al.* ont démontré qu'aucune souris ne survie plus de 45 minutes, sur les deux heures de l'expérimentation, avec une concentration à 4,5 mg/kg [104]. Dans notre laboratoire, l'utilisation d'une concentration de plus de 3 mg/kg a été écartée du fait de n'avoir observé aucune survie (n = 5) au-delà de 30 minutes (*données non publiées*). Finalement, suite à cette étude proposée par Tuinman *et al.* [103] l'investigation du complexe protéique CD40/CD40L au sein de la pathogénie du TRALI a été longtemps reléguée au second plan. Au cours de ma thèse, nous avons de nouveau étudié la place de ce couple immun dans le modèle murin du TRALI, aujourd'hui internationalement reconnu, avec l'induction du « second-hit » à 1 mg/kg. Nous avons ainsi pu démontrer que la neutralisation préemptive de l'interaction

du CD40 avec son ligand, le CD40L membranaire et soluble, prévient le développement d'une lésion pulmonaire dans notre modèle murin. Cette inhibition passe notamment par une réduction significative de la migration des cellules effectrices, que sont les neutrophiles, dans l'espace alvéolaire. Cette limitation de la leucostase des neutrophiles est corrélée avec une diminution importante de l'expression de Mac-1 et de CD40 à leur surface et une réduction de la complexification des neutrophiles avec les plaquettes circulantes, ces dernières étant moins activées lors de l'injection de ce traitement. Nous constatons, cependant, un état inflammatoire systémique non régulé malgré l'utilisation de ce traitement. Seule la communication cellulaire semblait directement impactée. Plusieurs champs méritent d'être plus investigués, en lien avec cette étude. En effet, nous n'avons pas étudié l'influence d'un tel traitement sur l'endothélium vasculaire, les monocytes, ou encore les macrophages pulmonaires. Il serait également intéressant d'évaluer l'effet d'une injection de sCD40L recombinant en tant que « second-hit » du TRALI, dans ce même modèle animal. Finalement, ce complexe immun, étant au cœur d'une communication cellulaire importante entre plusieurs cellules de l'inflammation [74], pourrait être impliqué dans plusieurs pathologies inflammatoires ou auto-immunes. L'établissement de futurs traitements, ciblant particulièrement ces protéines, pourrait permettre de mettre en place une régulation de plusieurs pathologies sans pour autant être délétère pour un type cellulaire précis, par exemple les plaquettes sanguines, et donc impacter la physiologie cellulaire naturelle du patient.

Un constat original a pu être fait au cours de cette thèse. En effet, nous avons observé, au sein de notre modèle animal, une atteinte des organes autres que les poumons. Nous avons notamment investigué l'atteinte du pancréas au cours du développement d'une lésion pulmonaire suite à l'injection successive de LPS et d'anticorps anti-CMH I au sein de notre modèle murin. Cette étude a été réalisée suite aux différents travaux présentant des points communs dans la physiopathologie de certains modèles expérimentaux de la pancréatite et celle décrite dans notre modèle animal du TRALI, impliquant les neutrophiles [117, 118], l'endothélium vasculaire [134, 135] et les plaquettes sanguines [149]. Certains ont également évoqué un lien évident entre l'atteinte du pancréas et le développement de lésion pulmonaire, lors d'une pancréatite expérimentale, qu'elle soit induite par injection intrapéritonéale de céruléine et de LPS ou de L-arginine [113, 114]. De plus, l'implication du couple protéique CD40/CD40L a également été démontrée dans des modèles murins de pancréatite avec atteinte pulmonaire [158], en lien avec notre manuscrit IV. Tous ces paramètres nous ont conduit à investiguer le développement d'une pancréatite suite à l'injection d'anticorps anti-CMH I chez les souris préalablement stimulées avec une injection intrapéritonéale de LPS. Nous avons ainsi pu démontrer que le développement de

l'ALI, dans ce modèle, était associé à une atteinte pancréatique, blessure limitée lors de l'utilisation d'anticorps anti-CD40L neutralisant de façon préemptive. Cependant, cette pancréatite semblait être modérée par rapport à une induction directe de cette pathologie, notamment observée par l'évaluation du score pathologique. L'évaluation de l'infiltration des leucocytes dans le tissu pancréatique n'a pas permis de dénombrer un taux important de neutrophiles dans le cas des souris mimant un TRALI par rapport aux autres groupes. Nous émettons ainsi l'hypothèse que lors du TRALI, chez l'homme, une atteinte des différents organes profonds, tels que le pancréas, peut justifier le fort taux de mortalité associé à cette pathologie. C'est probablement lors d'un TRALI sévère que les autres organes seront alors affectés à un degré similaire à celui des poumons. Cette étude mérite une investigation plus poussée, notamment en ciblant plus spécifiquement les leucocytes, les plaquettes et l'endothélium vasculaire des capillaires pancréatiques pour mieux en comprendre la mécanistique. Actuellement, nous menons une investigation sur le devenir des autres organes, tels que l'intestin, après l'induction expérimentale de la lésion pulmonaire, au sein de notre modèle animal. Un suivi des organes, autres que les poumons, lors de complications lésionnelles pulmonaires après transfusion sanguine pourrait permettre de prévenir, de façon plus prolifique, la mortalité liée à cette réaction transfusionnelle.

Conclusion

Les réactions transfusionnelles inflammatoires sont loin d'être comprises sur le plan mécanistique. En France, le TRALI immunologique connaît une réduction significative de sa fréquence. Cela est notamment dû à l'instauration des différentes précautions transfusionnelles. C'est le second type, le TRALI non-immunologique, qui connaît une progression importante. Il est donc essentiel de comprendre encore mieux la physiopathologie de cette réaction transfusionnelle. Ces travaux de thèse apportent de nouvelles preuves quant au rôle des plaquettes sanguines dans le processus inflammatoire et particulièrement au sein du TRALI expérimental. En effet, nous constatons une fonction plutôt pro- qu'anti-inflammatoire des plaquettes, notamment régulée par la libération de ces facteurs solubles contenus dans les granules- α , en particulier pour le sCD40L. La principale limite de cette thèse est l'utilisation d'un modèle murin se rapprochant des caractéristiques du TRALI, mais ne prenant pas en considération la variable transfusionnelle, c'est-à-dire l'hétérogénéité des donneurs, des produits sanguins labiles transfusés et des receveurs. De plus, ces résultats, hormis le premier manuscrit, ne sont applicables qu'aux souris et nécessitent de nouvelles investigations chez l'homme, car la physiopathologie du TRALI humain est mal connue et toujours débattue. En effet, la diversité des TRALI humains diagnostiqués est telle que la mécanistique cellulaire les régulant ne peut être seulement extrapolée depuis des modèles *in vivo* et *in vitro* expérimentaux. Finalement, de meilleures connaissances sur l'impact des procédures de préparation des différents produits sanguins labiles, ainsi qu'un meilleur management des patients à risque, pourrait réduire, à l'avenir, l'occurrence des réactions transfusionnelles inflammatoires, en particulier les TRALI non-immunologiques.

Références

1. Brittingham, T.E., *Immunologic studies on leukocytes*. Vox Sang, 1957. **2**(4): p. 242-8.
2. Barnard, R.D., *Indiscriminate transfusion: a critique of case reports illustrating hypersensitivity reactions*. N Y State J Med, 1951. **51**(20): p. 2399-402.
3. Popovsky, M.A., M.D. Abel, and S.B. Moore, *Transfusion-related acute lung injury associated with passive transfer of antileukocyte antibodies*. Am Rev Respir Dis, 1983. **128**(1): p. 185-9.
4. Kopko, P.M., et al., *Transfusion-related acute lung injury: report of a clinical look-back investigation*. JAMA, 2002. **287**(15): p. 1968-71.
5. Gajic, O., et al., *Transfusion-related acute lung injury in the critically ill: prospective nested case-control study*. Am J Respir Crit Care Med, 2007. **176**(9): p. 886-91.
6. Benson, A.B., M. Moss, and C.C. Silliman, *Transfusion-related acute lung injury (TRALI): a clinical review with emphasis on the critically ill*. Br J Haematol, 2009. **147**(4): p. 431-43.
7. Tariket, S., et al., *Transfusion-related acute lung injury: transfusion, platelets and biological response modifiers*. Expert Rev Hematol, 2016: p. 1-12.
8. Marik, P.E. and H.L. Corwin, *Acute lung injury following blood transfusion: expanding the definition*. Crit Care Med, 2008. **36**(11): p. 3080-4.
9. Goldman, M., et al., *Proceedings of a consensus conference: towards an understanding of TRALI*. Transfus Med Rev, 2005. **19**(1): p. 2-31.
10. Stainsby, D., et al., *Serious hazards of transfusion: a decade of hemovigilance in the UK*. Transfus Med Rev, 2006. **20**(4): p. 273-82.
11. Kleinman, S., *A perspective on transfusion-related acute lung injury two years after the Canadian Consensus Conference*. Transfusion, 2006. **46**(9): p. 1465-8.
12. Holness, L., et al., *Fatalities caused by TRALI*. Transfus Med Rev, 2004. **18**(3): p. 184-8.
13. Toy, P., S.H. Kleinman, and M.R. Looney, *Reply to concerns regarding dropping the term "possible TRALI"*. Transfusion, 2016. **56**(9): p. 2394-5.
14. Juffermans, N.P. and A.P. Vlaar, *Possible TRALI is a real entity*. Transfusion, 2017.
15. Bauer, T.T., et al., *Acute respiratory distress syndrome and pneumonia: a comprehensive review of clinical data*. Clin Infect Dis, 2006. **43**(6): p. 748-56.
16. Vlaar, A.P. and N.P. Juffermans, *Transfusion-related acute lung injury: a clinical review*. Lancet, 2013. **382**(9896): p. 984-94.
17. Silliman, C.C., et al., *Transfusion-related acute lung injury: epidemiology and a prospective analysis of etiologic factors*. Blood, 2003. **101**(2): p. 454-62.
18. Vlaar, A.P., et al., *Risk factors and outcome of transfusion-related acute lung injury in the critically ill: a nested case-control study*. Crit Care Med, 2010. **38**(3): p. 771-8.
19. Rana, R., et al., *Transfusion-related acute lung injury and pulmonary edema in critically ill patients: a retrospective study*. Transfusion, 2006. **46**(9): p. 1478-83.
20. Toy, P., et al., *Transfusion-related acute lung injury: incidence and risk factors*. Blood, 2012. **119**(7): p. 1757-67.
21. Bux, J. and U.J. Sachs, *The pathogenesis of transfusion-related acute lung injury (TRALI)*. Br J Haematol, 2007. **136**(6): p. 788-99.
22. Bom, R.A.M.a.J.G.v.d., *Transfusion-related acute lung injury not a two-bit, but a multicausal model*. Transfusion, 2014.
23. Rosendaal, F.R., *Venous thrombosis: a multicausal disease*. Lancet, 1999. **353**(9159): p. 1167-73.
24. Rothman, K.J., *Causes*. Am J Epidemiol, 1976. **104**(6): p. 587-92.
25. Politis, C., et al., *The International Haemovigilance Network Database for the Surveillance of Adverse Reactions and Events in Donors and Recipients of Blood Components: technical issues and results*. Vox Sang, 2016. **111**(4): p. 409-417.
26. Chabanel, A., et al., *National French observatory of the quality of blood components for transfusion*. Transfus Clin Biol, 2008. **15**(3): p. 85-90.
27. ANSM, *French Haemovigilance Activity Report 2015*. 2016.

28. Benson, A.B., et al., *Transfusion-related acute lung injury in ICU patients admitted with gastrointestinal bleeding*. Intensive Care Med, 2010. **36**(10): p. 1710-7.
29. Shaz, B.H., S.R. Stowell, and C.D. Hillyer, *Transfusion-related acute lung injury: from bedside to bench and back*. Blood, 2011. **117**(5): p. 1463-71.
30. Looney, M.R., et al., *Prospective study on the clinical course and outcomes in transfusion-related acute lung injury**. Crit Care Med, 2014. **42**(7): p. 1676-87.
31. Nakagawa, M. and P. Toy, *Acute and transient decrease in neutrophil count in transfusion-related acute lung injury: cases at one hospital*. Transfusion, 2004. **44**(12): p. 1689-94.
32. Marques, M.B., et al., *Acute transient leukopenia as a sign of TRALI*. Am J Hematol, 2005. **80**(1): p. 90-1.
33. Fadeyi, E.A., et al., *The transfusion of neutrophil-specific antibodies causes leukopenia and a broad spectrum of pulmonary reactions*. Transfusion, 2007. **47**(3): p. 545-50.
34. Vlaar, A.P., et al., *Transfusion-related acute lung injury in cardiac surgery patients is characterized by pulmonary inflammation and coagulopathy: a prospective nested case-control study*. Crit Care Med, 2012. **40**(10): p. 2813-20.
35. Yomtovian, R., et al., *Severe pulmonary hypersensitivity associated with passive transfusion of a neutrophil-specific antibody*. Lancet, 1984. **1**(8371): p. 244-6.
36. Leger, R., et al., *Transfusion-related lung injury with leukopenic reaction caused by fresh frozen plasma containing anti-NB1*. Anesthesiology, 1999. **91**(5): p. 1529-32.
37. Ilango, G., S. Senthilkumar, and N. Sambanthan, *TRALI in Perioperative Period-A Case Report*. Indian J Anaesth, 2009. **53**(2): p. 209-13.
38. Butt, Y., A. Kurdowska, and T.C. Allen, *Acute Lung Injury: A Clinical and Molecular Review*. Arch Pathol Lab Med, 2016. **140**(4): p. 345-50.
39. Goodman, R.B., et al., *Cytokine-mediated inflammation in acute lung injury*. Cytokine Growth Factor Rev, 2003. **14**(6): p. 523-35.
40. Roubinian, N.H., et al., *Cytokines and clinical predictors in distinguishing pulmonary transfusion reactions*. Transfusion, 2015.
41. Muller, M.C., et al., *Contribution of damage-associated molecular patterns to transfusion-related acute lung injury in cardiac surgery*. Blood Transfus, 2014. **12**(3): p. 368-75.
42. Kapur, R., et al., *Elevation of C-reactive protein levels in patients with transfusion-related acute lung injury*. Oncotarget, 2016. **7**(47): p. 78048-78054.
43. Kapur, R., et al., *Low levels of interleukin-10 in patients with transfusion-related acute lung injury*. Ann Transl Med, 2017. **5**(16): p. 339.
44. Middleton, E.A., A.S. Weyrich, and G.A. Zimmerman, *Platelets in Pulmonary Immune Responses and Inflammatory Lung Diseases*. Physiol Rev, 2016. **96**(4): p. 1211-59.
45. Xie, R.F., et al., *Platelet-derived microparticles induce polymorphonuclear leukocyte-mediated damage of human pulmonary microvascular endothelial cells*. Transfusion, 2015. **55**(5): p. 1051-7.
46. Cognasse, F., et al., *Platelet soluble CD40-Ligand level is associated with transfusion adverse reactions in a mixed threshold and hit model*. Blood, 2017.
47. Urner, M., et al., *Effects of blood products on inflammatory response in endothelial cells in vitro*. PLoS One, 2012. **7**(3): p. e33403.
48. Boudreau, L.H., et al., *Platelets release mitochondria serving as substrate for bactericidal group IIA-secreted phospholipase A2 to promote inflammation*. Blood, 2014. **124**(14): p. 2173-83.
49. Cognasse, F., et al., *Platelet components associated with adverse reactions: predictive value of mitochondrial DNA relative to biological response modifiers*. Transfusion, 2016. **56**(2): p. 497-504.
50. Yasui, K., et al., *Mitochondrial damage-associated molecular patterns as potential proinflammatory mediators in post-platelet transfusion adverse effects*. Transfusion, 2016. **56**(5): p. 1201-12.
51. Sun, S., et al., *Mitochondrial DAMPs increase endothelial permeability through neutrophil dependent and independent pathways*. PLoS One, 2013. **8**(3): p. e59989.
52. Zhang, L., et al., *Intra-Peritoneal Administration of Mitochondrial DNA Provokes Acute Lung Injury and Systemic Inflammation via Toll-Like Receptor 9*. Int J Mol Sci, 2016. **17**(9).

53. Lee, Y.L., et al., *Mitochondrial DNA Damage Initiates Acute Lung Injury and Multi-Organ System Failure Evoked in Rats by Intra-Tracheal Pseudomonas Aeruginosa*. Shock, 2017. **48**(1): p. 54-60.
54. Zhang, Q., et al., *Circulating mitochondrial DAMPs cause inflammatory responses to injury*. Nature, 2010. **464**(7285): p. 104-7.
55. Lacoste, E., I. Martineau, and G. Gagnon, *Platelet concentrates: effects of calcium and thrombin on endothelial cell proliferation and growth factor release*. J Periodontol, 2003. **74**(10): p. 1498-507.
56. Martineau, I., E. Lacoste, and G. Gagnon, *Effects of calcium and thrombin on growth factor release from platelet concentrates: kinetics and regulation of endothelial cell proliferation*. Biomaterials, 2004. **25**(18): p. 4489-502.
57. Huang, X., et al., *Prognostic value of endocan expression in cancers: evidence from meta-analysis*. Onco Targets Ther, 2016. **9**: p. 6297-6304.
58. Seo, K., et al., *Characteristics of serum endocan levels in infection*. PLoS One, 2015. **10**(4): p. e0123358.
59. Cox, L.A., et al., *Inflammation-Induced Increases in Plasma Endocan Levels Are Associated With Endothelial Dysfunction in Humans In Vivo*. Shock, 2015.
60. Balta, S., et al., *Endocan: A novel inflammatory indicator in cardiovascular disease? Atherosclerosis*, 2015. **243**(1): p. 339-43.
61. Tang, L., et al., *Endocan levels in peripheral blood predict outcomes of acute respiratory distress syndrome*. Mediators Inflamm, 2014. **2014**: p. 625180.
62. Mihajlovic, D.M., et al., *Endocan is useful biomarker of survival and severity in sepsis*. Microvasc Res, 2014. **93**: p. 92-7.
63. Orbegozo, D., et al., *Endocan as an early biomarker of severity in patients with acute respiratory distress syndrome*. Ann Intensive Care, 2017. **7**(1): p. 93.
64. Bastarache, J.A., et al., *Procoagulant alveolar microparticles in the lungs of patients with acute respiratory distress syndrome*. Am J Physiol Lung Cell Mol Physiol, 2009. **297**(6): p. L1035-41.
65. Shaver, C.M., et al., *Circulating microparticle levels are reduced in patients with ARDS*. Crit Care, 2017. **21**(1): p. 120.
66. Wang, L., et al., *Effect of Antiplatelet Therapy on Acute Respiratory Distress Syndrome and Mortality in Critically Ill Patients: A Meta-Analysis*. PLoS One, 2016. **11**(5): p. e0154754.
67. Mohananeey, D., et al., *Effect of antiplatelet therapy on mortality and acute lung injury in critically ill patients: A systematic review and meta-analysis*. Ann Card Anaesth, 2016. **19**(4): p. 626-637.
68. Bdeir, K., et al., *Platelet-Specific Chemokines Contribute to the Pathogenesis of Acute Lung Injury*. Am J Respir Cell Mol Biol, 2017. **56**(2): p. 261-270.
69. Lu, T., et al., *A NET Outcome*. Front Immunol, 2012. **3**: p. 365.
70. Tilgner, J., et al., *Aspirin, but Not Tirofiban Displays Protective Effects in Endotoxin Induced Lung Injury*. PLoS One, 2016. **11**(9): p. e0161218.
71. McVey, M.J., et al., *Acid sphingomyelinase mediates murine acute lung injury following transfusion of aged platelets*. Am J Physiol Lung Cell Mol Physiol, 2017. **312**(5): p. L625-L637.
72. Hechler, B., et al., *Platelets are dispensable for antibody-mediated transfusion-related acute lung injury in the mouse*. J Thromb Haemost, 2016.
73. Simic, D., et al., *Blocking alpha5beta1 Integrin Attenuates sCD40L-Mediated Platelet Activation*. Clin Appl Thromb Hemost, 2015.
74. Aloui, C., et al., *The signaling role of CD40 ligand in platelet biology and in platelet component transfusion*. Int J Mol Sci, 2014. **15**(12): p. 22342-64.
75. O'Connor, T., L. Borsig, and M. Heikenwalder, *CCL2-CCR2 Signaling in Disease Pathogenesis*. Endocr Metab Immune Disord Drug Targets, 2015. **15**(2): p. 105-18.
76. Stumpf, C., et al., *Platelet CD40 contributes to enhanced monocyte chemoattractant protein 1 levels in patients with resistant hypertension*. Eur J Clin Invest, 2016. **46**(6): p. 564-71.
77. Moller, K., et al., *Mechanism and functional impact of CD40 ligand-induced von Willebrand factor release from endothelial cells*. Thromb Haemost, 2015. **113**(5): p. 1095-108.

78. Greene, J.A., et al., *CD40-TRAF Signaling Upregulates CX3CL1 and TNF-alpha in Human Aortic Endothelial Cells but Not in Retinal Endothelial Cells*. PLoS One, 2015. **10**(12): p. e0144133.
79. Lievens, D., et al., *Platelet CD40L mediates thrombotic and inflammatory processes in atherosclerosis*. Blood, 2010. **116**(20): p. 4317-27.
80. Hausding, M., et al., *CD40L contributes to angiotensin II-induced pro-thrombotic state, vascular inflammation, oxidative stress and endothelial dysfunction*. Basic Res Cardiol, 2013. **108**(6): p. 386.
81. Bou Khzam, L., et al., *Soluble CD40 ligand impairs the anti-platelet function of peripheral blood angiogenic outgrowth cells via increased production of reactive oxygen species*. Thromb Haemost, 2013. **109**(5): p. 940-7.
82. Yacoub, D., et al., *Enhanced levels of soluble CD40 ligand exacerbate platelet aggregation and thrombus formation through a CD40-dependent tumor necrosis factor receptor-associated factor-2/Rac1/p38 mitogen-activated protein kinase signaling pathway*. Arterioscler Thromb Vasc Biol, 2010. **30**(12): p. 2424-33.
83. Kuijpers, M.J., et al., *Platelet CD40L Modulates Thrombus Growth Via Phosphatidylinositol 3-Kinase beta, and Not Via CD40 and IkappaB Kinase alpha*. Arterioscler Thromb Vasc Biol, 2015. **35**(6): p. 1374-81.
84. Zuchtriegel, G., et al., *Platelets Guide Leukocytes to Their Sites of Extravasation*. PLoS Biol, 2016. **14**(5): p. e1002459.
85. Jin, R., et al., *Soluble CD40 ligand stimulates CD40-dependent activation of the beta2 integrin Mac-1 and protein kinase C zeta (PKCzeta) in neutrophils: implications for neutrophil-platelet interactions and neutrophil oxidative burst*. PLoS One, 2013. **8**(6): p. e64631.
86. Khan, S.Y., et al., *Soluble CD40 ligand accumulates in stored blood components, primes neutrophils through CD40, and is a potential cofactor in the development of transfusion-related acute lung injury*. Blood, 2006. **108**(7): p. 2455-62.
87. Vanichakarn, P., et al., *Neutrophil CD40 enhances platelet-mediated inflammation*. Thromb Res, 2008. **122**(3): p. 346-58.
88. Zhao, L., et al., *P-selectin, tissue factor and CD40 ligand expression on platelet-leucocyte conjugates in the presence of a GPIIb/IIIa antagonist*. Platelets, 2003. **14**(7-8): p. 473-80.
89. Andre, P., et al., *Platelet-derived CD40L: the switch-hitting player of cardiovascular disease*. Circulation, 2002. **106**(8): p. 896-9.
90. Gerdes, N., et al., *Platelet CD40 Exacerbates Atherosclerosis by Transcellular Activation of Endothelial Cells and Leukocytes*. Arterioscler Thromb Vasc Biol, 2016. **36**(3): p. 482-90.
91. Rahman, M., et al., *Platelet shedding of CD40L is regulated by matrix metalloproteinase-9 in abdominal sepsis*. J Thromb Haemost, 2013. **11**(7): p. 1385-98.
92. Hwaiz, R., et al., *Rac1 regulates platelet shedding of CD40L in abdominal sepsis*. Lab Invest, 2014. **94**(9): p. 1054-63.
93. Rahman, M., et al., *Metalloproteinases regulate CD40L shedding from platelets and pulmonary recruitment of neutrophils in abdominal sepsis*. Inflamm Res, 2012. **61**(6): p. 571-9.
94. Rahman, M., et al., *Platelet-derived CD40L (CD154) mediates neutrophil upregulation of Mac-1 and recruitment in septic lung injury*. Ann Surg, 2009. **250**(5): p. 783-90.
95. Zhang, S., et al., *Simvastatin antagonizes CD40L secretion, CXC chemokine formation, and pulmonary infiltration of neutrophils in abdominal sepsis*. J Leukoc Biol, 2011. **89**(5): p. 735-42.
96. Setianto, B.Y., et al., *Circulating soluble CD40 ligand mediates the interaction between neutrophils and platelets in acute coronary syndrome*. Heart Vessels, 2010. **25**(4): p. 282-7.
97. Li, G., et al., *CD40 ligand promotes Mac-1 expression, leukocyte recruitment, and neointima formation after vascular injury*. Am J Pathol, 2008. **172**(4): p. 1141-52.
98. Dong, L., et al., *The activation of macrophage and upregulation of CD40 costimulatory molecule in lipopolysaccharide-induced acute lung injury*. J Biomed Biotechnol, 2008. **2008**: p. 852571.
99. Hashimoto, N., et al., *CD40 plays a crucial role in lipopolysaccharide-induced acute lung injury*. Am J Respir Cell Mol Biol, 2004. **30**(6): p. 808-15.

100. Moore, T.M., et al., *Involvement of CD40-CD40L signaling in postischemic lung injury*. Am J Physiol Lung Cell Mol Physiol, 2002. **283**(6): p. L1255-62.
101. Adawi, A., et al., *Disruption of the CD40-CD40 ligand system prevents an oxygen-induced respiratory distress syndrome*. Am J Pathol, 1998. **152**(3): p. 651-7.
102. Adawi, A., et al., *Blockade of CD40-CD40 ligand interactions protects against radiation-induced pulmonary inflammation and fibrosis*. Clin Immunol Immunopathol, 1998. **89**(3): p. 222-30.
103. Tuinman, P.R., et al., *Lack of evidence of CD40 ligand involvement in transfusion-related acute lung injury*. Clin Exp Immunol, 2011. **165**(2): p. 278-84.
104. Looney, M.R., et al., *Platelet depletion and aspirin treatment protect mice in a two-event model of transfusion-related acute lung injury*. J Clin Invest, 2009. **119**(11): p. 3450-61.
105. Banks, P.A., D.L. Conwell, and P.P. Toskes, *The management of acute and chronic pancreatitis*. Gastroenterol Hepatol (N Y), 2010. **6**(2 Suppl 3): p. 1-16.
106. Nordback, I. and K. Lauslahti, *Clinical pathology of acute necrotising pancreatitis*. J Clin Pathol, 1986. **39**(1): p. 68-74.
107. Xu, B., et al., *Interleukin-1beta induces autophagy by affecting calcium homeostasis and trypsinogen activation in pancreatic acinar cells*. Int J Clin Exp Pathol, 2014. **7**(7): p. 3620-31.
108. Berney, T., et al., *Serum profiles of interleukin-6, interleukin-8, and interleukin-10 in patients with severe and mild acute pancreatitis*. Pancreas, 1999. **18**(4): p. 371-7.
109. Hansen, M., et al., *Increased levels of YKL-40 and interleukin 6 in patients with chronic pancreatitis and secondary diabetes*. Pancreas, 2012. **41**(8): p. 1316-8.
110. McKay, C.J., et al., *Increased monocyte cytokine production in association with systemic complications in acute pancreatitis*. Br J Surg, 1996. **83**(7): p. 919-23.
111. Daniel, P., et al., *Circulating levels of visfatin, resistin and pro-inflammatory cytokine interleukin-8 in acute pancreatitis*. Pancreatology, 2010. **10**(4): p. 477-82.
112. Ueda, T., et al., *Significant elevation of serum interleukin-18 levels in patients with acute pancreatitis*. J Gastroenterol, 2006. **41**(2): p. 158-65.
113. Lu, G., et al., *Aspirin Protects against Acinar Cells Necrosis in Severe Acute Pancreatitis in Mice*. Biomed Res Int, 2016. **2016**: p. 6089430.
114. Qiao, Y.Y., et al., *Interleukin-22 ameliorates acute severe pancreatitis-associated lung injury in mice*. World J Gastroenterol, 2016. **22**(21): p. 5023-32.
115. Bonjoch, L., et al., *Involvement of exosomes in lung inflammation associated with experimental acute pancreatitis*. J Pathol, 2016. **240**(2): p. 235-45.
116. Wang, F., et al., *Ultrastructural changes in the pulmonary mechanical barriers in a rat model of severe acute pancreatitis-associated acute lung injury*. Ultrastruct Pathol, 2016. **40**(1): p. 33-42.
117. Pandol, S.J., et al., *Acute pancreatitis: bench to the bedside*. Gastroenterology, 2007. **132**(3): p. 1127-51.
118. Yang, Z.W., X.X. Meng, and P. Xu, *Central role of neutrophil in the pathogenesis of severe acute pancreatitis*. J Cell Mol Med, 2015. **19**(11): p. 2513-20.
119. Bhatia, M., et al., *The effects of neutrophil depletion on a completely noninvasive model of acute pancreatitis-associated lung injury*. Int J Pancreatol, 1998. **24**(2): p. 77-83.
120. Gukovskaya, A.S., et al., *Neutrophils and NADPH oxidase mediate intrapancreatic trypsin activation in murine experimental acute pancreatitis*. Gastroenterology, 2002. **122**(4): p. 974-84.
121. Chen, G., et al., *Depletion of neutrophils protects against L-arginine-induced acute pancreatitis in mice*. Cell Physiol Biochem, 2015. **35**(6): p. 2111-20.
122. Wetterholm, E., et al., *Platelet-derived CXCL4 regulates neutrophil infiltration and tissue damage in severe acute pancreatitis*. Transl Res, 2016.
123. Yu, C., et al., *Inhibition of Ras signalling reduces neutrophil infiltration and tissue damage in severe acute pancreatitis*. Eur J Pharmacol, 2015. **746**: p. 245-51.
124. Wu, D., et al., *Reverse-migrated neutrophils regulated by JAM-C are involved in acute pancreatitis-associated lung injury*. Sci Rep, 2016. **6**: p. 20545.

125. Hartwig, W., et al., *Expression of the adhesion molecules Mac-1 and L-selectin on neutrophils in acute pancreatitis is protease- and complement-dependent.* *Ann Surg*, 2001. **233**(3): p. 371-8.
126. Awla, D., et al., *Lymphocyte function antigen-1 regulates neutrophil recruitment and tissue damage in acute pancreatitis.* *Br J Pharmacol*, 2011. **163**(2): p. 413-23.
127. Frossard, J.L., et al., *The role of intercellular adhesion molecule 1 and neutrophils in acute pancreatitis and pancreatitis-associated lung injury.* *Gastroenterology*, 1999. **116**(3): p. 694-701.
128. Guice, K.S., et al., *Neutrophil-dependent, oxygen-radical mediated lung injury associated with acute pancreatitis.* *Ann Surg*, 1989. **210**(6): p. 740-7.
129. Raraty, M.G., et al., *Mechanisms of acinar cell injury in acute pancreatitis.* *Scand J Surg*, 2005. **94**(2): p. 89-96.
130. Merza, M., et al., *Neutrophil Extracellular Traps Induce Trypsin Activation, Inflammation, and Tissue Damage in Mice With Severe Acute Pancreatitis.* *Gastroenterology*, 2015. **149**(7): p. 1920-1931 e8.
131. Brinkmann, V., et al., *Neutrophil extracellular traps kill bacteria.* *Science*, 2004. **303**(5663): p. 1532-5.
132. Paulino, E.C., et al., *Neutrophils from acute pancreatitis patients cause more severe in vitro endothelial damage compared with neutrophils from healthy donors and are differently regulated by endothelins.* *Pancreas*, 2007. **35**(1): p. 37-41.
133. Jeon, T.J. and J.Y. Park, *Clinical significance of the neutrophil-lymphocyte ratio as an early predictive marker for adverse outcomes in patients with acute pancreatitis.* *World J Gastroenterol*, 2017. **23**(21): p. 3883-3889.
134. Abdulla, A., et al., *Platelets regulate P-selectin expression and leukocyte rolling in inflamed venules of the pancreas.* *Eur J Pharmacol*, 2012. **682**(1-3): p. 153-60.
135. Hartman, H., et al., *P-selectin mediates neutrophil rolling and recruitment in acute pancreatitis.* *Br J Surg*, 2012. **99**(2): p. 246-55.
136. Hartwig, W., et al., *Membrane-bound ICAM-1 is upregulated by trypsin and contributes to leukocyte migration in acute pancreatitis.* *Am J Physiol Gastrointest Liver Physiol*, 2004. **287**(6): p. G1194-9.
137. Folch, E., et al., *Role of P-selectin and ICAM-1 in pancreatitis-induced lung inflammation in rats: significance of oxidative stress.* *Ann Surg*, 1999. **230**(6): p. 792-8; discussion 798-9.
138. Pezzilli, R., et al., *Serum adhesion molecules in acute pancreatitis: time course and early assessment of disease severity.* *Pancreas*, 2008. **37**(1): p. 36-41.
139. Wereszczynska-Siemiatkowska, U., et al., *Serum profiles of E-selectin, interleukin-10, and interleukin-6 and oxidative stress parameters in patients with acute pancreatitis and nonpancreatic acute abdominal pain.* *Pancreas*, 2003. **26**(2): p. 144-52.
140. Ida, S., et al., *Significance of endothelial molecular markers in the evaluation of the severity of acute pancreatitis.* *Surg Today*, 2009. **39**(4): p. 314-9.
141. Chen, Y., et al., *Endothelial markers are associated with pancreatic necrosis and overall prognosis in acute pancreatitis: A preliminary cohort study.* *Pancreatology*, 2017. **17**(1): p. 45-50.
142. Chen, H.M., et al., *Early microcirculatory derangement in mild and severe pancreatitis models in mice.* *Surg Today*, 2001. **31**(7): p. 634-42.
143. Liu, X.M., et al., *Microcirculation disturbance affects rats with acute severe pancreatitis following lung injury.* *World J Gastroenterol*, 2005. **11**(39): p. 6208-11.
144. Keck, T., et al., *Pancreatic proteases in serum induce leukocyte-endothelial adhesion and pancreatic microcirculatory failure.* *Pancreatology*, 2005. **5**(2-3): p. 241-50.
145. Uhlmann, D., et al., *Pathophysiological role of platelets in acute experimental pancreatitis: influence of endothelin A receptor blockade.* *Cell Tissue Res*, 2007. **327**(3): p. 485-92.
146. Jamdar, S., et al., *Differential kinetics of plasma CD105 and transforming growth factor beta expression early in human acute pancreatitis.* *Pancreas*, 2006. **32**(2): p. 152-8.
147. Leveau, P., et al., *Severity of pancreatitis-associated gut barrier dysfunction is reduced following treatment with the PAF inhibitor lexipafant.* *Biochem Pharmacol*, 2005. **69**(9): p. 1325-31.

148. Lu, F., et al., *Intestinal capillary endothelial barrier changes in severe acute pancreatitis*. Hepatogastroenterology, 2011. **58**(107-108): p. 1009-17.
149. Abdulla, A., et al., *Role of platelets in experimental acute pancreatitis*. Br J Surg, 2011. **98**(1): p. 93-103.
150. Hackert, T., et al., *Platelet function in acute experimental pancreatitis*. J Gastrointest Surg, 2007. **11**(4): p. 439-44.
151. Hackert, T., et al., *Platelet function in acute experimental pancreatitis induced by ischaemia-reperfusion*. Br J Surg, 2005. **92**(6): p. 724-8.
152. Hackert, T., et al., *P-selectin inhibition reduces severity of acute experimental pancreatitis*. Pancreatology, 2009. **9**(4): p. 369-74.
153. Jiang, L., W. Ding, and M. Zhang, *The progressive increase of the platelet count in a patient with acute severe pancreatitis*. Am J Emerg Med, 2017. **35**(1): p. 191 e1-191 e2.
154. Akbal, E., et al., *Alterations of platelet function and coagulation parameters during acute pancreatitis*. Blood Coagul Fibrinolysis, 2013. **24**(3): p. 243-6.
155. Park, Y., N. Schoene, and W. Harris, *Mean platelet volume as an indicator of platelet activation: methodological issues*. Platelets, 2002. **13**(5-6): p. 301-6.
156. Osada, J., et al., *Platelet activation in acute pancreatitis*. Pancreas, 2012. **41**(8): p. 1319-24.
157. Beyazit, Y., et al., *Mean platelet volume as an indicator of disease severity in patients with acute pancreatitis*. Clin Res Hepatol Gastroenterol, 2012. **36**(2): p. 162-8.
158. Frossard, J.L., et al., *Cd40 ligand-deficient mice are protected against cerulein-induced acute pancreatitis and pancreatitis-associated lung injury*. Gastroenterology, 2001. **121**(1): p. 184-94.
159. Gultekin, F.A., et al., *Leptin treatment ameliorates acute lung injury in rats with cerulein-induced acute pancreatitis*. World J Gastroenterol, 2007. **13**(21): p. 2932-8.
160. Vosters, O., et al., *N-acetylcysteine derivative inhibits CD40-dependent proinflammatory properties of human pancreatic duct cells*. Pancreas, 2008. **36**(4): p. 363-8.
161. Abdulla, A., et al., *CD40L is not involved in acute experimental pancreatitis*. Eur J Pharmacol, 2011. **659**(1): p. 85-8.
162. Frossard, J.L., et al., *Soluble CD40 ligand in prediction of acute severe pancreatitis*. World J Gastroenterol, 2006. **12**(10): p. 1613-6.
163. Wera, O., P. Lancellotti, and C. Oury, *The Dual Role of Neutrophils in Inflammatory Bowel Diseases*. J Clin Med, 2016. **5**(12).
164. Kim, D.H. and J.H. Cheon, *Pathogenesis of Inflammatory Bowel Disease and Recent Advances in Biologic Therapies*. Immune Netw, 2017. **17**(1): p. 25-40.
165. Neurath, M.F., *Cytokines in inflammatory bowel disease*. Nat Rev Immunol, 2014. **14**(5): p. 329-42.
166. Buanne, P., et al., *Crucial pathophysiological role of CXCR2 in experimental ulcerative colitis in mice*. J Leukoc Biol, 2007. **82**(5): p. 1239-46.
167. Farooq, S.M., et al., *Therapeutic effect of blocking CXCR2 on neutrophil recruitment and dextran sodium sulfate-induced colitis*. J Pharmacol Exp Ther, 2009. **329**(1): p. 123-9.
168. Huang, E., et al., *NKT cells mediate the recruitment of neutrophils by stimulating epithelial chemokine secretion during colitis*. Biochem Biophys Res Commun, 2016. **474**(2): p. 252-8.
169. Daig, R., et al., *Increased interleukin 8 expression in the colon mucosa of patients with inflammatory bowel disease*. Gut, 1996. **38**(2): p. 216-22.
170. Mitsuyama, K., et al., *IL-8 as an important chemoattractant for neutrophils in ulcerative colitis and Crohn's disease*. Clin Exp Immunol, 1994. **96**(3): p. 432-6.
171. Vainer, B., O.H. Nielsen, and T. Horn, *Comparative studies of the colonic in situ expression of intercellular adhesion molecules (ICAM-1, -2, and -3), beta2 integrins (LFA-1, Mac-1, and p150,95), and PECAM-1 in ulcerative colitis and Crohn's disease*. Am J Surg Pathol, 2000. **24**(8): p. 1115-24.
172. Kruidenier, L., et al., *Intestinal oxidative damage in inflammatory bowel disease: semi-quantification, localization, and association with mucosal antioxidants*. J Pathol, 2003. **201**(1): p. 28-36.

173. Naito, Y., T. Takagi, and T. Yoshikawa, *Neutrophil-dependent oxidative stress in ulcerative colitis*. J Clin Biochem Nutr, 2007. **41**(1): p. 18-26.
174. He, Z., et al., *Phosphatidylserine exposure and neutrophil extracellular traps enhance procoagulant activity in patients with inflammatory bowel disease*. Thromb Haemost, 2016. **115**(4): p. 738-51.
175. Cibor, D., et al., *Endothelial dysfunction in inflammatory bowel diseases: Pathogenesis, assessment and implications*. World J Gastroenterol, 2016. **22**(3): p. 1067-77.
176. Danese, S., et al., *Adhesion molecules in inflammatory bowel disease: therapeutic implications for gut inflammation*. Dig Liver Dis, 2005. **37**(11): p. 811-8.
177. Hatoum, O.A., H. Miura, and D.G. Binion, *The vascular contribution in the pathogenesis of inflammatory bowel disease*. Am J Physiol Heart Circ Physiol, 2003. **285**(5): p. H1791-6.
178. Danese, S., *Role of the vascular and lymphatic endothelium in the pathogenesis of inflammatory bowel disease: 'brothers in arms'*. Gut, 2011. **60**(7): p. 998-1008.
179. Briskin, M., et al., *Human mucosal addressin cell adhesion molecule-1 is preferentially expressed in intestinal tract and associated lymphoid tissue*. Am J Pathol, 1997. **151**(1): p. 97-110.
180. Vowinkel, T., et al., *CD40-CD40 ligand mediates the recruitment of leukocytes and platelets in the inflamed murine colon*. Gastroenterology, 2007. **132**(3): p. 955-65.
181. Tolstanova, G., et al., *Early endothelial damage and increased colonic vascular permeability in the development of experimental ulcerative colitis in rats and mice*. Lab Invest, 2012. **92**(1): p. 9-21.
182. Goggins, M.G., et al., *Soluble adhesion molecules in inflammatory bowel disease*. Ir J Med Sci, 2001. **170**(2): p. 107-11.
183. Song, W.B., et al., *Soluble intercellular adhesion molecule-1, D-lactate and diamine oxidase in patients with inflammatory bowel disease*. World J Gastroenterol, 2009. **15**(31): p. 3916-9.
184. Kanazawa, S., et al., *VEGF, basic-FGF, and TGF-beta in Crohn's disease and ulcerative colitis: a novel mechanism of chronic intestinal inflammation*. Am J Gastroenterol, 2001. **96**(3): p. 822-8.
185. Oikonomou, K.A., et al., *Angiogenin, angiopoietin-1, angiopoietin-2, and endostatin serum levels in inflammatory bowel disease*. Inflamm Bowel Dis, 2011. **17**(4): p. 963-70.
186. Koutroubakis, I.E., et al., *Potential role of soluble angiopoietin-2 and Tie-2 in patients with inflammatory bowel disease*. Eur J Clin Invest, 2006. **36**(2): p. 127-32.
187. Matowicka-Karna, J., *Markers of inflammation, activation of blood platelets and coagulation disorders in inflammatory bowel diseases*. Postepy Hig Med Dosw (Online), 2016. **70**: p. 305-12.
188. Senchenkova, E., H. Seifert, and D.N. Granger, *Hypercoagulability and Platelet Abnormalities in Inflammatory Bowel Disease*. Semin Thromb Hemost, 2015. **41**(6): p. 582-9.
189. Voudoukis, E., K. Karmiris, and I.E. Koutroubakis, *Multipotent role of platelets in inflammatory bowel diseases: a clinical approach*. World J Gastroenterol, 2014. **20**(12): p. 3180-90.
190. Danese, S., L. Motte Cd Cde, and C. Fiocchi, *Platelets in inflammatory bowel disease: clinical, pathogenic, and therapeutic implications*. Am J Gastroenterol, 2004. **99**(5): p. 938-45.
191. Gao, Y.H., et al., *Relationship and significance between anti-beta2-glycoprotein I antibodies and platelet activation state in patients with ulcerative colitis*. World J Gastroenterol, 2008. **14**(5): p. 771-5.
192. Atsumi, T., et al., *Research around beta 2-glycoprotein I: a major target for antiphospholipid antibodies*. Autoimmunity, 2005. **38**(5): p. 377-81.
193. Wilhelmssen, P., et al., *Elevated platelet expression of CD36 may contribute to increased risk of thrombo-embolism in active inflammatory bowel disease*. Arch Physiol Biochem, 2013. **119**(5): p. 202-8.
194. Ghosh, A., et al., *Platelet CD36 mediates interactions with endothelial cell-derived microparticles and contributes to thrombosis in mice*. J Clin Invest, 2008. **118**(5): p. 1934-43.
195. Nergiz-Unal, R., et al., *Signaling role of CD36 in platelet activation and thrombus formation on immobilized thrombospondin or oxidized low-density lipoprotein*. J Thromb Haemost, 2011. **9**(9): p. 1835-46.

196. Park, Y.M., *CD36, a scavenger receptor implicated in atherosclerosis*. *Exp Mol Med*, 2014. **46**: p. e99.
197. Chen, K., et al., *A specific CD36-dependent signaling pathway is required for platelet activation by oxidized low-density lipoprotein*. *Circ Res*, 2008. **102**(12): p. 1512-9.
198. Andoh, A., et al., *Increased aggregation response of platelets in patients with inflammatory bowel disease*. *J Gastroenterol*, 2006. **41**(1): p. 47-54.
199. Yan, S.L., J. Russell, and D.N. Granger, *Platelet activation and platelet-leukocyte aggregation elicited in experimental colitis are mediated by interleukin-6*. *Inflamm Bowel Dis*, 2014. **20**(2): p. 353-62.
200. Sato, H., et al., *Platelet interaction with lymphatics aggravates intestinal inflammation by suppressing lymphangiogenesis*. *Am J Physiol Gastrointest Liver Physiol*, 2016. **311**(2): p. G276-85.
201. Gawronska, B., et al., *Markers of inflammation and influence of nitric oxide on platelet activation in the course of ulcerative colitis*. *Oncotarget*, 2017.
202. Bai, M., et al., *Mean platelet volume as a possible marker for monitoring the disease activity in ulcerative colitis*. *Int J Lab Hematol*, 2016. **38**(4): p. e77-9.
203. Kayahan, H., et al., *Reticulated platelet levels in patients with ulcerative colitis*. *Int J Colorectal Dis*, 2007. **22**(12): p. 1429-35.
204. Polinska, B., J. Matowicka-Karna, and H. Kemonia, *Assessment of the influence of the inflammatory process on the activation of blood platelets and morphological parameters in patients with ulcerative colitis (colitis ulcerosa)*. *Folia Histochem Cytobiol*, 2011. **49**(1): p. 119-24.
205. Tekelioglu, Y., H. Uzun, and G. Sisman, *Activated platelets in patients suffering from inflammatory bowel disease*. *Bratisl Lek Listy*, 2014. **115**(2): p. 83-5.
206. Pamuk, G.E., et al., *Increased circulating platelet-neutrophil, platelet-monocyte complexes, and platelet activation in patients with ulcerative colitis: a comparative study*. *Am J Hematol*, 2006. **81**(10): p. 753-9.
207. Kayo, S., et al., *Close association between activated platelets and neutrophils in the active phase of ulcerative colitis in humans*. *Inflamm Bowel Dis*, 2006. **12**(8): p. 727-35.
208. Ye, L., et al., *Serum platelet factor 4 is a reliable activity parameter in adult patients with inflammatory bowel disease: A pilot study*. *Medicine (Baltimore)*, 2017. **96**(11): p. e6323.
209. Ozturk, Z.A., et al., *Could platelet indices be new biomarkers for inflammatory bowel diseases?* *Eur Rev Med Pharmacol Sci*, 2013. **17**(3): p. 334-41.
210. Collins, C.E., et al., *Platelet aggregation and neutrophil sequestration in the mesenteric circulation in inflammatory bowel disease*. *Eur J Gastroenterol Hepatol*, 1997. **9**(12): p. 1213-7.
211. Di Sabatino, A., et al., *Oxidative stress and thromboxane-dependent platelet activation in inflammatory bowel disease: effects of anti-TNF-alpha treatment*. *Thromb Haemost*, 2016. **116**(3): p. 486-95.
212. Danese, S., et al., *Activated platelets are the source of elevated levels of soluble CD40 ligand in the circulation of inflammatory bowel disease patients*. *Gut*, 2003. **52**(10): p. 1435-41.
213. Ludwiczek, O., A. Kaser, and H. Tilg, *Plasma levels of soluble CD40 ligand are elevated in inflammatory bowel diseases*. *Int J Colorectal Dis*, 2003. **18**(2): p. 142-7.
214. Suzuki, K., et al., *Activated platelets in ulcerative colitis enhance the production of reactive oxygen species by polymorphonuclear leukocytes*. *Scand J Gastroenterol*, 2001. **36**(12): p. 1301-6.
215. Tekelioglu, Y. and H. Uzun, *Circulating platelet-leukocyte aggregates in patients with inflammatory bowel disease*. *J Chin Med Assoc*, 2013. **76**(4): p. 182-5.
216. Yan, S.L., et al., *Platelet abnormalities during colonic inflammation*. *Inflamm Bowel Dis*, 2013. **19**(6): p. 1245-53.
217. Danese, S., et al., *Platelets trigger a CD40-dependent inflammatory response in the microvasculature of inflammatory bowel disease patients*. *Gastroenterology*, 2003. **124**(5): p. 1249-64.
218. Patel, S.H., M.A. Rachchh, and P.D. Jadav, *Evaluation of anti-inflammatory effect of anti-platelet agent-clopidogrel in experimentally induced inflammatory bowel disease*. *Indian J Pharmacol*, 2012. **44**(6): p. 744-8.

219. Polese, L., et al., *The role of CD40 in ulcerative colitis: histochemical analysis and clinical correlation*. Eur J Gastroenterol Hepatol, 2002. **14**(3): p. 237-41.
220. Borcherding, F., et al., *The CD40-CD40L pathway contributes to the proinflammatory function of intestinal epithelial cells in inflammatory bowel disease*. Am J Pathol, 2010. **176**(4): p. 1816-27.
221. Danese, S., et al., *Critical role of the CD40 CD40-ligand pathway in regulating mucosal inflammation-driven angiogenesis in inflammatory bowel disease*. Gut, 2007. **56**(9): p. 1248-56.
222. Mulay, S.R., et al., *Targeting Inflammation in So-Called Acute Kidney Injury*. Semin Nephrol, 2016. **36**(1): p. 17-30.
223. Suarez-Alvarez, B., H. Liapis, and H.J. Anders, *Links between coagulation, inflammation, regeneration, and fibrosis in kidney pathology*. Lab Invest, 2016. **96**(4): p. 378-90.
224. Zuk, A. and J.V. Bonventre, *Acute Kidney Injury*. Annu Rev Med, 2016. **67**: p. 293-307.
225. Jang, H.R. and H. Rabb, *Immune cells in experimental acute kidney injury*. Nat Rev Nephrol, 2015. **11**(2): p. 88-101.
226. Takada, M., et al., *The cytokine-adhesion molecule cascade in ischemia/reperfusion injury of the rat kidney. Inhibition by a soluble P-selectin ligand*. J Clin Invest, 1997. **99**(11): p. 2682-90.
227. Donnahoo, K.K., et al., *Early kidney TNF-alpha expression mediates neutrophil infiltration and injury after renal ischemia-reperfusion*. Am J Physiol, 1999. **277**(3 Pt 2): p. R922-9.
228. Daha, M.R. and C. van Kooten, *Is the proximal tubular cell a proinflammatory cell?* Nephrol Dial Transplant, 2000. **15 Suppl 6**: p. 41-3.
229. Miura, M., et al., *Neutralization of Gro alpha and macrophage inflammatory protein-2 attenuates renal ischemia/reperfusion injury*. Am J Pathol, 2001. **159**(6): p. 2137-45.
230. Araki, M., et al., *Expression of IL-8 during reperfusion of renal allografts is dependent on ischemic time*. Transplantation, 2006. **81**(5): p. 783-8.
231. Nemoto, T., et al., *Small molecule selectin ligand inhibition improves outcome in ischemic acute renal failure*. Kidney Int, 2001. **60**(6): p. 2205-14.
232. Solez, K., L. Morel-Maroger, and J.D. Sraer, *The morphology of "acute tubular necrosis" in man: analysis of 57 renal biopsies and a comparison with the glycerol model*. Medicine (Baltimore), 1979. **58**(5): p. 362-76.
233. Kelly, K.J., et al., *Intercellular adhesion molecule-1-deficient mice are protected against ischemic renal injury*. J Clin Invest, 1996. **97**(4): p. 1056-63.
234. Rabb, H., et al., *Role of CD11a and CD11b in ischemic acute renal failure in rats*. Am J Physiol, 1994. **267**(6 Pt 2): p. F1052-8.
235. Jansen, M.P., et al., *Release of extracellular DNA influences renal ischemia reperfusion injury by platelet activation and formation of neutrophil extracellular traps*. Kidney Int, 2017. **91**(2): p. 352-364.
236. Li, X.H., et al., *Effect of Platelet-derived P-selectin on Neutrophil Recruitment in a Mouse Model of Sepsis-induced Acute Kidney Injury*. Chin Med J (Engl), 2017. **130**(14): p. 1694-1699.
237. Singbartl, K., S.B. Forlow, and K. Ley, *Platelet, but not endothelial, P-selectin is critical for neutrophil-mediated acute postischemic renal failure*. FASEB J, 2001. **15**(13): p. 2337-44.
238. Ramaiah, S.K. and H. Jaeschke, *Role of neutrophils in the pathogenesis of acute inflammatory liver injury*. Toxicol Pathol, 2007. **35**(6): p. 757-66.
239. Gujral, J.S., et al., *Neutrophils aggravate acute liver injury during obstructive cholestasis in bile duct-ligated mice*. Hepatology, 2003. **38**(2): p. 355-63.
240. Chosay, J.G., et al., *Neutrophil margination and extravasation in sinusoids and venules of liver during endotoxin-induced injury*. Am J Physiol, 1997. **272**(5 Pt 1): p. G1195-200.
241. Jaeschke, H. and T. Hasegawa, *Role of neutrophils in acute inflammatory liver injury*. Liver Int, 2006. **26**(8): p. 912-9.
242. Lentsch, A.B., et al., *Chemokine involvement in hepatic ischemia/reperfusion injury in mice: roles for macrophage inflammatory protein-2 and Kupffer cells*. Hepatology, 1998. **27**(2): p. 507-12.
243. Ohira, H., et al., *Adhesion molecules and CXC chemokines in endotoxin-induced liver injury*. Fukushima J Med Sci, 2003. **49**(1): p. 1-13.

244. Bajt, M.L., A. Farhood, and H. Jaeschke, *Effects of CXC chemokines on neutrophil activation and sequestration in hepatic vasculature*. *Am J Physiol Gastrointest Liver Physiol*, 2001. **281**(5): p. G1188-95.
245. Zhang, P., et al., *Attenuation of hepatic neutrophil sequestration by anti-CINC antibody in endotoxic rats*. *Shock*, 1995. **4**(4): p. 262-8.
246. Colletti, L.M., et al., *The role of cytokine networks in the local liver injury following hepatic ischemia/reperfusion in the rat*. *Hepatology*, 1996. **23**(3): p. 506-14.
247. Zhang, J., et al., *CCL2-CCR2 signaling promotes hepatic ischemia/reperfusion injury*. *J Surg Res*, 2016. **202**(2): p. 352-62.
248. Colletti, L.M., et al., *Role of tumor necrosis factor-alpha in the pathophysiologic alterations after hepatic ischemia/reperfusion injury in the rat*. *J Clin Invest*, 1990. **85**(6): p. 1936-43.
249. Suzuki, S. and L.H. Toledo-Pereyra, *Interleukin 1 and tumor necrosis factor production as the initial stimulants of liver ischemia and reperfusion injury*. *J Surg Res*, 1994. **57**(2): p. 253-8.
250. Castro-Santa, E., O. Salnikova, and E. Ryschich, *The role of beta2-integrins and CD44 in intrahepatic leukocyte sequestration*. *J Surg Res*, 2013. **184**(2): p. 1070-5.
251. Jaeschke, H., A. Farhood, and C.W. Smith, *Neutrophil-induced liver cell injury in endotoxin shock is a CD11b/CD18-dependent mechanism*. *Am J Physiol*, 1991. **261**(6 Pt 1): p. G1051-6.
252. Jaeschke, H., et al., *Functional inactivation of neutrophils with a Mac-1 (CD11b/CD18) monoclonal antibody protects against ischemia-reperfusion injury in rat liver*. *Hepatology*, 1993. **17**(5): p. 915-23.
253. Kono, H., et al., *ICAM-1 is involved in the mechanism of alcohol-induced liver injury: studies with knockout mice*. *Am J Physiol Gastrointest Liver Physiol*, 2001. **280**(6): p. G1289-95.
254. Gujral, J.S., et al., *Functional importance of ICAM-1 in the mechanism of neutrophil-induced liver injury in bile duct-ligated mice*. *Am J Physiol Gastrointest Liver Physiol*, 2004. **286**(3): p. G499-507.
255. Essani, N.A., et al., *Cytokine-induced upregulation of hepatic intercellular adhesion molecule-1 messenger RNA expression and its role in the pathophysiology of murine endotoxin shock and acute liver failure*. *Hepatology*, 1995. **21**(6): p. 1632-9.
256. Bystrom, P., et al., *Ischemic preconditioning modulates ROS to confer protection in liver ischemia and reperfusion*. *EXCLI J*, 2017. **16**: p. 483-496.
257. Chauhan, A., et al., *Platelets: No longer bystanders in liver disease*. *Hepatology*, 2016. **64**(5): p. 1774-1784.
258. Lang, P.A., et al., *Aggravation of viral hepatitis by platelet-derived serotonin*. *Nat Med*, 2008. **14**(7): p. 756-61.
259. Iannacone, M., et al., *Platelets mediate cytotoxic T lymphocyte-induced liver damage*. *Nat Med*, 2005. **11**(11): p. 1167-9.
260. Sitia, G., M. Iannacone, and L.G. Guidotti, *Anti-platelet therapy in the prevention of hepatitis B virus-associated hepatocellular carcinoma*. *J Hepatol*, 2013. **59**(5): p. 1135-8.
261. Pak, S., et al., *Platelet adhesion in the sinusoid caused hepatic injury by neutrophils after hepatic ischemia reperfusion*. *Platelets*, 2010. **21**(4): p. 282-8.
262. Lalor, P.F., et al., *Hepatic sinusoidal endothelium avidly binds platelets in an integrin-dependent manner, leading to platelet and endothelial activation and leukocyte recruitment*. *Am J Physiol Gastrointest Liver Physiol*, 2013. **304**(5): p. G469-78.
263. Sullivan, B.P., et al., *Protective and damaging effects of platelets in acute cholestatic liver injury revealed by depletion and inhibition strategies*. *Toxicol Sci*, 2010. **115**(1): p. 286-94.
264. Salter, J.W., et al., *Platelets modulate ischemia/reperfusion-induced leukocyte recruitment in the mesenteric circulation*. *Am J Physiol Gastrointest Liver Physiol*, 2001. **281**(6): p. G1432-9.
265. Andreu, G., et al., *Analysis of Transfusion-Related Acute Lung Injury and Possible Transfusion-Related Acute Lung Injury Reported to the French Hemovigilance Network From 2007 to 2013*. *Transfus Med Rev*, 2017.

266. Bechard, D., et al., *Endocan is a novel chondroitin sulfate/dermatan sulfate proteoglycan that promotes hepatocyte growth factor/scatter factor mitogenic activity*. J Biol Chem, 2001. **276**(51): p. 48341-9.
267. Garraud, O., et al., *Transfusion as an Inflammation Hit: Knowns and Unknowns*. Front Immunol, 2016. **7**: p. 534.
268. Reed, G.L., M.L. Fitzgerald, and J. Polgar, *Molecular mechanisms of platelet exocytosis: insights into the "secrete" life of thrombocytes*. Blood, 2000. **96**(10): p. 3334-42.
269. Flaumenhaft, R., *Molecular basis of platelet granule secretion*. Arterioscler Thromb Vasc Biol, 2003. **23**(7): p. 1152-60.
270. Kahr, W.H., et al., *Mutations in NBEAL2, encoding a BEACH protein, cause gray platelet syndrome*. Nat Genet, 2011. **43**(8): p. 738-40.
271. Lefrancais, E., et al., *The lung is a site of platelet biogenesis and a reservoir for haematopoietic progenitors*. Nature, 2017. **544**(7648): p. 105-109.
272. Zufferey, A., et al., *Characterization of the platelet granule proteome: evidence of the presence of MHC1 in alpha-granules*. J Proteomics, 2014. **101**: p. 130-40.
273. Semple, J.W., J.E. Italiano, Jr., and J. Freedman, *Platelets and the immune continuum*. Nat Rev Immunol, 2011. **11**(4): p. 264-74.
274. Caudrillier, A. and M.R. Looney, *Platelet-neutrophil interactions as a target for prevention and treatment of transfusion-related acute lung injury*. Curr Pharm Des, 2012. **18**(22): p. 3260-6.
275. Caudrillier, A., et al., *Platelets induce neutrophil extracellular traps in transfusion-related acute lung injury*. J Clin Invest, 2012. **122**(7): p. 2661-71.
276. Looney, M.R., et al., *Neutrophils and their Fc gamma receptors are essential in a mouse model of transfusion-related acute lung injury*. J Clin Invest, 2006. **116**(6): p. 1615-23.
277. McKenzie, C.G., et al., *Peripheral blood monocyte-derived chemokine blockade prevents murine transfusion-related acute lung injury (TRALI)*. Blood, 2014. **123**(22): p. 3496-503.
278. Strait, R.T., et al., *MHC class I-specific antibody binding to nonhematopoietic cells drives complement activation to induce transfusion-related acute lung injury in mice*. J Exp Med, 2011. **208**(12): p. 2525-44.
279. Manohar, M., et al., *Pathogenic mechanisms of pancreatitis*. World J Gastrointest Pharmacol Ther, 2017. **8**(1): p. 10-25.
280. Dasararaju, R. and M.B. Marques, *Adverse effects of transfusion*. Cancer Control, 2015. **22**(1): p. 16-25.
281. Garraud, O., et al., *[Blood transfusion and inflammation as of yesterday, today and tomorrow]*. Transfus Clin Biol, 2015. **22**(3): p. 168-77.
282. Heddle, N.M., *Pathophysiology of febrile nonhemolytic transfusion reactions*. Curr Opin Hematol, 1999. **6**(6): p. 420-6.
283. Hirayama, F., *Current understanding of allergic transfusion reactions: incidence, pathogenesis, laboratory tests, prevention and treatment*. Br J Haematol, 2013. **160**(4): p. 434-44.
284. Pagano, M.B., et al., *Hypotensive transfusion reactions in the era of prestorage leukoreduction*. Transfusion, 2015. **55**(7): p. 1668-74.
285. Peters, A.L., D. Van Stein, and A.P. Vlaar, *Antibody-mediated transfusion-related acute lung injury; from discovery to prevention*. Br J Haematol, 2015.
286. Peters, A.L., et al., *Pathogenesis of non-antibody mediated transfusion-related acute lung injury from bench to bedside*. Blood Rev, 2015. **29**(1): p. 51-61.
287. Aloui, C., et al., *Levels of human platelet-derived soluble CD40 ligand depend on haplotypes of CD40LG-CD40-ITGA2*. Sci Rep, 2016. **6**: p. 24715.
288. Baimukanova, G., et al., *Platelets regulate vascular endothelial stability: assessing the storage lesion and donor variability of apheresis platelets*. Transfusion, 2016. **56 Suppl 1**: p. S65-75.
289. Baimukanova, G., et al., *The effects of 22 degrees C and 4 degrees C storage of platelets on vascular endothelial integrity and function*. Transfusion, 2016. **56 Suppl 1**: p. S52-64.

290. Alvarez, P., et al., *Transfusion-Related Acute Lung Injured (TRALI): Current Concepts*. Open Respir Med J, 2015. **9**: p. 92-6.
291. Kechagia, M., I. Papassotiriou, and K.I. Gourgoulisianis, *Endocan and the respiratory system: a review*. Int J Chron Obstruct Pulmon Dis, 2016. **11**: p. 3179-3187.
292. Balta, S., et al., *Endocan--a novel inflammatory indicator in newly diagnosed patients with hypertension: a pilot study*. Angiology, 2014. **65**(9): p. 773-7.
293. De Freitas Caires, N., et al., *Identification of a 14 kDa endocan fragment generated by cathepsin G, a novel circulating biomarker in patients with sepsis*. J Pharm Biomed Anal, 2013. **78-79**: p. 45-51.
294. Rennel, E., et al., *Endocan is a VEGF-A and PI3K regulated gene with increased expression in human renal cancer*. Exp Cell Res, 2007. **313**(7): p. 1285-94.
295. Scherpereel, A., et al., *Endocan, a new endothelial marker in human sepsis*. Crit Care Med, 2006. **34**(2): p. 532-7.
296. Hamzeh-Cognasse, H., et al., *Immune-reactive soluble OX40 ligand, soluble CD40 ligand, and interleukin-27 are simultaneously oversecreted in platelet components associated with acute transfusion reactions*. Transfusion, 2014 **54**(3): p. 613-25.
297. Nguyen, K.A., et al., *A computerized prediction model of hazardous inflammatory platelet transfusion outcomes*. PLoS One, 2014. **9**(5): p. e97082.
298. Garraud, O. and F. Cognasse, *Are Platelets Cells? And if Yes, are They Immune Cells?* Front Immunol, 2015. **6**: p. 70.
299. Cognasse, F., et al., *The Inflammatory Role of Platelets via Their TLRs and Siglec Receptors*. Front Immunol, 2015. **6**: p. 83.
300. Damien, P., et al., *LPS stimulation of purified human platelets is partly dependent on plasma soluble CD14 to secrete their main secreted product, soluble-CD40-Ligand*. BMC Immunol, 2015. **16**: p. 3.
301. Cox, D., S.W. Kerrigan, and S.P. Watson, *Platelets and the innate immune system: mechanisms of bacterial-induced platelet activation*. J Thromb Haemost, 2011. **9**(6): p. 1097-107.
302. Schaufelberger, H.D., et al., *Platelets in ulcerative colitis and Crohn's disease express functional interleukin-1 and interleukin-8 receptors*. Eur J Clin Invest, 1994. **24**(10): p. 656-63.
303. Alexander, J.S., et al., *Platelet-derived lysophosphatidic acid decreases endothelial permeability in vitro*. Am J Physiol, 1998. **274**(1 Pt 2): p. H115-22.
304. Haselton, F.R. and J.S. Alexander, *Platelets and a platelet-released factor enhance endothelial barrier*. Am J Physiol, 1992. **263**(6 Pt 1): p. L670-8.
305. Lo, S.K., et al., *Role of platelets in maintenance of pulmonary vascular permeability to protein*. Am J Physiol, 1988. **254**(4 Pt 2): p. H763-71.
306. Minnear, F.L., et al., *Platelet lipid(s) bound to albumin increases endothelial electrical resistance: mimicked by LPA*. Am J Physiol Lung Cell Mol Physiol, 2001. **281**(6): p. L1337-44.
307. Patil, S., J.E. Kaplan, and F.L. Minnear, *Protein, not adenosine or adenine nucleotides, mediates platelet decrease in endothelial permeability*. Am J Physiol, 1997. **273**(5 Pt 2): p. H2304-11.
308. Paty, P.S., et al., *Role of adenosine in platelet-mediated reduction in pulmonary vascular permeability*. Am J Physiol, 1992. **262**(3 Pt 2): p. H771-7.
309. Ho-Tin-Noe, B., M. Demers, and D.D. Wagner, *How platelets safeguard vascular integrity*. J Thromb Haemost, 2011. **9 Suppl 1**: p. 56-65.
310. Boulaftali, Y., et al., *Platelet ITAM signaling is critical for vascular integrity in inflammation*. J Clin Invest, 2013. **123**(2): p. 908-16.
311. de Stoppelaar, S.F., et al., *Thrombocytopenia impairs host defense in gram-negative pneumonia-derived sepsis in mice*. Blood, 2014. **124**(25): p. 3781-90.
312. Goerge, T., et al., *Inflammation induces hemorrhage in thrombocytopenia*. Blood, 2008. **111**(10): p. 4958-64.
313. Gros, A., et al., *Single platelets seal neutrophil-induced vascular breaches via GPVI during immune-complex-mediated inflammation in mice*. Blood, 2015. **126**(8): p. 1017-26.

314. Obinata, H. and T. Hla, *Sphingosine 1-phosphate in coagulation and inflammation*. Semin Immunopathol, 2012. **34**(1): p. 73-91.
315. Schaphorst, K.L., et al., *Role of sphingosine-1 phosphate in the enhancement of endothelial barrier integrity by platelet-released products*. Am J Physiol Lung Cell Mol Physiol, 2003. **285**(1): p. L258-67.
316. Mammoto, T., et al., *Platelet-rich plasma extract prevents pulmonary edema through angiopoietin-Tie2 signaling*. Am J Respir Cell Mol Biol, 2015. **52**(1): p. 56-64.
317. Bozza, F.A., et al., *Amicus or adversary: platelets in lung biology, acute injury, and inflammation*. Am J Respir Cell Mol Biol, 2009. **40**(2): p. 123-34.
318. Nachman, R.L., B. Weksler, and B. Ferris, *Characterization of human platelet vascular permeability-enhancing activity*. J Clin Invest, 1972. **51**(3): p. 549-56.
319. Rondina, M.T., A.S. Weyrich, and G.A. Zimmerman, *Platelets as cellular effectors of inflammation in vascular diseases*. Circ Res, 2013. **112**(11): p. 1506-19.
320. Tabuchi, A. and W.M. Kuebler, *Endothelium-platelet interactions in inflammatory lung disease*. Vascul Pharmacol, 2008. **49**(4-6): p. 141-50.
321. Zarbock, A. and K. Ley, *The role of platelets in acute lung injury (ALI)*. Front Biosci (Landmark Ed), 2009. **14**: p. 150-8.
322. Grommes, J., et al., *Disruption of platelet-derived chemokine heteromers prevents neutrophil extravasation in acute lung injury*. Am J Respir Crit Care Med, 2012. **185**(6): p. 628-36.
323. Zarbock, A., K. Singbartl, and K. Ley, *Complete reversal of acid-induced acute lung injury by blocking of platelet-neutrophil aggregation*. J Clin Invest, 2006. **116**(12): p. 3211-9.
324. Medzhitov, R., *Origin and physiological roles of inflammation*. Nature, 2008. **454**(7203): p. 428-35.
325. Hottz, E.D., et al., *Platelets mediate increased endothelium permeability in dengue through NLRP3-inflammasome activation*. Blood, 2013. **122**(20): p. 3405-14.
326. Boogaerts, M.A., et al., *Enhancement of granulocyte-endothelial cell adherence and granulocyte-induced cytotoxicity by platelet release products*. Proc Natl Acad Sci U S A, 1982. **79**(22): p. 7019-23.
327. Vieira-de-Abreu, A., et al., *Platelets: versatile effector cells in hemostasis, inflammation, and the immune continuum*. Semin Immunopathol, 2012. **34**(1): p. 5-30.
328. Zago, A.C., et al., *The importance of the interaction between leukocyte integrin Mac-1 and platelet glycoprotein Ib-a for leukocyte recruitment by platelets and for the inflammatory response to vascular injury*. Arq Bras Cardiol, 2008. **90**(1): p. 54-63.
329. Hidalgo, A., et al., *Heterotypic interactions enabled by polarized neutrophil microdomains mediate thromboinflammatory injury*. Nat Med, 2009. **15**(4): p. 384-91.
330. Jenne, C.N., et al., *The use of spinning-disk confocal microscopy for the intravital analysis of platelet dynamics in response to systemic and local inflammation*. PLoS One, 2011. **6**(9): p. e25109.
331. Jenne, C.N., et al., *Neutrophils recruited to sites of infection protect from virus challenge by releasing neutrophil extracellular traps*. Cell Host Microbe, 2013. **13**(2): p. 169-80.
332. Sreeramkumar, V., et al., *Neutrophils scan for activated platelets to initiate inflammation*. Science, 2014. **346**(6214): p. 1234-8.
333. Chen, J. and J.A. Lopez, *Interactions of platelets with subendothelium and endothelium*. Microcirculation, 2005. **12**(3): p. 235-46.
334. Ostrovsky, L., et al., *A juxtacrine mechanism for neutrophil adhesion on platelets involves platelet-activating factor and a selectin-dependent activation process*. Blood, 1998. **91**(8): p. 3028-36.
335. von Hundelshausen, P., R.R. Koenen, and C. Weber, *Platelet-mediated enhancement of leukocyte adhesion*. Microcirculation, 2009. **16**(1): p. 84-96.
336. Zwaginga, J.J., et al., *Minimal platelet deposition and activation in models of injured vessel wall ensure optimal neutrophil adhesion under flow conditions*. Arterioscler Thromb Vasc Biol, 1999. **19**(6): p. 1549-54.
337. Green, S.A., et al., *Activated platelet-T-cell conjugates in peripheral blood of patients with HIV infection: coupling coagulation/inflammation and T cells*. AIDS, 2015. **29**(11): p. 1297-308.

338. Hottz, E.D., et al., *Platelet activation and apoptosis modulate monocyte inflammatory responses in dengue*. J Immunol, 2014. **193**(4): p. 1864-72.
339. Laidlaw, T.M., et al., *Cysteinyl leukotriene overproduction in aspirin-exacerbated respiratory disease is driven by platelet-adherent leukocytes*. Blood, 2012. **119**(16): p. 3790-8.
340. Rondina, M.T., et al., *In vivo platelet activation in critically ill patients with primary 2009 influenza A(H1N1)*. Chest, 2012. **141**(6): p. 1490-1495.
341. Rondina, M.T., et al., *Platelet-monocyte aggregate formation and mortality risk in older patients with severe sepsis and septic shock*. J Gerontol A Biol Sci Med Sci, 2015. **70**(2): p. 225-31.
342. Eickmeier, O., et al., *Aspirin-triggered resolvin D1 reduces mucosal inflammation and promotes resolution in a murine model of acute lung injury*. Mucosal Immunol, 2013. **6**(2): p. 256-66.
343. Ortiz-Munoz, G., et al., *Aspirin-triggered 15-epi-lipoxin A4 regulates neutrophil-platelet aggregation and attenuates acute lung injury in mice*. Blood, 2014. **124**(17): p. 2625-34.
344. Le, V.B., et al., *Platelet activation and aggregation promote lung inflammation and influenza virus pathogenesis*. Am J Respir Crit Care Med, 2015. **191**(7): p. 804-19.
345. Kuckleburg, C.J., et al., *Endothelial cell-borne platelet bridges selectively recruit monocytes in human and mouse models of vascular inflammation*. Cardiovasc Res, 2011. **91**(1): p. 134-41.
346. Lam, F.W., et al., *Platelets enhance neutrophil transendothelial migration via P-selectin glycoprotein ligand-1*. Am J Physiol Heart Circ Physiol, 2011. **300**(2): p. H468-75.
347. Passacquale, G., et al., *Monocyte-platelet interaction induces a pro-inflammatory phenotype in circulating monocytes*. PLoS One, 2011. **6**(10): p. e25595.
348. Zarbock, A., R.K. Polanowska-Grabowska, and K. Ley, *Platelet-neutrophil-interactions: linking hemostasis and inflammation*. Blood Rev, 2007. **21**(2): p. 99-111.
349. Brinkmann, V. and A. Zychlinsky, *Neutrophil extracellular traps: is immunity the second function of chromatin?* J Cell Biol, 2012. **198**(5): p. 773-83.
350. Kahr, W.H., et al., *Abnormal megakaryocyte development and platelet function in Nbeal2(-/-) mice*. Blood, 2013. **122**(19): p. 3349-58.
351. Deppermann, C., et al., *Platelet secretion is crucial to prevent bleeding in the ischemic brain but not in the inflamed skin or lung in mice*. Blood, 2017.
352. Sowerby, J.M., et al., *NBEAL2 is required for neutrophil and NK cell function and pathogen defense*. J Clin Invest, 2017. **127**(9): p. 3521-3526.
353. Tung, J.P., et al., *Age of blood and recipient factors determine the severity of transfusion-related acute lung injury (TRALI)*. Crit Care, 2012. **16**(1): p. R19.
354. Xie, R.F., et al., *The effect of platelet-derived microparticles in stored apheresis platelet concentrates on polymorphonuclear leucocyte respiratory burst*. Vox Sang, 2014. **106**(3): p. 234-41.
355. Maloney, J.P., et al., *Platelet Vascular Endothelial Growth Factor is a Potential Mediator of Transfusion-Related Acute Lung Injury*. J Pulm Respir Med, 2014. **4**.
356. Silliman, C.C., et al., *Plasma and lipids from stored platelets cause acute lung injury in an animal model*. Transfusion, 2003. **43**(5): p. 633-40.
357. Silliman, C.C., et al., *Mirasol Pathogen Reduction Technology treatment does not affect acute lung injury in a two-event in vivo model caused by stored blood components*. Vox Sang, 2010. **98**(4): p. 525-30.
358. Tung, J.P., et al., *A novel in vivo ovine model of transfusion-related acute lung injury (TRALI)*. Vox Sang, 2011. **100**(2): p. 219-30.
359. Chiang, N., et al., *Aspirin triggers antiinflammatory 15-epi-lipoxin A4 and inhibits thromboxane in a randomized human trial*. Proc Natl Acad Sci U S A, 2004. **101**(42): p. 15178-83.
360. Romano, M., et al., *Lipoxins and aspirin-triggered lipoxins in resolution of inflammation*. Eur J Pharmacol, 2015. **760**: p. 49-63.
361. Tong, S., et al., *Accumulation of CD62P during storage of apheresis platelet concentrates and the role of CD62P in transfusion-related acute lung injury*. Mol Med Rep, 2015. **12**(5): p. 7777-81.
362. Torii, Y., et al., *Antiplatelet antibody may cause delayed transfusion-related acute lung injury*. Int J Gen Med, 2011. **4**: p. 677-80.

363. Ikeda, H., *Platelet membrane protein CD36*. Hokkaido Igaku Zasshi, 1999. **74**(2): p. 99-104.
364. Kapur, R., et al., *Nouvelle cuisine: platelets served with inflammation*. J Immunol, 2015. **194**(12): p. 5579-87.
365. Evangelista, V., et al., *Platelet/polymorphonuclear leukocyte interaction: P-selectin triggers protein-tyrosine phosphorylation-dependent CD11b/CD18 adhesion: role of PSGL-1 as a signaling molecule*. Blood, 1999. **93**(3): p. 876-85.
366. Nomura, S., et al., *Platelets expressing P-selectin and platelet-derived microparticles in stored platelet concentrates bind to PSGL-1 on filtrated leukocytes*. Clin Appl Thromb Hemost, 2000. **6**(4): p. 213-21.
367. Phipps, R.P., J. Kaufman, and N. Blumberg, *Platelet derived CD154 (CD40 ligand) and febrile responses to transfusion*. Lancet, 2001. **357**(9273): p. 2023-4.
368. Blumberg, N., et al., *An association of soluble CD40 ligand (CD154) with adverse reactions to platelet transfusions*. Transfusion, 2006. **46**(10): p. 1813-21.
369. Blumberg, N., et al., *The platelet as an immune cell-CD40 ligand and transfusion immunomodulation*. Immunol Res, 2009. **45**(2-3): p. 251-60.
370. Hamzeh-Cognasse, H., et al., *Immune-reactive soluble OX40 ligand, soluble CD40 ligand, and interleukin-27 are simultaneously oversecreted in platelet components associated with acute transfusion reactions*. Transfusion, 2014. **54**(3): p. 613-25.
371. Akbiyik, F., et al., *Human bone marrow megakaryocytes and platelets express PPARgamma, and PPARgamma agonists blunt platelet release of CD40 ligand and thromboxanes*. Blood, 2004. **104**(5): p. 1361-8.

Annexes

Participation aux études :

1. Sut C, **Tariket S**, Cognasse F, Garraud O. **Determination of predictors of severity for recipient adverse reactions during platelet product transfusions.** *Transfusion Clinique et Biologique.* 2017
2. Sut C, **Tariket S**, Chou ML, Garraud O, Laradi S, Hamzeh-Cognasse H, Seghatchian J, Burnouf T, Cognasse F. **Duration of red blood cell storage and inflammatory marker generation.** *Blood transfusion.* 2017
3. Aloui C, Prigent A, **Tariket S**, Sut C, Fagan J, Cognasse F, Chakroun T, Garraud O, Laradi S. **Levels of human platelet-derived soluble CD40 ligand depend on haplotypes of CD40LG-CD40-ITGA2.** *Scientifique Report.* 2016

Communications orales :

1. **Tariket S**, Arthaud CA, Garraud O, Cognasse F. **La neutralisation de complexe CD40/CD40L inhibe le développement du TRALI, induit par du lipopolysaccharide combiné à un anticorps anti-CMH I, dans un modèle de souris.** *28^{ème} congrès de la Société Française de Transfusion Sanguines (SFTS).* Bordeaux, France. 2017
2. **Tariket S**, Arthaud CA, Garraud O, Cognasse F. **La neutralisation de complexe CD40/CD40L inhibe le développement du TRALI, induit par du lipopolysaccharide combiné à un anticorps anti-CMH I, dans un modèle de souris.** *International Society on Thrombosis and Haemostasis (ISTH).* Berlin, Allemagne. 2017
3. **Tariket S**, Arthaud CA, Garraud O, Cognasse F. **Investigation de la pathogenèse du syndrome de détresse respiratoire aiguë post-transfusionnel (TRALI) dans un modèle murin.** *17^{ème} Journées stéphanoises de cytométrie, imagerie cellulaire et tissulaire (Cytima).* Andrézieux-Bouthéon, France. 2016

Communications affichées :

1. **Tariket S**, Sut C, Arthaud CA, Eyraud MA, Laradi S, Hamzah-Cognasse H, Garraud O, Cognasse F. **Modeling the effect of platelet concentrate supernatants on endothelial cells: focus on Endocan/ESM-1.** *28^{ème} congrès de la Société Française de Transfusion Sanguines (SFTS).* Bordeaux, France. 2017
2. **Tariket S**, Sut C, Arthaud CA, Eyraud MA, Laradi S, Hamzah-Cognasse H, Garraud O, Cognasse F. **Modeling the effect of platelet concentrate supernatants on endothelial cells: focus on Endocan/ESM-1.** *27th regional congress of the International Society of Blood Transfusion (ISBT).* Copenhage, Danemark. 2017
3. **Tariket S**, Sut C, Arthaud CA, Eyraud MA, Laradi S, Hamzah-Cognasse H, Garraud O, Cognasse F. **Modeling the effect of platelet concentrate supernatants on endothelial cells: focus on Endocan/ESM-1.** *28^{ème} congrès de la Société Française de Transfusion Sanguines (SFTS).* Bordeaux, France. 2017
4. **Tariket S**, Meneveaux A, Arthaud CA, Garraud O, Cognasse F. **Investigation de la pathogénèse du syndrome de détresse respiratoire post-transfusionnelle (TRALI) dans un modèle murin.** *Journée de l'Académie de Médecine.* Saint-Etienne, France. 2016
5. **Tariket S**, Meneveaux A, Arthaud CA, Garraud O, Cognasse F. **Investigation de la pathogénèse du syndrome de détresse respiratoire post-transfusionnelle (TRALI) dans un modèle murin.** *Journée de l'Institut Fédératif de Recherche en Sciences et Ingénierie de la Santé (IFRESIS).* Saint-Etienne, France. 2016

Investigation de la pathogenèse du syndrome de détresse respiratoire aiguë post-transfusionnel (TRALI) dans un modèle murin

RESUME : La transfusion sanguine permet de sauver des vies et réduit la morbidité pour un grand nombre de maladies et d'affections cliniques, mais elle n'est pas exempte de complications. Un incident néfaste lié à une transfusion, également appelé Effet Indésirable Receveur (EIR), est un incident défavorable survenant chez un patient pendant ou après une transfusion sanguine. Parmi eux, le TRALI est considéré comme l'une des réactions inflammatoires les plus critiques. Cette pathologie se développe généralement dans les 6 heures après transfusion. On en reconnaît deux types, les TRALI immunologiques et les TRALI non-immunologiques. En France, les premiers sont presque entièrement prévenus par une politique de sécurité des produits sanguins, tandis que la fréquence des seconds augmente. La physiopathologie du TRALI reste mal connue. Tandis que certains y accordent une place importante aux plaquettes sanguines du patient transfusé, d'autres les considèrent comme pas réellement impliquées. Le but de ce travail de thèse a été, dans un premier temps, d'investiguer le potentiel inflammatoire des plaquettes sanguines conservées dans les concentrés plaquettaires et l'influence de cette inflammation sur l'endothélium vasculaire général. Ensuite, sera évalué le rôle des plaquettes sanguines de l'organisme, notamment par l'intermédiaire de leurs produits de sécrétion, dans la pathogénie de cette complication transfusionnelle. Pour cela, un ALI (mimant un TRALI) a été déclenché, dans un modèle *in vivo*, par une injection d'anticorps anti-CMH I chez des souris préalablement stimulées avec du LPS. L'ensemble de nos résultats confirme le potentiel inflammatoire des plaquettes sanguines, au sein des concentrés plaquettaires, pouvant probablement assumer l'entière responsabilité du déclenchement d'un TRALI non-immunologique, ainsi qu'un rôle secondaire des plaquettes sanguines de l'organisme, participant activement à l'amplification de la sévérité de la pathologie. Cette thèse s'inscrit dans la continuité logique des études menées, au sein du laboratoire GIMAP-EA3064, investiguant la place des plaquettes sanguines au sein de l'inflammation, ouvrant ainsi de nouvelles perspectives dans la sécurité transfusionnelle.

MOTS CLES : TRALI – Transfusion – Plaquettes – Inflammation – CD40L

Investigation of the pathogenesis of Transfusion-Related Acute Lung Injury (TRALI) in a mouse model

ABSTRACT: Blood transfusion saves lives and reduces morbidity for many diseases and clinical conditions, but it is not without complications. A transfusion-related adverse event, also known as the Adverse Reaction (AR), is an incident occurring in a patient during or after a blood transfusion. Among them, TRALI is considered as one of the most critical inflammatory reactions. This pathology usually occurs within 6 hours after transfusion. Two types are recognized: immune TRALI and non-immune TRALI. In France, the first is almost completely prevented by a blood product safety policy, while the frequency of the second increases. The pathophysiology of TRALI remains poorly understood. While some scientists give an important function of patient blood platelets, others consider them dispensable. The aim of this thesis was, first, to investigate the inflammatory potential of blood platelets stored in platelet concentrates and its impact on the general vascular endothelium. Next, the role of patient blood platelets, including their secretory products, in the pathogenesis of this transfusion complication will be evaluated. For it, an ALI (mimicking a TRALI) was triggered, in an *in vivo* model, by an injection of anti-MHC I antibody in mice previously stimulated with LPS. Our results confirm the inflammatory potential of blood platelets in platelet concentrates, which can probably assume the entire responsibility for triggering a non-immune TRALI, and a secondary role for patient blood platelets in the amplification of the severity of this pathology. This thesis is the continuity of studies conducted in the laboratory GIMAP-EA3064, investigating the function of blood platelets in inflammation, thus opening up new perspectives in transfusion safety.

KEYWORDS: TRALI – Transfusion – Platelets – Inflammation – CD40L