



**HAL**  
open science

# Data Reduction based energy-efficient approaches for secure priority-based managed wireless video sensor networks

Christian Salim

► **To cite this version:**

Christian Salim. Data Reduction based energy-efficient approaches for secure priority-based managed wireless video sensor networks. Networking and Internet Architecture [cs.NI]. Université Bourgogne Franche-Comté, 2018. English. NNT : 2018UBFCD052 . tel-02378363

**HAL Id: tel-02378363**

**<https://theses.hal.science/tel-02378363>**

Submitted on 25 Nov 2019

**HAL** is a multi-disciplinary open access archive for the deposit and dissemination of scientific research documents, whether they are published or not. The documents may come from teaching and research institutions in France or abroad, or from public or private research centers.

L'archive ouverte pluridisciplinaire **HAL**, est destinée au dépôt et à la diffusion de documents scientifiques de niveau recherche, publiés ou non, émanant des établissements d'enseignement et de recherche français ou étrangers, des laboratoires publics ou privés.

**PH.D. THESIS OF THE UNIVERSITY OF BOURGOGNE FRANCHE-COMTÉ**

**PREPARED AT THE UNIVERSITY OF FRANCHE-COMTÉ**

Doctoral school n°37

Engineering Sciences and Microtechnologies

Ph.D. in Computer Science

by

**CHRISTIAN SALIM**

**Data Reduction based energy-efficient approaches for secure priority-based managed wireless video sensor networks**

Thesis presented and defended in Belfort on December 3, 2018

Composition of the jury :

LORENZ PASCAL	Professor at University of Haute Alsace	Reviewer
SEBA HAMIDA	Assistant Professor (HDR) at University of Claude Bernard Lyon 1	Reviewer
MAIMOUR MOUFIDA	Assistant Professor at University of Lorraine	Examiner
DEMERJIAN JACQUES	Professor at Lebanese University	Examiner
GUYEUX CHRISTOPHE	Professor at University of Franche-Comté	Examiner and President
COUTURIER RAPHAËL	Professor at University of Franche-Comté	Supervisor
MAKHOUL ABDALLAH	Assistant Professor at University of Franche-Comté	Co-Supervisor
DARAZI RONY	Associate Professor at Antonine University	Co-Supervisor

**THÈSE DE DOCTORAT DE L'ÉTABLISSEMENT UNIVERSITÉ BOURGOGNE FRANCHE-COMTÉ**

**PRÉPARÉE À L'UNIVERSITÉ DE FRANCHE-COMTÉ**

École doctorale n°37

Sciences Pour l'Ingénieur et Microtechniques

Doctorat d'Informatique

par

**CHRISTIAN SALIM**

**Approches écoénergétiques basées sur la réduction des données  
pour les réseaux de capteurs vidéo sans fil**

Thèse présentée et soutenue à Belfort, le 3 Décembre 2018

Composition du Jury :

LORENZ PASCAL	Professeur à l'Université de Haute Alsace	Rapporteur
SEBA HAMIDA	Maître de Conférences (HDR) à l'Université Claude Bernard Lyon 1	Rapporteur
MAIMOUR MOUFIDA	Maître de Conférences à l'Université de Lorraine	Examinatrice
DEMERJIAN JACQUES	Professeur à l'Université Libanaise	Examineur
GUYEUX CHRISTOPHE	Professeur à l'Université de Franche Comté	Examineur et Président
COUTURIER RAPHAËL	Professeur à l'Université de Franche Comté	Directeur de thèse
MAKHOUL ABDALLAH	Maître de Conférences (HDR) à l'Université de Franche Comté	Codirecteur de thèse
DARAZI RONY	Professeur associé à l'Université Antonine, Liban	Codirecteur de thèse



SPIM

école doctorale sciences pour l'ingénieur et microtechniques

# ABSTRACT

## Data Reduction based energy-efficient approaches for secure priority-based managed wireless video sensor networks.

Christian Salim  
University of Bourgogne Franche-Comté, 2018

Supervisors: Abdallah Makhoul, Rony Darazi, Raphaël Couturier

The huge amount of data in Wireless Video Sensor Networks (WVSNs) for tiny limited resources sensor nodes increases the energy and bandwidth consumption challenges. Controlling the network is one of the challenges in WVSN due to the huge amount of images sent at the same time from the sensors to the coordinator. In this thesis, to overcome these problems, several contributions have been made. Each contribution concentrates on one or two challenges as follows: In the first contribution, to reduce the energy consumption a new approach for data aggregation in WVSN based on shot similarity functions is proposed. It is deployed on two levels: the video-sensor node level and the coordinator level. At the sensor node level, we propose a frame rate adaptation technique and a similarity function to reduce the number of frames sensed by the sensor nodes and sent to the coordinator. At the coordinator level, after receiving shots from different neighboring sensor nodes, the similarity between these shots is computed to eliminate redundancies. In the second contribution, some processing and analysis are added based on the similarity between frames on the sensor-node level to send only the important frames to the coordinator. Kinematic functions are defined to predict the next step of the intrusion and to schedule the monitoring system accordingly. In the third contribution, on the transmission phase, on the sensor-node level, a new algorithm to extract the differences between two images is proposed. This contribution also takes into account the security challenge by adapting an efficient ciphering algorithm on the sensor node level. In the last contribution, to avoid slower detection of intrusions leading to slower reactions from the coordinator, a mac-layer protocol based on S-MAC protocol has been proposed to control the network. This solution consists in adding a priority bit to the S-MAC protocol to give priority to critical data.

**Keywords:** Video Surveillance, Quick Reaction, Energy Consumption, Bandwidth Usage, Event Detection, Extend the Lifetime of the Network, Data Reduction, Data Processing, Data Transmission, Frame Rate Adaptation.



# RÉSUMÉ

## Approches écoénergétiques basées sur la réduction des données pour les réseaux de capteurs vidéo sans fils.

Christian Salim  
University of Bourgogne Franche-Comté, 2018

Superviseurs: Abdallah Makhoul, Rony darazi, Raphaël Couturier

L'énorme quantité de données dans les réseaux de capteurs vidéo sans fil (RCVSF) est une des causes qui aggrave les défis liés à la consommation d'énergie et à la consommation de bande passante vis-à-vis des ressources limitées des nœuds capteurs. La gestion du réseau est l'un des problèmes des RCVSFs en raison de l'énorme quantité d'images envoyées simultanément par les capteurs au coordinateur. Dans cette thèse, pour surmonter ces problèmes, plusieurs contributions ont été apportées. Chaque contribution se concentre sur un ou deux défis, comme suit: Dans la première contribution, pour réduire la consommation d'énergie, une nouvelle approche pour l'agrégation des données pour les RCVSFs basée sur des fonctions de similarité des plans est proposée. Un RCVSF est déployé sur deux niveaux: le niveau du nœud capteur vidéo et le niveau du coordinateur. Au niveau du nœud capteur, nous proposons une technique d'adaptation du taux de trame pour réduire le nombre de trames à capter par le nœud capteur. En outre, une fonction de similarité a été proposée pour réduire le nombre de trames envoyées par les nœuds capteurs au coordinateur. Au niveau du coordinateur, après avoir reçu des images de différents nœuds capteurs voisins, la similarité entre ces images est calculée pour éliminer les redondances. Dans la deuxième contribution, certains traitements et analyses sont ajoutés en fonction de la similarité entre les images au niveau du nœud capteur pour n'envoyer que les images importantes au coordinateur. Les fonctions cinématiques sont définies pour prévoir l'étape suivante de l'intrusion et pour planifier le système de surveillance en conséquence. Dans la troisième contribution, sur la phase de transmission, au niveau capteur-nœud, un algorithme d'extraction des différences entre deux images est proposé. Cette contribution prend également en compte le défi de sécurité en adaptant un algorithme de chiffrement efficace au niveau du nœud capteur. Dans la dernière contribution, pour éviter une détection plus lente des intrusions conduisant à des réactions plus lentes du coordinateur, un protocole de la couche liaison de données (couche MAC) basé sur le protocole S-MAC a été proposé pour contrôler



le réseau. Cette solution consiste à ajouter un bit de priorité au protocole S-MAC pour donner la priorité aux données critiques.

**Mots Clés:** Surveillance vidéo, réaction rapide, consommation d'énergie, utilisation de la bande passante, détection d'événements, prolongation de la durée de vie du réseau, réduction des données, traitement des données, transmission de données, Adaptation de la fréquence d'échantillonnage.

# REMERCIEMENTS

Je tiens tout d'abord à exprimer ma profonde gratitude aux deux établissements dans lesquels j'ai travaillé durant les trois années de thèse, l'Université de Bourgogne Franche Comté (UBFC) en France et l'Université Antonine (UA) au Liban. Un grand merci à l'Agence Universitaire de la Francophonie (AUF) qui a financé mes séjours en France.

Je veux bien exprimer mes sincères remerciements à mon directeur de thèse Prof. Raphaël Couturier. Son humour, sa disponibilité, sa réactivité, son immense soutien et surtout son écoute ainsi que ses judicieux conseils ont énormément contribué à alimenter ma réflexion et ont été décisifs pour la bonne réussite de cette thèse.

J'adresse de chaleureux remerciements à mes co-directeurs de thèse, Dr. Abdallah Makhoul (UBFC) et Dr. Rony Darazi (UA). Ils m'ont permis de réaliser ma thèse dans les meilleures conditions. Leurs deux méthodes différentes d'encadrement ont enrichi ma thèse surtout qu'ils étaient assez réactifs et compréhensifs durant la réalisation des travaux pendant ces trois années. Je suis également reconnaissant pour le temps conséquent qu'ils m'ont accordé et leurs qualités pédagogiques et scientifiques. C'était un très grand plaisir de travailler avec eux. Je remercie aussi Prof. Pascal Lorenz et Dr. Hamida Seba pour avoir accepté d'être les rapporteurs de mon travail. Merci aux Prof. Jacques Demerjian, Prof. Christophe Guyeux et Dr. Moufida Maimour pour avoir accepté de faire partie du jury.

Je tiens à remercier notamment Dr. Bechara Al Bouna, le chef du laboratoire de recherche TICKET à l'UA. Il voulait toujours se rassurer que les conditions de travail dans le laboratoire étaient les meilleures possibles. Il me demandait toujours s'il fallait changer quelque chose pour encore améliorer les conditions. Je le remercie pour sa confiance en moi. Je ne dois pas oublier M. Antoine Yazigi, le vice-recteur de l'UA (2012-2017), c'est la personne qui était la plus claire avec moi dès le début de mon aventure dans le monde académique et surtout à l'UA.

Je remercie toutes les personnes avec qui j'ai pu collaborer et travailler pendant ma thèse, tous les enseignants-chercheurs de l'UA et de l'UBFC. Ils étaient de vrais collègues avec qui j'aimais bien discuter durant les temps libres. Tous les doctorants dans les deux laboratoires Elie, Zahi, Nancy, Jimmy, Lama, Zeinab, Nesrine, Gaby, Anthony, Joseph, Amor, Luigi et Marco. Je les remercie pour leur soutien et pour tous les moments conviviaux que nous avons partagés tout au long de ces trois années.

Au niveau personnel, je remercie mon épouse Carol. Nous avons commencé nos deux thèses en même temps dans les mêmes conditions, et nous avons pu soutenir dans deux jours successifs. Elle était mon soutien pendant ces trois années et nous avons partagé ensemble les hauts et les bas. Sur un plan encore personnel, je remercie maman et papa pour m'avoir soutenu tout au long de mes études. Je désire en outre remercier mes amis à Lille, à Belfort, à Paris et au Liban. Merci pour les discussions enrichissantes, pour votre bonne humeur et surtout pour votre support moral et intellectuel. À vous tous, un grand merci!



# CONTENTS

<b>Abstract</b>	<b>i</b>
<b>Resumé</b>	<b>iii</b>
<b>1 Introduction</b>	<b>1</b>
1.1 General Introduction . . . . .	1
1.2 Contributions . . . . .	2
1.3 Outline . . . . .	3
<b>I Wireless Video Sensor Networks</b>	<b>5</b>
<b>2 Surveillance Background via WMSN</b>	<b>7</b>
2.1 Introduction . . . . .	7
2.2 Existing works . . . . .	9
2.3 Traditional vision vs WWSNFS vision . . . . .	9
2.4 Architecture . . . . .	11
2.5 Factors influencing the design of a WWSN . . . . .	12
2.5.1 Homogeneous vs non-homogeneous . . . . .	12
2.5.2 Stationary vs mobile . . . . .	13
2.5.3 Deployment: fixed, random, semi-random . . . . .	13
2.5.4 Coverage . . . . .	15
2.5.5 Monitoring context . . . . .	16
2.6 conclusion . . . . .	17
<b>3 Challenges and Solutions</b>	<b>19</b>
3.1 Routing Protocols . . . . .	19
3.1.1 WMSN Architecture . . . . .	20
3.1.2 QoS and Energy aware Protocols . . . . .	24
3.1.3 MAC-Layer Protocols . . . . .	25
3.2 Data Reduction . . . . .	26

3.2.1	Scheduling . . . . .	26
3.2.2	Data Redundancy . . . . .	27
3.2.3	Compressive Sensing . . . . .	28
3.2.4	Compression . . . . .	28
3.3	Security . . . . .	29
3.4	Applications . . . . .	29
3.5	Conclusion . . . . .	30
<b>II</b>	<b>Contribution</b>	<b>33</b>
<b>4</b>	<b>Similarity Based Frame Rate Adaptation for Data Reduction</b>	<b>35</b>
4.1	Introduction . . . . .	35
4.2	Related Work . . . . .	37
4.3	Local Detection System : Sensor Node Level . . . . .	38
4.3.1	Local Detection System . . . . .	39
4.3.1.1	Color Similarity . . . . .	40
4.3.1.2	Edge Similarity . . . . .	40
4.3.2	Multimedia Adaptive Sampling Rate Algorithm (MASRA) . . . . .	42
4.4	Data Aggregation Scheme: The Overlapping Method . . . . .	44
4.4.1	Video Sensing Model . . . . .	44
4.4.2	Camera's Overlapping Filtering . . . . .	45
4.4.2.1	The Angle Condition . . . . .	45
4.4.2.2	The two Points Condition . . . . .	46
4.4.3	Shot Selection Algorithm . . . . .	48
4.4.3.1	Motion Similarity . . . . .	48
4.4.4	Shots Similarity Estimation . . . . .	48
4.4.4.1	Different Frame Rates Solution . . . . .	49
4.5	Experiments . . . . .	50
4.5.1	The Sensor Node Level . . . . .	52
4.5.1.1	Number of Frames . . . . .	52
4.5.1.2	Bandwidth Consumption . . . . .	55
4.5.2	The Coordinator Level . . . . .	55
4.6	Energy Consumption Study . . . . .	56
4.6.1	Sensor Node Level . . . . .	57
4.7	Conclusion . . . . .	59

<b>5</b>	<b>Kinematics Based Data Reduction Technique</b>	<b>61</b>
5.1	Introduction . . . . .	61
5.2	Related work . . . . .	62
5.3	Sensor node level: Sensing Phase . . . . .	64
5.3.1	Movement State Vector . . . . .	64
5.3.2	Current State Movement Calculation . . . . .	65
5.4	Predictions . . . . .	66
5.4.1	Kinematics-Based . . . . .	66
5.4.2	Position-Based . . . . .	66
5.4.3	Adaptive frame rate function . . . . .	67
5.5	Sensor node level: Transmission Phase . . . . .	68
5.6	Experimental Results . . . . .	68
5.6.1	Data Reduction . . . . .	69
5.6.2	Energy Consumption Study . . . . .	73
5.6.3	Sensor Node Level . . . . .	74
5.7	Conclusion . . . . .	75
<b>6</b>	<b>Energy-Efficient Secured Data Reduction Technique</b>	<b>77</b>
6.1	Introduction . . . . .	77
6.2	Related work . . . . .	78
6.3	Architecture . . . . .	80
6.4	Data Reduction and Energy Consumption . . . . .	80
6.4.1	Sensing and Transmission Phases . . . . .	81
6.5	Data Security . . . . .	82
6.5.1	Encryption Algorithm . . . . .	83
6.6	Experimental Results . . . . .	84
6.6.1	Data Reduction and Energy Consumption . . . . .	85
6.6.1.1	Critical Frames . . . . .	86
6.6.1.2	Frame Rate Adaptation . . . . .	86
6.6.1.3	Comparison . . . . .	87
6.6.2	Data Security for Transmission . . . . .	89
6.7	Conclusion . . . . .	90
<b>7</b>	<b>Enhanced S-MAC Protocol for Early Reaction and Detection</b>	<b>91</b>
7.1	Introduction . . . . .	91
7.2	Related work . . . . .	92

7.3	MASRA Algorithm . . . . .	92
7.4	Theoretical Approach . . . . .	93
7.4.1	Ordering technique . . . . .	93
7.4.2	Proposed Order . . . . .	94
7.5	Conceptual analysis . . . . .	95
7.5.1	Scenario: Implementation of the Priority-SMAC protocol . . . . .	95
7.6	Experimental Results . . . . .	95
7.6.1	Real Experimentations . . . . .	96
7.6.2	Network Development . . . . .	97
7.6.3	Delay Solution . . . . .	98
7.7	Conclusion . . . . .	98
<b>III</b>	<b>Conclusion and Perspectives</b>	<b>99</b>
<b>8</b>	<b>General Conclusion</b>	<b>101</b>
8.1	Perspectives . . . . .	103
	<b>Publications</b>	<b>105</b>

# INTRODUCTION

## 1.1/ GENERAL INTRODUCTION

Wireless sensor networks (WSN) have become the rising star of the technology. Every object in this world tends to be sensorily developed, monitored and controlled. Wireless Video Sensor networks (WVSNs) have all the potential needed to increase the video surveillance efficiency at a low cost and reduce unnecessary human interference. WMSNs have to detect any abnormal situations in very well secured areas and send alerts to the respective people to take action accordingly. The main target of the WVSN is to monitor a very well known area of interest. Many applications can be fulfilled using WMSNs such as: emergency detection, intrusion detection, forest fire, context awareness for health-care... A WMSN is composed of wireless video sensor nodes, a coordinator and a sink. The video sensor nodes of limited energy resources, sense and collect videos and frames and send them to the coordinator for analysis. The coordinator is a node like the others but with greater energy resources capabilities. It manages the network by receiving the collected videos/frames and performs the data analysis and fusion to reach the monitoring application goal. However, several limitations exist in WMSNs such as the limited resources of the video sensor nodes. In this dissertation, we consider that the video sensor nodes are limited in energy and processing resources. We take also into consideration that multimedia data transmission is the most process that drains energy on the nodes especially that WMSNs are periodic and a huge amount of videos and frames are periodically collected and sent to the coordinator. The main motivation of this work is to extend the lifetime of the network by using several techniques such as reducing the amount of collected frames, detecting the abnormal situations earlier and reduce the amount of sent data by sending only the necessary data to the coordinator. While working to solve the energy consumption challenge, two other challenges popped up: the security and the network organization challenges. Those new challenges were the main reason to increase our motivation. To solve the security challenge, we need to secure/encrypt the frames on the sensor node level to be sent to the coordinator. Regarding the network organization, a lot of MAC-Layer protocols exist to do the job.

Therefore, the dissertation focused on those challenges to be able to solve all the required problems.



## 1.2/ CONTRIBUTIONS

The main contributions in this dissertation fall within the data management aspects especially in the data reduction field while taking into consideration the security and the network control manners. They reply to the previously mentioned challenges requirements while taking into consideration the constraints that are present in WMSNs. We summarize the main contributions of our research as follows:

- First, Data analysis starts at the sensor node level and continues at the coordinator level to match the greatest reduction possible in terms of energy and bandwidth consumption on both levels. Each video-sensor node compares all the frames in a shot to the last frame sent and computes the similarity between them. Based on the similarity function, only the frames in which an event occurs are sent. The selected frames are called critical frames and are sent to the coordinator. The similarity function at the sensor node level is based on color and edge similarities able to compare frames. This comparison selects the least required number of captured frames to be sent to the coordinator. By applying the similarity function, we reduce the energy consumption related to the Communication process by reducing the number of transmitted data.

Alongside the similarity function, the frame rate of each video-sensor node is adapted. A method based on signal frequencies presented in [64] is adopted and applied to WWSN in our approach. This method consists in reducing the number of frames captured by adapting the frame rate of each video-sensor node based on the number of critical frames detected in several consecutive past periods. Consequently, by adapting the frame rate, the Sensing process is reduced thus decreasing the energy consumption. At the coordinator level an updated version of the similarity function is implemented in which the motion similarity is added to the color and edge similarities. To avoid comparing all received shots at the coordinator level, a geometric study and a filtering condition are presented. Those conditions consist in reducing the number of possible comparisons.

- Another approach was studied to reduce the energy consumption related to the sensing process on the sensor level, a simple probabilistic method has been proposed to adapt the frame rate of every sensor node, depending on the level of criticality, the position and the trajectory direction of the intrusion in the scene (the movement's vector) based on a probability based prediction [95]. After adapting the number of frames sensed by the node in every period, the main goal is to reduce the number of frames sent from the sensor node to the coordinator. To reduce this number, each sensed frame is compared with the last frame sent. This comparison is an edge based comparison: according to [61], we are interested in the simple image processing algorithms. We try to detect critical events and track intrusions through the area of interest via a wireless video sensor network, while using an energy efficient method.
- To further reduce the energy consumption on the sensor node level, an approach has been proposed to reduce the energy consumption related to the sensing and transmission on the sensor node level using data reduction techniques. This approach consists of an algorithm to adapt the frame rate of every sensor node, depending on the number of critical frames transmitted from the sensor to the coordinator. The number of frames sensed by the sensor will be reduced, which leads to

a direct reduction of the energy consumption for the sensing process on the sensor node level. On the other hand, for the transmission process and after adapting the number of frames sensed by the node in every period, our aim is to continue with the data reduction technique to reduce the number of frames sent from the sensor node to the coordinator. In the same algorithm, a comparison of consecutive sensed frames is executed by comparing each frame sensed with the last frame sent. According to a predefined threshold of similarity, the node decides whether this frame is critical and different from the last frame sent to the coordinator. In this case the number of sent images is reduced, and the energy consumption related to the transmission reduces consequently. If the two frames are different, the sensor node decides to send only the different part of the new image to the coordinator causing a reduction of the size of the sent image and thus reducing the energy consumption furthermore. This part of the image is to be joined with the last sent image on the coordinator to rebuild the new frame. In this approach, a security algorithm is adopted from [146] to secure the data transmitted from the sensor node to the coordinator. The one-round, a ciphering algorithm [146] is efficient considering the low execution time needed to encrypt a frame. Thus, it does not take into account the integrity of the image.

- To organize and control the network, we focused on the transmission of images in a multimedia WSN under the constraint of limited energy. In any proposed scenario, the surveillance remains the most important criteria in our study, such as how to detect an intrusion on the sensor and coordinator levels and how to react accordingly. This approach develops a newer version of S-MAC protocol. The main objective of our work is to look for the possibility to improve the performance of the sensor network for a better surveillance system.

### 1.3/ OUTLINE

The dissertation is organized as follows: Chapter 2 gives an overview about Wireless video sensor networks. Chapter 3 exposes the domains studied in WMSNs by presenting the scientific background and going through some scientific research that have been made and have investigated these domains. Chapter 4 presents the first contribution resumed by a frame rate adaptation and a similarity function to reduce the amount of frames at the level of sensor nodes. Chapter 5 presents the Kinematics based approach to reduce the amount of frames sent to the coordinator. Chapter 6 presents the third contribution presenting the different image idea and the security technique adopted on the sensor node level and its real implementation on Raspberry PI 3. Chapter 7 presents the fourth contribution resumed by an adaptation of a MAC-Layer protocol to organize the network. Chapter 8 concludes the work that has been done in this thesis.





# WIRELESS VIDEO SENSOR NETWORKS



# SURVEILLANCE BACKGROUND VIA WMSN

Recent technological advances in electronics, wireless communication and signal processing have enabled the development of a new class of ad-hoc sensor networks: wireless video sensor networks (WVSN). This type of network covers a fairly wide class of applications. In this chapter, we have a particular interest to study WVSN for surveillance (WVSNFS). We present this type of networks and the different parameters of their design. We discuss more particularly the challenges faced to create the protocols, the energy-efficient techniques and the security properties used in WVSN.

## 2.1/ INTRODUCTION

Until now, research efforts in the field of wireless sensor networks (WSN) have been focused more particularly on scalar sensor nodes of low cost and limited capacity in terms of bandwidth, processing, storage and power supply. This kind of so-called scalar networks, made up of thousands and sometimes millions of nodes, is able to measure large amounts of environmental data such as temperature, voltage, speed of wind, humidity, etc., to perform specific treatments (fusion, compression) on these data by internal nodes and to transmit the obtained information to a base station (Sink) for further treatment and analysis. The purely scalar nature of this captured data makes this type of networks unsuitable for applications that implement very complex, highly critical and very accurate data during the capture operation that require rich and intensive information: visual information. As examples of these applications: automatic tracking of moving objects, monitoring and detection of intruders in an area of interest and assistance for elderly or disabled. The vision is therefore an effective way to capture this mass of information and is also a dominant channel through which people perceive the world [6]. Attaching the vision function to a sensor node, to form what are called the wireless video sensor networks (WVSN), is an innovative idea that began to emerge in recent years [21] [32] [36] [43].

This is motivated, first by recent technological advances in electronic, in wireless communication and in signal processing; and secondly by the availability of a significant heritage of algorithms and techniques in the field of vision having proved their effectiveness in conventional networks such as the Internet. A WVSN is generally composed of sensor nodes equipped with miniaturized video cameras, low cost and capable of capturing scenes while taking into consideration the application-dependent quality of service. Other types

of scalar nodes can be added to the network to transport video data. This type of network covers a very wide types of applications, in particular surveillance applications. In this chapter, we are particularly interested in wireless video sensor networks for surveillance (WVSNFS) as shown in Figure 2.1. Our choice is motivated by the fact that the research field in this domain is still not largely exploited for this type of networks and, on the other hand, in the existing studies on the WMSN in general, some very important issues are not taken into account, particularly those related to network aspects (routing, security, auto organization, ...) and to Data reduction techniques (Data Compression, Remove Redundancy, Frame Rate adaptation,...) for energy-efficiency. Our goal is to present this class of networks, to study the design space, to ascertain the importance of heterogeneity in this type of networks and especially to propose the challenges for protocol design and energy-efficiency and the future directions of research to explore in this field. The main objective in this dissertation, while studying the WVSNFS challenges in different aspects, is to extend the service lifetime of the network.

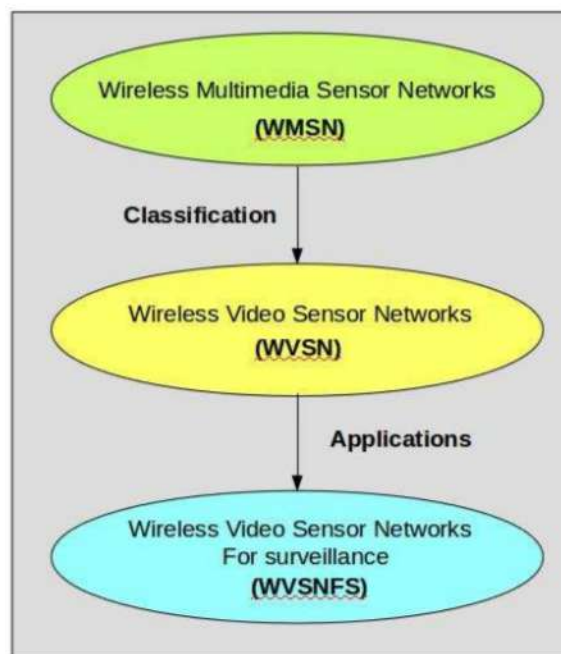

Figure 2.1: Wireless Video Sensor Networks For Surveillance

The rest of this chapter is organized as follows. In section two, we present few works on WMSN in general, which we could find in literature. Section three illustrates the differences between a vision with conventional networks and a vision with a WVSNFS. The architecture of the network is described in section four. In section five, the factors influencing the design of a WVSNFS and a study of the concept of heterogeneity which characterizes this type of networks are presented.

## 2.2/ EXISTING WORKS

In this section, we present some works done on WVSNs in general that show the interest and new challenges that the research community faces in the study of this large class of networks. In [36], the authors present a rather rich state of the art on multimedia sensor networks without wire (WMSN). This type of network groups together several types of sensors generating a content multimedia (image, video, sound), in addition to the scalar content. They present some problems and challenges in general relating to the communication protocols representing each of the protocol layers. The concept of heterogeneity has been studied by introducing the concept of multi-tier architecture. The method of protocol description by layer adopted by the authors sometimes makes it difficult to understand the factors influencing the design of an WMSN.

Although article [6] is ranked among the few early works on WWSN according to [32], it is far to be a reference rich enough in terms of the problems posed and the challenges to be met in this field in the years to come. It has the merit of predicting already in 2001 the mass proliferation of WWSN in the next 10 years.

The authors in [32] admit that the problem of limited resources of video sensor nodes remains always the main problem in WMSN. They show that WWSN has severe uncertainties in every aspect of system (uncertainty of the data captured, uncertainty of the sensor nodes, uncertainty of the routing and topology, compromised sensor nodes, fluctuation of communication channels, collision, inaccuracy in localization and synchronization, ...), than those of sensor networks classics. These uncertainties therefore require new and innovative approaches to offer a very high degree of assurance. The authors also present some challenges related to network aspects, security, node design and video data analysis. On the network level, the authors put focus on ensuring quality of service, including video data delivery time to the Sink for analysis. They also show the interest of internal processing (in-networking), such as the merger, by relay nodes, in the perspective of reducing the load of the network. They approach also, briefly, the coverage problem in the WWSN.

These network aspects as discussed are incomplete, for example, the routing function is briefly discussed, while a multi-path routing and its various variants [36] [35] for example is one of the key solutions currently proposed as an efficient data routing scheme video. Similarly, we find that the authors did not address issues and challenges that we appear vital on transport functions, MAC and inter layer approaches for a purpose optimization. The design part of a node treated by the authors focuses mainly on hardware aspects by neglecting other parameters that we deem very useful such as heterogeneity, reconfiguration, synchronization, the context of surveillance, to cite only a few.

## 2.3/ TRADITIONAL VISION VS WWSNFS VISION

Traditional vision systems, commercial or in the form of prototypes, have existed since several years and research in this field is mature [32]. Indeed, as shown in Figure 2.2, the infrastructure of such systems differs fundamentally from that of WWSN represented in Figure 2.3.



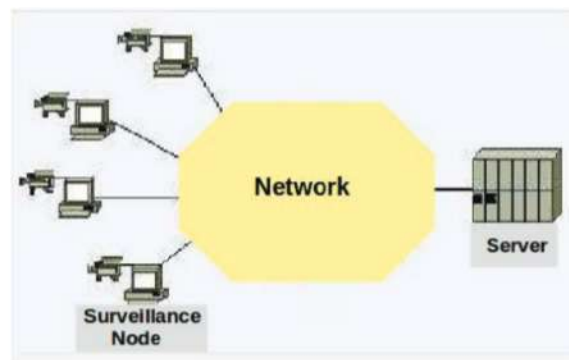

Figure 2.2: Traditional Video Surveillance System

It is built mainly on nodes equipped with high resolution cameras and very powerful processing units in terms of computing capacity and storage capacity.

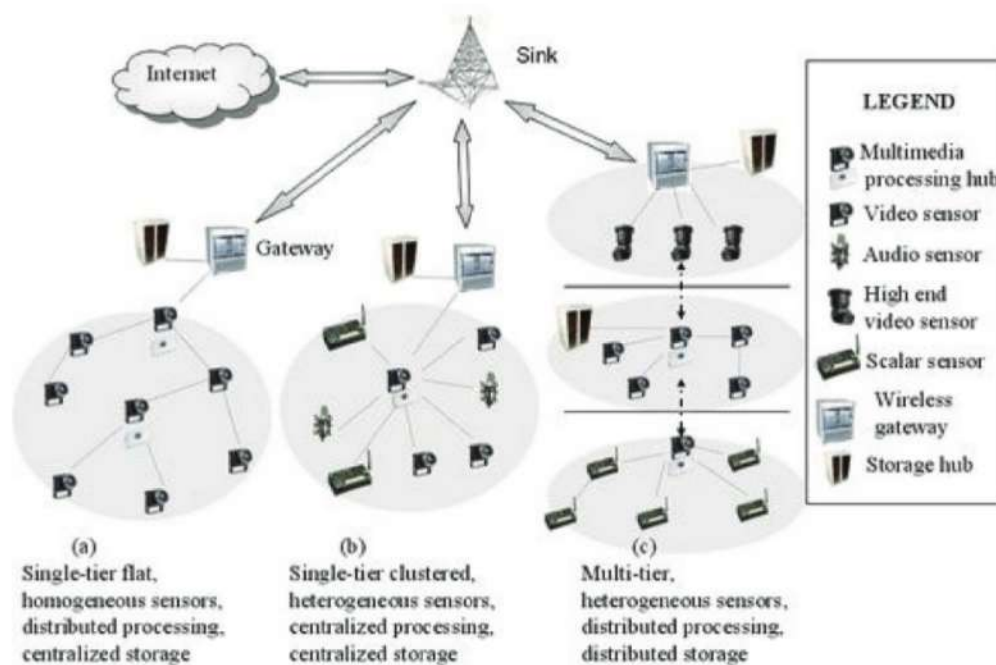

Figure 2.3: Wireless Multimedia Sensor Network Architecture

These nodes communicate in general with central servers via a high bandwidth network (e.g. Ethernet). Most of the research on these types of systems focuses on analyzing the video data received, after their capture of the environment, to study some phenomena such as identifying or tracking objects. In WMSN, the approach is totally different. Indeed, thousands of low-capacity camera nodes (resolution, processing and storage) of same range or similar ranges and / or scalar sensor nodes are deployed in an area of interest. These nodes use collaborative mechanisms to ensure the monitoring task of a given application and transmit via an ad-hoc network a useful video data

to one or more base stations. Pre-processing (compression, filtering, fusion) and post-processing (analysis) are performed on the data captured, respectively, by the sensor nodes and the base station.

## 2.4/ ARCHITECTURE

A WWSN for surveillance is composed of sensor nodes equipped with cameras to collect a quantity of rich and intensive data relating to a particular monitoring application. Scalar nodes may be deployed in the network to participate in the development of certain tasks within the network such as the transport of captured video data, sometimes the assurance of a service minimum monitoring in the event of a video node failure (further explication in the following paragraphs). Figure 2.3 shows an example of WWSN for surveillance architecture with several operating scenarios. We will refer to these scenarios every time we have need to illustrate some concepts that we introduce throughout this chapter. Sensor node: We know enough information about the structures of scalar nodes. Figure 2.4 gives a more specific look at video nodes that can be represented by a set of major components. Camera: this component can be characterized by three important parameters: Field of View noted FoV, spatial resolution and the length of the depth of the field noted DoF. Other parameters may be considered such as: Cost, consumption of resources (energy, wiring). There are several types of video cameras used in surveillance: Fixed Perspective Camera where the rotation parameters and the length of the DoF are constant, Pan-Tilt-Zoom camera where the rotation parameters and the length of the DoF are variable and omni-directional camera where the length of DoF and the horizontal angle for rotation are constant and the vertical angle for vertical rotation is variable of 360 °.

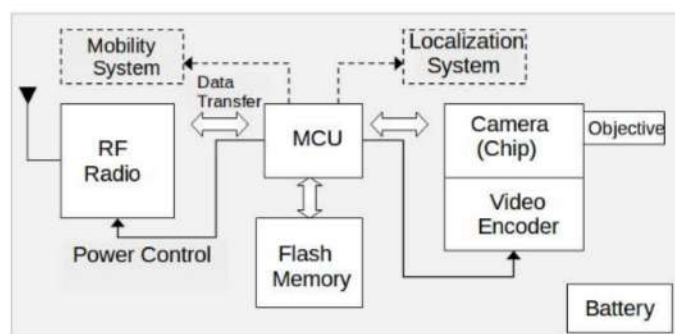

Figure 2.4: Major components of a video node. The dotted lines represent the optional components

Video Encoder: includes some features such as: filtering, compression, management / adaptation of the buffer, ... Given the severe technological limitations in the design of batteries and the low processing power of the video nodes, the encoder must be designed to consume a minimum of energy. MCUs and data storage memories: several options are considered for these two components. Some specific options: 32-bit microcontroller architecture, broad enough access to flash memory, mechanisms of standby

/ waking in periods of inactivity. RF radio: it is the transmission / reception component of video data (transceiver) similar to that of a scalar node. Battery: is the power source by which all the components of a node are powered by current. This amount of energy must be sufficient to ensure an acceptable longevity of a video sensor node. In some situations, the battery can be continuously powered by an external power source such as solar or vibration energy. The two optional components, mobility system and location system, are designed to make the node mobile (the position  $P = (x, y)$  mentioned in Figure 2.3 is therefore variable) and to always have the current position of a node, respectively. Examples of video sensor nodes include: Panops [21], cyclops [25]. The communication network: There are usually two modes of communication in this type of network: video nodes to allow collaborative processing in the surveillance function and communications for the transmission of video data to the Sink via a multi-mechanism jumps. Since the camera and RF radio components most often consume more energy, mechanisms for energy conservation are to be implemented to extend the overall life of the network.

## 2.5/ FACTORS INFLUENCING THE DESIGN OF A WWSN

### 2.5.1/ HOMOGENEOUS VS NON-HOMOGENEOUS

A WWSN (wireless video sensor network) can be either homogeneous, in which case all nodes have the same functionality and / or characteristics, either heterogeneous. This idea of heterogeneity is not new but the cost of video sensors are usually larger than scalar sensors, there is a stronger probability that a large-scale deployment is rather heterogeneous than homogeneous. In studies that have been made so far [36] [27], this heterogeneity is most often reflected by the multi-tier hierarchical architecture. Most often, distinction or prioritization are done based on material differences in order to save global energy by identifying gateway nodes. In the case of video sensors for surveillance, this heterogeneity seems to have far wider implications. We think that it has very significant impacts on the design of the protocols or mechanisms that can be put in place on these networks. Indeed, if the heterogeneous deployment is caused by the cost, the non video nodes can be either scalar sensors or communication relay nodes. In the first case, we can consider that the scalar nodes can work in a complementary way by video nodes in the event in which there are not enough of them to cover adequately the areas to be monitored (either because the initial deployment was not dense enough, either due to breakdowns or end of life of a number of video sensors). This means that in the case of a heterogeneous deployment, new research directions such as that the cooperation between heterogeneous sensors and the notion of service rendered can be put forward. For example, if the video sensors use the image to detect possible intruders, in areas not covered by the video scalar sensors can fulfill this role in a way or another even if they are not provided for this purpose, as an example: the accelerometer. If the sensor is "shoved" by the intruder, rapid variation of brightness if the intruder passes in front of the sensor, etc. More sophisticated collaboration schemes could even improve and / or validate some ambiguous scenes through active cooperation between different sensors of different types. These scenarios require, on the one hand, to reflect on new modes of cooperation and service composition, and secondly on architectures making these advanced mechanisms possible dynamic service composition. This will probably require designing systems more flexible and efficient operating systems as well as supervisory

resources (distributed or centralized).

### 2.5.2/ STATIONARY VS MOBILE

Most scenarios on sensor networks assume that these ones are immobile. Indeed, in deployment scenarios of very small sensors it is difficult to envisage that these will possess the necessary mechanics (and sufficient energy) to allow mobility (terrestrial). A less expensive form of mobility consists in placing the sensor on an element that is itself mobile like an animal for example. Video sensors have a less costly mobile form and more interesting to implement than traditional land mobility: the rotation of the camera on a sensor allows to change the coverage of the field of view (FOV) and so can be assimilated to mobility in the sense that the coverage area is no longer the same. If we assume that the sensors have no terrestrial mobility, or that of the camera, the type application is more of the type of zone surveillance, intrusion detection. The notion of coverage is directly related to the initial orientation (which is random if deployment is by cameras. In this case, the way in which we can parameterize the system is to determine the sensors assets based on their position and field of view to ensure the best coverage. If we assume that there is mobility, it is quite unrealistic for the moment to consider a mobility autonomous sensor, otherwise it is almost like having a robot. Mobility in this case can be either because the sensor is attached to a moving natural element, or by mobility of the camera. In the first case, the type of application is mainly exploratory, since there is no control over mobility, as it is imposed. This scenario raises problems of communication to the extent that the sensor may be out of reach of other sensors and therefore isolated (note that this may be the purpose of the application: count the number of sensors connected). Generally, the sensors must embark a non-volatile storage to allow data retrieval and analysis since communication is by no means guarantee. This type of scenario can be found in many animal-type applications (wild animals but also cattle, for example) like the ZebraNet project for wild animals from Kenya for example. In the case of video sensors, the information collected may be richer but the constraints in terms of storage are larger. There are, however, no significant differences from case of scalar sensors except that the video coverage of a sensor is expressed by a field of view. If we now consider the mobility enabled by the movement of the on-board camera, the perspectives are broader. We can of course apply zone surveillance, but also do a little bit of exploration because we are certain to be able to cover a field of view of 360 °. This form of mobility, very specific to video sensors, makes the setup of the system much more complex. Indeed, if the cameras have the possibility to cover any zone, the number of combinations sensors for a given coverage will be much larger.

### 2.5.3/ DEPLOYMENT: FIXED, RANDOM, SEMI-RANDOM

Deployment can be deterministic, random, or semi-random. A deterministic deployment consists of fixing the different locations where the sensors will be located. This is for example the case in a monitoring application of a zone by a set of video sensors manually placed at places considered strategic. In some cases, if the nodes are mobile, the deployment can be deterministic but the position becomes random depending on the mobility of the nodes (for example if the sensors are carried by animals, the targets are determined initially but they move). The Random Deployment Mode is the mode most commonly

mentioned in typical scenarios military surveillance or crisis management: an airplane or helicopter drops over a given area of sensors. One obvious difference between these modes of deployment is the coverage: there is no full coverage guarantee in random mode if there is no mobility opportunity like explained previously. The deployment mode in a WWSN has a considerable impact on the type of applications possible and vice-versa. These impacts are mainly due to the need to control the network sensors or process information for effective video surveillance. Indeed, the role of a network of video sensors for surveillance is to monitor strategic points and alert or provide relevant video footage. This means that from the point of view of the functionalities that must be present, there will be mechanisms for information fusion, localization and control. These algorithms most of the time require the ability to select a set of relevant sensors, or to know where an alert has been reported or to eliminate information considered redundant because it is covered by several sensors. If the deployment is fixed, it is possible to easily assign an area or a GPS coordinate to the sensor by downloading when they are manually deployed. In this case, the surveillance applications on demand, for a certain geographical area, are possible by remotely activating the sensors concerned (those covering the area in question). If the deployment is random, this type of application is possible with the condition of knowledge of a common landmark (such as a geographical north) or the presence an on-board hardware means for receiving a GPS signal. In the case of a system where all the nodes do not have the on-board GPS capability, methods of triangulation are possible and therefore we come back to a known case. If no geographic information is available, only continuous monitoring applications (observation, exploration) will be possible with an intrusion detection in a covered area. The deletion of redundancies will be much more difficult because it will be necessary to set up scene detection algorithms that are complex and therefore very power consumers. Note that in a random deployment scenario, we can imagine a particular mode that we called semi-random, which consists in arranging to spread the sensors per successive waves. The sensors of the same wave all have, for example, the same zone identifier encoded in memory with which it is possible to find the geographical area they cover by correspondence with a 2D plane as shown in Figure 2.5.

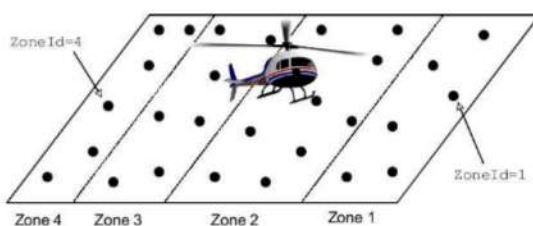

Figure 2.5: Example of a semi-random deployment scenario

If we identify the types of applications, we can have:

- On-demand monitoring of any geographical area and retrieve a video stream.
- Continuous surveillance of a covered area and retrieve a video stream if an alert happened.
- location.

### 2.5.4/ COVERAGE

The coverage problem in scalar WSN has been widely studied and very interesting results have been published [23]. Data collected by scalar nodes can be measured in different directions while the result is always the same. This is the reason why a coverage area of a scalar node is always represented by a simple geometric shape: a circle or a rectangle. This simplification made the study of the problem of coverage with energy saving, for example, relatively easy. Indeed, we have always aimed to optimize the preservation of the coverage, in case the network topology is dynamic (due to the disappearance or adding new nodes), often using the concept of redundancy to ensure fault tolerance and longevity of network life. This redundancy highlights the close relationship between the position of the node and the area it covers. So, two scalar nodes are likely to be redundant if they are closer to each other. Similarly, the operations of redundant data filtering (compression, fusion) are relatively simple in the scalar WSN. The notion of redundancy in WWSN has another dimension. First, the quantity of information captured by a video node is very important and the idea of sensing of capturing has a significant role. A video sensor performs the capture function according to a viewing angle, which we call field of view (FOV) in a 3D space, making the coverage problem more complex than in the case of scalar WSNs. The concept of angular position of the video sensor is very important in that case. Solving the problem of coverage in these types of networks by manipulating Three-dimensional geometric shapes is not an easy thing. The authors in [16], although have proven by an analytic approach that verification of the coverage in a 3D space can be done in polynomial time, they did not deal with the issue of optimization of coverage. For this purpose, new approaches have recently been proposed to reduce this complexity. Indeed, in [27], the authors presented a coverage scenario as illustrated in Fig 2.6.

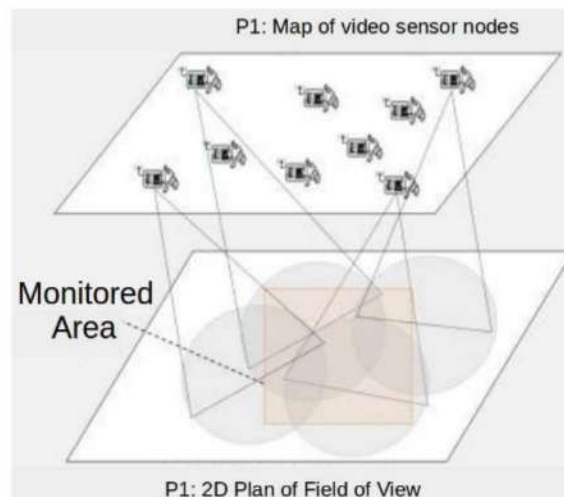

Figure 2.6: Simplified Coverage Scenario in WWSN

video nodes are deployed in one plan (noted P1) and their fields of vision are projected onto another plan (noted P2). The cover space in this case can be represented by a circle or a rectangle in the P2 plan. They showed that a study of coverage with such a simplification, using algorithms designed to cover scalar CHNs, do not always give

expected performance. The reason is simply that two video nodes can be redundant without being close to each other. In other words, the position of a video node is not dependent on the region it covers or vice versa in this type of networks.

Even if we admit that such redundancy can be exploited in an approach aiming at reducing the energy consumption, it seems much more difficult to choose the video node or nodes to put on standby, because this depends on the objectives of the application (several views are often desired) and the conditions in the covered region (sometimes it is necessary to move away from the target for better frame because of an obstacle or fog). If we add new parameters, such as the possibility of turning the camera on the sensor, we see that the determination of the coverage must take into account a cone that can capture an interval defined by the rotation capabilities of the camera. If the camera is able to rotate 360 ° the problem is probably even more complex because you have to choose again between video sequences with different recoils which will depend on objectives of the application. Similarly, in the presence of redundant scenes, we must always provide filtering treatments to reduce the mass of video information to be shown, but this emphasizes serious problems in terms of processing capacity, storage or bandwidth available in a video node. Thus, the study of coverage in this type of network requires new approaches to manage optimally the redundancy and filtering of video information. Ensure a very high level of redundancy by properly and optimally aligning video nodes to the targets, with some rotations of FOVs, is a very interesting optimization problem, which can be solved for example by formulating it as a linear program in integer number.

### 2.5.5/ MONITORING CONTEXT

An WWSN can operate in two different monitoring modes: the infrastructure and the open modes. Each mode has an impact on possible algorithms and scenarios. The infrastructure mode refers to a video surveillance mode where the infrastructure for monitoring is known, where we can locate predefined areas and on which we can place the sensors more or less in a random way. This is typically the case for monitoring a building for which we are interested in the entrance door and parking for example. In this mode, each sensor knows what is monitoring and it is easy to manage the coverage and information redundancy. In open mode, there is no motion precise area of surveillance (no strong semantics associated with a particular area): the whole area covered by the sensors is potentially relevant and it is usually more extensive geographically than in the infrastructure mode. Depending on the deployment scenario previously discussed, a number of applications are typical of open mode: intrusion surveillance in the covered area, observation, ... The random deployment seems the privileged method of the open mode. Each mode has a set of algorithms adapted to the surveillance context. In the mode infrastructure, the deployment is often manual, or at least semi-random while being sure that the strategic points will be covered. Using a totally random deployment in infrastructure mode totally often means that the infrastructure under surveillance is vast and that the entire area is under surveillance (e.g. surveillance of an airport by releasing sensors). In this case, we approach the open mode. Now, if we consider a real infrastructure mode as used in most building video surveillance applications such as houses, parking, campus, ..., this one uses more frequently fusion algorithms of data management, multi-view management and tracking, in addition to image processing algorithms for identification and pattern recognition.

Speaking of identification and recognition, the idea of initial view can be common in the 2 modes, but probably has more sense in open mode where there is often an environment learning in which the sensors land. For example, if the sensors are dropped in a forest randomly and the event we are trying to capture is the passage of animals, these sensors will define (by successive iterations) an image of reference that they will use to detect the event.

In open mode, it is more important to be able to manage the sensors spatial redundancy to ensure the greatest possible coverage and to maximize the service lifetime of the network. This last point raises very interesting perspectives in terms of sensor management and optimization of the initial state. Indeed, in a scenario of dense deployment of sensors in open mode it is important to maximize the lifetime of the network video surveillance by defining the sensors that will be active and the sensors that will be on standby state, while maintaining the maximum coverage. If we consider the previous example where the sensors are responsible for capturing the passage of a large animal, the sensors in activity will learn which external stimuli correspond to the type of event to be monitored and avoid to trigger alerts if a bird passes. When a sensor reaches the end of its life, it will wake up a sensor in standby state and it will then seek to transmit its heritage so that new sensor so it does not start with no knowledge. We then see that new quite original criteria can be taken into account to define the initial state and organize the wireless video sensor network to maximize both energy and coverage: minimum wealth transfer, maximum degree of sensor succession, choice of successor, ...

## 2.6/ CONCLUSION

In this chapter, we have explored the emergence of WWSN since its beginning. Then we have differentiates between different types of WWSN using different types of video sensor nodes in the heterogeneous WSN, while studying different techniques of deployment, surveillance, angle, field of views... in this domain.

In the next chapter some solutions to the main challenges in WWSN are exploited, as well as some examples of applications are listed below.





## CHALLENGES AND SOLUTIONS

Several applications for different purposes have been created using wireless sensor networks. In this work, wireless multimedia sensor networks (WMSN), and especially wireless video sensor networks (WVSN), are the main subject to be studied including their different areas of application, their mathematical techniques and their algorithms. The ultimate challenge in WMSN is the limited lifetime of the video sensor nodes. For this reason, the main purpose of the researchers in this domain is to extend the lifetime of the network. Reducing the power/energy consumption on the sensor node level and on the overall network is the main target for all researchers in this topic to be able to extend the lifetime of a wireless multimedia sensor network.

Since the emergence of wireless sensor networks, researchers have developed different kinds of energy efficient algorithms, protocols and architectures of wireless sensor networks to reduce the energy consumption on the sensor node level so the lifetime of the overall network is extended. Thus, in order to reach this aim, different scenarios and analysis have been discussed and several methods have been applied on every layer in WMSN. To discuss the background and all the recent trends in WMSN domain, several energy-efficient techniques have been studied such as: Routing protocols and Data reduction techniques.

For each category, different aspects are taken into consideration in this chapter, such as clustering techniques in the architecture category, the reduction of transmitted data in the data reduction category, Quality of Service (QoS) in the routing protocols sections and so on.

Another challenge in WMSN is data security. The transmission of surveillance video streams on a network without any security layer can attract hackers to do any malicious attack. The criticality of the application should be taken into consideration regarding the needed level of security, for example, the highest data security is needed for military surveillance.

Each aspect and approach are explained in the sections below in this chapter for the better of WMSN, as well as an application example from the literature.

### 3.1/ ROUTING PROTOCOLS

Routing protocols in WMSN have a big impact on energy efficiency since they can decide where to send the data and which path should the data take to reach its destination. Thus, changing paths is related to the residual energy of each sensor node in the WMSN.

Routing and MAC protocols are the main reason to organize the network, prevent congestion and decrease the delays and packets loss. Thus, as energy-efficient protocols, different types of routing protocols exist for WMSN such as:

- WMSN Architecture Protocols
- Quality of Service aware and Energy aware Routing Protocols
- MAC-Layer Protocols

In this section, all these types of protocols are analyzed below. Most of these protocols use the multi-paths theory for energy-efficiency.

### 3.1.1/ WMSN ARCHITECTURE

In WMSN, the architecture plays a big role in prolonging the lifetime of the network. Routing protocols have a big role to define and establish the architecture of the WMSN. Different architectures have been studied in the previous work, one of the most known architecture is the clustering technique. This technique possesses different methods to chose the clusters and the cluster head (CH). Thus, creating a clustering algorithm that suites the network to group sensors in areas can increase the energy efficiency in WMSN.

However, an additional overhead is added while clustering from the selection of the cluster head to the construction of the cluster. Isolated nodes technique has been used in WSNs in general it is called Regional Energy Aware Clustering with Isolated Nodes (REAC-IN) [109]. Residual energy of each sensor node and the average energy of all the sensors in each cluster are the main factors in REAC-IN to select the cluster head in the network. Isolated nodes become isolated from the cluster heads according to some distributed clustering algorithms. In this case they communicate directly with the sink which can consume a higher amount of energy. In REAC-IN, to prolong network lifetime, each isolated node chooses to send its data to the cluster head or to the sink based on the average energy of all the sensors in the cluster and on the distance between the sensors and the sink as shown in Figure 3.1. Based on the concept of the Low-energy adaptive clustering hierarchy (LEACH), The cluster head role is rotated between all nodes based on the residual energy, this procedure helps the energy consumption to be uniform for each node while using REAC-IN. A threshold is set to select the cluster head in REAC-IN. This threshold is the combination of the residual energy of each sensor and the average energy of all sensors in each cluster. This scenario distributes the CHs evenly and overtakes LEACH where the CHs selection is only based on a predetermined probabilistic study.

For instance, dividing the whole network field into several equal sub-regions can be a solution for energy consumption challenge in WMSN. A scalable and energy efficient routing protocol is needed with a new Linear Cluster Handling (LCH) Technique Towards Energy Efficiency. This protocol proposes the installation of multiple static sinks in the

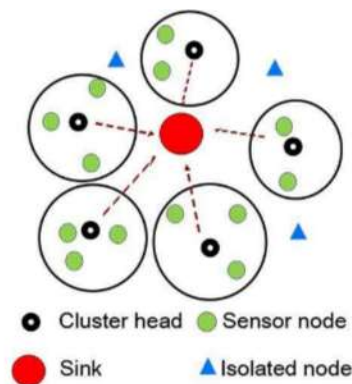

Figure 3.1: Architecture of WWSN in [144]

network field which is divided into several equal sub-regions. The sinks can be placed in a coherent way in the network i.e. two at the both corners and one at the center of the field for efficient data gathering. To solve the energy consumption problem, two protocols can be used, a proactive routing protocol named Distributed Energy Efficient Clustering with Linear Cluster Handling (DEEC-LCH) in the network field and a reactive protocol Threshold Sensitive Energy Efficient with Linear Cluster Handling (TEEN-LCH) used for the same scenario with three static sinks [114]. When implementing the TEEN-LCH protocol, the cluster head in each region sends the data to the closest sink, so it causes a reduction in the distance between cluster heads and sink regardless the protocol used to elect the cluster heads. To enhance this approach, it is better to have a homogeneous network by dividing the network area into equal regions and every region contains the same amount of identical nodes.

The stochastic approaches to select the cluster head in WMSN are experimented in LEACH and TEEN. Those methods do not guarantee the availability of a cluster head. As a solution to this problem and for clustering purposes in WMSN, the fuzzy inference system is used to improve the selection of the cluster head in the Threshold sensitive Energy Efficient sensor Network protocol (TEEN) [136]. As considered in all the works in the WMSN domain, the main problem that faces the sensor network is the energy consumption limitations of every sensor node, and especially video sensor node that transmits multimedia data and video streaming. TEEN is a representative routing protocol used for reactive type sensor network [7]. After clustering, using stochastic approaches, as usual the data from every member node in the cluster are gathered in the cluster head to be transmitted to the base station or sink node. TEEN Protocol computes two thresholds called Hard threshold (Ht) and Soft threshold (St). Those thresholds are broadcasted in the cluster when the cluster is created. Based on those thresholds TEEN decides to save and to transmit the sensed data. To innovate TEEN protocol, and to increase the energy-efficiency of this protocol, fuzzy logic algorithm is used for clustering in order to select the cluster head which ensures the improvement of stability and uniformity of energy in the network. To further increase the energy efficiency, a change in the transmission method is applied in TEEN protocol from periodic transmission to Event-Driven [7]. To solve the cluster head selection problem faced when using the stochastic methods, the residual energy, position and data collection frequency are the main properties to select cluster heads based on the Fuzzy Inference System approach. Another example of the Fuzzy Inference System is The LEACH-FL Protocol, Energy Level and node distance to the Sink

represent the Fuzzy input parameters [96]. Some protocols use the concentration, centrality of the node and residual energy as the Fuzzy parameters [22]. The expectations of those approaches tend to expect a reduction in the energy consumption when the transmission distance decreases. The amount of collected data and the energy consumption play the bigger role to select the cluster head in a cluster.

Another challenge appears when each cluster head communicates directly with the sink node. However, when dealing with large networks and for geographical reasons, the distance between the cluster head and the sink may cause some problems. The main problem as usual is the energy consumption problem, the distance between the cluster head and the sink is proportional to the energy consumption. To be able to deliver the data packets to the sink in one hop, the cluster head node needs to consume more energy when the distance is greater. As mentioned in [58], using a clustering method in large networks is not a feasible approach. Establishing multiple paths between the cluster head and the sink is one of the solutions where the cluster head communicates with the sink through intermediate cluster head nodes which leads to the Hierarchical Multi-Path Routing (HMPR) Protocol [140], Figures 3.2, 3.3, 3.4 show the difference between the studied architectures.

In this protocol, as usual the richest node in terms of energy resources is elected as the cluster head node. Several clusters are created where a strong connection is maintained between the cluster head nodes to create multiple paths suitable for data transmission to the sink node. The most powerful cluster head node serves as aggregator of all the multimedia data from all the clusters in order to decrease the energy consumption and bandwidth usage related to the amount of data transmission. The multi-paths technique from the cluster heads to the sink helps to distribute the energy consumption throughout the network. Every node in the cluster transmits its data only in its own cluster (one hop). This scenario ensures a reduction in the energy consumption, leads to a smaller delay and higher accuracy.

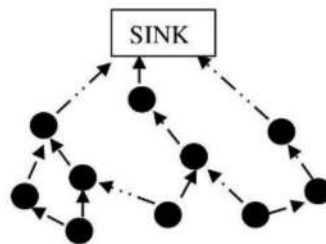

Figure 3.2: Flat Architecture of WMSN

The energy consumption challenge can become more severe when a tier-1 architecture is used and all the nodes have only video-sensors to detect and film any anomaly in the area of surveillance. A simple and efficient solution is to establish a multi-tier wireless multimedia sensor network where the tier-1 consists of scalar sensor for detection [125].

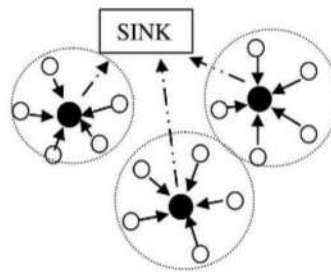

Figure 3.3: Hierarchical Architecture of WMSN

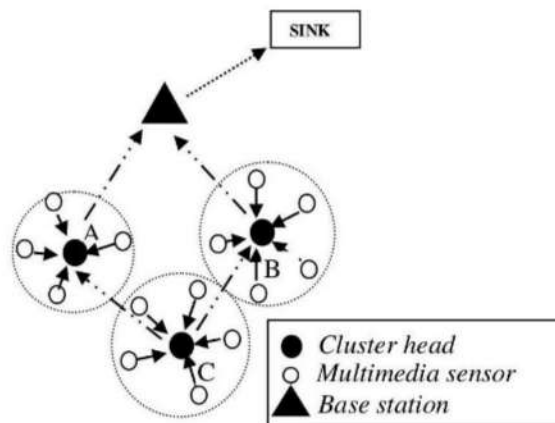

Figure 3.4: Multi-path Architecture in WMSN

Those scalar sensors have very low energy consumption, they are always active to detect any anomaly in the zone of interest. The tier-2 nodes are formed of more complex and energy-consuming multimedia sensors. They are kept in a low-power idle state. When the scalar sensors detect an abnormal behavior in the area, the tier-2 multimedia sensors are triggered and wake up from their idle mode. By comparing several scenarios and implementations of different architectures in the literature, taking into consideration different scenarios and states such as video acquisition, processing, and uploading, the multi-tier architecture overpowers the single tier architecture by reducing the energy consumption of the wireless video sensor nodes while keeping them in the idle mode and only trigger them when an intrusion is detected in the field.

Cloud-based wireless multimedia sensor network can be a solution to share and distribute multimedia data and reduce the energy consumption [106]. Processing, storing and distributing live surveillance can take place on the cloud where the energy resources are greater. The proposed architecture for cloud-based wireless multimedia sensor networks respects the cost reduction and performance improvement, but using the cloud to share video streams for surveillance purposes must be studied carefully especially to be able to secure the multimedia data in question.

Multi-paths routing schemes is one of the most studied solution for the energy consumption problem in WMSN. Those protocols are divided into QoS and Energy aware protocols and Geographical protocols. They are discussed in the next sections.

### 3.1.2/ QoS AND ENERGY AWARE PROTOCOLS

The QoS aware routing and Energy aware routing protocols, as their names mention, provide different solutions for energy and QoS challenges in WMSN. One of the most used protocols in WMSN for QoS and energy-efficiency purposes is Multi-Path and Multi-SPEED Routing Protocol (MMSPEED) [31]. MMSPEED was proposed as an improvement of SPEED protocol [10] which is a real communication, stateless, localized protocol which ensures the effectiveness of data delivery through its minimal control overhead. It is true that efficient routing is ensured in SPEED even if the energy resources of the node are minimal but its more control packets used reduces the packet speed which consumes more energy. In WMSN Probabilistic approach is adopted in the Multi-Path and Multi-SPEED Routing Protocol (MMSPEED) to guarantee the QoS. The probabilistic multi-path to ensure reliability and the multiple packet delivery speed for packets in the network satisfy the QoS. Dynamic compensation method is the main cause to enable the global geographic routing packets. High power consumption in the MMSPEED can be a consequence of the sub-optimal compatibility of the video data. Embedded information of multimedia data packets can serve as a solution for the compatibility problem to enhance the usage of the energy resources [47].

The two most important parameters in the routing approaches are Energy efficiency and delay parameters which are included in QoS parameters. That is why for wireless multimedia sensor networks (WMSN) the most preferred routing techniques are the QoS aware routing techniques. Supporting high data rates is one of the main challenges in WMSN, this support is ensured by QoS aware Routing (QoS-R) [48]. QoS-R is a multi-channel multi-path protocol. The required bandwidth and the distance to detect the path length are the main characteristics on which is based the routing decision. The bandwidth and delay requirements are met using QoS aware Protocol for real-time data, and by adjusting the service rate for this data an improvement of the throughput of the routing path is realized. Frequent switching to select routes is the main disadvantage and drawback of this protocol.

The energy aware routing protocol (EARQ) [56] was used to resolve the reliable packet delivery problem in real time large data transmission in sensor networks. The parameters of a path to the sink such as the energy cost, the delay and the reliability are determined by the node in EARQ, those decision are taken based on the information gathered from neighboring nodes. In consequence the best path to route the data is estimated using a probabilistic model. The inefficient load balancing is the main drawback of EARQ especially when some types of networks are used such as WLAN, Bluetooth... no compatibility exists for video data. To solve this problem a Load Balanced Hierarchical routing (LBHR) [74] algorithm is proposed. The limited resources and high data redundancy in WMSN reduce the overall QoS. In LBHR, to improve the QoS, some clustering techniques to find primary and secondary paths using a minimum spanning tree. The target with QoS requirements is to maintain the success rate of transmission, the ant-based multi-QoS routing (AntSensNet) sees the lights[66]. Suitable paths are selected by building a hierarchical network. An efficient multi-path video packet scheduling is implemented to get a minimum video distortion transmission.

Then the QoS NET protocol is proposed as one of the solutions for QoS in routing [67].

In QoS NET (a multi-path QoS routing protocol), the nodes are distributed into two

sub networks, the first one barely involved in routing decisions, while the second sub network takes the routing decisions. This method enhance the routing and the lifetime of the network. Different combinations of multi-path transport, watermarking-based error concealment (EC), forward error correction (FEC), and adaptive re-transmission mechanisms are used in the QoS aware routing approach for underwater multimedia sensor network [82]. The video packet scheduling with an energy aware hierarchical routing protocol are implemented in [77]. In this approach the routing paths are managed according to the remaining energy in the nodes, by consequence, the energy efficiency is improved. The bandwidth parameter has been added in the bandwidth-power aware multi-path routing [91] where QoS, bandwidth and energy efficiency are the main studied parameters to select the routing paths. To efficiently deliver visual information with respect to QoS constraints, A correlation-aware QoS routing algorithm (CAQR) has been proposed in [87]. This method is based on the correlation in the visual information observed by different camera sensors. A better load balancing and less congestion are assured and by consequence data re-transmission is reduced which reduces the energy consumption on the sensor nodes. Requiring efficient compression techniques for the correlation of the visual information is on of the main problems of this method. Potential-based Real-Time Routing (PRTR) does not choose point to point communication to provide better routing [100]. This approach improves the maintenance of the selected routes. A QoS aware routing technique (EE-QoS) to transmit the multimedia content uses the broadcast message from the sink and reduces the control messages to reduce the routing energy consumption [105] [131].

Real-time data transmission in Wireless Sensor Networks (WSNs) is necessary for all the new applications in surveillance, traffic monitoring, medical imaging and automation. New challenges are established to guarantee the QoS for real-time traffic for those applications. The new challenges are more and more complicated because of the new smart devices that are being involved in the technology, and the standardization of Machine Type Communications (MTC) the new 5G wireless networks generation. A new cross-layer QoS-provisioning strategy in Wireless Multimedia Sensor Networks (WMSNs) is proposed in [127]. In this approach, the estimation of QoS parameters is one on the network layer statistically. Genetic algorithms are used to discover the near-optimal QoS routes. The MAC (Medium Access Control) Layer functionality is based on the QoS requirements to classify the packets and to adapt automatically the contention window, to be able to transmit the data helped by the routing information gathered from the network layer. Better Throughput, lower delays and negligible energy consumption are the three achievements which define the performance of this approach [127].

### 3.1.3/ MAC-LAYER PROTOCOLS

In WMSNs, bandwidth for data packet transmissions is limited by the energy constraints. In some networks, we may have different sensor nodes streaming videos at the same time, this process could not be supported sometimes due to the limitations of the network protocols and defined links. For networks using IEEE 802.15.4 protocol, multimedia streaming is not the best option to be done. Some other protocols as IEEE 802.11 does not take into consideration the energy efficiency but it provides some good bandwidth



for video streaming. What WMSNs for video streaming need is a MAC Layer protocol that provides acceptable bandwidth while taking into account the energy consumption problem. A energy-efficient protocol is the solution [144]. In this protocol, Wi-Fi access points are turned off when underused using a fuzzy logic approach for it. This process keeps the network running normally to a certain extent. The IEEE 802.11 protocol can be enhanced to be an energy-efficient protocol for dense WMSNs. Wi-Fi access points are considered as sinks, and multiple sinks can serve the 1-hop communications to reduce the energy consumption caused by packet relaying. According to the parameters of the network, the number of active access points is dynamically managed based on the activity of the network (low transmission flows, high transmission flows ...). For instance, an optimization of the energy consumption is assured using this kind of protocols [144].

## 3.2/ DATA REDUCTION

It is true that the architectures and the protocols used in WMSN are important to control and organize the network in order to reduce the energy consumption of the network. Data reduction techniques are one of the most studied and most efficient techniques utilized for this same purpose in WMSN. Hence, data reduction has different forms on the application layer, those algorithms and applications have been divided into several categories such as:

- Scheduling
- Data Redundancy
- Compressive Sensing
- Compression

In every aspect of those categories, the energy consumption challenge remains the main and ultimate challenge.

### 3.2.1/ SCHEDULING

In WMSN, capturing multimedia data is periodic which cause a high energy consumption on the sensor node level. In order to reduce this energy consumption, some scheduling algorithms must be done to schedule the working periods of the sensors, depending on the events happening in the area of interest.

In every surveillance application, as discussed earlier, detecting all the intrusions in the monitored area is the main concern in WMSN. The weak and low power resources in WMSN cause a serious challenge regarding this aim. Scheduling approaches for WMSN are studied to extend the lifetime of the network while guaranteeing a full monitoring functionalities of the network.

Chaos-based methods for scheduling present a solution where every sensor, based on some criteria (hash value, last detection,...) decides if it has to go to sleep mode or

active mode. Normal scheduling approaches do not take into consideration a malicious attack. For sure the intruder has nothing to do with the WMSN and knows nothing about its functionalities. If the intruder is smart enough, a malicious attack can be done. Thus, the unpredictable behavior of the network in this approach can serve to withstand malicious attacks and for sure to extend the lifetime of the network [132].

Some scheduling techniques increase the number of cores for the multimedia sensor nodes while integrating energy harvesting to reduce the energy loss caused by the added cores. The lightweight processor technique (LWP) is applied on the first core, while the second core which is divided into two parts remains in the idle state with multiple lightweight processor implementation. The main part works to increase the processing speed, while the multiple LWPs cover up the flaws of missing deadlines when the number and complexity of tasks increase. When the battery capacity is still above 50%, the second core, using the RF energy harvesting scheme, comes in operation. This method overpowers the single core and single LWP method by increasing the lifetime of each sensor node from 38% to 60% [135]. Hence, the processing speed of each sensor node is increased while enhancing their capability to handle multiple tasks. This enhancement is made by applying a dual-core processor technique with RF energy harvesting system [124].

Cover sets and the node's redundancy level are the main parameters to create efficient scheduling activities in some approaches and to ensure the mission-critical surveillance of the area of interest. The studied results focus on the capture rate, percentage of active, sleep and dead nodes and the network lifetime. A dynamic efficient strategy for scheduling proposed in [147] is one of the options to extract the covers sets of the video sensors efficiently based on a distributed algorithm implemented on each sensor node to extract its cover sets depending on its neighbors and the overlapping Field of Views (FoVs). In this approach the FoV is presented by a sector. The state of the sensor node (sleep, active) is decided based on the activity of its neighbors. Behavior functions are used to adapt the frame rate capture depending on the cardinality of the node's cover set [81, 72]. The node's state is scheduled taking into account the cardinality of its cover sets. If the cardinality is large, the sensor node will most probably go to the sleep mode. This scheduling approach reduces the energy consumption while adjusting the frame capture rate and guaranteeing a high percentage of coverage.

Another challenge is to transmit several packets stored in the same node when the channel becomes free, immediate transmission of some packets are critical depending on the type of the packets (real time or not).

Delay and loss constraints can play a role to develop a packet scheduling technique [122]. This technique analyze every incoming data packet and assign a priority and it is scheduled based on this priority. This process ensure the transmission of the high priority data to guarantee the network proficiency. Time slots should get involved depending on the expected delay and packet loss rate at each node [116].

### 3.2.2/ DATA REDUNDANCY

Currently, a huge amount of visual data such as digital images and videos has been collected by visual sensor nodes, that is, camera nodes, and distributed on visual sensor networks. Near-duplicate images exist in the visual data, where several video sensor

nodes are streaming the same area of interest from different angles or different conditions [130, 110, 138]. Near-duplicate images, which cause a serious waste of computing, transmission, and limited storage resources of visual sensor networks has a negative impact on users' experience. All we need is a fast and accurate approach to eliminate a big percentage of those near-duplicate images. To do so a coarse-to-fine clustering method is adopted to cluster near-duplicate images. Then the images in each group are divided into two types, the seeded images to reserve them and the unseeded images to be removed, based on the contextual relevance analyzed by the PageRank algorithm [139].

### 3.2.3/ COMPRESSIVE SENSING

In Video surveillance, it is unnecessary to send the entire video to the coordinator because the video is unvarying, hence this process can save power in a resource constraint environment like WWSN.

Compressive sensing (CS) algorithms are used in WWSN for video surveillance based on five properties: stable, democratic, universal, asymmetrical and encrypted [143]. Stable: acquisition and recovery processes are stable. Democratic: The rate (number of samples) is fewer than the Nyquist rate while the same amount of information is carried by each sample measurement. asymmetrical: At the encoder, easy and simple code is running, while a smart decoder is implemented on the coordinator side where the most processing should be done. Universal: Different signal class can use the same compressive sensing techniques and projections/hardwares.

Compressive sensing background subtraction techniques are used to detect intrusions and anomalies in the video and to transmit only the foreground parameters to the coordinator or the analytical monitoring site [145]. A compressive sensing recovery algorithm is used to reconstruct the object at the coordinator (e.g. orthogonal matching pursuit algorithm MMD-ATS) [46].

Memory constraints, communication bandwidth and energy are all concerned in compressive sensing. Hence, the quality of the images will not be affected by CS for later target detection [133].

### 3.2.4/ COMPRESSION

Compressed multimedia data is another technique to reduce the size of the data on the network and as a consequence reduce the energy consumption related to the transmission. This technique consumes some energy to compress the data on the processing part of the data in the sensor node.

Strict storage, power consumption, processing and bandwidth limitations cause a big challenge for image compression in WWSNs.

A general architecture is to be used for some applications in WWSNs. In this architecture, after pre-processing and segmentation, a binary image is compressed [68]. After several explorations, applying this architecture, the CCITT Group 4 compression technique alongside JBIG2 and Gzip\_pack techniques are way better compared to other methods. To further reduce the energy consumption by data reduction, compressing only

a part of the image is an option where only this part of the image is changing and the differences between two adjacent frames are too small [142]. Change coding using meter reading, bat/bird detection help in data reduction for some applications in WWSNs [142].

Another simple not complex algorithm in the low Energy Image Compression Algorithm (LEICA) presents a compression solution for data reduction in WWSN [83]. The whole image is divided into regions of interest (ROI) and tiles in LEICA. The regions ROI, where the intrusions take place have a low compression ration when compressed. The background regions are compressed at a high compression ratio. One of the benefits of this approach is that LEICA preserves the quality of the images and reduce the energy consumption on the sensor nodes, thus, it helps to extend the lifetime of the network [83].

### 3.3/ SECURITY

In this section, the importance of data security in WMSN is revealed. Securizing the surveillance multimedia data is important to prevent the maleicious hackers to interact, but this security layer must respect the energy challenge faced in this kind of networks.

Security requirements is one of the most important challenges that has to be satisfied. In WMSNs, and for critical millitary application the security of multimedia and video data is necessary on different levels during collection and transmission. Integrity, privacy, authentication and confidentiality are the main factors to ensure a high quality protection of the data especially between sender/receiver. Furthermore, they prevent any change in the content by any unauthorized entity.

To fulfill the confidentiality, encryption is one of the solutions to prevent diclosure of the data by any anauthorized person. Communication between sender and receiver must be authentic to assure the authentication services. To prevent any change in the data while on the links integrity service is concerned [121].

Different security aspects has been performed: watermarking technique, encryption algorithms, stronger codes and compressed sensing [121]. Security manners must take into account the design of the network and the secure network routing protocol.

### 3.4/ APPLICATIONS

In WWSN, different energy-efficient techniques on the physical layer based on the encoders have been proposed. Controlling the encoding parameters (Frame rate, the Quantization Parameter (QP) and the shell function projection (FSP)) can be one of the solutions to affect the trade off between encoding and power consumption (e.g. H.264/AVC encoder) to be able to reduce the power consumption [126],[141]. On the practical side, several image sensor boards are available for visual sensors such as: Cyclops, MeshEyes, Citric, WiCa, SeedEyes, Panoptes, CMUcam3 and FireFly, CMUcam4, CMUcam5/PIXY, iMote2/IMB400, ArduCam, ... All these platforms/products can be a reference to build a platform for research on video sensor nodes for surveillance applications. One of the used and well experimented technologies is the Arduino-based solution, it is one of the most flexible solutions because of its simplicity in programming and design [113],[80],[107]. The arduino (e.g. Arduino MEGA2560, Teensy 3.2 and Arduino Due)

can be connected to an affordable external camera to get RAW image data as shown in Figures 3.5 and 3.6.



Figure 3.5: Arduino Due

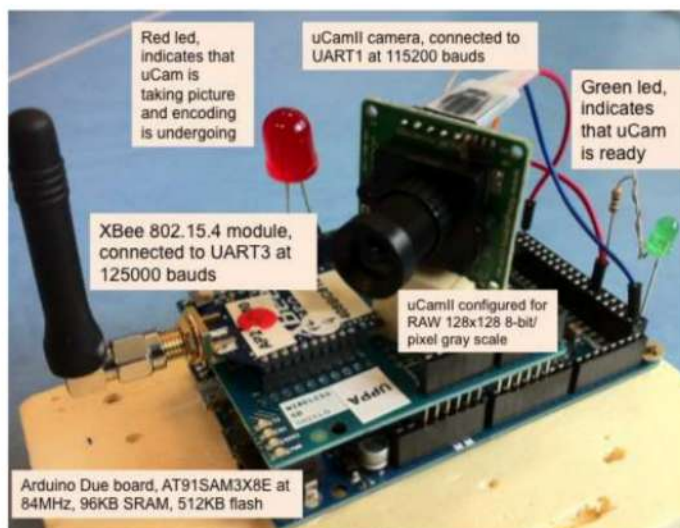

Figure 3.6: Arduino Due connected to the cam as in [113]

Then we can apply a fast and efficient compression scheme with the host microcontroller to produce robust and very small image data. Different types of connections can be used such as Lora and IEEE 802.15.4 (before). The drawbacks of arduino are its small memory and its soft processor compared to other small embedded devices such as the Raspberry PI 3 used in our contributions.

### 3.5/ CONCLUSION

In this chapter, we have explored the main contributions in WWSNs concerning their architecture, routing protocols, data reduction techniques and data security while citing some real applications in this field. It is true that a lot of previous works have taken the physical layer as the target to solve the WWSN problems and especially the energy-efficiency

problem, we expand our the data application layer contributions mainly based on data reduction techniques for energy-efficiency purposes in the next Part of this dissertation. Security and MAC-Layer Protocol in WMSN are exploited in contributions 3 and 4 respectively to respond to the main challenges in the WWSN domain.



# II

## CONTRIBUTION





## SIMILARITY BASED FRAME RATE ADAPTATION FOR DATA REDUCTION

In WVSNs, the problem of data redundancy arises when information are gathered from neighboring nodes. In this chapter, we propose a new approach for data aggregation in WVSN based on images and shot similarity functions. First, it adapts the frame rate at the sensor node level to reduce the number of frames sensed by the sensor nodes and sent to the coordinator. Then a similarity function is applied on the coordinator to compare shots received from neighbouring sensor nodes to eliminate redundancies. We evaluate our approach on a live scenario and compare the results with another approach from the literature in terms of data reduction and energy consumption. The results show that the two approaches have a significant data reduction to reduce the energy consumption, thus our approach tends to overcome the other one in terms of reducing the energy consumption related to the sensing process, and to the transmitting process while guaranteeing the detection of all the critical events at the node and the coordinator levels.

### 4.1/ INTRODUCTION

Nowadays, after the development of Wireless Video Sensor Networks (WVSN), the enhancement of the surveillance in terms of monitoring and detecting criticalities and anomalies has set big improvements in different fields (e.g. street, forest, traffic, personal, healthcare, industrial monitoring, etc [44]). Hence, after each anomaly and emergency detection, decisions must be made at the coordinator level. The coordinator may be a normal node or a specific node with greater resources. It manages a zone of interest, analyzes the data received from several camera sensor nodes and sends the necessary information to the sink which controls the whole network as shown in Figure 4.1. Different types of anomalies exist depending on the monitored environment and the predefined criteria and parameters such as quick motion, sound, or scene change, the decisions are made in order to avoid any action that can affect the monitored environment.

The detection of irregularities in any monitored scene is one of the main targets in WVSN. Every scene is permanently filmed using multiple video-sensor nodes. At the sensor node level, the sensor-nodes collect frames and send those frames to the coordinator. The coordinator is responsible for the data aggregation process. The aggregation is limited to either selecting, fusing or deleting the received frames. As a consequence, a significant amount of energy is consumed due to the huge amount of captured frames, which reduces the lifetime of the network. Moreover, the continuous transmission

process between all the components of the network (sensor nodes, coordinators and sink) has a big influence on the bandwidth capacity of the network which may cause a bottleneck on the network [38].

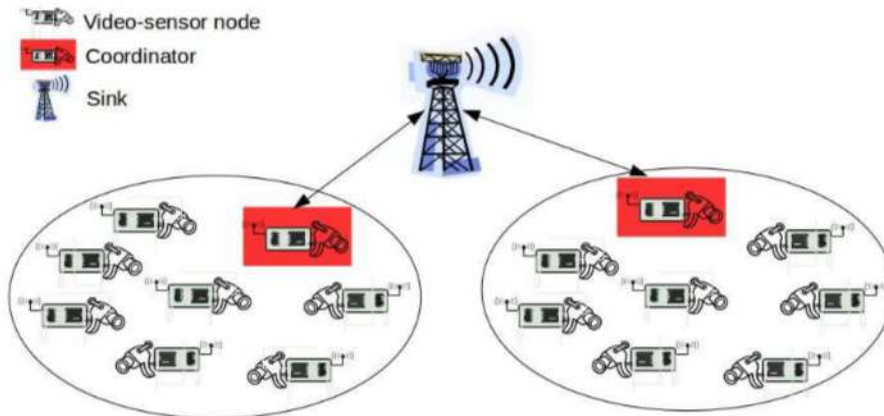

Figure 4.1: Architecture of WWSN

Video-sensor nodes operate periodically in WWSN. We define some keywords:

A fixed frame rate is defined on every sensor node to film the video accordingly, this frame rate is the number of captured frames per second (fps).

A period is a fixed time length during which frames are captured with a given frame rate.

A video shot is considered as a video sequence taken within a period.

Energy consumption and bandwidth limitation are two important challenges in WWSN. The first one is related to the sensing and transmission modules of the sensor node. The higher the frame rate and the number of frames sent, the more energy is consumed. The second one is related to the transmission module of the sensor node and the coordinator, the greater the number of frames sent on the network is the more bandwidth is used. The energy consumption and bandwidth usage issues on the coordinator's side can be addressed by reducing the amount of sent data from the coordinator to the sink node. In our approach, the data analysis starts at the sensor node level and continues at the coordinator level to match the greatest reduction possible in terms of energy and bandwidth consumptions on both levels. Each video-sensor node compares all the frames in a shot to the last frame sent and computes the similarity between them. Based on the similarity function, only the frames in which an event occurs are sent. The selected frames are called critical frames and are sent to the coordinator. The similarity function at the sensor node level is based on color and edge similarities able to compare frames. This comparison selects the least required number of captured frames to be sent to the coordinator. By applying the similarity function, we reduce the energy consumption related to the Communication process by reducing the number of transmitted data.

Alongside the similarity function, the frame rate of each video-sensor node is adapted. A method based on signal frequencies presented in [64] is adopted and applied to WWSN in our approach. This method consists in reducing the number of frames captured by adapting the frame rate of each video-sensor node based on the number of critical frames detected in several consecutive past periods. Consequently, by adapting the frame rate, the Sensing process is reduced thus decreasing the energy consumption. At the coordinator

level an updated version of the similarity function is implemented in which the motion similarity is added to the color and edge similarities. To avoid comparing all received shots at the coordinator level, a geometric study and a filtering condition are presented. Those conditions consist in reducing the number of possible comparisons. The remainder of this chapter is organized as follows. In section II, we present the related work to our approach. In section III, we describe the proposed method at the sensor node level within its two aspects: the local detection system and the adaptive sampling system, as well as their corresponding algorithms. In section IV, the data aggregation scheme is described and the proposed geometric method at the coordinator level is introduced. The experimental results and the comparison with another method are given in Section V. Finally, we conclude in Section VI with perspectives and future work.

## 4.2/ RELATED WORK

Several research work dealing with data redundancy and energy reduction have been conducted so far [62, 97, 89, 79, 102]. In [79], Akkaya et al. introduced a GPS module into scalar sensors in order to control the cameras. Thus, the system detects which camera should be actuated based on the sensor's position. In [97], Priyadarshini et al. proposed an approach which eliminates redundancies caused by the overlapping of the FOV's (Field Of View) of the video-sensors. To do so, it tends to turn off some cameras and activate the optimal number of cameras at the same time. In [102], Bahi et al. proposed an in-network data aggregation technique at the coordinator level which identifies the nearly duplicate nodes that generate similar data.

In [115], Akkaya et al. discussed the background subtraction (BS) and compression techniques as common data reduction schemes, which have been used for camera sensors to reduce energy consumption.

In [40] and [12], almost all of the studies deal with the physical and network layers. In [40] the authors use a CMOS image sensor where the image is recreated from two outputs, with the details in stationary objects and the suppressed motion in moving objects. It should be noticed that a high frame rate is only applied in the region-of-interest where it matters the most to detect and track any event.

In [80], the authors proposed two new approaches based on the cover set concept to help a node in finding its redundancy level. They proposed an algorithm to schedule the activity of sensor nodes according to the overlapping degree between sensors, and to know for certain if a sensor belongs to the cover set of another sensor.

In [50], the authors proposed a scheduling network solution to minimize power consumption using the multipath theory in wireless video sensor networks. They proposed an algorithm that transmits packets over multipath according to their importance.

Different strategies has been used to reduce energy consumption and bandwidth usage by using an adaptive video streaming etc. that can minimize the utilization of network bandwidth taking into consideration that bandwidth is the most important ressource in a network [148],[117],[123],[137]. All these works help to increase the lifetime of the network. Increasing the lifetime of the network is also studied in [128] specifically for smart camera network.

Several proposed methods in the literature discuss the similarity of images [3],[11],[4].

In [3], the authors used the  $L_1$ ,  $L_2$ - and  $L_\infty$ - distance between two cumulative color histograms to simulate the similarity between two color images. In [11], they are interested in the segmentation techniques to compute the similarity, all the techniques are mainly edge based techniques. In [4], the comparison is achieved through an exercise in determining the lack of spatial correlation between two images.

Many methods have been proposed in the literature concerning the visual information and motion estimation in wireless video sensor networks [54, 108, 5, 34]. In [54], the authors studied the correlation in visual information between different cameras with overlapped field of views (FOVs) where the new spatial correlation model function for visual information is implemented. The joint effect of multiple correlated cameras is taken into consideration in this study. An entropy-based analytical framework is developed to measure the amount of visual information provided by multiple cameras. The authors designed a correlation based camera selection algorithm which reduces the energy dissipation of the communication and the computation. This algorithm requires fewer cameras to report to the sink than a random algorithm.

In [108], Jbeily and al. proposed a new symmetric-object oriented approach for motion estimation in WWSN called SYMO-ME which reduces the high complexity of motion estimation, the authors main objective is to reduce the redundancy between successive frames. They adapt a new motion estimation energy consumption model for block matching algorithms (BMAs) in WWSN. This model depends on the energy consumption value of different executed instructions.

Many previous works focused on the scheduling method [62, 92, 63, 98, 28, 95]. In [62], the authors used a clustering methodology. They managed to make a scheduling approach to all overlapping cameras in the same cluster to avoid redundant data. Jiang et al. in [95] proposed a probability scheduling approach based on the kinematics functions and normal law to study the expected positions of the intrusion depending on the kinematics functions to track its trajectory.

In previous works regarding the similarity process, they do not use a pixel by pixel technique. They use the color histograms for color images [3] which can mislead the comparison if the same color happens to be in another place in the area with the same intensity. None of the mentioned works have proposed a data aggregation method at the coordinator level while taking into consideration data reduction performed at the sensor node level for energy consumption. In this chapter, both levels are taken into consideration, the sensor node and the coordinator levels. The reduction in terms of energy and bandwidth consumption is the main purpose of this approach. On the sensor level, a combination of color and edge similarity techniques is established to do the comparison between several images to send only the appropriate frames to the coordinator. The coordinator is responsible for sending to the sink the non similar frames received from different sensor nodes. A geometrical condition is implemented on the coordinator to select the sensor nodes where the comparison must take place.

### 4.3/ LOCAL DETECTION SYSTEM : SENSOR NODE LEVEL

The proposed method is divided into two sections. The first one consists of a local detection function that detects any change in the frames in order to be sent to the coordinator. This function is introduced in every period of our proposed "Multimedia Adaptive Sampling Rate Algorithm" (MASRA). The second section presents MASRA

algorithm. This algorithm adapts the sampling frequency of each sensor node based on the monitored area.

#### 4.3.1/ LOCAL DETECTION SYSTEM

In this section, the frame analysis at the video-sensor node level is introduced. This analysis helps sending only the different frames to the coordinator in order to prevent sending all the frames which costs in terms of energy and bandwidth. In some multimedia applications [52], only the middle frame of a shot is used to represent the shot content. But this solution could represent only static shots without taking into consideration the color similarity between frames in the shot nor the edge similarity or the motion similarity, etc.

Comparing the new approach to the Structural Similarity (SSIM) Index quality assessment index, which is based on the multiplicative combination of the luminance, the contrast and the structural terms, shows that this new approach conserves the information and is less complex than SSIM. Thus, SSIM is not used with tiny sensor-nodes because it drains energy a lot more than two simple low-level similarity metrics (color and edges). To compare between SSIM and Color-Edge function in Multimedia Adaptive Sampling Rate Algorithm (MASRA), we implement both algorithms on Raspberry PI 3 using OpenCV and C++ language. For the same images input, the results of the execution time needed are shown in table 4.1. The important execution time needed to run SSIM function proves why the SSIM is not used for tiny sensor nodes applications.

Table 4.1: Execution Time Comparison for SSIM and Color-Edge Function

Function	Execution Time
SSIM	3.7 s
Color-Edge	0.1 s

The proposed approach uses color and edge properties to find similarities between frames, to decide which frame to send. Below a brief explanation is presented to argue the choice of these two properties together and to prove their complementarity. Those two properties have been chosen for simple reasons: the edge property detects any change in the form of the objects in the area of interest or detects a new object that enters the scene. If a new object enters the scene, this property will represent new edges in the gray-scale format as explained later in the chapter.

As for the color property, it detects any change in the colors of the scene, an example of such a case is the change of the luminosity of the monitored scene when a burgler turns the lights off before acting. To conclude, the edge property cannot detect a change in the luminosity of the scene, and the color similarity cannot detect a new overlapping object in the scene if it has the same existing color. Thus, those two properties are complementary and are considered of equal importance in the rest of the chapter. They are also equally weighted in the similarity function of the approach.

## 4.3.1.1/ COLOR SIMILARITY

Each frame is compared to the last frame which has been sent to the coordinator. This comparison includes color similarity between frames. An image is generally a 2D matrix  $M(n,m)$ . Each pixel is divided into 3 different colors to be able to add the RGB color criteria. To do so, the original matrix of the image is transformed from a 2D to a 1D matrix, each element defining a pixel. Then, each pixel is represented by its 3 colors RGB by column (3 columns are needed). In brief, the RGB colors concentration of every pixel in the image is represented by a 2D matrix where the rows represent pixels and the columns represent the RGB colors concentration as shown in the matrix below:

	Red	Green	Blue
pixel <sub>0</sub>	2	3	4
pixel <sub>1</sub>	20	60	40
pixel <sub>2</sub>	5	10	20
⋮	⋮	⋮	⋮
⋮	⋮	⋮	⋮
⋮	⋮	⋮	⋮
pixel <sub>n×m</sub>	⋯	⋯	⋯

This color similarity consists in comparing the two frames pixel by pixel. First, it computes the total distance for each color between the two frames as shown in equation 1. Then, it normalizes each distance by dividing it by  $n \times m \times 255$ , Where  $n \times m$  is the number of pixels in the image, 255 is the maximum concentration of a color. Three distances are computed  $distance_{red}$ ,  $distance_{green}$  and  $distance_{blue}$ , each one normalized and  $\in [0;1]$ . E.g, for an image of  $540 \times 360 = 194400$  pixels, each of the 3 main distances is divided by  $194400 \times 255$ . The distance for each color (column) is computed as mentioned below:

$$distance_c = \frac{1}{n \times m \times 255} \times \sum_{i=0}^{n \times m} \frac{[M_1(i,c) - M_2(i,c)]^2}{2} \quad (4.1)$$

Where  $c$  is the color (R,G or B),  $i$  is the pixel in comparison. To compute the total distance difference between the two in comparison frames, a normalization of the sum of those 3 distances is a must by dividing this sum by 3 so the total distance  $\in [0;1]$ . The color similarity function  $Col\_sim$  is the inverse of the total distance and computed as follows:

$$Col\_sim = 1 - \frac{\sum distance_c}{3} \quad (4.2)$$

The distance is computed alone for every column then it is aggregated to be able to compute  $Col\_sim$ . In the above equations,  $c$  refers to any color vector in "RGB" color space while  $M_1$  and  $M_2$  are two Matrices composed of 3 vectors R,G and B.

## 4.3.1.2/ EDGE SIMILARITY

This similarity function is way less expensive in terms of energy consumption compared with the color similarity function. In this function, the compared frames are converted to their gray level format. Comparing the edges via their gray scale pixel values in the frame using the Canny function will not be affected by the absence of color.

The Canny function takes the grayscale image as an input, and returns a binary image

BW of the same size as an output. The output image contains 1's where the function finds edges in the input image and 0's elsewhere using the canny function. As shown in Figures 4.2,4.3 and 4.4, the original frame is transformed into the grayscale frame using the `rgb2gray` function in Matlab, then the canny function generates the canny frame where all the edges appear.



Figure 4.2: The Original Frame



Figure 4.3: The grayscale Frame



Figure 4.4: The Canny Frame

As presented in [2], edges are found by looking for local maxima of the gradient in the input image. The gradient is calculated using the derivative of a Gaussian filter. The method uses two thresholds, to detect strong and weak edges, and includes the weak edges in the output only if they are connected to strong edges. This method is therefore less likely than the others to be fooled by noise, and more likely to detect true weak edges. We compute all the edges in each frame using this function. When an edge is detected the number of edge points is incremented. The edge points represent the total number of edges in the frame. If both frames represent an edge in the same area, the number of matched edge points between both frames is incremented. Then the percentage of matched data which represents the edge similarity between the two frames is calculated:

$$\text{Total\_points} = \sum \text{edge\_points} \quad (4.3)$$

$$\text{Matched\_points} = \sum \text{Matched\_edge\_points} \quad (4.4)$$

$$\text{Edge\_sim} = \frac{\text{Matched\_points}}{\text{Total\_points}} \quad (4.5)$$

Where `Total_points` are the number of edge points in a frame, `Matched_points` are the number of edges in common between the two frames in comparison. The edge similarity `Edge_sim` is the ratio of the `Matched_points` over the `Total_points` of the first frame.



**Definition 1: Similarity Function**

It is the combination of the two independent similarities (color and edge). This function is the sum of the product between each similarity and its weighting factor (Col\_fact and Edge\_fact). It is represented as follows:

$$\text{Sim} = \text{Col\_sim} \times \text{Col\_fact} + \text{Edge\_sim} \times \text{Edge\_fact} \quad (4.6)$$

Where  $\text{Col\_fact} + \text{Edge\_fact} = 1$ .

As mentioned before, the edge property cannot detect a change in the luminosity of the scene, and the color similarity cannot detect a new overlapping object in the scene if it has the same existing color. Thus, Color and Edge similarities are complementary and each one targets different aspects of the image. For this reason, they are weighted equally in the reminder of this chapter.

**4.3.2/ MULTIMEDIA ADAPTIVE SAMPLING RATE ALGORITHM (MASRA)**

In this section, we focus on the reduction of the number of sensed frames on every video-sensor node. This reduction is based on adapting the frame rate of every sensor node. Inspired from [64], it consists in reducing the number of sensed frames at the sensor node level.

The term "frame rate FR" in this approach is used in the reminder of this chapter as the frame rate per period. A period consists of several seconds depending on the needs of the application.

To add that a condition must be satisfied in order to send a frame to the coordinator. This condition helps reducing the energy and the bandwidth consumption by decreasing the number of sent frames from the video-sensor node to the coordinator. Critical frames are only sent to the coordinator.

The first frame of each period is always sent to the coordinator as described in algorithm 1.

**Definition 2: Critical frame**

A critical frame is defined as a frame that represents a degree of similarity "sim" smaller than a predefined threshold  $\text{th}_{\text{sim}}$  as presented in the LDS function of (Algorithm 1). E.g, if the predefined threshold (least similarity needed) is set to 75%, supposing that  $\text{frame}_{n-1}$  is sent to the coordinator, if  $\text{frame}_n$  is similar to  $\text{frame}_{n-1}$  lesser than 75%, it is also sent.

Our objective in this method is to detect changes that are associated with the number of critical frames  $\text{Nb\_Cr}_0$  per period, where  $\text{Nb\_Cr}_0$  is directly related to the minimum sampling frame rate FR, denoted as follows:

$$\text{FR} \geq 2 \times \text{Nb\_Cr}_0 \quad (4.7)$$

In the proposed MASRA algorithm (Algorithm 1)  $\text{Nb\_Cr}_0$  is defined as the number of critical frames per period. We define FR as follows:

$$\text{FR} = c \times \text{Nb\_Cr}_0 \quad (4.8)$$

Where  $c$  is a confidence parameter between 2 and 5 as presented in [64]. In order to detect the variation in the number of critical frames, a user-defined confidence parameter

**Algorithm 1** Adapting Sampling Rate Algorithm MASRA

---

```

Store the first period's critical frames in Nb.Cr0
2: Set FR = c × Nb.Cr0
   Set d
4: Compute thup
   Compute thdown
6: Set h=number of consecutive detected changes required
   Set hup = 0
8: Set hdown = 0
   Set thsim the threshold similarity
10: Set Colfact and Edgefact
   Set sim the overall similarity between two frames
12: while Energy > 0 do
   for each period do
14:   Takes first frame f0
   Sends first frame f0
16:   Takes frame fi at Rt Rate
   Compares fi to the latest sent frame
18:   sim = Colsim × Colfact + Edgesim × Edgefact
   if sim < thsim then
20:     sends critical frame fi
   end if
22:   Nb.Cri = number of critical frames in this period
   if Nb.Cri > thup then
24:     hup = hup + 1
     hdown = 0
26:   else if Fcurr < thdown then
     hdown = hdown + 1
28:     hup = 0
   else
30:     hup = hdown = 0
   end if
32:   if (hup > h) || (hdown > h) then
     Compute Nb.Cr0 = Nb.Cri
34:     Compute FR = c × Nb.Cr0
     Compute thup
36:     Compute thdown
   end if
38:   end for
end while

```

---

d that represents the minimum detectable change (e.g, if  $d = 0.2$  then changes that affect  $Nb.Cr_0$  for more than  $0.2 \times Nb.Cr_0$  must be detected). A change is detected in the process when in the current period the current number of critical frames denoted  $Nb.Cr_i$  overcomes one of the following thresholds for h consecutive periods :

$$th_{up} = Nb.Cr_0 \times (1 + d) \quad (4.9)$$

$$th_{down} = Nb.Cr_0 \times (1 - d) \quad (4.10)$$

In this case the frame rate FR is modified according to the last value of  $Nb.Cr_i$  in order to adapt the frame rate as shown in the MASRA algorithm (Algorithm 1).

To sum up, the sensor node starts by sending the first frame to the coordinator and

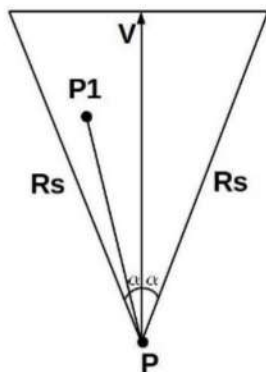

Figure 4.5: FOV

then compares the second sensed frame to the previously sent frame. The comparison is done based on the LDS similarity function presented in Algorithm 1. The second frame is sent to the coordinator based on the output of Algorithm 1. According to the number of sent frames in each period, Algorithm 1 detects if this number exceeds one of the two predefined thresholds  $th_{up}$  or  $th_{down}$ . If the previous condition is satisfied for  $h$  consecutive periods, the frame rate  $FR$  changes as follows:

$$FR = 2 \times Nb\_Cr_i \quad (4.11)$$

Where  $Nb\_Cr_i$  is the number of frames sent (critical frames) in the last period.

## 4.4/ DATA AGGREGATION SCHEME: THE OVERLAPPING METHOD

### 4.4.1/ VIDEO SENSING MODEL

A video sensor node  $S$  is represented by the FoV of its camera. In our approach, we consider a 2-D model of a video sensor node where the FoV is defined as a sector denoted by a 4-tuple  $S(P, R_s, \vec{V}, \alpha)$ . Here  $P$  is the position of  $S$ ,  $R_s$  is its sensing range,  $\vec{V}$  is the vector representing the line of sight of the camera's FoV which determines the sensing direction, and  $\alpha$  is the offset angle of the FoV on both sides of  $\vec{V}$ . Figure 4.5 illustrates the FoV of a video sensor node in our model. In [80] the authors presented the FOV with 4 points  $a, b, c$  and the center of gravity  $g$  as shown in Figure 4.6 to be able to detect the overlapping areas according to those points.

A point  $P_1$  is said to be in the FoV of a video sensor node  $S$  if and only if the two following conditions are satisfied:

1.  $d(P, P_1) \leq R_s$ , where  $d(P, P_1)$  is the Euclidean distance between  $P$  and  $P_1$ .
2. The angle between  $\overrightarrow{PP_1}$  and  $\vec{V}$  must be within  $[-\alpha, +\alpha]$ .

In other words, these two conditions are met if:

$$\|\overrightarrow{PP_1}\| \leq R_s \quad (4.12)$$

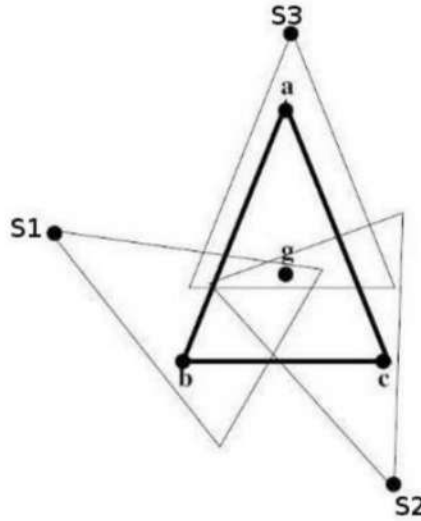

Figure 4.6: Video sensing and overlapping model

$$\overrightarrow{PP_1} \cdot \vec{V} \geq \|\overrightarrow{PP_1}\| \times \|\vec{V}\| \times \cos\alpha. \quad (4.13)$$

In the remainder of this chapter, we consider that all video nodes have the same characteristics: same sensing range  $R_s$  and same offset angle  $\alpha$ .

In this part, the frame analysis at the coordinator level is introduced. This analysis works when two or more video-sensor nodes are sensing the same area of interest, the algorithm implemented helps sending only the different shots to the sink node in order to prevent sending all the shots which is costly in terms of energy and bandwidth.

#### 4.4.2/ CAMERA'S OVERLAPPING FILTERING

We introduced, in the above sections, the functionalities of our similarity function. This function, when applied at the coordinator level, selects some video shots to be sent to the sink. To select a video instead of another one, the similarity function between the two must exceed a given threshold. A naive solution to find all similar shots is to compare each pair of shots. This method is obviously prohibitively expensive for video sensor networks, as the total number of comparisons is extremely high. We apply a geometric condition on the sensor nodes to select the appropriate comparison to be done and to reduce data latency. This geometric condition is a combination of the angle condition between the FOVs of the nodes and the ratio of the overlapped area between them.

##### 4.4.2.1/ THE ANGLE CONDITION

The angle between two neighbouring sensor nodes is defined as the angle between the vectors of their FOVs. Our idea is that if a wide angle is established between two sensor nodes FOVs, these two nodes can not take part in the similarity comparison function at the coordinator level. In this case, they are not sensing the same area of interest. A shot from two different perspectives can be widely different. To be able to define two sensor

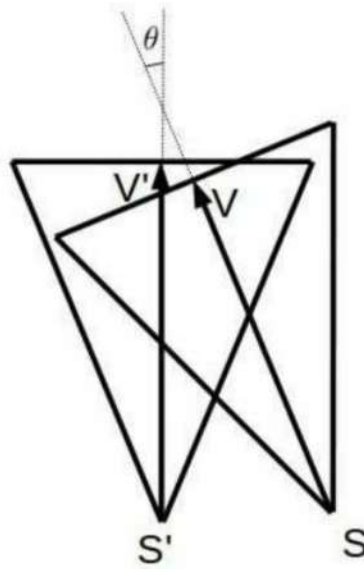

Figure 4.7: Two overlapping sensor nodes S and S'

nodes as candidates for the similarity function, the angle between their FOVs must not surpass a certain angle threshold. In order to determine the angle between the two vectors ( $\vec{V}$  and  $\vec{V}'$ ) of the sensor nodes S and S' respectively as shown in Figure 4.7, the scalar product method between those sensor nodes has been proposed. Both sensor nodes having the same dimensions (angle, FOV, energy resources,...), so both vectors  $\vec{V}$  and  $\vec{V}'$  in Figure 4.7 have the same length  $l$ . The scalar product can be calculated in two formats. The first one according to their coordinates (x and y) where  $\vec{V} = (X_V, Y_V)$  and  $\vec{V}' = (X_{V'}, Y_{V'})$ :

$$\vec{V} \cdot \vec{V}' = X_V \times X_{V'} + Y_V \times Y_{V'} \tag{4.14}$$

The second format is given according to the length of each vector and to the angle between both, as follows:

$$\vec{V} \cdot \vec{V}' = l^2 \times \cos(\theta) \tag{4.15}$$

Where  $l = \|\vec{V}\| = \|\vec{V}'\|$ .

Below we define the equation where the angle  $\theta$  between the two vectors can be calculated according to both formats of the scalar product :

$$\theta = \arccos((X_V \times X_{V'} + Y_V \times Y_{V'}) / l^2) \tag{4.16}$$

e.g, if an angle threshold  $\theta_{\text{angle}}$  is defined as 30 degrees, the angle between  $\vec{V}$  and  $\vec{V}'$  must remain less than 30 degrees so the two sensor nodes S and S' can proceed to the next step (the two points strategy), to be able at the end to take part in the similarity function process at the coordinator level.

#### 4.4.2.2/ THE TWO POINTS CONDITION

Inspired from [80] we present below the two points condition for overlapping filtering. A node S' satisfies the two points condition with another node S if g (the center of gravity of

abc) and any other point between a, b and c from  $S$ 's FOV, belong together to the FOV of  $S$  as shown in Figure 4.6.  $S_1$ ,  $S_2$  and  $S_3$  satisfy this condition separately with  $S$ . In this scenario each sensor node can be a candidate alongside  $S$  to apply the similarity function between them.

Our method is used to choose the candidates that can take part in the comparison process at the coordinator level. Two camera-sensor nodes  $S_1$  and  $S_2$  are chosen as candidates if  $S_2$  and  $S_1$  satisfy together the angle and the two points conditions as shown in algorithm 2. After choosing the candidate cameras, two cases are taken into consideration, the low similarity process and the high similarity process.

---

**Algorithm 2** Candidate Selection Algorithm CSA
 

---

```

Set  $S_1$  and  $S_2$  two sensor-nodes
2: Set ABC and DEF the two FOV triangles for  $S_1$  and  $S_2$ 
   Set  $G_1$  and  $G_2$  the two Gravity centers for ABC and DEF
4: Set  $V_1$  and  $V_2$  the two line of sight vectors for  $S_1$  and  $S_2$ 
   Set  $\alpha_{th}$  the angle threshold required
6: while Energy > 0 do
   if angle  $V_1, V_2 < \alpha_{th}$  then
8:     Go to the 2 points condition
     if  $(A,G) \in (DEF)$  OR  $(B,G) \in (DEF)$  OR  $(C,G) \in (DEF)$  then
10:        $S_1$  and  $S_2$  are candidates
       RUN SSA Algorithm
12:     end if
   end if
14: end while
  
```

---

**Definition 3: Low Similarity**

When the similarity between both compared video shots does not surpass the predefined similarity threshold percentage  $\beta_{sim}$  between shots, the coordinator works normally and sends both shots to the sink without any modification after each period, assuming that the similarity process is computed between both shots (all the frames sent from both sensor nodes take part in this similarity process) on a complete period and each period only represents one shot composed of several frames.

**Definition 4: High Similarity**

If the similarity between those shots surpasses the threshold, in this case the coordinator must choose one of these two shots to be sent to the sink node. The coordinator selects the video shot where there are more variations within the shot, in other words, where the number of critical frames is greater as shown in algorithm 3.

**Definition 5: similarity threshold percentage  $\beta_{sim}$  between shots**

This similarity between shots from overlapping sensor nodes, is the aggregation of all the similarities between the frames of these two shots, it can vary according to the application. For example and for military reasons,  $\beta_{sim}$  can reach 100% to be sure that the system does not miss any information.

### 4.4.3/ SHOT SELECTION ALGORITHM

In this section we discuss the SSA (Shot Selection Algorithm): After choosing the 2 candidates that meet the overlapping condition, this algorithm is implemented at the coordinator level to compare received frames from different sensor nodes sensing the same area of interest. This comparison is based on a similarity function that consists of edge, color and motion similarities as follows:

#### 4.4.3.1/ MOTION SIMILARITY

To evaluate the motion content in a shot, we use a function related to the color similarity function by generating the mean of the sum of the inverse of the color similarity for each frame of a complete shot (period). Inspired from [26] and based on the color similarity function from MASRA algorithm, this motion content  $mot_u$  of a shot  $u$  is computed and normalized as follows:

$$mot_u = \frac{1}{b-a} \sum_{f=a}^{b-1} (1 - Col\_sim(f, f+1)) \quad (4.17)$$

Where  $mot_u \in [0, 1]$ ,  $a$  and  $b$  are the first and last frames sent from the sensor node to the coordinator in a period respectively and  $f, f+1$  the two frames from  $Shot_u$  which are sent by a sensor node.

The motion similarity between two shots  $mot\_sim$  associated to two shots  $Shot_u$  and  $Shot_v$  from two different sensor nodes is defined as follows:

$$mot\_sim = 1 - |mot_u - mot_v| \quad (4.18)$$

In the last equation  $mot\_sim \in [0, 1]$ , if closer to 1 it marks that the two shots are similar in motion, and when this value is close to 0, the two shots are motionly different. In our approach we consider that the cameras in sensor nodes are fixed and not rotatable. Hence, the motion content value of the shots is much higher when an event is detected. Therefore, it is important to use this motion content in shots similarity estimation.

### 4.4.4/ SHOTS SIMILARITY ESTIMATION

As explained below, shots sent from neighboring nodes to the same coordinator often have similar visual (color and edge) and/or action (motion) contents. Usually, in WVSNs, the motion content of shots depends on the event detection in the zone of interest. Therefore, when no event is detected the visual correlation between shots from candidates video-sensor nodes becomes higher. In our approach, we compute the similarities between shots as a function of their visual and motion content features. The color and edge similarities comparing two shots at the coordinator level are equal to their means all over the period, to be able to add them to the motion similarity at the end of each period. A solution for the synchronization problem is given later in this chapter. The similarity between shots from different sensor nodes after each period is represented as follows :

we consider :

$$cf = Col\_fact_c; cs = Col\_sim_c$$

ef = Edge\_fact<sub>c</sub>; es = Edge\_sim<sub>t</sub>  
mf = Mot\_fact<sub>c</sub>; ms = Mot\_sim<sub>t</sub>

$$SIM = (cf \times cs) + (ef \times es) + (mf \times ms) \quad (4.19)$$

Where Col\_fact<sub>c</sub>, Edge\_fact<sub>c</sub> and Mot\_fact<sub>c</sub> are considered as weights for color, edge and motion similarities on the coordinator level respectively, such that:  
Col\_fact<sub>c</sub> + Edge\_fact<sub>c</sub> + Mot\_fact<sub>c</sub> = 1.

In this approach, if two shots have similar motion contents, their Mot\_sim<sub>t</sub> function have a higher value. Note that Col\_sim<sub>t</sub>, Edge\_sim<sub>t</sub> and Mot\_sim<sub>t</sub> are in the range of [0,1].

---

### Algorithm 3 Shot Selection Algorithm SSA

---

```

Set Shot1 and Shot2
2: Set sim the overall similarity between two frames
   Set simt the overall similarity between two shots
4: Set βsim the threshold similarity between two shots
   Set Col_factc, Edge_factc and Mot_factc
6: Set CR.F1 the number of critical frames in shot1
   Set CR.F2 the number of critical frames in shot2
8: while Energy > 0 do
   for each period do
10:   Run the LDS
   end for
12:   Compute Col_simt
   Generate Edge_simt
14:   Generate Mot_simt
   Compute similarity simt
16:   simt = Col_simt × Col_factc + edge_simt × Edge_factc + Mot_simt × Mot_factc
   if simt > βsim then
18:     Run the LDS on sensor node 1 to Generate CR.F1
     Run the LDS on sensor node 2 to Generate CR.F2
20:     if CR.F1 > CR.F2 then
       Send shot1
22:     else
       Send shot2
24:     end if
   end if
26: end while

```

---

#### 4.4.4.1/ DIFFERENT FRAME RATES SOLUTION

In this scenario, a synchronization problem is faced when two candidates sensor nodes S1 and S2 have two different frame rates FR<sub>1</sub> and FR<sub>2</sub> respectively, or when different critical scenes are sensed on each sensor node. At this point, the similarity process at the coordinator level can be broken, e.g., at time t = 1, S2 sends a frame to the coordinator but S1 does not send a frame, due to a criticality difference or to a frame rate difference between sensor nodes. To solve this problem, the comparison must take place between the frame received from S1 and the last frame received from S2 (if S2 did not



send a frame at the same time) and vice versa. E.g, at time  $t = 1$ , S1 and S2 send two frames  $f_{11}$  and  $f_{21}$  to the coordinator respectively. At time  $t = 2$ , S2 sends a frame  $f_{22}$  to the coordinator but S1 does not send a frame. The comparison process continues by comparing Frame  $f_{22}$  with the last frame sent from S1 which is  $f_{11}$ . In other words, this can be a solution because a sensor node does not send a new frame to the coordinator when there is no new event in the scene. In this case, we consider the last frame sent by a sensor node as the actual frame of that sensor node.

## 4.5/ EXPERIMENTS

In this section, several experiments have been conducted to validate our approach at the sensor node and the coordinator levels, aiming to minimize the energy consumption and bandwidth usage by reducing the number of data (sensed and transmitted) all over the network. We compare our approach with Jiang et al. [95]. We have used a Matlab based simulator in our experiments. First of all, we introduce a scenario as shown in Figure 4.8 where 6 video-sensor nodes S1,S2,S3,S4,S5,S6 are deployed to monitor the same area of interest from different perspectives. The main purpose in our work is to send to the coordinator the frames that represent the critical situations. The coordinator reacts accordingly. We have used 6 Microsoft LifeCam VX-800 cameras to film a short video of 600 seconds, each camera is connected to a laptop to do the processing via a Matlab simulator. In our study an intrusion has been detected in the sensor-nodes at the following time-intervals:

S1: 40 seconds from 75 to 115.

S2: 40 seconds from 80 to 120.

S3: 200 seconds from 120 to 320

S4: 160 seconds from 300 to 460

S5: 40 seconds from 450 to 490

S6: 0 seconds. We have run our MASRA and SSA algorithms for 600 periods, each period consists of 1 second, with a frame rate equal to 30 frames per second. The frame rate in each sensor node changes independantly according to the number of critical frames related to its sensor node. In each period, every sensor node senses a certain number of frames according to the assigned frame rate. The minimum frame rate is set to  $FR = 1$  frame per period. We consider the initial and maximum frame rate  $FR = 15$  frames per period. In this case the sensor node senses 15 frames from the 30 ones in the period.

As for the parameters at the sensor node level we used a color factor and edge factor equal to 50%. At the coordinator level : we used a color factor and edge factor equal to 25% each and the motion factor is equal to 50%.

Table 4.2: Weights of Small similarities at both levels

Level	Col. fact <sub>c</sub>	Edge fact <sub>c</sub>	Mot. fact <sub>c</sub>
Sensor node	0.5	0.5	0
Coordinator	0.25	0.25	0.5

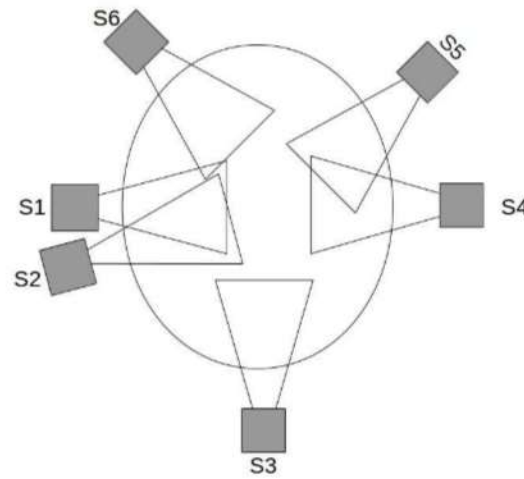

Figure 4.8: The setup of the video sensor nodes

As shown in Table 4.2 the motion factor  $Mot\_fact_c$  has a higher weight at the coordinator level. A frame received from a sensor node is known to be a critical frame, so an information about the motion is more important at the coordinator level to be sent to the sink.

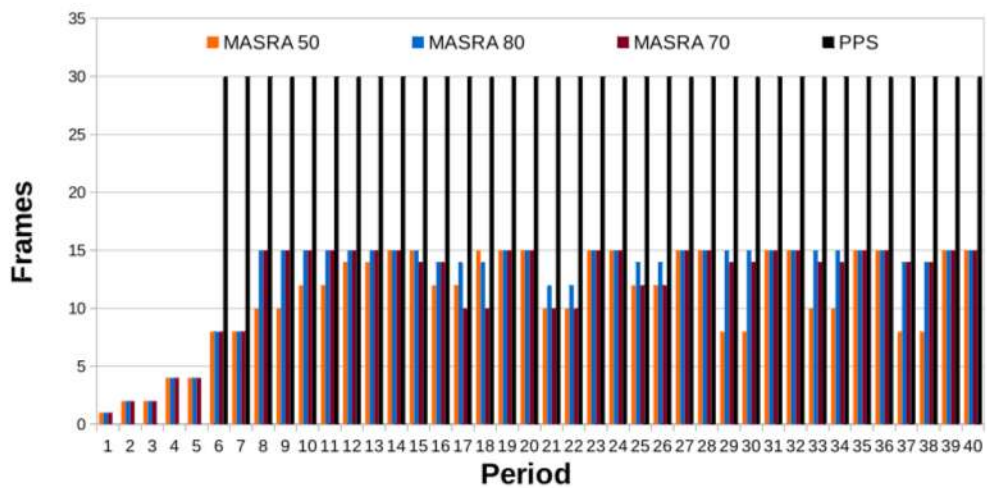

Figure 4.9: Difference between MASRA and PPSS on the sensing phase

Then, we implemented the PPSS approach in [95], and we did run the same video sequence. This algorithm adopts the normal law of probability and the kinematics rules. Its role is to schedule the monitoring time of the sensor-node depending on the trajectory of the intrusion and the time needed to reach its FOV and the sensor-node sends all the sensed frames to the coordinator while the intrusion is in its FOV, and then it goes back

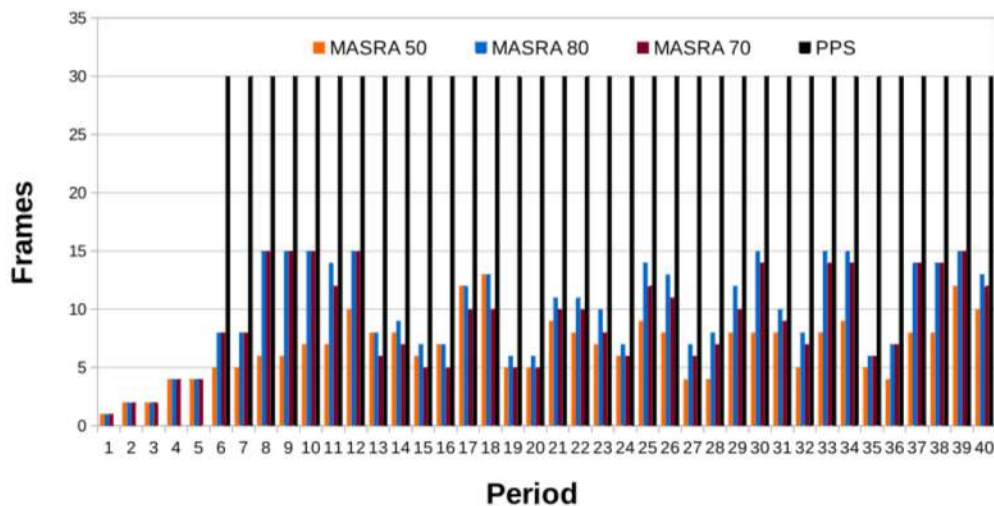

Figure 4.10: Difference between MASRA and PPSS on the transmission phase

to the sleep mode. After several experiments, this approach tends to lose information up to 15% due to probability errors. This loss of data in PPSS is shown in Figures 4.9 and 4.10 for sensor S1 in our scenario when the intrusion passes by its FOV.

#### 4.5.1/ THE SENSOR NODE LEVEL

##### 4.5.1.1/ NUMBER OF FRAMES

The biggest challenge in WSN is the energy consumption due to the limited resources of the sensor nodes and to the big number of frames on the network. When no specified or adapted frame rate is implemented, the amount of sensed frames remains at 30 for each period. In terms of energy consumption and bandwidth usage, sending all the frames is costly while a lot of frames are identical and do not represent any criticality. Sending frames with a time difference inferior to 0.03 seconds in a video surveillance does not represent any additional information. For this reason, we set the initial and maximal frame rate to  $FR = 15$  frames sensed per period. The MASRA algorithm is implemented on every video-sensor node to reduce the number of frames sensed and sent to the coordinator. For every sensor node, the frame rate is adapted after two periods where  $P = 1$  second. Every sensor node sends the first frame of each period. For sensor node S1, as seen in Figure 4.10, the MASRA algorithm only sends the critical frames to the coordinator according to a predefined threshold of similarity as explained in the upper sections, this threshold varies from 50% to 70% to 80%. In the latter stages we chose a threshold equal to 70% as a mean to all other values. The number of frames sent in each period is the parameter that influences the frame rate. The frame rate variation seen in Figure 4.9 validates our frame rate adaptation method in the active mode of sensor S1, when an intrusion is detected.

In Figure 4.10, we can see the number of critical frames sent to the coordinator via S1, this variation in the number of critical frames per period is proportional to the adaptation of the frame rate. Figure 4.9 and Figure 4.10 present a slight difference when

the threshold changes from 50 to 70 to 80. Thus, the choice of 70% is validated. As seen in Tables 4.3 and 4.4 for S1 and in Tables 4.5 and 4.6 for S3, adapting the frame rate reduces the sent data by more than 90%. Then, applying our similarity function causes the degradation of the number of sent frames by 94% from 14700 frames to 818 frames. Reducing the number of sensed frames via the adaptation of the frame rate, and reducing the number of frames sent to the coordinator by using our similarity function at the sensor node level prove that our algorithm reduces the number of frames in terms of sensing and transmitting as detailed in Tables 4.7,4.9 for all the network.

Table 4.3: The difference in terms of number of frames for S1 over 40s

Nb of Periods	All Frames	Sampled Frames	Critical Frames
40	1200	490	360

Table 4.4: The difference in terms of number of frames for S1 over 490s

Nb of Periods	All Frames	Sampled Frames	Critical Frames
490	14700	938	818

Table 4.5: The difference in terms of number of frames for S3 over 200s

Nb of Periods	All Frames	Sampled Frames	Critical Frames
200	6000	2940	2055

Table 4.6: The difference in terms of number of frames for S3 over 490s

Nb of Periods	All Frames	Sampled Frames	Critical Frames
490	14700	3245	2360

Table 4.7: Sensor by Sensor evaluation in terms of number of frames in active and passive modes for MASRA Algorithm

Sensor (active time)	Passive Mode		Active Mode	
	Sensed	Transmitted	Sensed	Transmitted
S1 (40s)	448	448	490	360
S2 (40s)	448	448	520	380
S3 (200s)	305	305	2940	2055
S4 (160s)	333	333	2340	1710
S5 (40s)	448	448	500	400
S6 (0s)	490	490	0	0
Total	2472	2472	6790	4905

By comparing these numbers to the number of frames in Tables 4.10,4.11,4.12,4.13, while applying PPSS algorithm, we can conclude that the efficiency of our algorithm for the sensing and transmission process surpasses the PPSS algorithm. And this gain grows furthermore when the time interval of the active mode of the sensor grows, as

Table 4.8: Sensor by Sensor evaluation in terms of number of frames in active and passive modes for PPSS Method

Sensor (active time)	Passive Mode		Active Mode	
	Sensed	Transmitted	Sensed	Transmitted
S1 (40s)	0	0	1080	1080
S2 (40s)	0	0	1102	1102
S3 (200s)	0	0	5134	5134
S4 (160s)	0	0	4120	4120
S5 (40s)	0	0	1065	1065
S6 (0s)	0	0	0	0
Total	0	0	12501	12501

Table 4.9: Comparison between MASRA and PPSS in terms of number of frames on the overall Network

	MASRA		PPSS	
	Sensed	Transmitted	Sensed	Transmitted
Total Frames	9262	7377	12501	12501

shown for sensor-node S3. For probability reasons, the first sequence of frames for every sensor is lost in PPSS, once the intrusion opts in the FOV of the sensor node. Tables 4.7, 4.8 and 4.9 show the efficiency of our approach sensor by sensor and on the overall network regarding the number of sensed and transmitted frames.

Table 4.10: The difference in terms of number of frames for S1 over 40s PPSS

Nb of Periods	All Frames	Sampled Frames	Critical Frames
40	1200	1080	1080

Table 4.11: The difference in terms of number of frames for S1 over 490s PPSS

Nb of Periods	All Frames	Sampled Frames	Critical Frames
490	14700	1080	1080

Table 4.12: The difference in terms of number of frames for S3 over 200s PPSS

Nb of Periods	All Frames	Sampled Frames	Critical Frames
200	6000	5134	5134

Table 4.13: The difference in terms of number of frames for S3 over 490s PPSS

Nb of Periods	All Frames	Sampled Frames	Critical Frames
490	14700	5134	5134

#### 4.5.1.2/ BANDWIDTH CONSUMPTION

The bottleneck issue is a problem caused by the limited resources in terms of bandwidth capacity and by the huge number of frames sent all over the network. For the same algorithm (MASRA) as we can see in Table 4.14 for the network, the size of the sent frames varies and is by far reduced. At the sensor node level, the frame rate adaptation and the similarity function applied are responsible for this reduction by only sending the critical frames to the coordinator which reduces the size of the total number of frames sent within a period as shown in Table 4.14. The size of the video filmed in total is equal to 300MB, this number is cut by 90% to reach 19MB when we send all the frames by adapting the frame rate, and from 300MB to 15MB if we implement our algorithm with all its functionalities as mentioned in Table 4.14.

Sending 15MB in 490 seconds is equivalent to having a bit rate equal to 31KB/s which is a very small bit rate which will avoid causing a bottleneck problem even if we have a big number of video-sensor nodes in the network. In this case a capacity of 100MB can serve more than 2,000 sensor-nodes at the same time.

Table 4.14: The ultimate bandwidth total reduction MASRA

Nb of Periods	All Frames	Sampled Frames	Critical Frames
490	300 MB	19 MB	15 MB

In [95], they reduce the bandwidth usage, but depending on the similarity function presented in our method, the bandwidth reduction is better by 5% from 90% in PPSS to 95% in MASRA algorithm as mentioned in Tables 4.14,4.15.

Table 4.15: The ultimate bandwidth total reduction PPSS

Nb of Periods	All Frames	Sampled Frames	Critical Frames
490	300 MB	29 MB	29 MB

#### 4.5.2/ THE COORDINATOR LEVEL

The SSA algorithm is implemented on the coordinator. As seen in Figure 4.8, and based on angle and position conditions, only video-sensor nodes S1 and S2 satisfy the overlapping method geometric conditions so their frames can be compared at the coordinator level by the SSA algorithm. The coordinator will send the frame of the more critical video-sensor node to the sink with respect to a predefined similarity metric threshold  $\beta_{sim}$ . In our experiments S1 and S2 send 938 and 968 frames to the coordinator respectively, which gives S2 the edge to be the more critical node. In this case when a comparison takes place between two frames, if the similarity exceeds the predefined  $\beta_{sim}$ , the frame from S2 is sent to the sink and the other one from S1 will be rejected. Otherwise both frames are sent to the sink.

In our experiments, the coordinator receives a sum of 1906 frames from S1 and S2 combined. By modifying the threshold  $\beta_{sim}$  from 50% to 80%, the number of frames sent to the sink changes. The changes are recognised, the number of sent frames and  $\beta_{sim}$

are proportional. Table 4.16 summarizes the coordinator behavior by showing the percentages of reduction that degrades from 48% for  $\beta_{sim}=50$  to reach zero when  $\beta_{sim}=80$ . For  $\beta_{sim}=50$ , the 48% reduction in terms of number of frames sent from the coordinator to the sink added to the 90% reduction at the sensor node level increases the lifetime of the network by reducing the number of frames and the bandwidth usage due to transmission reduction on both levels. As for PPSS, they do send every frame received by the

Table 4.16: The Coordinator Behavior

$\beta_{sim}$	Received Fr	Sent Fr	Sent(%)	Reduction(%)
50	1906	1000	52%	48%
60	1906	1296	68%	32%
70	1906	1640	86%	14%
80	1906	1906	100%	0%

coordinator to the sink node, disregarding the correlation of several sensor-nodes and the similarity of their frames.

Table 4.17: The Coordinator Behavior PPSS

$\beta_{sim}$	Received Fr	Sent Fr	Sent(%)	Reduction(%)
50	1906	1906	100%	0%
60	1906	1906	100%	0%
70	1906	1906	100%	0%
80	1906	1906	100%	0%

As shown in Tables 4.16 and 4.17, our algorithm on the coordinator level helps to reduce furthermore the number of frames sent to the sink by more than 32% if  $\beta_{sim} < 60\%$  for the correlated sensor-nodes.

## 4.6/ ENERGY CONSUMPTION STUDY

In this section, our energy consumption comparison study is based on the energy model proposed in [71]. The consumed energy as in [71] is divided into two parts, the radio energy for the transmission of the data on the radio and the computational energy for the in-node processing. as shown in the equation below:

$$E = E_{radio} + E_{comp} \quad (4.20)$$

Table 4.18 shows the different parameters to compute the energy consumption while considering:

$I_{TX}$  and  $I_{RX}$  the electric power needed for sending and receiving by the radio respectively.

$T_{TX}$  and  $T_{RX}$  the corresponding operating time over 1 byte.

$V$  be the constant voltage supply throughout the transmission.

$$E_{radio}(k) = k.I_{TX}.V.T_{TX} + k.I_{RX}.V.T_{RX} \quad (4.21)$$

Taking into account that  $k$  is the number of bytes sent from a specific sender to a specific receiver. For the computational energy consumption:

$Q_{add}$ ,  $Q_{mul}$ ,  $Q_{cmp}$ ,  $Q_{sh}$  are the basic operations (shift, addition, comparison, multiplication, etc...), Table 4.18 shows the required energy for each operation. To compute this energy consumption, we only need to count the number of each basic operation in the algorithm:

$$E_{comp} = N_{add} \times Q_{add} + N_{sh} \times Q_{sh} + N_{mul} \times Q_{mul} + N_{cmp} \times Q_{cmp} \quad (4.22)$$

Table 4.18: Parameters of the Energy Model

Parameter	Value
$I_{TX}$	17.4 mA
$I_{RX}$	19.7 mA
$T_{TX}$	$3.2 \times 10^{-5}$ s
$T_{RX}$	$3.2 \times 10^{-5}$ s
$V$	3.3 V
$I_{cpu}$	31 mA
$f_{cpu}$	48 MHz
$Q_{add}$	2.13 nJ
$Q_{mul}$	6.39 nJ
$Q_{cmp}$	2.13 nJ
$Q_{sh}$	4.26 nJ

In order to compare both approaches, we calculate the energy consumption of both the processing and the transmission tasks of a wireless sensor node equipped with a CC2420 radio transceiver and an ARM7TDMI microprocessor. Table 4.18 displays the parameters that are used in the calculations and which are found in the data sheets of the node's components [71].

#### 4.6.1/ SENSOR NODE LEVEL

In our experiments, when running the MASRA algorithm, 9262 frames were sensed and compared using the similarity function. For a  $640 \times 480$  frame size, 307200 pixels exist in each frame. Each similarity takes into account all the pixels in every frame. The MASRA algorithm consists of 2 additions, 2 multiplications and 1 comparison. We can compute the computational energy for  $E_{comp}$  for 9262 similarities as follows:

$$E_{comp} = 9262 \times 640 \times 480 \times (2 \times Q_{add} + 2 \times Q_{mul}) + 9262 \times Q_{cmp} \quad (4.23)$$

In this case,  $E_{comp,masra} = 49$  J.

If we apply PPSS,  $E_{comp,ppss} = 0.1$  J.

To move on to the transmission phase, where our network for the MASRA algorithm transmits 7377 frames = 15 MB, comparing to the 12501 frames = 29 MB for PPSS. In the MASRA algorithm, the sensors only send the frames to the coordinator, but in PPSS when a sensor-node detects a frame, the node sends a message to its neighbors containing several information such as the id of the sensor, the position of the intrusion .... Adding



to the 29 MB of frames that has been sent on the network, the sensor-nodes in PPSS in our experiments send to each other 25600 messages of 4 KB for each message. which means 100 MB to be added in the received data.

$$E_{\text{radio,masra}} = 15 \times 1024 \times 1024 \times 17.4 \times 10^{-3} \times 3.3 \times 3.2 \times 10^{-5} = 28.9\text{J} \quad (4.24)$$

$$\begin{aligned} E_{\text{radio,ppss}} &= 29 \times 1024 \times 1024 \times 17.4 \times 10^{-3} \times 3.3 \times 3.2 \times 10^{-5} \\ &\quad + 100 \times 1024 \times 1024 \times 19.7 \times 10^{-3} \times 3.3 \times 3.2 \times 10^{-5} \\ &= 276.13\text{J} \end{aligned}$$

To compute the total energy consumption consumed by the network on the sensor node level, the energy consumptions related to the computation and to the transmission must be added to each other.

$$E_{\text{masra}} = E_{\text{comp,masra}} + E_{\text{radio,masra}} = 49 + 28.9 = 77.9\text{J} \quad (4.25)$$

$$E_{\text{ppss}} = E_{\text{comp,ppss}} + E_{\text{radio,ppss}} = 0.1 + 276.13 = 276.23\text{J} \quad (4.26)$$

Table 4.19: Energy consumption comparison for MASRA and PPSS

Energy	MASRA	PPSS
$E_{\text{Comp}}$	49 J	0.1 J
$E_{\text{radio}}$	28.9 J	276.13 J
$E_{\text{total}}$	77.9 J	276.23 J

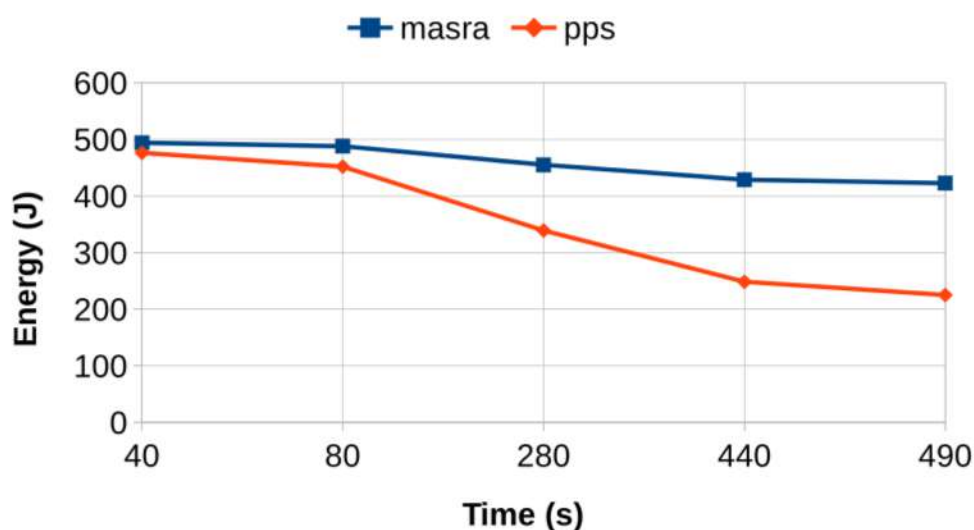

Figure 4.11: Energy consumption comparison for MASRA and PPSS

As shown in Table 4.19, while comparing with PPSS, our algorithm consumes more energy on the computational level, but reduces much more energy on the transmission level. Figure 4.11 compares both approaches in terms of energy consumption over time on the overall network while considering a start energy of 500 J for the network. The gain of our approach is positive, PPSS and as shown in Figure 4.11 consumes more energy than our approach in our experiments.

## 4.7/ CONCLUSION

In this chapter, we introduced an adaptive frame rate algorithm with a similarity detection function for wireless video sensor nodes. Also, a Shot Selection algorithm is implemented at the coordinator level. The proposed work allows a dynamic frame rate control of each video-sensor node. The conducted experiments show that the proposed algorithms did not miss any event in the recorded video sequence. Thus, the algorithms send the minimum required frames to the sink node by using a similarity detection function at the sensor node and coordinator levels. The selected frames are transmitted by the sensor nodes to the coordinator and by the coordinator to the sink without missing any required information. The results show that the size of the transmitted data in each period is reduced and the energy consumption is decreased, thus, preventing any bottleneck problem regarding the bandwidth limitation issue.

Comparing our approach with PPSS algorithm in terms of data reduction and energy consumption, helps us to find out that our algorithm outperforms PPSS, and reduces the number of data for more than 40% than PPSS. Thus, PPSS consumes 4 times more energy than our approach on the sensor node level.



# KINEMATICS BASED DATA REDUCTION TECHNIQUE

Kinematic functions are defined to predict the next step of the intrusion and to schedule the monitoring system accordingly. Compared to a fully scheduling approach based on predictions, this approach minimizes the transmission on the network. Thus, it reduces the energy consumption and the possibility of any bottleneck while guaranteeing the detection of all the critical events at the sensor-node level as shown in the experiments.

## 5.1/ INTRODUCTION

In wireless video sensor networks, WWSN, the event driven and periodic approaches are combined. The wireless video sensor networks are 3 layers network: The Wireless Sensor Node level, The Coordinator level and the Sink as explained in the first contribution in Figure 4.1.

Normally if there is no critical event in the area of interest, the WWSN operates periodically. To reduce the energy consumption related to the sensing process on the sensor level, a simple probabilistic method has been proposed to adapt the frame rate of every sensor node, depending on the level of criticality, the position and the trajectory direction of the intrusion in the scene (the movement's vector) based on a probability based prediction [95].

After adapting the number of frames sensed by the node in every period, the main goal is to reduce the number of frames sent from the sensor node to the coordinator. To reduce this number, each sensed frame is compared with the last frame sent. This comparison is an edge based comparison: according to [61], Local processing can involve simple image processing algorithms such as edge detection. According to a predefined threshold of similarity, the node decides whether to send this frame to the coordinator or not.

The coordinator of an area of interest serves as a cluster head leading a defined number of nodes.

Meanwhile, tracking the objects/intrusions in the area of interest while saving energy is one of our main concern in this chapter. Thus, the kinematics functions provide the necessary solution for this purpose to detect the estimated trajectory and the future locations of an intrusion. To sum up, we try to detect critical events and track intrusions

through the area of interest via a wireless video sensor network, while using an energy efficient method.

The reminder of this chapter is divided as follows: section II introduces the state of the art, section III explains in brief the Movement State Vector for later use in the kinematic based approach. For Data Reduction on the sensing phase, the kinematic based and position based approaches used for predictions, as well as the frame rate adaptation technique are explained in section IV. Data Reduction technique on the transmission phase is discussed in section V. In section VI, some experimental results validate the approach. At the end, section VII concludes the chapter.

## 5.2/ RELATED WORK

In this section, some previous works regarding this topic in the literature are explored. Several works dealt with the location of the intrusion and the target in the zone of interest [93, 118, 134, 42, 70, 78]. In [93], the authors implement an evolution of the time difference of arrival (TDOA) using 4 stationary sensor nodes as reference nodes in the area of interest. The intersection of several hyperboles are studied to perform the localization process which needs 4 equations from the 4 reference nodes. This new method outperforms the traditional TDOA in terms of error rate. Machine learning has been used for target localization in WSN in [118]. In [134, 42, 70, 78], the Intrusion Detection System (IDS) has been used. This system divides the network into several areas and each area into sub-areas. The location of the intrusion is equal to the group position. In [14], the authors develop a small algorithm that detects and tracks a moving target in WSN. The sensor that detects the intrusion sends an alert according to the projected path of the target. They use the triangulation method to locate the target. Several works have studied the path of an intrusion in the area of interest in the literature. In [49], the authors develop a method that exploits the traces of target presence. The sensor node plays a role in decreasing a trace intensity with time and propagates them to the network. A tracking agent is used to follow the traces. This agent can be a pure software originated by a mobile sink, a human being with a device to communicate with the network or a mobile robot. The objective is to follow the traces from the first alert message detecting a target, the agent can immediately start with the first trace by studying the intensity of the trace, and then by grouping 2 or more traces, the path can be built. In [129] the target is considered as an unknown sensor with RFF. Measurement selection in this work are based on fuzzy modeling, the position estimation is aggregated through neighborhood functions. An optimization of this work is done by the Generalized Kalman Filter method. The authors in [120] compare between several target tracking approaches in WSN. They show the different aspects of tracking: security, energy efficiency, network structure, accuracy, mobility of the target, fault tolerance... Several metrics in [120] have been taken into consideration:

- 1) The network structure : Tree Structure, Face structure or Cluster structure
- 2) Prediction-based Tracking: to predict the next position of the target several approaches use the kinematics functions, Kalman filter, extended Kalman filter and particle filter.
- 3) The number of targets: it differs if there is 1 target or several targets which can be more consuming with high complexity.
- 4) Type of the Object: Discrete (people, animals, vehicles) or Continuous (forest fires, oil

spills, ....).

Several reasons may cause the loss of the target in [120] such as communication failures, abrupt changes in the speed and direction of the target, the energy-hole problem, the inaccuracy and the delay caused by the computation of the algorithms.

Authors in [101, 65] adopted spanning tree methods to locate and track the intrusions in the area of interest in WSN.

A lot of works focus on cluster-based approaches to track the targets in the network [88, 86, 39, 99, 104, 76]. In [99], they use a hybrid cluster-based target tracking. This method has static clusters, each node cooperates with its cluster head to track the mobile target. Once a target approaches the boundaries, sensors from different clusters can cooperate forming a dynamic cluster on the borders. When the target moves away, the dynamic cluster is dismissed. It is energy consuming and uses a lot of overhead to form and dismiss a cluster.

Some papers concentrate on the contour tracking using minimal contour tracking algorithms to improve energy-efficiency such as [41] where all sensors in the contour are on and all the others are off depending on a sleep schedule. In [73, 45], the authors transform the whole tracking area to voronoi polygons while having 3 kinds of sensors: workers, border and computational.

Other approaches are based on kinematics rules and the probability theory [95], kinematics rules are used to detect the path of the target in the network, and the probability theory can help to schedule the sleep mechanism of the sensors according to the trajectory of the target and its future predicted positions, acceleration and speed.

In this chapter, 2 sensor nodes are neighbors as shown in Fig 5.1 if there is a geometrical correlation between their FOVs. A node to node connection is established. If an intrusion is detected in sensor node  $S_1$ , this sensor studies the direction vector of the trajectory  $D$  of this intrusion, and send this vector to all its neighbors. In this figure  $S_2$  is the neighbor that receives the vector. In other terms, this vector also represents an alert that an intrusion is taking place in the monitored area.

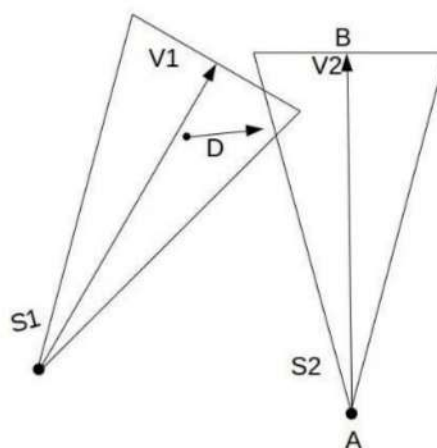

Figure 5.1: Direction Vector

In the kinematics based approach (KBA) proposed in this chapter, every sensor node starts the sensing process by taking as a frame rate the minimum frame rate possible.

When this sensor is triggered by another node (after the probability study of the trajectory and the new location of the intrusion) that an intrusion may pass by its FOV, it adapts the frame rate according to the level of probability sent in the alarm message from the sending sensor. In this chapter, we consider that a sensor node can determine the position of the intrusion at detection [95].

### 5.3/ SENSOR NODE LEVEL: SENSING PHASE

In the sensing phase section, we introduce the probability based prediction method to determine the trajectory of the intrusion. This process leads to adapt the frame rate of the triggered sensors in the region of the predicted path. This adaptation of the frame rate differs in the same region between sensor nodes according to the probability. This probability defines the percentage of the intrusion to pass by this sensor's field of view (FOV). It all depends on the trajectory vector generated from the first sensor that detects the intrusion.

When a node detects a target, it sends an alarm to actively raise the frame rate of all its neighbor sensor nodes. In this case all these nodes will be ready to detect the approaching target. But the target may move to a side that is disproportional to some sensor's field of views, in this case the variation of the frame rate varies between sensor nodes depending on the direction of the target. A node by which the intrusion may not pass by is called a low-probability sensor node, this node raises its frame rate to a certain extent in case any abrupt change of direction or speed of the intrusion happens. However, a node by which the intrusion has a high probability to pass by, raises its frame rate to the maximum frame rate.

The target prediction technique is based on two big studies: first, the kinematics rules to calculate the expected displacement of the intrusion (position after a certain time  $t$  and moving direction). Secondly, the probability theory to adapt the frame rate of each sensor node. Based on these predictions, the decision of raising the frame rate in each sensor node is made according to the probabilistic study that also schedules the time to raise the frame rate when the probability is close to one. This approach reduces the energy consumption of the whole network by selecting the sensors that need to adapt their frame rate not only in the whole network but also in a very specific region.

To summarize, 3 steps are needed to apply the KBA (kinematics based approach) approach on the sensor node level:

- 1) The target prediction.
- 2) The reduction of the number of triggered node to adapt their frame rate.
- 3) The adaptation time control: based on the probability, the approach schedules the node to adapt its frame rate when the probability of detecting the target in its FOV is equal or close to 1.

#### 5.3.1/ MOVEMENT STATE VECTOR

Let us start by defining the Movement Vector. The movement state vector is a combination of 5 parameters related to the movement.  $\overrightarrow{MS}(n) = \{t_n, x_n, y_n, \overrightarrow{v}(n), \overrightarrow{a}(n)\}$ , where:  $t_n$  is the actual time,  $x_n$  and  $y_n$  define the position of the target at  $t_n$ ,  $\overrightarrow{v}(n)$  is the average velocity

vector defined by its scalar speed  $v_n$  and its moving direction  $\theta_n$  and  $\vec{a}(n)$  refer to the acceleration during  $[t_{n-1}, t_n]$ .

### 5.3.2/ CURRENT STATE MOVEMENT CALCULATION

First to calculate the first movement state vector of the intrusion, the first two detected positions of the intrusion are needed. To be able to calculate the movement state vector at time  $t_n$ , all we need to have are  $\vec{MS}(n-1)$  and the position  $x_n, y_n$  at  $t_n$  so the functions can calculate the velocity  $\vec{v}(n)(v_n, \theta_n)$  and acceleration  $\vec{a}(n)$  vectors to compose the new movement state vector  $\vec{MS}(n)$  at  $t_n$  as shown in Fig 5.2 and in the equations below:

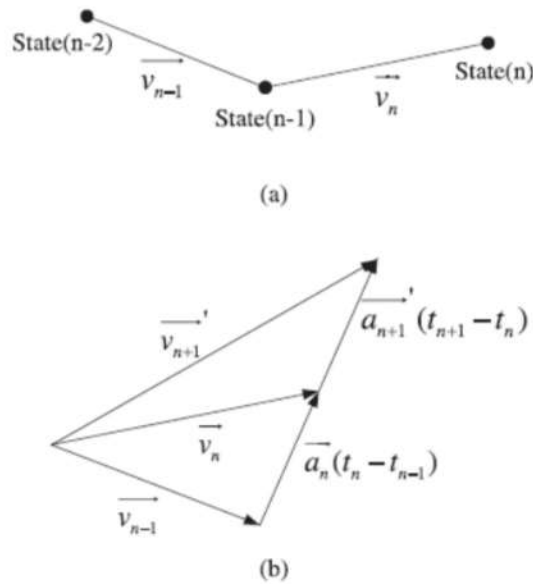

Figure 5.2: Movement State Vector and kinematics rules

$$v_n = \frac{\sqrt{(y_n - y_{n-1})^2 + (x_n - x_{n-1})^2}}{t_n - t_{n-1}} \quad (5.1)$$

$$\theta_n = \arctan \frac{y_n - y_{n-1}}{x_n - x_{n-1}}, \quad x_n \neq x_{n-1} \quad (5.2)$$

$$\vec{a}_n = \frac{\vec{v}_n - \vec{v}_{n-1}}{t_n - t_{n-1}} \quad (5.3)$$

In this approach, the sensor nodes are time synchronized locally in a small range, so that the received  $t_{n-1}$  may be used in the calculation. Local time synchronization may be easily achieved with a protocol such as RBS [9], or simply with HELLO message exchange [57].



## 5.4/ PREDICTIONS

In this section, we discuss the kinematics-Based prediction technique.

In this type of prediction, we suppose that  $\tau = t_{n+1} - t_n$  as the lapse of time between two states, and all the prediction vectors are labeled with an apostrophe such as  $\overrightarrow{MS}_{n+1}'$ .

### 5.4.1/ KINEMATICS-BASED

The kinematics rules are used to generate a prediction about  $\overrightarrow{v}_{n+1}'$  and  $\overrightarrow{MS}_{n+1}'$ . To do so, we consider the acceleration  $\overrightarrow{a}_n$  as constant during a defined time of  $t_{n+1} - t_n$  indeed, according to the displacements Taylor polynomial, its rate of change can be ignored because it is the third derivative of displacement. In this case, the predicted velocity, acceleration, trajectory and position of any intrusion can be computed based on the kinematics rules and equations as follows:

$$\overrightarrow{a}_{n+1}' = \overrightarrow{a}_n \quad (5.4)$$

$$\overrightarrow{v}_{n+1}' = \overrightarrow{v}_n + \overrightarrow{a}_{n+1}' \times \tau \quad (5.5)$$

$$\overrightarrow{MS}_{n+1}' = \overrightarrow{v}_{n+1}' \times \tau + \overrightarrow{a}_{n+1}' \times \tau^2 \quad (5.6)$$

### 5.4.2/ POSITION-BASED

To be able to compute the following predicted positions, at least the first two positions of the intrusion must be detected before any prediction.

$$\overrightarrow{(x_{n+1}, y_{n+1})}' = \overrightarrow{(x_n, y_n)} + \overrightarrow{MS}_{n+1}' \quad (5.7)$$

The fact of considering  $\overrightarrow{a}_{n+1}' = \overrightarrow{a}_n$  should to be respected over a time  $\tau = t_{n+1} - t_n$  for the estimation. But once the sensor senses the new position of the intrusion, the new  $\overrightarrow{a}_{n+1}$  is computed and taken into account in the rest of the processing. The distance between position n and n + 1 is calculated as follows:

$$d'_{n+1} = v_{n+1} \times \tau \quad (5.8)$$

$$d'_{n+1} = \frac{d_{n+1}}{\tau} = \frac{(x_n - x_{n+1})^2 + (y_n - y_{n+1})^2}{\tau} \quad (5.9)$$

The main target in this work is to get the estimation of the new position of the intrusion  $(x_{n+1}, y_{n+1})$ . A straight line can be drawn for y displacement as a function of x such as:

$$y_{n+1} = \frac{y_n - y_{n-1}}{x_n - x_{n-1}} \times x_{n+1} + b \quad (5.10)$$

This above equation is also valid for  $x_n$  and  $y_n$  already sensed and stored, their values are used to get b. In the next step, a system of two equations for x and y are used to get  $x_{n+1}$  and  $y_{n+1}$  as follows:

$$\begin{aligned} x_{n+1} &= \frac{1}{2} a'_{n+1} \tau^2 + v_{n+1} \tau + x_n \\ y_{n+1} &= \frac{1}{2} a'_{n+1} \tau^2 + v_{n+1} \tau + y_n \end{aligned} \quad (5.11)$$

### 5.4.3/ ADAPTIVE FRAME RATE FUNCTION

In this section the Adaptive Frame Rate function is discussed. This function is dedicated to changing the frame rate of each sensor node according to the direction conditions, the generated probability and the maximum Frame Rate of the sensor node.

Each sensor that detects the intrusion sends an alarm message to its neighbor nodes. This message contains the ID and the position of the alarm node, as well as the movement state vector  $\overrightarrow{MS}_n$  and the prediction results  $(\overrightarrow{MS}_{n+1}, X, Y)$ .

Every sensor that receives the message checks the received values and predictions with its own FOV. If the intrusion is set to pass by this sensor the probability prob is different than 0. In this case, this sensor node increases its frame rate FR according to the predefined maximum frame rate  $FR_{max}$  as follows:

$$FR = FR_{max} \times prob \quad (5.12)$$

As shown in Figure 5.3, if the probability prob is close to 1 then the frame rate of this sensor node increases and approximately reaches its maximum frame rate available. The probability is computed based on the number of periods  $nb_p$  needed by the intrusion to reach the sensor-node in question as the equation below shows:

$$prob = \frac{1}{nb_p} \quad (5.13)$$

The number of periods needed is computed based on the distance between the intrusion and the sensor node and the speed of the intrusion.

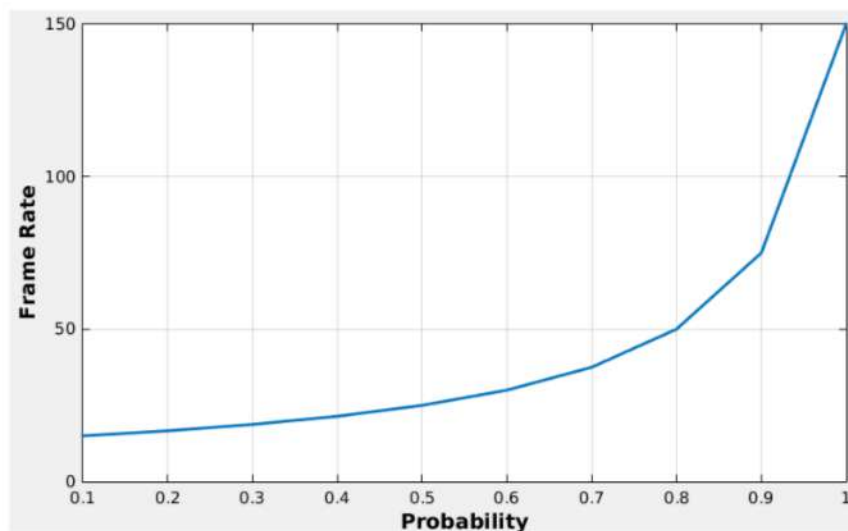

Figure 5.3: Adaptive Frame Rate Function

## 5.5/ SENSOR NODE LEVEL: TRANSMISSION PHASE

After adapting the number of frames sensed by the node in every period, the aim is to reduce the number of frames sent from the sensor node to the coordinator. To reduce this number, each sensed frame is compared with the last sent frame to the coordinator. This comparison is an edge based comparison: according to the study in [61], we are interested in the simple image processing algorithms. Local (on-board) processing of the image data reduces the total amount of data that needs to be communicated through the network. Local processing can involve simple image processing algorithms (such as background subtraction for motion/object detection, and edge detection). According to a predefined threshold of similarity, the node decides whether to send this frame to the coordinator or not.

## 5.6/ EXPERIMENTAL RESULTS

In this section, several experiments have been conducted using MATLAB simulator, connected to multiple Microsoft Vx-800 cameras. A defined scenario has been taken into consideration as shown in Figure 5.4 and Table 5.1. This table represents the sensor nodes in their active mode, when the intrusion is in their FOV, and in their passive mode when no intrusion is detected in their area of interest.

Table 5.1: Scenario Time Table

Sensor	Active mode	Passive mode
S1	64s	656s
S2	64s	656s
S3	304s	416s
S4	244s	476s
S5	64s	656s
S6	0s	720s

A stable frame rate of 30 frames per second (Fps) is set to be the frame rate of the cameras. The maximum frame rate in those experiments is decreased to 15 Fps. This approach is compared to the PPSS algorithm proposed in [95]. The main purpose in this work is to send to the coordinator the frames that represent the critical situations. The coordinator reacts accordingly. We have used 6 Microsoft LifeCam VX-800 cameras to film a short video of 750 seconds, each camera is connected to a laptop to do the processing via a Matlab simulator. In this study, an intrusion has been detected in the sensor-nodes at the following time-intervals:

S1: 60 seconds from 30 to 90.

S2: 60 seconds from 70 to 130.

S3: 300 seconds from 120 to 420

S4: 240 seconds from 400 to 640

S5: 60 seconds from 630 to 690

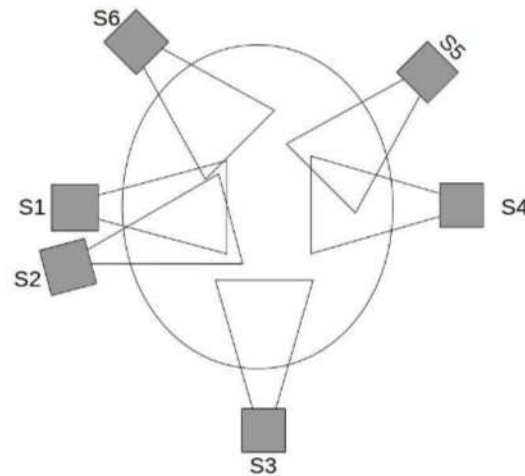

Figure 5.4: Network Setup

S6: 0 seconds. The process has been run for 720 periods, each period consists of 1 second, with a frame rate equal to 30 frames per second. The frame rate in each sensor node changes independently according to the theory explained above. In each period, every sensor node senses a certain number of frames according to the assigned frame rate. The minimum frame rate is set to  $FR = 1$  frame per period. The initial and maximum frame rate is considered as  $FR = 15$  frames per period. In this case the sensor node senses 15 frames from the 30 ones in the period.

Then, the PPSS approach has been implemented like in [95] for the same video sequence. This algorithm adopts the normal law of probability and the kinematics rules. Its role is to schedule the monitoring time of the sensor-node depending on the trajectory of the intrusion and the time needed to reach its FOV and the sensor-node sends all the sensed frames to the coordinator while the intrusion is in its FOV, and then it goes back to the sleep mode. But after several experiments, this approach tends to lose information up to 15% due to probability errors. This loss of data in PPSS is shown in Figures 5.5 and 5.6 for sensor S1 in our scenario.

### 5.6.1/ DATA REDUCTION

In this section, the biggest challenge in WSN is exploited, which is the energy consumption problem due to the limited resources of the sensor nodes and to the big number of data (frames) transmitted all over the network. On the sensor node level, the energy consumption problem is the main issue as well as the bandwidth limitations. In the proposed scenario, when no adapted frame rate is implemented on each sensor node, the amount of sensed frames remains at 30 for each period. In terms of energy consumption and bandwidth usage, sending all the frames is costly while a lot of frames are identical and do not represent any criticality. Sending frames with a time difference inferior to 0.03

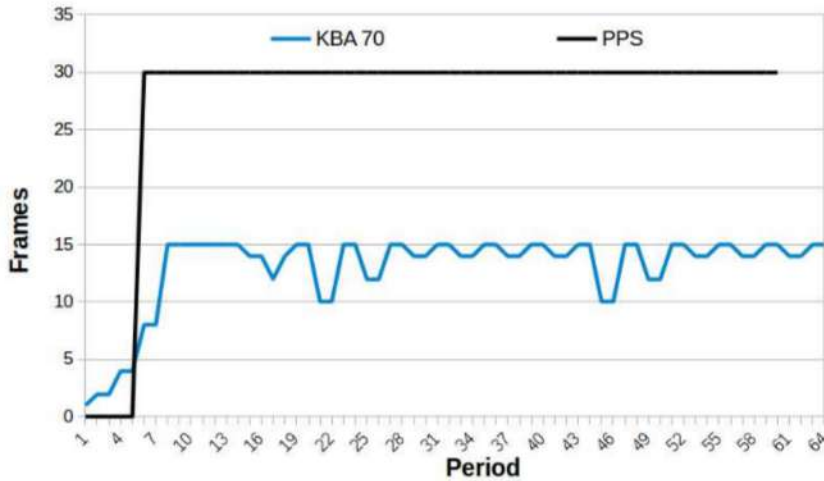

Figure 5.5: Difference between KBA and PPSS on the sensing phase

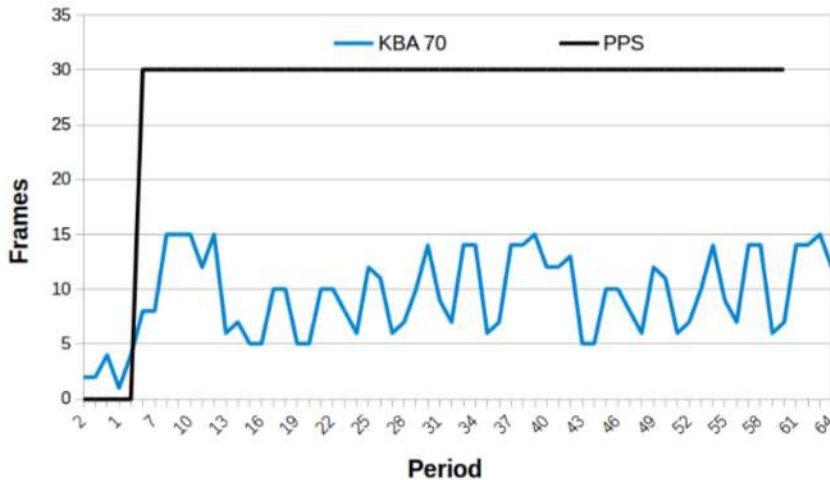

Figure 5.6: Difference between KBA and PPSS on the transmission phase

seconds in a video surveillance does not represent any additional information. For this reason, we set the initial and maximal frame rate to  $FR = 15$  frames sensed per period. The proposed method is implemented on every video-sensor node to reduce the number of frames sensed and sent to the coordinator. For every sensor node, the frame rate is adapted after two periods where  $P = 1$  second. Every sensor node sends the first frame of each period. For sensor node S1, as seen in Figure 5.6, this technique only sends the critical frames to the coordinator according to a predefined threshold of similarity as explained in the upper sections, this threshold is set to 70%. The number of frames sent in each period is the parameter that influences the frame rate. The frame rate variation seen in Figure 5.5 validates the frame rate adaptation method in the active mode of sensor S1, when an intrusion is detected.

Figure 5.6 reveals the number of critical frames sent to the coordinator via S1, this variation in the number of critical frames per period is proportional to the adaptation of the frame rate. As seen in Tables 5.2 and 5.3 for S1 and in Tables 5.4 and 5.5 for S3, adapting the frame rate reduces the sent data by more than 90%. Then, applying

the similarity function proposed in this chapter causes the degradation of the number of sent frames by 92% from 129,600 frames to 11,041 frames. Tables 5.6,5.8 show the data reduction caused by KBA on the sensing and transmission levels.

Table 5.2: Data Reduction for S1 over 64s

Nb of Periods	All Frames	Sampled Frames	Critical Frames
64	1920	730	540

Table 5.3: Data Reduction for S1 over 720s

Nb of Periods	All Frames	Sampled Frames	Critical Frames
720	21600	1386	1196

Table 5.4: Data Reduction for S3 over 300s

Nb of Periods	All Frames	Sampled Frames	Critical Frames
304	9120	4407	3100

Table 5.5: Data Reduction for S3 over 490s

Nb of Periods	All Frames	Sampled Frames	Critical Frames
720	21600	4437	3530

Table 5.6: Number of Frames in active and passive modes for KBA approach

Sensor	P. Mode		A. Mode	
	Sensed	Transmitted	Sensed	Transmitted
S1 (64s)	656	656	730	540
S2 (64s)	658	658	788	585
S3 (304s)	430	430	4407	3100
S4 (244s)	482	482	3523	2620
S5 (64s)	650	650	760	600
S6 (0s)	720	720	0	0
Total	3596	3596	10190	7445

By comparing these numbers to the number of frames in Tables 5.9, 5.10, 5.11, 5.12, while applying PPSS algorithm, the efficiency of the KBA approach for the sensing and transmission process surpasses the PPSS algorithm. This gain grows furthermore when the time interval of the active mode of the sensor grows, as shown for sensor-node S3 when comparing the values in Table 5.5 to the values in Table 5.12. For probability reasons, the first sequence of frames for every sensor is lost in PPSS, once the intrusion opts in the FOV of the sensor node. Tables 5.6, 5.7 and 5.8 show the efficiency of KBA approach sensor by sensor and on the overall network regarding the number of sensed and transmitted frames.

As for the bottleneck issue, the bandwidth capacity is the main concern and the KBA approach decreases the use of this capacity by reducing the number of frames

Table 5.7: Number of frames in active and passive modes for PPSS Method

Sensor	P. Mode		A. Mode	
	Sensed	Transmitted	Sensed	Transmitted
S1 (60s)	0	0	1618	1618
S2 (60s)	0	0	1454	1454
S3 (300s)	0	0	6778	6778
S4 (240s)	0	0	5439	5439
S5 (60s)	0	0	1405	1405
S6 (0s)	0	0	0	0
Total	0	0	17694	17694

Table 5.8: Data Reduction on the overall Network

	All-Frames	KBA		PPSS	
		Sensed	Transmitted	Sensed	Transmitted
Total	129600	13786	11041	17694	17694

Table 5.9: Data Reduction for S1 over 60s PPSS

Nb of Periods	All Frames	Sampled Frames	Critical Frames
60	1800	1618	1618

Table 5.10: Data Reduction for S1 over 700s PPSS

Nb of Periods	All Frames	Sampled Frames	Critical Frames
700	21000	1618	1618

Table 5.11: Data Reduction for S3 over 300s PPSS

Nb of Periods	All Frames	Sampled Frames	Critical Frames
300	9000	7778	7778

Table 5.12: Data Reduction for S3 over 700s PPSS

Nb of Periods	All Frames	Sampled Frames	Critical Frames
700	21000	7778	7778

transmitted all over the network as shown in Table 5.13. Table 5.13 shows the upper hand of KBA over PPSS in the bandwidth consumption reduction.

Table 5.13: The ultimate bandwidth total reduction KBA and PPSS

Approach	Nb of Periods	All Frames	Sampled	Critical
KBA	720	2640 MB	275 MB	220 MB
PPSS	700	2520 MB	354 MB	354 MB

### 5.6.2/ ENERGY CONSUMPTION STUDY

In this section, an energy model is adopted from [57] where the radio energy for the transmission of the data on the radio and the computational energy for the in-node processing are the core of the energy consumption of every sensor node as shown in the equation below:

$$E = E_{\text{radio}} + E_{\text{comp}} \quad (5.14)$$

Table 4.18 shows the different parameters to compute the energy consumption while considering:

$I_{\text{TX}}$  and  $I_{\text{RX}}$  the electric power needed to respectively send and receive by the radio while  $T_{\text{TX}}$  and  $T_{\text{RX}}$  the respective corresponding operating times over 1 byte, and  $V$  is the constant voltage supply throughout the transmission.

$$E_{\text{radio}}(k) = kI_{\text{TX}} \cdot V \cdot T_{\text{TX}} + kI_{\text{RX}} \cdot V \cdot T_{\text{RX}} \quad (5.15)$$

Taking into account that  $k$  is the number of bytes sent from a specific sender to a specific receiver. For the computational energy consumption:

$Q_{\text{add}}$ ,  $Q_{\text{mul}}$ ,  $Q_{\text{comp}}$ ,  $Q_{\text{shft}}$  are the basic operations (shift, addition, comparison, multiplication, etc...), Table 5.14 shows the required energy for each operation. To compute this energy consumption, the number of each basic operation in the algorithm must be counted:

$$E_{\text{comp}} = N_{\text{add}} \times Q_{\text{add}} + N_{\text{shft}} \times Q_{\text{shft}} + N_{\text{mul}} \times Q_{\text{mul}} + N_{\text{comp}} \times Q_{\text{comp}} \quad (5.16)$$

Table 5.14: Parameters of the Energy Model

Parameter	Value
$I_{\text{TX}}$	17.4 mA
$I_{\text{RX}}$	19.7 mA
$T_{\text{TX}}$	$3.2 \times 10^{-5}$ s
$T_{\text{RX}}$	$3.2 \times 10^{-5}$ s
$V$	3.3 V
$I_{\text{cpu}}$	31 mA
$f_{\text{cpu}}$	48 MHz
$Q_{\text{add}}$	2.13 nJ
$Q_{\text{mul}}$	6.39 nJ
$Q_{\text{comp}}$	2.13 nJ
$Q_{\text{shft}}$	4.26 nJ

In order to compare both approaches, the two components of the energy consumption have been computed using a CC2420 radio transceiver and an ARM7TDMI micro-processor. Table 5.14 displays the parameters that are used in the calculations and which are found in the data sheets of the node's components [57].



### 5.6.3/ SENSOR NODE LEVEL

In the experiments, when running the KBA technique, 9262 frames were sensed and compared using the similarity function. For a  $640 \times 480$  frame size, 307,200 pixels exist in each frame. Each similarity takes into account all the pixels in every frame. The KBA approach consists of 1 comparison. The maximum computational energy for  $E_{\text{comp}}$  for 9,262 similarities is computed as follows:

$$E_{\text{comp}} = 13,768 \times 640 \times 480 \times Q_{\text{cmp}} \quad (5.17)$$

For KBA,  $E_{\text{comp,KBA}}=9\text{ J}$ .

For PPSS,  $E_{\text{comp,PPSS}}=0.1\text{ J}$ .

To move on to the transmission phase, using KBA, where the network transmits 11,041 frames = 220 MB, comparing to the 17,694 frames = 354 MB for PPSS.

$$E_{\text{radio,KBA}} = 423\text{ J} \quad (5.18)$$

$$E_{\text{radio,PPSS}} = 682\text{ J} \quad (5.19)$$

The total energy consumption is computed as follows:

$$E_{\text{KBA}} = E_{\text{comp,KBA}} + E_{\text{radio,KBA}} = 432\text{ J} \quad (5.20)$$

$$E_{\text{PPSS}} = E_{\text{comp,ppss}} + E_{\text{radio,ppss}} = 682\text{ J} \quad (5.21)$$

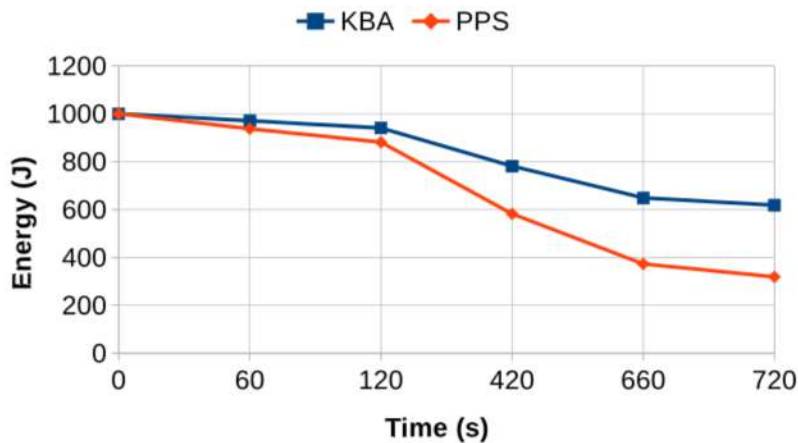

Figure 5.7: Energy consumption comparison for KBA and PPSS

Based on Figure 5.7, KBA algorithm consumes more energy on the computational level, but reduces much more energy on the transmission level. Figure 5.7 compares both approaches in terms of energy consumption on the overall network while considering a starting energy of 1,000 J for the network.

## 5.7/ CONCLUSION

In this chapter, a kinematics based approach for an adaptive frame rate with a similarity detection function for wireless video sensor nodes has been introduced. The conducted experiments show that the proposed algorithm did not miss any event in the recorded video sequence. Thus, the algorithm sends the minimum required frames to the coordinator node by using a similarity detection function at the sensor node level. The selected frames are transmitted by the sensor nodes to the coordinator without missing any required information. The results show that the size of the transmitted data in each period is reduced and the energy consumption is decreased, thus, preventing any bottleneck problem regarding the bandwidth limitation issue.

Comparing KBA approach with [9] in terms of data reduction and energy consumption, helps us to find out that KBA approach outperforms PPSS, and reduces the number of data for more than 40% than PPSS. Thus, PPSS consumes 2 times more energy than KBA.



# ENERGY-EFFICIENT SECURED DATA REDUCTION TECHNIQUE

This chapter shows the importance of security in WWSN while proposing a method to compress and reduce the data on the sensor node level. Data transmitted on the network from several sensor nodes to a coordinator must be secured. Thus, the security challenge emerges in WWSN. For data reduction, in the sensing phase, the MASRA algorithm has been adopted and adapted from the first contribution, for the transmission phase a new algorithm based on the image difference is proposed. For the security challenge, a one-round algorithm from [146] is adapted to our approach and scenario. This approach is validated by experimentations using OpenCV and C++ language on Raspberry PI 3 and by comparing it to other previous, existing approaches.

## 6.1/ INTRODUCTION

In this chapter, our main challenge is to reduce the energy consumption on the sensor node level especially the energy consumption related to the sensing and transmission processes taking into account the security issue in WWSN.

WWSN operates periodically if the sensor nodes do not detect any intrusion in the monitored area of interest. Fig 4.1 shows the architecture of WWSN, where the network can be divided into several areas composed of a certain number of sensor nodes connected to a coordinator, and different coordinators from different areas are connected to the sink. In this chapter, an approach has been proposed to reduce the energy consumption related to the sensing and transmission on the sensor node level using data reduction techniques. This approach consists of an algorithm to adapt the frame rate of every sensor node, depending on the number of critical frames transmitted from the sensor to the coordinator. The number of frames sensed by the sensor will be reduced, which leads to a direct reduction of the energy consumption for the sensing process on the sensor node level.

On the other hand, for the transmission process and after adapting the number of frames sensed by the node in every period, our aim is to continue with the data reduction technique to reduce the number of frames sent from the sensor node to the coordinator. In the same algorithm, a comparison of consecutive sensed frames is executed by comparing each frame sensed with the last frame sent. This comparison is an edge based

comparison: according to [61], we are interested in the simple image processing algorithms. Local (on-board) processing of the image data reduces the total amount of data that needs to be communicated through the network. Local processing can involve simple image processing algorithms (such as background subtraction for motion/object detection, edge detection and norm distance difference). According to a predefined threshold of similarity, the node decides whether this frame is critical and different from the last frame sent to the coordinator. In this case the number of sent images is reduced, and the energy consumption related to the transmission reduces consequently. If both frames are different, the sensor node decides to send only the different part of the new image to the coordinator (the difference image) causing a reduction of the size of the sent image and thus reduce the energy consumption furthermore. This part of the image is to be joined with the last sent image on the coordinator to rebuild the new frame.

Hence security issues are emerging nowadays in WWSN depending on the type of application. In this approach, a security algorithm is adopted from [146] to secure the data transmitted from the sensor node to the coordinator. The one-round algorithm [146] is efficient considering the low execution time needed to encrypt a frame. Thus, it does not take into account the integrity of the image.

This chapter is divided into 6 sections, section II introduces the state of the art in this specific domain while section III briefly explains the proposed method. Data Reduction technique is explained in detail in section IV. In section V, the security contribution is discussed to conclude the proposed method. Section VI presents some simulations and experimentations results to validate our approach. At the end, section VII concludes the chapter.

## 6.2/ RELATED WORK

Different techniques have been proposed in the literature to reduce energy consumption in Wireless Sensor Networks: Data Redundancy techniques [62, 97, 89, 79, 102, 111, 112], Data aggregation [102], Background subtraction [115], Geometrical criteria [92, 20, 103], Physical and Network layers approaches [40, 12] and Scheduling [62, 80, 63, 98, 28]. Data redundancy has been considered in several research work for energy reduction. A GPS module introduction to control the cameras and detect which camera is to be actuated depending on the sensor's position is presented in Akkaya et al. [79]. The overlapping approach has been studied by in Priyadarshini et al. [97] where their work eliminates redundancies by turning off some cameras and activating the optimal number of cameras according to the overlapping FOV's of different cameras. An in-network data aggregation technique at the coordinator level is proposed in [102]. This proposition by Makhoul et al. identifies similar data generated by the nearly duplicate nodes. In order to save energy, some sensors are turned off.

In order to reduce the energy consumption on the sensor node level, Akkaya et al. in [115] adopted the background subtraction (BS) and compression techniques as common data reduction schemes.

Scheduling techniques are one of the most used methods in many previous works [62, 80, 63, 98, 28]. The authors in [62] divided the region into several clusters using a clustering methodology. In each cluster, to avoid data redundancy for all overlapping cameras, a scheduling approach has been adopted in their method. Authors

In [80] divided the region according to the different risk levels of the sensor nodes to form several areas of interest. Each area has its own adaptive scheduling model. This model changes the capture speed of the node based on its risk level and environment.

Several studies tried to solve this issue by proposing physical and network layers solutions [40, 12]. In [40] a CMOS image sensor was proposed to generate two outputs, in order to differentiate between the normal image with a normal frame rate of 30 fps and the images of moving objects with an adaptable frame rate of 960 fps and over. They reconstruct the image from both outputs. This construction shows the details in stationary objects and the suppressed motion in moving objects. Frame rate is higher in the hottest region where it matters the most to detect and track any event.

In [92, 20, 103], some geometrical criterias are taken into consideration. In [92] the cover set concept and the behavior functions modeled by quadratic Bezier curves are used to help a node to find its redundancy level and to adapt the frame capture speed of video node which is related to its assigned criticality depending on its position on the network and its redundancy level. In this approach the nodes on the borders detect the intrusion in the first place, that is why a higher criticality is assigned to those node in comparison with interior nodes with lower criticality. A scheduling algorithm is proposed to control the activity of sensor nodes according to the redundancy level and criticality of each node.

Unfortunately, these studies in WMSN make all the analysis on the coordinator level, disregarding what can be done on the video-sensor level concerning the reduction in terms of energy and bandwidth consumption starting from the very first layer.

This chapter also focuses on the security challenge. Hence, a lot of previous encryption standards and algorithms are present in the literature: The asymmetric Encryption algorithms such as Elgamal [1] and Diffie-Hellman [30]. This kind of encryption is known to guarantee that the person who is receiving the public key is the person who was supposed to receive it, and so it is safe to let him/her receive the encrypted information. The symmetric encryption such as: Data Encryption Standard (DES)[55, 15], in those works the authors proposed algorithms to enhance the quality of the images based on a chaotic map where the DES block cipher is installed to increase the key space. As mentioned in [53], the huge amount of multimedia data transceived by all the modern applications can not be supported by the DES implementation. Thus, in [8] an Advanced Encryption Standard (AES) algorithm is defined to encrypt images after performing some changes on the key generation or other components. In [53] the authors modified the AES algorithm proposed in [8] in order to improve the performance in securing images. The AES encryption technique has also its disadvantages: it requires a high number of rounds which is not feasible or efficient for tiny limited sensor nodes. Thus, the one round algorithm technique proposed in [146] and adopted in our work is a simple algorithm that requires less execution time than AES and less rounds.

In this chapter, a method that detects the critical frames and send them to the coordinator is proposed. The frame rate of the video-sensors is adapted. Our approach for the sensing and transmission part on the sensor node level is inspired from our first contribution and from [64]. In our first contribution, we studied how to send only the critical frames to the coordinator by introducing a local detection system on the sensor node level. In [64], the authors proposed the ASA algorithm which consists

of changing the sampling rate after several consecutive numbers of critical values in consecutive periods. Then, to add security to the data sent to the coordinator, the one-round algorithm has been adopted from [146]. In the next section, the architecture of WWSN is briefly discussed. The proposed approach is explained in the following sections.

### 6.3/ ARCHITECTURE

WWSN as mentioned before, is divided into three main layers: The wireless video sensor nodes, the coordinator and the sink as shown in figure 6.1. Each sensor node captures the required data, in the wireless video sensor network, the frames in a video sequence is the data sensed by the sensor node. Then the sensor node transmits the data to the coordinator responsible for the area of interest. The coordinator gathers all the data from all the sensors in its area and sends it to the sink so that the team which is in charge of this field analyze it.

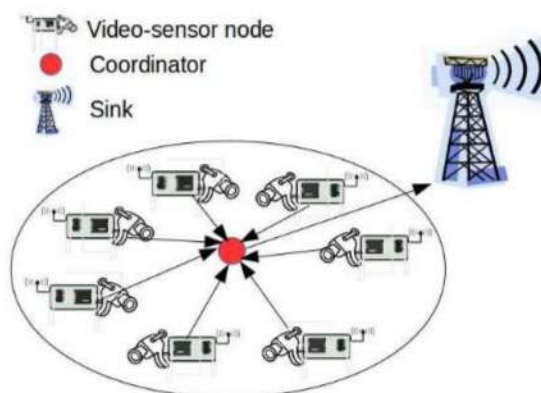

Figure 6.1: Architecture of WWSN

In a simple WSN, no algorithms are set on any level. Thus, the huge number of frames captured by several sensors in each area of interest increases the energy consumption on every sensor node especially that they have limited energy resources. By sending 15 frames per second, for a tiny sensor, this process can damage its battery quickly. In this chapter, the idea of reducing the energy consumption on the sensor-node level and the overall network is developed in its two phases: the sensing phase and the transmission phase. Then the security model for the transmitted images from the sensor-nodes to the coordinator is discussed.

### 6.4/ DATA REDUCTION AND ENERGY CONSUMPTION

In WSN, sensor-nodes operate periodically, and send a huge number of packets to the coordinator. This scenario causes the presence of the energy consumption challenge

which is the most important challenge in WSN in general. More specifically this challenge is present in WWSN because images are multimedia data of greater size than simple numerical data and the video-sensor nodes have limited energy resources. Data reduction is one of the methods to overcome this challenge. In this approach, data reduction is adopted for the sensing phase and the transmission phase on the sensor-node level. This process has a functionality to reduce the huge number of raw images sensed from the sensors, and the number of images sent by the sensors to the coordinator.

#### 6.4.1/ SENSING AND TRANSMISSION PHASES

On the video-sensor node level, an adaptation of the MASRA algorithm proposed, in our first contribution, has been suggested. This adaptation replaces the color-edge similarity method to compare two consecutive frames in MASRA with a norm simple euclidean distance similarity method to reduce the energy consumption related to transmission using the norm L2 relative error function in C++ in OpenCV. To apply this function, each image is transformed to a matrix. The frame rate adaptation technique is used to reduce the number of sensed frames on the sensing level. As shown in STAFRA (sensing and transmission adaptive frame rate algorithm) algorithm 4 The role of the similarity pattern is to detect any difference in two consecutive images sensed by the sensor-node by using a norm similarity function. If the difference between those images does not surpass a certain threshold of similarity  $sim$ , the sensor-node creates a new image called  $img\_diff$  of the same size that represents the difference between both images. To be able to create this  $img\_diff$ , the absolute images difference function  $absdiff(MATA, MATB)$  is adopted. This function is a simple operation that takes the two matrix of the compared images as parameters. It computes the absolute value of the difference for each pixel, for each channel. A difference image is generated throughout this function. The size of this new image is smaller than a full image, since it only includes the difference and not a complete image. The sent image is called critical frame in the remainder of this chapter because it means that an event is happening in the area of interest.

Hence, in our approach the number of critical frames in each period affects the frame rate of the sensor-node for the next period. If in a given period  $i$ , the number of critical frames  $nb_{cr_i}$  exceeds one of the two predefined threshold  $th_{up}$  or  $th_{down}$  the frame rate changes according to the number of critical frames in this period. Both thresholds as shown in algorithm 4 are generated based on a parameter  $d$  that represents the minimum detectable change. In this case, the frame rate of the next period  $i + 1$  is calculated as mentioned below:

$$FR = 2 \times nb_{cr_i} \quad (6.1)$$

The frame rate in the STAFRA Algorithm varies according to the criticality of the events happening in the area of interest. If no critical frames are detected in a period, the sensor node senses the first frame of every period and sends it to the coordinator as the only frame of the actual period. The period in our approach is equal to 1 second, and the initial maximal frame rate is 30 frames per second. In a non critical scenario the sensor node only captures the first frame of every period and sends it to the coordinator, neglecting the other 29 frames. Thus, this method can reduce the number of frames captured by every sensor node, and also the number of frames sent to the coordinator. This data reduction helps to reduce the energy consumption on the sensor node level by



a significant percentage presented in our experiments.

---

**Algorithm 4** Sensing and Transmission Adaptive Frame Rate Algorithm STAFRA
 

---

```

    Store the first period's critical values in  $nb_{cr}$ 
2: Set  $FR = 2 \times nb_{cr}$ 
    Set  $d$  the parameter that represents the minimum detectable change
4: Set  $th_{up} = nb_{cr} \times (1 + d/2)$ 
    Set  $th_{down} = nb_{cr} \times (1 - d/2)$ 
6: Set  $sim$  the maximum similarity needed to send the next frame
    Set  $norm.sim$  distance similarity between two frames
8: while Energy > 0 do
    for each period  $i$  do
10:   Takes first frame  $kf_0$ 
    Sends first frame  $kf_0$ 
12:   Takes frame  $kf_i$  at  $R_t$  Rate
    Compares  $kf_i$  to the latest sent frame
14:   Generates  $norm.sim$  as the dist similarity between the two frames.
    if  $norm.sim < sim$  then
16:     Generates frame the  $img\_diff$  between the 2 frames
    Sends  $img\_diff$  to the coordinator
18:      $nb_{cr_i}++$ 
    end if
20:    $i++$ 
    end for
22:  $nb_{cr_i}$  = number of critical frames in this period
    if  $nb_{cr_i} > th_{up}$  OR  $nb_{cr_i} < th_{down}$  then
24:   Set  $nb_{cr} = nb_{cr_i}$ 
    Set  $FR = 2 \times nb_{cr}$ 
26:   Set  $th_{up} = nb_{cr} \times (1 + d/2)$ 
    Set  $th_{down} = nb_{cr} \times (1 - d/2)$ 
28:   end if
    end while
  
```

---

## 6.5/ DATA SECURITY

Sending surveillance images on the network without paying attention to security purposes is not the best thing to do in WWSN. In the proposed scenario, a simple efficient and quick algorithm is needed to do the encryption. One-round algorithm is a simple cipher scheme [146], it is based on simple operations (XOR). In this algorithm, the keys are dynamically produced, based on a dynamic key that changes according to the session or the input image. As several scientists affirm that confusion and diffusion must be preserved in any encryption algorithm, the one-round algorithm guarantees the confusion and diffusion since 2 substitution boxes are used. One of the most encouraging advantages of this algorithm is that it can be adapted to simple limited devices such as raspberry pi, or sensors in wireless video sensor networks. In the following the encryption algorithm is described.

### 6.5.1/ ENCRYPTION ALGORITHM

After reducing the number and size of the data sent from the sensor nodes to the coordinator, securing the data is one of the needs in WVSNS. Thus, an energy efficient encryption algorithm must be implemented on the sensor node level. The one-round algorithm is symmetric and is based on a secret key SK shared between the sender and the receiver. As stated in [146], this key is employed with a Nonce to produce a dynamic key. This dynamic key is split to obtain four sub-keys that will be used to build the primitives of the encryption/decryption processes. This cipher is based on only one round since a dynamic key with a large size is used. In the encryption process, an input image of size  $C \times R \times P$  is divided into  $\alpha$  sub-matrices  $x_1, x_2, \dots, x_\alpha$  having a square size equal to  $h \times h$  bytes each. If the number of bytes of an image is not a multiple of  $h^2$ , a padding operation is performed to adjust the size of the last sub-matrix ( $x_\alpha$ ). In addition,  $h$  can be equal to 4, 8, 16 or 32. On the other hand, the sub-matrices number  $\alpha$  is obtained as follows:

$$\alpha = \frac{R \times C \times P}{h^2} \quad (6.2)$$

In this chapter, the size of the blocks is set to 4 to have better security noting that it was 8 in [146]. The sub-matrix selection, function  $f$ , function  $g$ , the switch operation as well as an illustration of the encryption and decryption algorithms are all used as mentioned and explained in [146].

As mentioned before, this algorithm presents a good security result with very low execution times. Algorithm 5 for encryption purposes is implemented on the sensor node's level and algorithm 6 for decryption is implemented on the coordinator's level. This work focuses more on the sensor node level behavior because it is the level where the energy consumption is the most critical. Thus, in the experimentations and simulations, the energy consumption on the sensor node level is studied based on the complexity and the time of execution of each algorithm. That is why, the decryption algorithm can be said to be disregarded in the experimentations.

---

#### Algorithm 5 One Round Encryption Algorithm.

---

```

1: START One_Round_Encryption(X)
2: for  $i = 1$  to  $\alpha$  do
3:    $x_i = X[i]$ 
4:    $y_i = X[\pi[i]]$ 
5:    $cx_i = S_2(S_1(x_i) \oplus RM_1 \oplus y_i)$ 
6:    $cy_i = S_1(S_2(y_i) \oplus RM_1 \oplus RM_2)$ 
7:    $X[i] = cx_i$ 
8:    $X[\pi[i]] = cy_i$ 
9: end for
10: END One_Round_Encryption(X)

```

---

**Algorithm 6** One round decryption Algorithm

---

```

1: START One_Round_Decryption(X)
2: for  $i = 1$  to  $\alpha$  do
3:    $c_{x_i} = X[i]$ 
4:    $c_{y_i} = X[\pi[i]]$ 
5:    $y_i = S_2^{-1}(S_1^{-1}(c_{y_i}) \oplus RM_1 \oplus RM_2)$ 
6:    $X[i] = S_1^{-1}(S_2^{-1}(c_{x_i}) \oplus RM_1 \oplus y_i)$ 
7:    $X[\pi[i]] = y_i$ 
8: end for
9: END One_Round_Decryption(X)

```

---

## 6.6/ EXPERIMENTAL RESULTS

In this section we present the simulations used to validate our technique. This part is divided into two subsections:

- Data Reduction and Energy Consumption.
- Data Security for Transmission.

In the first part, the experimentations check the data reduction based for the sensing phase on the sensor node level by adapting the frame rate according to the technique mentioned above. Then, it checks the data reduction in terms of size of the data for the transmission phase, by sending only the difference between the images. And at the end it computes the total reduction of energy consumption if the STAFRA algorithm is adopted while comparing it to the MASRA algorithm.

In the latter, as in [146], a one-round algorithm is tested first on big images (800 KB images) to check the validity of the approach. Then it is tested on the sent images from the sensor-node (raspberry pi) to the coordinator/server (laptop). Those sensed and transmitted images are of 320 x 240 pixels on RGB and compressed to jpeg images as per STAFRA algorithm before starting the security algorithm process.

For this purpose, both algorithms presented in this chapter have been tested using OpenCV and C++ language on Raspberry PI 3 connected to a nano camera to monitor the area of interest as shown in Figure 6.2.

The Raspberry PI serves as the sensor node in our network, it is wirelessly connected to an octa core i7 16 GB RAM laptop that has the coordinator's functionalities. The network in this chapter is a client server network (The Raspberry PI as a client and the laptop is the server where the images are stored). This network is described in figure 6.3, where the sensor-node is wirelessly connected to the coordinator.

In the experimentations, the initial and maximum frame rate is set to 10 frames per second for the sensor-node. The minimum FR (frame rate) in this work is 2 frames per period. A period is equal to 2 seconds which means 20 frames exist in every period. If no critical event is happening in the area of interest, the frame rate is set to its minimum,



Figure 6.2: Raspberry PI 3 and Nano Camera

sensing 2 frames per period. The frame rate varies according to the number of critical frames (sent frames) in every period. The sensor-node sends the first frame of each period to the coordinator. All the other sensed frames in the same period are compared to this frame (or the last sent frame). If those compared frames are not similar, the new frame is sent to the coordinator. In this method, the different part of this new frame is sent and not the full image. Note that every sent frame is encrypted using one-round algorithm [146]. Both algorithms are run for 60 seconds (30 periods).

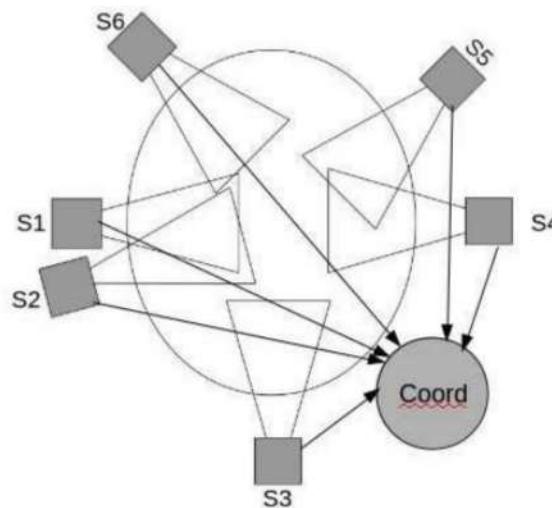

Figure 6.3: Experimental Network

### 6.6.1/ DATA REDUCTION AND ENERGY CONSUMPTION

The reduction of the energy consumption on the sensor node level can be done via several techniques, one of these techniques is data reduction on the sensing phase and on the transmission phase. Each sensor-node in a WWSN operates periodically and sends all the data sensed to the coordinator. The key to reducing the frames transmitted from the sensor to the coordinator is to send only the different frames sensed by the sensor node in each period.

### 6.6.1.1/ CRITICAL FRAMES

The critical frames are the frames that are different from the first frame in each period. To be able to specify those frames, the edge similarity in STAFRA algorithm compares the consecutive sensed images. The first sent image in the period is called the "background image" to which all the other images are compared to. The images that are sent to the coordinator are only the images that are different from this background image. In this approach, the algorithm sends the different parts of the image comparing with the background image using the absolute difference function. Instead of sending a raw image of  $320 \times 240 \times 3$  which means 230 KB, this method compresses the image into a jpeg image of 6 KB to be sent to the coordinator, and 4 KB if only the difference is sent. Tables 6.1 and 6.2 shows a comparison between sending a raw image and a jpeg image depending on the execution time of every operation on the sensor node. In Table 6.1: "sim" is the execution time of the similarity process, "compress" is the execution time for compression, "difference" represents the execution time to create the difference image and "send" is the time needed to transmit the image to the coordinator.

Table 6.1: Execution Time Comparison per Event

Type	Size	Sim	Compress	Difference	Send
Raw	230 KB	1 ms	0	0	1000 ms
JPEG	6 KB	0.7 ms	0.02 ms	0	26 ms
JPEG +DIFF	4 KB	0.7 ms	0.02 ms	4 ms	17 ms

Table 6.2: Total Execution Time Comparison

Img Type	Total Execution Time
Raw	1001 ms
JPEG	27 ms
JPEG +DIFF	22 ms

### 6.6.1.2/ FRAME RATE ADAPTATION

Different scenarios have been taken into consideration in the experimentations. The frame rate varies according to the number of sent data in the last period.

For the sensing phase, the frame rate adaptation serves to reduce the number of frames sensed per period depending on the number of critical frames sent in the previous period.

Figure 6.4 shows the adaptation of the frame rate on the sensing phase depending on the criticality of the event in the monitored area. This adaptation causes the reduction of the number of frames sensed by the sensor-node as shown in table 6.3. A data reduction of 50% is reached by adapting the Frame Rate, and another 25% are added when applying the critical frames method.

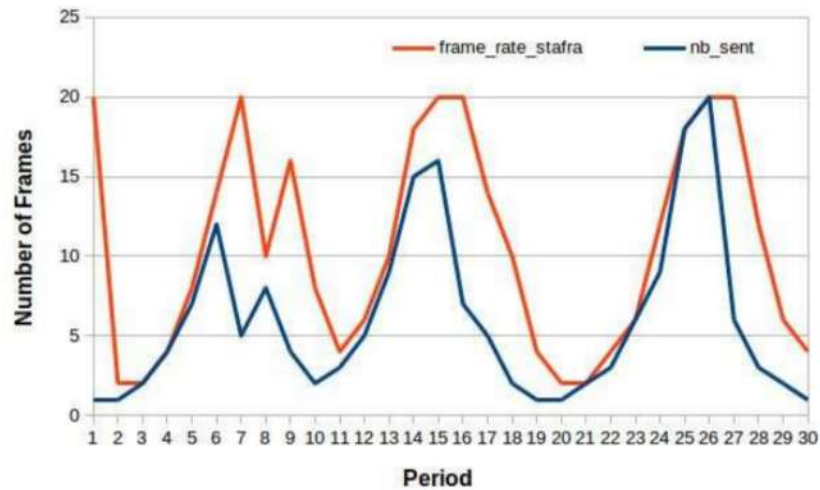

Figure 6.4: Frame Rate Adaptation

Table 6.3: Frame Rate Adaptation Data Reduction over 60 seconds

ALL	Sensed Frames	Critical Frames
600	300	170

### 6.6.1.3/ COMPARISON

This approach is compared to several other methods on the sensor node level regarding the execution time and the frame rate adaptation. For the execution time and accuracy of the similarity, this method is compared to the MASRA algorithm where the colour and edge similarities were both present to detect the difference between images. The difference between STAFRA and MASRA algorithms for the frame rate adaptation has an influence on the number of critical frames sent per period as shown in Figures 6.5 and 6.6.

The frame rate adaptation in the MASRA algorithm changes after at least two periods of intrusion detection. For this reason, some needed frames can not be captured because the frame rate is not adapted on time. It should be added that the frame rate decreases once the intrusion leaves the area.

Those two figures show the superiority of the STAFRA algorithm to change the frame rate earlier than MASRA. Thus, STAFRA has less errors while detecting and tracking the intrusion, and it resets the sensor-node to its idle mode with a FR= minimum frame rate earlier than MASRA. This process captures less frames and save energy while increasing the quality of the surveillance.

A comparison of the execution time for several approaches on the sensor node level. This comparison takes into consideration the similarity, the compression, the transmission

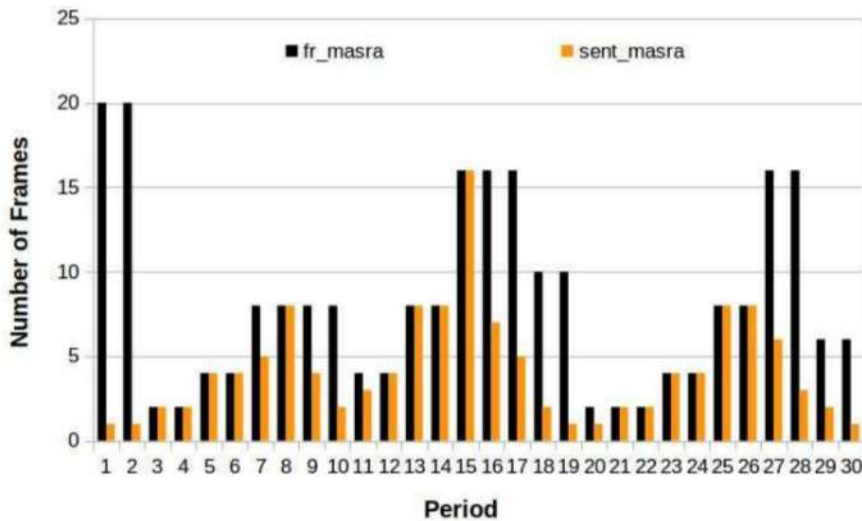

Figure 6.5: MASRA Frame Rate Adaptation and Number of Sent Frames

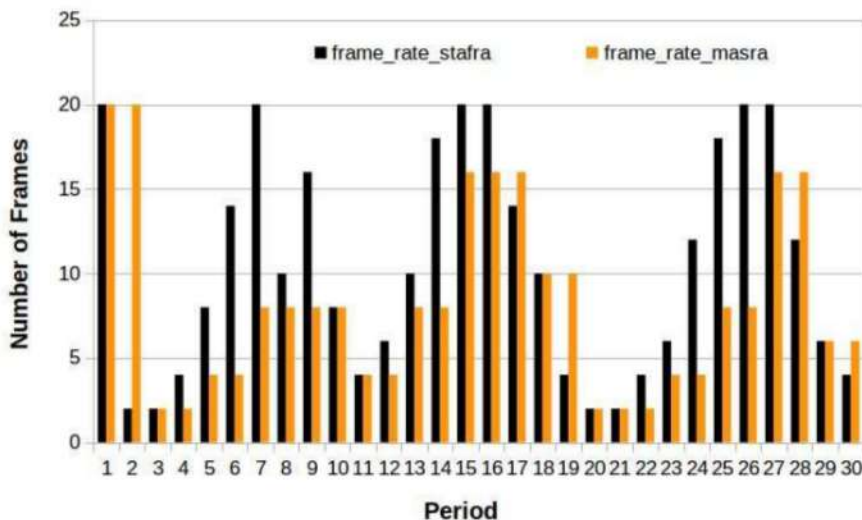

Figure 6.6: Frame Rate Adaptation Comparison

as shown in tables 6.4 and 6.5 where all the execution times are in ms. Edge similarity, color-edge similarity and Norm similarity are compared in those tables. Note that images sent using the MASRA algorithm are RAW images, but the compression of those images into jpeg images is also taken into consideration. In Table 6.4: "sim" is the execution time of the similarity process, "compr" is the execution time for compression, "Diff" represents the execution time to create the difference image and "send" is the time needed to transmit the image to the coordinator.

Tables 6.4 and 6.5 show the superiority of STAFRA algorithm and the similarity method over MASRA algorithm using the edge or the color-edge similarities. The execution time proves a gain of at least 30% when implementing STAFRA algorithm.

Table 6.4: Execution Time Comparison per Method per Function

Method	Type	Size	Sim	Compr	Diff	Send
Color-Edge	Raw	230 KB	5	0	0	1000
Edge	Raw	230 KB	3	0	0	1000
Norm	Raw	230 KB	1	0	0	1000
Color-Edge	JPEG	6 KB	4.2	0	0	26
Edge	JPEG	6 KB	2.7	0	0	26
Norm	JPEG	6 KB	0.7	0	0	26
Norm	JPEG+DIFF	4 KB	0.7	0	0.3	17

Table 6.5: Total Execution Time Comparison

Method	Img Type	Total Execution Time
Color-Edge	Raw	1005 ms
Edge	Raw	1003 ms
Norm	Raw	1001 ms
Color-Edge	JPEG	30 ms
Edge	JPEG	29 ms
Norm	JPEG	26 ms
Norm	JPEG+DIFF	18 ms

### 6.6.2/ DATA SECURITY FOR TRANSMISSION

As discussed in this chapter, securizing the data transmitted on the network is one of the important issues in WMSN. To secure the frames on the sensor node level, the one round algorithm is implemented. In the table below, the difference of the execution time of this algorithm is presented with different image types.

Table 6.6: One Round Algorithm Execution Time

Method	Img Type	Execution Time
One_round	Raw	500 ms
One_round	JPEG	15 ms
One_round	JPEG+DIFF	10 ms

As shown above in table 6.6, the execution time for the One-Round algorithm for the difference image sent from the sensor node to the coordinator, costs 10 ms. By adding the 18 ms needed for all the functions mentioned in the section above, 28 ms are needed to compute and send the image from the sensor node to the coordinator. Referring to table 6.5, this execution time remains better than execution times of other approaches without applying the security algorithm to enhance the security on the network.

Figures 6.7,6.8,6.9 show the validity of the security algorithm and how the frame can be retrieved on the coordinator using the decryption algorithm.





Figure 6.7: The Original Frame

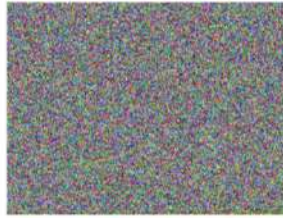

Figure 6.8: The Encrypted Frame



Figure 6.9: The Decrypted Frame

## 6.7/ CONCLUSION

In this chapter, a new data reduction, adaptive frame rate algorithm STAFRA is presented to adapt the frame rate of each sensor node according to the event happening in the area of interest. This adaptation leads to reduce the number of sensed frames on the sensor node level. Thus, it reduces the energy consumption needed for the sensing process. The data reduction algorithm adds a comparison between frames with the last frame sent, if both images are similar, the second one is not sent to the coordinator. In case the second image is different, it is not sent in total to the coordinator, instead the difference between the two images is sent as an image of the same size. The difference image is 30% smaller than the original image. This functionality reduces the energy consumption for the transmission process on the sensor node level by reducing the number and the size of the images sent to the coordinator.

As for the security manner, our algorithm offers the security required for the network, while maintaining a low execution time and low energy consumption on the sensor node level.

## ENHANCED S-MAC PROTOCOL FOR EARLY REACTION AND DETECTION

Sending images at the same time from different sensor nodes to a coordinator causes several problems. Besides energy consumption and bandwidth usage that represent the two major challenges in WSN, the queue of images on the coordinator can cause slower detection of intrusions and thus slower reaction from the coordinator which does not guarantee the QoS functionality. These reasons increase the need of a mac-layer protocol to control the network. In this chapter, We propose a new modified communication protocol based on the S-MAC protocol. This solution consists of adding a priority bit to the S-MAC protocol. Our approach is validated by experimentation using Raspberry PI 3 and by simulation in OMNET++.

### 7.1/ INTRODUCTION

Several communication protocols have been proposed in order to organize the WWSN, taking into account the energy consumption to extend the life of the network. Numerous MAC protocols for wireless sensor networks adopt "duty cycle" operation to save energy (S-MAC, T-MAC, B-MAC, X-MAC, WiseMAC, RIMAC, ContikiMAC, ...) [119],[37] while organizing the network. In fact, our work focuses on the transmission of images in a multimedia WSN under the constraint of limited energy. In any proposed scenario, the surveillance remains the most important criteria in our study, such as how to detect an intrusion on the sensor and coordinator levels and how to react accordingly. A bibliographic study of WSN, MAC layer protocols is given. A newer version of S-MAC protocol is developed in this chapter. The main objective of our work is to look for the possibility to improve the performance of the sensor network for a better surveillance system.

This chapter is divided into 3 sections, the first introduces the state of the art in this specific domain, the second explains in detail the proposed improvements and the third represents the different results obtained.

## 7.2/ RELATED WORK

In this section, several works from the literature working on the MAC-Layer protocol domain in WSN have been exploited.

Different categories of MAC Protocols can be found in the literature: Asynchronous, Synchronous and Hybrid schemes [94], [69], [75].

If the asynchronous schemes are adopted, every sensor becomes autonomous regarding its state (idle or active), so a wake up call is integrated in every sensor node to switch between active and sleeping states. It is defined by a specific MAC-Protocol applied in the network such as B-MAC [17], X-MAC [29], RI-MAC [51] and PW-MAC [84].

The synchronous category is divided into two sections, the locally synchronized and the globally synchronized [94]. S-MAC [19] and T-MAC [13] are two locally synchronized MAC-protocols that also adopt the duty cycling. Nodes are allowed to turn off their radio transmission module when no communication occurs during a certain time period to save energy related to transmission [119]. In the synchronous MAC-Protocols, all the neighboring nodes in a cluster wake up at the same time, which reflects the main difference with the asynchronous ones.

I-MAC [18] and Tree-MAC [60] are globally synchronized frame slotted MACs. They use the time-slot technique, dividing time into time slots and assigning time slots to nodes. The main problem of synchronized MACs is the high control overhead due to the synchronization of the network.

Several MAC-Protocols were designed to be QoS-aware (Quality of Service) for WSNs like in real time applications such as Q-MAC [24], PQ-MAC [59], RL-MAC [33] and CoSens [90]. To ensure a certain level of QoS by the application, additional challenges are imposed. Thus, flexibility and dynamicity are needed to react if any changes occur in the network [119] [85].

None of the above protocols takes into account the case when a critical frame is detected on a sensor node. This frame must have priority over all the other frames in the coordinator's queue for quicker detection and reaction from the coordinator. In our approach, we are interested in adding a bit for criticality in the S-MAC protocol to be able to detect directly if the frame/image is critical or not. If the frame is critical, the protocol considers it has priority in the process over a non critical frame on the network. For data reduction in our approach, MASRA algorithm has been used. Sensor nodes are usually scattered in a capture area. Each of these nodes has the ability to collect data and route them to one or more coordinator nodes. The latter is a collection point for captured data. It can communicate the collected data to the end user through a communication network, possibly the Internet. Users can in turn use the base station as a gateway, in order to transmit their requests to the network. The coordinator plays a key part when an intrusion is detected by one of its sensors. Its role is to react quickly so as not to miss any information about this intrusion (increasing the frame rate of the sensors, alerting the monitoring team ...).

## 7.3/ MASRA ALGORITHM

In this section, we present a brief overview about the MASRA (Multimedia Adaptive Sampling Rate Algorithm) algorithm where the network and sensor-nodes operate periodically

and how it can be adapted to resolve the delay problem. In our approach, the MASRA algorithm is used for data reduction on the sensor node level while sensing and transmitting data to the coordinator. In this algorithm, the frame rate of every video sensor-node varies in accordance with the number of critical frames sent all over a period. This frame rate increases when the number of critical frames increases and is set to a minimum of 1 FR/s in the passive state when there is no intrusion in the FOV (Field of View) of the sensor. Each sensor only sends the different frames to the coordinator depending on a color-edge similarity approach and a threshold of similarity. This approach helps reducing the data sensed and transmitted by the sensor nodes and thus reduces the energy consumption by more than 80%. In the passive time, when the frame rate is equal to 1 FR/s, each sensor sends the first frame of each period. A problem can occur in the passive sequence, if a zone of interest includes 200 sensor-nodes, and the 200<sup>th</sup> sensor node detects an intrusion, this frame must be sent to the coordinator. It must wait in the queue of the coordinator so the 199 other first frames of the 199 other sensors get processed by the coordinator with a minimum of 50 ms for every frame. This problem leaves a gap of 5 seconds before a reaction from the coordinator. 10 seconds of non reaction can help an intrusion whose speed is 20 m/s to riffle around 200 meters in the area of interest. To solve this problem, the critical frames must have a certain priority bit/flag to be processed before all the non critical frames.

## 7.4/ THEORETICAL APPROACH

The S-MAC (Sensor MAC) protocol is based on the CSMA / CA (Carrier sense multiple access) method. It uses the RTS / CTS (Request to Send / Clear to Send) mechanism to deal with the problem of hidden nodes. S-MAC introduces a period of activity and standby as shown in Fig 7.1. Nodes must be synchronized in order to communicate. To do this, the nodes are organized in virtual clusters. Each node periodically broadcasts its scheduling program (its sleep and activity period) in a SYNC packet to other nodes in the same cluster. If a node belongs to two clusters, it must make a compromise between the two scheduling programs. S-MAC uses the concept of message passing, which allows fragments of a long message to be sent in a burst. As in the case of IEEE 802.11, the duration of the transmission is known by the NAV (Network Allocation Vector) which is included in the RTS and CTS control packets. S-MAC adds the duration of the remaining transmission in each fragment and in each ACK, this will allow the nodes that wake up in the middle of the transmission to return to the sleep state.

Several advantages emerge by adopting the S-MAC protocol:

- The loss of energy caused by listening to the free channel is reduced by the standby cycle.
- The protocol is simple.

### 7.4.1/ ORDERING TECHNIQUE

The communication between two nodes is characterized by the sending of signals: RTS and CTS indicating that a node has data to send (RTS: Ready to send / CTS: Clear to

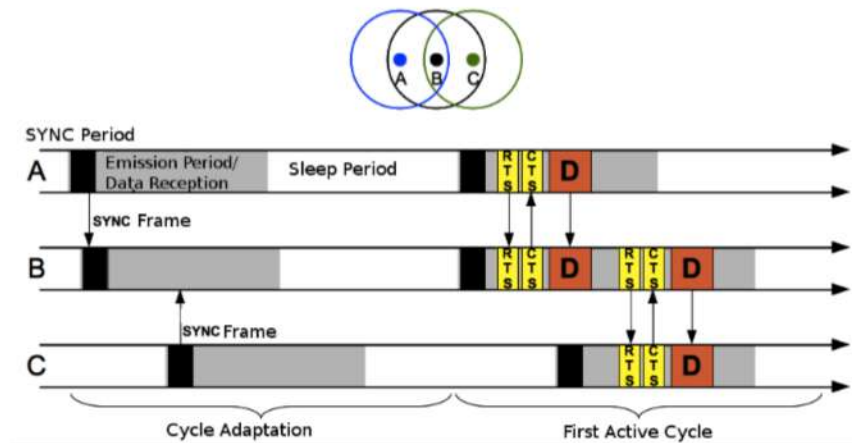

Figure 7.1: S-MAC Period of activity and standby

Send) and that a node is ready to receive.

1. Each node chooses its active and inactive periods according to its neighbors.
2. The first node to start is the only one freely choosing its periods, and then periodically announces its periods by sending synchronization signals (SYNC) during a dedicated period (at the beginning of the active period).
3. The other nodes will adapt their own periods to those announced by the previous nodes. This adaptation mechanism is called "adaptive listening".
4. In Fig 7.1 Node B, the last one to start the "adaptive listening", adapts its active period to that of its neighbours A and C.
5. In Fig 7.1, we assume node B is the last one to send its first frame of the period to the coordinator in the idle mode (Frame Rate = 1 FR/s). Each node (A and C) has sent a frame to the coordinator before B. The frame sent by B must wait for the coordinator to process the other 2 frames the wait time (delay) is given as follow:

$$t_w = n \times t_p \quad (7.1)$$

Where  $t_w$  is the wait time (delay),  $n$  the number of frames to wait for and  $t_p$  the time needed by the coordinator to process one frame.

#### 7.4.2/ PROPOSED ORDER

A WWSN designed for image transmission is considered by modifying the S-MAC protocol to introduce a priority bit relating to the criticality of the monitored event. These critical data are selected by priority bit of the Beacon band. By this procedure, the source node resides in idle mode and this will decrease the power consumption. Thus, if the priority bit is set to 0, the data sent is critical and should be processed in the first place on the coordinator. Otherwise, the data is not critical and can wait normally in the queue of the coordinator.

Fig 7.2 shows the frame format for the S-MAC protocol. Adding the priority bit in the beacon frame of S-MAC protocol, helps to detect the critical data at the reception of

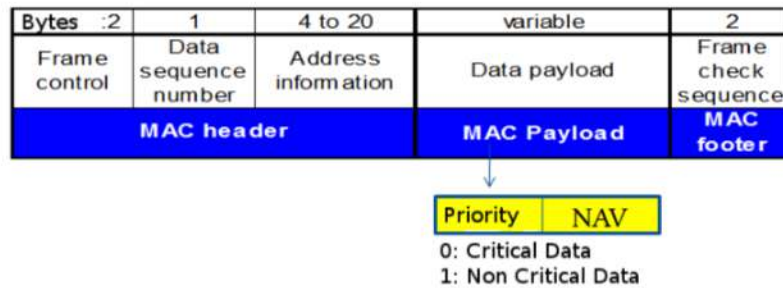

Figure 7.2: Frame Format

the packet. The coordinator can easily process the critical packets before the non critical ones, which can lead to quicker reactions and energy savings due to the organization of the network.

## 7.5/ CONCEPTUAL ANALYSIS

In this part the conceptual analysis and the theoretical approach are explained. The different steps of the simulation are presented.

### 7.5.1/ SCENARIO: IMPLEMENTATION OF THE PRIORITY-SMAC PROTOCOL

Let's consider a WSN in star topology consisting of a coordinator as a central unit and 5 sensor-nodes (OMNeT++).

Step 1: Configuration Phase - All Sensor Nodes are ready to transmit their data to the destination node. Before that, they add a tag frame with data packets and the priority bit of this tag frame is decided in the following steps.

Step 2: At the source node - Multiple nodes transmit their data by setting their priority bit to 0 or 1. If the data is more critical, the priority bit is set to 0, otherwise less critical data are sent and the priority bit is set to 1. Criticality is determined based on the MASRA similarity approach.

Step 3: At the receiving node: according to the beacon frame priority bit: If higher priority data are obtained, these data are sent on the queue. The receiver notifies the transmitter having the highest priority with a beacon frame and the latter transmits the data. The receiver node, coordinator, in our work is a dual core 2 GB Ram PC. It is 4 times more powerful than a Raspberry PI 3 which can be used as the sensor node where a camera can be installed. This coordinator, applies the simplest algorithm just to save the images/frames on the HDD (hard disk drive). This process, to save an image, takes 50 ms, so  $t_p=50$  ms.

## 7.6/ EXPERIMENTAL RESULTS

This section consists in the presentation of our experimentations and simulations that were undertaken to validate our technique.

## 7.6.1/ REAL EXPERIMENTATIONS

Our network is described in figure 7.3, every sensor-node is connected directly to a coordinator. In this work, the MAC-Layer protocol is the IEEE 802.11 for the communication between the sensor nodes and the coordinator. 6 raspberry pi of the 3<sup>rd</sup> generation represent the sensor nodes, and a core 2 duo 2.0 GHz 2 GB RAM PC serves as the coordinator. C++ language on Open CV has been used to configure and program the raspberry pi. The images in our experimentations are color images of 23 KB and  $240 \times 320$  each. The MASRA algorithm was implemented on every Raspberry PI 3 for data reduction on the sensing and transmission phases on the sensor node level to reduce the energy consumption. The network operates periodically, every sensor sends the first frame of every period when no intrusion is detected. In this approach, a period is equal to 1 second. The maximum frame rate for the nodes is 15 FR/s (Frames per second), and the minimum frame rate that should be adopted when on idle mode (no intrusion) is 1 FR/s.

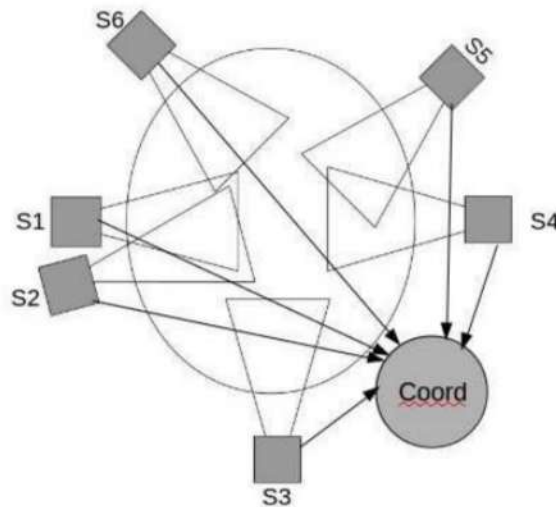

Figure 7.3: Experimental Network

On the coordinator (pc), a simple algorithm to save the images on the HDD is adopted. It does not need any exceptional processing. During the idle phase, when all the nodes have a Frame Rate  $FR = 1$  frame per second, they send the first frame of every period, the coordinator receives 6 frames at the same time. Saving an image on the HDD is taking  $t_p = 50$  ms (if an algorithm is implemented on the coordinator this delay increases directly). To save the 6<sup>th</sup> frame sent from S6, we should wait  $t_w = 5 \times t_p = 250$  ms to save the other five frames before saving the 6<sup>th</sup>.

This delay causes a late detection of an intrusion while on the idle mode (Frame Rate = 1 FR/s) before increasing the frame rate of the sensors. A late detection on the coordinator causes a late reaction from the coordinator.

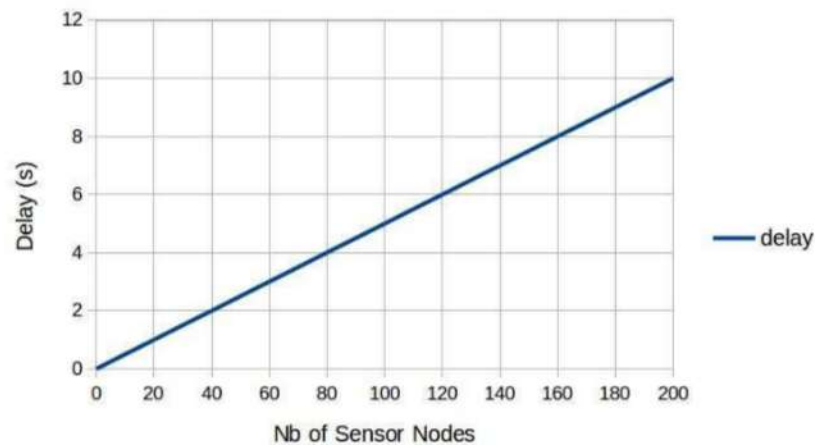

Figure 7.4: The Correlation Between the Delay and the Number of Sensors

Figure 7.4 shows the effect of the number of sensor-nodes in an area of interest on the delay. This delay can reach a maximum of 10 seconds ( $t_w = 200 \times t_p$ ) if the area of interest is constituted of 200 sensor-nodes and the 200<sup>th</sup> sensor detects the intrusion in the first place. For an average walking speed of 5 km/h, a distance of 14 meters can be covered by the walking person without any reaction from the coordinator (alerting other sensors, alerting the team in charge of the network, ...). The relation between different speeds of intrusions and non reactable distances are shown in table 7.1.

Table 7.1: Non Reactable Distance Depending on the Speed of the Intrusion

Event	Speed (km/h)	Delay (s)	Distance (m)
Walking	5	10	14
Biking	15	10	42
Low Speed Vehicule	40	10	111
Medium Speed Vehicule	60	10	167
High Speed Vehicule	80	10	223

To avoid this delay, our approach seeks to add a priority parameter for the S-MAC protocol as mentioned in the theoretical part of this chapter. This priority parameter prevents the delay on the coordinator level, the first frame with a priority 0 will be processed directly before all the other frames. If any algorithm for the reaction is there, the coordinator will react accordingly without waiting in the queue. For this purpose, Castalia and INET simulators were used for sensor networks, both simulators are based on the OMNeT++ platform.

### 7.6.2/ NETWORK DEVELOPMENT

In order to implement the network both frameworks were used to access the different modules as shown in figure 7.5. On the one hand the battery module in INET to calculate the energy and the creation of the sensor node as the central node. On the other hand, the priority SMAC protocol is integrated in Castalia. Our network has been initialized using Star Topology. The size of each packet in the simulations is equal to 23 KB.



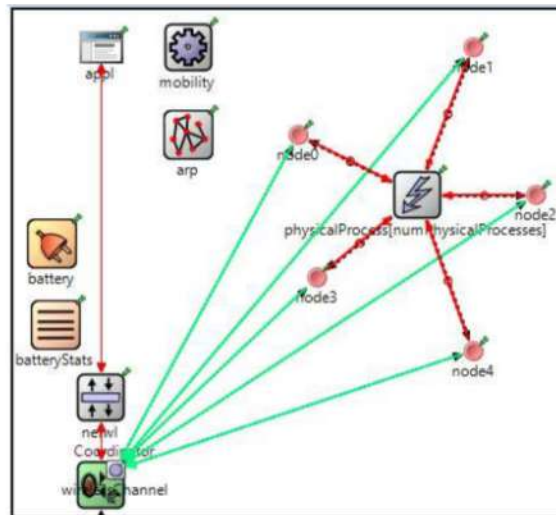

Figure 7.5: Network development using Castalia and INET

Every node is composed of different modules: resource manager, communication, sensing, application.

### 7.6.3/ DELAY SOLUTION

By studying the frames sent from the 5<sup>th</sup> sensor (node4), the delay before being processed by the coordinator is close to 5 ms when the packet has a priority bit = 0 (critical frame), which is not the case if the priority bit is not added (delay=250 ms).

## 7.7/ CONCLUSION

In this chapter, the issue at stake is how to save energy by using MASRA algorithm while detecting the intrusion on the coordinator quicker than usual by adapting the S-MAC protocol used for sensor networks. The enhancement of the S-MAC protocol removes the delay on the queue for the critical frames. The first critical frame on the network on the idle mode must be processed in the first place on the coordinator without any delay. This delay can cause the slower detection of an intrusion on the coordinator level, it leads to a slower reaction by the coordinator. In other words, the delay weakens and affects the surveillance system negatively. Energy consumption in sensor networks is a constraint that has changed many considerations for these networks. This chapter focuses on the applications of WSN using the imagery and the difficulties generated by the latter because of the large amount of data contained in the representation of an image. As a result, first it was found that the energy consumption is reduced on the sensing phase and the transmission phase, and the delay is totally removed from the queue of the coordinator once the first critical frame is detected. Those results validate our priority SMAC protocol for better surveillance, quicker detection and quicker reaction on the coordinator level.



## CONCLUSION AND PERSPECTIVES



## GENERAL CONCLUSION

Recently, Wireless Video Sensor Networks (WVSNs) have been one of the most used technologies for surveillance, event tracking, nature catastrophe and other sudden events. Wireless Video Sensor Networks (WVSNs) are composed of small embedded video and camera nodes capable of extracting the surrounding environmental information. A WVSN is divided into 3 different layers: the video sensor-node layer, the coordinator layer and the sink. The sensor nodes locally process the information and then wirelessly transmit it to the coordinator and to the sink to be further processed and analyzed. In a normal scenario, the load of collected images and videos from different sensor nodes on the same network is huge. As a consequence, more abundant videos and images data are collected. In such densely deployed networks, the problem of data redundancy arises when information are gathered from neighboring nodes. Sending all the images from all the sensor nodes to the coordinator consumes a lot of energy on every sensor, and may cause a bottleneck. Hence, several challenges appear in such a densely deployed system. The huge energy consumption problem for capturing, processing and transmitting several images on the network is the leading challenge in WVSN based on the limited energy resources of the video sensor nodes. It is not the only challenge. Data transmitted on the network from several sensor nodes to a coordinator must be secured. Thus, the security challenge emerges in WVSN. Besides energy consumption, bandwidth usage and security challenges in WSN, the queue of images on the coordinator can cause slower detection of intrusions and thus slower reaction from the coordinator because of the big amount of data sent at the same time from different sensors to the coordinator. In this thesis, to overcome those problems, several contributions have been proposed. Each contribution solves one or two challenges as follows:

(A) To overcome the energy consumption and bandwidth usage problems, two contributions have been proposed based on data aggregation for data reduction, which is essential to be cost-efficient:

- In the first contribution, we propose a new approach for data aggregation in WVSN based on images and shot similarity functions. It is deployed on two levels: the video-sensor node level and the coordinator level. At the sensor node level the proposed algorithms aim at reducing the number of frames sensed by the sensor nodes and sent to the coordinator. At the coordinator level, after receiving shots from different neighbouring sensor nodes, the similarity between these shots is computed to eliminate redundancies and to only send the frames which meet a certain condition to the sink. The similarity between shots is evaluated based on their color, edge

and motion information. We evaluate this approach on a live scenario and compare the results with another approach from the literature in terms of data reduction and energy consumption. The results show that the two approaches ensure data reduction to reduce the energy consumption. Our approach tends to overcome the other one in terms of energy-efficiency related to sensing and transmission while guaranteeing the detection of all the critical events at the node and the coordinator levels.

- In the second contribution, some processing and analysis are added based on the similarity between frames on the sensor-node level to send only the important frames to the coordinator. Kinematic functions are defined to predict the next step of the intrusion and to schedule the monitoring system accordingly. Compared to a fully scheduling approach based on predictions, this approach minimizes the transmission on the network. Thus, it reduces the energy consumption and the possibility of any bottleneck while guaranteeing the detection of all the critical events at the sensor-node level as shown in the experiments.

(B) In the third contribution, data reduction is also taken into consideration to reduce energy and bandwidth consumption on the network. On the transmission phase on the sensor-node level, a new algorithm based on the image difference is proposed. This contribution also takes into account the security challenge by adopting the one-round, a ciphering algorithm, on the sensor node level. This algorithm helps to secure the data sent from every sensor to the coordinator. This approach is validated by experimentation using OpenCV and C++ language on Raspberry PI 3 and by comparing it to other previous, existing approaches.

(C) In the last contribution in this thesis, the queue of images on the coordinator can cause slower detection of intrusions leading into slower reaction from the coordinator, that is why a mac-layer protocol based on S-MAC protocol has been proposed to control the network. We propose a new modified communication protocol based on the S-MAC protocol. This solution consists of adding a priority bit to the S-MAC protocol. Our approach is validated by experimentation using Raspberry PI 3 and by simulation in OMNET++.

## 8.1/ PERSPECTIVES

In our work, we have concentrated on implementing different energy-efficient algorithms that deal with one type of multimedia data, specifically image content. In this context, we have proposed several data reduction approaches that take into consideration the special characteristics of images as well as the different requirements of the wireless video sensor networks in the targeted applications.

The first data reduction technique is two-fold: A frame rate adaptation scheme and a critical based transmission process based on a pixel by pixel similarity function. However, further analysis and studies should be made concerning the complexity and processing resources required by the similarity function. This matter, indeed, has an effect on the energy consumed by the sensor nodes to process the algorithm. An optimization of this function or other existing algorithms could be tested and compared to our proposed technique to find the best trade off between event detection and the network's lifetime.

Second, an intrusion detection and monitoring management approach for the WWSN was proposed. The purpose of the monitoring management is to extend the network's lifetime by performing data reduction on the sensor node level. In this approach neighbouring sensor nodes capture and send the frames of the same scene to the coordinator. This can lead to redundant information and waste of energy on the limited resources video sensor nodes. Thus, a technique can be proposed to deal with this issue. For example, the coordinator managing this area of interest can put neighbouring nodes on idle or active modes based on the background image and disparity map comparison. This complementary approach sounds robust to extend this work. We are somehow worried about the real experimentations of this method on real sensor nodes. A lot of functions needed to be implemented on the processing level on the sensor node. A network of some Raspberry PI 3 would do the job but this technique needs some optimization concerning its complexity.

Additionally, concerning the image compression technique proposed in the third contribution, it would be very interesting if we continue this work by adding an energy-efficient algorithm on the coordinator to rebuild each new image after the decryption. It needs to combine the last background image with the new difference image.

The work that has been done in this thesis opens up various perspectives in different research domains. For instance, smart cities are currently a hot topic. They include safety and security solution by employing wireless video sensor networks for surveillance. The monitored scene in a city is characterized by continuous movements which leads to decrease the network's lifetime due to continuous sensing and transmission by all the sensor nodes. How can data reduction be ensured in those types of networks without compromising the safety and security requirements? First, one solution involves using object and face recognition techniques in order to launch critical transmission at the sensor node based on the predefined intrusion event of interest. Second, in those types of networks multiple intrusions are detected at the same time which causes a big challenge to our previously proposed approaches.

Big data is generated in this system. The big data can be useful in multiple applications using artificial intelligence, such as: traffic monitoring statistics all over the week, tracking homeless people, by applying some machine learning techniques. Depending on object and face recognition techniques, this big data can help furthermore to detect and recognize criminals, and thus, decrease the crime rate in the city.



# PUBLICATIONS

## JOURNAL PAPERS

- Christian Salim, Abdallah Makhoul, Rony Darazi, and Raphaël Couturier. "Similarity based image selection with frame rate adaptation and local event detection in wireless video sensor networks". In **Multimedia Tools and Applications (2018)**. pages: 1-27.
- Carol Habib, Abdallah Makhoul, Rony Darazi and Christian Salim. "Self-Adaptive Data Collection and Fusion for Health Monitoring Based on Body Sensor Networks". In **IEEE Transactions on Industrial Informatics**, Volume 12 (6), pages: 2342-2352, December 2016.

## CONFERENCE PAPERS

- Christian Salim, Abdallah Makhoul, Rony Darazi and Raphaël Couturier. "Kinematics Based Approach for Data Reduction in Wireless Video Sensor Networks". In **2018 IEEE 14th International Conference on Wireless and Mobile Computing, Networking and Communications (WiMob)**, Accepted in August 2018.
- Christian Salim, Amani Srour, Rony Darazi, Abdallah Makhoul, and Raphaël Couturier. "Enhanced S-MAC Protocol for Early Reaction and Detection in Wireless Video Sensor Networks". In **2018 17th International Symposium on Parallel and Distributed Computing (ISPDC)**, pages: 33-37, June 2018.
- Christian Salim, Abdallah Makhoul, Rony Darazi and Raphaël Couturier. "Combining frame rate adaptation and similarity detection for video sensor nodes in Wireless Multimedia Sensor Networks". In **Wireless Communications and Mobile Computing Conference (IWCMC)**, pages: 327-332. IEEE, 2016.
- Christian Salim, Abdallah Makhoul, Rony Darazi and Raphaël Couturier. "Adaptive sampling algorithms with local emergency detection for energy saving in wireless body sensor networks". In **Network Operations and Management Symposium (NOMS)**, IEEE/IFIP, pages. 745-749. IEEE, 2016.

## SUBMITTED PAPERS

- Christian Salim, Abdallah Makhoul and Raphaël Couturier. "Energy-Efficient Secured Data Reduction Technique using Image Difference Function in Wireless Video Sensor Networks". In **Multimedia Tools and Applications**. Submitted in October 2018.





# BIBLIOGRAPHY

- [1] ELGAMAL, T. **A public key cryptosystem and a signature scheme based on discrete logarithms**. IEEE Transactions on Information Theory 31, 4 (Jul 1985), 469–472.
- [2] CANNY, J. **A computational approach to edge detection**. IEEE Transactions on Pattern Analysis and Machine Intelligence PAMI-8, 6 (1986), 679–698.
- [3] STRICKER, M. A., AND ORENKO, M. **Similarity of color images**. Proc. SPIE 2420 (1995), 381–392.
- [4] SAHASRABUDHE, N., WEST, J. E., MACHIRAJU, R., AND JANUS, M. **Structured spatial domain image and data comparison metrics**. 97–515.
- [5] NGUYEN, H. T., WORRING, M., AND DEV, A. **Detection of moving objects in video using a robust motion similarity measure**. IEEE Trans on Image Processing (2000), 1 – 4.
- [6] FENG, W.-C., WALPOLE, J., PU, C., AND FENG, W.-C. **Moving towards massively scalable video-based sensor networks**.
- [7] MANJESHWAR, A., AND AGRAWAL, D. P. **Teen: a routing protocol for enhanced efficiency in wireless sensor networks**. In Proceedings 15th International Parallel and Distributed Processing Symposium. IPDPS 2001 (April 2001), pp. 2009–2015.
- [8] DAEMEN, J., AND RIJMEN, V. **Aes - the advanced encryption standard**. The Design of Rijndael 1, 1 (2002), 1–238.
- [9] ELSON, J., GIROD, L., AND ESTRIN, D. **Fine-grained network time synchronization using reference broadcasts**. SIGOPS Operating System Rev. (2002), 147–163.
- [10] HE, T., STANKOVIC, J. A., LU, C., AND ABDELZAHER, T. **Speed: a stateless protocol for real-time communication in sensor networks**. In 23rd International Conference on Distributed Computing Systems, 2003. Proceedings. (May 2003), pp. 46–55.
- [11] PRIETO, M. S., AND ALLEN, A. R. **A similarity metric for edge images**. IEEE TRANSACTIONS ON PATTERN ANALYSIS AND MACHINE INTELLIGENCE 25, 10 (2003).
- [12] STEWART, R., TRAHAN, K., CHESAVAGE, D., CASEY, S., ROME, M., AND KOKINAKES, C. **Surveillance system and method with adaptive frame rate**. Patent Application Publication 21 (2003), 234–241.

- [13] VAN DAM, T., AND LANGENDOEN, K. **An adaptive energy-efficient mac protocol for wireless sensor networks**. In Proceedings of the 1st International Conference on Embedded Networked Sensor Systems (New York, NY, USA, 2003), SenSys '03, ACM, pp. 171–180.
- [14] GUPTA, R., AND DAS, S. **Tracking moving targets in a smart sensor network**. in proceedings of the 58th IEEE Vehicular Technology Conference (2004).
- [15] HEMME, L. **A differential fault attack against early rounds of (triple-)des**. In Cryptographic Hardware and Embedded Systems - CHES 2004 (2004), M. Joye and J.-J. Quisquater, Eds., Springer Berlin Heidelberg, pp. 254–267.
- [16] HUANG, C.-F., TSENG, Y.-C., AND LO, L.-C. **The coverage problem in three-dimensional wireless sensor networks**. In Global Telecommunications Conference, 2004. GLOBECOM'04. IEEE (Nov 2004), vol. 5, pp. 3182–3186 Vol.5.
- [17] POLASTRE, J., HILL, J., AND CULLER, D. **Versatile low power media access for wireless sensor networks**. In Proceedings of the 2Nd International Conference on Embedded Networked Sensor Systems (New York, NY, USA, 2004), SenSys '04, ACM, pp. 95–107.
- [18] VAN HOESEL, L., AND HAVINGA, P. **A Lightweight Medium Access Protocol (LMAC) for Wireless Sensor Networks: Reducing Preamble Transmissions and Transceiver State Switches**. Society of Instrument and Control Engineers (SICE), 2004, pp. 205–208.
- [19] YE, W., HEIDEMANN, J., AND ESTRIN, D. **Medium access control with coordinated adaptive sleeping for wireless sensor networks**. IEEE/ACM Trans. Netw. 12, 3 (June 2004), 493–506.
- [20] BENBERNOU, S., MAKHOUL, A., HACID, M., AND MOSTEFAOUI, A. **A spatio-temporal adaptation model for multimedia presentations**. ISM (2005), 143–150.
- [21] FENG, W.-C., KAISER, E., FENG, W. C., AND BAILLIF, M. L. **Panoptes: Scalable low-power video sensor networking technologies**. ACM Trans. Multimedia Comput. Commun. Appl. 1, 2 (May 2005), 151–167.
- [22] GUPTA, I., RIORDAN, D., AND SAMPALLI, S. **Cluster-head election using fuzzy logic for wireless sensor networks**. In 3rd Annual Communication Networks and Services Research Conference (CNSR'05) (May 2005), pp. 255–260.
- [23] HUANG, C.-F., AND TSENG, Y.-C. **The coverage problem in a wireless sensor network**. Mobile Networks and Applications 10, 4 (Aug 2005), 519–528.
- [24] LIU, Y., ELHANANY, I., AND QI, H. **An energy-efficient qos-aware media access control protocol for wireless sensor networks**. In IEEE International Conference on Mobile Adhoc and Sensor Systems Conference, 2005. (Nov 2005), pp. 3 pp.–191.
- [25] RAHIMI, M., BAER, R., IROEZI, O. I., GARCIA, J. C., WARRIOR, J., ESTRIN, D., AND SRIVASTAVA, M. **Cyclops: In situ image sensing and interpretation in wireless sensor networks**. In Proceedings of the 3rd International Conference on Embedded Networked Sensor Systems (2005), SenSys '05, ACM, pp. 192–204.

- [26] RASHEED, Z., AND SHAH, M. **Detection and representation of scenes in videos.** *IEEE Transactions on Multimedia* 7 (2005), 1097–1105.
- [27] SORO, S., AND HEINZELMAN, W. B. **On the coverage problem in video-based wireless sensor networks.** In 2nd International Conference on Broadband Networks, 2005. (Oct 2005), vol. 2, pp. 932–939.
- [28] YAO, Y., AND GIANNAKIS, G. B. **Energy-efficient scheduling for wireless sensor networks.** *IEEE TRANSACTIONS ON COMMUNICATIONS* 53, 8 (2005), 1–10.
- [29] BUETTNER, M., YEE, G. V., ANDERSON, E., AND HAN, R. **X-mac: A short preamble mac protocol for duty-cycled wireless sensor networks.** In Proceedings of the 4th International Conference on Embedded Networked Sensor Systems (New York, NY, USA, 2006), SenSys '06, ACM, pp. 307–320.
- [30] DIFFIE, W., AND HELLMAN, M. **New directions in cryptography.** *IEEE Trans. Inf. Theor.* 22, 6 (Sept. 2006), 644–654.
- [31] FELEMBAN, E., LEE, C.-G., AND EKICI, E. **Mmspeed: multipath multi-speed protocol for qos guarantee of reliability and. timeliness in wireless sensor networks.** *IEEE Transactions on Mobile Computing* 5, 6 (June 2006), 738–754.
- [32] LIU, Y., AND DAS, S. K. **Information-intensive wireless sensor networks: potential and challenges.** *IEEE Communications Magazine* 44, 11 (November 2006), 142–147.
- [33] LIU, Z., AND ELHANANY, I. **Rl-mac: A qos-aware reinforcement learning based mac protocol for wireless sensor networks.** In 2006 IEEE International Conference on Networking, Sensing and Control (2006), pp. 768–773.
- [34] SPAGNOLO, P., ORAZIO, T., LEO, M., AND DISTANTE, A. **Moving object segmentation by background subtraction and temporal analysis.** *Image and Vision Computing* 24, 5 (2006), 411–423.
- [35] TANIYAMA, K., MORII, T., KOIZUMI, S., NOGUCHI, K., KOTANI, Y., AND KATTO, J. **Experimental evaluation of an on-demand multipath routing protocol for video transmission in mobile ad hoc networks.** *Journal of Zhejiang University-SCIENCE A* 7, 1 (Jan 2006), 145–150.
- [36] AKYILDIZ, I. F., MELODIA, T., AND CHOWDHURY, K. R. **A survey on wireless multimedia sensor networks.** *Computer Networks* 51, 4 (2007), 921 – 960.
- [37] AKYILDIZ, I. F., MELODIA, T., AND CHOWDHURY, K. R. **A survey on wireless multimedia sensor networks.** *Computer networks* 51, 4 (2007), 921–960.
- [38] AKYILDIZ, I. F., MELODIA, T., CHOWDHURY, K. R., AND KAUSHIK, R. **A survey on wireless multimedia sensor networks.** *Computer networks* 51, 4 (2007), 921–960.
- [39] BOUKERCHE, A., OLIVEIRA, H. A. B. F., NAKAMURA, E. F., AND LOUREIRO, A. A. F. **Localization systems for wireless sensor networks.** *IEEE Wireless Communications* 14, 6 (2007), 6–12.

- [40] CHOI, J., HAN, S., KIM, S., CHANG, S., AND YOON, E. **A spatial-temporal multiresolution cmos image sensor with adaptive frame rates for tracking the moving objects in region-of-interest and suppressing motion blur.** JSSC 42, 12 (2007).
- [41] JEONG, J., HWANG, T., HE, T., AND DU, D. **Mcta: target tracking algorithm based on minimal contour in wireless sensor networks.** in proceedings of the 26th IEEE International Conference on Computer Communications (2007), 2371–2375.
- [42] KRONTIRIS, I., DIMITRIOU, T., AND FREILING, F. **Towards intrusion detection in wireless sensor networks.** 13th European Wireless Conference (2007), 1–7.
- [43] KUNDUR, D., LIN, C.-Y., AND LU, C.-S. **Visual sensor networks,** 2007.
- [44] AKYILDIZ, I. F., MELODIA, T., AND CHOWDHURY, K. R. **Wireless multimedia sensor networks: Applications and testbeds.** Proceedings of the IEEE 96, 10 (2008), 1588–1605.
- [45] ALSALIH, W., ISLAM, K., RODRIGUEZ, Y., AND XIAO, H. **Distributed voronoi diagram computation in wireless sensor networks.** in proceedings of the 20th Annual Symposium on Parallelism in Algorithms and Architectures (2008).
- [46] CEVHER, V., SANKARANARAYANAN, A., DUARTE, M. F., REDDY, D., BARANIUK, R. G., AND CHELLAPPA, R. **Compressive sensing for background subtraction.** In European Conference on Computer Vision (2008), Springer, pp. 155–168.
- [47] DARABI, S., YAZDANI, N., AND FATEMI, O. **Multimedia-aware mmspeed: A routing solution for video transmission in wmsn.** In 2008 2nd International Symposium on Advanced Networks and Telecommunication Systems (Dec 2008), pp. 1–3.
- [48] HAMID, M. A., ALAM, M. M., AND HONG, C. S. **Design of a qos-aware routing mechanism for wireless multimedia sensor networks.** In IEEE GLOBECOM 2008 - 2008 IEEE Global Telecommunications Conference (Nov 2008), pp. 1–6.
- [49] MARCULESCU, A., NIKOLETSEAS, S., POWELL, O., AND ROLIM, J. **Efficient tracking of moving targets by passively handling traces in sensor networks.** IEEE GLOBECOM2008 (2008).
- [50] POLITIS, I., TSAGKAROPOULOS, M., AND KOTSOPOULOS, S. **Optimizing video transmission over wireless multimedia sensor networks.** IEEE GLOBECOM (2008), 1 – 6.
- [51] SUN, Y., GUREWITZ, O., AND JOHNSON, D. B. **Ri-mac: A receiver-initiated asynchronous duty cycle mac protocol for dynamic traffic loads in wireless sensor networks.** In Proceedings of the 6th ACM Conference on Embedded Network Sensor Systems (New York, NY, USA, 2008), SenSys '08, ACM, pp. 1–14.
- [52] X, Z., W, H., W, L., X, Z., AND B, X. **Keyframe extraction using dominant-set clustering.** IEEE International Conference on Multimedia and Expo 1, 1 (2008), 1285–1288.
- [53] ZEGHID, M., MACHHOUT, M., KHRIJI, L., BAGANNE, A., AND TOURKI, R. **A modified aes based algorithm for image encryption.** International Journal of Advanced Trends in Computer Science and Engineering 21 (01 2008).

- [54] DAI, R., AND AKYILDIZ, I. F. **A spatial correlation model for visual information in wireless multimedia sensor networks**. *IEEE Trans on Multimedia* 11, 6 (2009).
- [55] GONG-BIN, Q., QING-FENG, J., AND SHUI-SHENG, Q. **A new image encryption scheme based on des algorithm and chua's circuit**. In 2009 IEEE International Workshop on Imaging Systems and Techniques (May 2009), pp. 168–172.
- [56] HEO, J., HONG, J., AND CHO, Y. **Earq: Energy aware routing for real-time and reliable communication in wireless industrial sensor networks**. *IEEE Transactions on Industrial Informatics* 5, 1 (Feb 2009), 3–11.
- [57] JIANG, B., RAVINDRAN, B., AND CHO, H. **Cflood: A constrained flooding protocol for real-time data delivery in wireless sensor networks**. *Proc. 11th Int'l Symp. Stabilization, Safety, and Security of Distributed Systems* (2009), 413–427.
- [58] JING, Y., MAI, X., JINFU, X., BAOGUO, X., AND LU, H. **A cluster-based multipath delivery scheme for wireless sensor networks**. In 2009 2nd IEEE International Conference on Broadband Network Multimedia Technology (Oct 2009), pp. 286–291.
- [59] KIM, H., AND MIN, S.-G. **Priority-based qos mac protocol for wireless sensor networks**. In 2009 IEEE International Symposium on Parallel Distributed Processing (May 2009), pp. 1–8.
- [60] SONG, W.-Z., HUANG, R., SHIRAZI, B., AND LAHUSEN, R. **Treemac: Localized tdma mac protocol for real-time high-data-rate sensor networks**. *Pervasive and Mobile Computing* 5, 6 (2009), 750 – 765. *PerCom 2009*.
- [61] SORO, S., AND HEINZELMAN, W. **A survey of visual sensor networks**. *Advances in Multimedia 2009* (2009), 21.
- [62] ALAEI, M., AND BARCELO-ORDINAS, J. M. **A method for clustering and cooperation in wireless multimedia sensor networks**. *Sensors* 10, 1 (2010), 3145–3169.
- [63] ALAEI, M., AND BARCELO-ORDINAS, J. M. **A method for clustering and cooperation in wireless multimedia sensor networks**. *Patent Application Publication* 10 (2010), 3145–3169.
- [64] ALIPPI, C., ANASTASI, G., FRANCESCO, M., AND ROVERI, M. **An adaptive sampling algorithm for effective energy management in wireless sensor networks with energy-hungry sensors**. *IEEE Trans on Inst and Measurement* 59, 2 (2010).
- [65] CHEN, M.-X., HU, C.-C., AND WENG, W.-Y. **Dynamic object tracking tree in wireless sensor network**. *EURASIP Journal on Wireless Communications and Networking* 2010 (2010).
- [66] COBO, L., QUINTERO, A., AND PIERRE, S. **Ant-based routing for wireless multimedia sensor networks using multiple qos metrics**. *Computer Networks* 54, 17 (2010), 2991 – 3010.
- [67] HOUNGBADJI, T., AND PIERRE, S. **Qosnet: An integrated qos network for routing protocols in large scale wireless sensor networks**. 1334–1342.

- [68] IMRAN, M., KHURSHEED, K., O'NILS, M., AND LAWAL, N. **Exploration of target architecture for a wireless camera based sensor node**. In NORCHIP 2010 (Nov 2010), pp. 1–4.
- [69] LANGENDOEN, K., AND MEIER, A. **Analyzing mac protocols for low data-rate applications**. ACM Trans. Sen. Netw. 7, 1 (Aug. 2010), 10:1–10:34.
- [70] LI, G., HE, J., AND FU, Y. **Group-based intrusion detection system in wireless sensor networks**. Computer Communications 31, 18 (2010), 4324–4332.
- [71] LIANG, Y., AND PENG, W. **Minimizing energy consumptions in wireless sensor networks via two-modal transmission**. SIGCOMM Comput. Commun. Rev. 40, 1 (Jan. 2010), 12–18.
- [72] MAKHOUL, A., SAADI, R., AND PHAM, C. **Risk management in intrusion detection applications with wireless video sensor networks**. In IEEE WCNC (2010), vol. 182.
- [73] RAHMAN, A. A. U., NAZNIN, M., AND MOLLAH, M. A. I. **Energy efficient multiple targets tracking using target kinematics in wireless sensor networks**. in proceedings The 4th International Conference on Sensor Technologies and Applications (2010), 275–280.
- [74] YUAN LI, Z., AND CHUAN WANG, R. **Load balancing-based hierarchical routing algorithm for wireless multimedia sensor networks**. The Journal of China Universities of Posts and Telecommunications 17 (2010), 51 – 59.
- [75] CANO, C., BELLALTA, B., SFAIROPOULOU, A., AND OLIVER, M. **Low energy operation in wsns: A survey of preamble sampling mac protocols**. Computer Networks 55, 15 (2011), 3351 – 3363.
- [76] DELDAR, F., AND YAGHMAEE, M. H. **Designing a predictionbased clustering algorithm for target tracking in wireless sensor networks**. IEEE International Symposium on Computer Networks and Distributed Systems CNDS '11 (2011), 199–203.
- [77] KANDRIS, D., TSAGKAROPOULOS, M., POLITIS, I., TZES, A., AND KOTSOPOULOS, S. **Energy efficient and perceived qos aware video routing over wireless multimedia sensor networks**. Ad Hoc Networks 9, 4 (2011), 591 – 607. Multimedia Ad Hoc and Sensor Networks.
- [78] MISRA, S., KRISHNA, P., AND ABRAHAM, K. **A simple learning automata-based solution for intrusion detection in wireless sensor networks**. Wireless Communications and Mobile Computing, Special Issue: Architectures and Protocols for Wireless Mesh, Ad Hoc, and Sensor Networks 11, 3 (2011), 426–441.
- [79] NEWELL, A., AND AKKAYA, K. **Distributed collaborative camera actuation for redundant data elimination in wireless multimedia sensor networks**. Ad Hoc Networks 45, 4 (2011).
- [80] PHAM, C., MAKHOUL, A., AND SAADI, R. **Risk-based adaptive scheduling in randomly deployed video sensor networks for critical surveillance applications**. JNCA 34, 2 (2011).

- [81] PHAM, C.-D., ABDALLAH, M., AND SAADI, R. **Risk-based adaptive scheduling in randomly deployed video sensor networks for critical surveillance applications**. *Journal of Network and Computer Applications* 34, 2 (Mar. 2011), 783–795.
- [82] SARISARAY-BOLUK, P., GUNGOR, V., BAYDERE, S., AND HARMANCI, A. **Quality aware image transmission over underwater multimedia sensor networks**. *Ad Hoc Networks* 9, 7 (2011), 1287 – 1301.
- [83] SUN, E., SHEN, X., AND CHEN, H. **A low energy image compression and transmission in wireless multimedia sensor networks**. *Procedia Engineering* 15 (2011), 3604 – 3610. CEIS 2011.
- [84] TANG, L., SUN, Y., GUREWITZ, O., AND JOHNSON, D. B. **Pw-mac: An energy-efficient predictive-wakeup mac protocol for wireless sensor networks**. In *2011 Proceedings IEEE INFOCOM* (April 2011), pp. 1305–1313.
- [85] YIGITEL, M. A., INCEL, O. D., AND ERSOY, C. **Qos-aware mac protocols for wireless sensor networks: A survey**. *Computer Networks* 55, 8 (2011), 1982 – 2004.
- [86] CHENG, L., WU, C., ZHANG, Y., WU, H., LI, M., AND MAPLE, C. **A survey of localization in wireless sensor network**. *International Journal of Distributed Sensor Networks* 2012 (2012), 12.
- [87] DAI, R., WANG, P., AND AKYILDIZ, I. F. **Correlation-aware qos routing with differential coding for wireless video sensor networks**. *IEEE Transactions on Multimedia* 14, 5 (Oct 2012), 1469–1479.
- [88] DARABKH, K. A., ISMAIL, S. S., AL-SHURMAN, M., JAFAR, I. F., ALKHADER, E., AND AL-MISTARIHI, M. F. **Performance evaluation of selective and adaptive heads clustering algorithms over wireless sensor networks**. *Journal of Network and Computer Applications* 35, 6 (2012), 2068–2080.
- [89] LUO, W., LU, Q., AND XIAO, Q. **Distributed collaborative camera actuation scheme based on sensing-region management for wireless multimedia sensor networks**. *Distributed Sensor Networks* 12, 0 (2012), 1–14.
- [90] NEFZI, B., AND SONG, Y.-Q. **Qos for wireless sensor networks: Enabling service differentiation at the mac sub-layer using cosens**. *Ad Hoc Networks* 10, 4 (2012), 680 – 695. *Advances in Ad Hoc Networks* (II).
- [91] XU, H., HUANG, L., QIAO, C., ZHANG, Y., AND SUN, Q. **Bandwidth-power aware cooperative multipath routing for wireless multimedia sensor networks**. *IEEE Transactions on Wireless Communications* 11, 4 (April 2012), 1532–1543.
- [92] BENZERBADJ, A., AND KECHAR, B. **Redundancy and criticality based scheduling in wireless video sensor networks for monitoring critical areas**. *Procedia Computer Science* 21 (2013), 234–241.
- [93] GHELICHI, A., YELAMARTHI, K., AND ABDELGAWAD, A. **Target localization in wireless sensor network based on time difference of arrival**. *IEEE 56th International MWSCAS 2013* (2013).



- [94] HUANG, P., XIAO, L., SOLTANI, S., WUTKA, M. W., AND NING, X. **The evolution of mac protocols in wireless sensor networks: a survey**. *IEEE Communications Surveys and Tutorials* 15, 1 (2013), 101–120.
- [95] JIANG, B., RAVINDRAN, B., AND CHO, H. **Probability-based prediction and sleep scheduling for energy-efficient target tracking in sensor networks**. *IEEE TRANSACTIONS ON MOBILE COMPUTING* 12, 4 (2013).
- [96] MOSTAFA, B. **Fuzzy logic approach to improving stable election protocol for clustered heterogeneous wireless sensor networks**.
- [97] PRIYADARSHINI, S. B., ACHARYA, B. M., AND DAS, D. S. **Redundant data elimination and optimum camera actuation in wireless multimedia sensor network (wmsn)**. *IJERT* 2, 6 (2013).
- [98] QIN, Z., WANG, L., MA, C., XU, J., AND LU, B. **An overlapping clustering approach for routing in wireless sensor networks**. *IJ DSN* 2013, 0 (2013), 1–11.
- [99] WANG, Z., W. LOU, Z. W., MA, J., AND CHEN, H. **A hybrid cluster-based target tracking protocol for wireless sensor networks**. *International Journal of Distributed Sensor Networks* 2013, 1 (2013), 16.
- [100] XU, Y., REN, F., HE, T., LIN, C., CHEN, C., AND DAS, S. K. **Real-time routing in wireless sensor networks: A potential field approach**. *ACM Trans. Sen. Netw.* 9, 3 (June 2013), 35:1–35:24.
- [101] ALAYBEYOGLU, A., KANTARCI, A., AND ERCIYES, K. **A dynamic lookahead tree based tracking algorithm for wireless sensor networks using particle filtering technique**. *Computers and Electrical Engineering* 40, 2 (2014), 374–383.
- [102] BAHİ, J. M., MAKHOUL, A., AND MEDLEJ, M. **An optimized in-network aggregation scheme for data collection in periodic sensor networks**. *ADHOC-NOW* 11 (2014), 153–166.
- [103] BAHİ, J. M., MAKHOUL, A., AND MEDLEJ, M. **A two tiers data aggregation scheme for periodic sensor networks**. *Ad Hoc and Sensor Wireless Networks* 21, 1/2 (2014), 77–100.
- [104] KONG, J.-I., KIM, J.-W., AND EOM, D.-S. **Energy-aware distributed clustering algorithm for improving network performance in wsns**. *Journal of Sensors* 2014, 1 (2014), 10.
- [105] LEE, S.-K., KOH, J.-G., AND JUNG, C.-R. **An energy-efficient qos-aware routing algorithm for wireless multimedia sensor networks**. 245–252.
- [106] NAN, G., MAO, Z., LI, M., ZHANG, Y., GJESSING, S., WANG, H., AND GUIZANI, M. **Distributed resource allocation in cloud-based wireless multimedia social networks**. *IEEE Network* 28, 4 (July 2014), 74–80.
- [107] PHAM, C. **Communication performances of ieee 802.15.4 wireless sensor motes for data-intensive applications: A comparison of waspmote, arduino mega, telosb, micaz and imote2 for image surveillance**. *Journal of Network and Computer Applications* 46 (2014), 48 – 59.

- [108] JBEILY, T., ALKUBEILY, M., AND HATEM, I. **A new symmetric-object oriented approach for motion estimation in wireless multimedia sensor networks.** *IJSR* 4, 11 (2015).
- [109] LEU, J. S., CHIANG, T. H., YU, M. C., AND SU, K. W. **Energy efficient clustering scheme for prolonging the lifetime of wireless sensor network with isolated nodes.** *IEEE Communications Letters* 19, 2 (Feb 2015), 259–262.
- [110] LI, J., LI, X., YANG, B., AND SUN, X. **Segmentation-based image copy-move forgery detection scheme.** *IEEE Transactions on Information Forensics and Security* 10, 3 (March 2015), 507–518.
- [111] MAKHOUL, A., HARB, H., AND LAIYMANI, D. **Residual energy-based adaptive data collection approach for periodic sensor networks.** *Ad Hoc Networks* 35 (2015), 149–160.
- [112] MAKHOUL, A., LAIYMANI, D., HARB, H., AND BAHY, J. M. **An adaptive scheme for data collection and aggregation in periodic sensor networks.** *IJSNet* 18, 1/2 (2015), 62–74.
- [113] PHAM, C. **Low cost wireless image sensor networks for visual surveillance and intrusion detection applications.** In *2015 IEEE 12th International Conference on Networking, Sensing and Control* (April 2015), pp. 376–381.
- [114] SAJID, M., KHAN, K., QASIM, U., KHAN, Z. A., TARIQ, S., AND JAVAID, N. **A new linear cluster handling (lch) technique toward's energy efficiency in linear wsns.** In *2015 IEEE 29th International Conference on Advanced Information Networking and Applications* (March 2015), pp. 389–393.
- [115] SARISARAY-BOLUK, P., AND AKKAYA, K. **Performance comparison of data reduction techniques for wireless multimedia sensor network applications.** *Hindawi Publishing Corporation* 15 (2015), 1–15.
- [116] TANG, L., GUAN, Q., JIANG, S., AND GUO, B. **A deadline-aware and distance-aware packet scheduling algorithm for wireless multimedia sensor networks.** *International Journal of Distributed Sensor Networks* 11, 3 (2015), 803123.
- [117] USMAN, M. R., USMAN, M. A., AND SHIN, S. **Subjective quality assessment for impaired videos with varying spatial and temporal information.** 1574–1579.
- [118] YOO, J., AND KIM, H. J. **Target localization in wireless sensor networks using online semi-supervised support vector regression.** *Sensors* 2015 15 (2015), 12539–12559.
- [119] ALSKAIFY, T., BELLALTA, B., ZAPATA, M. G., AND ORDINAS, J. M. **Energy efficiency of mac protocols in low data rate wireless multimedia sensor networks: a comparative study.** *ADHOC Networks* (December 2016), 1–17.
- [120] EZ-ZAIDI, A., AND RAKRAK, S. **A comparative study of target tracking approaches in wireless sensor networks.** *Journal of Sensors* 2016, 1 (2016).
- [121] GHADI, M., LAOUAMER, L., AND MOULAHI, T. **Securing data exchange in wireless multimedia sensor networks: perspectives and challenges.** *Multimedia Tools and Applications* 75, 6 (Mar 2016), 3425–3451.

- [122] JUSTUS, J. J., AND SEKAR, A. C. **Energy efficient priority packet scheduling with delay and loss constraints for wireless sensor networks**. In 2016 International Conference on Inventive Computation Technologies (ICICT) (Aug 2016), vol. 3, pp. 1–7.
- [123] KYRKOU, C., LAOUDIAS, C., THEOCHARIDES, T., PANAYIOTOU, C. G., AND POLYCARPOU, M. **Adaptive energy-oriented multitask allocation in smart camera networks**. IEEE Embedded Systems Letters 8, 2 (June 2016), 37–40.
- [124] MUNIR, S. W., AMJAD, O., ZEYDAN, E., AND ERCAN, A. O. **Optimization and analysis of wlan rf energy harvesting system architecture**. In 2016 International Symposium on Wireless Communication Systems (ISWCS) (Sept 2016), pp. 429–433.
- [125] PORAMBAGE, P., HEIKKINEN, A., HARJULA, E., GURTOV, A., AND YLIANTTILA, M. **Quantitative power consumption analysis of a multi-tier wireless multimedia sensor network**. In European Wireless 2016; 22th European Wireless Conference (May 2016), pp. 1–6.
- [126] SARIF, B. A. B. **Energy efficient video sensor networks for surveillance applications**. PhD thesis, University of British Columbia, 2016.
- [127] SOHN, K., KIM, Y. Y., AND SAXENA, N. **A new cross-layer qos-provisioning architecture in wireless multimedia sensor networks**. KSII TRANSACTIONS ON INTERNET AND INFORMATION SYSTEMS 10, 12 (Dec 2016).
- [128] USMAN, M. A., USMAN, M. R., AND SHIN, S. Y. **A no reference method for detection of dropped video frames in live video streaming**. 839–844.
- [129] WEN, Y., GAO, R., AND ZHAO, H. **Energy efficient moving target tracking in wsn**. SENSORS 16, 29 (2016).
- [130] ZHOU, Z., YANG, C.-N., CHEN, B., SUN, X., LIU, Q., AND WU, Q. J. **Effective and efficient image copy detection with resistance to arbitrary rotation**. IEICE Transactions on Information and Systems E99.D, 6 (2016), 1531–1540.
- [131] AL-ARIKI, H. D. E., AND SWAMY, M. N. S. **A survey and analysis of multipath routing protocols in wireless multimedia sensor networks**. Wireless Networks 23, 6 (Aug 2017), 1823–1835.
- [132] BAHİ, J. M., GUYEUX, C., MAKHOUL, A., AND PHAM, C. **Low cost monitoring and intruders detection using wireless video sensor networks**. CoRR abs/1702.02516 (2017).
- [133] FAYED, S., YOUSSEF, S. M., EL-HELW, A., PATWARY, M., AND MONIRI, M. **Analytical framework for adaptive compressive sensing for target detection within wireless visual sensor networks**. Multimedia Tools and Applications (Oct 2017).
- [134] GHOSAL, A., AND HALDER, S. **A survey on energy efficient intrusion detection in wireless sensor networks**. Journal of Ambient Intelligence and Smart Environments 9 (2017), 239–261.
- [135] JAMSHED, M. A., AMJAD, O., AND ZEYDAN, E. **Multicore energy efficient scheduling with energy harvesting for wireless multimedia sensor networks**. In 2017 International Multi-topic Conference (INMIC) (Nov 2017), pp. 1–5.

- [136] JUNG, K., LEE, J.-Y., AND JEONG, H.-Y. **Improving adaptive cluster head selection of teen protocol using fuzzy logic for wmsn.** *Multimedia Tools and Applications* 76, 17 (Sep 2017), 18175–18190.
- [137] SHAHAB, M. B., USMAN, M. A., AND SHIN, S. Y. **Bandwidth adaptation by squeezing idle traffic in browsers: An active window detection based approach for next generation networks.** *IEEE Communications Letters* 21, 2 (Feb 2017), 310–313.
- [138] ZHOU, Z., WANG, Y., WU, Q. M. J., YANG, C., AND SUN, X. **Effective and efficient global context verification for image copy detection.** *IEEE Transactions on Information Forensics and Security* 12, 1 (Jan 2017), 48–63.
- [139] ZHOU, Z., WU, Q. J., HUANG, F., AND SUN, X. **Fast and accurate near-duplicate image elimination for visual sensor networks.** *International Journal of Distributed Sensor Networks* 13, 2 (2017), 1550147717694172.
- [140] ACHARYA, B. M., AND NAYAK, A. K. **Hierarchical multi path routing protocol for wireless multimedia sensor networks.** *International Journal of Intelligent Engineering and Systems* 11, 1 (Jan 2018).
- [141] ALAOUI FDILI, O., COUDOUX, F. X., FAKHRI, Y., CORLAY, P., AND ABOUTAJDINE, D. **Energy-efficient joint video encoding and transmission framework for wvsn.** *Multimedia Tools and Applications* 77, 4 (Feb 2018), 4509–4541.
- [142] AURANGZEB, K., ALHUSSEIN, M., AND O'NILS, M. **Data reduction using change coding for remote applications of wireless visual sensor networks.** *IEEE Access* (2018).
- [143] BAVARVA, A., JANI, P. V., AND GHETIYA, K. **Performance improvement of wireless multimedia sensor networks using mimo and compressive sensing.** *Journal of Communications and Information Networks* 3, 1 (Mar 2018), 84–90.
- [144] COLLOTTA, M., PAU, G., AND COSTA, D. G. **A fuzzy-based approach for energy-efficient wi-fi communications in dense wireless multimedia sensor networks.** *Computer Networks* 134 (2018), 127 – 139.
- [145] NANDHINI, S. A., RADHA, S., AND KISHORE, R. **Efficient compressed sensing based object detection system for video surveillance application in wmsn.** *Multimedia Tools and Applications* 77, 2 (Jan 2018), 1905–1925.
- [146] NOURA, H., CHEHAB, A., SLEEM, L., NOURA, M., COUTURIER, R., AND MANSOUR, M. M. **One round cipher algorithm for multimedia iot devices.** *Multimedia Tools and Applications* (Jan 2018).
- [147] SALIM, A., OSAMY, W., AND KHEDR, A. M. **Effective scheduling strategy in wireless multimedia sensor networks for critical surveillance applications.** *Journal of Applied Mathematics And Information Sciences* 12, 1 (2018), 101–1011.
- [148] USMAN, M. A., USMAN, M. R., AND SHIN, S. Y. **An intrusion oriented heuristic for efficient resource management in end-to-end wireless video surveillance systems.** 1–6.



# LIST OF FIGURES

2.1	Wireless Video Sensor Networks For Surveillance . . . . .	8
2.2	Traditional Video Surveillance System . . . . .	10
2.3	Wireless Multimedia Sensor Network Architecture . . . . .	10
2.4	Major components of a video node. The dotted lines represent the optional components . . . . .	11
2.5	Example of a semi-random deployment scenario . . . . .	14
2.6	Simplified Coverage Scenario in WWSN . . . . .	15
3.1	Architecture of WWSN in [144] . . . . .	21
3.2	Flat Architecture of WMSN . . . . .	22
3.3	Hierarchical Architecture of WMSN . . . . .	23
3.4	Multi-path Architecture in WMSN . . . . .	23
3.5	Arduino Due . . . . .	30
3.6	Arduino Due connected to the cam as in [113] . . . . .	30
4.1	Architecture of WWSN . . . . .	36
4.2	The Original Frame . . . . .	41
4.3	The grayscale Frame . . . . .	41
4.4	The Canny Frame . . . . .	41
4.5	FOV . . . . .	44
4.6	Video sensing and overlapping model . . . . .	45
4.7	Two overlapping sensor nodes $S$ and $S'$ . . . . .	46
4.8	The setup of the video sensor nodes . . . . .	51
4.9	Difference between MASRA and PPSS on the sensing phase . . . . .	51
4.10	Difference between MASRA and PPSS on the transmission phase . . . . .	52
4.11	Energy consumption comparison for MASRA and PPSS . . . . .	58
5.1	Direction Vector . . . . .	63
5.2	Movement State Vector and kinematics rules . . . . .	65
5.3	Adaptative Frame Rate Function . . . . .	67

5.4	Network Setup . . . . .	69
5.5	Difference between KBA and PPSS on the sensing phase . . . . .	70
5.6	Difference between KBA and PPSS on the transmission phase . . . . .	70
5.7	Energy consumption comparison for KBA and PPSS . . . . .	74
6.1	Architecture of WWSN . . . . .	80
6.2	Raspberry PI 3 and Nano Camera . . . . .	85
6.3	Experimental Network . . . . .	85
6.4	Frame Rate Adaptation . . . . .	87
6.5	MASRA Frame Rate Adaptation and Number of Sent Frames . . . . .	88
6.6	Frame Rate Adaptation Comparison . . . . .	88
6.7	The Original Frame . . . . .	90
6.8	The Encrypted Frame . . . . .	90
6.9	The Decrypted Frame . . . . .	90
7.1	S-MAC Period of activity and standby . . . . .	94
7.2	Frame Format . . . . .	95
7.3	Experimental Network . . . . .	96
7.4	The Correlation Between the Delay and the Number of Sensors . . . . .	97
7.5	Network development using Castalia and INET . . . . .	98

# LIST OF TABLES

4.1	Execution Time Comparison for SSIM and Color-Edge Function . . . . .	39
4.2	Weights of Small similarities at both levels . . . . .	50
4.3	The difference in terms of number of frames for S1 over 40s . . . . .	53
4.4	The difference in terms of number of frames for S1 over 490s . . . . .	53
4.5	The difference in terms of number of frames for S3 over 200s . . . . .	53
4.6	The difference in terms of number of frames for S3 over 490s . . . . .	53
4.7	Sensor by Sensor evaluation in terms of number of frames in active and passive modes for MASRA Algorithm . . . . .	53
4.8	Sensor by Sensor evaluation in terms of number of frames in active and passive modes for PPSS Method . . . . .	54
4.9	Comparison between MASRA and PPSS in terms of number of frames on the overall Network . . . . .	54
4.10	The difference in terms of number of frames for S1 over 40s PPSS . . . . .	54
4.11	The difference in terms of number of frames for S1 over 490s PPSS . . . . .	54
4.12	The difference in terms of number of frames for S3 over 200s PPSS . . . . .	54
4.13	The difference in terms of number of frames for S3 over 490s PPSS . . . . .	54
4.14	The ultimate bandwidth total reduction MASRA . . . . .	55
4.15	The ultimate bandwidth total reduction PPSS . . . . .	55
4.16	The Coordinator Behavior . . . . .	56
4.17	The Coordinator Behavior PPSS . . . . .	56
4.18	Parameters of the Energy Model . . . . .	57
4.19	Energy consumption comparison for MASRA and PPSS . . . . .	58
5.1	Scenario Time Table . . . . .	68
5.2	Data Reduction for S1 over 64s . . . . .	71
5.3	Data Reduction for S1 over 720s . . . . .	71
5.4	Data Reduction for S3 over 300s . . . . .	71
5.5	Data Reduction for S3 over 490s . . . . .	71
5.6	Number of Frames in active and passive modes for KBA approach . . . . .	71
5.7	Number of frames in active and passive modes for PPSS Method . . . . .	72



5.8	Data Reduction on the overall Network . . . . .	72
5.9	Data Reduction for S1 over 60s PPSS . . . . .	72
5.10	Data Reduction for S1 over 700s PPSS . . . . .	72
5.11	Data Reduction for S3 over 300s PPSS . . . . .	72
5.12	Data Reduction for S3 over 700s PPSS . . . . .	72
5.13	The ultimate bandwidth total reduction KBA and PPSS . . . . .	72
5.14	Parameters of the Energy Model . . . . .	73
6.1	Execution Time Comparison per Event . . . . .	86
6.2	Total Execution Time Comparison . . . . .	86
6.3	Frame Rate Adaptation Data Reduction over 60 seconds . . . . .	87
6.4	Execution Time Comparison per Method per Function . . . . .	89
6.5	Total Execution Time Comparison . . . . .	89
6.6	One Round Algorithm Execution Time . . . . .	89
7.1	Non Reactable Distance Depending on the Speed of the Intrusion . . . . .	97

# LIST OF DEFINITIONS

1	Definition: Similarity Function . . . . .	42
2	Definition: Critical frame . . . . .	42
3	Definition: Low Similarity . . . . .	47
4	Definition: High Similarity . . . . .	47
5	Definition: similarity threshold percentage $\beta_{sim}$ between shots . . . . .	47



