



HAL
open science

A Systems Engineering-based semantic model to support “Product-Service System” life cycle

Elaheh Maleki

► **To cite this version:**

Elaheh Maleki. A Systems Engineering-based semantic model to support “Product-Service System” life cycle. Other [cs.OH]. École centrale de Nantes, 2018. English. NNT: 2018ECDN0064. tel-02389981

HAL Id: tel-02389981

<https://theses.hal.science/tel-02389981>

Submitted on 2 Dec 2019

HAL is a multi-disciplinary open access archive for the deposit and dissemination of scientific research documents, whether they are published or not. The documents may come from teaching and research institutions in France or abroad, or from public or private research centers.

L'archive ouverte pluridisciplinaire **HAL**, est destinée au dépôt et à la diffusion de documents scientifiques de niveau recherche, publiés ou non, émanant des établissements d'enseignement et de recherche français ou étrangers, des laboratoires publics ou privés.

THESE DE DOCTORAT DE

L'ÉCOLE CENTRALE DE NANTES
COMUE UNIVERSITE BRETAGNE LOIRE

ECOLE DOCTORALE N° 602
Sciences pour l'Ingénieur
Spécialité : Génie industriel

Par

« **Elaheh MALEKI** »

« **A Systems Engineering-based semantic model to support
“Product-Service System” life cycle** »

Thèse présentée et soutenue à « Ecole Centrale Nantes », le « 21 Décembre 2018 »
Unité de recherche : Laboratoire des Sciences du Numérique de Nantes (LS2N), UMR CNRS 6004

Rapporteurs avant soutenance :

Mme. Nadège TROUSSIER
Professeur, Université de Technologie de Troyes

M. Emmanuel CAILLAUD
Professeur, Université de Strasbourg, UFR Physique
et Ingénierie

Composition du Jury :

Président du Jury
M. Dimitris MOURTZIS,
Professeur, Université de Patras (Grèce) – Laboratoire LMS

Membres du Jury
Mme. Nadège TROUSSIER
Professeur, Université de Technologie de Troyes
M. Emmanuel CAILLAUD
Professeur, Université de Strasbourg, UFR Physique et Ingénierie

Mme. Lilia GZARA
Maitre de conférences, Institut National Polytechnique de Grenoble
M. Eric BONJOUR
Professeur, École nationale supérieure en génie des systèmes et
innovation, Nancy

M. Xavier BOUCHER
Professeur, Ecole Nationale Supérieure des Mines de Saint-Etienne

Directeur de Thèse
M. Alain BERNARD
Professeur, Ecole Centrale de Nantes

Co-Directeur de Thèse
M. Farouk BELKADI
Enseignant-Chercheur, Ecole Centrale de Nantes

ACKNOWLEDGMENTS

I would like to thank my PhD advisors for their support of my study. Besides my advisors, I wish to express my sincere thanks to the rest of my thesis committee for accepting to review my thesis.

I would also like to pay my regards to my best friends for supporting me during the hard times.

Finally, I must express my very profound gratitude to my family for providing me with unfailing support. My heartfelt thanks go to my parents to teach me to be a better person. This accomplishment would not have been possible without my lovely mother.

Elaheh Maleki

December 2018

TABLE OF CONTENTS

GENERAL INTRODUCTION	1
INTRODUCTION GÉNÉRALE	5
CHAPTER I. RESEARCH CONTEXT AND PROBLEMATIC.....	9
I.1. INTRODUCTION	11
I.2. RESEARCH CONTEXT AND AMBITIONS.....	11
<i>I.2.1. PSS definition</i>	<i>12</i>
<i>I.2.2. PSS typology</i>	<i>13</i>
<i>I.2.3. PSS life cycle.....</i>	<i>15</i>
<i>I.2.4. PSS development process</i>	<i>18</i>
<i>I.2.5. PSS value creation model.....</i>	<i>22</i>
I.3. APPLICATION CONTEXT: THE ICP4LIFE EUROPEAN PROJECT	22
<i>I.3.1. Project description</i>	<i>23</i>
<i>I.3.2. Lessons learned from the Industrial Context PSS modeling request.....</i>	<i>25</i>
I.4. THESIS PROBLEMATIC.....	26
<i>I.4.1. The challenges of PSS architecture construction</i>	<i>26</i>
<i>I.4.2. The challenges of collaboration.....</i>	<i>27</i>
<i>I.4.3. The challenges of data management</i>	<i>27</i>
<i>I.4.4. The challenges of knowledge reuse and sharing</i>	<i>28</i>
<i>I.4.5. Problem Statement.....</i>	<i>28</i>
<i>I.4.6. Research Methodology.....</i>	<i>29</i>
I.5. SYNTHESIS AND CONCLUSION.....	31
CHAPTER II. SYSTEM MODELING FRAMEWORKS: STATE OF THE ART	33
II.1. INTRODUCTION	35
II.2. KNOWLEDGE MODELING FOUNDATIONS	35
<i>II.2.1. Modeling languages and tools</i>	<i>36</i>
<i>II.2.2. Ontology as support for knowledge classification</i>	<i>37</i>
II.3. EXAMPLES OF MODELING FRAMEWORKS WITHIN AN INDUSTRIAL CONTEXT	40
<i>II.3.1. Examples of standard modeling frameworks</i>	<i>40</i>
<i>II.3.2. Examples of PSS-dedicated modeling frameworks.....</i>	<i>43</i>
<i>II.3.3. Examples of PSS-dedicated modeling with a functional analysis approach</i>	<i>47</i>
II.4. SYSTEMS ENGINEERING APPROACH.....	50
II.5. REFINED RESEARCH QUESTIONS	53
II.6. SYNTHESIS AND CONCLUSION.....	54
CHAPTER III. PSS MODEL CONSTRUCTION WITHIN SYSTEMS ENGINEERING PERSPECTIVE	57
III.1. INTRODUCTION	59
III.2. PSS MODEL CONCEPTUALIZATION WITHIN SE PERSPECTIVE	59
<i>III.2.1. PSS modular architecture with SE.....</i>	<i>60</i>
<i>III.2.2. PSS value framework</i>	<i>62</i>

III.2.3. PSS architecture integration within the SE V-model.....	64
III.3. PSS MODEL DESCRIPTION WITH UML FORMALISM.....	66
III.3.1. The global model of PSS	66
III.3.2. The requirements and functional model.....	67
III.3.3. The System of Interest model	70
III.3.4. The Enabling Systems model	72
III.3.5. The business process model.....	74
III.3.6. The life cycle model	78
III.3.7. The interface model.....	79
III.4. SYNTHESIS AND CONCLUSION	83
CHAPTER IV. MODEL VALIDATION AND VERIFICATION	85
IV.1. INTRODUCTION	87
IV.2. THE BIKE SHARING SYSTEM (THE ACADEMIC CASE)	87
IV.3. ICP4LIFE PROJECT	93
IV.3.1. Case A: Machinery (Machine Health Monitoring).....	94
IV.3.2. Case B: Energy provider (Energy Management Services).....	100
IV.4. SYNTHESIS AND CONCLUSION	104
CHAPTER V. MODELING FRAMEWORK APPLICATION	107
V.1. INTRODUCTION	109
V.2. ICP4LIFE PLATFORM	109
V.3. SENSOR ONTOLOGY STRUCTURE	114
V.4. ADDITIONAL APPLICATION: PSS CONFIGURATOR BASED ON RFLP APPROACH.....	121
V.5. SYNTHESIS AND CONCLUSION	122
CONCLUSION AND PERSPECTIVES	123
BIBLIOGRAPHY	129
SELF-CITATION REFERENCES	129
EXTERNAL REFERENCES	131
ANNEXES.....	A
ANNEX I: PSS TERMINOLOGY AND DEFINITION	C
ANNEX II: CLASSES DEFINITION FROM THE LITERATURE INVESTIGATION	G
ANNEX III: UML DIAGRAMS OF THE GLOBAL MODEL	W

LIST OF FIGURES

Figure 1. The thesis structure	3
Figure 2. PSS types (Adrodegari et al. 2015).....	14
Figure 3. Evolution of the Product Service-System concept (Baines et al. 2007)	15
Figure 4. Technical service design process (Aurich et al. 2006)	17
Figure 5. PSS lifecycle (Beuren et al. 2017).....	18
Figure 6. The transition from tool provider to PSS provider	19
Figure 7. Eco-system model of synergism for PSS development (Xing et al. 2013).....	21
Figure 8. ICP4Life concept (from ICP4Life website).....	23
Figure 9. The ICP4Life components	24
Figure 10. Research Methodology	29
Figure 11. Kinds of ontologies (Guarino 2015)	38
Figure 12. Top-Level Categories of ontology (Noy & Hafner 1997)	38
Figure 13. A simplified example of ontology (Compton et al. 2012).....	39
Figure 14“process-centered knowledge” model (Han & Park 2009).....	40
Figure 15. EUML Meta-Model (Vernadat 2002).....	41
Figure 16. Overview of IPPOP model (Noël & Roucoules 2008).....	42
Figure 17. Core product model representing design information (Fenves 2001).....	43
Figure 18. A visualization support method for PSS development (Kim et al. 2011).....	44
Figure 19. Extended/Product Service Blueprint meta-model (Idrissi et al. 2017)	45
Figure 20. PSS Conceptual Model (Pirayesh et al. 2018).....	46
Figure 21. Root concepts to describe the ontology of PSS (Annamalai et al. 2010)	46
Figure 22. “Meta-ontology of modular product-service” (Wang et al. 2014).....	47
Figure 23. PSS design framework (Andriankaja et al. 2018).....	48
Figure 24. Integrated PSS design model (Trevisan & Brissaud 2016)	49
Figure 25. The heterogeneous concept modeling approach in PSS	49
Figure 26. Knowledge-based Systems Engineering (Gardan & Matta 2017).....	51
Figure 27. The System of Interest and Enabling Systems.....	52
Figure 28. The transition from the requirements to the final architecture model (Faisandier 2012)	53

Figure 29. Mutual Contribution of PSS and SE.....	55
Figure 30. PSS characteristics extraction from literature.....	60
Figure 31. Value offer in PSS	62
Figure 32. PSS System from the Systems Engineering perspective	63
Figure 33. PSS V-model based on Systems Engineering and RFLP	65
Figure 34. Tailored RFLP model	65
Figure 35. Different viewpoints in PSS development based on RFLP approach.....	66
Figure 36. Package diagram.....	67
Figure 37. Requirements analysis	68
Figure 38. PSS Functional model based on IDEF0 (Menzel & Mayer 1998).....	68
Figure 39. PSS functional architecture.....	69
Figure 40. PSS function business view	70
Figure 41. The System of Interest general model	71
Figure 42. The PSS pattern and instance	72
Figure 43. Digital and Physical Infrastructures.....	73
Figure 44. Organizational Capability	74
Figure 45. Value offer and capabilities	75
Figure 46. Main business processes	76
Figure 47. Processes and Sub-processes	76
Figure 48. Life Stage-Events-Action chain.....	78
Figure 49. PSS life cycle model.....	79
Figure 50. Interface model	80
Figure 51. The interface configuration.....	81
Figure 52. The port and the flow classes.....	82
Figure 53. Example of bike sharing	87
Figure 54. Bike sharing process	88
Figure 55. The object diagram for bike sharing	90
Figure 56. Bike sharing scenario and interfaces	91
Figure 57. Bike sharing use case sample of interface analysis	92
Figure 58. ICP4Life Services interconnections.....	94
Figure 59. Machine Health Monitoring	95

Figure 60. Description of the use case	96
Figure 61. UML Sequences diagram for Machine Health Monitoring	96
Figure 62. IDEF model of Machine health Monitoring Service	99
Figure 63. The interfaces example	99
Figure 64. ICP4Life Integrated Services model.....	101
Figure 65. Power Interruption Planning service.....	102
Figure 66. Energy Consumption Management service	102
Figure 67. PSS network for Energy services for machine operation	103
Figure 68. Knowledge-based PSS life cycle	105
Figure 69. Global architecture of the ICP4Life Platform (Maleki et al. 2018).....	110
Figure 70. Use case diagram for machine health monitoring design	111
Figure 71. The sensor implementation process for maintenance and monitoring perspective (Maleki, Belkadi, Ritou, et al. 2017).....	112
Figure 72. UML Sequences diagram for sensor selection.....	113
Figure 73. The meta-model heading the sensor ontology	115
Figure 74. Sensing system ontology designed in Protégé software	116
Figure 75. Sensor typology	118
Figure 76. Ontology-based integration of sensor and machine component	118
Figure 77. Measurement specification as key performance indicators of the sensor	119
Figure 78. Information ontology	120
Figure 79. Sensor working condition specification.....	121
Figure 80. The configurator user interface example (Slayman 2018).....	122
Figure 81. PSS requirement-function global model.....	x
Figure 82. The global model of System of Interest.....	y
Figure 83. The global model of the Enabling Systems	z
Figure 84. The global model of PSS business processes	aa
Figure 85. PSS life cycle schema	bb
Figure 86. PSS interfaces model	cc

LIST OF TABLES

Table 1. Sub-life cycles of the functional product by (Lindström et al. 2015)	16
Table 2. Comparing PSS conceptual models	84
Table 3. Description of the bike sharing use case	89
Table 4. The industrial cases	93
Table 5. The components of the use case	97
Table 6. Machine health Monitoring Interfaces Matrix	100
Table 7. The whole system components	103
Table 8. Knowledge-based PSS life cycle.....	105
Table 9. The main contributions of the thesis	126

General Introduction

English Title:

A Systems Engineering-based semantic model to support “Product-Service System” life cycle

Over the last decades, industrial companies tend to be more sustainable by adopting resource efficient and through life cycle approach. This leads them to reconfiguring their value creation system (Ford & Despeisse 2016) by shifting the derived value from the physical product to the non-tangible aspects of the system (Mont 2002). This new value creation approach is established by actors’ network collaborating to integrate resources and infrastructures with their product and/or service to provide a customized solution for the customer (Vargo & Lusch 2016)(Hein et al. 2018). In the academic literature, when combining both tangible and intangible components, this kind of system of value creation, is reviewed as Product-Service System (PSS) (Tukker 2015).

Indeed, evolving product-centered business models to the solution-centered one has passed through a transition from the simple after-sale services to the current “knowledge-intensive socio-technical” system (Meier et al. 2010). In order to create this system, PSS providers improve their capabilities in the synergetic integration of product and service with the dedicated infrastructure and the necessary supportive systems (Mont 2002)(Lim et al. 2012). In doing so, PSS benefits from all the skills of multidisciplinary stakeholders to improve the firm’s strategic, organizational and operational capabilities (Bonjour et al. 2008)(Gebauer et al. 2017).

The PSS sub-systems have different modes of value delivering which could be integrated into a unique PSS offer. As a result, the PSS life cycle is characterized by the connection of various interdependent life cycles of its tangible and intangible components (Lindström et al. 2015). This heterogeneity implies several difficulties to manage the engaged business views and to deal with organizational and technical constraints (Mamrot et al. 2016). Face to this complexity, there is a crucial need to consider the different characteristics of PSS and integrate all different points of view in a unique model. In this matter, the academic literature has pointed out a need for a tailored systemic approach for modeling the transition towards PSS provision (Tukker 2015). Prior studies note that to model the whole system, it is vital to study all possible decompositions and clearly define their configuration as well as their functional constraints at

the earlier design stages (Song & Sakao 2017). Also, as a system, identifying the system and its sub-systems boundaries are necessary to obtain an accurate representation of PSS.

Modeling the PSS is challenging due to the “functionality interconnection” among heterogeneous sub-systems and “process interconnection” among homogeneous components (Estrada & Romero 2016). Broadly speaking, there are two main challenges in PSS development and modeling. One is dealing with its heterogeneous elements and related organizational and technical complexity. The second challenge is distinguishing the borders of these elements and their interactions (Mamrot et al. 2016). To deal with these challenges, an engineering approach based on system thinking is advantageous to define the PSS boundaries and interconnections along its life cycle (Pezzotta et al. 2015). Indeed, Systems engineering principles allow the analysis and modeling the “heterogeneous functional systems” as well as the tangible and intangible components (Pineda & Lopes 2013) and to generate a common understanding of the system to support the collaborative system development (SEBoK 1.7 2016).

The genesis of this PhD work is the European ICP4Life (An Integrated Collaborative Platform for Managing the Product-Service Engineering Life cycle). IS3P research group (Systems Engineering: Product, Performance, Perception) was involved in a critical task concerning the development of a knowledge repository as a kernel part of the ICP4Life platform. The aim is to support the knowledge capitalization and sharing between heterogeneous business experts during the creation of new PSS. Our role is to develop the semantic model as an implementable ontology structuring the repository. A conceptual modeling framework is proposed as a scientific foundation at the meta-level.

The above-mentioned challenge, besides our collaboration in the ICP4Life project, motivates this thesis. In a global view, this thesis adopted an analytical, conceptual research method (Cavalieri & Pezzotta 2012). Starting with extracting the domain knowledge from the academic and industrial context, the PSS model is constructed with the multidisciplinary viewpoint obtained from the domain knowledge and the lessons learned from the ICP4Life project. Finally, a Scenario-Based Test is carried out to validate the model.

The thesis is structured as follows (Figure 1). Chapter 1 explains the research context and motivation from both academic and industrial perspectives. This helps us to define the research questions at the heart of this research work. Chapter 2 presents a state of the art on current modeling frameworks for generic systems and PSS tailored models. Focusing on the problematic of PSS design with a system thinking approach, the research questions are refined. Chapter 3 is dedicated to the conceptual framework construction and the model explanation. The knowledge extraction of PSS characteristics from the literature and industrial context is realized as a prerequisite. Chapter 4 uses scenario-based validation method to illustrate the application of the proposed model on industrial cases. Chapter 5 describes the ontology model as a specification of the conceptual model and its usage in the ICP4Life platform. As another

application of the model, a prototype of PSS configurator is developed by a Master student based on the PSS global model. The concluding chapter draws the thesis main contributions and the research perspectives.

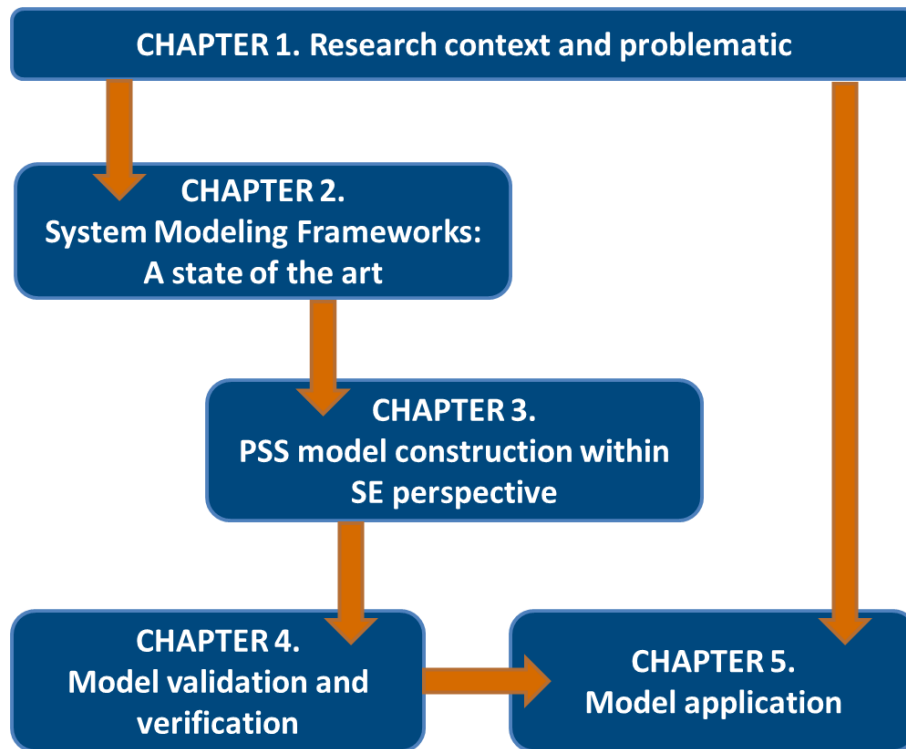

Figure 1. The thesis structure

Introduction générale

Titre Français :

Un modèle sémantique basé sur l'ingénierie des systèmes pour supporter le cycle de vie des Systèmes "Produit-Service"

Durant les dernières décennies, les sociétés industrielles sont en recherche de solutions durables à travers une gestion efficace des ressources et du cycle de vie du produit. Ceci les conduit à reconfigurer sans cesse les différents systèmes de création de la valeur (Ford & Despeisse 2016) en faisant évoluer leur stratégie du business orienté produit tangible vers des business incluant des services intangibles (Mont 2002). Cette chaîne de création de valeur est construite dans un réseau d'acteurs variés qui collaborent pour intégrer les infrastructures et autres ressources avec un produit ou service. Le but est d'offrir une solution personnalisable pour chaque catégorie de clients (Vargo & Lusch 2016)(Hein et al. 2018). Dans la littérature, un système de création de valeur basé sur la combinaison de composants tangibles et composants intangibles est appelé un Système Produit-Service (SPS) (Tukker 2015).

En effet, l'évolution d'un modèle économique centré produit vers celui centré solution est réalisé à travers la transition du simple service après-vente au paradigme de « système sociotechnique à base de connaissances » (Meier et al. 2010). Pour créer ce système, les fournisseurs SPS doivent améliorer leurs capacités d'intégration des composants produit / service avec des infrastructures externes et des systèmes supports (Mont 2002)(Lim et al. 2012). En faisant cela, la solution SPS va bénéficier de l'ensemble des compétences disponibles chez les différentes parties prenantes pour améliorer les capacités stratégiques, organisationnelles et opérationnelles (Bonjour et al. 2008)(Gebauer et al. 2017).

Les sous-systèmes d'un SPS sont dotés de différents modes de fourniture de valeur qui peuvent être inclus dans une offre SPS unique. Par conséquent, le cycle de vie d'un SPS est caractérisé par la connexion de plusieurs cycles de vie indépendants des composants tangibles et intangibles (Lindström et al. 2015). Cette hétérogénéité implique plusieurs difficultés dans la gestion des différents métiers impliqués dans le processus de création de valeur SPS aussi bien sur le plan technique qu'organisationnel (Mamrot et al. 2016).

Face à cette complexité, il est crucial de considérer les différentes caractéristiques d'un SPS et d'intégrer les différents points de vue associés dans un modèle unique. Dans ce domaine, la littérature a souligné le besoin de construire des approches systémiques robustes pour supporter la transition vers des systèmes SPS (Tukker 2015). Des études ont montré que pour modéliser un système complexe, il est important d'étudier l'ensemble des décompositions et de définir les différentes configurations possibles ainsi que les contraintes fonctionnelles associées, dès les premières phases de conception (Song & Sakao 2017). Aussi, pour avoir une représentation robuste d'un SPS, il est nécessaire dans une démarche systémique, d'identifier les frontières et les chevauchements entre les différents sous-systèmes qui le composent.

La modélisation des SPS présente un vrai challenge en raison de l'interconnexion fonctionnelle et opérationnelle entre les composants hétérogènes (Estrada & Romero 2016). Concrètement, deux challenges majeurs sont souvent identifiés : le premier est relatif à l'hétérogénéité des composants organisationnels, informationnels et techniques. Le second concerne la clarification des frontières de ces éléments et les interactions entre eux (Mamrot et al. 2016). Pour répondre à ces challenges, une démarche d'ingénierie système semble avantageuse pour la représentation de l'ensemble du cycle de vie (Pezzotta et al. 2015).

En effet, les principes de l'ingénierie des systèmes permettent l'analyse et la modélisation de systèmes de systèmes fonctionnels et la considération avec la même vision des composants tangibles et intangibles (Pineda & Lopes 2013). Elle permet aussi de générer une compréhension mutuelle du système dans une perspective de processus de développement collaboratif (SEBoK 1.7 2016).

La genèse de ce travail de thèse vient du projet Européen ICP4Life (An Integrated Collaborative Platform for Managing the Product-Service Engineering Life cycle / une plateforme collaborative intégrée pour la gestion du cycle d'ingénierie des systèmes produit service). Dans ce projet, l'équipe IS3P (Ingénierie Système Produit-Processus-Performance) est impliquée dans la tâche de développement de la base de connaissances commune de la plateforme. L'objectif est de supporter la capitalisation et le partage des connaissances et données entre les différents experts métier participants dans le processus de création d'un nouveau SPS. Notre rôle est de développer le modèle sémantique sous forme d'une ontologie structurant la base de données. Un cadre de modélisation conceptuel est alors proposé comme un fondement scientifique au niveau méta.

Au regard des challenges présentés plus haut, cette thèse adopte globalement une méthode de recherche analytique et conceptuelle (Cavalieri & Pezzotta 2012). Après une étape d'extraction des connaissances à partir de sources académiques et industrielles, les modèles SPS sont construits avec une vision pluridisciplinaire obtenue également des leçons apprises du projet ICP4Life. Une application supplémentaire du modèle est réalisée pour supporter la configuration des SPS.

Ce rapport de thèse est organisé comme suit: le chapitre 1 explique le contexte et les motivations de ce travail de recherche d'un point de vue académique et industriel. Ceci permet de positionner les problématiques de recherche. Le chapitre 2 présente un état de l'art sur les frameworks de modélisation à la fois pour des systèmes génériques et les systèmes SPS. En se focalisant sur la problématique de conception de SPS à travers une approche ingénierie système, les questions de recherche sont précisées. Le chapitre 3 est dédié à la construction de l'approche conceptuelle et l'explication des modèles. L'extraction des connaissances à partir de l'état de l'art et des besoins industriels est un prérequis. Le chapitre 4 utilise une approche « scenario-based » pour illustrer le potentiel de l'approche et son applicabilité dans un contexte industriel. Le chapitre 5 décrit l'ontologie développée comme une spécification du méta modèle d'un point de vue pragmatique et son utilisation dans la plateforme ICP4Life. Comme deuxième cadre d'application, un démonstrateur de configurateur SPS a été développé sur la base des modèles proposés par un travail de Master. Enfin, la conclusion explique les principales contributions et les perspectives de ce travail.

Chapter I.

Research context and problematics

CHAPTER I. RESEARCH CONTEXT AND PROBLEMATICS	9
I.1. INTRODUCTION	11
I.2. RESEARCH CONTEXT AND AMBITIONS	11
<i>I.2.1. PSS definition.....</i>	<i>12</i>
<i>I.2.2. PSS typology.....</i>	<i>13</i>
<i>I.2.3. PSS life cycle</i>	<i>15</i>
<i>I.2.4. PSS development process</i>	<i>18</i>
<i>I.2.5. PSS value creation model</i>	<i>22</i>
I.3. APPLICATION CONTEXT: THE ICP4LIFE EUROPEAN PROJECT.....	22
<i>I.3.1. Project description.....</i>	<i>23</i>
<i>I.3.2. Lessons learned from the Industrial Context PSS modeling request</i>	<i>25</i>
I.4. THESIS PROBLEMATIC	26
<i>I.4.1. The challenges of PSS architecture construction.....</i>	<i>26</i>
<i>I.4.2. The challenges of collaboration</i>	<i>27</i>
<i>I.4.3. The challenges of data management.....</i>	<i>27</i>
<i>I.4.4. The challenges of knowledge reuse and sharing.....</i>	<i>28</i>
<i>I.4.5. Problem Statement</i>	<i>28</i>
<i>I.4.6. Research Methodology</i>	<i>29</i>
I.5. SYNTHESIS AND CONCLUSION	31

I.1. Introduction

The emergence of new solutions as a response to the economic development and sustainability issues affects the product-centric business models. “The design approaches included at the product innovation level are crucial to reducing the environmental impact of products and production processes. However, although they are fundamental and necessary, they are not on their sufficient to obtain the radical improvements required to achieve sustainability” (Ceschin & Gaziulusoy 2016). To fulfill this challenge, the evolution of product offer towards an integrated solution combining the product with advanced services is widely considered as a competitive advantage for manufacturing companies.

In this matter, Product-Service System (PSS) has been brought into the discussion by the United Nations Environment Program (UNEP) in the late 1990s to deal with economic, social and environmental challenges (Qu et al. 2016) and as the most “feasible dematerialization strategy” to achieve “sustainable economic growth” (Mont 2002). Despite its importance, after the first publication about PSS in 1999 (Goedkoop et al. 1999) the only remarkable increase in PSS related publication happened during 2006 (Baines et al. 2007). In order to characterize PSS (its entities, actors, classification of typologies and life cycle) the literature is explored as the first step in the domain knowledge extraction and analysis (Cavalieri & Pezzotta 2012).

This chapter is dedicated to setting up the context of this research study from both academic and industrial applications point of view. The following sections describe the main characteristics of the product-service concept and related development processes. Based on this, the key challenges that affect PSS development performance are discussed before defining the research question. Finally, the research methodology to resolve this problem is detailed in the last section.

I.2. Research context and ambitions

Potentials of Product-Service Systems (PSS) as one of the possible solutions to tackle sustainability issues is considerable (Bocken et al. 2014). A sustainable PSS is “an offer model providing an integrated mix of products and services that are together able to fulfill a particular customer demand (to deliver a ‘unit of satisfaction’). This offer is based on innovative interactions between various stakeholders of the value production system (satisfaction system), where the economic and competitive interest of the providers continuously seeks environmentally and socio-ethically beneficial new solutions” (Vezzoli et al. 2014).

“PSS-oriented approach is an innovative strategy and value propositions oriented toward delivering value-in-use to customers” (Costa et al. 2018). PSS development process is different from the conventional product development process. PSS Design requires a systemic approach considering all its heterogeneous components simultaneously (Ceschin & Gaziulusoy 2016). In

order to consider these components, clarifying the concept and characteristics of PSS is a prerequisite. In doing so, the following sections are related to the main characteristics of the PSS concept.

I.2.1. PSS definition

Evolving product-centered business models to the solution-centered one have been brought into the discussion from 1962 (Boehm & Thomas 2013). Thenceforward, it gained attention and has been studied from various perspectives and under different terminologies, yet with high overlaps (Boehm & Thomas 2013).

Several definitions are given to the concept of PSS as shown in the first table of Appendix A. The most utilized terminologies to define this new approach are “Servitization” (Vandermerwe & Rada 1988); “Product-Service Systems (PSS)” (Goedkoop et al. 1999); “Function-Oriented Business Models” (Tukker 2004); “Functional Product (FP) or Total Care Product” (Alonso-Rasgado et al. 2004); “Integrated Solutions” (Davies et al. 2006); and “Hybrid Value Creation” (Boehm & Thomas 2013). Also, it has been used in different contexts and presented as “Sharing Economy” (Tukker 2004); “Industrial Product-Service System (IPSS)” (Meier et al. 2010) and “Sustainable Product-Service System or S.PSS” (Vezzoli et al. 2014).

Despite the differences in the terminologies, all PSS definitions mentioned product (hard or tangible element) and service (soft or intangible element) as the core components of PSS. Besides product and services, Vandermerwe et al. (1988) proposed a complete definition which considers “support” and “knowledge” as the other necessary components of PSS (Vandermerwe & Rada 1988). Afterward, “supporting network” (Mont 2002) or “service support system” (Alonso-Rasgado et al. 2004) has been considered in the PSS definitions. While the economic aspect of PSS has always been implied in PSS definitions, the environmental aspect has been bolded from 2002 (Mont 2002). Later, the innovative nature of PSS design which was implied in the previous definitions has been bolded (Manzini & Vezzoli 2003) and the life cycle approach developed the definition of PSS (Brady et al. 2005).

Meier et al. (2010) broadened the definition by using “knowledge-intensive socio-technical system” for PSS (Meier et al. 2010). Accordingly, new PSS definitions include software components and Cyber-Physical Systems (CPS) (Cavalieri & Pezzotta 2012) (Boehm & Thomas 2013). This aspect has been bolded by considering PSS as a “software-product-service” triangle (Mikusz 2014), which is discussed explicitly during the latter years (Lindström et al. 2015)(Scholze et al. 2016).

Also, the organizational and informational aspects of PSS received attention (Ericson & Larsson 2009). For instance, it is proposed that people, facilities and procedures must be organized as a whole to accomplish the final PSS solution (Cavalieri & Pezzotta 2012). These definitions highlight the critical fact that PSS is an integration of tangible and intangible

elements coming from different business areas. The PSS core components, considering procedures and actors, are defined within the Systems Engineering approach (Cavalieri & Pezzotta 2012).

According to the similarities between definitions in the literature, the following main points about PSS are of interest:

- PSS is a system of tangible and intangible components (Tukker 2004)
- PSS is a system of real or abstract interdependent entities (Meier et al. 2010)
- PSS is a combination of hard and soft elements (Alonso-Rasgado et al. 2004)
- PSS delivers an integrated solution (Brady et al. 2005)
- PSS is a functional solution providing added value (Sakao & Shimomura 2007)
- PSS integrates business models throughout all life stages (Vasantha et al. 2012)
- PSS consists of “knowledge” (Vandermerwe & Rada 1988)
- PSS needs the system supporting network and infrastructure (Mont 2002)

Considering all the above and inspired from various definitions of PSS in the literature, the PSS concept is considered in this work as follows. Product-Service System (PSS) is a resource efficient solution to deal with the sustainability issues and to achieve the circular economy (Tukker 2015). Quite literally, PSS is not a substitute for the product or service; it is an integrated solution (Mont 2002) with the dedicated infrastructure and the necessary supportive systems (Lim et al. 2012). Its object is to create a new offer (Shimomura & Akasaka 2013), to increase the overall value (Brady et al. 2005), and to promote stakeholders benefits (Vezzoli et al. 2014) within a “knowledge-intensive socio-technical” system (Meier et al. 2010).

I.2.2. PSS typology

PSS development is intimately connected to the design of the optimum sustainable solution and social innovation together (Maxwell & Van der Vorst 2003)-which is to say it is vital to redefine the production and consumption modalities (Ceschin 2014). In this context, the PSS typology affects the design process and customer integration during the development process (Gaiardelli et al. 2014). It has different effects on the PSS development complexity and collaboration tactics as well as the focus and the level of integration of PSS components (Reim et al. 2015).

The proposed typology for PSS by Tukker (Tukker 2004) is the most preferred classification in PSS literature (Adrodegari et al. 2015). This typology makes “a distinction between three main categories of PSS: Product-Oriented Services, Use-Oriented Services, and Result-Oriented Services” (Tukker 2004). The Result-Oriented as the most complex PSS is specified by “much personal communication and implement new working routines” in coordination activities, “lowest formalization and highest complexity” in responsibilities of

stakeholders and “high degree of customization and flexibility” in design tactics (Reim et al. 2014).

Schuh et al. (2004) distinguished three categories of PSS providers as “traditional manufacturing enterprise, service providing enterprise and manufacturing service enterprise” (Schuh et al. 2004). The description of these groups is mostly similar to Tukker’s typology. Adrodegari et al. (2015) proposed a new form of PSS typology that relies on the “building blocks of the business model framework” that presents “different revenue mechanisms for different value propositions, and to select the relevant business model variables that have to be considered in order to define a structured PSS typology” (Adrodegari et al. 2015). In this typology, “ownership-oriented” is similar to “product-oriented” services in Tukker (2004) point of view, and “service-oriented” is more like “Use-Oriented” and “Result-Oriented” services.

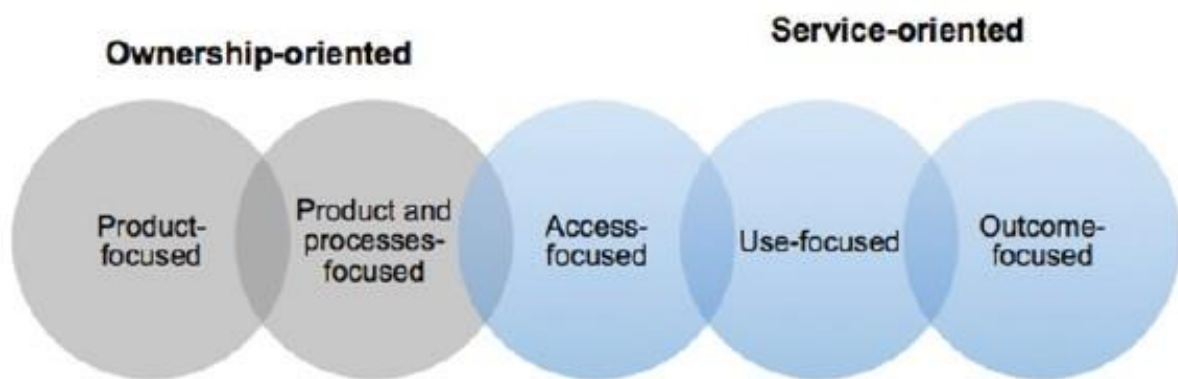

Figure 2. PSS types (Adrodegari et al. 2015)

The PSS typology in the energy context provides the possible energy services with various characteristics such as value propositions structure, energy system operation and ownership, organizational form, target customers and their relationship with the provider, payment and financing mechanisms, and environmental sustainability potential (Emili et al. 2016). In this viewpoint, PSS with various flexible energy services can be a tailored solution for a particular use case.

The PSS adoption follows either the convergence of ‘servitization’ of product or ‘productization’ of service (Baines et al. 2007). This approach considers the solution providing as the most developed and desirable for the customer; which is to say that neither product nor the service is the source of value creation and the final solution creates value by the simultaneous combination of the products and services (Figure 3).

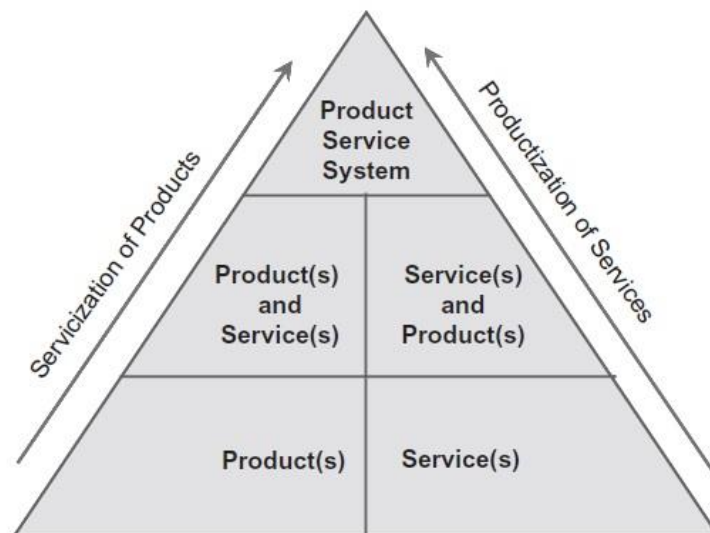

Figure 3. Evolution of the Product Service-System concept (Baines et al. 2007)

I.2.3. PSS life cycle

Companies create added value in PSS offer by providing an integrated system of tangible and intangible components interacting “throughout the life cycle stages” to meet the customer’s need while reducing environmental impacts (Manzini & Vezzoli 2003). Consequently, PSS consists of a set of various sub-systems in permanent interactions and incorporates several sub-life cycles that are different in characteristics and development activities (Lindström et al. 2015). So, as shown in Table 1, PSS development process is challenging because its general life cycle built up of sub-life cycles of components like hardware, software, service-support system and management of operation (Lindström & Karlberg 2017).

As a result, PSS development is associated with engineering intangible service and processes (Xing et al. 2013) as well as with a technological transition in the product along with its life cycle (Scholze et al. 2016). Adopting this life cycle approach increases the fields of action in PSS development (Meier et al. 2010). Consequently, engineers need to “find, promote and facilitate innovation configurations between different stakeholders” to “operate/facilitate a participatory design process” among stakeholders and to “orient this process towards sustainable solutions” (Vezzoli et al. 2014).

On one hand, the scope of the PSS life cycle has similarities to the traditional product life cycle. On the other hand, compared to the product or the service, PSS sub-systems have different modes of value delivering which must be integrated into a unique PSS offer (Tran & Park 2014). With PSS offer, companies create additional value for the customer through a long-term relationship covering a large part of the PSS life cycle (Vasantha et al. 2012).

The other specificity of PSS life cycle is the connection of at least two interdependent life cycles (product and service)(Tran & Park 2014). A challenging phase in PSS design is “to close loops between PLM (Product Life cycle Management) and SLM (Service Life cycle

Management)” (Wiesner et al. 2015). PSS life cycle incorporates the association of various interdependent life cycles of tangible and intangible components. Thus, PSS life cycle management strategy should ensure structural and process models synchronization, covering different life cycles from different perspectives. The product life cycle management solutions can be extended to manage the PSS life cycle, in condition to consider the PSS specific characteristics as independent but integrated components, interconnected stakeholders network, value creation process, prolonged life cycle phases and domain-specific application (Meier et al. 2010).

Table 1. Sub-life cycles of the functional product by (Lindström et al. 2015)

	Hardware	Software	Service-support system	Operation Management
Planning	customer requirements, constraints, tangible asset, network, and ICT infrastructure	customer requirements, constraints, operating systems, communication / ICT infrastructure, application platforms, programming languages, software tools/portals/ environments	customer requirements, constraints, communications/ ICT infrastructure, monitoring systems/analytics/ warning/notification systems, information systems/ knowledge management systems, set-up of service-support organization	customer requirements, constraints, life-cycle engineering, risk sharing, research collaboration
Design and Development	Test and Simulation	Test and Simulation	Test and Simulation	Test, Simulation, and Optimization
Realization	Integration Test	Integration Test	Integration Test	Integration Test
Usage	remanufacturing, upgrade, waste, reuse	bug fix, patch, upgrade, waste (code and knowledge etc. not to be reused)	monitoring, reactive/proactive maintenance, self-service, maintenance, support, asset management (obsolescence/change/c onfiguration management), knowledge management	life cycle management, decision making, risk management, availability measurement and management
End-of-life				

Life Cycle Oriented Design of Technical Product-Service Systems proposed by (Aurich et al. 2006) is one of the most accepted models in PSS design methodology (Tukker 2015). Using the Life cycle Engineering (LCE) concepts, they do not restrict the products to the physical artifacts but the PSS as the mixed design of physical products and non-physical components together. This model is a translation of the “traditional process of product design” into a “process of technical service design” which “propose a parallel, interactive process of product and service development for PSS” (Tukker 2015). They pointed out that the product-service life cycle should be considered by two different points of view (Figure 4). To provide the product, the manufacturer point of view is important which in product life cycle consists of “design, manufacturing, servicing, remanufacturing” but the related technical services should be provided considering customer point of view of the product life cycle, which are phases as “purchasing, usage, and disposal” (Aurich et al. 2006).

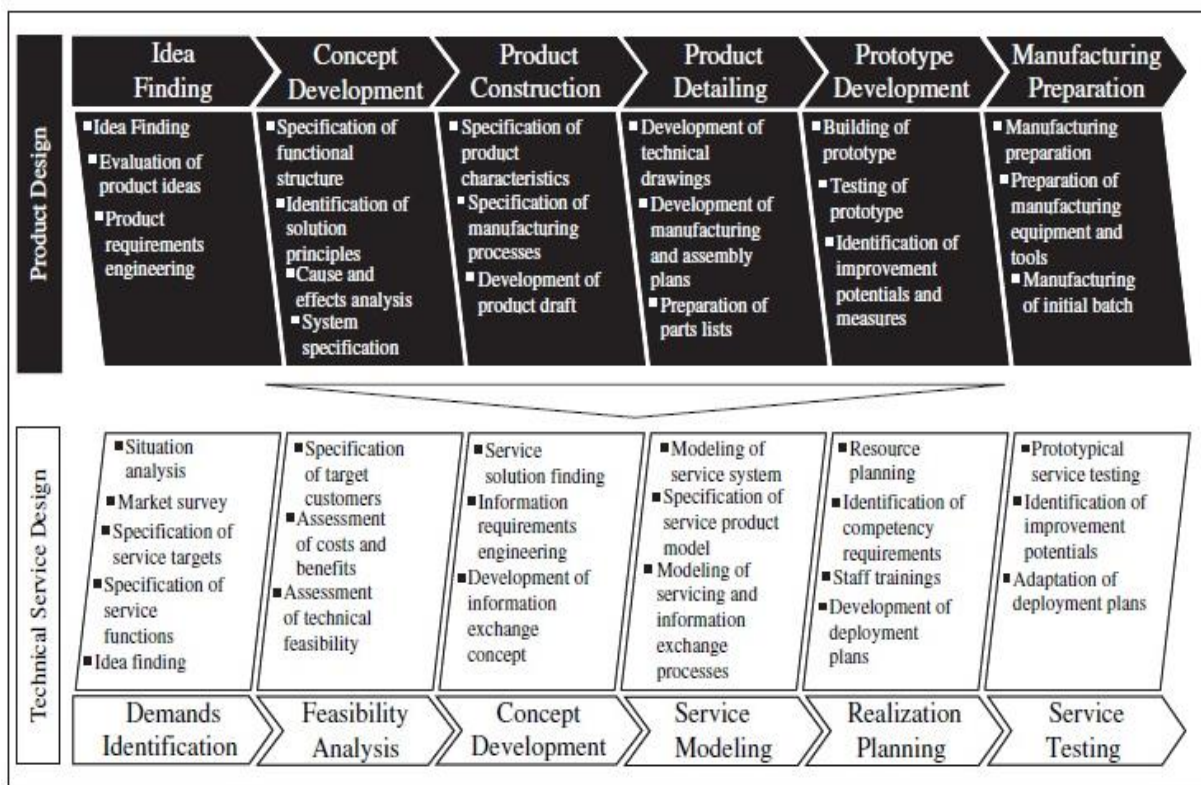

Figure 4. Technical service design process (Aurich et al. 2006)

Despite the variety of PSS sub-systems and their life cycle, PSS, as an integrated system, its life cycle can be considered as a chain of stages which in the there is an action per life stage (Beuren et al. 2017). For instance, the service renewal is considered as an input for the PSS implementation (Figure 5). In literature, few methods consider PSS life cycle based on its typology (Tran & Park 2014)(Beuren et al. 2017). What is mutual in these approaches is that the main stages of the life cycle are the same and the difference is in the detailed activities in each phase.

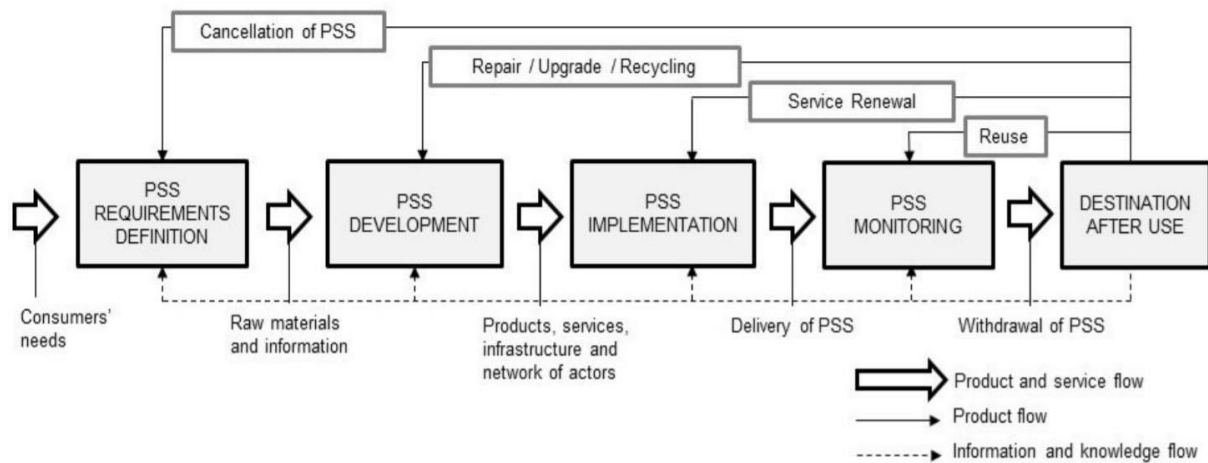

Figure 5. PSS lifecycle (Beuren et al. 2017)

I.2.4. PSS development process

PSS aims at organizing the products, services, supportive infrastructures, stakeholders' network (Lim et al. 2012), knowledge (Vandermerwe & Rada 1988) and procedures (Cavaliere & Pezzotta 2012) altogether. Therefore, it results from the synergetic integration of tangible and intangible components (Cavaliere & Pezzotta 2012) continuously interacting with each other through the system life cycle (Tukker 2004). Consequently, PSS providers are fostered to strengthen their capability in system integration to keep their place in the market (Davies et al. 2006). Though, the traditional stage-gate product design process needs to evolve to combine both product and service design to provide PSS. In this matter, based on their core competencies and their revenue mechanisms for value proposition, companies adopt and customize the PSS type they would be capable of providing for their customers (Tukker 2015)(Wang et al. 2014). They use "formal or informal approach to PSS design and they also use their own tools and procedures" (Tukker & Tischner 2006) in an "unstructured fashion" (Gaiardelli et al. 2014).

In moving towards the adoption of the PSS business model, industries need to create a new integrated system of solution providing by rethinking their current development processes. Some authors proposed a parallel interactive process of product and service development for PSS by translating the traditional product-process into a process of technical service (Maussang et al. 2009)(Marques et al. 2013). Later, many researchers support the view that PSS design process cannot be considered as an extension of product or service design processes but as the design process of an integrated system (Cavaliere & Pezzotta 2012)(Tukker 2015)(Fargnoli et al. 2018). According to this viewpoint, PSS development represents an extension of the activities and more complex processes than product development (Hinz et al. 2013) and must follow a systematic flexible and dynamic roadmap (Ceschin 2013). The integration of such a system consists of managing the complexity and heterogeneity caused by inter-connected domains that are collaborating to create the function (Gausemeier et al. 2013).

Moreover, PSS has been passed throughout a transition from the primary after-sale services to the current internet based life cycle solution (Van Ostaeyen et al. 2013). As a result, the competitive capability of companies is not anymore on adding offline services to their product but to propose a smart function or solution to fulfill the customer needs. Additionally, PSS development process is associated with a technological transition in the product “along with its life cycle” as well as service enablers (Scholze et al. 2016). In this matter, Cyber-Physical System (CPS) can accurately describe PSS new technological approach in integrating ICT in product life cycle engineering and advanced services (Boehm & Thomas 2013). Connecting Cyber-Physical System to PSS or function design has been proposed by various researchers (Stark et al. 2014)(Lindström & Karlberg 2017). Providing customized, real-time intelligent services are enabled by CPS for traditional manufacturing systems (Yue et al. 2015). In this matter, the design of intelligent service provided by CPS has a very strong Systems Engineering flavor (Yue et al. 2015). As an example, Schuh et al. (2014) proposed the Cyber-Physical System as an enabler for the tool making industry in the service provision (Schuh et al. 2014). In this proposition, the transition from tool provider to the service provider is a progressive process shown in Figure 6.

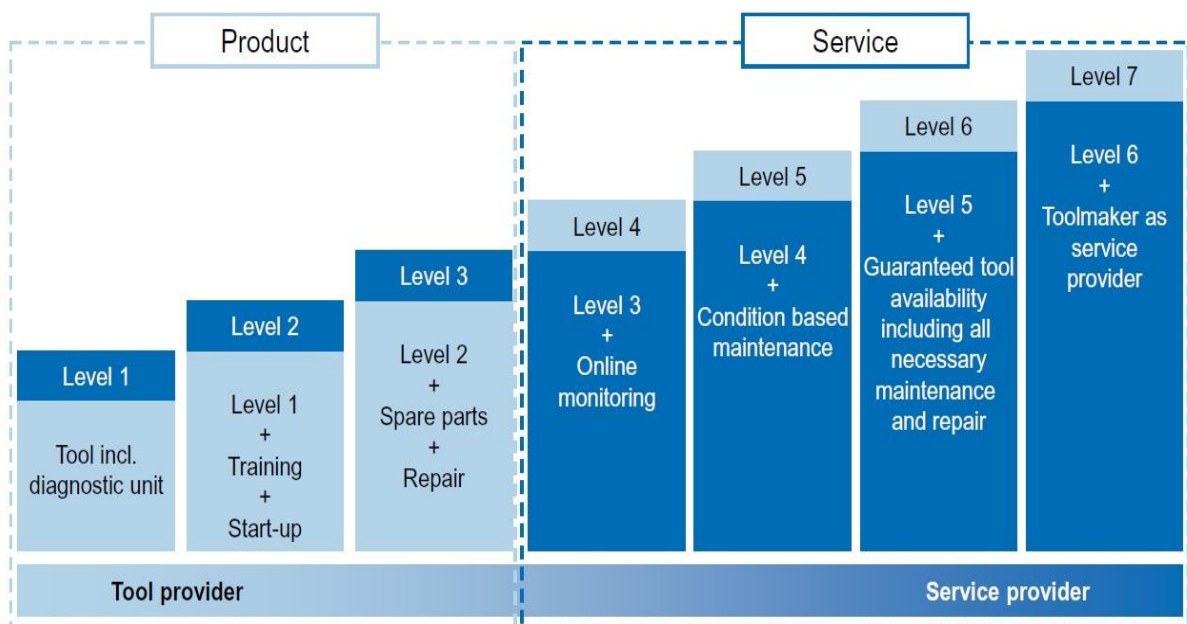

Figure 6. The transition from tool provider to PSS provider

Adopting the life cycle approach increases fields of action in PSS design (Meier et al. 2010). The interdisciplinary nature of this new phenomenon increases the number of disciplines and components involved in the development process and imply the need for robust coordination and collaboration efforts (Reim et al. 2015). Furthermore, activities in PSS development project have different content depending on the nature and the life stage of the sub-systems. “Coordination of the technical sub-life cycles is necessary for them to stay aligned with each other when introducing new functionality, managing emerging customer requirements, the technical aspects of contracts and managing operations over the long term”

(Lindström & Karlberg 2017). This phenomenon implies a gap of maturity between these sub-systems at the same milestone and increases the integration complexity (Lindström et al. 2015).

In addition to physical product and service architectures (as the core elements of PSS); processes, resources, and organization are the main pillars of PSS development project management (Mont 2002)(Xing et al. 2013)(Scholze et al. 2016). As a result, the PSS development project requires considering the co-evolution of these pillars (Schenkl et al. 2014)(Sadek & Köster 2011). Process pillar concerns the structuring of all operational and support activities contributing to the realization of the final solution. It includes also the management of the long term relationship with the client who buys the final PSS and the consumer who uses it. Resources pillar interests in the allocation with a suitable role of available resources to the defined activities. The organization pillar connects these resources to their belonging organizational structures (department, company, work team, etc.) respecting their hierarchical functions and technical skills.

Companies, who are evolving to the integrated solution providers, need to achieve a set of capabilities and adjust their organization capability by strengthening their customer relationship, flexible production and organization focusing on the “reusable integrated solution” (Davies et al. 2006). The system must be based on building modular offer to increase the repeatability of the customized integrated solution and reducing risk and cost. It needs to follow modularity in design and integration in function delivering (Davies et al. 2006). To facilitate the PSS offer, they “provide common components of solutions-ready products and services that can be “mixed and matched” in different combinations by the Customer Facing Units (Davies et al. 2006).

One of the early projects in PSS development is SusProNet (EU Network on Sustainable Product-Service Development)(Tukker 2015). Based on an analytic review of the best practices in PSS design projects, they developed a ‘practical guide for PSS development’ describing steps as “preparation and introduction, analyzing PSS opportunities, PSS idea generation, PSS design, make implementation plan” (Tukker & Tischner 2004). Afterward, more methods link PSS concept and system thinking to enhance participatory processes for collaborative decision-making and enabling inter-organizational communication and cooperation for systems solutions. These methods are useful when “sustainability and human values need to be integrated into technical system design and management” (Xing et al. 2013). Based on the Soft Systems Methodology (SSM) approach, “the various elements of a PSS, including products, services, networks of actors and supporting infrastructure” are considered as a “connected whole” with synergetic interactions among entities (Xing et al. 2013). This methodology based on “SSM is particularly capable of enhancing participatory processes for group decision-making and enabling inter-organizational communication and cooperation for systems solutions when sustainability and human values need to be integrated into technical system design and management” (Xing et al. 2013). The architecture of the model proposed by (Xing et al. 2013) consists of five major components as follow: (Figure 7)

- “Context and Boundaries”: This group considers the “environmental, economic, cultural, social-political perspectives” effecting PSS development.
- “Collaboration Networks”: This group is a collection of “entities that can, or have the intention to, form partnerships and contribute to explore and achieve common goals and collective benefits”.
- “Capability Networks”: This group consists of various “competences of the participating entities that are available to contribute to solution development (product competencies, service competencies, and enabling mechanisms)”.
- “Transformation Goals”: This group mentions the “worldviews among all partners on feasible and desirable changes” for PSS development.
- “PSS Modes”: This group considers “a scenario, a task force, and product-service configurations” during PSS development.

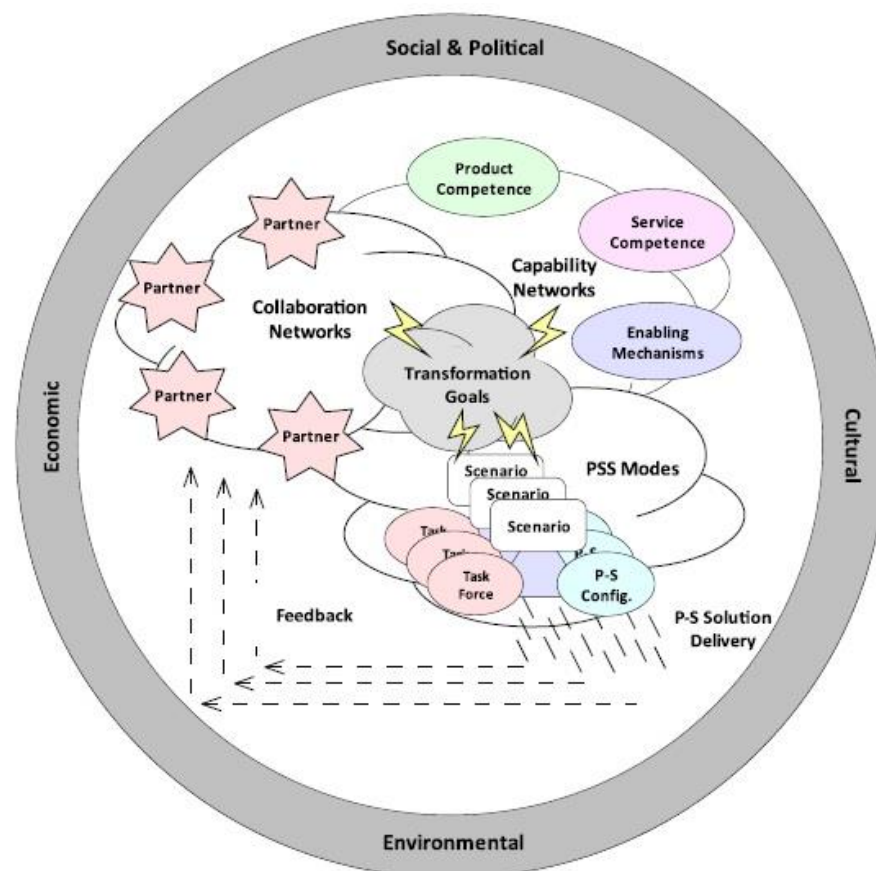

Figure 7. Eco-system model of synergism for PSS development (Xing et al. 2013)

While the concepts and incentives for PSS adoption are well-defined, there is an inconclusive debate on PSS development methodology. There is a growing literature on PSS development project that indicates the need of systematic approaches addressing its complexity (Pezzotta et al. 2012)(Lindström et al. 2015)(Vasanthan et al. 2012). In this context, various approaches have been put forward to solve this issue by adopting either product or service development processes (Tukker & Tischner 2004). Others, consider PSS development as an innovative process following standard phases to develop an artifact from requirement analysis to the end of life stage (Nguyen et al. 2014). Though, several authors have called these methods

into question (Tukker 2015) and argued that rather than adopting classical approaches in product or service development it might be more useful to tailor the development process based on PSS characteristics as an integrated system (Beuren et al. 2016; Song & Sakao 2017).

I.2.5. PSS value creation model

The PSS “value co-creation” is established by actors’ network collaborating to integrate supportive systems, resources and infrastructures into the PSS architecture during the service exchange (Pineda & Lopes 2013)(Vargo & Lusch 2016)(Hein et al. 2018). In this matter, the network capability is improving by the “collaborative process of value co-creation between parties” (Vargo & Lusch 2017) that enables the “customer value creation” and facilitates the “transition towards PSS” (Story et al. 2017)(Pagoropoulos et al. 2017). In fact, the value co-creation progressed from focusing on the product to focus on the solution and finally derived from the experience of the company (Liu et al. 2018). In this context, the PSS performance will be achieved by integrating three axes namely product-service, Enabling Systems and actors network which benefits from knowledge capitalization from the actors’ multi-viewpoints to improve the firm’s strategic, organizational and operational capabilities (Bonjour et al. 2008)(Gebauer et al. 2017).

To accomplish this value offering approach, PSS is considered as a system made up of independent operational sub-systems which are “collaboratively integrated” (Maier 1996)(Varga et al. 2017). The multiple points of view in PSS affects its architecture (Finkelsetin et al. 1992)-which is to say the perception of PSS architecture and its sub-systems depends on the solution provider interests (Haskins 2010). So, in successfully designing PSS, it is vital to clearly define its modules and components as well as their configuration (Song & Sakao 2017). It is also important to consider all operating environments and related constraints at the earlier design stages.

I.3. Application context: The ICP4Life European project

The previous section points out the multi-disciplinary aspect of PSS and the need to develop specific collaborative supports to manage the whole life cycle, including the relationship with the end user, and the management of all knowledge used during the PSS collaborative development process. The ICP4Life project receives funding from the European Commission under the H2020 program related to the “Factory of the Future” (FoF5) call. Twelve partners are involved in this project: four academic and research entities, two Original Equipment Manufacturers (OEM), three Small and Medium Enterprises (SME) and three software developers in charge of the development of the final solution.

I.3.1. Project description

The aim of ICP4Life project is to propose an integrated, collaborative platform for the design, development, and support of product-service systems for SMEs, equipment manufacturers and energy suppliers to maximize the impact in the European industry”¹.

The scope of the ICP4Life projects covers a large variety of industrial PSS. Three industrial use cases are considered as representative of this variety of problematics, namely: Equipment manufacturing, SME manufacturer and energy supplier (Figure 8).

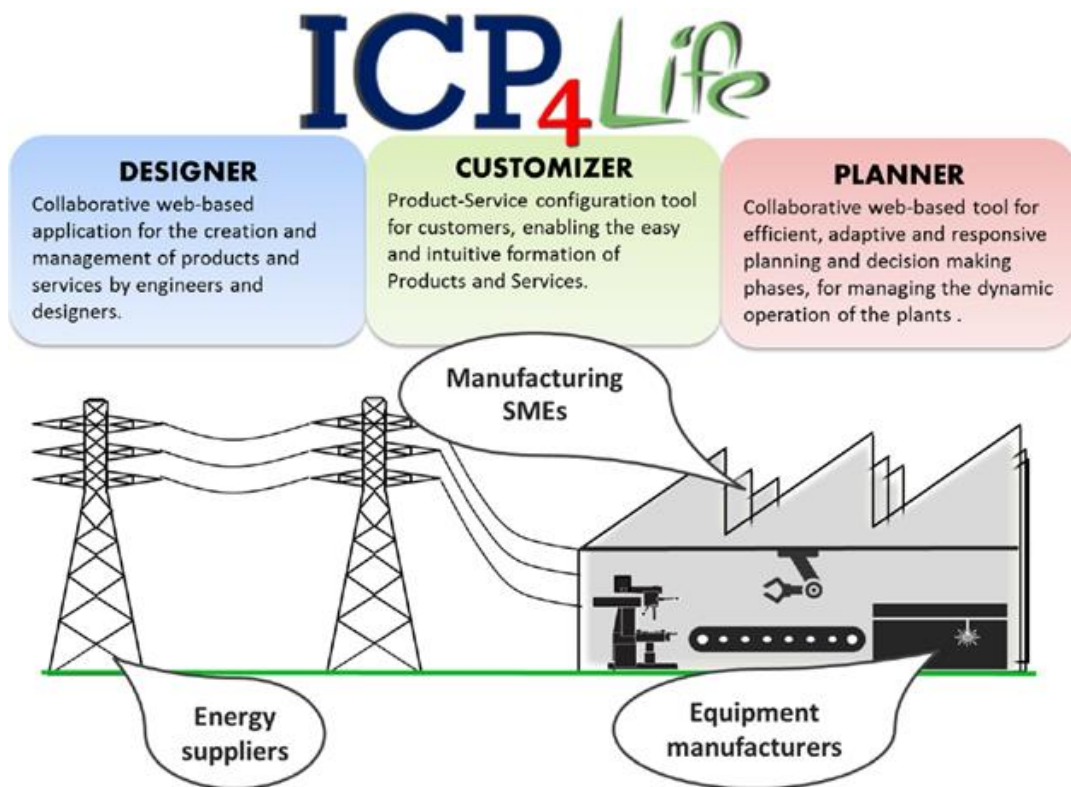

Figure 8. ICP4Life concept (from ICP4Life website)².

As a result, the ICP4Life collaborative platform comprises three main components that cover the whole PSS life cycle: customizer, Designer and Planner. The platform is able to address the need for providing a neutral, easy to the interface system, featuring a more efficient collaboration strategy and an effective knowledge sharing environment. The components are separately dedicated to the following needs (Figure 9)³:

- Designer: “to support the creation and management of product and service data by engineers of multiple disciplines, through the use of a common semantic model”;

¹ <http://www.icp4life.eu/>

² <http://www.icp4life.eu/results/>

³ <http://www.icp4life.eu/concept/>

- Customizer: “to support the easy and intuitive configuration of Products and Services by customers of different profiles for different types of products”;
- Planner: “To support the semi-automatic design and reconfiguration of lines and energy supply grids through simulation services on the cloud connected to a common model for the whole supply chain”.

All these modules are interacting through a central repository that guarantees knowledge and data sharing in a consistent way. In addition, a procurement module is dedicated to managing the population of this knowledge repository with data and knowledge from various stakeholders.

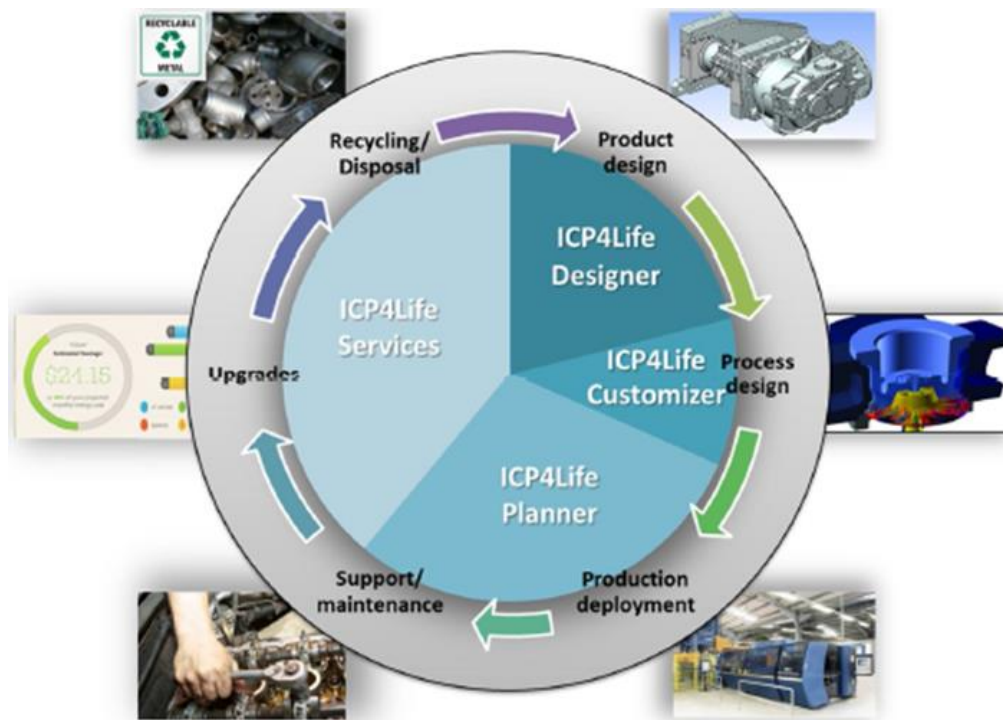

Figure 9. The ICP4Life components ⁴

Ecole Centrale Nantes (ECN) is leading two key tasks in the project: the conception of the designer module and definition of the semantic model structuring the common knowledge repository. During the collaborative design process, the designer module supports engineers to create product-service data as well as to manage information flows to improve design efficiency. By using the designer module, engineers manage the whole design process from the conception to the configuration to fulfill the requirement specifications. Furthermore, this module eases the connection with the different specific legacy CAX tools to circulate the information flow and data management. In doing so, there are several interactions between the designer module and the other modules of the ICP4Life platform.

⁴ <http://www.icp4life.eu/concept/>

Consequently, this research work has the ambition to contribute to the ICP4Life project through two main contributions: Firstly, clarifying the design process from a methodological point of view as a background of the Designer tool; secondly, providing a semantic model to support the variety of data and models in the common knowledge repository. In order to fulfill this task, a mixed methodology is used consisted of three methods as follows:

1. The literature review is carried out as a top-down method to extract the domain knowledge in the general functionalities and components of PSS design tools.
2. The requirements analysis review is carried out as a bottom-up method to identify the functional and non-functional requirements and components of PSS.
3. The experimental design method is carried out to adjust the functionalities and components of PSS. This method is based on one scenario in one of the use cases. During the experimental design, the primary conceptual architecture of the designer module is developed. In doing so, the models of PSS components, business processes, and functions are created and their specifications are identified. During this scenario, the whole process of collaborative development is observed and the difficulties and characteristics of the PSS development are identified. This information is then used to refine the designer module development.

More generally, the next section addresses the scientific challenges of this research work.

1.3.2. Lessons learned from the Industrial Context PSS modeling request

ICP4Life aims at proposing an innovative PSS structure and configuration method. By observing and analyzing the project structure and development process, the main characteristics of the project and its architecture are extracted as:

In ICP4Life, PSS is a System of Systems made of sub-PSSs. It is a PSS network made of smaller PSSs in the machinery, manufacturing, and energy providing contexts. The sub-PSSs' typologies are different. While, the machinery use case is a product-oriented and the energy providing use case is a performance-oriented PSS; the ICP4Life platform as a PSS is a user-oriented PSS focusing on the providing Software as a service (SaaS), Platform as a service (PaaS) and Infrastructure as a service (IaaS). Its role is managing the feedback and notification to support the design and operation of the PSS network. Considering ICP4Life as an integrated PSS, this platform plays the role of the Enabling Systems. The platform functionality is supporting the various services in the project by managing the product/process-focused data and feedback acquired by the embedded systems and from the observation of the user behavior as well as easing data flow between different ICP4Life partners.

ICP4Life proposes a life cycle focused framework. The project considers the main phases of the PSS life cycle as marketing, design, planning, production, delivery, usage and recycle. Though, the sub-systems have different life cycles which will be considered and integrated into

the PSS development and architecture. The product life cycle phases are product design, process design, production deployment, support maintenance, upgrade, recycling/disposal.

The ICP4Life architecture is based on Product-Process-Resource model and follows a “knowledge-driven approach”. This knowledge is extracted by the semantic case-based reasoning (CBS) method. The ICP4Life platform is a supportive element in the whole PSS network. It manages information and knowledge (semantic model, ontology in the knowledge repository) to support the decision making and communication process during the PSS development and operation. Product-Related knowledge describes the product structure and characteristics. It is bounded with the product configuration and production-related knowledge as well as quality assurance knowledge. The acquired data will be saved in the knowledge repository and retrieved from it.

I.4. Thesis Problematic

The literature survey and the topic of the ICP4Life project point out several scientific challenges that should be resolved as part of a global methodological approach to improve the efficiency of the PSS development project. The following challenges are at the origin of the scientific problematic of this research work.

I.4.1. The challenges of PSS architecture construction

Even though the tangible product is considered as an essential sub-system in the PSS development (Joore & Brezet 2015), comparing to product development, PSS development “represents an extension of activities” (Hinz et al. 2013). As a result, PSS can be considered as an integrated system with unique characteristics as:

- PSS development process incorporates various sub-life cycles that are different in characteristics and development activities (Lindström et al. 2015). In addition to product development, PSS development is associated with intangible service and enabling mechanisms which can be consisted of physical and non-physical components (Xing et al. 2013).
- PSS development process is associated with a technological transition in the product “along with its life cycle” (Scholze et al. 2016). So, the tangible sub-system of PSS could be a mechatronic system consists of a mechanic, electric and cybernetic components (Muller et al. 2007).
- PSS development process concerns Enabling Systems namely infrastructure, information support and organizational aspects to support the connection between tangible and intangible components in the whole PSS integrated architecture (Gausemeier et al. 2013)(Mont 2002)(SEBOK1.8 2017).

As a result of this heterogeneity of PSS components, the challenge of PSS architecture construction is the identification of all its subsystems but also the distinguishing of the borders

and the connections between these sub-systems. Due to the diversity of its components, the second challenge is to provide a unified description of all aspects and properties of the PSS architecture.

I.4.2. The challenges of collaboration

The collaborative character of the development process is resulting from a variety of stakeholders involved at different stages of the PSS life cycle. For instance, it is possible to distinguish the main categories of stakeholders according to their level of connection with the PSS offer and their implication at different life stages: PSS main provider, PSS associated suppliers involved in the provision of some service functions during the usage stage, classical suppliers in charge of providing PSS components, PSS client and future owner of the solution, and accessory, the end user who can take advantages from the PSS offer.

The core functionalities of PSS are mainly provided through various collaborations between the customer, the end user and the providers that are engaged in a virtual enterprise (VE). This last concept refers to a temporary partnership (or alliance) of independent and geographically distributed companies sharing resources, costs, and skills to take advantage of an emerging business opportunity (Wei and Wang 2010). As an agile form of organization, the VE members have complementary contributions and are engaged in a contract-based relationship following a win-to-win model within the PSS business objectives.

However, even if the PSS development process exploits the classical design and production methods and tools to integrate the physical dimension; the current approaches lack integration of such collaboration constraints (Cavalieri & Pezzotta 2012). So, it is important to anticipate in the design stage the definition of all collaborative scenarios alternatives and related organizational capabilities to cover different potential situations along the PSS life cycle.

I.4.3. The challenges of data management

As a direct consequence of the customer long-term relationship property of the PSS business paradigm, there is a need to collect, store, process and reconstitute a big amount of heterogeneous data during the operation stage. The problematic of data management is classically linked to the PLM (Product Life cycle Management) approach that aims to implement in a consistent way a set of processes and tools for supporting all product and process related information through the entire life cycle (Srinivasan 2011). According to Srinivasan (2011), the scope and definition of PLM are expanding and maturing to meet the demands of an increasingly complex network of industrial partners spread globally and bound together by common business objectives (Srinivasan 2011).

The PSS related data are split between various sources and described in different file formats (such as application log files, measures databases, reports, customer datasheets, etc.). This implies an auxiliary challenge of interoperability for data exchange between all engaged

resources. In consequence, there is an important need to classify all these data types, their sources, and files as well as the connection between all of them within the realization process.

I.4.4. The challenges of knowledge reuse and sharing

Knowledge sharing and reuse influence enterprise performance (Lopes et al. 2017). During the different stages of the system development, the knowledge about the final solution progressively increases (Dewulf 2013). This earned knowledge and experiences are used to reduce the risk of the system fails to guarantee the success of future projects. PSS development is an innovative process resulting from the combination of heterogeneous and independent sub-systems. Accordingly, the existing knowledge management system is an advantage for the PSS stakeholders to be informed about the characteristics and usage constraints of other subsystems.

In order to enhance the impact of knowledge asset on the global performance, it is necessary to improve the knowledge sharing capabilities by transferring or disseminating knowledge from one person, group or organization to another (Lee 2001). Since every actor can take benefits from the experience of other actors, the company is able to make the right and quick decisions and reduce the risk produced by the inconsistency.

In this context, the knowledge representation is crucial for successful knowledge sharing and reuse by means of unveiling the knowledge hidden behind the set of data and information (Bertschi et al. 2013). In doing so, developing models, semantic languages, and formal rules are crucial for knowledge representation (Chein et al. 2013).

I.4.5. Problem Statement

The involved tangible and intangible elements, with organizational and technical complexity as well as their different configuration mechanisms, are the key challenges of PSS development (Mamrot et al. 2016). To tackle the PSS development problems, a complete modeling framework covering all PSS aspects with respect to the previous challenges would be beneficial (Wang et al. 2014). Considering the PSS representation challenges, the primary concern is the potential of using or extending current modeling approaches as a framework to represent the main conceptual dimensions of PSS.

Consequently, the initial Research Question is formulated as follows:

How to represent an integrated architecture for Product-Service System while considering different viewpoints through its life cycle?

The above research question leads us to an auxiliary but important question concerning the selection of suitable methodological foundation and modeling languages that allow constructing a robust PSS modeling framework able to support the representation of all PSS

related knowledge at the conceptual level and to provide detailed model ready to implement and use in the ICP4Life framework.

Considering all the above, PSS can be considered as a System of Systems (SOS) since it is made up of independent operational sub-systems that are “collaboratively integrated” in a unified and consistent architecture (Maier 1996)(Varga et al. 2017). Following this characteristic, *the kernel hypothesis of this research work is that Systems Engineering (SE) provides suitable methodological foundations to support the building of the PSS modeling framework.*

Indeed, SE proved its applicability to support the definition and integration of multi-domains systems along with their life cycles. Chapter 2 provides a state of the art on the Systems Engineering and its applications in PSS domain. More generic knowledge modeling approaches are also discussed with a focus on ontology-based language as one of the most used modeling tools in knowledge engineering.

I.4.6. Research Methodology

This research adopted an analytical, conceptual research method (Cavaliere & Pezzotta 2012). This method is a mixed research method of top-down for an academic point of view and bottom-up from the pragmatic point of view (Figure 10).

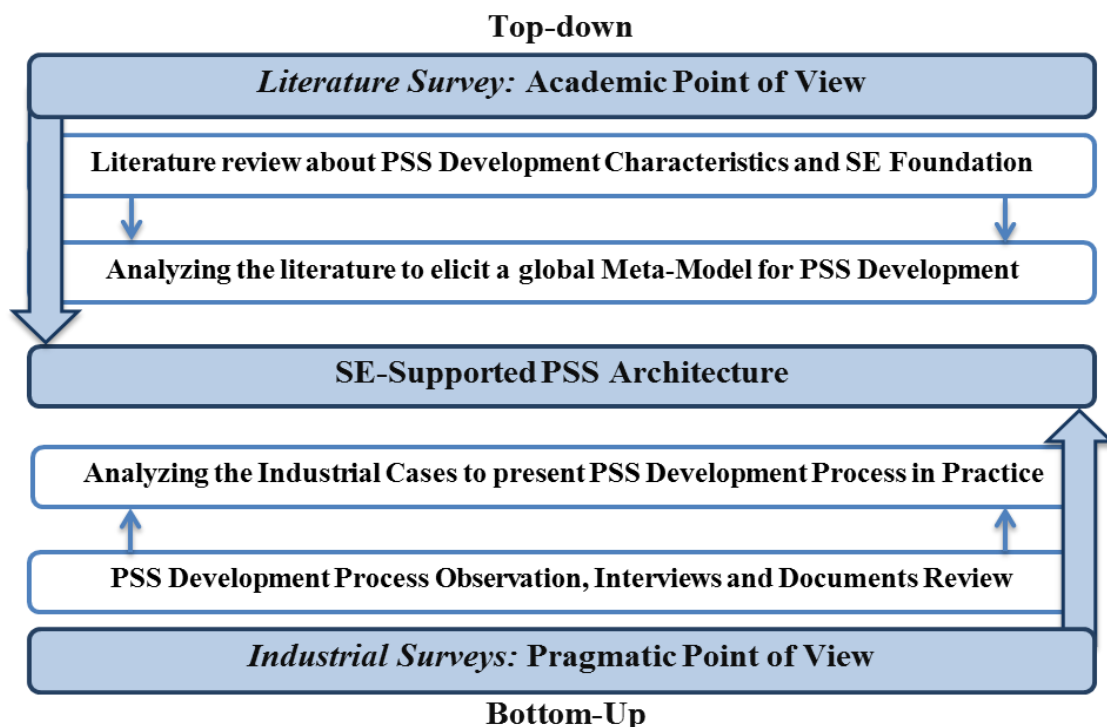

Figure 10. Research Methodology

The model construction includes three main steps as:

- *Domain knowledge extraction and analysis*

The literature review is a “potential source for methodological development” (Trevisan 2016). In this matter, the domain knowledge extraction consists of two parallel phases. First, the literature survey is a top-down academic point of view that addresses both areas of PSS development and current applications of system thinking in PSS development and modeling. The first aim is to elicit knowledge about the structure and methods of PSS development. The second aim is to identify the elements which characterize the system design approaches. This analysis starts with eliciting PSS characteristics and development methods. It describes system thinking capability to be used in the PSS development project.

As the second phase, an industrial survey is fulfilled conjointly, as a bottom-up pragmatic point of view, to extract and compare current practices with the theoretical findings. Case studies from the industrial project (ICP4Life European project) are analyzed to capture knowledge as well as to validate the results in two main steps as follows. Required information is acquired by observing the development activities. Additional data is gathered from projects’ documentation. The second step is dedicated to analyzing the results from industrial cases in accordance with the academic point of view.

- *Model construction*

The next phase is providing a conceptual framework adapted to the specificities of the PSS development project. An initial meta-model for PSS development will be built based on the “logical relationship among past theoretical assumptions” (Cavalieri & Pezzotta 2012)-which is to say it integrates academic and industrial point of view to best present the integrated PSS architecture.

- *Model validation and verification*

Conceptual model validity determines that “(1) the theories and assumptions underlying the conceptual model are correct, and (2) the model representation of the problem entity and the model’s structure, logic, and mathematical and causal relationships are “reasonable” for the intended purpose of the model” (Sargent 2013). Various techniques are used for model validation (Sargent 2013)(Kösters et al. 2001). In this research, we use two techniques for validation and verification of the system as follows.

A Scenario-Based Test is the main tool to validate the model. We use the industrial scenarios used in the ICP4Life projects. Three industrial partners are active in the project. We test the model through the different scenarios in each industrial case. Model-Based Testing (MBT) is gaining its place in verifying the complex system models (Biswal et al. 2008). “Scenarios (Use cases) are used to describe the functionality and behavior of a system from a user-centered perspective” (Ryser & Glinz 1999). In this context, the scenario is “an ordered set of interactions between partners, usually between a system and a set of actors external to the system. May comprise a concrete sequence of interaction steps (instance scenario) or a set of possible interaction steps (type scenario)” (Ryser & Glinz 1999). Accordingly, the Use case is

“a sequence of interactions between an actor (or actors) and a system triggered by a specific actor, which produces a result for an actor” (Ryser & Glinz 1999).

- *Model application*

Based on the validated scenarios, the model is applied by means of ontologies. This application supports the system design and integration. It also can support the further development of advanced configurators. An Ontology-Based Test is also a way to validate the model. In the project, ontological models are used to validate the conceptual framework (Shanks et al. 2003) and to propose an implemented solution for the support of the ICP4Life common knowledge repository. “Ontologies are unlikely to help with decisions about scope and participation in the validation process. However, regarding validation methodology, they help in three important ways: choosing the conceptual modeling grammar for representing the focal domain; understanding the phenomena represented in conceptual modeling scripts (diagrams), and making sense of ambiguous semantics in conceptual models” (Shanks et al. 2003).

I.5. Synthesis and Conclusion

This chapter explored the main characteristics of Product-Service System and the general challenges of providing a robust modeling framework for the representation of the related PSS complexity.

As an integrated system to provide a customized solution, PSS results from the synergetic integration of various components (tangible and intangible) with continuous interaction during the system lifecycle. This is to say, the outcomes of the PSS design process are more complicated because they concern the detailed definition of additional components and features as well as the technical solutions linking the components of product, service and support systems. Consequently, system integration is a valuable capability for PSS providers to provide a successful solution for their customer. In this matter, their core competencies and revenue mechanisms for value propositions are the main support for them to adopt a PSS development strategy.

More challenges arise during the integration of heterogeneous components through the PSS life cycle, which requires collaborative action between various experts with different viewpoints. In this context, the knowledge sharing mechanisms facilitate collaboration in such an interdisciplinary system development. While there is no doubt about the need for a multi-viewpoint model for PSS, yet, adopting a practical modeling approach is a debatable issue.

The primary review on PSS characteristics (definition, typology, life cycle, development process, and value creation model) besides the lessons learned from the ICP4Life project lead us to the conclusion that adopting a system-based approach for PSS development is a promising

method to manage the complexity of such projects. It also supports the coherent modular design and modeling of the various components with different points of view in PSS.

In order to make the basis to represent the Product-Service System architecture, the next chapter explores the standard modeling frameworks and tools for knowledge classification as well as PSS-dedicated ones. To shed light on the primary idea of adopting a system-based approach in PSS development and modeling is investigated.

Chapter II.

System modeling frameworks: State of the art

Chapter II. System modeling frameworks: State of the art	33
II.1. INTRODUCTION	35
II.2. KNOWLEDGE MODELING FOUNDATIONS.....	35
<i>II.2.1. Modeling languages and tools.....</i>	<i>36</i>
<i>II.2.2. Ontology as support for knowledge classification</i>	<i>37</i>
II.3. EXAMPLES OF MODELING FRAMEWORKS WITHIN AN INDUSTRIAL CONTEXT.....	40
<i>II.3.1. Examples of standard modeling frameworks.....</i>	<i>40</i>
<i>II.3.2. Examples of PSS-dedicated modeling frameworks</i>	<i>43</i>
<i>II.3.3. Examples of PSS-dedicated modeling with a functional analysis approach.....</i>	<i>47</i>
II.4. SYSTEMS ENGINEERING APPROACH	50
II.5. REFINED RESEARCH QUESTIONS.....	53
II.6. SYNTHESIS AND CONCLUSION	54

II.1. Introduction

A model is an abstract and simplified representation of the real world. It allows the observer to analyze and understand the different properties of a given system according to a specific perspective, which is connected to his problem of interest (Belkadi et al. 2004). The first objective of modeling activity is then to reduce the complexity of the studied system inadequacy with the limited perceptive and cognitive capacities of the observer. The complexity of the system is also obtained by decomposing the problem of interest to several elementary problems. In this case, the model is used to represent in a consistent way the integration of all sub-dimensions in the global one. Similarly, a model can guarantee the integration of various business points of view. This will allow communication between heterogeneous stakeholders who are interested in the same system but with different intentions. Likewise, the model is used as a support to describe a standard to be shared between the larger community of business and academic actors such as for example the graphical language (EL KHALKHALI 2002), the model is currently used to support the specifications to be considered for the design of a technical system (mechanical product, software, company, etc.).

Regarding our problem of interest, establishing a common understanding of the system characteristics is the primary step in modeling and developing any system (Haskins 2010). Likewise, understanding the characteristics of PSS and its relevant domains is of primary importance not only for the academic community but also in the PSS development application, especially regarding the different viewpoints integration (Gaiardelli et al. 2014).

In this regard, the areas related to the systems modeling have been explored in this chapter to refine the research question and to construct the modeling framework. To do so, the remainder of this chapter is organized as follow: the first section is dedicated to introducing the main categories of modeling languages and tools with some significant models deployed in industrial engineering. A focus is given in section 2 to the ontology concept as one of the key knowledge modeling tools. Section 3 describes the main characteristics of model-based system engineering as a methodological foundation to support the proposed modeling framework. Section 4 presents an overview of the existing modeling framework dedicated to PSS. A discussion of the advantages and limits of this literature will help us to refine the research question and to clarify the scope of the proposed PSS modeling framework.

II.2. Knowledge modeling foundations

The major knowledge modeling frameworks in the literature currently integrate two main categories of elements (Belkadi et al. 2012): semantic concepts representing the core content of the domain and a set of relations between these semantic concepts, which contribute to the understanding of the whole problem of interest. Modeling principles are currently used for representing data, information, and knowledge. These three concepts are different: data refer to

symbols (characters, words and/or numbers) that represent a fact or statement of the event but without any meaning, since it is decoupled from any context (Ackoff 1989). Information is contained in descriptions and is built from a combination of data to which meaning is attributed with an appropriate semantic (Keller and Tergan, 2005). Unlike data and information, knowledge is more difficult to define since it is associated with cognitive resources and expert activity (Grundstein, 2000). The most known definitions argue that the knowledge results from the acquisition of information and its interpretation in a given operational context (Prax, 2000).

Natural language is ambiguous and inconsistent for knowledge representation. In this matter, formal languages such as the semantic networks and conceptual graphs are used as modeling frameworks in several domains (Jakus et al., 2013). The modeling approaches focus on three different aspects as (Mentink 2004),:

- “Communication-Based modeling: defines processes in terms of communication acts between costumers and performers”.
- “Artefacts-Based modeling: focuses on the objects (e.g. data or information) that are created, modified, and used within a process along with their paths through a series of activities”.
- “Activity-Based modeling focuses on the activities that are to be performed within a process, along with dependencies and constraints among them”

To represent the domain knowledge, choosing suitable modeling tool is necessary. In doing so, this section makes a review of knowledge modeling frameworks and tools.

II.2.1. Modeling languages and tools

OMG (Object Management Group)⁵ as an international technology standards consortium developed several standardization languages to support knowledge representation. For instance, Service-oriented approaches (SOA) can be used to implement business processes (BPs) in a very flexible way so that business changes can rapidly be considered in PLM solutions (HACHANI et al. 2013). Business process modeling is often considered as an essential stage for the analysis of any business domain, by using different modeling languages such as BPMN (Business Process Modeling Notation), UML (Unified Modeling Language) and IDEF3 of the ICAM Definition (IDEF) method (where 'ICAM' is an acronym for Integrated Computer-Aided Manufacturing) (HACHANI et al. 2013)(Vernadat 2002). OMG uses a general framework based on the MOF (Meta-Object Facility) to define other similar languages (OMG 2013). Following this couple of standards, UML meta-model allows defining generic concepts. This facility is generally used to create domain dedicated generic representation through a set of standard concepts (Cranefield & Purvis 1999).

⁵ <http://www.omg.org/>

UML is a “standard graphical representation” for describing all kinds of object-oriented artifacts (physical or virtual) as well as its static and dynamic behavior to support the concepts discovering (Cranefield & Purvis 1999). UML proposes various types of complementary diagrams to represent different views on the system as the structure (with class, package, and object diagrams); Functional (with use case diagram); Behavior and operational (with activity, sequence, state-machine and collaboration diagrams); Physical implementation (with components and deployment diagrams) (NGO 2018). UML is vastly used in different industrial system modeling (Zheng et al. 2014). It is also proposed as an ontology modeling language (Cranefield & Purvis 1999). Consequently, considering Ontology-based modeling besides UML is unavoidable.

II.2.2. Ontology as support for knowledge classification

The commonly accepted approach for structuring the domain knowledge is constructing domain ontologies (Medina-Oliva et al. 2014). Ontology is defined as “a set of concepts and relationships used to describe a particular domain of knowledge” (Nadoveza & Kiritsis 2014). In other words, it provides the vocabulary for a domain and uses formal language to explicitly represent and manipulate complex models (Nadoveza & Kiritsis 2014). They are used to formalize the knowledge of a domain and thus add a semantic layer to computer systems and applications.

Ontology-based modeling is a well-known approach to support knowledge integration and interoperability between IT systems (Barbau et al. 2012) to facilitate data exchange between engineering activities during the collaborative business process (Zhou et al. 2017). In this context, its main purpose is to produce a set of information elements to be shared and reused by human and computer systems (Fitzpatrick et al. 2012) by means of data integration, knowledge management, and decision support (Bodenreider, 2008). Ontologies are developed as an OWL file with the Protégé software (Protégé n.d.). Protégé is a “graphical tool for ontology editing and knowledge acquisition that we can adapt to enable conceptual modeling with new and evolving Semantic Web languages (Noy et al. 1991)

As shown in Figure 11, three types of ontology are distinguished as global ontologies, domain ontologies and application ontologies (Guarino 2015). Global ontologies (Top-Level Ontology) propose a formal representation of general concepts which are “independent of a particular problem or domain”. They are the result of a systematic, consensual and rigorous development that allow sharing knowledge and transferring one context to another. Domain ontologies define the vocabulary of general domains or tasks or activities, by “specializing the terms introduced in the top-level ontology”. Application ontologies describe concepts in a particular domain or task, which are often “specializations of both the related ontologies” (Guarino 2015).

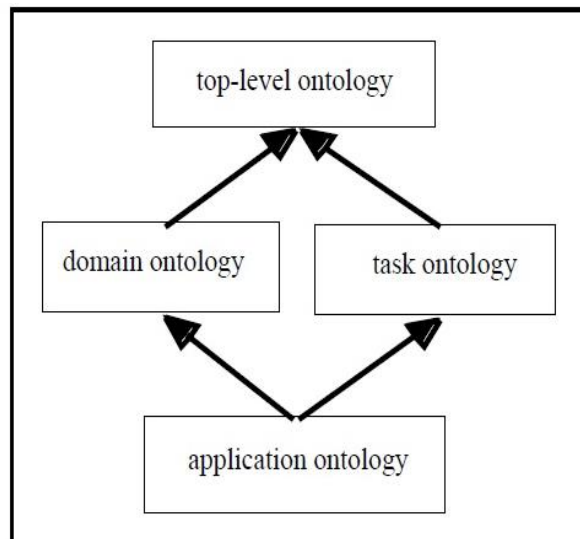

Figure 11. Kinds of ontologies (Guarino 2015)

The main structure of ontology with the core classes are presented in Figure 12.

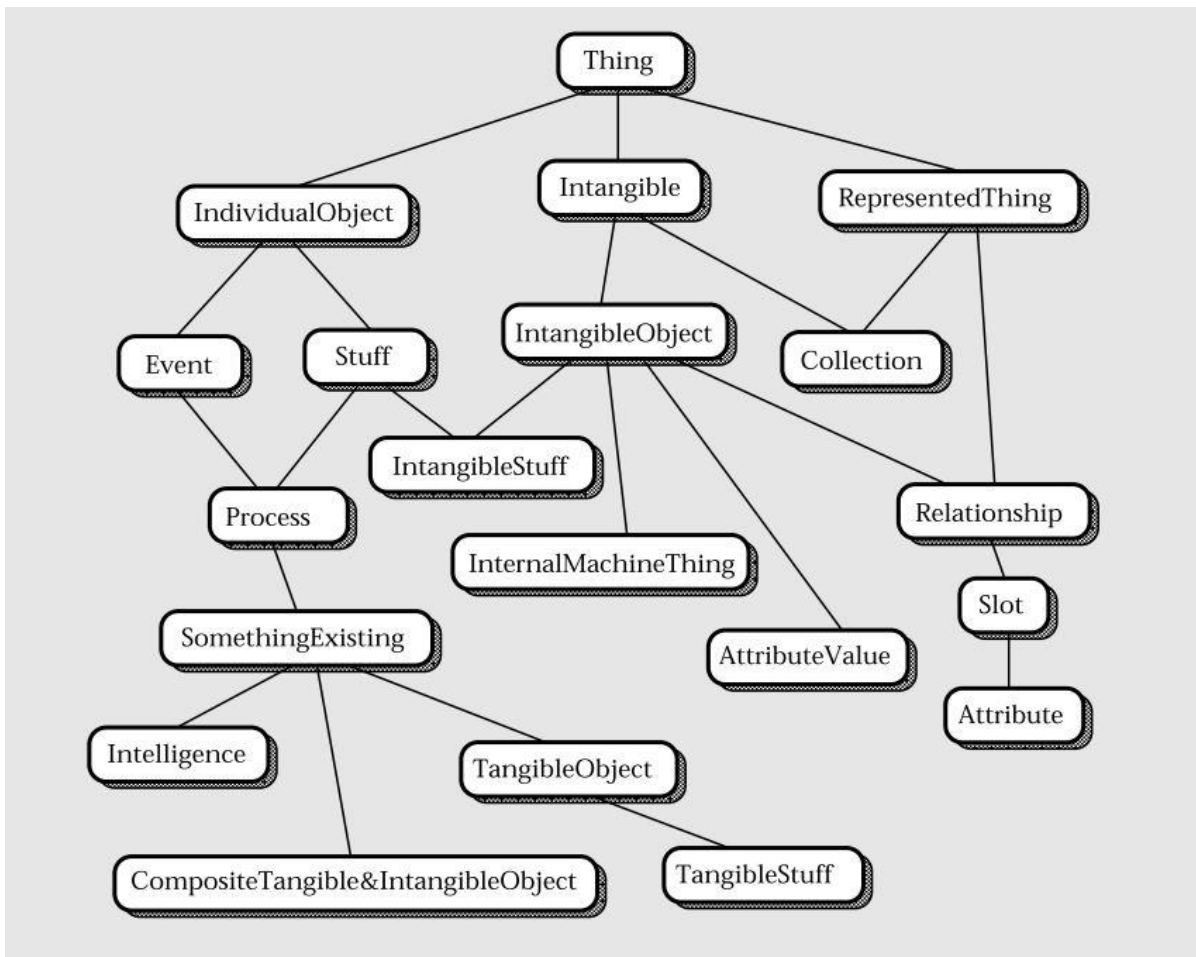

Figure 12. Top-Level Categories of ontology (Noy & Hafner 1997)

The main components of ontology are defined based on a “hierarchy of concepts related by subsumption relationships” and axioms to “express other relationships between concepts and to constrain their intended interpretation” (Guarino 2015). As shown in Figure 12, the top

of the hierarchy is the “Thing concept, which does not have any properties of its own” and concepts will be created under this main concept (Noy & Hafner 1997).

The main steps to produce ontology are defining the use-case scenarios; reusing existing ontologies; defining the ontology concepts and UML representation; and finally identifying the “concept to properties and instance relationships” (WANG, P. P. et al. 2011). A simplified example of an ontology is presented in Figure 13 from the Semantic Sensor Network XG Final Report (Compton et al. 2012). This ontology identifies the sensor, observation, and information acquiring and their relationships (Figure 13).

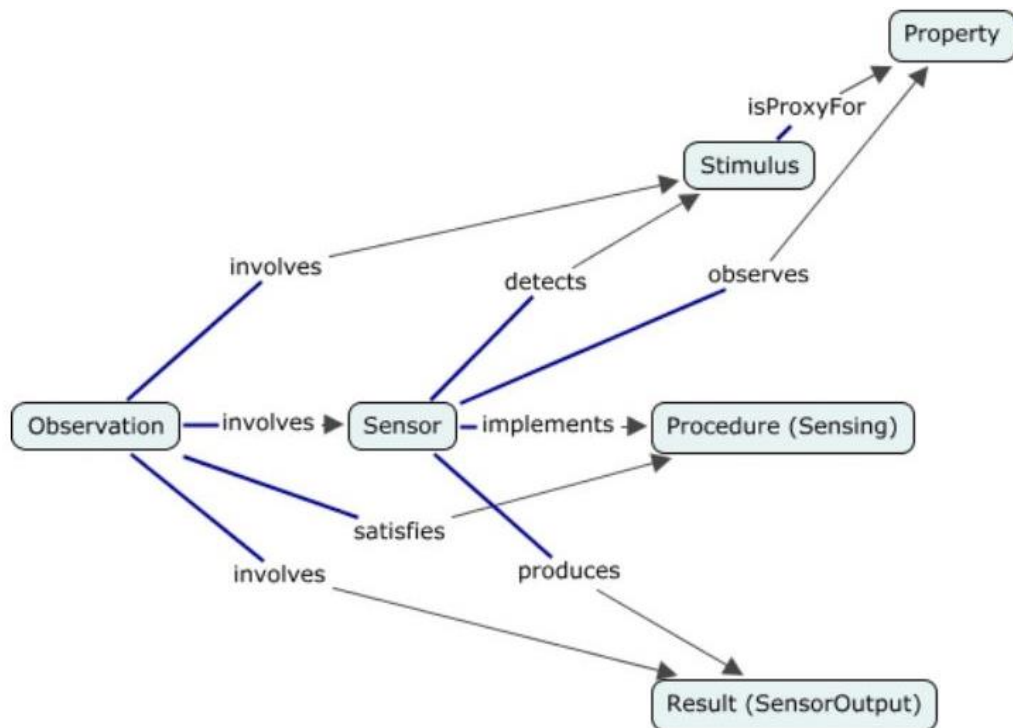

Figure 13. A simplified example of ontology (Compton et al. 2012)

In order to cope with the complexity of engineering knowledge, modularity in ontology design is proposed as a promising approach (Fowler & Rose 2004). Modular ontology development proposes that rather than having a massive ontology to cover a domain, it is necessary to abstract and generalize concepts into separate ontologies. This will be useful to allow better reusability, flexibility, and maintainability. The World Wide Web Consortium (W3C) provided various domain ontologies as the referenced modular ontology which can be used as a whole or adopted module (OMG 2013). The ONTOlogy for Product Data Management (ONTO-PDM) framework is an example of such solutions to allow information exchange and interoperability between enterprise applications (Panetto et al. 2012). The “process-centered knowledge” model (Figure 14) is another example of domain ontology “which represents major enterprise concepts, and the relationships between them” (Han & Park 2009).

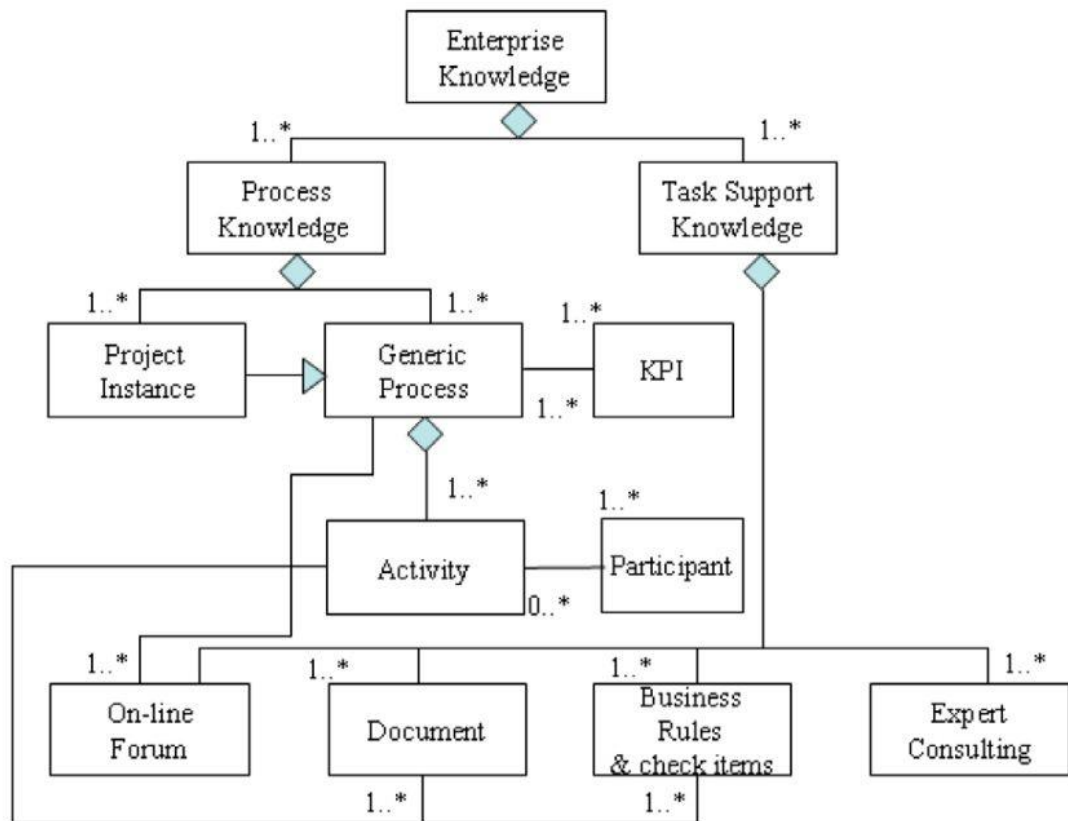

Figure 14 “process-centered knowledge” model (Han & Park 2009)

Next section provides an overview of the main standard modeling frameworks within an industrial context.

II.3. Examples of modeling frameworks within an industrial context

II.3.1. Examples of standard modeling frameworks

In the industry, three main categories of knowledge are generally distinguished: product engineering knowledge, manufacturing process knowledge, and organizational knowledge. Product knowledge refers to different types of characteristics describing the functional, behavior and structural views as well as geometry (Gero & Kannengiesser 2004). Process knowledge refers to the concept of activity which allows creating the link between products, resources (facilities, humans...) and their characteristics (rules, sequences, tasks, etc.). It concerns the process scheduling, the set of resources (human resources, machines, tools, and tooling), the organization of the production unit (work centers) and the manufacturing know-how (FORTIN & HUET 2007). In addition, information about decisions taken during the project, their justifications and their context of consideration are other important types of knowledge necessary to achieve reasoning (Kwan & Balasubramanian 2003).

From the organizational perspective, Enterprise Unified Modeling Language (EUML) is proposed by (Vernadat 2002) as a meta-model dedicated to describing all concepts and relations

in an industrial enterprise (Figure 15). This meta-model distinguishes three types of enterprise objects that can be transformed by a set of activities in a given business process. The resources are participating in the activities according to a specific role that requires qualifications and competencies. Similar models are existing in the literature that proposes a classification of organizational concepts such for example the enterprise ontology proposed in (Uschold et al. 1998) and the Enterprise Architecture Model developed with UML formalism in (Sousa et al. 2007).

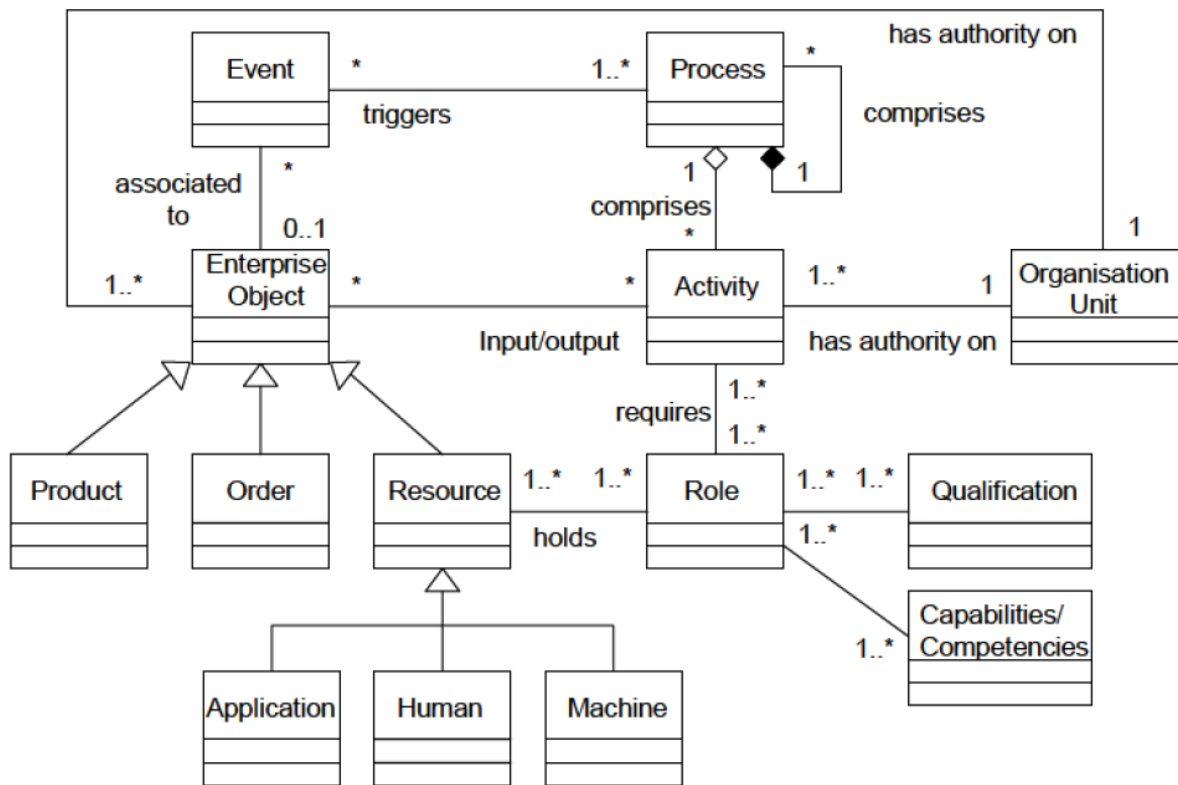

Figure 15. EURL Meta-Model (Vernadat 2002)

The integrated product-process design has been bolded by the emergence of concurrent engineering considering physical aspects besides the manufacturing processes and stakeholders involvement (Trevisan & Brissaud 2017). The PPO (Product, Process, Organization) model considers data from the product, process, and organization during the collaborative product development process (Noël & Roucoules 2008) (Figure 16). This model has been extended to integrate these components to improve engineering performance (le Duigou et al. 2011). Based on modularity, the generic meta-model of the IPPOP (Integration of Product, Process and Organization for improvement of engineering Performance) identifies four main packages as the activity (projects and process planning); the product (the produced product and its components); the resource (places, tools, humans and software) and the organization (suppliers, customers and collaborators) (le Duigou et al. 2011).

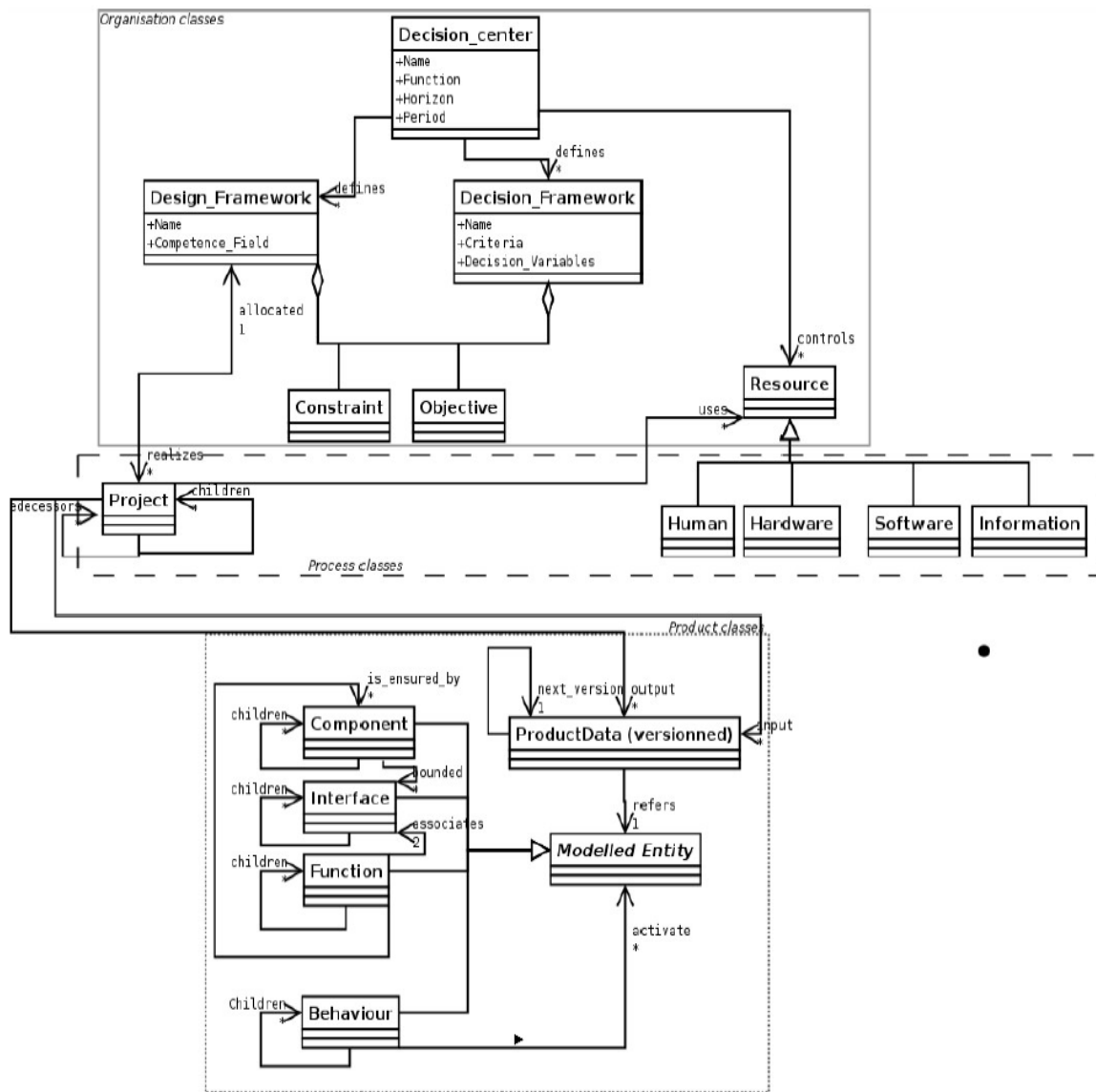

Figure 16. Overview of IPPOP model (Noël & Roucoules 2008)

Product modeling, as the physical structure of PSS, is often studied in the literature and several models have been proposed covering various facets. Product modeling throughout the whole life cycle results after implementation in the spine of the PDM (Product Data Management) information system. Several product models have been proposed and used along the recent years (Sudarsan & Fenves 2005). The CPM (Core Product Model) is another type of meta-model dedicated to supporting product knowledge (Fenves 2001). This model has been extended in various contexts (Zheng et al. 2013). The CPM follows the “form, function, and behavior” representation of the artifact (Fenves 2001). The CPM follows the conceptual and representational aspects proposed by the MOKA (Methodology and tools Oriented to Knowledge-based engineering Applications) product model (Oldham et al. 1998). Likewise MOKA, CPM provides a through life cycle data-model (Fenves 2001). An example of CPM for representing design information is presented in Figure 17 (Fenves 2001).

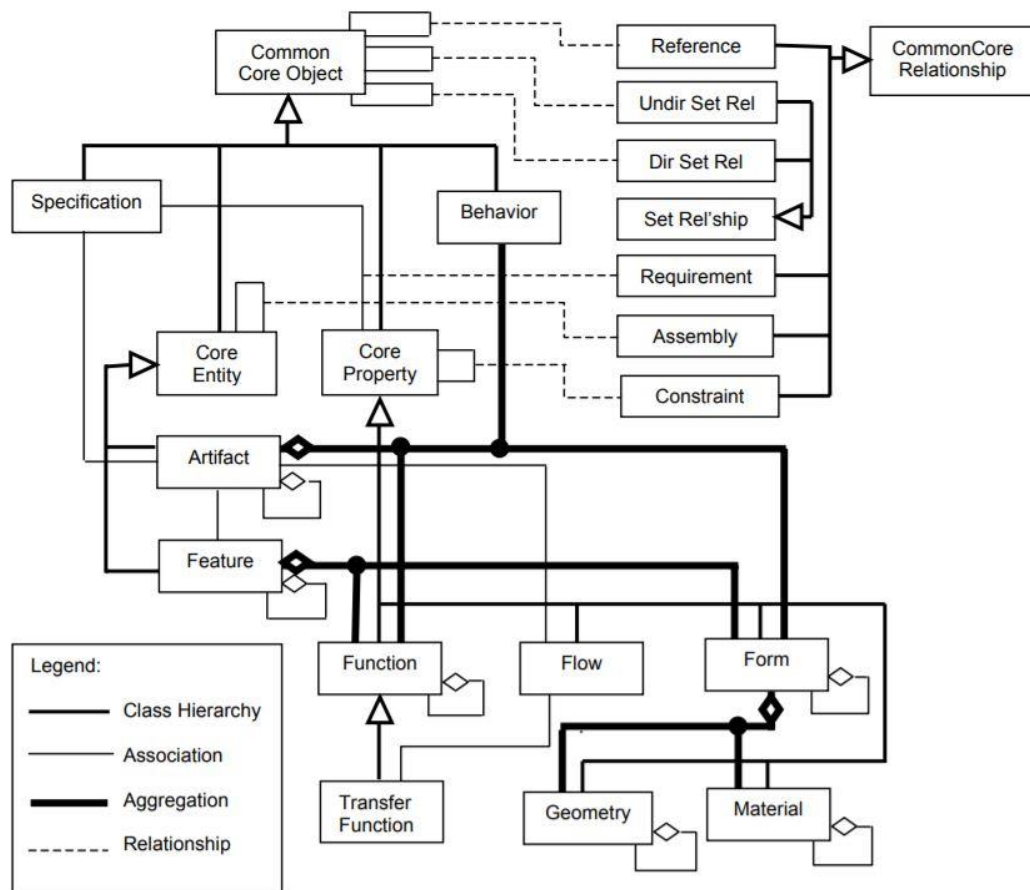

Figure 17. Core product model representing design information (Fenves 2001)

The FBS (Function-Behavior-Structure) is the most known modeling approach focusing on the vital knowledge for designing expert systems (Gero & Kannengiesser 2002). This model has been adopted in various context and extended as RFBS model (Requirements–Function–Behavior–Structure) which considers the product and service functional performance criteria extracted from the requirement analysis (Christophe et al. 2010). While the function dimension describes the expectations of the product, the structure dimension concerns the list of product components, their interrelationships, and related geometry. The behavior dimension is how these components work and interact to provide the expected functions. More recently, Catia V6 from Dassault system adopts the RFLP model (Requirements–Functional–Logical–Physical Design) for tentative implementation of the SE approach in their PLM framework (Mejía-Gutiérrez & Carvajal-Arango 2017). It is also proposed as a structure of specific V-model for mechatronic systems engineering (Zheng et al. 2013).

II.3.2. Examples of PSS-dedicated modeling frameworks

Entering into the field of software-based smart services, tool makers evolved to service providers. While the focus of tool makers is on primary services, service providers upgrade the level of service to “online monitoring, condition based maintenance, and an availability guarantee” (Schuh et al. 2014). Life cycle monitoring and providing customized services are some differences between traditional manufacturing systems and advanced service providers

(Yue et al. 2015). Consequently, to cope with the competitive market of industrial PSS, OEMs need to bear in mind some key considerations about information capturing mechanisms (Lindström et al. 2015). To offer the above-mentioned integrated system of product, service, and sensor, several actors from various disciplines are involved in the design process. In this context, it is crucial to ensure semantic interoperability and efficient communication between the various stakeholders involved during both the system’s implementation and execution. This could be fulfilled by supporting the design process with domain knowledge as a semantic backbone adjusted to the maintenance design (Figure 18).

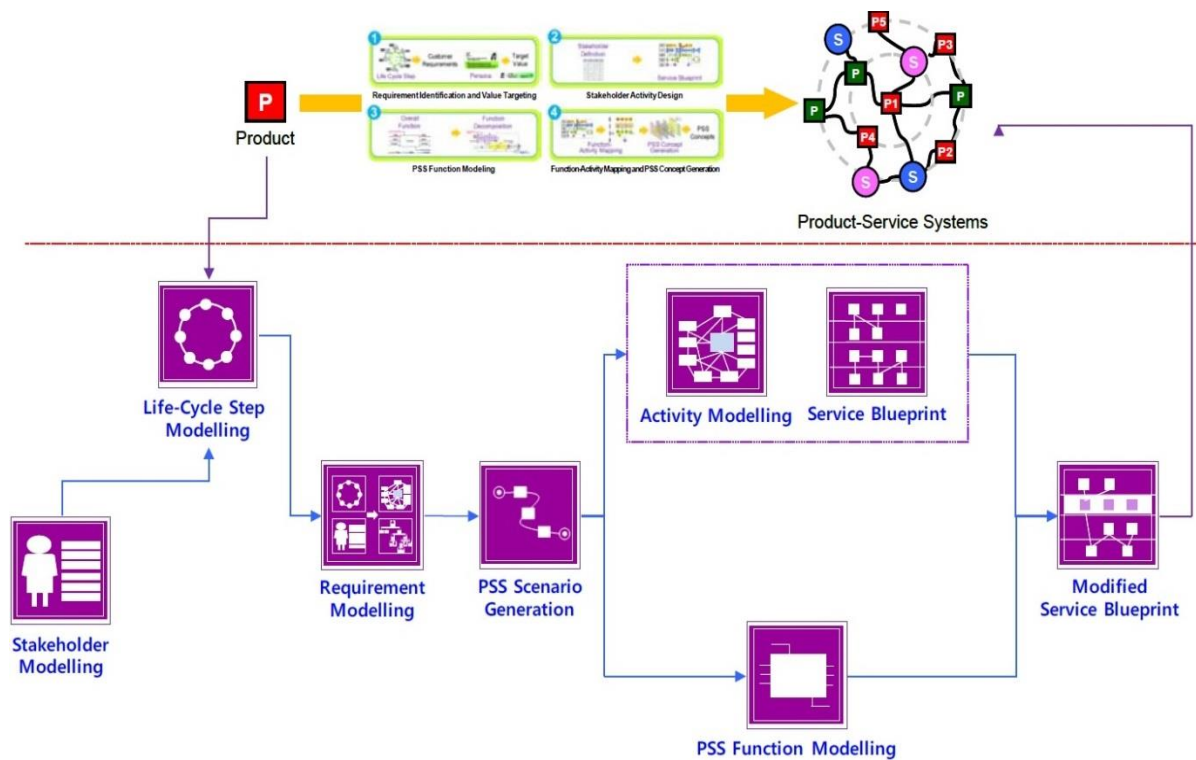

Figure 18. A visualization support method for PSS development (Kim et al. 2011)

This is a well-accepted approach in PSS modeling to consider it as an integrated system with specific characteristics (Pezzotta et al. 2012). In order to represent all aspects and processes of PSS development in just one plan, its global model should be made of various sub-models with different tools and approaches (Kim et al. 2011) (Trevisan & Brissaud 2016). In this context, various visualization frameworks are proposed in the literature with different viewpoints such as functional analysis, through life cycle modeling, modular modeling, system map, ontology-based model and blueprint based model (Cavaliere & Pezzotta 2012)(Lim et al. 2012). As a consequence, we need to use multiple tools and integrate these different plans to draw the complete model of PSS (Figure 18).

“A blueprint could be regarded as a two-dimensional picture of a service process. The horizontal axis represents the chronology of actions conducted by members of either the customer or the supplier organization. The vertical axis distinguishes between different areas of actions” (Fliess & Becker 2006). The Blueprinting method is used to visualize the service processes (Fliess & Becker 2006)(Hussain et al. 2012). However, Lim et al. (2012) discussed

that the blueprint model has a holistic point of view and is not enough detail in all aspects of PSS (Lim et al. 2012). The blueprint is vastly used to define the service process (Song & Sakao 2017) and recently to identify the PSS modules based on the blueprinting structure (Rondini et al. 2018). A PSS blueprint meta-model is proposed to support the knowledge capitalization to during the PSS design (Idrissi et al. 2017). This model is based on multi-viewpoints modeling presenting nine conceptual views as Requirement, Product, Service, Activity, Organization, Demand, Offer, Performance, and Scenario. This is to say this model has a multi-viewpoint approach in representing PSS (Figure 19).

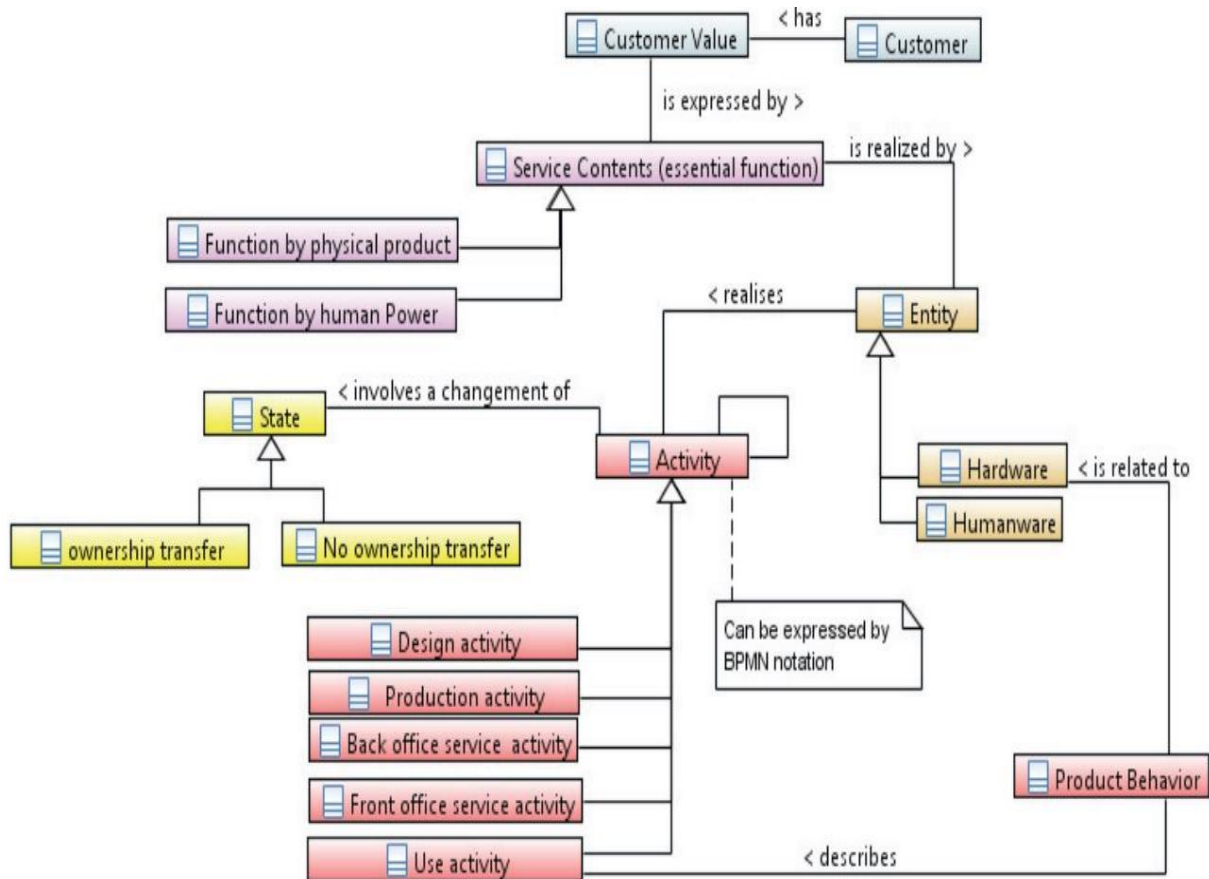

Figure 19. Extended/Product Service Blueprint meta-model (Idrissi et al. 2017)

One of the latest proposed conceptual models focuses on the PSS core business and processes based on the characterizing PSS as an integrated value-creation system (Pirayesh et al. 2018). This model defines the main classes' components, activity, process, stakeholders, ecosystem, product-service, decision, and a performance indicator. This model describes the organizational aspect as the internal and external resources and infrastructures (Figure 20).

Some efforts are done to proposes a metadata model for IPS2 life cycle management (Abramovici et al. 2009)(Hajimohammadi et al. 2017). One of the detailed PSS ontology has been proposed by Cranfield University (Figure 21). They provided a PSS ontology which is consist of all important elements for PSS. Using a modular ontology approach, the Root Concepts of PSS in their ontology consist of "PSS Requirement, Stakeholder, Product-Service, Business Model, PSS Life Cycle, PSS Design, Support System and PSS Outcome".

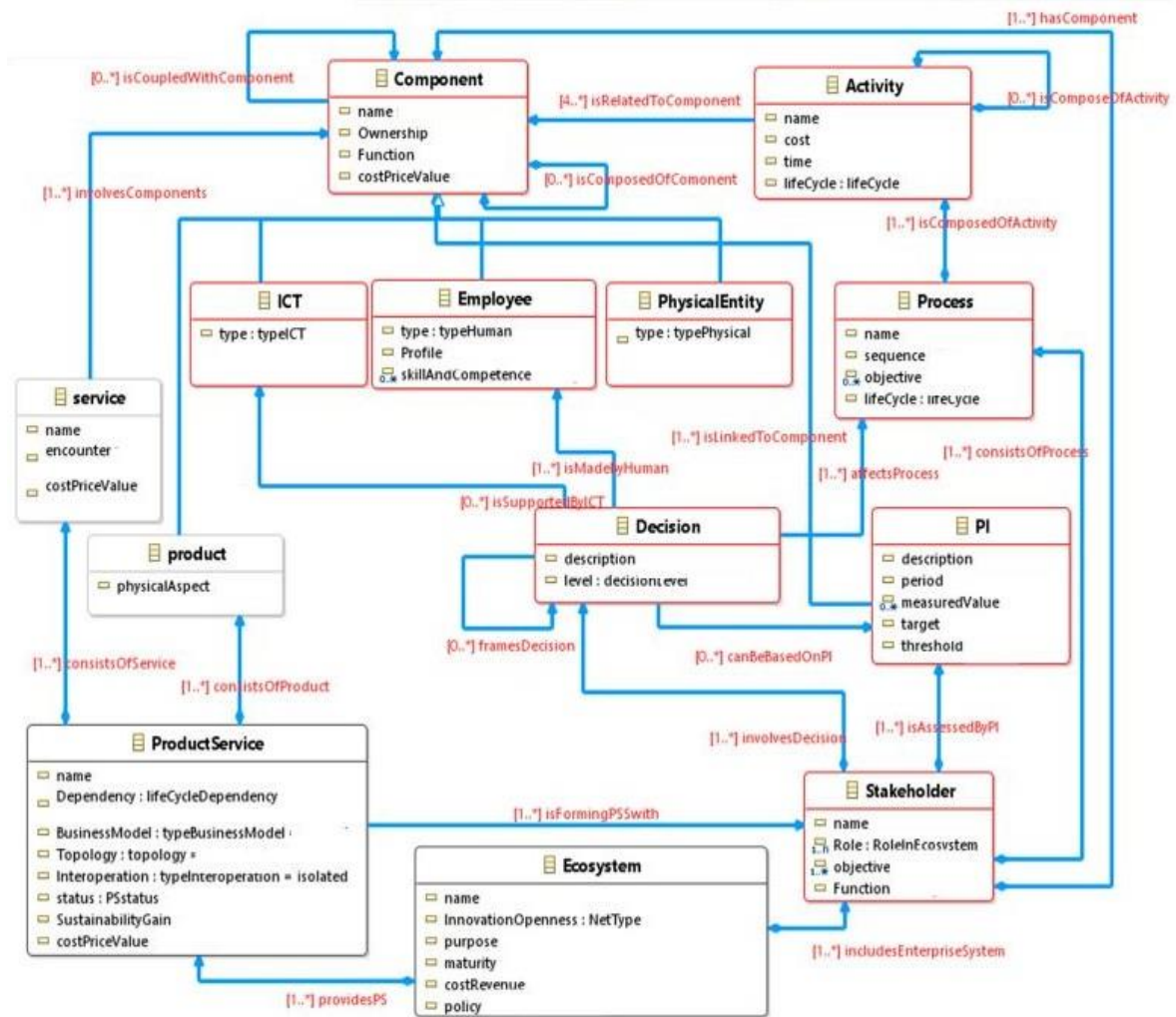

Figure 20. PSS Conceptual Model (Pirayesh et al. 2018)

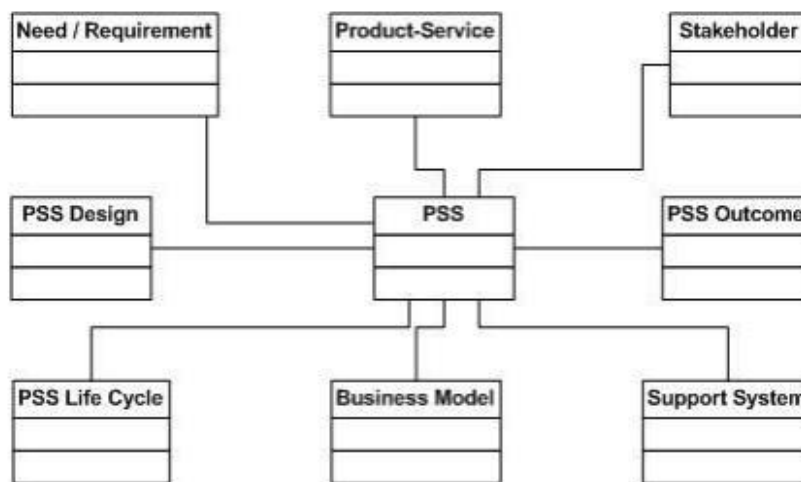

Figure 21. Root concepts to describe the ontology of PSS (Annamalai et al. 2010)

The other example of a PSS model is the one proposed by (Wang et al. 2014). This model is a modular model based on service function, process, interfaces, and configuration. This model is focusing mostly on the function module and process module. The function module is

based on the value that is delivered by the solution. The processing module consists of service provision and support activities. The PSS configuration is considered the same as product configuration which is enabled by means of a meta-ontology defining the main classes and their relationships (Figure 22).

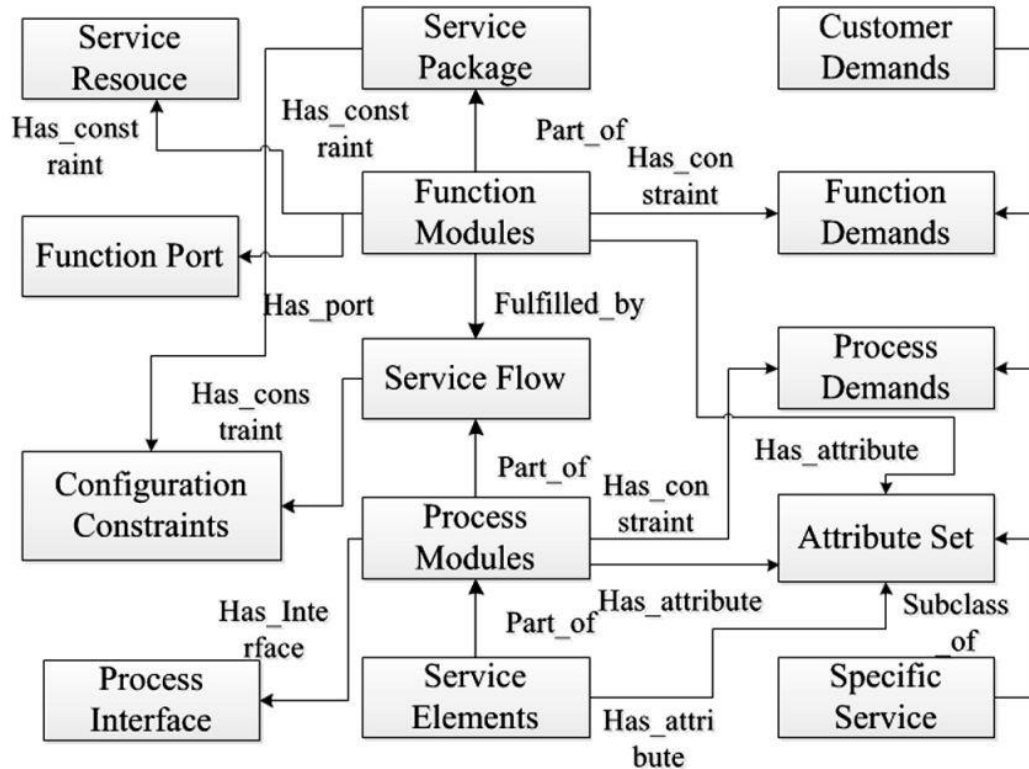

Figure 22. “Meta-ontology of modular product-service” (Wang et al. 2014)

II.3.3. Examples of PSS-dedicated modeling with a functional analysis approach

Functional Analysis is proposed to “map all the elements of a particular solution, which is both physical elements and service units are detailed and linked” and to “define the sequence that allows the precision of the specifications of the product–service to deliver” (Maussang et al. 2009). By making a cross-analysis of the requirements and capabilities of existing methods in PSS design, an extension of the Functional Analysis (FA) approach is applied for PSS design by (Andriankaja et al. 2018). This model adopts a system design approach starting with the requirements analysis (Figure 23). It, then, makes a detailed functional analysis and final phase is the “performance evaluation model building and scenario performance analyses” (Andriankaja et al. 2018).

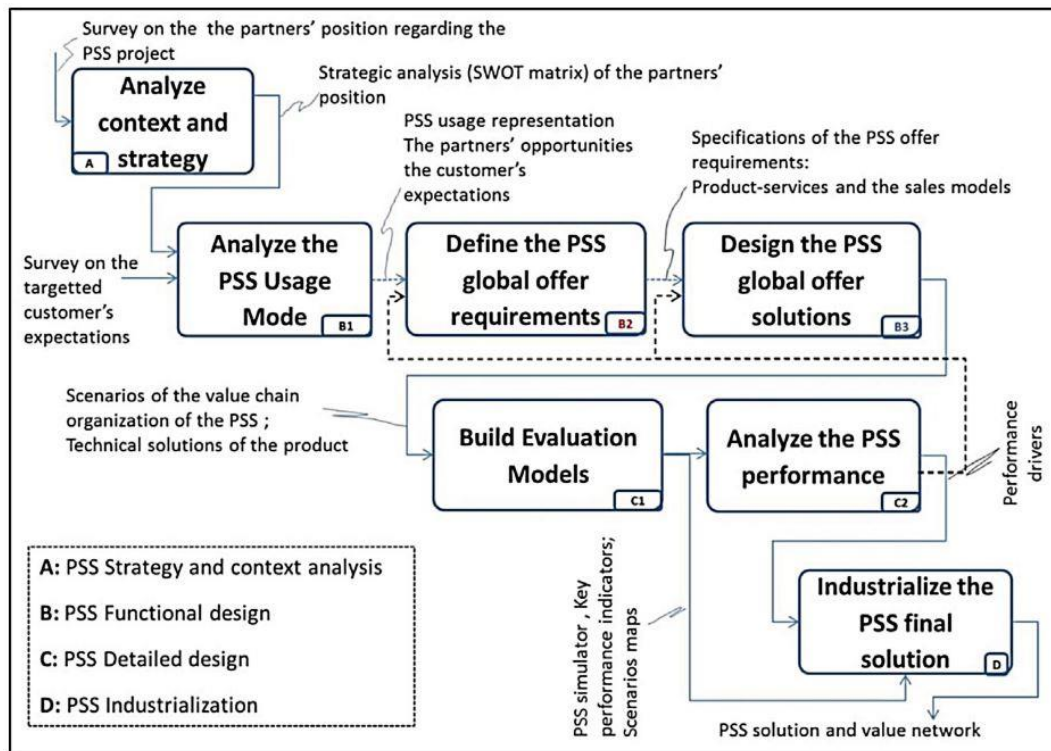

Figure 23. PSS design framework (Andriankaja et al. 2018)

Modeling with a Functional Analysis (FA) approach is proposed by other PSS models as well. In this context, IDEF0 (Integration definition for function modeling) is used to provide an integrated view to present the PSS functional and process model by (Trevisan & Brissaud 2016). This approach is based on multi-viewpoints modeling and decomposition of the functions, processes, and systems (Trevisan & Brissaud 2016). According to this model, on one side the product view is represented by the graph of interactors and FAST; the service view by the process model: and the PSS integrated view by IDEF0. On the other side, the structure model consists of the product view modeled by the block diagram and service view by the flow model. Finally, the final « structural organization modeling » is represented by means of the Functional Block Diagram (FBD) and Blueprint based Model (BBM) (Figure 24).

The Characteristics-Properties Modeling/Property-Driven Development approach (CPM/PDD) is proposed for PSS modeling (Weber et al. 2004). Accordingly, it has been used with a systems-based approach in PSS (Welp & Sadek 2008). According to this approach, the PSS modeling is based on “distinguishing between characteristics and properties” (Welp & Sadek 2008). Based on PSS development path, main views to model the whole system are defined as PSS requirements, functions, processes, behavior and object (Figure 25). This model is presented as the conceptual framework to support the various model assessable (Welp & Sadek 2008). This viewpoint is useful in PSS modular modeling and integration.

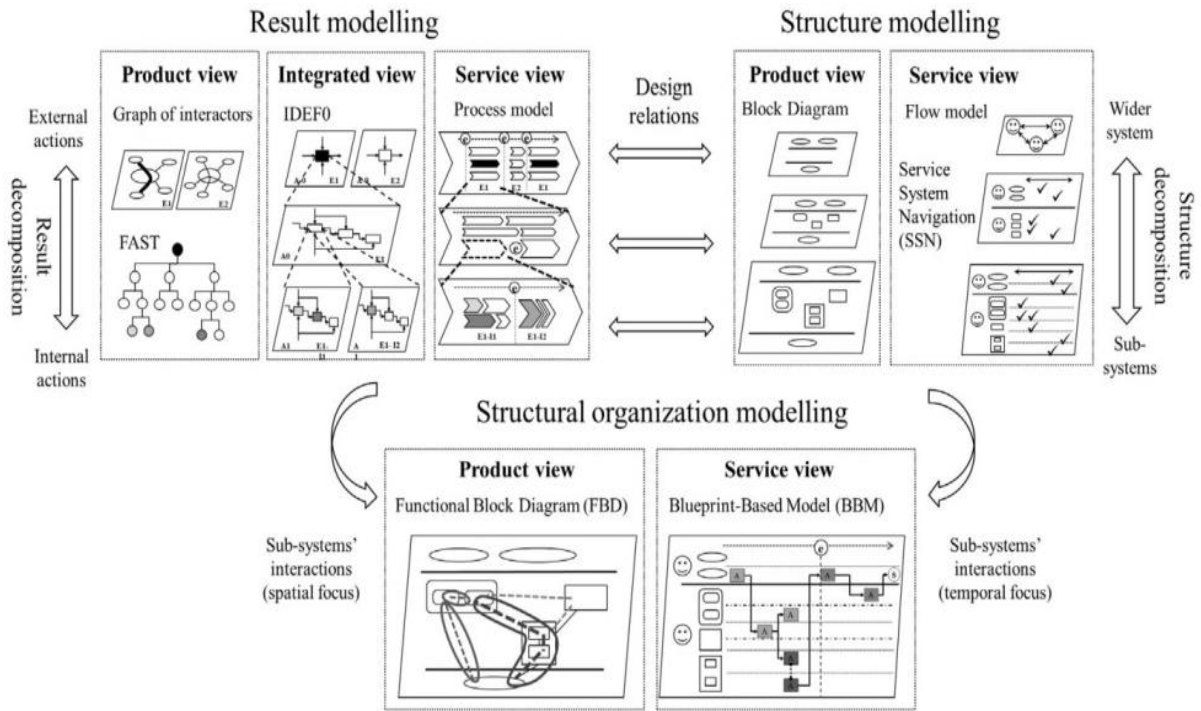

Figure 24. Integrated PSS design model (Trevisan & Brissaud 2016)

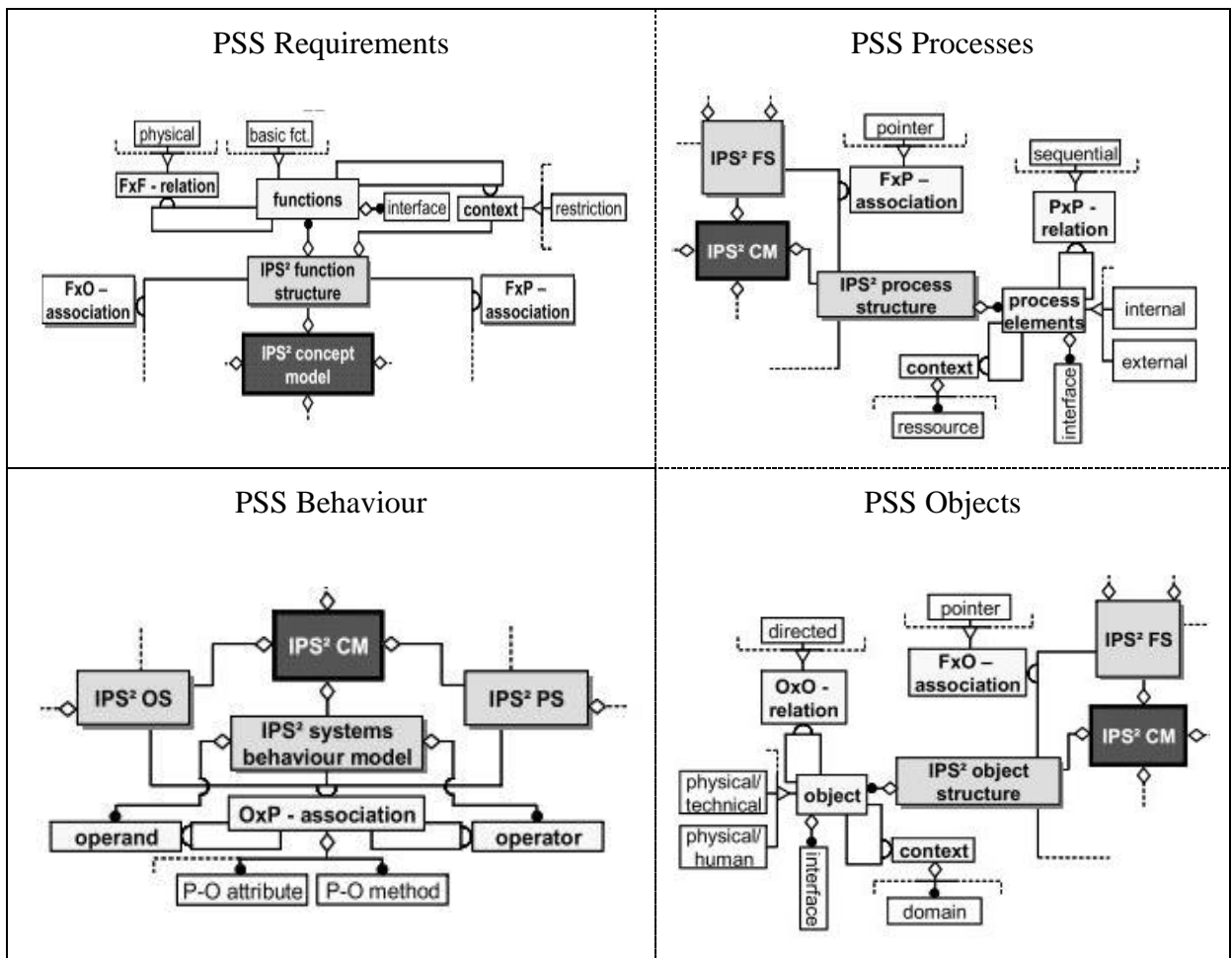

Figure 25. The heterogeneous concept modeling approach in PSS

The literature survey shows a large variety of conceptual modeling frameworks that are emerged during the three last decades. However, few models are extended to the PSS concept. On one hand, these models can provide valuable knowledge about the different aspects of PSS and its characteristics but generally are dedicated to a specific context. On the other hand, these meta-models are generally dedicated to a specific aspect of the system and fail to provide an integrated framework that covers all dimensions within a common conceptual framework. This shows the need for a methodological foundation as a support to build such a framework.

The next section provides a synthesis of Model-Based Systems Engineering approach as an answer to such problematic.

II.4. Systems Engineering Approach

Systems Engineering (SE) is a “multidisciplinary approach and means to enable the realization of successful systems” and “to deliver successful projects (and systems) in complex environments” (INCOSE, 2010). It supports a wide range of activities from “characterizing the existing system” to the “concept formulation, design synthesis, and integration” of the system (SEBoK 1.7 2016). It also supports the architecture of the “network of components as a set of inter-connected components” (Hartmann et al. 2017). SE is used for flexible integration of “heterogeneous functional systems” and tangible and intangible components to realize a new functionality to “improve robustness, lower cost, and increase reliability” (Pineda & Lopes 2013).

SE has been evolved to deal with new systems complexity in “representing system architectures or modeling specific system properties” (Lee & Miller 2007)(SEBOK1.8 2017). The new transformed approach in SE is “relevant to a broad range of application domains, well beyond its traditional roots in aerospace and defense, to meet society’s growing quest for sustainable system solutions providing” (SEBOK1.8 2017). The multiple points of view in SE affects the systems’ elements and architecture (Finkelsetin et al. 1992). Consequently, choosing SE methodology depends on the context and organizational structure of the system under development (Pennock & Wade 2015).

System development is a knowledge-centered “recursive process” fulfilled by means of requirements analysis, operational scenario definition and life cycle management model (Gardan & Matta 2017) (Figure 26). As a result, common knowledge representation is an essential pillar that supports consistency between all viewpoints. Management of various viewpoints, in complex system development, deals with organizing interactions between multiple actors from diverse domain knowledge and applying different development strategies (Finkelsetin et al. 1992). By providing interdisciplinary models, SE generates a common understanding of the system to support the collaborative system development (SEBoK 1.7 2016). The details of the interdisciplinary cooperation could be specified by organizational and operational structure (G Pahl 2013)(Maussang et al. 2009).

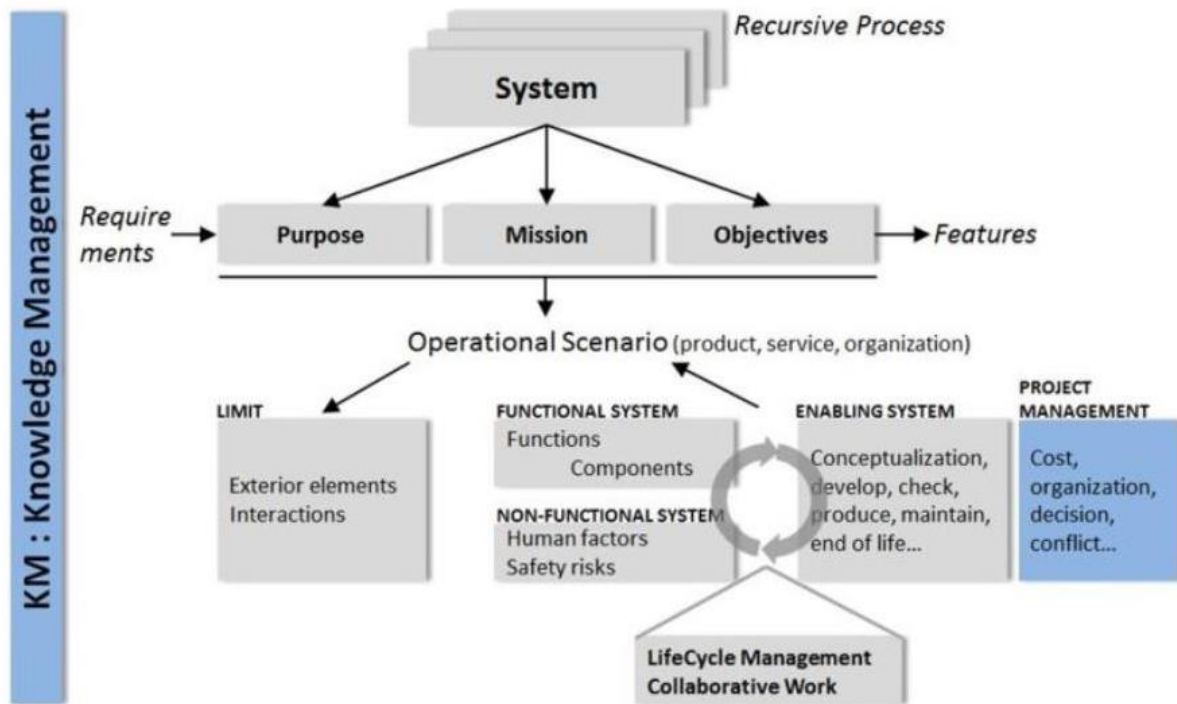

Figure 26. Knowledge-based Systems Engineering (Gardan & Matta 2017)

Based on the playing role, the system's sub-systems are System of Interest and Enabling Systems (Figure 27). According to ISO/IEC 15288 Standard, "the top system in the system structure is called a System of Interest (SOI)" (Jarmo Alanen & Salminen 2016). It can be considered as the final result of the development process to be consumed by the client. The concept of System of Interest is close to the concept of end-product that is defined in EIA632 standard as "the portion of the system that performs the operational functions and is delivered to an acquirer" (Alliance 1999). The System of Interest (SOI) is the final result of the development process to be consumed by the client (the delivered products and services) and consists of lower level sub-systems (Jarmo Alanen & Salminen 2016). In ISO/IEC 15288 and EIA632 Standards, the Enabling Systems (ES) are the systems "that complement a System of Interest during its life cycle stages but do not contribute directly to its function during operation" (SEBOK1.8 2017). "An enabling system is a system which makes possible the creation, or ongoing availability for use, of the System of Interest during some part of its life cycle" (Halligan 2011). They can be systems such as development, training, and production (Jarmo Alanen & Salminen 2016). Enabling Systems facilitate the progression of System of Interest (creation, production, exploitation, and dismantling) through its life cycle stages (Haskins 2010). The scope of SE is to support the concurrent development of both Systems of Interest and related Enabling Systems (Halligan 2011).

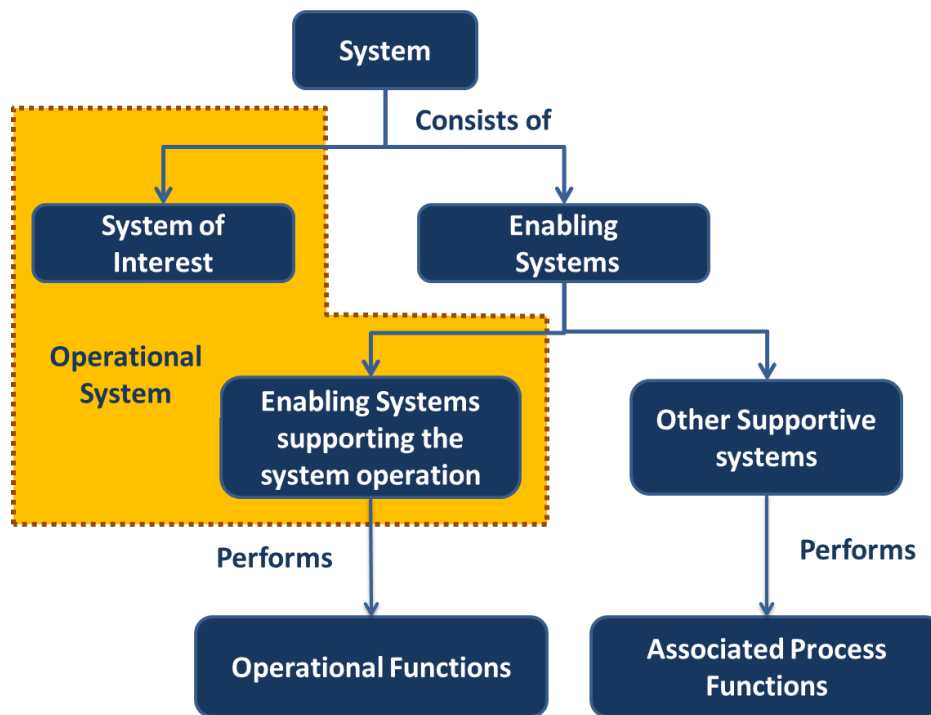

Figure 27. The System of Interest and Enabling Systems

In order to model the system, SEBOK (SEBOK1.8 2017) proposes an iterative process from the system requirements to its logical and physical architecture models (Faisandier 2012)(Figure 28). The logical architecture is created based on nominal functional scenarios (SEBOK1.8 2017). “A functional architecture model is a set of functions and their sub-functions that defines the transformations performed by the system to complete its mission” (SEBOK1.8 2017). The functional decomposition is created by means of the structured analysis design techniques such as “Integration Definition for Functional Modeling (IDEF0)” (SEBOK1.8 2017).

The logical architecture is created based on “nominal scenarios of functions” followed by function tree (SEBOK1.8 2017). Its purpose is to “elaborate models and views of the functionality and behavior of the future engineered system as it should operate, while in service” (SEBOK1.8 2017). This definition leads to determining the primary modules at the “logical view of the system architecture” (SEBOK1.8 2017). The logical architecture plays the role of the intermediate model during the translation of the system requirements to the physical architecture (SEBOK1.8 2017). It is “composed of a set of related technical concepts and principles that support the logical operation of the system” (SEBOK1.8 2017). During the logical architecture, the modules and their interfaces will be defined independently of technology. “Subsequent logical architecture model iterations can take into account allocations of functions to system elements and derived functions coming from physical solution choices” (SEBOK1.8 2017).

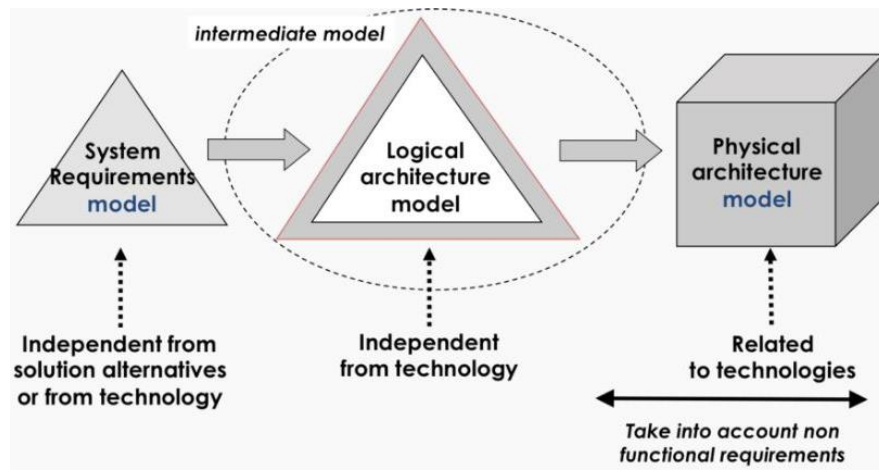

Figure 28. The transition from the requirements to the final architecture model (Faisandier 2012)

The physical model “is used to determine the main system elements that could perform system functions and to organize them” and its focus is on “interfaces rather than on system elements” (SEBOK1.8 2017). In order to finalize the system architecture, several “iterations between the logical and the physical architecture models development” are needed until they are consistent and detailed (SEBOK1.8 2017).

RFLP model is proposed as a structure of specific V-model for mechatronic systems engineering (Zheng et al. 2013). It is used as a holistic support for Systems Engineering application in system development to facilitate its multi-disciplinary and model-based analysis (Mejía-Gutiérrez & Carvajal-Arango 2017). It proposes to model the system from various viewpoints to reach the detailed architecture of the system by using multi-domain modeling methods to support concurrent engineering (Zheng et al. 2014). It is, also, used for tentative implementation of the SE approach in the PLM framework (Kleiner et al. 2013).

II.5. Refined Research Questions

The main challenge in PSS modeling is the “high number of involved elements, dealing with organizational and technical complexity and different models of technical products and services” (Mamrot et al. 2016) as well as distinguishing the borders and overlaps of its sub-systems and interfaces. While in theory, classifying and modeling PSS and its sub-systems and components is possible, a function-based process model to cover its whole life cycle in the practical cases is still indeterminate (Hollauer et al. 2015)(Wang et al. 2014)(Welp & Sadek 2008). Despite the wealth of research dedicated to the PSS design, existing “theories and methodologies for PSS are weak and too general” (Vasanthan et al. 2012) to explain how PSS elements are integrated throughout the development process (Cavalieri & Pezzotta 2012)(Boehm & Thomas 2013).

More detail, the specification of the interactions between all tangible and intangible components is not explained in any models of PSS. Furthermore, the existing models do not

illustrate the specific interactions related to service delivery due to the simultaneity between service production and consumption. These interactions are achieved through the connections of sub-systems according to particular interfaces. The primary step is then the definition of the interfaces between all components when building the PSS architecture as well as the identification of mutual influences between them.

Systems Engineering (SE) recommendations could be advantageous since it provides a guide for integrating the heterogeneous interconnected components of the system (Chenouard et al. 2016). The scope of application of the systems engineering approach for PSS leads us to the identification and the analysis of these interactions. SE enables firms to develop PSS as an interdisciplinary system that consists of diverse and interrelated components (tangible and intangible) to provide the required function (Mamrot et al. 2016). SE approach is vastly applied to develop mechatronic systems (Lefèvre et al. 2014). As a result, its applicability to support the development of a physical component of PSS is promising. However, integrating diverse elements in PSS development is still a challenge (Mamrot et al. 2016).

This research aims at proposing a tailored conceptual modeling framework supporting the identification and classification of heterogeneous sub-systems and their interfaces for a given PSS architecture. Systems Engineering (SE) is proposed to deal with PSS complexity in “representing system architectures or modeling specific system properties” (Lee & Miller 2007). SE proved its applicability to support the definition and integration of multi-domains systems along with their development process. This advantage could be exploited as a methodological background for dedicated PSS modeling framework (Lee & Miller 2007). The proposed model is based on Systems Engineering (SE) recommendations to define the systems’ boundaries and interconnections along its life cycle. So, the research question is refined as follows.

“How to extend the capacities of Systems Engineering for representing all aspects of the Product-Service System architecture with a unified semantic?”

In order to answer this question, it is crucial to characterize both areas of PSS architecture modeling and current applications of Systems Engineering in PSS development and modeling. This can be expressed by three questions as:

- What are the characteristics of PSS?
- What are the SE capabilities to be used in the PSS development project?
- How to apply all this knowledge in a common model?

II.6. Synthesis and Conclusion

The previous sections provided a global context for PSS modeling by characterizing the already existing frameworks based on the system thinking approach. The findings of this literature survey are entirely convincing to lead us to support the hypothesis that extending the

capacities of SE is a promising method to represent the PSS architecture. Systems Engineering is adapted to support various application domains and it is already considered as an accepted practice in PSS development projects. Yet, a PSS-specific model to cover its whole life cycle dealing with both organizational and technical complexity in the practical cases is still indeterminate.

The research outcomes can create a mutual contribution between Product-Service System and Systems Engineering modeling approach (Figure 29). Expanding the “application of Systems Engineering across industry domains” is considered as the Systems Engineering Vision 2025 (INCOSE 2014). In this context, according to the French Chapter of INCOSE (AFIS)⁶, PSS is considered as a specific domain in a Systems Engineering perspective, added to the “Service Systems Engineering – Body of Knowledge” (AFIS 2017).

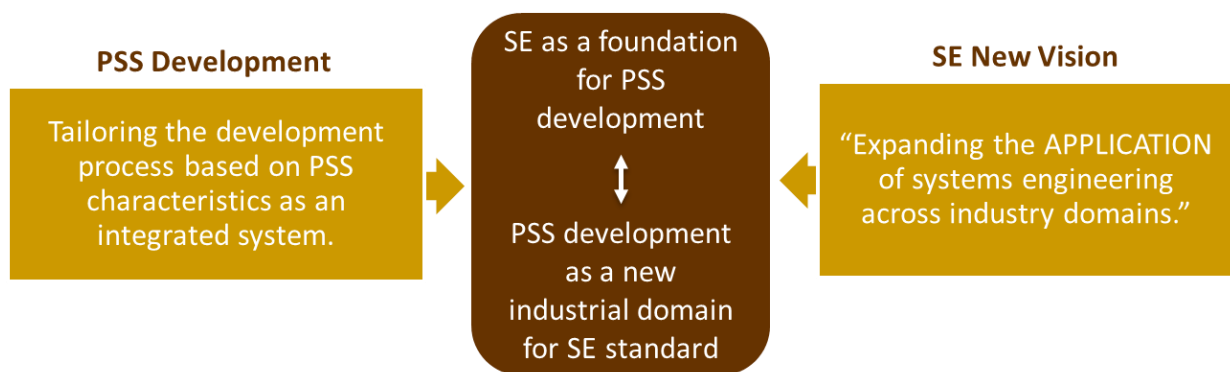

Figure 29. Mutual Contribution of PSS and SE

⁶ http://www.ssebok.afis.community/index.php?title=12.Product_System_Services

Chapter III.

PSS model construction within Systems Engineering perspective

Chapter III. PSS model construction within Systems Engineering perspective.....	57
III.1. INTRODUCTION.....	59
III.2. PSS MODEL CONCEPTUALIZATION WITHIN SE PERSPECTIVE.....	59
III.2.1. PSS modular architecture with SE	60
III.2.2. PSS value framework.....	62
III.2.3. PSS architecture integration within the SE V-model	64
III.3. PSS MODEL DESCRIPTION WITH UML FORMALISM.....	66
III.3.1. The global model of PSS	66
III.3.2. The requirements and functional model	67
III.3.3. The System of Interest model.....	70
III.3.4. The Enabling Systems model.....	72
III.3.5. The business process model	74
III.3.6. The life cycle model	78
III.3.7. The interface model	79
III.4. SYNTHESIS AND CONCLUSION.....	83

III.1. Introduction

Considerable efforts have been made to adopt the Systems Engineering (SE) in PSS development projects. Recent papers have explored PSS design with SE approaches using the Spiral Model (Pezzotta et al. 2012) and the V-Model (Meier et al. 2010). The Model-Based Systems Engineering approach in PSS development is based on the descriptive model with “hierarchical structure” to aggregate the various components through the system’s levels (Joore & Brezet 2015)(Wiesner et al. 2015).

Based on the lessons learned from the previous literature survey and respecting the modeling requirements expressed in chapter 1 from both academic and industrial perspectives, this chapter describes the proposed model for PSS architecture based on Systems Engineering principles. The first part of this chapter is dedicated to set-up the main methodological foundations adopted to realize the semantic model. Based on this, the second part is to detail the different components of the modeling framework.

The realization of the global semantic model is resulting from the combination of four complementary dimensions: the key characteristics of PSS that should be considered in a robust modeling framework as identified from the literature and the current PSS models; the standard modeling concepts as identified in sections 2.2.1 to confirm the conceptual framework with existing standards; systems engineering principles as a methodology to organize the model building process in a consistent way; and finally, a modeling language to support the representation of all identified concepts and relationships.

Concretely, the used modeling language is UML. The sources of domain knowledge are the academic literature review and the industrial context. The academic context explains the PSS characteristics (definition, typology, development process, and life-cycle) as well as the existing modeling approaches. Regarding the literature survey, the main categories of key knowledge for PSS modeling are product-process, system design and PSS as an integrated system. Finally, the existing PSS models are defined. The industrial context is the main lesson learned from the ICP4Life project.

III.2. PSS model conceptualization within SE perspective

A literature analysis besides the lessons learned from the project is made to extract the key concepts and their characteristics as a preliminary classification of PSS related axioms. Figure 30 gives an overview of this analysis results. The detailed list of literature sources is presented in annex II where more than 120 axioms are identified. Some of them are referring to a common concept with different definitions.

The next step of the analysis is the grouping of all identified concepts following their common meanings and interest for the proposed modeling approach. Consequently, the following categories of knowledge are at the heart of the semantic model:

- The classification of PSS tangible and intangible components
- The relations between all the components within a common PSS architecture
- The variety of stakeholders involved in the whole PSS life cycle
- The key stages of this life cycle and the related processes
- The functional architectures of PSS, etc.

In order to integrate all the above aspects in a unified model within a system engineering perspective, a conceptual framework is needed. The following sections give the main directions for the consideration of the PSS model.

Concept	Definition	Reference
Infrastructure	Any artifacts specifically required to provide products and services (e.g., technologies, devices, and service scape evidence, such as spatial layouts)	(Lim et al. 2012)
Infrastructure	In moving towards system innovation, it has been recognized that a change in the device concept must be accompanied by a change in the infrastructural or institutional context in which the device is both designed and used	(Williams 2007)
Infrastructure	Within existing notions of PSS, infrastructure represents “existing structures and systems within society, such as recycling technologies, waste collection points, and incineration plants, the existence and suitability of which should be considered when a product and services are developed”. Against this background, it is likely that, within the mobility field, current versions of use-oriented and result-oriented services have the potential to facilitate significant changes to the institutional and infrastructural context.	(Williams 2007)
Infrastructure capabilities	A complementary capability we have termed ‘appropriate retention of service infrastructure’, allows customers to support the service delivery process; for example, in-house providers to service older products and external providers to service newer technology.	(Story et al. 2017)
Infrastructure: Information System	An information system is needed to manage the reservation data (DEFINE step), authenticate the user (CONFIRM step), and calculate the distance driven and time elapsed (CONCLUDE step).	(Lim et al. 2012)
Infrastructure: Physical Space (Physical Infrastructure)	parking spaces, such as off street public and private parking spaces, are needed for parking the cars and delivering them to customers in the LOCATE and CONCLUDE steps	(Lim et al. 2012)
Infrastructure: Service Station	Repair stations are required to repair the damaged cars in the RESOLVE step	(Lim et al. 2012)

Figure 30. PSS characteristics extraction from literature

III.2.1. PSS modular architecture with SE

PSS architecture can be considered as a “network of inter-connected components” (Chenouard et al. 2016). In this viewpoint, PSS consists of product modules which can be considered as a mechatronic system (Muller et al. 2007), service modules and supportive systems characterized by integrated development process and function allocation (Lindström et al. 2015)(Mikusz 2014)(Trevisan & Brissaud 2017). Each module is detailed by its components that can be either tangible (hardware, physical infrastructure, mechanical components, etc.) or intangible (business processes, information, algorithms, etc.)(SEBOK 1.8 2017).

According to ISO/IEC 15288:2008, systems may be configured with various elements as “hardware, software, data, humans, processes, procedures, facilities, materials and naturally occurring entities” (Finkelsetin et al. 1992). Accordingly, Product-Service, as a system, is composed of tangible products, intangible services, software components, and collaboration network; as well as organizational aspects and enabling mechanisms supporting the connection

between all these components in the whole PSS integrated architecture (Mont 2002)(Tukker 2004).

In order to apply the above-mentioned point of view in PSS development, recent methods emphasize the interaction between tangible and intangible components and designing the “modular components that can be easily combined to form different PSS” (Tukker 2015). Modular design supports the combinability of PSS components to achieve maximum flexibility during customization (Wang et al. 2014). As a result, it is crucial for the creation of the “solution-ready” packages of components that can be “mixed and matched” in development of different PSS types and for various usage contexts (Davies et al. 2006). Using these solution-ready packages is a competitive advantage and it would be beneficial to reduce the PSS cost and time to the market (Bask et al. 2010). However, its configuration is complicated because of being a mixed system of components with different characteristics and life cycles (Tukker 2015)(Maier 1996).

In this context, there is a breadth of related research on modular product-service development methods which focus on the modular engineering of product, service, actors, and enablers in PSS (Wang et al. 2014)(Tukker 2015). The power of modularity is highlighted in the literature to manage and model both physical and organizational structure of systems (Sako 2005). This quality is advantageous for the modeling of complex aspects of PSS. For instance, modularity or layer modeling has been used for the interdisciplinary integration of PSS components (Wang et al. 2014). In this approach, the basic structure of the system is defined in each module like mechanical, electrical, software, etc. In a modular-based approach, describing the sub-systems borders and interfaces is a crucial issue. The compatibility among modules is ensured by “design rules that govern the architecture, interfaces, and standardized tests of the system” (Baldwin, Carliss Young 2000).

PSS modular development approach is linked to the systems thinking to “understand how the various elements of a PSS, including products, services, networks of actors and supporting infrastructure, may all be viewed as a connected whole which, through synergies between the elements and optimization, may contribute to integrated sustainability” (Xing et al. 2013). Various models are proposed based on several layers to detail the system into its sub-systems and modules and their relations (Welp & Sadek 2008) with a “cross-disciplinary integration framework” (Hollauer et al. 2015). Most of the standards in system modeling propose multi-dimensional modeling approach for the definition of system requirements, functional architecture, and physical architecture to integrate the system’s components and to create the system (SEBOK1.8 2017). For example, a requirement model for various types of PSS based on the delivery system and value proposition is proposed (Durugbo 2011). Another example is the modeling phases as need analysis, value design, function design and structural design in the service CAD system (Sakao et al. 2009). Also, service engineering as an essential part of PSS is designed with a systematic approach (Pezzotta et al. 2015).

The main aim of this chapter is to characterize the various elements of PSS, including products, services, networks of actors and supporting infrastructure, and represent them as a connected whole. Based on the standards in system modeling, multi-dimensional modeling approach for the definition of system requirements, functional architecture, and physical architecture to integrate the system's components and to create the system is adopted.

In doing so, the main aspects to be presented and considered in the framework are:

- The PSS value framework: this framework is built based on an analytical literature review in chapter I.2.5.
- Main sub-systems of PSS and their boundaries: this framework is the main basis for the UML detailed model.
- PSS architecture integration within the SE V-model: this framework is the basis for the multi-viewpoints modeling.

III.2.2. PSS value framework

The PSS value offer is based on integrating product-service, Enabling Systems and actors' network. This mechanism is supported by knowledge capitalization to improve the PSS provider's different capabilities (Figure 31).

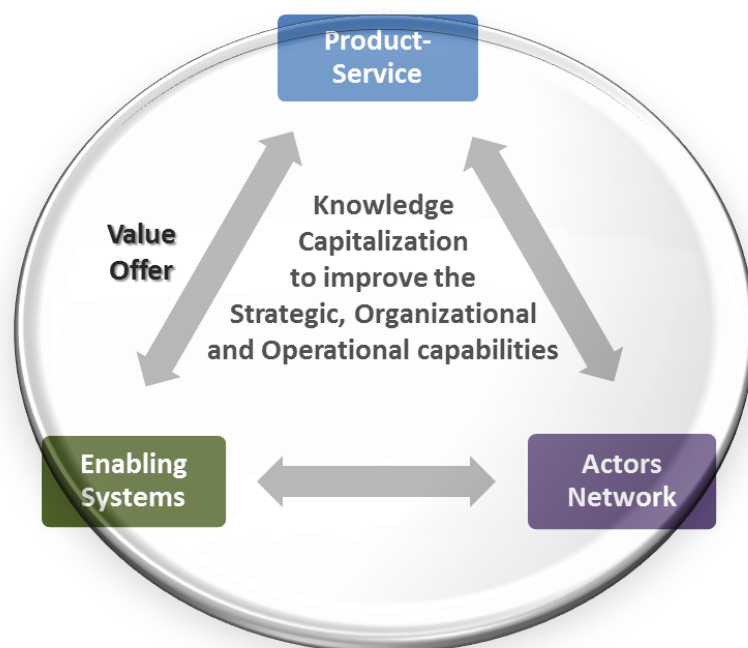

Figure 31. Value offer in PSS

Considering the above-mentioned value creation mechanism, two main criteria are considerable for classifying and structuring the PSS components. First, the system that contributes directly to the PSS value. Second, the system that contributes indirectly to the

realization of this value. Based on these criteria, PSS can be defined as an integrated system of two main sub-systems namely System of Interest (SOI) and Enabling Systems (ES) (Figure 32).

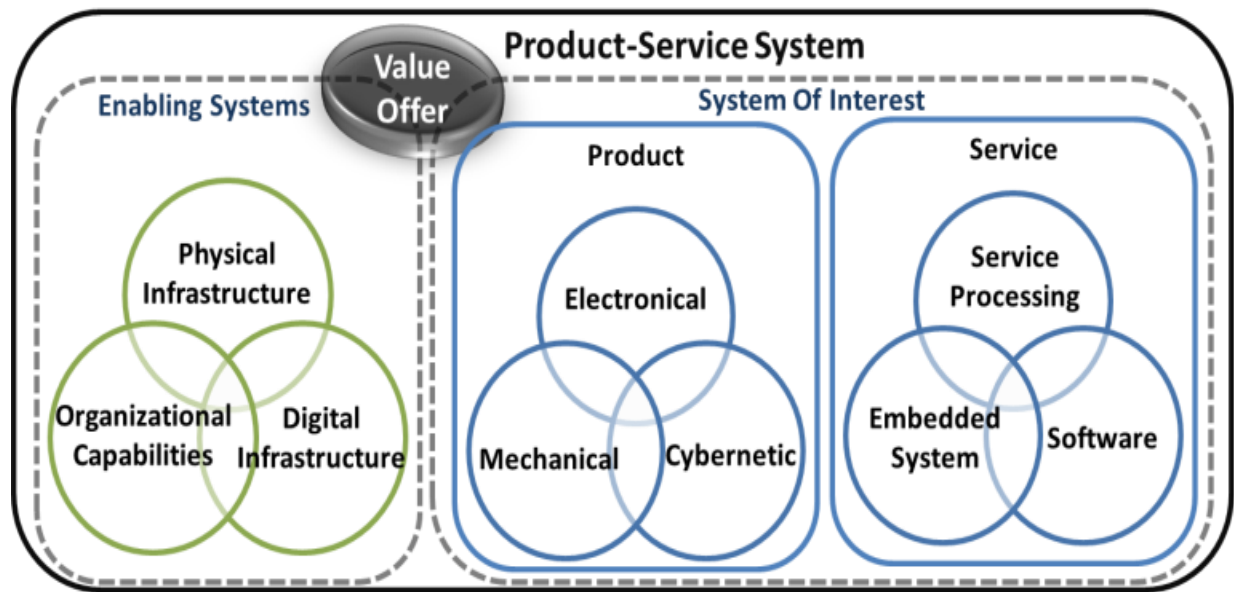

Figure 32. PSS System from the Systems Engineering perspective

The system of Interest and Enabling Systems mutually contribute to providing the function, and the value is offered based on both systems with an integrated development approach. Though, some components from the same family can be identified in both architectures playing different roles.

The System of Interest (SOI) could be defined as the provided solution (integrated products and services) which the customer pays to use with product and service as its lower level sub-systems. Affected by the servitization, the product could be detailed as the mechanic, electric and cybernetic components. The service is evolved into the “software-based services embedded in the physical product” (Van Ostaeyen et al. 2013). Based on this approach, the service is defined as a system of software, embedded systems, and service processing components.

The Enabling Systems (ES) are the collection of any supportive systems (e.g. technology, resources, people, etc.) to deliver the integrated products and services (Trevisan & Brissaud 2017)(Andriankaja et al. 2018)(Rauffet et al. 2016). They may directly be used by the customer or by the PSS provider. It also can be considered as “non-core” activities or elements of the PSS (Brady et al. 2005) which have a tight relationship with various capabilities the firm needs to support the PSS business model (Story et al. 2017). The Enabling Systems consist of organizational capability and infrastructures (digital and physical).

The organizational capability is the company’s capacity for value-creating and competitive advantage gaining as well as all resources and business processes to support the PSS life cycle (Gebauer et al. 2017). Business processes support service processing in the System of Interest. The physical Infrastructure represents the necessary structures and systems that currently exist within the stakeholder's network and organization (such as the physical spaces and service

stations) (Williams 2007). The digital infrastructure is all Information Technology supports for service processing (Lim et al. 2012). Looking at the variety of PSS typologies, several design processes can be applied. To consistently manage the structural dimension connected to the functional one, the development process of the SOI and the ES is achieved through an iterative process guided by propagation of constraints, generated at different stages of each sub-models (Kleiner et al. 2013).

III.2.3. PSS architecture integration within the SE V-model

The development process to provide the final PSS follows the through life cycle engineering which starts from the requirements analysis to the end of the life of the integrated system. In PSS, there are “functionality interconnection” among heterogeneous sub-systems and “process interconnection” among homogeneous components (Estrada & Romero 2016). To model the whole system, all possible decompositions and functions must be studied (Hartmann et al. 2017).

The integrated solutions life cycle can be detailed as “strategic engagement (system requirements), value proposition (system function), system integration (system logical & physical structure) and operational services phase” (Davies & Hobday 2005). In doing so, PSS is theoretically analyzed from requirements definition to the functional and structural architecture to provide an integrated information model spanning the whole life cycle of PSS (Kleiner et al. 2013). As a tool to model this life cycle, RFLP approach represents PSS as a whole with a focus on structuring its tangible and intangible components as well as their borders and functions (Kleiner et al. 2013).

The classical V model is tailored to manage the whole PSS development project based on the concurrent development of two parallel V sub-models of the System of Interest and the Enabling Systems. This method is based on conserving separate models for the PSS components architectures to have a classification of components-function. Then, it merges various layers of sub-systems to one as System of Interest and Enabling Systems and adds transverse model describing the integration infrastructure. While each of these V-models consists of domain-specific models, the final PSS is an integrated system of various sub-systems. This V-model is presented by means of RFLP approach (Figure 33).

RFLP approach can be used as an SE approach supported PLM software based on the V-shape model (Mejía-Gutiérrez & Carvajal-Arango 2017). The classical RFLP model is tailored to be applicable to PSS modeling (Figure 34).

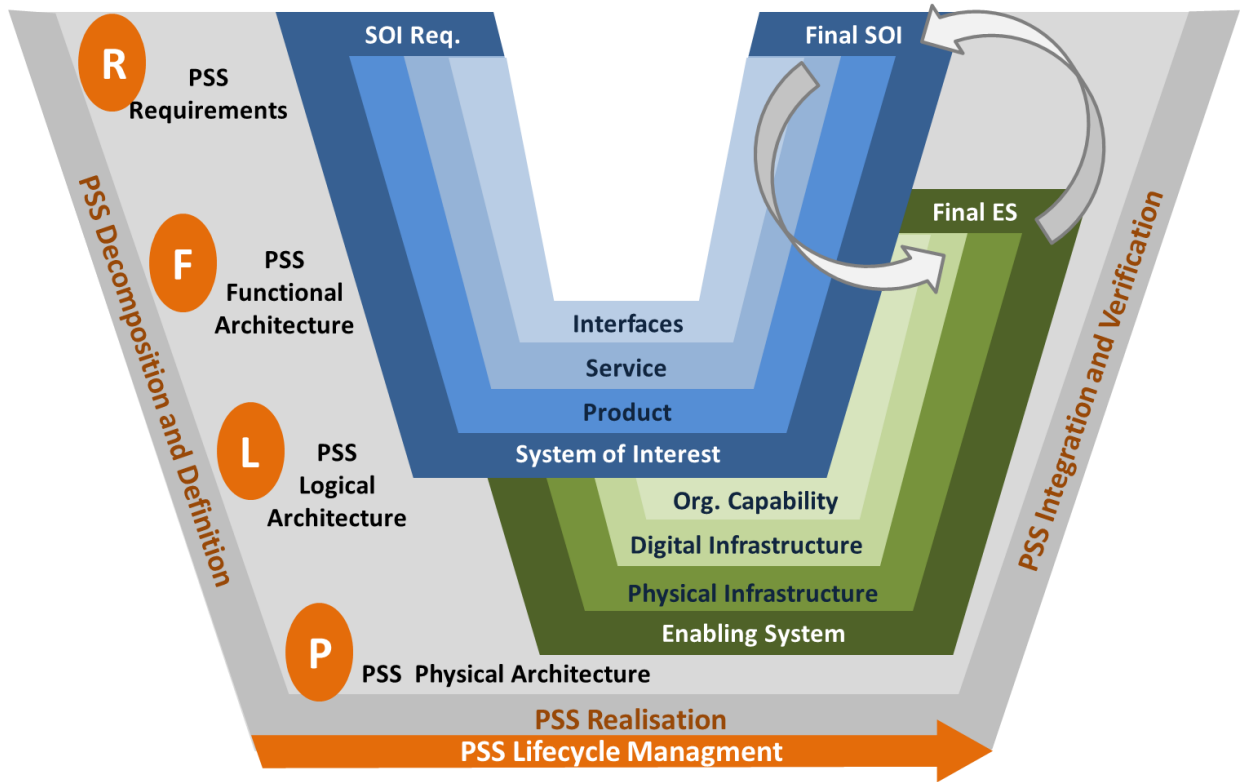

Figure 33. PSS V-model based on Systems Engineering and RFLP

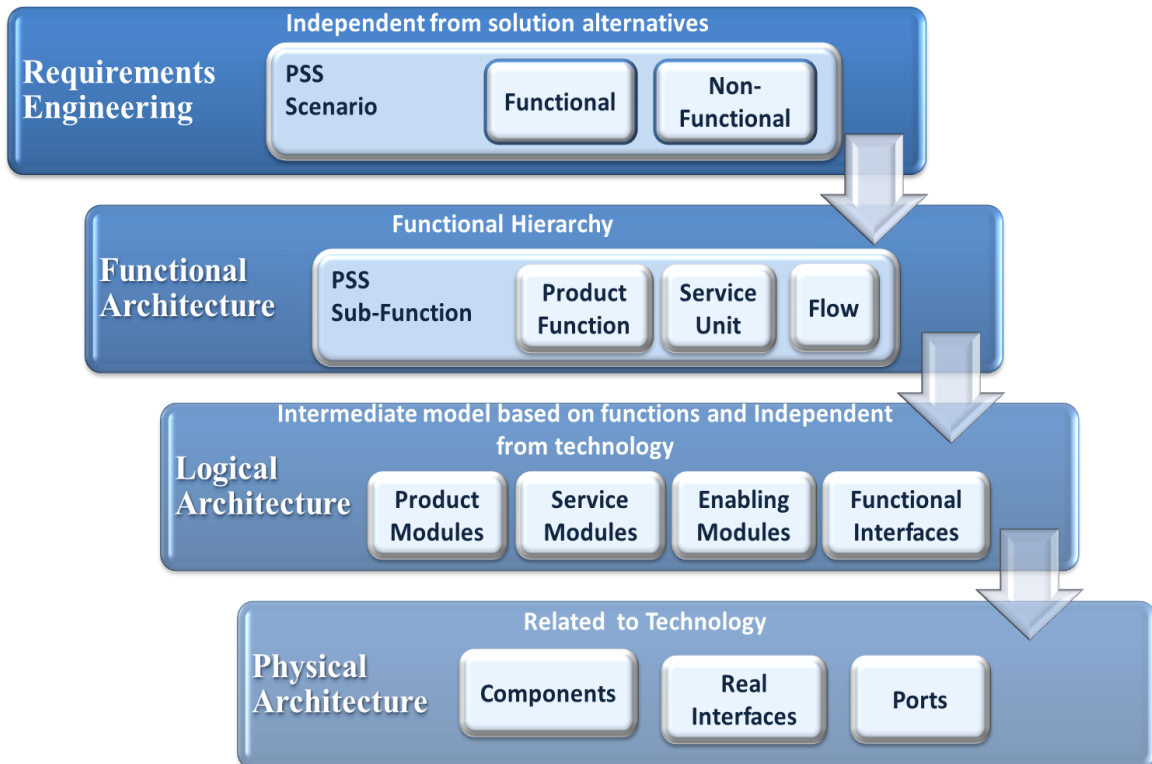

Figure 34. Tailored RFLP model

The start point of the PSS meta-model is the requirement analysis followed by the functional architecture. The requirements engineering is defined through scenarios and independent of solution alternatives and technology. It determines the functional and non-

functional requirements (Estrada & Romero 2016). Next step, the PSS function tree is defined. According to the requirement analysis, the PSS function, the related sub-functions (which can be simultaneously executed) and the flow between them that performs the PSS functions will be defined at the functional level (Andriankaja et al. 2018). The third step, the logical architecture connecting the functions and sub-systems is created. Finally, the physical architecture of PSS (as a technology-related viewpoint) integrates the system’s components and provides the full prototype. It is “an arrangement of physical elements that provides the solution for a product, service, or enterprise” (SEBOK1.8 2017).

III.3. PSS Model description with UML formalism

III.3.1. The global model of PSS

According to the PSS sub-systems typology mentioned above and the multi-viewpoints modeling based on RFLP, the whole PSS is modeled as a collection of interconnected packages. This approach represents the PSS model from different viewpoints. First, the requirements and functional model is presented; then, the logical view is presented in two parts for the System of Interest model and the Enabling Systems model. In order to define the life cycle approach, the business process and life cycle model are detailed and their connection is defined. Finally, the interface model is presented (Figure 35).

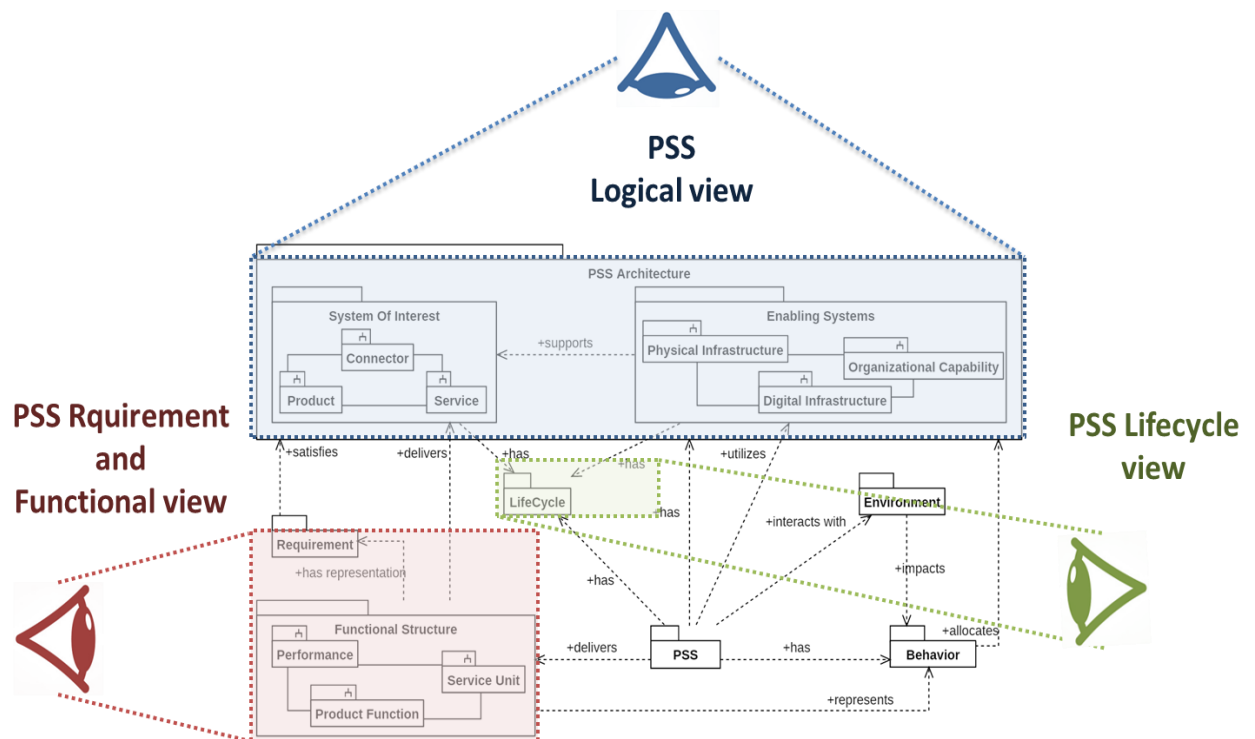

Figure 35. Different viewpoints in PSS development based on RFLP approach

This global model is presented by means of a package diagram which is the start point for modeling the PSS. Then, each package diagram is detailed by means of interconnected models to create the whole system model (Figure 36).

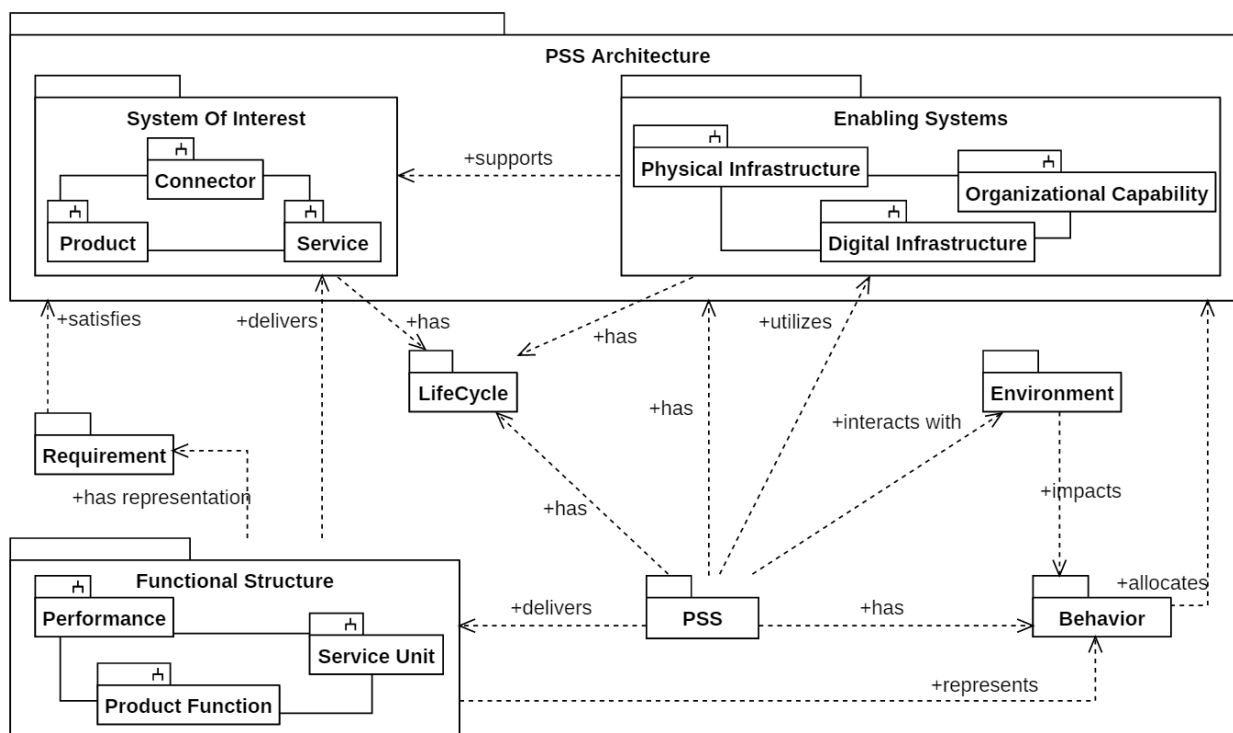

Figure 36. Package diagram

III.3.2. The requirements and functional model

The requirements analysis is according to the “PSS solution design based on scenarios” (Andriankaja et al. 2018). According to this approach, “PSS delivers function” (Van Ostaeyen et al. 2013) and this function represents “the intended purpose” (Keuneke 1991) and behavior of PSS (Estrada & Romero 2016) which could be represented by two dimensions as (Figure 37).

- The functional requirements (customer demands) which are the subjective dimensions of representation for PSS function (Estrada & Romero 2016) and directly related to the primary capabilities provided by the System of Interest (Bertoni et al. 2016). The functional requirements are defined by the stakeholders.
- The non-functional requirements (the must exhibit attributes to comply with customer demands) which are the objective dimensions of representation for PSS function (Estrada & Romero 2016) and related to the complementary aspects of the PSS like “availability, supportability, security, and training” (Bertoni et al. 2016). As a part of the PSS “function determination process”, the functional requirements will be translated into the non-functional requirements (Estrada & Romero 2016).

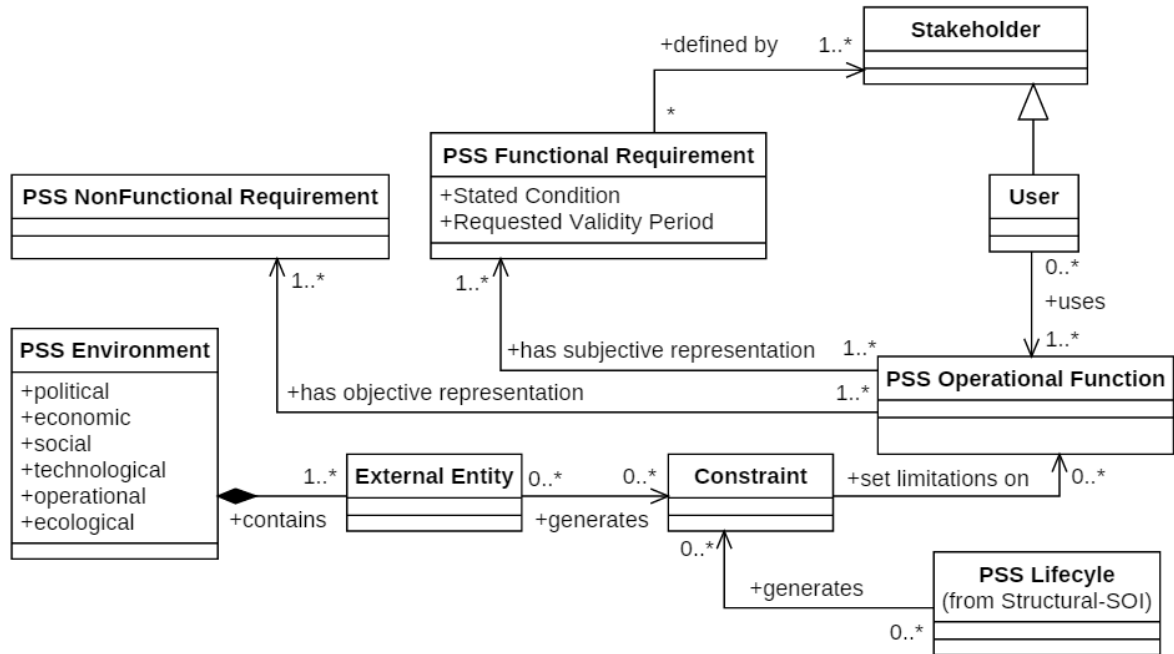

Figure 37. Requirements analysis

Besides the functional and non-functional requirements, the PSS life cycle and the external entities such as the PSS environment generate constraint and set limitations on the PSS operational function. IDEF0 approach is used to represent the hierarchical function tree (Figure 38). To elicit the requirements, use cases' scenarios are used together with IDEF0 to detail PSS function with a hierarchical approach by means of continuous detailing of the functions while keeping the link between its components (Hussain et al. 2012)(Morelli 2006). In this context, each involved entity associated with the function could be an input, a control, an enabling mechanism, or an output (Menzel & Mayer 1998).

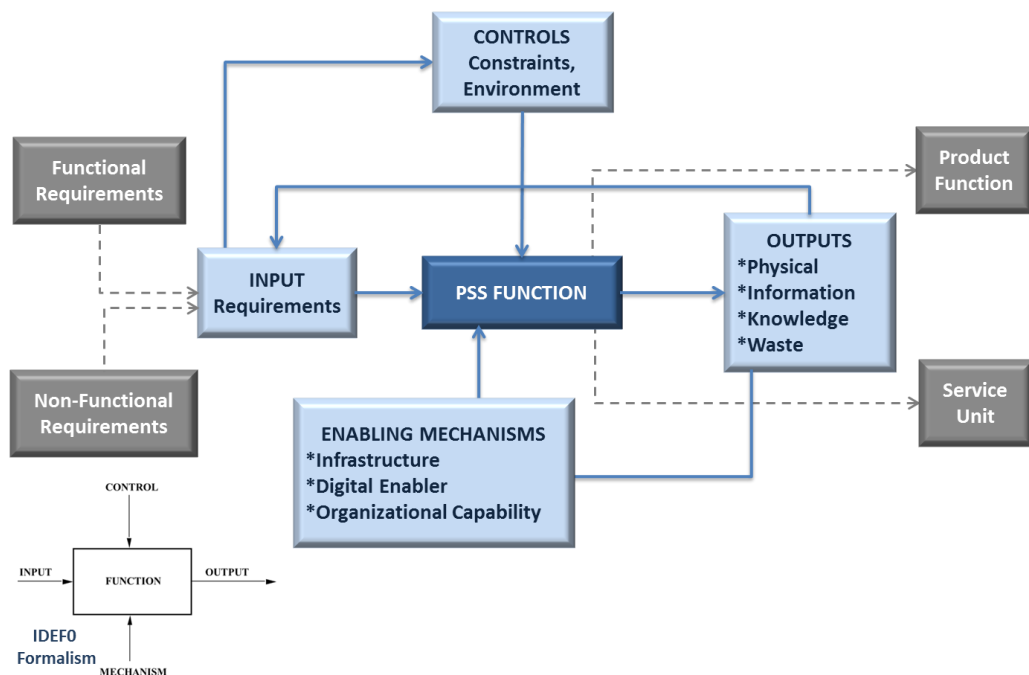

Figure 38. PSS Functional model based on IDEF0 (Menzel & Mayer 1998)

Based on RFLP, the PSS function tree is made of the product function, the service unit, and the flow. The product functional specification and ideas about the services per life cycle stage are explored. Then, they will be translated to the product technical specification and services opportunities (Andriankaja et al. 2018). (Figure 39)

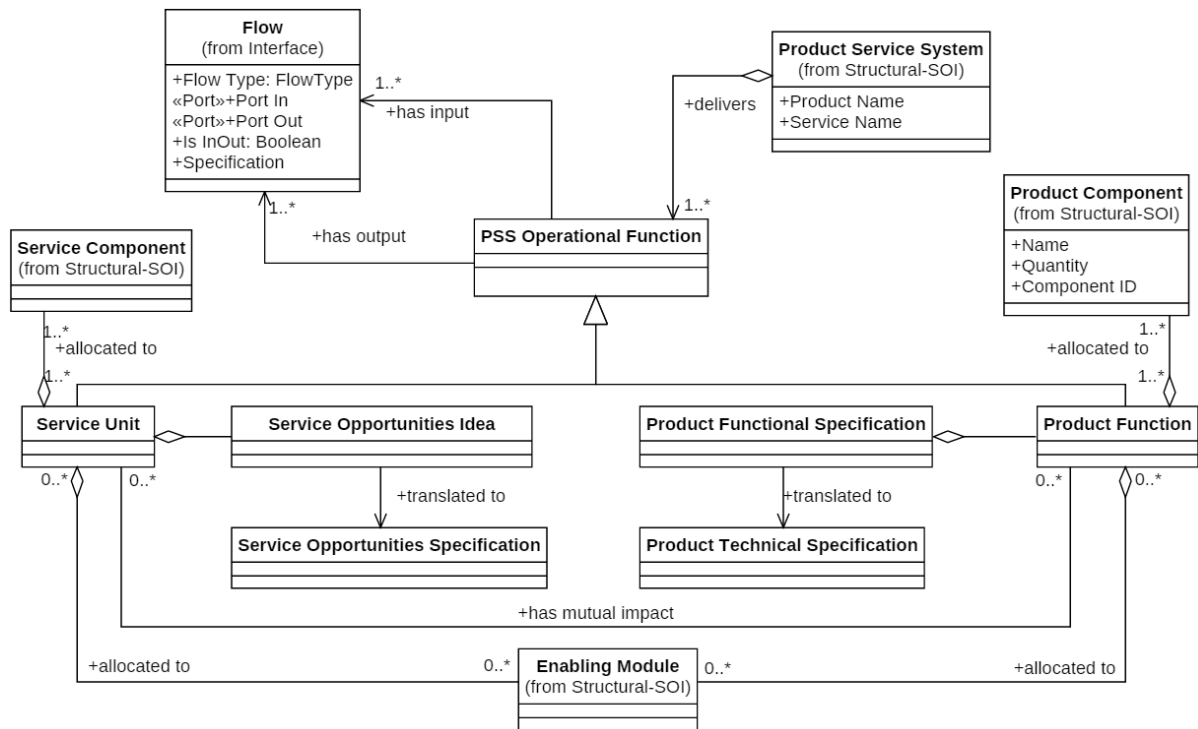

Figure 39. PSS functional architecture

The revenue mechanism defines “how the elements within the PSS generate income for the PSS provider” (Van Ostaeyen et al. 2013). The contract is vital to control the coordination mechanism (Velamuri et al. 2011) as well as resources which finally represent the PSS life-cycle assessment impacts (van der Veen et al. 2017). In the PSS context, companies undertake the “outcome-based service contracts” (Batista et al. 2017) or “performance-based contracting” which is based on integrating different stakeholders (Kleemann & Essig 2013). The revenue mechanism, in these contracts, clarifies the system ownership and the payment while the financing is used as a supplementary value (Brax & Visintin 2017)(Figure 40).

This meta-model is based on function delivery to fulfill both customer needs and sustainability issues (Figure 40). Following the PSS function tree, the PSS functional performance expresses the amount and the quality of the delivered outputs (Van Ostaeyen et al. 2013). It can be assessed by looking at a combination of a heterogeneous set of FPIs (Van Ostaeyen et al. 2013). In this context, System Quality Attribute (SQA) is used to quantify the PSS functionality (Estrada & Romero 2016). SQA is expressed by Functionality (Reliability or Effectiveness, Availability, and Responsiveness or Efficiency); Operational Status Robustness, Stability, and Recoverability; Effect (Traceability, Monitoring, Maintainability, and Reparability) (Estrada & Romero 2016).

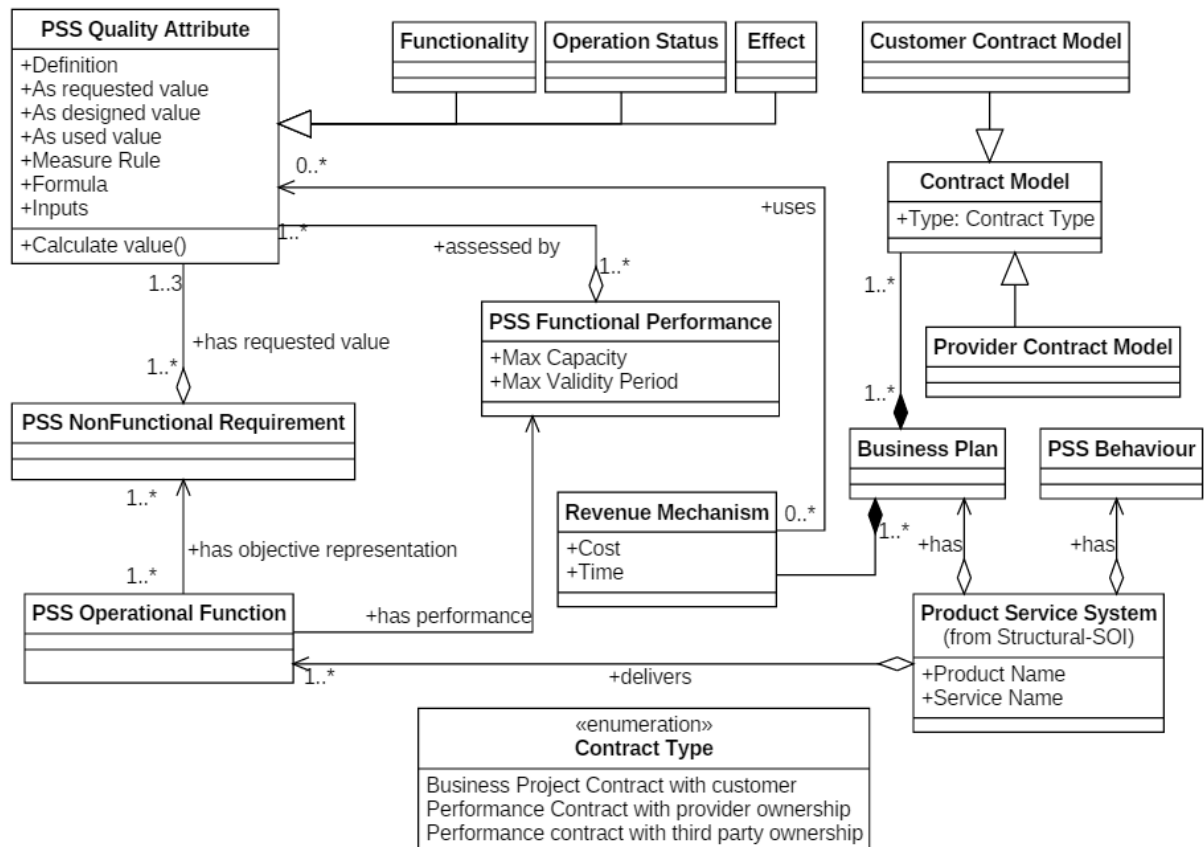

Figure 40. PSS function business view

III.3.3. The System of Interest model

According to ISO/IEC/IEEE15288, system element is “a discrete part of a system that can be implemented to fulfill design properties. It can be hardware, software, data, humans, processes (e.g., processes that provide a service to users), procedures (e.g., operator instructions), facilities, materials, and naturally occurring entities (e.g., water, organisms, and minerals), or any combination of these” (SEBOK1.8 2017). Components are the basic constituents of the PSS modules (Song & Sakao 2017).

PSS structure is composed of product, service and enabling modules as well as interfaces which the system integration solution is obtained by. The System of Interest is composed of product and service modules detailed by the components. In PSS, the product could be detailed as the mechanic, electric and cybernetic components (Kleiner et al. 2013)(Muller et al. 2007). The service is defined as a system of software, embedded systems, and service processing components. The product and service modules are allocated to the product function and service unit relatively. This is the transverse point between functional and logical architecture (Figure 41).

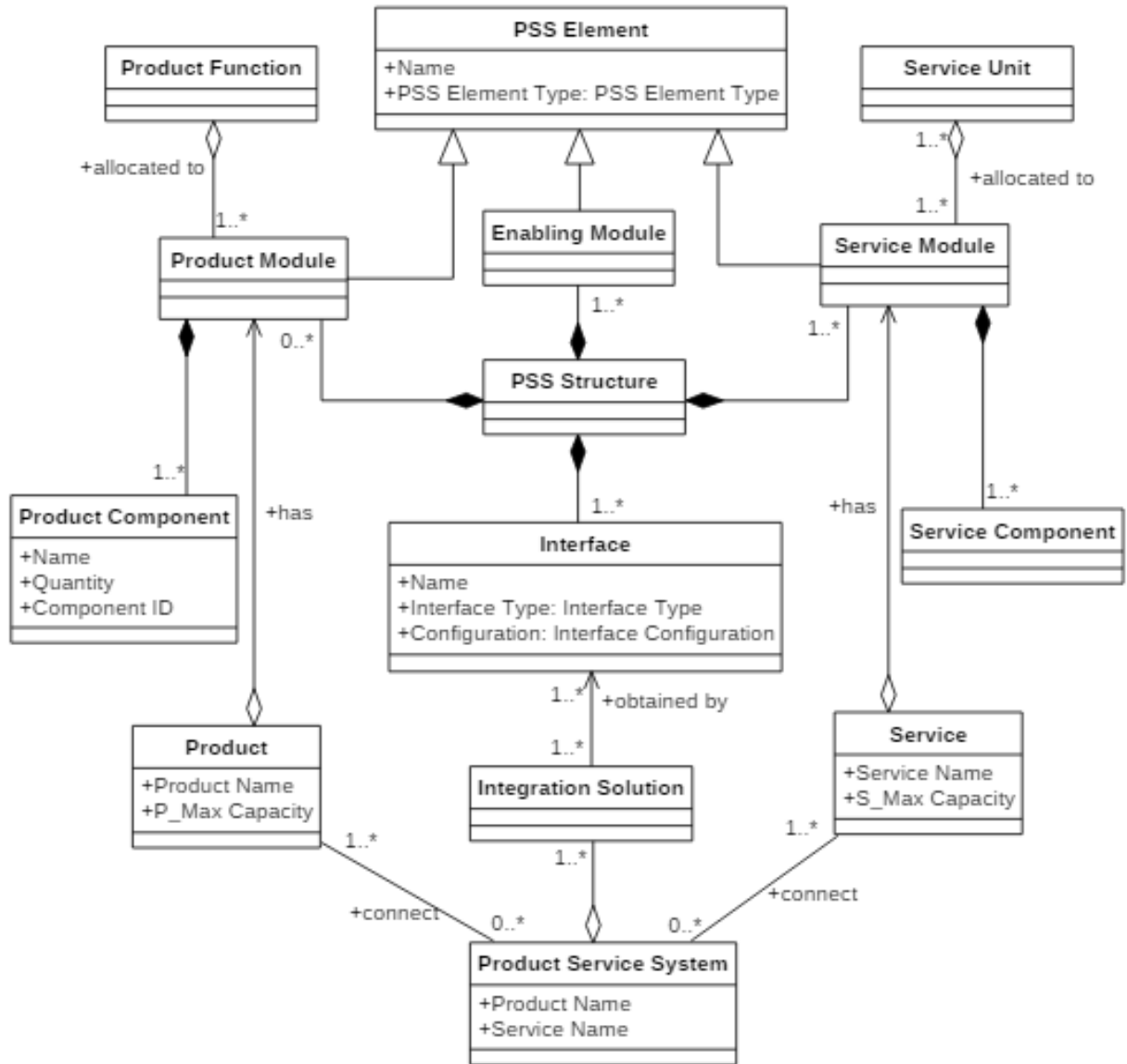

Figure 41. The System of Interest general model

Considering the development methodology, PSS consists of the PSS pattern and instance (Figure 42). The PSS pattern is a “collection of potential solutions” and the PSS instance is “one detailed solution” (Belkadi, Yicha Zhang, et al. 2017). The PSS pattern is created by the process of knowledge capturing from the previous PSS implementation (Goh & McMahon 2009) which the solution-ready customization is instanced from it (Bask et al. 2010). The PSS instance is also constrained by the PSS instance usage condition generated by the PSS environment. The customer purchases the PSS instance as a customized solution. The integration solution concerns the configuration of the PSS components from various modules (Belkadi, Yicha Zhang, et al. 2017).

The global model of System of Interest is presented in Figure 82. The structure of the System of Interest is detailed and connected to its functional dimension. This model is used as one of the sub-models during the logical architecture of PSS.

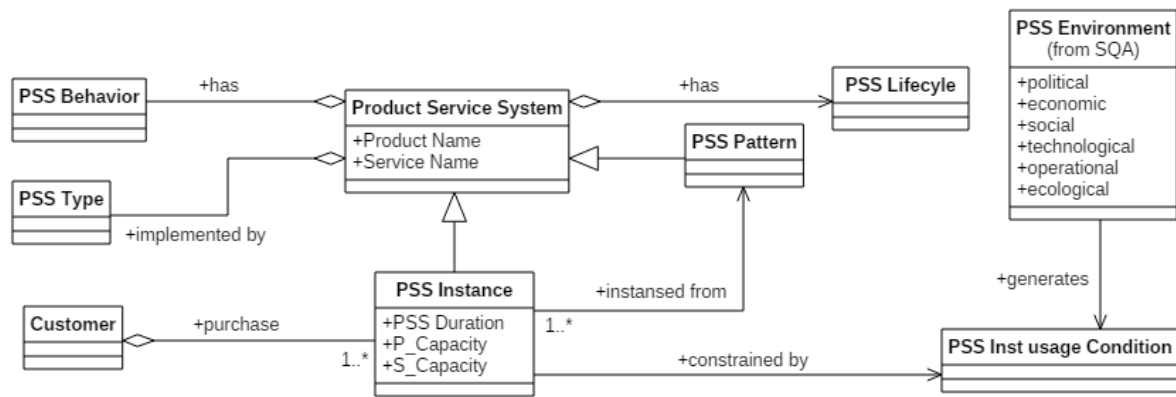

Figure 42. The PSS pattern and instance

III.3.4. The Enabling Systems model

Enabling Systems are defined as the “back-stage supports” (such as business processes, capabilities, technology, knowledge management, logistic, etc.) which assure the service quality (Pineda & Lopes 2013). To support the value delivery in PSS, Enabling Systems consist of physical and digital infrastructures as well as organizational capability (Williams 2007)(Lim et al. 2012)(van der Veen et al. 2017).

Considered as a prerequisite for PSS development (van der Veen et al. 2017), the infrastructure is defined as the “existing structures and systems within society, the existence and suitability of which should be considered when a product and services are developed” (Mont 2001). Two main categories of infrastructure are distinguished in PSS development as the physical infrastructures (such as local service stations, buildings, and other spaces and equipment) and the digital infrastructures (such as software and information systems)(Story et al. 2017)(Lim et al. 2012).

The physical infrastructure represents the necessary structures and systems that currently exist within the stakeholder's network and organization (e.g. the equipment, technology, and physical spaces and service station) (Williams 2007). The physical infrastructure could be a part of the organizational structure of the PSS stakeholders or from its environment.

Using IoT (Internet of Things) to provide advanced smart services is the new path in PSS. In this context, all Information Technology (IT) supports for service processing are considered as digital enablers. It also consists of product life cycle monitoring enablers, communication enablers, virtual transactions, business intelligent, etc. (Lim et al. 2012). The digital infrastructure is the vital support for the PSS integration as well as service processing (Lim et al. 2012). It also supports the firm's digital capabilities and processes (Pagoropoulos et al. 2017). Digital capabilities namely data generation and “service-related data processing” (Gebauer et al. 2017) and analysis (e.g. data staging, data warehousing, data analysis, and KPI assessment) are enabled by business intelligence and other IT infrastructures (Pagoropoulos et al. 2017). The “digitally-enabled servitization” is based on digital resources and infrastructures

to improve the data processing capability of the firm in PSS (Coreynen et al. 2017). In this viewpoint, ICT could increase the value and operational efficiency of PSS (Figure 43).

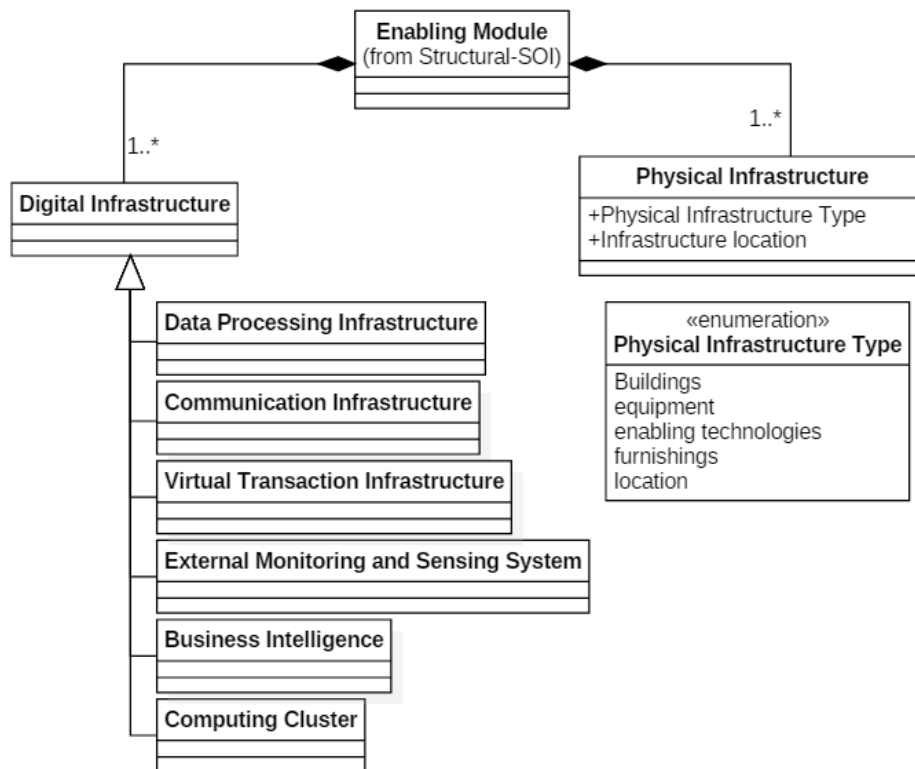

Figure 43. Digital and Physical Infrastructures

Resources and organizational capabilities are presented in Figure 44. Based on SE, the organizational aspects are included in the PSS development process (Maussang et al. 2009). The organizational aspects consider the company’s capability which is value-creating and competitive advantage gaining (Gebauer et al. 2017). The organizational view utilizes the resources, business processes and roles, and inter/intra organizational networks to support the PSS life cycle (Gebauer et al. 2017)(Velamuri et al. 2011).

The organizational capability is supported by active learning to “innovate and renew its functioning to ensure a sustainable and ‘long-term’ performance” (Rauffet et al. 2016). It is interconnected with other necessary capabilities (Story et al. 2017) such as digitization, operational capabilities and value co-creation which are the essential competitive capabilities for companies to adopt PSS (Pagoropoulos et al. 2017). As a result, creating new capabilities or improving the current ones is crucial to provide PSS (Huikkola et al. 2016). The strategic capability of the PSS provider is enabled by the strategic business processes and resources such as “productivity-increasing, customer value enhancing, and innovation-enabling process” (Huikkola & Kohtamäki 2017). As an example, PSS providers need to achieve an important capability called “organizing for repeatable solutions” by assessing learning processes, capability building and organizational change (Davies et al. 2006). Capabilities are formulated and developed during the PSS life cycle, which is to say, they will be defined during the

requirements engineering and functionally analyzed during the PSS configuration and re-used in operation (Andriankaja et al. 2018).

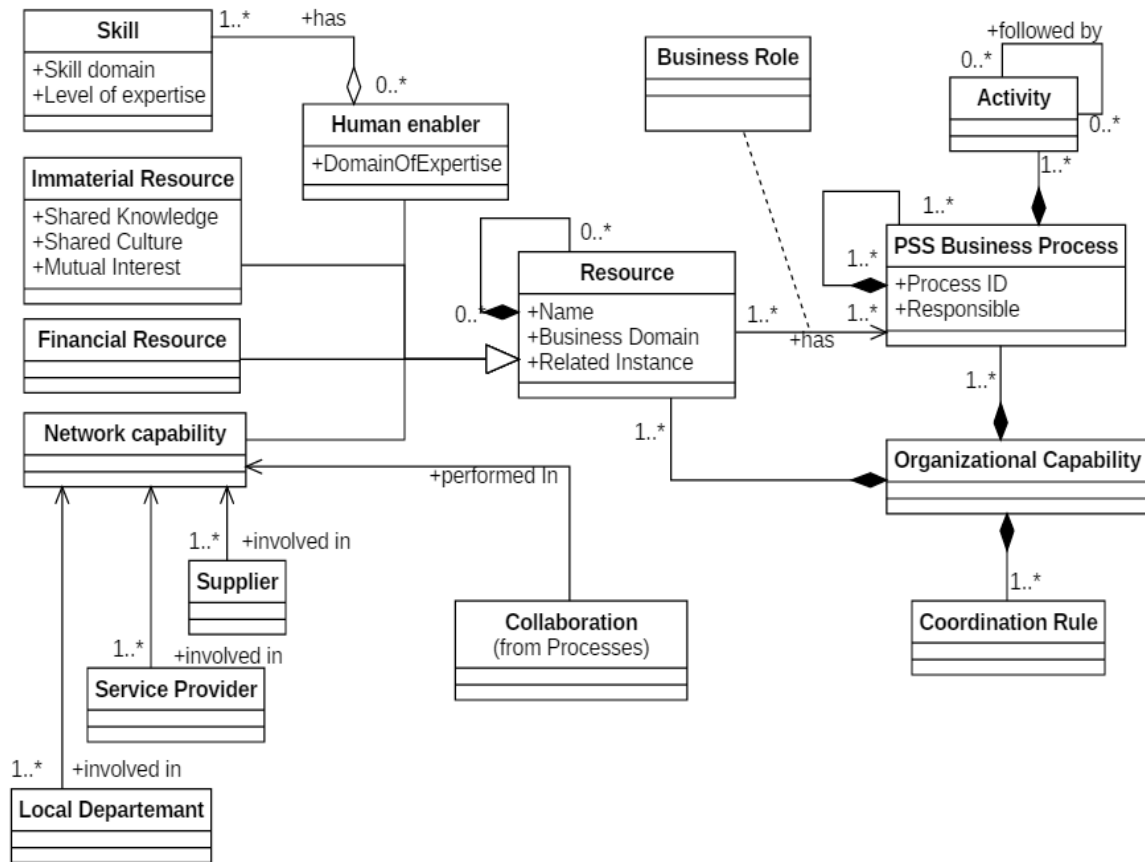

Figure 44. Organizational Capability

The business processes “define procedures that formalize the product and service design phase, ensuring the participation of different business function and defining their role and standardize back-office processes (while maintaining front-office customization) and service delivery” (Adrodegari et al. 2017).

Main resources needed for PSS are immaterial resources (Bullinger et al. 2003) like the firm’s knowledge (Pagoropoulos et al. 2017)(Sandin & Berggren 2015), business culture (Story et al. 2017), human assets and skills (Sakao et al. 2017), financial assets (Huikkola & Kohtamäki 2017), and interdisciplinary cooperation networks with various stakeholders (G Pahl 2013)(van der Veen et al. 2017). Creation of specific teams, roles, and key activities with service attitude such as “a dedicated direct sale-channel for service” is vital to increase the firm organizational capability as well as the “customers’ awareness of the new offering/value” (Adrodegari et al. 2017).

III.3.5. The business process model

The organizational capabilities are value-creating and firms try to continuously convert them to the core competencies by using the captured knowledge during the business processes (Gebauer et al. 2017). In PSS, the core capabilities are system integration (Davies et al. 2006),

knowledge capturing and learning (Goh & McMahon 2009), and solution-ready customization (Bask et al. 2010). In this context, alignment or realignment of resources (financial, technological and physical) is vital to emerging the dynamic capabilities (Huikkola et al. 2016) and increasing the competitive advantage of the firm (Sirmon et al. 2007). Processes in PSS are knowledge-intensive which means they would be useful to improve the strategic capabilities if the company uses the important resources for the key stakeholders (Kohtamäki & Partanen 2016)-which is to say they have interconnection (Figure 45).

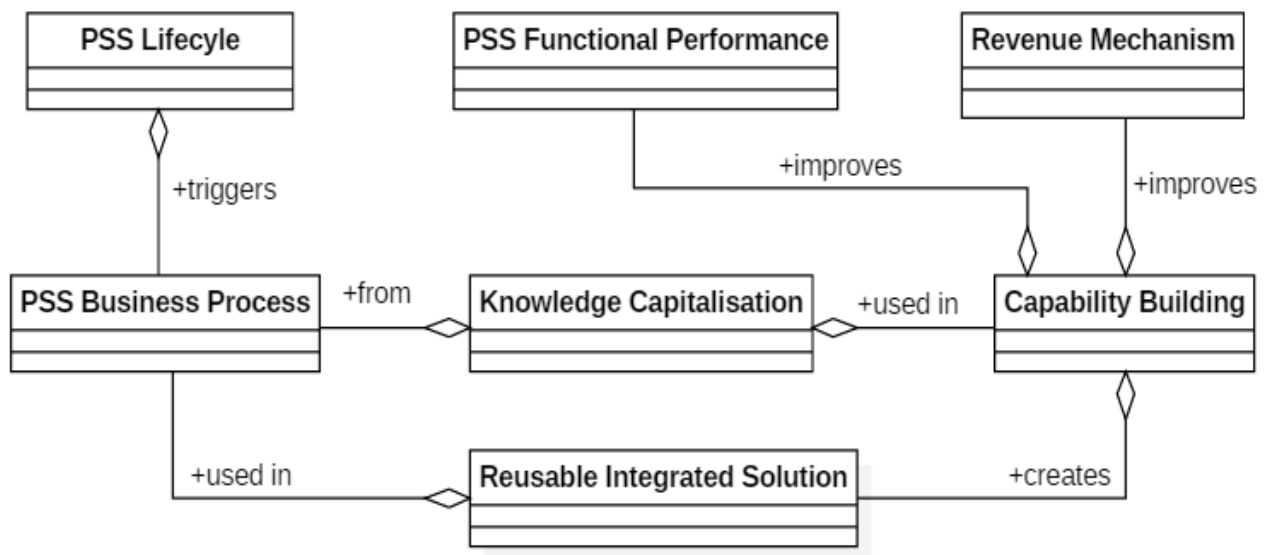

Figure 45. Value offer and capabilities

To proceed toward the system life cycle stages, the business process is performed. In PSS, all business processes are considered as Enabling Systems (Figure 46). Four main categories of processes during the PSS life cycle are distinguished as follows.

1. PSS creation process
2. PSS associated process
3. PSS operation process
4. PSS operation control process

There is an interconnection between various processes and to put the processes in action they all require collaboration between key actors in the value chain (between manufacturers and their suppliers, customers, customers' networks, and intermediaries) (Gebauer et al. 2017).

The above mentioned main business processes are divided into the sub-processes with different characteristic, yet, highly interdependent (Figure 47).

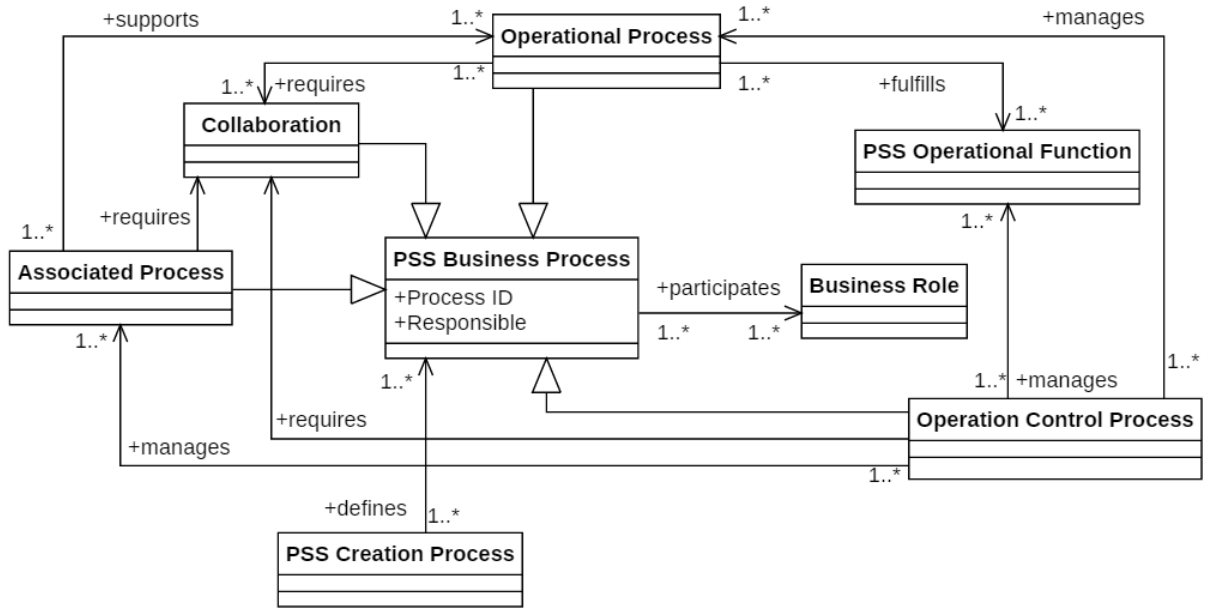

Figure 46. Main business processes

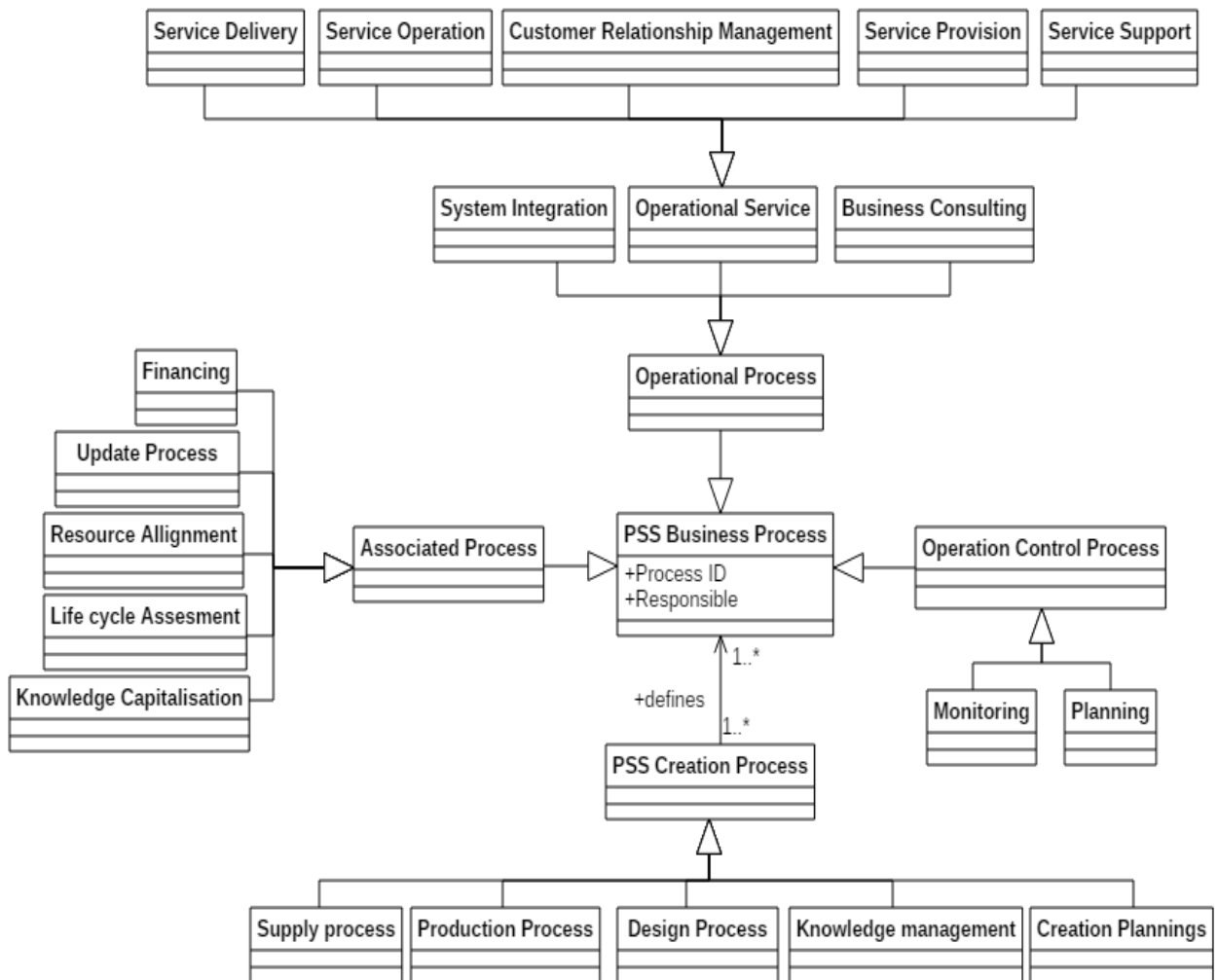

Figure 47. Processes and Sub-processes

The PSS creation processes are made up of all processes (such as design, supply, and production) to create a new PSS or its re-usable packages of products and services. The servitization affects the product design process and product specifications will be refined to “optimize service intervals” (Bertoni et al. 2016). The key knowledge processes (creation, integration, and transfer of knowledge), will be extended upwards and integrates the “task-specific capabilities” into the functional capabilities (Gebauer et al. 2017).

The associated processes are the prerequisite processes (such as life cycle assessment, financing, and resource alignment) to support the PSS operation. The financing processes support the capability of helping customers to “manage an installed base of capital assets” (Brady et al. 2005). The resource alignment is “the comprehensive process of structuring the firm’s resource portfolio, bundling the resources to build capabilities, and leveraging those capabilities with the purpose of creating and maintaining value for customers and owners” (Sirmon et al. 2007). The knowledge capitalization is “the process which allows reusing, in a relevant way, the knowledge of a given domain previously stored and modeled, in order to perform new tasks” (SIMON 1996).

In moving towards system innovation and PSS process steps, “infrastructural or institutional context” change would be necessary (Williams 2007)(Lim et al. 2012) which means infrastructures need to be retained to “support the service delivery process” (Story et al. 2017). Considering all the above, main associated processes are the innovation, interaction and networking, infrastructure management (development, adoption, usage) and financing capabilities (Story et al. 2017).

The operational processes are the necessary process (such as operational service, system integration, and business consultant) to set the PSS in motion (Brady et al. 2005). The operational service processes support the firm’s capability to “maintain, operate, upgrade and renovate a product through its operational life cycle” (Brady et al. 2005). From the service engineering viewpoint, these processes can be detailed as service provision, delivery, operation, support and customer relationship (Pineda & Lopes 2013). Business Consulting is a capability for firms to understand customer needs and translate it into the functional requirements (Brax & Visintin 2017). It also provides customers with “advice on how to develop business plans, design and build a system and maintain and operate it” (Brady et al. 2005). The system integration is the firm capability to integrate the system’s “internally or externally developed hardware, software, and services” (Brady et al. 2005).

The operation control processes are the collection of processes (such as monitoring and planning) to manage the operational process as well as the associated process and the creation one. It is the system responsible for “defining strategies and long-term forward planning” as well as “optimization, internal regulation, and generation of synergy between the operational units” (Batista et al. 2017). The above-mentioned processes fulfill capability building and support PSS through its life stages.

III.3.6. The life cycle model

Connecting to the circular economy, PSS life cycle is associated with a circular chain of service provision for maintenance, re-use, re-manufacturing and recycling fulfilled by various actors (Spring & Araujo 2017). In this context, the idea of services per life cycle stage (system life cycle stages and processes) is proposed to fulfill the need for each phase (Andriankaja et al. 2018). There is a mutual effect between PSS life stages and the corrective action like repair, renewal, reuse, etc. (Beuren et al. 2017).

The system life cycle processes are defined based on ISO/IEC/IEEE 15288 standard (Jarmo Alanen & Salminen 2016). Based on the already existing approaches in PSS literature (Bullinger et al. 2003)(Beuren et al. 2017), its life cycle is defined by connecting the chain of Life Stage-Events-Action-Process (Figure 48). In this point of view, each event during the PSS life cycle triggers a new stage. As an example, the service-related data for EOL considers the required actions related to the materials flows which are possible to recover or to reuse in the same PSS or other systems (Corti et al. 2016).

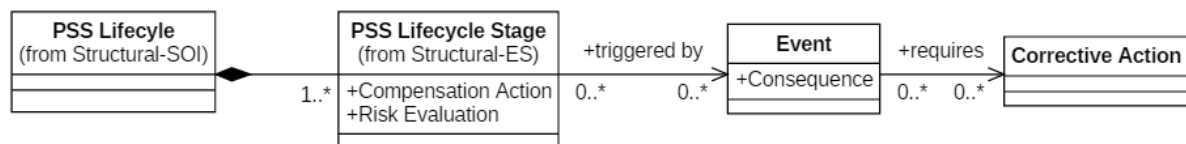

Figure 48. Life Stage-Events-Action chain

The system life cycle stages are defined based on ISO/IEC 2001 (ISO/IEC 2001). These stages start with the PSS definition which considers the requirements definition and conceptual design. Next step is system realization followed by the system operation which could be followed by system pending or ending of life. In the end, the system evolution might be the choice to upgrade the system (Figure 49).

Events are the operation or collaboration related changes that happen during the PSS life cycle. The operation related events are any failure in the product, technology obsolescence or infrastructure out of capability. The collaboration related event is related to the payment pending, partners leaving, contract ending or service stopping. These events could occur as an incidence or according to the PSS life-stages (Figure 49).

Corrective actions are the PSS provider respond to the events. These actions are based on the contract and the nature of the event. The corrective actions will be fulfilled by processes from the Enabling Systems (Figure 49).

The business processes support service processing in the System of Interest (Figure 49). According to the global model proposed in this research, the PSS life cycle stages are triggered according to events. To fulfill each event's need, the corrective actions are performed by various business processes to support the service processing in SOI. In doing so, real-time life cycle

data capturing and knowledge discovered from the data is continuously performed during the whole life cycle of PSS (Zhang et al. 2017). As an example, service provision happens during the MOL which has knowledge exchange with BOL as PSS creation processes like product design and manufacturing (Zhang et al. 2017).

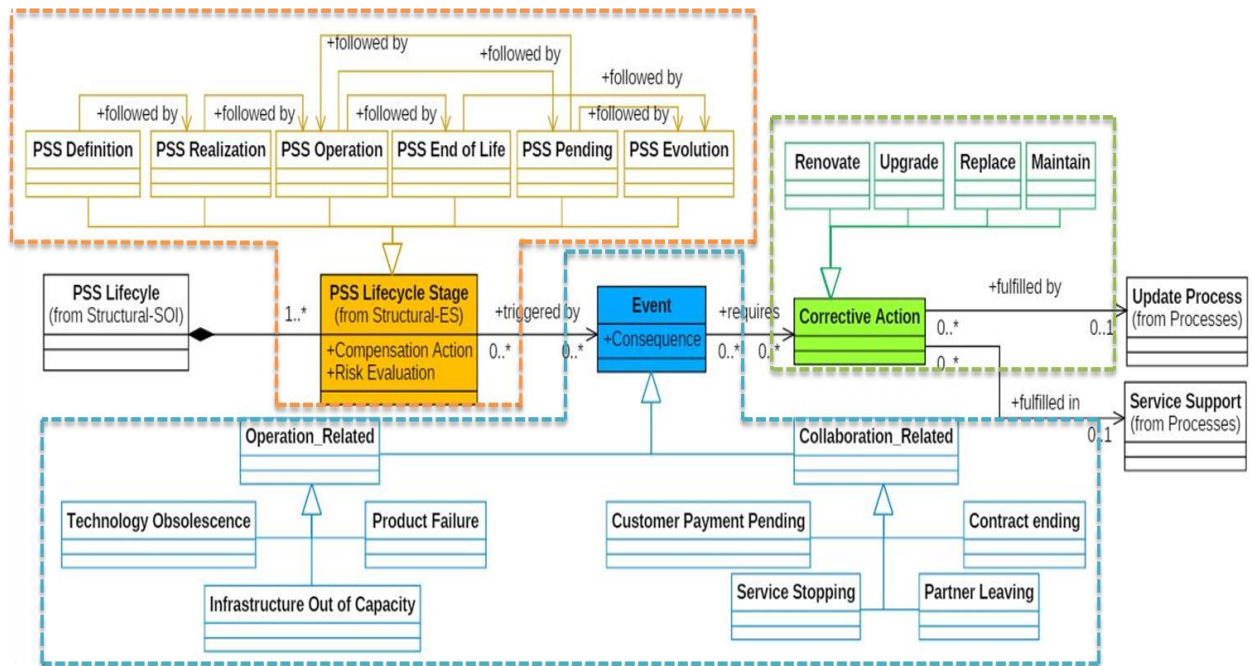

Figure 49. PSS life cycle model

III.3.7. The interface model

Establishing all possible interfaces and ensuring their compatibility are crucial tasks in PSS configuration (Klingner & Becker 2012). Poor interface management during system integration will fail the system during its operation. The interfaces compatibility is ensured by “identifying all functional and physical characteristics of interacting entities from different organizations” (Bruun et al. 2015). Because of the PSS modularity (Wang et al. 2014) and stimulus interaction between its heterogeneous components (Sasa & Lindström 2014), it becomes evident that defining interfaces is more challenging in PSS design. In order to achieve an appropriate interface management strategy, developing a robust semantic model defining the interfaces characteristics and features are of great interest. In doing so, providing PSS interface models with an ontological viewpoint is crucial (Andriankaja et al. 2018).

Many efforts are made to develop intelligent systems to manage the physical interfaces in the mechatronics systems which are supported by ontology (Zheng et al. 2016)(Rahmani & Thomson 2012). Though, the currently existing semantic models for PSS do not give enough details about the interfaces between tangible and intangible components. Some models are focusing on human-human or physical interfaces (Boucher & Medini 2016)(Annamalai et al. 2010); functional and process interfaces (Wang et al. 2014) or data interfaces with an organizational viewpoint (Dorka et al. 2014). Some PSS models are proposed with a

sociotechnical perspective (Hollauer et al. 2015) based on the flow and relation concepts between heterogeneous components (Wolfenstetter et al. 2014).

According to ISO/IEC 2382:2015, the interface is the “shared boundary between two functional units, defined by various characteristics about the functions, physical interconnections, signal exchanges, and other characteristics” (ISO/IEC 2382 2015). In mechatronics systems, the interaction logic is based on defining the details of interactions between the system’s components. The global view is that system’s entities (internal and external) have the software, hardware and human interaction (Fosse & Delp 2013). In this matter, the logical sequence of functions (flows and interfaces) is analyzed by the functional view of the system to define the blocks of the final system architecture (Maubourgne & Loise 2016). The interaction can “connect to other operational entities according to its interaction specification” (Fosse & Delp 2013).

The proposed model for interface uses the same logic as a mechatronic system. In the enumerations are detailed considering the intangible elements of PSS besides the tangible ones (Figure 50).

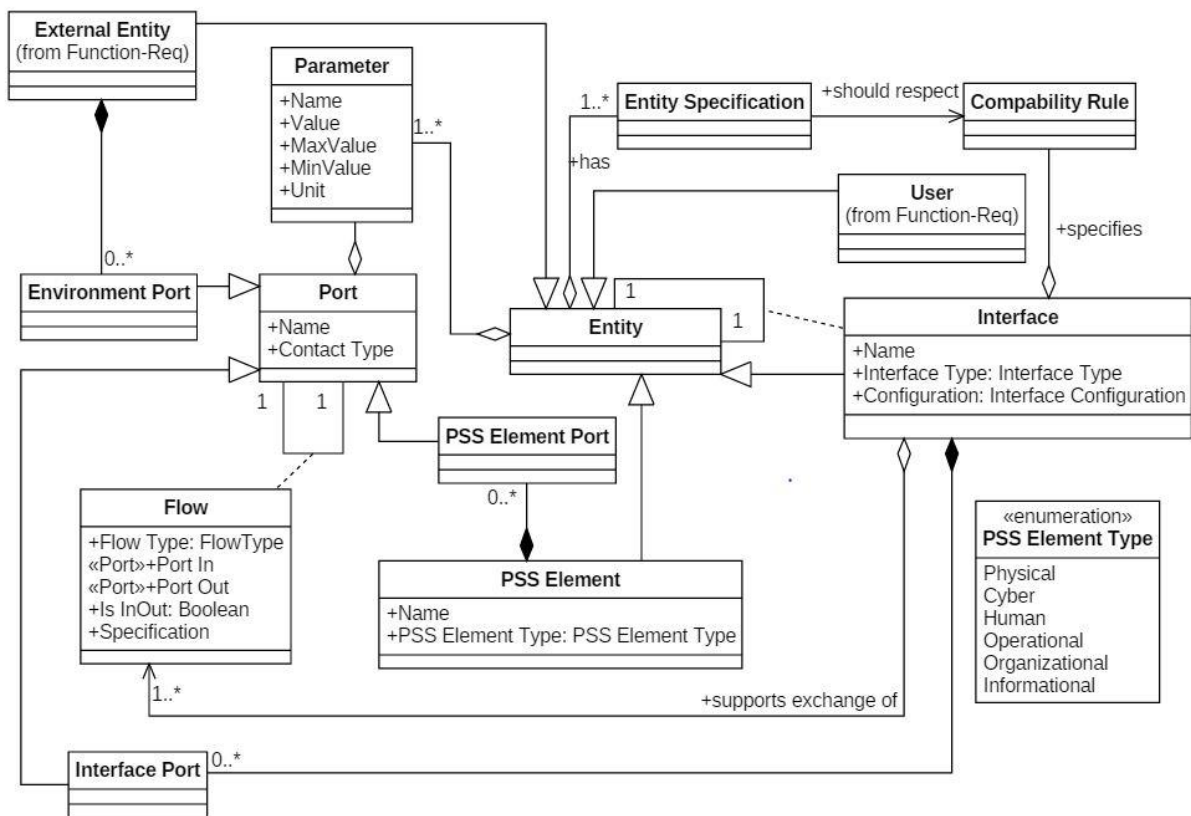

Figure 50. Interface model

Considering the definition of the interface in mechatronics systems, the class interface is defined by attributes named interface type and configuration to represent its specifications (Zheng et al. 2016). These specifications describe the components in interaction and the way they interact with interface type (Functional, Physical, Cyber, Organizational, Transactional, and Human-Machine). They also describe how an operational entity (system, organization, or

service) can affect another operational entity when a connection exists (Fosse & Delp 2013). The interaction is an “instance of an operational entity” (system, organization, or services) interface (Fosse & Delp 2013).

The interface model in PSS consists of components from the System of Interest as well as the Enabling Systems. “The Macro level interface describes the associations between subsystems, both to indicate their inter-dependence and to provide high-level guidance for how subsystems should be joined in the final product. The macro level interfaces can help engineers to achieve the basis for the integration of the subsystems” (Zheng et al. 2014). In doing so, the Interface Configuration is the combination of interfaces between components as Product Components (PC), Service Components (SC), Enabling Components (EC), Interface (I), Environment (E) and User (U). The multidisciplinary interfaces are the logical or physical relationships integrating the system components from various sub-systems (Zheng et al. 2016).

Finally, to define the interface between each pair of components, their specifications should be identified and matched according to the compatibility rules. The PSS components are heterogeneous and vary from the tangible to the intangible parts. As a result, despite the classical interface model in the Systems Engineering and mechatronics, the entities’ specification plays an important role to verify the compatibility between interfaces. The interface specification describes the nature of the boundary presented by a system or component in terms of properties and functionality (Figure 51).

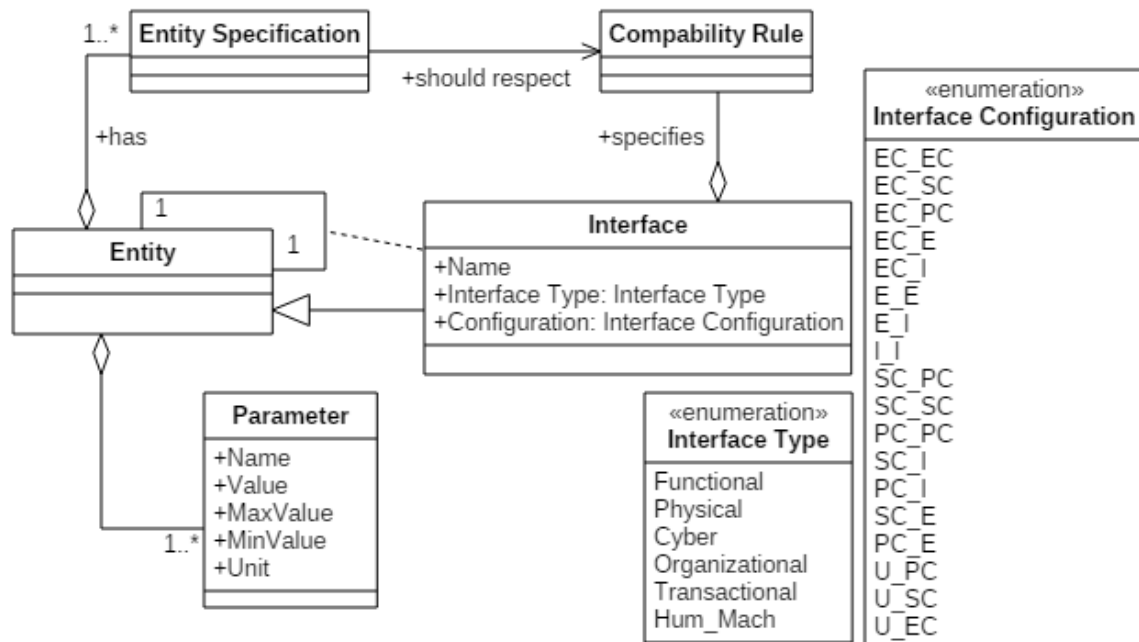

Figure 51. The interface configuration

The port and flow classes are shown in Figure 52. A system includes functional interfaces to support flows of material, energy or information, and physical interfaces to bind two elements physically (Dorka et al. 2014). To materializing the functional interfaces, ports are defined

(Maubourgne & Loise 2016). Each interface exchange is supported by the flow that can be actualized through ports (Zheng et al. 2016)(Hartmann et al. 2017).

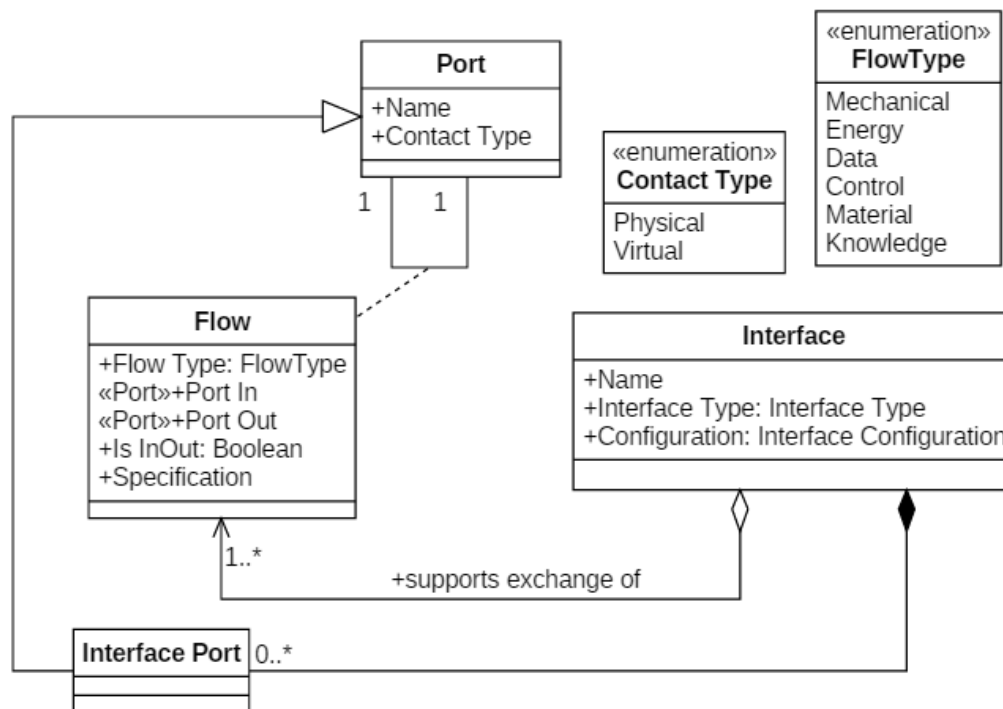

Figure 52. The port and the flow classes

Representing the sub-systems interfaces, the port is the interaction point between components (Rahmani & Thomson 2012) that “allows binding the system element to another one with a physical interface” (Faisandier 2012). In mechatronic, the port refers to the “primary location through which one part of the system interacts with other parts of the environment” (Zheng et al. 2016). “A port is a flow connector with four attributes, a type from the port ontology, a direction, a maximal multiplicity, and a minimal multiplicity” (Chenouard et al. 2016). The port can be contacted physically or virtually (contact type). For example, the USB port in a computer is a physical port but the connection point between software and database to exchange data is considered as the virtual port. To define the flow class, the model clarifies the input and output ports as well as the flow type. The Parameter “specifies the principle parameter related to the port which can be quantified”.

The flow types are as follows: (Zheng et al. 2016)

- Mechanical flow is considered as the physical connection between PSS tangible components “which is mainly related to mechanical geometry of interface defined in the feature-based product model for Computer-Aided Design”.
- Energy flow shows how the transferred energy between elements.
- Data flow is the information transferred between software during the communication process. During the observation process and feedback as well as service provision, data flow is the most transferred flow.

- Control flow in mechatronic is related to the electronic disciplines. In PSS, it also is related to the control process during the service provision.
- Material flow is mostly used in use-oriented PSS where the product or other equipment are rented or shared and returned. It is also the flow related to the PSS life stages change.
- Knowledge flow is the flow which happens during the collaboration and coordination “by sharing information through formal or informal interaction”. This flow is crucial for knowledge-based PSS to allow the exchange and share knowledge between disciplines.

III.4. Synthesis and conclusion

This work is a preliminary stage towards the definition of a global semantic model that helps to understand the complexity of PSS paradigm and to supports its development process. Considering the PSS characteristics, we propose to use through life cycle modeling approach to support the integrative PSS architecture. Such architecture will let us adopt required modules to use/reuse in special PSS development projects which will be beneficial in the matter of PSS cost and time to market.

Based on the guide provided by (Cavalieri & Pezzotta 2012), the already existing conceptual models which have a system view and are detailed in the system components are reviewed in chapter II.3. Comparing to these existing models, the model proposed in this research has some extra advantages. The main strength and limits of these models are presented in Table 2.

Considering all the above, PSS architecture can be supported by several contributions of the proposed model which the most important ones are as follows:

- It applied SE recommendations for characterizing PSS components and their boundaries based on their role during the function provided. Based on a fundamental concept in SE, the main sub-systems of PSS are defined as the System of Interest (SOI) and Enabling Systems (ES). Though infrastructure and support systems are mentioned in the PSS literature, there is no application of this concept in PSS models. The model proposed in this work they are integrated as the Enabling Systems to support the final function through its lifecycle.
- While presenting V-model with RFLP approach is an accepted approach in product development, representing the tangible and intangible components and their interfaces in PSS context is new. The proposed model tailored V-model based on mechatronic literature. It, also, tailored the RFLP approach to adding the detail of PSS on its layers. In the end, representing V-model by the RFLP model is the final contribution to adopt multi-viewpoints approaches in PSS modeling.

The detailed models provided with UML are requirements and functional analysis, the System of Interest, the Enabling Systems, the business process, the life cycle, and the interface model. These detailed models are modular and can be used as a whole or independently adopted and integrated with various PSS context.

Table 2. Comparing PSS conceptual models

Model	Strength & Limits	Our model contribution
A Conceptual Model for Product Service System (PSS) (Pirayesh et al. 2018)	The model is general and represents the first layer of concepts. Main categories of PSS-related concepts are represented and detailed in enumerations. Though it considers the supportive and organizational aspects, their role in PSS is not identified.	The majority of PSS related concepts are reported in the model. The main layers are represented and the supportive aspects are categorized based on their characters and roles in PSS.
A generic conceptual model to support PSS design processes (Idrissi et al. 2017)	It has a multi-viewpoint to represent the entire system and to support various models to represent each view. The aim of the model is providing a general model and detailing the components is out of its scope.	The multi-viewpoint approach is adopted by means of tailoring RFLP and SE principles. It, then, detailed the main classes to their sub-classes and their relationships are identified.
Research on industrial product-service configuration driven by value demands based on ontology modeling (Wang et al. 2014)	This model is modular. It considers process interfaces, flows, and configuration in the model. But, it does not have a life cycle approach.	The system configuration is presented based on the process and components interfaces. The life cycle model is also presented based on the events and actions through the system life stages.
An ontology for Product-Service Systems (Annamalai et al. 2010)	The UML model is detailed in Protégé and related modules are adoptable. Though it considers business element as the processes and infrastructures necessary to support PSS, there is no detailed model for process and its connection with other support systems.	Detailed UML models at the meta-level and a specific ontology for the operational scenario are created. The business process and infrastructures as the Enabling Systems are detailed and their connection with service is defined.

Chapter IV.

Model Validation and Verification

Chapter IV. Model Validation and Verification	85
IV.1. INTRODUCTION.....	87
IV.2. THE BIKE SHARING SYSTEM (THE ACADEMIC CASE)	87
IV.3. ICP4LIFE PROJECT	93
<i>IV.3.1. Case A: Machinery (Machine Health Monitoring)</i>	94
<i>IV.3.2. Case B: Energy provider (Energy Management Services)</i>	100
IV.4. SYNTHESIS AND CONCLUSION	104

IV.1. Introduction

The proposed models in chapter III set-up various concepts and relationships with the ambition to represent various aspects of PSS during its life cycle. The validation checks whether the conceptual model accurately represents the system by examining its accuracy, completeness, conflict-free, and no-redundancy (Shanks et al. 2003). This chapter aims to verify the representation capacity of the proposed models through their partial applications on some significant use cases covering the variety of PSS types. First, the model is applied to the bike sharing system as an academic case to clarify the usage of the different concepts proposed in chapter 3. Then, the industrial cases (Machinery and Energy provider) from the ICP4Life project are used to validate the model from an industrial viewpoint.

IV.2. The bike sharing system (The academic case)

In order to clarify the different aspects of the proposed model, an academic use case is conducted. This case is related to a bicycle sharing system (Figure 53). Various solutions have been launched in this domain and the majority of them are really used in the daily life of citizens. The one is considered in this research uses an integrated system of bicycle and mechatronic systems to propose a self-service and station-less bicycle sharing system⁷. In this matter, a Systems Engineering project is launched. Using currently existing communication infrastructures and highly supported by other Information Technology, this system can be run efficiently. The solution consists of a system (mobile application and a mechatronic device that controls the services and enables to attach the bike). It will allow a user, from his/her smartphone, to geolocate available bicycles; to reserve one; to start the service at the moment of detachment of the bike; then to drop the bike by fixing it quickly on a point of attachment; to receive an alert notification if the bike was severely attached; and to proceed to the payment of the hiring at the end of the service.



Figure 53. Example of bike sharing

⁷ <http://gobeebike.fr/fr/>

The operational scenario is as follows. I want to take a bike next to my current position. I spot a bike with a dedicated mobile application. The system informs me about the available bikes in my area. I detach it from its attachment point and I start the service. I leave with the bike. I drop it next to the destination. I fix it securely. I confirm the end of the service and the payment. Usage data is saved in my history. This simple scenario-based requirement is then translated to the functional scenario to support the engineering and integration of the whole PSS solution. Based on this scenario and defined interfaces, the whole logical system determining the bike sharing process is illustrated in the sequence diagram. This diagram specifies how system components interact with each other, with message exchanges and with external systems by specific interfaces (standard protocols, particular procedures, etc.) to achieve the bike sharing system.

To define the system interfaces, it is necessary to translate the general operation scenario to the functional and logical scenario as follows (Figure 54).

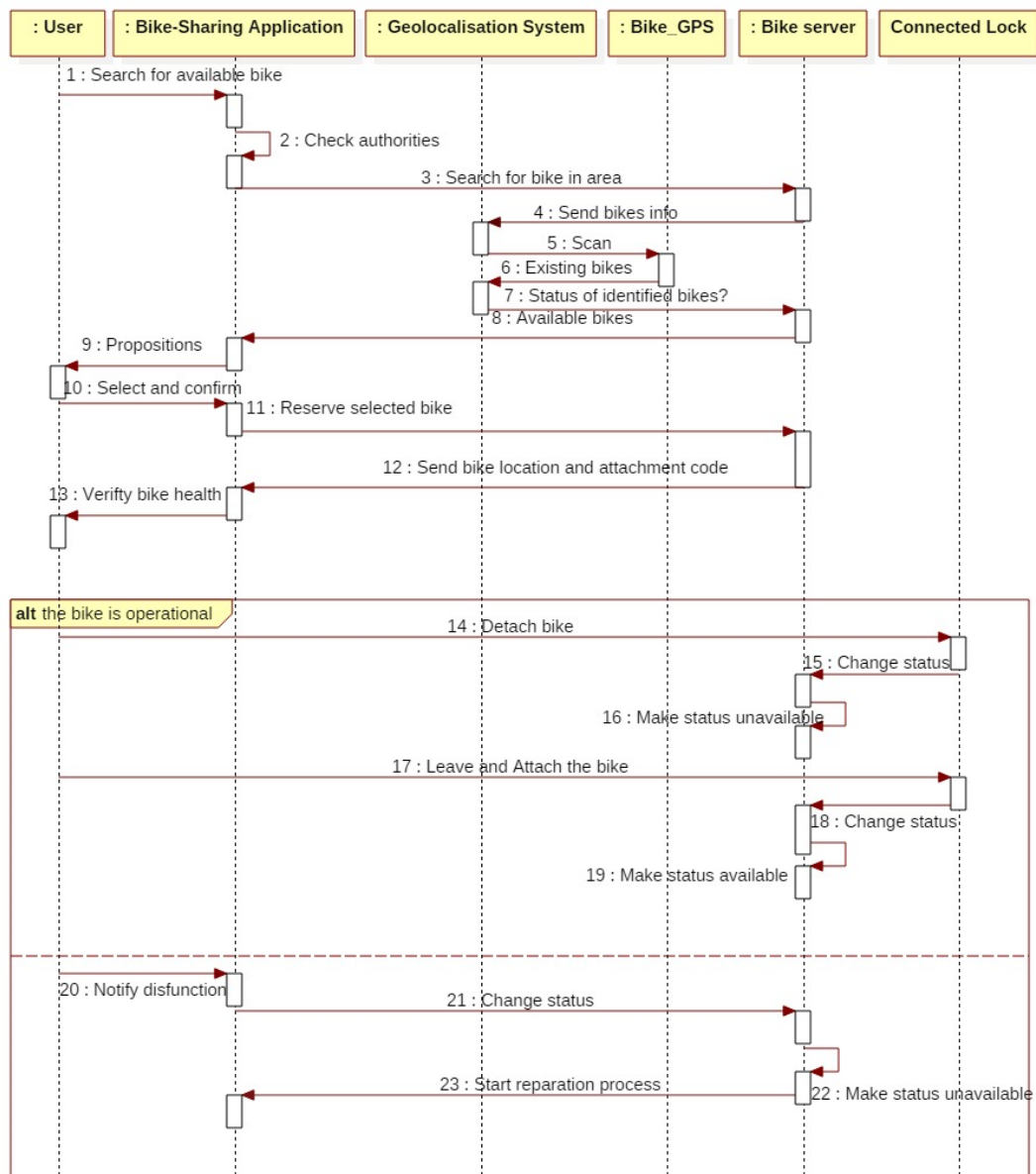

Figure 54. Bike sharing process

The bikes are “geolocated” by the dedicated geolocation system. A connected application will allow the user to unlock with a unique "QR code" for each bike. Matching the barcode in the application and the one on the bike, the client, can detach the bike to use. This system will allow users to reserve the bike when needed, to manage the bike park and users, to hold on the use of some bike at a distance (for maintenance). After usage, the connected application will automatically detect the dropped bike, make it available for use and calculate the price of service. A notification may be sent to other potential users in the same area to indicate this new available bike (Figure 54).

To ease the analysis of the case, its components are defined. Its System of Interest (product and service) and Enabling Systems (organizational capability, physical infrastructure, and digital infrastructure) are presented in Table 3 according to the proposed classification in chapter III. As an example, the bike sharing application is a service component from the System of Interest; while the bike GPS is one of the Enabling Systems.

Table 3. Description of the bike sharing use case

PSS Structure	Definition
The System of Interest (SOI)	A self-service station-less bicycle sharing system
Product (SOI)	The Bike
Mechanic	Bike core components
Electric	Energy providing
Cybernetic	NA
Service (SOI)	Drag and Drop the Bike
Embedded System	Connected lock, Bike GPS
Software	Bike sharing application on a smartphone
Service Processing	Find and make available ready to use bikes
Enabling Systems (ES)	Support system to design and deliver PSS
Organizational capabilities	Sale service, maintenance service, logistic service, Help desk
Physical Infrastructure	Bike Warehouse, logistic vehicle, authorized free parks, the
Digital Infrastructure	Smartphone, User account management, Payment system, bike server, Geolocalisation system

Next step, to apply the proposed model in this case, the object diagram of this simple scenario is created. In the following, each part of the PSS under study is connected to the reference of the related semantic model presented in chapter III the SOI (Figure 41), ES (Figure

43), life cycle (Figure 49) to show how the model covers the different aspects according to a specific point of view (Figure 55).

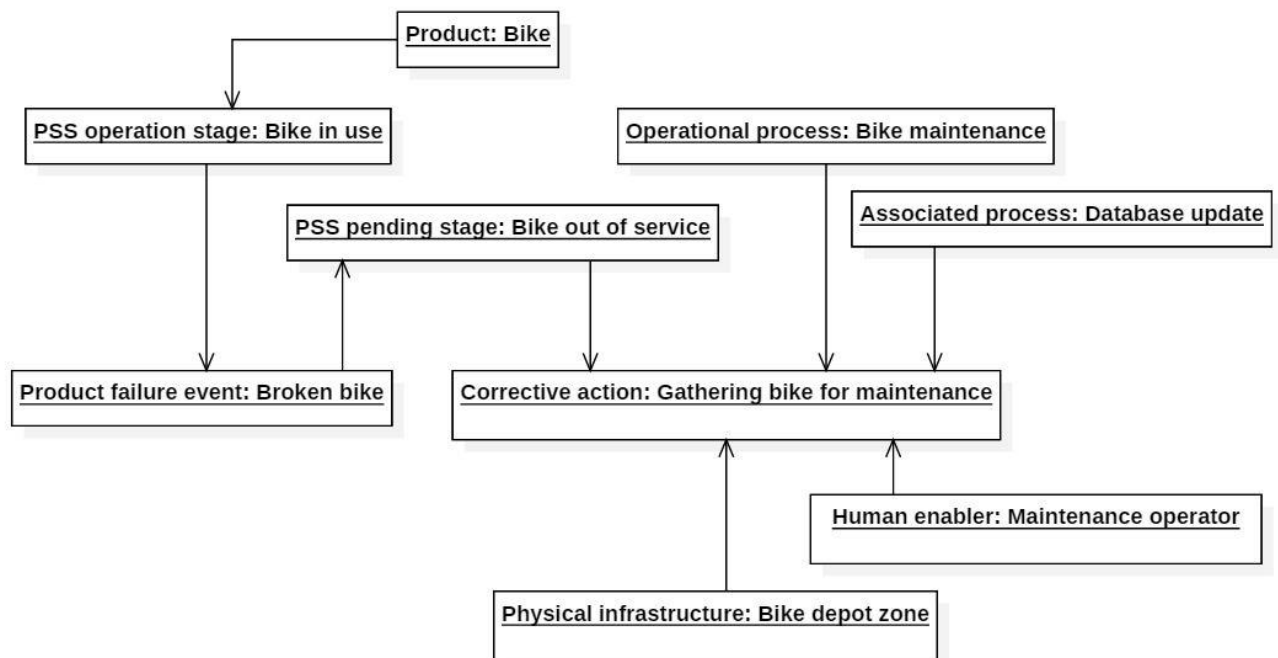

Figure 55. The object diagram for bike sharing

The bike-sharing process sequence diagram precisely defines the steps and its related components during the bike sharing process. As an example, to drop the bike, the bike's connected lock is involved in four processes as:

- Detaching the bike which consists of an interaction between the user and the connected lock;
- Changing status from available to unavailable that consists of an interaction between the connected lock and the bike server;
- Attaching the bike which consists of an interaction between the user and the connected lock;
- Changing status from unavailable to available that consists of an interaction between the connected lock and the bike server;

After defining the functional scenario and the system components, interfaces will be detailed based on the interface model (Figure 51 & Figure 52). According to the scenario, sub-functions and associated elements in each function are defined. The general scenario, the associated components from the System of Interest or the Enabling Systems and the required interfaces between them are shown in Figure 56. In general, interfaces are defined as follows.

Physical interfaces:

An electronic box is fixed on the bike and has two types of components. The first one is a sensor/GPS, and the second one is a bar code reader. The second physical connection is between the bike and the connected lock.

- **Cyber interfaces:**

The bike’s GPS is in connection with the geolocation system (standard communication protocol). For geolocation of available (locked) bikes, a signal from the bike’s lock will be sent to the system, and its location will be shown as the available bike. The second cyber interface is between the bar code reader and the screen of the smartphone to read/display the barcode.

- **Human-machine interfaces:**

During the whole process, the user has various interactions with the bike sharing application. Then, there will be an interaction between the user and the bike during the usage phase.

- **Organizational interfaces:**

The organizational interaction accrues between the user, maintenance employees, and logistics employees. If users can’t unlock the bike or need help, the support team will interact with them.

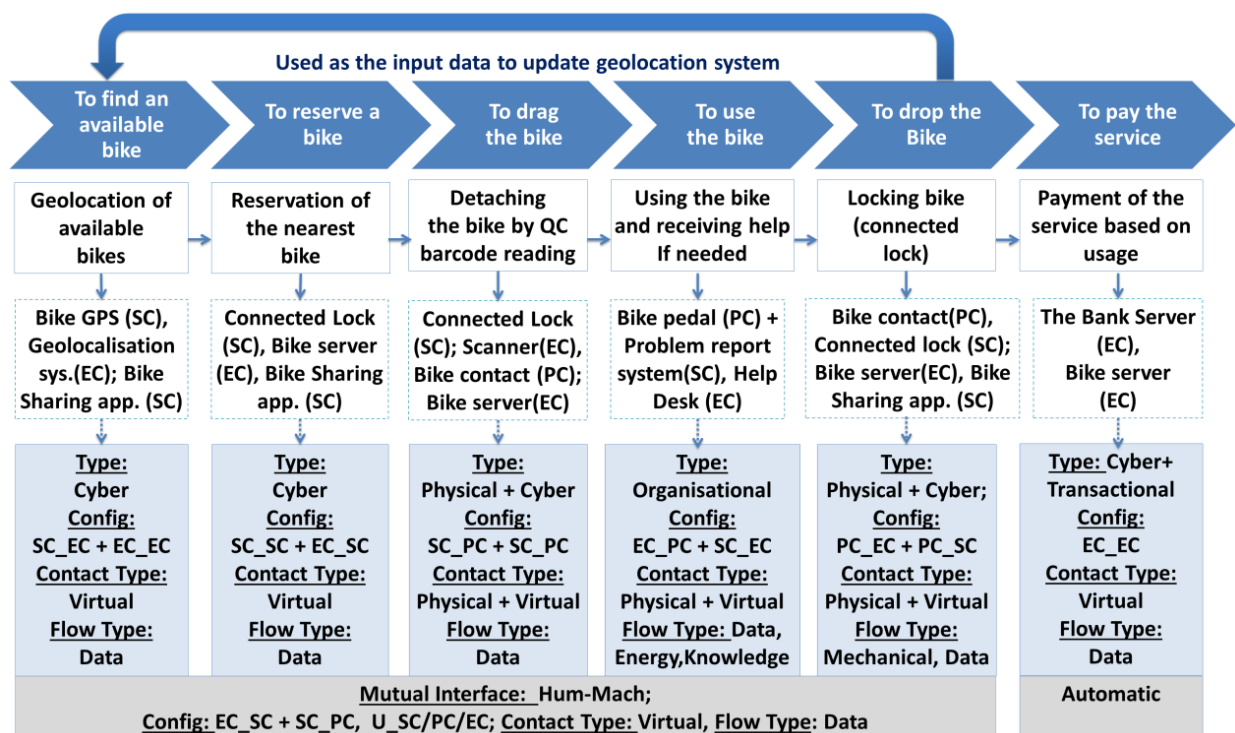

Figure 56. Bike sharing scenario and interfaces

The compatibility rules will be defined to match each pair of components. One example of the compatibility rules could be the compatibility between the locking system (connected lock) and the geolocation system. A bike will be considered as “available” if it is correctly locked and if it is not under maintenance. So, all data from the bike’s lock should be analyzed by the bike sharing application. In this case, the interfaces between the connected lock and bike server to transfer the bike’s status data are essential.

Based on this scenario and defined interfaces, the whole logical system determining the bike sharing process is illustrated in the sequence diagram. This diagram specifies how system

components interact with each other, with message exchanges and with external systems by specific interfaces (standard protocols, particular procedures, etc.) to achieve the bike sharing system.

The process sequence and the scenario based interfaces definition together support the analysis of interactions in detail. It will be mainly used to define interfaces to support system integration during the PSS architecture design. In this example, the interfaces analysis focuses on the two primary phases as ‘to find an available bike’ and ‘to reserve a bike’. These two main phases consist of various steps during the bike sharing process which is defined by the process diagram. The output of this process is the detailed interfaces between all components (Figure 57).

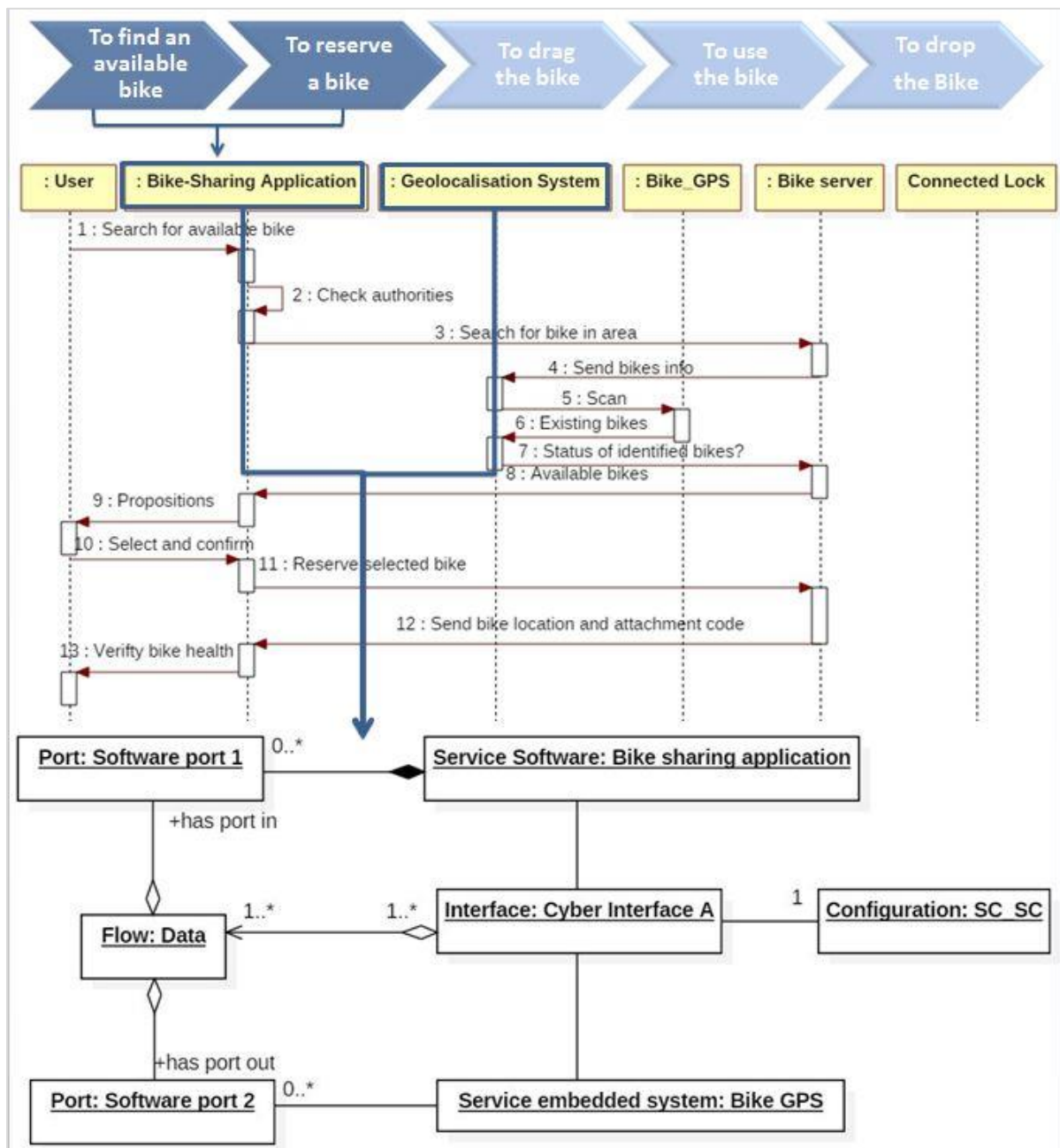

Figure 57. Bike sharing use case sample of interface analysis

As an example, the interactions during the finding of an available bike are analyzed. One of the interactions between the ‘bike-sharing application’ and the ‘Bike GPS’ is defined. Based on Table 3, they are components of the service (System of Interest). The bike-sharing application is software and the bike GPS is an embedded system. As a result, we have an interface between two elements of SOI. Accordingly, these interactions are analyzed based on Figure 56. For each pair of interaction, the ports and flows are defined. This process is repeated for each pair of components which have been defined as interacting. In summary, the attributes are defined as: Interfaces between the bike-sharing application (SOI-SC) & bike GPS (SOI-SC); Interface Type: Cyber; Configuration: Service Components (Bike sharing application) & Enabling Components (Bike GPS); Contact Type: Virtual; Flow Type: Data (Figure 57).

IV.3. ICP4LIFE PROJECT

The proposed framework and the supportive typologies can be applied to different PSS engineering. To check the model application, the proposed model has been examined in different contexts. The primary model has been created in the context of industrial PSS where the manufacturer is adding advanced services to the product to develop PSS. Then, the model has been applied in a specific PSS context where the whole system of product and service is used to ease the transport need. In this context, the proposed interface model enriches the interface description by defining all possible flows and interfaces and compatibility rules between each pair of elements (system components, external factors).

This chapter focuses on a network of industrial partners creating an innovative customized solution to fulfill various services in the ICP4Life project. Each partner is going to provide a customized PSS offer according to their core competencies (machine health monitoring and maintenance as well as energy management).

Table 4. The industrial cases

Case	Domain	PSS typology	Service
Case A	Machinery	Product-oriented	Machine Health Monitoring
Case B	Energy provider	Result-oriented	Energy Management

While the scenarios are customized to each case, there are service exchanges between partners to create global PSS. The integrated PSS network is enabled through a collaborative platform supported by a common knowledge repository. In general, the leading actor in this industrial use case is a manufacturer of industrial machines, wishing to upgrade the existing machines to provide a “Machine Health Monitoring service”; it also collaborates with an energy provider partner for two more services as “Power Interruption Planning” and “Energy Consumption Management” (Figure 58).

For each case, the following steps are taken to imply the proposed model. First, the operational scenario is defined. This process leads us to define the requirements as well as PSS sub-functions (product function, service unit). Then, the PSS sub-systems will be detailed (product module, service module, enabling module). Finally, functional interfaces are presented.

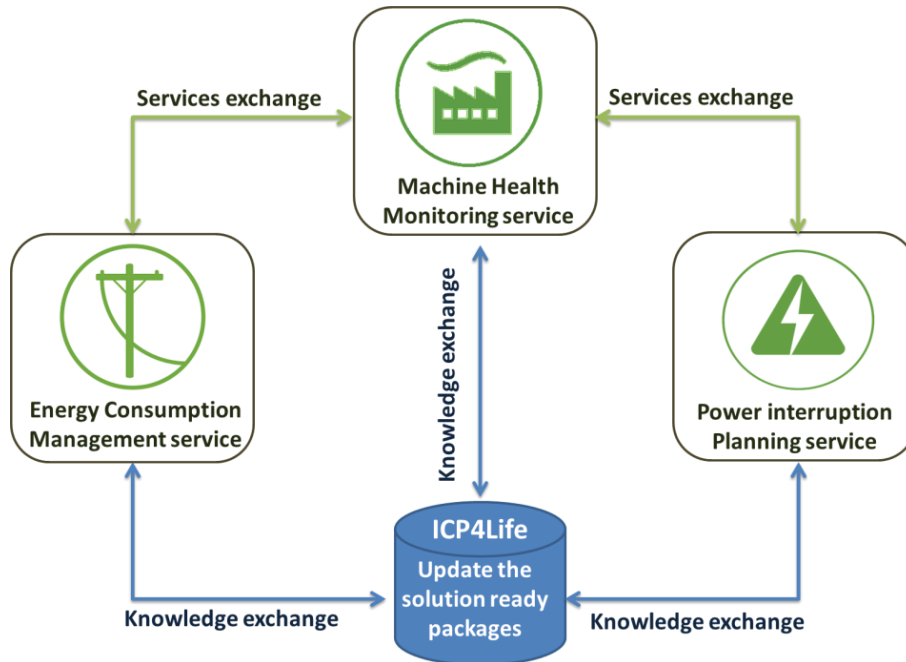

Figure 58. ICP4Life Services interconnections

IV.3.1. Case A: Machinery (Machine Health Monitoring)

Case A is a manufacturer of industrial machines from the ICP4Life project. Given a particular machine, the manufacturer aims at upgrading the existing machine for potential customers by adding the Health Monitoring service to the machine. In the new offer, the object is not any more machine selling but providing the machine with customized smart services. The operational scenario is as follows. The manufacturer puts the machine in the routine operation. He receives the notifications about any deviation from acceptable acceleration and frequency during the machine's normal operation. He stops the machine operation for any maintenance. The general scenario is a chain of steps as the machine's operation routine, monitoring vibration amplitude, sending a related notification, saving vibration patterns and predicting maintenance need.

The Machine Health Monitoring service is the basis of predictive maintenance and highly relies on vibration monitoring. Involving the sensors in the PSS life cycle eases the monitoring and predicting services like maintenance. To fulfill this service, vibration sensors are integrated with the machine to monitor its vibration during operation. In doing so, the part of the machine which should be observed will be chosen to add the sensor. The health monitoring application will analyze data from this sensor. When the vibration amplitude shows a deviation from

acceptable acceleration and frequency during its normal operation, an alarm notification will be sent to the equipment user. The vibration pattern (the machine behavior) is saved and used as a reference for vibration deviation detection. Based on this, the maintenance need is predicted (Figure 59).

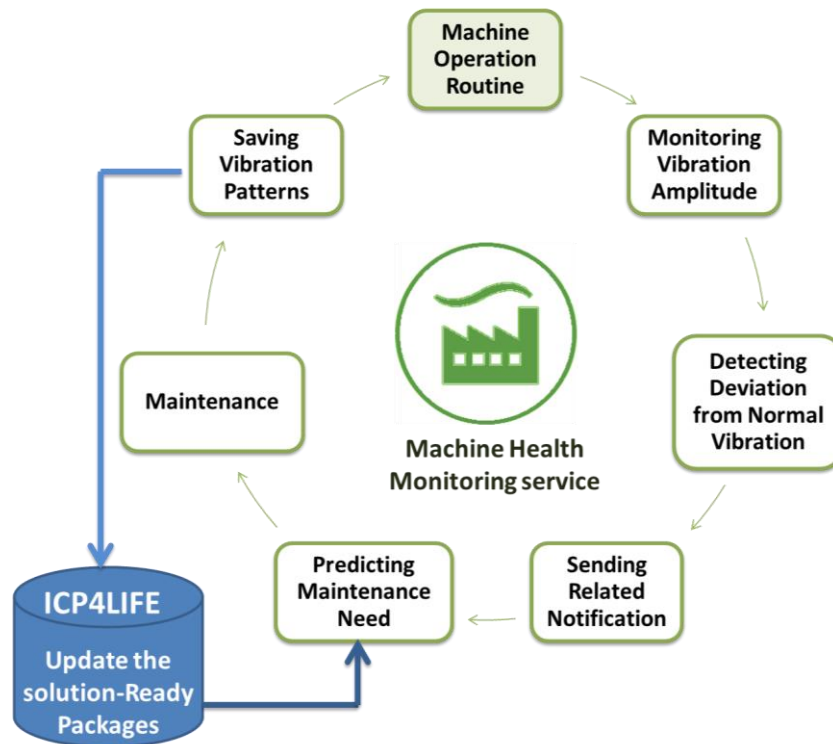

Figure 59. Machine Health Monitoring

The necessary process for each step of the scenario is then defined. As an example, predicting maintenance need is fulfilled by the service support process. Accordingly, the components involved in each process are determined. According to this scenario, the product function is the cutting operation routine, and the service unit is the whole process of analyzing machine vibrations during its operation. Then, the main sub-systems will be defined according to their function. Cutting system (the Product component) moves above the pages according to the cutting pattern. The embedded sensing system (the Service component) observes the machine vibration during the operation. The health data capturing system (the Enabling Systems component) saves all data from the machine vibration as well as its vibration pattern. Finally, the data analysis process uses the data from the health web application to predict the maintenance need (Service component). The technological solution (such as sensors and vibration analyzing software) to fulfill the function of each sub-system will be defined at the physical level.

In this case, PSS consists of the machine, the software to monitor it, embedded software in the machine and the collaborative platform. According to the required function, each PSS component (e.g. software) can be identified with a logical view as a part of the product, the service or the support needed to ensure the integration of the whole PSS structure. From the engineers' viewpoint, the software can be considered as a part of Enabling Systems (the digital

infrastructure). The development process to provide the final PSS follows the through life cycle engineering (Figure 60).

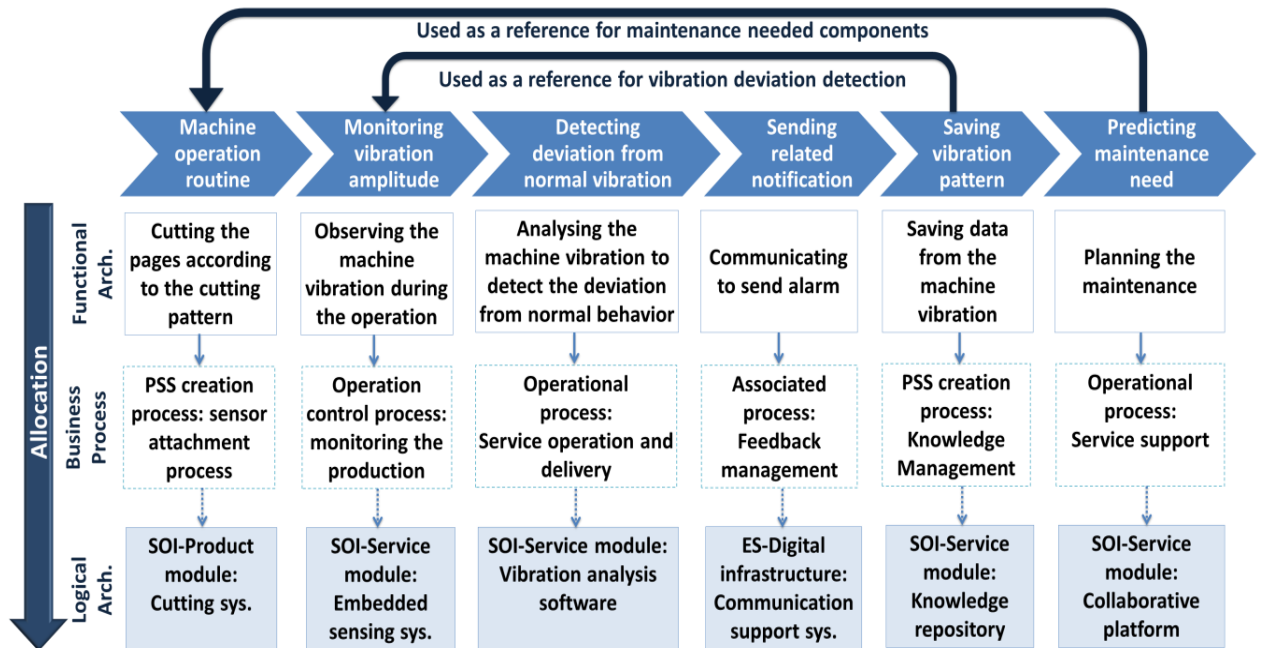

Figure 60. Description of the use case

In order to show the flow between sub-systems, the sequence diagram for this scenario is presented in Figure 61.

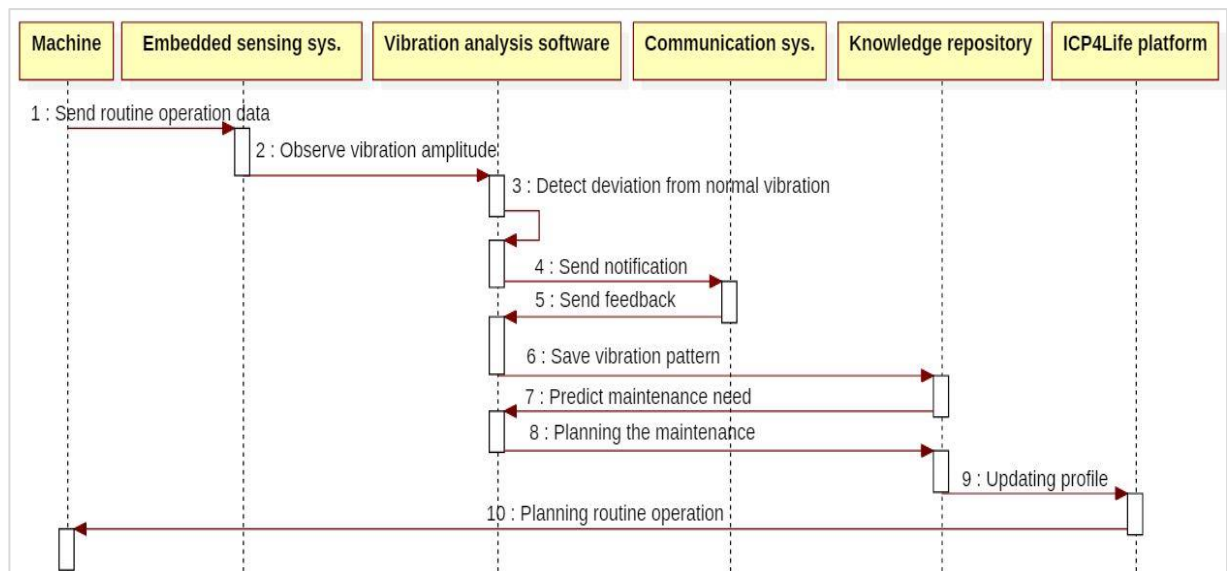

Figure 61. UML Sequences diagram for Machine Health Monitoring

The first challenge during the PSS development is to distinguish the elements that are part of the System of Interest (such as software) from others considered as the Enabling Systems to make the job done (such as digital infrastructure). In this case, PSS consists of software to monitor the machine, embedded software in the machine to get the job done and software as the collaborative platform. The detailed architecture of the related PSS is defined following the

concepts of System of Interest and Enabling Systems. The synthetic description of the components forming these sub-systems is given in Table 5.

According to the required function, each PSS component (e.g. software) can be identified as a part of the product, the service or the Enabling Systems (digital infrastructure). PSS elements, in this case, are categorized according to the proposed model. The product is the customizable machine which is associated with some intelligent health monitoring services. The components of service are various from hardware to service processing and software. The collaborative platform supports knowledge sharing through life cycle development process. The architecture of the proposed supportive platform is based on a central knowledge repository through which different business applications are interconnected to provide technical assistance to users during PSS collaborative development. Other infrastructures and organizational aspects are also identified to enable PSS development.

Table 5. The components of the use case

PSS Structure	Definition	
The System of Interest (SOI)	The Laser Cut Machine with Health Monitoring Services	
Product (SOI)	Laser Cut Machine	
Mechanic	Machine Bogie, Head, Laser, Lens, Motor, Nozzle	
Electric	The power system, Electrical Parts	
Cybernetic	Control system, wireless modules, and software of the machine	
Service (SOI)	Machine Health Monitoring service (Minimize the machine breakdown times by observing and recording the machine vibration pattern through its lifetime and use it detect any variation from the normal behavior.)	
Embedded System	The sensing system & connectors, communication equipment, IOT devices	
Software	The collaborative platform, cloud-based collaborative portal, installed service related software to automatically perform vibration analysis (vibration analysis software)	
Service Processing	Information Processing (Feedback management, Parameters)	Vibration measure and analysis; Feedback from the <u>production monitoring</u> (dimensional tolerances, real production time of the component); <u>process monitoring</u> (temperature of the sheet metal, sheet metal thick); <u>vibration monitoring</u> (vibration of the laser head, vibration of the machine table, status of the machine, abnormal vibration over a threshold, damage of a tool parameters)
		Contract according to the price, delivery time and place
Enabling System (ES)	Support system to design and deliver PSS	

PSS Structure	Definition	
Resources	Resources-Human	Maintenance network (maintenance technicians, control center personnel, etc.), engineering and manufacturing team, supply chain actors (internal and external), sales or customer service personnel, reverse supply chain and disassembly technicians
	Resources-Immaterial	PSS pattern saved in the knowledge repository
	Business Processes	<p><u>PSS Creation Processes</u>: laser installation, sensors attachment design, mechanical assembly;</p> <p><u>Associated Processes</u>: data management & storage and knowledge repository update, digital resources planning, Supply chain, disassembly of the machine;</p> <p><u>Operational Processes</u>: service management, sensor selection and placement optimizing, sensor compatibilities verifying, PSS pattern selection and instance optimizing; machine transformation and correction, customer site installation, training & startup production;</p> <p><u>Operation Control Processes</u>: documentation, planning generation, bill of processes creation, alternative production plan generator, production planning</p>
Physical Infrastructure	Creating prerequisites to provide PSS	Shop floor equipment, monitoring data center, maintenance equipment, transformation or correction of machines or spare parts; PSS hardware (PC, laptops, cloud server, network equipment)
Digital Infrastructure	Software support	PSS software (sensor data load, acquisition, and drivers, AR application, Android application, EOL calculator), Browser (access services frontend and backend)
	Communication support	Message transfer (sms, email ...)

Based on the generic model of PSS processes (Figure 47) in chapter III, IDEF model (Figure 38) is used to decompose the general process to the activities of this scenario (Figure 62). Then sub-functions are modeled in details (F1, F2, F3, F4, and F5).

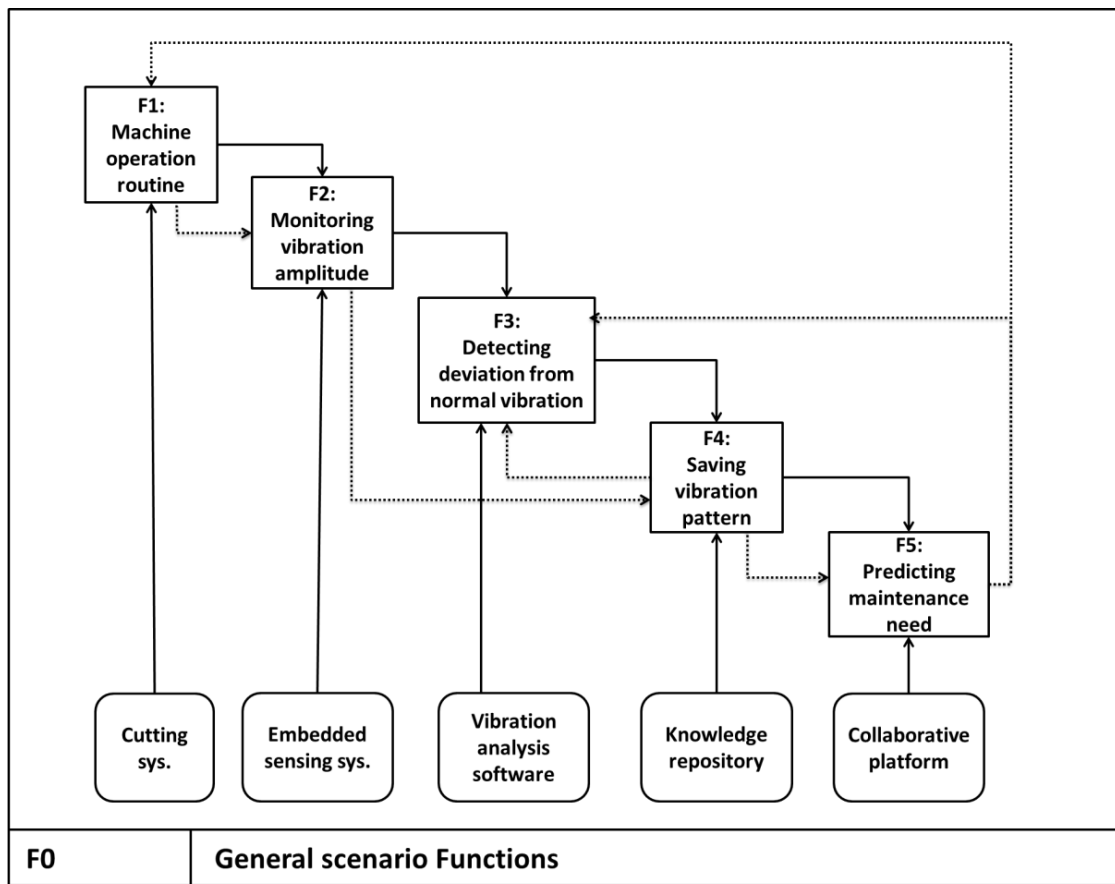

Figure 62. IDEF model of Machine health Monitoring Service

Based on the IDEF detailed model, the interaction between each pair of components is analyzed. One example of the interfaces characteristics between the vibration analysis software and the knowledge repository is provided in Figure 63. This example defines the components and their role, required ports, interface, and data flow.

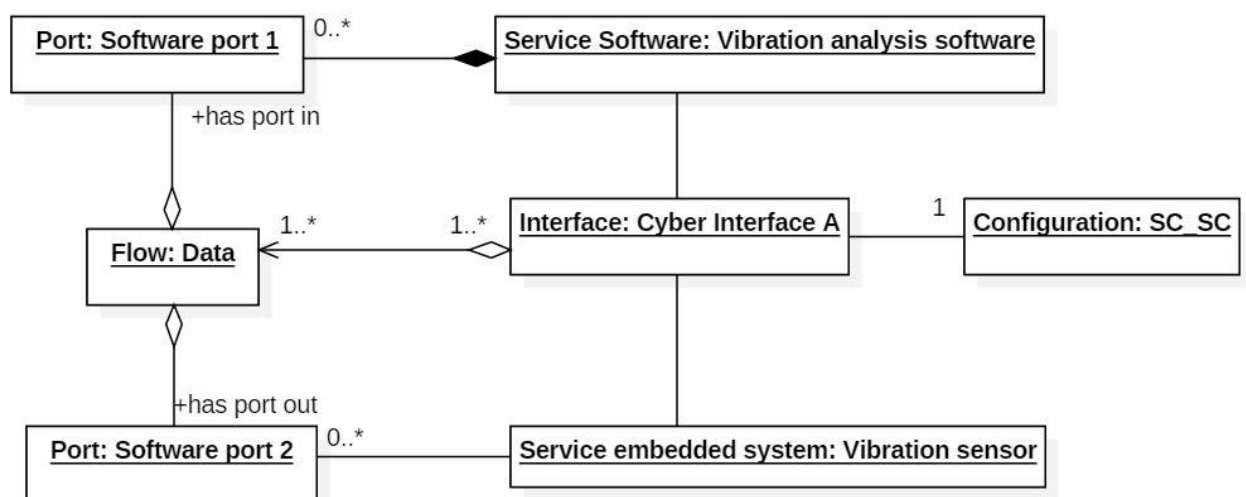

Figure 63. The interfaces example

Based on this process, the detailed interfaces matrix is provided in Table 6. This matrix shows the Flow Type (FT), Interface Type (IT), Contact Type (CT) and Configuration (CF).

Table 6. Machine health Monitoring Interfaces Matrix

Config.	PC	SC	SC	EC	EC	SC	
Components	Machine	Embedded sensing sys.	Vibration analysis software	Comm. Sys.	Knowledge repository	ICP4Life platform	
PC	Machine	FT: Data IT: Physical CT: Physical CF: PC-SC	Not a direct interface	Not a direct interface	Not a direct interface	Not a direct interface	
SC	Embedded sensing sys.	FT: Data IT: Physical CT: Physical CF: SC-PC		FT: Data IT: Cyber CT: virtual CF: SC-SC	FT: Data IT: Cyber CT: Virtual CF: SC-EC	FT: Data IT: Cyber CT: Virtual CF: SC-EC	Not a direct interface
SC	Vibration analysis software	Not a direct interface	FT: Data IT: Cyber CT: Virtual CF: SC-SC		FT: Data IT: Cyber CT: Virtual CF: SC-EC	FT: Data IT: Cyber CT: Virtual CF: SC-EC	FT: Data IT: Cyber CT: Virtual CF: SC-SC
EC	Comm. Sys.	Not a direct interface	FT: Data IT: Cyber CT: Virtual CF: EC-SC	FT: Data IT: Cyber CT: Virtual CF: EC-SC		Not a direct interface	Not a direct interface
EC	Knowledge repository	Not a direct interface	FT: Data IT: Cyber CT: Virtual CF: EC-SC	FT: Data IT: Cyber CT: Virtual CF: EC-SC	Not a direct interface		FT: Data IT: Cyber CT: Virtual CF: EC-SC
SC	ICP4Life platform	Not a direct interface	Not a direct interface	FT: Data IT: Cyber CT: Virtual CF: SC-SC	Not a direct interface	FT: Data IT: Cyber CT: Virtual CF: EC-SC	

IV.3.2. Case B: Energy provider (Energy Management Services)

The icp4life project aim is to provide a PSS network by integrating various customized PSS in a chain of industrial partners. During the above mentioned integrated PSS, continues

exchange between the analytical software and the project knowledge repository happen to predict deviations, maintenance and power interruption need and forecasting energy need as well as to create/update the solution ready packages. The energy provider monitors the machine during its routine operation to provide related two different services as “Energy Consumption Management service” and “Power Interruption Planning service”. These two services are linked to the “Machine Health Monitoring service” (Figure 64).

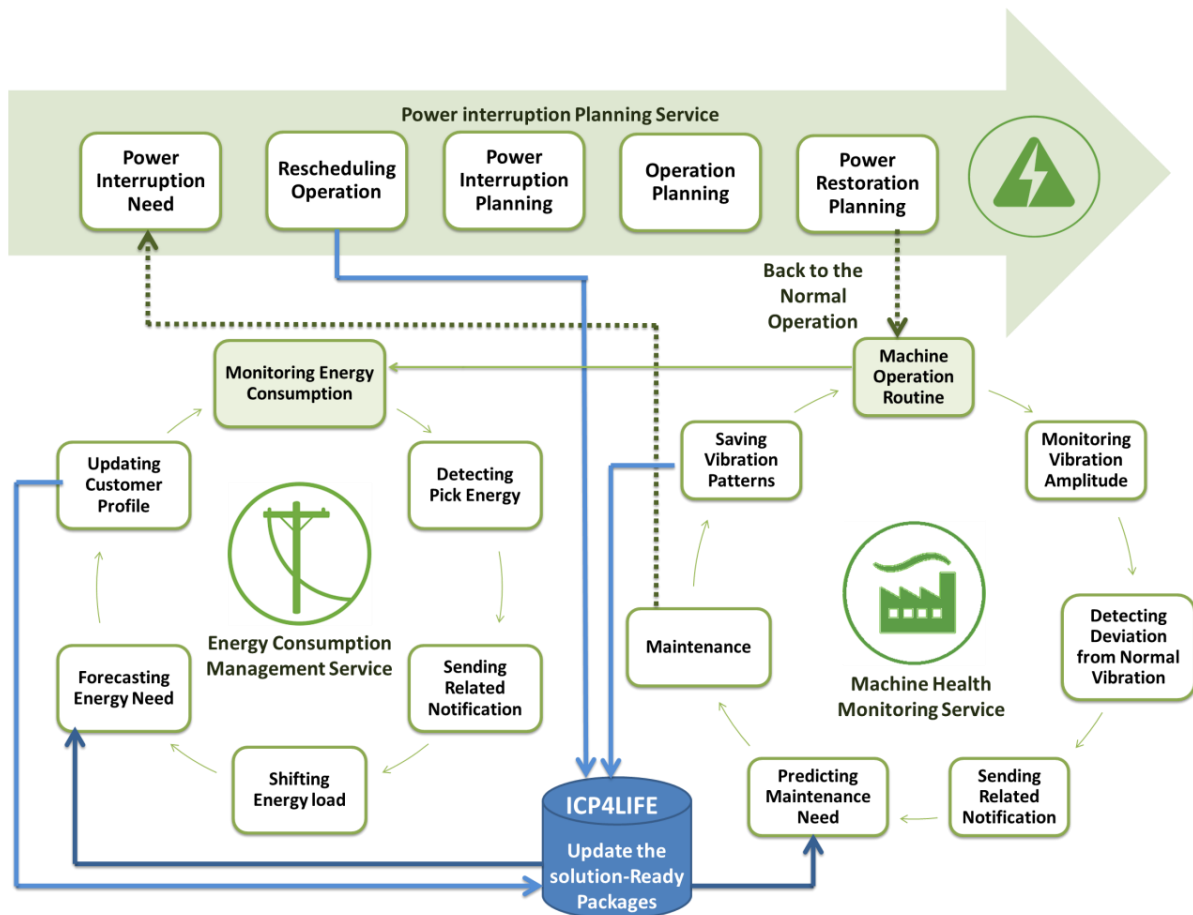

Figure 64. ICP4Life Integrated Services model

Energy Performance Contract (EPC) is considered as a result-oriented PSS model and the energy provider takes control over the equipment and energy demand of consumer (Hannon et al. 2015).

The “Power Interruption Planning service” supports the maintenance in the “Machine Health Monitoring service”. After predicting the maintenance need the manufacturer needs to plan the maintenance (service operation). In doing so, power interruption is planned based on the maintenance plan. Making the power restoration and starting the machine operation routine is the final step (Figure 65).

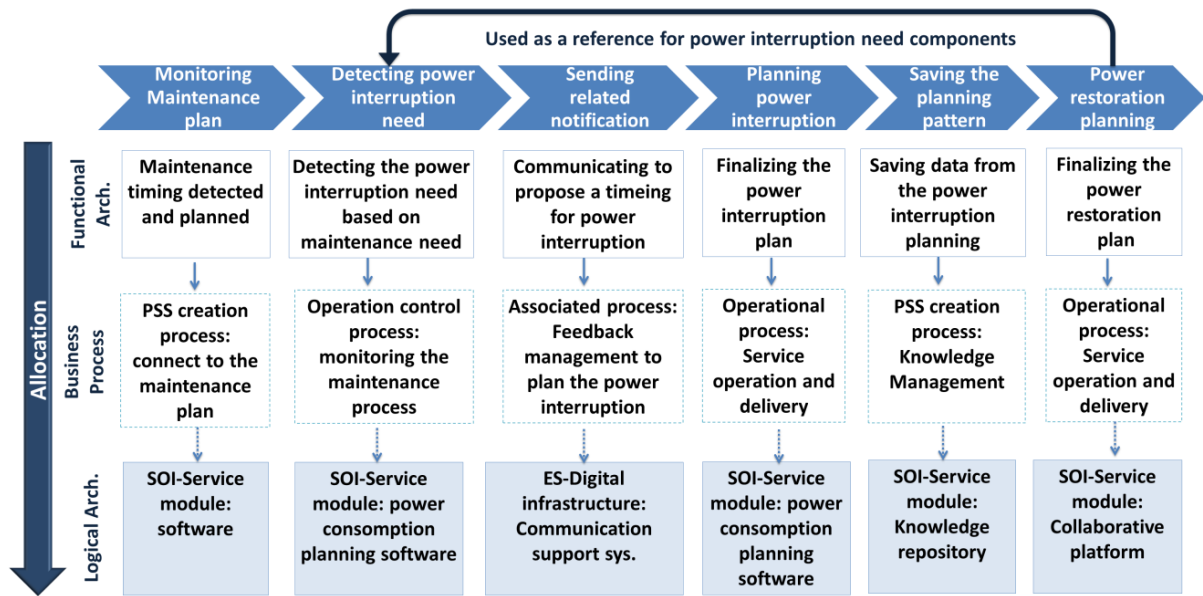

Figure 65. Power Interruption Planning service

In parallel, the “Energy Consumption Management service” is as follow. The machine is in its routine operation. The Embedded process sensors and measurement devices are added to the machine. These sensors detect any deviation from normal energy usage as well as energy picks. The system sends related notifications for the manufacturer to shift the energy consumption. Based on the energy consumption pattern, the system forecast the energy need and updates the customer energy consumption profile (Figure 66).

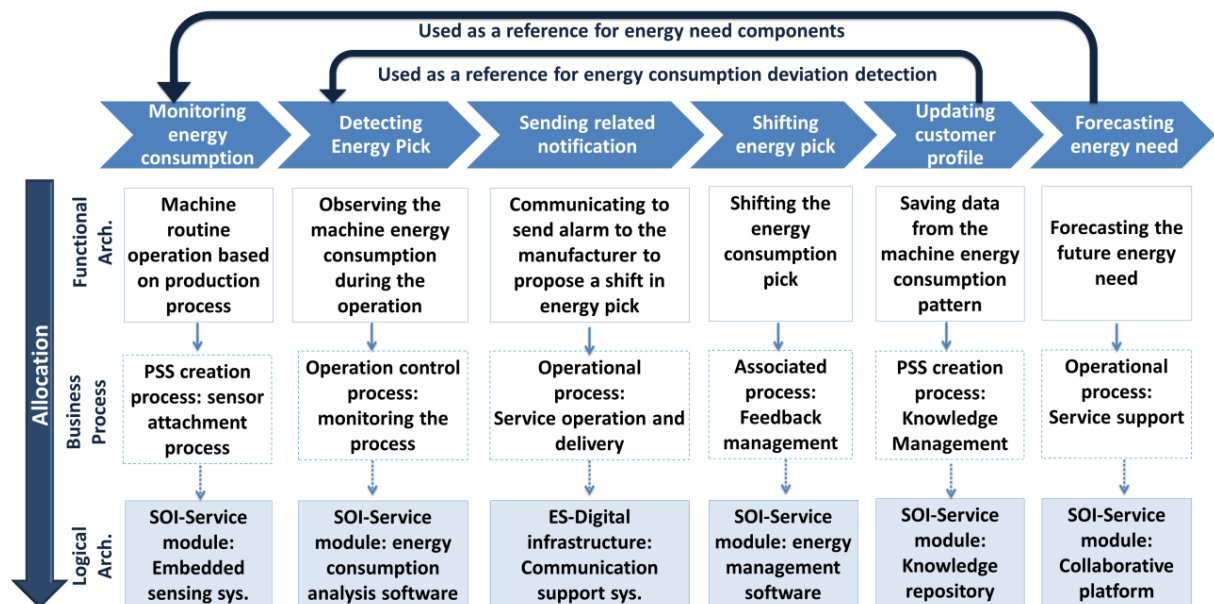

Figure 66. Energy Consumption Management service

These two processes are connected to the Machine Health Monitoring service as it is shown in the following activity diagram (Figure 67).

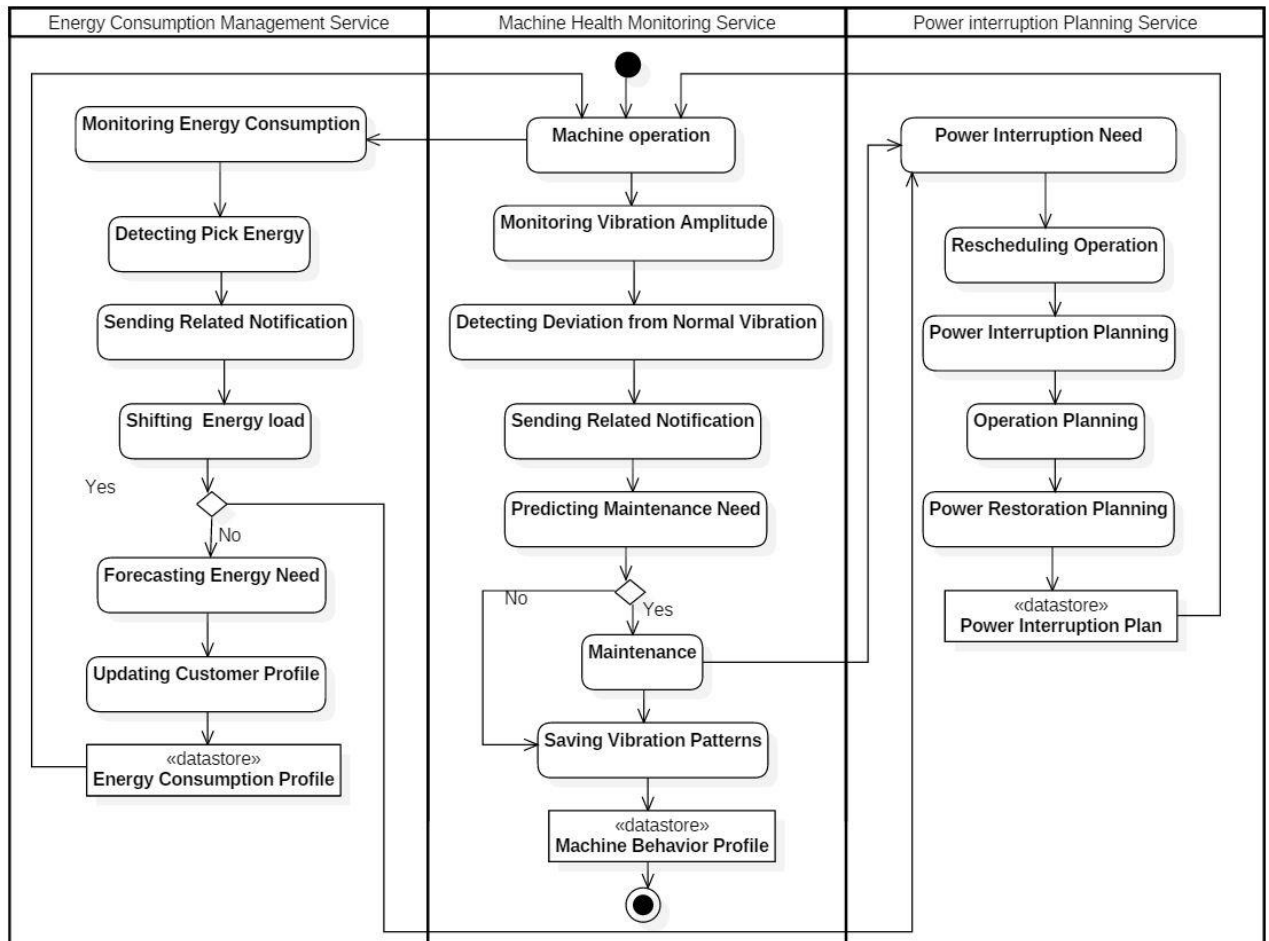

Figure 67. PSS network for Energy services for machine operation

In order to apply the PSS, the energy provider integrates required process sensors and measurement devices with the machine.

Table 7. The whole system components

Components	Energy Consumption Manager	Power Interruption Planner
PSS	Optimizing the machine’s energy consumption	Minimizing the impact of electricity interruptions
Product	Energy (provision)	Energy (provision)
Mechanical	Electric grid	Electric grid
Electronical		
Cybernetic		
Service	Machine’s energy usage and Customer’s energy consumption profile management	Change energy consumption by a virtual circuit, maintenance action or problem-failure from industrial side or electric grid side
Service Processing	Check for peaks and send energy usage recommendations, KPI calculation, and monitoring	Informing customer for problems in smart grid
Software	ICP4LIFE PSS Services	Power interruption planner software

Components	Energy Consumption Manager	Power Interruption Planner
Embedded system	Embedded process sensors and measurement devices	Embedded process sensors and measurement devices
Organizational Capability	Processing and visualizing data from energy demand patterns, Feedback management	Power interruption planning
Physical Infrastructure	A set of different laptop or desktop devices are used by the different roles to connect to the ICP4LIFE Platform and services remotely	A set of different laptop or desktop devices are used by the different roles to connect to the ICP4LIFE Platform and services remotely
Digital Infrastructure	Cloud Servers that run the ICP4LIFE Platform, the electrical system of the client, A backend IT system infrastructure that collects and correlates the data coming from the energy provider Sensor Systems, network equipment is used to connect the equipment in the premises of energy provider to the cloud-hosted software	Energy provider internal system, Energy stock, communication infrastructure

IV.4. Synthesis and Conclusion

This chapter provided three different PSS cases to test the model. Different sub-models of the proposed global framework are used in different scenarios. In each case with different modeling tool based on the scenario, the use case is presented according to the model. In each case, after defining the scenario, the system components are defined based on their role in the SOI or ES (according to Figure 32 from chapter III).

Comparing the different scenarios which are based on various services in ICP4Life (the machine health monitoring, the energy consumption, and power interruption management) and the academic case (the bike sharing system), a general life cycle for a knowledge-based PSS network is defined. The PSS network is a knowledge-based system and its life cycle contains some steps for knowledge management. Based on our proposed model of PSS life cycle in chapter III (the chain of Life Stage-Events-Action-Process), the main stages, necessary information and tools to support the knowledge-based PSS is defined as follows (Table 8).

This process can be shown as a circle of life stages-information-tools (Figure 68). This cycle is based on information and knowledge sharing and reuse through the PSS life stages in operation.

Table 8. Knowledge-based PSS life cycle

PSS Life Cycle	Transferred Information	Service Enablers
Monitoring routine operation	Product and process data	Embedded sensing systems
Detecting events	Deviations, life stages, failures, needs	KPIs repository
Notifying user	Alarms and suggestions	Feedback system
Performing required action	Corrective and preventive actions data	Business processes
Saving pattern	Behavior and operation	Customer profile
Updating knowledge repository	Solution-ready packages	Knowledge repository

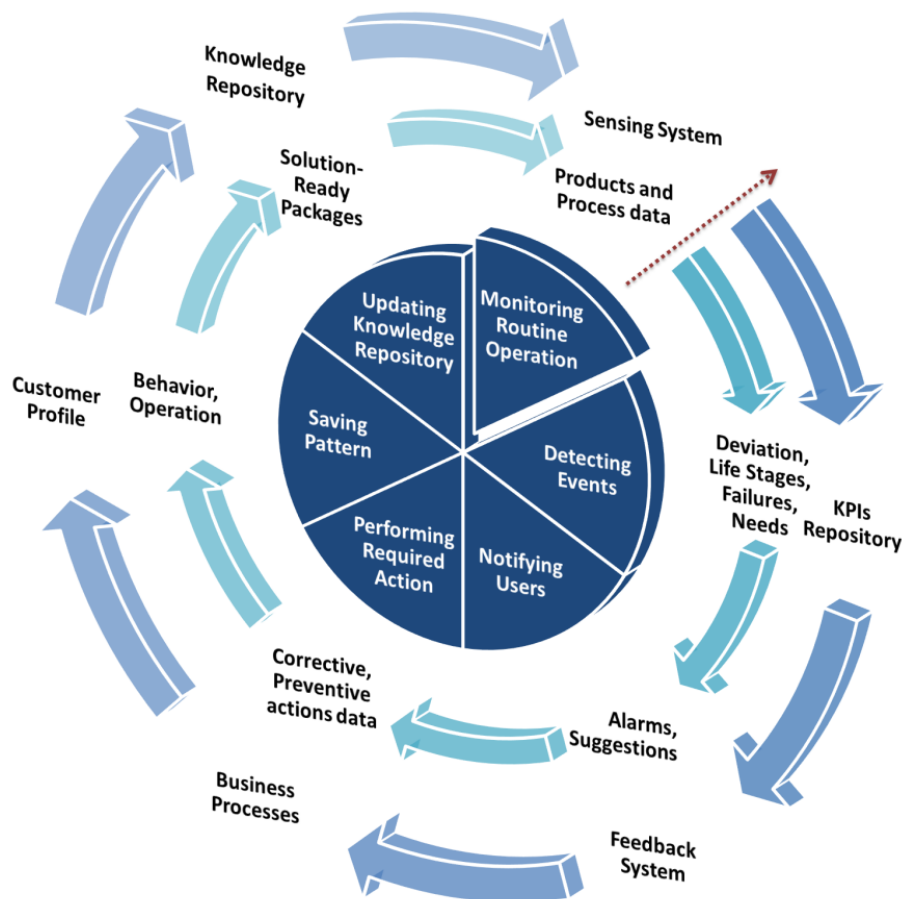

Figure 68. Knowledge-based PSS life cycle

During the scenario-based test of the model, the model has been revised based on the lacks we faced during applying the model. These improvements are mostly in the sub-systems

boundaries. As a result, to apply the model on the cases, considering the special specifications of the case is important. It is to say, while the model is global and useable in different PSS, choosing the modules from the model depends on the scenario of use. As an example, for the lifecycle of PSS in the machine health monitoring service, the event that triggers the action is either a break down in a component of the machine or a prediction of its end life. In energy management, on the other hand, the event to trigger the action is the received information about the energy usage which comes from the monitoring system. So, to represent the life cycle model of these two cases, adopting the “product failure” and “infrastructure out of capacity” will present cases respectively.

The cases come from different PSS typology. Based on the fact that companies focus on their core competencies to adopt the PSS type, the system structure would be defined. In the product-oriented PSS, which is the case of the machine health monitoring service, the product module would be detailed to increase the possible solution. In this case, the main criteria for choosing the best sensors to add to the machine would be the amount of modification of the machine. This is to say, the service component selection is based on the product specifications and preferences; while it is opposite in the performance or result oriented services. The proposed model can be used in both cases by clearly defining the sub-systems boundaries and functions.

Chapter V.

Modeling framework

application

Chapter V. Modeling framework application	107
V.1. INTRODUCTION.....	109
V.2. ICP4LIFE PLATFORM	109
V.3. SENSOR ONTOLOGY STRUCTURE	114
V.4. ADDITIONAL APPLICATION: PSS CONFIGURATOR BASED ON RFLP APPROACH	121
V.5. SYNTHESIS AND CONCLUSION	122

V.1. Introduction

As stated in chapter one, the main contribution of the IS3P team in the ICP4Life project is to support the conception of the Designer module and the common repository of the platform. To do so, the ontology of sensors has been developed and connected to the ontology of services. This model can be seen as a first level specification of the meta-model developed in chapter 3 but covering only the physical aspects of the PSS. This is because the pragmatic need of the platform users is mainly oriented to this aspect.

V.2. ICP4Life Platform

The ICP4Life framework is dedicated to managing the whole life-cycle of industrial PSS. In doing so, several interactions between engineers from different business domains are achieved to design the optimal solution for PSS implementation regarding its target working environment, as specified by the customer. Thus, engineers need methods and tools to consistently manage a massive quantity of information during the design processes of both standard PSS offers and specific solutions answering customers' demands. The global framework is made of four modules supporting different phases and stakeholders of PSS as follows (Maleki et al. 2018).

- Customizer module to support the customer during the customization and configuration of PSS.
- Designer module to support the engineer
- During the design of PSS through a “set of knowledge-based and collaboration facilities”.
- Planner module to support the manufacturer during the process of planning and production of PSS,
- Service module to support the stakeholders during the operation of PSS.

The architecture of the proposed PSS design support platform is based on a central knowledge repository as a kernel component through which different business applications are interconnected to provide technical assistance and collaboration facilities to users (Figure 69). To define and implement the structure of this knowledge repository, domain ontologies will be defined and connected to form the whole PSS semantic model (Maleki, Belkadi, Zhang, et al. 2017).

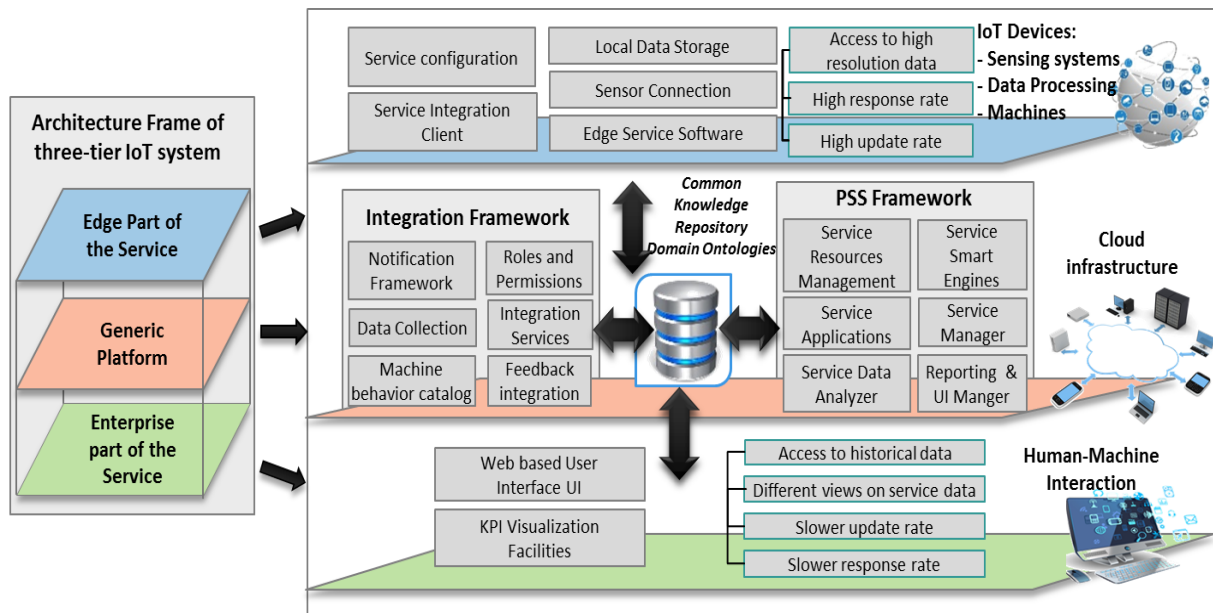

Figure 69. Global architecture of the ICP4Life Platform (Maleki et al. 2018)

The platform is used to facilitate collaboration between several actors during the conception and the implementation of the machine health and energy management services but also for the structuration of the data collected during the usage phase. The proposed ontology is designed based on modular domain ontologies to cover different types of knowledge requested by the different modules. To define the general structure of this ontology, the process of solution integration in the industrial context is reviewed. This process is highly dependent on a proper matching of product components and sensors' features specifications based on the objectives of the target PSS. A structured classification of these features is then required. The principal involved actors and their roles during this process are as follows (Figure 70).

- 1) The maintenance engineer fixes the maintenance objectives and processes. He collaborates with the mechanical engineer during all analysis activities requested at the earlier stages of the sensor implementation process.
- 2) The sensor engineer creates and manages sensor data and the technical specifications of the existing sensors in the repository. He contributes to the identification of the best sensor kits.
- 3) The mechanical engineer uses legacy CAD (computer-aided design) tools to update and manage the necessary technical data of machine components in connection with the sensors. He provides his expertise on the nominal machine behavior as a contribution to the task of possible failures analysis.
- 4) The project leader has the central role of supervising the interactions between involved engineers through the collaborative platform. He validates the maintenance strategy and coordinates the integration of the final solution of the target PSS.

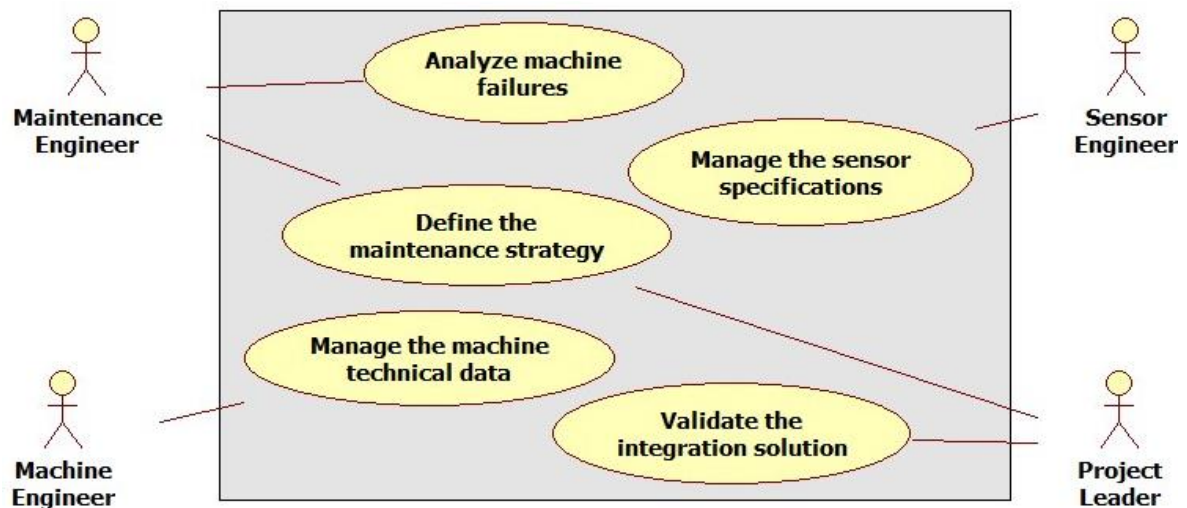

Figure 70. Use case diagram for machine health monitoring design

Figure 71 shows the proposed empirical process for the identification and the implementation of the best sensors able to support the services. FMECA (Failure Mode, Effects and Criticality Analysis) is the first step to be performed at the product or component level to detect the potential risk of failures as well as the concerned components along a machine's life cycle. Additional analyses are then made as a part of the FMECA process. The analyses identify the main causes-effects and the global risk priority number (RPN) for each detected failure based on the evaluation of the related failure severity, occurrence, and detection indicators (Hayes et al. 2014).

Based on the machine's characteristics and history and considering the failure type and RPN, experts have to adopt a suitable maintenance strategy for each critical failure. In this third step, a continuous monitoring process has to be defined to support either condition-based or predictive or preventive maintenance. This includes the identification of the needed measures, monitoring criterion, and decision rules to be applied to resolve machine health problems. Remaining Useful Life (RUL) is one of the most significant indicators generally used to evaluate the time length from the current instance to the end of the useful life of the system (Si et al. 2011).

The implementation of the planned maintenance strategy consists in the identification of suitable types of sensors for the needed measures and to check the possibility of using already installed sensors in the machine. This requires verifying the possible measuring technology for the measurement of any specific information (Figure 71).

According to the academic viewpoint, creating the "solution-ready" packages of components that can be "mixed and matched" in development of different PSS types is considered as an important capability for firms (Davies et al. 2006). In ICP4Life, these packages are defined as the "PSS pattern" and "PSS instance" (Belkadi, Y. Zhang, et al. 2017). So, the requirement analysis is followed by the design and creation of the PSS pattern and instance, finalized with the validation. The PSS pattern includes the following knowledge: the product

features definition with PSS integration perspective; the service definition; and the integration solution based on service requirements and product features (Belkadi, Y. Zhang, et al. 2017).

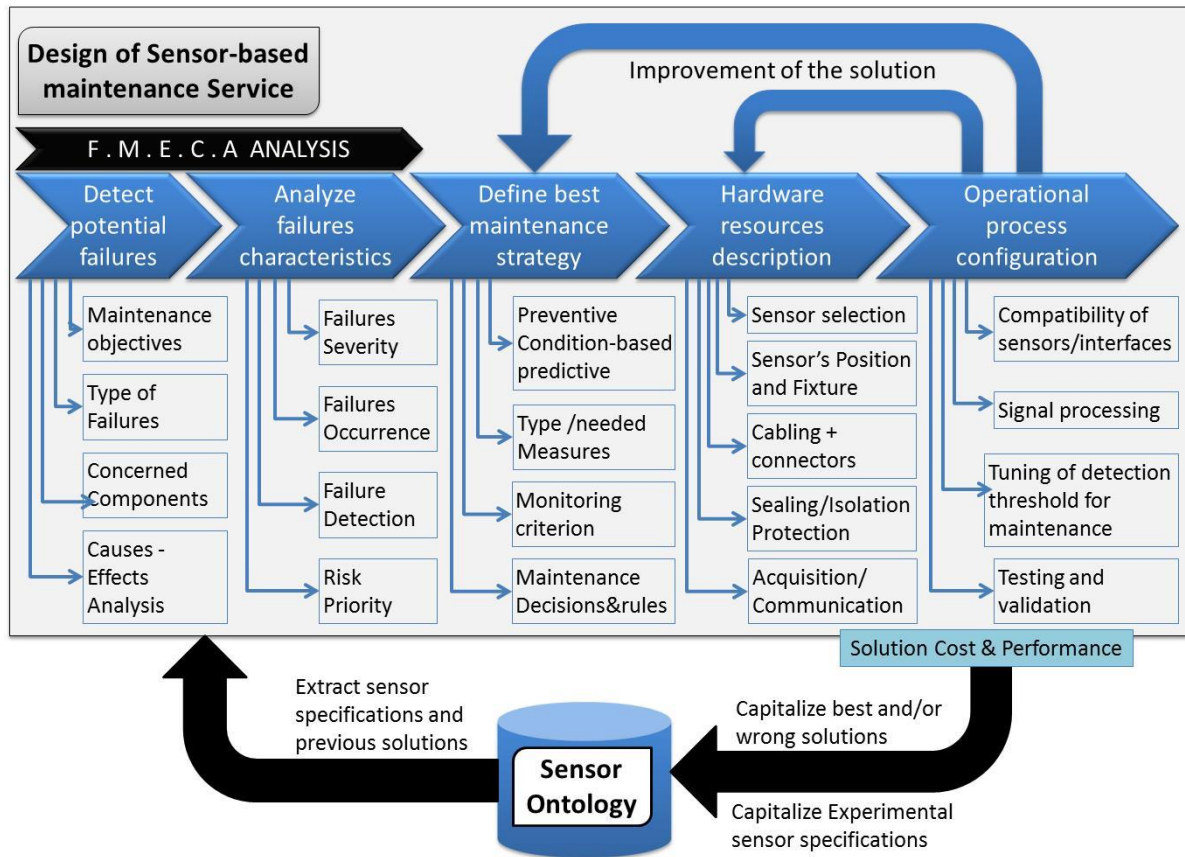

Figure 71. The sensor implementation process for maintenance and monitoring perspective (Maleki, Belkadi, Ritou, et al. 2017)

Consequently, one of the critical functions of the ICP4Life Designer module is to help to identify the suitable sensing systems that cope with the desired PSS performance. The detailed design stage concerns how to configure all hardware resources (e.g., sensors) as well as how to arrange and handle identified service information, etc. For instance, the following questions need to be answered when defining a potential integration solution:

- What sensor specification is needed to support measuring performance, depending on the product's working conditions?
- What additional equipment is needed to support the functioning of the selected sensors?
- What are the main potential positions of sensors regarding the product's structure for maximum measuring performance?
- What is the ideal fixture system for connecting sensors to the product's components?
- What is the expected performance of the selected sensor following a specific product-service configuration?
- What type of data processing and analysis method is needed?

The integration solution could also include useful information about the potential assembly steps to connect all sensors and equipment to a machine's components. The last stage is the configuration and validation of all operational conditions to have the maintenance solution ready for use. The first critical question is the verification of compatibility and interfacing between sensors as well as between sensors and machine components. Mechanical and electrical behaviors, as well as signal processing and sensitivity analysis, are examples of the performed tests. The last configuration step is the tuning of detection thresholds necessary to trigger maintenance decisions during the machine's usage life stage.

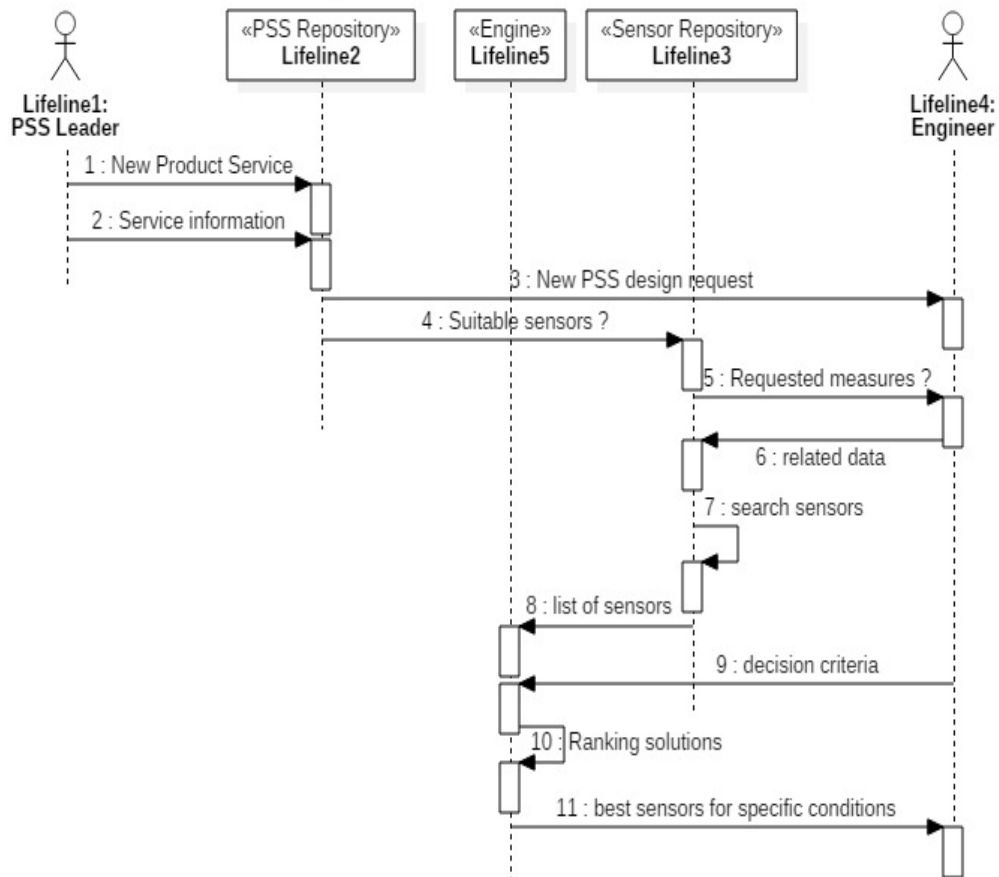

Figure 72. UML Sequences diagram for sensor selection

Following a knowledge-based approach (Figure 72), during the design process, the engineers have to connect to the knowledge repository in order to extract and reuse useful knowledge. The knowledge-based design is a process to reuse capitalized knowledge from past experience in new projects (Monticolo et al. 2015). It is also conducted through knowledge sharing between involved stakeholders to ensure a common representation of the problem and consistency of the final solution (Belkadi et al. 2012). By using a sensor repository, engineers can obtain rapid access to the detailed specifications of a variety of sensors as provided by the related manufacturer. They also have access to the real specifications capitalized from past “in situ” experimentations. The measurement requirements will be matched with the sensors' capabilities and the machine's working conditions with the sensor's recommended working conditions as specified in the repository. The result of this matching supports the selection of

the best sensor for every service-needed measure. To be efficient, the sensor repository should be organized in a consistent way to facilitate searching and queries.

V.3. Sensor Ontology Structure

The proposed ontology is developed with an operational perspective based on a literature survey and analysis of the project's functions. The first step for ontology building is the analysis of engineering practices during the design process in terms of knowledge and information exchange. Then, the sensor ontology is created based on the literature survey and commercial information to capture the domain knowledge and currently developed ontologies about sensors (Maleki, Belkadi, Zwaag, et al. 2017). Using related handbooks and the W3C Semantic Sensor Network Incubator Group (SSN-XG), we extracted the elements, features, and characteristics of sensors. These elements are extended and classified to connect sensor specification to different facets of industrial service design and implementation. SSN uses the "Stimulus-Sensor-Observation ontology design pattern", which is a "generic and reusable component for all kinds of observation-related ontologies" and "introduces the key classes and their relations such as stimuli, sensors, and observations" (Janowicz & Compton 2010).

The first step in building the ontology is defining its architecture to specify the components and their relationships "within a system coupled with topology" (ROY et al. 2013). Building the ontology is based on an incremental process starting with the identification of main concepts from the identified product-service development process. This process is followed by the extraction of all concepts, properties, and relationships from the common meta-model to form the backbone of the ontology. The last step is expanding the extracted concepts to a set of detailed taxonomies. The whole ontology is developed as a web ontology language (OWL) file with the Protégé tool.

To understand whether the ontology is coherent with the domain knowledge, industrial partners from the project check its formal structure, such as taxonomies and relationships. This validation has been done to finalize the sensor ontology for integration into the global ontology. In order to use the ontology from the knowledge repository, query algorithms are proposed to provide engineers with useful information. To investigate whether the ontology is able to fulfill information retrieval and interoperability needs, it has been tested in one specific scenario from the project.

To build the generic sensor ontology, the global meta-model is extended, and all concepts which have a direct effect on the sensor are extracted, connected, and classified. This allows for the identification of all ontology classes. Then, the relationships between classes are identified to form the final ontology structure. At the meta-level, as shown in Figure 73, the main classes heading the ontology structure are an Industrial machine, maintenance activity, information, sensor, and sensor specification.

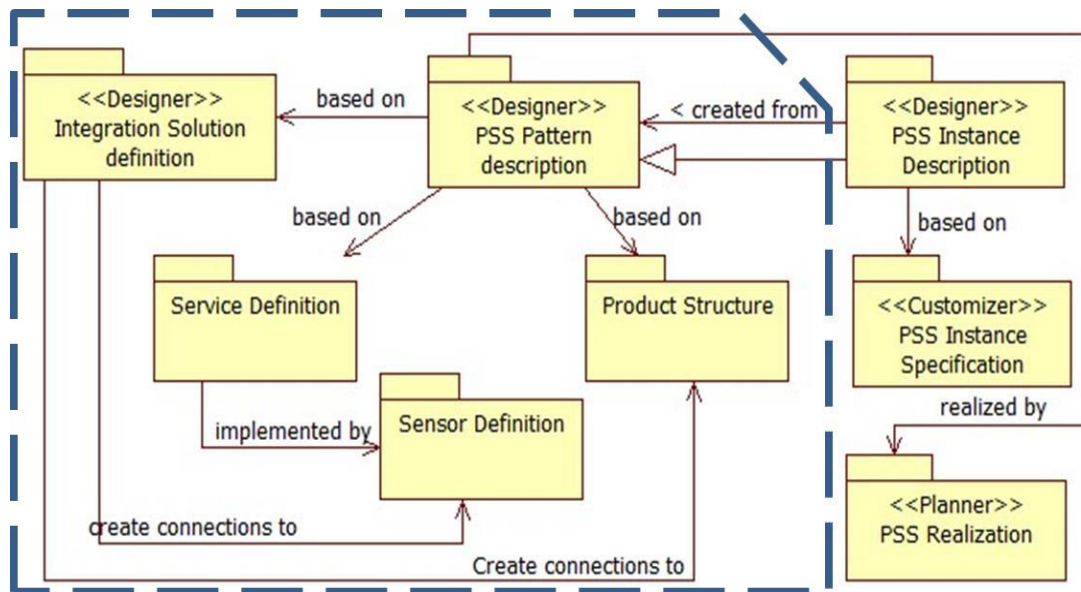

Figure 73. The meta-model heading the sensor ontology

Considering the industrial context of PSS, domain ontologies are as follows:

- Product Ontology:** Supports the classification of main categories and features of products (domestic appliances, machines, transport facilities, etc.). This helps the identification of some standard technical constraints to be respected for the definition of the technical solution. “Product features definition with PSS integration perspective includes all information necessary for the design of the PSS. In this case, the type of the machine is Laser cutting from Alpha family, which has the function of cutting the metal sheet and with laser power. The performance of the machine is described by the maximum number of parts per hour, maximum thickness of sheet as well nominal working temperature at the laser head. These performance indicators will form the working environment of the future sensors to be selected to provide service information. In addition, the structure of the machine and related assembly constraints is defined as a product tree.” (Belkadi, Y. Zhang, et al. 2017)
- Service Ontology** helps the classification of main service categories with a list of standard information and KPIs necessary to describe each service type. For example, monitoring machine health requires environmental data like humidity, temperature, and dust. “Service definition includes all knowledge necessary for the selection of the optimal solution. In this case “dust detection” in the machine is a completely new service that requires information about the density of dust and the presence of smoke on the internal/external environment of the machine. As experts, the mechanical engineers are capable to identify what quantity and where dust can affect the normal working of the machine. Thus, measurement performance indicators are identified like the granularity of dust, the sensitivity or the number of minimum measure nodes to obtain an exact evaluation of dust presence in sensitive areas of the machine” (Belkadi, Y. Zhang, et al. 2017).

- **Sensors ontology** includes a classification of technical sensors according to a set of standard indicators useful for search and selection of optimal sensor to implement a specific service. The logic is that the service requires a set of information to be measured at various places of the Product of interest.
- **Connector ontology** proposes a classification of main connection possibilities and constraints according to sensors and product types. This will help the definition of the integration solution between PSS items. Integration solution based on service requirements and product features is composed of a set of possible sensor kits able to provide these requirements, respecting the working conditions of the product (i.e. machine).

The above defined main structure is modeled in protégé software (Figure 74) based on a sensor system according to the Semantic Sensor Network (W3C Incubator Group Report).

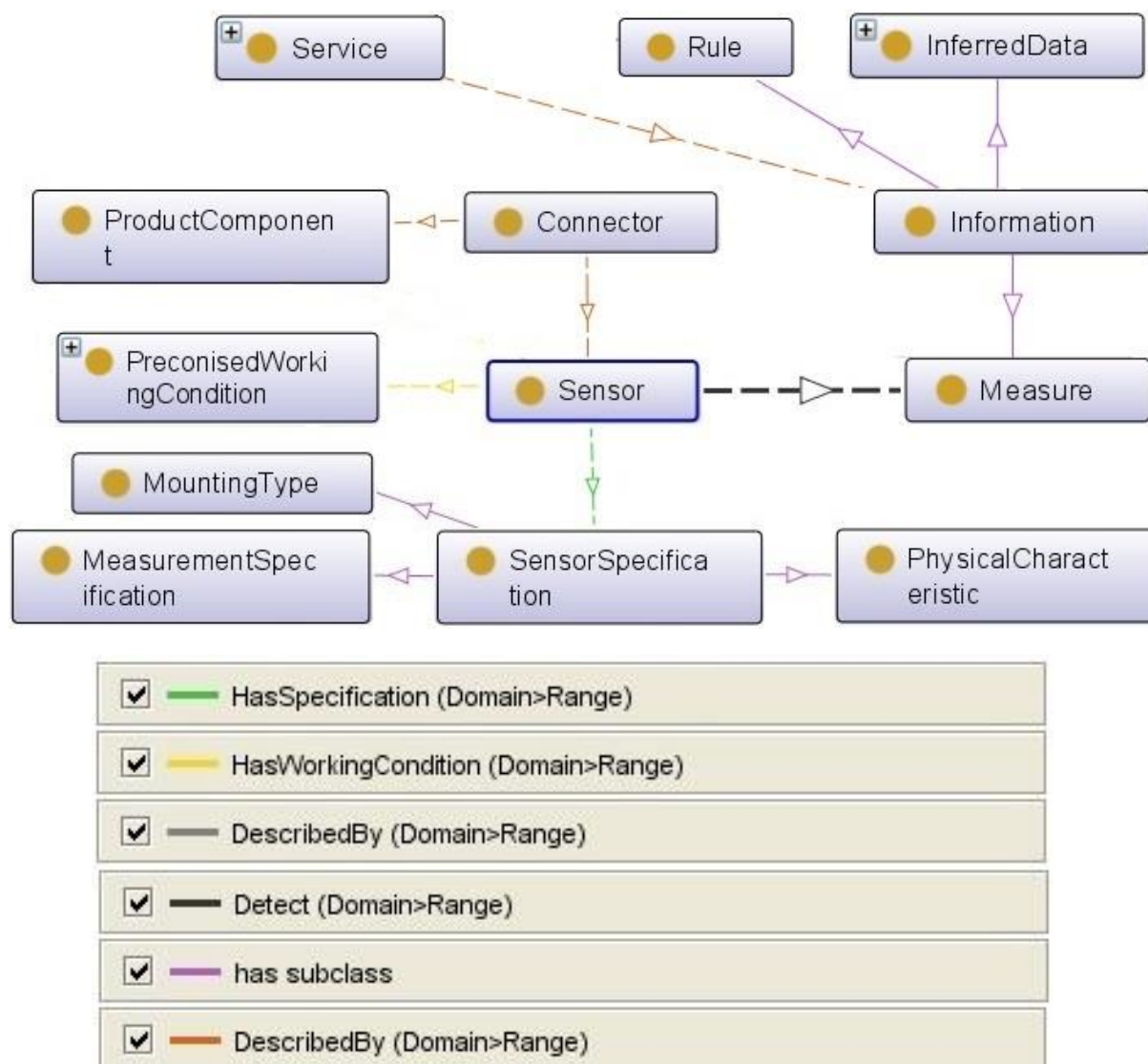

Figure 74. Sensing system ontology designed in Protégé software

Protégé software is a free, open source ontology editor and a knowledge management system. It provides a graphic user interface to define ontologies and includes deductive

classifiers to validate the consistency of developed models and to infer new information based on the analysis of ontology. Protégé manages ontology models in both Web Ontology Language (OWL) and The Resource Description Framework (RDF) files (Protégé n.d.)(Gašević et al. 2009).

The class sensor takes a central place in the final ontology. It is one of the most critical tasks during the service design process to identify the best sensors for the related integration solution. To do so, a definition of the sensor is provided by a set of complementary taxonomies giving different points of view on the same sensor. The general logic behind this model is a scenario in which the requested service is analyzed then the information which is needed to fulfill the required maintenance activity is defined. This information describes the changes in the machine and its environment that the sensors detect. The sensor is characterized by a technological point of view and its connection with the machine's components. The other important parameter is the specifications of the sensor, measurement, and working conditions. This class is detailed to define different sensors in detail. In the end, the ontology provides a complete list of well-described sensors with their precise specifications and working conditions. This class's attributes will be connected with the product, service, and information classes' attributes to define the algorithm in Protegé.

To cover the domain knowledge, it is necessary to abstract and generalizes concepts into separate ontologies. According to this modular ontology strategy, each of these classes in the sensor ontology is detailed in their ontology.

Considering all the above, we defined various main classes in the sensor ontology as:

- Sensor (Technological Solution);
- Maintenance Activity as the Service;
- Information and Measure;
- Product/Machine Component;
- Sensor Specification;
- Mounting Type;
- Physical Characteristic;
- Measurement Specification;
- Working Condition; and
- Connection Constraint.

Using a sensor's expert knowledge, the first step in the description of the sensor ontology is the classification of a variety of sensor types. Each sensor is described by its input-output and its measurement specifications (Figure 75). This taxonomy is extracted from commercial portals and guidelines from sensor handbooks. This taxonomy is used to obtain the technical pre-defined specifications that suppliers or manufacturers provide in the sensors' datasheets.

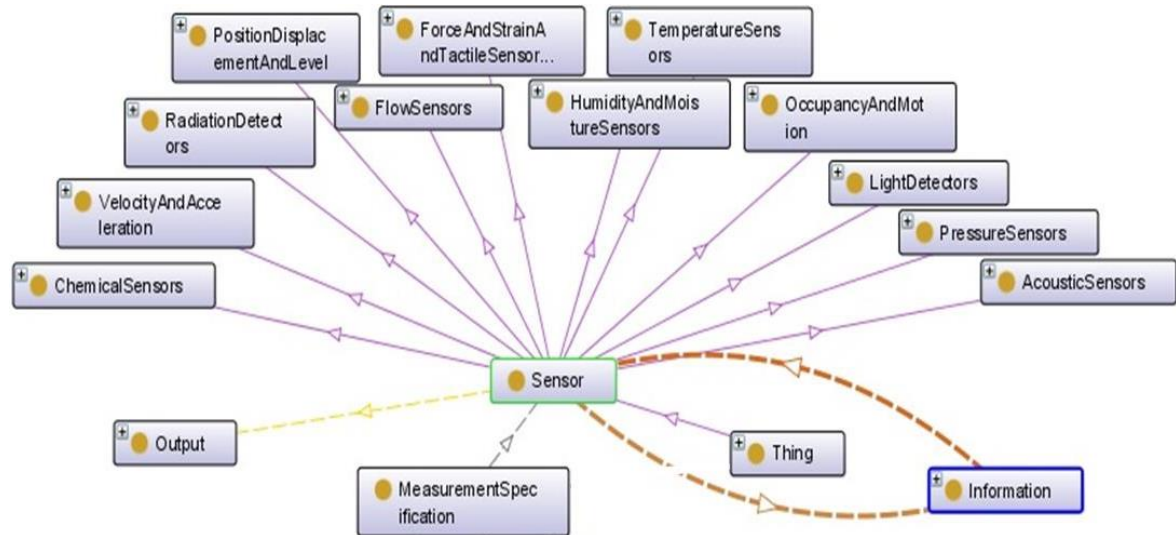

Figure 75. Sensor typology

The sensor taxonomy is based on the related technological solution used to provide the desired measurement from the sensor of interest. It is a principle of the solution to give the requested measurement by the sensor. This will help, for example, in the identification of the main technological constraints to be respected when selecting a sensor. It is also required by the compatibility verifier component to check if the used technologies allow the use of two different sensors (or more) in the same physical area of the product. The other sample is that each sensor can detect at least one change in the humidity or temperature of its environment. Some sensors can detect more than one kind of measure, such as humidity and temperature.

The process of providing the optimal integration solution starts with matching the sensors' specifications and machine components' specifications (Figure 76). This requires the implementation of specific connectors, and it is highly dependent on the machine's properties. To support the connection process, the sensor ontology could also include the classification of connector types, such as physical connection, information flow, and energy flow.

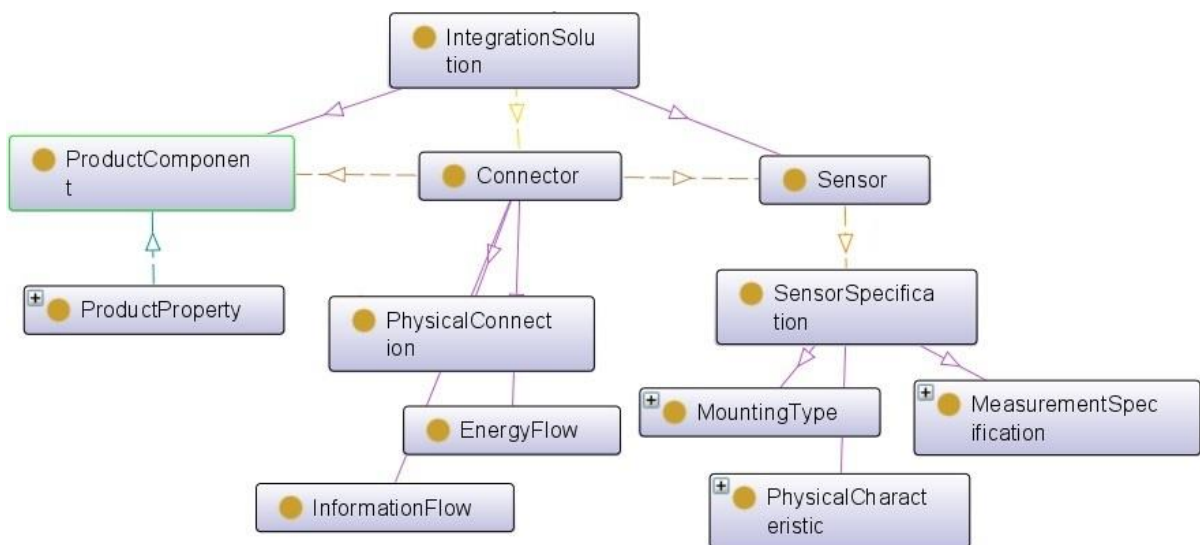

Figure 76. Ontology-based integration of sensor and machine component

The sensor specification gives the main characteristics of the sensor as described by the sensor provider. This will help, for example, in the rapid identification of possible connection constraints according to the mounting type. Also, the concept of a sensor is described by the stimulus and additional properties. According to the W3C Semantic Sensor Network Incubator Group, Measure or Stimulus is “an event in the real world that triggers the sensor”(Compton et al. 2012). We considered this measure as information detected by the sensor from its environment.

A sensor may have some measurement capabilities describing the “capability of the sensor in various conditions” (Compton et al. 2012). The measurement specification class can indicate these capabilities. It represents the sensor’s operation range, which can be used in KPI (key performance indicator) as well as sensor selection. This will help the connection of the sensor to the related categories of information for the rapid identification of suitable sensors for one maintenance activity. Three types can be distinguished based on the relationship of their key indicators to the final performance of the sensor, namely: desired, undesired, and mixed (Figure 77). The first category includes the key indicators of the sensor’s measurement performance. The second one presents all factors that can reduce the performance, for example, the presence of a dead zone or high response time. The mixed indicators are the capacity, frequency, detection limit, and measurement range of the sensors. These indicators provide the necessary information to choose the best sensor for different situations. For the same usage, the desired and undesired specifications indicate the weaknesses and advantages of each sensor.

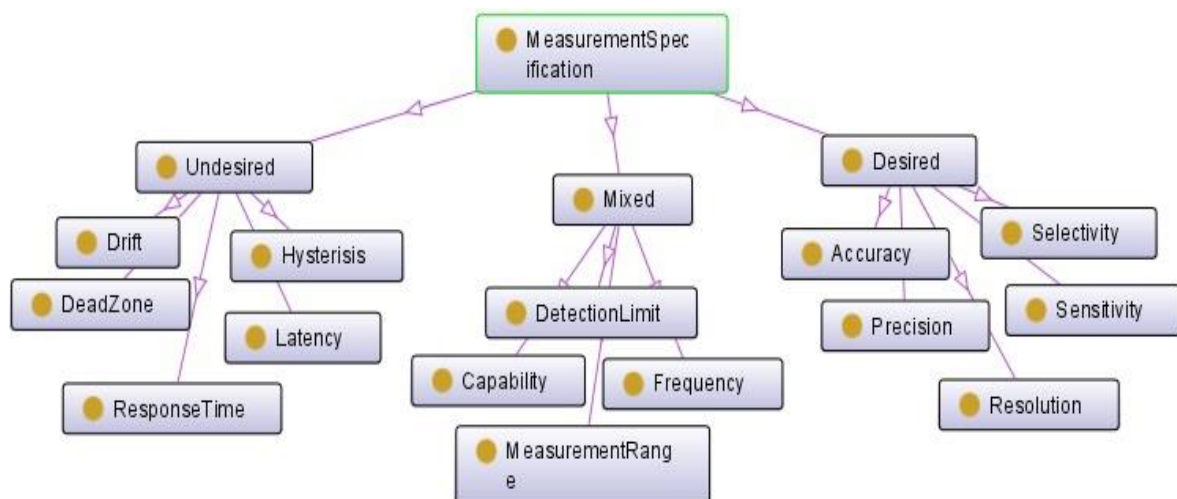

Figure 77. Measurement specification as key performance indicators of the sensor

For more details, the ontology is extended by including taxonomies of central concepts that have a direct connection to the class sensor. For instance, each maintenance activity is defined by various information, namely: (1) measurement data collected from sensors; (2) rules supporting the interpretation of received data regarding the characteristics of the business domain of interest (e.g., safe or hazard range); and (3) inferred data representing the results of the application on one rule. Also, “Measurand” and “Stimuli” are defined as “detectable changes in the environment” (Janowicz & Compton 2010) that “trigger the sensor” (Gašević et al. 2009).

From a technological point of view, each sensor measures a special event. The classification of measurement types supports the rapid identification of the primary attributes according to the measurement domain. This will help engineers to introduce new sensors in the knowledge repository correctly and as a result, identify more easily the best sensors at the conception stage (Figure 78).

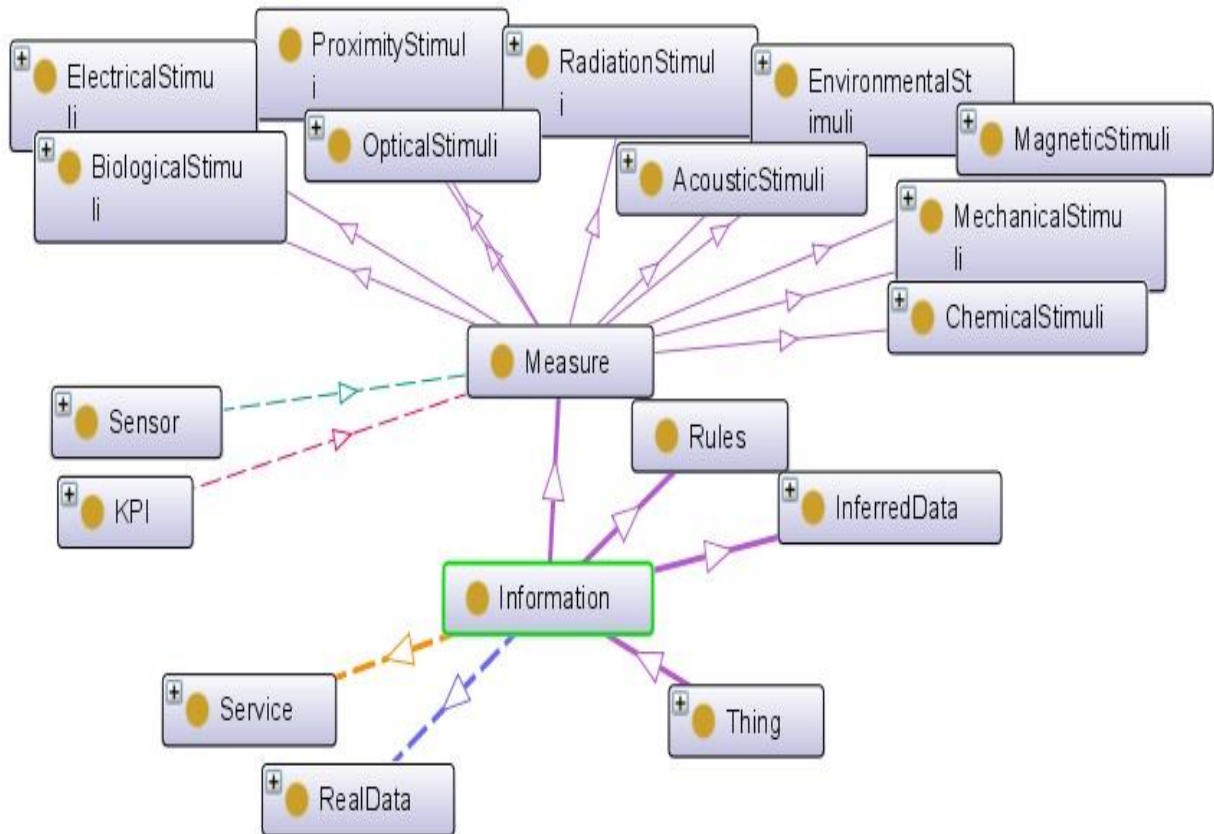

Figure 78. Information ontology

The last category of modules describes the working condition that defines the environment where a sensor is embedded (Figure 79). Connecting sensor specifications and working conditions is one of the most important criteria to select the best sensor and the optimum solution. This is based on the matching between the nominal working conditions and the real working conditions of the target product. For example, matching the temperature or vibration which is produced by the machine with the temperature or vibration which a sensor can tolerate is an essential issue.

Finally, to integrate service with a product, the connector plays the role of connecting the sensors, the equipment, and the product components. Connecting to the mounting type, this will help for example the identification of all constraints to be considered when fixing a sensor to a product component.

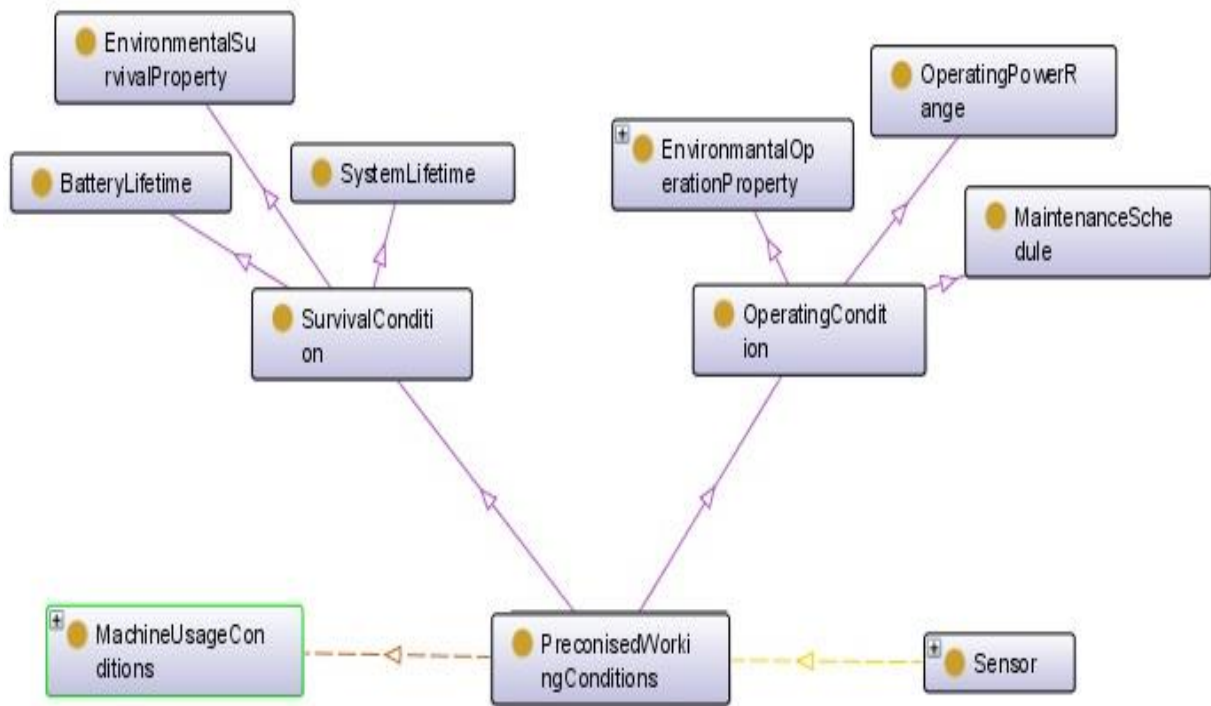

Figure 79. Sensor working condition specification

V.4. Additional application: PSS Configurator based on RFLP approach

An academic Master project is realized with the ambition to support the configuration of new PSS within RFLP approach (Slayman 2018). This work is the first step in developing a smart system to support PSS integration. This system will check the selected components for a specific scenario, possible interfaces between them, and compatibility between the interfaces for integration. To validate the potential of the proposed approach, some of the generic models of chapter three have been implemented as a database. This concerns principally the scenario, the functional, the life cycle, and interface models in addition to PSS components. In order to apply the model, the necessary classes are selected and an integrated tailored model to represent the interfaces configuration is created. The selected classes from the SOI (Figure 41), ES (Figure 43), life cycle (Figure 49), and interface model (Figure 51 & Figure 52).

Next step is defining the algorithms for identifying and verifying interfaces between the components/modules. Compatibility verification algorithms are implemented in a demonstrator created in JAVA to support the engineers to manipulate components and interfaces to build the PSS architecture. The outcome of this work is a configurator with a simple user interface (Figure 80).

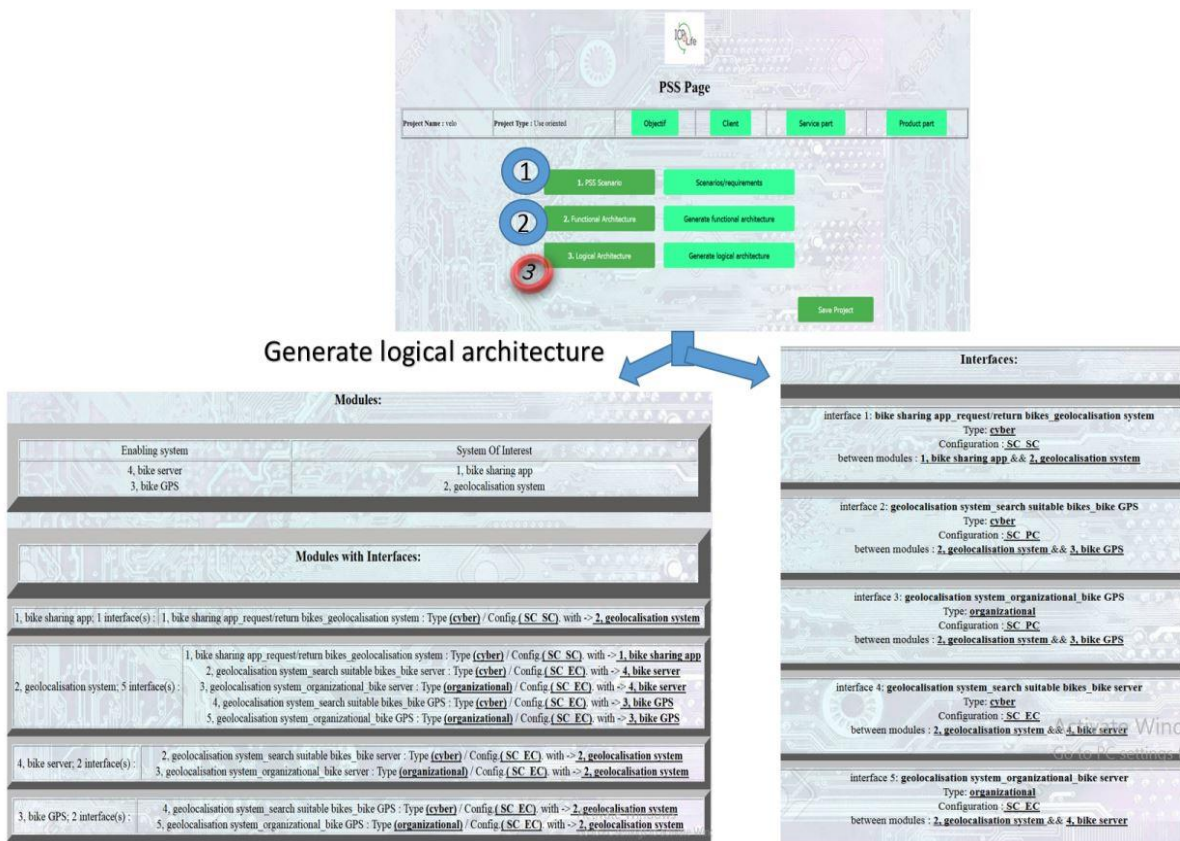

Figure 80. The configurator user interface example (Slayman 2018)

V.5. Synthesis and Conclusion

The sensor ontology provided for the project is one example of the model application. In this case, defining the sensor system is based on the special needs of PSS and adopting and tailoring modules from the sensor ontology provided by W3C. While the reference sensor network ontology is mostly based on the technical approach, the proposed ontology in this work is defined in accordance with the service characteristics defined by the proposed model. This approach is advantageous in defining a clear border between system components and their relationships in the ontology. This application is also crucial in providing solution-ready packages to customize a PSS based on the special needs of the customer.

Next application of the model is supporting the interface configuration. The smart configurator is capable of checking the compatibility of the components and interfaces. It would support engineers during the system integration process. Testing one scenario in the developed configurator shows that in order to apply the model in different PSS typology, providing domain ontologies are crucial. Combination of the model as the reference frame with the domain ontologies can support such a configurator.

Conclusion and perspectives

The main research question addressed in this PhD work is how to represent a semantic architecture for Product-Service System based on Systems Engineering recommendations. A conceptual framework is proposed for characterizing all PSS architecture components to be created through a PSS development process. The proposed model is applied to support the knowledge-based collaborative design of PSS, including the management of the whole life cycle of the system. Building the global integrated semantic model of PSS and its subsystems forming the System of Interest and respectively the Enabling Systems is the main base for the global model. Such architecture will let us adopt required modules to use/reuse in a special PSS development project which will be beneficial in increasing the organizational capabilities and reducing the time of development when providing a customized PSS.

- **The main strengths of the model are as follows.**

1. The model is built based on a dual viewpoint. A pragmatic viewpoint from the lessons learned from an industrial collaborative project; as well as an academic viewpoint from analyzing the concepts and models proposed by the academic community as an important source for methodological development. The validation of the model is also made through a pragmatic viewpoint. This scenario-based validation allows us to verify the model applicability and drawbacks in a real industrial context.
2. The proposed model enriches the components and their boundaries by defining possible interactions and compatibility between each pair of elements. To validate the model, it has been examined in different contexts. The primary model has been created in the context of industrial PSS in ICP4Life project. Then, the model has been applied in a specific PSS context where the whole system of product and service is used to ease the transport need. Finally, it has been tested in industrial cases for machine health and energy management PSS.

3. The scenario-based test helps us revise the model based on the lacks we faced during the model application. These improvements are mostly in the sub-systems boundaries definition. This conducts the identification of guidelines for the applications in various industrial cases, considering the specifications of every case. It is to say, while the model is global and usable in different PSS, choosing the modules from the model depends on the scenario of use.
 4. The cases come from different PSS typology. Based on the fact that companies focus on their core competencies to adopt the PSS type, the proposed model can be used in different contexts by clearly defining the sub-systems boundaries and functions. So the main advantage of the model is its application flexibility.
- **In a practical viewpoint, the main contributions of this research are as follows** (Table 9Erreur ! Source du renvoi introuvable.).
 1. PSS SE-based structure: It applied SE recommendations for characterizing PSS components and their boundaries based on their role during the function provision. Based on a fundamental concept in SE, the main sub-systems of PSS are defined as the System of Interest (SOI) and Enabling Systems (ES). Though the infrastructure and support systems are mentioned in the PSS literature, there is no application of this concept in PSS models.
 2. PSS sub-systems integration with multi-viewpoints approaches: While presenting V-model with RFLP approach is an accepted approach in product development, presenting the tangible and intangible components and their interfaces in PSS context is new. The proposed model tailored V-model based on mechatronic literature. It, then, tailored the RFLP approach to adding the detail of PSS on its layers. In the end, representing V-model by the RFLP model is the final contribution to adopt multi-viewpoints approaches in PSS modeling.
 3. Detailed applicable semantic model: The detailed models provided with UML are modular and can be used independently. These detailed models for requirements and functional analysis; the System of Interest; the Enabling Systems; the business process; the life cycle; and the interface model can be adopted and integrated with various PSS context.

Besides the above-mentioned contributions, the prospect of being able to make a common language to support PSS design serves as a continuous incentive for future research.





In a global view, the main operational perspectives of the model are as follows.

1. The model proposes a knowledge-based PSS network and its life cycle contains some crucial steps for knowledge management integrated into the global development process. This approach integrates key enablers and capabilities to create value in PSS offer along with its lifecycle.

2. The sensor ontology provided for the project is one example of the model application. In this case, adopting and tailoring modules from the sensor ontology provided by W3C to define the sensor system is based on the special characteristics of PSS. While the reference sensor network ontology is mostly based on the technical approach, the proposed ontology in this work is defined in accordance with the service characteristics defined by the proposed model. This approach is advantageous in defining a clear border between system components and their relationships in the ontology. This application is also crucial in providing solution-ready packages to customize a PSS based on the special needs of the customer.
 3. One master project is defined based on this model with the aim to design a smart configurator capable of checking the compatibility of the PSS components and interfaces. It would support engineers during the system integration process. Testing one scenario in the developed configurator shows that in order to apply the model in different PSS typology, providing domain ontologies are crucial. Combination of the model as the reference framework with the domain ontologies can support such a configurator.
- **The main research perspectives of the model are as follows.**
 1. This model is advantageous in PSS conception phase and life-cycle assessment. The research problematic could be then the definition of a standard PSS development methodology as an extension of the proposed framework.
 2. By providing the characteristics of the PSS paradigm and related development process, the key question is the monitoring of such a process by defining the right performance indicators and decision making supports. For instance, this work is on the basis of a new PhD focusing on the evaluation and management of PSS collaboration processes. In doing so, the new thesis will refine the organizational aspect.
 3. The research outcomes can create a mutual contribution to the both Product-Service System and Systems Engineering modeling approach. In this context, a collaboration process has been started to contribute to the French Chapter of INCOSE body of knowledge.
 4. Contribution to the standardization effort at the international level through collaboration and knowledge exchange with PSS cluster⁸.

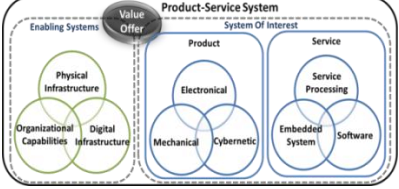
⁸ <http://www.fof-pss-cluster.eu/>

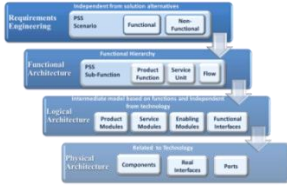
Table 9. The main contributions of the thesis

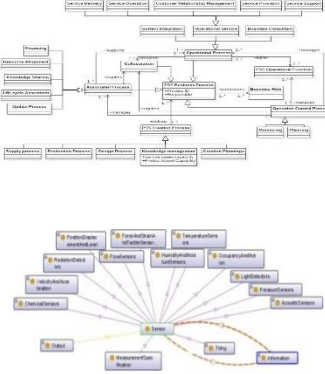
Research Question	SE Approach	Model Contribution (Created and tailored Frameworks and detailed models)
<p>Q1: What are the characteristics of PSS? (based on SE)</p> <p>A1: Components role and borders</p>	<p>Main Sub-Systems based on their role in system delivery and operation</p>	<p>A meta-model for PSS based on System of Interest and Enabling Systems</p> 
<p>Q2: What are the SE capabilities to be used in the PSS development project?</p> <p>A2: Multi viewpoint modeling</p>	<p>A systems model should be able to represent multiple views of the system.</p>	<p>A multi-viewpoint for PSS modeling: Tailored V-model which is detailed with the RFLP approach to progressively detail the model</p>  
<p>Q3: How to apply SE in a (PSS) common model?</p> <p>A3: PSS Lifecycle</p>	<p>Concurrent processes for sub-lifecycles (V-model)</p> <p>Interpersonal and innovation-based processes</p>	<p>Tailored V-model</p> <p>Proposing PSS lifecycle based on life stage-event-action-process</p> 
<p>Q4: How to apply SE in a (PSS) common model?</p> <p>A4: PSS business processes</p>	<p>Enabling Systems perform Operational Functions & Associated Process Functions</p>	<p>Considering business processes as Enabling Systems and categorizing them based on their role</p> 

- **The main limits of the model are as follows.**
 1. The model is mostly product oriented. The industrial context is mainly based on machinery and energy management in the same context. Though the ambition is to provide a generic model, the specificities of other PSS types should be better considered in the model.
 2. The proposed model aims to present a vast group of concepts related to PSS development. As a result, concepts like contract and performance measurement are not discussed in detail.
 3. This model is generic and tries to cover a maximum of aspects. This makes the application of the model complex and requires additional adaptation and specialization steps regarding the topic of each use case.
 4. The sensor ontology as the practical example is a limited example of model usage. Providing the whole system ontology is out of the scope of this research and could be considered as a further step to apply the model.

Bibliography

Self-citation References

- **Journals**

- [1] MALEKI, Elaheh, BELKADI, Farouk, BOLI, Nikoletta, et al. (2018) “Ontology-based framework enabling smart Product-Service Systems: Application of sensing systems for machine health monitoring”. *IEEE Journal Internet of Things*, Vol. 5, Issue 6, p. 4496 - 4505.
- [2] BELKADI, Farouk, BOLI, Nikoletta, Usatorre, BOLI, Nikoletta, et al. (2018) “A knowledge-based framework for PSS design and manufacturing” *CIRP Journal of Manufacturing Science and Technology* (Early access)
- [3] MALEKI, Elaheh, BELKADI, Farouk, RITOU, Mathieu, et BERNARD, Alain (2017) “A Tailored Ontology Supporting Sensor Implementation for the Maintenance of Industrial Machines” *Sensors*, Vol. 17, no 9, p. 2063.

- **International Conferences Proceedings**

- [1] MALEKI, Elaheh, BELKADI, Farouk, BONJOUR, Eric, and BERNARD, Alain (2018) “Interfaces modeling for Product-Service System integration”, In *IEEE 2018 13th Annual Conference on System of Systems Engineering (SoSE)* (pp. 319-326).
- [2] MALEKI, Elaheh, BELKADI, Farouk, and BERNARD, Alain (2018) “Industrial Product-Service System modeling base on Systems Engineering”, *16th IFAC Symposium on Information Control Problems in Manufacturing, INCOM*. Bergamo, Italy, 11-13 June.
- [3] MALEKI, Elaheh, BELKADI, Farouk, and BERNARD, Alain (2018) “A Meta-model for Product-Service System based on Systems Engineering approach”, *10th CIRP Conference on Industrial Product-Service Systems, IPSS*, Linköping, Sweden, 29-31 May. In: *Procedia CIRP*, Vol. 73, 39–44.
- [4] BELKADI, Farouk, ZHANG, Yicha, IRAZUSTA, Luis Usatorre, et al. (2017) “PSS Pattern concept for knowledge representation in design process of industrial product-service systems”, *27th CIRP Design Conference*, Cranfield, United Kingdom, 10-12 May. In: *Procedia CIRP*, 2017, vol. 60, p. 428-433.
- [5] MALEKI, Elaheh, BELKADI, Farouk, and BERNARD, Alain (2017) “Systems Engineering as a Foundation for PSS Development Project: Motivations and Perspectives”, *9th CIRP IPSS Conference*, Copenhagen, Denmark, 19-21 June. In: *Procedia CIRP*, Vol. 64, 205-210.
- [6] MALEKI, Elaheh, BELKADI, Farouk, VAN DER ZWAAG, Berend Jan, and BERNARD, Alain (2017) “A sensor ontology enabling service implementation in Industrial Product-Service Systems”, *20th World Congress of the International Federation of Automatic Control, IFAC*. Toulouse, France, 9–14 July. In: *IFAC-Papers OnLine*, Vol. 50, N° 1, 13059-13064.

- [7] MALEKI, Elaheh, BELKADI, Farouk, and BERNARD, Alain (2017) “Model-Based Systems Engineering for PSS Development: Review and Problem Statement”, Doctoral workshop of the 20th World Congress of the International Federation of Automatic Control, IFAC. Toulouse, France, 9–14 July.
- [8] MALEKI, Elaheh, BELKADI, Farouk, ZHANG, Yicha, and BERNARD, Alain (2016) “Towards a new collaborative framework supporting the design process of industrial Product Service Systems”, Int. Joint Conf. on Mechanics, Design Engineering & Advanced Manufacturing. Catania, Italy, 14-16 September 2016. In: Lecture Notes in Mechanical Engineering, Advances on Mechanics, Design Engineering and Manufacturing, pp. 139-146. Springer Publisher 2017.

- **National Conference**

- [1] MALEKI, Elaheh, BELKADI, Farouk, and BERNARD, Alain (2017) “Sensor ontology to support collaborative design of Industrial Product-Service System”, 15ème Colloque National AIP-Priméca (La Plagne), 12 - 14 avril 2017.

External References

- Abramovici, M. et al., 2009. Metadata Reference Model for IPS 2 Lifecycle Management. , (April), pp.1–2.
- Adrodegari, F. et al., 2015. From ownership to service-oriented business models: A survey in capital goods companies and a PSS typology. *Procedia CIRP*, 30, pp.245–250. Available at: <http://dx.doi.org/10.1016/j.procir.2015.02.105>.
- Adrodegari, F., Pashou, T. & Saccani, N., 2017. Business Model Innovation: Process and Tools for Service Transformation of Industrial Firms. *Procedia CIRP*, 64, pp.103–108. Available at: <http://dx.doi.org/10.1016/j.procir.2017.03.056>.
- AFIS, 2017. “Service Systems Engineering – Body of Knowledge.” *AFIS*. Available at: http://www.ssebok.afis.community/index.php?title=Service_Systems_Engineering_Body_of_Knowledge.
- Alliance, E.I., 1999. EIA surveillance, 1998. *Journal of Equine Veterinary Science*, 19(6), pp.390–390. Available at: <http://linkinghub.elsevier.com/retrieve/pii/S0737080699802901>.
- Alonso-Rasgado, T., Thompson, G. & Elfström, B.O., 2004. The design of functional (total care) products. *Journal of Engineering Design*, 15(6), pp.515–540.
- Andriankaja, H., Boucher, X. & Medini, K., 2018. A method to design integrated product-service systems based on the extended functional analysis approach. *CIRP Journal of Manufacturing Science and Technology*, 21, pp.120–139. Available at: <https://doi.org/10.1016/j.cirpj.2018.02.001>.
- Annamalai, G. et al., 2010. *An Ontology for Product-Service Systems*, Available at <http://dspace.lib.cranfield.ac.uk/handle/1826/5582>.
- Aurich, J.C., Fuchs, C. & Wagenknecht, C., 2006. Life cycle oriented design of technical Product-Service Systems. *Journal of Cleaner Production*, 14(17), pp.1480–1494.
- Baines, T.S. et al., 2007. State-of-the-art in product-service systems. *Proceedings of the Institution of Mechanical Engineers, Part B: Journal of Engineering Manufacture*, 221(10), pp.1543–1552. Available at: <http://sdj.sagepub.com/lookup/10.1243/09544054JEM858>.
- Barbau, R. et al., 2012. OntoSTEP: Enriching product model data using ontologies. *CAD Computer Aided Design*, 44(6), pp.575–590. Available at: <http://dx.doi.org/10.1016/j.cad.2012.01.008>.
- Bask, A. et al., 2010. The concept of modularity: diffusion from manufacturing to service production. *Journal of Manufacturing Technology Management*, 21(3), pp.355–375. Available at: <http://www.emeraldinsight.com/doi/10.1108/17410381011024331>.
- Batista, L. et al., 2017. Servitization through outcome-based contract – A systems perspective from the defence industry. *International Journal of Production Economics*, 192(October 2015), pp.133–143. Available at: <http://dx.doi.org/10.1016/j.ijpe.2016.12.005>.
- Belkadi, F. et al., 2012. Annual Reviews in Control A meta-modeling framework for knowledge consistency in collaborative design. *Annual Reviews in Control*, 36(2), pp.346–358. Available at: <http://dx.doi.org/10.1016/j.arcontrol.2012.09.016>.
- Belkadi, F., Zhang, Y., et al., 2017. PSS Pattern Concept for Knowledge Representation in Design Process of Industrial Product-service Systems. *Procedia CIRP*, 60, pp.428–433. Available at: <http://dx.doi.org/10.1016/j.procir.2017.01.001>.
- Belkadi, F., Zhang, Y., et al., 2017. PSS Pattern Concept for Knowledge Representation in Design Process of Industrial Product-service Systems. In *Procedia CIRP*.
- Belkadi, F., Bonjour, E. & Dulmet, M., 2004. Proposition of a Situation Model in View to Improve Collaborative Design. *IFAC Proceedings Volumes*, 37(4), pp.329–334. Available at: [http://dx.doi.org/10.1016/S1474-6670\(17\)36138-4](http://dx.doi.org/10.1016/S1474-6670(17)36138-4).
- Bertoni, M., Panarotto, M. & Larsson, T.C., 2016. Boundary objects for PSS Design. *Procedia CIRP*, 47, pp.329–334. Available at: <http://dx.doi.org/10.1016/j.procir.2016.03.226>.
- Bertschi, S. et al., 2013. What is knowledge visualization? Eight reflections on an evolving discipline.

- In Knowledge visualization currents*, pp.13–32.
- Beuren, F.H., Pereira, D. & Fagundes, A.B., 2016. Product-service Systems Characterization Based on Life Cycle: Application in a Real Situation. *Procedia CIRP*, 47, pp.418–423. Available at: <http://linkinghub.elsevier.com/retrieve/pii/S2212827116300865>.
- Beuren, F.H., Sousa-Zomer, T.T. & Cauchick-Miguel, P.A., 2017. Proposal of a framework for product-service systems characterization. *Production*, 27(0), pp.1–12. Available at: http://www.scielo.br/scielo.php?script=sci_arttext&pid=S0103-65132017000100327&lng=en&tlng=en.
- Biswal, B.N., Nanda, P. & Mohapatra, D.P., 2008. A Novel Approach for Scenario-Based Test Case Generation. *2008 International Conference on Information Technology*, pp.244–247. Available at: <http://ieeexplore.ieee.org/document/4731334/>.
- Bocken, N.M.P. et al., 2014. A literature and practice review to develop sustainable business model archetypes. *Journal of Cleaner Production*, 65, pp.42–56. Available at: <http://dx.doi.org/10.1016/j.jclepro.2013.11.039>.
- Boehm, M. & Thomas, O., 2013. Looking beyond the rim of one's teacup: A multidisciplinary literature review of Product-Service Systems in Information Systems, Business Management, and Engineering & Design. *Journal of Cleaner Production*, 51, pp.245–250. Available at: <http://dx.doi.org/10.1016/j.jclepro.2013.01.019>.
- Bonjour, E. et al., 2008. Pilotage des activités de conception par l'Ingénierie Système (IS). To cite this version : Pilotage des activités de conception par l'Ingénierie Système.
- Boucher, X. & Medini, K., 2016. Towards a Generic Meta-Model for PSS Scenarios Modeling and Analysis. In *Procedia CIRP*.
- Brady, T., Davies, A. & Gann, D.M., 2005. *Creating value by delivering integrated solutions*,
- Brax, S.A. & Visintin, F., 2017. Meta-model of servitization: The integrative profiling approach. *Industrial Marketing Management*, 60, pp.17–32. Available at: <http://dx.doi.org/10.1016/j.indmarman.2016.04.014>.
- Bruun, H.P.L. et al., 2015. PLM system support for modular product development. *Computers in Industry*, 67, pp.97–111.
- Bullinger, H.J., Fähnrich, K.P. & Meiren, T., 2003. Service engineering - Methodical development of new service products. *International Journal of Production Economics*, 85(3), pp.275–287.
- Cavaliere, S. & Pezzotta, G., 2012. Product-service systems engineering: State of the art and research challenges. *Computers in Industry*, 63(4), pp.278–288. Available at: <http://dx.doi.org/10.1016/j.compind.2012.02.006>.
- Ceschin, F., 2013. Critical factors for implementing and diffusing sustainable product-Service systems: Insights from innovation studies and companies' experiences. *Journal of Cleaner Production*, 45, pp.74–88. Available at: <http://dx.doi.org/10.1016/j.jclepro.2012.05.034>.
- Ceschin, F., 2014. How the design of socio-technical experiments can enable radical changes for sustainability. *International Journal of Design*, 8(3), pp.1–21.
- Ceschin, F. & Gaziulusoy, I., 2016. Evolution of design for sustainability: From product design to design for system innovations and transitions. *Design Studies*, 47, pp.118–163. Available at: <http://dx.doi.org/10.1016/j.destud.2016.09.002>.
- Chein, M. et al., 2013. Visual reasoning with graph-based mechanisms: the good, the better and the best. *Knowledge Engineering Review, Cambridge University Press (CUP)*, 28((Special Issue 3)), pp.249–271. Available at: [10.1017/S0269888913000234](http://dx.doi.org/10.1017/S0269888913000234).
- Chenouard, R. et al., 2016. Computational Design Synthesis Using Model-Driven Engineering and Constraint Programming. , pp.265–273. Available at: http://link.springer.com/10.1007/978-3-319-50230-4_20.
- Chesbrough, H. & Spohrer, J., 2006. A research manifesto for services science. *Communications of the ACM*, 49(7), p.35. Available at: <http://portal.acm.org/citation.cfm?doid=1139922.1139945>.
- Christophe, F., Bernard, A. & Coatanéa, É., 2010. RFBS: A model for knowledge representation of

- conceptual design. *CIRP Annals - Manufacturing Technology*, 59(1), pp.155–158.
- Compton, M. et al., 2012. The SSN ontology of the W3C semantic sensor network incubator group. *Journal of Web Semantics*, 17, pp.25–32. Available at: <http://dx.doi.org/10.1016/j.websem.2012.05.003>.
- Coreynen, W., Matthyssens, P. & Van Bockhaven, W., 2017. Boosting servitization through digitization: Pathways and dynamic resource configurations for manufacturers. *Industrial Marketing Management*, 60, pp.42–53. Available at: <http://dx.doi.org/10.1016/j.indmarman.2016.04.012>.
- Corti, D., Fontana, A. & Montorsi, F., 2016. Reference Data Architecture for PSSs Life Cycle Inventory. *Procedia CIRP*, 47, pp.300–304. Available at: <http://dx.doi.org/10.1016/j.procir.2016.03.033>.
- Costa, N. et al., 2018. Bringing Service Design to manufacturing companies: Integrating PSS and Service Design approaches. *Design Studies*, 55, pp.112–145.
- Cranefield, S. & Purvis, M., 1999. UML as an Ontology Modeling Language. *The Information Science Discussion Paper Series*, (99).
- Davies, A., Brady, T. & Hobday, M., 2006. Charting a path toward integrated solutions. *MIT Sloan Management Review*, 43(7), pp.39–48. Available at: <http://sro.sussex.ac.uk/28536/>.
- Davies, A. & Hobday, M., 2005. THE BUSINESS Managing Innovation in Complex Products and Systems.
- Davies, A. & Hobday, M., 2014. *The Business of Projects: Managing Innovation in Complex Products and Systems*, Cambridge University Press.
- Dewulf, K., 2013. Sustainable Product Innovation: The Importance of the Front-End Stage in the Innovation Process. *Advances in industrial design engineering, InTech*. Available at: <http://dx.doi.org/10.5772/52461>.
- Dorka, T., Morlock, F. & Meier, H., 2014. Data interfaces of IPS2-Execution Systems - Connecting virtual organization units for the delivery management of IPS2. *Procedia CIRP*, 16, pp.373–378. Available at: <http://dx.doi.org/10.1016/j.procir.2014.01.020>.
- le Duigou, J., Bernard, A. & Perry, N., 2011. Framework for Product Lifecycle Management integration in small and medium enterprises networks. *Computer-Aided Design and Applications*, 8(4), pp.531–544.
- Emili, S., Ceschin, F. & Harrison, D., 2016. Product-Service System applied to Distributed Renewable Energy: A classification system, 15 archetypal models and a strategic design tool. *Energy for Sustainable Development*, 32, pp.71–98. Available at: <http://dx.doi.org/10.1016/j.esd.2016.03.004>.
- Ericson, Å.M. & Larsson, T.C., 2009. People , Product and Process Perspectives on Product / Service-System Development. *Development*, (Grönroos 2000), pp.219–236. Available at: <http://www.springerlink.com/content/p735k5n7v3505h60/fulltext.pdf>.
- Estrada, A. & Romero, D., 2016. A System Quality Attributes Ontology for Product-Service Systems Functional Measurement Based on a Holistic Approach. *Procedia CIRP*, 47, pp.78–83. Available at: <http://dx.doi.org/10.1016/j.procir.2016.03.215>.
- Faisandier, A., 2012. *Syatem Architecture and Design*, Belberaud, France: Sinergy'Com Publishers.
- Fargnoli, M. et al., 2018. Product service-systems implementation: A customized framework to enhance sustainability and customer satisfaction. *Journal of Cleaner Production*, 188, pp.387–401.
- Fenves, S.J., 2001. A Core Product Model for Representing Design Information. , NISTIR 673(January 2001), pp.1–38.
- Finkelsetin, A. et al., 1992. Viewpoints : A Framework for Integrating Multiple Perspectives in System Development. *International Journal of Software Engineering and Knowledge Engineering*, 2(March), pp.31–57.
- Fitzpatrick, D., Coallier, F. & Ratté, S., 2012. A holistic approach for the architecture and design of an ontology-based data integration capability in product master data management. *IFIP Advances in Information and Communication Technology*, 388 AICT, pp.559–568.

- Fliess, S. & Becker, U., 2006. Supplier integration - Controlling of co-development processes. *Industrial Marketing Management*, 35(1), pp.28–44.
- Ford, S. & Despeisse, M., 2016. Additive manufacturing and sustainability: an exploratory study of the advantages and challenges. *Journal of Cleaner Production*, 137, pp.1573–1587.
- FORTIN, C. & HUET, G., 2007. Manufacturing Process Management: iterative synchronisation of engineering data with manufacturing realities. *International Journal of Product Development*, 4(3–4), pp.280–295.
- Fosse, E. & Delp, C.L., 2013. Systems engineering interfaces: A model based approach. *2013 IEEE Aerospace Conference*, pp.1–8. Available at: <http://ieeexplore.ieee.org/lpdocs/epic03/wrapper.htm?arnumber=6497322>.
- Fowler, J.W. & Rose, O., 2004. Grand challenges in modeling and simulation of complex manufacturing systems. *Simulation*, 80(9), pp.469–476.
- G Pahl, W.B., 2013. *Engineering design: a systematic approach*, Springer Science & Business Media.
- Gaiardelli, P. et al., 2014. A classification model for product-service offerings. *Journal of Cleaner Production*, 66, pp.507–519.
- Gardan, J. & Matta, N., 2017. Enhancing Knowledge Management into Systems Engineering through New Models in SysML. *Procedia CIRP*, 60, pp.169–174.
- Gašević, D., Djurić, D. & Devedžić, V., 2009. *Model Driven Engineering and Ontology Development* 2nd ed., Berlin: Springer Science & Business Media.
- Gausemeier, J., Gaukstern, T. & Tschirner, C., 2013. Systems engineering management based on a discipline-spanning system model. *Procedia Computer Science*, 16, pp.303–312. Available at: <http://dx.doi.org/10.1016/j.procs.2013.01.032>.
- Gebauer, H. et al., 2017. Organizational capabilities for pay-per-use services in product-oriented companies. *International Journal of Production Economics*, 192(November 2015), pp.157–168. Available at: <http://dx.doi.org/10.1016/j.ijpe.2016.12.007>.
- Gero, J. & Kannengiesser, U., 2002. The Situated Function–Behaviour–Structure Framework. *AI in Design 002*. Kluwer, pp.89–104.
- Gero, J.S. & Kannengiesser, U., 2004. The situated function-behaviour-structure framework. *Design Studies*, 25(4), pp.373–391.
- Goedkoop, M.J. et al., 1999. *Product Service systems, Ecological and Economic Basics*,
- Goh, Y.M. & McMahon, C., 2009. Improving reuse of in-service information capture and feedback. *Journal of Manufacturing Technology Management*, 20(5), pp.626–639.
- Guarino, N., 2015. Formal Ontology and Information Systems. *Information and Software Technology*, 46(6), pp.1–4. Available at: <http://dl.acm.org/citation.cfm?id=998675.999432%5Cnhttp://citeseerx.ist.psu.edu/viewdoc/download?doi=10.1.1.29.1776&rep=rep1&type=pdf%5Cnhttp://portal.acm.org/citation.cfm?doid=337180.337201%5Cnhttp://www.biomedcentral.com/1471-2164/14/S6/S2%5Cnhttp://lin>.
- HACHANI, S., GZARA, L. & VERJUS, H., 2013. A service-oriented approach for flexible process support within enterprises: application on PLM systems. *Enterprise Information Systems*, 7(1), pp.79–99.
- Hajimohammadi, A., Cavalcante, J. & Gzara, L., 2017. Ontology for the PSS Lifecycle Management. *Procedia CIRP*, 64, pp.151–156. Available at: <http://dx.doi.org/10.1016/j.procir.2017.03.016>.
- Halligan, R.J., 2011. “An introduction to systems engineering.” In *INCOSE Brazil Emerging Chapter Event: Systems engineering Week, December 12, Sao Jose dos Campos, Brazil 2011*.
- Han, K.H. & Park, J.W., 2009. Process-centered knowledge model and enterprise ontology for the development of knowledge management system. *Expert Systems with Applications*, 36(4), pp.7441–7447. Available at: <http://dx.doi.org/10.1016/j.eswa.2008.09.031>.
- Hannon, M.J., Foxon, T.J. & Gale, W.F., 2015. “Demand pull” government policies to support Product-Service System activity: The case of Energy Service Companies (ESCOs) in the UK. *Journal of*

- Cleaner Production*, 108, pp.1–16. Available at: <http://dx.doi.org/10.1016/j.jclepro.2015.05.082>.
- Hartmann, C. et al., 2017. A conceptual framework leading to different Dynamic Systems Architectures. *Annual Forum Proceedings - AHS International*.
- Haskins, C., 2010. *Systems Engineering Handbook: A guide for system lifecycle processes and activities*, SE Handbook Working Group International Council on Systems Engineering (INCOSE). Available at: <http://linkinghub.elsevier.com/retrieve/pii/0016003266904509>.
- Hayes, W., Cohen, J. & Ferguson, R., 2014. *Risk Priority Number: A Method for Defect Report Analysis*.
- Hein, A.M. et al., 2018. A Methodology for Architecting Collaborative Product Service System of Systems. In *13th Annual Conference on System of Systems Engineering (SoSE) IEEE*. pp. 53–59.
- Hinz, H.N., Bey, N. & Mcaloone, T.C., 2013. Timing and Targeting of PSS Methods and Tools: An Empirical Study amongst Academic Contributors. , pp.131–139. Available at: <http://link.springer.com/10.1007/978-3-642-30820-8>.
- Hollauer, C. et al., 2015. Towards a meta-model for the description of the sociotechnical perspective on Product-Service Systems. *Procedia CIRP*, 30, pp.359–365. Available at: <http://dx.doi.org/10.1016/j.procir.2015.02.022>.
- Huikkola, T. & Kohtamäki, M., 2017. Solution providers' strategic capabilities. *Journal of Business & Industrial Marketing*, 32(5), pp.752–770. Available at: <http://www.emeraldinsight.com/doi/10.1108/JBIM-11-2015-0213>.
- Huikkola, T., Kohtamäki, M. & Rabetino, R., 2016. Resource realignment in servitization: A study of successful service providers explores how manufacturers modify their. *Research Technology Management*, 59(4), pp.30–39.
- Hussain, R., Lockett, H. & Annamalai Vasantha, G.V., 2012. A framework to inform PSS Conceptual Design by using system-in-use data. *Computers in Industry*, 63(4), pp.319–327. Available at: <http://dx.doi.org/10.1016/j.compind.2012.02.013>.
- Idrissi, N.A., Boucher, X. & Medini, K., 2017. Generic conceptual model to support PSS design processes. *Procedia CIRP*, 64, pp.235–240. Available at: <http://dx.doi.org/10.1016/j.procir.2017.03.055>.
- INCOSE, 2014. Systems Engineering Vision 2025. *The Future State*.
- ISO/IEC, 2001. Systems Engineering — System Life Cycle Processes. *15288 Fcd*, (30).
- ISO/IEC 2382, 2015. Information technology — Vocabulary.
- Janowicz, K. & Compton, M., 2010. The stimulus-sensor-observation ontology design pattern and its integration into the semantic sensor network ontology. *CEUR Workshop Proceedings*, 668.
- Jarmo Alanen & Salminen, K., 2016. Systems Engineering Management Plan template V1. *Research report VTT*.
- Joore, P. & Brezet, H., 2015. A Multilevel Design Model: The mutual relationship between product-service system development and societal change processes. *Journal of Cleaner Production*, 97, pp.92–105. Available at: <http://dx.doi.org/10.1016/j.jclepro.2014.06.043>.
- Keuneke, A.M., 1991. Device Representation The Significance of Functional Knowledge. *IEEE Expert-Intelligent Systems and their Applications*, 6(2), pp.22–25.
- EL KHALKHALI, I., 2002. *Système intégré pour la modélisation, l'échange et le partage des données de produits*. Lyon, INSA.
- Kim, Y.S. et al., 2011. Design Support Tools for Product-Service Systems. *International Conference on Engineering Design (ICED11)*, 1(August), pp.288–298.
- Kleemann, F.C. & Essig, M., 2013. A providers' perspective on supplier relationships in performance-based contracting. *Journal of Purchasing and Supply Management*, 19(3), pp.185–198. Available at: <http://dx.doi.org/10.1016/j.pursup.2013.03.001>.
- Kleiner, S., Kramer, C. & Ag, M., 2013. Model based design with systems engineering based on RFLP using V6. *Smart Product Engineering*, pp.93–102. Available at: <http://link.springer.com/10.1007/978-3-642-30817-8>.

- Kohtamäki, M. & Partanen, J., 2016. Co-creating value from knowledge-intensive business services in manufacturing firms: The moderating role of relationship learning in supplier-customer interactions. *Journal of Business Research*, 69(7), pp.2498–2506. Available at: <http://dx.doi.org/10.1016/j.jbusres.2016.02.019>.
- Kösters, G., Six, H. & Winter, M., 2001. Validation and Verification of Use Cases and Class Models. *In 6th International Conference on Requirements Engineering for Software Quality (REFSQ)*.
- Kwan, M.M. & Balasubramanian, P., 2003. KnowledgeScope: Managing knowledge in context. *Decision Support Systems*, 35(4), pp.467–486.
- Lee, J., 2001. The impact of knowledge sharing, organizational capability and partnership quality on IS outsourcing success. , 38.
- Lee, J.S. & Miller, L.E., 2007. INCOSE - Systems Engineering Handbook. *Systems Engineering*, (August), p.304. Available at: <http://dl.acm.org/citation.cfm?id=552393>.
- Lefèvre, J. et al., 2014. Multidisciplinary modeling and simulation for mechatronic design. *J. of Design Research*, 12(1/2), p.127. Available at: <http://www.inderscience.com/link.php?id=60937>.
- Lim, C.H. et al., 2012. PSS Board: A structured tool for product-service system process visualization. *Journal of Cleaner Production*, 37, pp.42–53. Available at: <http://dx.doi.org/10.1016/j.jclepro.2012.06.006>.
- Lindström, J., Dagman, A. & Karlberg, M., 2015. The Functional Products Technical Lifecycle and its Four Sub-lifecycles. *Procedia CIRP*, 38, pp.222–227. Available at: <http://dx.doi.org/10.1016/j.procir.2015.07.052>.
- Lindström, J. & Karlberg, M., 2017. Outlining an overall Functional Product lifecycle – Combining and coordinating its economic and technical perspectives. *CIRP Journal of Manufacturing Science and Technology*, 17, pp.1–9.
- Liu, Z. et al., 2018. A perspective on value co-creation-oriented framework for smart product-service system. *Procedia CIRP*, 73, pp.155–160. Available at: <https://linkinghub.elsevier.com/retrieve/pii/S2212827118305377>.
- Lopes, C.M. et al., 2017. An analysis of the interplay between organizational sustainability, knowledge management, and open innovation. , 142, pp.476–488.
- Maier, M.W., 1996. Architecting Principles for Systems-of-Systems. *INCOSE International Symposium*, 6(1), pp.565–573. Available at: <http://doi.wiley.com/10.1002/j.2334-5837.1996.tb02054.x>.
- Maleki, E., Belkadi, F., Zwaag, B.J.V.D., et al., 2017. A sensor ontology enabling service implementation in Industrial Product-Service Systems. *IFAC-PapersOnLine*, 50(1).
- Maleki, E., Belkadi, F., Ritou, M., et al., 2017. A tailored ontology supporting sensor implementation for the maintenance of industrial machines. *Sensors (Switzerland)*, 17(9).
- Maleki, E. et al., 2018. Ontology-based framework enabling smart Product-Service Systems: Application of sensing systems for machine health monitoring. *IEEE Internet of Things Journal*.
- Maleki, E., Belkadi, F., Zhang, Y., et al., 2017. *Towards a new collaborative framework supporting the design process of industrial product service systems*,
- Mamrot, M. et al., 2016. Concept for a Sustainable Industrial Product Service Systems based on Field Data. *Procedia CIRP*, 40, pp.688–693. Available at: <http://dx.doi.org/10.1016/j.procir.2016.01.155>.
- Manzini, E. & Vezzoli, C., 2003. A strategic design approach to develop sustainable product service systems: Examples taken from the “environmentally friendly innovation” Italian prize. *Journal of Cleaner Production*, 11(8 SPEC.), pp.851–857.
- Marques, P. et al., 2013. A methodology for product-service systems development. *Procedia CIRP*, 7, pp.371–376. Available at: <http://dx.doi.org/10.1016/j.procir.2013.06.001>.
- Maubourgne, P. & Loise, D., 2016. *Vers une ingenierie de systemes surs de fonctionnement basee sur les modeles des conception innovante*.

- Maussang, N., Zwolinski, P. & Brissaud, D., 2009. Product-service system design methodology: from the PSS architecture design to the products specifications. *Journal of Engineering Design*, 20(4), pp.349–366. Available at: <http://www.tandfonline.com/doi/abs/10.1080/09544820903149313>.
- Maxwell, D. & Van der Vorst, R., 2003. Developing sustainable products and services. *Journal of Cleaner Production*, 11(8 SPEC.), pp.883–895.
- Medina-Oliva, G. et al., 2014. Predictive diagnosis based on a fleet-wide ontology approach. *Knowledge-Based Systems*, 68, pp.40–57. Available at: <http://dx.doi.org/10.1016/j.knosys.2013.12.020>.
- Meier, H., Roy, R. & Seliger, G., 2010. Industrial Product-Service systems-IPS2. *CIRP Annals - Manufacturing Technology*, 59(2), pp.607–627.
- Mejía-Gutiérrez, R. & Carvajal-Arango, R., 2017. Design Verification through virtual prototyping techniques based on Systems Engineering. *Research in Engineering Design*, 28(4), pp.477–494.
- Mentink, R., 2004. *Process Management in Design & Engineering: Applying dynamic process modeling based on evolving information content (PhD Thesis)*. M.C. Escher Company B.V.-Baarn Holland, 2004.
- Menzel, C. & Mayer, R.J., 1998. The IDEF family of languages. *Handbook on architectures of information systems*, pp.209–241. Available at: <http://www.springerlink.com/index/lt77071635420258.pdf>.
- Mikusz, M., 2014. Towards an understanding of cyber-physical systems as industrial software-product-service systems. *Procedia CIRP*, 16, pp.385–389. Available at: <http://dx.doi.org/10.1016/j.procir.2014.02.025>.
- Mont, O., 2002. Clarifying the concept of product – service system. *Journal of Cleaner Production*, 10, pp.237–245.
- Mont, O., 2001. Introducing and developing a Product-Service System (PSS) concept in Sweden. *Lund: IIIIEE, Lund University and NUTEK*, p.124.
- Monticolo, D. et al., 2015. A meta-model for knowledge configuration management to support collaborative engineering. *Computers in Industry*, 66, pp.11–20. Available at: <http://dx.doi.org/10.1016/j.compind.2014.08.001>.
- Morelli, N., 2006. Developing new product service systems (PSS): methodologies and operational tools. *Journal of Cleaner Production*, 14(17), pp.1495–1501.
- Muller, P., Schmidt-Kretschmer, M. & Blessing, L.T.M., 2007. Function Allocation in Product-Service System - Are There Analogies between PSS and Mechatronics? *AEDS 2007 Workshop*, (October), pp.47–55.
- Nadoveza, D. & Kiritsis, D., 2014. Ontology-based approach for context modeling in enterprise applications. *Computers in Industry*, 65(9), pp.1218–1231.
- NGO, T.N., 2018. *Une approche PLM pour supporter les collaborations et le partage des connaissances dans le secteur médical: Application aux processus de soins par implantation de prothèses*. ECN.
- Nguyen, H.N. et al., 2014. Operationalizing IPS2 development process: A method for realizing IPS2 developments based on Process-based project planning. *Procedia CIRP*, 16, pp.217–222. Available at: <http://dx.doi.org/10.1016/j.procir.2014.01.024>.
- Noël, F. & Roucoules, L., 2008. The PPO design model with respect to digital enterprise technologies among product life cycle. *International Journal of Computer Integrated Manufacturing*, 21(2), pp.139–145.
- Noy, N.F. et al., 1991. Creating Semantic Web Contents with Protégé-2000. *Preprint - Society of Mining Engineers of AIME*.
- Noy, N.F. & Hafner, C.D., 1997. The State of the Art in Ontology Design A Survey and Comparative Review. *AI Magazine*, 18(3), pp.53–74.
- Oldham, K. et al., 1998. MOKA – a methodology and tools oriented to knowledge-based engineering applications. In *Proceedings of the Conference on Integration in Manufacturing, Goteborg, Sweden*, pp. 198–207.

- OMG, 2013. OMG Meta Object Facility (MOF) Core Specification. *Document, N°: formal/2013-06-01. Standard*. Available at: <http://www.omg.org/spec/MOF/2.4.1>.
- Van Ostaeyen, J. et al., 2013. A refined typology of product-service systems based on functional hierarchy modeling. *Journal of Cleaner Production*, 51, pp.261–276.
- Pacheco, D.A.D.J. et al., 2016. Systematic Eco-innovation in Lean PSS Environment: An Integrated Model. *Procedia CIRP*, 47, pp.466–471. Available at: <http://dx.doi.org/10.1016/j.procir.2016.03.211>.
- Pagoropoulos, A., Maier, A. & McAloone, T.C., 2017. Assessing transformational change from institutionalising digital capabilities on implementation and development of Product-Service Systems: Learnings from the maritime industry. *Journal of Cleaner Production*, 166, pp.369–380. Available at: <http://dx.doi.org/10.1016/j.jclepro.2017.08.019>.
- Panetto, H., Dassisti, M. & Tursi, A., 2012. ONTO-PDM: Product-driven ONTOlogy for Product Data Management interoperability within manufacturing process environment. *Advanced Engineering Informatics*, 26(2), pp.334–348. Available at: <http://dx.doi.org/10.1016/j.aei.2011.12.002>.
- Pennock, M.J. & Wade, J.P., 2015. The top 10 illusions of systems engineering: A research agenda. *Procedia Computer Science*, 44(C), pp.147–154. Available at: <http://dx.doi.org/10.1016/j.procs.2015.03.033>.
- Pezzotta, G. et al., 2015. A Service Engineering framework to design and assess an integrated product-service. *Mechatronics*, 31, pp.169–179. Available at: <http://dx.doi.org/10.1016/j.mechatronics.2015.05.010>.
- Pezzotta, G., Cavalieri, S. & Gaiardelli, P., 2012. A spiral process model to engineer a product service system: An explorative analysis through case studies. *CIRP Journal of Manufacturing Science and Technology*, 5(3), pp.214–225. Available at: <http://dx.doi.org/10.1016/j.cirpj.2012.07.008>.
- Pineda, R. & Lopes, A.J., 2013. Service systems engineering applications. *Procedia Computer Science*, 16, pp.678–687. Available at: <http://dx.doi.org/10.1016/j.procs.2013.01.071>.
- Pirayesh, A.E. et al., 2018. A Conceptual Model for Product Service System (PSS). , (February), pp.1–21.
- Protégé, Protégé Website. Available at: <https://protege.stanford.edu> [Accessed July 20, 2008].
- Qu, M. et al., 2016. State-of-the-art of design, evaluation, and operation methodologies in product service systems. *Computers in Industry*, 77(127), pp.1–14. Available at: <http://dx.doi.org/10.1016/j.compind.2015.12.004>.
- Rahmani, K. & Thomson, V., 2012. Ontology based interface design and control methodology for collaborative product development. *CAD Computer Aided Design*, 44(5), pp.432–444. Available at: <http://dx.doi.org/10.1016/j.cad.2011.12.002>.
- Rauffet, P., Cunha, C. Da & Bernard, A., 2016. Managing resource learning in distributed organisations with the organisational capability approach. *International Journal of Technology Management*, 70(4), p.300. Available at: <http://www.inderscience.com/link.php?id=75902>.
- Reim, W. et al., 2014. Functional Product Business Models: A Review of the Literature and Identification of Operational Tactical Practices. *Procedia CIRP*, 22, pp.157–162. Available at: <http://www.sciencedirect.com/science/article/pii/S221282711400835X>.
- Reim, W., Parida, V. & Örtqvist, D., 2015. Product-Service Systems (PSS) business models and tactics - A systematic literature review. *Journal of Cleaner Production*, 97, pp.61–75.
- Rondini, A. et al., 2018. Standardizing delivery processes to support service transformation: A case of a multinational manufacturing firm. *Computers in Industry*, 100(March 2017), pp.115–128.
- ROY, R., ERKOYUNCU, J.A. & SHAW, A., 2013. The future of maintenance for industrial product-service systems. *Product-Service Integration for Sustainable Solutions*. Springer, Berlin, Heidelberg, pp.1–15.
- Ryser, J. & Glinz, M., 1999. A scenario-based approach to validating and testing software systems using statecharts. ... *International Conference on Software and Systems* Available at <http://citeseerx.ist.psu.edu/viewdoc/download?doi=10.1.1.22.10&rep=rep1&type=pdf>.

- Sadek, T. & Köster, M., 2011. Conceptual Development of Industrial Product-Service Systems. , 6(2), pp.35–53.
- Sakao, T., Song, W. & Matschewsky, J., 2017. Creating service modules for customising product/service systems by extending DSM. *CIRP Annals - Manufacturing Technology*, 66(1), pp.21–24. Available at: <http://dx.doi.org/10.1016/j.cirp.2017.04.107>.
- Sandin, J. & Berggren, C., 2015. A Simplified Service Engineering Approach used by an Industrial Service Solutions Provider. *Procedia CIRP*, 30, pp.30–35. Available at: <http://dx.doi.org/10.1016/j.procir.2015.02.141>.
- Sargent, R.G., 2013. Verification and validation of simulation models. , 7(1), pp.12–24. Available at: <http://dx.doi.org/10.1057/jos.2012.20>.
- Sasa, D. & Lindström, J., 2014. Advancing development of product-service systems using ideas from functional product development. *Procedia CIRP*, 21(December), pp.242–246.
- Schenkl, S.A., Sauer, R.M. & Mörtl, M., 2014. A technology-centered framework for Product-Service Systems. *Procedia CIRP*, 16, pp.295–300. Available at: <http://dx.doi.org/10.1016/j.procir.2014.01.029>.
- Scholze, S., Correia, A.T. & Stokic, D., 2016. Novel Tools for Product-service System Engineering. *Procedia CIRP*, 47, pp.120–125. Available at: <http://dx.doi.org/10.1016/j.procir.2016.03.237>.
- Schuh, G. et al., 2014. Modular sensor platform for service-oriented cyber-physical systems in the european tool making industry. *Procedia CIRP*, 17, pp.374–379. Available at: <http://dx.doi.org/10.1016/j.procir.2014.01.114>.
- Schuh, G., Friedli, T. & Gebauer, H., 2004. Fit for Service: Industrie als Dienstleister. , 90(D), pp.22665–22665. Available at: http://files.hanser.de/hanser/docs/20050204_252414223-79_3-446-22665-6_buchvorstellung.pdf.
- SEBOK1.8, 2017. *Guide to the Systems Engineering Body of Knowledge (SEBoK)-V1.8*, Available at <http://g2sebok.incose.org/app/mss/menu/index.cfm>.
- Shanks, G., Tansley, E. & Weber, R., 2003. Using ontology to validate conceptual models. *Communications of the ACM*, 46(10), p.85. Available at: <http://portal.acm.org/citation.cfm?doid=944217.944244>.
- Shimomura, Y. & Akasaka, F., 2013. Toward Product-Service System Engineering: New System Engineering for PSS Utilization. , pp.27–40. Available at: <http://link.springer.com/10.1007/978-3-642-30820-8>.
- Si, X.S. et al., 2011. Remaining useful life estimation - A review on the statistical data driven approaches. *European Journal of Operational Research*, 213(1), pp.1–14. Available at: <http://dx.doi.org/10.1016/j.ejor.2010.11.018>.
- SIMON, G., 1996. Knowledge acquisition and modeling for corporate memory: lessons learnt from experience. *Proc. of KAW*, pp.41–1.
- Sirmon, D.G., Hitt, M.A. & Ireland, R.D., 2007. Managing Firm Resources in Dynamic Environments to Create Value: Looking inside the black box. *The Academy of Management Review*, 32(1), pp.273–292.
- Slayman, A., 2018. *Développement d'un système de configuration et vérification des architectures des systèmes produit-service*,
- Song, W. & Sakao, T., 2017. A customization-oriented framework for design of sustainable product/service system. *Journal of Cleaner Production*, 140, pp.1672–1685. Available at: <http://dx.doi.org/10.1016/j.jclepro.2016.09.111>.
- Sousa, P. et al., 2007. Enterprise Architecture Modeling with the Unified Modeling Language. In *Enterprise Modeling and Computing with UML*, pp.67–94.
- Spring, M. & Araujo, L., 2017. Product biographies in servitization and the circular economy. *Industrial Marketing Management*, 60, pp.126–137. Available at: <http://dx.doi.org/10.1016/j.indmarman.2016.07.001>.
- Srinivasan, V., 2011. Computer-Aided Design An integration framework for product lifecycle

- management. *Computer-Aided Design*, 43(5), pp.464–478. Available at: <http://dx.doi.org/10.1016/j.cad.2008.12.001>.
- Stark, R. et al., 2014. Advanced technologies in life cycle engineering. *Procedia CIRP*, 22(1), pp.3–14. Available at: <http://dx.doi.org/10.1016/j.procir.2014.07.118>.
- Story, V.M. et al., 2017. Capabilities for advanced services: A multi-actor perspective. *Industrial Marketing Management*, 60, pp.54–68. Available at: <http://dx.doi.org/10.1016/j.indmarman.2016.04.015>.
- Sudarsan, R. & Fenves, S.J., 2005. A product information modeling framework for product lifecycle management. *Computer-Aided Design*, 37, pp.1399–1411.
- Tran, T.A. & Park, J.Y., 2014. Development of integrated design methodology for various types of product — service systems. *Journal of Computational Design and Engineering*, 1(1), pp.37–47. Available at: <http://linkinghub.elsevier.com/retrieve/pii/S2288430014500048>.
- Trevisan, L., 2016. Cadre Conceptuel pour l' Eco- Conception Intégrée de Systèmes Produit-Service INTEGRATED PRODUCT-SERVICE SYSTEMS.
- Trevisan, L. & Brissaud, D., 2017. A system-based conceptual framework for product-service integration in product-service system engineering. *Journal of Engineering Design*, 28(10–12), pp.627–653.
- Trevisan, L. & Brissaud, D., 2016. CIRP Journal of Manufacturing Science and Technology Engineering models to support product – service system integrated design. *CIRP Journal of Manufacturing Science and Technology*, 15, pp.3–18. Available at: <http://dx.doi.org/10.1016/j.cirpj.2016.02.004>.
- Tukker, A., 2004. Eight Types of Product Service Systems. *Business Strategy and the Environment*, 13, pp.246–260.
- Tukker, A., 2015. Product services for a resource-efficient and circular economy - A review. *Journal of Cleaner Production*, 97, pp.76–91. Available at: <http://dx.doi.org/10.1016/j.jclepro.2013.11.049>.
- Tukker, A. & Tischner, U., 2004. New Business for old europe. *Suspronet*, 2, pp.132–48. Available at: <http://www.ncbi.nlm.nih.gov/pubmed/18048240>.
- Tukker, A. & Tischner, U., 2006. Product-services as a research field: past, present and future. Reflections from a decade of research. *Journal of Cleaner Production*, 14(17), pp.1552–1556.
- Uschold, M. et al., 1998. The Enterprise Ontology. *The Knowledge Engineering Review*, 13(1), pp.31–89.
- Vandermerwe, S. & Rada, J., 1988. Servitization of business: Adding value by adding services. *European Management Journal*, 6(4), pp.314–324.
- Varga, P. et al., 2017. Making system of systems interoperable – The core components of the arrowhead framework. *Journal of Network and Computer Applications*, 81, pp.85–95. Available at: <http://dx.doi.org/10.1016/j.jnca.2016.08.028>.
- Vargo, S.L. & Lusch, R.F., 2016. Institutions and axioms: an extension and update of service-dominant logic. *Journal of the Academy of Marketing Science*, 44(1), pp.5–23.
- Vargo, S.L. & Lusch, R.F., 2017. Service-dominant logic 2025. *International Journal of Research in Marketing*, 34(1), pp.46–67. Available at: <http://dx.doi.org/10.1016/j.ijresmar.2016.11.001>.
- Vasanth, G.V.A. et al., 2012. A review of product-service systems design methodologies. *Journal of Engineering Design*, 23(9), pp.635–659.
- van der Veen, R.A.C., Kisjes, K.H. & Nikolic, I., 2017. Exploring policy impacts for servicising in product-based markets: A generic agent-based model. *Journal of Cleaner Production*, 145, pp.1–13. Available at: <http://dx.doi.org/10.1016/j.jclepro.2017.01.016>.
- Velamuri, V.K., Neyer, A.K. & Möslin, K.M., 2011. Hybrid value creation: A systematic review of an evolving research area. *Journal fur Betriebswirtschaft*, 61(1), pp.3–35.
- Vernadat, F., 2002. UEMML: Towards a Unified Enterprise Modeling Language, *Int. J. of Production Research*, 40, pp.1–15.
- Vezzoli, C., Kohtala, C. & Srinivasan, A., 2014. *Product-Service System Design for Sustainability*,

- WANG, P. P., MING, X.G. & LI, D., 2011. Status review and research strategies on product-service systems. *International Journal of Production Research*, 49(22), p.6863–6883.
- Wang, P.P. et al., 2014. Research on industrial product-service configuration driven by value demands based on ontology modeling. *Computers in Industry*, 65(2), pp.247–257.
- Weber, C. et al., 2004. MODELING OF PRODUCT-SERVICE SYSTEMS (PSS) BASED ON THE PDD APPROACH 2. Property-Driven Development / Design (PDD). *Design 2004*, pp.1–8.
- Welp, E.G. & Sadek, T., 2008. Conceptual design of Industrial Product Service Systems (Ips 2) based on the extended heterogeneous modeling approach. *Proceedings DESIGN 2008, the 10th International Design Conference*, pp.545–552. Available at: <https://www.scopus.com/inward/record.uri?eid=2-s2.0-84861494739&partnerID=40&md5=1010746ffaedf45978eae8752de52416>.
- Wiesner, S. et al., 2015. Interactions between service and product lifecycle management. *Procedia CIRP*, 30, pp.36–41. Available at: <http://dx.doi.org/10.1016/j.procir.2015.02.018>.
- Williams, A., 2007. Product service systems in the automobile industry: contribution to system innovation? *Journal of Cleaner Production*, 15(11–12), pp.1093–1103.
- Wolfenstetter, T. et al., 2014. Supporting the cross-disciplinary development of product-service systems through model transformations. *IEEE International Conference on Industrial Engineering and Engineering Management*, 2015–Janua, pp.174–178.
- Xing, K., Ness, D. & Lin, F.R., 2013. A service innovation model for synergistic community transformation: Integrated application of systems theory and product-service systems. *Journal of Cleaner Production*, 43, pp.93–102. Available at: <http://dx.doi.org/10.1016/j.jclepro.2012.11.052>.
- Yang, X. et al., 2009. A practical methodology for realizing product service systems for consumer products. *Computers and Industrial Engineering*, 56(1), pp.224–235. Available at: <http://dx.doi.org/10.1016/j.cie.2008.05.008>.
- Yue, X. et al., 2015. Cloud-assisted industrial cyber-physical systems: An insight. *Microprocessors and Microsystems*, 39(8), pp.1262–1270. Available at: <http://dx.doi.org/10.1016/j.micpro.2015.08.013>.
- Zhang, Y. et al., 2017. A big data analytics architecture for cleaner manufacturing and maintenance processes of complex products. *Journal of Cleaner Production*, 142, pp.626–641. Available at: <http://dx.doi.org/10.1016/j.jclepro.2016.07.123>.
- Zheng, C. et al., 2016. Multidisciplinary interface model for design of mechatronic systems. *Computers in Industry*, 76, pp.24–37.
- Zheng, C. et al., 2013. Survey of design process models for mechatronic systems engineering. *10ème Congrès International de Génie Industriel CIGI2013*, (April).
- Zheng, C. et al., 2014. Survey on mechatronic engineering: A focus on design methods and product models. *Advanced Engineering Informatics*, 28(3), pp.241–257. Available at: <http://dx.doi.org/10.1016/j.aei.2014.05.003>.
- Zhou, Q., Yan, P. & Xin, Y., 2017. Research on a knowledge modeling methodology for fault diagnosis of machine tools based on formal semantics. *Advanced Engineering Informatics*, 32, pp.92–112. Available at: <http://dx.doi.org/10.1016/j.aei.2017.01.002>.

Annexes

ANNEXES	A
ANNEX I: PSS TERMINOLOGY AND DEFINITION.....	C
ANNEX II: CLASSES DEFINITION FROM THE LITERATURE INVESTIGATION	G
ANNEX III: UML DIAGRAMS OF THE GLOBAL MODEL	W

Annex I: PSS terminology and definition

Reference	Terminology	PSS Definition	Main Components
Vandermerwe et al. (1988)	Servitisation / Servicification	“Offering fuller market packages or “bundles” of customer-focused combinations of goods, services, support, self-service, and knowledge.”	Product, Service, Support, Knowledge
Goedkoop et al. (1999)	Product-Service System (PSS)	“A marketable set of products and services capable of jointly fulfilling a user’s needs“	Product, Service
Mont (2002)	PSS	“A system of products, services, supporting networks and infrastructure that is designed to be: competitive, satisfy customer needs and have a lower environmental impact than traditional business models”.	The product, Service, Supporting Network, Infrastructure
Manzini and Vezzoli (2003)	PSS	“An innovation strategy, shifting the business focus from designing (and selling) physical products only, to designing (and selling) a system of products and services which are jointly capable of fulfilling specific client demands”.	Product, Service
Alonso-Rasgado et al. (2004)	Functional Product (FP) / Total Care Product	"Products that comprise combinations of ‘hard’ and ‘soft’ elements. Typically, they are described as comprising hardware combined with a service support system"	Hardware, Software, Service Support System
Tukker et al. (2004)	Function-Oriented Business Models	“A system of tangible products and intangible services designed and combined so that they jointly are capable of fulfilling specific customer needs”.	Tangible products, Intangible services
Wong (2004)	PSS	“A solution offered for sale that involves both a product and a service element, to deliver the required functionality”.	Product, Service

Reference	Terminology	PSS Definition	Main Components
Brady et al. (2005)	Integrated Solution	“Delivering integrated solutions to meet users need involves a new type of project which extends the traditional life cycle of a project beyond the delivery phase into the operational phase.”	Product, Service
Lindahl et al. (2006)	Integrated Product-Service Offering	(IPSO) "Implies that suppliers create an offer that best meets customer needs, from a life cycle perspective, with as few resources and costs as possible."	Product, Service, Resources
Baines et al. (2007)	PSS	“A PSS is an integrated product and service offering that delivers value in use. A PSS offers the opportunity to decouple economic success from material consumption and hence reduce the environmental impact of economic activity”.	Product, Service
Sakao et al. (2007)	Functional Solution	“A functional solution that fulfills a defined customer need. The focus is, with reference to the customer value, to optimize the functional solution from a life-cycle perspective.”	Product, Service
Müller et al., (2009)	PSS	“A concept that integrates products and services in one scope for planning, development, and delivery, thus for the whole life-cycle.”	Product, Service
Meier et al. (2010)	Industrial PSS (IPS2)	“The integrated and mutually determined planning, development, provision, and use of product and service shares including its immanent software components and represents a knowledge-intensive socio-technical system”.	The product, Service, software components
Cavalieri et al. (2012)	PSS	“A collection of real or abstract interdependent entities – hardware, software, people, facilities and procedures- organized as a whole in order to accomplish a common set of goals”	hardware, Software, facilities, procedures, people

Reference	Terminology	PSS Definition	Main Components
Lim et al. (2012)	PSS	<p>“A system consisting of</p> <ul style="list-style-type: none"> • Products: Tangible commodities to get a job done. • Services: Intangible activities to achieve a certain range of desired outcomes (e.g., technical, informative, and knowledge-related activities). • Dedicated infrastructures: Any artifacts specifically required to provide products and services (e.g., technologies, devices, and servicescape evidence, such as spatial layouts). • Provider network: PSS provider and its partners (e.g., retailer, supplier, repair)” 	Product, Service, Dedicated infrastructures, Provider network
Vasantha et al. (2012)	PSS	“PSS design should focus on integrating business models, products and services together throughout the life cycle stages, creating innovative value addition for the system.”	Product, Service
Boehm et al. (2013)	Cyber-Physical System (CPS)	“Integrating sensors and internet with product and service opens up a new direction in PSS research. This integrated approach is known as a cyber-physical system.”	The product, Service, Software, Sensor
Roy, R. et al. (2013)	Through-Life Engineering Services (TES)	“Through-life engineering services address the needs of high-value products and systems from conceptual design all the way to end of life.”	Product, Service
Shimomura and Akasaka (2013)	PSS	"PSS can be defined as a social system that enhances social and economic values for stakeholders through the co- and cross-offering of products, services, and product-services within the system."	Product, Service
Vezzoli et al. (2014)	Sustainable PSS (S.PSS)	“An offer model providing an integrated mix of products and services that are together able to fulfil a particular customer demand (to deliver a ‘unit of satisfaction’), based on innovative interactions between the stakeholders of the value production system (satisfaction system), where the economic and competitive interest of the providers continuously seeks environmentally and socio-ethically beneficial new solutions”	Product, Service

Reference	Terminology	PSS Definition	Main Components
Mikusz, M., (2014)	Software-Product-Service System (ISPS ²)	"A well-founded conceptualization for CPS shall make CPS as an object of research more accessible to research in the area of IPS ² . That is, it shall reflect the character of CPS as a software-enabled hybrid solution, consisting of software as well as of service and tangible product parts. For this purpose, the contribution at hand proposes the conceptualization of the industrial software-product-service system	The product, Service, Software, Sensor
Lindström et al. (2015)	Functional Products	"FP integrates the four main constituents: hardware, software, service-support system and management of the operation, into the provision of a function with a guaranteed or agreed-upon level of availability to the customers."	hardware, Software, service-support system, management of the operation
Scholze, Sebastian et al. (2016)	Product Extension Services (PES)	"Manufacturing companies enter in a continuous process of upgrading their products along with their life cycle under the frame of adding cyber-physical features and establishing/further enhancing Product-Service System (PSS) model." "The objective is to develop new engineering tools to support effective collaborative development of PSS, and specifically PES around the products with CPF." "One example of a typical CPS is an intelligent manufacturing line"	The product, Service, Software, Sensor

Annex II: Classes definition from the literature investigation

Concept	Definition	Reference
Associated Process Function	ES performs Associated Process Function	I'EIA-632
Behavioral Architecture Model	An arrangement of functions and their sub-functions as well as interfaces (inputs and outputs) that define the execution sequencing, conditions for control or data-flow, and performance level necessary to satisfy the system requirements ISO/IEC/IEEE 26702 (ISO 2007). A behavioral architecture model can be described as a set of inter-related scenarios of functions and/or operational modes.	(SEBOK1.8 2017)
Business model	The company business model is used as a reference object to establish a dialogue between the service and hardware domains.	(Bertoni et al. 2016)
Business consulting capabilities	To provide customers with advice on how to develop business plans, design and build a system and maintain and operate it.	(Brady et al. 2005)
Business Intelligence system	BI system enables digital capabilities, as they are central in highlighting opportunities and evaluating the cost impact of implemented PSS.	(Pagoropoulos et al. 2017)
Business processes	Uptake of digital capabilities can transform business processes	(Pagoropoulos et al. 2017)
Collaboration	Companies should be able to develop partnerships with key actors in the value chain. This work stresses collaboration between manufacturers and their suppliers (Baines and Lightfoot, 2014), manufacturers and customers, manufacturers and their customers' networks, and manufacturers and intermediaries (service integrators/distributors).	(Gebauer et al. 2017)
Control interface	Indicates how one element will be controlled by others, which is mainly related to the electronic discipline of mechatronic systems.	(Zheng et al. 2016)

Concept	Definition	Reference
Convert capabilities into core competencies	To maintain competitive advantages for pay-per-use services over the long-term, companies need to convert capabilities into core competencies (Ceci and Masini, 2011).	(Gebauer et al. 2017)
Cost Estimation	One particular dynamic capability that is recognized as essential to the survival of servitized companies (Roy and Cheruvu, 2009) is cost estimation.	(Pagoropoulos et al. 2017)
Customer Facing Units	Once channel control is established, companies must create customer-facing units to manage strategic engagements with the customer, develop value propositions, integrate systems and provide operational services.	(Davies et al. 2006)
Data	The car-sharing company provides the service to support the reservation of cars by informing the customers about the available cars and managing the reservation data in the DEFINE step.	(Lim et al. 2012)
Data interface	Indicates how communication information is transferred between components, which is mainly related to the software discipline of mechatronic systems.	(Zheng et al. 2016)
Data processing	Further capabilities include service-related data processing, risk mitigation, design-to-service, and hybrid-offering sales and/or deployment (Ulaga and Reinartz, 2011).	(Gebauer et al. 2017)
Data Processing and Analysis	Data processing and analysis relied primarily on business logic delivered by means of Business Intelligence tools, combined with Artificial Intelligence for data analytics.	(Pagoropoulos et al. 2017)
Derived requirements	During system design, technological choices can potentially lead to new functions, new input/output and control flows, and new physical interfaces. These new elements can lead to the creation of new system requirements, called derived requirements. Corresponding derived requirements should be added to the system requirements baseline when they impact the system-of-interest (SoI). This may be achieved through the knowledge and experience of the systems engineer or through the application of system patterns.	(SEBOK1.8 2017)
Digital Infrastructure	As projects and activities gradually became more standardized, the role of the researchers changed to supporting digital infrastructure and refining digital	(Pagoropoulos et al. 2017)

Concept	Definition	Reference
Effect: Traceability, Monitoring, Maintainability, and Reparability	This level represents the effects that PSS subsystems exert upon the PSS functional performance. As previously discussed, the effects that PSS subsystems have on the PSS functional performance can be: (a) change, (b) maintain, and (c) measure/monitor. Reparability belongs to the first effect, while Maintainability to the second one.	(Estrada & Romero 2016)
Enabler: Digital capabilities	Digital capabilities are critical enablers for service delivery	(Chesbrough & Spohrer 2006)
Enabler: Digital capabilities	Digital capabilities allow PSS supply chains to be responsive, facilitating PSS implementation and delivery.	(Pagoropoulos et al. 2017)
Energy interface	Indicates how energy (electrical energy, mechanical energy...) is transferred between elements.	(Zheng et al. 2016)
Financing capabilities	To help customers purchase high-cost products and manage an installed base of capital assets.	(Brady et al. 2005)
Function	“The intended purpose of the system”	(Keuneke 1991)
Function	PSS delivers Function	(Van Ostaeyen et al. 2013)
Functional requirements	Functional requirements are directly related to the primary capability provided by the system-of-interest	(Bertoni et al. 2016)
Functional analysis	PSS solution design based on scenarios is proposed for functional analysis (FA).	(Andriankaja et al. 2018)
Functional Performance Indicator	The functional performance of a system describes how well its functions or intended purposes are being performed. Functional performance can be assessed by looking at a combination of Functional Performance Indicators (FPIs). Occasionally, one FPI suffices to demonstrate how successful a particular function is attained, but in most cases, functional performance should be assessed according to a heterogeneous set of FPIs.	(Van Ostaeyen et al. 2013)

Concept	Definition	Reference
Functionality	The representation of PSS's behavior	(Estrada & Romero 2016)
Functionality: Reliability, Availability, and Responsiveness	Reliability expresses the effectiveness dimension of the PSS function, while Availability and Responsiveness represent the efficiency dimension.	(Estrada & Romero 2016)
Ideas of services per life cycle stage of the PSS	Explore new services opportunities	(Andriankaja et al. 2018)
Infrastructure	Any artifacts specifically required to provide products and services (e.g., technologies, devices, and servicescape evidence, such as spatial layouts)	(Lim et al. 2012)
Infrastructure	In moving towards system innovation, it has been recognized that a change in the device concept must be accompanied by a change in the infrastructural or institutional context in which the device is both designed and used	(Williams 2007)
Infrastructure	Within existing notions of PSS, infrastructure represents “existing structures and systems within society, such as recycling technologies, waste collection points, and incineration plants, the existence and suitability of which should be considered when a product and services are developed”. Against this background, it is likely that, within the mobility field, current versions of use-oriented and result-oriented services have the potential to facilitate significant changes to the institutional and infrastructural context.	(Williams 2007)
Infrastructure capabilities	A complementary capability we have termed ‘appropriate retention of service infrastructure’, allows customers to support the service delivery process; for example, in-house providers to service older products and external providers to service newer technology.	(Story et al. 2017)
Infrastructure: Information System	An information system is needed to manage the reservation data (DEFINE step), authenticate the user (CONFIRM step), and calculate the distance driven and time elapsed (CONCLUDE step).	(Lim et al. 2012)

Concept	Definition	Reference
Infrastructure: Physical Space (Physical Infrastructure)	parking spaces, such as off-street public and private parking spaces, are needed for parking the cars and delivering them to customers in the LOCATE and CONCLUDE steps	(Lim et al. 2012)
Infrastructure: Service Station	Repair stations are required to repair the damaged cars in the RESOLVE step	(Lim et al. 2012)
Infrastructure: Software	Third, user authentication technology is needed for user authentication in the CONFIRM and CONCLUDE steps.	(Lim et al. 2012)
Innovation types	Product and process redesign, Functional innovation, Institutional innovation, System innovation	(Williams 2007)
Integrated solutions life cycle	Strategic engagement (system Requirements) , value proposition (system Function), system integration (system logical & Physical structure) and operational services phase	(Davies & Hobday 2014)
Interaction	An instance of an operational entity (system, organization, or services) interface. It can connect to other operational entities according to its Interaction Specification.	(Fosse & Delp 2013)
Interaction Specification	Describes how an operational entity (system, organization, or service) can affect another operational entity when a connection exists.	(Fosse & Delp 2013)
Interface	The system boundary that is presented by a system for interaction with other systems.	(Fosse & Delp 2013)
Interface	<ol style="list-style-type: none"> 1. A shared boundary between two functional units, defined by various characteristics pertaining to the functions, physical signal exchanges, and other characteristics. (ISO/IEC 1993) 2. A hardware or software component that connects two or more other components for the purpose of passing information from one to the other. (ISO/IEC 1993) 3. To connect two or more components for the purpose of passing information from one to the other. (ISO/IEC/IEEE 2009) 	(SEBOK1.8 2017)
Interface compatibility	“Ensuring interface compatibility is the process of identifying all functional and physical characteristics of interacting entities from different organization and the proposed characteristics are assessed and approved before implementation”.	(Zheng et al. 2016)

Concept	Definition	Reference
Interface Requirement	A requirement that defines the conditions of interaction between items. Includes logical and physical interfaces. (EIA 632)	http://homepages.laas.fr/kader/Glossaire_IS.pdf
Interface Specification	Interface Specification Describes the nature of the boundary presented by a system or component in terms of properties and functionality.	(Fosse & Delp 2013)
Interfaces	<p>The interface between two components (C_I_C) indicates how one component connects, interacts and collaborates with another. we describe it as interfaces between tangible components and intangible components (TC_I_IC), and between subsystems (SS_I_SS)</p> <p>The interface between component and environment (C_I_E) indicates how the component operates and functions in a certain environment. we describe it as interfaces between environment and tangible components (TC_I_E), intangible components (IC_I_E), subsystems (SS_I_E)</p> <p>The interface between component and interface (C_I_I) indicates that are interface must be accommodated by the effects generated by other components, such as heat, magnetic fields, vibration, and other effects, or one component must be accommodated by the effects generated by an interface. We describe it as interfaces between the interface and tangible components (TC_I_I), intangible components (IC_I_I), subsystems (SS_I_I)</p> <p>The interface between two interfaces (I_I_I) indicates that two interfaces are affected and interacted by each other. (I_I_I)</p> <p>The interface between the environment and interface (I_I_E) Indicates how an interface is affected by environmental effects. (I_I_E)</p>	(Zheng et al. 2016)
Iterations between Logical and Physical Architecture Model Development	<p>Whatever the approach, architecture activities require spending several iterations between logical architecture models development and physical architecture models development, until both logical and physical architecture models are consistent and provide the necessary level of detail. One of the first architecture activities is the creation of a logical architecture model based on nominal scenarios (of functions). The physical architecture model is used to determine main system elements that could perform system functions and to organize them.</p>	(SEBOK1.8 2017)

Concept	Definition	Reference
Knowledge	Resources include the firm's knowledge and organizational capabilities.	(Pagoropoulos et al. 2017)
Knowledge-Based Capabilities	“This study specifically addresses advanced services capabilities and provides six propositions of capabilities that appear unique and critical for advanced services.” Knowledge-Based Capabilities are one of them.	(Story et al. 2017)
Knowledge-Based Process	Furthermore, the knowledge-based view of the firm describes, in general terms, the creation, integration, and transfer of knowledge. This view has recently been used to identify key knowledge processes, in order to explain why product firms fail in their service growth initiatives (Valtakoski, 2016).	(Gebauer et al. 2017)
Local service infrastructure	Developing a global infrastructure operational at a local level Oliva and Kallenberg (2003)	(Story et al. 2017)
Logical architecture/ Logical View of the System Architecture	Subsequent logical architecture model iterations can take into account allocations of functions to system elements and derived functions coming from physical solution choices. The logical architecture model of an engineered System of Interest (SoI) is composed of a set of related technical concepts and principles that support the logical operation of the system.	(SEBOK1.8 2017)
Macro-level interface	Describes the associations between subsystems, both to indicate their inter-dependence and to provide high-level guidance for how subsystems should be joined in the final product. The macro level interfaces can help engineers to achieve the basis for integration of the subsystems.	(Zheng et al. 2014)
Micro-level interface	The engineers need another kind of interface which allows them to exchange and share information or data from other disciplines during the process of mechatronic design. It intends to help designers to collaborate or coordinate by sharing information through formal or informal interaction.	(Zheng et al. 2014)

Concept	Definition	Reference
Network Capabilities	Network capabilities for both providers and customer, as the locus of value creation, moves from the “producer” to a collaborative process of value co-creation between parties (Vargo and Lusch,2008). Network capabilities are often a prerequisite for external stakeholders since they enable customer value creation (Berghman et al., 2006) and facilitate the transition towards PSS (Story et al., 2016).	(Pagoropoulos et al. 2017)
Non-functional requirements	Non-functional requirements relate to aspects like availability, supportability, security, and training.	(Bertoni et al. 2016)
Operational Function	SOI performs Operational Function	l’EIA-632
Operational service capabilities	To maintain, operate, upgrade and renovate a product through its operational life cycle,	(Brady et al. 2005)
Operational Status: Robustness, Stability, and Recoverability	PSS operational status, which can be “above minimum required performance level”, or “below the minimum required performance level”. Both Robustness and Stability belong to the first PSS status.	(Estrada & Romero 2016)
Organizational Interface	The organizational interface is used to guide the design tasks and support collaboration throughout the whole design process. The organizational interface can help engineers have well-organised concurrent engineering for mechatronic system design, focusing on possible inconsistencies or poor integration.	(Zheng et al. 2014)
Organizational approach (Organizational approach: Human resource)	Change of mental models to view service as a business opportunity and as a potential source of value creation. It has to support actively a service culture focused on providing a specific training course for a new incentive system. Define a specific team for the new service development & service engineering. Define a specific team for analysis and interpretation of data. Development of Service Business: the creation of the role of sales of service is crucial for the development of the new BM. A dedicated direct sale-channel for service will be established to increase the customers’ awareness of the new offering/ value. Creation of new commercial roles with service attitude: “sales support & customer service profile” is also crucial for the development of the new BM. In the organizational chart, new roles will be defined with an associated list of key activities to be performed.	(Adrodegari et al. 2017)

Concept	Definition	Reference
Organizational Capability	A capability which is difficult to replicate or imitate, and which is value-creating and utilizes rare resources is considered a distinctive capability. By creating distinctive organizational capabilities, firms can gain competitive advantages.	(Gebauer et al. 2017)
Organizational Capability types	Three organizational capabilities for pay-per-use services: (a) financing pay-per-use services, (b) aligning costs to product usage, and (c) collaborating with customers.	(Gebauer et al. 2017)
Organizational Knowledge Hierarchy	The knowledge held by individual organizational members is at the base of this hierarchy. This hierarchy extends upwards, starting with task-specific capabilities, continuing with specialized and activity-related capabilities and further integrating these into functional and cross-functional capabilities (Grant, 1996).	(Gebauer et al. 2017)
Parameter	The class Parameter specifies the principle parameter related to the port which can be quantified, such as the wheel size, the input impedance or the image resolution.	(Zheng et al. 2016)
Physical interface	Indicates how one element is physically connected to another, which is mainly related to the mechanical geometry of interface defined in the feature-based product model for CAD.	(Zheng et al. 2016)
Physical architecture	Once a logical architecture model is defined, concrete physical elements have to be identified that can support functional, behavioral, and temporal features as well as the expected properties of the system deduced from non-functional system requirements.	(SEBOK1.8 2017)
Physical architecture	A physical architecture model is an arrangement of physical elements, (system elements and physical interfaces) that provides the solution for a product, service, or enterprise.	(SEBOK1.8 2017)
Physical architecture input and output	Generic inputs include the selected logical architecture model, system requirements, generic patterns and properties that architects identify and utilize to answer requirements, outcomes from system analysis, and feedback from system verification and system validation. Generic outputs are the selected physical architecture model, allocation matrix of functional elements to physical elements, traceability matrix with system requirements, stakeholder requirements of each system and system element composing the physical architecture model, and rejected solutions.	(SEBOK1.8 2017)

Concept	Definition	Reference
Physical Architecture Development: Focus on Interfaces	Focusing on interfaces rather than on system elements is another key element of a successful architecture and design for abstract levels of systems.	(SEBOK1.8 2017)
Physical Architecture Development: Modularity	Restrict the number of interactions between the system elements and consider the modularity principle (maximum of consistency inside the system element, minimum of physical interfaces with outside) as the right way for architecting systems.	(SEBOK1.8 2017)
Port	A port is a flow connector with four attributes, a type from the port ontology, a direction, a maximal multiplicity, and a minimal multiplicity.	(Chenouard et al. 2016)
Port	<p>Regarding the needs of the multidisciplinary interface model for the design of mechatronic systems, the “port” refers to the primary location through which one part of the system interacts with other parts of the environment.</p> <p>According to the configurations of interfaces, three types of ports exist in a mechatronic system: Component port, interface port (IP) and environment port (EP).</p> <p>*Component port: The component port is the connection point of a component which interacts with other components of a system. Every component can interact with several components in one system, so one component can possess more than one port.</p> <p>*Environment port: The environment port is the point where the external factor of the environment affects other components of the system. The environment can affect several components in one system, so it can possess more than one port.</p> <p>*Interface port: The interface port is the location which affects other components of the system. Like the part and the environment, the interface can also possess more than one port. However, the main function of one interface is to connect two separated components and to exchange the information between them. Therefore an interface can possess more than one port, But it can only connect two ports. we divided components port to tangible components port (TCP), intangible components port (ICP), and added subsystems port (SSP)</p>	(Zheng et al. 2016)

Concept	Definition	Reference
PPO model	The PPO model is effective to support for the development process of a complex system because the data of the product, process, and organization during the design process have been taken into account by the PPO model, but it should be further specialized for mechatronic system design. As shown with recent PPO model developments, PPO is generally considered as an extensible data model.	(Zheng et al. 2014)
Procedure and practices (Organizational approach: Business Processes)	Define procedures that formalize the product and service design phase, ensuring the participation of different business function and defining their role. Define a procedure that formalizes and standardize back- office processes (while maintaining front-office customization) and service delivery. Marketing initiative for new full-service contracts / new monitoring services (publicity and communication) Marketing and commercial specific approach to customers. The company has started developing a dedicated page on the website to new services that will be offered to customers.	(Adrodegari et al. 2017)
Process-Activity-role	Process-Activity-role	(Bullinger et al. 2003)
Product Based Capabilities	“This study specifically addresses advanced services capabilities and provides six propositions of capabilities that appear unique and critical for advanced services.” Product Based Capabilities are one of them.	(Story et al. 2017)
product specifications	Engineers refine hardware specifications to optimize service intervals	(Bertoni et al. 2016)
Product Functional specification	Specify the functional requirements of Technical system (product)	(Andriankaja et al. 2018)
Product metamodel (Activity, Product, Resource, Organization)	*The activity package groups activities such as projects and process planning. *The product package groups the products produced by the enterprise and all their components. *The resource package groups the work centers, the tools, the humans and the software of the company. *The organization package groups suppliers, customers and collaborators of the company.	(le Duigou et al. 2011)
product modularity	concepts such as product modularity and upgradeability may become an increasingly important part of the design process	(Williams 2007)

Concept	Definition	Reference
Product Technical specification	Specify the functional architecture of Technical system (product)	(Andriankaja et al. 2018)
PSS Function Determination Process	Translation from PSS functional requirements into PSS non-functional requirements. Both functional result and functional performance enable the translation from PSS functional requirements into PSS non-functional requirements	(Estrada & Romero 2016)
PSS functional requirements: The subjective dimension of representation for PSS Function	The subjective representation describes customer demands (what the customer wants the PSS to do); for the case of the proposed approach, this subjective representation is called: PSS functional requirements.	(Estrada & Romero 2016)
PSS functional performance	Expresses how many functional results are being delivered and how well	(Van Ostaeyen et al. 2013)
PSS functional result	The standardized unit of function delivery (system output)	(Van Ostaeyen et al. 2013)
PSS Information category	PSS product and service attributes	(Pacheco et al. 2016)
PSS Information category for BOL (Product-related data: electricity mix)	Electricity mix used by the supply chain element. Electricity is a very important energy carrier that can be obtained through different technologies, characterized by different environmental and economic impacts. Electricity mix is thus crucial in order to assess the sustainability effects of a specific operation performed both upstream, for instance in a manufacturing process, and downstream, for instance, the use of a product. Each supply chain member can be characterized by a different electricity mix, that is in turn characterized by a specific cost and impact on nature. Energy mixes may vary from national mixes to a very specific one if the supply chain element is able to generate its electrical energy by its own or is able to choose the source of the electricity purchased.	(Corti et al. 2016)
PSS Information category for BOL (Service-related data: electricity mix)	Amount of recycled/reused material, components, and refurbished products	(Corti et al. 2016)

Concept	Definition	Reference
PSS Information category for BOL (Product-related data: Product BOM)	The tree structure of the product representing assemblies and components constituting the product itself; *Materials used for each component; o quantity of material, components and subcomponents (coefficient of use) included in one unit of product o defectiveness o list of the manufacturing operations performed internally to obtain each component.	(Corti et al. 2016)
PSS Information category for BOL (Product-related data: Supply Chain)	* Structure of the supply chain. The supply network is described considering both upstream elements (material suppliers, components suppliers, operation suppliers...) and downstream ones (distributors, logistic partners, the market or directly the customer...); * distance matrix that is a table identifying the distances existing between the supply chain members; * for outsourced operations, the same set of info included in the previous group (internal operations) plus the specification of the supplier providing it in terms of distance, travel costs; * cost of transportation; * cost of purchased materials, components, assemblies and of outsourced operations	(Corti et al. 2016)
PSS Information category for EOL (Service-related data)	<ul style="list-style-type: none"> • The list of the end of life operations performed to dismantle or recover the tangible parts of the PSS. These operations are characterized by elements similar the manufacturing process description such as a functional attribute, specific to the operation type or the operation cost; • service provider; • the cost of service; • energy and materials flows that is possible to recover and to use within the same PSS or in other systems 	(Corti et al. 2016)
PSS Information category for MOL (Product-related data)	<ul style="list-style-type: none"> • The typical parameters which describe the usage scenario of the product. For example, the frequency of use, parameter setting during the functioning and so on. These parameters can vary a lot depending on the type of product that is being considered, so a generalized list can be hardly provided. • an expected lifetime of the product 	(Corti et al. 2016)
PSS Information category for MOL (Service-related data)	<ul style="list-style-type: none"> • List of services that are associated to the product usage (it is worth noting that, even though the customer pays off the performance, the tangible part of the offer is always assumed to be present). For each service, the following information is needed: <ul style="list-style-type: none"> o the average number of time the service will be requested over the product life cycle; o associated consumables needed to provide the service; o service supplier and distances traveled to deliver the service; o cost of the service; • consumables needed to use the product specifying their quantity, origin and unitary cost. 	(Corti et al. 2016)

Concept	Definition	Reference
PSS infrastructure	PSS infrastructure is defined according to the PSS process steps	(Lim et al. 2012)
PSS non-functional requirements: The objective dimension of representation for PSS Function	The objective representation of the function of the PSS corresponds to the set of attributes that the PSS must exhibit in order to comply with customer demands. This dimension is called: PSS non-functional requirements.	(Estrada & Romero 2016)
Requirement	System Structure satisfies Requirement definition	(Gardan & Matta 2017)
Resource alignment	Resource realignment defined as “the comprehensive process of structuring the firm ’s resource portfolio, bundling the resources to build capabilities, and leveraging those capabilities with the purpose of creating and maintaining value for customers and owners . . . using processes (i.e., acquiring, accumulating, and divesting) to obtain the resources that the firm will use for bundling and leveraging purposes” (Sirmon, Hitt, and Ireland 2007, p. 273), is critical for creating value through a business model shift.	(Huikkola et al. 2016)
Resources	Immaterial Resource, Material Resource, Human Resource.	(Bullinger et al. 2003)
Reusable Integrated Solution	The modular reusable approach cuts costs and improves the reliability of the integrated Solution.	(Davies et al. 2006)
Revenue Mechanism	How the elements within the PSS (products and services) generate income for the PSS provider.	(Van Ostaeyen et al. 2013)
RFLP	The RFLP approach is a specific V-model derived method particularly adapted to design of the mechatronic system. The RFLP method fully supports concurrent engineering. Multi-domain modeling methods are used to fully support the macro level collaboration in the logic view.	(Zheng et al. 2014)
Service dimensions	Describe service development by using the dimensions outcome, structure and process.	(Sandin & Berggren 2015)

Concept	Definition	Reference
Service dimensions: outcome	The first dimension outcome concerns the service product, i.e. what the service produces. This can be modeled in different ways to analyze the impact on the customer: as a product model, a view model, an intentional service model, and a scenario model.	(Sandin & Berggren 2015)
Service dimensions: process (value delivery chain)	The third dimension process can be described in the model of all the activities, from the initial provider to the final receiver.	(Sandin & Berggren 2015)
Service dimensions: resources	The second dimension, resources, is connected to human, material as well as immaterial resources in a resource model.	(Sandin & Berggren 2015)
Service enabler	A software agent and defined as “an information management system or expert system or combination of both that is capable of receiving product life cycle data and using them to facilitate the creation and delivery of appropriate product-related services during a product life cycle“. It is a collection of suitable software components such as database, knowledge base, information engine and inference engine capable of receiving product life cycle data and processing them to provide information and knowledge which can then be used by service providers in the delivery of services (e.g. remote diagnostics, life cycle monitoring). The service enabler is different from the service provider in that service enabler is concerned with information extraction and knowledge discovery from the life cycle data gathered and packaging or integrating them into suitable service content, whereas the service provider is responsible for providing services to the customers and Stakeholders.	(Yang et al. 2009)
Service operation	"To co-create integrated solutions in manufacturing contexts, the Service Design and PSS approaches require better coupling. This is especially important at later stages of the design process for operationalizing the service system and the organizational network to enable the desired customer experience"	(Costa et al. 2018)
Services opportunities catalog	Specify services opportunities	(Andriankaja et al. 2018)
servitization	The notion of servitization refers to a strategy of dematerialization and environmentally conscious design and manufacturing by adding services to product”.	(Vandermerwe & Rada 1988)

Concept	Definition	Reference
servitization	Servitization affect the hardware design process	(Bertoni et al. 2016)
solutions-ready products and solutions-ready services	Provide common components of solutions-ready products and services that can be “mixed and matched” in different combinations by the Customer Facing Units.	(Davies et al. 2006)
System element	A system element is a discrete part of a system that can be implemented to fulfill design properties. A system element can be hardware, software, data, humans, processes (e.g., processes that provide a service to users), procedures (e.g., operator instructions), facilities, materials, and naturally occurring entities (e.g., water, organisms, and minerals), or any combination of these ISO/IEC/IEEE 15288 (ISO 2015). A physical interface binds two system elements together; this is similar to a link or a connector.	(SEBOK1.8 2017)
System Integration Capability	To design and integrate systems composed of internally or externally developed hardware, software, and services,	(Brady et al. 2005)
Technology	The role of technology in product-service integration	(Lim et al. 2012)
Tool (Organizational approach: Digital Capabilities)	The creation of the new diagnostic tool (HW/SW) will be the key element for the implementation of the new BM. The new diagnostic tool will provide the service technician with the capability of understanding the health state of the critical electro-spindle component Define the list of data and protocol: list of failures we want to recognize, validate the defined test protocol and add predictive capabilities to the SW. New additional sensors will be added in order to improve spindle diagnostics: an analogical sensor for drawbar positioning; part contact sensor that prevents start rotation when there is contact; temperature sensors on the upper and lower bearings; a temperature sensor on the motor; a 3 axial accelerometer to monitor vibrations on the spindle	(Adrodegari et al. 2017)

Annex III: UML diagrams of the global model

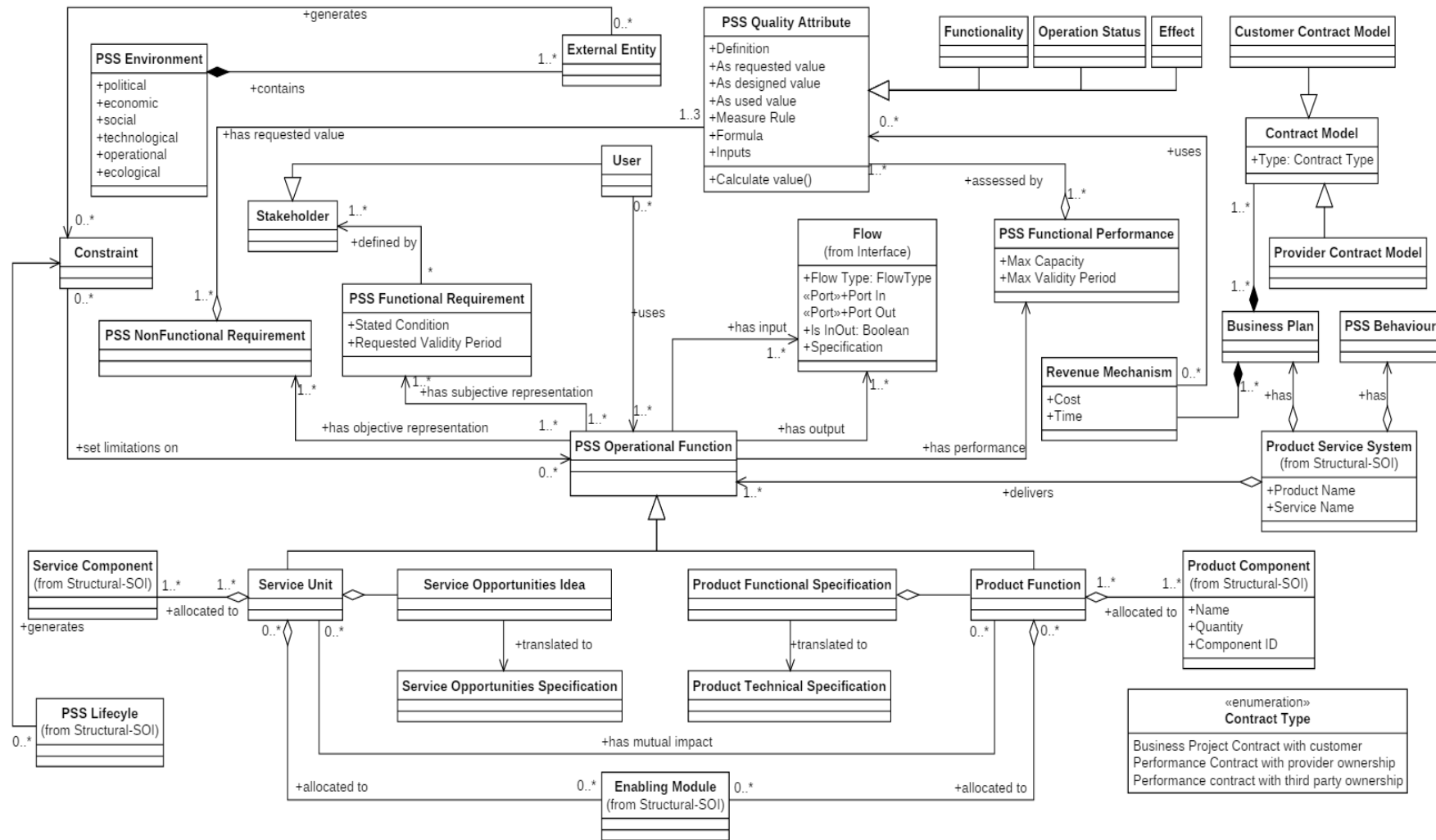

Figure 81. PSS requirement-function global model

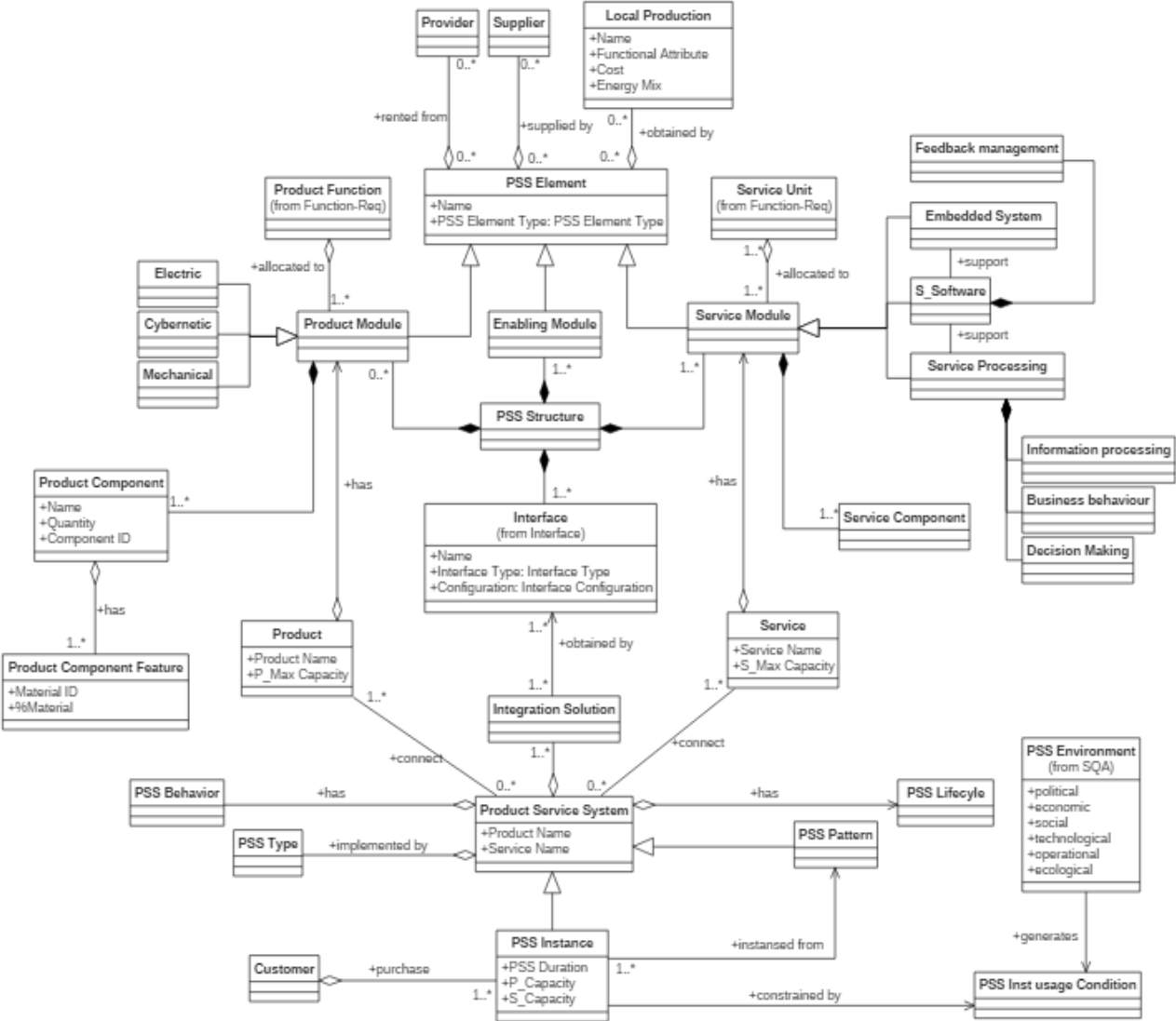

Figure 82. The global model of System of Interest

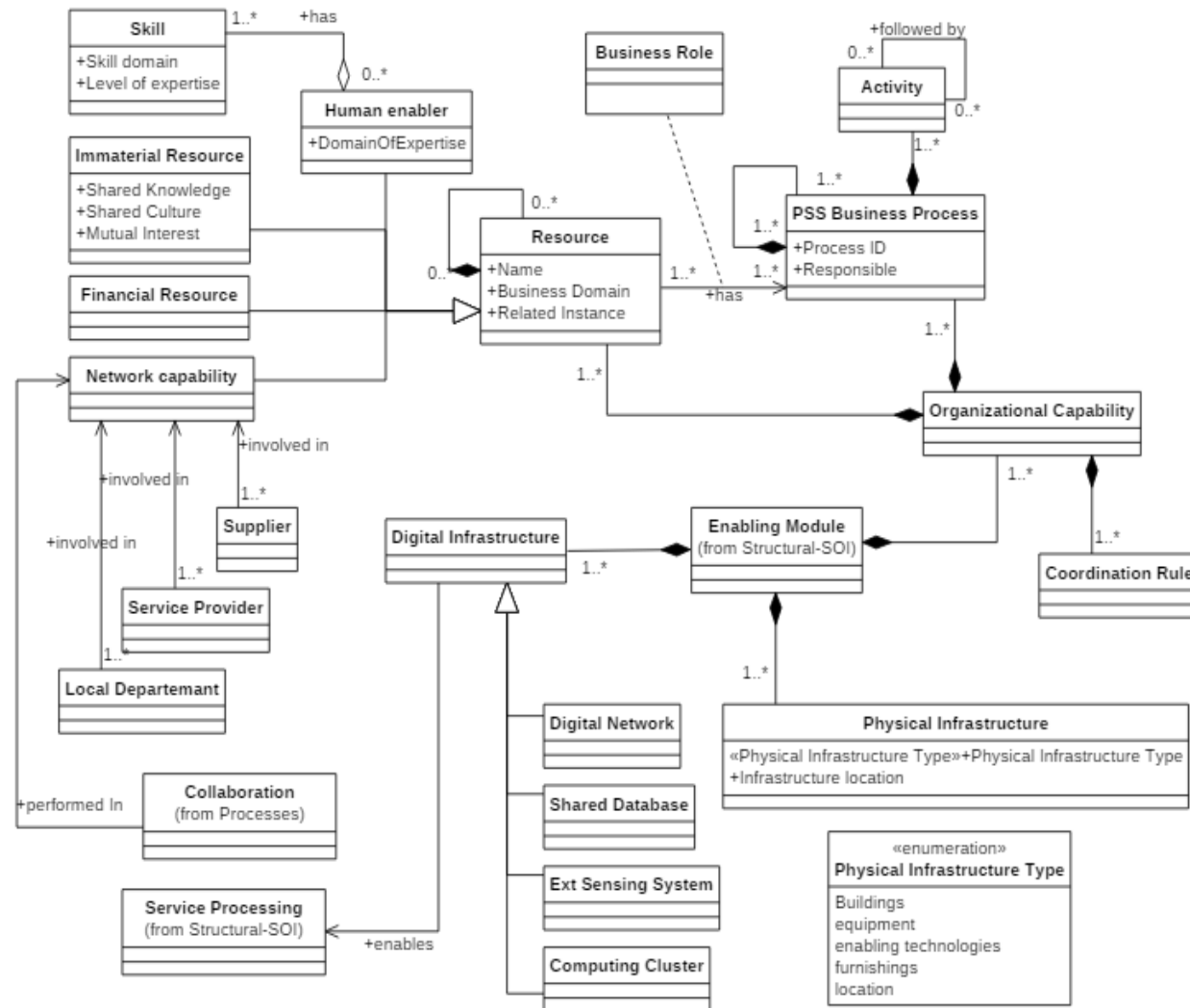

Figure 83. The global model of the Enabling Systems

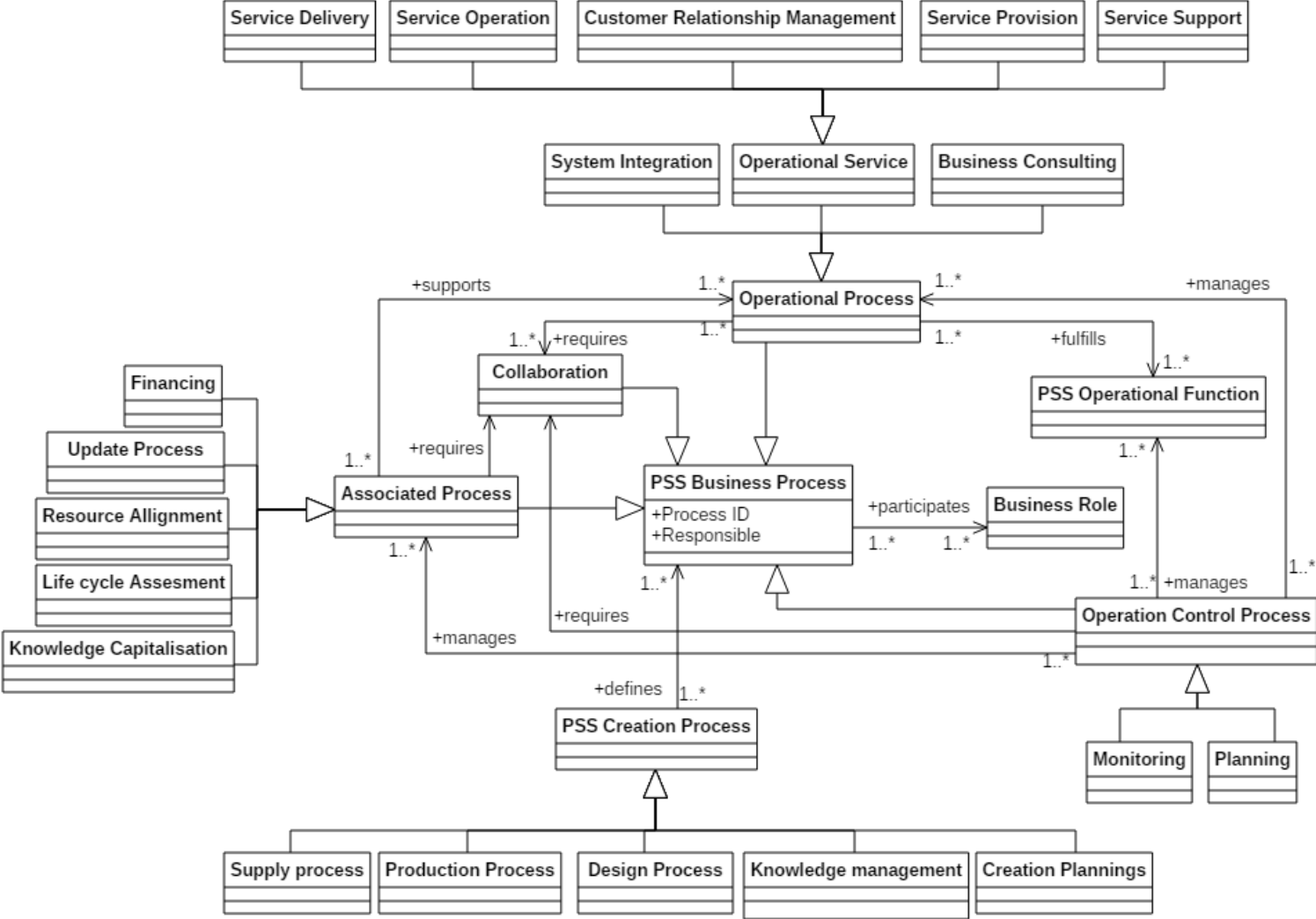

Figure 84. The global model of PSS business processes

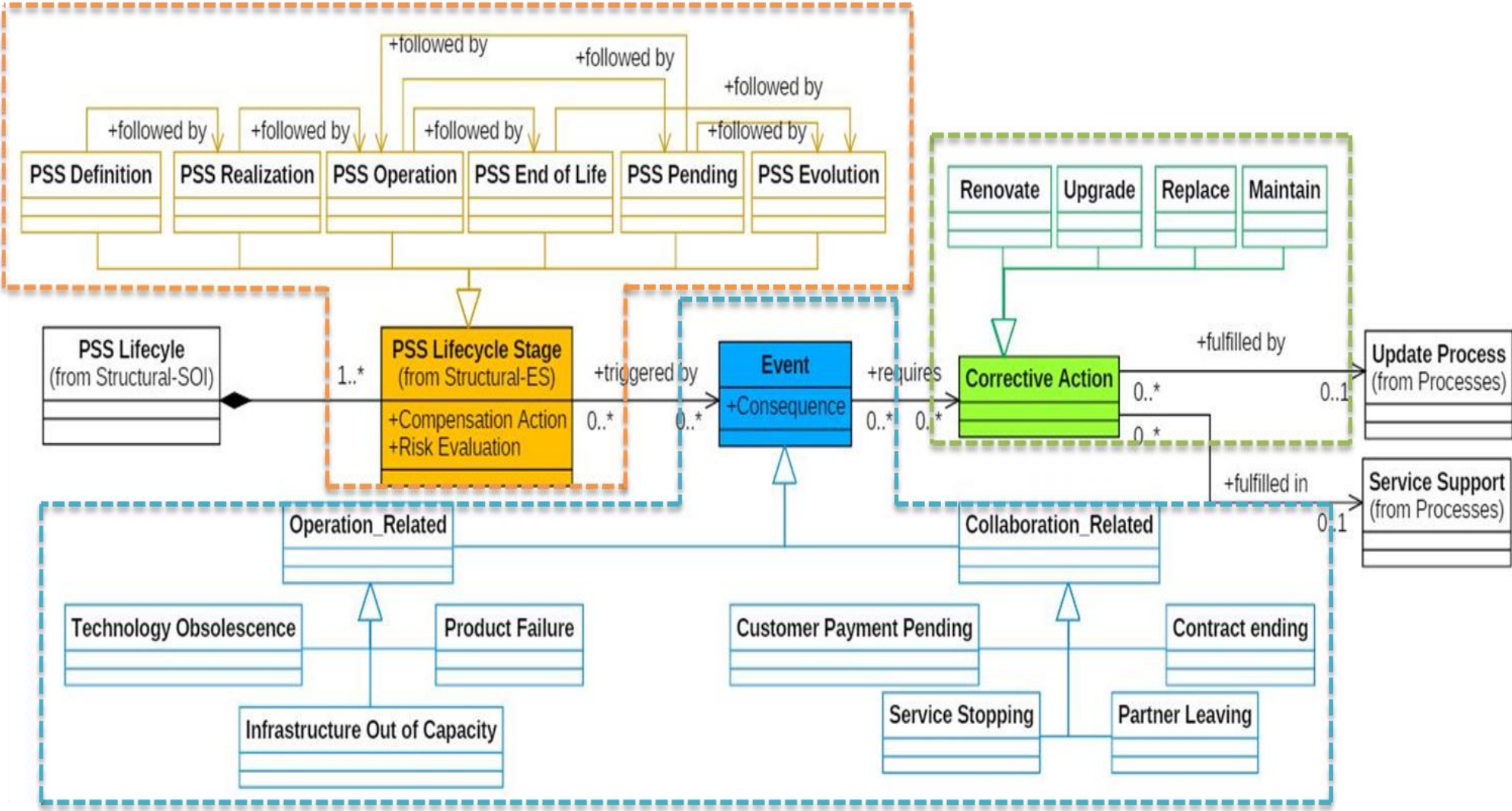

Figure 85. PSS life cycle schema

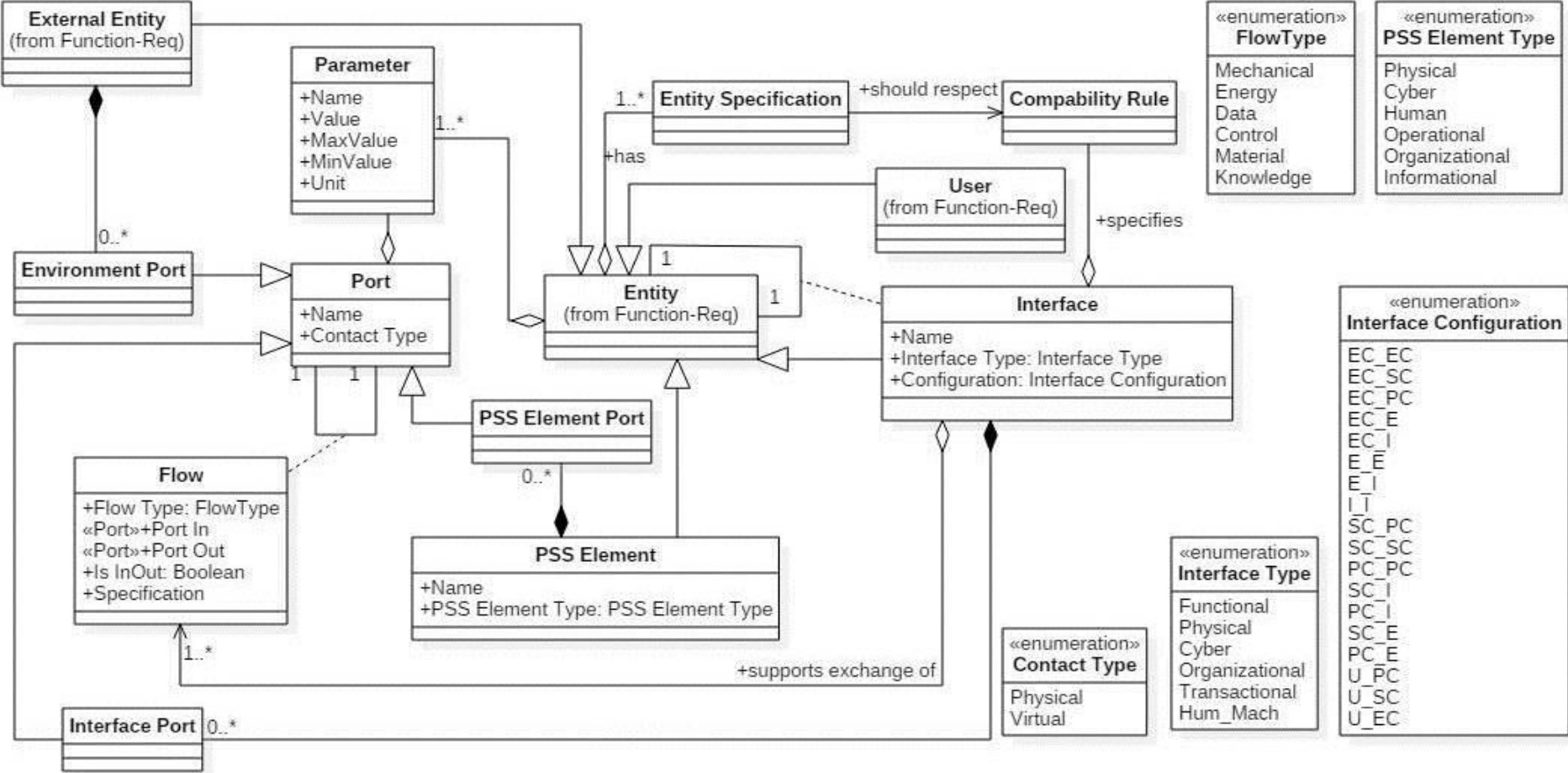

Figure 86. PSS interfaces model

Titre : Un modèle sémantique basé sur l'ingénierie des systèmes pour supporter le cycle de vie des Systèmes "Produit-Service"

Mots clés : Système Produit-Service, Modèle sémantique, L'Ingénierie des Systèmes, Ontologie, ICP4Life

Résumé : Les Systèmes Produit-Service (SPS) résultent d'une intégration de composants hétérogènes couvrant à la fois des aspects matériels et immatériels (mécanique, électrique, logiciel, processus, organisation, etc.). Le processus de développement d'un SPS est fortement collaboratif impliquant des acteurs métier très variés.

Ce caractère interdisciplinaire nécessite des référentiels sémantiques standardisés pour gérer la multitude des points de vue métier et faciliter l'intégration de tous les composants hétérogènes dans un système unique. Ceci est encore plus complexe dans le cas des PSS personnalisables, majoritaires dans le milieu industriel. Malgré les nombreuses méthodologies dans littérature, la gestion des processus de développement du SPS reste encore limitée face à cette complexité.

Dans ce contexte, l'Ingénierie des Systèmes (IS) pourrait être une solution avantageuse au regard de ses qualités bien prouvées pour la modélisation et la gestion de systèmes complexes.

Cette thèse vise à explorer le potentiel d'utilisation de l'Ingénierie des Systèmes (IS) comme fondement conceptuel pour représenter d'une façon intégrée tous les différents points de vue métier associés au cycle de vie du PSS. Dans ce cadre, un méta-modèle de SPS est proposé et exemplifié dans des cas industriels. Un modèle ontologique est aussi présenté comme une application d'une partie des modèles pour structurer le référentiel commun de la plateforme ICP4Life.

Title: A Systems Engineering-based semantic model to support "Product-Service System" life cycle

Keywords: Product-Service System (PSS), Semantic model, Systems Engineering (SE), Ontology, ICP4Life

Abstract: Product-Service Systems (PSS) result from the integration of heterogeneous components covering both tangible and intangible aspects (mechanical, electrical, software, process, organization, etc.). The process of developing PSS is highly collaborative involving a wide variety of stakeholders. This interdisciplinary nature requires standardized semantic repositories to handle the multitude of business views and facilitate the integration of all heterogeneous components into a single system. This is even more complex in the case of customizable PSS in the industrial sector. Despite the many methodologies in literature, the management of the development processes of the PSS is still limited to face this complexity.

In this context, Systems Engineering (SE) could be an advantageous solution in terms of its proven qualities for the modeling and management of complex systems.

This thesis aims at exploring the potentials of Systems Engineering (SE) as a conceptual foundation to represent various different business perspectives associated with the life cycle of the PSS. In this context, a meta-model for PSS is proposed and verified in industrial cases. An ontological model is also presented as an application of a part of the model to structure the common repository of the ICP4Life platform.