



HAL
open science

Bringing methodological light to ecological processes : are ecological scales and constrained null models relevant solutions?

Sylvie Clappe

► **To cite this version:**

Sylvie Clappe. Bringing methodological light to ecological processes : are ecological scales and constrained null models relevant solutions?. Ecology, environment. Université de Lyon, 2018. English. NNT : 2018LYSE1272 . tel-02411567v1

HAL Id: tel-02411567

<https://theses.hal.science/tel-02411567v1>

Submitted on 15 Dec 2019 (v1), last revised 16 Dec 2019 (v2)

HAL is a multi-disciplinary open access archive for the deposit and dissemination of scientific research documents, whether they are published or not. The documents may come from teaching and research institutions in France or abroad, or from public or private research centers.

L'archive ouverte pluridisciplinaire **HAL**, est destinée au dépôt et à la diffusion de documents scientifiques de niveau recherche, publiés ou non, émanant des établissements d'enseignement et de recherche français ou étrangers, des laboratoires publics ou privés.



Numéro d'ordre NNT: 2018LYSE1272

THÈSE de DOCTORAT DE L'UNIVERSITÉ DE LYON

opérée au sein de

l'Université Claude Bernard Lyon 1

École Doctorale N° 341

Evolution, Écosystèmes, Microbiologie, Modélisation

Spécialité de doctorat : Écologie Statistique

Discipline : Écologie

Soutenue publiquement le 14/12/2018 par :

Sylvie Clappe

Bringing methodological light to ecological processes: are ecological scales and constrained null models relevant solutions?

Devant le jury composé de :

Fortin Marie-Josée, Professeure, Université de Toronto

Gillet François, Professeur, Université de Franche-Comté

Doledec Sylvain, Professeur, Université Lyon 1

Meynard Christine, Chargée de recherche INRA, CBGP

Rapporteure

Rapporteur

Examineur

Examinatrice

Dray Stéphane, Directeur de recherche CNRS, Université Lyon 1

Peres-Neto Pedro, Professeur, Université de Concordia

Directeur de thèse

Co-directeur de thèse

UNIVERSITÉ CLAUDE BERNARD - LYON 1

Président de l'Université	M. le Professeur Frédéric FLEURY
Président du Conseil Académique	M. le Professeur Hamda BEN HADID
Vice-président du Conseil d'Administration	M. le Professeur Didier REVEL
Vice-président du Conseil Formation et Vie Universitaire	M. le Professeur Philippe CHEVALIER
Vice-président de la Commission Recherche	M. Fabrice VALLÉE
Directrice Générale des Services	Mme Dominique MARCHAND

COMPOSANTES SANTÉ

Faculté de Médecine Lyon Est – Claude Bernard	Directeur : M. le Professeur G.RODE
Faculté de Médecine et de Maïeutique Lyon Sud – Charles Mérieux	Directeur : Mme la Professeure C. BURILLON
Faculté d'Odontologie	Directeur : M. le Professeur D. BOURGEOIS
Institut des Sciences Pharmaceutiques et Biologiques	Directeur : Mme la Professeure C. VINCIGUERRA
Institut des Sciences et Techniques de la Réadaptation	Directeur : M. X. PERROT
Département de formation et Centre de Recherche en Biologie Humaine	Directeur : Mme la Professeure A-M. SCHOTT

COMPOSANTES ET DÉPARTEMENTS DE SCIENCES ET TECHNOLOGIE

Faculté des Sciences et Technologies	Directeur : M. F. DE MARCHI
Département Biologie	Directeur : M. le Professeur F. THEVENARD
Département Chimie Biochimie	Directeur : Mme C. FELIX
Département GEP	Directeur : M. Hassan HAMMOURI
Département Informatique	Directeur : M. le Professeur S. AKKOUCHE
Département Mathématiques	Directeur : M. le Professeur G. TOMANOV
Département Mécanique	Directeur : M. le Professeur H. BEN HADID
Département Physique	Directeur : M. le Professeur J-C PLENET
UFR Sciences et Techniques des Activités Physiques et Sportives	Directeur : M. Y. VANPOULLE
Observatoire des Sciences de l'Univers de Lyon	Directeur : M. B. GUIDERDONI
Polytech Lyon	Directeur : M. le Professeur E. PERRIN
Ecole Supérieure de Chimie Physique Électronique	Directeur : M. G. PIGNAULT
Institut Universitaire de Technologie de Lyon 1	Directeur : M. le Professeur C. VITON
École Supérieure du Professorat et de l'Éducation	Directeur : M. le Professeur A. MOUGNIOTTE
Institut de Science Financière et d'Assurances	Directeur : M. N. LEBOISNE



Thèse réalisée au : Laboratoire de Biométrie et Biologie Evolutive – Université Lyon 1,
Bât. Grégor Mendel, 43 bd du 11 novembre 1918,
69622 VILLEURBANNE cedex,
France

et au : Laboratory of Community and Quantitative Ecology,
Concordia University, Loyola Campus,
7141 Sherbrooke Street West,
Montreal, Quebec H4B 1R6,
Canada

Financée par : Bourse ministérielle française

Sous la direction de: Stéphane Dray (Université de Lyon)
et Pedro Peres-Neto (Université de Concordia)

Scientific contributions

Publications

- **Published**

S. Clappe, S. Dray and P. R. Peres-Neto. 2018. Beyond neutrality: disentangling the effects of species sorting and spurious correlations in community analysis. *Ecology*, 99 (8): 1737-1747.

- **Submitted**

J. Crabot * , S. Clappe * , S. Dray and T. Datry. 2018. Restoring the Mantel statistic with a spatially-constrained permutation procedure. Submitted in *Method in Ecology and Evolution*.

* These authors contributed equally to this work

- **In preparation**

S. Clappe, P. R. Peres-Neto and S. Dray. Phylogenetic and spatial scaling of trait-mediated environmental filtering.

B. Fournier, H. Vazquez-Rivera, S. Clappe, L. Donelle, P. H. Henrique Pereira and P. R. Peres-Neto. The spatial frequency of climatic conditions drives the functional composition of Angiosperm communities at the global scale.

Talks in national and international conferences

- **2017:** S. Clappe, P.R. Peres-Neto and S. Dray, Phylogenetic and spatial scaling of trait-mediated environmental filtering. *Ecology Across Borders: Joint Annual Meeting 2017* (Ghent, Belgium)
- **2017:** S. Clappe and Louis Donelle (co-presentation), Oecologia in silico : l'utilisation de simulations pour comprendre les processus écologiques. *R Québec 2017* (Québec, Canada)

- **2016: S. Clappe**, S. Dray and P.R. Peres-Neto, Beyond neutrality: disentangling the effects of species sorting and spurious correlations in community analysis. *Invited seminar at the National Research Institute of Science and Technology for Environment and Agriculture* (Lyon, France)
- **2016: S. Clappe**, S. Dray and P.R. Peres-Neto, Beyond neutrality: disentangling the effects of species sorting and spurious correlations in community analysis. *GDR Ecostat annual meeting 2016* (Montpellier, France)

*Emportez avec vous votre esprit aux aguets,
Votre curiosité et votre émerveillement,
Nous commençons ensemble une nouvelle histoire...*

*Bring your sharp mind,
Bring your curiosity and your wonder,
Together, we begin a new story....*



REC

Bringing methodological light to ecological processes: are ecological scales and constrained null models relevant solutions?

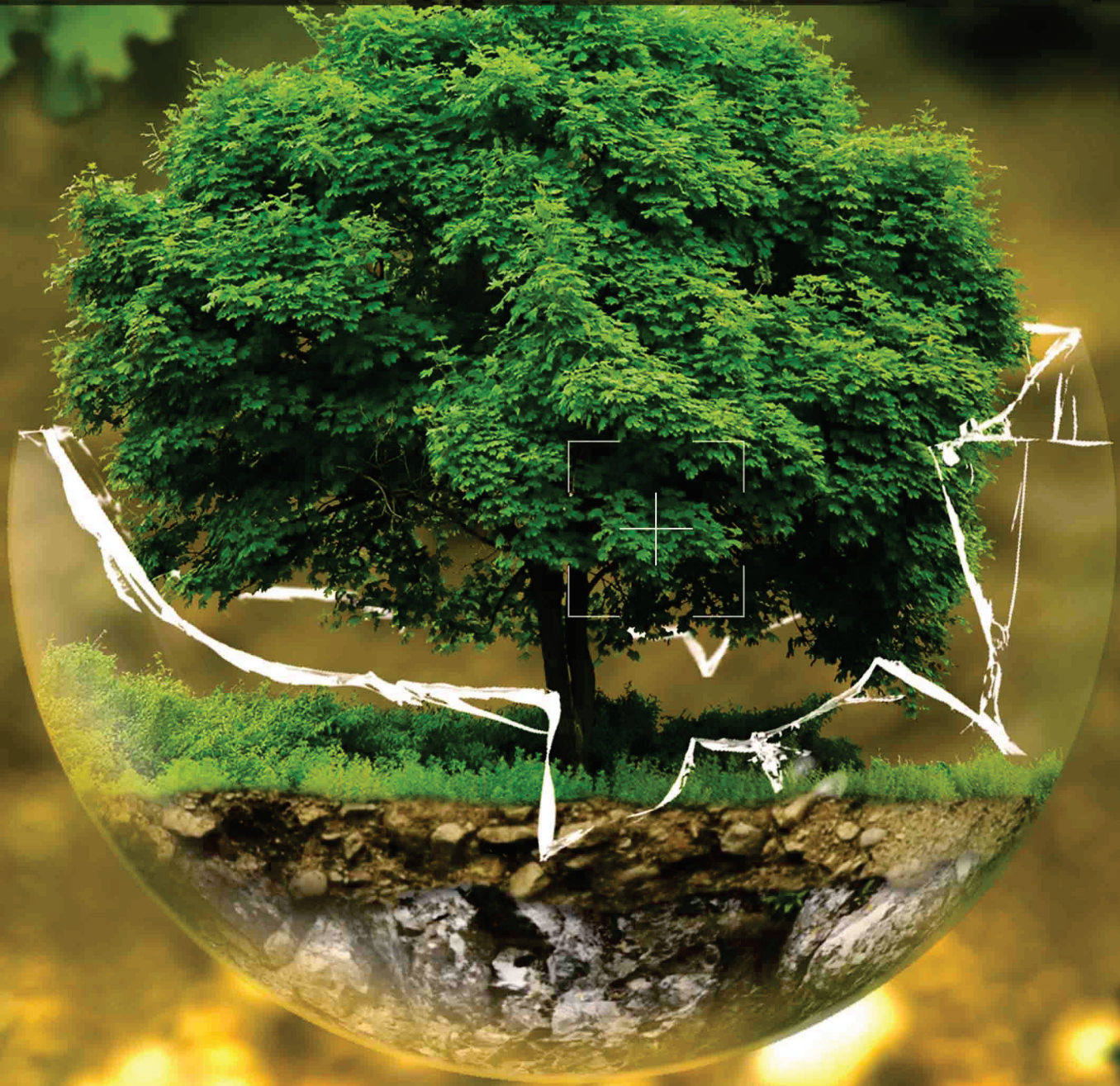

00:00:00

3..2..1...1..2..3

Abstract

Species distributions observed in a heterogeneous environment result from multiple deterministic and stochastic processes acting as filters to constrain species co-existence. As a direct consequence, the successive actions of these processes spatially structure communities composition and the variation of these compositions (i.e., beta-diversity). One of the major objectives in community and metacommunity ecology is to identify and quantify the respective effects of these different processes on communities beta-diversity to better understand and predict the distribution of biodiversity. Experiments being hardly possible, processes responsible for the spatial variation of communities composition are generally inferred from spatial patterns of species distributions observed in nature. In this context, the thesis aims at improving multivariate statistical tools conducted to identify and quantify the effects of ecological processes shaping communities and metacommunities. In particular, this thesis proposes to integrate ecological scales and constrained null models to study the effect of environment.

Decomposing trait-environment relationships through spatial and phylogenetic scales allows to further study environmental filtering. The association of spatial scales involved in environmental filtering with the phylogenetic signals of traits allowed to capture the species evolutive history related to environmental filtering. The interpretation in terms of evolutive processes is however limited and phylogenetically-constrained null models should be considered to improve the analysis. Following on from this work, spatially-constrained null models were developed and integrated into two multivariate analyses widely used in community ecology (i.e., variation partitioning and Mantel tests) to estimate and test the effect of environmental filtering on species assemblages. Both approaches presented overestimation of their computed statistic as well as high rates of false positive when species distributions (*via* limited dispersal) and environmental conditions were independently spatially structured. Integrating spatially-constrained null models allowed to adjust both their tests and the values of their statistic, as such demonstrating the need of using ecologically-constrained null models to correctly identify and quantify ecological processes.

For future works, the thesis suggests that adopting a scaling approach to study ecological processes in addition to mechanistic null models could offer the possibility to distinguish processes from one another.

Keywords: community ecology ; hypothesis-testing ; multivariate analyses ; variation partitioning ; Mantel test ; fourth-corner ; environmental filtering ; mechanistic models ; spatial scale ; phylogenetic scale.

Résumé

Les distributions d'espèces observées dans un environnement hétérogène résultent de plusieurs processus déterministes et stochastiques agissant comme des filtres pour contraindre la coexistence des espèces. L'action successive de ces processus a pour conséquence directe de structurer spatialement la composition des communautés et la variation de ces compositions (i.e., diversité bêta). Un des objectifs majeurs de l'écologie des communautés et métacommunautés consiste à identifier et quantifier les effets respectifs de ces différents processus sur la diversité bêta des communautés afin de mieux comprendre et prédire la distribution de la biodiversité. L'expérimentation étant difficilement possible, les processus responsables de la variation spatiale de la composition des communautés sont généralement inférés à partir des structures spatiales des distributions d'espèces observées dans la nature. La thèse s'inscrit dans ce contexte et vise à améliorer les outils de statistique multivariée permettant d'identifier et quantifier l'effet des processus écologiques structurant les communautés et métacommunautés. En particulier, il est proposé d'intégrer les échelles écologiques et les modèles nuls contraints pour étudier l'effet de l'environnement.

La décomposition des relations trait-environnement dans les échelles spatiales et phylogénétiques permet une étude plus approfondie du filtrage environnemental en associant son échelle spatiale d'action au signal phylogénétique des traits sélectionnés pour capturer l'histoire évolutive des espèces associée au filtrage environnemental. Les conclusions sur les processus évolutifs sous-jacents sont néanmoins limitées et mériteraient la considération de modèles nuls phylogénétiquement contraints pour une analyse plus fine. Dans la continuité, des modèles nuls spatialement contraints ont été développés et intégrés à deux analyses multivariées très largement utilisées en écologie des communautés (i.e., partitionnement de variation et test de Mantel) pour estimer et tester l'effet de l'environnement sur les assemblages d'espèces. Ces deux analyses présentaient une surestimation de leur statistique mesurée ainsi qu'un taux anormal de faux positifs lorsque les distributions d'espèces (*via* processus de dispersion limitée) et l'environnement étaient indépendamment spatialement structurés. L'intégration de modèles nuls spatialement contraints a permis d'ajuster à la fois les estimations et les tests de ces deux analyses illustrant ainsi le besoin d'utiliser des modèles nuls écologiquement contraints pour une identification et quantification correctes des processus écologiques.

En perspectives, cette thèse suggère que la mise en place d'une démarche multi-échelle lors de l'étude des processus écologiques, couplée à des modèles nuls mécanistes, pourrait offrir la possibilité de distinguer les processus écologiques les uns des autres.

Mots clés : écologie des communautés ; tests d'hypothèses ; analyses multivariées ; partitionnement de variation ; test de Mantel ; quatrième coin ; processus écologiques ; modèles mécanistes ; échelle spatiale ; échelle phylogénétique ; modèles nuls.

~ Table of contents ~

General Introduction

List of figures.....	1
I. History and ecological challenges.....	2
A. What is a community?.....	2
1. History and definition.....	2
2. A community: more than a species assembly.....	3
a. Community composition.....	3
b. Community structure.....	4
B. What does shape communities structure and composition: role of ecological processes.....	7
1. Speciation and Extinction.....	8
2. Dispersal.....	8
3. Environmental filtering.....	9
4. Biotic interactions.....	9
II. Methodologies to study communities.....	13
A. Empirical and theoretical approaches: two points of view.....	13
1. Empirical approach.....	13
2. Theoretical approach.....	14
B. Bridging empirical and theoretical approaches: a gradient of methods...	16
1. Empirical and theoretical approaches: limits.....	16
2. A gradient of methodological tools.....	17
a. Direction 1: bringing theoretical approach to empirical approach.....	18
b. Direction 2: bringing empirical approach to theoretical approach.....	19
III. Bringing theoretical approach to empirical approach (<i>Direction 1</i>): a major limit and two possible solutions.....	22
A. <i>Direction 1</i> remains pattern-based.....	22
B. Ecological scales.....	23
1. Definition.....	23
2. Spatial scales.....	24
3. Phylogenetic scales.....	25
C. Ecologically-constrained null models.....	27
1. Hypothesis-testing and null models.....	27
2. Building a null model.....	29

IV. Methodological improvements proposed in this thesis.....	32
A. Data collection.....	32
B. Multivariate methods.....	36
C. Mechanistic simulations.....	38
V. Organisation of this thesis.....	41

Axis 1 – Ecological scales: crutches or real assets

Chapter 1: Phylogenetic and spatial scaling of trait-mediated environmental filtering

List of figures & tables.....	43
List of appendices.....	44
Abstract.....	45
I. Introduction.....	46
II. Methodological framework.....	50
III. Results.....	60
IV. Discussion.....	64

**Axis 2 – Spatial autocorrelation biases: is spatially-constrained
null model a magic wand to quantify ecological processes?**

***Chapter 1: Testing the Mantel statistic with a spatially-constrained permutation
procedure***

List of figures.....	69
List of appendices.....	70
Abstract.....	71
I. Introduction.....	72
II. Materials and Methods.....	74
III. Results.....	81
IV. Discussion.....	84
V. Acknowledgements.....	87

Chapter 2: Beyond neutrality: disentangling the effects of species sorting and spurious correlation in community analysis

List of figures.....	88
List of appendices.....	89
Abstract.....	90
I. Introduction.....	91
II. Methodological framework.....	95
III. Results.....	102
IV. Discussion.....	105
V. Acknowledgements.....	110

General Discussion

List of figures.....	111
I. Ecological scales and ecologically-constrained null models: what to think?.....	112
A. Objective of the thesis.....	112
B. Ecological scales.....	112
1. Phylogenetic and spatial scaling of trait-environment relationships: conclusions.....	112
2. An inherent problem remains.....	113
a. Spatial grain and extent.....	113
b. Spatial eigenvectors.....	114
3. Ecological scales: crutches or real assets?.....	115
C. Ecologically-constrained null models.....	118
1. Spatially-constrained null model in Mantel test and Variation Partitioning: conclusions.....	118
2. Ecologically-constrained null models: a relevant solution?.....	119
3. Mechanistic null models: a real improvement?.....	123
D. Preliminary conclusion.....	125
II. What about model-based approaches?.....	128
A. Limits and solutions.....	128
B. Have scaling approach and constrained null models a place in model-based methods?.....	130
III. Methodological reasoning: is there still a dichotomy?.....	133

IV. A small “out of scope” opinion: are ordination multivariate methods dead?.....	136
V. General Conclusion.....	138
References.....	142
Remerciements et résumé.....	168
Appendices.....	187
List of appendices.....	186
Axis 1 – Chapter 1.....	188
Axis 2 – Chapter 1.....	210
Axis 2 – Chapter 2.....	222
Article in collaboration.....	237



REC



General Introduction

00:00:00

3..2..1..1..2..3

List of figures

<i>Figure 1: Phylogenetic diversity.....</i>	4
<i>Figure 2: Community spatial structure.....</i>	5
<i>Figure 3: Phylogenetic patterns of a species functional trait.....</i>	6
<i>Figure 4: The metacommunity and diversities concepts.....</i>	7
<i>Figure 5: Hierarchical ecological filters select resident species of a community from pools of potential residents.....</i>	10
<i>Figure 6: Gradient of methodologies from pure empirical to pure theoretical approaches.....</i>	18
<i>Figure 7: Spatial scales in term of grain and extent.....</i>	25
<i>Figure 8: Phylogenetic scales in term of grain and extent.....</i>	27
<i>Figure 9: Random and ecologically-constrained null models.....</i>	31
<i>Figure 10: Studying environmental filtering requires five major matrices.....</i>	32
<i>Figure 11: Multi-scale spatial patterns represented by Moran’s Eigenvector Maps.....</i>	34
<i>Figure 12: Multi-scale phylogenetic structures dispensed by phylogenetic eigenvectors.....</i>	35
<i>Figure 13: Principal Component Analysis on the species matrix L</i>	38

I. History and ecological challenges

A. What is a community?

1. History and definition

Taking a look at the past to understand how our current scientific context was slowly build is not always the funniest part, I admit. The journey can however encounter some surprises and is essential to realise that science is, before anything else, the result of a long and intensive collaborative work.

The first stone was brought by Haeckel in 1866 who introduced ecology as the study of the relationships between living organisms and their environment. This definition was then enlarged to the study of living organisms and their interactions with both their environment and each other (Dajoz 1983). Belonging to the large discipline of ecology, community ecology is a relatively young field and emerges from numerous studies which exchanged (often tensely) ideas over time about two oldest questions: *Why are there so many living species? How do they co-exist?*

Although the basic concepts and ideas of community ecology can be considered as emerging between 1950 and 1960, the term “*community*” is much older and historically referred to an association of species plants (Gleason 1926) or animals (Elton 1927). One of the most famous historical debates which funded our modern definition of a community took place in the early 20th century between the botanists Frederic E. Clements and Henry A. Gleason. Both struggled for the unity of community organisation and presented two different points of view. In his different works, Clements (1905, 1916, 1936), perceived plant associations (i.e., communities) as a whole entity, a “super-organism”, and suggested that this entity evolved through successive patterns in response to temporal and spatial variations of local environment toward a stable climax community. From Clements’ vision, communities were thus discrete entities with delimited edges and a unique organisation. In contrast with this “super-organism” concept of communities, Gleason (1926, 1939) suggested that communities should be studied from an individualistic point of view. He asserted that communities were the fortuitous results of species responding to global environmental gradients through individual characteristics. Even if Gleason’s statement was ignored at first,

it led eventually to the rejection of Clements' assertions (see Simberloff 1980 for further historical details).

This debate was followed by many others and they all represent essential steps of scientific understanding and reflection to create our modern definition of a community as *a local assemblage of species living together in space and time with or without direct or indirect interactions between them* (Magurran 2003; Emerson and Gillespie 2008).

2. A community: more than a species assembly

Studying communities requires to go beyond the simple definition stated above and to characterise communities through measurable features. In the ecological literature, two major characteristics are used: community *composition* and *structure*.

a. Community composition

Three different types of composition can be studied:

- *Species composition*: defines the identity and the relative abundances (i.e., number of individual) of species present in the community. It can be summarised and measured through diversity indices such as species richness accounting for the number of species in a community (Magurran 2004).
- *Functional composition*: determines the identity and values of functional traits displaying by species present in the community. Note that a species functional trait is defined as morphological, physiological or phenomenological trait indirectly impacting the performance of selection of an individual in a community through their effects on growth, reproduction and survival (Violle et al. 2007). It is mostly characterised by diversity indices such as functional diversity (Petchey and Gaston 2002) that is a measure of the functional differences among species in a community (Tilman 2001).
- *Phylogenetic composition* characterises the phylogenetic lineages present in the community. It is generally summarised through diversity indices such as phylogenetic diversity which defines the magnitude of divergences

among species that have evolved since a common ancestor and is calculated as the sum of phylogenetic branch lengths separating species on a phylogenetic tree following a minimum spanning path (Faith 1992). In other words, phylogenetic diversity is essentially a measure of the level of species kinship in a community (Fig. 1).

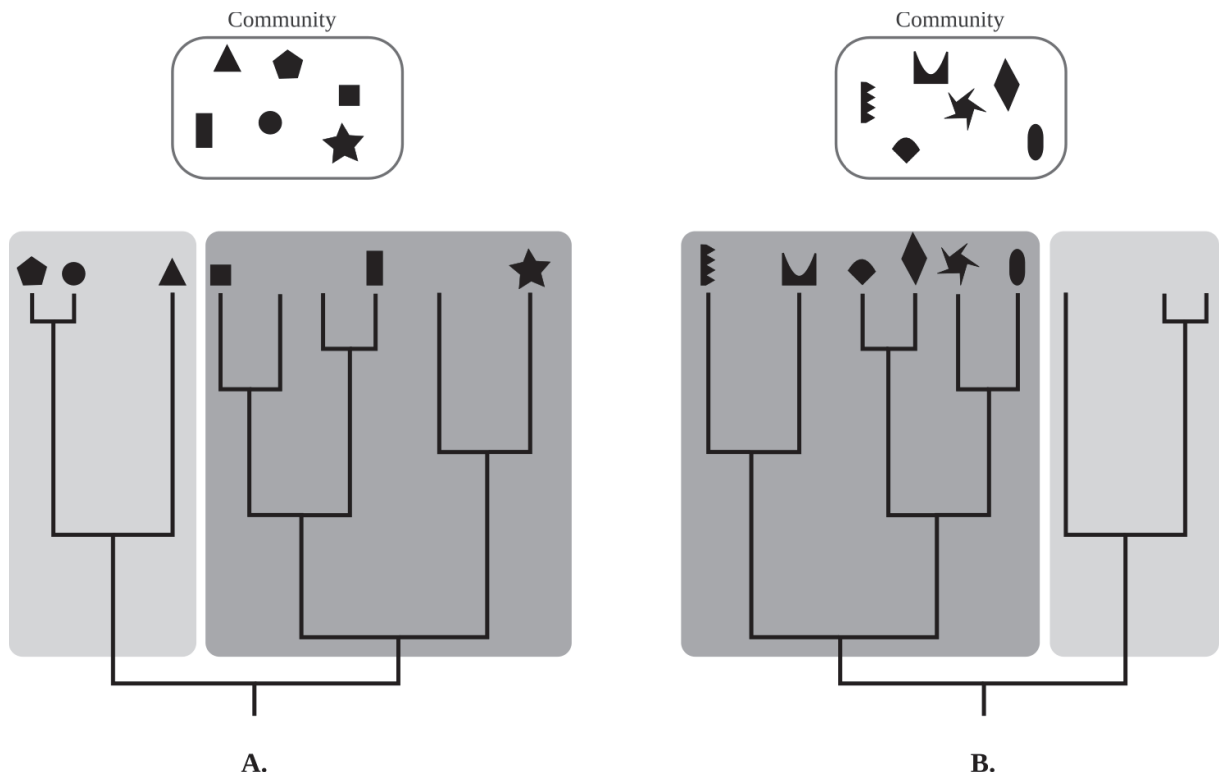

Figure 1: Phylogenetic diversity. (A) and (B) are two respective communities presenting both 6 different species belonging to two different phylogenetic trees. Phylogenetic diversity is higher in (A) than (B) as species in (A) belong to two different phylogenetic clades (dark and light grey squares) whereas species in (B) belong to the same phylogenetic clade (dark grey square). (A-B) Species are represented through different symbols.

b. Community structure

Similarly to community composition, the structure of a community can be characterised in two ways:

- *Spatial structure* defines the spatial distributions of individual inside the community (Fig. 2). *Spatial structure* of individuals inside a community may vary from clustered (Fig. 2B) to randomly (Fig. 2A) and evenly dispersed (Fig. 2C). Individuals are randomly dispersed if their respective locations are independent from each other. On the contrary, individuals are clustered when they tend to be closely located and evenly dispersed when

they tend to avoid each other. These structures are notably analysed with spatial-point pattern which represents individuals within the community through their coordinates (see Velázquez et al. 2016 for a review).

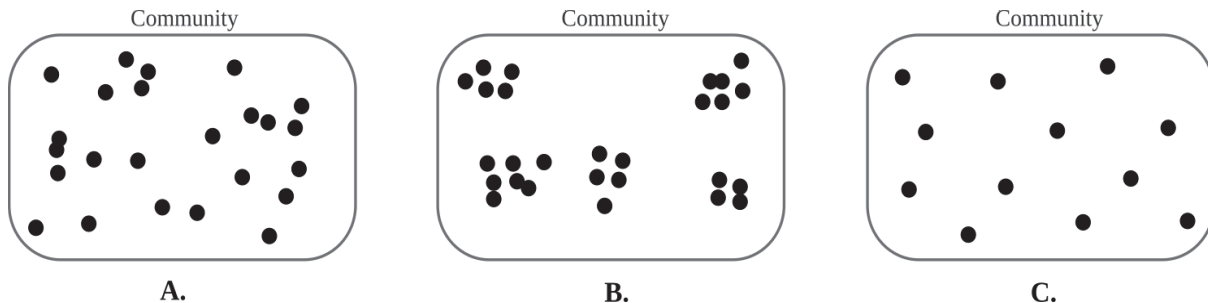

Figure 2: Community spatial structure. (A-C) Grey squares represent communities and black points are individuals. Inside the community, individuals are (A) randomly dispersed, (B) clustered and (C) evenly dispersed.

- Phylogenetic structure* defines the distribution of the species or functional traits composing a community along the phylogeny relative to another species or trait pool (Fig. 3). This allows to retrace both species and traits evolutionary history to determine if (i) species of a community are closely or distantly related (i.e., species convergence or divergence) and (ii) functional traits of a community are conserved along the phylogeny (i.e., trait conservation or loss among closely related species). Similarly to spatial structure of individuals in a community, species or functional traits can be clustered (Fig. 3A), randomly (Fig. 3B) or evenly dispersed (Fig. 3C) along a phylogeny. Those structures are determined in comparison to species or traits present in another species or trait pool. This latter pool can either be a random species pool, a larger pool than the community (e.g., metacommunity) (Webb 2000), or a pool simulated under model of evolution such as Brownian motion (i.e., evolution under random walk; Felsenstein 1985) or Ornstein-Uhlenbeck (i.e., evolution towards a selective optimum; Hansen 1997). Note that comparing with a simulated pool under evolutive model can indicate *how* species and traits have evolved along the phylogeny. Generally, analyses performing such comparisons are known as phylogenetic comparative methods (Felsenstein 1985).

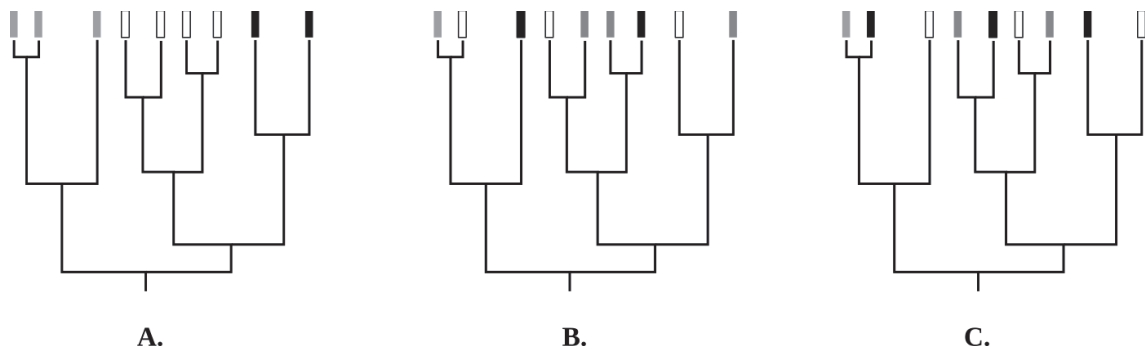

Figure 3: Phylogenetic patterns of a species functional trait. Trait values are (A) clustered, (B) randomly and (C) evenly dispersed along the phylogeny. The different colors represent the values taken by the species trait.

However, studying only at the scale of community is a bit reductive as it is a local species assemblage. To enlarge the scope of studies, the metacommunity concept was formalised in 2004 by Leibold et al. who defined the metacommunity as a set of several communities interconnected by immigration and emigration flows of species individuals (i.e., dispersal; Fig. 4A). Just like communities, metacommunities can be characterised through structure and composition. Concerning composition, I take advantage of the metacommunity larger scale to replace gamma-, beta- and alpha-diversity defined by Whittaker (1960) in the metacommunity concept (Fig. 4B). Metacommunity species, functional and phylogenetic compositions correspond to gamma-diversity, that is compositions at regional spatial scale. In contrast, alpha-diversity is associated with community compositions at local spatial scale. Finally, beta-diversity is defined as the variation in compositions from one community to another, or from individual communities compared to the regional pool.

In fact, the composition and diversity (i.e., alpha, beta and gamma) derived from them as well as the structure of communities and metacommunities constitute what is called *biodiversity patterns*. The very existence of these biodiversity patterns suggests that some ecological rules might determine where and which species can or cannot co-exist. Hence, the fundamental question in community ecology: *What does shape the structure of communities and their variation in composition?*

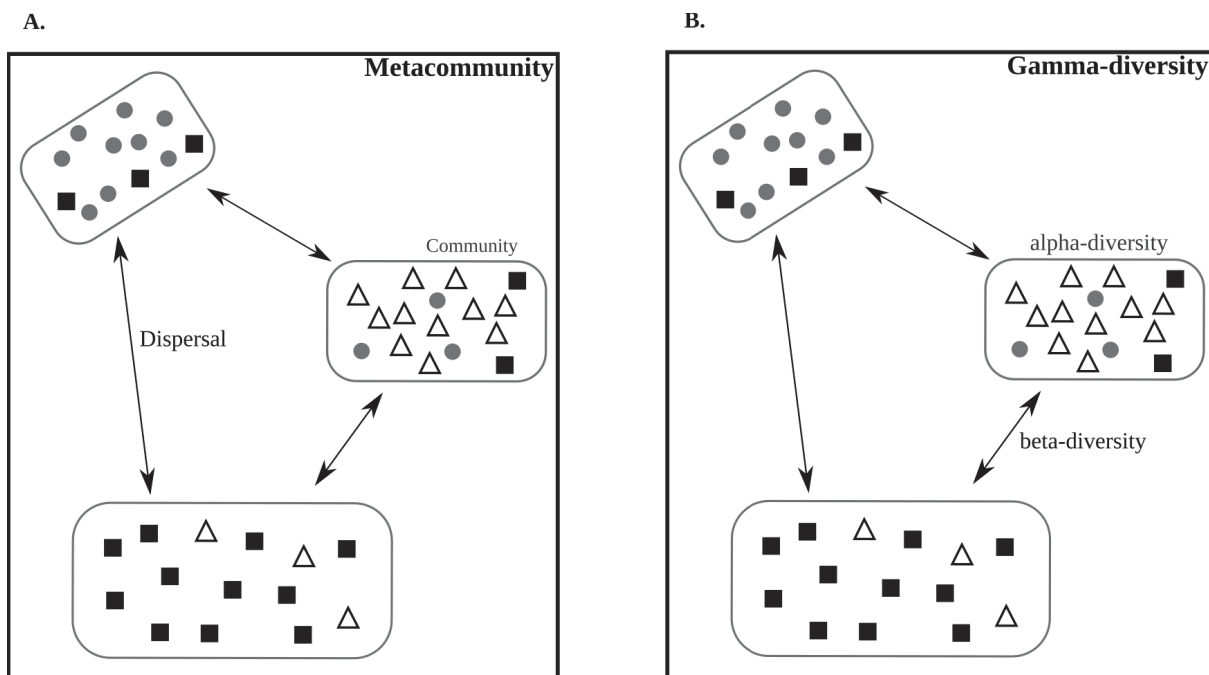

Figure 4: The metacommunity (A) and diversities (B) concepts. (A) The metacommunity is composed of three communities interconnected through immigration and emigration flows (i.e., dispersal; black arrows) of species individuals. (B) Alpha-diversity corresponds here to species composition at the community scale. Gamma-diversity encompasses species composition constituted by the three communities. Finally beta-diversity is the differences in species composition among communities. (A-B) For simplicity, gamma-, alpha- and beta-diversity were defined through species composition only. The three colored symbols represent individuals of three different species.

B. What does shape communities structure and composition: role of ecological processes

In 1975, Diamond suggested that the composition of fruit-eating bird communities living in the New Guinea archipelago was driven by “*assembly rules*” defined as possible and “*impossible combinations of species*” generated by species interactions (i.e., competition among species). Let aside the discussions that followed (Connor and Simberloff 1979, Keddy 1992), the modern rationale following this observation is that *ecological processes*, also called “*ecological filters*”, act on a *global species pool* (i.e., set of species at the globe scale able to colonise and/or settle in a focal community) to shape community composition and structure through assembly rules (Fig. 5). Without ecological processes determining assembly rules, composition and structure of communities would be random as every species from the global species pool would be able to settle in the community.

Numerous ecological processes are recognised and studied in community and metacommunity ecology (Ricklefs 1987, Chesson 2000, Hubbell 2001, Leibold et al. 2004,

Leibold and Chase 2017). In order to simplify the kit of all the possible processes underlying community structure and composition, Vellend (2010) proposed to regroup them into 4 general classes namely: *speciation* which creates new species, *drift* characterising stochastic changes in community species composition and structure, *dispersal* representing the movement of organisms across different communities and *selection* which select organisms based on their specific characteristics. Following the rationale of Vellend (2010), local community composition and structure are nowadays mostly viewed as resulting from 4 major hierarchical ecological filters (Lortie et al. 2004, Götzenberger et al. 2012, Marteinsdóttir and Eriksson 2014, Cadotte and Tucker 2017; Fig. 5):

1. Speciation and Extinction

Speciation and extinction are both evolutionary processes. Together they form a historical filter which determines phylogeographic assembly rules (Götzenberger et al. 2012) by selecting species to constitute the *historical species pool* (Fig. 5). Species extinction is offset by speciation, which creates new species, insuring a constant high species diversity in the historical species pool.

According to Vellend's categorisation of processes, this filter would be akin to speciation but also drift and selection as causes of extinction can be either stochastic (drift) or deterministic (selection) (Vellend 2010).

2. Dispersal

Dispersal characterises the capacity of an organism to move from its original local community to another. This filter hence determines the *geographic species pool* (Fig. 5) defined as all species from the historical species pool able to disperse to a focal community (Begon et al. 2006). The capacity of dispersal is species-dependent with strong dispersers able to reach more distant communities than weak-dispersers. For instance, in plant species which essentially disperse through their seeds, tall species or species with small seed mass were shown to have a stronger dispersal distance (Muller-Landau et al. 2008, Thomson et al. 2011). This distance is primordial, as it will allow species to reach communities with suitable conditions (see the two other filters below) in which they can successfully settle.

Obviously, this filter is identical to the dispersal of Vellend (2010) and is considered as a semi-stochastic and semi-deterministic process (Lowe and McPeck 2014). Dispersal particularly implies stochasticity when species are passive dispersers (e.g., plant seeds

dispersed by the wind) but also deterministic aspects as dispersal capacity varies among and within species (Lowe and McPeck 2014).

3. Environmental filtering

As suggested by its name, environmental filtering selects species capable of survival and persistence in the environmental conditions (i.e., abiotic factors) of a focal community. This selection is based on species functional traits discarding all species with unsuitable functional trait combinations given community environmental conditions. For example, Pavoine et al. (2010) found that regularly flooded and rich-salted environments were dominated by perennial and anemogamous (i.e., reproduction mode in which pollen is conveyed by wind) species presenting salt-resistance. On the contrary, dryer and low-salted habitats were mostly occupied by annual and biennial species with entomogamous (i.e., insect pollination) or autogamous (i.e., self-reproduction) reproduction. As a function of species functional traits, environmental filtering is thus considered as a deterministic process (Chase and Myers 2011).

Environmental filtering defines the *habitat species pool* (Fig. 5) corresponding to all species from the geographic species pool able to persist under the abiotic conditions of a focal community (Begon et al. 2006). According to Vellend's categorisation, environmental filtering will be part of selection.

4. Biotic interactions

This last ecological filter defines the *local species pool* (Fig. 5) characterising all species from the habitat species pool able to settle under the pressure of biotic interactions present in a focal community (Begon et al. 2006). This filter regroups all species interactions among which is interspecific competition. This type of interaction is negative and occurs between organisms of different species usually when resources (e.g., environment, space) are limited or shared. Ultimately, interspecific competition results in two major aspects. Either the growth rate of the weaker competitor decreases or becomes null leading to the species exclusion (i.e., competitive exclusion; outcome of Volterra 1926 and Lotka 1932). Or, on the contrary, competitors can also co-exist if they present functional trait values sufficiently dissimilar to present different functional responses to the same environment (i.e. limiting similarity; MacArthur and Levins 1967).

Similarly to environmental filtering, biotic interactions are considered as deterministic processes (Chase and Myers 2011) and are part of Vellend's selection category.

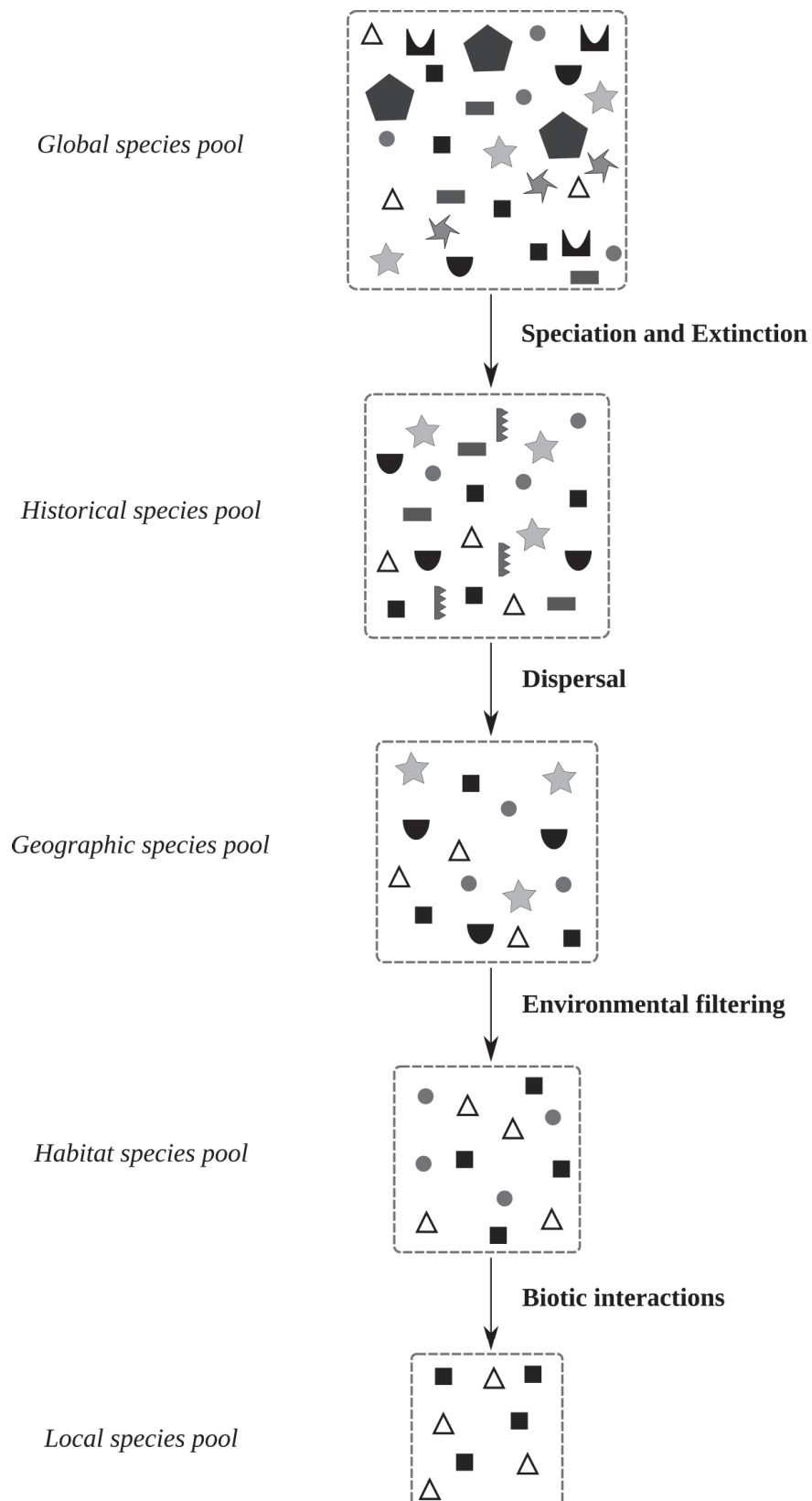

Figure 5: Hierarchical ecological filters select resident species of a community (i.e., local species pool) from pools of potential residents. Species are reported by different colored symbols. The dashed squares represent the different species pools.

Historically, only the effects of deterministic processes (e.g., biotic interactions and environmental filtering) were considered, with less importance given to stochastic ones (speciation, extinction, dispersal) (Grinnell 1917, Gause 1934, Andrewartha and Birch 1954, Huntchison 1957). In 2001 however, Hubbell's Unified Neutral Theory of Biodiversity demonstrated that species distributions similar to the one observed in nature could be obtained from a model considering solely equivalent species and stochastic events (i.e., death, birth, speciation, extinction, migration and dispersal) meaning that ecological drift and historical processes were also important and should not be ignored. This contributed to end in the four ecological filters described above and eventually leading to consider community assembly as taking place on a continuum of deterministic and stochastic processes (Gravel et al. 2006). Note that, alike Vellend's four categories of processes, the four filters presented above can be viewed as "essential" processes forming the basis of community ecology as numerous ecological theories and "secondary" processes can be expressed as combinations of them. For example, the neutral theory of Hubbel (2001) would be a combination of the first two filters. Then, the processes of invasion or mass-effect (i.e., patches where species compete for the local environmental conditions and can be rescued from local competitive exclusion by immigration flows; Leibold et al. 2004) would be a mixed of dispersal, environmental filtering and biotic interactions.

A major challenge in community ecology is to identify and quantify ecological processes shaping community structure and composition as well as their variations among communities (Cottenie 2005, Jones et al. 2008, Sharma et al. 2011, Wan et al. 2015, Duan et al. 2016). Despite the simplicity of the hierarchical representation of the four "essential" processes, answering this problematic is not straightforward for three main reasons:

- (i) The four "essential" processes influence each other. For example, Astorga et al. (2012) highlighted that the effect of environmental filtering was dependent on dispersal with strong dispersers more correlated to environmental conditions than weak-dispersers;
- (ii) Processes act differently through ecological scales (e.g., spatial, phylogenetic, temporal; see section III.B); as such, the hierarchy presented above and the interactions between processes could change depending on the scale;

(iii) Controlled experiments to study ecological processes in communities of multiple co-existing species are rather scarce (Stoll and Prati 2001, Langenheder and Székely 2011) as difficult to proceed. As a consequence, the major available information to study ecological processes rely in the *biodiversity patterns* created by ecological processes when electing species which can co-exist. The major issue when inferring ecological processes from biodiversity patterns is that several processes can result in a similar pattern (Cale et al. 1989, Real and McElhany 1996). For example, it has been shown that environmental filtering and competition could both lead to clusterings in phylogenetic structure (Kraft et al. 2007; see section III.A for more details). As such, signals of the four “essential” processes can be strongly similar creating difficulties to identify them with certainty. Moreover, as previously stated, numerous “secondary” processes can be derived from the combination of the four “essential” processes. Thus, the different combinations and the strength of associations between these four processes should define the uniqueness of the pattern of the “secondary” processes. However, given the potential similarity of patterns between “essential” processes, “secondary” processes will suffer of the same issue and could show a redundancy of patterns between several processes.

To sum up, identifying and quantifying ecological processes shaping communities is not easy and, due to the difficulty of conducting controlled experiments, relies on the inference of ecological processes from biodiversity patterns. Such methodological reasoning based on the test of patterns to conclude on processes is traditionally called *pattern-based*.

Given the three highlighted issues above, studying ecological processes underlying communities is in fact an important methodological challenge leading to the development of numerous statistical tools over the past decades.

II. Methodologies to study communities

A. Empirical and theoretical approaches: two points of view

Historically, scientific inquiry at identifying and quantifying the ecological processes shaping community structure and composition can be viewed as following two broad methodological paths: empirical and theoretical approaches. This dichotomy was well-known and a strong concern in the middle of the 1980s giving birth to the book “Trends in research in ecology for the 1980s” (Cooley 1984). In this volume, authors explicitly admit this division. In particular, in the Preface, F. Bourliere states that ecologists “*have the feeling of no longer belonging to a unified and mature scientific discipline. Many of them claim to be mere empiricists, whereas others are proud to be considered theoreticians*”. By acknowledging the general dichotomy, this book calls for a better communication between these two worlds. Here, we rapidly expose both empirical and theoretical points of view and their limits to understand why the current methodological tools to analyse empirical datasets merge both of them.

1. Empirical approach

Often reported as a “soft” science with no predictive goal, empirical ecology has a long history and is fundamentally interested in the description of biodiversity patterns of various taxa in ecological systems (Humboldt and Bonpland 1807, Candolle 1874, Merriam and Stejneger 1890, Warming 1895, Merriam 1898, Jaccard 1912, Watt 1940). In his preface (“Trends in research in ecology for the 1980s”, Cooley 1984), F. Bourliere defined empirical ecologists as pure naturalists “*ignorant of, if not allergic to, the use of any mathematical representation of living phenomena*”, therefore underlying the absence of any mathematical design in the empirical approach of ecology. Nevertheless, for the purpose of this study, we considered the use of phenomenological statistics to describe how biodiversity is structured (without involving any statistical tests) as belonging to this category.

At the beginning, studies were mostly focused on species diversity in terms of species identity, number and abundance (Jaccard 1912, Watt 1940). Phenomenological statistics such as diversity indices were particularly suited in that case. For instance, species richness allowed to qualify the number of species in a focal site, and Shannon (sensitive to rare species; Shannon 1948) and Simpson (sensitive to abundant species; Simpson 1949) indices

characterised the species diversity relatively to their own abundances. Nowadays however, datasets on species distributions in terms of species occurrences or abundances are available at very large spatial extents (GBIF-Global Biodiversity Information Facility, Edwards et al. 2000) extending the interest to the spatial variations of species composition (i.e., beta-diversity). As such, phenomenological statistics such as correlograms and (semi-)variograms (which represent respectively the correlation and (semi-)variance against classes of distances among sites; Legendre and Legendre 2012) and ordination analyses (e.g., Principal Component Analysis, Correspondence Analysis; Legendre and Legendre 2012; see section IV.B for further details) are also very useful to identify particular features of species spatial structures.

Lastly, over the past 50 years, functional and phylogenetic information have been collected and are now available for numerous species (TRY-global database of plant traits, Kattge et al. 2011; BIEN-Botanical Information and Ecology Network, <http://bien.nceas.ucsb.edu/bien/>). These new datasets can be characterised either by new diversity indices (e.g., phylogenetic and functional diversity) or the same phenomenological statistics exposed above (i.e., correlograms, (semi-)variograms, ordination analyses). By bringing these additional information on species, modern ecological questioning presents more challenging and complex problematics to understand community composition and structure.

2. Theoretical approach

Although theoretical and empirical approaches were developed in parallel having both a long history, they differ in their way of treating ecology. If empirical ecologists aimed at describing observed biodiversity patterns, theoreticians focused on the development of mathematical models to provide insights about how they are produced thus improving our comprehension of species assemblages structure and functioning but without being directly based on empirical data (i.e., theoretical models of Stenseth 1977). Therefore, models implying curve fitting (i.e., empirical models of Stenseth 1977) are not considered in this category because they require empirical data to estimate biological parameters.

At first, mathematical models were deterministic, non-mechanistic and purely analytical as developed to reproduce population dynamics to understand how they were produced and evolved. Their history begins with Verhulst (1838) who first introduced the logistic equation to describe population growth. From there, logistic models were re-exploited by numerous authors and in particular Lotka (1925) and Volterra (1926) who became eponyms for their

famous equations describing predator-prey or parasite-host relationships. In fact, many of the next mathematical developments were studying competition (Nicholson and Bailey 1935, Williamson 1957, Rosenzweig and MacArthur 1963). All these theoretical works contributed (with others) to invalidate Clement's super-organism hypothesis for the benefit of Gleason's individualistic vision of communities marking what I would consider as a first decisive shift towards the developments of theoretical models of species assemblages.

As a legacy of population ecology modelling, numerous studies developed community models to study competition among (i.e., intra) or between (i.e., inter) species. Among others, the works of R. H. MacArthur, R. M. May and R. Levins played important roles in community modelling. MacArthur provided important insights on limiting similarity (MacArthur and Pianka 1966, MacArthur and Levins 1967, May and MacArthur 1972) and species ecological niche following the work of his mentor Huntchison (1957) (MacArthur 1970). May mostly worked on community stability and in particular its relation with community complexity (May 1971, 1972, 1973). Finally, Levins brought the community matrix (Levins 1968) which allowed to specify the strength of interactions between and among species (notably competition). Levins' community matrix was broadly applied especially to study interspecific competition relatively to community stability (Clark and Hallam 1982) and invasibility (Case 1990), and to the number of co-existing species in a community (Vandermeer 1970, 1972). It is worth noting that the period of community model developments also corresponds to the introduction of stochasticity in population deterministic models (Leslie and Gower 1958, Bartlett 1960, Chiang 1968, Pielou 1977). This notion of stochasticity also appeared in community models especially with the work of May (1973) where he incorporated statistical noise in Levin's community matrix to produce stochastic neighbourhood of community dynamics.

At the end of the 1970s, after the reflections about the existence of assembly rules resulting from ecological mechanisms (Diamond 1975; see I.B), theoretical ecologists slowly changed from pure descriptive models to mechanistic models (Schoener 1986). Descriptive models purely aim at describing biodiversity patterns of community mostly relying on the best mathematical expressions qualitatively embodied the focal pattern(s) (Schoener 1986). In contrast, mechanistic models are defined by the use of organisms ecological characteristics (e.g., behavior, physiology, morphology) as theoretical bases to model ecological processes to understand how they shape communities (Schoener 1986, Persson and Diehl 1990, Leibold

1995, Hubbell 2001, Chave et al. 2002). Mechanistic models then gave birth to mechanistic simulations now widely used in community ecology for many purposes (IV.C; Zurell et al. 2010, see D’Amen et al. 2017, Cabral et al. 2017 for a review on mechanistic simulations).

B. Bridging empirical and theoretical approaches: a gradient of methods

1. Empirical and theoretical approaches: limits

Solely relying on either empirical or theoretical approaches to identify and quantify ecological processes shaping communities is limited. Given that the empirical approach aims at describing ecological systems *via* direct ecological characteristics (i.e., identity, number and abundances of species) and phenomenological statistics calculated from these features (i.e., diversity indices, correlograms, ordination analyses), its incontestable advantage is to be directly based on observed datasets as such giving realistic descriptions of the system. However, this approach presents one major pitfall to identify and quantify ecological processes underlying communities. Despite the possibility to quantify biodiversity patterns through phenomenological statistics (see section II.A.1), those quantities cannot be reliably associated with ecological processes. Although it would be possible to indicate the presence of ecological processes based on the deviation of the phenomenological statistics from an ecological (not statistical) *a priori*, the lack of predictive ability makes the definition of the ecological *a priori* rather subjective. In addition, given that various processes may create the same pattern (Cale et al. 1989, Real and McElhany 1996), being based solely on the deviation of a phenomenological statistics describing biodiversity patterns would restrict ecological conclusion to pure assumptions.

The major interest of the theoretical approach lies in the use of mathematical modelling to bring deterministic and mechanistic comprehensions of how biodiversity patterns are produced. This offers a predictive facet to the study of processes as it allows not only to qualitatively reproduce an observed biodiversity pattern (deterministic models such as Lotka-Volterra equations) but especially to produce one expected under a particular ecological process (mechanistic models; Nathan and Muller-Landau 2000, Hubbell 2001, Chave et al. 2002, Nathan and Casagrandi 2004). However, the high topological diversity of theoretical models (i.e., number, definition and order of parameters) is both a great advantage and an important shortcoming. For example, Vellend (2010) counted at least 2304 possible Lotka-Volterra models to define species interactions just by adding different level of complexities

one by one (i.e., spatial and temporal heterogeneity, stochasticity, immigration, age, size and number of species). This high diversity is important to define what is theoretically possible to represent a focal system from what is not. But it is also a curse as “possible” does not imply “ecologically realised” and the relevant ones have to be filtered out. This selection appears however difficult without being linked to empirical data.

Overall, to identify and quantify ecological processes shaping communities, empirical and theoretical approaches have to be combined so that the theoretical approach can offer predictive power to the empirical one, and that the empirical approach can bring ecological realism through empirical data as well as helping to select (and build) models that are ecologically relevant. To take Maynard Smith’s words, “*Mathematics without natural history is sterile, but natural history without mathematics is muddled*” (Maynard Smith 1982).

2. A gradient of methodological tools

Nowadays, methods available in ecological scientists’ toolbox to study ecological processes result from the merging of both empirical and theoretical approaches and can be considered as belonging to a gradient from purely empirical to purely theoretical (Fig. 6). In fact, there are two ways of moving along this gradient and combining the two approaches (Fig. 6): (i) *Direction 1* in which modelling is implemented into phenomenological statistics and whose philosophy is to infer ecological processes from biodiversity patterns. And (ii) *Direction 2* in which empirical data and phenomenological statistics are used to improve and select mathematical models to explain biodiversity patterns through process-based modelling. As the rationale of both directions is different, methodological tools belonging to each of them will reflect this dissimilarity as the first contains methods based on descriptive statistics and the second based on mathematical modelling.

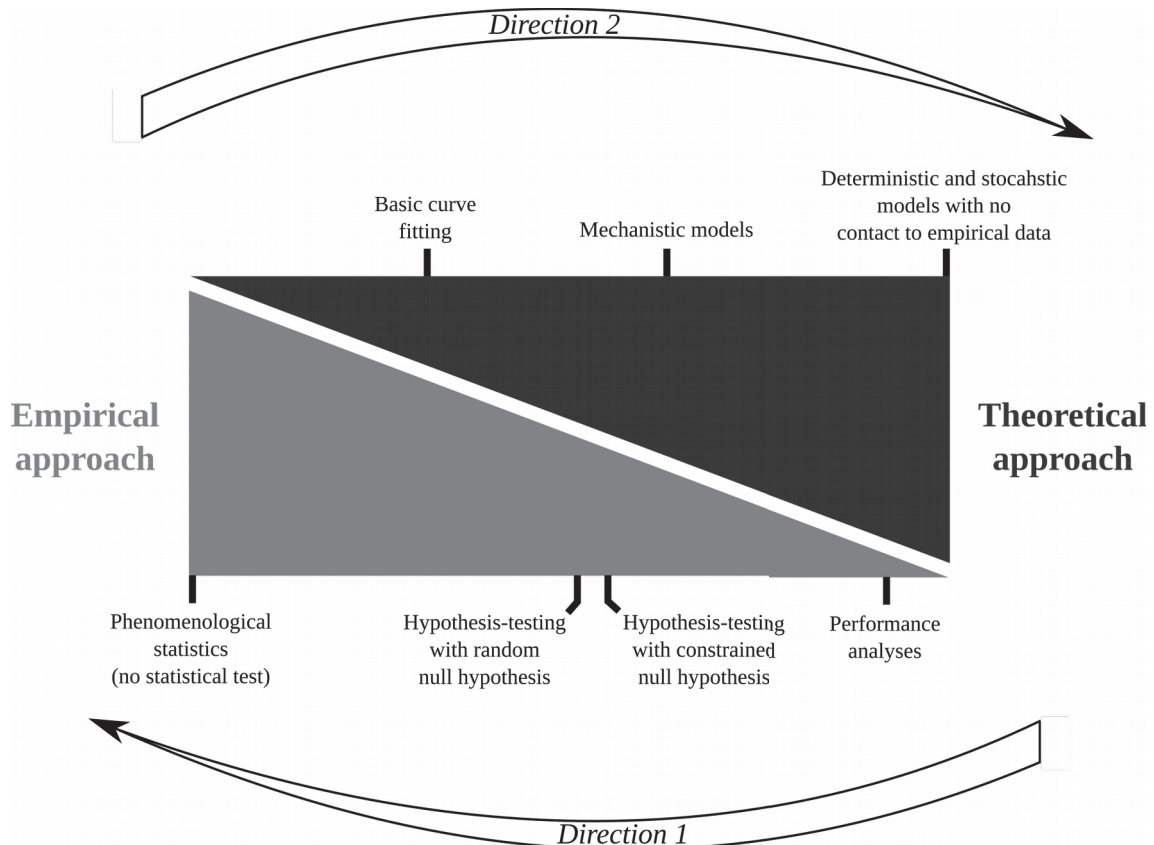

Figure 6: Gradient of methodologies from pure empirical to pure theoretical approaches. *Direction 1* corresponds to methods developed by bringing the theoretical approach to the empirical one. In this direction, along a gradient from empirical to theoretical approach, methods are increasingly model-based. First phenomenological statistics (e.g., diversity indices, Principal Component Analysis), then hypothesis-testing with random null hypothesis requiring smaller mathematical manipulations than constrained null hypothesis. Finally, performance analyses where mechanistic simulations are usually used. *Direction 2* represents methods developed by linking the theoretical approach to the empirical one solely through estimation of model parameters from empirical data. In this direction, along a gradient from empirical to theoretical approach, basic curve fitting (e.g., regression-based models) are simpler models than mechanistic models which are based on the modelling of ecological processes or individual characteristics. Lastly, models with no parameter estimation from empirical data are considered as pure theoretical approaches.

a. Direction 1: bringing theoretical approach to empirical approach

Along the gradient, *Direction 1* first displays the tests of hypothesis (Fig. 6) in which can notably be found multivariate methods such as Mantel test (Mantel 1967; see Axis 2 Chapter 1) and variation partitioning (Borcard et al. 1992, Peres-Neto et al. 2006; see Axis 2 Chapter 2) widely used to study the effect of environmental filtering over spatial processes (e.g., dispersal) on communities (Moritz et al. 2013, Arellano et al. 2016). The hypothesis-testing approach is entirely based on the rejection of a null hypothesis (hereafter H_0) defining the simplest negative answer to an ecological question. For instance, one can ask if species

distributions of a community are structured in space. The H0 corresponding to this question is: “*species distributions are not spatially structured in the community*” meaning that species are randomly distributed in space. Following this idea, the H0 to identify and quantify ecological processes shaping communities is defined as the biodiversity pattern(s) in absence of the ecological processes under study. H0 is defined through mathematical manipulations going from simple permutations to express randomness to constrained permutations and randomisations to conserve specific ecological features as such characterising more complex ecological assumptions (Gotelli 2000, Wagner and Dray 2015; Fig. 6). Further details on the characterisation of H0 are provided in the next section (III.C).

Finally, closer to theoretical approach, *Direction 1* presents performance analyses (Fig. 6). Those analyses evaluate the statistical performances of phenomenological statistics and tests of hypothesis in term of measured value (compared to an expected), type I error rate (i.e., detecting H0 as true although false) and power (i.e., rejecting H0 when false) under different theoretical ecological contexts (Smith and Lundholm 2010, Münkemüller and Gallien 2015). In short, performance analyses allow to identify ecological situations in which descriptive statistics and hypothesis-testing fail to detect the biodiversity patterns resulting from ecological processes of interest, as such defining the limitations of their use. Therefore, performance analyses are mostly meant to serve as preliminary analyses to help choosing the descriptive statistics and tests of hypothesis to perform. Most of the time those analyses require mechanistic simulations to reproduce particular ecological processes under which the focal descriptive statistic or hypothesis test are performed and the outputs (measured value and H0 rejection or not) are compared to the known input of the simulation (Smith and Lundholm 2010, Münkemüller and Gallien 2015). For example, Münkemüller and Gallien (2015) showed, *via* mechanistic simulations reproducing patterns of invasion under environmental filtering and competition, that phylogenetic indices based on invaders were better suited under environmental filtering to detect invasion. Inversely, community-based phylogenetic indices performed better under competition scenario.

b. Direction 2: bringing empirical approach to theoretical approach

For mathematical models to present a good explanatory power and fit of empirical datasets, model parametrisation is crucial and would remain purely theoretical if not directly based on those datasets. As such, models developed in *Direction 2* all gravitate towards mathematical

models with parameter estimations directly from the studied empirical data. Briefly, the rationale behind the conception of a model parameterised with observed data is the following:

- (1) Build potential models (mechanistic or not) to explain the empirical dataset;

- (2) Estimate parameters of the models from empirical data. Methods available to perform parameter estimations mostly belong to either likelihood functions (see Bolker et al. 2009 for a review of them in the case of generalised linear mixed models) or Pattern-Oriented Modelling and Approximate Bayesian Computation (see Hartig et al. 2011 for a review). This will be more detailed in the General Discussion (section II);

- (3) Evaluate the goodness-of-fit and explanatory power of models through summary statistics. Goodness-of-fit allows to quantify how well the values predicted by the whole model are close to the empirical values. It can notably be assessed by looking at the estimates values and their confidence intervals but also checking the posterior distributions if a Bayesian framework was performed (Etienne and Olf 2005, Jabot and Chave 2009). Other summary statistics such as R²-type values but also hypothesis-testing such as χ^2 to evaluate the difference between the observed and modeled values distributions can also be used, notably in the case of non-mechanistic models (Bolker et al. 2009 for a review on generalised linear mixed models). If the model is not mechanistic, the explanatory power can be evaluated to quantify how well each explanatory variable of the model explain the observed values. It can be quantified by R²-type values and test of hypothesis such as Fisher- or Student-types statistics (Bolker et al. 2009 for generalised linear mixed models). Note that we purposefully remained general in exposing these steps and do not address the issue of model selection which will be discussed in last section of the manuscript (General Discussion section II).

Along the gradient of methods (Fig. 6), models are ranked by increasing level of sophistication from “basic curve fitting” to mechanistic models. In this manuscript, “basic curve fitting” represent non-mechanistic models using a unique classical function family such as logistic or linear functions to fit the empirical data. Regression-based models are the most widely used with Generalised Linear Models and Generalised Linear Mixed Models (Zuur

2009, Bolker et al. 2009) as well as canonical analyses such as Canonical Correspondence Analysis (ter Braak 1986, 1987) and Redundancy Analysis (Rao 1964). Those analyses allow to explain the response variable(s) with explanatory variables which can potentially be used as proxies for ecological processes such as environmental conditions to study the effect of environmental filtering. To go further, mechanistic models based on the direct modelling of ecological processes and organisms individual characteristics can be used to explain empirical data. For instance, Jabot and Chave (2011) showed that tropical tree communities were more likely shaped by environmental filtering by designing a mechanistic model extended from Hubbell's neutral model.

In this manuscript, I do not aim at comparing *Directions 1* and *2* and will focus only on *Direction 1* that is why *Direction 2* was shortly detailed. Nevertheless it was important to introduce both of them to understand that the merging of both theoretical and empirical approaches, regardless of the direction of combination (theoretical into empirical and inversely), is at the origin of the wide range of methodological tools available nowadays therefore providing multiple possible ways to study ecological processes underlying communities.

In the next section, I will further develop *Direction 1* by presenting its major limit as well as two potential solutions to overcome it. Note that *Direction 2* will be addressed in the last section of this manuscript (General Discussion).

III. Bringing theoretical approach to empirical approach (*Direction 1*): a major limit and two possible solutions

A. *Direction 1* remains pattern-based

Implementing a theoretical approach in classical phenomenological statistics (i.e., empirical approach) brought two major insights: (I) possibility to identify and quantify a link between ecological processes and community structure and composition through tests of null hypotheses and (ii) guidance in the choice of phenomenological statistics and hypothesis-testing through preliminary analyses of statistical performances. Despite those advantages, *Direction 1* is still based on biodiversity patterns with classical phenomenological statistics describing patterns and tests of hypothesis testing patterns by defining the null hypothesis as the biodiversity pattern without the effect of the ecological processes of interest. As such, the major and well-known pitfall of the empirical approach remains: a single pattern may be the result of multiple processes (Cale et al. 1989, Real and McElhany 1996). For instance, effects of environmental filtering and interspecific competition are still not always distinguishable as they can result in similar phylogenetic structures (Kraft et al. 2007). Based on the hypothesis that closely related species have similar trait values (Harvey and Pagel 1991), competition can result in communities composed of either (i) distantly related species (i.e., phylogenetic evenness) under competitive exclusion as closely related species will strongly compete and exclude one another (Webb et al. 2002) or (ii) closely related species (i.e., phylogenetic clustering) under limiting similarity as competing species can co-exist if their trait values are sufficiently dissimilar (Kraft et al. 2007). Likewise, communities under environmental filtering can result in communities either (i) phylogenetically clustered as only species with specific range of trait values will be selected (Kraft et al. 2007) or (ii) phylogenetic evenness if the set of trait values filtered out is convergent (i.e., distant relative species independently present the same range of trait values) along the phylogeny (Kraft et al. 2007). Among other cases, this example clearly demonstrates that the use of biodiversity patterns *per se* cannot be sufficient to precisely identify and quantify ecological processes shaping communities. Two solutions are proposed and studied along this manuscript: implementing ecological scales (e.g., spatial, phylogenetic, temporal, organismic) and ecologically-constrained (e.g. spatially-constrained) null models into hypothesis-testing (see below).

B. Ecological scales

1. Definition

As reported by Graham et al. (2018), the concept of ecological scales is based on the fact that some ecological entities (e.g., spatial regions such as local community and metacommunity) can be ordered relatively to one another (e.g., local community then metacommunity). The position within this hierarchy defines the scale (e.g, local community is at finer scale than metacommunity). In this manuscript, I considered two particular ecological scales:

- *Spatial scales* determining the spatial area of action (e.g., global or local) of ecological processes;
- *Phylogenetic scales* corresponding to the level of phylogenetic organisation of organisms living in a community (e.g., species, clade; see Graham et al. 2018 for a review). In particular, phylogenetic scales can indicate the degree of conservatism (i.e., conserved, divergent, convergent) of functional traits influenced by a particular ecological process (see Axis 1). In fact, the assumption is that traits level of conservatism increases with the number of ancient lineages with which actual lineages shared those traits. Note that taxonomic scales (e.g., species, genus, family, order, class) are often used as a proxy for phylogenetic scales (Graham et al. 2018). However, taxonomic scales differ from phylogenetic ones because they are mostly based on morphological and ecological attributes, thus excluding the evolutionary aspect of phylogeny due to temporal hierarchy (Graham et al. 2018). In the same way, if phylogenetic scales are intimately linked with temporal scales, they are nevertheless distinct type of scale as temporal scales ignore taxonomic hierarchy along the phylogeny.

2. Spatial scales

In ecological studies, spatial scales are usually described in term of extent (i.e., size of the area of study) and grain (i.e., size of the local sites sampled in the area of study) (Fig. 7; Siefert et al. 2012, Barton et al. 2013, Chalmandrier et al. 2017) but spatial eigenvectors (e.g., Moran's Eigenvector Maps; Dray et al. 2006; Fig. 11; IV.A) are also widely used (Dray et al. 2012, Chang et al. 2013, da Silva Menezes et al. 2016).

Spatial dependency is relevant for both community composition and structure as species distributions (Levin 1992) and richness (Gleason 1922) vary among spatial scales. Indeed, species number is recognised to increase with the size of the spatial area considered (Gleason 1922) meaning that species richness will be more important at large than local spatial scale. Therefore, species and functional compositions of local communities are expected to increase with the size of the spatial grain as more different species will be included in the communities (Fig. 7A). Similarly, at fixed size of grain, beta-diversity (i.e., differences in species composition between communities) is expected to be higher at large spatial extent as it will cover more communities with different species composition (Fig. 7B; Barton et al. 2013, Ochoa-Ochoa et al. 2014). Concerning community structure, it has notably been shown for phylogenetic structure that closely related species tend to co-occur (i.e., phylogenetic clustering) at large but not at local spatial scale (Lovette and Hochachka 2006, Procheş et al. 2008).

Overall, the multi-scale nature of community composition and structure in space suggests that the underlying ecological processes are also multi-scale and have a spatial signature varying with spatial scales (Levin 1992). In particular, environmental filtering has been shown to act at both large and local spatial scales through environmental variables respectively structured at large (e.g. climatic variables) and local (e.g., soil variables) spatial scales (see Siefert et al. 2012 for a meta-analysis, da Silva Menezes et al. 2016). Likewise, as species display various dispersal abilities (i.e., strong, intermediate, and weak dispersers; Wetzel et al. 2012, da Silva Menezes et al. 2016), dispersal might thus be expected to influence the spatial distributions of species with strong dispersers structured at large spatial scale and weak dispersers at fine spatial scale (da Silva Menezes et al. 2016). In fact, studies found that spatial structure of community composition similarity decreased more rapidly when species were weak than strong dispersers (Maloney and Munguia 2011, Wetzel et al. 2012).

To conclude, given that ecological processes act at multiple spatial scales, thus inducing multi-scale biodiversity patterns, spatial scales have to be taken into account to correctly study ecological processes by helping to identify and quantify them (Chase 2014). Several studies have notably showed that the effects of environmental filtering and spatial processes (e.g., dispersal) in shaping communities and their spatial differences could be successfully identified and differed in their relative importance through spatial scales (Legendre et al. 2009, Li et al. 2011, Kivlin et al. 2014, Arellano et al. 2016).

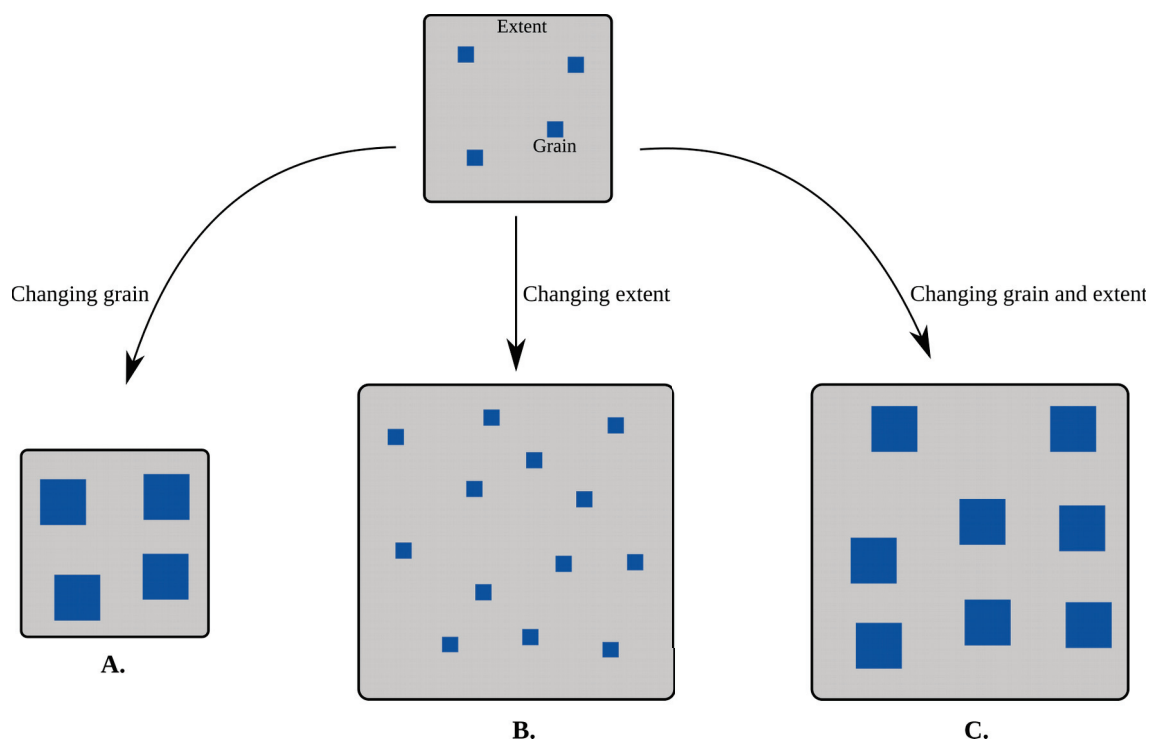

Figure 7: Spatial scales in term of grain and extent. (A-C) Grey squares represent the spatial extent whereas blue squares correspond to spatial grain. The spatial extent is the sampling area and the spatial grain is the sampling unit. Here, grains are considered as local communities and the extent as the size of a metacommunity. Three situations of grain and extent variations can be considered. **(A)** Changing the spatial grain while maintaining the spatial extent fixed. In the example, the size of the spatial grain increases leading to increase the alpha-diversity of each community. **(B)** Changing spatial extent while conserving the size of the grain. Here for instance, increasing the size of the metacommunity leads to increase the difference in species compositions between local communities (i.e., beta-diversity). **(C)** Grain and extent can be changed at the same time.

3. Phylogenetic scales

Contrary to spatial scales, defining phylogenetic scales appears to be a little more challenging... If space can be commonly measured in distance units in all ecological studies, this is not the case for phylogeny and several phylogenetic characteristics such as taxonomic rank, node-to-root distance, tree depth, clade size and age can be used as unit for phylogenetic

scales (Graham et al. 2018). As such, readers have to pay attention to their units when comparing between different ecological studies. Despite this difference, phylogenetic scales can be defined as spatial scales in term of grain (i.e., unit of phylogenetic scales defined above) and extent (i.e., the entire phylogeny containing all the phylogenetic units) (Fig. 8), but also with phylogenetic eigenvectors (e.g., PVR; Diniz-Filho et al. 1998; Fig. 12; IV.A).

As large phylogenetic scales (e.g., domain, kingdom) contain more species than small ones (e.g., family, genus), community composition is expected to present a wider range of species and functional trait values at large than fine phylogenetic scales (Fig. 8). Likewise, community structure is known to be strongly influenced by phylogenetic scales which may completely reversed ecological conclusions (Münkemüller et al. 2014). For instance, phylogenetic structure has been shown to completely change over phylogenetic scales with phylogenetic evenness at small scales and clustering at large scales (Cavender-Bares et al. 2006, Swenson et al. 2006).

Altogether, the variation of community composition and structure across phylogenetic scales suggest that ecological processes might act differently through them. To our knowledge however, no study explicitly tried to differentiate ecological processes across phylogenetic scales solely, whereas it has been extensively done with spatial scales (Li et al. 2011, Kivlin et al. 2014, Arellano et al. 2016). This could be explained by the relatively recent recognition of phylogenetic scales (Graham et al. 2018). Nevertheless, although studying ecological processes through different phylogenetic scales is still not widespread in community ecology, it is gaining in interest (Cavender-Bares et al. 2006, Swenson et al. 2006, Pavoine et al. 2010, Münkemüller et al. 2014, see Graham et al. 2018 for a quick review) and could bring important insight on which ecological processes have a key role on structuring specific clades of a community.

In conclusion, spatial and phylogenetic scales are promising empirical characteristics to implement in current methodological tools to help correctly identify and quantify ecological processes shaping communities. In particular, recent studies highlighted the importance of considering both spatial and phylogenetic scales at the same time (Procheş et al. 2008, Thuiller et al. 2010, Münkemüller et al. 2014, Parmentier et al. 2014) to study the relative importance of ecological processes. For instance, Parmentier et al. (2014) investigated the phylogenetic structure of tree communities through both spatial and phylogenetic scales by

changing the size of spatial and phylogenetic grain. They showed that phylogenetic clustering was detected at all phylogenetic scales and all but very fine spatial scale where the signal vanished. They concluded that environmental filtering shaped communities at all except very fine spatial scales where competition appeared to predominate.

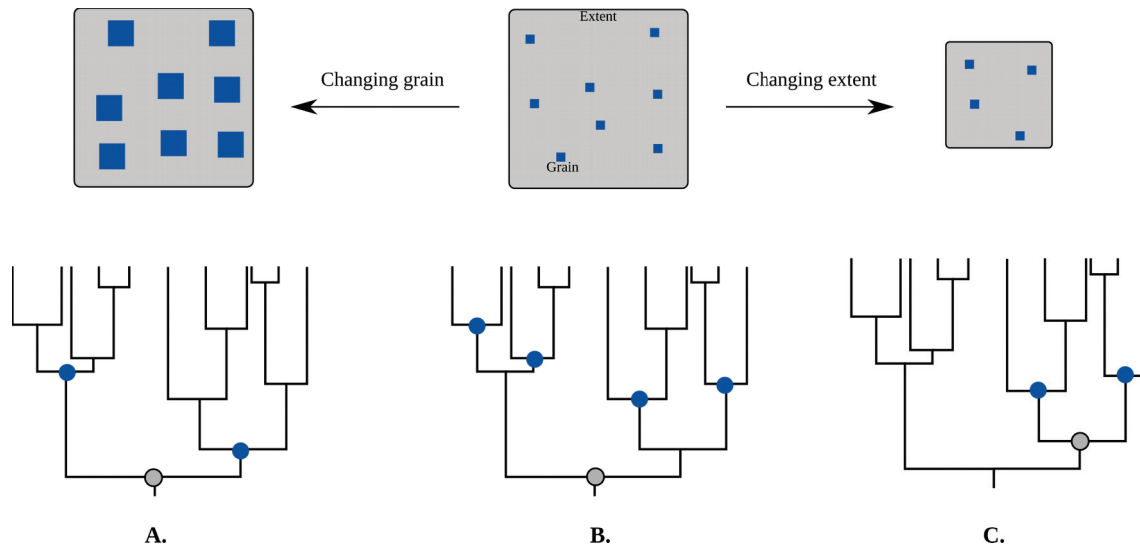

Figure 8: Phylogenetic scales in term of grain and extent. The first row represents the (A) change of spatial grain and (C) change of spatial extent from an original state (B). As in Fig. 7, grey and blue squares are the extent and grain respectively. The second row corresponds to phylogenetic scales with changes in phylogenetic grain (A) and extent (C) from an initial state (B). Similarly to the first row, grey and blue circles on phylogenetic trees correspond to phylogenetic extent and grain respectively. This figure is inspired from Graham et al. (2018).

C. Ecologically-constrained null models

1. Hypothesis-testing and null models

If implementing ecological scales can be seen as an “empirical” solution relying on empirical observations and new data, defining null models can be, on the contrary, viewed as a theoretical solution based on mathematical manipulations. To understand why and how to create a null model, we first have to go back to the definition of hypothesis-testing. The global approach is the following (Gotelli 2000):

- (1) Define the verbal null hypothesis H_0 in response to an ecological problematic. To illustrate, we will answer the following question: “*Is the variation of species composition among communities (i.e., beta-diversity) spatially structured?*”. The corresponding H_0 is “*Communities species composition (i.e., beta-diversity) is not structured through space*”.

- (2) Translate the verbal H0 into a mathematical H0 through the definition of a null model algorithm M0 characterising the spatial structure of the variation in beta-diversity expected under H0 that is: no spatial structure of the variation in community composition across space. In our example, the M0 should be defined as the same set of communities but randomly distributed in space.
- (3) Define a statistic k to compute. k is chosen to describe, with a single value, the spatial structure of the variation in beta-diversity.
- (4) Simulate a first null dataset with M0 and compute the statistic k on the simulated dataset to obtain a statistic k_{obs-H0} expected under H0.
- (5) Repeat step 4 many times (usually 1000 times) to generate the distribution of the statistic k_{obs-H0} expected if H0 was true (i.e., null distribution).
- (6) Compute k_{obs} the observed statistic on the empirical dataset. In our case, k_{obs} is calculated from a species matrix with species in columns and communities in rows (hereafter matrix \mathbf{L}).
- (7) Interpret k_{obs} in regards of the null distribution of k_{obs-H0} , that is calculate the probability of a $|k_{obs-H0}|$ to be superior or inferior to $|k_{obs}|$ (for bilateral test). By convention, if this probability is superior to the threshold $\alpha = 0.05$, H0 is rejected.

From there it is now possible to understand *why* a null model is needed and *what* it is. A null model is essential as the observed statistics has to be compared to something to be interpreted. In general, a null model can be defined, in concordance to the null hypothesis, as an expected biodiversity pattern in the absence of a specific ecological process or empirical feature. In our example, the null model was defined as the random spatial distribution of the same set of communities. Until here however, a critical point was not addressed: *How to construct an adequate null model?*

2. Building a null model

In community ecology, the most widely used null models are developed through permutation and randomisation procedures applied on the original empirical matrix of data (Connor and Simberloff 1979, Graves and Gotelli 1996, Gotelli 2000, Ulrich and Gotelli 2010, Ulrich et al. 2012). But these permutation and randomisation algorithms have to be carefully designed. In our example, we wanted to know if the variation in beta-diversity was spatially structured. The corresponding null model has thus to keep species composition of communities constant but randomly distributed them in space. The simplest and intuitive way to build such a null model is to randomly permute the rows of the species matrix \mathbf{L} (sites-by-species) so that species compositions are kept intact but the order of communities are changed (Fig. 9A).

Our example was made simple for the purpose of understanding, but the algorithm used to construct a null model obviously depends on the ecological question, meaning that the same random null model will not be adequate for all problematics. In particular, if we come back to the general problematic of this study which was to identify and quantify the ecological processes shaping community structure and composition, randomness would not be the best null model to achieve such goal. Indeed, by comparing a biodiversity pattern to randomness one can only conclude “*biodiversity patterns are not different from randomness*” or “*biodiversity patterns are different from randomness (i.e., structured)*” but without any relation to the ecological processes. In fact, comparing biodiversity patterns against randomness is the oldest null model (Connor and Simberloff 1979, Jackson et al. 1992, see Graves and Gotelli 1996 for a brief review of null models debates and history). The historical idea behind such comparison was to highlight that one should not jump easily on conclusions without testing biodiversity patterns, but also (ii) to recognise that biodiversity patterns that are not different from randomness do not necessarily mean that no ecological processes underline them and that biodiversity patterns result from processes that are not always easily detectable (Connor and Simberloff 1979). Be that it may, comparison to randomness to study ecological processes do not allow to precisely identify and quantify the relative effects of ecological processes separately (McIntire and Fajardo 2009). Doing so requires null models presenting stronger ecological restrictions than simply preserving community composition as presented above. The idea would be to develop new ecological constraints so that we can study an ecological process A while the other processes are kept fixed, meaning that the

null model should preserve all the features of the empirical data except those expected to be influenced by process A . For example, one way to test environmental filtering effect over dispersal, would be to randomise the species matrix L (sites-by-species) while preserving the spatial features of species distributions due to dispersal (Fig. 9B). Those types of null models ecologically restricted to reproduce non-random biodiversity patterns are hereafter called *ecologically-constrained* null models.

For the last years, ecologically-constrained null models attracted a lot of interest and were increasingly developed (Hardy 2008, Thuiller et al. 2010, Chalmandrier et al. 2013, Braga et al. 2018). Note that ecologically-constrained null models can be defined through randomisation procedures (Hardy 2008, Chalmandrier et al. 2013, Braga et al. 2018) but also with mechanistic null models (Caswell 1976, Buschke et al. 2015). The first type is addressed in Axis 2 and the second in the General Discussion. Despite the increasing developments of ecologically-constrained null models, a lot of work still remains to be done. In particular, lots of statistical tests widely used to identify and quantify ecological processes underlying communities (e.g., Mantel test and variation partitioning are multivariate methods widely used to separate the effect of environmental filtering from spatial processes) still use classic random null models. This, however, leads to biased statistical results and misinterpretations because the null model does not correctly match the null hypothesis by controlling for the biodiversity patterns not induced by the ecological processes under study (Axis 2; Smith and Lundholm 2010, Guillot and Rousset 2013). As such, implementing the current statistical tests with ecologically-constrained null models seems essential to allow ecologists to keep using them while obtaining unbiased results and drawing correct conclusions on ecological processes (Axis 2).

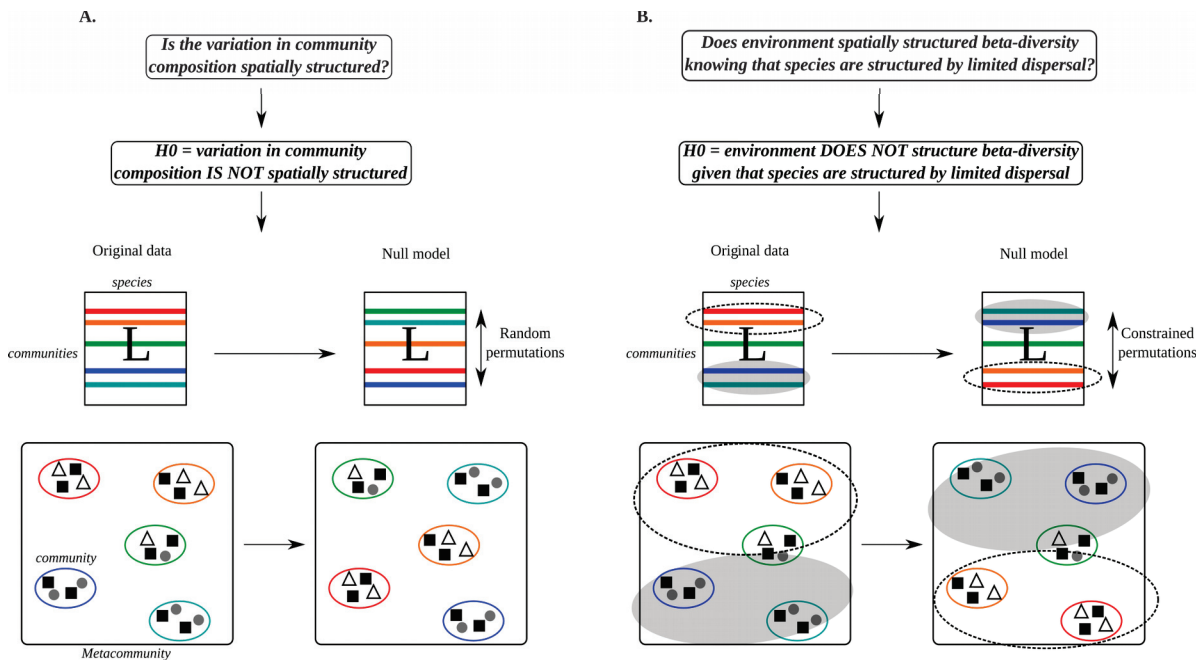

Figure 9: Random and ecologically-constrained null models. (A) To test for spatial structure of beta-diversity (i.e., difference in species composition among communities), the null model is built random. To do so, rows of species matrix L are randomly permuted to produce null communities randomly distributed through space while conserving their exact species composition. (B) Testing for an environmental effect on community species composition knowing that they are already spatially structured requires to perform constrained-permutation where rows of L are permuted while maintaining set of communities connected by dispersal as they are likely to present a similar composition. The dashed and grey ellipses correspond to the limited dispersal of the triangle and circle species respectively. (A-B) White triangles, black squares and grey circles represent three different species. Colours of communities correspond to the colours of L rows.

In general conclusion, due to the availability of empirical datasets ever more complex and massive, ecological questions relative to ecological processes shaping communities become more complex and diverse. As fundamentally based on the test of biodiversity patterns, current hypothesis-testing does not allow to correctly face this tidal wave of increasing data and questioning calls. In this manuscript, I propose to improve hypothesis-testing methods by implementing them with both ecological scales and ecologically-constrained null models to enhance their ability to detect different biodiversity patterns to draw relevant conclusions on ecological processes.

IV. Methodological improvements proposed in this thesis

This thesis aims at enlarging the ecological toolbox by implementing ecological scales and ecologically-constrained null models in hypothesis-testing methods to improve the identification and quantification of the ecological processes shaping communities and metacommunities. In particular, I adopted the scale of the metacommunity and focused on the study of environmental filtering for which I studied both its selection of species functional traits among communities, as well as its effect on beta-diversity (i.e., variation in species composition among communities). To have better insights on those two aspects of environmental filtering, I proposed to improve three widely used multivariate analyses: fourth-corner approach, the Mantel test and variation partitioning. In this section, I explain *why* those methods were chosen, *with what* and *why* they were improved and *how* those improvements were evaluated. But let's start by the beginning... Which data are required to study environmental filtering?

A. Data collection

Five basic ecological tables can be used to study the effect of environmental filtering (Fig. 10). The first obvious one is a matrix **L** of species abundances (or presence-absence) to

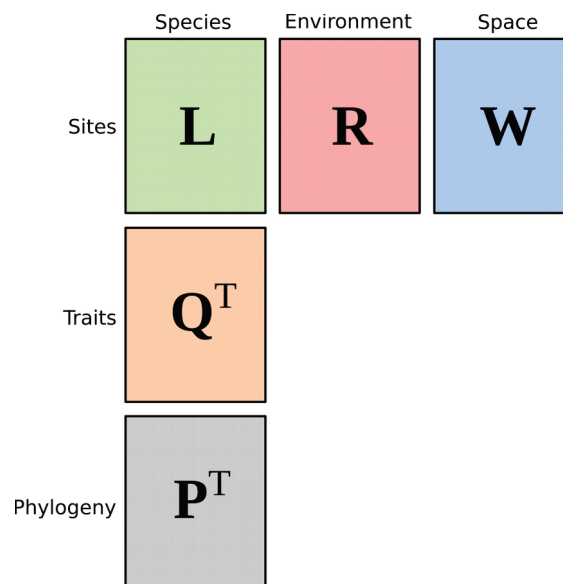

Figure 10: Studying environmental filtering requires five major matrices. **L** represents species abundance composition per sites, **Q** records the values of functional traits for each species, **P** defines the phylogenetic relationships between species, **R** describes the environmental conditions per sites and **W** characterises the spatial structures of sites.

characterise species composition with species in columns and sites (i.e., communities) in rows (Fig. 10). As such, **L** is composed by either species number of individual or occurrences in each sites of a metacommunity. The second mostly expected table is a matrix **R** of environmental conditions with environmental variables in columns and sampled sites in rows to characterise the environmental conditions present in each sites of a metacommunity (Fig. 10). The third one is a matrix **Q** of species functional traits with traits in columns and species in rows. As such, **Q** represents the value of functional traits for each species (Fig. 10). The two others are less intuitive and pertain to both space and phylogeny.

Space is important as closely located communities tend to be dependent from one another by presenting similarities (or dissimilarities) in terms of species compositions (matrix **L**) as well as environmental conditions (matrix **R**). Such dependency is called spatial autocorrelation and can be either positive, if nearby communities are similar, or negative, if they tend to be dissimilar (Legendre 1993, Legendre and Legendre 2012), and affects both table **L** and table **R**. Similarly, species cannot be considered independent as they are part of a hierarchically structured phylogeny, sharing a common evolutionary history (Felsenstein 1985). This leads to create phylogenetic signal both in traits (table **Q**, i.e., phylogenetic autocorrelation; Blomberg and Garland 2003) with closely related species presented more similar or dissimilar trait values but also in species composition (matrix **L**) with communities presenting more closely or distantly related species (Hardy 2008). Both types of dependencies are thus important to take into account during the study of environmental filtering. Hence the fourth table is a matrix **W** describing the spatial sampling of communities inside a metacommunity and the fifth is a matrix **P** characterising phylogenetic relationships between species.

W can be defined through three general ways. The first and most intuitive is to use geographical coordinates of sites where longitude and latitude are in columns and sites in rows. However this will only represent spatial patterns that are a function of linear combinations of longitude and latitude providing poor descriptors of the complex spatial patterns found in species data. That is why other representations based on polynomial transformations of geographical coordinates were first used (Borcard et al. 1992, Legendre and Legendre 2012). Unfortunately, those polynomials trends can only model patterns at broad spatial scales. As such, a more complex representation based on spatial eigenvectors (i.e., Moran's Eigenvector Maps, Dray et al. 2006; MEM) has been developed. MEM define

orthogonal spatial predictors which are eigenvectors calculated from a neighbour matrix of sites. They allow to represent space into all possible orthogonal scales, which, combined, are capable of describing very complex spatial structures (Griffith and Peres-Neto 2006). In other words, each eigenvector will represent a spatial pattern going from large scale (north-south or east-west gradients) to very fine scale (chessboard patterns representing, for instance, repulsion between species) (Fig. 11).

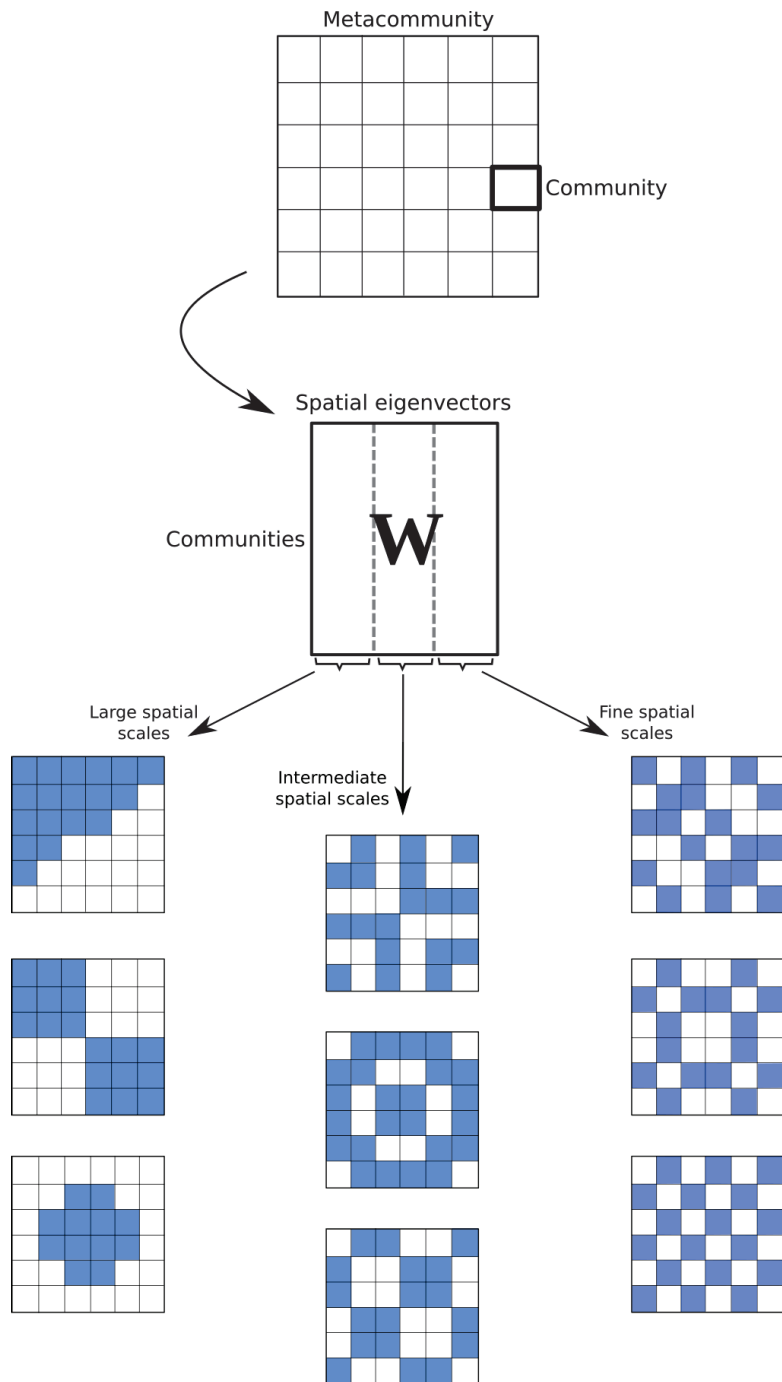

Figure 11: Multi-scale spatial patterns represented by Moran's Eigenvector Maps. For a metacommunity of 36 communities arranged as a 6 x 6 grid, the spatial matrix W containing Moran's Eigenvector Maps in columns describes the spatial structure of communities at large, intermediate and fine spatial scales. Blue color represents positive values and white color negative values. Only three spatial schematic patterns are presented for each category of spatial scales as examples.

Finally, \mathbf{P} can be obtained in two different ways, but either way originates from a phylogenetic tree. The first is to represent \mathbf{P} as a matrix of phylogenetic distances either between sites (sites x sites table; e.g., Graham and Fine 2008) or between species (species x species tables; e.g., Campbell et al. 2011, Ernst et al. 2012). Then, \mathbf{P} can also be a matrix of phylogenetic eigenvectors (PVR; Diniz-Filho et al. 1998), similar to MEM for \mathbf{W} . PVR define orthogonal phylogenetic predictors as eigenvectors obtained from a phylogenetic distance matrix. They allow to model phylogenetic structures from large (e.g., clade niche conservatism) to fine phylogenetic scales (e.g., late local divergence phenomenon) (Fig. 12).

Now that all matrices of data have been introduced, they can be related to three multivariate methods widely used to study environmental filtering: the fourth-corner approach, the Mantel test and variation partitioning.

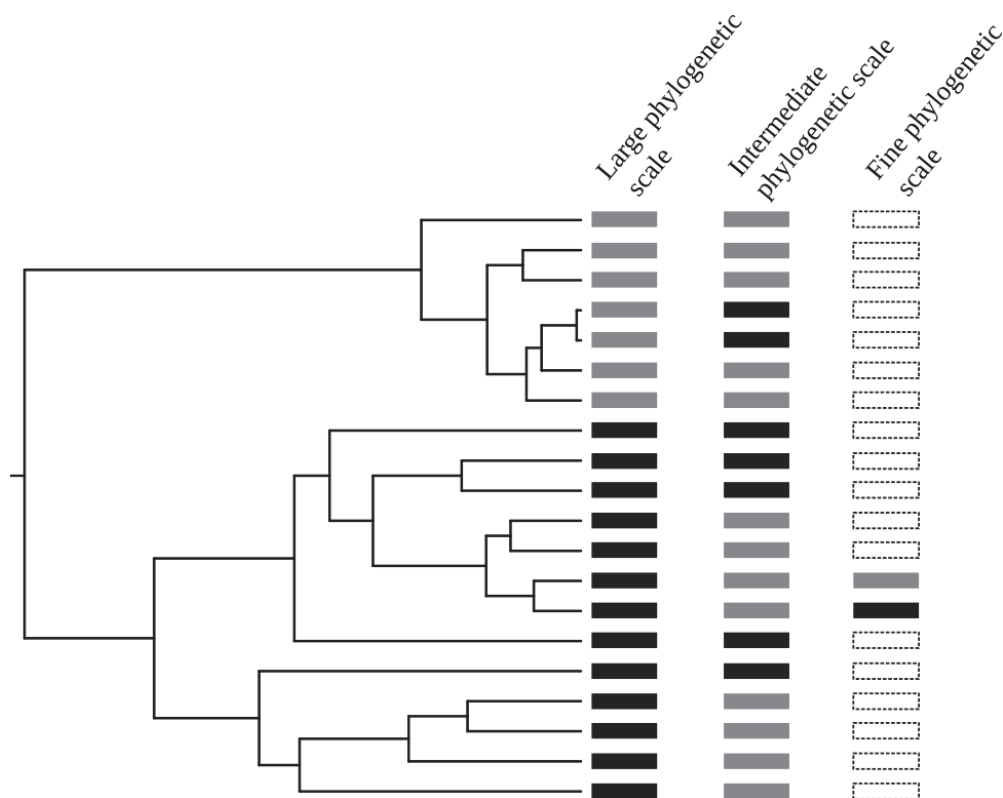

Figure 12: Multi-scale phylogenetic structures dispensed by phylogenetic eigenvectors. From a phylogenetic tree of 20 species, three phylogenetic structures corresponding to large, intermediate and fine phylogenetic scales are presented. Large phylogenetic scale separates species according to the first clade separation indicating early clade divergence. Intermediate scale identifies more recent species divergence. Finally, fine phylogenetic scale highlights very late local (i.e., between two species) divergence letting the rest of the species aside. Black rectangles represent positive values and grey squares positive ones. White dashed rectangles equal to 0.

B. Multivariate methods

In this manuscript I focused on two aspects of environmental filtering: (i) the selection of functional traits and (ii) its effect on beta-diversity. To study those two aspects, I focused on the use of multivariate analyses (Legendre and Legendre 2012).

The study of environmental selection of species' functional traits pertains to the study of trait-environment relationships. Among all the available frameworks, the fourth-corner approach is widely used (Legendre et al. 1997, Dray and Legendre 2008, Peres-Neto et al. 2016). This method is based on three of the five tables introduced above: a matrix \mathbf{L} of species composition per community, a vector of environmental conditions per community (\mathbf{R} is reduced to one column) and a vector of trait values per species (\mathbf{Q} is reduced to one column). Using these three types of information, the fourth-corner method calculates a weighted correlation between the environmental variable and the species trait, both standardised and weighted through species abundances. However, as previously stated, environment and traits may respectively present spatial and phylogenetic dependencies which ultimately lead to structure them across spatial and phylogenetic scales respectively. Therefore, studying environmental filtering through trait-environment relationships in the light of both spatial and phylogenetic scales could bring interesting insights. Indeed, in addition to identifying the particular trait and environmental variable involved in environmental filtering, implementing spatial and phylogenetic scales would allow to identify the spatial scales at which trait-mediated environmental filtering is acting, as well as identifying the degree of conservatism (through the phylogenetic scales profile) of traits involved in the filtering. Overall, studying trait-environment relationships across both spatial and phylogenetic scales would allow to associate the spatial scale(s) of environmental filtering to species' evolutionary history. As such, the classic fourth-corner approach was here extended to include both spatial and phylogenetic scales leading to take into account all the five information tables described in the previous section: species, environment, trait, space and phylogeny (see Axis 1).

To study the variation in species composition among communities, two broadly used multivariate methods were considered: Mantel test (Mantel 1967) and variation partitioning (Borcard et al. 1992, Peres-Neto et al. 2006). Those two tests are especially used to study the effect of environment over spatial processes such as dispersal (Moritz et al. 2013, Arellano et

al. 2016). For this, matrices \mathbf{L} , \mathbf{R} and \mathbf{W} are necessary. Note however that unlike variation partitioning, which is directly performed with \mathbf{L} , \mathbf{R} and \mathbf{W} , Mantel test is performed on distance matrices (which can be derived from the above matrices). If the spatial dependency of \mathbf{L} and \mathbf{R} was previously perceived as an interesting fact to study the structure of trait-environment relationships across spatial scales, it is considered as a curse when studying environmental over spatial effects as it violates the assumption of data independence (Legendre 1993) required by the statistical testing procedure. This leads to strong biases resulting in both overestimating the environmental effect and a high rate of false positives meaning that environmental effect is detected even if there is none. Mantel test and variation partitioning are both impacted by those biases (Smith and Lundholm 2010, Guillot and Rousset 2013). As such, the correct identification and quantification of environmental effect is compromised. In this manuscript, those biases were tackled by implementating spatially-constrained null models able to take into account the spatial dependencies in the testing procedure (see Axis 2).

Finally, note that variation partitioning belongs to the wide family of multivariate ordination methods. Those approaches can be categorised in two sub-categories: unconstrained and constrained ordination. Unconstrained ordination such as Principal Component Analysis (PCA; Hotelling 1933) and Correspondence Analysis (CA; Hill 1974) allow to study the structure of individuals and variables of a dataset by defining a new space of reduced dimensions (i.e., principal component) maximising the differences between projected points. For example, for the species matrix \mathbf{L} , one can study the structure of species across sites or sites across species (Fig. 13). The principal components in which species are projected are a linear combination of sites, and inversely for sites projection. Each projected species or sites are thus defined by new coordinates in their respective newly reduced space (Fig. 13). However, unconstrained analyses do not allow to study the effect of environmental filtering on species composition which requires to identify and test the link between variables of different nature therefore taking into account both \mathbf{L} and \mathbf{R} . Constrained ordination methods such as Canonical Correspondence Analysis (CCA; ter Braak 1986, 1987) and Redundancy Analysis (RDA; Rao 1964), on which variation partitioning are based, respond to this need by integrating a supplementary step of regression where the sites coordinates obtained from an unconstrained ordination method (e.g., PCA, CA) are regressed on the environmental variables. The predicted values of this regression are then coordinates of

sites in a new space whose axes are a linear combination of the environmental variables. Those types of analyses are thus able to identify the environmental variables explaining most of the variation in species composition among sites.

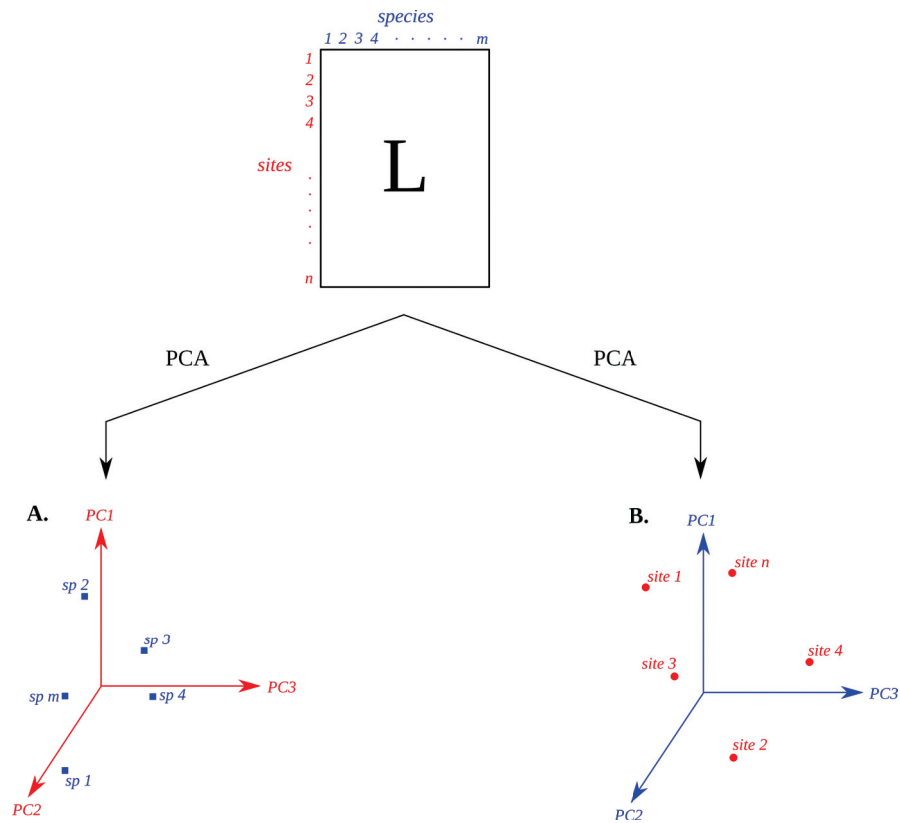

Figure 13: Principal Component Analysis on the species matrix L . Principal component analysis applied to project (A) species in a space of reduced dimensions where the axes are linear combination of sites and (B) sites in a space of reduced dimensions where the axes are linear combination of species.

Once the fourth-corner approach, the Mantel test and variation partitioning have been modified by implementing ecological scales for the former and spatially-constrained null models for the two latter, the enhanced methods need to be evaluated. Performance analyses based on mechanistic simulations were thus conducted to assess the ability of the modified method to identify and quantify the effects of environmental filtering when present.

C. Mechanistic simulations

Developing and improving statistical tools requires to study their performances to validate their relevance and identify their limits. Mechanistic simulations are the perfect tools to answer such need as they allow to simulate species assemblages with explicit assumptions

about the underlying ecological processes (Zurell et al. 2010, Cabral et al. 2017). Since the two last decades, an increasing amount of mechanistic simulation algorithms were developed creating the need to review what has been and still needs to be done (D'Amen et al. 2017, Cabral et al. 2017). Mechanistic simulations can be generally classified through three types of ecological scales: (i) the organismic scale (e.g., individual, species, functional group, phylogenetic clade), (ii) the temporal scale that is *static* (i.e., one generation) or *dynamic* (i.e., several generations) and (iii) the spatial scale that is *explicit* (i.e., displacements of organisms are considered through space) or *implicit* (i.e., organisms do not move or their displacements are not considered through space). Here I present and explain the choices of mechanistic simulations made to simulate the species matrix \mathbf{L} . Note that the scale of the metacommunity was taken for all simulations and simulated species were considered as plant species. Finally, note also that each simulation algorithm is further detailed in the following chapters of the manuscript.

To evaluate the performance of the enhanced fourth-corner to detect the spatial and phylogenetic structures of the trait-environment relationships, species assemblages were simulated solely based on environmental filtering. The metacommunity was represented as a grid where each cell is a community characterised by environmental conditions on which species abundances were simulated with a temporally-static spatially-implicit model. This model implies that (i) a single generation of species was simulated and (ii) species do not move in space. The distribution of species in each community of the metacommunity grid depended on the local environmental conditions with each species settling where the conditions were suitable. As the studied spatial and phylogenetic structures were respectively displayed by both environmental and functional trait vectors, the spatial and phylogenetic structures of \mathbf{L} reflected the structures simulated in those vectors. For example, if the environmental vector is simulated at large spatial scale such as north-south temperature gradient, the settling of the species in each community will mirror this gradient with cold-tolerant species in the north and non-cold-tolerant species in the south. The structures of \mathbf{L} was not under study in this case, as such \mathbf{L} did not need to present spatial dependencies in itself through species movement between communities. That is why \mathbf{L} was simulated with a temporally-static spatially-implicit model (see Axis 1).

In the case of the study of environmental effect on beta-diversity, the enhanced variation partitioning was evaluated based on a species assemblages simulated under environmental

filtering and dispersal. Indeed, to assess the potential biases in the measure of environmental effect of the enhanced variation partitioning due to strong spatial dependencies, species matrix \mathbf{L} had to present strong spatial dependencies not related to the one present in \mathbf{R} . In this case, a temporally-dynamic and spatially-explicit model was performed to allow species to disperse among communities at each generation. Because of species dispersal, the metacommunity were simulated as a torus where each cell represented a community characterised by local environmental conditions (see Axis 2 Chapter 2).

Finally note that the case of Mantel test did not rely on mechanistic simulations because this method was presented for treating the issue of spatial dependencies in a broader way regardless of the ecological origin of those dependencies as such regardless of the ecological nature of response and predictive variables (see Axis 2 Chapter 1).

V. Organisation of this thesis

This thesis aims at integrating ecological scales and ecologically-constrained null models into multivariate analyses to better identify and quantify the effect of ecological processes underlying communities and metacommunities. This manuscript especially focused on the study of environmental filtering and adopted the scale of the metacommunity. The argumentation follows two major axes respectively corresponding to the implementations of ecological scales and ecologically-constrained null models:

The first axis focuses on the study of environmental filtering through the relationships between species functional traits and environmental variables. Among other frameworks, the fourth-corner approach is widely used to study trait-environment relationships and calculates a weighted correlation between a single species functional trait and a single environmental variable both standardised and weighted through species abundances. However, environment and species traits both respectively present spatial and phylogenetic dependencies leading to structure environmental variables and species traits across spatial and phylogenetic scales respectively. Those spatial and phylogenetic signals could bring interesting insights regarding: (i) the spatial scale of the environmental variable involved in the environmental filtering and (ii) the level of conservatism of the species trait selected by the environmental variable. This axis thus proposes to extend the fourth-corner approach by including both spatial and phylogenetic scales to study trait-environment relationships (Axis 1 – Chapter 1). Statistical performances of this new approach were evaluated in terms of power and type I error rates *via* mechanistic simulations.

The second axis is centred on the use spatially-constrained null models to overcome statistical issues due to spatial autocorrelation when testing for environmental filtering. Although spatial autocorrelation can be seen as a useful characteristic resulting from ecological processes, it can also be a real nuisance for statistical testing and estimation because it violates the assumption of data independence (Legendre 1993). In particular, regression-based models are known to be affected by spatial autocorrelation leading to biased estimations and inflation of type I error rates (F. Dormann et al. 2007). As such, identifying and quantifying ecological processes in presence of spatial autocorrelation can lead to (i) finding an ecological process although there is none (due to high type I error rate) and (ii)

overestimation of the effect of a process. Axis 2 focuses on the identification and quantification of environmental filtering in presence of limited dispersal inducing spatial autocorrelation in species distribution. Spatially-constrained null models were implemented in two regression-based multivariate analyses widely used to study environmental filtering over spatial processes: Mantel test (Axis 2 – Chapter 1) and variation partitioning (Axis 2 – Chapter 2). Statistical performances of the improved approaches were evaluated with simulated data but were also illustrated with empirical datasets.

To finish, the relevance of implementing ecological scales and ecologically-constrained null models in statistical tools was discussed in the light of the results obtained during the thesis. The scope of the study was then enlarged to highlight some perspectives following the works conducted. In particular, the role of mechanistic models (*Direction 2*) will be addressed in addition to a more global reflexion on scientific reasoning when studying ecological processes from empirical data and ecological theories.



REC



Axis 1

Ecological scales:
crutches or real assets?

00:00:00

3..2..1..1..2..3



REC



Chapter 1

Spatial and phylogenetic
scaling of trait-mediated
environmental filtering

00:00:00

3..2..1..1..2..3

List of figures & tables

<i>Figure 1:</i> Schematic summary of the multi-scale fourth-corner approach.....	55
<i>Figure 2:</i> Spatial decomposition of trait-environment relationship.....	61
<i>Figure 3:</i> Phylogenetic decomposition of trait-environment relationship.....	63
<i>Figure 4:</i> Decomposition of trait-environment relationship trough both spatial and phylogenetic scales.....	65
<i>Table 1:</i> Statistical power (Scenario A) and type I error rates (scenarios B, C and D) of the fourth corner approach using a spatially- and phylogenetically-constrained null model when trait and environment are simulated unrelated.....	59

List of appendices

<i>Appendix S1: Standardisations applied in the multi-scale fourth-corner.....</i>	<i>188</i>
<i>Appendix S2: ACDC transformations of phylogenetic trees.....</i>	<i>190</i>
<i>Appendix S3: R scripts to reproduce the simulations of the manuscript.....</i>	<i>191</i>
<i>Appendix S4: Spatial profiles of the environmental vector for values of g equals to 0, 2 and 100.....</i>	<i>200</i>
<i>Appendix S5: Phylogenetic profiles of the trait vector for values of ρ equals to: -0.8 and 0.....</i>	<i>202</i>
<i>Appendix S6: Decomposition of trait-environment relationship across both spatial and phylogenetic scales</i>	<i>203</i>
<i>Appendix S7: Standard deviation associated to the mean R^2 represented in scalograms of Figure 4 of the main manuscript and Appendix S6.....</i>	<i>206</i>

Abstract

It is now well acknowledged that species sorting is mechanistically driven by species functional traits responding to major environmental filters. Studying trait-mediated environmental filtering thus requires to investigate how trait-environment relationships drive species spatial distributions. However, as environmental variables are usually spatially-structured, trait-environmental relationships are likely to vary depending on spatial scales. Similarly, as traits are intimately linked to phylogeny displaying various phylogenetic signals, including phylogeny in the analysis of trait-environmental relationships could bring interesting insights to study the evolutionary history of species niches defined by environmental filtering. As such, a major issue is to understand how trait-mediated environmental filtering and its associated evolutionary history are structured in space and at which spatial scales they occur. Among different frameworks, the fourth-corner method is widely used to analyse the link between traits and environment. However, it does not allow to include phylogenetic and spatial information. Here we extend the fourth-corner approach by integrating phylogenetic and spatial eigenvectors to (i) quantify the trait-environment relationship, (ii) identify the spatial scales of the trait-mediated environmental filtering, (iii) identify the phylogenetic signal and degree of conservatism of the trait involved in the filtering and (iv) identify the associations between spatial and phylogenetic scales to determine if the environmental variable (partially) structures the phylogenetic signal of the trait at its spatial scale(s) of action. Statistical performances of our approach were evaluated in terms of R^2 , power and type I error rate with traits simulated with increasing phylogenetic signals and environment variables displaying no spatial structure and a structure at large and fine spatial scales. The approach successfully detected every spatial and phylogenetic signals and their associations with good statistical power and type I error rates, thereby promising favourable insights for future studies on environmental filtering.

Keywords: trait-environment relationships; fourth-corner approach; phylogenetic signal; spatial signal; Moran's Eigenvectors Maps; phylogenetic eigenvectors; RLQ; community ecology; ecological processes; scalogram.

Phylogenetic and spatial scaling of trait-mediated environmental filtering

Article in preparation for submission in Ecography

Sylvie Clappe¹, Pedro R. Peres-Neto² and Stéphane Dray¹

¹Université de Lyon, F-69000, Lyon; Université Lyon 1; CNRS, UMR5558, Laboratoire de Biométrie et Biologie Evolutive, Villeurbanne, France

²Department of Biology, Concordia University, Montreal, Quebec, Canada H4B 1R6, Canada

I. Introduction

Determining the nature of ecological processes and how ecological scales (e.g., spatial; temporal; organismic such as individual, species, functional group or phylogenetic clade) influence their strength in structuring composition of species assemblages is a major challenge in community ecology (Cottenie 2005; Chase and Myers 2011; Erős et al. 2012; Chang et al. 2013; Fernandes et al. 2014). It is now well acknowledged that the structure and composition of communities result from a complex combination of stochastic and deterministic ecological processes acting hierarchically through ecological scales to constrain species coexistence (Götzenberger et al. 2012, Cadotte and Tucker 2017). Among other processes structuring communities, environmental filtering stipulates that species distributions result from differences and similarities in species response to local environment (Chase and Leibold 2003; Leibold and Chase 2017). One of the most intuitive approaches to study species-environment relationships is to explain taxonomic diversity of communities (i.e., abundances or presence-absence) with local environmental conditions. In particular, indirect and direct gradient analyses (Whittaker 1978; Ter Braak and Prentice 2004) in addition to species distributions models (Guisan and Zimmermann 2000; Guisan and Thuiller 2005; Elith and Leathwick 2009 for a review) are widely used methods to study relationships between local communities taxonomic composition and their environment. Yet, over the few past decades, it has been well established that environmental filtering is mechanistically driven by species functional traits discarding all species with unadapted traits combinations (i.e., hereafter trait-mediated environmental filtering; Keddy 1992; Weiher et al. 1998; Sommer et al. 2014). Thereby, studying trait-mediated environmental filtering requires to investigate how trait-environment relationships drive species distributions. Among others (Dolédec et al. 1996; Legendre et al. 1997; Dray and Legendre 2008; Webb et al. 2010; Jamil et al. 2013; Brown et al. 2014; Dray et al. 2014), the fourth-corner approach (Legendre et al. 1997; Dray

and Legendre 2008; Peres-Neto et al. 2016) is widely used to study trait-environment relationships and calculates a weighted correlation between a single environmental variable and a single trait both standardised and weighted in regards to species abundances. Taken separately however, trait and environment present dependencies likely to affect trait-environment relationships.

Because species are linked through phylogeny, functional traits are expected to present phylogenetic dependencies with values of conserved traits being more similar for closely related species than unrelated ones (Harvey and Pagel 1991). Hence, communities driven by trait-mediated environmental filtering should be characterised by phylogenetic clustering if traits are conserved along the phylogeny, but evenness if traits are convergent (Webb et al. 2002; Kraft et al. 2007). These phylogenetic structures have been however shown to vary across phylogenetic scales (Cavender-Bares et al. 2004; Swenson et al. 2006). For example, Cavender-Bares et al. (2006) showed that environmental filtering led to phylogenetic clustering at large phylogenetic scale as traits tend to be conserved whereas small phylogenetic scale displayed phylogenetic evenness due to trait convergence. Environmental variables, on the other hand, display spatial dependencies, as environmental conditions of nearby locations are likely to be more similar (positive spatial autocorrelation) or dissimilar (negative spatial autocorrelation), contributing to structure them through multiple spatial scales. Due to this multi-scale structure, the strength and relative importance of environmental effect on community species and functional compositions are likely to vary with spatial scales (Hortal et al. 2008; Chalmandrier et al. 2017). For instance, environmental filtering was shown to mostly drive functional diversity of plant communities at large spatial scales whereas its effect remained slight at small spatial scales where competition predominated (Chalmandrier et al. 2017). In addition, spatial scales are also known to influence community phylogenetic structure as, in particular, phylogenetic clustering was observed to increase with the spatial scale considered (Swenson et al. 2006; Willis et al. 2009). Overall, both phylogenetic and spatial scales respectively are expected to influence trait-environment relationships.

Although trait-environment relationships have already been shown to vary through spatial scales (Brind'Amour et al. 2011; Ernst et al. 2012), they were, to our knowledge, barely studied through phylogenetic scales nor through the combination of both spatial and

phylogenetic scales. However, adopting a scaling approach by combining several ecological scales has been encouraged in the recent years (Swenson et al. 2006; Thuiller et al. 2010; Münkemüller et al. 2014) and has been proven highly relevant especially to distinguish between environmental filtering and competition (Chalmandrier et al. 2013; Parmentier et al. 2014). Taking into consideration both spatial and phylogenetic scales when studying trait-mediated environmental filtering could offer important insights by decomposing trait-environment relationships to (i) follow the evolution of environmental filtering through spatial scales and identify the environmental variables successively involved, (ii) associate the change of phylogenetic patterns with the variation of environmental filtering across spatial scales and (iii) capture the evolutionary history surrounding trait-environment relationships to replace the effect of the environmental filtering as an ancient or recent ecological process.

Studying trait-environment relationships in explicit spatial and phylogenetic contexts implies to combine five different information: abundances, traits, environment, phylogeny and space. Although, integrating these five information to study environmental filtering is not new (Diniz-Filho et al. 2007; Freckleton and Jetz 2009; Kühn et al. 2009; Pavoine et al. 2011), none of them decomposed trait-environment relationships through both spatial and phylogenetic scales. Among them, the approach of Pavoine et al. (2011) remains the closer to this objective as they developed a framework notably able to identify both the phylogenetic lineage and spatial areas of environmental variables involved in the trait-environment relationships, in addition to the identification of the particular sets of environmental conditions and species functional traits involved in environmental filtering. In contrast, the methodologies developed in the rest of the studies were outside the scope of scale decomposition as they aimed mainly at either studying trait-environment relationships freed from spatial and phylogenetic effects by removing spatial autocorrelation in environmental variables and spatially-structured phylogenetic autocorrelation or phylogenetic signal associated with trait (Kühn et al. 2009), or distinguish phylogenetic and environmental effects on trait diversity (Diniz-Filho et al. 2007; Freckleton and Jetz 2009), or traits spatial variation (Diniz-Filho et al. 2007).

In summary, the novelty of our approach relies on identifying spatial and phylogenetic scales separately involved in trait-environment relationships, but especially on identifying the strength of association between the two scales to quantify the influence of environmental

variables in structuring phylogenetic signal of the trait-environment relationship at its particular spatial scale(s). This study offers a new framework by extending the fourth-corner method to integrate explicit spatial and phylogenetic context and decompose the trait-environment relationship across both spatial and phylogenetic scales. The proposed approach aims at:

- i. Identifying traits and environmental variables involved in trait-mediated environmental filtering and quantifying their relationship;
- ii. Identifying the spatial scales at which trait-mediated environmental filtering is acting;
- iii. Identifying the phylogenetic signal and degree of conservatism (through the phylogenetic scales profile) of trait involved in the filtering;
- iv. Identifying the strength of relationship between spatial and phylogenetic scales of trait-mediated environmental filtering to relate the species evolutionary history to particular spatial scale(s).

II. Methodological framework

Multi-scale fourth-corner approach

Decomposition of trait-environment relationship across spatial and phylogenetic scales

In community ecology, the fourth-corner approach (Legendre et al. 1997; Dray and Legendre 2008; Peres-Neto et al. 2016) is used to identify and quantify trait-environment relationships. The classical method calculates the correlation between an environmental vector \mathbf{e} (one environmental value per site) and a species trait vector \mathbf{t} (one trait value per species) through a species abundance matrix \mathbf{L} (sites-by-species). The correlation is defined as follows (Peres-Neto et al. 2016):

$$cor_{\mathbf{P}}(\mathbf{t}, \mathbf{e}) = \tilde{\mathbf{e}}_{\mathbf{W}_n}^T \cdot \mathbf{P} \cdot \tilde{\mathbf{t}}_{\mathbf{W}_s} = \tilde{\mathbf{t}}_{\mathbf{W}_s}^T \cdot \mathbf{P}^T \cdot \tilde{\mathbf{e}}_{\mathbf{W}_n} \quad (1)$$

where \mathbf{P} is the matrix of species relative frequencies derived from \mathbf{L} as

$$\mathbf{P} = [p_{ij}] = [l_{ij} / \sum_{i=1}^n \sum_{j=1}^s l_{ij}] \quad \text{with } l_{ij} \text{ the abundance of the } j\text{-th species at the } i\text{-th site contained}$$

in the matrix \mathbf{L} , n the total number of sites, and s the total number of species. \mathbf{W}_n and \mathbf{W}_s are the diagonal matrices of sites (rows) and species (columns) weights derived from \mathbf{P} as

$$\mathbf{W}_n = \text{diag} \left(\sum_{j=1}^s p_{1j}, \dots, \sum_{j=1}^s p_{nj} \right) \quad \text{and} \quad \mathbf{W}_s = \text{diag} \left(\sum_{i=1}^n p_{i1}, \dots, \sum_{i=1}^n p_{is} \right) . \quad \tilde{\mathbf{e}}_{\mathbf{W}_n} \text{ and } \tilde{\mathbf{t}}_{\mathbf{W}_s} \text{ are the}$$

standardised (mean=0 and variance=1) vectors of, respectively, environmental values weighted by \mathbf{W}_n and trait values weighted by \mathbf{W}_s (see Appendix S1 for details).

Integrating spatial and phylogenetic scales in the fourth-corner approach requires to introduce a matrix of spatial predictors \mathbf{S} (sites-by-predictors) and a matrix of phylogenetic predictors \mathbf{U} (species-by-predictors). In this study, Moran's Eigenvector Maps (MEM; Dray et al. 2006) were used to compose the spatial matrix \mathbf{S} allowing to efficiently model spatial patterns from large (e.g., north-south gradient) to fine spatial scales (e.g., chessboard repulsion pattern). Similarly, the phylogenetic matrix \mathbf{U} was composed of phylogenetic Moran's Eigenvectors (PME; Peres-Neto 2006) which correspond to phylogenetic predictors allowing to model large (i.e., early divergence event) to fine phylogenetic structures (i.e., late divergence phenomenon). Note that other constructions of phylogenetic eigenvectors can be used (Diniz-Filho et al. 1998; Guénard et al. 2013).

The multi-scale fourth-corner approach begins with the computation of environmental and phylogenetic vectors expected at each spatial and phylogenetic scales respectively. A multivariate linear regression of the unstandardised environmental vector \mathbf{e} on MEM is thus performed allowing to entirely decompose \mathbf{e} into a sum of predicted environmental vectors $\hat{\mathbf{e}}_k$ at each k spatial scales (Eq. 2; Fig. 1). The same rationale is applied to the unstandardised trait vector \mathbf{t} which is regressed on PME so that it can be decomposed into a sum of predicted trait vectors $\hat{\mathbf{t}}_l$ for each l phylogenetic scales (Eq. 3; Fig. 1). As such, \mathbf{e} and \mathbf{t} can be re-written as:

$$\mathbf{e} = \sum_{k=1}^{n-1} \hat{\mathbf{e}}_k \quad (2)$$

$$\mathbf{t} = \sum_{l=1}^{s-1} \hat{\mathbf{t}}_l \quad (3)$$

with \mathbf{e} and \mathbf{t} representing the unstandardised environmental and trait vectors, $\hat{\mathbf{e}}_k$ the predicted environmental vector at the k -th spatial scale obtained from the regression of \mathbf{e} on MEM_k , and $\hat{\mathbf{t}}_l$ the predicted trait vector at the l -th phylogenetic scale obtained from the regression of \mathbf{t} on PME_l . Note that the total number of spatial (k) and phylogenetic (l) scales are respectively $n-1$ and $s-1$ corresponding to the number of columns of \mathbf{S} and \mathbf{U} matrices due to the removal of one eigenvector with a null eigenvalue (see Dray et al. 2006 for details).

The trait-environment correlation ($\text{cor}_p(\mathbf{t}, \mathbf{e})$) can then be entirely and additively decomposed through:

1. Spatial scales by replacing the standardised environmental vector $\tilde{\mathbf{e}}_{\mathbf{w}_n}$ with the standardised predicted environmental vectors weighted by \mathbf{W}_n ($\hat{\mathbf{e}}_{\mathbf{w}_n}$; Appendix S1) defined for every spatial scales (Eq. 2) in Eq. 1 (Fig. 1A):

$$\text{cor}_p(\mathbf{t}, \mathbf{e}) = \sum_{k=1}^{n-1} \hat{\mathbf{e}}_{\mathbf{w}_n, k}^T \cdot \mathbf{P} \cdot \tilde{\mathbf{t}}_{\mathbf{w}_s} = \sum_{k=1}^{n-1} \tilde{\mathbf{t}}_{\mathbf{w}_s}^T \cdot \mathbf{P}^T \cdot \hat{\mathbf{e}}_{\mathbf{w}_n, k} \quad (4)$$

2. Phylogenetic scales by substituting the standardised trait vector $\tilde{\mathbf{t}}_{\mathbf{w}_s}$ for the standardised predicted trait vectors weighted by \mathbf{W}_s ($\hat{\mathbf{t}}_{\mathbf{w}_s}$; Appendix S1) defined for each phylogenetic scale (Eq.3) in Eq. 1 (Fig. 1B):

$$cor_{\mathbf{p}}(\mathbf{t}, \mathbf{e}) = \sum_{l=1}^{s-1} \tilde{\mathbf{e}}_{\mathbf{w}_n}^T \cdot \mathbf{P} \cdot \hat{\mathbf{t}}_{\mathbf{w}_s l} = \sum_{l=1}^{s-1} \hat{\mathbf{t}}_{\mathbf{w}_s l}^T \cdot \mathbf{P}^T \cdot \tilde{\mathbf{e}}_{\mathbf{w}_n} \quad (5)$$

3. Spatial and phylogenetic scales by respectively replacing the standardised environmental ($\tilde{\mathbf{e}}_{\mathbf{w}_n}$) and trait ($\tilde{\mathbf{t}}_{\mathbf{w}_s}$) vectors with the spatially-predicted environmental vectors ($\hat{\mathbf{e}}_{\mathbf{w}_n}$, Eq. 2) and the phylogenetically-predicted vectors ($\hat{\mathbf{t}}_{\mathbf{w}_s}$, Eq. 3) in Eq. 1 (Fig. 1C):

$$cor_{\mathbf{p}}(\mathbf{t}, \mathbf{e}) = \sum_{k=1}^{n-1} \sum_{l=1}^{s-1} \hat{\mathbf{e}}_{\mathbf{w}_n k}^T \cdot \mathbf{P} \cdot \hat{\mathbf{t}}_{\mathbf{w}_s l} = \sum_{l=1}^{s-1} \sum_{k=1}^{n-1} \hat{\mathbf{t}}_{\mathbf{w}_s l}^T \cdot \mathbf{P}^T \cdot \hat{\mathbf{e}}_{\mathbf{w}_n k} \quad (6)$$

These three decompositions result in spectra akin to scalograms (Dray et al. 2012; Fig. 1A-C) where each MEM and/or PME predictor explains a part of total fourth-corner correlation statistic $cor_{\mathbf{p}}(\mathbf{t}, \mathbf{e})$. Note that MEM and PME were grouped to smooth the graphical representation (Fig. 1A&B). Moreover, instead of directly representing $cor_{\mathbf{p}}(\mathbf{t}, \mathbf{e})$, results were presented with a statistic related to R^2 and normalised to sum to 1 (Fig. 1A-C) to facilitate the interpretation. For instance, R^2 for the spatial decomposition was obtained as follows:

$$R_{\text{spatial}}^2 = \sum_{k=1}^{n-1} R_k^2 = 1 \quad (7)$$

with

$$R_k^2 = \frac{cor_{\mathbf{p}}(\tilde{\mathbf{t}}, \hat{\mathbf{e}}_k)^2}{\sum_{k=1}^{n-1} cor_{\mathbf{p}}(\tilde{\mathbf{t}}, \hat{\mathbf{e}}_k)^2} \quad (8)$$

where $cor_{\mathbf{p}}(\tilde{\mathbf{t}}, \hat{\mathbf{e}}_k)$ is the fourth-corner correlation between the standardised trait vector $\tilde{\mathbf{t}}$ and $\hat{\mathbf{e}}_k$ the environmental vector predicted at the scale k .

Testing the decomposition

The multi-scale fourth-corner approach is a two-steps procedure firstly testing for the presence of a trait-environment relationship. In case of significant relationship, its spatial and phylogenetic structures are then tested (Fig. 1).

1. **Testing for the presence of a trait-environment relationship** (Fig. 1 step 1). The corresponding null hypothesis $H0_1$ states that “*there is no trait-environment relationship given the spatial and phylogenetic structures of the environmental and trait variables*”. Recently, Braga et al. (2018) showed that the spatial and phylogenetic structures inflated type I error rates when testing for trait-environment relationship leading to detect significant associations although there were none. To correct this issue, they developed a fourth-corner approach based on a spatially- and phylogenetically-constrained null model (i.e., null model presenting similar spatial and phylogenetic structures than the testing trait and environmental variables) using Moran Spectral Randomization (Wagner and Dray 2015; see Braga et al. 2018 for the detailed method). We used the framework developed by Braga et al. (2018) to avoid inflated type I error rates when testing for trait-environment relationship.
2. **Testing spatial and phylogenetic structures of the trait-environment relationship if significant** (Fig. 1 step 2). The null hypothesis $H0_2$ states that “*the trait-environment relationship has no spatial and/or phylogenetic structure*”. The corresponding null model was thus build randomly (i.e., no spatial and/or phylogenetic structure) while conserving the initial trait-environment link. Preserving the trait-environment relationship implied to keep the original matrix \mathbf{L} and vectors \mathbf{e} and \mathbf{t} to calculate the spatial and/or phylogenetic decomposition (Eq. 4, 5 and 6). To break the spatial and phylogenetic structures of \mathbf{e} and \mathbf{t} respectively while conserving their link, rows of MEM and PME were randomly permuted leading to randomly represent space and phylogeny and thus decomposing \mathbf{e} and \mathbf{t} on unstructured bases. As such, predicted $\hat{\mathbf{e}}$ and $\hat{\mathbf{t}}$ were not structured and allowed to conserve the initial trait-environment relationship as they originate from the initial vectors \mathbf{e} and \mathbf{t} .

In practice, the testing procedure for spatial structures alone implied to permute rows of MEM, then predict \mathbf{e} on this new basis ($\hat{\mathbf{e}}$), and finally calculate the spatial decomposition of the trait-environment relationship (Eq. 4). Repeating these three steps n times (e.g., $n = 999$) allowed to build the null distribution of the spatial decomposition expected under $H0_2$. The same approach was performed to test for phylogenetic structures: permuting rows PME, predicting \mathbf{t} on this new basis ($\hat{\mathbf{t}}$) and phylogenetically decompose the trait-environment relationship (Eq. 5). Finally, testing for both spatial and phylogenetic structures led to take the maximum p-value between the tests for spatial and phylogenetic structures alone.

Interpretation of the decomposition

The spatial decomposition of the trait-environment relationship (Eq. 4; Fig. 1A) indicates the spatial structure of the environmental vector and as such the spatial scale involved in trait-mediated environmental filtering. The rationale is that MEM represent a gradient of spatial scales with the first MEM corresponding to the large spatial scales and the last to fine spatial scales. Similarly, the phylogenetic decomposition (Eq. 5; Fig. 1B) displays the phylogenetic signal associated to the trait selected by environmental filtering with the first PME representing large phylogenetic scales (e.g., early niche divergence resulting in clade niche conservatism) and the last fine phylogenetic scales (e.g., late niche divergence resulting niche lability). Finally, the decomposition of the fourth-corner correlation through spatial and phylogenetic scales at the same time (Eq. 6) allows to characterise the strength of association between the environmental spatial signal and the trait phylogenetic signal to determine if the environmental variable is responsible for the niche divergence at its particular spatial scale.

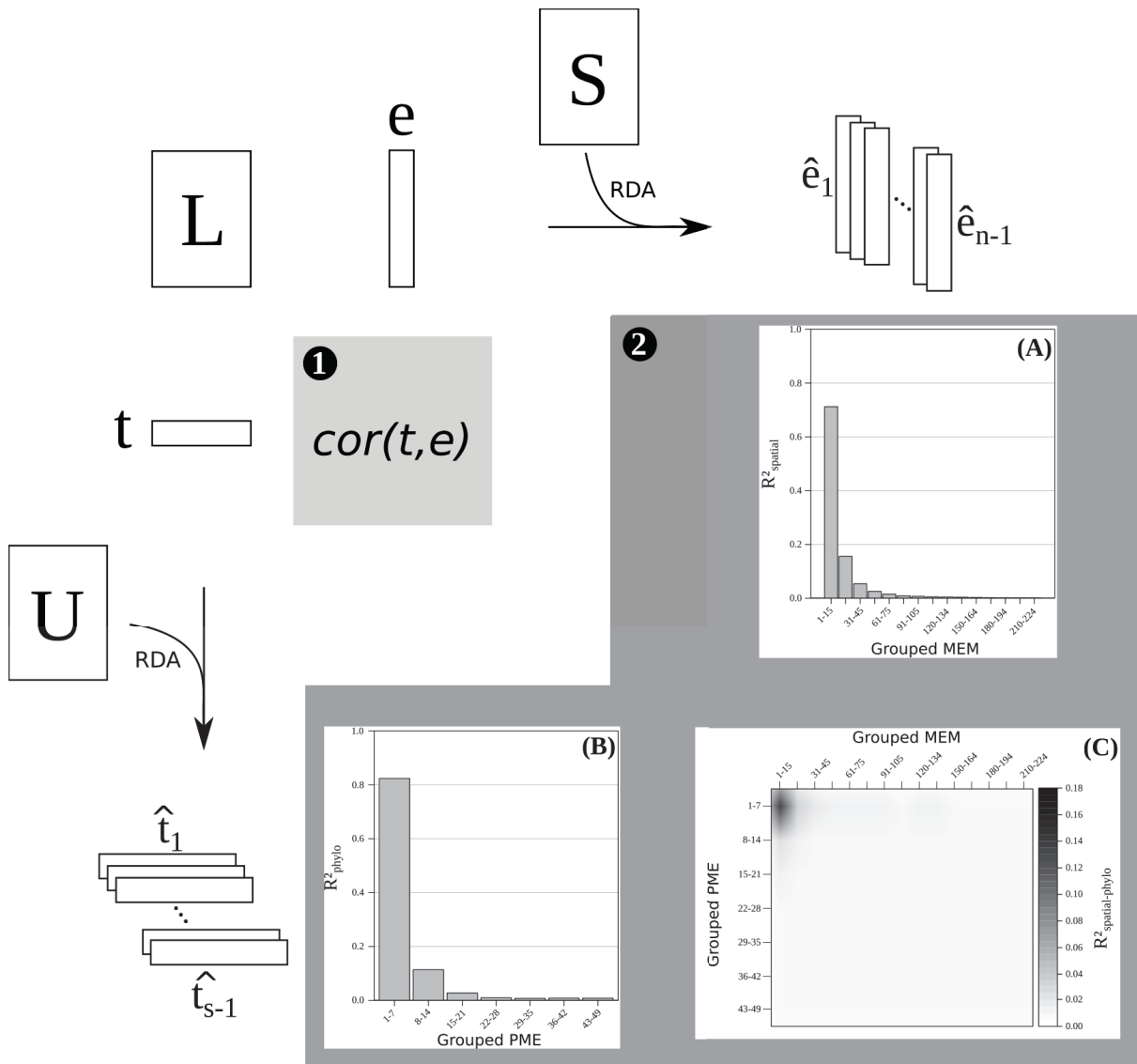

Figure 1: Schematic summary of the multi-scale fourth-corner approach. (1) The first step (light grey square), calculates and test the fourth-corner correlation between the trait vector \mathbf{t} and the environmental vector \mathbf{e} through a table of species abundances \mathbf{L} to characterize trait-environment relationship. The relationship is tested with a spatially- and phylogenetically-constrained null model. (2) If significant, the second step (dark grey area) is to respectively predict \mathbf{t} and \mathbf{e} across phylogenetic ($\hat{\mathbf{t}}$) and spatial ($\hat{\mathbf{e}}$) scales using multivariate linear regressions (redundancy analyses; RDA) with a table \mathbf{U} of phylogenetic eigenvectors (PMEs) and a matrix \mathbf{S} of spatial eigenvectors (MEM). $\hat{\mathbf{t}}$ and $\hat{\mathbf{e}}$ are then used to decompose the fourth-corner correlation of the significant trait-environment relationship into (A) spatial scales, (B) phylogenetic scales, (C) spatial and phylogenetic scales. Each structure is tested under a random null model. (A-C) Results are presented in terms of R^2 summing to 1 to facilitate interpretations. MEM and PEM are grouped to smooth the results. Phylogenetic and spatial signals presented here were simulated with $g = 0$ and $\rho = 0.8$ respectively. (A-B) Phylogenetic and spatial decomposition are represented by scalograms.

Simulation study

A simulation study was conducted to assess the statistical performances of the multi-scale fourth-corner approach through power (i.e., rejection of the null hypothesis when false) and type I error rates (i.e., rejection of the null hypothesis when true).

Environment

To study the detection sensibility of the multi-scale fourth-corner approach to environmental spatial structure, the environmental vector \mathbf{e} was simulated with (i) no spatial structure, structured at (ii) fine and (iii) large spatial scales (Fig. 2).

Following the protocol of Dray (2011), a single environmental variable for 225 sites was generated on a 15 x 15 grid with an autoregressive model of parameter ρ used to define the spatial structure and equalled to 0 for no spatial structure, and -0.8 and 0.8 for a structure at fine and large spatial scales respectively.

Phylogeny and trait

Similarly to the simulation of the environmental vector \mathbf{e} , a trait vector \mathbf{t} for 50 species was generated with four phylogenetic signals: (i) high, (ii) medium, (iii) low and (iv) no phylogenetic signal (Fig. 3).

The 50 values of \mathbf{t} evolved under a Brownian motion along a pure birth stochastic phylogenetic tree of 50 species. To introduce increasing phylogenetic signal, the phylogenetic tree was modified through ACDC transformation (Blomberg and Garland 2003) of parameter g allowing to increase or decrease the evolutionary rate. As such, when $g=0$ the tree is not modified and traits evolved under classic Brownian motion (case ii; Appendix S2 Fig. A2B, Fig. 3B). However, for $g<0$ the length of the branches close to the root are extended leading to decrease the evolutionary rate through time and thus a phylogenetic signal stronger than classic Brownian motion (case i; $g=-2$; Appendix S2 Fig. A2A, Fig. 3A). Inversely, for $g>0$ the length of the branches close to the tips are extended leading to increase the evolutionary rate through time resulting in a phylogenetic signal weaker than classic Brownian motion (case iii; $g=2$; Appendix S2 Fig. A2C, Fig. 3C) or even no phylogenetic signal (case iv; $g=100$; Appendix S2 Fig. A2D, Fig. 3D).

Metacommunity

Following the protocol of Peres-Neto et al. (2016), the species abundances l_{ij} of the matrix of communities \mathbf{L} (225 sites x 50 species) were drawn from a Poisson distribution of mean μ_{ij} defined as the unimodal response for the j -th species in the i -th site:

$$\mu_{ij} = 30 \cdot h_j \cdot \exp\left(\frac{-(e_i - t_j)^2}{2 \cdot s \cdot \sigma_j^2}\right) \quad (9)$$

where e_i is the environmental value at the i -th site, t_j is the trait value of the j -th species, $s \cdot \sigma_j^2$ the species niche breadth, and $30 \cdot h_j$ the abundance of the j -th species at its optimum t_j . s was fixed to 1.5, values of σ and h were randomly drawn from a uniform distribution ranging from 0 to 1, and 0.3 to 1 respectively.

Statistical analysis

Spatial predictors of matrix \mathbf{S} were generated using Moran's Eigenvector Maps (MEM; Dray et al. 2006) of a spatial weighting matrix defined for the 4 closest neighbours (i.e., rook's neighbourhood) and using row standardisation specification. Phylogenetic predictors of \mathbf{U} were produced using phylogenetic Moran's Eigenvectors (PME; (Peres-Neto 2006) of a

phylogenetic proximities matrix defined as $1 - \frac{d_{ij}}{d_{max}}$ with d_{ij} the patristic distance (i.e., the inverse sum of branch length) between the i -th and j -th species, and d_{max} the maximum patristic distance between two species of the phylogenetic tree. This definition is tightly linked to Brownian motion model under which proximities between species have been shown to decrease linearly as a function of the time's square root (Letten and Cornwell 2015).

Four scenarios were considered in this study to evaluate the performances of the multi-scale fourth corner approach:

- Scenario A: $\mathbf{e} \Leftrightarrow \mathbf{L} \Leftrightarrow \mathbf{t}$: scenario with a trait-environment relationship where the environmental vector \mathbf{e} and the trait vector \mathbf{t} were used to (i) generate the abundances of the community matrix \mathbf{L} ; and (ii) calculate the multi-scale fourth corner approach (Eq. 4, 5 and 6).

- Scenario B: $\mathbf{e} \not\leftrightarrow \mathbf{L} \not\leftrightarrow \mathbf{t}$: scenario with no trait-environment relationships but with spatial and phylogenetic signals. Here, the environmental vector \mathbf{e} and the trait vector \mathbf{t} were used to (i) generate the abundances of the community matrix \mathbf{L} but not to calculate of the multi-scale fourth corner approach (Eq. 4, 5 and 6) for which they were replaced by \mathbf{e}_2 and \mathbf{t}_2 simulated with spatial and phylogenetic structures similar to \mathbf{e} and \mathbf{t} .
- Scenario C: $\mathbf{e} \not\leftrightarrow \mathbf{L} \Leftrightarrow \mathbf{t}$: scenario with no trait-environment relationships but with spatial and phylogenetic signals. In this case, the trait vector \mathbf{t} was used to (i) generate the abundances of the community matrix \mathbf{L} ; and (ii) to calculate of the multi-scale fourth corner approach (Eq. 4, 5 and 6). But the environmental vector \mathbf{e} was solely used to generate the abundances of the community matrix \mathbf{L} but replaced by \mathbf{e}_2 (simulated with a phylogenetic structure similar to \mathbf{e}) to calculate of the multi-scale fourth corner approach (Eq. 4, 5 and 6).
- Scenario D: $\mathbf{e} \Leftrightarrow \mathbf{L} \not\leftrightarrow \mathbf{t}$: scenario with no trait-environment relationships but with spatial and phylogenetic signals. Here, the environmental vector \mathbf{e} was used to (i) generate the abundances of the community matrix \mathbf{L} ; and (ii) to calculate of the multi-scale fourth corner approach (Eq. 4, 5 and 6). Bu, the trait vector \mathbf{t} was solely used to generate the abundances of the community matrix \mathbf{L} but replaced by \mathbf{t}_2 (simulated with a phylogenetic structure similar to \mathbf{t}) to calculate of the multi-scale fourth corner approach (Eq. 4, 5 and 6).

Each scenario was simulated 1000 times for each combination of spatial and phylogenetic structures. The power of detection (i.e., rejecting the null hypothesis when false; Scenario A) and the type I error rates (rejecting the null hypothesis when true; scenarios B, C and D) of the multi-scale fourth corner approach were based on 999 randomisations and a significance level alpha of 0.05 for all tests. Results are presented in a smoothed version where spatial and phylogenetic scales are respectively represented by 15 groups of MEM and 7 groups of PME. Finally, note that the first step of the testing procedure was performed bilaterally, as there was no expectation on the position of the observed value of the trait-environment correlation compared to the null distribution, but the second was unilateral, as the null hypothesis was random but trait and environment were both structured.

All statistical analyses were conducted under R 3.4.4 (R Core Team 2018), in particular using the functions *pbtrees* (package *phytools*; Revell 2012) and *rescale.phylo* (package *geiger*; Harmon et al. 2008) to simulate and transform phylogenetic trees. The functions *me.phylo* (package *adephylo*; Jombart et al. 2010) and *scores.listw* (package *adespatial*; Dray et al. 2017) were used to generate PME and MEM respectively. The multi-scale fourth corner approach (*scalo.fourth.corner*) is available on *adespatial*. R scripts to reproduce the simulations of the present study are available in Appendix S3.

Table 1: Statistical power (Scenario A) and type I error rates (scenarios B, C and D) of the fourth corner approach using a spatially- and phylogenetically-constrained null model when trait and environment are simulated unrelated.

Simulation scenarios	Trait phylogenetic signal (g)	Environmental spatial structure (ρ)		
		Large ($\rho = 0.8$)	Fine ($\rho = -0.8$)	No structure ($\rho = 0$)
Scenario A	Stronger than BM ¹ ($g = -2$)	1	1	1
	Equal to BM ¹ ($g = 0$)	1	1	1
	Weaker than BM ¹ ($g = 2$)	1	1	1
	No signal ($g = 100$)	1	1	1
Scenario B	Stronger than BM ¹ ($g = -2$)	0.006	0.001	0.005
	Equal to BM ¹ ($g = 0$)	0.004	0.009	0.009
	Weaker than BM ¹ ($g = 2$)	0.006	0.009	0.009
	No signal ($g = 100$)	0.012	0.010	0.021
Scenario C	Stronger than BM ¹ ($g = -2$)	0.048	0.045	0.050
	Equal to BM ¹ ($g = 0$)	0.051	0.049	0.047
	Weaker than BM ¹ ($g = 2$)	0.048	0.042	0.048
	No signal ($g = 100$)	0.051	0.045	0.048
Scenario D	Stronger than BM ¹ ($g = -2$)	0.044	0.056	0.045
	Equal to BM ¹ ($g = 0$)	0.051	0.055	0.058
	Weaker than BM ¹ ($g = 2$)	0.051	0.044	0.038
	No signal ($g = 100$)	0.052	0.039	0.061

¹Brownian Motion

III. Results

Testing for trait-environment relationship

Regardless of the respective spatial and phylogenetic structures of environmental and species functional trait vectors, the approach detected significant trait-environment relationships with an excellent power when \mathbf{e} and \mathbf{t} were simulated linked (Scenario A; Table 1). Likewise, the approach presented correct type I error rates for scenarios B, C and D where trait and environment were simulated unrelated (i.e., no trait-environment relationships; Table 1). These results were expected as partially supported by the previous study of Braga et al. (2018) which developed the spatially- and phylogenetically-constrained null model for the fourth-corner method. Note, however, that the type I error rate was slightly higher for scenario D when \mathbf{e} and \mathbf{t} were not spatially and phylogenetically structured respectively (Table 1).

Testing for spatial and phylogenetic signals of trait-environment relationship

As previously highlighted, spatial and phylogenetic structures of trait-environment relationship are tested solely if the relationship is significant (Scenario A). As spatial signals were similar regardless of the strength of the species functional trait phylogenetic signal used to perform the multi-scale fourth-corner, results on environmental spatial structures were presented for $g=-2$ (see Appendix S4 for spatial profiles under other g values). Likewise, results on trait phylogenetic signals were presented for $\rho=0.8$ (see Appendix S5 for phylogenetic profiles under other ρ values).

The multi-scale fourth-corner approach detected with a high statistical power the spatial structures of the environmental variable involved in the trait-environment relationship (Fig. 2A and B; Appendix S4 Fig. A4.1A and B, Fig. A4.2A and B, Fig. A4.3A and B). Indeed, when the environmental vector was simulated at large spatial scale, the approach identified the two first blocks of grouped MEM characterising the large spatial scales as highly significant over the 1000 simulations (Fig. 2A; Appendix S4 Fig. A4.1A, Fig. A4.2A, Fig. A4.3A). Inversely, the last block of MEM corresponding to fine spatial scales was detected as highly significant when the environmental variable involved in the filtering was simulated at fine spatial scales (Fig. 2B; Appendix S4 Fig. A4.1B, Fig. A4.2B, Fig. A4.3B). Finally, when the environmental vector was not spatially structured, our framework did not detect

significant spatial pattern with a correct type I error rate (Fig. 2C; Appendix S4Fig.A4.1C, Fig.A4.2C, Fig.A4.3C).

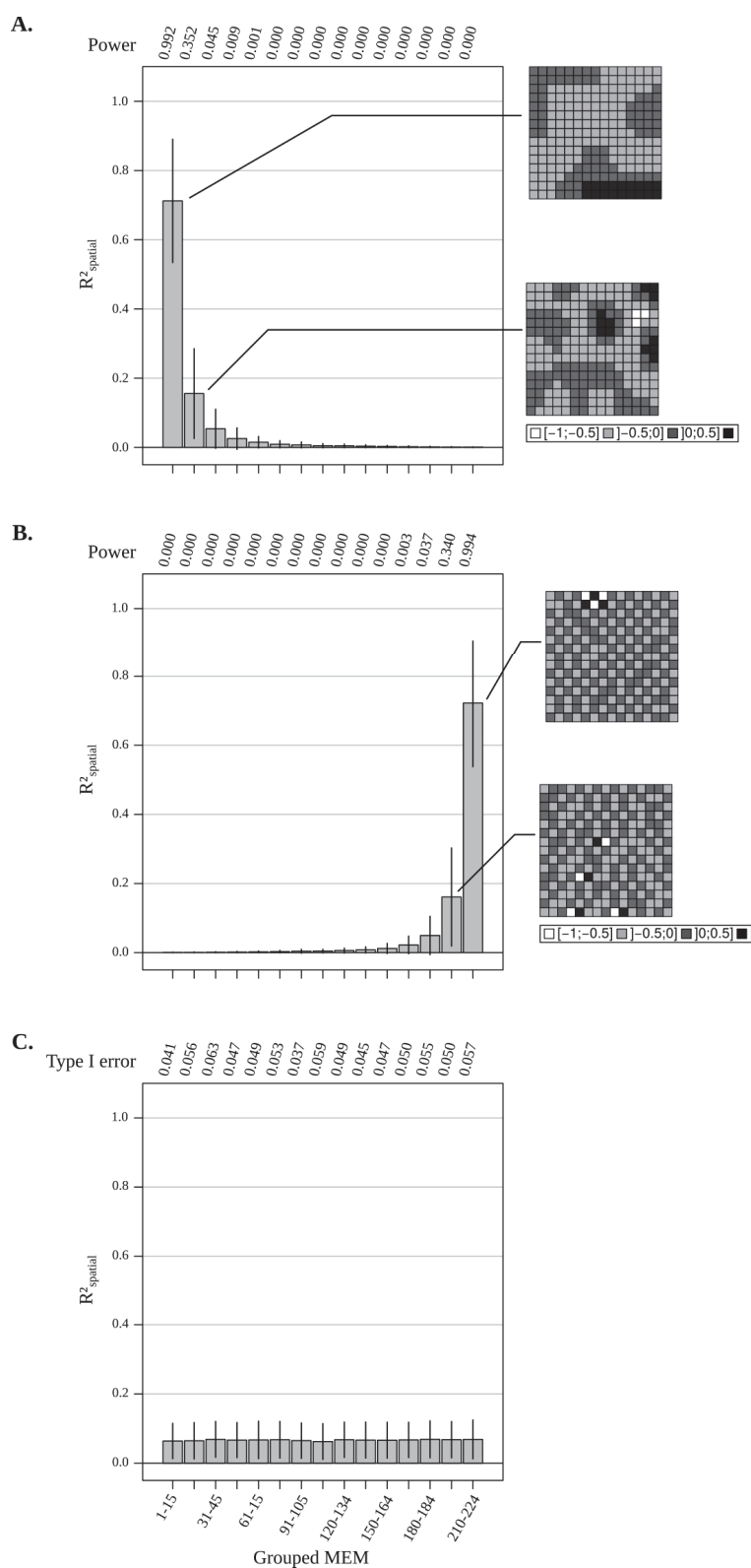

Figure 2: Spatial decomposition of trait-environment relationship (Scenario A). (A-B) R^2 estimations and associated power of the spatial signal of the environmental variable involved in trait-environment relationship when displaying spatial structures at (A) large spatial ($\rho = 0.8$) and (B) fine spatial scales ($\rho = -0.8$). (C) R^2 estimations and associated type I error rates of spatial signal when the environmental variable involved in the filtering is not spatially-structured ($\rho = 0$). (A-B) The grid of coloured squares represents the mean spatial structure of their corresponding MEM blocks. The color of the squares is proportional to the mean MEM values and is defined by a gradient from white (high negative values) to black (high positive values). (A-C) Spatial structures are all presented for trait-environment relationships whose trait has a phylogenetic signal stronger than Brownian motion ($g = -2$). Scalograms represent the mean spatial signal over the 1000 simulations. Vertical black bars are the standard deviations. MEM are regrouped to meet 15 blocks of eigenvectors to smooth the spatial signal.

Similarly, the multi-scale fourth-corner approach successfully detected the decreasing phylogenetic signal of trait-environment relationship with a good power and type I error rates (Fig. 3; Appendix S5 Fig. 5A.1 and Fig. 5A.2). Note that this decrease resulted in both a decrease in R^2 values of the first block of PME and its associated statistical power (Fig. 3A, B, C; Appendix S5 Fig. 5A.1 and Fig. 5A.2). Also, it has however to be noticed that a slight phylogenetic signal was detected when species functional trait evolved along a star-like phylogenetic tree although it was supposed to result in no phylogenetic structure among trait values (first block of PME with significant higher R^2 ; Fig. 3D; Appendix S5 Fig. A5.1 and Fig. A5.2).

Once both spatial and phylogenetic signals of, respectively, environmental and trait variables are identified, it is interesting to investigate the relationships between these two types of scales to assess if the phylogenetic structure related to the trait-mediated environmental filtering corresponds to the spatial scale of filtering. When environment and functional trait were respectively spatially and phylogenetically structured, our approach succeeded in detecting a significant association between every pair of spatial and phylogenetic scales implied in the trait-environment relationship with a good power (Fig. 4; Appendix S6 Fig. A6.1 and Fig. A6.2). Note that, as observed above, the R^2 between both types of scales and the statistical power decreased with the strength the phylogenetic signal (Fig. 4A and B; Appendix S6 Fig. A6.1A-C and A-G and Fig. A6.2A-C and E-G). If no spatial and/or phylogenetic structure was present in the environmental and/or trait vector, the approach presented smaller R^2 than if both were structured and did not detect them as significant with correct type I error rates (Fig. 4C and D; Appendix S6 Fig. A6.3A-H). Note however that, due to the remaining phylogenetic signal observed above when trait evolved along a star-like phylogenetic tree, type I error rate can be slightly inflated when environment is spatially structured (Appendix S6 Fig. A6.1H, Fig. A6.2H).

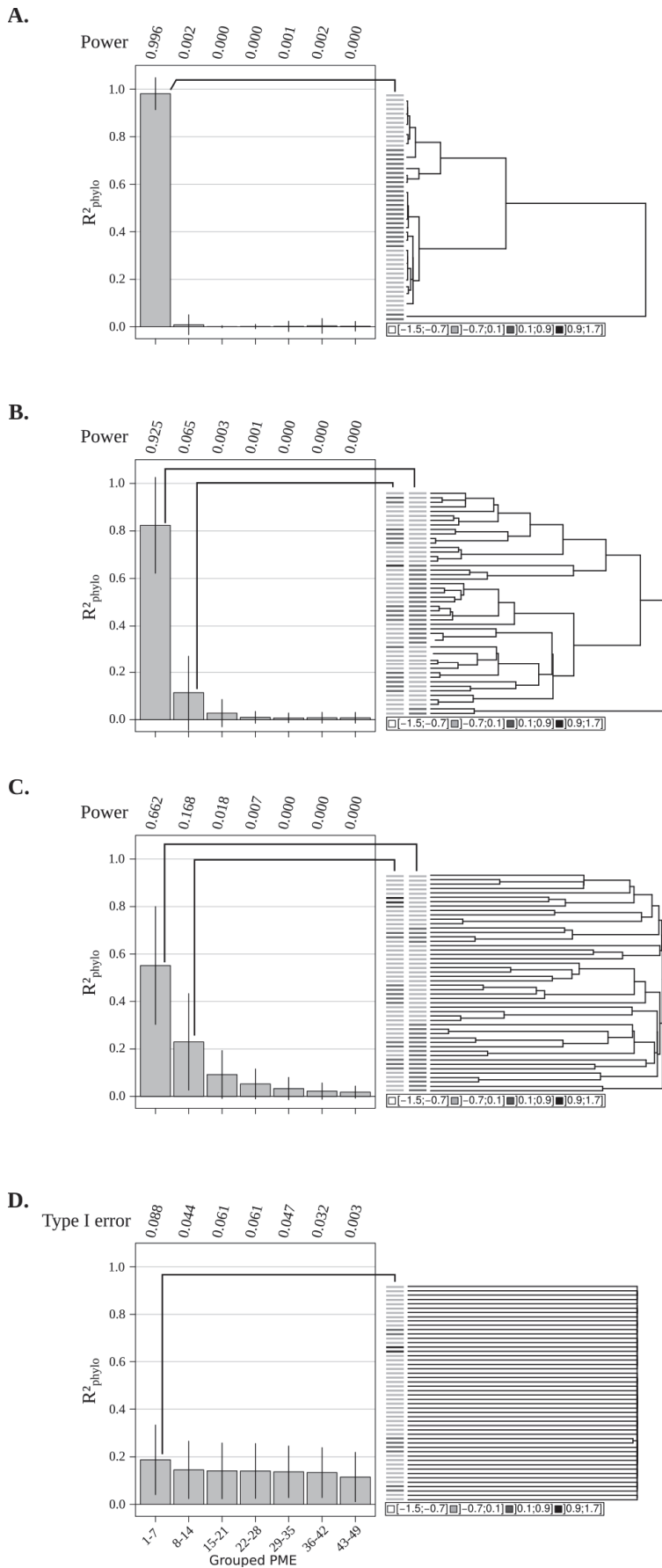

Figure 3: Phylogenetic decomposition of trait-environment relationship (Scenario A). (A-B) R^2 estimations and associated power of the trait phylogenetic signal when evolving along a phylogenetic tree modified by ACDC transformation to characterize a phylogenetic structure (A) stronger than Brownian motion (BM; $g = -2$), (B) equal to BM ($g = 0$) and (C) weaker than BM ($g = 2$). (D) R^2 estimations and associated type I error rates of phylogenetic signal when the trait evolved along a phylogenetic tree transformed by ACDC to define no phylogenetic structure ($g = 100$). (A-D) A phylogenetic tree corresponding to each ACDC transformation is represented next to its corresponding phylogenetic profile. The mean phylogenetic structure of the trait values corresponding to significant phylogenetic scales is represented on the tips of phylogenetic trees by coloured rectangles. The colours are proportional to the mean PME values and are characterised by a gradient going from white (high negative values) to black (high positive values). (A-D) Phylogenetic signals are all presented for trait-environment relationships whose environment has a spatial structure at large spatial scale ($\rho = 0.8$). Scalograms represent the mean phylogenetic signal over the 1000 simulations. Vertical black bars are the standard deviations. PME are grouped in 7 blocks of eigenvectors to smooth the phylogenetic signal.

IV. Discussion

The goal of this study was to extend the fourth-corner approach to investigate the spatial and phylogenetic scales of the trait-mediated environmental filtering. Firstly, the multi-scale fourth-corner approach tested for classical trait-environment relationship to quantify the association and identify traits and environmental variables involved in environmental filtering. The approach detected trait-environment relationships with a high statistical power when present and showed correct type I error rates when there was no link between the species functional trait and the environmental variable, hence supporting the results previously found by Braga et al. (2018). Scenario D presented however a type I error rate slightly higher when both the environmental variable and functional trait were not structured. This result is still not fully apprehended especially as every other type I error rates are correct, therefore further works are required to investigate this point.

If significant, the trait-environment relationship was then decomposed through spatial and phylogenetic scales. The multi-scale fourth-corner method succeeded in detecting with a high statistical power the spatial scales at which the environmental variable involved in the trait-environment relationship was simulated. Likewise, when the environmental vector was not spatially structured, the approach identified no spatial signal with correct type I error rates. Phylogenetic scales of the trait involved in trait-environment relationship were successfully detected by our framework. Both R^2 and the statistical power expectedly decreased with the strength of the phylogenetic signal as it became more difficult to detect. Note however that a slight significant phylogenetic signal was identified when functional trait was supposed to be simulated with no phylogenetic structure (i.e., along a star-like phylogenetic tree). Worth mentioning that our results showed a strong large-scaled phylogenetic signal of trait evolving under pure Brownian motion model (BM; $g=0$) confirming the conservative pattern of BM commonly admitted (Diniz-Filho and Sant'Ana 2000; Diniz-Filho et al. 2007; Letten and Cornwell 2015) and supporting the fact that phylogenetic niche conservatism can be produced by BM solely (Wiens 2008; Wiens et al. 2010).

The main novelty of our approach is to relate the spatial and phylogenetic scales of trait-environment relationship to associate phylogenetic structure to particular spatial scales. Our framework succeeded in detecting the associations of phylogenetic and spatial scales involved in trait-environment relationship with a good statistical power. Ultimately, if the functional trait and environmental variable involved in the trait-environment relationship are

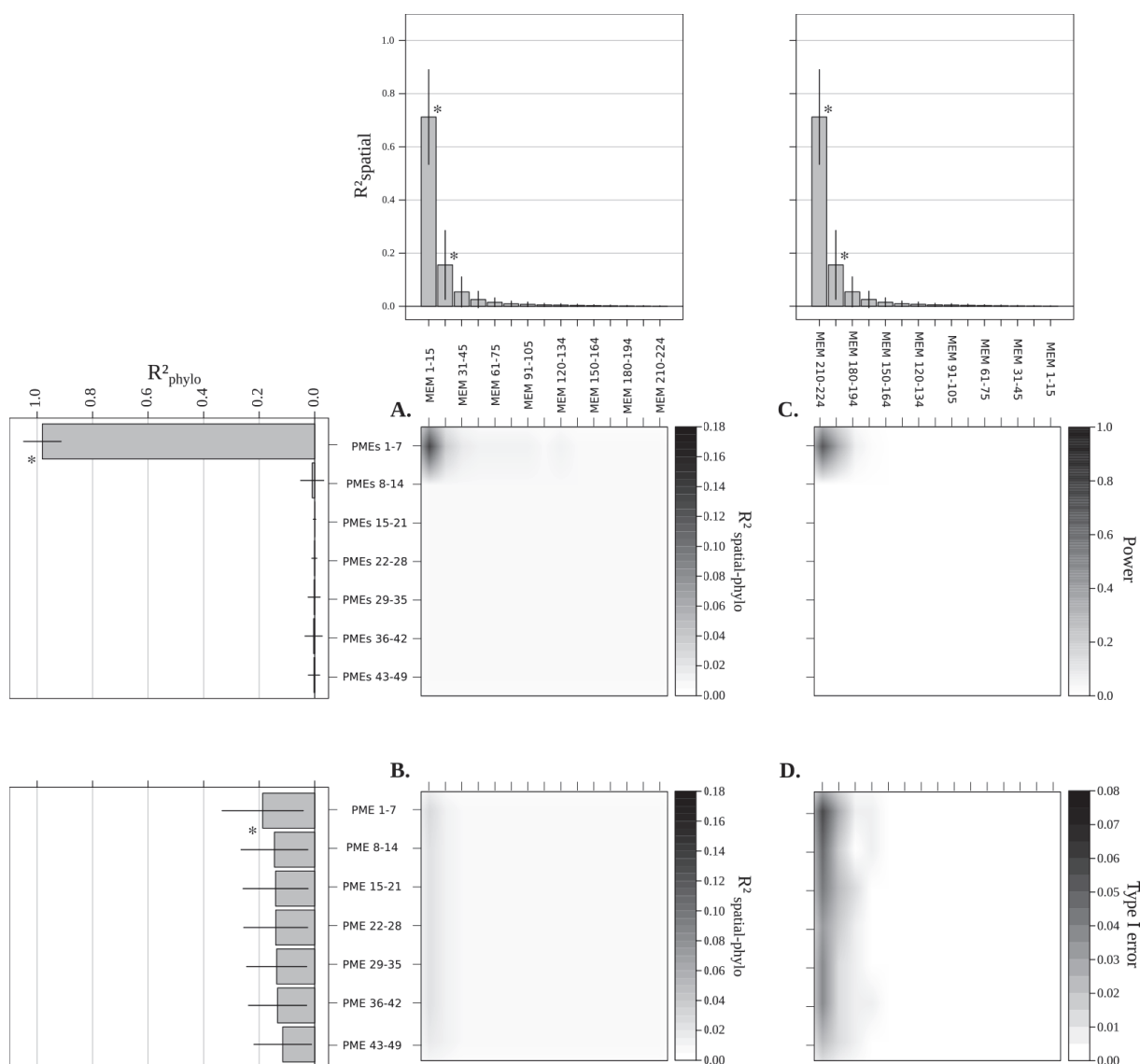

Figure 4: Decomposition of trait-environment relationship through both spatial and phylogenetic scales (Scenario A). (A-B) R^2 estimations of trait-environment relationship when decomposed through both spatial and phylogenetic scales for an environmental variable structured at large spatial scale ($\rho = 0.8$) and a trait displaying (A) a phylogenetic signal stronger than Brownian motion ($g = -2$) and (B) no phylogenetic signal ($g = 0$). (C-D) Power and type I error rates associated with the R^2 of the decomposition when environmental variable is structured at large spatial scale ($\rho = 0.8$) and the trait presents (C) a phylogenetic signal stronger than Brownian motion ($g = -2$) and (D) no phylogenetic signal ($g = 0$). (A-D) The color gradient is proportional to the values of R^2 , statistical power and type I error rates going from white (values near 0) to black (values close to 1). Results are averaged over the 1000 simulations, standard deviations are reported in Appendix S7 Table A7.1. Scalograms represent the phylogenetic and spatial signals alone as reported in Fig. 2 and 3 to facilitate the interpretation of the maps. The stars indicate the significant phylogenetic and spatial scales.

respectively phylogenetically and spatially structured, the approach allows to establish if the phylogenetic signal of the trait corresponds to the spatial scale of the environmental variable meaning that this variable (partially) structures the phylogenetic signal of the trait at this particular spatial scale. For instance, a trait structured at large phylogenetic scale related to a large spatial scaled environmental variable (Fig. 4A and C) could support allopatric or parapatric speciation of ancient lineages in response to a large-scaled environmental constraint. At the opposite, a large-scaled trait phylogenetic structure associated with a fine-scaled spatial structure of environment would support an ancient niche divergence related to micro-habitat (e.g., edaphic variables) presenting few temporal variations. Then, if the trait presents a phylogenetic signal but the environmental variable is not spatially structured, one can conclude that the phylogenetic signal either (i) results from other processes than trait-mediated environmental filtering or (ii) is structured by another unmeasured environmental variable. Inversely, if the trait displays no phylogenetic signal and the environmental variable spatially structured (Fig. 4B and D), the reasonable conclusion is that environmental filtering does not phylogenetically structure the functional trait.

Interpreting phylogenetic signals of the trait involved in the trait-environmental relationship in terms of evolutionary processes is however partially limited. Our approach is more descriptive than explicative, allowing to identify the level of phylogenetic conservatism presented by the species functional trait. The rationale is that the PME significantly detected by our framework indicates *from where* the species functional trait has been conserved along the phylogeny (i.e., qualitative information on trait conservatism level characterised as ancient or recent by identifying the phylogenetic lineages). Then, the R^2 value of PME determines *how strong* is trait conservation along the phylogeny. In other words, if the firsts PME are significantly detected with high R^2 values, the species functional trait has been strongly conserved (i.e., small evolutionary rate) from ancient lineages along the phylogeny. On the contrary, firsts significant PME with weak R^2 values indicate that even if the trait has been conserved from ancient lineages, the evolutionary rate increased along the phylogeny as species tended to diverge with time. Detection of medium and last PME respectively suggest that trait is conserved from lineages originated in the middle and at the end of the phylogenetic tree. As such, medium and last PME could be interpreted as phylogenetic signal for increasing divergence in species functional trait values along the phylogeny. To go further, we believe that the integration of phylogenetically-constrained null models (Cavender-Bares

et al. 2004; Kembel and Hubbell 2006; Helmus et al. 2007; Hardy 2008) in our framework would bring important insights to identify the evolutionary processes of species functional trait values along the phylogeny. In particular, if the trait phylogenetic signal is known to be partially structured by other processes (e.g., historical biogeography; Leibold et al. 2010), defining a null model conserving this structure could allow to establish if the phylogenetic signal induced by environmental filtering is significantly stronger and, as such, is predominantly responsible for the phylogenetic structure. Moreover, given that most of phylogenetic comparative methods traditionally use BM as null model to study phylogenetic signal (Joseph Felsenstein 1985; Diaz-Uriarte and Garland 1996; Pagel 1999; Blomberg and Garland 2003), introducing a null model defined under particular trait evolution model such as BM or Ornstein-Uhlenbeck could help to better characterise the trait phylogenetic signal dispensed by trait-environment relationship. However, such developments require to overcome one major methodological challenge. As previously exposed in the Methodological framework, null models testing for spatial and phylogenetic structures must conserve trait-environment relationship. Therefore, phylogenetically-constrained null models have to be defined carefully and future works need to address this issue more specifically.

Our framework can also be used with other statistics than R^2 decomposition in spatial and phylogenetic scales. One can indeed be interesting in the decomposition of environmental and trait values variance across spatial and phylogenetic scales. Then, instead of decomposing trait and environmental variable involved in the trait-environment relationship in phylogenetic and spatial bases respectively, the environmental variable and species trait could be respectively decomposed through PME to identify the phylogenetic scale(s) mostly influenced by environmental conditions and MEM to characterise distribution of species traits in space. Another way of studying environmental filtering is to investigate trait-environment relationship after removing its spatial and phylogenetic structure (Kühn et al. 2009). Our framework allows to go further by characterising the link of trait that are not phylogenetically structured with spatially-structured environment (and inversely). In such case, the multi-scale fourth corner approach can notably be applied on (i) normalised residuals of a phylogenetic generalised least square model (Duarte et al. 2018) or (ii) raw residuals of a phylogenetic eigenvector regression performed on the species functional trait (Diniz-Filho et al. 2011). Finally, our approach was solely developed in the univariate context. As such, in the case of multiple traits and environmental variables available, two possibilities in particular can be

considered: (i) performing a RLQ and applying our approach on RLQ axes, and (ii) performing the multi-scale fourth corner for each combination of trait and environmental variable and corrected for multiple tests.

In conclusion, this study offers a new methodological framework to decompose trait-mediated environmental filtering through phylogenetic and spatial scales allowing to characterise phylogenetic and spatial signal of the trait and environmental variable involved in the trait-environment relationship. The major insight of this approach is the ability to determine if the environmental variable influences the species trait phylogenetic signal by establishing a link between phylogenetic and spatial scales. In conclusion, this new framework is promising and offers multiple extension possibilities, notably including constrained null models, to bring valuable insights in ecological and conservation studies concerning the role of environmental filtering.



REC



Axis 2

Spatial autocorrelation
biases: is spatially-con-
strained null model a
magic wand to quantify
ecological processes?

00:00:00

3..2..1..1..2..3



REC



Chapter 1

Testing the Mantel
statistic with a
spatially-constrained
permutation procedure

00:00:00

3..2..1..1..2..3

List of figures

<i>Figure 1:</i> Schematic representation of the MSR-Mantel procedure using Moran Spectral Randomization as a spatially-constrained null model.....	80
<i>Figure 2:</i> Type I error rates and values of Mantel statistic for simple and partial Mantel tests and MSR-Mantel for irregular sampling.....	82
<i>Figure 3:</i> Type I error rates and values of Mantel statistic for simple and partial Mantel tests and MSR-Mantel for irregular sampling with increasing number of variables.....	83
<i>Figure 4:</i> Power of simple and partial Mantel tests and MSR-Mantel for irregular sampling when X and Y are linearly related.....	85

List of appendices

<i>Appendix 1:</i> Type I error rates and values of Mantel statistic for simple and partial Mantel tests and MSR-Mantel for irregular sampling with increasing number of samples.....	210
<i>Appendix 2:</i> Type I error rates and values of Mantel statistic for simple and partial Mantel tests and MSR-Mantel for a regular sampling.....	211
<i>Appendix 3:</i> Type I error rates and values of Mantel statistic for simple and partial Mantel tests and MSR-Mantel for regular sampling with increasing number of variables.....	212
<i>Appendix 4:</i> Type I error rates and values of Mantel statistic for simple and partial Mantel tests and MSR-Mantel for regular sampling with increasing number of samples.....	213
<i>Appendix 5:</i> Illustration of the MSR approach applied on Mantel test.....	214

Abstract

1. Mantel tests are widely used in ecology to assess the significance of the relationship between two distance matrices computed between pairs of samples. However recent studies demonstrated that the presence of spatial autocorrelation in both distance matrices induced inflations of parameter estimates and type I error rates. These results also hold for partial Mantel test which is supposed to control for the spatial structures.

2. To address the issue of spatial autocorrelation in testing the Mantel statistic, we developed a new procedure based on spatially-constrained randomisations using Moran Spectral Randomization. A simulation study was conducted to assess the performance of this new procedure. Different scenarios were considered by manipulating the number of variables, the number of samples, the regularity of the sampling design and the level of spatial autocorrelation.

3. As identified by previous studies, we found that Mantel statistic and its associated type I error rate are inflated in simple and partial Mantel tests when both distance matrices are spatially structured. We showed that these biases increased with the number of variables, decreased with the number of samples, and were slightly lower for regular than irregular sampling. The new procedure succeeded in correcting the spurious inflations of the parameter estimates and type I error rates in any of the presented scenarios.

4. Our results suggest that studies from several fields (e.g., genetic or community ecology) could have been overestimating the relationship between two distance matrices when both presented spatial autocorrelation. We proposed an alternative solution applicable in every field to correctly compute Mantel statistic with a fair type I error rate.

Keywords: Mantel test, distance decay relationships, Moran Spectral Randomization, spatial autocorrelation, type I error inflation, spatially-constrained null model, principal coordinates analysis, community ecology, population genetics.

Testing the Mantel statistic with a spatially-constrained permutation procedure

Article submitted in Methods in Ecology and Evolution

Julie Crabot^{1*}, Sylvie Clappe^{2*}, Stéphane Dray² & Thibault Datry¹

¹IRSTEA, UR-MALY, centre de Lyon-Villeurbanne, 5 rue de la Doua CS 20244, 69625 VILLEURBANNE Cedex, France.

²Université de Lyon, F-69000, Lyon; Université Lyon 1; CNRS, UMR5558, Laboratoire de Biométrie et Biologie Evolutive, Villeurbanne, France

*These authors contributed equally to this work

I. Introduction

The Mantel test is a well-known statistical procedure pertaining to the distance decay relationships framework (Nekola and White 1999) which assesses the correlation between two distance matrices computed between pairs of samples and evaluates its significance using random permutations (Mantel 1967). Although criticised in the literature concerning its assumption of a linear relationship between the two distance matrices, the formulation of its null hypothesis and the interpretation of its statistic which are not as trivial as with raw data (Legendre et al. 2015), this test is still widely used by ecologists from different fields. For instance, in community ecology, Mantel test is often used to disentangle the roles of habitat selection and dispersal processes on community and metacommunity organisation (Jones et al. 2006, Moritz et al. 2013, dos Santos et al. 2015). In molecular ecology, Mantel test is routinely used to test the link between two matrices of phenotypic (resp. genetic) distances measured on individuals or populations (Storfer et al. 2010, Shafer and Wolf 2013, Richardson et al. 2016).

When distance matrices are computed on samples located in space, a major problem lies in the possible presence of spatial autocorrelation (Legendre and Fortin 2010, Meirmans 2012). Spatial autocorrelation is a well-known problem in statistical ecology (Sokal and Oden 1978) as it violates the assumption of data independence required in many statistical methods (Diniz-Filho et al. 2003, Legendre and Legendre 2012). As such, it induces an inflation of type I error rate, i.e. rejecting the null hypothesis too often (Cliff and Ord 1981). Mantel tests have been shown to be strongly affected by spatial autocorrelation when present in both distance matrices (Oden and Sokal 1992, Guillot and Rousset 2013, Legendre et al. 2015). As

such, the partial Mantel test was developed (Smouse et al. 1986) to control for spatial structures when testing the link between the two distance matrices of interest.

However, through a deep investigation of simple and partial Mantel tests, Guillot and Rousset (2013) showed that partial Mantel test was unable to correct for the effect of spatial autocorrelation and that both tests presented inflated type I error rates. The problem lies in the random permutation procedure which breaks the potential dependencies between distance matrices (as expected by the null hypothesis) but also their inherent autocorrelation structures (Guillot and Rousset 2013). To solve this issue, Guillot and Rousset (2013) mentioned different alternatives including shift permutations (Upton and Fingleton 1985). This type of permutation allows randomising the data to break the link between the two distance matrices, while preserving their individual spatial structures so that they are taken into account in the testing procedure. Nevertheless, shift permutations can only be applied when samples originate from a regular grid, whereas many empirical studies implement irregular samplings for practical reasons. Following this idea, we propose here another strategy using Moran Spectral Randomization (MSR, Wagner and Dray 2015). This spatially-constrained randomisation procedure initially developed in the simple case of bivariate correlation, allows generating random replicates that preserve the original spatial structures of the data while breaking their correlations. Contrary to shift permutations, this procedure can be applied to regular or irregular samplings.

In this paper, we first performed a simulation study to illustrate how simple and partial Mantel tests can be affected by spatial autocorrelation. Second, we proposed and evaluated a new approach based on MSR to improve the testing and computing of the Mantel statistic in the presence of spatial autocorrelation.

II. Materials and Methods

Simple and partial Mantel tests

The Mantel test considers two n -by- n symmetric matrices \mathbf{D}_X and \mathbf{D}_Y containing pairwise distances among n samples. If original data consist in raw data stored in tables \mathbf{X} and \mathbf{Y} (i.e., samples by variables), they should be transformed in distance matrices \mathbf{D}_X and \mathbf{D}_Y prior to the computation of the Mantel statistic.

The observed Mantel statistic (r_{M-obs}) is defined as the sum of cross products between both distance matrices \mathbf{D}_X and \mathbf{D}_Y :

$$r_{M-obs} = \sum_{i=1}^{n-1} \sum_{j=i+1}^n \mathbf{D}_{X_{ij}} \mathbf{D}_{Y_{ij}} \quad (1)$$

Partial Mantel test, introduced by Smouse et al. (1986), is widely used in ecology to control for spatial autocorrelation present in the data. The test considers \mathbf{D}_X , \mathbf{D}_Y , and an additional distance matrix \mathbf{D}_Z which can be derived from a raw data table \mathbf{Z} . To control for spatial structure, \mathbf{Z} generally contains geographical coordinates so that \mathbf{D}_Z represents the geographical distances between samples. Partial Mantel test is based on the correlation coefficient between \mathbf{D}_X and \mathbf{D}_Y while controlling for the effect of the third matrix \mathbf{D}_Z .

The significance of simple and partial Mantel tests is assessed with a permutation procedure. The two matrices (\mathbf{D}_X and \mathbf{D}_Y , or equivalently \mathbf{X} and \mathbf{Y} if \mathbf{D}_X and \mathbf{D}_Y are obtained from raw data) are permuted independently (i.e., rows and columns are permuted in the same manner for distance matrices; only rows for raw data) and the Mantel statistic is recomputed. This permutation procedure is repeated n_{RND} times (e.g., $n_{RND}=999$) to obtain the distribution of the Mantel statistic under the null hypothesis. Note that permuting both matrices is not required as this distribution can be obtained by permuting only one matrix (\mathbf{D}_X or \mathbf{D}_Y). The observed value of the statistic r_{M-obs} is then compared to this distribution to assess its significance. The null hypothesis H_0 associated to this testing procedure states that “*the distances in \mathbf{D}_X are not linearly related to the corresponding distances in \mathbf{D}_Y* ” (Legendre et al. 2015).

Overcoming the spatial autocorrelation problem with an alternative randomisation procedure

As used in Mantel tests, classical permutation procedures assume implicitly that samples are exchangeable. The presence of spatial autocorrelation induces a kind of pseudo-replication (Hurlbert 1984) leading to a violation of the exchangeability assumption hence an inflation of type I error rates and imprecise parameter estimates. To address the issue of spatial autocorrelation in testing the Mantel statistic, we used the Moran Spectral Randomization (Wagner and Dray 2015) instead of standard permutation procedure. The MSR aims at producing random replicates which preserves the spatial structures of the original variables so that spatial autocorrelation is taken into account in the testing procedure.

Moran Spectral Randomization starts by defining a n -by- n spatial weighting matrix \mathbf{W} . This matrix is a mathematical representation of the geographical layout of the region under study. The spatial weights reflect a priori the absence ($w_{ij} = 0$), presence or intensity ($w_{ij} > 0$) of the spatial relationships between the samples i and j . The doubly-centered matrix \mathbf{W} is diagonalised and we define $\mathbf{\Lambda} = \text{diag}(\lambda_1, \dots, \lambda_{n-1})$ the diagonal matrix of eigenvalues and \mathbf{V} the n -by- $(n-1)$ matrix with associated eigenvectors $\mathbf{v}_1, \dots, \mathbf{v}_{n-1}$ stored as columns. These eigenvectors, named Moran's Eigenvector Maps (MEM) by Dray et al. (2006), are orthogonal and maximise spatial autocorrelation measured by the Moran's index of spatial autocorrelation. If we consider a centred variable \mathbf{x} , the Moran's index of autocorrelation is equal to (Dray 2011):

$$I(\mathbf{x}) = \sum_{i=1}^{n-1} \lambda_i \text{cor}^2(\mathbf{v}_i, \mathbf{x}) \quad (2)$$

with

$$\sum_{i=1}^{n-1} \text{cor}^2(\mathbf{v}_i, \mathbf{x}) = 1 \quad (3)$$

The variable \mathbf{x} can thus be entirely decomposed on the orthogonal basis of MEM as follows:

$$\mathbf{x} = \sum_{i=1}^{n-1} \mathbf{v}_i \text{cor}(\mathbf{v}_i, \mathbf{x}) \quad (4)$$

This decomposition allows to define a scalogram (Dray et al. 2012), depicting the multi-scale structure of \mathbf{x} , where each MEM explains a proportion of the variance of \mathbf{x} equal to

$cor^2(\mathbf{v}_i, \mathbf{x})$. In its strictest version, the MSR algorithm aims to find a set of coefficients

a_1, \dots, a_{n-1} to define a new variable $\mathbf{x}_{MSR} = \sum_{i=1}^{n-1} a_i \mathbf{v}_i$ with the following additional

constraints:

$$I(\mathbf{x}) = I(\mathbf{x}_{MSR}) \sum_{i=1}^{n-1} \lambda_i a_i^2 \quad (5)$$

$$a_i^2 = cor^2(\mathbf{v}_i, \mathbf{x}) \quad (6)$$

$$\sum_{i=1}^{n-1} a_i^2 = 1 \quad (7)$$

This ensures that the new variable \mathbf{x}_{MSR} (MSR replicate) has the same global level of spatial autocorrelation and multi-scale structure than the original variable \mathbf{x} . More details can be found in Wagner and Dray (2015), especially concerning the case of multivariate data.

Applying the MSR procedure to test the Mantel statistic

We considered two cases: (i) if data from \mathbf{D}_X originates from a raw data table \mathbf{X} or (ii) if data have been obtained directly as distances in \mathbf{D}_X . The complete procedure consists in:

1. Compute the observed Mantel statistic r_{M-obs} between \mathbf{D}_X and \mathbf{D}_Y ;
2. Build a MSR replicate \mathbf{D}_{X-MSR} of the original distance matrix \mathbf{D}_X :
 - i. if data from \mathbf{D}_X originate from a raw data table \mathbf{X} , MSR is applied on \mathbf{X} to produce a random replicate \mathbf{X}_{MSR} . Then, \mathbf{X}_{MSR} is transformed in \mathbf{D}_{X-MSR} using the same computation of distances applied to obtain \mathbf{D}_X from \mathbf{X} .
 - ii. if data have been obtained directly as distances in \mathbf{D}_X , a principal coordinates analysis (PCO; Torgerson 1958, Gower 1966) is applied on \mathbf{D}_X . MSR is then performed on the complete set of principal coordinates to produce a random replicate \mathbf{X}_{MSR} . Euclidean distances are computed from \mathbf{X}_{MSR} to obtain \mathbf{D}_{X-MSR} .
3. Compute the Mantel statistic r_{M-MSR} between \mathbf{D}_{X-MSR} and \mathbf{D}_Y .

4. Repeat n_{MSR} times the steps 2 and 3 (e.g., $n_{MSR}=999$). The p-value of the test is then simply the number of r_{M-MSR} that are higher or equal to the observed value (r_{M-obs} plus one) divided by ($n_{MSR}+1$) in the case of an upper-tailed test.

The value of the observed Mantel statistic can eventually be corrected, to take into account the spurious correlation due to spatial autocorrelation, as follows:

$$r_{M-MSR}^* = r_{M-obs} - E(r_{M-MSR}) \quad (8)$$

Where $E(r_{M-MSR})$ is the average of the r_{M-MSR} values and corresponds to the expected value of the Mantel statistic under the null hypothesis H_{0-MSR} stating that “*considering the levels of spatial autocorrelation in original data, the distances in \mathbf{D}_X are not linearly related to the corresponding distances in \mathbf{D}_Y* ”. As such, the MSR procedure allows using a new null hypothesis compared to the Mantel test to take into account spatial autocorrelation by randomising the original data while preserving their spatial structures. The method is schematically represented in Figure 1 and denoted MSR-Mantel in the rest of the paper.

Simulations

To assess the performance of the MSR-Mantel approach to correct for the spurious correlation found in simple and partial Mantel tests, we conducted a simulation study. To evaluate type I error rates and values of the statistics under the null hypothesis, two tables \mathbf{X} and \mathbf{Y} with identical dimensions were independently generated by randomly drawing values from a normal distribution. We considered the measurement of 5 variables for 225 randomly located samples (i.e., irregular sampling design; geographic coordinates are drawn from two independent uniform distributions). Following Dray (2011), variables in \mathbf{X} and \mathbf{Y} were generated spatially autocorrelated using a univariate simultaneous autoregressive model with increasing levels of autocorrelation (autoregressive parameter ρ varying from 0 to 0.8) and a row-standardised spatial weighting matrix defined by a Gabriel graph (\mathbf{W}_{gab}).

We assessed the effect of (i) the level of spatial autocorrelation ($\rho = \{0, 0.2, 0.4, 0.6, 0.8\}$) for 5 variables and 225 samples, (ii) the number of variables by considering 1, 5 and 10

variables for 225 samples in both \mathbf{X} and \mathbf{Y} with $\rho = 0.8$; (iii) the number of samples by generating 100, 225 and 400 samples for 5 variables with $\rho = 0.8$; (iv) the sampling design with 225 samples located on a square grid with rook specification (i.e., regular sampling).

To evaluate power, \mathbf{X} was simulated with the same protocol as above with 5 variables, 225 irregular samples and $\rho = 0.8$. However, \mathbf{Y} was generated as linearly correlated to \mathbf{X} with the following formula:

$$\mathbf{Y} = a\mathbf{X} + (1 - a)\mathbf{N} \quad (9)$$

where a is a real number controlling for the strength of the link between \mathbf{X} and \mathbf{Y} , and \mathbf{N} is a table of non-spatially structured random noise obtained by permuting the rows of \mathbf{X} (this allows to ensure that both \mathbf{X} and \mathbf{N} have the same level of variance). We tested for the strength of the relationship between \mathbf{X} and \mathbf{Y} by varying values of a from 0.1 to 0.5.

To describe space (table \mathbf{Z}) in the partial Mantel tests, we used the geographic coordinates of the sites. Distances matrices were obtained by computing Euclidean distances from tables \mathbf{X} , \mathbf{Y} and \mathbf{Z} . In these simulations, the MSR procedure was performed using \mathbf{W}_{gab} , i.e. the spatial weighting matrix also used to generate the data. We performed 1000 simulations for each scenario.

In the case of real data sets, an important step of the MSR procedure lies in the definition of the spatial weighting matrix \mathbf{W} . Hence, in a second simulation study, we evaluated the procedure of Bauman et al. (2018) recently developed to select a spatial weighting matrix \mathbf{W} among a set of potential candidates. In the case of MSR, this procedure consists in three main steps (see Bauman et al. 2018 for further details):

1. Perform two multivariate linear regressions of \mathbf{X} on Moran's Eigenvectors Maps associated to positive and negative eigenvalues, respectively, for each \mathbf{W} candidate. Therefore, each \mathbf{W} candidate is characterised by two adjusted R^2 with their corresponding p-value (corrected for multiple tests).
2. Add the significant adjusted R^2 for each \mathbf{W} candidate which is then characterised by a sum of adjusted R^2 .
3. Select the \mathbf{W} matrix with the highest sum of adjusted R^2 .

In this study, we first reported the effects of a misspecification of \mathbf{W} on MSR performance over 1000 simulations. We generated \mathbf{X} with the spatial weighting matrix \mathbf{W}_{gab} but performed MSR-Mantel with a different spatial weighting matrix \mathbf{W}_{dist} defined as a distance-based graph. In such representation, two samples are connected solely if their geographic distance is inferior to a certain threshold, defined here as the maximum branch length of the minimum spanning tree connecting all samples (i.e., the most parsimonious path connecting all samples, see (Legendre and Legendre 2012) for details in neighbor graph definitions). Second, we evaluated the ability of the selection procedure proposed by Bauman et al. (2018 in the context of MSR-Mantel. For this, \mathbf{X} was simulated 1000 times using five different spatial weighting matrices (200 tables \mathbf{X} generated for each definition, see Legendre and Legendre 2012): (i) \mathbf{W}_{gab} , (ii) \mathbf{W}_{dist} , (iii) \mathbf{W}_{mst} obtained from a minimum spanning tree, (iv) \mathbf{W}_{del} defined with a Delaunay triangulation and (v) \mathbf{W}_{rel} obtained from a relative neighbourhood graph. We applied the selection procedure considering all the five spatial weighting matrices as candidates and evaluate type I error rates of the MSR-Mantel conducted using the selected spatial weighting matrix. The study on misspecification and selection procedure considered \mathbf{X} and \mathbf{Y} generated as previously with an autoregressive model of parameter $\rho = 0.8$ and with 5 variables and 225 irregular samples.

Statistical analysis

For each pair of distance matrices, we applied simple and partial Mantel tests, and the MSR-Mantel procedure. Using the 1000 simulations, we computed type I error rates corresponding to the proportion of significant relationships identified when \mathbf{X} and \mathbf{Y} are not linked (i.e., false positives). In the cases where \mathbf{X} and \mathbf{Y} are linearly correlated, the proportion of significant relationships represents the power of the test. We used 999 permutations for the simple and partial Mantel tests, and 99 replicates for the MSR procedure to reduce the computation time. Statistical tests and simulations were computed with R software 3.3.2 (R Core Team 2016). Simple and partial Mantel tests were respectively computed with *ade4* (Dray and Dufour 2007) and *vegan* (Oksanen et al. 2017) packages. MSR procedure was performed using *adespatial* package (Dray et al. 2017). Examples showing how to reproduce the analysis and the selection procedure in R are provided in Appendix 5.

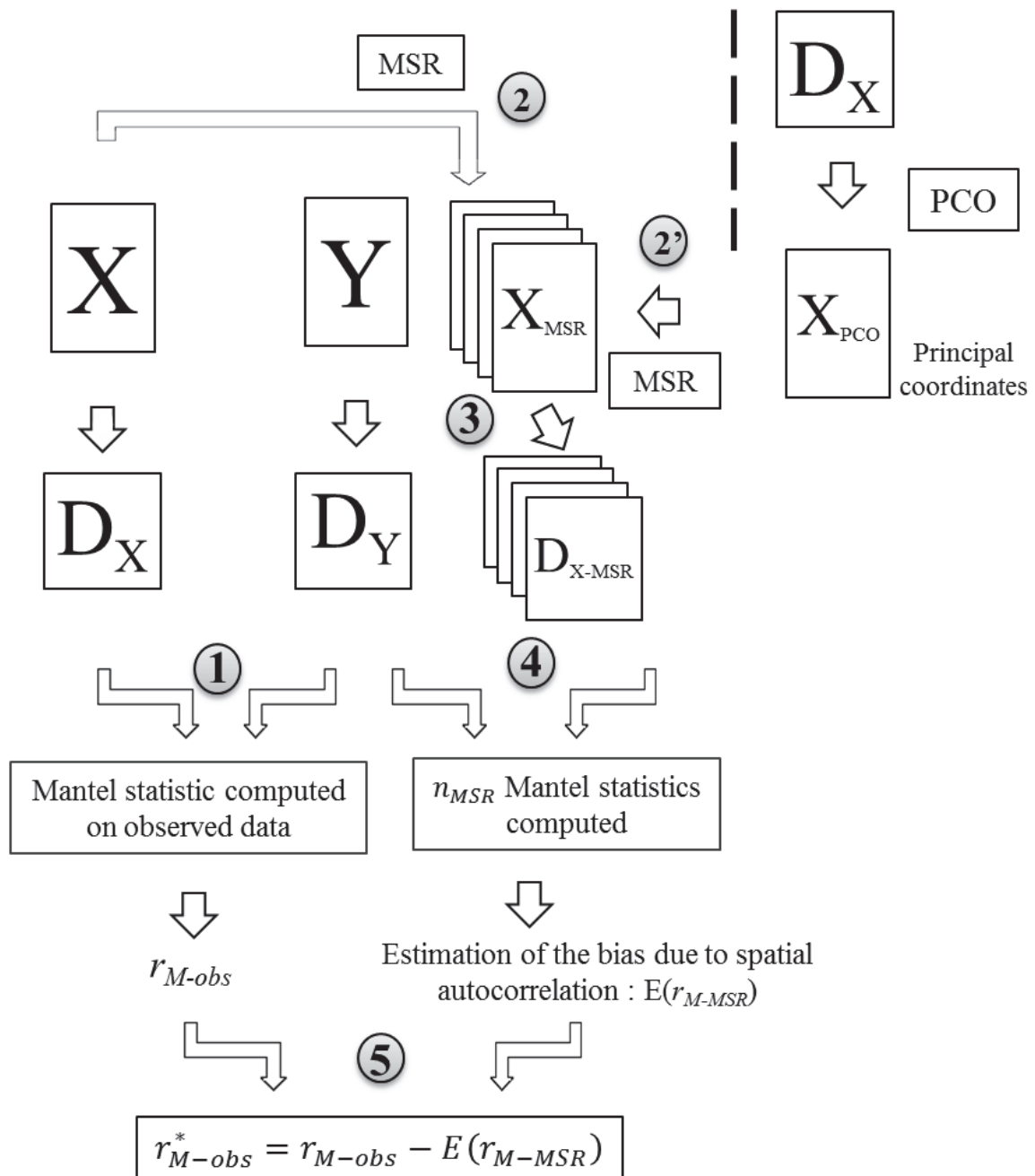

Figure 1: Schematic representation of the MSR-Mantel procedure using Moran Spectral Randomization as a spatially-constrained null model. (1) Distance matrices D_X and D_Y are respectively computed from matrices X and Y (case with raw data). The statistic r_{M-obs} is computed between distance matrices D_X and D_Y . (2) If distance matrix D_X originates from raw data matrix X , n_{MSR} replicates X_{MSR} preserving spatial autocorrelation of table X are generated with MSR. (2') If D_X does not originate from raw data, a principal coordinates analysis (PCO) is conducted on D_X and the replicates X_{MSR} are generated by applying MSR on the complete set of principal coordinates. (3) Distance matrices D_{X-MSR} are then computed from the n_{MSR} X_{MSR} replicates. (4) n_{MSR} Mantel statistics are then computed between D_Y and D_{X-MSR} to produce r_{M-MSR} . The expected value $E(r_{M-MSR})$ is an estimate of the bias due to spatial autocorrelation (i.e., expected under H_{0-MSR}). (5) The effect of spatial autocorrelation is removed from r_{M-obs} to obtain the unbiased statistic r_{M-MSR}^* .

III. Results

When \mathbf{D}_X and \mathbf{D}_Y were not correlated (i.e., \mathbf{X} and \mathbf{Y} independently generated), r_{M-obs} was expected to be 0. Simple Mantel test performed well when there was no spatial autocorrelation (the r_{M-obs} are centred on 0 and type I error rate close to 0.05 for $\rho = 0$; Figure 2a). On the contrary, type I error rates and r_{M-obs} were increasingly inflated with higher levels of spatial autocorrelation (Figure 2a) and this bias increased with the number of variables (Figure 3a) but decreased with the number of samples (Appendix 1a). Note also that the variance of r_{M-obs} on 1000 simulations increased with the level of spatial autocorrelation (Figure 2a). Likewise, type I error rates and r_{M-obs} presented similar inflations for a regular sampling design (Appendix 2a, 3a, 4a). Worth noting that in the case of regular sampling grids r_{M-obs} was not overestimated and type I error rate presented no inflation for the lowest levels of spatial autocorrelation (Appendix 2a).

As observed in other studies, partial Mantel tests did not control for the spatial autocorrelation effect: the r_{M-obs} statistic remained overestimated and, although improved, type I error rates were still inflated (Figure 2b). As previously observed for the simple Mantel tests, the number of variables increased r_{M-obs} and type I error rates (Figure 3b), and inversely for the number of samples (Appendix 1b). However, worth noting that in the case of regular sampling grids, even if r_{M-obs} was still overestimated, type I error rates presented lower inflations (Appendix 2b, 3b, 4b).

The use of the MSR-Mantel fully controlled for inflations due to spatial autocorrelations so that estimates and type I error rates behave as expected (r_{M-MSR}^* and type I error rates respectively centred on 0 and 0.05; Figure 2c). Similarly, the procedure succeeded for the various situations considered: increasing number of variables (Figure 3c), increasing number of samples (Appendix 1c) and for regular sampling (Appendix 2c). Moreover, even when conducted on the principal coordinates of \mathbf{D}_X and not on raw data, the use of MSR procedure successfully controlled for spatial autocorrelation biases (Figure 2d). Note however that our approach did not correct the increase of the variance for high level of spatial autocorrelation (Figure 2c, Appendix 2c).

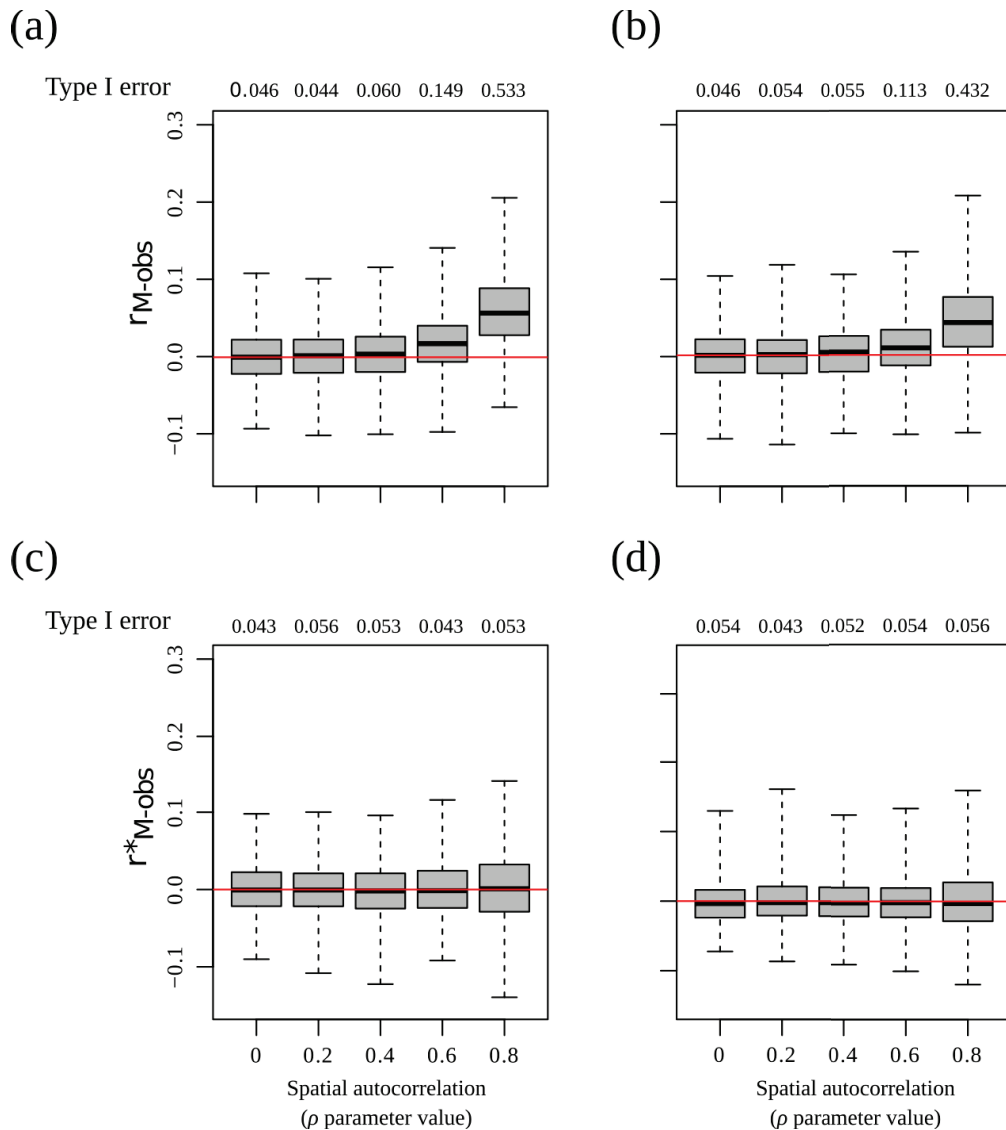

Figure 2: Type I error rates and values of Mantel statistic for simple and partial Mantel tests and MSR-Mantel for irregular sampling. (a-b) Observed Mantel statistic (r_{M-obs}) and type I error rates for (a) simple, and (b) partial Mantel test. (c-d) Corrected Mantel statistic (r_{M-obs}^*) and type I error rates of MSR-Mantel on (c) raw table \mathbf{X} , or (d) the principal coordinates obtained from a PCO on \mathbf{D}_x . \mathbf{X} and \mathbf{Y} contain 5 variables and 225 samples. Both tables present spatial autocorrelation varying from $\rho = 0$ to $\rho = 0.8$. r_{M-obs} and r_{M-obs}^* are reported with boxes representing the 25, 50 and 75 quartiles, the whiskers are minimum and maximum values. Red lines corresponds to $r_M = 0$.

When \mathbf{D}_x and \mathbf{D}_y were linearly correlated, the performances of the Mantel tests (simple, partial) and MSR-Mantel were very similar and their power increased with the strength of the correlation between the two matrices (Figure 4). These similarities showed that MSR-Mantel did not affect the ability to detect a link between \mathbf{D}_x and \mathbf{D}_y when present. However, as simple and partial Mantel tests had inflated type I error rates (Figure 2a, b), they should not be used and their power was only given for comparison purposes.

Performing MSR-Mantel with a misspecified spatial weighting matrix (\mathbf{W}_{dist} instead of \mathbf{W}_{gab}) led to an inflated type I error rate (0.115 over 1000 simulations). When the selection procedure developed by Bauman et al. (2018) is applied prior to MSR-Mantel, the type I error rate drops down to 0.049.

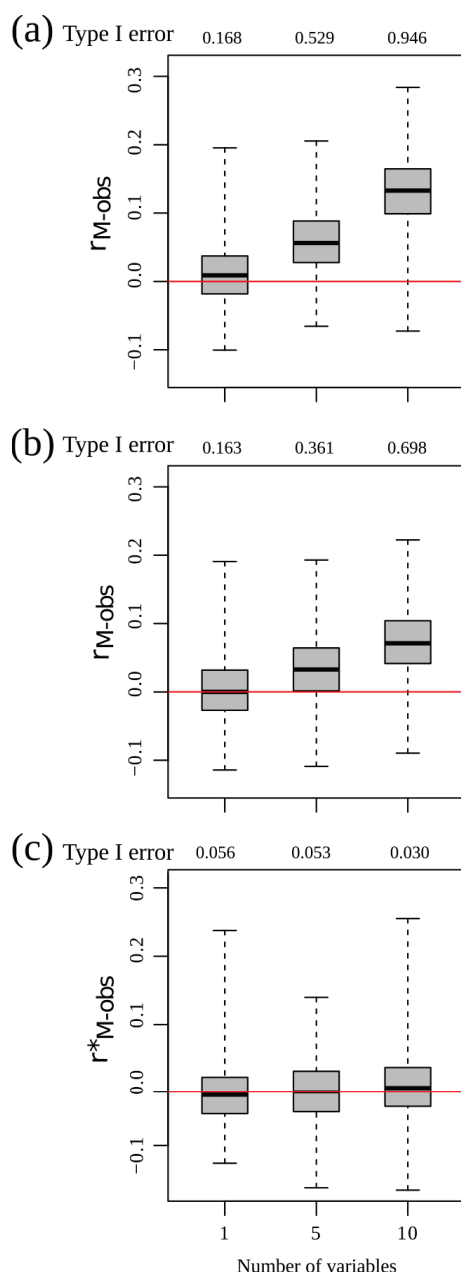

Figure 3: Type I error rates and values of Mantel statistic for simple and partial Mantel tests and MSR-Mantel for irregular sampling with increasing number of variables. (a-b) Observed Mantel statistic (r_{M-obs}) and type I error rates for (a) simple, and (b) partial Mantel test. (c) Corrected Mantel statistic (r^*_{M-obs}) and type I error rates of MSR-Mantel on raw table X. (a-c) X and Y contain 225 samples and increasing number of variables: 1, 5, and 10. Both tables present spatial autocorrelation fixed to $\rho = 0.8$. r_{M-obs} and r^*_{M-obs} are reported as in Figure 2. Red line corresponds to $r_M = 0$.

IV. Discussion

In this study, we developed a new procedure based on MSR (Wagner and Dray 2015) to overcome the biases when testing the Mantel statistic when distance matrices \mathbf{D}_x and \mathbf{D}_y present independent spatial autocorrelations.

As shown previously (Guillot and Rousset 2013), we found that simple Mantel tests performed well in the absence of spatial autocorrelation but that the statistic and associated type I error rates were spuriously inflated as soon as spatial autocorrelation was introduced. Moreover, these inflations increased with the number of variables. This trend was expected as a higher number of independent spatially structured variables in both distance matrices leads to a higher diversity of spatial patterns and thus higher chances to obtain spurious correlations between \mathbf{D}_x and \mathbf{D}_y . On the contrary, increasing the number of samples reduce the effects of spatial autocorrelation, as such decreasing the detection of spurious correlations. Likewise, partial Mantel tests presented similar inflations of type I error rates and estimations with the same trends relative to the number of variables and samples. However, partial Mantel test biases were lower than for simple Mantel test due to the used of the geographic distance matrix \mathbf{D}_z to consider space. Worth noting that for high spatial autocorrelation ($\rho = 0.8$), the regular sampling offered a better Type I error even in the case of high number of variables and low number of samples. To sum up, as reported by Guillot and Rousset (2013), we confirmed that partial Mantel tests failed to adequately correct for the effect of spatial autocorrelation observed in Mantel tests.

In contrast, our approach based on MSR procedure provided acceptable levels for type I error rates when distance matrices were independently generated but both spatially autocorrelated. On the other hand, when distance matrices were linearly correlated and spatially structured, our procedure detected the relationship with a high statistical power. This demonstrates the efficiency of our procedure to correct for the spurious correlation induced by spatial autocorrelation, while conserving the ability to detect correlations when present. In addition, our procedure can be applied on regular as well as irregular samplings, commonly used in ecological surveys (e.g., Saito et al. 2015, Tuomisto et al. 2016). Besides, by subtracting the expected value of the Mantel statistic under H_{0-MSR} , our formula provided a correction to the Mantel statistic but does not improve its precision as the variance of the statistic is not transformed. Therefore, computing standardised effect size (SES, e.g., Gotelli

and McCabe 2002) by dividing equation (8) by the standard deviation of MSR replicates would probably be more adapted to compare the values of the corrected Mantel statistics between studies.

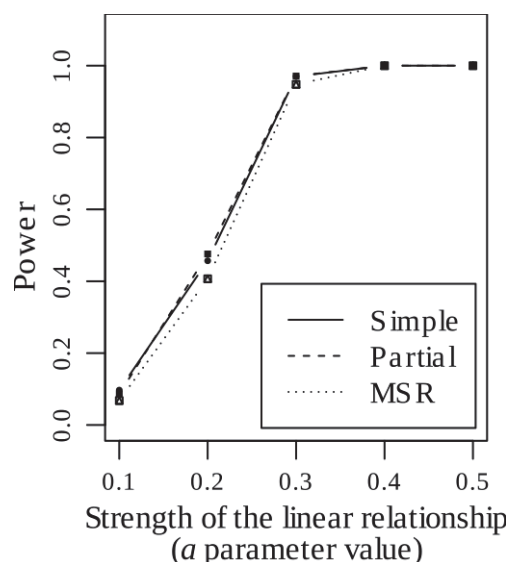

Figure 4: Power of simple and partial Mantel tests and MSR-Mantel for irregular sampling when X and Y are linearly related. Comparison of the power of simple (solid line) Mantel test, partial (dashed line) Mantel test, and MSR-Mantel procedure (dotted line). X and Y contain 225 samples and 5 variables. Both tables present spatial autocorrelation fixed to $\rho = 0.8$. The strength of the linear relationship varied from $a = 0.1$ to $a = 0.5$.

While this new procedure is promising, it has some limitations. MSR-Mantel relies on MSR whose first step is to define a spatial weighting matrix \mathbf{W} . The specification of \mathbf{W} plays an important role in determining the appropriate form of spatial model (e.g., Stakhovych and Bijmolt 2009 in the case of spatial autoregressive models). Hence, its misspecification can greatly influence the performance of our procedure by defining incorrectly the potential spatial dependence between observations. Indeed, we showed that, when \mathbf{W} is misspecified, MSR-Mantel failed to control for the inflation of type I error rates in the presence of spatial autocorrelation. Our results indicate that the selection procedure proposed by Bauman et al. (2018) offers a promising solution to optimise the choice of \mathbf{W} among a set of candidates. Furthermore, the MSR procedure is only able to deal with continuous variables in X, excluding counts, binary and categorical variables. Moreover, in the case where data have

been obtained directly as distances matrices, our procedure based on principal coordinates analysis assumes that data can be represented in a Euclidean space. Hence, further work is required to extend these promising results to other types of variables and non-Euclidean distance matrices. When non-Gaussian response variables are expected, alternative methods based on generalised linear mixed models may be considered. In genetics for instance, Guillot et al. (2014) developed a spatially explicit model that directly consider autocorrelation and Rousset and Ferdy (2014) presented fitting procedures for spatial GLMM providing correct estimate of correlation parameters. However, spatial GLMM are only suitable when raw data are available or when they can be reconstructed from available distance matrices and, as the MSR-Mantel, they can be sensitive to the specification of the spatial model (Duncan et al. 2017).

Our approach aims to consider spatial autocorrelation when studying the link between two distance matrices. From a theoretical viewpoint, this issue pertains to the necessity to account for nuisance parameters during the analysis of parameters of interest. Raufaste and Rousset (2001) designed a simple simulation model where the objective is to study the effect of an environmental variable on the abundance of a species at location k (x_k) in the presence of migration flows from the two adjacent populations (x_{k+1} and x_{k-1}). They showed that “the partial Mantel test is inadequate in this model because the permutations will not hold constant the (minimal) sufficient statistic for the nuisance parameter under the null hypothesis”. In their model, these statistics are:

$$\left(\sum_k x_k, \sum_k x_k^2, \sum_k (x_{k+1} + x_{k-1})x_k, \sum_k (x_{k+2} + x_{k-2})x_k \right) \quad (10)$$

The MSR procedure, by preserving the mean, variance and global level of autocorrelation measured by Moran’s index (Wagner and Dray 2015), holds constant the first three elements, but not the fourth. However, results showed that type I error rates were controlled in all cases with our simulation design suggesting that the MSR-Mantel procedure seemed quite robust. An alternative is to use the MSR-Mantel procedure in the context of maximised Monte-Carlo (Dufour 2006) so that the distribution of the statistic under the null hypothesis is built for the values of nuisance parameters that maximised the p-value. This ensures that the test is exact.

In conclusion, our results confirmed Guillot and Rousset (2013)'s findings and suggest that several studies ranging from genetic (e.g. Shafer and Wolf 2013) to community ecology (e.g., Astorga et al. 2012) could have wrongly identify an effect when standard or partial Mantel tests were used in the presence of spatial autocorrelation. Spatial autocorrelation is a problem regularly underlined when quantifying the spatial structure of genetic (Manel et al. 2010) and community data (Smith and Lundholm 2010, Gilbert and Bennett 2010) and our procedure could solve this issue by providing an alternative distance-based statistical approach.

V. Acknowledgements

This work was supported by Irstea, the French National Research Institute of Science and Technology for Environment and Agriculture, which funds the PhD of Julie Crabot supervised by Thibault Datry. Simulations were performed using the computing facilities of the CC LBBE/PRABI and Irstea.



REC



Chapter 2

Beyond neutrality:
disentangling the effects
of species sorting and
spurious correlations in
community analysis

00:00:00

3..2..1..1..2..3

List of figures

<i>Figure 1:</i> Objective of the study: adjusting for spurious correlation in variation partitioning due to neutral dynamics.....	93
<i>Figure 2:</i> Results of variation partitioning fractions [ab], [a] and [b] for neutral metacommunities as a function of number of environmental variables.....	103
<i>Figure 3:</i> Results of variation partitioning fractions [ab], [a] and [b] for metacommunities structured by neutral dynamics and species sorting.....	104
<i>Figure 4:</i> Results of variation partitioning fractions [ab], [a] and [b] for mixed metacommunities.....	106

List of appendices

<i>Appendix S1:</i> Mathematical details of the spatially-constrained variation partitioning procedure.....	221
<i>Appendix S2:</i> Detailed simulation model used in the manuscript.....	223
<i>Appendix S3:</i> Respective mean and standard deviation of [ab], [a] and [b] fractions in the three simulation scenarios.....	225
<i>Appendix S4:</i> Effect of Moran's Eigenvectors Maps selection on estimation and Type I error of fraction [a] in pure neutral metacommunities.....	229
<i>Appendix S5:</i> Environmental contribution (fraction [ab]) of mixed metacommunities is a weighted mean of species sorting and neutral environmental contributions.....	231
<i>Appendix S6:</i> Empirical application of the spatially-constrained variation partitioning.....	233

Abstract

The methods of direct gradient analysis and variation partitioning are the most widely used frameworks to evaluate the contributions of species sorting to metacommunity structure. In many cases, however, species are also driven by spatial processes that are independent of environmental heterogeneity (e.g., neutral dynamics). As such, spatial autocorrelation can occur independently in both species (due to limited dispersal) and the environmental data, leading to spurious correlations between species distributions and the spatialised (i.e., spatially-autocorrelated) environment. In these cases, the method of variation partitioning may present high Type I error rates (i.e., reject the null hypothesis more often than the pre-established critical level) and inflated estimates regarding the environmental component that is used to estimate the importance of species sorting. In this paper, we (1) demonstrate that metacommunities driven by neutral dynamics (via limited dispersal) alone or in combination with species sorting leads to inflated estimates and Type I error rates when testing for the importance of species sorting; and (2) propose a general and flexible new variation partitioning procedure to adjust for spurious contributions due to spatial autocorrelation from the environmental fraction. We used simulated metacommunity data driven by pure neutral, pure species sorting, and mixed (i.e. neutral + species sorting dynamics) processes to evaluate the performances of our new methodological framework. We also demonstrate the utility of the proposed framework with an empirical plant dataset in which we show that half of the variation initially due to the environment by the standard variation partitioning framework was due to spurious correlations.

Keywords: metacommunity ecology, neutral dynamics, Moran spectral randomization, direct gradient analysis, variation partitioning, spatially-constrained null model, limited dispersal, environmental effect, spatial autocorrelation

Beyond neutrality: disentangling the effects of species sorting and spurious correlation in community analysis

Article published in Ecology, 99(8), 2018, pp. 1737–1747

© 2018 by the Ecological Society of America

Sylvie Clappe¹, Pedro R. Peres-Neto² and Stéphane Dray¹

¹Université de Lyon, F-69000, Lyon; Université Lyon 1; CNRS, UMR5558, Laboratoire de Biométrie et Biologie Evolutive, Villeurbanne, France

²Department of Biology, Concordia University, Montreal, Quebec, Canada H4B 1R6, Canada

I. Introduction

Determining which factors and processes underlie the variation in species compositions across local communities within large landscapes is a focal question in ecology (Cottenie 2005, Jones et al. 2008, Sharma et al. 2011, Wan et al. 2015). Among different frameworks for investigating the mechanisms governing species distributions in space, metacommunity ecology focuses on how dispersal interacts with local community assembly processes (e.g., niche preferences and biotic interactions) in determining how and which species are selected to compose local communities (Leibold et al. 2004). Species sorting via environmental filtering has been long recognised as a key mechanism underlying metacommunity structure in which variation in species compositions is driven by differential species responses to environmental heterogeneity among patches (Chase and Leibold 2003, Leibold and Chase 2017). Notwithstanding, it is also widely accepted that the spatial structure of metacommunities can be also influenced by other processes such as patch dynamics, mass-effect dynamics, neutral dynamics (Leibold et al. 2004), among other processes (e.g., historical biogeography; Leibold et al. 2010). Notably, neutral dynamics caused by stochastic events such as death, birth and limited dispersal can lead to spatial arrangements in the distribution of species within a metacommunity that are as complex as the ones generated by species sorting (Hubbell 2001, Bell 2001). Because both mechanisms are likely to be important in many metacommunities, a major challenge in contemporary ecology has been to understand the relevance of species sorting to metacommunity structure that are beyond those expected under neutrality (Gravel et al. 2006, Paknia and Pfeiffer 2014).

Among the quantitative tools currently available to study metacommunities, variation partitioning (hereafter referred as to VP; Borcard et al. 1992, Peres-Neto et al. 2006) is the only one often assumed (but see below) to be able to distinguish between species sorting and neutral dynamics (Gilbert and Lechowicz 2004, Cottenie 2005, Chang et al. 2013, Paknia and Pfeiffer 2014, Arellano et al. 2016). VP is a widely used quantitative framework in community ecology (i.e., more than 3000 WoS citations for Borcard et al. 1992 and Peres-Neto et al. 2006 that allows decomposing the variation in species composition (or abundance) across local communities (i.e., beta-diversity) into the amount of variation explained by environmental (fraction [ab]) and spatial components (fraction [bc]). Independent contributions are also estimated and represent: non-spatially structured environmental variation (fraction [a]), pure spatial variation (fraction [c]), spatialised (i.e., spatially-autocorrelated) variation of the environment (fraction [b]), and non-explained and non-spatialised residual variation (fraction [d]) (Fig. 1).

Pure spatial variation (fraction [c]) cannot be directly linked to a unique process as it may be due to stochastic neutral dynamics via dispersal limitation, missing spatialised environmental predictors influencing species sorting and/or other types of spatial dynamics (e.g., biotic interactions). Additionally, spatialised-environmental variation (fraction [b]) may not necessarily represent the contribution of spatialised environment to species sorting given that fraction [b] can be inflated by spurious correlations between spatialised (measured) environmental variables and spatial variation in species distributions due to spatial processes such as neutral dynamics (Smith and Lundholm 2010 ; Fig. 1A, C). As such, VP can in principle only estimate the importance of species sorting by analysing and testing its non-spatialised environmental contribution (fraction [a]; Peres-Neto and Legendre 2010, Logue et al. 2011). Ideally, however, one should estimate the contribution of the total environmental variation (i.e., fraction [ab]) containing both its non-spatial (fraction [a]) and spatial (fraction [b]) components (Fig. 1). This would allow to adjust the estimates of the environmental contribution and, in many cases, increase the power of detection of species sorting given that fraction [ab] is greater than fraction [a] alone. To do that, however, one needs to separate the variation in fraction [b] that is due to the spatialised measured environment and the variation due to neutral dynamics (Fig. 1A, C).

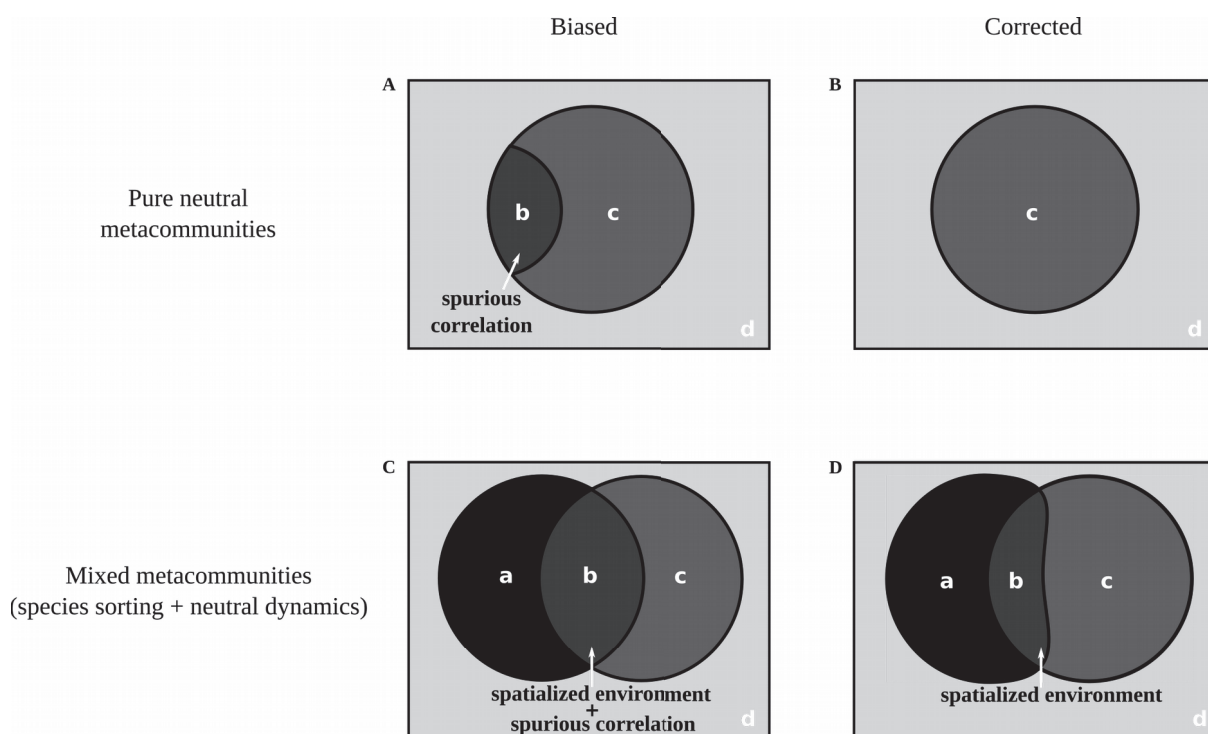

Figure 1: Objective of the study: adjusting for spurious correlation in variation partitioning due to neutral dynamics. (A) The effects of spurious correlation on variation partitioning on metacommunities driven by neutral dynamics, leading to inflated fraction [b] (and [ab] as a consequence) but not [a]; (B) The effects of our procedure on variation partitioning on metacommunities driven by neutral dynamics in which only a spatial effect (fraction [c]) should be expected; (C) The effects of spurious correlation on variation partitioning on metacommunities driven by neutral dynamics and species sorting, leading to inflated fraction [b] (and [ab] as a consequence) but not [a]; (D) The effects of our procedure on variation partitioning on metacommunities driven by neutral dynamics and species sorting, leading to a reduced fraction [b] (and [ab] as a consequence). Note that the spatial fraction [bc] does not change as a function of our procedure, but fraction [c] increases given that fraction [b] decreases.

Although not often acknowledged, estimating the contribution of species sorting over neutral dynamics parallels the issues of statistical estimation and testing for species-environment associations (Peres-Neto and Legendre 2010, Dray et al. 2012). Spatial autocorrelation in species distributions and their environments is extremely common (Houlahan et al. 2007) and poses a challenge in statistical testing and estimation because it violates the assumption of data independence (Legendre 1993). VP and canonical analyses such as Redundancy Analysis and Canonical Correspondence Analysis (see Legendre and Legendre 2012 for a review) are regression-based models (Peres-Neto et al. 2006) whose estimates and tests are known to be affected by spatial autocorrelation (F. Dormann et al. 2007). Direct gradient analyses are a commonly used quantitative framework in ecology that are based on canonical analyses but do not consider spatialised variation. Statistical testing in direct gradient analyses is based on testing fraction [ab] and, as such, they need appropriate

solutions to separate the environmental from neutral contributions. This latter issue has escaped the attention of ecologists who use direct gradient analysis to describe and test for the importance of environmental variation on species distributions. Finally, performing VP with both environmental and spatial predictors to estimate and test for species sorting (i.e., environmental contribution to species distributions, fraction [ab]) fails to control for biases due to spatial autocorrelation (Peres-Neto and Legendre 2010, Smith and Lundholm 2010, Gilbert and Bennett 2010). Given that VP have become the *de facto* framework to describe and assess the importance of species sorting, robust solutions to the potential biases generated by the spatial structure in species distributions and their environments need to be developed.

The goal of this paper is to provide a synthesis of the issues and implications of spatial autocorrelation in community and metacommunity analyses as well as a solution to address current challenges when distinguishing between neutral dynamics and species sorting. More specifically we: 1) demonstrate via simulations the conditions in which spatial autocorrelation biases direct gradient analyses (i.e., canonical analyses) and VP in estimating and testing for the importance of species sorting in metacommunities; 2) derive new estimates and statistical tests for assessing the role of species sorting in structuring species distributions and beta-diversity patterns. Finally, we demonstrate the utility of the proposed framework in an empirical plant data set in which we show that half of the variation initially due to the environment using the standard variation partitioning framework was due to spurious correlations.

In this study, we chose to use neutral dynamics as the source of spatial autocorrelation in species distributions and bias in canonical analysis given that neutrality has been the focus of much research regarding the mechanisms underlying the structure of metacommunities. Note, however, that our framework is able to deal with any mechanism generating spatial autocorrelation and thus tackle other sources of biases while testing and estimating the importance of species sorting in ecological communities.

II. Methodological framework

Variation partitioning

Variation partitioning (Borcard et al. 1992) is used in metacommunity studies to decompose the total variation of a species distribution matrix \mathbf{Y} (communities by species; abundance or presence-absence data) into four fractions of variation: [a] unique variation in \mathbf{Y} explained by the environment, [c] unique variation due to space, [b] shared variation between environment and space, and [d] non-explained (residual) variation. The approach is based on three separate sets of multi-response multivariate linear regressions with the response matrix \mathbf{Y} (i.e., sites by species matrix) (Peres-Neto et al. 2006): 1) a regression of \mathbf{Y} on a matrix \mathbf{X} containing environmental predictors to estimate [ab]; 2) a regression of \mathbf{Y} on a matrix \mathbf{W} of spatial predictors to estimate [bc]; 3) a regression of \mathbf{Y} on both \mathbf{X} and \mathbf{W} (all columns in \mathbf{X} and \mathbf{W} are used together as predictors) to estimate the total amount of variation explained by space and environment together (fraction [abc]). All fractions are then obtained via subtractions ([a]=[abc]-[bc]; [c]=[abc]-[ab]; [b]=[abc]-[a]-[c]; [d]=1-[abc]). Further computational details can be found in Peres-Neto et al. (2006). Note that decomposing a species distribution matrix \mathbf{Y} is equivalent to decomposing a beta-diversity matrix (community by community) into its environmental and spatial components (Legendre et al. 2005) and, as such, the issues discussed here also apply to the analysis of beta-diversity. The matrix \mathbf{W} (sites by spatial predictors) can, in principle, contain the geographical coordinates of sites, trend surface polynomials performed on these coordinates or spatial eigenvectors (Dray et al. 2012). However, geographical coordinates (simple or their polynomials) are only able to deal with simple large-scale spatial patterns whereas spatial eigenvectors are capable to model complex spatial structures occurring at both large and very fine scales (Griffith and Peres-Neto 2006). As such, in this study we use Moran's Eigenvector Maps (MEM; Dray et al. 2006) to compose the spatial matrix \mathbf{W} which are routinely used in VP and known to be an efficient set of predictors to model simple and complex spatial patterns at multiple scales.

Fractions of variation are coefficients of determination (i.e., R^2) and need to be adjusted to account for the number of predictors as shown in Peres-Neto et al. (2006). Adjustments to correct for inflated variation explained in \mathbf{Y} due to irrelevant predictors is standard in multiple regression analysis (e.g., Ezekiel 1929) and as such also apply to canonical analysis and VP (see Peres-Neto et al. 2006) which are simple extensions of multiple regressions. For instance,

in the case of fraction [ab], the adjusted canonical coefficient of determination $\tilde{R}_{[ab]}^2$ is defined as:

$$\tilde{R}_{[ab]}^2 = 1 - \frac{n-1}{n-p-1} (1 - R_{[ab]}^2) \quad (1)$$

where n is the number of sites (i.e., communities), p is the number of environmental predictors in \mathbf{X} , and $R_{[ab]}^2$ is the coefficient of determination calculated on the basis of a multi-response multiple regression of species table \mathbf{Y} on the environmental matrix \mathbf{X} only. The same adjustments are performed on fractions [bc] (spatial) and [abc] (spatial and environmental combined) using the appropriate degrees of freedom involved prior to calculating unique and shared fractions via subtraction as detailed above.

The significance of fractions is estimated by a randomisation test where the rows (i.e., sites) of the predictors (\mathbf{X} , \mathbf{W} or \mathbf{XW}) are permuted and appropriate F-statistics related to each fraction are calculated (Legendre and Legendre 2012). Note that in the case of a simple canonical analysis without a spatial matrix (i.e., direct gradient analysis), only fraction [ab] is tested. In the case of the environmental fraction $R_{[ab]}^2$ the null hypothesis H_0 is “the absence of species-environment relationships” (i.e., species sorting is not important). Under this null hypothesis, the expected value of the unadjusted coefficient of determination is

$$E(R_{[ab]}^2 | H_0) = \frac{p}{n-1} \quad (\text{Ezekiel 1929, Peres-Neto et al. 2006})$$

so that, after some mathematical manipulations, the adjusted value (Eq. 1) becomes (Peres-Neto et al. 2006):

$$\tilde{R}_{[ab]}^2 = 1 - \frac{1}{1 - \frac{p}{n-1}} (1 - R_{[ab]}^2) \quad (2)$$

and therefore:

$$\tilde{R}_{[ab]}^2 = 1 - \frac{1}{1 - E(R_{[ab]}^2 | H_0)} (1 - R_{[ab]}^2) \quad (3)$$

As such, the expected value under the null hypothesis of no relationship between species distributions and the (measured) environment $E(\tilde{R}_{[ab]}^2 | H_0) = 0$. However, when species and environmental factors are independent but both spatially autocorrelated, $R_{[ab]}^2$ becomes

inflated under the null hypotheses so that $E(\tilde{R}_{[ab]}^2|H_0) > 0$. This was shown by Smith and Lundholm (2010) using neutral dynamics to impose spatial autocorrelation on species distributions and estimating $\tilde{R}_{[ab]}^2$ based on autocorrelated environments. Moreover, when \mathbf{X} and \mathbf{Y} are autocorrelated but not associated, permutation tests used in canonical analysis (i.e., direct gradient analysis) to test for $\tilde{R}_{[ab]}^2$ are also biased, having a rejection rate that is larger than the pre-established nominal significance level alpha (i.e., inflated Type I error rates; Peres-Neto and Legendre 2010). Here, we propose a new framework to estimate $E(R_{[ab]}^2|H_0)$, leading to an adjusted estimator and a valid statistical test for assessing the importance of species sorting on metacommunity dynamics that would be otherwise biased by spatial autocorrelation.

A spatially-constrained null model to estimate and remove biases due to spurious environmental effects

Similarly to Chase and Myers (2011), our approach is based on the development of a constrained null model to study the environmental contribution (i.e., fraction [ab]) in the face of the stochasticity induced by neutral dynamics (via limited dispersal). To do so, here we adapt a method recently proposed by Wagner and Dray (2015), namely the Moran Spectral Randomization (MSR) that allows generating random replicates of a data matrix while keeping its original inter-correlations and spatial structures (i.e., spatially-constrained randomisation) to produce unbiased model fit estimates and statistical tests in the context of direct gradient analysis (i.e., canonical analysis) and VP. As such, MSR was used to produce a spatially-constrained null model in which H_{0-MSR} is best described as “*the absence of species-environment relationships given the spatial structure of the environmental variables*”. In addition to conserving the original spatial autocorrelation in the environmental predictors, MSR also preserves the original correlation structure of the environment, a property important to assure that randomisation tests with multiple predictors have correct Type I error rates even when predictors are non-spatially autocorrelated (Peres-Neto et al. 2006). Note that, if environmental predictors are not spatially structured, the resulting replicate is also random in respect to space. The MSR was used to generate replicates of randomised environmental

matrices \mathbf{X} that were independent of the species distribution matrix \mathbf{Y} (in this study we used $n_{MSR}=1000$ replicates).

For every randomised environmental matrix (\mathbf{X}_{MSR} replicate), a VP for \mathbf{Y} on \mathbf{X}_{MSR} and \mathbf{W} (spatial predictors based on MEM) was produced and corresponding fractions calculated. These computations were repeated for each \mathbf{X}_{MSR} replicate so that the expected distribution of $\tilde{R}_{[ab]}^2$ under H_{0-MSR} was produced. As such, our spatially-constrained randomisation procedure allows estimating the statistical distribution of the $R_{[ab]}^2$ values expected under pure spurious species-environment relationships for a given species data matrix \mathbf{Y} . The estimated expected value under the null hypothesis $E(R_{[ab]}^2|H_{0-MSR})$ is then simply the average of the n_{MSR} random replicates of $R_{[ab]}^2$. Consequently, the estimated expected value of the coefficient of determination adjusted for spurious correlations is simply:

$$\tilde{R}_{[ab]MSR}^2 = 1 - \frac{1}{1 - E(R_{[ab]}^2|H_{0-MSR})} (1 - R_{[ab]}^2) \quad (4)$$

Likewise, fractions [a] and [b] are adjusted as follows:

$$\tilde{R}_{[b]MSR}^2 = 1 - \frac{1}{1 - E(R_{[b]}^2|H_{0-MSR})} (1 - R_{[b]}^2) \quad (5)$$

$$\tilde{R}_{[a]MSR}^2 = \tilde{R}_{[ab]MSR}^2 - \tilde{R}_{[b]MSR}^2 \quad (6)$$

where $E(R_{[b]}^2|H_{0-MSR})$ is the mean of the n_{MSR} random replicates of $R_{[b]}^2$. Detailed calculations to obtain fractions [bc], [abc], [c] and [d] using the MSR-based new VP procedure follow similar implementations and are shown in Appendix S1.

Fig. 1 represents a summary of the issues related to spurious autocorrelation and how our framework adjusts for them. In metacommunities driven solely by neutral dynamics, the total environmental contribution (fraction [ab]) is inflated because spurious correlations generated by independent spatial autocorrelation in environmental factors and species distributions inflate fraction [b] (Fig. 1A; see result section for simulations demonstrating this issue). In these cases, our proposed MSR-based VP is expected to generate an unbiased estimation of fraction [b] (and thus [ab]) as zero (Fig. 1B). In metacommunities driven by both species sorting and neutral dynamics, fraction [b] and, as consequence, fraction [ab] are inflated due

to the species dynamics driven by neutral dynamics (Fig. 1C). In these cases, our MSR-based spatially-constrained null model adjusts for this spurious contribution in the total environmental fraction [ab] by reducing fraction [b] to the contribution of the spatially-structured environment to species distributions independent on spatial autocorrelation (Fig. 1D).

Simulation study

We designed a simulation study to (i) describe how spatial autocorrelation affects the ability of direct gradient analysis (i.e., canonical analysis) and VP to disentangle the effects of species sorting and neutrality; (ii) demonstrate the performance of our environmental spatially-constrained approach (i.e., MSR-based VP) to generate an unbiased test for assessing the importance of species sorting over neutral dynamics. Traditionally, spatial predictors are selected via a forward model selection to compose the spatial matrix \mathbf{W} in VP (Blanchet et al. 2008, Smith and Lundholm 2010). Peres-Neto and Legendre (2010), however, showed that selected MEM subsets do not successfully remove spatial autocorrelation from model residuals, leading to inflated estimation and type I error rates of fraction [a] (i.e., species sorting). That is why, here, we used all positively spatially autocorrelated MEM.

Metacommunities simulation

We used a dynamic spatially explicit individual-based model originally developed by Bell (2000, 2003, 2005) and implemented by Smith and Lundholm (2010). We modified the initial model to simulate the spatial distributions of $S=50$ (number of species) on a $M \times M$ torus ($M=15$) where each cell (patch) represented a local community ($n = 225$ local communities). We first simulated metacommunities solely composed of 50 generalist species (i.e., a form of neutrality in which all individuals have the same fitness) where the survival probabilities of all individuals were equal and independent of the environmental conditions in a particular patch. We then simulated metacommunities composed of 50 specialist species (i.e., here driven by species sorting dynamics) in which the survival probability of an individual was a function of the difference between its species niche optima and the local environmental conditions. A third type of metacommunity was composed by a mix of 25 species structured by neutral dynamics and 25 species structured by environmental sorting (mixed metacommunity).

Simulations to generate a single metacommunity were run for 5000 generations to meet population equilibrium without incurring major species extinctions. For each type of dynamics (i.e., neutral, species sorting, and mixed), 1000 metacommunities were generated. Simulations details are provided in Appendix S2.

Environment

In all simulations, we used 5 spatialised (i.e., spatially-autocorrelated) environmental variables that were generated following Dray (2011) in which an autoregressive model with parameter ρ varying between 0 (no spatial structure) and 0.8 (strong positive autocorrelation) was used to generate each variable independently. In the case of neutral dynamics only, we also considered an environmental matrix X containing 10 and 20 variables generated with a strong autocorrelation ($\rho=0.8$).

Values of all environmental variables were kept constant through time within any given local community (i.e., cell).

Statistical analysis

Spatial predictors in table W were generated using Moran's Eigenvector Maps (MEM; Dray et al. 2006) of a spatial weighting defined by a "Queen's neighborhood" (i.e., 8 closest patches). Species matrices were Hellinger transformed prior to VP as it generates unbiased estimates of fractions for abundance data (Peres-Neto et al. 2006).

As noted in the Introduction, VP can, in principle, only estimate the importance of species sorting. As such, here we reported results only regarding the environmental fraction: 1) estimations of fractions [ab] (environmental + spatial), [a] (environmental variation independent of space) and [b] (spatialised environmental fraction); and 2) rejection rates for significance tests of fractions [ab] and [a]; note that fraction [b] is not testable under current statistical implementations. Type I error rates corresponded to the number of cases where the null hypothesis (i.e. no association between species distributions and the environment) was detected as false although true (i.e., under neutral dynamics only) divided by the total number of tests (i.e., 1000 metacommunities). For the two other scenarios (species sorting metacommunities and mixed metacommunities), rejection of the null hypothesis corresponded to the estimation of statistical power as, in these cases, environment acted as a real driver of

species distributions (i.e., species sorting was important). Significance tests were based on 999 randomisations and a significance level (alpha) of 0.05 was used in all tests.

All statistical analyses and simulations were performed with R 3.2.2 (R Core Team 2016). R function for the application of the new VP procedure using MSR as a spatially-constrained null model is available in packages *ade4* (Dray and Dufour 2007) and *adespatial* (Dray et al. 2017). An example of the new variation partitioning procedure (and related R code) on an empirical vegetation dataset is provided in Appendix S6.

III. Results

The results based on metacommunities driven by neutral dynamics highlight the issue of how spatial autocorrelation impacts the estimation of fractions and associated hypotheses testing (Fig. 2 left panel). The total contribution of environment (fraction [ab]) becomes greater than the expected (zero) and it increases with the number of autocorrelated environmental variables used to assess the importance of species sorting (Fig. 2A). Type I error rates for fraction [ab] are extremely high leading to non-valid tests, implying strong species sorting for neutrally generated metacommunities. Notably, although the spatial predictors generate appropriate estimates and Type I error rates for the pure environmental contribution (fraction [a]; Fig. 2B), VP based on these predictors lead to inflated estimates of the spatial component of the environment (fraction [b]; Fig. 2C), explaining why fraction [ab] (but not [a]) is biased under neutral dynamics. Our spatially-constrained null model framework completely removes the biases in estimation due to spatial autocorrelation in fraction [b] and [ab] (and associated statistical testing of fraction [ab]), leaving fraction [a] as expected, i.e., zero (Fig. 2D-F). The results presented so far were based on high levels of spatial autocorrelation in the environment ($\rho=0.8$). Using a lower level of autocorrelation ($\rho=0.4$), estimates of fractions [ab] and [b] were also biased (Fig. 3A-C; Appendix S3 Tables S1, S2, and S3) though (as expected) relatively closer to zero in contrast to estimates based on high levels of spatial autocorrelation ($\rho=0.8$). Note, however, that Type I error rates for fraction [ab] were equally high for both levels of spatial autocorrelation. As for high levels of spatial autocorrelation (Fig. 2), our spatially-constrained null model also led to adjusted estimates and Type I error rates for lower levels of autocorrelation for all fractions (Fig. 3D-F; Appendix S3 Tables S1, S2, and S3).

The simulations and results based on metacommunities solely driven by species sorting demonstrated that our spatial null model tends to only slightly reduce fraction estimates by about less than 0.1% in most cases (Fig. 3J-L, Appendix S3) when compared to unadjusted results (Fig. 3G-I; Appendix S3 Tables S1, S2, and S3). Note, however, that statistical power is the same between unadjusted and adjusted versions.

For the case of mixed metacommunities, where some species are driven by neutral dynamics and others by environmental sorting, our spatial null model produces estimates for fractions [ab] and [b] that are smaller (Fig. 4D-F; Appendix S3 Tables S1, S2, and S3) in

contrast to the non-adjusted (biased) estimates (Fig. 4A-C; Appendix S3 Tables S1, S2, and S3), particular in the cases of high spatial autocorrelation ($\rho=0.8$). This reduction is obviously a result of the fact that the relationship between some species and their environments are spurious. As such, our procedure is also relevant when metacommunities are structured by mixes of processes (i.e., neutral and species sorting).

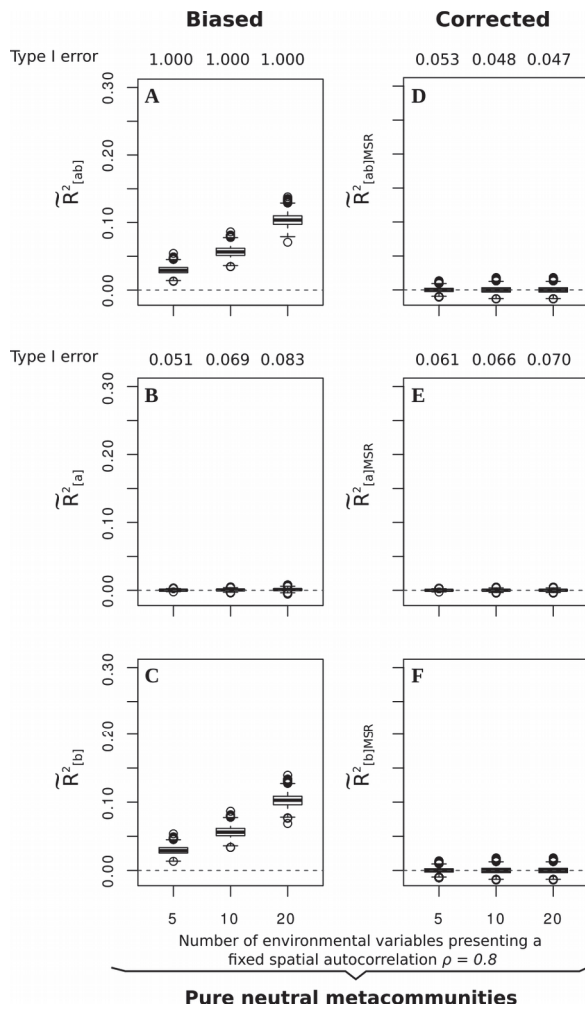

Figure 2: Results of variation partitioning fractions [ab], [a] and [b] for neutral metacommunities as a function of number of environmental variables. (A-C) observed \tilde{R}^2 of fractions [ab], [a], and [b] ($\tilde{R}^2_{[ab]}$; $\tilde{R}^2_{[a]}$; $\tilde{R}^2_{[b]}$ respectively) and their associated Type I error rates. (D-F) adjusted \tilde{R}^2 of fractions [ab], [a], and [b], respectively, ($\tilde{R}^2_{[ab]MSR}$; $\tilde{R}^2_{[a]MSR}$; $\tilde{R}^2_{[b]MSR}$) and their respective Type I error rates; (A-F) Note that fraction [b] cannot be tested and as a result Type I errors are not estimated. All fractions \tilde{R}^2 are reported with boxes representing the 25, 50 and 75 quartiles, the lower whisker is the first quartile minus 1.5 times the interquartile range, and the upper whisker is the third quartile plus 1.5 times the interquartile range. Extreme values (i.e., exceeding the whiskers) are plotted. Environment presents successively 5, 10 and 20 environmental variables whose spatial autocorrelation is fixed to $\rho=0.8$. Dashed grey line corresponds to the expected \tilde{R}^2 . Ordinates are scales from 0 to 0.3 to facilitate comparisons with Figures 3 (left panel) and 4.

Applied to an empirical dataset, our new procedure allowed to substantially reduce estimates of fractions [ab] and [b] as [b] was reduced from 0.12 to 0.060 (Appendix S6 Table S1), thus adjusting for the effect of spatial autocorrelation on both species distributions and environmental data. This result demonstrates the original total environmental fraction [ab], which contains fraction [b], was heavily driven by spurious spatial autocorrelations in these data.

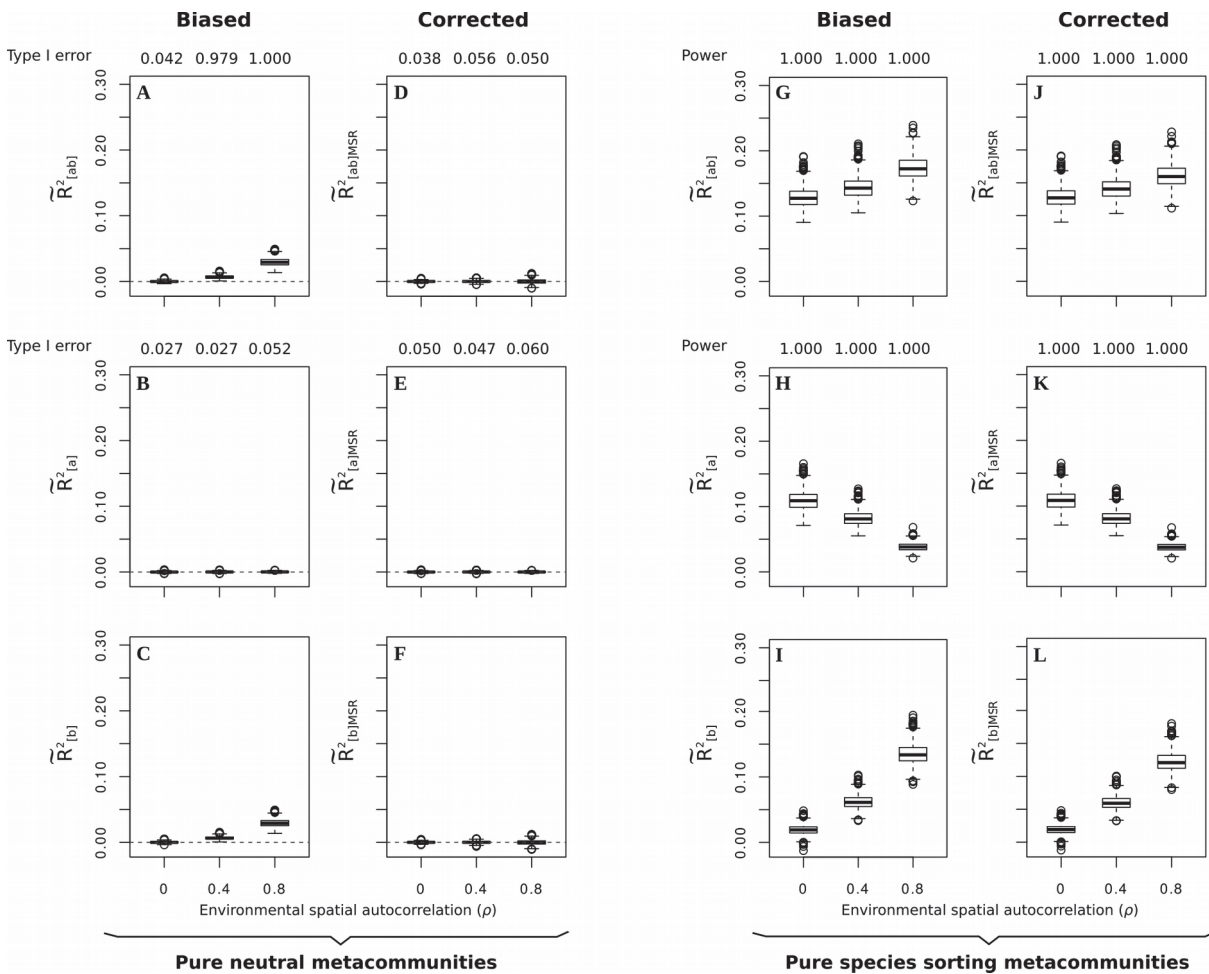

Figure 3: Results of variation partitioning fractions [ab], [a] and [b] for metacommunities structured by neutral dynamics and species sorting. *Left panel:* results for neutral metacommunities. (A-C) estimation of total environmental contribution (fraction [ab]; $\tilde{R}_{[ab]}^2$), non-spatialised (fraction [a]; $\tilde{R}_{[a]}^2$), spatialised (fraction [b]; $\tilde{R}_{[b]}^2$), and their respective Type I error rates; (D-F) Estimates for adjusted fractions [ab] ($\tilde{R}_{[ab]MSR}^2$), [a] ($\tilde{R}_{[a]MSR}^2$), and [b] ($\tilde{R}_{[b]MSR}^2$) their respective Type I error rates. Note that fraction [b] cannot be tested and as a result Type I errors are not estimated. Dashed grey line (at zero) corresponds to the expected variation explained for neutral metacommunities. *Right panel:* results for metacommunities structured solely by species sorting; order of figures are the same as for the left panel. (A-L) Boxplot specifics are explained in the legend of Figure 2. Ordinates are scaled from 0 to 0.3 to facilitate comparisons with Figures 3 (left panel), 2 and 4.

IV. Discussion

The goal of this paper was twofold: (i) identify and summarise the issues regarding how the importance of species sorting is artificially inflated by neutral dynamics if spatial autocorrelation is not accounted for; and (ii) propose a general and flexible procedure based on a spatially-constrained model to tackle these issues regarding parameter estimation (fractions) and inference (hypothesis testing). We centred on direct gradient analysis and VP because they are the most used quantitative frameworks to infer species sorting in community ecology (Cottenie 2005, Soininen 2016, Leibold and Chase 2017), though our framework is general and relatively simple enough to be imbedded in any type of analysis (e.g., null models of species distributions, trait and phylogenetic community analysis, analyses of beta-diversity patterns).

VP applied to neutral metacommunities showed increasing inflations of fraction [ab] ($\tilde{R}_{[ab]}^2$) and associated Type I error rates as environmental spatial autocorrelation increases. In particular, Type I error rates became extremely high (equal to one) for a strong spatial autocorrelation in environmental features, thus systematically detecting a significant species sorting contribution when in fact there was none. Bias in estimation and inflation of Type I error rates rapidly increased with the number of environmental variables and can be easily explained by the fact that increasing the number of predictors provides greater chance to obtain spurious correlations between environment and species distribution data. It is now well recognised in ecology that when model residuals are spatially autocorrelated (F. Dormann et al. 2007, Dray et al. 2012; i.e., when the model does not fully account for the spatial variation in the response Y), model slope estimates have much greater uncertainty (large confidence intervals) than expected under the assumption of residual independence. Although slopes are not biased per se (i.e., their average across sampling values equals the true population value; F. Dormann et al. 2007), their distribution is wider so that large slope values (positive and negative) will contribute to increase R^2 (i.e., fraction) values (adjusted or not), leading to inflated fraction [ab]. This is clearly the reason why under neutral dynamics, species sorting is detected when using only fraction [ab]. Note that studies only carrying out direct gradient analysis (i.e., canonical analysis) without considering VP need to be also aware of this issue and adjust estimates and tests accordingly using an appropriate spatial model such as the one developed here.

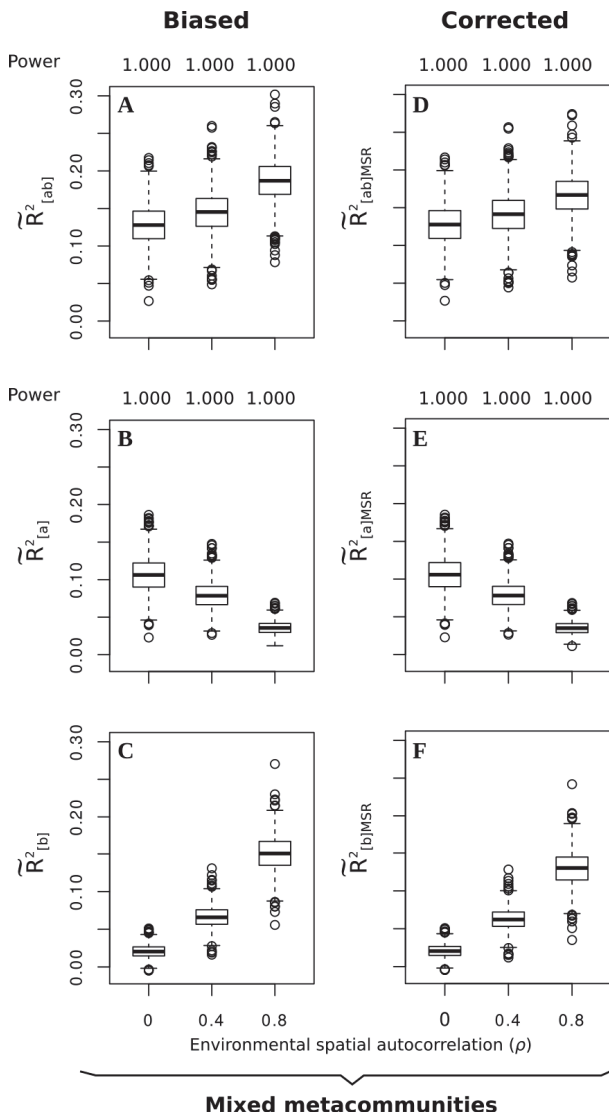

Figure 4: Results of variation partitioning fractions [ab], [a] and [b] for mixed metacommunities. (A-C) observed estimates of fractions [ab] ($\tilde{R}_{[ab]}^2$), [a] ($\tilde{R}_{[a]}^2$) and [b] ($\tilde{R}_{[b]}^2$), and their respective power as a function of different levels of spatial autocorrelation in environmental variables. (D-F) Estimates for adjusted fractions [ab] ($\tilde{R}_{[ab]MSR}^2$), [a] ($\tilde{R}_{[a]MSR}^2$), and [b] ($\tilde{R}_{[b]MSR}^2$) by our procedure to remove the effects of spurious correlation due to neutral dynamics. (A-F) Boxplot specifics are explained in the legend of Figure 2. Ordinates are scaled from 0 to 0.3 to facilitate comparisons with Figures 3 (left panel) and 2.

The main contribution of the present study is that we determined a way to consider spatial autocorrelation when testing for species sorting. As such, we propose new estimates of the environmental contribution (species sorting) via an adjustment to fraction [ab] instead as previous studies that only considered fraction [a] as a test of species sorting given that the assumption was that the entire fraction [b] had to be foregone because one could not separate the effects of spurious correlation from the spatial structure of the environment. Moreover, we expect, in many cases, our procedure will increase the statistical power for detecting species sorting given that fraction [ab] is greater than fraction [a] alone. Note that for communities structured by neutral dynamics only, even though the expected value of fraction [ab] ($\tilde{R}_{[ab]}^2$) was properly estimated (i.e., average value equal to zero), its variance increased slightly with the level of environmental spatial autocorrelation. Given that this increase of variance was

also present for the initial value of fraction [ab] ($\tilde{R}_{[ab]}^2$) for communities generated solely by neutral dynamics and was absent from the others scenarios considered in this study (i.e., species sorting and mixed), it indicates that this issue is not linked to our new procedure but rather to the fact that increased spatial autocorrelation leads to great uncertainty (variance) in parameter estimates (model slopes; F. Dormann et al. 2007). This issue deserves further attention in future studies.

In this study, we developed a method and articulated a rationale in which fraction [ab] (and not fraction [a] alone) should be interpreted as the total (spatial and non-spatial) environmental contribution to species distributions (and related patterns such as beta-diversity). This is because our method separates the spatialised (i.e., spatially-autocorrelated) contribution of the environment (fraction [b]) that is due to spurious correlations from the contributions of the environment to species sorting. We did not consider the issues of estimating the spatial fraction ([bc] and [c]) given that spatial variation cannot be directly linked to a unique process and may be due to stochastic neutral dynamics via dispersal limitation, missing spatialised environmental predictors influencing species sorting and/or other types of spatial dynamics (e.g., biotic interactions). Note, however, that our framework needs to consider a spatial component (matrix **W** containing MEM). Because most studies that use VP apply a model selection (usually forward selection; e.g., Smith and Lundholm 2010, Gilbert and Bennett 2010) to reduce the number of spatial predictors and increase the statistical power of detecting a significant fraction [a] (i.e., non-spatialised environmental contribution) and now fraction [ab] as per our study, we felt important to further discuss this issue here. In the original VP procedure, although estimates of fraction [a] are not biased under neutral dynamics (i.e., average values are zero; Fig. 2B and 3B) with (Appendix S4 Fig. S1B; Smith and Lundholm 2010) or without selection of spatial predictors (our study; Fig. 2B and 3B; Appendix S4 Fig. S1E), tests of fraction [a] have inflated Type I errors under neutral dynamics when subsets (i.e., selected) of spatial predictors are used (Appendix S4 Fig. S1B ; Peres-Neto and Legendre 2010). This is related to the fact that variance of fraction [a] (as for fraction [ab]) is inflated under neutral dynamics leading to inflated Type I errors and, as such, a number of fraction [a] estimates are higher (due to the high variance issue as discussed above) than fraction [a] estimates from communities that are driven by species sorting, leading to inflated Type I error rates. This issue, however, is corrected by our framework in which both estimates and Type I error rates of fractions [a] and [b] (and [ab] as a consequence) are

adjusted with and without forward selection for the spatial predictors (Appendix S4 Fig. S1G,H,I).

A novel finding in the present study is that estimates of fraction [b] under neutral dynamics are the ones inflated (Fig. 2C, Fig. 3C) even when all spatial predictors are used, leading to an inflation of fraction [ab]. Note that our spatially-constrained null model fully accounts for this bias (Fig. 2F, Fig. 3F). Given these results, we can now establish that fraction [b] has four origins:

1. Spatial structure of the measured environment;
2. Spatial structure of unmeasured spatialised environmental variables that influence species distributions and that are partially correlated with the measured environment;
3. Dispersal dynamics that track measured and/or unmeasured environmental variables (i.e., non-neutral). In other words, species can track suitable environments through dispersal (i.e., environmental tracking; Grönroos et al. 2013, Gianuca et al. 2017, Hill et al. 2017) . As species are not considered equivalent in species sorting dynamics, even if they can reach many different environments through dispersal, they will only persist in those environments that are well suited. In our simulation model, this corresponds to the birth and death rate (weighted by survival probability and environmental selection) which determine if species establishment succeeds (i.e., species survive and reproduce in the community) or fails (i.e., species do not reproduce and die just after arriving in the community);
4. Dispersal dynamics via neutral dynamics (i.e., independent of environmental variation).

Therefore, our spatially-constrained null model allows separating the contributions of spatially structured species sorting via environment (origins 1 to 3) in contrast to what is expected under neutral dynamics (4th origin; i.e., fraction [b] due to spurious relationships between autocorrelated species and environmental features, Appendix S3). Note, however, that our model cannot separate between origins 1 and 3. As discussed above, this separation allows to use fraction [ab] and not only [a] to estimate and test for species sorting.

As species-environment relationships were defined as constant in our simulations, the increase of fraction [ab] ($\tilde{R}_{[ab]}^2$) as a function of increased levels of environmental spatial

autocorrelation (Fig. 3G&J) in the case of species-sorting metacommunities can appear somewhat counter-intuitive. One could indeed expect fraction [ab] to be also constant across different levels of spatial autocorrelation of the environment. This result can be easily explained by the interaction between the spatial structure of the environment and dispersal (3rd origin of fraction [b]; i.e., dispersal dynamics tracking environmental features). Given that dispersal limitation was kept fixed across all simulation scenarios, as the spatial autocorrelation of the environment increases, the probability of finding suitable environments increases as well, leading to greater variation explained by the environment (i.e., fraction [ab]). Note that our spatially-constrained null model does not affect this pattern because this increase is truly related to species sorting (i.e., not induced via spurious correlation due to spatial autocorrelation).

The environmental fraction [ab] ($\tilde{R}_{[ab]}^2$) for mixed metacommunities was reduced by our framework (Appendix S3 Tables S2 and S3). This can be explained by species undergoing neutral dynamics that inflates fraction [b] by adding the unwanted 4th origin (i.e., dispersal without species sorting; Appendix S5 Fig. S1). Our spatially-constrained null model was able to estimate the spurious contributions in fraction [b] (Appendix S3) and produce adjusted estimates of the environmental contribution.

In this study, we demonstrated that the environmental contribution (fraction [ab]) in direct gradient analysis and VP could be strongly inflated in the case of spatially autocorrelated environment. As spatial autocorrelation is inherent to environmental predictors and given that both latter frameworks are extremely used in ecology to estimate environmental effect (Soininen 2014), it is most likely that the role of species sorting has been overemphasised in recent ecological studies. Our MSR-based VP produces adjusted estimates of the VP fractions that would be otherwise inflated by spatial autocorrelation. As such, it allows for a better evaluation of the importance of species sorting shaping beta diversity. More importantly, our new framework allows ecologist to revise their previous results without collecting new data.

Our study highlights the need for more sophisticated null models than those furnished by standard permutation procedures. Constrained null models offer a nice framework to consider the properties of the ecological data, allowing testing for more complex ecological hypotheses than the usual full random hypothesis. Consequently, they are promising tools to disentangle

processes underlying metacommunity and community structure (Buschke et al. 2015, Mori et al. 2015, Brown et al. 2016).

V. Acknowledgements

We thank the computing facilities of the CC LBBE/PRABI with which all simulations and statistical tests were performed. This work was supported by an NSERC (Natural Sciences and Engineering Research Council of Canada) discovery grant and the Canada Research Chair in Spatial Ecology and Biodiversity to P. R. Peres-Neto. We would like to thank Dave Jenkins and an anonymous reviewer for their comments which greatly contributed to improve this manuscript.



Desert du Namib



Thaïlande



Australie



Congo



Nouvelle-Zélande



Tanzanie

General Discussion



Corse

List of figures

<i>Figure 1:</i> Ecological processes in a space of multiple ecological dimensions.....	116
<i>Figure 2:</i> Apparent distinction between hypothesis-testing and model-based approaches to study an ecological problematic.....	134

I. Ecological scales and ecologically-constrained null models: what to think?

A. Objective of the thesis

Lawton (1999) famously characterised community ecology as a “mess” and attributed it to the high contingency of ecological rules (i.e., processes) preventing any generalisations on communities assembly. In this manuscript, I assumed that part of Lawton’s “mess” in fact pertained to methodological issues and could be unravelled through: (i) taking into account ecological scales and (ii) defining null models to depict more complex ecological null hypotheses.

The aim of this thesis was thus to improve ecologists’ statistical toolbox by implementing ecological scales and ecologically-constrained null models to better identify and quantify ecological processes underlying community structure and composition.

B. Ecological scales

1. Phylogenetic and spatial scaling of trait-environment relationships: conclusions

The first axis of the manuscript focused on the study of environmental filtering through spatial and phylogenetic scales. The fourth-corner approach (Legendre et al. 1997, Dray and Legendre 2008, Peres-Neto et al. 2016) was extended to decompose trait-environment relationships across spatial and phylogenetic scales alone or at the same time. This approach aimed at (i) identifying the spatial scales involved in environmental filtering; (ii) determining the degree of conservatism of functional traits selected by environmental filtering; and (iii) identifying and quantifying the relationships between both spatial and phylogenetic scales involved in trait-mediated environmental filtering to associate species evolutionary history to particular spatial scale(s).

The extended fourth-corner approach succeeded in identifying the spatial and phylogenetic scales involved in trait-mediated environmental filtering with good type I error rates and statistical power. The results brought important insights in the study of trait-mediated environmental filtering by providing the spatial and phylogenetic signals of, respectively, the environmental variable and functional trait involved in the filtering. But, more importantly, the approach established an explicit relationship between those two scales allowing to study how environmental filtering spatial scale(s) structure the trait phylogenetic signal by inducing

ancient or recent divergences of species functional trait values. Overall, this axis showed that taking ecological scales into account in methodological approaches is useful as it brings complementary information to draw relevant conclusions on how ecological processes shape communities.

2. An inherent problem remains...

It all begins with a trivial statement: integrating ecological scales requires to define them. Nobody could disagree with this point, yet every study present their own definition of “large”, “intermediate” and “fine” ecological scales (see below). Those terms are largely employed in ecological studies but remains strongly study-dependent and, to my knowledge, no general consensus has been made so far about what can exactly be qualified as “large”, “intermediate”, and “fine” ecological scales and in particular: what are the limits between those three categories? To illustrate this issue, I will take the case of spatial scales. Note however that the issue is similar with other ecological scales (e.g., temporal and phylogenetic).

As exposed in the General Introduction (section III.B.2), two main ways are used to design spatial scales: (i) spatial grain and extent and (ii) spatial eigenvectors (i.e., Moran’s Eigenvector Maps; Dray et al. 2006). Both present the same issue of “large”, “intermediate” and “fine” spatial scales definition. Note that other constructions of spatial scales can be used such as wavelets (Keitt and Urban 2005) but are not addressed here.

a. Spatial grain and extent

Characterising spatial scales in term of spatial grain and extent is the most intuitive way as spatial scales increase with the spatial area used to define the grain and extent. The limits of spatial areas used to define “large”, “intermediate” and “fine” spatial scales are however confusing and leads to contradictory results between studies. For example, in the study of the differential importance of edaphic and climatic variables on community species composition across increasing spatial extents, Arellano et al. (2016) showed that climatic conditions remained a stronger determinant of community species composition compared to soil variables at all spatial scales. On the contrary, in their meta-analysis, Siefert et al. (2012) found that soil variables were stronger determinants than climatic conditions at fine spatial scales and inversely at large spatial scales. In their study, Arellano et al. (2016) explicitly suggested that this contradiction could emerge from a dissimilarity in areas considered to

define the “fine” spatial extent which was $\sim 250 \text{ km}^2$ in their study while Siefert et al. (2012) included much smaller ones. As such, the absence of “universal” limits to define what is considered as “large”, “intermediate” and “fine” spatial scales induces difficulties to compare results from different studies often leading to contradictory results although they are probably not.

b. Spatial eigenvectors

As exposed in the General Introduction (section III.B.2), spatial eigenvectors are obtained from a neighbour matrix of sites. In the case of Moran’s Eigenvector Maps (MEM; General Introduction Fig.11; Dray et al. 2006), the spatial eigenvectors maximise the spatial autocorrelation between sites based on Moran’s I (i.e., index of spatial autocorrelation). As such, they describe large to very fine patterns of spatial autocorrelation which, by extension, define large to very fine spatial scales. The use of MEM to represent spatial scales is far less intuitive than spatial grain and extent. Indeed, an explicit relationship between spatial autocorrelation and spatial scales is still lacking in the literature. The general assumption is that the spatial scale increases with the sites similarities and decreases with the increasing dissimilarities between sites. In other words, MEM associated with positive spatial autocorrelation (hereafter positive MEM) should correspond to large spatial scales and, on the contrary, those associated with negative spatial autocorrelation (hereafter negative MEM) should represent fine spatial scales (Peres-Neto 2006, Dray et al. 2012). However, to what extent this statement is true and to what extent spatial autocorrelation can be used as proxy for spatial scales remain important issues to be addressed especially because MEM are widely used in ecological studies to model spatial scales (Legendre et al. 2012, Dray et al. 2012, Chang et al. 2013, da Silva Menezes et al. 2016).

This lack of relationship between spatial autocorrelation and spatial scales entails difficulties and confusions in defining which MEM is to be considered to define “large”, “intermediate” and “fine” spatial scales. Even based on the general statement that the first MEM represent large spatial scales, the latest correspond to fine spatial scales and those in the middle are the intermediate spatial scales, ecological studies remain incomparable for two reasons. First, the number of MEM depends on the number of sites considered and the way they are connected through space (Dray et al. 2006). Second, studies can choose to represent spatial scales with all MEM (i.e., positive and negative MEM; Chang et al. 2013) or just a

subset selected by forward selection (see Blanchet et al. 2008 for the forward selection method, da Silva Menezes et al. 2016). As such, two studies with the exact same ecological question and area of study can present two different sets of MEM if their sampling designs are different or if one selects a subset of MEM but not the other.

Overall, the lack of “universal” rule to define “large”, “intermediate” and “fine” spatial scales leads to contradictory even incomparable results between studies. Presently, I could not offer the perfect solution concerning this rule and I even doubt one can be established. One fact is though certain: further works are needed to clarify and homogenise the use of spatial scales in ecological studies. Two possibilities could potentially be sensed. One first way could be to establish clear and general limits in term of spatial distances to define different categories of spatial scales. This however appears irrelevant and difficult as every species have a different spatial area of interaction, making communities unequal in their perception of spatial scales. For example, bacterial communities (Martiny et al. 2011) will perceive space in terms of square centimeters, whereas perception of plants communities is measurable in meters and kilometers (Arellano et al. 2016). As such, definitions of the spatial scales categories will obviously have to depend on the type of organisms composing communities as fine spatial scales for bacterial communities will be smaller than those for plant communities. The second possibility would be to abandon the categorisation of spatial scales and consider that ecological processes shape communities on a spatial continuum. Thinking in terms of spatial continuum would allow to reduce the need of taking into account other ecological scales, such as organismic scale, to define categorisations. Either exposed possibilities require however to translate pattern of spatial autocorrelation dispensed by MEM in spatial distances to make ecological studies comparable regardless of their definition of spatial scales.

3. Ecological scales: crutches or real assets?

The first axis showed that ecological scales are useful to identify and quantify specific features of a particular ecological process. But what about using them to distinguish between several ecological processes? For instance, Chase (2014) suggested that spatial scales should allow to separate the respective roles of environmental filtering and limited dispersal in community assemblage. Using one type of ecological scale begins however to be recognised as insufficient and studies increasingly support the use of multiple ecological scales (Levin

1992, Thuiller et al. 2010, Münkemüller et al. 2014) to study the importance of ecological processes underlying communities. The idea behind this is to consider ecological processes as placed in a space of multiple ecological dimensions along which they shape communities similarly and/or dissimilarly (Fig. 1). Consequently, the ecological signature of each ecological process left on communities could be defined as a precise position in this multi-dimensional space. Adding ecological dimensions to this space would thus increase the possibility of different locations along ecological axes and therefore increasing the probability of distinguishing ecological processes. For example, in Figure 1, solely considering the spatial scale to separate three ecological processes (1, 2 and 3) is not enough (Fig. 1A). However when the phylogenetic scale is added, signatures of the three processes begin to be distinguishable from each other (Fig. 1B). After considering the temporal scale, the signature of process 1 is completely different from the signatures of the two other processes. Nevertheless, additional ecological scales would still be needed to distinguish between the signatures of processes 2 and 3 (Fig. 1C). Note that considering ecological scales as continuum encourages this point of view.

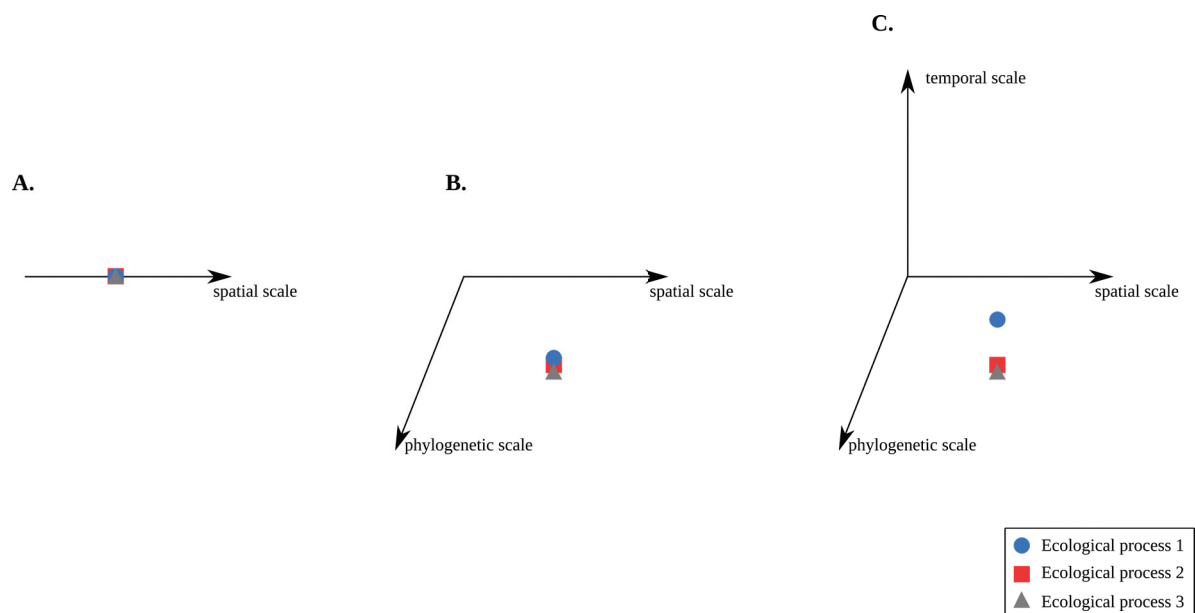

Figure 1: Ecological processes in a space of multiple ecological dimensions. (A) The three ecological processes (red square, blue circle and grey triangle) are not distinguishable based on spatial scale only. (B) The signature of the three ecological processes begin to present small differences when phylogenetic scale is considered. (C) When adding temporal scale, the signature of the ecological process 1 is completely distinguishable from the two others, however other ecological scales would be needed to separate ecological processes 2 and 3. (A-C) Ecological axes correspond to ecological scales and are drawn orthogonal to simplify the graphical representation and interpretation.

If ecological scales can be considered as real assets to identify and quantify particular features of ecological processes (Axis 1) or community dynamics (e.g., change of composition over time, Auber et al. 2017), more cautious is required about calling them real assets to distinguish between ecological processes. Until now, using ecological scales for the first goal has brought important insights to describe and understand how a focal ecological process punctually acts on biodiversity and how variation in biodiversity evolves. For example, Auber et al. (2017) used temporal scales to describe and quantify the variation of fish communities composition over time. In particular, they identified species varying the most and their trends of variation (e.g., increase or decrease). Also, the first axis brought interested insights on trait-mediated environmental filtering by identifying its spatial scale(s) of action as well as the degree of conservatism of the species functional trait selected, as such giving information about the evolutionary period of the filtering. However, even if I am intimately convinced that ecological scales could also be real assets to distinguish between ecological processes, no solid proofs have yet been proposed to support it. Indeed, if the assumption that ecological processes can be separated through spatial scales is commonly found (Thuiller et al. 2010, Chase 2014), to my knowledge, studies are still not based on more than two ecological scales (e.g., spatial and phylogenetic, Parmentier et al. 2014; spatial and temporal, Bernhardt-Römermann et al. 2015; spatial scale only, Arellano et al. 2016; temporal scale only, Auber et al. 2017). This could be partially explained by two real challenges: (i) the intensive periods of fieldworks required to collect large amounts of data, and (ii) the need of developing methodological tools handling the analyses of massive datasets along multiple ecological dimensions while maintaining clarity and concision of ecological results and interpretations, as well as their comparability across different scales. Both challenges are currently in progress as (i) studies sampling designs are increasingly based on long-term (Fernandes et al. 2014) or numerous spatial extents data (see Siefert et al. 2012 for a meta-analysis, Arellano et al. 2016), and (ii) data analysis toolkit has been constantly improving to directly take into account ecological scales (e.g., see Axis 1 for spatial and phylogenetic scales; see Auber et al. 2017 for temporal scales). Nevertheless, most of the time, if studies identify shifts of biodiversity patterns through ecological scales, they remain rather evasive concerning the identification of ecological processes underlying these patterns. For instance, Parmentier et al. (2014) showed that tree communities were phylogenetically clustered at all but very fine spatial scales. They suggested that competition could be a dominant process at

this spatial scale. This type of evasiveness in conclusions could be due, in part, to (i) the need of additional ecological scales to facilitate the identification of ecological processes, and especially (ii) the need of theoretical expectations about biodiversity patterns across each ecological scales to confirm that ecological processes can truly be distinguished through ecological scales and facilitate the identification of ecological processes. In 2016, Brown et al. investigated the performances of spatial statistics to separate spatial signals of biodiversity patterns produced by several ecological processes through mechanistic simulations. In the same way, further works could explore through mechanistic simulations and different statistics the expected biodiversity patterns and draw general conclusions about their distinction across ecological scales. Note however that such work would certainly be difficult to perform and with no certainty of general conclusions as mechanistic simulations are based on mathematical modeling, hence topological sensitivity pertaining to the numerous possibilities of model structures and parameter estimations (Babtie et al. 2014) could prevent drawing general conclusions.

To conclude, ecological scales seem to be a current cornerstone of ecological data analyses. Adopted a scaling approach is indeed encouraged (Levin 1992, Swenson et al. 2006, Thuiller et al. 2010, Münkemüller et al. 2014) and increasingly performed (Siefert et al. 2012, Fernandes et al. 2014, Parmentier et al. 2014, Arellano et al. 2016, Auber et al. 2017), as such it is now almost becoming and viewed as a standard methodology.

C. Ecologically-constrained null models

1. Spatially-constrained null model in Mantel test and Variation Partitioning: conclusions

The second axis focused on the integration of a spatially-constrained null model to correct for biases in estimations and type I error rates in Mantel test (Axis 2 Chapter 1) and variation partitioning (Axis 2 Chapter 2) used to study the effect of environmental filtering over spatial processes (Moritz et al. 2013, Arellano et al. 2016). Indeed, this axis showed that the presence of independent spatial structures in both species distributions (e.g., via limited dispersal; table **L**) and environmental variables (table **R**) led to overestimations and inflated type I error rates of the environmental effect on the variation in community species composition, as such even detecting an effect although there was none. Both chapters concluded that these issues were due to the null hypothesis used to test environmental effect, which is classically

defined with a random null model obtained by randomly permuting rows of \mathbf{R} . Such null model did not take into account the spatial dependencies of sites in \mathbf{R} induced by spatial autocorrelation. To overcome this problem, a spatially-constrained null model was substituted to the random null model used in Mantel test and variation partitioning.

The integration of spatially-constrained null models allowed to correct type I error rates and adjust estimations of environmental effect for the spurious correlations induced by spatial autocorrelation. Overall, this axis showed that the specification and choice of the null model have important effects, and taking into consideration ecological features of ecological data in the definition of the null hypothesis and null model of a statistical test is essential to correctly identify and quantify ecological processes shaping communities.

2. Ecologically-constrained null models: a relevant solution?

As previously exposed in General Introduction (section III.C), the purpose of an ecologically-constrained null model designed to study ecological processes shaping communities is to produce species assemblages induced by all ecological processes but the one of interest so that its effect can be isolated and tested. The data simulated by the ecologically-constrained null model thus reproduced non-random biodiversity patterns corresponding to the ecological processes still acting. For the purpose of the manuscript, I distinguished them from constrained and unconstrained null models designed purely to reproduce randomness. Note that this distinction is arbitrary as ecologically-constrained null models can also be viewed as random distributions of fixed biodiversity patterns.

In the two past decades, ecologically-constrained null models have been increasingly used (or encouraged to be) in hypothesis-testing to study the effect of a focal ecological process while maintaining specific structures of species assemblages associated with other ecological processes (Peres-Neto et al. 2001, Schurr et al. 2004, Hardy 2008, Lessard et al. 2012, Chalmandrier et al. 2013, Braga et al. 2018). In fact, this recent interest results from an important methodological need to have available tools to not only correctly identify and quantify ecological processes shaping communities, but also to distinguish between them. In 2009, McIntire and Fajardo suggested that the often criticised imperfect capacity of identifying and distinguishing ecological processes based on their inference from biodiversity patterns illustrated a limitation of the precision available in current data analyses methods to match null hypothesis rather than a real biological pattern-process incompatibility. They

illustrated their point with the study of Schurr et al. (2004) which used two ecologically-constrained null models (one fixing conspecific competition and the other dispersal) to test whether competition or dispersal drove desert shrub occurrences. They concluded in favor of dispersal therefore bringing a temporal answer to this longstanding question. With this example, McIntire and Fajardo (2009) called for more complex constrained null model to enhance the precision of hypothesis-testing methods in identifying and distinguishing processes. To reinforce this point of view, the General Introduction (section I.B) presented that “secondary” processes can be expressed as a combination of four “essential” processes (i.e., speciation/extinction, dispersal, environmental filtering, biotic interactions). Intuitively, the signal of “secondary” ecological processes would be expected to present only slight differences between them, which could easily be rather perceived as redundancies by methodologies with little degree of precision. By excluding the effect of a focal ecological process, ecologically-constrained null models allow to display more complex biodiversity patterns than complete randomness or simple aggregation and evenness making them highly relevant to enhance statistical precision.

Improving the precision of current hypothesis-testing methods is directly linked to the definition of the perfect match between the null hypothesis and the null model. Consequences of a mis-match and the relevance of ecologically-constrained null models to solve them was well illustrated by the mis-use of a row-constrained random null model to identify and quantify the effect of environmental filtering over spatial processes (e.g., dispersal) in variation partitioning (Axis 2 Chapter 2). Testing against randomness makes little sense in that case as it ignores the biodiversity patterns induced by the spatial processes expected to influence species distributions in communities. By using a random null model, the null hypothesis is thus only partially treated and eventually leads to quantify an effect of environmental filtering on species assemblages although there is none (Axis 2 Chapter 2). Using a spatially-constrained null model allowed to correct this bias by fixing the observed spatial structures of communities. However even if the problem of distinction and correct identification and quantification of ecological processes shaping communities certainly lies in this lack of analytical precision when defining the null hypothesis and its imperfect correspondence with a null model, it seems unlikely that it is the only issue. As discussed previously, ecological scales are also essential to take into consideration when studying ecological processes. As such, studies now try to incorporate both ecologically-constrained

null models and ecological scales to separate ecological processes. This combination is particularly used to distinguish between environmental filtering and competition (Chalmandrier et al. 2013, Scherrer et al. 2018), which are well recognised to present high similarity of biodiversity patterns (see General Introduction section III.A; Kraft et al. 2007).

Despite their excellent relevance in defining complex null hypotheses to enhance analytical precision to identify and quantify ecological processes, de Bello (2012) encourages to be more cautious when using null models in general. Developing a null model (ecologically-constrained or not) specifically corresponding to the null hypothesis answering a particular ecological question has become practically standard in community ecology as most of recent studies describe the null model they used in their Material and Methods (de Bello et al. 2009, Chalmandrier et al. 2013, 2017, Fernandes et al. 2014, Arellano et al. 2016). In his study, de Bello (2012) criticised the general impression given by the literature that choosing and building a null model is straightforward comparing it to “*waving some kind of magic wand*”. In particular, he highlighted the difficulties to identify the criteria of inclusion or exclusion of ecological processes when defining a null model and called both for a better description of null algorithms and systematic analyses of their performances (when previously unpublished) before using them to study ecological processes shaping communities. Let aside (temporarily) the choice of constraints underlined by de Bello’s (2012) argument, the choice of a null model is still all but trivial. First, mirroring the high topological diversity of theoretical models, a null model can be defined with different relevant constraints or through many different algorithms for a same constrain. For instance, the spatially-constrained null model presented in Axis 2 could have also been based on a wavelet decomposition instead of the Moran’s Eigenvector Maps decomposition. Second, if several null models are possible to depict a null hypothesis, the problem of the selection of the best null model arises. However, as topological diversity of null models is still scarcely recognised, the issue of null model selection represents a future area of research. Indeed, as quickly underlined by Gotelli and Ulrich (2012), information criteria used to select theoretical models (e.g., Akaike or Bayesian Information Criterion) would probably not be adequate to select null models as they notably rely on the number of parameters to rank competing models (Anderson 2008), and it would seem unlikely that the number of constrains could be equally used to the number of parameter to compute information criteria. They concluded that the selection of the best null model should be based on their simplicity, biological realism and evaluation with performances

analyses against simulated data to evaluate type I and type II errors (Gotelli 2000, Ulrich and Gotelli 2010, Braga et al. 2018, Axis 2). Be that it may, the question is still open to new ideas.

Even indirectly related to null models, selecting appropriate metrics to answer the null hypothesis is another issue. To take de Bello's (2012) words, "*if indices do not discriminate ecological processes well, running elegant null models will still show uncertain results*". First, an appropriate metric quantifies biodiversity patterns resulting from the ecological process(es) of interest without measuring patterns associated with other processes. Finding the appropriate metric is difficult as biodiversity patterns are inherently multivariate and summarising all these multivariate information in one single metric seems highly improbable. To overcome this issue, one solution would be to adopt a multi-level testing implying multiple metrics (McGill et al. 2006). Second, the definition of a null model (ecologically-constrained or not) highly depends on the metric choice. Indeed, null model constraints have to be independently established from the constraints already present in the ecological metric. For example, Legendre et al. (1997) described four types of null models to test the fourth-corner statistic. These four models were proposed on the basis of ecological *a priori* but their efficiency to test the fourth-corner statistic was not evaluated. A decade later, Dray and Legendre (2008) demonstrated through simulations that these models did not allow to correctly test the fourth-corner statistic (i.e., inflation of type I error rates) due to the complexity of links between the three tables (species matrix, environmental vector and trait vector) which were not adequately taken into account, and rather proposed a two-step procedure. Overall, the metric/null model couple is extremely important and a systematic performance analysis should be performed before analysing community datasets to select the best couple. Such idea is not new as already implemented with benchmark tests (Gotelli 2000, Ulrich and Gotelli 2010, Gotelli and Ulrich 2012). Benchmark tests aim at testing the performances of multiple metric/null model couples in terms of type I (i.e., reject the null hypothesis although true) and type II (i.e., accept the null hypothesis although false) errors. Those tests rely on simulated data containing defined levels of signal and noise to both evaluate (i) if the couple metric/null model correctly detects the biodiversity pattern(s) expected to result from focal ecological process(es) and not other unexpected patterns, and (ii) at which level of noise the couple is still relevant to detect the signal. As they are supposed to be preliminary tests when analysing datasets through hypothesis-testing, it is difficult to evaluate how commonly they are used in community ecology through publications.

Nevertheless, studying the performances of metric and null models represents an essential step in the construction of a good test and should be more encouraged and visible in the literature.

The last issue regarding the construction of ecologically-constrained null models is the choice of the constraints to include. Insuring that the established constraints match the null hypothesis by fixing the processes not under study and exclude the one(s) of interest constitutes, by far, the major challenge of ecologically-constrained null models (Gotelli and Ulrich 2012, de Bello 2012). As still fundamentally pattern-based, it can be difficult to identify which ecological features have to be fixed due to the long-known remaining fact that several ecological processes can influence the same biodiversity pattern (Cale et al. 1989, Real and McElhany 1996). Consequently, if the constrained ecological feature results in part from the processes of interest, the effect of this process is smuggled into the test, potentially leading to inevitable biases. More generally, relying on permutations and randomisations to fix biodiversity patterns induced by a focal ecological process(es) lacks a clear causal process-pattern link, leading to the impression that hypothesis-testing is somehow imprecise and speculative. A way over this would be to go further in the use of mathematical modelling and define null hypotheses through mechanistic null models (see below).

In conclusion, despite the choice of the ecological constraints which still needs further works to be thoroughly addressed (notably through mechanistic null models), and given that benchmark tests offer an interesting solution to the choice of the best null model(s) and metric(s), ecologically-constrained null models can be considered as relevant tools to identify and quantify ecological processes. Using ecologically-constrained null models in hypothesis-testing in fact allows for a better definition of the null hypothesis, which can be more complex than pure randomness (Schurr et al. 2004, Chalmandrier et al. 2013, Scherrer et al. 2018), but especially testing them with correct statistical performances (Axis 2, Braga et al. 2018).

3. Mechanistic null models: a real improvement?

Using the outputs of mechanistic models and simulations as null expectations started to attract some interest after the publication of Hubbell's neutral theory of biodiversity in 2001. If, at first, the scientific community did not receive positively this new theory due to the questioning it implied of long-term convictions about niche-based view of community ecology, it nevertheless saw a promising opportunity to improve hypothesis-testing by using

neutral theory as a null model (Leigh et al. 2004, Nee 2005, Gilbert et al. 2006, Leigh 2007, Jabot and Chave 2011). This represented an important step toward a process-based point of view of the null hypotheses and null models, and non-neutral mechanistic null models have then been developed to model other ecological processes (Gotelli et al. 2009, Jabot and Chave 2011, Pigot and Etienne 2015). In fact, contrary to null models based on randomisations and permutations, which are more perceived as pattern-based as they rely on the reproduction of biodiversity patterns presumably resulting from the ecological processes of interest, mechanistic null models are based on the modelling of processes supposedly shaping communities to produce simulated communities directly driven by those processes. The slight difference between the two types of null models relies on the need of ecological *a priori* on both processes shaping communities and biodiversity patterns resulting from those processes. They are both indispensable for permuted/randomised null models to exclude the patterns influenced by the process(es) of interest and fix the others but, in the case of mechanistic null models, only the knowledge of acting ecological processes is necessary. Two direct advantages come out of it. First, the causal link between patterns and processes is explicit, adding to the realism of the null model. Second, it is easier to fix the effect of a combination of ecological processes by modelling them individually than to do so through permutation and randomisation procedures given the difficulty to deduce *a priori* for the combined biodiversity pattern.

Despite their interesting assets, mechanistic null models remain, to my knowledge, still poorly used. This could be explained by the appearance of a new well-known and vexing challenge in addition to model selection: model parameter estimation. Both points are further treated in the next section (II.A). Briefly, as previously exposed for permuted/randomised null models, model selection is related to topological sensitivity which is a well-known challenging issue in modelling (Economo and Keitt 2007, Babbie et al. 2014, Singer et al. 2016) relative to the various ways processes can be modelled and the order in which they act. However, contrary to permuted/randomised null models, mechanistic null models are defined with parameters allowing to perform classical selection methods such as (among others detailed in the next section) information criteria selecting best fitted models (Burnham and Anderson 2002, Anderson 2008). The second issue about parameter estimation is mostly related to the mathematical complexity and the need of large empirical datasets (Beeravolu et al. 2009), both increasing with the number of parameter to estimate. For example,

parametrisation of a neutral model, which can be considered as a relatively simple mechanistic model, has been proven particularly delicate (Munoz et al. 2007, Beeravolu et al. 2009). Finally note that, although perceived as process-based, using mechanistic null model does not avoid the classic pattern-based problem of one biodiversity pattern potentially influenced by several processes. Hypothesis-testing relies on the test of a biological metric measuring biodiversity patterns, as such if the simulated datasets produced by mechanistic models display a pattern close to the ecological process(es) of interest, the test could potentially be biased.

Nevertheless, mechanistic null models represent a promising future to depict more complex null hypotheses and more precise null models. Both permuted/randomised and mechanistic null models come with (similar) limitations which are important to be aware of. The choice of using one over the other is totally open to users and should not depend on the mathematical complexity, which could encourage unaware users to choose permuted/randomised null models over mechanistic ones, but on the level of complexity needed in the null hypotheses and null models to answer particular ecological problematics. This potential default choice according to mathematical difficulties will probably soon disappear as, nowadays, many mechanistic simulations are increasingly developed and available. Those tools could therefore easily be used as mechanistic null model (Nathan et al. 2001, Sokol et al. 2010, Smith and Lundholm 2010, Fournier et al. 2016, Munoz et al. 2017), especially given that some directly integrate methods to estimate model parameters (Munoz et al. 2017).

D. Preliminary conclusion

What has been concluded until here? Identifying and quantifying ecological processes shaping communities with current hypothesis-testing methods is dangerously embraced with a twofold problem: (i) the multi-scaled action of processes inducing a multi-scaled response of communities and (ii) the imprecision of the null hypotheses and especially their mis-match with null models. To solve these issues, ecological scales and ecologically-constrained null models have been proven highly relevant in improving hypothesis-testing approach. First, adopting a scaling approach when studying the effect of ecological processes has been shown to offer the opportunity to identify particular features of a focal ecological process (e.g., spatial area, evolutive history) and quantify the evolution of its effect over different gradients

(e.g., temporal, spatial, phylogenetic). Second, using ecologically-constrained null models has been shown to be an essential help in fulfilling the lack of precision entailed to the definition of both null hypotheses and null models, but also to their correct correspondence.

Until here, ecological scales and ecologically-constrained null models were presented as two separate solutions, this makes however little sense. Both have to be considered as being part of a larger solution which aims at including both of them in hypothesis-testing. This is actually what has been done in the first axis as the fourth-corner approach was implemented with both a spatially- and phylogenetically-constrained null model and spatial and phylogenetic scales. Chalmandrier et al. 2013 illustrated well this need of combination but integrated it in a different way compared to what was done in Axis 1. In their study, they proposed a family of null models manipulating both spatial and phylogenetic scales through different randomisations schemes to distinguish the effects of environmental filtering and competition. Their results showed that the combined use of constraints on spatial and phylogenetic scales was essential to uncover the effect of competition when masked by large-scale (spatial and phylogenetic) environmental filtering. Based on their conclusions and what has been evoked in this first section of General Discussion, I think that considering both ecological scales and ecologically-constrained null models could be a major keystone for future works to separate the role of different ecological processes.

Throughout this manuscript, I chose to focus on *Direction 1*, that is methods resulting from theoretical approach brought to empirical approach, with hypothesis testing and performances analyses to evaluate the different methodologies developed in the thesis (Fig. XX; Axes 1 and 2). In the General Introduction (section II.B.2) however, I introduced another category of data analyses corresponding to methods resulting from empirical approach brought to theoretical approach (i.e., *Direction 2*). Given that both two directions compose the wide range of analytical tools used by ecologists nowadays, it seems unwarranted to not develop a little further *Direction 2*. In particular, I extensively discussed about limits of hypothesis-testing relative to the one-scale approach and the mis-definition and mis-match of null models. This should not encourage ecologists to perceive *Direction 1* as centralising all methodological issues but also as all the potential improvements. As such, I propose in the next section to briefly expose the limitations of *Direction 2* and rapidly determine if ecologically-constrained

null models (for “basic curve fitting” only) and ecological scales can still be relevant (but not how they are including) in this kind of analyses. Note once again that I do not intend to compare *Direction 1* and *Direction 2*.

II. What about model-based approaches?

A. Limits and solutions

As exposed in General Introduction, *Direction 2* (i.e., methods resulting from bringing empirical approach to theoretical approach) displays two major approaches: “basic curve fitting” and mechanistic models. Based on modelling, they both embrace two major challenges: parameter estimation and model selection. If these two issues were only briefly introduced for permuted/randomised models, they however make complete sense in the case of mechanistic (null) models. Note that I chose not to address the problem of model validation here. Let’s dig a little further to understand why they are challenges, the existing ways to overcome them and the remaining limits.

For both approaches of *Direction 2*, the first most intuitive way to estimate a focal model parameter is obviously the likelihood functions whose maximum is taken as an estimation (Burnham and Anderson 2002, Anderson 2008, Bolker et al. 2009). However, given the inherent multivariate nature of ecological systems, likelihoods are not always tractable leading to the development of other approaches to overcome this issue (Hartig et al. 2011) as Approximate Bayesian Computation (ABC; Csilléry et al. 2010, Beaumont 2010, Sisson et al. 2018) or Pattern-Oriented Modeling (POM; Grimm et al. 2005, Grimm and Railsback 2012). ABC and POM bypass the computation of likelihood functions through simulations. Relying on bayesian inference, the rationale of ABC is to draw the values of parameters of interest from a prior distribution (defined by the user) and generate data with the focal model (mechanistic or basic curve fitting) and the parameter values extracted from the prior distribution. Only parameters values resulting in simulated data close to empirical ones are retained. Most of the time, empirical and simulated data are reduced to “summary statistics” and the drawn parameters are rejected based on the distance between the observed and the simulated summary statistics. The retained parameter values are then used to construct a posterior distribution (see Beaumont 2010, Sisson et al. 2018 for more details). POM presents strong similarities with ABC to estimate parameters but is based on the comparison between empirical pre-selected patterns and simulated ones. Moreover, POM does not rely on prior to draw parameter from. Note that if likelihood functions and ABC can be used for both “basic curve fitting” and mechanistic models, to my knowledge, POM has been only performed for the latter.

Although not appearing difficult until here, parameter estimation does present some limitations related to the availability of empirical data, as their scarcity could prevent correct estimations, and with the evaluation of the estimations. Assessing the quality of a parameter estimation pertains to determine the relevance of the parameter contribution to the global fit of the model, but also to characterise the effect of variations in parameter values (i.e., parameter uncertainty) on the global fit. The latter can be assessed with sensitive analyses but are rarely performed and, if so, on a single model thus ignoring the potential influence of model structure (Babtie et al. 2014). The former pertains to model selection and arises from the temptation of increasing the number of parameters to define the most realistic model to better fit empirical datasets.

One of the most classical ways to select for model is information criteria such as AIC or BIC, which rank models based on the relative loss of information when approximating biological reality while taking into account their respective number of parameters (Burnham and Anderson 2002, Anderson 2008). Information criteria are especially used for “basic curve fitting” such as generalised linear mixed models (Bolker et al. 2009, Dumbrell et al. 2010, Cote et al. 2017). For a bayesian framework, the Bayes factor is usually used to rank models and is defined as the ratio of the marginal likelihoods of model i over model j (Robert et al. 2011, Kirk et al. 2013). When likelihoods are not tractable however, ABC can be used to approximate Bayes factor with the approximate of the marginal posterior distribution of models (Toni et al. 2009, Robert et al. 2011). Finally, POM can also be used for model selection and, similarly to parameter estimation, selects the best model candidate based on its capacity to reproduce empirical pre-selected particular biodiversity patterns (Grimm and Railsback 2012). One of the major limitations with model selection is the validation of the selected model. Note that if “basic curve fitting” model selection is only related to the number of parameters, mechanistic models need to be selected both for parameter number but also for the topology as different possibilities of order and mathematical modelling of ecological processes through dynamic equations are possible, therefore increasing the number of potential models (Babtie et al. 2014).

To sum up, parameter estimation and model selection are challenges because they often call for mathematical computations which can be either very difficult, as in the case of likelihood functions, or incomputable in a manageable time (Tavaré et al. 1997, Beaumont et

al. 2002). To overcome this issue, approaches as ABC or POM were developed. However, POM is only based on a qualitative comparison between simulated and observed biodiversity patterns (Grimm and Railsback 2012) and ABC requires to choose priors and, usually, summary statistics. If the choice of priors are usually based on ecological *a priori*, summary statistics have the constraint to be as close as possible to sufficient statistics (i.e., statistics containing all the information of the original data) to ensure both a correct inference (Hartig et al. 2011) and model selection (Robert et al. 2011). This choice is not trivial and can add a supplementary step by performing a sensitivity analysis on different summary statistic candidates (Jabot and Chave 2009). Moreover, due to the potential influence of the variation in parameter values and model topology, others additional steps of sensitivity analyses should be performed to draw ecological conclusions associated with parameter and topological uncertainties (Babtie et al. 2014, Singer et al. 2016). To conclude, as with *Direction 1*, tools of *Direction 2* have to be used with caution to identify and quantify ecological processes as, although considered as more “process-based”, they still rely on biodiversity patterns to explain data and present the same limits of interpretations. In particular, in the case of the study of ecological processes shaping communities, what to conclude of a mis-fit between a model and observed datasets? There are three possibilities: (i) the modelled ecological processes do not shape communities, (ii) ecological processes are wrongly modelled (mechanistic models) or ecological proxies do not well represent processes (“basic curve fitting” such as environmental variables as proxy for environmental filtering for GLMM), and (iii) parameters are badly estimated. Associating ecological conclusions with parameter and structural uncertainties is thus important to assess their robustness.

So far, this thesis has shown that implementing ecological scales and ecologically-constrained null models in hypothesis-testing could improve the study of ecological processes shaping communities. Could it also be the case with model-based methods of *Direction 2*?

B. Have scaling approach and constrained null models a place in model-based methods?

As exposed in the General Introduction (section III.B), the variation of community structure and composition across ecological scales indicates a multi-scale influence of ecological processes in shaping communities. Adopting a scaling approach in *Direction 2* (i.e.,

methods resulting from bringing empirical approach in theoretical approach) is thus as essential as in *Direction 1* (i.e., methods resulting from bringing theoretical approach in empirical approach) to correctly identify and quantify ecological processes underlying communities. Beyond this ecological aspect, a scaling approach is also extremely relevant to ensure a correct fit of empirical datasets. This is notably underlined by Grimm et al. (2005), in the case of the POM approach, who clearly reported that a single summary statistics (pattern) was not sufficient to reduce uncertainties on model estimations and structure, and therefore encouraged to combine several summary statistics operating at different ecological scales. As such, a scaling approach could help both in estimating parameters and choosing the model during sensitivity analyses, and could potentially result in accepting different models to capture different aspects of empirical datasets and explain them across multiple ecological scales. Note that the same remark is also true for ABC approach based on summary statistics, making this warning important for both “basic curve fitting” and mechanistic models.

What about ecologically-constrained null models? The relation with *Direction 2* (i.e., model-based approaches) and null models is much more indirect than with ecological scales. For “basic curve fitting”, they generally intervene when testing for the parameters. Most of “basic curve fitting” methods rely on test of significance (e.g., confidence intervals, Student, Fisher, χ^2) where the observed value of the parameter is compared to 0 (i.e., random null model corresponding to a null hypothesis with no effect of the predictor). For instance this is the case for generalised linear (mixed) models (GLM and GLMM), which usually use Wald Fischer or Student tests (Bolker et al. 2009). Everything works well when all predictors are independent. However, when dependencies occur, such as spatial autocorrelation, parameter values should not be compared to 0. In those cases, an approach taking into account these dependencies in ecologically-constrained null models could potentially be relevant (direct approach in Veech 2012). For example, spatially-constrained null models have proven efficient in the case of multiple regressions (Axis2 Chapter 2). For mechanistic models however, to my knowledge, hypothesis-testing is not performed unless to validate the model by comparing observed values to predictive ones (Nathan et al. 2001). In those cases, ecologically-constrained do not seem relevant.

To conclude, ecological scales are still highly relevant in *Direction 2* for both depicting the differential effects of ecological processes in shaping communities across multiple scales, but

also improving parameter estimation and model selection. Ecologically-constrained null models however appear to be of minor relevance for *Direction 2* to identify and quantify ecological processes as model selection is performed to determine the model that best explains empirical datasets. Nevertheless, they could have a potential relevant use for testing “basic curve fitting” model parameters.

Throughout this General Discussion, I presented many concepts and discussed about their relevance concerning the general problematic of identifying and quantifying ecological processes shaping communities: ecological scales, ecologically-constrained null models, methodologies belonging to *Direction 1* and *Direction 2*. If ecological scales and ecologically-constrained null models relevance were exposed for *Direction 1* and briefly for *Direction 2*, both approaches seem however somehow disconnected. In the next section, I propose to summarise by replacing all of these concepts and their connexions in the larger scope of scientific reasoning when answering an ecological problematic.

III. Methodological reasoning: is there still a dichotomy?

If the dichotomy between empirical and theoretical approaches (General Introduction section II.A) is now outdated as both were combined to give birth to a wide range of methodological tools, the general impression from the literature feels like, as a legacy, a dichotomy still exists between ecologists using hypothesis-testing approaches (*Direction 1*) and those rather performing model-based approaches (*Direction 2*) (Johnson and Omland 2004, Stephens et al. 2005). Figure 2 notably depicts this current dichotomy by defining hypothesis-testing methods opposed to model-based approaches when answering an ecological question. As Johnson and Omland (2004) and Stephens et al. (2005), I think that both approaches present advantages and drawbacks leading them to be relevant depending on the circumstances. The choice of one approach over the other is entirely up to users who analyse those circumstances to, taking Johnson and Omland's (2004) words, "*decide when it is most appropriate to use model selection, and when it is most appropriate to use designed experiments and inferences based on significance tests*". For example, in the case of pioneer researches, it seems unlikely that sufficient knowledge of the ecological system would be available to construct and correctly estimate and select the best model fitting empirical datasets. In that case, an approach based on hypothesis-testing would be better suited to explore the ecological system (Stephens et al. 2005). Despite this apparent dichotomy, both directions nevertheless present some bridges between each others but also a strong similarity (Fig. 2).

Directions 1 and *2* rely on a shared foundation where the ecological problematic is first translated into verbal hypothesis(es) which is(are) then translated into mathematical hypothesis(es) influencing the choice of the methodological approach to conduct (can be both!). After all these essential steps, data are collected with a sampling design presenting all the constraints necessary to correctly match the pre-established ecological hypothesis(es) (Fig. 2). Note that data collection is here encouraged to be conducted *after* the choice of the data analysis(es), to design sampling consistent with both the ecological hypothesis(es) and the potential conditions required to perform the chosen method(s). From there, *Directions 1* and *2* split but still present a strong similarity as they both need to adopt scaling as well as multi-metric and multi-model approaches. *Direction 1* should indeed start by performance analyses to select the best couples of ecological metrics/null models for the ecological scales of interest

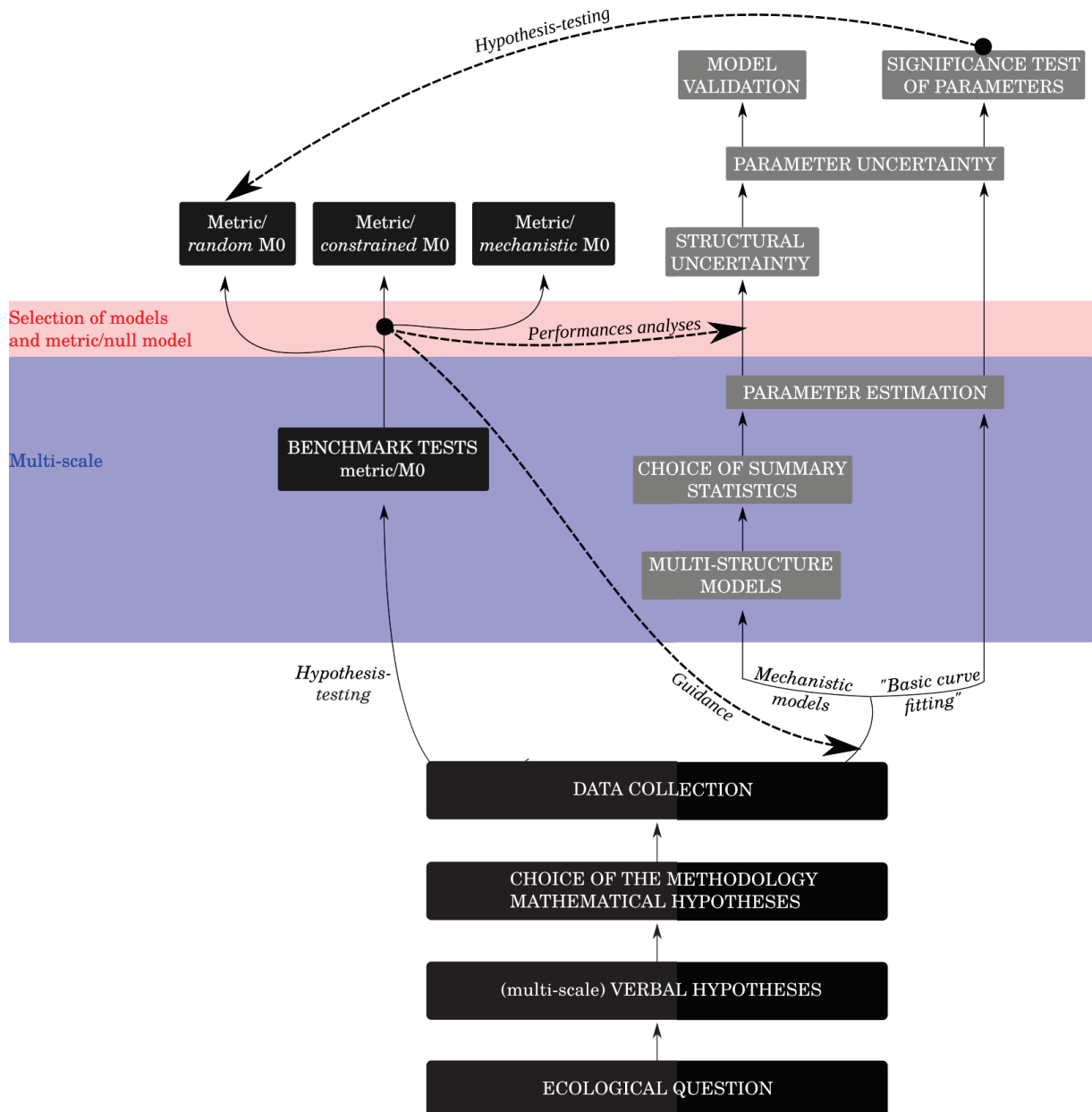

Figure 2: Apparent distinction between hypothesis-testing and model-based approaches to study an ecological problematic. Black boxes represent the shared foundation of hypothesis-testing and model-based approaches. Dark grey boxes corresponds to hypothesis-testing approach and light grey boxes to model-based approach. Blue and red squares respectively represents the scaling approach ad the selection step to chose the most adequate models and couple metric/null model. “M0” corresponds to null model. Dashed arrows are the major connexions established between hypothesis-testing and model-based approaches. From top to bottom, the first dashed arrow corresponds to the use of hypothesis testing to test the significance of model parameter of “basic curve fitting” models (e.g., GLM, GLMM, among others). The middle dashed arrow represents the need to estimate parameter and structural uncertainties of (ecologically-) constrained and mechanistic null models through performance analyses. Finally the last dashed arrow corresponds to the potential use of hypothesis-testing approach to guide the construction of mechanistic and “basic curve fitting” models to reduce the starting group of possible models.

but also for the ecological hypothesis (Fig. 2). These analyses can be performed by benchmark tests (Gotelli 2000, Ulrich and Gotelli 2010) or using the same logic but with mechanistic simulations (Kembel 2009). For a single metric, the null model will define the

position of the couple metric/null model along a “process-based” gradient with random null models integrating no ecological processes and (ecologically-) constrained null models and mechanistic null models respectively integrating them indirectly (i.e., pattern reproduction) and directly (i.e., process modelling) (Fig. 2). The type of ecological questions addressed will therefore increasingly involve the ecological processes. *Direction 2* also presents this gradient with “basic curve fitting” integrating no processes and mechanistic models modelling them directly. Both are, as for *Direction 1*, conducting at multiple ecological scales. In particular, the multi-scale selection for mechanistic models is applied at three different levels: (i) summary statistics (if used), (ii) model structure and (iii) parameter estimation (Fig. 2). Note that only (iii) is relevant for “basic curve fitting”. As for the couples metric/null models, several summary statistics and models should be selected to better catch the multi-scale functioning of ecological systems. Then, uncertainties about parameter estimation and model structure (for mechanistic models only) are assessed for the selected models before going to the next step of model validation and tests of the parameter significance (Fig. 2).

From the above description, three major connexions can be established between *Direction 1* and *Direction 2* (Fig. 2). The first one is the use of hypothesis testing when testing for parameter significance of “basic curve fitting”. The second concerns the use of (ecologically-) constrained and mechanistic null models respectively needing performances analyses to determine the structural and parameter (only for mechanistic null models) uncertainties. The last one is less obvious and relies on the possibility of using hypothesis-testing to guide modelling. The basic idea behind this guidance would be to analyse the empirical datasets with an increasing strength of complexity. This would begin with preliminary analyses to identify ecological scales and source of variation through untested statistics (e.g., biodiversity indices, principal component analysis) and random and (ecologically) constrained null models, and end with the fit of models (mechanistic or not). The major advantage of such an approach would be to avoid performing a scaling approach for hundreds of possible models by reducing the starting pool of possible models.

Now is the time to conclude about our journey retracing 3 years of scientific reflections. But before doing it, I would like to go a little off the scope of the thesis by rapidly addressing one particular point that I have encountered since the beginning of this work.

IV. A small “out of scope” opinion: are ordination multivariate methods dead?

Well... What an astonishing question isn't it? I faced it during my participation to the British Ecological Society colloquium. It was actually quiet more surprising as it came that way: “You know, if you want to do carrier, you should stop working on that stuff”. Finding something intelligent to say was impossible at the time of the event. However, some elements of response appeared since.

In fact the point was that multivariate ordination analyses present some limits. The major reproach is that they assume a linear response of species along the explanatory variable. If this is true for principal component (Hotelling 1933) and redundancy analyses (Rao 1964), correspondence and canonical correspondence analyses allow for taking into account Gaussian species responses by maximising the separation of the species optimums (Hill 1974, ter Braak 1987). But the criticism remains and is notably related to the development of generalised linear (mixed) models able to take into account other families of response such as binomial or Poisson (Bolker et al. 2009). This calls for further developments of multivariate ordination analyses. Another important aspect to consider in those future improvements of ordination methods would be to allow the analysis of time series. This obviously pertains the importance of integrating ecological scales supported throughout this manuscript. Some methods are already available such as functional data analysis (Ramsay and Silverman 2005) allowing to fit ecological curves (e.g., temporal curves for different sites) and compared them through summary statistics such as functional principal component analysis. Recently, principal response curve initially developed by van den Brink and ter Braak (1999) to analyse temporal response of community composition to toxicants relative to a control treatment was extended by Auber et al. (2017) to analyse spatio-temporal variation of community composition relative to a control time period. Although both approaches can bring important insights, ordination analyses still need further developments to include temporal aspect to answer the growing need of ecologists notably with time series brought by remote sensing (Pasquarella et al. 2016).

Despite those obvious needs of improvements, I do not think ecologists will give up easily on ordination analyses. In particular, this new era of Big Data will prove full of challenges for model-based approaches, which will probably have hard times to achieve convergence. Moreover, ecologists will need tools able to reduce the dimensions of their data to explore

them more easily and guide their future steps of analysis. Furthermore, without being sarcastic, implementing and interpreting model-based approaches such as mechanistic models may be difficult for ecologists with a light mathematical background. Multivariate ordination methods can offer more simple implementations and interpretations in comparison. Finally, they are still widely used to summarise datasets before integrating their outputs in a model-based approach. For example, axes of principal component analyses performed on empirical data can be integrated to generalised linear mixed models (Espírito-Santo et al. 2013).

V. General Conclusion

This thesis aimed at extending the ecological toolbox to improve the identification and quantification of the role of ecological processes underlying structure and composition of communities and metacommunities. The study proposed to integrate ecological scales and ecologically-constrained null models to enhance the precision and allow a multi-scale approach of the current hypothesis-testing methods. The major conclusions of the manuscript are:

- Ecological scales and ecologically-constrained null models appear highly relevant to offer a correct identification and quantification of processes' effects for hypothesis-testing methods.
- Adopting a scaling approach combined with ecologically-constrained (or mechanistic) null models could be a cornerstone of future works to separate the roles of different ecological processes.
- Adopting a scaling approach and conducting a selection procedure are essential for both hypothesis-testing and model-based approaches.
- A dichotomy is slightly present between hypothesis-testing and model-based approaches. Despite this division, they present some connexions and, given the rapid statistical advance we have faced since the 1980s, bridges between these two approaches are expected to multiply leading either a methodological globalisation or the co-existence of multiple specific sub-approaches.

Ecological scales and ecologically-constrained null models are just another step further on the road of methodological improvements to better identify, quantify and distinguish ecological processes underlying communities and metacommunities. Although they do not offer solutions to all the limits presented by methodologies, the progresses that will nevertheless be achieved through them will allow to build new (even if incomplete and

temporary) certitudes giving chances for new questions to appear, therefore contributing to enhanced the global knowledge in ecology.

As a final conclusion, I could finally answer the sharp criticism raised by a professor I encountered during my second year of Ph.D. It was a sunny lunchtime and I remember very clearly how he ruined my day by fiercely assuring that it was *stupid* for a Ph.D student to work on methodological developments because, first, the student does not learn anything about ecology and, second, because it does not contribute to make any progress in ecology. Given the work achieved for the three years allotted, I could now answer without wincing: “Pr. X, you are mistaken. A Ph.D in statistical ecology is relevant and contributes to scientific progress in ecology”.

*Notre voyage s'achève,
Et j'espère que ce pas supplémentaire que nous avons fait,
S'inscrira dans la continuité d'une marche vers le savoir*

*Our journey is coming to an end,
And I hope that this additional step we did
Will be part of the perpetual progress towards knowledge*



REC

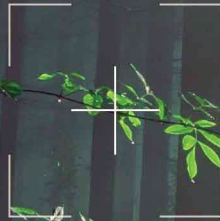

References

00:00:00

3..2..1..1..2..3

- Anderson, D. R. 2008. Model based inference in the life sciences: a primer on evidence. Springer, New York, NY.
- Andrewartha, H. G., and L. C. Birch. 1954. The distribution and abundance of animals. University of Chicago Press.
- Arellano, G., J. S. Tello, P. M. Jørgensen, A. F. Fuentes, M. I. Loza, V. Torrez, and M. J. Macía. 2016. Disentangling environmental and spatial processes of community assembly in tropical forests from local to regional scales. *Oikos* 125:326–335.
- Astorga, A., J. Oksanen, M. Luoto, J. Soininen, R. Virtanen, and T. Muotka. 2012. Distance decay of similarity in freshwater communities: do macro- and microorganisms follow the same rules? *Global Ecology and Biogeography* 21:365–375.
- Auber, A., M. Travers-Trolet, M. C. Villanueva, and B. Ernande. 2017. A new application of principal response curves for summarizing abrupt and cyclic shifts of communities over space. *Ecosphere* 8:e02023.
- Babtie, A. C., P. Kirk, and M. P. H. Stumpf. 2014. Topological sensitivity analysis for systems biology. *Proceedings of the National Academy of Sciences* 111:18507–18512.
- Bartlett, M. S. 1960. Stochastic population models in ecology and epidemiology. Methuen; Wiley, London, New York.
- Barton, P. S., S. A. Cunningham, A. D. Manning, H. Gibb, D. B. Lindenmayer, and R. K. Didham. 2013. The spatial scaling of beta diversity. *Global Ecology and Biogeography* 22:639–647.
- Bauman, D., T. Drouet, M.-J. Fortin, and S. Dray. 2018. Optimizing the choice of a spatial weighting matrix in eigenvector-based methods. *Ecology* 99:2159–2166.
- Beaumont, M. A. 2010. Approximate Bayesian Computation in Evolution and Ecology. *Annual Review of Ecology, Evolution, and Systematics* 41:379–406.
- Beaumont, M. A., W. Zhang, and D. J. Balding. 2002. Approximate Bayesian Computation in Population Genetics:2025–2035.
- Beeravolu, C. R., P. Couteron, R. Pélissier, and F. Munoz. 2009. Studying

- ecological communities from a neutral standpoint: A review of models' structure and parameter estimation. *Ecological Modelling* 220:2603–2610.
- Begon, M., C. R. Townsend, and J. L. Harper. 2006. *Ecology: from individuals to ecosystems*. 4. ed. Blackwell, Malden, Mass.
- Bell, G. 2000. The distribution of abundance in neutral communities. *The American Naturalist* 155:606–617.
- Bell, G. 2001. Neutral Macroecology. *Science* 293:2413–2418.
- Bell, G. 2003. The interpretation of biological surveys. *Proceedings of the Royal Society of London B: Biological Sciences* 270:2531–2542.
- Bell, G. 2005. The Co-Distribution of Species in Relation to the Neutral Theory of Community Ecology. *Ecology* 86:1757–1770.
- de Bello, F. 2012. The quest for trait convergence and divergence in community assembly: are null-models the magic wand? *Global Ecology and Biogeography* 21:312–317.
- de Bello, F., W. Thuiller, J. Lepš, P. Choler, J.-C. Clément, P. Macek, M.-T. Sebastià, and S. Lavorel. 2009. Partitioning of functional diversity reveals the scale and extent of trait convergence and divergence. *Journal of Vegetation Science* 20:475–486.
- Bernhardt-Römermann, M., L. Baeten, D. Craven, P. De Frenne, R. Hédl, J. Lenoir, D. Bert, J. Brunet, M. Chudomelová, G. Decocq, H. Dierschke, T. Dirnböck, I. Dörfler, T. Heinken, M. Hermy, P. Hommel, B. Jaroszewicz, A. Keczyński, D. L. Kelly, K. J. Kirby, M. Kopecký, M. Macek, F. Máliš, M. Mirtl, F. J. G. Mitchell, T. Naaf, M. Newman, G. Peterken, P. Petřík, W. Schmidt, T. Standovár, Z. Tóth, H. V. Calster, G. Verstraeten, J. Vladovič, O. Vild, M. Wulf, and K. Verheyen. 2015. Drivers of temporal changes in temperate forest plant diversity vary across spatial scales. *Global Change Biology* 21:3726–3737.
- Blanchet, F. G., P. Legendre, and D. Borcard. 2008. Forward Selection of Explanatory Variables. *Ecology* 89:2623–2632.
- Blomberg, S. P., and T. Garland. 2003. Testing for phylogenetic signal in comparative data: behavioral traits are more labile:717–745.

- Bolker, B. M., M. E. Brooks, C. J. Clark, S. W. Geange, J. R. Poulsen, M. H. H. Stevens, and J.-S. S. White. 2009. Generalized linear mixed models: a practical guide for ecology and evolution. *Trends in Ecology & Evolution* 24:127–135.
- Borcard, D., P. Legendre, and P. Drapeau. 1992. Partialling out the Spatial Component of Ecological Variation. *Ecology* 73:1045–1055.
- ter Braak, C. J. F., and I. C. Prentice. 2004. A Theory of Gradient Analysis. Pages 235–282 *Advances in Ecological Research*. Elsevier.
- ter Braak, C. J. F. ter. 1986. Canonical Correspondence Analysis: A New Eigenvector Technique for Multivariate Direct Gradient Analysis. *Ecology* 67:1167–1179.
- Brind'Amour, A., D. Boisclair, S. Dray, and P. Legendre. 2011. Relationships between species feeding traits and environmental conditions in fish communities: a three-matrix approach. *Ecological Applications* 21:363–377.
- van den Brink, P. J., and C. J. F. ter Braak. 1999. Principal response curves: analysis of time-dependent multivariate responses of biological community to stress. 18:138–148.
- Brown, A. M., D. I. Warton, N. R. Andrew, M. Binns, G. Cassis, and H. Gibb. 2014. The fourth-corner solution – using predictive models to understand how species traits interact with the environment. *Methods in Ecology and Evolution* 5:344–352.
- Brown, C., J. B. Illian, and D. F. R. P. Burslem. 2016. Success of spatial statistics in determining underlying process in simulated plant communities. *Journal of Ecology* 104:160–172.
- Burnham, K. P., and D. R. Anderson. 2002. Model selection and multimodel inference: a practical information-theoretic approach. 2. ed., [4. printing]. Springer, New York, NY.
- Buschke, F. T., L. De Meester, L. Brendonck, and B. Vanschoenwinkel. 2015. Partitioning the variation in African vertebrate distributions into environmental and spatial components – exploring the link between ecology and biogeography. *Ecography* 38:450–461.
- Cabral, J. S., L. Valente, and F. Hartig. 2017. Mechanistic simulation models in macroecology and

- biogeography: state-of-art and prospects. *Ecography* 40:267–280.
- Cadotte, M. W., and C. M. Tucker. 2017. Should Environmental Filtering be Abandoned? *Trends in Ecology & Evolution* 32:429–437.
- Cale, W. G., G. M. Henebry, and J. A. Yeakley. 1989. Inferring Process from Pattern in Natural Communities. *BioScience* 39:600–605.
- Campbell, V., P. Legendre, and F.-J. Lapointe. 2011. The performance of the Congruence Among Distance Matrices (CADM) test in phylogenetic analysis. *BMC Evolutionary Biology* 11:64.
- Candolle, A. de. 1874. Constitution dans le règne végétal des groupes physiologiques applicables à la géographie botanique ancienne et moderne. *Archives des sciences de la bibliothèque universelle*.
- Case, T. J. 1990. Invasion resistance arises in strongly interacting species-rich model competition communities. *Proceedings of the National Academy of Sciences* 87:9610–9614.
- Caswell, H. 1976. Community Structure: A Neutral Model Analysis. *Ecological Monographs* 46:327–354.
- Cavender-Bares, J., D. D. Ackerly, D. A. Baum, and F. A. Bazzaz. 2004. Phylogenetic Overdispersion in Floridian Oak Communities. *The American Naturalist* 163:823–843.
- Cavender-Bares, J., A. Keen, and B. Miles. 2006. Phylogenetic Structure of Floridian Plant Communities Depends on Taxonomic and Spatial Scale. *Ecology* 87:S109–S122.
- Chalmandrier, L., T. Münkemüller, M.-P. Colace, J. Renaud, S. Aubert, B. Z. Carlson, J.-C. Clément, N. Legay, G. Pellet, A. Saillard, S. Lavergne, and W. Thuiller. 2017. Spatial scale and intraspecific trait variability mediate assembly rules in alpine grasslands. *Journal of Ecology* 105:277–287.
- Chalmandrier, L., T. Münkemüller, L. Gallien, F. de Bello, F. Mazel, S. Lavergne, and W. Thuiller. 2013. A family of null models to distinguish between environmental filtering and biotic interactions in functional diversity patterns. *Journal of Vegetation Science* 24:853–864.
- Chang, L.-W., D. Zelený, C.-F. Li, S.-T. Chiu, and C.-F. Hsieh. 2013. Better environmental data may reverse conclusions about niche- and dispersal-based processes in

- community assembly. *Ecology* 94:2145–2151.
- Chase, J. M. 2014. Spatial scale resolves the niche versus neutral theory debate. *Journal of Vegetation Science* 25:319–322.
- Chase, J. M., and M. A. Leibold. 2003. *Ecological Niches: Linking Classical and Contemporary Approaches*. University of Chicago Press.
- Chase, J. M., and J. A. Myers. 2011. Disentangling the importance of ecological niches from stochastic processes across scales. *Philosophical Transactions of the Royal Society of London B: Biological Sciences* 366:2351–2363.
- Chave, J., H. C. Muller-Landau, and S. A. Levin. 2002. Comparing classical community models: theoretical consequences for patterns of diversity. *The American Naturalist* 159:1–23.
- Chesson, P. 2000. Mechanisms of maintenance of species diversity. *Annual review of Ecology and Systematics* 31:343–366.
- Chiang, C. L. 1968. *Introduction to stochastic processes in biostatistics*. John Wiley and Sons.
- Clark, C. E., and T. G. Hallam. 1982. The community matrix in three species community models. *Journal of Mathematical Biology* 16:25–31.
- Cliff, A. D., and J. K. Ord. 1981. *Spatial Processes Models and Applications*. Pion, London.
- Connor, E. F., and D. Simberloff. 1979. The Assembly of Species Communities: Chance or Competition? *Ecology* 60:1132–1140.
- Cooley, J. H., editor. 1984. *Trends in Ecological Research for the 1980s*. Springer US.
- Cote, J., T. Brodin, S. Fogarty, and A. Sih. 2017. Non-random dispersal mediates invader impacts on the invertebrate community. *Journal of Animal Ecology* 86:1298–1307.
- Cottenie, K. 2005. Integrating environmental and spatial processes in ecological community dynamics. *Ecology Letters* 8:1175–1182.
- Csilléry, K., M. G. B. Blum, O. E. Gaggiotti, and O. François. 2010. Approximate Bayesian Computation (ABC) in practice. *Trends in Ecology & Evolution* 25:410–418.
- Dajoz, R. 1983. *Ecologia geral*. Ed. Vozes.
- D’Amen, M., C. Rahbek, N. E. Zimmermann, and A. Guisan. 2017. Spatial predictions at the community

- level: from current approaches to future frameworks: Methods for community-level spatial predictions. *Biological Reviews* 92:169–187.
- Diamond, J. M. 1975. Assembly of species communities:342–444.
- Diaz-Uriarte, R., and T. Garland. 1996. Testing hypotheses of correlated evolution using phylogenetically independent contrasts: sensitivity to deviations from Brownian motion. *Systematic Biology* 45:27–47.
- Diniz-Filho, J. A. F., L. M. Bini, and B. A. Hawkins. 2003. Spatial autocorrelation and red herrings in geographical ecology. *Global Ecology and Biogeography* 12:53–64.
- Diniz-Filho, J. A. F., L. M. Bini, M. Á. Rodríguez, T. F. L. V. B. Rangel, and B. A. Hawkins. 2007. Seeing the forest for the trees: partitioning ecological and phylogenetic components of Bergmann's rule in European Carnivora. *Ecography* 30:598–608.
- Diniz-Filho, J. A. F., M. V. Cianciaruso, T. F. Rangel, and L. M. Bini. 2011. Eigenvector estimation of phylogenetic and functional diversity. *Functional Ecology* 25:735–744.
- Diniz-Filho, J. A. F., and C. E. R. de Sant'Ana. 2000. Phylogenetic correlograms and the evolution of body size in South American owls (Strigiformes). *Genetics and Molecular Biology* 23:285–292.
- Diniz-Filho, J. A. F., C. E. R. de Sant'Ana, and L. M. Bini. 1998. An eigenvector method for estimating phylogenetic inertia. *Evolution* 52:1247–1262.
- Dolédec, S., D. Chessel, C. J. F. ter Braak, and S. Champely. 1996. Matching species traits to environmental variables: a new three-table ordination method. *Environmental and Ecological Statistics* 3:143–166.
- Dray, S. 2011. A new perspective about moran's coefficient: spatial autocorrelation as a linear regression problem. *Geographical Analysis* 43:127–141.
- Dray, S., F. G. Blanchet, D. Borcard, G. Guénard, T. Jombart, G. Larocque, P. Legendre, N. Madi, and H. H. Wagner. 2017. *adespatial: Multivariate multiscale spatial analysis*.
- Dray, S., P. Choler, S. Doledec, P. R. Peres-Neto, W. Thuiller, S. Pavoine, and C. J. ter Braak. 2014. Combining the fourth-corner and the RLQ methods

- for assessing trait responses to environmental variation. *Ecology* 95:14–21.
- Dray, S., and A.-B. Dufour. 2007. The ade4 package: Implementing the duality diagram for ecologists. *Journal of Statistical Software* 22.
- Dray, S., and P. Legendre. 2008. Testing the Species Traits–Environment Relationships: The Fourth-Corner Problem Revisited. *Ecology* 89:3400–3412.
- Dray, S., P. Legendre, and P. R. Peres-Neto. 2006. Spatial modelling: a comprehensive framework for principal coordinate analysis of neighbour matrices (PCNM). *Ecological Modelling* 196:483–493.
- Dray, S., R. Péliissier, P. Couteron, M.-J. Fortin, P. Legendre, P. R. Peres-Neto, E. Bellier, R. Bivand, F. G. Blanchet, M. De Cáceres, A.-B. Dufour, E. Heegaard, T. Jombart, F. Munoz, J. Oksanen, J. Thioulouse, and H. H. Wagner. 2012. Community ecology in the age of multivariate multiscale spatial analysis. *Ecological Monographs* 82:257–275.
- Duan, M., Y. Liu, Z. Yu, J. Baudry, L. Li, C. Wang, and J. C. Axmacher. 2016. Disentangling effects of abiotic factors and biotic interactions on cross-taxon congruence in species turnover patterns of plants, moths and beetles. *Scientific Reports* 6:23511.
- Duarte, L. D. S., V. J. Debastiani, M. B. Carlucci, and J. A. F. Diniz-Filho. 2018. Analyzing community-weighted trait means across environmental gradients: should phylogeny stay or should it go? *Ecology* 99:385–398.
- Dufour, J.-M. 2006. Monte Carlo tests with nuisance parameters: A general approach to finite-sample inference and nonstandard asymptotics. *Journal of Econometrics* 133:443–477.
- Dumbrell, A. J., M. Nelson, T. Helgason, C. Dytham, and A. H. Fitter. 2010. Relative roles of niche and neutral processes in structuring a soil microbial community. *The ISME Journal* 4:337–345.
- Duncan, E. W., N. M. White, and K. Mengersen. 2017. Spatial smoothing in Bayesian models: a comparison of weights matrix specifications and their impact on inference. *International Journal of Health Geographics* 16:47.

- Dwan, K., D. G. Altman, J. A. Arnaiz, J. Bloom, A.-W. Chan, E. Cronin, E. Decullier, P. J. Easterbrook, E. V. Elm, C. Gamble, D. Ghersi, J. P. A. Ioannidis, J. Simes, and P. R. Williamson. 2008. Systematic Review of the Empirical Evidence of Study Publication Bias and Outcome Reporting Bias. *PLOS ONE* 3:e3081.
- Economu, E. P., and T. H. Keitt. 2007. Species diversity in neutral metacommunities: a network approach. *Ecology Letters* 10:071117033013001-???
- Edwards, J. L., M. A. Lane, and E. S. Nielsen. 2000. Interoperability of Biodiversity Databases: Biodiversity Information on Every Desktop. *Science* 289:2312–2314.
- Elith, J., and J. R. Leathwick. 2009. Species Distribution Models: Ecological Explanation and Prediction Across Space and Time. *Annual Review of Ecology, Evolution, and Systematics* 40:677–697.
- Elton, C. 1927. *Animal Ecology*. New York, Macmillan Company.
- Emerson, B. C., and R. G. Gillespie. 2008. Phylogenetic analysis of community assembly and structure over space and time. *Trends in Ecology & Evolution* 23:619–630.
- Ernst, R., A. Keller, G. Landburg, T. U. Grafe, K. E. Linsenmair, M.-O. Rödel, and F. Dziocck. 2012. Common ancestry or environmental trait filters: cross-continental comparisons of trait-habitat relationships in tropical anuran amphibian assemblages: Habitat templates in anuran trait communities. *Global Ecology and Biogeography* 21:704–715.
- Erős, T., P. Sály, P. Takács, A. Specziár, and P. Bíró. 2012. Temporal variability in the spatial and environmental determinants of functional metacommunity organization – stream fish in a human-modified landscape. *Freshwater Biology* 57:1914–1928.
- Espírito-Santo, H. M. V., M. A. Rodríguez, and J. Zuanon. 2013. Reproductive strategies of Amazonian stream fishes and their fine-scale use of habitat are ordered along a hydrological gradient. *Freshwater Biology* 58:2494–2504.
- Etienne, R. S., and H. Olf. 2005. Confronting different models of community structure to species-abundance data: a Bayesian model

- comparison. *Ecology Letters* 8:493–504.
- Ezekiel, M. 1929. The application of the theory of error to multiple and curvilinear correlation. *Journal of the American Statistical Association* 24:99–104.
- F. Dormann, C., J. M. McPherson, M. B. Araújo, R. Bivand, J. Bolliger, G. Carl, R. G. Davies, A. Hirzel, W. Jetz, W. Daniel Kissling, I. Kühn, R. Ohlemüller, P. R. Peres-Neto, B. Reineking, B. Schröder, F. M. Schurr, and R. Wilson. 2007. Methods to account for spatial autocorrelation in the analysis of species distributional data: a review. *Ecography* 30:609–628.
- Faith, D. P. 1992. Conservation evaluation and phylogenetic diversity. *Biological Conservation* 61:1–10.
- Fanelli, D. 2012. Negative results are disappearing from most disciplines and countries. *Scientometrics* 90:891–904.
- Fanelli, D. 2018. Opinion: Is science really facing a reproducibility crisis, and do we need it to? *Proceedings of the National Academy of Sciences* 115:2628–2631.
- Felsenstein, J. 1985. Phylogenies and the Comparative Method. *The American Naturalist* 125:1–15.
- Fernandes, I. M., R. Henriques-Silva, J. Penha, J. Zuanon, and P. R. Peres-Neto. 2014. Spatiotemporal dynamics in a seasonal metacommunity structure is predictable: the case of floodplain-fish communities. *Ecography* 37:464–475.
- Fournier, B., N. Mouquet, M. A. Leibold, and D. Gravel. 2016. An integrative framework of coexistence mechanisms in competitive metacommunities. *Ecography*.
- Fraser, H., T. Parker, S. Nakagawa, A. Barnett, and F. Fidler. 2018. Questionable research practices in ecology and evolution. *PLOS ONE* 13:e0200303.
- Freckleton, R. P., and W. Jetz. 2009. Space versus Phylogeny: Disentangling Phylogenetic and Spatial Signals in Comparative Data. *Proceedings: Biological Sciences* 276:21–30.
- Gause, G. F. 1934. *The Struggle for Existence*. Williams and Wilkins Company, Baltimore.
- Gianuca, A. T., S. A. J. Declerck, P. Lemmens, and L. De Meester. 2017. Effects of dispersal and

- environmental heterogeneity on the replacement and nestedness components of β -diversity. *Ecology* 98:525–533.
- Gilbert, B., and J. R. Bennett. 2010. Partitioning variation in ecological communities: do the numbers add up? *Journal of Applied Ecology* 47:1071–1082.
- Gilbert, B., W. F. Laurance, L. Egbert Giles Jr., and H. E. M. Nascimento. 2006. Can Neutral Theory Predict the Responses of Amazonian Tree Communities to Forest Fragmentation? *Ecology* 87:304–317.
- Gilbert, B., and M. J. Lechowicz. 2004. Neutrality, niches, and dispersal in a temperate forest understory. *Proceedings of the National Academy of Sciences of the United States of America* 101:7651–7656.
- Gleason, H. A. 1922. On the Relation Between Species and Area. *Ecology* 3:158–162.
- Gleason, H. A. 1926. The Individualistic Concept of the Plant Association. *Bulletin of the Torrey Botanical Club* 53:7.
- Gleason, H. A. 1939. The Individualistic Concept of the Plant Association *Ecology* 20:21–20.
- Gotelli, N. J. 2000. Null model analysis of species co-occurrence patterns. *Ecology* 81:2606–2621.
- Gotelli, N. J., and D. J. McCabe. 2002. Species co-occurrence: a meta-analysis of J. M. Diamond's assembly rules model. *Ecology* 83:2091–2096.
- Gotelli, N. J., and W. Ulrich. 2012. Statistical challenges in null model analysis. *Oikos* 121:171–180.
- Götzenberger, L., F. de Bello, K. A. Bråthen, J. Davison, A. Dubuis, A. Guisan, J. Lepš, R. Lindborg, M. Moora, M. Pärtel, L. Pellissier, J. Pottier, P. Vittoz, K. Zobel, and M. Zobel. 2012. Ecological assembly rules in plant communities—approaches, patterns and prospects. *Biological Reviews* 87:111–127.
- Gower, J. C. 1966. A Q-Technique for the Calculation of Canonical Variates. *Biometrika* 53:588–590.
- Graham, C. H., and P. V. A. Fine. 2008. Phylogenetic beta diversity: linking ecological and evolutionary processes across space in time. *Ecology Letters* 11:1265–1277.
- Graham, C. H., D. Storch, and A. Machac. 2018. Phylogenetic scale in ecology and evolution. *Global Ecology and Biogeography* 27:175–187.

- Gravel, D., C. D. Canham, M. Beaudet, and C. Messier. 2006. Reconciling niche and neutrality: the continuum hypothesis. *Ecology Letters* 9:399–409.
- Graves, G. R., and N. J. Gotelli. 1996. Null models in ecology. Smithsonian Institution Press.
- Griffith, D. A., and P. R. Peres-Neto. 2006. Spatial Modeling in Ecology: The Flexibility of Eigenfunction Spatial Analyses. *Ecology* 87:2603–2613.
- Grimm, V., and S. F. Railsback. 2012. Pattern-oriented modelling: a ‘multi-scope’ for predictive systems ecology. *Phil. Trans. R. Soc. B* 367:298–310.
- Grimm, V., E. Revilla, U. Berger, F. Jeltsch, W. M. Mooij, S. F. Railsback, H.-H. Thulke, J. Weiner, T. Wiegand, and D. L. DeAngelis. 2005. Pattern-Oriented Modeling of Agent-Based Complex Systems: Lessons from Ecology. *Science* 310:987–991.
- Grinnell, J. 1917. The Niche-Relationships of the California Thrasher. *The Auk* 34:427–433.
- Grönroos, M., J. Heino, T. Siqueira, V. L. Landeiro, J. Kotanen, and L. M. Bini. 2013. Metacommunity structuring in stream networks: roles of dispersal mode, distance type, and regional environmental context. *Ecology and Evolution* 3:4473–4487.
- Guénard, G., P. Legendre, and P. Peres-Neto. 2013. Phylogenetic eigenvector maps: a framework to model and predict species traits. *Methods in Ecology and Evolution* 4:1120–1131.
- Guillot, G., and F. Rousset. 2013. Dismantling the Mantel tests. *Methods in Ecology and Evolution* 4:336–344.
- Guillot, G., R. Vitalis, A. le Rouzic, and M. Gautier. 2014. Detecting correlation between allele frequencies and environmental variables as a signature of selection. A fast computational approach for genome-wide studies. *Spatial Statistics* 8:145–155.
- Guisan, A., and W. Thuiller. 2005. Predicting species distribution: offering more than simple habitat models. *Ecology Letters* 8:993–1009.
- Guisan, A., and N. E. Zimmermann. 2000. Predictive habitat distribution models in ecology. *Ecological Modelling* 135:147–186.
- Haeckel, E. (1834-1919) A. du texte. 1866. *Generelle Morphologie der*

- Organismen : allgemeine Grundzüge der organischen Formen-Wissenschaft, mechanisch begründet durch die von Charles Darwin reformirte Descendenz-Theorie. Allgemeine Anatomie der Organismen, kritische Grundzüge der mechanischen Wissenschaft von den entwickelten Formen der Organismen, begründet durch die Descendenz-Theorie / von Ernst Haeckel.
- Hardy, O. J. 2008. Testing the spatial phylogenetic structure of local communities: statistical performances of different null models and test statistics on a locally neutral community. *Journal of Ecology* 96:914–926.
- Harmon, L. J., J. T. Weir, C. D. Brock, R. E. Glor, and W. Challenger. 2008. GEIGER: investigating evolutionary radiations. *Bioinformatics* 24:129–131.
- Hartig, F., J. M. Calabrese, B. Reineking, T. Wiegand, and A. Huth. 2011. Statistical inference for stochastic simulation models – theory and application. *Ecology Letters* 14:816–827.
- Harvey, P. H., and M. D. Pagel. 1991. *The Comparative Method in Evolutionary Biology*. Oxford University Press, Oxford, New York.
- Helmus, M. R., T. J. Bland, C. K. Williams, and A. R. Ives. 2007. Phylogenetic Measures of Biodiversity. *The American Naturalist* 169:E68–E83.
- Hill, M. J., J. Heino, I. Thornhill, D. B. Ryves, and P. J. Wood. 2017. Effects of dispersal mode on the environmental and spatial correlates of nestedness and species turnover in pond communities. *Oikos*:n/a-n/a.
- Hill, M. O. 1974. Correspondence Analysis: A Neglected Multivariate Method. *Journal of the Royal Statistical Society. Series C (Applied Statistics)* 23:340–354.
- Hortal, J., J. Rodríguez, M. Nieto-Díaz, and J. M. Lobo. 2008. Regional and environmental effects on the species richness of mammal assemblages. *Journal of Biogeography* 35:1202–1214.
- Hotelling, H. 1933. Analysis of complex of statistical variables into principal components 24:417–441.
- Houlahan, J. E., D. J. Currie, K. Cottenie, G. S. Cumming, S. K. M. Ernest, C. S. Findlay, S. D. Fuhlendorf, U. Gaedke, P. Legendre, J. J. Magnuson, B. H. McArdle, E. H.

- Muldavin, D. Noble, R. Russell, R. D. Stevens, T. J. Willis, I. P. Woiwod, and S. M. Wondzell. 2007. Compensatory dynamics are rare in natural ecological communities. *Proceedings of the National Academy of Sciences* 104:3273–3277.
- Hubbell, S. P. 2001. *The Unified Neutral Theory of Biodiversity and Biogeography*. Princeton University Press.
- Humboldt, A. von, and A. Bonpland. 1807. *Ideen zu einer Geographie der Pflanzen: nebst einem Naturgemälde der Tropenländer: auf Beobachtungen und Messungen gegründet, welche vom 10ten Grade nördlicher bis zum 10ten Grade südlicher Breite, in den Jahren 1799, 1800, 1801, 1802 und 1803 angestellt worden sind* /. Bey F.G. Cotta :Bey F. Schoell, Tübingen :Paris ;
- Huntchison, G. E. 1957. Concluding remarks. Pages 415–427.
- Hurlbert, S. H. 1984. Pseudoreplication and the Design of Ecological Field Experiments. *Ecological Monographs* 54:187–211.
- Jabot, F., and J. Chave. 2009. Inferring the parameters of the neutral theory of biodiversity using phylogenetic information and implications for tropical forests. *Ecology Letters* 12:239–248.
- Jabot, F., and J. Chave. 2011. Analyzing Tropical Forest Tree Species Abundance Distributions Using a Nonneutral Model and through Approximate Bayesian Inference. *The American Naturalist* 178:E37–E47.
- Jaccard, P. 1912. The Distribution of the Flora in the Alpine Zone.1. *New Phytologist* 11:37–50.
- Jackson, D. A., K. M. Somers, and H. H. Harvey. 1992. Null models and fish communities: evidence of nonrandom patterns 139:930–951.
- Jamil, T., W. A. Ozinga, M. Kleyer, and C. J. F. ter Braak. 2013. Selecting traits that explain species–environment relationships: a generalized linear mixed model approach. *Journal of Vegetation Science* 24:988–1000.
- Johnson, J. B., and K. S. Omland. 2004. Model selection in ecology and evolution. *Trends in Ecology & Evolution* 19:101–108.
- Jombart, T., F. Balloux, and S. Dray. 2010. adephylo: new tools for investigating the phylogenetic signal

- in biological traits. *Bioinformatics* 26:1907–1909.
- Jones, M. M., H. Tuomisto, D. Borcard, P. Legendre, D. B. Clark, and P. C. Olivas. 2008. Explaining variation in tropical plant community composition: influence of environmental and spatial data quality. *Oecologia* 155:593–604.
- Jones, M. M., H. Tuomisto, D. B. Clark, and P. Olivas. 2006. Effects of mesoscale environmental heterogeneity and dispersal limitation on floristic variation in rain forest ferns. *Journal of Ecology* 94:181–195.
- Kattge, J., S. Díaz, S. Lavorel, I. C. Prentice, P. Leadley, G. Bönisch, E. Garnier, M. Westoby, P. B. Reich, I. J. Wright, J. H. C. Cornelissen, C. Violle, S. P. Harrison, P. M. Van BODEGOM, M. Reichstein, B. J. Enquist, N. A. Soudzilovskaia, D. D. Ackerly, M. Anand, O. Atkin, M. Bahn, T. R. Baker, D. Baldocchi, R. Bekker, C. C. Blanco, B. Blonder, W. J. Bond, R. Bradstock, D. E. Bunker, F. Casanoves, J. Cavender-Bares, J. Q. Chambers, F. S. Chapin Iii, J. Chave, D. Coomes, W. K. Cornwell, J. M. Craine, B. H. Dobrin, L. Duarte, W. Durka, J. Elser, G. Esser, M. Estiarte, W. F. Fagan, J. Fang, F. Fernández-Méndez, A. Fidelis, B. Finegan, O. Flores, H. Ford, D. Frank, G. T. Freschet, N. M. Fyllas, R. V. Gallagher, W. A. Green, A. G. Gutierrez, T. Hickler, S. I. Higgins, J. G. Hodgson, A. Jalili, S. Jansen, C. A. Joly, A. J. Kerkhoff, D. Kirkup, K. Kitajima, M. Kleyer, S. Klotz, J. M. H. Knops, K. Kramer, I. Kühn, H. Kurokawa, D. Laughlin, T. D. Lee, M. Leishman, F. Lens, T. Lenz, S. L. Lewis, J. Lloyd, J. Llusà, F. Louault, S. Ma, M. D. Mahecha, P. Manning, T. Massad, B. E. Medlyn, J. Messier, A. T. Moles, S. C. Müller, K. Nadrowski, S. Naeem, Ü. Niinemets, S. Nöllert, A. Nüske, R. Ogaya, J. Oleksyn, V. G. Onipchenko, Y. Onoda, J. Ordoñez, G. Overbeck, W. A. Ozinga, S. Patiño, S. Paula, J. G. Pausas, J. Peñuelas, O. L. Phillips, V. Pillar, H. Poorter, L. Poorter, P. Poschlod, A. Prinzing, R. Proulx, A. Rammig, S. Reinsch, B. Reu, L. Sack, B. Salgado-Negret, J. Sardans, S. Shiodera, B. Shipley, A. Siefert, E. Sosinski, J.-F. Soussana, E. Swaine, N. Swenson, K. Thompson, P. Thornton, M. Waldram, E. Weiher,

- M. White, S. White, S. J. Wright, B. Yguel, S. Zaehle, A. E. Zanne, and C. Wirth. 2011. TRY – a global database of plant traits. *Global Change Biology* 17:2905–2935.
- Keddy, P. A. 1992. Assembly and response rules: two goals for predictive community ecology. *Journal of Vegetation Science* 3:157–164.
- Keitt, T. H., and D. L. Urban. 2005. Scale-specific inference using wavelets. *Ecology* 86:2497–2504.
- Kembel, S. W. 2009. Disentangling niche and neutral influences on community assembly: assessing the performance of community phylogenetic structure tests. *Ecology Letters* 12:949–960.
- Kembel, S. W., and S. P. Hubbell. 2006. The Phylogenetic Structure of a Neotropical Forest Tree Community. *Ecology* 87:S86–S99.
- Kirk, P., T. Thorne, and M. P. Stumpf. 2013. Model selection in systems and synthetic biology. *Current Opinion in Biotechnology* 24:767–774.
- Kivlin, S. N., G. C. Winston, M. L. Goulden, and K. K. Treseder. 2014. Environmental filtering affects soil fungal community composition more than dispersal limitation at regional scales. *Fungal Ecology* 12:14–25.
- Knight, J. 2003. Null and void 422:554–555.
- Kraft, N. J. B., W. K. Cornwell, C. O. Webb, D. D. Ackerly, A. E. S. B. Heard, and E. M. C. Whitlock. 2007. Trait Evolution, Community Assembly, and the Phylogenetic Structure of Ecological Communities. *The American Naturalist* 170:271–283.
- Kühn, I., M. P. Nobis, and W. Durka. 2009. Combining spatial and phylogenetic eigenvector filtering in trait analysis. *Global Ecology and Biogeography* 18:745–758.
- Lawton, J. H. 1999. Are There General Laws in Ecology? *Oikos* 84:177.
- Legendre, P. 1993. Spatial autocorrelation: trouble or new paradigm? *Ecology* 74:1659–1673.
- Legendre, P., D. Borcard, and P. R. Peres-Neto. 2005. Analyzing beta diversity: partitioning the spatial variation of community composition data. *Ecological Monographs* 75:435–450.
- Legendre, P., D. Borcard, and D. W. Roberts. 2012. Variation partitioning involving orthogonal spatial

- eigenfunction submodels. *Ecology* 93:1234–1240.
- Legendre, P., and M.-J. Fortin. 2010. Comparison of the Mantel test and alternative approaches for detecting complex multivariate relationships in the spatial analysis of genetic data. *Molecular Ecology Resources* 10:831–844.
- Legendre, P., M.-J. Fortin, and D. Borcard. 2015. Should the Mantel test be used in spatial analysis? *Methods in Ecology and Evolution*.
- Legendre, P., R. Galzin, and M. L. Harmelin-Vivien. 1997. Relating Behavior to Habitat: Solutions to Thefourth-Corner Problem. *Ecology* 78:547–562.
- Legendre, P., and L. F. J. Legendre. 2012. *Numerical Ecology*. Elsevier.
- Legendre, P., X. Mi, H. Ren, K. Ma, M. Yu, I.-F. Sun, and F. He. 2009. Partitioning beta diversity in a subtropical broad-leaved forest of China. *Ecology* 90:663–674.
- Leibold, M. A. 1995. The Niche Concept Revisited: Mechanistic Models and Community Context. *Ecology* 76:1371–1382.
- Leibold, M. A., and J. M. Chase. 2017. *Metacommunity Ecology*. Princeton University Press.
- Leibold, M. A., E. P. Economo, and P. Peres-Neto. 2010. Metacommunity phylogenetics: separating the roles of environmental filters and historical biogeography: Phylogeny in metacommunities. *Ecology Letters* 13:1290–1299.
- Leibold, M. A., M. Holyoak, N. Mouquet, P. Amarasekare, J. M. Chase, M. F. Hoopes, R. D. Holt, J. B. Shurin, R. Law, D. Tilman, M. Loreau, and A. Gonzalez. 2004. The metacommunity concept: a framework for multi-scale community ecology. *Ecology Letters* 7:601–613.
- Leigh, E. G. 2007. Neutral theory: a historical perspective. *Journal of Evolutionary Biology* 20:2075–2091.
- Leigh, E. G., D. Priya, C. W. Dick, J.-P. Puyravaud, J. Terborgh, H. ter Steege, and S. J. Wright. 2004. Why Do Some Tropical Forests Have So Many Species of Trees? *Ecology* 36:447–473.
- Leslie, P. H., and J. C. Gower. 1958. The Properties of a Stochastic Model for two Competing Species. *Biometrika* 45:316.
- Lessard, J.-P., J. Belmaker, J. A. Myers, J. M. Chase, and C. Rahbek. 2012.

- Inferring local ecological processes amid species pool influences. *Trends in Ecology & Evolution* 27:600–607.
- Letten, A. D., and W. K. Cornwell. 2015. Trees, branches and (square) roots: why evolutionary relatedness is not linearly related to functional distance. *Methods in Ecology and Evolution* 6:439–444.
- Levin, S. A. 1992. The Problem of Pattern and Scale in Ecology: The Robert H. MacArthur Award Lecture. *Ecology* 73:1943–1967.
- Levins, R. 1968. *Evolution in Changing Environments: Some Theoretical Explorations*. Princeton University Press.
- Li, Q., X. Yang, J. Soininen, C.-J. Chu, J.-Q. Zhang, K.-L. Yu, and G. Wang. 2011. Relative importance of spatial processes and environmental factors in shaping alpine meadow communities. *Journal of Plant Ecology* 4:249–258.
- Logue, J. B., N. Mouquet, H. Peter, and H. Hillebrand. 2011. Empirical approaches to metacommunities: a review and comparison with theory. *Trends in Ecology & Evolution* 26:482–491.
- Lortie, C. J., R. W. Brooker, P. Choler, Z. Kikvidze, R. Michalet, F. I. Pugnaire, and R. M. Callaway. 2004. Rethinking plant community theory. *Oikos* 107:433–438.
- Losos, J. B. 2008. Phylogenetic niche conservatism, phylogenetic signal and the relationship between phylogenetic relatedness and ecological similarity among species. *Ecology Letters* 11:995–1003.
- Lotka, A. J. 1925. *Elements of physical biology*. Williams and Wilkins Company, Baltimore.
- Lotka, A. J. 1932. The growth of mixed populations: Two species competing for a common food supply. *Journal of the Washington Academy of Sciences* 22:461–469.
- Lovette, I. J., and W. M. Hochachka. 2006. Simultaneous effects of phylogenetic niche conservatism and competition on avian community structure. *Ecology* 87:S14–S28.
- Lowe, W. H., and M. A. McPeck. 2014. Is dispersal neutral? *Trends in Ecology & Evolution* 29:444–450.
- M. L. Rosenzweig, and R. H. MacArthur. 1963. Graphical Representation and Stability Conditions of Predator-

- Prey Interactions. *The American Naturalist* 97:209–223.
- MacArthur, R. 1970. Species packing and competitive equilibrium for many species. *Theoretical Population Biology* 1:1–11.
- MacArthur, R. H., and E. R. Pianka. 1966. On Optimal Use of a Patchy Environment. *The American Naturalist* 100:603–609.
- MacArthur, R., and R. Levins. 1967. The Limiting Similarity, Convergence, and Divergence of Coexisting Species. *The American Naturalist* 101:377–385.
- Magurran, A. E. 2004. *Measuring Biological Diversity*. Blackwell Publishing Company.
- Maloney, K. O., and P. Munguia. 2011. Distance decay of similarity in temperate aquatic communities: effects of environmental transition zones, distance measure, and life histories. *Ecography* 34:287–295.
- Manel, S., S. Joost, B. K. Epperson, R. Holderegger, A. Storfer, M. S. Rosenberg, K. T. Scribner, A. Bonin, and M.-J. Fortin. 2010. Perspectives on the use of landscape genetics to detect genetic adaptive variation in the field. *Molecular Ecology* 19:3760–3772.
- Mantel, N. 1967. The detection of disease clustering and a generalized regression approach 27:209–220.
- Marteinsdóttir, B., and O. Eriksson. 2014. Trait-based filtering from the regional species pool into local grassland communities. *Journal of Plant Ecology* 7:347–355.
- Martiny, J. B. H., J. A. Eisen, K. Penn, S. D. Allison, and M. C. Horner-Devine. 2011. Drivers of bacterial β -diversity depend on spatial scale:7850–7854.
- May, R. H. 1972. Will a large complex system be stable? 238:413–414.
- May, R. M. 1971. Stability in multispecies community models 12:59–79.
- May, R. M. 1973. Stability and complexity in model ecosystems. *Monographs in Population Biology* 6:1–235.
- May, R. M., and R. H. M. MacArthur. 1972. Niche Overlap as a Function of Environmental Variability. *Proceedings of the National Academy of Sciences* 69:1109–1113.
- Maynard Smith, J. 1982, May 13. *Storming the Fortress*. *The New York Review of Books*.
- McGill, B. J., B. A. Maurer, and M. D. Weiser. 2006. Empirical evaluation

- of neutral theory. *Ecology* 87:1411–1423.
- McIntire, E. J. B., and A. Fajardo. 2009. Beyond description: the active and effective way to infer processes from spatial patterns. *Ecology* 90:46–56.
- Meirmans, P. G. 2012. The trouble with isolation by distance. *Molecular Ecology* 21:2839–2846.
- Merriam, C. H. (Clinton H. 1898. Life zones and crop zones of the United States. Washington, D.C.: U.S. Dept. of Agriculture.
- Merriam, C. H., and L. Stejneger. 1890. Results of a biological survey of the San Francisco Mountain region and desert of the Little Colorado, Arizona. Govt. Print. Off., Washington,.
- Mori, A. S., S. Fujii, R. Kitagawa, and D. Koide. 2015. Null model approaches to evaluating the relative role of different assembly processes in shaping ecological communities. *Oecologia* 178:261–273.
- Moritz, C., C. N. Meynard, V. Devictor, K. Guizien, C. Labrune, J.-M. Guarini, and N. Mouquet. 2013. Disentangling the role of connectivity, environmental filtering, and spatial structure on metacommunity dynamics. *Oikos* 122:1401–1410.
- Muller-Landau, H. C., S. J. Wright, O. Calderón, R. Condit, and S. P. Hubbell. 2008. Interspecific variation in primary seed dispersal in a tropical forest. *Journal of Ecology* 96:653–667.
- Münkemüller, T., and L. Gallien. 2015. VirtualCom: a simulation model for eco-evolutionary community assembly and invasion. *Methods in Ecology and Evolution* 6:735–743.
- Münkemüller, T., L. Gallien, S. Lavergne, J. Renaud, C. Roquet, S. Abdulkhak, S. Dullinger, L. Garraud, A. Guisan, J. Lenoir, J.-C. Svenning, J. Van Es, P. Vittoz, W. Willner, T. Wohlgemuth, N. E. Zimmermann, and W. Thuiller. 2014. Scale decisions can reverse conclusions on community assembly processes: Scale choice in community ecology. *Global Ecology and Biogeography* 23:620–632.
- Munoz, F., P. Couteron, B. R. Ramesh, and R. S. Etienne. 2007. Estimating Parameters of Neutral Communities: From One Single Large to Several Small Samples. *Ecology* 88:2482–2488.
- Munoz, F., M. Grenié, P. Denelle, A. Taudière, F. Laroche, C. Tucker, and

- C. Violle. 2017. ecolottery: Simulating and assessing community assembly with environmental filtering and neutral dynamics in R. *Methods in Ecology and Evolution*:n/a-n/a.
- Nathan, R., and R. Casagrandi. 2004. A simple mechanistic model of seed dispersal, predation and plant establishment: Janzen-Connell and beyond. *Journal of Ecology* 92:733–746.
- Nathan, R., and H. C. Muller-Landau. 2000. Spatial patterns of seed dispersal, their determinants and consequences for recruitment. *Trends in Ecology & Evolution* 15:278–285.
- Nathan, R., U. N. Safriel, and I. Noy-Meir. 2001. Field validation and sensitivity analysis of a mechanistic model for tree seed dispersal by wind. *Ecology* 82:374–388.
- Nee, S. 2005. The neutral theory of biodiversity: do the numbers add up? *Functional Ecology* 19:173–176.
- Nekola, J. C., and P. S. White. 1999. The distance decay of similarity in biogeography and ecology. *Journal of Biogeography* 26:867–878.
- Nicholson, A. J., and V. A. Bailey. 1935. The Balance of Animal Populations.-Part I. Proceedings of the Zoological Society of London 105:551–598.
- Ochoa-Ochoa, L. M., M. Munguía, A. Lira-Noriega, V. Sánchez-Cordero, O. Flores-Villela, A. Navarro-Sigüenza, and P. Rodríguez. 2014. Spatial scale and β -diversity of terrestrial vertebrates in Mexico. *Revista Mexicana de Biodiversidad* 85:918–930.
- Oden, N. L., and R. R. Sokal. 1992. An investigation of three-matrix permutation tests. *Journal of Classification* 9:275–290.
- Oksanen, J., F. G. Blanchet, R. Kindt, P. Legendre, R. B. O'Hara, G. L. Simpson, P. Solymos, M. H. H. Stevens, and H. H. Wagner. 2017. *Vegan: community ecology package*.
- Pagel, M. 1999. Inferring the historical patterns of biological evolution. *Nature* 401:877–884.
- Paknia, O., and M. Pfeiffer. 2014. Niche-based processes and temporal variation of environment drive beta diversity of ants (Hymenoptera: Formicidae) in dryland ecosystems of Iran. *Myrmecol. News* 20:15–23.
- Parmentier, I., M. Réjou-Méchain, J. Chave, J. Vleminckx, D. W.

- Thomas, D. Kenfack, G. B. Chuyong, and O. J. Hardy. 2014. Prevalence of phylogenetic clustering at multiple scales in an African rain forest tree community. *Journal of Ecology* 102:1008–1016.
- Pasquarella, V. J., C. E. Holden, L. Kaufman, and C. E. Woodcock. 2016. From imagery to ecology: leveraging time series of all available Landsat observations to map and monitor ecosystem state and dynamics. *Remote Sensing in Ecology and Conservation* 2:152–170.
- Pavoine, S., M. Baguette, and M. B. Bonsall. 2010. Decomposition of trait diversity among the nodes of a phylogenetic tree. *Ecological Monographs* 80:485–507.
- Pavoine, S., E. Vela, S. Gachet, G. de Bélair, and M. B. Bonsall. 2011. Linking patterns in phylogeny, traits, abiotic variables and space: a novel approach to linking environmental filtering and plant community assembly. *Journal of Ecology* 99:165–175.
- Peres-Neto, P. R. 2006. A unified strategy for estimating and controlling spatial, temporal and phylogenetic autocorrelation in ecological models. *Oecologia Brasiliensis* 10:7.
- Peres-Neto, P. R., S. Dray, and C. J. F. ter Braak. 2016. Linking trait variation to the environment: critical issues with community-weighted mean correlation resolved by the fourth-corner approach. *Ecography* 40:806–816.
- Peres-Neto, P. R., and P. Legendre. 2010. Estimating and controlling for spatial structure in the study of ecological communities. *Global Ecology and Biogeography* 19:174–184.
- Peres-Neto, P. R., P. Legendre, S. Dray, and D. Borcard. 2006. Variation partitioning of species data matrices: estimation and comparison of fractions. *Ecology* 87:2614–2625.
- Peres-Neto, P. R., J. D. Olden, and D. A. Jackson. 2001. Environmentally constrained null models: site suitability as occupancy criterion. *Oikos* 93:110–120.
- Persson, L., and S. Diehl. 1990. Mechanistic individual-based approaches in the population/community ecology of fish. *Annales Zoologici Fennici* 27.
- Petchey, O. L., and K. J. Gaston. 2002. Functional diversity (FD), species

- richness and community composition. *Ecology Letters* 5:402–411.
- Pielou, E. C. 1977. *Mathematical Ecology*. John Wiley & Sons.
- Price, P. W. 1984. Research questions in ecology relating to community ecology, plant-herbivore interactions, and insect ecology in general. Pages 75–88 *Trends in ecological research for the 1980s*. Springer US.
- Procheş, Ş., J. R. U. Wilson, D. M. Richardson, and M. Rejmánek. 2008. Searching for phylogenetic pattern in biological invasions. *Global Ecology and Biogeography* 0:070909153804002-???
- R Core Team. 2016. *R : A Language and Environment for Statistical Computing*. R Foundation for Statistical Computing. Vienna, Austria.
- R Core Team. 2018. *R : A Language and Environment for Statistical Computing*. R Foundation for Statistical Computing. Vienna, Austria.
- Ramsay, J., and B. W. Silverman. 2005. *Functional Data Analysis*. Second edition. Springer-Verlag, New York.
- Rao, C. R. 1964. The use and interpretation of principal component analysis in applied research. *Sankhyā: The Indian Journal of Statistics, Series A* (1961-2002) 26:329–358.
- Raufaste, N., and F. Rousset. 2001. Are Partial ManTEL Tests Adequate? *Evolution* 55:1703–1705.
- Real, L. A., and P. McElhany. 1996. Spatial pattern and process in plant-pathogen interactions 77:1011–1025.
- Revell, L. J. 2012. phytools: an R package for phylogenetic comparative biology (and other things). *Methods in Ecology and Evolution*:217–223.
- Richardson, J. L., S. P. Brady, I. J. Wang, and S. F. Spear. 2016. Navigating the pitfalls and promise of landscape genetics. *Molecular Ecology* 25:849–863.
- Ricklefs, R. E. 1987. Community Diversity: Relative Roles of Local and Regional Processes. *Science* 235:167–171.
- Robert, C. P., J.-M. Cornuet, J.-M. Marin, and N. S. Pillai. 2011. Lack of confidence in approximate Bayesian computation model choice. *Proceedings of the National Academy of Sciences* 108:15112–15117.

- Rousset, F., and J.-B. Ferdy. 2014. Testing environmental and genetic effects in the presence of spatial autocorrelation. *Ecography* 37:781–790.
- Saito, V. S., J. Soininen, A. A. Fonseca-Gessner, and T. Siqueira. 2015. Dispersal traits drive the phylogenetic distance decay of similarity in Neotropical stream metacommunities. *Journal of Biogeography* 42:2101–2111.
- dos Santos, A. S., D. D. Saraiva, S. C. Müller, and G. E. Overbeck. 2015. Interactive effects of environmental filtering predict beta-diversity patterns in a subtropical forest metacommunity. *Perspectives in Plant Ecology, Evolution and Systematics* 17:96–106.
- Scherrer, D., H. K. Mod, J. Pottier, A. Litsios-Dubuis, L. Pellissier, P. Vittoz, L. Götzenberger, M. Zobel, and A. Guisan. 2018. Disentangling the processes driving plant assemblages in mountain grasslands across spatial scales and environmental gradients. *Journal of Ecology*.
- Schoener, T. W. 1986. Mechanistic Approaches to Community Ecology: A New Reductionism. *American Zoologist* 26:81–106.
- Schurr, F. M., O. Bossdorf, S. J. Milton, and J. Schumacher. 2004. Spatial pattern formation in semi-arid shrubland: a priori predicted versus observed pattern characteristics. *Plant Ecology* 173:271–282.
- Shafer, A. B. A., and J. B. W. Wolf. 2013. Widespread evidence for incipient ecological speciation: a meta-analysis of isolation-by-ecology. *Ecology Letters* 16:940–950.
- Shannon, C. E. 1948. A mathematical theory of communication 27:379–423.
- Sharma, S., P. Legendre, M. De Cáceres, and D. Boisclair. 2011. The role of environmental and spatial processes in structuring native and non-native fish communities across thousands of lakes. *Ecography* 34:762–771.
- Siefert, A., C. Ravenscroft, D. Althoff, J. C. Alvarez-Yépiz, B. E. Carter, K. L. Glennon, J. M. Heberling, I. S. Jo, A. Pontes, A. Sauer, A. Willis, and J. D. Fridley. 2012. Scale dependence of vegetation-environment relationships: a meta-analysis of multivariate data. *Journal of Vegetation Science* 23:942–951.

- da Silva Menezes, L., S. C. Müller, and G. E. Overbeck. 2016. Scale-specific processes shape plant community patterns in subtropical coastal grasslands. *Austral Ecology* 41:65–73.
- Simberloff, D. 1980. A succession of paradigms in ecology: Essentialism to materialism and probabilism. *Synthese* 43:3–39.
- Simpson, E. H. 1949. Measurement of Diversity 163:688.
- Singer, A., K. Johst, T. Banitz, M. S. Fowler, J. Groeneveld, A. G. Gutiérrez, F. Hartig, R. M. Krug, M. Liess, G. Matlack, K. M. Meyer, G. Pe'er, V. Radchuk, A.-J. Voinopolsassu, and J. M. J. Travis. 2016. Community dynamics under environmental change: How can next generation mechanistic models improve projections of species distributions? *Ecological Modelling* 326:63–74.
- Sisson, S. A., Y. Fan, and M. A. Beaumont. 2018. *Handbook of Approximate Bayesian Computation*. CRC Press, Taylor & Francis group, New York.
- Smith, T. W., and J. T. Lundholm. 2010. Variation partitioning as a tool to distinguish between niche and neutral processes. *Ecography* 33:648–655.
- Smouse, P. E., J. C. Long, and R. R. Sokal. 1986. Multiple Regression and Correlation Extensions of the Mantel Test of Matrix Correspondence. *Systematic Zoology* 35:627–632.
- Soininen, J. 2014. A quantitative analysis of species sorting across organisms and ecosystems. *Ecology* 95:3284–3292.
- Soininen, J. 2016. Spatial structure in ecological communities – a quantitative analysis. *Oikos* 125:160–166.
- Sokal, R. R., and N. L. Oden. 1978. Spatial autocorrelation in biology: 1. Methodology. *Biological Journal of the Linnean Society* 10:199–228.
- Sokol, E. R., B. L. Brown, and J. E. Barrett. 2010. A simulation-based approach to understand how metacommunity characteristics influence emergent biodiversity patterns. *Oikos* 126:723–737.
- Sommer, B., P. L. Harrison, M. Beger, and J. M. Pandolfi. 2014. Trait-mediated environmental filtering drives assembly at biogeographic transition zones. *Ecology* 95:1000–1009.
- Stakhovych, S., and T. H. A. Bijmolt. 2009. Specification of spatial models: A

- simulation study on weights matrices. *Papers in Regional Science* 88:389–408.
- Stenseth, N. C. 1977. Modelling the Population Dynamics of Voles: Models as Research Tools. *Oikos* 29:449.
- Stephens, P. A., S. W. Buskirk, G. D. Hayward, and C. M. D. Rio. 2005. Information theory and hypothesis testing: a call for pluralism. *Journal of Applied Ecology* 42:4–12.
- Storfer, A., M. A. Murphy, S. F. Spear, R. Holderegger, and L. P. Waits. 2010. Landscape genetics: where are we now? *Molecular Ecology* 19:3496–3514.
- Swenson, N. G., B. J. Enquist, J. Pither, J. Thompson, and J. K. Zimmerman. 2006. The Problem and Promise of Scale Dependency in Community Phylogenetics. *Ecology* 87:2418–2424.
- Tavaré, S., D. J. Balding, R. C. Griffiths, and P. Donnelly. 1997. Inferring coalescence times from DNA sequence data 145:505–518.
- ter Braak. 1987. The analysis of vegetation-environment relationships by canonical correspondence analysis 69:69–77.
- Thomson, F. J., A. T. Moles, T. D. Auld, and R. T. Kingsford. 2011. Seed dispersal distance is more strongly correlated with plant height than with seed mass. *Journal of Ecology* 99:1299–1307.
- Thuiller, W., L. Gallien, I. Boulangeat, F. De Bello, T. Münkemüller, C. Roquet, and S. Lavergne. 2010. Resolving Darwin’s naturalization conundrum: a quest for evidence: Resolving Darwin’s naturalization conundrum. *Diversity and Distributions* 16:461–475.
- Tilman, D. 2001. Functional diversity. Pages 109–120 *Encyclopedia of Biodiversity*. Academic Press, San Diego, CA.
- Toni, T., D. Welch, N. Strelkova, A. Ipsen, and M. P. H. Stumpf. 2009. Approximate Bayesian computation scheme for parameter inference and model selection in dynamical systems. *Journal of The Royal Society Interface* 6:187–202.
- Torgerson, W. S. 1958. *Theory and methods of scaling*. Wiley.
- Tuomisto, H., G. M. Moulatlet, H. Balslev, T. Emilio, F. O. G. Figueiredo, D. Pedersen, and K. Ruokolainen. 2016. A compositional turnover zone of biogeographical magnitude

- within lowland Amazonia. *Journal of Biogeography* 43:2400–2411.
- Ulrich, W., and N. J. Gotelli. 2010. Null model analysis of species associations using abundance data. *Ecology* 91:3384–3397.
- Ulrich, W., M. Piwczynski, F. T. Maestre, and N. J. Gotelli. 2012. Null model tests for niche conservatism, phylogenetic assortment and habitat filtering. *Methods in Ecology and Evolution* 3:930–939.
- Upton, G. J. G., and B. Fingleton. 1985. *Spatial Data Analysis by Example: Point pattern and quantitative data*. Wiley.
- Vandermeer, J. H. 1970. The Community Matrix and the Number of Species in a Community. *The American Naturalist* 104:73–83.
- Vandermeer, J. H. 1972. On the Covariance of the Community Matrix. *Ecology* 53:187–189.
- Veech, J. A. 2012. Significance testing in ecological null models. *Theoretical Ecology* 5:611–616.
- Velázquez, E., I. Martínez, S. Getzin, K. A. Moloney, and T. Wiegand. 2016. An evaluation of the state of spatial point pattern analysis in ecology. *Ecography* 39:1042–1055.
- Vellend, M. 2010. Conceptual Synthesis in Community Ecology. *The Quarterly Review of Biology* 85:183–206.
- Verhulst, P. 1838. Notice sur la loi que la population suit dans son accroissement. *Curr. Math. Phys* 10:113.
- Violle, C., M.-L. Navas, D. Vile, E. Kazakou, C. Fortunel, I. Hummel, and E. Garnier. 2007. Let the concept of trait be functional! *Oikos* 116:882–892.
- Volterra, V. 1926. Fluctuations in abundance of a species considered Mathematically 118:558–560.
- Wagner, H. H., and S. Dray. 2015. Generating spatially constrained null models for irregularly spaced data using Moran spectral randomization methods. *Methods in Ecology and Evolution* 6:1169–1178.
- Wan, Y., L. Xu, J. Hu, C. Xu, A. Wan, S. An, and Y. Chen. 2015. The role of environmental and spatial processes in structuring stream macroinvertebrates communities in a large river basin. *CLEAN – Soil, Air, Water* 43:1633–1639.
- Warming, E. 1895. *Plantesamfund - Grundtræk af den økologiske*

- Plantegeografi. Philipsens Forlag, Kjøbenhavn.
- Watt, A. S. 1940. Studies in the Ecology of Breckland. *Journal of Ecology* 28:42–70.
- Webb, C. O. 2000. Exploring the phylogenetic structure of ecological communities: an example for rain forest trees. *The American Naturalist* 156:145–155.
- Webb, C. O., D. D. Ackerly, M. A. McPeck, and M. J. Donoghue. 2002. Phylogenies and Community Ecology. *Annual Review of Ecology and Systematics* 33:475–505.
- Webb, C. T., J. A. Hoeting, G. M. Ames, M. I. Pyne, and N. LeRoy Poff. 2010. A structured and dynamic framework to advance traits-based theory and prediction in ecology. *Ecology Letters* 13:267–283.
- Weiher, E., G. D. P. Clarke, and P. A. Keddy. 1998. Community Assembly Rules, Morphological Dispersion, and the Coexistence of Plant Species. *Oikos* 81:309.
- Wetzel, C. E., D. de C. Bicudo, L. Ector, E. A. Lobo, J. Soininen, V. L. Landeiro, and L. M. Bini. 2012. Distance Decay of Similarity in Neotropical Diatom Communities. *PLOS ONE* 7:e45071.
- Whittaker, R. H. 1960. Vegetation of the Siskiyou Mountains, Oregon and California. *Ecological Monographs* 30:279–338.
- Whittaker, R. H. 1978. Direct Gradient Analysis. Pages 7–50 *Ordination of Plant Communities*. Springer, Dordrecht.
- Wiens, J. J. 2008. Commentary on Losos (2008): niche conservatism déjà vu. *Ecology Letters* 11:1004–1005.
- Wiens, J. J., D. D. Ackerly, A. P. Allen, B. L. Anacker, L. B. Buckley, H. V. Cornell, E. I. Damschen, T. Jonathan Davies, J.-A. Grytnes, S. P. Harrison, B. A. Hawkins, R. D. Holt, C. M. McCain, and P. R. Stephens. 2010. Niche conservatism as an emerging principle in ecology and conservation biology: Niche conservatism, ecology, and conservation. *Ecology Letters* 13:1310–1324.
- Williamson, M. H. 1957. An elementary theory of interspecific competition 180:422–425.
- Willis, C. G., M. Halina, C. Lehman, P. B. Reich, A. Keen, S. McCarthy, and J. Cavender-Bares. 2010. Phylogenetic community structure in Minnesota oak savanna is influenced by spatial

- extent and environmental variation. *Ecography* 33:565–577.
- Zobel, M. 1997. The relative of species pools in determining plant species richness: an alternative explanation of species coexistence? *Trends in Ecology & Evolution* 12:266–269.
- Zurell, D., U. Berger, J. S. Cabral, F. Jeltsch, C. N. Meynard, T. Münkemüller, N. Nehrbass, J. Pagel, B. Reineking, B. Schröder, and V. Grimm. 2010. The virtual ecologist approach: simulating data and observers. *Oikos* 119:622–635.
- Zuur, A. F., editor. 2009. *Mixed effects models and extensions in ecology with R*. Springer, New York, NY.



REC

Remerciements et résumé

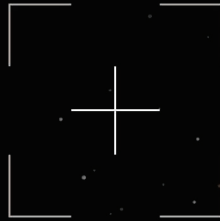

00:00:00

3..2..1...1..2..3

A tous ceux qui ont apporté leurs contributions à cette thèse. Qu'elles soient scientifiques, artistiques, humoristiques, émotionnelles ou tout simplement présentes, elles ont toujours été apportées avec la plus grande attention et je ne les en remercierai jamais assez.

Aux membres de mon jury

Je tenais tout d'abord à remercier M-J. Fortin, F. Gillet, C. Meynard et S. Dolédec d'avoir accepté de faire partie de mon jury pour discuter de ce travail de thèse. J'espère que vous apprécierez la lecture autant que les discussions qui en découleront.

A mes pères de science

Nous voici arrivés au bout des 3 ans au cours desquels nous nous étions engagés à suivre un chemin scientifique similaire. Si cette période a pu être ponctuée de quelques moments de frustration, elle a surtout été marquée par votre constante volonté de partager vos connaissances et de m'aider à rentrer dans le milieu de la recherche. Un aspect pour lequel je vous suis certainement le plus reconnaissant est que vous ne m'avez jamais laissé passer aucune erreur que ce soit un vocabulaire approximatif ou une argumentation faible en bibliographie. Au-delà de cet aspect commun, voilà plus particulièrement pourquoi j'ai apprécié travailler avec chacun d'entre vous :

Stéphane, tu fais toujours ce que tu dis et tu es toujours là quand il faut. Je n'ai pas toujours été simple et pourtant tu as su gérer mon caractère qui pourrait être qualifié de purement stochastique dans les moments de doute et de stress. Ta franchise est certainement ce qu'on retient généralement le plus de toi mais j'ai décidé de retenir ton empathie, ton écoute et ta psychorigidité sur ce qu'est un « bon code ». *Merci* d'avoir tenté cette thèse avec moi.

Pedro, tu es passionné par la recherche : les nouveaux projets, les nouvelles idées, les échanges, enfin « tu vois qu'ai-je dit ». Même si tu aimes faire croire le contraire, je suis sûre que tu aimes avoir des étudiants car ils t'apportent des contradictions sur lesquelles tu aimes beaucoup trop réfléchir ! Enfin, je te remercie d'avoir accepté de co-diriger cette thèse et de m'avoir accueilli à Concordia, je retiendrai notamment de nos échanges qu'un bon manuscrit doit présenter un contenu linéaire (et non artificiel!) avec un anglais irréprochable.

En conclusion, vous avoir eu comme directeurs de thèse a été une véritable chance.

Aux membres de mon comité de pilotage

Une sincère reconnaissance à mes 4 membres de comité de pilotage : S. Dolédec, F. Munoz, W. Thuiller et O. Hardy. Je tenais à vous remercier non seulement pour nos échanges scientifiques qui ont toujours été des plus intéressants, mais également pour votre écoute et compréhension qui ont fait que la « petite famille scientifique » formée avec mes directeurs a impeccablement roulé.

Aux personnes que j'ai côtoyées au laboratoire de Lyon

Un grand merci au pôle administratif et au pôle informatique sans qui de nombreuses choses n'auraient pas été réalisables et qui ont vaillamment supporté mes interruptions avec encore et toujours des soucis allant de l'organisation de missions au cluster de calcul.

Merci tout spécialement à mes co-bureaux : Louise, Eliane, Elodie et Victor.

Victor, pour les rires qu'on a pu partager sur les coquilles des copies étudiantes.

Elodie, pour ta personnalité très naturelle et franche. Toutes tes mésaventures administratives nous auront tous bien fait rire de par leur absence totale de sens et de logique !

Eliane, pour ton amitié qui m'est très précieuse et tous ces moments musicaux que nous avons partagés. J'espère que tu les auras appréciés autant que moi et j'attends avec impatience notre prochain projet !

Louise, pour le soutien mutuel qu'on a pu s'apporter dans les derniers moments de la rédaction. Le partage des informations de soutenance et des soucis des derniers jours a permis une diminution bien significative de nos stress respectifs !

Merci également à tous ceux avec qui j'ai pu échanger : Timothée, Laura, Morgane, Jennifer, Valentine, Kamal, Florentin, Florian, Salomé, Etienne, Elisa, Elise, Mickaël, Marie-Pauline, Gabriel, Thibault, Sébastien. Des mentions spéciales pour Karine qui a pris beaucoup de temps pour me donner des conseils sur les candidatures de post-docs mais aussi pour toutes les discussions scientifiques que nous avons partagées. Une pour Célia pour avoir partagé nos doutes sur l'avenir. Une pour Nicolas qui a vaillamment supporté mes visites pour de nombreuses questions écologiques mais aussi sur la rédaction de thèse. Marie-Claude pour

m'avoir chaperonnée dans mes débuts en enseignement. Et enfin Aurélie pour avoir répondu à mes questions sur R mais surtout pour t'être toujours demandé si ça allait ou pas.

Aux personnes de l'équipe de Pedro Peres-Neto

Une énorme pensée à Bertrand et Hector, vous m'avez apporté énormément de connaissances à la fois en écologie mais également en épistémologie, et surtout comment un chercheur fait de la bonne science et du travail en collaboration. Au-delà de ça, je me rappellerai de toutes les sorties qu'on a pu faire ensemble à Montréal au cours desquelles j'ai pu d'autant plus apprécier vos personnalités.

Huge thanks to Bertrand and Hector. You brought me so much knowledge! In ecology of course, but I remember also our conversations about epistemology and especially about how a researcher should do good science and how to work in collaboration. Beyond that, I will always remember our outings in Montreal which were for me the occasion to appreciate your company even more!

Un grand merci à Pedro (l'étudiant), Louis mais aussi Andrew !

A mes ami(e)s

Une pensée toute particulière à Anne-Béatrice que je considère comme plus qu'une simple collègue. C'est grâce à toi si je suis ici aujourd'hui puisque sans ce stage de M1 pour lequel je t'ai contacté (un peu maladroitement il est vrai), je n'aurais jamais réalisé cette thèse sous la supervision de Stéphane et Pedro. Tu as été le lien par lequel cette histoire a pu débiter et je t'en remercie énormément. Je te suis également reconnaissante pour toutes les discussions que nous avons pu avoir sur la place Ambroise Paré, elles resteront gravées dans ma mémoire.

Un grand merci à Léa, Mégane, Quentin et Simon. Nos sorties ont toujours été un grand bol d'air et de rire ! Léa et Mégane, merci pour nos discussions et votre amitié sans borne depuis notre rencontre à l'ENS. Simon, merci d'avoir été patient lorsque j'ai tenté d'apprendre le JAVA (et temporairement échouée), ce n'est que partie remise ! Quentin, merci pour ton humour et ton optimisme de chaque instant (et aussi pour m'avoir prêté ton ordi...).

Enfin, Agnès et Morgane... Votre amitié est infaillible et irremplaçable. Toujours là quand ça ne va pas, toujours là pour partager mes actions les plus stupides, toujours là pour discuter sérieusement ou juste pour rire. Morgane, merci pour nos longues discussions au téléphone sur l'avenir et sur ce qu'on veut vraiment. Et surtout merci d'être aussi crue parfois ! Agnès, merci de m'avoir rappelé de penser à moi mais aussi de ne jamais avoir peur de dire les choses telles qu'elles sont.

A ma famille

Vous avez toujours été là, votre soutien à la fois silencieux mais aussi complètement engagé puisque vous avez tous votre patte dans cette thèse :

Jérôme, pour toutes mes pages d'axes et chapitres. Je te l'ai déjà dit mais cette fois je l'écris : elles sont magnifiques *merci* ! Tu as pris un temps conséquent sur ton planning d'étudiant déjà bien serré à la fois pour la conception de ces pages mais aussi pour toujours parlé avec moi quand j'en avais besoin. Je n'oublierai jamais ma semaine de rédaction à Nantes, à la fois très sérieuse mais aussi pleine de fun et c'est ça aussi ta force. Je peux *toujours* compter sur toi.

Bruno, pour tes petits textes de début et de fin de thèse. Ah, tu es un artiste dans l'âme tu sais ? T'entendre improviser au piano c'est comme une pluie balayant mes soucis, ma mauvaise humeur et ma tristesse. Pour moi, tu seras toujours un drôle de petit clown avec de la magie dans la tête et au bout des doigts. Tout comme pour Jérôme, je sais que tu seras *toujours* là pour moi.

Mon oncle Michel, pour m'avoir hébergé pendant mes deux premières années de licence. Tu sais que sans toi je n'en serai probablement pas là ? Je me souviendrais toujours de la façon dont tu avais de régler mes grosses périodes de stress et chagrins : un bon bain, un bon repas, un bon gâteau et un bon film ! Merci pour ces moments partagés, tu es un oncle formidable.

Mes parents, pour avoir accepté de relire les parties françaises de cette thèse et notamment le résumé vulgarisé. Mais votre investissement ne s'arrête pas là puisqu'il a débuté bien avant, dès le moment où vous m'avez poussée à faire des études. Sans vous rien n'aurait été pareil alors merci pour tout : pour vous être toujours pliés en

quatre pour moi, pour toute la tendresse et les attentions qui ont fait la personne que je suis aujourd'hui, et pour m'avoir écoutée me plaindre à longueur de journée quand ma thèse me frustrait trop.

Et enfin, à celui qui partage ma vie. Merci pour ton soutien constant, ça n'a pas été facile pour toi de m'entendre râler et me plaindre plutôt que de réagir. Tu as toujours été là pour me le rappeler d'ailleurs et c'est comme ça que tu as le plus contribué : tu m'as constamment stoppé dans mes descentes noires en me bottant les fesses mais aussi en m'apportant toute ta tendresse dans les moments où j'étais au bout. Robin, sans toi je n'aurais pas vécu ma thèse de la même manière et je te remercie d'avoir été présent pendant ces trois années. Je n'ai que trois mots à ajouter : à ton tour !

RÉSUMÉ FRANÇAIS

Apporter une lumière méthodologique sur les processus écologiques : les échelles écologiques et modèles nuls contraints sont-ils des solutions pertinentes ?

Cher(e) Lecteur(rice),

Avant d'entamer cette lecture, prenez donc le temps de rassembler votre curiosité, votre esprit critique et votre âme d'enfant. Vous êtes prêts ? Alors prenez une dernière respiration et embarquez avec moi dans ce fabuleux voyage de trois ans de recherche (version résumée et vulgarisée)...

Vous aurez certainement conclu du titre que cette thèse se place dans la discipline de l'écologie. Elle se concentre en fait sur une sous-discipline appelée *écologie des communautés*. On définit une communauté comme un ensemble d'espèces qui coexistent dans l'espace et le temps et pouvant (ou non) interagir directement ou indirectement entre elles (Magurran 2004, Emerson et Gillespie 2008). Les communautés sont étudiées par le biais de deux de leur caractéristiques principales : leur *composition* et leur *structure*. La composition se décline en trois catégories : (i) la *composition en espèces* reportant l'identité et l'abondance

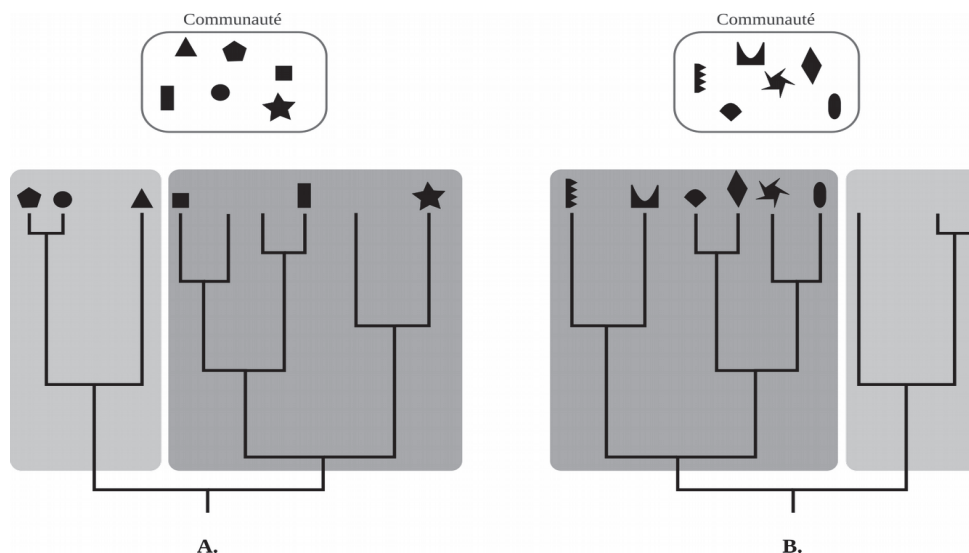

Figure 1 : Concept de composition phylogénétique. (A) et (B) sont deux communautés différentes toutes deux composées de 6 espèces qui se répartissent sur deux arbres phylogénétiques distincts. La composition phylogénétique de la communauté (A) est plus diversifiée que la (B) car les espèces de la communauté (A) appartiennent à deux clades ou groupes phylogénétiques différents (carrés gris clair et foncé) tandis que celles de la communauté (B) n'appartiennent qu'à un seul clade (carré gris foncé). (A-B) Les espèces sont représentées par des symboles.

relative (i.e., le nombre d'individus) de chaque espèce présente dans la communauté ; (ii) la *composition fonctionnelle* décrivant l'identité et la valeur des traits fonctionnels (e.g., taille, masse corporel, surface foliaire...) présentés par les espèces ; et (iii) la *composition phylogénétique* détaillant les lignages phylogénétiques présents dans la communauté permettant ainsi de définir le niveau de parenté existant entre les espèces de la communauté (Fig. 1). La structure se décompose, quant à elle, en deux catégories. En premier, la *structure spatiale* décrivant la position spatiale des individus (ou des traits) dans la communauté (Fig. 2). Celle-ci est définie comme « aléatoire » si la position d'un individu est indépendante des autres individus (Fig. 2A), « groupée » si les individus ont tendance à être localisés les uns à

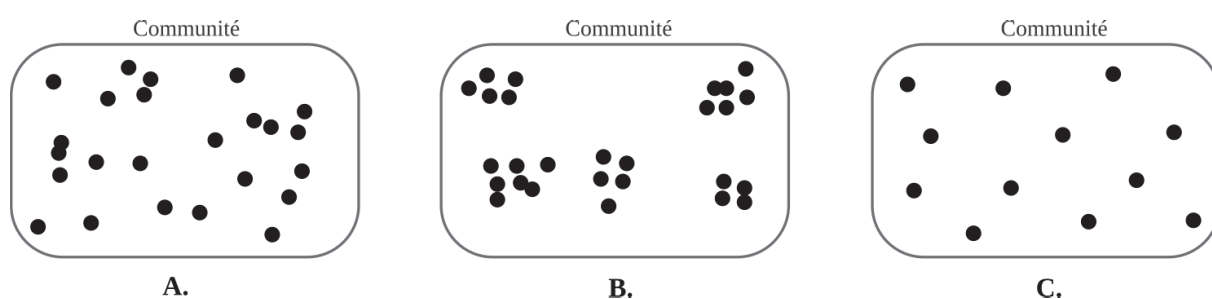

Figure 2 : Structure spatiale d'une communauté. (A-C) Les carrés gris représentent des communautés et les points noirs sont des individus. Dans les communautés, les individus sont soit (A) dispersés aléatoirement, soit (B) groupés ou encore (C) dispersés uniformément.

côté des autres, et « dispersée » si les individus ont tendance à être localisés séparément les uns des autres. En second, la *structure phylogénétique* caractérisant la distribution des espèces ou des traits le long de l'arbre phylogénétique par rapport à un autre ensemble d'espèces ou de traits (Fig. 3). L'ensemble utilisé pour la comparaison peut être soit un ensemble d'espèces ou de traits plus large que celui dont on étudie la structure, soit simulé le long de l'arbre phylogénétique sous un processus évolutif particulier comme le mouvement Brownien (i.e.,

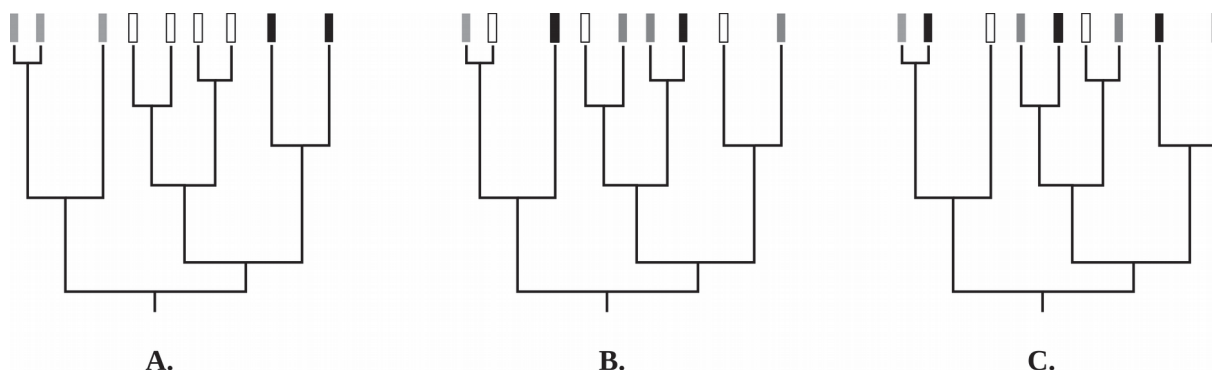

Figure 3 : Structure phylogénétique des traits fonctionnels d'espèces. Les rectangles représentent un trait d'espèce (e.g., la taille) et les différentes couleurs correspondent aux différentes valeurs possibles de ce trait. Sur les arbres phylogénétiques, les valeurs du trait sont soit (A) groupées, soit (B) aléatoirement dispersées, ou encore (C) dispersées uniformément.

évolution par marche aléatoire le long de l'arbre phylogénétique). Cette comparaison permet de définir la structure phylogénétique comme étant « groupée » (Fig. 3A), « aléatoirement dispersée » (Fig. 3B) ou « uniformément dispersée » (Fig. 3C) par rapport à autre un ensemble d'espèces ou de traits.

Cependant, rester à l'échelle de la communauté est un peu réducteur, n'ayons pas peur de voir plus grand ! Mais plus grand comment ? En 2004, Leibold et collab. développent le concept de *méta-communauté* défini comme un ensemble de communautés reliées entre elles par la dispersion (i.e., déplacement d'un individu de sa communauté originelle à une autre) (Fig.4). L'échelle de la méta-communauté est intéressante car elle permet d'étudier les variations en compositions (i.e., espèces, traits, phylogénie) entre les communautés, aussi appelée diversité-bêta.

Les structures spatiales et phylogénétiques des communautés ainsi que la variation en composition (i.e., espèces, trait ou phylogénie) d'une communauté à une autre représentent ce que l'on appelle les *patrons de biodiversité*. L'existence même de ces patrons nous amène à nous poser une question essentielle de l'écologie des communautés : **Quels sont les processus écologiques responsables de la structuration et de la variation en composition des communautés ?**

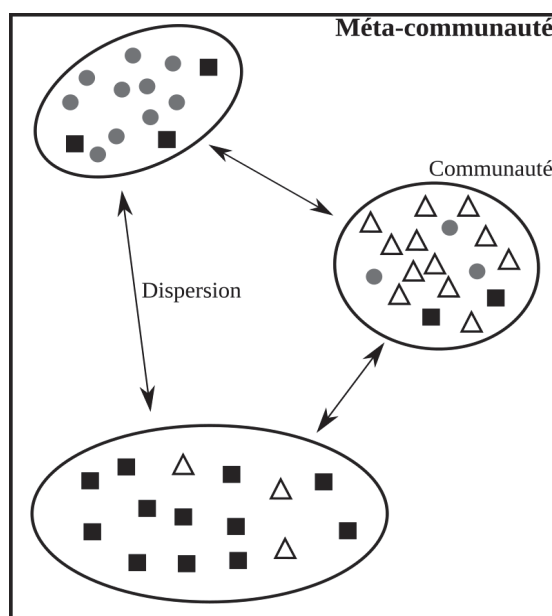

Figure 4 : Le concept de méta-communauté. Les symboles colorés représentent des espèces différentes. La métacommunauté (carré noir) est ici composée de trois communautés (carrés gris) qui sont connectées entre elles par la dispersion (flèches noires).

Il existe quatre grands processus écologiques qui agissent comme des filtres successifs sur un groupe *global* d'espèces (i.e., pool d'espèces à l'échelle du globe) pour contraindre la coexistence des espèces (Fig. 5; Zobel 1997, Götzenberger et collab. 2012, Martensdóttir et Eriksson 2014). En premier, la spéciation (i.e., apparition de nouvelles espèces) et l'extinction

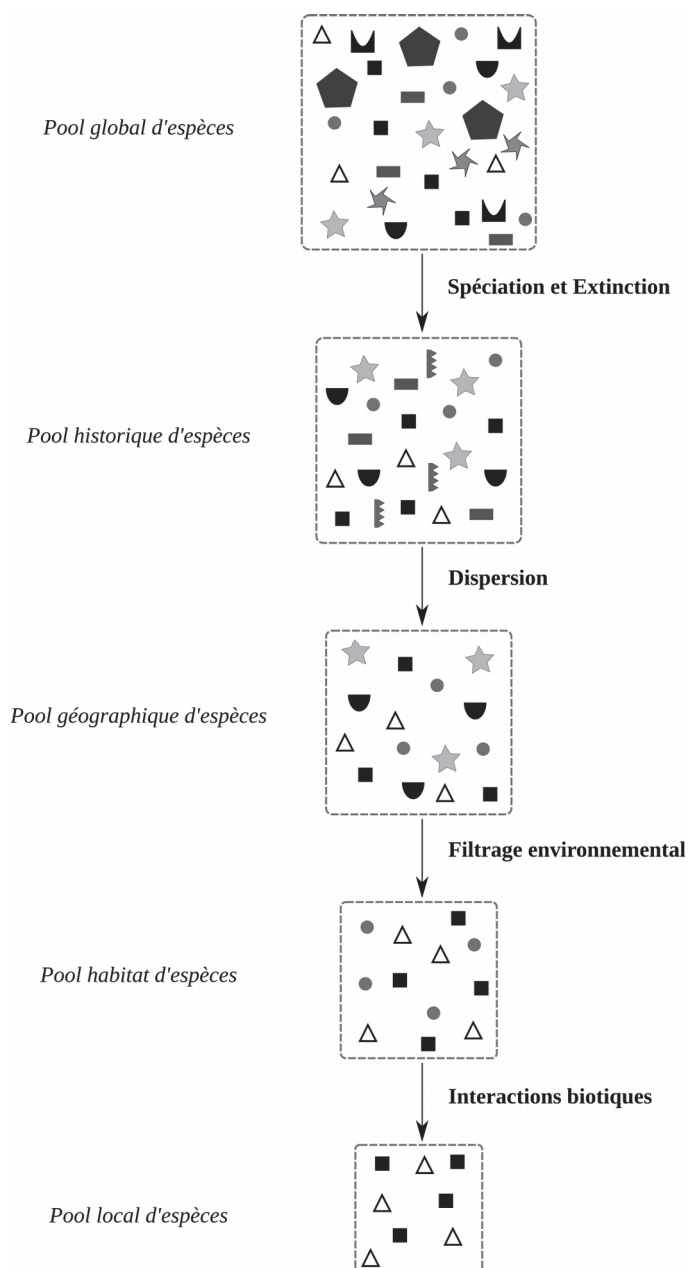

Figure 5: Des filtres hiérarchiques sélectionnent les espèces résidentes dans une communauté. Les espèces sont rapportées par des symboles colorés. Les interactions biotiques correspondent aux interactions entre espèces telle que la compétition. Le pool local d'espèces correspond au pool d'espèces final constituant la communauté.

(i.e., disparition de certaines espèces) sont tous deux des processus dit « évolutifs » et forment un filtre historique qui permet de réduire le pool d'espèces global à un pool *historique* d'espèces. Ce pool d'espèces est composé de toutes les espèces pouvant potentiellement s'établir dans une communauté donnée. Ensuite, la dispersion réduit le pool d'espèces historique au pool *géographique* d'espèces constitué de toutes les espèces pouvant atteindre une communauté donnée. Puis, les espèces sont sélectionnées par l'environnement pour former le pool *habitat* d'espèces capables de survivre dans les conditions environnementales d'une communauté donnée. Ce processus est communément appelé le filtrage environnemental et sélectionne les espèces selon leurs traits fonctionnels. Et enfin, les interactions entre espèces (i.e., interactions biotiques) telle que la compétition entre espèces réduit le pool habitat d'espèces au pool *local* d'espèces c'est à dire aux espèces présentes dans une communauté donnée (Fig. 5).

Un des objectifs majeurs en écologie des communautés est d'identifier et de quantifier les processus écologiques responsables de la structuration et variation en composition des communautés. La représentation schématique précédente peut présenter la réponse à cette question comme tout à fait triviale. Mais il n'en est pourtant rien... Le seul moyen d'étudier les processus repose sur les patrons de biodiversité qu'ils induisent. Cependant, chaque processus n'induit pas un patron unique et plusieurs processus peuvent être la cause d'un seul patron (Cale et collab. 1989, Real et McElhany 1996). Par exemple, il a été montré que la compétition et le filtrage environnemental pouvaient tous deux mener à une structure phylogénétique groupée ou uniformément dispersée (Kraft et al. 2007). L'affaire devient donc bien compliquée... Comment peut-on arriver à correctement identifier et quantifier les processus sous-jacents aux communautés si les signatures des processus se ressemblent ? Cette thèse propose d'explorer deux pistes.

La première est purement écologique. Il a été montré en effet que les processus écologiques agissent en fait à de multiples échelles écologiques (e.g., temporelle, spatiale, phylogénétique). Par exemple, l'environnement agit à large échelle spatiale au travers de variables climatiques (e.g., température) mais aussi à fine échelle spatiale au travers de variables du sol (e.g., pH) (Siefert et collab. 2012). De même, la dispersion peut agir à large échelle spatiale si la capacité de dispersion de l'individu atteint de longues distances, mais aussi à fine échelle spatiale si cette capacité est réduite à une très faible distance géographique (da Silva Menezes et collab. 2016). Ainsi, aller dans les échelles écologiques pourrait apporter

une meilleure identification du patron de biodiversité associé aux processus. Par ailleurs, cela permettrait de savoir comment évolue le signal du processus le long des échelles écologiques et donc comment leur rôle dans la formation des communautés varie en terme d'intensité et de variables impliquées.

La seconde piste est purement statistique et concerne le degré de précision des méthodes d'analyse. Parmi les nombreux outils disponibles pour identifier et quantifier les processus écologiques à l'origine des communautés, la communauté scientifique utilise les tests d'hypothèses. Leur principe est basé sur le test d'une hypothèse qu'on appelle « hypothèse nulle » ou « H_0 » définie comme la réponse négative la plus simple à une question écologique. Prenons par exemple la question suivante: « Le filtrage environnemental structure-t-il la variation en composition en espèces des communautés ? » La H_0 correspondante est « Le filtrage environnemental NE structure PAS la variation en composition en espèces des communautés ». Les tests d'hypothèses sont basés sur le rejet ou non de H_0 . Pour cela, il faut déjà traduire cette H_0 verbale en H_0 mathématique. On va alors définir un « modèle nul » M_0 qui permettra de simuler des données sous H_0 . Dans notre cas, il s'agira donc de définir un modèle permettant de simuler une variation en composition en espèces des communautés qui ne dépend pas de l'environnement. Nous verrons comment définir M_0 dans la suite du paragraphe. Une fois M_0 défini, on va choisir une statistique k à calculer et qui permettra de quantifier l'effet du filtrage environnemental. Le principe est maintenant de simuler un jeu de données sous M_0 où la variation en composition en espèces des communautés ne dépend pas de l'environnement et de calculer k sur ce jeu de données. On obtient alors k_{H_0} qui est la valeur de k sous H_0 , donc la valeur attendue de k quand la variation en composition en espèces des communautés ne dépend pas de l'environnement.

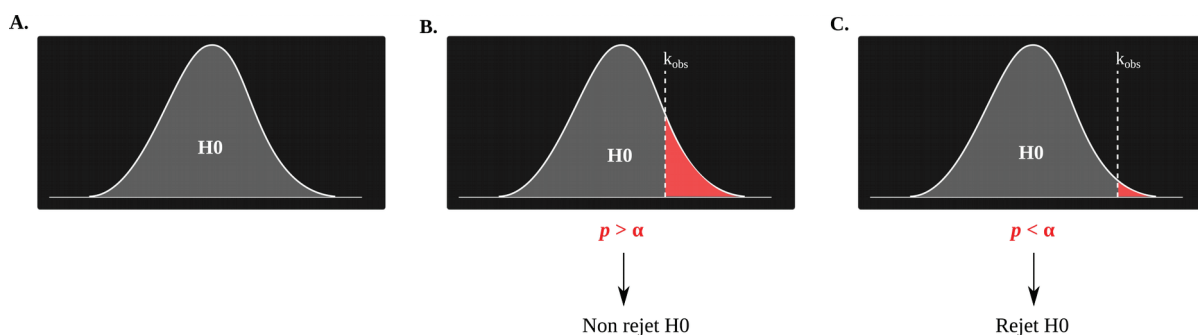

Figure 6 : Principe des tests d'hypothèses. (A) La distribution nulle des valeurs de k_{H_0} . (B-C) La valeur observée k_{obs} est ensuite comparée à cette distribution nulle. Si la probabilité p pour k_{H_0} d'être supérieur à k_{obs} dépasse α , H_0 est maintenue (B). Au contraire H_0 est rejetée si cette probabilité dépasse α (C).

L'étape de calcul de k_{H0} est répétée de très nombreuses fois (e.g., 999 fois) permettant ainsi de construire une distribution nulle c'est-à-dire une distribution des valeurs de k attendues sous $H0$ (Fig. 6A). Ensuite, la statistique k est calculée sur le jeu de données empiriques (i.e. récolté dans la nature), on obtient alors k_{obs} qui est l'effet observé de l'environnement sur la composition d'espèces des communautés. Comme étape finale, k_{obs} est comparé à la distribution nulle de k_{H0} . Dans le cas d'un test unilatéral, on dit que si la probabilité pour les k_{H0} d'être supérieurs à k_{obs} dépasse un seuil alpha (i.e., 0,05), alors $H0$ ne peut pas être rejetée (Fig. 6B). Autrement dit, il n'y a pas d'effet de l'environnement. Inversement, si cette probabilité est inférieure à alpha, $H0$ est rejetée et on conclue qu'il y a éventuellement un effet de l'environnement (Fig. 6C). Mais comment définir $M0$? La plupart du temps, $M0$ est défini par des permutations des matrices de jeux de données. Si on reprend notre cas, pour étudier l'effet de l'environnement, deux tableaux (i.e., matrices) de données sont requis : une matrice de composition d'espèces **L** avec les espèces en colonnes et les communautés en lignes ce qui permet d'avoir la composition en espèces de chaque communauté (Fig. 7), et une matrice des conditions environnementales **R** présentes dans les communautés avec les variables environnementales en colonnes et les communautés en lignes (Fig. 7). k permet de calculer un lien entre ces deux matrices, k_{obs} calcule donc le lien empirique entre **R** et **L**. Comme $M0$ a été défini comme un modèle nul permettant de simuler un jeu de données sous $H0$ où la variation en composition d'espèces des communautés ne dépend pas de l'environnement, il faut donc briser le lien entre **R** et **L**. La manière la plus simple de faire cela est de permuter aléatoirement les lignes de **L**. Chaque lignes de **L** peut en fait être assimilée à la position de chaque communauté dans l'espace. Ainsi, effectuer des permutations aléatoires des lignes de **L** revient à changer aléatoirement la position spatiale des communautés (Fig. 8).

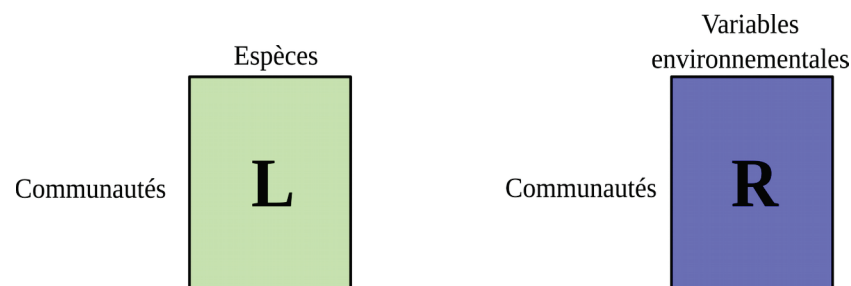

Figure 7 : Tableaux de jeux de données espèces **L** et environnementales **R**.

Cependant, définir M_0 sur la base de permutations et randomisations aléatoires n'est pas suffisant pour répondre à une question écologique complexe. Dans notre cas par exemple, l'environnement n'est en fait pas seul à structurer la variation spatiale de la composition en espèces des communautés. En effet, comme introduit précédemment, les espèces peuvent dispersées d'une communautés à une autre, provoquant une dépendance spatiale entre les communautés puisque des communautés proches auront tendance à présenter une composition en espèces similaire. Si on ne prend pas en compte cette structure sous-jacente liée à la dispersion, le test peut trouver un lien entre L et R alors qu'il n'y en a pas. Ainsi, dans cette thèse, on propose d'augmenter la précision des modèles nuls en les contraignant à respecter des structures écologiques présentes dans les jeux de données initiaux. Pour reprendre notre exemple, il faudrait contraindre les permutations pour reproduire les

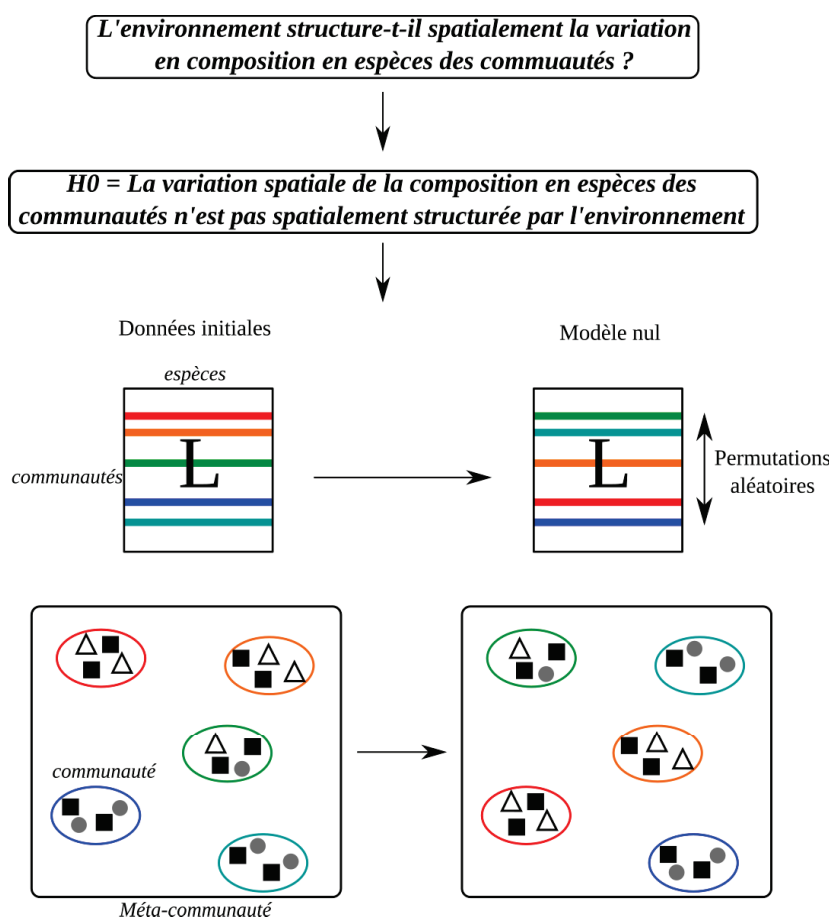

Figure 8 : Construction d'un modèle nul. Le modèle nul correspondant à la question écologique est la permutation aléatoire des lignes de la matrice L représentant la composition en espèces des communautés, permettant de produire des communautés aléatoirement structurées dans l'espace tout en gardant leur composition intacte. Les triangles blancs, carrés noirs et cercles gris représentent trois espèces différentes. Les couleurs des communautés correspondent aux couleurs des lignes de L .

structures spatiales de \mathbf{L} qui ne dépendent pas de l'environnement (donc de la dispersion) (Fig. 9). Ces modèles nuls sont appelés « modèles nuls écologiquement contraints ».

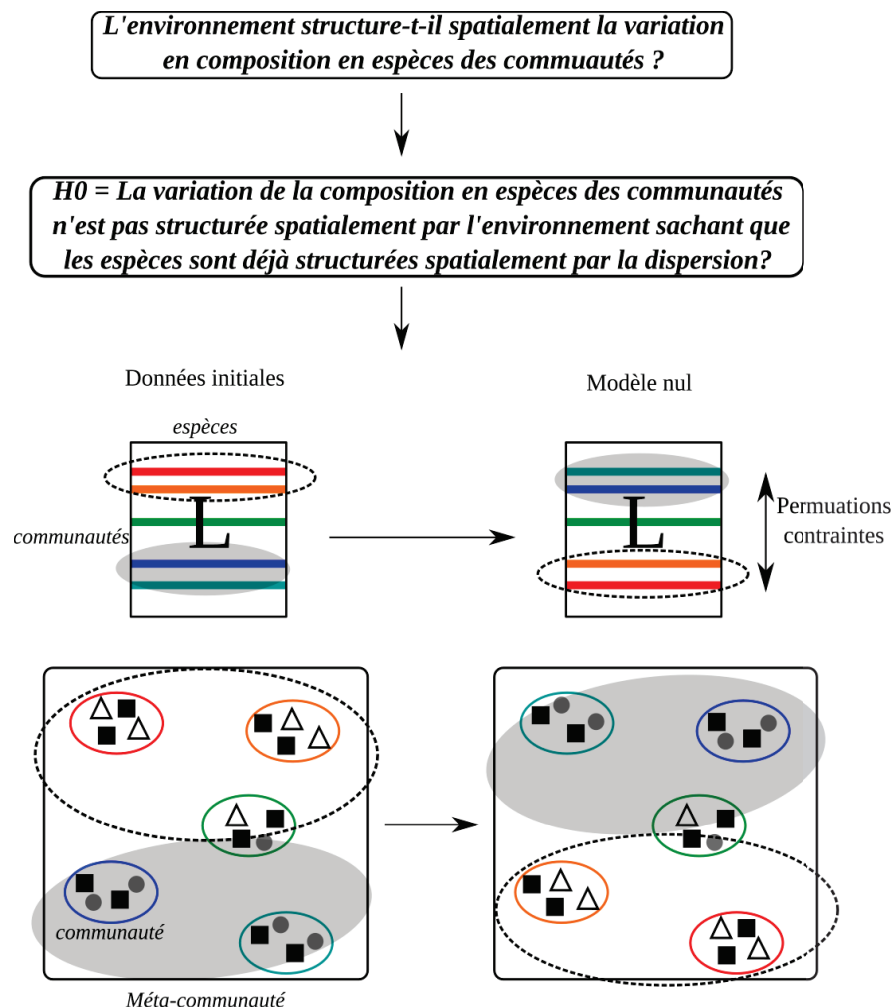

Figure 9 : Construction d'un modèle nul écologiquement contraint. Comme les compositions des communautés ne sont pas indépendantes, dû à la dispersion (ellipses en pointillés et grises), le modèle nul correspondant à la question écologique est une procédure de permutation de la matrice \mathbf{L} respectant la contrainte écologique de la structure spatiale donnée par la dispersion (ellipses en tirets et grise). Les triangles blancs, carrés noirs et cercles gris représentent trois espèces différentes. Les couleurs des communautés correspondent aux couleurs des lignes de \mathbf{L} .

En résumé, la thèse propose d'intégrer les échelles écologiques et des modèles nuls écologiquement contraints dans les tests d'hypothèses. Le manuscrit prend le cas particulier de l'étude du filtrage environnemental sur la variation en composition en espèces des communautés de plantes dans une méta-communauté. Trois analyses multivariées largement utilisées pour étudier l'effet du filtrage environnemental ont été considérées dans ce

manuscrit : le quatrième coin, le test de Mantel et le partitionnement de variation. Notez qu'une analyse multivariée est une analyse statistique capable de gérer des tableaux de données c'est-à-dire présentant plusieurs variables (matrices **L** et **R** Fig. 7). Nous parlerons d'abord de l'implémentation des échelles dans la méthode du quatrième coin, puis de l'intégration de modèle nuls dans les tests d'hypothèses du test de Mantel et du partitionnement de variation. Vous êtes prêts ? Non ? Oh, vous savez c'est comme un pansement qu'on doit enlever, il ne faut pas hésiter et y aller d'un coup sec. Là c'est pareil, laissez vos yeux glisser d'un mouvement rapide au paragraphe suivant.

Le filtrage environnemental est maintenant bien connu pour sélectionner les espèces sur la base de leurs traits fonctionnels en écartant toutes les espèces qui présentent des combinaisons de traits non adaptées. Il est donc intéressant d'étudier les relations trait-environnement pour identifier quels traits sont sélectionnés par quelles variables environnementales. Parmi d'autres méthodes, le quatrième coin est une analyse multivariée très utilisée pour mesurer la relation trait-environnement entre un unique trait et une unique variable environnementale tout en prenant compte de l'abondance des espèces (Legendre et collab. 1997, Dray et Legendre 2008, Peres-Neto et collab. 2016). Cependant, il a été montré que l'environnement et les traits présentent des dépendances susceptibles d'influencer la relation trait-environnement.

L'environnement présente en effet de fortes dépendances spatiales puisqu'il a été souligné plus haut que les variables environnementales n'agissaient pas toutes à la même échelle spatiale avec des variables plutôt à large échelle (e.g., variables climatiques) ou à fine échelle (e.g., variables du sol). Les traits souffrent, quant à eux, de fortes dépendances phylogénétiques puisque les espèces présentent des relations de parenté lié au partage d'une histoire évolutive commune. Cette dépendance s'exprime par le fait que les espèces apparentées ont soit tendance à présenter des valeurs de traits similaires indiquant que la niche écologique des espèces n'a pas changé depuis leur divergence d'un ancêtre commun ancien (large échelle phylogénétique ; Fig. 10A), soit dissimilaires indiquant que leur niche écologique est différente et que cette divergence de niche s'est produite récemment (fine échelle phylogénétique ; Fig. 10B). Il est donc intéressant d'intégrer les échelles spatiales et phylogénétiques dans le quatrième coin pour capturer les informations suivantes : (i) identifier l'échelle spatiale à laquelle une variable environnementale sélectionne un trait en particulier ;

(ii) identifier l'échelle phylogénétique du trait sélectionné par une variable environnementale particulière. L'échelle phylogénétique va indiquer le degré de conservatisme du trait filtré pour savoir si la niche des espèces est conservée (i.e., le trait est conservé le long de la phylogénie = large échelle phylogénétique) ou divergente (i.e., le trait n'est pas conservé le long de la phylogénie = fine échelle phylogénétique). En résumé, intégrer les deux types d'échelles va permettre de capturer à la fois l'histoire spatiale du filtrage environnemental pour identifier les variables environnementales successivement impliquées au cours des échelles spatiales, mais aussi l'histoire évolutive des espèces sélectionnées par ce filtrage, à savoir : a-t-il induit une différence de niche ancienne ou récente ?

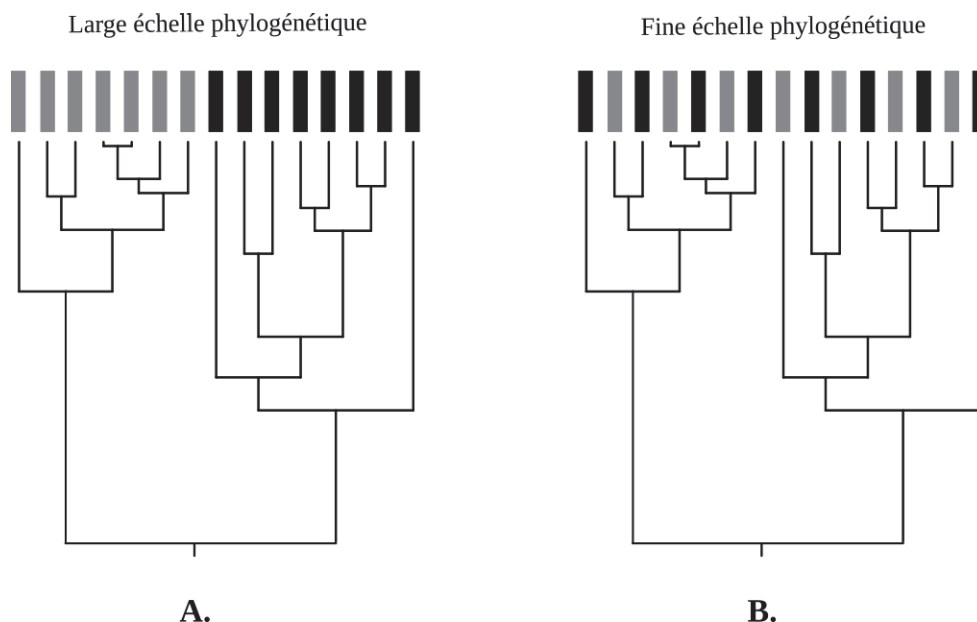

A. **B.**
Figure 10 : Échelles phylogénétiques. (A-B) Les rectangles gris et noirs représentent respectivement des valeurs de traits d'espèces négatives et positives. (A) Les traits sont structurés à large échelle phylogénétique puisqu'un clade phylogénétique présente des valeurs de traits négatives et un autre positives. Ceci indique que la niche écologique des espèces est conservée au sein d'un clade puisque toutes les espèces présentent des valeurs similaires de traits. (B) A l'inverse, toutes les espèces présentent une valeur de traits différente de l'espèce qui lui est la plus proche. Ainsi, la niche écologique de ces espèces est différente puisque les valeurs de traits ne sont pas conservées entre espèces apparentées.

La nouvelle méthode développée est appelée « quatrième coin multi-échelle » et présente de très bonnes performances. En effet, les résultats ont montré que les échelles spatiales et phylogénétiques étaient correctement identifiées et détectées significatives pour chaque scénario de simulations. Cette méthode sera disponible prochainement sous le logiciel R dans le package *adespatial*. En conclusion, cette approche permet d'apporter des informations

nouvelles dans l'étude du filtrage environnemental permettant d'affiner la connaissance des patrons de biodiversité fournis par ce processus.

La seconde partie de la thèse se concentre sur l'identification et la quantification de l'effet du filtrage environnemental sur la variation en composition en espèces des communautés. Le partitionnement de variation et le test de Mantel sont deux analyses multivariées très utilisées pour répondre à cette question, et notamment pour séparer l'effet de l'environnement par rapport aux processus spatiaux tels que la dispersion. Comme présenté dans l'exemple plus tôt, étudier l'influence de l'environnement sur la structure spatiale de la variation en composition en espèces des communautés implique de faire un modèle nul prenant en compte la structure spatiale déjà induite par la dispersion (Fig. 9). En effet, si le modèle nul est seulement construit sur la base de permutations aléatoires (Fig. 8), les deux méthodes présentent d'importants biais puisqu'elles détectent un effet significatif de l'environnement quand il n'y en a pas et surestiment l'effet de l'environnement quand il est présent. La mise en place d'un modèle nul spatialement contraint prenant en compte les structures spatiales induites par la dispersion a permis de corriger ces deux biais dans le partitionnement de variation et le test de Mantel. Cette procédure de test basée sur un modèle spatialement contraint est maintenant disponible pour le partitionnement de variation et le test de Mantel dans le package R *adespatial* (fonction *msr*). Cette partie a aussi nécessité le développement d'un simulateur de données d'espèces qui sera certainement intégré au package R *adespatial*. En conclusion, la modification du test d'hypothèse du partitionnement de variation et du test de Mantel est une avancée conséquente pour l'identification et la quantification de l'effet du filtrage environnemental puisqu'elle permet une estimation exempte des biais dû à la dispersion et illustre bien l'importance de prendre en compte des contraintes écologiques dans les modèles nuls associés aux tests d'hypothèses.

Cette thèse avait pour objectif d'élargir la boîte à outils méthodologique disponible en écologie pour améliorer l'identification et la quantification des processus écologiques responsables de l'assemblage des communautés et méta-communautés. Pour ce faire, l'étude proposait d'intégrer les échelles écologiques et les modèles nuls écologiquement contraints dans les méthodes multivariées reposant sur les tests d'hypothèses pour étudier l'effet de l'environnement. Les résultats obtenus, ainsi que ceux présents dans la littérature scientifique, montrent que les échelles écologiques et les modèles nuls écologiquement contraints sont des

solutions tout à fait pertinentes pour améliorer l'identification et la quantification des processus écologiques. Pour aller plus loin, le thèse soutient que ces deux approches ne doivent pas rester isolées et que l'adoption d'une approche multi-échelles combinée aux modèles nuls écologiquement contraints représenterait certainement une approche « clé de voûte » pour arriver à séparer correctement les processus écologique les uns des autres.

J'espère que ce voyage de quelques pages au cœur de l'écologie des communautés vous aura satisfait et que vous repartirez, cher(e) Lecteur(rice), avec de nombreuses nouvelles questions car, après tout, la science avance grâce à l'ensemble des réflexions que ces questions procurent.



REC

Appendices



00:00:00

3..2..1...1..2..3

List of appendices

Axis 1 – Chapter 1: Phylogenetic and spatial scaling of trait-mediated environmental filtering

<i>Appendix S1:</i> Standardisations applied in the multi-scale fourth-corner.....	188
<i>Appendix S2:</i> ACDC transformations of phylogenetic trees.....	190
<i>Appendix S3:</i> R scripts to reproduce the simulations of the manuscript.....	191
<i>Appendix S4:</i> Spatial profiles of the environmental vector for values of g equals to 0, 2 and 100.....	200
<i>Appendix S5:</i> Phylogenetic profiles of trait vector for values of ρ equals to -0.8 and 0.....	202
<i>Appendix S6:</i> Decomposition of trait-environment relationship across both spatial and phylogenetic scales.....	203
<i>Appendix S7:</i> Standard deviation associated to the mean R^2 represented in scalograms of Figure 4 of the main manuscript and Appendix S6.....	206

Axis 2 – Chapter 1: Testing the mantel statistic with a spatially-constrained permutation procedure

<i>Appendix 1:</i> Type I error rates and values of Mantel statistic for simple and partial Mantel tests and MSR-Mantel for irregular sampling with increasing number of samples.....	210
<i>Appendix 2:</i> Type I error rates and values of Mantel statistic for simple and partial Mantel tests and MSR-Mantel for a regular sampling.....	211
<i>Appendix 3:</i> Type I error rates and values of Mantel statistic for simple and partial Mantel tests and MSR-Mantel for regular sampling with increasing number of variables.....	212
<i>Appendix 4:</i> Type I error rates and values of Mantel statistic for simple and partial Mantel tests and MSR-Mantel for regular sampling with increasing number of samples.....	213
<i>Appendix 5:</i> Illustration of the MSR approach applied on Mantel test.....	214

Axis 2 – Chapter 2: Testing the mantel statistic with a spatially-constrained permutation procedure

Appendix S1: Mathematical details of the spatially-constrained variation partitioning procedure.....221

Appendix S2: Detailed simulation model used in the manuscript.....223

Appendix S3: Respective mean and standard deviation of [ab], [a] and [b] fractions in the three simulation scenarios.....225

Appendix S4: Effect of Moran’s Eigenvectors Maps selection on estimation and Type I error of fraction [a] in pure neutral metacommunities.....229

Appendix S5: Environmental contribution (fraction [ab]) of mixed metacommunities is a weighted mean of species sorting and neutral environmental contributions.....231

Appendix S6: Empirical application of the spatially-constrained variation partitioning.....233

Article in collaboration

Spatial frequency of global climatic conditions drives community functional composition: a test with Angiosperms.....238

Axis 1 – Chapter 1

Supplementary material ECOG-XXXX. Appendix S1. Sylvie Clappe, Pedro R. Peres-Neto and Stéphane Dray. Phylogenetic and spatial scaling of trait-mediated environmental filtering.

This document details the standardisations applied in the multi-scale fourth-corner.

The first step of the approach requires to calculate the classical fourth-corner correlation $cor(\mathbf{t}, \mathbf{e}) = \tilde{\mathbf{e}}_{\mathbf{w}_n}^T \cdot \mathbf{P} \cdot \tilde{\mathbf{t}}_{\mathbf{w}_s} = \tilde{\mathbf{t}}_{\mathbf{w}_s}^T \cdot \mathbf{P}^T \cdot \tilde{\mathbf{e}}_{\mathbf{w}_n}$ in which the environmental vector \mathbf{e} and the trait vector \mathbf{t} are the respectively standardized by \mathbf{W}_n (i.e., diagonal matrices of sites (rows) weights; see manuscript for details) and \mathbf{W}_s (i.e., diagonal matrix of species (columns) weights; see manuscript for details). $\tilde{\mathbf{e}}_{\mathbf{w}_n}$ and $\tilde{\mathbf{t}}_{\mathbf{w}_s}$ are standardized as follow:

$$\tilde{\mathbf{e}}_{\mathbf{w}_n} = \frac{\mathbf{e} - \sum_1^n \mathbf{W}_n \cdot \mathbf{e}}{\sqrt{\sum_1^n \mathbf{W}_n \cdot (\mathbf{e} - \sum_1^n \mathbf{W}_n \cdot \mathbf{e})^2}} \quad (\text{Eq. A1.1})$$

$$\tilde{\mathbf{t}}_{\mathbf{w}_s} = \frac{\mathbf{t} - \sum_1^s \mathbf{W}_s \cdot \mathbf{t}}{\sqrt{\sum_1^s \mathbf{W}_s \cdot (\mathbf{t} - \sum_1^s \mathbf{W}_s \cdot \mathbf{t})^2}} \quad (\text{Eq. A1.2})$$

Note that $\sum_1^n \mathbf{W}_n = 1$ and $\sum_1^s \mathbf{W}_s = 1$.

If the trait-environment relationship is significant, the final step of our approach is the decomposition of the relationship in phylogenetic and spatial scales in which each predicted environmental vector at the k -th spatial scale ($\hat{\mathbf{e}}_k$) and each predicted trait vector at the l -th phylogenetic scale ($\hat{\mathbf{t}}_l$) are standardized as follows:

$$\hat{\mathbf{e}}_{\mathbf{w}_n, k} = \frac{\hat{\mathbf{e}}_k - \sum_1^n \mathbf{w}_n \cdot \hat{\mathbf{e}}_k}{\sqrt{\sum_1^n \mathbf{w}_n \cdot (\hat{\mathbf{e}} - \sum_1^n \mathbf{w}_n \cdot \hat{\mathbf{e}})^2}} \quad (\text{Eq. A1.3})$$

$$\hat{\mathbf{t}}_{\mathbf{w}_s, l} = \frac{\hat{\mathbf{t}}_l - \sum_1^s \mathbf{w}_s \cdot \hat{\mathbf{t}}_l}{\sqrt{\sum_1^s \mathbf{w}_s \cdot (\hat{\mathbf{t}} - \sum_1^s \mathbf{w}_s \cdot \hat{\mathbf{t}})^2}} \quad (\text{Eq. A1.4})$$

where $\hat{\mathbf{e}}$ and $\hat{\mathbf{t}}$ are, respectively, the environmental matrix containing environmental vectors predicted at all spatial scales and the trait matrix containing trait vectors predicted at all phylogenetic scales. Each predicted environmental and trait vector are respectively divided

by the variance of $\hat{\mathbf{e}}$ and $\hat{\mathbf{t}}$ so that $\hat{\mathbf{e}}_{\mathbf{w}_n} = \sum_{k=1}^{n-1} \hat{\mathbf{e}}_{\mathbf{w}_n, k}$ and $\hat{\mathbf{t}}_{\mathbf{w}_s} = \sum_{l=1}^{s-1} \hat{\mathbf{t}}_{\mathbf{w}_s, l}$.

Supplementary material ECOG-XXXX. Appendix S2. Sylvie Clappe, Pedro R. Peres-Neto and Stéphane Dray. Phylogenetic and spatial scaling of trait-mediated environmental filtering.

This document details the ACDC transformations of phylogenetic trees.

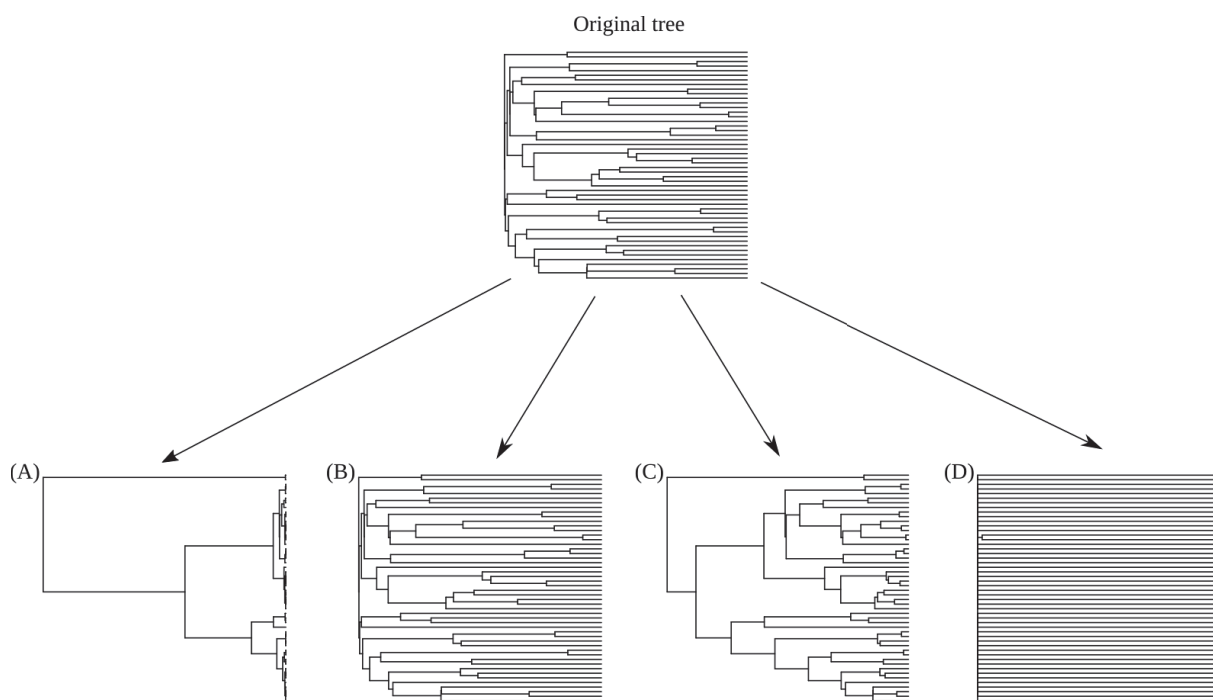

Figure A2: ACDC transformations of phylogenetic tree for (A) $g = -2$, (B) $g = 0$, (C) $g = 2$, and (D) $g = 100$.

Supplementary material ECOG-XXXX. Appendix S3. Sylvie Clappe, Pedro R. Peres-Neto and Stéphane Dray. Phylogenetic and spatial scaling of trait-mediated environmental filtering.

This document provides R scripts to reproduce the simulation presented in our manuscript. We present scenarios A and B detailed in the study with an environmental variable structured at large spatial scale ($\rho=0.8$) and a trait simulated under Brownian motion along a phylogenetic tree not modified by ACDC transformation ($g=0$).

Data

Performing the multi-scaled fourth corner approach requires five information: (i) a table of species abundances (species x sites), (ii) a species functional trait (one trait x species), (iii) an environmental variable (one variable x sites), (iv) a table of spatial predictors (sites x spatial predictors; here Moran's Eigenvector Maps; Dray et al. 2006), and (v) a table of phylogenetic predictors (sites x predictors; phylogenetic Moran's Eigenvector; Dray et al. 2006; Peres-Neto 2006).

```
### Required packages###
library(ade4)
library(spdep)
library(adespatial)
library(adegraphics)
library(ape)
library(adephylo)
library(phytools)
library(geiger)

### Simulation functions###
## Generate species community (from Peres-Neto et al. 2016)##
generate_community <- function(tolerance,E,T,preset_nspecies,preset_ncommunities){
  repeat {
    # one trait, one environmental variable
    h <- runif(preset_nspecies,min=0.3,max=1)
    sigma <- runif(preset_nspecies)*tolerance
    L <- matrix(data=0,nrow=preset_ncommunities,ncol=preset_nspecies)
    for(j in 1:preset_nspecies){
      L[,j] <- rpois(preset_ncommunities,30*h[j]*exp(-(E-T[j])^2/(2*sigma[j]^2)))
    }
    n_species_c <- sum(colSums(L)!=0) # _c for check
    n_communities_c <- sum(rowSums(L)!=0)
    if ((n_species_c == preset_nspecies) & (n_communities_c == preset_ncommunities))
    {break}
  }
}
```

```

}
return(L)
}

##Generate spatially structured environmental on a 15x15 grid##
generate_env<-function(x,autocor,M){
  grid1 <- cell2nb(M,M)
  lw2 <- nb2listw(grid1)
  rhos1 <- autocor
  matInv1 <- lapply(rhos1, function (y) invlrW(lw2,y))
  alea1 <- matrix(rnorm(x*length(grid1)),nrow=length(grid1))
  envvec <- lapply(matInv1,function(z) scale(z%*%alea1))
  envmatrix<-envvec[[1]]
  colnames(envmatrix)<-paste("X_",seq(1,x,1),"_",autocor,sep="")
  rownames(envmatrix)<-seq(1,M*M,1)
  return(envmatrix)
}

###Data simulation###
set.seed(1)
##Generate an environmental vector with 225 sites structured at large spatial scale##
environment <- generate_env(1, 0.8, 15)

##Generate trait values along a phylogenetic tree##
#Pure birth model to generate the phylogenetic tree#
tree <- pbtree(b = 1, d = 0, n = 50, nsim = 1)

#ACDC transformation#
tree <- rescale(tree, "EB", 0)#no transformation

#Trait values#
trait <- rTraitCont(tree, model = "BM")

##Generate species distributions##
species<- generate_community(tolerance = 1.5, scale(environment), scale(trait), 50,
225)

##Generate the spatial vectors (MEM)##
grid.env <- cell2nb(15, 15)
lw1.env <- nb2listw(grid.env)
MEM <- scores.listw(listw = lw1.env, MEM.autocor = "all")

##Generate the phylogenetic vectors (PME)##
PME <- me.phylo(tree, f = function(x) 1-(x/max(x)))
colnames(PME) <- paste("PME", seq(1,49,1), sep="")

```

Multi-scale fourth-corner

The multi-scaled fourth-corner can now be performed to (i) identify if the species functional trait is linked to the environment variable, (ii) identify the spatial scale at which trait-mediated environmental filtering is acting, (iii) identify the phylogenetic signal of the trait involved in the filtering, and (iv) identify the association (and its strength) of spatial and phylogenetic scales of trait-mediated environmental filtering.

Function (soon in adespatial)

```
###Function###
fourth.spatial.phylo.test<- function(L, R, Q, MEM, PME, nblocks.MEM = ncol(MEM),
nblocks.PME = ncol(PME), nbperm = nbperm){

fourth.stat.simple <- function (L, R, Q){
  ##First : Definig blocks and transform MEM and PME in matrices
  MEM <- as.matrix(MEM)
  PME <- as.matrix(PME)
  fac.MEM <- cut(1 : ncol(MEM), nblocks.MEM)
  col.start.m <- tapply(1 : ncol(MEM), fac.MEM, min)
  col.stop.m <- tapply(1 : ncol(MEM), fac.MEM, max)

  fac.PME <- cut(1 : ncol(PME), nblocks.PME)
  col.start.p <- tapply(1 : ncol(PME), fac.PME, min)
  col.stop.p <- tapply(1 : ncol(PME), fac.PME, max)

  ##Second : calculate the 4th corner statistic

  Pn <- apply(L, 1, sum)#row total abundance
  Ps <- apply(L, 2, sum)#column total abundance
  Ptot <- sum(L)#total abundance
  P <- as.matrix(L/Ptot)

  Fn <- Pn/Ptot
  Fs <- Ps/Ptot

  Wn <- diag(Fn)#sites weights
  Ws <- diag(Fs)#species weights

  #Standardise R and Q by weights
  Qst <- (Q-sum(Fs*Q))/sqrt(sum(Fs*(Q-sum(Fs*Q))^2))#standardised trait
  Rst <- (R-sum(Fn*R))/sqrt(sum(Fn*(R-sum(Fn*R))^2))#standardised env

  #fourth corner statistic
  CA.L <- dudi.coa(L, scannf = F, nf = 3)

  fourth.corner <- t(Rst) %*% P %*% Qst
  Chessel.fourth.corner <- fourth.corner/sqrt(CA.L$eig[1])
  return(fourth.corner)
}

fourth.stat <- function (L, R, Q, MEM, PME, nblocks.MEM, nblocks.PME){
```

```

##First : Defining blocks and transform MEM and PME in matrices
MEM <- as.matrix(MEM)
PME <- as.matrix(PME)
fac.MEM <- cut(1 : ncol(MEM), nblocks.MEM)
col.start.m <- tapply(1 : ncol(MEM), fac.MEM, min)
col.stop.m <- tapply(1 : ncol(MEM), fac.MEM, max)

fac.PME <- cut(1 : ncol(PME), nblocks.PME)
col.start.p <- tapply(1 : ncol(PME), fac.PME, min)
col.stop.p <- tapply(1 : ncol(PME), fac.PME, max)

##Second : calculate the 4th corner statistic

Pn <- apply(L, 1, sum)
Ps <- apply(L, 2, sum)
Ptot <- sum(L)
P <- as.matrix(L/Ptot)

Fn <- Pn/Ptot
Fs <- Ps/Ptot

Wn <- diag(Fn)
Ws <- diag(Fs)

#Standardise R and Q by weights
Qst <- (Q-sum(Fs*Q))/sqrt(sum(Fs*(Q-sum(Fs*Q))^2))
Rst <- (R-sum(Fn*R))/sqrt(sum(Fn*(R-sum(Fn*R))^2))

#fourth corner statistic
CA.L <- dudi.coa(L, scannf = F, nf = 3)

fourth.corner <- t(Rst) %*% P %*% Qst
Chessel.fourth.corner <- fourth.corner/sqrt(CA.L$eig[1])

##Third: Spatial and Phylogenetic decomposition of the fourth corner statistic
#Prediction of R by all MEMs, prediction of Q by all PMEs
f2 <- function(Y, X) {lm(Y~X-1)$fitted}
R.predMEM.tot <- f2(R, MEM)
Q.predPME.tot <- f2(Q, PME)

#R predicted by MEMs
R.predMEM <- apply(MEM, 2, f2, Y=R)
colnames(R.predMEM) <- paste("Xpred-MEM", seq(1,dim(MEM)[2],1))
Rst.predMEM <- (R.predMEM-sum(Fn*R.predMEM))/sqrt(sum(Fn*(R.predMEM.tot-
sum(Fn*R.predMEM.tot))^2))

#Q predicted by PME
Q.predPME <- apply(PME, 2, f2, Y=Q)
colnames(Q.predPME) <- paste("Qpred-PME", seq(1,dim(PME)[2],1))
Qst.predPME <- (Q.predPME-sum(Fs*Q.predPME))/sqrt(sum(Fs*(Q.predPME.tot-
sum(Fs*Q.predPME.tot))^2))

#Function to calculate the fourth corner statistic
f3 <- function(Env, Weights, Traits){t(Env) %*% Weights %*% Traits}
f4 <- function(Traits, Weights, Env){t(Traits) %*% t(Weights) %*% Env}

#Perform the fourth corner statistic for all spatial and phylogenetic scale

```



```

independently
spatial.decomp <- apply(Rst.predMEM, 2, f3, Weights = P, Traits = Qst)^2
names(spatial.decomp) <- seq(1, ncol(MEM), 1)
sum.spatial.decomp <- sum(spatial.decomp)
spatial.decomp <- spatial.decomp / sum.spatial.decomp

phylo.decomp <- apply(Qst.predPME, 2, f4, Weights = P, Env = Rst)^2
names(phylo.decomp) <- seq(1, ncol(PME), 1)
sum.phylo.decomp <- sum(phylo.decomp)
phylo.decomp <- phylo.decomp / sum.phylo.decomp

#Smooth if needed: if nblocks.MEM < ncol(MEM) and nblocks.PME < ncol(PME)
if(nblocks.MEM < ncol(MEM)){
  spatial.decomp <- tapply(spatial.decomp, fac.MEM, sum)
  names(spatial.decomp) <- paste(col.start.m, col.stop.m, sep = "-")
}else{spatial.decomp <- spatial.decomp}

if(nblocks.PME < ncol(PME)){
  phylo.decomp <- tapply(phylo.decomp, fac.PME, sum)
  names(phylo.decomp) <- paste(col.start.p, col.stop.p, sep = "-")
}else{phylo.decomp <- phylo.decomp}

##Fourth: Spatial and Phylogenetic decomposition at the same time
spatio.phylo.decomp <- matrix(NA, nrow = ncol(Rst.predMEM), ncol =
ncol(Qst.predPME))
colnames(spatio.phylo.decomp) <- colnames(PME)
rownames(spatio.phylo.decomp) <- colnames(MEM)
for (nbQpred in 1 : ncol(Qst.predPME)){
  spatio.phylo.decomp[,nbQpred] <- apply(Rst.predMEM, 2, f3, Weights = P, Traits =
Qst.predPME[,nbQpred])^2
}
spatio.phylo.decomp <- spatio.phylo.decomp / sum(spatio.phylo.decomp)

if (nblocks.MEM == ncol(MEM) && nblocks.PME == ncol(PME)) {
  spatio.phylo.decomp.final <- spatio.phylo.decomp
}else{
  spatio.phylo.decomp.blocks <- matrix(NA, nrow = nblocks.MEM, ncol = nblocks.PME)
  colnames(spatio.phylo.decomp.blocks) <- paste(col.start.p, col.stop.p, sep = "-")
  rownames(spatio.phylo.decomp.blocks) <- paste(col.start.m, col.stop.m, sep = "-")

  for (nblocksPME in 1 : nblocks.PME){
    for (nblocksMEM in 1 : nblocks.MEM){
      spatio.phylo.decomp.blocks [nblocksMEM, nblocksPME] <-
sum(spatio.phylo.decomp[col.start.m[nblocksMEM] : col.stop.m[nblocksMEM],
col.start.p[nblocksPME] : col.stop.p[nblocksPME]])
    }
  }
  spatio.phylo.decomp.final <- spatio.phylo.decomp.blocks
}
return(list(fourth.corner = fourth.corner, Chessel.fourth.corner = Chessel.fourth.corner,
spatial.decomp = spatial.decomp, phylo.decomp = phylo.decomp,spatio.phylo.decomp =
spatio.phylo.decomp.final ))
}
##Fifth: test the significance of everything by permutation tests
#Do the test to have the observed values
obs <- fourth.stat(L = L, R = R, Q = Q, MEM = MEM, PME = PME, nblocks.MEM =
nblocks.MEM, nblocks.PME = nblocks.PME)

```

```

spatial.decomp.sim <- matrix(NA, nrow = nbperm, ncol = nblocks.MEM)
phylo.decomp.sim <- matrix(NA, nrow = nbperm, ncol = nblocks.PME)
decomp.sim1 <- matrix(NA, nrow = nbperm, ncol = nblocks.MEM * nblocks.PME)
decomp.sim2 <- matrix(NA, nrow = nbperm, ncol = nblocks.MEM * nblocks.PME)
decomp.sim3 <- matrix(NA, nrow = nbperm, ncol = nblocks.MEM * nblocks.PME)

Rmsr <- msr(R, MEM, nrepet = nbperm, simplify = T)
Qmsr <- msr(Q, PME, nrepet = nbperm, simplify = T)

fourth.sim.Rmsr <- apply(Rmsr, 2, fourth.stat.simple, L = L, Q = Q)
fourth.sim.Qmsr <- apply(Qmsr, 2, fourth.stat.simple, L = L, R = R)

fourth.Rmsr.pval <- as.krandtest(obs = obs$fourth.corner, sim =
as.matrix(fourth.sim.Rmsr))
fourth.Qmsr.pval <- as.krandtest(obs = obs$fourth.corner, sim =
as.matrix(fourth.sim.Qmsr))
fourth.pval.max <- max( fourth.Rmsr.pval$pvalue, fourth.Qmsr.pval$pvalue)

if (fourth.pval.max <= 0.05){
  if(is.matrix(R) == FALSE){R <- as.matrix(R)}
  if(is.matrix(Q) == FALSE){Q <- as.matrix(Q)}
}

for (nperm in 1 : nbperm){
  MEM.rnd <- MEM[sample(nrow(MEM)),]
  PME.rnd <- PME[sample(nrow(PME)),]

  sim.MEMperm <- fourth.stat(L, R, Q, MEM.rnd, PME, nblocks.MEM = nblocks.MEM,
nblocks.PME = nblocks.PME)
  sim.PMEperm <- fourth.stat(L, R, Q, MEM, PME.rnd, nblocks.MEM = nblocks.MEM,
nblocks.PME = nblocks.PME)

  spatial.decomp.sim[nperm,] <- sim.MEMperm$spatial.decomp
  phylo.decomp.sim[nperm,] <- sim.PMEperm$phylo.decomp
  decomp.sim1[nperm,] <- fourth.stat(L, R, Q, MEM.rnd, PME.rnd, nblocks.MEM =
nblocks.MEM, nblocks.PME = nblocks.PME)$spatio.phylo.decomp
  decomp.sim2[nperm,] <- sim.MEMperm$spatio.phylo.decomp
  decomp.sim3[nperm,] <- sim.PMEperm$spatio.phylo.decomp
}
  spatial.decomp.pval <- as.krandtest(obs = obs$spatial.decomp, sim =
spatial.decomp.sim, names = paste("MEM",names(obs$spatial.decomp)))
  phylo.decomp.pval <- as.krandtest(obs = obs$phylo.decomp, sim =
phylo.decomp.sim, names = paste("PME",names(obs$phylo.decomp)))

  PMEnames <- as.vector(t(matrix(rep( paste("PME",
colnames(obs$spatio.phylo.decomp)), nblocks.MEM), nrow = nblocks.PME, ncol =
nblocks.MEM)))
  MEMnames <- rep(paste("MEM", rownames(obs$spatio.phylo.decomp)), nblocks.PME)
  names.tot <- paste(PMEnames, MEMnames)

  decomp.sim1.pval <- as.krandtest(obs =
as.vector(as.vector(obs$spatio.phylo.decomp)), sim = decomp.sim1, names = names.tot)
  decomp.sim2.pval <- as.krandtest(obs =

```

```

as.vector(as.vector(obs$spatio.phylo.decomp)), sim = decomp.sim2, names = names.tot)
  decomp.sim3.pval <- as.krandtest(obs =
as.vector(as.vector(obs$spatio.phylo.decomp)), sim = decomp.sim3, names = names.tot)
  decomp.sim4.pval <- apply(cbind(decomp.sim2.pval$pvalue,
decomp.sim3.pval$pvalue), 1, max)

  res.frouth.corner <- rbind(obs$fourth.corner, obs$Chessel.fourth.corner,
fourth.Rmsr.pval$pvalue, fourth.Qmsr.pval$pvalue, fourth.pval.max)
  rownames(res.frouth.corner) <- c("fourth. corner", "Chessel.fourth.corner", "R_MSR-
randomization p-value", "Q_MSR-randomization p-value", "maximum p-value")

  res.decomp.spatial <- cbind(as.matrix(obs$spatial.decomp),
as.matrix(spatial.decomp.pval$pvalue))
  colnames(res.decomp.spatial) <- c("observed spatial decomposition", "p-value")
  rownames(res.decomp.spatial) <- paste("MEM", names(obs$spatial.decomp))

  res.decomp.phylo <- cbind(as.matrix(obs$phylo.decomp),
as.matrix(phylo.decomp.pval$pvalue))
  colnames(res.decomp.phylo) <- c("observed phylo decomposition", "p-value")
  rownames(res.decomp.phylo) <- paste("PME", names(obs$phylo.decomp))

  res.decomp.spatio.phylo <- cbind(decomp.sim1.pval$obs, decomp.sim1.pval$pvalue,
decomp.sim2.pval$pvalue, decomp.sim3.pval$pvalue, decomp.sim4.pval)
  rownames(res.decomp.spatio.phylo) <- decomp.sim1.pval$names
  colnames(res.decomp.spatio.phylo) <- c("Obs", "MEM&PME-perm p-value", "MEM-perm
p-value", "PME-perm p-value", "p-val max")

  return(list(summary.fourth.corner = res.frouth.corner, spatial.decomposition =
res.decomp.spatial, phylo.decomposition = res.decomp.phylo, spatio.phylo.decomposition
= res.decomp.spatio.phylo))
}

else{
  res.frouth.corner <- rbind(obs$fourth.corner, obs$Chessel.fourth.corner,
fourth.Rmsr.pval$pvalue, fourth.Qmsr.pval$pvalue, fourth.pval.max)
  rownames(res.frouth.corner) <- c("fourth. corner", "Chessel.fourth.corner", "R_MSR-
randomization p-value", "Q_MSR-randomization p-value", "maximum p-value")

  return(list(summary.fourth.corner = res.frouth.corner, spatial.decomposition = NULL,
phylo.decomposition = NULL, spatio.phylo.decomposition = NULL))
}
}

```

Scenario A: trait and environmental vectors are linked

```
###Scenario A###
res.A <- fourth.spatial.phylo.test(L = species, R = environment , Q = trait, MEM = MEM,
PME = PME, nblocks.MEM = 15, nblocks.PME = 7, nbperm = 99)
res.A$summary.fourth.corner
##
## fourth. corner [ ,1]
## Chessel.fourth.corner 0.5076006
## R_MSR-randomization p-value 0.0100000
## Q_MSR-randomization p-value 0.0100000
## maximum p-value 0.0100000
```

The relationship between trait and environment is significant (maximum p-value<0.05), the approach thus decomposes this relationship into spatial scales, phylogenetic scales and both of them.

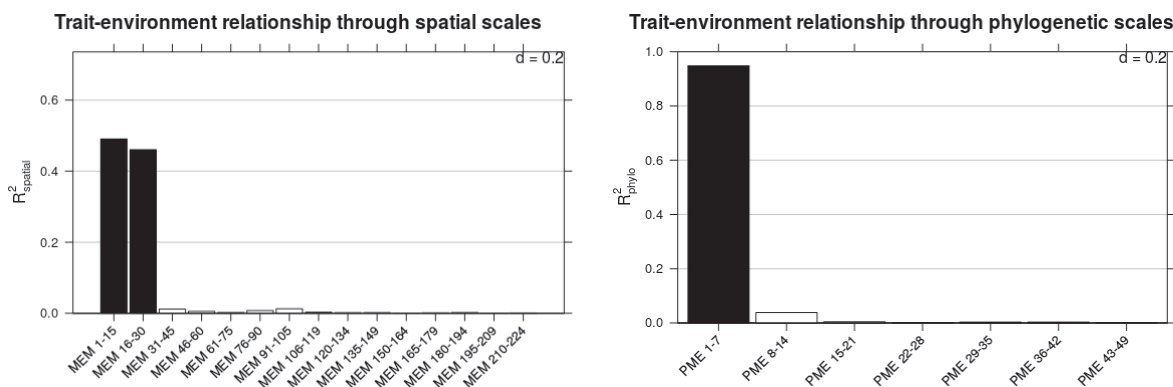

Our approach successfully detects large spatial and phylogenetic scales as significant (black bars). The environmental variable involved in the trait-environment filtering thus filters the trait at large spatial scales. Similarly, the strong phylogenetic signal of the trait implies that trait value are strongly conserved along the phylogeny.

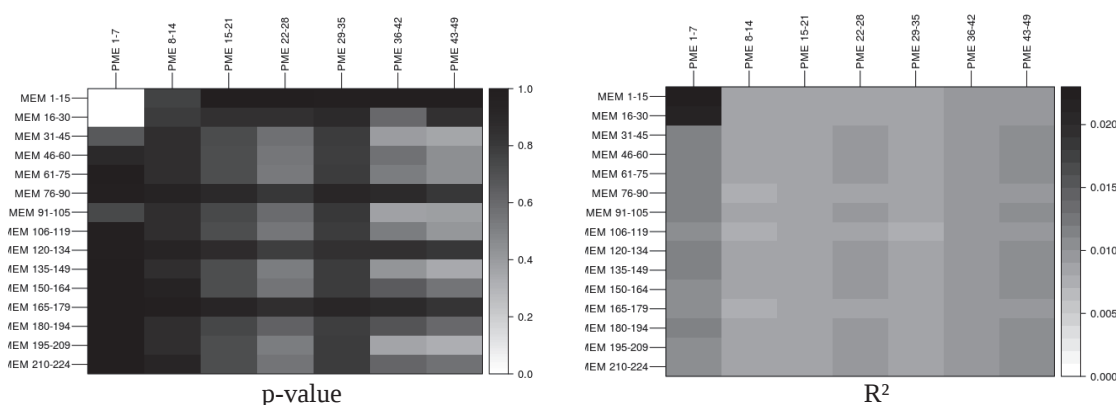

As expected, our framework detected significant associations with a higher R^2 solely between large spatial scales and large phylogenetic scales meaning that the environmental variable (partially) structured the phylogenetic signal at large spatial scale suggesting that the trait-mediated environmental filtering at large spatial scale could be ancient.

Scenario B: trait and environmental vectors are unrelated

```
###Scenario B###
environment2 <- generate_env(1, 0.8, 15)
tree2 <- pbtree(b = 1, d = 0, n = 50, nsim = 1)
tree2 <- rescale(tree2, "EB", 0)
trait2 <- rTraitCont(tree2, model = "BM")

res.B <- fourth.spatial.phylo.test(L = species, R = environment2 , Q = trait2, MEM =
MEM, PME = PME, nblocks.MEM = 15, nblocks.PME = 7, nbperm = 99)
res.B
## $summary.fourth.corner
##                               [,1]
## fourth. corner                -0.0003827166
## Chessel.fourth.corner         -0.0007004944
## R_MSR-randomization p-value   0.4700000000
## Q_MSR-randomization p-value   0.5000000000
## maximum p-value              0.5000000000
##
## $spatial.decomposition
## NULL
##
## $phylo.decomposition
## NULL
##
## $spatio.phylo.decomposition
## NULL
```

As expected, the approach does not detect significant relationship between trait2 and environment2 (maximum p-value>0.05) as they were simulated unrelated. As such, the approach stops at the first step (i.e., test of trait-environment relationship) and the decomposition of the trait-environment relationship across spatial and phylogenetic scales is not performed.

Supplementary material ECOG-XXXX. Appendix S4. Sylvie Clappe, Pedro R. Peres-Neto and Stéphane Dray. Phylogenetic and spatial scaling of trait-mediated environmental filtering.

This document reports spatial profiles of the 1000 environmental vectors used in the simulations of scenario A of the manuscript for every values of the ACDC phylogenetic tree transformation parameter g equals: 0 (Fig. A4.1), 2 (Fig. A4.2), and 100 (Fig. A4.3).

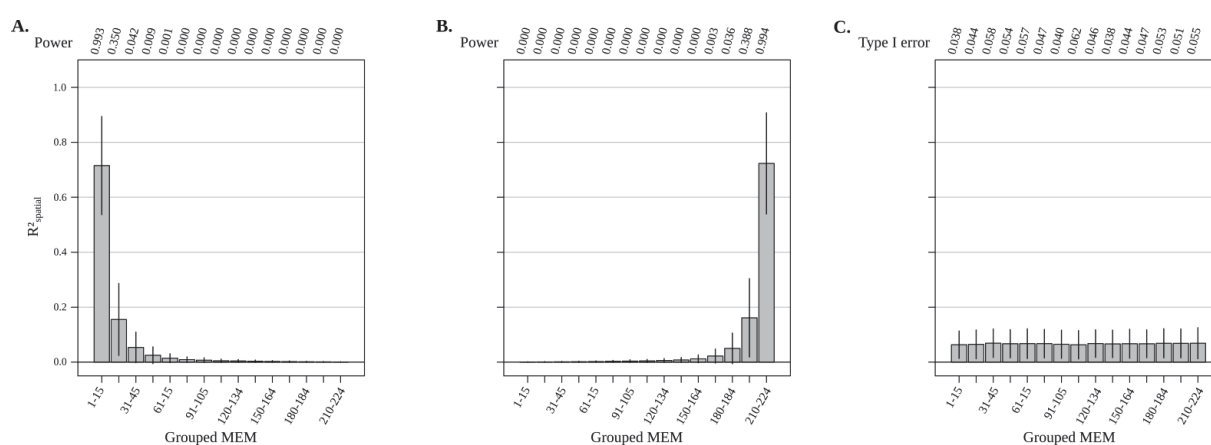

Figure A4.1: Spatial signal of the environmental variable involved in trait-environment relationship for a trait evolving under a phylogenetic tree ACDC transformed with $g = 0$. (A-B) R^2 estimations and power of spatial scales for environment variable simulated at (A) large spatial scale ($\rho = 0.8$) and (B) fine spatial scale ($\rho = -0.8$). (C) R^2 estimations and type I error rates of spatial scales for environment variable simulated with no spatial structure ($\rho = 0$). (A-C) Scalograms represent the mean spatial signal over the 1000 simulations. Vertical black bars are the standard deviations. MEM are regrouped to meet 15 blocks of eigenvectors to smooth the spatial signal.

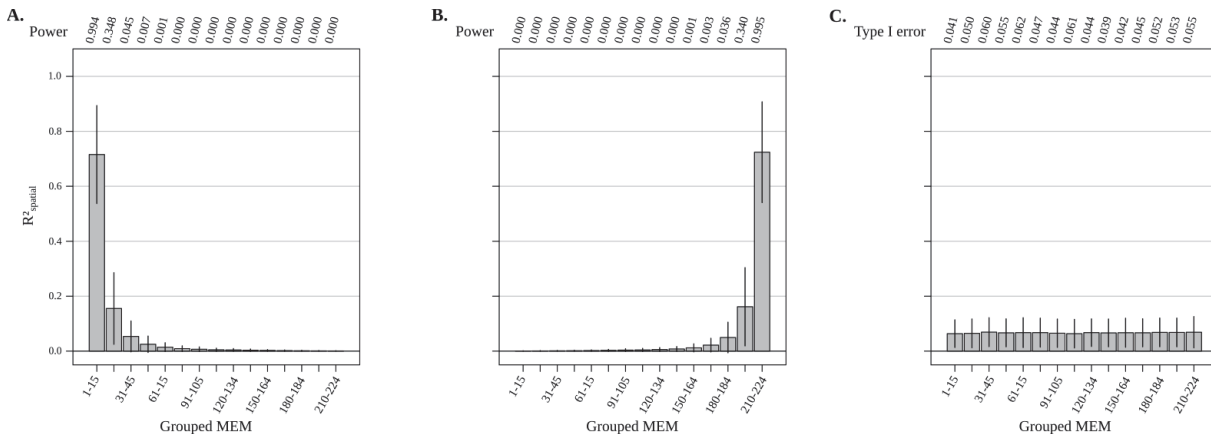

Figure 4.2: Spatial signal of the environmental variable involved in trait-environment relationship for a trait evolving under a phylogenetic tree ACDC transformed with $g = 2$. (A-B) R^2 estimations and power of spatial scales for environment variable simulated at (A) large spatial scale ($\rho = 0.8$) and (B) fine spatial scale ($\rho = -0.8$). (C) R^2 estimations and type I error rates of spatial scales for environment variable simulated with no spatial structure ($\rho = 0$). (A-C) Scalograms represent the mean spatial signal over the 1000 simulations. Vertical black bars are the standard deviations. MEM are regrouped to meet 15 blocks of eigenvectors to smooth the spatial signal.

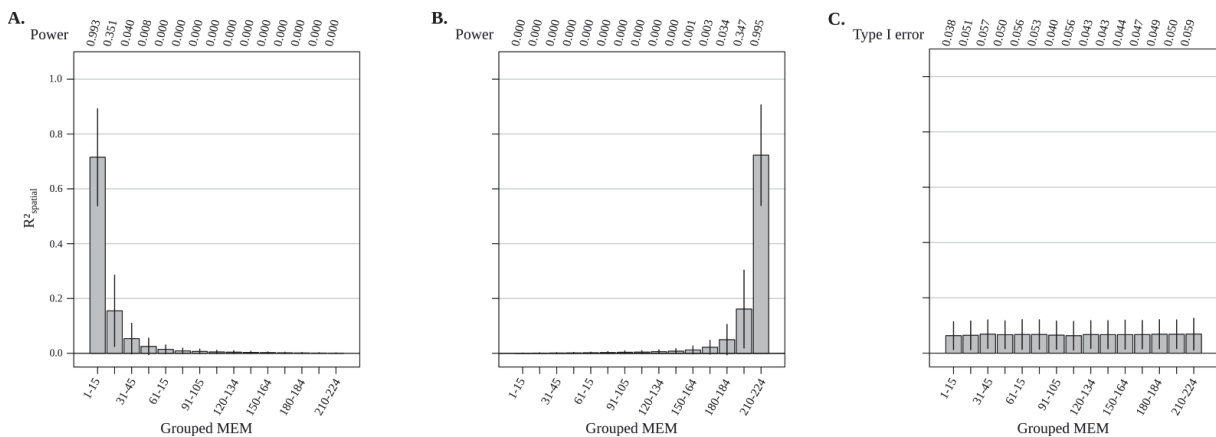

Figure 4.3: Spatial signal of the environmental variable involved in trait-environment relationship for a trait evolving under a phylogenetic tree ACDC transformed with $g = 100$. (A-B) R^2 estimations and power of spatial scales for environment variable simulated at (A) large spatial scale ($\rho = 0.8$) and (B) fine spatial scale ($\rho = -0.8$). (C) R^2 estimations and type I error rates of spatial scales for environment variable simulated with no spatial structure ($\rho = 0$). (A-C) Scalograms represent the mean spatial signal over the 1000 simulations. Vertical black bars are the standard deviations. MEM are regrouped to meet 15 blocks of eigenvectors to smooth the spatial signal.

Supplementary material ECOG-XXXX. Appendix S5. Sylvie Clappe, Pedro R. Peres-Neto and Stéphane Dray. Phylogenetic and spatial scaling of trait-mediated environmental filtering.

This document reports phylogenetic profiles of the 1000 trait vectors used in the simulations of scenario A of the manuscript for every environmental structures defined by $\rho = -0.8$ (Fig. A5.1) and $\rho = 0$ (Fig. A5.2).

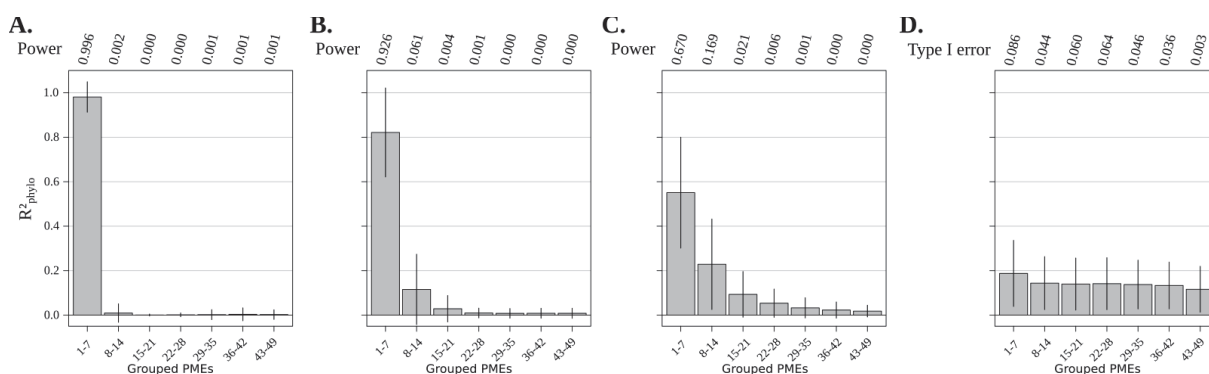

Figure A5.1: Phylogenetic signal of the trait variable involved in trait-environment relationship for an environmental variable structured at fine spatial scale ($\rho = -0.8$). (A-C) R^2 estimations and power of phylogenetic scales for trait vector simulated with phylogenetic signal (A) stronger than Brownian motion ($g = -2$), (B) equal to Brownian motion ($g = 0$), and (C) weaker than Brownian motion ($g = 2$). (D) R^2 estimations and type I error rates of phylogenetic scales for trait vector simulated with no phylogenetic structure ($g = 100$). (A-D) Scalograms represent the mean spatial signal over the 1000 simulations. Vertical black bars are the standard deviations. PME are regrouped to meet 7 blocks of eigenvectors to smooth the spatial signal.

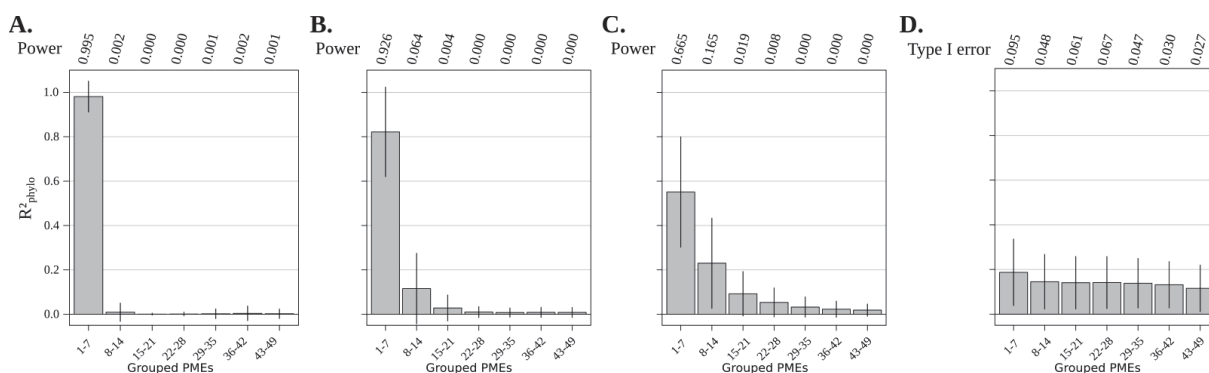

Figure A5.2: Phylogenetic signal of the trait variable involved in trait-environment relationship for an environmental variable not spatially structured ($\rho = 0$). (A-C) R^2 estimations and power of phylogenetic scales for trait vector simulated with phylogenetic signal (A) stronger than Brownian motion ($g = -2$), (B) equal to Brownian motion ($g = 0$), and (C) weaker than Brownian motion ($g = 2$). (D) R^2 estimations and type I error rates of phylogenetic scales for trait vector simulated with no phylogenetic structure ($g = 100$). (A-D) Scalograms represent the mean spatial signal over the 1000 simulations. Vertical black bars are the standard deviations. PME are regrouped to meet 7 blocks of eigenvectors to smooth the spatial signal.

Supplementary material ECOG-XXXX. Appendix S6. Sylvie Clappe, Pedro R. Peres-Neto and Stéphane Dray. Phylogenetic and spatial scaling of trait-mediated environmental filtering.

This document details the decomposition of trait-environment relationship through both spatial and phylogenetic scales to associate phylogenetic structure to particular spatial scales. As such, the strength of the association were characterized for all combination of spatial and phylogenetic scales. Results are presented in term of R^2 associated with its statistical power or type I error rate. Phylogenetic signal of trait are successively tested with environmental variable structured at large spatial scale ($\rho = 0.8$;Fig. A6.1), fine spatial scale ($\rho = -0.8$;Fig. A6.2) and not spatially structured ($\rho = 0$;Fig. A6.3).

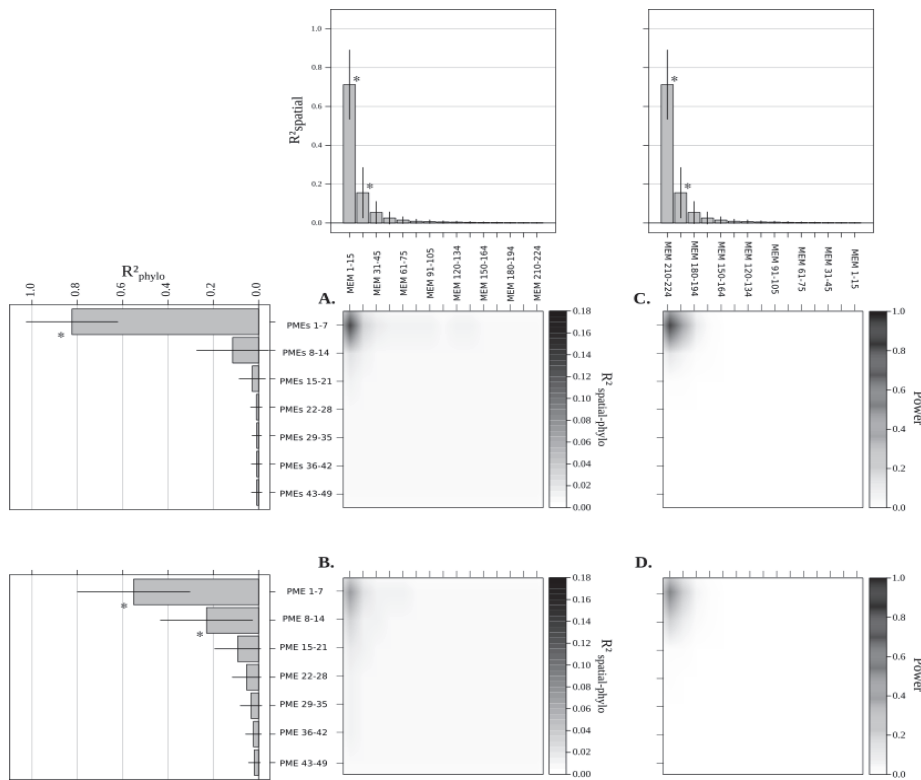

Figure 6.1: Decomposition of trait-environment relationship through both spatial and phylogenetic scales when environmental vector structured at large scale ($\rho = 0.8$) only. (A-B) R^2 estimations of the trait-environmental relationship when environmental variable is structured at large scale and trait presenting phylogenetic signal (A) equal to Brownian motion ($g = 0$) and (C) weaker than Brownian motion ($g = 2$). Standard deviations are reported in Appendix S7 Table S2. (C-D) Statistical power associated with the R^2 estimations of the trait-environment relationship decomposition. (A-D) Scalograms represent the phylogenetic and spatial signals alone as reported in figures 2 and 3 of the main manuscript to facilitate the interpretation of the maps. The stars indicate the significant phylogenetic and spatial scales.

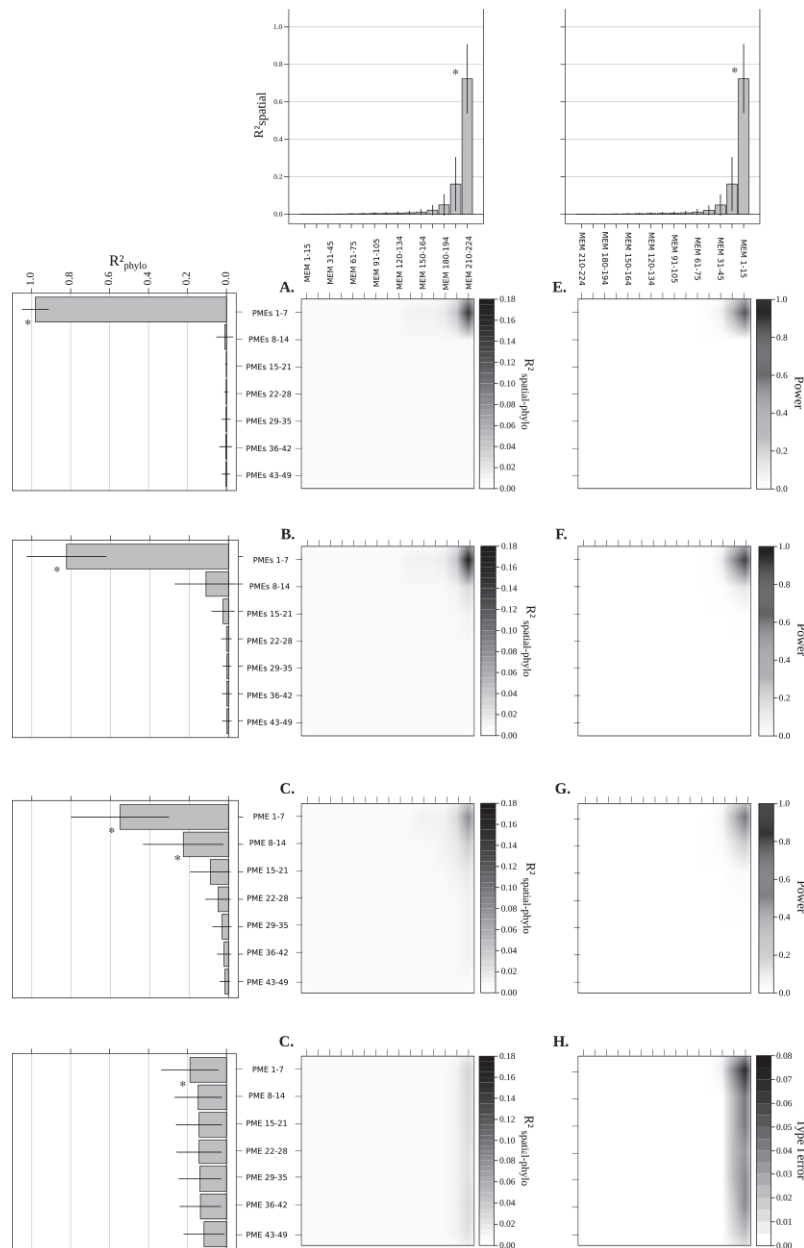

Figure 6.2 : Decomposition of trait-environment relationship through both spatial and phylogenetic scales when environmental vector structured at fine scale ($\rho = -0.8$) only. (A-D) R^2 estimations of the trait-environmental relationship when environmental variable is structured at large scale and trait presenting phylogenetic signal (A) stronger than Brownian motion ($g = -2$), (B) equal to Brownian motion ($g = 0$), and (C) weaker than Brownian motion ($g = 2$), and (D) no phylogenetic structure ($g = 100$). Standard deviations are reported in Appendix S7 Table S3. (E-H) Statistical power (E, F, G) and type I error rates (H) associated with the R^2 estimations of the trait-environment relationship decomposition. (A-D) Scalograms represent the phylogenetic and spatial signals alone as reported in figures 2 and 3 of the main manuscript to facilitate the interpretation of the maps. The stars indicate the significant phylogenetic and spatial scales.

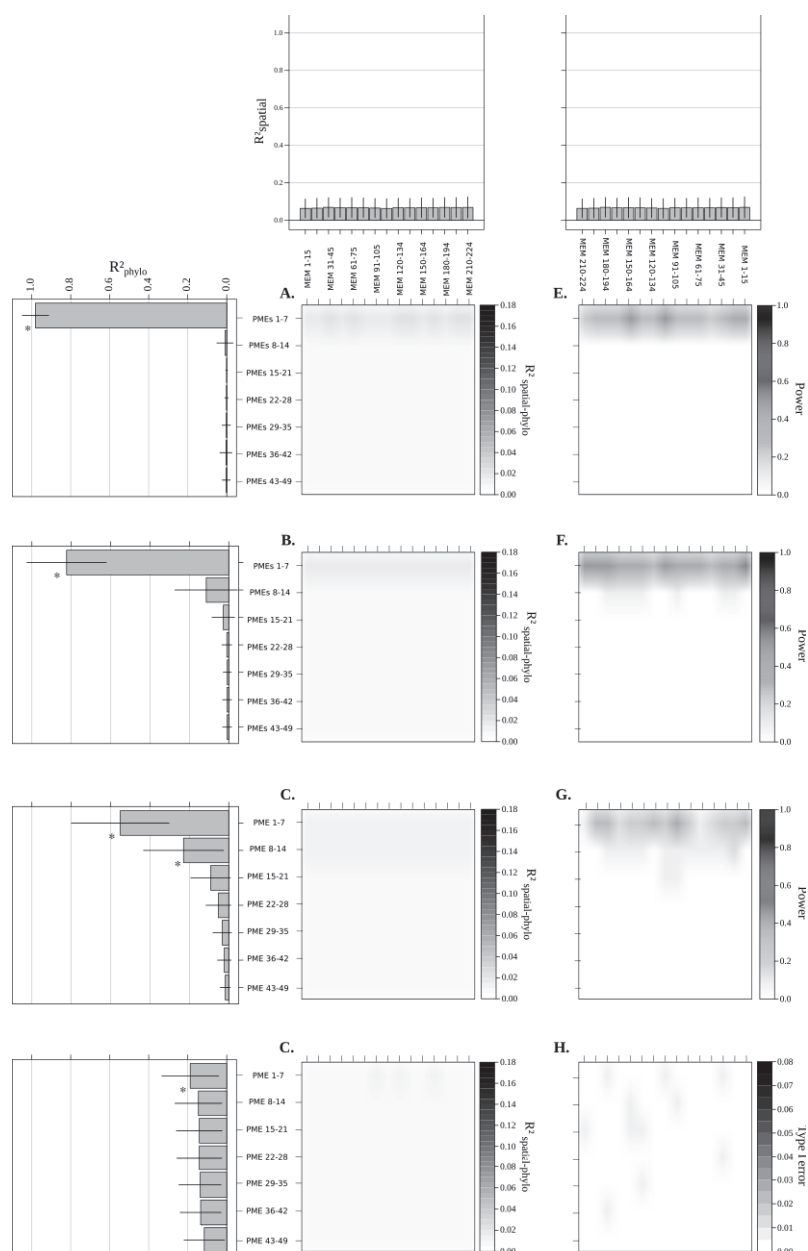

Figure 6.3 : Decomposition of trait-environment relationship through both spatial and phylogenetic scales when environmental vector is not spatially structured ($\rho = 0$). (A-D) R^2 estimations of the trait-environmental relationship when environmental variable is structured at large scale and trait presenting phylogenetic signal (A) stronger than Brownian motion ($g = -2$), (B) equal to Brownian motion ($g = 0$), and (C) weaker than Brownian motion ($g = 2$), and (D) no phylogenetic structure ($g = 100$). Standard deviations are reported in Appendix S7 Table S4. (E-H) Statistical power (E, F, G) and type I error rates (H) associated with the R^2 estimations of the trait-environment relationship decomposition. (A-D) Scalograms represent the phylogenetic and spatial signals alone as reported in figures 2 and 3 of the main manuscript to facilitate the interpretation of the maps. The stars indicate the significant phylogenetic and spatial scales.

Supplementary material ECOG-XXXX. Appendix S7. Sylvie Clappe, Pedro R. Peres-Neto and Stéphane Dray. Phylogenetic and spatial scaling of trait-mediated environmental filtering.

This document reports the standard deviation associated to the mean R^2 represented in scalograms of Figure 4 of the main manuscript (Table A7.1) and Appendix S6 figures A6.1 (Table A7.2), A6.2 Table A7.3) and A6.3 (Table A7.4).

Table A7.1: Standard deviations associated with R^2 reported in Figure 4.

Trait phylogenetic signal (g)	Grouped PME	Grouped MEM																			
		1-15	16-30	31-45	46-60	61-75	76-90	91-105	106-119	120-134	135-149	150-164	165-179	180-194	195-209	210-224					
$g=-2$	1-7	0.2300	0.0610	0.0180	0.0130	0.0072	0.0067	0.0062	0.0054	0.0058	0.0059	0.0058	0.0057	0.0057	0.0057	0.0057	0.0058	0.0058			
	8-14	0.0072	0.0032	0.0032	0.0032	0.0032	0.0032	0.0032	0.0030	0.0032	0.0032	0.0032	0.0032	0.0032	0.0032	0.0032	0.0032	0.0032			
	15-21	0.0031	0.0031	0.0032	0.0032	0.0032	0.0032	0.0032	0.0030	0.0032	0.0032	0.0032	0.0032	0.0032	0.0032	0.0032	0.0032	0.0032			
	22-28	0.0048	0.0031	0.0032	0.0032	0.0032	0.0032	0.0032	0.0030	0.0032	0.0032	0.0032	0.0032	0.0032	0.0032	0.0032	0.0032	0.0032			
	29-35	0.0047	0.0031	0.0032	0.0032	0.0032	0.0032	0.0032	0.0030	0.0032	0.0032	0.0032	0.0032	0.0032	0.0032	0.0032	0.0032	0.0032			
	36-42	0.0038	0.0033	0.0032	0.0032	0.0032	0.0033	0.0032	0.0030	0.0033	0.0033	0.0033	0.0033	0.0033	0.0033	0.0033	0.0033	0.0033			
	43-49	0.0043	0.0033	0.0033	0.0033	0.0033	0.0033	0.0033	0.0031	0.0033	0.0033	0.0034	0.0034	0.0034	0.0034	0.0034	0.0034	0.0034			
$g=100$	1-7	0.0420	0.0100	0.0052	0.0043	0.0038	0.0035	0.0034	0.0032	0.0034	0.0035	0.0035	0.0035	0.0035	0.0035	0.0035	0.0035	0.0035			
	8-14	0.0300	0.0086	0.0035	0.0034	0.0032	0.0032	0.0033	0.0031	0.0033	0.0033	0.0033	0.0033	0.0033	0.0033	0.0033	0.0033	0.0033			
	15-21	0.0300	0.0070	0.0036	0.0035	0.0032	0.0033	0.0033	0.0031	0.0033	0.0033	0.0033	0.0034	0.0034	0.0034	0.0034	0.0034	0.0034			
	22-28	0.0300	0.0082	0.0037	0.0036	0.0034	0.0033	0.0033	0.0031	0.0034	0.0034	0.0034	0.0034	0.0034	0.0034	0.0034	0.0034	0.0034			
	29-35	0.0380	0.0093	0.0040	0.0034	0.0031	0.0031	0.0032	0.0030	0.0032	0.0032	0.0032	0.0032	0.0033	0.0033	0.0033	0.0033	0.0033			
	36-42	0.0310	0.0080	0.0040	0.0040	0.0033	0.0033	0.0033	0.0031	0.0033	0.0033	0.0033	0.0033	0.0034	0.0034	0.0034	0.0034	0.0034			
	43-49	0.0270	0.0061	0.0032	0.0030	0.0032	0.0031	0.0032	0.0030	0.0032	0.0032	0.0032	0.0032	0.0032	0.0033	0.0033	0.0033	0.0033			

Table A7.2: Standard deviations associated with R^2 reported in Appendix S6 Figure A6.1.

Trait phylogenetic signal (g)	Grouped PME	Grouped MEM																	
		1-15	16-30	31-45	46-60	61-75	76-90	91-105	106-119	120-134	135-149	150-164	165-179	180-194	195-209	210-224			
$g=0$	1-7	0.2000	0.0540	0.0240	0.0120	0.0072	0.0067	0.006	0.0055	0.0058	0.0058	0.0057	0.0058	0.0058	0.0059	0.0059	0.0059		
	8-14	0.0350	0.0140	0.0048	0.0043	0.0041	0.0039	0.0039	0.0036	0.0039	0.0039	0.0040	0.0039	0.0039	0.0039	0.0039	0.0039		
	15-21	0.0100	0.0040	0.0033	0.0033	0.0033	0.0033	0.0033	0.0031	0.0033	0.0033	0.0033	0.0033	0.0033	0.0033	0.0033	0.0033		
	22-28	0.0053	0.0032	0.0032	0.0033	0.0033	0.0033	0.0033	0.0031	0.0033	0.0033	0.0033	0.0033	0.0033	0.0033	0.0033	0.0033		
	29-35	0.0048	0.0037	0.0032	0.0033	0.0033	0.0033	0.0033	0.0031	0.0033	0.0033	0.0033	0.0033	0.0033	0.0033	0.0033	0.0033		
	36-42	0.0065	0.0033	0.0032	0.0032	0.0032	0.0032	0.0032	0.0030	0.0032	0.0033	0.0033	0.0033	0.0033	0.0033	0.0033	0.0033		
	43-49	0.0055	0.0033	0.0032	0.0033	0.0033	0.0033	0.0033	0.0031	0.0033	0.0033	0.0033	0.0033	0.0033	0.0033	0.0033	0.0033		
	1-7	0.1200	0.0290	0.0120	0.0073	0.0049	0.0046	0.0044	0.0041	0.0043	0.0043	0.0044	0.0044	0.0044	0.0044	0.0044	0.0045		
	8-14	0.0620	0.0160	0.0065	0.0046	0.0041	0.0041	0.0041	0.0039	0.0041	0.0041	0.0041	0.0041	0.0041	0.0041	0.0041	0.0041		
	15-21	0.0280	0.0077	0.0053	0.0031	0.0033	0.0032	0.0032	0.0030	0.0032	0.0032	0.0032	0.0032	0.0032	0.0032	0.0032	0.0033		
22-28	0.0160	0.0046	0.0036	0.0032	0.0033	0.0033	0.0033	0.0031	0.0033	0.0033	0.0034	0.0034	0.0034	0.0034	0.0034	0.0034			
29-35	0.0110	0.0031	0.0029	0.0030	0.003	0.0031	0.0031	0.0029	0.0031	0.0031	0.0031	0.0031	0.0031	0.0031	0.0031	0.0031			
36-42	0.0068	0.0037	0.0034	0.0031	0.0031	0.0032	0.0032	0.0030	0.0032	0.0032	0.0032	0.0032	0.0032	0.0032	0.0032	0.0032			
43-49	0.0059	0.0030	0.0030	0.0031	0.0031	0.0031	0.0031	0.0029	0.0031	0.0031	0.0031	0.0031	0.0031	0.0031	0.0031	0.0031			

Table A7.3: Standard deviations associated with R^2 reported in Appendix S6 Figure A6.2.

Trait phylogenetic signal (g)	Grouped PME	Grouped MEM																		
		1-15	16-30	31-45	46-60	61-75	76-90	91-105	106-119	120-134	135-149	150-164	165-179	180-194	195-209	210-224				
$g=-2$	1-7	0.0054	0.0054	0.0052	0.0052	0.0053	0.0054	0.0055	0.0050	0.0054	0.0062	0.0067	0.0120	0.0250	0.080	0.240				
	8-14	0.0034	0.0034	0.0034	0.0034	0.0034	0.0034	0.0034	0.0031	0.0034	0.0034	0.0034	0.0033	0.0033	0.0035	0.0067				
	15-21	0.0034	0.0034	0.0034	0.0034	0.0034	0.0034	0.0034	0.0031	0.0034	0.0034	0.0034	0.0033	0.0033	0.0033	0.0032				
	22-28	0.0034	0.0034	0.0034	0.0034	0.0034	0.0034	0.0034	0.0031	0.0034	0.0034	0.0034	0.0033	0.0033	0.0033	0.0034				
	29-35	0.0034	0.0034	0.0034	0.0034	0.0034	0.0034	0.0034	0.0031	0.0034	0.0034	0.0034	0.0033	0.0033	0.0033	0.0040				
$g=0$	36-42	0.0034	0.0034	0.0034	0.0034	0.0034	0.0034	0.0034	0.0031	0.0034	0.0033	0.0033	0.0033	0.0033	0.0039	0.0037				
	43-49	0.0034	0.0034	0.0034	0.0034	0.0034	0.0034	0.0034	0.0032	0.0034	0.0034	0.0034	0.0033	0.0033	0.0033	0.0043				
	1-7	0.0050	0.0050	0.0050	0.0050	0.0050	0.0050	0.0056	0.0051	0.0051	0.0057	0.0072	0.0100	0.0230	0.0690	0.230				
	8-14	0.0038	0.0038	0.0038	0.0038	0.0038	0.0038	0.0038	0.0035	0.0038	0.0038	0.0038	0.0040	0.0054	0.018	0.044				
	15-21	0.0035	0.0035	0.0035	0.0035	0.0035	0.0035	0.0035	0.0033	0.0035	0.0035	0.0035	0.0034	0.0034	0.0044	0.015				
$g=2$	22-28	0.0036	0.0036	0.0036	0.0036	0.0036	0.0036	0.0036	0.0033	0.0036	0.0036	0.0035	0.0035	0.0035	0.0034	0.007				
	29-35	0.0035	0.0035	0.0035	0.0035	0.0035	0.0035	0.0035	0.0033	0.0035	0.0035	0.0035	0.0035	0.0035	0.0035	0.0054				
	36-42	0.0036	0.0036	0.0036	0.0036	0.0036	0.0036	0.0035	0.0033	0.0035	0.0035	0.0035	0.0035	0.0035	0.0035	0.0054				
	43-49	0.0036	0.0036	0.0036	0.0036	0.0036	0.0036	0.0035	0.0033	0.0035	0.0035	0.0035	0.0035	0.0035	0.0034	0.0067				
	1-7	0.0040	0.0039	0.0040	0.0039	0.0039	0.0039	0.0040	0.0037	0.0041	0.0041	0.0052	0.0064	0.0160	0.0390	0.1300				
$g=100$	8-14	0.0037	0.0036	0.0037	0.0036	0.0037	0.0036	0.0037	0.0035	0.0037	0.0038	0.0040	0.0040	0.0076	0.0180	0.0700				
	15-21	0.0032	0.0032	0.0032	0.0032	0.0032	0.0032	0.0032	0.0030	0.0032	0.0032	0.0036	0.0032	0.0040	0.0082	0.0280				
	22-28	0.0033	0.0033	0.0033	0.0033	0.0033	0.0033	0.0033	0.0031	0.0033	0.0032	0.0032	0.0033	0.0033	0.0053	0.0190				
	29-35	0.0033	0.0032	0.0033	0.0033	0.0032	0.0032	0.0032	0.0030	0.0032	0.0032	0.0032	0.0032	0.0031	0.0037	0.0120				
	36-42	0.0032	0.0032	0.0032	0.0032	0.0032	0.0032	0.0032	0.0030	0.0032	0.0032	0.0032	0.0031	0.0033	0.0038	0.0093				
43-49	0.0032	0.0032	0.0032	0.0032	0.0032	0.0032	0.0032	0.0030	0.0032	0.0032	0.0032	0.0031	0.0031	0.0034	0.0065					

Table A7.4: Standard deviations associated with R² reported in Appendix S6 Figure A6.3.

Trait phylogenetic signal (<i>g</i>)	Grouped PME	Grouped MEM																		
		1-15	16-30	31-45	46-60	61-75	76-90	91-105	106-119	120-134	135-149	150-164	165-179	180-194	195-209	210-224				
<i>g</i> = -2	1-7	0.0033	0.0033	0.0033	0.0034	0.0033	0.0033	0.0033	0.0033	0.0033	0.0033	0.0033	0.0033	0.0033	0.0033	0.0033	0.0033			
	8-14	0.0032	0.0032	0.0032	0.0032	0.0032	0.0032	0.0032	0.0030	0.0032	0.0032	0.0032	0.0032	0.0032	0.0032	0.0032	0.0032			
	15-21	0.0032	0.0032	0.0032	0.0032	0.0032	0.0032	0.0030	0.0030	0.0032	0.0032	0.0032	0.0032	0.0032	0.0032	0.0032	0.0032			
	22-28	0.0032	0.0032	0.0032	0.0032	0.0032	0.0032	0.0030	0.0030	0.0032	0.0032	0.0032	0.0032	0.0032	0.0032	0.0032	0.0032			
	29-35	0.0032	0.0032	0.0032	0.0032	0.0032	0.0032	0.0030	0.0030	0.0032	0.0032	0.0032	0.0032	0.0032	0.0032	0.0032	0.0032			
	36-42	0.0032	0.0032	0.0032	0.0032	0.0032	0.0032	0.0030	0.0030	0.0032	0.0032	0.0032	0.0032	0.0032	0.0032	0.0032	0.0032			
	43-49	0.0033	0.0033	0.0033	0.0034	0.0033	0.0033	0.0033	0.0031	0.0033	0.0033	0.0033	0.0033	0.0033	0.0033	0.0033	0.0033			
	1-7	0.0210	0.0210	0.0220	0.0190	0.0180	0.0190	0.0220	0.0200	0.0200	0.0220	0.0230	0.0210	0.0180	0.0220	0.0240				
	8-14	0.0056	0.0054	0.0061	0.005	0.0049	0.0052	0.0047	0.0048	0.0053	0.0046	0.0054	0.0051	0.0044	0.0050	0.0047				
15-21	0.0034	0.0033	0.0031	0.0034	0.0032	0.0032	0.0032	0.0029	0.0031	0.0032	0.0032	0.0033	0.0031	0.0031	0.0031					
22-28	0.0031	0.0031	0.0031	0.0031	0.0031	0.0031	0.0031	0.0029	0.0031	0.0031	0.0031	0.0031	0.0031	0.0031	0.0031					
29-35	0.0032	0.0032	0.0032	0.0032	0.0032	0.0031	0.0031	0.0030	0.0032	0.0032	0.0031	0.0033	0.0032	0.0032	0.0032					
36-42	0.0031	0.0031	0.0032	0.0032	0.0032	0.0031	0.0031	0.0029	0.0031	0.0031	0.0031	0.0032	0.0032	0.0031	0.0032					
43-49	0.0031	0.0031	0.0031	0.0031	0.0031	0.0031	0.0031	0.0029	0.0031	0.0031	0.0031	0.0031	0.0031	0.0031	0.0031					
<i>g</i> = 0	1-7	0.011	0.012	0.012	0.012	0.011	0.011	0.015	0.011	0.011	0.0093	0.015	0.0098	0.011	0.011					
	8-14	0.0062	0.0054	0.0063	0.0061	0.0054	0.0075	0.0074	0.0064	0.0059	0.0062	0.0061	0.0059	0.0063	0.0055					
	15-21	0.0036	0.0036	0.0033	0.0034	0.0036	0.0033	0.0036	0.003	0.0036	0.0033	0.0034	0.0044	0.0035	0.004					
	22-28	0.0031	0.0032	0.0031	0.0033	0.0035	0.0031	0.0031	0.003	0.0031	0.0031	0.0032	0.0032	0.0031	0.0031					
	29-35	0.0028	0.0028	0.0027	0.0028	0.0028	0.0028	0.0028	0.0026	0.0028	0.0028	0.0029	0.0027	0.0027	0.0028					
	36-42	0.003	0.0029	0.0028	0.0028	0.0029	0.0029	0.0028	0.0027	0.0028	0.0028	0.0028	0.0029	0.0028	0.0028					
	43-49	0.0027	0.0028	0.0028	0.0027	0.003	0.0027	0.0027	0.0028	0.0028	0.0028	0.0028	0.0028	0.0028	0.0028					
	<i>g</i> = 2	1-7	0.0041	0.0038	0.0042	0.0040	0.0039	0.0040	0.0047	0.0042	0.0053	0.0047	0.0039	0.0051	0.0050	0.0038				
		8-14	0.0037	0.0036	0.0040	0.0043	0.0043	0.0037	0.0048	0.0033	0.0036	0.0035	0.0040	0.0044	0.0040	0.0038				
15-21		0.0038	0.0038	0.0039	0.0040	0.0034	0.0036	0.0037	0.0037	0.0038	0.0040	0.0038	0.0039	0.0035	0.0043					
22-28		0.0036	0.0036	0.0037	0.0040	0.0045	0.0036	0.0037	0.0031	0.0035	0.0034	0.0034	0.0034	0.0040	0.0035					
29-35		0.0036	0.0037	0.0039	0.0039	0.0051	0.0044	0.0036	0.0037	0.0039	0.0036	0.0038	0.0037	0.0035	0.0048					
36-42		0.0039	0.0036	0.0039	0.0040	0.0034	0.0037	0.0036	0.0031	0.0040	0.0037	0.0042	0.0043	0.0036	0.0040					
43-49		0.0030	0.0033	0.0032	0.0036	0.0040	0.0032	0.0032	0.0032	0.0032	0.0037	0.0038	0.0046	0.0033	0.0030					
<i>g</i> = 100		1-7	0.0041	0.0038	0.0042	0.0040	0.0039	0.0040	0.0047	0.0042	0.0053	0.0047	0.0039	0.0051	0.0050	0.0038				
		8-14	0.0037	0.0036	0.0040	0.0043	0.0043	0.0037	0.0048	0.0033	0.0036	0.0035	0.0040	0.0044	0.0040	0.0038				
	15-21	0.0038	0.0038	0.0039	0.0040	0.0034	0.0036	0.0037	0.0037	0.0038	0.0040	0.0038	0.0039	0.0035	0.0043					
	22-28	0.0036	0.0036	0.0037	0.0040	0.0045	0.0036	0.0037	0.0031	0.0035	0.0034	0.0034	0.0034	0.0040	0.0035					
	29-35	0.0036	0.0037	0.0039	0.0039	0.0051	0.0044	0.0036	0.0037	0.0039	0.0036	0.0038	0.0037	0.0035	0.0048					
	36-42	0.0039	0.0036	0.0039	0.0040	0.0034	0.0037	0.0036	0.0031	0.0040	0.0037	0.0042	0.0043	0.0036	0.0040					
	43-49	0.0030	0.0033	0.0032	0.0036	0.0040	0.0032	0.0032	0.0032	0.0032	0.0037	0.0038	0.0046	0.0033	0.0030					

Axis 2 – Chapter 1

Appendix 1: Type I error rates and values of Mantel statistic for simple and partial Mantel tests and MSR-Mantel for irregular sampling with increasing number of samples. (a-b) Observed Mantel statistic r_{M-obs} and type I error rates for (a) simple and (b) partial Mantel test. (c) Corrected Mantel statistic r_{M-obs}^* and type I error rates of MSR-Mantel on raw table X. X and Y contain 5 variables and increasing number of samples: 100, 225 and 400. Both tables present spatial autocorrelation fixed to $\rho = 0.8$. r_{M-obs} and r_{M-obs}^* are reported as in Figure 2. Red line corresponds to $r_M=0$.

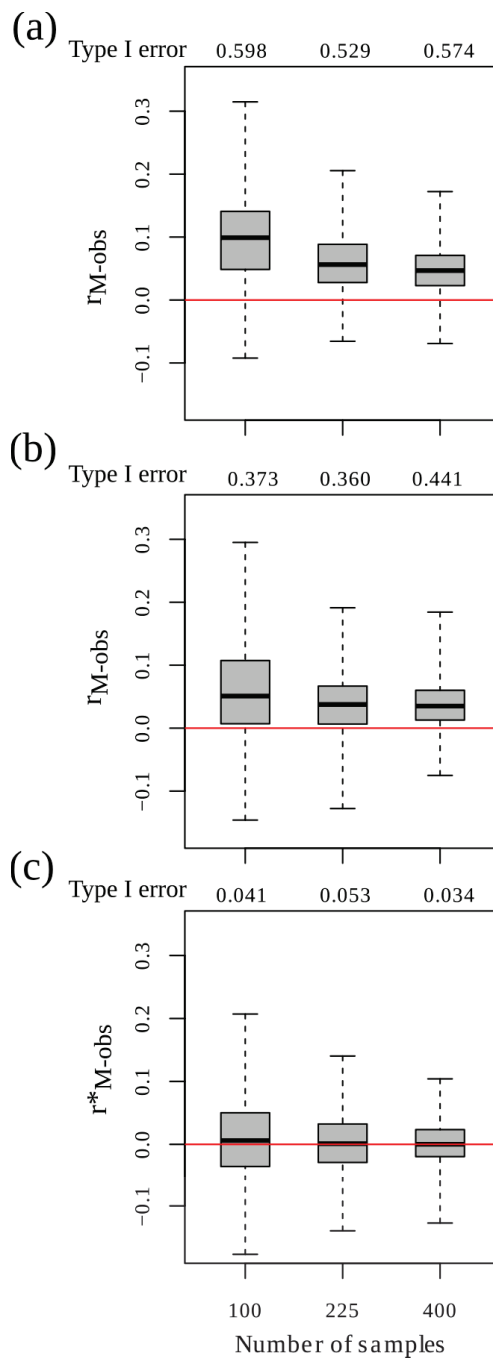

Appendix 2: Type I error rates and values of Mantel statistic for simple and partial Mantel tests and MSR-Mantel for a regular sampling. (a-b) Observed Mantel statistic r_{M-obs} and type I error rates for (a) simple and (b) partial Mantel test. (c) Corrected Mantel statistic r_{M-obs}^* and type I error rates of MSR-Mantel on raw table X. X and Y contain 5 variables and 225 samples. Both tables present spatial autocorrelation varying from $\rho = 0$ to $\rho = 0.8$. r_{M-obs} and r_{M-obs}^* are reported as in Figure 2. Red line corresponds to $r_M=0$.

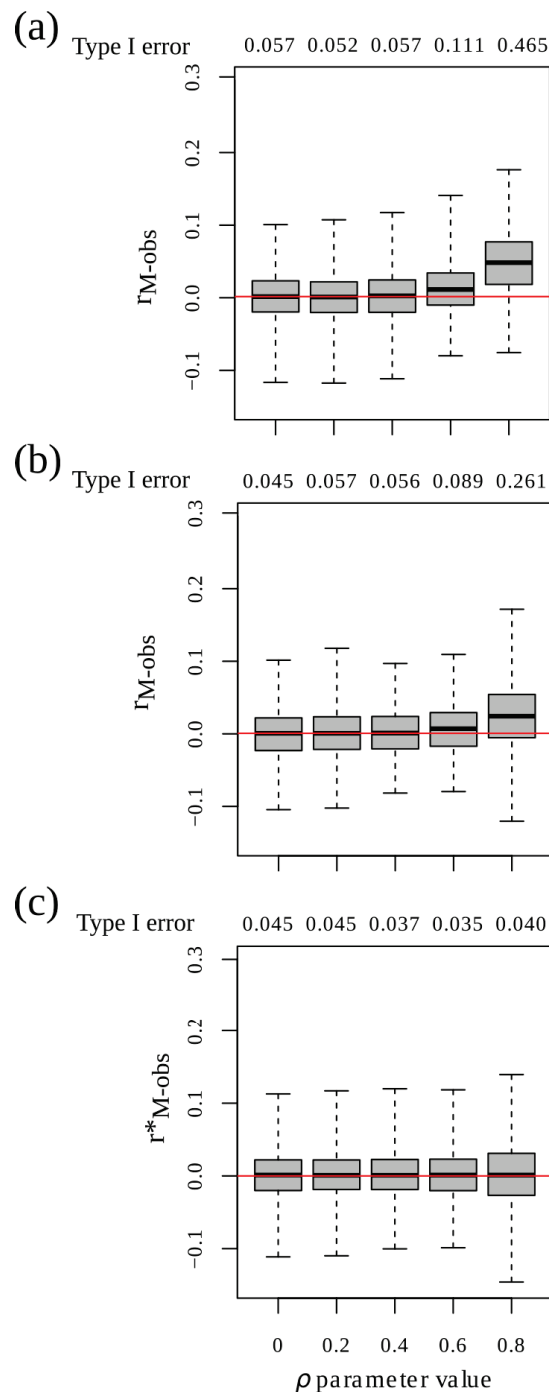

Appendix 3: Type I error rates and values of Mantel statistic for simple and partial Mantel tests and MSR-Mantel for regular sampling with increasing number of variables.

(a-b) Observed Mantel statistic r_{M-obs} and type I error rates for (a) simple and (b) partial Mantel test. (c) Corrected Mantel statistic r_{M-obs}^* and type I error rates of MSR-Mantel on raw table **X**. **X** and **Y** contain 225 samples and increasing number of variables: 1, 5 and 10 variables. Both tables present spatial autocorrelation fixed to $\rho = 0.8$. r_{M-obs} and r_{M-obs}^* are reported as in Figure 2. Red line corresponds to $r_M=0$.

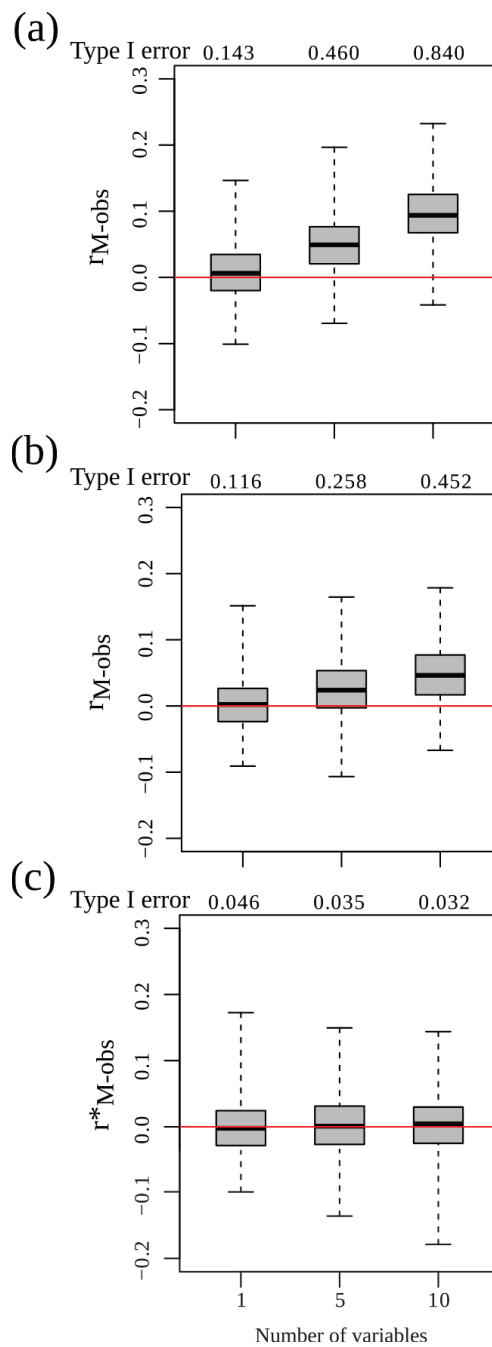

Appendix 4: Type I error rates and values of Mantel statistic for simple and partial Mantel tests and MSR-Mantel for regular sampling with increasing number of samples.

(a-b) Observed Mantel statistic r_{M-obs} and type I error rates for (a) simple and (b) partial Mantel test. (c) Corrected Mantel statistic r_{M-obs}^* and type I error rates of MSR-Mantel on raw table **X**. **X** and **Y** contain 5 variables and increasing number of samples: 100, 225 and 400. Both tables present spatial autocorrelation fixed to $\rho = 0.8$. r_{M-obs} and r_{M-obs}^* are reported as in Figure 2. Red line corresponds to $r_M=0$.

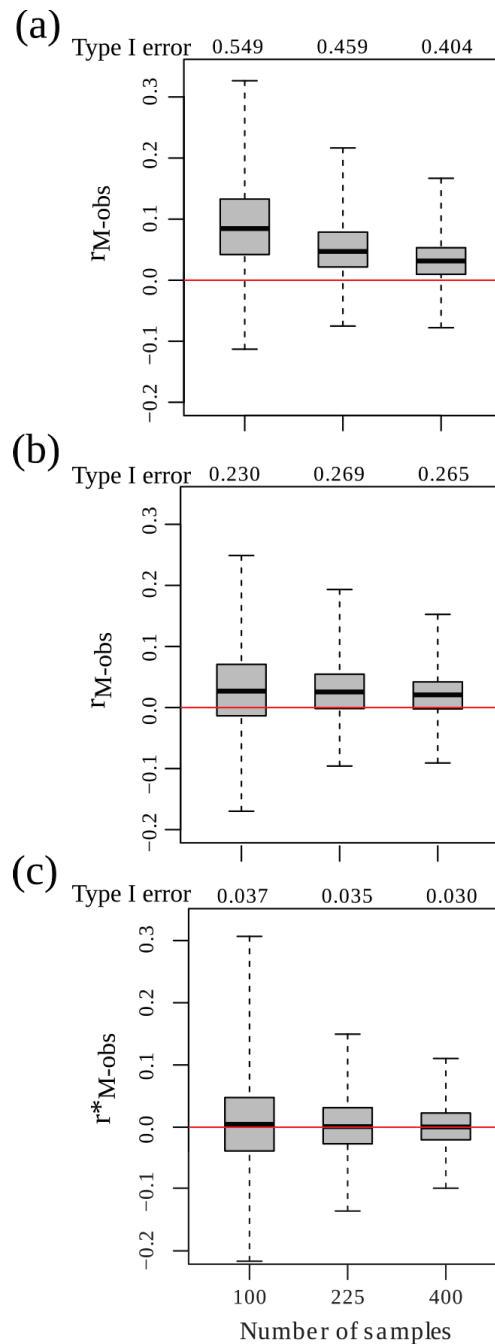

Appendix 5: Illustration of the MSR approach applied on Mantel test.

This document presents an application of MSR-Mantel developed in Crabot et al. (2018) to test the Mantel statistic using a spatially-constrained randomization procedure.

First, we illustrate the biases of simple and partial Mantel tests when performed in presence of spatial autocorrelation, then we present the MSR-Mantel developed in the paper. We follow the structure of the study by first simulating two matrices (\mathbf{X} and \mathbf{Y}) independently or linearly correlated. Then, Mantel tests (simple and partial) and MSR-Mantel were performed in each case. Note that in the case of MSR-Mantel, MSR was performed on both (i) the principal coordinates obtained from a principal coordinates analysis on the distance matrix or (ii) raw data table \mathbf{X} . We only illustrate the case of irregular sampling. We also illustrate the reduces performance of MSR-Mantel induced by a misspecification of the spatial weighting matrix \mathbf{W} . Finally, we show how the selection procedure recently developed by Bauman et al. (2018) can help in optimizing the choice of the best \mathbf{W} when several candidates are considered.

Data simulation

We begin by simulating the data. First, we defined the number of samples (`nbsamp`), the level of spatial autocorrelation parameter (`autocor`) fixed to 0.8, the number of variables (`nbvar`) contained in tables \mathbf{X} and \mathbf{Y} fixed to 5, and the strength of the linear trend between \mathbf{X} and \mathbf{Y} fixed to 0.5.

```
library(spdep)
## Loading required package: sp
## Loading required package: Matrix
## Loading required package: spData
## To access larger datasets in this package, install the spDataLarge
## package with: `install.packages('spDataLarge',
## repos='https://nowosad.github.io/drat/', type='source')`
library(ade4)
##
## Attaching package: 'ade4'
## The following object is masked from 'package:spdep':
##
##   mstree
library(adespatial)
##
## Attaching package: 'adespatial'
```

```
## The following object is masked from 'package:ade4':
##
##   multispati
library(vegan)
## Loading required package: permute
## Loading required package: lattice
## This is vegan 2.5-2

# Parameters setting
nbsamp <- 225
autocor <- 0.8
nbvar <- 5
a <- 0.5
```

Then, we generate \mathbf{X} and \mathbf{Y} independently (xind and yind), and linearly correlated (ycor) following the equation (9) of the manuscript. We also simulate the spatial matrix \mathbf{Z} containing geographical coordinates of samples.

A function create.autocor is implemented to generate spatial patterns in the data using an autoregressive model:

```
# Function to create spatial autocorrelation
create.autocor <- function(nb, rho = 0.8, nrep = 1000, nvar = 1) {
  lw1 <- nb2listw(nb)
  matInv <- invlrW(lw1, rho)
  alea1 <- matrix(rnorm((nvar) * nrep * length(nb)), nrow = length(nb))
  res <- data.frame(t(matInv %*% alea1))
  res <- split(res, rep(1:nrep, each = nvar))
  res <- lapply(res, t)
  return(res)
}
```

Then simulated data are generated with an autoregressive model and row-standardized spatial weighting matrix defined by a Gabriel graph (\mathbf{W}_{gab}):

```
# Data simulation
set.seed(1)
xy <- cbind(runif(nbsamp), runif(nbsamp))
nb1 <- graph2nb(gabrielneigh(xy), sym = T)
lw1 <- nb2listw(nb1)

w <- dist(xy)

# X and Y independent
xind <- create.autocor(nb1, rho = autocor, nrep = 1, nvar = nbvar)
yind <- create.autocor(nb1, rho = autocor, nrep = 1, nvar = nbvar)

xind <- xind[[1]]
yind <- yind[[1]]
```

```
# Y linearly correlated to X
ycor <- a * xind + (1 - a) * xind[sample(nrow(xind))]
```

Simple and partial Mantel tests

We perform the simple and partial Mantel tests for **X** and **Y** independent and linearly correlated.

Linearly correlated data

```
# X and Y linearly correlated
m.cor <- mantel.randtest(dist(xind), dist(ycor))
p.cor <- mantel.partial(dist(xind), dist(ycor), w)

m.cor
## Monte-Carlo test
## Call: mantel.randtest(m1 = dist(xind), m2 = dist(ycor))
##
## Observation: 0.4025879
##
## Based on 999 replicates
## Simulated p-value: 0.001
## Alternative hypothesis: greater
##
##      Std.Obs Expectation  Variance
## 11.010087334 -0.001636525 0.001347918
p.cor
##
## Partial Mantel statistic based on Pearson's product-moment correlation
##
## Call:
## mantel.partial(xdis = dist(xind), ydis = dist(ycor), zdis = w)
##
## Mantel statistic r: 0.3981
##      Significance: 0.001
##
## Upper quantiles of permutations (null model):
##   90%  95% 97.5%  99%
## 0.0496 0.0621 0.0762 0.0915
## Permutation: free
## Number of permutations: 999
```

Results demonstrate that both simple and partial Mantel tests identify the true relationships in the data.

Independent data

```
# X and Y independent
m.ind <- mantel.randtest(dist(xind), dist(yind))
```



```

p.ind <- mantel.partial(dist(xind), dist(yind), w)

m.ind
## Monte-Carlo test
## Call: mantel.randtest(m1 = dist(xind), m2 = dist(yind))
##
## Observation: 0.1324142
##
## Based on 999 replicates
## Simulated p-value: 0.001
## Alternative hypothesis: greater
##
##   Std.Obs Expectation   Variance
## 3.970607006 -0.003138546 0.001165474
p.ind
##
## Partial Mantel statistic based on Pearson's product-moment correlation
##
## Call:
## mantel.partial(xdis = dist(xind), ydis = dist(yind), zdis = w)
##
## Mantel statistic r: 0.1054
##   Significance: 0.002
##
## Upper quantiles of permutations (null model):
## 90% 95% 97.5% 99%
## 0.0470 0.0590 0.0702 0.0883
## Permutation: free
## Number of permutations: 999

```

Here, results show that both simple and partial Mantel tests wrongly identify a relationship when both data sets are spatially autocorrelated.

MSR-Mantel

Algorithm on principal coordinates

The package `adespatial` provides a method `msr` that can be applied on the outputs produced by the `mantel.randtest` function. In this case, the test is performed by applying principal coordinates analysis on the distance matrix:

```

# X and Y independent
msr.ind <- msr(m.ind, lw1, 999)
msr.ind
## Monte-Carlo test
## Call: msr.mantelrtest(x = m.ind, listwORorthobasis = lw1, nrepet = 999)
##
## Observation: 0.1324142
##

```

```

## Based on 999 replicates
## Simulated p-value: 0.18
## Alternative hypothesis: greater
##
## Std.Obs Expectation Variance
## 0.871033278 0.087604475 0.002646516
# X and Y linearly correlated
msr.cor <- msr(m.cor, lw1, 999)
msr.cor
## Monte-Carlo test
## Call: msr.mantelrtest(x = m.cor, listwORorthobasis = lw1, nrepet = 999)
##
## Observation: 0.4025879
##
## Based on 999 replicates
## Simulated p-value: 0.001
## Alternative hypothesis: greater
##
## Std.Obs Expectation Variance
## 8.992252428 0.036198654 0.001660154

```

The MSR procedure allows to correct for spatial autocorrelation so that the link between both distance matrices is no longer significant for independently generated distance matrices.

The value of the statistic corrected for spatial autocorrelation is obtained by subtracting the expected value obtained by the MSR procedure:

```

r.msr <- msr.ind$obs - msr.ind$expvar["Expectation"]
names(r.msr) <- "rM.msr"
r.msr

##rM.msr
## 0.0448097

```

Algorithm based on raw data

The `msr.default` function allow to create, by hand, a test where MSR is applied on raw data instead of principal coordinates. Outputs are then formatted using the `as.randtest` function:

```

# X and Y independent
msr.x <- msr(xind, lw1, 999, simplify = FALSE)
m.ind.x <- sapply(1:length(msr.x), function(j) mantel.randtest(dist(msr.x[[j]]),
  dist(yind), nrepet = 0)$obs)
m.ind.x <- as.randtest(obs = m.ind$obs, sim = m.ind.x)

m.ind.x
## Monte-Carlo test
## Call: as.randtest(sim = m.ind.x, obs = m.ind$obs)

```

```
##
## Observation: 0.1324142
##
## Based on 999 replicates
## Simulated p-value: 0.217
## Alternative hypothesis: greater
##
## Std.Obs Expectation Variance
## 0.810265849 0.090533820 0.002671564
```

MSR-Mantel and spatial weighting matrix W

Misspecification of W

MSR-Mantel is performed with a misspecified spatial weighting matrix: a spatial weighting matrix W_{dist} defined as a distance-based graph is used to perform MSR-Mantel instead of W_{gab} initially used to generate X . W_{dist} defines two samples connected solely if their distance is inferior to a certain threshold which was here defined, as in the manuscript, by the maximum branch length of the minimum spanning tree. We only illustrate the case with X and Y independently simulated.

```
# X and Y independent
set.seed(1)
xy.dist <- dist(xy)
lim <- give.thresh(xy.dist)
lw.wrong <- nb2listw(dnearneigh(x = xy, d1 = 0, d2 = (1 + sqrt(.Machine$double.eps)) *
  lim), style = "W")

msr.x.wrong <- msr(xind, lw.wrong, 999, simplify = FALSE)

m.ind.x.wrong <- sapply(1:length(msr.x.wrong), function(j)
  mantel.randtest(dist(msr.x.wrong[[j]],
    dist(yind), nrepet = 0)$obs)
m.ind.x.wrong <- as.randtest(obs = m.ind$obs, sim = m.ind.x.wrong)

m.ind.x.wrong
## Monte-Carlo test
## Call: as.randtest(sim = m.ind.x.wrong, obs = m.ind$obs)
##
## Observation: 0.1324142
##
## Based on 999 replicates
## Simulated p-value: 0.05
## Alternative hypothesis: greater
##
```

```
## Std.Obs Expectation Variance
## 1.588711578 0.063170311 0.001899645
```

MSR-Mantel fails to correct the spurious detection of a significant relationship when the spatial weighting matrix \mathbf{W} is misspecified.

Selection procedure to optimize the choice of W

We apply the recently developed procedure to optimize the choice of \mathbf{W} when unknown (Bauman et al., 2018). To do so, we simulate 4 other \mathbf{W} candidates: (i) \mathbf{W}_{dist} , (ii) \mathbf{W}_{mst} obtained from a minimum spanning tree, (iii) \mathbf{W}_{del} defined with a Delaunay triangulation and (iv) \mathbf{W}_{rel} obtained from a relative neighborhood graph. The selection procedure was performed using those four wrong candidates and the true candidate \mathbf{W}_{gab} .

```
# W selection procedure
set.seed(1)
lw.cand <- listw.candidates(xy, weights = "binary", style = "W", nb = c("gab",
  "dnear", "mst", "del", "rel"))
Wsel <- listw.select(xind, candidates = lw.cand, method = "global", MEM.autocor
= "all")
Wsel$best.id
## Gabriel_Binary
##          2
```

The selection procedure succeeds in choosing the true spatial weighting matrix \mathbf{W}_{gab} . We encourage to use this procedure prior to MSR-Mantel to help avoiding misspecification of the spatial weighting matrix \mathbf{W} inducing inflation of type I error in MSR-Mantel.

Axis 2 – Chapter 2

Sylvie Clappe, Stéphane Dray, and Pedro R. Peres-Neto. **Beyond neutrality: disentangling the effects of species sorting and spurious correlations in metacommunity analysis.** *Ecology*. 2018.

Appendix S1. Mathematical details of the spatially-constrained variation partitioning procedure.

Consider \mathbf{Y} the species matrix, \mathbf{X} the environmental variables matrix, and \mathbf{W} a matrix of spatial predictors (here, Moran's Eigenvector Maps (Dray et al. 2006)).

Let be $R_{[abc]}^2$, $R_{[ab]}^2$, $R_{[bc]}^2$, $R_{[a]}^2$, $R_{[b]}^2$, $R_{[c]}^2$, and $R_{[d]}^2$, the unadjusted estimates of fractions [abc], [ab], [bc], [a] (i.e., [abc]-[ab]), [b] (i.e., [ab]-[a]), [c] ([abc]-[bc]), and [d] (1-[abc]) obtained with a first variation partitioning based on the null hypothesis H_0 : “the absence of species-environment relationships” (i.e., species sorting is not important).

Moran Spectral Randomization (MSR; Wagner and Dray 2015) is applied on \mathbf{X} so that $n_{MSR}=1000$ replicates \mathbf{X}_{MSR} conserving the original spatial and correlation structure of \mathbf{X} are produced. A VP is then computed for each randomized environment using \mathbf{Y} , \mathbf{X}_{MSR} , and \mathbf{W} . The null hypothesis is now modified as H_{0-MSR} : “the absence of species-environment relationships given the spatial structure of the environmental variables”. n_{MSR} unadjusted estimates of all fractions are thus obtained. However, only the n_{MSR} unadjusted estimates of fractions [ab], [a], and [b] will be kept for the new variation partitioning. Indeed, as solely \mathbf{X} is randomized with MSR to give \mathbf{X}_{MSR} , \mathbf{Y} and \mathbf{W} remain unchanged and thus the estimate of fraction [bc] will stay constant (i.e., $E(R_{[bc]}^2|H_{0-MSR})=\tilde{R}_{[bc]}^2$ with $\tilde{R}_{[bc]}^2$ adjusted with Eq. 2) as it is calculated from table \mathbf{Y} and \mathbf{W} , and [abc], [c] and [d] can be calculated from the others. As such, the mean of unadjusted estimates of the fractions [ab], [a], and [b], hereafter

$E(R_{[ab]}^2|H_{0-MSR})$, $E(R_{[a]}^2|H_{0-MSR})$, and $E(R_{[b]}^2|H_{0-MSR})$, will represent the expected values of the fractions under H_{0-MSR} and will be used to correct the initial unadjusted estimates $R_{[abc]}^2$, $R_{[ab]}^2$, $R_{[a]}^2$, $R_{[b]}^2$, $R_{[c]}^2$, and $R_{[d]}^2$ as below ($R_{[bc]}^2$ remains constant):

$R_{[ab]}^2$ is first corrected with Eq. 4 of the manuscript:

$$\tilde{R}_{[ab]MSR}^2 = 1 - \frac{1}{1 - E(R_{[ab]}^2 | H_{0-MSR})} (1 - R_{[ab]}^2) \quad (4)$$

Likewise, fractions [a] and [b] are corrected with Eq. 4 and 5 of the manuscript:

$$\tilde{R}_{[b]MSR}^2 = 1 - \frac{1}{1 - E(R_{[b]}^2 | H_{0-MSR})} (1 - R_{[b]}^2) \quad (5)$$

$$\tilde{R}_{[a]MSR}^2 = \tilde{R}_{[ab]MSR}^2 - \tilde{R}_{[b]MSR}^2 \quad (6)$$

The other unbiased fractions are then obtained by the following operations:

$$\tilde{R}_{[c]MSR}^2 = \tilde{R}_{[bc]MSR}^2 - \tilde{R}_{[b]MSR}^2 \quad (S1)$$

$$\tilde{R}_{[abc]MSR}^2 = \tilde{R}_{[ab]MSR}^2 + \tilde{R}_{[c]MSR}^2 \quad (S2)$$

$$\tilde{R}_{[d]MSR}^2 = 1 - \tilde{R}_{[abc]MSR}^2 \quad (S3)$$

Sylvie Clappe, Stéphane Dray, and Pedro R. Peres-Neto. **Beyond neutrality: disentangling the effects of species sorting and spurious correlations in metacommunity analysis.** *Ecology*. 2018.

Appendix S2. Detailed simulation model used in the manuscript

We used a dynamic spatially explicit individual-based model originally developed by Bell (2000, 2003, 2005) and implemented by Smith and Lundholm (2010). We modified the initial model to simulate a $M \times M$ torus ($M=15$) where each cell (patch) represented a community defined by a carrying capacity $K=500$ individuals and was initialized with K/S individuals belonging to $S=50$ species. At each generation, individuals gave birth to a unique descendant with a probability b , and then died with a probability d . Offsprings dispersed randomly to the 8 adjacent cells with a probability u and settled permanently with a probability $1-u$; if not, they continue to disperse with a probability u . A single immigrant from each species arrived from the regional species pool with a probability m , dispersed randomly to the 8 adjacent cells and settled permanently. At the end, if the total number of individuals N in the cell exceeded K , $N-K$ individuals were removed with a random draw according to their survival probability (i.e., less adapted individuals have more chance to die).

Each species was characterized by a survival probability λ , defined as a unimodal response curve depending on community environmental factors, and characterized by the optimum position and breadth of the species niche:

$$\lambda_{ij} = \prod_{k=1}^p e^{\frac{-(E_{jk}-\mu_{ik})^2}{2\sigma_{ik}^2}} \quad (S1) \text{ (Gravel et al, 2006)}$$

where λ_{ij} is the survival probability of the i -th species for the environmental value of j -th the community, p the total number of environmental values, E_{jk} the k -th environmental value of the j -th community, μ_{ik} and σ_{ik} the niche optimum and breadth of the i -th species for k -th environmental value of the j -th community. These survival probabilities were then used to weight individual death and birth rate depending on their species identities as:

$$br_{ij} = b - b \times (1 - \lambda_{ij}) \times sel \quad (S2)$$

$$dr_{ij} = d - d \times \lambda_{ij} \times sel \quad (S3)$$

where br_{ij} and dr_{ij} are death rate and birth rate of the i -th species in the j -th community respectively, d and b death and birth probability respectively which are fixed for all species. Then, λ_{ij} is the survival probability of the i -th species in the j -th community, and sel an environmental selection factor ranges from 0 to 1 which is fixed for all communities. As such, when $sel=0$, br_{ij} is maximum and dr_{ij} is minimum for $\lambda=1$, inversely for $\lambda=0$. Therefore, individual selection relies on both λ and K .

Following parameters values used in previous studies (Bell 2000, 2003, 2005, Smith and Lundholm 2010), we configured our model such as all species presented the same probability of birth $b=0.505$ and death $d=0.5$. The dispersal probability was fixed to $u=0.005$ and $u=0.1$ for generalist and specialist species respectively. Generalist species were defined equivalent in their response to environment by fixing the survival probability to $\lambda=0.6$, as such they were not influenced by environment as their survival probability did not change with local environmental values. Specialist species optimums were randomly drawn from a uniform distribution whose maximum and minimum values were those of the environmental table X. The niche breadth of specialist species were randomly drawn from a uniform distribution defined between 1 and 2. Specialist survival probability was then calculated from niche characteristics values and local environmental values. We fixed the immigration probability to $m=0.01$ and environmental selection to $sel=0.3$.

Sylvie Clappe, Stéphane Dray, and Pedro R. Peres-Neto. Beyond neutrality: disentangling the effects of species sorting and spurious correlations in metacommunity analysis. Ecology. 2018.

Appendix S3. Respective mean and standard deviation of [ab], [a] and [b] fractions in the three simulation scenarios.

We reported here means and standard deviations of adjusted (through new variation partitioning procedure) estimations of fractions [ab], [a], and [b] for every simulated scenarios (neutral, species sorting, and mixed) calculated over the 1000 simulations presented in Figures 2 and 3. Results are presented in three different tables according to the spatial autocorrelation of environment ($\rho=0$ - Table S1; $\rho=0.4$ - Table S2; $\rho=0.8$ - Table S3). Biased \tilde{R}^2 correspond to those adjusted with Eq. 2 ($\tilde{R}_{[ab]}^2$, $\tilde{R}_{[a]}^2$, $\tilde{R}_{[b]}^2$), and corrected R^2 ($\tilde{R}_{[ab]MSR}^2$, $\tilde{R}_{[a]MSR}^2$, $\tilde{R}_{[b]MSR}^2$) are adjusted with Eq. 4, 5, and 6 of the manuscript (i.e., new variation partitioning procedure).

In Table S1, as no environmental spatial autocorrelation is present, estimations of fractions [ab] ($\tilde{R}_{[ab]}^2$), [a] ($\tilde{R}_{[a]}^2$), and [b] ($\tilde{R}_{[b]}^2$) are unbiased. However, when both species and environmental data are spatially autocorrelated (Tables S2 and S3), $\tilde{R}_{[ab]}^2$ and $\tilde{R}_{[b]}^2$ are overestimated in neutral and mixed scenarios due to neutral dynamics. Our new spatially-constrained procedure is able to remove the spurious correlation due to neutral dynamics and thus obtain the real measure of environmental contribution ($\tilde{R}_{[ab]MSR}^2$ and $\tilde{R}_{[b]MSR}^2$).

Table S1. Mean and variance of fractions [ab], [a], and [b] for each simulated scenario with an environmental spatial autocorrelation $\rho=0$

Scenario	Fraction	Mean		Standard deviation	
		Biased ¹	Corrected ²	Biased	Corrected
Neutral	[ab]	-1.51×10^{-05}	-1.22×10^{-05}	1.33×10^{-03}	1.10×10^{-03}
	[a]	-8.93×10^{-06}	-9.62×10^{-06}	8.51×10^{-04}	8.48×10^{-04}
	[b]	-6.22×10^{-06}	-2.61×10^{-06}	1.41×10^{-03}	1.18×10^{-03}
Species sorting	[ab]	1.20×10^{-01}	1.28×10^{-01}	1.53×10^{-02}	1.53×10^{-02}
	[a]	1.10×10^{-01}	1.09×10^{-01}	1.44×10^{-02}	1.44×10^{-02}
	[b]	1.92×10^{-02}	1.93×10^{-02}	7.28×10^{-04}	7.20×10^{-03}
Mixed	[ab]	1.28×10^{-01}	1.28×10^{-01}	2.79×10^{-02}	2.79×10^{-02}
	[a]	1.07×10^{-01}	1.07×10^{-01}	2.52×10^{-02}	2.51×10^{-02}
	[b]	2.08×10^{-02}	2.09×10^{-02}	8.87×10^{-03}	8.78×10^{-03}

¹ Observed estimations.

² Estimations corrected with the new variation partitioning procedure based on a spatially-constrained null model.

Table S2. Mean and variance of fractions [ab], [a], and [b] for each simulated scenario with an environmental spatial autocorrelation $\rho=0.4$

Scenario	Fraction	Mean		Standard deviation	
		Biased ¹	Corrected ²	Biased	Corrected
Neutral	[ab]	6.76×10^{-03}	9.63×10^{-05}	2.38×10^{-03}	1.73×10^{-03}
	[a]	1.38×10^{-04}	4.30×10^{-05}	8.52×10^{-04}	8.47×10^{-04}
	[b]	6.62×10^{-03}	5.33×10^{-05}	2.42×10^{-03}	1.79×10^{-03}
Species sorting	[ab]	1.44×10^{-01}	1.42×10^{-01}	1.61×10^{-02}	1.61×10^{-02}
	[a]	8.20×10^{-02}	8.15×10^{-02}	1.11×10^{-02}	1.11×10^{-02}
	[b]	6.18×10^{-02}	6.01×10^{-02}	1.04×10^{-02}	1.02×10^{-02}
Mixed	[ab]	1.45×10^{-01}	1.41×10^{-01}	2.89×10^{-02}	2.90×10^{-02}
	[a]	7.91×10^{-02}	7.86×10^{-02}	1.90×10^{-02}	1.90×10^{-02}
	[b]	6.61×10^{-02}	6.27×10^{-02}	1.52×10^{-02}	1.51×10^{-02}

¹ Observed estimations.

² Estimations corrected with the new variation partitioning procedure based on a spatially-constrained null model.

Table S3. Mean and variance of fractions [ab], [a], and [b] for each simulated scenario with an environmental spatial autocorrelation $\rho=0.8$

Scenario	Fraction	Mean		Standard deviation	
		Biased ¹	Corrected ²	Biased	Corrected
Neutral	[ab]	2.96×10^{-02}	2.05×10^{-05}	5.86×10^{-03}	3.55×10^{-03}
	[a]	2.32×10^{-04}	4.07×10^{-05}	8.69×10^{-04}	8.68×10^{-04}
	[b]	2.94×10^{-02}	-2.01×10^{-05}	5.89×10^{-03}	3.62×10^{-03}
Species sorting	[ab]	1.74×10^{-01}	1.62×10^{-01}	1.77×10^{-02}	1.73×10^{-02}
	[a]	3.85×10^{-02}	3.38×10^{-02}	6.27×10^{-03}	6.23×10^{-03}
	[b]	1.35×10^{-01}	1.27×10^{-01}	1.57×10^{-02}	1.51×10^{-02}
Mixed	[ab]	1.86×10^{-01}	1.66×10^{-01}	2.90×10^{-02}	2.91×10^{-02}
	[a]	3.61×10^{-02}	3.54×10^{-02}	2.90×10^{-02}	9.16×10^{-03}
	[b]	1.50×10^{-01}	1.31×10^{-01}	2.42×10^{-02}	2.38×10^{-02}

¹ Observed estimations.

² Estimations corrected with the new variation partitioning procedure based on a spatially-constrained null model.

Sylvie Clappe, Stéphane Dray, and Pedro R. Peres-Neto. Beyond neutrality: disentangling the effects of species sorting and spurious correlations in metacommunity analysis. *Ecology*. 2018.

Appendix S4. Effect of Moran's Eigenvectors Maps selection on estimation and Type I error of fraction [a] in pure neutral metacommunities.

In this appendix, $\tilde{R}_{[a]}^2$ is adjusted with Eq. 5 of the manuscript.

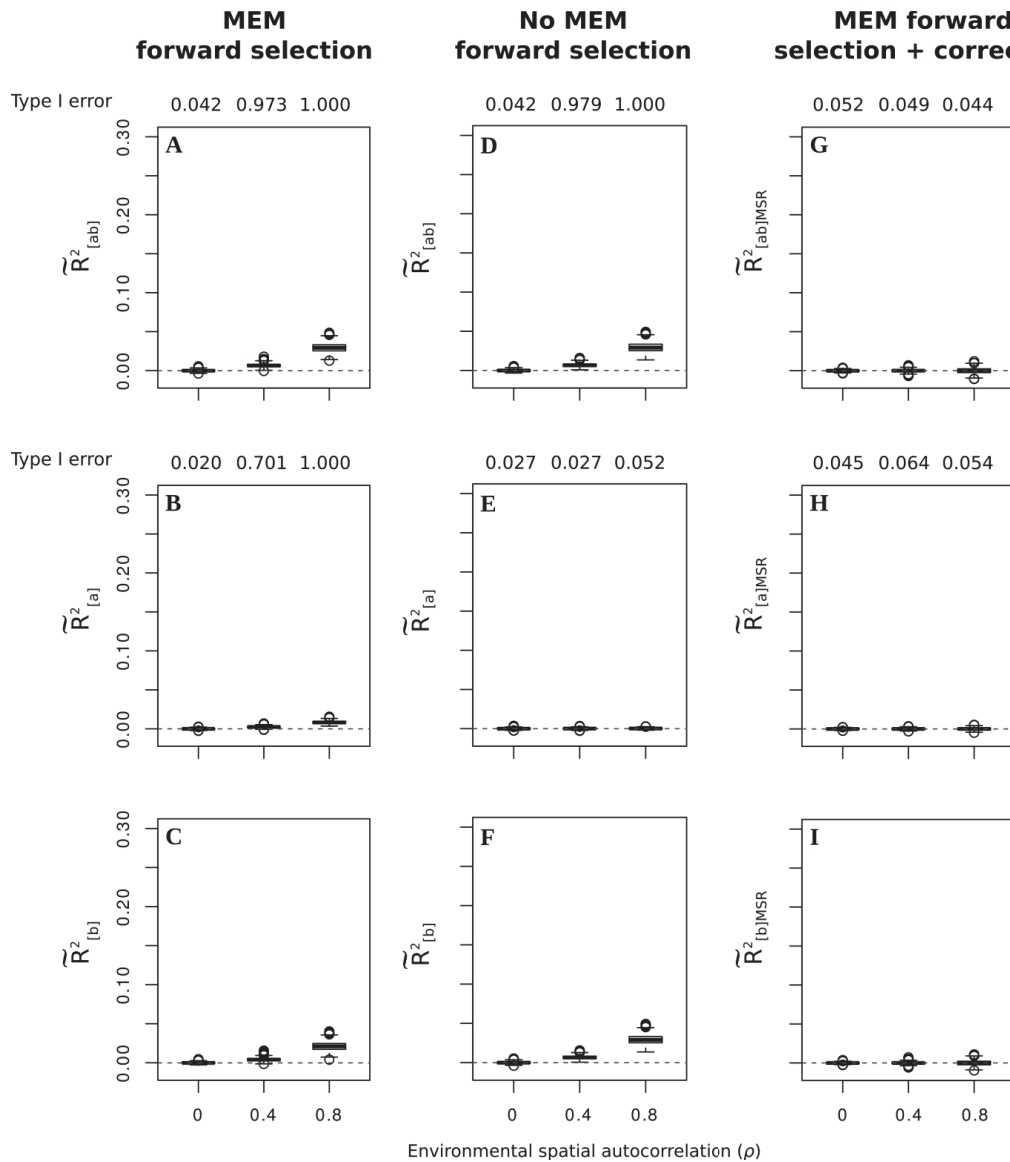

Figure S1: Impact of Moran's Eigenvectors Maps forward selection on variation partitioning estimations and Type I errors of fractions [ab], [a] and [b] for neutral metacommunities. (A-C) Estimation of total environmental contribution (fraction [ab]; $\tilde{R}_{[ab]}^2$), non-spatialized (fraction [a]; $\tilde{R}_{[a]}^2$), spatialized (fraction [b]; $\tilde{R}_{[b]}^2$), and their respective Type I error rates using variation partitioning with a subset of spatial predictors (i.e., Moran's Eigenvectors Maps; MEM; Dray et al. 2006) selected by forward selection (Blanchet et al. 2008); (D-F) Estimation and type I error of fractions [ab], [a] and [b], respectively, using variation partitioning with all positive MEMs (i.e., no selection procedure as in Figure 2 left panel); (G-I) Application of our MSR-based variation partitioning to correct for spurious correlation and inflated Type I error rates of fractions [ab], [a] and [b], respectively, with a subset of MEMs selected by forward selection. (A-I) Note that fraction [b] cannot be tested and as a result Type I errors are not estimated. All \tilde{R}^2 are reported with boxes representing the 25, 50 and 75 quartiles, the lower whisker is the first quartile minus 1.5 times the interquartile range, and the upper whisker is the third quartile plus 1.5 times the interquartile range. Extreme values (i.e., exceeding the whiskers) are plotted. Environmental spatial autocorrelation varies from $\rho=0$ to $\rho=0.8$. Dashed grey line corresponds to the expected \tilde{R}^2 under neutral dynamics (zero). Boxplot were performed with 1000 simulated neutral metacommunities.

Sylvie Clappe, Stéphane Dray, and Pedro R. Peres-Neto. Beyond neutrality: disentangling the effects of species sorting and spurious correlations in metacommunity analysis. *Ecology*. 2018.

Appendix S5. Environmental contribution (fraction [ab]) of mixed metacommunities is a weighted mean of species sorting and neutral environmental contributions.

In this appendix, all \tilde{R}^2 are adjusted R^2 using Eq. 4 of the manuscript.

Environmental contribution (fraction [ab]) of mixed metacommunities is smaller than environmental contribution in pure niche metacommunities as it is a weighted mean of both species sorting and neutral dynamics. Here, we chose to give an example of the calculation process with a high spatialised environment ($\rho=0.8$) so that the environmental contribution will be fully overestimated by neutral dynamics.

Environmental contribution (fraction [ab]; $\tilde{R}_{[ab]-mixed}^2$) is first calculated for the mixed metacommunity (Step 1 Fig.S1). We want to get back to this value (0.2090) at the end of our demonstration.

Species data table of mixed metacommunities were then divided into two tables respectively containing the species with species sorting and neutral dynamics (Step 2 Fig.S1). Environmental contribution ($\tilde{R}_{[ab]-sorting}^2$; $\tilde{R}_{[ab]-neutral}^2$) and variance ($SSV_{sorting}$; $SSV_{neutral}$) were performed for these two tables separately (Step 3 Fig.S1).

We aim at demonstrating that $\tilde{R}_{[ab]-mixed}^2$ is the weighted mean of $\tilde{R}_{[ab]-sorting}^2$ and $\tilde{R}_{[ab]-neutral}^2$, see below:

$$\frac{SSV_{sorting} \times \tilde{R}_{[ab]-sorting}^2 + SSV_{neutral} \times \tilde{R}_{[ab]-neutral}^2}{SSV_{sorting} + SSV_{neutral}} \quad (S1)$$

$$\frac{0.4967 \times 0.2376 + 0.1867 \times 0.1331}{0.4967 + 0.1867} = 0.2090 = \tilde{R}_{[ab]-mixed}^2$$

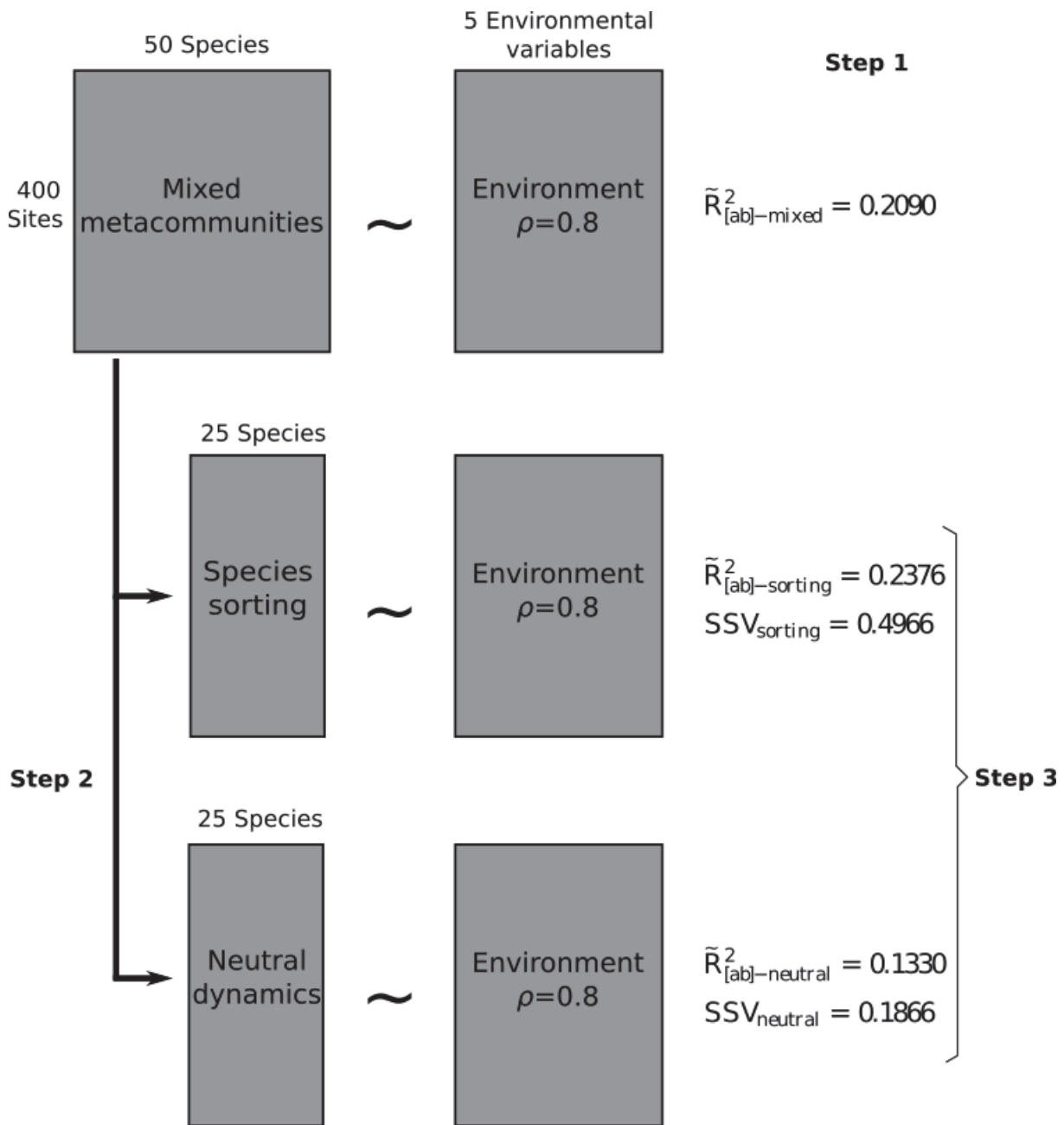

Figure S1: Calculation of mixed $\tilde{R}^2_{[ab]-mixed}$ from pure species sorting $\tilde{R}^2_{[ab]-sorting}$ and pure neutral $\tilde{R}^2_{[ab]-neutral}$. Step 1: Calculation of $\tilde{R}^2_{[ab]}$ for mixed metacommunities ($\tilde{R}^2_{[ab]-mixed}$). The species matrix contains 50 species (25 with species sorting dynamics, and 25 with neutral dynamics). Step 2: Separation of the species with species sorting and neutral dynamics into two respective species data tables. Step 3: Calculation of environmental contribution and variance of both tables: species sorting ($\tilde{R}^2_{[ab]-sorting}$; $SSV_{sorting}$), and neutral dynamics ($\tilde{R}^2_{[ab]-neutral}$; $SSV_{neutral}$).

Sylvie Clappe, Stéphane Dray, and Pedro R. Peres-Neto. **Beyond neutrality: disentangling the effects of species sorting and spurious correlations in metacommunity analysis.** *Ecology*. 2018.

Appendix S6. Empirical application of the spatially-constrained variation partitioning.

This document presents an application of the variation partitioning using Moran Spectral Randomization (MSR) as a spatially-constrained null model. We illustrate the method on the `mafragh` dataset available the package `ade4`. This dataset contains a table of abundances of 56 species sampled in 97 sites, a table of 11 environmental variables measured in the 97 sites, and the neighborhood graph of the sites. These data were recorded from La Mafragh in Algeria.

Data

First, load the data:

```
library(ade4)
data(mafragh)
```

To perform variation partitioning, three table are required: a table of species abundance which is Hellinger-transformed (sites x species; `species-hell`); a table of environmental variables (sites x environmental predictors; `environment`), and table representing “space” (sites x spatial predictors; `eigenfw`). Here, we consider a table of spatial vectors designed by Moran’s Eigenvector Maps (MEM; Dray et al., 2006) associated to positive spatial autocorrelation. We conduct a forward selection to reduce the number of spatial predictors.

```
library(adespatial)
library(spdep)
library(vegan)

##Species matrix
species <- mafragh$flo
species.hell <- decostand(species, method = "hell")

##Environmental matrix
environment <- mafragh$env

##Spatial matrix
mafragh.lw <- nb2listw(mafragh$nb)
```

```
MEM <- scores.listw(mafragh.lw, MEM.autocor = "positive")

#Forward selection of Moran's Eigenvector Maps:
pca.species <- dudi.pca(species.hell, scale = F, scannf = F)
rda <- pcaiv(pca.species, MEM, scannf = F)
R2 <- sum(rda$eig)/sum(pca.species$eig)
fw <- forward.sel(mafragh$flo, MEM, adjR2thresh = RsquareAdj(R2, nrow(MEM),
ncol(MEM)))
## Testing variable 1
## Testing variable 2
## Testing variable 3
## Testing variable 4
## Testing variable 5
## Testing variable 6
## Testing variable 7
## Testing variable 8
## Testing variable 9
## Testing variable 10
## Testing variable 11
## Testing variable 12
## Testing variable 13
## Testing variable 14
## Testing variable 15
## Procedure stopped (alpha criteria): pvalue for variable 15 is 0.059000 (> 0.050000)

#Final spatial matrix
eigenfw <-MEM[,fw$order]
```

Variation partitioning

Now that we have the three tables, we can perform variation partition to identify the variation in beta-diversity explained by pure environment [a], spatialised environment [b], pure space [c], and the non explained variation [d].The function `varipart` implemented in `ade4` returns a list of different objects. `varipart$R2` and `varipart$R2.adj` give the tests and partitioning with unadjusted R^2 and adjusted R^2 respectively.

Classical procedure

```
vprda <- varipart(pca.species, environment, eigenfw, type = "parametric")
vprda
## Variation Partitioning
## class: varipart list
##
## Test of fractions:
## class: krandtest lightkrandtest
## Monte-Carlo tests
## Call: varipart(Y = pca.species, X = environment, W = eigenfw, type = "parametric")
##
## Number of tests: 3
##
## Adjustment method for multiple comparisons: none
```

```
## Permutation number: 999
## Test   Obs Std.Obs Alter Pvalue
## 1  ab 0.2317274 9.458489 greater 0.001
## 2  bc 0.4041022 18.347309 greater 0.001
## 3  abc 0.4898897 12.630856 greater 0.001
##
##
## Individual fractions:
##      a      b      c      d
## 0.08578753 0.14593983 0.25816239 0.51011025
##
## Adjusted fractions:
##      a      b      c      d
## 0.007909892 0.124393953 0.177969618 0.689726536
```

Note that we put `type = "parametric"` to adjust with the classical formula of Ezequiel (Eq. 1 of the manuscript). Results are summarised in Table S1.

New procedure using MSR

To take into account the possible spatial structures of the species distributions and environmental variables, tests and estimations can be corrected using spatially-constrained null models using MSR.

```
vprdaMSR <- msr(vprda, mafragh.lw, nrepet = 999)
vprdaMSR
## Variation Partitioning
## class: varipart list
##
## Test of fractions:
## Monte-Carlo test
## Call: msr.varipart(x = vprda, listwORorthobasis = mafragh.lw, nrepet = 999)
##
## Observation: 0.2317274
##
## Based on 999 replicates
## Simulated p-value: 0.006
## Alternative hypothesis: greater
##
##      Std.Obs Expectation  Variance
## 2.5869483451 0.1769392606 0.0004485357
##
## Individual fractions:
##      a      b      c      d
## 0.08578753 0.14593983 0.25816239 0.51011025
##
## Adjusted fractions:
##      a      b      c      d
## 0.00600713 0.06055916 0.24180441 0.69162930
All results can be summarized as follows:
```

```

res <- rbind(vprda$R2.adj, vprdaMSR$R2.adj.msr)
rownames(res) <- c("Standard VP", "MSR VP")
res
##           a         b         c         d
## Standard VP 0.007909892 0.12439395 0.1779696 0.6897265
## MSR VP      0.006007130 0.06055916 0.2418044 0.6916293

```

Fractions [a], [b], and [ab] were smaller after correction (i.e., new variation partitioning procedure based on MSR, Table S1). This corrected amount of fractions [a], [b] and [ab] correspond to the spurious correlations due to spatial autocorrelation in both species and environmental data.

Table S1: Estimations of fractions for standard variation partitioning and after correction for spurious correlations (based on MSR).

	a	b	c	d
Standard VP	0.0079099	0.1243940	0.1779696	0.6897265
MSR VP	0.0060138	0.0596478	0.2427158	0.6916226

Whereas the role of spatialised environment is estimated to 12.44 %, its estimation is equal to 6.06% using the MSR procedure. On the other hand, the part of pure spatial patterns increases from 17.8% to 24.18% when MSR is applied. The effect of non-spatialised environmental predictors is negligible.

*Article in
collaboration*

Spatial frequency of global climatic conditions drives community functional composition: a test with Angiosperms

Article in preparation

Bertrand Fournier^a, Héctor Vázquez-Rivera^a, **Sylvie Clappe^{a,b}**, Louis Donelle^a, Pedro Henrique Pereira Braga^a and Pedro Peres-Neto^a

^a*Community and Quantitative Ecology Laboratory, Department of Biology, Concordia University, 7141 Sherbrooke Street West, Montreal, QC H4B 1R6, Canada*

^b*Université de Lyon, F-69000, Lyon; Université Lyon 1; CNRS, UMR5558, Laboratoire de Biométrie et Biologie Evolutive, Villeurbanne, France*

BF - E-mail: bfourni@gmail.com

HVR - E-mail: hvzqzr@gmail.com

SC - E-mail: sylvie.clappe@gmail.com

LD - E-mail: louis.donelle@gmail.com

PHPB – E-mail: pedrohenrique.pereirabraga@mail.concordia.ca

PPN: E-mail: pedro.peres-neto@concordia.ca

Corresponding Author: Bertrand Fournier (bfourni@gmail.com)

Abstract

Global climatic conditions vary in spatial frequency. Spatially rare climatic conditions provide fewer suitable environments than common ones. This spatial variation in climate should thus impose constraints on ecological niches and community functional diversity. However, these constraints have remained unexplored. Here, we use 467 North American angiosperms to test, for the first time, the effect of the spatial frequency of climatic conditions at the global scale on ecological niche specialization and functional diversity. Our results show that the interaction of global climate rarity and regional climate heterogeneity drives woody angiosperms niche specialization as well as community functional diversity. Finally, the present study brings attention to the importance of considering climate frequency and its interaction with heterogeneity when studying the effect of climate on ecological communities.

Keywords: Angiosperms; climate frequency; climate heterogeneity; functional diversity; functional trait; generalist; niche breadth; specialist; species assembly

I. Introduction

How environmental features drive community composition at biogeographical to global scales is a central question in ecology. Previous research has demonstrated the effect of climate-related variables such as temperature, precipitation, and evapotranspiration on taxonomic diversity (Currie 1991; Currie *et al.* 2004; Field *et al.* 2009), species composition (Buckley & Jetz 2008, Qian & Ricklefs 2007; Ulrich *et al.* 2014), and community phylogenetic and functional structure (Cavender-Bares *et al.* 2006; Bryant *et al.* 2008; Butterfield *et al.* 2013, Freschet *et al.* 2011; de Bello *et al.* 2013; Safi *et al.* 2011; Spasojevic *et al.* 2014). In contrast to these studies that have focused on how the spatial variation of climate influences the selection of species and traits, we focus here on the spatial frequency of climatic conditions, hereafter referred to as climatic frequency. We argue that, in addition to physiological constraints that can act as filters of the species that may inhabit local communities, climatic frequency regardless of local climatic conditions themselves should impose demographical constraints on population that will affect species niche specialization as well as community functional composition.

Climatic frequency represents a limit to the number of suitable conditions available for a species at large spatial scales. However, the strength of this limitation is likely to vary among species. For instance, species differ in their niche breadth with some species being strong competitors in a restricted range of conditions (i.e. specialist species) and other being relatively weak competitors but tolerating a broad range of conditions (i.e. generalist species) (Levins 1968). Therefore, specialist species in rare climates should have access to fewer suitable habitats than specialist species in common climates, lowering their population sizes and increasing extinction risks. These demographical constraints should affect the success of generalists and specialists. For instance, specialists should have lower extinction risks in common climates than in rare climates, whereas generalists can limit these demographical constraints by being able to thrive in various climatic conditions thus increasing population sizes and decreasing extinction risks. Therefore, even without considering the direct physiological effects of climate on the selection of species to assemble in local communities, rare climates should select for generalists and common climates should select for specialists.

However, at the community level, coexistence of generalist and specialist species has been well-documented (Wilson & Yoshimura 1994; Morris 1996; Abrams 2006). This raises the question of where specialists and generalists coexist the most along the climatic frequency gradient. Because there is a broad theoretical and empirical evidence that specialists are better competitors than generalists (e.g. MacArthur & Connell 1966; Wilson & Yoshimura 1994), it is likely that generalists will be restricted to the rarest climates where demographic effects decrease specialist population size allowing the coexistence of generalists and specialists. In terms of community functional composition, it is unclear whether the climatic frequencies that allow the coexistence of generalists and specialists will correspond to a peak of functional diversity. On the one side, a community dominated by few specialists or few generalists should limit local functional diversity suggesting that the peak of functional diversity is likely to correspond to the peak of specialist-generalist coexistence. On the other side, studies have shown that niche packing as a results of increased species functional specialization can explain the higher biodiversity observed in tropical ecosystems (Pigot, Trisos & Tobias 2016) suggesting that functional diversity might peak in specialist-dominated communities. Finally, heterogeneity in climatic conditions has been linked to higher species richness and trait variation because species can exploit a greater diversity of resources thus allowing more species to coexist locally (Kassen 2002; Stein, Gerstner & Kreft 2014; Stark *et al.* 2017).

Therefore, climatic frequency is likely to interact with other aspects of the spatial distribution of climatic conditions such as heterogeneity that can further influence species assembly into local communities.

Studies relating climatic frequency to community composition are scarce. However, rare climates have been associated to species with restricted spatial distributions and small populations (i.e., rare species) (Cowling et al. 1996; Ohlemüller 2008; Morueta-Holme et al. 2013). No study, however, has investigated the role of the frequency of climatic conditions for species niche specialization and functional diversity which would provide a mechanistic understanding of the role of climate for species assembly into communities. Furthermore, the definition and measures of climatic frequency vary among studies. For example, Cowling et al. (1996) considered the Mediterranean climate to be rare because it covers only approximately 5% of the planet's surface. This categorical measure ignores the potentially important variation within the considered climate zone (i.e., Mediterranean climate). The metrics of climatic frequency proposed either by Ohlemüller et al. (2008) or by Morueta-Holme et al. (2013) describe frequency as unusual conditions relative to the surrounding regions, that is, within a given distance from a given focal geographic position. The choice of a distance around the focal position depends on either the ecological properties of the target organism such as its dispersal capacity, or the boundaries of the sampling region (e.g. continental limits). However, using a constrained geographical definition of the region of interest ignores important eco-evolutionary processes for community functional composition such as long distance dispersal events (Nathan et al. 2008). These processes are likely to occur beyond the scale of the region of interest (Ricklefs & Schluter 1993). Thus, understanding community assembly requires knowledge of the conditions over which eco-evolutionary dynamics take place. In the present study, we focus on woody angiosperms across the continental US. We define the species pool as all angiosperm species worldwide that are potentially able to tolerate US climates. Given the variation of US climatic conditions, we considered the extent covered by this pool of species to be global except for extreme Northern and Southern latitudes where no angiosperm occurs. We therefore characterized quantitatively, for the first time, the frequency of climatic conditions across the whole distribution of angiosperms (i.e. between 85° N and 60° S), hereafter global climatic frequency, and its effect on ecological niches and community functional diversity.

Here we set out to test whether species inhabiting rare climates, regardless of the type of climate, have broader niches than species in common climates. If true, then, we should observe (i) the communities with most generalist species in rare climates (i.e. negative correlation between CFI and community mean niche breadth, NB_{mean}). We further expect few specialists to dominate communities in common climate leading to a relatively low functional diversity while we expect the coexistence of generalists and specialists in rare climates to result in higher functional diversity. This leads to two predictions: (ii) the community standard deviation of niche breadth (NB_{sd}) should increase in rare climates (i.e. negative correlation between CFI and NB_{sd}) and (iii) functional diversity (FD) should increase in rare climates (i.e. negative correlation between CFI and FD). Furthermore, we test the effect of regional climate heterogeneity on these relationships expecting stronger trends in rare and heterogeneous climates as compared to rare and homogeneous climates.

II. Methods

Study area

The extent of the study area corresponds to the continental United States of America, which covers 48 contiguous states, excluding Alaska and Hawaii. This area encompasses a broad range of climatic conditions and the amount of available species occurrence data is high. Species data were restricted to this area, but climate data were estimated globally. We carried out the study at three different geographic resolutions using 3 equal-area projection grids varying in geographic cell size (20 km × 20 km, 50 km × 50 km and 100 km × 100 km).

Species occurrence data

This study focuses on 500 species among the most common angiosperms occurring across the continental United States of America (48 contiguous states, excluding Alaska and Hawaii) (Hawkins *et al.* 2014). We downloaded all georeferenced records for these species from the Global Biodiversity Information Facility (GBIF, <http://www.gbif.org/>, Edwards, Lane & Nielsen 2000), using the R package “rgbif” (Chamberlain *et al.* 2013), and revised the dataset for inconsistencies (i.e., removed duplicated occurrences, homonyms and location errors). Specifically, location errors, occurrences clearly falling outside of the expected range, were identified by comparing the distribution of species obtained from GBIF to that of the United States Department of Agriculture plant database (USDA, <https://plants.usda.gov/>) and

removed from the dataset. We then generated three matrices representing the presences-absences of species in geographic cells by overlapping occurrences onto the equal-area projection grids (geographic cell sizes = 20 km × 20 km, 50 km × 50 km and 100 km × 100 km, respectively). The final database included 467 angiosperm species.

Climatic variables

To estimate climate frequency and climate heterogeneity per geographic cell, we used nineteen biologically relevant climatic variables (averaged for the period of 1960 to 1990) derived from monthly temperature and precipitation data (WorldClim v2.0; Hijmans *et al.* 2005). All variables were originally downloaded at the 2.5 arc-minutes resolution, approximately 5 km × 5 km after projected to equal area. We used the values at this resolution to calculate the mean value of each climatic variable for each geographic cell in each of the three equal-area grids.

Climate frequency index

In this study we introduce a new climatic frequency index (CFI) that describes the spatial frequency of a given set of climatic conditions at the global scale. Our index is independent of the climatic values per se. As such, it does not distinguish different sets of climatic conditions with similar spatial frequencies. It follows that a warm and moist climate can have the same frequency as a cold and dry one. Therefore, this index allows us to assess the impact of climate spatial frequency regardless of direct physiological effects of climatic conditions on organisms.

Here, we calculated the climate frequency of all geographic cells between around 85° N and 60° S (i.e. the extend covered by the species pool potentially able to tolerate US climates). In order to calculate CFI, first, a principal component analysis (PCA) on a correlation matrix (i.e., variables standardized to mean = 0 and variance = 1) was performed on the 19 climate variables. PCA axes were selected to represent 95% of the total variation. Then, climatic frequency was estimated as the spatial probability density of geographic cells in the ordination space defined by climatic variables. To do so, we applied a multivariate kernel density estimation on the PCA sites scores. The bandwidth for optimal data smoothing was selected using Asymptotic Mean Integrated Squared Error (AMISE) criterion, a commonly-used measure of the quality of the kernel density estimator (see Wand and Jones 1994 for further details). Rare climatic conditions therefore have low CFI values, and

common ones have high CFI values. We replicated this procedure and calculated CFI independently for all three spatial resolutions. We used the R packages *ade4* (Dray & Dufour 2007) and *ks* (Duong 2007) to compute PCAs and the kernel density function used to calculate CFI, respectively.

Climate heterogeneity index

We calculated climate heterogeneity for each geographic cell in each of the three equal-area grids. To do this, for a given cell, we took the raw data (i.e. the 5 km × 5 km values) of each climatic variable and projected them to the same PCA that was used to determine the climate frequency index. Then, we used the resulting 5 km × 5 km projected coordinates to calculate their centroid as the mean coordinates along each PCA axis. Finally, climate heterogeneity in the geographic cell was estimated as the mean Euclidean distance to the centroid.

Niche breadth

Niche breadth for any given species was estimated using the tolerance index of Dolédec et al. (2000) using the R package “*ade4*” (Dray & Dufour 2007). This index estimates niche breadth in terms of species environmental (here climatic) tolerance (Hurlbert 1978; Thuiller et al. 2004) using the dispersion of geographic cells that contain the target species in the climatic multivariate space. Low values of the index correspond to specialists and high values to generalists. Finally, we calculated the mean (NB_{mean}) and standard deviation (NB_{sd}) of this index in each community to estimate the dominance of generalists or specialists and their coexistence, respectively.

Functional traits and functional diversity

We selected four traits representing various aspects of species response to climatic conditions. These traits were obtained from Hawkins et al. (2014) and were: (i) realized cold tolerance, (ii) dispersal capacity, (iii) normal maximum tree height, and (iv) leaf persistence. Realized cold tolerance reflects species measured physiological cold tolerance; specifically, the minimum temperature in degree Celsius for the coldest month within the entire range of each given species (Hawkins et al. 2014). Dispersal capacity relates to the type and average distance of seed dispersal (Hawkins et al. 2014). Species were grouped in three categories of

increasing dispersal capacity (1 = low, 2 = medium, and 3 = high). Normal maximum tree height was estimated in meters using the method of Elias (1980) and it ranged from around 1.5 meter to more than 40 meters. Leaf persistence defines a given species as either evergreen or deciduous (0 = evergreen, 1 = deciduous) and describes different strategies to cope with temperature and humidity (Hawkins et al. 2014).

Functional diversity was measured over all traits using the corrected Rao entropy-based functional diversity index (FD) (de Bello et al., 2010; Jost, 2007). We first performed a principal component analysis (PCA) on a correlation matrix (i.e., variables standardized to mean = 0 and variance = 1) using species trait data. PCA axes were selected to represent 95% of the total variation. We then computed a Euclidean distance matrix based on PCA species coordinates in trait space. This matrix was used to compute FD. The main advantage of this index is that it is expressed in terms of effective number of functionally equally distinct species (Chao, Chiu & Jost 2014), which allows a more unified and intuitive interpretation of diversity (Jost 2006; Jost 2007). Another advantage is that it provides a common mathematical framework to compute different components of biodiversity (taxonomic, functional, and phylogenetic). See appendix S1 Figure S3, for a comparison with other commonly used functional diversity indices.

Statistical analyses

We predicted (i) a negative correlation between CFI and NB_{mean} , (ii) a positive correlation between NB_{sd} and CFI and (iii) a positive correlation between FD and CFI. We evaluated these predictions at the 0.1, 0.2, ..., 0.9 quantiles using linear quantile regression models of community mean niche breadth, community standard deviation of niche breadth, or functional diversity (response variables) and CFI as explanatory variables. Climate heterogeneity and its interaction with CFI were also considered as covariates in the models. Linear quantile regressions model linear relationships at quantiles of the response variable (Koenker & Bassett Jr 1978). It does not assume equal variances across covariate values nor does it make assumptions about the distribution of errors. It is, therefore, typically used when more than one slope describes the relationship between a response variable and predictor variables (Cade & Noon 2003). Here, quantile regression allows us to test for the effect of CFI on the targeted response variables by controlling for the level of heterogeneity. We used the R package “quantreg” (Koenker 2018) to fit the linear quantile regressions.

Finally, we assessed whether the effect of climatic frequency is scale-independent. All analyses were repeated for each spatial resolution (geographic cell size = 20 km × 20 km, 50 km × 50 km and 100 km × 100 km). The effects of climatic frequency on species and community functional diversity were consistent across resolutions (see Appendix S1 Figures S4-S5), but the percentage of explained variance decreased slightly at the smallest resolutions. Varying the spatial resolution did not change the direction or shape of the relationships, therefore, we present the results obtained with the 50 × 50km grid only. All statistical analyses were performed in *R version 3.5.0* (R Development Core Team 2016).

Results

Characteristics and distribution of rare and heterogeneous climates

At the global scale, the rarest climates are found along coasts, in mountain ranges such as the Himalayas or Andes, and in large Islands such as the Japan or Madagascar (Figure 1A). In contrast, the most common climates are found in continental areas along the Cancer and Capricorn tropics as well as in the boreal region. Examples of common climates include the Russian Taiga, the Saharan desert and the Australian outback. In the US, the rare climates are found along the west coast, in Florida as well as in the Sierra Nevada and the Rocky Mountains. Common climates occur mainly in continental grasslands and temperate forests.

The most heterogeneous climates are found in mountain ranges and, to a lesser extent along coasts and along major climatic transitions (Figure 1B). The most homogeneous climates are found predominantly in continental areas including the Amazon basin, the Australian outback, and the boreal region. In the US, the cells with the highest heterogeneity are found in the Rocky and Appalachian Mountains, as well as in the Sierra Nevada.

Finally, there is a strong negative relationship between the log of climate frequency at the global scale and the log of heterogeneity within cells ($R^2 = 0.58$; $p < 0.001$), where cells in common climates are characterized by low heterogeneity and cells in rare climates vary in heterogeneity (Figure 2A).

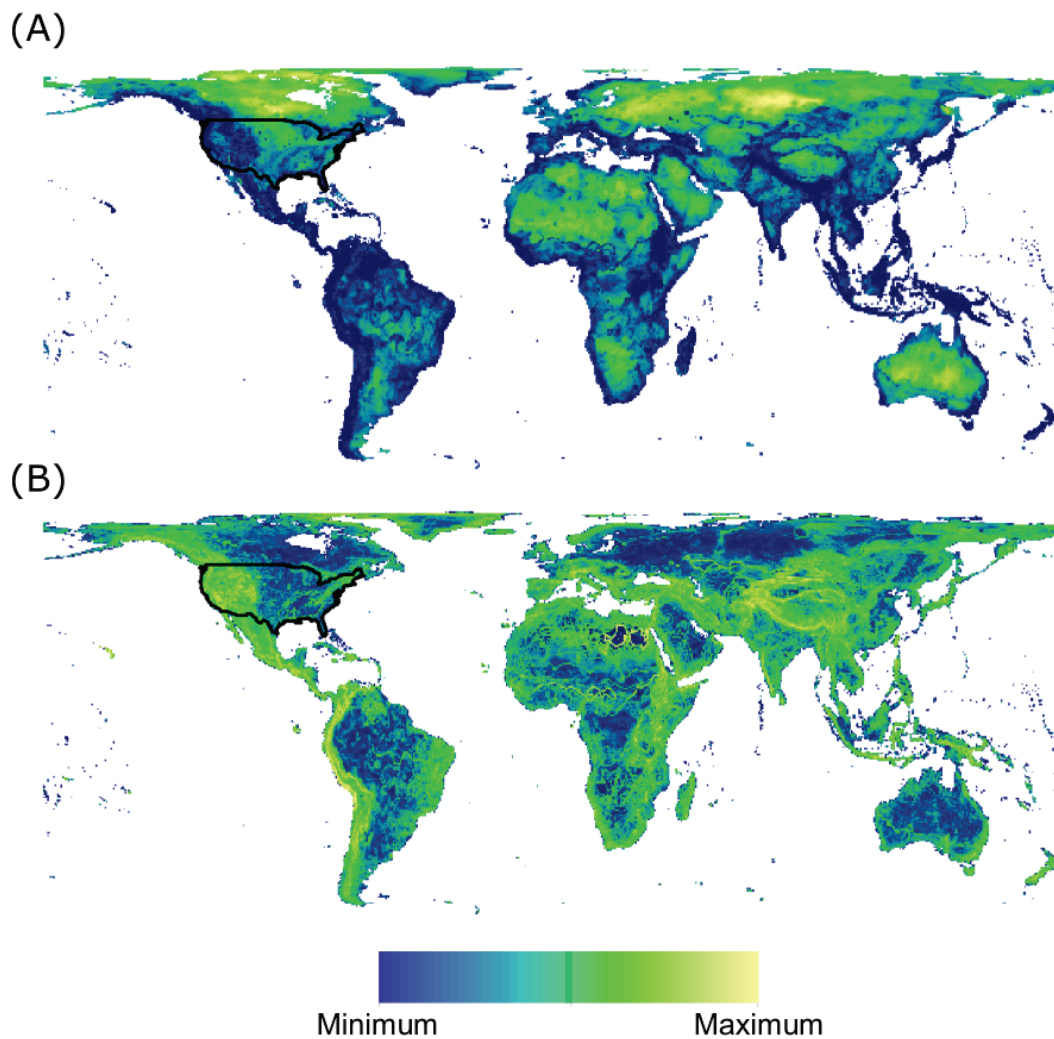

Figure 1. Climate frequency (A) and heterogeneity (B) at the global scale. The bold black line highlight the study area.

Do rare climates harbor species with broader niches?

As predicted, we observe a peak in mean niche breadth in rare climates (Figure 2A). Quantile regressions show that CFI has a positive effect on mean niche breadth after controlling for heterogeneity (Figure 3A). Similarly, heterogeneity has a positive effect on mean niche breadth after controlling for CFI (Figure 3B). Quantile regressions reveal an interaction between CFI and heterogeneity, which has a significant negative effect on NB_{mean} in all quantiles (Figure 3C).

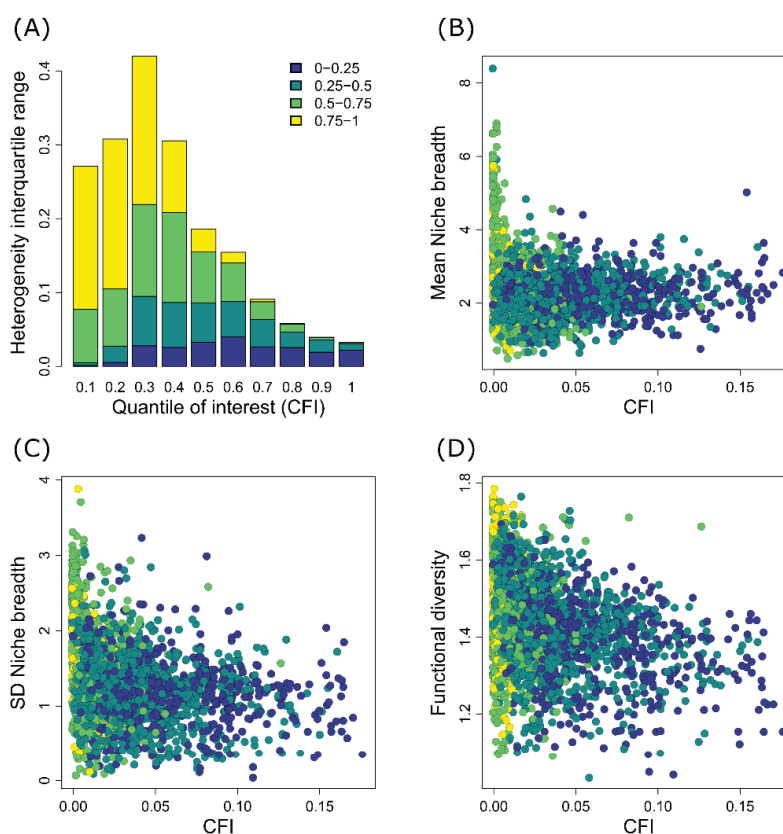

Figure 2. Relationship between climatic frequency (CFI) and three community composition indices. (A) Variability in heterogeneity values per quantile of CFI. (B) Community mean niche breadth. (C) Community standard deviation of niche breadth. (D) Functional diversity. Colors indicate climatic heterogeneity quartiles.

Do rare climates promote the coexistence of specialists and generalists?

As expected, the communities with the highest standard deviation of niche breadth (NB_{sd}) are found in rare climates (Figure 2B). Quantile regressions reveal that CFI, after controlling for heterogeneity, is negatively associated to NB_{sd} for quantiles 0.6 to 0.9 (Figure 3D). NB_{sd} increased with increasing heterogeneity for all quantiles after controlling for CFI (Figure 3E). Quantile regression also reveals an interaction between CFI and heterogeneity which has a significant negative effect on NB_{sd} in all quantiles (Figure 3F).

Does functional diversity increase in rare climates?

The communities with the highest functional diversity (FD) are found in rare climates (Figure 2C). Quantile regressions reveal that CFI, after controlling for heterogeneity, is negatively associated to FD in all quantiles (Figure 3G). FD increased with increasing

heterogeneity in quantiles 0.6 to 0.9 after controlling for CFI (Figure 3H). Quantile regressions reveal an interaction between CFI and heterogeneity, which had a significant negative effect on FD in quantiles 0.7 and 0.8 (Figure 3I). All other functional diversity indices except for functional evenness show a similar trend as the Rao entropy-based index (Supplementary material Figure S3).

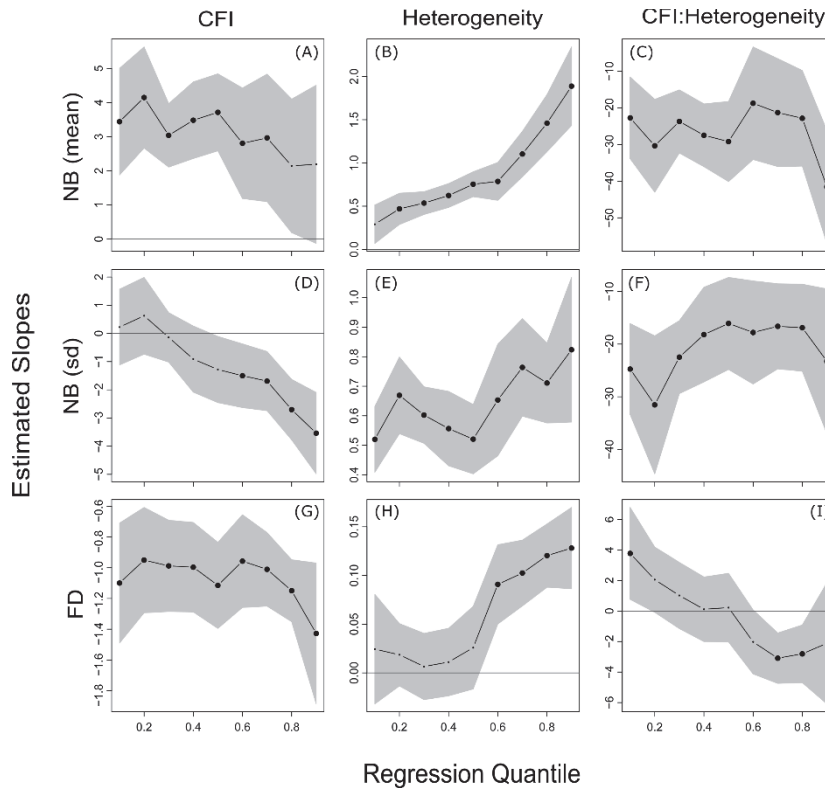

Figure 3. Estimated rates of change (i.e. regression slopes) of response variables (Mean niche breadth = NB_{mean} , standard deviation of niche breadth = NB_{sd} , and functional diversity = FD) as a function of CFI and climatic heterogeneity for each quantile of interest. The first column (panels A, D, and G) shows the estimated rate of change in the different response variables as a function of CFI while controlling for heterogeneity. The second column (panels B, E, and H) shows the estimated rate of change as a function of heterogeneity while controlling for CFI. The third column (panels C, F, and I) shows the estimated rate of change in the coefficient for CFI for every 0.1 increase in climatic heterogeneity. Larger dots show significant coefficients. Grey areas show bootstrap-based standard deviation.

Discussion

Studies aiming at explaining how climate drives species distributions and community structure have mainly focused on metrics describing the mean (e.g. Currie, 1991, Wang *et al.* 2010) and in some cases the heterogeneity of climate (e.g. Stein, Gerstner & Kreft 2014). However, despite evidence that the spatial frequency of climatic conditions relates to species distributions (Brown 1984; Ohlemüller *et al.* 2008; Morueta-Holme *et al.* 2013), no study has linked the functional composition of communities to the spatial frequency of climatic conditions. We advanced over existing research by assessing the effects of global climate frequency and heterogeneity on niche breadth and functional diversity. Our results show that global climate frequency and its interaction with regional climate heterogeneity drives woody angiosperms species niche specialization as well as community functional structure and composition across the continental US.

Do species have broader niche in rare climates?

We have explored whether species inhabiting rare climates have broader niches than species in common climates. Our results confirm that the communities with most generalist species are found in rare and heterogeneous climates, while specialist-dominated communities are commonly found along the whole gradient of climatic frequency (Figure 2A). Quantile regressions show that this pattern was mostly explained by the interaction of climatic frequency and heterogeneity (Figure 3C). Indeed, the effect of frequency and heterogeneity alone (i.e. while controlling for the other covariate) was positive (Figure 3A-B). These results support the idea that the success of generalist species in common climates is limited by the presence of superior competitors (specialists). These results further suggest that, in rare climates, the level of heterogeneity within geographic cells will determine the success of both specialists and generalists, with communities dominated by specialists occurring in relatively homogeneous cells. In agreement, several population-level studies have shown that environmental heterogeneity favor generalists (Futuyma & Moreno 1988; Kassen 2002). And, there is evidence that specialists can be found in rare climates as small populations (Cowling 1996; Ohlemüller 2008).

Do rare climates promote the coexistence of specialists and generalists?

Our results show that the most variable communities in term of species niche breadth (i.e. coexistence of specialist and generalist) are found in rare and heterogeneous climates. Quantile regressions further show that this pattern is mostly driven by CFI and its interaction with heterogeneity (Figure 3D, F), that is, the coexistence of generalists and specialists increases in heterogeneous climates but tends to decrease under frequent climates. The interaction between climate rarity and climate heterogeneity likely decreases the capacity of specialists to exclude generalists in rare climates by limiting specialists' population size and/or by imposing dispersal limitations that prevent them from occupying all available optimal habitats (Büchi & Vuilleumier 2014). Therefore, our results suggest that competitive interactions limit the coexistence of specialists and generalists along the whole gradient of climatic frequency, but climate heterogeneity prevents specialist species from dominating communities in rare climates.

Does functional diversity increase in rare climates?

Our results confirmed that local communities (species found within any given geographic cell) tend to be functionally more diverse in rare climates (Figure 2C) suggesting that climatic frequency is an important driver of FD. Overall, these results show that the peak of functional diversity corresponds with the peak of specialist-generalist coexistence, and suggest that strong dominance by either specialists or generalists limits local angiosperm functional diversity in the continental US. This contrasts with previous studies that suggest that competition promotes diversification in heterogeneous environments (Jasmin & Kassen 2007). Indeed, previous studies have shown positive relationships between species diversity and climate heterogeneity (Veech & Crist 2007), although evidence of negative relationships also exists (Tamme *et al.* 2010). Our results extend this question to functional diversity and suggest that the inconsistencies in the environmental heterogeneity-diversity relationship can be explained by changes in spatial frequency of climate or environmental conditions at larger scale. In agreement with the area-heterogeneity trade-off (Allouche *et al.* 2012), our results suggest that functional diversity is driven by the interplay of habitat availability over the extent of the species pool and within-habitat heterogeneity.

Methodological consideration and perspectives

Although we focused on climate, our approach has a much broader scope and can be readily applied to any environmental factor and scale relevant to particular taxonomic groups. Application of our approach at higher resolution (e.g. 100 by 100 meters cells), however, will require more proximal variables that captures ecologically relevant local variation in environmental conditions. Similarly, while we focused on niche specialization and community functional composition, our approach can be used to study other aspects of community composition such as phylogenetic relatedness among species. And, it can be extended to study population dynamics as well.

Our results proved to be consistent across different community indices and robust to changes in spatial resolution. However, further studies are needed to assess whether our results can be further generalized across a broader range of scales and taxonomic groups. Future studies should thus test for biogeographical effects in the observed patterns by, for example, applying our approach in different regions (i.e. changing location and extent) using taxonomic groups that differ in their mobility and dispersal capacity, as both these traits are likely to influence the effect of climatic frequency on communities. Finally, theoretical approaches based on metacommunity simulation models are likely to provide finer hypotheses about the mechanisms driving the pattern observed in the present study allowing to further understand the joint effect of climate frequency and heterogeneity on ecological communities.

Conclusion

In a context of worldwide decline of specialist species (Clavel, Julliard & Devictor 2010), our study provides valuable insights on the mechanisms driving ecological niche specialization and community functional composition. Indeed, our results suggest that competition limits the success of generalist species. But this effect weakens in rare and heterogeneous habitats where demographic and dispersal constraints likely limit the success of specialists allowing the coexistence of specialists and generalists. Our results further show that rare and heterogeneous climates harbor the functionally most diverse communities suggesting that functional diversity decreases in specialist-dominated communities. Taken together, our results provide a mechanistic hypothesis about the dynamics of ecological niche specialization and community functional composition under varying frequency distribution of

climatic or environmental conditions. Finally, the present study brings attention to the importance of considering the interaction of climate frequency and heterogeneity when studying the effect of climate on ecological communities.

Acknowledgements

BF is supported by CNAES, NSERC and CRC, Canada; and HVR by CONACyT, Mexico; and LD by Vanier CGS, NSERC and FRQNT. PHPB is funded by a scholarship provided by the Brazilian National Council for Scientific and Technological Development (CNPq 248975/2013-0).

Author Contributions

All authors contributed to the initial concept and design of the study. HV and BF collected and cleaned the data. SC, LD, PHPB, HV, and BF analyzed the data. PPN oversaw the analyses. All authors contributed to the writing.

References

- Abrams, P.A. (2006) The prerequisites for and likelihood of generalist-specialist coexistence. *The American Naturalist*, **167**, 329-342.
- Allouche, O., Kalyuzhny, M., Moreno-Rueda, G., Pizarro, M. & Kadmon, R. (2012) Area-heterogeneity tradeoff and the diversity of ecological communities. *Proceedings of the National Academy of Sciences*, **109**, 17495-17500.
- de Bello, F., S. Lavergne, C. N. Meynard, J. Lepš, & W. Thuiller. 2010. The partitioning of diversity: showing Theseus a way out of the labyrinth. *Journal of Vegetation Science*, **21**, 992-1000.
- de Bello F., Lavorel S., Lavergne S., Albert C.H., Boulangeat I., Mazel F. & Thuiller W. (2013). Hierarchical effects of environmental filters on the functional structure of plant communities: a case study in the French Alps. *Ecography*, **36**, 393-402.
- Breiman, L. 2017. Classification and regression trees. Routledge. pp. 368.
- Brown, J.H. (1984) On the relationship between abundance and distribution of species. *The American Naturalist*, **124**, 255-279.

- Brown J.H. (2014). Why are there so many species in the tropics? *J. Biogeogr.*, **41**, 8-22.
- Bryant J.A., Lamanna C., Morlon H., Kerkhoff A.J., Enquist B.J. & Green J.L. (2008). Microbes on mountainsides: Contrasting elevational patterns of bacterial and plant diversity. *Proceedings of the National Academy of Sciences*, **105**, 11505-11511.
- Büchi, L. & Vuilleumier, S. (2014) Coexistence of specialist and generalist species is shaped by dispersal and environmental factors. *The American Naturalist*, **183**, 612-624.
- Buckley L.B. & Jetz W. (2008). Linking global turnover of species and environments. *Proceedings of the National Academy of Sciences*, **105**, 17836-17841.
- Butterfield B.J., Cavieres L.A., Callaway R.M., Cook B.J., Kikvidze Z., Lortie C.J., Michalet R., Pugnaire F.I., Schöb C., Xiao S., Zaitchek B., Anthelme F., Björk R.G., Dickinson K., Gavilán R., Kanka R., Maalouf J.P., Noroozi J., Parajuli R., Phoenix G.K., Reid A., Ridenour W., Rixen C., Wipf S., Zhao L. & Brooker R.W. (2013). Alpine cushion plants inhibit the loss of phylogenetic diversity in severe environments. *Ecol. Lett.*, **16**, 478-486.
- Cade, B.S. & Noon, B.R. (2003) A gentle introduction to quantile regression for ecologists. *Frontiers in Ecology and the Environment*, **1**, 412-420.
- Cavender-Bares J., Keen A. & Miles B. (2006). Phylogenetic structure of floridian plant communities depends on taxonomic and spatial scale. *Ecology*, **87**, S109-S122.
- Chamberlain, S., Boettiger, C., Ram, K., Barve, V. & Mcglinn, D. (2013) rgbif: Interface to the global biodiversity information facility API. R package version 0.4.0. <http://CRAN.R-project.org/package=rgbif>.
- Chao, A., Chiu, C.-H. & Jost, L. (2014) Unifying species diversity, phylogenetic diversity, functional diversity, and related similarity and differentiation measures through Hill numbers. *Annual Review of Ecology, Evolution, and Systematics*, **45**, 297-324.
- Chen, I.-C., Hill, J.K., Ohlemüller, R., Roy, D.B. & Thomas, C.D. (2011) Rapid range shifts of species associated with high levels of climate warming. *Science*, **333**, 1024-1026.
- Clavel, J., Julliard, R. & Devictor, V. (2010) Worldwide decline of specialist species: toward a global functional homogenization? *Frontiers in Ecology and the Environment*, **9**, 222-228.
- Cowling R.M., Rundel P.W., Lamont B.B., Kalin Arroyo M. & Arianoutsou M. (1996). Plant diversity in mediterranean-climate regions. *Trends Ecol. Evol.*, **11**, 362-366.

- Currie D.J. (1991). Energy and large-scale patterns of animal- and plant-species richness. *The American Naturalist*, **137**, 27-49.
- Currie D.J., Mittelbach G.G., Cornell H.V., Field R., Guegan J.F., Hawkins B.A., Kaufman D.M., Kerr J.T., Oberdorff T., O'Brien E. & Turner J.R.G. (2004). Predictions and tests of climate-based hypotheses of broad-scale variation in taxonomic richness. *Ecol. Lett.*, **7**, 1121-1134.
- Davis, M.B., Shaw, R.G. & Etterson, J.R. (2005) Evolutionary responses to changing climate. *Ecology*, **86**, 1704-1714.
- De'ath, G. & Fabricius, K.E. (2000) Classification and regression trees: a powerful yet simple technique for ecological data analysis. *Ecology*, **81**, 3178-3192.
- Diaz S., Cabido M. & Casanoves F. (1998). Plant functional traits and environmental filters at a regional scale. *J. Veg. Sci.*, **9**, 113-122.
- Dolédec, S., Chessel, D. & Gimaret-Carpentier, C. (2000) Niche separation in community analysis: a new method. *Ecology*, **81**, 2914-2927.
- Dray, S. & Dufour, A.B. (2007) The ade4 package: implementing the duality diagram for ecologists. *Journal of Statistical Software*, **22**, 1-20.
- Duong, T. (2007) ks: Kernel density estimation and kernel discriminant analysis for multivariate data in R. *Journal of Statistical Software*, **7**, 21:16.
- Edwards, J.L., Lane, M.A. & Nielsen, E.S. (2000) Interoperability of biodiversity databases: biodiversity information on every desktop. *Science*, **289**, 2312-2314.
- Elias, T. S. 1980. The complete trees of North America. Field guide and natural history. Van Nostrand Reinhold Company & Times Mirror Magazines Inc., New York.
- Enquist B., Norberg J., Bonser S., Violle C., T. Webb C., Henderson A., L. Sloat L. & Savage V.m. (2015). Scaling from Traits to Ecosystems: Developing a General Trait Driver Theory via Integrating Trait-Based and Metabolic Scaling Theories. *Advances in Ecological Research*, **52**, 249-318.
- Field R., Hawkins B.A., Cornell H.V., Currie D.J., Diniz-Filho J.A.F., Guégan J.-F., Kaufman D.M., Kerr J.T., Mittelbach G.G., Oberdorff T., O'Brien E.M. & Turner J.R.G. (2009). Spatial species-richness gradients across scales: a meta-analysis. *J. Biogeogr.*, **36**, 132-147.

- Fortunel C., Paine C.E.T., Fine P.V.A., Kraft N.J.B. & Baraloto C. (2014). Environmental factors predict community functional composition in Amazonian forests. *J. Ecol.*, **102**, 145-155.
- Freschet G.T., Dias A.T.C., Ackerly D.D., Aerts R., van Bodegom P.M., Cornwell W.K., Dong M., Kurokawa H., Liu G., Onipchenko V.G., Ordoñez J.C., Peltzer D.A., Richardson S.J., Shidakov I.I., Soudzilovskaia N.A., Tao J. & Cornelissen J.H.C. (2011). Global to community scale differences in the prevalence of convergent over divergent leaf trait distributions in plant assemblages. *Glob. Ecol. Biogeogr.*, **20**, 755-765.
- Futuyma, D.J. & Moreno, G. (1988) The evolution of ecological specialization. *Annual Review of Ecology and Systematics*, **19**, 207-233.
- Gouveia, S.F., Hortal, J., Cassemiro, F.A., Rangel, T.F. & Diniz-Filho, J.A.F. (2013) Nonstationary effects of productivity, seasonality, and historical climate changes on global amphibian diversity. *Ecography*, **36**, 104-113.
- Grime J.P. (2006). Trait convergence and trait divergence in herbaceous plant communities: Mechanisms and consequences. *J. Veg. Sci.*, **17**, 255-260.
- Hawkins, B.A., Rueda, M., Rangel, T.F., Field, R. & Diniz-Filho, J.A.F. (2014) Community phylogenetics at the biogeographical scale: cold tolerance, niche conservatism and the structure of North American forests. *Journal of Biogeography*, **41**, 23-38.
- Hijmans, R.J., Cameron, S.E., Parra, J.L., Jones, P.G. & Jarvis, A. (2005) Very high resolution interpolated climate surfaces for global land areas. *International journal of climatology*, **25**, 1965-1978.
- Hothorn, T., Hornik, K. & Zeileis, A. (2006) Unbiased recursive partitioning: A conditional inference framework. *Journal of Computational and Graphical Statistics*, **15**, 651-674.
- Hurlbert, S. H. 1978. The measurement of niche overlap and some relatives. *Ecology*, **59**, 67-77.
- Jasmin, J.N. & Kassen, R. (2007) On the experimental evolution of specialization and diversity in heterogeneous environments. *Ecology Letters*, **10**, 272-281.
- Jost, L. (2006) Entropy and diversity. *Oikos*, **113**, 363-375.
- Jost, L. (2007) Partitioning diversity into independent alpha and beta components. *Ecology*, **88**, 2427-2439.
- Kassen, R. (2002) The experimental evolution of specialists, generalists, and the maintenance of diversity. *Journal of Evolutionary Biology*, **15**, 173-190.

- Koenker, R. (2018) quantreg: Quantile Regression. R package version 5.36. <https://CRAN.R-project.org/package=quantreg>.
- Koenker, R. & Bassett Jr, G. (1978) Regression quantiles. *Econometrica: journal of the Econometric Society*, **46**, 33-50.
- Levins, R. (1968) *Evolution in changing environments: some theoretical explorations*. Princeton University Press, pp. 132
- Laliberté, E. & Legendre, P. (2010) A distance-based framework for measuring functional diversity from multiple traits. *Ecology*, **91**, 299-305.
- MacArthur, R.H. & Connell, J.H. (1966) *The biology of populations*. Wiley, New York, pp. 216.
- Marks, C.O., Muller-Landau, H.C. & Tilman, D. (2016) Tree diversity, tree height and environmental harshness in eastern and western North America. *Ecology Letters*, **19**, 743-751.
- McGill B.J., Enquist B.J., Weiher E. & Westoby M. (2006). Rebuilding community ecology from functional traits. *Trends Ecol. Evol.*, **21**, 178-185.
- McKinney, M.L. & Lockwood, J.L. (1999) Biotic homogenization: a few winners replacing many losers in the next mass extinction. *Trends in Ecology & Evolution*, **14**, 450-453.
- Morris, D.W. (1996) Coexistence of specialist and generalist rodents via habitat selection. *Ecology*, **77**, 2352-2364.
- Morueta-Holme, N., Enquist, B.J., McGill, B.J., Boyle, B., Jørgensen, P.M., Ott, J.E., Peet, R.K., Šímová, I., Sloat, L.L., Thiers, B., Violle, C., Wisser, S.K., Dolins, S., Donoghue, J.C., Kraft, N.J.B., Regetz, J., Schildhauer, M., Spencer, N. & Svenning, J.-C. (2013) Habitat area and climate stability determine geographical variation in plant species range sizes. *Ecology Letters*, **16**, 1446-1454.
- Mouillot, D., Bellwood, D.R., Baraloto, C., Chave, J., Galzin, R., Harmelin-Vivien, M., Kulbicki, M., Lavergne, S., Lavorel, S., Mouquet, N., Paine, C.E.T., Renaud, J. & Thuiller, W. (2013) Rare species support vulnerable functions in high-diversity ecosystems. *PLoS Biology*, **11**, e1001569.
- Mulroy, T. W., and P. W. Rundel. 1977. Annual plants: adaptations to desert environments. *Bioscience*, **27**, 109-114.

- Muscarella R. & Uriarte M. (2016). Do community-weighted mean functional traits reflect optimal strategies? *Proc. R. Soc. B*, **283**, 20152434.
- Muscarella R., Uriarte M., Erickson D.L., Swenson N.G., Kress W.J. & Zimmerman J.K. (2016). Variation of tropical forest assembly processes across regional environmental gradients. *Perspectives in Plant Ecology, Evolution and Systematics*, **23**, 52-62.
- Nathan, R., Schurr, F.M., Spiegel, O., Steinitz, O., Trakhtenbrot, A. & Tsoar, A. (2008) Mechanisms of long-distance seed dispersal. *Trends in Ecology & Evolution*, **23**, 638-647.
- Ohlemüller R., Anderson B., Araújo M., H M Butchart S., Kudrna O., S Ridgely R. & Thomas C. (2008). The coincidence of climatic and species frequency: High risk to small-range species from climate change. *Biol. Lett.*, **4**, 568-572.
- Pigot, A.L., Trisos, C.H. & Tobias, J.A. (2016) Functional traits reveal the expansion and packing of ecological niche space underlying an elevational diversity gradient in passerine birds. *Proceedings of the Royal Society B: Biological Sciences*, **283**, 20152013.
- Poorter H., Niinemets Ü., Poorter L., Wright I.J. & Villar R. (2009). Causes and consequences of variation in leaf mass per area (LMA): a meta-analysis. *New Phytol.*, **182**, 565-588.
- Qian H. & Ricklefs R.E. (2007). A latitudinal gradient in large-scale beta diversity for vascular plants in North America. *Ecol. Lett.*, **10**, 737-744.
- R Development Core Team (2016) R: A language and environment for statistical computing. R Foundation for Statistical Computing, Vienna, Austria.
- Reich, P.B. (2014) The world-wide 'fast-slow' plant economics spectrum: a traits manifesto. *Journal of Ecology*, **102**, 275-301.
- Ricklefs, R.E. & Schluter, D. (1993) *Species diversity in ecological communities*, University of Chicago Press, pp. 414.
- Robertson, M.P., Visser, V. & Hui, C. (2016) Biogeo: an R package for assessing and improving data quality of occurrence record datasets. *Ecography*, **39**, 394-401.
- Safi K., Cianciaruso M.V., Loyola R.D., Brito D., Armour-Marshall K. & Diniz-Filho J.A.F. (2011). Understanding global patterns of mammalian functional and phylogenetic diversity. *Philosophical Transactions of the Royal Society B: Biological Sciences*, **366**, 2536-2544.

- Spasojevic M.J., Grace J.B., Harrison S. & Damschen E.I. (2014). Functional diversity supports the physiological tolerance hypothesis for plant species richness along climatic gradients. *J. Ecol.*, **102**, 447-455.
- Stark, J., Lehman, R., Crawford, L., Enquist, B.J. & Blonder, B. (2017) Does environmental heterogeneity drive functional trait variation? A test in montane and alpine meadows. *Oikos*, **126**, 1650-1659.
- Stein, A., Gerstner, K. & Kreft, H. (2014) Environmental heterogeneity as a universal driver of species richness across taxa, biomes and spatial scales. *Ecology Letters*, **17**, 866-880.
- Svoboda J. & Henry G.H.R. (1987). Succession in Marginal Arctic Environments. *Arctic and Alpine Research*, **19**, 373-384.
- Swenson N.G. & Enquist B.J. (2007). Ecological and evolutionary determinants of a key plant functional trait: wood density and its community-wide variation across latitude and elevation. *Am. J. Bot.*, **94**, 451-459.
- Swenson N.G., Enquist B.J., Pither J., Kerkhoff A.J., Boyle B., Weiser M.D., Elser J.J., Fagan W.F., Forero-Montaña J., Fyllas N., Kraft N.J.B., Lake J.K., Moles A.T., Patiño S., Phillips O.L., Price C.A., Reich P.B., Quesada C.A., Stegen J.C., Valencia R., Wright I.J., Wright S.J., Andelman S., Jørgensen P.M., Lacher Jr T.E., Monteagudo A., Núñez-Vargas M.P., Vasquez-Martínez R. & Nolting K.M. (2012). The biogeography and filtering of woody plant functional diversity in North and South America. *Glob. Ecol. Biogeogr.*, **21**, 798-808.
- Tamme, R., Hiiesalu, I., Laanisto, L., Szava-Kovats, R. & Pärtel, M. (2010) Environmental heterogeneity, species diversity and co-existence at different spatial scales. *Journal of Vegetation Science*, **21**, 796-801.
- Thuiller W., Lavorel S., Midgley G., Lavergne S. & Rebelo T. (2004). Relating plant traits and species distributions along bioclimatic gradients for 88 *Leucadendron* taxa. *Ecology*, **85**, 1688-1699.
- Ulrich W., Soliveres S., Maestre F.T., Gotelli N.J., Quero J.L., Delgado-Baquerizo M., Bowker M.A., Eldridge D.J., Ochoa V., Gozalo B., Valencia E., Berdugo M., Escolar C., García-Gómez M., Escudero A., Prina A., Alfonso G., Arredondo T., Bran D., Cabrera O., Cea A.P., Chaieb M., Contreras J., Derak M., Espinosa C.I., Florentino A., Gaitán J.,

- Muro V.G., Ghiloufi W., Gómez-González S., Gutiérrez J.R., Hernández R.M., Huber-Sannwald E., Jankju M., Mau R.L., Hughes F.M., Miriti M., Moneris J., Muchane M., Naseri K., Pucheta E., Ramírez-Collantes D.A., Raveh E., Romão R.L., Torres-Díaz C., Val J., Veiga J.P., Wang D., Yuan X. & Zaady E. (2014). Climate and soil attributes determine plant species turnover in global drylands. *J. Biogeogr.*, **41**, 2307-2319.
- van der Valk A.G. (1981). Succession in Wetlands: A Gleasonian Approach. *Ecology*, **62**, 688-696.
- Veech, J.A. & Crist, T.O. (2007) Habitat and climate heterogeneity maintain beta-diversity of birds among landscapes within ecoregions. *Global Ecology and Biogeography*, **16**, 650-656.
- Villéger, S., Mason, N.W.H. & Mouillot, D. (2008) New multidimensional functional diversity indices for a multifaceted framework in functional ecology *Ecology*, **89**, 2290-2301.
- Wand, M.P. & Jones, M.C. (1994) Multivariate plug-in bandwidth selection. *Computational Statistics*, **9**, 97-116.
- Wang, Z., Fang, J., Tang, Z. & Lin, X. (2010) Patterns, determinants and models of woody plant diversity in China. *Proceedings of the Royal Society of London B: Biological Sciences*, **278**, 2122–2132.
- Webb, C.O., Ackerly, D.D., McPeck, M.A. & Donoghue, M.J. (2002) Phylogenies and community ecology. *Annual Review of Ecology and Systematics*, **33**, 475-505.
- Weiher E. & Keddy P.A. (1995). The assembly of experimental wetland plant communities. *Oikos*, **73**, 323-335.
- Williams, J.W. & Jackson, S.T. (2007) Novel climates, no-analog communities, and ecological surprises. *Frontiers in Ecology and the Environment*, **5**, 475-482.
- Wilson, D.S. & Yoshimura, J. (1994) On the coexistence of specialists and generalists. *The American Naturalist*, **144**, 692-707.
- Wright I.J., Reich P.B., Cornelissen J.H.C., Falster D.S., Groom P.K., Hikosaka K., Lee W., Lusk C.H., Niinemets Ü., Oleksyn J., Osada N., Poorter H., Warton D.I. & Westoby M. (2005). Modulation of leaf economic traits and trait relationships by climate. *Glob. Ecol. Biogeogr.*, **14**, 411-421.

Supplementary information

Appendix 1: Supplementary results

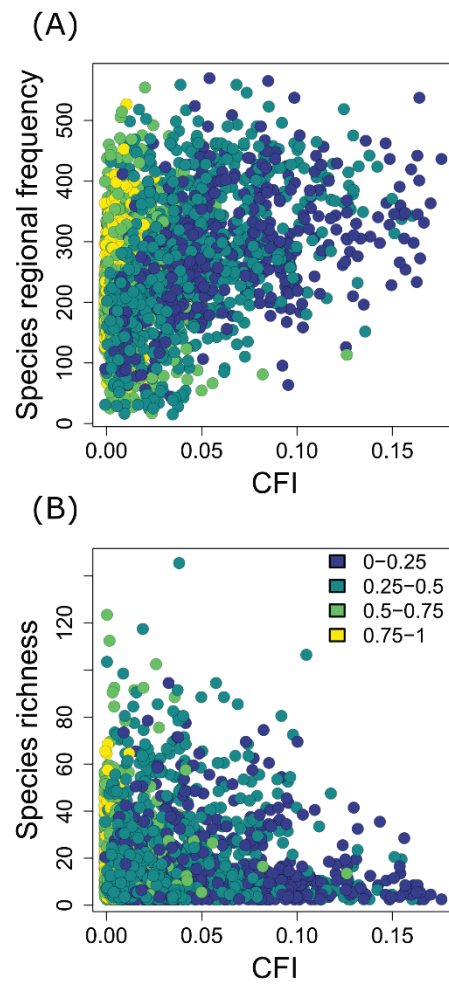

Figures S1. Relationship between climatic frequency (CFI) and (A) species regional frequency and (B) species richness. Colors indicate climatic heterogeneity quartiles.

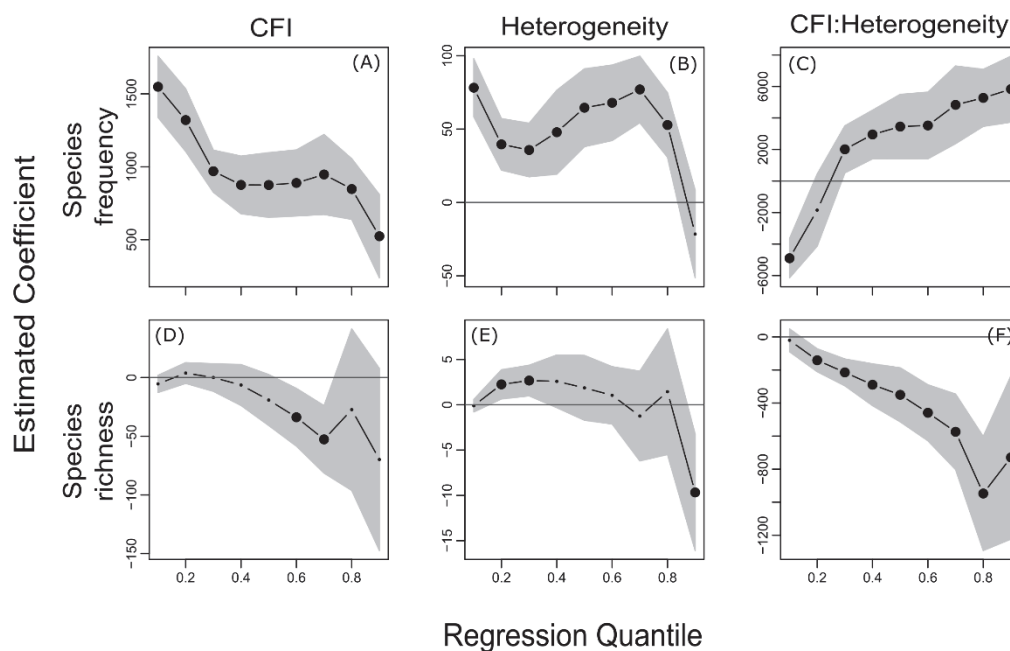

Figures S2. Estimated rates of change of species regional frequency and species richness as a function of CFI and climatic heterogeneity for each quantile of interest. The first column (panels A and D) shows the estimated rate of change in the different response variables as a function of CFI, at average value of heterogeneity. The second column (panels B and E) shows the estimated rate of change as a function of heterogeneity, at average value of CFI. The third column (panels C and F) shows the estimated rate of change in the coefficient for CFI for every 0.1 increase in climatic heterogeneity. Larger dots show significant coefficients. Grey areas show bootstrap-based standard deviation.

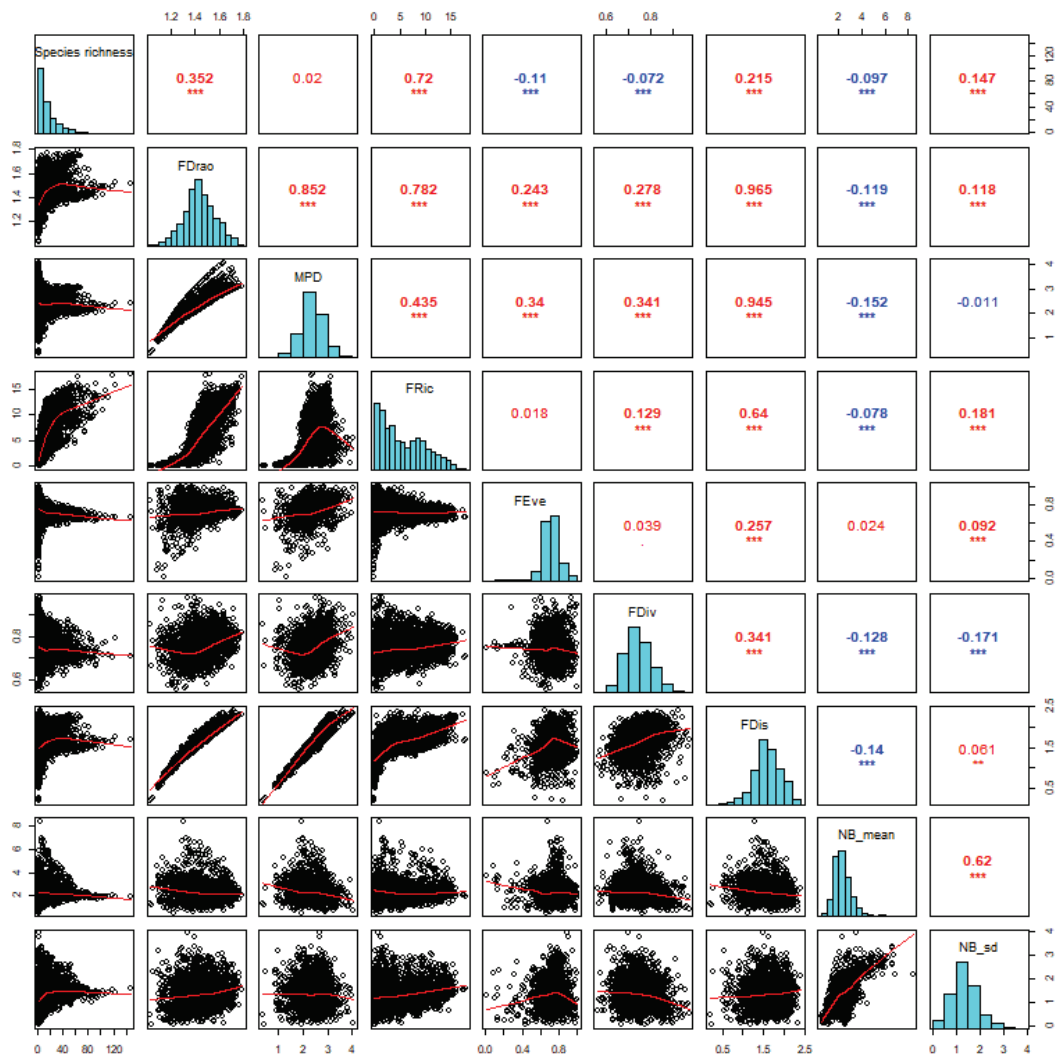

Figures S3. Correlation matrix of community indices. The upper panel shows correlation coefficient (r) with red highlighting positive relationships and blue negative ones. The lower panel shows scatter plots for each pair of variable. The diagonal show the name and the distribution of each community index: species richness, Rao quadratic entropy functional diversity index (FDrao) the functional indices of Villéger et al. (2008) (functional divergence FDiv, functional evenness FEve, and functional richness FRic), the distance-based functional dispersion index (FDis) of Laliberté and Legendre (2010) that assesses the mean distance in multidimensional trait space of individual species to the centroid of all species, the mean pairwise functional distance among species (MPD) Webb et al. (2002), and finally, the mean and standard deviation of niche breadth (NB_{mean} and NB_{sd} , respectively).

Figure S4. Effect of spatial resolution on the relationship between climate frequency (CFI), climate heterogeneity, and community composition indices. Idem Figure 2 with all scales – *in preparation*

Figure S5. Effect of spatial resolution on the relationship between climate frequency (CFI), climate heterogeneity, and community composition indices. Idem Figure 3 with all scales – *in preparation*

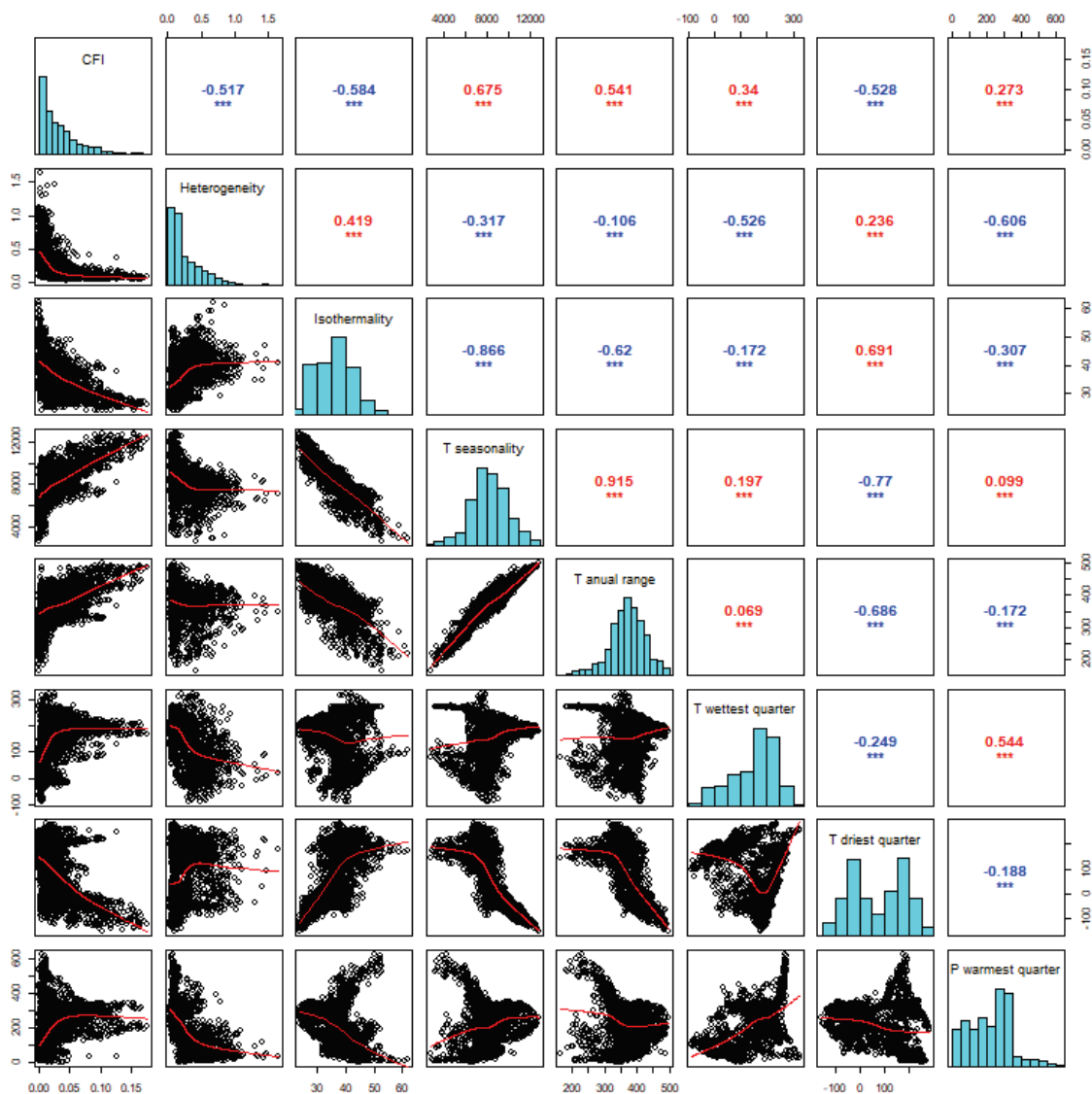

Figures S6. Correlation matrix of climate frequency, climate heterogeneity, and selected climate variables. The upper panel shows correlation coefficient (r) with red highlighting positive relationships and blue negative ones. The lower panel shows scatter plots for each pair of variable. The diagonal show the name and the distribution of each variable.

