



HAL
open science

Hydrogen systems: what contribution to the energy system? Findings from multiple modelling approaches

Olfa Tlili

► **To cite this version:**

Olfa Tlili. Hydrogen systems: what contribution to the energy system? Findings from multiple modelling approaches. Chemical and Process Engineering. Université Paris Saclay (COMUE), 2019. English. NNT: 2019SACLC083 . tel-02414562

HAL Id: tel-02414562

<https://theses.hal.science/tel-02414562v1>

Submitted on 16 Dec 2019

HAL is a multi-disciplinary open access archive for the deposit and dissemination of scientific research documents, whether they are published or not. The documents may come from teaching and research institutions in France or abroad, or from public or private research centers.

L'archive ouverte pluridisciplinaire **HAL**, est destinée au dépôt et à la diffusion de documents scientifiques de niveau recherche, publiés ou non, émanant des établissements d'enseignement et de recherche français ou étrangers, des laboratoires publics ou privés.

Hydrogen Systems: What Contribution to the Energy System? Findings from multiple modelling approaches

Thèse de doctorat de l'Université Paris-Saclay
préparée à Centrale Supélec

École doctorale n°573 Approches interdisciplinaires, fondements,
applications et innovation (Interfaces)

Spécialité de doctorat : Ingénierie des Systèmes Complexes

Thèse présentée et soutenue à Gif-sur-Yvette, le 07/11/2019, par

Olfa TLILI BEN GHANEM

Composition du Jury :

Patrice Geoffron Professeur, Université Paris-Dauphine (Centre de Géopolitique de l'Energie et des Matières Premières, CGEMP)	Rapporteur
Frédéric Lantz Professeur, IFP School	Rapporteur
Jean-Guy Devezeaux de Lavergne Ingénieur Chercheur, Docteur d'Etat, CEA (Institut de technico-économie des systèmes énergétiques, I-tésé)	Examineur
Céline Guivarch Directrice de recherche, Ecole des PontsParisTech (Centre International de Recherche sur l'Environnement et le Développement, CIRED)	Présidente du jury
Zeynep Kurban PhD, Imperial College	Examinatrice
Asgeir Tomasgard Professeur, NTNU (Department of industrial economics and technology management)	Examineur
Christine Mansilla Ingénieur Chercheur, HDR, CEA (Institut de technico-économie des systèmes énergétiques, I-tésé)	Directrice de thèse
Yannick Perez Professeur, CentraleSupélec (Laboratoire de Génie Industriel, LGI)	Co-Directeur de thèse
Jean André PhD, Expert international, Air Liquide	Membre invité
Valérie Seguin Ingénieur Chercheur, CEA (Laboratoire d'Innovation pour les Technologies des Energies Nouvelles et les nanomatériaux, Liten)	Membre invitée

Title: Hydrogen Systems: What Contribution to the Energy System? Findings from multiple modelling approaches

Keywords: Low carbon hydrogen, Energy systems, Techno-economic analysis, Multi-model approach

Abstract: Hydrogen... This simple, very abundant element holds great promise to contribute to the transition towards a cleaner future energy system, but under which techno-economic and political conditions? This thesis is a contribution to the assessment of the hydrogen penetration feasibility into the energy system, using a multi-model approach. The focus is put on low-carbon hydrogen, obtained by electrolysis.

Our multi-regional analysis on the European, American, Chinese and Japanese energy context (presenting contrasted energy challenges) show that, with the current energy policies implemented which result in a modest penetration of hydrogen into the energy system, hydrogen may achieve approximately 3% of the effort that needs to be done by the four regions, in order to limit the increase of the temperature to 2°C, compared to preindustrial levels. We highlight in this thesis that blending hydrogen with natural gas, and thereby avoiding methane leakages to a certain extent, may represent a significant contribution in achieving the carbon mitigation goals.

The hydrogen market analysis has been carried out following two steps. First, each market (industrial and energy-related) was tackled aside in order to propose market entry costs considering the four energy contexts and investigate the timeframe of the market penetration potential. Then, the different hydrogen applications were examined within the overall energy system through the TIMES-PT model (for a Portugal case study), allowing to investigate the hydrogen potential for energy sector coupling. Based on this work, the markets attractiveness was evaluated: mobility (using fuel cell vehicles) appears to be the most favourable.

Then, we tackled the required costs over the whole hydrogen supply chain in order to enter the mobility market.

To do so, we used temporally and spatially resolved models (GLAES, EuroPower and InfraGis) starting with the production side where we studied the hydrogen potential role in providing the electricity system with flexibility and the impact of such electrolysis operation on the hydrogen generation costs in the context of high shares of renewable energies in France. Our results show that hydrogen can contribute to improve the flexibility of the electric system by allowing avoiding renewable curtailment (between 1.4 and 7.9 TWh depending on the interconnection capacity scenario) but also by taking advantage of nuclear plant available energy (thereby avoiding nuclear ramping), the latter ensuring a low carbon and low cost electricity provision. However, a special attention needs to be dedicated to the utilisation rate of the electrolyser, to keep the hydrogen production costs low enough.

Last but not least, we focused on how to link the hydrogen production sites and its final use for mobility applications, the delivery infrastructure being a major issue hampering the hydrogen investments. Five transport and delivery pathways were geographically designed and economically assessed, for the French case. According to our findings, during the very first market penetration phases (1% scenario), it is more interesting to start with decentralised production that proved to be less expensive for the whole pathway at this stage.



Titre : Systèmes à hydrogène: quelle contribution au système énergétique? Résultats de plusieurs approches de modélisation

Mots clés : Hydrogène bas carbone, Systèmes énergétiques, Analyse technico-économique, Approche multi-modèle

Abstract: L'hydrogène... Cet élément simple et très abondant pourrait être un contributeur clé à la transition énergétique, mais dans quelles conditions technico-économiques et politiques ? Cette thèse propose une contribution à l'évaluation de la faisabilité de pénétration de l'hydrogène dans le système énergétique, en mettant en œuvre différents modèles qui permettent des éclairages complémentaires. Elle se concentre sur l'hydrogène bas carbone, obtenu par électrolyse de l'eau.

Notre analyse multirégionale qui porte sur le contexte énergétique européen, américain, chinois et japonais (régions qui présentent des défis énergétiques contrastés) montre que les politiques énergétiques actuelles ne facilitent qu'une faible pénétration de l'hydrogène dans le système énergétique, lui permettant de réaliser environ 3% de l'effort à fournir par les quatre régions afin de limiter l'augmentation de la température à 2°C par rapport aux niveaux préindustriels. Nous soulignons dans cette thèse que l'injection d'hydrogène dans les réseaux de gaz naturel qui permet dans une certaine mesure d'éviter des fuites de méthane à fort pouvoir de réchauffement, pourrait jouer un rôle significatif dans la réalisation des objectifs de réduction des émissions de gaz à effet de serre.

L'analyse des marchés de l'hydrogène a été menée en deux étapes. Tout d'abord, chaque marché (industriel ou énergétique) a été abordé individuellement afin d'établir des coûts d'entrée sur ce marché (pour les différents contextes énergétiques considérés). Ensuite, les différentes applications de l'hydrogène ont été resituées en interaction avec l'ensemble du système énergétique à travers le modèle TIMES-PT et un cas d'étude portant sur le Portugal, permettant ainsi d'examiner le potentiel de couplage entre les secteurs énergétiques rendu possible par l'hydrogène. Ces travaux ont permis de qualifier l'attractivité des différents marchés, celui de la mobilité apparaissant comme le plus favorable.

Nous nous sommes ensuite intéressés aux coûts requis sur l'ensemble de la chaîne d'approvisionnement en hydrogène afin de pénétrer le marché de la mobilité.

Pour ce faire, nous avons utilisé des modèles avec une maille géographique et temporelle fine (GLAES, EuroPower et InfraGis), en commençant par l'étape de production. Nous avons étudié le rôle potentiel de l'hydrogène pour la fourniture de flexibilité au système électrique dans un contexte de forte pénétration des énergies renouvelables intermittentes en France. Nos résultats montrent que l'hydrogène pourrait permettre non seulement d'éviter d'écarter la production d'énergies renouvelables (entre 1,4 et 7,9 TWh en fonction du scénario de capacité d'interconnexion), mais pourrait aussi mettre à profit l'énergie nucléaire disponible (bas carbone donc), évitant par-là d'imposer de fortes rampes de puissances aux centrales. Cependant, une attention particulière doit être accordée au taux d'utilisation de l'électrolyseur afin de maintenir les coûts de production d'hydrogène suffisamment bas.

Enfin, nous nous sommes concentrés sur l'approvisionnement de l'hydrogène, depuis les sites de production jusqu'à l'utilisation pour la mobilité, la question de l'infrastructure étant un problème majeur entravant les investissements dans l'hydrogène. Cinq filières d'approvisionnement (transport et distribution) ont été développées à la maille régionale et comparées sur le plan économique pour le cas français. Nos résultats montrent que, lors des toutes premières phases de pénétration du marché (scénario 1%), il est plus intéressant de privilégier la production décentralisée.



Acknowledgement

My biggest thanks go to my supervisor Christine Mansilla for the wonderful person she is and for her continuous support during these three years of work, not only professionally but also personally. It was such a delight working with her. I would also like to thank all my PhD committee members, Jean André, Yannick Perez, Valérie Seguin and Jean Guy Devezeaux, for their precious advice and for their contribution to my thesis. It was a pleasure working with them, having very different backgrounds, which was significantly enriching. Special thanks to my jury members Céline Guivarch, Patrice Geoffron, Frédéric Lantz, Zeynep Kurban, and Asgeir Tomasgard for accepting to evaluate my work and for allowing me to defend my thesis.

I also thank all the people I had the opportunity to work with during my thesis, in particular my colleagues from the Jülich Forschungszentrum, Martin Robinius, Jochen Linßen, Markus Reuß, Dilara Caglayan, Chloe Syranidis and Severin Ryberg who were very helpful and open for collaboration. Many thanks to my colleagues from the Lisbon Nova University, FCT CENSE, especially Sofia Simoes who opened the doors for me to start working on the TIMES model and accepted me in her team during the collaboration. I also thank Patricia Fortes for her availability to answer my questions and for her encouragements.

I am very grateful to my I-tésé colleagues and the previous PhD students for all the great moments we had together during these three years of work. You are so precious.

I would also like to thank my colleagues from Air Liquide for their professional advice allowing me to have an enriching industrial feedback on my work.

I would not finish without thanking the most precious people in my life, my parents, my husband, my brother and sister, and all my family and friends. Thank you for believing in me and for encouraging me all these years, and sorry for all my bad moments and for not having enough time for you during my PhD work.

Last but not least, I thank my homeland Tunisia for giving me the chance to come to France to pursue my studies. I hope that one day I could return the favor to the most beautiful country in my eyes.



List of Content

SYNTHESE	9
GENERAL INTRODUCTION	11
PART I	22
LITERATURE REVIEW AND ANALYSIS: HYDROGEN IN THE ENERGY SCENARIOS AND MODELS	22
1. Introduction	24
2. Hydrogen in the global energy scenarios	25
3. Hydrogen consideration evolving through time	32
3.1. Interest in Hydrogen	32
3.2. Market consideration	33
4. Data assumption relevance	35
5. Modelling approach impact on hydrogen representation	39
5.1. Optimisation versus simulation models	40
5.2. Bottom-up vs. top-down approaches	42
5.3. The compromise of the temporal resolution	43
5.4. The impact of the geographic resolution	43
6. Conclusions	47
PART II	54
GLOBAL VIEW ON HYDROGEN ROLE IN THE ENERGY SYSTEM – MULTIREGIONAL APPROACH	54
INTRODUCTION	57
CHAPTER I	59
A multi-regional overview of current and future hydrogen markets based on governmental roadmaps: Fostering the hydrogen potential through adequate policies	59
1. Introduction	59
2. Methodology	60
2.1. Market potential assessment: Assessment of market sector sizes	61
2.2. CO₂ mitigation assessment of the hydrogen markets	62
3. Results and discussion	64
3.1. Estimate of hydrogen market sizes	64
3.2. Impact of hydrogen generation via electrolysis on the electricity demand	77
3.3. CO₂ mitigation potential of the considered hydrogen market sectors	78
4. Conclusion and Policy Implications	82

APPENDIX	91
Methodology section.....	91
Results and discussion.....	94
CHAPTER II	100
Hydrogen market penetration feasibility assessment: mobility and natural gas markets in the US, Europe, China and Japan	100
I- Introduction	100
1. Objective of the study.....	101
II- Top-down approach	102
1. Evaluation of market penetration costs methodology	103
2. Results.....	106
III- Bottom-up approach: Evaluation of hydrogen current costs	111
1. Methodology.....	111
2. Results:	116
IV- Market penetration feasibility assessment	124
V- Discussions	128
VI- Conclusion.....	131
CONCLUSION.....	136
PART III	139
USING A BOTTOM-UP OPTIMIZATION MODEL FOR HYDROGEN MODELLING: THE CASE STUDY OF TIMES-PT	139
1. INTRODUCTION	141
2. Assessing the hydrogen systems contribution to decarbonize the Portuguese energy system	143
2.1. Hydrogen representation in the TIMES_PT model	143
2.2. Sensitivity analysis and scenario design	145
3. Sensitivity analysis results	147
3.1. Impact of the cost reductions across the supply chain on the hydrogen penetration feasibility	147
3.2. Hydrogen and the CO ₂ emission reduction.....	156
4. CONCLUSION.....	160
PART IV.....	174
USING SPATIALLY AND TEMPORALLY REFINED MODELS TO ASSESS THE HYDROGEN DEPLOYEMENT IN FRANCE	174
INTRODUCTION.....	176
CHAPTER I.....	179

Implementing the Energy Transition at the Regional Level: The Case of the French Electric System.....	179
CHAPTER II	207
Role of electricity interconnections and impact of the geographical scale on the French potential of producing hydrogen via electricity surplus by 2035	207
1. Introduction	207
2. Methodology.....	210
3. Regional implementation of the power system	216
4. Assessment of the surplus energy.....	218
4.1. First case study: Isolated France (no interconnection)	218
4.2. Second case study: Interconnected France	223
5. Hydrogen potential.....	227
6. Conclusion.....	232
CHAPTER III.....	238
Geospatial modelling of the hydrogen infrastructure in France in order to identify the most suited supply chains.....	238
1. Introduction	238
2. Method and Data	241
2.1. Hydrogen supply chain modelling and global assumptions.....	242
2.2. Hydrogen production	244
2.3. Hydrogen storage.....	246
2.4. Hydrogen transmission and distribution.....	248
2.5. Refuelling stations	250
2.6. Connectors	252
2.7. Scenario Framework and analysed supply chain	253
3. Results.....	254
3.1. Hydrogen demand	254
3.2. Levelling hydrogen production and storage	256
3.3. Delivery pathways comparison	259
4. Summary and discussion	271
5. Conclusion.....	272
CONCLUSION.....	277
GENERAL CONCLUSION	279

SYNTHESE

Beaucoup d'attentes portent sur l'hydrogène. Cet élément simple et très abondant pourrait être un contributeur clé à la transition énergétique, mais dans quelles conditions technico-économiques et politiques ? Cette thèse propose une contribution à l'évaluation de la faisabilité de pénétration de l'hydrogène dans le système énergétique, en mettant en œuvre différents modèles qui permettent des éclairages complémentaires. Elle se concentre sur l'hydrogène bas carbone, obtenu par électrolyse de l'eau.

Notre analyse multirégionale qui porte sur le contexte énergétique européen, américain, chinois et japonais (régions qui présentent des défis énergétiques contrastés) montre que les politiques énergétiques actuelles ne facilitent qu'une faible pénétration de l'hydrogène dans le système énergétique, lui permettant de réaliser environ 3% de l'effort à fournir par les quatre régions afin de limiter l'augmentation de la température à 2°C par rapport aux niveaux préindustriels. Nous soulignons dans cette thèse que l'injection d'hydrogène dans les réseaux de gaz naturel qui permet dans une certaine mesure d'éviter des fuites de méthane à fort pouvoir de réchauffement, pourrait jouer un rôle significatif dans la réalisation des objectifs de réduction des émissions de gaz à effet de serre.

L'analyse des marchés de l'hydrogène a été menée en deux étapes. Tout d'abord, chaque marché (industriel ou énergétique) a été abordé individuellement afin d'établir des coûts d'entrée sur ce marché (pour les différents contextes énergétiques considérés). Ensuite, les différentes applications de l'hydrogène ont été resituées en interaction avec l'ensemble du système énergétique à travers le modèle TIMES-PT (en collaboration avec le centre CENSE de l'université NOVA FCT de Lisbonne) et un cas d'étude portant sur le Portugal, permettant ainsi d'examiner le potentiel de couplage entre les secteurs énergétiques rendu possible par l'hydrogène. Ces travaux ont permis de qualifier l'attractivité des différents marchés, celui de la mobilité apparaissant comme le plus favorable (en particulier pour la mobilité longues distances).

Nous nous sommes ensuite intéressés aux coûts requis sur l'ensemble de la chaîne d'approvisionnement en hydrogène afin de pénétrer le marché de la mobilité.

Pour ce faire, nous avons utilisé des modèles avec une maille géographique et temporelle fine (GLAES, EuroPower et InfraGis en collaboration avec l'institut IEK-3 du centre de recherche de Jülich, Allemagne), en commençant par l'étape de production. Nous avons étudié le rôle potentiel de l'hydrogène pour la fourniture de flexibilité au système électrique dans un contexte de forte pénétration des énergies renouvelables intermittentes en France. Différents scénarios de capacités d'interconnexions électriques, de demande hydrogène et de localisation des électrolyseurs par rapport à la demande, ont été examinés. Nos résultats montrent que l'hydrogène pourrait permettre non seulement d'éviter d'écarter la production d'énergies renouvelables (entre 1,4 et 7,9 TWh en fonction du scénario de capacité d'interconnexion), mais pourrait aussi mettre à profit l'énergie nucléaire disponible (et bas carbone), évitant par-là d'imposer de fortes baisses de production aux centrales. Cependant, une attention particulière doit être accordée au taux d'utilisation de l'électrolyseur afin de maintenir les coûts de production d'hydrogène suffisamment bas.

Enfin, nous nous sommes concentrés sur l'approvisionnement de l'hydrogène, depuis les sites de production jusqu'à l'utilisation pour la mobilité, la question de l'infrastructure étant un problème majeur entravant les investissements dans l'hydrogène. Cinq filières d'approvisionnement (transport et distribution) ont été développées à une maille régionale fine et comparées sur le plan économique pour le cas français. Nos résultats montrent que, lors des toutes premières phases de pénétration du marché (scénario 1% de la flotte de véhicules particuliers), il est plus intéressant de privilégier la production

d'hydrogène décentralisée (proche des sites de demande) afin d'éviter de lourds investissements d'infrastructure.

GENERAL INTRODUCTION

In the last decade, awareness regarding climate change has been increasingly rising around the globe. Draining fossil fuels and burning them has proved to become environmentally costly, leading to the rise of the earth's surface temperature and accordingly, to many natural calamities. Earth as we know might change forever if no action is undertaken to hinder the global warming [1].

In order to mitigate climate change and fall in line with the decarbonisation targets expected worldwide, most energy mixes must undergo transformations with country-specific energy transition pathways. The universal Paris agreement, signed in December 2015, fixed a long-term goal of keeping the increase in global average temperature below 2°C above pre-industrial levels [2]. This implies that, for each country, specific measures must be considered in order to reduce greenhouse gas (GHG) emissions. The challenge remains on identifying the optimal way to reduce these emissions, while preserving growth, competitiveness and security of supply.

Nowadays, the global energy sector is responsible for 32.2 Gt of CO₂ emissions, with a high share related to power generation (42%) [2]. Electricity is a core issue since significant decarbonisation of the energy system will be driven by both the electrification of different sectors and decarbonizing the power sector [3].

This second driver has led to the spread of renewable energies (REN). The latter present the advantage of lowering the carbon emissions while ensuring a renewable resource for energy production. Despite the efficiency and cost improvements of REN, efforts still need to be done in order to ensure a complete decarbonisation of the energy system.

Beyond the efficiency and cost matters, the integration of the renewable energies into the system may present some challenges, requiring new needs in terms of system stability.

In fact, due to their dependency on weather conditions (except for biomass), the renewable energies can engender higher risks of power system imbalances, thus jeopardizing the grid stability. This situation is a new challenge for the system operators who are responsible for maintaining the balance of the electric system in real time. Seeking reserve procurement might hence be more frequent and new flexibility technologies like batteries and other storage facilities may find a suitable environment to emerge.

Nonetheless, in order to reach the 2° goal, thinking beyond the electric system is required. Other sectors like transport which accounts for nearly 22.7% of the total energy related CO₂ emissions [2] will need to be considered in the decarbonisation strategy. Transportation is challenging, being so far highly dependent on fossil fuel combustion engines. However governmental pledges have been set in several regions worldwide. The European Union (EU) has set CO₂ reduction targets for the transport activity aiming to reach a 95 g_{CO2}/km cap by 2020. These targets are ambitious compared to the ones announced by the United States (US), China and Japan (121, 117 and 105 g_{CO2}/km respectively) [4].

Accordingly, new transport technologies have emerged aiming for a “cleaner” mobility provision, for instance, fully electric or hybrid vehicles, hydrogen, biofuels, etc.

The same logic is applicable to the industrial and residential sectors. However, tackling each sector apart might not be the most efficient way, compared to adopting a multi-sectorial decarbonisation approach. Synergies between sectors can be created.

In this perspective, hydrogen systems can be key enablers to promote promising synergies between sectors, thanks to the hydrogen versatility [5]. The produced hydrogen can be used for both chemical purposes and energy applications: industry, transport, heating, etc. [6], [7].

Accordingly, provided that hydrogen (H_2) is produced via low carbon technologies such as electrolysis coupled with a decarbonized power mix, multi-sectorial decarbonisation can be achieved.

To properly address each hydrogen market according to its specificities, segmentation was designed within two main categories:

- Hydrogen used for its chemical properties: this includes the current markets where hydrogen is required as a chemical product. Three main market segments are considered [6], [8]: ammonia production, refinery applications, and methanol production;
- Hydrogen used as an energy carrier for diverse applications. For these applications, hydrogen competes with other energy carriers. They are mobility use, injection in the gas network, and stationary applications.

The segmentation is detailed in the following sections, starting with hydrogen as a chemical product.

1. Industrial markets

In fact, hydrogen is not a new comer. Its current global consumption is around 61 Mt. Today, as shown in Figure 1, hydrogen demand is mostly driven by the chemical markets like ammonia production or refinery processes, which together account for approximately 80% of the total demand [9].

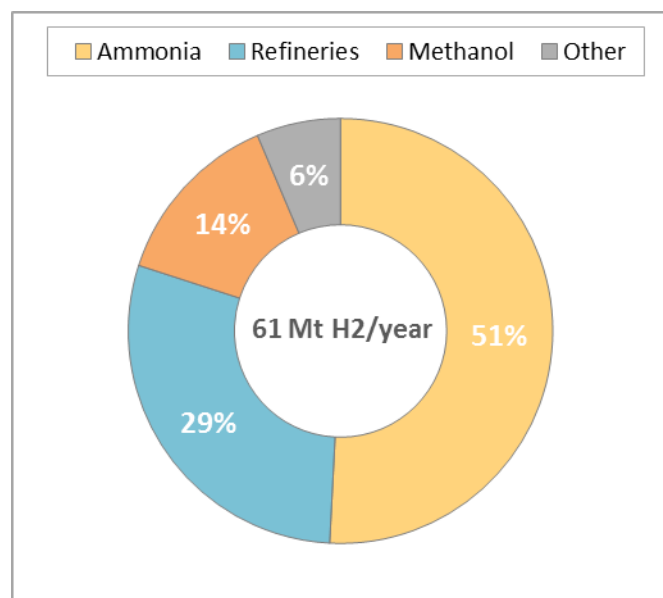

Figure 1: Hydrogen current markets breakdown – adapted from [9]

China is the first hydrogen consumer in the world (17% of the global demand) with 60% of its demand dedicated to ammonia production. It is followed by the United States which account for nearly 9% of the global hydrogen demand. The US hydrogen consumption is mainly driven by the refining activity with a share of 62% of its total demand [9].

Thus, nowadays, hydrogen is mainly used as a chemical component for industrial purposes with different ways of market procurement. Some industries rely on captive hydrogen which means that they invest in their own hydrogen production means, while others opt for merchant hydrogen provided by other industries. A third category of hydrogen procurement is the “co-product” hydrogen, a case that occurs when a certain industrial process provides more than two outputs, in which hydrogen appears, to be then consumed in other processes. This is the case in refineries for example where hydrogen is produced during naphtha or oil reforming and then consumed in the hydro-cracking and hydrodesulfurization processes [6].

The segmentation of the hydrogen industrial markets is detailed hereafter:

- **Ammonia production**

Ammonia is produced through the catalytic reaction of nitrogen and hydrogen.

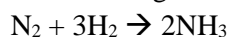

It is then mainly used to produce fertilisers for the agricultural activity [10]. The current industrial production of hydrogen requires the use of a feedstock, mainly natural gas, coal or naphtha [6]. Ammonia plants are mainly a captive market, which means that hydrogen production plants belong to the ammonia industrial actors, to meet their own hydrogen demand [6], [11].

- **Refinery applications**

Hydrogen is both produced and consumed in the refining process. Hydrogen is a co-product of the catalytic reforming process step. It is consumed to reduce the sulphur content of oil fractions, in the refining step called hydro-treating, and to upgrade low quality heavy oils, in the hydro-cracking stage [6], [12]. When hydrogen demand is greater than its co-production, external hydrogen inputs are needed. Most refineries own steam methane reformers to produce the lacking amount of hydrogen required for the processes mentioned above. Hydrogen can also be provided by other industries as a merchant product.

- **Methanol production**

From hydrogen and carbon dioxide it is possible to synthesize other carbon chains such as methanol. Traditionally, methanol production uses natural gas as feedstock in order to produce the required hydrogen and carbon molecules as well as to provide the different processes with the heat they need for the chemical reactions. Today’s methanol production represents around 14% of the global hydrogen demand [9]. According to the IHS Chemical Handbook, “it can either be used directly or further transformed to produce a wide range of chemicals that ultimately find applications in diverse sectors (construction, textiles, packaging, furniture, paints, coatings, etc.)” [13].

In addition, methanol can also be of direct interest to the field of energy to serve as additives to current fuels or synthetic fuels in substitution for fossil fuels. In particular, methanol can be an alternative for mobility.

The energy-related markets are further detailed hereafter.

2. Energy-related markets:

So far, only small amounts of hydrogen are used in energy applications, although hydrogen can be injected into natural gas networks, or used for transport, heating or power supply purposes [9]. Nowadays the main hydrogen demand for energy purposes comes from demonstration projects around the world. One of the most important ones is the deployment of hydrogen refuelling stations across Europe and mainly in Germany for fuel cell vehicles recharging. Germany is at the forefront of the deployment of refuelling stations with a total number of 35 in 2017 (operating refuelling stations) [14]. Many plans are already set to increase this number to 400 by 2030 [15].

- **Mobility use**

Hydrogen can either be used as a direct fuel via fuel cells in vehicles - FCEV (cars, buses, trucks, trains, etc.), or as a chemical additive for the production of advanced biofuels for mobility purposes. The direct use of hydrogen in internal combustion engine vehicles was abandoned due to efficiency issues [6]. The fuel cell logic is as follows: hydrogen sourced via the vehicle reservoir reacts with oxygen from the ambient air to produce water while generating electricity following the chemical reactions mentioned below:

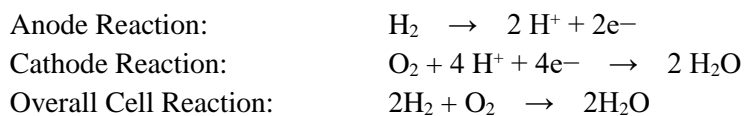

The electricity is then used to propel the transport engine.

Synergies between the hydrogen vehicles and the fully electric ones can also take place. For instance, the “range-extender” vehicle presents a promising option that allows improving the electric vehicle autonomy while easing the hydrogen penetration [16], [17].

As mentioned above, hydrogen can also be considered in the short term as a feedstock for the production of advanced biofuels. Indeed, they are liquid fuels that do not require any change of the current engines. In this process, hydrogen allows enhancing the efficiency by increasing the amount of biofuel to be obtained from a given biomass quantity [18].

Other transport markets include the use of hydrogen for space applications (seen as a marginal use), aeronautics (rather through synthetic fuels, although H_2 can help on some energy needs on board), and last but not least the forklift application that is marginal in terms of volumes but one of the first markets already profitable [19].

The Shell Hydrogen Study [20] details the Technology Readiness Levels (TRL) of the different potential mobile fuel cell uses (see Figure 2). Several technologies are already commercialized and have proven economic interest, like the forklift use for example. Considering the transport sector, the passenger vehicles present the highest TRL compared to the other transportation means. Nonetheless, hydrogen is particularly well-suited to heavy-duty transportation means, allowing to overcome the range, charging time and payload issues faced by battery-electric vehicles (BEVs) [21].

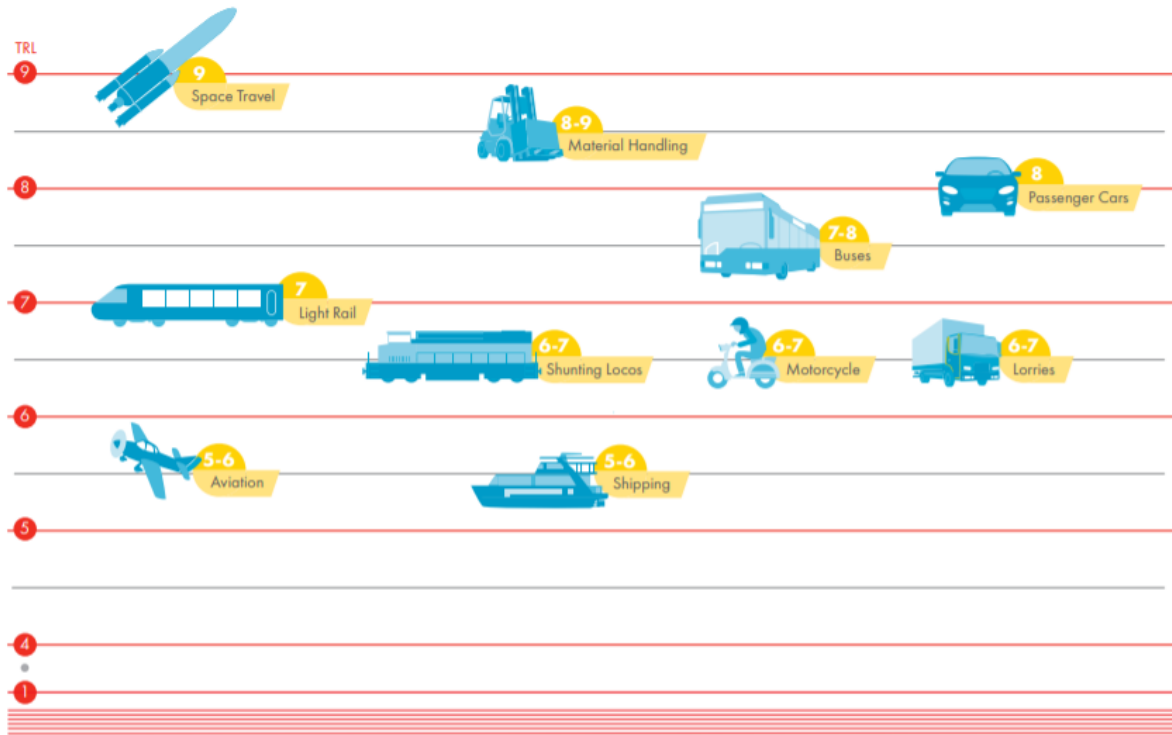

Figure 2: Technology Readiness Level of hydrogen mobility applications [20]

- **Injection into gas networks**

Injecting hydrogen into natural gas networks is also a promising solution for natural gas decarbonisation, since it contributes to making it more sustainable, which could make it eligible to benefit from a feed-in tariff or a premium in the transition period [22]. In this market segment, hydrogen can be valorised in two ways. It can be partially blended with natural gas (NG) up to a certain concentration limit, or consumed together with carbon dioxide to produce synthetic methane (via the methanation process) that will be injected into the network. The resulting gas, or mixture, can then address most of the known markets for natural gas. However, concentration proportion limits should be respected. A mixture of up to 10 % by volume of hydrogen to natural gas can be feasible without requiring major modifications on the end-use devices [22].

- **Stationary applications**

Stationary applications of hydrogen refer to power and heat supply via hydrogen as an energy carrier. Hydrogen can provide flexibility to the electric system by playing the role of seasonal storage while also representing a flexible demand, hence easing the renewable energy integration.

Hydrogen can be stored in pressurized tanks or underground caverns or in liquid forms (liquid H₂ tanks, liquid organic hydrogen carrier - LOHC), and then used to produce electricity when needed (e.g. during peak load periods) using a fuel cell or a hydrogen gas turbine [7]. Hydrogen conversion into electricity has though poor energy efficiency, ranging from 30% to 70%, depending on the technology that is used [6], [7]. Combined power and heat provision for buildings (residential, commercial or industrial) is also feasible using a CHP (combined heat and power) hydrogen fuel cell.

As detailed above, numerous are the ways to use hydrogen, however in order to ensure a decarbonisation effect, low carbon hydrogen production must be implemented, which is not the case today.

In 2015, 96% of the global hydrogen demand was provided through fossil-sourced production means [8].

The traditionally dominating method is the steam methane reforming that consists in splitting the methane molecule into hydrogen and carbon monoxide under high temperatures following the reaction stated below [23]:

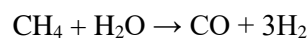

Overall, including the emissions that are due to the energy consumed during the process to ensure high temperatures, this process emits around 10 kg of CO₂ per kg of hydrogen produced [19]. However, more environmentally efficient methods can be envisaged including the consideration of Carbon Capture and Storage (CCS) [19].

Among other options, hydrogen can be produced via electrolysis, requiring a low carbon electricity mix to make it environmentally-friendly. The electrolysis principle is as follows: the water molecule is split into hydrogen and oxygen using electricity. Electrolysers can be differentiated by the electrolyte materials and the temperature at which they are operated [24].

Three main types of electrolysers have been developed. The most commercialized one is the alkaline technology which is mature, followed by the Proton Exchange Membrane (PEM) technology which is in earlier commercial phase (especially for high-capacity electrolysers) but its high flexibility and simple design makes it the most adapted for grid service, being able to withstand variable loads. These two technologies operate at low temperatures.

High-temperature electrolysis (including the Solid Oxide Electrolyser Cell - SOEC) is still under research and development [7], [24]. This process offers interesting perspectives in terms of efficiency and the possibility to conduct reversible operation, and co-electrolysis of water and carbon dioxide to generate syngas.

The current electrolyser techno-economic characteristics are detailed by type in Table 1.

Table 1: Current performance of electrolyzers - taken from [7] and [25]

	Capacity	Efficiency	Investment cost	Lifetime	Maturity
Alkaline	Up to 150 MW	65-82% (HHV)	850-1500 \$ / kW	60 000 - 90 000 hours	Mature
PEM	Up to 150 kW (stacks) Up to 1MW (systems)	65 - 78 % (HHV)	1500 - 3800 \$ / kW	20 000 - 60 000 hours	Early market
SOEC	Prototype/demonstration	85-90% (HHV)	>2000 \$ / kW	<10,000 hours	Demonstration

Other low carbon hydrogen production means can also be considered including the biomass gasification process [26], [27] and the biogas reforming [28].

In addition to the intentionally produced hydrogen, large volumes of by-product hydrogen are generated from a variety of production processes. As mentioned before, one of the most important sources of by-product hydrogen is catalytic reforming processes in refineries. This hydrogen is typically recovered and used directly in other refinery operations (“captive” use) [6], [9].

Despite its promising potential, hydrogen has been going through ups and downs in the last decades which can be explained by the non-synchronization between governmental incentives and industrial efforts coupled with the issue of the technology maturity [29]. However, in the last three years, a significant upwards trend has occurred raising again the interest in hydrogen not only as an energy carrier conquering new markets, but also as a chemical component allowing the electrification of several industrial applications so far dependent on fossil fuels [23]. In 2017, an international industrial initiative was created under the name of the “Hydrogen Council”, gathering 53 leading companies from different fields, in the energy, transport and industry sectors, and with different sizes (big, medium and small companies) presenting a united and long-term vision for the development of the hydrogen economy [30]. This initiative had a significant impact on clearing the fog of uncertainty regarding the perspectives of hydrogen. In parallel, several new governmental incentives have emerged (in France, Korea, Australia, etc.).

National targets are set in several regions in order to draw a roadmap for hydrogen integration into the energy system. Japan, China, Korea, Australia and France are some examples [15], [31]–[34]. In other regions (Germany and California for instance), the efforts are rather industry-driven, where industrial pledges and programs for hydrogen penetration have been set especially in the transport sector (H2Mobility for instance setting a number of refuelling stations to be reached across Europe by 2030).

The research organisations and institutes are also of big importance. As a matter of fact, over the last 40 years, the IEA has shown an increasing interest in hydrogen, reflected not only through the different reports tackling the hydrogen potential (the most recent ones are [7], [14], [23]) but also through its Hydrogen Technology Collaboration Program including different tasks addressing different aspects related to hydrogen systems (production, storage, conversion, safety, etc.) [35]. The impact of the IEA is also reaching the governmental level of decision making. In fact, the IEA provided the G20 with a hydrogen report, under the Japanese presidency [36]. The G20 is held every year to discuss the critical

issues affecting the global economy, and it brings together policy makers, industrial stakeholders as well as research organisms. It is hence an opportunity to join the efforts to move forward.

Research in the hydrogen field has also evolved. Previously, hydrogen potential was only mentioned for the mobility sector, and for the passenger light duty vehicles via FCEV in particular. This was reflected by the presence of this only specific application in the global energy reference scenarios ([2], [37], [38], etc.) with rare exceptions tackling the other hydrogen markets [39]. Accordingly, somehow, the research activity was penalizing hydrogen at the entrance of the markets, since the core potential of this energy vector is its capacity to link between different energy sectors. Representing the different markets is important allowing the “costlier” electrolyzers to improve their profitability leading to more hydrogen volumes in the results. Furthermore, focusing on passenger light duty vehicles only (via FCEV) have put hydrogen in direct competition with the battery electric vehicles which penalized hydrogen integration.

Lately, interest in other applications has risen, highlighting the multi-sectorial potential of hydrogen systems and also the advantages of hydrogen in long distance and heavy mobility [3], [19], [40].

Beyond policies, industries and research efforts, the hydrogen potential is also dependent on the energy context. For instance, the regional energy mix defines the carbon footprint of hydrogen generation hence its decarbonisation potential, the electricity system’s need for flexibility varies from one region to another depending on the electricity mix and the already existent means of flexibility, etc. Therefore, the hydrogen potential can vary from one region to the other.

Despite the advanced improvements of hydrogen technologies and the awareness of their potential, efforts are still needed to avoid a downward trend in interest for hydrogen as was the case in previous experiences.

Objective of the thesis

Accordingly, the objective of this thesis is to propose a comprehensive approach to:

- Assess the hydrogen prospective potential considering regional specificities;
- Identify and quantify the challenges of hydrogen penetration, i.e. the techno-economic and political bottlenecks;
- And discuss potential solutions and suggest recommendations.

Outline of the thesis

To do so, in the first part a review of the literature is conducted inspecting the hydrogen role in the global energy scenarios with a focus on hydrogen modelling challenges as a new component of the energy system.

Then, based on modelling results and beyond the “technical tool issues”, hydrogen techno-economic and political integration challenges into the energy system are identified and discussed going from global to local scale and zooming on all steps of the hydrogen supply chain from final markets down to the production step.

Thus, Part II suggests a global view of hydrogen challenges based on a multi-regional analysis:

- Mapping the current energy context and investigating the impact of today's policies and governmental roadmaps on hydrogen deployment in different regions of the world;
- Raising the questions: Are the current policies allowing hydrogen to fulfil its potential in the future as multi-sectorial decarbonisation means? Will hydrogen be competitive one day compared to the current energy options that are already on the market, and under which political and techno-economic conditions?

In Part III, a case study of the hydrogen integration into a national energy system is studied using an optimisation model (TIMES-PT) applied for the Portuguese context. The aim of this part is to challenge hydrogen in a competition environment and identify which technologies are the most attractive and which steps of the hydrogen supply chain are the most economically challenging.

Part IV zooms on a regional to local level allowing to go into more details for a given market: mobility, to investigate the challenges on the infrastructure level from the production up to the final delivery point. The case of the French energy system is studied, while positioning France in the European context. Temporally and spatially refined models (GLAES, Europower and InfraGIS) are used allowing the examination of hydrogen production prospects with regards to the potential of flexibility provision to the electricity system. Then, a refined analysis of the hydrogen delivery infrastructure is conducted for the French case comparing different potential supply chains in order to select the optimal one (economically speaking) depending on different scenarios (timeframe and regional distribution). Mobility was the selected market given its potential and the critical logistic issues associated.

Finally, in the general conclusion, recommendations are proposed in order to overcome the challenges hampering the hydrogen deployment from different perspectives and calling the joint efforts of academic, industrial and political bodies. Perspectives to this thesis are also suggested in order to overcome the limitations confronted in this work.

REFERENCES

- [1] Intergovernmental Panel on Climate Change (IPCC), “Climate Change 2013, The Physical Science Basis, Working Group I, Contribution to the Fifth Assessment Report of the Intergovernmental Panel on Climate Change.” 2013.
- [2] International Energy Agency (IEA), “World Energy Outlook.” 2016.
- [3] International Energy Agency (IEA), “World Energy Outlook.” 2018.
- [4] McKinsey, “Electric vehicles in Europe: gearing up for a new phase?” 2014.
- [5] Department of Development and Planning, Aalborg University, Denmark, “IDA’s Energy Vision 2050.” 2015.
- [6] SBC Energy Institute, “Leading the Energy Transition Factbook, Hydrogen-based energy conversion - More than storage: system flexibility.” 2014.
- [7] International Energy Agency - IEA, *Technology Roadmap : Hydrogen and Fuel Cells*. 2015.
- [8] Jean-Louis DURVILLE, Jean-Claude GAZEAU, Jean-Michel NATAF, Jean CUEUGNIET, and Benoît LEGAIT, “Filière hydrogène-énergie, Report to the Government,” 2015.
- [9] IHS Chemical, *Chemical Economics Handbook, Hydrogen*. 2015.
- [10] Food and Agricultural Organization of the United Nations, “World fertilizer trends and outlook to 2020, Summary Report,” 2017.
- [11] Aikaterini Boulamanti and Jose A. Moya, “Production costs of the chemical industry in the EU and other countries: Ammonia, methanol and light olefins,” *Renewable and Sustainable Energy Reviews*, 2017.
- [12] Camille Cany, “Interactions entre énergie nucléaire et énergies renouvelables variables dans la transition énergétique en France: Adaptation du parc électrique vers plus de flexibilité.” 2017.
- [13] “Chemical Economics Handbook, Methanol.” IHS Markets, Dec-2017.
- [14] IEA Hydrogen, *Hydrogen Implementing Agreement 2017, Annual Report*. 2018.
- [15] Hydrogen Council, “How hydrogen empowers the energy transition,” 2017.
- [16] A. Le Duigou, Y. Guan, and Y. Amalric, “On the competitiveness of electric driving in France: Impact of driving patterns,” *Renewable and Sustainable Energy Reviews*, 2014.
- [17] A. Le Duigou and A. Smatti, “On the comparison and the complementarity of batteries and fuel cells for electric driving,” *Int. J. Hydrog. Energy*, vol. 39, no. 31, pp. 17873–17883, Oct. 2014.
- [18] C. Mansilla, S. Avril, J. Imbach, and A. Le Duigou, “CO₂-free hydrogen as a substitute to fossil fuels: What are the targets? Perspective assessment of the hydrogen market attractiveness,” *International Journal of Hydrogen Energy*, 2012.
- [19] Hydrogen Council, “Hydrogen scaling up, A sustainable pathway for the global energy transition,” Nov. 2017.
- [20] SHELL, “SHELL Hydrogen Study, Energy of the Future? Sustainable Mobility through Fuel Cells and H₂,” 2017.

- [21] “Hydrogen, Tracking Clean Energy Progress,” *International Energy Agency*, 2019. [Online]. Available: <https://www.iea.org/tcep/energyintegration/hydrogen/>.
- [22] ENEA Consulting, “The potential of Power to Gas: Technology review and economic potential assessment,” 2016.
- [23] International Energy Agency (IEA), “Renewable Energy For Industry, From green energy to green materials and fuels.” 2017.
- [24] FCHJU, “Development of Water Electrolysis in the European Union, Final Report.” 2014.
- [25] O. Schmidt, A. Gambhir, I. Staffell, A. Hawkes, J. Nelson, and S. Few, “Future cost and performance of water electrolysis: An expert elicitation study,” *Int. J. Hydrog. Energy*, vol. 42, no. 52, pp. 30470–30492, Dec. 2017.
- [26] Matthias Binder, Michael Kraussler, Matthias Kuba, and Markus Luisser, *Hydrogen from biomass gasification*. IEA Bioenergy: Task 33, 2018.
- [27] Ilkka Hannula, *Hydrogen production via thermal gasification of biomass in near-to-medium term*. VTT, 2009.
- [28] Y. Gao, J. Jiang, Y. Meng, F. Yan, and A. Aihemaiti, “A review of recent developments in hydrogen production via biogas dry reforming,” *Energy Convers. Manag.*, vol. 171, pp. 133–155, Sep. 2018.
- [29] R. Belot and F. Picard, “The Three Ages of Fuel Cell Research in France: A Socio-Technical System’s Resistance to Change,” *Fuel Cells*, vol. 14, no. 3, pp. 525–532, Mar. 2014.
- [30] “The Hydrogen Council: an Introduction,” *Hydrogen Council*, 2019. [Online]. Available: <http://hydrogencouncil.com/>.
- [31] “METI has strategic road map for hydrogen and fuel cells in Japan,” *Fuel Cells Bull.*, vol. 2014, no. 7, p. 9, 2014.
- [32] Hong Dae-sun and Choi Ha-yan, “South Korean government announces roadmap for hydrogen economy,” *HANKYOREH*, Jan-2019. [Online]. Available: http://english.hani.co.kr/arti/english_edition/e_business/879097.html.
- [33] Bruce S *et al.*, “National Hydrogen Roadmap, Pathways to an economically sustainable hydrogen industry in Australia.” CSIRO, 2018.
- [34] Ministère de la transition écologique et solidaire, “Plan de déploiement de l’hydrogène pour la transition énergétique, Dossier de presse.” Paris, Vendredi juin-2018.
- [35] IEA, “Hydrogen TCP,” *IEA Technology Collaboration Programmes*, 2019. [Online]. Available: <https://www.iea.org/tcp/renewables/hydrogen/>.
- [36] Ministry of Foreign Affairs of Japan, “Summit Information,” *G20 2019 Japan*, 2019. [Online]. Available: <https://g20.org/en/>.
- [37] International Energy Agency (IEA), “Energy Technology Perspectives.” 2016.
- [38] World Energy Council, “World Energy Scenarios, The Grand Transition,” 2016.
- [39] “Global Energy Assessment, Toward a Sustainable Future.” GEA, IIASA, 2012.
- [40] IRENA, “Hydrogen from renewable power.” IRENA, Sep-2018.

PART I

LITERATURE REVIEW AND ANALYSIS: HYDROGEN IN THE ENERGY SCENARIOS AND MODELS

Abstract

Given the importance of the energy scenarios in attracting the attention of the decision makers towards the most attractive new technologies, the hydrogen representation in such scenarios is of big importance since it can trigger the investments. A review of hydrogen presence in reference global energy scenarios is conducted allowing us to depict how different organisations see the future of hydrogen markets, and how this vision is evolving through time. An analysis is then conducted in order to identify the drivers behind the hydrogen emergence in the scenario results, based on a proposed typology for the scenario designs as well as the models used to generate them.

Résumé

Étant donnée la capacité des scénarios énergétiques à attirer l'attention des décideurs sur le potentiel des nouvelles technologies, la représentation de l'hydrogène dans de tels scénarios revêt une grande importance pouvant même déclencher les investissements. Un examen de la représentation de l'hydrogène dans les scénarios énergétiques mondiaux de référence est mené, ce qui nous permet d'appréhender la manière dont différents organismes envisagent l'avenir des marchés de l'hydrogène, ainsi que l'évolution de cette vision dans le temps. Une analyse est ensuite conduite à partir d'une typologie que nous proposons pour les scénarios et les modèles utilisés pour les générer, et ce afin d'identifier les facteurs à l'origine de l'émergence de l'hydrogène dans les résultats desdits scénarios.

ACRONYMS

WEO	World Energy Outlook
CP	Current Policies
NP	New Policies
SD	Sustainable Development
FiES	“The Future is Electric” Scenario
ETP	Energy Technology Perspectives
DS	Degree scenario (ex: 2 Degree Scenario - 2DS)
B2DS	Beyond 2°C Scenario
RTS	Reference Technology Scenario
WEC	World Energy Council
IRENA	International Renewable Energy Agency
IEA	International Energy Agency
H₂	Hydrogen
FC	Fuel Cell
CCS	Carbon Capture and Storage
CCU	Carbon Capture Utilization
PEM	Polymer Electrolyte Membrane
SOEC	Solid Oxide Electrolyser Cell
SMR	Steam Methane Reforming
FCEV	Fuel Cell Electric Vehicles
LDV	Light Duty Vehicles
MDV	Medium Duty Vehicles
HDV	Heavy Duty Vehicles
P2X	Power to X
CHP	Combined Heat and Power
GHG	Greenhouse Gas

1. Introduction

As Scott Adams once said:

“Methods for predicting the future: 1) read horoscopes, tea leaves, tarot cards, or crystal balls... collectively known as “nutty methods;” 2) put well-researched facts into sophisticated computer... commonly referred to as “a complete waste of time.””[1].

Indeed, in other words and in a less provocative way, modelling and scenario design are not a way to predict THE future. They, instead, allow tracing several potential futures depending on contextual elements. In other terms, scenarios are a way to assess the consequences of different choices.

The future is neither completely predictable nor completely random. Accordingly, designing prospective scenarios can be a way to manage the many uncertainties surrounding the future possibilities for sector evolution: economics, technologies, business, etc. It aims to construct representations of possible futures, as well as the paths leading to them. Scenarios can thus be considered as a guide to strategic action helping through the process of decision making [2].

In particular, with regards to the energy system transition occurring in several regions worldwide, the prospective approach in the energy field allows energy stakeholders and decision makers to have a long term view in order to maintain the energy supply-demand balance and to optimize the investment decisions under the global environmental targets, hence the importance of scenarios in shaping the future of the technological “ecosystem” in different sectors.

In this perspective, the representation of hydrogen in the global reference energy scenarios (that are often consulted by decision makers) is of big importance in terms of not only raising the awareness about hydrogen potential but also triggering the required investments.

McDowall et al. (2006) [3] reviewed the hydrogen scenario literature, using a six-fold typology to map the state of the art of scenario construction. Then, in 2018, an updated review was carried out by Hanley et al. (2018) [4] who reviewed 21 global energy scenarios and over two dozen regional ones for 2050, based on integrated energy system models with a focus on the role that hydrogen has in the results.

Despite its promising potential, hydrogen is not (or barely) represented in some of the most renowned energy scenarios and models.

This chapter of the thesis investigates the reasons behind such an observation. Firstly, a review of hydrogen presence in reference global energy scenarios is carried out, complementing the Hanley et al. study [4] and quantifying the hydrogen volumes reached by scenario. This allows us to depict how different energy-scenario organisations foresee the future of hydrogen markets, and how this vision is evolving through time. An analysis is then conducted in order to identify the drivers behind the hydrogen emergence in the scenario results as well as the barriers hampering the hydrogen deployment. This work goes beyond the above-mentioned studies from the literature to focus not only on the energy system specific factors defining the hydrogen emergence, but also on the scenario design itself, highlighting the importance of the data assumptions and the specificities of the modelling approaches.

2. Hydrogen in the global energy scenarios

A review of 32 global energy scenarios published by renowned energy organizations is conducted focusing on the representation of the hydrogen role in the energy system. Both the hydrogen-specific scenarios as well as the global energy system ones are considered¹.

Some scenarios choose to focus on the hydrogen potential alone allows tracing the possible evolution of the different markets and the associated technology costs. On the other hand, other scenarios study the evolution of the energy system as a whole, considering the different energy sectors, which allows putting hydrogen in perspective with the competing technologies (provided that they are represented on a level-playing field), which in turn makes it possible to identify which markets are economically attractive and under which conditions.

Amongst the reviewed scenarios, two “hydrogen specific” ones are identified. The Hydrogen Council² scenario [7] depicts the hydrogen potential by 2050 in terms of market volumes, and related technology costs. This scenario reflects the industrial vision regarding the desired evolution of hydrogen markets in the years to come. It was elaborated with the objective to highlight the readiness of the different industries involved in the Hydrogen Council to start mass investments in hydrogen technologies once a clear regulatory framework is defined. The second “hydrogen specific” scenario is the IEA hydrogen roadmap [8] which is different in the design of the study itself since it does not provide explicit hydrogen volumes that can be reached in the years to come. On the other hand, it fulfils the objective of a roadmap which is to provide detailed technology information with focus on the different parts of the supply chain and on the potential evolution of the related technology costs and performances. This roadmap was based on the 2DS scenario of the IEA (detailed hereafter). It hence draws a picture of the contribution brought by hydrogen in a world where the 2°C climate target is achieved.

The remaining 30 scenarios consider the whole energy system with no specific focus on hydrogen. A short summary of these scenarios is presented in Table 2.

Table 2: Brief summary of the considered energy system scenarios

Organization	Scenario	Brief Summary
IEA – WEO 2015 [9]	CP	Reflects a continuance of current policies / business as usual
	NP	Taking into account the newly announced policies and governmental targets and intentions
	450	Pathway to limit long-term global warming to 2 °C above preindustrial levels
IEA - WEO 2016 [10]	CP	Reflects a continuance of current policies / business as usual
	NP	Taking into account the newly announced policies and governmental targets and intentions
	450	Pathway to limit long-term global warming to 2 °C above preindustrial levels
IEA - WEO 2017 [11]	CP	Reflects a continuance of current policies / business as usual
	NP	Taking into account the newly announced policies and governmental targets and intentions

¹ A related paper is under preparation based on a collaborative effort aiming at analyzing the review results [5]

² Gathering 53 leading energy, transport and industry companies: Air Liquide, Total, Shell, Honda, Hyundai, BMW Group, Bosch, etc. [6]

LITERATURE REVIEW AND ANALYSIS

	SD	Universal access to modern energy services by 2030, achievement of the objectives of the Paris Agreement, improvement in global air quality
IEA - WEO 2018 [12]	CP	Reflects a continuance of current policies / business as usual
	NP	Taking into account the newly announced policies and governmental targets and intentions
	SD	Universal access to modern energy services by 2030, achievement of the objectives of the Paris Agreement, improvement in global air quality
	FiES	Considerably enhancing the role of electricity in the energy system
IEA - ETP 2016 [13]	6DS	Reflects a continuance of current policies / business as usual
	4DS	Takes into account recent pledges by countries to limit emissions and improve energy efficiency, which help limit the long-term temperature rise to 4°C.
	2DS	Pathway to limit long-term global warming to 2 °C above preindustrial levels
IEA - ETP 2017 [14]	RTS	Reflects a continuance of current policies / business as usual
	2DS	Pathway to limit long-term global warming to 2 °C above preindustrial levels
	B2DS	Going beyond the 2°C target, carbon neutrality by 2060
WEC 2016 [15]	Hard Rock	Explores the consequences of weaker and unsustainable economic growth with inward-looking policies, low renewable penetration
	Unfinished Symphony	A world in which more ‘intelligent’ and sustainable economic growth models emerge as the world drives to a low carbon future High renewable share supported by strong policies, with high nuclear and hydro capacities
	Modern Jazz	Represents a ‘digitally disrupted’, innovative, and market-driven world. Renewables evolve enabled by distributed systems, digital technologies, and battery innovation.
IRENA 2017 [16], [17]	Reference scenario	Reflects a continuance of current policies / business as usual
	ReMap	94% CO ₂ emission reductions from renewables, and energy efficiency
Greenpeace 2015 [18]	Reference scenario	Reflects a continuance of current policies / business as usual
	R[E]volution	Achieves a set of environmental policy targets resulting in a pathway towards a widely decarbonised energy system by 2050
	Adv. R[E]volution	Pathway towards a fully decarbonised energy system reaching a 100% renewable share already by 2050
Shell 2018 [19], [20]	Mountains	Rigidity of the system to the penetration of new technologies, natural gas is a backbone to the global energy system
	Oceans	The competition and the rise of the emerging countries lead to an increase of the energy demand creating a stress on energy supply. High carbon emissions due to an increased use of fossil fuels
	Sky	Pathway to limit long-term global warming to 2 °C above preindustrial levels. Carbon neutrality by 2070

As shown in Table 2, the selected scenarios are contrasted in terms of environmental constraints, economy evolutions, political incentives, energy mix considerations, market designs, etc. This allows inspecting the impact of different factors on the feasibility of hydrogen penetration into the energy system. This analysis is carried out hereafter.

Beyond the energy system-specific factors, the scenario design itself can have an impact on the hydrogen emergence in the results.

Indeed, two major types of scenario design can be identified: the descriptive and the normative scenarios. Basically, the descriptive scenarios start from the current situation and investigate the consequences of different measures (or absence of new measures) on the evolution of the energy system. In contrast with the descriptive scenarios, the normative ones do set in advance an objective future to be achieved and allow (except when a ‘vision’ is only provided) tracing back the possible pathways to reach it.

A typology is proposed in

Table 3, introducing sub-categories in the two main ones. The reviewed scenarios are then classified by category.

Table 3: Typology of the considered energy scenarios

		Global energy system	Hydrogen specific
Descriptive	<u>Forecasts</u> use extrapolation and modelling to predict likely futures from current trends.	WEO ³ : CP ETP ⁴ : 6 DS, RTS IRENA : Ref. scenario Greenpeace : Ref. Scenario	
	<u>Exploratory scenarios</u> explore possible futures emphasising the drivers, and do not specify a predetermined desirable end state towards which storylines must progress.	WEO ³ : NP, FiES ETP ⁴ : 4 DS WEC : Hard Rock, Unfinished Symphony, Modern Jazz Shell : Mountains, Oceans	

³ As specified in Table 1, four editions of the World Energy Outlook were reviewed: 2015, 2016, 2017, and 2018

⁴ As specified in Table 1, two editions of the ETP were reviewed: 2016 and 2017

Normative	<u>Visions</u> are elaborations of a desirable future.		
	<u>Back-casts and pathways</u> set a targeted situation predetermining a desirable end state and trace the possible pathways leading to it.	WEO ³ : 450, SD ETP ⁴ : 2 DS, B2DS IRENA : ReMap Greenpeace : Revolution, Advanced Revolution Shell : Sky	Hydrogen Council : H2 Scaling Up
	<u>Roadmaps</u> describe a sequence of measures designed to lead to a targeted future.		IEA : Technology Roadmap - H2 and FC

All of the hydrogen-specific scenarios are normative, generally drawing a desirable future to be reached, or assessing the hydrogen potential once the adequate policy measures and industrial efforts are put in place.

In what follows, the impact of the scenario design on the hydrogen emergence in the results is assessed through the resulting hydrogen volumes in the respective studies. Collecting this information from all of the considered scenarios proved to be a challenging task due to a lack of transparency we faced with several scenarios. Indeed, some of the scenarios do discuss hydrogen in the results highlighting its prospective role in the energy system without giving orders of magnitude of the consequent hydrogen volumes obtained in the results. This is case of the IEA scenarios for example (in the WEO and the ETP), as well as the Shell ones.

Other scenarios like the B2DS of the ETP 2017 [14] provide only insights regarding the potential evolution of hydrogen applications (methanol, ammonia industries). Hence, calculations are conducted in order to quantify the resulting hydrogen volumes. The latter scenario suggests an evolution of the ammonia and methanol industry from which a hydrogen demand is deduced, assuming the following ratios: 0.2 kg H₂ / kg ammonia produced [21], [22], and 0.1 kg H₂ / kg methanol produced [23].

The results of hydrogen volume significance by scenario type are presented in Figure 3.

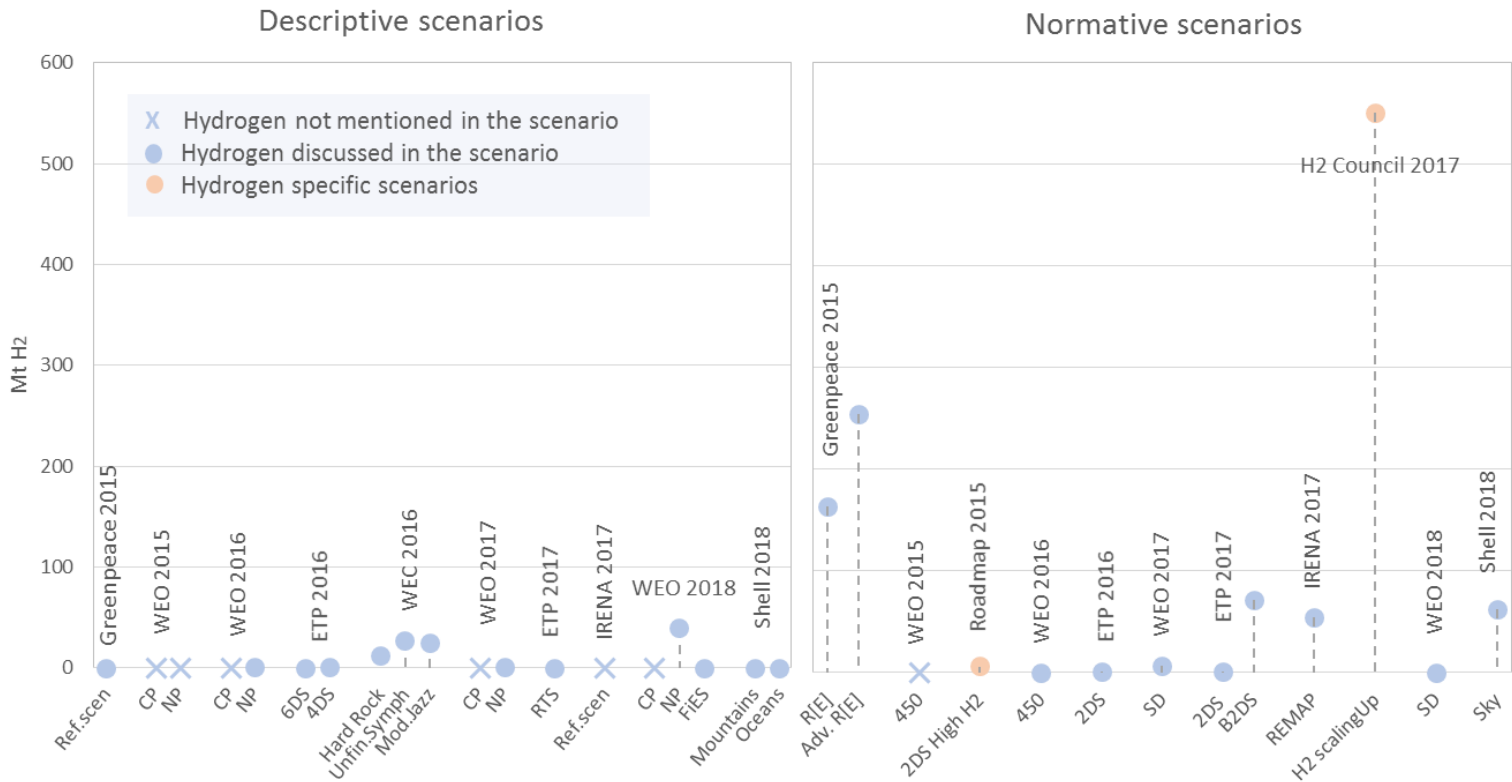

Figure 3: Hydrogen volume assessment in the considered scenarios

It is worth noticing that the normative studies show higher hydrogen volumes than the descriptive ones. The normative scenarios are generally characterized by ambitious environmental or energy goals. 67% of the reviewed normative scenarios set the objective of limiting global warming to 2°C or even less (ex: B2DS scenario [14]), compared to pre-industrial levels. 25% target carbon neutrality for a fixed timeframe.

Apart from the environmental targets, energy-specific goals are also considered. For instance, the Advanced R[E]volution scenario of Greenpeace [18] aims at reaching a 100% renewable share in the total energy supply by 2050. The “hydrogen-specific” scenarios [7], [8] present a hydrogen-centred view of the energy transition concept.

All of these factors provide a suitable environment for hydrogen penetration.

The environmental targets encompass different measures that can impact the energy mix (including the 100% renewable target), the demand (energy efficiency, demand side management, etc.), the technological “landscape” (new technologies in the different sectors: residential, energy storage, mobility, etc.), and even the system design itself (shifting from centralized to decentralized systems for example).

Such a fundamental transformation of the energy system implies new challenges but also new opportunities for the emerging technologies to prove their potential in contributing to the transition.

The results comparison shows that the scenarios with the most stringent environmental constraints present the higher hydrogen volumes. Indeed, higher volumes are reached when a carbon neutrality target is set (Adv. R[E] by 2050 [18], B2DS by 2060 [14] and Sky by 2070 [19]). Furthermore, the sooner the target timeframe, the higher the amounts of hydrogen are in the results. The focus on renewable energies also allows highlighting the hydrogen potential role in providing the electric system with flexibility especially in the context of rising shares of intermittent energies (addressed in the IRENA study on the hydrogen production potential from renewables [17]).

Moreover and quite logically, the highest hydrogen volume is reached when focusing on hydrogen only and identifying the specific required conditions for its emergence. The “hydrogen-specific” scenario elaborated by the Hydrogen Council [7] points out the expansion potential of the hydrogen markets once the propitious conditions are completed. The study highlights the crucial role of the governmental involvement which allows unlocking the industrial investments, so far hampered by the high uncertainties and the “foggy” political positioning vis-à-vis the hydrogen penetration. Several governmental incentives are suggested as drivers in the document with regards to each market. A common required effort consists in setting a clear hydrogen specific target (hydrogen fleet to be reached, number of fueling stations, etc.). This would highly contribute in reducing the many uncertainties hence fostering the investments. Then, easing the first phases of hydrogen penetration through tax exemptions and subsidies seems needed to create the desired scale effect allowing industries to lower the costs.

The analysis of the descriptive scenarios shows that, in all of the forecasts assuming a continuation of the current policies (CP, RTS, 6DS, Ref. scenarios), there is no hydrogen in the results. This again highlights the importance of the adequate policies in triggering the hydrogen economy. On the other hand, in some of the explorative scenarios, hydrogen makes a small contribution, recalling some of the drivers discussed above (political incentives, renewable potential). For instance, there is some hydrogen demand for mobility use in the World Energy Council scenarios [15], and more specifically in the Unfinished Symphony and Modern Jazz characterized by high renewable shares enabled either by strong policies or a favourable market environment and system design.

A hydrogen contribution also appeared in the latest “New Policies” scenario of the IEA, where an assessment of the future hydrogen volumes for the refining activity is proposed evolving from 35 Mt consumed today to 39 Mt by 2040. The mobility and natural gas blending markets are also referenced in the document but with no distinct associated volumes [12].

Other scenarios of the IEA also tackle hydrogen, but as mentioned previously, no clear quantification of the respective volumes is provided. For instance, “The Future is Electric” scenario focuses on the role of hydrogen in industry, and more specifically in electrifying the industrial uses so far relying on fossil fuels as a feedstock (ammonia, methanol and steel production).

The Shell descriptive scenarios (Mountains and Oceans [20]) also discuss the potential of hydrogen in transport and industry but without quantifying it. The Oceans scenario limits the use of hydrogen in the transport sector to light duty passenger cars, while in the Mountains scenario, the buses and trucks are also considered.

The divergence of the hydrogen volumes obtained in the different scenarios can be explained by the consideration of the hydrogen markets. Some of the studies take into account all of the markets (industry, mobility, natural gas blending, etc.) while others restrict the hydrogen use to one specific sector. It is though difficult to distinguish the studies limiting the hydrogen applications from those where all the markets are included but the modelling results favours some over others due to economic constraints.

The next section discusses the evolution trends of hydrogen market consideration in the scenarios through time.

3. Hydrogen consideration evolving through time

3.1. Interest in Hydrogen

The number of international energy organizations interested in hydrogen has been increasing through time, especially in the last three years, reflecting a rise of the interest in hydrogen as a decarbonisation means. Indeed, awareness regarding the hydrogen potential seems to be improved. This is not only reflected through the increase of number of publications considering or at least mentioning the hydrogen potential. A significant rise in hydrogen studies was observed in the last 5 years according to a review of around 200 hydrogen related documents in the literature, conducted by Robinius et al. (2018) [24]. It can also be seen in the evolution of the organisation interest in hydrogen through time. The IEA is a good example, publishing at least one global energy scenario every year (WEO, and ETP). As shown in Figure 3, in the World Energy Outlook 2015 edition, there was no single mention of the hydrogen potential in the document. Then, in 2016, some discussions were included highlighting the hydrogen potential in easing the penetration of renewable energies in different sectors (mainly transportation and the natural gas system), but also featuring the prohibitively high costs of the hydrogen technologies. The 2017 edition of the document presented more details regarding the possible hydrogen perspectives, specifying the advantages of hydrogen for heavy and long distance transport means (trucks and ships for example), and discussing for the first time the hydrogen potential in decarbonizing several industrial applications (ammonia, methanol, refinery, etc.). In this edition, the hydrogen production potential from renewables is assessed at 7Mt by 2040 according to the Sustainable Development scenario [11]. Later, the WEO 2018 edition further detailed the hydrogen applications in industry with foci on the electrification potential that is enabled by integrating the electrolysis technology in the industrial processes. The suggested analysis is based on a previous report on the potential of renewables in industry also elaborated by the IEA [23]. In this report, hydrogen was considered as a vector linking the renewables connected to the electric system and the industrial applications so far dependent on fossil fuel-based chemical processes. The IEA's interest in hydrogen then continued to grow, resulting in the elaboration of a Hydrogen Report presented at the G20 summit in Japan (2019) to provide governmental leaders and industrial decision makers with comprehensive information [25].

The IEA is not the only organisation that put a focus on hydrogen in the last three years. In 2017, Shell published a hydrogen study detailing techno-economic aspects throughout the whole hydrogen supply chain considering the different markets [26]. Then in 2018, the IRENA released a hydrogen report discussing the hydrogen production potential from renewables based on its previous ReMap scenario, but this time presenting more refined definitions of the different steps of the supply chain and more detailed insights regarding the techno-economic perspectives of the related technologies [17]. Later, in 2019, the World Energy Council published an analysis of the hydrogen use as feedstock in industry (ammonia, methanol, steel production, refinery applications, etc.). The document focuses on the techno-economic relevance of converting the existing grey hydrogen production within these industries to 'blue' (fossil-based process with CCS) and 'green' (from renewable electricity) hydrogen production, considering different hydrogen delivery pathways. The report proposes a set of policy recommendations aiming at unlocking the first stages of the hydrogen deployment.

3.2. Market consideration

Overall, interest in hydrogen has been evolving. The market focus differs from one scenario to the other and from one period to the other. For instance, as shown in Figure 4 the percentage of documents (presented in Table 2) tackling the hydrogen industrial markets (H₂ feedstock) has been increasing since 2015, while the attractiveness of the hydrogen use as a fuel (natural gas blending/substitution for example) seems to have decreased as well as the stationary energy applications (e.g.: electricity storage). On the other hand, the mobility market (fuel cell vehicles) seems to continue to drive the hydrogen interest as an energy carrier.

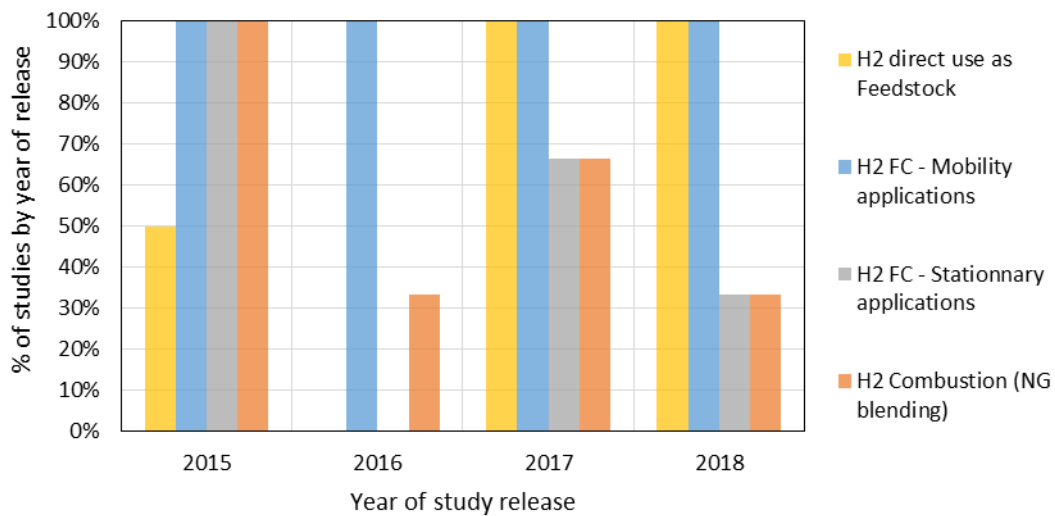

Figure 4: Evolution of the number of studies considering a given market segment throughout the years

The reviewed studies emphasize the transitional role of the industrial markets in establishing a low carbon hydrogen economy. The demand in these markets is already existent and represents nowadays more than 80% of the hydrogen consumption worldwide. Accordingly, switching to low carbon hydrogen production in these markets would allow creating the required scale effect to lower the costs of the new hydrogen production technologies. This would thus ease the hydrogen penetration into the hydrogen energy markets while contributing to the decarbonisation of the industrial sector. Amongst the energy applications of hydrogen systems, the mobility emerges as the most attractive market presenting the most mature technologies, while questions are often raised regarding the feasibility of natural gas blending due to the concentration limitations [11]. The use of hydrogen as an energy carrier for stationary applications (fuel cells for electricity and/or heat generation) is less highlighted in the documents. They are often developed for a regional or local case [14].

Adopting a holistic perspective increases the hydrogen representation in the results, by considering the different hydrogen applications all together in the scenario. Indeed, the volume amounts are raised due to the multiplication of the markets, but not only. Another factor that can be of significant importance is the sector coupling potential of hydrogen systems that arises only in the scenarios which consider

different hydrogen markets in different sectors. Sector coupling can be searched for in the context of stringent climate and energy system constraints. It allows to root the low carbon energy from one sector to another achieving a multi-sectorial decarbonisation.

Figure 5 shows the evolution of the number of tackled markets in the scenarios by period of time. The aim of this figure is to identify whether a correlation can be established between the number of markets considered in the study and the resulting volumes of hydrogen. Each circle corresponds to a given scenario. The size of the circles maps the hydrogen volumes of the scenarios.

In addition to the scenarios identified previously in Table 2, two recent hydrogen reports are included in the graph to highlight the evolution of hydrogen market consideration throughout the years: the IRENA report [17] re-mentioning the results of the previous ReMap scenario [16] in terms of hydrogen volumes but further detailing the hydrogen applications in other sectors (not discussed in the previous document), and the Shell report [26] adopting the IEA 2DS High H2 scenario for FCEV penetration in Japan, Europe and the US but further detailing each part of the hydrogen supply chain.

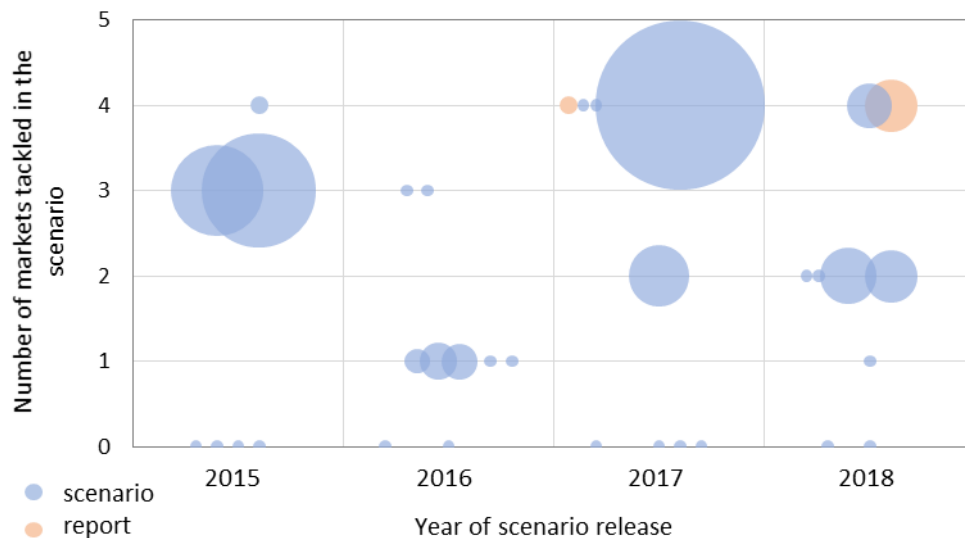

Figure 5: Evolution of the number of H2 markets tackled through time in the scenarios (The bubble size represents the H2 volumes)

It is very often difficult to distinguish the results from the general discussion regarding the hydrogen-related insights in the scenarios. Many of the studies do discuss the different hydrogen potential applications without precisely quantifying the resulting volumes/market sizes. Some of the documents present an evaluation of the hydrogen volumes but not for all of the markets they tackle [12], [17], [26]. Hence, it is not clear whether the non-quantified markets are failing to prove competitive in the scenarios or are simply not included in the calculation. Amongst the scenarios that present a quantification of the prospective hydrogen volumes, 92% show values for the use of hydrogen in transportation, 38% quantify the chemical use of hydrogen in industry, and 28% evaluate the volumes of hydrogen use as a fuel (natural gas and other fossil fuels substitution). However, no specific values are found in the reviewed documents regarding the use of hydrogen for electricity production and/or heat generation via fuel cells.

In order to investigate the reasons behind such representation, focus is put on the description of the hydrogen technologies in the different scenarios. The next section investigates the technology choice that is made in each scenario (considering the whole supply chain from the production up to the final market), as well as the related techno-economic assumptions in order to identify the technological bottlenecks that may hamper the contribution of hydrogen in the results.

4. Data assumption relevance

The existence of a hydrogen demand in a sector is obviously coupled with the available description of the relevant hydrogen technologies for this sector, and their techno-economic parameters. It is only logical that when no hydrogen technology option is considered for a given sector, no hydrogen demand can arise there.

In general, little information is given regarding what specific technologies are considered in the studies. Moreover, it can be stated that when the technologies are mentioned, the techno-economic assumptions are often not detailed.

In what follows, the technologies that are considered for each step of the hydrogen supply chain are discussed with regards to the reviewed studies. Figure 6 establishes a rating of the hydrogen technologies (classified into H₂ production, H₂ storage, H₂ transport and H₂ end use technologies with sector specification) based on their citation occurrence in the reviewed documents.

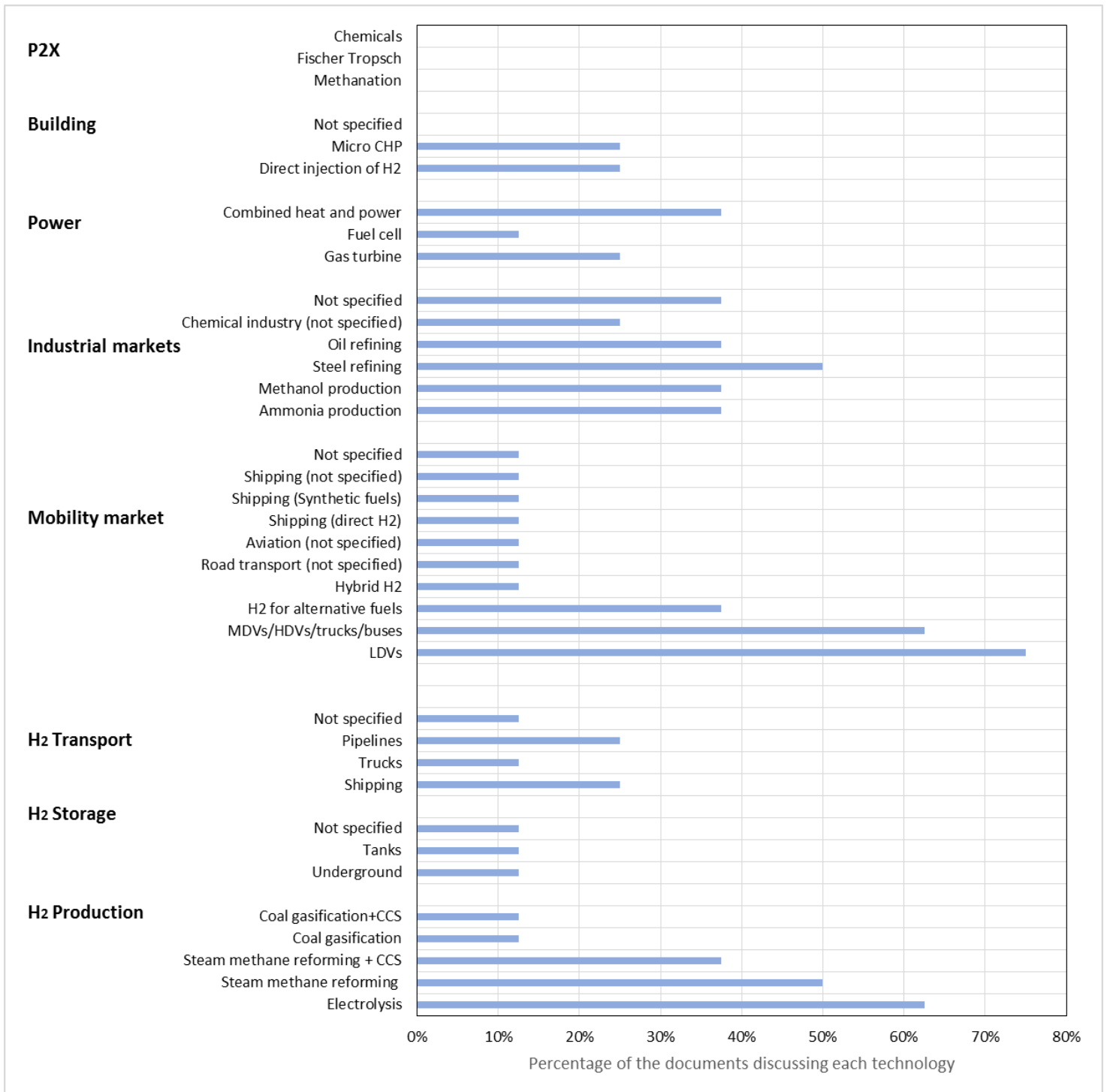

Figure 6: Hydrogen technologies rated by scenario citation

As depicted in Figure 6 the production and end-use technologies are the parts of the hydrogen supply chain that are the more often detailed. However, the linking between them still needs to be clarified in the scenarios. This is further detailed in what follows.

Hydrogen production step:

When the techno-economic assumptions are detailed, they are often related to the production step of the hydrogen supply chain. In the majority of the cases, it is electrolysis that is considered. Often, the electrolyser type is not specified (PEM, alkaline or others [12], [16], [18]–[20]). As for the SOEC technology, it is rarely considered (only in the IEA Technology Roadmap Hydrogen and Fuel Cells [8]). This can be explained by its lower technology readiness level that also reflects the economics of its integration into the system.

In a number of studies, the non-electrolytic production pathways (SMR w or w/o CCS, coal gasification, biomass based, etc.) are taken into account [7], [8], [12], [14], [19], [20]. They are mainly mentioned when comparing hydrogen production costs or emphasized as a transitional step to fully decarbonized hydrogen. The techno-economic assumptions related to these technologies (mainly SMR/SMR+CCS) are often presented in the documents, highlighting the cost convergence between electrolysis and SMR with CCS that is expected in the years to come [8].

End-use – Mobility applications:

Apart from the production part of the hydrogen supply chain, it is the end-use technologies that are more mentioned and detailed in the scenarios, and among the different hydrogen potential applications, it is more often the transport market that is detailed with technology specification and sometimes with the according assumptions.

When the technologies are mentioned, the predominant technology is FCEV for passengers LDV that is considered in almost all of the studies (but not all of the examined scenarios). A trend can also be noticed: previously, only passenger vehicles were included in the scenarios, but in recent documents more transport applications are investigated such as trucks, buses, ships etc. [7], [12], [14], [19]. The assumptions are rarely mentioned however: when they are, it is more a question of governmental objectives (not necessarily quantified) or allocated subsidies (also without quantification) [12], than techno-economic hypotheses (only detailed in [7], [8]).

Hydrogen use for alternative fuels is also attracting some interest in the considered scenarios, but on a lower level than the direct use of hydrogen in fuel cells [7], [14], [18]. The use of these “electrofuels” is often associated with aviation and shipping, for which no assumption is detailed [14], [19], [20].

End-use – Industry applications:

Next after mobility, the industrial markets are being increasingly present in the scenarios, with a majority of the studies mentioning steel/iron production and ammonia. The methanol and refining activities come in second place. In these markets, the electrification of the processes via electrolysis and CCU is often cited [7], [12], [14], but there are no technical or economic assumptions given, except when comparing production costs by electrolysis and SMR, the latter process being the current main means of hydrogen production in industry.

End-use – Gas network applications:

The injection of hydrogen into the natural gas networks is often mentioned in the discussions (hydrogen and natural gas blending and / or methanation) but not clearly quantified in the results [7], [8], [11]. As for the assumptions, only the concentration rate is mentioned, but rarely. The value depends on the

pipelines (10% in gas transmission pipelines, 30 to 50% in the distribution pipelines [12] and up to 100% with specific pipeline material [7]), and end-use. Indeed, the ability of some end-users to consume a blend of hydrogen and natural gas is still raising questions. For instance, many existing natural gas turbines, can only handle approximately 1% hydrogen injection for performance and safety reasons, although they may be capable of tolerating 5-15% injection but after some modifications [11].

End-use – Stationary energy applications:

The production of electricity or heat is rarely considered but when they are, the assumptions regarding the fuel cells, the gas turbines and CHPs performances and costs are mentioned [8], [18] (see Table 6 in the annex for more details).

Hydrogen storage:

The storage of hydrogen is very rarely detailed; one wonders whether it is really taken into account at all. It is more often evoked in the “hydrogen-specific” scenarios. Otherwise, some studies explicitly mention hydrogen storage but do not further detail the topic in the result discussion [7], [8], [18].

Hydrogen transport:

The presence of information on the transport of hydrogen is much correlated with the presence of those on its storage options. In the global energy scenarios, the maritime transport/shipping of hydrogen in the form of chemicals is often mentioned [7], [12], [20]. Otherwise pipelines, trucks, etc. are also present but less frequently. For example, the Greenpeace scenario [18] theoretically discusses the rededication of gas pipelines and storage facilities to use them for hydrogen. A refined definition of the hydrogen transport pathways via trucks (liquid, gaseous, etc.) is suggested in the Shell Hydrogen Study [26].

However, usually, the associated costs (when they are mentioned) seem to be exogenous from the calculation and are not a result of the scenario [12]. This part of the hydrogen supply chain seems to be rather included as a discussion in almost all the studies. Due to a lack of associated cost results and/or explicit assumptions, it is not clear whether the transport/distribution of hydrogen is really included in the study.

The infrastructure in general is not actually addressed. No explicit storage or transmission infrastructure design is detailed, be it for hydrogen, gas or electricity, in all the studies.

This can also reflect the geographical resolution of the models behind. The modelling framework might not allow investigating the infrastructure issues, due to a simplified spatial and temporal representation.

5. Modelling approach impact on hydrogen representation

Methods for producing energy scenario results are diverse, and not always clearly presented. Most major energy scenarios are based on an energy system model. Typically, these models are concerned with satisfying demands for energy, taking advantage of the available technologies and given the market behaviour. Inputs to the model depend on the scenario and can include resource amounts, the costs of the various energy technologies (e.g. investment and operational costs) and policies.

These models are useful tools for developing energy system scenarios, and several models or model families have been used for multiple scenarios, even by multiple organisations. Reviews of energy systems models have been performed previously and provide further insights [24, 25, 26].

A review of the models that are used to generate the scenarios that are considered in this study is presented in Table 4.

Table 4: A review of the models used to generate the considered scenarios

	Scenario	Model	Developer/User	Sectors
IEA	WEO	World Energy Model (WEM) (The model was updated in 2018) Mobility Model (MoMo)	The IEA Energy Technology Systems Analysis Programme	All energy sectors represented by separate modules for: industry, buildings, transport (+ hybrid model - MoMo), energy access, demand side response, power generation, emissions)
	ETP (including H2 Roadmap - 2DS High H2)	ETP TIMES Model MoMo model Global buildings sector model	IEA ETSAP (for TIMES model)	Sectors represented via four soft-linked models: <ul style="list-style-type: none"> • energy conversion: ETP TIMES model • industry: ETP TIMES model • transport: MoMo model • buildings (residential and commercial/services): Global buildings sector model
WEC	Grand Transition	Global Multi-Regional MARKAL Model (GMM)	Paul Scherrer Institute (PSI)	All
IRENA	ReMap	ReMap tools	IRENA	All
		For macro-economic analyses: E3ME Model	Cambridge Econometrics	World economies, energy systems, emissions and material demands
Greenpeace	Energy Revolution	Mesap Planet	Seven2one Informationssysteme GmbH	All

		REMix (Renewable Energy Mix for Sustainable Electricity Supply): sub-models EnDAT, OptiMo, CEM	German Aerospace Center (DLR)	Power sector
Shell	New Lens scenarios Sky scenario	World Energy Model (WEM)	Shell (scenario team)	All
		Global Supply Model (GSM)	Shell (scenario team)	- Oil and gas production (inputs to the WEM model)
H2 Council	H2 Scaling Up	Information not available		

In what follows, the challenges of hydrogen modelling are discussed with regards to selected model definition criteria. To do so, a typology is searched for. Four definition criteria are identified, based on which the reviewed models are classified (see Table 5):

- The programming nature: optimisation vs. simulation
- The approach: top down vs. bottom up
- The temporal resolution
- The geographic resolution

5.1. Optimisation versus simulation models

The aim of the optimisation models is to reach an optimal solution responding to an objective function which has a number of decision-variables that are subject to a set of constraints. Mathematically speaking, this can be achieved through different optimisation methods e.g., linear programming, mixed integer linear programming and non-linear programming (see [27] for a comparison of these three approaches).

Specifically, in the energy system scenario design field, and for a long time, these models were used in order to optimise the operation of a given system or the investment decisions. However the objective function has been varying through time depending on the scenario purpose. Previously, the major energy challenges concerned fossil fuel cost and security supply of due to geo-politics, while, today, challenges have been evolving to include the integration of new energy technologies and the achievement of the climate governmental targets. Beyond the objective function, these changes can be challenging for the model design as well, since they can even impact the representation of the energy system itself, reshaping it to a more decentralized structure.

In this context, the optimization models allow to suggest potential pathways or representations of the future minimizing the costs, the energy consumption, etc. or maximizing the global welfare while respecting a set of constraints like lowering the GHG emissions to the targeted levels. They are hence, in general, suited for normative scenario elaboration.

Simulation models can be defined as a representation of a system used to simulate and envisage its behaviour under a given set of conditions. In contrast with the optimisation models, the simulation models only intend to envisage the performance of a given system, given certain assumptions, without searching for the optimal system design. They are thus suited to generate descriptive scenarios (forecasts and exploratory scenarios).

However, in practice the two types of models (optimisation and simulation models) can be used for all kinds of scenario design depending on the context and the objective of the analysis.

As discussed before, higher hydrogen volumes are reached in the normative scenario results. However, this does not automatically mean that optimisation models lead to more hydrogen in the results compared to simulation methods, since both models can be used for normative and descriptive scenario elaboration. This may stem from the incorporated assumptions.

An important difference between the two modelling approaches that can impact the hydrogen emergence in the results, is the modelling process regarding the design and technology choices within the energy system.

According to Lund et al. (2017) [28], the design decisions are made internally in the optimisation models on the basis of in-built rules, restrictions and presumptions while they can be decided in advance in the simulation models, in an exogenous way outside the computing process, after a spectrum of options are considered by the modeller. This means that if hydrogen is pre-configured in the system design, it will appear in the simulation solution, however, this is not the case in the optimisation models. The latter make the technology choices that are “the best” to reach the optimal solution.

For instance, the consideration of an objective function that aims at minimizing the system cost implies choosing the “cheapest” technologies. Accordingly, even if the cost discrepancy between two technologies is small, the model chooses the lowest cost one at the expense of the slightly more expensive technology, unless a specific constraint is set, for instance to avoid an abrupt switch from one technology to another. Therefore, it is possible for hydrogen technologies to be overlooked due to cost differences (however big or small they are). This raises the question of the consumer choice and behaviour are acknowledged and modelled, since prices are not the only influential factors.

An example that can illustrate such facts is the competition between battery electric and fuel cell vehicles (although technology synergies could occur, e.g. range extender vehicles). It is true that today the full electric vehicles have proved lower costs than the hydrogen-fuelled ones. Although, different studies show that the vehicle costs are expected to converge in the years to come [29]–[31]; the risk for FCEV of being “over-shadowed” by the electric mobility is still present due to the cost effect, acting in a “binary” manner. It is in fact difficult to represent the consumer preferences and choices, which are human and behavioural aspects, in a mathematical model, especially if they are unpredictable. However, even if some can be quantified, in a cost-based model, representing the preference towards a larger vehicle range or a shorter refuelling time can be challenging.

In order to capture the consumer behavioural aspects that drive the energy demand, agent-based modelling (ABM) can be considered. The ABM provides the ability to represent behaviours of energy

consumers (such as individual households) using a range of theories. It also allows examining how the interaction of heterogeneous agents at the micro-level produces macro effects impacting the global energy system. More insights are detailed in Rai et al. (2016) [32].

5.2. Bottom-up vs. top-down approaches

Two contrasting modelling approaches can be considered when solving the problem of satisfying an energy demand under economic conditions: the bottom-up (also named engineering [33]) approach and the top-down (often related to macroeconomics) approach.

The bottom-up process is a technology-rich approach based on thorough descriptions of technologic aspects of the energy system and how it can develop in the future. In this kind of modelling, the evolution of the energy demand is typically provided exogenously, and the models make it possible to analyse how the given energy demand can be fulfilled. These models are not able to evaluate the feedback effects of the technological improvements on the general economy, they are hence in general partial-equilibrium models.

On the other hand, the top-down models are essentially general equilibrium econometric models. They describe the whole economy, and aim at optimizing the social welfare. They include endogenous representation of most macroeconomic parameters like prices and demand elasticities impacting the evolution of the energy demand. However, these models do not include many technical aspects as they present higher sectorial aggregation.

In all of the considered scenarios, a bottom-up approach is adopted, which can be explained by the scenario objective itself, which is describing the potential evolution of the energy system and the related technological “landscape”.

Hydrogen emergence in such models is hence dependent on the refined description of the current and prospective hydrogen technologies and the associated techno-economic assumptions. The bottom-up approach allows designing the hydrogen technological pathways, and more precisely the different steps of the hydrogen supply chain (if included in the model), which is of crucial role in identifying the economic bottlenecks of hydrogen integration. In fact, it allows determining the required technology improvements in order to reach market penetration. Implementing proper learning curves in the models is required to capture accurately the deployment potential. However, as stated by Wiesenthal et al. (2012) [33], “bottom-up engineering estimates are based on current knowledge and state of the technology, and therefore discount possible breakthroughs and therefore tend to be too pessimistic”.

In contrast with the bottom-up approach, the top-down one does not allow a refined technological representation, the demand sectors being often aggregated. However, it is suited for the estimation of the impact of the new technologies integration on the total system. An interesting outcome of such an approach is to assess the potential externalities on a system cost level. More precisely, an example that can be applied to the hydrogen case, and more specifically in the transport sector, is its impact on lowering the GHG and particulate emissions. This can be economically translated through societal costs related to air-pollution-induced illness, and the related governmental expenses on healthcare. Same approach can be applied to other externalities like noise pollution, national energy dependency on fuel

imports, impact on the tax revenues, etc. Such aspects can only be visualized through a holistic top-down approach [34].

Although their quantitative assessment can be challenging, the consideration of these externalities can favour hydrogen economy and ease its competitiveness with the fully and partly fossil-fuelled vehicles [35].

5.3. The compromise of the temporal resolution

As shown in Table 5, the temporal resolution of energy models can vary from one minute to multiple-year steps. In general, it is hard to keep a high temporal resolution while elaborating a scenario integrating pathways over multiple years. This is directly related to the computing capacity impacting the time of problem resolution. However, at least hourly temporal resolution seems crucial when considering the modelling of the electric system, especially with the rising integration of the renewable energies and new end-use technologies (ex: electric mobility) into the energy system [36]. The variability of the electricity supply and demand requires an adequate temporal resolution in order to be properly addressed. Accordingly, as shown in Table 5, most of the scenario frameworks present an annual or a simplified time-slice temporal resolution. In order to remedy this limit, linkages with a specific dispatch model are often considered (e.g. WEO and ETP scenarios).

Indeed, amongst the different hydrogen potential contributions to the energy system, its ability to provide flexibility to the electric system can be a game changer in improving the electrolysis process profitability [37]. However, in order to capture this potential, an important factor that should be taken into account is the temporal resolution of the considered models. Indeed, hydrogen can provide flexibility over very short periods like frequency regulation for example where the PEM technology have proved quick time responses to flexibility solicitation [38]; or over long periods for seasonal storage increasingly searched for with the increasing penetration of renewables. Furthermore, the high temporal resolution allows to accurately assess the hydrogen cost through the adequate estimation of the load factor that can be improved via the flexibility provision (participation to the reserve markets for instance).

Therefore, neglecting this potential due to inadequate time resolution may lower the hydrogen contribution in the results.

5.4. The impact of the geographic resolution

Likewise, the geographical scope can vary from analysing single projects or systems to modelling the energy system of the whole world. For instance, the geographic information system (GIS)-based models allow reaching very high spatial resolution through the possibility of mapping large sets of data. More details are available in [39].

The spatial resolution can be of major importance when considering the infrastructure deployment issue. In turn, the infrastructure representation impacts the cost, the energy consumption and the emissions of a given energy vector. Beyond the transmission and distribution selected pathway (pipeline or trucks),

the delivery cost highly depends on the travelled distance and the geography of the travelled pathway. Furthermore, a refined geographic resolution can provide useful insights regarding the relevance of the system design and the location strategies of the different facilities, for instance, highlighting the trade-off between a centralized and a decentralized design.

The remaining question concerns the degree of accuracy to be reached depending on the research question, and the level of complexity that is appropriate in long term energy system models given the uncertainty in the inputs over time.

To sum up, all modelling approaches present assets and limitations. No model is perfectly complete. No model suits any research question. In order to overcome the limits, one option can be to complement the models with one another: linking between different kinds of modelling tools improves the representation of the energy system. Several examples can be found in the literature [40]–[43].

Table 5: Criteria definition applied to the reviewed model

Scenario	Model	Optim/Simul	Approach	Geo. Resolution	Timeframe	Time resolution
WEO	World Energy Model (WEM) (The model was updated in 2018)	Simulation Some optimisation is included in: - energy access module - demand response module (smart charging optimizer) - hybrid gas infra. Model	Bottom-up with some exceptions: - the hybrid WEM gas supply module involves bottom-up and top-down approaches	- World aggregated in 13 regions - More refined level for EU in some sectors: The model is complemented by • Artelys Crystal Super Grid model for electricity markets modelling by country in Europe • Internal gas infrastructure model for the European countries)	2100	- Four time segments: i) baseload demand; ii) low-midload demand iii) high-midload demand and iv) peakload demand. - Hourly resolution in the separate WEM hourly dispatch model
ETP (including H2 Roadmap - 2DS High H2)	ETP Model	- ETP TIMES: Optimisation - MoMo: Simulation - Buildings: Simulation	Bottom-up	28 regions	2060	- ETP TIMES: a year is divided into four seasons, with each season being represented by a typical day, which again is divided into 12 daily load segments of two-hour- duration - Supplementary linear dispatch model: hourly resolution
Grand Transition	Global Multi-Regional MARKAL Model (GMM)	Optimisation	Bottom-up	15 regions	2050	Annually (10 year time-steps)

LITERATURE REVIEW AND ANALYSIS

ReMap	ReMap tools	Simulation	Combined Bottom-up and Top-down approaches	70 countries	2050	Annually
	For macro-economic analyses: E3ME Model	Econometric	Combined Bottom-up and Top-down approaches	61 regions	2050	Annually
Energy Revolution	Mesap Planet	Simulation	Bottom-up	National/State/Regional	No limit	From 1min to multiple years
	REMix (REN Energy Mix for Sustainable Electricity Supply): sub-models EnDAT, OptiMo, Capacity Expansion Model (CEM)	- EnDAT: Simulation - Optimo: Optimisation (Linear) - CEM: Optimisation (MILP)	- CEM: Bottom-up	Flexible: world regions to single cities - EnDat: High spatial resolution	(No information available)	- EnDAT: High temporal resolution - CEM: 10 to 40 years
New Lens scenarios Sky scenario	World Energy Model (WEM)	Simulation	Combined Bottom-up and Top-down approaches	World (detailed country level)	2100	Annually
	Global Supply Model (GSM)	Simulation	Top-down	World (detailed country level)	2100	Annually
H2 Scaling Up	No available information					

6. Conclusions

Given the importance of the energy scenarios in attracting the attention of the decision makers towards the most attractive new technologies, which can allow the achievement of the governmental environmental targets, the hydrogen representation in such scenarios is of big importance.

Interest in hydrogen have been rising in the last few years, multiplying the number of reports tackling the hydrogen potential and giving emergence to new organizations such as the Hydrogen Council that gathers numerous industrial stakeholders [6]. This trend was coupled with an increasing interest of government bodies which was reflected through several governmental roadmaps and pledges regarding hydrogen integration [44]–[47].

The appraisal of hydrogen possible contribution to the energy system, however, has been evolving through time. Recently, more analyses have been tackling the hydrogen potential for industrial applications [12], [14], [23]. The latter represents an efficient way to electrify the industrial sectors so far dependent on fossil fuels, and contribute to lower the carbon emissions (if electrolysis is now considered to replace carbon-intensive hydrogen production processes). This market seems key as a transitional step towards the hydrogen economy, by allowing to reach the required economies of scale.

Amongst the hydrogen energy markets, it is the use of hydrogen in mobility that keeps attracting most of the scenarios interest, also presenting the highest rates of technology specification. The other markets (injection into natural gas networks, fuel cell stationary applications, etc.) are less tackled in the scenarios.

The review of the selected scenarios shows that hydrogen is more present in normative scenarios which are characterized by stringent environmental constraints. This highlights the decarbonisation potential of hydrogen systems but also the crucial role of strong policies. The hydrogen-specific scenarios allow addressing all of the hydrogen pathways while in the global energy system scenarios, only a set of selected pathways emerge in the results. It is though difficult to distinguish the results from the general discussions, since many of the reviewed global energy scenarios do tackle all of the hydrogen aspects but without specifying whether they emerge in the results.

In the case of scenarios generated by optimization models, only the most economic hydrogen pathways are meant to play a role in the energy system.

Hence, beyond the energy system characteristics and the technological landscape, the modelling approach itself has significant impact on the hydrogen emergence in the results. Optimisation models challenge hydrogen by conditioning its penetration with its competitiveness compared to other technologies; which allows assessing the required improvements (cost reductions, efficiency) to achieve market penetration. On the other hand, simulation models allow drawing different potential hydrogen futures as a result of specific conditions.

Bottom up models are technology-rich; they allow a detailed design of the hydrogen technologies throughout the supply chain. However, they may fail in representing the future potential technological breakthroughs. Top down models have limited technological description but allow identifying broader impacts of hydrogen integration on the global economy. Time resolution is crucial for flexibility potential assessment; flexibility being a characteristic which can ease hydrogen penetration via improving the business case by taking advantage of different markets, while geographic resolution can be of big interest when addressing the infrastructure deployment.

None of the scenarios studied above is based on a geographically refined model. This type of models could be useful to support the development of hydrogen, by shedding light on the tracks of its deployment scheme and by providing complementary elements to the global energy scenarios.

Therefore, the adequate level of complexity varies depending on the research question.

In this thesis we suggest to compare different approaches of hydrogen modelling. Various model types are used to answer specific questions regarding the hydrogen integration challenges.

First, an in-house multi-regional analysis is conducted to assess the potential evolution of the hydrogen volumes and the consequent mitigation potential in the context of the current announced policies and governmental roadmaps, hence adopting a descriptive approach. Assuming the same political context, the hydrogen penetration feasibility into the new markets (mobility and natural gas blending) is then analysed. The designed descriptive scenario aims at evaluating whether the current policies are propitious for hydrogen integration into the energy system. Policy recommendations are then proposed with regards to the specificity of each hydrogen market and each part of the supply chain.

The simulation model tackles each hydrogen market aside and does not represent the sector-coupling potential.

To do so, a multi-sectorial optimization model (TIMES-PT) is used to study the possible simultaneous interactions of the hydrogen systems with the global energy system while considering a large set of competing technologies challenging the hydrogen penetration. The model however presents limitations in terms of hydrogen production and delivery costs assessment. Although a wide range of associated technology description is available in the modelling framework, the time and geographic resolution are not refined enough to accurately represent the hydrogen production flexibility interacting with the electricity system nor the hydrogen delivery pathways whose cost depends on geographic considerations.

Accordingly, time and spatial refined models (GLAES, EuroPower and InfraGis) are applied to a national case study evaluating the techno-economic relevance of hydrogen production from electricity surplus and appraising the cost of delivery infrastructure deployment (comparing different pathways).

REFERENCES

- [1] David L. Kurtz, *Contemporary Marketing*, South-Western Cengage Learning. Boone&Kurtz, 2013.
- [2] Isabelle Gozé-Bardin, “Le scénario prospectif, outil d’exploration de l’intention stratégique ?,” *Management & Avenir* 2008/3 (n° 17), 2008.
- [3] W. McDowall and M. Eames, “Forecasts, scenarios, visions, backcasts and roadmaps to the hydrogen economy: A review of the hydrogen futures literature,” *Hydrogen*, vol. 34, no. 11, pp. 1236–1250, Jul. 2006.
- [4] E. S. Hanley, J. P. Deane, and B. Ó. Gallachóir, “The role of hydrogen in low carbon energy futures—A review of existing perspectives,” *Renew. Sustain. Energy Rev.*, vol. 82, pp. 3027–3045, 2018.
- [5] Chris Quarton *et al.*, “Working paper: The curious case of the missing hydrogen: Why is hydrogen not showing up more in large-scale energy scenarios?” 2019.
- [6] “The Hydrogen Council: an Introduction,” *Hydrogen Council*, 2019. [Online]. Available: <http://hydrogencouncil.com/>.
- [7] Hydrogen Council, “Hydrogen scaling up, A sustainable pathway for the global energy transition,” Nov. 2017.
- [8] International Energy Agency, “Technology Roadmap Hydrogen and Fuel Cells.” 2015.
- [9] International Energy Agency (IEA), “World Energy Outlook.” 2015.
- [10] International Energy Agency (IEA), “World Energy Outlook.” 2016.
- [11] International Energy Agency (IEA), “World Energy Outlook.” 2017.
- [12] International Energy Agency (IEA), “World Energy Outlook.” 2018.
- [13] International Energy Agency (IEA), “Energy Technology Perspectives.” 2016.
- [14] International Energy Agency (IEA), “Energy Technology Perspectives.” 2017.
- [15] World Energy Council, “World Energy Scenarios, The Grand Transition,” 2016.
- [16] International Renewable Energy Agency (IRENA), “Accelerating the Energy Transition through Innovation,” 2017.
- [17] IRENA, “Hydrogen from renewable power.” IRENA, Sep-2018.
- [18] Greenpeace, “Energy [R]evolution, A sustainable World Energy Outlook 2015, 100% Renewable Energy for all,” 2015.
- [19] “Shell Scenarios, Sky, Meeting the goals of the Paris agreement.” Shell, 2018.
- [20] “New Lens Scenarios, A shift in perspective for a world in transition.” Shell, 2018.
- [21] IHS, “Chemical Economics Handbook, Hydrogen.” 2015.
- [22] Food and Agricultural Organization of the United Nations, “World fertilizer trends and outlook to 2020, Summary Report,” 2017.
- [23] International Energy Agency (IEA), “Renewable Energy For Industry, From green energy to green materials and fuels.” 2017.

- [24] M. Robinius *et al.*, “Techno-economic potential and market trends for Power-to-Hydrogen and Hydrogen-to-X based on a collaborative and international review,” presented at the 22nd World Hydrogen Energy Conference (WHEC 2018), Rio de Janeiro, Brazil, 17-Jun-2018.
- [25] Ministry of Foreign Affairs of Japan, “Summit Information,” *G20 2019 Japan*, 2019. [Online]. Available: <https://g20.org/en/>.
- [26] SHELL, “SHELL Hydrogen Study, Energy of the Future? Sustainable Mobility through Fuel Cells and H₂,” 2017.
- [27] T. Ommen, W. B. Markussen, and B. Elmegaard, “Comparison of linear, mixed integer and non-linear programming methods in energy system dispatch modelling,” *Energy*, vol. 74, pp. 109–118, Sep. 2014.
- [28] H. Lund *et al.*, “Simulation versus Optimisation: Theoretical Positions in Energy System Modelling,” *Energies*, vol. 10, no. 7, 2017.
- [29] M.W. Melaina and M. Penev, “Comparing infrastructure costs for hydrogen and electricity,” presented at the 2012 Department of Energy Fuel Cell Technologies Program Annual Merit Review, Arlington, VA, 15-May-2012.
- [30] Alain Le Duigou and Aimen Smatti, “On the comparison and the complementarity of batteries and fuel cells for electric driving,” *International Journal of Hydrogen Energy*, 2014.
- [31] Martin Robinius *et al.*, “Comparative Analysis of Infrastructures: Hydrogen Fueling and Electric Charging of Vehicles.” Forschungszentrums Jülich, 2018.
- [32] V. Rai and A. D. Henry, “Agent-based modelling of consumer energy choices,” *Nat. Clim. Change*, vol. 6, p. 556, May 2016.
- [33] T. Wiesenthal *et al.*, “Technology Learning Curves for Energy Policy Support,” European Commission, Joint Research Centre (JRC), ISBN 978-92-79-25676-9, 2012.
- [34] Artem Korzhenevych *et al.*, “Update of the Handbook on External Costs of Transport, Final Report.” RICARDO-AEA for European Commission – DG Mobility and Transport, 08-Jan-2014.
- [35] Anthony D Owen, “Externalities and Subsidies: the Economics of Hydrogen-based Transportation Technologies.” School of Economics, The University of New South Wales, Sydney, Australia, 2004.
- [36] Marco Nicolosi, Andrew Mills, and Ryan Wiser, “The Importance of High Temporal Resolution in Modeling Renewable Energy Penetration Scenarios.” 9th Conference on Applied Infrastructure Research, TU Berlin, Berlin, Germany, 08-Oct-2010.
- [37] Tractebel and Hincio, “Study on early Business Cases for hydrogen in energy storage and more broadly power to H₂ applications, Final report.” FCHJU, Jun-2017.
- [38] SBC Energy Institute, “Leading the Energy Transition Factbook, Hydrogen-based energy conversion - More than storage: system flexibility.” 2014.
- [39] “What is GIS?,” *esri*. [Online]. Available: <https://www.esri.com/en-us/what-is-gis/overview>. [Accessed: 27-May-2019].
- [40] N. Strachan, N. Balta-Ozkan, D. Joffe, K. McGeevor, and N. Hughes, “Soft-linking energy systems and GIS models to investigate spatial hydrogen infrastructure development in a low-carbon UK energy system,” *Int. J. Hydrog. Energy*, vol. 34, no. 2, pp. 642–657, Jan. 2009.

- [41] J. P. Deane, A. Chiodi, M. Gargiulo, and B. P. Ó Gallachóir, “Soft-linking of a power systems model to an energy systems model,” *8th World Energy Syst. Conf. WESC 2010*, vol. 42, no. 1, pp. 303–312, Jun. 2012.
- [42] A. Krook-Riekkola, C. Berg, E. O. Ahlgren, and P. Söderholm, “Challenges in top-down and bottom-up soft-linking: Lessons from linking a Swedish energy system model with a CGE model,” *Energy*, vol. 141, pp. 803–817, Dec. 2017.
- [43] F. Riva, F. Gardumi, A. Tognollo, and E. Colombo, “Soft-linking energy demand and optimisation models for local long-term electricity planning: An application to rural India,” *Energy*, vol. 166, pp. 32–46, Jan. 2019.
- [44] Bruce S *et al.*, “National Hydrogen Roadmap, Pathways to an economically sustainable hydrogen industry in Australia.” CSIRO, 2018.
- [45] “METI has strategic road map for hydrogen and fuel cells in Japan,” *Fuel Cells Bull.*, vol. 2014, no. 7, p. 9, 2014.
- [46] Hong Dae-sun and Choi Ha-yan, “South Korean government announces roadmap for hydrogen economy,” *HANKYOREH*, Jan-2019. [Online]. Available: http://english.hani.co.kr/arti/english_edition/e_business/879097.html.
- [47] Ministère de la transition écologique et solidaire, “Plan de déploiement de l’hydrogène pour la transition énergétique.” 2018.

ANNEX

Table 6: Survey on the data specification in the reviewed documents [5]

		Study		Scenario													
		World Energy Outlook (IEA) 2016	World Energy Outlook (IEA) 2017	World Energy Outlook (IEA) 2018	The Grand Transition (WEC) 2016	REmap (IRENA) 2018	Energy Technology Perspectives (IEA) 2016	Energy Technology Perspectives (IEA) 2017	Energy Revolution (Greenpeace) 2015	Shell scenarios 2018	Global Energy Assessment 2012			H2 Council 2017	H2FC Roadmap 2015		
Sector	Technology	Current Policies New Policies 450 Scenario	Current Policies New Policies Sust. Development	Current Policies New Policies Sust. Development The Future is Electric	Hard Rock Unfinished Symphony Modern Jazz	Reference REmap	6DS 4DS 2DS	RTS 2DS B2DS	Reference E[R] ADV E[R]	Mountains Oceans Sky	Supply (Conv Trans) Mix (Conv Trans) Efficiency (Conv Trans) Supply (Adv Trans) Mix (Adv Trans) Efficiency (Adv Trans)	Hydrogen - scaling up 2DS High H2					
Production	Electrolysis		R	R						R R	R R R R R R R R R R	R R					
	From biomass										R R R R R R R R R R	R R					
	Steam methane reforming			R						R R	R R R R R R R R R R	R R					
	Coal gasification									R	R R R R R R R R R R	R R					
Storage	General storage									R		R R					
Transport	Shipping (chemicals/liquid)			R							R R R R R R R R R R	R R					
	Trucks											R R					
	Pipelines											R R					
	Considered but not specified									R		R R					
Re-conversion	Fuel Cell														R R		
	CCGT														R R		
	CHP														R R		
Mobility	LDVs				R R R		R R			R R R	R R R R R R R R R R	R R					
	MDVs/HDVs/trucks/buses			R						R R R	R R R R R R R R R R	R R					
	H2 for alternative fuels									R R R	R R R R R R R R R R	R R					
	Aviation											R R					
	Shipping											R R					
Considered but not specified					R R												
Industry	Refining			R R											R R		
	Chemicals			R											R R		
	Not specified					R R									R R		
Gas grid	Direct injection of H2														R R		
	Methanation														R R		

Legend

- No mention in the scenario
- Not modelled, but discussed
- Modelled, but no data assumptions provided
- Modelled, with data assumptions provided
- R** Included in the scenario results

PART II

GLOBAL VIEW ON HYDROGEN ROLE IN THE ENERGY SYSTEM – MULTIREGIONAL APPROACH

Abstract

Making it possible to bridge different energy sectors thanks to its versatility, hydrogen is a promising enabler for a multi-sectorial decarbonisation. The aim of this part of the thesis is to assess the evolution prospects of hydrogen markets considering the latest energy policies in four different regions (USA, Europe, Japan, and China). The market entry feasibility in the transport and natural gas sectors is then assessed for different timeframes (up to 2040).

According to our analysis, the energy related markets are expected to expand in the years to come changing the distribution of hydrogen demand by market segment. This latter varies from one region to another depending on the local context (energy mix, policies, roadmaps, etc.). Current policies result in a modest penetration of hydrogen into the energy system, which can allow achieving only 3.3% of the effort that needs to be done (by the four considered regions) in order to limit the increase of the temperature to 2°C, compared to preindustrial levels. However the hydrogen potential for decarbonizing the energy system is much higher, calling for strong energy policies.

From an economic standpoint, the most promising market in the four regions is hydrogen for mobility. This market even presents a potential room for taxation in the medium term. In contrast, blending with natural gas struggles to reach competitiveness. Both industrial and political efforts are required in the two markets in order to lower the costs and prepare a suitable market penetration environment.

Résumé

Permettant de relier différents secteurs de l'énergie grâce à sa polyvalence, l'hydrogène est un catalyseur prometteur pour une décarbonisation multisectorielle. Cette partie de la thèse a pour objectif d'évaluer les perspectives d'évolution des marchés de l'hydrogène en tenant compte des dernières politiques énergétiques dans quatre régions différentes (États-Unis, Europe, Japon et Chine). La faisabilité d'entrée sur les marchés énergétiques dans les secteurs du transport et des usages du gaz naturel est ensuite évaluée pour différentes périodes (allant jusqu'en 2040).

Selon notre analyse, les marchés liés à l'énergie devraient se développer dans les années à venir, ce qui modifiera la répartition de la demande en hydrogène par segment de marché. Cette répartition varie d'une région à une autre en fonction du contexte local (mix énergétique, politiques, feuilles de route, etc.). Les politiques actuelles se traduisent par une faible pénétration de l'hydrogène dans le système énergétique, ce qui ne peut permettre de réaliser que 3,3% de l'effort à fournir (pour les quatre régions considérées) afin de limiter l'augmentation de la température à 2°C, par rapport aux niveaux préindustriels. Cependant, le potentiel de l'hydrogène à décarboner le système énergétique est beaucoup plus élevé, ce qui milite pour des politiques énergétiques plus fortes.

D'un point de vue économique, le marché le plus prometteur dans les quatre régions est l'hydrogène pour la mobilité. Ce marché présente même une marge potentielle de taxation à moyen terme. En revanche, le mélange avec le gaz naturel peine à devenir compétitif. Des efforts industriels et politiques sont nécessaires sur les deux marchés afin de réduire les coûts et de préparer un environnement approprié pour la pénétration du marché.

ACRONYMS

CCS	Carbon Capture and Storage
ETP	Energy Technology Perspectives
EU	Europe
EV	Electric Vehicles
FC	Fuel Cell
FCEB	Fuel Cell Electric Bus
FCEV	Fuel Cell Electric Vehicle
FCHJU	Fuel Cell and Hydrogen Joint Undertaking
GHG	Greenhouse Gas
GWP	Global Warming Potential
ICE	Internal Combustion Engine
IEA	International Energy Agency
IMO	International Maritime Organization
LCOH	Levelized Cost of Hydrogen
LNG	Liquefied Natural Gas
METI	Ministry of Economy, Trade and Industry (Japan)
NG	Natural Gas
NP scenario	New Policies Scenarios
OECD	Organization for Economic Co-operation and Development
PEM	Polymer Electrolyte Membrane
PLDV	Passenger Light Duty Vehicles

HYDROGEN ROLE IN THE ENERGY SYSTEM
A MULTIREGIONAL APPROACH

SMR	Steam Methane Reforming
TCO	Total Cost of Ownership
TDCPP	Tax on Domestic Consumption of Petroleum Products
US	United States
VAT	Value-Added Tax
WEO	World Energy Outlook

INTRODUCTION

The comparison of the hydrogen representation in the energy scenarios have shown that most of the scenarios presenting high hydrogen volumes are normative scenarios, considering high renewable shares or stringent climate constraints announcing the role that hydrogen can play within the energy system.

Indeed, the hydrogen strength lies in its capacity to contribute to the decarbonisation of the energy system with a multi-sectorial potential [1], [2]. Currently, hydrogen is mainly used as a chemical component in several industrial applications like the refining activity and the ammonia and methanol production [3]. However, new energy-related hydrogen markets are emerging in different sectors (transportation, residential and industrial heating, etc.) [4].

Among other applications, hydrogen can be used to root the renewable energies up to different end-use sectors whose decarbonisation can be challenging (transport, chemical applications in industry, etc.). This can also help provide the electricity system with flexibility.

Hence, hydrogen applications are multiple, but how attractive are they compared to one another? What are their evolution prospects? And under which economic and political conditions can they be developed?

In contrast with the reviewed studies showing more hydrogen in normative scenarios, a different approach is suggested in this section. Based on a designed descriptive scenario, the assessment of the hydrogen potential in the context of the latest announced policies and roadmaps is conducted, aiming at evaluating the consequences of the latter on the hydrogen deployment.

The attractiveness of the different markets is assessed with regards to their size development and carbon mitigation potential; the entry cost being examined for each market.

This approach helps quantify the hydrogen potential while identifying the economic and political bottlenecks behind the hydrogen emergence in the energy system. Contrasted geographic contexts are selected in order to inspect the hydrogen market penetration feasibility facing different energy system challenges.

To do so, a techno-economic analysis is conducted.

This part is hence divided into two chapters. In the first one, the prospective hydrogen volumes and corresponding carbon mitigation potential are assessed for each region adopting the descriptive scenario, and highlighting the political efforts that need to be done in order to allow hydrogen to fully prove its potential.

In the second chapter, a market-oriented study is carried out focusing on the penetration feasibility of the hydrogen systems into the energy markets from a techno-economic standpoint essentially, although political aspects are also discussed. The latter tackle the impact of different political measures (carbon pricing, subsidy, etc.) on the hydrogen economy.

REFERENCES

- [1] International Energy Agency, “Technology Roadmap Hydrogen and Fuel Cells.” 2015.
- [2] IRENA, “Hydrogen from renewable power.” IRENA, Sep-2018.
- [3] SBC Energy Institute, “Leading the Energy Transition Factbook, Hydrogen-based energy conversion - More than storage: system flexibility.” 2014.
- [4] SHELL, “SHELL Hydrogen Study, Energy of the Future? Sustainable Mobility through Fuel Cells and H₂,” 2017.

CHAPTER I

A multi-regional overview of current and future hydrogen markets based on governmental roadmaps: Fostering the hydrogen potential through adequate policies

1. Introduction

Hindering the global warming represents one of today's biggest challenges. Climate targets have been set by different countries around the world aiming at limiting the CO₂ emissions so that the temperature rise does not exceed 2°C compared to the pre-industrial levels [1], [2].

In this context, hydrogen has a promising potential allowing a simultaneous decarbonisation of different sectors.

The aim of this chapter is to quantify the hydrogen carbon mitigation potential, examining the current implemented (or planned) energy policies and roadmaps and their impact on the hydrogen market deployment.

To do so, different geographies are considered: USA, Europe, China and Japan, encompassing the variety of the political landscapes present in these considered regions. The reason behind the focus on these specific geographies is their weight on the environmental policy. All together, they represent 18 Gt of CO₂ emissions annually (55% of the global CO₂ emissions) [3]. They also represent diverse concerns (in terms of growth, pollution, energy resource, energy independency), and diverse energy policies accordingly. Although most of the announced hydrogen plans are taking place in the selected regions, other countries are emerging when it comes to hydrogen deployment plans. For instance, South Korea has recently developed a hydrogen roadmap aiming at integrating hydrogen as a pillar for energy security with a focus on the mobility sector [4]. Hydrogen deployment plans are also emerging in Australia with a view not to only enhance domestic hydrogen use, but also position the region as a large exporter of hydrogen in the years to come [5].

For the selected regions, the future potential of hydrogen in terms of market size and CO₂ mitigation is characterized taking into account a variety of hydrogen applications. Both industrial and energy related markets are considered.

To do so, the chapter builds on a prospective analysis carried out to identify the future markets for hydrogen and the attached prospective market volumes. The resulting additional power supply is assessed if the demand were to be supplied by electrolysis processes. Then, the carbon mitigation potential associated with the prospective volumes is estimated, considering a low carbon hydrogen generation.

Current policies are discussed, and recommendations are proposed regarding the measures to be implemented, in order to take advantage of the hydrogen decarbonisation. Hydrogen being at the junction between energy supply and demand, both sides are addressed.

The current chapter constitutes the basis of a paper submitted to Energy Policy [6].

2. Methodology

This chapter assesses the future hydrogen potential estimated for 2030 and 2040 taking into account the most recent energy policies and roadmaps in four regions of the world (the United States, Europe, China and Japan). The relevant policies and roadmaps define the governmental targets in terms of hydrogen penetration (e.g. the fuel cell vehicle fleets to be reached) on the one hand, and describe the changes in the energy system as a whole (with no apparent relation to hydrogen), such as the announced changes in the refining sector or the governmental strategy for electricity supplies and/or natural gas consumption on the other hand. We referred to the New Policies scenario published by the International Energy Agency [7] to understand changes in the energy demand; it takes into account the latest governmental energy pledges and announcements, and assesses changes in the electricity, oil and natural gas demand by region. However other aspects unrelated to energy can impact specific hydrogen markets (e.g. population and farming activities), which will be discussed in more detail in the following sections.

A market sectoration method for each of the considered regions is conducted. Both industrial and energy-related markets were investigated. By-product hydrogen was not taken into account as the emerging hydrogen markets tend to be based on merchant and captive production for energy-related applications.

Detailed information on how the power system operates and its related market design [8], [9] is required to analyse stationary hydrogen applications when referring to power supply via hydrogen as an energy carrier, which falls outside the scope of this chapter.

Accordingly, the markets in question are:

- Industrial markets: refinery, ammonia and methanol industries
- Hydrogen for mobility use as a direct fuel or via advanced biofuels
- Hydrogen injection into natural gas networks.

The markets have been characterised by two main indicators: the market size and the CO₂ mitigation potential. The electricity consumption required to produce the corresponding hydrogen volumes via electrolysis has also been assessed in order to estimate the significance of this additional power consumption.

These indicators have been developed based on the design of a prospective scenario. This scenario takes into account the policies and measures already in place, as well as the targets and pledges announced by governments, even if they are yet to be implemented. The aim of this approach is to assess the penetration potential of hydrogen in the context of the latest announced energy strategies. This approach has then been used for comparison with more voluntarist approaches recently developed to evaluate the future hydrogen potential.

The specific policies impacting the hydrogen market volumes are discussed in what follows below. CO₂ mitigation has then been assessed on the basis of the resulting hydrogen market sizes. Further details regarding the adopted methodology are provided in the appendix.

2.1. Market potential assessment: Assessment of market sector sizes

The volume represents the expansion potential of a given hydrogen market, depending on the context specific for each region and each timeframe. As mentioned before, the context relates to the latest governmental announcements (industry- and energy-related). Hence, a consistent scenario has been built for each market sector to provide an estimate of the market volumes involved within such a perspective. The policies and contexts impacting each relevant market sector are detailed here below.

To determine the hydrogen demand that is driven by the refineries, the current hydrogen consumption for refining purposes has been evaluated in each region (hydrocracking and hydro-desulphurisation). The evolving demand has then been assumed to follow the trends of the refining sector based on the latest announcements regarding any expected openings or closures of refineries in each region. To do so, the IEA New Policies scenario is adopted [7] to assess changes in the oil sector. Unlike the other regions, we used the Energy Information Administration (EIA) reference scenario [10] for the US as it provides the latest view of the American government on the evolution of its oil demand.

Evaluation of the hydrogen demand for ammonia production is subject to two opposite drivers. According to the United Nations, the population is expected to grow in the years to come [11], hence increasing farming activities and increasing the need for ammonia for fertilisation on the one hand. However, a shift to biological fertilisers driven by the political trend to more eco-friendly soil fertilisation is expected to hamper the ammonia demand on the other hand. In this study, the short-term hydrogen demand driven by this market sector is assumed to follow the same trends as of today. Then, it is assumed to stabilise in the regions in question (the US, Europe, China and Japan) due to the opposing trends mentioned above. Another reason behind the choice of such a trend for these regions is the fact that the future ammonia demand increase is expected to be led by emerging countries like India and African countries, etc. [12]

The prospective hydrogen demand for methanol production was assessed on the basis of changes occurring in the methanol industry in each region. In order to remain in line with the latest governmental announcements, trends for the future methanol demand were defined in line with the New Policies scenario published by the World Energy Outlook [3].

Regarding mobility use, the volumes of hydrogen required as a direct fuel in passenger light-duty vehicles (PLDV) were estimated on the basis of national targets and programmes for the deployment of fuel cell electric vehicles. However, as the timeframes of these targets do not exceed 2030, hence two fleet size evolution scenarios are investigated. The first one assumes a continuous trend from 2030 to 2040. The second scenario follows the IEA Hydrogen Roadmap [13] for the period between 2030 and 2040. The average travelled distance by vehicle was also defined for each region.

Using the same logic of deduction, the use of hydrogen in bus fleets was estimated taking into account fuel cell bus deployment programmes by region. However, as the timeframe of these programmes does not go beyond 2020, a prospective scenario was designed on the basis of the same trends up to 2040.

Since there are no clear government targets set for fuel cell train development, a scenario for this market sector was defined. The potential hydrogen demand for this market sector was assessed considering the potential substitution of non-electrified train lines (fossil-fuelled trains) and assuming a constant train fleet for the different timeframes. The maximum hydrogen potential (corresponding to a 100% substitution of the diesel train fleet) is assessed. Then a share of 10% and 15% of the total substitution

capacity of fossil-fuelled trains was allocated to hydrogen in each region for the 2030 and 2040 timeframes respectively. This share was suggested by the recent study published by the Hydrogen Council [14].

Advanced biofuel production was assumed to evolve in line with government targets in terms of its integration in the years to come. According to the International Energy Agency, advanced biofuels are expected to be largely deployed in OECD regions with a share of 18% of all biofuel used by 2035 [15]. Hydrogen consumption was then deduced assuming a ratio of 0.2 kg of H₂ per litre of biofuel produced [16].

For gas markets, only took into account the direct injection of hydrogen into the gas network. No governmental target has been announced for this market so far, hence a scenario assuming a ratio of 10% equivalent volume is examined. Up to this level, no major equipment modification is required, such as for boilers, burners, gas turbines and other machines [17], [18]. This market sector is impacted by the evolving natural gas demand in each of the relevant regions. To remain in line with the latest governmental energy strategies, our assumptions were based on the IEA prospective values suggested in the New Policies scenario [7] (see the appendix for more details). The industrial sector gas demand was disregarded in our calculations in order to avoid cases where natural gas is required as a pure chemical product (e.g. for steam methane reforming). Methanation has also been disregarded in this chapter due to its high cost compared with the direct injection of hydrogen into the grid [19]. Another reason behind the choice of disregarding methanation is the methane emissions that can be generated by the introduction of this market. The issue of methane leakages is addressed hereafter.

A key effect of a potential new hydrogen demand (if totally generated by electrolysis) is the additional electricity demand it would induce. The impact of this effect has also been assessed herein. In order to provide a rough estimate of this consumption compared with the total national consumption, the expected trends for electricity generation by region in the New Policies scenario were developed for the 2030 and 2040 timeframes [7].

A discussion on the resulting CO₂ emissions follows.

2.2. CO₂ mitigation assessment of the hydrogen markets

Given the volumes assessed for the different market sectors, the potential for CO₂ mitigation was then evaluated for each application. The calculations estimate the amounts of reduced emissions which would result from substituting the carbonised competitors with hydrogen technologies.

Upstream, the low-carbon hydrogen production footprint was assumed to be equal to the threshold set by the CertifHy project. This threshold was endorsed by a number of companies including the major gas firms (see the appendix for more details) [20]. The threshold set by the CertifHy project to define “low-carbon” production is 36.4 g_{CO2}/MJ of hydrogen produced, equivalent to a 60% reduction in steam methane reforming (SMR) emissions [20].

For industrial markets, the CO₂ mitigation potential can be defined as the result of replacing carbonised hydrogen production processes (e.g. steam methane reforming) with low-carbon production means (e.g. water electrolysis assuming a decarbonised power mix). Considering that hydrogen as a co-product in refineries is not replaced, only merchant and captive hydrogen were considered, i.e. approximately 64% of the total hydrogen demand of this market sector [21]. In the mobility market sector, hydrogen replaces diesel or gasoline depending on the region in question.

Regarding the natural gas markets and beyond CO₂ mitigation, the contribution of hydrogen in reducing methane leakages has also been assessed in this chapter. For this market sector, hydrogen was assumed to substitute 10% (volume rate) of the natural gas demand (industrial sector excluded). The methane leakages associated with this substitution could therefore be avoided. Methane leakage rates were estimated as a percentage of the processed natural gas for each region. The appendix provides further details about the origins of gas leakages according to the region.

The assumptions concerning the global warming potential of methane compared with carbon dioxide were based on IPCC (Intergovernmental Panel on Climate Change) data [1]. Based on these values, the impact of methane leakages was converted into CO₂-equivalent emissions in order to assess the total mitigation potential of this market sector.

In order to assess this impact, the global warming potential (GWP) was measured. This refers to the ratio of the energy absorbed by a tonne of a greenhouse gas (in this case, the methane) to the energy absorbed by a tonne of CO₂ over a given timeframe. The GWP expresses all the greenhouse gases emitted in CO₂-equivalent terms. The atmospheric lifetime of methane is much shorter than CO₂ (around 12 years compared with centuries for CO₂), however, methane absorbs much more energy while it is in the atmosphere [3].

According to the IPCC, the methane GWP is between 84 and 87 when considering its impact over a 20-year timeframe (GWP₂₀), and between 28 and 36 when considering its impact over a 100-year timeframe (GWP₁₀₀). This means that methane is far more effective at trapping heat as a greenhouse gas than CO₂ [1].

In order to evaluate the CO₂ equivalence of the avoided methane leakages resulting from substituting 10% natural gas with hydrogen, a value of 40 and then 45 (as GWP) is adopted, corresponding to the view over 70 and 60 years respectively. The timeframe considered in this calculation was 2100 (hence 70 years from 2030 and 60 years from 2040), with a target of reducing CO₂ emissions by 60% compared with 2015 levels [14]. This reduction corresponds to a total mitigation of 21 Gt of CO₂ that is necessary to limit global warming to 1.5 °C or 2 °C above preindustrial levels. China, the US, Europe, and Japan together represent 55% of the current emissions. Reducing their emissions by 60% corresponds to the mitigation of 11 Gt of CO₂. The amount of avoided leakages in the relevant regions is discussed in the next sections. This approach does not set out to thoroughly assess the mitigation potential, as climatologists would do, but only aims at providing some insight into the possible leakage impact.

More details regarding the assumptions are provided in the appendix.

3. Results and discussion

Results have been provided for three levels of analysis. The market volumes expected in the years to come were first assessed based on the latest governmental strategies as discussed in section 2.1. From these results, the additional electricity demand resulting from hydrogen generation was calculated. The carbon mitigation potential of low-carbon hydrogen integration was then derived.

3.1. Estimate of hydrogen market sizes

This section details the hydrogen market size potential for each market sector taking into account the latest energy policies.

3.1.1 Ammonia production

The ammonia demand evolves differently depending on the regional context related to the population, disposable income growth, dietary trends, natural gas prices and government strategies for fertilisation methods. Accordingly, Figure 7 shows changes in the quantities of hydrogen required for ammonia production in the four regions.

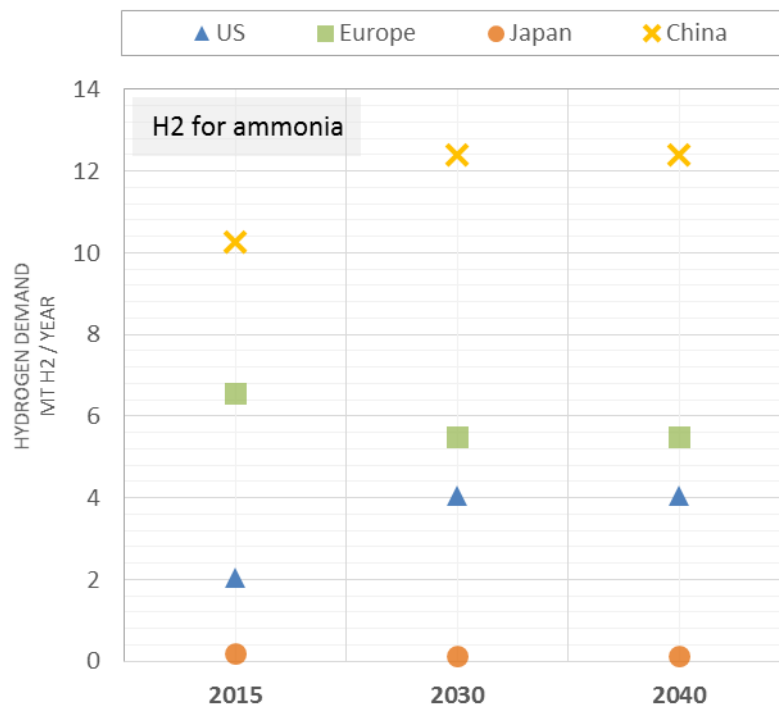

Figure 7: Prospective hydrogen demand for ammonia production in the four regions

China is the leader when it comes to the hydrogen demand for ammonia production, being one of the most populated countries requiring important agricultural output. Starting from 2025, the Chinese

hydrogen demand for this market sector exceeds the sum of the consumption for all the other regions combined. However, driven by China's zero fertiliser consumption policy [22], [23], the trend is expected to stabilise partly due to the more restrained use of fertilisers compared with their over-use in previous years. The hydrogen demand for ammonia production is already decreasing in the European region, which is also due to the gradual phase-out of chemical fertilisers as stipulated by the law [24] in this region. The growth of demand in the US is related to the decrease in natural gas (currently used to produce hydrogen via SMR) prices due to shale gas exploitation [25]. In Japan, the demand has been dropping slightly and is expected to remain at low levels until 2040. The low hydrogen demand for ammonia in Japan (compared with the other regions) can be explained by two main factors; the first is the considerably smaller surface areas devoted to farming compared with the other regions, and second, Japanese soil has proved to be rather fertile, thus requiring less fertiliser [26] and accordingly a lower demand for hydrogen.

3.1.2 Refinery applications

The hydrogen demand for refinery applications (hydro-desulphurisation and hydro-cracking) is driven by three main factors: the evolving oil demand, the quality of crude oil, and restrictive sulphur regulations.

Oil production and demand are most probably expected to continue to grow globally in the years to come according to the IEA [7], as is refining (except for some regions like Europe where refinery shutdown plans have already been defined). Petrochemicals and road transport are the sectors that represent the largest contributions to the global oil demand growth [7]. This leads to an increase in the light-fraction (gasoline, diesel, etc.) demand, hence boosting hydro-cracking activities.

Furthermore, the exploitation of heavier crude oil is increasing, including extra-heavy oil and bitumen, tight oil and natural gas liquids. The sourer a crude oil is, the greater the amount of hydrogen will be needed for sulphur removal.

Coupled with more restrictions on sulphur contents, this will boost the hydrogen demand for hydro-desulphurisation.

Downstream, stringent vehicle and power-plant regulations have been implemented in recent decades in North America, Europe and Asia to prevent sulphur dioxide emissions (SO₂), due to their negative health effects and role in creating acid rain [27]–[29].

Marine bunkers are also facing more stringent limits on fuel sulphur contents. The International Maritime Organization (IMO) has set a global cap of 0.50% m/m (mass/mass) for 2020. This target represents a significant cut from the 3.5% m/m global limit currently in place [30]. This situation raised questions about the sufficiency of the current capacity of desulphurisation plants in refineries in order to meet the 2020 target [31].

As a consequence, the hydrogen demand for refinery applications is expected to increase in the coming years.

This analysis can be challenged considering the rising interest in electrifying the transport sector which may hamper refining activities and the related hydrogen demand in particular.

More regional insights are discussed hereafter.

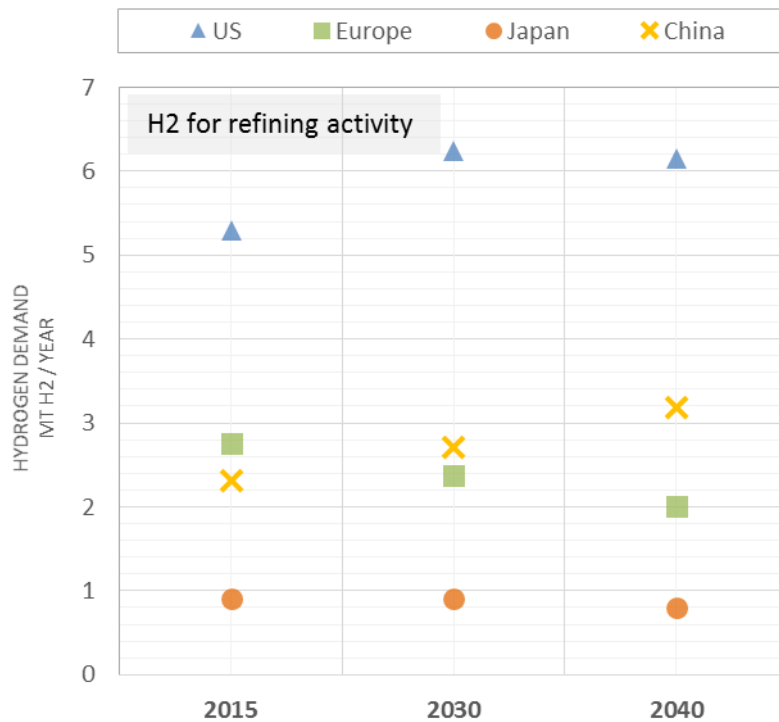

Figure 8: Prospective hydrogen demand for refinery applications in the four regions

As shown in **Figure 8**, different trends are clearly visible. Most of the hydrogen demand for refining is expected to be driven by the US due to the rising need for heavy oils [10]. Demand in China is also expected to increase due to the continuous growth in refining activities [3] and the expected robust economic growth leading to the rapid urbanisation and growing number of passenger vehicles on the road [3]. The latter may be hindered by the switch to low-carbon mobility and the expected phase-out of gasoline and diesel cars announced by Xin Guobin, vice minister of industry and information technology [32]. Conversely, the hydrogen demand for this market sector in Europe is rather likely to drop due to the closure of several refineries [33]. This may be supported by the different targets set by several European countries to reduce the CO₂ emissions. For example, France has decided to ban any new hydrocarbon exploration projects [34]. This includes oil, natural gas, coal and non-conventional resources. The end of gasoline and diesel car sales in 2040 is also expected in France as announced by the former Ministry of Ecological and Solidarity Transition [34]. Lately, several cities across Europe have also decided to ban diesel vehicles [35]. This decision was initiated by the German Court. Stuttgart, Düsseldorf and Hamburg were the first to respond to this call. Paris and Copenhagen are also planning to follow suit [35]. These trends will also impact the diesel demand and consequently the hydrogen use for refining. Plans for shutting down refineries have already been defined for several oil companies in Japan. This decision was pushed by the Japanese Government in order to consolidate refining activities by shutting down inefficient plants, which in turn helps improve the refinery load factor. Accordingly, the Government has set pledges for each refining company in terms of requested utilization rates to be reached [36], [37].

Overall, due to the opposing factors discussed above, the hydrogen demand for refinery applications is expected to stabilise and even decrease from 2030 when considering the four regions in question.

3.1.3 Methanol production

The global methanol production is expected to continue to grow in the coming years, driving the hydrogen demand for this market sector as it grows.

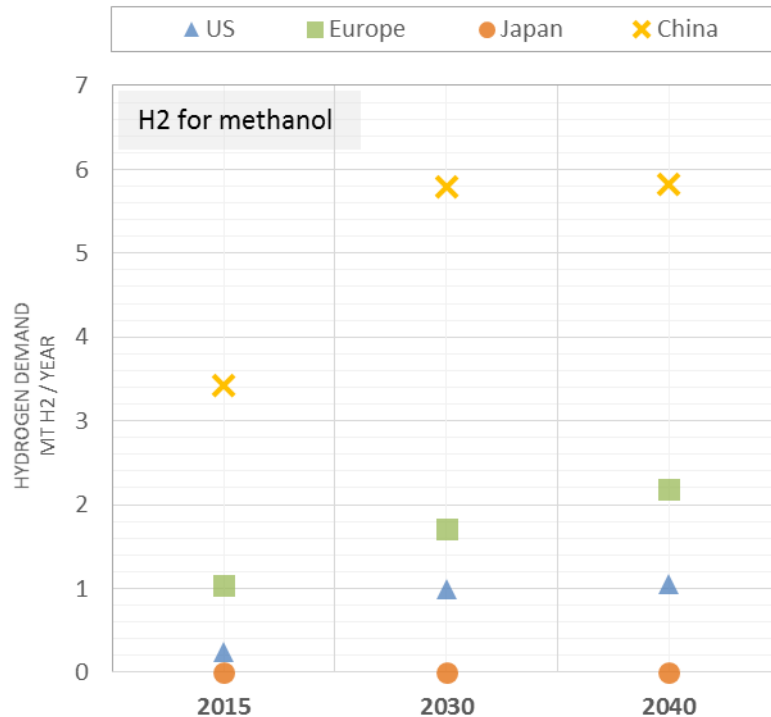

Figure 9: Prospective hydrogen demand for methanol production in the four regions

As shown in Figure 9, China is at the forefront of methanol production with an expected increase in its production levels in the years to come. This increase is fostered by the government’s support of alternative fuels; a national standard of a 15% blend of methanol with gasoline is pending approval [3]. Regarding Europe, the methanol industry trends are divided according to three sub-regional extents. In Western Europe, a slight decrease can be noticed in methanol production due to imports from the Middle East and other low-cost methanol production regions. In Central Europe, methanol production stopped due to non-competitive prices and high dependency on gas imports from Russia. In Eastern Europe, however, methanol production represents an important part of the hydrogen consumed for the chemical industry and its demand is expected to continue to grow in the next few years [25]. In the United States, low gas prices are spurring on the growth of the methanol industry. Much of this growth is export-driven: chemicals like ammonia and methanol are easier and cheaper to transport than LNG [3]. Conditions in the US are so favourable that several Chinese companies are investing in methanol plants over there so they can export methanol back to China [3]. Currently, there is no hydrogen demand for methanol production in Japan [33]. According to [38], “*there are no facilities for methanol production*

in Japan at the moment and the scenario is likely to remain the same in the future". Most of the methanol demand in this region is met by imports from China where the operational costs for methanol production are significantly lower [38].

To conclude, from a short-term perspective, the refinery, ammonia and methanol markets will continue to play an important role in driving the hydrogen demand worldwide. These markets are already mature and currently represent the majority of hydrogen consumption. However, the stringent carbon emission constraints facing these industries may lead to the emergence of new, cleaner ways to produce hydrogen.

New market sectors are emerging and can have a considerable impact on the hydrogen demand in the years to come where hydrogen can play the role of an energy carrier bridging energy sectors.

3.1.4 Mobility use

The prospective hydrogen demand for mobility use has been evaluated for three types of transportation means (PLDV, buses and trains). This demand is affected by political measures such as CO₂ mitigation targets, the ban of fossil-fuelled vehicles, or specific FCEV fleet targets to be reached. Other than government efforts, industrial programmes can also impact the attractiveness of hydrogen in the transport sector. The specific political and industrial measures influencing the hydrogen penetration into the transport sector are discussed in this section for each region in question.

Starting with PLDVs, Table 7 shows the current status in terms of FCEV fleet and refuelling station number as well as the future targets by region.

Table 7: Current status and governmental goals of FCEV development in the PLDV sector [25], [39], [40]

	Current hydrogen fleet	Governmental goal for hydrogen vehicle fleet	Number of refuelling stations	Governmental goal for refuelling station deployment
US	5900	2 million by 2020	60	1000 by 2030 (California)
Europe	1500	4 million by 2030	120	750 by 2025
Japan	2900	800 000 by 2030	100	320 by 2025
China	63	1 million by 2030	12	more than 1000 by 2030
Rest of the world	637	-		

Figure 10 shows the hydrogen demand both for the direct use of hydrogen as a fuel and for advanced biofuel production in the relevant regions according to different timeframes and the announced governmental roadmaps. Since the governmental targets regarding the hydrogen fuel cell vehicle fleet stop at 2030 as a timeframe, two scenarios are investigated from 2030: one supposing a continuing trend of the hydrogen penetration, and the second inspects the potential proposed by the IEA in the 2DS High H2 scenario.

HYDROGEN ROLE IN THE ENERGY SYSTEM A MULTIREGIONAL APPROACH

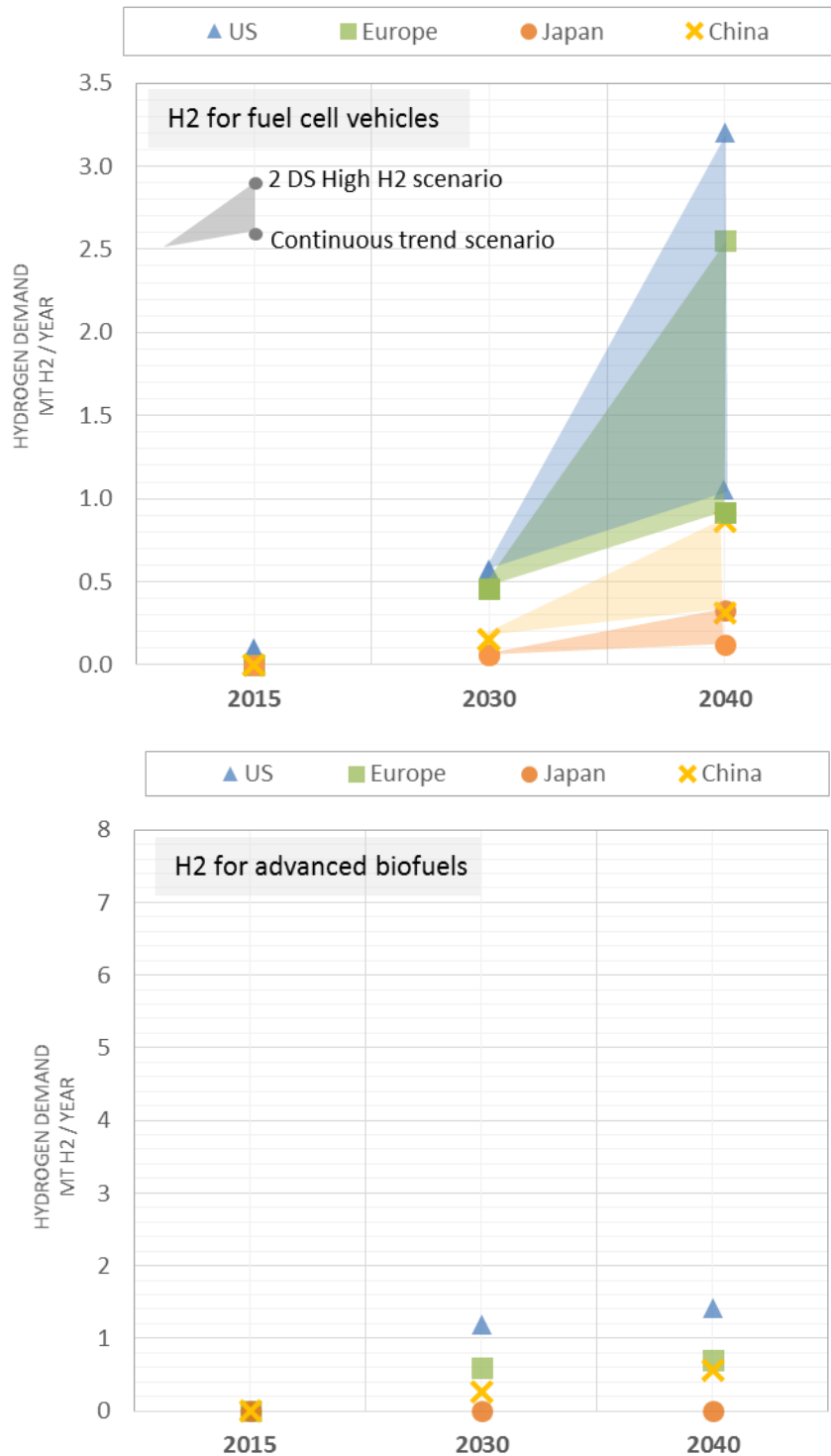

Figure 10: Prospective hydrogen demand in the mobility sector for PLDVs in the four regions

In the mid-term, the advanced biofuel sector may drive hydrogen production as it is easier to implement since biofuels do not require any major modifications to the engine, compared with the fuel cell option. Furthermore, there are currently more biofuel integration targets than for fuel cells. However, right after

2030, a shift can be noticed between these two markets in most of the regions. Hydrogen usage in fuel cell electric vehicles (FCEV) is then expected to drive the demand growth in the transport sector (for PLDVs). At this time, the refuelling infrastructure is expected to be widely deployed, and hydrogen mobility programmes deployed by the different automobile industries would be completed, making the market more mature and enabling the widespread use of fuel cell mobility [14], [41].

On a European level, about 100 hydrogen refuelling stations have been deployed so far across different countries [40]. This initiative is industry-driven through the "H2 Mobility" programme lead by Air Liquide, Daimler, Linde, OMV, Shell and Total; it is planning to deploy 400 hydrogen stations by 2030 in Germany alone. Similar deployment efforts can be observed in parts of the United States (e.g. California) and Japan [13].

Japan is a special case for FCEV expansion, presenting both political and industrial incentives. Considering the share of hydrogen fuel cell mobility in the total PLDV fleets in the different regions, Japan takes the lead. It is the first country to have granted subsidies for fuel cell vehicles, being particularly focused on increasing the use of hydrogen fuel cells to limit carbon emissions. One hundred new hydrogen refuelling stations were operational in the most populated areas of the country in 2015 [42]. Major car manufacturers like Toyota and Honda are competing to introduce the next-generation zero-emission hydrogen vehicles. In 2015, Toyota produced 700 of their Mirai hydrogen vehicles globally. Most of the vehicles are for sale in Toyota's home market in Japan [41]. Nevertheless, Toyota has recently been conquering other regions. In early 2018, Toyota sold more than 3,000 of its Mirai fuel cell model in California alone [43] and Canadian markets are also opening up to the new hydrogen car [44].

The Japanese experience is proof of successful collaboration between government incentives and industry efforts. By defining clear roadmaps for hydrogen penetration into the energy system and the transport sector in particular, the Ministry of Economy, Trade and Industry (METI) made it possible to reduce the uncertainties hampering new industrial investments in hydrogen mobility.

China is one of the rare countries setting targets for hydrogen penetration into the mobility sector. The governmental pledge is to reach 1 million fuel cell vehicles by 2030 which can help the country resolve its environmental pollution issues due to urban vehicle traffic [45].

On a global scale, the hydrogen development is still slow compared with its potential due to the lack of supporting regulations. According to the Hydrogen Council, by 2050, *"hydrogen could power a global fleet of more than 400 million cars, 15 to 20 million trucks, and around 5 million buses"* [14]. In this report, hydrogen industries expressed their intention to invest massively once clear regulations have been set.

- Hydrogen buses

Beyond the use of hydrogen in PLDVs, in the shorter term, public transportation may play a major role in fostering the hydrogen demand. Governments and local authorities across the world are rethinking public transportation. Some of them (e.g. Paris, the Netherlands, etc.) have already adopted national targets for reducing public transport emissions [46].

Seeking alternatives to diesel buses and trains is crucial for not only reaching the emission reduction targets, but also for reducing noise pollution and vibrations that have a negative impact on health [46]. Facing these challenges, the electrification of public transportation seems to be inevitable. Given the

importance of the energy required to propel public commuting engines, hydrogen fuel cells may offer several advantages compared with batteries. The autonomy and charging time they offer makes them suited for freight and public transport [13], [14]. Hydrogen also has a much higher energy density per weight than batteries (currently around 2.3 MJ per kg). With these advantages, FCEVs are able to travel longer distances and perform better for heavier vehicles [14].

Figure 11 shows the evolving hydrogen demand for bus fleets in the four regions considered in the study, based on government roadmaps and industrial pledges.

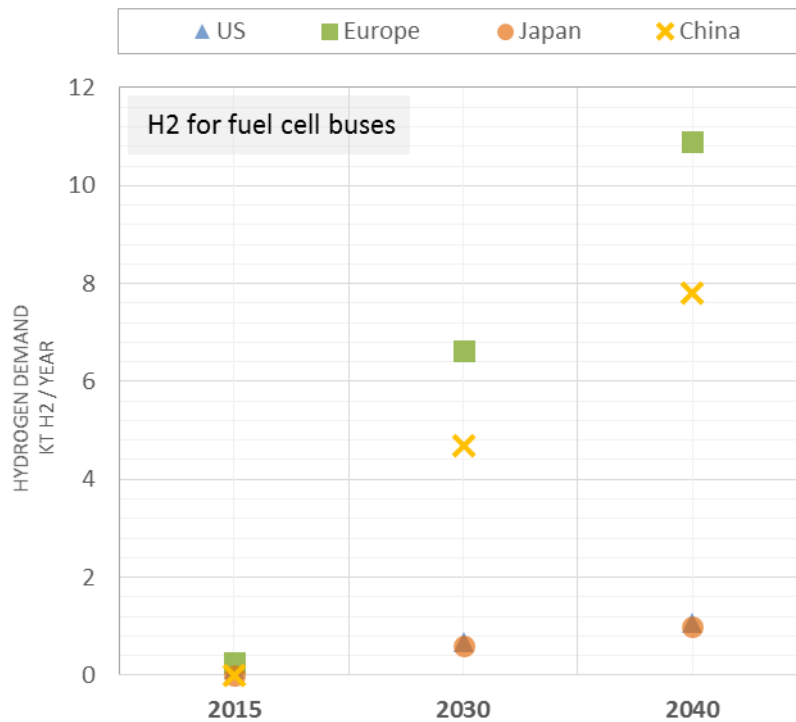

Figure 11: Prospective hydrogen demand for fuel cell bus fleets in the four regions (the US and Japan data has been superimposed)

Europe is at the forefront of hydrogen bus penetration. A fuel cell electric bus (FCEB) coalition was created to foster the development of hydrogen buses and to identify the required number to be deployed to create economies of scale and reduce costs. The first plans of the coalition published in 2015 consisted in implementing large-scale demonstration projects with an approximate total of 300 to 400 fuel cell buses by 2020 [46]. The FCH JU predicts that this number could rise to 700 buses by 2020 in Europe [47]. The FCH JU is an example of collaboration between political, industrial and academic institutes [48].

Other projects and demonstrations are taking place in Japan and China. In October 2016, Toyota announced plans to introduce 100 FCEBs in Japan prior to the Tokyo 2020 Olympic and Paralympic Games, and the deployment of 300 FCEBs is planned in China by 2020 [47], [49].

In the United States (the US curve is superimposed on the Japanese curve in Figure 11), the total number of fuel cell electric buses exceeded 25 in 2017 and expansion is expected to be rapid. Approximately 40 other FCEBs are planned to be delivered soon [49].

- Hydrogen trains

Train transportation can also represent an important market for hydrogen penetration. Substituting the remaining fossil-fuelled trains with hydrogen would help decarbonise the railway sector. Figure 12 shows the energy consumption distribution of rail by type in the different regions.

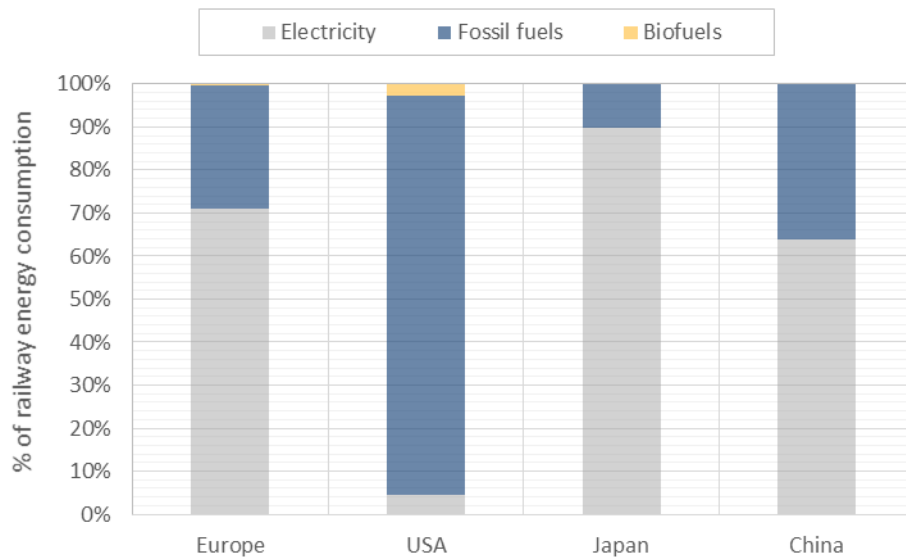

Figure 12: Current railway energy consumption by region - adapted from [50]

The opportunities for hydrogen penetration in this market sector vary from one region to another depending on the electrification rate of the rail network. Globally, the share of electricity in rail energy does not exceed 40% [50].

Assuming that all fossil-fuelled trains were to be replaced by hydrogen ones, the maximum potential volume for hydrogen demand in rail transport were then assessed based on a constant train fleet. The assumption on the constant numbers of trains can be challenged by the fact that, in the years to come, a switch to more public transportation may take place, which is highly encouraged by political support schemes already implemented in several regions (transport fare subsidies [51] and even free public transportation [52]). This will then help enhance the train fleet size.

Applying a 10% replacement rate in 2030 and investigating two scenarios: a 15% substitution rate following the Hydrogen Council vision and a full substitution of the diesel train fleet, referred to as maximum potential, Figure 13 shows the resulting regional hydrogen volumes.

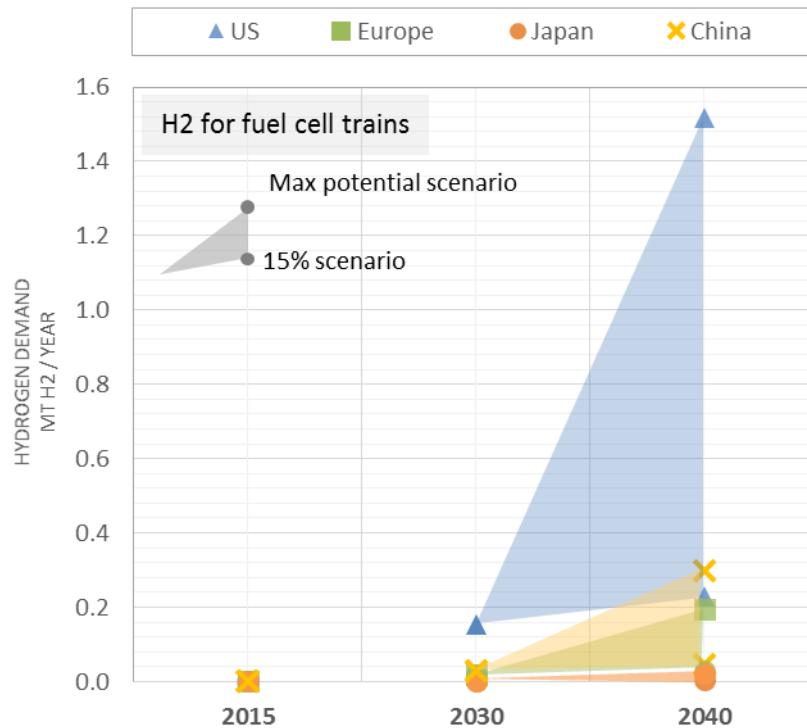

Figure 13: Prospective H₂ penetration potential into the rail transport market sector in the four regions

In the United States, the electrification rate of railway lines is low, which represents an opportunity for hydrogen penetration. Rail transport in the US consists primarily of freight transport over long distances and heavy shipments [53]. American rail freight activities more than doubled between 1975 and 2013 [50], while passenger rail transport plays a limited role compared with other regions. In Europe, for example, passenger traffic practically always has priority over freight traffic [54] and the electrification rate is around 70% [50]. Several hydrogen train projects have been launched in Europe. Germany is the first to test hydrogen penetration in railway transport. The first fuel cell passenger train, called Coradia iLint, was tested in Salzgitter, Lower Saxony in March 2017 according to the manufacturer Alstom [55]. Its autonomy ranges from 600 to 800 km and it can reach speeds up to 140 km/h [55]. Other tests have also been conducted in Velim (Czech Republic) and projects are under investigation in Bourgogne-Franche-Comté (France) [56], [57].

Compared with the other market sectors, the hydrogen volumes associated with the rail transport sector are insignificant and do not have an impact on the total future demand of hydrogen in a visible way. However, they can foster the demand volumes in the short term. The required infrastructure is limited since hydrogen-fuelled trains can immediately utilize the existent non-electrified railways [14]. However, train refuelling stations would still be needed.

3.1.5 Injection into natural gas networks

No political targets or industrial programmes (except for some demonstration projects) have been announced so far for the injection of hydrogen into the natural gas system on a nation-wide level. Different factors can impact this market sector, starting with the natural gas demand and the government strategy to natural gas in the first place. Some regions intend to completely phase out the use of any fossil fuel including gas [58], [59], while others consider it as a pillar for a ‘smooth’ transition to a cleaner energy system [60]. Hence the impact of political orientations vis-a-vis the use of natural gas is crucial in defining the potential future of hydrogen blending with the latter.

For the purpose of this chapter and to provide insights into this market sector potential, a 10% concentration level is considered as explained in section 2.1 (although higher values can be set, depending on the downstream technologies).

The results are provided in Figure 14. They show that, in the mid-term, hydrogen injection into natural gas networks has a very high potential, given the global final consumption of natural gas (excluding the industrial sector). According to the adopted scenario, the market size for all four regions combined is expected to reach 11.5 Mt by 2040.

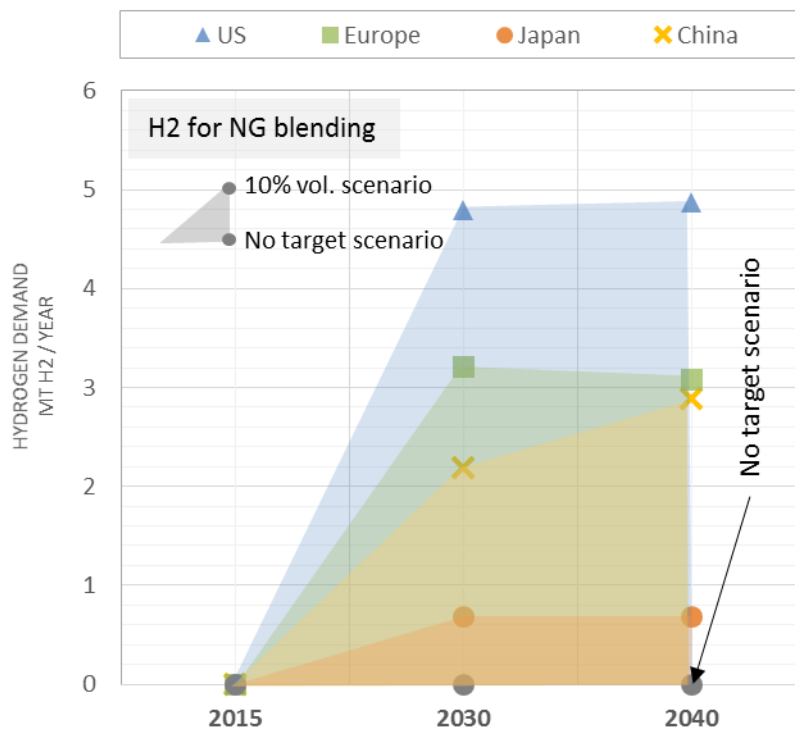

Figure 14: Prospective potential of hydrogen injection into NG networks in the four regions

The United States, followed by Europe, are expected to lead the NG blending market sector in 2040 given their high gas demand and the extent and development of their natural gas networks [61], [62]. The US is expected to continue exploiting the economically attractive shale gas.

In the second place, although it has the most developed natural gas pipelines (2,030,058 km [63]), Europe's natural gas demand is expected to decrease between 2030 and 2040 [7], driven by the stringent CO₂ emission targets set by the European Commission aiming to reach carbon neutrality by 2050 [64]. Japan is relying on LNG imports for its gas demand. The latter is expected to drop in the mid to long term since the government strategy is considering a lower-carbon future based on the continued nuclear use plus renewables and imported hydrogen [65]. As for the Chinese case, the rising gas demand in China is a result of the ongoing policy to move households and industry from coal to gas, including power generation. According to this government target, the natural gas market share in the total energy mix is expected to increase to 10% by 2020 and to 15% by 2030 [66].

3.1.6 Market comparisons

To sum up, Figure 15 shows the variations in the different hydrogen markets for the four regions considered in the study.

HYDROGEN ROLE IN THE ENERGY SYSTEM A MULTIREGIONAL APPROACH

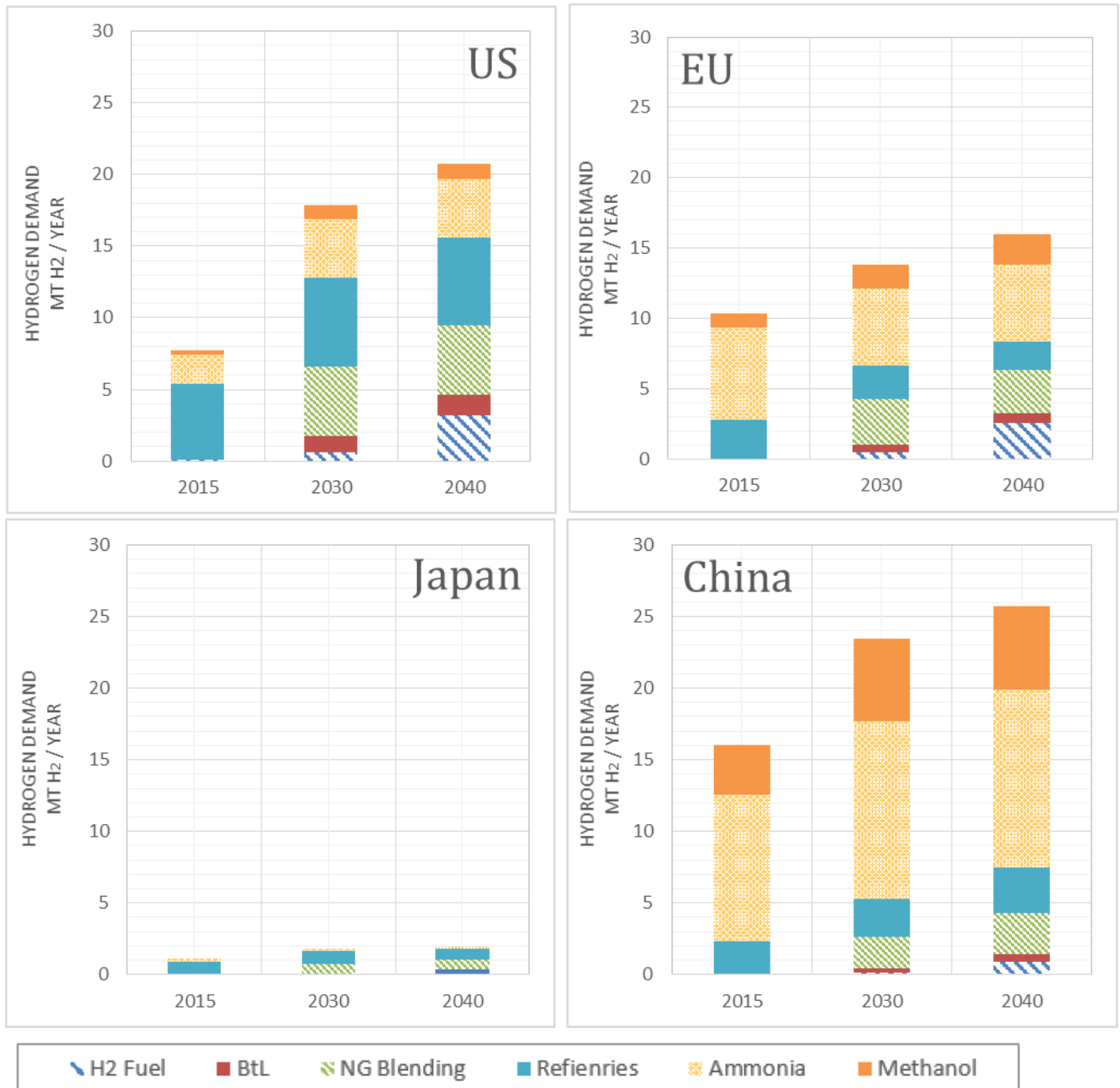

Figure 15: Prospective hydrogen market sizes by region

Industrial markets are likely to continue to drive the hydrogen demand in the different regions. Different trends may however exist, reflecting the diversity of the government policies in the relevant regions. Regarding energy-related markets, the injection of hydrogen into natural gas networks has the highest potential for hydrogen as an energy carrier compared with other applications. The potential of this market sector can even exceed the demand driven by the refinery or ammonia production markets (the US and Europe for example). However, this potential will highly depend on government incentives that have yet to be implemented. The hydrogen demand for mobility use (as a direct fuel) is expected to grow

significantly as of 2030, but this will also depend on policies and support schemes deployed to encourage mass deployment and to foster infrastructure investments.

3.2. Impact of hydrogen generation via electrolysis on the electricity demand

In this section, the electricity consumption needed to generate the total volume of hydrogen demand by region is evaluated, based on the assumption that hydrogen is produced exclusively by electrolysis.

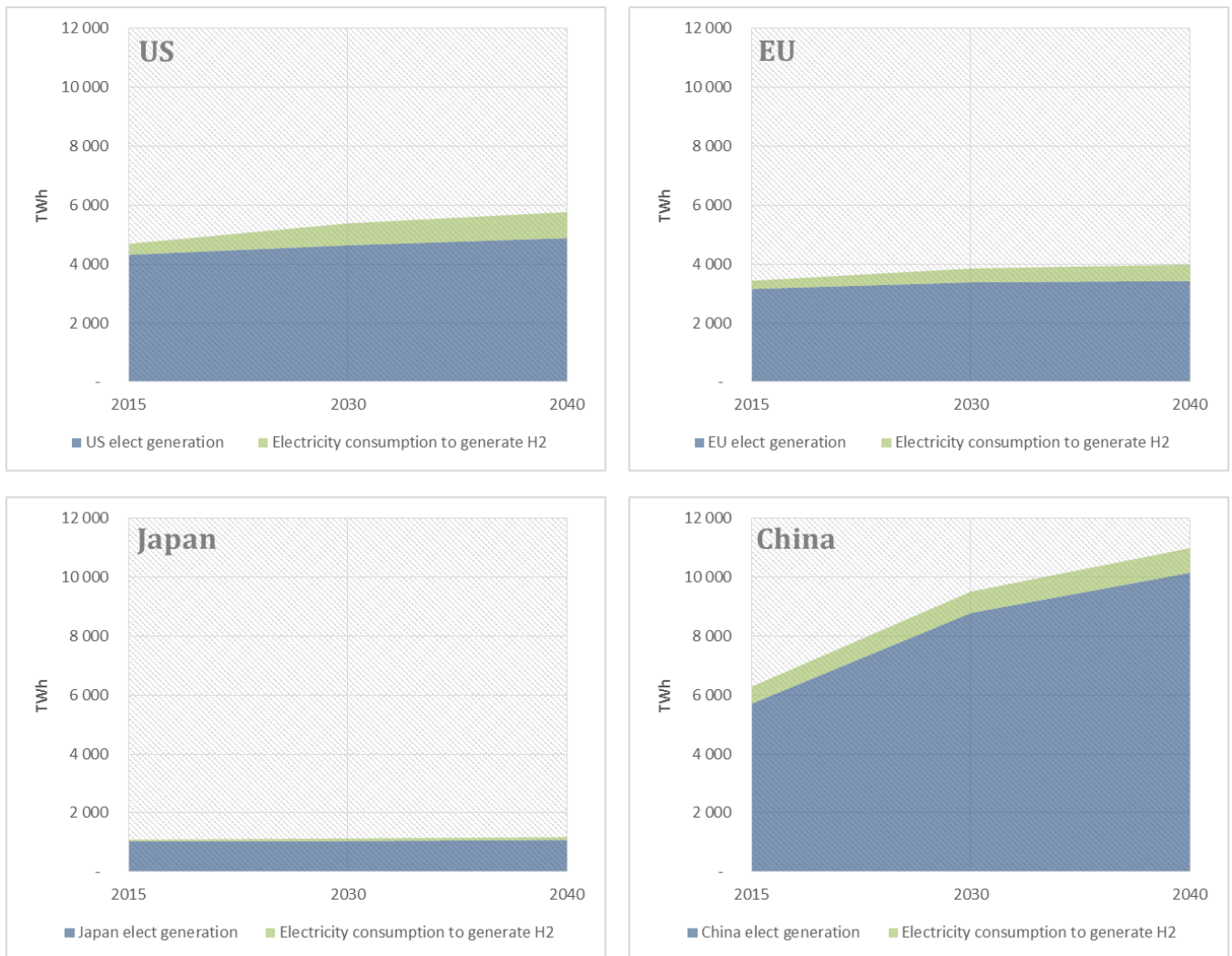

Figure 16: Prospective additional electricity demand for hydrogen generation via electrolysis in the four regions

Figure 16 shows the additional electricity demand required to generate the total amounts of hydrogen evaluated in section 3.1 if electrolysis were to be the only generation option.

By 2040, the hydrogen-production-related electricity demand would represent 8 to 18% of the total electricity generation depending on the region.

These values are significant, leading to a rise in future electricity demand. However, this demand has the privilege of being highly flexible especially if the PEM technology is considered [13], [21], [67]. PEM electrolyzers can reach full load in less than 10 seconds from a cold start [13]. This means that they can provide the grid with services such as frequency regulation and reserve control which are highly valued in a context of future high shares of renewables in the electricity mix [21]. Additionally, a dynamic operating mode does not result in the faster degradation of the electrolyzers [13]. According to [21], the annual degradation of electrolyzers (with the power consumption increase per year in baseload utilization) ranges from 2% to 4% in the case of flexible operation.

Finally, the results discussed in this chapter may be challenged once the carbon content of the electricity generation is taken into account when assessing the impact of electrolysis. Sourcing hydrogen production with electricity from the grid may not be the best environmentally efficient way to make hydrogen a low-carbon energy carrier. As shown in Table 8, the carbon footprint of hydrogen production from electrolysis can be higher than that for SMR (i.e. approximately 10 kg CO₂/kgH₂) when considering electricity from the grid.

Table 8: Carbon footprint of hydrogen generation based on the regional electricity mix in the NP scenario [7]

kg CO₂/kg H₂	2014	2030	2040
US	24.4	17.4	14.8
Europe	17.9	10.9	7.7
Japan	27.6	17	14.7
China	38.4	25.9	21.6

Accordingly, producing hydrogen from low-carbon electricity should be further investigated. Two potential options can be considered. Nevertheless, renewable energies can be used to achieve low-carbon intensities at low electricity cost, but they imply low load factors leading to a high hydrogen production cost. Some exceptions can exist in regions where renewables are abundant such as in Australia according to the analysis provided in [68]. Another option worth considering is the available nuclear energy that is not dispatched due to higher renewable production for regions where nuclear energy is used. This effect is discussed in more detail for the French case in [69]. Overall, electric sourcing for electrolysis needs to be efficient in order to make hydrogen low-carbon.

Based on the assumption of efficient low-carbon hydrogen generation, the carbon mitigation potential of the latter is assessed in the next section.

3.3. CO₂ mitigation potential of the considered hydrogen market sectors

Additional efforts to reduce GHG emissions are required to meet the 2°C target. Reducing carbon emissions from the current 34 Gt to approximately 18 Gt by 2040 will be crucial to reach the 2 degree

target [14], [70]. From this perspective, hydrogen technologies can help achieve this goal. In this section, the CO₂ mitigation potential for the selected hydrogen market sectors is quantified.

Given the market size results evaluated in section 3.1, the carbon mitigation potential of hydrogen applications has been assessed based on the decrease in CO₂ emissions achieved by replacing fossil fuels (gasoline, diesel and natural gas) with hydrogen and by assuming low-carbon hydrogen production as detailed in section 2.2.

The results are shown for the different markets in Figure 17. The contribution of the four regions in lowering the global CO₂ emissions is discussed hereafter with focus on each market sector.

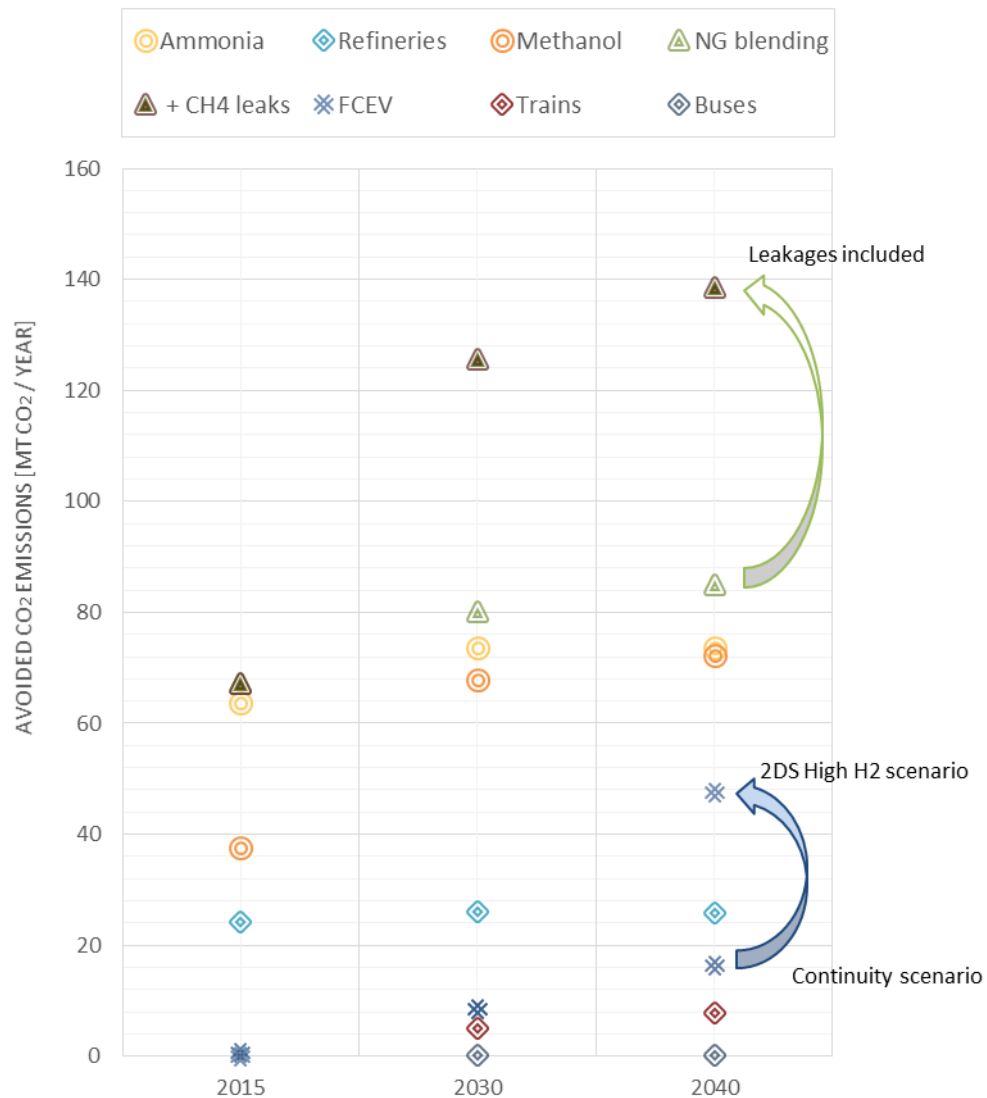

Figure 17: CO₂ mitigation potential of hydrogen by market sector considering the four regions (points are represented as scatter)

3.3.1. Hydrogen industrial markets

As shown in Figure 17, shifting to low-carbon hydrogen production in industrial markets (refineries, methanol and ammonia) could have high potential in terms of CO₂ mitigation. These markets currently rely on steam methane reforming for hydrogen production. This process emits approximately 8 kg of CO₂ per kg of hydrogen produced [21], [67]. Ammonia and methanol have approximately the same mitigation impact although they do not represent the same amounts of hydrogen. This is related to the fact that, considering the new process for methanol production, not only are SMR-related emissions avoided, but the process also consumes CO₂ leading to negative emissions.

Regarding the refining industry, the emissions related to hydrogen production (SMR hydrogen plants) represent 11% of the total CO₂ emissions in refineries [71]. Hence, introducing low-carbon means of hydrogen production may have promising perspectives, given the stringent constraints that refiners have to take into account to limit their emissions and reduce the carbon intensity of their products, including diesel and gasoline [31], [71]. This may therefore be considered as a transient step to decarbonise the transport sector.

3.3.2. Natural gas blending market sector

Natural gas blending provides the highest reduction in CO₂ emissions compared with the other market sectors. These values correspond to the substitution of 10% of the methane demand, which can be considered as an optimistic rate for hydrogen injection since no clear target has been set so far by governments for this market sector.

If so, the contribution of this market to CO₂ mitigation is twofold. Introducing hydrogen into the blend makes it possible to reduce carbon dioxide emissions due to the downstream combustion of natural gas, while reducing the environmental footprint due to methane leakages during processing upstream.

Leakage rates vary from one region to the other depending on the different factors discussed in section 2 (see the appendix for more details). These methane emissions are taken into account through their conversion into CO₂-equivalent emissions.

Given the global warming potential of methane, these leakages could represent a significant GHG contribution. According to Howarth *et al.* (2014) [72], unless the methane and black carbon emissions are reduced, the Earth's average temperature will rise by 2°C between 2045 and 2050, whether CO₂ emissions are mitigated or not [73]. The same issue is raised by Dessus *et al.* (2017) [74]. The main reason behind the temperature rise between 2000 and 2090 appears to be due to methane emissions. Introducing hydrogen into the blend could then be a game changer for reducing the global warming impact of these leakages.

Based on the GWP values (see the CO₂ equivalency is evaluated for 2030 and 2040 (considering 2100 as a timeframe for the equivalency). The results are given in

Table 9.

Table 9: Mitigation potential of the gas market sector (sum of the four regions)

	2030	2040
--	------	------

CO₂ mitigation potential (MtCO₂) (methane leakage impact included)	75	80
Share of the avoided methane leakages in the total mitigation potential	$45.5/75 = 60\%$	$64/80 = 68\%$

As highlighted above, methane leakages are critical in terms of their impact on global warming. They make it possible to enhance the CO₂ mitigation potential of the natural gas market sector by more than 60%, thus putting this market sector at the forefront of the hydrogen potential in lowering carbon emissions compared with the other hydrogen markets considered in this study (see Figure 17). As pointed out in [74], disregarding methane emissions could lead to exceeding the 2°C target set by climate experts. Hence, a proactive policy is required to take into account the impact of methane emissions and hydrogen could play a role in this case.

3.3.3. Hydrogen mobility markets

Decarbonising the transport sector is one of the largest obstacles to overcome since it is highly reliant on fossil fuels. Hydrogen mobility through FCEVs in passenger light-duty vehicles helps reduce transport-related emissions. For example, as shown in **Figure 18**, the contribution of hydrogen in reducing Japan’s transport sector CO₂ emissions is the most significant. Introducing 4 million FCEVs by 2040 in Japan (which seems reasonable given the current governmental incentives) would lead to a 7% reduction in the transport carbon footprint.

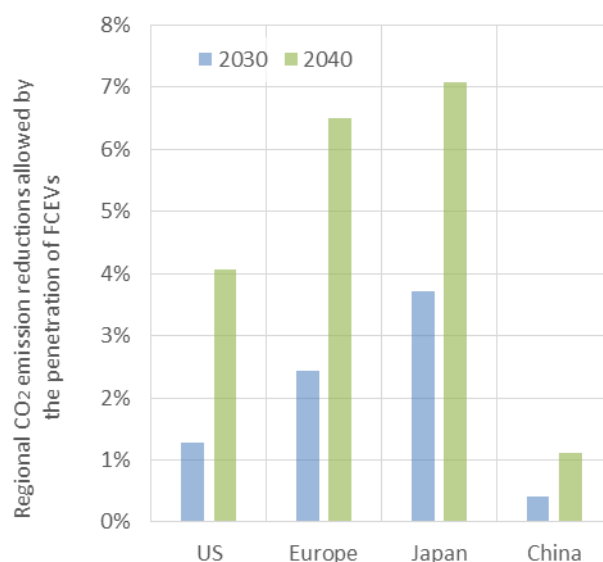

Figure 18: Share of CO₂ emissions avoided by FCEVs in the total transport sector emissions by region

Public transportation conversion to low-carbon mobility will help to further decrease CO₂ emissions related to transport. According to the FCH JU [75], if carbon-free hydrogen production is considered,

one FC bus could approximately save 800 tonnes of CO₂ in its lifetime (i.e. the amount of diesel bus emissions avoided).

Although it does not represent a high share of the total hydrogen demand in terms of market volumes, the rail sector has significantly contributed to the CO₂ mitigation potential. Hydrogen penetration into the rail sector could make it possible to increase the CO₂ mitigation potential of hydrogen used as a transport fuel by 60% in 2030 and 16% in 2040, compared with the case where only PLDVs are considered. This highlights its important role as a short to mid-term decarbonisation option. The US has the highest potential since it has the lowest rail electrification rate compared with the other regions considered in the study.

Overall, as shown in Figure 17, the total CO₂ mitigation potential of hydrogen markets (considering the selected regions) can reach 360 Mt by 2040, which represents 3.3% of the carbon reduction efforts required by the four regions in order to reach the 2°C target. To reach this target, CO₂ emissions need to be decreased by 60% compared with 2015 levels, which means lowering emissions by approximately 11 Gt in the four regions. The avoided methane leakages significantly contribute to enhancing the mitigation potential of the natural gas market sector, therefore becoming the leader in terms of its CO₂ “inhibition” potential.

Although the results in this study are neither optimistic nor refined enough to capture the whole potential of hydrogen, hydrogen applications seem to present promising potential in the future, especially if their development is fostered by strong political support, beyond the current environmental initiatives taken into account to carry out the estimate done in the present work.

4. Conclusion and Policy Implications

Making it possible to bridge different energy sectors thanks to its versatility, hydrogen is a promising enabler for a multi-sectorial decarbonisation. In this chapter the evolution prospects of hydrogen markets was analysed considering the latest energy policies in four different regions: the USA, Europe, Japan, and China. As shown in this chapter, the hydrogen market size is dependent on the regional context. Overall, the industrial markets are expected to continue driving the hydrogen demand in the years to come. These markets have been lately more subjected to stringent CO₂ emission constraints which may present an opportunity for hydrogen systems. As a matter of fact, decarbonizing the hydrogen generation means used in the considered industries (ammonia, methanol and refineries) allows reaching in part the decarbonisation targets as set by the governments for these industries, while at the same time creating economies of scale leading to the desired cost reductions of low carbon hydrogen production technologies. The International Energy Agency (IEA) recently stressed out the role of renewables in industry [76]. This report emphasizes the potential role of ammonia (produced from renewable hydrogen) in industry, be it as feedstock, process agent or fuel. Other industrial routes include substituting natural gas with renewable-based hydrogen for manufacturing methanol from renewable-based water electrolysis and recycled CO₂. Using recycled CO₂ for methanol production could even drive negative emissions [76].

As for the energy-related hydrogen markets, different trends may be noticed and discussed depending on the political and industrial context of the considered regions.

Strong governmental support is taking place in Japan fostering the integration of hydrogen systems. Accordingly, high goals have been set for hydrogen mobility as well as the use of fuel cells in the residential sector. Such governmental involvement have helped reduce the uncertainty blocking the industrial investments. As a result the Japanese automotive industries are at the forefront of hydrogen vehicle manufacturing. Nevertheless, the intended hydrogen sourcing is still questionable. As a matter of fact, Japan is willing, as a first phase of its hydrogen roadmap, to import hydrogen from Australia, the latter currently using coal-gasification for hydrogen generation. The decarbonisation potential of hydrogen in this case is reduced to a simple geographic re-allocation of the emissions in the best case scenario. Australia is though planning to switch towards more eco-friendly means to ensure its hydrogen sourcing [5], [77]. This might not help reduce the Japanese energy dependency towards Australia; however, with regards to the natural gas market segment, substituting part of the natural gas demand with hydrogen could contribute to the reduction of LNG import dependency towards the Middle East [65].

The other considered regions have shown more modest governmental incentives with comparison to the Japanese case. In the US, most of the efforts to ease hydrogen penetration are taking place in California [78] and are mobility-oriented. In July 2018, the California Fuel Cell Partnership, an industry-government collaboration, issued a vision report targeting 1 million FCEV and 1,000 hydrogen fuelling stations by 2030 [79]. Coupled with the Zero Emission Vehicle Programme [80], this effort led the US to have the largest FCEV fleet with 4,500 FCEV in April 2018 [79]. However, concentrating the efforts in the Californian region may lead to the under-investment in the refuelling infrastructure in the other States of the country. As for the natural gas blending market, the US may be the hardest to penetrate due to very low gas prices, especially when considering the unconventional resources. Accordingly, hydrogen would not only face hard market entry conditions due to its high costs compared to NG, but also the switch to electrolysis may be slower than expected since SMR will continue to present more economically attractive costs unless high carbon taxes are applied. And again, in this case, it is almost only California that presents an active carbon pricing program in the US. In fact, natural gas prices are so attractive that China is investing in methanol production plants in the US with the objective to deliver it back to China. Nevertheless, taking into account the methane leakages and somehow penalizing them via an adequate policy may be a game changer. Indeed, the US natural gas system presents the highest shares of methane leakages compared to the other regions considered in this study. Accordingly, hydrogen blending in the US would benefit from incentives in this respect.

The European case is promising. Several industrial programs (but not only) are launched aiming at developing the hydrogen mobility across countries in Europe. Germany may be the first visible example of such efforts. The transport market segment may present an opportunity for hydrogen in Europe following the “Diesel Gate” announced in several countries. On the other hand, penalizing fossil fuels through carbon taxation should be considered in a more delicate way in order to ensure social acceptance (“Yellow Vests” protests in France). Integrating hydrogen mobility can also help reduce energy dependency, which implies domestic hydrogen production. However, considering the carbon footprint of electricity sourcing from the grid (in Europe as a whole), this might not be the most environmentally relevant option, although some countries present low carbon electricity generation systems (such as Norway, France, Sweden, etc.). Consequently, renewable (or nuclear in some countries) sourcing should

be considered in more details. This might be done through adequate policies allowing hydrogen to act as flexibility means, associated to implementation of certificates of origin.

Last but not least, focus is also put on the mobility market segment in China. The announced governmental ban of fossil fuel vehicles [32] may present a propitious condition to the deployment of hydrogen vehicles. On the other hand, competitiveness with electric vehicles might be difficult to reach knowing that China is subsidising battery electric vehicles (up to 60% of their market price [81]). Subsidy cuts have recently been announced by the Chinese Government aiming at reaching an economically-competitive EV industry by 2020 [82]. Similar support schemes should also be applied to the fuel cell vehicles in order to level the playing field for all new technologies to prove their potential.

The carbon mitigation potential of hydrogen systems may also vary from one geographic area to another due to different local contexts (oil and gas prices, renewable energies penetration, and policy support). The present study estimates a total CO₂ mitigation potential of approximately 413 Mt in 2040, given the current policies in the four considered regions, and for the market segments considered in this chapter. Hydrogen contribution could be significantly higher though. The recent report of the Hydrogen Council presents a more voluntarist scenario compared to the one elaborated in this chapter considering more favourable political and industrial conditions [14]. The study shows that hydrogen can represent 20% of the primary energy demand by 2050, resulting in a CO₂ emission reduction of 6 Gt in 2050 globally [14].

To leverage the hydrogen potential, which lies to a large extent in its versatility, policies need to act on different levels.

The results of this chapter show that the obtained projections are not up to the potential imagined by the Hydrogen Council. Hence, which would be the drivers for hydrogen to take a more important place?

Further support is needed as highlighted in the more voluntarist scenarios discussed in the introduction.

First, implementing a carbon price is required to both increase the profitability of low-carbon hydrogen production (compared to benchmark processes such as steam methane reforming), and the profitability of hydrogen use as a substitute to fossil-fuel options (for transport, gas use, etc.). In the EUCO scenarios, considered as reference by the European Commission, a balanced scenario explores the potential role of hydrogen as an energy carrier, as a feedstock for the production of synthetic clean fuels, or as a means of electricity storage [83]. Overall, the balanced scenario abates CO₂ at an average cost of 88€/tCO₂, which is less than half the cost in the basic decarbonisation scenario that does not highlight hydrogen perspectives (182€/tCO₂ abated) [83].

Upstream, low-carbon hydrogen production requires low-carbon electricity. Energy policies should promote renewable energy penetration, or more generally low-carbon electricity. This is a win-win strategy since hydrogen production can serve as a measure to avoid curtailment of excess electricity, to adjust the power demand by providing grid balancing services, or even to allow more renewable electricity to enter new applications in the form of a green gas, green chemical and green fuel. Hydrogen business cases can become more profitable when hydrogen systems are allowed to participate in grid balancing services and capacity mechanisms. However, this participation can be considered as a double-

edged sword, since the more numerous the participants to the flexibility market, the lower the remuneration for the service provision, which is somehow a “cannibalisation” effect.

Downstream, hydrogen system deployment can be fostered by sector-specific measures, via implementing standards and/or incentives during the transition.

As mentioned previously, the industrial markets are expected to continue to drive the hydrogen demand worldwide. However stronger environmental constraints regarding the sulphur content or the carbon footprint of these industry activities can play a major role in enhancing the hydrogen demand. As a matter of fact, according to [31], refineries will have to invest in larger capacities for hydrogen production in order to cope with the new environmental measures. Investment subsidies to replace fossil fuels in industry can also foster the transition to low carbon hydrogen production via the development of electrolysis.

The injection into natural gas networks will need government support in order to promote its market penetration. Acknowledging the contribution of methane to global warming, a clear target for the hydrogen blending concentration into the gas grid could be set. This concentration currently varies a lot from one region to another. It can reach 10% (of the volume) like in Germany for example, while it does not exceed 6% in France and 0.1% in the UK [83], [84]. A harmonization of the standards at the European level (but not only) is crucial to prepare a more suitable market penetration environment. Additionally, to foster the development of “green” gas, feed-in tariffs may be implemented in the transition. Such schemes exist for bio-methane injection [85]. Hydrogen or synthetic methane could be made eligible for similar support.

Regarding the mobility market segment, moving to the decarbonisation of the transport sector may go through the coexistence of the different technologies in order to be able to meet the GHG emissions reduction targets. Setting a pledge for the carbon emission reductions related to the transport sector is not sufficient since it does not clarify the prospects for each low-carbon mobility option. It is leading to the misconception of considering that these options will only compete against each other, while they can complement each other in order to achieve the targets. A clear strategic roadmap leading to the realization of the pledged targets is required. Incentives could also include support for the infrastructure deployment and/or, in the transition, grants to reduce the vehicle price paid by the consumer.

Overall, to unleash the hydrogen mitigation potential, governmental support is needed. This study shows that under the current policies, hydrogen contribution is not high. Private industrial initiatives cannot, alone, foster its development. Governmental and regional support can take different forms. It can be financial like granting subsidies, feed-in tariffs or premiums (which is already the case for the injection of biogas into the grid, and in some countries for EV). Or it can be setting standards or targets such as the concentration of hydrogen into the NG grid, or the modalities of a potential hydrogen participation to the electricity reserve market. Thus, relevant policies require a holistic approach, by proposing adequate measures for the industry and energy sectors (gas and power) adapted to the regional contexts.

The next chapter tackles the monetary aspects focusing on the economic competitiveness of hydrogen and its penetration feasibility into the energy-related markets (mobility and injection into natural gas networks) in the different regions considered in this chapter [86].

REFERENCES:

- [1] Intergovernmental Panel on Climate Change (IPCC), “Climate Change 2013, The Physical Science Basis, Working Group I, Contribution to the Fifth Assessment Report of the Intergovernmental Panel on Climate Change.” 2013.
- [2] “Spécial COP 21 - Les engagements nationaux de la France,” *Gouvernement.fr*, 30-Nov-2015. [Online]. Available: <https://www.gouvernement.fr/special-cop-21-les-engagements-nationaux-de-la-france-3390>.
- [3] International Energy Agency (IEA), “World Energy Outlook.” 2017.
- [4] Joanna Sampson, “South Korea unveils hydrogen economy plans,” *gasworld*, 17-Jan-2019. [Online]. Available: <https://www.gasworld.com/south-korea-unveils-hydrogen-economy-plans/2016332.article>.
- [5] Bruce S *et al.*, “National Hydrogen Roadmap, Pathways to an economically sustainable hydrogen industry in Australia.” CSIRO, 2018.
- [6] Olfa Tlili, Christine Mansilla, and Yannick Perez, “A multi-regional evaluation of hydrogen future potential considering the latest governmental policies,” *Submitt. Energy Policy*, 2019.
- [7] International Energy Agency (IEA), “World Energy Outlook.” 2016.
- [8] Benjamin Guinot, Florent Montignac, Bénédicte Champel, and Didier Vannucci, “Profitability of an electrolysis based hydrogen production plant,” *Int. J. Hydrog. Energy*, vol. 40, no. 29, pp. 8778–8787, 2015.
- [9] Christine Mansilla *et al.*, “Electric system management through hydrogen production – a market driven approach in the French context,” *Int. J. Hydrog. Energy*, vol. 37, no. 15, pp. 10986–10991, 2012.
- [10] U.S. Energy Information Administration (eia), “Annual Energy Outlook 2017 with projections to 2050.” 2017.
- [11] United Nations, Department of Economic and Social Affairs, and Population Division, “World Population Prospects, The 2017 Revision,” 2017.
- [12] Food and Agricultural Organization of the United Nations, “World fertilizer trends and outlook to 2020, Summary Report,” 2017.
- [13] International Energy Agency - IEA, *Technology Roadmap : Hydrogen and Fuel Cells*. 2015.
- [14] Hydrogen Council, “Hydrogen scaling up, A sustainable pathway for the global energy transition,” Nov. 2017.
- [15] International Renewable Energy Agency - IRENA, “Innovation Outlook: Advanced Liquid Biofuels,” 2016.
- [16] Jean-Marie Seiler, Carole Hohwiller, Juliette Imbach, and Jean-François Luciani, “Technical and economical evaluation of enhanced biomass to liquid fuel processes,” *Energy*, vol. 35, no. 9, pp. 3587–3592, 2010.
- [17] ENEA Consulting, “The potential of Power to Gas: Technology review and economic potential assessment,” 2016.
- [18] E&E Consultant, Hespul, Solagro, “Study on hydrogen and methanation as a process for the recovery of excess electricity,” 2014.
- [19] “A 100% renewable gas mix by 2050 ?” ADEME, 2018.

- [20] Javier Castro, “CertifHy— Developing a European Framework for the generation of guarantees of origin for green hydrogen,” presented at the GO scheme, 2014.
- [21] SBC Energy Institute, “Leading the Energy Transition Factbook, Hydrogen-based energy conversion - More than storage: system flexibility.” 2014.
- [22] Robyn Wainwright, “Advancements in the Asian Fertilizer Market,” *World Fertilizer Magazine*, 17-Dec-2018. [Online]. Available: <https://www.worldfertilizer.com/nitrogen/17122018/advancements-in-the-asian-fertilizer-market/>. [Accessed: 30-Apr-2019].
- [23] Briony Harris, “China cut fertilizer use and still increased crop yields. This is how they did it,” *World Economic Forum*, 26-Mar-2018. [Online]. Available: <https://www.weforum.org/agenda/2018/03/this-is-how-china-cut-fertilizer-use-and-boosted-crop-yields/>. [Accessed: 30-Apr-2019].
- [24] European Commission, “Proposal for a Regulation of the European Parliament and of the Council laying down rules on the making available on the market of CE marked fertilising products and amending Regulations (EC) No 1069/2009 and (EC) No 1107/2009.” 17-Mar-2016.
- [25] IHS, “Chemical Economics Handbook, Hydrogen.” 2015.
- [26] Lutz Goedde, Jakob Fischer, Nicolas Denis, Masaaki Tanaka, and Yuito Yamada, “Empowering Japanese agriculture for global impact.” McKinsey&Company, Oct-2016.
- [27] European Petroleum Refiners Association AISBL, “Static Graphs, Fig19. Maximum on-Road Diesel Sulphur Limits,” *FuelsEurope, Refining Products for our Everyday Life*, 2015. [Online]. Available: <https://www.fuelseurope.eu/dataroom/static-graphs/>.
- [28] United States Environmental Protection Agency (EPA), “What is Acid Rain?” [Online]. Available: <https://www.epa.gov/acidrain/what-acid-rain>.
- [29] World Health Organization, “Ambient air pollution: A global assessment of exposure and burden of disease.” 2016.
- [30] International Maritime Organization, “Third IMO Greenhouse Gas Study.” 2014.
- [31] EnSys Energy with Navigistics Consulting, “Supplemental Marine Fuel Availability Study, MARPOL Annex VI Global Sulphur Cap, 2020 Supply-Demand Assessment, Final Report.” 2016.
- [32] “China moves towards banning the internal combustion engine,” *The Economist*, Sep-2017.
- [33] IHS Chemical, *Chemical Economics Handbook, Hydrogen*. 2015.
- [34] Ministère de la transition écologique et solidaire, “Conseil des ministres, Projet de loi mettant fin à la recherche et à l’exploitation des hydrocarbures.” 2017.
- [35] Markus Wacket and Ilona Wissenbach, “Diesel cars can be banned from German cities, court rules,” *Reuters, Business News*, 27-Feb-2018.
- [36] Loftur Thorarinsson, “A Review of the Evolution of the Japanese Oil Industry, Oil Policy and its Relationship with the Middle East.” Oxford Institute for Energy Studies, Feb-2018.
- [37] Petroleum Association of Japan, “Petroleum Industry in Japan 2015.” Sep-2015.
- [38] “Methanol Industry in Japan.” Research and Markets, Jul-2012.
- [39] Hydrogen Infrastructure for Transport (HIT), “Towards a comprehensive hydrogen infrastructure for fuel cell electric cars in view of EU GHG reduction targets,” 2014.
- [40] Hydrogen Council, “How hydrogen empowers the energy transition,” 2017.
- [41] Hugo Vandenborre, “Hydrogen Mobility: More than just a Vision.” 2016.

- [42] Marcel Weeda, Reinhold Wurster, Geert Schaap, and Floris Mulder, “Towards a comprehensive hydrogen infrastructure for fuel cell electric cars in view of EU GHG reduction targets.” *Hydrogen Infrastructure for Transport (HIT)*, 2015.
- [43] Russ Koble and Brian Lyons, “Hydrogen is Going the Distance: Toyota Surpasses 3,000 Mirai Hydrogen Fuel Cell Vehicle Sales in California,” *Toyota, USA Newsroom*, 23-Jan-2018. [Online]. Available: <http://toyotanews.pressroom.toyota.com/releases/toyota+surpasses+3000+mirai+hydrogen+fuel+cell+vehicle+sales+in+california.htm>.
- [44] “The Toyota Mirai Fuel Cell Electric Vehicle to Go on Sale This Year in Canada Starting in Québec,” *Toyota, Global Newsroom*, 18-Jan-2018. [Online]. Available: <https://newsroom.toyota.co.jp/en/toyota/20724107.html>.
- [45] “Hydrogen Fuel Cell Vehicle Technology Roadmap.” Strategy Advisory Committee of the Technology Roadmap for Energy Saving and New Energy Vehicles, 2018.
- [46] Roland Berger, “Fuel Cell Electric Buses – Potential for Sustainable Public Transport in Europe, A Study for the Fuel Cells and Hydrogen Joint Undertaking.” 2015.
- [47] FCHJU, “FCH2 JU: Making hydrogen and fuel cells a reality in Europe.” 2016.
- [48] (FCHJU), “Who we are,” *Fuel Cells and Hydrogen Joint Undertaking*. [Online]. Available: <https://www.fch.europa.eu/page/who-we-are>. [Accessed: 30-Apr-2019].
- [49] National Renewable Energy Laboratory, “Fuel Cell Buses in U.S. Transit Fleets: Current Status 2017.” 2017.
- [50] International Energy Agency (IEA) and International Union of Railways (UIC), “Railway Handbook 2016 - Energy Consumption and CO2 Emissions, Focus on Sustainability targets.” 2015.
- [51] Cannix Yau, “Hong Kong’s Public Transport Fare Subsidy Scheme: who benefits from it and how to claim your subsidy,” *South China Morning Post*, 15-Feb-2019. [Online]. Available: <https://www.scmp.com/news/hong-kong/transport/article/2186077/hong-kongs-public-transport-fare-subsidy-scheme-who>. [Accessed: 29-Apr-2019].
- [52] Michiel Modijefsky, “Estonia launches the largest free public transport scheme in the world,” *Eltis, The urban mobility observatory*, 18-Jul-2018. [Online]. Available: <http://www.eltis.org/discover/news/estonia-launches-largest-free-public-transport-scheme-world>. [Accessed: 29-Apr-2019].
- [53] U.S. Department of Transportation, Bureau of Transportation Statistics, “National Transportation Statistics.” 2017.
- [54] Uwe Clausen and Robert Voll, “A comparison of North American and European railway systems, Why Europe needs particular optimization models for railway freight traffic,” *European Transport Research Review*, 2013.
- [55] ALSTOM, “Alstom’s hydrogen train Coradia iLint first successful run at 80 km/h,” 14-Mar-2017. [Online]. Available: <http://www.alstom.com/press-centre/2017/03/alstoms-hydrogen-train-coradia-ilint-first-successful-run-at-80-kmh/>.
- [56] Ministry of Transportation, “Ontario Taking Next Steps in Testing Hydrogen-Powered Train Technology, Province Transforming GO Transit to Provide Faster and More Frequent Service,” *Ontario, Newsroom*, 22-Feb-2018. [Online]. Available: <https://news.ontario.ca/mto/en/2018/02/ontario-taking-next-steps-in-testing-hydrogen-powered-train-technology.html>.

- [57] “Tendre vers l’efficacité énergétique dans les transports, Atelier Hydrogène : compte rendu.” 1^{er} Colloque de l’Observatoire Régional des Transports de Bourgogne-Franche-Comte, 28-Nov-2017.
- [58] “The Cities Seeking a Natural Gas Phase Out,” *DEXMA*. [Online]. Available: <https://www.dexma.com/cities-natural-gas-phase-out/>. [Accessed: 30-Apr-2019].
- [59] “Amsterdam homes to be gas free by 2050,” *Dutch News*, 30-Apr-2019. [Online]. Available: <https://www.dutchnews.nl/news/2016/11/amsterdam-homes-to-be-gas-free-by-2050/>.
- [60] “The importance of the gas infrastructure for Germany’s energy transition.” Frontier Economics, IAEW, 4Management, EMCEL, Jan-2018.
- [61] Central Intelligence Agency (CIA), “The World Factbook, Pipelines,” 2017. [Online]. Available: <https://www.cia.gov/library/publications/the-world-factbook/fields/2117.html>.
- [62] International Energy Agency (IEA), *Energy Supply Security, Emergency Response of IEA Countries 2014, Part 3, Chapter 5*. 2014.
- [63] European Commission, Directorate-General Environment, “Assessing the case for EU legislation on the safety of pipelines and the possible impacts of such an initiative.” 2011.
- [64] “2050 long-term strategy,” *European Commission*, Nov-2018. [Online]. Available: https://ec.europa.eu/clima/policies/strategies/2050_en. [Accessed: 30-Apr-2019].
- [65] Sally Bogle, “Japan tries again for greater flexibility on LNG,” *Petroleum Economist*, 15-Jan-2019. [Online]. Available: <https://www.petroleum-economist.com/articles/politics-economics/asia-pacific/2018/japan-tries-again-for-greater-flexibility-on-lng>.
- [66] “Gas processing LNG, China’s growing natural gas demand—key projects and market insights.” Gulf Energy Information, 2019.
- [67] FCHJU, “Development of Water Electrolysis in the European Union, Final Report.” 2014.
- [68] International Energy Agency (IEA), “World Energy Outlook.” 2018.
- [69] O. Tlili *et al.*, “Role of electricity interconnections and impact of the geographical scale on the French potential of producing hydrogen via surplus electricity by 2035,” *Energy*, vol. 172, pp. 977–990, 2019.
- [70] International Energy Agency (IEA), “Energy Technology Perspectives.” 2016.
- [71] Amir F.N. Abdul-Manan, Abdullah Arfaj, and Hassan Babiker, “Oil refining in a CO₂ constrained world: Effects of carbon pricing on refineries globally,” *Energy*, vol. 121, no. 15, pp. 264–275, 2017.
- [72] Robert W. Howarth, “A bridge to nowhere: methane emissions and the greenhouse gas footprint of natural gas,” *Energy Sci. Eng.*, vol. 2, no. 2, pp. 47–60, 2014.
- [73] Ecofys - A Navigant Company, “Gas for Climate, How gas can help to achieve the Paris Agreement target in an affordable way.” 2018.
- [74] Benjamen Dessus, Bernard Laponche, and Hervé Le Treut, “Le méthane, un gaz qui pèse lourd sur le climat,” *La Recherche*, no. 529, pp. 69–72, Nov. 2017.
- [75] Nicolas Brahy, “Fuel Cell Electric Buses – Potential for Sustainable Public Transport in Europe, An initiative by the Fuel Cells and Hydrogen Joint Undertaking,” Lyon, Avril-2015.
- [76] International Energy Agency (IEA), “Renewable Energy For Industry, From green energy to green materials and fuels.” 2017.
- [77] “Japan’s hydrogen future may be fuelled by Australian renewables,” *ARENA WIRE*, 27-Jul-2018. [Online]. Available: <https://arena.gov.au/blog/hydrogen-future-australian-renewables/>.
- [78] Joshua Eichman, Aaron Townsend, and Marc Melaina, “Economic Assessment of Hydrogen Technologies Participating in California Electricity Markets.” National Renewable Energy Laboratory (NREL), Feb-2016.

HYDROGEN ROLE IN THE ENERGY SYSTEM
A MULTIREGIONAL APPROACH

- [79] “Hydrogen, Tracking Clean Energy Progress,” *International Energy Agency*, 2019. [Online]. Available: <https://www.iea.org/tcep/energyintegration/hydrogen/>.
- [80] “California: ZEV,” *TransportPolicy.net*, 2018. [Online]. Available: <https://www.transportpolicy.net/standard/california-zev/>.
- [81] Jing Qian, “Evaluating the Electric Vehicle Subsidy Program in China.” Oct-2018.
- [82] Chris Randall, “China makes deep cuts to EV subsidies,” *electrive.com, industry service for electric mobility*, 27-Mar-2019. [Online]. Available: <https://www.electrive.com/2019/03/27/china-makes-deep-cuts-to-ev-subsidies/>.
- [83] A. De Vita et al., “Sectoral integration long-term perspective in the EU Energy System, Final report.” Feb-2018.
- [84] Fuel Cells and Hydrogen Joint Undertaking - FCHJU, “Development of Business Cases for Fuel Cells and Hydrogen Applications for European Regions and Cities.” 2017.
- [85] F. Dolci *et al.*, “Incentives and legal barriers for power-to-hydrogen pathways: An international snapshot,” *Int. J. Hydrog. Energy*, vol. 44, no. 23, pp. 11394–11401, May 2019.
- [86] O. Tlili, C. Mansilla, D. Frimat, and Y. Perez, “Hydrogen market penetration feasibility assessment: Mobility and natural gas markets in the US, Europe, China and Japan,” *Int. J. Hydrog. Energy*, vol. 44, no. 31, pp. 16048–16068, Jun. 2019.

APPENDIX

The appendix provides technical details (methodology assumptions, additional results)

Methodology section

i. Market potential assessment: Additional assumptions regarding the assessment of the market segment sizes

For **methanol** production, a ratio of $0.125 t_{H_2} / t_{\text{methanol}}$ [1] is considered to evaluate the hydrogen demand for this market segment.

Regarding **mobility** use, the average travelled distance by vehicle by year is also defined for each region in order to assess the hydrogen demand (see table 1), considering an average H_2 consumption of 0.8 kg/100 km [2] and assuming an evolution to 0.7 kg / 100 km by 2040.

Table 10: Average travelled distances per vehicle per year

km/year/vehicle	2015
US [3]	19,100
EU [4]	13,000
Japan [5]	9,300
China [6]	19,400

The average travelled distances by bus are also evaluated for each region (see table 2). A consumption of 10 kg/100 km [7] is considered assuming an evolution to 8 kg/100 km by 2040 [7].

Table 11: Average travelled distances per bus per year

km/year/vehicle	2015
US [3]	54,400
EU [8]	39,650
Japan [5]	24,900
China [6]	65,000

Regarding advanced biofuel production, a ratio of 0.2 kg of H_2 per litre of biofuel produced is considered in the calculations [9].

For the **gas markets**, regional natural gas demand assumptions are based on the IEA prospective values suggested in the New Policies scenario and presented in Table 3.

Table 12: Gas consumption – industrial sector excluded (Mtoe/year) [data from [10]]

	2015	2030	2040
World	1,783	2,178	2,516
US	404	415	421
EU	227	278	267
Japan	93	60	60
China	65	189	250

To assess the **additional electricity demand** induced by hydrogen production through electrolysis, a ratio of 50 kWh_e / kg H₂ is considered [11], [12].

ii. CO₂ mitigation potential assessment: Additional assumptions

Given the volumes assessed for the different market segments in [13], the potential for CO₂ mitigation is evaluated for each application. The calculations estimate the amounts of reduced emissions which would result from the substitution of the carbonized competitors by hydrogen technologies. Additional assumptions are provided hereafter, for the considered market segments.

The threshold set by the CertifHy project to define “low-carbon” production is 36.4 g_{CO2}/MJ of hydrogen produced, equivalent to a reduction of 60% of the SMR process emissions [14].

Table 13 summarizes the CO₂ emissions related to the consumption of the different fuels considered in the study.

Table 13: Life cycle CO₂ emissions by fuel

	g _{CO2} /MJ
Diesel [15]	92
Gasoline [15]	93
NG [16]	97

In order to assess the carbon mitigation potential in the mobility market segment, a consumption of 7.3 l/100km is assumed for gasoline passenger light duty vehicles and of 6.29 l/100km for the diesel ones [17]. These values correspond to the mean of real-world fuel consumption estimations of different brands of PLDVs. For the bus carbon footprint evaluation, a value of 44 l/100km was adopted [18]–[20]. The carbon footprint of the train fleets corresponds to the avoided carbon emissions that are due to the substitution of 10% of the diesel trains consumption with hydrogen by 2030, and 15% by 2040.

Regarding the natural gas markets, the following happens.

During upstream operations (NG extraction), gas is sometimes vented rather than flared. While flaring consists in burning the methane and hence producing CO₂ emissions, venting is more tricky to estimate and involves the release of methane in the atmosphere [21]. Upstream leakage rates also depend on the

type of the natural gas to be extracted. Shale gas extraction emits more methane which is caused by more venting during the flow-back period after the hydraulic fracturing [22]. It is no surprise then that the US present the highest leakage rates compared to the other regions (Table 14).

The major causes of onshore methane leakages in the downstream phase (transmission and distribution) are the age, the nature of the pipelines and the length of transmission lines. The low pressure distribution systems using old iron pipes present high risks of methane leakages. In the United States for example, parts of the distribution systems in many north-eastern cities were first deployed a century ago and half of the high pressure transmission pipelines are older than 50 years [22]. In Europe, most of the gas trade comes through pipelines from Siberia crossing long distances. In order to maintain a constant pressure in the pipelines, compression stations equipped with valves are used throughout the transmission lines, which also enhances the risk of methane leakages. In China, most of the natural gas demand is currently met by domestic production and transported across the country via pipelines [23], [24]. However; in Japan, all of the NG demand is satisfied via LNG imports [24].

Throughout the LNG supply chain, leakages may occur in the different corresponding stages. The main factors behind can be “losses due to heat absorption and venting from storage tanks over time; (2) venting of displaced vapour when filling a storage tank; (3) LNG liquid and vapour purged from hoses and lines after fuelling a vessel; and (4) flash losses created from precooling lines and storage tanks or from transferring LNG from a high-pressure to a low-pressure tank” [25].

Data regarding the leak rates are presented in the table below.

Table 14: Methane leakage rates as a % of the processed natural gas

Leakage %	
USA [22]	5.8%
EU [22]	3.9%
Japan [25]	4.7%
China [22]	3.9%

Both upstream (extraction and processing) and downstream (transport and distribution) leakages are taken into account. They depend on different factors (considering conventional gas or shale gas, considering gaseous or liquefied natural gas (LNG)). The leakage values in the United States correspond to the exploitation of shale gas wells. A large share of the European gas demand is met through imports from Russia via pipelines [24], hence the leak values in Europe correspond to conventional extraction and pipeline transmission of NG. Same for China whose gas production allows responding to approximately 70% of its demand, with imports mainly coming through pipelines [24]. The data for the Japanese case correspond to LNG leakage values.

Table 15 presents the evolution of the global warming potential of methane over the years, using the lower values.

Table 15: Global warming potential of methane compared to CO₂ emissions – adapted from [26]

YEARS	1	5	10	15	20	25	30	40	50	100
GWP	120	114	104	94	84	75	68	57	48	28

Results and discussion

i. Hydrogen markets size: Additional results

In this section, additional information is provided regarding the diverse hydrogen markets.

Figure 1 displays the top ten biggest ammonia producing countries around the world.

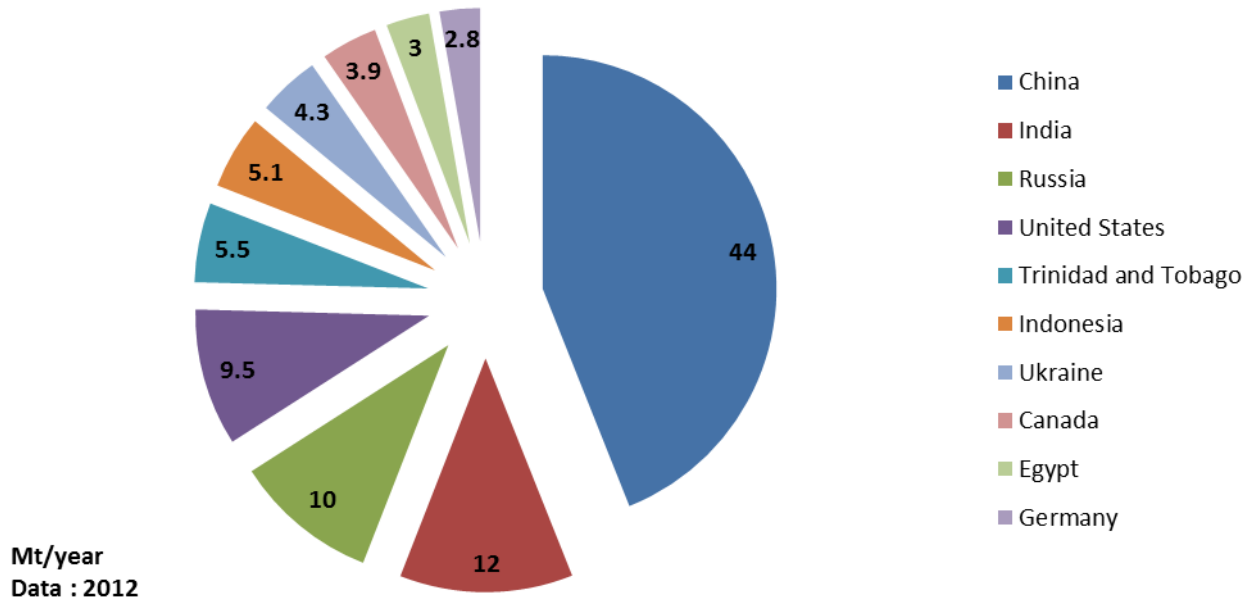
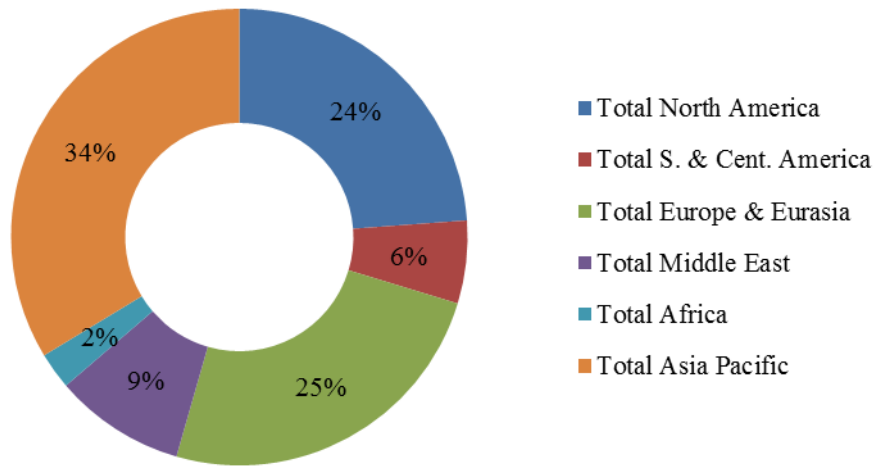

Figure 19: Top ten global ammonia producers (data from [27])

Figure 20 shows the distribution of refinery throughput by region in 2015.



Total world : 79609 Thousand barrels daily

Figure 20: Refinery throughput by region in 2015 – adapted from BP statistical review [24]

ii. CO₂ mitigation potential: additional results

• Methane leakages

In Figure 21, the avoided methane leakages related to the processing of the NG demand are evaluated for the four regions considered in this study. Leakage rates vary from one region to the other depending on the different factors discussed in section 0 paragraph ii.

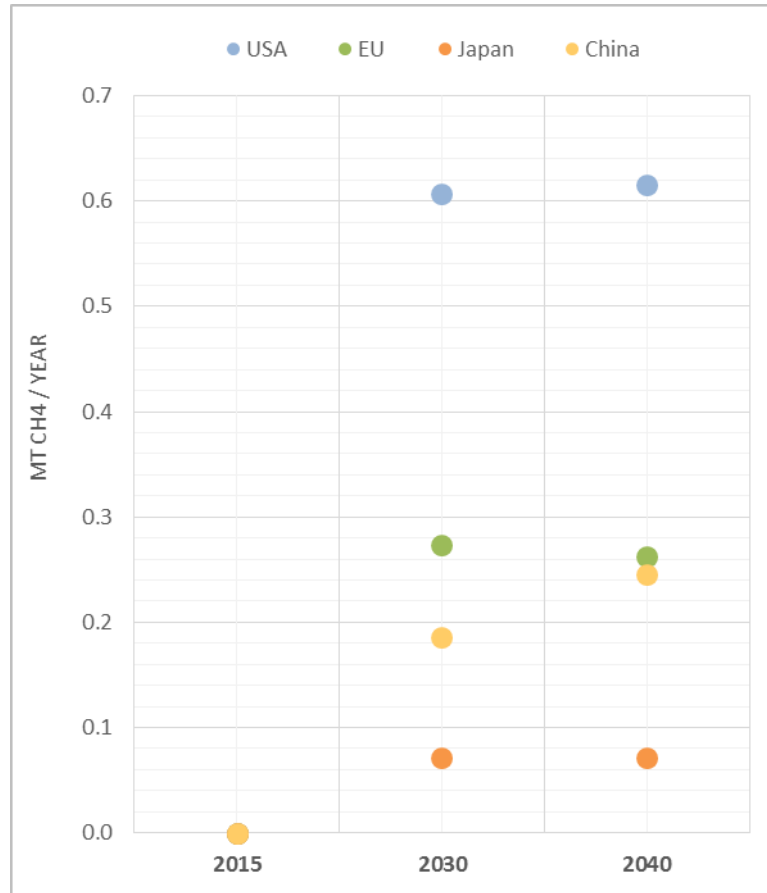

Figure 21: Methane leakages in the US, EU, China and Japan

In this study, the impact of avoided leakages is investigated for only four regions of the world. Only the leakages that are related natural gas processing are considered; no assessment was conducted to encompass the total energy-related methane emission sources (including leakages from oil fields and coal mining). Such an assessment is beyond the scope of this chapter which focuses on the hydrogen potential to mitigate GHG emissions. The total energy-related methane leakages amount to 18% to the total global methane emissions [28] (other sources include agriculture, forests, household waste, etc.). Consequently, in this study we covered less than 1.8% of the methane emission impact for the considered regions.

- **Mobility impact**

Figure 22 presents the CO₂ mitigation potential of integrating FC buses by 2040 as taken in the scenario, and assuming a hydrogen carbon footprint that equals the CertifHy threshold. The mitigation potential is proportional to the number of FC buses by region.

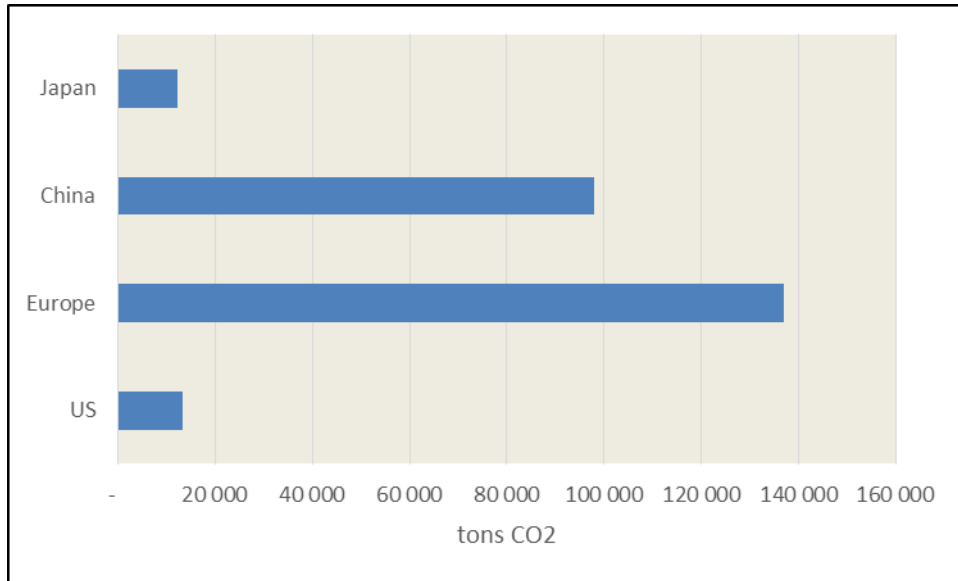

Figure 22: Tons of CO₂ mitigated by the penetration of FCEV buses by 2040

Figure 23 shows the amounts of CO₂ emissions that can be avoided by replacing a part of the remaining diesel train fleets with hydrogen fuel cell ones (10% in 2030 and 15% in 2040 as detailed in [13]).

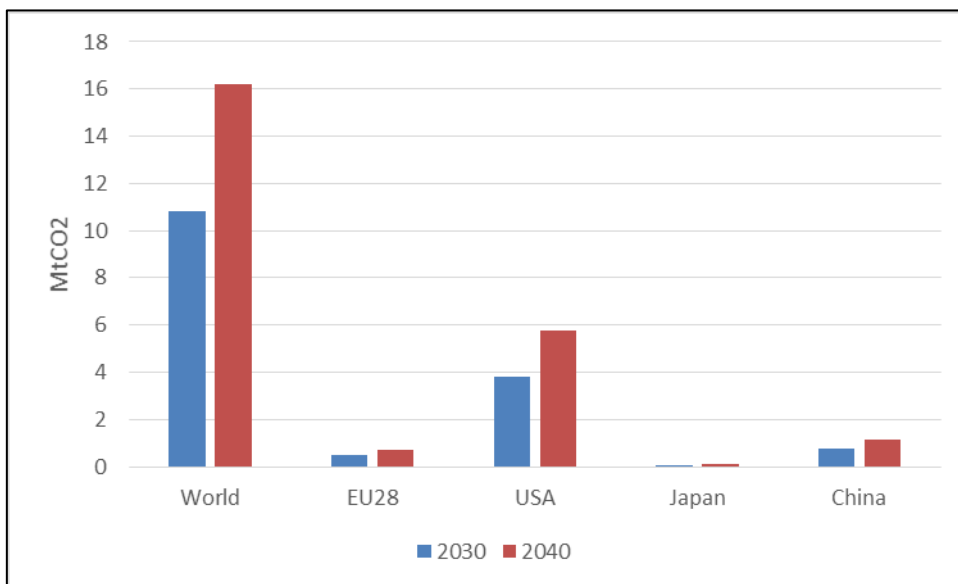

Figure 23: Hydrogen CO₂ mitigation potential in the railway transportation

REFERENCES

- [1] International Energy Agency (IEA), “Renewable Energy For Industry, From green energy to green materials and fuels.” 2017.
- [2] C. Mansilla, S. Avril, J. Imbach, and A. Le Duigou, “CO₂-free hydrogen as a substitute to fossil fuels: What are the targets? Perspective assessment of the hydrogen market attractiveness,” *International Journal of Hydrogen Energy*, 2012.
- [3] US Department of Energy, Alternative Fuels Data Center. Maps and Data, “Average Annual Vehicle Miles Traveled of Major Vehicle Categories [Online].” .
- [4] Allgemeiner Deutscher Automobil-Club e.V. (ADAC), “Benefits of passenger car travel in Europe.” 2015.
- [5] Ministry of Land, Infrastructure, Transport and Tourism Government of Japan, “2010 Inter-Regional Travel Survey in Japan,” 2010.
- [6] Hong Huo, Qiang Zhang, Kebin He, Zhiliang Yao, and Michael Wang, “Vehicle-use intensity in China: Current status and future trend,” *Energy Policy*, vol. 43, pp. 6–16, 2012.
- [7] FCHJU, “FCH₂ JU: Making hydrogen and fuel cells a reality in Europe.” 2016.
- [8] Commissariat Général du Développement Durable, “Le transport collectif routier de voyageurs en 2014 : circulation en progression pour les autobus et stable pour les autocars.” 2015.
- [9] Jean-Marie Seiler, Carole Hohwiller, Juliette Imbach, and Jean-François Luciani, “Technical and economical evaluation of enhanced biomass to liquid fuel processes,” *Energy*, vol. 35, no. 9, pp. 3587–3592, 2010.
- [10] International Energy Agency, “World Energy Outlook.” 2016.
- [11] FCHJU, “Development of Water Electrolysis in the European Union, Final Report.” 2014.
- [12] International Energy Agency - IEA, *Technology Roadmap : Hydrogen and Fuel Cells*. 2015.
- [13] Olfa Tlili, Christine Mansilla, Jean André, and Yannick Perez, “A multi-regional overview of current & future hydrogen markets based on governmental roadmaps. Part 1: Assessment of hydrogen market size potential,” 2018.
- [14] Javier Castro, “CertifHy— Developing a European Framework for the generation of guarantees of origin for green hydrogen,” presented at the GO scheme, 2014.
- [15] Amir F.N. Abdul-Manan, Abdullah Arfaj, and Hassan Babiker, “Oil refining in a CO₂ constrained world: Effects of carbon pricing on refineries globally,” *Energy*, vol. 121, no. 15, pp. 264–275, 2017.
- [16] Timothy J. Skone, “Life Cycle Greenhouse Gas Emissions: Natural Gas and Power Production,” presented at the 2015 EIA Energy Conference, Washington, D.C., 2015.
- [17] Uwe Clausen, Peter Mock, Nikiforos Zacharof, and Vicente Franco, “Real-world fuel consumption of popular European passenger car models.” ICCT, 2015.
- [18] Michele Tozzi – 3iBS Project Manager - UITP, “3iBS, The Intelligent, Innovative, Integrated Bus System,” presented at the Annual POLIS Conference, 2014.
- [19] Nils-Olof Nylund, Kimmo Erkkilä, and Tuukka Hartikka, “Fuel consumption and exhaust emissions of urban buses, Performance of the new diesel technology.” VTT Technical Research Centre of Finland, 2007.
- [20] Shaojun Zhang *et al.*, “Real-world fuel consumption and CO₂ emissions of urban public buses in Beijing,” *Appl. Energy*, vol. 113, pp. 1645–1655, 2014.
- [21] Jonathan Stern, Oxford Institute for Energy Studies, “The Future of Gas in Decarbonising European Energy Markets: the need for a new approach.” 2017.

HYDROGEN ROLE IN THE ENERGY SYSTEM
A MULTIREGIONAL APPROACH

- [22] Robert W. Howarth, “A bridge to nowhere: methane emissions and the greenhouse gas footprint of natural gas,” *Energy Sci. Eng.*, vol. 2, no. 2, pp. 47–60, 2014.
- [23] Xin Li, Oxford Institute for Energy Studies, “Natural gas in China: a regional analysis.” 2015.
- [24] BP, “BP Statistical Review of World Energy,” 2017.
- [25] Dana Lowell, Haifeng Wang, and Nic Lutsey, “Assessment of the fuel cycle impact of liquefied natural gas as used in international shipping.” ICCT, May-2013.
- [26] Benjamin Dessus and Bernard Laponche, “Forçage radiatif et PRG du méthane dans le rapport AR5 du GIEC.” 05-Jul-2014.
- [27] Centre for European Policy Studies, *For a study on composition and drivers of energy prices and costs in energy intensive industries: The case of the chemical industry - Ammonia*. 2014.
- [28] Global Carbon Project, “Global Methane Budget,” *Global Carbon ATLAS*, 2017. [Online]. Available: <http://www.globalcarbonatlas.org/en/CH4-emissions>.

CHAPTER II

Hydrogen market penetration feasibility assessment: mobility and natural gas markets in the US, Europe, China and Japan

I- Introduction

As seen in the previous chapter, hydrogen can contribute to decarbonize a variety of sectors, including the most challenging ones like transport (the latter being highly dependent on fossil fuels), but how far is it from being able to penetrate these markets?

The aim of this chapter is to characterize the market penetration feasibility based on an assessment of both the hydrogen prospective costs through different production and delivery pathways and the market entry costs (based on the competitor). The economic assessment is conducted in the context of the latest governmental announcements and energy policies, in order to evaluate whether the current policies are sufficient to trigger the hydrogen development.

The development of these diverse markets will be related to the regional contexts, namely the energy-related policies that may ensure or hinder the large deployment. A multi-regional assessment of hydrogen market penetration feasibility is conducted in this chapter in view of the latest announced policies and targets. The considered regions are the United States, Europe, China and Japan, presenting different energy contexts and allowing challenging hydrogen under different circumstances. The evaluated markets in this chapter are the mobility sector via fuel cell electric vehicles (FCEV, for passenger light duty vehicles) and the direct injection of hydrogen into natural gas networks.

The first part of the study is a prospective analysis carried out to identify the future market entry costs for the two considered applications. This market entry cost represents the benchmark that should not be exceeded in order to reach competitiveness with other reference options and is then based on the competitor cost. In the second part of the chapter, the current and prospective hydrogen costs (starting from production and adding up other cost components to the pump, considering different pathways) are evaluated and compared to the target costs, in order to assess the market penetration feasibility based on the gap between the two evaluated costs. The larger the gap is, the harder the market penetration will be.

This chapter was published in the International Journal of Hydrogen Energy [1].

1. Objective of the study

As mentioned in the introduction, the aim of this chapter is to examine whether the current and near-term energy policy environment is suitable for hydrogen penetration, to assess the deployment feasibility of hydrogen in the considered markets. To do so, the economic penetration feasibility of hydrogen systems into the new markets is evaluated considering the latest governmental energy policies and orientations in four different regions of the world: the United States (USA), Europe (EU), Japan and China. For each of these regions, the hydrogen integration feasibility is assessed for different timeframes up to 2040. This variety of geographies and target dates impacts the energy prices considered in the calculations. The future electricity, oil, natural gas and carbon prices are exogenous parameters in this study. They are taken from the World Energy Outlook (WEO) accordingly with the New Policies Scenario [2]. These values are hence in harmony with the Governments' views on their future energy systems. They take into account the policies already communicated (but not necessarily put in place) that will shape the future energy systems in each of the regions considered in this study. Hence, in other terms, the approach of this chapter consists in evaluating the consequences of the governmental targets and pledges on the penetration feasibility of hydrogen into the energy system.

The energy and carbon prices adopted in this chapter are presented in Table 16.

Table 16: Energy prices according to the New Policies Scenario [2]

	New Policies Scenario		
	2015	2030	2040
Oil prices - \$/boe			
World	51	111	124
Gas prices - \$/boe			
USA	15	31	40
EU	41	60	67
Japan	60	69	72
China	56	67	70
CO2 prices - \$/tCO2			
USA	-	-	-
EU	-	37	50
Japan	-	-	-
China	-	23	35

Generally, according to the latest energy strategies and pledges, the overall prices are expected to grow by 2040. A sensitivity analysis is conducted in order to investigate other scenarios for the carbon price (450 ppm scenario carbon prices), since some of the regions that are considered in this study do not show yet an explicit carbon pricing scheme. The evolution of the oil and gas prices may be subject of

discussion. Indeed, the so called “Green Paradox” predicts that switching to a greener energy system will result in a drastic reduction in oil and gas consumption following the GHG mitigation targets. The latter can lead to a drop in oil and gas prices due to the low demand falling below the supply potentials [3].

The energy-related markets that are considered in this study are: 1) mobility applications via fuel cell vehicles for the passenger light duty sector 2) and direct injection of hydrogen into natural gas networks (methanation is not considered due to its high costs compared to the direct injection of hydrogen into the grid [4]).

The energy-related markets represent new markets for hydrogen, hence the interest of investigating the feasibility of entry into these markets. The already existing ones (the industrial/chemical applications of hydrogen) are not included. Previous work tackled the future market size potential of these markets as well as their contribution in decarbonizing the industrial sector [5]. Besides, in these markets, hydrogen is already present but mainly produced via steam methane reforming (SMR). Therefore, the competition will rather be between the carbonised and the low carbon hydrogen production. A recent study in the literature [6] evaluated the potential of green hydrogen in the industrial sector. The outcomes of this study show that hydrogen production via electrolysis could compete with the SMR method in regions where renewable sources (for electricity production) are abundant. In such regions, hydrogen production cost via electrolysis can be lower than 2\$/kg of H₂ which is the result of a combination of a decreasing renewable cost and a profitable load factor.

In order to assess the competitiveness of hydrogen in each of the considered market segments, two different approaches are coupled. A top-down approach considers the evaluation of the market entry cost depending on the competing technology. This view is completed with a bottom-up approach evaluating the existent and expected future costs of hydrogen throughout its supply chain. To do so, the hydrogen production cost is evaluated for different production technologies and for different scenarios of electricity prices and load factors. Then, depending on whether centralized or decentralized the production systems are, the delivery costs are added in order to obtain the hydrogen cost at the pump/end-use. The gap between this hydrogen cost and the targeted cost is then assessed in order to quantify the industrial efforts that need to be done in order to lower the hydrogen costs throughout the whole supply chain. This gap is also an evaluation of the need for governmental incentives or subsidies that are required to ease the first stage penetration of hydrogen technologies into the markets. The evolution of this gap over the years also gives an idea on the timeframe of the competitiveness achievement.

The specific assumptions regarding the market entry costs in each of the mentioned market segments, as well as the hydrogen production and delivery costs, are detailed below.

II- Top-down approach

In this section the general methodology of the chapter is explained as well as the assumptions considered in order to conduct the study for the different market segments.

1. Evaluation of market penetration costs methodology

In order to penetrate the different markets, hydrogen will have to compete with the historically preponderant technologies already prevailing on the market. Hence, the penetration feasibility is represented in this study by the target cost that should not be exceeded in order to be able to compete with the other options on the market. The aim behind this top-down logic is to evaluate the capability of hydrogen systems to provide same services for the client with similar or lower costs in the future. This approach was also used in the past back in the nineties where natural gas wells were discovered in the north of Europe (in Groningen specifically). At that time, Exxon knew that in order to sell gas to Germany, France, Belgium, and eventually even to Italy that already had a local gas production, the natural gas must be priced to sell in competition with and by reference to the alternative fuels already present in the market. This approach was referred to as the “Market Value” method [7], which was used to set long term natural gas contracts, linking the gas price with the oil one [8], [9].

Similarly, the hydrogen market entry costs also depend on the competitors which vary from one market segment to another and from one region to another as well. The competitor definition is detailed in the next subsections for the considered market segments.

In order to evaluate the role of environmental policies, the impact of the CO₂ price on the market entry cost, and consequently, on the hydrogen penetration feasibility is assessed in section IV-, by using the carbon prices from the 450 ppm scenario as a variant. According to the International Energy Agency (IEA), not all of the regions around the world will be able to establish the carbon market pricing nationally. In the USA for example only regional carbon prices may arise like in California for example but no federal target has been announced so far [10]. The carbon pricing is still an ambiguous issue in Japan. Hence, in the central case, future carbon prices are considered only for Europe and China [2].

Table 17 displays the CO₂ emissions related to the combustion of the hydrogen competing fuels. These values are considered in the calculation of the carbon tax included when assessing the market entry costs.

Table 17: Combustion CO₂ emissions by fuel

g_{CO2}/MJ	
Diesel [11]	66.6
Gasoline [11]	58.3
NG [12]	50.3

The next sections detail the assumptions behind the target costs calculation for each of the market segments.

1.1. Mobility markets

Regarding mobility applications, hydrogen is considered in this study as a direct fuel via fuel cell vehicles. Few studies in the literature tackled the competitiveness of hydrogen as a feedstock product for advanced biofuels; it seems that hydrogen still has a long way to go to be able to enter this market segment economically speaking [13], despite the fact that, technically, advanced biofuels do not require major modifications in the car engine [14]. Besides, the regulatory framework for identifying hydrogen-based fuels as advanced fuels is not sufficiently defined, making it difficult today to characterize the hydrogen to be produced for these fuels [15]. This market segment is then not included in the study. In order to assess market entry costs for mobility use as a direct fuel in FCEV, only particular light duty vehicles are considered. Today, road transport represents more than 70% of the global transport energy consumption, of which 71% is PLDV-related [16], [17]. However, other transport segments such as trains and maritime transport may emerge in the short term, driven by environmental standards [18]–[20].

The reference alternative to FCEV is the use of fossil fuels in internal combustion engine (ICE) vehicles. The most used fossil fuel is considered the first competitor. Gasoline is the major fuel in almost all the regions except for Europe, where diesel is rather the first fossil competitor [21]. Note that the recent controversies about the diesel use in Europe may become a game changer [22]. Lately, several cities across Europe have also decided to ban the circulation of diesel vehicles [22]. This decision was initiated by the German Court enabling the cities in Germany to ban the most heavily polluting diesel cars from their streets. Stuttgart, Düsseldorf and Hamburg were the first ones to respond to this call. Paris and Copenhagen are also planning to join this decision [22].

For long term competitiveness assessment, hydrogen vehicles will also compete with electric vehicles (EV), which are expected to largely expand in the years to come. This competition may take place sooner than expected. Comparing FCEV to EV is beyond the scope of this study. A proper comparison would require a detailed competitiveness assessment based on not only the fuel cost but also the infrastructure cost. A recent study compared the investment amounts required for both types of mobility in Germany, according to the number of vehicles. Higher costs for hydrogen at small penetration rates are amortized when the fleet develops [23]. Furthermore, one could argue that FCEV are electric vehicles and that FCEV and EV should not be opposed. On the contrary, synergies can be found, either technically with the implementation of range extenders [16], [17], or from the market standpoint by positioning the most appropriate technology on each market segment, overall contributing to decarbonize the transport sector [24].

The market entry cost of hydrogen in this study is assessed based on the cost to travel one km. For hydrogen as a fuel, in order to enter this market segment, its selling price must be at the most equal to the oil product price that a consumer pays at a refueling station to cover the same distance. In order to be competitive with the other fuels, hydrogen must provide the same service for the same price or less. This criterion is important to the consumer preference [13]. The total cost of ownership (TCO) is also an important factor to take into consideration in order to assess in more details the competitiveness of different mobility options [16], [17], [25]–[27]. The evaluation of the TCO of hydrogen vehicles compared to the main competitors will be the aim of future works. Here, we consider as it is projected by [28], that the price of the FCEV compares to the ICE one by approximately 2025 as a timeframe.

In accordance with the durability criteria defined by the European Union, hydrogen fuel should be competitive in the long term, without subsidies, with alternative fuels [13], [29]. All fuels were thus considered to be subjected to the same amount of taxes except for the “TDCPP” (Tax on Domestic Consumption of Petroleum Products) which represents the tax on the petroleum products. The amount of this tax depends on the nature of the product (gasoline or diesel for example), but also the type of consumption (use as fuel or for heating). In France, it has integrated a carbon component since 2014 indexed on a carbon reference price [30], [31]. In order to assess the impact of higher carbon prices on this tax, a specific carbon tax is included in the chapter as discussed in section II-2.3.

The TDCPP tax is then not considered when assuming a clean hydrogen production as in this chapter. However, this can be challenged by future policies, since the revenues of this tax are used to finance local authorities and the projects involving energy transition targets and transport infrastructure deployment [31].

The equation below defines the costs to travel one kilometer using gasoline or diesel.

$$\text{Travel cost } \left(\frac{\$}{\text{km}} \right) = \frac{\text{Oil price } \left(\frac{\$}{\text{l}} \right) + \text{Refining and distribution costs } \left(\frac{\$}{\text{l}} \right) + \text{TDCPP } \left(\frac{\$}{\text{l}} \right)}{\text{Energy to travel 1 km } \left(\frac{\text{km}}{\text{l}} \right)} * (1 + \text{VAT } (\%))$$

The oil prices are detailed in Table 16, they evolve according to the New Policies scenario up to 2040 [2]. Refining and distribution costs are assumed to be the same in the four regions and for the different timeframes considered in this study (see Table 18). Regarding the TDCPP, it varies depending on the region. Table 18 shows the tax amount by region. The tax on the added value (VAT) is then considered to assess the final cost [32]–[35].

Table 18: Fuel cost assumptions [\$/l] (adapted from [13], [36], [37])

	Gasoline	Diesel	
<i>Refining cost</i>	0,12	0,16	\$/litre
<i>Distribution cost</i>	0,10	0,11	\$/litre
<i>Fuel Tax - US</i>	0,13	0,14	\$ ₂₀₁₆ /litre
<i>EU</i>	0,83	0,59	\$ ₂₀₁₆ /litre (French Tax ~ mean in EU)
<i>Japan</i>	0,71	0,43	\$ ₂₀₁₆ /litre
<i>China</i>	0,17	0,13	\$ ₂₀₁₆ /litre

For fossil-fueled engines, a consumption of 7.4 l/100km and 6.3 l/100km are considered for gasoline and diesel vehicles respectively [28], [38], [39]. These values correspond to real-world fuel consumption on the road. Progress in motorization performance is also taken into account. Energy efficiency is assumed to reach 18% in 2030 and remain constant until 2040 (average from [28], [39]–[41]).

Once the travel cost is assessed, the targeted hydrogen cost at the pump (market entry cost) is evaluated. It represents the ratio of the cost to travel one km by the hydrogen consumption (amount of hydrogen needed to travel the same distance).

$$\text{Hydrogen target cost at the pump} \left(\frac{\$}{kg} \right) = \frac{\text{Travel cost} \left(\frac{\$}{km} \right)}{\text{Hydrogen consumption by km} \left(\frac{kg}{km} \right)}$$

The hydrogen consumption is detailed in Table 19 assuming efficiency evolution by 2030 to the theoretical consumption value announced for the Mirai model [42].

Table 19: Hydrogen consumption per km

H2 consumption (kg/km)	Current	2030	2040
	0.008	0.0076	0.007

Based on the hydrogen target cost at the pump, the segmentation of the supply chain is conducted in order to evaluate a targeted hydrogen production cost. In section IV-, the top-down approach is confronted with the bottom-up approach in order to evaluate the penetration feasibility of hydrogen into this market.

1.2. Natural gas markets

The hydrogen penetration potential into the natural gas market is based on the cost of the thermal energy consumed, in \$/MWh. Indeed, to be competitive, hydrogen mixture should provide the same energy for the same price (or less) as natural gas. A mixture of 10%_{vol.} hydrogen and 90%_{vol.} natural gas is considered. According to the literature, this composition does not require major modifications of the existing installations and equipments currently functioning on natural gas [43], [44] (this assumption can be limited by the end use technology. Higher and lower values can also be considered depending on the latter). Natural gas prices are detailed in Table 16.

2. Results

As detailed in the methodology section, market entry costs are assessed according to the competitor cost in the market. The higher the cost is, the easier it will be to reach, and hence be able to penetrate the market.

Firstly, results are given without considering carbon taxation. Then, the impact of environmental policies will be analysed through the consideration of prospective CO₂ prices.

The results are detailed for each of the considered market segments in the following sections.

2.1. Mobility market segment

In order to be cost competitive, hydrogen will have to provide the same service (here mobility) for same or better costs. Hence, competing with diesel and gasoline, the cost to travel one km with hydrogen should at maximum be equal to the travel cost using the competing fuels. In Figure 24, the maximum allowed costs to travel one kilometre are displayed. Since Europe is the only region where diesel is the first prevailing fuel, it has different cost values than the other regions where gasoline is adopted as a first used fuel for transportation. However, diesel dominance in the European mobility sector is expected to decrease in the years to come.

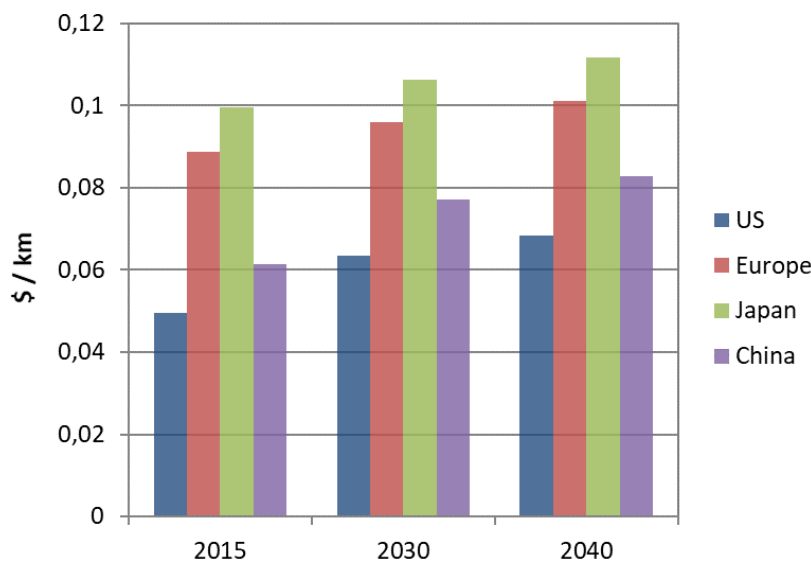

Figure 24: Cost to travel one km using diesel (Europe) and gasoline (the rest of the regions)

In the US, China and Japan gasoline is the most common fuel used for transportation. Consequently, fuel consumption is considered to be the same in these regions. However, beyond the type of the fuel itself, other factors may impact the fuel consumption, like the size of the car, the driving patterns (e.g. speed, driver behaviour), the average number of people by car and the driving conditions in general (state of the roads, weather, etc.) [17]. These factors may vary from one region to another. For example, American cars tend to have bigger engines than the average vehicles. Hence, even with the same fuel, we can have different travel cost values for each region. To take into account these differences, social aspects should be included in the calculation which is beyond the scope of this chapter. In this study, it

is rather the tax amounts varying from one region to another that impact the fuel cost. Japan presents the highest tax levels compared to the other considered regions. This led to much higher fuel costs by km easing the competitiveness in this region. Europe presents the second highest tax rates (Table 18), nevertheless the energy efficiency of diesel outweighs the tax effect on the travel cost.

The slight increase of the travel costs between 2015 and 2040 is mainly related to the increase of the oil prices in the scenario as shown in Table 16.

Based on these fuel costs by km, the market entry costs are evaluated for the different regions. Figure 25 shows the target costs of hydrogen at the pump. These costs should not be exceeded in order to keep hydrogen in the competitiveness area.

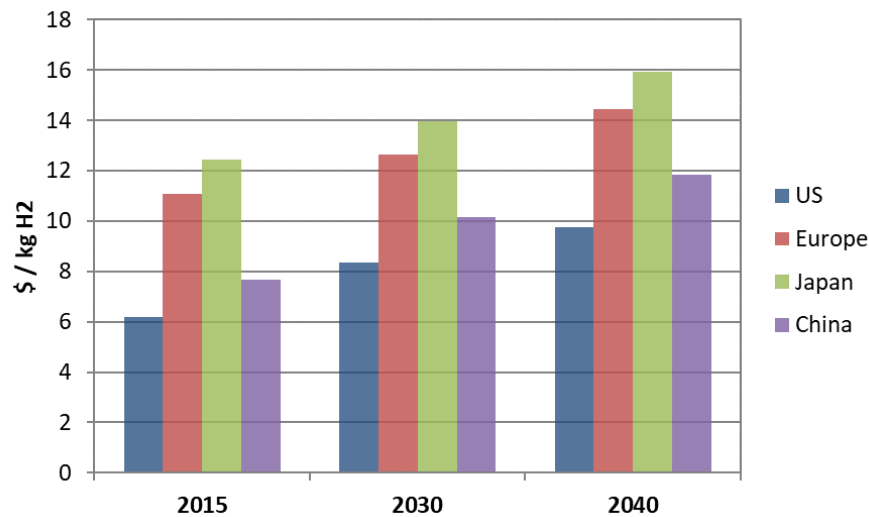

Figure 25: Hydrogen target costs at the pump in the mobility market segment by region

Values for 2040 show that hydrogen can be sold at the pump at a price varying between approximately 9\$/kg_{H2} and 16\$/kg_{H2}, depending on the region. This price represents the threshold of hydrogen total cost at the pump including the taxes.

The decrease of hydrogen costs at the pump will depend on the deployment and penetration rate of hydrogen technologies. In the years to come, the competitiveness gets easier according to the results. The market entry cost increases, meaning that hydrogen can be sold at higher prices. This increase in the market entry cost is related to both the increase of oil prices and the decrease of hydrogen consumption by kilometre assumed in the scenario. Together, these factors overcome the improvement of the fuel efficiency of the thermal internal engines assumed in the scenario (section 1.1).

2.2. Natural gas market segment

In this section, the competitiveness with natural gas usage is assessed on an energy basis, meaning that, in order to be competitive, hydrogen must provide the same service (in terms of energy content in this case) for the same or lower costs.

Results show that, despite the high potential in terms of market size that was identified in previous work [5], the hydrogen market penetration costs for the natural gas market segment turn out to be harder to reach compared to the mobility case (Figure 25). Figure 26 summarizes the results for the different regions considered in the study.

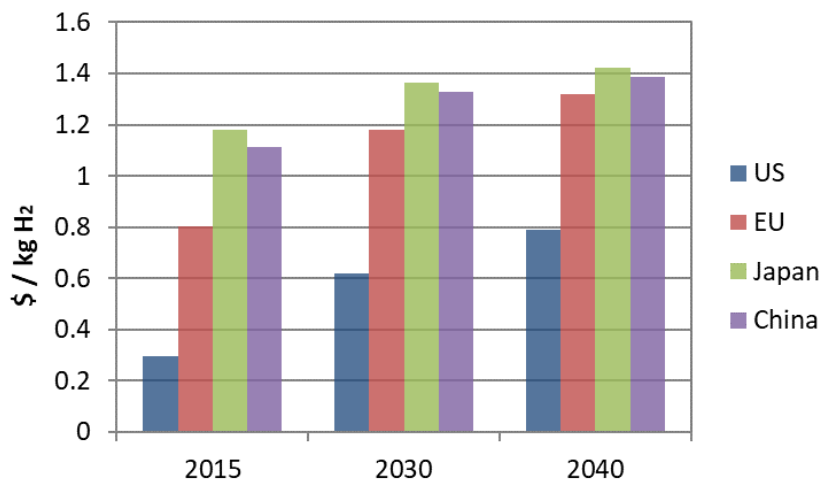

Figure 26: Natural Gas blending market penetration costs by region and timeframe

Overall, market penetration costs are slightly increasing in all of the regions when moving from the short to the mid, and to long term. The difference between 2015 and 2040 values varies between 0.2 and 0.5 \$/kg which is quite low. In the USA, competitiveness is hard to achieve. The exploitation of shale gas led to a sharp decrease of natural gas prices, hence becoming hard to compete with. Japan represents the highest market penetration cost followed by China. However, the most promising region for hydrogen injection into gas networks is Europe which combines a comparatively high gas price [2] and the most developed gas networks (2,030,058 km [45]), easing the hydrogen penetration into this market segment. Germany is now leading the European R&D activity [43]. This interest for power-to-gas is directly linked to its decarbonisation targets set in the Energiewende and to the higher shares of renewable electricity production that are expected in the years to come and that do not necessarily match the evolution of the demand. The localization of the electric demand which is often situated far from the production centres is also problematic requiring energy routing solutions. Hence hydrogen is needed as an energy carrier [43].

Nonetheless, the potential of this market segment highly depends on the governmental incentives that will ease the market penetration, not only financially but by also fixing the allowed volume proportions of hydrogen to be injected in order to trigger its development.

In the next section, the environmental policies are evaluated through the CO₂ price impact on the results.

2.3. Impact of environmental policies (carbon pricing)

Environmental policies are crucial in order to ease the development of new “clean” technologies. The aim of this section is to evaluate whether CO₂ pricing as a supporting scheme is sufficient in order to trigger the different market segments.

As detailed in section I- paragraph 1, we use the carbon price assumptions from the IEA New Policies scenario which takes into account the latest national policies and pledges (a variant will be studied in section IV-, following the 450ppm scenario). Only Europe and China have set CO₂ price targets for the years to come [2]. In the USA, there is no federal carbon price. However, several States, mainly California, do have a carbon trading system with a current CO₂ price of 15\$/tCO₂ [46]. Data for Japan is lacking. A current price of 3\$/t CO₂ is mentioned in [46] but no future targets have been set so far for carbon pricing.

In Figure 27, the CO₂ tax impact on the market penetration costs is presented for the mobility market segment considering the two different competitors (diesel and gasoline).

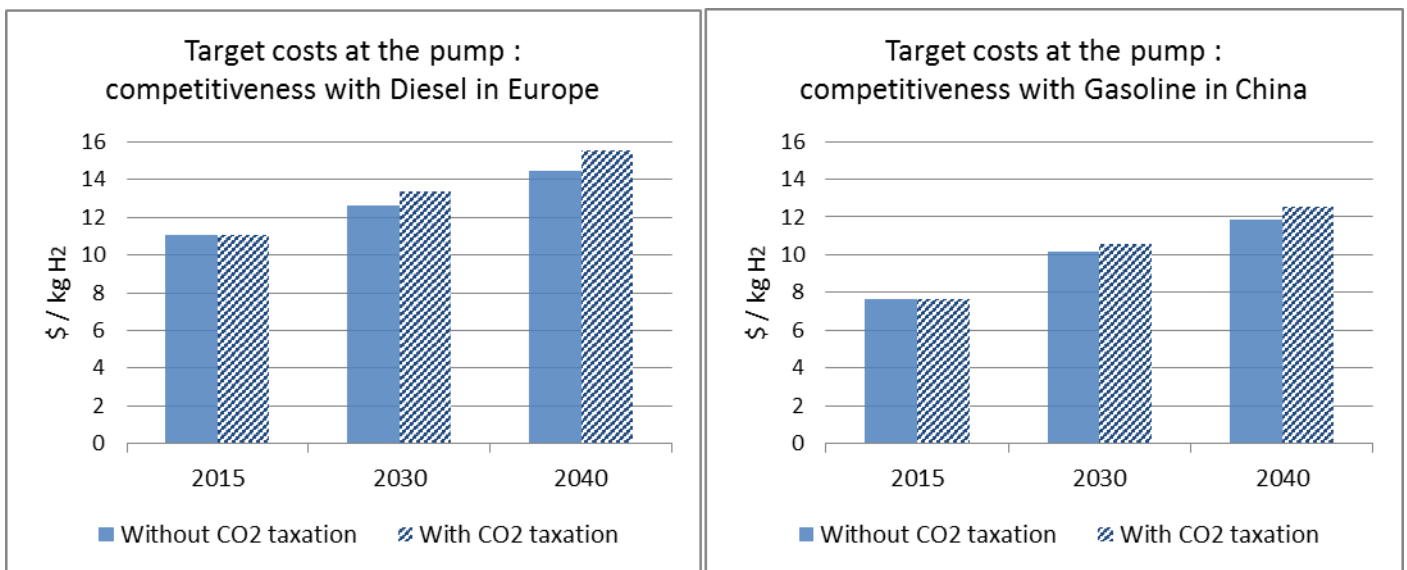

Figure 27: Target Costs at the pump considering carbon taxation

As shown in the figure and as expected, considering a CO₂ price penalizes the fossil fuels. Target costs are likely to increase by approximately 10% in Europe and 5% in China by 2040 if CO₂ taxation is considered. This will ease the competitiveness since it allows hydrogen to be sold at higher prices at the pump. In other terms, carbon taxation eases reaching the break-even threshold.

The injection into natural gas networks is likely to be harder to achieve, even if carbon taxation is implemented (at the expected levels). Figure 28 shows the impact of carbon taxation on the natural gas market entry cost.

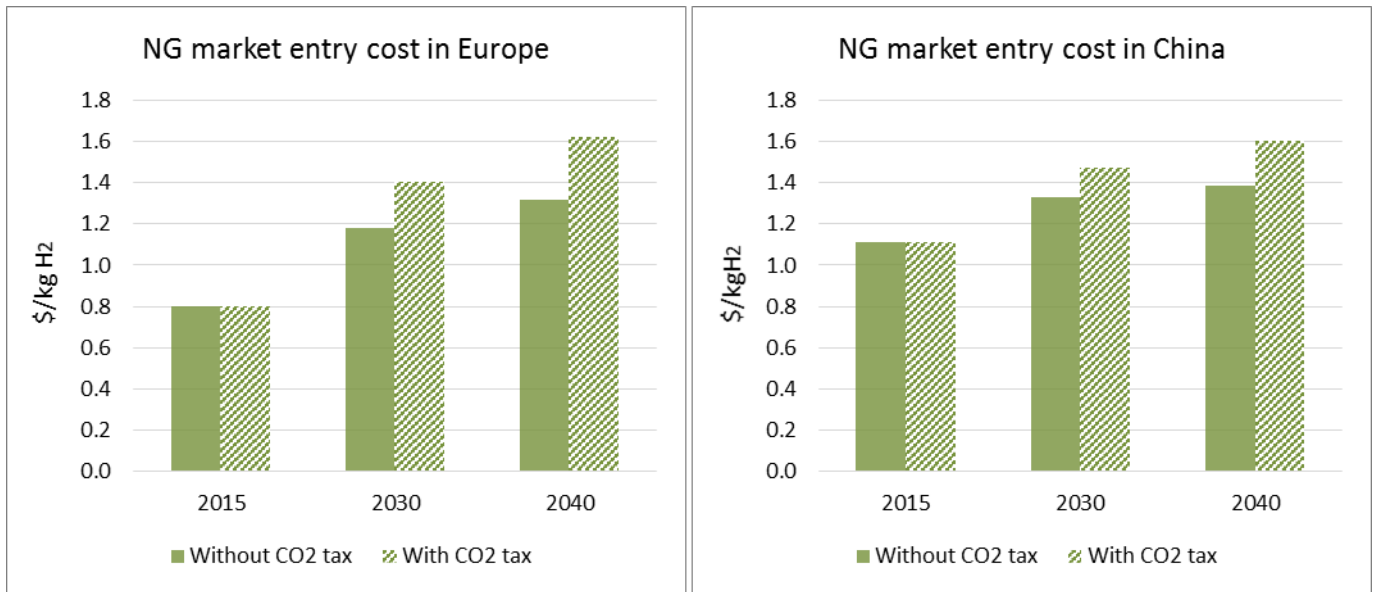

Figure 28: Natural Gas blending market penetration costs considering CO₂ taxation

The carbon price consideration by 2040 increases the market entry cost by around 23% in Europe and 14% in China. However, this increase is not sufficient and the target cost values remain very low.

Introducing a carbon price eases the penetration of hydrogen technologies into the different market segments that are considered. However, it may not be sufficient. While the mobility have higher market entry costs, the injection into natural gas networks seems to present some challenges although it has, as detailed in previous work [5], the highest CO₂ mitigation potential compared to any of its other market segments (both industrial and energy related). This potential is 60% higher when considering the impact of methane leakages [5] that are avoided by hydrogen blending and that have much higher global warming potential than the carbon dioxide [47], [48]. Accordingly, since the injection of low-carbon hydrogen into the grid allows decreasing the carbon footprint of natural gas, it should be eligible for a feed-in tariff or a premium supporting its market penetration, during the transition phase. Further potential governmental support schemes are discussed in section V-.

In order to be able to conclude regarding the feasibility of market penetration, the market entry costs will be compared to the actual costs of hydrogen detailed in the next section.

III- Bottom-up approach: Evaluation of hydrogen current costs

1. Methodology

The bottom-up approach consists in assessing the hydrogen current and expected future costs throughout the supply chain. The final total cost is then compared with the targeted one previously established (section II-), in order to evaluate the market penetration feasibility.

1.1. Production cost evaluation

The production costs are evaluated in the different regions for 2030 and 2040 considering two electrolysis options: PEM and alkaline technologies. To do so, the levelised cost of hydrogen (LCOH) is assessed according to the following equation.

$$LCOH = \frac{\sum_{t=0}^n \frac{C_I + C_R + C_M + C_E}{(1+r)^t}}{\sum_{t=0}^n \frac{P_{H_2}}{(1+r)^t}}$$

C_I: investment cost, *C_R*: replacement cost, *C_M*: maintenance cost, *C_E*: electricity consumption cost, *P_{H₂}*: Hydrogen production, *r*: discount rate, *n*: project lifetime

For the calculation of the LCOH (\$/kg), a duration (*n*) of 30 years is adopted for the project lifetime with a discount rate (*r*) of 8%.

C_I and *C_R* correspond respectively to the investment and replacement costs, assuming that the replacement occurs in the middle of the project lifetime. The investment costs depend on the type of the electrolysis. The adopted costs for the electrolyzers are displayed in Table 20.

Table 20: Electrolyser costs for PEM and Alkaline technologies (adapted from [49]–[52])

\$/kWe	2015	2030	2040
Alkaline	867	615	447
PEM	1749	750	459

A drop in the cost of the production technology is expected in the years to come [20], [49]. The data for the alkaline technology correspond to the investment cost assumptions made in the ETP (Energy Technology Perspectives [21]) hydrogen supply-side analysis [49]. The cost of the PEM technology is assumed to converge with the alkaline one by 2040 [51].

Regarding the maintenance costs (*C_M*), they are assumed to be 2% of the total investment cost per year and remain constant during the project period.

As for the electricity consumption costs (*C_E*), a value of 50 kWh/kg H₂ [14] is adopted in the calculation. The electricity prices are displayed in

Table 21. They correspond to the industrial sector prices of the IEA scenarios, consistent with the energy prices considered elsewhere [2].

Table 21: Electricity prices (including taxes) adopted in the calculation of the H₂ production cost [2]

\$/MWh	2015	2030	2040
USA	70	74	77
EU	132	150	150
Japan	161	140	130
China	125	146	145

The electricity price is mainly affected by the wholesale price. The latter highly depends on the fuel cost and the electricity mix in general. Hence, the low electricity prices in the United States can be explained by the fact that most of the electricity is generated through coal, natural gas and nuclear [53]. Coal and natural gas, being locally produced, are very cheap in the US while nuclear, as capital intensive as it is, presents very low operational costs. Coupling these different factors with low tax levels compared to the other regions [2], the US exhibits the lowest electricity price in this study. On the other hand, Europe struggles to decrease its electricity price, being driven by the pledges in terms of renewable energy investments and the simultaneous phase-out of the conventional thermal power production [54]. However, several countries within Europe are an exception and do not have the same electricity values, like France for example which benefits from much lower electricity prices [55], [56] due to its high share of low cost nuclear power generation. The prices in China are expected to rise by 2040 according to [2], as carbon prices become more widespread. As for Japan, the high electricity prices are related to the phase-out of nuclear generation after the Fukushima accident (but there is an intention to restart a portion of its nuclear fleet) and the switch to natural gas power plants with high natural gas import costs [2], [57].

Thus, the electrolysis plant is assumed to be supplied with power at a given price (which does not only include the power production cost but all the cost factors, including taxation), whatever the load profile. However, other strategies could be considered, namely by taking advantage of low power prices on the market, and avoiding peak ones. Also, as previously mentioned, some specific contexts, more favourable, could be identified. A sensitivity analysis is then conducted in order to investigate the impact of the electricity price on the final production cost of hydrogen.

Based on the previous assumptions, the hydrogen production cost is assessed for different load factors that have a specific impact on the depreciation of the electrolyzer. In order to give orders of magnitude, the current costs of hydrogen production via SMR are provided being the benchmark process, assuming a natural gas price of 35.7 \$/MWh and considering two case studies: with and without carbon taxation (100\$/t CO₂). Two scenarios are then compared (centralized and decentralized production) impacting the costs of the transport and distribution infrastructure in the calculation.

1.2. Delivery cost evaluation

The hydrogen infrastructure costs are exogenous parameters in this study. The delivery cost evaluation requires a geographically detailed model for each of the considered regions. Values for the transport, storage, distribution and refuelling costs are taken from [14], [58]. These values are provided by the JRC-EU-TIMES modelling framework and the Schlumberger SBC Energy Institute which present the most detailed hydrogen cost data found in the literature. The selected values are detailed in the sections below (Figure 29, Table 22 and Table 23).

- Mobility markets

The delivery steps considered in the mobility market segment consist in the compression of hydrogen, its transport and distribution via the different pathways detailed in the previous paragraph, and finally the refueling to the station (gas to gas).

Three pathways are considered for hydrogen transportation and distribution:

- Transport in gaseous state at 180 bar via tube trailer trucks,
- Transport in liquid form in cryogenic tanks,
- And transport via pipelines.

In order to compare the three pathways on the same basis, the travelled distance and the total hydrogen throughput chosen in this study are the same for the three options (50 km and 1MW_{H2} throughput). Varying these parameters changes the order of the pathways in terms of costs. Figure 29 shows the impact of the transport distance (50 km and 200 km) and the hydrogen throughput (1 MW and 50 MW) on the pathway cost.

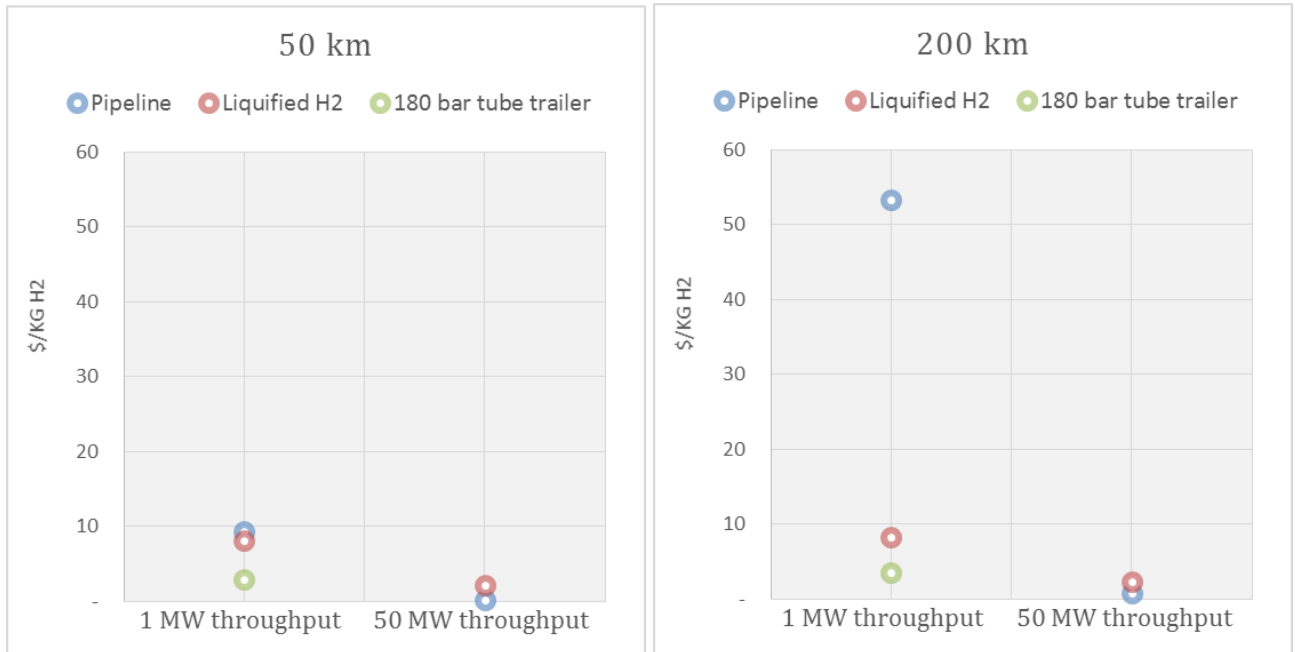

Figure 29: Hydrogen transport pathways comparison (adapted from [14])

The gaseous transport pathway via tube trailers is the cheapest option regardless of the travelled distance when 1 MW throughput capacity is considered. However, this option completely disappears from the graph (the cost becomes extremely high) when it comes to high throughput capacity transportation. This is due to the low transport capacity by truck especially considering the poor energy density by volume of gaseous hydrogen which leads to a need for multiple trucks or multiple travels to transport the same quantity as the other pathways. The transport distance have little impact on the liquid hydrogen pathway, yet with higher hydrogen throughput, the costs can be divided by four approximately (drop from around 8\$/kg_{H2} to around 2.3\$/kg_{H2}) when going from 1MW to 50 MW. As for the pipeline option, as shown in Figure 29, this pathway is clearly not the most economical option for low throughput capacities especially if long travel distances are required. This is due to the high initial investment cost that requires high throughput in order to have profitable payback time. When considering 50MW of throughput capacity, the pipeline transport cost drops from 53\$/kg_{H2} to 0.8\$/kg_{H2} making it the most economically attractive option.

The refuelling costs are assumed to be the same in all of the regions as presented in Table 22.

Table 22: Hydrogen refuelling costs for the mobility market segment \$/kgH2 (data adapted from [58])

2015	2030	2040
1.52	1.24	1.01

Data is available only up to the 2030 timeframe, hence a continuity in the trend is assumed to generate the cost values for 2040. A sensitivity analysis is carried out to test the impact of the scenario choice (in terms of delivery pathway and cost) on the final results.

- Injection into natural gas network

The injection into natural gas networks includes, as upstream stages, the compression of hydrogen, the storage in centralized underground caverns, the transmission via pipelines and the blending into the natural gas network. The associated costs are displayed in Table 23.

Table 23: Hydrogen delivery costs for the natural gas market segment \$/kgH₂ (data adapted from [58])

2015	2030	2040
0.19	0.17	0.15

As in the mobility market segment, the delivery costs for 2040 are based on a continuity of the trend.

2. Results:

As detailed in section III- paragraph 1, the bottom-up approach aims at assessing the different costs throughout the hydrogen supply chain or pathway up to the refuelling station or the injection into the natural gas network step. The final cost is then compared to the market entry cost in order to evaluate the feasibility of market penetration.

In the next subsections, the hydrogen production and delivery costs are appraised for different pathways.

2.1. Production costs

This section is dedicated to the evaluation of the hydrogen production cost. This cost varies from one region to another depending on the specific context (here specifically, the electricity price). In this chapter, the hydrogen production technologies that are considered are the SMR with CCS and the alkaline and PEM electrolyzers. Nevertheless, there are other options for hydrogen production (high-temperature steam electrolysis, photoelectrolysis, etc.). These options are not mature enough or still under research and development and further work is required to lower the costs, enhance the efficiency or improve the lifetime of the corresponding materials [14], [59]–[61].

A general assessment of the hydrogen production cost via electrolysis is conducted in order to evaluate the impact of the different cost components on the final cost, before connecting the production costs to the regional context. Varying the electricity price, the annual load factor and the investment cost (cost of the electrolyser), Figure 30 presents the cost results as a function of the different variables. The evolution of the electrolyser cost between 2015 and 2040 is detailed in the methodology section (section III-0).

HYDROGEN ROLE IN THE ENERGY SYSTEM A MULTIREGIONAL APPROACH

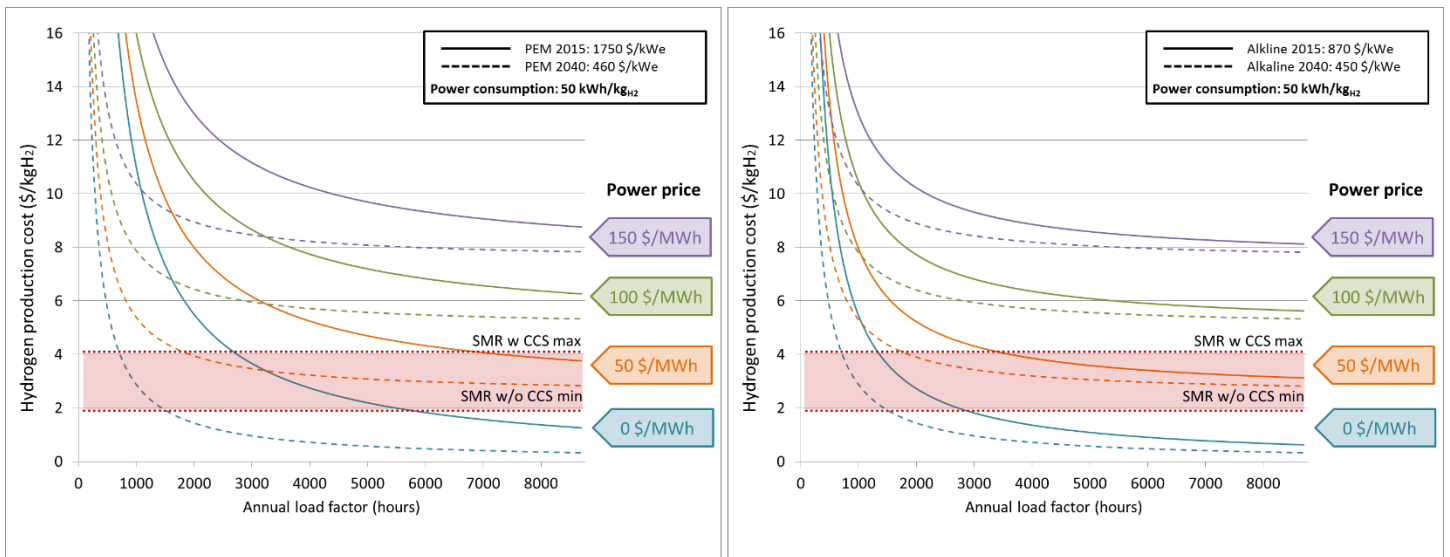

Figure 30: Hydrogen production cost assessment

Globally, in 2015, the alkaline technology led to lower production costs regardless of the electricity price or the load factor. This is related to the investment cost itself, where alkaline electrolyzers present cheaper alternatives since the technology was the most mature one then available on the market [14], [62]. However; the higher the load factor is, the lower the impact of the investment cost on the production cost gets. In the future, the capital cost of the PEM electrolyzers is expected to drop and converge with the alkaline cost values.

The load factor is a key variable impacting the production cost. Even with no electricity fees (0\$/MWh), if the load factor is not high enough to cover the capital costs, hydrogen production will not be economically acceptable. The higher the load factor is, the lower cost we get. However, the results show that, starting from a certain threshold of load factor, around 5,000 hours, the production cost almost stabilizes.

Electricity prices have high influence on the production cost. They impact linearly the LCOH. The current production costs via SMR can be reached with an electricity price of a maximum of 50\$/MWh for the PEM technology assuming a high load factor, and it is possible to go up to 75\$/MWh for the alkaline technology.

With lower electricity prices, cost parity can be reached for lower load factors. For instance, at 50\$/MWh, the break-even point can be reached at 7,000h as load factor for the PEM technology while it does not exceed 4,000h for the alkaline technology.

Figure 31 presents the evolution of the hydrogen production costs in the four considered regions from 2015 to 2040 considering the electrolysis and the SMR (with and without CCS) options for the production. The cost parity timeframe and conditions are searched for. To do so, a sensitivity analysis regarding the electricity price, the gas price and the carbon price is conducted.

HYDROGEN ROLE IN THE ENERGY SYSTEM A MULTIREGIONAL APPROACH

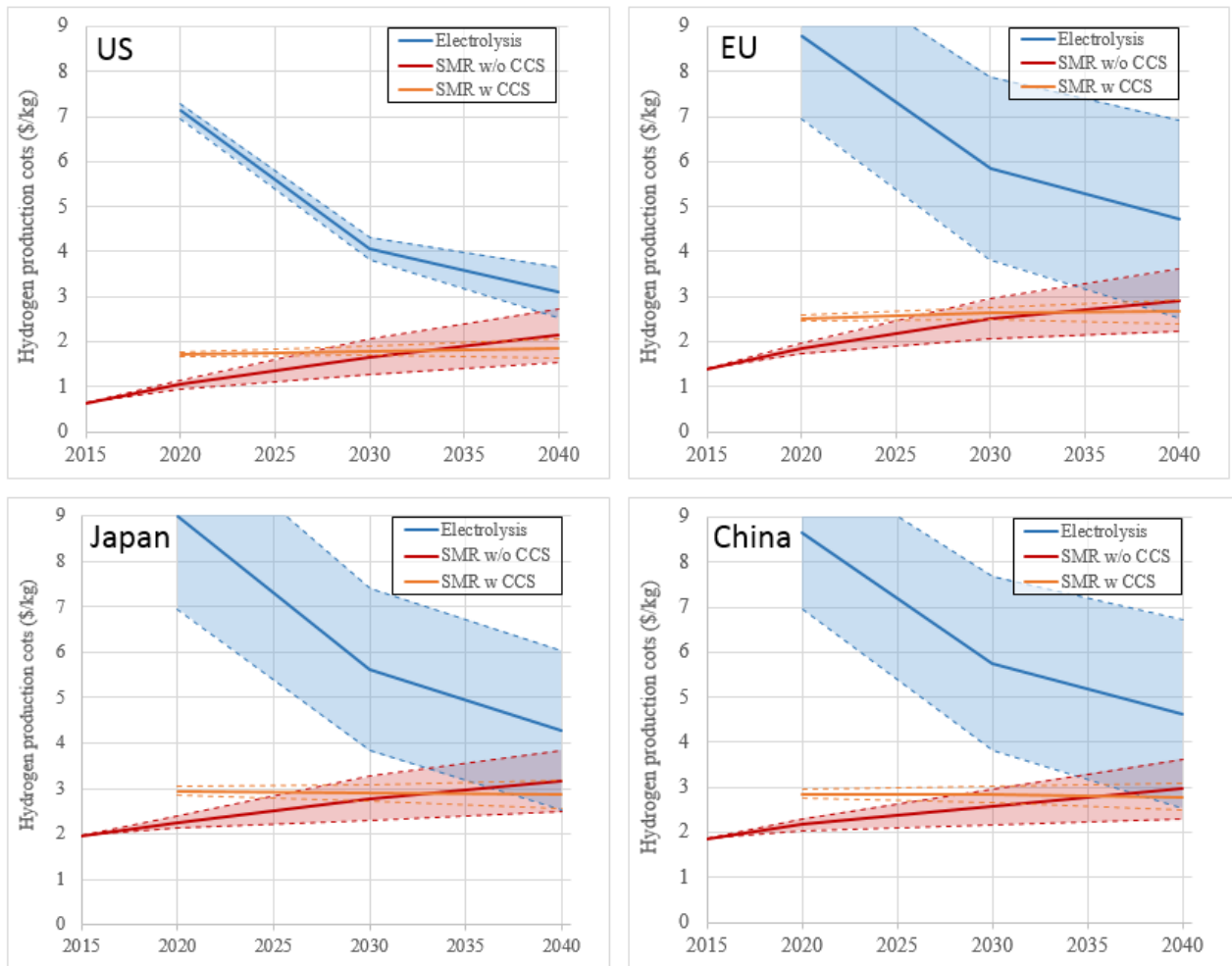

Figure 31: Hydrogen production cost evolution in the considered regions

Regarding the electrolysis curves, the electricity prices that are considered as a maximum value correspond to the electricity tariffs of the industrial sector. A minimum going from 65\$/MWh in 2020 to 50\$/MWh in 2040 (which would correspond to favourable energy policy, e.g. via tax exemption) is then considered allowing to establish a cost sensitivity area, presented in the graph in blue colour.

As shown in Figure 31, considering the industrial sector tariffs for the electricity prices leads to high production costs even in the long term. In this case, despite the drop of the electrolyser cost and regardless of the load factor, the electrolysis cannot compete with the SMR presented in red (and orange for the SMR with CCS) colour in the graph. Accordingly, the switch from SMR to electrolysis is unlikely to come naturally. Specific support mechanisms like tax exemption or grid fee exemption need to be set in order to lower the operational costs by acting on the electricity prices. As presented in Figure 31, lowering the electricity prices down to 50\$/MWh by 2040 allows to reach the cost parity especially if a carbon cost is taken into account penalizing the SMR costs. The cost parity can be reached by different timeframes that depend on the regional context. The American case study is quite special, although the electricity prices are the lowest compared to the other regions, the break-even point is not likely to be reached any time before 2040. In this case, lowering the electricity price down to 50\$/MWh is not

enough to compete with the very low gas prices that lead to low hydrogen production costs via SMR, even if a high carbon tax (going up to 140\$/t) is applied. Nevertheless, the results show that Europe, Japan and China can reach the hydrogen cost parity by 2033-2035 if a carbon tax going up to 140\$/t is considered. Otherwise, it can be reached around 2037. The maximum carbon tax considered in this study is far from representing the required tax that should be applied in order to reach the 1.5°C target. According to [63], the carbon price could reach 400\$/t CO₂ by 2040 if we commit to the 1.5°C target. Hence higher values for the carbon cost could favour the electrolysis as a hydrogen production means.

In order to further lower the hydrogen production cost via electrolysis, further decrease in the capital costs is desirable. Besides, the electrolysis option has the advantage of being highly flexible especially if the PEM technology is considered [14], [50], [62]. PEM electrolyzers can reach full load in less than 10 seconds from cold start. Their easy start-and-stop operation, without the need for preheating or purging inert gases makes them a perfect match with the grid flexibility needs [50]. This means that they can provide the grid with services such as frequency regulation and reserve control which are highly required in a context of future high shares of renewables in the electricity mix [14]. Taking advantage of the remuneration for these services provided by the grid operator can help improve the electrolysis profitability.

Considering SMR plus CCS can be an attractive option. It presents lower costs than the electrolysis in the short to medium term (but this may change if the previously discussed factors are taken into account) and reaches cost parity with SMR between 2032 and 2035 (and between 2025 and 2030 when assuming higher carbon prices penalizing the SMR option) depending on the region. It can hence be considered as a transitional hydrogen production pathway allowing decreasing its carbon footprint. However, further issues regarding the availability and the geography of carbon storage locations need to be considered more carefully. Another option that is not included in the chapter and that should be considered more carefully is the hydrogen supply via imports which can be the case in Japan for example [64] planning to import hydrogen from Australia, the latter having recently presented a promising hydrogen roadmap [65].

Added to the production costs, the storage and delivery costs are required to assess the total costs at the pump. The next section details the impact of different hydrogen transport and distribution pathways on the final cost and assesses the market penetration feasibility.

2.2. Hydrogen cost at the pump

As detailed in the methodology section, the hydrogen final cost at the pump is appraised taking into account two major scenarios: centralized and decentralized production.

- Mobility market segment:

For the mobility market segment, the final cost at the pump corresponds to the cost at the refuelling station.

Figure 32 compares, for the centralized case, the final costs of hydrogen at the pump considering three pathways for hydrogen transportation and distribution (three lines in the figure):

- Transport in gaseous state at 180 bar via trucks (tube trailers) (first line graphs in Figure 32),
- Transport in liquid for in cryogenic tanks (second line graphs),
- And transport via pipelines (third line graphs).

The two columns in the figure correspond to the two case studies that are considered for the throughput capacity (1 MW and 50 MW). Indeed, as shown in Figure 32, the liquid and the pipeline options are investigated considering two capacities of throughput (1 MW and 50 MW). On the other hand, the gas tube trailers are considered for only 1 MW throughput capacity, since for high capacities, they would require large volumes that can be solved by rather multiple trailers or multiple travels, leading to an excessively high cost. The transport distance value taken into account is 50 km.

Since the focus in this section is put on the delivery costs, only one value by region and timeframe is adopted for the production cost as an example. Therefore, the production costs in this graph correspond to the PEM technology and a load factor of 6000h.

The choice of the technology does not impact the final cost in a significant way compared to the transport and refuelling costs detailed hereafter. Switching to the alkaline alternative impacts the final cost by, at maximum 0.92 \$/kgH₂ in 2015 and 0.01\$/kgH₂ in 2040. Besides, the regional context only influences the production cost contribution.

HYDROGEN ROLE IN THE ENERGY SYSTEM A MULTIREGIONAL APPROACH



Figure 32: Hydrogen cost at the pump for the centralized case study in 2040 (left column 1 MW, right column 50 MW of throughput capacity, each line corresponds to a delivery pathway)

As shown in Figure 32, the throughput capacity of the hydrogen transport and distribution pathway has an important impact on the final cost. The higher the throughput capacity is, the lower the hydrogen transport cost gets. This means that going from early market penetration to full deployment allows decreasing the costs at the pump. For high throughput capacities (50 MW), the pipeline option is the most economical hydrogen transport pathway. On the other hand, the compressed gas tube trailers

cannot be considered for such important volumes. Enhancing the transport capacity also helps decrease the liquid hydrogen pathway cost by 73% making it an attractive option for hydrogen transportation.

The delivery costs are exogenous in this study, they are assumed to be the same for the different regions. However, in reality, they are tightly related to the geographical context and the amount of hydrogen to be transported by region. More detailed information about production and demand localization is required to assess the infrastructure costs. Other transport and distribution pathways can also be considered (liquid organic hydrogen carrier for example, etc.) yet they are not included in this study due to lack of data. As for the potential hydrogen demand amounts by region, a previous work tackled this issue elaborating a scenario for future demand based on the latest governmental policies [5].

A drop in the refuelling station cost is expected in the years to come. Nowadays, the deployed hydrogen station costs between \$2 million to \$3 million per station. According to [66], the mean cost is expected to drop in the years to come to approximately \$1 million per station and even lower (hence a sharper decrease than what is assumed in this study). This drop in the costs can be explained by the rising penetration of the hydrogen fuel cell vehicles into the fleet, leading to more investments in station deployment (hence creating an economy of scale effect) and higher utilisation of the recharging stations. Globally, as of July 2017, the number of fuel cell electric vehicles reached 4,500 cumulative vehicles. California accounts for approximately 48% of the FCEV sales, followed by Japan for about 35%, Europe 14%, and 3% in South Korea [66]. An increase of the size of the hydrogen vehicle fleet is expected in the years to come, according to Toyota announcements planning to sell 30,000 fuel cell vehicles per year by 2020 [66]. Several governmental targets have been set around the world for hydrogen penetration into the PLDV sector (800,000 FCEV in Japan and 1 million in China by 2030) [67], [68].

Overall for the centralised case study and considering the electrolytic hydrogen, the cost at the pump may range between approximately 6 \$/kg and 18 \$/kg by 2040, depending on the region, the throughput capacity and the selected transport and distribution pattern. On the other hand, considering the SMR plus CCS allows reaching lower costs at the pump that may range between 3\$/kg and 13\$/kg, but the availability of carbon storage locations nearby should be investigated. As presented in section III- 2.1, the electrolysis costs can be decreased if lower electricity prices or tax exemptions are considered. Taking into consideration the services to the grid that can be procured by the electrolyser flexibility may also result in more advantageous costs for the electrolytic hydrogen.

A second scenario considers decentralized production. This means that the electrolyser is located next to the recharging station. Figure 33 compares the hydrogen cost at the pump for the different regions in 2040 for this scenario. The transport and distribution costs are avoided. However, a local storage bulk on site can be required. The gap with the centralized case is about 8 \$/kgH₂ by 2040 when compared with the pipeline or liquid transport case for 1 MW throughput (and 2.25 \$/kgH₂ with the tube trailer gaseous transport case). If storage is not included, the gap would represent the cost of the transport and distribution.

HYDROGEN ROLE IN THE ENERGY SYSTEM A MULTIREGIONAL APPROACH

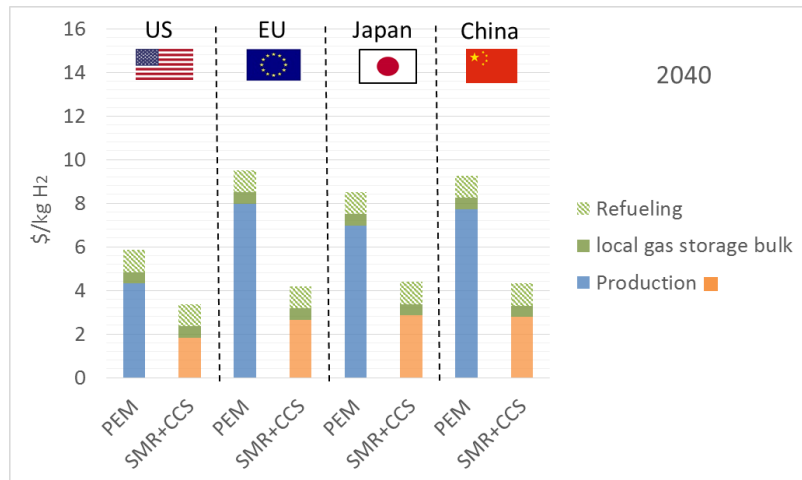

Figure 33: Hydrogen cost at the pump for the decentralized case study

To sum up, the hydrogen cost at the pump for the decentralized case by 2040 ranges from nearly 6\$/kg to 9.5\$/kg depending on the region. As for the SMR plus CCS case study, the costs range between 3 and 4\$/kg approximately. However, having lower costs at the pump for the decentralized case study does not guarantee the competitiveness of hydrogen since generally decentralized production would imply lower capacities which often mean higher CAPEX per installed capacity.

- Injection into natural gas network

Similarly to the mobility case study, the infrastructure costs are exogenously added to the production costs analysed in section 2.1.

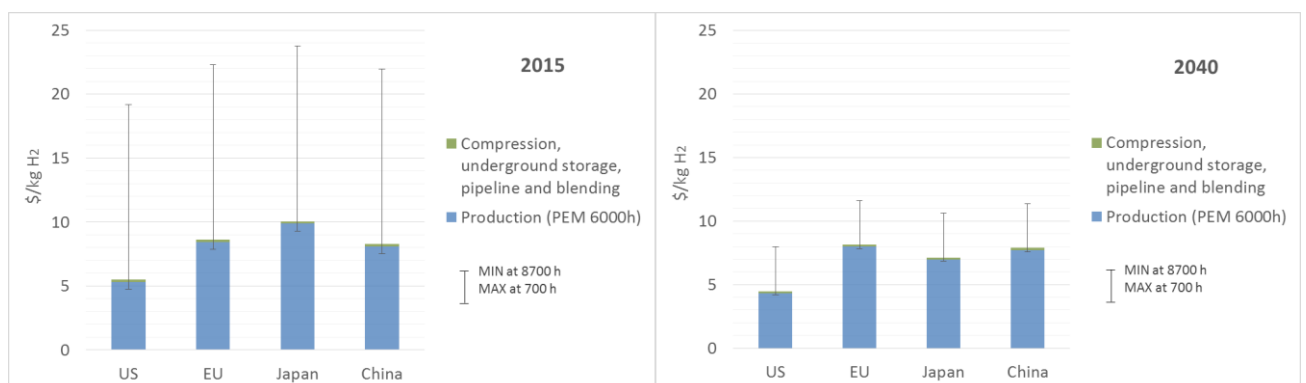

Figure 34: Hydrogen cost after blending

As shown in Figure 34, the infrastructure costs are negligible compared to the production costs when it comes to the injection of hydrogen into natural gas networks. Accordingly, this market segment is one of the least capital-intensive ones, since it does not require heavy infrastructure investments like the mobility case for example. Technically speaking, as detailed in the methodology section, hydrogen injection into natural gas networks is feasible up to 10% of injection rate (in terms of volume), however some concerns about the variation of the composition of the transported gas in the pipeline have been expressed by the industries. No clear regulation has been set so far to fix the allowable rate in order to trigger this market segment.

In order to address the penetration feasibility, the top-down and bottom-up approaches are confronted to each other. The market penetration feasibility into the different markets is assessed in the next section.

IV- Market penetration feasibility assessment

- Mobility market

Once the final cost at the pump is assessed, the aim of this section is to evaluate the market penetration feasibility by comparing the costs at the pump with the market entry costs, evaluated in sections II- and III-. Figure 35 shows the evolution of the two costs between 2015 and 2040 for the mobility case study. The hydrogen cost at the pump is presented for three pathways: i) centralized with tube trailer gaseous transport, ii) centralized with pipeline transport, and iii) decentralized with storage facility. The costs at the pump (for the different pathways assuming a hydrogen production via PEM electrolysis and considering 6,000 hours as load factor) shown in the graph include the value added tax (VAT) since, as detailed in the methodology section, hydrogen will have to prove its long-term competitiveness without any subsidies or tax exemptions.

A sensitivity analysis is conducted on the market penetration cost. In Figure 35, the impact of the CO₂ taxation is presented via the interval area in light blue. The carbon price is varied between zero and the required price to reach the climate targets mentioned in the 450 ppm scenario of the IEA [2] (i.e.: 140€/tCO₂ for USA, EU and Japan, and 125€/tCO₂ for China).

HYDROGEN ROLE IN THE ENERGY SYSTEM A MULTIREGIONAL APPROACH

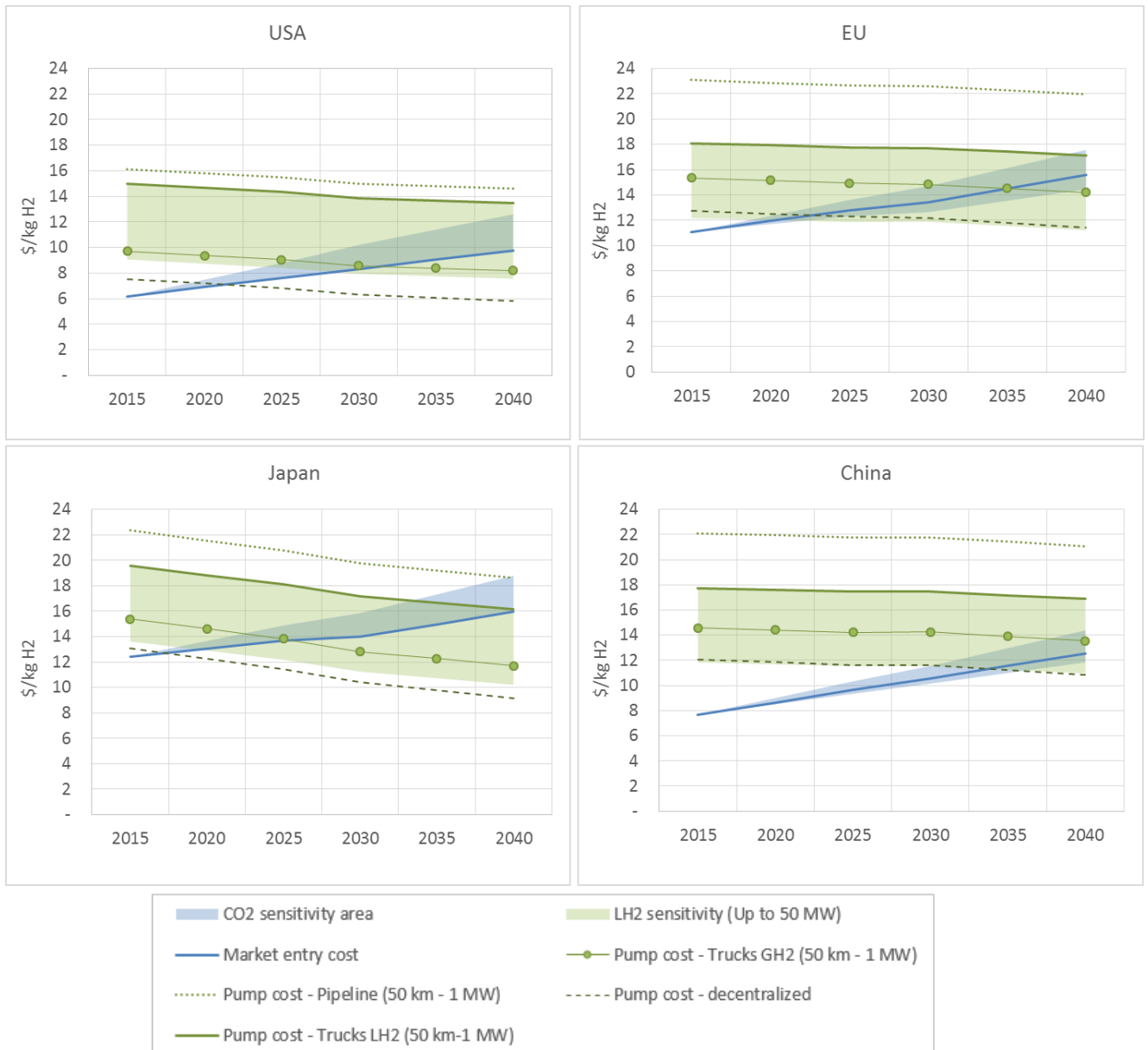

Figure 35: Mobility market penetration feasibility in the considered regions

The market penetration feasibility is marked by the intersection of the two curves (cost at the pump and market entry cost). At the break-even point, the hydrogen cost equals the competitor fuel price at the pump. However, going lower in terms of cost may be needed in order to take into account profit margins and additional taxes. By 2040, considering the compressed gas tube trailer pathway, almost all of the considered regions show feasible market penetration, where hydrogen can easily compete with the fossil fuels with no specific need for subsidies. The cost reductions achieved by 2040 give enough room for hydrogen taxation and even profits except for the Chinese case where the break-even point cannot be reached by 2040 without higher carbon prices (for the centralized case). Considering higher carbon taxes on the fossil fuels (up to 140\$/tCO₂ in the US, Europe and Japan, and 125\$/tCO₂ in China according to

the 450ppm scenario of the IEA) helps accelerate the market penetration feasibility and advances the break-even point by approximately five years.

Hydrogen transport via pipelines is more expensive than the compressed gas tube trailer option in this case study (50 km travel distance and 1 MW throughput), which leads to a significant delay of the market penetration feasibility. However, as detailed in the methodology section, this depends on different factors like the transport distance and the hydrogen demand volumes. Hence in the short term, with low volumes of hydrogen to be transported, pipelines are not the first pathway to be deployed. A more detailed study on infrastructure cost is required in order to capture the impact of the delivery pathway on the market penetration feasibility. Transporting hydrogen in liquid form is more advantageous than the pipeline pathway when considering low and medium throughput capacities, it thus can serve as a transitional pathway between early market penetration and advanced hydrogen deployment.

The results show that Japan is the first to achieve hydrogen competitiveness. The break-even point is already reached by 2025 for the tube trailers pathway even without carbon taxation on the fossil fuels. This can be explained by the fact that Japan presents the highest tax rates on gasoline compared to the other regions [37] which eases the competitiveness of hydrogen. Many programs are already launched in Japan to trigger hydrogen development [68], [69], which may lead to an even earlier market penetration.

The US is the second most promising region for hydrogen penetration. Although it presents low tax rates on gasoline as a fuel, it shows the lowest electricity prices compared to the other regions for the years to come (according to the IEA [2]), thus leading to low hydrogen production costs and low costs at the pump.

The European case is quite special since the competitor is different. In Europe hydrogen is competing with diesel. Nevertheless, seeing the latest controversies about diesel in the last few years, gasoline may become the first competitor, but further cost reductions on the hydrogen production side are still needed (regardless of the competitor) to ensure earlier market penetration. The electricity prices in Europe are high, hence the need to consider a specific market design where hydrogen can benefit from lower power prices and/or participate to the reserve market.

China seems to struggle compared to the other regions when it comes to hydrogen penetration. It combines both high electricity prices leading to high hydrogen costs and low fuel taxes not penalizing enough the competitor. Consequently, higher carbon prices (up to 125\$/t_{CO2}) are required to reach the break-even point by 2040.

Considering the decentralized production with a storage facility helps achieve the market penetration feasibility significantly earlier. The cost profiles for the decentralized case study cross the market entry cost curves approximately 10 years before the tube trailer pathway break-even point.

- Injection into natural gas networks

Despite the fact that the penetration in the natural gas market segment does not require heavy initial investments, hydrogen competitiveness with natural gas does not seem to be easily achievable. Figure

36 compares the injected hydrogen costs after the blending step and the market entry costs in the different regions. The impacts of the tax (VAT) and the electricity price on the costs of the injected hydrogen are also presented in the graph. The light green area represents the interval of hydrogen cost assessed after injection considering lower electricity prices, down to 0\$/MWh.

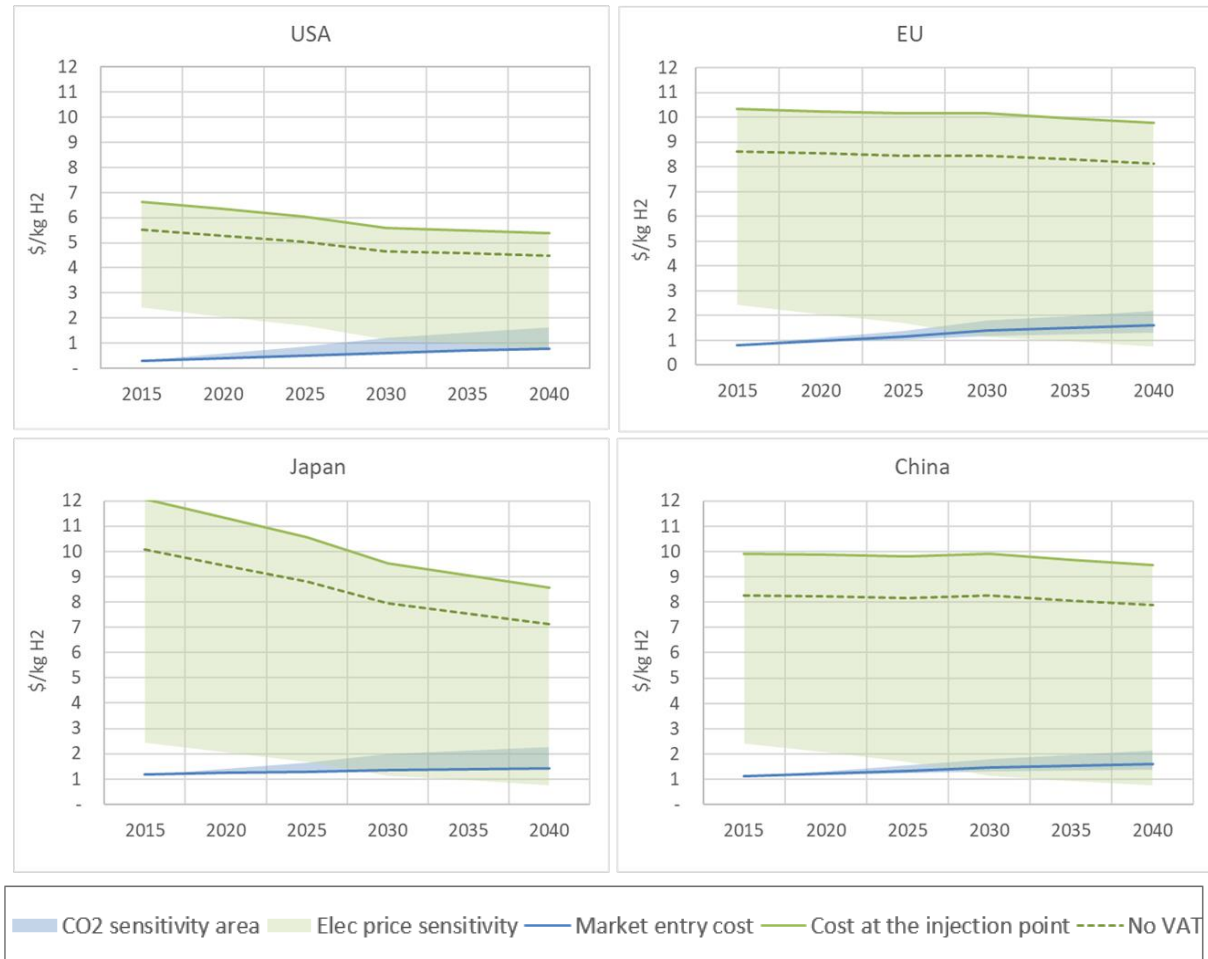

Figure 36: Natural gas market penetration feasibility in the considered regions

According to the results, even with tax exemptions, hydrogen is not able to compete with natural gas. Since natural gas is a relatively cheap energy carrier, it seems to be hard to achieve in the short to mid-term. Dramatic cost reductions on the hydrogen side need to be achieved in order to facilitate the market penetration. These reductions concern mainly the hydrogen production costs since in this case, and as shown in section III-2.2, the delivery costs are negligible compared to the production ones. This can be achieved either through a technology-push approach lowering the costs of the production technologies (further electrolysis cost reductions) or via a market-pull approach involving governmental incentives to ease the market penetration. The sensitivity analysis shows that the carbon taxation of natural gas is not sufficient to ease the hydrogen competitiveness. However, with much lower electricity prices, hydrogen market integration can be feasible. This would require a governmental support allowing hydrogen production to benefit from lower electricity prices. A clear regulation regarding the participation of the electrolyzers in the provision of ancillary services can be a game changer in this case

study, since it will allow hydrogen production to exploit its flexibility potential and gain profits on the electricity market which is proved to often help achieve lower production costs through better load factors [70], [71], and higher revenues than systems engaging in only hydrogen markets [62], [72].

Another market-pull support scheme is the possibility to benefit from feed-in tariffs which is already the case for the biomethane injection into the grid. A study conducted by Tractebel and Hincio and funded by the FCH-JU (Fuel Cell and Hydrogen Joint Undertaking) [73] evaluated the amount of feed-in tariffs that are required for hydrogen penetration into the gas market segment. An interesting outcome of the study is that, besides the fact that the feed-in tariffs are needed to trigger the market penetration, coupling the natural gas blending market with the mobility market (in other terms considering a system producing hydrogen for both markets) allows to lower the feed-in tariff needs by 10 to 20% and enhances the hydrogen system profitability. Hydrogen versatility should be taken advantage of, to leverage the most profitable markets so as to open the other ones.

But together with the financial support, the allowed hydrogen concentration into the natural gas networks is also a key factor in the development of this market. Hence a clear standard needs to be set in order to trigger this market, which can be a huge contribution to decarbonize the energy system.

V- Discussions

Compared to the current and prospective hydrogen costs, the market penetration for the mobility segment seems to reach more easily the targets. As discussed in the methodology section, the market penetration cost in this case study is based on the fuel cost only, while the total cost of ownership may reflect, in a better way, the choice of the final consumer. The TCO includes the car purchase price, the maintenance costs, the insurance and also the decommissioning costs. According to the literature [16], [25]–[27], the current TCO of a hydrogen vehicle is higher than the conventional mobility one although fuel cell cars require less maintenance than the diesel engines. However in the future, the total cost of a hydrogen vehicle is expected to drop and be equal to the diesel car one. This will mainly depend on the development of hydrogen mobility in the future creating an economy of scale effect. According to [25], the TCO break even between diesel and hydrogen mobility is reached when at least 50,000 units of fuel cell vehicles are manufactured by year.

Another important factor to take into account is the external costs [61], [74]–[76], in terms of social and environmental costs, that are not directly paid by the final costumer, but represent a non-negligible spending at the national scale. These costs reflect the environmental damages and adverse effects on human health caused by the emissions of CO₂ and other greenhouse gases [75]. Substituting the carbonized transport means by clean hydrogen ones helps cities gain direct and indirect benefits that can outweigh short-term costs [76].

However, the expansion of electric mobility may be faster than expected, following recent announcements of total phase out of internal combustion engine vehicle sales by 2040 in several countries, like France and China [22]. This new competition, if it proves to be one, since we could also witness technology cooperation (see for instance the hydrogen range-extender technology for electric vehicles that relies on a small fuel cell to extend the autonomy of a battery electric vehicle), should be

further analysed. Indeed, comparing fuel cell vehicles to the battery electric ones should not only be based on “fuel cost” but also include specific aspects. For instance, it is true that the electric vehicles consume less electricity than the fuel cell ones to travel one km (from a well-to-wheel analysis viewpoint), however the autonomy of the vehicle as well as the required refuelling time are also key issues to take into consideration, especially when tackling the consumer behaviour and preference. As a matter of fact, the annual mean travelled distance by vehicle that may reflect the need for autonomy varies according to the driving patterns that are diverse when considering different regions. Another aspect that needs to be further investigated is the segmentation of mobility by type. When it comes to heavy duty transport (freight trucks, buses, etc.), autonomy and refuelling time are key aspects to take into account. New customer practices may also emerge like car-sharing that allows enhancing the usage of a given vehicle as a potential way to reduce the total number of vehicles, and thus contribute to CO₂ mitigation. Such new usage of vehicles, and more generally all the intensive use (e.g. taxi fleets) could require longer autonomies and quicker refuelling of the vehicle, making hydrogen the preferred option. Beyond the vehicle itself and the consumer preference, switching to a fully decarbonized vehicle fleet would require an in-depth analysis of the infrastructure requirements. Indeed, fuel cell vehicle deployment is dependent on the infrastructure availability. The latter would also depend not only on industrial investments but also governmental efforts to reduce the risks for the companies. Such governmental support has been observed in the recent years to trigger the electric charging station deployment. In addition, regarding the infrastructure required for the electric mobility, apart from the recharging station installation, advanced electric mobility adoption may also require a reinforcement of the electricity distribution network and maybe also transmission network. Hence, a detailed comparison of the cost of infrastructure deployment for both means of low carbon mobility (FCEV and EV) should be conducted. Studies can be found in the literature tackling this issue for different countries. For instance, a recent study investigating the German case was elaborated in the framework of H2Mobility project [23]. It inspects the expenses that are required for infrastructure deployment for both EV and FCEV considering different levels of market penetration. The results show that for early market integration phases and up to around 50% of the vehicle fleet, the electric mobility deployment shows economic advantages when it comes to infrastructure requirements. However, for higher market penetration levels, hydrogen infrastructure deployment may become more economical reducing the costs due to the scaling effect. Nonetheless, as introduced before, complementarities can be searched for between FCEV and EV: in technology terms such as the “range-extender vehicles, or in economic terms, by bringing the most appropriate solutions to the diverse market segments. Overall, the decarbonisation of the transport sector can be reached through different pathways not necessarily competing with one another.

As for the injection into the natural gas network it seems to still have a long way to go to reach competitiveness. The needed support is not only financial, e.g. via tax or electricity fees exemption or a subsidy such as the feed-in tariff scheme discussed before; it is also required to set a clear target for the maximum concentration of hydrogen into the gas grid. This concentration currently highly varies from one region to another. It can reach 10% (of the volume) like in Germany for example while it does not exceed 6% in France and 0.1% in the UK [20], [77]. In Japan it is not allowed at all. A harmonization of the standards at the European level (but not only) is crucial to prepare a more suitable market penetration environment.

Despite the disparity of the cost ranges, both markets would need support schemes in order to be triggered, hence the importance of governmental involvement through encouraging regulations and policies.

Finally, the results discussed in this chapter may be challenged once the carbon impact of the electricity generation is taken into account when considering electrolysis. As a matter of fact, sourcing hydrogen production with electricity from the grid may not be the best environmentally-efficient way to make hydrogen a low carbon energy carrier. Indeed, as shown in

Table 24 the carbon footprint of hydrogen production from electrolysis can be higher than the SMR one (i.e. approximately 10 kg CO₂/kgH₂) when considering the electricity from the grid. A carbon taxation is already taken into account in the electricity prices considered in the NP scenario [2], the impact of considering higher carbon taxes on electrolytic hydrogen cost is not discussed in this chapter.

Table 24: Carbon footprint of hydrogen generation considering the regional electricity mix as stated in NP scenario [2]

kg CO ₂ /kg H ₂	2014	2030	2040
US	24.4	17.4	14.8
EU	17.9	10.9	7.7
Japan	27.6	17	14.7
China	38.4	25.9	21.6

Accordingly, producing hydrogen from low carbon electricity should be further investigated. Two potential options can be considered. On the one hand, renewable energies allow reaching low carbon intensities at low electricity cost but induce low load factors leading to a high hydrogen production cost as presented in Figure 30. Some exceptions to this fact can take place in regions where renewables are abundant such as in Australia where according to the analysis made in [78] “The cost of electricity in these locations in 2040 would be less than \$47/MWh with the hybrid systems operating at capacity factors of between 30% and 40% (depending on the optimal combination of solar PV and wind). This 100 Mtoe of hydrogen could be manufactured at less than \$3/kg H₂”. Another option that can also be considered is the available nuclear energy that is not dispatched due to higher renewable production, for the regions where nuclear is installed. This effect is discussed in more details for the French case in [79]. Overall, the electric sourcing for electrolysis needs to be adequate, to make hydrogen low-carbon. This can be done by direct sourcing from low-carbon power generation plants, or by sourcing from the grid, provided that the power mix is low carbon enough, by avoiding peak hours where fossil power plants are the peaking units.

VI- Conclusion

The aim of this chapter is to evaluate the hydrogen penetration feasibility into the energy-related markets. The focus is put on the mobility sector via FCEV and the injection of hydrogen into the natural gas networks considering four regions (USA, Europe, Japan and China). Although the focus was put on specific regions in this study, other geographies recently emerged in terms of hydrogen deployment potential. For instance, South Korea has recently developed a hydrogen roadmap aiming at integrating hydrogen as a pillar for energy security [80]. By 2040, the government seeks to “increase the cumulative total of fuel cell vehicles to 6.2 million, raise the number of hydrogen refuelling stations to 1,200 (from only 14 today) and also boost the supply of power-generating fuel cells” [81]. Hydrogen deployment plans are also emerging in Australia with a view not to only enhance domestic hydrogen use, but also position the region as a large exporter of hydrogen in the years to come [65].

Top-down and bottom-up approaches were compared in order to assess the timeframe of hydrogen competitiveness. The results show that the most promising market among the ones examined here is hydrogen as a direct fuel for mobility in fuel cell vehicles, from an economic standpoint. This market is easier to penetrate in all the considered regions, it even presents a potential room for taxation in the medium to long term. However investments still need to be triggered by a clear political positioning, in order to hinder the uncertainties and the risk perception. The mobility market is more favourable in Japan, due to the coupling of interesting patterns penalizing the competitor (high taxes on gasoline) and support schemes for hydrogen (a clear roadmap for hydrogen penetration). On the other hand, the injection into natural gas networks exhibits much lower market entry costs, then harder to achieve. They do not exceed 2.3\$/kg of H₂, even when a carbon taxation going up to 140 \$/t_{CO2} is considered. Thus, the current policies are still insufficient to trigger this market segment and stronger governmental support is required in order to ease the market penetration. A potential support scheme that can be envisaged is the possibility to benefit from feed-in tariffs which are already implemented for biomethane blending. Another uncertainty hindering the development of this market segment is the uncertainty regarding the allowed concentration of hydrogen. Different standards are applied in different countries even within the same region (for example among the European countries [43], [82]). Harmonizing the regulations is key.

Regarding hydrogen production, implementing a multi-sectorial approach seems essential to benefit from the versatility of hydrogen as a chemical component and an energy carrier, thus enhancing the margins and gain in profitability of the hydrogen generation. Hydrogen production via electrolysis can also participate to the provision of flexibility to the electricity grid. This would help hydrogen systems further increase their revenues than systems engaging in only hydrogen markets. Tax exemptions can also be part of the solution to lower the costs and ease the early market penetration.

Overall, different options can be considered in order to surpass the economic barriers: both industrial and political efforts need to be achieved to lower the costs and prepare a suitable market penetration environment.

REFERENCES

- [1] O. Tlili, C. Mansilla, D. Frimat, and Y. Perez, “Hydrogen market penetration feasibility assessment: Mobility and natural gas markets in the US, Europe, China and Japan,” *Int. J. Hydrog. Energy*, vol. 44, no. 31, pp. 16048–16068, Jun. 2019.
- [2] International Energy Agency (IEA), “World Energy Outlook.” 2016.
- [3] Hans Werner Sinn, *The Green Paradox, A Supply-Side Approach to Global Warming*. Mit Press Libri, 2012.
- [4] “A 100% renewable gas mix by 2050 ?” ADEME, 2018.
- [5] Olfa Tlili, Christine Mansilla, and Yannick Perez, “A multi-regional evaluation of hydrogen future potential considering the latest governmental policies,” *Submitt. Energy Policy*, 2019.
- [6] International Energy Agency (IEA), “Renewable Energy For Industry, From green energy to green materials and fuels.” 2017.
- [7] Patrick Heren, “Removing the government from European gas,” *Energy Policy*, vol. 27, pp. 3–8, 1999.
- [8] Jonathan P. Stern, “Is there a rationale for the continuing link to oil product prices in continental European long-term gas contracts?,” *Int. J. Energy Sect. Manag.*, vol. 1, no. 3, pp. 221–239, 2007.
- [9] J. Stern, “International gas pricing in Europe and Asia: A crisis of fundamentals,” *Energy Policy*, vol. 64, pp. 43–48, 2014.
- [10] World Bank, Ecofys, and Navigant company, “State and Trends of Carbon Pricing 2018.” World Bank, May-2018.
- [11] U.S. Energy Information Administration (eia), “How much carbon dioxide is produced from burning gasoline and diesel fuel?,” *FREQUENTLY ASKED QUESTIONS*, 19-May-2017. [Online]. Available: <https://www.eia.gov/tools/faqs/faq.php?id=307&t=11>.
- [12] U.S. Energy Information Administration (eia), “How much carbon dioxide is produced when different fuels are burned?,” *FREQUENTLY ASKED QUESTIONS*, 2017. [Online]. Available: <https://www.eia.gov/tools/faqs/faq.php?id=73&t=11>.
- [13] C. Mansilla, S. Avril, J. Imbach, and A. Le Duigou, “CO₂-free hydrogen as a substitute to fossil fuels: What are the targets? Prospective assessment of the hydrogen market attractiveness,” *Int. J. Hydrog. Energy*, vol. 37, no. 12, pp. 9451–9458, Jun. 2012.
- [14] SBC Energy Institute, “Leading the Energy Transition Factbook, Hydrogen-based energy conversion - More than storage: system flexibility.” 2014.
- [15] Laura Buffet, “How to make the Renewable Energy Directive (RED II) work for renewable electricity in transport.” TE (Transport & Environment), Jun-2017.
- [16] A. Le Duigou and A. Smatti, “On the comparison and the complementarity of batteries and fuel cells for electric driving,” *Int. J. Hydrog. Energy*, vol. 39, no. 31, pp. 17873–17883, Oct. 2014.
- [17] A. Le Duigou, Y. Guan, and Y. Amalric, “On the competitiveness of electric driving in France: Impact of driving patterns,” *Renew. Sustain. Energy Rev.*, vol. 37, pp. 348–359, Sep. 2014.
- [18] EnSys Energy with Navigistics Consulting, “Supplemental Marine Fuel Availability Study, MARPOL Annex VI Global Sulphur Cap, 2020 Supply-Demand Assessment, Final Report.” 2016.
- [19] ALSTOM, “Alstom’s hydrogen train Coradia iLint first successful run at 80 km/h,” 14-Mar-2017. [Online]. Available: <http://www.alstom.com/press-centre/2017/03/alstoms-hydrogen-train-coradia-ilint-first-successful-run-at-80-kmh/>.
- [20] A. De Vita et al., “Sectoral integration long-term perspective in the EU Energy System, Final report.” Feb-2018.

- [21] International Energy Agency (IEA), “Energy Technology Perspectives.” 2016.
- [22] Markus Wacket and Ilona Wissenbach, “Diesel cars can be banned from German cities, court rules,” *Reuters, Business News*, 27-Feb-2018.
- [23] Martin Robinius *et al.*, “Comparative Analysis of Infrastructures: Hydrogen Fueling and Electric Charging of Vehicles.” Forschungszentrums Jülich, 2018.
- [24] Hydrogen Council, “Hydrogen scaling up, A sustainable pathway for the global energy transition,” Nov. 2017.
- [25] Fabio Ferrari, “Deploying Hydrogen Vehicles,” presented at the FCH-JU meeting, Session “How did the FCH-JU Contribution impact the sector,” 23-Nov-2016.
- [26] Anna Creti, Alena Kotelnikova, Guy Meunier, and Jean-Pierre Ponsard, “A cost benefit analysis of fuel cell electric vehicles,” [Research Report] <hal-01116997>, 2015.
- [27] Michael Dolman, Saleem Butt, Ben Madden, and Element Energy, “Hydrogen transport strategy for London,” Jun-2014.
- [28] McKinsey, “Electric vehicles in Europe: gearing up for a new phase?” 2014.
- [29] “Committee of French Automobile Manufacturers. dashboard N°44 - 3rd Quarter 2015.” 2015.
- [30] *Code des douanes, Taxes diverses perçues par la douane, LOI n° 2013-1278 du 29 décembre 2013 de finances pour 2014.* .
- [31] Assemblée nationale, *Projet de loi de finances pour 2014.* .
- [32] Kyle Pomerleau, “How High are Other Nations’ Gas Taxes?,” *Tax Foundation*, 03-Mar-2015. [Online]. Available: <https://taxfoundation.org/how-high-are-other-nations-gas-taxes/>.
- [33] European Commission, “VAT rates applied in the Member States of the European Union, Situation at 1st January 2018.” 2018.
- [34] “Japan Sales Tax Rate - Consumption Tax,” *Trading Economics*, 2018. [Online]. Available: <https://tradingeconomics.com/japan/sales-tax-rate>.
- [35] KPMG, “China: Country VAT Essentials Guide 2017.” 2017.
- [36] U.S. Energy Information Administration (eia), “Gasoline and Diesel Fuel Update,” *PETROLEUM & OTHER LIQUIDS*, 2017. [Online]. Available: <https://www.eia.gov/petroleum/gasdiesel/>.
- [37] U.S. Department of Energy, “Fuel Taxes by Country,” *Alternative Fuel Data Center*, Sep-2016. [Online]. Available: <https://www.afdc.energy.gov/data/10327>.
- [38] European Commission Joint Research Centre (JRC) and CONCAWE, “Well-to-Wheels analysis of Future Automotives Fuels and Powertrains in the European Context,” 2014.
- [39] National Research Council of the National Academies, “Transitions to alternative vehicles and fuels.” 2013.
- [40] Paul Codani, Yannick Perez, and Marc Petit, “Electric Vehicles as a Mobile Storage Device. Wiley. Handbook of Clean Energy Systems, Energy Storage,” 2015.
- [41] Sonsoles Díaz, Uwe Tietge, and Peter Mock, “CO2 emissions from new passenger cars in the EU: Car manufacturers’ performance in 2015.” The International Council on Clean Transportation - ICCT, Jun-2016.
- [42] “Toyota Mirai,” *Automobile propre*, 2017. [Online]. Available: <http://www.automobile-propre.com/voitures/toyota-mirai/>.
- [43] ENEA Consulting, “The potential of Power to Gas: Technology review and economic potential assessment,” 2016.
- [44] E&E Consultant, Hespul, and Solagro, “Etude portant sur l’hydrogène et la méthanation comme procédé de valorisation de l’électricité excédentaire.” Sep-2014.

- [45] European Commission, Directorate-General Environment, “Assessing the case for EU legislation on the safety of pipelines and the possible impacts of such an initiative.” 2011.
- [46] World Bank, Ecofys, and Vivid Economics, “State and Trends of Carbon Pricing 2017.” World Bank, Nov-2017.
- [47] Global Carbon Project, “Global Methane Budget,” *Global Carbon ATLAS*, 2017. [Online]. Available: <http://www.globalcarbonatlas.org/en/CH4-emissions>.
- [48] Robert W. Howarth, “A bridge to nowhere: methane emissions and the greenhouse gas footprint of natural gas,” *Energy Sci. Eng.*, vol. 2, no. 2, pp. 47–60, 2014.
- [49] Uwe Remme, Energy Technology Policy Division, and International Energy Agency, “Hydrogen in the ETP supply-side analysis: Current status and ideas for model improvements,” 2017.
- [50] International Energy Agency - IEA, *Technology Roadmap : Hydrogen and Fuel Cells*. 2015.
- [51] S. M. Saba, M. Müller, M. Robinius, and D. Stolten, “The investment costs of electrolysis – A comparison of cost studies from the past 30 years,” *Int. J. Hydrog. Energy*, vol. 43, no. 3, pp. 1209–1223, 2018.
- [52] Joris Proost, “Task force ED: Electrolysers’ Data,” presented at the IEA Hydrogen Implementation Agreement Task38 meeting, Washington DC, 08-Jun-2017.
- [53] U.S. Energy Information Administration (eia), Office of Energy Analysis, and U.S. Department of Energy, “Annual Energy Outlook, with projections to 2050.” Feb-2018.
- [54] European Commission, “The European Union Leading in Renewables.” 2015.
- [55] Commission for Regulation of Electricity and Gas - CREG, “A European comparison of electricity and gas prices for large industrial consumers.” pwc, 29-Mar-2017.
- [56] “Global electricity prices by select countries in 2017 (in U.S. dollars per kilowatt hour),” *Statistica, The Statistics Portal*, 2018. [Online]. Available: <https://www.statista.com/statistics/263492/electricity-prices-in-selected-countries/>.
- [57] The Federation of Electric Power Companies of Japan, “Electricity Review Japan.” 2016.
- [58] Alessandra Sgobbi, Wouter Nijs, Rocco De Miglio, Alessandro Chiodi, Maurizio Gargiulo, and Christian Thiel, “How far away is hydrogen? Its role in the medium and long term decarbonisation of the European energy system,” 2016.
- [59] K.-Y. Show, Y. Yan, M. Ling, G. Ye, T. Li, and D.-J. Lee, “Hydrogen production from algal biomass – Advances, challenges and prospects,” *Bioresour. Technol.*, vol. 257, pp. 290–300, 2018.
- [60] P. Nikolaidis and A. Poullikkas, “A comparative overview of hydrogen production processes,” *Renew. Sustain. Energy Rev.*, vol. 67, pp. 597–611, 2017.
- [61] I. Dincer and C. Acar, “Review and evaluation of hydrogen production methods for better sustainability,” *Int. J. Hydrog. Energy*, vol. 40, no. 34, pp. 11094–11111, 2015.
- [62] FCHJU, “Development of Water Electrolysis in the European Union, Final Report.” 2014.
- [63] Simon Dietz, Alex Bowen, Baran Doda, Ajay Gambhir, and Rachel Warren, “The Economics of 1.5° C Climate Change,” *Annu. Rev. Environ. Resour.*, vol. 43, pp. 455–480, 2018.
- [64] “Japan’s hydrogen future may be fuelled by Australian renewables,” *ARENA WIRE*, 27-Jul-2018. [Online]. Available: <https://arena.gov.au/blog/hydrogen-future-australian-renewables/>.
- [65] Bruce S *et al.*, “National Hydrogen Roadmap, Pathways to an economically sustainable hydrogen industry in Australia.” CSIRO, 2018.
- [66] The International Council on Clean Transportation (ICCT), “Developing hydrogen fueling infrastructure for fuel cell vehicles: A status update.” ICCT, Oct-2017.
- [67] Hydrogen Council, “How hydrogen empowers the energy transition,” 2017.

- [68] “METI has strategic road map for hydrogen and fuel cells in Japan,” *Fuel Cells Bull.*, vol. 2014, no. 7, p. 9, 2014.
- [69] International Energy Agency, “Energy Policies of IEA Countries, Japan, 2016 Review.” OECD/IEA, 2016.
- [70] S.Bennoua, A. Le Duigou, M.-M.Quéméré, and S.Dautremont, “Role of Hydrogen in Resolving Electricity Grid issues,” *Int. J. Hydrog. Energy*, vol. 40, pp. 7231–7245, 2015.
- [71] Martin Kopp, “Potential of the daily optimization of the power purchase of PtG-plants – explained by the project ‘Energiepark Mainz,’” presented at the 22th World Hydrogen Energy Conference - WHEC, Rio De Janeiro, Brasil, 18-Jun-2018.
- [72] Joshua Eichman, Aaron Townsend, and Marc Melaina, “Economic Assessment of Hydrogen Technologies Participating in California Electricity Markets.” National Renewable Energy Laboratory (NREL), Feb-2016.
- [73] Tractebel and Hincio, “EARLY BUSINESS CASES FOR H2 IN ENERGY STORAGE AND MORE BROADLY POWER TO H2 APPLICATIONS.” Jun-2017.
- [74] European Commission, “Hyways, The European Hydrogen Roadmap.” 2008.
- [75] Artem Korzhenevych *et al.*, “Update of the Handbook on External Costs of Transport, Final Report.” RICARDO-AEA for European Commission – DG Mobility and Transport, 08-Jan-2014.
- [76] Roland Berger, “Fuel Cell Electric Buses – Potential for Sustainable Public Transport in Europe, A Study for the Fuel Cells and Hydrogen Joint Undertaking.” 2015.
- [77] Fuel Cells and Hydrogen Joint Undertaking - FCHJU, “Development of Business Cases for Fuel Cells and Hydrogen Applications for European Regions and Cities.” 2017.
- [78] International Energy Agency (IEA), “World Energy Outlook.” 2018.
- [79] O. Tlili *et al.*, “Role of electricity interconnections and impact of the geographical scale on the French potential of producing hydrogen via surplus electricity by 2035,” *Energy*, vol. 172, pp. 977–990, 2019.
- [80] Joanna Sampson, “South Korea unveils hydrogen economy plans,” *gasworld*, 17-Jan-2019. [Online]. Available: <https://www.gasworld.com/south-korea-unveils-hydrogen-economy-plans/2016332.article>.
- [81] Hong Dae-sun and Choi Ha-yan, “South Korean government announces roadmap for hydrogen economy,” *HANKYOREH*, Jan-2019. [Online]. Available: http://english.hani.co.kr/arti/english_edition/e_business/879097.html.
- [82] F. Dolci *et al.*, “Incentives and legal barriers for power-to-hydrogen pathways: An international snapshot,” *Int. J. Hydrog. Energy*, vol. 44, no. 23, pp. 11394–11401, May 2019.

CONCLUSION

Hydrogen can play a key role in lowering the carbon emissions of an energy system. It can be used as a chemical component as well as an energy carrier allowing to link different sectors as well as their simultaneous decarbonisation.

This part of the thesis quantifies the hydrogen potential from various standpoints. The hydrogen carbon mitigation potential is assessed with regards to the potential evolution of the different hydrogen markets in the years to come, considering the currently in place and the newly announced policies. Then, the penetration feasibility to these markets is analysed setting targets for the hydrogen costs and detailing different possible pathways to reach them.

The results show that basing the analysis on the economic attractiveness only may, in some cases, lead to under-estimate the market potential. For instance, the natural gas blending market have proved to be struggling to reach economic competitiveness regardless of the regional context. However, it presents a considerably high carbon mitigation potential compared to the mobility market, the latter showing more economic attractiveness.

The role of the industrial markets is non negligible especially in the short to mid-term. These markets are expected to continue representing a high share of the hydrogen demand. They hence can play a double climate and economic role allowing, if a switch from steam methane reforming to electrolysis (or any other low carbon hydrogen production option) occurs, the decarbonisation of a part of the industrial sector while creating the required economies of scale to reduce the low carbon hydrogen production costs.

Throughout the two chapters, a special focus is put on the role of policies in triggering the adequate deployment of hydrogen.

The results show that the latest announced energy policies are not sufficient to adequately trigger the hydrogen potential. Many bottlenecks are still hampering the hydrogen development.

First, the uncertainties regarding the governmental strategic positioning vis-à-vis the hydrogen deployment is source of a high risk perception. This is particularly keeping the industries from starting massive investments in hydrogen despite its potential. For instance, the uncertainty can be identified in the mobility market and it is one of the causes behind slowing the infrastructure investments. It is also visible in the natural gas blending segment, where there is a need to clearly setting a common standard defining the allowed concentration rate of hydrogen in the gas grid. A regulatory framework defining the modalities of a potential participation of the electrolyzers to the reserve markets (or flexibility provision in general) is also crucial.

Therefore, the hydrogen deployment, and accordingly its carbon mitigation role, are hampered by this uncertainty, but not only.

The hydrogen economy also needs improvements, and policy can help. As for any new technology trying to enter the market, the competitiveness with the historical technology options can be challenging calling for a need of governmental support.

HYDROGEN ROLE IN THE ENERGY SYSTEM A MULTIREGIONAL APPROACH

Several political incentives are discussed in the two chapters, including feed-in tariffs (as for the natural gas blending), subsidies (on fuel cell cars during the first market phases to help the end user overcome the high investment cost issue), remuneration of hydrogen flexibility, tax exemptions, etc.

The political and economic efforts that are considered in the two chapters are evaluated with the same level of priority, the hydrogen supply chain being considered as one entity. The next part of the thesis allows identifying which part of the hydrogen supply chain is most impacting the hydrogen penetration feasibility. This is carried out via a bottom-up energy system optimization model allowing a deeper investigation of the hydrogen technologies from the production up to the final use.

HYDROGEN ROLE IN THE ENERGY SYSTEM
A MULTIREGIONAL APPROACH

PART III

USING A BOTTOM-UP OPTIMIZATION MODEL FOR HYDROGEN MODELLING: THE CASE STUDY OF TIMES-PT⁵

Abstract

A case study of hydrogen integration into the energy system is conducted using the TIMES model for the Portuguese context. TIMES is a bottom-up optimization model generator. This type of models only lets the most cost-effective markets and technologies emerge in the results allowing to assess technological roadmap options, and more specifically here to test the role of hydrogen in a competitive environment. A sensitivity analysis is conducted in order to evaluate the weight of each part of the supply chain in the penetration feasibility of hydrogen into the energy system. The limits of the model are then confronted with a discussion on the relevance of the results with regards to the temporal and spatial resolution of the model.

Résumé

Une étude de cas traitant de l'intégration de l'hydrogène dans le système énergétique est réalisée à l'aide du modèle TIMES prenant en compte le contexte portugais. TIMES (acronyme de Système Intégré MARKAL-EFOM) est un générateur de modèle d'optimisation économique. Ce type de modèle ne permet qu'aux marchés et technologies les plus attractifs d'émerger dans les résultats, ce qui permet d'interroger des feuilles de route technologiques, et en particulier ici de confronter l'hydrogène à un environnement concurrentiel. Une analyse de sensibilité est effectuée afin d'évaluer le poids de chaque partie de la chaîne d'approvisionnement quant à la faisabilité de la pénétration de l'hydrogène dans le système énergétique. Les limites du modèle sont alors examinées, grâce à une discussion sur la pertinence des résultats par rapport à la résolution temporelle et spatiale du modèle.

⁵ This work is the result of a collaboration with the Center for Environmental and Sustainability Research (CENSE), NOVA School of Science and Technology, NOVA University Lisbon, Portugal.

ACRONYMS

ANCRE	French National Alliance for Energy Research Coordination
CCS	Carbon Capture and Storage
CHP	Combined Heat and Power
DIST	Distribution
ETSAP	Energy Technology Systems Analysis Programme
EU	End-Use
ETP	Energy Technology Perspectives
FC	Fuel Cell
GEN	Generation
GHG	Greenhouse Gas
HD	Heavy Duty
IEA	International Energy Agency
LD	Light Duty
MARKAL	MARKet ALlocation
PEM	Polymer electrolyte membrane
PT	Portugal
PV	Photovoltaic
RES	Renewable
SMR	Steam Methane Reforming
TIMES	The Integrated MARKAL-EFOM System
EFOM	Energy Flow Optimization Model

1. INTRODUCTION

After having described the hydrogen political and techno-economic challenges for each application separately, the aim of this chapter is to assess the integration of the different hydrogen technologies into a complete energy system and consider the potential interactions that can take place between markets allowing the creation of a link between sectors.

To do so, a global energy system optimization approach is searched for. The reason behind this choice is twofold. As discussed in Part I, the optimization models (and specifically the ones adopting a bottom-up approach) select the most attractive technologies throughout the whole supply chain from the production, to transport and up to the final users, which allows assessing the technology relevance depending on the energy context. Alongside, this makes it possible to develop and test technological roadmaps and to assess what are the required technological improvements to make technologies successfully enter the energy system in different economic environments. Moreover, these models provide insights on the relative attractiveness of the different applications for each considered technology compared with the other options in the overall energy system.

Accordingly, a case study of hydrogen integration into the energy system is conducted using the TIMES model for the Portuguese energy system (TIMES_PT).

TIMES is a technology optimization model generator that was developed in a collaborative effort under the auspices of the International Energy Agency “Energy Technology Systems Analysis Program” (ETSAP). The model is often used to estimate the dynamics of an energy system over a period of time varying between 20 to 100 years. It is based on a technology-rich approach and is usually applied for the analysis of the entire energy system but may also be used to study specific sectors. As inputs, the model requires historic data regarding the end-use energy demands, the stock of the energy-related equipment in all sectors, and the techno-economic characteristics of available future technologies. Using the input data, the model establishes the prospective supply and demand equilibrium at minimum global cost (more accurately for the minimum loss of total surplus). However, the scope of the model is not restricted to energy-specific issues. It can in fact be extended to tackle the environment emissions, the material challenges, etc. [1].

At the moment, the TIMES model framework is used in 70 countries by numerous institutions to model the energy system at different scales [2]. For instance, it is used to generate some of the scenarios reviewed in Part I of the thesis like the Energy Technology Perspectives ones.

For the purpose of this study, the Portuguese TIMES model (TIMES_PT) is used in order assess the hydrogen integration feasibility considering different carbon mitigation targets including the carbon neutrality objective to be reached by 2050.

The choice of such a scenario is policy-driven by the European as well as the national level. On 28 November 2018, the European Commission presented its strategic long-term vision regarding the evolution of the energy system and how Europe can lead the way to climate neutrality by 2050, while preserving competitiveness [3]. At the national level, in the COP22 taking place in Marrakesh, the Portuguese Prime Minister announced the Government’s intention to drive the Portuguese economy to a carbon neutral economy by 2050 [4].

In this context, and as seen in the previous chapters, hydrogen can play a role in decarbonizing the energy system, hence contributing to the achievement of the carbon neutrality goal. The aim of this chapter is to assess this potential, integrating hydrogen into a national energy system and confronting it with a set of competitors under contrasted carbon mitigation targets. Doing so, the relevance of such models to guide policies will be discussed.

The first section describes the hydrogen representation in the TIMES-PT model. Then, based on a set of designed scenarios for cost reductions and climate targets, a sensitivity analysis is conducted in order to estimate the cost thresholds allowing for hydrogen technologies to reach competitiveness, as well as the impact of climate targets on the hydrogen role.

2. Assessing the hydrogen systems contribution to decarbonize the Portuguese energy system

In this section, the hydrogen modelling assumptions in TIMES-PT are presented. The design of the scenarios that served as basis for the sensitivity analyses in the initial modelling framework is then detailed.

2.1. Hydrogen representation in the TIMES_PT model

Being based on a bottom-up approach, the model allows a detailed representation of the hydrogen technologies throughout the whole supply chain.

Figure 37 shows the modelling structure of hydrogen pathways in TIMES-PT.

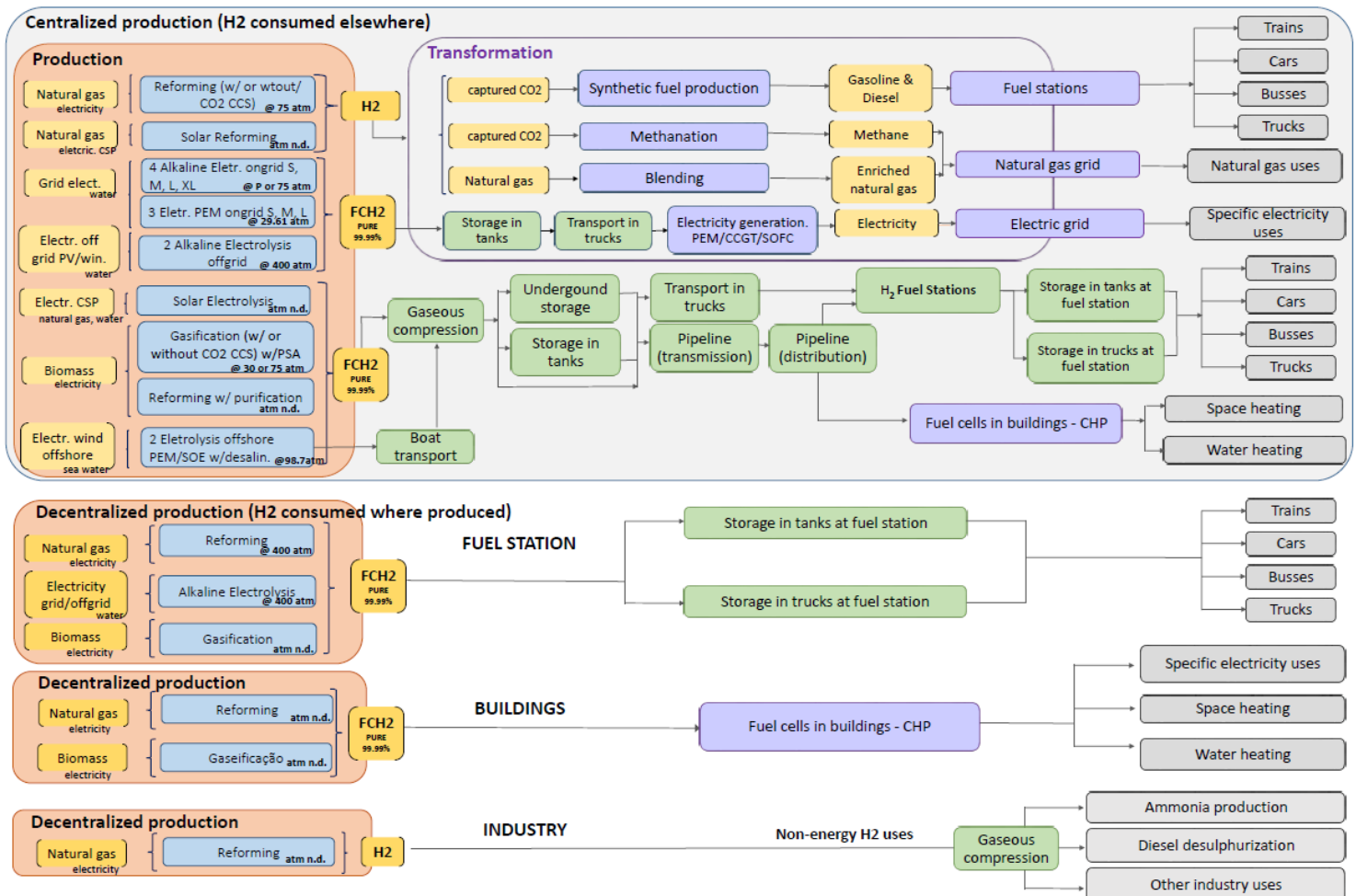

Figure 37: Hydrogen modelling structure in TIMES-PT

To simply represent the principle of the system design in TIMES in general and in TIMES_PT in particular, the technologies (called Processes in the model jargon) can be considered as “functions” with inputs and outputs (called Commodity-In and Commodity-Out) in the form of a flow of energy or materials. The naming of the inputs and outputs creates the link between the functions [1].

The model requires as input the definition of the different technologies in spreadsheet form, where the inputs and outputs are defined, and where the techno-economic assumptions (investment costs, variable costs, lifetime, efficiency, etc.) are detailed for the different periods considered up to the final timeframe. A 5-year step is considered for the typical period duration. The model contains one node representing Portugal as a whole. It does not include more refined regional/local data (although this is feasible in the TIMES modelling framework in general). The geographic and time resolution obviously impact the computing time and results [5].

Regarding the hydrogen representation, over 40 technologies are considered for the hydrogen production differing by: i/ the process type (SMR, oil partial oxidation, coal gasification, biomass gasification, PEM and alkaline electrolysis, etc.), considering or not CCS for the fossil fuel based ones, ii/ the input energy source (e.g. electricity from grid, PV, wind, etc.), iii/ the size of the plant (categorized into small, medium and large size), and iv/ the design of the hydrogen system (centralized vs. decentralized). In the decentralized option hydrogen is generated near to where it is consumed, whereas in the centralized option large scale hydrogen facilities are considered producing hydrogen that needs to be delivered over a large transport and distribution infrastructure to the end-users.

Other low carbon options can also be considered like photo-electrolysis and algal hydrogen generation, however these are less mature pathways and are not yet included in the model.

Overall, over 20 delivery pathways are implemented in the TIMES-PT model for both centralized and decentralized generation cases. Each pathway considers all of the processes that can take place between the production and the final use. The storage, the transmission, the distribution and the connecting steps (compression, liquefaction, etc., and the refuelling station in the case of the transport sector) are considered as one simplified process. In the centralized case, pipelines and trucks (liquid and gaseous form) are both taken into account. As for the storage, underground caverns, tanks and tube trailers are included (without spatial resolution considerations, since a generic cost is used not detailing assumptions on different distances and geographical features). In the decentralized case, the delivery pathway essentially consists of connecting steps (mainly compression since focus is put on the gaseous hydrogen in this case) and, in some cases, a local storage means (bulk, tank, or truck-trailer).

In the TIMES_PT model, blending hydrogen with natural gas is considered as a delivery pathway (up to a maximum blending of 20% in volume) that can source the different sectors (residential, commercial, agricultural, transport, industrial, electricity production and primary energy supply for the refinery process and for synthetic fuel production). Methanation is not included so far in the model.

Amongst the final applications, a more detailed representation of the hydrogen technologies is included for the transport sector. Hydrogen light and heavy-duty vehicles are implemented for both passenger and freight transport. Accordingly, hydrogen can fuel cars, busses, motorbikes and trucks. The hydrogen use in trains, aviation and shipping is not included so far in the model.

The use of hydrogen for electricity generation can be further refined. So far, only PEM fuel cells are implemented in the model. The use of hydrogen for heat generation is represented in the model via hydrogen burners and combined heat and power units (CHP).

Besides CHP, the use of hydrogen for industrial purposes is only restricted to refining sector. Portugal has no ammonia industry, although for the short term analysis, it might be interesting to model the switch from SMR to electrolyzers in the hydrogen-consuming industries.

Most of the hydrogen techno-economic assumptions considered in the model are based on the JRC TIMES input data available in A. Sgobbi et al. (2016) [6]. A data sample is presented in Table 25 and Table 26 in the ANNEX.

2.2. Sensitivity analysis and scenario design

A first run of the model is conducted, under which the hydrogen role in a potential future Portuguese energy system is investigated.

The base scenario assumes an increase of Portugal economic development linked to structural changes in production chains led by creativity and knowledge industries and services. “New production ecosystems emerge, based on small and medium-sized enterprises with a different configuration, more competent, competitive and collaborative. Portugal affirms itself internationally for its competitiveness attracting investment in the most innovative sectors. Population numbers recovers partially, mostly through the migratory balance. Medium-sized cities and the country-side increase its relevance in economy endorsing rural cohesion and competitiveness. Agriculture and forest move to intelligent explorations, with multifunctional and regenerative structures. Circularity of economy is obtained through the redesign of the productive processes leading to higher levels of efficiency” as in Fortes et al. (2019) [7].

The base scenario has been complemented with more scenarios considering different carbon caps and cost reductions on each step of the hydrogen supply chain. These variations of the base scenario are a sensitivity analysis allowing to investigate the impact of carbon mitigation caps and costs reductions on the hydrogen integration into the Portuguese energy system. .

Therefore, the impact of the increase of the hydrogen volumes on the total system CO₂ emissions is assessed. Then, reciprocally, different scenarios of CO₂ mitigation targets are examined in order to assess the consequences of more stringent carbon constraints on the hydrogen attractiveness, highlighting the carbon mitigation potential of hydrogen integration into the energy system. Thus, three scenarios are taken into account lowering the carbon emission by 75%, 85% and 95% by 2050 compared to 2005 emission levels.

Four cost reduction scenarios (lowering the hydrogen technologies investment costs) are elaborated separately for the hydrogen production and the distribution technologies (-30%, -50%, -70%, and -90% of investment costs). The final-use technologies are subjected to a more refined sensitivity due to their

higher impact on the results as will be detailed in the results section. Hence two additional cost reduction scenarios are considered -10% and -20%.

These contrasted scenarios aim at evaluating cost thresholds for hydrogen system to appear in the solution. In other terms, these thresholds can be understood as market entry costs or required improvements to reach competitiveness (target costs of a technological roadmap).

Separating the cost reduction scenarios for each part of the supply chain allows evaluating their respective impact on the hydrogen deployment feasibility and identifying which part of the hydrogen supply chain cost reductions should be prioritized.

The relevance of the considered cost reductions is then discussed based on expert view from members of the ANCRE French Alliance (French National Alliance for Energy Research Coordination) [8].

Beyond the analysis of the hydrogen systems, special focus is put on the competing technologies. The technology mix by energy sector (where hydrogen emerges) is thus analysed.

3. Sensitivity analysis results

The outputs of the sensitivity analysis regarding the economic improvements and the carbon emission caps that are required to trigger the hydrogen penetration in the different sectors are presented in what follows.

3.1. Impact of the cost reductions across the supply chain on the hydrogen penetration feasibility

A cost sensitivity analysis is conducted on the hydrogen technologies that are categorized, according to the part of the supply chain. The aim of such classification is to identify which part of the hydrogen chain, from the production up to the final use, is more critical when it comes to hydrogen penetration feasibility into the energy system.

Figure 38 shows the resulting hydrogen production volumes for the base case and for the considered cost reduction scenario for the timeframe of 2050. Results are shown for cost reductions in only hydrogen generation technologies (GEN) or in only distribution technologies (DIST) or only in end-use technologies (EU). The hydrogen production and end-use technologies emerging in the results are also indicated in the figure.

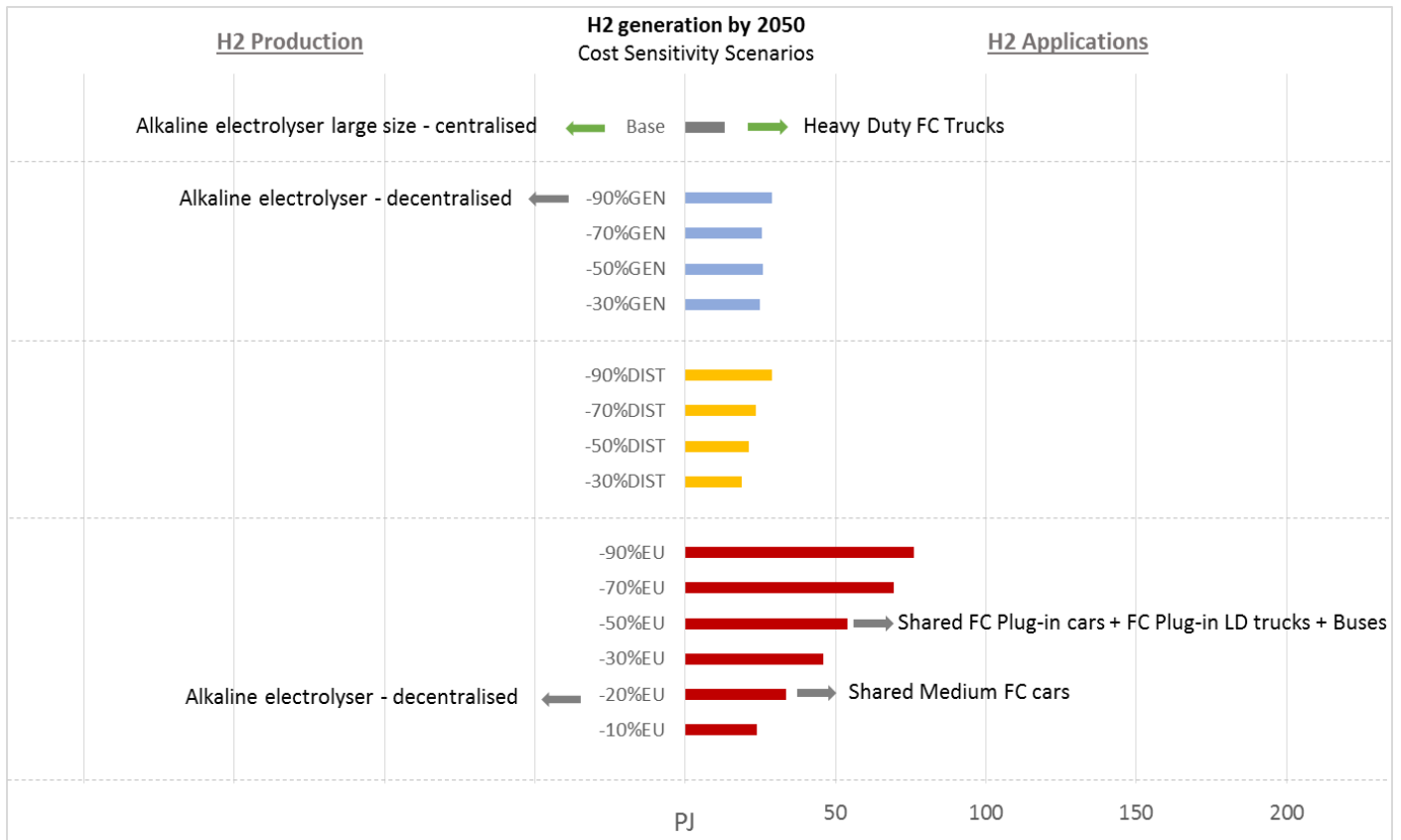

Figure 38: Resulting hydrogen production volumes by cost reduction scenario (2050) - (arrows indicate production and end use technologies emerging in the results besides the ones appearing in the base scenario)

(EU: end use, DIST: distribution, GEN: generation)

As shown in the figure, hydrogen production volumes appear in the base scenario, amounting to around 13 PJ (1.1 Mt_{H2}) which corresponds to around 3% of the final national energy demand by 2050. According to the results, large centralized electrolyser technologies are solicited for hydrogen generation, supplied with electricity from the grid. For the same base scenario in 2050, the electricity mix is as follows.

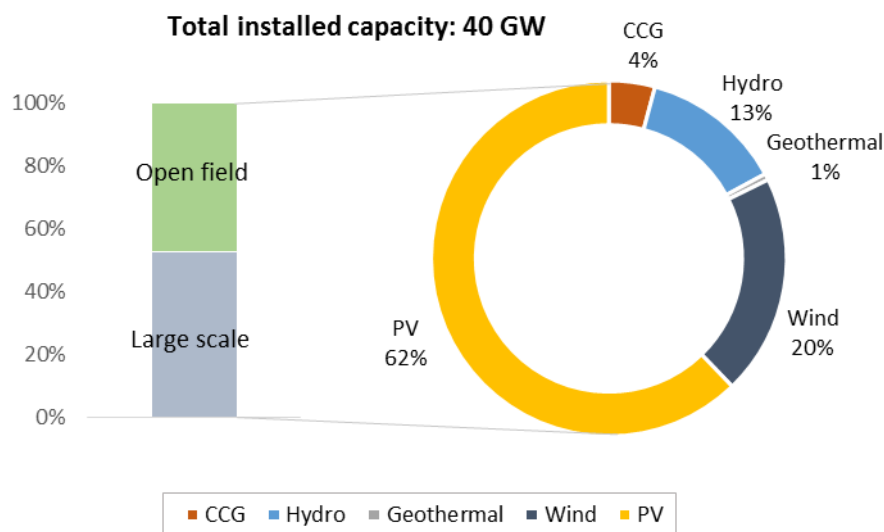

Figure 39: Resulting Electricity Mix by 2050

*CCG: combined cycle gas turbines

As shown in Figure 39 already in the Base scenario (without any stringent emission cap), 96% of the electricity capacity mix is renewable-based which allows providing a low carbon hydrogen generation. The latter contributes accordingly to the decarbonisation of the end-use sectors. The associated carbon mitigation potential will be discussed in section 3.2.

The hydrogen demand is coming only from the transport sector to fuel heavy duty trucks. It is no surprise that the first hydrogen market to prove economic relevance (apart from the industrial markets not considered in this study) is the long distance and heavy duty mobility where hydrogen is advantageous compared to electric mobility [9].

Although acknowledging that technology cost reductions as modelled are challenging, regardless of the considered technology (to be discussed hereafter), the impact of cost reductions on the hydrogen penetration is assessed and the effect of cost reductions in the different components (generation, distribution and end-use) show that it is the end-use technology competitiveness that impacts the most the hydrogen penetration feasibility. As shown in Figure 38, when comparing the same cost reduction ratio on different parts of the supply chain, we can observe that acting on the end-use can lead to three times more hydrogen in the results compared to the production and distribution cost reduction scenarios (up to 76 PJ in the most favourable scenario). Besides, new applications (apart from the heavy-duty trucks) are emerging only when end-use technology costs are decreased. Acting on the production costs or the distribution ones does not help to penetrate additional markets, beside heavy-duty truck mobility. The results show that, starting from a 20% cost reduction of end-use technologies, hydrogen enters the light duty mobility market, but only for shared medium cars (car-pooling). This is related to the intensive use of such vehicles, hence the need for high range. Then, starting from a 50% end-use cost reduction, additional markets open to hydrogen: fuel cell buses, as well as the hydrogen range-extender option penetrating the shared car and the light duty truck markets.

An analysis of the competing technologies is presented hereafter. Figure 40 shows the evolution of the transport mix focusing on the technologies presenting a hydrogen share in the solution (trucks, buses and cars). Since the end-use costs only have an impact on the emergence of new hydrogen applications compared to the base scenario, only a selection of end-use scenarios are presented in the figure.

USING A BOTTOM-UP OPTIMIZATION MODEL
THE CASE STUDY OF TIMES-PT

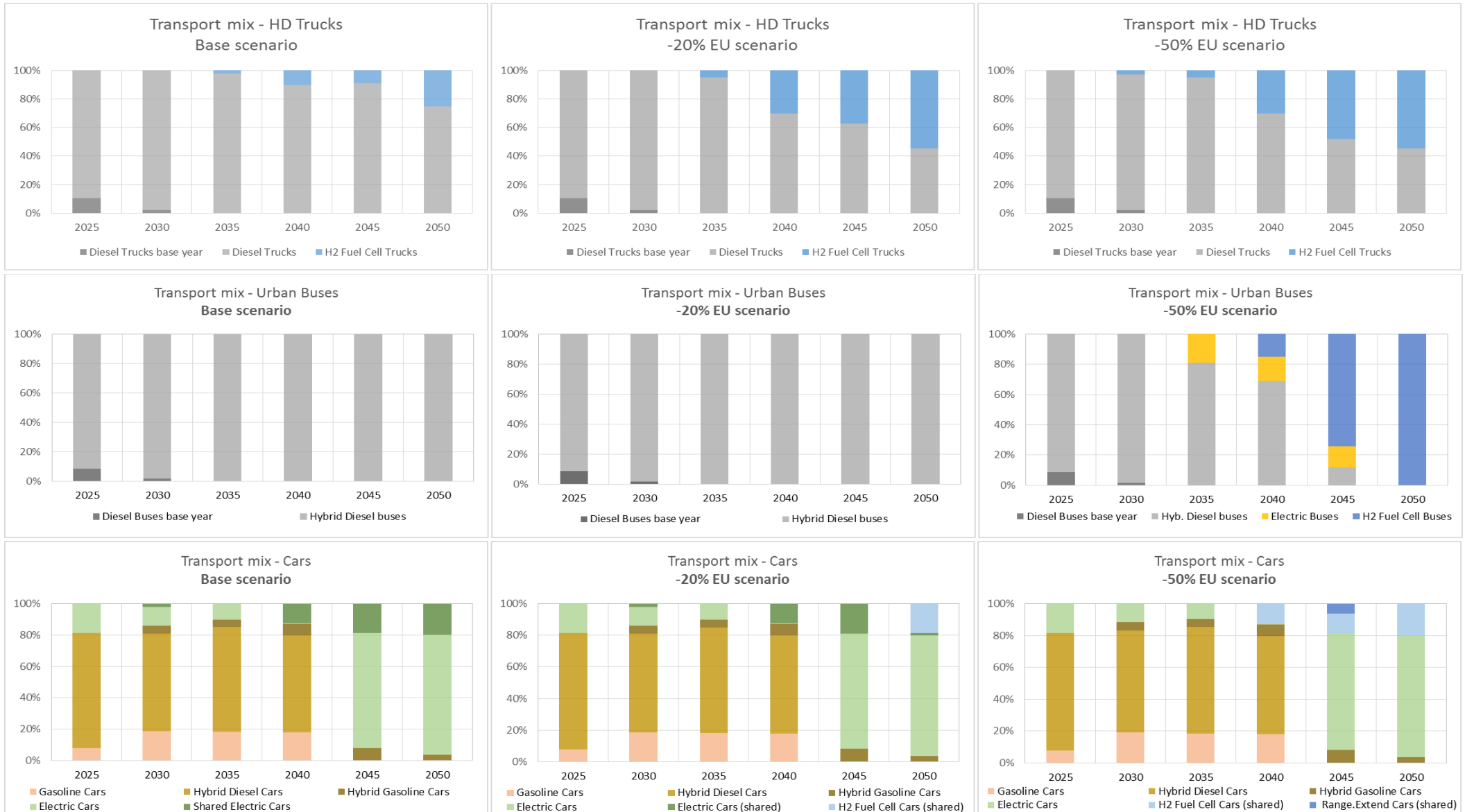

Figure 40: Transport mix – Trucks, Cars and Buses

As explained, in the base case, hydrogen is used in the transport sector. The first technologies entering the mobility market are the heavy-duty trucks. Hydrogen presents a share of supplied mobility (tonnes.kilometer) of 2% in the base scenario in 2035, and up to 25% in 2050. The main competitor in this market segment is the diesel truck. As shown in the figure, the battery electric mobility is not emerging in the solution for the truck segment, the latter requiring large ranges. Lowering the end-use costs results in an increased share of the hydrogen mobility, up to 95% for a 90% cost decrease, of 83% for -70% cost, and 55% for -30% cost.

Hydrogen buses emerge in the mix starting from a 50% end-use cost reduction. They appear by 2040 and compete with the battery electric buses. Indeed, a 50% cost reduction allows hydrogen to reach same investment costs compared to the electric battery buses by 2040. The two low carbon buses do have lower cost than the hybrid diesel ones. However, the latter are more efficient. The model hence makes a trade-off between cost and efficiency (as it is considering cost-effectiveness in the solution). Applying the same cost reduction factor on the hydrogen bus investment cost in 2045 and 2050 allows widening the cost gap compared to the electric and diesel buses, which in turn leads to higher shares of FC buses in these years. In other words, the cost factor becomes preponderant compared to the efficiency one.

As displayed in Figure 40, hydrogen faces more competitors in the car transport segment (gasoline vehicles, hybrid vehicles, electric vehicles). In the latter, hydrogen emerges via the shared mobility market (shared vehicles) starting from a 20% vehicle investment cost reduction. In this case, hydrogen deployment appears by 2050. Range extender cars also contribute to the solution, should a 50% end-use cost reduction be achieved. However, they are replaced by hydrogen shared fuel cell vehicles by 2050.

Unrealistic switches are noticed in the car segment results. For instance, the transition between 2040 and 2045 is abrupt: gasoline and hybrid diesel cars (representing together around 80% of the car fleet) are completely replaced by battery electric ones in only five years.

This can be explained by the fact that the TIMES model is based on cost optimisation which results in choosing the most economical solution even if the result is not realistic. Hence, once the electric mobility cost reaches a lower value than the hybrid one, the model switches from one technology to the other. This is also a common behaviour of linear programming algorithms (basis of the TIMES model) reaching “corner points” as solutions which can lead to extreme results. Facing this limit, two options have been suggested in the literature by members of the TIMES modelling community. The first solution is to implement constraints setting minimal or maximal vehicle shares in the model in order to ensure a smoother transition between the time periods (as tackled in P. Dodds (2014) et al. [10]). The second solution suggested in the literature considers including an aging factor that allows a more realistic representation of the vehicle lifetime avoiding an abrupt phase out at the end of the latter. To do so, a new attribute can be integrated in TIMES as detailed by J. Tattini and M. Gargiulo (2018) in [11]. Coupling TIMES with a transport specific model that allows a more realistic representation of the vehicle investments and/or the consumer behaviour can also be considered (see [11]–[14]).

Diminishing the hydrogen distribution costs does not impact the hydrogen production mix, or the attainable markets. The volumes may be increased though, representing a higher market share of heavy-duty fuel cell trucks on this segment.

As regards the hydrogen production, large centralised electrolyzers ensure most of the hydrogen generation in the base case. The decentralized option emerges starting from a 20% end-use cost reduction. This can be seen as a threshold of hydrogen demand starting from which the decentralized

option becomes cost-effective, despite its higher production cost. Decentralised hydrogen production by electrolysis also contributes to the solution if a 90% reduction of the generation costs is achieved. In such a case it represents 11% of the hydrogen generation compared to 89% for centralised electrolysis. Not decreasing the end-use or distribution technology costs, 90% reduction of the generation costs is the stage from which hydrogen volumes rise. This is not linked to the emergence of new end-uses though. In the 90% generation cost reduction scenario, the hydrogen demand is still driven by the heavy-duty trucks. This demand level is enough from the base case to make the centralised option attractive, despite the delivery cost that needs to be added. When the generation costs are drastically decreased (down to -90%), the decentralised production becomes competitive comparing to the centralised option (to which the unchanged delivery costs need to be added).

Inspecting the delivery costs using a high spatial resolution model for an earlier market phase will be investigated in Part IV, Chapter III of the thesis.

Apart from the technology cost-effective choices and market attractiveness, the cost scenarios can also impact the timeframe of hydrogen emergence in the energy system. Figure 41 shows the time evolution of the hydrogen demand by scenario.

In the base scenario, the hydrogen deployment starts in 2030. Only the end-use cost reduction scenarios lead to an earlier emergence of hydrogen in the system supporting the findings discussed above. Indeed, as shown in Figure 41, hydrogen deployment can start by 2025 if end-use costs are reduced by 50% and even earlier for further cost reductions (but such cost reductions in the very short term are unlikely).

Regarding the cost reduction on hydrogen generation, it can be seen that between -30% and -70%, the total hydrogen amount in the 2050 energy system is unchanged, but the higher the reduction, the sooner the increase of the volume. Among the modelled scenarios, the distribution cost reductions below -90% do not impact the dynamics, only the hydrogen amounts.

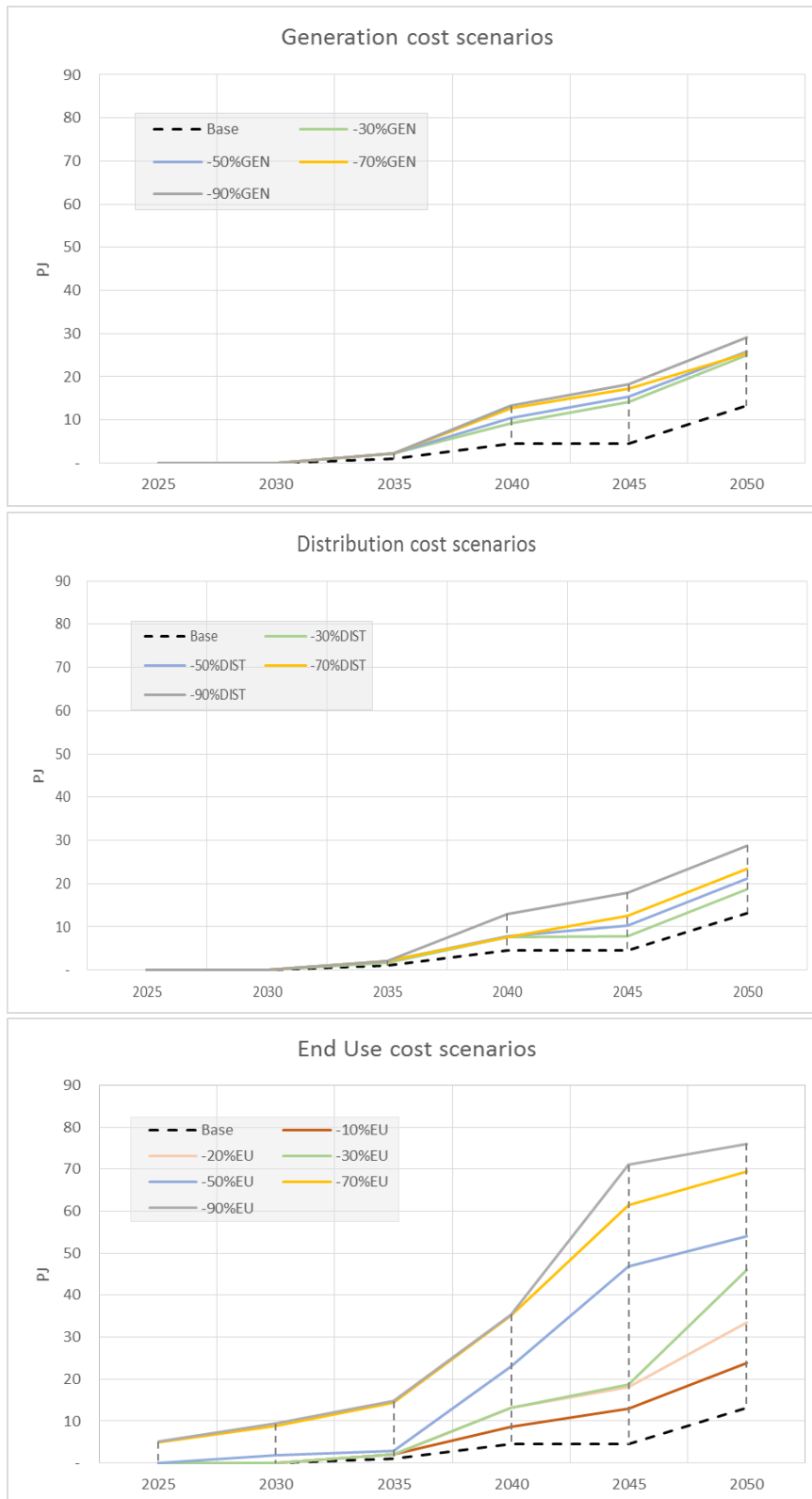

Figure 41: Time dynamics of hydrogen demand by scenario

The feasibility and relevance of the cost reductions on which the scenarios were based are to be discussed. Indeed, achieving a given reduction percentage may not be as easy whatever the technology is.

A study was recently carried out for the French Parliament by an expert consortium, in the framework of the French plan to phase out of the internal combustion engines (in car transportation) by 2040. [8]. This study reports insights on the potential cost evolutions of hydrogen technologies, namely regarding end-use.

As to these costs, and specifically the car investment cost, experts claim that the reduction cost potential goes down from 50k€ nowadays to approximately 20k€ by 2040 in the most optimistic scenario. Similar values are set in the TIMES_PT model for the base scenario as seen in Figure 44. Thus, the 20 to 30% cost decrease by 2050 seems feasible however, considering further cost reductions by 2050 (as designed via the end-use cost scenarios in this study) seem unlikely, but may occur sooner depending on the energy policy framework.

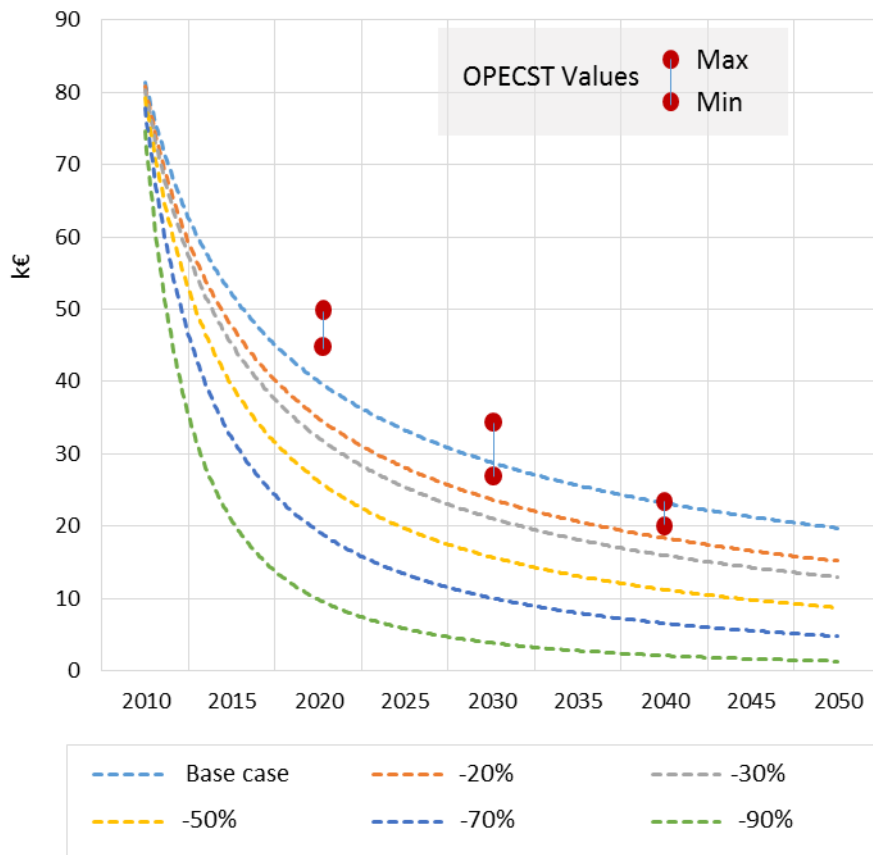

Figure 42: Comparison of the scenario values to the OPECST assumptions

Overall, investigating cost reduction scenario is of course not a means to predict the future, but a way to identify cost thresholds for the emergence of hydrogen. Such thresholds may be relevant to design technology roadmaps and propose insights as to the privileged targets for subsidies or other support schemes.

3.2. Hydrogen and the CO₂ emission reduction

The carbon mitigation potential of higher hydrogen integration levels is assessed in this section. The analysis is complemented by a reciprocal investigation tackling the impact of the carbon emission reduction targets on the hydrogen penetration feasibility. To do so, three decarbonisation scenarios are inspected. The latter aim at reducing the total GHG emissions in 2050 by 75%, 85% and 95% compared to 2005 levels (knowing that the base scenario leads to a 55% emission reduction compared to today's levels).

Lowering the hydrogen technology costs throughout the supply chain results in higher hydrogen volumes (with different weights depending on the supply chain step as discussed in the previous section). Figure 43 shows the consequences of the resulting increase of hydrogen use on the CO₂ emissions of the total energy system compared to the base case.

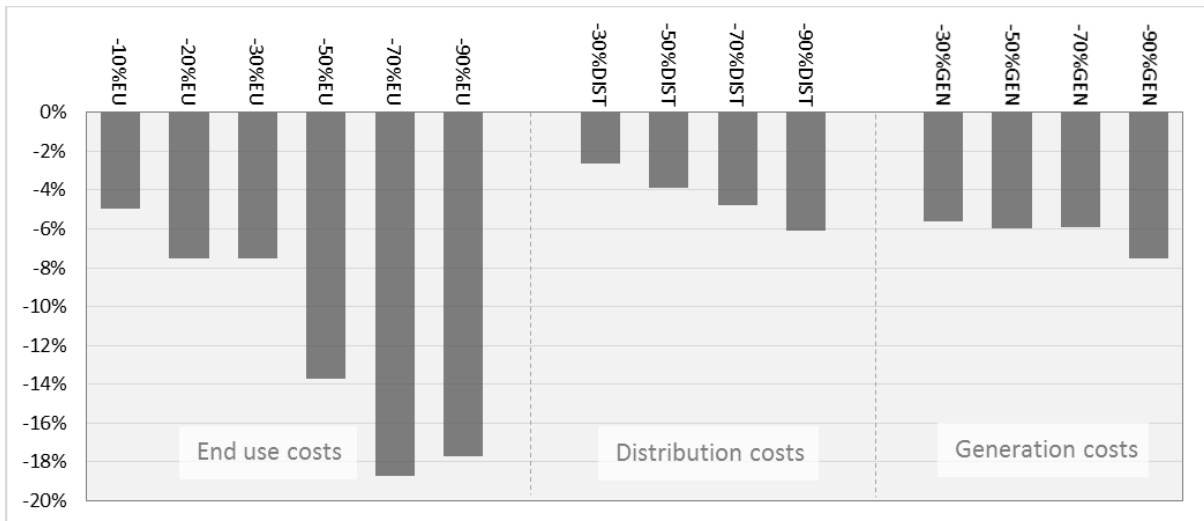

Figure 43: CO₂ emission variation compared to the base scenario (2050)

Hydrogen contributes to decarbonize the energy system, under the base cost assumptions only by entering the heavy-duty mobility market. As seen in the figure, the higher the hydrogen cost reductions, the lower the CO₂ emissions. This means that the rising use of hydrogen in the energy system results in lowering the energy system carbon emissions and more specifically the transport related ones (representing 35% of the nowadays Portuguese carbon emissions [15]). In accordance with the results discussed in section 2.2.1, the highest impact is reached when taking into account the end-use cost reductions, the latter leading to the highest hydrogen volumes and to the emergence of new hydrogen technologies (cars and buses for instance). The carbon emissions can be reduced by up to approximately 19% compared to the base scenario, when considering a 70% end use reduction. The emission reductions are mainly related in this case to a higher substitution rate of diesel trucks by FC ones and to the replacement of hybrid diesel buses by a full hydrogen fleet. The passenger car segment contributes to the carbon mitigation through the emergence of the shared vehicle usage where hydrogen plays a role but remains limited compared to the heavy-duty segment.

The generation and distribution cost reductions (representing lower impact on the hydrogen market volumes) lead to a maximum of 8% of CO₂ emission decrease compared to the base case. These

relatively small CO₂ emission reductions due to increased hydrogen deployment are partly because electricity generation in Portugal, even in a base case without any overall CO₂ mitigation cap, is already mostly renewable by 2050. Thus, in a base case, there is already a large deployment of electric passenger cars and a substantial greenhouse gas emission reduction. The added deployment of hydrogen trucks and busses lowers emissions but most of the responsible for emissions (power sector and passenger cars) are already decarbonized in 2050.

The consequences of setting stringent CO₂ emission reduction caps on the hydrogen market penetration feasibility is assessed in this section. Three carbon mitigation scenarios are assessed. The resulting hydrogen volumes are presented in Figure 44.

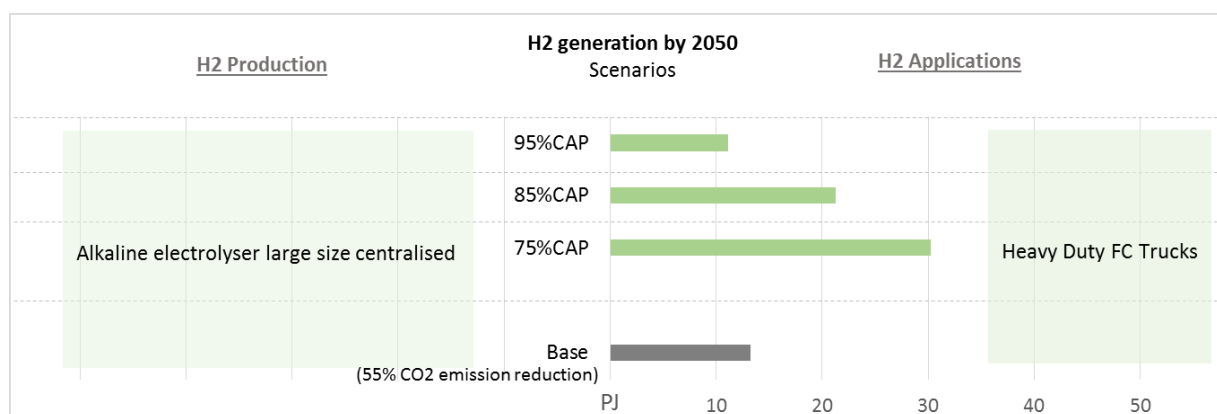

Figure 44: Hydrogen volumes by GHG emission reduction scenario

As discussed in the previous section, hydrogen is already part of the energy system in the base case where it contributes to decarbonize the heavy-duty mobility sector via fuel cell trucks. In the base scenario, the carbon emissions are reduced by around 55% compared to 2005 levels. As shown in Figure 41, setting a carbon cap to 75% emission reduction compared to 2005 levels results in a higher hydrogen use in the energy system. The results show that no new hydrogen technology is emerging in the solution and thus the heavy-duty truck segment keeps driving the hydrogen demand.

However, for higher CO₂ caps, as shown in the figure, the more stringent the scenario cap is, the lower hydrogen volumes are obtained in the solution. Indeed, when aiming at drastic GHG reductions, competition between low-carbon technologies is high. In this case more stringent constraints have led to the rise of the renewable shares. Exploiting the maximum potential of onshore wind and PV, the model starts investing in more expensive options like floating offshore wind. Furthermore, with the rising share of renewables and the stringent CO₂ caps (hindering the fossil fuelled backup power plants), costly flexibility options (large batteries) are integrated into the system resulting in an increase in the electricity costs, which in turn, impacts the economics of hydrogen production. Accordingly, the stringer the environmental constraint is, the more expensive the hydrogen, hence creating competitiveness issues when comparing with more efficient electric technologies. Figure 45 shows the evolution of the transport technology mix in the truck segment when going from the 75% carbon mitigation target to the 95% case study.

USING A BOTTOM-UP OPTIMIZATION MODEL
THE CASE STUDY OF TIMES-PT

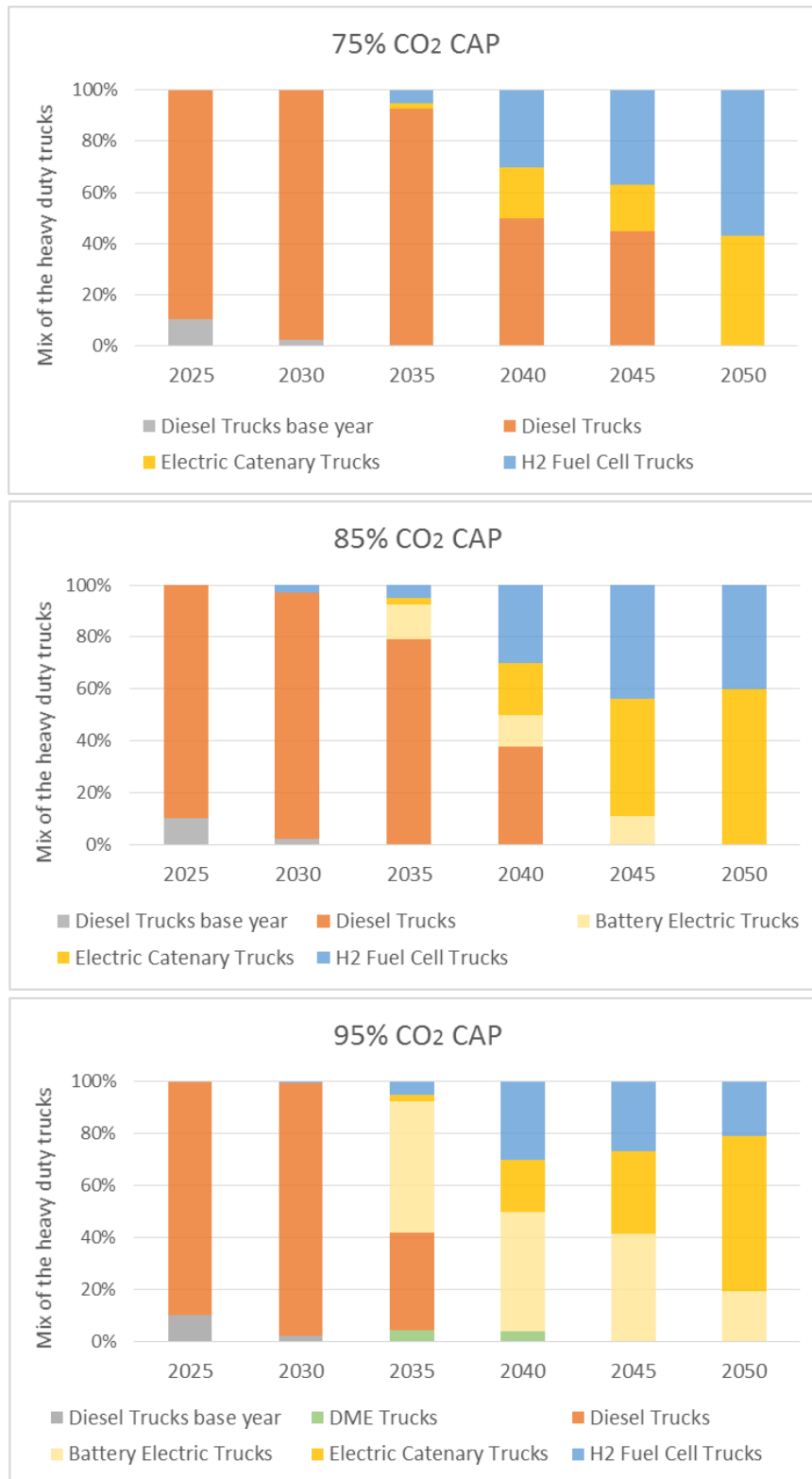

Figure 45: The transport technology mix considering the heavy-duty truck segment

Setting carbon mitigation targets leads to the emergence of catenary electric trucks in the transport mix replacing the diesel trucks. Their share increases from 2035 to 2050 reaching up to 60% of the delivered heavy freight tonnes.kilometers in the truck mix by 2050. The catenary systems can be deployed on

various highway segments, since they allow for greater range and significantly smaller batteries compared to battery full electric buses. They hence emerge first in the solution. According to a study led by the ICCT [16], this technology, whether combined with an internal combustion engine or a limited battery system, results in lower vehicle prices compared to full electric trucks, but the primary obstacle is the construction of a catenary system, as these trucks cover large distances and would need extensive charging (overhead catenary wires, or in-road inductive or conductive charging).

The full electric trucks start gaining relevance in the solution in the 85% cap scenario. The more stringent the cap is, the higher share of full electric trucks in the transport mix, gradually replacing the fuel cell technology. The latter, although allowing greater ranges, is less energy efficient compared to full electric technology. Thus, the operational costs can be behind the switch between the technologies.

A more refined analysis of the infrastructure cost for the different options is required in order to accurately represent the competitiveness of each technology choice. To do so, spatial resolution of the model is key factor in defining the infrastructure deployment cost. Coupling TIMES with a spatially refined model for infrastructure analysis can thus be an option.

4. CONCLUSION

The objective of this part is twofold: first, suggest how energy system modelling can enlighten the potential role of hydrogen systems into decarbonizing the energy system, and in doing so, provide insights for technology roadmap development and energy policy guidance; and secondly, discuss the sensitivity of the modelling framework, which is especially critical for hydrogen to reveal its multi-sectorial decarbonisation potential.

The TIMES_PT model allowed identifying the sensitivity of the cost reduction of the different parts of the hydrogen supply chain (from the production to the end-use) on the hydrogen deployment feasibility. It also enabled the examination of the most attractive hydrogen technologies and their economics in a competitive environment, suggesting cost thresholds for their emergence in a global national energy system.

The results highlight the impact of the end-use cost of hydrogen, the competitiveness being relative to the economic performance of technological alternatives already prevailing or newly integrating the market. This can inform on how to orientate the efforts (governmental and industrial) in order to ease the hydrogen penetration.

Regarding the applications, it is the heavy-duty mobility and more specifically the heavy-duty truck segment that shows the highest likelihood for hydrogen penetration, in the Portuguese energy system under the adopted modelling framework. In this segment, hydrogen presents the advantage of the vehicle range which makes it more attractive than its low carbon competitors (for instance, the battery electric mobility). More optimistic cost reduction scenarios result in hydrogen entering additional markets, but still in mobility applications (fuel cell buses and the shared cars). A 50% and a 20% reduction compared to the costs assumed in the base scenario are required to access the bus and car market segments, respectively. Such reductions are very optimistic, and even somewhat unrealistic (according to the current expertise [8]). However, these scenarios allow informing on the required financial support schemes to ease the hydrogen market penetration to these segments.

An additional value stream could be withdrawn from the provision of services to the electric system, thus improving the hydrogen systems economics (although this market is competitive too). This can be achieved thanks to hydrogen production flexibility via electrolysis. To fully address this issue, several aspects need to be covered, beyond the electrolyser connection to the power source. One critical factor is the time resolution of the models. In the current modelling framework, the time resolution is represented by twelve time slices corresponding to day, night and peak hours, specific to each season [1]. Although several teams succeeded in improving the TIMES temporal resolution [17]–[19], the hourly representation of the year remains challenging, namely because of computer requirements, which makes the model not perfectly suited for the electricity system studies (renewable variability, storage aspects, etc.). Linking with dispatch models could be a solution to further investigate [20].

Apart from the temporal resolution of the model, the spatial one is limiting especially when addressing the infrastructure issues. According to the sensitivity analysis, the delivery costs do not have a major impact on the final results in terms of hydrogen market penetration. This provides some insights on the weight of this part of the supply chain on the total hydrogen cost. However, this impact is probably not enough accurately taken into account, to assess the relevance of diverse infrastructures that need to be built from scratch, namely, to supply hydrogen refuelling stations. .

USING A BOTTOM-UP OPTIMIZATION MODEL THE CASE STUDY OF TIMES-PT

Overall, the assets and limits of each kind of model need to be acknowledged. Cost optimization models such as TIMES appear useful to grasp the hydrogen decarbonisation potential with a systemic view, even if modelling advances are still needed to let hydrogen reveal its full multi-sectorial potential in such modelling frameworks. This is on the IEA research agenda. In what follows, the hydrogen interaction with the electricity system considering high renewable shares is addressed with focus on the flexibility potential of the electrolysis systems using temporally and spatially resolved models. Then, focus is done on the mobility market with another highly resolved modelling framework allowing to investigate infrastructure issues.

REFERENCES

- [1] Richard Loulou, Uwe Remme, Amit Kanudia, Antti Lehtila, and Gary Goldstein, “Documentation for the TIMES Model, Part I.” Energy Technology Systems Analysis Programme (ETSAP), Jul-2016.
- [2] D. Connolly, H. Lund, B. V. Mathiesen, and M. Leahy, “A review of computer tools for analysing the integration of renewable energy into various energy systems,” *Appl. Energy*, vol. 87, no. 4, pp. 1059–1082, Apr. 2010.
- [3] European Commission, “2050 long-term strategy,” *European Commission, Climate Strategies & Targets*. [Online]. Available: https://ec.europa.eu/clima/policies/strategies/2050_en. [Accessed: 29-May-2019].
- [4] J. Seixas, P. Fortes, J.P. Gouveia, and S. G. Simoes, “The Role of Electricity for the Decarbonization of the Portuguese Economy, Technical Report I - Energy Modelling.” Faculdade De Ciências E Tecnologia, Universidade NOVA De Lisboa, CENSE (center for environmental and sustainability research), 30-Jun-2017.
- [5] S. Simoes, M. Zeyringer, D. Mayr, T. Huld, W. Nijs, and J. Schmidt, “Impact of different levels of geographical disaggregation of wind and PV electricity generation in large energy system models: A case study for Austria,” *Renew. Energy*, vol. 105, pp. 183–198, May 2017.
- [6] Alessandra Sgobbi, Wouter Nijs, Rocco De Miglio, Alessandro Chiodi, Maurizio Gargiulo, and Christian Thiel, “How far away is hydrogen? Its role in the medium and long term decarbonisation of the European energy system,” 2016.
- [7] Patrícia Fortes, Júlia Seixas, Luís Dias, Rita Lopes, and João Pedro Gouveia, “The mix & match between stakeholders and energy system modelling towards a carbon neutral economy, Conference paper, IEW2019.” ACENSE, NOVA School for Science and Technology, NOVA University Lisbon, Portugal, 2019.
- [8] CEA and IFP Energies Nouvelles, “Scénarios technologiques de la mobilité en France et conditions de réalisation pour atteindre l’objectif d’arrêt des ventes de véhicules particuliers thermiques en 2040, Etude pour l’OPECST.” 2019.
- [9] Hydrogen Council, “Hydrogen scaling up, A sustainable pathway for the global energy transition,” Nov. 2017.
- [10] P. E. Dodds and W. McDowall, “Methodologies for representing the road transport sector in energy system models,” *Int. J. Hydrog. Energy*, vol. 39, no. 5, pp. 2345–2358, Feb. 2014.
- [11] J. Tattini and M. Gargiulo, “Integrating realistic technology’s retirement profile in TIMES models - The case of the Danish car sector.” DTU, 2018.
- [12] J. Tattini *et al.*, “Improving the representation of modal choice into bottom-up optimization energy system models – The MoCho-TIMES model,” *Appl. Energy*, vol. 212, pp. 265–282, Feb. 2018.
- [13] K. Ramea, D. S. Bunch, C. Yang, S. Yeh, and J. M. Ogden, “Integration of behavioral effects from vehicle choice models into long-term energy systems optimization models,” *Energy Econ.*, vol. 74, pp. 663–676, Aug. 2018.
- [14] D. L. McCollum *et al.*, “Improving the behavioral realism of global integrated assessment models: An application to consumers’ vehicle choices,” *Transp. Res. Part Transp. Environ.*, vol. 55, pp. 322–342, Aug. 2017.
- [15] “Portuguese energy consumption and CO2 emissions at a glance,” *Global CCS Institute*. [Online]. Available: <https://hub.globalccsinstitute.com/publications/co2-capture-and-storage-portugal-bridge-low-carbon-economy/1-portuguese-energy-consumption-and-co2-emissions-glance>. [Accessed: 06-Sep-2019].

- [16] Marissa Moulak, Nic Lutsey, and Dale Hall, "Transitioning to Zero-Emission Heavy-Duty Freight Vehicles." ICCT, Sep-2017.
- [17] R. Kannan and H. Turton, "A Long-Term Electricity Dispatch Model with the TIMES Framework," *Environ. Model. Assess.*, vol. 18, no. 3, pp. 325–343, Jun. 2013.
- [18] Audun Fidje, Eva Rosenberg, and Karen Byskov Lindberg, "Regional TIMES model for Norway with high time resolution, Extended Abstract, IEW2009." Institute for Energy Technology (IFE), Kjeller, Norway, The Norwegian Water Resources and Energy Directorate (NVE), Oslo, Norway.
- [19] André Pina, Carlos Silva, and Paulo Ferrão, "High-resolution modeling framework for planning electricity systems with high penetration of renewables, Conference Paper, IEW2012." Center for Innovation, Technology and Policy Research, Technical University of Lisbon, Portugal - MIT-Portugal Program, 2012.
- [20] K. Kanellopoulos and H. Blanco Reano, "The potential role of H₂ production in a sustainable future power system, An analysis with METIS of a decarbonised system powered by renewables in 2050, JRC Technical Reports." Joint Research Centre (JRC), the European Commission, 2019.

USING A BOTTOM-UP OPTIMIZATION MODEL
THE CASE STUDY OF TIMES-PT

ANNEX

Table 25: Hydrogen production - Technology definition table

*TechDesc	Input	Input~2020	Input~2025	Input~2030	Output	Av. Fact	INV COST	INV COST~2020	INV COST~2025	INV COST~2030	FIXO M	FIX OM~2020	FIX OM~2025	FIX OM~2030	FIX OM~2050	VAR OM	VAR OM~2020	VAR OM~2025	VAR OM~2030	LIFE
<i>Technology Description</i>							€/kW	€/kW	€/kW	€/kW	€/kW	€/kW	€/kW	€/kW	€/kW	€/GJ	€/GJ	€/GJ	€/GJ	Years
H2 Production-Coal Gasification, large size, centralized	1.77	1.77	1.77	1.62		90%	462.5	462.5	462.5	350.9	27.5	27.5	27.5	22.4		0.16		0.16	0.12	20
	0.07	0.07	0.07	0.02																
					1															
H2 Production-Coal Gasification, medium size, centralized	1.75	1.75				80%	573.4	573.4			14.3	14.3				0.22				20
					1															
					0.08															
H2 Production-Coal Gasification + Carbon Capture, big size, centralized	1.77	1.77	1.77	1.62		90%	571.0	520.4	520.4	363.5	41.0	41.0	41.0	22.7		0.20		0.20	0.13	20
	0.111	0.111	0.111	0.023																
					1															
H2 Production-Coal Gasification + Carbon Capture, medium size, centralized	1.72	1.72				80%	660.8	660.8			27.5	27.5				0.26				20
					1															
					0.08															
H2 Production-Biomass Gasification, small size, TRA tank decentralized	3	3				71%	4101.1	3099.1			81.9	81.9				1.83				20
	0.2	0.2																		
					1															
H2 Production-Biomass Gasification, small size, TRA truck decentralized	3	3				71%	4101.1	3099.1			81.9	81.9				1.83				20
	0.2	0.2																		
					1.00															
H2 Production-Biomass Gasification, small size, COM decentralized	3	3				71%	4101.1	3099.1			81.9	81.9				1.83				20
	0.2	0.2																		
					1															
H2 Production-Biomass Gasification, small size, RSD decentralized	3	3				71%	4101.1	3099.1			81.9	81.9				1.83				20

USING A BOTTOM-UP OPTIMIZATION MODEL
THE CASE STUDY OF TIMES-PT

*TechDesc	Input	Input~2020	Input~2025	Input~2030	Output	Av. Fact	INV COST	INV COST~2020	INV COST~2025	INV COST~2030	FIXO M	FIX OM~2020	FIX OM~2025	FIX OM~2030	FIX OM~2050	VAR OM	VAR OM~2020	VAR OM~2025	VAR OM~2030	LIFE
Technology Description							€/kW	€/kW	€/kW	€/kW	€/kW	€/kW	€/kW	€/kW	€/kW	€/GJ	€/GJ	€/GJ	€/GJ	Years
	0.2	0.20																		
					1.00															
H2 Production-Biomass Gasification, medium size, centralized	2.78	1.804				90%	2637.6	1290.6			131.7	64.5				0.93	0.45			20
	0.195	0.097			1															
H2 Production-Biomass Gasification + Carbon Capture, medium size, centralized	2.78	1.804				90%	2651.2	1309.2			111.5	65.3				0.93	0.46			20
	0.27	0.143			1.00															
H2 Production-Kvaerner Process, centralized	1.75	1.75				90%	1993.3	1993.3			79.8	79.8				0.70				20
	0.35	0.35			1															
H2 Production-Biomass Steam Reforming, centralized	1.36	1.36				90%	519.3	519.3			20.8	20.8				0.18				20
	0.044	0.04			1.00															
H2 Production-Methane Steam Reforming, large size, centralized	1.32	1.32	1.32	1.25		90%	201.2	201.2	201.2	158.3	9.8	9.8	9.8	7.7		0.08		0.08	0.05	20
	0.02	0.02	0.02	0.021	1															
H2 Production-Methane Steam Reforming, small size, centralized	1.575	1.575	1.575	1.48		90%	431.8	431.8	431.8	344.4	16.4	16.4	16.4	12.8		0.14		0.14	0.05	20
	0.03	0.03	0.03	0.02	1.00															
H2 Production-Methane Steam Reforming + Carbon Capture, large size, centralized	1.52	1.52	1.52	1.4		90%	284.7	272.8	272.8	191.3	14.2	14.2	14.2	11.5		0.53		0.53	0.07	20
	0.05	0.05	0.05	0.04	1															
H2 Production-Methane Steam Reforming + Carbon Capture, small size, centralized	1.65	1.65	1.65	1.4		90%	590.4	565.2	565.2	450.8	29.5	29.5	29.5	23.8		0.20		0.20	0.07	20
	0.067	0.07	0.07	0.04																

USING A BOTTOM-UP OPTIMIZATION MODEL
THE CASE STUDY OF TIMES-PT

*TechDesc	Input	Input~2020	Input~2025	Input~2030	Output	Av. Fact	INV COST	INV COST~2020	INV COST~2025	INV COST~2030	FIXO M	FIX OM~2020	FIX OM~2025	FIX OM~2030	FIX OM~2050	VAR OM	VAR OM~2020	VAR OM~2025	VAR OM~2030	LIFE	
Technology Description							€/kW	€/kW	€/kW	€/kW	€/kW	€/kW	€/kW	€/kW	€/kW	€/kW	€/GJ	€/GJ	€/GJ	€/GJ	Years
H2 Production-CSP Solar Steam Reforming of Methane, centralized	1.15	1.15				87%	309.9	309.9			21.7	21.7				0.11				20	
	0.23	0.23			1																
H2 Production-Methane Steam Reforming, medium size, decentralized	1.36	1.36	1.36			86%	485.8	485.8	485.8		28.2	28.2	41.8			0.04	0.04	0.04		20	
	0.25	0.25	0.067		1																
H2 Production-Methane Steam Reforming, medium size, IND decentralized	1.36	1.36	1.36			86%	485.8	485.8	485.8		28.2	28.2	41.8			0.04	0.04	0.04		20	
	0.25	0.25	0.067		1																
H2 Production-Methane Steam Reforming, small size, COM decentralized	1.81	1.81	1.81	1.55		90%	1847.7	1642.9	1642.9	1157.8	44.6	44.6	44.6	23.0		0.65		0.65	0.40	20	
	0.065	0.07	0.07	0.05	1																
H2 Production-Methane Steam Reforming, small size, RSD decentralized	1.81	1.81	1.81	1.55		90%	1847.7	1642.9	1642.9	1157.8	44.6	44.6	44.6	23.0		0.65		0.65	0.40	20	
	0.065	0.065	0.065	0.05	1																
H2 Production-Methane Steam Reforming, small size TRA tank, decentralized	1.81	1.81	1.81	1.55		90%	1847.7	1642.9	1642.9	1157.8	44.6	44.6	44.6	23.0		0.65		0.65	0.40	20	
	0.065	0.07	0.07	0.05	1																
H2 Production-Methane Steam Reforming, small size, TRA truck decentralized	1.81	1.81	1.81	1.55		90%	1847.7	1642.9	1642.9	1157.8	44.6	44.6	44.6	23.0		0.65		0.65	0.40	20	
	0.065	0.065	0.065	0.05	1																
H2 Production-Ethanol Steam Reforming, decentralized	88.432	88.43283				90%	7379.7	7379.7								19.65				10	
	8358	58			1																
	0.177	0.18			1																
H2 Production-Solar Steam Reforming of Methane, decentralized	1.72	1.72				33%	851.9	851.9			17.1	17.1								20	
	0.234	0.234			1																

USING A BOTTOM-UP OPTIMIZATION MODEL
THE CASE STUDY OF TIMES-PT

*TechDesc	Input	Input~2020	Input~2025	Input~2030	Output	Av. Fact	INV COST	INV COST~2020	INV COST~2025	INV COST~2030	FIXO M	FIX OM~2020	FIX OM~2025	FIX OM~2030	FIX OM~2050	VAR OM	VAR OM~2020	VAR OM~2025	VAR OM~2030	LIFE
Technology Description							€/kW	€/kW	€/kW	€/kW	€/kW	€/kW	€/kW	€/kW	€/kW	€/GJ	€/GJ	€/GJ	€/GJ	Years
H2 Production-Central PO of Heavy Oil (CPO3)	1.3	1.3				90%	431.8	431.8			21.6	21.6				0.14				25
	0.063	0.06																		
H2 Production-Alkaline Electrolyser, medium size, centralized	1.50	1.50	1.50			90%	1779.0	497.7	497.7	445.0	89.9	89.9	89.9			0.1		0.1		20.0
H2 Production-Alkaline Electrolyser, large size, centralized	1.53	1.53	1.53	1.53		90%	750.0			750.0	38.0	38.0		38.0		0.2		0.1		20.0
H2 Production-Alkaline Electrolyser, small size, centralized	1.74	1.74	1.74	1.74		90%	1200.0			1200.0	60.0	60.0		60.0		1.0		1.0	0.2	20.0
H2 Production-Alkaline Electrolyser, wind offgrid, centralized	1.65	1.65	1.65	1.65		27%	2136.0			2136.0	107.0	107.0		107.0		0.2		0.1		30.0
H2 Production-Alkaline Electrolyser, PV offgrid, centralized	1.65	1.65	1.65	1.65		15%	2063.0			2063.0	103.0	103.0		103.0		0.2		0.1		30.0
H2 Production-Alkaline Electrolyser, off grid TRA tank, decentralized	1.62	1.62	1.62	1.41		90%	1941.0	866.0		513.0	137.0	137.0		25.0		1.0		1.0	0.2	20.0
H2 Production-Alkaline Electrolyser, off grid TRAs truck, decentralized	1.62	1.62	1.62	1.41		90%	1941.0	866.0		513.0	137.0	137.0		25.0		1.0		1.0	0.2	20.0
H2 Production-PEM Electrolyser, large size, centralized	1.74	1.74	1.74	1.74		90%	1200.0			1200.0	60.0	60.0		60.0		0.2		0.1		20.0
H2 Production-PEM Electrolyser, medium size, centralized	1.83	1.83	1.83	1.83		90%	1300.0			1300.0	65.0	65.0		65.0		0.2		0.1		20.0

USING A BOTTOM-UP OPTIMIZATION MODEL
THE CASE STUDY OF TIMES-PT

*TechDesc	Input	Input~ 2020	Input~2 025	Input~2 030	Out put	Av. Fact	INV COST	INV COST~ 2020	INV COST~ 2025	INV COST~ 2030	FIXO M	FIX OM~ 2020	FIX OM~ 2025	FIX OM~ 2030	FIX OM~ 2050	VAR OM	VAR OM~ 2020	VAR OM~ 2025	VAR OM~ 2030	LIFE
<i>Technology Description</i>							<i>€/kW</i>	<i>€/kW</i>	<i>€/kW</i>	<i>€/kW</i>	<i>€/kW</i>	<i>€/kW</i>	<i>€/kW</i>	<i>€/kW</i>	<i>€/kW</i>	<i>€/GJ</i>	<i>€/GJ</i>	<i>€/GJ</i>	<i>€/GJ</i>	<i>Years</i>
					1.00															
H2 Production-PEM Electrolyser, small size, centralized	1.89	1.89	1.89	1.89		90%	1500.0			1500.0	75.0	75.0		75.0		1.0		1.0	0.2	20.0
					1.00															
H2 Production-PEM Electrolyser, offshore, centralized			2.09	2.09		45%		2428.0	2282.0	2136.0				114.1		1.0		1.0	0.2	20.0
					1.00															
H2 Production-SOE Electrolyser, offshore, centralized			2.19	2.19		45%		1675.0	1675.0	1675.0				83.8		1.0		1.0	0.2	20.0
					1.00															
H2 Production-CSP Electrolyser, centralized			2.19	2.19		60%		11142.0	11142.0	11142.0				233.0		1.0		1.0	0.2	20.0

Table 26: Hydrogen end-use technology definition table (focus on mobility use)

Technology Description	Capacity Unit	Activity Unit	Year	Efficiency	FIXOM	VAROM	INVCOST	LIFE
							k€	Years
Car.Medium.GH2.FC.10	1000 vehicles	Million pkm	2010	674.66	0.69		69.21	12
			2015	713.44	0.59		59.14	
			2020	756.94	0.41		40.58	
			2025	806.09	0.36		36.28	
			2030	862.07	0.32		31.99	15.00
			2035	902.93	0.28		27.70	
			2040	947.87	0.23		23.41	
			2045	997.51	0.19		19.12	
			2050	1052.63	0.15		17	
Car.Medium.GH2.FCPlugIn.10		Million pkm	2010	1238.83	0.69		69.21	12
			2015	1238.83	0.59		59.14	
			2020	1238.83	0.41		40.58	
			2025	1294.82	0.34		34.26	
			2030	1353.76	0.30		30.18	15.00
			2035	1415.80	0.26		26.10	
			2040	1481.10	0.22		22.03	
			2045	1549.85	0.19		21.00	
			2050	1622.21	0.15		20.00	
Bus.Intercity.GH2.FC.10	1000 vehicles	Million pkm	2006			13.59		
			2010	205.02			679.06	12
			2015				526.26	
			2020				430.57	
			2025				393.77	
			2030				371.69	15.00
			2035				350.85	

USING A BOTTOM-UP OPTIMIZATION MODEL
THE CASE STUDY OF TIMES-PT

Technology Description	Capacity Unit	Activity Unit	Year	Efficiency	FIXOM	VAROM	INVCOST	LIFE
							k€	Years
			2040				331.17	
			2045				312.60	
			2050	263.09	58255.11		295.07	
Bus.Urban.GH2.FC.10	1000 vehicles	Million pkm	2006		13.59			
			2010	118.30			679.06	12
			2015				526.26	
			2020				430.57	
			2025				393.77	
			2030				371.69	15.00
			2035				350.85	
			2040				331.17	
			2045				312.60	
			2050	131.52	7.08		295.07	
Truck.HeavyDuty.GH2.FC.10	1000 vehicles	Million tkm	2006	138.89	5.43		337.00	12
			2010	139.53			337	
			2015	140.17			318	
			2020	140.81			266.67	
			2025	141.45			230.56	
			2030	142.10			194.44	15.00
			2035	142.74			158.33	
			2040	143.38			146.22	
			2045	144.02			134.11	
			2050	145.30	4.76		122.00	
Truck.LightDuty.GH2.FC.10	1000 vehicles	Million tkm	2010	674.66	0.69		69.21	12
			2015	713.44	0.59		59.14	
			2020	756.94	0.41		40.58	
			2025	806.09	0.36		36.28	

USING A BOTTOM-UP OPTIMIZATION MODEL
THE CASE STUDY OF TIMES-PT

Technology Description	Capacity Unit	Activity Unit	Year	Efficiency	FIXOM	VAROM	INVCOST	LIFE
							k€	Years
			2030	862.07	0.32		31.99	15.00
			2035	902.93	0.28		27.70	
			2040	947.87	0.23		23.41	
			2045	997.51	0.19		19.12	
			2050	1052.63	0.15		17.00	

PART IV

USING SPATIALLY AND TEMPORALLY REFINED MODELS TO ASSESS THE HYDROGEN DEPLOYMENT IN FRANCE

Abstract

The renewable development can be leveraged through a variety of energy carriers. The aim of this part is to assess the potential of producing low-carbon hydrogen from electricity surplus considering the French case for the timeframe of 2035. The analysis is conducted on a regional basis, in order to investigate the potential locations for electrolyser placements. To do so, it builds on an assessment of the land and ocean eligibility to identify a precise geographic distribution of the renewable energies (photovoltaics, and onshore and offshore wind) across France. The surplus energy is assessed regionally using a dispatch model showing that little energy is actually available to produce hydrogen when only considering the renewable curtailments. Using the nuclear available energy allows to enhance the hydrogen production potential while respecting the low carbon footprint criterion.

Then, different hydrogen delivery pathways are compared, going from the production step up to the fuelling station, and tackling pipeline and truck delivery options. According to the results, economies of scale that can be driven by high market penetration rates have significant impact on lowering the hydrogen cost.

Résumé

Le développement des énergies renouvelables peut être mis à profit via une variété de vecteurs énergétiques. L'objectif de cette partie est d'évaluer le potentiel de production de l'hydrogène à faible contenu carbone à partir d'excédents d'électricité renouvelable en France à l'horizon 2035. L'analyse est menée sur une base régionale afin d'examiner les sites propices à l'installation d'électrolyseurs. Pour ce faire, l'étude s'appuie sur une évaluation de la disponibilité géographique pour le déploiement des énergies renouvelables afin d'identifier une répartition géographique précise de ces dernières (photovoltaïque, éolien onshore et offshore) sur l'ensemble du territoire français. Les résultats montrent que faire fonctionner les électrolyseurs seulement pendant les heures de surplus électriques n'est pas économiquement viable. L'utilisation de

l'énergie nucléaire disponible peut augmenter le potentiel de production d'hydrogène tout en respectant le critère de faible empreinte carbone.

Ensuite, différentes voies de transport et distribution de l'hydrogène ont été comparées. Les résultats montrent que des économies d'échelle significatives peuvent être générées avec l'augmentation des taux de pénétration de marché, conduisant ainsi à faire baisser les coûts de l'infrastructure.

ACRONYMS

ADEME	French Agency for the Environment and Energy Management
ANCRE	National Alliance of Coordination for Energy Research
CAPEX	Capital Expenditures
FCEV	Fuel Cell Electric Vehicles
GH₂	Gaseous Hydrogen
GHI	Global Horizontal Irradiance
GLAES	Geospatial Land Availability for Energy Systems
K_p	Capacity factor (nuclear)
LCOH	Levelized Cost of Hydrogen
LF	Load Factor
LH₂	Liquid Hydrogen
LOHC	Liquid Organic Hydrogen Carrier
OM	Operation and Maintenance
OPEX	Operational Expenditures
PLDV	Passenger Light Duty Vehicles
P_{nom}	Nominal capacity
PPE	Programmation Pluriannuelle de l'Energie (Multiannual Energy Program)
PV	Photovoltaic
REN	Renewable
RTE	Réseau Transport Electricité (French TSO)
SRCAE	Regional Schemes for Climate Air Energy
TOTEX	Total Expenditures
WACC	Weighted Average Cost of Capital

INTRODUCTION

Following the Paris agreement, France has set several environmental targets regarding the carbon footprint and the energy production and consumption for different timeframes. The French pledges announced at the COP21 aim at reducing the greenhouse gas (GHG) emissions by 40% by 2030 and 75% by 2050 compared to 1990 levels [1], [2]. Thus, in order to fulfil these promising targets, thinking beyond the electricity system and the implementation of renewable energies (REN) is crucial.

In 2015, the French total carbon emissions reached 336.6 MtCO₂ excluding LULUCF (Land Use, Land Use Change and Forestry) emissions. 69.3% of these emissions were energy-related, from which only 9.2% were energy industry-related (including electricity and heat production, and refining activity) [3]. According to RTE, the French electricity transport system operator (TSO) [4], only 19.11 Mt of CO₂ were due to power generation in 2015. Indeed, the French electric system is one of the least emitting in Europe [5], [6] with a high share of nuclear generation exceeding 70% [7].

However, in the years to come, the French electric system is expected to go through some transformations particularly in the context of the rising shares of renewables [1], [2], [9]. The objective that was set during the COP21 aims at increasing the REN share to 32% in the final energy consumption by 2030 [2]. As a result of the continuing penetration of REN into the electric system, the nuclear production is expected to drop. A target of reducing the nuclear share to 50% by 2025 was set in the Climate Plan [1] but has been lately postponed to 2030 [10]. Regardless of the timeframe of this targeted decrease, the nuclear share drop must be coupled with a strong support to the renewable production via the procurement of the adequate flexibility means (storage facilities, demand side management, etc.). Otherwise fossil fuelled power production will be activated as a backup resulting in an increase of GHG emissions. Other challenges related to the balance of the electric grid are also foreseen. The variability of renewables that does not necessarily match with the electricity demand profiles may endanger the stability of the electric grid, hence the urgent need for flexibility means.

Nonetheless, the remaining challenge for the future is also related to the decarbonisation of the other sectors (transport, industry, etc.).

In 2015, the transport emissions in France accounted for 29% of the total energy related emissions [3]. Transportation is still highly dependent on fossil fuels with diesel being the first used fuel for road transport and specifically for passenger light duty vehicles (PLDV) [11]. The latest controversies about diesel in Europe [12] may lead to a progressive phase out of this fuel in the years to come. However, a more serious shift towards low carbon transportation is inescapable in order to ensure the required reductions in GHG emissions by 2050. In the short term, France set a pledge during the COP21 to reduce the emissions in the transport sector by 29% over the period 2015-2028 [2]. Same is applicable for the industrial sector, with a target to reduce the carbon emissions by 24% over the same period (2015-2028).

In this context hydrogen can be a key enabler for a multi-sectorial decarbonisation allowing routing the renewable energy from the electric system side up to other sectors like transport and industry.

The following chapters tackle the last type of modelling approaches that are considered in the thesis which are the temporally and spatially refined models. These models allow addressing topics that were not tackled in the previous parts of the thesis. Indeed, high temporal and spatial resolution is needed to study the

hydrogen infrastructure aspects. Hence, special focus is put in this part on the flexibility potential of the hydrogen production based on a French case study considering a high renewable electricity share.

To do so, Chapter I investigates the land and ocean eligibility for renewable deployment in order to accurately position the photovoltaic and wind capacities with regards to socio-political and techno-economic constraints. The precise location of the renewable installation allows generating accurate generation time series based on temporally and spatially resolved weather data.

The electricity system dispatch is then conducted in Chapter II with focus on the hydrogen production potential during surplus hours.

Then, the hydrogen delivery pathways are compared investigating different hydrogen demand scenarios for the transport market.

This work is conducted in collaboration with the IEK-3 Institute at the Jülich Forschungszentrum in Germany, a collaboration that materialized via being part of the team as a guest scientist for a period of three months. The work of the IEK-3 was supported by the Helmholtz Association under the Joint Initiative “EnergySystem 2050—A Contribution of the Research Field Energy.

REFERENCES

- [1] L’Assemblée nationale and Le Sénat, *LOI n° 2015-992 du 17 août 2015 relative à la transition énergétique pour la croissance verte (1)*, vol. NOR: DEVX1413992L. 2015, p. 14263.
- [2] “Spécial COP 21 - Les engagements nationaux de la France,” *Gouvernement.fr*, 30-Nov-2015. [Online]. Available: <https://www.gouvernement.fr/special-cop-21-les-engagements-nationaux-de-la-france-3390>.
- [3] Commissariat général au développement durable, “Chiffres clés du climat: France, Europe et Monde.” Service de la donnée et des études statistiques (SDES), 2018.
- [4] RTE, “Production, Emissions de CO₂,” *Bilan électrique 2017*, 2017. [Online]. Available: <http://bilan-electrique-2017.rte-france.com/production/29-emissions-de-co2/>.
- [5] Tomorrow, “Climate Impact by Area, Ranked by carbon intensity of electricity consumed (gCO₂eq/kWh),” *Electricity Map*, 2018. [Online]. Available: <https://www.electricitymap.org/?page=map&solar=false&remote=true&wind=false>.
- [6] International Energy Agency (IEA), “Statistics, Emissions Factors.” 2018.
- [7] RTE, “Production,” *Bilan électrique 2017*, 2017. [Online]. Available: <http://bilan-electrique-2017.rte-france.com/production/le-parc-de-production-national/>.
- [8] “Parc nucléaire français,” *Connaissance des Energies*, 2018. [Online]. Available: <https://www.connaissancedesenergies.org/fiche-pedagogique/parc-nucleaire-francais>.
- [9] RTE, “Bilan prévisionnel de l’équilibre offre-demande d’électricité en France, Edition 2017.” 2017.
- [10] Pierre Le Hir and Nabil Wakim, “Hulot recule sur la baisse du nucléaire à 50 % de la production électrique en 2025,” *Le Monde*, 09-Nov-2017.
- [11] Ademe, “Évolution du marché, caractéristiques environnementales et techniques - Véhicules particuliers neufs vendus en France.” 2017.

ASSESSING THE HYDROGEN DEPLOYMENT IN FRANCE
THE USE OF TEMPORALLY AND SPACIALLY REFINED MODELS

- [12] Markus Wacket and Ilona Wissenbach, “Diesel cars can be banned from German cities, court rules,” *Reuters, Business News*, 27-Feb-2018.

CHAPTER I

Implementing the Energy Transition at the Regional Level: The Case of the French Electric System

1. Introduction

As stated in the introduction of this part, in the years to come, transformations of the French electric system are expected, particularly in the context of rising shares of renewables [1]–[3]. The objective set during the COP21 aims at increasing the REN share to 32% in the final energy consumption by 2030 [3].

The PPE (Programmation Pluriannuelle de l'Énergie) [4] published in the beginning of 2019 details the trajectory envisaged by the Government to reach the announced targets. The PPE announces 74 GW of installed renewable capacity in 2023, corresponding to a 50% increase compared to 2017, and from 102 to 113 GW in 2028, corresponding to twice the 2017 levels. Accordingly, the renewable share in the electricity mix is expected to reach 27 % of by 2023, and 36% by 2028. In 2023, most of it will be provided by hydroelectricity (25.7 GW), onshore wind (24.6 GW), photovoltaics (20.6 GW) and offshore wind (2.4 GW). In 2028, photovoltaics will be first in capacity (35.6 to 44.5 GW), followed by onshore wind (34.1 to 35.6 GW), hydropower (26.4 to 26.7 GW) and offshore wind (4.7 to 5.2 GW). Onshore wind objectives involve increasing the total wind turbine number from 8,000 to 14,500 in ten years. The offshore wind power objective will depend in particular on the outcome of the Dunkirk project. A support framework is already planned for, with a prospect of 60 €/MWh by 2024, according to the multi-year tendering calendar.

In order to meet these ambitious targets, an evaluation of the land and ocean eligibility for renewable installation seems to be crucial, allowing us to locate the potential renewable integration spots and assess the maximum feasible penetration rate by region.

The aim of this chapter is hence to propose a potential geographic distribution of the renewable capacities across France in order to meet the future governmental targets in terms of REN shares, taking into account the different constraints defining land and ocean eligibility. To do so, environmental, socio-political and techno-economic criteria constraining the implementation of renewable generation facilities are considered. Different feasible renewable penetration scenarios are compared in order to select a scenario that ensures the system supply and demand balance, in accordance with the governmental targets. Focus is put on open-field photovoltaics as well as onshore and offshore wind. The results allow for the identification of a precise geographic distribution of the potential renewable energy locations across France. The maximum renewable integration capacities are hence evaluated for each of the twelve regions in France. Then, in order to select the most propitious spots that respond to the targeted capacity, a multi-criteria analysis is conducted.

Only few studies found in the literature tackled the maximum REN integration capacity issue in France considering a regional segregation.

T. Hubert and E. Vidalenc (2012) [5] inspected the renewable deployment potential in France, assessing technical and social criteria defining the feasibility of REN installation in France. Rooftop PV, onshore and

offshore wind, hydropower, geothermal energy, ocean and bioenergy were considered. Maximum production potential is evaluated for each type of REN generation. The analysis is then completed with an energy balance assessment in order to examine the sufficiency of the evaluated potential in terms of demand satisfaction. Although it was stated in the paper that the study is conducted at a department level, taking into account 96 departments in Metropolitan France, no specific value is given for the renewable potential by region.

Later, in 2016, the Ademe study (2017) [6] detailed the maximum renewable potential at a regional scale. The study aimed to investigate the potential of reaching a 100% renewable electricity mix in France by 2050. The results show that the renewable potential could reach 700 GW including (apart from PV and wind) tidal, geothermal and cogeneration energy which are not considered in our scope.

Other studies investigated the renewable deployment eligibility issue for a specific region or for a specific renewable energy source. For example, A. Nadaï and O. Laboussière (2009) [7] focused on the landscape criteria applied to the wind power planning in the Aveyron region (in southern France). Later in 2017 [8], the authors further analysed social opposition to wind installation with regards to the landscape criteria in the region of Seine-et-Marne (Parisian Basin, France). A. Rogeau et al. (2017) [9] inspected the deployment feasibility of small pumped hydro energy storage in France taking into account technical criteria and acceptability constraints. The authors also designed a ranking system in order to identify the best locations to start with.

Other studies tackling renewable energy potential have been conducted for France neighbouring countries like Germany (Robinius et al. [10]), or for Europe in general considering PV and wind deployment [11]–[13] as well as biomass feedstock availability [14].

Amongst the reviewed literature, it is the Ademe study [6] that exhibits the most complete analysis regarding the evaluation of renewable penetration potential, taking into account the whole French territory. However, when it comes to a transitional phase, and when the full potential is not exploited, the approach of the study does not allow selecting the most suitable locations to start with. A multi-criteria ranking approach is only suggested in [9] but for small pumped hydro storage facilities in France.

Our assessment goes beyond the evaluation of the maximum penetration potential of open field PV, offshore and onshore wind in France, to propose a possible precise distribution of these generation means by region when considering a selected scenario that goes in line with the governmental targets [1], [4], [15].

The first part of our study compares different French electricity mix scenarios in order to assess a feasible evolution of the renewable capacities in the years to come. Then, once a national scenario is selected, the second part of the chapter details the methodology adopted to distribute the expected national capacities by region respecting the maximum geographic penetration potential. The constraints defining the geographic availability for REN implementation are then detailed followed by a multi-criteria analysis that selects the best spots in response to the capacities suggested in the selected scenario. Finally, the results of the precise spots for renewable penetration are displayed.

This chapter is submitted for publication in the Energy System journal and is under review [16].

2. Methodology

The aim of this section is to detail the methodology adopted in order to identify a potential regional distribution of renewable capacities. First, a national scenario of electricity mix is selected following the Energy Transition Law targets [2]. Then, land and ocean eligibility are analysed in order to precisely place the renewable installations across France.

2.1. Scenario selection

In order to investigate the future evolution of the electric system, different organizations contribute to the exercise of designing energy scenarios. These scenarios aim at investigating different potential futures in order to anticipate the possible impacts of the current governmental energy strategies, or to help decision makers when it comes to setting a new energy transition roadmap. The reference organizations that are renowned for energy scenario elaboration at the French level are mainly RTE, ADEME and ANCRE. RTE is the sole operator of the French public electricity transmission network. ADEME is the French Agency for the Environment and Energy Management, and participates in the implementation of public policies in the fields of environment, energy and sustainable development. Lastly, ANCRE is the National Research Coordination Alliance for Energy, and it coordinates and enhances the effectiveness of energy research conducted by national public bodies. It also participates in the implementation of the French research and development strategy for this sector.

To carry out our prospective study, we reviewed different scenarios from the literature that have the advantage of being balanced and simulated on the French electric grid. Figure 46 shows the capacities as well as the power generations reported in the reviewed scenarios. The description of the latter is given in Table 27.

To conduct this research, the latest scenarios that take into account the most recent governmental announcements in terms of energy strategy are considered.

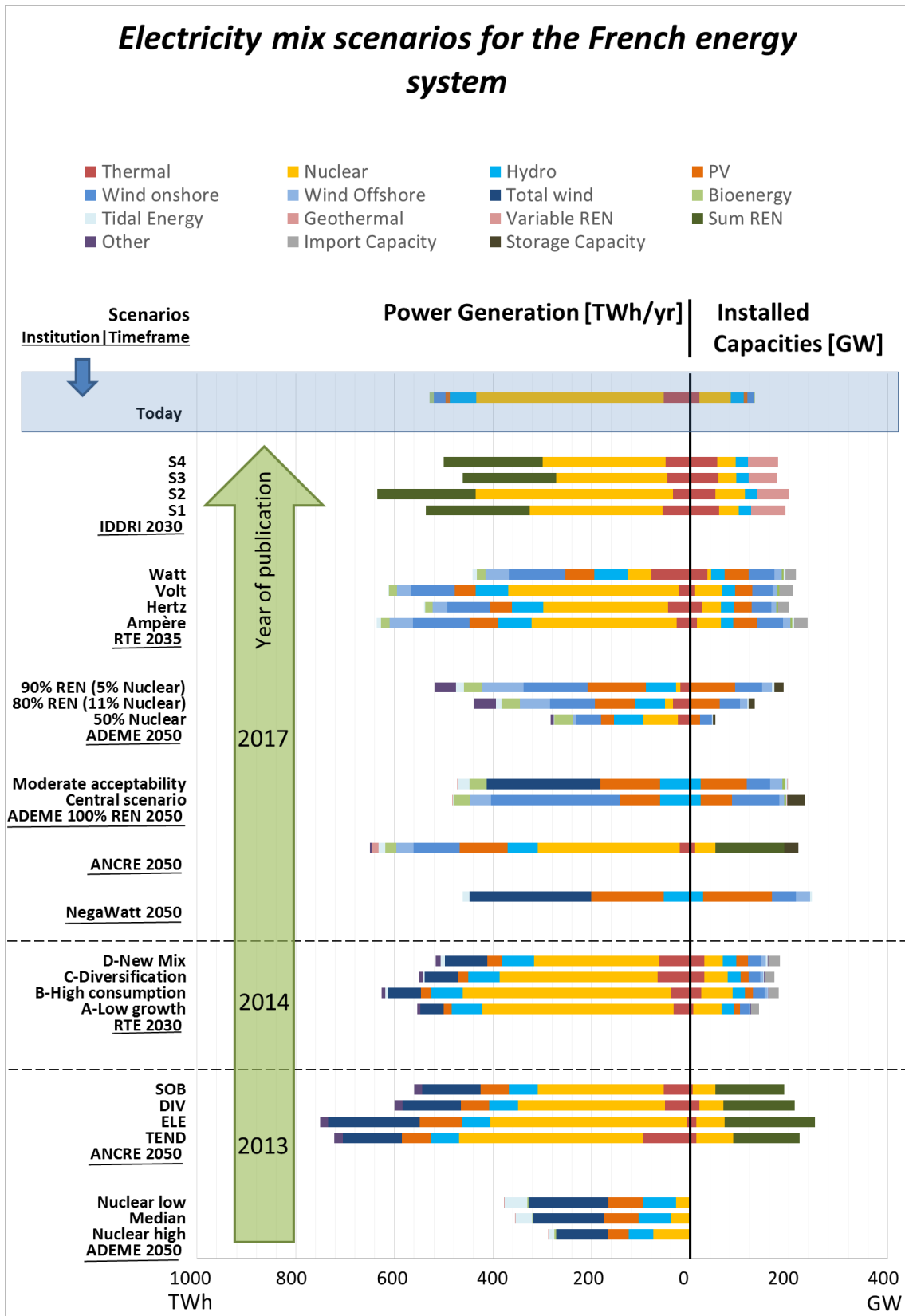

Figure 46: Electricity mix scenario comparison - Review of the literature [1], [17]–[25]
*each group of rows correspond to a set of scenarios published by an institution for a given timeframe (left axis, underlined text). The year of publication is indicated by the text in the green arrow.

ASSESSING THE HYDROGEN DEPLOYMENT IN FRANCE
THE USE OF TEMPORALLY AND SPACIALLY REFINED MODELS

The bars on the right correspond to the installed capacities as given in the scenarios. The bars on the left indicate the corresponding electricity generation by type

Table 27: Description of the reviewed scenarios

Institution	Scenarios	Year of publication	Timeframe	Description
ADEME	Nuclear high	2013	2050	The share of nuclear power in electricity generation is maintained at 50% in 2050
	Median			The decline of the nuclear power share in electricity production continues to reach 25% by 2050
	Nuclear low			The share of nuclear in electricity production reaches 18% in 2050 which corresponds to maximum exploitation of potential RES
ANCRE	TEND	2013	2050	It illustrates what would be the dynamics of the French energy system if we prolong the trends currently observed, taking into account the government commitments of energy and climate policies
	ELE			Focus is put on energy efficiency, a limited strengthening of electrical uses, with a strong focus on the diversification of sources (including biomass) and energy carriers, and on a significant role of integrated energy systems
	DIV			Based on the combination of a marked effort of energy efficiency and an increase in uses on the part of electricity, whether of renewable or nuclear origin, as a substitute for fossil fuels
	SOB			Based essentially on the triptych sobriety pushed, enhanced energy efficiency and development of renewable energy
RTE	A-Low growth	2014	2030	Based on a sluggish economic context, on the trend evolution of production capacities and interconnections and on maintaining the current share of nuclear power in the production mix
	B-High consumption			Assumes a dynamic development of the system around a high electrification combining the development of electrical uses and a relatively modest effort of energy efficiency, a continuation of existing energy policies for the development of renewable energies and a nuclear capacity equal to the ceiling of 63 , 2 GW set by the bill on the energy transition for green growth
	C-Diversification			Increasing energy efficiency and renewable energy, and leading to a diversified electricity mix in the perspective of a significant 60% reduction in the share of nuclear power in the production mix.
	D-New Mix			Based on energy sobriety, which reduces consumption, and a significant surge in renewable energy with a view to reducing the share of nuclear energy to 50% of the production mix.
NegaWatt	NegaWatt 2050	2017	2050	Thanks to the actions of sobriety and efficiency that result in the elimination of wastes, the final energy consumption in 2050 is reduced by half and the primary energy by 63%. It is possible to cover all of France's energy needs by renewable sources by 2050. Solid biomass remains the main source of renewable energy production, followed closely by wind and photovoltaic
ANCRE	ANCRE 2050	2017	2050	Demand for electricity is growing by 15% between 2015 and 2050, mainly because it is replacing carbon-based energy in all sectors, particularly in terms of mobility. Production from renewable energies is multiplied by more than 3

ASSESSING THE HYDROGEN DEPLOYMENT IN FRANCE
THE USE OF TEMPORALLY AND SPACIALLY REFINED MODELS

ADEME 100% REN	Central scenario	2017	2050	The totality of electricity consumed by different sectors of the economy is derived from renewable energy sources
	Moderate acceptability			The totality of electricity consumed is renewable, but social acceptability constraints restrict wind energy and PV ground and lead to the development of PV rooftop, marine energy, and wind at sea
ADEME	50% Nuclear	2017	2050	Reduces by 25% the share of nuclear power by 2035 which remains stable beyond 2050, 44% of the electricity produced is renewable, with renewable energy accounting for 46% of the gross final energy consumption and 37% of the gas consumed.
	80% REN (11% Nuclear)			80% renewable electricity, without inter-seasonal storage, extends the option "low nuclear scenario." In 2050, in this variant, renewable energy accounts for 60% of gross final energy consumption and 35% of final gas consumption.
	90% REN (5% Nuclear)			Considers a larger deployment of renewable electricity, upgraded as syngas. Additional capacities of photovoltaic, onshore and offshore wind, and marine energies are deployed. In 2050, the renewable energy accounts for 69% of gross final consumption of energy and 49% of the gas consumed
RTE	Ampère	2017	2035	The shutdown of the nuclear power plants is carried out after 40 years of operation if the development of renewable energies is sufficient to allow the same level of electricity production over the year.
	Hertz			This scenario makes it possible to study the place of the thermal sector in the transition of the electrical system, and in particular to identify - with respect to the Ampère scenario - whether it is possible to reach the 50% nuclear the production of electricity on the basis of a mix whose diversification includes a strengthening of the place of the thermal means. The addition of new thermal means should not lead to the degradation of the CO2 emission levels engendered by the French electricity fleet compared to the current situation. An emission cap is therefore integrated into the modelling
	Volt			The development of renewable energies in France and in Europe is accelerating and the share of nuclear energy is changing according to the economic opportunities on the European market
	Watt			The decommissioning of nuclear power corresponds to an automatic and technical decommissioning at 40. In line with the "50% nuclear" objective in 2025, this scenario is achieved by relying on a strong development of renewable energies.
IDDR	S1	2017	2030	The strategy S1 gives a representation of a scenario where the transition is slow to be triggered, because of the uncertainties surrounding the decisions to close down nuclear reactors." Electronuclear production hardly decreases before 2023 (-10 TWh), and efforts of transformation to achieve the 50% target in 2025 focus primarily on the period 2023 to 2025.
	S2			Strategy S2 is based on a vision of continuity with the existing mix, and based on the assumption that the extension of the life of existing reactors represents an important economic opportunity, it aims to extend all reactors operation time over 40 years, while pursuing an effort to diversify the electricity mix. Thus, the objectives of diversification of the electricity mix (50% of nuclear in 2025 and 40% of renewable electricity

ASSESSING THE HYDROGEN DEPLOYMENT IN FRANCE
THE USE OF TEMPORALLY AND SPACIALLY REFINED MODELS

in 2030) are maintained, by transferring the constraint on domestic consumption alone (net of net trade balance), and not total electricity production.

S3

Conversely, the S3 strategy proposes a more proactive approach to the transformation of the French electricity system, based on a faster development of renewable energies (high assumptions of the PPE) and a more pronounced decline in nuclear power generation by 2023 (-65 TWh), in order to smooth the diversification effort and the achievement of the 2025 target.

S4

The strategy S4 responds to the desire to smooth the transformation of the French electricity system as much as possible in order to avoid too rapid changes, the objective of reducing the share of nuclear power is shifted to 2030, facilitating the implementation coherence with the ENR objective, so that it aims to reconstruct a coherent trajectory based solely on the objectives of diversification of the electricity mix by 2030 (50% nuclear, 40% ENR, 10% fossil thermal).

With regards to the purpose of our work, the aim of the scenario investigation is to look for balanced capacities that are already tested with the grid suitability. Our model then allows to regionalize the renewable capacities and generate the time series for these scenarios that are developed at the national level.

As shown in Figure 46, not all of the reviewed scenarios detail the installed capacities by means of power generation (like the ADEME and ANCRE 2013 scenarios). Besides, the border interconnections are rarely investigated or included in the study as an endogenous parameter (with few exceptions like the RTE scenarios). Putting these obstacles aside, the remaining reference scenarios are those of RTE. Of these scenarios, the Ampere scenario is selected since it presents the highest shares of renewables and lowest share of thermal generation, while respecting the 50% governmental target for the nuclear share in the energy mix by 2035. In this scenario, the breakdown of the generation capacities is as follows: 52 GW for onshore wind, 15 GW for offshore wind, 48 GW for PV, 26 GW for hydroelectrics, 48.5 GW for nuclear, 13.2 GW for thermal.

Then, precise localization of the power plants and distribution of the capacities by region is carried out to accurately assess the renewable production. Indeed, it is related to the nature of renewables whose production profiles depend on the geographic data for weather time series (varying from one spot to the other). The first step is therefore to analyse land and ocean eligibility for renewable integration which permits the assessment of the maximum allowable capacities by region.

Then, the second step consists in defining the most suitable spots for the PV and wind farm deployment following a multi-criteria analysis that establishes a ranking system for the eligible spots.

2.2. Land and ocean eligibility analysis

As seen in the previous section, the provided scenario presents national scale capacities and does not specify the distribution of the different renewables by region.

In order to ensure that the allocated capacities by region for PV and wind (onshore and offshore) do not exceed the region's maximum capacity of renewable integration, land and ocean eligibility for renewable deployment is investigated using the GLAES (Geospatial Land Availability for Energy Systems) model [11], [26].

2.2.1. Model description

The GLAES model [27] is an open source project developed for the purpose of standardizing the implementation of LE (Land Eligibility) analyses. This project was initialized in part to address the methodological inconsistencies currently present in the LE literature. GLAES is designed to be adaptable to common geospatial data formats, to be scalable to large geographical areas, to minimize expected errors resulting from geospatial operations, and to be methodologically transparent [26]. The model has been implemented in the Python 3 programming language, with primary dependencies on the Geospatial Data Abstraction Library (GDAL) [28] for geospatial operations and on the SciPy [29] ecosystem for general numerical and matrix computations, both of which are also open source projects. To conduct an LE analysis with GLAES, the following steps must be taken. First, a study region must be defined in the form of a vector file and used to initialize a GLAES analysis. Values for resolution and spatial reference system can also be provided. Following this, multiple exclusion constraints can be applied one at a time by providing GLAES with a data source to exclude from and instructions on how

ASSESSING THE HYDROGEN DEPLOYMENT IN FRANCE THE USE OF TEMPORALLY AND SPACIALLY REFINED MODELS

to indicate the areas which should be excluded. The manner by which GLAES accomplishes this depends on the data source. If given a raster source, GLAES will expect a minimal and maximal value defining the pixels which should be excluded. If given a vector source, GLAES can accept a Structured Query Language (SQL) filter string to identify the specific features which should be excluded. Furthermore, these data sources do not need to be expressed in the same projection system as the one with which the analysis was initialized, as GLAES is capable of translating between projection systems as needed. Finally, regardless of the type of source which was provided, GLAES can also be given a buffer value by which the indicated exclusion areas can be grown. Once all of the desired exclusions constraints have been applied, GLAES can generate a raster file of the resulting available areas. For the purposes of this work, all computations in GLAES were performed in the EPSG3035 projection system with a spatial resolution of 100 m.

As discussed by Ryberg et al. [26], evaluations of land eligibility is a common practice within the energy modelling community, although there is much inconsistency in regards to the datasets used, constraints employed, and methodological implementations.

Therefore the GLAES model was developed to offer a standardized land eligibility methodology that is applicable anywhere. Furthermore, several pre-processed datasets, called Priors, were generated over the European context covering the most commonly desired land eligibility constraints [10]. Both the GLAES model as well as these Prior datasets are used for the land eligibility evaluations conducted here. Additionally, another feature of the GLAES model, identification of minimally-distant locations within the eligible areas, is also used.

Although the production of the Prior datasets is not discussed in detail here, the fundamental databases used are briefly described. The Corine Land Cover (CLC) [30] is the most frequent fundamental source for the Priors used in this study. This is a raster dataset which describes the land cover at each 100 m patch of land across Europe. Many different land cover classes are found in this dataset, including settlement areas, mining sites, open water bodies, and different designations of agricultural areas. Note that the means of distinguishing these geospatial features from one another based on satellite imagery is already discussed in full within the CLC documentation [30]. The OpenStreetMap (OSM) [31] dataset was extracted and is developed via volunteered geospatial information. Taking the form of a vector dataset, features such as roadways, power-lines, touristic and leisure areas can be easily identified. The Digital Elevation Model Over Europe (EU-DEM) [32] dataset from the European Environment Agency is a digital elevation raster dataset providing elevation values over Europe and possesses a pixel resolution approximating 30 m. This dataset was used to determine the elevation, slope, and aspect at all locations. The World Database on Protected Areas (WDPA) [33] is the result of a multinational effort to monitor protected areas and includes designations of protected areas as described by the International Union for Conservation of Nature [34]. This dataset includes designations for bird areas and habitats identified by the European Union's bird's directive [35] and habitat directive [36]. Indications of designated protected areas of all types can be found in this vector database, which was filtered differently for each of the conservation constraints. An important note in regards to the WDPA is that features are not mutually exclusive, and thus a single location could be defined as protected according to multiple designations. The World Wildlife Foundations' HydroLAKES [37] database is a vector source which was used to identify lakes and other stagnant water bodies. The Global Wind Atlas (GWA) [38] is the result of a collaboration between the Technical University of Denmark and The World Bank to simulate typical wind speeds at each 1 km by 1 km location across the globe; values at altitudes of 50, 100, and 200 m are provided, but only those at 100 m values are used in this analysis. Similarly, the Global Solar Atlas (GSA) [39] is the result of The World Bank's effort to estimate average daily irradiances at most 1 km by 1 km location in the world, excluding latitudes above 60° and below -45.5°. The GSA provides average values for the global horizontal irradiance, direct normal irradiance, and other parameters

related to solar energy, although only global horizontal irradiance values are used in this analysis. Finally, three datasets available on EuroStat were used. The first of these differentiated large airports, those with more than 150,000 annual passengers, from smaller airfields, those with fewer than 150,000 annual passengers [40]. This dataset simply provides location and usage data for airports within Europe, which were then matched with footprints found using CLC. The second EuroStat dataset is a vector source tracing probable routes of running water [41]. This source was used to identify rivers and stream too small to be found in CLC. The third EuroStat source provides vector representations of urban settlements [42] and was used to differentiate urban from general settlements as seen in CLC.

Following a standard land eligibility workflow, investigating the maximum capacities for wind and PV integration first requires the exclusion of areas which are unavailable due to various sociotechnical concerns. Towards this purpose, a unique set of constraints are enforced for both onshore and offshore wind turbines, as well as open field PV parks using the GLAES model; which are further discussed in section 2.2.21. Rooftop PV is not addressed in this work as the mechanisms of its spatial distribution are inherently different to that of open field PV, and thus would necessitate an evaluation procedure significantly different to the one developed in this work. Nevertheless, rooftop PV will likely be considered in further developments. Following the exclusion procedure, GLAES' placement algorithm is then used to locate the maximal number of turbines, or park areas in the case of open field PV, which are available across the French landscape. With an assumed capacity of each unit, the total technical capacity of each region is easily found. Once again, section 2.2.2 offers a more detailed discussion of the assumptions made during the item distribution and unit capacity assignment.

After the exclusion and placement procedure, the design of the regional scenario is conducted with regards to the previously revealed maximum renewable capacities for each region. It is based on the region targets in terms of PV and wind deployment. These targets and pledges are stated in the so-called SRCAE (Schémas Régionaux Climat Air Energie - Regional Schemes for Climate Air Energy) [15], [43], [44] which define qualitative and quantitative objectives to be attained (by geographical area) in terms of valorization of renewable and energy recovery potential, as well as the implementation of energy efficiency techniques, in line with the objectives of the European energy and climate legislation.

Once the designed regional scenario is checked with the maximum allowable capacities by region, the precise localisation of the renewable plants is investigated. The accurate spatially-resolved localisation of PV and wind capacities is necessary in order to generate reliable estimations of renewable power generation, since this latter also depends on spatially-resolved weather data. To do so, a multi-criteria approach is conducted to select the most suitable locations for PV and wind farms.

In the next sub-sections, the adopted parameters for eligibility definition and the multi-criteria analysis are described.

2.2.2. Maximum REN capacities evaluation: Identification of exclusion criteria

Different constraints need to be taken into account to define whether a specific area is suitable for wind and/or PV (open field) penetration. These constraints can be divided into categories: socio-political, physical, techno-economic and environmental. The social and political group refers to constraints which were considered due to social preferences or political mandates of local citizens and other stakeholders. They include for example the distance to keep from the urban areas (which can be specifically constraining for wind turbines), tourism or camping sites for (among other reasons) a matter of landscape view preservation, mining sites, etc. The physical group refers to constraints derived from limitations

ASSESSING THE HYDROGEN DEPLOYMENT IN FRANCE
THE USE OF TEMPORALLY AND SPACIALLY REFINED MODELS

imposed by physical characteristics of the land, such as the soil type, or presence of a water body or a forest. The environmental group corresponds to constraints related to conservation efforts by local, national, and international organizations regarding protected areas or fauna and flora habitats. Finally, the techno-economic group refers to constraints which are fundamentally included for economic reasons, such as excluding distances too far from power lines beyond which connection costs become exorbitant [11].

Table 28 summarizes the different criteria that are taken into account for each of the investigated technologies. Constraint nature and values are not the same for PV and wind (onshore and offshore). They depend on the specificity of the renewable power plant facility and also the specificity of the regulation regarding the implementation of each kind of these facilities. Data regarding the measures of the constraints that are specific to the French context are very hard to find. Most of the French adapted values are related to wind turbine installation constraints and are taken from [45]–[49] for onshore wind and [50], [51] for offshore. As for PV, most of the French context-related constraints found in the literature [48] deal with areas to avoid (for example agricultural land, forests, urban areas, etc.), but no quantified measures are given for the distances to keep from these areas. The rest of the constraint measures are taken from [11] which is based on an extended literature review of 43 publications tackling land eligibility analysis. Hence the lacking values for the French constraints are assumed to be similar to the ones stated in the literature for other countries.

The constraint values are provided in Table 28, along with the according references.

Table 28: Exclusion constraint values for PV and wind (onshore and offshore) installation areas

Criteria	Exclude value	Constraint threshold		
		PV	Onshore wind	Offshore wind
Socio-political				
Distance from settlement areas [30]	below	200 m	1000 m	n.a.
Distance from railway [31]	below	n.a.	50 m	
Distance from roads [31]	below	n.a.	500 m	n.a.
Distance from power lines [31]	below	n.a.	200 m	
Distance from airport [30], [40]	below	0 m	10 000 m	n.a.
Distance from touristic areas [31]	below	1000 m	5000 m	n.a.
Distance from camping sites [31]	below	1000 m	1000 m	n.a.
Distance from leisure areas [31]	below	1000 m	1000 m	n.a.
Distance from permanent crop areas [30]	below	0 m	n.a.	n.a.
Distance from arable agriculture areas[30]	below	0 m	n.a.	n.a.
Distance from pastures [30]	below	0 m	n.a.	n.a.
Distance from shore [52]	below	n.a.	n.a.	11 000 m
Distance from ocean traffic [53]	below	n.a.	n.a.	5700 m
Distance from underwater cables [54], [55]	below	n.a.	n.a.	500 m
Distance from underwater pipelines [56]	below	n.a.	n.a.	600 m
Physical				
Slope threshold [32]	above	10°	11.3°	n.a.
Slope north-facing threshold [32]	above	3°	n.a.	n.a.
Elevation threshold [32]	above	1750 m	1750 m	n.a.
Distance from woodlands [30]	below	0 m	200 m	n.a.

ASSESSING THE HYDROGEN DEPLOYMENT IN FRANCE
THE USE OF TEMPORALLY AND SPACIALLY REFINED MODELS

Distance from wetlands [30]	below	1000 m	n.a.	n.a.
Distance from water bodies [30], [41], [57]	below	1000 m	25 000 m	n.a.
Distance from sandy areas [30]	below	1000 m	n.a.	n.a.
Environmental				
Distance from protected parks [33]	below	0 m	0 m	n.a.
Distance from protected habitats [33]	below	500 m	500 m	n.a.
Distance from protected bird zones [33]	below	n.a.	500 m	5000 m
Distance from protected landscapes [33]	below	0 m	0 m	n.a.
Distance from ocean natural reserves [33]		n.a	n.a	1000 m
Techno-economic				
Wind speed threshold (100 m) [38]	below	n.a.	4.5 m/s	n.a.
Grid connection distance [31]	above	20 000 m	20 000 m	n.a.
Accessibility distance	above	10 000 m	n.a.	n.a.
Maximum water depth [58]	below	n.a	n.a	-50 m

Most of the constraints are present as buffer distances to keep, meaning that the ill-suited surfaces plus the indicated distances are excluded. Hence, when zero is mentioned as a constraint measure, it does not mean that the constraint is neglected. It rather implies that the corresponding area is excluded without including an additional safety distance.

In order to assess the renewable capacities that can be allocated to the eligible surfaces, the following assumptions are adopted. A wind turbine capacity of 4.2 MW (for the onshore wind) is considered for all of the installed wind turbines, assuming a minimum distance of 1 km between the turbines (for aerodynamic issues [47], [48]). For the offshore wind implementation, a turbine capacity of 6.15 MW is adopted leaving 1.2 km between the turbines. For the PV capacity computation, a capacity coverage factor of 25 m² per kWp is assumed to account for both the PV modules themselves as well as the spaces between the PV panels and supporting facilities [48]. Using this, the corresponding eligible area around each available location identified by the GLAES model is directly converted to a capacity in kilowatts.

After the elimination of the impossible areas for wind and PV penetration, the remaining adapted surfaces present the maximum REN capacity integration potential by region which exceeds the adopted national scenario. Hence, selecting specific spots for REN installations that would result in the exact targeted REN capacities (with regards to the scenario) is required. To do so, a multi-criteria analysis (described in the next section) is conducted to identify the most suited spots by creating a ranking system of the different potential locations.

2.2.3. Multi-criteria analysis and design of a regional scenario

As detailed previously, the identification of the precise locations of PV and wind installations that correspond to the adopted national scenario is based on a multi-criteria analysis that selects the most suitable locations. But first, in order to ensure that the regional targets for PV and wind penetration are

fulfilled, an investigation of the SRCAE pledges is conducted. These pledges concern different aspects of the energy transition strategy and are not only restricted to the integration of renewables into the electric system. In this section, the focus is put on the PV and wind penetration targets announced by the different regions. They are summarized in Table 29.

Table 29: Regional SRCAE targets for renewable penetration by 2020 [43]

Region	Capacities [MW]	
	PV	Wind
AUVERGNE RHÔNE-ALPES	2600	2000
GRAND EST	900	4500
NOUVELLEAQUITAINE	2800	3000
OCCITANIE	3000	3600
HAUTS-DE-FRANCE	700	4100
PACA	2350	800
BOURGOGNE FRANCHE-COMTÉ	750	2100
ÎLE-DE-FRANCE	500	500
BRETAGNE	400	1800
NORMANDIE	400	1900
CENTRE	250	2600
PAYS DE LA LOIRE	650	1800

As shown in Table 29, the timeframe for these targets is 2020, while the current study aims at designing a regional scenario for 2035 that is in harmony with the adopted scenario for the national capacities. Then, the evolution trends of REN penetration from 2017 capacities till 2020 targets are extrapolated to 2035, making sure that the sum does not exceed the adopted scenario for the national capacities. In other words, since the 2020 SRCAE targets reflect the willingness of each region to integrate the different kinds of renewables, we assumed that the regional distribution of the expected effort to deploy renewables will remain the same by 2035.

Once the capacities are allocated for each region, the precise locations of the installations within the region are defined based on a ranking system of the different potential spots that allows to select the best locations. This is based on a multi-criteria analysis that creates a hierarchy between the criteria defining their priority level.

The hierarchy definition adopted in this study is detailed hereafter. For the wind turbine placements, four criteria are selected: the wind speed, the road distance, the power line distance and the distance from urban areas. A ranking function is attributed to each of these parameters establishing a score going from 0 to 1, with 1 indicating a favourable value. The model then starts with the spots that have the highest scores (for each of the regions) and goes down in ranking until the targeted capacity is reached. A similar approach is adopted for the PV installation distribution for which the wind speed criteria is replaced by the GHI (Global Horizontal Irradiance) response. Figure 47 and Figure 48 describe the scoring functions associated to the different criteria taken into account for PV and onshore wind separately. As for the offshore wind, the ranking was based only on wind speed consideration.

ASSESSING THE HYDROGEN DEPLOYMENT IN FRANCE
THE USE OF TEMPORALLY AND SPACIALLY REFINED MODELS

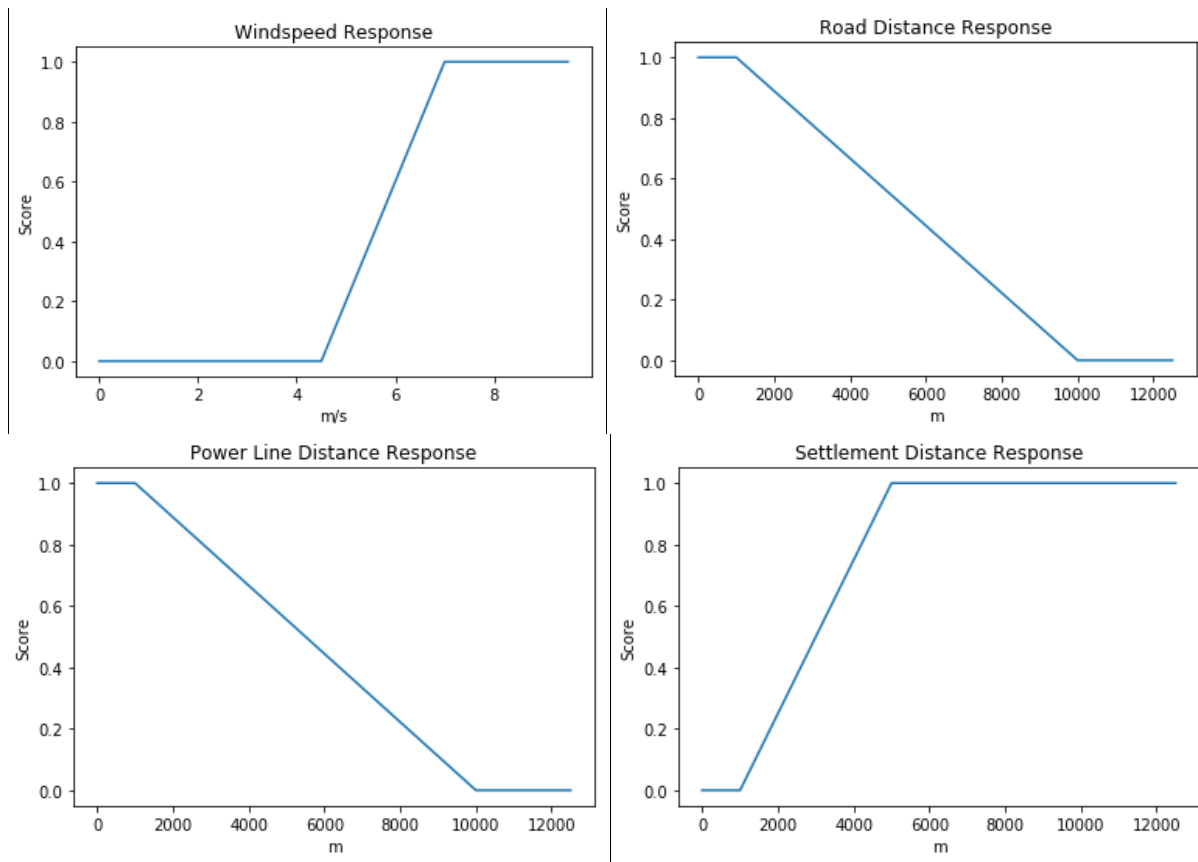

Figure 47: Wind criteria scoring functions

ASSESSING THE HYDROGEN DEPLOYMENT IN FRANCE
THE USE OF TEMPORALLY AND SPACIALLY REFINED MODELS

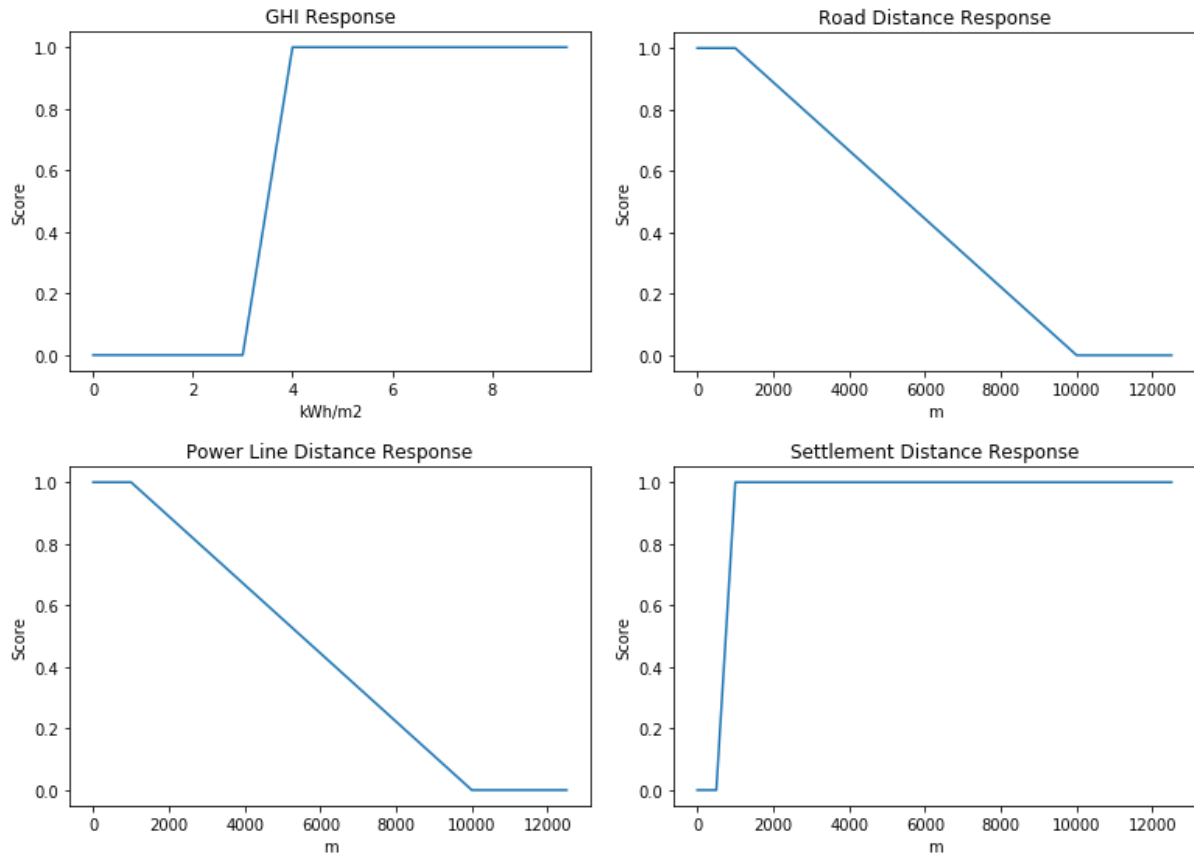

Figure 48: PV criteria scoring functions

This approach allowed to select the best locations according to the adopted parameters. For example, when it comes to wind turbine installations, the spots presenting wind speed average values higher than 7 m/s are attributed 1 as a score. Spots with lower wind speed values have lower scores, down to zero which is reached when the exclusion value is attained (e.g. 4.5 m/s for the wind speed criterion, as shown in Table 28).

Then, in order to combine the different rankings in one scoring function, the criteria are levelled according to their importance compared to each other. This means that, in the end, for a given spot, the final score would be x considering:

$$x = \sum_{i=1}^{\text{number of criteria}} C_{i_score} * C_{i_importance}$$

With C_{i_score} being the score of the spot according to the criteria C_i , and $C_{i_importance}$ the importance level of the criteria.

The importance level of the considered criteria is detailed in Table 30.

Table 30: Importance levels of criteria

	Wind	PV
Wind speed response	40%	
GHI response		50%
Settlement distance response	30%	10%
Power line distance response	20%	20%
Road distance response	10%	20%
Total	100%	100%

The importance level definition of the criteria is a subjective decision since it depends on the stakeholder point of view of what they consider as more or less important. In this study, the choice of the criteria is mainly based on socio-economic considerations. The wind speed and the GHI highly and directly impact the power output of the installations, thus they are attributed the highest scores in the hierarchy definition detailed in Table 30. The distances to the roads and powerlines are also related to economic considerations since they define, respectively, the accessibility to the installation for maintenance issues and the feasibility of dispatching the generated power on the electric grid without extra (heavy) investments for network development. The settlement criteria corresponds to the distance to keep from the urban areas for social considerations. It has high impact on the wind installations seeing their size (affecting the landscape) and their acoustic effect [45], [46], [49].

3. Results: regional scenarios and maximum renewable capacity potential distribution

In this section, the results regarding the assessment of land and ocean eligibility, the design of the regional scenario and the multi-analysis criteria investigation are presented.

3.1. Maximum potential for REN installation according to the regions

The ill-suited areas for wind and PV penetration are excluded depending on different criteria detailed in section 1. The results show that the remaining eligible areas represent respectively 7.71% of the total national surface (without considering the Corsica region) corresponding to a total potential surface of 40,694 km² for PV panel installations, and 4.76% for onshore wind turbines corresponding to a total potential surface of 25,741 km². Figure 49 shows the distribution of the eligible areas.

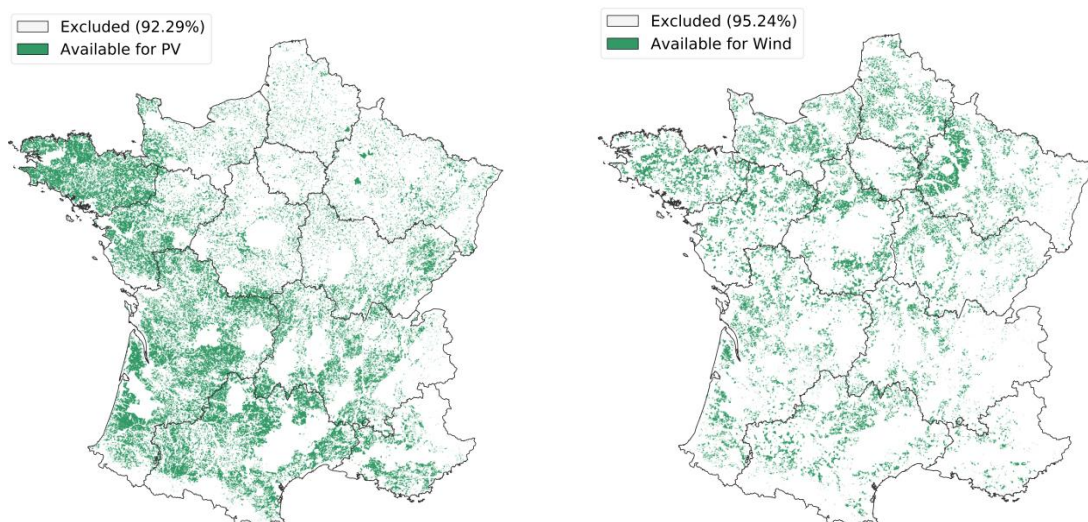

Figure 49: Eligible areas for PV (left map) and onshore wind (right map) integration. Available areas are accentuated for better visibility.

According to our research, and after reviewing the literature regarding the possible kinds of constraints that face the renewable integration in France [15], [45]–[49], [59]–[62], we noticed that wind penetration faces more and stricter constraints compared to PV. Constraints concerning the deployment of solar panels are scarce in the literature.

According to [61], today, 53% of planned wind projects (corresponding to 235 projects) are subject to legal action. The development of wind energy faces numerous difficulties, related to technical constraints or environmental ones, as well as acceptability issues from environmental protection associations and local residents (particularly in view of its impact on the landscape). The locations that present potentially favourable wind conditions are finally very constrained by other issues and uses that are incompatible with the installation of wind turbines [59]. Furthermore, military issues may also interfere with the development of wind projects for the regions that are defined as training areas, tactical combat helicopter flight zones, prohibited or dangerous zones, etc. [61], [62].

These different constraints complicate and seriously delay the development of wind implementation projects in France, or even lead, in certain situations, to their abandonment [60].

Same methodology is adopted in order to assess the maximum capacity for the offshore wind. The total assessed maximum capacity is evaluated at 33 GW distributed as shown in Figure 50 in red colour.

ASSESSING THE HYDROGEN DEPLOYMENT IN FRANCE THE USE OF TEMPORALLY AND SPACIALLY REFINED MODELS

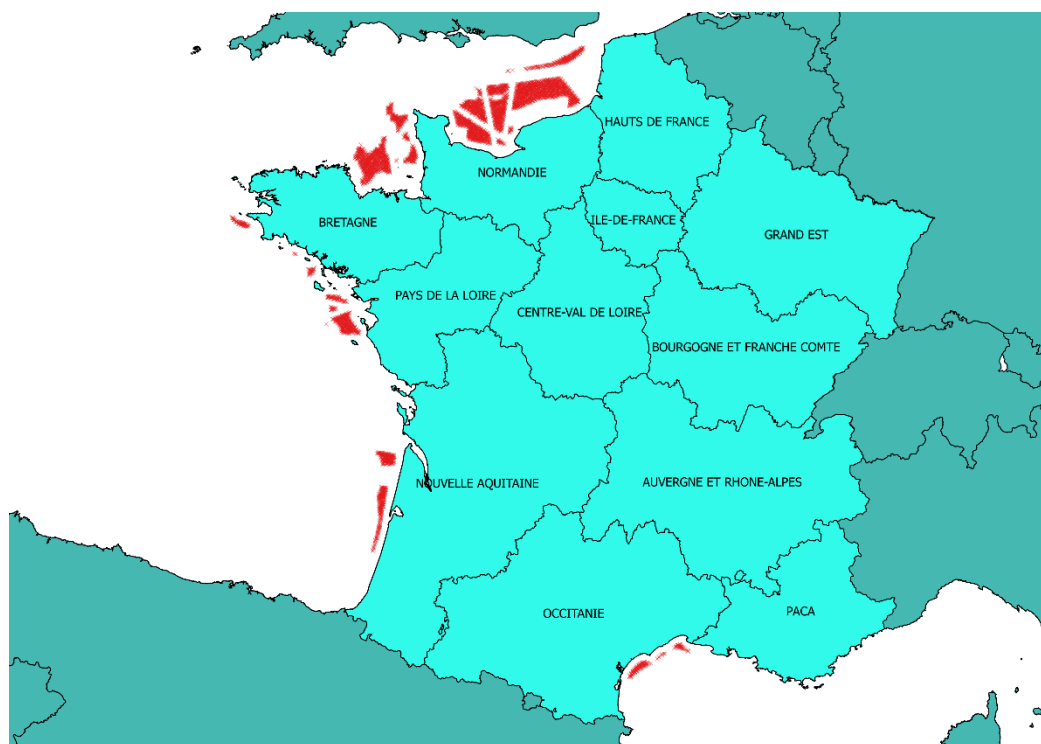

Figure 50: Ocean eligibility results for offshore wind integration

As shown in the figure, most of the offshore eligible areas are located in the north of France. This is mainly related to the water depth conditions that are more favourable than the ones in the west and south parts of France [31].

Accordingly, the maximum onshore and offshore renewable potential is presented in Table 31. Maximum PV and onshore wind capacities are shown for each of the considered regions.

Table 31: Maximum capacity deployment potential by source and by region

Region [MW]	Max Onshore Wind	Max Offshore Wind	Max PV Open Field
AUVERGNE ET RHONE-ALPES	24 981		177 681
BOURGOGNE ET FRANCHE COMTE	26 136		91 103
BRETAGNE	24 994	4 730	216 434
CENTRE-VAL DE LOIRE	24 385		57 111
GRAND EST	37 417		64 789
HAUTS DE FRANCE	24 561	250	21 717
ILE-DE-FRANCE	5 905		7 472
NORMANDIE	25 733	20 840	50 678
NOUVELLE AQUITAINE	49 606	3 050	423 850
OCCITANIE	35 464	1 250	319 099
PACA	7 249		64 120
PAYS DE LA LOIRE	21 424	3 030	131 735

As displayed in Table 31, the region of Nouvelle Aquitaine presents both the highest potential in terms of PV and onshore wind penetration. Its maximal wind integration capacity (49.6 GW) is almost able to meet by itself the targeted whole national capacity value (52 GW). Grand-Est has the second rank with a maximal wind capacity of 37.4 GW. The PV maximum capacity far outweighs the onshore wind one. This can be explained by the more stringent constraints applied on wind installation decisions, as detailed above. Most of the potential is concentrated in the southern regions (Nouvelle Aquitaine and Occitanie) with the exception of the Bretagne region that presents low sunshine average levels, but large available surfaces for open field PV installation.

A previous study of the ADEME [6] aiming at designing a 100% renewable electricity mix scenario by 2050 tackled the land eligibility topic and evaluated the maximal allowable REN capacities by region. A comparison with the results of this study is conducted. The results of the comparison for the maximum onshore wind capacities by region are presented in Figure 51.

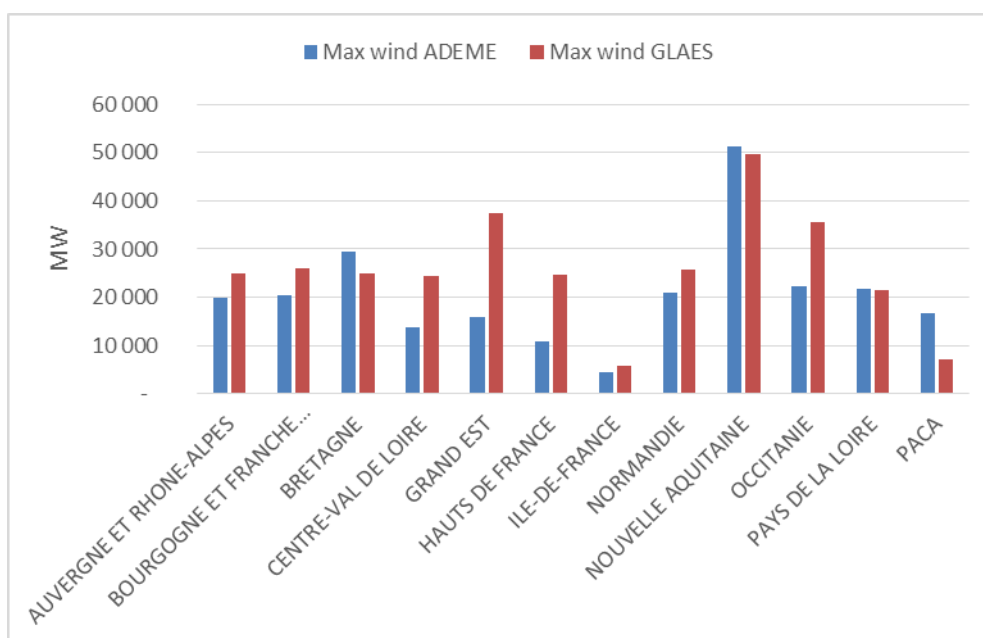

Figure 51: Comparison with ADEME values for the maximum wind penetration capacities

Wind penetration values are more or less comparable with the ADEME study ones; however, high gaps are noticed for the PV case. We predict on average 30 times higher open field PV potentials compared to the ADEME study. This may be related to lacking constraint values in our study or stricter ones made by the ADEME regarding the eligible areas for PV implementation. As mentioned previously, data regarding the PV installation constraints are scarcer than the wind case study ones in the literature. Another reason that could be behind this gap is the fact that in our analysis no assumptions regarding future evolution of the urban areas are made, which may not be the case in the ADEME study. The available open field surface taken into account in the model is based on the current geographic data [31].

In the next sections, a regionalisation of the targeted renewable capacities is suggested proposing precise locations for the REN installations and taking into account the maximum penetration potential by region as evaluated in this section.

3.2. Regional scenario for REN installation

In order to regionalize the national scenario that was selected in section 2.1, the SRCAE targets by region are considered establishing an extrapolation to 2035. The renewable capacities for each region are obtained as shown in Figure 52.

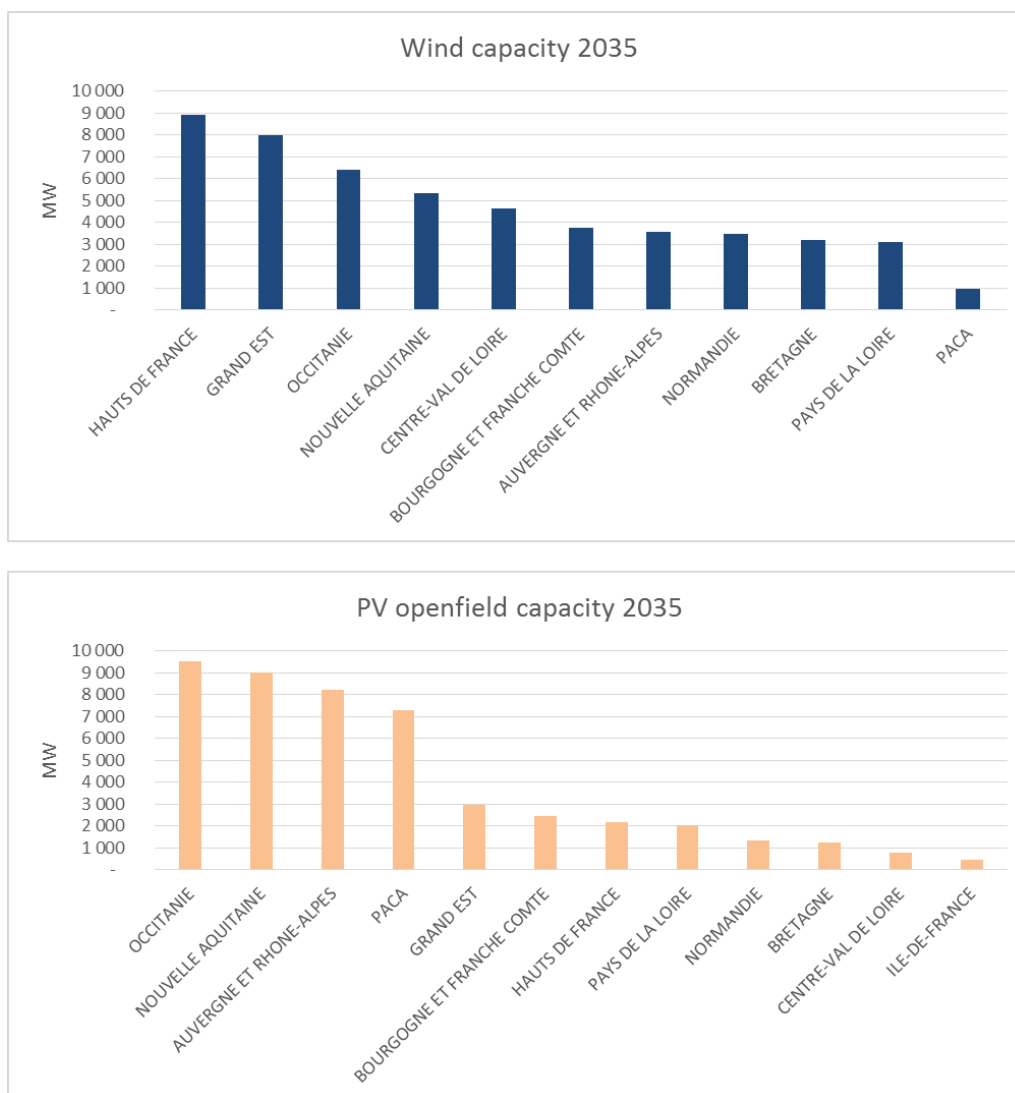

Figure 52: The designed regional scenario

According to the scenario, most of the PV integration occurs in the south of France with Occitanie presenting the highest capacity reaching approximately 10 GW. This is not surprising seeing that the south of France is characterised by more sunshine than the other regions [39]. As for the wind penetration (onshore), the two first regions presenting the highest targets are Hauts-de-France and Grand-Est which are both located in the north-eastern part of the country. Hauts-de-France present favourable wind speed mean values [38]. However wind turbines implementation strategy does not only

ASSESSING THE HYDROGEN DEPLOYMENT IN FRANCE THE USE OF TEMPORALLY AND SPACIALLY REFINED MODELS

depend on wind speed criteria. Other geographic parameters such as elevation and topography are also important. But at this stage of the study, the capacities shown here do rather reflect the targets set by the regions. These targets are also a function of the willingness of the different regions to integrate renewables into their electricity mix as well as their financial capability to invest in such installations considering the existing electricity mix. As for the offshore wind, same approach was adopted leading to the capacity distribution indicated in Table 32.

Table 32: Offshore wind SRCAE targets and the adopted scenario for 2035

	Target - wind offshore [MW]			Adopted for 2035
	2022	2025	2030	
France	2920	6000	15000	15000
Manche East-Mer du Nord	1444	3000 - 3500	6000 - 8000	7000
Nord Atlantique-Manche west	1476	2000 - 2500	4000 - 6000	5000
Sud Atlantique	0	0-1000	1000-2000	2000
Méditerranée	0	0-500	0-1000	1000

Most of the capacities are located in the north distributed between the North Sea and the north of the Atlantic Ocean. These regions combine both suitable water depth conditions as well as high wind speed values [38]. The fact that the northern coast is larger than the southern may also impact the capacity values.

With respect to the target capacities by region and the eligibility analysis detailed before, the precise locations of the renewable installations are defined in the next section.

3.3. Area selection for the targeted REN capacities

The eligible spots for REN integration are subjected to a multi-criteria analysis in order to establish a scoring system that allows to select the most propitious spots for the PV and wind targeted capacities (as detailed in section 2.2.3). The results of the selected locations for the PV and the onshore and offshore wind cases are presented in Figure 53, Figure 54 and Figure 55. The colours (reflecting the scores of the locations) go from red to blue, red representing the highest scores. The map on the left hand side displays the ranked eligible locations while the map on the right hand side shows the selected locations to reach the targeted REN capacities (the highest scores are selected for each region hence no ranking is applied on the right hand side graphs).

ASSESSING THE HYDROGEN DEPLOYMENT IN FRANCE
THE USE OF TEMPORALLY AND SPACIALLY REFINED MODELS

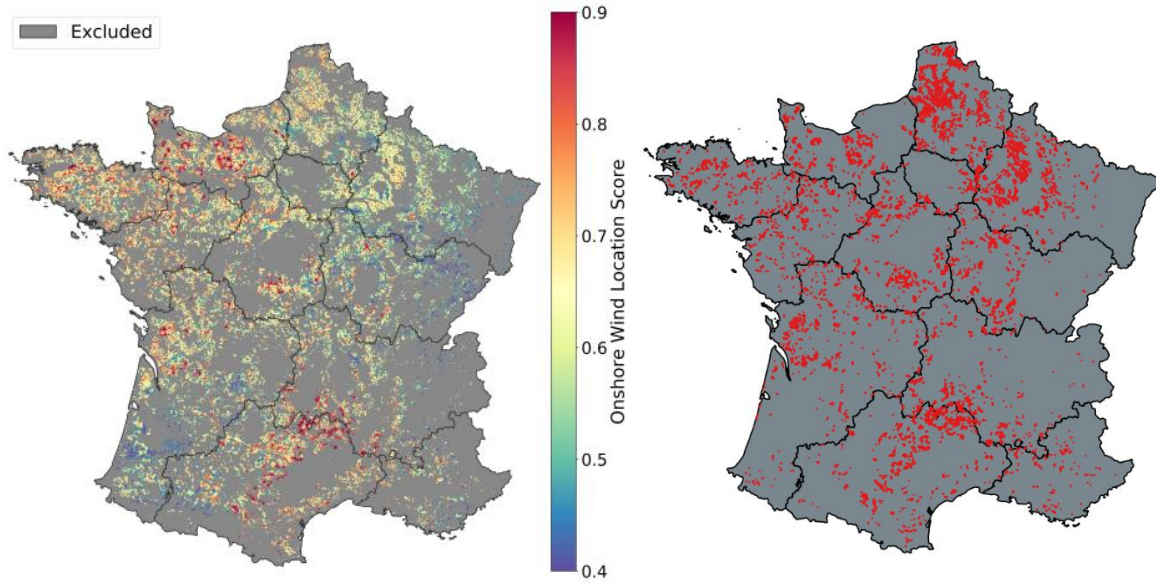

Figure 53: Wind turbine placement considering the multi-criteria approach

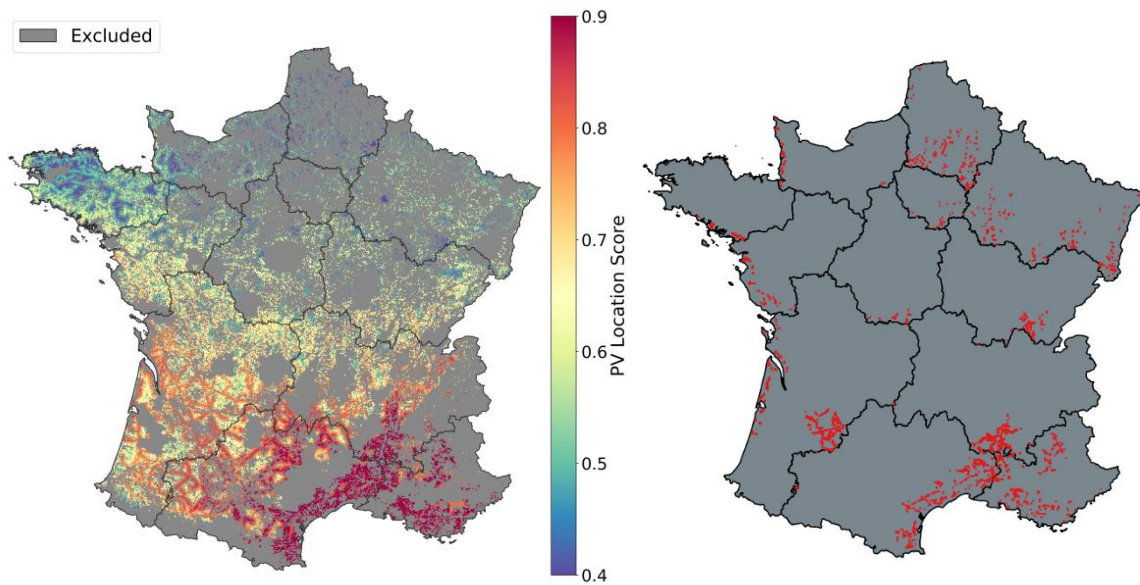

Figure 54: PV installation placement considering the multi-criteria approach

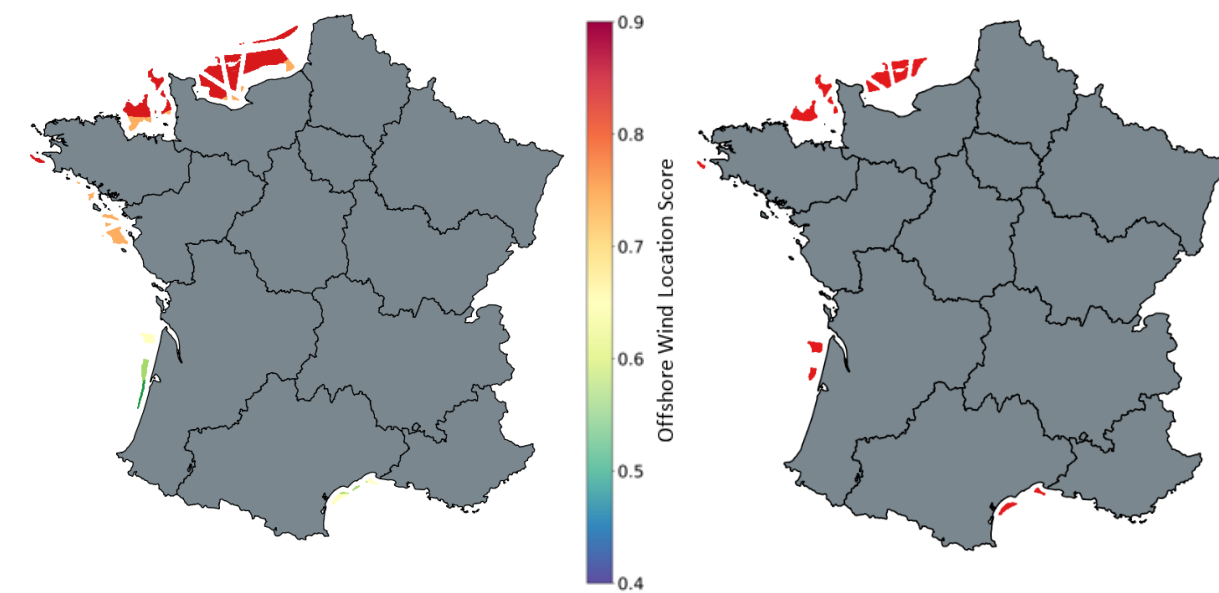

Figure 55: Offshore wind turbine placements

As shown in the figures, this approach reduces the number of possibilities in order to select the locations presenting the highest scores with regards to the considered criteria. The distribution of the locations may vary when the criteria are changed or even when the importance levels of the criteria are modified.

In order to place the renewables corresponding to the national capacity scenario, the model has to select the “best” locations with respect to the regional targets, which explains why some installations are made in green or yellow areas (with lower scores). Otherwise, the model would rather place all of the capacities in red spots, which would lead to a non-even distribution of the capacities across France and most importantly, to neglect the regional renewable penetration strategies.

The results show that the selected spots of onshore and offshore wind turbines and PV panels correspond to a surface of around 4374 km², 3136 km² and 1213 km² respectively.

From the precise locations of the REN capacity installation, the power output potential and the generation time series are computed. 2015 is selected as a reference weather year. The estimated power output of the selected renewable capacities is as follows: 104.6 TWh for onshore wind, 42.9 TWh for offshore wind and 56.3 TWh for photovoltaic. The time series generated using weather data are then used as input to a dispatch model in order to further analyse the impact of higher shares of renewables on the French electric system. This will be the aim of a following study investigating the flexibility needs of a potential future French electric system in the context of higher REN penetration [63]. Special focus will be put on the potential of producing hydrogen via the surplus of electricity in order to contribute to the decarbonisation of the mobility sector

4. Conclusion

The French electric system is undergoing a transition towards higher shares of renewables following the Paris agreement targets. In this context, different questions are raised regarding the impact of this evolution on the electric system however little work has been done so far to investigate a possible regional distribution of the renewable capacities across France. In this study, the maximal renewable potential is investigated by region discussing in details the different types of criteria defining the land and ocean eligibility for renewable penetration. Social, political, environmental and techno-economic constraints are taken into account with a special focus on the French regulation regarding the criteria defining the feasibility of a renewable installation construction. To do so, solar PV, onshore and offshore wind installations are considered. According to our review, wind penetration faces more and stricter constraints compared to PV in France. The development of wind energy faces numerous difficulties not only related to technical constraints or environmental ones. The acceptability issues from environmental protection associations and local residents (particularly in view of its impact on the landscape) are key factors in deciding the approval or the withdrawal of a wind installation project.

Once the maximal penetration potential is identified, a multi-criteria analysis is applied to select the most suitable spots for renewable integration in order to meet a future target for renewable capacities. The energy and climate strategies of each of the twelve French regions are considered in order to make sure that the suggested distribution of renewables is in harmony with the regional energy targets.

According to the results, the maximum renewable penetration is distributed as follows:

- i) 1.6 TW for solar PV mainly placed in the southern regions with Nouvelle Aquitaine retaining the biggest share. These regions are also selected for PV installation placements since they present the highest irradiation values across France coupled with a voluntarist strategy for solar integration.
- ii) 306 GW for onshore wind and 33 GW for offshore are attainable on a national level. To meet the desired scenario, the wind capacities are rather placed in the northern regions of France presenting suitable wind speed conditions and a strong will to enhance the share of wind energy in their electricity mix. Offshore wind placement also depends on marine conditions that proved to be more propitious in the north mainly due to sea depth constraints.

As discussed in section 2.2.3, the multi-criteria decision making is subjective and may vary from one stakeholder to another depending on the ranking of the criteria based on their importance level. Nevertheless, the methodology proposed in this study allows identifying precise possible locations for the renewable installations for each region, which is of great value when it comes to estimate the generation potential of the identified capacities. The precise distribution of the REN locations is crucial to generate accurate production time series. Hence this work serves as a basis for a future study [63] tackling the impact of integrating higher shares of renewables on the balance of the electric grid, orienting the focus on the evolution of the flexibility needs and the potential of producing green hydrogen using the surplus of electricity.

Acknowledgements

The present work is carried out in the framework of a PhD thesis funded by Air Liquide. It was the result of collaboration between the Institute of Electrochemical Process Engineering (IEK-3) of the Forschungszentrum Jülich GmbH, and the Institute for techno-economics for energy systems (I-tésé) of

ASSESSING THE HYDROGEN DEPLOYMENT IN FRANCE THE USE OF TEMPORALLY AND SPACIALLY REFINED MODELS

the CEA. The work of the IEK-3 was supported by the Helmholtz Association under the Joint Initiative “EnergySystem 2050—A Contribution of the Research Field Energy

REFERENCES

- [1] RTE, “Bilan prévisionnel de l’équilibre offre-demande d’électricité en France, Edition 2017.” 2017.
- [2] L’Assemblée nationale and Le Sénat, *LOI n° 2015-992 du 17 août 2015 relative à la transition énergétique pour la croissance verte (1)*, vol. NOR: DEVX1413992L. 2015, p. 14263.
- [3] “Spécial COP 21 - Les engagements nationaux de la France,” *Gouvernement.fr*, 30-Nov-2015. [Online]. Available: <https://www.gouvernement.fr/special-cop-21-les-engagements-nationaux-de-la-france-3390>.
- [4] Ministère de la transition écologique et solidaire, “Stratégie Française pour l’Energie et le Climat, Programmation Pluriannuelle de l’Energie, 2019-2023, 2024-2028, Projet pour consultation.” 2019.
- [5] T. Hubert and E. Vidalenc, “Renewable Electricity Potentials in France: A Long Term Perspective,” *Energy Procedia*, vol. 20, pp. 247–257, 2012.
- [6] ADEME, “Vers un mix électrique 100% renouvelable en 2050, Rapport final.” 2017.
- [7] A. Nadaï and O. Labussière, “Wind power planning in France (Aveyron), from state regulation to local planning,” *Land Use Policy*, vol. 26, no. 3, pp. 744–754, 2009.
- [8] A. Nadaï and O. Labussière, “Landscape commons, following wind power fault lines. The case of Seine-et-Marne (France),” *Energy Policy*, vol. 109, pp. 807–816, 2017.
- [9] A. Rogeau, R. Girard, and G. Kariniotakis, “A generic GIS-based method for small Pumped Hydro Energy Storage (PHES) potential evaluation at large scale,” *Appl. Energy*, vol. 197, pp. 241–253, 2017.
- [10] Martin Robinius *et al.*, “Linking the Power and Transport Sectors — Part 2 : Modelling a Sector Coupling Scenario for Germany,” *Energies*, vol. 10, no. 957, 2017.
- [11] David Severin Ryberg, Martin Robinius, and Detlef Stolten, “Evaluating Land Eligibility Constraints of Renewable Energy Sources in Europe,” *Energies*, vol. 11, no. 5, 2018.
- [12] S. Jerez *et al.*, “The CLIMIX model: A tool to create and evaluate spatially-resolved scenarios of photovoltaic and wind power development,” *Renew. Sustain. Energy Rev.*, vol. 42, pp. 1–15, 2015.
- [13] M. Šúri, T. A. Huld, E. D. Dunlop, and H. A. Ossenbrink, “Potential of solar electricity generation in the European Union member states and candidate countries,” *Sol. Energy*, vol. 81, no. 10, pp. 1295–1305, 2007.
- [14] P. F. STAMPFL, J. C. CLIFTON-BROWN, and M. B. JONES, “European-wide GIS-based modelling system for quantifying the feedstock from Miscanthus and the potential contribution to renewable energy targets,” *Glob. Change Biol.*, vol. 13, no. 11, pp. 2283–2295, 2007.
- [15] Ministère de l’écologie et du développement durable, “Schémas Régionaux Climat Air Energie - SRCAE,” *Pôle Territoires et Changement Climatique*. [Online]. Available: <http://www.srcae.fr/>.
- [16] Olfa Tlili *et al.*, “Implementing the energy transition at the regional level: the case of the French electric system,” *Submitt. Energy Syst.*, 2019.
- [17] ADEME, “Contribution de l’ADEME à l’élaboration de visions énergétiques 2030-2050, Synthèse.” 2013.
- [18] ANCRE, “Scénarios de l’ANCRE pour la transition énergétique, Rapport 2013.” 2013.
- [19] RTE, “Bilan prévisionnel de l’équilibre offre-demande, édition 2014.” 2014.
- [20] Association négaWatt, “Scénario négaWatt 2017-2050, Dossier de Synthèse.” 2017.
- [21] ANCRE, “Prospective énergétique France 2050 : le scénario de la Loi de Transition Énergétique.” 2017.
- [22] ADEME, “Un Mix Électrique 100 % Renouvelable ? Analyses Et Optimisations.” 2017.
- [23] ADEME, “Actualisation Du Scénario Énergie-Climat, ADEME 2035-2050.” 2017.
- [24] IDDRI, “La transition du système électrique français à l’horizon 2030.” 2017.

ASSESSING THE HYDROGEN DEPLOYMENT IN FRANCE
THE USE OF TEMPORALLY AND SPACIALLY REFINED MODELS

- [25] RTE, “Bilan électrique 2017,” 2017. [Online]. Available: <http://bilan-electrique-2017.rte-france.com/europe/75-vision-europeenne-de-lelectricite/>.
- [26] D. S. Ryberg, M. Robinius, and D. Stolten, “Methodological Framework for Determining the Land Eligibility of Renewable Energy Sources,” *ArXiv Prepr. ArXiv171207840*, pp. 1–35, 2017.
- [27] D.S.Ryberg, Z.Tulemat, M. Robinius, and D.Stolten, “Geospatial Land Availability for Energy Systems (GLAES).” [Online]. Available: <https://github.com/FZJ-IEK3-VSA/glaes/releases/tag/v1.0.0>. [Accessed: 14-May-2018].
- [28] GDAL Development Team, *GDAL-Geospatial Data Abstraction Library*. Chicagi, IL, USA: Open Source Geospatial Foundation, 2017.
- [29] E.Jones, T.Oliphant, and P.Peterson, “SciPy: Open Source scientific tolls for Python,” *Comput Sci Eng*, vol. 9, pp. 10–20, 2017.
- [30] Copernicus. European Environmental Agency (EEA), “Corine Land Cover (CLC) 2012, Version 18.5.1 [Dataset].” 2012.
- [31] OpenStreetMap Contributors, “OpenStreetMap,” 2017. [Online]. Available: <https://www.openstreetmap.org>.
- [32] European Environmental Agency, “Digital Elevation Model over Europe (EU-DEM).” [Online]. Available: <https://www.eea.europa.eu/data-and-maps/data/eu-dem>. [Accessed: 01-Apr-2017].
- [33] UNEP-WCMC and IUCN. Cambridge, UK., “Protected Planet: The World Database on Protected Areas (WDPA),” 2016. [Online]. Available: www.protectedplanet.net. [Accessed: 01-Apr-2017].
- [34] International Union for Conservation of Nature (IUCN), Gland, Switzerland, “Guidelines for Applying Protected Area Management Categories.” Nigel Dudley, 2008.
- [35] Official Journal of the European Union, *Directive 2009/147/EC of the European parliament and the Council of 30 November 2009 on the conservation of wild birds (codified version)*. pp. 7–25.
- [36] “Council Directive 92/43/EEC of 21 May 1992 on the conservation of natural habitats and wild fauna and flora,” *Official Journal of the European Union*, pp. 7–50, 1992.
- [37] Mathis Loïc Messenger, Bernhard Lehner, Günther Grill, Irena Nedeva, and Oliver Schmitt, “Estimating the volume and age of water stored in global lakes using a geo-statistical approach,” *Nat. Commun.*, vol. 7, no. 13603, 2016.
- [38] Technical University of Denmark. DTU, “Global Wind Atlas 1 km Resolution.” [Online]. Available: <https://irena.masdar.ac.ae/gallery/#map/103>. [Accessed: 01-Apr-2017].
- [39] The World Bank Group, “Global Solar Atlas,” 2018. [Online]. Available: <http://globalsolaratlas.info/?c=36.809285,7.514648,4&s=45.213002,2.548828>. [Accessed: 30-Jan-2018].
- [40] GEODATA, GISCO, Eurostat, “Transport Networks: Airports 2013.” [Online]. Available: <http://ec.europa.eu/eurostat/web/gisco/geodata/reference-data/transport-networks>. [Accessed: 01-Apr-2017].
- [41] Eurostat, “Hydrography (LAEA),” *GEODATA, GISCO*. [Online]. Available: <http://ec.europa.eu/eurostat/web/gisco/geodata/reference-data/elevation/hydrography-laea>. [Accessed: 01-Apr-2017].
- [42] GEODATA, GISCO, Eurostat, “Clusters: Urban 2011.” [Online]. Available: <http://ec.europa.eu/eurostat/web/gisco/geodata/reference-data/population-distribution-demography/clusters>.
- [43] Julien Courtel, Aude Richard, and Juliette Talpin, “Le baromètre 2017 des énergies renouvelables électriques en France.” Observ’ER, 2017.
- [44] RTE, “Panorama de l’électricité renouvelable en 2017.” 2017.
- [45] Préfet de la région Alsace, Région Alsace, “Schéma régional Climat Air Énergie Alsace, Schéma régional éolien.” 2012.
- [46] Préfet de la région Champagne Ardenne, “Plan Climat Air Energie Champagne Ardenne, Schéma Régional Eolien, Annexe.” Mai-2012.
- [47] Agence Bocage, “Notions générales sur l’éolien, Schéma paysager éolien du département du Nord.” .
- [48] Préfet de la région Nord-Pas-de-Calais, “Annexe : ‘Schéma Régional Eolien.’” .

ASSESSING THE HYDROGEN DEPLOYMENT IN FRANCE
THE USE OF TEMPORALLY AND SPACIALLY REFINED MODELS

- [49] île de France, “Schéma Régional Eolien : île de France, C : Recommandations et potentiel éolien.” 2012.
- [50] Préfet maritime de la Méditerranée, Préfet de la région Provence-Alpes-Côte d’Azur, “Document de planification Le développement de l’éolien en mer Méditerranée.” 2015.
- [51] Ministère de l’Environnement, de l’Energie et de la Mer, “Infrastructures, transports et mer, Note technique du 11 juillet 2016 relative aux mesures de sécurité maritime applicables à la planification d’un champ éolien en mer.” 2016.
- [52] “GADM database of Global Administrative Areas, version 2.0,” *Global Administrative Areas*, 2012. [Online]. Available: <https://gadm.org/>.
- [53] Benjamin Halpern, Melanie Frazier, John Potapenko, Kenneth Casey, and Kellee Koenig, “Cumulative human impacts: raw stressor data (2008 and 2013),” *Knbn. Knowledge Network for Biocomplexity*, 2015. [Online]. Available: <https://knbn.ecoinformatics.org/view/doi:10.5063/F1S180FS>.
- [54] “EMODnet Human Activities, Cables, Actual Routes,” 2015. [Online]. Available: <http://www.emodnet-humanactivities.eu>.
- [55] “EMODnet Human Activities: Telecom cables (schematic routes),” 2014. [Online]. Available: <http://www.emodnet-humanactivities.eu>.
- [56] “Natural Gas Pipelines in Europe, Asia, Africa & Middle East,” *World Map*. [Online]. Available: https://worldmap.harvard.edu/data/geonode:natural_gas_pipelines_j96. [Accessed: 04-Apr-2017].
- [57] M. L. Messenger, B. Lehner, G. Grill, I. Nedeva, and O. Schmitt, “Estimating the volume and age of water stored in global lakes using a geo-statistical approach,” *Nat. Commun.*, vol. 7, p. 13603, 2016.
- [58] “The GEBCO 2014 Grid, version 20141103,” *General Bathymetric Chart of the Oceans (GEBCO)*. [Online]. Available: <http://www.gebco.net>.
- [59] Laurent Fayein, Patrick Albrecht, and Michel Dumont, “Instruction administrative des projets éoliens, Rapport.” CGEDD - Conseil Général de l’Environnement et du développement durable, Mai-2011.
- [60] Jérôme Christin, “Les énergies renouvelables en zone de montagne : Contraintes et opportunités de développement – Étude sur la partie Sud des Alpes.” Cerema, Direction Territoriale Méditerranée, Oct-2016.
- [61] Stéphane Mandard, “Les contraintes militaires croissantes menacent la filière éolienne terrestre,” *Le Monde*, 13-Oct-2017.
- [62] “Contraintes militaires et développement éoliens, 14e législature,” *Sénat*, 2017. [Online]. Available: <https://www.senat.fr/questions/base/2017/qSEQ170225211.html>.
- [63] O. Tlili *et al.*, “Role of electricity interconnections and impact of the geographical scale on the French potential of producing hydrogen via surplus electricity by 2035,” *Energy*, vol. 172, pp. 977–990, 2019.

CHAPTER II

Role of electricity interconnections and impact of the geographical scale on the French potential of producing hydrogen via electricity surplus by 2035

1. Introduction

In the context of the rising shares of variable renewables challenging the system balance management, hydrogen production can help avoid the waste of low carbon available energy either by consuming the “surplus” of renewable generation during off peak periods or benefiting from the “excess” of available nuclear production that is due to the modulation of nuclear power plants to follow the residual demand variations [3], alongside linking the different energy sectors together [1], [4]–[6].

“The Hydrogen Plan” presented by Nicolas Hulot [7], Minister of Ecological Transition and Solidarity until August 2018 sets targets for the development of hydrogen in the energy transition, and seeks above all to “green” the existing industrial uses of hydrogen, starting with the uses closest to economic profitability. Then after creating the required economies of scale and reducing the costs, it is envisaged to develop the new uses related to mobility (first around captive fleets) and the storage of renewable energy in the gas networks (when the need arises). Consequently, the French hydrogen roadmap aims at:

“- Introducing 10% decarbonised hydrogen into the industrial hydrogen markets by 2023 (approximately 100,000 t) and 20 to 40% by 2028.

- Deploying territorial ecosystems of hydrogen mobility, based in particular on fleets of professional vehicles, with the introduction of around 5,000 light commercial vehicles and 200 heavy vehicles (buses, trucks, regional trains, ships) and the construction of 100 stations fuelled by hydrogen produced locally by 2023. By 2028, the target is to reach from 20,000 to 50,000 light commercial vehicles, 800 to 2,000 heavy vehicles and 400 to 1000 stations.”

Thus, the aim behind the interest in electrolysis in this study is to evaluate the potential of producing hydrogen via the surplus of electricity and investigate the sufficiency of the resulting hydrogen volumes in meeting part of the hydrogen volume targets as set by the hydrogen Plan.

Several studies in the literature tackled the use of excess electricity (that has low carbon footprint) in France for hydrogen production. They mainly deal with the use of the available nuclear power that is not used due to renewable penetration. This available production has a low carbon content and presents low electricity generation costs. It can thus be used for low cost hydrogen production.

Scamman and Newborough (2016) [8] investigated the French potential of hydrogen production using the available nuclear energy that otherwise would be lost while following the electricity load profile or providing ancillary services. Different case studies are compared, considering weekly or annual nuclear profiles with an electrolyser capacity ranging from 0.5 GW to 20 GW. A 20 GW electrolyser would be able to produce (annually with an average utilization rate of 66%) enough hydrogen to cover the predicted hydrogen mobility fuel demand for 2050 and a 5% concentration of hydrogen in the gas networks (volume wise) plus 33 TWh of synthetic methane that could also be injected into the gas grid, while smoothing the nuclear weekly profiles.

Earlier, Gutiérrez-Martín et al. (2009) [9] evaluated the potential of producing hydrogen using the excess of electricity in the French system evaluated at 22 TWh in 2007. Hourly average surplus of electricity are assessed and result in a potential of a daily production volume reaching 1314 tons of hydrogen from a total installed capacity of 5.8 GW and an average utilization rate of 42.8%. The resulting hydrogen volumes are sufficient to meet a fuel demand for 3 million fuel cell vehicles leading to a mitigation of approximately 6720 ktonCO₂/year.

Cany et al. (2017) [10] inspected the extent to which excess nuclear power in France could contribute to producing low carbon hydrogen. Different scenarios for nuclear capacity as well as renewable penetration were investigated. The results show that by 2030, if the nuclear capacity is maintained at 60 GW, the nuclear-based hydrogen production could meet up to 100% of the demand considering the high scenario (23% of total produced electricity). However, if nuclear capacities are reduced to 40 GW, there would be no sufficient excess to consider hydrogen production even with the high scenario for renewable penetration.

For all the above-mentioned studies, the analysis is conducted at the French national scale and the interconnections are exogenous in most of the cases. Other studies investigated the role of hydrogen in the provision of flexibility to the grid in a larger scope not only considering the available nuclear energy potential.

Mansilla et al. (2011) [11] inspected the discontinuous operation of alkaline electrolyser in order to benefit from low electricity prices. Different scenarios for the electricity threshold prices were investigated.

Later in 2012, Mansilla et al. [12] investigated both the implementation of hydrogen production as a flexible demand and the possibility of its participation to the balancing mechanisms. Different sourcing strategies on the electricity markets were compared. According to the results, such flexible operation of electrolysers would allow to reduce the hydrogen production costs by nearly 10% compared to continuous operation. The carbon content of the consumed electricity would also be lowered by approximately 15%.

Then, in 2013, the authors evaluated the economic competitiveness of hydrogen production with a multi-regional approach, comparing France to its neighbours (Germany and Spain) [13]. The aim was to assess the impact of different renewable penetration rates on the hydrogen profitability (since Germany and Spain are characterized with higher share of REN). The gain provided by discontinuous operation in such case was very small and not correlated with REN penetration, but rather with the variability of the electricity prices.

ASSESSING THE HYDROGEN DEPLOYMENT IN FRANCE THE USE OF TEMPORALLY AND SPACIALLY REFINED MODELS

Bennoua et al. (2015) [14] analysed the role of hydrogen in resolving the electric grid issues in France, investigating the exploitation of the excess of nuclear power (due to electricity load following) and the balancing mechanisms (downwards and upwards) for hydrogen production. The study is based on the profile of a single nuclear power plant (Bugey presenting four reactors) taken as an example. Depending on the scenario, the hydrogen production potential can go up to nearly 5760 tonnes / year per reactor. Providing the balancing mechanisms with hydrogen production only would result in a volume of 670 kt_{H₂}/year with costs varying between 1.38 €/kg and 1.44 €/kg.

Caumon et al. (2015) [15] studied the role of hydrogen as a flexible demand and its impact on the French and European power system while keeping hydrogen production close to economic competitiveness. A threshold for electricity prices is set in order to avoid sourcing the electrolyzers with carbon-intensive electricity provided by expensive fossil fuel plants activated during peak hours. The impact of hydrogen production flexibility on the mitigation of the renewable energy curtailment in France and Europe is then assessed considering different scenarios for the electricity mix, the price threshold and the electrolyser capacity. When considering a moderate renewable penetration, hydrogen flexible production proved to be costly (as a result of low utilization rates) and carbon intensive (a 50% utilization rate is reached when 80€/MWh is set as electricity threshold meaning that it would consume carbon-intensive electricity) regardless of the electricity price threshold scenario. Only voluntarist scenarios in terms of renewable penetration lead to significant amounts of competitive low-carbon hydrogen production.

Later in 2017, a study funded by the FCHJU [16] identified the locations with maximum renewable curtailment in France which may lead to access electricity at a lower price than the wholesale electricity price. The scenario adopted in the study assumed a 31% share (of generation mix) for the renewable penetration by 2025. According to the results, the total renewable curtailment amounts to 630 GWh in 2025, corresponding to 0.7% of the total REN production, with the Albi region presenting the highest curtailment amounts. Accordingly, this report assesses the profitability of producing hydrogen for the mobility market segment in the Albi region. An acceptable hydrogen fuel price to end-users at the pump was identified at 9-10€/kg.

The reviewed studies elaborated a quite extensive situation analysis for hydrogen systems for the French case, starting from the production possibilities up to the market penetration feasibility. However; none of the listed studies (except for [16] which takes the interconnections as an exogenous parameter based on historic values with respect to the interconnection capacity evolutions) developed a regional approach making it possible to locate the surplus by region, which provides insights about the regional disparity and where to start deploying the electrolyzers. The impact of the interconnections on the electricity surplus was also neglected except for Caumon et al. [15]. As a matter of fact, Caumon et al. (2015) [15] concluded that, when favoring the interconnections, the hydrogen production potential is enhanced thanks to the import of renewables from the neighboring countries. The study was performed for 2050 assuming a high level of both renewable and nuclear power.

In this chapter, special attention is dedicated to the impact of the geographic scale on the results with a focus on the role of the interconnections in defining the flexibility of the electric system, hence the remaining electricity surplus. The study is conducted at the regional scale in France for the timeframe of 2035 considering the twelve French regions. Conducting the study at a regional level helps us identify

the regions presenting higher surplus (hence more grid issues). It also helps identify the potential flow of the produced hydrogen between the regions.

The first aim of this chapter is to evaluate the flexibility needs of a future potential electric system in France assuming higher capacities for renewable production and a reduced share of nuclear power to 50% by 2035, in compliance with the French Energy Transition Law targets. Since special focus is put on the impact of considering the interconnections on the flexibility needs, two contrasted case studies are elaborated; a theoretic one considering France isolated, with no border exchange, and a more realistic one comparing two alternatives for export capacities. The flexibility requirements are assessed through the investigation of the electricity surplus that may arise in such a context leading to the second aim of this chapter which is evaluating the hydrogen production potential using this energy surplus.

The first part of the chapter details the methodology adopted and the assumptions of the study. Then in the results part, the regional implementation of the power system is depicted followed by the analysis of the surplus for the case studies described above. The hydrogen production potential is then assessed based on the regional allocation of the available energy.

This chapter is published in Energy [17].

2. Methodology

In this section, the methodology adopted to assess the potential electricity surplus that may arise when higher shares of renewables are integrated into the generation mix is presented. The resulting hydrogen amounts produced via this surplus are then investigated.

To do so, a balanced scenario of the electricity mix is selected [18] suggesting high shares of renewable penetration while respecting the 50% governmental target for the nuclear share in the energy mix by 2035. This scenario is designed by the French TSO (RTE) in the framework of evaluating different future evolution possibilities of the electric mix. The “Ampere” scenario that is selected is the closest to the Energy Transition Law targets [19]. In this scenario, the breakdown of the generation capacities is as follows: 52 GW for onshore wind, 15 GW for offshore wind, 48 GW for PV, 26 GW for hydroelectrics, 48.5 GW for nuclear, 13.2 GW for thermal, and 33 GW export capacity (27 GW import capacity).

The aim of the scenario selection is to look for balanced capacities that are already tested with the French grid suitability. The selection of this scenario was discussed in details in [20].

The current study builds on the work presented in the previous chapter that investigated the precise locations of the renewable installations across France based on land and ocean eligibility analysis for REN penetration [20] which uses models developed from Robinius et al. [21], Ryberg et al. [22], [23] and Caglayan et al. [24]. This precise geographic distribution allowed to generate accurate time series of the renewable production.

In addition to the renewable energy surplus, the nuclear energy availability is also assessed due to its low-carbon content and particular position in the French electric system. Thus, in this study, the definition of electricity surplus can be divided into two categories presenting:

ASSESSING THE HYDROGEN DEPLOYMENT IN FRANCE
THE USE OF TEMPORALLY AND SPACIALLY REFINED MODELS

- i) The renewable curtailment which includes the onshore and offshore wind, and the PV, as well as the hydro spill (spilling water from reservoirs without producing electricity in order to respect the reservoir capacities and constraints) called “REN surplus” in what follows;
- ii) The available nuclear energy that is not dispatched in periods of high renewable generation or low electricity demand levels in accordance with the merit order logic.

The electricity system balance modelling is conducted via a Power Flow Model which is called ‘Europower’ [25].

The model is a generation dispatch or short-term electricity market model. It is a linear programming, mono-objective optimization problem where the total operational costs of the system are minimized for one year. It is implemented with the PyPSA framework [26], where the DC flow and storage constraints are included. Furthermore, the linear approximation of the thermal generation flexibility and the grouped flow constraints are added as well.

The model takes as input the time series of electricity demand for each region as well as the regional time series of the renewable generation once aggregated by type, then it establishes the equilibrium of the electric system and generates the time series of the different electricity generation means.

The formulation of the optimization problem is detailed as follows:

$$\min \left\{ \sum_t \left[\sum_i c_{i,t}^g \cdot g_{i,t}^{eff} + \sum_i c_{i,t}^s \cdot sud_{i,t} \right] \right\} \quad \text{Objective} \quad (1)$$

$$\text{s.t.} \quad \sum_i g_{i,n,t} + \sum_i sud_{i,n,t} - \sum_i suc_{i,n,t} - \sum_l K_{nl} f_{l,t} - \sum_i d_{i,n,t} = 0 \quad \forall n, t \quad \text{Energy balance} \quad (2)$$

$$\underline{P}_{i,t} \leq g_{i,t} \leq \overline{P}_{i,t} \quad (3)$$

$$g_{i,t}^{eff} \geq g_{i,t} \quad (4)$$

$$g_{i,t}^{eff} \geq N \cdot g_{i,t-k} \quad \forall k \leq K \quad (5)$$

$$\underline{E}_{i,t} \leq f_{i,t} \leq \overline{E}_{i,t} \quad (6)$$

$$\underline{NTC}_{L,t} \leq \sum_{l \in L} f_{l,t} \leq \overline{NTC}_{L,t} \quad \text{Grouped flows} \quad (7)$$

ASSESSING THE HYDROGEN DEPLOYMENT IN FRANCE
THE USE OF TEMPORALLY AND SPACIALLY REFINED MODELS

$$f_{l,t}^{AC} = \frac{\theta_{n0,t} - \theta_{n1,t}}{x_l} \quad \text{DC flow} \quad (8)$$

$$0 \leq sud_{i,t} \leq \bar{S}_{i,t} \quad (9)$$

$$0 \leq suc_{i,t} \leq \bar{S}_{i,t} \quad (10)$$

$$0 \leq soc_{i,t} \leq \overline{SOC}_{i,t} \quad (11)$$

$$soc_{i,t} = soc_{i,t-1} + \eta_{i,t}^{store} \cdot suc_{i,t} - sud_{i,t} + inflow_{i,t} - spillage_{i,t} \quad (12)$$

where i refers to units, t to time steps, n to network nodes and l to network branches

The modelling parameters and the optimization variables are detailed in Table 33 and Table 34.

Table 33: Modelling parameters

Parameter	Explanation	Unit
$c_{i,t}^g$	marginal cost of operation for generator i at time t	€/MWh
$c_{i,t}^s$	marginal cost of operation for storage unit i at time t	€/MWh
K_{nl}	incidence matrix of the network topology	{-1, 0, 1}
$d_{i,n,t}$	electricity load of consumer i on node n at time t	MW
$\underline{P}_{i,t}$	must-run generation (20% of nominal capacity if nuclear, 0 else)	MW
$\bar{P}_{i,t}$	generation capacity of generator i	MW
N	minimum load of the units in the corresponding aggregate	p.u.
K	start-up time of the units in the corresponding aggregate	Number of hourly time steps
$\underline{F}_{i,t}$	power flow capacity of branch i at time t on the direction opposite to the defined	MW
$\bar{F}_{i,t}$	power flow capacity of branch i at time t on the direction in accordance to the defined	MW
L	set of branches belonging to the cross-border interconnection	-

ASSESSING THE HYDROGEN DEPLOYMENT IN FRANCE
THE USE OF TEMPORALLY AND SPACIALLY REFINED MODELS

$\underline{NTC}_{L,t}$	net transfer capacity of interconnection L at time t on the direction opposite to the defined	MW
$\overline{NTC}_{L,t}$	net transfer capacity of interconnection L at time t on the direction in accordance to the defined	MW
x_l	reactance of line l	Ohm
$\bar{S}_{i,t}$	power capacity of storage unit i at time t	MW
$\overline{SOC}_{i,t}$	energy capacity of storage unit i at time t	MWh
$\eta_{i,t}^{store}$	storing efficiency of storage unit i	[0, 1]
$inflow_{i,t}$	energy inflow rate of storage unit i at time t	MW

Table 34: Optimization variables

Variable	Explanation
$g_{i,t}^{eff}$	effective generation of generator i at time t
$sud_{i,t}$	discharging rate of storage unit i at time t
$g_{i,t}$	generation of generator i at time t
$suc_{i,t}$	charging rate of storage unit i at time t
$f_{l,t}$	power flow rate branch l at time t in accordance to the defined direction (the AC indicator corresponds to AC lines)
$\theta_{n0,t}$	voltage angle of node $n0$ at time t , where $n0$ and $n1$ refer to the end nodes of branch l
$soc_{i,t}$	state of charge (energy content of inventory) of storage unit i at time t
$spillage_{i,t}$	energy spillage rate of storage unit i at time t

Since the adopted weather year for renewable generation is 2016, and since the Ampere scenario assumes that the total national electricity demand is expected to remain the same by 2035 (same as in 2016), the regional electricity demand time series of our designed scenario are then taken from [27] and correspond to the 2016 series. A limit of this approach is that game changers may appear such as electric vehicle charging that may modify the profiles of the electricity demand as studied in [28].

The renewable time series are implemented in the model as inputs since they have the priority on the grid. Having the lowest marginal costs, they are called for dispatch before all of the other power generation means (following the merit order logic [29]). Hence, with regards to the distribution of the renewable sources and demand, 'Europower' distributes the other capacities while making sure that the balance and the integrity of the system are preserved. The outputs of the model allow to have insights regarding which nuclear (or other thermal) power plants will have to be shut down first if the total

nuclear capacity is expected to drop (following the energy transition targets). To do so, the age of the power plants is also taken into account [30].

The national capacities that are considered for the different generation means follow the Ampere scenario and are detailed in Table 35.

Table 35: Power generation capacities [GW] following the adopted Ampere scenario [18]

	2025	2030	2035
Nuclear	54.9	48.5	48.5
Thermal	13.9	13.9	13.2
Hydro	25.5	25.5	25.5
of which	4.2	4.2	4.2
pumped hydro			
Wind Onshore	30.3	41.3	52.3
Wind Offshore	5	10	15
PV	23.7	36	48.5
Bioenergy	2.9	3.5	4.1

Accordingly, after distributing and dispatching the different capacities, 'Europower' generates the time series for the power flow and evaluates the potential surplus of electricity on an hourly basis.

The dispatching computation does not consider each power plant apart. For each region, all the units are gathered, adding the capacities for each kind of power generation. A linear optimization under constraints is adopted taking into account the unit commitment (i.e. the power plant operational constraints). The constraints are then not applied at the power plant level but rather at the regional capacity level for the different power generation types.

As for the nuclear generation, an availability factor of 80% [31], [32] is assumed which allows to consider the maintenance periods, the fuel refilling time, etc. However, this factor is considered constant along the one year period adopted in this study, which presents a limit for our calculations, since unavailability periods are often programmed in advance and are generally placed during the summer time when the electricity demand levels are low.

A flexible operation of the nuclear fleet is assumed with a ramp limit of 5% of the nominal capacity (P_{nom}) per minute and an ability to go down to 20% of the P_{nom} [3], [33]. These values reflect the current characteristics of the French nuclear fleet operation. The regulation in France allows the flexible operation of the nuclear generation in order to cope with the variability of both the electricity demand and the renewable output. In order to assess the available nuclear energy, two scenarios regarding nuclear flexibility are considered:

- i) Allowing the nuclear fleet to go down to 20% of P_{nom} without considering the available nuclear generation that is not dispatched
- ii) Taking advantage of the full available nuclear energy (nuclear generation at 100% of P_{nom})

Hydro generation is implemented in the model as an endogenous parameter that also brings flexibility to the electric system. The evolution possibilities of the hydro capacities are limited since the hydro

ASSESSING THE HYDROGEN DEPLOYMENT IN FRANCE THE USE OF TEMPORALLY AND SPACIALLY REFINED MODELS

potential has already been (nearly) fully exploited in France [34]. In the Ampere scenario, the hydro capacity is assumed to remain constant till 2035 (25.5 GW of which 4.2 GW for pumped hydro storage) [18].

The hydro resources are distributed by region and by type of hydro generation (run of the river, reservoirs, pumped hydro storage, etc.).

The hydro constraints are mainly related to the size of the reservoir and the flow limits that should be respected in order to preserve the surrounding ecosystem. They aim at maintaining a minimum flow ("reserved flow") in the watercourse allowing at least to guarantee the necessary conditions for the development of life in the section that is short-circuited by the installation [35].

These constraints may be presented by the "emptying constant" value which presents the number of hours required to fully empty or fill the reservoir. This constant varies depending on the type of the installation [35]–[37].

The interconnections are endogenously considered in the model. The evolution of the electric grid is taken into account considering the projects in terms of grid line reinforcements or investments (including interconnections). The new capacities comply with the Ten Year Network Development Plan (TYNDP) taken from [38] and presented in Figure 56.

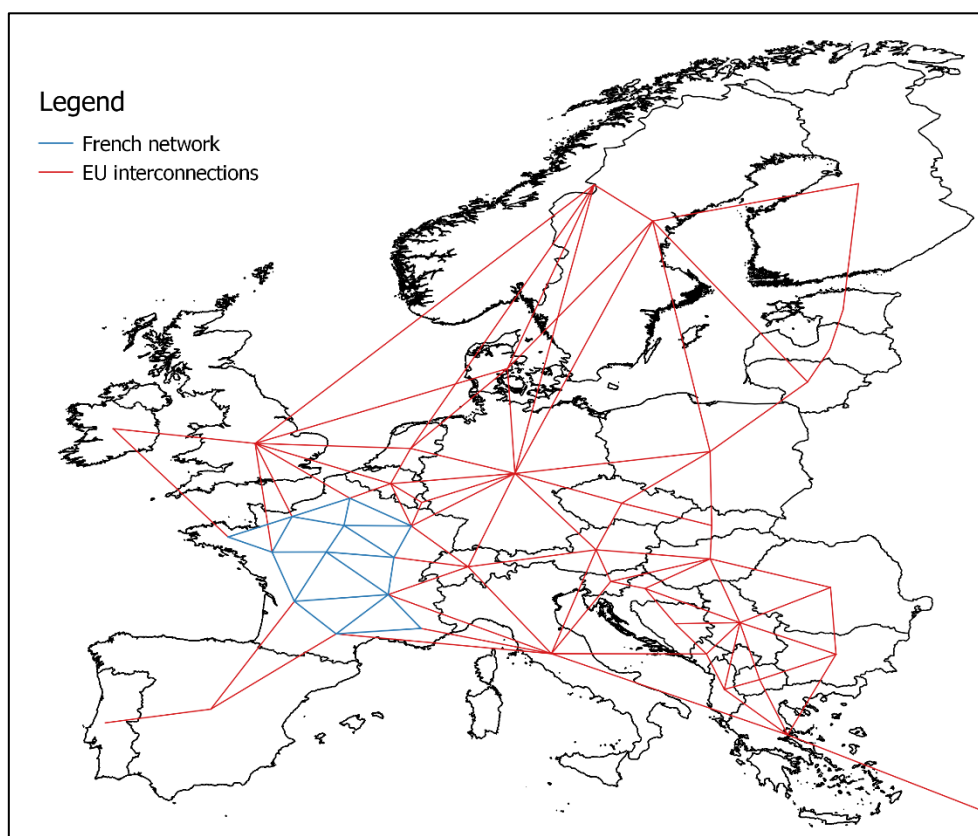

Figure 56: Electric grid lines as implemented in the model

As introduced before, two different case studies are considered for the interconnections: first, the electricity system is assumed isolated, without interconnections with the neighbouring countries; the second takes the interconnections into account. The electricity mix scenarios for the neighbouring countries are taken from the Ampere scenario [18].

Regarding the second case study, two alternatives are evaluated by defining two different values for the export/import capacities of France. One considers the Ampere scenario value (33 GW), and the other assumes only a slight increase of the current capacity (i.e. 15 GW) to 17.2 GW by 2035. This approach allows highlighting the impact of considering the electricity interconnections on the surplus potential that could be used for hydrogen generation. As presented in section 1, this issue is rarely tackled in the literature. The interconnections are most often taken as an exogenous parameter which may overestimate or underestimate the electricity surplus potential. In this study, the neighbouring countries are presented by one node each in the model, while France includes twelve nodes (one for each region). The second part of the chapter presents the results in details. To assess the surplus energy at the regional level, the regional implementation of the power system is first carried out. The results regarding the surplus energy and the potential for hydrogen production are then detailed.

3. Regional implementation of the power system

From the methodology detailed above, the regional allocation of power capacities is carried out using 'Europower'.

Taking as inputs the demand and renewable generation time series generated from detailed geographical allocation [20], as well as the hydro capacities distribution (remaining the same as of today), the model distributes the thermal capacities by region with respect to the global balance of the system considering the adopted national scenario. In the Ampere scenario, the nuclear capacity is assumed to be reduced to 48.5 GW by 2035 (vs. 63 GW today). The other thermal capacities are lowered to 13.2 GW (currently amounting to 20.4 GW). This means that nearly 14.5 GW of nuclear and 7.2 GW of thermal capacities are expected to be shut down in the years to come, raising the question of the geographical distribution of these shut-downs. The results of the model allow having insights regarding this issue. The model takes into account the age of the power plants and shuts down the oldest ones as far as the balance of the total system is respected. This means that it can decide to leave an older power plant operating if this latter is crucial to preserve the equilibrium of the grid taking into account the distribution of the demand by region.

Figure 57 presents the resulting breakdown of nuclear capacity by region if the total national nuclear capacity is reduced to 48.5 GW following the Ampere scenario. The Auvergne-Rhône-Alpes region presents the highest nuclear capacity followed by the Normandie and Grand-Est regions. The resulting capacity shutdowns by region are presented in Table 36.

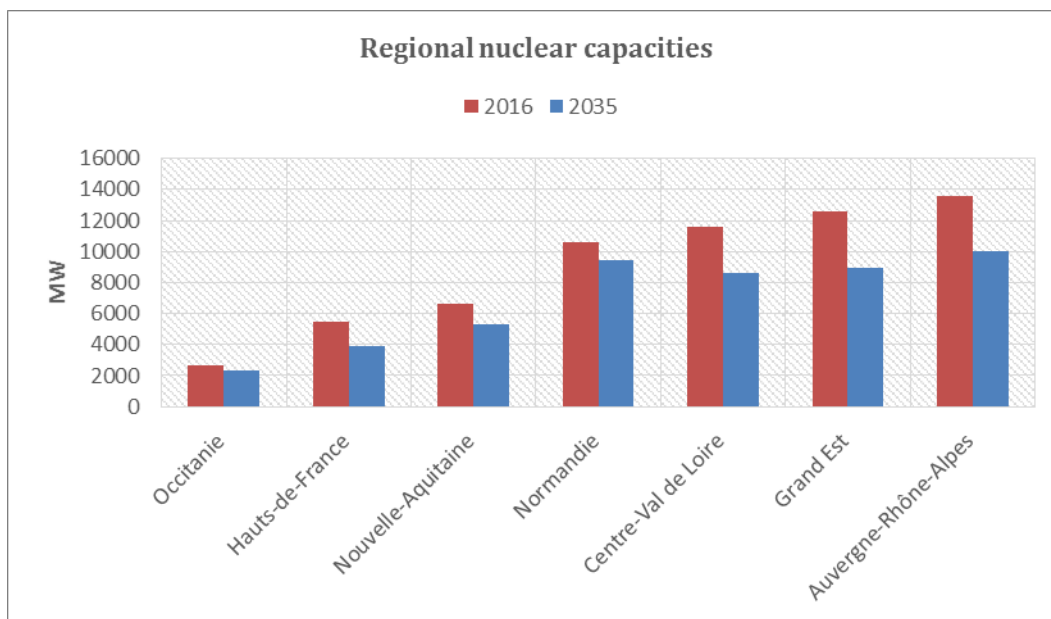

Figure 57: Nuclear capacity distribution by region - designed scenario

Table 36: Nuclear capacity shut downs by region considering the Ampere scenario

	MW
Grand Est	3,718
Auvergne-Rhône-Alpes	3,589
Centre-Val de Loire	3,071
Hauts-de-France	1,600
Nouvelle-Aquitaine	1,380
Normandie	1,293
Occitanie	341

Most of the shut downs take place in the Grand-Est and Auvergne-Rhône-Alpes regions. Although most of the shut downs occur in these regions, they still hold (together with the Normandie region) the majority if the nuclear capacities in France by 2035.

Same approach is conducted for the thermal power plants. The new thermal power distribution by region is presented in Table 37.

Table 37: New thermal capacity breakdown by region (excluding nuclear)

Region	Thermal Capacity [MW]	%
Pays de la Loire	1652	33%
Grand Est	1585	32%
Auvergne-Rhône-Alpes	504	10%
Normandie	415	8%
Provence-Alpes-Côte d Azur	412	8%
Ile-de-France	223	4%
Hauts-de-France	175	4%
Centre-Val de Loire	-	0%
Nouvelle-Aquitaine	-	0%
Occitanie	-	0%

The remaining thermal power generation installations are mainly gas-fuelled since the scenario aims at completely phasing out coal power generation and limiting the oil-fuelled generation to 1 GW by 2035. The three regions presenting the highest thermal capacities (including nuclear) are Grand Est, Auvergne Rhône Alpes and Normandie, accounting together for almost 60% of the total thermal generation fleet. These regions are characterized by either river abundance or ocean proximity, which are favourable locations for nuclear power plants (responding to their cooling requirements). They are also either characterized by high electricity demand or are located next to a region with a high one, like Ile-de-France for example, hence requiring high generation capacities. Another common point of these regions is their proximity to the borders and then to the interconnections.

The aim behind the regional segregation is to identify the locations where the electricity surplus may arise. This provides insights regarding the potential future spots for electrolyser investments. Electrolysers will allow the production of low carbon hydrogen via the low carbon surplus of electricity, while at the same time providing the electricity system with flexibility.

In the next sections, the potential surplus reflecting the future flexibility needs of the French electric system is analysed with regards to different case studies. Special focus is put on the impact of considering the interconnections at the European level.

4. Assessment of the surplus energy

4.1. First case study: Isolated France (no interconnection)

In the first case study we investigate an isolated France with no interconnections, which is clearly a theoretical case study, but it will be a basis for comparison, and allow highlighting the role of the interconnections and their impact on the surplus of electricity that may take place in the context of higher renewable shares.

ASSESSING THE HYDROGEN DEPLOYMENT IN FRANCE THE USE OF TEMPORALLY AND SPACIALLY REFINED MODELS

As defined in section 2, the electricity surplus includes both the renewable curtailment and the hydro spill (called “REN surplus”), as well as the available nuclear power that is not dispatched through the grid (referred to as “available nuclear energy”).

According to our analysis, the renewable curtailments resulted in approximately 7.9 TWh of “unused” energy for the isolated scenario. The distribution of the REN surplus by region is presented in Figure 58.

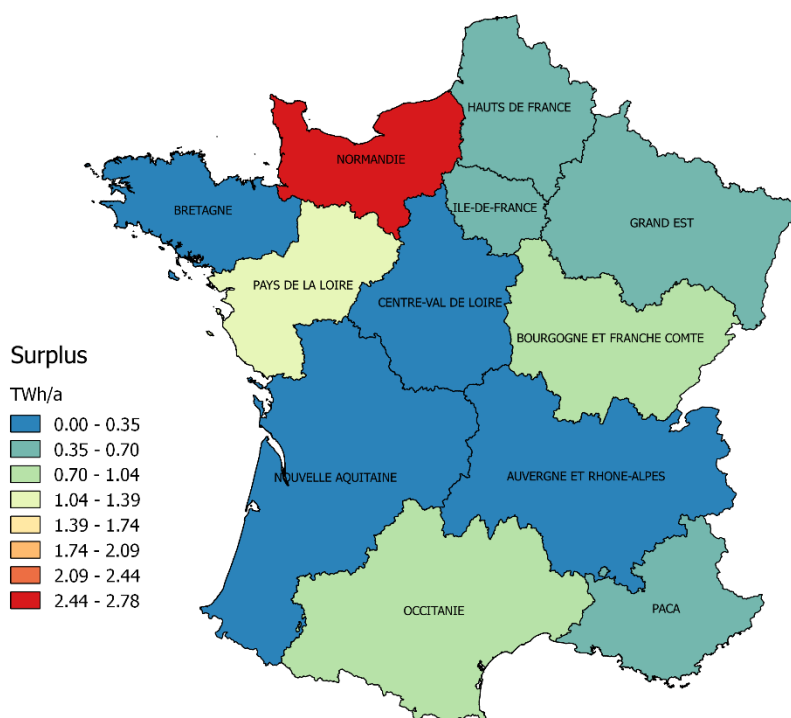

Figure 58: Distribution of the renewable surplus by region for the isolated case study

The Normandie region presents the highest REN surplus amounting to 2.7 TWh. In order to analyse the surplus geographical distribution, an investigation of the electricity mix and demand by region is conducted.

Although the Normandie region does not present the highest total installed capacity as shown in Figure 59, it presents a high share of renewables (54% of its capacity mix) together with the second highest nuclear capacity (accounting for 44% of its capacity mix).

ASSESSING THE HYDROGEN DEPLOYMENT IN FRANCE THE USE OF TEMPORALLY AND SPACIALLY REFINED MODELS

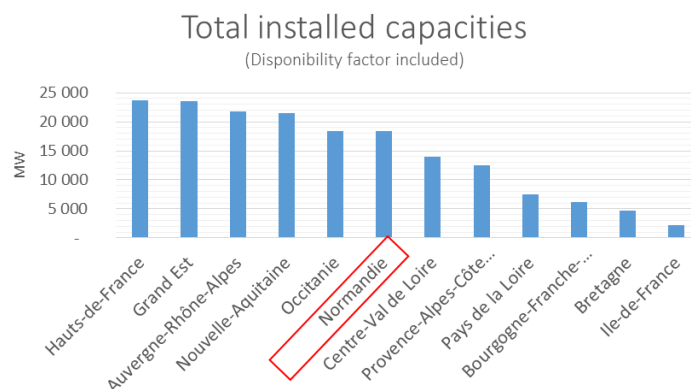

Figure 59: Total installed generation capacity by region

As flexible as it is, the nuclear modulation may not be sufficient to cope with the balancing needs of the electric system. This is especially the case of this region that has one of the lowest electricity demands in France [27]. Despite its neighbourhood with Ile-de-France that presents the highest electricity demand, the Normandie region is not able to export that much of its production in this direction because other regions surrounding Ile-de-France are already exporting their surplus to the same direction. The presence of flexibility means like the hydro pump storage is also a key factor in defining the geographical distribution of the electric surplus.

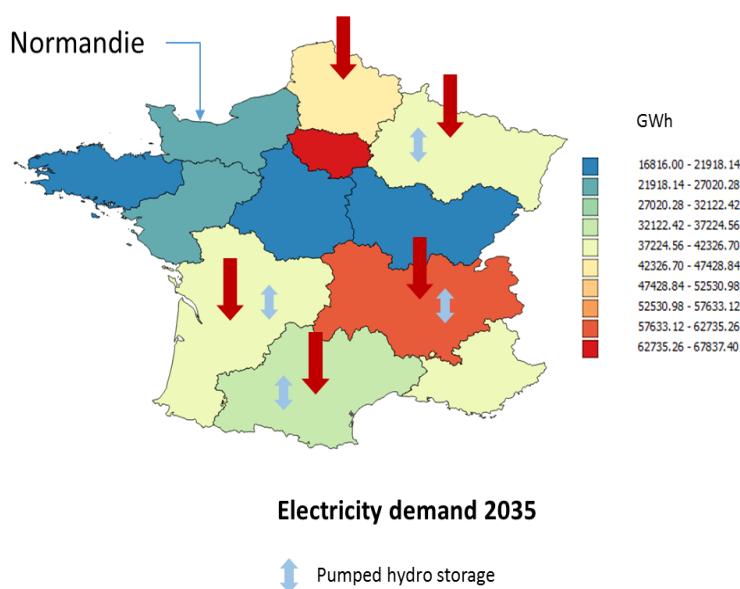

Figure 60: Electricity demand distribution by region (blue arrows show the locations of pumped hydro storage facilities; red arrows point to the five regions with the highest installed power generation capacities).

Figure 60 presents the distribution of the electricity demand by region. Additionally, the focus is put in the Figure on the five first regions in terms of total installed generation capacities pointed to by a red arrow and on the presence or absence of pumped hydro storage in these regions (presented by the light blue arrows).

All of the regions coming before Normandie in terms of total installed generation capacity have higher electricity demand and almost all of them (except for Hauts-de-France) possess pumped hydro storage facilities, which highlights the importance of these latter in “absorbing” the electricity surplus by providing the required flexibility.

An hourly distribution profile of the national renewable surplus is plotted, in order to assess the surplus capacity available during a given number of hours, which gives an idea regarding the full load hour value of a potential electrolyser operating during surplus periods. Figure 61 presents the results of the distribution.

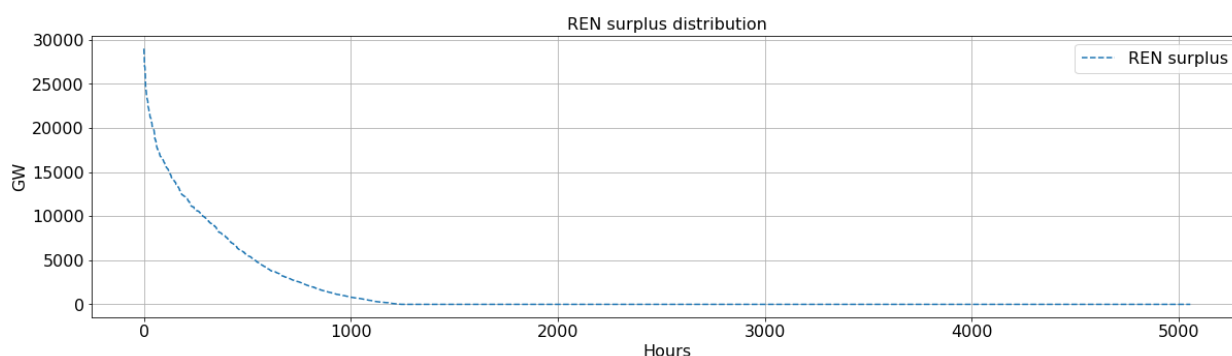

Figure 61: Hourly distribution of the renewable surplus in France

The surplus distribution is characterised by high surplus capacities (reaching at maximum 30 GW), occurring during few hours over the year and resulting in a total number of surplus hours of approximately 1200. This distribution is not economically viable for operating an electrolyser, even for a low capacity. The small number of full load hours would lead to high hydrogen production costs [4], [39], [40].

Accordingly, since electrolysers cannot be operated on the renewable surplus only from an economic standpoint, other options are investigated for hydrogen generation, while at the same time keeping a low carbon footprint.

Indeed, according to the adopted scenario, the French electric system still presents an important share of nuclear power in the generation mix (50% by 2035) allowing to have low carbon electricity. With the penetration of renewables into the system, the nuclear fleet will have to cope with the variations of the renewable generation, together with the variation of the electricity demand which may result in high manoeuvrability requirements. The nuclear response to the balance of the electric system is presented in Figure 62 (blue line).

ASSESSING THE HYDROGEN DEPLOYMENT IN FRANCE THE USE OF TEMPORALLY AND SPACIALLY REFINED MODELS

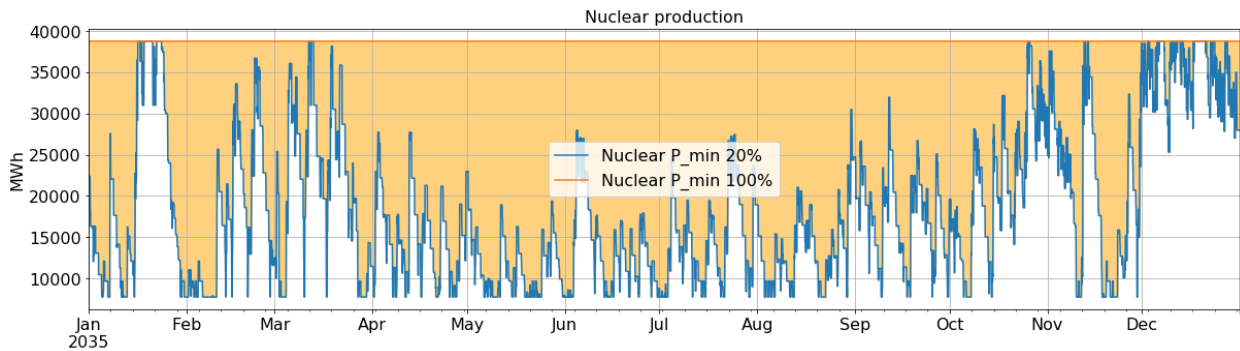

Figure 62: Nuclear available energy for hydrogen production

As shown in the figure, without any export possibilities, the nuclear fleet has to go down to 20% of its nominal capacity (set as minimal load) very often during the year and especially during summer time resulting in a capacity factor (Kp) of around 38%, which is far from being economically acceptable [41]. Therefore, we investigate in this study the potential of producing hydrogen using the available nuclear power that is not dispatched through the grid. As detailed in section 2, this case study considers a nuclear fleet that would operate at 100% of its nominal available capacity throughout the year (baseload mode). Accordingly, the resulting new nuclear profile is presented in Figure 62 by an orange line. The area in light orange presents the available nuclear energy that could be used for hydrogen production.

According to the results, the available nuclear energy is much higher than the renewable one, reaching 176 TWh. The hourly distribution of the available nuclear energy is presented in Figure 63.

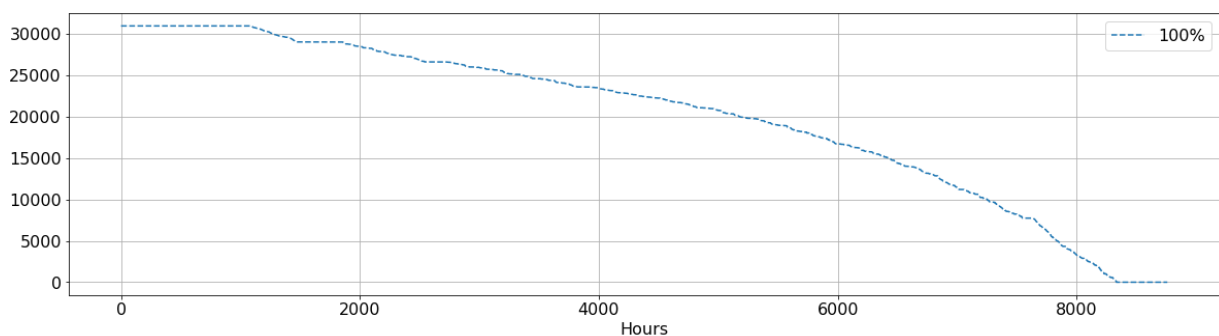

Figure 63: Hourly distribution of the available nuclear energy in [MW]

Unlike the renewable surplus, the available nuclear energy presents a profitable timely distribution with a total number of possible full load hours (depending on the electrolyser considered capacity) exceeding 8,000 hours. These values would result in high utilisation rates of the electrolysers which help produce hydrogen at competitive costs. According to Cany et al. [10] and considering an electricity price that equals the nuclear operation costs, the levelised cost of hydrogen significantly increases when going below 3,500 of full load hours, leading to the non-competitiveness of hydrogen compared to the other options present on the markets.

The economic assessment of hydrogen production is out of the scope of this chapter and will be tackled in future work. The aim here is to evaluate the impact of considering the electricity interconnections on the flexibility needs and the resulting potential surplus that could be used to produce hydrogen.

In the next section, the impact of the geographical scale is assessed considering the role of the interconnections in providing the electric system with flexibility and the resulting impact on the surplus amounts.

4.2. Second case study: Interconnected France

Implementing the interconnections into the model is crucial to have a realistic representation of the electric system behaviour. Today, the interconnections play a major role in providing the electric system with the flexibility it needs. They allow sharing generation means across Europe and can help reduce the impact of the variability of renewables. France has a central role in Europe being highly interconnected with its neighbouring countries. In 2017, the interconnection balance was around +36 TWh defining France as one of the largest exporters in Europe, but not the first. Over the 2016-2017 period, Germany has become the most exporting country (+53 TWh) in Europe due to the development of its renewable production [42].

As detailed in section 2, two alternatives are considered for the interconnection capacity: 17.2 GW and 33 GW for export capacity. The first alternative considers an only slight increase of the export capacity in France going from 15 GW currently in place to 17.2 GW. The second option is more voluntarist and fixes the export capacity to 33 GW as suggested by the Ampere scenario [18].

Figure 64 presents the hourly interconnection balance throughout the year for the two alternatives.

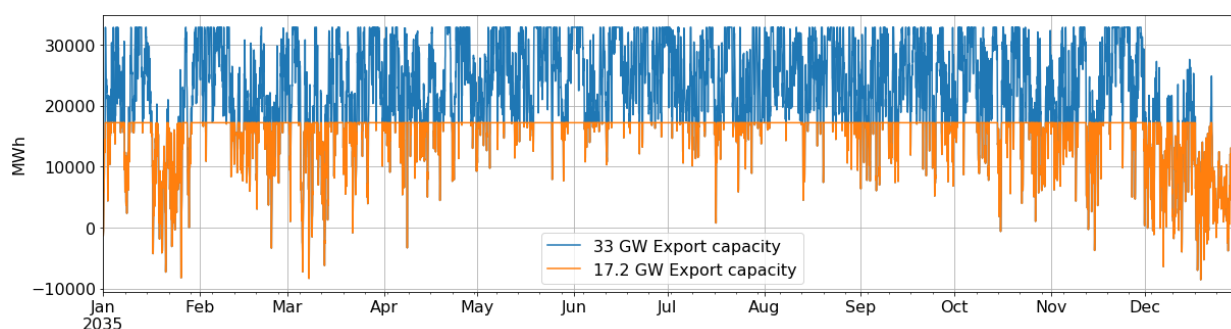

Figure 64: Interconnection balance profiles throughout the year 2035 for the two considered scenarios

As shown in the figure, the export capacities are fully used very often during the year, which can be explained by the simplified representation of the electric grid in the model as exhibited in Figure 56. Modelling the neighbouring countries as one node each may have led to the over-use of the interconnection lines.

Regardless of the export capacity, the balance is highly exporter during the whole year but specifically during summer time where the electricity demand is at its lowest values in France. This effect can also be visualized via the evaluation of the gap between the national electricity demand and the total production as presented in Figure 65. This gap is larger during summer, reflecting a higher use of the interconnections for export. The French electricity demand is sensitive to weather conditions (thermo-sensitive) which is related to the large electrification of the heating devices. Higher loads are noticed during winter time reflecting higher electricity consumption for heating, lighting, etc. During summer, the need for cooling is not important enough to impact the demand.

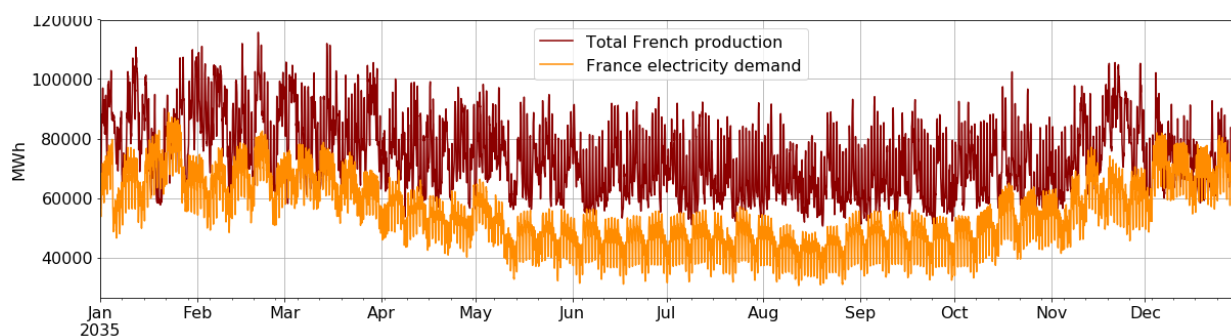

Figure 65: Hourly profile of the electric demand and the total electricity production in France

When considering the interconnections, the total amount of surplus coming from renewable curtailment is reduced to hardly 1.4 TWh, compared to 7.9 TWh for the isolated case study. The total number of REN surplus hours does not exceed 230 hours throughout the year (as presented in Figure 66) which makes it economically infeasible to operate an electrolyser, regardless of the electrolyser capacity.

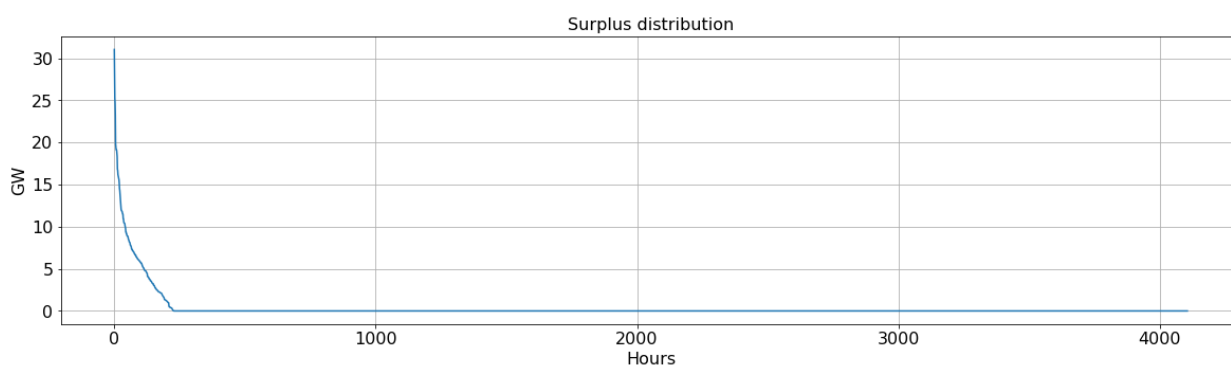

Figure 66: Renewable surplus hourly distribution in the interconnected case study

This highlights the importance of the geographic scale, and more precisely of the border exchange considerations, in defining the flexibility needs of an electric system as well as the hydrogen production potential using the excess of energy.

ASSESSING THE HYDROGEN DEPLOYMENT IN FRANCE THE USE OF TEMPORALLY AND SPACIALLY REFINED MODELS

Moving from 17.2 GW to 33 GW as export capacity does not impact the renewable curtailment according to our calculation, however, it impacts the available nuclear energy that is not dispatched through the grid and that could be considered as surplus. The nuclear generation profiles are presented in Figure 67 for the two alternatives.

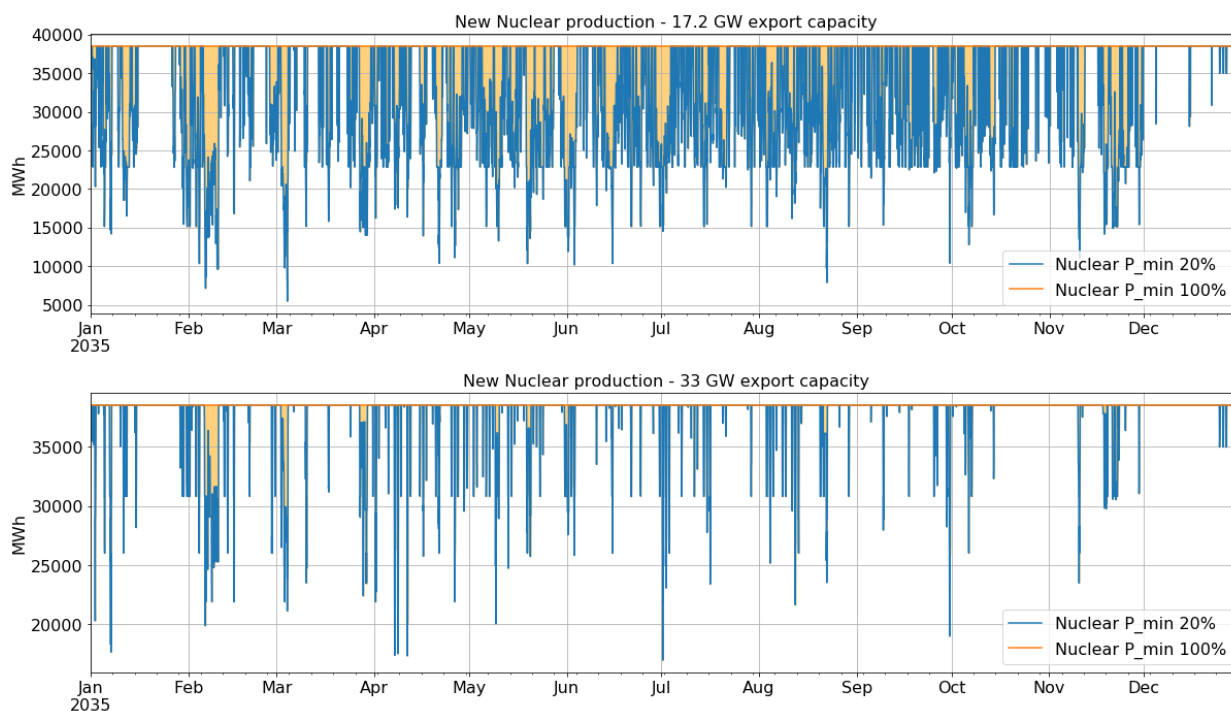

Figure 67: Nuclear generation profile and available energy for the two alternatives of export capacity. The upper figure corresponds to the 17.2 GW export capacity case study and the lower figure to 33 GW one

Two scenarios for nuclear operation are considered as in the isolated France case study. The first one allows the French nuclear fleet to go down to 20% of its nominal capacity which is presented by the blue line. The second scenario considers a steady nuclear operation at 100% of its nominal capacity (baseload) presented by the orange line. The gap between the two scenarios is the available nuclear energy that is presented by the light orange area.

The impact of load following is much present in the first alternative with lower export capacity. The nuclear fleet modulates more its generation in order to cope with the variability of renewables and preserve the balance of the system leading to a lower capacity factor (66% compared to 77% for the second alternative). Figure 68 shows the renewable generation profiles for each trimester of the year.

ASSESSING THE HYDROGEN DEPLOYMENT IN FRANCE THE USE OF TEMPORALLY AND SPACIALLY REFINED MODELS

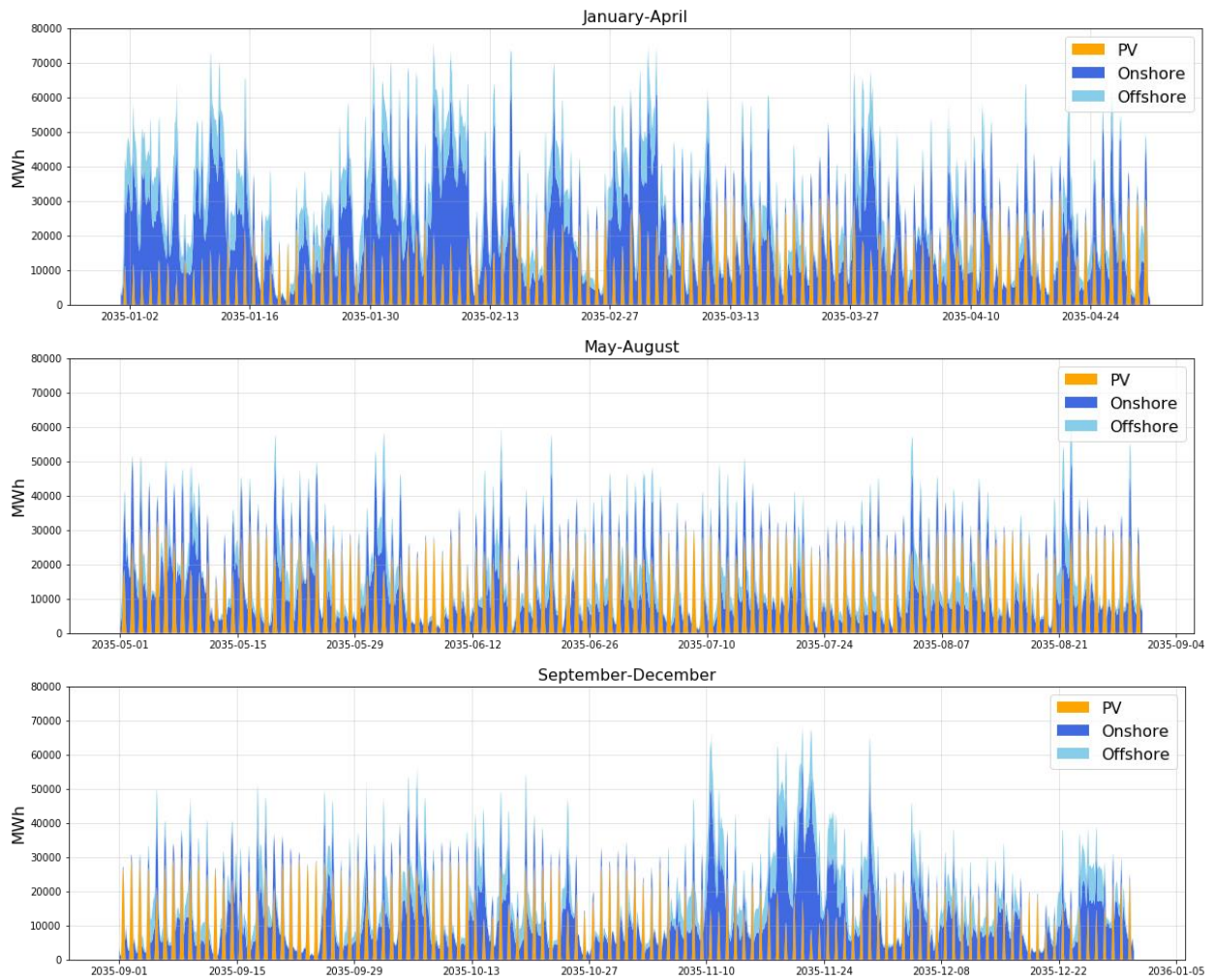

Figure 68: Renewable production throughout the year - Quarterly distribution

The wind generation profiles are more randomly distributed (than the PV profiles) but reach higher levels during winter time. Accordingly, the total nuclear available energy that is not dispatched is estimated at 58 TWh for the first alternative (17.2 GW of export capacity) and 7.9 TWh for the second (33 GW of export capacity). The hourly distribution of the available nuclear energy is presented in Figure 69 for the two considered alternatives.

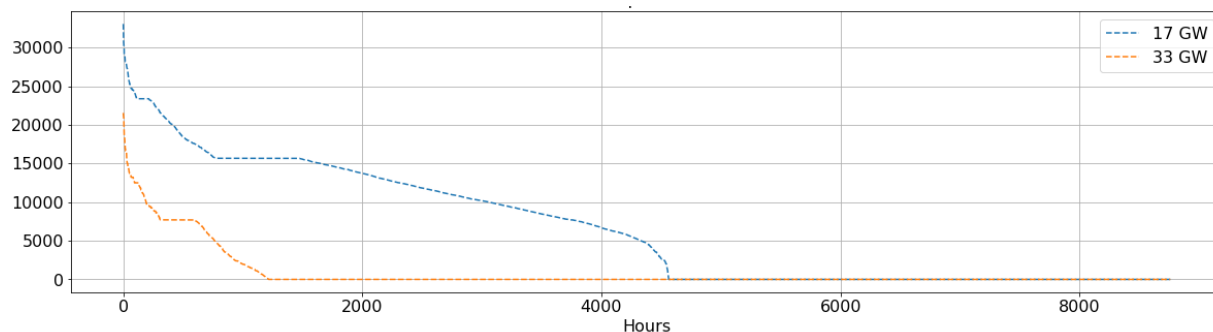

Figure 69: Hourly distribution of the available nuclear energy for the two sub-scenarios [in MW]

The total number of available nuclear energy hours reaches 4,500 hours in the first case while it does not exceed 1,216 hours in the second. The choice of the electrolyser capacity that could generate hydrogen using the available nuclear energy depends on economic constraints that will be tackled in future work. Both the full load hour value and the electricity prices should be considered in order to reach a competitive hydrogen production cost. Next section will deal with the assessment of the potential hydrogen volumes produced using the renewable surplus and the available nuclear energy.

5. Hydrogen potential

Consuming the entire surplus (REN and nuclear) to produce hydrogen (assuming an electrolyser electricity consumption of 50 kWh/kg_{H2}), would result in an annual hydrogen volume potential varying between 0.19 Mt and 3.68 Mt, depending on the interconnection capacity level (as shown in

ASSESSING THE HYDROGEN DEPLOYMENT IN FRANCE THE USE OF TEMPORALLY AND SPACIALLY REFINED MODELS

Table 38). The more interconnected France is, the less surplus is obtained which highlights the importance of the interconnections in providing the French electric system (and beyond, the European one) with flexibility. The maximum hydrogen production potential via surplus by 2035 is assessed assuming that the total amount of surplus is used to produce hydrogen to catch the potential. However, hydrogen will face competition in using available low-cost energy.

The aim of this section is to evaluate the sufficiency of the assessed hydrogen maximum volumes in meeting the future potential hydrogen demand for the passenger light duty mobility.

To do so, the French hydrogen roadmap is investigated [7]. The target of the French government is to reach 20,000 to 50,000 light duty fuel cell electric vehicles by 2028 [7]. If an average annual travelled distance of 13,000 km per vehicle and a hydrogen consumption of 1 kg_{H2}/100 km are considered, the hydrogen demand for PLDVs mobility would reach 2.6 to 6.5 kt to fuel the expected PLDV fleet.

In such a case, all of the scenarios allow to meet the French target in terms of hydrogen penetration into the passenger light duty mobility sector. However, this target is still modest and corresponds to the timeframe of 2028.

The total number of surplus hours and more precisely the hourly distribution of the surplus previously displayed in Figure 61, Figure 63, Figure 66 and Figure 69 is key factor in defining the feasibility of producing hydrogen using the surplus from an economic standpoint. Other factors like competitiveness with other flexibility options to use the surplus may also define lower surplus amounts to be used for hydrogen production.

According to the results of the surplus hourly distribution, the renewable surplus by its own does not allow to meet the evaluated hydrogen demand by 2028. The total number of surplus hours does not exceed 230 hours for the interconnected case study, which means that no matter what electrolyser capacity we can consider, the full load hour value will be too low to ensure an economically feasible operation of the electrolyser. Adding the available nuclear energy allows to have higher operation hours and more available surplus energy.

ASSESSING THE HYDROGEN DEPLOYMENT IN FRANCE
THE USE OF TEMPORALLY AND SPACIALLY REFINED MODELS

Table 38: Surplus results and hydrogen production potential for the different case studies

Case study	Renewable surplus		Available nuclear energy		Hydrogen volumes **
	TWh	Hours*	TWh	Hours*	Mt
Isolated France	7.9	1200	176	8,333	3.68
Interconnected France					
17.2 GW	1.4	228	58	4,562	1.19
33 GW	1.4	228	7.9	1,216	0.19
*Number of hours during which the surplus occurs					
** If the entire surplus is used to produce hydrogen					

The total surplus reaches 59.4 TWh and 9.3 TWh corresponding respectively to the 17.2 GW and 33GW case studies for the export capacity. These amounts allow respectively to meet (if fully used) up to 28% of the total French passenger light duty vehicles if substituted with fuel cell electric ones in the first case study and around 4.4% in the second one. These values consider a total passenger light duty vehicle fleet of approximately 32 millions [43].

The distribution of the resulting hydrogen demand, as well as the maximal potential for hydrogen production using the surplus energy by region, is presented in Figure 70. The estimation of the distributed hydrogen demand is based on the number of cars by region. For the case of the 33 GW as export capacity taken here as an example, the surplus allows to “fuel” 4.4% of the fleet. Therefore, this percentage is applied for all of the regions to define the regional segregation of the demand, although the reality might be different. The estimation of the resulting hydrogen volumes is based on the same assumptions previously adopted (1 kg/100 km and 13,000 km as annual travelled distance).

ASSESSING THE HYDROGEN DEPLOYMENT IN FRANCE THE USE OF TEMPORALLY AND SPACIALLY REFINED MODELS

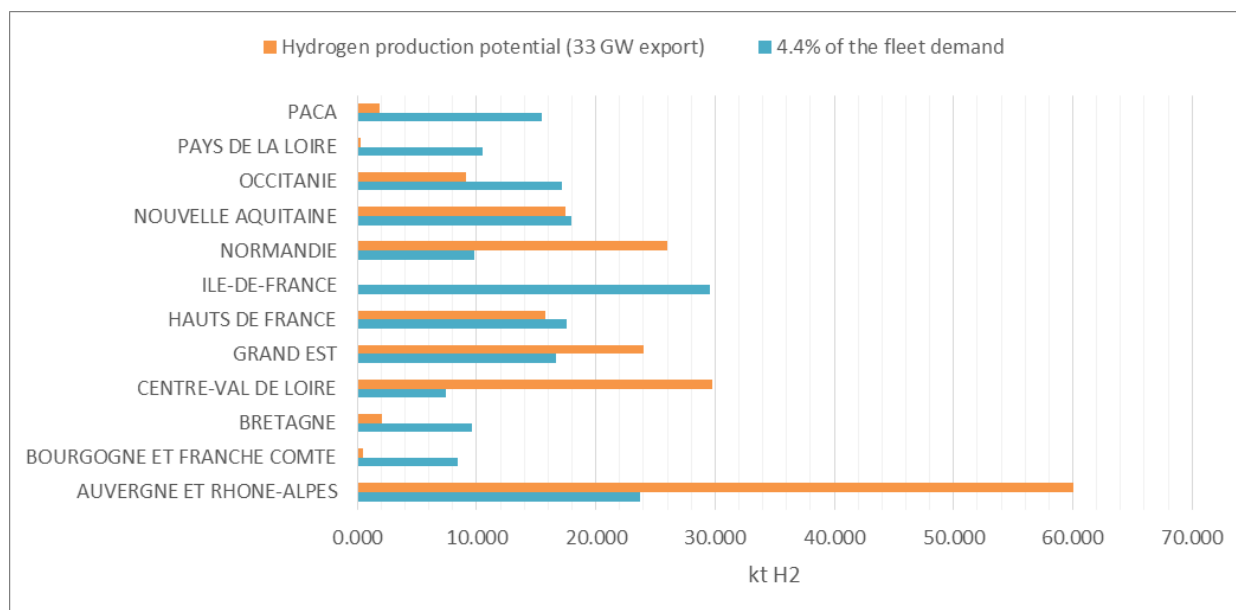

Figure 70: Regional distribution of hydrogen demand for mobility use (for 4.4% penetration) and the hydrogen production potential via the electricity surplus by region

This distribution allows to provide insights regarding the potential locations of future electrolyser implementation as well as the hydrogen flow between the different regions. In the case of producing hydrogen via the surplus of electricity, nine potential regions may present a propitious location for large electrolyser investments. These are the ones exhibiting significant hydrogen production potential amounts as presented in Figure 70 by orange bars. Four of these regions could be hydrogen exporters since their available nuclear energy is higher than their hydrogen demand (for the 4.4% scenario). The Auvergne-Rhône-Alpes region could be the largest exporter presenting a hydrogen demand that accounts for less than 50% of its total available energy. This potential is coupled with the willingness of this region to be the first hydrogen provider in France [44]. The potential of this region can be further highlighted by the fact that it presents an exceptional high concentration of stakeholders in the hydrogen field which drove it to target voluntarist projects in terms of hydrogen penetration in the transport sector. Indeed, in order to stimulate hydrogen mobility, the region is launching the Zero Emission Valley project. The aim is to deploy 20 hydrogen stations and a fleet of 1,000 fuel cell electric vehicles. A public / private partnership is to be built around the stakeholders including the start-ups present on the territory, targeting to offer the hydrogen vehicles at the same price as the equivalent diesel vehicle on the market [44], [45]. On the opposite, Ile-de-France is the largest importer region having the highest hydrogen demand for mobility use, and no available energy surplus for hydrogen production.

Table 39 presents more insights about the electricity mix in each region.

**ASSESSING THE HYDROGEN DEPLOYMENT IN FRANCE
THE USE OF TEMPORALLY AND SPACIALLY REFINED MODELS**

Table 39: Electricity generation and demand by region [TWh] (for the 33 GW export case study)

	Electricity demand	Generation																			Import/Export
		Nuclear	%	NG	%	RoR	%	PV	%	Onshore	%	Offshore	%	Bioenergy	%	Hydro Res	%	PHS +	%	PHS -	
Auvergne-Rhône-Alpes	67.25	67.55	59%	4.03	4%	16.36	14%	8.23	7%	7.79	7%	0	0%	0.64	1%	6.78	6%	7.56	7%	- 5.29	46.40
Bourgogne-Franche-Comté	21.79	0	0%	0	0%	0.34	3%	2.15	21%	5.93	58%	0	0%	1.36	13%	0.48	5%	0	0%	0	- 11.53
Bretagne	22.46	0	0%	0	0%	0	0%	0.97	8%	6.11	50%	0	0%	5.22	42%	0	0%	0	0%	0	- 10.16
Centre-Val de Loire	18.87	58.57	86%	0	0%	0	0%	0.50	1%	7.04	10%	0	0%	1.95	3%	0.12	0%	0	0%	0	49.31
Grand Est	46.52	60.95	62%	11.52	12%	8.69	9%	2.96	3%	11.92	12%	0	0%	0.98	1%	0	0%	1.36	1%	- 0.78	51.09
Hauts-de-France	51.19	26.44	36%	1.06	1%	0	0%	2.12	3%	19.16	26%	21.96	30%	3.06	4%	0	0%	0	0%	0	22.61
Ile-de-France	72.72	0	0%	0.59	8%	0	0%	0.48	6%	1.21	16%	0	0%	5.23	70%	0	0%	0	0%	0	- 65.21
Normandie	28.48	64.25	68%	2.47	3%	0	0%	1.41	1%	8.50	9%	15.03	16%	3.51	4%	0	0%	0	0%	0	66.69
Nouvelle-Aquitaine	43.65	36.03	55%	0	0%	0.23	0%	10.04	15%	10.50	16%	3.54	5%	2.47	4%	2.16	3%	0.22	0%	- 0.15	21.40
Occitanie	37.42	15.65	28%	0	0%	3.19	6%	14.84	26%	16.58	30%	0	0%	1.19	2%	3.70	7%	3.35	6%	- 2.51	18.58
Pays de la Loire	27.52	0	0%	10.09	40%	0	0%	2.65	10%	7.24	28%	0	0%	5.53	22%	0	0%	0	0%	0	- 2.02
Provence-Alpes-Côte d'Azur	40.69	0	0%	2.61	8%	8.87	27%	9.95	31%	2.62	8%	2.37	7%	2.99	9%	2.96	9%	0	0%	0	- 8.32
France	478.57	329.44	50%	32.37	5%	37.69	6%	56.30	9%	104.60	16%	42.91	7%	34.11	5%	16.20	2%	12.50	2%	- 8.73	178.82

There is a visible correlation between the nuclear capacities by region and the distribution of the hydrogen exporting regions. In other words, the regions presenting high hydrogen production potential via surplus are the four regions with the highest nuclear capacities/generation.

The distribution of the exporter regions is propitious since it allows to cover the French territory. In other terms, the exporter regions are not concentrated in one area of the French map as presented in Figure 71. The regions in blue present the hydrogen exporting regions while the regions in red present the regions where the hydrogen demand (for PLDV) exceeds the production capacity via the surplus of electricity. Each importing region is surrounded by at least one exporting region which allows a possible “uniform” distribution of hydrogen across the country.

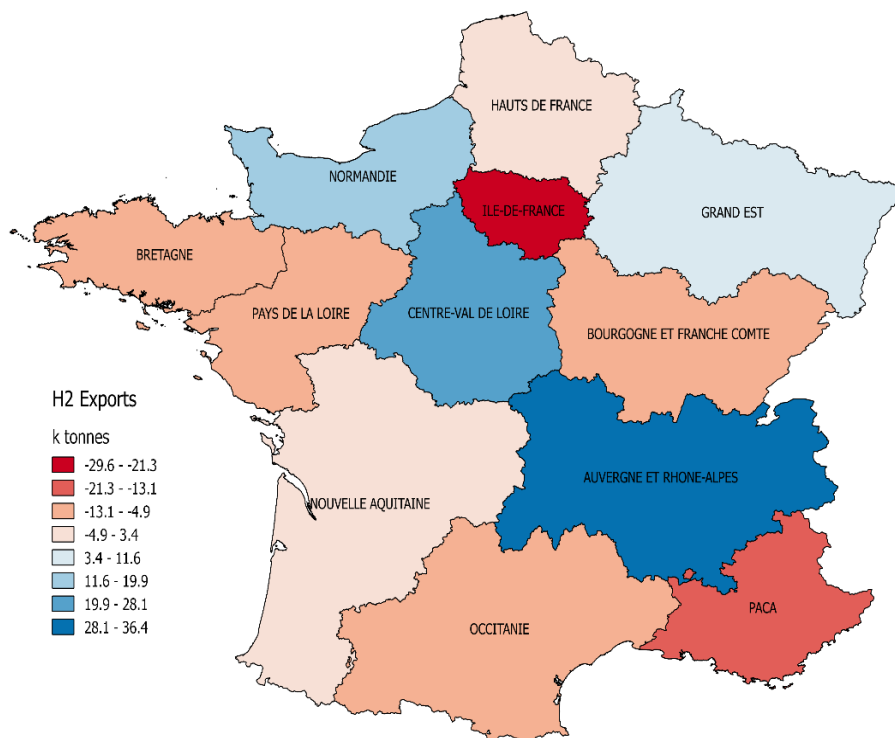

Figure 71: Distribution of the hydrogen export and import regions in France (for the 33 GW export case study)

The electrolyser placement will be discussed in details in future work, by comparing two options for the locations. The first consists in placing the electrolysers next to the nuclear power plants and the second considers placing them near the demand. A comparison of the cost of hydrogen at the pump is carried out for the two options considering different transport, storage and distribution pathways.

6. Conclusion

The French energy system is undergoing a transition towards higher shares of renewables. In this context, hydrogen could play a key role in providing flexibility to the system, as a versatile energy carrier produced when desired and required. On the one hand, the flexibility needs of a future potential electric system in France is evaluated assuming higher capacities for renewable production and a reduced share of nuclear power to 50% by 2035, in compliance with the French Energy Transition Law targets. Special focus is put on the impact of considering the interconnections on the flexibility needs. Hence, two contrasted case studies are elaborated, a theoretic one considering France isolated, with no border exchange, and a realistic one comparing two alternatives for export capacities (with simplified interconnection modelling: one node per country, one per French region). The flexibility requirements are assessed through the investigation of the electricity surplus that may arise in such a context, leading

to the second aim of this chapter which is evaluating the hydrogen production potential using this energy surplus. In this study, the surplus is seen in two manners. First an investigation of the renewable curtailment together with the hydro spills is conducted. Second, the available nuclear energy that is not dispatched to the grid due to the effect of load following by the nuclear fleet is also considered as a surplus that is low-carbon and low-cost, then useful to produce “clean” hydrogen. A regional segregation is searched for, aiming at identifying the potential locations for electrolyser implementation depending on the distribution of the surplus by region. One limit that can be acknowledged is the fact that the approach adopted in this study is linear, starting with the estimation of the renewable generation, the assessment of the energy surplus, and last the calculation of the hydrogen demand that can be supplied with that. However, the reality can be more complex. The hydrogen demand may be developed independently of the evolution of the electricity mix and the surplus potential, driven by decarbonisation incentives. This may lead to consider it as a separate demand to be included in the supply and demand balance of the electricity system (which is not the case in this chapter). The interaction is bidirectional in the “real world”. This means that the hydrogen production via electrolysis can act as a flexible demand providing the electricity system with flexibility and impacting the electricity prices, which will reciprocally drive the hydrogen demand by impacting its production costs. Another interaction (and possible additional value stream) to consider is the provision of ancillary services and the participation to the reserve market.

Nevertheless, this study allows to have insights regarding the flow of hydrogen between regions.

According to the results, the potential REN surplus by 2035 is not sufficient to produce hydrogen in an economic way. The total number of surplus hours does not exceed in the best case 1200 hours throughout the year. Such a low load factor for an electrolyser leads to high production costs [4], [39]. Implementing the interconnections into the model leads to reduce the renewable surplus by 82% (going from 7.9 TWh down to 1.4 TWh). This highlights the importance of the interconnections in evaluating the flexibility needs of an electric system. Most of the literature tackling the potential of hydrogen production in France using the electricity surplus, either considers the current electric system which leads to under-estimate this potential since no extra specific flexibility means are required nowadays, or does consider a future mix but without taking into account (endogenously) the role of the interconnections. This leads to an overestimation of the hydrogen potential, since a large part of the flexibility of the system is ensured by the border exchanges that allow smoothing the variable generation peaks by distributing them upon the neighbouring regions when possible.

Using the available nuclear energy helps reach higher hydrogen production volumes and allows enhancing the nuclear load factor. The available nuclear energy also varies depending on the interconnection level. The total nuclear available energy for a potential hydrogen production is strongly reduced (from 176 TWh to 7.9 TWh) when going from an isolated case study to a highly interconnected one. Hence the more interconnected the French system is, the more nuclear generation is dispatched to the grid. This means that most of the nuclear generation is used to source the neighbouring countries, highlighting the weight of the nuclear fleet in the European electricity system, since the national electricity demand would require operating the nuclear fleet at only 38% of its available capacity during the year. From an economic viewpoint, the nuclear CAPEX is also better amortized. Indeed, going from an isolated case study to a highly interconnected one (33 GW as export capacity) results in more than doubling the nuclear capacity factor that is increased from 38% to 77% respectively. Dividing the interconnection capacity by nearly 2 (going from 33GW to 17.2 GW) results in lowering the nuclear

ASSESSING THE HYDROGEN DEPLOYMENT IN FRANCE THE USE OF TEMPORALLY AND SPACIALLY REFINED MODELS

capacity factor by approximately 16%. According to a recent study made by the French Association for Nuclear Energy [46], the recommended capacity for nuclear generation should not go under 35 GW to 40 GW in order to preserve a dispatchable and low carbon future power basis in Europe.

The resulting hydrogen production potential varies between 0.19 Mt for the most interconnected case study to 3.68 Mt for the isolated one. These values assume that the entire surplus is used to produce hydrogen which may not be the case for different reasons but allows appraising the maximum technical potential of hydrogen production via the “excess” of electricity. Different factors may impact this potential. To start with, an economic evaluation of the hydrogen production should be taken into account in order to make sure that the generated hydrogen via the surplus can penetrate the markets at competitive prices. Moreover, other flexibility options may compete with hydrogen in order to use the surplus of electricity (storage facilities, electric vehicles, etc.). Last but not least, the evaluated potential in this study is tightly linked to the chosen scenario of the electric mix in France. Accordingly, having higher variable renewable capacities may lead to higher hydrogen potential volumes.

As evaluated in this study, the maximum hydrogen production potential allows to meet the hydrogen demand for the PLDV fleet in France according to the targets set by the French hydrogen roadmap for the timeframe of 2028. For the timeframe of 2035, it allows to meet up to 28% of the total French passenger light duty vehicles if substituted with fuel cell electric ones in the first case study (17 GW of export capacity) and around 4.4% in the second one (33 GW of export capacity).

Suggesting a regional potential of hydrogen production and demand may be the main innovation of this chapter. The aim of this approach is to have more insights regarding the potential locations for electrolyser implementation as well as whether the different regions can be self-sufficient when it comes to meeting their own demand. The resulting possible flow of hydrogen volumes between the regions can be deduced accordingly. According to the results, Auvergne-Rhône-Alpes is the region with the highest hydrogen production potential via electricity surplus, being self-sufficient with more than 50% of its hydrogen production dedicated to exports to feed other regions (in the case of mobility demand only, as investigated in this study). This potential is coupled with the willingness of this region to be the first hydrogen provider in France [44].

In next chapter we investigate the infrastructure issues, still by focusing on the transport sector, and by modelling possible hydrogen supply chains in order to compare their competitiveness for different market penetration.

REFERENCES

- [1] Hydrogen Council, “Hydrogen scaling up, A sustainable pathway for the global energy transition,” Nov. 2017.
- [2] SBC Energy Institute, “Leading the Energy Transition Factbook, Hydrogen-based energy conversion - More than storage: system flexibility.” 2014.
- [3] C. Cany, C. Mansilla, G. Mathonnière, and P. da Costa, “Nuclear power supply: Going against the misconceptions. Evidence of nuclear flexibility from the French experience,” *Energy*, vol. 151, pp. 289–296, 2018.
- [4] International Energy Agency, “Technology Roadmap Hydrogen and Fuel Cells.” 2015.
- [5] Olfa Tlili, Christine Mansilla, Jean André, and Yannick Perez, “A multi-regional overview of current & future hydrogen markets based on governmental roadmaps. Part 2: Assessment of hydrogen carbon mitigation potential,” *Work. Pap.*, 2018.
- [6] M. Robinius *et al.*, “Linking the Power and Transport Sectors - Part1: The principle of Sector Coupling,” *Energies*, p. 956, 2017.
- [7] Ministère de la transition écologique et solidaire, “Plan de déploiement de l’hydrogène pour la transition énergétique, Dossier de presse.” Paris, Vendredi juin-2018.
- [8] D. Scamman and M. Newborough, “Using surplus nuclear power for hydrogen mobility and power-to-gas in France,” *Int. J. Hydrog. Energy*, vol. 41, no. 24, pp. 10080–10089, 2016.
- [9] F. Gutiérrez-Martín, J. M. G.-D. María, A. Baïri, and N. Laraqi, “Management strategies for surplus electricity loads using electrolytic hydrogen,” *Int. J. Hydrog. Energy*, vol. 34, no. 20, pp. 8468–8475, 2009.
- [10] C. Cany, C. Mansilla, P. da Costa, and G. Mathonnière, “Adapting the French nuclear fleet to integrate variable renewable energies via the production of hydrogen: Towards massive production of low carbon hydrogen?,” *Int. J. Hydrog. Energy*, vol. 42, no. 19, pp. 13339–13356, 2017.
- [11] C. Mansilla, S. Dautremont, B. S. Tehrani, G. Cotin, S. Avril, and E. Burkhalter, “Reducing the hydrogen production cost by operating alkaline electrolysis as a discontinuous process in the French market context,” *Int. J. Hydrog. Energy*, vol. 36, no. 11, pp. 6407–6413, 2011.
- [12] C. Mansilla *et al.*, “Electric system management through hydrogen production – A market driven approach in the French context,” *Int. J. Hydrog. Energy*, vol. 37, no. 15, pp. 10986–10991, 2012.
- [13] C. Mansilla, J. Louyrette, S. Albou, C. Bourasseau, and S. Dautremont, “Economic competitiveness of off-peak hydrogen production today – A European comparison,” *Energy*, vol. 55, pp. 996–1001, 2013.
- [14] S. Bennoua, A. L. Duigou, M.-M. Quéméré, and S. Dautremont, “Role of hydrogen in resolving electricity grid issues,” *Int. J. Hydrog. Energy*, vol. 40, no. 23, pp. 7231–7245, 2015.
- [15] P. Caumon, M. L.-B. Zulueta, J. Louyrette, S. Albou, C. Bourasseau, and C. Mansilla, “Flexible hydrogen production implementation in the French power system: Expected impacts at the French and European levels,” *Energy*, vol. 81, pp. 556–562, 2015.
- [16] Tractebel and Hincio, “Study on early Business Cases for hydrogen in energy storage and more broadly power to H2 applications, Final report.” FCHJU, Jun-2017.
- [17] O. Tlili *et al.*, “Role of electricity interconnections and impact of the geographical scale on the French potential of producing hydrogen via surplus electricity by 2035,” *Energy*, vol. 172, pp. 977–990, 2019.
- [18] RTE, “Bilan prévisionnel de l’équilibre offre-demande d’électricité en France, Edition 2017.” 2017.

ASSESSING THE HYDROGEN DEPLOYMENT IN FRANCE
THE USE OF TEMPORALLY AND SPACIALLY REFINED MODELS

- [19] L'Assemblée nationale and Le Sénat, *LOI n° 2015-992 du 17 août 2015 relative à la transition énergétique pour la croissance verte (1)*, vol. NOR: DEVX1413992L. 2015, p. 14263.
- [20] Olfa Tlili *et al.*, “Implementing the energy transition at the regional level: the case of the French electric system,” *Submitt. Energy Syst.*, 2019.
- [21] Martin Robinius *et al.*, “Linking the Power and Transport Sectors — Part 2 : Modelling a Sector Coupling Scenario for Germany,” *Energies*, vol. 10, no. 957, 2017.
- [22] David Severin Ryberg, Martin Robinius, and Detlef Stolten, “Evaluating Land Eligibility Constraints of Renewable Energy Sources in Europe,” *Energies*, vol. 11, no. 5, 2018.
- [23] David Severin Ryberg, Dilara Caglayan, Sabrina Schmitt, Jochen Linßen, Detlef Stolten, and Martin Robinius, “Variable-Capacity Cost Analysis of Wind Production via the Distribution and Simulation of Single Turbines, Working paper.” 2018.
- [24] Dilara Gulcin Caglayan, D. Severin Ryberg, Heidi Heinrichs, Jochen Linßen, Martin Robinius, and Detlef Stolten, “Technical and Economic Potential of Offshore Wind Energy Accross Europe.” 2018.
- [25] K. Syranidis, M. Robinius, and D. Stolten, “Control techniques and the modeling of electrical power flow across transmission networks,” *Renew. Sustain. Energy Rev.*, vol. 82, pp. 3452–3467, 2018.
- [26] “Pypsa.” [Online]. Available: <https://pypsa.org/>. [Accessed: 15-Feb-2018].
- [27] RTE, “OpenData,” *RTE*, 2018. [Online]. Available: <https://opendata.rte-france.com/pages/accueil/?flg=fr>. [Accessed: 15-Jan-2018].
- [28] RTE, Commission “Perspectives Système et Réseau,” “Point d’étape sur les travaux du Bilan prévisionnel et du Schéma décennal de développement réseau.” RTE, 28-Sep-2018.
- [29] Lars Dittmar (TU Berlin), Dennis Volk &, and Matthew Wittenstein (IEA), “Electricity markets, Opening up to competition and investments,” presented at the IEA Energy Training Week, Paris, 04-Nov-2014.
- [30] P. Markewitz, M. Robinius, and D. Stolten, “The Future of Fossil Fired Power Plants in Germany—A Lifetime Analysis,” *Energies*, vol. 11, no. 6, 2018.
- [31] C. Cany, C. Mansilla, G. Mathonnière, and P. da Costa, “Nuclear contribution to the penetration of variable renewable energy sources in a French decarbonised power mix,” *Energy*, vol. 150, pp. 544–555, 2018.
- [32] Camille Cany, “Interactions entre énergie nucléaire et énergies renouvelables variables dans la transition énergétique en France: Adaptation du parc électrique vers plus de flexibilité.” 2017.
- [33] M. Alexey Likhov, “Suivi de charge dans les centrales nucléaires,” *Actual. AEN Infos 2011*, no. 29.2, pp. 19–22, 2011.
- [34] World Energy Council, “World Energy Resources: Hydro.” 2013.
- [35] “Hydroélectricité,” *Ministère de la Transition écologique et solidaire*, Jeudi décembre-2016. [Online]. Available: <https://www.ecologique-solidaire.gouv.fr/hydroelectricite>. [Accessed: 26-Feb-2018].
- [36] “Hydroélectricité,” *Connaissance des Energies*, avril-2013. [Online]. Available: <https://www.connaissancedesenergies.org/fiche-pedagogique/hydroelectricite>. [Accessed: 26-Feb-2018].
- [37] Julien Courtel, Aude Richard, and Juliette Talpin, “Le baromètre 2017 des énergies renouvelables électriques en France.” *Observ’ER*, 2017.
- [38] “TYNDP 2018 - Project Sheets,” *enstoe*, 2018. [Online]. Available: <https://tyndp.entsoe.eu/tyndp2018/projects/>. [Accessed: 15-Feb-2018].

ASSESSING THE HYDROGEN DEPLOYMENT IN FRANCE
THE USE OF TEMPORALLY AND SPACIALLY REFINED MODELS

- [39] FCHJU, “Development of Water Electrolysis in the European Union, Final Report.” 2014.
- [40] Tractebel and Hinicio, “EARLY BUSINESS CASES FOR H2 IN ENERGY STORAGE AND MORE BROADLY POWER TO H2 APPLICATIONS.” Jun-2017.
- [41] C. Cany, C. Mansilla, P. da Costa, G. Mathonnière, T. Duquesnoy, and A. Baschwitz, “Nuclear and intermittent renewables: Two compatible supply options? The case of the French power mix,” *Energy Policy*, vol. 95, pp. 135–146, 2016.
- [42] RTE, “Bilan électrique 2017,” 2017. [Online]. Available: <http://bilan-electrique-2017.rte-france.com/europe/75-vision-europeenne-de-lelectricite/>.
- [43] Insee, “Véhicules en service en 2016, Données annuelles de 1990 à 2016,” 10-May-2017. [Online]. Available: <https://www.insee.fr/fr/statistiques/2045167>.
- [44] Fiona Urbain, “Auvergne-Rhône-Alpes veut devenir la première région à hydrogène de France,” *Ecom News*, Juillet-2018. [Online]. Available: <https://ecomnews.fr/article/Auvergne-rhone-alpes-veut-devenir-premiere-region-hydrogene-france>.
- [45] “Pour une filière hydrogène d’excellence,” *La Région Auvergnnes-Rhône-Alpes*. [Online]. Available: <https://www.auvergnerhonealpes.fr/278-pour-une-filiere-hydrogene-d-excellence.htm>. [Accessed: 14-Sep-2018].
- [46] Michel Berthélémy *et al.*, “Le nucléaire français dans le système énergétique européen, Scénarios basés sur le modèle PRIMES pour la SFEN.” SFEN, Apr-2018.

CHAPTER III

Geospatial modelling of the hydrogen infrastructure in France in order to identify the most suited supply chains

1. Introduction

The transport sector caused 29% of the total French energy-related CO₂ emissions in 2015 [1] due to its high dependency on fossil fuels for road transport and specifically for passenger light duty vehicles (PLDV) [2]. The latest discussions about diesel in Europe [3] may lead to a progressive phase out of this fuel in the years to come. Meanwhile, a more serious shift towards zero emission mobility has to be achieved in order to ensure the required reductions in CO₂ emissions by 2050. In the short term, France set a pledge during the COP 21 to reduce the emissions in the transport sector by 29% until 2028 [4].

As mentioned already, hydrogen (H₂) systems present a promising potential for multi-sectorial decarbonisation (including the transport sector via the fuel cell electric vehicles (FCEV)) while contributing to the provision of flexibility services to the grid, as long as hydrogen is produced via low carbon technologies such as electrolysis coupled with a decarbonized power mix [5], [6].

Hydrogen development in France have been going through different periods with ups and downs that are strongly dependent on the role of the Government in the guidance of public research [7]–[9]. Belot and Picard (2014) [7] detailed the trends of hydrogen concern in France from a historical perspective, citing the main events and the role of actors (policy makers, industrials, researchers) from 1960 to 2010. Three major phases were identified. The first one starting in the sixties raising the awareness regarding hydrogen potential and strongly pushed by governmental involvement and “the weight of geopolitical considerations in defining national research orientations”. The second phase is characterised by a withdrawal in the hydrogen interest wave, which is due to the absence of real industrial application prospects and the weakening of the Government’s strategic role. However, in the late nineties till 2005, marked by a rise in the oil prices, more environmental awareness and the investigation of new energy sources in the field of transport, research in fuel cells and hydrogen systems rose dramatically. Nevertheless, reluctance towards hydrogen potential remained in France. In August 2014, the French roadmap left little room for hydrogen development in the proposed energy strategy [9], [10]. Later in 2015, a report that was commissioned by the Ministry of Environment [11] detailed the technical and economic obstacles to the development of hydrogen systems in France. The different production options and market prospects were investigated leading to a set of twenty recommendations that did not result in regulatory actions at that time. However recently, following the energy transition debates and the PPE (Programmation Pluriannuelle de l’Energie - Multiannual Energy Program), the interest in hydrogen rose again but this time along with governmental involvement and a clear deployment strategy. The Government will dedicate 100 M€ starting from 2019 to the deployment of hydrogen projects. “The Hydrogen Plan” presented by Nicolas Hulot, Minister of Ecological Transition and Solidarity until

ASSESSING THE HYDROGEN DEPLOYMENT IN FRANCE THE USE OF TEMPORALLY AND SPACIALLY REFINED MODELS

August 2018, aims at supporting the first industrial deployments of low-carbon hydrogen, with a target to make it a pillar of the energy transition in the medium term. The French hydrogen roadmap aims at:

“- Introducing 10% decarbonised hydrogen into the industrial hydrogen markets by 2023 (approximately 100,000 t p.a.) and 20 to 40% by 2028.

- Deploying territorial ecosystems of hydrogen mobility, based in particular on fleets of commercial transport, with the introduction of around 5,000 light commercial vehicles and 200 heavy vehicles (buses, trucks, regional trains, ships) and the construction of 100 hydrogen fuelling stations with on-site hydrogen production by 2023. By 2028, the target is to reach from 20,000 to 50,000 light duty commercial vehicles, 800 to 2,000 heavy duty vehicles and 400 to 1000 stations.”

Up to now, Paris counts four refuelling stations deployed in the framework of the “Hype project” that aims at reaching 600 hydrogen taxis in Paris by 2020 [12].

However, the remaining question is how to deploy the adequate infrastructure to meet this potential demand.

The aim of this chapter is to analyse a potential future hydrogen supply infrastructure and assess the cost of hydrogen at the pump for different possible pathways of delivery. The deployment of the infrastructure is based on spatially resolved modelling framework that allows the analysis of the distribution of the infrastructure.

Only a few studies in the literature tackled the hydrogen infrastructure issues in France.

On the production and storage parts of the hydrogen supply chain, Menanteau et al. (2011) [13] investigated the economic viability of producing hydrogen from wind electricity for use in transport applications considering onsite storage in tube trailers in gaseous form. The study is conducted in the framework of the HyFrance3 Project [14]. The results showed considerable variations in hydrogen production costs depending on the demand profiles concerned. Keeping the use of storage systems to the minimum proved to lead to the most favourable configurations, economically speaking.

Later in 2017, continuing the HyFrance 3 analysis, Le Duigou et al. (2017) [15] investigated the underground storage in salt caverns relevance for large scale hydrogen deployment in France. Potential storage sites are identified and the hourly operation of the selected cavern is modelled. The hydrogen production is assumed to occur via electrolysis sourced from wind farms and the electricity grid. The hydrogen market segments that are considered are mobility, industry and “Power-to-gas” here referring to the injection of hydrogen into natural gas networks. The study shows that the need for high storage capacity appears when the renewable penetration rate reaches 50%. As for the levelized hydrogen production cost (LCOH), it varies between 4.5€/kg_{H2} and 6.6€/kg_{H2} depending on the scenario of the electricity source (percentage of the wind penetration rate). Regardless of the scenario, the cost of the underground hydrogen storage always represents less than 5% of the overall cost.

As for the hydrogen delivery infrastructure, André et al. (2013) [16] suggested a new optimal design approach for hydrogen transmission pipeline networks based on a method adjusting pipeline diameters by section in order to reduce the costs (called the Delta Change method) instead of looking for the minimal length network topology. The method is then tested on the French case to respond to a hydrogen demand assuming 100% market share for hydrogen as a fuel for passenger cars for a timeframe beyond

2050. Two scenarios are considered for the production sites: a centralized one with a single production plant (with two sub-scenarios for its location vis-à-vis the consumption areas), and a distributed one considering regional hydrogen production plants. According to the results, the total infrastructure investment decreased by 18% when adopting the “Delta Change” approach. The plant location has also a significant impact on the final cost for the centralized case study. Considering a regional distribution of hydrogen production allows reducing the investment costs by 30% compared to the centralized case study.

Later in 2014, André et al. (2014) [17] considered the time deployment of the pipeline network taking into account the competitiveness of the pipelines as a hydrogen transmission option compared to other alternate ones, in particular the transportation via trucks in liquid or compressed gas form. The study is then applied to the deployment of a new transmission network for the North of France for two hydrogen demand scenarios (high and low) for the mobility sector (passenger cars). The results show that for low market shares, trucks are the most economical options. On the other hand, the pipeline option becomes economically attractive when the hydrogen market share (mobility) reaches 10%. The transport distance of hydrogen has an important impact as well on the attractiveness of the transmission options. Indeed, compressed gas trucks are competitive for short distances while cryogenic trucks require a minimal distance of 300 km to be economically justified.

D. Almaraz et al. (2015) [18] suggested a potential infrastructure layout for hydrogen deployment based on a multi-objective optimisation in order to minimize, for the French case, the total daily cost of hydrogen at the pump, its environmental impact and its safety risk. The aim is to meet a potential hydrogen demand for the mobility sector (passenger cars, light duty vehicles and buses). The different components of the supply chain are considered (production, storage, delivery in liquid form and refuelling station) for different timeframes going up to 2050. A spatial based approach is used to present the geographic and demographic data of France allowing to have a snapshot on the geographic deployment of the infrastructure and its feasibility. A sensitivity analysis to the geographic scale is conducted to test the differences between the regional and national scales. According to the results, considering the national scale presents better economic trade-off than the regional case study. This latter presenting an important issue for the flow rate of liquid hydrogen because the demand on the district scale is lower than the tanker truck capacity, resulting in low usage rate and high costs especially in the first time periods.

None of the literature studies regarding hydrogen infrastructure in France tackled all of the components of the supply chain while considering different options for the hydrogen storage, transmission and distribution pathways. All of the studies either focus on one part of the supply chain or consider the whole supply chain but with only one option for the transport/distribution.

In this chapter, the whole supply chain starting from the production from electrolysis up to the deployment of the refuelling stations for passenger light duty vehicles is investigated, taking into account different options for hydrogen storage and different options for transport and distribution (pipelines and trailer trucks), including transporting hydrogen in gaseous and liquid forms.

The aim of this chapter is to identify optimal supply chains depending on different hydrogen market penetration rates (with a focus on passenger cars) and the electrolyser placements.

The structure of the chapter is as follows. Section 2 details the methodology adopted to assess the cost of each step of the supply chain. Different scenarios are considered presenting the potential time and

geographic deployment of the hydrogen infrastructure. Next, in section 3, the geographical representation of the infrastructure is presented based on a spatially resolved model and the costs of the different delivery pathways are compared.

The current chapter constitutes the basis of a paper submitted to the International Journal of Hydrogen Energy [19].

2. Method and Data

The different delivery pathways are assessed and compared based on the total levelized cost of hydrogen delivered at the pump.

In this section, the methodology as well as the assumptions taken into account to assess the hydrogen cost at the pump are presented. The different stages of the supply chain are taken into account. The targeted market in this study is the transport sector considering fuel cell electric vehicles for the passenger cars. Different scenarios for the demand in terms of market penetration are considered and will be detailed in section 0. In order to meet this demand, different hydrogen delivery pathways are considered as presented in Figure 72. The aim is to identify the least cost option for each market penetration value which gives an idea on deployment time of the required infrastructure. In the next subsections the different assumptions regarding the calculation of the hydrogen cost at each step of the supply chain are detailed.

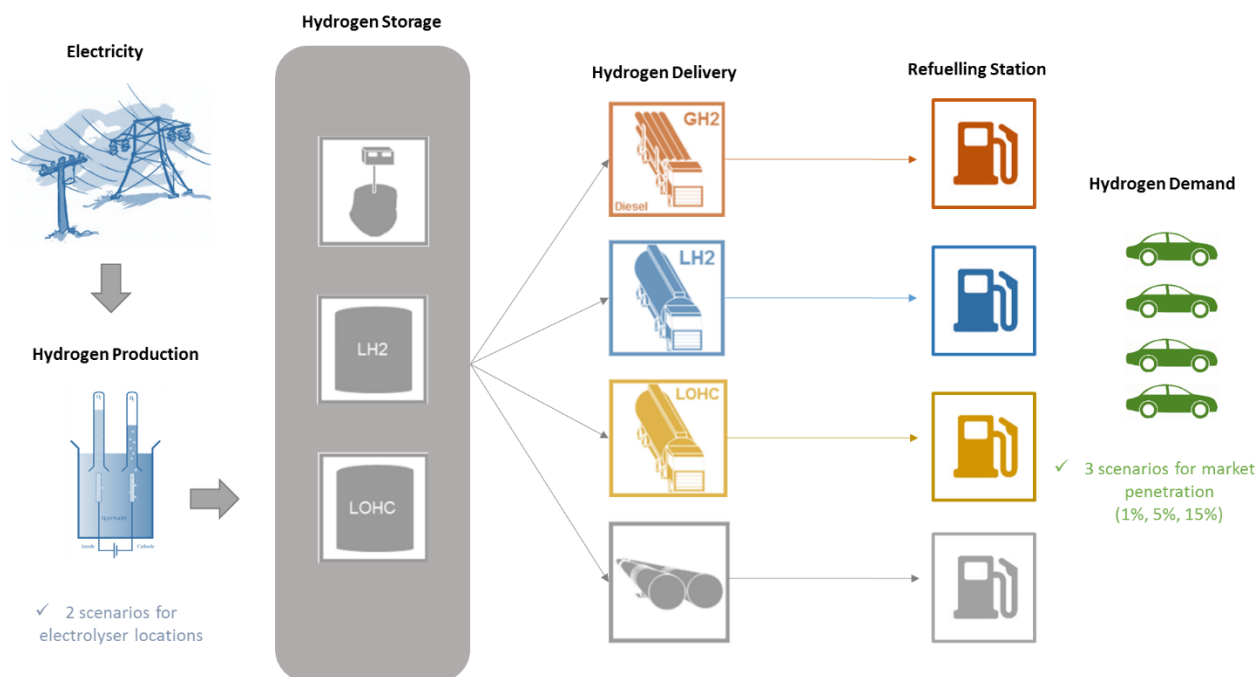

*GH2: Gaseous hydrogen - LH2: Liquid hydrogen - LOHC: liquid organic hydrogen carrier

Figure 72: Representation of the considered hydrogen supply chains

2.1. Hydrogen supply chain modelling and global assumptions

The general methodology for assessing the hydrogen supply chain is based on Reuß et al. [20], who developed a supply chain model for analysing hydrogen production, storage, transport and fuelling of passenger cars. Between the different steps of each pathway a connector is taken into account ensuring the adequacy of the hydrogen state and pressure level. For each step, the specific hydrogen costs (total expenditures – TOTEX) are calculated with regards to capital expenditures (CAPEX), fixed operation and maintenance costs (fixOPEX) and variable operational costs (varOPEX). To do so, technological details like investments, energy consumption and losses have to be taken into account for each step. However, the cost calculation in each step is similar. The TOTEX of each step is the sum of all occurring costs:

$$\text{Eq. (1)} \quad \text{TOTEX} = \text{CAPEX} + \text{fixOPEX} + \text{varOPEX}$$

To evaluate the total investment for each technology scaling functions are used to take “economy of scale” into account:

$$\text{Eq. (2)} \quad \text{Invest}_{New} = \text{Invest}_{Ref} \cdot \left(\frac{\text{Capacity}_{New}}{\text{Capacity}_{Ref}} \right)^{\alpha}$$

With Invest_{New} as the total necessary investment, Capacity_{New} as the size of the new plant, Invest_{Ref} as the investment necessary for a reference plant, Capacity_{Ref} as the reference plant size and α as the scaling factor.

The capacity evaluation is based on the assessment of the storage needs. Accordingly, the evaluation of the capital expenditure (CAPEX) per kg of hydrogen includes the real annual throughput:

$$\text{Eq. (3)} \quad \text{CAPEX} = \frac{\text{Invest}_{New} \cdot AF}{\text{throughput}}$$

With AF being the annuity factor based on the depreciation period n and the weighted average cost of capital (WACC):

$$\text{Eq. (4)} \quad AF = \frac{(1+WACC)^n \cdot WACC}{(1+WACC)^n - 1}$$

ASSESSING THE HYDROGEN DEPLOYMENT IN FRANCE THE USE OF TEMPORALLY AND SPACIALLY REFINED MODELS

The fixOPEX is calculated similar with a fixed percentage value representing the share of annual costs for operation and maintenance (OM) compared to the total investment based on empirical values for each technology:

$$\text{Eq. (5)} \quad \text{fixOPEX} = \frac{\text{Invest}_{\text{New}} \cdot \text{OM}}{\text{throughput}}$$

The varOPEX is calculated based on the specific demand of energy carriers electricity (EL), natural gas (NG) and hydrogen (H2) and their respective prices:

$$\text{Eq. (6)} \quad \text{varOPEX} = \text{costs}_{\text{H}_2} * \text{demand}_{\text{H}_2} + \text{costs}_{\text{EL}} * \text{demand}_{\text{EL}} + \text{costs}_{\text{EL}} * \text{demand}_{\text{EL}}$$

The supply chain model finally adds up all parts of a predefined pathway and calculates the overall costs with a setup as shown in Figure 73. The electrolyzers are operated when the electricity price is under a certain threshold. An optimisation is carried out in order to set the optimal threshold that ensures a minimal production cost. To address this, storage of hydrogen is necessary before transportation. In this study, the transport is divided into transmission and distribution for the case of locating the electrolysis next to the nuclear power plant. If the electrolysis is located next to the demand, no additional transmission is necessary. The storage capacity as well as the share of hydrogen that can be bypassed is calculated in advance. We consider a flexible production of the electrolysis and Connector 1 and 2. After the storage module, all technologies are considered to operate continuously 24/7. The hydrogen is finally just used for fuelling 700 bar fuel cell cars. The general supply chain setup is in accordance with Reuß et al.[21].

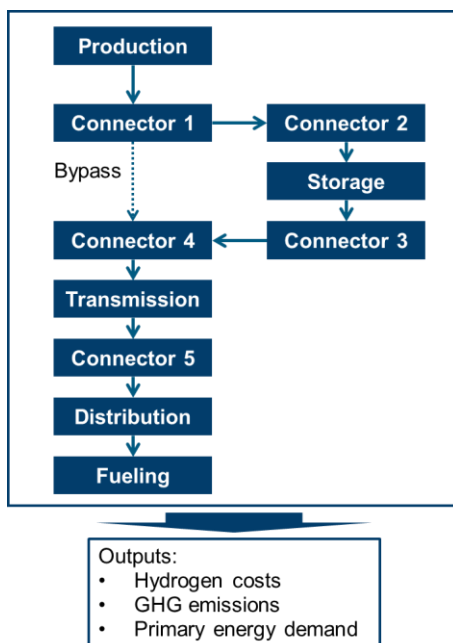

Figure 73: Supply chain setup used in this study

The different assumptions taken into account in this study regarding each step of the hydrogen supply chain are further detailed in the next sections.

2.2. Hydrogen production

The hydrogen production modelling is carried out following two major steps. First the geographic locations of the electrolyzers are identified following two scenarios. In the first scenario, the electrolyzers are located next to the nuclear power plants. These latter present a centralized low carbon electricity source that can be available at low cost especially in the context of high renewable penetration [22]. No direct coupling with the nuclear power plant is considered though. The connection would be done at the transmission grid nodes, close to the nuclear power plants. A second scenario investigates locating the production of hydrogen next to the demand using a clustering method to minimize the travelled distance between the production site and the refuelling stations (for hydrogen delivery). These two scenarios allow having strategic insights on where to locate the electrolyzers in a manner that ensures low costs of the supply chain.

A prospective electrolyser investment cost (C_I) going down to 500€/kW is assumed for the considered timeframe (2035) which is in line with what is expected in the years to come in terms of cost reductions according to the literature [23]. As for the annual maintenance costs, they are assumed to represent 3% of the investment costs. The depreciation time (referred to by n) is set at 10 years.

E_P being the electricity price threshold value and LF is the resulting load factor that corresponds to the number of hours throughout the year where the electricity price is equal to or below E_P . This means that a fixed electricity price (the threshold) is payed during the period that is defined by the load factor, even when the electricity price is under the threshold. In this way, the over-estimation of the production cost

(that may be improved by the non-consideration of the electrolyser operation impact on the electricity price time series) can, in part, be avoided. To do so, time series of electricity cost throughout the year are adopted based on a previous work [24] assuming a 50% share of renewables in the electricity generation mix and a reduction of nuclear capacities from 63 GW in 2017 to 48.5 GW by 2035, in accordance with a scenario designed by the French Transmission System Operator RTE. The electricity price time series are presented in Figure 74.

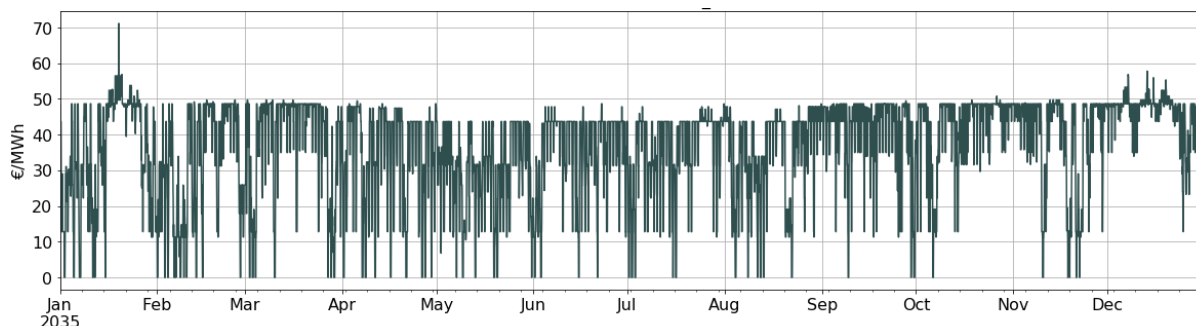

Figure 74: The adopted electricity price time series throughout the year

Added to the electricity generation cost, the grid fees are also included when the electrolyser location is near the demand hubs. and are taken from Eurostat [25] for the French case.

Hence, an electricity grid fee exemption is assumed for the case where the electrolysers are located next to the power plants in transmission grid nodes.

Electricity taxes are not included in the cost.

Finally, the evaluation of the hydrogen production is carried out as follows, per kW of installed electrolysis capacity:

$$\text{Eq. (7)} \quad P_{H_2} = \frac{LF}{C_{EL}}$$

C_{EL} is the electrolyser electricity consumption that is assumed to be improved to 47.6 kWh/kg by 2035 knowing that nowadays it is approximately 50 kWh/kg [23], [26].

Accordingly, minimizing the *LCOH* (or *TOTEX* of the production step) is a function of the electricity price that is taken as a threshold (E_p) and the resulting number of hours of operation (LF).

More techno-economic assumptions regarding the hydrogen production are presented in Table 40.

Table 40: Techno-economic assumptions of hydrogen production [20], [23], [26], [27]

	Electrolyser
Pressure Out (bar)	30
Investment (€/kW)	500
Depreciation Time (a)	10
OM costs (% of inv. Costs)	0.03
Electricity Demand (kWh/kg)	47.6
Water Demand (m³/kg)	0.01

Next section addresses the assumptions of the hydrogen storage step.

2.3. Hydrogen storage

The hydrogen storage role is twofold. On the one hand, it allows ensuring a seasonal storage in order to cope with the variability of renewable energy resources. On the other hand, hydrogen storage is a key component of the hydrogen supply chain allowing to bridge between discontinuous production and demand, exhibiting non-matching profiles. This will be further detailed in section 3.2 (see Figure 77).

Since hydrogen is the lightest element, the storage and handling remains a challenge. The energy volumetric density is low at normal conditions (0.003 kWh/l) compared to conventional fuels such as gasoline (10 kWh/l) [6], [28]. High energy densities are important to decrease specific costs for hydrogen transport and long-term storage. Therefore, the energy density of hydrogen requires further adjustments [20] and different storage options are considered in this study.

The most common way to achieve higher hydrogen storage densities is via compression in gaseous form [20]. Stationary tube systems normally have pressures of between 200 and 350 bar [28]. Gaseous hydrogen at 700 bar is generally regarded as the most viable storage system for on-board hydrogen storage in automotive applications [6]. However, high-pressure gas vessels have high investment costs and special requirements for the vessel material. Storing hydrogen in salt caverns can also be a viable option especially for large hydrogen volumes [6]. In this case, the hydrogen is stored on geological conditions up to 150 bar [20]. However, salt rocks for the construction of caverns are not available everywhere in France. This will be further discussed in section 3.3.

Liquid hydrogen offers the possibility of increasing the density up to 71 kg/m³ (2.4 kWh/l) by cooling the hydrogen below 21 K. Liquid hydrogen can be stored in cryogenic tanks with a robust insulation at low pressure (<10 bar), which allows the use of large bulk storage systems with high energy densities. On the other hand, the liquefaction process is energy intensive presenting electricity consumption needs that can reach 36 to 45% of the overall hydrogen energy content today, as discussed in Reuß et al. [20].

Aside from the compressed and liquid storage options, the liquid organic hydrogen carriers (LOHC) are considered in this study. The LOHC are based on capturing hydrogen in the middle of molecules of "refillable" organic liquids such as naphthalene or benzene. To do so, these liquids are hydrogenated at higher temperature (< 300°C) leading to obtain two new stable molecules (cyclohexane and decalin), which are then conditioned at low temperature to be easily stored, transported and used. Hydrogen can

ASSESSING THE HYDROGEN DEPLOYMENT IN FRANCE
THE USE OF TEMPORALLY AND SPACIALLY REFINED MODELS

afterwards be extracted via a dehydrogenation reaction (endothermic reaction) [29]. The main advantage of the LOHC technology is that it enables hydrogen storage in a chemically bound form under ambient conditions without the necessity for high-pressure or super insulated tank. The technology can use the existing infrastructure for fossil fuel like tanker ships, rail trucks, road tankers and tank farms [20].

The operational costs are annual maintenance costs (OM), assessed by a percentage of the investment.

The techno-economic assumptions taken into account in the calculation of the storage cost are derived from a previous work applied to the German case study [20] as detailed in Table 41.

Table 41: Techno-economic assumptions of hydrogen storage [20]. x corresponds to the installed capacity in t_{H_2} (number of caverns for the cavern) of each storage option.

	GH2-Cavern*	LH2-Tank	LOHC-Tank	Unit
Pressure	58-175	1	1	bar
Investment costs	23 Mio. EUR $+ 38.8 \text{ Mio. EUR} * \frac{x}{\text{cavern}}$	$25 \text{ EUR} * \frac{x}{\text{kg}}$	$50 \text{ EUR} * \frac{x}{\text{kg}}$	€
Invest Scale	0.28	1	1	
Depreciation	30	20	20	a
fixed Operation and Maintenance	2%	2%	2%	
Losses	0%	0.03%	0%	/day

* cavern size is set to 500,000 m³ per cavern

2.4. Hydrogen transmission and distribution

The link between the hydrogen production and storage sites and the demand locations is investigated considering five possible pathways, combining the different options for storage and transmission/distribution.

2.4.1. Technical and techno-economic details

The techno-economic assumptions considered in the calculation of the transport and distribution costs are presented in Table 42.

Table 42: Techno economic assumptions of the transport and distribution infrastructure [20].

GH2-Pipeline		Truck	
Pressure In	70 - 100 bar	Invest (diesel truck)	160,000 €
		Invest (H2 truck)	400,000 €
Invest A	0.0022 €/mm ²	Depreciation Period	8 years
Invest B	0.86 €/mm	Utilization	2000 h/year
Invest C	247.50 €	Fixed maintenance cost	12%
Depreciation Period	40 years	Diesel Demand	35 l/100 km
fixed O&M	5 €/m/a	Speed rural streets	30 km/h
		Speed highway	60 km/h
Trailer	GH2	LH2	LOHC
Invest	550,000 €	860,000 €	150,000 €
Depreciation Period	12 years	12 years	12 years
Utilization	2000 h/year	2000 h/year	2000 h/year
OM	2%	2%	2%
Payload	1100 kg	4500 kg	1800 kg
Net Capacity	1000 kg	4300 kg	1680 kg
Loading Time	1.5 h	3 h	1.5 h

In the case of hydrogen transport via pipelines, the investment cost corresponds to the total length of the deployed pipelines multiplied with the specific investment costs caused by the necessary diameter. The specific investment cost are evaluated as follows [20]:

$$\text{Eq. (8) } C_{I_pipeline} \left[\frac{\text{€}}{\text{m}} \right] = \text{Invest}_A \times d^2 + \text{Invest}_B \times d + \text{Invest}_C$$

With d as diameter in mm, Invest A, Invest B and Invest C as polynomial coefficient of second order according to Baufumé et al. [30].

The variable operation costs include the fuel costs and the driver cost in the case of trucks. Regarding the fuel cost, it corresponds to diesel or hydrogen consumption cost in the case of the trucks and to the electricity consumption cost in the case of pipelines. As for the driver cost, it is assumed that only one driver is allocated to each truck with a wage of 35€/h [31]. The truck costs are calculated in accordance to Teichmann et al. [31] and Yang and Ogden [32] by calculating the TOTEX of the roundtrip of each trailer.

2.4.2. Spatial methodology for elaborating transmission and distribution length

To assess the travelled distances for trucks as well as the design of transmission and distribution pipeline grids, georeferenced methods for designing hydrogen transport are used, according to the methodology presented in Reuß et al. [21].

To examine the travelled distance of trucks, a truck routing model is applied. The street grid from OpenStreetMap [33] is used as a basic graph separated into highways and remaining roads. The truck speed is set to 60 km/h on motorways and 30 km/h on all remaining roads. Each fuelling station, hub or transmission grid node connected to the nuclear power plant is connected by a beeline to the closest street node. For each edge, the travelled distance and time is calculated. Based on this information, a linear flow optimization is conducted, minimizing the used time.

The pipeline system design is separated into three steps, similar to Reuß et al. [21] without applying pressure drops. First, a candidate grid is derived from the work of Baufumé et al. [30]. For Euclidian distances a detour factor of 1.4 is added. Second, the topology selection is then performed by applying a minimum spanning tree algorithm [34]. Last, on the resulting tree, a linear flow optimization similar to the truck routing is conducted to get the resulting flow, the necessary diameters, and respective the investment costs for each pipe. Similar to Baufume et al. [30] the gas velocity was set to 15 m/s and the hydrogen density was assumed to be 5.7 kg/m³.

The street grid as well as the existing natural gas pipeline routes that are used for the georeferenced transportation design are shown in Figure 75.

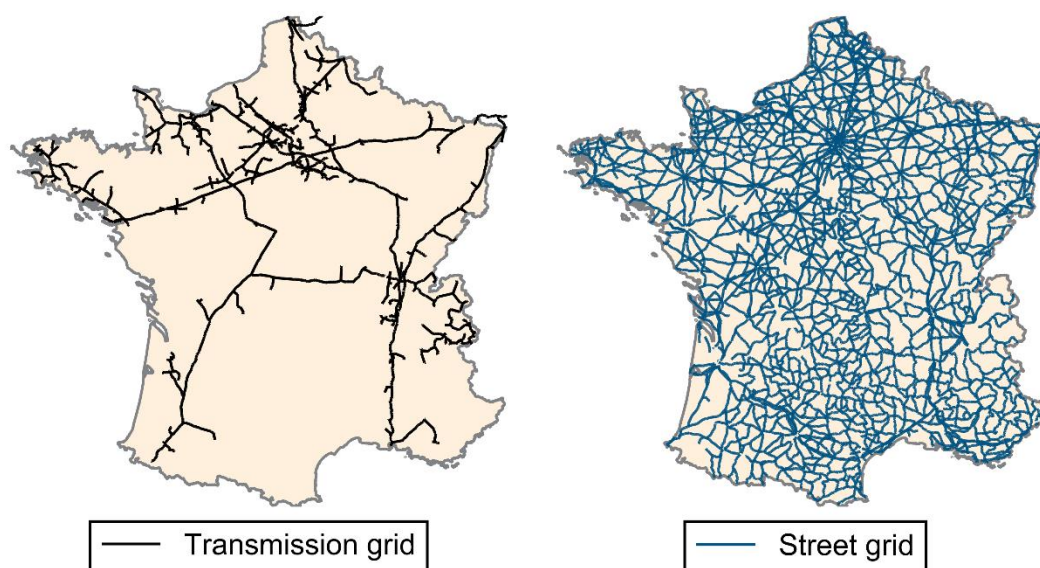

Figure 75: Input data for the candidate pipeline grid (left) and the French street network (primary and secondary routes) extracted from OpenStreetMap [33]

2.5. Refuelling stations

The fuelling station is the last step in the supply chain, supplying GH_2 at 700 bar to a stock of FCEV.

2.5.1. Technical and techno-economic background

In Germany, H2MOBILITY [35] developed three different fuelling station concepts: small (212 kg/day), medium (420 kg/day) and large (1000 kg/day). For the timeframe of 2035, we assume a medium sized fuelling station to be the average station type.

The characteristics of the fuelling stations are varying with each supply mode and can have a major impact on the final costs. Reuß et al. [21] estimate fuelling station investment costs on the basis of previous estimations from Robinius et al. [36] and results from the HRSAM [37], as well as own considerations. However, Melaina and Penev [38] claim that, as with other technologies, fuelling stations are subjected to learning and scaling effects. Comparing the today's low number of four hydrogen fuelling stations in Paris with the numbers of large stations of more than 1000 necessary for supplying a meaningful stock of FCEVs in future, the learning and scaling effects could have a significant impact on fuelling station costs. Therefore, Reuß et al. [21] conducted a bottom-up analysis of hydrogen fuelling station investment costs based on the approach of the HRSAM [37] for GH_2 , LH_2 , and LOHC fuelling station types in order to determine the scaling effects, as well as base investment costs for all supply types. Reuß et al. [21] suggests for the investment costs of different supply modes the following equation:

ASSESSING THE HYDROGEN DEPLOYMENT IN FRANCE
THE USE OF TEMPORALLY AND SPACIALLY REFINED MODELS

$$\text{Eq. (9) Station Investment} = 1,3 * 600.000 \text{ EUR} * \gamma * \left(\frac{\text{station capacity}}{212 \frac{\text{kg}}{\text{day}}} \right)^\alpha,$$

with γ as the base investment of each supply mode compared to the reference station and α as the scaling factor compared to a small sized fueling station. The scaling and base investment costs compared to a reference station design are given in Table 43 together with other techno-economic assumptions that are considered in the calculation.

Table 43: Techno-economic assumptions considered for the refuelling station cost assessment

	GH2 (Pipeline)	GH2 (Trailer)	LH2	LOHC
Station Capacity (kg/d)	420	420	420	420
Scaling factor - α	0.7	0.7	0.6	0.66
Base Multiplier - γ	0.8	0.6	0.9	1.4
Station Lifetime (a)	10	10	10	10
Station OM (investment share)	0.05	0.05	0.05	0.05
Electricity demand (kWh/kg)	2	1.6	0.6	4.4
Heat Demand supplied with natural gas (kWh/kg)	0	0	0	9
Losses (related to H₂ output)	0.5%	0.5%	3%	0.5%

The electricity demand of fuelling stations consists of compression/pump energy and precooling with the assumptions based on the DOE values [39]. To supply the heat demand required for the LOHC station, natural gas is assumed as an energy source in accordance to Reuß et al. [21].

2.5.2. Spatial methodology and distribution of hydrogen demand

In order to assess the potential demand of hydrogen in the mobility sector, the total number of passenger light duty vehicles is appraised on a district level based on 2016 Eurostat values [40]. Then, different scenarios for market penetration are considered, 1%, 5% and 15% for the timeframe of 2035. In order to evaluate the hydrogen consumption corresponding to these scenarios, the following assumptions are considered: an average annual travelled distance by car equal to 13 000 km [41] and a hydrogen consumption of 0.7 kg_{H2}/100 km.

In order to evaluate the hydrogen demand profile throughout the year, a seasonal, a weekly and an hourly distribution of the demand are assumed based on data for a Chevron refuelling station operation profile [42], that is representative of a typical refuelling station.

According to [42], the fuel demand is 10% higher during summer time and 10% lower during winter. As for the weekly distribution, a peak is noticed for the station operation by the end of the week (Thursday, Friday). During the day, the fuel demand reaches its highest levels between 2pm and 6pm.

Based on the regional distribution of the hydrogen demand, the total number of required fuelling stations in each county is evaluated. As stated above, a medium sized fuelling station with 420 kg/day is selected for the analysis. A maximal utilisation of 70% is assumed for each station with respect to a varying number of cars refuelling per day and during the year in accordance to H2MOBILITY [35] expectations. Once the number of required fuelling stations is identified, their geographic locations are selected. We assumed in this study that the current locations of fuelling stations for diesel and gasoline are very likely to be used for hydrogen fuelling in future. Therefore, the locations of current fuelling stations which are extracted from OpenStreetMap [33] are used as candidate locations for future fuelling stations. The penetration order is based on the following territorialities: metropolitan area (>1million inhabitants), urban area (<1 million inhabitants) and rural area based on the GRUMP model [43], which offers a population density on global scale. Metropolitan fuelling stations are selected first, rural stations last. If there are not enough fuelling stations available, an additional fuelling station at an existing location will be selected.

As discussed in Reuß et al. [21], the placement of the hub is important, because it defines the ratio between the pipeline lengths of transmission to the distribution. The allocation of hubs to separate between transmission and distribution is carried out by a predefined number of fuelling stations, which are clustered to one cluster centre by a k-means cluster algorithm from scikit-learn [44], which is a tool for data mining and data analysis in python. The number of fuelling stations that are clustered is set to 250.

2.6. Connectors

Different storage methods necessitate conversion technologies to change between GH₂, LH₂ and LOHCs. Five technological capabilities are considered, namely: Compression, liquefaction, evaporation, hydrogenation and dehydrogenation. Detailed information are given in Reuß et al. [20],

ASSESSING THE HYDROGEN DEPLOYMENT IN FRANCE
THE USE OF TEMPORALLY AND SPACIALLY REFINED MODELS

Teichmann et al. [31], [45], the Nexant Report [42] and Aasadnia and Mehrpooya [46]. Table 44 shows all techno-economic assumptions for conversion technologies employed in this study.

Table 44: Techno-economic assumptions of the connector assumptions; x corresponds to the installed capacity in $\frac{t_{H2}}{d}$ (kW_{el} for the compressor) of each unit. The compressor investment is multiplied with an installation factor f_{inst} dependent on the utilization ($f_{inst} = 2.5$ for pipeline compressors, $f_{inst} = 3$ for truck terminal compressors and $f_{inst} = 2$ for storage compressors). *The heat demand is supplied with natural gas.

System	Investment costs	Depreciation period	O&M	Energy demand/supply		Loss
				Electricity	Heat*	
	EUR	a	1/a	$\frac{kWh_{el}}{kg_{H2}}$	$\frac{kWh_{NG}}{kg_{H2}}$	
Liquefaction	105 million EUR $* \left(\frac{x}{50 \frac{t_{H2}}{d}} \right)^{0,66}$	20	4%	6.78	0	1.65%
Hydrogenation	40 million EUR $* \left(\frac{x}{300 \frac{t_{H2}}{d}} \right)^{0,66}$	20	3%	0.37	-9.1	1%
Dehydrogenation	30 million EUR $* \left(\frac{x}{300 \frac{t_{H2}}{d}} \right)^{0,66}$	20	3%	0.37	9.1	1%
Compressor	$15,000 \frac{EUR}{kW} * x^{0,6089}$	15	4%	calculated	0	0.5%
Evaporator	$3,000 EUR * \frac{x}{\frac{t_{H2}}{d}} * f_{inst}$	10	3%	0.6	0	0
LH₂ Pump	$30,000 EUR * \frac{x}{\frac{t_{H2}}{d}}$	10	3%	0.1	0	0
LOHC Pump	$500 EUR * \frac{x}{\frac{t_{H2}}{d}}$	10	3%	0.1	0	0

2.7. Scenario Framework and analysed supply chain

In order to route the hydrogen up to the refuelling station, three major delivery pathways can be identified:

- Transmission and distribution via trucks (GH2, LH2 and LOHC),
- Transmission and distribution via pipelines,
- Transmission via pipelines and distribution via trucks (GH2).

These combinations allow having an extensive representation of the different hydrogen delivery possibilities. For each of the identified pathways, the model deploys the selected infrastructure linking between the production sites and the demand locations while minimizing the required delivery distance across France.

3. Results

The aim behind the extensive representation of the supply chain is to identify which pathway is most suited for which situation, in terms of geography and time scale, based on the assessment of the levelized hydrogen cost at the pump. The progressive demand scenarios (1%, 5% and 15% of vehicle fleet) allow representing the potential time development of the required infrastructure, while the electrolyser location scenarios (detailed in section 2.2) allow comparing two different possible situations: producing hydrogen next to the available power sources or next to the hydrogen demand hubs. Other case studies can also be considered such as placing the electrolysers next to point sinks of hydrogen (e.g. refineries). This approach can contribute to the decision making regarding the integration of the hydrogen transmission and distribution installations.

The modelling results are detailed in the next subsections.

3.1. Hydrogen demand

Based on the total number of vehicles by region and the assumptions detailed in section 2.5, the hydrogen demand by region is appraised. The total amounts of hydrogen that are required to fuel the FCEV fleet in each scenario are presented in Table 45.

Table 45: Resulting hydrogen demand by scenario, 2035

	Percentage of the total PLDV fleet		
	1%	5%	15%
FCEV fleet size	320 000	1 600 000	4 800 000
Hydrogen demand [kt/a]	29	146	437

Figure 76 shows the distribution of the demand across France for the scenario of 5% market penetration. The distribution (between the regions) remains the same for the other scenarios but with higher/lower demand values depending on the penetration rate.

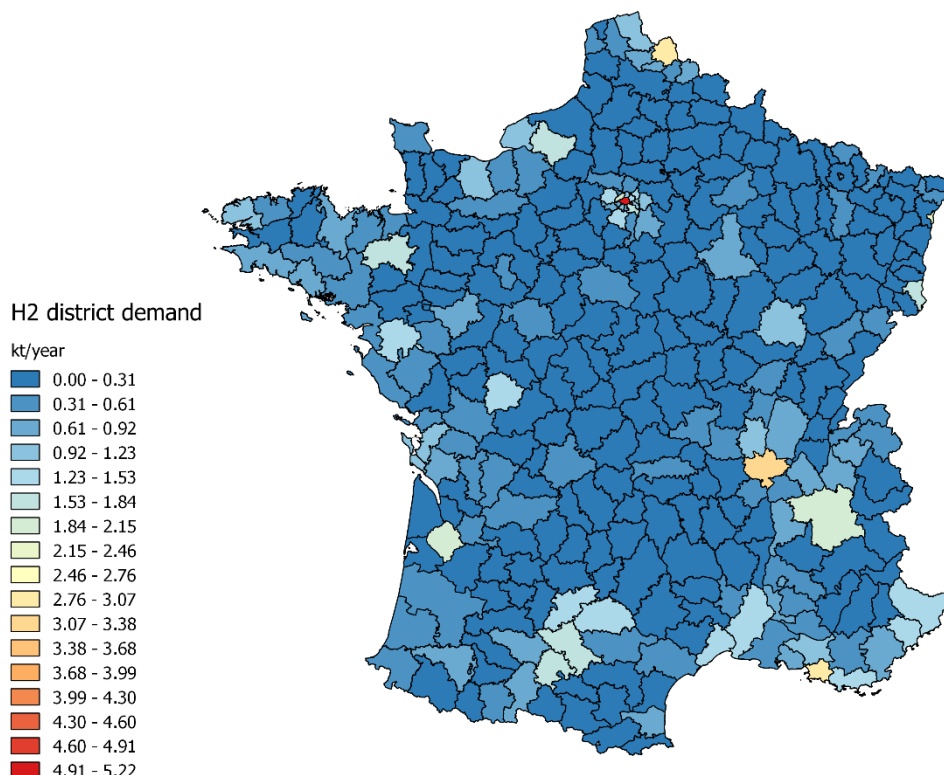

Figure 76: Distribution of hydrogen demand for mobility use for the scenario of 5% market penetration

The demand is concentrated in few areas of the map which are the big cities and the most urbanized areas (Paris, Lyon, Lille, Marseille, Toulouse, etc.). The highest demand is identified in Paris having the highest concentration of cars. Nowadays, the Parisian region attracts hydrogen vehicle penetration projects. For instance, the “Hype project” aims at deploying hydrogen taxis in the Parisian region.

A methodological limit that can be mentioned here is the fact that the same penetration rate is adopted for all of the regions in each scenario. However, in the real world, the distribution of the demand may rather depend on the emergence of hydrogen projects by region and the willingness of each region to deploy the hydrogen required infrastructure, which can be both an industrial and a governmental effort on a regional scale. Several projects are emerging in different regions across France (Auvergne Rhône Alpes [47], [48], Toulouse [49], Dunkirk [50], etc.).

As detailed in section 2.5, the hydrogen demand tackled in this chapter corresponds to the passenger light duty vehicle fleet. However, an interesting perspective that can be evaluated is to include the other types of transportation (buses, trains, trucks, etc.). This can be more complicated to implement, since once the long distance transportation is tackled, it can be tricky to identify the demand distribution knowing (especially for trucks) that the refuelling may occur anywhere between the starting location and the final destination of the vehicle. On the other hand, including the long distance vehicle fleets may present a game changer in lowering the final cost of hydrogen since the demand requirements can be higher than the ones driven by the passenger light duty vehicles. And this can lead to the required

economies of scale that allow enhancing the utilization rates of the production and delivery infrastructure.

Following the assumptions detailed in section 2.5, the demand profile is constructed. The constructed hourly profile of the hydrogen demand is presented in Figure 77 for the example of 5% market penetration on a national level (similar approach is adopted for all the scenarios).

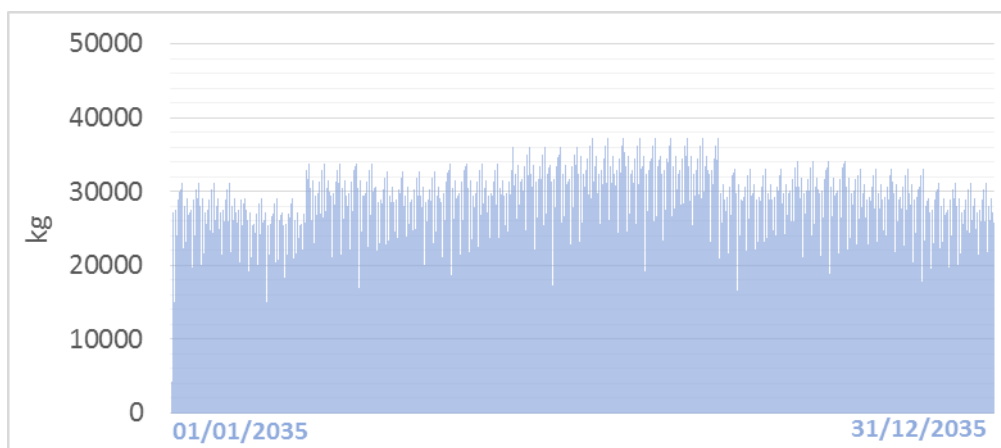

Figure 77: Hourly profile of hydrogen demand throughout the year – example scenario 5% market penetration

The demand is expected to be higher during summer time driven by the travelling for vacation, as for the weekly distribution, an increase in the demand is noticed by the end of the week, which can be explained by the refuelling of the vehicles in preparation for the weekends and the beginning of the following week. These aspects are highly dependent on consumer preferences that can vary from one region to another. Accordingly, a quite strong assumption consists in applying the same profile variations for all of the refuelling stations across France, which, in the real world, can be different.

In the next section, the hydrogen production profile is assessed which allows, once coupled with the demand profile, to evaluate the storage capacity needs.

3.2. Levelling hydrogen production and storage

In order to meet the hydrogen demand that is presented in the previous section, several hydrogen production plants are deployed across the country. The evaluated total capacity needs for hydrogen production are presented in Table 46 for each demand scenario.

Table 46: Total electrolyser capacities by penetration scenario

Percentage of the total PLDV fleet

ASSESSING THE HYDROGEN DEPLOYMENT IN FRANCE
THE USE OF TEMPORALLY AND SPACIALLY REFINED MODELS

	1%	5%	15%
FCEV fleet size	320,000	1,600,000	4,800,000
Electrolyser total capacity [GW]	0.23	1.15	3.5

As detailed in the methodology section, in this study, the electrolysers are operated when the electricity price is under a certain threshold that is defined in a way that minimizes the production cost (depending on the total number of operation hours).

Figure 78 shows the evolution of the hydrogen production cost (LCOH or production step “Totex”, red line, right axis) and the total number of operation hours (blue line, left axis), as functions of the electricity price (€/MWh).

The LCOH is the production cost taking into account the electricity price, the load factor and the investment cost of the electrolyser. It does not include the storage costs.

The number of operation hours corresponds to the number of hours for which the electricity price is below the selected electricity price in the x axis. Accordingly, the total number of hours for which the electricity price is under 10€/MWh for example is very low. –It does not exceed 500 hours- which leads

to a very high production cost of nearly 20€/kg, due to insufficient CAPEX amortization. The higher the threshold is, the higher operation hours are reached.

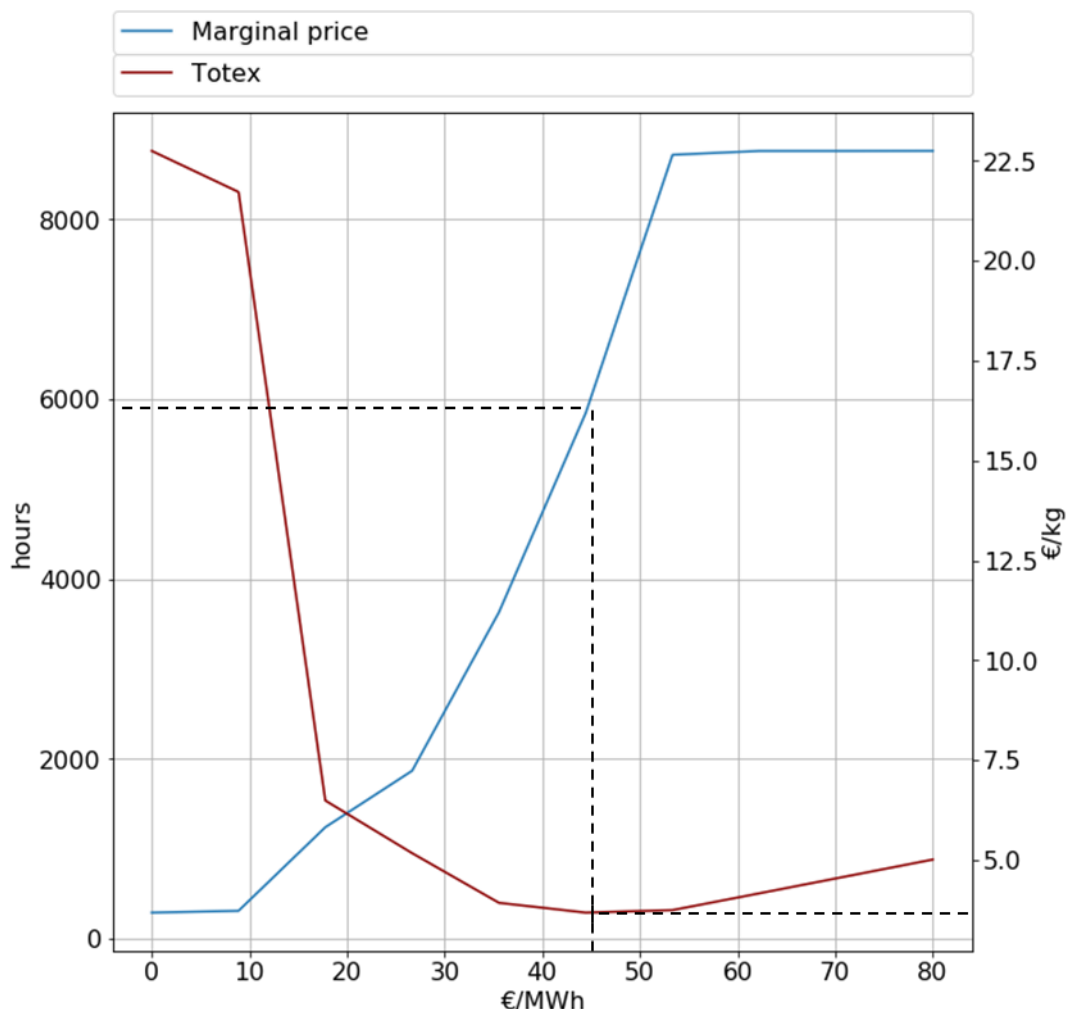

Figure 78: Hydrogen production cost evolution (LCOH, or production step TOTEX) and the total number of operation hours depending on the electricity price

As a result, there is a trade-off to make between CAPEX amortization (the higher the load factor, the better) and the cost of electricity consumption (the higher the load factor, the higher due to more expensive power). As shown in Figure 78, the electricity price threshold that ensures a minimal hydrogen production cost is 45€/MWh, with a load factor of 6000h. The grid fees [25] are included for the case study in which electrolyzers are located close to the demand hubs, resulting in an optimal production cost of 3.7 €/kg. These results do not depend on the market penetration scenario, since no scaling effect was assumed for the electrolyser investment in the present study.

When opting for a lower electricity threshold, higher electrolyser capacity is needed to meet the same demand since the total number of operation hours drops raising the hydrogen production cost due to degraded amortization.

On the other hand, when operating the electrolyzers at higher electricity prices, the hydrogen production carbon footprint is likely to increase due to the activation of polluting power plants during peak hours [51].

In order to accurately assess the hydrogen production cost, including hydrogen as a flexible demand seems crucial, especially when considering the high FCEV penetration rates for which the required electrolyser capacities reach the GW scale, which can impact the electricity prices. Hence, the “price taker” strategy reaches its limits for hydrogen penetration rates higher than 1%. On the other hand, considering that the electrolyser is always paying the electricity price at the threshold value even when the real price is under the threshold, allows to partially avoid the underestimation of the hydrogen production cost.

Coupling the production with the demand profile allows to construct the state of charge of a generic storage and to identify the storage capacity needs as presented in Figure 79.

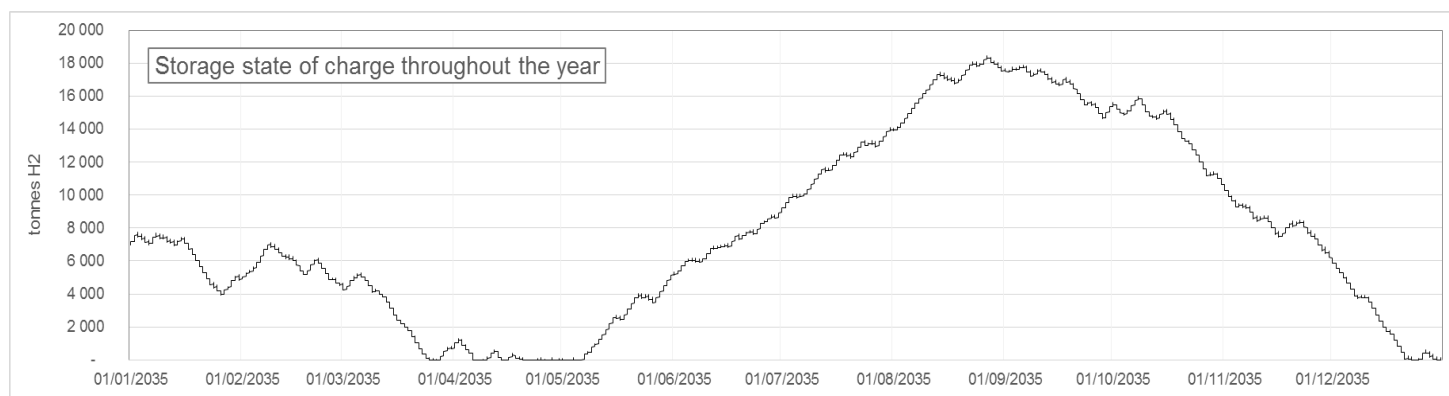

Figure 79: Hydrogen storage needs for the 5% penetration rate scenario

Figure 79 highlights the seasonal energy storage role ensured by hydrogen. Indeed, linking the hydrogen production to the electricity prices allows reflecting the seasonal variability of the renewables based on a previous work analysis [22]. Accordingly, this highlights the multi-sectorial decarbonisation potential of hydrogen, easing the penetration of renewable energies into the system while contributing to the decarbonisation of the transport sector.

3.3. Delivery pathways comparison

In order to link the hydrogen production sites to the refuelling stations, several pathways are considered as detailed in section 0.

Special focus is put on the geographical representation of the hydrogen infrastructure deployment. This deployment is mapped for the different scenarios of electrolyser locations as well as the various pathways that are considered in this study. Figure 80 presents the mapping of the infrastructure for the example of a 5% penetration rate.

ASSESSING THE HYDROGEN DEPLOYMENT IN FRANCE THE USE OF TEMPORALLY AND SPACIALLY REFINED MODELS

The fuelling stations are presented in coloured circles. The colours are graduated from blue to red depending on the demand that is satisfied by the refuelling stations. The red colour represents the highest demand levels (also highest operation rates). As shown in the figure, the most utilized refuelling stations correspond to the metropolitan and urban areas where demand levels and vehicle concentrations are higher, while the further we get from the big cities, the lower the utilisation rates are, which impacts the profitability of the stations. However this may change when considering long distance transportation like trucks for example that would increase the utilisation rates of the refuelling stations outside the urban areas, on the highways for instance. Furthermore, in order to reduce the risks, deploying smaller refuelling stations with lower capacities can be envisaged for the rural areas, which is not the case in this chapter (only one size was assumed).

The hydrogen production sites are represented by green squares on the maps, with different sizes representing the capacity of each production site.

As presented in section 2.2, two scenarios are adopted for the electrolyser locations. In the first scenario, the electrolysers are located next to strong transmission grid nodes (connected to the nuclear power plants) avoiding electricity grid fees while in the second scenario, the hydrogen production is rather located next to the demand hub. Accordingly, two different distributions of the hydrogen production capacities by region are obtained. For example, in the first scenario, the hydrogen production is directly linked to the presence of a nuclear power plant, hence not all of regions present a hydrogen production capacity. However in the second scenario, each region is supplied via an internal hydrogen production capacity.

As shown in Figure 80, more electrolyser facilities are deployed in the first scenario (next to nuclear power plants) accounting for 19 potential locations while in the second scenario, only 12 electrolyser facilities are installed. However, locating the electrolysers next to the demand hubs leads to a more homogenous distribution of the capacities. In this scenario, almost each region presents an internal hydrogen production capacity (except for Centre Val de Loire and Pays de la Loire), limiting the need for trades between the regions. However, in the first scenario, it is tricky to reach certain locations that are remote from the nuclear power plants (for example the south of the Bretagne region and the south of the Occitanie region for example). What is more, adjusting to the nuclear power plant locations leads to locate electrolysers in regions where the demand is particularly low. A visible example is the Centre Val de Loire region that, as shown in Figure 76, presents low demand values, but the model allocates four electrolyser locations there. This distribution can have a significant impact on the final cost of hydrogen at the pump, since it affects the deployment of the required infrastructure. Trade-offs may be observed there, depending on the demand levels. On the other hand, locating the electrolysers next to the nuclear power plants allows avoiding the electricity grid fees that correspond to the cost of transporting electricity. These fees are though included in the electricity price when considering a decentralized distribution of the electrolysers.

In order to route the hydrogen up to the refuelling station, three major delivery pathway representations can be identified:

- Transmission and distribution via trucks (GH₂, LH₂ and LOHC),
- Transmission and distribution via pipelines,
- Transmission via pipelines and distribution via trucks (GH₂).

Figure 80 presents in black lines the roads that are taken by the trucks for the delivery as well as the transmission and distribution pipelines. Transmission pipelines are needed only for the scenario where

ASSESSING THE HYDROGEN DEPLOYMENT IN FRANCE THE USE OF TEMPORALLY AND SPACIALLY REFINED MODELS

the electrolysers are located next to the nuclear power plants, since some of the latter are far from the demand centres. On the other hand, considering the scenario where the electrolysers are rather located near the demand, only distribution pipelines are needed since the delivery distances are shorter.

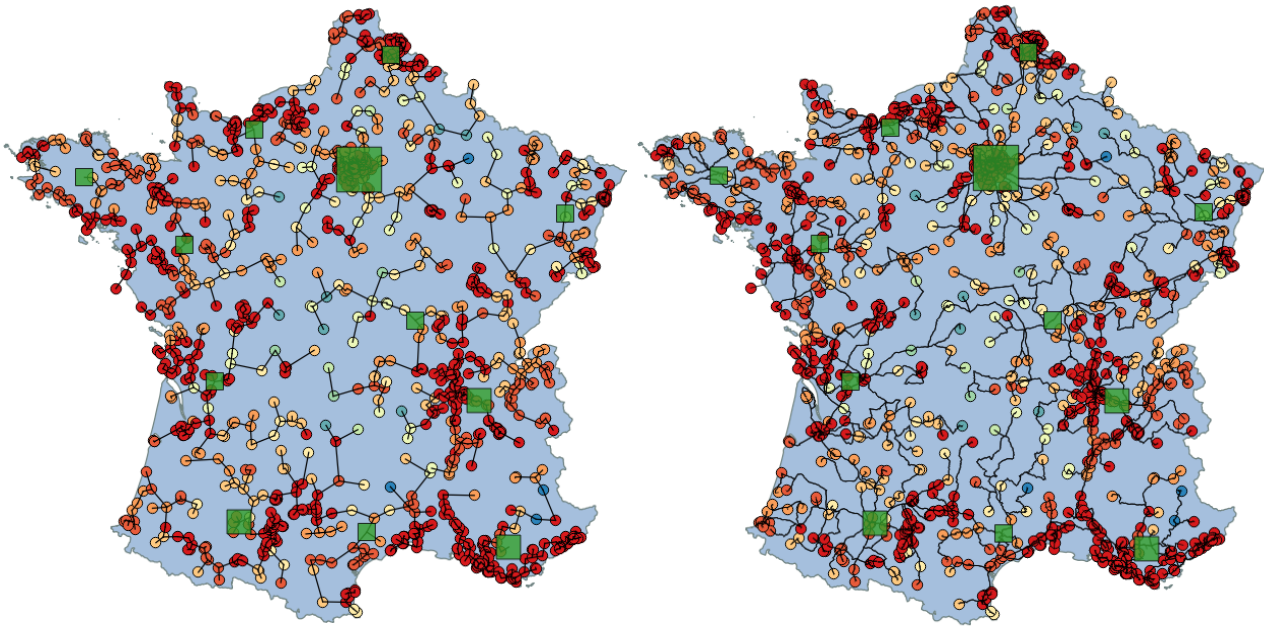

a) TR: Pipeline – Distr: Pipeline
electrolyser next to the demand

b) TR: Trucks – Distr: Trucks
electrolyser next to the demand

ASSESSING THE HYDROGEN DEPLOYMENT IN FRANCE
THE USE OF TEMPORALLY AND SPACIALLY REFINED MODELS

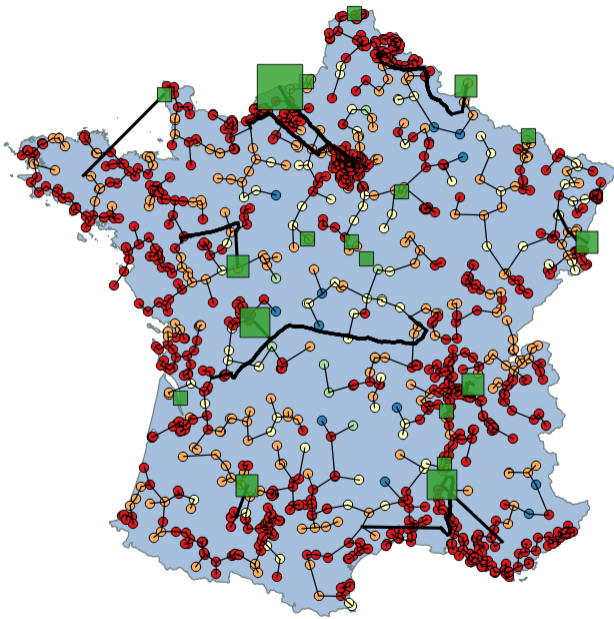

c) TR: Pipeline – Distr: Pipeline
electrolyser next to the nuclear power plants

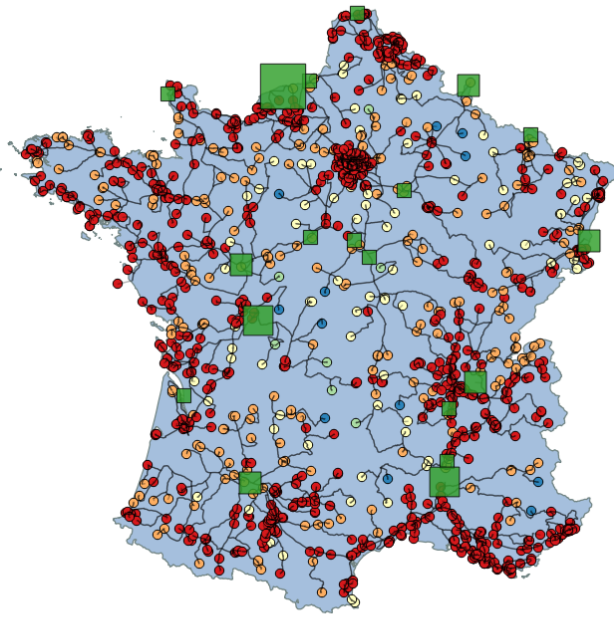

d) TR: Trucks – Distr: Trucks
electrolyser next to the nuclear power plants

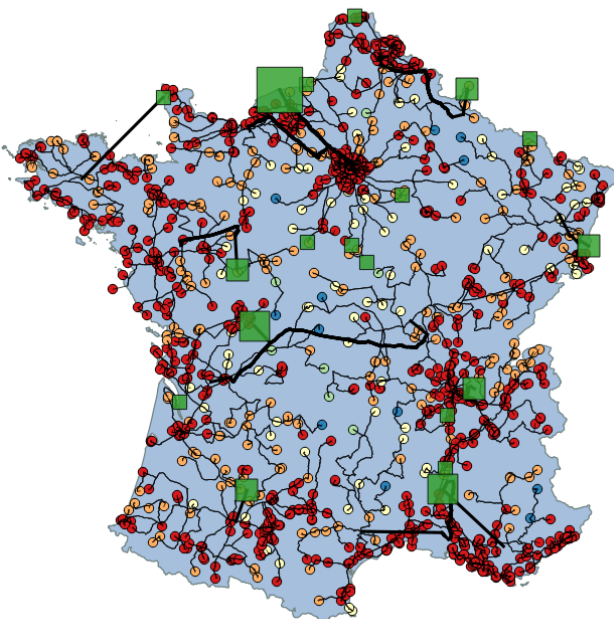

e) TR: Pipeline – Distr: Trucks
electrolyser next to the nuclear power plants

Legend

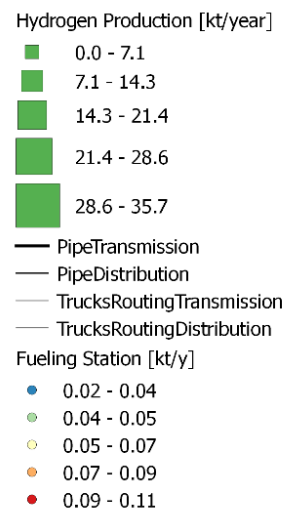
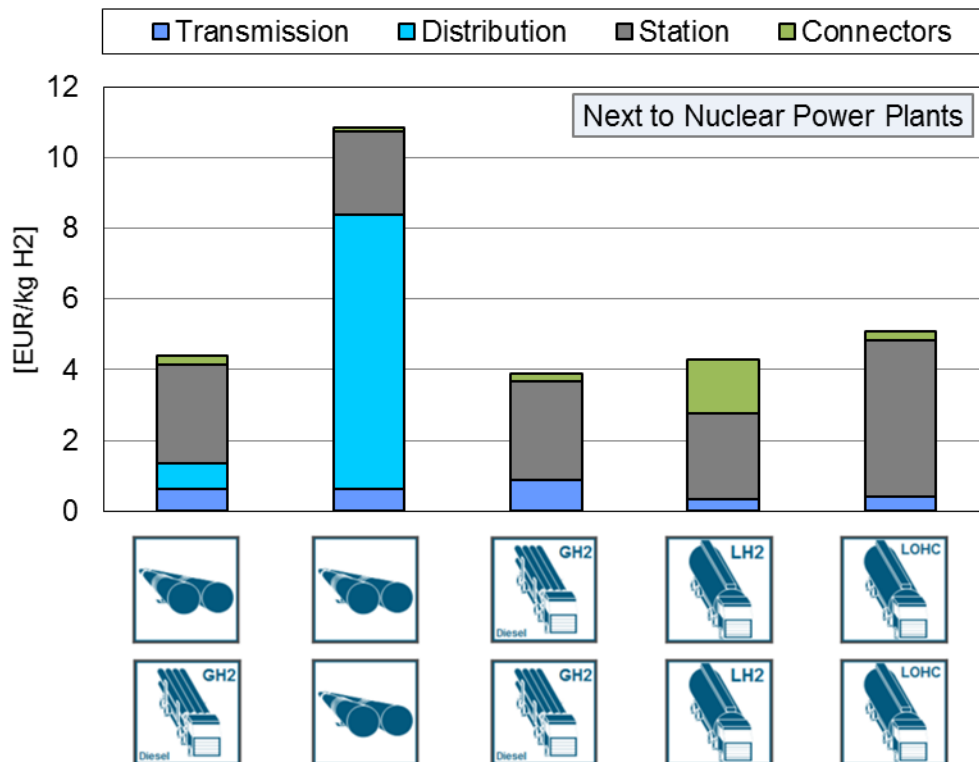

Figure 80: Geographic representation of the hydrogen infrastructure deployment (pipelines and trucks for 5% penetration rate) considering the two scenarios (a,b: electrolyser next to the demand – c,d and e: electrolyser next to the nuclear power plants)

In this study, the deployment of the pipelines is based on a point to point delivery consideration. Further work is needed in order to take into consideration the constraints that may impact the installation of a pipeline and modify its path. These constraints can also significantly impact the cost of pipeline installation. A visible example in Figure 80 (compare c and e) is the transmission pipeline crossing the ocean from the Normandie region to Bretagne. Such configuration may be too expensive to be considered.

In Figure 81, the cost of hydrogen delivery is compared for the five pathways, considering the example of 5% market penetration. The top graph corresponds to the scenario where the electrolyzers are located next to the nuclear power plants, while in the bottom graph, their location is optimized to be near the refuelling stations.



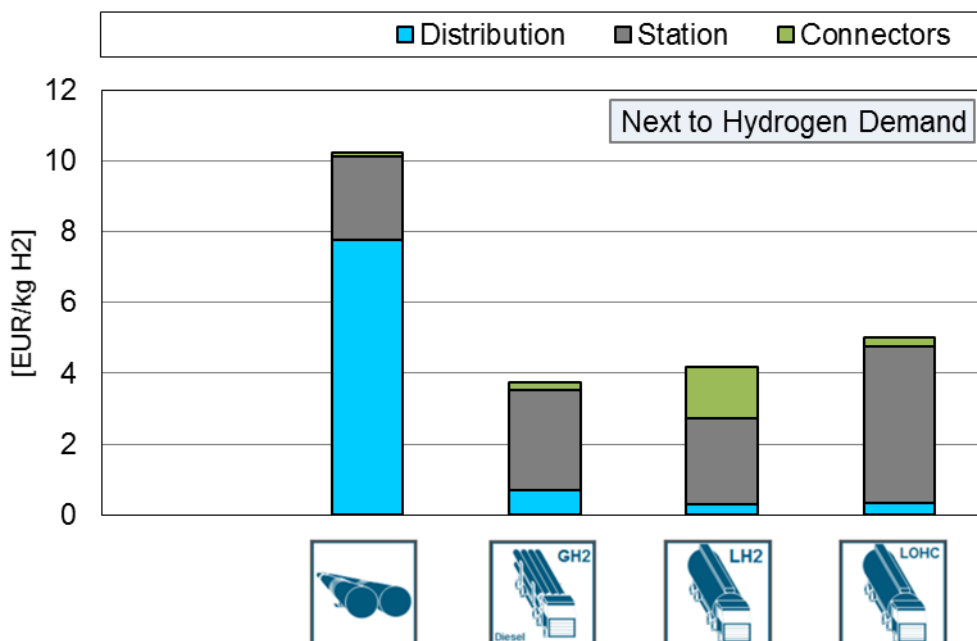

Figure 81: Hydrogen delivery cost (scenario 5% market penetration)

Amongst the five pathways that are considered in Figure 81, the pipeline transmission option is not applicable to the second scenario (electrolysers next to the demand), since in the latter the production sites are located in an optimal way to minimize the distance to the refuelling stations using a clustering method, which leads to the unnecessary of deploying heavy transmission pipeline. Additionally, in this scenario, the resulting transported quantities (from the production site to the refuelling station) are not high enough to trigger transmission pipeline investments. However, distribution pipelines can be deployed. On the other hand, in the first location scenario, considering the truck pathways (GH2, LH2 and LOHC), the trucks are used for both transmission and distribution of hydrogen.

As shown in Figure 81, for each selected pathway, the final delivery costs of hydrogen at the pump for both electrolyser location scenarios are very close. Hence at the end, both electrolyser location scenarios present similar cost values considering the 5% penetration rate. However, this may change when taking into account different market penetration rates as detailed in the next paragraphs.

Starting with the 5% penetration scenario, most of the pathways present a cost of hydrogen delivery that is in the range between 3.7€/kg and 5€/kg, the latter cost value corresponding to the LOHC supply chain. Only one specific pathway can be distinguished, clearly leading to higher costs, which is the second pathway presenting high costs of hydrogen distribution via pipelines. The delivery cost of hydrogen at the dispenser reaches 10.9€/kg in this case. Indeed, on the distribution level, the hydrogen throughput is reduced to respond to the demand at the station level, which makes investments in pipelines a non-viable option for both scenarios.

Regarding the delivery pathways via trucks, the gaseous option seems to present the most attractive alternative (third bar on the graph) when it comes to the 5% penetration rate scenario, as presented in Figure 81. The connectors between the supply chain steps (and within the refuelling station as for the LOHC case), in the gaseous hydrogen pathway, mainly consist in compressing hydrogen from a pressure level to the required one for the next step, which is less energy-intensive than the liquefaction/evaporation and the hydrogenation/dehydrogenation that are required for LH2 and LOHC. On the other hand, the cost fraction related to the transmission alone (without considering the connectors) is more attractive in the LH2 and LOHC cases compared to the GH2 one, which can be explained by the higher capacities of the LH2 and LOHC trailers allowed by the higher hydrogen volumetric densities.

Upstream, the cost of hydrogen production and hydrogen storage is assessed for the different supply chains. Production costs amount to 3.7 €/kg approximately. Slightly lower hydrogen production costs are reached in the first scenario (putting the electrolyzers next to the nuclear power plants) due to the electricity grid fee exemptions. In this case, the production cost reaches 3.2 €/kg.

However, this gain is compensated by a higher cost of hydrogen storage in this scenario that is due to the inadequacy of the electrolyser locations compared to the demand centres. Considering a representative hydrogen storage facility characterized with cost similar to underground cavern to be installed next to the production sites, the storage cost amounts to 0.93€/kgH₂ in the first location scenario (next to nuclear power plants) and 0.62€/kgH₂ in the second one. Nonetheless, regarding underground storage, this would clearly be an under-estimation of the cost since it depends on the possibility to build storage facilities in salt caverns next to every hydrogen production site (which is not the case in France, this will be further detailed hereafter, see Figure 84, which implies that the cost of transporting hydrogen up to the available storage sites and then to the demand hubs needs to be added. The liquid and LOHC storage options are more realistic in this case, presenting a flexibility of location; the corresponding costs vary between 0.4€/kgH₂ and 0.7€/kgH₂ for the 5% penetration scenario, comparable to gaseous storage cost estimate. Overall, the storage cost range is not large: the storage cost component varies between 0.4€/kgH₂ and 0.9€/kgH₂ for the 5% penetration scenario depending on the considered pathway (gaseous, liquid or LOHC storage) and the electrolyser location scenario. Storage is not the first cost contribution, whatever the selected option.

Based on the analysis made above, four main pathways are selected for further investigation, taking into account the impact of the scenario (the location of the electrolyser and the FCEV penetration rate) on the final cost at the pump in order to investigate if a cost gap between location scenarios is created when moving from one penetration rate to the other. The selected pathways are applicable to all of the scenarios (hence the transmission via pipeline option is excluded).

Accordingly, the following delivery pathways are investigated:

- Gaseous storage, GH2 trailer trucks;
- Gaseous storage, LH2 trailer trucks;
- Liquid storage in tanks, LH2 trailer trucks;
- And gaseous storage with LOHC trailer trucks.

For each pathway, six scenarios are compared as presented in Figure 82: two scenarios for the location of the electrolyser facilities and for each one of them, three case studies are suggested for the market

ASSESSING THE HYDROGEN DEPLOYMENT IN FRANCE
THE USE OF TEMPORALLY AND SPACIALLY REFINED MODELS

penetration (1%, 5% and 15%). The selection of different market penetration scenarios for the fuel cell electric vehicle deployment allows having an idea on the potential dynamic development of the required infrastructure and the evolution of the “most suitable” delivery option depending on the FCEV penetration rate.

ASSESSING THE HYDROGEN DEPLOYMENT IN FRANCE
THE USE OF TEMPORALLY AND SPACIALLY REFINED MODELS

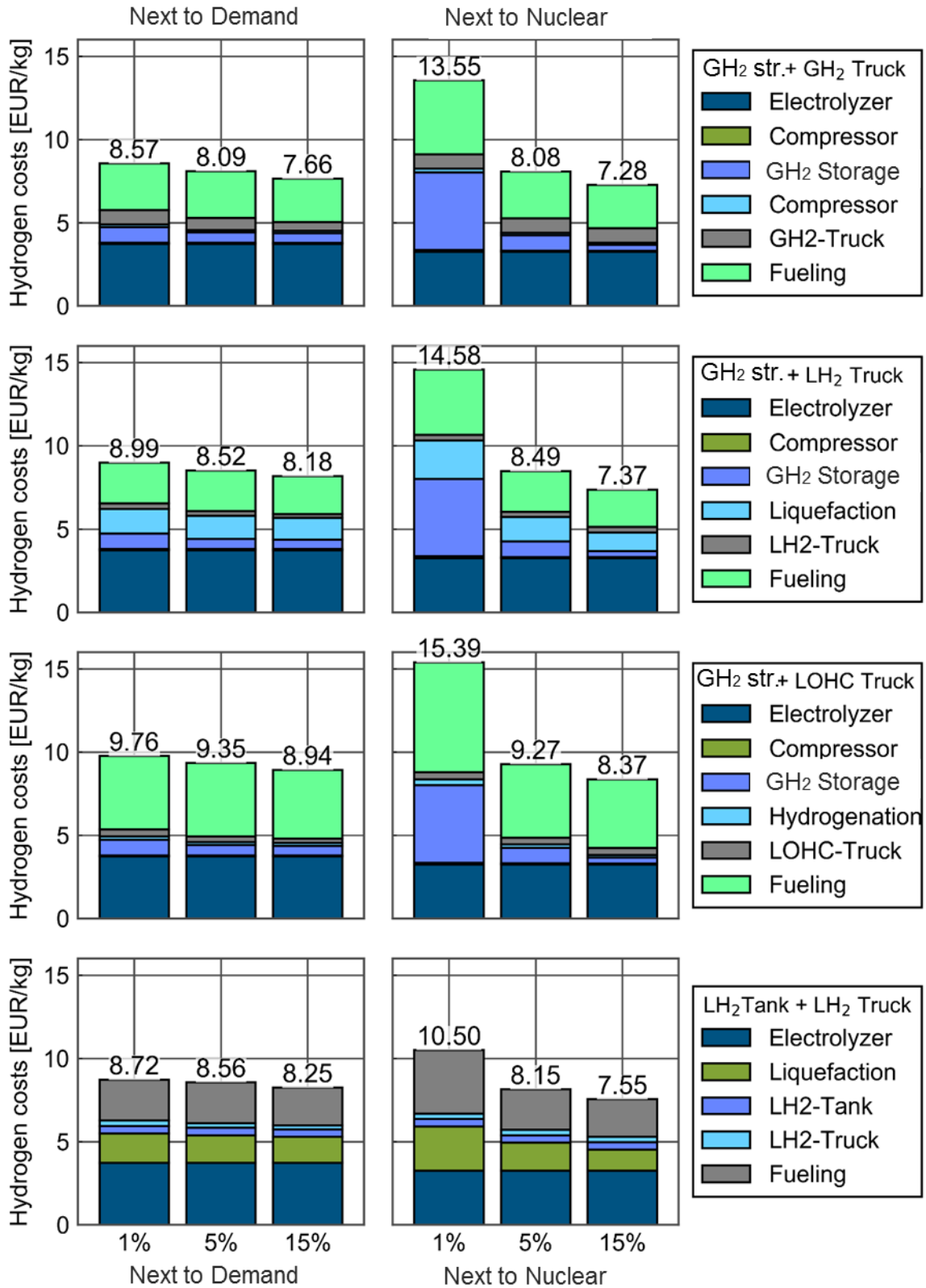

*GH2: Gaseous Hydrogen - LH2: Liquid Hydrogen - LOHC: Liquid Organic Hydrogen Carrier

Figure 82: Impact of the scenario on the final cost at the dispenser

As shown in Figure 82, for all of the four selected pathways, the higher the market penetration, the lower the cost at the pump, highlighting the benefit of creating economies of scale. The nuclear scenario (placing the electrolyzers next to the nuclear power plants) is more sensitive to the scale effect. This is significantly visible when it comes to the cost fraction related to the gaseous storage. In this case, during the early hydrogen market penetration phase presented here by the 1% penetration rate scenario, massive gaseous hydrogen storage seems to present a non-viable option. This is balanced out with higher penetration rates allowing higher hydrogen throughput and better load factors.

It is interesting to notice the trade-off between the two location scenarios. As a matter of fact, the results show that during the early market penetration phases, placing the electrolyzers near the demand is more economically attractive than placing them next to the nuclear power plants. The latter scenario implying higher investments require high throughput to be amortized. Indeed, when increasing the market penetration rate up to around 5%, the two location scenarios seem to converge in terms of economic attractiveness.

Figure 83 allows following the impact of the hydrogen market penetration on the cost break-even point between the two location scenarios.

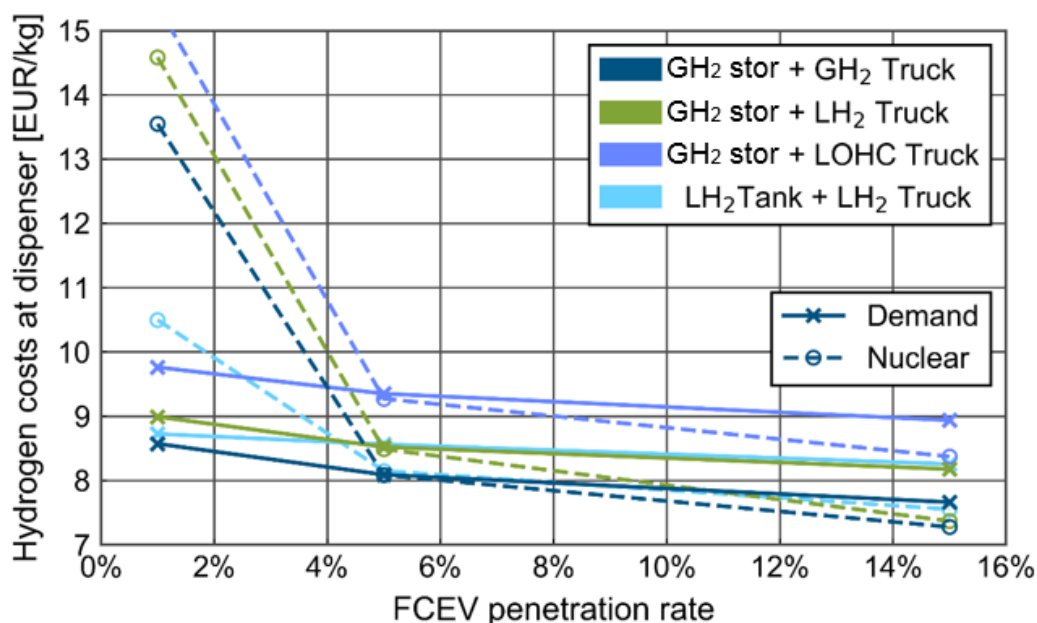

Figure 83: Comparison of total hydrogen costs at the dispenser for the placement next to nuclear power plants and next to the demand for supply pathways

Indeed, in almost all of the considered pathways, the break-even point is reached at around 5% market penetration rate except for the “all-liquid” pathway where the intersection occurs at around 3%. Starting from which, the first option (placing the electrolyzers next to the nuclear power plants) becomes more economically attractive than the second one. At this stage, the hydrogen demand levels allow to amortize the infrastructure costs, besides, placing the electrolyzers next to the nuclear power plants allows to

reach cheaper hydrogen production costs thanks to electricity grid fee exemption as considered in the study and to the scale effect.

In other terms, this also allows to partially analyse the economic attractiveness of both energy vectors (electricity and hydrogen) when it comes to transporting energy. Indeed, in the second case study, when the electrolysers are placed near the demand, energy is rooted from the power plants up to the hydrogen demand centres in the form of electricity using the existing power grid. On the other hand, when placing the electrolysers next to the power plants, the electricity transmission up to the hydrogen demand hubs is replaced with hydrogen delivery pathways.

Although it seems not fair to compare investing in new hydrogen infrastructure to using the already installed electric grid to root the required energy, the results show that starting from a 5% market penetration rate, it can be considered that hydrogen presents economic advantages when it comes to transporting energy compared to electricity. Conducting a cost analysis of the infrastructure investments comparing the potential upgrade of the power grid and the deployment of hydrogen infrastructure can give further insights regarding the energy vector comparison [52].

Amongst the four considered hydrogen pathways, the “all gaseous option” always presents the lowest cost, no matter what the scenario is, except for the 1% case study in the nuclear location case where the “all-liquid pathway” (liquid storage and LH2 trailer truck) seems to present the most suitable supply chain for hydrogen early market penetration. This is mainly related to the hydrogen storage cost for such low throughput and such geographic configuration. Hence the liquid hydrogen storage option is more attractive when it comes to low market penetration rates and long delivery distances.

When higher market penetration rates are reached, new hydrogen delivery options may emerge such as the LOHC option. The latter presents big advantage in terms of delivery costs (compared to both gaseous and liquid options) which is related to its high energy density. However, reducing the refuelling station costs seems to be a challenge even at high penetration rates. This can be related to the energy-intensive dehydrogenation step that is required to extract hydrogen from the carrier.

The needed storage capacities are compared for the penetration rate scenarios. The results are presented in Table 47.

Table 47: Storage capacity needs

		Storage capacity needs		
FCEV penetration rate	1%	3.5	kt	115
	5%	17.5		577
	15%	52.5		1,732
				GWh

Although the geographic location of the salt caverns is not taken into account in this chapter, their capacity adequacy to the storage needs as assessed in this chapter is investigated.

Table 48 presents the salt caverns capacity in France.

ASSESSING THE HYDROGEN DEPLOYMENT IN FRANCE
THE USE OF TEMPORALLY AND SPACIALLY REFINED MODELS

Table 48: Salt cavern capacities in France (adapted from [53])

	Etrez	Manosque	Tersanne	Hauterives	
	1,117	496	262	200	million m ³
Salt cavern capacity	Total: 2,075				million m ³
	Total: 200 *				kt

*Hydrogen density = 0.08988 kg/m³

*Methane density = 0.656 kg/m³

It is interesting to notice that, as shown in Table 47 and Table 48, the salt cavern capacities are sufficient to cope with the storage needs that are assessed in this chapter. Nevertheless, many questions are still remaining regarding the real availability of these caverns for hydrogen storage, knowing that they are already operated today for natural gas storage [53]. The latter will still be needed in future and therefore a reconversion to hydrogen stays in competition with the gas storage market.

There are a number of regions across France that are suitable for underground hydrogen storage (see Figure 84). These geographic locations are characterized by the presence of geological salt formation. New caverns may be built, provided that the soil nature is appropriate.

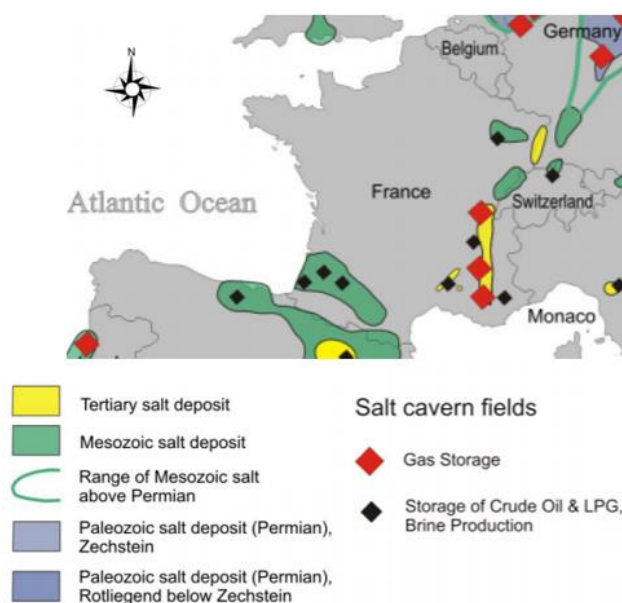

Figure 84: Salt cavern locations across France (adapted from [54])

However, in the present study, when considering the storage in the calculation, the model assumes that the geographic availability is given.

In order to overcome cavern geographic availability issue, considering liquid storage can be an economically viable option as presented in Figure 82, with costs amounting to 0.45\$/kg_{H₂}. If the underground storage were to be replaced by compressed gas storage, the resulting costs are expected to

be higher. According to Tzimas et al. [55], the compressed gas storage cost can vary from approximately 0.9\$/kg_{H₂} to nearly 5\$/kg_{H₂} depending on the storage capacity.

To sum up, there is no one best option for hydrogen delivery in France according to the results. It depends on the adopted scenario defining the market deployment phase. At low market penetration rates, placing the electrolyzers near the demand allows avoiding over-scaled infrastructure and hence presents lower costs than the first scenario (electrolyzers next to the nuclear power plants). At more advanced deployment phases (starting from 5% penetration rate), placing the electrolyzers next to the nuclear power plants becomes more economically attractive having the advantage of lower production costs due to electricity grid fee exemption.

Nevertheless, regardless of the electrolyser location, some pathways present relatively low costs compared to other ones considered in this study. For instance, as a general trend, the all-gas pathway coupled with an underground storage seems to be the most economically attractive option in most of the scenarios, once the early market penetration step is achieved.

This result is tightly dependent in the real world on the availability of the underground storage next to the production sites, which can be considered as a strong assumption in this study. Resorting to higher hydrogen volumetric density via the all-liquid hydrogen pathway can be an alternative option, followed by the LOHC pathway.

4. Summary and discussion

Different studies in the literature tackled the hydrogen infrastructure deployment issue in France but partially, assessing either one part of the hydrogen supply chain or the whole supply chain but for one possible delivery pathway.

This chapter compares five different hydrogen pathways, going from the production step up to the fuelling station. Different storage and delivery options are investigated for both gaseous and liquid hydrogen. In order to capture the time evolution aspect of the infrastructure deployment needs, three demand scenarios are investigated, going from 1% of market penetration up to 15%. Additionally, two scenarios are taken into account when it comes to the location of the hydrogen production sites vis-à-vis the demand centres.

One interesting outcome of the study is the order of hydrogen pathway adoption preferences depending on the situation. According to the results, during the very first market penetration phases (1% scenario), it is more interesting to store and transport hydrogen in liquid form, which allows to benefit from the high volumetric density of this option while avoiding to resort to gaseous storage and delivery that proved to be expensive at this stage. Beyond the results of this chapter, similar results regarding liquid hydrogen are reached for the shipping supply chain (for imports/exports for example) [56].

However, when the hydrogen market penetration gets higher, the gaseous pathway proves to be the most economically attractive option. However, the real geographic availability of the salt caverns in France

for hydrogen storage needs to be taken into account, since otherwise, the delivery costs are underestimated neglecting the cost of transporting hydrogen to the storage cavern and then to the demand.

Higher penetration rates also give room for the new technologies like LOHC to emerge allowing to create the economies of scale. However, the carbon impact of the LOHC supply chain is far from being attractive as far as the natural gas is still the energy source for heating during the dehydrogenation step.

Overall, regardless of the selected supply chain option or the scenario, the production cost represents a high share of the final cost of hydrogen at the pump, varying between 10% and 50% depending on the scenario and the pathway. Further studies should be conducted in order to assess the potential of reducing the hydrogen production cost by benefiting from the electrolyser flexibility and the possibility to participate to the reserve market or to act as a flexible demand, thanks to which the electrolyser operator can be remunerated. Such studies were carried out in [51], [57]–[61], but special attention should be dedicated to “cannibalisation” effects that may appear when more flexibility providers compete to participate to this market which reduces the income share of each.

Finally, the approach adopted in this chapter is deterministic, assuming the same hydrogen penetration rate everywhere across France and deploying each time one possible supply chain. Nevertheless, in the real world, hydrogen demand can be heterogeneous across the country, which may be in part lead by regional and local, governmental and industrial incentives. Presenting a mixed infrastructure deployment depending on the regional demand can be a perspective to this chapter in addition to considering the other hydrogen markets, whether they are related to the mobility sector (buses, trucks, trains, etc.) or the industry and natural gas sectors. The geographic distribution of these demands can highly impact the infrastructure development needs.

5. Conclusion

Hydrogen is a promising solution for a multi-sectorial decarbonisation. It also allows to link between the electricity system (provided that it is produced via electrolysis) and the other energy sectors (industry, transport, natural gas system). This chapter focuses on the transport sector and specifically the use of hydrogen in fuel cell electric vehicles for light duty passenger mobility. One major issue that is source of uncertainty holding back the hydrogen deployment there is the infrastructure development needs and costs.

According to the results, economies of scale that can be driven by higher market penetration rates have significant impact on lowering the hydrogen cost at the pump. This impact is more visible in the first stages of hydrogen deployment (going from 1% to 5% market penetration results in a cost drop of around 2€/kg), highlighting the necessity of growing in size in order to reach the targeted cost reductions. This step can be fostered by governmental incentives to help industries overcome the “death-valley”.

Placing the electrolysers next to the demand helps reduce the infrastructure needs. This would allow lowering the costs of hydrogen delivery which is crucial especially during the first market penetration phases. When higher penetration rates are reached, placing the electrolysers next to the electricity source proved to be more economically attractive.

Acknowledgment:

The present work is carried out in the framework of a PhD thesis funded by Air Liquide. It was the result of collaboration between the Institute of Electrochemical Process Engineering (IEK-3) of the Forschungszentrum Jülich GmbH, and the Institute for techno-economics for energy systems (I-tésé) of the CEA. The work of the IEK-3 was supported by the Helmholtz Association under the Joint Initiative “EnergySystem 2050—A Contribution of the Research Field Energy”.

REFERENCES

- [1] Commissariat général au développement durable, “Chiffres clés du climat : France, Europe et Monde.” Service de la donnée et des études statistiques (SDES), 2018.
- [2] Ademe, “Évolution du marché, caractéristiques environnementales et techniques - Véhicules particuliers neufs vendus en France.” 2017.
- [3] Markus Wacket and Ilona Wissenbach, “Diesel cars can be banned from German cities, court rules,” *Reuters, Business News*, 27-Feb-2018.
- [4] “Spécial COP 21 - Les engagements nationaux de la France,” *Gouvernement.fr*, 30-Nov-2015. [Online]. Available: <https://www.gouvernement.fr/special-cop-21-les-engagements-nationaux-de-la-france-3390>.
- [5] Hydrogen Council, “Hydrogen scaling up, A sustainable pathway for the global energy transition,” Nov. 2017.
- [6] SBC Energy Institute, “Leading the Energy Transition Factbook, Hydrogen-based energy conversion - More than storage: system flexibility.” 2014.
- [7] R. Belot and F. Picard, “The Three Ages of Fuel Cell Research in France: A Socio-Technical System’s Resistance to Change,” *Fuel Cells*, vol. 14, no. 3, pp. 525–532, Mar. 2014.
- [8] K. Andriopoulos and S. Silvestre, “French energy policy: A gradual transition,” *Energy Policy*, vol. 106, pp. 376–381, 2017.
- [9] M. Becherif, H. S. Ramadan, K. Cabaret, F. Picard, N. Simoncini, and O. Bethoux, “Hydrogen Energy Storage: New Techno-Economic Emergence Solution Analysis,” *Energy Procedia*, vol. 74, pp. 371–380, 2015.
- [10] Étienne Beeker, “Does Hydrogen Have a Place in the Energy Transition?,” *France Stratégie, Policy Brief*, no. No.15, Aug-2014.
- [11] Jean-Louis DURVILLE, Jean-Claude GAZEAU, Jean-Michel NATAF, Jean CUEUGNIET, and Benoît LEGAIT, “Filière hydrogène-énergie, Report to the Government,” 2015.
- [12] “Les taxis Hype carburent à l’hydrogène,” *Les Echos*, 16-Jan-2018. [Online]. Available: <https://www.lesechos.fr/thema/0301145664677-les-taxis-hype-carburent-a-lhydrogene-2145259.php>.
- [13] P. Menanteau, M. M. Quéméré, A. L. Duigou, and S. L. Bastard, “An economic analysis of the production of hydrogen from wind-generated electricity for use in transport applications,” *Energy Policy*, vol. 39, no. 5, pp. 2957–2965, 2011.
- [14] A. L. Duigou *et al.*, “Hydrogen pathways in France: Results of the HyFrance3 Project,” *Energy Policy*, vol. 62, pp. 1562–1569, 2013.
- [15] A. L. Duigou, A.-G. Bader, J.-C. Lanoix, and L. Nadau, “Relevance and costs of large scale underground hydrogen storage in France,” *Int. J. Hydrog. Energy*, vol. 42, no. 36, pp. 22987–23003, 2017.
- [16] J. André *et al.*, “Design and dimensioning of hydrogen transmission pipeline networks,” *Eur. J. Oper. Res.*, vol. 229, no. 1, pp. 239–251, 2013.
- [17] J. André, S. Auray, D. D. Wolf, M.-M. Memmah, and A. Simonnet, “Time development of new hydrogen transmission pipeline networks for France,” *Int. J. Hydrog. Energy*, vol. 39, no. 20, pp. 10323–10337, 2014.

ASSESSING THE HYDROGEN DEPLOYMENT IN FRANCE
THE USE OF TEMPORALLY AND SPACIALLY REFINED MODELS

- [18] S. D.-L. Almaraz, C. Azzaro-Pantel, L. Montastruc, and M. Boix, "Deployment of a hydrogen supply chain by multi-objective/multi-period optimisation at regional and national scales," *Chem. Eng. Res. Des.*, vol. 104, pp. 11–31, 2015.
- [19] Olfa Tlili *et al.*, "Geospatial modelling of the hydrogen infrastructure in France in order to identify the most suited supply chains," *Submitt. Int. J. Hydrog. Energy*, 2019.
- [20] M. Reuß, T. Grube, M. Robinius, P. Preuster, P. Wasserscheid, and D. Stolten, "Seasonal storage and alternative carriers: A flexible hydrogen supply chain model," *Appl. Energy*, vol. 200, pp. 290–302, 2017.
- [21] M. Reuß, T. Grube, M. Robinius, and D. Stolten, "A hydrogen supply chain with spatial resolution: Comparative analysis of infrastructure technologies in Germany," *Appl. Energy*, vol. 247, pp. 438–453, Aug. 2019.
- [22] O. Tlili *et al.*, "Role of electricity interconnections and impact of the geographical scale on the French potential of producing hydrogen via surplus electricity by 2035," *Energy*, vol. 172, pp. 977–990, 2019.
- [23] S. M. Saba, M. Müller, M. Robinius, and D. Stolten, "The investment costs of electrolysis – A comparison of cost studies from the past 30 years," *Int. J. Hydrog. Energy*, vol. 43, no. 3, pp. 1209–1223, 2018.
- [24] Olfa Tlili *et al.*, "Role of electricity interconnections and impact of the geographical scale on the French potential of producing hydrogen via surplus electricity by 2035. Part 2: Results," *Submitt. Energy*.
- [25] "Prix de l'électricité par type d'utilisateur," *Eurostat*, 2018. [Online]. Available: <https://ec.europa.eu/eurostat/tgm/table.do?tab=table&init=1&language=fr&pcode=ten00117&plugin=1>. [Accessed: 15-Mar-2018].
- [26] Fuel Cells and Hydrogen Joint Undertaking - FCHJU, "Deployment of Water Electrolysis in the European Union," 2014.
- [27] International Energy Agency, "Technology Roadmap Hydrogen and Fuel Cells." 2015.
- [28] M. Klell, "Storage of Hydrogen in the Pure Form," in *Handbook of Hydrogen Storage*, John Wiley & Sons, Ltd, 2010, pp. 1–37.
- [29] ERH2-Bretagne, "LOHC: Nouveau procédé de stockage liquide d'Hydrogène en Allemagne," 2016. [Online]. Available: <http://erh2-bretagne.strikingly.com/blog/lohc-nouveau-procede-de-stockage-liquide-d-hydrogene-en-allemag>.
- [30] S. Baufumé *et al.*, "GIS-based scenario calculations for a nationwide German hydrogen pipeline infrastructure," *Int. J. Hydrog. Energy*, vol. 38, no. 10, pp. 3813–3829, 2013.
- [31] D. Teichmann, W. Arlt, and P. Wasserscheid, "Liquid Organic Hydrogen Carriers as an efficient vector for the transport and storage of renewable energy," *Int. J. Hydrog. Energy*, vol. 37, no. 23, pp. 18118–18132, 2012.
- [32] C. Yang and J. Ogden, "Determining the lowest-cost hydrogen delivery mode," *Int. J. Hydrog. Energy*, vol. 32, no. 2, pp. 268–286, Feb. 2007.
- [33] OpenStreetMap Contributors, "OpenStreetMap," 2017. [Online]. Available: <https://www.openstreetmap.org>.
- [34] E. W. Dijkstra, "A note on two problems in connexion with graphs," *Numer. Math.*, vol. 1, no. 1, pp. 269–271, Dec. 1959.
- [35] H2Mobility, "H2 tanken - Wasserstoffmobilität beginnt jetzt.," 2018. [Online]. Available: <https://h2.live/>.
- [36] Martin Robinius *et al.*, "Linking the Power and Transport Sectors — Part 2: Modelling a Sector Coupling Scenario for Germany," *Energies*, vol. 10, no. 957, 2017.
- [37] Argonne National Laboratory, *Hydrogen Refueling Station Analysis Model (HRSAM) VI.1*. 2016.
- [38] M. Melaina and M. Penev, "Hydrogen Station Cost Estimates Comparing Hydrogen Station Cost Calculator Results with other Recent Estimates." National Renewable Energy Laboratory (NREL), 2013.

ASSESSING THE HYDROGEN DEPLOYMENT IN FRANCE
THE USE OF TEMPORALLY AND SPACIALLY REFINED MODELS

- [39] DOE, “Multi-year reasearch, development and demonstration plan - 3.2 hydrogen delivery,” 2015. [Online]. Available: <https://www.energy.gov/eere/fuelcells/downloads/fuel-cell-technologies-office-multi-year-research-development-and-22>.
- [40] “Database,” *Eurostat*. [Online]. Available: <https://ec.europa.eu/eurostat/data/database>. [Accessed: 02-Feb-2018].
- [41] Allgemeiner Deutscher Automobil-Club e.V. (ADAC), “Benefits of passenger car travel in Europe.” 2015.
- [42] “H2A Hydrogen Delivery Infrastructure Analysis Models and Conventional Pathway Options Analysis Results.” Nexant, May-2008.
- [43] Center for International Earth Science Information Network (CIESIN), “Documentation for the Global Rural-Urban Mapping Project, Version 1 (GRUMPv1): Urban Extent Polygons, Revision 01 [Dataset].” NY: NASA Socioeconomic Data and Applications Center, 2017.
- [44] F. Pedregosa and et al., “Scikit-learn: Machine Learning in {P}ython,” *Journal of Machine Learning Research*, pp. 2825–2830, 2011.
- [45] Daniel Teichmann, “Konzeption und Bewertung einer Nachhaltigen Energieversorgung auf Basis flüssiger Wasserstoffträger (LOHC).” *Berichte aus der Energietechnik*, 2015.
- [46] M. Aasadnia and M. Mehrpooya, “Large-scale liquid hydrogen production methods and approaches: A review,” *Appl. Energy*, vol. 212, pp. 57–83, Feb. 2018.
- [47] Fiona Urbain, “Auvergne-Rhône-Alpes veut devenir la première région à hydrogène de France,” *Ecom News*, Juillet-2018. [Online]. Available: <https://ecomnews.fr/article/Auvergne-rhone-alpes-veut-devenir-premiere-region-hydrogene-france>.
- [48] “Pour une filière hydrogène d’ excellence,” *La Région Auvergnnes-Rhône-Alpes*. [Online]. Available: <https://www.auvergnnerhonealpes.fr/278-pour-une-filiere-hydrogene-d-excellence.htm>. [Accessed: 14-Sep-2018].
- [49] Pierrick Merlet, “Hydrogène : le projet HyPort prend forme à l’aéroport de Toulouse-Blagnac,” *La Tribune*, 20-Mar-2019. [Online]. Available: <https://toulouse.latribune.fr/innovation/recherche-et-developpement/2019-03-20/hydrogene-le-projet-hyport-prend-forme-a-l-aeroport-de-toulouse-blagnac-811175.html>.
- [50] Gaétane Deljurie, “A Dunkerque, l’hydrogène stocke les énergies renouvelables,” *La Tribune*, 06-Dec-2018. [Online]. Available: <https://www.latribune.fr/entreprises-finance/industrie/energie-environnement/a-dunkerque-l-hydrogene-stocke-les-energies-renouvelables-781524.html>.
- [51] C. Mansilla *et al.*, “Electric system management through hydrogen production – A market driven approach in the French context,” *Int. J. Hydrog. Energy*, vol. 37, no. 15, pp. 10986–10991, 2012.
- [52] Martin Robinius *et al.*, “Comparative Analysis of Infrastructures: Hydrogen Fueling and Electric Charging of Vehicles.” Forschungszentrums Jülich, 2018.
- [53] “Nos sites,” *Storengy France*. [Online]. Available: <https://www.storengy.com/countries/france/fr/nos-sites.html>. [Accessed: 03-May-2018].
- [54] Gillhaus Axel, “Natural Gas Storage in Salt Caverns - Present Status, Developments and Future Trends in Europe.” Solution Mining Research Institute, 2007.
- [55] E. TZIMAS, C. FILIOU, S.D. PETEVES, and J.-B. VEYRET, “Hydrogen Storage: State-of-the-art and Future Perspective.” European Commission, Directorate General Joint Research Centre (DG JRC), Institute for Energy, 2003.
- [56] P.-M. Heuser, D. S. Ryberg, T. Grube, M. Robinius, and D. Stolten, “Techno-economic analysis of a potential energy trading link between Patagonia and Japan based on CO2 free hydrogen,” *Spec. Issue Sel. Contrib. Eur. Hydrog. Energy Conf. 2018 Málaga Spain March 14th - 16th*, vol. 44, no. 25, pp. 12733–12747, May 2019.
- [57] C. Mansilla, S. Dautremont, B. S. Tehrani, G. Cotin, S. Avril, and E. Burkhalter, “Reducing the hydrogen production cost by operating alkaline electrolysis as a discontinuous process in the French market context,” *Int. J. Hydrog. Energy*, vol. 36, no. 11, pp. 6407–6413, 2011.
- [58] C. Mansilla, J. Louyrette, S. Albou, C. Bourasseau, and S. Dautremont, “Economic competitiveness of off-peak hydrogen production today – A European comparison,” *Energy*, vol. 55, pp. 996–1001, 2013.

ASSESSING THE HYDROGEN DEPLOYMENT IN FRANCE
THE USE OF TEMPORALLY AND SPACIALLY REFINED MODELS

- [59]S. Bennoua, A. L. Duigou, M.-M. Quéméré, and S. Dautremont, “Role of hydrogen in resolving electricity grid issues,” *Int. J. Hydrog. Energy*, vol. 40, no. 23, pp. 7231–7245, 2015.
- [60]P. Caumon, M. L.-B. Zulueta, J. Louyrette, S. Albou, C. Bourasseau, and C. Mansilla, “Flexible hydrogen production implementation in the French power system: Expected impacts at the French and European levels,” *Energy*, vol. 81, pp. 556–562, 2015.
- [61]F. Gröger, O. Hoch, J. Hartmann, M. Robinius, and D. Stolten, “Optimized electrolyzer operation: Employing forecasts of wind energy availability, hydrogen demand, and electricity prices,” *Eur. Fuel Cell Conf. Exhib. 2017*, vol. 44, no. 9, pp. 4387–4397, Feb. 2019.

CONCLUSION

In accordance with the climate targets set at the COP21 [1], the French electric system is undergoing a transition towards higher shares of renewable energies. In this context, hydrogen can have an interesting role in routing the renewable energy from the electric system to final energy sectors that can be challenging to decarbonize.

After studying the attractiveness of the different hydrogen markets in the previous parts of the thesis, this part focuses on the mobility market for the French case tackling in details the hydrogen infrastructure related issues from the production step up to the fuelling station, a topic that needs a spatially and temporally refined approach in order to be properly addressed.

To do so, the part starts with a regional distribution of the renewable capacities with respect to the socio-political and techno-economic criteria constraining the land and ocean eligibility for renewable deployment. This analysis allows locating the renewable installations precisely in order to have as accurate electricity generation time series as possible, after consideration of weather data. These time series are then integrated in the hourly dispatch model, where the balance of the electricity system is established in the context of a prospective potential mix respecting the French Energy Transition Targets [2], [3].

Building on a refined geographic and temporal representation, the hydrogen generation potential from the electricity surplus is evaluated by region, giving an idea on the possible hydrogen trades (exporting and importing) between regions. Special focus is put on the potential of flexibility provision to the nuclear fleet since relying only on the renewable curtailment hours proved to be a non-economically viable option.

The results show that the maximum hydrogen production potential (from the renewable surplus and the available nuclear energy) allows to meet the hydrogen demand for the passenger light duty fleet in France that is targeted by the French hydrogen roadmap for the timeframe of 2028 [4]. For the timeframe of 2035, it allows to meet up to 28% (depending on the interconnection capacity scenario) of the total French passenger light duty vehicles if substituted with fuel cell electric ones.

The cost of the hydrogen delivery up to the refuelling stations is then addressed by comparing different possible pathways. This allows optimizing the deployment of the hydrogen infrastructure from a strategic standpoint.

It is noticed that placing the electrolyzers next to the demand helps reduce the infrastructure needs which is crucial especially during the first market penetration phases. Moreover, transporting hydrogen in liquid form is identified as the “best practice” option for the early market integration phases.

Several perspectives can be considered in order to overcome the limitations of this part of the thesis. Indeed, being highly dependent on the weather data, inspecting different weather years for the renewable generation and different electricity mixes for the dispatch analysis would improve the robustness of the findings obtained in Chapter I and Chapter II. As for Chapter III, special attention still needs to be dedicated to the underground storage issue with regards to the geographic location of the salt caverns and their availability.

REFERENCES

- [1] “Spécial COP 21 - Les engagements nationaux de la France,” *Gouvernement.fr*, 30-Nov-2015. [Online]. Available: <https://www.gouvernement.fr/special-cop-21-les-engagements-nationaux-de-la-france-3390>.
- [2] IDDRI, “La transition du système électrique français à l’horizon 2030.” 2017.
- [3] Ministère de la transition écologique et solidaire, “Stratégie Française pour l’Energie et le Climat, Programmation Pluriannuelle de l’Energie, 2019-2023, 2024-2028, Projet pour consultation.” 2019.
- [4] Ministère de la transition écologique et solidaire, “Plan de déploiement de l’hydrogène pour la transition énergétique.” 2018.

GENERAL CONCLUSION

The universal Paris agreement, signed in December 2015, fixed a long-term goal of keeping the increase in global average temperature below 2°C above pre-industrial levels [1]. Many countries are targeting a carbon neutral energy system by 2050 [2]. In order to fall in line with these targets expected worldwide, most energy mixes must undergo transformations with country-specific energy transition pathways. Renewables are at the lead of the energy transition. However, their integration can be challenging due to their variability and the resulting need for flexibility options in order to preserve the stability of the electric system. Furthermore, thinking beyond the electric system may be crucial in the context of a carbon neutrality policy. Indeed, other sectors like transport and industry must also undergo some transformation in order to reach the climate targets. In this context, low carbon hydrogen can be part of the solution if not a major player in the energy transition.

Indeed, hydrogen is able to contribute to the decarbonisation of different sectors. The first condition being that large future hydrogen uses would rely on a low carbon intensity of this vector. Besides, thanks to its versatility, it can play the role of an energy carrier and a chemical component allowing sector coupling.

Consequently, hydrogen has attracted over years the interest of academics, industries and policy makers.

The aim of this thesis is to enlighten the hydrogen role in the energy system with a focus on its integration feasibility.

As presented in the general introduction part of the manuscript, this aim encompasses three main levers which are:

- The assessment of the hydrogen prospective potential in terms of market size and carbon emission reduction considering regional specificities;
- The identification and quantification of the techno-economic and political challenges of hydrogen penetration (with focus on the different steps of the hydrogen supply chain);
- And the discussion of potential solutions suggesting a set of recommendations regarding the integration of low carbon hydrogen into the energy system.

Therefore, the thesis tackles in details the conditions under which hydrogen technologies and uses could evolve. The techno-economic and political bottlenecks are discussed throughout the thesis (mainly Part II, Part III and Part IV). Beyond, the thesis sheds light on the importance of the modelling approaches in adequately addressing the low carbon hydrogen potential as a contributor to the energy transition.

1. Methodological approach:

As detailed throughout the manuscript, different approaches are required to grasp different aspects of the hydrogen integration into the energy system and its contribution to the energy transition. A typology of the energy system modelling tools is conducted in Part I highlighting the specificity of each modelling approach and its adequacy with regards to the assessment of different hydrogen integration issues.

Then, five models are used in the framework of the PhD allowing examining the hydrogen challenges throughout the entire supply chain. Techno-economic analysis, overall energy system optimisation and temporally and specially resolved models are used depending on the research questions. The latter being different but complementary requiring different approaches to be tackled.

The techno-economic assessment that is conducted in Part II is hydrogen specific, and it allowed evaluating the consequences of the current energy policies on the hydrogen potential evolution in the years to come, in terms of market volumes, carbon mitigation potential and competitiveness feasibility. Regions with contrasted energy contexts and challenges are selected (the United States, Europe, Japan and China). This first approach allowed identifying the key factors behind reaching a competitiveness threshold in order to be able to penetrate the selected markets.

After tackling each market aside, the energy system optimisation model (TIMES-PT) allows positioning hydrogen in the overall energy context, moving towards stringent climate targets and simultaneously considering the different hydrogen applications. The case study deals with the Portuguese energy system. By confronting hydrogen with a set of challenging competitors, the attractiveness of segments of the hydrogen markets is discussed. Since the model is based on a bottom-up approach, the hydrogen technologies (from the production step up to the final end-uses) are economically evaluated, the modelling framework allowing to identify the most competitive ones.

Due to relatively poor time and spatial resolution, the above-mentioned models fail to accurately reflect some aspects of the hydrogen supply chain, for instance, the hydrogen production flexibility, the storage issues and the hydrogen infrastructure deployment.

Hence, in order to address these aspects, being crucial in the discussion of the hydrogen integration challenges, highly time and spatial resolved models (GLAES, Europower and InfraGIS) are used. France is selected as a case study, where the potential of producing hydrogen from low carbon electricity surplus is assessed. Then, hydrogen delivery pathways are compared with the objective of identifying the most economically attractive ones depending on the market size and the location of the electrolyzers.

The findings reached throughout the thesis regarding the hydrogen potential as a contributor to energy transition as well as the required policy measures for its integration are discussed in what follows.

Hydrogen, a key facilitator of the energy transition?

The hydrogen decarbonisation potential has been studied throughout the thesis using first a hydrogen specific techno-economic analysis tool to assess the potential of each market aside and then an energy system optimisation model in order to evaluate its role in reaching the climate targets and reciprocally assess the impact of different levels of carbon mitigation caps on its integration feasibility into the energy system.

What do we learn from our works using the techno-economic analysis tool?

The assessment conducted in Chapter I, Part II has proven that the hydrogen decarbonisation potential is non negligible, especially when considering the avoided methane leaks (thanks to the blending of hydrogen with natural gas). Our findings show that, although the current energy policies (detailed in Part II, Chapter I) result in a modest penetration of hydrogen into the energy system, hydrogen can achieve up to 3.3% (equivalent to more than 400 Mt of yearly emission reduction by 2040) of the effort that needs to be done by the US, Europe, China and Japan, in order to limit the increase of the temperature to 2°C, compared to preindustrial levels. However the hydrogen potential for decarbonizing the energy system can be much higher, calling for stronger energy policies. Few studies in the literature quantify the hydrogen full potential. For instance, the Hydrogen Council study estimated the hydrogen contribution to 6 Gt of CO₂ emission reduction in 2050 globally [3]. However this contribution is of course dependent on the presence of more propitious political and regulatory context (compared to our

study in Part II) as well as the technical progress of hydrogen and other technologies participating to the decarbonisation of the energy system.

What do we learn from our work with the global energy system optimisation model?

The study we have carried out with TIMES-PT confirms the findings of Chapter I, Part II detailed above. Depending on the hydrogen cost scenario, when more hydrogen is integrated into the system, the resulting CO₂ emissions can be down to 14% lower than in the base scenario. However, unlike the assessment made in Chapter I, Part II, the energy system optimisation modelling takes into account the complete system and the overall energy balance. Such integrated vision allows studying the energy sector coupling that can be provided by the integration of hydrogen into the energy system.

A more detailed discussion on the hydrogen uses that are emerging in the solution will be provided hereafter.

The impact of stringent CO₂ emission targets on the hydrogen deployment potential is also addressed in Part III. Our results show that when moving from the base scenario (leading to a 55% CO₂ emission reduction by 2050 compared to today's levels) to the 75% CO₂ cap scenario, the hydrogen volumes are doubled in the solution, which highlights the carbon mitigation potential of hydrogen but also, reciprocally, the importance of the climate targets and the governmental involvement in fostering the new technologies. However, higher decarbonisation targets (85% cap and 95% cap scenarios) have led to lower hydrogen volumes. This is related to the fact that with more stringent climate targets, renewables are increasingly integrated into the energy system requiring flexibility options that can be expensive. This leads to high electricity prices, which in turn hampers the economics of hydrogen generation. Nonetheless, these outputs depend on the regional context (renewable availability and load factors, electricity mix, flexibility options, etc.). Besides, the results can also be impacted by the modelling framework, as hydrogen can play the role of multi-timescale storage easing the renewable penetration. The latter can also lead to hours of surplus and hence of low electricity prices depending on the context which can rather be beneficial for hydrogen. However, the time resolution of the TIMES-PT model is not sufficient to grasp this aspect.

Using the TIMES-PT model allows us to assess another important role of hydrogen into the energy system which is sector coupling. In fact, hydrogen allows to link the electricity system with other sectors that are otherwise challenging to decarbonize (transportation, chemical applications, natural gas use, etc.) rooting to them the renewable energy generation. Indeed, our findings show that, among the low carbon hydrogen generation technologies, the privileged one is electrolysis which roots the renewable electricity generation (used to source the electrolysers) to the hydrogen final use (as discussed in Part IV, the hydrogen demand comes first from the heavy duty transportation).

Beyond the renewable rooting to the diverse sectors, hydrogen can also contribute to ease their penetration by providing the electricity system with flexibility (frequency regulation, storage, etc.), but as previously mentioned, the TIMES modelling framework does not allow to capture these aspects precisely due to poor time resolution (12 representative time slices of the year).

To resolve this issue, we used spatially and temporally resolved models: this will be discussed hereafter.

What do we learn from our work, using temporally and spatially refined models?

As detailed in Chapter II, Part IV, based on geographically and time resolved models, hydrogen can provide the electricity system with flexibility in the context of high shares of renewable energies. The case we studied assumed a share of around 50% for the renewable electricity generation in France. Our results show that hydrogen not only allows avoiding renewable curtailment (varying between 1.4 and 7.9 TWh depending on the interconnection capacity scenario) but can also contribute to improve the

flexibility of the electric system by avoiding big variation impacts on the conventional plants like nuclear, the latter insuring a low carbon and low cost electricity provision.

Furthermore, hydrogen can represent an option to transport the renewable energy from remote production centres to demand hubs. In other words, it can be an alternative to investing in electricity grid extension. This aspect is not tackled in the framework of the thesis although some insights are provided in Chapter III, Part IV regarding the cost of transporting hydrogen from the electricity plant locations to hydrogen demand centres or transporting electricity up to the latter centres and produce hydrogen locally. Our findings show that, when high hydrogen penetration rates are reached in France (higher than 5% of the passenger vehicle fleet), placing the electrolyzers next to the nuclear plants and transporting energy in the form of hydrogen proved to be more economically attractive than transporting electricity up to the hydrogen demand hubs. The cost gap between the two options can go up to around 1€/kg of hydrogen at the pump. However, this calculation does not consider new investments in the electricity infrastructure (unlike hydrogen) but only assumes the use of the already installed electric lines. Further studies are needed in order to accurately tackle this subject with respect to the French case.

To sum up, hydrogen can ease the renewable penetration into the energy system by providing flexibility to the electric system but also by rooting the energy from the propitious production sites to demand hubs that do not necessarily match. Hydrogen can also contribute to a broader decarbonisation effect including end-use sectors like industry and transportation.

Why has hydrogen not been implemented yet? What is keeping it from emerging in the system?

The response to this question is twofold. First, it is related to the energy context itself: is there an imminent need for hydrogen (given its role as discussed above)?

It depends on the regional context (energy mix, flexibility options already implemented, decarbonisation policies, etc.), and not all energy systems are facing urgent transitions. The stringent decarbonisation targets were only set in the last few years and they often target relatively distant future (2050 for example). Therefore, so far, the use of low carbon hydrogen is not solicited (transport, industry, etc.).

Besides, not all energy systems are facing urgent short-term needs for flexibility provision to the electric system. Some do have sufficient and low cost flexibility options (pumped hydro generation, interconnections, etc.).

The second part of the answer concerns the hydrogen systems themselves. Although the review of the hydrogen-related technologies have shown that maturity is not of an issue (see the general introduction part), many technologies being already commercialized, the economics still have to be improved to ensure the hydrogen competitiveness.

What do we learn from our work using the techno-economic analysis tool?

As studied in Chapter II, Part II, today's hydrogen current costs are in general still high compared to the options that are already present in the market. Therefore, from a final user perspective, hydrogen is not often attractive enough to trigger a spontaneous market demand. Our results show that, depending on the region, the cost parity (i.e. between hydrogen and the "historical" options prevailing on the market) could be reached either shortly or up to around 2040 for the mobility market for example. The evolution of the hydrogen technology cost and efficiency characteristics are important factors impacting the latter timeframe. The hydrogen delivery pathway costs, the energy prices and the carbon tax consideration are also key parameters in defining the hydrogen competitiveness feasibility. Nowadays, these factors are not advantageous enough for a hydrogen penetration.

Accordingly, industrial efforts are needed to reduce costs. Economies of scale are also required to drive the cost decrease across the different parts of the hydrogen supply chain that needs to be amortized once deployed. Thus, clear political incentives are crucial in triggering the hydrogen deployment.

If the hydrogen cost is the main bottleneck, where to begin the efforts?

What do we learn from our work, using the global energy system optimisation model?

Our cost reduction sensitivity study, conducted using the TIMES-PT model, allows us to identify the most impacting parts of the supply chain on the hydrogen competitiveness.

Indeed, lowering the technology costs across the different steps of the hydrogen supply chain shows that the production and delivery steps do not have the major impact on the resulting hydrogen volumes in the solution. Yet, it is clear that without the appropriate infrastructure deployment, hydrogen penetration will be hampered (the so called chicken and egg problem). It is hence a paramount step that depends on the industrial policy of the governments.

On the other hand, cost reductions conducted on the hydrogen end-use technologies (fuel cell vehicles, hydrogen burners for heating, domestic fuel cells, etc.) have shown the highest impact on the hydrogen integration into the energy system. This is related to the fact that the end-use technologies are the closest stage to the final consumer. The latter is directly impacted by the cost. Hence, adopting the hydrogen end-use technology drives the market demand allowing the creation of a scale effect which can further impact the infrastructure (production, delivery and end-use-related) costs.

Thus, we can say that the end-use technology push effort can lead to a market pull effect.

But which markets are concerned?

What are the most promising markets for the hydrogen penetration?

What do we learn from our work using the techno-economic analysis tool?

As seen in Chapter I, Part II, an efficient way to create a market-pull effect is to start with the already existent markets which are the industrial markets (ammonia, refinery, methanol) representing most of the current hydrogen use. These markets are already established and seem to be likely to continue driving a high share of the hydrogen demand in the years to come (although their volumes are not significantly rising compared to the energy-related market trends).

Decarbonizing these markets by switching from steam methane reforming (for hydrogen generation) to electrolysis can be a key enabler in lowering the electrolyser costs by creating the required scale effects. Besides, this can be a way to root the renewable energies from the electricity system to the chemical applications that are otherwise challenging to decarbonize.

Therefore, in accordance with the International Energy Agency's (IEA) view [4], [5], starting with the industrial markets can be a strategic turning point in creating the required economies of scale that will facilitate the penetration into the new energy-related markets.

Our analysis shows that, amongst the new hydrogen markets, it is the mobility use that exhibits the most promising prospects in terms of hydrogen penetration (in terms of market size and technology economics). Governmental plans and pledges are emerging around the world concerning the increase of

the hydrogen vehicle fleets, which is not the case for the other new hydrogen markets, where the political positioning vis-à-vis their development is still ambiguous.

As detailed in Chapter II, Part II, based on a cross-analysis of top-down and bottom-up approaches, we have assessed the timeframe of hydrogen competitiveness. From an economic standpoint, the mobility market is easier to penetrate than the natural gas blending, in all the considered regions. It even presents a potential room for taxation in the medium to long term. However infrastructure investments still need to be triggered by a clear political positioning, in order to hinder the uncertainties and the risk perception. Japan presents the most favourable conditions, where the market penetration seems to be achievable in the very short term (before 2025, compared to 2030 in the US and 2035 in China) due to the coupling of interesting patterns penalizing the competitor (high taxes on gasoline) and support schemes for hydrogen (a clear roadmap for hydrogen penetration).

On the other hand, the injection into the natural gas networks exhibits much less propitious market entry costs. The attractiveness of this market still struggles to be proved due to low natural gas prices. According to our results, even with tax exemptions, hydrogen is not able to compete with natural gas (especially in the US) unless a high carbon tax, going up to 530\$/tCO₂ by 2040, is applied.

Nevertheless, the injection of hydrogen into natural gas networks can be more interesting when coupled with another hydrogen market to improve the profitability of the electrolysis system which was studied by the FCHJU tackling different business cases and showing that coupling the natural gas blending market with the mobility or industrial demand allows improving the economics of the system since it leads to a better utilisation rate of the electrolysers (hence lower production costs) [6].

Furthermore, as addressed in Chapter I, Part II, considering the carbon mitigation potential topples our perception of this market by revealing its promising potential. Indeed, our work shows that the natural gas blending is a very efficient option for carbon mitigation especially when considering the avoided methane leakages that may have higher global warming impact than the CO₂ emissions. Therefore, this market segment is worth triggering since it helps reach the climate targets.

What do we learn from our work with the energy system optimisation model?

Our TIMES-PT modelling results confirm the attractiveness of the mobility market and allow having a more detailed idea on the technology choices that are privileged in the solution.

As a matter of fact, even without setting stringent climate targets, hydrogen emerges in the solution via the heavy duty transportation. Indeed, hydrogen presents range advantages compared to the battery electric vehicles, making it more suitable for long distance and heavy transportation.

As discussed in Part III hydrogen use in passenger transportation (cars and buses) does not emerge in the solution under the considered assumptions. A 20% cost reduction (compared to the base case) applied on the end-use technologies leads to the penetration of the fuel cell cars but only via a shared use (i.e. an intensive one). The demand for hydrogen in the bus segment does not appear in the mix unless a cost reduction of 50% (compared to the base scenario) is applied allowing it to reach competitiveness with the hybrid diesel buses prevailing on the market.

What do we learn from our work with temporally and spatially refined models?

The spatially resolved models allow the identification of the geographical location of the potential demand hubs. This aspect is of major interest for the optimization of the electrolyser positioning vis-à-vis the demand centres, which in turn directly impacts the infrastructure deployment decision as will be tackled below.

How to supply these markets in order to ensure an economic and low carbon hydrogen provision? What production and distribution paths to be adopted?

What do we learn from our work using the techno-economic analysis tool?

Assuming a low carbon electricity mix, the electrolysis appears as a promising option for hydrogen generation. Considering the carbon capture and storage for the steam methane reforming can also be an option.

The analysis results presented in Chapter II, Part II, show that the economics of the two low carbon production means (electrolysis and steam methane reforming with carbon capture and storage) are expected to converge in the years to come. Major factors impacting this convergence are the electricity price, the load factor, the natural gas price and the carbon price.

The carbon capture and storage option can be an interesting way to lower the hydrogen carbon footprint (currently mainly produced via steam methane reforming); however, it does not allow sector coupling as electrolysis does, ignoring the potential link between hydrogen production and the electricity system and its related challenges (renewable variability, flexibility needs, etc.). Furthermore, the carbon capture and storage option raises the issues of storage availability and social acceptance, which are not tackled here.

Hence, we focus on hydrogen generation via electrolysis throughout the thesis. The electrolysis system profitability depends on three main factors:

- The capital cost: prospects are announcing a decrease in the investment costs mainly via economies of scale; thus, this decrease will not take place if the demand is not triggered enough to create the economies of scale. The latter is also related to the industrial policy of governments choosing or not to foster the development of low carbon hydrogen.
- The electricity price: it affects the operational costs (approximately 70% of the hydrogen production cost for baseload operation); depending on the region, operating the electrolyser only during low electricity price periods may result in very high hydrogen production prices due to low utilisation rates.
- The utilisation rate: below 4,000 to 5,000 hours annually, the load factor is of major importance impacting the amortization of the investments. The higher the utilization rate, the lower the hydrogen generation cost. A trade-off is to be found between the load factor and the electricity price effect, calling for a more refined time resolution that is not implemented in the analysis model but will be discussed hereafter (via the resolved models that were used).

Beyond the cost, the carbon footprint of the hydrogen generation is key in defining the attractiveness of the latter. For instance, sourcing the electrolyser from the electricity grid may not be the best environmentally-efficient way to make hydrogen a low carbon energy carrier. Indeed, as addressed in Chapter I, Part II, the carbon footprint of hydrogen production from electrolysis can be higher than the steam methane reforming one (i.e. approximately 10 kg CO₂/kgH₂) when considering the electricity from the grid (even when the mix that is suggested in the New Policies scenario of the IEA [1]). Accordingly, requiring low carbon electricity is crucial, but special attention should be paid to the utilization rates again, especially when dealing with renewables.

Other low carbon hydrogen production options can be considered as tackled below.

What do we learn from our work with the energy system optimisation model?

We have examined a larger set of hydrogen low carbon production options via the TIMES-PT model. The input data includes biomass gasification, methane reforming, solar reforming and coal gasification

with carbon capture and storage. The less mature technologies like the photo-electrolysis and algal hydrogen production are not considered. The optimization allows inspecting their relative attractiveness when integrated in a global energy system under cost and environmental constraints.

According to our modelling results, the electrolysis is by far the preponderant option in the solution (around 99% of the hydrogen production) in all of the tested scenarios, although, in the short term, very small volumes coming from biomass gasification are appearing in the results.

This highlights the attractiveness of the electrolysis from an overall energy system benefit point of view, which in turn allowed studying the sector coupling effect of hydrogen integration into the system (linking the electricity system to the transport sector in this case).

More details regarding the flexibility provision potential are presented below.

What do we learn from our results, using temporally and spatially refined models?

We used a dispatch model (EuroPower) in Chapter II, Part IV, in order to assess the potential of producing hydrogen from the electricity surplus in France, considering a high share of renewables in the electricity mix.

Our results show that activating the electrolyzers during the surplus hours alone is not economically viable due to very low utilization rates. In countries where nuclear is available (like France), leveraging this other low-carbon production plants makes it possible to increase the load factors and improve the potential for low-cost low-carbon hydrogen production. Reciprocally, hydrogen flexibility preserves nuclear plants from important variations, which is beneficial for nuclear from an economic standpoint, even if the French nuclear plants are very flexible. However, the situation can be different for other countries like Germany, where surplus is already an issue. Special focus is put on the importance of the interconnection consideration, which is another way to provide flexibility to the system already being highly solicited.

More detailed studies are needed to capture the potential of hydrogen participation to the reserve markets and the possible benefits from being remunerated, paying attention to the “cannibalisation” effect that can be engendered by the multiplication of the flexibility providers on the market, leading to low remuneration levels in the end.

The spatial resolution is crucial when it comes to the system design, geographically speaking. Using the InfraGis model allows us to optimize the location of the electrolyzers vis-à-vis the demand. The location impacts the production cost as to including the electricity grid fee in the cost calculation, and also influencing the electrolyser capacity needs. We have investigated two case studies. The first considers that hydrogen production is located next to the nuclear power plants which allowed avoiding the grid fees. The second case study positions the electrolyzers next to the hydrogen demand centres (which are far from the electricity production facilities), thus the electricity grid fees were included.

Our results show that paying the electricity grid fees has minor impact on the total hydrogen production cost. However, the electrolyser location in itself does impact the final cost of hydrogen at the pump. Indeed, our modelling results show that the system favours locating the electrolyzers next to the hydrogen demand hubs during first market phases since it allows avoiding the cost intensive delivery infrastructure detailed in what follows.

The infrastructure development needs and costs are one of the major issues that are source of uncertainty holding back the hydrogen deployment.

Being directly impacted by the transport distances, it is not surprising that tackling the delivery infrastructure issue requires high spatial but also temporal resolution.

The temporal resolution is essential mainly when dealing with the hydrogen storage.

Different storage options are considered in the thesis: underground storage (e.g. in salt caverns), compressed gaseous storage, liquid storage in tanks and liquid organic hydrogen carrier (LOHC) storage (further detailed in Chapter III, Part IV). The underground storage can be a promising way to store large amounts of hydrogen (which can be the case in the years to come where hydrogen can play a role of seasonal storage easing the penetration of renewable energies); however special attention should be paid to the geographic availability of the salt caverns since some of them are already used for natural gas storage.

As for the delivery pathways, according to our results, during the very first market penetration phases (1% scenario), it is more interesting to store and transport hydrogen in a liquid form, which allows to benefit from the high volumetric density of this option while avoiding to resort to gaseous storage and delivery that proved to be expensive at this stage.

As previously mentioned, the modelling framework shows that it is more economically viable to limit the need for heavy infrastructure deployment during the first market phases by locating the electrolyzers next to the demand. This helps avoiding the deployment of oversized infrastructure that will struggle to reach competitiveness at such low throughputs.

As for the refuelling stations, the industrial policy plays a major role. Some countries have chosen to foster the deployment of the hydrogen refuelling infrastructure in order to encourage investments in fuel cell vehicles. For example, Germany leads the deployment of refuelling stations with a total of 35 in 2017 (operating refuelling stations) [7]. Many plans are already set to increase this number to 400 by 2030 [8]. While other countries like France have chosen a co-development of refuelling stations and hydrogen vehicles based on the use of captive fleets [9].

According to our results, economies of scale that can be driven by higher market penetration rates have significant impact on lowering the hydrogen cost at the pump. This impact is more visible in the first stages of hydrogen deployment (going from 1% to 5% market penetration results in a cost drop of around 2€/kg), highlighting the necessity of growing in size in order to reach the targeted cost reductions. This step can be fostered by governmental incentives to help industries overcome the “death-valley” as proposed in the study made by I-tésé and IFPEN [10].

Hence, as highlighted throughout this part, different modelling approaches are required to tackle the various aspects of the hydrogen deployment. The modelling allowed identifying the hydrogen potential in specific geographic contexts from different standpoints: economic competitiveness, timeframe of market penetration, weight of each part of the supply chain on the final cost and hence the market penetration feasibility, flexibility potential of the hydrogen production and infrastructure deployment strategies. Therefore, the different modelling approaches have proved complementarity in grasping the different aspects of the hydrogen potential.

2. Recommendations

Based on the analysis made throughout the thesis, we can propose a set of recommendations. We here classify them according to the type of stakeholders they are intended to.

a. The energy research/modelling community

As repeatedly highlighted in this thesis, different tools are needed to answer different research questions, as there is no model that can provide all the answers. Thus, linking different models helps grasp different aspects of a given subject.

Beyond the model choice, the same model can give different results depending on the modelled system design, the techno-economic data and the macro-economic framework.

The design of the energy system defines the integrated pathways between the primary resources and the final use. A technology that is not modelled in the framework cannot appear in the results. When it comes to the specific case of hydrogen systems, including the possibility of having decentralised production for example can help improve the penetration feasibility of hydrogen in some early stage markets.

Furthermore, data has a major impact on the modelling results and should hence be treated carefully especially in the context of governmental advice. The latter can (and is designed to) directly impact the decision making regarding the new technology investments and accordingly can shape the future technology mix. The transparency of the data and the modelling framework is also of crucial importance in enlightening the conditions under which the results are obtained. In this way, we advocate for a large publication of both data and models, and, generally, we can see with great interest new projects of common database and model sharing as expected in the new Task 41 of the Hydrogen Implementation Agreement of the International Energy Agency (HIA-IEA) [7]. The aim of this task is twofold; first, gather researchers working on hydrogen to construct a common database tackling the hydrogen technologies (from the production step up to the final use) and second, suggest best practice of hydrogen modelling in an energy system.

The macro-economic context does also impact the energy system modelling results since it shapes the evolution of the energy demand (via insights regarding population, GDP, etc.), it can even define the design of the system (centralised vs decentralised depending on the distribution of the demand, for example urban vs rural, etc.), and it may impact the cost of the system and the technological landscape through political incentives like taxes and subsidies.

Finally, adopting an adequate “language” to make the results understandable by non-academics is crucial in transferring the desired message, highlighting the importance of communication in improving the impact of the research and better fulfilling the “advisor” mission. In other terms, the know-how also includes being able to bridge between science, industry and policy.

b. The industries

All of the conducted studies and modelling work presented in this thesis do assume hydrogen technological cost reductions in the years to come, highlighting the importance of creating economies of scale. However this scale effect may not come spontaneously. There is a clear need to foster the market demand. This will depend on the governmental strategy towards the hydrogen penetration if there is any. In a propitious context for hydrogen industries, support from governmental bodies is provided. Such a case can sometimes (especially when it comes to new technologies) be crucial in helping the industries overcome the “valley of death”. In this case, the industries can trigger the hydrogen demand through the collaboration with local authorities via starting projects allowing hydrogen to prove its potential. The Hype taxi project in the Parisian region can be an example of such “symbioses” between industry and governmental bodies [11].

Another important lever that should be taken into account is also the role of the industrial research, development and innovation in triggering the cost reductions and also boosting the technology maturity via the demonstration projects.

Last but not least, “Marketing”... this is a particular point that is not often raised despite its significant impact. Marketing can be a game changer in raising the policy maker and the end-user awareness towards the potential of hydrogen technologies. This potential is still not well renowned by the public compared to competing technologies (like Tesla electric cars for instance). This can directly impact the consumer choice. In other terms, if people are not aware of the interesting features or even in some cases the mere existence of a certain technology, no demand may arise.

In this respect, the Hydrogen Council is a promising initiative that already started to raise political and public awareness [12]. It is hence important for industries to express their readiness and intention to start investing in hydrogen once the regulatory framework is better defined. This will be part of the set of signals to the policy makers.

c. The policy makers

As seen in Part II of the thesis, hydrogen has a promising carbon mitigation potential that is in line with the governmental climate targets that are set in different regions. However, the current policies are still insufficient to trigger the hydrogen markets. Stronger governmental support is required in order to ease the market penetration.

The industrial markets (facing decarbonisation targets) are expected to continue to drive the hydrogen demand worldwide, at least in the short to mid-term, a phase where hydrogen is in need for economies of scale in order to enter new markets.

From a strategic standpoint, fostering the hydrogen industrial markets, or more precisely switching from steam methane reforming to electrolysis, can be of major impact on the economics improvement of the low carbon hydrogen production. Indeed, as previously discussed, being already established and presenting significant volumes, the industrial markets can create the required economies of scale.

In order to trigger the low carbon hydrogen deployment in the industrial applications, strong industry-specific environmental targets need to be set. For instance, the regulations that were set on the maritime fuel sulphur content [13] are expected to play a non-negligible role in enhancing the hydrogen demand in refineries. As a matter of fact, according to [14], refineries will have to invest in larger capacities for hydrogen production in order to cope with the new environmental measures.

This can also be achieved through the carbon pricing mechanism that in turn will penalize the carbonized hydrogen generation means, calling for the deployment of low carbon alternatives.

Investment subsidies to replace fossil fuels in industry can also foster the transition to low carbon hydrogen production via the development of electrolysis.

As for the new hydrogen markets, even if economies of scale allowed by decarbonising the industrial markets are achieved, governmental involvement is still needed. According to our results, the mobility market has proved to be easier to penetrate given the competitors. Moving towards the decarbonisation of the transport sector may go through the coexistence of the different technologies in order to be able to meet the greenhouse gas mitigation targets. Setting a governmental pledge for the carbon emission reductions related to the transport sector is not sufficient since it does not clarify the prospects for each

low-carbon mobility option. Favouring a specific technology over others due to short term competitiveness may not be the most optimized strategy from a long term perspective [15]. It is leading to the misconception of considering that these options will only compete against each other, while they can complement each other in order to achieve the targets (see for instance the range extender technology [16]). A clear strategic governmental roadmap leading to the realization of the pledged targets is required. This can also help foster the infrastructure deployment investments by hindering the uncertainties and the risk perception.

Strong governmental support is taking place in Japan fostering the integration of hydrogen systems in this market. Accordingly, clear goals have been set for the size of the hydrogen vehicle fleet. Such governmental involvement have helped reduce the uncertainty blocking the industrial investments. As a result the Japanese automotive industries are at the forefront of the hydrogen vehicle manufacturing.

Incentives could also include, in the transition, grants to reduce the vehicle price paid by the consumer.

Indeed, the competitiveness with the electric vehicles might be difficult to reach knowing that, in some countries like China, subsidies are granted to the battery electric vehicles (representing up to 60% of their market price [17]). Subsidy cuts have recently been announced by the Chinese Government aiming at reaching an economically-competitive EV industry by 2020 [18]. Similar support schemes should also be applied to the fuel cell vehicles in order to level the playing field for all new technologies to prove their potential.

The natural gas blending seems to struggle to prove its attractiveness from an economic standpoint. However seeing its carbon mitigation potential (with regards to the avoided methane leakages) as detailed in Chapter I, Part II, this market is worth fostering since it can help reach the governmental climate targets set worldwide.

To do so, a potential support scheme that can be envisaged is the possibility to benefit from feed-in tariffs which are already implemented for biomethane blending. Another uncertainty hindering the development of this market segment is the uncertainty regarding the allowed concentration of hydrogen. Different standards are applied in different countries even within the same region (for example among the European countries [19], [20]). Harmonizing the regulations is therefore key in reducing the uncertainties hampering the penetration of hydrogen into this market segment.

The deployment of the different markets discussed above depend on the availability of the hydrogen infrastructure. The latter representing one of the major uncertainties hindering the hydrogen market penetration. In order to overcome this issue, clear signals are needed when it comes to clarifying the governmental positioning related to the hydrogen deployment strategy. Such an approach is a key factor in “clearing the fog” regarding the hydrogen prospects on a regional level, which in turn is crucial to trigger the industrial investments in the hydrogen infrastructure, due to high risks. Collaborations between governmental and industrial bodies are also essential in clarifying the bottlenecks from both sides and working together to solve them. Hence, here, communication is key.

Upstream, low-carbon hydrogen production requires low-carbon electricity. Energy policies should promote renewable energy penetration, or more generally low-carbon electricity. This is a win-win

strategy since hydrogen production can serve as a measure to avoid curtailment of excess electricity, to adjust the power demand by providing grid balancing services, or even to allow more renewable electricity to enter new applications in the form of a green gas, green chemicals and green fuels. Hydrogen business cases can become more profitable when hydrogen systems are allowed to participate in grid balancing services and capacity mechanisms. However, this participation needs a clearer regulatory framework in order to be effectively put in place. Finally, financial incentives like electricity tax exemptions can also be part of the solution to lower the hydrogen production costs and ease the early market penetration.

Overall, different options can be considered in order to surpass the economic barriers: both industrial and political efforts need to be achieved to lower the costs and prepare a suitable market penetration environment. Governmental and regional support can take different forms. It can be financial like granting subsidies, feed-in tariffs or premiums (which is already the case for the injection of biogas into the grid, and in some countries for the battery electric vehicles) or it can be setting standards or targets such as the concentration of hydrogen into the natural gas grid, or the modalities of a potential hydrogen participation to the electricity reserve market. Thus, relevant policies require a holistic approach, by proposing adequate measures for the industry and energy sectors (gas and power) adapted to the regional contexts. This is also related to the governmental policy/strategy towards national industries and whether governments are willing to make of their industries the leaders in the hydrogen related fields and hence have an exporting weight worldwide.

3. Perspectives

Besides the systemic approach tackling hydrogen from technical, economic and political standpoints, one specific contribution of this thesis to the hydrogen-related research field lies in the use of different complementary modelling approaches, allowing the comparison between different models with a focus on the hydrogen deployment challenges, and how they can be tackled using the appropriate type of modelling framework.

We tried to bring an external point of view to the different modelling communities with some hindsight regarding the advantages and limits of each modelling approach, from a hydrogen system integration perspective.

However, the thesis does not investigate all of the possible modelling approaches. For instance, a macro-economic analysis would have brought additional enlightenments.

Generally, it can allow studying the impact of the hydrogen tax exemptions (the petroleum fuel taxes in particular) on the global economy and discuss the effects on the trade balance (avoided expenses due to the petroleum product imports).

Moreover, such kinds of approaches can help quantify externalities. They can be related to the avoided health issues (due to air pollution) and noise pollution in cities related to the transport activity.

Another perspective for further research is modelling the new mobility services and behaviours, including the aspects that drive the user preferences, since capturing these aspects like the preference of drivers towards the vehicle recharging time and autonomy could lead to different results regarding hydrogen penetration in the mobility sector.

More specific perspectives include:

Regarding the techno-economic analysis part, our study is limited in terms of geographical scope. Indeed, as detailed in Part II of the thesis, focus is put on four regions (the United States, Europe, China and Japan). However, new rising geographies in terms of hydrogen prospective deployment are emerging (like Australia and South Korea). Including the latter regions with special focus on the potential inter-continental trade of hydrogen volumes (already programmed for Japan and Australia) can represent an interesting perspective to the study.

Regarding the TIMES modelling, a deeper focus on the hydrogen representation in the model is needed with special regards to the impact of the system design on the final solution⁶. Therefore, testing new design features may help better understand the role that hydrogen can play via such a model. Potential improvements can address the production side of the hydrogen supply chain in order to reflect the possibility to interact with the electricity system in a flexible way (although the time resolution can be a limit for the related analysis). The storage and the delivery parts of the supply chain are so far gathered (in TIMES-PT) in a one step process. A separate representation of the hydrogen storage can give more insights on the seasonal storage role that hydrogen can play. Finally, the TIMES-PT model suggests a very detailed set of hydrogen end-use technologies but only for the energy related markets. Although challenging, the implementation of the industrial markets (considering the industries with a hydrogen demand that are present in Portugal in this case) can help capture the transition between steam methane reforming in these markets to electrolysis (or any other low carbon production means if it proves to be more economic). This can have an impact on the results in terms of low carbon hydrogen penetration timeframe and maybe cost.

Finally, as for the temporally and spatially refined models, the following perspectives can be suggested:

- the consideration of the hydrogen generation as a flexible demand going beyond the price-taker approach to consider its impact on the electricity prices,
- the assessment of the electricity surplus for different mix scenarios,
- the industrial policies (France and Europe first) in given segments of the H2 value chain and H2 systems, commencing with the car industry.
- the consideration of the industrial market demand in France which may impact the design of the delivery infrastructure,
- the examination of the geolocation and availability of the hydrogen underground storage,
- And the comparison of the hydrogen infrastructure deployment costs with the electricity grid reinforcement (and probably generation capacity expansion) needs that could be driven by the expansion of the battery electric vehicles.

To conclude, no model is able to do “everything”. Linking different kinds of models may (once the technical issues related to the programming are overcome) be the most accurate way to deal with the hydrogen topic from different standpoints. Going to new “models of models” would be in fact a manner of enlarging the capability to answer highly intricate questions, as the future of hydrogen appears to be one of the most complex domains in the next decades.

A whole field of research remains open there in order to examine different linking approaches (soft linking, hard linking or complete integration).

⁶ In the framework of the ETSAP (Energy Technology Systems Analysis) community, a task aiming (with the collaboration of the Task 41 of the HIA-IEA) to improve the modelling of hydrogen systems in TIMES is under definition.

REFERENCES

- [1] International Energy Agency (IEA), “World Energy Outlook.” 2016.
- [2] European Commission, “2050 long-term strategy,” *European Commission, Climate Strategies & Targets*. [Online]. Available: https://ec.europa.eu/clima/policies/strategies/2050_en. [Accessed: 29-May-2019].
- [3] Hydrogen Council, “Hydrogen scaling up, A sustainable pathway for the global energy transition,” Nov. 2017.
- [4] IEA Hydrogen, *Hydrogen Implementing Agreement 2017, Annual Report*. 2018.
- [5] Hydrogen Council, “How hydrogen empowers the energy transition,” 2017.
- [6] Ministère de la transition écologique et solidaire, “Plan de déploiement de l’hydrogène pour la transition énergétique.” 2018.
- [7] International Energy Agency (IEA), “Energy Technology Perspectives.” 2017.
- [8] International Energy Agency (IEA), “Renewable Energy For Industry, From green energy to green materials and fuels.” 2017.
- [9] Fuel Cells and Hydrogen Joint Undertaking - FCHJU, “Development of Business Cases for Fuel Cells and Hydrogen Applications for European Regions and Cities.” 2017.
- [10] CEA and IFP Energies Nouvelles, “Scénarios technologiques de la mobilité en France et conditions de réalisation pour atteindre l’objectif d’arrêt des ventes de véhicules particuliers thermiques en 2040, Etude pour l’OPECST.” 2019.
- [11] “Les taxis Hype carburent à l’hydrogène,” *Les Echos*, 16-Jan-2018. [Online]. Available: <https://www.lesechos.fr/thema/0301145664677-les-taxis-hype-carburent-a-lhydrogene-2145259.php>.
- [12] “The Hydrogen Council: an Introduction,” *Hydrogen Council*, 2019. [Online]. Available: <http://hydrogencouncil.com/>.
- [13] International Maritime Organization, “Third IMO Greenhouse Gas Study.” 2014.
- [14] EnSys Energy with Navigistics Consulting, “Supplemental Marine Fuel Availability Study, MARPOL Annex VI Global Sulphur Cap, 2020 Supply-Demand Assessment, Final Report.” 2016.
- [15] Chris Quarton *et al.*, “Working paper: The curious case of the missing hydrogen: Why is hydrogen not showing up more in large-scale energy scenarios?” 2019.
- [16] A. Le Duigou, Y. Guan, and Y. Amalric, “On the competitiveness of electric driving in France: Impact of driving patterns,” *Renewable and Sustainable Energy Reviews*, 2014.
- [17] Jing Qian, “Evaluating the Electric Vehicle Subsidy Program in China.” Oct-2018.
- [18] Chris Randall, “China makes deep cuts to EV subsidies,” *electrive.com, industry service for electric mobility*, 27-Mar-2019. [Online]. Available: <https://www.electrive.com/2019/03/27/china-makes-deep-cuts-to-ev-subsidies/>.
- [19] ENEA Consulting, “The potential of Power to Gas: Technology review and economic potential assessment,” 2016.
- [20] F. Dolci *et al.*, “Incentives and legal barriers for power-to-hydrogen pathways: An international snapshot,” *Int. J. Hydrog. Energy*, vol. 44, no. 23, pp. 11394–11401, May 2019.

