



HAL
open science

Data Model Proposal to Integrate GIS with PLM for DfS

Kiyan Vadoudi

► **To cite this version:**

Kiyan Vadoudi. Data Model Proposal to Integrate GIS with PLM for DfS. Economics and Finance. Université de Technologie de Troyes, 2017. English. NNT : 2017TROY0014 . tel-02421423

HAL Id: tel-02421423

<https://theses.hal.science/tel-02421423>

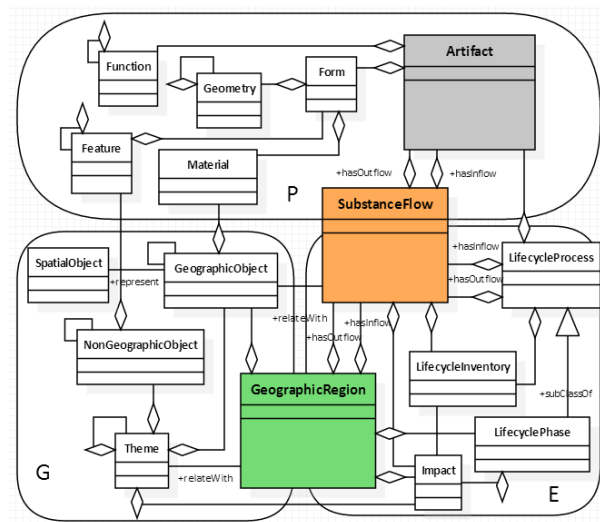
Submitted on 20 Dec 2019

HAL is a multi-disciplinary open access archive for the deposit and dissemination of scientific research documents, whether they are published or not. The documents may come from teaching and research institutions in France or abroad, or from public or private research centers.

L'archive ouverte pluridisciplinaire **HAL**, est destinée au dépôt et à la diffusion de documents scientifiques de niveau recherche, publiés ou non, émanant des établissements d'enseignement et de recherche français ou étrangers, des laboratoires publics ou privés.

Kiyan VADOUDI

Data Model Proposal to Integrate GIS with PLM for DfS



Spécialité :

**Ingénierie Sociotechnique des Connaissances,
des Réseaux et du Développement Durable**

2017TROY0014

Année 2017

THESE

pour l'obtention du grade de

DOCTEUR de l'UNIVERSITE DE TECHNOLOGIE DE TROYES

**Spécialité : INGENIERIE SOCIOTECHNIQUE DES CONNAISSANCES,
DES RESEAUX ET DU DEVELOPPEMENT DURABLE**

présentée et soutenue par

Kiyan VADOUDI

le 19 juin 2017

Data Model Proposal to Integrate GIS with PLM for DfS

JURY

Mme P. ZWOLINSKI	PROFESSEUR DES UNIVERSITES	Président
M. A. CHAKRABARTI	PROFESSOR	Rapporteur
M. R. P. GOUVINHAS	PROFESSOR	Examineur
M. V. ROBIN	MAITRE DE CONFERENCES	Examineur
M. S. ROHMER	MAITRE DE CONFERENCES	Examineur
M. L. ROUCOULES	PROFESSEUR DES UNIVERSITES	Rapporteur
Mme A. SEKHARI	MAITRE DE CONFERENCES	Examineur
Mme N. TROUSSIER	PROFESSEUR DES UNIVERSITES	Directeur de thèse

Abstract

There are different approaches to implement sustainability and Design for Sustainability (DfS) is the one that give more accurate result by considering both global and regional scales. Integration of Life Cycle Assessment (LCA) into Product Lifecycle Management (PLM) is an example of tool integration to support sustainability. In LCA framework, Life Cycle Inventory (LCI) is the quantified and classified list of input and output flow of the LCA model that is a model of the product system, linking the technological system to the ecosphere (Environment system). As each region has a unique environmental system, design characteristics and specifications of technological system should be modified and adopted based on these differences. Implementation of this approach will require geographical information of interacted environmental systems, which is a kind of new strategy in DfS. Therefore, we tested the interest of the integration of Geographical Information Systems (GIS) with PLM to support geographical considerations during product development activities. The main research question of this research work is then how to propose this PLM-GIS integration for DfS.

Thus, we conducted that literature review on existing data models about product, environment, geography and their combination is a key to prove the link among them. Later the state of art highlighted the lack of a comprehensive product model integrated with geography and environment models, which could enable to support DfS. In the beginning of chapter 4 through section 4.1, case study of a simple flash light is proposed to identify the details on the relation between product and environment with geographic data classes. Later in section 4.2 a comprehensive data model is proposed, which could integrate product data with geography, through environmental impacts. Finally, in the last section of chapter 4, we discuss proposed data model in details with a defined scope on material aspect. In chapter 5, data model illustration of two existing desalination systems for two regions are analyzed to highlight how geographical differences could change product structure specifications.

Abbreviation

BOL	B eginning O f L ife
CAD	C omputer A ided D esign
CAE	C omputer A ided E ngineering
CO ₂	C arbon D ioxide
CPM	C ore P roduct M odel
DfS	D esign for S ustainability
DRM	D esign R esearch M ethodology
DS	D escriptive S tudy
EOL	E nd of L ife
GIS	G eographical I nformation S ystem
ICT	I nformation and C ommunication T echnology
LCA	L ife C ycle A ssessment
LCI	L ife C ycle I nventory
ILCD	I nternational Reference L ife C ycle D ata system
ISO	I nternational Organization for S tandardization
IT	I nformation T echnology
MFA	M aterial F low A nalysis
MML	M OKA M odeling L anguage
MOL	M iddle O f L ife
NIST	N ational Institute of S tandard & T echnology
OAM	O pen A ssembly M odel
OWL	W eb O ntology L anguage
PDM	P roduct D ata M anagement
PLM	P roduct L ifecycle M anagement
PP	P olypropylene
PS	P rescriptive S tudy
PSRL	P roduct S emantic R epresentation L anguage
SO ₂	S ulfur D ioxide
UML	U nified M odeling L anguage
WEEE	W aste E lectrical & E lectronic E quipment
XML	E xtensible M arkup L anguage

Acknowledgements

The Research Centre for Environmental Studies and Sustainability's (CREIDD) at the University of Technology of Troyes (UTT) has supported the work reported in this thesis. The author gratefully acknowledges this support and its importance for the reported work.

I would like to thank my academic supervisor professor Nadège Troussier for her guidance, constructive criticism and support through my PhD. I could not have completed this work without her input.

I would like to acknowledge Professor Junbeum Kim, and Florian Bratec for many interesting and fruitful discussions, and co-publications. I would also like to thank Professor Serge Rohmer who gave me the opportunity to participate in the project “Solar Tears” to perform the second case study.

I would like to express my gratitude to my colleagues at CREIDD for an inspiring and dynamic research environment! Especially, I am grateful to students who participated in the case studies performed during this thesis, and with whom I have had many fruitful discussions.

I wish to acknowledge the work of all the researchers whom I have cited, and whose writings that have influenced my thinking and reinforced my ideas during this research.

I am particularly indebted to my family, for their endless support and for believing in me.

Kiyan Vadoudi

Troyes, June 2017

Table of Contents

Abstract	I
Abbreviation	II
Acknowledgements	III
Table of Contents	IV
List of figures	VII
List of tables	X
1 Introduction	1
1.1 Background.....	1
1.2 Problem formulation and scope of thesis	5
1.3 Thesis overview	6
2 PLM and sustainable development	9
2.1 Design	9
2.1.1 Sustainability	10
2.1.2 Design for Sustainability	12
2.2 Product Lifecycle Management.....	13
2.2.1 Product data model	17
2.3 Life Cycle Assessment methodology	24
2.3.1 LCA data model.....	26
2.3.2 Uncertainty in LCA	27
2.3.3 LCA and geographical scales	29
2.4 Geographical Information Systems	34
2.4.1 GIS Data Model.....	37
2.5 Problem formulation.....	43
2.6 Research question and hypothesis	45

3 Data models to link techno & eco spheres	47
3.1 Combined data models	50
3.1.1 Integration between product and environment	50
3.1.2 Integration between environment and geography.....	57
3.1.3 Integration between product and geography.....	59
3.1.4 Integration between product, environment and geography.....	63
3.2 Product, environment and geographical relation.....	64
3.3 Research approach.....	68
3.3.1 Phase I.....	68
3.3.2 Phase II	70
3.3.3 Phase III.....	70
3.3.4 Phase IV.....	71
3.3.5 Phase V	72
3.3.6 Future works	72
4 PEG data model proposal.....	73
4.1 Case study flashlight.....	75
4.1.1 Bill of Materials.....	75
4.1.2 System boundary for flows analysis	78
4.1.3 Semantic presentation of manufacturing process	82
4.2 Semantic data model proposal (PEG).....	85
4.2.1 Material selection for DfS	91
4.2.2 Foreground- Background approach	92
4.3 Chapter summary.....	96
5 Model's function illustration.....	98
5.1 Evaluation methodology.....	100
5.2 Case 1: Solar Tears in Champagne Ardennes	102
5.3 Case 2: Solar Tears in Yazd	108
5.4 Case 3: Eliodomestico in Yazd.....	112
5.5 Discussion and conclusion on case studies.....	116
6 Conclusion.....	121
6.1 Summary.....	121

6.1.1 Research objectives	122
6.1.2 Research questions.....	124
6.2 Limitations.....	126
6.2.1 Model validation.....	128
6.3 Future research	128
6.3.1 Further research in strategy	128
6.3.2 Future research in ICT	129
Bibliography	133
Appendix A	152
Appendix B	153
Appendix C	157
Appendix D	162
Appendix E	164
Appendix F.....	168

List of figures

- Figure 1.1 The economy as dissipative structure (Rees 1999)
- Figure 1.2 Ecosphere and technosphere system and information exchange
- Figure 1.3 Ecosphere and technosphere ICT system
- Figure 1.4 Thesis overview
- Figure 2.1 Situatedness as the interaction of three worlds (Gero & Kannengiesser.2006)
- Figure 2.2 Product lifecycle phases (Terzi et al. 2010)
- Figure 2.3 Holistic PLM model (Silventoinen et al. 2011)
- Figure 2.4 Map of IT tools along the product lifecycle (Terzi et al. 2010)
- Figure 2.5 CPM abstract classes (Fenves.2001)
- Figure 2.6 LCA Uncertainty propagation (Kota & Chakrabarti 2010)
- Figure 2.7 “Results map” tab in regionalized LCIA results editor (www.openlca.org)
- Figure 2.8 GIS Functions and Applications (Mennecke 1997)
- Figure 2.9 Raster and vector representation (Carver, Cornelius, & Heywood 2006)
- Figure 2.10 GeoFrame class diagram (Iochpe 1999)
- Figure 2.11 Product, environment and geography data models
- Figure 3.1 Setting up the ACR diagram
- Figure 3.2 ARC diagram (Blessing and Chakrabarti 2009)
- Figure 3.3 Combined data model and ontology between product, geography and environment
- Figure 3.4 MIM model (Roy & Sarigecili 2016)
- Figure 3.5 The CPMe³ extension to support eco-design (Kozemjakin da Silva et al., 2013)
- Figure 3.6 LCA-oriented concept model for the product life cycle (Zhang et al. 2015)
- Figure 3.7 The relation between product and environment systems

Figure 3.8 The three systems in LCA represented as GIS layer (Bengtsson et al. 1998)

Figure 3.9 The relation between environment and geography systems

Figure 3.10 Urban Street Traffic Network” classes’ diagram (Lisboa Filho et al. 2002)

Figure 3.11 GIS presentation of the company’s sale (Boulil et al. 2015)

Figure 3.12 Model proposal supportive boundary

Figure 3.13 Interaction between product and territory

Figure 3.14 Reference model

Figure 3.15 The research methodology

Figure 4.1 A simple flashlight (Flashlightsales.com)

Figure 4.2 Flashlight part break down (Flashlightsales.com)

Figure 4.3 Flashlight product structure model

Figure 4.4 Lifecycle stages for a simple flashlight

Figure 4.5 Plastic shell (Flashlightsales.com)

Figure 4.6 Manufacturing Process of a flashlight

Figure 4.7 Product, environment and geography data classes for plastic shell

Figure 4.8 Semantic presentation for plastic shell production

Figure 4.9 Class diagrams for plastic shell production

Figure 4.10 PEG data model

Figure 4.11 Artifact class input and output data

Figure 4.12 Input and output of a SubstanceFlow class

Figure 4.13 GeographicRegion class input, output data

Figure 4.14 Material selection in DfS

Figure 4.15 Foreground and background systems

Figure 4.16 Foreground and background systems for whole lifecycle

Figure 4.17 PEG model proposal with foreground and background regions

Figure 4.18 Impact model revised after proposed model

Figure 5.1 Annual rainfall and sunshine in France

Figure 5.2 Champagne ardenne geographical resources

Figure 5.3 Solar tears part details

Figure 5.4 PEG model presentation for solar tears in Champagne ardenne

Figure 5.5 Annual rainfall and sunshine in France

Figure 5.6 Annual rainfall and sunshine in France

Figure 5.7 Foreground-Background approach for Solar Tear product in Yazd province

Figure 5.8 PEG model presentation of Solar tears for Yazd province

Figure 5.9 Eliodomestico

Figure 5.10 Foreground-Background approach for Eliodomestico in Yazd province

Figure 5.11 Comparisons between Eliodomestico and Solar Tears

Figure.5.12. Product proposal for two different regions for better DfS

Figure 6.1 Use of LCA in EOL (Terzi et al. 2010)

Figure 6.2 Improved ICT structure in product lifecycle (Vadoudi, Allais, et al. 2014)

Figure 6.3 Data model relationships between product, environment and geography

Figure 6.4 Proposed CAD-LCA-GIS software platform

Figure 6.5 Traditional and proposed approach presentation on SO2 emission

List of tables

Table 2.1 Product data models

Table 2.2 LCA data models

Table 2.3 GIS data models

Table 3.1 Combined data models between product and environment

Table 3.2 Combined data models between environment and geography

Table 3.3 Combined data models between product and geography

Table 3.4 Combined data models between product, environment and geography

Table 4.1 Evaluation table used to choose the case study

Table 4.2 BOM for a simple flashlight

Table 5.1 The BOM for Solar tears

Table 5.2 The BOM for Eliodomestico

Chapter 1

Introduction

1.1 Background

In the past forty years the scale of environmental problems has shifted, from local and temporary to global scale. Human-induced atmospheric and climate changes and ozone depletion, etc., have become the daily headlines and affect people everywhere. Despite the growing unease, human pressure on the planet is increasing relentlessly which has raised material expectations sustained by an economic system that assumes the latter are insatiable. Little wonder that the global economy has expanded five-fold in half a century and the benefits of this economic explosion have not been evenly distributed. However, rather than contemplate mechanisms to redistribute the world's wealth, the global community has determined to abolish material poverty through sheer economic growth (Rees 1999). Despite the warnings of its scientists, main-stream industrial society does not yet see 'the environment' as a serious constraint on the required additional five-to ten-fold expansion in industrial activity. The 'environment' serves the economy as an open growing subsystem of the materially-closed non growing ecosphere (Figure 1.1).

Despite the growing interest in sustainability and environmental requirements, many industries still have to progress to make in preserving resources and reducing environmental problems (Roy 1997). Industry must be significantly restructured and existing breakthrough technologies must be more innovatively applied to realize green growth by focusing on the optimization of design, modeling, simulation and evaluation of product, production systems and processes (Belkadi et al. 2015). In this schema, design

phase has a significant impact on the sustainability of a product (Stark & Pförtner 2015), because it determines essential characteristics and properties of a product and correspondingly sets boundary conditions for subsequent lifecycle phases such as manufacturing and product use (Weber et al. 2003).

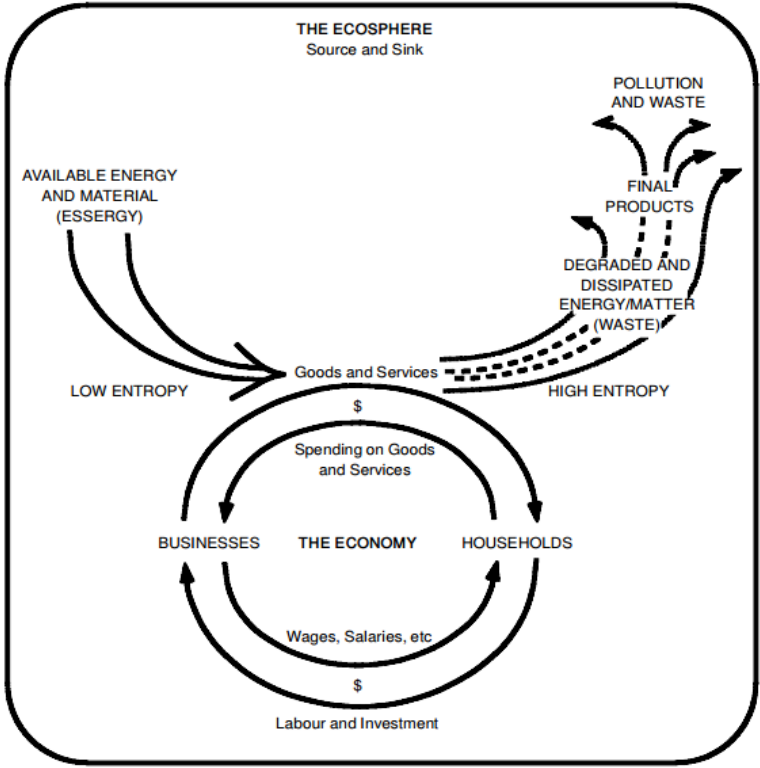


Figure 1.1 The economy as dissipative structure (Rees 1999)

Assessing sustainability is directly connected with defining its scope, depending on the appropriate geographical scale (Reiljan 2014). Scale can be viewed as a continuum between micro and macro (Meyer et al. 1992), but although scale matter in a wide variety of aspects of driving forces, impacts, and responses to sustainable development challenges, it is not the only key to sustainability and its main importance is not theoretical or conceptual although scale matters in a wide variety of aspects of driving forces, impacts, and responses to sustainable development challenges. Scale matters most because it is directly related to how and where the governance decisions that affect sustainable

development are made that affect sustainable development. Most especially, it is relevant at this time because different geographical scales of decision-making, from global to local, are not being coordinated and integrated in the interests of sustainability (Wilbanks 2007). Local, regional (above the local and below the national level) and global are different scales for implementing sustainability (Vadoudi & Troussier 2015) and the regional understanding of the term makes it more accurate (Péti 2012).

Design for Sustainability (DfS) is a new concept for sustainable development including the more limited concept of Eco-design. It enables companies work to improve efficiencies, product quality and market opportunities (local and export) while simultaneously improving environmental performance (Crul et al. 2006). DfS could make sustainability more articulate, actual, and pragmatic due to the fact that local people and stakeholders obviously know and manage their own regional social, economic, and natural environment better (Vadoudi & Troussier 2015). Indeed taking into account regional geographical conditions of regions in terms of technological and environmental aspects requires accurate regional information. Collection of regional information, processing them and distributing it to the various organizations is essential for DfS and highlights the significant role of Information and Communication technology (ICT).

Regarding the increasing role of the ICT, these systems might foster better consideration of the sustainability aspects by supporting the management and the traceability of relevant data and information (Reichel et al. 2011). In the literature (Amann 2002; Stark 2015), Product Lifecycle Management (PLM) is considered as a strategic business approach that applies a consistent set of business solutions to support the integration and collaborative creation, management, use, and dissemination of product information by the involvement of several tools such as; ERP (Enterprise Resource Planning) modules, PDM (Product Data Management), related tools (CAD, CAE, etc.) and in recent years LCA (Life Cycle Assessment) to support the environmental aspect of sustainability.

Environment is inherent to a specific geographic area and consequently it should suffice to state only the location of a flow. However, this is not always true since many of the

systems modeled in LCA are not site-specific but represent average processes in larger areas. In these cases there may be a lack of consistency between environment and geographical location (Bengtsson et al. 1998).

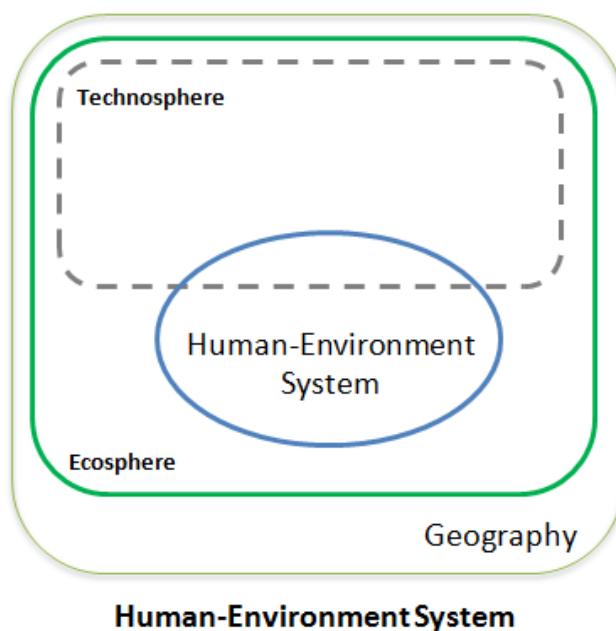


Figure 1.2 Ecosphere and technosphere system

In the current LCI studies, the environmental space of the product life cycle is geographical and is divided into technosphere and ecosphere systems. Figure 1.2 presents the interactions between these systems. Through this system, geography is the base system including physical features of the earth, atmosphere, the population distribution, resources and political and economic activities (Dahlman et al. 2011). The technosphere system refers to the global technology systems integrating all human activities and the ecosphere system refers to the human-environmental system. Input flows that directly enter the technosphere directly come from the ecosphere (relating to natural resources), and all the output flows (which generally cause the environmental impacts (Kougoulis 2009)) that directly exit the technosphere to the ecosphere all belong to specific geography.

1.2 Problem formulation and scope of thesis

In terms of the information exchange between ecosphere and technosphere systems (Figure 1.3), the relation of products data (PDM) with environment is addressed by LCA for the evaluation of the environmental impacts of products (Jensen et al. 1997) through LCI results. The relation between geographical and environmental information is addressed by regionalization of LCA (RLCA) as a solution to improve the accuracy of LCA, which is coupled with a Geographical Information System (GIS) (Rodríguez et al. 2014; Mutel & Hellweg 2009; Bartl et al. 2012; Mutel et al. 2012). GIS, by accessing different sources of information (biological resources, pollution sources and affected areas, land cover and use, water availability and quality and energy sources and use), enables the use of a set of simple operations such as overlay, classification, interpolation and aggregation of spatial information (Rodríguez et al. 2014) to generate useful information for decision makers in support of DfS.

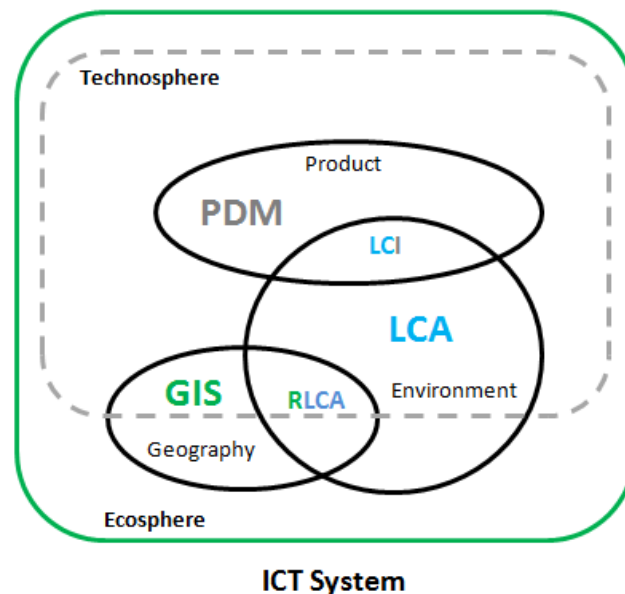


Figure 1.3 Ecosphere and technosphere ICT system

However, insufficient attention has been paid to industrial products, in terms of their regionalized LCI, the study of the related geographic location and the status of

environmental impacts before and after proposed design for each step of lifecycle. Thus, integrating GIS and PLM could be the next step for sustainability, in order to include geographical knowledge in design process.

The research carried out in this thesis aims at contributing towards understanding the relation of geographical data to product data, in order to build a geography based information support for design for sustainability (DfS). The scientific aim is focused on identifying the way, how to consider geographical features in the early design phase and to see how these features, could change design specifications.

1.3 Thesis overview

This thesis is organized as follows:

Chapter 1 provides an introduction to the thesis, and the problems that are attempted within this research. The important challenge in DfS that this research attempts to address is listed to build up the main problem statement.

Chapter 2 describes the literature review due to to reveal the areas of investigation to define the framework of thesis; Design for Sustainability (DfS), Product Lifecycle Management (PLM), Life cycle impact Assessment (LCA), Geographical Information System (GIS), PLM tools, data models and other related topics. The result of these literature helped to identify the general research questions: “What is the link between information concerning product design and geography for DfS? “What is the role of the environment in this link? And, specifically, where is the place for LCA in PLM’s IT structure?”

Chapter 3 explains one part of the first descriptive study, where the aim is to gain a sufficient understanding of the current situation through literature search performed in relation to combined data models between product & geography, geography & environment, product & environment and product & environment & geography with

different types of solutions and data models. At the end of this chapter the specific research question “How could geographical features change design specifications for better DfS?” is proposed. It is the part, where we are in the manuscript.

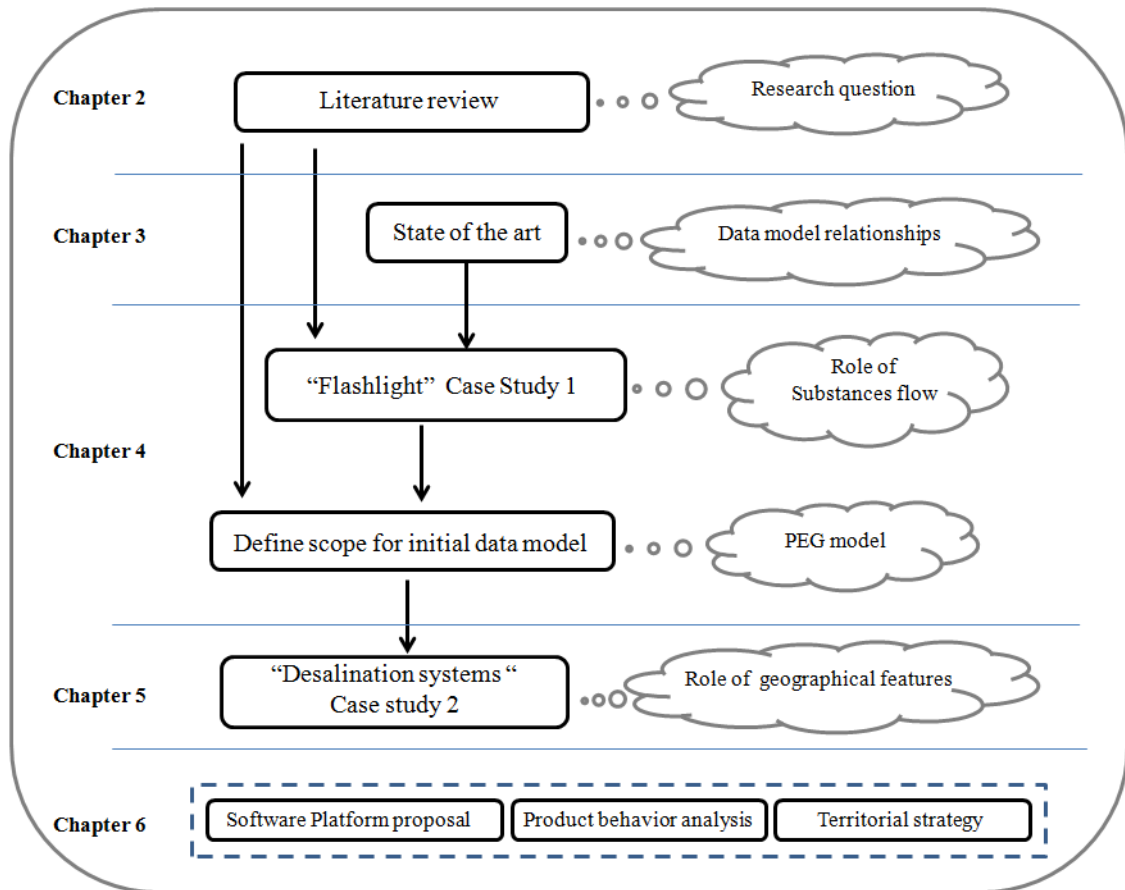


Figure 1.4 Thesis overview

Chapter 4 provides further details about the relationships between product, geography and environmental impacts by doing a sample case study (Flashlight) to find those relations through a real case. The results obtained from literature review, state of the art and the flashlight case study help us to justify the first version of the proposed model (PEG). A model which could integrate geographical information model with product and environment information models to include geographical features during the first design steps. The first version of the model included many aspects, thus we decided to limit the

scope to material aspect that is most relevant to analysis and relation with geographical features. This helped us to introduce a new approach in terms of material flows called foreground-background approach that separates interacted lifecycle stages in terms of flows for the same geographical region or different regions (background). We therefore added `ForegroundRegion` and `BackgroundRegion` classes to the proposed data model.

Chapter 5 highlights the importance of geographical differences on design choices by illustration of two existing desalination system designs in two geographical regions (Champagne Ardennes in France and Yazd in Iran) to compare their design specification based on geographical features. The specific research question which proposed at the end of previous chapter: “How could geographical features and their differences, change design specification in terms of product structure?” is answered at the end of this chapter.

Chapter 6 concludes the thesis by summarizing the findings gained, presenting the areas where future efforts will be devoted, and providing inspirations by means of the benefits that could be attained by successful fulfillment of future research goals.

Chapter 2

PLM and sustainable development

2.1 Design

To start with, design is widely regarded as one of the most important steps in the development of a product. A design cannot just be a thought and it must be expressed in some material form (sketch, article, music, text etc.) to change the world. Gero's framework (Gero & Kannengiesser 2006) presents this action process through three kinds of worlds (Figure 2.1).

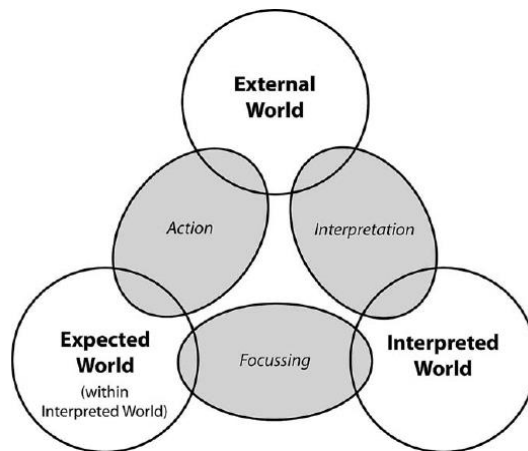


Figure 2.1 Situatedness as the interaction of three worlds (Gero & Kannengiesser 2006)

The external world is composed of representations outside the designer or design agent's scope. The interpreted world is the world that is built up inside the designer or design agent

in terms of sensory experiences, percepts and concepts. It is the internal, interpreted representation of the part of the external world that the designer interacts with. The expected world is the world that the imagined actions of the designer or design agent will produce. It is the environment in which the effects of actions are predicted according to current goals and our interpretations of the real world. These three worlds are recursively linked together by three different processes. The process of interpretation transforms variables, which are sensed in the external world, into the interpretations of experiences, percepts and concepts that compose the interpreted world. This is caused by the interaction of sensation, perception and conception processes. The process of focusing takes some aspects of the interpreted world and uses them as goals in the expected world it suggests actions which, if executed in the external world should produce states that reach the goals. The result of an action is an effect, which brings about a change in the external world according to the goals in the expected world.

Since the beginning of the 20th century the design of industrial products and systems has been impacted by the mass production of objects, which have generated negative social, environmental or institutional aspects. Awareness of these aspects provides incentives for companies to create products and services that are not just sustainable, but that also deliver better value in a dynamically changing business and user context. “Design” as one of the important phases in a product’s life cycle is faced with the challenge to contribute to the transition towards a sustainable development. Design has a pivotal role in sustainable consumption and production, and ‘without the contribution of design, the full potential of sustainability cannot be realized’ (Spangenberg et al. 2010).

2.1.1 Sustainability

The concept of sustainability is a complex one. However, it is possible to distil some of its most basic and general characteristics by adopting a systemic approach (Gallopín 2003). All physically existent systems are open, exchanging energy, matter and information with their environment that are significant for their functioning. What the system “does”, its behavior, depends not only on the system itself, but also on the factors, elements or

variables coming from the environment of the system and impinging on it. The only option that makes sense in the long-term is to seek the sustainability of the whole socio ecological system. A socio ecological system (Gallopín 2003) is defined as any system composed of a societal subsystem in interaction with an ecological component. It can be either urban or rural, and it may be defined at different scales from local to global. The concept of sustainable development is quite different from that of sustainability in that the word “development” clearly points to the idea of change. All living systems are changing systems and the essential point is not to eliminate change, but to avoid the destruction of the sources of renewal, so that the system can recover from the unavoidable stresses and disturbances to which it is exposed because of its condition of being an open system. What is sustained, or has to be made sustainable, is the process of improvement of the human condition, a process that does not necessarily require indefinite growth in the consumption of energy and materials (Gallopín 2003).

One important research aspect of sustainability is the move toward more sustainable product (Moreno et al. 2011). It is vital that the designer defines the use and disposal of the finished product and clearly chooses the raw materials which cause the least environmental damage, and then influences both the manufacturing and distribution systems to minimize the environmental and social impacts (Howarth & Hadfield 2006). In fact, the concept of sustainable design aims to enable tangible and intangible factors, such as products, parts, systems, and services to better conform to environmental and social protection requirements. In the 2000s this approach evolved from Eco-design into design for sustainability by embracing social and economic, as well as environmental, concerns (Crul et al. 2006). Nowadays design is faced with the challenge of contributing to the transition towards a sustainable society. DfS is a response to this challenge. DfS research area explores new themes in design and sustainability. It asks, for instance, how sustainability can be successfully integrated into product development at the conceptual steps, when not only the consumer demands but also the technologies involved are not yet fixed; how

design can stimulate more sustainable lifestyles; what we can learn from frugal innovation; and how visioning and scenario-building can become integral to sustainable design.

2.1.2 Design for Sustainability

Improved product/system design which applying sustainability criteria is one of the most useful instruments available to enterprises and governments to deal with environmental, economic and social challenges. Design for Sustainability (DfS or D4S) (Crul et al. 2006), also referred to as sustainable product design, is a globally recognized way to deal with those challenges by working on improving efficiencies, product quality and market opportunities on a local scale, while simultaneously improving environmental performance along a product's supply chain and through its life cycle (cradle to grave). DfS goes beyond the Eco-design approach (dealing mainly with environmental and economic effects) and addresses all dimensions of sustainability, looking at bigger systems and asking more fundamental questions about consumption and production. In between production and consumption are the products (including services) and the ways they are used. The domain of production is the best understood phase one in terms of the innovations needed for a transition towards sustainability (Spangenberg et al. 2010).

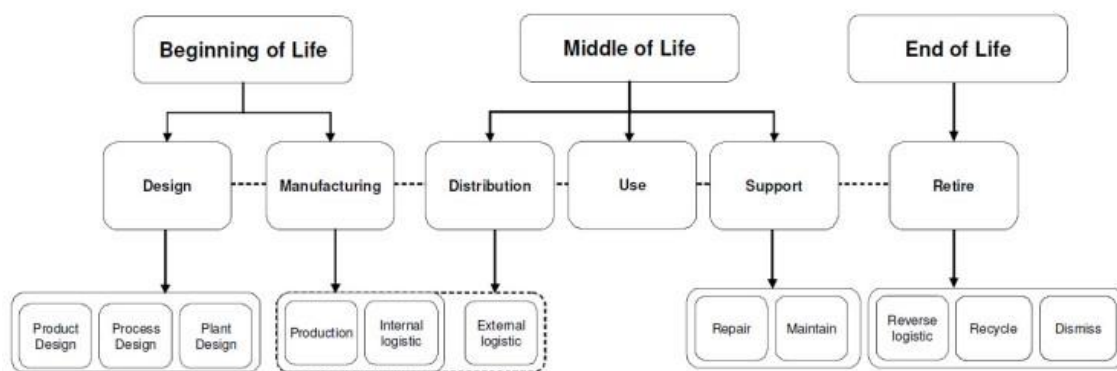


Figure 2.2 Product lifecycle phases (Terzi et al. 2010)

The DfS approach is based on taking a life cycle view of a product (Crul et al. 2006). The term 'life cycle' generally indicates all the phases, or independent stages to be

passed/followed/performed by a product, from ‘its cradle to its grave’. These can be grouped into three main phases as shown in figure 2.2. Beginning of life (BOL) includes design and manufacturing. In this phase, the product concept is generated and physically achieved. The product design and the production process is developed, using a variety of tools, techniques and methodologies, by designers, planners and engineers who plan the production facilities and manage the manufacture of products with diverse suppliers. Middle of life (MOL) includes distribution, use and support. In this phase, the product is in the hands of the final customer, i.e. product user/consumer and/or some service providers, e.g. maintenance actors and logistic providers. In the MOL phase, products are distributed, used and supported (repaired and maintained) by customers and/or service providers. End of life (EOL) is the phase where products are collected, disassembled, refurbished, recycled, reassembled, reused or disposed. EOL starts when the product no longer satisfies its users (Kiritsis et al. 2003; Terzi et al. 2010).

In order to support these processes a set of interface technologies is required. Without such technologies even trivial tasks such as supplements of old constructions fail because of the incompatibility of data formats. To overcome such problems, scientists are working on life cycle modelling strategies (Niemann et al. 2008). Standardized data structures like STEP, XML, Unified Modelling Language (UML) form the data containers, which in turn are integrated into PLM systems in order to manage the “Big Data” (Niemann et al. 2008; Stark et al. 2014). PLM and PDM systems mainly rely on a central database (gathering the various files from the different experts’ supports) associated with a management workflow (Eynard et al. 2004).

2.2 Product Lifecycle Management

Product Lifecycle Management (PLM) has evolved to enable managing design information to be managed and is moving toward precise decision management. Holistic PLM is based on the understanding that product lifecycle management is an integrator of

tools and technologies that streamlines the flow of information through the various stages of the product lifecycle (Terzi et al. 2010). Holistic PLM brings together products, services, organizational structures (Alemanni et al. 2008), activities, processes, people, skills, Information Technology (IT) systems, data, knowledge, techniques, practices and standards. All these aspects are needed in order to develop and manufacture products which fulfill customer requirements and the regulations set by authorities as well as complying with environmental requirements. Silventoinen proposes a holistic model of PLM (Figure 2.3) and emphasizes that to be able to plan the effective implementation of PLM into an organization, it needs to be understood as far more than just another IT system (Silventoinen et al. 2011).

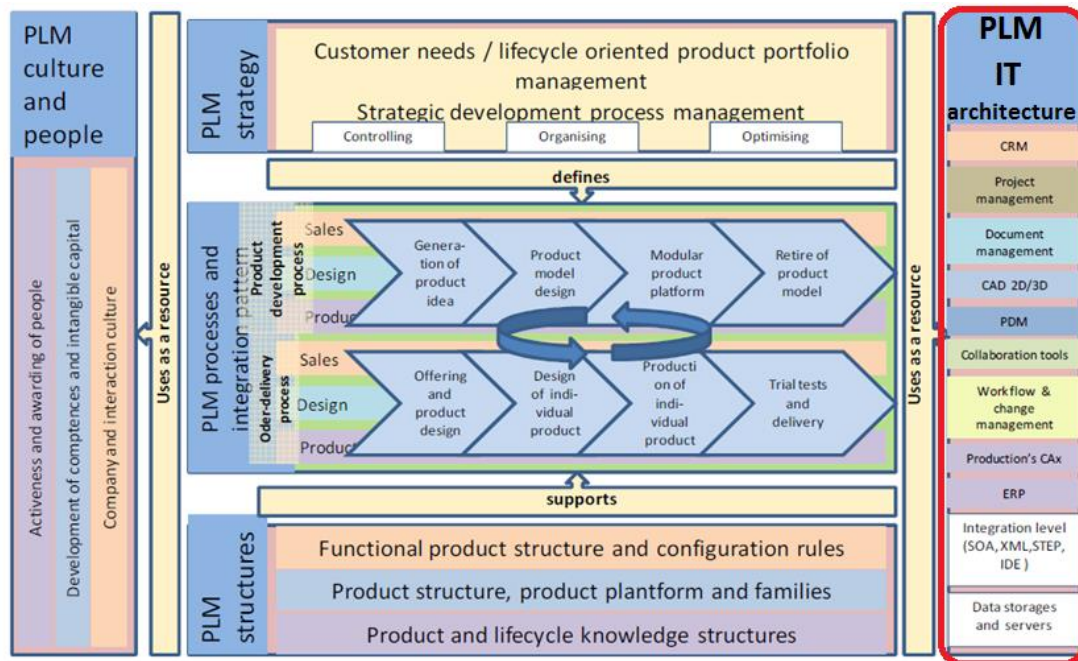


Figure 2.3 IT architecture through holistic PLM model (Silventoinen et al. 2011)

PLM IT architecture contains tools that assist a corporation in the implementation of PLM concepts. One of the main questions regarding PLM systems is: “What constitutes the PLM systems’ functionality?” The full PLM IT system functionality can be achieved by the combination of (Sudarsan et al. 2005):

- Information Technology
- IT Infrastructure
- Product Information Modeling Architecture
- Development Toolkit and Environment
- Set of Business Applications

Through these different components, the IT infrastructure is the foundation that includes integration of different hardware, software, and internet technologies, underlying representation and computing languages, and distributed objects and components (Sudarsan et al. 2005). The core of PLM is in the creations and central management of all product data and the technology used to access this information and knowledge (Stark 2015) by different tools (Figure 2.4): authoring tools (CAD, etc.) and collaborative product development platforms (PDM, etc.) in the design activity, plus a set of enterprise applications (ERP, SCM, CRM, etc.) in the manufacturing and distribution activities. Computer-aided design CAD is the use of computer programs to create two or three dimensional graphical representations of physical objects that is usually used in BOL (Kunii et al. 2011). PDM is the use of software to manage product data and process-related information in a single, central system which mostly is used during BOL and early stages of MOL. This information includes CAD data, models, parts information, manufacturing instructions, requirements, notes and documents (Li et al. 2013). Computer-aided manufacturing (CAM) commonly refers to the use of numerical control (NC) computer software applications to create detailed instructions (G-code) that drive computer numerical control (CNC) machine tools for manufacturing parts. Manufacturers in a variety of industries depend on the capabilities of CAM to produce high-quality parts. Enterprise resource planning (ERP) is business process management software that allows an organization to use a system of integrated applications to manage the business and automate many back office functions related to technology, services and human resources through the whole lifecycle. Supply chain management (SCM) is the oversight of

materials, information, and finances as they move in a process from supplier to manufacturer to wholesaler to retailer to consumer.

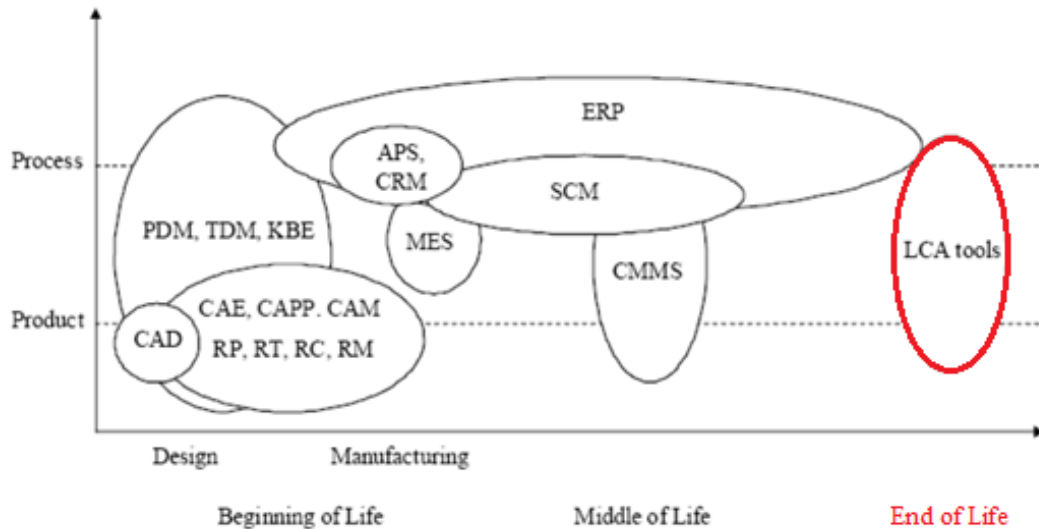


Figure 2.4 Map of IT tools along the product lifecycle (Terzi et al. 2010)

In recent years, LCA, as an important methodology in the IT structure of PLM, is used for the environmental assessment of products (Figure 2.4). However, LCA mostly is applied at EOL and not in the early stages of design, because of the various levels of uncertainty sources. Due to this uncertainty, most of the existing tools based on LCA do not focus on design, since they are set for a strategic management or a retrospective analysis of existing products. These sources of uncertainty are usually generated by empirically inaccurate parameters in the LCI, originally caused by not considering the spatial and temporal characteristics. In fact, a real LCA can only be correctly used for a completely defined product where accurate data about lifecycle is available. This is why LCA tools are used mostly in EOL for analyzing the environmental impact of designed products.

A central issue among these necessary information technologies is product modeling, which generates an information tank of complete product data to support various activities at different product development phases. To facilitate the discussion, the semantic meaning

and terminology related to the subject of product data modeling is defined. In this thesis, product is a materialized, artificially generated object which forms a functional unit. The term “model” relates to the way in which it contains relevant information including data, structures, and algorithms and the term product model can then be interpreted as the logical accumulation of all relevant information concerning a given product during the product life cycle. Product modeling, as an essential part of the computer-aided product development activity, yields a product data model as its results to support the whole product life cycle concerns (Krause et al. 1993). The product data model should be setup to describe, categorize, analyze, store, trace and transit all product data in PLM. In order to ensure that the right data is sent to the right person at the right time, the product data model should have integrality, consistency, safety, diversity, share, activity, traceability, and other characteristics (Li et al. 2011).

2.2.1 Product data model

The importance of product modeling has been widely recognized by the research and application communities over the past few years. Product data modeling techniques includes geometric solid modeling, product features modeling, integrated product information modeling, unified data modeling, ontology-based data modeling, product family modeling and various other methods. Different types of data models are presented in Table 2.1. These are based on three categories of product, product & process and process presented by different researchers used in different phases of product development processes. The main objective of preparing this table is to present the most common existing data models in the product category, giving a short explanation about their objectives and specifications which helped us to justify a model that is closer to the objective of our proposed data model. These data models are selected from 43 literature studies searched using Google scholar by key words: Modelling; product modelling; multilevel modelling framework; OWL; product information modelling; semantic product modelling; Unified Modelling Language; feature-based modelling; ontology; knowledge-based engineering; information models and product lifecycle management. The keywords

are identified based on two steps; (1) following the main objective of the search (Modelling, product modelling, semantic modelling, product information modelling and product lifecycle management, ontology) and (2) other keywords introduced by identified literature throughout the first step (multilevel modelling framework, OWL, UML, feature-based modelling, ontology, knowledge-based engineering). The data models that are not included in table 2.1, are oriented towards specific aspect of modelling such as assembly, requests, behaviors, manufacturing and etc.

Table 2.1 Product data models

Data Model	Field	Specification	Objective
Core product model (CPM) (Fenves 2001)	Product	Not tied to any vendor software, open, non-proprietary, simple, generic, expandable, and independent of any one product development process.	For capturing all information relevant to the ongoing design process until the product design is firm ed up, approved and committed to purchasing or manufacturing.
CPM2 (Fenves et al. 2008)	Product	For physical products with roots in electromechanical systems as opposed to conceptual products, systems, software, or services. CPM extension.	A generic, abstract model with generic semantics, intended to support a broad range of information relevant to product lifecycle management.
Open Assembly Model (OAM) (Fiorentini et al. 2007)	Product	The assembly model, defines both a system level conceptual model and the associated hierarchical relationships. CPM extension.	To provide a way for tolerance representation and propagation, kinematics representation, and engineering analysis at the system level.
PSRL (Patil et al. 2005)	Product	Formal description logic (OWL) is used to encode the PSRL. CPM extension.	To Represent product information in formal approach.
Design Analysis Integration (Fenves et al. 2003)	Product	CPM serves as the organizing principle of the Master Model from which discipline-specific functional models (views) are idealized.	To provide tighter integration of spatial and functional design and support analysis-driven design and opportunistic analysis
Product Family Evolution Model (Wang et al. 2003)	Product	CPM extension	To represent the independent evolution of products and components through families, series and versions, and the rationale for the changes.
Heterogeneous Material Model (Biswas et al. 2008)	Product	Distance fields are associated with a set of material features, where values and rates of material properties are specified. CPM extension.	Two components with continuously varying material properties.
Mechatronic Device Model (Xu et al. 2005)	Product	Interacts between the use-environment and the device can have different qualitative	To support the conceptual design of multiple interaction-state mechatronic devices,

		structures. CPM extension.	
Embedded System Model (Zha et al. 2005)	Product	Feature-based approach. CPM extension	To co-design of hardware and software in embedded systems
Standard for the Exchange of Product model data (STEP) - ISO 10303 (Bloor 1991)	Product	Cover geometry, topology, tolerances, relationships, attributes, assemblies, configuration and more. It is based on a language (EXPRESS) and can be extended to any industry.	For the electronic exchange of product data between computer-based product life-cycle systems
STEP AP203 (Clark & Staley 1995)	Product	Defines the geometrical, topology, and configuration management data of solid models for mechanical parts and assemblies. STEP protocol.	The mostly used ones in the domain of 3D CAD - applies to Mechanical CAD in genera
STEP AP214 (Yang & Han 2002)	Product	Has everything a AP203 file includes, but adds colors, layers, geometric dimensioning and tolerance, and design intent. STEP protocol.	The mostly used ones in the domain of 3D CAD - is more focused on Automotive Industry
MOKA (Brimble & Sellini 2000)	Product	Divided into two main parts with informal model and formal model as their representatives. Based on Knowledge Based Engineering (KBE)	Aimed at capturing and applying knowledge within aeronautical and automotive industries of the design of complex mechanical products
Product specification model (Uddin & Ma 2015)	Product	Based on specification features	To enable capturing design intention and common product information at the onset of new product development.
OntoSTEP (Barbau et al. 2012)	Product	Combines geometrical information represented in STEP with non-geometry information, such as function and behavior, represented using the NIST's Core Product Model (CPM).	Can easily be integrated with any OWL ontologies to create a semantically rich model.
Ontology for product service systems (PSS) (Annamalai et al. 2011)	Product	Collection of PSS concepts, the definition of each concept, the grouping and structuring of the concepts hierarchically as well as the identification of the relationships between these concepts.	To aid clarity to the top-level concepts of PSS, this would help to communicate these concepts better between researchers and practitioners.
ONTO-PDM (Panetto et al. 2012)	Product	As a facilitator for interoperating all application software that share information during the physical product lifecycle.	For facilitating systems interoperability in a manufacturing environment.
A Semantic Product Modeling Framework and Its Application to Behavior Evaluation (Lee et al. 2012)	Product	The framework is defined within the Model-Driven Architecture using the multilevel (data, model, meta model) approach.	To enable stakeholders to define product models and relate them to physical or simulated instances.
PRONOA2 (Gruhier et al. 2015)	Product Process	Product relationships are considered and described in the part-whole theory supported by mereology and its extension, mereotopology. Assembly oriented	To make assembly information accessible and exploitable in order to support product architects and designer's activities.

design			
KCModel (Monticolo et al. 2015)	Product Process	Acquisition, traceability, re-use and consistency of explicit knowledge used in configuration.	Industrial design and simulation processes especially in automotive and aerospace areas.
Product Evolution Exploring Model (PEEM) (Taheri et al. 2015)	Product Process	Distinguishes the functional, behavioral and structural changes in a common level of technical characteristics. Generic model	To provide a data base of applied knowledge in technological systems during design processes for supporting the framework of inventive design performance measurement system (IDPMS) within the DEFI project.
UML-2 (Gunendran & Young 2010)	Product Process	By organizing knowledge into part families and features and most importantly by defining the relationships between part families, between part families and features, and between features.	Identification of manufacturing consequences during the product design process.
AsD ontology (Kim et al. 2006)	Product Process	Using OWL (Web Ontology Language) and SWRL (Semantic Web Rule Language)	Can capture both assembly and joining intents by a demonstration with a realistic mechanical assembly.
Ontology-based approach for PLM (Matsokis & Kiritsis 2010)	Product Process	Using Web Ontology Language-Description Logic (OWL-DL), converting existing PLM models to ontologies is provided.	Aim of implementing ontology advantages and features into PLM
An approach for knowledge-driven product, process and resource mappings for assembly automation (Ferrer et al. 2015)	Product Process	Mapping of engineering data sets to interconnect product attributes to manufacturing process and resources.	To compress the development time and engineering cost by enabling collaboration and realization of product and manufacturing resources in a virtual environment.
The PPO design model (Noël & Roucoules 2008)	Product Process	An integrated design perspective that is achieved by assessing PPO behaviors.	It provides efficient assistance to collaboration during innovative design project.
The PPR model (Cutting-Decelle et al. 2007)	Product Process	The use of international standards and ontology based approach to find the common 'essence' of the information handled	For Managing Modularity in Production Management with the objectives of reducing manufacturing costs, time to market and improving quality
RFLP (Requirements, Functional, Logical, Physical) (Kleiner & Kramer 2013)	Process	Close interaction between the different engineering disciplines render resources and processes more efficient, enhance quality, and ensure that the target system ultimately meets the requirements, while reducing design cycle time and engineering lead time.	For requirements engineering and management, functional and logical design, as well as physical design in different domains for the multidisciplinary development process based on a Systems Engineering approach early in the design process. In leading PLM systems.
DFM ontology (Chang 2008)	Process	Exploring an ontology-based method	To solve the limitations in present computer-based information systems for product design.
User centric knowledge	Process	Each domain of expertise retains its own data in the form most	To establish a suitable model for machine-mediated

representations (Lee & Jeong 2012)	appropriate for its needs, and collaboration. where ontology-based, intelligent filters translate neutral design data into domain-specific ones.
----------------------------------------------	-----------------------------------------------------------------------------------------------------------------------------------------------------------

Out of selected models, eighteen are proposed for the product domain, and are mostly used in the first steps of design. Some of these models are generic and base models like Core Product Model (CPM) (Fenves 2001) and Standard for the Exchange of Product model data (STEP) (Clark & Staley 1995) and some are extensions of other models like Open Assembly Model (OAM) (Fiorentini et al. 2007) and OntoSTEP (Barbau et al. 2012). Property, entity, behavior, requirement etc. are some specifications which these models are addressing with the objective of capturing all the information relevant to the ongoing design process until the product design. Nine models like UML-2 (Gunendran & Young 2010) and PPO (Noël & Roucoules 2008) are represented to support product with related processes such as design and manufacturing and finally three of these models like DFM (Chang 2008) are presented for multidisciplinary and coordinator fields that are supporting the process aspect of the product.

However, these data models (Table 2.1) that are prepared based on different modeling methods are deficient in describing and managing all data information throughout product lifecycle. Their disadvantages and limitations are summarized as:

- A product category model tries to express all product information throughout the whole lifecycle by using a single model. However, the product unified model proposed may be a static model, which does not describe dynamic data and process information.
- They only consider product and process data, but do not pay attention to the environmental impacts information in the product development process, this is important for DfS in PLM, and needs to be supported.
- They only manage generic product data, but do not consider spatial and temporal data information.

The Core Product Model (CPM) developed by the researchers at the National Institute of Standards and Technology (NIST) (Fenves 2001) is selected for detailed explanation due to some significant reasons that differentiate this model from others. (1) It is a general model and used as a basis for some of existing data models on product category. Beside its genericity, it is simple, open, non-proprietary, extensible, and independent of any specific product development process. (2) The core property class of this model includes flow and material classes that could be related to environmental (Roy & Sarigecili 2016) and geographical aspects through a substance flows class as the base class of the flow ontology with three subclasses: ElementaryFlows class, ProductFlows class and WasteFlows class. (3) The core object class of this model supports function, behavioral aspects which have a role in the context of a form and material. A function defined as an abstract object often can be achieved through different forms/material, and the function will have different behavior under each separate form/material context.

This model consists of two sets of classes, called object and relationship classes, patterned after the Entity-Relationship model (Chen 1976), equivalent to UML (Booch et al. 1999) classes and association classes. CommonCoreObject (Figure 2.5) is the base class for all object classes, including CoreProperty, CoreEntity, Behavior, Requirement and Specification classes. CoreEntity is the base class from which Artifact and Feature are specialized and CoreProperty is the base class from which Function, Flow, Form, Geometry and Material are specialized.

Below some of the most important classes related with core property class are explained:

- Artifact class: It represents a distinct entity in a product, whether that entity is a component, part, subassembly or assembly.
- Material class: It is the description of the internal composition of the artifact.
- Feature class: A portion of the artifact's form including some specific function. An artifact may have design features, analysis features, manufacturing features, etc., as determined by their respective functions.

- Function class: Is what the artifact is supposed to do.
- Form class: This class is the proposed design solution for the design problem specified by the function, represented in terms of its geometry and material.

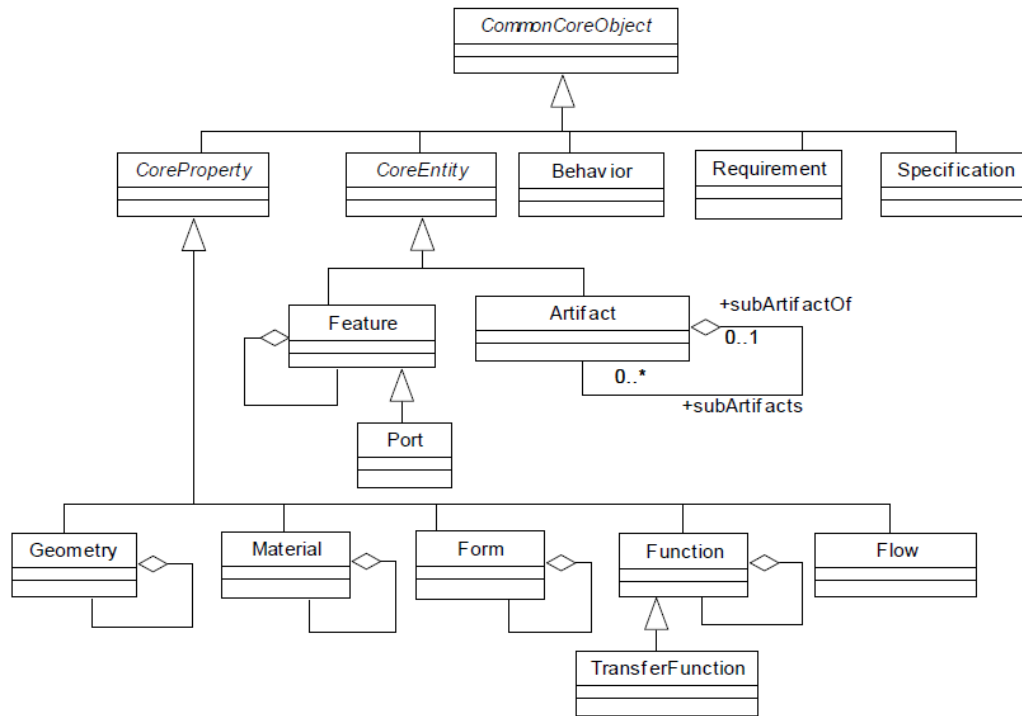


Figure 2.5 CPM abstract class (Fenves 2001)

CPM extended to CPM² (Fenves et al. 2008) to support a broad range of information relevant to PLM. This model has other extensions such as; The Open Assembly Model (OAM), which provides a standard representation and exchange protocol for assemblies (Rachuri et al. 2006); the Product Semantic Representation Language (PSRL) that develops a formal representation of product information using web ontology language (OWL) (Patil et al. 2005); The Design-Analysis Integration study proposes CPM as the organizing principle for tighter integration of spatial and functional design (Fenves et al. 2003); The Product Family Evolution Model extends CPM to the representation of the evolution of product families and of the rationale of the changes involved (Wang et al. 2003); The Heterogeneous Material Model extends CPM to components with continuously

varying material properties (Biswas et al. 2008). To make this model more feasible, (Gujarathi & Ma 2011) developed a common data model (CDM) containing all required parametric information for both CAD modeling and CAE analysis for CAD/CAE parametric integration.

The CPM model successfully provides the information about: (1) the form, i.e., the geometry and material selected for the intensifier; (2) the function information to represent the design intent; (3) the behavior information to represent the necessary engineering equations. The materials chosen must be analyzed the designed form and other designed parameters, overall production feasibility, and especially the environmental impact of the material used.

The environmental impacts of product could be quantified as the summation of the environmental impact of the material needed to produce the component, the impact associated with its manufacture, the impact related to the entire phase of use, which directly depends on the choice of material, and the impact of the EOL (recycling, remanufacturing, and disposal). Evaluation of these constraints could be achieved by LCA (Keoleian 1993; Guinée 2002) which has emerged as the most comprehensive analytical tool for evaluating the environmental profile of a product, see PLM IT tools (Figure 1.6) in EOL.

2.3 Life Cycle Assessment methodology

Life Cycle Assessment (LCA) is an environmental assessment methodology for collecting and evaluating information on the environmental performance of a product/service or an activity across its full life cycle, from cradle to grave (Astrup Jensen et al. 1997). According to ISO 14040 (ISO 14040 1997; Finkbeiner et al. 2006), the methodological framework for LCA consists of four phases which are; (1) Goal and scope definition, (2) Life-Cycle Inventory analysis (LCI), (3) Life-Cycle Impact Assessment (LCIA) and (4) interpretation. Inventory analysis is an important part of LCA. It is a

systematic, objective, stepwise procedure for quantifying energy and raw materials requirement, atmospheric emissions, water borne emissions, solid wastes, and other releases for the entire life cycle of a product, package process, material or activity (Babu 2006).

Although the inadequacy of current techniques for managing LCA data and computations has been discussed in one form or another for many years (Ayres 1995), a gulf has remained about data interoperability. Problems of data collecting and interoperability limits the widespread use of data in LCA models and hide modeling decisions regarding connections between data sources that may have a hidden influence on modeling results. The underlying architecture of current LCA models does not facilitate interoperability. While the standardized XML based LCA data exchange formats primarily Ecospold (Jungbluth et al. 2011) and ILCD (Wolf et al. 2012) do allow for the exchange of LCA data, the formats alone do not guarantee that a dataset from one source will be interoperable with another as there is still no consensus on a single nomenclature for LCA flows or model structure, and consensus is not likely to be reached in the near future (Kuczynski et al. 2016). Furthermore, these formats are not broadly defined enough to capture data from other non-LCA models that may underlie a unit process or characterization model. Semantic technologies similar ontologies are promising methods to support interoperability in LCA. They foster semantic interoperability without the need to enforce a single domain schema (Yan et al. 2015).

An ontology is a “formal model that uses mathematical logic to clarify and define concepts and relationships within a domain of interest” (Madin et al. 2008). The use of ontology-based approaches for LCA was first suggested in 2005 (Kraines et al. 2005), where it was envisioned as part of a multi-tier system for distributed knowledge management in integrated environmental assessment. Given this interoperability challenge, the next section reviews existing knowledge models for LCA, including the above explicit semantic models, as well as the implicit models in established formats for LCI data exchange.

2.3.1 LCA data model

There have been previous efforts at developing ontologies and data models suitable for LCA. A review of these data models is presented in table 2.2, which is useful to help identify common elements of the supply chain and environmental LCA that may be used to develop a data model. The selected data models are the result of a key word search of Life Cycle Inventory, LCA ontology, data models, semantic web, process flow and data model for LCA through google scholar. The premium search revealed that there is little research in this field (less than twenty data models) especially on LCI modelling, and most of the data models are object-oriented with concentration on matrix presentation and hybrid analysis. The objective of this table preparation is not to compare the ontologies and data models, but to introduce them by a short explanation about their objectives and specifications.

Table 2.2 LCA data models

Data Model	Field	Specification	Objective
LCAO Ontology (Bräscher et al. 2007)	Environ.	Follow-up of Life Cycle Assessment (FLCA) according to ISO 14040.	Aimed at organization and retrieval of information, and a contribution to consensual vision.
Ontology for environmental impact assessment (Garrido & Requena 2011)	Environ.	For developers of EIA methodologies in order to give access to structured information so that natural language definitions are included.	For Environmental impact assessment to establish a conceptual framework and the building process.
A Semantic Approach to Life Cycle Assessment (Bertin et al. 2012)	Environ.	Based on the coexistence of two digraphs; (1) the detailed-graph, a transposition of the Input/output matrix. (2) the macrograph, containing dependencies between regrouped processes	A semantic approach for the modelling of life cycle inventory databases. The method has the advantage of offering a more comprehensible model.
Toward Collaborative LCA Ontology Development (Takhom et al. 2015)	Environ.	Integrated with rule-based knowledge, to provide user defined policies for LCI based on Data Quality Indicator (DQI) and as a collaborative environment	For knowledge engineers and domain experts to define the knowledge explication and recommendation rules based on usage scenario.
A new data architecture for advancing life cycle assessment (Ingwersen et al. 2015)	Environ.	Combines, stores, and annotates data for life cycle assessment. It will enables increased interoperability of LCA data and more structured and automated incorporation of non-LCA data into LCA models.	To map and store data from different sources and to clearly capture user-defined relationships between nomenclatures for easy use.

SPINE (Steen et al. 1995b)	Environ.	It is implemented as relational databases, such as MS Access, Oracle, and Sybase.	Allows for reuse of data through storage of data on an arbitrary level of aggregation, i.e. a whole life cycle (flow model of connected processes)
O-LCA Ontology (Takhom et al. 2013)	Environ.	Knowledge formalization in conceptual design based on description logic	Facilitates information sharing and discussion among domain experts.

In order to judge the quality and applicability of data models introduced in table 2.2, we need to know under which assumptions the model was conceived and how the inventory process itself was conducted. It concerns information such as goal definition, purpose, functional unit, system boundaries, practitioner, etc. All these are reasons for these models to be unique and objective which makes it difficult to choose and use one as a generic. The ontologies and data models discussed above all have strengths and drawbacks that depend on the interests and experiences of the researchers who developed them. However, while none of them can be considered to be fully adequate because of their object-oriented and rational approach that makes dealing with complex systems difficult. Another reason is the lack of a standard data model to cover the wide range of application. Nevertheless, because all the models are concerned with process-based LCA, they must have certain elements in common. These aspects could cause substantial uncertainty in the environmental impact calculations in LCA.

2.3.2 Uncertainty in LCA

If LCA is to be used throughout the design process, the degree of uncertainty involved in the estimations must be assessed and taken into account in the decision making processes during design without which the decisions might be unduly biased or incorrect (Björklund 2002; Kota & Chakrabarti 2010). Uncertainty assessment is necessary for better decision support, transparency and quality comparison. However, usually this is not carried out in LCA studies due to the additional effort needed and the lack of methods (Prins 1997). From a survey of LCA studies (Ross et al. 2002), it is identified that uncertainty introduced by the data and the methodology and the aggregation of data over different spatial and temporal scales are the main sources of uncertainty. While existing literature discusses

uncertainty in data and methodology; analyses of descriptive studies by (Kota & Chakrabarti 2010) identified further uncertainty in product structure and lifecycle phases. The four uncertainty categories are presented in figure 2.6 their propagation to the overall uncertainty.

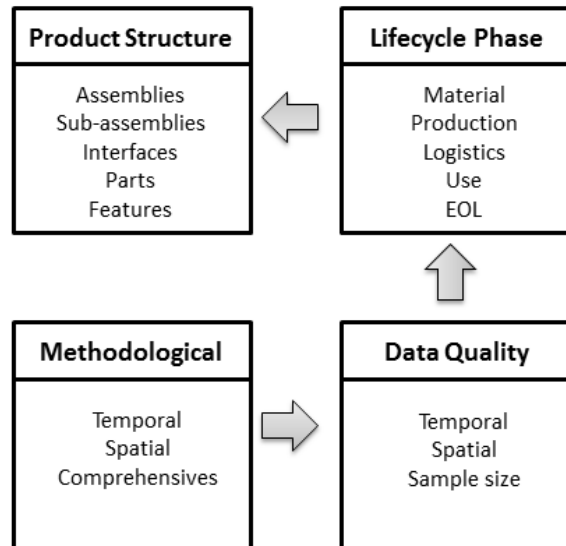


Figure 2.6 LCA Uncertainty propagation (Kota & Chakrabarti 2010)

Uncertainty about the structure of a product is related to its subsystems, parts and interfaces. LCA requires information about the materials and processes used in the lifecycle of the product. A product's structure fundamentally contains only parts and interfaces, each having various features. These parts and interfaces are hierarchically organized into groups called assemblies and sub-assemblies, where sub-assemblies contain only parts and interfaces while assemblies also contain subassembly or other assemblies. The uncertainty in the lifecycle-phases category is accounts for whether or not a designer considers individual phases (i.e., material, production, distribution, usage, or after-usage). The uncertainty in the data quality category can be in terms of the data being old (temporal), nonlocal (spatial) and the number of sources on which the data is based (sample size). The uncertainty in methodological choices can be in terms of being old,

being from a different region than where applied, and in terms of only some of the potential impacts being considered (Kota & Chakrabarti 2010).

2.3.3 LCA and geographical scales

In recent years there has been much discussion about how inventory data could relate to environmental impacts (Ross & Evans 2002) due to prediction of actual impacts. Geographical, temporal or technological differences are typical sources for uncertainty associated with inventory data in LCA; for instance, geographical and technological differences in lifecycle inventory data are shown to be major sources of uncertainty in LCA for processes in waste incinerators (Ciroth et al. 2002). Indeed, life cycles of a products cause release of pollutants at many different locations. The location of a given source and the conditions of its surroundings strongly influence the fate of the emitted. Nowadays, this source of variation is usually neglected in most LCA studies, although it has been realized for several decades that the pattern of impacts predicted by site-generic LCIA in some cases deviates significantly from the actual pattern of impacts, and that this may have serious implications for the validity of the conclusions drawn from the LCA (Potting et al. 1998).

Regionalization, in the context of LCA, is the recognition that industrial production characteristics and the environmental impact of environmental flows vary spatially according to the scale applied (Potting et al. 1998):

- Site-generic LCA. There is no difference in the locations of sources or receiving environment due to the lack of spatial information and the assumption of globally homogeneous effects.
- Site-dependent LCA. Some spatial information in sources and receiving environment determines the impact. Sources are typically defined at the level of countries or regions within countries (scale 50-500 km). The receiving environment is typically defined at 5 - 150 km.

- Site-specific LCA a very detailed spatial differentiation is performed by considering in sources and receiving environment at specific locations. This requires local knowledge about the fate, exposure and effect of a pollutant. The site-specific methods can be considered as the traditional modeling methods, which require a large amount of time, effort, and money.

The spatial information available for individual processes in LCA will typically support site-dependent impact modelling. For most processes, at least the country location will be known as this information is required to select the appropriate process technologies and, as part of the system delimitation, to develop transportation scenarios for the product system. The site-dependent level is thus the relevant level of spatial differentiation for most characterization modelling. When lifecycle assessment is going to be implemented at a site-dependent level, the complexity of the system will increase, because of a rise in flows and data analyzed. This is when the need to find tools to simplify the system emerges. Indicators capable of structuring and simplifying systems data can be one of these tools. The estimation of certain indicators often requires large amounts of precise data. In other cases, complicated estimation methods produce final numbers with no concrete sense/meaning. Integration of LCA with Material Flow Analysis (MFA) is an approach to decrease and manage the complexity of LCA in regional scale.

MFA (also referred to as substance flow analysis) is a widespread and standardized methodology accounting for the input and output material flows of a system, and for estimating their derived environmental indicators (Bringezu et al. 2004). All flows and indicators are measured in mass units, giving a physical quantification of the system's material requirements. The methodology has mainly been applied to countries and regions in order to analyze their social metabolism (Ayres & Ayres 2002), but not to industrial areas. At that scale it is more frequent to apply input output analysis, substance flow analysis and other similar methodologies (Hashimoto & Moriguchi 2004) and to apply environmental management accounting to companies. However, the added value in applying MFA at this level is the quantification of all material flows that will enable the

detection of critical points and reflect the state and evolution of the system's metabolism (Sendra et al. 2007). Combining the MFA and LCA techniques is useful, particularly in studies of complex systems that comprise numerous products and services, such as countries, cities, regions, economic sectors, and industrial or service polygons (Sanyé-Mengual et al. n.d.). The use of MFA allows for a macro-analysis of the metabolism. However, it does not allow for the calculation of environmental impacts or identification of hotspots in as much detail as LCA. Conversely, the stand-alone use of LCA in such systems is unfeasible due to the numerous products and services involved. Thus, combining the MFA and LCA methodologies can provide an in-depth and more synergetic analysis of the system metabolism than the individual use of these techniques.

The combined approach is new, and few studies on the topic have been published. (Venkatesh et al. 2009) applied the MFA + LCA approach in an urban infrastructure system to analyze the waste water pipeline network in Norway. In the construction sector in Spain (Fraile-García et al. 2015), MFA + LCA applied to evaluate five different facade construction systems. They used MFA to evaluate the total requirements and the ecological rucksack, and LCA to assess environmental impacts. With regard to waste management, (Wäger et al. 2011) used a MFA + LCA approach to study Waste Electrical and Electronic Equipment (WEEE), calculating the impacts of collection, preprocessing and end-processing for Swiss WEEE collection and recovery systems. (Kiddee et al. 2013) used MFA + LCA to evaluate toxic substances in WEEE and their potential environmental impacts, as well as waste management strategies adopted in various countries. In Colombia, (Rochat et al. 2013) used the combined MFA + LCA approach with multi-attribute utility theory to assess end-of-life scenarios for Polyethylene Terephthalate (PET) materials in the city of Tunja. Recently (Sevigné-Itoiz et al. 2014) adopted MFA + LCA to analyze the environmental consequences of recycling scrap aluminum in Spain (Silva et al., 2015). In another approach proposed by Azapagic (Azapagic et al. 2007) an integrated life cycle methodology was implemented to map the flows of pollutants in an urban

environment. To allow that to happen, the LCA–SFA methodology was integrated within a GIS platform.

In site-specific modelling a very detailed spatial differentiation is performed by considering sources at specific locations. Site-specific modelling allows increased accuracy in modelling of the impact at individual locations in the surroundings of the source, such as a particular factory or landfill. This typically involves local knowledge about conditions of specific ecosystems exposed to the emissions. After years of methodology development, none of the spatially differentiated characterization methodologies have yet been integrated into any of the major LCA tools, and site-dependent life cycle impact assessment is therefore still mainly applied with a sensitivity based approach focusing on the key processes of the product system. The additional requirements of the software development are limited; the database format for the life cycle unit processes typically already has a field for geographical information, and this needs to be linked to the choice of characterization factor. Moreover, not only we need to concentrate on these concerns, but also the properties of the environment where those events and processes take place (Steen et al. 1995a), which is another issue. It can be argued that the environment is inherent to a specific geographic area and both the inventory and the impact assessment phase of a LCA might be affected by site-specific conditions. Because environmental impacts in LCA are driven by the emission of substances into the environment, site-specific assessments are often necessary to deal with spatial variation, which refers to differences in geology, topography, land cover, and etc.

As different spatial scales may be selected for defining each of different variables, as well as for defining the process locations, it is fundamental in a regionalized impact assessment to be able to deal with multiscale systems without compromising the correctness of the results. To overcome this challenge, GIS can be used not only for the calculation of regionalized impact factors but also for creating site-specific inventories and matching each of these.

Recently the significance of geographical focus in LCA has considered by different researchers (Hauschild 2006; Bare et al. 1999; Pennington et al. 2004; Rodríguez et al. 2014) and OpenLCA v.1.5.0 (www.openlca.org) includes the functionality for handling GIS data (Figure 2.7). This approach is allowing the user to include this type of data in the process locations, as well as for defining site-specific impact factors in the method.

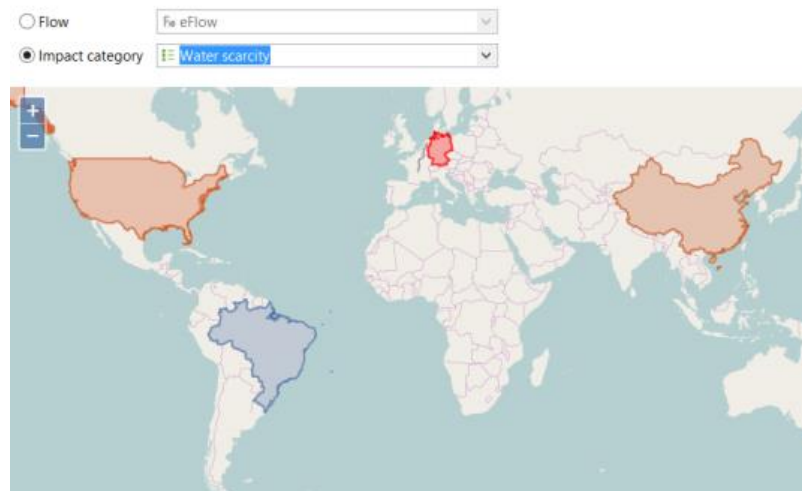


Figure 2.7 “Results map” tab in regionalized LCIA results editor (www.openlca.org)

In sum up, in fact in current LCA little attention is paid to the spatial aspects of emissions: the place where an emission is released and the area and or target system on which the emission has its impact. This lack of differentiation affects the relevance of the assessed impact (Potting et al. 1998). Many production processes, such as resource extraction or available products and materials, manufacturing locations, logistics and etc. are related to geographical locations. Whereas these spatially explicit aspects of varying locations are problematic for standard LCA they are quite straightforward with GIS technology. Varying geographical scales and features highlight the importance of coupling GIS with LCA. GIS can store observed data for specific locations (e.g., soil types, climate factors), and it can model new information from these data (e.g., potential crop yield) through empirical statistical analysis, mechanistic process models, or rule based logic

methods. GIS can also calculate regional summaries, such as total potential emissions or resource depletions (Geyer et al. 2010).

2.4 Geographical Information Systems

Geographers are concerned with the where, how, and why of the physical environment on which life is based, the spatial organizational structures erected and operated by human societies to sustain and promote their material well-being, and the nature of the places which they have created within those structures (Johnston 1999). In pursuing those interests, they have engaged with a variety of approaches to science, and applied their findings in a number of different ways. Geographic information is the data or information that identifies the geographic location of features and boundaries on Earth, such as natural or constructed features, oceans, etc. (Zeilhofer & Topanotti 2008). The natural environment is the primary concern of geographers by studying Earth's seasons, climate, atmosphere, soil, streams, landforms, and oceans. Cultural geography is the second concern by studying the distribution and networks of people and cultures on Earth's surface (Burrough & McDonnell 1998).

Geographical Information Systems (GIS) are based upon computer systems that enable users to collect, store, process, analyze and present geographical information. The basic data types in a GIS are spatial data and attribute data. Spatial data describe the absolute and relative location of geographic features (Maguire 1991). Attribute data describes characteristics of the spatial features. These characteristics can be quantitative and/or qualitative in nature. Attribute data is often referred to as tabular data. It provides an electronic representation of information, called spatial data, about the Earth's natural and man-made features, which can be separated into different layers for ease of maintenance, analysis, and visualization. Application of GIS, empowered by the falling price of workstations and increasing power of graphics, are beginning to make their way from urban planning (Walsund 2013), natural resource management (Zhang et al. 2010; Şener et

al. 2006), waste management (Vadoudi et al. 2015; Şener et al. 2006), science and technology allocation (Wu et al. 2014) and cartographic production shops into mainstream business (Prakash & Technology n.d.; Johnston 1999).

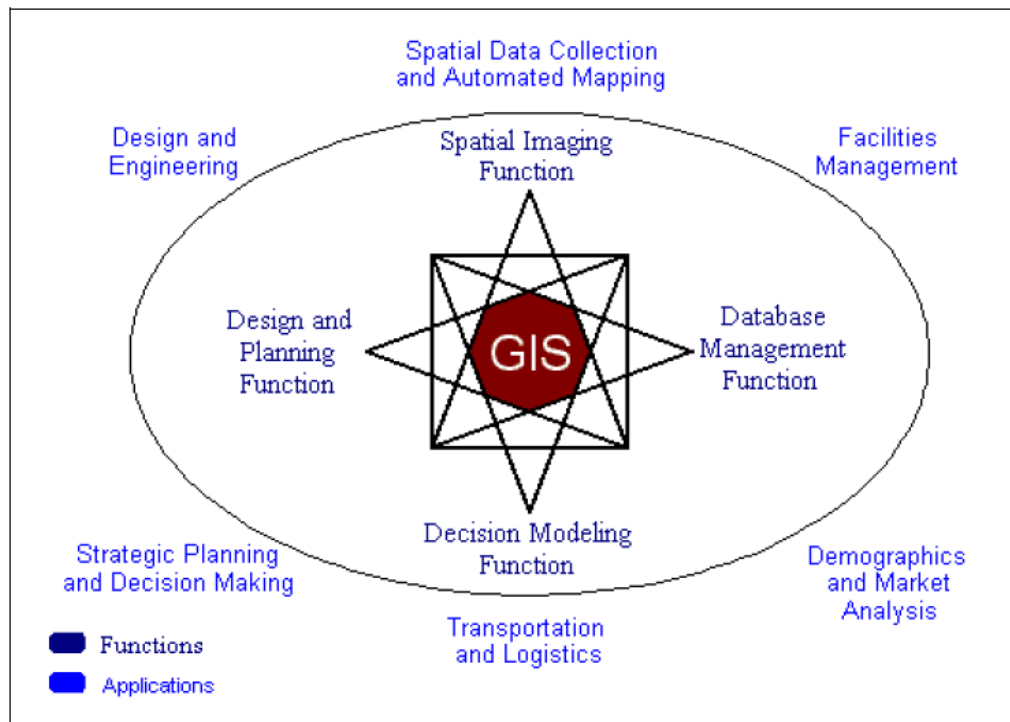


Figure 2.8 GIS Functions and Applications (Mennecke 1997)

While GIS made inroads into public service and natural resource management in the late 1980s, widespread applications in business (Pick 2005) have only recently emerged. The fact that businesses have begun to use GIS is not surprising, particularly given the fact that much of the data that organizations typically use include significant spatial components (estimates range between 50% and 85%) (Azaz 2011). Most organizations use these information systems for transaction processing, operations, inventory control, planning and decision-making, plus internal management and control. GIS can be used for these functions because this technology possesses capabilities that are common to traditional spatial information systems. These relationships are portrayed in a conceptual model of GIS (Figure 2.8) that portrays four GIS functions (spatial visualization, database

management, decision modelling, and design and planning) together with related applications. Spatial imaging refers to the fundamental GIS capability to represent displays of data and information within a spatially defined coordinate system. The database management function represents the capability of GIS to store, manipulate, and provide access to data. The decision modelling function represents the capability of GIS to be used to provide support for analysis and decision-making (Antenucci et al. 1991; Bracken & Webster 1989; Murphy 1995).

In order to represent geographic data in digital format and connect it with other systems, a geographic data model has to be created. Modeling the spatial aspect is important in the creation of a geographic database. Because it deals with an abstraction of geographic reality where the user's view of the real world varies depending on what he needs to represent and what he expects to gain from this representation (Borges et al. 2001).

It is worth saying a few words about the data that is used in GIS that must representing the real world in a digital format as vector or raster data models (Figure 2.9). A vector spatial data model uses two-dimensional Cartesian (x, y) to store the shape of a spatial entity. Line and areas entities are constructed by connecting a series of points into chains (lines) and polygons. The raster spatial data model is one of a family of spatial data models described as mosaics. In the raster world individual cells are used as building blocks for creating images of point, line, area and surface entities. Each entity can contain a value. For example the relief of the area can be modelled by giving every cell in the raster image an altitude value. In raster world the basic block is the individual grid cell, and the shape and character of an entity is creating by grouping of cells (Carver et al. 2006; Di Virgilio 2012).

The development of GIS applications involves data input, data management, data manipulation and analysis, and data output activities among geographic databases as the main component of a GIS. The function of this database is to structure and store data in order to enable the analysis to be carried out with spatial data (Lisboa-Filho et al. 2010). The main bottleneck in developing GIS applications is the characteristics of spatial

information and different functionality that users expect from these systems. Spatial data modeling allows dealing with these problems to be dealt with by better understanding the domain of the problem, thus enabling solutions to be found which satisfy the real needs of the user.

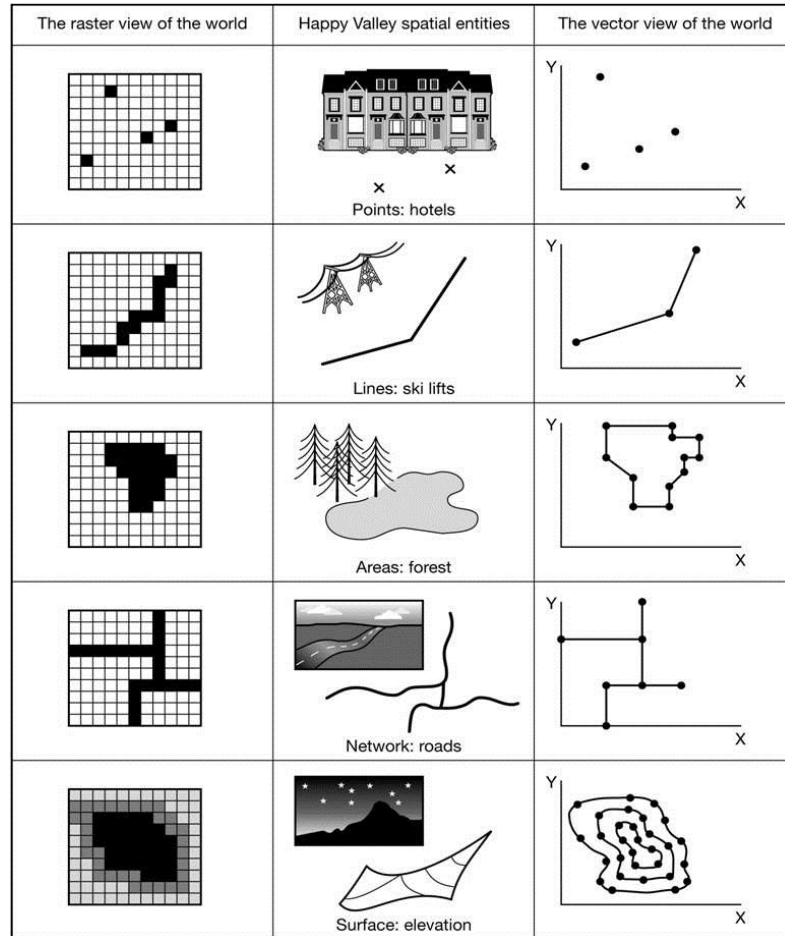


Figure 2.9 Raster and vector representation (Carver et al. 2006)

2.4.1 GIS Data Model

Two general modeling approaches for spatial data modeling have been adopted: the Entity Relationship approach and the object-oriented approach (Worboys & Duckham 2004). So far, the Entity Relationship approach has been the predominant; but as more application systems are becoming object-oriented. Table 2.3 represents existing data

models in the geographical field. It has been prepared by searching literature reviews on Google scholar by key words: GIS data model, conceptual modelling, spatial modelling, geographic database, GIS UML, GIS software design, object-oriented modelling and geographic application. Despite the proposed studies in this field, to date, there is no standard model meeting the requirements for modeling a geographic database. However, several models presented in this table, it is important to stand out the balance between coverage and simplicity of these models. As indicated by objective and specifications, some models define a large set of elements trying to be general enough to be applied in several domains, but usually, they are too complex to be used by users and developers. Other models are simpler and easier to use, but are restricted and it is necessary to include some additional textual information to describe a specific domain.

Table 2.3 GIS data models

Data Model	Field	Specification	Objective
Geo-ER Model (Hadzilacos & Tryfona 1997)	Geo.	By modeling the concepts of position and space-dependant attributes of geographic objects. Entity relationship approach.	An extended ER model to capture spatial particularities at the conceptual level of geographic database design is presented.
GeoOOA (Kosters et al. 1997)	Geo.	Object-Oriented approach, without thematic aspects. It includes partial spatial and temporal aspects.	With suitable geo-primitives which allows an adequate treatment of GIS-specific requirements.
GeoFrame (Lisboa et al. 1998)	Geo.	Relies on an extension of the UML that can also be used to define new analysis patterns for geographic applications.	Serves as a starting point for the conceptual modeling of geographic databases.
MADS (Parent et al. 1998)	Geo.	Includes the features of the ODMG standard model for object-oriented systems, with respect to traditional entity-relationship modeling. A visual schema editor and a visual query editor are being developed. Includes temporal aspects.	In an application context of land management and planning, Orthogonality between the structural and the spatial dimensions. It allows topological relationships between objects to be explicitly described.
Visual modelling of spatial databases: towards spatial PVL and UML (Bedard 1999)	Geo.	Plug-in for UML, which is implemented in a CASE tool called Perceptory	Support for spatiotemporal properties that are aligned with the ISO-standards for geographic information
OMT-G (Borges et al. 2001)	Geo.	Includes tools to specify transformation process and presentation. Without temporal	Provides primitives for modeling the geometry and the topology of spatial data,

		aspects.	supporting different topological structures, multiple views of objects and spatial relationships.
Conceptual model for spatial data cubes (Boulil et al. 2015)	Geo.	Generating different logical representations of the SDW (Spatial Data Warehouse) model (star schema and snow-flake schema). Implementing complex SOLAP analysis indicators using MDX	A tool for the automatic implementation of conceptual spatial data cube models, designed using profile, in SOLAP architecture.
Discovery of complex geospatial features (Yue et al. 2013)	Geo.	Using spatial semantics among elementary features and thematic semantics among feature types, workflow-based service.	A workflow- based approach for discovery of complex geospatial features that uses geospatial semantics and services.
GeoProfile (Lisboa-Filho et al. 2010)	Geo.	Temporal aspects on MADS, Spatial aspects on OMT-G and UML- GeoFrame	For the conceptual modeling of geoDB taking into account the requirements imposed on this application domain.
UML GeoFrame (Lisboa-Filho et al. 2010)	Geo.	Based on the class hierarchy defined in the GeoFrame framework	Used at the planning level to identify themes related to the geographic region, allowing a top-down approach to the problem.

Tryfona and Jensen developed an icon-based extension to the ER model, that includes spatiotemporal entities, attributes, and relationships (Hadzilacos & Tryfona 1997). Bedard developed a spatial and temporal plug-in for UML, which is implemented in a CASE tool called Perceptory (Bedard 1999). UML is a modelling methodology commonly used in object oriented software programming to support planning and code generation activities (Thomas 2003). Further, UML is a comprehensive tool for system modelling. There are several kinds of diagrams available in the UML methodology (Hadar & Hazzan 2004), but class, and object diagrams are utilized because we are addressing information from three different areas (Product, Environment and Geography). The class diagram graphically illustrates the database structure while the object diagram graphically illustrates the instances of the classes with the actual relationships.

Perceptory is an extension to UML based on stereotypes (icons) and adds support for spatiotemporal properties that are aligned with the ISO-standards for geographic information (Brodeur et al. 2000). Price et al. developed a spatiotemporal extension to UML by adding a set of constructs that can be applied to classes, attributes, and associations (Price et al. 2002). Borges proposed OMT-G for defining spatial data integrity

constraints (Borges et al. 2001). OMT-G is a spatial extension to OMT supporting both entity-based and field-based data (Borges et al. 1999). Each of the proposed models, though, presents limitations that can make the specification of analysis patterns more difficult. For example the GMOD model (De Oliveira et al. 1997) supplies quite a complete class diagram, but some characteristics make this model unnecessarily complex for the definition of analysis patterns of geographic databases. Furthermore, the approach based on instances specification for user created class diagrams results in quite a large final schema, thus reducing their readability (Iochpe 1999).

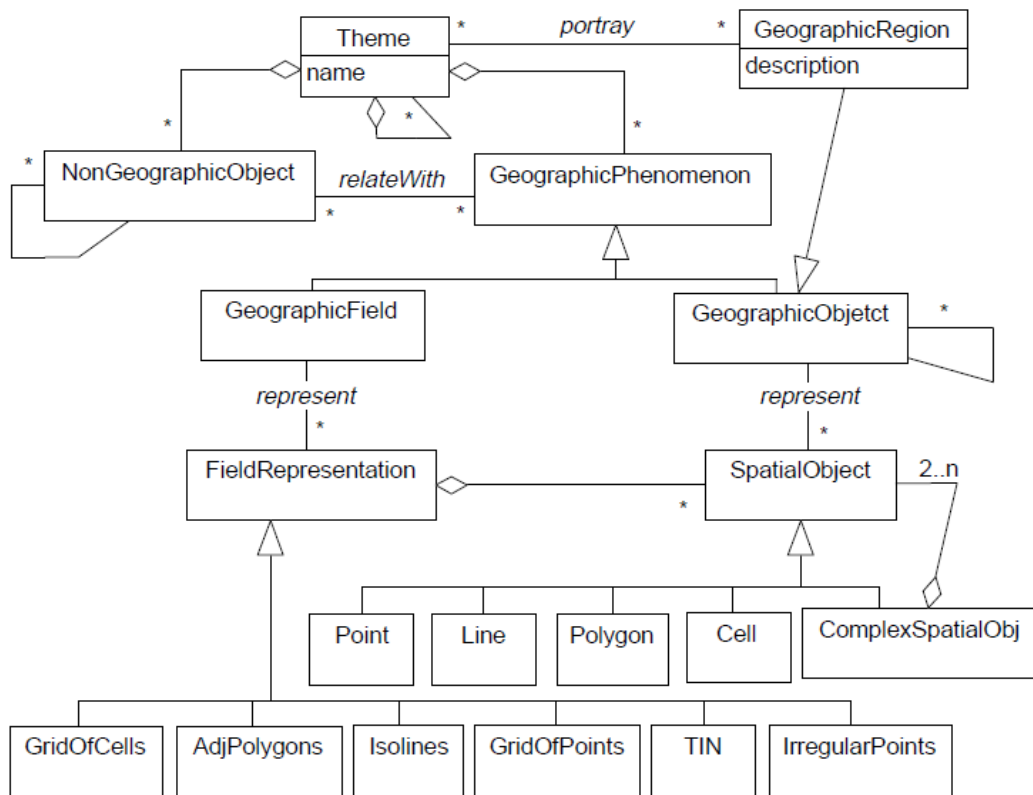


Figure 2.10 GeoFrame class diagram (Iochpe 1999)

Among these models we believe GeoFrame (Iochpe 1999) is a standard model, which meets the requirements for modeling a geographic database and could be used in different domains because of its simplicity and genericity that makes it easy to learn and to use. The genericity of this model is important due to the fact that GIS application designers have

different backgrounds (e.g., cartographers, biologists, and architects), and usually have little knowledge of software development methods. Moreover, this model is presented as an UML extension for class diagram specification as well as analysis patterns description for geographic applications. GeoFrame is a conceptual framework that supplies a diagram of basic classes in order to assist the designer in the conceptual modeling of geographic phenomena as well as in specifying analysis patterns for geographic databases. Its class diagram is an evolution of a basic class library that has been developed to be used as a starting point for the conceptual modeling of geographic applications (Borges et al. 2001). GeoFrame class diagram (Figure 2.10) includes Theme, GeographicObject, GeographicRegion classes that could play important role in connecting GIS data model to ecospheres and technospheres.

Theme Class does not necessarily entail the implementation of a data layer in a GIS. A theme defined during conceptual design can lead to the implementation of several layers. This issue depends on the software used as well as on the user's needs. The use of themes allows the designer to divide the schema into cohesive sub-schemas, in which classes that are strongly related to each other are put together. GeographicPhenomenon Class generalizes any phenomenon whose location in relation to the earth's surface is being considered. Therefore, a geographic phenomenon is a phenomenon that requires two descriptors: "what is present, and where it is." The class GeographicPhenomenon can be broken down into two subclasses; the classes GeographicField and GeographicObject which are allowing to the designer to specify in a distinct way, the geographic fields and objects, respectively. GeographicObject Class is a generalization of all classes of the domain that are perceived in the object view. Each class mapped like this class, generates at least one layer inside the corresponding database, whose spatial representation is defined according to the representation's stereotype. The attributes defined in the class are mapped as a field of rational table. GeographicRegion Class can be defined by physical characteristics, human characteristics, and functional characteristics. Regions tend to be based on natural features such as ecosystems, biomes, drainage basins, mountain ranges,

soil types. NongeographicObject Class generates directly one relational table. Objects are classified as Non-geographic exactly for having no spatial representation. Another contribution of this model is the proposition of a method for the conceptual modeling of geographic phenomena. Most of the models proposed in the literature deal only with phenomena in the object view. The inclusion of classes such as Point, Polygon, Grid of Cells in the class diagram is related to the form of perception of the spatial component of each geographic phenomenon and not to the data structures used to store those data in the GIS.

GIS has the ability to bring together so many data sets into one simple to use graphic and database format which makes it quick and easy to compile, manipulate and present information, to a broad range of decision makers. There are already many projects around the world where GIS and digital mapping are being used to manage competing interests, particularly in developing nations where environmental protection of delicate ecosystems is a key to public health, but development is a key to economic growth, and sometimes these things are in conflict (Longley 2005). Most importantly, GIS maps are interactive and for the end user, a visual image is the best output. Not only can we manage sustainability with GIS, but in turn it also helps us to see the individual needs of the various ecosystems around the world. In fact, economic, social, and environmental processes are inherently spatial, which cannot be fully understood without taking into account their spatial dimensions. The relationship between man and the environment cannot be represented without a reference to a special location, because the environment is described by the topological relationships among physical objects and human activities producing spatial impacts on the environment spatially (Campagna 2005).

Review of related works throughout section 2.2, 2.3 and 2.4 indicate that current PLM solutions for supporting DfS often still are often inadequate for the management of product design information due to two major problems. (1) There is a lack of specificity for implementing sustainability in different territories. It means sustainable development, which is implemented in one region, is not necessarily sustainable elsewhere. (2) Most of

the existing tools based on LCA that use a PLM structure do not focus on design due to the high level of uncertainty, since they are set up for a strategic management or a retrospective analysis of existing products. These sources of uncertainty are usually generated by empirically inaccurate parameters in the life cycle inventory LCI caused by not considering the territorial characteristics. These two major problems could oblige industries not only to think about product and process dimensions, but also to consider territorial differences in their product development strategies by including geographical knowledge as the third dimension.

2.5 Problem formulation

The research carried out in this thesis aims at contributing towards understanding the relation of geographical data to product data, in order to build a geography based information support for design for sustainability (DfS). The scientific aim is focused on identifying the way, how to consider geographical features in the early design phase and to see how these features, could change design specifications.

This research is based on a qualitative approach, because this research question of this study could not be answered applying quantitative methods. There are two reasons for this: (1) It is largely exploratory in nature, and (2) the purpose is to gain general insight into a topic on which little literature exists. In fact the character of this study requires access to profound expert information on the topic which could not be answered through a standardized questionnaire with predetermined answer categories as used in quantitative research. The aim is not to quantify or measure something, but to improve our understanding of a phenomenon by obtaining information through existing literature, experts on critical experiences and critical incidents.

We identified that including geographical features is considering a new kind of strategy for product design for DfS. Therefore, we were looking for a fundamental solution and we identified support of GIS as an advanced information technology to integrate and

coordinate with PLM to support various life-cycle considerations during product development activities. Subsequently, we reflected on the realized that product modeling is the central issue in the information technology, since it generates an information reservoir of complete product data to support various activities at different product development phases. Therefore, we concluded that a product model combined with geographical and environmental data was the key factor in determining the success of the new product development strategy. Later, supportive descriptive literature searches about data models related with product, geography and environment were carried out (Table 2.1, 2.2, 2.3) to identify the specifications of data models and their possibilities of integration with each other. Results obtained from the literature led us to investigate on perspective literature (Step 3) focusing on existing combined data models and ontologies.

Although each of the product, environment and geography aspects has a somewhat different focuses and approaches, they all share one fundamental requirement which is the need for advanced information technologies to integrate and coordinate them during product development activities. Central issues among these necessary information technologies are data models, which generate a complete information reservoir of product, environment and geography data to support various activities at different categories. Figure 2.11 presents diagram that illustrates the existing researches on GIS, PLM and LCA data model mainly reviews as three independent fields.

In order to relate products to environment and geography, data models need to be combined between these categories. Other sources of information will be presented in chapter 2. However, the state of the art on existing combined data models between product & geography, product & environment, environment & geography and product, environment has to be more deeply understood in order to analyze how an integrated framework for DfS could use an integrated view of those three fields. For that, we assume that geography will help to link the product and its environmental impact considerations in the design process. The intention is to study these proposed data model and propose a

comprehensive data model which could relate product to geography through the environmental impacts.

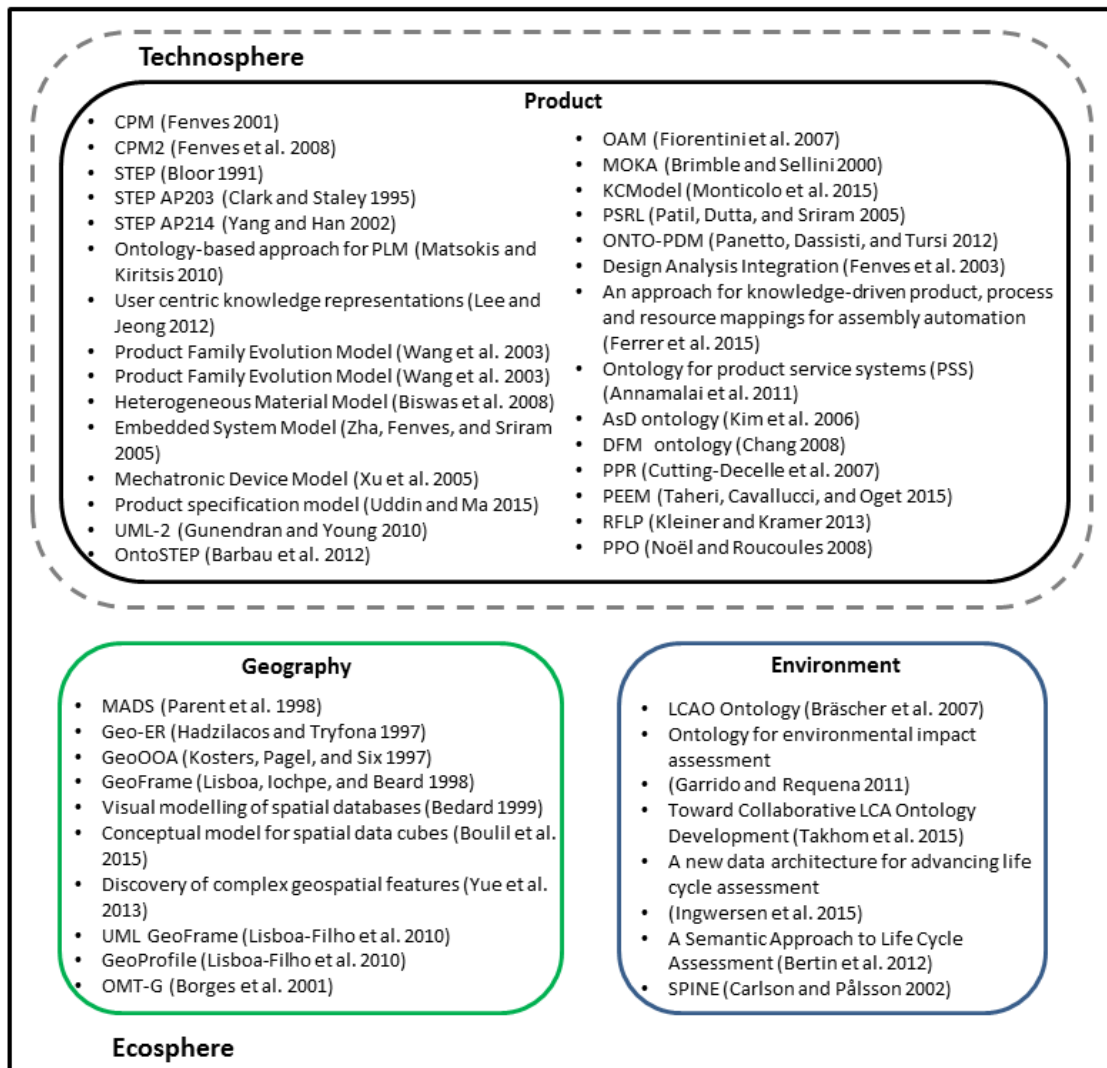


Figure 2.11 Product, environment and geography data models

2.6 Research question and hypothesis

Based on the literature review and scope of this research, the following research question is proposed.

- What is the link between information concerning product design and geography for DfS? What is the role of the environment in this link? More particularly, where is the place for LCA in PLM's IT structure?

In fact we assume that technological and geographical aspects are not independent and a change in the geographical features and environmental status of ecospheres would change technological systems. But we do not know how these differences would change design choices, especially in terms of products structure. Implementation of this approach in product and system design will require geographical information about related ecosphere (s).

Chapter 3

Data models to link techno & eco spheres

Literature reviews helped us to understand the current situation within the design for sustainability, and identify the factors that led to this situation. The study is review-based, and relevant literature is searched to identify and find the evidence of a problem, or a proposal attacking a particular problem within the design based on geographical features and environmental status.

As explained by Blessing and Chakrabarti (2009, chap. 3), it is important to look at disciplines other than one's own field of research for interesting theories, studies, methods, and concepts that could be relevant. Therefore, a number of potentially relevant areas, including those that are not directly related to the research topic of this thesis were looked at, such as data models, ontology, Unified Modeling Language (UML), and CAD. Figure 3.1 shows the Areas of Relevance and Contribution diagram (ARC) (Blessing & Chakrabarti 2009). For developing this diagram, we draw “Sustainable Development” oval which carrying the research topic and research question. Later we draw “Product Lifecycle Management”, “Environment”, “Geography”, “Design” and “Computer Support” areas that could be relevant for the research topic in providing possible information and supports. And finally we identified the specific topics within the disciplines that seem relevant. The areas and their relations are the results of our understanding from literature and the objective of the research.

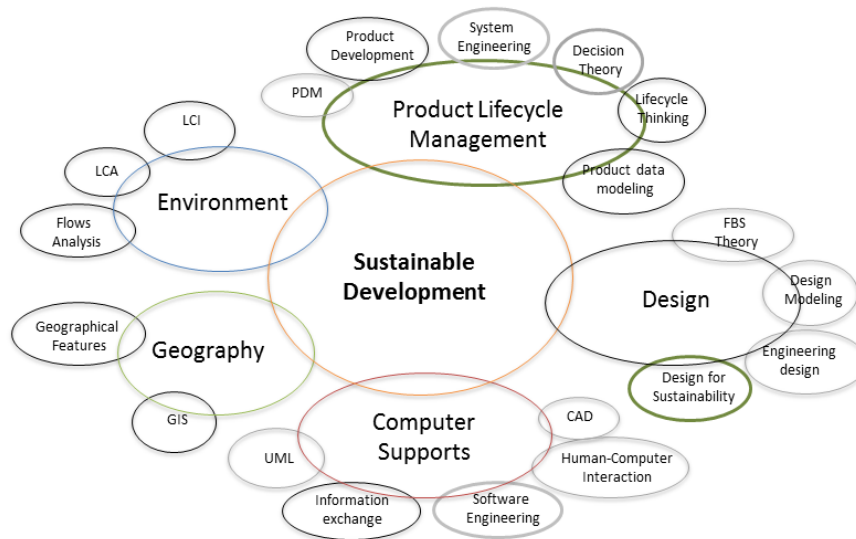


Figure 3.1 Setting up the ACR diagram

Useful areas are those which are not directly related to the topic of this thesis, but worth searching for concepts. Other areas include those directly related to the topic of this thesis (essential areas), and the ones in which scientific contributions are expected (areas of contribution).

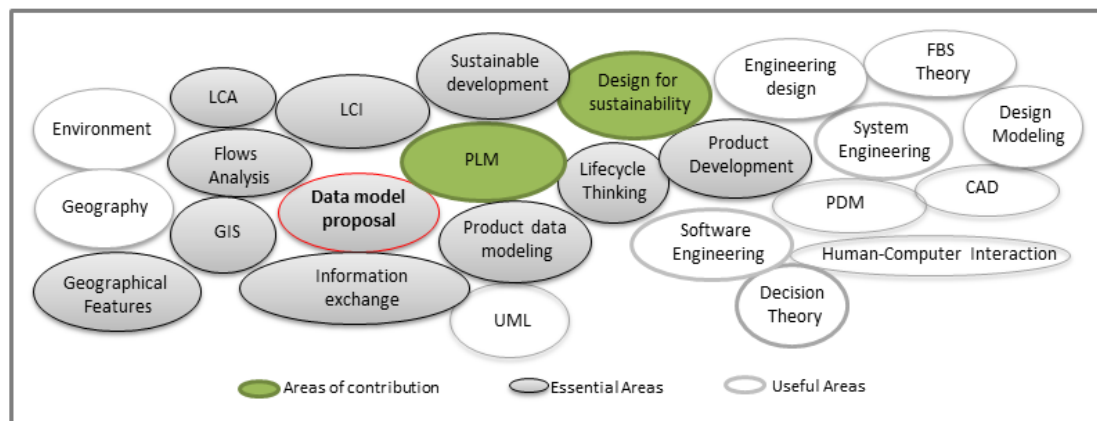


Figure 3.2 ARC diagram (Blessing & Chakrabarti 2009)

In figure 3.2 we present ellipses with their relation to the topics of this thesis and a “data model proposal” ellipse as the main subject area, which is driving the literature search.

At the end of chapter 2, we argued that we expected a relation between technological and geographical aspects and the modification of design characteristics and specifications of technologies based on these differences, but we lacked knowledge about “What is the link between information concerning product design and geography for DfS?” Moreover, we insisted on the importance of data modelling as the main driver of this required information, to generate an information reservoir of complete product data to find and support geographical information through various activities at different product development phases.

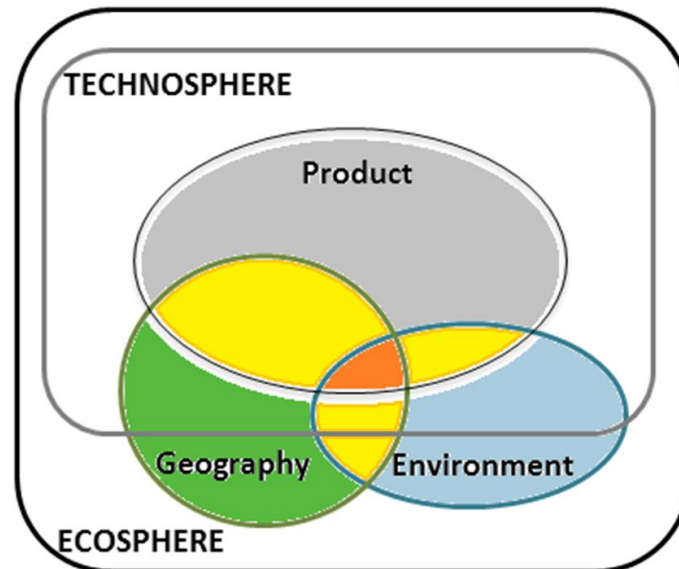


Figure 3.3 Combined data model between product, geography and environment

In this chapter first we discuss about the state of existing combined models product/geography/environmental (yellow and orange parts of Figure 3.3). This literature review analysis methodology of existing combined data models is an approach to answer our general question; “What is the link between information concerning product design and geography for DfS? What is the role of the environment in this link? More particularly, where is the place for LCA in PLM’s IT structure?”

LCA-PLM ontology, LCA and GIS integration, Semantic presentation of combined product data model, environmental consideration, ontology based sustainable development, ontology for environment assessment, LCA-CAD integration, GIS and urban planning, ontology for eco-design, LCA and spatial modelling and GIS for land use are the keywords used to search Google scholar and Science Direct. In the next section, four categories of combined data models are presented: Integration between product and environment, integration between environment and geography, Integration between product and geography, and finally integration between product, environment and geography.

3.1 Combined data models

Among the research on the development of information models, some of the following integrated models have been addressed.

3.1.1 Integration between product and environment

Table 3.1 presents the existing data models integrating product and environmental impacts with different objectives of: accommodating standard development in design and manufacturing with their requirements for LCA; to support eco-concept; to capture environmental data from the whole lifecycle and etc. The goal of preparing this table is to highlight the existing data models by giving a short description in terms of their characteristics and objectives.

The first LCA ontology project was designed under Project CASCADE (Cappellaro et al. 2002) in the standard data format guideline in ISO14048 (SO/TS 14048:2002). This data format ontology aims to accommodate standard development in design and manufacturing with their requirements for LCA. (Bertin et al. 2012) presented a semantic approach to LCA knowledge in 2012 where it is applied to energy environmental impact data management. This LCI ontology consists of economic activities considered as elementary

processes linked together through interdependency relations. LCI can also be semantically represented as manipulatable databases using relational algebra.

Table 3.1 Combined data models between product and environment

Data Model	Field	Specification	Objective
CASCADE (Cappellaro et al. 2002)	Product & Process & Environ..	In the standard data format guideline in ISO14048. The project achievements are delivered in LCA ontology OWL, a W3C recommended ontology language.	The data format ontology aims to accommodate standard development in design and manufacturing with their requirements for LCA
Ontology-based process-oriented framework for eco design (Lin et al. 2013)	Product & Process & Environ.	The Design Chain Operations Reference model (DCOR) and the design structure matrix (DSM) are used to describe and classify the process with an eco-design dimension.	To support the product development with an eco-design concept
CPMe³ (Kozemjakin da Silva et al., 2013)	Product & Process & Environ.	The heart of the model is the link between Flow, Process, ProcessPlan, Product and Artifact. CPM extension.	A formal model allowing capture the data from the whole product's lifecycle with a link to the environmental evaluation.
LCA-oriented semantic representation for the product life cycle (Zhang et al. 2015)	Product & Process & Environ.	Product lifecycle processes, flows and the semantic relationships between them are analyzed in detail. SemanticWeb technology is introduced into the LCI modeling for the product life cycle,	It can adequately represent the information of the product life cycle for an LCA study and provide more advantages than traditional modeling methods in the interoperability, scalability and the knowledge processing.
Life cycle management of production facilities using semantic web technologies (Harms et al. 2010)	Product & Process & Environ.	Distributed semantic web knowledge bases enable companies or networks to make knowledge explicitly available to all involved agents at the right place and on the right time.	A semantic web based approach for the life cycle management of production facilities, which verifies it on a reuse planning
Ontological framework for enterprise sustainability (Muñoz et al. 2013)	Product & Process & Environ.	Represents a step towards supporting the integration of various software tools applicable to the management and exploitation of plant data.	Sharing knowledge models for the environmental assessment of the enterprise.
Integrating CAD, PLM and LCA (THERET et al. 2011)	Product & Process & Environ.	Three software prototypes will be presented based on the ENOVIA v6 PLM platform (by Dassault Systèmes) and Simapro, openLCA and the ReSICLED recycling tool.	Data pattern mapping and the materials and processes reconciliation between PLM and LCA databases will be detailed with the benefits to support "Design for Environment"
Integrated Product Information Model (IPIM) (Roy & Sarigecili 2016)	Product & Process & Environ.	Comprised of three sub-models: (1) information model for the product's structure (form and structure); (2) information model for the product's performance requirement specification; and (3) information model for the product's function and behavior. CPM based.	For organizing and managing material and manufacturing related information, required for any product realization.

Ontology-Based System for supporting Manufacturing Sustainability (Giovannini et al. 2012)	Product & Process & Environ.	Concepts of product, processes and resources are associated to functions and sustainable manufacturing knowledge	To automatically identify change opportunities and to propose alternatives on the basis of the existing production scenario.
------------------------------------------------------------------------------------------------------	------------------------------	------------------------------------------------------------------------------------------------------------------	------------------------------------------------------------------------------------------------------------------------------

In these different models, some of them concentrate design intention on eco-design by including flow analysis and environmental aspect throughout the product life cycle. These models are explained in details below.

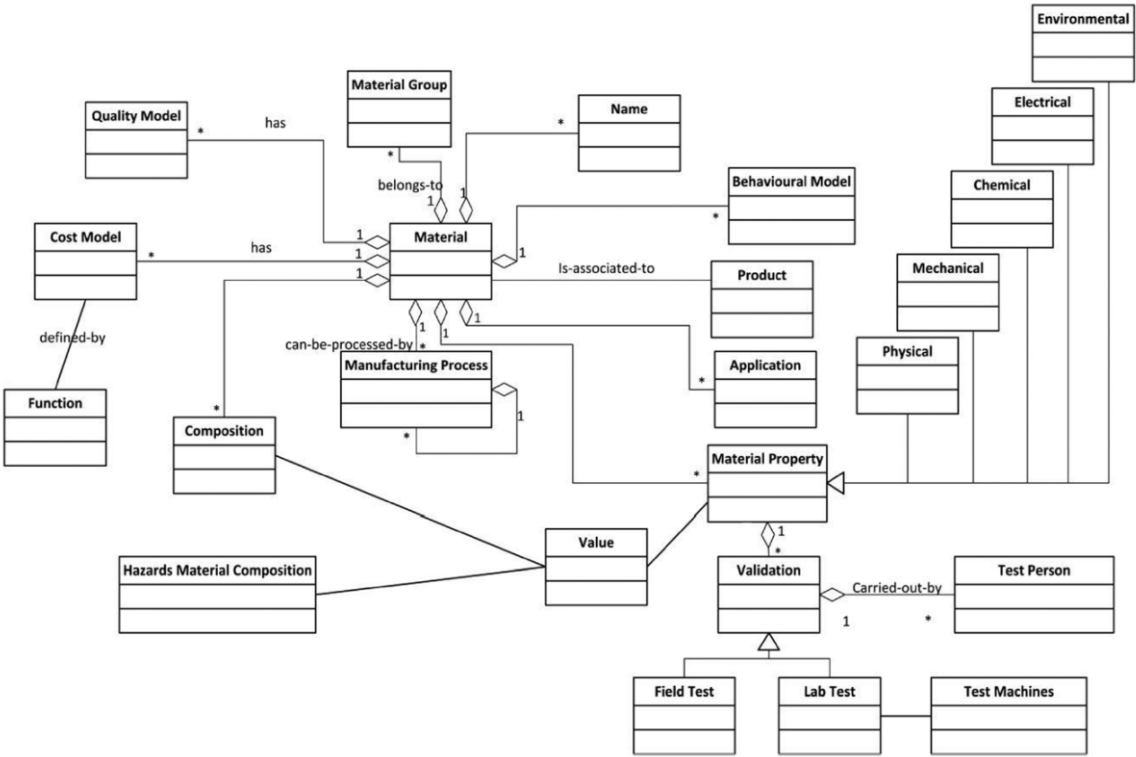


Figure 3.4 MIM model (Roy & Sarigecili 2016)

MIM/IPIM model (Roy & Sarigecili 2016), based on CPM, is presented for Processing Product Lifecycle Functionalities and Interfaces for Sustainable Manufacturing. This model provides information about the form, i.e., the geometry and material selected for the intensifier, the function information to represent the design intent, the behavior information to represent the necessary engineering equations and the design rationale that helps

mapping the performance requirements to the required material indices used for the materials selection process. As shown in Figure 3.4, the MIM has three major informational components: (1) a structure-based property that manifests as its physical, mechanical, and electrical properties; (2) hazardous material composition, and (3) process-based material property like creep, fatigue limits, etc. This model highlights the importance of material selection and its relation to product, process and the environmental impact. Moreover, part of this model is influenced by CPM (Fenves 2001) which relates properties and behavior classes with material as part of the artifact. The contribution of this model highlights the relations between environment and product structure with related manufacturing process.

CPMe³ (Kozemjakin da Silva et al., 2013) is another model proposal based on CPM (Fenves 2001) for capturing and reusing eco-design knowledge to support LCA. The logic of this model is based on systems thinking, similar to the modelling logic of LCA software; Gabi ([Http://www.gabi-software.com](http://www.gabi-software.com)) and Umberto ([Http://www.umberto.de](http://www.umberto.de)). The heart of the CPMe³ model is the link between Flow, Process, ProcessPlan, Product and Artifact (Figure 3.5). The environmental impact is given for a Flow, so the impact of a Process is the sum of the impacts of the Flows. Consequently, the impact of a series of processes (ProcessPlan) is the sum of each Process' impact. Finally, the impact of a Product is the sum of the impacts of the ProcessPlan. The Product then, inherits the classes from CPM by being connected to Artifact. The other part of this model describes the lifecycle aspects. A Flow is classified by its nature, either material goods like Part, Assembly and Consumable&tools or immaterial goods like Energy or even a Substance. The main contribution of this model is its holistic view of the whole lifecycle of product. Moreover, it highlights the role of flows as a link between product, process and environmental impact. Using CPM as a base model in IPIM and CPMe³ models highlights the existence of relationships between product and environmental data model.

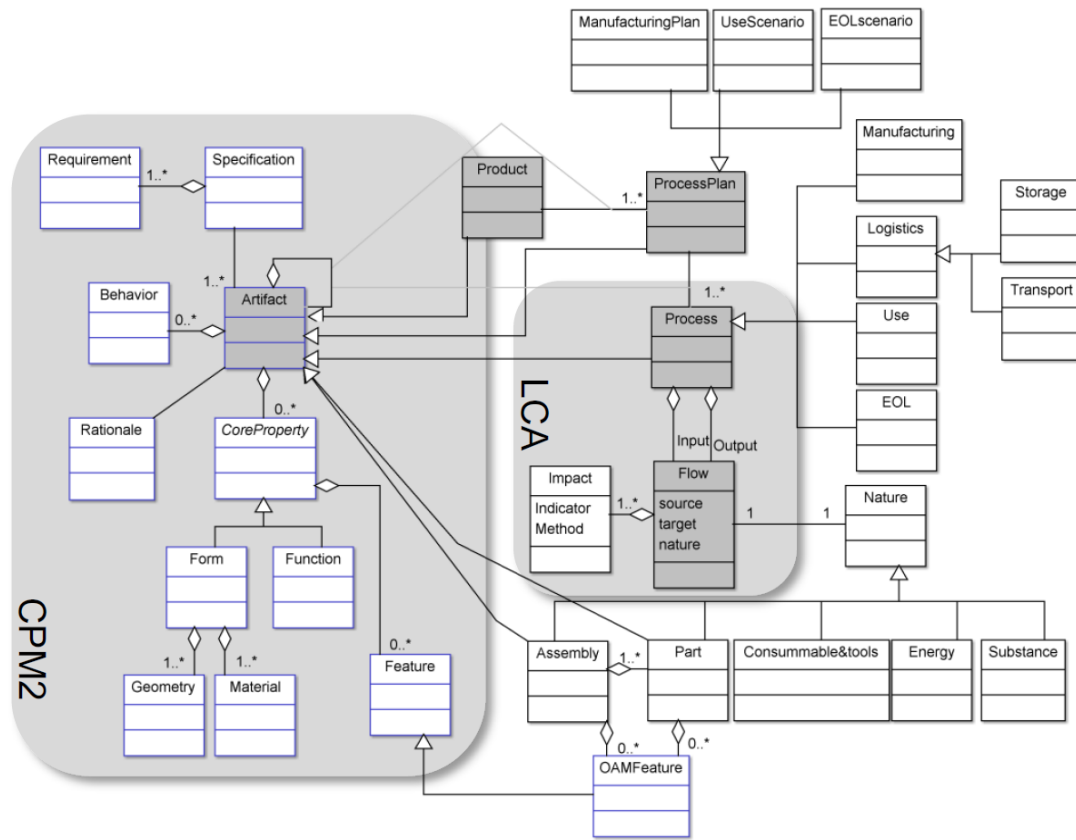


Figure 3.5 The CPMe³ extension to support eco-design (Kozemjakin da Silva et al., 2013)

Similar to the concept of the previous model, an LCA-oriented and ontology-based semantic representation model and methodology (Zhang et al. 2015) for the product life cycle has recently been proposed by Zhang et al. Based on the proposed semantic representation model, all processes, flows, and the relationships among them are represented as a Resource Description Framework (RDF) graph in which each node is an instance tagged by an ontology class (Figure 3.6). Moreover, studying substance flows in details and including unit with quantity of flows make this model more mature compared with the CPMe³ model.

In this semantic concept model, three top-level classes ProductLifecycle class, LifecycleProcess class and Substanceflow class are defined. The ProductLifecycle class is

associated with four life cycle process classes: ProductionPhase class, TransportProcess class, UsePhase class and DisposalPhase class. The LifecycleProcess class is associated with the Substanceflow class through the hasInflow and hasOutflow relation. At the same time, by means of the hasInflow and hasOutflow relation, and the intermediate product flow, the processes in the various stages of the product life cycle are linked to form a network of the process relationships. A node in the network denotes an instance of the process class or the flow class, and the arcs denote a hasInflow relation or a hasOutflow relation.

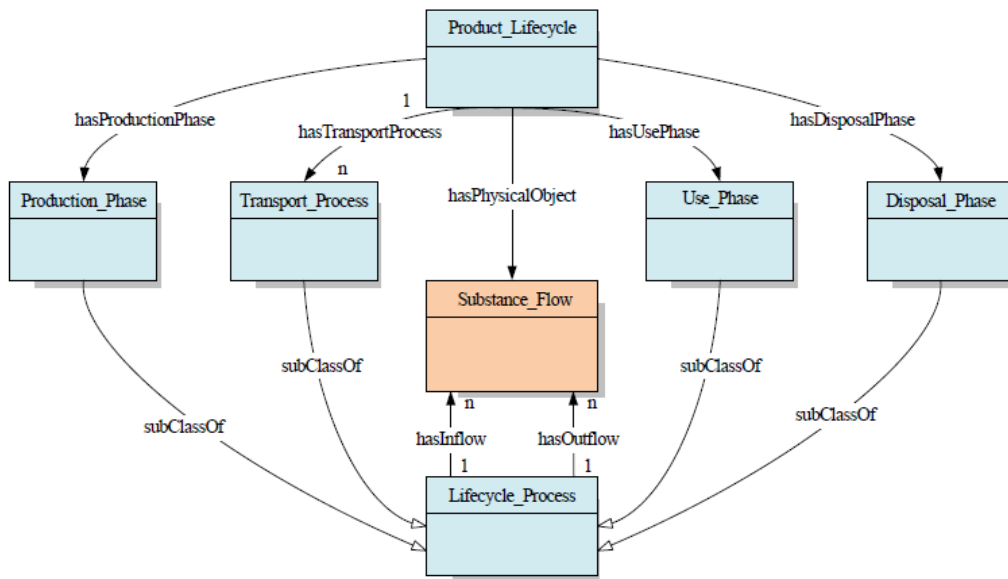


Figure 3.6 LCA-oriented concept model for the product life cycle (Zhang et al. 2015)

The SubstanceFlows class is defined as the base class of the flow ontology, which consists of three subclasses: ElementaryFlows class, ProductFlows class and WasteFlows class. Elementary flows are the foundation for calculating environmental impacts of a product life cycle which is classified into two subclasses of Resources class and Emissions class. Resources class itself has four further subclasses of MaterialResources class, EnergyResources class, Land class, WaterResources class, and Forest class. The Emissions class is used to describe all the output flows that exit the technological system directly to

the ecosphere, causing the environmental impacts. The Emissions class itself has three subclasses: EmissionsAir class, EmissionsSoil class, and EmissionsWater class. This data model proposal is the only model that analyses the environmental aspect of product life cycle.

Figure 3.7 summarizes the relation between product and environment in UML format based on analyzed data models. A color code is introduced to identify product lifecycle (Gray), environment (Blue), Substances flows (Orange), geography (Green) and lifecycle process (White) and will be used throughout the rest of the manuscript. The product's life cycle is collection of activities or processes. Each activity has input and output of substances flow, which are presented as two aggregation relations between ProductLifecycle class and SubstanceFlow class. Elementary flows, product flows and waste flows as sub parts of environment are the input and output result of different activities. This relation between environment and flows could be presented as an aggregation between SubstanceFlows class and Environment class. The result of product lifecycle activities with input and output flows makes the relation between product and environment.

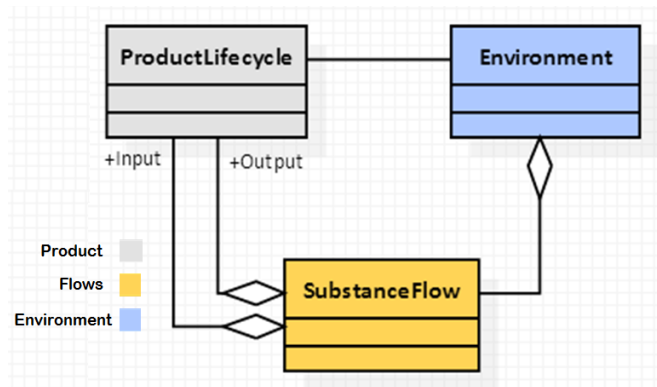


Figure 3.7 The relation between product and environment systems

A color code is introduced for data classes to identify product (grey), environment (blue), geography (green), interlink (orange) and process (white), and will be used throughout the rest of the manuscript.

3.1.2 Integration between environment and geography

Effective environmental management aims to achieve goals for optimizing resource use and minimizing environmental impact. Environmental management activities are closely associated to the character of environmental problems with a spatial nature that require a great deal of information and analytical capacity. The environmental application of GIS could support these problems by operations such as handling of coverage data (e.g., land use, land cover, geology and soils), handling of network oriented data (e.g., streams, water distribution systems) and handling of subsurface information (e.g., groundwater modeling). These systems may include models linked to GIS visualisation tools which could better help decision makers (Campagna 2005).

In terms of data models, there are not that much research in this field and Table 3.2 presents the existing literature. Of three models proposed, the Bengtsson model gives the relations between the LCA and geographical information (Bengtsson et al. 1998).

Table 3.2 Combined data models between environment and geography

Data Model	Field	Specification	Objective
Integrated geographical assessment of environmental condition in water catchments (Aspinall & Pearson 2000)	Geo. & Environ.	The focus on water catchments as hydrological systems leads to development of indicators based on analysis of spatial patterns and processes in the landscape.	To develop environmental models within a GIS for integrated assessment of activities and processes within water catchments for land management and planning.
An ontology for landscapes (Lepczyk et al. 2008)	Geo. & Environ.	A technique novel to ecology, to define 'landscape,' thereby clearly delineating one subset of its potential general usage. A checklist for landscape studies.	This approach provides a set of necessary conditions for landscape studies to reduce linguistic uncertainty, and facilitate interoperability of data.
An approach for handling geographical information in life cycle assessment using a relational database (Bengtsson et al. 1998)	Geo. & Environ.	The high level data model is expressed as relations between different entities using the entity relationship modelling language.	A data model has been developed to handle information relevant to site-specific LCA. The new data model provides the possibility of enhancing LCA and reach more relevant results emerge due to a higher site specificity

This model indicates that system model of LCA with the technical, environmental and social systems harmonizes well with an expansion covering geographically referenced data (Bengtsson et al. 1998). The technical system of LCA is aggregated from geographically described subsystems. The environmental changes caused by this system are calculated by use of geographically related data on both the technical and the environmental system. The impact assessment is calculated, or otherwise analyzed, by relating each environmental change at each geographical location to the information on each appurtenant local, regional or global attitude to this change (Figure 3.8).

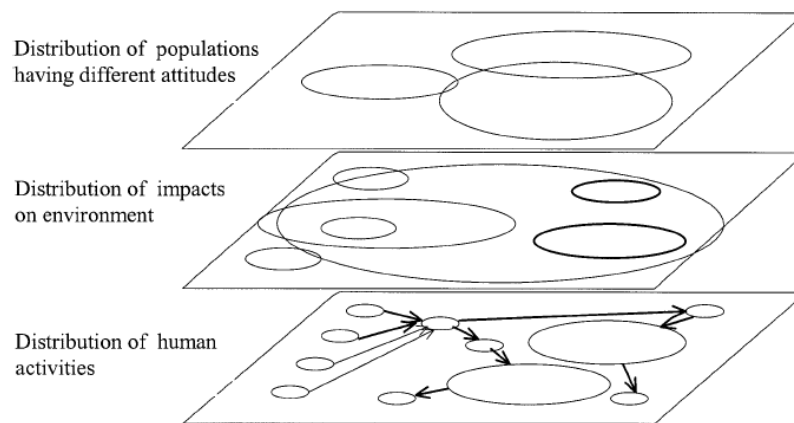


Figure 3.8 The three systems in LCA represented as GIS layers (Bengtsson et al. 1998)

Based on analyzed data models, the relation between environment and geography is illustrated as figure 3.9. It can be argued that the environment is inherent to a specific geographic area, shown by a composition between Geography and Environment Classes. Consequently it would suffice to state that each flow occurs in a geographical location with input and output of substances. Accordingly environment and geography could be chosen as separate and independent entities that supply complementary information about a flow.

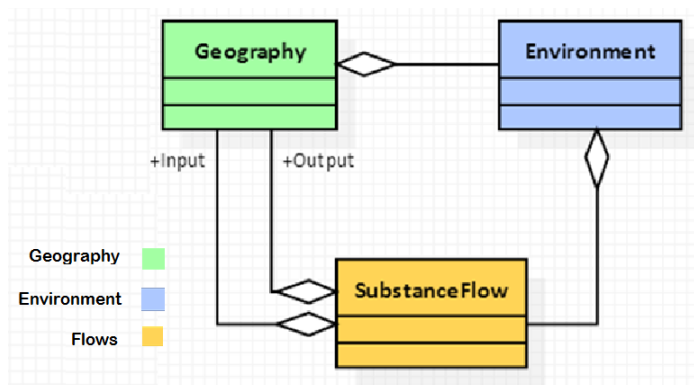


Figure 3.9 The relation between environment and geography systems

3.1.3 Integration between product and geography

The use of geographical indications may highlight particular qualities of a product, which are due to human factors found in the place of origin of the products, such as specific manufacturing skills and traditions. Public management have grown interest into GIS use has grown due to the needs of integrated city management and of providing urban quality of life. The agricultural sector is also showing its interest in using geographical information. Table 3.3 presents existing data models, integrating geography and technological systems. Few attempts have been made at research in this field, and in the following we present two of them that have much more relation with the use phase (marketing) and urban planning that is close to the concept of industrial ecology and smart cities.

Table 3.3 Combined data models between product and geography

Data Model	Field	Specification	Objective
Integrated land use and transportation interaction (Shaw & Xin 2003)	Process & Product & Geo.	A spatiotemporal GIS design. Provides a foundation for the development of spatiotemporal analysis functions to systematically explore land use and transportation interaction.	Offers exploratory data analysis capabilities to interactively examine land use and transportation interaction at user-specified spatial and temporal scales.
A UML Profile for Conceptual Modeling in GIS Domain (Lisboa-Filho et al. 2010)	Process & Product & Geo.	Unification of the various existing models, aiming primarily at semantic interoperability.	An UML profile developed specifically for conceptual modeling of geographic databases called GeoProfile.
An ontological	Product &	A query-based Methodology in	To support different

engineering approach for integrating CAD and GIS (Peachavanish et al. 2006)	Geo.	support of infrastructure management	architecture, engineering, construction and infrastructure management related processes.
Analysis Patterns for GIS Data Schema Reuse on Urban Management Applications (Lisboa Filho et al. 2002)	Process & Geo.	An analysis patterns' approach to improve municipal Management applications using GIS	Analysis patterns to reuse of geographic database design for urban area planning and management applications,
Ontology for construction concepts in urban infrastructure products (El-Diraby & Osman 2011)	Process & Geo.	A set of related constraints, mechanisms, actors and processes are identified along with products. (owed to the top-down modeling approach used)	Conceptualization of the essence of knowledge that relates to construction products. Product attributes and modalities are also presented to help describe the behavior of these products and support the generation of types or classes of these products.
Developing GIS based information system for manufacturing industry clusters evaluation (Zhang et al. 2012)	Process & Geo.	Integrating Gini, CR5 to provide a visual analysis for the development trends of wine industry clusters.	GIS-based information system for wine industry clusters evaluation

One of the many processes that is receiving special attention is the use of GIS that allow software components reuse through pattern definitions, mainly in the object oriented systems community. Lisboa Filho et al. proposed three analysis patterns applicable to requirement analysis and conceptual geographic database modeling stages (Lisboa Filho et al. 2002); Urban Street Mesh Pattern, Urban Street Traffic Network Pattern and Urban Zoning Pattern. The StreetTrafficNetwork class (Figure 3.10) has a complex spatial representation formed by traffic stretches and conversion nodes representation. This class concerns operations involving the whole network. Each traffic stretch may be associated with several road stretches, giving compact networks overlapping the whole area.

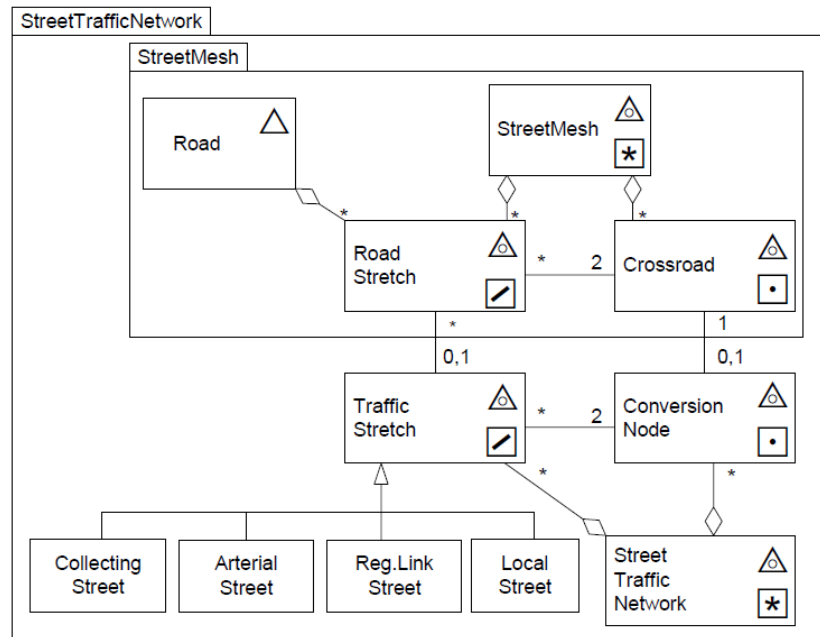


Figure 3.10 Urban Street Traffic Network” classes’ diagram (Lisboa Filho et al. 2002)

Boulil et al. proposed another data model as a UML (Unified Modeling Language) profile for modelling complex Spatial Data Warehouses and aggregations with a case study on business strategy which is an integration between product and geography (Boulil et al. 2015). In this model, decision makers are interested in the analysis of two aspects of their activities: the product supplies and the product sales. The Sales multidimensional model is detailed in Figure 3.11. As shown in this figure, sales subclasses are described as five classes of “price” (sales amounts), “quantity-sold” (quantities of sold products), “quantity-stock” (stock quantities of products), “costs” (sales costs) and “unit-price” (unit sales prices).

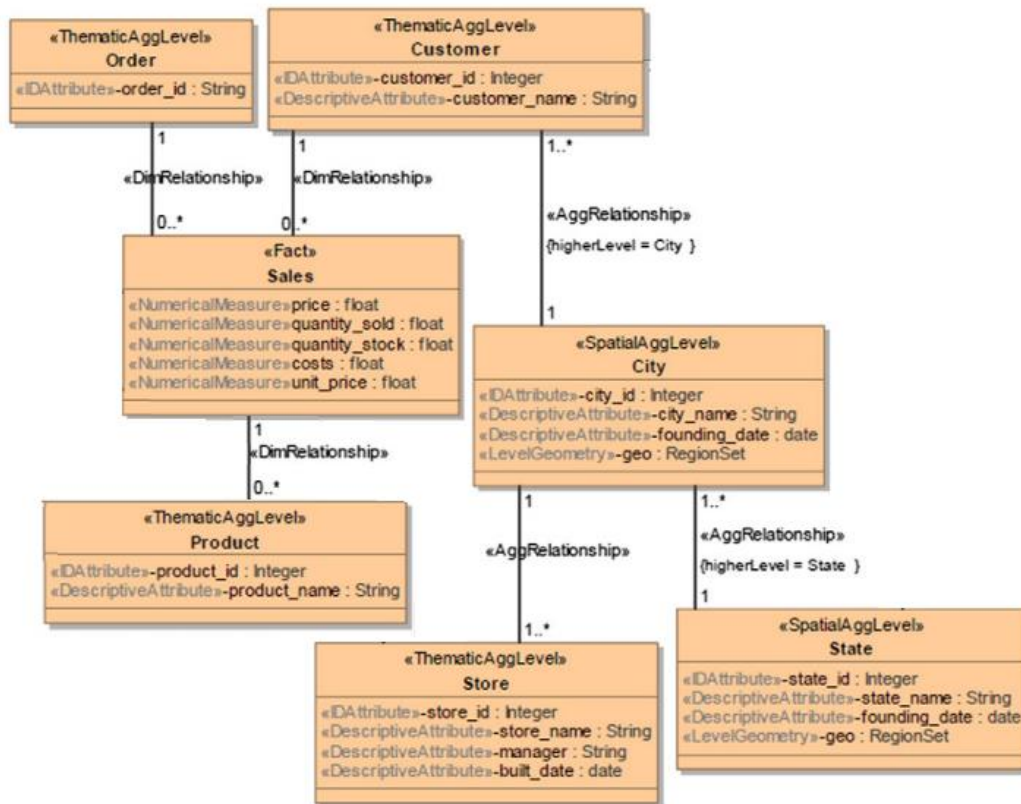


Figure 3.11 GIS presentation of the company's sale (Boulil et al. 2015)

There is not significant attention to the relation between product and geography in design aspects of the industrial product. GIS mostly is used as a tool to support urban management but is not the sole tool for achieving sustainable urban development. It should rather be seen and used as a support for decision making in the planning process, for evaluating different alternatives and for establishing realistic goals for future planning. Many analyses have to be made for economic and social sustainability in urban environments: population distribution; proximity to recreations centers; location of schools; flows of people and goods; demographics etc., but there is still no known method to combine all three pillars of sustainability on a regional scale. On this aspect, working on GIS in future research could support knowledge for decision makers both in sustainable urban and product development (Walsund 2013).

3.1.4 Integration between product, environment and geography

Nowadays, the combination between of LCA and GIS is used for agricultural products in order to provide an integrated methodology for determining suitable areas for cultivation. Agricultural products typically have qualities that derive from their place of production and are influenced by specific local factors, such as climate and soil. Huang & Deng build geo-ontology for agriculture products by virtue of some theories such as location theory and topology (Huang & Deng 2013). Although the content of agricultural information is very complex, all agricultural information is located in a specific geographic space, and possesses spatial variation. As a result, all agricultural information referring to geographic spatial distribution may be called as agricultural geographic information, which is related to environment characteristics of all kinds of natural resources and agricultural infrastructures. Table 3.4 presents the existing data model in this field.

Table 3.4 Combined data models between product, environment and geography

Data Model	Field	Specification	Objective
Agricultural Geographic Information Ontology (Huang & Deng 2013)	Geo. & Environ.& Product	Introduces mereology, location theory and topology, and then discusses how to adopt these three theories to build geo-ontology.	Specific map for agricultural
LCA-GIS integrated approach (Di Virgilio 2012)	Geo. & Environ.& Product	LCA was used to estimate impact indicators of some herbaceous food and energy crops, and was combined with vulnerability maps defined using GIS, through the calculation of “allocation risk” values for each crop vulnerable land combination.	To define a method to spatially relate crop impacts to the environment and then to include it in land suitability procedures.
Integrated land use and transportation interaction (Shaw & Xin 2003)	Geo. & Environ.& Product	A spatiotemporal interaction framework, implemented with temporal GIS databases, provides a foundation for the development of spatiotemporal analysis functions to systematically explore land use and transportation interaction.	A temporal GIS design that offers exploratory data analysis capabilities to interactively examine land use and transportation interaction at user-specified spatial and temporal scales.
Coupling GIS and LCA for biodiversity assessments of land use (Geyer et al. 2010)	Geo. & Environ.& Product	GIS-based inventory modeling of land use allows important refinements in LCA theory and practice.	GIS modeling was used to generate crop production scenarios for corn and sugar beets that met a range of ethanol production targets.

Agriculture is normally expected to be environmentally safe, as expressed in the “Directions towards sustainable agriculture of the Commission of the European Communities” (Communities 1999), which decreases attentions in terms of geographical and design considerations for all products. However, the same production chains located in different environments can give different results in term of yield production, incomes for farmers, cost efficiency, economic sustainability, etc. The integration of these two tools gives the possibility of increasing the environmental sustainability of agriculture by highlighting the importance of geographical features.

3.2 Product, environment and geographical relation

The state of the art in the previous section is summarized in figure 3.12, in order to answer the general question about the existing relations between geography, product and environment.

Existing literature indicates a strong relation between product and environment, mostly through LCA methodology. The relation between geography and technological systems is analyzed in terms of logistics, marketing and urban planning, without contributions to design aspects and the relation between geography with environment by regionalization of LCA (RLCA). Concerning product, geography and environment relations, the main thrust of the limited research which has been done is on agriculture based products.

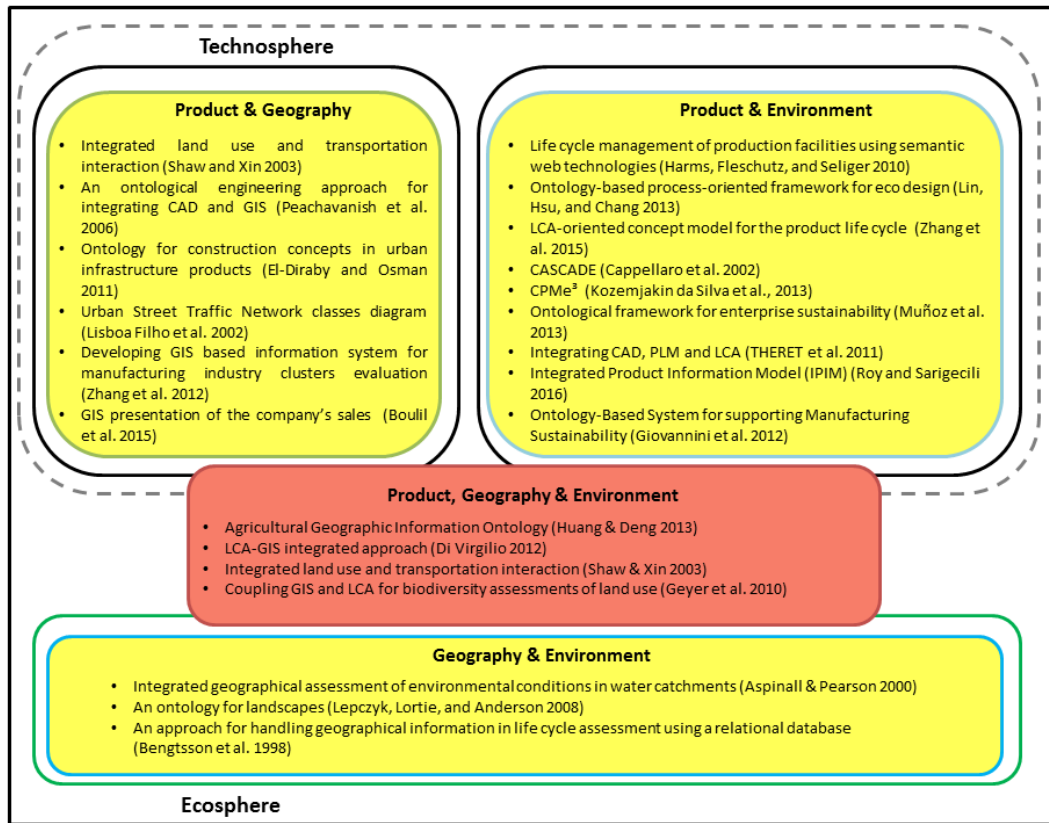


Figure 3.12 Model proposal supportive boundaries

Based on what has been learned from section 3.1.1 (Integration between product and environment) and section 3.1.2 (Integration between environment and geography), we could state that the nature of geographical indication is considered in the structure of LCI and LCIA through subsections of technical and environmental systems that make links between production and process dimensions with geography through the substances flows (Figure 3.13). Product lifecycle includes steps (BOL, MOL and EOL) with different processes geographically referenced by LCI via different types of substances flows including product flow, waste flow and elementary flow, which differ from one geographical region to other in terms of their availability, quality and quantity. The environmental status of each geography through the results of LCIA gives relevant information for modeling the flows and assessment of their environmental impact. As

these substance flows include the whole product life cycle, thinking about and including geographical features could produce better decisions about design choices.

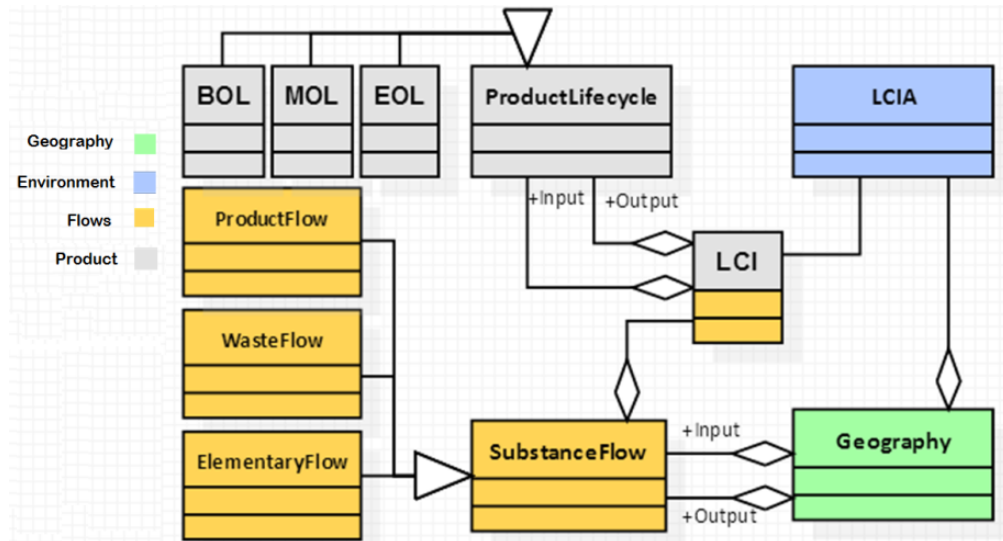


Figure 3.13 Interaction between product, geography and environment

The current situation can be represented through a reference model, as shown in figure 3.14, according to Blessing and Chakrabarti (Blessing & Chakrabarti 2009, chap.4). In this figure, the minus sign reflects a negative effect, such as a decrease in level of geographical scale and the plus sign reflects a positive effect like increasing the importance of DfS. The reference model shows the key factors (root causes) analyzed and identified through literature review, which seem to be the most useful factors to address in order to improve an existing situation.

Based on this reference model, accelerating processes of globalization and trade liberalization, changed the patterns of consumption and production in all countries and caused lots of social, environmental and economic impacts (Frankel 2009). DfS as a new approach could improve region's economy and social aspects and while simultaneously improving environmental performance (Crul et al. 2006). However, lack of knowledge about the territory's features and its environmental status, and lack of integrity between that knowledge and the product are barriers to searching for a possible design concept. It is

important to consider these issues early in the design process for DfS. In the aim of dealing with those barriers, using Geographical Information System (GIS) could be a solution, due to its ability to capture, store, check, and displaying data related to positions on Earth's. Therefore, we conclude that the success factor for DfS is the integration between geography and the product data model. In this way, designers will be able to include geographical features in design choices for better DfS, if we integrate geographical information model with product information model through environmental information model.

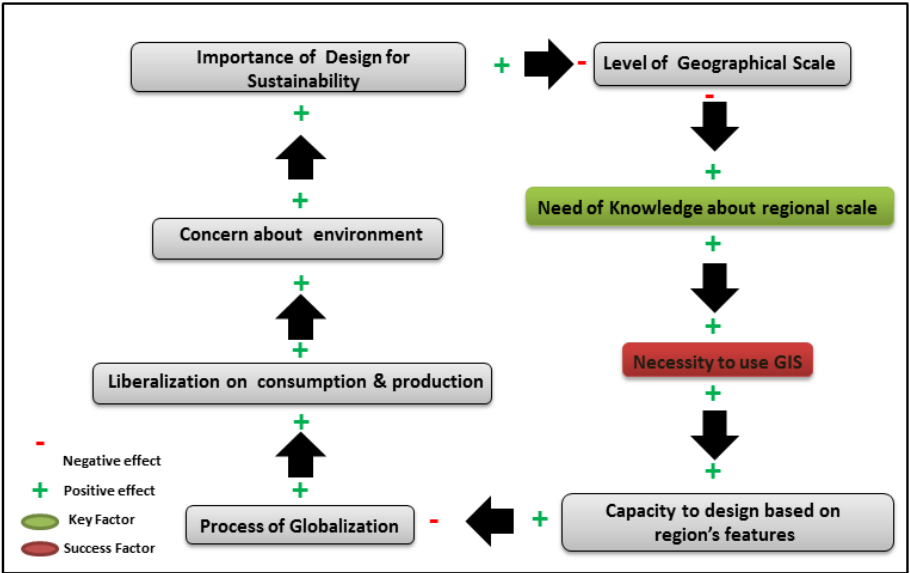


Figure 3.14 Reference model

Based on what we have learned from section 3.2, we reach to our specific research question:

- How could geographical features change design specifications in terms of product structure for better DfS?

Our overall research plan to answer this specific research question is formulated in the next section, based on five main phases, each devoted to a particular aim.

3.3 Research approach

Initial steps of methodology are inspired by Design Research Methodology (DRM) (Blessing & Chakrabarti 2009). The reason for choosing DRM is due to the emphasis of this research methodology on engineering design, which is line with the aim of this thesis. Regarding to different steps in DRM, the last three phases in the research methodology in the thesis (Phases III and IV) are part of PS (In phase III developing an “intended support”, and in phase IV developing a non-computational version of an “actual support”), with some level of DS II in phase V. The proposal for a computational support as part of future works is akin to an initial second PS. In effect, what the thesis seems to have done is to follow DRM in its entirety, where Review Based RC and DS I are followed by a comprehensive PS and an initial DS II and another initial PS, which is similar to the type IV category of research in DRM (Chapter 2, Blessing & Chakrabarti 2009). In the following section, different steps of methodology are explained in details with their logic and objectives (Figure 3.15).

3.3.1 Phase I

The research starts with the research clarification phase. During this step, an exploratory review of the literature is implemented (Sim & Duffy 2003; Ullman 2001; Ullman 2002; Nakano & Hirao 2011; John R Ehrenfeld 1997; Karlsson & Luttrupp 2006) to clarify the current understanding and expectations, by identifying the extent to which the problems are already solved in practice and what still remains to be solved (The role of geographical information during design phases).

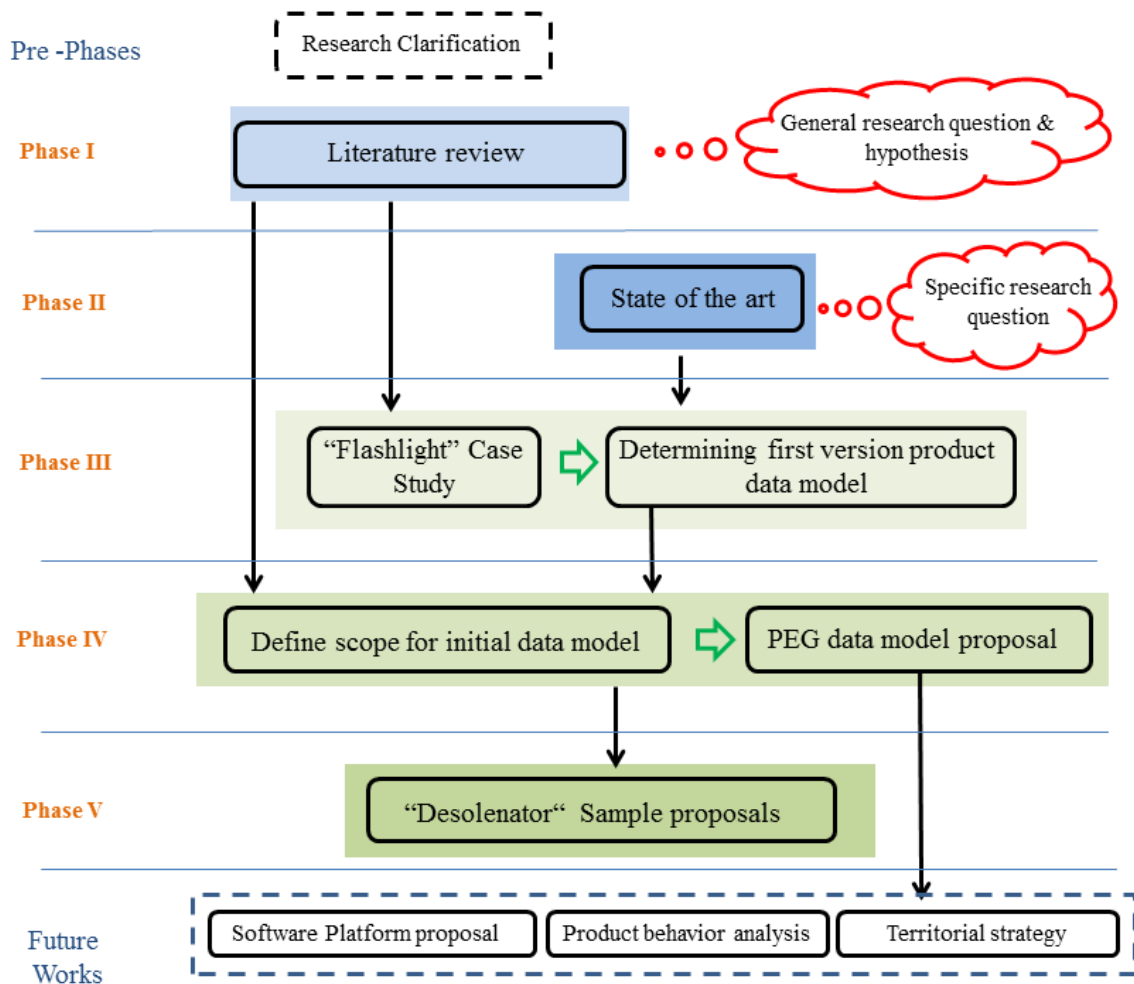


Figure 3.15 The research methodology

The next step is the literature review due to obtain sufficient understanding of the current situation. An extensive study of literature was undertaken to reveal the areas of investigation to define the framework of thesis; Design for Sustainability (DfS) (Spangenberg et al. 2010), Product Lifecycle Management (PLM) (Saaksvuori & Immonen 2008), Life cycle impact Assessment (LCA) (Astrup Jensen et al. 1997), Geographical Information System (GIS) (Campagna 2005), PLM tools (Ostad-Ahmad-Ghorabi et al. 2009; Peachavanish et al. 2006), data models (Wei & Carlson 2002; Fenves 2001) and other related topics. The result of these literature helped to identify the general research questions: “What is the link between information concerning product design and

geography for DfS? “What is the role of the environment in this link? And, specifically, where is the place for LCA in PLM’s IT structure?”

3.3.2 Phase II

This phase corresponds to revealing what kinds of supports are proposed by the state of the art, considering combined data models between product & geography, geography & environment, product & environment and product & environment & geography with different types of solutions and data models (Figure 3.12). Studying these models help us to identify their different specifications of different models and also identifying the role of substances flows as the main driver that relates geography with product. At the end of this phase the specific research question “How could geographical features change design specifications for better DfS?” is proposed. It is the part, where we are in the manuscript.

3.3.3 Phase III

As the literature search was not sufficient to identify the details of relations between product, geography and environmental impacts, we planned to do a sample case study to find those relations through a real case. The reason that we selected just one case study is because of the qualitative aspect of this research. Whereas quantitative research works with random probability sampling, there are no specific rules for determination of sample size in qualitative research. Sample size rather depends on consideration of the researcher related to the purpose of the study, the usefulness and the credibility of selected cases and last but not least, on the available time and resources. Through 10 different industrial products with four variables of selection; data accessibility, complexity, mechanical system and manufacturing system as explained in table 4.1, a simple flashlight is selected to support part of our methodology to identify the geographic relation with product, process and environment. This step provided information about the existing gaps in the proposed data models. The information obtained through the first case study, along with the prescriptive literature, provided a partial answer for identifying geographical features in DfS. Interviews were another option to use in this step, but the information extracted through

interviews is strongly influenced by the respondent, who acts and interprets his environment on the basis of his previous experiences. Bases on this consideration, it becomes clear that the goal of a qualitative interview is to provide understanding of things that can not directly be observed, such as thoughts, opinions and feeling of interviewees, which are not enough relevant to use in this thesis.

The results obtained from the state of the art and the flashlight case study help us to identify geographical data relations with product's life cycle and environmental aspects throughout different flows. We have used a semantic presentation, which helped to easily combine and check easily for consistency of knowledge from multiple sources. Semantics is chosen, because it has been widely used in the field of industrial process automation in recent years. In the field of manufacturing, Semantic Web and Web Services provide the ideal framework for implementing new fabrication methods and representing industrial processes. The results obtained from literature review, state of the art and the flashlight case study help us to justify the first version of the proposed model. A model which could integrate geographical information model with product and environment information models to include geographical features during the first design steps. The first version of the model included many aspects, thus we decided to limit the scope to an aspect most relevant to analysis and relation with geographical features.

3.3.4 Phase IV

In order to begin to test our proposal to answer the specific research question, this section focuses on the development of the final version of the PEG model, by restricting the model to product structure and specifically to material class. A finished product model contains the information of function-feature mapping specified by the designer. Such relationships need to be specified for all of the components that will be used for Bill of Material (BOM) variation. At the moment of the material selection, adopting a Life Cycle Approach means designing an eco-product. This has to be achieved not only by choosing materials which ensure reduced environmental impact from cradle to gate, but also by choosing materials which fulfill different needs during the different life cycle phases (Brezet et al. 1997;

Allione et al. 2012). This helped us to introduce a new approach in terms of material flows called foreground-background approach that separates interacted lifecycle stages in terms of flows for the same geographical region or different regions (background). We therefore added ForgeroundRegion and BackgroundRegion classes to the proposed data model.

3.3.5 Phase V

To answer the specific research question which proposed at the end of this chapter: “How could geographical features and their differences, change design specification in terms of product structure?” we propose two existing desalination system designs in two geographical regions (Champagne Ardennes in France and Yazd in Iran) to compare their design specification based on geographical features. This system is selected, because of its high dependency on geographical features like different amounts of daily sunshine in different territories. Moreover, in terms of use and manufacturing phases, it has high dependency with type on material type, temperatures and energy uses.

3.3.6 Future works

The proposed data model investigates the GIS based decision-making approach to help decision makers for better DfS. Based on the function of the proposed data model, a software platform proposal is developed to show how product and environmental data formats could be converted from XML to SQL, in order to be able to show data through different layers on the map. This platform is an example to show, how the use of GIS could help decision makers to change design structure specification through the environmental impacts results, which is demonstrated by different maps.

Chapter 4

PEG data model proposal

In the first two chapters, the state of the art provided theoretical answer to our general question about the existing relations between geography with product and environment. Studies in the literature indicate the importance of flows as the link between product and geography. They also revealed that product resources, wastes, material resources, energy resources, land, water resources, forest and emissions as part of LCI are a sub category of flows that differ from one territory to other territory in terms of availability, quantity and quality. As these flows encompass the entire products life cycle, considering and including geographical features could bring better decisions about design choices. Thus, access to product models integrated with geographical and environmental data would able designers to include geographical features in design choices for better DfS. It led to propose a research methodology to deeper address the following research question, “What is the link between information concerning product design and geography for DfS? What is the role of the environment in this link? More particularly, where is the place for LCA in PLM’s IT structure?”

In this chapter, we first present a single case study on a simple flashlight to analyse the relation between product and geography through environmental impacts (flows) in a real case. Later, based on existing data models provided in figure 2.11 and the result of the flashlight case study, a data model proposal is provided.

Initially, 10 products were selected based on primary DfS criteria stemming from the purpose of the case studies, leading to the choice of simple consumable products, available and usable in different geographical locations.

Four other criteria are defined to make the final selection from the 10 products chosen:

- Data accessibility: Refers to the ability to access data stored within available database through internet and university's libraries.
- Product complexity: The most effective balance of manufacturing and assembly difficulty.
- Mechanical system: A system that manages power to accomplish a task that involves forces and movement.
- Manufacturing system: the arrangement and operation of machines, tools, material, people and information to produce an added- value physical product.

Table 4.1 presents the evaluation process of the 10 products based on these four criteria. The evaluation uses a weighting approach for each product. A weight of 3 is defined for difficulty to access the data, high product complexity, high details in terms of mechanical and manufacturing system. The weight of 2 is given for medium and 1 for low.

Table 4.1 Evaluation of the difficulties to choosing the case study

Product	Data Accessibility	Complexity	Mechanical system	Manufacturing system	Sum
Chair	1	1	1	2	5
Bicycle	1	2	2	3	8
Lawn mower	2	3	3	3	11
Urban bin	1	1	2	1	6
Battery	2	2	3	2	9
Coffee machine	2	2	3	2	9
Flashlight	1	2	2	2	7
Scooter	2	2	2	2	8
Shoes	2	2	1	1	6
Refrigerator	3	3	3	3	12

The weightings obtained range from a maximum (12) for the refrigerator to a minimum (5) for the chair. We decided to select a product. Out of bicycle, scooter and flashlight with

average marks, we selected the flashlight due to better results for data accessibility and less complexity in terms of the manufacturing system to begin with.

4.1 Case study flashlight

We provide an initial research methodology case study in this section, in order to analyze the relations between product, environment and geography. A single case study to relate product data classes with environment and geography data classes through a semantic presentation based on existing data models was carried out for a flashlight part. The life cycle stages are intended to be in a hypothetical geographical location.

The most common flashlight design is a simple household light (Figure 4.1), consisting of a tube-like handle containing batteries. This handle is affixed to a threaded head assembly that houses the bulb mechanism. These units operate on standard batteries and provide a light output.



Figure 4.1 Simple flashlight (Flashlightsales.com)

In order to evaluate environmental impacts of the product, the information about the composition of all the materials, with their weight is needed. One of the results of the engineering process is the product “Bill of Materials” (BoM) that provides this needed information by giving a description on the hierarchy of the product with all its components (primary parts or assemblies) and its engineering properties.

4.1.1 Bill of Materials

A Bill of Materials (BoM) is a list of the raw materials, sub-assemblies, intermediate assemblies, sub-components, parts and the quantities of each needed to manufacture a

product. A BoM may be used for communication between manufacturing partners, or confined to a single manufacturing plant. The “manufacturing BoM” (mBoM) describes the manufacturing and assembly processes, from the raw materials or input parts coming from the suppliers to the product at the gate of the plant. The flashlight can be broken down into thirteen basic parts (Figure 4.2). The numbering of the parts of the flashlight in the figure below corresponds to the item number in table 4.2.

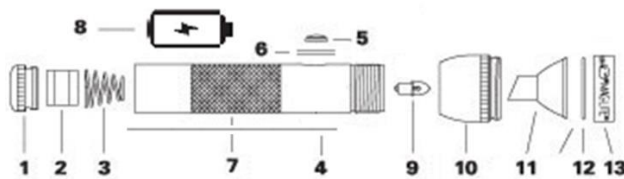


Figure 4.2 Flashlight part break down (Flashlightsales.com)

Tail Cap is usually made out of plastic. This plastic button, when is closed, allows the spring to touch the batteries. This, in return, completes the circuit and when the On/Off button is pressed, the bulb lights up. When the tail cap is taken off the button, the circuit breaks and it is possible to change batteries. The Plastic Shell accommodates the battery. The tube is made out of plastic and holds all of the parts of the flashlight. The Head is made out of plastic to hold the lamp holder and reflector. The Reflector is also made out of plastic and is plated with a thin silver layer. This piece is located on top of the bulb and protects the bulb. Finally, the Cap is made out of plastic and keeps the lens in place.

Table 4.2 BOM for a simple flashlight

Item	Part	Material	Mass (g)	Quantity
1	Tail Cap	Polypropylene (PP)	9	1
2	Lamp Holder	Brass	6	1
3	Spring	Steel	5	1
4	Connector	Brass	3	1
5	On/Off Switch	Polypropylene (PP)	7	1
6	Brass Slide	Brass	4	1
7	Plastic Shell	Polypropylene (PP)	184	1
8	Battery	N/A	134	2

9	Lamp (LED)	N/A	5	1
10	Head	Polypropylene (PP)	20	1
11	Reflector	Polypropylene (PP)	5	1
12	Lens	Polypropylene (PP)	4	1
13	Cap	Polypropylene (PP)	10	1

Access to the list of materials helps us to illustrate the structure model as a graphical representative of the hierarchy and connectivity among the product's components. Each node in the structure model denotes a component, a module, or a product, and is linked with its correspondent geometric model and attributes. If a designer changes the geometry of a component in a solid modeler, the attributive values of the component are also updated and the connectivity of the component to its neighboring components may change.

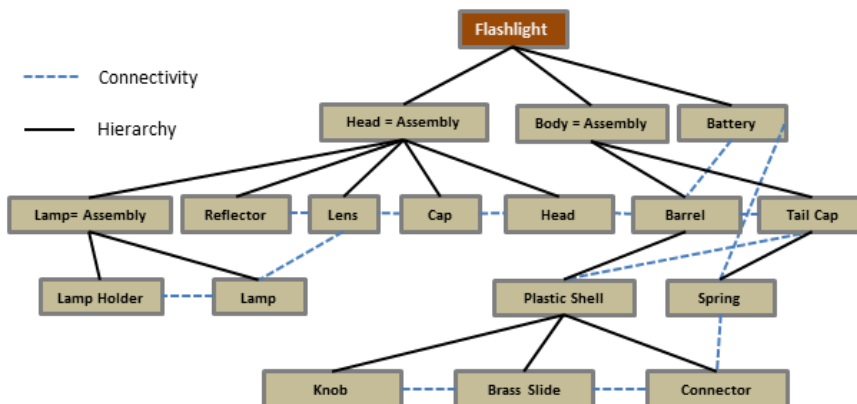


Figure 4.3 Flashlight product structure model

In figure 4.3, nodes are connected by two types of edges, hierarchy and connectivity. The hierarchal edges are directed links from a parent node to its child nodes, meaning that the parent node denotes an assembly of the child nodes. The connectivity edges denote the connection types of fixation, motion constraint, signal transmission, power transmission, fluid transportation, etc. among the components in the same hierarchy. In the first level of hierarchy, Flashlight is divided into three assembly components, presented as nodes; head assembly, body assembly and battery assembly. The head assembly is a combination

between of five nodes: lamp assembly, reflector, lens, cap and head. The body assembly is supported by barrel and tail cap nodes. In the second level of the hierarchical model, lamp assembly includes lamp holder and lamp, the barrel includes plastic shell and tail cap contains spring. We have plastic shell in the third level of this model which contains knob, brass slide and connector. The other aspect of the structure model presents the connectivity between parts when the whole product is assembled. For instance, knob is connected to brass slide and connector in the fourth level. Then connector is connected to spring as a part of power system and so on. Access to a structure model is useful, when design choices are going to change. Change in one part in term of material or function could change other connected parts.

Dealing with the questions of the eco-compatibility of the product involves taking into account the environmental performances of the product along all its life cycle, and assessing the various input and output flows during the different life cycle phases. As these input and output flows arrive from one or more geographical locations, identifying the relation of flows with territories, studying and managing them could reduce the environmental impacts on these territories. An analysis of input and output flows and their relations with product life cycle and geography is implemented for the flashlight case in the next section to highlight the importance of geographical relations with product and impacts.

4.1.2 System boundary for flows analysis

The life cycle starts with upstream processes for material extraction such as the mining of ore (Material 1). Once the raw materials are extracted and refined they are transported to a manufacturing facility where those materials are processed and assembled into finished products (Figure 4.4). After manufacturing process, the flashlight is transported from the manufacturing plant location to the distribution center. The products are subsequently transported from the distribution center to retailers, where the use stage takes place. Finally, at the end- of- life, all product types are transported to a nearby waste facility where they are incinerated or sent to a landfill.

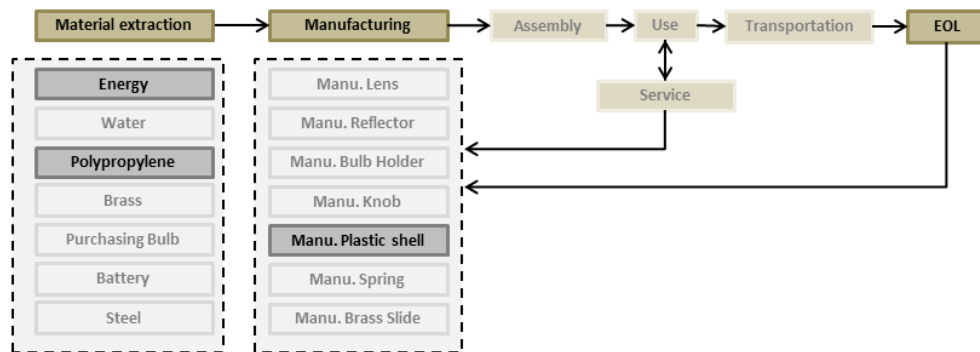


Figure 4.4 Life cycle stages for a simple flashlight

As the objective of presenting this single case study is to specify and find the relation of classes to product, flows and geography, even one stage of lifecycle could provide this information. Thus, we limit the life cycle to material extraction, manufacturing process and end of life for the plastic shell (Figure 4.5).



Figure 4.5 Plastic shell (Flashlightsales.com)

We choose these three stages because they involve flows, compared with use and transportation stages. Moreover, most of the parts used in the proposed flashlight are made from polypropylene (PP) and the three phases of material extraction, manufacturing process and end of life almost identical for all parts, but as the plastic shell is the biggest piece (using more material), therefore it is more sensible and easier to concentrate on this. However, the full result of LCA for flashlight is available in appendix B. Thus, the case study is limited to one part (plastic shell) and three life cycle stages (material extraction, manufacturing and end of life). The functional unit is supposed 1000 hours illumination, but as the selected part does not have that much relation with battery and LED function, therefore, the amount of functional unit will not change the amount of impacts of plastic shell.

The plastic components used in flashlight construction are typically injection molded using polystyrene and other durable polymers. In this process (Figure 4.6), plastic pellets are mixed with plasticizing agents and colorants. This mixture is liquefied by heating and then injected into appropriately shaped molds via an injection plunger. The molds are then subjected to high pressure to ensure they are completely filled, and to hold them together against the force of injected liquid plastics. The end closures are also molded, where usually both internal and external threads are molded.

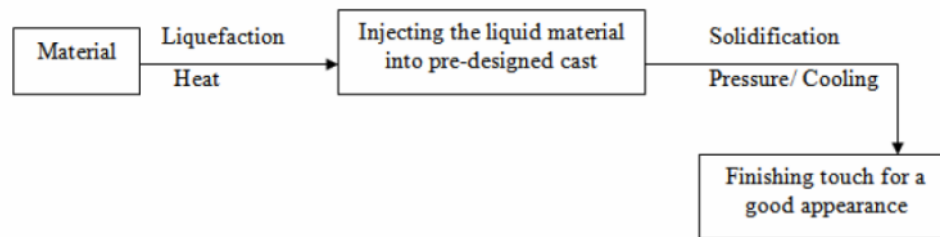


Figure 4.6 Simplified Manufacturing Process of a flashlight

After the injection process, the molten plastic is cooled by forcing water through channels in the mold. The plastic hardens as it cools and the pressure is released. At this point, the two halves of the mold are separated and the plastic part can be removed for finishing. The plastic polymers used in this process are thermoplastic, meaning they can be repeatedly melted so the scrap pieces can be reworked to make additional parts. Therefore, there is very little wasted plastic in this process. Subsequent operations may be required to polish, cut, and finish the plastic parts.

Acidification is selected as the only environmental impact of the defined life cycle stages due to site-specific level of impact. SO₂ as the significant flow of this impact is chosen for consideration in the semantic presentation. The results of the EcoDesignStudio for the flashlight shows the total value of 9,97e-4 of SO₂ equivalent per 1 kg of plastic shell, which is the result of 3.251 E-5 for electricity for injection process which are made from and 1.245 E-5 for transportation by small lorries between resource extraction, manufacturing locations and end of life. We can highlight that, choosing of site specific

LCIA (acidification) and substance flow (SO₂) does not have impact on the result of our case.

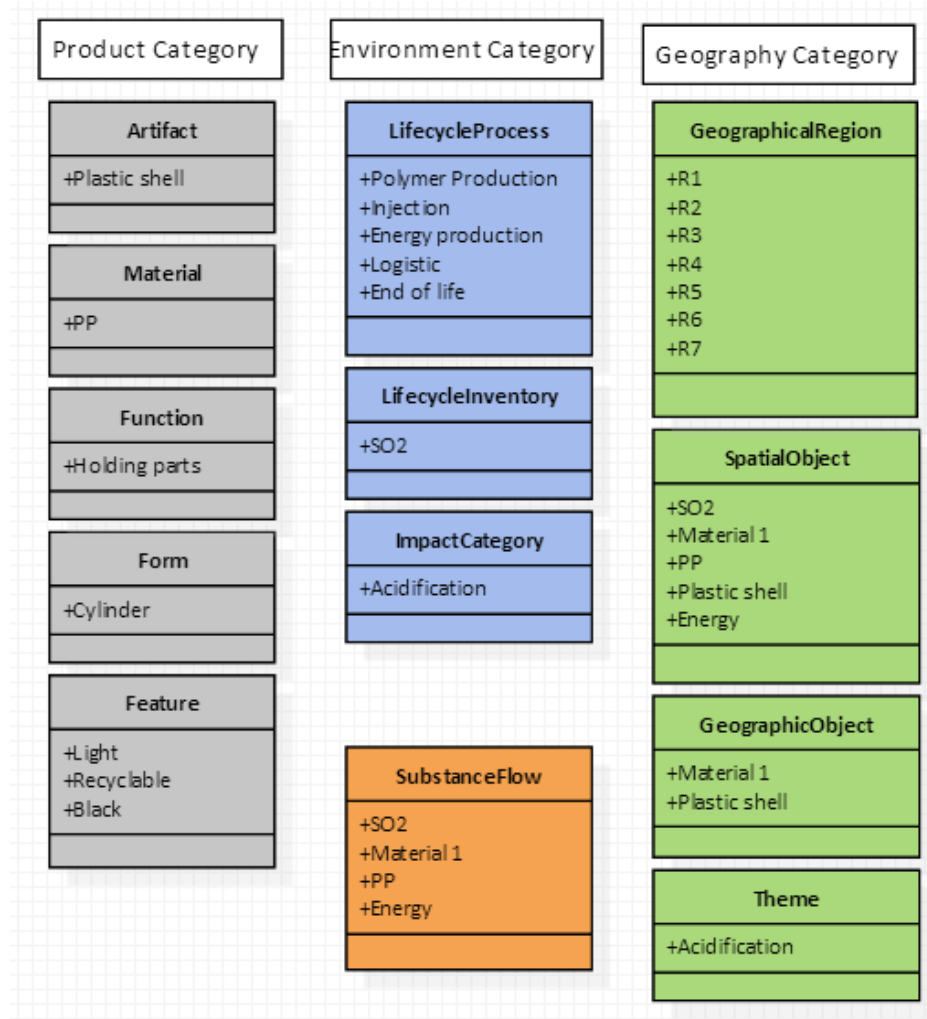


Figure 4.7 Product, environment and geography data classes for plastic shell

Based on the objectives of the case and the framework that is defined for it, we conclude this section by proposing the existing data classes (Figure 4.7). Product category contains six classes of artifact, life cycle phase, material, feature, function and form. The environment category has four classes of Substance flow, Life cycle inventory, Impact and life cycle process and the geography with four classes of geographic region, geographic

object, spatial object and theme. These classes are related with/to each other, to identify their connectivity a semantic presentation is provided in the next section to show how different objects are related.

4.1.3 Semantic presentation of manufacturing process

Semantic representation as a product modeling techniques is able to find the consistency between different knowledge from multiple sources (Lee et al. 2012). As explained in the previous section, the life cycle is limited to material extraction, manufacturing and end of life processes (LifecycleProcess, LifecyclePhase) for the plastic shell (Artifact & GeographiObject). The manufacturing phase of the plastic shell consists of manufacturing unit processes (gate to gate), which converts the polypropylene material by an injection process into a final shell product (Figure 4.8).

This semantic presentation is implemented in order to show the knowledge relations between product, process, environment, and flows and geography. As it is shown in figure 4.8, each process (White rectangle) has some input and output flows (Orange color) with specific geographic locations (Green rectangle). R1 & R2 are considered as the geographical regions where all up-stream processes of electricity (SubstanceFlow & NonGeographiObject) and material productions (SubstanceFlow, Material, LifecyclePhase & GeographiObject) are located. Polypropylene material, result of the “Polymer_Production” is shown as class “Material_1”. The geographical production location of the polymer is referenced as “R_1” class, which could be presented as a geographical object on the map as a part of the up-stream process. This class could be named as the elementary flow/polymer producer/raw material/ etc layers. Polymer production needs electrical energy (“Energt_1” class) produced in another geographical location of the same region (“class R_2”). “Injection_process_1” is part of the manufacturing process, and “SO2_3” is an instance of the Air_Emission class and its substance name is SO2, which is an instance of “GeoObject” in geographic region R_3. In terms of end of life, two approaches to collecting waste are usually implemented. Either individuals deliver waste to collection points inside cities or the second approach involves

producers or individuals using out-of-town recovery centers. The first approach is assumed as the EOL process for this case study. Plastic shell as the result of outflow from the use stage has input flow to collection points (R_5). After collection come the logistics of delivering wastes to recycling centers (R_7).

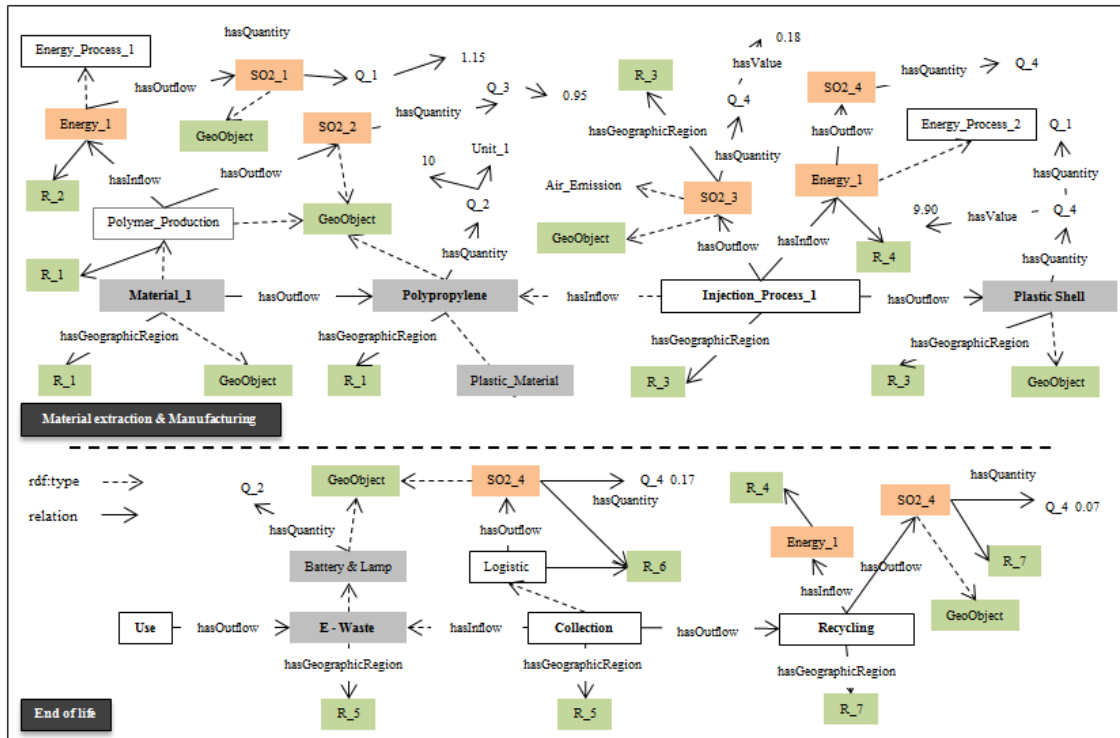


Figure 4.8 Semantic presentation for plastic shell production

An important result of this semantic presentation has been to define a class diagram structure (Figure 4.9), supporting the design knowledge in terms of relation with geographical (green) and environmental information (orange), which may be used in producing parts and features (product life cycle shown as grey and white classes). The utilized approach is an object oriented approach to capture best practice knowledge and we have used UML as the most generally accepted method.

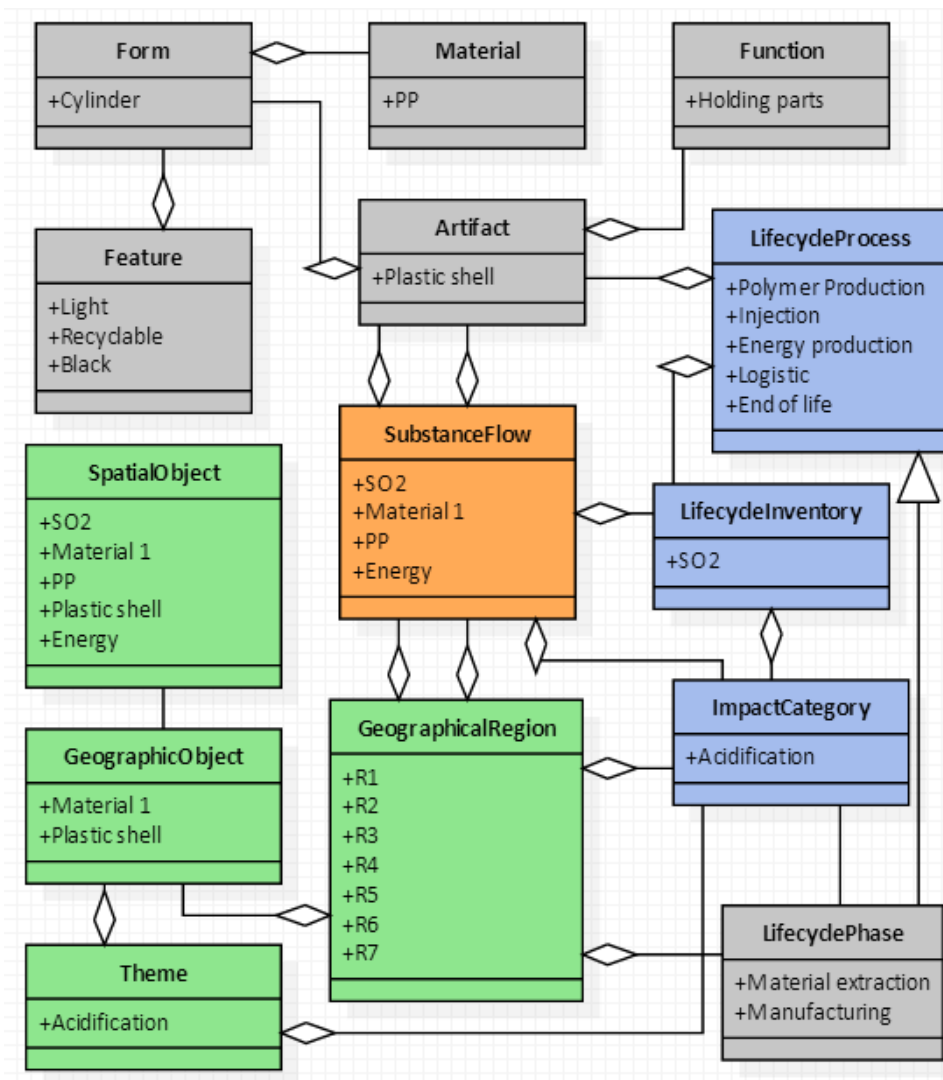


Figure 4.9 Class diagrams for plastic shell production

For instance, the ‘Shell’ class as an artifact with specific “Function” is related to ‘Manufacturing’ class through manufacturing process, using the ‘has’ relationship. Class ‘Material’, which is related to the ‘Resource’ class, facilitates the capture of required material information. Each material is a kind of biotic or abiotic resource that is related to a specific geographical region (‘Region’ Class). Manufacturing process has input and output flows (‘Flow’ Class) and part of these flows is for consumption of resources and the rest are pollution or emission (‘Lifecycle inventory’ Class). Resource and life cycle inventory

as part of geographical region, have spatial dimensions ('SpatialObject' Class) that could be illustrated as geographical objects ('GeographicalObject' Class) on the map.

The semantic presentation and class diagram help to identify the geographical data relation with product, flows and environmental impacts. Based on what we are learned through this case study, a data model proposal is presented in the next section.

4.2 Semantic data model proposal (PEG)

This model seeks to connect product, process and territory through technological and environment systems, which is unique in itself, but its components are composed of existing models in product and geography fields. The model contains three sub-models for ontological modeling namely, product (P), environment (E) and geography (G). Although each of these sub-models are not itself novel, but integrating them creates a unique data model that contributes to a more effective overarching model. The core model integrates those three elements to deal with geographical differences for characterizing design elements such as product structure and function, while maintaining sustainability. The main classes of the model are: Artifact, representing any physical entity in a product (e.g. part and assembly); SubstanceFlow, supporting related flows (product, waste and elementary) and GeographicRegion, the boundary of territory which includes SubstanceFlow and Artifact. SubstanceFlow is the heart of the model which links product with territory. The environmental impact is given for each Flow, so the impact of a Process is the sum of the impacts of the Flows. Consequently, the impact of a series of processes (LifecycleProcess) is the sum of each Process' impact. The impact of each process is a theme that could be represented as a data layer on the map. Moreover, Substance Flow could be presented as them by its nature.

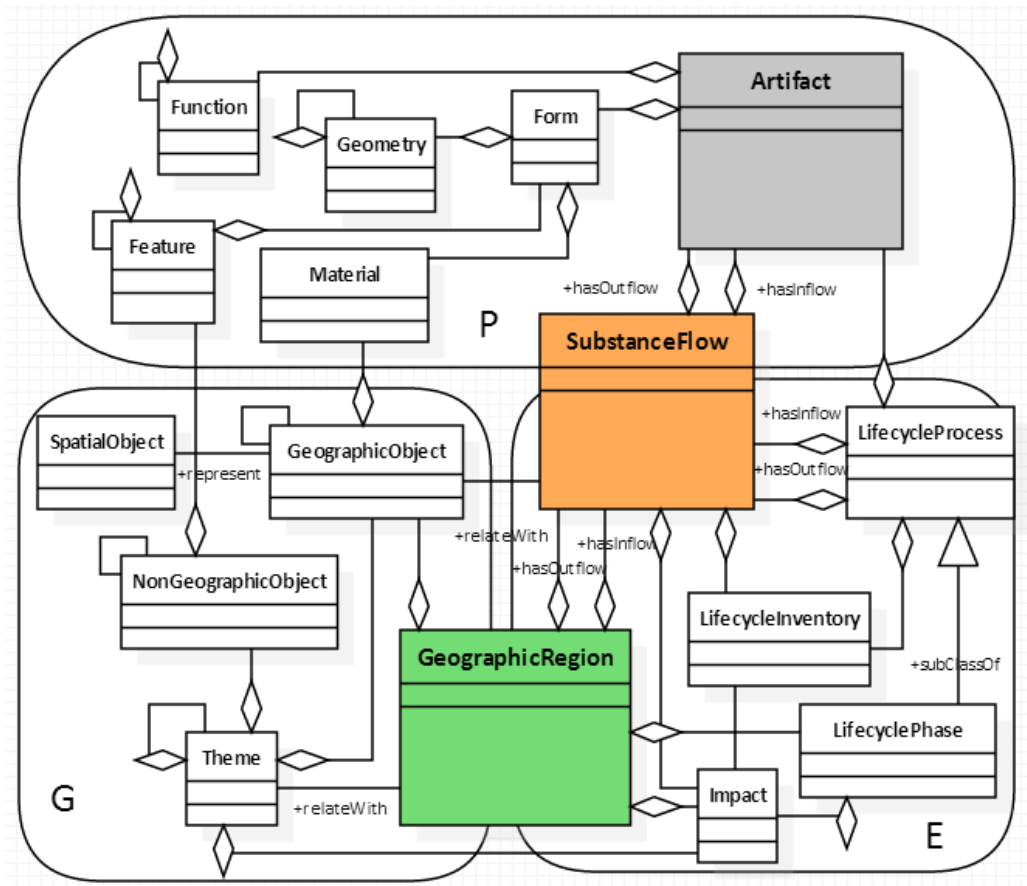


Figure 4.10 PEG data model

Category P of the model (Figure 4.10) contains six main classes: artifact, material, feature, function, geometry and form. Artifact is the main class of category (P). Artifact, material and features classes connect P category with geography and environment. The artifact class has a relation with LifecycleProcess through different substance flows, the material class counts as a geographical object that connects product with geography. ‘Product features’ has relation with geographical features in terms of available raw materials and manufacturing technology, user needs and behavior, and market features and available end of life scenarios. Figure 4.11 presents input and output data types for the heart of product category classes (Artifact). Raw materials, sub-assemblies, intermediate assemblies, sub components, other artifacts, quantities, weights, geometries, features,

forms, tolerances, functions, requirements and manufacturing information are the input data which supports other classes by accessing to Bill of Material (BoM), Product Data management (PDM) and Computer Aided Design (CAD) files. The output (final product) could be presented as CAD files or 2D/3D prints. The input data of this class is the main data the feeds LCA software, especially in terms of LCI data.

Artifact	
Input Data	Output Data
<ul style="list-style-type: none"> • Raw Materials • Sub Assemblies • Intermediate As. • Sub components • Artifacts • Quantities • Weightes • Geometries • Features • Forms • Features • Tolerances • Functions • Requirements • Manufacturing info. 	<ul style="list-style-type: none"> • Product • Product 2D/3D • CAD

Figure 4.11 Artifact class input and output data

The E part of this data model, is responsible for managing the data related to environmental impacts consists of four main classes: SubstanceFlow; LifecyclePhase; Impact and LifecycleProcess. SubstanceFlow as a base of flow ontology supports three main flows: elementary flows; product flows and waste flows. Elementary flows are the foundation for calculating environmental impacts of a product life cycle, which can be classified into two sub flows: Resources and Emissions. The product flows are used to describe all the valuable output substances produced from a process. According to the process producing product flows, the product flows can be classified into five sub categories: Part; assembly; chemical product; energy product class, and material product. Waste flows class is used to describe all undesired substances produced by a process. The waste flow class includes waste product and Waste. In general, the waste products are not

directly discharged into the environment but Waste enters the environment directly without a disposal phase. Cradle to gate, gate to gate, cradle to grave, and gate to grave are the four main system boundary options for LifecyclePhase. The option of cradle to grave is the widest scope boundary, in which a product life cycle experiences at least three phases: production phase, use phase and disposal phase. The environmental impact is given for each substance flow, so the impact of a process is the sum of the impacts of the flows. Consequently, the impact of a series of processes is the sum of each Process's impact. Finally, the impact of a Product is the sum of the impacts of all processes. LifecycleProcess Class consists of a set of processes (internal and external), which are functions or tasks to create, transform, and deliver products. Substance flow class is related to GeographicObject and GeographicRegion classes from the Geography category of the model, and Artifact class from the Product part which connects E part of the model with geography through its impacts.

SubstanceFlow	
Input Data	Output Data
<ul style="list-style-type: none"> • Energy Resources <ul style="list-style-type: none"> • Electricity • Crude Oil • Natural Gas • ... • Mineral Resources <ul style="list-style-type: none"> • Iron ore • Oil • Cooper • ... • Renewable Resources <ul style="list-style-type: none"> • Wood • Water • Vegetables • 	<ul style="list-style-type: none"> • Release to air <ul style="list-style-type: none"> • CO2 • SOx • NOx • ... • Release to water <ul style="list-style-type: none"> • BOD • COD • ... • Release into soil <ul style="list-style-type: none"> • Solid waste • Polluted sludge • ... • Products • Solid waste • Other release

Figure 4.12 Input and output of a SubstanceFlow class

Inputs and outputs data presented in figure 4.12 is highlighting the certain elements as substance flows which have input and output data relation with Artifact and

GeographicRegion classes. In fact this class is a link between geography and product. Energy, mineral and renewable resources are elements with roots in geography used in different life cycle steps. On the other side different types of products, wastes and emissions are the result of different life cycle processes still with roots in geography.

Category G of the model includes five classes; GeographicRegion, Theme, GeographicObject, NongeographicObject and SpatialObject. The classes Theme and GeographicRegion, as the basis of any geographic application, have as their main objective the management and the manipulation of a data set for any given region, constituting a geographic database. A collection of themes can be specified for each geographic area. A theme defined during conceptual design can lead to the implementation of several layers, for example a simple theme such as “materials” can generate more than one data layer, one containing only linear spatial objects and another containing polygonal spatial objects. GeographicRegion class defines regions that are areas broadly divided by physical characteristics (physical geography), human-impact characteristics (human geography), and the interaction of humanity and the environment (environmental geography). The abstract class GeographicObject class is a generalization of all classes of geographic phenomena that can be individualized. This class could include all data for each geographical boundary in terms of everything that could be considered as an object. NongeographicObject class is responsible for non-material data like temperature, humidity and etc. Geographic and nongeographic object classes differ from one territory to other territory because of differences in resources and geographical features. However, SpatialObject class is a general class which supports all data that has a spatial root and could be used for all geographic and non-geographic objects.

Figure 4.13 presents input and output data for GeographicRegion class. The input data includes two categories: (1) Natural geographic features like rivers, mountain and etc., physical entities such as woodlands, vegetable fields and geographic phenomena like temperature, rain fall and etc. and (2) Cultural geographic features that include man made features and social economic aspects. Moreover, this figure presents also the input data in

terms of the areas near the surface of the earth and can be divided up into four inter-connected "geo-spheres:" the lithosphere, hydrosphere, biosphere, and atmosphere. The lithosphere is the solid, rocky crust covering entire planet. The hydrosphere is composed of all of the water on or near the earth. The biosphere is composed of all living organisms and the atmosphere is the body of air which surrounds our planet. The data as output can be presented as three categories of spatial properties concerned with points, polylines and polygons, thematic properties to show quantity, quality, status and etc. and temporal properties.

GeographicRegion		
Input Data		Output Data
<ul style="list-style-type: none"> • Lithosphere <ul style="list-style-type: none"> • Soil • Mineral • Resources • Gas • Road • Railways • Hydrosphere <ul style="list-style-type: none"> • Oceans • Cryosphere • Rivers • Humidity • Channels • Water tanks 	<ul style="list-style-type: none"> • Atmosphere <ul style="list-style-type: none"> • Climate • Air • Wind • Temperature • Planes • Pressure • Biosphere <ul style="list-style-type: none"> • Humans • Forests • Animals • Fields • Employees • Consumers 	<ul style="list-style-type: none"> • Spatial Property <ul style="list-style-type: none"> • X,Y,Z • Point • Polyline • Polygon • Thematic Property <ul style="list-style-type: none"> • Property • Type • Status • Quantity • Quality • Temporal Property <ul style="list-style-type: none"> • Property • Relative Time • Absolute Time • Frequency Time • Overlaps

Figure 4.13 GeographicRegion class input, output data

As the product category of PEG model includes different aspects of, function and structure, it is complicated to study all these aspects in one PhD. Therefore we have concentrated on the structure issue, focusing particularly on material and form classes to show how geographical features could change design choices.

4.2.1 Material selection for DfS

Material selection is one possibility for innovation at the beginning of the design process. Subsequently, as the concept evolves, the options regarding function and form decrease the number of materials. Whilst technical constraints are crucial to deliver on functionality through understanding a material's technical properties, there is less understanding about the process of material decision-making from a non-technical perspective. Designers face new challenges when incorporating environmental criteria into material decision-making. DfS material selection differs from conventional material selection insofar as information required for selecting materials is based on available resources within a defined geographical boundary (Figure 4.14).

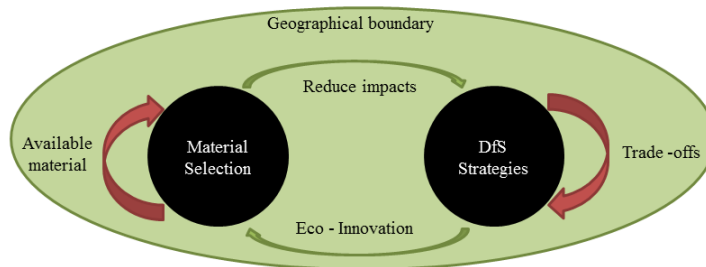


Figure 4.14 Material selection in DfS

A product model could link physical components with functional specifications. A finished product model contains the information of function-feature mapping specified by the designer. Such relationships need to be specified for all of the components that will be used for BOM variation. Many factors can be varied to generate different options for product architecture. From an environmental sustainability point of view, thinking that the eco-compatibility of a product can be achieved simply by combining the best environmental materials appears too simplistic. Moreover, dealing with the concept of the best environmental materials in an absolute sense is meaningless when these materials are assembled together as components of a product. Even if rankings of the best eco-efficiency materials are available, generally those rankings are elaborated by taking into account the environmental status of interacted territory(s). This means a material or semi-product that

is eco-efficient in one geographical location could change its status by changing the geographical features of a different territory.

A territory's sustainability depends on a stable balance between various flows of materials. Because material flows are the main vehicles carrying information and energy flows, material flows play the most important role in determining ecosystem stability, but can be significantly affected by resource extraction and waste emissions from the technosphere. The flows from biosphere to technosphere is acting as "Input" in the form of raw materials, and, conversely, flows from technosphere to biosphere as "Output" in form of products, emissions and waste. Material flow analysis (MFA), which focuses on tracking matter flows within technosphere systems from extraction to disposal, should therefore be a key tool for sustainable development assessment. In fact, every stage in the material flow (including source, transport, transfer and fate of a given material or substance) can be linked by an MFA system model (Huang et al. 2012). Analyzing the structure and processes of material and substance flows provides insights into their impacts on society, the economy, the resource base, as well as the environment. By applying MFA, a sustainability assessment can simultaneously be carried out for the socioeconomic subsystem, resource use and the environmental system.

As a result, there is a close relationship between material flows and sustainable development, due to the impacts of resource extraction in the upstream material or substance flow, and the environmental pollution and ecological damage due to waste emission across all material or substance flow processes. Therefore the boundary and scope of our proposed model will be restricted to material class with the related classes to product and environment. To highlight this approach, we defined foreground-background approach for the study territory in terms of material flows.

4.2.2 Foreground- Background approach

The environmental impacts caused by a product system are not only the result of its related flows and activities. Wide ranges of environmental impacts of each territory are the result of activities happening outside the studied territory, which should be included in

impacts calculations. In this section we propose a methodology that divides the technosphere system into two subsystems as foreground and background (Figure 4.15).

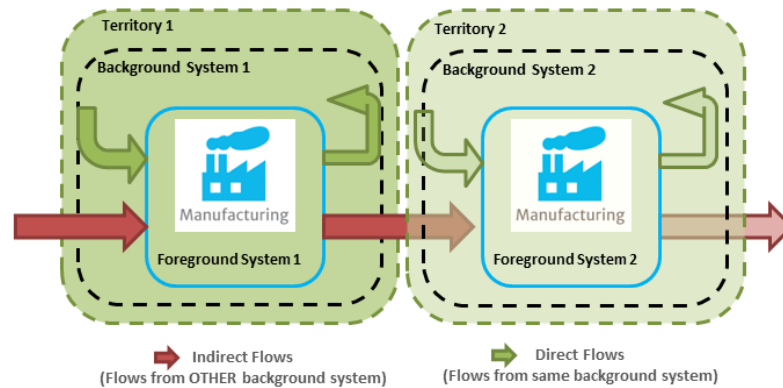
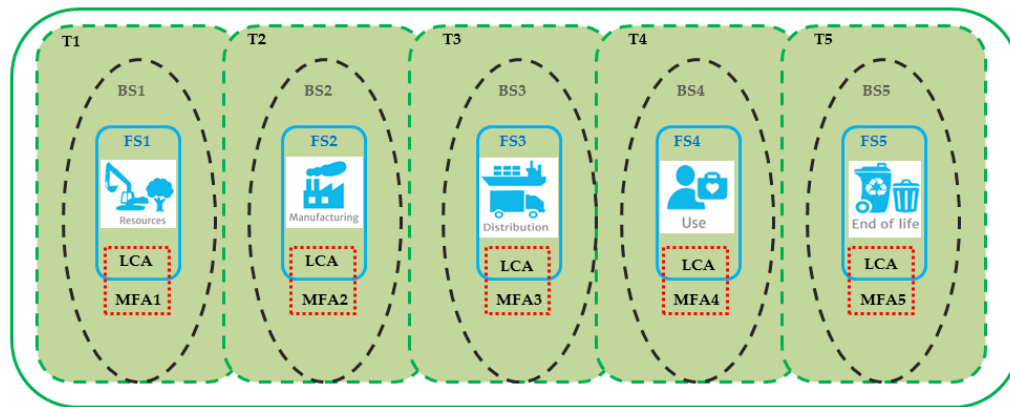


Figure 4.15 Foreground and background systems

The foreground system is defined as a set of activities or processes involving a product, while the background system supports the activities in the foreground by supplying the necessary resources and resources through direct and indirect flows. Direct flows are resources, products, wastes and emissions produced in the same background system, while indirect flows are imported from or exported to other backgrounds. This distinction between the foreground and background is particularly useful when it is important to include territorial characteristics in terms of flows and impacts during the design process. Any improvement activity taken in a foreground system may reduce the environmental impact in that system, but increase it in same or other backgrounds.

Application of the foreground-background approach produces two scales of impacts calculations, one generated by LCA and one by LCA-MFA. The former comprises all direct flows generated by a product, process or an activity on a life cycle basis by its defined “functional unit” for the foreground system and the latter is defined by the levels of a particular flow generated by different product systems in the background system. Note that Figure 4.16 shows a total of foreground and background systems for whole life cycle with each foreground having an associated background.



BS : Background System FS : Foreground System T: Territory LCA : Lifecycle impact assessment MFA : Material Flow Analysis

Figure 4.16 Foreground and background systems for whole life cycle

In reality, in any one analysis there will be a number of foreground activities or flows which will be supported by a number of activities and flows from different background systems. This approach could be extended by a mathematical model for the integrated LCA–MFA framework, although this is not the objective of this thesis. Applying the foreground–background approach can help integrate the two tools of MFA and LCA which are addressed by different approaches in some literature (Silva et al. 2015; Venkatesh et al. 2009; Rochat et al. 2013; Azapagic et al. 2007).

ForegroundRegion and BackgroundRegion are two classes that are added to the final model (Figure 4.17), based on the methodological approach that is proposed in this section. These classes are subclasses of the GeographicRegion class with direct relation to Impact class. Each step of the life cycle, takes place in a geographic region. When a geographic region is same as in other steps of the life cycle, it is foreground and when it is in another geographical territory, will be part of Background geography. The concept of DfS is to minimize all background regions. The more life cycle steps take place in foreground geography, the closer the design is closer to DfS.

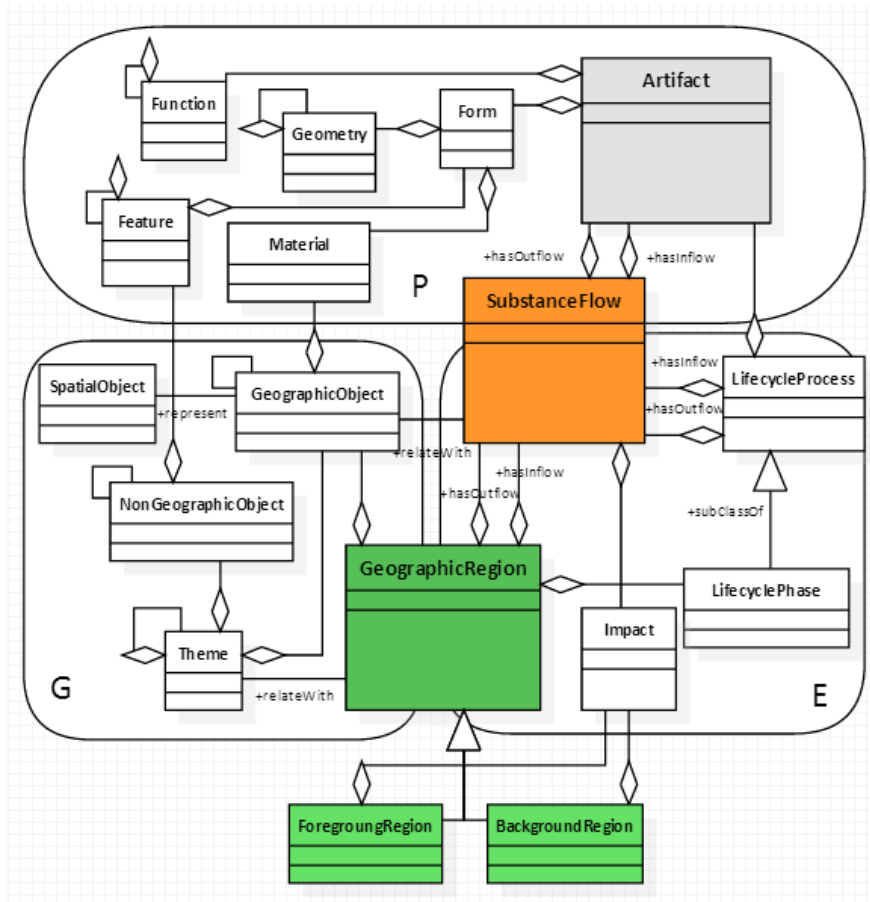


Figure 4.17 PEG model proposal with foreground and background regions

By defining these subclasses, GeographicObject class defines a boundary for each Foreground and Background based on available objects (Materials, resources, emissions and etc.). Moreover, the impact is aggregated with both boundaries, which helps to separate impacts of each life cycle step based on the interaction with related territory(s). LifecyclePhase is another class that aggregates with both foreground and background classes to present the phases of the life cycle for interacted territories. This separation for phases could help to show data on the map as different layers for each geographic region, which means the facilitation of data access for each life cycle stages and related territories in terms of different substance flows. Access to these two classes could separate flows from one life cycle step to other and illustrate different flow and impact maps for each

interacted territory. Moreover, available substance flow data on foreground and background territories could present an environmental status of territory (ies) based on previous activities. Access to the status map of each territory brings sustainable development from global to regional level which is in line with the objectives of DfS.

4.3 Chapter summary

Product knowledge and information in a product life cycle will require the representation of geographical related data and models in order to integrate them across different life cycle stages. These needs gave rise to a multilevel information model like PEG which defines the multilevel approach consisting of geographical data supported by GIS and integrates them into LCI and product life cycle information through substance flows. This could be integrated by PLM in order to support strategic decisions for DfS based on geographical features.

The environmental statuses of life cycle stages usually are not taken into account in sustainable development. In many cases, only an abstract notion of environment is applied that deals only with national or international environmental policy directives and threshold targets but not with the specific territory or social–economic context. Therefore, a site-relevantly tailored set of criteria would be useful for assessing the real region-specific environmental and other conditions. Our proposed PEG model by integrating geographical information with product and interacted environmental status, could act as a basis in terms of information modeling for this objective.

Figure 4.18 presents the impact model after the PEG model proposal. The impact model shows the success factor, means that increasing the consistency between product and interacted territory increases the capacity to propose design solutions based on territorial features, which facilitates DfS and improves the level of sustainability.

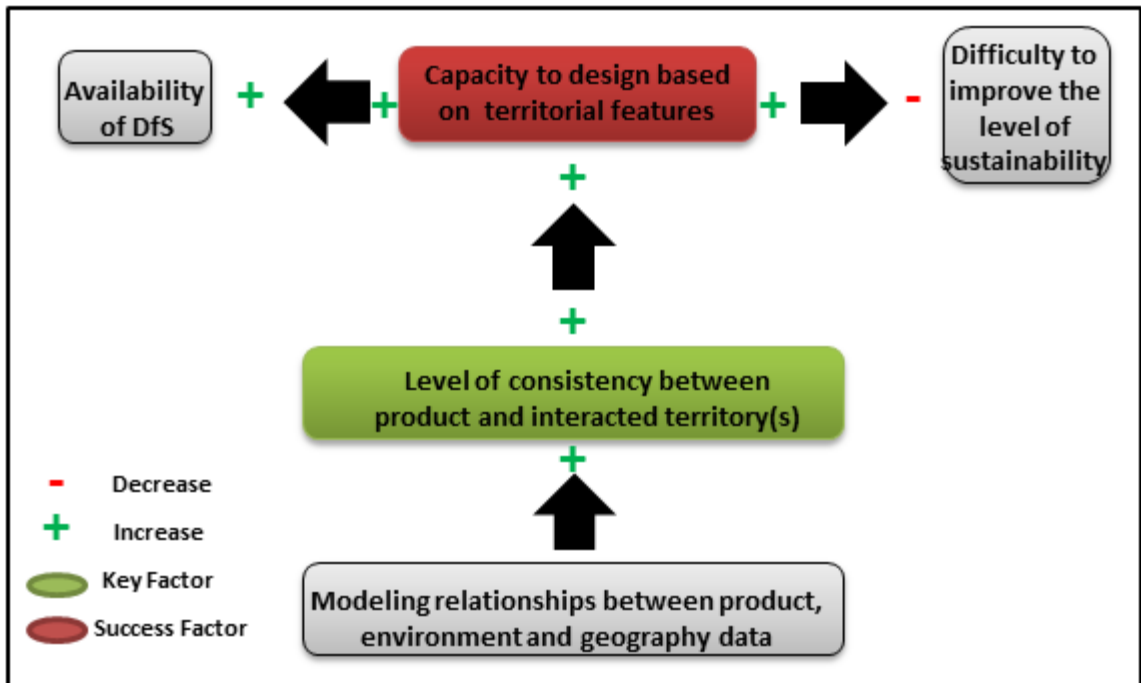


Figure 4.18 Impact model revised after proposed model

In the next chapter, the use of the PEG model with the methodological approach to material selection is shown by the second case study. This chapter is going to tests the way our proposal can help to answer the specific research question “How could geographical features change design choices for better Dfs”. Re-design of a solar distiller system is chosen. The objective is to design the system based on available material sources in two territories of France and Iran, well known to us, compared with other geographical locations in terms of available resources and geographical features.

Chapter 5

Model's function illustration

In this chapter we study the design and environmental impact of two designated small scale desalination systems (Solar Tears and Eliodomestico) for two different territories (Champagne Ardennes, France and Yazd provinces, Iran) to prove how geographical differences can impact design choices in terms of products structure and related environmental impacts (Figure 5.1). A desalination system is selected as the case study due to its dependency on the geographical features and its exposure to the sunshine. Different intensities cause different product functions and behavior, which could change the structure in terms of material choice and product shapes. Moreover, the importance of water supply in sustainable development and their critical role in socio-economic development, healthy ecosystems and human survival are other reasons to choose this product.



Figure 5.1 Yazd and Champagne Ardennes

The distillation system makes fresh drinking water from undrinkable water, which can be implemented on large and small scales. However, the main problems with the use of solar

thermal energy in large scale desalination plants are the relatively low productivity rate, the low thermal efficiency and the considerable land area required. Since solar desalination plants are characterized by free energy and insignificant operation cost, this technology is, on the other hand, suitable for small-scale production, especially in remote arid areas and islands, where the supply of conventional energy is scarce. The use of this system is motivated in some regions (South Mediterranean Countries, Middle East, Sub-Saharan Countries, Eastern African Countries and India) by the fact that it implies a way for energy independence and water insurance. The low environmental impact as well as the easy operation and maintenance are also incitements for this technology.

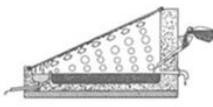

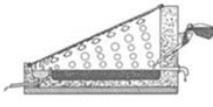



	Product	Location
Case 1	 Solar Tears	 Champagne ardenne
Case 2	 Solar Tears	 Yazd
Case 3	 Eliodomestico	 Yazd

Figure 5.2 Two products comparisons for two regions in three combinatory cases

A province in the Middle East (Yazd, Iran) and another in Europe (Champagne Ardennes, France) are territories selected to analysis two desalination systems through three cases. Yazd is selected due to this dry area’s need for this technology and Champagne Ardennes is chosen because of its contrasting geographical features compared

with Yazd province. The first case is the analysis of Solar Tears in Champagne Ardennes in terms of the availability of resources and its environmental impacts. The second case is analysis of same product (Solar Tears) in Yazd province. Subsequently, as we demonstrate the failure of using Solar Tears in Yazd, we present Elidomestico as our third design proposal is our design proposal by an Italian designer, Gabriele Diamanti, based on the geographical features of this province for DfS. These comparisons of two products for two regions are shown in figure 5.2as three combinatory cases.

A short description of geographical features for both territories is provided below. Later, in each case, we studied the desalination systems and proposed a PEG model to show the relation of geographical data with product and related environmental impacts. Finally, a conclusion based on comparisons of territories and products is made.

5.1 Evaluation methodology

In terms of its environmental impact analysis, according to ISO 14040, the first steps in a life cycle project are defining the goal and scope of the project to ensure that the final results meet the specific needs of the user. The scope of the study is a cradle to grave life cycle assessment which begins with the extraction of all raw materials used in different parts of Solar Tears through to the disposal after consumer use, including all the transport associated with the delivery of raw materials and the shipping and disposal of final product in each region. The function of the product system under study is producing fresh water. The functional unit is the capacity of producing 600 liters fresh water during three years with 120 hours of its function per year.

For Life Cycle Assessment methodology, there are several software (Simapro, Gabi, OpnLCA, EcoDesignStudio and etc.) to choose. What make difference between them are used databases (ILCD, Ecoinvent, FD E01-008), data types (General data, specialized data) and calculation approaches (flow approach and material/process approach). In terms of calculation approach, process/material is less time consuming and complicated compare

with flow approach and concerning with the data type, use of specialized data is more accurate compare with general data. Thus, combination of these factors through different software brings different results in terms of their accuracy and simplicity. Simapro and EDS both are using the material & process approach, but what makes different between them is their used database. Simapro is using specified database (ILCD and Ecoinvent databases), which need to implement characterization factor. But EDS is using a general database (E01-008), which does not need to consider characterization factor and results more realistic and accurate calculation. Automatic flow modeling is another advantage for using EDS, compare with Simapro, Gabi and OpenLCA. As this process is time consuming and sometimes complicated, working with EDS is simpler than others. These advantages of EDS are a reason for us to choose it as the software to evaluate environmental impacts of case studies in this chapter. Eco Design Studio (EDS) is online software (<http://www.ecodesign-studio.com>) developed by Altermaker Company (<http://www.altermaker.com/fr>). This software is using FD E01-008 database with specialized (mechanical products) data type and its calculation approach is material/process.

In terms of impact analysis, we decided to observe two impacts: one at a regional scale (acidification) and the other at a global scale (climate change). As the goal of this validation is to highlight the effect of geographical features on the product's form, the impacts are analyzed only by two main elementary flows driver (SO₂ for acidification and CO₂ for climate change).

Another important aspect of calculating LCAs is the use of allocation procedures when differentiating the use of energy and raw materials associated with individual products within a single system. However, all life cycle stages of this product are in one territorial boundary, thus the allocation procedures are not considered. Moreover, other aspects in terms of maintenance sequences for parts, specific methodological approach and end different of life scenarios are not considered in these cases.

5.2 Case 1: Solar Tears in Champagne Ardennes

Champagne-Ardenne is a former administrative region of France, located in the northeast of the country. Its geographical features are (www.regions-of-france.com/regions/champagne_ardenne):

- Surface area: 25 606 sq. km
- Population: 1,342,363 (52 people per sq. km)
- Climate Type: Oceanic
- Average temperature: Summer 18°C, Winter 2°C, Max 24°C
- Average sunshine 1,700 hours per year
- Average rainfall: Between 550 and 700 mm per year

This region is rich in water resources due to the high amounts of rainfall, which decrease the need and access to use a solar distiller system. However design and research is never limited to a specific geographic region and could be useful in other regions. In terms of geographical resources, the agro-food industry is the central driver of regional economic activities. Newer industries are automobile components, plastics, and food and beverage processing. The region's chemical, glass, packaging, and printing industries are directly related to the needs of the champagne producers (www.champagne-ardenne.cci.fr).

Figure 5.3 presents G category of the PEG data model related to Champagne Ardennes geographical data. In this figure, temperature and rainfall are presented as non-geographic objects with maxima 24°C and 700 mm by NonGeographicObject data class. This class has an aggregation relation with Theme class that corresponds to three themes: amount of rainfall, sunshine and resources. GeographicObject class is another data class of this category which presents forest, propylene (PP), textile, glass, agriculture products and energy sources as available resources in this territory. The last class is SpatialObject that supports types of data that could be presented on the map as different spatial objects on separate data layers.

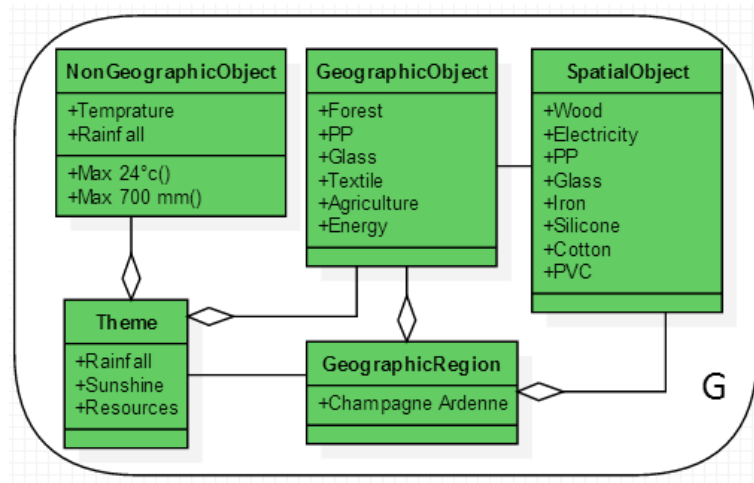


Figure 5.3 Geographical data related to Solar Tears for Champagne Ardennes

Solar Tears is an innovative household solar distiller (Figure 5.4). It was designed in Champagne Ardennes by a group of researchers and students from the CREIDD research team at the university of technology of Troyes (UTT) under supervision of professor Serge Rohmer. It is based on the concept of frugal engineering to answer the question of accessing clean water in developing countries. The basic principle of Solar Tears is very simple, like other solar stills function, as distillation replicates the way nature makes rain. The sun's energy heats water to the point of evaporation. As the water evaporates, water vapor rises, condensing on the glass surface for collection. This process removes impurities such as salts and heavy metals as well as eliminates microbiological organisms. The end result is water cleaner than the purest rainwater.

It produces 3 to 5 liters of fresh healthy water per day in full sunlight, which would be enough for a small family. This device is designed for regions with proximate maximum temperature of 35° C. It is essential that each component has adequate thermal stability to withstand higher temperature conditions. Therefore, all PVC based components have to be replaced by other materials, since PVC deforms rapidly with increasing temperature (60-70 ° C). The total weight of this device is 4 kg and it contains 15 sub-assemblies in the form of a rectangle.

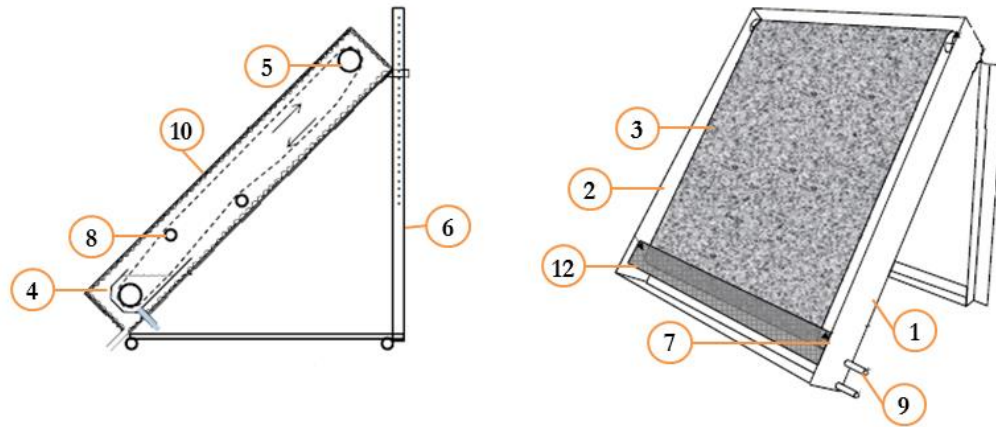


Figure 5.4 Solar tears part details

A list of the raw materials, sub-assemblies, intermediate assemblies, sub-components, parts and the quantities of each needed to manufacture the end product are indicated in the figure above corresponds to the item number in table 4.1. The product structure is made up by assembling fourteen parts and a motor as the fifteenth part that provides the electrical power. The use of a motor indicates the dependency of its function on electrical energy, which could be a negative point to be used in locations without access to this type of energy.

Table 5.1 The BOM for Solar tears

Item	Part	Material	Mass (g)	Quantity
1	Box	MDF	600	1
2	Top window	Glass	500	1
3	Mat	Cotton	100	1
4	Gutter	PVC	100	1
5	Moving rolls circular	PVC	50	2
6	Moving rolls axe	Aluminum	170	2
7	Stretcher rod	Steel	80	2
8	Stretcher rod connector	Brass	20	4
9	Water pipe	PVC	30	2
10	Bracket	Wood	550	1

11	Screw	Steel	2	30
12	Liquid gasket	Silicone	10	1
13	Spring	Steel	5	8
14	Paint	-	200	1
15	Motor	-	700	1

The data on product structure and environmental impact, responsible for P and E categories of PEG model, is presented in figure 5.5. Category E includes Impact, LifecycleProcess, SubstanceFlow and LifecyclePhase classes and category P contains Artifact, Function, Geometry, Form, Material and Feature classes.

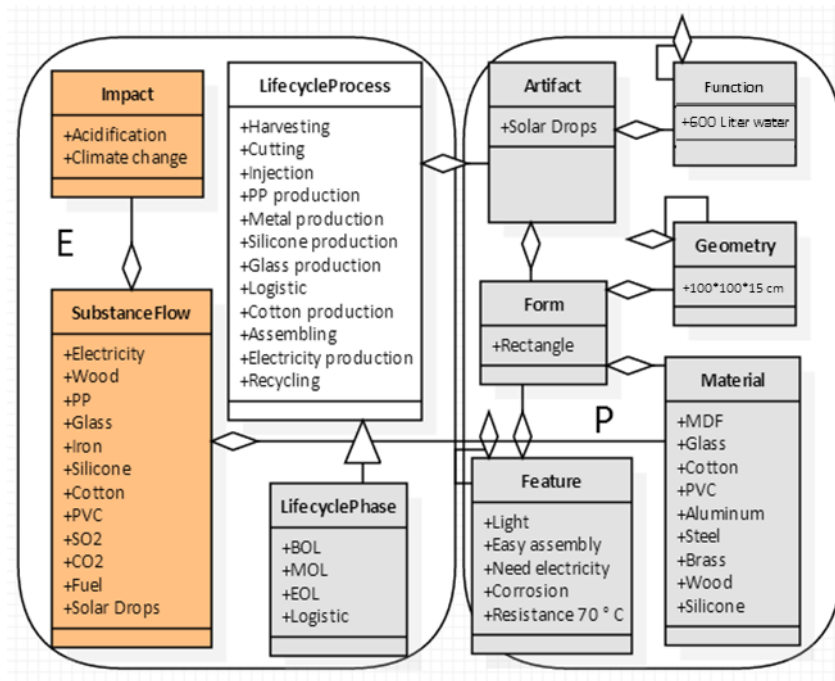


Figure 5.5 Solar tears part details

The class Artifact has an aggregation relation with LifecycleProcess class through different lifecycle phases. Artifact has relation with its environmental impacts through the Material class that is aggregated with SubstanceFlow class. More details on the relation

and content of data models are proposed by integrating category G and presenting complete PEG data models.

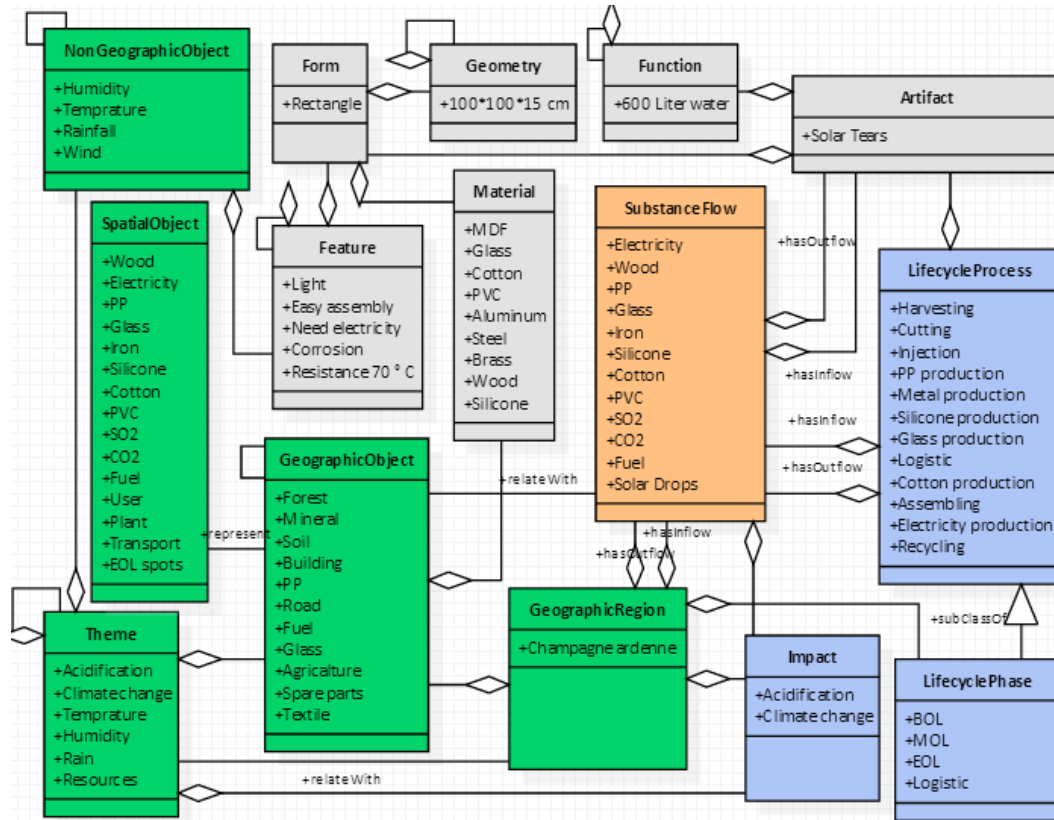


Figure 5.6 PEG model for solar tears in Champagne Ardennes

The PEG data model for Solar Tears is presented in figure 5.6. All life cycle steps are in one geographical region. Therefore the foreground and background classes are fused and presented as GeographicRegion class. The Solar Drop is the defined artifact. It has a rectangular form presented as the object of form class, with the function of producing five liters of water per day. The form class has aggregation relation with material, geometry and feature (Light, easy assembly, need for electricity, corrosion ability and temperature resistance of max 70 ° C). The artifact is made of nine materials (MDF, glass, cotton, PVC, aluminum, steel, brass, wood and silicone) presented as fourteen objects of material class defined in product BOM (Table 5.1). GeographicObject class corresponds to

available objects (Natural and cultural geographical objects) in the defined geographic region (Champagne Ardennes). This class has an aggregation relation with material class, which means that material used in the designed artifact is supplied from champagne Ardennes. NonGeographicObject is another class related to defined territory, which includes some geographical features of this region in terms of humidity, rainfall, temperature and wind. These features have an aggregation relation with artifact features, which mean the features of the product have a strong relation with features of the geography. For instance, if the temperature of area rises above 40° C, the plastic parts will lose their resistance and they will reshape.

The Artifact's life cycle consists of twelve life cycle processes from BOL until EOL. These processes have input and output flows that are shown by SubstanceFlow class. In this class we show the objects that are the result of input/output material, energy and SO₂ and CO₂ emissions related to two impacts of acidification and climate change. The amounts of CO₂ and SO₂ emissions (2.71e-1 kg and 5.04e+1kg) are the results of life cycle processes feeding SubstanceFlow class (all impacts are available in Appendix C).

This class has an aggregation relation with artifact and GeographicRegion classes, which acts as a connector between artifact and territory. To present the result and data on the map we have two classes of SpatialObject and Theme. These classes are general and could be defined for each product of all products in each geographical region. Theme shows the result as a polygon and spatialobject as line and points. These results allow us to present all data by different classes of product, geography and environment through the PEG model. Two classes of GeographicalObject and NonGeographicalObject define a specific territory based on geographical features and existing substances flows which make unique the results of impacts, theme and spatial objects unique for each geographical boundary. Access to themes of each territory could give information about environmental status, which could help designers make their decisions in terms of material selection and the subsequently environmental impacts of decisions.

In the next section, we will observe the proposition of a Solar Tears project for another territory (Yazd, Iran) to present the status of data models for the same product in a new territory and analyze the environmental impacts which are produced.

5.3 Case 2: Solar Tears in Yazd

Yazd Province is one of the 31 provinces of Iran. It is in the center of the country, and its administrative center is the city of Yazd with limitations regarding water resources. This problem has become more obvious in recent decades due to economic and urban development. Economic and population growth have caused a deterioration in available water resources both in terms of quantity and quality aspect (Amighpey & Arabi 2016).

- Surface area: 131,575 sq. km
- Population: 750,769, of which 75.1% are urban residents while 24.9% resided in rural areas
- Climate Type: Desert
- Average temperature: Summer 40°C, Winter 12°C.
- Average sunshine 74% of a whole year
- Average rainfall: Between 60 and 100 mm per year

This province is situated at an oasis where the Dasht-e Kavir desert and the Dasht-e Lut desert meet and in July temperatures rise above 40C, which shows the importance of access to drinkable water. Yazd is now one of Iran's industrial textile centers. The average amount of rainfall and the annual 74% availability of sunshine, indicate the importance of using small scale desalination systems to provide drinkable water for people in this area (www.ostanyazd.ir). The main natural resources of this territory are restricted to metal processing, textile and food processing, which make it difficult to access wood and plastic as the main materials for the Solar Tears product. This limited access to these resources is another problem in terms of manufacturing this product in Yazd province (www.atbayazd.ir).

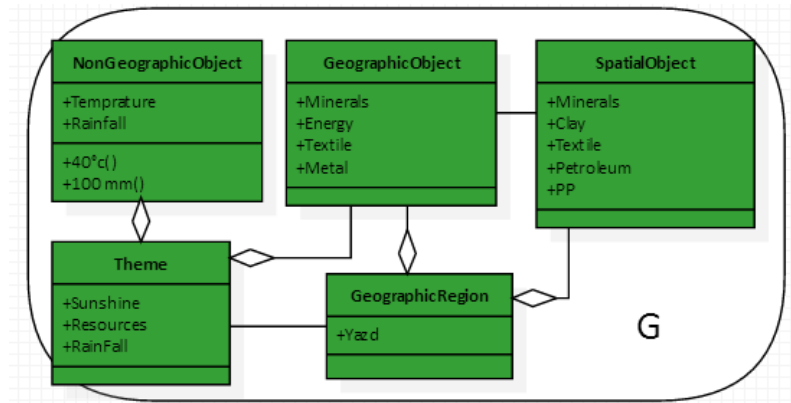


Figure 5.7 G category of PEG model corresponding to geographical data for Yazd

Figure 5.7 presents G category of the PEG data model related to Yazd geographical data. In this figure, temperature and rainfall are presented as non-geographic objects with maximum 40°c in and maximum 100 mm rainfall in NonGeographicObject data class. This class has aggregation relation with Theme class that corresponds to three themes: amount of rainfall, sunshine and resources. GeographicObject class is another data class of this category which presents available resources in this territory as minerals, clay, propylene (PP), textile and petroleum sources. The last class is SpatialObject that supports type of data that could be presented on the map as different spatial objects on separate data layers.

The average temperature of Yazd region in summer is around 40°. This has a big negative impact on parts of Solar Tears which are made from plastic. When the temperature of the region reaches 40° and sometimes more, the internal temperature of the device could be more than 70°, which causes deformation of plastic parts. In terms of manufacturing use and EOL stages, figure 5.8 presents the availability of resources for this product in Yazd province. In terms of manufacturing stage, red items are resources, which have to be imported from other background (s) and green items are the ones that are available in the territory. Another critical design problem of using Solar Tear occurs in the use stage when electricity is needed, whereas in rural areas of this province electricity is unavailable. Regarding the end of life phase there is no systematic approach to managing the end of life

scenario for the product in Yazd province. Moreover, importing different resources from other background(s) needs transportation, which itself has additional environmental impacts.

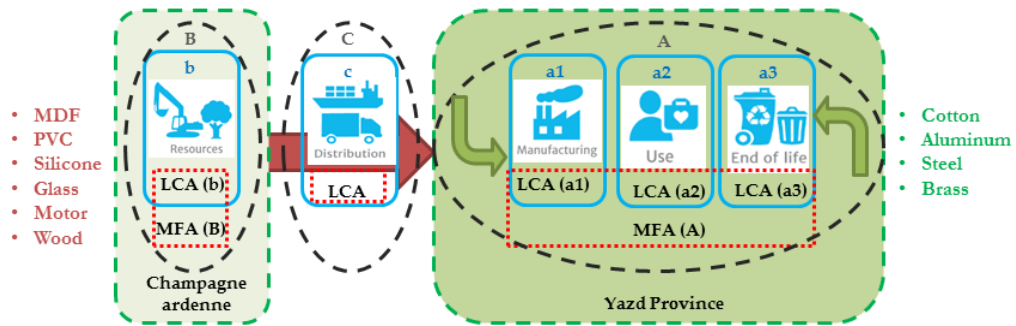


Figure 5.8 Foreground-Background approaches for Solar Tear product in Yazd

Figure 5.9 presents these data (geographical features, substance flows, impacts and product features) by defining ForegroundRegion and BackgroundRegion. This analysis illustrates the difference in developing the Solar Tears product, designed originally based on geographical features and substances flows in Champagne Ardennes, in Yazd province. Each of these classes contains specific GeographicObject class to present available objects in terms of resources. GeographicObject class could contain all objects (Natural and cultural) that are available in each territory, but for this case we only considered objects relevant to material resources on this product. GeographicObjectFG is defined for the foreground territory (Yazd), comprising mineral, clay, petroleum, textile and PP related to design of this product. The geographicObjectBG is specified for background geography (Champagne Ardennes) with the objects are/were presented in the previous PEG model in figure 4.6.

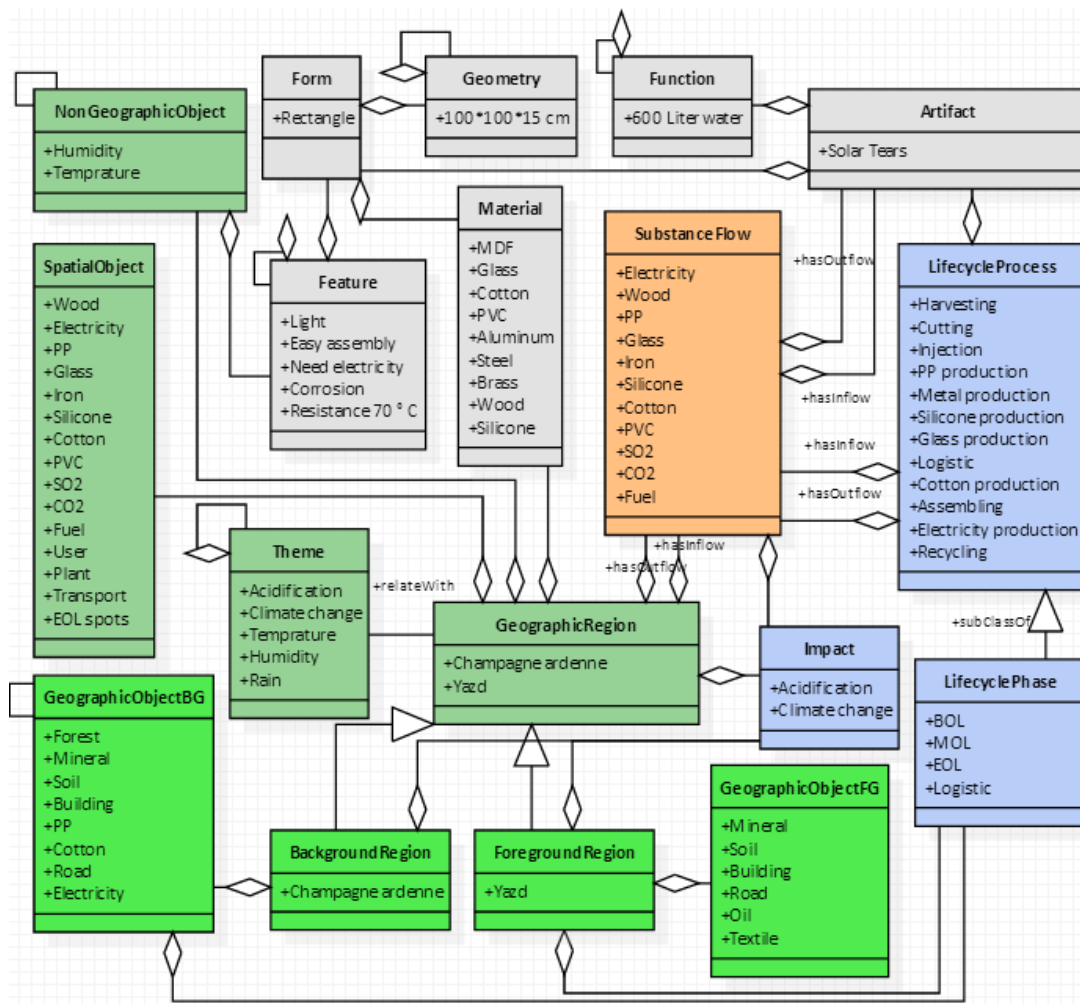


Figure 5.9 PEG model presentation of Solar tears for Yazd province

Each of these territories has a NonGeographicalObject class, which presents the geographical features of each area in terms of temperature and rainfall that have impacts on product features, but as these features have direct relation with product feature, only one class is defined. Impact class has aggregation with each geographic region (FG and BG) to study and present site-specific impacts and also with GeographicRegion class to analysis the impact at global scale level. LifecyclePhase class has aggregate connection with ForegroundRegion and BackgroundRegion classes due to the different locations where each phase of BOL, MOL and EOL could happen.

In terms of environmental impact, result is same as for Solar Tears in Champagne Ardennes, which is explained in section 5.2, but the transportation of product from Champagne Ardennes to Yazd (5000 km) makes additional impacts shown in appendix D. The amount of this additional impact increases the amount of SO₂ from 2.71e-1kg to 2.79 e-1kg and CO₂ from 5.04e+1 kg to 5.26e+1.

Based on the problems and limits mentioned for the manufacturing and use of Solar Tears for Yazd province, we propose another desalination system, called Eliodomestico, developed based on geographical features of this territory

5.4 Case 3: Eliodomestico in Yazd

Geographical features like climate and natural resources can impact design solutions and the architecture of cities and villages is an example of that. Yazd province has lots of mineral resources and clay is one of those resources. It is used as a base material for design of many products in the pottery industry. Pottery is made by forming a clay body into objects of a required shape and heating them to high temperatures in a kiln. This removes all the water from the clay and induces reactions that lead to permanent changes, including increased strength and hardening and setting the shape. Based on the concept of pottery, there is a design proposal for a desalination system called Elidomestico (Figure 5.9), which is an innovative solar distiller for households, designed by Italian designer Gabriele Diamanti, to function without filters or electricity. The device is made from readily available materials, such as burnt clay and tin metal, and can be entirely produced by local craftsmen.

Eliodomestico is a simple device which delivers drinking water in areas where salt or brackish water is prevalent as ground and/or surface water. The system can provide positive outcomes for local economies as it is designed to be entirely produced on site, thus, generating small businesses. The device is self-explanatory and, apart from cleaning, no maintenance is required. Traditional forms and materials make the product highly

recognizable and easy to understand, especially in rural areas. In the morning a water tank is filled with dirty or salty water, and in the evening clean water can be collected. The water evaporates and re-condenses in a portable recipient placed underneath the tank. The prototype model which has a diameter of 60 cm and a surface area of 0.28 m² produces around five liters (1.09 gal) of fresh water per day. The lower container's basin is designed to be transported on the head, which is a common practice in developing countries.

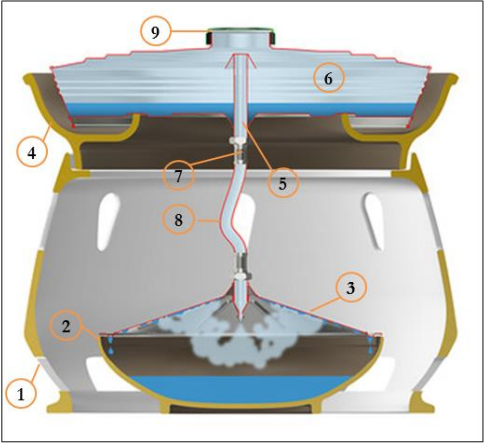


Figure 5.10 Eliodomestico

This product is broken down into 9 basic parts (Figure 5.10). The numbering of the parts of the Eliodomestico in the figure below corresponds to the item number in table 5.2.

Table 5.2 the BOM for Eliodomestico

Item	Part	Material	Mass (g)	Quantity
1	Main body	Clay	12000	1
2	Bowl	Clay	5000	1
3	Condenser lid	Tin	1500	1
4	Evaporator support	Clay	2000	1
5	Evaporator pipe	Tin	500	1
6	Evaporator	Tin	3000	1
7	Bolt	Tin	100	2
8	Flexible tube	Tin	200	1

The body is made of two ceramic pieces, the main body (1) and evaporator support (4) that sits on top of main body. The Evaporator is a black container into which salt water is poured. The sun heats the container, turning the water to steam. As pressure builds, the steam is forced down a tube into a bowl and condenser lid in the lower piece. There it condenses against the lid and collects in the basin of the container. Detail of the foreground-background approach is shown in figure 5.11, from which it is possible to deduce how flows of the product system are interconnected through same background system flows. The Life cycle starts with upstream processes for material resource preparation (clay). Once the raw material is extracted and refined, the manufacturing process starts with beating and kneading of clay. As the manufacturing and assembling process is simple, there will not be any difficulty for users in terms of use and maintenance.

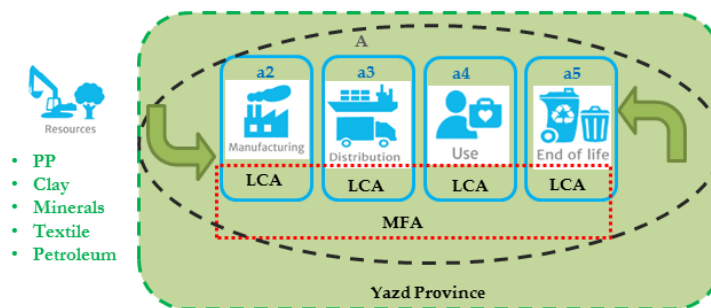


Figure.5.11. Foreground-Background approach for Eliodomestico in Yazd province

According to ISO 14040, the scope of the study is a cradle to grave life cycle assessment which begins with the extraction of all raw materials used in different parts of Eliodomestico through to the disposal after consumer use, including all the transport associated with the delivery of raw materials and the shipping and disposal of final product in Yazd province (200 km). The function of the product system under study is producing fresh water. The functional unit is same as Solar Tears with the capacity of producing 600

liters fresh water during three years with 120 hours of its function per year. The “EcoDesignStudio” software (<http://proto.ecodesign-studio.com>) was used to calculate the consumption of energy, fuels, and raw materials, and generation of solid, liquid, and gaseous wastes starting from the extraction of primary raw materials. In terms of impact analysis, we decided to observe two impacts: one at a regional scale (acidification) and the other at a global scale (climate change). However, the full result of LCA for this product is available in Appendix E. To present in our data model, the total SO₂ and CO₂ emissions for this product are 7.35e-1 kg and 1.06e+2 kg. Evaporator in the manufacturing phase with 53% of SO₂ and 55% of CO₂ has the main impact corresponding to acidification and climate change. These amounts of impact are more than Solar Tears, but as it mentioned in previous section, the main problem of using Solar Tears in Yazd are its function in terms of electricity availability and high average temperature.

The PEG data model for Eliodomestico is presented in figure 5.12. All life cycle steps are in one geographical region. Therefore the foreground and background classes are fused and presented as GeographicRegion class. The Eliodomestico is the defined artifact with the function of producing five liter of water per day as presented as a rectangular form as the object of form class. The form class has an aggregation with material, geometry (Ø60 cm) and feature (Heavy, easy assembly, no need for electricity, temperature resistance more than 90 ° C). The artifact is made from three materials (PP, clay and tin) presented as nine objects of material class defined in product BOM (Table 5.2). GeographicObject class corresponds to available objects (Natural and cultural geographical objects) in the defined geographic region (Yazd). This class has an aggregation with material class which means used material in the designed artifact is supplied from the Yazd region. NonGeographicObject is another class related to the defined territory which includes some geographical features of this region in terms of rainfall, temperature. These features have an aggregation with artifact features, which means the features of the product have a strong relation to features of the geography. For instance, if the temperature rises above 40° C, the product will resist in terms of structure shape and function.

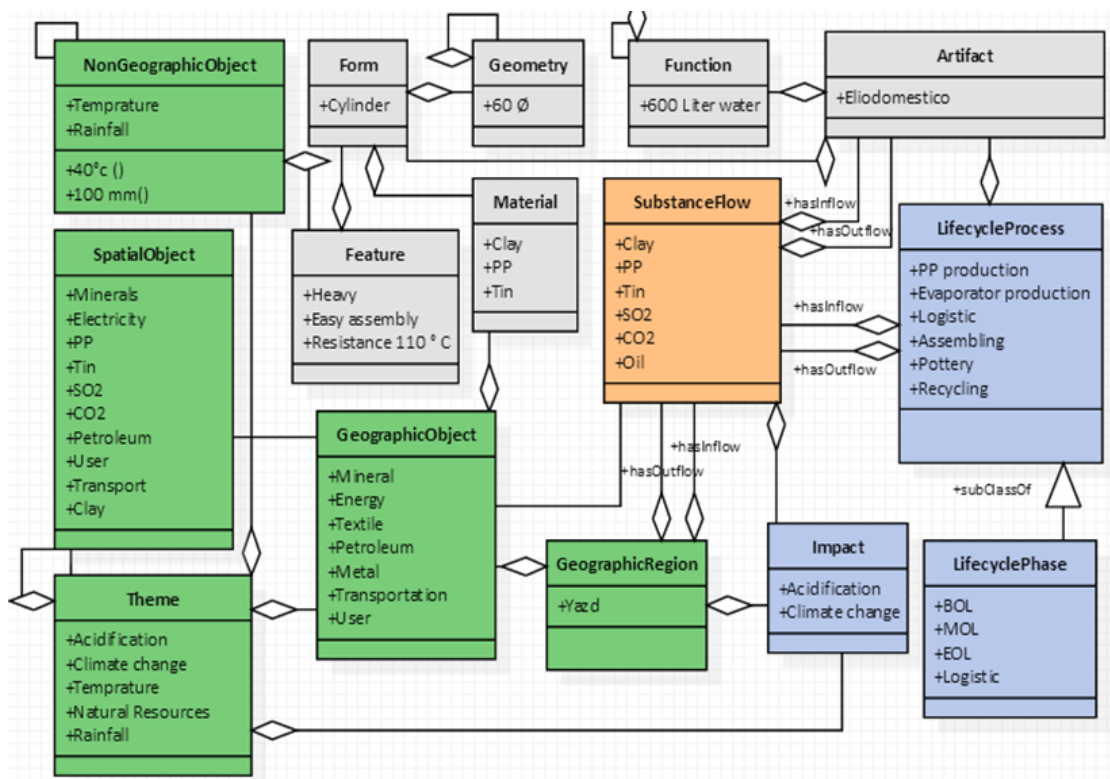


Figure 5.12 Foreground-Background approaches for Eliodomestico in Yazd province

5.5 Discussion and conclusion on case studies

Comparisons between two products for two regions through three combined cases, tried to highlight the importance influence of geographical information on design, in terms of available resources and geographical features. This analysis shows how changes in geographical region could change design choices to produce better functions and different environmental impacts. Through these cases, partial analyses are implemented on design aspects in terms of product structure and function without considering the aspect of product behavior, which is not taken into account by our methodology. Moreover, other parameters, which have important impact in DfS such as access to accurate information, all

regional resources, precise environmental status, available manufacturing technologies, cost, social and cultural aspects and etc. are not considered on the comparisons between the three cases. On the other hand, the environmental impact assessment is implemented based on available databases on EcoDesignStudio software (ELCD), which is at site-generic level and does not reflect the environmental status of studied territories.

As it explained in previous sections, Solar Tears is a product designed in Champagne Ardennes based on available resources of this region (wood, PVC, glass etc.). The function of this product needs electricity, which is accessible in habitable zones and maximum temperature is not a problem for the functionality of assembled parts. However, the usability of this product fails, when the region of manufacturing and use changes from Champagne Ardennes to Yazd because of geographical features (temperature) and regional resources (No access to wood and electricity in rural areas). Thus, the Eliodomestico design solution is proposed for Yazd region which is based on geographical features of new region but supports the same function as Solar Tears. Eliodomestico's design shape reflects traditional archetypes so is not alien, and the materials involved in the production belong to territorial traditions which make the use easier. The maintenance is simple compared to Solar Tears: there is no glass to keep clean; the salt stays in the evaporator; nothing in the system can be clogged up, because when the water evaporates, the salt is left behind and stays on the bottom. The only maintenance (about once a month) is to unscrew the pipe, take out the evaporator and wash it. Moreover, transportation is quite short because all steps of the life cycle are very close to each other and all are in same background system.

Figure 5.11 illustrates differences between the products, in terms of form and the amount SO₂ and CO₂ flows, acidification and climate change for related environmental impacts, function and amount of used territorial resources. Using territorial resources (Clay) from Yazd territory requires a pottery process to manufacture some parts which change the form from rectangular to cylinder. This change in used material implies changes in the product's CAD due to differences in manufacturing technologies which answers our research

question” How geographical differences could change the product proposition in terms of structure and form?”.

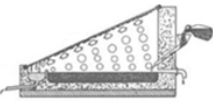
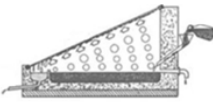

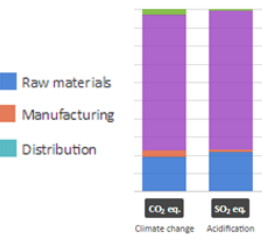
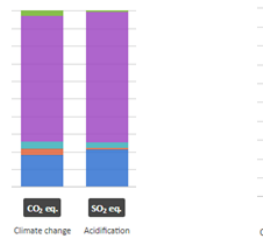
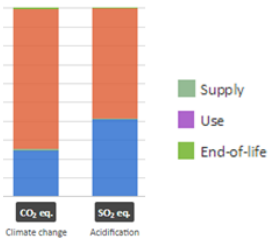

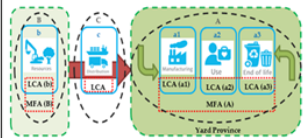
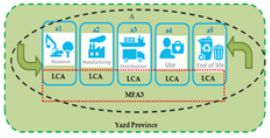
	Case 1	Case 2	Case 3
Function	5 liters per day	deformation of plastic parts at temperatures above 40°C	5 liters per day
Use regional resources	✔	✘	✔
Form			
LCA software	EcoDesignStudio	EcoDesignStudio	EcoDesignStudio
Functional unit	600 liters fresh water in 3 years (120 hours per year)	600 liters fresh water in 3 years (120 hours per year)	600 liters fresh water in 3 years (120 hours per year)
Distance	100 km	5000 km	200 km
CO2 emission	5.04e+1 Kg	5.26e+1Kg (Transport)	1.06e+2 kg
SO2 emission	2.71e-1kg	2.79 e-1kg (Transport)	7.35e-1 kg
Acidification & Climate change			
Foreground-Background Approach			

Figure.5.11. Comparisons between Eliodomestico and Solar Tears

In terms of environmental impact, the negative environmental impact of Eliodomestico is more than Solar Tears. Changing the product design from Solar Tears to Eliodomestico increase the amount of SO2 and CO2 flows. However, this increase in the amount of CO2 and SO2 emission could be neglected, if Solar Tears was going to be used and manufactured in Yazd because of failure in its function and availability of resources. More than 90% material flows for manufacturing use and other life cycle steps of Eliodomestico

in Yazd province are from inside of the territory. On the other hand, if the objective was to develop Solar Tears in Yazd, the territory's geographical features in terms of temperature, lack of access to electricity for the use step and insufficient other resources would make this unrealistic. The result was the need to import some resources from outside the boundary (foreground + background) systems. Moreover, the design specifications of Solar Tears do not match the geographical features of Yazd province. In summer, temperatures in this territory increase up to 19° which is not suitable for the function of some parts used in this product. Using clay as a material related with Yazd province solves the problem of imports from other geographical boundary and matches design specification with geographical features. All in all, it is not clear for us the real environmental impact of Eliodomestico in Yazd province, due to the lack of available information about environmental status of this territory. However, the positive social and economic impacts of this product are other aspects which could be discussed in future.

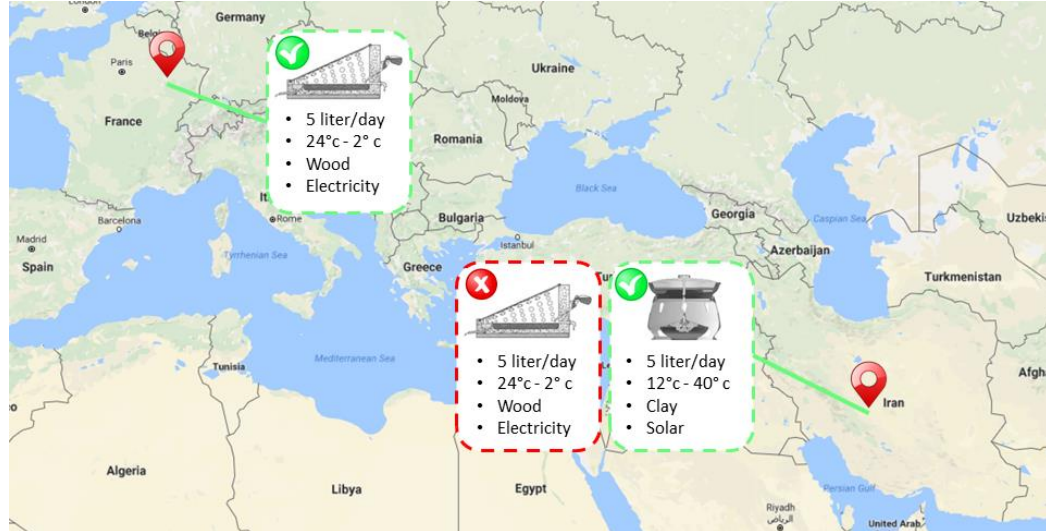


Figure.5.12. Product proposal for two different regions for better DfS

This chapter compared two desalination systems (Solar Tears & Eliodomestico) with the same function (about 600 liters) for two different regions (Champagne Ardennes & Yazd) to demonstrate the fact that the function and environmental impact of a product in a region is not same if the region's lifecycle stages change. In fact, geographical features such as

availability of resources, energy, climate and etc. have a direct impact on product structure and function (Figure 5.12). The impact of geographical differences on design choices and especially on DfS highlights more than ever the importance of including geographical information in the product design process.

This establishes the fact that there is a clear, strong relationship between natural resources and sustainable development and because of differences on the quality, quantity and accessibility of these resources, a product that is sustainable in a foreground region, is not sustainable in a background region. Using a data model like PEG, which connects product with geography, could support geographical information related to substances flows and related environmental impacts throughout design process for more appropriate decisions. However, access to accurate geographical data, policies and laws are significant barriers to implementing this approach to design, especially concerning DfS, which is more relevant for developing countries. Moreover, decision makers, more especially in developing countries, have a challenge implementing policies, laws and strategies, which promote the sustainable utilization of the resources to achieve sustainable development. A key area of decision-making concerns economic and environmental trade-offs. Developing countries, more especially those less developed, are not only faced with the challenge of insufficient and unreliable geographical and environmental data, but also with the challenge of sharing such data and information. However, in this design approach, while we might not have all the information we would like to have before acting, we do now know enough to begin to take into account the importance of geographical information in DfS.

Based on the results obtained through chapters 4 and 5, a number of conclusions can be drawn. Further, based on the identified limitations, future research areas can be identified. These conclusions and research opportunities are detailed in the next chapter.

Chapter 6

Conclusion

The aim of this research was to understand the relationship between product and geographical information to improve DfS. To this end a data model proposal (PEG) was proposed and created to highlight this relationship. Subsequently, a foreground-background approach for PEG was implemented to restrict the scope of the proposed model to the material class (available regional resources). The final step was to compare two existing small scale desalination systems for two different regions through 3 proposed cases to show how regional differences (geographical features and available resources) could impact design specifications in terms of product structure.

This chapter outlines the major conclusions that can be drawn from the research presented in this thesis. Firstly, a summary of the research is presented. Secondly, the implications of the research are outlined, the contribution to current knowledge is presented. Thirdly, the limitations are discussed and finally, areas for further research are outlined.

6.1 Summary

Each of the research objectives was tackled in order to address the overarching via two research questions.

6.1.1 Research objectives

There were five research objectives forming the foundation of the research. This section outlines each objective, how it was addressed, the main findings and where this can be found within the thesis.

Objective 1: To highlight the absence of LCA during the first design stages.

This objective was addressed by the literature review in section 2.2. LCA is usually applied at EOL (Figure 6.1) and not in the early stages of design, because of the various levels of uncertainty, caused by not considering the spatial and temporal characteristics. Due to these uncertainties, which are usually generated by empirically inaccurate parameters in the life cycle inventory LCI, most of the existing tools based on LCA do not focus on design, since they are set for a strategic management or a retrospective analysis of existing products.

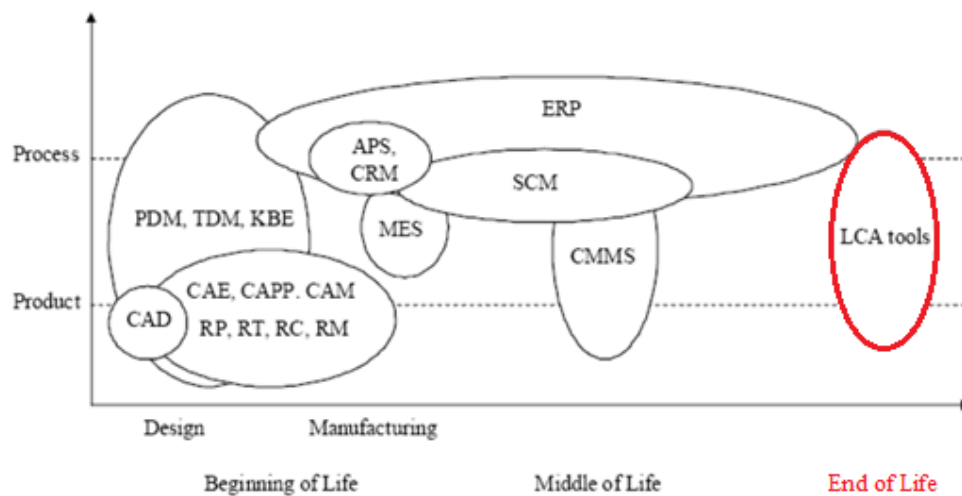


Figure 6.1 Use of LCA in EOL (Terzi et al. 2010)

Objective 2: To identify that integrating GIS with PLM is a new kind of strategy for product design and development, especially in the field of DfS.

This objective was addressed in section 2.2, 2.4 and 2.5 by the fact that much of the data products developers typically use includes significant spatial components. Researchers and

professionals have seen the potential of using GIS in the planning for a sustainable development. Mapping substances flows in different periods and spatial areas, hence making it easier and more correct to design based on the environmental status of spatial areas and to predict future changes and make well founded planning decisions for DfS (Figure 6.2).

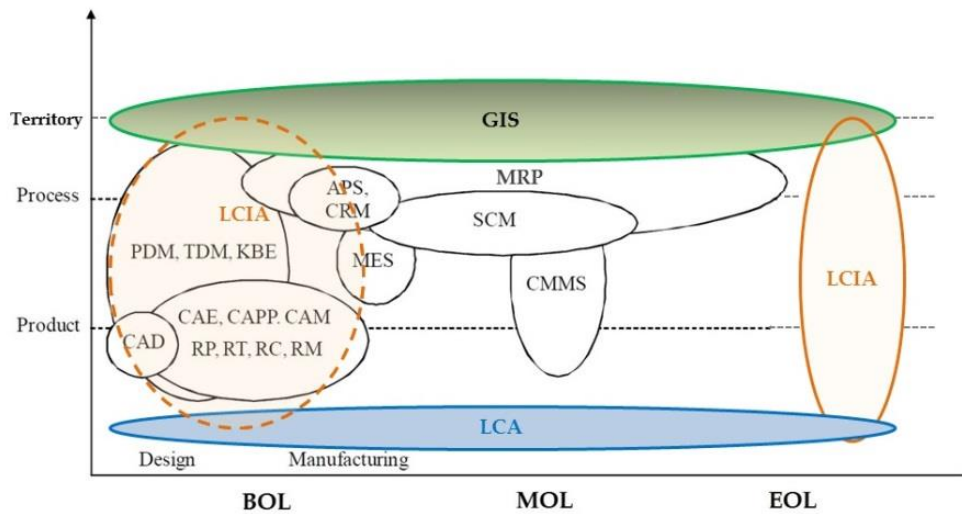


Figure 6.2 Improved ICT structure in product life cycle (Vadoudi et al. 2014)

In consequence, the essential requirement is to identify and develop technology for current PLM structure beginning at company scale to enable product development processes based on the result of sustainability at the regional scale, in order to solve the issue of sustainability at a global scale. By means of GIS integration, designers can facilitate and conceptualize a sustainable product. However, product design is simply the first stage of product development. Thus, there are further opportunities to use LCA in the initial design steps to make improvements from an environmental perspective. Access to territorial substances flows, a more efficient transportation and material and energy flows through industrial systems could all contribute to a better DfS.

Objective 3: To identify the link between technosphere, eco sphere and geography.

This objective was addressed by the identification of relationships between existing data models in three areas of product, environment and geography, which are characterized and categorized in Tables 2.1, 2.2, 2.3, 3.1, 3.2, 3.3 and 3.4. These relationships are defined by the fact that the environmental space of the product life cycle is geographical and is divided into technosphere and ecosphere systems. As environmental systems differ geographically, technological systems should be modified based on these differences.

Objective 4: To propose an integrated data model to link product with geography through environment.

This objective was addressed by the PEG data model proposal in section 4.2, which connects product, process and geographical region through substances flows as the main drivers of environmental impacts. The model contains three sub-models for ontological modeling namely, product (P), environment (E) and geography (G).

Objective 5: To identify the fact that a product could have different functions in different geographical regions.

This objective was addressed in chapter 5 by comparing two small scale desalination systems (Solar Tears and Eliodomestico) for two different territories (Champagne Ardennes and Yazd provinces). As it explained, Solar Tears, which is designed based on geographical features in Champagne Ardennes, failed to develop in Yazd territory because of different geographical features and available material resources.

The research objectives mentioned above, describe the general and specific aims and outcomes that this thesis intends to achieve. They are directly linked to our research questions, which are explained in the next section.

6.1.2 Research questions

Based on the completed research objectives, it is possible to answer the two research questions. This section outlines each of the research questions, how they have been answered and which objectives contributed to them.

Research questions 1: What is the link between information concerning product design and geography for DfS? What is the role of the environment in this link? More specifically, where is the place for LCA in PLM's IT structure?

This research question was addressed using objectives 1, 2 and 3. As it explained, there is a strong relation between technological system design and environmental systems. Part of the environmental system is related to geographical features and another part is related to the environmental impacts of the technological system. In fact, the environment plays a role as a link between geographic and technological systems. With this approach, the place of LCA in the IT structure of PLM is moved to the beginning. This movement converts the use of LCA from a tool evaluating the final product to one which changes design specifications.

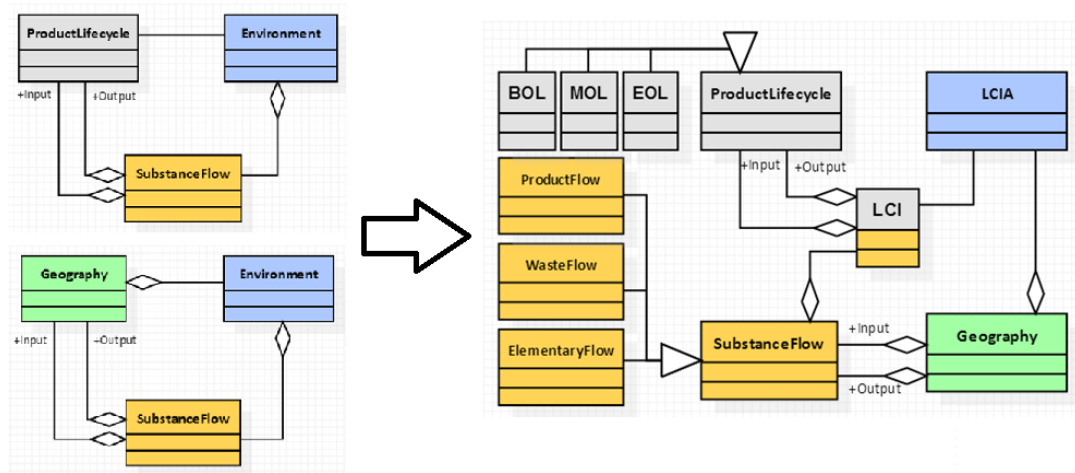


Figure 6.3 Data model relationships between product, environment and geography

Research questions 2: How could geographical features change design specifications in terms of product structure for better DfS?

This research question was addressed using objectives 4 and 5. Access to a data model like PEG could support geographical information related to geographical features in terms of substances flows and related environmental impacts throughout the design process,

which could help designers or decision makers to make precise decisions. Moreover, changes in product form by changing the used material could prove this point that geographical features could impact design specification. In this thesis, the link between product structures is closely connected to the selection of materials and their related environmental impacts.

After identifying and addressing two phenomena, which are addressed by research questions, we hope to attain our research goal.

Global research aim: To better assess DfS concepts, by providing geographical information during design process, linking product with geography.

This thesis presented a data model for including geographical features in early design steps. The state of the art suggests that this partitioning into regional-specific design activities leads to substantial gaps between activities performed across product, environmental and geographical domains, some of which are addressed by existing models. Inadequate information transfer across DfS domains has thus been listed as a major challenge. It is vital to provide a means of information transfer across geographical, product and environmental borders to bridge such gaps and to smoothly continue the design process. By providing the means for such information transfer, it is possible to assess DfS concepts better. However, there will always be situations where the concept cannot be assessed because the required information is unavailable. A wide variety of challenges are faced during DfS, and these constitute an extensive field of research. To date, no single methodology or data model providing adequate support for DfS exists.

6.2 Limitations

In this section we are going to concentrate on two aspects whose limitations had the greatest potential impact on the research:

Lack of prior research studies on this topic: Using geographical information for product design is a new topic and there is little research in this field, this caused some

difficulties at the beginning of research in the literature review and state of the art sections. On the other hand, this issue serves an important opportunity to identify gaps in the literature and to describe the need for further research.

Lack of available and reliable data: As the objective of this thesis was to use geographical information throughout the design process, a shift of data use from global to regional scales was needed. For instance, in the LCA studies of existing cases, the used data bases used were at a site-generic level, which did not give reliable results for the regions studied. The problem of insufficient and unreliable geographical and environmental data is more significant in some geographical areas especially in developing countries.

Longitudinal effects: Since DfS considering geographical differences requires time for diffusion, and needs to be done in very different territories with different technological systems, it was not possible to test it in more cases due to limited time constraints. Many questions still need to be addressed in order to know whether this approach would be applicable to all kinds of industrial products. This question requires further study, many tests and analysis.

Technological limitations: Access to proper technology in terms of manufacturing, material resources extractions and etc. is another limitation. In some cases, all the information necessary to implement DfS based on geographical features might be available but without the technology to run it.

Other limitations: Nowadays trade liberalization is an important issue, which in some cases could decrease the price of materials and costs of importing them from other territories. We might ask ourselves to what extent decision makers are willing to resist the attraction of cheaper materials in order to use local resources and be flexible enough to change design choices.

Socio-economic aspects are two very interesting fields which vary a lot when changing geographical territories, and have not been studied in this thesis. These two aspects could be analyzed and combined with the environmental aspect to give better results in terms of sustainability in future research.

6.2.1 Model validation

Upon validation of proposed semantic data model (PEG), we found some limitation and difficulties; (1) not including the cardinalities and (2) not access to complete geographical data. About the first issue, because of longitudinal effects and also the nature of geographical and environmental data, we were not able to support the model with cardinalities and in terms of limitation, access to precise data there are a big lack in terms of updated and validated geographical information. Creation a set of useful data for validation is indeed an important topic to go beyond pure conceptual approach. What we propose to support this data container is through two approaches:

1- Micro approach which concentrates on product (Micro) scale by concentration on specific product category and supporting related geographical and environmental data.

2- Macro approach which concentrates on product system (Macro) scale by concentration on specific geographic boundary and supporting the geographical and environmental data for all included products.

6.3 Future research

Finally, the discussion outlined in this chapter and the conclusions identified in this chapter highlighted several potential areas for further research. These falls into two main areas:

6.3.1 Further research in strategy

With prospects of a rising globalization, it seems increasingly apparent that “business as usual” in global scale development is not an option for a sustainable future, and a strategic change is required in the scale of development by shifting from global to regional scales. Features of this route to regional sustainable development might be: (1) a system that knows its region well in terms of its resources, limits, consumption, or personal and

institutional caps or quotas imposed on energy, goods, water, etc.; (2) a closed-loop system where nothing is allowed to be wasted or discarded into the environment, which reuses, repairs, and remakes in preference to recycling; (3) a system built on collaboration and sharing, rather than aggressive competition etc. (Bocken et al. 2014). These types of changes require a quantum shift in the purpose of business and almost every aspect of how it is conducted. Regional development aims to rapidly improve an area's economy rapidly in such a way that this development will not adversely affect the ecosystem. It needs coordination of economic development and ecosystem preservation to harmonious social progress (Wan et al. 2017). Business model innovation is increasingly recognized as a key to delivering greater social and environmental sustainability in the industrial systems (Lüdeke-Freund 2010; Teece 2010). However, the understanding of regional sustainable business models and the options available for innovation for sustainability at lower scales than the country seems limited at present.

While there is extensive literature on the theory of business models for delivering sustainability (Stubbs & Cocklin 2008), and specific examples for example (Baines et al. 2007) there is no comprehensive view of how firms should approach regional sustainability in their business models. The goal is to move from a micro scale of design to macro scale to expand boundaries beyond the factory wall to optimizing the resources utilization. At the macro level businesses measure the sustainability of an industry or territory to make decisions about their design stages. This means they are not thinking solely about themselves, but that there is a higher level entity, which is managing the sustainability as a whole. Vertical integration of industries, cross industry mixes and community involvement could be subjects for further studies, in order to bring them into the PLM structure by using geographical information as parameters across industries.

6.3.2 Future research in ICT

Socio-economic developments will not be sustainable without proper monitoring and controlling. Such development will lead to economic losses and waste of natural resources. Monitoring and controlling requires accurate information in real time. Collection of timely

information, processing them and distributing it among various organizations is essential. Therefore, Information and Communication technology (ICT) has a significant role to play in sustainable development. A fundamental concern to ICT supporting sustainable development is the recognition of the existing challenges in ICT itself and how well these demands can be resolved to enhance organizational and spatial integration. A growing number of tools for the management and monitoring of sustainable development have gained worldwide acceptance in the last decade, like Life Cycle Assessment (LCA) (John R. Ehrenfeld 1997), Material Flow Analysis (MFA) (Brunner & Rechberger 2004), Geographical Information System (GIS) (Campagna 2005) and combined tools such as LCA-CAD (Ostad-Ahmad-Ghorabi et al. 2009) and MFA-LCA (Silva et al. 2015). They have been supported by a number of organizations and programs. This variety has led to some confusion regarding the qualities, differences and linkages between various tools, and, consequently, questions on how best to apply them.

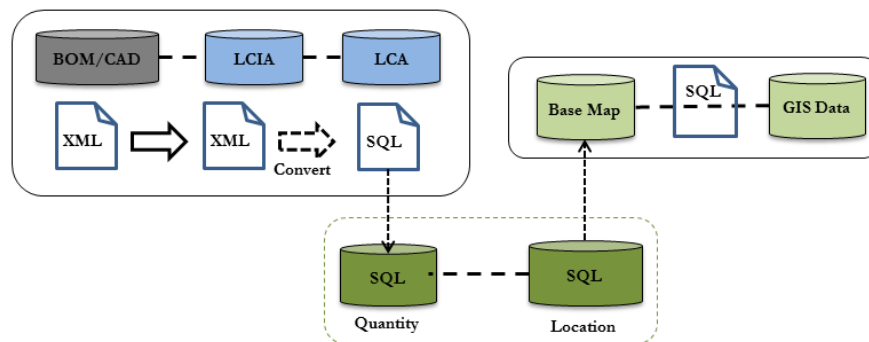


Figure 6.4 Proposed CAD-LCA-GIS software platform

Recently LCA has been integrated with GIS by OpenLCA v.1.5.0 (www.openlca.org), but this software platform supports geographical information at the Site-dependent LCA scale level. Support information at this scale could not be accurate enough to count on. Moreover, this software only proposes to present the impacts unrelated to design specifications.

Figure 6.4 shows the software system platform proposal for CAD-LCA-GIS integration. This software integration platform consists of two systems. The first transfers the CAD

data to LCA and the second transforms data from the LCA to the GIS system. CAD implicitly contains different data about the component, referring to its shape, dimensions, features and materials. These values are useful to determine the production process characteristics. All information can be chosen from the LCA database, where processes are divided into sub categories according to the different product life cycle phases (raw material extraction, manufacturing process, utilization, end of life). There are various CAD software packages available on the market, all using different file formats. Figure 6.5 is an example of this software proposal for the flashlight case study, which was explained in section 3.1. This figure presents SO₂ emission for different geographical locations as GIS data layers.



Figure 6.5 Traditional and proposed approach presentation on SO₂ emission

Making use of this software could provide the following information:

- Mapping the environmental status of territory related to substance flows, providing visual information about the main emissions and available resources.

- Mapping the environmental impacts of the designed product on interacted territory, defining specified design parameters like the materials.
- Finding patterns for environmental impacts by comparing different maps which help to predict the environmental status of territory.
- Taking into account environmental conditions of territory in product and system design which could lead to have changes in design specifications.

Bibliography

- Alemanni, M. et al., 2008. Key performance indicators for PLM benefits evaluation: The Alcatel Alenia Space case study. *Computers in Industry*, 59(8), pp.833–841.
- Allione, C. et al., 2012. From ecodesign products guidelines to materials guidelines for a sustainable product. Qualitative and quantitative multicriteria environmental profile of a material. *Energy*, 39(1), pp.90–99.
- Amann, K., 2002. Product lifecycle management: empowering the future of business. *CIMdata, Inc.*
- Amighpey, M. & Arabi, S., 2016. Studying land subsidence in Yazd province, Iran, by integration of InSAR and levelling measurements. *Remote Sensing Applications: Society and Environment*, 4, pp.1–8.
- Annamalai, G. et al., 2011. An ontology for product-service systems. In *Functional Thinking for Value Creation*. Springer, pp. 231–236.
- Antenucci, J.C. et al., 1991. *Geographic Information Systems: a guide to the technology*,
- Aspinall, R. & Pearson, D., 2000. Integrated geographical assessment of environmental condition in water catchments: Linking landscape ecology, environmental modelling and GIS. *Journal of Environmental Management*, 59(4), pp.299–319.
- Astrup Jensen, A. et al., 1997. Life Cycle Assessment (LCA)-A guide to approaches, experiences and information sources. *Environmental Issues Series*.
- Ayres, R.U., 1995. Life cycle analysis: A critique. *Resources, conservation and recycling*, 14(3), pp.199–223.
- Ayres, R.U. & Ayres, L., 2002. *A handbook of industrial ecology*, Edward Elgar Publishing.
- Azapagic, A., Pettit, C. & Sinclair, P., 2007. A life cycle methodology for mapping the flows of pollutants in the urban environment. *Clean Technologies and Environmental Policy*, 9(3),

pp.199–214.

Azaz, L., 2011. The use of Geographic Information Systems (GIS) in Business. *International Conference on Humanities*, pp.299–303. Available at: <http://psrcentre.org/images/extraimages/1211200.pdf> [Accessed February 14, 2014].

Babu, B. V, 2006. Life Cycle Inventory Analysis (LCIA). *Life cycle Assessment & Life Cycle Management Methodologies*.

Baines, T.S. et al., 2007. State-of-the-art in product-service systems. *Proceedings of the Institution of Mechanical Engineers, Part B: Journal of Engineering Manufacture*, 221(10), pp.1543–1552.

Barbau, R. et al., 2012. OntoSTEP: Enriching product model data using ontologies. *Computer-Aided Design*, 44(6), pp.575–590.

Bare, J.C., Pennington, D.W. & de Haes, H.A.U., 1999. Life cycle impact assessment sophistication. *The International Journal of Life Cycle Assessment*, 4(5), pp.299–306.

Bartl, K., Verones, F. & Hellweg, S., 2012. Life cycle assessment based evaluation of regional impacts from agricultural production at the Peruvian coast. *Environmental science & technology*, 46(18), pp.9872–80. Available at: <http://www.ncbi.nlm.nih.gov/pubmed/22894858>.

Bedard, Y., 1999. Visual modelling of spatial databases: towards spatial PVL and UML. *Geomatica*, 53(2), pp.169–186.

Belkadi, F., Bernard, A. & Laroche, F., 2015. Knowledge Based and PLM Facilities for Sustainability Perspective in Manufacturing: A Global Approach. *Procedia CIRP*, 29, pp.203–208.

Bengtsson, M. et al., 1998. An approach for handling geographical information in life cycle assessment using a relational database. *Journal of Hazardous Materials*, 61(1–3), pp.67–75. Available at: <http://linkinghub.elsevier.com/retrieve/pii/S0304389498001095>.

Bertin, B. et al., 2012. A semantic approach to life cycle assessment applied on energy

- environmental impact data management. In *Proceedings of the 2012 Joint EDBT/ICDT Workshops*. ACM, pp. 87–94.
- Biswas, A. et al., 2008. Representation of heterogeneous material properties in the Core Product Model. *Engineering with Computers*, 24(1), pp.43–58.
- Björklund, A.E., 2002. Survey of approaches to improve reliability in LCA. *The International Journal of Life Cycle Assessment*, 7(2), p.64.
- Blessing, L.T.M. & Chakrabarti, A., 2009. *DRM: A Design Research Methodology*, Springer.
- Bloor, M.S., 1991. STEP-standard for the exchange of product model data. *IEE Colloquium on Standards and Practices in Electronic Data Interchange*, p.2/1-2/3.
- Bocken, N.M.P. et al., 2014. A literature and practice review to develop sustainable business model archetypes. *Journal of cleaner production*, 65, pp.42–56.
- Booch, G., Rumbaugh, J. & Jacobson, I., 1999. *The unified modeling language user guide*, Pearson Education India.
- Borges, K.A. V, Davis, C.A. & Laender, A.H.F., 2001. OMT-G: an object-oriented data model for geographic applications. *GeoInformatica*, 5(3), pp.221–260.
- Borges, K.A. V, Laender, A.H.F. & Davis Jr, C.A., 1999. Spatial data integrity constraints in object oriented geographic data modeling. In *Proceedings of the 7th ACM international symposium on Advances in geographic information systems*. ACM, pp. 1–6.
- Boulil, K., Bimonte, S. & Pinet, F., 2015. Conceptual model for spatial data cubes: A UML profile and its automatic implementation. *Computer Standards & Interfaces*, 38, pp.113–132.
- Bracken, I. & Webster, C., 1989. Towards a typology of geographical information systems. *International Journal of Geographical Information System*, 3(2), pp.137–152.
- Bräscher, M., Monteiro, F. & Silva, A., 2007. Life cycle assessment ontology. In *La interdisciplinaredad y la transdisciplinaredad en la organización del conocimiento científico: Interdisciplinarity and transdisciplinarity in the organization of scientific*

- knowledge: Actas del VIII Congreso ISKO-Espana, León, 18, 19 y 20 de Abril de. Servicio de Publicaciones, pp. 169–178.*
- Brezet, H. et al., 1997. *Ecodesign: a promising approach to sustainable production and consumption*, UNEP.
- Brimble, R. & Sellini, F., 2000. The moka modelling language. In *Knowledge Engineering and Knowledge Management Methods, Models, and Tools*. Springer, pp. 49–56.
- Bringezu, S. et al., 2004. International comparison of resource use and its relation to economic growth: The development of total material requirement, direct material inputs and hidden flows and the structure of TMR. *Ecological economics*, 51(1), pp.97–124.
- Brodeur, J., Bédard, Y. & Proulx, M.-J., 2000. Modelling geospatial application databases using UML-based repositories aligned with international standards in geomatics. In *Proceedings of the 8th ACM international symposium on Advances in geographic information systems*. ACM, pp. 39–46.
- Brunner, P.H. & Rechberger, H., 2004. Practical handbook of material flow analysis. *The International Journal of Life Cycle Assessment*, 9(5), pp.337–338.
- Burrough, P. & McDonnell, R., 1998. *Principles of geographical information systems*, Available at: http://www.rc.unesp.br/igce/geologia/GAA01048/papers/Burrough_McDonnell-Two.pdf [Accessed February 14, 2014].
- Campagna, M., 2005. *GIS for sustainable development*, Crc Press.
- Cappellaro, F. et al., 2002. CASCADE. In *The 16th Internationale Conference: informatics for environment protection*. pp. 490–493.
- Carver, S.J., Cornelius, S.C. & Heywood, D.I., 2006. *An Introduction to Geographical Information Systems*.
- Ceschin, F. & Gaziulusoy, I., 2016. Evolution of design for sustainability: From product design to design for system innovations and transitions. *Design Studies*.
- Chang, X., 2008. *Ontology Development and Utilization in Product Design*.

- Chen, P.P.-S., 1976. The entity-relationship model—toward a unified view of data. *ACM Transactions on Database Systems (TODS)*, 1(1), pp.9–36.
- Ciroth, A. et al., 2002. Geographical and technological differences in life cycle inventories shown by the use of process models for waste incinerators part I. technological and geographical differences. *The International Journal of Life Cycle Assessment*, 7(5), pp.295–300.
- Clark, A.L. & Staley, S.M., 1995. STEP AP203 data exchange study. In *Proceedings of the third ACM symposium on Solid modeling and applications*. ACM, pp. 213–224.
- Crul, M., Diehl, J.C. & Ryan, C., 2006. Design for sustainability. *A practical approach for developing economies, United Nation Environmental Programme, TU Delft, Paris*.
- Cutting-Decelle, A.-F. et al., 2007. ISO 15531 MANDATE: a product-process-resource based approach for managing modularity in production management. *Concurrent Engineering*, 15(2), pp.217–235.
- Dahlman, C.T., Renwick, W.H. & Bergman, E.F., 2011. *Introduction to Geography: People, Places & Environment*, Prentice Hall.
- Ehrenfeld, J.R., 1997. Industrial ecology: a framework for product and process design. *Journal of cleaner production*, 5(1), pp.87–95.
- Ehrenfeld, J.R., 1997. The Importance of LCAs—Warts and All. *Journal of Industrial Ecology*, 1(2), pp.41–49. Available at: <http://www.blackwell-synergy.com/doi/abs/10.1162/jiec.1997.1.2.41>.
- El-Diraby, T.E. & Osman, H., 2011. A domain ontology for construction concepts in urban infrastructure products. *Automation in Construction*, 20(8), pp.1120–1132.
- Eynard, B. et al., 2004. UML based specifications of PDM product structure and workflow. *Computers in industry*, 55(3), pp.301–316.
- Fenves, S.J., 2001. *Core Product Model for Representing Design Information*, Citeseer.
- Fenves, S.J. et al., 2008. CPM2: a core model for product data. *Journal of Computing and*

Information Science in Engineering, 8(1), p.14501.

Fenves, S.J. et al., 2003. *Master Product Model for the Support of Tighter Integration of Spatial and Functional Design*, US Department of Commerce, Technology Administration, National Institute of Standards and Technology.

Ferrer, B.R. et al., 2015. An approach for knowledge-driven product, process and resource mappings for assembly automation. In *2015 IEEE International Conference on Automation Science and Engineering (CASE)*. IEEE, pp. 1104–1109.

Finkbeiner, M. et al., 2006. The new international standards for life cycle assessment: ISO 14040 and ISO 14044. *The international journal of life cycle assessment*, 11(2), pp.80–85.

Fiorentini, X. et al., 2007. Towards an ontology for open assembly model. In *International Conference on Product Lifecycle Management, Milan, Italy*.

Flashlightsales.com, <http://flashlightsales.com/shop/maglite-parts-lists-ezp-1.html>.

Fraile-García, E. et al., 2015. Combined assessment of the environmental, economic and social impacts of structural solutions for residential construction. *Informes de la Construcción*, 67(539), pp.10–3989.

Frankel, J.A., 2009. Environmental effects of international trade.

Gallopín, G., 2003. *A systems approach to sustainability and sustainable development*, United Nations Publications.

Garrido, J. & Requena, I., 2011. Proposal of ontology for environmental impact assessment: An application with knowledge mobilization. *Expert Systems with Applications*, 38(3), pp.2462–2472.

GERO, J.S. & Kannengiesser, U.D.O., 2006. A function-behaviour-structure ontology of processes. In *Design Computing and Cognition '06*. Springer, pp. 407–422.

Geyer, R. et al., 2010. Coupling GIS and LCA for biodiversity assessments of land use. *The International Journal of Life Cycle Assessment*, 15(5), pp.454–467.

- Giovannini, A. et al., 2012. Ontology-based system for supporting manufacturing sustainability. *Annual Reviews in Control*, 36(2), pp.309–317.
- Gruhier, E. et al., 2015. A formal ontology-based spatiotemporal mereotopology for integrated product design and assembly sequence planning. *Advanced Engineering Informatics*, 29(3), pp.495–512.
- Guinée, J.B., 2002. Handbook on life cycle assessment operational guide to the ISO standards. *The international journal of life cycle assessment*, 7(5), pp.311–313.
- Gujarathi, G.P. & Ma, Y.-S., 2011. Parametric CAD/CAE integration using a common data model. *Journal of Manufacturing Systems*, 30(3), pp.118–132.
- Gunendran, A.G. & Young, R.I.M., 2010. Methods for the capture of manufacture best practice in product lifecycle management. *International Journal of Production Research*, 48(20), pp.5885–5904.
- Hadar, I. & Hazzan, O., 2004. On the contribution of UML diagrams to software system comprehension. *Journal of Object Technology*, 3(1), pp.143–156.
- Hadzilacos, T. & Tryfona, N., 1997. An extended entity-relationship model for geographic applications. *Acm Sigmod Record*, 26(3), pp.24–29.
- Harms, R., Fleschutz, T. & Seliger, G., 2010. Life cycle management of production facilities using semantic web technologies. *CIRP Annals-Manufacturing Technology*, 59(1), pp.45–48.
- Hashimoto, S. & Moriguchi, Y., 2004. Proposal of six indicators of material cycles for describing society's metabolism: from the viewpoint of material flow analysis. *Resources, Conservation and Recycling*, 40(3), pp.185–200.
- Hauschild, M., 2006. Spatial differentiation in life cycle impact assessment: a decade of method development to increase the environmental realism of LCIA. *The International Journal of Life Cycle Assessment*, 11, pp.11–13.
- Howarth, G. & Hadfield, M., 2006. A sustainable product design model. *Materials & design*,

27(10), pp.1128–1133.

[Http://www.gabi-software.com/](http://www.gabi-software.com/), GaBi software.

[Http://www.umberto.de](http://www.umberto.de), Umberto Software. Available at: <http://www.umberto.de>.

Huang, C.-L. et al., 2012. Using material/substance flow analysis to support sustainable development assessment: a literature review and outlook. *Resources, Conservation and Recycling*, 68, pp.104–116.

Huang, Y. & Deng, G., 2013. Research on development of agricultural geographic information ontology. In *Proceedings of the 2012 International Conference on Communication, Electronics and Automation Engineering*. Springer, pp. 335–341.

Ingwersen, W.W. et al., 2015. A new data architecture for advancing life cycle assessment. *The International Journal of Life Cycle Assessment*, 20(4), pp.520–526.

Iochepe, C., 1999. Specifying analysis patterns for geographic databases on the basis of a conceptual framework. In *Proceedings of the 7th ACM international symposium on Advances in geographic information systems*. ACM, pp. 7–13.

ISO14048, 2002. ISO/TS 14048:2002 - Environmental management – Life cycle assessment – Data documentation format.

ISO 14040, 1997. *ISO 14040: Environmental Management-Life Cycle Assessment-Principles and Framework*, Geneva, Switzerland: International Organisation for standardisation.

Johnston, R., 1999. Geography and GIS. *Geographical information systems: Principles, ...*, pp.39–48. Available at: http://www.geos.ed.ac.uk/~gisteac/gis_book_abridged/files/ch03.pdf [Accessed February 14, 2014].

Jungbluth, N. et al., 2011. Life cycle inventory database on demand: EcoSpold LCI database of ESU-services. *Uster, Switzerland*.

Karlsson, R. & Luttrupp, C., 2006. EcoDesign: what's happening? An overview of the subject area of EcoDesign and of the papers in this special issue. *Journal of Cleaner Production*,

- 14(15–16), pp.1291–1298. Available at:
<http://linkinghub.elsevier.com/retrieve/pii/S0959652605002374> [Accessed November 15, 2013].
- Keoleian, G.A., 1993. The application of life cycle assessment to design. *Journal of Cleaner Production*, 1(3), pp.143–149.
- Kiddee, P., Naidu, R. & Wong, M.H., 2013. Electronic waste management approaches: An overview. *Waste Management*, 33(5), pp.1237–1250.
- Kim, K.-Y., Manley, D.G. & Yang, H., 2006. Ontology-based assembly design and information sharing for collaborative product development. *Computer-Aided Design*, 38(12), pp.1233–1250.
- Kiritsis, D., Bufardi, A. & Xirouchakis, P., 2003. Research issues on product lifecycle management and information tracking using smart embedded systems. *Advanced Engineering Informatics*, 17(3–4), pp.189–202. Available at:
<http://linkinghub.elsevier.com/retrieve/pii/S1474034604000187> [Accessed January 20, 2014].
- Kleiner, S. & Kramer, C., 2013. Model based design with systems engineering based on RFLP using V6. In *Smart Product Engineering*. Springer, pp. 93–102.
- Kosters, G., Pagel, B.-U. & Six, H.-W., 1997. GIS-application development with GeoOOA. *International Journal of Geographical Information Science*, 11(4), pp.307–335.
- Kota, S. & Chakrabarti, A., 2010. A method for estimating the degree of uncertainty with respect to life cycle assessment during design. *Journal of Mechanical Design*, 132(9), p.91007.
- Kougoulis, I.-S., 2009. *Symmetric functional modeling in life cycle assessment*,
- Kraines, S. et al., 2005. Internet- Based Integrated Environmental Assessment Using Ontologies to Share Computational Models. *Journal of Industrial Ecology*, 9(3), pp.31–50.
- Krause, F.-L. et al., 1993. Product modelling. *CIRP Annals-Manufacturing Technology*, 42(2), pp.695–706.

- Kuczenski, B. et al., 2016. Semantic catalogs for life cycle assessment data. *Journal of Cleaner Production*, 137, pp.1109–1117.
- Kunii, E., Fukushige, S. & Umeda, Y., 2011. Development of CAD System for Life Cycle Scenario-Based Product Design. In *Glocalized Solutions for Sustainability in Manufacturing*. Springer, pp. 118–123.
- Lee, J. & Jeong, Y., 2012. User-centric knowledge representations based on ontology for AEC design collaboration. *Computer-aided design*, 44(8), pp.735–748.
- Lee, J.H. et al., 2012. A semantic product modeling framework and its application to behavior evaluation. *Automation Science and Engineering, IEEE Transactions on*, 9(1), pp.110–123.
- Lepczyk, C.A., Lortie, C.J. & Anderson, L.J., 2008. An ontology for landscapes. *ecological complexity*, 5(3), pp.272–279.
- Li, S.-H. et al., 2013. Investigation on auditing principles and rules for PDM/PLM system implementation. *Computers in Industry*, 64(6), pp.741–753.
- Li, Y., Wan, L. & Xiong, T., 2011. Product data model for PLM system. *The International Journal of Advanced Manufacturing Technology*, 55(9–12), pp.1149–1158.
- Lin, J.-S., Hsu, W.-L. & Chang, J.-H., 2013. An Ontology-based Product Development Framework Considering Eco-design. In *Proceedings of the International MultiConference of Engineers and Computer Scientists*.
- Lisboa-Filho, J. et al., 2010. A uml profile for conceptual modeling in gis domain. In *Proceedings of the International Workshop on Domain Engineering at CAiSE. Hammamet, Tunisia*. Citeseer, pp. 18–31.
- Lisboa, J., Iochpe, C. & Beard, K., 1998. Applying analysis patterns in the GIS domain. In *10th Colloquium of the Spatial Information Research Centre, University of Otago, New Zealand*. pp. 16–19.
- Lisboa Filho, J., Iochpe, C. & Borges, K.A. V, 2002. Analysis patterns for GIS data schema reuse on urban management applications. *CLEI Electronic Journal*, 5(2), pp.1–15.

- Longley, P., 2005. *Geographic information systems and science*, John Wiley & Sons.
- Lüdeke-Freund, F., 2010. *Towards a conceptual framework of business models for sustainability*, ERSCP-EMU Conference, Delft, The Netherlands.
- Madin, J.S. et al., 2008. Advancing ecological research with ontologies. *Trends in Ecology & Evolution*, 23(3), pp.159–168.
- Maguire, D.J., 1991. An overview and definition of GIS. *Geographical Information Systems: principles and applications*, 1, pp.9–20.
- Matsokis, A. & Kiritsis, D., 2010. An ontology-based approach for Product Lifecycle Management. *Computers in industry*, 61(8), pp.787–797.
- Mennecke, B.E., 1997. Understanding the role of geographic information technologies in business: Applications and research directions. *Journal of Geographic Information and Decision Analysis*, 1(1), pp.44–68.
- Meyer, W.B. et al., 1992. The local-global continuum. *Geography's Inner Worlds: Pervasive Themes in Contemporary American Geography*, pp.255–279.
- Monticolo, D. et al., 2015. A meta-model for knowledge configuration management to support collaborative engineering. *Computers in Industry*, 66, pp.11–20.
- Moreno, A. et al., 2011. Application of product data technology standards to LCA data. *Journal of Industrial Ecology*, 15(4), pp.483–495.
- Muñoz, E. et al., 2013. Considering environmental assessment in an ontological framework for enterprise sustainability. *Journal of cleaner production*, 47, pp.149–164.
- Murphy, L.D., 1995. Geographic information systems: are they decision support systems? In *System Sciences, 1995. Proceedings of the Twenty-Eighth Hawaii International Conference on*. IEEE, pp. 131–140.
- Mutel, C.L. & Hellweg, S., 2009. Regionalized life cycle assessment: computational methodology and application to inventory databases. *Environmental science & technology*, 43(15), pp.5797–803. Available at: <http://www.ncbi.nlm.nih.gov/pubmed/19731679>.

- Mutel, C.L., Pfister, S. & Hellweg, S., 2012. GIS-based regionalized life cycle assessment: how big is small enough? Methodology and case study of electricity generation. *Environmental science & technology*, 46(2), pp.1096–103. Available at: <http://www.ncbi.nlm.nih.gov/pubmed/22206467>.
- Nakano, K. & Hirao, M., 2011. Collaborative activity with business partners for improvement of product environmental performance using LCA. *Journal of Cleaner Production*, 19(11), pp.1189–1197. Available at: <http://linkinghub.elsevier.com/retrieve/pii/S0959652611000837> [Accessed November 10, 2013].
- Niemann, J., Tichkiewitch, S. & Westkämper, E., 2008. *Design of sustainable product life cycles*, Springer.
- Noël, F. & Roucoules, L., 2008. The PPO design model with respect to digital enterprise technologies among product life cycle. *International Journal of Computer Integrated Manufacturing*, 21(2), pp.139–145.
- De Oliveira, J.L., Pires, F. & Medeiros, C.B., 1997. An environment for modeling and design of geographic applications. *GeoInformatica*, 1(1), pp.29–58.
- Ostad-Ahmad-Ghorabi, H., Collado-Ruiz, D. & Wimmer, W., 2009. Towards integrating LCA into CAD. In *DS 58-7: Proceedings of ICED 09, the 17th International Conference on Engineering Design, Vol. 7, Design for X/Design to X, Palo Alto, CA, USA, 24.-27.08. 2009*.
- Panetto, H., Dassisti, M. & Tursi, A., 2012. ONTO-PDM: product-driven ONTOlogy for Product Data Management interoperability within manufacturing process environment. *Advanced Engineering Informatics*, 26(2), pp.334–348.
- Parent, C. et al., 1998. Modeling spatial data in the MADS conceptual model. In *Proc. of the 8th Int. Symp. on Spatial Data Handling, SDH' 98*.
- Patil, L., Dutta, D. & Sriram, R., 2005. Ontology-based exchange of product data semantics.

- Automation Science and Engineering, IEEE Transactions on*, 2(3), pp.213–225.
- Peachavanish, R. et al., 2006. An ontological engineering approach for integrating CAD and GIS in support of infrastructure management. *Advanced Engineering Informatics*, 20(1), pp.71–88.
- Pennington, D.W. et al., 2004. Life cycle assessment Part 2: Current impact assessment practice. *Environment international*, 30(5), pp.721–739.
- Péti, M., 2012. A territorial understanding of sustainability in public development. *Environmental Impact Assessment Review*, 32(1), pp.61–73. Available at: <http://linkinghub.elsevier.com/retrieve/pii/S0195925511000527> [Accessed August 11, 2014].
- Pick, J.B., 2005. *Geographic information systems in business*, Igi Global.
- Potting, J. et al., 1998. Comparison of the acidifying impact from emissions with different regional origin in life-cycle assessment. *Journal of Hazardous Materials*, 61(1), pp.155–162.
- Prakash, A. & Technology, I., Geographical Information Systems – An Overview. *Indian Institute of Information Technology*.
- Price, R., Tryfona, N. & Jensen, C.S., 2002. Extended spatiotemporal UML: Motivations, requirements, and constructs. *Successful Software Reengineering*, p.143.
- Prins, J.F., 1997. Design for environment in practice. *Schriftenreihe WDK*, pp.611–618.
- Rachuri, S. et al., 2006. A model for capturing product assembly information. *Journal of Computing and Information Science in Engineering*, 6(1), pp.11–21.
- Rees, W.E., 1999. The built environment and the ecosphere: a global perspective. *Building Research & Information*, 27(4–5), pp.206–220.
- Reichel, T. et al., 2011. Energy Data Acquisition and Utilization for Energy-Oriented Product Data Management. In *Glocalized Solutions for Sustainability in Manufacturing*. Springer, pp. 513–518.

- Reiljan, J., 2014. Regional Development Sustainability Analysis Concept. *Discussions on Estonian Economic Policy: EU Member States After the Economic Crisis*, (1).
- Rochat, D. et al., 2013. Combining material flow analysis, life cycle assessment, and multiattribute utility theory. *Journal of Industrial Ecology*, 17(5), pp.642–655.
- Rodríguez, C., Cirolto, A. & Srocka, M., 2014. The importance of regionalized LCIA in agricultural LCA—new software implementation and case study. In *Proc. 9th Int. Conf. Life Cycle Assess Agri-Food Sector. San Francisco*. pp. 1120–1128.
- Ross, S. & Evans, D., 2002. Excluding site-specific data from the LCA inventory: how this affects life cycle impact assessment. *The International Journal of Life Cycle Assessment*, 7(3), pp.141–150.
- Ross, S., Evans, D. & Webber, M., 2002. How LCA studies deal with uncertainty. *The international journal of life cycle assessment*, 7(1), p.47.
- Roy, R., 1997. *Proposal for an educational module on sustainable product development*, Working Group on Sustainable Product Development, United Nations Environment Programme.
- Roy, U. & Sarigecili, M.I., 2016. Information Models for Processing Product Lifecycle Functionalities and Interfaces for Sustainable Manufacturing. *Journal of Computing and Information Science in Engineering*, 16(1), p.11005.
- Saaksvuori, A. & Immonen, A., 2008. *Product lifecycle management*, Springer Science & Business Media.
- Sanyé-Mengual, E. et al., Towards the design of “Smart Parks”: development of industrial ecology tools for industrial and service parks in Brazil and Spain. *LCA, Tool for inno*, p.356.
- Sendra, C., Gabarrell, X. & Vicent, T., 2007. Material flow analysis adapted to an industrial area. *Journal of Cleaner Production*, 15(17), pp.1706–1715.
- Şener, B., Süzen, M.L. & Doyuran, V., 2006. Landfill site selection by using geographic

- information systems. *Environmental geology*, 49(3), pp.376–388.
- Seigné-Itoiz, E. et al., 2014. Environmental consequences of recycling aluminum old scrap in a global market. *Resources, Conservation and Recycling*, 89, pp.94–103.
- Shaw, S.-L. & Xin, X., 2003. Integrated land use and transportation interaction: a temporal GIS exploratory data analysis approach. *Journal of transport geography*, 11(2), pp.103–115.
- Silva, D.A.L. et al., 2015. Combined MFA and LCA approach to evaluate the metabolism of service polygons: A case study on a university campus. *Resources, Conservation and Recycling*, 94, pp.157–168.
- da Silva, M.K. et al., 2013. A product model to capture and reuse ecodesign knowledge. In *IFIP International Conference on Product Lifecycle Management*. Springer, pp. 220–228.
- Silventoinen, A. et al., 2011. Towards future PLM maturity assessment dimensions. Available at: [http://www.phi-kpe.nl/docs/480_Silventoinen - Towards future PLM maturity assessment dimensions.pdf](http://www.phi-kpe.nl/docs/480_Silventoinen_-_Towards_future_PLM_maturity_assessment_dimensions.pdf) [Accessed February 2, 2014].
- Sim, S.K. & Duffy, A.H.B., 2003. Towards an ontology of generic engineering design activities. *Research in Engineering Design*, 14(4), pp.200–223. Available at: <http://link.springer.com/10.1007/s00163-003-0037-1> [Accessed November 15, 2013].
- Spangenberg, J.H., Fuad-Luke, A. & Blincoe, K., 2010. Design for Sustainability (DfS): the interface of sustainable production and consumption. *Journal of Cleaner Production*, 18(15), pp.1485–1493.
- Stark, J., 2015. *Product lifecycle management*, Springer.
- Stark, R. et al., 2014. Advanced Technologies in Life Cycle Engineering. *Procedia CIRP*, 22, pp.3–14.
- Stark, R. & Pförtner, A., 2015. Integrating ontology into PLM-tools to improve sustainable product development. *CIRP Annals-Manufacturing Technology*, 64(1), pp.157–160.
- Steen, B., Carlson, R. & Löfgren, G., 1995a. A relation database structure for life cycle assessments. *IVL Swedish Environmental Research Institute, report No B, 1227*.

- Steen, B., Carlson, R. & Löfgren, G., 1995b. Spine: A Relation Database Structure for Life Cycle Assessments. *SWEDISH WATER AND AIR POLLUTION RESEARCH LABORATORY-PUBLICATIONS-IVL B*.
- Stubbs, W. & Cocklin, C., 2008. Conceptualizing a “sustainability business model.” *Organization & Environment*, 21(2), pp.103–127.
- Sudarsan, R. et al., 2005. A product information modeling framework for product lifecycle management. *Computer-aided design*, 37(13), pp.1399–1411.
- Taheri, A., Cavallucci, D. & Oget, D., 2015. A model for exploring technological changes in new systems. *Procedia Engineering*, 131, pp.1146–1156.
- Takhom, A. et al., 2013. Ontology-enhanced life cycle assessment: Toward formalizing the standard guidelines. In *The International Conference on Information and Communication Technology for Embedded Systems (ICICTES 2013)*, Samutsongkhram, Thailand.
- Takhom, A. et al., 2015. Toward Collaborative LCA Ontology Development: a Scenario-Based Recommender System for Environmental Data Qualification.
- Teece, D.J., 2010. Business models, business strategy and innovation. *Long range planning*, 43(2), pp.172–194.
- Terzi, S. et al., 2010. Product lifecycle management—from its history to its new role. *International Journal of Product Lifecycle Management*, 4(4), pp.360–389.
- THERET, J.-P. et al., 2011. Integrating CAD, PLM and LCA: new concepts, data model, architecture & integration proposals.
- Thomas, D., 2003. UML—Unified or Universal Modeling Language. *Journal of Object Technology*, 2(1), pp.7–12.
- Uddin, M.M. & Ma, Y., 2015. A feature-based engineering methodology for cyclic modeling and analysis processes in plastic product development. *Computer-Aided Design and Applications*, 12(6), pp.772–783.
- Ullman, D., 2002. Toward the ideal mechanical engineering design support system. *Research in*

- Engineering Design*, 13. Available at: <http://link.springer.com/article/10.1007/s00163-001-0007-4> [Accessed November 15, 2013].
- Ullman, D.G., 2001. Robust decision-making for engineering design. *Journal of Engineering Design*, 12(1), pp.3–13.
- Vadoudi, K. et al., 2015. E-waste management and resources recovery in France. *Waste Management & Research*. Available at: <http://wmr.sagepub.com/content/early/2015/08/17/0734242X15597775.abstract>.
- Vadoudi, K. et al., 2014. Sustainable Product Lifecycle Management and Territoriality: New structure for PLM. In *PLM International Conference*. p. 10.
- Vadoudi, K. & Troussier, N., 2015. Territory Based Industrial Product-Service System Design. *Procedia CIRP*, 30, pp.126–131.
- VADOUDI, K. & TROUSSIER, N., 2015. A SUSTAINABLE PRODUCT MODEL. *DS 80-10 Proceedings of the 20th International Conference on Engineering Design (ICED 15) Vol 10: Design Information and Knowledge Management Milan, Italy, 27-30.07. 15*.
- Venkatesh, G., Hammervold, J. & Brattebø, H., 2009. Combined MFA- LCA for Analysis of Wastewater Pipeline Networks. *Journal of Industrial Ecology*, 13(4), pp.532–550.
- Di Virgilio, N., 2012. LCA-GIS Integrated approach for a Sustainable Land Use Under Energy Crops.
- Wäger, P.A., Hischier, R. & Eugster, M., 2011. Environmental impacts of the Swiss collection and recovery systems for Waste Electrical and Electronic Equipment (WEEE): A follow-up. *Science of the Total Environment*, 409(10), pp.1746–1756.
- Walsund, E., 2013. Geographical Information Systems as a Tool in Sustainable Urban Development.
- Wan, L. et al., 2017. A study of regional sustainable development based on GIS/RS and SD model—Case of Hadaqi industrial corridor. *Journal of Cleaner Production*, 142, pp.654–662.

- Wang, F. et al., 2003. Towards modeling the evolution of product families. In *ASME 2003 International Design Engineering Technical Conferences and Computers and Information in Engineering Conference*. American Society of Mechanical Engineers, pp. 421–430.
- Weber, C., Werner, H. & Deubel, T., 2003. A different view on Product Data Management/Product Life-Cycle Management and its future potentials. *Journal of engineering design*, 14(4), pp.447–464.
- Wei, B. & Carlson, R., 2002. Practical Pre-Study of GIS application with LCA database SPINE. In *Proc 5th Int Conf EcoBalance 2002*. pp. 353–356. Available at: <http://sciencelinks.jp/j-east/article/200408/000020040804A0199068.php> [Accessed November 15, 2013].
- Wilbanks, T.J., 2007. Scale and sustainability. *Climate Policy*, 7(4), pp.278–287.
- Wolf, M.-A. et al., 2012. The International Reference Life Cycle Data System (ILCD) Handbook-JRC Reference Reports.
- Worboys, M.F. & Duckham, M., 2004. *GIS: a computing perspective*, CRC press.
- Wu, J. et al., 2014. Spatial variation of regional sustainable development and its relationship to the allocation of science and technology resources. *Sustainability*, 6(9), pp.6400–6417.
- www.atbayazd.ir, Yazd.
- www.champagne-ardenne.cci.fr, CRCI.
- www.ostanyazd.ir/, Yazd.
- www.regions-of-france.com/regions/champagne_ardenne, regions-of-france.
- Xu, C. et al., 2005. Towards computer-aided conceptual design of mechatronic devices with multiple interaction-states. In *ASME 2005 International Design Engineering Technical Conferences and Computers and Information in Engineering Conference*. American Society of Mechanical Engineers, pp. 455–467.
- Yan, B. et al., 2015. An ontology for specifying spatiotemporal scopes in life cycle assessment. In *Diversity++ Workshop at ISWC*.

- Yang, J. & Han, S., 2002. Healing of STEP AP214 Automotive CAD Data. *Transactions of the Society of CAD/CAM Engineers*, 7(3), pp.170–176.
- Yue, P. et al., 2013. Intelligent services for discovery of complex geospatial features from remote sensing imagery. *ISPRS Journal of Photogrammetry and Remote Sensing*, 83, pp.151–164.
- Zeilhofer, P. & Topanotti, V.P., 2008. GIS and ordination techniques for evaluation of environmental impacts in informal settlements: A case study from Cuiaba, central Brazil. *Applied Geography*, 28(1), pp.1–15.
- Zha, X.F., Fenves, S.J. & Sriram, R.D., 2005. A feature-based approach to embedded system hardware and software co-design. In *ASME 2005 International Design Engineering Technical Conferences and Computers and Information in Engineering Conference*. American Society of Mechanical Engineers, pp. 609–620.
- Zhang, G.Z., Zhao, W.N. & Liu, H., 2010. A GIS-based decision support system for water trade management of river basin cities. *Procedia Environmental Sciences*, 2, pp.650–655.
- Zhang, X. et al., 2012. Developing GIS based information system for manufacturing industry clusters evaluation: case of Chinese wine industry. *J Food Agric Environ*, pp.939–942. Available at: http://world-food.net/download/journals/2012-issue_2/172.pdf [Accessed November 13, 2014].
- Zhang, Y. et al., 2015. LCA-oriented semantic representation for the product life cycle. *Journal of Cleaner Production*, 86, pp.146–162.

Appendix A

List of publications

Vadoudi, K., Kim, J., Laratte, B., Lee, S.-J., & Troussier, N. (2015). *E-waste management and resources recovery in France*. Journal of Waste Management & Research, Volume 33, Issue 10.

Vadoudi, K., Troussier, N., & Zhu, T. W. (2014). *IT framework for Sustainable Manufacturing*. In Proceedings of Joint Conference on Mechanical, Design Engineering & Advanced Manufacturing (IDMME14), Toulouse, France, June 18th–20th.

Vadoudi, K., Troussier, N., & Zhu, T. W. (2014). *Toward Sustainable Manufacturing through PLM, GIS and LCA interaction*. In 20th ICE Conference–IEEE TMC Europe Conference, Bergamo, Italy, June 23th-25th,

Vadoudi, K., Allais, R., Reyes, T., & Troussier, N. (2014). *Sustainable Product Lifecycle Management and Territoriality: New structure for PLM*. In PLM International Conference, Japan, Yokohama, July 7th-9th.

Vadoudi, K., Troussier, N. (2015). *A sustainable product model*. Proceedings of the 20th International Conference on Engineering Design (ICED 15), Milan, Italy.

Vadoudi, K., Troussier, N. (2015). *Territory Based Industrial Product-Service System Design*. Procedia CIRP, 30, 126–131. Saint-Étienne, France, May 21-22.

Vadoudi, K., Troussier, N. (2016). *GIS-oriented lifecycle management for sustainability*. In PLM International Conference, USA, SC, Colombia, July 11-13

Vadoudi, K., & Troussier, N. (2015). *Conception de produits territorialisés*. 14th Aip Primeca, Produits, Procédés, Systèmes, intelligents et durables, La Plagne, France, 31 March - 2 April

Appendix B

LCA for a simple Flashlight

METHODOLOGY

Products Studied

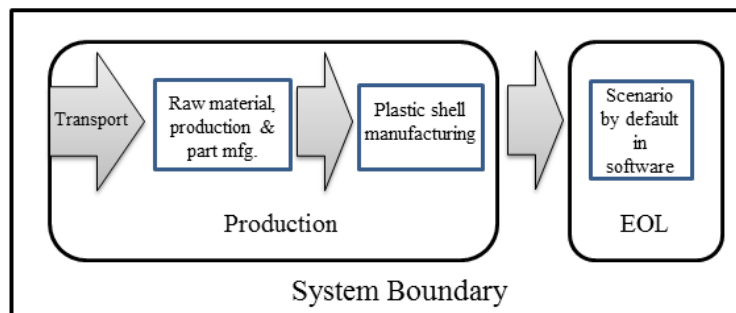
A simple flashlight, a portable, battery-operated device used for illumination.

Adherence to the ISO Standards

This LCA adheres to the principles, framework and guidelines in ISO 14040.

System Boundaries

Figure presents the study system boundaries. Life cycle stages include production, distribution to the customer, use of the Solar Tears, and end of life.



Data Sources

Premium data on product details provided throughout internet available on 10 March 2017 (<https://www.slideshare.net/JMcKay333/the-sharper-image-magnetic-induction-flashlight>). Data available from LCA software databases were evaluated and the most current data available at the time of the study were used. EcoDesignStudio (proto.ecodesign-studio.com) a commercial LCA software product was used to model and calculate the LCA. The study included data from the latest available version of the Eco Invent database.

Function and Functional Unit

The function of a simple flashlight is to support light, knob, brass slide and connector. The source of the light is usually light-emitting diode (LED). For this study, the functional unit is defined as lighting 1000 hours.

MODELING AND ASSUMPTIONS

Production

Production stage, includes raw material and energy preparation (PP, steel, brass)

Manufacturing

The manufacturing process includes parts forming and assembling presented in the following table (e.g., injection molding of plastic parts, parts forming of brass and steel parts, etc.).

Part	Material	Mass (g)	Q.
Plastic Shell	Polypropylene (PP)	184	1
Lamp Holder	Brass	6	1
Spring	Steel	5	1
Connector	Brass	3	1
On/Off Switch	Polypropylene (PP)	7	1
Brass Slide	Brass	4	1
Plastic Shell	Polypropylene (PP)	184	1
Battery	N/A	134	2
Lamp (LED)	N/A	5	1
Head	Polypropylene (PP)	20	1
Reflector	Polypropylene (PP)	5	1
Lens	Polypropylene (PP)	4	1
Cap	Polypropylene (PP)	10	1

Distribution

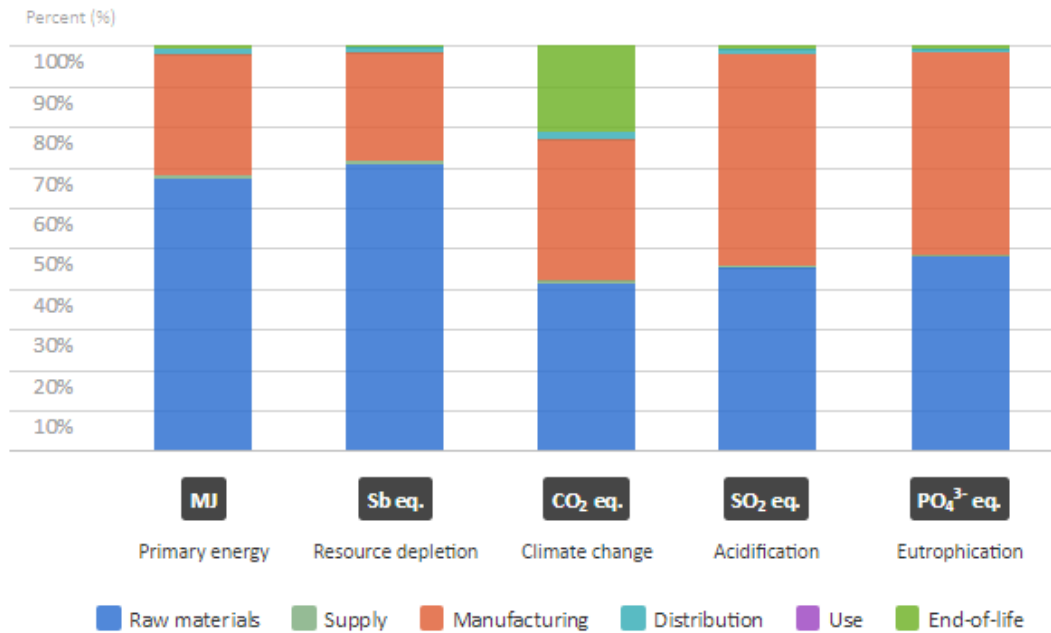
The distribution stage refers to the delivery of the PP, brass and steel to manufacturing location and delivery used product to the EOL spots. Total transportation is assumed around 200 km.

End of life

In terms of end of life, there is a default scenario implemented in the software EcoDesignStudio (proto.ecodesign-studio.com).

RESULTS

Distribution of impacts by lifecycle step (Product)



Amount of emissions for each lifecycle stage

Flashlight - kg	MJ	Sb eq.	CO ₂ eq.	SO ₂ eq.	PO ₄ ³⁻ eq.	C ₂ H ₄ eq.
Raw materials	1,85e+1	8,04e-3	5,03e-1	3,02e-3	9,26e-4	1,90e-4
Manufacturing	8,17	3,04e-3	4,32e-1	3,49e-3	9,78e-4	1,36e-4
Supply	1,90e-1	7,97e-5	1,14e-2	4,27e-5	8,53e-6	1,33e-6
Distribution	3,95e-1	1,66e-4	2,36e-2	8,88e-5	1,78e-5	2,76e-6
Use	0	0	0	0	0	0
End of life	1,86e-1	7,58e-5	2,65e-1	7,32e-5	2,07e-5	3,610e-6
Total	2,75e+1	1,14e-2	1,24	6,71e-3	1,95e-3	3,34e-4

Reference product (Climate Change - Raw materials)

Climate change	kg CO2 eq.	% Raw materials	% life cycle
Plastic shell	3,57e-1	70.91%	28.89%
Head	3,88e-2	7.71%	3.14%
Cap	1,94e-2	3.85%	1.57%
Tail cap	1,75e-2	3.47%	1.41%
Lamp Holder	1,40e-2	2.78%	1.13%
On/Off Switch	1,36e-2	2.70%	1.10%
Reflector	9,70e-3	1.93%	0.79%
Spring	9,45e-3	1.88%	0.76%
Brass Slide	9,32e-3	1.85%	0.75%
Lens	7,76e-3	1.54%	0.63%
Others	6,99e-3	1.39%	0.57%

Reference product (Acidification - Raw materials)

Climate change	kg CO2 eq.	% Raw materials	% life cycle
Plastic shell	9,97e-4	33.05%	14.85%
Lamp Holder	7,80e-4	25.85%	11.62%
Brass Slide	5,20e-4	17.23%	7.74%
Connector	3,90e-4	12.92%	5.81%
Head	1,08e-4	3.59%	1.61%
Cap	5,42e-5	1.80%	0.81%
Tail cap	4,88e-5	1.62%	0.73%
On/Off Switch	3,79e-5	1.26%	0.57%
Spring	3,23e-5	1.07%	0.48%
Reflector	2,71e-5	0.90%	0.40%
Others	2,17e-5	0.72%	0.32%

Appendix C

LCA for Solar Tears in Champagne Ardennes

METHODOLOGY

Products Studied

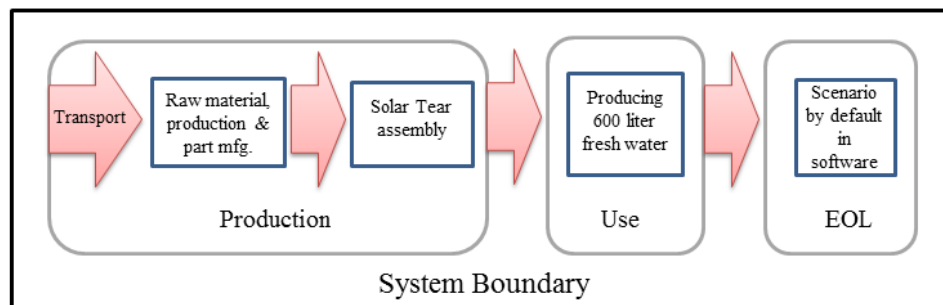
Solar Tears is an innovative household solar distiller, designed in Champagne Ardennes by a group of researchers and students from the CREIDD research team at the university of technology of Troyes (UTT) under supervision of professor Serge Rohmer. It is based on the concept of frugal engineering to answer the question of accessing clean water in developing countries.

Adherence to the ISO Standards

This LCA adheres to the principles, framework and guidelines in ISO 14040.

System Boundaries

Figure presents the study system boundaries. Life cycle stages include production, distribution to the customer, use of the Solar Tears, and end of life.



Data Sources

Premium data on product details provided by UTT research group under supervision of professor Serge Rohmer (http://creidd.utt.fr/fr/_plugins/mypage/mypage/content/rohmer.html) which are designed the product based on geographical resources of Champagne Ardennes, Secondary data sources were evaluated for temporal, geographical, and technological coverage. Data available from LCA software

databases were evaluated and the most current data available at the time of the study were used. EcoDesignStudio (proto.ecodesign-studio.com) a commercial LCA software product was used to model and calculate the LCA. The study included data from the latest available version of the Eco Invent database.

Function and Functional Unit

In order to conduct an ISO-compliant LCA, all flows within the system boundaries must be normalized to a unit summarizing the function of the system, enabling the comparison of products or systems on an equivalent basis. The function of a solar distiller is to change undrinkable water to fresh water. With the function defined, a “functional unit”, or reference flow, is chosen in order to calculate the systems on that quantitative basis. For this study, the functional unit is defined as “producing of 600liter fresh water” in three years (120 hours per year).

MODELING AND ASSUMPTIONS

Production

The Solar Tears production stage includes parts forming presented in the following table (e.g., injection molding of plastic parts, parts forming of aluminum and steel parts, etc.).

Part	Material	Mass (g)	Q.
Box	MDF	600	1
Top window	Glass	500	1
Mat	Cotton	100	1
Gutter	PVC	100	1
Moving rolls circular	PVC	50	2
Moving rolls axe	Aluminum	170	2
Stretcher rod	Steel	80	2
Stretcher rod connector	Brass	20	4
Water pipe	PVC	30	2
Bracket	Wood	550	1
Screw	Steel	2	30
Liquid gasket	Silicone	10	1

Spring	Steel	5	8
Paint	-	200	1
Motor	-	700	1
Cable	-	400	
Total		4000	

Manufacturing

Solar Tears manufacturing includes, wood, metal and plastic parts forming, painting and intermediate and final assembly.

Distribution

The distribution stage refers to the delivery of the parts to assembly location and delivery final assembly to the end user. Total transportation is assumed around 200 km.

Use

Use stage modeling accounts for the amount of electricity needed to produce 600 liter fresh water which will be around 378 kWh.

Maintenance

It is assumed that in three years use, the product does not need maintenance.

End of life

In terms of end of life, there is a default scenario implemented in the EcoDesignStudio software (proto.ecodesign-studio.com).

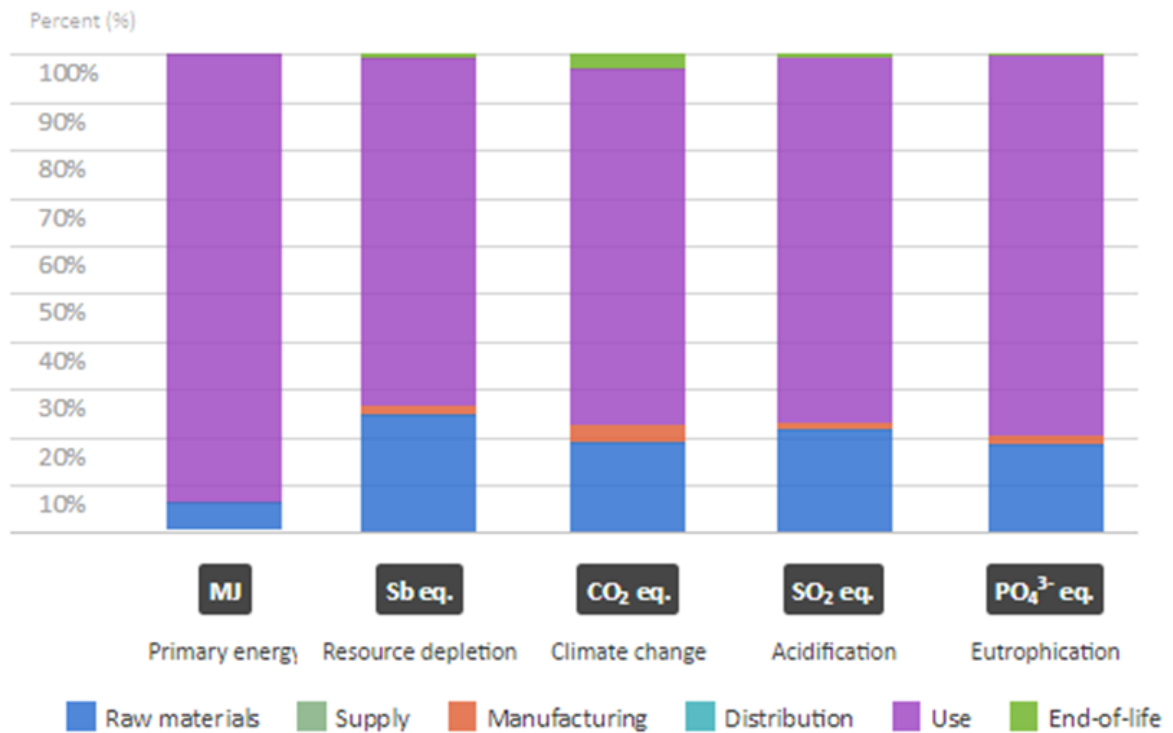
RESULTS

Amount of emissions for each lifecycle stage

Solar Tears - kg	MJ	Sb eq.	CO2 eq.	SO2 eq.	PO43- eq.	C2H4 eq.
Raw materials	2,73e+2	7,92e-2	9,34	5,90e-2	1,58e-2	3,90e-3
Manufacturing	8,98	6,09e-3	1,83	3,09e-3	1,45e-3	4,34e-3
Supply	1,33	5,58e-4	7,96e-2	2,99e-4	0,00e-1	0,00e-1

Distribution	2,66	1,12e-3	1,59e-1	5,98e-4	1,20e-4	0,00e-1
Use	4,42e+3	2,37e-1	3,76e+1	2,06e-1	6,80e-2	7,75e-3
End of life	8,47	3,45e-3	1,61	2,04e-3	3,62e-4	0,00e-1
Total	4,71e+3	3,26e-1	5,05e+1	2,71e-1	8,58e-2	1,61e-2

Distribution of impacts by lifecycle step (Product)



Reference product (Climate Change - Raw materials)

Climate change	kg CO ₂ eq.	% Raw materials	% life cycle
Box	3,39	36.32%	6.70%
Motor	2,09	22.33%	4.12%
Paint	5,68e-1	6.08%	1.12%

Moving rolls axe	5,34e-1	5.71%	1.05%
Top Window	4,34e-1	4.64%	0.86%
Mat	4,27e-1	4.57%	0.84%
Stretcher rod	3,92e-1	4.20%	0.77%
Bracket	3,19e-1	3.41%	0.63%
Gutter	2,92e-1	3.13%	0.58%
Moving rolls circular	2,92e-1	3.13%	0.58%
Others	6,06e-1	6.49%	1.20%

Reference product (Acidification - Raw materials)

Acidification	kg SO2 eq.	% Raw materials	% life cycle
Motor	1,83e-2	30.95%	6.73%
Box	1,26e-2	21.42%	4.66%
Stretcher rod	8,80e-3	14.91%	3.24%
Top Window	4,33e-3	7.33%	1.59%
Paint	4,18e-3	7.08%	1.54%
Moving rolls axe	2,28e-3	3.87%	0.84%
Bracket	1,85e-3	3.13%	0.68%
Stretcher rod	1,55e-3	2.63%	0.57%
Gutter	1,48e-3	2.51%	0.55%
Moving rolls circular	1,48e-3	2.51%	0.55%
Others	2,17e-3	3.68%	0.80%

Appendix D

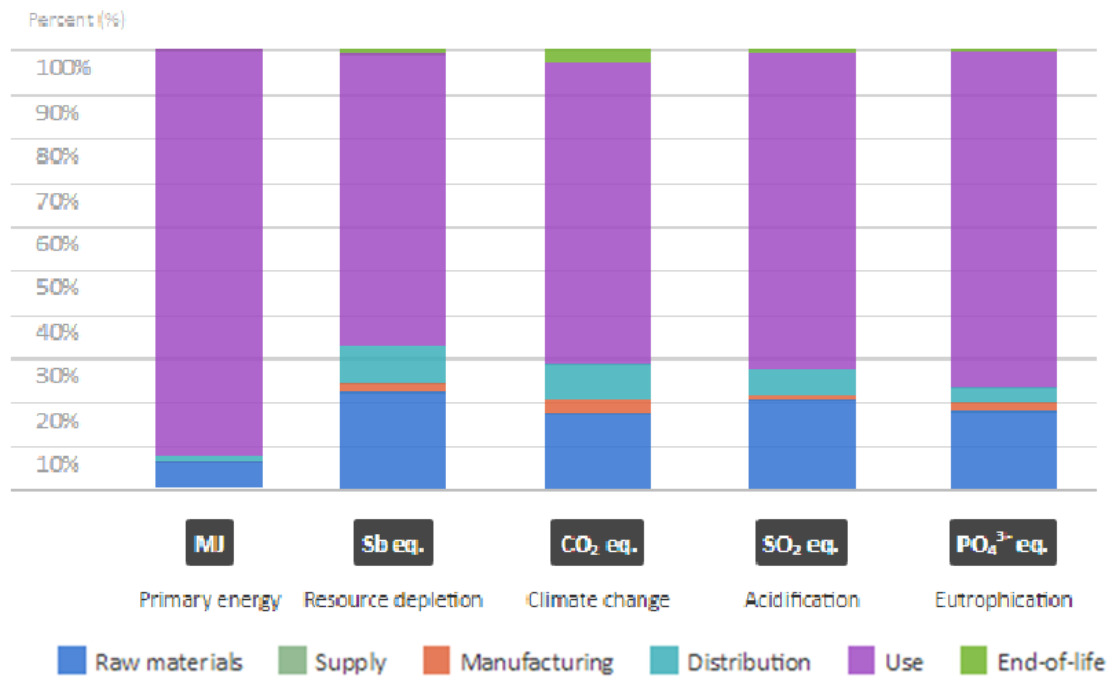
LCA for Solar Tears in Yazd

All assumption is same with previous appendix and the only difference is transportation of Solar Tears to the Yazd province.

Distribution

The distribution stage refers to the delivery of the final product from Champagne Ardennes to the end user in Yazd. Total transportation is assumed around 5000 km.

Distribution of impacts by lifecycle step (Product)



Amount of emissions for each lifecycle stage

Solar Tears - kg	MJ	Sb eq.	CO ₂ eq.	SO ₂ eq.	PO ₄ ³⁻ eq.	C ₂ H ₄ eq.
Raw materials	2,73e+2	7,92e-2	9,34	5,90e-2	1,58e-2	3,90e-3
Manufacturing	8,98	6,09e-3	1,83	3,09e-3	1,45e-3	4,34e-3

Supply	1,33	5,58e-4	7,96e-2	2,99e-4	0,01e-1	0,02e-1
Distribution	7,38e+1	3,10e-2	4,42	1,66e-2	3,32e-3	5,16e-4
Use	4,42e+3	2,37e-1	3,76e+1	2,06e-1	6,80e-2	7,75e-3
End of life	8,47	3,45e-3	1,61	2,04e-3	3,62e-4	0,02e-1
Total	4,71e+3	3,26e-1	5,05e+1	2,71e-1	8,58e-2	1,61e-2

Appendix E

LCA for Eliodomestico in Yazd

METHODOLOGY

Products Studied

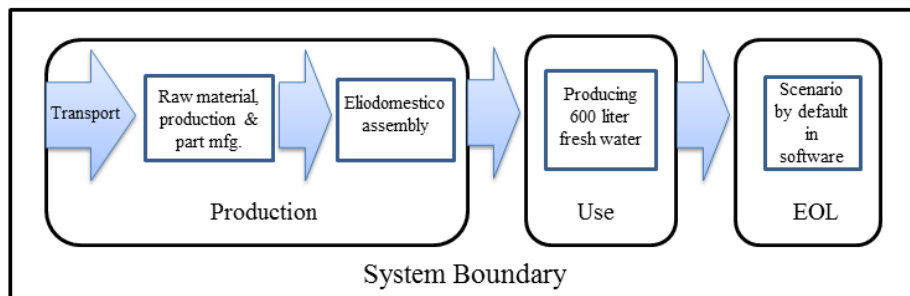
Eliodomestico is an innovative household solar distiller, designed by Italian designer Gabriele Diamanti, to function without filters or electricity. The device is made from readily available materials, such as burnt clay and tin metal, and can be entirely produced by local craftsmen.

Adherence to the ISO Standards

This LCA adheres to the principles, framework and guidelines in ISO 14040.

System Boundaries

Figure presents the study system boundaries. Life cycle stages include production, distribution to the customer, use of the Solar Tears, and end of life.



Data Sources

Premium data on product details provided by the designer throughout his personal website on the last review of page on 10 March 2017 (<http://www.gabrielediamanti.com/projects/eliodomestico>). Data available from LCA software databases were evaluated and the most current data available at the time of the study were used. EcoDesignStudio (proto.ecodesign-studio.com) a commercial LCA software product was used to model and calculate the LCA. The study included data from the latest available version of the Eco Invent database.

Function and Functional Unit

The function of Eliodomestico is to change undrinkable water to fresh water. With the function defined, a “functional unit”, or reference flow, is chosen in order to calculate the systems on that quantitative basis. For this study, the functional unit is defined as “producing of 600liter fresh water” in three years (120 hours per year).

MODELING AND ASSUMPTIONS

Production

The Eliodomestico production stage includes parts forming presented in the following table (e.g., injection molding of plastic part, pottery of clay parts and forming of tin parts, etc.).

Part	Material	Mass (g)	Q.
Main body	Clay	12000	1
Bowl	Clay	5000	1
Condenser lid	Tin	1500	1
Evaporator support	Clay	2000	1
Evaporator pipe	Tin	500	1
Evaporator	Tin	3000	1
Bolt	Tin	100	2
Flexible tube	Tin	200	1
Cap	PP	70	1
Total		24470	

Manufacturing

Eliodomestico manufacturing includes clay, tin and plastic parts forming, and final assembly.

Distribution

The distribution stage refers to the delivery of the parts to assembly location and delivery final assembly to the end user. Total transportation is assumed around 200 km.

Use

Use stage of this product only need solar energy.

Maintenance

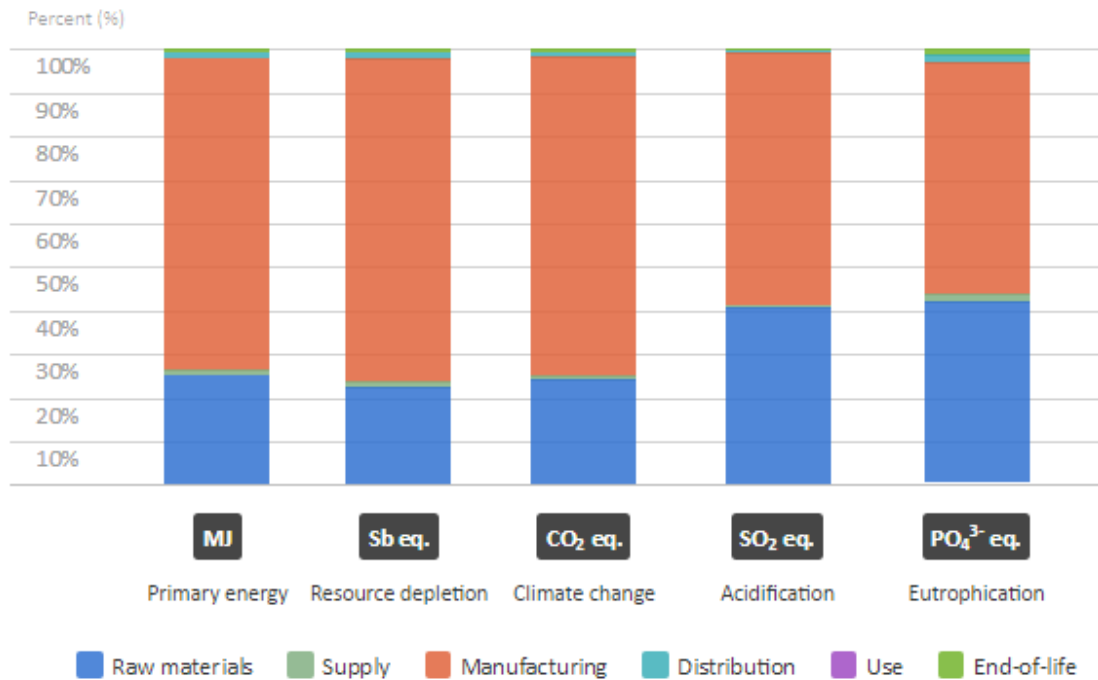
It is assumed that in three years use, the product does not need maintenance.

End of life

In terms of end of life, there is a default scenario implemented in the software (EcoDesignStudio).

RESULTS

Distribution of impacts by lifecycle step (Product)



Amount of emissions for each lifecycle stage

Eliodomestico - kg	MJ	Sb eq.	CO2 eq.	SO2 eq.	PO43- eq.	C2H4 eq.
Raw materials	4,06e+2	1,17e-1	2,54 e+1	2,99e-1	1,68e-2	1,08e-1
Manufacturing	1,14 e+3	3,97e-1	7,83 e+1	4,29e-1	2,17e-2	1,06e-2
Supply	1,81 e+1	7,59e-3	1,08	4,06e-3	8,12e-4	1,26e-4
Distribution	1,81e+1	7,59e-3	1,08	4,06e-3	8,12e-4	1,26e-4
Use	0	0	0	0	0	0
End of life	1,13e+1	4,76e-3	8,51e-1	2,96e-3	6,12e-4	1,37e-4
Total	1,57e+3	5,27e-1	1,06e+2	7,35e-1	3,99e-2	1,19e-1

Reference product (Climate Change - Raw materials)

Climate change	kg CO2 eq.	% Raw materials	% life cycle
Evaporator	1,40e+1	55.18%	13.28%
Condenser lid	7,02	27.59%	6.64%
Evaporator pipe	5,68e-1	6.08%	2.21%
Bolt	9,36e-1	3.68%	0.89%
Flexible tube	1,36e-1	0.53%	0.13%
Cap	1,36e-1	0.53%	0.13%
Main body	2,40e-2	0.09%	0.02%
Bowl	10,00e-3	0.04%	0.01%
Evaporator support	4,00e-3	0.02%	0.00%

Reference product (Acidification - Raw materials)

Acidification	kg SO2 eq.	% Raw materials	% life cycle
Evaporator	1,59e-1	53.2%	21.65%
Condenser lid	7,97e-2	26.61%	10.83%
Evaporator pipe	2,66e-2	8.87%	3.61%
Bolt	1,06e-2	3.5%	1.44%
Flexible tube	1,06e-2	3.55%	1.44%
Main body	7,70e-3	2.57%	1.05%
Bowl	3,21e-3	1.07%	0.43%
Evaporator support	1,28e-3	0.43%	0.17%
Cap	3,79e-4	0.13%	0.13%

Appendix F

Résumé français

Proposition d'un modèle de données pour l'intégration de données géographiques dans le PLM (Product Lifecycle Management) pour le DfS (Design for Sustainability)

I. Introduction

Design for Sustainability (DfS) est un concept qui regroupe les méthodes de conception de produits et services dans une perspective de développement durable. Il intègre entre autres le concept plus limité d'éco-conception. Le DfS vise à concevoir des produits et services permettant d'améliorer l'efficacité, la qualité (en tant que réponse au besoin de la société) et d'obtenir de nouvelles opportunités de marché sur un territoire, ainsi que d'améliorer la performance environnementale (Crul et autres 2006). Le DfS doit pouvoir contribuer à un développement plus durable (ou soutenable), car il intègre dès la conception les interactions du produit et de son cycle de vie avec son environnement social, économique et les espaces naturels (Vadoudi et Troussier 2015). Pour cela il est nécessaire de

considérer dès la conception de produit des informations géographiques qui caractérise sur des aspects socio-économiques et environnementaux les espaces dans lesquels le cycle de vie du produit va prendre place. Le travail de thèse présenté ici aborde ce sujet en proposant une approche réduite à l'analyse des informations disponibles pour les concepteurs à partir des outils numériques en support de la conception. On considèrera en particulier les outils du Product Lifecycle Management (PLM) qui intègrent l'ensemble des outils de conception permettant de définir et gérer les informations sur les produits techniques (Sudarsan et al. 2005). En assurant une meilleur gestion et traçabilité des données et informations de conception sur l'ensemble du cycle de vie du produit, le PLM doit aider à la prise de décision en conception (Reich et al. 2011). Dans la littérature (Amann 2002 ; 2015 Stark), le PLM est considéré comme une approche stratégique qui s'applique à un ensemble cohérent de modèles d'affaires pour soutenir l'intégration et la création collaborative, la gestion, l'utilisation et la diffusion de l'information sur le produit. Pour cela, il met en oeuvre des outils numériques supports tels que l'ERP (Enterprise Resource Planning) et ses différents modules, le PDM (Product Data Management), et les outils de définition du produit comme le DAO (Dessin Assisté par Ordinateur), la CAO (Conception Assistée par Ordinateur) et l'IAO (Ingénierie Assistée par Ordinateur). Parmi les outils d'IAO, on retrouver l'ensemble des outils numériques permettant de travailler à l'évaluation et l'optimisation des performances du produit. Concernant l'évaluation des performances environnementales, c'est à dire l'évaluation de l'impact systémique du produit et de son cycle de vie sur les espaces naturels, les outils d'ACV (Analyse de Cycle de Vie) font référence (ISO 14040).

Plus précisément, les outils d'ACVV s'intéressent aux échanges de matières et de substances entre l'écosphère et la technosphère sous la forme de flux. La quantification de ces flux sur l'ensemble du cycle de vie du produit conduit à l'ICV (inventaire du Cycle de Vie). Sur la base de cet ICV, les méthodes de calcul d'Impacts de Cycle de Vie (AICV) permettent d'estimer le potentiel d'impact environnemental sous la forme d'indicateurs de dommage (indicateurs midpoint) ou d'indicateur des conséquences de ces dommages

(indicateurs endpoint). L'évaluation de ces indicateurs à partir des flux des matières et de substances devraient considérer les caractéristiques géographiques spécifiques des sites considérés mais ce n'est pas toujours le cas. Beaucoup de systèmes modélisés en ACV ne sont pas spécifiques au site, mais sont construits à partir de données moyennées issues de sites différents. Dans ces cas, il peut y avoir un manque de cohérence entre l'environnement et l'emplacement (Bengtsson et al., 1998). Dans les études actuelles de l'inventaire du cycle de vie (ICV), l'espace environnemental du cycle de vie du produit est géographique et est divisé en systèmes technosphère et écosphère. La figure 1 (A) présente les interactions entre ces systèmes et (B) l'échange d'informations entre eux. Grâce à ce système, la géographie est le système de base y compris les caractéristiques physiques de la terre comme l'atmosphère, la caractérisation des espaces naturels, la répartition de la population, les ressources et les activités politiques et économiques (Dahlman et al., 2011).

En ce qui concerne l'échange d'informations entre ces systèmes (Figure 1 (B)), la relation entre les données de définition des produits et de leur cycle de vie gérée dans le PDM et l'environnement est abordée par l'ACV pour l'évaluation des potentiels d'impacts environnementaux des produits (Jensen et al., 1997), par le biais des résultats ICV. La relation entre les informations géographiques et environnementales a été corrigée par la régionalisation de l'ACV (RLCA) comme une solution pour améliorer la précision de l'ACV, qui est couplé avec un système d'Information géographique (SIG) (Rodriguez et al., 2014 ; Mutel & Hellweg 2009 ; Bartl al 2012 ; Mutel et al., 2012).

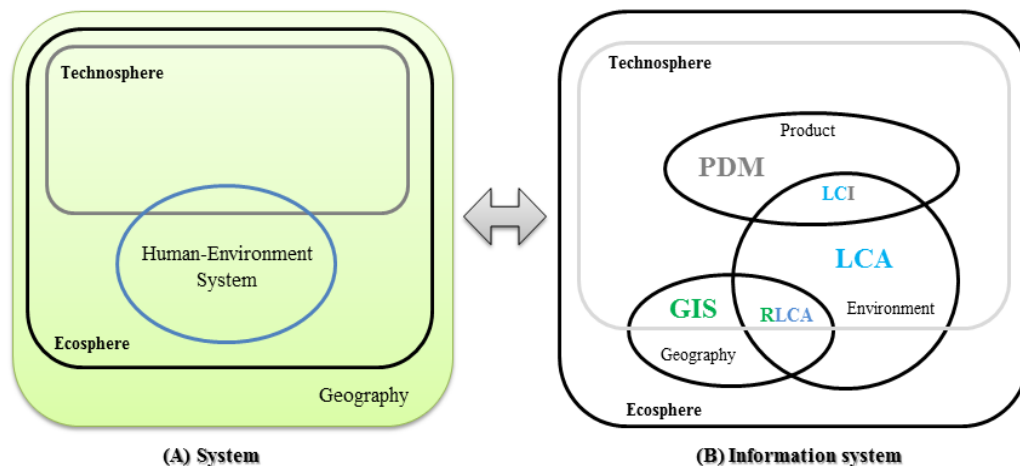


Figure 1 Ecosphere and technosphere system and information exchange

En accédant aux différentes sources d'information, permettant l'utilisation d'un ensemble d'opérations simples comme une superposition, classification, interpolation et agrégation d'informations spatiales (Rodríguez et coll. 2014) pour générer des informations utiles par les décideurs en appui du DfS. Toutefois, une attention insuffisante a été portée aux produits industriels, en termes d'ICV régionalisé. L'étude de la localisation géographique et l'évaluation des impacts sur l'environnement avant et après la conception proposée pour chaque étape du cycle de vie reste peu considérée. Aussi, la travail de thèse proposé fait l'hypothèse qu'une plus grande intégration des information issues des SIG dans le PLM pourrait permettre une meilleure intégration des impacts environnementaux pour le DfS. Ceci permettrait d'inclure et de formaliser des connaissances géographiques dans le processus de conception, ce qui est à l'heure actuelle peut fait.

II. PLM et développement durable

La recherche effectuée dans cette thèse vise alors à mieux comprendre les relations qui existent entre les données géographiques celles liées au produit et à son cycle de vie. A partir de cette connaissance, l'objectif du travail est d'établir un cadre de conception pour la durabilité (DfS). Une question centrale de ce travail est donc de savoir comment

considérer et intégrer des caractéristiques géographiques pendant la phase de conception et voir comment ces caractéristiques pourraient changer la définition du produit conçu et/ou de son cycle de vie.

Cette recherche est basée sur une approche qualitative. Il y a deux raisons à cela : (1) ce travail est en grande partie d'une nature exploratoire, et (2) le but est de contribuer à une analyse globale sur un sujet sur lequel peu de littérature existe. Le caractère global et novateur de cette étude ne pourrait pas être abordé par un questionnaire normalisé avec des catégories prédéterminées de réponse comme utilisé dans la recherche quantitative compte tenu de l'état des connaissances. Le but n'est pas de mesurer quelque chose, mais d'améliorer notre compréhension d'un phénomène en obtenant une information à partir de la littérature existante d'une part, et d'expérimentation avec des experts d'autre part.

Pour commencer, nous avons cherché à identifier les données intégrées dans les outils supports du DfS et en particulier les outils de PLM, ACV et les SIG. Pour cela, un état de l'art sur les modèles de données définissant ces outils a été réalisé. Dans un premier temps, chaque type d'outil a été considéré indépendamment et les modèles de données les plus représentatifs des données que le produit et son environnement ont été identifiés. Ensuite, les travaux visant à articuler ces différents types d'outils ont été analysés pour proposer un modèle permettant d'articuler les données ç la fois du PLM, de l'ACV et des SIG.

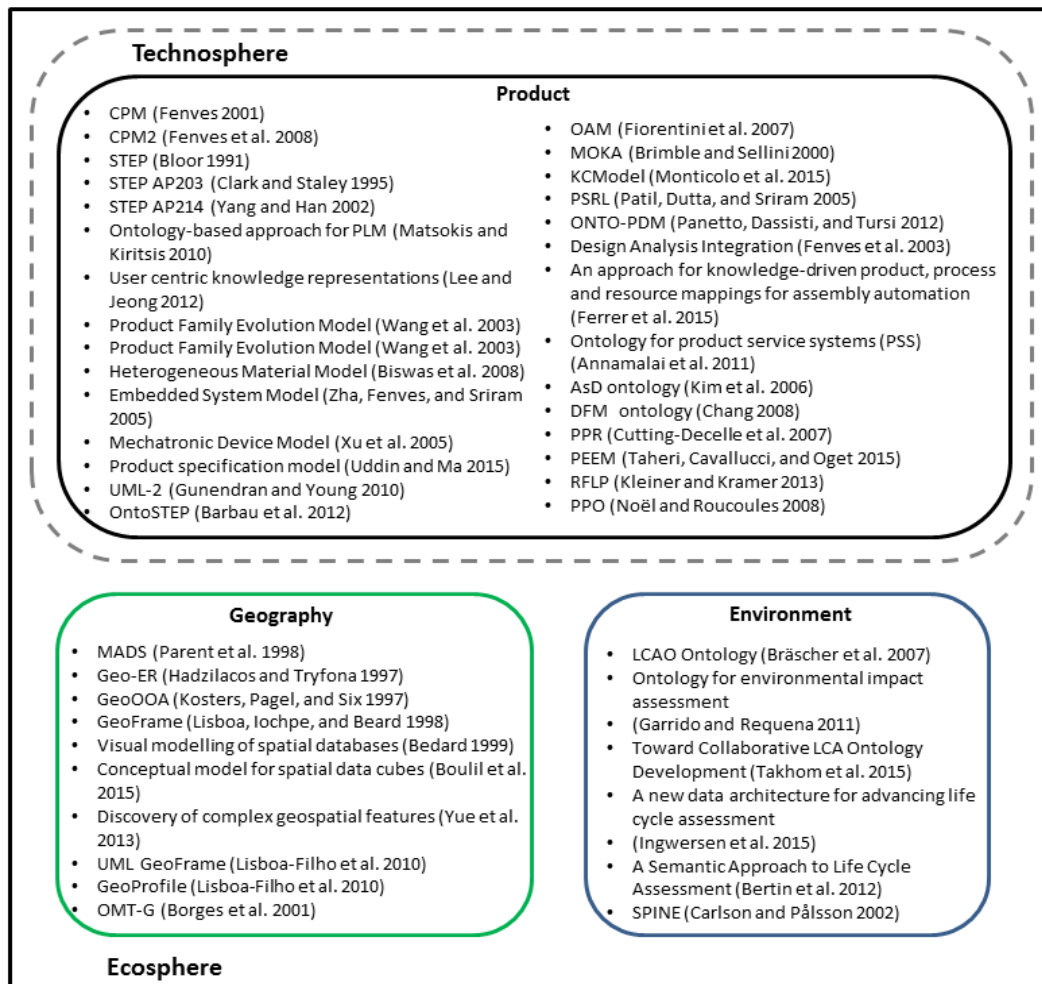


Figure 2. Modèles de données produit, géographique et pour l'évaluation environnementale

La figure 2 présente le diagramme qui explique les recherches existantes sur les SIG, le PLM et l'ACV, abordées principalement sous la forme de trois champs indépendants. Concernant les modèles de données produit du PLM, le CPM et son évolution le CPM² ont été identifiés comme particulièrement intéressants car ils sont à la fois relativement complets et servent de référence à de nombreux travaux d'intégration par l'intérêt de leur approche modulaire en « packages » spécifiques autour d'un noyau commun. Concernant l'ACV, il n'y a pas de modèle de données particulier qui a été identifié mais plutôt surtout la nécessité de considérer la notion de procédé élémentaire et de flux, concepts support de toutes les méthodes d'évaluation environnementale, que ce soit l'ACV ou encore le MFA

(analyse des flux de matière et d'énergie). Concernant les SIG, le modèle de données GeoFrame a été identifié car il est à la fois simple et générique. Il est accompagné de processus décrivant son exploitation pour différentes applications géographiques ce qui aide à sa compréhension.

Afin de relier les produits, l'environnement et la géographie, des modèles de données doivent être combinés entre ces différents champs. Cependant, l'état de l'art existantes sur les relations entre données produit & géographie, données produit & environnement, données sur l'environnement & géographie doit être plus analysé pour savoir comment construire un cadre de conception intégré dans le DfS (intégré au sens qu'il présente une vue intégrée de ces trois domaines). Pour cela, nous supposons que la géographie aidera à relier le produit et son impact environnemental. L'intention est d'étudier ces modèles et d'offrir un exemple de données qui montrerait comment la prise en compte des données géographiques peut modifier la définition du produit et de son impact environnemental.

III. Hypothèse et la question de recherche

A partir de l'analyse bibliographique précédente, nous nous sommes attachés à comprendre :

- Quel est le lien entre les informations concernant la définition du produit et la géographie pour nécessaire pour déployer le DfS ? Comment ce lien impacte-t-il l'évaluation des impacts environnementaux du produit et de son cycle de vie ?

En effet, nous supposons que la technologie et les aspects géographiques ne sont pas indépendants et un changement dans les caractéristiques géographiques et l'état écologique des écosphères changerait les systèmes technologiques. Cependant nous ne savons pas comment ces changements modifieraient les choix de conception, notamment en termes de structure de produits. Nous avons donc cherché à mieux comprendre ceci à la fois d'un point de vue bibliographique mais aussi à travers la mise en œuvre d'études de cas.

Pour cela, nous nous sommes intéressés aux travaux scientifiques qui cherchent à mettre en relation les données de la technosphère (vu comme les données sur les produits et leur cycle de vie) avec celles sur l'écosphère (vu comme les données sur les espaces naturels et de vie). Ensuite nous avons mis en œuvre un cas d'étude permettant d'analyser les relations entre structure produit, géographie et impacts environnementaux.

IV. Les modèles de données pour lier technosphère et écosphère

L'état de l'art est résumé dans la figure 3 concernant les relations existantes entre les données de la géographie, du produit et de l'environnement.

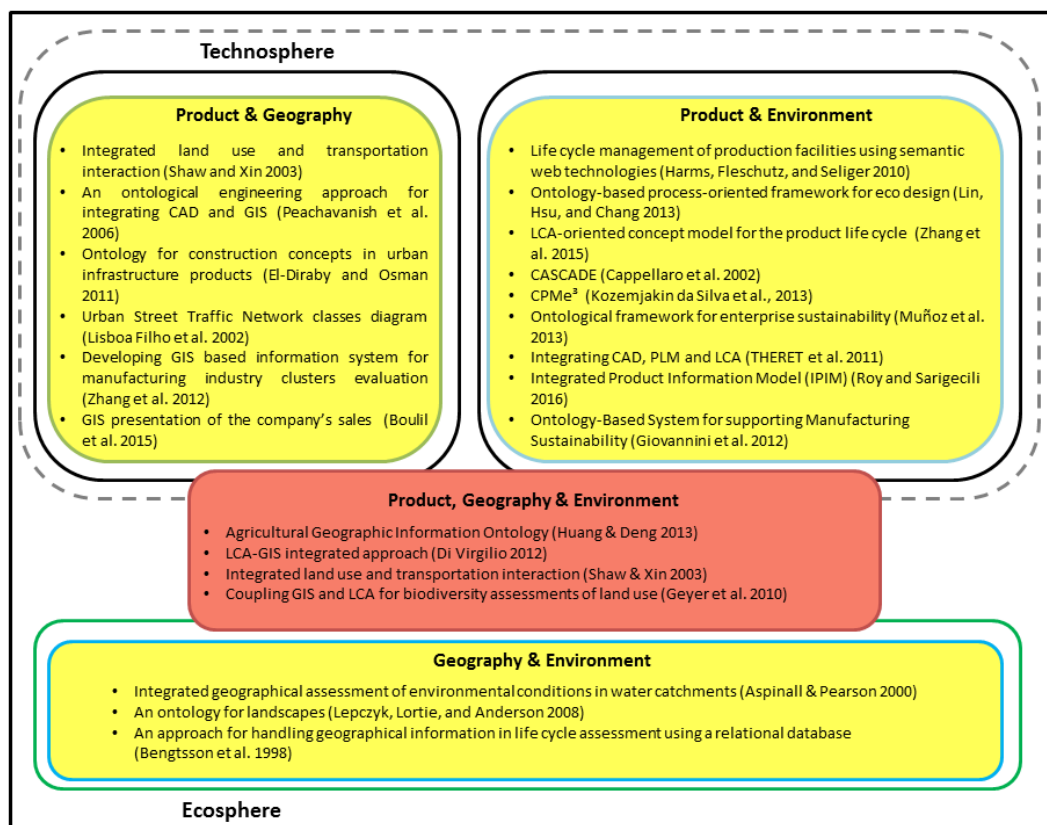


Figure 3. Etat de l'art sur les relations entre données produit, géographiques et d'impact sur l'environnement

La figure 4 résume la relation entre le produit et l'environnement au format UML basé sur des modèles de données analysés, issus de la figure 2. Un code couleur est mis en place pour identifier le produit (gris), l'environnement (bleu), les flux de Substances (Orange), la géographie (vert) et le processus de cycle de vie (blanc). Ce code de couleurs est utilisé dans le reste du manuscrit.

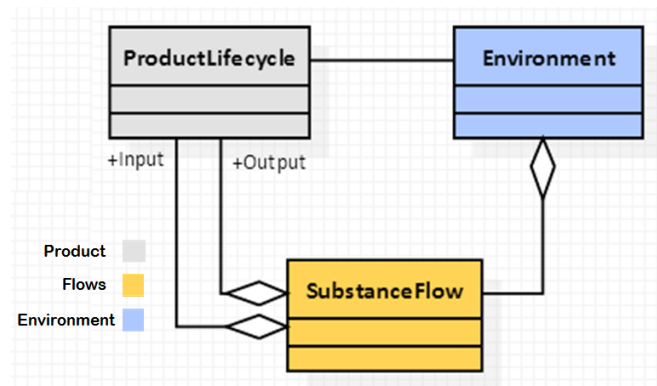


Figure 4. Les flux comme la relation entre le produit et l'environnement.

Le cycle de vie du produit est vu comme une collection d'activités ou de processus. Chaque activité dispose d'une entrée et d'une sortie du flux de substances, qui sont présentés comme deux relations d'agrégation entre les classes « Product Life cycle » et « Substance Flow ». Les flux élémentaires, flux de produits et les flux de déchets sont le résultat d'entrée et de sortie des différentes activités. La relation entre l'environnement et les flux est présentée comme une agrégation entre les classes Substance Flows et environnement. Le résultat des activités du cycle de vie produit avec des flux d'entrée et de sortie porte la relation entre le produit et l'environnement. La relation entre l'environnement et la géographie basées sur des modèles de données analysés, est illustrée, figure 5.

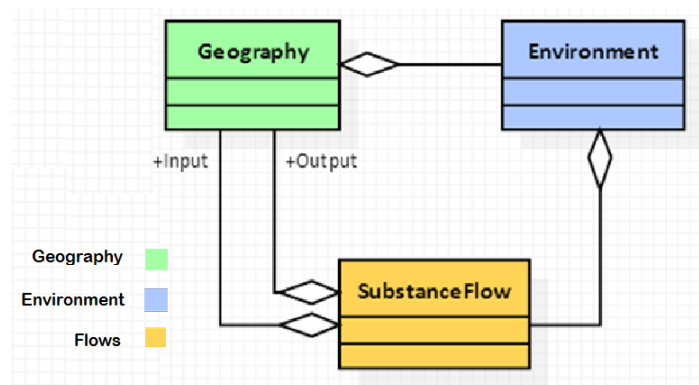


Figure 5. La relation entre environnement et géographie

On peut affirmer que l'environnement est inhérent à une zone géographique déterminée, illustrée par une composition entre la géographie et les classes d'environnement. Par conséquent, il suffirait de dire que chaque flux se produit dans un secteur géographique. En conséquence, l'environnement et la géographie pourraient être choisis comme des entités distinctes et indépendantes qui fournissent des informations complémentaires sur un flux.

Dans les travaux scientifiques, il n'y a pas beaucoup d'attention portée à la relation entre le produit et la géographie en conception de produit. Pour la plupart, le SIG est utilisé comme un outil pour appuyer la gestion urbaine, mais ce n'est pas le seul outil pour parvenir à un développement urbain durable. Il doit plutôt être vu et utilisé comme un support pour la prise de décisions dans le processus de planification du cycle de vie du produit, pour évaluer les différentes alternatives et établir des objectifs réalistes pour la planification future. Le nombre d'analyses doit être effectuées pour une durabilité économique et sociale en milieu urbain : répartition de la population ; proximité des centres de loisirs ; emplacement des écoles ; flux des personnes et des biens ; démographie, etc., mais il n'y a encore aucune méthode connue pour combiner chacun des trois piliers du développement durable à l'échelle régionale. Sur cet aspect, le travail sur les SIG dans les recherches futures pourrait soutenir des connaissances pour les décideurs dans le développement durable urbain et de produit (Walsund 2013).

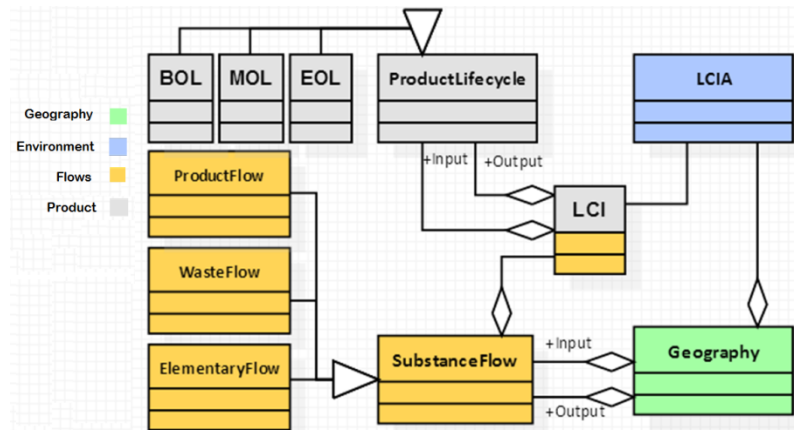


Figure 6. Modèle de données initial décrivant l'interdépendance entre les données produit, géographiques et les impacts environnementaux

Nous avons vu que les liens entre les produit, la production et le cycle de vie avec la géographie sont essentiellement vus à travers les flux de matières. Le cycle de vie est décrit sous la forme de différents processus géographiquement référencées par ICV via différents types de flux de substances et produits, flux de déchets sous la forme flux élémentaires, qui diffèrent d'une région géographique à l'autre en fonction de leur disponibilité, la qualité et la quantité. L'état écologique de chaque espace géographique à travers des résultats de l' AICV donne des informations pertinentes pour modéliser les flux et l'évaluation de leur impact environnemental. Le dommage et la conséquence d'un flux élémentaire affectant l'état de l'écosphère devrait également dépendre de l'état spécifique et initial de l'espace géographique considéré.

Finalement, l'ensemble des liens identifiés sont synthétisés dans la figure 6, qui constitue notre modèle de données initial pour ensuite prolonger l'analyse des relations entre ces différentes informations sur la base d'un cas d'étude. Avant de présenter ce cas d'étude, un point est fait sur l'ensemble de la méthodologie de recherche adoptée dans ce travail pour construire et valider la contribution proposée.

V. Méthodologie de la recherche

Les premières étapes de la méthodologie sont inspirées par la Design Research Methodology (DRM) (Blessing & Chakrabarti 2009). Le choix de DRM est due à l'adaptation de cette méthodologie de recherche à la recherche sur l'ingénierie de la conception, qui est en ligne avec cette thèse. Par la suite, différentes étapes de la méthodologie sont expliquées en détails avec leurs objectifs et de leur logique.

La recherche commence avec la phase de clarification. Au cours de cette étape, un examen exploratoire de la littérature est mis en œuvre afin de clarifier les connaissances et les attentes actuelles. L'étape suivante est la revue de la littérature due afin d'obtenir une compréhension suffisante de la situation actuelle. Une étude approfondie de la littérature a été entreprise pour révéler les domaines d'investigations de définir le cadre de la thèse. Il correspond à révéler quels types de supports qui sont proposés par l'état de l'art, ce qui a été fait dans les sections précédentes.

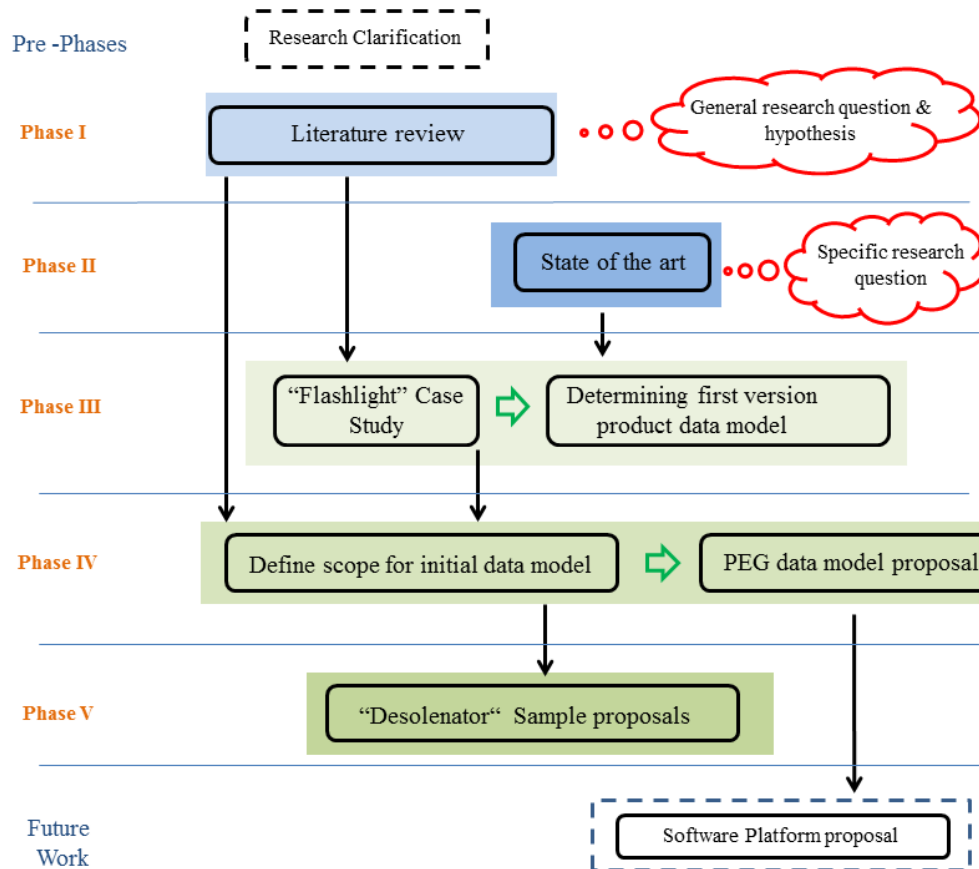


Figure 7. La méthode de recherche

Afin d’approfondir l’identification des relations fournies précédemment par une première mise à l’épreuve du modèle identifié, nous mettons en œuvre un cas d’étude sur une lampe de poche électrique. Ce cas d’étude a été choisi à la fois pour sa simplicité et la disponibilité des données nécessaires à l’étude. Ce cas d’étude permettra de formaliser une première version du modèle initial consolidé. Dans la phase IV, nous nous concentrons sur le développement de la version finale du modèle PEG (Product – Environnement – Geography), en restreignant le modèle produit à la partie relative à la structure du produit et en se focalisant en particulier sur la définition des matériaux. Enfin, pour répondre à la question spécifique de la recherche, qui a été proposée à la fin de ce chapitre : « Comment l’introduction d’informations géographiques impacte-t-elle la définition du produit et de son

cycle de vie ainsi que l'évaluation des impacts environnementaux ?» nous proposons l'analyse de deux systèmes de dessalement d'eau existants dans deux régions géographiques (Champagne Ardennes en France et Yazd en Iran) pour comparer leurs caractéristiques de conception fondées sur les caractéristiques géographiques. Ceci est résumé dans la figure 7 ci-dessus.

VI. Cas d'étude : lampe de poche

L'objectif de présenter cette étude de cas est de spécifier et de trouver la relation entre les données sur le produits, les flux de substances et matières et la géographie. Nous concentrerons cette analyse sur un composant de la lampe de poche supposant que l'information obtenue sera représentative des relations pour les autres composants et le produit complet. Ainsi, nous limitons l'analyse à l'extraction de matériaux, au procédés de fabrication et à la fin de vie pour la coque en plastique. De la même façon, une seule catégorie d'impact est choisie pour conduire l'analyse. Nous avons choisi un indicateur local, l'acidification en raison du niveau in situ de l'impact. Le flux de dioxyde de soufre, SO₂, est choisi à titre d'illustration et parce qu'il est le flux principal considéré dans l'impact d'acidification.. Sur la base du modèle initial identifié à partir de l'état de l'art (figure 6) et en analysant le cas d'étude lampe de poche avec les restrictions énoncées précédemment, un modèle de données enrichi est obtenu et présenté en figure 8 et illustré sur le cas d'tude, la coque plastique de la lampe de poche.

La présentation sémantique sous la forme du diagramme de classe nous aide à identifier la relation entre les données géographiques et le produit, les flux et les impacts sur l'environnement. Basé sur ce que nous avons tirés de cette étude de cas, une proposition de modèle de données est présentée dans la section suivante. Le code de couleur énoncé précédemment est toujours utilisé dans cette figure 8 pour identifier les champs sémantiques relatifs aux classes.

A partir de ce cas d'étude spécifié, nous définissons le modèle de données initial générique identifié que nous cherchons à généraliser dans la section suivante.

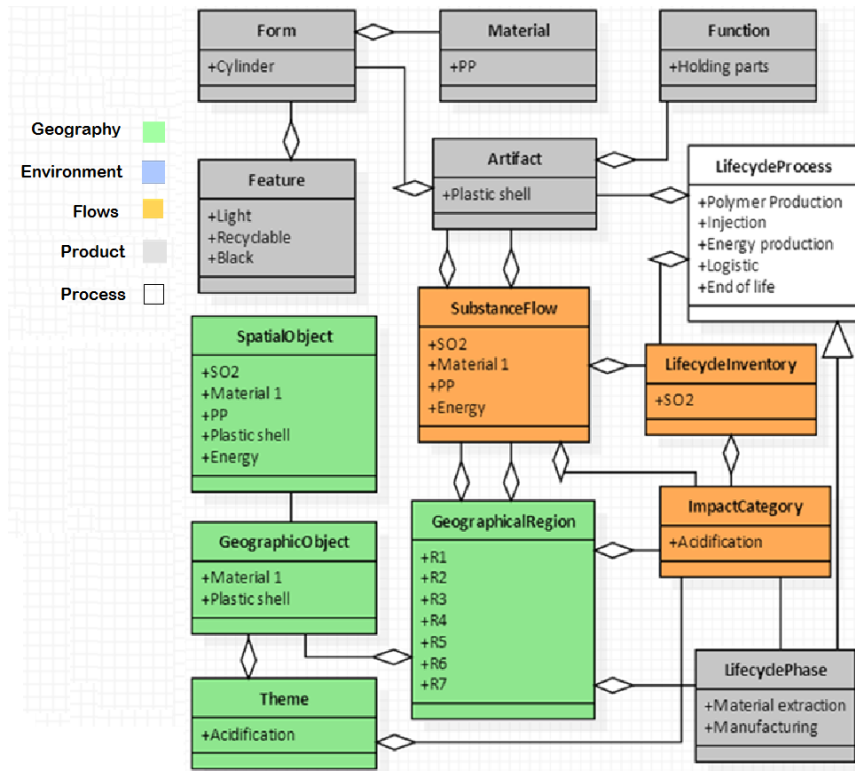


Figure 8. Diagramme de classe pour la production de la coque en plastique

VII. Proposition du modèle de données (PEG, Product – Environment - Geography)

Ce modèle, présenté en figure 9, vise à connecter des informations sur les produits, les processus et le territoire géographique à travers les flux de substances manipulés dans l'analyse des impacts environnementaux. Le modèle contient trois sous-modèles pour la modélisation ontologique, nommément le produit (P), l'environnement (E) et la géographie (G), correspondant aux champs sémantiques des données. Bien que chacun de ces sous-modèles ne soit pas nouveau, c'est leur intégration en un modèle de données unique qui

constitue la proposition originale de ce travail. Les classes principales du modèle sont : artefact, ce qui représente de toute entité physique d'un produit (par exemple pièce et assemblage) tel que défini dans le CPM² ; SubstanceFlow, soutenant des flux (produits, déchets et élémentaire) et Geographic Region, la limite du territoire qui comprend SubstanceFlow et artefact. SubstanceFlow est le cœur du modèle qui relie le produit avec le territoire géographique. L'impact environnemental est donné pour chaque flux, donc l'impact d'un processus est la somme des effets des flux agrégé à ce processus. En conséquence, l'impact d'une série de procédés (LifecycleProcess) est la somme des effets de chaque processus. L'impact de chaque processus est un thème qui pourrait être représenté comme une couche de données sur une carte. En outre, Substance Flow pourrait être présenté de la même façon par sa nature et sa quantification.

La catégorie P du modèle (Figure 9) contient six classes principales issues du CPM²: l'Artefact, le Matériau, la Fonction, la Fonction géométrique, la Géométrie et la Forme. Artefact est la classe principale de la catégorie (P). L'Artefact, les Matériaux et les Fonctions géométriques de la catégorie P portent le lien avec la géographie et l'environnement. La classe Artefact porte la relation avec LifecycleProcess à travers les flux de substances et l'inventaire de cycle de vie. La classe Matériaux est liée à la région géographique et relie le produit avec la géographie. « Caractéristiques du produit » a un rapport avec les caractéristiques géographiques en termes de matières premières disponibles, de technologie de fabrication, de besoins des utilisateurs, de comportement et de caractéristiques du marché et de disponibilité des méthodes de traitement en fin de vie.

La partie E de ce modèle de données, est en charge de gérer les données relatives aux effets sur l'environnement et se compose de quatre classes principales : SubstanceFlow ; LifecyclePhase ; Impact et LifecycleProcess. SubstanceFlow est la base de l'ontologie de débit et prend en charge trois principaux flux : le flux élémentaires , le flux de produits et le flux de déchets. Les flux élémentaires sont utilisés pour le calcul des impacts environnementaux d'un cycle de vie du produit (calculs de l'ICV et de l'AICV), qui

peuvent être classées en deux flux de substances : ceux concernant les ressources et ceux concernant les émissions.

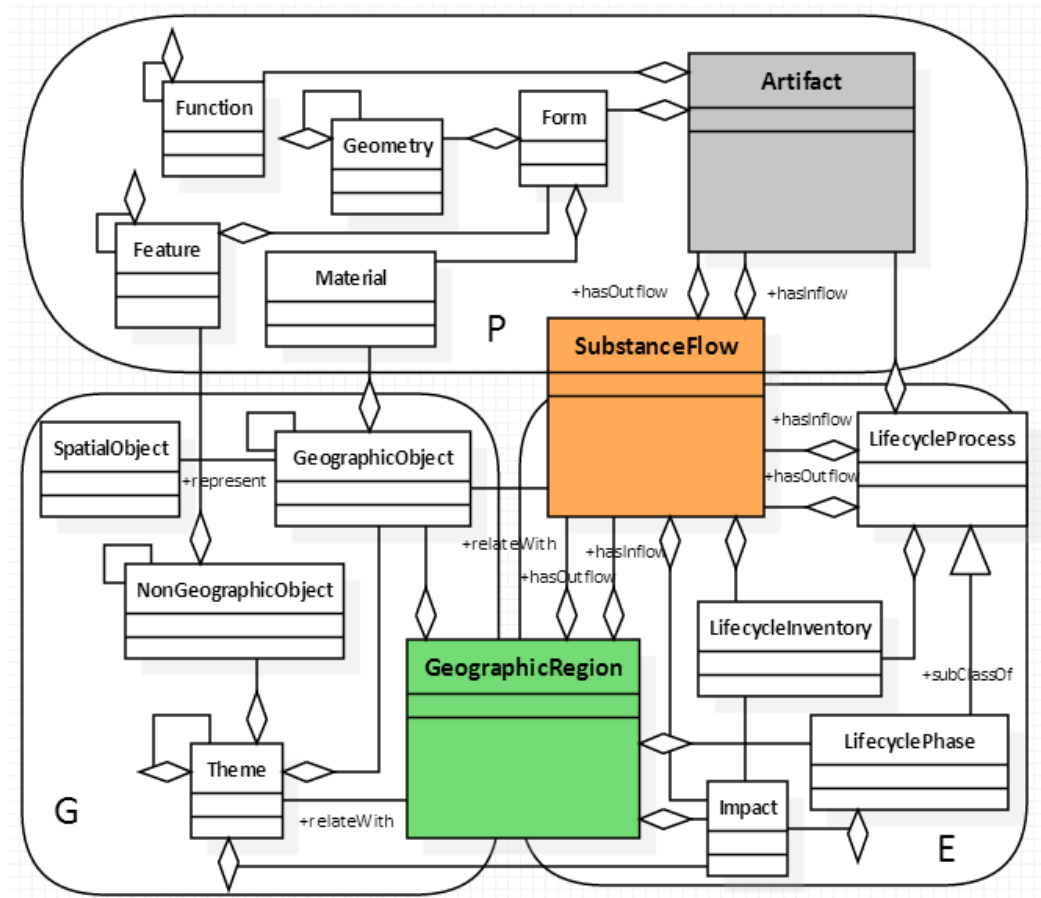


Figure 9. Modèle PEG

La catégorie G du modèle comprend cinq classes ; GeographicRegion, Theme, GeographicObject, NonGeographicObject et SpatialObject. Les classes Theme et GeographicRegion, sont la base de n'importe quelle application géographique. Elles ont pour l'objectif principal la gestion et la manipulation d'un ensemble de données pour une région donnée, qui constitue une base de données géographique.

La catégorie de produit du PEG modèle comprend de différents aspects de la structure et la fonction, il est compliqué d'étudier tous ces aspects dans le temps d'une thèse de doctorat.

C'est pourquoi nous nous sommes focalisés sur la question de la structure, en se concentrant particulièrement sur le matériau et les classes associées pour montrer comment l'intégration de données géographiques pourrait changer les choix de matériau.

VIII. Geography based design proposals

Dans cette section, nous étudions la conception et l'impact environnemental de deux systèmes de dessalement conçus à petite échelle (Solar Tears et Eliodomestico) pour deux territoires géographiques différents (Champagne Ardennes, France et Yazd, Iran). Il est à noter que le produit appelé Solar Tears n'est pas celui issu du projet Solar Tears mené à l'UTT mais celui testé avant le lancement du projet Solar Tears. Celui-ci n'ayant pas de nom spécifique nous l'avons appelé ici Solar Tears. L'objectif est de montrer comment les différences géographiques ont pu influencer sur les choix de conception en ce qui concerne la structure des produits et des impacts environnementaux liés (Figure 10). Un système de dessalement est sélectionné comme l'étude de cas en raison de sa dépendance à l'égard des caractéristiques géographiques et son exposition au soleil. On a donc pris trois cas : Solar Tears en Champagne Ardennes, Solar Tears à Yazd, et Eliodomestico à Yazd.

La figure 10 présentant les résultats obtenus pour l'analyse comparative de ces trois cas afin de tenter de mettre en évidence l'influence de l'importance de l'information géographique sur la conception, en ce qui concerne en particulier les ressources disponibles et les caractéristiques géographiques. Cette analyse montre comment les informations sur la région géographique pourraient changer les choix de conception pour produire mieux répondre au besoin des usagers et, dans le même temps, générer moins impacts sur l'environnement. Dans cette analyse comparative, les analyses partielles sont implémentés sur des aspects de la conception en termes de fonction et de structure du produit sans tenir compte de son comportement, ce qui est restrictif et biaisé. En outre, les autres paramètres, qui ont un impact important dans le DfS tels que l'accès à des renseignements précis, tels que les ressources régionales disponibles, l'état écologique

précis, la disponibilité des technologies, le coût de fabrication et les aspects sociaux et culturels et etc. ne sont pas considérés. Cette étude comparative n'a donc qu'une vocation de démonstration à titre illustratif, montrant par l'exemple l'impact de la prise en compte de certaines informations géographiques sur certains éléments de définition du produit. ON suppose que cet impact serait d'autant plus fort que l'on élargirait le spectre des éléments considérés.




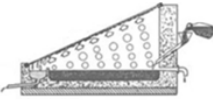
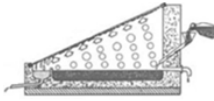

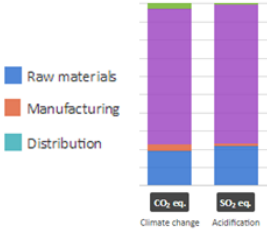
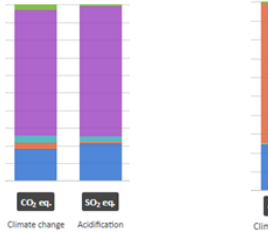
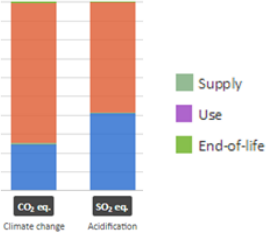

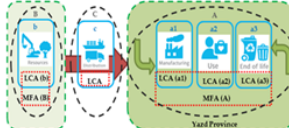
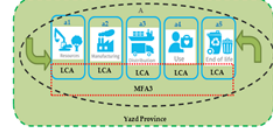
	Case 1	Case 2	Case 3
Function	5 liters per day	deformation of plastic parts at temperatures above 40°C	5 liters per day
Use regional resources			
Form			
LCA software	EcoDesignStudio	EcoDesignStudio	EcoDesignStudio
Functional unit	600 liters fresh water in 3 years (120 hours per year)	600 liters fresh water in 3 years (120 hours per year)	600 liters fresh water in 3 years (120 hours per year)
Distance	100 km	5000 km	200 km
CO2 emission	5.04e+1 Kg	5.26e+1Kg (Transport)	1.06e+2 kg
SO2 emission	2.71e-1kg	2.79 e-1kg (Transport)	7.35e-1 kg
Acidification & Climate change			
Foreground-Background Approach			

Figure 10. Comparaison de deux dessalinisateurs dans deux territoires géographiques différents

Donc, à titre d'exemple illustratif, Solar Tears a besoin d'électricité, qui est accessible dans les zones habitables et la température maximale n'est pas un problème pour la fonctionnalité des pièces constituantes. Toutefois, des difficultés de maintenance et d'usage sont à prévoir dans le cas d'une utilisation à Yazd en raison des caractéristiques géographiques (température) et de ressources régionales (pas d'accès au bois ni à l'électricité dans les zones rurales). Ainsi, la solution de conception de Eliodomestico est proposée pour la région de Yazd qui repose sur des caractéristiques géographiques de cette région, mais prend en charge les mêmes fonctions que Solar Tears. La conception de Eliodomestico forme reflète les archétypes traditionnels n'est donc pas étranger, et les matériaux impliqués dans la production appartiennent aux traditions territoriales qui rendent l'utilisation plus facile. La maintenance est simple comparée au Solar Tears : il n'y a pas de verre à nettoyer ; le sel reste dans l'évaporateur ; rien dans le système peut être bouché, parce que quand l'eau s'évapore, le sel reste sur le fond. La seule maintenance (environ une fois par mois) est de dévisser le tuyau, le sortir de l'évaporateur et le laver. En outre, le transport est assez court, car toutes les étapes du cycle de vie sont très proches entre eux, et tous sont dans le même territoire. La figure 10 illustre les différences entre les produits, en termes de forme et de quantité de SO₂ et CO₂, d'évaluation de l'acidification et du changement climatique pour les impacts environnementaux liés, la fonction du système et la quantité de ressources locales utilisées. À l'aide des ressources locales (argile) du territoire de Yazd, Eliodomestico requiert un processus de poterie pour la fabrication de certaines pièces qui changent la forme du produit. Ce changement de matériau utilisé implique des changements en conception sur la forme du produit et ici le choix d'une ressource et d'un savoir faire de transformation local impact la définition du produit et permet d'illustrer « comment les différences géographiques pourraient modifier la proposition de produit en termes de structure et la forme ? ».

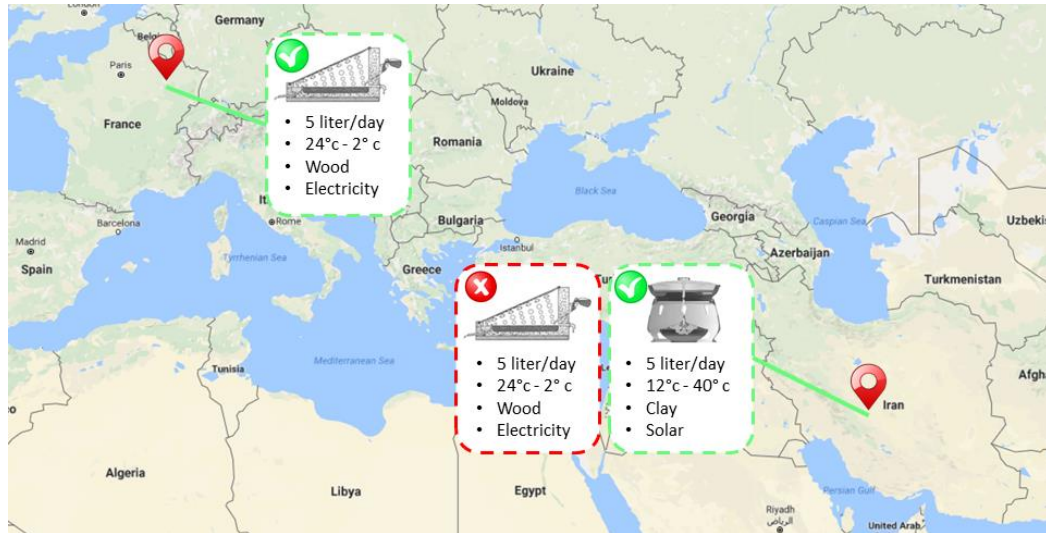


Figure.11. Proposition de produit pour deux régions différentes pour un meilleur DfS

En termes d'impact sur l'environnement, l'impact environnemental de Eliodomestico est plus important que Solar Tears. Changer la conception du produit de SolarTears à Eliodomestico augmenter la quantité de flux de SO₂ et CO₂. Plus de 90 % des flux matière pour l'utilisation industrielle et autres étapes du cycle de vie des Eliodomestico dans la province de Yazd sont à l'intérieur du territoire.

Cette section a comparé deux systèmes de dessalement (Solar Tears & Eliodomestico) avec la même fonction (environ 5 litres/jour) pour deux régions différentes (Champagne Ardennes & Yazd) pour démontrer le fait que la fonction et l'impact environnemental d'un produit dans une région n'est pas le même si l'on intègre des données régionales dès la conception (figure 11). En effet, les caractéristiques géographiques telles que la disponibilité des ressources matérielles et énergétiques, le climat et etc. ont un impact direct sur la fonction et la structure de produit. L'impact des différences géographiques sur les choix de conception met en lumière plus que jamais l'importance d'inclure des informations géographiques dans le processus de conception de produit.

IX. Conclusions et perspectives

Ce travail de thèse a cherché à explorer si l'intégration de données géographiques en conception de produits pouvant changer la définition du projet conçu et aller vers du DfS. L'analyse de l'état de l'art ainsi que celle d'un cas d'étude sur une coque plastique de lampe de poche a permis de formaliser des relations existantes entre des données géographiques et des données sur la définition du produit et de son cycle de vie ainsi que sur les impacts environnementaux potentiels. Ces analyses ont conduit à la proposition d'un modèle de données structurant ces relations. Une analyse comparative de la conception de différents produits utilisés dans différentes régions montre bien que l'intégration de données géographiques sur les régions peut grandement modifier la définition du produit. Par contre, l'analyse ne démontre pas en l'état de gain potentiel sur les impacts environnementaux.

Ce travail exploratoire nécessiterait d'être prolonger pour élargir le spectre des éléments considérés dans les analyses et approfondir l'évaluation des impacts environnementaux pour conclure quant à l'intérêt de la proposition pour le DfS. L'implémentation d'un outil informatique intégrant les données géométriques permettrait d'entamer une démarche expérimentale dans des activités de conception et évaluer de façon plus quantitative et systémique l'intérêt de la proposition pour le DfS.

Kiyan VADOUDI
Doctorat : Ingénierie Sociotechnique des Connaissances,
des Réseaux et du Développement Durable
Année 2017

Proposition de modèle de données pour intégrer les SIG avec PLM pour DfS

Le déploiement du développement durable passe par des enjeux de transition sociétale et technique auxquels cherche à répondre le Design for Sustainability (DfS). Dans le cadre de la conception des systèmes de production, et en particulier pour les produits manufacturés, les impacts environnementaux que ce soit en termes de consommation de ressources ou de rejets (déchets, émissions) doivent être intégrés comme des paramètres de conception. L'évaluation des impacts environnementaux (par exemple par l'Analyse de Cycle de Vie, ACV) doit donc s'articuler avec la gestion du cycle de vie des produits (PLM). L'inventaire de cycle de vie, ICV est un élément central du lien entre le système de production et son environnement, caractérisé par des informations géographiques et spatiales sur l'écosphère. Le travail de thèse proposé stipule que les impacts environnementaux des systèmes conçus dépendent de cette caractérisation géographique. Les approches d'écoconception et de DFS doivent donc intégrer ces informations géographiques ce qu'elles ne font que très peu, ces informations n'étant pas intégrées dans les outils de conception. La thèse propose donc une approche de modélisation pour intégrer les informations relatives au produit et son système de production (via le PLM), l'évaluation de son potentiel d'impact environnemental (via l'ACV et en particulier l'ICV), et les informations géographiques en conception. Pour cela, les informations géographiques à associer sont identifiées et des cas d'études illustratifs sont construits pour montrer l'impact de ces informations sur la définition des produits.

Mots clés : développement territorial durable - design durable - modèles d'information - Système d'Information Géographique - analyse du cycle de vie.

Data Model Proposal to Integrate GIS with PLM for DfS

There are different approaches to implement sustainability and Design for Sustainability (DfS) is the one that give more accurate result by considering both global and regional scales. Integration of Life Cycle Assessment (LCA) into Product Lifecycle Management (PLM) is an example of tool integration to support sustainability. In LCA framework, Life Cycle Inventory (LCI) is the quantified and classified list of input and output flow of the LCA model that is a model of the product system, linking the technological system to the ecosphere (Environment system). As each region has a unique environmental system, design characteristics and specifications of technological system should be modified and adopted based on these differences. Implementation of this approach will require geographical information of interacted environmental systems, which is a kind of new strategy in DfS. Therefore, we tested the interest of the integration of Geographical Information Systems (GIS) with PLM to support geographical considerations during product development activities. The main research question of this research work is then how to propose this PLM-GIS integration for DfS.

Thus, we conducted that literature review on existing data models about product, environment, geography and their combination is a key to prove the link among them.

Keywords: Product Lifecycle Management - design for sustainability - Geographical Information System - Life Cycle Assessment - data modeling - product design - information modeling - sustainable design.