



HAL
open science

Mouvement brownien branchant et autres modèles hiérarchiques en physique statistique

Michel Pain

► **To cite this version:**

Michel Pain. Mouvement brownien branchant et autres modèles hiérarchiques en physique statistique. Probabilités [math.PR]. Sorbonne Université, 2019. Français. NNT: . tel-02435953v1

HAL Id: tel-02435953

<https://theses.hal.science/tel-02435953v1>

Submitted on 11 Jan 2020 (v1), last revised 15 Feb 2021 (v2)

HAL is a multi-disciplinary open access archive for the deposit and dissemination of scientific research documents, whether they are published or not. The documents may come from teaching and research institutions in France or abroad, or from public or private research centers.

L'archive ouverte pluridisciplinaire **HAL**, est destinée au dépôt et à la diffusion de documents scientifiques de niveau recherche, publiés ou non, émanant des établissements d'enseignement et de recherche français ou étrangers, des laboratoires publics ou privés.



SORBONNE UNIVERSITÉ
École Doctorale de Sciences Mathématiques de Paris Centre
Laboratoire de Probabilités, Statistique et Modélisation

THÈSE DE DOCTORAT
Discipline : Mathématiques

présentée par

Michel PAIN

Mouvement brownien branchant et autres modèles hiérarchiques en physique statistique

sous la direction de **Zhan SHI**

Rapporteurs :

M. **Jean BERTOIN** Universität Zürich
M. **Ofer ZEITOUNI** Weizmann Institute of Science

Soutenue le 5 juin 2019 devant le jury composé de :

M. Élie AÏDÉKON	Sorbonne Université	Examinateur
M. Julien BÉRESTYCKI	Sorbonne Université	Examinateur
Mme. Brigitte CHAUVIN	Université de Versailles Saint-Quentin	Examinatrice
M. Bernard DERRIDA	École Normale Supérieure	Examinateur
M. Yueyun HU	Université Paris 13	Examinateur
M. Zhan SHI	Sorbonne Université	Directeur
M. Ofer ZEITOUNI	Weizmann Institute of Science	Rapporteur

Laboratoire de Probabilités, Statistique et Modélisation (LPSM, UMR 8001)
Sorbonne Université, Sorbonne Paris Cité, CNRS
4 place Jussieu, 75005 Paris, FRANCE

Département de Mathématiques et Applications (DMA, UMR 8553)
École Normale Supérieure, CNRS, PSL
45 rue d'Ulm, 75005 Paris, FRANCE

Mouvement brownien branchant et autres modèles
hiérarchiques en physique statistique

Branching Brownian motion and other hierarchical models in
statistical physics

Mouvement brownien branchant et autres modèles hiérarchiques en physique statistique

Résumé

Le mouvement brownien branchant est un système de particules sur \mathbb{R} , dans lequel les particules se déplacent selon un mouvement brownien pendant un temps de vie de loi exponentielle avant de mourir en donnant naissance à un nombre aléatoire d'enfants en leur position. Dans un premier chapitre, nous étudierons avec précision la transition de phase qui a lieu au sein de ce système de particules près de son minimum, en se plaçant dans le cas dit presque-critique. Cela permet de faire apparaître différents comportements intermédiaires entre ceux déjà obtenus dans la littérature pour la fonction de partition et pour la position et la trajectoire typiques des particules sous la mesure de Gibbs. Les deux chapitres suivants, écrits avec Pascal Maillard, décrivent les fluctuations 1-stable universelles qui apparaissent dans le front du mouvement brownien branchant, ainsi que le comportement typique des particules qui y contribuent.

Une version du mouvement brownien branchant avec sélection, le L -BBM, sera également étudiée. Dans ce modèle, les particules sont tuées quand elles descendent à une distance L de la particule la plus haute. Nous verrons comment cette règle de sélection affecte la vitesse de déplacement des individus les plus rapides quand L est grand.

Ensuite, dans un travail écrit avec Olivier Zindy, motivés par la question du chaos en température pour les verres de spin, nous étudions le champ libre gaussien discret en dimension 2, un modèle possédant une structure hiérarchique approximative et des propriétés très proches de celles du mouvement brownien branchant. Nous montrons que lorsque l'on tire deux particules selon les mesures de Gibbs à deux températures différentes, leur distance relative ne se comporte plus de manière universelle, comme c'est le cas pour deux particules tirées à la même température.

Finalement, la dernière partie de cette thèse porte sur le modèle de Derrida–Retaux, qui est également défini par une structure hiérarchique mais n'a pas de lien direct avec le mouvement brownien branchant. Dans ce travail écrit avec Yueyun Hu et Bastien Mallein, nous introduisons une version continue de ce modèle, qui possède une famille exactement soluble de solutions. Cela nous permet de répondre à différentes conjectures existantes sur le modèle discret et, dans le cas critique, de faire apparaître un objet limite qui devrait être universel pour une certaine classe de modèles.

Mots-clés : mouvement brownien branchant, marche aléatoire branchante, martingale additive, martingale dérivée, transition de phase, limites d'échelle, fluctuations, processus de Lévy 1-stable, équation F-KPP, sélection, champ libre gaussien discret, verres de spin, chaos en température, valeurs extrêmes, modèle de Derrida–Retaux, modèle exactement soluble.

MSC 2010 : 60J80, 60F17, 60K35 (35K57, 82B44, 82D30, 60G70, 60J70).

Branching Brownian motion and other hierarchical models in statistical physics

Abstract

Branching Brownian motion is a particle system on the real line, where particles move according to a Brownian motion during an exponentially distributed lifetime before splitting into a random number of children. In a first part, we will study precisely the phase transition occurring for this particle system close to its minimum, in the setting of the so-called near-critical case. This leads to different intermediary behaviors between the existing results in the literature, concerning the partition function or the typical position and trajectory of a particle chosen according to the Gibbs measure. Both following chapters, written with Pascal Maillard, describe the universal 1-stable fluctuations appearing in the front of branching Brownian motion and identify the typical behavior of particles contributing to them.

A version of branching Brownian motion with selection, called L -BBM, will be also studied. In this model, particles are killed when going down at a distance larger than L from the highest particle. We will see how this selection rule affects the speed of the fastest individuals in the population, when L is large.

Then, in a joint work with Olivier Zindy, motivated by temperature chaos in spin glasses, we study the 2-dimensional discrete Gaussian free field, which is a model with an approximative hierarchical structure and properties similar to branching Brownian motion. We show that, when two particles are chosen according to the Gibbs measures at two different temperatures, their relative distance does not behave anymore in a universal way, as is the case with two particles chosen at the same temperature.

Finally, the last part of this thesis is dedicated to the Derrida–Retaux model, which is also defined by a hierarchical structure, but is not directly connected with branching Brownian motion. In this work written with Yueyun Hu and Bastien Mallein, we introduce a continuous time version of this model and exhibit a family of exactly solvable solutions. This allows us to answer several conjectures stated on the discrete time model and, at criticality, to obtain a scaling limit which should be universal for a larger class of models.

Keywords : branching Brownian motion, branching random walk, additive martingale, derivative martingale, phase transition, scaling limits, fluctuations, 1-stable Lévy process, FKPP equation, selection, discrete Gaussian free field, spin glasses, temperature chaos, extreme value theory, Derrida–Retaux model, exactly solvable model.

MSC 2010: 60J80, 60F17, 60K35 (35K57, 82B44, 82D30, 60G70, 60J70).

Table des matières

1	Introduction	11
1.1	Le mouvement brownien branchant et la marche aléatoire branchante	12
1.1.1	Définitions et hypothèses	12
1.1.2	Les martingales additives	15
1.1.3	Quelques outils	17
1.1.4	La martingale dérivée et le front du mouvement brownien branchant .	20
1.2	Motivations et modèles reliés	25
1.2.1	Les premières motivations	25
1.2.2	La classe d'universalité des champs log-corrélés	27
1.2.3	Physique statistique	32
1.2.4	Autres modèles reliés	35
1.3	Le front du mouvement brownien branchant	35
1.3.1	Le cas presque-critique	35
1.3.2	Les fluctuations du front du mouvement brownien branchant	38
1.4	L'overlap dans le mouvement brownien branchant	41
1.4.1	Overlap à une température	41
1.4.2	Overlap à deux températures	42
1.5	Mouvement brownien branchant avec sélection	43
1.5.1	Sélection par une droite	43
1.5.2	Le N -mouvement brownien branchant	44
1.5.3	Le L -mouvement brownien branchant	45
1.6	Le modèle de Derrida–Retaux	46
1.6.1	Modèle en temps discret	46
1.6.2	Modèle en temps continu	51
2	The near-critical Gibbs measure of the branching random walk	57
2.1	Introduction and main results	57
2.1.1	Definitions and assumptions	57
2.1.2	The partition function	59
2.1.3	Trajectory of particles under the Gibbs measure	61
2.1.4	Genealogy under the Gibbs measure	63
2.1.5	Comments on the results	64
2.1.6	Organization of the chapter	65
2.2	Preliminary results	66

2.2.1	Many-to-one lemma and change of probabilities	66
2.2.2	One-dimensional random walks	68
2.2.3	Convergence towards the Brownian meander	70
2.2.4	Convergence towards the Brownian excursion	71
2.3	The critical window	71
2.4	The near-critical window in the weak disorder regime	72
2.5	The near-critical window in the strong disorder regime	76
2.5.1	Change of probabilities	77
2.5.2	Proof of Proposition 2.5.1 and of part (i) of Corollary 2.1.3	78
2.5.3	First moments of $\widetilde{W}_{\beta_n, n}^{(L, K)}(F)$ and $Y_n(F_n)$	81
2.5.4	Addition of the second barrier	84
2.5.5	From F to F_n	86
2.5.6	The peeling lemma	86
2.5.7	Second moment of $Y'_n(F_n)$	91
2.A	Convergence of random measures	94
2.A.1	General space	95
2.A.2	Weak convergence in $\mathcal{D}([0, 1])$	96
2.B	Proofs of preliminary results concerning random walk	97
2.B.1	Convergence towards the Bessel process and the Brownian meander	98
2.B.2	Local limit theorems	99
2.B.3	Convergence towards the Bessel bridge	100
2.B.4	Convergence towards the Brownian excursion	102
2.C	Trajectories in the weak disorder regime	104
3	1-stable fluctuations in branching Brownian motion at critical temperature	
	I: the derivative martingale	105
3.1	Introduction	105
3.1.1	Definitions and assumptions	106
3.1.2	Results	108
3.1.3	Comments and heuristics	109
3.1.4	Related literature	111
3.1.5	Organization of the chapter	112
3.2	One-dimensional marginals: a (fairly) short proof	112
3.3	Strategy of the proof of Theorem 3.1.1	114
3.4	Preliminary results on BBM with a barrier	117
3.4.1	Many-to-one formula and change of probabilities	117
3.4.2	Truncated derivative martingale: moments	118
3.4.3	Number of particles killed by the barrier	120
3.4.4	Truncation of the critical additive martingale	122
3.5	Particles staying above γ_t : proof of Proposition 3.3.2	124
3.6	Contribution of killed particles	126
3.6.1	The “bad” particles	126
3.6.2	The number of “good” particles	127
3.6.3	Contribution of the “good” particles	129
3.7	Proof of Proposition 3.2.2	130
3.A	Weak convergence in probability	132
3.B	Some formulae for the three-dimensional Bessel process	134
3.C	Asymptotic of Ψ_{Z_∞}	137
3.D	Rate of convergence of the derivative martingale	138

4	1-stable fluctuations in branching Brownian motion at critical temperature	
	II: the derivative Gibbs measure	141
4.1	Introduction	141
4.1.1	Definitions and result	141
4.1.2	Comments	143
4.1.3	Organization of the chapter and notation	144
4.2	Strategy of the proof of Theorem 4.1.1	145
4.3	Preliminary results on branching Brownian motion	148
4.3.1	Many-to-few formulas	148
4.3.2	Branching Brownian motion killed at 0	149
4.3.3	Number of killed particles	152
4.4	A first control on the rate of convergence	154
4.4.1	Branching Brownian motion with barrier between times s^a and s	155
4.4.2	Number of killed particles at level γ	156
4.4.3	The early killed particles	157
4.4.4	Dealing with all killed particles	160
4.4.5	Rate of convergence of $Z_s(f, \Delta)$	161
4.5	Precise behavior of $Z_t(f, \gamma_t)$	162
4.5.1	Proof of Proposition 4.2.4	162
4.5.2	Simplifying the contribution of killed particles	162
4.5.3	Proof of Proposition 4.2.5	166
4.6	From centring around γ_t to centring around 0	170
4.A	Weakening the condition on β_t	172
4.A.1	Introducing the multi-level barrier	172
4.A.2	First moment with the multi-level barrier	173
4.A.3	Second moment with the new barrier	176
4.A.4	General proof of Proposition 4.2.4	178
4.B	Two constants depending of f are identical	179
4.C	Technical results on the 3-dimensional Bessel process	179
4.C.1	Brownian motion killed at 0	179
4.C.2	Some calculus on the law of R_1	180
4.C.3	Some consequences of Assumptions (i) and (ii)	182
5	Two temperatures overlap for the two-dimensional discrete Gaussian free field	185
5.1	Introduction	185
5.1.1	Spin glasses and chaos phenomenon	185
5.1.2	The two-dimensional discrete Gaussian free field	186
5.1.3	Overlap distribution at two different temperatures	189
5.1.4	Organization of the chapter	192
5.2	Convergence of the overlap distribution	192
5.2.1	Proof of Part (i) of Theorem 5.1.1	192
5.2.2	Proof of Part (ii) of Theorem 5.1.1	194
5.3	Comparison with the overlap for the REM	198
5.3.1	Structure of the proof of Theorem 5.1.2	198
5.3.2	Change of point process	200
5.3.3	Random perturbation of a nonincreasing sequence	201
5.3.4	Decorations are nontrivial	202
5.A	Some useful results	204

6	Velocity of the L-branching Brownian motion	207
6.1	Introduction	207
6.1.1	Statement of the results	207
6.1.2	Motivations	209
6.1.3	Proof overview and organization of the chapter	211
6.2	Some useful results	212
6.2.1	Standard branching Brownian motion	212
6.2.2	Branching Brownian motion in a strip	213
6.3	Existence of the asymptotic velocity	215
6.4	Lower bound for v_L	220
6.4.1	Proof of the lower bound	220
6.4.2	Proof of Proposition 6.4.1	221
6.5	Upper bound for v_L	224
6.5.1	Proof of the upper bound	225
6.5.2	Comparison with the BBM in a strip	226
6.5.3	Proof of Proposition 6.5.1	230
6.5.4	Proof of Proposition 6.5.3	230
7	An exactly solvable continuous-time Derrida–Retaux model	235
7.1	Introduction	235
7.1.1	The discrete-time Derrida–Retaux model	236
7.1.2	A continuous-time version of the model, tree and process	238
7.1.3	An exactly solvable model	241
7.1.4	Organization of the chapter	243
7.2	Different constructions of the continuous-time Derrida–Retaux model	244
7.2.1	Construction from a Yule tree: the Derrida–Retaux tree	245
7.2.2	Associated McKean–Vlasov type SDE	246
7.2.3	The partial differential equation representation	248
7.3	Exactly solvable Derrida–Retaux model	251
7.3.1	Phase diagram of the model	252
7.3.2	Asymptotic behavior of the solutions	254
7.3.3	Proof of the Derrida–Retaux conjectures	256
7.4	Critical Derrida–Retaux tree conditioned on survival	259
7.4.1	The red tree as a Markovian branching process	260
7.4.2	Scaling limit of the red tree	263
7.5	Asymptotic behavior of the number and mass of red leaves	264
7.5.1	The Laplace transform of the mass and number of red leaves	265
7.5.2	An auxiliary differential equation	267
7.5.3	Asymptotics of the Laplace transform	269
7.6	Some properties of Derrida–Retaux models	272
	References	278

Chapitre 1

Introduction

En probabilité, les processus de branchement désignent les modèles décrivant l'évolution aléatoire d'une population dans le temps. Leur propriété fondamentale est l'indépendance entre les descendance des différents individus vivants à un instant donné, appelée *propriété de branchement*. Le processus le plus simple remonte à Bienaymé [Bie45] en 1845 puis à Galton et Watson [GW74] en 1874, qui s'intéressaient à la probabilité de survie des familles nobles : on part d'un individu à la génération 0, puis chaque individu de la génération n a un nombre aléatoire d'enfants, tiré indépendamment des autres selon une loi fixée, et l'ensemble de ces enfants forme la génération $n + 1$. Ils obtiennent le résultat assez intuitif suivant : pour que la population ait une chance de survivre indéfiniment, il faut que les individus aient en moyenne strictement plus d'un enfant. Depuis lors, les processus de branchement ont été l'objet d'une littérature très riche, voir Kendall [Ken66, Ken75]. Les modèles se sont complexifiés, avec par exemple Bellman et Harris [BH48] qui ajoutent une durée de vie aléatoire aux individus, puis Crump et Mode [CM68] et Jagers [Jag69] qui permettent aux individus d'avoir des enfants tout au long de leur vie.

Une autre extension possible consiste à partir d'un processus de branchement markovien et à associer à chaque individu une valeur (sa position géographique, sa taille, son génotype...). Cette valeur peut varier au cours de la vie de l'individu et influencer sa loi de reproduction, puis elle est transmise à ses enfants, éventuellement après une modification aléatoire. Cette extension constitue la famille des processus de Markov branchants introduite dans [KD47, Moy62, INW65]. Le mouvement brownien branchant est un des modèles les plus simples de cette famille : on considère des individus avec une position dans \mathbb{R} variant au fil du temps selon un mouvement brownien et qui vivent pendant une durée de loi exponentielle avant de donner naissance selon une loi fixée à un nombre aléatoire d'enfants, apparaissant à la position de leur parent et continuant de même. La marche aléatoire branchante est la version en temps discret de ce modèle : à la génération n , chaque individu, indépendamment des autres, a un nombre aléatoire d'enfants qui font un saut aléatoire par rapport à la position de leur parent et l'ensemble de ces enfants forme la génération $n + 1$. Voir la Figure 1.1. Ces deux modèles seront introduits en détail en Section 1.1, dans laquelle nous présenterons également une partie des résultats établis ces cinquante dernières années sur le sujet, ainsi que quelques outils utilisés pour les démontrer. Au delà de l'aspect biologique de ces modèles évoqué plus haut, de nombreuses autres raisons venues de la physique statistique ou d'autres objets mathématiques ont motivé l'étude du mouvement brownien branchant et de la marche

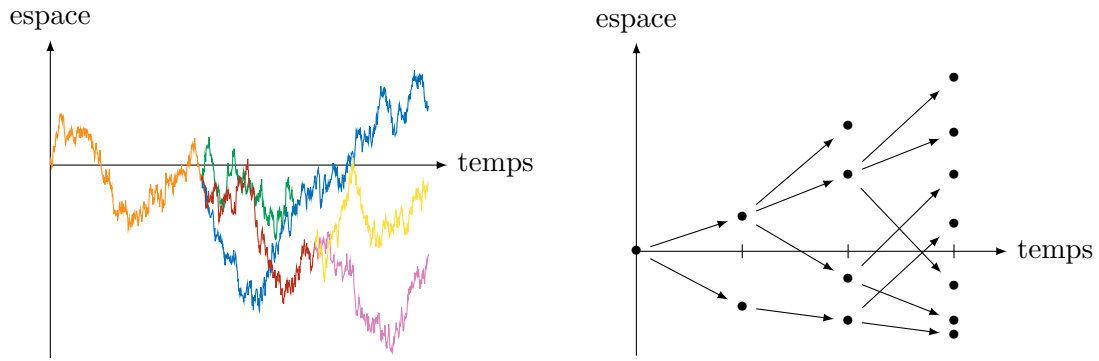

FIGURE 1.1 – À gauche, réalisation d’un mouvement brownien branchant, où la trajectoire de chaque individu est représentée dans une couleur différente. À droite, réalisation d’une marche aléatoire branchante.

aléatoire branchante, et certaines d’entre elles seront présentées en Section 1.2.

Dans les sections suivantes de cette introduction, nous présenterons les résultats établis dans cette thèse et contenus dans les articles [Pai18, MP18, MP19, PZ18a, Pai16, HMP19]. Ces travaux portent pour une part sur l’étude du mouvement brownien branchant près de ses extrêmes et contribuent à décrire précisément le comportement des particules appartenant au front de la population (Chapitre 2) et à comprendre les fluctuations universelles qui apparaissent dans le développement de ce front (Chapitres 3 et 4). Le Chapitre 5 est consacré à la question du chaos en température, motivée par la théorie des verres de spin, dans le cadre du champ libre gaussien discret en dimension 2, qui est un modèle avec un comportement similaire à celui du mouvement brownien branchant, mais où la structure hiérarchique est seulement approximative. Dans le Chapitre 6, nous nous intéresserons à un modèle de mouvement brownien branchant auquel on ajoute une règle de sélection éliminant les individus avec une position trop basse par rapport aux autres, ce qui complexifie l’étude en supprimant la propriété de branchement. Finalement, le Chapitre 7 porte sur l’étude d’un autre modèle de physique statistique avec une structure hiérarchique : le modèle de Derrida–Retaux. Nous introduirons une version en temps continu de ce modèle pour laquelle une famille exactement soluble de solutions permet d’obtenir de nombreux nouveaux résultats.

1.1 Le mouvement brownien branchant et la marche aléatoire branchante

1.1.1 Définitions et hypothèses

Un formalisme pour les arbres. Pour définir proprement la marche aléatoire branchante puis le mouvement brownien branchant, nous allons tout d’abord introduire le formalisme de Neveu [Nev86] pour les arbres. Notons $\mathcal{U} := \{\emptyset\} \cup \bigcup_{n \geq 1} (\mathbb{N}^*)^n$ l’ensemble des suites finies d’entiers de \mathbb{N}^* , où \emptyset correspond à la suite de longueur nulle. Les éléments de \mathcal{U} représentent les nœuds des arbres : $u = u(1) \cdots u(n) \in \mathcal{U}$ est le $u(n)$ -ième enfant du $u(n-1)$ -ième enfant du \dots du $u(1)$ -ième enfant de la racine \emptyset .

Cela conduit aux définitions suivantes. Pour $u = u(1) \cdots u(n) \in \mathcal{U}$, on note $|u| := n$ la *génération* de u . Si $n \geq 1$, on note $p(u) := u(1) \cdots u(n-1)$ le *parent* de u . Alors, un *arbre plan enraciné* \mathcal{T} est un sous-ensemble de \mathcal{U} vérifiant les propriétés suivantes :

- (i) $\emptyset \in \mathcal{T}$,
- (ii) $\forall u \in \mathcal{T} \setminus \{\emptyset\}, p(u) \in \mathcal{T}$,
- (iii) $\forall u \in \mathcal{T}, \forall j \in \mathbb{N}^*, (uj \in \mathcal{T}) \Rightarrow (\forall 1 \leq i \leq j, ui \in \mathcal{T})$.

Pour $u = u(1) \cdots u(n) \in \mathcal{U}$, on notera $u_i = u(1) \cdots u(i)$ pour tout $0 \leq i \leq n$ de sorte que u_0, \dots, u_n représente la *lignée* de u depuis la racine. On dit que v est un *ancêtre* de u s'il existe $k \leq |u|$ tel que $v = u_k$ et on note alors $v \leq u$. Si en outre $v \neq u$, on note $v < u$. Enfin, on note $u \wedge v$ le *plus proche ancêtre commun* entre u et v . Voir la Figure 1.2 pour un exemple.

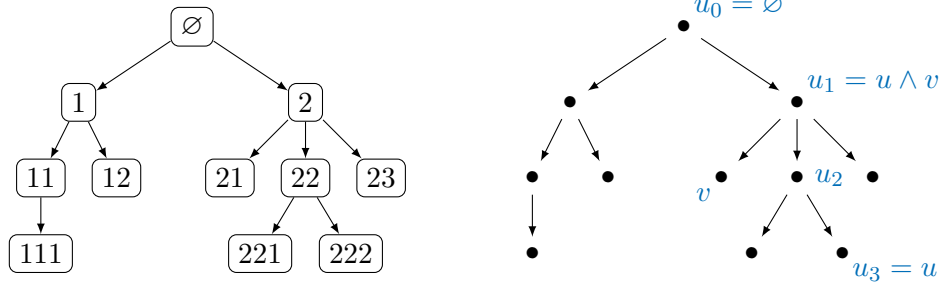

FIGURE 1.2 – Un exemple d'arbre. À gauche les étiquettes de chaque nœud sont représentées. À droite, la lignée d'un individu u est représentée, ainsi que le plus proche ancêtre commun entre u et un autre individu v .

La marche aléatoire branchante. Pour définir la marche aléatoire branchante sur \mathbb{R} , il faut se donner un processus ponctuel de reproduction $\mathcal{L} = \sum_{i=1}^L \delta_{Y_i}$ sur \mathbb{R} , qui décrit le nombre d'enfants N d'un individu ainsi que leurs déplacements respectifs Y_i par rapport à la position du parent. Soit $(\mathcal{L}(u))_{u \in \mathcal{U}}$ une famille de copies i.i.d. de \mathcal{L} , avec $\mathcal{L}(u) = \sum_{i=1}^{L(u)} \delta_{Y_i(u)}$ qui représente la manière dont u se reproduit et dont ses enfants se déplacent par rapport à sa position. Alors, on définit $\mathbb{T}_0 := \{\emptyset\}$ et récursivement, pour $n \geq 1$,

$$\mathbb{T}_n := \{uj : u \in \mathbb{T}_{n-1} \text{ et } 1 \leq j \leq L(u)\}$$

l'ensemble des individus de la génération n . Alors $\mathbb{T} := \bigcup_{n \geq 0} \mathbb{T}_n$ est un arbre plan enraciné aléatoire. À chaque individu $u \in \mathbb{T}$, on associe une position

$$X(u) := \sum_{i=1}^{|u|} Y_{u(i)}(u_{i-1}),$$

qui est la somme des déplacements effectués le long de sa lignée depuis la racine. On dit que $(X(u), u \in \mathbb{T})$ est une *marche aléatoire branchante* (ou BRW) de processus ponctuel de reproduction \mathcal{L} . Notons que cette définition autorise le fait qu'un individu ait une infinité d'enfants et qu'il y ait des corrélations entre le nombre d'enfants d'un individu et leurs déplacements respectifs.

Notre objectif dans la suite sera d'étudier le comportement en temps long de la marche aléatoire branchante et nous supposons donc que

$$\mathbb{E}[L] > 1, \tag{1.1}$$

de sorte que la population a une probabilité strictement positive de survivre indéfiniment. Autrement dit, on suppose que l'arbre généalogique \mathbb{T} est un arbre de Galton–Watson sur-critique. On note alors S l'événement où la population ne s'éteint jamais et on travaillera régulièrement sous $\mathbb{P}^* := \mathbb{P}(\cdot | S)$, c'est-à-dire conditionnellement à la survie.

Une autre hypothèse qui est généralement faite pour étudier le comportement de la marche aléatoire près de son minimum est

$$\mathbb{E} \left[\sum_{|u|=1} e^{-X(u)} \right] = 1 \quad \text{et} \quad \mathbb{E} \left[\sum_{|u|=1} X(u) e^{-X(u)} \right] = 0. \quad (1.2)$$

On dit alors que la marche aléatoire branchante est dans le *boundary case*, en référence à l'article [BK05]¹. Dans de nombreux cas, on peut se ramener à cette hypothèse en considérant une transformation affine de la marche aléatoire branchante, voir la version arXiv de Jaffuel [Jaf12] pour une discussion sur cette hypothèse.

Le mouvement brownien branchant. Passons maintenant à la définition du mouvement brownien branchant. Pour cela, il faut attribuer à chaque individu son temps de vie, sa trajectoire et son nombre d'enfants. Soit L une loi sur \mathbb{N} , $\varrho \in \mathbb{R}$, $\sigma^2 > 0$ et $\lambda > 0$. On se donne $(L_u, e_u, Y_u)_{u \in \mathcal{U}}$ une famille de variables indépendantes, où L_u a même loi que L , e_u suit une loi exponentielle de paramètre λ , $Y_u = (Y_u(t))_{t \geq 0}$ est un mouvement brownien de variance σ^2 avec drift ϱ . Alors, on peut définir l'arbre \mathbb{T} comme précédemment de sorte que chaque individu u ait L_u enfants. Puis, pour $u \in \mathbb{T}$, on définit l'*instant de naissance* de u par

$$b_u := \sum_{v < u} e_v,$$

et l'*instant de mort* de u par $d_u := b_u + e_u$. On note alors $\mathcal{N}(t) := \{u \in \mathbb{T} : b_u \leq t < d_u\}$ l'ensemble des individus vivants à l'instant $t \geq 0$. Finalement, pour $t \geq 0$ et $u \in \mathcal{N}(t)$, on définit la position de u à l'instant t par

$$X_u(t) := \sum_{v < u} Y_v(e_v) + Y_u(t - b_u).$$

En outre, il est pratique d'étendre cette définition pour tout $s \in [0, t]$, en notant $X_u(s)$ la position de l'unique ancêtre de u à l'instant s . On dit que $(X_u(t), u \in \mathcal{N}(t), t \geq 0)$ est un *mouvement brownien branchant* (ou BBM) de loi de reproduction L , de taux de branchement λ , de variance σ^2 et de drift ϱ . Comme pour la marche aléatoire branchante, nous nous placerons toujours dans le cas où $\mathbb{E}[L] > 1$. On notera S l'événement de survie et $\mathbb{P}^* := \mathbb{P}(\cdot | S)$.

Sans perte de généralité, on peut fixer les différents paramètres. Un choix naturel, qui a souvent été fait dans la littérature [Bra78, LS87, ABK13], consiste à prendre $\varrho = 0$, $\sigma^2 = \lambda = 1$ et $\mathbb{E}[L] = 2$. Cependant, nous prendrons plutôt dans la suite

$$\sigma^2 = \varrho = 1 \quad \text{et} \quad \lambda = \frac{1}{2\mathbb{E}[L - 1]}. \quad (1.3)$$

En effet, ce choix, fait aussi dans [ABBS13], a l'avantage de simplifier les formules quand on travaille sur le comportement du minimum du mouvement brownien branchant et aussi de correspondre aux hypothèses usuelles pour la marche aléatoire branchante en garantissant que

$$\mathbb{E} \left[\sum_{u \in \mathcal{N}(t)} e^{-X_u(t)} \right] = 1 \quad \text{et} \quad \mathbb{E} \left[\sum_{u \in \mathcal{N}(t)} X_u(t) e^{-X_u(t)} \right] = 0,$$

qui est l'analogie de (1.2). Voir la Figure 1.3 pour une illustration de ces deux choix de paramètres.

1. En fait, cette dénomination ne correspond pas vraiment à ce que Biggins et Kyprianou [BK05] entendent par "boundary case". Dans leur papier, ils veulent dire par là qu'ils s'intéressent à l'équation de point fixe vérifiée par la martingale additive critique (voir la Section 1.1.2) alors que précédemment la littérature se consacrait au cas sous-critique : en ce sens, ils considèrent le "cas limite".

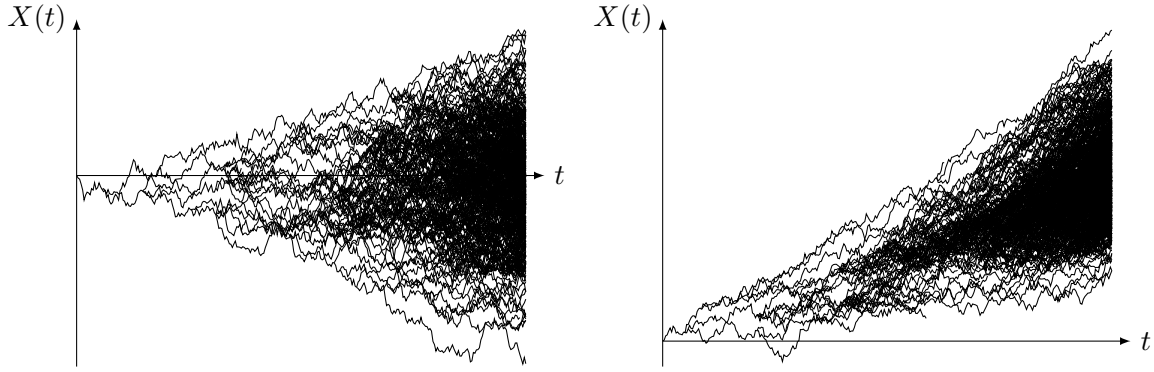

FIGURE 1.3 – Deux réalisations du mouvement brownien branchant. À gauche, on a $\rho = 0$, $\sigma^2 = \lambda = 1$ et $\mathbb{E}[L] = 2$. À droite, on a $\sigma^2 = \rho = 1$, $\lambda = 1/2$ et $\mathbb{E}[L] = 2$.

Il est communément admis qu'il est plus difficile de traiter avec la marche aléatoire branchante qu'avec le mouvement brownien branchant : on sort du cadre gaussien, on ne peut pas utiliser de calcul stochastique ni le lien avec l'équation F-KPP (voir la Section 1.2.1). En outre, un squelette discret du mouvement brownien branchant est une marche aléatoire branchante, ce qui peut permettre de transférer certains résultats. Cependant, pour plus de simplicité, nous présenterons la plupart des résultats dans le cadre du mouvement brownien branchant. Une exception sera faite pour les résultats du Chapitre 2 qui concernent la marche aléatoire branchante, mais le choix des paramètres ci-dessus permet d'avoir des formules quasi-identiques entre les deux modèles.

1.1.2 Les martingales additives

Les *martingales additives* sont à la fois un outil très important pour l'étude du mouvement brownien branchant et un objet d'étude intéressant en soi. Elles ont été introduites par McKean [McK75] (et par Mandelbrot [Man74a] et Kingman [Kin75] pour la marche aléatoire branchante), mais sont parfois appelées martingales de Biggins en référence à [Big77]. Elles sont définies, pour tout $\beta \in \mathbb{R}$, par

$$W_t(\beta) := \sum_{u \in \mathcal{N}(t)} e^{-\beta X_u(t) - \frac{(\beta-1)^2 t}{2}}, \quad t \geq 0.$$

En d'autres termes, en voyant $X_u(t)$ comme l'énergie de la particule u , $W_t(\beta)$ est la *fonction de partition* de notre système de particules à l'instant t avec température inverse β , renormalisée par son espérance. Étudier $W_t(\beta)$ et les particules qui y contribuent revient à comprendre à quoi ressemble typiquement le comportement d'une particule choisie selon la mesure de Gibbs à la température inverse β .

Notons \mathcal{F}_t la tribu contenant toute l'information jusqu'à l'instant t , c'est-à-dire

$$\mathcal{F}_t := \sigma(\mathcal{N}(s), 0 \leq s \leq t) \vee \sigma(X_u(s), 0 \leq s \leq t, u \in \mathcal{N}(s)),$$

alors $(W_t(\beta))_{t \geq 0}$ est bien une martingale par rapport à $(\mathcal{F}_t)_{t \geq 0}$. Comme elle est positive, elle converge presque sûrement :

$$W_t(\beta) \xrightarrow[t \rightarrow \infty]{\text{(p.s.)}} W_\infty(\beta).$$

Remarque 1.1.1. Cette convergence des martingales additives permet de montrer facilement qu’aucun individu ne descend très bas. En effet, notons que

$$W_t(1) = \sum_{u \in \mathcal{N}(t)} e^{-X_u(t)} \geq \exp\left(-\min_{u \in \mathcal{N}(t)} X_u(t)\right),$$

où $\min \emptyset := +\infty$, et comme $W_t(1)$ admet une limite finie p.s. on en déduit que

$$\liminf_{t \rightarrow \infty} \min_{u \in \mathcal{N}(t)} X_u(t) > -\infty \quad \text{p.s.}, \quad (1.4)$$

ce qui signifie que p.s. le BBM est borné inférieurement. Pour L suffisamment grand, on sait donc qu’avec grande probabilité aucune particule ne descend en-dessous du niveau $-L$. Ainsi, on peut supposer que les particules sont tuées en $-L$ sans que cela ne modifie le BBM avec grande probabilité. On appellera cela “ajouter une barrière en $-L$ ”. Ce résultat obtenu à moindre coût se révélera très précieux dans la suite.

Par la propriété de branchement, on peut écrire $W_\infty(\beta)$ comme une somme sur les enfants de la racine de copies indépendantes de $W_\infty(\beta)$, multipliée par un facteur dépendant de la position de la racine à sa mort. Il en découle, comme pour le processus de Galton–Watson, que $W_\infty(\beta)$ est soit strictement positive p.s. soit nulle p.s. sur l’événement de survie. La transition de phase entre ces deux comportements a d’abord été observée pour la marche aléatoire branchante par Kahane et Peyrière [KP76] et Biggins [Big77] (voir aussi Lyons [Lyo97]), puis pour le mouvement brownien branchant par Neveu [Nev88] et Kyprianou [Kyp04]. Ils montrent que, si $\mathbb{E}[L \log_+ L] < \infty$, alors, conditionnellement à la survie de la population, on a presque sûrement

$$\begin{cases} W_\infty(\beta) > 0 & \text{si } \beta \in [0, 1), \\ W_\infty(\beta) = 0 & \text{si } \beta \in [1, \infty). \end{cases} \quad (1.5)$$

On parle donc de phase *sous-critique* pour $\beta \in [0, 1)$ et *sur-critique* pour $\beta \in (1, \infty)$. Le cas *critique* $\beta = 1$ jouera un rôle particulier dans la suite, donc pour alléger les notations nous noterons simplement $W_t := W_t(1)$. Nous excluerons le cas $\mathbb{E}[L \log_+ L] = \infty$, où la limite est alors nulle pour tout β , de manière analogue au théorème de Kesten–Stigum [KS66b] pour le processus de Galton–Watson.

Les martingales additives jouent un rôle clé dans la description du mouvement brownien branchant. Tout d’abord, notons que pour $\beta = 0$, $W_t(0)$ donne le nombre total d’individus dans la population à l’instant t , renormalisé par sa moyenne. Comme ces individus se déplacent selon un mouvement brownien avec drift $\varrho = 1$, on peut dire que $W_t(0)$ décrit la croissance du BBM dans la direction de pente 1. Puis, pour $\beta > 0$, le poids $e^{-\beta X_u(t)}$ a tendance à favoriser des particules plus basses : tirer une trajectoire brownienne $(B_s)_{s \in [0, t]}$ proportionnellement à $e^{-\beta B_t}$ revient à lui ajouter un drift $-\beta$. Ainsi, $W_t(\beta)$ décrit la croissance du BBM dans la direction de pente $1 - \beta$: en effet, il a été observé par Biggins [Big79] que, pour tous $\beta \in [0, 1)$ et $g : \mathbb{R} \rightarrow \mathbb{R}$ continue à support compact, on a

$$\sqrt{2\pi t} e^{(\beta^2 - 1)t/2} \sum_{u \in \mathcal{N}(t)} g(X_u(t) - (1 - \beta)t) \xrightarrow[t \rightarrow \infty]{\text{(p.s.)}} W_\infty(\beta) \int_{\mathbb{R}} g(z) e^{\beta z} dz. \quad (1.6)$$

En outre, on peut formaliser la description ci-dessus de la trajectoire d’une particule typique contribuant à $W_t(\beta)$ de la manière suivante : en notant $\mathcal{C}([0, t])$ l’ensemble des fonctions continues de $[0, t]$ dans \mathbb{R} , on a, pour tous $\beta \in [0, 1)$ et $F : \mathcal{C}([0, t]) \rightarrow \mathbb{R}$ continue bornée,

$$\frac{1}{W_t(\beta)} \sum_{u \in \mathcal{N}(t)} e^{-\beta X_u(t) - \frac{(\beta-1)^2}{2} t} F\left(\frac{X_u(st) - (1 - \beta)s}{\sqrt{t}}, s \in [0, 1]\right) \xrightarrow[t \rightarrow \infty]{\text{(P*)}} \mathbb{E}[F(B)], \quad (1.7)$$

où $B = (B_s)_{s \in [0,1]}$ est un mouvement brownien standard. Cette convergence est démontrée pour la marche aléatoire branchante dans la Section 2.C, voir la Figure 1.4 pour une illustration.

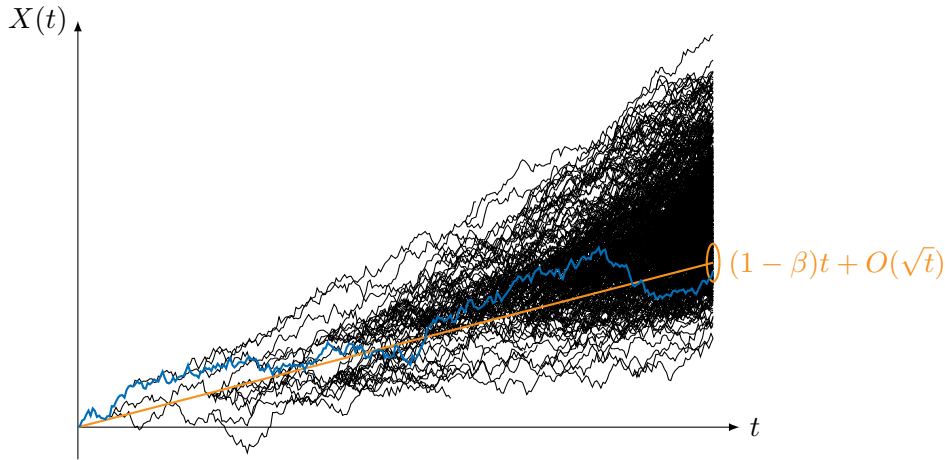

FIGURE 1.4 – Réalisation d'un BBM en noir. À l'instant t , les particules contribuant le plus à $W_t(\beta)$ sont celles à hauteur $(1 - \beta)t + O(\sqrt{t})$. En bleu, la trajectoire d'une particule tirée à l'instant t proportionnellement à $e^{-\beta X_u(t)}$ est représentée : c'est approximativement un mouvement brownien avec drift $1 - \beta$.

Nous avons vu en (1.4) qu'il n'y a pas de particules qui descendent très bas : cela implique que les propriétés évoquées ci-dessus ne peuvent plus être valides pour $\beta \geq 1$ et explique que $W_\infty(\beta)$ soit nulle dans ce cas. Ainsi les martingales additives sont le bon outil quand on s'intéresse au cœur du mouvement brownien branchant, mais, pour étudier son comportement près de ses extrêmes, nous verrons en Section 1.1.4 qu'il faut introduire une autre martingale. Notons aussi ici que le cas des martingales additives complexes où $\beta \in \mathbb{C}$ a aussi été étudié par Uchiyama [Uch82], Biggins [Big91, Big92] et Derrida, Evens et Speer [DES93] en physique et a connu un regain d'intérêt ces dernières années, voir [BJM10, MRV15, HK15, KM17, HK18, IKM18a].

1.1.3 Quelques outils

Une des principales stratégies pour l'étude du mouvement brownien branchant consiste à se ramener à un calcul de moments de certaines quantités : les sommes, sur les particules à un instant t , de fonctions de leur trajectoire jusqu'à l'instant t . Dans cette section, nous présenterons les outils fondamentaux pour calculer ces moments.

Lemme many-to-one. Il sera pratique pour la suite de permettre au mouvement brownien branchant de commencer d'une particule positionnée en un point $x \in \mathbb{R}$ quelconque et, dans ce cas, on écrira \mathbb{P}_x et \mathbb{E}_x au lieu de \mathbb{P} et \mathbb{E} . Le *lemme many-to-one* permet de calculer le premier moment des quantités mentionnées ci-dessus : pour tous $x \in \mathbb{R}$, $t \geq 0$ et $F: \mathcal{C}([0, t]) \rightarrow \mathbb{R}_+$ mesurable,

$$\mathbb{E}_x \left[\sum_{u \in \mathcal{N}(t)} F(X_u(s), s \in [0, t]) \right] = e^{t/2} \mathbb{E}_x [F(B_s + s, s \in [0, t])], \quad (1.8)$$

où $(B_s)_{s \geq 0}$ est un mouvement brownien standard partant de x sous \mathbb{P}_x . Ce résultat découle des deux observations suivantes : à l'instant t , il y a en moyenne $e^{t/2}$ particules et, conditionnellement à l'arbre généalogique, la trajectoire d'une particule $u \in \mathcal{N}(t)$ est un mouvement

brownien avec drift 1. Pour étudier le mouvement brownien branchant près de son minimum, on utilisera plutôt la version suivante du lemme many-to-one,

$$\mathbb{E}_x \left[\sum_{u \in \mathcal{N}(t)} e^{-X_u(t)} F(X_u(s), s \in [0, t]) \right] = e^{-x} \mathbb{E}_x [F(B_s, s \in [0, t])], \quad (1.9)$$

qui s'obtient à partir de (1.8) en utilisant le théorème de Girsanov. Pour le cas de la marche aléatoire branchante, voir le Lemme 2.2.1 et (2.32).

Exemple 1.1.2. Tout l'art du many-to-one réside dans le choix des quantités auxquelles on l'applique. Par exemple, l'espérance de la martingale additive critique $W_t = \sum_{u \in \mathcal{N}(t)} e^{-X_u(t)}$ est égale à 1, alors que l'on a vu que $W_t \rightarrow 0$ p.s., donc le calcul du premier moment ne donne pas d'information intéressante. Le problème réside dans le fait que certains comportements rares gonflent l'espérance : nous allons donc les éliminer en ajoutant une barrière en $-L$ avec $L > 0$ grand mais fixé (cf. Remarque 1.1.1). Alors, avec grande probabilité aucune particule ne passe jamais en-dessous de $-L$ et donc, sur cet événement,

$$W_t = \sum_{u \in \mathcal{N}(t)} e^{-X_u(t)} \mathbb{1}_{\forall s \in [0, t], X_u(s) > -L}.$$

Grâce au lemme many-to-one, on calcule alors l'espérance de la martingale additive à laquelle on a retiré les particules au comportement gênant :

$$\mathbb{E} \left[\sum_{u \in \mathcal{N}(t)} e^{-X_u(t)} \mathbb{1}_{\forall s \in [0, t], X_u(s) > -L} \right] = \mathbb{P}(\forall s \in [0, t], B_s > -L) \sim L \sqrt{\frac{2}{\pi t}},$$

quand $t \rightarrow \infty$. On en déduit que W_t est au plus d'ordre $1/\sqrt{t}$ et on verra en (1.15) que c'est le bon ordre de grandeur.

Lemme many-to-two. Les calculs de premier moment n'apportent aucune information concernant les corrélations entre les trajectoires des différentes particules : ils donnent le même résultat pour le BBM à l'instant t que pour $e^{t/2}$ mouvements browniens avec drift 1 indépendants sur $[0, t]$. Pour voir les corrélations liées à la structure d'arbre, il faut calculer les moments d'ordres supérieurs. Pour les moments d'ordre 2, on utilise le *lemme many-to-two* (voir Bramson [Bra78, Lemma 10]) : si $\mathbb{E}[L^2] < \infty$, alors, pour tous $t \geq 0$ et $F: \mathcal{C}([0, t]) \rightarrow \mathbb{R}_+$ mesurable, on a

$$\begin{aligned} & \mathbb{E} \left[\sum_{\substack{u, v \in \mathcal{N}(t) \\ \text{tels que } u \neq v}} F(X_u(r), r \in [0, t]) F(X_v(r), r \in [0, t]) \right] \\ &= \mathbb{E}[L(L-1)] e^t \int_0^t e^{-s/2} \mathbb{E} \left[F(B_r^{(1,s)} + r, r \in [0, t]) F(B_r^{(2,s)} + r, r \in [0, t]) \right] ds, \end{aligned} \quad (1.10)$$

où, pour $s \geq 0$, $B^{(1,s)}$ et $B^{(2,s)}$ sont des mouvements browniens coïncidant jusqu'à l'instant s et indépendants ensuite. De la même manière, on peut calculer les moments d'ordre $k \geq 3$, voir Harris et Roberts [HR17]. Comme pour le lemme many-to-one, il faut souvent tronquer les quantités auxquelles on applique le lemme many-to-two pour obtenir un résultat intéressant : on élimine certaines particules qui ont un comportement rare ou une contribution négligeable au moment d'ordre 1, mais qui font exploser le moment d'ordre 2.

Exemple 1.1.3. On peut utiliser le lemme many-to-two pour calculer $\mathbb{E}[W_t(\beta)^2]$. Quand $\beta < 1/\sqrt{2}$, on observe ainsi que la martingale $(W_t(\beta))_{t \geq 0}$ est bornée dans L^2 donc elle converge dans L^2 et la limite $W_\infty(\beta)$ est non triviale. Pour $\beta \geq 1/\sqrt{2}$, les moments d'ordre 2 divergent, il faut donc tronquer pour accéder au véritable comportement de $W_t(\beta)$. Comme dans l'Exemple 1.1.2, on ajoute une barrière en $-L$ avant de calculer le second moment. Pour cette version tronquée de $W_t(\beta)$, on obtient que les moments d'ordre 2 restent bornés en t quel que soit β . Pour $\beta \in (0, 1)$, comme la martingale tronquée garde une espérance très proche de 1, cela permet de conclure que la limite est non triviale et de montrer (1.5). Pour $\beta = 1$, on peut observer que le moment d'ordre 2 de W_t tronquée est d'ordre $1/t$, ce qui confirme que W_t est bien d'ordre $1/\sqrt{t}$. Pour $\beta > 1$, il faut tronquer plus pour obtenir le bon ordre de grandeur de $W_t(\beta)$.

Changements de mesure. L'un des défauts du lemme many-to-two est qu'il nécessite de travailler sous l'hypothèse que la loi de reproduction admet un moment d'ordre 2 et, pour se passer de cette hypothèse, on peut à la place utiliser un changement de mesure et la décomposition épinale associée. Cette méthode remonte à Kahane et Peyrière [KP76] pour la BRW et à Chauvin et Rouault [CR88] pour le BBM. La description du changement de mesure en terme de décomposition épinale est due à Lyons, Pemantle et Peres [LPP95] pour les arbres de Galton-Watson et a ensuite été adaptée à la BRW par Lyons [Lyo97] et au BBM par Kyprianou [Kyp04]. Un formalisme plus général a été proposé par Hardy et Harris [HH09] dans le des processus de Markov branchant avec une loi de reproduction supportée par $\{1, 2, \dots\}$, puis a été étendu par Liu, Ren et Song [LRS11] au cas $\mathbb{P}(L = 0) > 0$. Voir aussi le monographe de Shi [Shi15] pour un recueil d'applications de cette technique à la marche aléatoire branchante.

L'idée de la méthode est la suivante : on définit une nouvelle mesure \mathbb{Q} en utilisant une martingale positive de moyenne 1 comme densité par rapport à \mathbb{P} (par exemple $(W_t(\beta))_{t \geq 0}$) puis on interprète le mouvement brownien branchant sous la nouvelle mesure comme un processus avec une lignée infinie de particules marquée, appelée l'*épine*, qui se comporte différemment des autres particules. Pour les sommes sur les particules à l'instant t , le calcul d'un moment d'ordre 1 sous \mathbb{P} se ramène alors à l'espérance d'une quantité ne dépendant que de l'épine sous \mathbb{Q} . Un moment d'ordre 2 sous \mathbb{P} se ramène à un calcul de moment d'ordre 1 sous \mathbb{Q} : on décompose alors la somme sur les particules $u \in \mathcal{N}(t)$ selon le moment où la lignée de u s'est séparée de l'épine, d'où le nom de *décomposition épinale*. Voir les Sections 2.2.1 et 3.4.1 pour une présentation des changements de mesure les plus utilisés pour étudier le front de la marche aléatoire branchante et du mouvement brownien branchant respectivement.

Un des intérêts de cette méthode est qu'elle permet de calculer les moments d'ordre 1 et 2 de quantités plus compliquées, faisant entre autres intervenir le nombre d'enfants qu'il y a eu le long de la lignée de la particule $u \in \mathcal{N}(t)$ sur laquelle on somme. Ainsi, pour se passer de l'hypothèse $\mathbb{E}[L^2] < \infty$, on ne prend en compte que les particules qui n'ont pas eu trop d'enfants le long de leur lignée, en montrant que la contribution des autres est négligeable par un argument de premier moment, puis on calcule le moment d'ordre 2 de cette quantité tronquée en utilisant la décomposition épinale : la troncature permet alors de contrôler le nombre d'enfants le long de l'épine.

La difficulté réside dans le choix de la troncature : il faut généralement contrôler le nombre d'enfants en fonction de la position à laquelle la particule se reproduit, voir la Section 3.4 pour des exemples. Dans le cas de la marche aléatoire branchante, le contrôle ne doit pas porter seulement sur le nombre d'enfants mais sur tout le processus ponctuel de reproduction, ce qui complique la situation, ainsi l'obtention des résultats concernant le front de la BRW sous des hypothèses optimales n'ont été obtenus que très récemment par Aidékon [Aid13],

Aïdékon et Shi [AS14]. La partie assez technique consistant à montrer que l'on peut tronquer la reproduction le long de l'épine a été appelée *peeling lemma* par Shi [Shi15] ; une version générale sera démontrée en Section 2.5.6. Soulignons également le travail récent de Boutaud et Maillard [BM19] proposant une approche de ces méthodes permettant de se passer du calcul de moments d'ordre 2 et ainsi du *peeling lemma*.

1.1.4 La martingale dérivée et le front du mouvement brownien branchant

Depuis les premiers articles sur le mouvement brownien branchant jusqu'aux nombreux progrès de ces dix dernières années, une majeure partie de la littérature a porté sur le comportement du minimum ou des particules près du minimum. Dans cette section, nous allons parcourir en partie les résultats obtenus.

La martingale dérivée. En Section 1.1.2, nous avons vu que $W_t(\beta)$ pour $\beta \in [0, 1)$ décrit la croissance du mouvement brownien branchant dans la direction $1 - \beta$, mais que la martingale additive critique $W_t = \sum_{u \in \mathcal{N}(t)} e^{-X_u(t)}$ n'est pas la bonne quantité pour décrire le BBM dans la direction de son minimum, car elle tend vers 0 presque sûrement. La bonne quantité à considérer est la *martingale dérivée*², introduite par Lalley et Sellke [LS87] et définie par

$$Z_t := \sum_{u \in \mathcal{N}(t)} X_u(t) e^{-X_u(t)}, \quad t \geq 0.$$

Cette martingale est signée de moyenne nulle, mais elle converge presque sûrement vers une limite $Z_\infty \in [0, \infty)$.

Remarque 1.1.4. Une manière simple de montrer cette convergence presque-sûre, due à Kyprianou [Kyp04], est d'introduire la *martingale dérivée tronquée* définie pour $L > 0$ par

$$\tilde{Z}_t^{(L)} := \sum_{u \in \mathcal{N}(t)} (X_u(t) + L) e^{-X_u(t)} \mathbb{1}_{\forall s \in [0, t], X_u(s) > -L}, \quad t \geq 0.$$

C'est une martingale positive³ donc elle converge p.s. vers $\tilde{Z}_\infty^{(L)} \in [0, \infty)$. Or, grâce à (1.4), on sait que pour L grand, avec grande probabilité, aucune particule ne descend jamais en-dessous de $-L$. Mais, sur cet événement, on a $\tilde{Z}_t^{(L)} = Z_t + LW_t$ et donc $Z_t \rightarrow \tilde{Z}_\infty^{(L)}$ car $W_t \rightarrow 0$ p.s.

La condition nécessaire et suffisante pour la non-trivialité de la limite Z_∞ a été obtenue par Yang et Ren [YR11] : on a $Z_\infty > 0$ \mathbb{P}^* -p.s. si et seulement si

$$\mathbb{E}[L \log_+^2 L] < \infty,$$

ce que nous supposerons dans la suite. Chen [Che15b] a obtenu un critère analogue pour la marche aléatoire branchante. Les différents résultats présentés dans la suite de cette section mettront en évidence le fait que la martingale dérivée est la bonne quantité pour décrire le mouvement brownien branchant près de son minimum.

2. Elle est appelée ainsi car elle s'obtient en dérivant $-W_t(\beta)$ par rapport à β en $\beta = 1$.

3. Une manière simple de voir que $(\tilde{Z}_t^{(L)})_{t \geq 0}$ est une martingale consiste à remarquer que c'est la martingale $(Z_t + LW_t)_{t \geq 0}$ stoppée le long d'une ligne d'arrêt en $-L$.

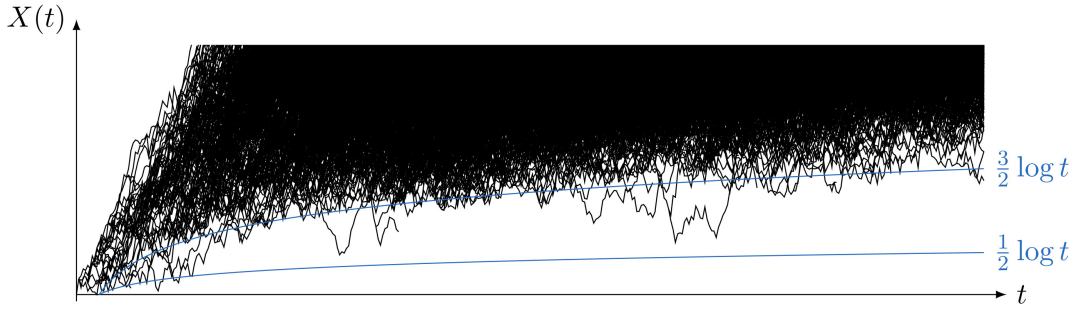

FIGURE 1.5 – Réalisation d'un mouvement brownien branchant jusqu'à $t = 40$. Le minimum est la plupart du temps au niveau $\frac{3}{2} \log t$ mais certaines particules arrivent à descendre jusqu'en $\frac{1}{2} \log t$.

La position du minimum. Au delà des motivations qui seront présentées dans la section suivante, on peut voir le mouvement brownien branchant comme un modèle naturel pour l'étude des valeurs extrêmes en dehors du cadre de variables indépendantes : il y a des corrélations, mais leur structure hiérarchique rend l'étude abordable. Ainsi, il est important de comparer le minimum du BBM à l'instant t avec celui de $e^{t/2}$ mouvements browniens indépendants avec drift 1 à l'instant t .

Les premiers résultats sur la position du minimum ont été obtenus pour le mouvement brownien branchant par McKean [McK75, McK76] comme une conséquence du lien qu'il établit avec l'équation F-KPP (voir la Section 1.2.1) et pour la marche aléatoire branchante par Hammersley [Ham74], Kingman [Kin75] et Biggins [Big76] : ils donnent la vitesse de déplacement du minimum, qui avec nos paramètres s'écrit

$$\frac{1}{t} \min_{u \in \mathcal{N}(t)} X_u(t) \xrightarrow[t \rightarrow \infty]{(p.s.)} 0,$$

sous \mathbb{P}^* . Notons qu'à cet ordre le comportement est le même que celui de $e^{t/2}$ mouvements browniens indépendants avec drift 1 à l'instant t .

L'ordre suivant a été obtenu par Bramson [Bra78] qui montre la convergence en probabilité suivante

$$\frac{1}{\log t} \min_{u \in \mathcal{N}(t)} X_u(t) \xrightarrow[t \rightarrow \infty]{(\mathbb{P}^*)} \frac{3}{2}, \quad (1.11)$$

en utilisant aussi le lien avec l'équation F-KPP. Le même résultat pour la marche aléatoire branchante n'a été montré que 30 ans plus tard par Hu et Shi [HS09] et Addario-Berry et Reed [AR09]. En outre, Hu et Shi [HS09] montrent le résultat presque sûr suivant, conditionnellement à la survie,

$$\limsup_{t \rightarrow \infty} \frac{1}{\log t} \min_{u \in \mathcal{N}(t)} X_u(t) = \frac{3}{2} \quad \text{et} \quad \liminf_{t \rightarrow \infty} \frac{1}{\log t} \min_{u \in \mathcal{N}(t)} X_u(t) = \frac{1}{2}. \quad (1.12)$$

Ainsi, même si le minimum est la plupart du temps en $\frac{3}{2} \log t$, infiniment souvent certaines particules vont réussir à descendre jusqu'en $\frac{1}{2} \log t$, voir la Figure 1.5.

C'est au niveau de ce correctif logarithmique que l'on peut voir le rôle des corrélations : si les $(B^i)_{i \geq 1}$ sont des mouvements browniens indépendants sans drift, on a le développement asymptotique suivant pour le minimum

$$\min_{1 \leq i \leq e^{t/2}} (B_t^i + t) - \frac{1}{2} \log t \xrightarrow[t \rightarrow \infty]{(loi)} G, \quad (1.13)$$

où G suit une loi Gumbel. Ce changement de constante de 1 à 3 entre (1.13) et (1.11) pour le correctif logarithmique s'explique grâce à la barrière en $-L$ que l'on peut ajouter dans le

cas du BBM (voir la Remarque 1.1.1). En effet, pour $L > 0$ grand, avec grande probabilité, les particules du mouvement brownien branchant à l'instant t ont eu une trajectoire qui est restée au-dessus de $-L$. Cette barrière rajoute un coût approximatif de $1/t$ pour arriver près du minimum par rapport au cas des mouvements browniens indépendants, et ce coût est responsable du décalage de $\log t$ pour la position du minimum.

Grâce à une étude précise de l'équation F-KPP dans son livre [Bra83], Bramson a montré que le minimum recentré par $\frac{3}{2} \log t$ converge en loi. La description de la limite a été obtenue quelques années plus tard par Lalley et Sellke [LS87] et fait intervenir la martingale dérivée : ils montrent que, sous \mathbb{P}^* ,

$$\min_{u \in \mathcal{N}(t)} X_u(t) - \frac{3}{2} \log t + \log Z_\infty \xrightarrow[t \rightarrow \infty]{(loi)} G, \quad (1.14)$$

où G suit une loi Gumbel. Le comportement des premières générations joue un rôle d'ordre constant dans la position du minimum à long terme, qui est entièrement capturé par la martingale dérivée : après un temps long mais fixé, la martingale dérivée a à peu près atteint sa valeur limite et on ne voit plus qu'une compétition entre un grand nombre de BBM indépendants qui fait apparaître des fluctuations de loi Gumbel, comme en (1.13). Le résultat analogue pour la marche aléatoire branchante a été obtenu bien plus tard par Aïdékon [Aïd13] sous les hypothèses optimales pour que Z_∞ soit non triviale. Mentionnons également que Bachmann [Bac00] avait montré plus tôt, pour une certaine famille de marches aléatoires branchantes, que le minimum recentré par sa médiane convergait vers une loi Gumbel shiftée aléatoirement, sans pour autant obtenir que ce recentrage est de taille $\frac{3}{2} \log n + O(1)$.

Le front du mouvement brownien branchant. Le *front* du mouvement brownien branchant désigne les particules à une distance d'ordre \sqrt{t} du minimum à l'instant t , qui sont les particules contribuant principalement à W_t et à Z_t . Nous allons voir que Z_∞ joue le même rôle dans la direction du minimum que $W_\infty(\beta)$ dans la direction $1 - \beta$ (cf. (1.6)).

Le premier résultat dans ce sens a été obtenu par Aïdékon et Shi [AS14] pour la marche aléatoire branchante, qui montrent que la martingale additive critique, à une renormalisation près, se comporte comme la martingale dérivée : on a la convergence

$$\sqrt{t}W_t \xrightarrow[t \rightarrow \infty]{(\mathbb{P})} \sqrt{\frac{2}{\pi}} Z_\infty, \quad (1.15)$$

voir aussi [BM19] pour une démonstration simplifiée.

Cette convergence a été généralisée par Madaule [Mad16a] qui s'intéresse à toute une famille de quantités portées par le front : pour $g : \mathbb{R} \rightarrow \mathbb{R}$ continue bornée, on définit

$$W_t(g) := \sum_{u \in \mathcal{N}(t)} g\left(\frac{X_u(t)}{\sqrt{t}}\right) e^{-X_u(t)}, \quad t \geq 0.$$

Il montre, dans le cas de la marche aléatoire branchante (voir aussi [MZ16] pour le BBM), que

$$\sqrt{t}W_t(g) \xrightarrow[t \rightarrow \infty]{(\mathbb{P})} \sqrt{\frac{2}{\pi}} Z_\infty \int_0^\infty g(x) x e^{-x^2/2} dx, \quad (1.16)$$

ce qui signifie que, au facteur Z_∞ près, la distribution des particules du front est déterministe. Madaule [Mad16a] obtient en fait un résultat plus fort, montrant que la trajectoire d'une particule choisie à l'instant t proportionnellement à $e^{-X_u(t)}$ converge vers un méandre brownien après changement d'échelle. Ceci s'explique encore une fois par la barrière que l'on peut mettre en $-L$ (cf. Remarque 1.1.1). Le poids $e^{-X_u(t)}$ amène la trajectoire dans la direction

du minimum en compensant le drift, mais cette trajectoire est obligée de rester supérieure à $-L$: cela donne un méandre brownien à la limite.

À partir de ce résultat, Madaule [Mad16a] montre également que l'on peut obtenir Z_∞ en dérivant la martingale additive après passage à la limite : on a

$$\frac{W_\infty(\beta)}{1-\beta} \xrightarrow[\beta \uparrow 1]{(\mathbb{P})} 2Z_\infty, \quad (1.17)$$

où l'apparition du facteur 2 montre que l'on ne peut pas échanger l'ordre entre la dérivation en β et le passage à la limite en $t \rightarrow \infty$.

Le processus extrémal. En théorie des valeurs extrêmes, une fois le développement asymptotique de la position du minimum obtenu, l'étape suivante consiste à décrire le *processus extrémal*, c'est-à-dire le processus ponctuel formé par les valeurs vues depuis la position théorique du minimum. Par exemple, dans le cas de mouvements browniens indépendants $(B^i)_{i \geq 1}$, on a la convergence suivante pour le processus extrémal [LLR83] :

$$\sum_{1 \leq i \leq e^{t/2}} \delta_{B_t^i + t - \frac{1}{2} \log t} \xrightarrow[t \rightarrow \infty]{(\text{loi})} \sum_{k \geq 1} \delta_{\xi_k}, \quad (1.18)$$

où les $(\xi_k)_{k \geq 1}$ sont les atomes d'un processus ponctuel de Poisson sur \mathbb{R} d'intensité $ce^x dx$, avec $c > 0$.

Pour le mouvement brownien branchant, le *processus extrémal* est défini par

$$\mathcal{E}_t := \sum_{u \in \mathcal{N}(t)} \delta_{X_u(t) - \frac{3}{2} \log t}, \quad t \geq 0,$$

La question de sa convergence a été résolue pendant la dernière décennie : Arguin, Bovier, Kistler [ABK13] et Aïdékon, Berestycki, Brunet, Shi [ABBS13] ont obtenu simultanément la convergence suivante, pour la topologie vague et conditionnellement à la survie,

$$\mathcal{E}_t \xrightarrow[t \rightarrow \infty]{(\text{loi})} \mathcal{E}_\infty, \quad (1.19)$$

où \mathcal{E}_∞ est un processus ponctuel de Poisson décoré défini par

$$\mathcal{E}_\infty := \sum_{k \geq 1} \sum_{i \geq 1} \delta_{\xi_k + d_i^k},$$

où les $(\xi_k)_{k \geq 1}$ sont les atomes d'un processus ponctuel de Poisson sur \mathbb{R} d'intensité aléatoire $cZ_\infty e^x dx$, avec $c > 0$, et les $(d_i^k)_{i \geq 1}$ sont les atomes du processus ponctuel \mathcal{D}^k , avec $(\mathcal{D}^k)_{k \geq 1}$ des copies i.i.d. d'un processus ponctuel \mathcal{D} , appelé la *décoration*, indépendantes de $(\xi_k)_{k \geq 1}$. En outre, presque sûrement, \mathcal{D} est supporté par \mathbb{R}_+ et a un atome en 0. Deux descriptions différentes de \mathcal{D} sont données dans [ABK13] et [ABBS13]. Pour la marche aléatoire branchante, la convergence du processus extrémal a été montrée par Madaule [Mad17], en s'appuyant sur un résultat de Maillard [Mai13], et une description de la limite a été obtenue par Mallein [Mal18b]. Notons finalement que la méthode développée par Biskup et Louidor [BL16b, BL18b] pour montrer la convergence du processus extrémal du champ libre gaussien discret pourrait également s'appliquer pour le BBM ou la BRW gaussienne.

Avant d'expliquer ce résultat, remarquons que la trajectoire d'une particule proche du minimum à l'instant t ressemble à une excursion brownienne de longueur t , car elle doit revenir près de 0 à l'instant t tout en restant au-dessus de $-L$ avec grande probabilité. Ainsi, Arguin, Bovier et Kistler [ABK11] montrent que cette trajectoire est typiquement d'ordre \sqrt{s}

à un instant $s \in [r, t-r]$ pour r grand. Notons que la convergence de la trajectoire menant à la particule la plus basse, après changement d'échelle, vers une excursion brownienne standard a été montrée par Chen [Che15a] dans le cadre de la marche aléatoire branchante.

Cette remarque indique que les particules du processus extrémal proviennent du front du BBM à un instant s grand mais fixé. À cet instant, un grand nombre (proportionnel à $Z_s \simeq Z_\infty$) de BBM indépendants sont lancés et certains d'entre eux ont un minimum proche de $\frac{3}{2} \log t$ à l'instant t : de manière analogue au cas indépendant (1.18), le processus ponctuel de leurs minima vus depuis $\frac{3}{2} \log t$ converge vers un PPP($cZ_\infty e^x dx$). Mais, chaque particule arrivant près du minimum apporte avec elle ses proches cousins : ils forment la décoration attachée à cette particule. Ainsi, le processus extrémal peut être subdivisé en groupes au sein desquels les particules ont toutes un ancêtre commun très proche et tels que l'ancêtre commun à deux groupes est proche de la racine, voir la Figure 1.6. Un résultat de convergence du processus extrémal prenant en compte la généalogie des particules et leur position dans l'arbre sous-jacent a été montré par Bovier et Hartung [BH17] et Mallein [Mal18b], en faisant intervenir une mesure aléatoire sur la frontière de l'arbre, construite à partir de la martingale dérivée.

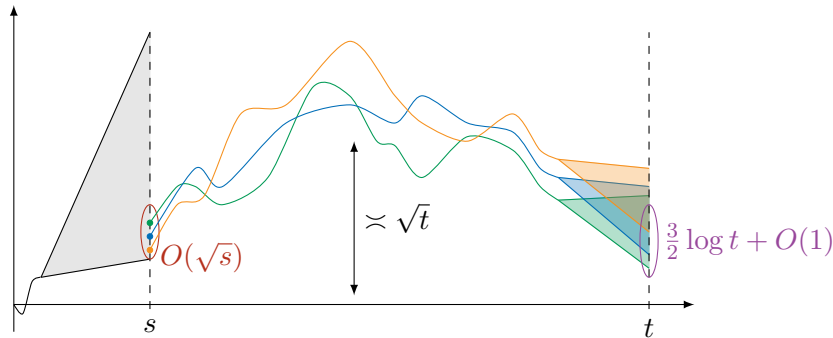

FIGURE 1.6 – Schéma représentant la trajectoire de particules arrivant près du minimum à l'instant t , amenant avec elles leurs proches cousins.

Les martingales additives sur-critiques. Comme pour la martingale additive critique, on peut chercher l'ordre de grandeur de $W_t(\beta)$ pour $\beta > 1$. En premier lieu, on peut s'intéresser à l'énergie libre de notre modèle définie par

$$f(\beta) := \lim_{t \rightarrow \infty} \frac{1}{t} \mathbb{E} \left[\log \sum_{u \in \mathcal{N}(t)} e^{-\beta X_u(t)} \right] \leq \lim_{t \rightarrow \infty} \frac{1}{t} \log \mathbb{E} \left[\sum_{u \in \mathcal{N}(t)} e^{-\beta X_u(t)} \right] = \frac{(\beta - 1)^2}{2}. \quad (1.20)$$

Alors, Derrida et Spohn [DS88] ont remarqué que les résultats de Bramson [Bra83] sur l'équation F-KPP permettent de montrer que $f(\beta) = \frac{(\beta-1)^2}{2} \mathbb{1}_{\beta \leq 1}$ pour tout $\beta \geq 0$. Ainsi, pour $\beta \leq 1$, il y a égalité dans (1.20) puis, pour $\beta > 1$, on entre dans une phase gelée où l'énergie libre devient linéaire. Ce phénomène, appelé *freezing* en anglais, apparaît dans de nombreux autres modèles, voir les Sections 1.2.2 et 1.2.3.

Les résultats de Bramson [Bra83] permettent même d'obtenir la bonne renormalisation de $W_t(\beta)$, pour $\beta > 1$, afin d'obtenir une limite non-triviale (voir Madaule [Mad17] pour la marche aléatoire branchante), et cette limite a été identifiée par Barral, Rhodes, Vargas [BRV12] : on a

$$t^{3\beta/2} e^{\frac{(\beta-1)^2 t}{2}} W_t(\beta) \xrightarrow[t \rightarrow \infty]{(\text{loi})} Z_\infty^\beta \mathcal{S}_{1/\beta}, \quad (1.21)$$

où $S_{1/\beta}$ est une loi $1/\beta$ -stable spectralement positive et indépendante de Z_∞ . En outre, $W_t(\beta)$ est portée par les particules extrémales, c'est-à-dire celles de position $\frac{3}{2} \log t + O(1)$, et Chen, Madaule, Mallein [CMM19] ont montré que la trajectoire typique d'une particule contribuant à $W_t(\beta)$ converge, après changement d'échelle, vers une excursion brownienne standard, ce qui s'accorde avec l'heuristique discutée ci-dessus pour le processus extrémal.

1.2 Motivations et modèles reliés

Dans cette section, nous présentons une liste non exhaustive de raisons de s'intéresser au mouvement brownien branchant ou à la marche aléatoire branchante : ces modèles sont suffisamment simples dans leur définition pour qu'ils apparaissent dans de nombreux cadres différents.

1.2.1 Les premières motivations

Modèles de populations. Les processus de branchement modélisent l'évolution d'une population et la marche aléatoire branchante s'inscrit dans cette optique. Ainsi, c'est dans le but de trouver l'instant de la première naissance dans la n -ième génération d'un processus de Crump–Mode–Jagers que Hammersley [Ham74], Kingman [Kin75] et Biggins [Big76] ont commencé à s'intéresser au minimum d'une marche aléatoire branchante.

Si, au fil du temps, de nombreuses autres motivations sont venues de la physique statistique, les méthodes développées pour l'étude de la marche aléatoire branchante se sont aussi révélées utiles pour d'autres modèles de population comme les superprocessus [Wat68, Daw75], les processus de croissance-fragmentation [Ber17b, BW18] ou les Λ -Fleming-Viot spatiaux [BEV10, EFPS17].

Les cascades multiplicatives. La marche aléatoire branchante a aussi été introduite indépendamment par Mandelbrot [Man74c, Man74a, Man74b] sous la forme de cascade multiplicative, pour étudier les phénomènes de turbulence intermittente. Considérons pour simplifier le cas dyadique sur $[0, 1]^2$. Alors, une *cascade multiplicative* est une suite de mesures $(\mu_n)_{n \in \mathbb{N}}$ sur $[0, 1]^2$ définie par récurrence, avec μ_0 la mesure de Lebesgue et, pour $n \geq 1$ et pour tout carré dyadique C de côté 2^{-n} , la restriction de μ_n à C est définie par $Y_C \mu_{n-1}$, où les Y_C pour C carré dyadique sont des copies i.i.d. d'une v.a. Y positive de moyenne 1. Cela revient exactement à considérer l'exponentielle d'une marche aléatoire branchante, où les individus ont 4 enfants qui sautent indépendamment selon la loi de $\log Y$.

Les questions soulevées par Mandelbrot (résolues par Kahane et Peyrière [KP76]) concernaient la convergence de μ_n vers une mesure limite μ non triviale, ce qui correspond à l'étude de la convergence des martingales additives, et la dimension de Hausdorff de cette mesure limite (voir la Figure 1.7). Par construction, la mesure μ vérifie une propriété d'autosimilarité : ses restrictions aux carrés dyadiques de côté $\frac{1}{2}$ forment 4 mesures indépendantes, chacune ayant la même loi que μ changée d'échelle et multipliée par un facteur indépendant de même loi que Y . Même si leur définition est équivalente à celle des marches aléatoires branchantes, les cascades multiplicatives ont fait l'objet d'une littérature à part, se concentrant sur d'autres propriétés, comme le caractère *multifractal* de la mesure limite [FP85, BPPV84], voir [BM04] pour une revue de la littérature.

Équations de réaction-diffusion. Une autre des raisons initiales de l'étude du mouvement brownien branchant est son lien avec les équations de réaction-diffusion, mis en avant

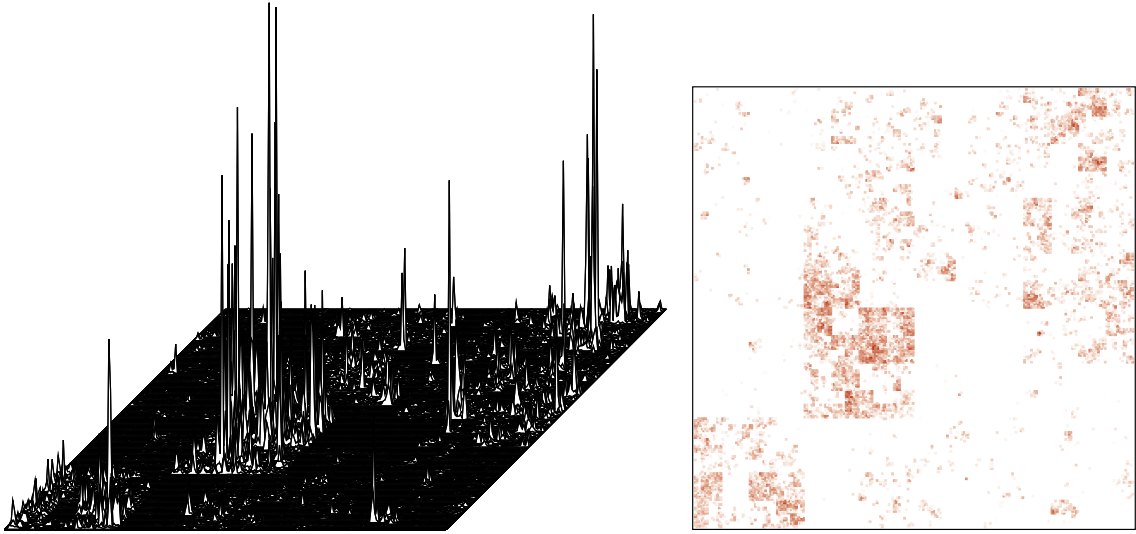

FIGURE 1.7 – Réalisation de la mesure μ_n sur $[0, 1]^2$ avec $n = 8$ et $\log Y$ de loi gaussienne, choisie pour que la martingale additive associée soit à la température inverse $\beta = \beta_c/2$. À gauche, la mesure est représentée comme une fonction sur $[0, 1]^2$ renormalisée par son maximum. Comme pour la martingale additive sous-critique, la mesure μ_n n'est pas portée asymptotiquement par les carrés dyadiques ayant une mesure maximale et donc la représentation de gauche ne donnerait pas une bonne idée du support de μ_n pour n grand. À droite sont représentés les carrés dyadiques de côté 2^{-n} portant la plupart de la masse μ_n , ce qui donne une meilleure image du support de la mesure limite.

par McKean [McK75]. L'équation *F-KPP*, introduite par Fisher [Fis37] et Kolmogorov, Petrovsky et Piskunov [KPP37] est l'équation d'inconnue $u: \mathbb{R}_+ \times \mathbb{R} \rightarrow [0, 1]$ suivante

$$\frac{\partial u}{\partial t} = \frac{\sigma^2}{2} \frac{\partial^2 u}{\partial x^2} + \lambda(u - u^2), \quad (1.22)$$

où le premier terme de la partie droite est le terme de *diffusion* et le second celui de *réaction*. On peut voir $u(t, x)$ comme la concentration en élément A au point x à l'instant t d'un mélange d'un grand nombre de particules A et B , avec les mécanismes suivants : diffusion des particules sur la droite réelle et réaction chimique $A + B \rightarrow 2A$, qui a lieu à un taux proportionnel à $u(t, x)(1 - u(t, x))$. Ainsi, l'équation décrit comment un milieu stable (les particules A) envahit un milieu instable (les particules B).

McKean [McK75] montre que l'on peut construire les solutions de l'équation F-KPP à partir du mouvement brownien branchant. Soit $(X_u(t), u \in \mathcal{N}(t), t \geq 0)$ un mouvement brownien branchant de loi de reproduction *binnaire*, de taux de branchement λ , de variance σ^2 et de drift ρ . Alors, pour tout $h: \mathbb{R} \rightarrow [0, 1]$ mesurable, la fonction u définie par

$$u(t, x) := 1 - \mathbb{E} \left[\prod_{u \in \mathcal{N}(t)} (1 - h(x + X_u(t) - \rho t)) \right]$$

est solution de l'équation F-KPP (1.22) avec condition initiale $u(0, x) = f(x)$. Si l'on considère une loi de reproduction aléatoire L , alors le terme u^2 dans (1.22) est remplacé par $\mathbb{E}[u^L]$, mais cela reste dans le cadre plus général introduit par Kolmogorov, Petrovsky et Piskunov [KPP37]. Un des cas les plus importants est celui où l'on considère $h(x) = \mathbb{1}_{x \leq 0}$ car on a alors

$$u(t, x) = \mathbb{P} \left(\min_{u \in \mathcal{N}(t)} X_u(t) \leq \rho t - x \right).$$

C'est en utilisant cette connexion que Bramson [Bra83] a obtenu la convergence en loi du minimum du BBM recentré : il montre, avec $\beta_c := \sqrt{2\lambda}/\sigma$, que

$$u\left(t, \beta_c \sigma^2 t - \frac{3}{2\beta_c} \log t + x\right)$$

converge uniformément en $x \in \mathbb{R}$, dès que la condition initiale est proche de 1 en $-\infty$ et tend suffisamment vite vers 0 en $+\infty$, voir [Bra83, Theorem 3]⁴. L'étude du processus extrémal par Arguin, Bovier, Kistler [ABK13] repose aussi sur le lien avec l'équation F-KPP. Voir le monographe de Bovier [Bov17] pour une approche du mouvement brownien branchant reposant sur ce lien. Notons finalement que Webb [Web11] a réussi à exploiter une version discrète de l'équation F-KPP pour étudier la marche aléatoire branchante.

Dans l'autre sens, on peut démontrer des résultats sur l'équation F-KPP grâce à une étude probabiliste du mouvement brownien branchant. Cependant, cette approche utilisée par Harris [Har99] et Kyprianou [Kyp04] a pour l'instant toujours été en retard par rapport aux arguments analytiques.

1.2.2 La classe d'universalité des champs log-corrélés

Carpentier et Le Doussal [CLD01] ont remarqué que différents résultats sur le mouvement brownien branchant, comme le phénomène de *freezing* ou le comportement des extrêmes, sont en fait partagés par une plus grande famille de modèles : les champs log-corrélés. Ainsi, les méthodes développées pour l'étude du mouvement brownien branchant se sont révélées utiles pour traiter d'autres modèles sans structure branchante apparente.

La marche aléatoire branchante. Commençons par expliquer pourquoi la marche branchante est un champ log-corrélé approximatif. Considérons une marche aléatoire branchante dans laquelle chaque individu a 2^d enfants qui font tous un saut indépendant de loi $\mathcal{N}(0, 1)$ par rapport à leur parent. Dans ce cas, pour u et v à la génération n , $X(u)$ et $X(v)$ suivent la loi $\mathcal{N}(0, n)$ et leur covariance est donnée par $|u \wedge v|$ la génération de leur plus proche ancêtre commun. En outre, on peut voir l'arbre 2^d -aire comme une manière canonique d'encoder les cubes dyadiques de $[0, 1]^d$: les individus de la génération n correspondent aux cubes de côté 2^{-n} et chacun se subdivise en 2^d cubes plus petits. Alors, quand tout se passe bien, la covariance entre deux particules se comporte comme la valeur absolue du logarithme de leur distance dans $[0, 1]^d$, mais il y a aussi des particules très proches complètement décorréelées, voir la Figure 1.8. On peut dire que la marche aléatoire branchante est un champ au plus log-corrélé.

Champs gaussiens log-corrélés et chaos multiplicatif gaussien. On considère un domaine $D \subset \mathbb{R}^d$ borné et un champ gaussien $X = (X(x))_{x \in D}$ centré avec un noyau de covariance de la forme

$$\mathbb{E}[X(x)X(y)] = \log_+ \frac{1}{|x - y|} + g(x, y), \quad x, y \in D,$$

4. Du point de vue de la communauté probabiliste, l'approche de Bramson est donc considérée comme analytique : elle ne s'applique pas directement à la marche aléatoire branchante, ce qui explique que la convergence du minimum n'ait été obtenue que trente ans plus tard pour la marche branchante. Cependant, la méthode de Bramson pour traiter l'équation F-KPP reste assez probabiliste car elle repose en grande partie sur une représentation de Feynman-Kac des solutions. Pour une démonstration analytique de ses résultats voir [Lau85], puis récemment [HNRR13, NRR17].

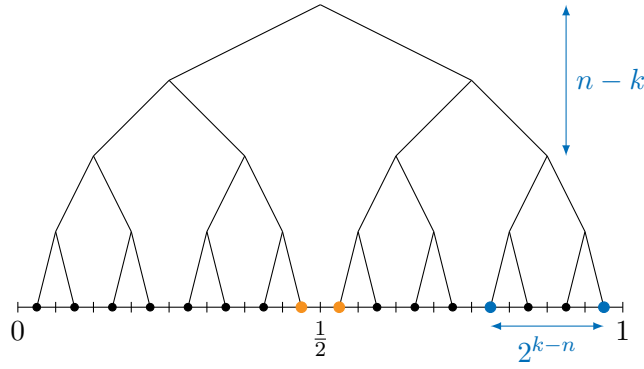

FIGURE 1.8 – Schéma illustrant l'association entre les feuilles d'un arbre binaire de hauteur n et les intervalles dyadiques de $[0, 1]$ de longueur 2^{-n} . Les deux particules bleues sont distantes de 2^{k-n} et leur covariance est $n - k$. Pour les particules oranges, ça se passe mal : elles sont très proches mais complètement décorréées.

où $g: D \rightarrow \mathbb{R}$ est continue. Le champ log-corrélé X est défini comme une distribution aléatoire et $X(x)$ n'a pas de sens car sa variance serait infinie. Un cas particulier de tel champ est le champ libre gaussien en dimension 2, voir [She07] pour une introduction.

De manière analogue à la cascade multiplicative, qui est une mesure avec pour densité l'exponentielle d'une marche aléatoire branchante, on cherche à définir le *chaos multiplicatif gaussien* comme la mesure

$$M_\gamma(dx) := e^{\gamma X(x) - \frac{\gamma^2}{2} \mathbb{E}[X(x)^2]} dx,$$

mais cela n'a pas de sens car on ne peut pas prendre directement l'exponentielle d'une distribution. Kahane [Kah85] a donné un sens rigoureux à cette définition sous certaines hypothèses sur le noyau de covariance qui ont été affaiblies depuis dans [RV10, Sha16] entre autres, voir [RV14] pour une revue de la littérature. L'idée consiste à définir une régularisation X_ε du champ X , obtenue par exemple en convolant X avec une approximation de Dirac [RV10], et de montrer la convergence suivante

$$M_{\gamma,\varepsilon}(dx) := e^{\gamma X_\varepsilon(x) - \frac{\gamma^2}{2} \mathbb{E}[X_\varepsilon(x)^2]} dx \xrightarrow[\varepsilon \rightarrow 0]{(\mathbb{P})} M_\gamma(dx),$$

où la mesure limite M_γ est non triviale si et seulement si $\gamma < \sqrt{2d}$, voir [Ber17a] pour une démonstration élémentaire. Comme les cascades multiplicatives, le chaos multiplicatif gaussien a servi à étudier le comportement intermittent et multifractal des turbulences [CRV10, CGRV17]. Notons qu'une construction du chaos multiplicatif gaussien sous forme de cascade multiplicative, mais avec un découpage aléatoire donné par les lignes de niveau du champ libre gaussien, a été établie dans [APS17]. Cependant, l'engouement de ces dernières années pour le chaos multiplicatif est principalement dû au rôle fondamental qu'il joue dans la définition rigoureuse de la théorie quantique de Liouville introduite en physique par Polyakov [Pol81] dans le cas de la dimension 2, voir [DKRV16, DRV16, HRV18, Rem18].

Certains travaux se placent dans le cas particulier des champs \star -scale invariants introduits dans [ARV13], pour lesquels la mesure limite possède une propriété d'invariance d'échelle, qui peut être vue comme l'analogue des propriétés d'autosimilarité des cascades multiplicatives. En outre, avec une régularisation bien choisie, on peut faire apparaître une structure branchante approximative et les masses $M_{\gamma,\varepsilon}(A)$ d'un borélien A forment une martingale quand $\varepsilon \downarrow 0$, qui joue le rôle de la martingale additive pour le mouvement brownien branchant.

Dans le cas critique $\gamma = \gamma_c$, de manière analogue à l'introduction de la martingale dérivée pour le mouvement brownien branchant, on peut essayer de renormaliser $M_{\gamma_c,\varepsilon}$ pour obtenir

une mesure limite non triviale. Cette approche a été mise en place par Duplantier, Rhodes, Sheffield, Vargas [DRSV14a] qui montrent la convergence

$$M'_\varepsilon(dx) := \left(\gamma_c \mathbb{E} \left[X_\varepsilon(x)^2 \right] - X_\varepsilon(x) \right) e^{\gamma_c X_\varepsilon(x) - \frac{\gamma_c^2}{2} \mathbb{E} [X_\varepsilon(x)^2]} dx \xrightarrow[\varepsilon \rightarrow 0]{(\mathbb{P})} M'(dx), \quad (1.23)$$

puis, dans [DRSV14b], que M' peut aussi s'obtenir par une renormalisation similaire à (1.15) :

$$\sqrt{\log \frac{1}{\varepsilon}} e^{\gamma_c X_\varepsilon(x) - \frac{\gamma_c^2}{2} \mathbb{E} [X_\varepsilon(x)^2]} dx \xrightarrow[\varepsilon \rightarrow 0]{(\mathbb{P})} M'(dx),$$

où $\log(1/\varepsilon)$ joue le rôle de t dans le BBM. Le fait que la limite ne dépend pas de la régularisation a été montré par [JS17, HRV18, Pow18]. Une troisième construction de M' , en tant que dérivée de M_γ par rapport à γ en γ_c (de manière analogue à (1.17)) a été obtenue par Aru, Powell et Sepulveda [APS18].

L'un des comportements caractéristiques de la classe des champs log-corrélés est le développement asymptotique du maximum ou du minimum avec un correctif en $\frac{3}{2\gamma_c} \log t$ puis une loi Gumbel shiftée aléatoirement, comme dans le cas du mouvement brownien branchant. Pour certains champs log-corrélés, Madaule [Mad15] a ainsi obtenu la convergence suivante, analogue à (1.14) :

$$\sup_{x \in D} X_\varepsilon(x) - \left(\gamma_c \log \frac{1}{\varepsilon} - \frac{3}{2\gamma_c} \log \log \frac{1}{\varepsilon} + \frac{1}{\gamma_c} \log M'(D) \right) \xrightarrow[\varepsilon \rightarrow 0]{(\text{loi})} G,$$

où G suit une loi Gumbel (voir également [Aco14] qui montre la tension). Le phénomène de *freezing* a ensuite été démontré par Madaule, Rhodes et Vargas [MRV15].

Contrairement au cas de la limite de la martingale dérivée pour le BBM, on peut parfois calculer explicitement la loi de $M'(D)$ grâce aux propriétés d'invariance conforme du chaos multiplicatif gaussien, voir [FB08a, FLDR09] en physique et [Rem17, RZ18] pour une approche rigoureuse.

Le champ libre gaussien discret en dimension 2. Une autre approche des champs log-corrélés consiste à en considérer une version discrète définie sur un réseau approximant le domaine D . Dans ce contexte, l'un des modèles les plus étudiés est le champ libre gaussien discret en dimension 2. On considère $D \subset \mathbb{R}^2$ et on se donne une partie finie $D_N \subset \mathbb{Z}^2$ de sorte que $N^{-1}D_N$ soit une approximation de D . On note G_N la fonction de Green de la marche aléatoire simple sur \mathbb{Z}^2 tuée en sortant de D_N : $G_N(x, y)$ est le nombre moyen de passages en y pour la marche partant de x avant de sortir de D_N . Alors, le *champ libre gaussien discret* (DGFF) sur D_N est le champ gaussien $(X(x))_{x \in D_N}$ centré de fonction de covariance G_N . C'est un champ log-corrélé : en effet, pour N grand et loin du bord de D_N , on a $G_N(x, y) \simeq \frac{2}{\pi} \log \frac{N}{\|x-y\|}$, voir la Section 5.A pour un énoncé précis.

Comme pour le mouvement brownien branchant, une grande partie de la littérature a porté sur l'étude des extrêmes du DGFF, qui possèdent un comportement analogue avec la correspondance $t = \log N^2$. Le premier ordre du maximum a été obtenu par Bolthausen, Deuschel et Giacomin [BDG01], puis le correctif logarithmique ainsi que la tension à l'ordre constant par Bramson et Zeitouni [BZ12] en s'appuyant sur [BDZ11]. Finalement, Ding et Zeitouni [DZ14] ont établi différents résultats sur la queue de distribution et la géométrie des extrêmes qui ont permis à Bramson, Ding et Zeitouni [BDZ16] de montrer l'analogue de (1.14) : la convergence vers une loi Gumbel avec un décalage aléatoire. Ces différents articles se placent dans le cas où $D = (0, 1)^2$ et $D_N = (0, N)^2 \cap \mathbb{Z}^2$ et s'appuient sur une comparaison avec la marche aléatoire branchante. En effet, la propriété de Markov spatiale du DGFF permet de faire apparaître une structure branchante approximative : on découpe le carré D_N

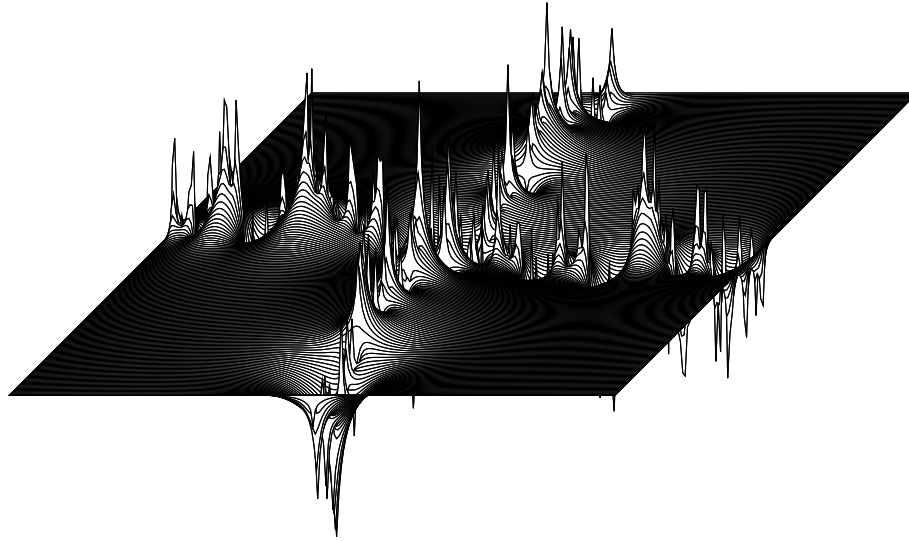

FIGURE 1.9 – Réalisation d’un DGFF sur $D_N = (0, N)^2 \cap \mathbb{Z}^2$ avec $N = 256$, dont on a représenté la restriction à la croix centrale prolongée de manière harmonique sur D_N avec condition nulle au bord. Si on ajoute à cette fonction des DGFF indépendants sur chacun des quatre petits carrés, on obtient un DGFF sur D_N . J’en profite pour remercier Marek Biskup, dont je m’inspire librement pour ces représentations en 3D.

en quatre carrés plus petits séparés par une croix et alors le DGFF X sur D_N peut être obtenu en se donnant quatre DGFF indépendants définis sur les petits carrés, auxquels on ajoute la restriction de X à la croix prolongée de manière harmonique sur D_N avec condition nulle au bord, voir la Figure 1.9. Ce dernier terme est celui qui fausse la structure hiérarchique, qui n’est donc pas exacte pour ce modèle.

Ce comportement asymptotique du maximum, avec le correctif logarithmique et la convergence vers une loi Gumbel shiftée, a ensuite été établi pour toute une classe de champs gaussiens log-corrélés discrets par Ding, Roy et Zeitouni [DRZ17]. Cette classe contient par exemple le DGFF en dimension 2, mais également le modèle de membrane en dimension 4, comme l’a vérifié Schweiger [Sch19].

Récemment, Biskup et Louidor [BL16b, BL14, BL18b] ont montré la convergence du processus extrémal vers un processus ponctuel de Poisson décoré pour des domaines D généraux et mis en évidence un phénomène de *freezing*. Ils ajoutent dans le processus extrémal la localisation géométrique dans D des maxima locaux, qui fait apparaître à la limite une mesure aléatoire Z^D qui est, à une constante près, le chaos multiplicatif critique M' associé au champ libre continu (cf. (1.23)). Cette mesure Z^D est l’analogie de la mesure construite sur la frontière de l’arbre généalogique à partir de la martingale dérivée, qui apparaît dans la description du processus extrémal du BBM [BH17, Mal18b]. Les résultats du Chapitre 5 de cette thèse s’appuient sur la convergence du processus extrémal du DGFF et elle y sera donc présentée plus en détail.

Le comportement du DGFF dans la phase sous-critique est également similaire à celui du mouvement brownien branchant : Daviaud [Dav06] puis Biskup et Louidor [BL16c] ont décrit la taille et la géométrie des ensembles de niveau $\{x \in D_N : X(x) \asymp \alpha \log N^2\}$ pour α strictement inférieur à la vitesse du maximum. Le résultat est similaire à (1.6), avec un chaos multiplicatif gaussien sous-critique qui joue le rôle de la limite de martingale additive. Voir la Figure 1.10.

Polynômes caractéristiques de matrices aléatoires. Il a été montré que le logarithme du polynôme caractéristique d’une grande matrice aléatoire converge, pour certains modèles,

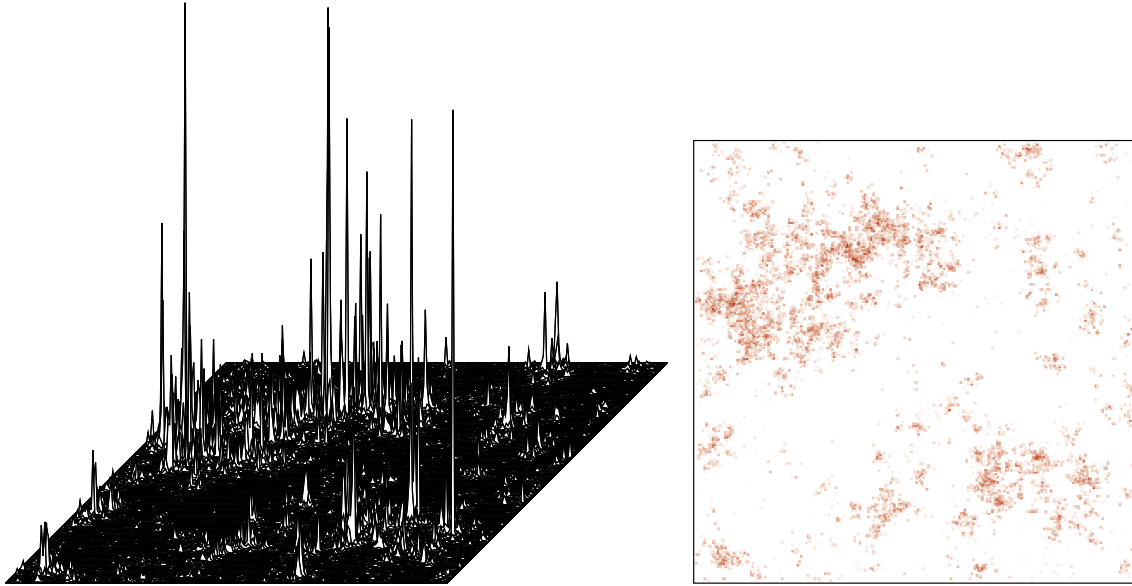

FIGURE 1.10 – À droite, réalisation de $e^{\beta X}$, où X est un DGFF sur $D_N = (0, N)^2 \cap \mathbb{Z}^2$ avec $N = 256$ et $\beta = \beta_c/2$. À gauche, représentation des points supportant la mesure de Gibbs à température inverse β . Cette figure est à comparer avec la Figure 1.7 illustrant les cascades multiplicatives.

vers un champ log-corrélé, voir [HKO01] pour les matrices unitaires uniformes, [RV07] pour les matrices de Ginibre et [FKS16] pour les matrices gaussiennes hermitiennes. Il a donc été conjecturé dans [FHK12, FK14, FS16] que les comportements de la classe d'universalité devraient apparaître : convergence vers un chaos multiplicatif gaussien, développement asymptotique du maximum, phénomène de *freezing*. Ces dernières années, de nombreux progrès ont été faits dans ce sens, une des difficultés majeures résidant dans le fait que le champ n'est ici qu'asymptotiquement gaussien. La convergence de certaines puissances du polynôme caractéristique vers le chaos multiplicatif a été démontrée par [Web15, LOS18, NSW18] pour les matrices unitaires uniformes, [BWW18] pour les ensembles hermitiens invariants et [Lam19b] pour une famille plus générale de modèles. La loi des grands nombres pour le maximum a été établie par [ABB17] pour les matrices unitaires uniformes, [LP19] pour les ensembles hermitiens invariants et [Lam19a] pour les matrices de Ginibre. Paquette et Zeitouni [PZ18b] ont obtenu le correctif logarithmique pour les matrices unitaires uniformes et Chhaibi, Madaule, Najnudel [CMN18] ont démontré la tension à l'ordre constant pour une famille plus générale de modèles. Leur démonstration s'appuie sur les méthodes développées pour l'étude du mouvement brownien branchant.

La fonction ζ de Riemann. Un premier lien entre l'espacement des zéros de la fonction ζ et celui des valeurs propres de l'ensemble gaussien unitaire a été conjecturé par Montgomery [Mon73], ce qui a ensuite conduit Keating et Snaith [KS00] à une autre conjecture sur les moments de la fonction ζ . Le comportement asymptotiquement gaussien de la fonction ζ sur la ligne critique avait été observé très tôt par Selberg [Sel46], mais ce n'est que récemment que Bourgade [Bou10] a montré des corrélations logarithmiques à une échelle mésoscopique. Ces différents indices ont mené à des conjectures très précises dans [FHK12, FK14] concernant le comportement du maximum du champ $(\log|\zeta(\frac{1}{2} + i(\omega + u))|)_{u \in [-1, 1]}$ pour ω une variable aléatoire uniforme dans $[T, 2T]$, quand $T \rightarrow \infty$. Ici, la correspondance avec le mouvement brownien branchant se fait avec $t = \log \log T$. Le premier ordre a été démontré récemment par [Naj18] sous l'hypothèse de Riemann et par [ABB⁺19] sans cette hypothèse. En paral-

lèle, Saksman et Webb [SW16] ont montré la convergence vers le chaos multiplicatif gaussien. Des progrès ont également été faits sur un modèle aléatoire de la fonction ζ , pour lequel le deuxième ordre du maximum a été obtenu [ABH17]. Les techniques venant des marches aléatoires branchantes jouent un rôle important dans ces démonstrations, voir [ABH17, ABB⁺19].

Temps de recouvrement en dimension 2. Considérons un mouvement brownien sur une variété Riemannienne M compacte connexe sans bord de dimension 2. Pour $\varepsilon > 0$ et $x \in M$, on note $T_\varepsilon(x)$ le premier instant où le mouvement brownien entre dans la boule de centre x et rayon ε . Alors, $(T_\varepsilon(x))_{x \in M}$ forme un champ log-corrélé, dont le maximum correspond au temps de recouvrement de M par le mouvement brownien à ε près. Le comportement asymptotique du temps de recouvrement quand $\varepsilon \rightarrow 0$ a été établi au premier ordre par Dembo, Peres, Rosen, Zeitouni [DPRZ04] (voir Schmidt [Sch18] pour une démonstration plus élémentaire) et le correctif logarithmique a été obtenu par Belius et Kistler [BK17] pour le tore (voir aussi Abe [Abe17] pour le cas discret). Finalement, Belius, Rosen, Zeitouni [BRZ17] ont montré pour la sphère la tension à l'ordre constant, après le correctif logarithmique. Encore une fois, la démonstration repose sur l'identification d'une structure hiérarchique là où il n'y en avait pas en apparence.

1.2.3 Physique statistique

En dehors des champs log-corrélés, la marche aléatoire branchante est apparue en physique statistique pour différentes raisons, dont deux sont présentées ci-dessous.

Verres de spin. Les modèles de verres de spin et de systèmes désordonnés sont l'objet d'une littérature gigantesque tant en physique qu'en mathématiques et il ne s'agit ici que d'expliquer rapidement les motivations de l'étude de la marche aléatoire branchante dans ce contexte.

Le modèle de verre de spin à champ moyen le plus élémentaire dans sa définition est le modèle de Sherrington–Kirkpatrick [SK75], voir les livres de Talagrand [Tal11a, Tal11b] et Panchenko [Pan13b] pour un traitement mathématique du modèle. On attribue à chaque configuration de spin $\sigma \in \{-1, +1\}^N$ le *Hamiltonien*

$$H_N(\sigma) := \frac{1}{\sqrt{N}} \sum_{i,j=1}^N g_{i,j} \sigma_i \sigma_j,$$

où les $g_{i,j}$ pour $1 \leq i, j \leq N$ sont des gaussiennes standard i.i.d., qui forment le *désordre*. Notons que $H_N(\sigma)$ suit la loi $\mathcal{N}(0, N)$. On définit alors la *mesure de Gibbs* $\mathcal{G}_{\beta,N}$ de température inverse $\beta > 0$ par

$$\mathcal{G}_{\beta,N} := \frac{1}{Z_{\beta,N}} \sum_{\sigma \in \{-1,+1\}^N} e^{-\beta H_N(\sigma)} \delta_\sigma,$$

où $Z_{\beta,N} := \sum_{\sigma} e^{-\beta H_N(\sigma)}$ est la *fonction de partition*. L'étude de ce modèle s'est concentrée d'une part sur le calcul de l'*énergie libre*

$$f(\beta) := \lim_{N \rightarrow \infty} \frac{1}{N} \mathbb{E}[\log Z_{\beta,N}],$$

permettant entre autres de comprendre le comportement asymptotique de $\mathbb{E}[\max_{\sigma} H_N(\sigma)]$ qui apparaît naturellement comme un problème d'optimisation, et d'autre part sur la géométrie

de la mesure de Gibbs. Pour ce second point, on introduit l'*overlap* entre deux configurations σ et σ' , défini par

$$q_N(\sigma, \sigma') := \sqrt{\frac{\mathbb{E}[H_N(\sigma)H_N(\sigma')]}{N}} = \frac{1}{N} \sum_{i=1}^N \sigma_i \sigma'_i \in [-1, 1],$$

de sorte que $1 - q_N$ soit une distance sur $\{-1, +1\}^N$ (qui ici est proportionnelle à la distance de Hamming). On s'intéresse à l'*overlap* entre des configurations $\sigma^1, \dots, \sigma^k$ tirées indépendamment selon $\mathcal{G}_{\beta, N}$, ce qui donne asymptotiquement une description géométrique de la mesure de Gibbs. Généralement, $q_N(\sigma^1, \sigma^2)$ se concentre sur une seule valeur pour β petit⁵, mais peut prendre plusieurs valeurs pour β grand : si l'*overlap* est asymptotiquement supporté par $k + 1$ valeurs, on dit que le modèle est de type k -RSB (pour *replica symmetry breaking*) et si son support asymptotique est continu, on parle de type *full*-RSB.

Dans leur article [SK75], Sherrington et Kirkpatrick proposent une première formule pour l'énergie libre obtenue par la méthode des répliques, mais elle n'est en fait correcte que pour β suffisamment petit. Leur approche est complétée par Parisi [Par79, Par80] qui obtient une formule pour l'énergie libre valide à toute température, grâce au procédé de *replica symmetry breaking* (voir le livre de Mézard et Montanari [MM09] pour une présentation claire de cette méthode non-rigoureuse). Pour faire son calcul, Parisi choisit un nouvel *Ansatz* pour appliquer la méthode des répliques, qui est une matrice avec une structure hiérarchique, dont le nombre de niveaux doit être arbitrairement grand pour obtenir la formule dans le cas du modèle de Sherrington–Kirkpatrick. Cela traduit le fait que c'est un modèle de type *full*-RSB : en effet, Parisi [Par83] remarque que le choix de la matrice dans la méthode des répliques a un lien avec la distribution de l'*overlap* sous la mesure de Gibbs. Enfin, une interprétation de ce choix de matrice avec structure hiérarchique en terme de géométrie de la mesure de Gibbs a été donnée dans [MPS⁺84a, MPS⁺84b] : ils conjecturent que la mesure de Gibbs limite doit avoir un support ultramétrique (pour la distance fournie par l'*overlap*, qui n'est pas ultramétrique sur l'espace des configurations tout entier). Une vingtaine d'années plus tard, la formule de Parisi pour l'énergie libre a finalement été démontrée par Talagrand [Tal06], puis l'ultramétrie du support de la mesure de Gibbs par Panchenko [Pan13a].

Avant d'en arriver à ces démonstrations rigoureuses, une étape importante dans la compréhension du modèle de Sherrington–Kirkpatrick et des autres modèles à champ moyen a été l'introduction de modèles beaucoup plus simples, pour lesquels la structure ultramétrique est implémentée dès la définition, afin d'en comprendre ses implications. L'étude de ces modèles a conduit au développement de techniques et à l'introduction de nouveaux objets (comme les cascades de Ruelle [Rue87] ou le coalescent de Bolthausen–Sznitman [BS98]) qui ont joué un rôle important dans l'approche rigoureuse des modèles à champ moyen.

Le premier de ces modèles simplifiés est le *random energy model* (REM) introduit par Derrida [Der80, Der81], où l'on suppose que les énergies $H_N(\sigma)$ pour $\sigma \in \{-1, +1\}^N$ sont indépendantes de loi $\mathcal{N}(0, N)$. Étonnamment, le REM présente déjà de nombreux comportements intéressants, comme une transition de phase avec un phénomène de *freezing*, et il permet d'illustrer simplement le procédé de replica symmetry breaking (voir [MM09]). Pour ce modèle, on définit l'*overlap* comme

$$q_N(\sigma, \sigma') := \frac{\mathbb{E}[H_N(\sigma)H_N(\sigma')]}{N} \in [0, 1], \quad (1.24)$$

ce qui donne $q_N(\sigma, \sigma') = \mathbb{1}_{\sigma=\sigma'}$. Pour $\beta \leq \beta_c$, la mesure de Gibbs est portée par un grand nombre de configurations donc l'*overlap* est asymptotiquement toujours 0. Pour $\beta > \beta_c$, ce

5. Ici pour β petit, la mesure de Gibbs est très éparpillée sur l'hypercube et l'*overlap* entre deux particules tirées selon $\mathcal{G}_{\beta, N}$ est asymptotiquement nul.

sont les quelques configurations de Hamiltonien minimal qui portent la mesure de Gibbs : alors l'overlap peut prendre à la fois les valeurs 0 et 1. Le REM est donc un modèle de type 1-RSB, voir la Section 1.4.1 pour plus de détails.

Une version plus élaborée a ensuite été étudiée par Derrida et Gardner [Der85, DG86b, DG86a] : le *generalised random energy model* (GREM). Ce modèle est obtenu en prenant pour $(H_N(\sigma))_{\sigma \in \{-1, +1\}^N}$ une structure de covariance hiérarchique avec un nombre fixé d'étages k , voir la Figure 1.11. L'overlap est toujours défini par (1.24), mais il peut à présent prendre $k+1$ valeurs différentes. Cependant, en fonction de la taille des différents étages et des variances associées, le modèle peut être de type j -RSB pour tout $1 \leq j \leq k$ et exhiber un phénomène de *freezing* progressif.

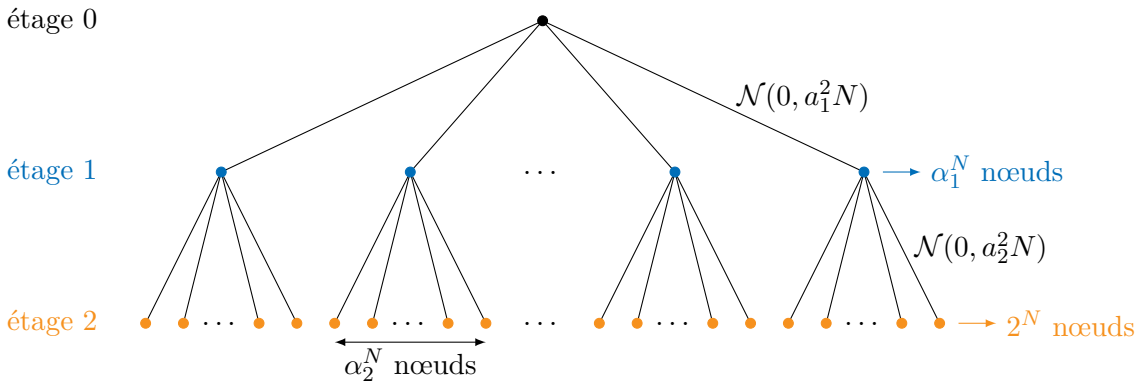

FIGURE 1.11 – Schéma illustrant la définition d'un GREM à deux étages. Il y a α_1^N noeuds à l'étage 1 de l'arbre et chacun a α_2^N enfants, avec $\alpha_1 \alpha_2 = 2$. À chaque arête est associée une gaussienne indépendante, de variance $a_1^2 N$ entre les étages 0 et 1, et $a_2^2 N$ entre les étages 1 et 2, avec $a_1^2 + a_2^2 = 1$. Les 2^N noeuds de l'étage 2 représentent les configurations de $\{-1, +1\}^N$. Chacune a pour Hamiltonien la somme des valeurs sur les deux arêtes qui mènent à la racine.

On peut finalement faire varier le nombre de hiérarchies avec N en considérant un arbre binaire comme structure de covariance. Si la variance ne dépend pas des étages, on obtient alors la marche aléatoire branchante binaire de saut $\mathcal{N}(0, a^2)$ et c'est un modèle de type 1-RSB avec un comportement très proche du REM : les deux modèles ont la même énergie libre et la même distribution asymptotique de l'overlap (voir la Section 1.4.1). Mais, en permettant à la variance de dépendre de la hauteur dans l'arbre, on obtient un modèle plus général : le *continuous random energy model* (CREM) introduit par Bovier et Kurkova [BK04b]. En fonction du choix de la fonction donnant la variance en fonction de la hauteur dans l'arbre, ce modèle peut exhiber des comportements très différents et, entre autres, être de type full-RSB.

Polymères dirigés en milieux aléatoires. Les polymères dirigés en environnement aléatoire sont un autre type de système désordonné introduit en physique par [HH85] et en mathématiques par [IS88, Bol89], voir aussi le livre de Comets [Com17]. Ce modèle décrit le comportement d'une longue molécule dans un milieu avec des impuretés, ici \mathbb{Z}^{d+1} avec à chaque sommet x une énergie d'interaction ω_x , où les $(\omega_x)_{x \in \mathbb{Z}^{d+1}}$ sont i.i.d. Un polymère dirigé de longueur n en dimension $d+1$ est une marche aléatoire simple dans \mathbb{Z}^d de longueur n , changée de mesure par les poids de Boltzmann associés à la somme des énergies d'interaction le long du chemin.

Derrida et Spohn [DS88] constatent que la marche aléatoire branchante correspond au cas $d = \infty$ des modèles de polymères dirigés : plus la dimension est grande, plus deux chemins qui se séparent ont peu de chances de se recroiser, ce qui donne à la limite une structure d'arbre. Cook et Derrida [CD90] montrent ensuite qu'en plongeant un arbre dans le réseau, on peut

obtenir des comparaisons entre la marche branchante et le polymère dirigé en dimension fixée, voir aussi [Com17, Chapitre 4]. D'autre part, certaines méthodes développées dans le cadre branchant se sont révélées utiles dans le cadre des polymères, en particulier pour étudier la fonction de partition du système qui, une fois renormalisée par son espérance, forme une martingale analogue aux martingales additives.

1.2.4 Autres modèles reliés

Les limites des martingales additives de la marche aléatoire branchante ont également été étudiées en tant que solutions de l'équation suivante, appelée équation de point fixe de la *smoothing transform* [DL83],

$$W \stackrel{(\text{loi})}{=} \sum_{i=1}^N A_i W^{(i)},$$

où les $W^{(i)}$ sont des copies i.i.d. de W , indépendantes de (N, A_1, \dots, A_N) . Ce type d'équation est lié à l'équation de perpétuité $X = AX + B$ en loi, avec (A, B) un couple indépendant de X [Gui90], qui a aussi été l'objet d'une riche littérature. Les questions étudiées sont principalement l'existence et l'unicité des solutions, ainsi que l'étude de la queue de distribution de ces solutions. Cette approche a ainsi permis d'obtenir la queue de la limite de la martingale additive $W_\infty(\beta)$ [Liu98] et celle de la limite de la martingale dérivée Z_∞ [Bur09].

Citons aussi, entre autres, les liens avec la marche aléatoire en milieu aléatoire sur les arbres [LP92, HS16], le modèle $O(n)$ sur les quadrangulations aléatoires [CCM17], le modèle infini d'urnes [MR16], ainsi qu'avec différents problèmes issus de l'informatique comme les arbres de recherche et arbres récursifs [Dev86, CKMR05, KMS17], les réseaux d'attachement préférentiel [EM14, EMO18] et l'analyse numérique [HTT14, HOT⁺19].

1.3 Le front du mouvement brownien branchant

Une partie de cette thèse a été consacrée à l'étude détaillée du front du mouvement brownien branchant, au delà des résultats présentés en Section 1.1.4.

1.3.1 Le cas presque-critique

Dans cette section sont présentés les résultats de l'article [Pai18], qui sont contenus dans le Chapitre 2. On se place ici dans le cadre de la marche aléatoire branchante sous les conditions (1.1) et (1.2), ainsi que sous d'autres hypothèses de moments qui seront précisées au Chapitre 2. Mentionnons tout de même que l'on suppose que

$$\sigma^2 := \left[\sum_{|u|=1} X(u)^2 e^{-X(u)} \right] \in (0, \infty),$$

car cette constante σ^2 , que l'on avait choisie égale à 1 dans le cas du BBM, ne peut pas être ici supposée égale à 1 sans perte de généralité et va donc apparaître dans les résultats.

Objectifs. Le but de l'étude du cas presque-critique est de comprendre plus précisément la transition de phase qui a lieu en $\beta = 1$ pour la marche aléatoire branchante. Cette transition apparaît à travers différents changements de comportement de la *mesure de Gibbs* $\mathcal{G}_{\beta,n}$, qui est la mesure aléatoire sur $\{u \in \mathbb{T} : |u| = n\}$ définie par

$$\mathcal{G}_{\beta,n} := \frac{1}{\widetilde{W}_{\beta,n}} \sum_{|u|=n} e^{-\beta X(u)} \delta_u, \quad n \in \mathbb{N}, \quad (1.25)$$

où $\widetilde{W}_{\beta,n} := \sum_{|u|=n} e^{-\beta X(u)}$ est la fonction de partition. Dans le cadre de la marche aléatoire branchante, les comportements sont en grande partie encodés dans la transformée de log-Laplace de la loi de reproduction définie par

$$\Psi(\beta) := \log \mathbb{E} \left[\sum_{|u|=1} e^{-\beta X(u)} \right] \in [0, \infty], \quad \beta \geq 0.$$

C'est une fonction convexe et les conditions (1.1) et (1.2) sont équivalentes à $\Psi(1) > 0$ et $\Psi(1) = \Psi'(1) = 0$. La martingale additive s'écrit alors

$$W_n(\beta) := \sum_{|u|=n} e^{-\beta X(u) - n\Psi(\beta)} = e^{-n\Psi(\beta)} \widetilde{W}_{\beta,n}, \quad n \in \mathbb{N},$$

pour tout β tel que $\Psi(\beta) < \infty$. Dans le cas critique, on a $W_n(1) = \widetilde{W}_{1,n}$ que l'on note simplement W_n . Pour comparer avec la présentation du mouvement brownien branchant faite en Section 1.1, notons que l'on avait $\Psi(\beta) = (\beta - 1)^2/2$ dans ce cadre.

Le premier changement qui nous intéresse est celui qui apparaît dans le comportement asymptotique de la fonction de partition : pour $\beta \in [0, 1)$, $\widetilde{W}_{\beta,n}$ est d'ordre $e^{n\Psi(\beta)}$, puis $\widetilde{W}_{1,n} = W_n$ est d'ordre $n^{-1/2}$ par (1.15) et enfin, pour $\beta > 1$, $\widetilde{W}_{\beta,n}$ est d'ordre $n^{-3\beta/2}$ par (1.21). Ensuite, nous considérerons les changements dans le comportement d'une particule u tirée selon la mesure de Gibbs $\mathcal{G}_{\beta,n}$. Pour $\beta \in [0, 1)$, nous avons vu en (1.7) que $X(u)$ est typiquement d'ordre $-\Psi'(\beta)n + O(\sqrt{n})$ et la trajectoire de la lignée de u se comporte comme un mouvement brownien autour de la droite de pente $-\Psi'(\beta)$. Dans le cas critique, on a vu que $X(u)$ est d'ordre \sqrt{n} et que la trajectoire de la lignée de u converge après changement d'échelle vers un méandre brownien (cf (1.16) et la discussion qui suit). Finalement, pour $\beta > 1$, la mesure de Gibbs est portée par les particules extrémales qui sont en $\frac{3}{2} \log n + O(1)$ et leur trajectoire converge vers une excursion brownienne (cf. page 24).

Pour comprendre précisément la transition entre ces différents comportements, on se donne une suite $(\beta_n)_{n \in \mathbb{N}}$ de réels positifs convergeant vers $\beta_c = 1$ et on étudie le comportement asymptotique de $\widetilde{W}_{\beta_n,n}$ et d'une particule tirée selon $\mathcal{G}_{\beta_n,n}$: c'est le cas *presque-critique*. Alberts et Ortgièse [AO13] s'étaient déjà intéressés à cette question, mais les techniques développées ces dernières années permettent d'obtenir des résultats beaucoup plus précis. Leur travail était motivé par les polymères dirigés en milieu aléatoire pour lesquels le cas presque-critique a aussi été étudié récemment [AKQ14, CSZ17a, CSZ17b, KQ18]. Ici, trois nouvelles phases apparaissent au sein du cas presque-critique, selon si $\beta_n - 1 = O(n^{-1/2})$, $\beta_n - 1 \gg n^{-1/2}$ ou $1 - \beta_n \gg n^{-1/2}$. Nous présentons les résultats successivement dans chacune de ces phases et la Figure 1.12 illustre les comportements associés.

La fenêtre critique. On se place ici dans le cas où $\beta_n - 1 = O(n^{-1/2})$. Comme β_n tend suffisamment vite vers 1, les comportements sont très proches de ceux du cas critique. En effet, les particules u contribuant à W_n sont à une position $X(u)$ d'ordre \sqrt{n} , donc la modification $(\beta_n - 1)X(u)$ joue un rôle au plus d'ordre constant. Ainsi, la fonction de partition $\widetilde{W}_{\beta_n,n}$ est toujours d'ordre $n^{-1/2}$ et portée par les particules à une position d'ordre \sqrt{n} , et la trajectoire limite d'une particule tirée selon $\mathcal{G}_{\beta_n,n}$ reste à densité par rapport au méandre brownien.

Avant d'énoncer précisément le résultat, fixons quelques notations. On note $\mathcal{D}([0, 1])$ l'ensemble des fonctions càdlàg de $[0, 1]$ dans \mathbb{R} que l'on munit de la distance de Skorokhod et $\mathcal{C}_b(\mathcal{D}([0, 1]))$ l'ensemble des fonctions continues bornées de $\mathcal{D}([0, 1])$ dans \mathbb{R} . Rappelons que pour u à la génération n , on note $u_0 = \emptyset, u_1, \dots, u_n = u$ les individus de sa lignée.

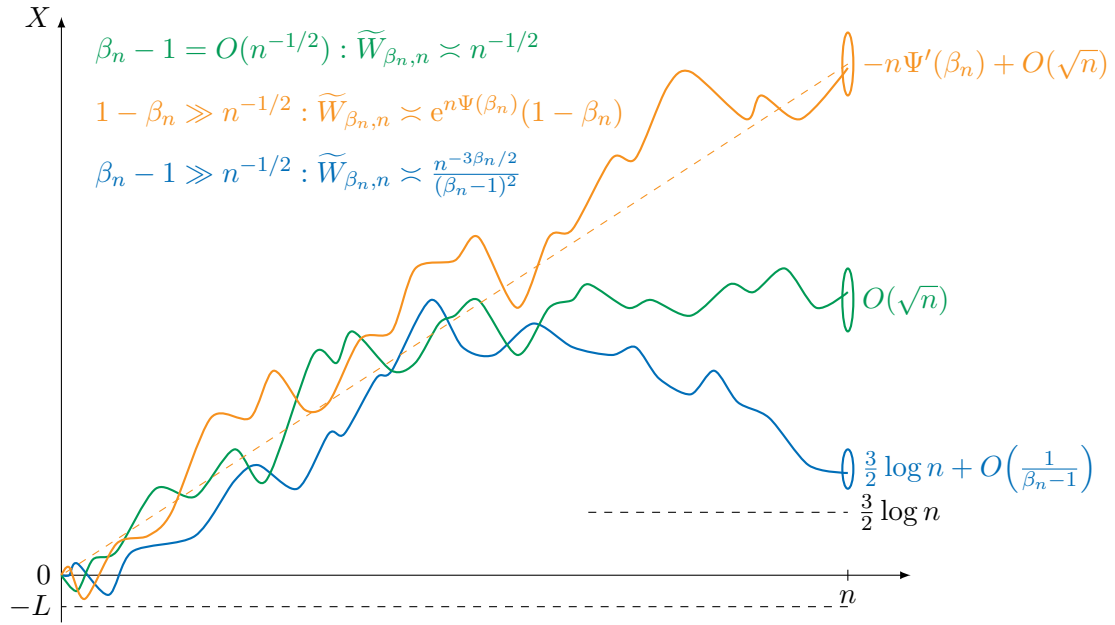

FIGURE 1.12 – Illustration des comportements associés aux trois phases apparaissant dans le cas presque-critique.

Théorème 1.3.1. *Sous certaines hypothèses d'intégrabilité, si $(\beta_n - 1)\sqrt{n} \rightarrow \gamma \in \mathbb{R}$ quand $n \rightarrow \infty$, alors on a les convergences suivantes*

$$\sqrt{n}\widetilde{W}_{\beta_n, n} \xrightarrow[n \rightarrow \infty]{(\mathbb{P}^*)} \frac{1}{\sigma} \sqrt{\frac{2}{\pi}} \mathbb{E}[e^{-\sigma\gamma\mathcal{M}(1)}] Z_\infty$$

et, pour tout $F \in \mathcal{C}_b(\mathcal{D}([0, 1]))$,

$$\frac{1}{\widetilde{W}_{\beta_n, n}} \sum_{|u|=n} e^{-\beta_n X(u)} F\left(\frac{X(u_{\lfloor sn \rfloor})}{\sigma\sqrt{n}}, s \in [0, 1]\right) \xrightarrow[n \rightarrow \infty]{(\mathbb{P}^*)} \frac{1}{\mathbb{E}[e^{-\sigma\gamma\mathcal{M}(1)}]} \mathbb{E}[e^{-\sigma\gamma\mathcal{M}(1)} F(\mathcal{M})],$$

où \mathcal{M} est un méandre brownien standard sur $[0, 1]$.

C'est dans cette phase que l'on voit apparaître la transition entre les fluctuations browniennes autour d'une droite de pente positive (quand $\gamma \rightarrow -\infty$), le méandre brownien (quand $\gamma = 0$) et l'excursion brownienne (quand $\gamma \rightarrow \infty$).

La fenêtre presque-critique dans le régime fortement désordonné. On se place ici dans le cas où $\beta_n - 1 \gg n^{-1/2}$. Alors, un équilibre se joue entre le poids $e^{-(\beta_n - 1)X(u)}$ qui favorise les particules les plus basses et le fait que la barrière en $-L$ rend moins probable les trajectoires avec un point terminal trop bas. Un calcul utilisant les moyennes déviations des marches aléatoires conditionnées à rester au-dessus d'une barrière montre que la stratégie optimale est une position terminale d'ordre $1/(\beta_n - 1)$.

Cependant, cela ne peut pas être correct pour $\beta_n - 1 \gg 1/\log n$ car la particule la plus basse se trouve environ en $\frac{3}{2} \log n$. Pour obtenir le bon résultat, il faut ajouter une deuxième barrière tueuse en $\frac{3}{2} \log n - L$ entre les instants $n/2$ et n . Contrairement à la barrière en $-L$, cette barrière est touchée par beaucoup de particules (cf. (1.12)), mais on montre par un moment d'ordre 1 qu'elles ont une contribution négligeable. Cette deuxième barrière a joué un rôle clé dans la démonstration des résultats concernant les particules extrémales de

la marche aléatoire branchante, voir [Aïd13, Mad17]. Une fois qu'elle est prise en compte, on observe que les particules typiques sous $\mathcal{G}_{\beta_n, n}$ sont plutôt à une distance d'ordre $1/(\beta_n - 1)$ au-dessus de $\frac{3}{2} \log n$. Comme la position finale est négligeable devant \sqrt{n} la trajectoire limite est toujours l'excursion brownienne dans cette phase.

Théorème 1.3.2. *Sous certaines hypothèses d'intégrabilité, si $(\beta_n - 1)\sqrt{n} \rightarrow \infty$ quand $n \rightarrow \infty$, alors on a les convergences suivantes*

$$(\beta_n - 1)^2 n^{3\beta_n/2} \widetilde{W}_{\beta_n, n} \xrightarrow[n \rightarrow \infty]{(\mathbb{P}^*)} \frac{1}{\sigma^3} \sqrt{\frac{2}{\pi}} Z_\infty,$$

et, pour tout $F \in \mathcal{C}_b(\mathcal{D}([0, 1]))$,

$$\frac{1}{\widetilde{W}_{\beta_n, n}} \sum_{|u|=n} e^{-\beta_n X(u)} F\left(\frac{X(u_{|sn|})}{\sigma\sqrt{n}}, s \in [0, 1]\right) \xrightarrow[n \rightarrow \infty]{(\mathbb{P}^*)} \mathbb{E}[F(\mathbf{e})],$$

où \mathbf{e} est l'excursion brownienne standard sur $[0, 1]$. En outre, pour tout $\varepsilon > 0$, il existe $C > 0$ tel que, pour n suffisamment grand, on ait

$$\mathbb{P}^*\left(\mathcal{G}_{\beta_n, n}\left(\left\{|u| = n : X(u) \in \left[\frac{3}{2} \log n + \frac{C}{\beta_n - 1}, \frac{3}{2} \log n + \frac{C}{\beta_n - 1}\right]\right\}\right) \geq 1 - \varepsilon\right) \geq 1 - \varepsilon.$$

Ce résultat décrit précisément la modification d'ordre de grandeur pour la fonction de partition entre les phases critique et sur-critique, ainsi que le changement de position des particules y contribuant.

La fenêtre presque-critique dans le régime faiblement désordonné. Le dernier cas est celui où $1 - \beta_n \gg n^{-1/2}$. Alors, β_n tend suffisamment lentement vers 1 par valeurs inférieures pour que l'on retrouve les comportements du cas sous-critique : le drift $-\Psi'(\beta_n)$ subi par les particules tirées selon $\mathcal{G}_{\beta_n, n}$ n'est plus négligeable car $-\Psi'(\beta_n)n \sim \sigma^2(1 - \beta_n)n \gg \sqrt{n}$. La trajectoire est donc brownienne autour de la droite de pente $-\Psi'(\beta_n)$. Mais comme cette pente tend malgré tout vers 0, la barrière en $-L$ a un impact sur le début de la trajectoire (pendant une durée d'ordre $(1 - \beta_n)^{-2}$) et le coût de cette contrainte ajoute un facteur $(1 - \beta_n)$ à la fonction de partition par rapport au cas sous-critique.

Théorème 1.3.3. *Sous certaines hypothèses d'intégrabilité, si $(\beta_n - 1)\sqrt{n} \rightarrow -\infty$ quand $n \rightarrow \infty$, alors on a les convergences suivantes*

$$\frac{e^{-n\Psi(\beta_n)}}{1 - \beta_n} \widetilde{W}_{\beta_n, n} \xrightarrow[n \rightarrow \infty]{(\mathbb{P}^*)} 2Z_\infty,$$

et, pour tout $F \in \mathcal{C}_b(\mathcal{D}([0, 1]))$,

$$\frac{1}{\widetilde{W}_{\beta_n, n}} \sum_{|u|=n} e^{-\beta_n X(u)} F\left(\frac{X(u_{|sn|}) + sn\Psi'(\beta_n)}{\sigma\sqrt{n}}, s \in [0, 1]\right) \xrightarrow[n \rightarrow \infty]{(\mathbb{P}^*)} \mathbb{E}[F(B)],$$

où B est le mouvement brownien standard sur $[0, 1]$.

1.3.2 Les fluctuations du front du mouvement brownien branchant

Cette section contient les résultats établis dans les articles [MP18, MP19] co-écrits avec Pascal Maillard et présentés dans les Chapitres 3 et 4.

Motivations. Différents travaux en littérature physique se sont consacrés à la recherche de fluctuations universelles dans le comportement asymptotique de certains systèmes de particules. Un des exemples les plus célèbres sont les prédictions de Ebert et van Saarloos [Ev00] concernant la position du front des solutions des équations de réaction-diffusion. Par exemple, si u est une solution de l'équation F-KPP (1.22) avec une condition initiale décroissant suffisamment vite en $+\infty$, alors le front à l'instant t se trouve en

$$\beta_c \sigma^2 t - \frac{3}{2\beta_c} \log t + c_1 - \frac{c_2}{\sqrt{t}} + o\left(\frac{1}{\sqrt{t}}\right), \quad (1.26)$$

où la constante c_1 dépend de la condition initiale mais pas la constante c_2 . Ce résultat a récemment été démontré par Nolen, Roquejoffre et Ryzhik [NRR16] et amélioré par Graham [Gra17], voir aussi la nouvelle approche (non rigoureuse) de [BBD18].

Motivés par la chromodynamique quantique, Mueller et Munier [MM14] se sont intéressés aux fluctuations apparaissant dans le front du mouvement brownien branchant : en s'appuyant sur un scénario phénoménologique pour l'évolution du front, ils formulent des conjectures concernant les fluctuations de $\sqrt{\pi t}/2W_t$ et Z_t autour de leur limite Z_∞ . La loi de la limite de la martingale dérivée Z_∞ dépend de la loi de reproduction de manière non-explicite, mais les fluctuations sont universelles. En outre, ils se servent de ce calcul pour retrouver le terme correctif de Ebert et van Saarloos.

Résultats. Les théorèmes qui vont suivre établissent rigoureusement les prédictions de Mueller et Munier [MM14] concernant la martingale additive critique et la martingale dérivée. Nous avons vu que la martingale dérivée est la bonne quantité à considérer pour décrire le front du mouvement brownien branchant et c'est également plus simple d'obtenir les fluctuations de Z_t plutôt que celles de la martingale additive critique.

Pour la martingale dérivée, le deuxième terme du développement asymptotique est d'ordre $(\log t)/\sqrt{t}$, mais on peut considérer ce terme comme déterministe car il ne dépend que de Z_∞ . Les vraies fluctuations en loi apparaissent à l'ordre $1/\sqrt{t}$:

$$\sqrt{t} \left(Z_\infty - Z_t + \frac{\log t}{\sqrt{2\pi t}} Z_\infty \right) \xrightarrow[t \rightarrow \infty]{(loi)} S_{Z_\infty},$$

où $S = (S_r)_{r \geq 0}$ est un processus de Lévy 1-stable spectralement positif indépendant de Z_∞ . Plus précisément, le résultat obtenu est une convergence fonctionnelle conditionnellement à \mathcal{F}_t , ce qui permet d'identifier le fait que, dans la limite S_{Z_∞} , l'instant Z_∞ dépend de ce qui a lieu avant l'instant t mais pas le processus S .

Théorème 1.3.4. *Si $\mathbb{E}[L(\log_+ L)^3] < \infty$, alors les lois fini-dimensionnelles conditionnelles de $(\sqrt{t}(Z_\infty - Z_{at} + \frac{\log t}{\sqrt{2\pi at}} Z_\infty))_{a \geq 1}$ sachant \mathcal{F}_t convergent faiblement en probabilité vers les lois fini-dimensionnelles conditionnelles de $(S_{Z_\infty/\sqrt{a}})_{a \geq 1}$ sachant Z_∞ , où $(S_r)_{r \geq 0}$ un processus de Lévy 1-stable spectralement positif indépendant de Z_∞ .*

Pour W_t , le fait que ce soit une martingale ne semble pas faciliter l'étude de ses fluctuations et notre approche permet de calculer les fluctuations pour toute la famille des $W_t(g)$ décrivant la position typique d'une particule sous la mesure de Gibbs critique⁶ : rappelons que l'on a défini, pour $g: \mathbb{R} \rightarrow \mathbb{R}$,

$$W_t(g) := \sum_{u \in \mathcal{N}(t)} g\left(\frac{X_u(t)}{\sqrt{t}}\right) e^{-X_u(t)}, \quad t \geq 0.$$

6. Dans le Chapitre 4, nous travaillerons plutôt sous la mesure de Gibbs dérivée car elle ne nécessite pas de renormalisation par \sqrt{t} et cela facilite légèrement les calculs. Mais le théorème présenté ici est une conséquence directe du Théorème 4.1.1.

Alors, le résultat suivant décrit les fluctuations qui ont lieu dans la convergence (1.16) de $\sqrt{t}W_t(g)$ pour des fonctions g suffisamment régulières.

Théorème 1.3.5. *Supposons $\mathbb{E}[L^2] < \infty$. Soit $g: \mathbb{R} \rightarrow \mathbb{R}$ une fonction deux fois dérivable sur $(0, \infty)$ et \mathcal{M} un méandre brownien standard. Supposons qu'il existe $C > 0$ tel que, pour tout $x > 0$, $g''(x) \leq Ce^{Cx}$. Alors, on a*

$$\sqrt{t} \left(\sqrt{t}W_t(g) - \sqrt{\frac{2}{\pi}} \mathbb{E}[g(\mathcal{M}_1)]Z_\infty - \mathbb{E}[g'(\mathcal{M}_1)] \frac{\log t}{\sqrt{2\pi t}} Z_\infty \right) \xrightarrow[t \rightarrow \infty]{(loi)} S_{Z_\infty}^g,$$

où $(S_r^g)_{r \geq 0}$ est un processus de Lévy 1-stable indépendant de Z_∞ , dont les paramètres s'expriment en fonction de g .

L'hypothèse $\mathbb{E}[L^2] < \infty$ n'est pas nécessaire pour avoir ce résultat, mais permet de simplifier la démonstration qui est assez technique. La condition optimale est probablement $\mathbb{E}[L(\log_+ L)^3] < \infty$ comme dans le Théorème 1.3.4. En outre, la méthode utilisée permettrait également d'obtenir une convergence fonctionnelle analogue à celle du Théorème 1.3.4.

En considérant le cas de la fonction $g \equiv 1$, on obtient les fluctuations pour la martingale additive, énoncées dans le corollaire suivant. Dans ce cas, le terme en $(\log t)/\sqrt{t}$ disparaît et la loi limite 1-stable est en fait une loi de Cauchy.

Corollaire 1.3.6. *Supposons $\mathbb{E}[L^2] < \infty$. Alors, on a*

$$\sqrt{t} \left(\sqrt{t}W_t - \sqrt{\frac{2}{\pi}} Z_\infty \right) \xrightarrow[t \rightarrow \infty]{(loi)} Z_\infty C,$$

où C est une variable aléatoire de Cauchy indépendante de Z_∞ .

Méthode. L'approche utilisée pour démontrer ces résultats n'est pas directement celle suggérée par Mueller et Munier [MM14]. Le point clé est d'identifier le comportement des particules responsables de ces fluctuations : ce sont celles qui créent les fluctuations d'ordre logarithmique dans la position du minimum du BBM en descendant exceptionnellement bas, voir (1.12). On va donc considérer une barrière à un niveau $\gamma_t := \frac{1}{2} \log t + \beta_t$ avec β_t qui tend lentement vers $+\infty$. Mais ici les particules qui sont tuées en touchant la barrière ne sont pas négligeables : au contraire, ce sont les contributions de leur descendance qui créent les fluctuations.

Pour les fluctuations de Z_t , on introduit la barrière au niveau γ_t sur $[t, \infty)$. Alors, avec cette barrière tueuse, le comportement du front du mouvement brownien branchant sur $[t, \infty)$ devient déterministe (à un facteur Z_∞ près) à l'échelle qui nous intéresse. Pour obtenir les fluctuations, il suffit alors de calculer la somme des contributions à Z_∞ des particules tuées. Mais ces contributions sont des copies indépendantes de $e^{-\gamma_t} Z_\infty$ et la variable Z_∞ est dans le domaine d'attraction d'une loi 1-stable (voir [BBS13]). Leur somme fait donc apparaître une loi 1-stable à la limite, après une compensation qui est fournie par le terme en $(\log t)/\sqrt{t}$. Quand a grandit, seules les particules tuées sur $[at, \infty)$ contribuent aux fluctuations de $Z_\infty - Z_{at}$ et on prend donc en compte de moins en moins de contributions, ce qui fait apparaître le processus de Lévy S .

Pour les fluctuations de $W_t(g)$, on considère plutôt $\sqrt{t}W_t(g) - \sqrt{2/\pi} \mathbb{E}[g(\mathcal{M}_1)]Z_t$ et on peut remplacer ensuite Z_t par Z_∞ grâce au Théorème 1.3.4. Cette fois-ci, on introduit la barrière au niveau γ_t sur $[t^\alpha, t]$ avec $\alpha < 1$ et on montre de nouveau que les fluctuations proviennent uniquement des contributions des particules tuées. Mais ici la loi d'une contribution dépend de l'instant où la particule est tuée. On montre donc d'abord une première version plus faible

du résultat donnant une borne supérieure de la vitesse de convergence de $\sqrt{t}W_t(g)$, que l'on applique ensuite aux contributions des particules tuées afin de contrôler leur loi et d'obtenir le résultat final.

La méthode développée dans ces articles semble pouvoir servir à aborder de futures questions, dont une démonstration probabiliste du terme correctif de Ebert et van Saarloos ou d'une version légèrement différente portant directement sur les fluctuations apparaissant dans la position du minimum du mouvement brownien branchant. Cela concerne les particules extrémales plutôt que celles portant la mesure de Gibbs critique, mais nous avons vu que les particules extrémales à l'instant t proviennent des particules à une position d'ordre \sqrt{t} à l'instant at pour tout $a \in (0, 1)$ donc ces questions sont sûrement liées.

1.4 L'overlap dans le mouvement brownien branchant

1.4.1 Overlap à une température

Nous avons déjà évoqué la notion d'overlap, qui provient de la théorie des verres de spin. Dans le cadre du mouvement brownien branchant, on définit l'*overlap* entre deux particules $u, v \in \mathcal{N}(t)$ par $q_t(u, v) := d_{u \wedge v}/t \in [0, 1]$ où l'on rappelle que $d_{u \wedge v}$ est l'instant de mort du plus proche ancêtre commun à u et v . Cette définition est cohérente avec (1.24) car, conditionnellement à l'arbre généalogique, $d_{u \wedge v}$ est la covariance entre $X_u(t)$ et $X_v(t)$.

Comme pour la marche aléatoire branchante en (1.25), on note $\mathcal{G}_{\beta, t}$ la mesure de Gibbs sur $\mathcal{N}(t)$ à température inverse β . Motivés par les verres de spin, nous nous intéressons ici à $\omega_{\beta, t}$ la mesure image de $\mathcal{G}_{\beta, t}^{\otimes 2}$ par la fonction q_t . Cette mesure aléatoire sur $[0, 1]$ donne la distribution de l'overlap entre deux particules tirées indépendamment selon $\mathcal{G}_{\beta, t}$. Pour $\beta \in [0, 1]$, la mesure de Gibbs $\mathcal{G}_{\beta, t}$ est portée par un grand nombre de particules dont le plus proche ancêtre commun est typiquement proche de la racine et on a donc la convergence suivante

$$\omega_{\beta, t} \xrightarrow[t \rightarrow \infty]{(\mathbb{P}^*)} \delta_0.$$

Pour $\beta > 1$, $\mathcal{G}_{\beta, t}$ n'est plus portée que par un petit nombre de particules : les particules extrémales. Grâce à la convergence du processus extrémal (voir (1.19) et la discussion qui suit), on prédit la dichotomie suivante : soit on tire deux particules dans la même décoration et leur overlap est proche de 1, soit elles sont dans deux décorations différentes et leur overlap est proche de 0. Ces groupes de particules ayant un overlap mutuel proche de 1 sont appelés les *états purs*, d'après la terminologie des verres de spin. Cette description mène à la convergence suivante (voir Mallein [Mal18b]) :

$$\omega_{\beta, t} \xrightarrow[t \rightarrow \infty]{(\text{loi})} \left(1 - Q^{\text{BBM}}(\beta, \beta)\right) \delta_0 + Q^{\text{BBM}}(\beta, \beta) \delta_1, \quad (1.27)$$

avec

$$Q^{\text{BBM}}(\beta, \beta) := \frac{\sum_{k \geq 1} \left(\sum_{i \geq 1} e^{-\beta(\xi_k + d_i^k)} \right)^2}{\left(\sum_{k \geq 1} \sum_{i \geq 1} e^{-\beta(\xi_k + d_i^k)} \right)^2},$$

où les $(\xi_k)_{k \geq 1}$ sont les atomes d'un PPP($cZ_\infty e^x dx$) et les $(d_i^k)_{i \geq 1}$ pour $k \geq 1$ sont i.i.d. et indépendants de $(\xi_k)_{k \geq 1}$. Or, les processus ponctuels de Poisson d'intensité exponentielle sont invariants par translation des atomes par des variables i.i.d. (à un facteur constant près dans l'intensité). Cette propriété, qui remonte au moins à Ruzmaikina et Aizenman [RA05], implique que la loi de $Q^{\text{BBM}}(\beta, \beta)$ ne dépend pas de la loi des décorations dans le processus

extrémal : on obtient l'égalité suivante en loi

$$Q^{\text{BBM}}(\beta, \beta) \stackrel{(\text{loi})}{=} \frac{\sum_{k \geq 1} e^{-2\beta\zeta_k}}{(\sum_{k \geq 1} e^{-\beta\zeta_k})^2},$$

où les $(\zeta_k)_{k \geq 1}$ sont les atomes ordonnés par ordre croissant d'un PPP($e^x dx$). Ainsi, la distribution limite de l'overlap est la même que pour le REM : on a vu en (1.18) que le processus extrémal limite pour le REM est simplement un PPP($ce^x dx$) et l'overlap vaut 1 si et seulement si on tire deux fois la même particule. Dans les deux cas, les poids sous la mesure de Gibbs des états purs sont donnés par la suite $(e^{-\beta\zeta_k} / \sum_{j \geq 1} e^{-\beta\zeta_j})_{k \geq 1}$, qui est distribuée selon une loi de Poisson–Dirichlet de paramètre β_c/β .

Ainsi, pour ce qui est de l'overlap entre deux particules tirées indépendamment selon la mesure de Gibbs à température inverse β , les champs log-corrélés sont indistinguables du REM : ils sont de type 1-RSB et leurs états purs ont asymptotiquement des poids de Poisson–Dirichlet de paramètre β_c/β sous la mesure de Gibbs. En dehors du mouvement brownien branchant, cela a aussi été démontré pour le champ libre gaussien discret en dimension deux [AZ15, BL18b] et la version aléatoire de la fonction ζ [AT17, Oui18] entre autres.

1.4.2 Overlap à deux températures

Avec Olivier Zindy, dans l'article [PZ18a] contenu dans le Chapitre 5, nous nous sommes intéressés à la distribution de l'overlap entre deux particules tirées selon la mesure de Gibbs à deux températures différentes. Ce travail se place dans le cadre du champ libre gaussien discret en dimension 2, mais les résultats sont présentés ici pour le mouvement brownien branchant par soucis de simplicité. Une des motivations pour cette étude est la notion de chaos en température pour les verres de spin : pour certains modèles, l'overlap entre deux particules tirées selon la mesure de Gibbs à deux températures *différentes* se concentre toujours autour d'une unique valeur, alors que pour deux particules tirées à une *même* température suffisamment haute, l'overlap peut prendre plusieurs valeurs. Ce phénomène est par exemple conjecturé pour le modèle de Sherrington–Kirkpatrick [BM87], voir le Chapitre 5 pour une brève revue de la littérature.

Pour le mouvement brownien branchant, il est clair qu'il n'y a pas de chaos en température : pour $\beta, \beta' > 1$, les mesures de Gibbs $\mathcal{G}_{\beta,t}$ et $\mathcal{G}_{\beta',t}$ sont portées par les particules extrémales et elles ont une probabilité strictement positive de tirer deux particules dans la même décoration. Pour préciser cela, on note $\omega_{\beta,\beta',t}$ la mesure image de $\mathcal{G}_{\beta,t} \otimes \mathcal{G}_{\beta',t}$ par la fonction q_t . Par une méthode similaire à celle de Mallein [Mal18b], on peut montrer la convergence suivante :

$$\omega_{\beta,\beta',t} \xrightarrow[t \rightarrow \infty]{(\text{loi})} (1 - Q^{\text{BBM}}(\beta, \beta'))\delta_0 + Q^{\text{BBM}}(\beta, \beta')\delta_1,$$

où l'on a posé

$$Q^{\text{BBM}}(\beta, \beta') := \frac{\sum_{k \geq 1} \left(\sum_{i \geq 1} e^{-\beta(\xi_k + d_i^k)} \right) \left(\sum_{i \geq 1} e^{-\beta'(\xi_k + d_i^k)} \right)}{\left(\sum_{k \geq 1} \sum_{i \geq 1} e^{-\beta(\xi_k + d_i^k)} \right) \left(\sum_{k \geq 1} \sum_{i \geq 1} e^{-\beta'(\xi_k + d_i^k)} \right)}.$$

Une question naturelle est alors de comparer ce résultat au cas du REM, pour lequel une convergence similaire a lieu avec

$$Q^{\text{REM}}(\beta, \beta') := \frac{\sum_{k \geq 1} e^{-\beta\zeta_k} e^{-\beta'\zeta_k}}{\left(\sum_{k \geq 1} e^{-\beta\zeta_k} \right) \left(\sum_{k \geq 1} e^{-\beta'\zeta_k} \right)}.$$

Le résultat suivant montre que dans le cas de deux températures différentes, les deux modèles ne se comportent plus de la même manière.

Théorème 1.4.1. *Pour tous $\beta, \beta' > \beta_c$ distincts, on a $\mathbb{E}[Q^{\text{BBM}}(\beta, \beta')] < \mathbb{E}[Q^{\text{REM}}(\beta, \beta')]$.*

Cette inégalité peut s'expliquer simplement. Pour le REM, les états purs ont des poids ordonnés de la même manière sous les mesures de Gibbs à différentes températures. Au contraire, pour le mouvement brownien branchant, un état pur formé d'une particule très haute accompagnée d'une petite décoration aura plus de poids qu'un état pur moins haut formé d'une grande décoration sous $\mathcal{G}_{\beta,t}$ avec β grand, mais cela peut s'inverser pour β plus petit. Ainsi, il y a moins de chances pour le mouvement brownien branchant que pour le REM de tirer sous $\mathcal{G}_{\beta,t} \otimes \mathcal{G}_{\beta',t}$ deux particules dans le même état pur.

L'approche pour la démonstration de ce résultat est assez générale et s'applique donc à la fois au champ libre gaussien discret et au mouvement brownien branchant. Pour aller plus loin, il serait intéressant de comparer entre eux des modèles qui ne sont pas de type 1-RSB, comme le GREM et le CREM.

1.5 Mouvement brownien branchant avec sélection

Une façon d'interpréter la position d'un individu dans le mouvement brownien branchant est de considérer qu'elle représente sa capacité à survivre et à se reproduire (sa valeur sélective ou fitness en termes biologiques) : cette valeur varie au cours de la vie à cause des mutations, puis est transmise aux enfants. Pour introduire un phénomène de sélection naturelle, on ajoute à la définition du mouvement brownien branchant une règle de sélection éliminant les particules les plus basses. Comme l'attention se portera plutôt sur le maximum du BBM et pour correspondre au cadre du Chapitre 6, on considère, dans cette section uniquement, un mouvement brownien branchant avec variance 1, taux de branchement 1 et loi de reproduction L telle que $\mathbb{E}[L] = 2$.

1.5.1 Sélection par une droite

Kesten [Kes78] s'est intéressé au cas de la sélection par une droite : on fixe une droite et toute particule passant en-dessous meurt instantanément. Quitte à faire partir le mouvement brownien branchant de la position $x > 0$ et de lui ajouter un drift $-\mu$, on peut supposer que la droite tueuse est l'axe des abscisses. Sous l'hypothèse $\mathbb{E}[L^2] < \infty$ (dont on peut se passer, voir [Mai12]), Kesten [Kes78] montre que la population s'éteint presque sûrement si et seulement si $\mu \geq v_{\max}$, où $v_{\max} := \sqrt{2}$ est la vitesse du maximum du mouvement brownien branchant avec les paramètres choisis ci-dessus (sans drift). Voir la Figure 1.13.

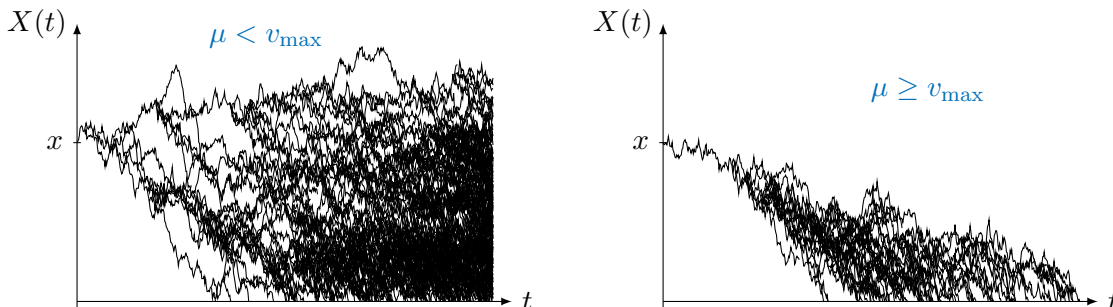

FIGURE 1.13 – Deux réalisations du mouvement brownien branchant issu de x avec drift $-\mu$.

Le mouvement brownien branchant tué par une droite a été l'objet d'une riche littérature que nous ne détaillerons pas ici, concernant principalement la probabilité de survie et, en cas d'extinction, la taille totale du processus ou le nombre d'individus tués par la barrière.

Pour ce modèle, en temps long, il n'y a que deux comportements possibles : l'extinction ou la croissance exponentielle de la population. Nous allons plutôt considérer dans la suite des règles de sélection permettant de garder une population de taille relativement constante.

1.5.2 Le N -mouvement brownien branchant

Soit N un entier positif. Le N -mouvement brownien branchant (ou N -BBM) est défini en ajoutant la règle de sélection suivante : dès qu'il y a plus de N particules, la plus basse est tuée. On note ce processus $(X_u^N(t), u \in \mathcal{N}^N(t), t \geq 0)$, que l'on peut coupler pour être inclus dans un BBM sans sélection. On suppose ici que les particules ont toujours au moins un enfant, sinon la population s'éteindrait presque sûrement. Ainsi, la population commence par grandir puis reste fixée à N individus. Alors, la sélection a pour effet de favoriser la montée des particules, voir la Figure 1.14. Cependant, elles ne peuvent pas monter aussi vite que le maximum du BBM sans sélection et on s'intéresse à la différence de vitesse entre ces processus.

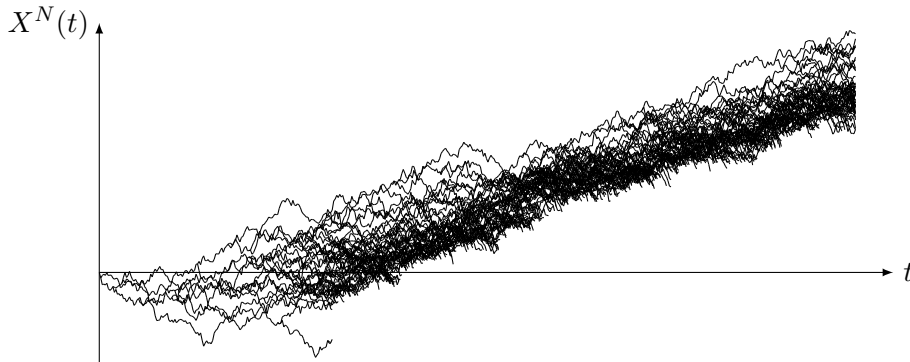

FIGURE 1.14 – Réalisation d'un N -mouvement brownien branchant avec $N = 50$.

Au delà de l'interprétation biologique, une des principales motivations pour étudier la vitesse du N -BBM vient de la littérature physique. L'équation F-KPP (1.22) décrit l'évolution de nombreux systèmes de particules dans l'approximation d'une population de taille infinie. Dans le but d'évaluer l'erreur commise en supposant la population infinie, Brunet et Derrida [BD97, BD99] s'intéressent à l'effet d'ajouter un seuil pour la solution u pour signifier qu'elle ne peut pas prendre de valeurs entre 0 et $1/N$. Puis, dans [BD01], ils proposent de modifier l'équation F-KPP en ajoutant un terme de bruit d'ordre microscopique. Dans les deux cas, la question est l'impact de cette modification sur la vitesse de propagation du front pour les solutions. Une approche proposée pour cette étude est de travailler directement sur un modèle stochastique de population auquel on ajoute une règle de sélection empêchant la croissance illimitée de la population : le N -mouvement brownien branchant est l'un de ces modèles et son comportement a fait l'objet de conjectures très précises dans [BDMM06b].

La vitesse du N -BBM a été étudiée par Bérard et Gouéré [BG10], dans le cadre de la marche aléatoire branchante. Ils montrent que, pour N fixé,

$$\frac{1}{t} \max_{u \in \mathcal{N}^N(t)} X_u^N(t) \xrightarrow[t \rightarrow \infty]{(p.s.)} v_N$$

et que cette vitesse vérifie le développement asymptotique suivant, quand $N \rightarrow \infty$,

$$v_N = \sqrt{2} - \frac{\pi^2}{\sqrt{2}(\log N)^2} + o\left(\frac{1}{(\log N)^2}\right). \quad (1.28)$$

Ainsi, quand l'effet de la sélection disparaît, v_N converge bien vers la vitesse maximale quand il n'y a pas de sélection, c'est-à-dire $v_{\max} = \sqrt{2}$, mais cette convergence est très lente, comme l'avaient prédit Brunet et Derrida [BD97]. La démonstration de Bérard et Gouéré repose sur une comparaison avec la sélection par une droite dans le cas presque-critique où $\mu \uparrow v_{\max}$ et des résultats de Gantert, Hu et Shi [GHS11] sur la probabilité de survie dans ce cas.

Maillard [Mai16] a obtenu une description précise de l'évolution du N -BBM sur une échelle de temps d'ordre $(\log N)^3$ sous une condition initiale particulière. Des modèles de N -marche aléatoire branchante avec des sauts à queue plus lourde et donc des comportements différents ont été étudiés par [BM14, Mal18a]. D'autres travaux [DR11, DMFPS17] ont établi la convergence de la mesure empirique du N -BBM quand $N \rightarrow \infty$ sur un intervalle de temps de longueur fixée.

1.5.3 Le L -mouvement brownien branchant

Dans leur article [BDMM06b], Brunet, Derrida, Mueller et Munier proposent différents modèles avec sélection qui devraient exhiber la même phénoménologie. L'un d'eux est le L -mouvement brownien branchant (ou L -BBM), défini en ajoutant la règle de sélection suivante, pour $L > 0$ fixé : dès qu'une particule se trouve à une distance au moins L de la particule la plus haute, elle meurt, voir la Figure 1.15. On note ce processus $(X_u^L(t), u \in \mathcal{N}^L(t), t \geq 0)$ et on peut se poser les mêmes questions que pour le N -BBM. Même si ici la population n'est pas fixée, Brunet, Derrida, Mueller et Munier [BDMM06b] conjecturent que le comportement doit être le même avec $L = (\log N)/\sqrt{2}$.

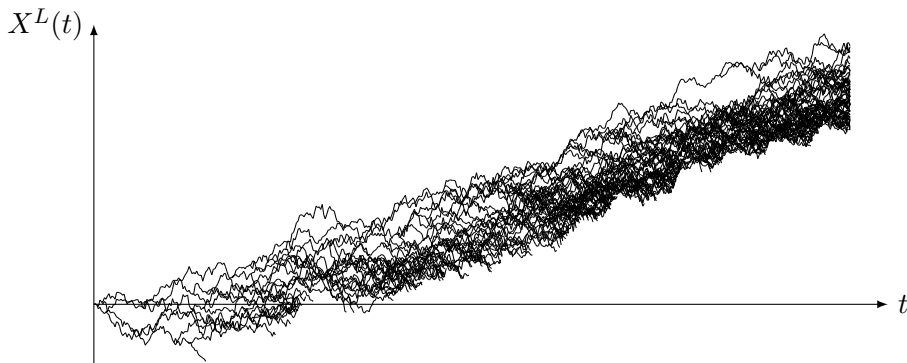

FIGURE 1.15 – Réalisation d'un L -mouvement brownien branchant avec $L = 4$.

Dans le Chapitre 6 de cette thèse qui contient l'article [Pai16], cette correspondance est démontrée pour le premier ordre du développement de la vitesse du L -BBM, à comparer à (1.28).

Théorème 1.5.1. *Pour tout $L > 0$, il existe $v_L \geq 0$ tel que*

$$\frac{1}{t} \max_{u \in \mathcal{N}^L(t)} X_u^L(t) \xrightarrow[t \rightarrow \infty]{(p.s.)} v_L.$$

Quand $L \rightarrow \infty$, on a le développement asymptotique suivant

$$v_L = \sqrt{2} - \frac{\pi^2}{2\sqrt{2}L^2} + o\left(\frac{1}{L^2}\right).$$

Comme pour le N -BBM, la difficulté dans l'étude du L -BBM réside dans l'absence de propriété de branchement, qui est cependant préservée par la sélection par une droite. La

démonstration repose donc également sur des comparaisons avec la sélection par une droite dans le cas presque-critique et sur les travaux de Berestycki, Berestycki et Schweinsberg [BBS11, BBS13], sans toutefois ressembler à l’approche de Bérard et Gouéré pour le N -BBM, notamment à cause de l’absence de monotonie en fonction de la condition initiale pour le L -BBM.

Différentes conjectures de Brunet, Derrida, Mueller et Munier [BDMM06b, BDMM07] restent ouvertes pour le L -BBM et le N -BBM. L’une d’entre elles est l’ordre suivant dans le développement de la vitesse quand $L \rightarrow \infty$: on aurait

$$v_L = \sqrt{2} - \frac{\pi^2}{2\sqrt{2}L^2} + \frac{3\pi^2 \log L}{2L^3} + o\left(\frac{\log L}{L^3}\right),$$

où l’ordre suivant serait dû à certaines particules, qui sur des échelles de temps d’ordre L^3 , parviendraient à monter à une distance d’environ $\frac{3}{\sqrt{2}} \log L$ au-dessus du reste du groupe et dont la descendance générerait un décalage de l’ensemble de la population. Ce scénario serait universel pour les modèles de propagation de front avec bruit, de manière analogue au correctif de Ebert et van Saarloos (cf. 1.26). L’ordre de grandeur de ce correctif a été obtenu pour l’équation F-KPP avec bruit par Mueller, Mytnik et Quastel [MMQ11] et, pour le N -BBM, les résultats de Maillard [Mai16] indiquent fortement que ce correctif devrait être le bon.

Une autre conjecture identifie la généalogie de ces processus : sur une échelle de temps d’ordre L^3 , la généalogie du L -BBM devrait converger vers un coalescent de Bolthausen–Sznitman [BS98] quand $L \rightarrow \infty$. Un progrès dans cette direction a été réalisé par Berestycki, Berestycki et Schweinsberg [BBS13] qui montrent une convergence vers le coalescent de Bolthausen–Sznitman pour le mouvement brownien avec sélection par une droite dans le cas presque-critique. Cortines [Cor16] puis Cortines et Mallein [CM17, CM18] ont obtenu la généalogie de certains modèles exactement solubles de processus avec sélection.

1.6 Le modèle de Derrida–Retaux

Le modèle de Derrida–Retaux est un modèle hiérarchique introduit pour étudier un certain type de transition de phase en physique statistique. Il n’y a pas de lien direct avec la marche aléatoire branchante, mais nous verrons qu’un processus de Markov branchant se cache malgré tout dans ce modèle.

1.6.1 Modèle en temps discret

Motivations et définitions. Le modèle de Derrida–Retaux est un modèle jouet dont la définition provient de simplifications successives des modèles d’accrochages (*pinning models*). Cette famille de modèles de polymères a été introduite sous différentes formes et pour plusieurs raisons, entre autres par Poland et Scheraga [PS66b, PS66a] pour étudier la dénaturation de l’ADN et par Fisher [Fis84] pour le phénomène de mouillage. Voir les deux livres de Giacomin [Gia07, Gia11] pour un traitement mathématique de ces modèles. On considère un polymère représenté par une chaîne de Markov de longueur n dans \mathbb{Z}^d qui interagit uniquement lors de ses passages en 0 : il y gagne une énergie d’interaction constante dans le cas *homogène* ou aléatoire dans le cas *inhomogène*. L’énergie d’une trajectoire est donc donnée par la somme sur les passages en 0 des énergies d’interaction et on note $Z_{\beta,n}$ la fonction de partition de ce modèle. Deux phases apparaissent en fonction de la valeur de l’énergie libre

$$F(\beta) := \lim_{n \rightarrow \infty} \frac{\mathbb{E}[\log Z_{\beta,n}]}{n}.$$

Si $F(\beta) > 0$, cela signifie que le polymère passe une proportion strictement positive de son temps en 0 et on parle de phase *accrochée* ou *localisée*. Au contraire, si $F(\beta) = 0$, alors le polymère passe une proportion négligeable de son temps en 0 et on parle de phase *décrochée* ou *délocalisée*. Une des questions principales sur ce modèle est la pertinence du désordre : est-ce que le fait que les énergies d'interaction soient aléatoires déplace le point critique et modifie le comportement de l'énergie libre autour de ce point ?

Pour répondre à cette question, on peut essayer de calculer la fonction de répartition du polymère par renormalisation, par exemple en le découpant en deux, mais cela donne une formule de récurrence assez complexe. Derrida, Hakim et Vannimenus [DHV92] proposent de travailler sur un réseau en diamant qui permet d'avoir la formule de récurrence suivante (en loi)

$$Z_{2^{n+1}} \stackrel{(\text{loi})}{=} \frac{Z_{2^n} \tilde{Z}_{2^n} + b - 1}{b}, \quad (1.29)$$

où Z_{2^n} est la fonction de partition pour un polymère de longueur 2^n , \tilde{Z}_{2^n} est une copie indépendante de Z_{2^n} et $b > 1$ est un paramètre fixé. Cette relation de récurrence fournit une structure de renormalisation hiérarchique qui facilite l'étude du modèle. La question de la pertinence du désordre a finalement été résolue, à la fois pour le modèle d'accrochage hiérarchique [LT09, GLT10b, GLT10a] et pour le modèle d'accrochage initial [Ale08, DGLT09, BL18a]. Cependant, une question reste ouverte : quel est le comportement de l'énergie libre près du point critique ? On sait déjà que la transition de phase est au moins d'ordre 2, mais il est conjecturé qu'elle soit en fait d'ordre infini [TC01].

Un argument en faveur de cette conjecture a été donné par Derrida et Retaux [DR14], en s'appuyant sur une version simplifiée du modèle d'accrochage hiérarchique défini par (1.29). En posant $X_n := \log Z_{2^n}$, la relation de récurrence exprime X_{n+1} en fonction de $X_n + \tilde{X}_n$. Derrida et Retaux proposent de remplacer cette fonction par ses deux asymptotes en $-\infty$ et $+\infty$ (voir la Figure 1.16), ce qui donne la relation de récurrence suivante

$$X_{n+1} \stackrel{(\text{loi})}{=} \max(X_n + \tilde{X}_n - c_1, c_2),$$

avec $c_1 > c_2$, où l'on a simplifié la forme de la non-linéarité par rapport à (1.29).

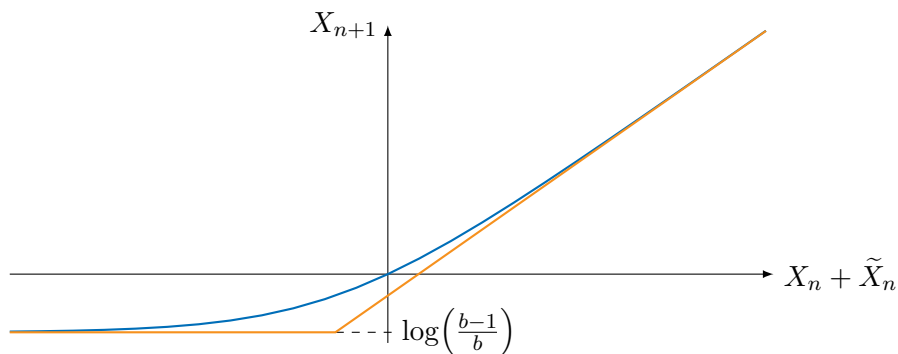

FIGURE 1.16 – Graphes des fonctions définissant X_{n+1} à partir de $X_n + \tilde{X}_n$ pour $b = 3/2$: en bleu pour le modèle d'accrochage hiérarchique et en orange pour le modèle de Derrida–Retaux.

Cependant, quitte à faire une modification affine des X_n , on peut se ramener au cas où $c_1 = 1$ et $c_2 = 0$. Nous nous restreindrons donc à ce cas en définissant le modèle comme suit. On part d'une variable aléatoire X_0 de loi donnée sur $[0, \infty)$ puis on définit par récurrence

$$X_{n+1} \stackrel{(\text{loi})}{=} (X_n + \tilde{X}_n - 1)_+, \quad n \geq 0 \quad (1.30)$$

où \tilde{X}_n et une copie indépendante de X_n et $x_+ := \max(x, 0)$. Cela définit une famille de loi $(\mathcal{L}(X_n))_{n \geq 0}$ que l'on appelle *modèle de Derrida-Retaux*. C'est un modèle hiérarchique : on peut construire X_n en se donnant un arbre binaire de hauteur n , en attachant des copies indépendantes de X_0 sur les feuilles puis en descendant l'arbre des feuilles vers la racine en appliquant la formule de récurrence, voir la Figure 1.17. Notons que ce modèle a en fait été introduit trente ans plus tôt par Collet, Eckmann, Glaser et Martin [CEGM84], dans le cadre de la théorie des verres de spin.

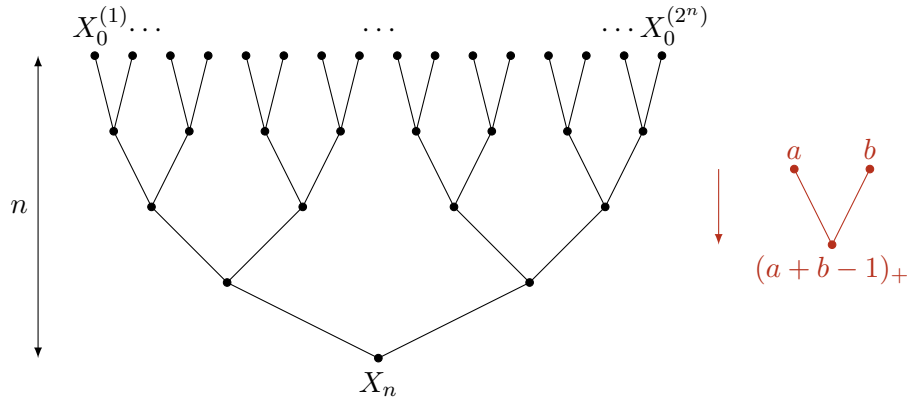

FIGURE 1.17 – Schéma illustrant la construction de X_n à partir d'un arbre binaire. On se donne 2^n copies i.i.d. de X_0 que l'on attache aux feuilles de l'arbre. Puis la procédure est déterministe : en allant des feuilles vers la racine, on attribue à un nœud interne la valeur $(a + b - 1)_+$ si ses enfants ont pour valeurs a et b . La valeur de la racine est X_n .

Dans ce nouveau cadre, l'énergie libre est définie par

$$F_\infty := \lim_{n \rightarrow \infty} \frac{\mathbb{E}[X_n]}{2^n} \in [0, \infty).$$

Comme précédemment, cela définit deux phases : la phase *délocalisée* ou *sous-critique* dans laquelle $F_\infty = 0$ et la phase *localisée* ou *sur-critique* dans laquelle $F_\infty > 0$.

Remarque 1.6.1. L'existence de la limite dans la définition de l'énergie libre est facile à justifier. En effet, à partir de l'inégalité $X_n + \tilde{X}_n - 1 \leq X_{n+1} \leq X_n + \tilde{X}_n$, on remarque que la suite $(\mathbb{E}[X_n]/2^n)_{n \geq 0}$ est décroissante et la suite $(\mathbb{E}[X_n - 1]/2^n)_{n \geq 0}$ est croissante. Ainsi, en plus de justifier l'existence de l'énergie libre, cela donne l'encadrement suivant, pour tout $n \geq 0$:

$$\frac{\mathbb{E}[X_n] - 1}{2^n} \leq F_\infty \leq \frac{\mathbb{E}[X_n]}{2^n}, \quad (1.31)$$

ce qui fournit un contrôle non-asymptotique de la vitesse de convergence.

La transition de phase. Une première question consiste à classifier les lois initiales dans les deux phases. Dans le cas général, il ne semble pas y avoir de critère simple sur la loi de X_0 pour dire si F_∞ sera nulle ou non. Cependant, Collet, Eckmann, Glaser et Martin [CEGM84] donnent un critère quand la loi de X_0 est supportée par $\mathbb{N} := \{0, 1, \dots\}$. Nous nous placerons donc toujours dans ce cas pour la suite. Leur résultat est l'équivalence suivante

$$F_\infty = 0 \quad \Leftrightarrow \quad \mathbb{E}[X_0 2^{X_0}] \leq \mathbb{E}[2^{X_0}] < \infty. \quad (1.32)$$

La démonstration repose essentiellement sur une étude analytique de la fonction génératrice G_n de X_n : en particulier, il est facile de voir que le signe de $2G'_n(2) - G_n(2)$ est un invariant

de la dynamique. Ils obtiennent également la dichotomie suivante pour le comportement asymptotique de X_n (si X_0 n'est pas constante égale à 1) :

$$\begin{cases} \frac{X_n}{2^n} \xrightarrow[n \rightarrow \infty]{(p.s.)} F_\infty & \text{si } F_\infty > 0, \\ X_n \xrightarrow[n \rightarrow \infty]{(\mathbb{P})} 0 & \text{si } F_\infty = 0. \end{cases}$$

Le critère (1.32) permet de définir un cas critique : on dit que la loi de X_0 est dans la phase *critique* si $\mathbb{E}[X_0 2^{X_0}] = \mathbb{E}[2^{X_0}] < \infty$.

Afin d'étudier la transition entre ces phases, on fixe une mesure de probabilité ν sur \mathbb{N}^* telle que $\nu \neq \delta_1$ et, pour $p \in [0, 1]$, on considère la condition initiale

$$X_0 \stackrel{(\text{loi})}{=} p\nu + (1-p)\delta_0.$$

On note $F_\infty(p)$ l'énergie libre associée à cette condition initiale : notons que l'on a $F_\infty(0) = 0$ et $F_\infty(1) > 0$ car ν est forcément sur-critique. Le point critique est alors défini comme

$$p_c := \inf\{p \in [0, 1] : F_\infty(p) > 0\}.$$

Le critère (1.32) permet de calculer explicitement la valeur de p_c pour une loi ν donnée sur \mathbb{N}^* . En particulier, on en déduit l'équivalence⁷

$$p_c > 0 \quad \Leftrightarrow \quad \int_{\mathbb{N}} x 2^x d\nu(x) < \infty. \quad (1.33)$$

Derrida et Retaux [DR14] conjecturent le comportement suivant pour l'énergie libre au voisinage de p_c , dès que $p_c > 0$,

$$F_\infty(p) = \exp\left(-\frac{K + o(1)}{(p - p_c)^{1/2}}\right), \quad p \downarrow p_c, \quad (1.34)$$

ce qui implique une transition d'ordre infini, voir la Figure 1.18.

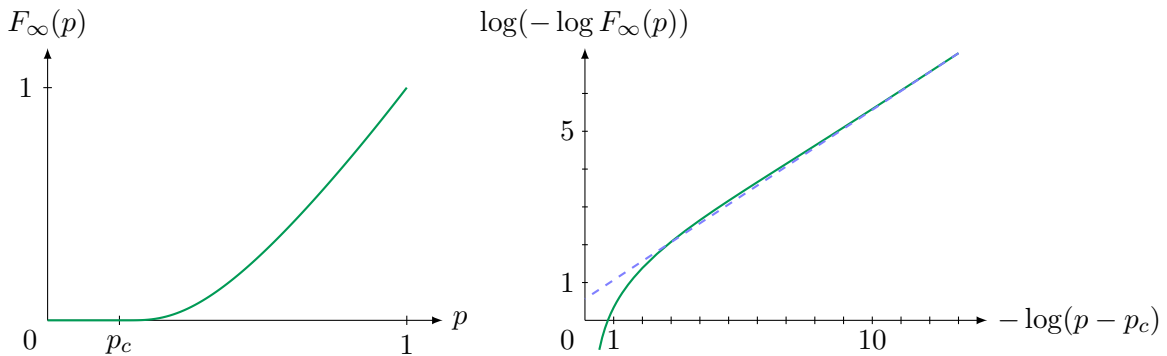

FIGURE 1.18 – Calcul numérique de l'énergie libre $F_\infty(p)$ dans le cas où $\nu = \delta_2$ (on a alors $p_c = \frac{1}{5}$), en l'approximant par $\mathbb{E}[X_n]/2^n$ pour $n = 100$ à gauche et $n = 1500$ à droite (la précision est explicite par (1.31)). À droite, la droite bleue en pointillés a une pente $\frac{1}{2}$.

Des résultats rigoureux ont été obtenus récemment, toujours dans le cas où ν est supportée par \mathbb{N}^* . Hu et Shi [HS18] se sont intéressés au cas où $p_c = 0$, c'est-à-dire où (1.33) n'est pas

7. Ce critère reste vrai même dans le cas où ν n'est pas à valeurs dans les entiers [HS18, Proposition 1.2].

vérifié, en distinguant selon la queue de distribution de ν . Si $\nu([n, \infty)) \sim ca^{-n}$ avec $a \in (1, 2)$ et $c > 0$, alors on a le comportement polynomial

$$F_\infty(p) = p^{\beta+o(1)}, \quad (1.35)$$

avec $\beta = \log(2)/\log(2/a)$. Si $\nu([n, \infty)) \sim cn^{-\alpha}2^{-n}$ avec $\alpha < 2$ et $c > 0$, alors on a

$$F_\infty(p) = \exp\left(-p^{-\chi+o(1)}\right), \quad (1.36)$$

où l'exposant $\chi = \frac{1}{2-\alpha} \in (0, \infty)$ peut-être à la fois inférieur et supérieur à $\frac{1}{2}$. Dans un travail en préparation, Chen, Dagard, Derrida, Hu, Lifshits et Shi [CDD⁺19] traitent le cas où $p_c > 0$. Pour que le comportement (1.34) soit vérifié, il faut en fait supposer une hypothèse plus forte que (1.33) : si $\int_{\mathbb{N}} x^3 2^x d\nu(x) < \infty$, alors ils démontrent que

$$F_\infty(p) = \exp\left(-(p - p_c)^{-\frac{1}{2}+o(1)}\right).$$

Si, au contraire, on a $\nu([n, \infty)) \sim cn^{-\alpha}2^{-n}$ avec $\alpha \in (2, 4)$ et $c > 0$, alors la transition est encore plus lisse :

$$F_\infty(p) = \exp\left(-(p - p_c)^{-\chi+o(1)}\right),$$

avec l'exposant $\chi = \frac{1}{\alpha-2} \in (\frac{1}{2}, \infty)$.

Le cas critique. La valeur de l'énergie libre pour une condition initiale faiblement sur-critique est régie principalement par le temps perdu par la trajectoire en passant près de la variété critique. Il y a donc un lien fort entre la compréhension du comportement asymptotique sur la variété critique et de celui de la transition de phase pour l'énergie libre [DR14, CDD⁺19]. Plaçons nous toujours dans le cas où X_0 est à valeurs dans \mathbb{N} . Supposons que la loi de X_0 appartient à la variété critique, c'est-à-dire $\mathbb{E}[X_0 2^{X_0}] = \mathbb{E}[2^{X_0}] < \infty$, et intéressons nous au comportement asymptotique de X_n . Pour soutenir leur scénario de transition de phase d'ordre infini, Derrida et Retaux [DR14] prédisent par exemple que

$$\mathbb{P}(X_n > 0) \sim \frac{4}{n^2}, \quad n \rightarrow \infty, \quad (1.37)$$

alors que, dans le cas sous-critique ($\mathbb{E}[X_0 2^{X_0}] < \mathbb{E}[2^{X_0}] < \infty$), la convergence vers 0 est exponentiellement rapide. Chen et al. [CDH⁺17] conjecturent également que X_n conditionné par $X_n > 0$ converge en loi vers une distribution géométrique de paramètre $\frac{1}{2}$, ainsi que le comportement asymptotique de différents moments, dont

$$\mathbb{E}[X_n] \sim \frac{8}{n^2} \quad \text{et} \quad \mathbb{E}[2^{X_n}] - 1 \sim \frac{2}{n}, \quad n \rightarrow \infty. \quad (1.38)$$

Cependant, peu de résultats rigoureux ont été établis dans le cas critique. Ils se trouvent essentiellement dans l'article de Chen et al. [CDH⁺17], qui montrent qu'il existe des constantes $0 < c_1 < c_2$ telles que, pour tout $n \geq 0$,

$$\frac{c_1}{n} \leq \mathbb{E}[2^{X_n}] - 1 \leq \frac{c_2}{n}.$$

Cela implique en particulier que $\mathbb{P}(X_n > 0) \leq \mathbb{E}[X_n] \leq \frac{c_2}{n}$, mais on ne dispose pas d'un meilleur contrôle pour l'instant pour ces quantités, ni de bornes inférieures satisfaisantes.

Rappelons la construction de X_n à partir d'un arbre binaire en Figure 1.17. Une question importante pour la compréhension du cas critique consiste à essayer de décrire comment

la masse est apportée jusqu'à la racine quand $X_n > 0$. Pour cela, on colorie en rouge les chemins allant des feuilles jusqu'à la racine le long desquels on n'a pas utilisé l'opération "partie positive" (autrement dit les chemins dont chaque nœud a soit une valeur supérieure à 1, soit un frère avec une valeur supérieure à 1). L'ensemble de ces chemins forme l'*arbre rouge*, voir la Figure 1.19. Cet arbre rouge joue un rôle important dans l'étude de la transition de phase par Chen et al. [CDD⁺19].

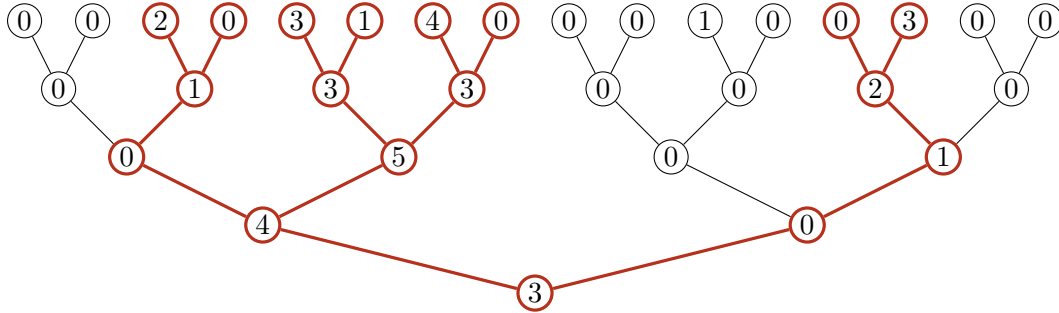

FIGURE 1.19 – Schéma illustrant la définition de l'arbre rouge.

Les résultats sur la version continue du modèle de Derrida–Retaux, présentés dans la section suivante et dans le Chapitre 7, permettent de formuler différentes conjectures sur cet arbre rouge dans le cas discret. Sachant que la racine de l'arbre binaire de hauteur n est rouge, on peut montrer⁸ que l'arbre rouge muni des valeurs sur ses nœuds, considéré de la racine vers les feuilles, est un processus de Markov branchant inhomogène en temps. Après changement d'échelle du temps et des valeurs sur les nœuds par n , ce processus devrait converger vers un processus explicite de croissance-fragmentation inhomogène en temps sur $[0, 1)$, dont le nombre de feuilles explose au voisinage de 1, voir la Figure 1.20. En particulier, le premier instant de branchement serait d'ordre n et sa loi après renormalisation convergerait vers une limite explicite, voir la Remarque 7.4.6 avec des simulations numériques pour soutenir le parallèle entre le modèle continu et le modèle discret. Finalement, il est aussi conjecturé que le nombre total de feuilles dans l'arbre rouge, ainsi que la somme de leurs masses, soient d'ordre n^2 .

1.6.2 Modèle en temps continu

Dans cette section, nous présentons une version continue du modèle de Derrida–Retaux, introduite et étudiée dans [HMP19], un travail coécrit avec Yueyun Hu et Bastien Mallein et contenu dans le Chapitre 7. L'intérêt de ce modèle est qu'il possède une famille exactement soluble de solutions, sur laquelle il est possible de calculer facilement la transition de phase de l'énergie libre et de démontrer de nombreux résultats concernant le cas critique et l'arbre rouge.

Définition. Soit X_0 une variable aléatoire positive dont la loi μ_0 sera notre condition initiale. Soit $t > 0$. Par analogie avec la construction à partir d'un arbre binaire de hauteur n dans le cas discret, on se donne un *arbre de Yule* de hauteur t , c'est-à-dire un arbre où les individus vivent pendant une durée exponentielle de paramètre 1, puis donnent naissance à deux individus. On va décrire la construction de X_t à partir d'une procédure de peinture de

8. Voir le Lemme 7.4.2 pour la démonstration dans le cas du modèle continu, mais c'est encore plus élémentaire pour le modèle discret où l'arbre n'est pas aléatoire. Notons qu'en fait, l'intégralité du processus sur l'arbre binaire, considéré de la racine vers les feuilles, est un processus de Markov branchant inhomogène en temps.

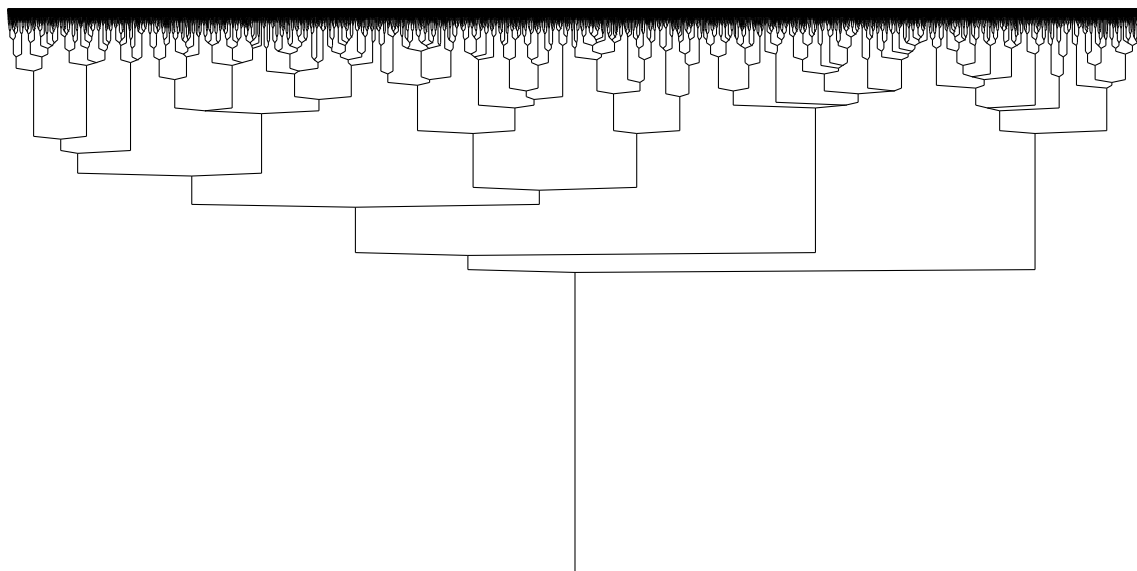

FIGURE 1.20 – Réalisation d'un arbre rouge de hauteur $n = 200$ pour un modèle de Derrida–Retaux avec pour loi initiale $\frac{4}{5}\delta_0 + \frac{1}{5}\delta_2$, qui est dans la phase critique. Il y a ici 23596 feuilles rouges. À comparer avec la Figure 7.4 obtenue pour le modèle continu.

l'arbre de Yule. Initialement, sur chaque feuille de l'arbre se trouve un peintre avec une quantité de peinture tirée selon la loi de X_0 indépendamment des autres. Ensuite, la procédure est déterministe. Tous les peintres descendent l'arbre à la même vitesse en peignant les branches, consommant une unité de peinture par unité de longueur de branche jusqu'à n'avoir plus de peinture, leur pot restant alors avec une quantité nulle de peinture. Quand deux branches se rejoignent, les peintres mettent en commun leurs pots en additionnant leurs quantités de peinture. La quantité de peinture qu'il reste quand on arrive à la racine définit une variable aléatoire X_t , dont on note μ_t la loi. On dit alors que $(\mu_t)_{t \geq 0}$ est un *modèle de Derrida–Retaux* en temps continu. Voir la Figure 1.21.

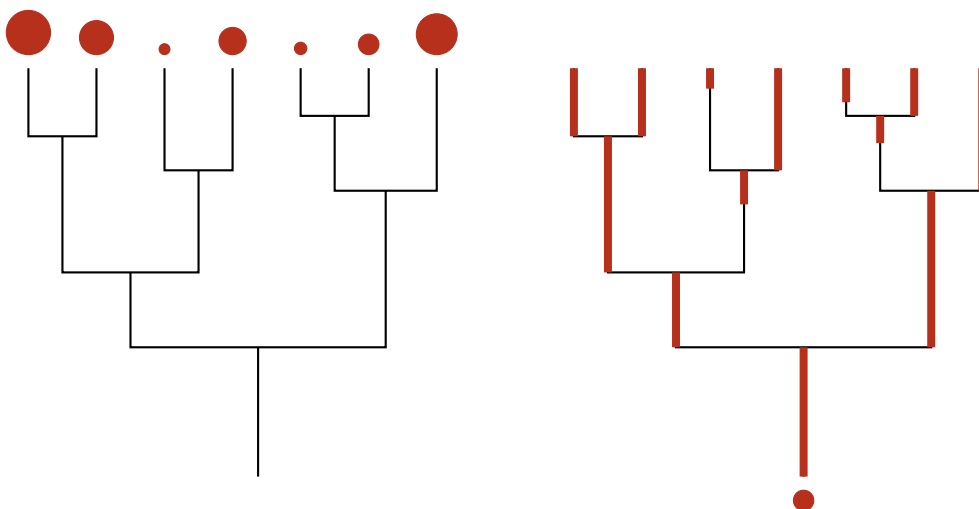

FIGURE 1.21 – Illustration de la procédure de peinture de l'arbre de Yule. À gauche, les peintres commencent sur les feuilles avec une quantité aléatoire de peinture. À droite, les peintres ont descendu l'arbre, peignant les branches tant qu'ils le pouvaient. La quantité de peinture qu'il reste à la racine définit la variable X_t .

Nous donnons deux autres descriptions de la famille de lois $(\mu_t)_{t \geq 0}$. Premièrement, on

peut voir $(\mu_t)_{t \geq 0}$ comme la famille des lois uni-dimensionnelles d'un processus $(X_t)_{t \geq 0}$, unique solution de l'équation de type McKean–Vlasov suivante, avec pour condition initiale X_0 ,

$$dX_t = -\mathbb{1}_{X_t > 0} + \int_{[0,1]} F_s^{-1}(u) N(dt, du), \quad \text{avec } \forall x, t \geq 0, F_t(x) = \mathbb{P}(X_t \leq x),$$

où N est un processus ponctuel de Poisson d'intensité $dt du$ sur $\mathbb{R}_+ \times [0, 1]$. Cela correspond au comportement suivant : X_t décroît linéairement à vitesse 1 tant que $X_t > 0$ puis reste nul et, à taux 1, se voit ajouter une copie indépendante de lui-même. Deuxièmement, $(\mu_t)_{t \geq 0}$ est l'unique solution faible (en un sens à préciser) de l'équation aux dérivées partielles suivante, avec pour condition initiale μ_0 ,

$$\partial_t \mu_t = \partial_x (\mathbb{1}_{x > 0} \mu_t) + \mu_t * \mu_t - \mu_t. \quad (1.39)$$

Cette équation ressemble à l'Équation (33) de Derrida et Retaux [DR14], mais avec l'ajout d'une troncature $\mathbb{1}_{x > 0}$ qui permet aux mesures μ_t de rester à support dans $[0, \infty)$. Le lien entre ces différentes définitions du modèle est établi dans le Théorème 7.1.8.

Dans ce nouveau cadre, l'énergie libre est définie par

$$F_\infty := \lim_{t \rightarrow \infty} e^{-t} \mathbb{E}[X_t] \in [0, \infty).$$

Si $F_\infty > 0$, alors nous montrons que $e^{-t} X_t$ converge en loi vers une distribution exponentielle de paramètre $1/F_\infty$. En outre, nous établissons quelques conditions nécessaires et suffisantes pour que $F_\infty = 0$, mais celles-ci portent sur l'intégralité des X_t pour $t \geq 0$, et il ne semble pas y avoir de critère simple analogue à (1.32). De nombreuses questions restent ouvertes concernant le cas général pour ce modèle et certaines d'entre elles sont posées en Section 7.6. L'objectif principal du Chapitre 7 est plutôt l'étude d'une famille exactement soluble de solutions pour ce modèle continu, une telle famille n'ayant pas été trouvée pour l'instant pour le modèle discret.

Le cas exactement soluble. On s'intéresse dorénavant à une condition initiale μ_0 donnée par un mélange entre un Dirac en 0 et une loi exponentielle :

$$\mu_0(dx) = p_0 \delta_0(dx) + (1 - p_0) \lambda_0 e^{-\lambda_0 x} dx, \quad (1.40)$$

avec $p_0 \in [0, 1)$ et $\lambda_0 > 0$. À partir de l'EDP (1.39), on peut facilement constater que cette famille de loi est préservée par la dynamique : si $(\mu_t)_{t \geq 0}$ est le modèle de Derrida-Retaux avec condition initiale μ_0 , alors, pour tout $t \geq 0$, on a

$$\mu_t(dx) = p(t) \delta_0(dx) + (1 - p(t)) \lambda(t) e^{-\lambda(t)x} dx,$$

où $p: \mathbb{R}_+ \rightarrow [0, 1)$ et $\lambda: \mathbb{R}_+ \rightarrow \mathbb{R}_+$ sont les uniques solutions de l'équation différentielle couplée suivante

$$\begin{cases} p' = (1 - p)(\lambda - p) \\ \lambda' = -\lambda(1 - p) \end{cases} \quad (1.41)$$

avec pour conditions initiales $p(0) = p_0$ et $\lambda(0) = \lambda_0$. Cette équation différentielle ordinaire n'admet pas de solutions explicites mais elle permet de faire des calculs sur le comportement asymptotique des lois μ_t et ainsi de décrire précisément la transition de phase pour l'énergie libre ainsi que le comportement dans le cas critique. Dans ce qui suit, les résultats seront seulement esquissés et leur énoncé détaillé sera reporté au Chapitre 7.

On peut tout d'abord noter que la fonction $t \mapsto \frac{p(t)}{\lambda(t)} + \log \lambda(t)$ est constante, et donc, en posant $H := \frac{p_0}{\lambda_0} + \log \lambda_0$, on a

$$p(t) = H\lambda(t) - \lambda(t) \log \lambda(t),$$

pour tout $t \geq 0$. Cela permet d'obtenir le diagramme de phase présenté en Figure 1.22. Les points attractifs pour $(\lambda(t), p(t))$ (représentés en orange) sont $\{(0, 0)\}$ et $[1, \infty) \times \{0\}$ et, en fonction du comportement asymptotique de $(\lambda(t), p(t))$, on peut délimiter deux phases séparées par la variété critique \mathcal{C} définie par

$$\mathcal{C} := \{(\lambda, p) \in \mathbb{R}_+ \times [0, 1) : p = \lambda - \lambda \log \lambda\}.$$

Dans les phases critique et sous-critique, on a $(\lambda(t), p(t)) \rightarrow (x, 1)$ avec $x \geq 1$. Ainsi, on en déduit que

$$F_\infty = \lim_{t \rightarrow \infty} e^{-t} \frac{1 - p(t)}{\lambda(t)} = 0.$$

Dans la phase sur-critique, on a $(\lambda(t), p(t)) \rightarrow (0, 0)$ et on peut montrer que $\lambda(t) \sim Ke^{-t}$ avec K une constante dépendant des conditions initiales (λ_0, p_0) , ce qui montre que $F_\infty > 0$ et justifie le nom de la phase.

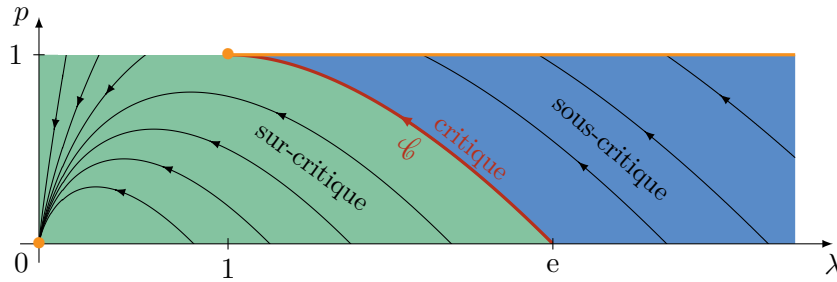

FIGURE 1.22 – Le diagramme de phase associé à l'équation différentielle (1.41).

Intéressons-nous à présent à la transition de phase pour l'énergie libre. Pour cela, on fixe $\lambda_0 \in (0, e)$ et on fait augmenter p_0 afin de passer de la phase sur-critique à la phase sous-critique. Notons que, par rapport au modèle discret, p_0 joue ici le rôle de $1 - p$ auparavant. Si $\lambda_0 > 1$, alors le point critique est en $p_c(\lambda_0) := \lambda_0 - \lambda_0 \log \lambda_0 \in (1, e)$ et on obtient une transition de phase d'ordre infini similaire à celle prédite par Derrida et Retaux en (1.34). C'est une transition de type Berezinskii–Kosterlitz–Thouless [KT73, KT13] et notre modèle fournit un représentant exactement soluble de cette classe de modèles. Le comportement de l'énergie libre peut s'illustrer à partir du diagramme de phase : plus p_0 est proche de $p_c(\lambda_0)$, plus la trajectoire de $(\lambda(t), p(t))$ perd de temps en passant près du point critique et l'énergie libre se comporte approximativement comme e^{-T} où T est ce temps perdu. Quand $\lambda_0 = 1$, on observe un comportement assez similaire, qui correspond au cas $\alpha = 2$ de (1.36). La précision des calculs permet d'obtenir également un préfacteur polynomial. Finalement, si $\lambda_0 \in (0, 1)$, on a un comportement polynomial analogue à (1.35).

Décrivons maintenant le comportement dans le cas critique. Soit $(p_0, \lambda_0) \in \mathcal{C}$ et X_t une variable aléatoire de loi μ_t pour tout $t \geq 0$. On a déjà vu que $(\lambda(t), p(t)) \rightarrow (1, 1)$, ce qui signifie en particulier que $X_t \rightarrow 0$ en probabilité et que X_t conditionné à être non-nul converge en loi vers une exponentielle de paramètre 1. Plus précisément, on a le développement suivant, quand $t \rightarrow \infty$,

$$\lambda(t) = 1 + \frac{2}{t} - \frac{8 \log t}{3t^2} + o\left(\frac{\log t}{t^2}\right) \quad \text{and} \quad p(t) = 1 - \frac{2}{t^2} + \frac{16 \log t}{3t^3} + o\left(\frac{\log t}{t^3}\right), \quad (1.42)$$

qui permet de montrer l’analogie des conjectures (1.37) et (1.38) pour le modèle discret.

Supposons à présent que la peinture utilisée pour définir le modèle de Derrida–Retaux soit rouge. Alors, une fois la procédure de peinture terminée, l’arbre de Yule se décompose en différentes composantes connexes rouges, qui sont toutes des sous-arbres. Sur l’événement où de la peinture arrive jusqu’à la racine (c’est-à-dire $X_t > 0$), on définit l’*arbre rouge* comme la composante connexe de la racine. On considère cet arbre ainsi que les quantités de peinture dans les pots le long de ses branches, en parcourant le temps en sens inverse de la procédure de peinture. Alors, cela forme un processus de Markov branchant inhomogène en temps sur $[0, t]$ que l’on peut décrire comme suit, conditionnellement à $X_t = x$:

- (i) Le processus commence à l’instant 0 avec une unique particule de masse x .
- (ii) La masse de chaque particule croît linéairement à vitesse 1.
- (iii) Une particule de masse m à l’instant s se sépare à taux $\lambda(t-s)(1-p(t-s))m$ en deux enfants, la masse m étant répartie entre les enfants selon une loi uniforme.
- (iv) Les particules se comportent indépendamment après l’instant de branchement.

Notons que cette description est vraie également pour une condition initiale dans la phase sous-critique ou sur-critique. Cependant, c’est uniquement dans le cas critique $(\lambda_0, p_0) \in \mathcal{C}$, que l’on peut obtenir une limite d’échelle pour ce processus en divisant le temps et les masses par t . L’objet limite est un processus de Markov branchant inhomogène en temps sur $[0, 1]$, défini comme précédemment mais avec un taux de branchement $2m/(1-s)^2$ pour une particule de masse m à l’instant s . Ce taux, qui s’obtient directement à partir de (1.42), explose au voisinage de 1, près duquel le nombre de particules tend vers l’infini.

Finalement, toujours dans le cas critique, nous démontrons une convergence pour le nombre N_t de feuilles de l’arbre rouge de hauteur t , ainsi que pour leur masse totale M_t : le couple $(N_t/t^2, M_t/t^2)$ converge en loi vers $(\gamma_1\eta, \gamma_2\eta)$ où $\gamma_1, \gamma_2 > 0$ sont des constantes dépendant de (λ_0, p_0) et η est une variable aléatoire de loi explicite. Cette convergence ne découle pas de la limite d’échelle ci-dessus, mais s’obtient en travaillant sur l’équation aux dérivées partielles vérifiée par la transformée de Laplace de (N_t, M_t) .

Nous pensons que ces comportements pour l’arbre rouge devraient être universels au point critique pour les modèles de Derrida–Retaux continu et discret avec condition initiale générale, ainsi que pour une classe plus large de modèles de renormalisation hiérarchique. Dans le cadre continu, cela reviendrait à remplacer $\mathbb{1}_{x>0}$ dans l’EDP (1.39) par une autre fonction croissante et bornée en x : il serait intéressant de trouver une telle fonction pour laquelle on peut résoudre partiellement l’EDP comme c’est le cas ici, afin de comparer la transition de phase et le comportement au point critique entre ces modèles.

Chapter 2

The near-critical Gibbs measure of the branching random walk

Abstract

This chapter contains the results of the paper [Pai18], published in the *Annales de l'Institut Henri Poincaré, Probabilités et Statistique*. We consider a supercritical branching random walk on the real line and the associated Gibbs measure $\mathcal{G}_{\beta,n}$ on the n^{th} generation with inverse temperature β . The convergence of the partition function $\widetilde{W}_{\beta,n}$, after rescaling, towards a nontrivial limit has been proved by Aïdékon and Shi [AS14] in the critical case $\beta = 1$ and by Madaule [Mad15] when $\beta \geq 1$. We study here the near-critical case, where $\beta_n \rightarrow 1$, and prove the convergence of $\widetilde{W}_{\beta_n,n}$, after rescaling, towards a constant multiple of the limit of the derivative martingale. Moreover, trajectories of particles chosen according to the Gibbs measure $\mathcal{G}_{\beta,n}$ have been studied by Madaule [Mad16a] in the critical case, with convergence towards the Brownian meander, and by Chen, Madaule and Mallein [CMM19] in the strong disorder regime, with convergence towards the normalized Brownian excursion. We prove here the convergence for trajectories of particles chosen according to the near-critical Gibbs measure and display continuous families of processes from the meander to the excursion or to the Brownian motion.

2.1 Introduction and main results

2.1.1 Definitions and assumptions

The branching random walk on the real line is a natural extension of the Galton-Watson process, with addition of a position to each individual, and is defined as follows. Initially, there is a single particle at the origin, forming the 0^{th} generation. It gives birth to children, scattered in \mathbb{R} according to some point process \mathcal{L} and forming the 1^{st} generation. Then, each particle of the 1^{st} generation produces its own children disposed around its position according to the law of \mathcal{L} independently of others: this set of children forms the 2^{nd} generation. The system goes on indefinitely, unless there is no particle at some generation.

The genealogical tree of the branching random walk, denoted by \mathbb{T} , is a Galton-Watson tree (where an individual can have an infinity of children). For $z \in \mathbb{T}$, we denote by $|z|$ the generation of the particle z and by $X(z)$ its position in \mathbb{R} . We denote by Ψ the log-Laplace

transform of \mathcal{L} : we set, for each $\beta \in \mathbb{R}_+$,

$$\Psi(\beta) := \log \mathbb{E} \left[\sum_{|z|=1} e^{-\beta X(z)} \right] \in (-\infty, \infty],$$

noting that \mathcal{L} has the same law as $(X(z), |z| = 1)$.

Throughout the chapter, we assume the following integrability conditions on the reproduction law \mathcal{L} . First of all, we need to assume that the Galton-Watson tree \mathbb{T} is *supercritical*, that is

$$\mathbb{E} \left[\sum_{|z|=1} 1 \right] > 1, \quad (2.1)$$

so that the survival event S has positive probability and, thus, we can introduce the new probability $\mathbb{P}^* := \mathbb{P}(\cdot | S)$. Moreover, we work in the *boundary case* (Biggins and Kyprianou [BK05]) by assuming

$$\mathbb{E} \left[\sum_{|z|=1} e^{-X(z)} \right] = 1 \quad \text{and} \quad \mathbb{E} \left[\sum_{|z|=1} X(z) e^{-X(z)} \right] = 0, \quad (2.2)$$

which means $\Psi(1) = 0$ and $\Psi'(1) = 0$. We assume also that

$$\sigma^2 := \mathbb{E} \left[\sum_{|z|=1} X(z)^2 e^{-X(z)} \right] \in (0, \infty) \quad \text{and} \quad \mathbb{E} \left[W_1 (\log_+ W_1)^2 + Z_1^+ \log_+ Z_1^+ \right] < \infty, \quad (2.3)$$

where we set, for $y \geq 0$, $\log_+ y := \max(0, \log y)$ and

$$W_1 := \sum_{|z|=1} e^{-X(z)} \quad \text{and} \quad Z_1^+ := \sum_{|z|=1} X(z)_+ e^{-X(z)} \quad (2.4)$$

with $X(z)_+ := \max(0, X(z))$. The first part of (2.3) gives $\Psi''(1) = \sigma^2$. We will say that \mathcal{L} is (h, a) -*lattice* if $h > 0$ is the largest real number such that the support of \mathcal{L} is contained by $a + h\mathbb{Z}$ and, then, h is called the *span* of \mathcal{L} . In this chapter, we work in both lattice and nonlattice cases, but we will need sometime to distinguish these cases. Finally, we set two last assumptions that are not supposed to hold in the whole chapter, but only in specific cases of the results. The following assumption,

$$\exists 0 < \delta_0 < 1 : \mathbb{E} \left[\sum_{|z|=1} e^{-(1-\delta_0)X(z)} \right] < \infty, \quad (2.5)$$

means that Ψ is finite on $[1 - \delta_0, 1]$ and, thus, analytic on $(1 - \delta_0, 1)$ and, using (2.2) and (2.3), we have $\Psi(\beta) = \frac{\sigma^2}{2}(\beta - 1)^2 + o((\beta - 1)^2)$ as $\beta \uparrow 1$ by a Taylor expansion. The second one,

$$\exists 0 < \delta_1 < \delta_2 < 1/4 : \mathbb{E} \left[\left(\sum_{|z|=1} e^{-(1-\delta_1)X(z)} \right)^{1+2\delta_2} \right] < \infty, \quad (2.6)$$

comes from Madaule [Mad16a] and is probably not optimal for the results where it is used. Under assumption (2.6), Ψ is finite on $[1 - \delta_1, 1 + \delta_2/2]$ and, therefore, analytic on a neighbourhood of 1, so we can improve the Taylor expansion: $\Psi(\beta) = \frac{\sigma^2}{2}(\beta - 1)^2 + O((\beta - 1)^3)$ as $\beta \rightarrow 1$.

For $n \in \mathbb{N}$ and $\beta \in \mathbb{R}_+$, we set

$$\widetilde{W}_{\beta,n} := \sum_{|z|=n} e^{-\beta X(z)} \quad \text{and} \quad \mathcal{G}_{\beta,n} := \frac{1}{\widetilde{W}_{\beta,n}} \sum_{|z|=n} e^{-\beta X(z)} \delta_z,$$

as soon as $\widetilde{W}_{\beta,n} < \infty$, which holds a.s. for $\beta \geq 1$ under assumption (2.2). Then, $\mathcal{G}_{\beta,n}$ is a random probability measure on $\{z \in \mathbb{T} : |z| = n\}$, which is called the *Gibbs measure* of parameter β on the n^{th} generation of the branching random walk. It is also the law of a directed polymer on the tree \mathbb{T} in a random environment, introduced by Derrida and Spohn [DS88] as a mean field limit for directed polymer on a lattice as dimension goes to infinity: with this terminology, $X(z)$ is the energy of the path leading from the root to particle z , β is the inverse temperature and $\widetilde{W}_{\beta,n}$ is the *partition function*. In the case $\beta = \infty$, we can define $\mathcal{G}_{\infty,n}$ as the uniform measure on the random set $\{|x| = n : X(x) = \min_{|z|=n} X(z)\}$.

As we will see, the Gibbs measure exhibits a phase transition at the critical inverse temperature $\beta_c = 1$ and our aim in this chapter is to study the near-critical case, where β depends on n and tends from above and below to $\beta_c = 1$ as $n \rightarrow \infty$. The near-critical case has been recently studied for the directed polymer on the lattice in dimension $1 + 1$ and $1 + 2$ by Alberts, Khanin and Quastel [AKQ14] and Caravenna, Sun and Zygouras [CSZ17a, CSZ17b], with the emergence of the so-called intermediate disorder regime. For the polymer on a tree, some work near criticality has been done by Alberts and Ortgiese [AO13] and Madaule [Mad16a], mostly on the partition function.

Before stating our results, we recall some well-known properties of the branching random walk, that hold under assumptions (2.1), (2.2) and (2.3). First, the sequence

$$Z_n := \sum_{|z|=n} X(z) e^{-X(z)}, \quad n \in \mathbb{N},$$

is a martingale, called the *derivative martingale*, and Biggins and Kyprianou [BK04a] (under slightly stronger assumptions) and Aidékon [Aid13] showed that we have

$$Z_n \xrightarrow[n \rightarrow \infty]{} Z_\infty > 0, \quad \mathbb{P}^* \text{-a.s.} \quad (2.7)$$

Moreover, Chen [Che15b] proved that these assumptions are optimal for the nontriviality of Z_∞ . Furthermore, Aidékon [Aid13] also showed that, in the nonlattice case, $\min_{|z|=n} X(z) - \frac{3}{2} \log n$ converges in law under \mathbb{P}^* and described the limit as a random shift (depending on Z_∞) of a Gumbel distribution. In the lattice case, we do not have this convergence, but the tightness still holds (see Equation (4.20) of Chen [Che15a] or Mallein [Mal16]): for each $\varepsilon > 0$, there exists $C > 0$ such that

$$\mathbb{P} \left(\min_{|z|=n} X(z) - \frac{3}{2} \log n \in [-C, C] \right) \geq 1 - \varepsilon, \quad (2.8)$$

for n large enough.

2.1.2 The partition function

The process $(\widetilde{W}_{\beta,n})_{n \in \mathbb{N}}$ for some fixed $\beta \in \mathbb{R}_+$ has been intensively studied because, if $\Psi(\beta)$ is finite, then the renormalized process $(W_n(\beta))_{n \in \mathbb{N}} := (e^{-n\Psi(\beta)} \widetilde{W}_{\beta,n})_{n \in \mathbb{N}}$ is a nonnegative martingale, called *additive martingale*, and, therefore, converges a.s. to some limit $W_\infty(\beta)$. Kahane and Peyrière [KP76], Biggins [Big77] and Lyons [Lyo97] have determined when this

limit is nontrivial: under the additional assumption that the expectation $\mathbb{E}[\widetilde{W}_1(\beta) \log_+ \widetilde{W}_1(\beta)]$ is finite, we have the following dichotomy

$$\begin{cases} W_\infty(\beta) > 0 & \mathbb{P}^*\text{-a.s. if } \beta \in [0, 1), \\ W_\infty(\beta) = 0 & \mathbb{P}^*\text{-a.s. if } \beta \geq 1. \end{cases} \quad (2.9)$$

With the terminology of polymers' literature (see [CY06]), the region $\beta \in [0, 1)$ is thus called the *weak disorder regime* and the region $\beta \geq 1$ the *strong disorder regime*. In the critical case $\beta = 1$, note that $\widetilde{W}_{1,n} = W_n(1)$ and we will simply write W_n .

In the strong disorder regime $\beta \geq 1$, it is natural to seek a proper renormalization of $\widetilde{W}_{\beta,n}$, so that it converges towards a nontrivial limit. This question has already been answered when β does not depend on n . In the critical case $\beta = 1$, Aïdékon and Shi [AS14] proved that we have

$$\sqrt{n}W_n \xrightarrow[n \rightarrow \infty]{} \frac{1}{\sigma} \sqrt{\frac{2}{\pi}} Z_\infty, \quad \text{in } \mathbb{P}^*\text{-probability,} \quad (2.10)$$

and that the particles that contribute mainly to W_n are those of order \sqrt{n} . On the other hand, Theorem 2.3 of Madaule [Mad15] shows (in the nonlattice case) that, in the case $\beta > 1$, we have

$$n^{3\beta/2} \widetilde{W}_{\beta,n} \xrightarrow[n \rightarrow \infty]{} Z_\infty^\beta S_{1/\beta}, \quad \text{in law,}$$

with $S_{1/\beta}$ a spectrally positive $1/\beta$ -stable random variable independent of Z_∞ , where the law of the limit has been identified by Barral, Rhodes and Vargas [BRV12]. Moreover, the particles that contribute mainly to $\widetilde{W}_{\beta,n}$ are in $[\frac{3}{2} \log n - C, \frac{3}{2} \log n + C]$ with C some large constant and, thus, are close to the lowest particle at time n (see (2.8)).

Since there is a discontinuity in the size of the partition function $\widetilde{W}_{\beta,n}$ as $\beta \downarrow 1$ between $n^{-3\beta/2}$ and $n^{-1/2}$, and also as $\beta \uparrow 1$ between exponential and polynomial size, we try to understand this transition by considering the near-critical case where $\beta_n \rightarrow 1$ as $n \rightarrow \infty$. Some work has been done to this end by Alberts and Ortgiese [AO13], who considered the case where $\beta_n = 1 \pm n^{-\delta}$ for $\delta > 0$ and proved, under stronger assumptions, that

$$\widetilde{W}_{\beta_n,n} = \begin{cases} n^{2\delta-3/2+o(1)} & \text{if } \beta_n = 1 + n^{-\delta} \text{ with } 0 < \delta < 1/2, \\ n^{-1/2+o(1)} & \text{if } \beta_n = 1 \pm n^{-\delta} \text{ with } \delta \geq 1/2, \\ \exp(\frac{\sigma^2}{2} n^{1-2\delta}(1+o(1))) & \text{if } \beta_n = 1 - n^{-\delta} \text{ with } 0 < \delta < 1/2. \end{cases} \quad \text{in } \mathbb{P}^*\text{-probability.}$$

Moreover, the behavior of the limit $W_\infty(\beta)$ of the additive martingale has been studied near criticality by Madaule [Mad16a], who showed under assumption (2.6) the following convergence

$$\frac{W_\infty(\beta)}{1-\beta} \xrightarrow[\beta \uparrow 1]{} 2Z_\infty, \quad \text{in } \mathbb{P}^*\text{-probability,} \quad (2.11)$$

and, although this is not exactly our setting where $n \rightarrow \infty$ and $\beta \rightarrow 1$ simultaneously, this result and its proof are useful in this chapter. The following theorem improves Alberts and Ortgiese's result, showing convergence to a nontrivial limit of $\widetilde{W}_{\beta_n,n}$ after rescaling, for every sequence $\beta_n := 1 \pm 1/\alpha_n$.

Theorem 2.1.1. *Assume (2.1), (2.2), (2.3) and that $\alpha_n \rightarrow \infty$ as $n \rightarrow \infty$. Let \mathcal{M} denotes the Brownian meander of length 1.*

(i) If $\beta_n := 1 + 1/\alpha_n$ and $\sqrt{n}/\alpha_n \rightarrow \infty$ as $n \rightarrow \infty$, then we have

$$\frac{n^{3\beta_n/2}}{\alpha_n^2} \widetilde{W}_{\beta_n, n} \xrightarrow[n \rightarrow \infty]{} \frac{1}{\sigma^3} \sqrt{\frac{2}{\pi}} Z_\infty, \quad \text{in } \mathbb{P}^*\text{-probability.}$$

(ii) If $\beta_n := 1 + 1/\alpha_n$ and $\sqrt{n}/\alpha_n \rightarrow \gamma \in [0, \infty)$ as $n \rightarrow \infty$, then we have

$$\sqrt{n} \widetilde{W}_{\beta_n, n} \xrightarrow[n \rightarrow \infty]{} \frac{1}{\sigma} \sqrt{\frac{2}{\pi}} \mathbb{E} \left[e^{-\sigma \gamma \mathcal{M}(1)} \right] Z_\infty, \quad \text{in } \mathbb{P}^*\text{-probability.}$$

(iii) If (2.5) holds, $\beta_n := 1 - 1/\alpha_n$ and $\sqrt{n}/\alpha_n \rightarrow \gamma \in [0, \infty)$ as $n \rightarrow \infty$, then we have

$$\sqrt{n} \widetilde{W}_{\beta_n, n} \xrightarrow[n \rightarrow \infty]{} \frac{1}{\sigma} \sqrt{\frac{2}{\pi}} \mathbb{E} \left[e^{\sigma \gamma \mathcal{M}(1)} \right] Z_\infty, \quad \text{in } \mathbb{P}^*\text{-probability.}$$

(iv) If (2.6) holds, $\beta_n := 1 - 1/\alpha_n$ and $\sqrt{n}/\alpha_n \rightarrow \infty$ as $n \rightarrow \infty$, then we have

$$\alpha_n e^{-n\Psi(\beta_n)} \widetilde{W}_{\beta_n, n} \xrightarrow[n \rightarrow \infty]{} 2Z_\infty, \quad \text{in } \mathbb{P}^*\text{-probability.}$$

Note that, in case (i), the size of $\widetilde{W}_{\beta_n, n}$ can be a $o(n^{-3/2})$ as soon as $\alpha_n \log \alpha_n \ll \log n$: this possibility does not appear in Alberts and Ortgiese's result.

2.1.3 Trajectory of particles under the Gibbs measure

The second main result of this chapter concerns the trajectory of particles chosen according to the Gibbs measure. We first need to introduce some additional notation. For a particle z at the n^{th} generation and $0 \leq i \leq n$, we denote by z_i its ancestor at the i^{th} generation and we set

$$\mathbf{X}(z) := \left(\frac{X(z_{\lfloor tn \rfloor})}{\sigma \sqrt{n}}, t \in [0, 1] \right)$$

the rescaled trajectory of z 's lineage. We work here in the set $\mathcal{D}([0, 1])$ of the càdlàg functions from $[0, 1]$ to \mathbb{R} , with the Skorokhod distance (see Section 2.A.2). For $n \in \mathbb{N}$ and $\beta \geq 1$, we denote by $\mu_{\beta, n}$ the image measure of the Gibbs measure $\mathcal{G}_{\beta, n}$ by \mathbf{X} , that is the random measure on $\mathcal{D}([0, 1])$ such that, for each $F \in \mathcal{C}_b(\mathcal{D}([0, 1]))$, we have

$$\mu_{\beta, n}(F) := \frac{1}{\widetilde{W}_{\beta, n}} \sum_{|z|=n} e^{-\beta X(z)} F(\mathbf{X}(z)),$$

where $\mathcal{C}_b(\mathcal{D}([0, 1]))$ denotes the set of continuous bounded functions from $\mathcal{D}([0, 1])$ to \mathbb{R} .

Convergence of $\mu_{\beta, n}$ has already been studied in the strong disorder regime when β does not depend on n , under assumptions (2.1), (2.2) and (2.3). In the critical case $\beta = 1$, Theorem 1.2 of Madaule [Mad16a] shows¹ that, for all $F \in \mathcal{C}_b(\mathcal{D}([0, 1]))$,

$$\mu_{1, n}(F) \xrightarrow[n \rightarrow \infty]{} \mathbb{E}[F(\mathcal{M})], \quad \text{in } \mathbb{P}^*\text{-probability.} \quad (2.12)$$

On the other hand, in the case $\beta > 1$, Chen, Madaule and Mallein [CMM19] proved (in the nonlattice case) that, under \mathbb{P}^* , we have, for all uniformly continuous $F \in \mathcal{C}_b(\mathcal{D}([0, 1]))$,

$$\mu_{\beta, n}(F) \xrightarrow[n \rightarrow \infty]{} \sum_{k \in \mathbb{N}} p_k F(\mathbf{e}_k), \quad \text{in law,} \quad (2.13)$$

1. Actually, Madaule [Mad16a] considers the linear interpolation of the trajectory, instead of \mathbf{X} , and the convergence on $\mathcal{C}([0, 1])$, instead of $\mathcal{D}([0, 1])$. But the convergence (2.12) follows from Madaule's result.

where $(\epsilon_k)_{k \in \mathbb{N}}$ is a sequence of i.i.d. normalized Brownian excursions and $(p_k)_{k \in \mathbb{N}}$ follows an independent Poisson-Dirichlet distribution with parameter $(\beta^{-1}, 0)$. The convergence in (2.13) is believed to hold for all $F \in \mathcal{C}_b(\mathcal{D}([0, 1]))$. Moreover, Chen [Che15a] considered the case $\beta = \infty$ and showed that, for all $F \in \mathcal{C}_b(\mathcal{D}([0, 1]))$, we have $\mathbb{E}^*[\mu_{\infty, n}(F)] \rightarrow \mathbb{E}[F(\epsilon)]$ as $n \rightarrow \infty$, where ϵ denotes the normalized Brownian excursion.

Finally, in the weak disorder regime $\beta < 1$, if there is some $p > 1$ such that $\mathbb{E}[\widetilde{W}_1(\beta)^p] < \infty$, we have the following convergence, with $\sigma_\beta^2 := \Psi''(\beta)$, for all $F \in \mathcal{C}_b(\mathcal{D}([0, 1]))$,

$$\frac{1}{\widetilde{W}_{\beta, n}} \sum_{|z|=n} e^{-\beta X(z)} F\left(\frac{X(z_{[tn]}) + tn\Psi'(\beta)}{\sigma_\beta \sqrt{n}}, t \in [0, 1]\right) \xrightarrow{n \rightarrow \infty} \mathbb{E}[F(B)], \quad (2.14)$$

in \mathbb{P}^* -probability². It means that the trajectory is a straight line of slope $-\Psi'(\beta) > 0$ at first order and around which Brownian fluctuations occur at second order.

Our aim is to prove the convergence for trajectories of particles chosen according to the Gibbs measure in the near-critical case, in order to explain how happens the transition between the Brownian excursion, the Brownian meander and the straight line with Brownian fluctuations.

Theorem 2.1.2. *Assume (2.1), (2.2), (2.3) and that $\alpha_n \rightarrow \infty$ as $n \rightarrow \infty$. Let ϵ denotes the normalized Brownian excursion, \mathcal{M} the Brownian meander of length 1 and B the Brownian motion.*

(i) *If $\beta_n := 1 + 1/\alpha_n$ and $\sqrt{n}/\alpha_n \rightarrow \infty$ as $n \rightarrow \infty$, then we have, for all $F \in \mathcal{C}_b(\mathcal{D}([0, 1]))$,*

$$\mu_{\beta_n, n}(F) \xrightarrow{n \rightarrow \infty} \mathbb{E}[F(\epsilon)], \quad \text{in } \mathbb{P}^*\text{-probability.}$$

(ii) *If $\beta_n := 1 + 1/\alpha_n$ and $\sqrt{n}/\alpha_n \rightarrow \gamma \in [0, \infty)$ as $n \rightarrow \infty$, then we have, for all $F \in \mathcal{C}_b(\mathcal{D}([0, 1]))$,*

$$\mu_{\beta_n, n}(F) \xrightarrow{n \rightarrow \infty} \frac{1}{\mathbb{E}[e^{-\sigma_\gamma \mathcal{M}(1)}]} \mathbb{E}[e^{-\sigma_\gamma \mathcal{M}(1)} F(\mathcal{M})], \quad \text{in } \mathbb{P}^*\text{-probability.}$$

(iii) *If (2.5) holds, $\beta_n := 1 - 1/\alpha_n$ and $\sqrt{n}/\alpha_n \rightarrow \gamma \in [0, \infty)$ as $n \rightarrow \infty$, then we have, for all $F \in \mathcal{C}_b(\mathcal{D}([0, 1]))$,*

$$\mu_{\beta_n, n}(F) \xrightarrow{n \rightarrow \infty} \frac{1}{\mathbb{E}[e^{\sigma_\gamma \mathcal{M}(1)}]} \mathbb{E}[e^{\sigma_\gamma \mathcal{M}(1)} F(\mathcal{M})], \quad \text{in } \mathbb{P}^*\text{-probability.}$$

(iv) *If (2.6) holds, $\beta_n := 1 - 1/\alpha_n$ and $\sqrt{n}/\alpha_n \rightarrow \infty$ as $n \rightarrow \infty$, then we have, for all $F \in \mathcal{C}_b(\mathcal{D}([0, 1]))$, in \mathbb{P}^* -probability,*

$$\frac{1}{\widetilde{W}_{\beta_n, n}} \sum_{|z|=n} e^{-\beta_n X(z)} F\left(\frac{X(z_{[tn]}) + tn\Psi'(\beta_n)}{\sigma \sqrt{n}}, t \in [0, 1]\right) \xrightarrow{n \rightarrow \infty} \mathbb{E}[F(B)].$$

We now state a corollary of this theorem, concerning the location of the mass of the Gibbs measure. Note that, for the terminology of the polymers' literature, this position is the typical energy of the polymer in the near-critical case.

Corollary 2.1.3. *Assume (2.1), (2.2), (2.3) and that $\alpha_n \rightarrow \infty$ as $n \rightarrow \infty$.*

2. To our knowledge, this result has not been proved yet (except when F only depends on the final position, see [Big79]), so a proof is given in Section 2.C of the appendix.

- (i) If $\beta_n := 1 + 1/\alpha_n$ and $\sqrt{n}/\alpha_n \rightarrow \infty$ as $n \rightarrow \infty$, then, for all $\varepsilon > 0$, there exists $C > 0$ such that for n large enough

$$\mathbb{P}^* \left(\mathcal{G}_{\beta_n, n} \left(\left[\frac{3}{2} \log n + C^{-1} \alpha_n, \frac{3}{2} \log n + C \alpha_n \right] \right) \geq 1 - \varepsilon \right) \geq 1 - \varepsilon.$$

- (ii) If $\beta_n := 1 + 1/\alpha_n$ and $\sqrt{n}/\alpha_n \rightarrow \gamma \in [0, \infty)$ as $n \rightarrow \infty$, then, for all $\varepsilon > 0$, there exists $C > 0$ such that for n large enough

$$\mathbb{P}^* \left(\mathcal{G}_{\beta_n, n} \left([C^{-1} \sqrt{n}, C \sqrt{n}] \right) \geq 1 - \varepsilon \right) \geq 1 - \varepsilon.$$

- (iii) If (2.5) holds, $\beta_n := 1 - 1/\alpha_n$ and $\sqrt{n}/\alpha_n \rightarrow \gamma \in [0, \infty)$ as $n \rightarrow \infty$, then the same property as in case (ii) holds.

- (iv) If (2.6) holds, $\beta_n := 1 - 1/\alpha_n$ and $\sqrt{n}/\alpha_n \rightarrow \infty$ as $n \rightarrow \infty$, then, for all $\varepsilon > 0$, there exists $C > 0$ such that for n large enough

$$\mathbb{P}^* \left(\mathcal{G}_{\beta_n, n} \left([-\Psi'(\beta_n)n - C\sqrt{n}, -\Psi'(\beta_n)n + C\sqrt{n}] \right) \geq 1 - \varepsilon \right) \geq 1 - \varepsilon.$$

Proof. In cases (ii), (iii) and (iv), it is a direct consequence of Theorem 2.1.2. For case (i), the assertion will be proved at the end of Section 2.5.2. \square

2.1.4 Genealogy under the Gibbs measure

We state here a direct consequence of Theorem 2.1.2 concerning the overlap in the branching random walk, introduced by Derrida and Spohn [DS88] in the context of polymers on trees. We set, for $x, y \in \mathbb{T}$,

$$|x \wedge y| := \max\{k \leq \min(|x|, |y|) : x_k = y_k\},$$

that is the generation of the most recent common ancestor of x and y . For some couple of particles (x, y) chosen according to $\mathcal{G}_{\beta, n}^{\otimes 2}$, we are interested in the *overlap* between x and y defined by $|x \wedge y|/n$. Thus, we set, for a Borel set $A \subset [0, 1]$,

$$\omega_{\beta, n}(A) := \mathcal{G}_{\beta, n}^{\otimes 2} \left(\frac{|x \wedge y|}{n} \in A \right)$$

so that $\omega_{\beta, n}$ is a random probability measure on $[0, 1]$. See Section 1.4 and Chapter 5 for more details concerning motivations for the study of the overlap.

Madaule [Mad16a] gives the following consequence of (2.12) in the case $\beta = 1$:

$$\omega_{1, n} \xrightarrow[n \rightarrow \infty]{} \delta_0, \quad \text{in } \mathbb{P}^* \text{-probability.}$$

For the other extremal case $\beta = \infty$, one can prove in the nonlattice case only³ that,

$$\omega_{\infty, n} \xrightarrow[n \rightarrow \infty]{} \delta_1, \quad \text{in } \mathbb{P}^* \text{-probability.} \quad (2.15)$$

The transition between this two cases appears with case $\beta \in (1, \infty)$, with which Chen, Madaule and Mallein [CMM19] deal, but their result (2.13) is only proved for $F \in \mathcal{C}_b^u(\mathcal{D}([0, 1]))$

3. For example, using the stopping line $\mathcal{Z}[A] := \{z \in \mathbb{T} : X(z) \geq A > \max_{k < |z|} X(z_k)\}$ for large A , it is possible to show that, with high probability for n large, all particles under $\mathcal{G}_{\infty, n}$ have the same ancestor in $\mathcal{Z}[A]$. Then (2.15) follows from Lemma 3.3 of Chen [Che15a]. In the lattice case, it is clear that (2.15) cannot hold.

and, thus, the convergence in law of $\omega_{\beta,n}$ cannot be obtained as a corollary. However, Mallein [Mal18b] shows that, under \mathbb{P}^* , we have

$$\omega_{\beta,n} \xrightarrow[n \rightarrow \infty]{} (1 - \pi_\beta)\delta_0 + \pi_\beta\delta_1, \quad \text{in law,}$$

where $\pi_\beta := \sum_{k \in \mathbb{N}} p_k^2$ and $(p_k)_{k \in \mathbb{N}}$ follows a Poisson-Dirichlet distribution with parameter $(\beta^{-1}, 0)$. It confirms a conjecture of Derrida and Spohn [DS88].

In the near critical case, we can state the following consequence of Theorem 2.1.2.

Corollary 2.1.4. *In each case of Theorem 2.1.1, under the same assumptions, we have*

$$\omega_{\beta,n} \xrightarrow[n \rightarrow \infty]{} \delta_0, \quad \text{in } \mathbb{P}^*\text{-probability.}$$

Proof. We give the proof for the case (i), but it is exactly the same for other cases (only the limiting trajectory changes). First note that, for all $F \in \mathcal{C}_b(\mathcal{D}([0, 1])^2)$, we have, with \mathbf{e} and \mathbf{e}' independent normalized Brownian excursions,

$$\mu_{\beta,n}^{\otimes 2}(F) = \frac{1}{\widetilde{W}_{\beta,n}^2} \sum_{|x|=|y|=n} e^{-\beta_n X(x) - \beta_n X(y)} F(\mathbf{X}(x), \mathbf{X}(y)) \xrightarrow[n \rightarrow \infty]{} \mathbb{E}[F(\mathbf{e}, \mathbf{e}')], \quad (2.16)$$

in \mathbb{P}^* -probability and therefore in L^1 , because $\mu_{\beta,n}^{\otimes 2}(F)$ is bounded. Indeed, by Theorem 2.1.2, (2.16) holds when F is of the form $F(x, y) = G_1(x)G_2(y)$ for some $G_1, G_2 \in \mathcal{C}_b(\mathcal{D}([0, 1]))$ and, the general case follows. Then, we consider some $\varepsilon > 0$ and the closed set $A := \{(x, y) \in \mathcal{D}([0, 1])^2 : \forall t \leq \varepsilon, x_t = y_t\}$ of $\mathcal{D}([0, 1])^2$. We have

$$\mathbb{E}[\omega_{\beta,n}([\varepsilon, 1])] \leq \mathbb{E}[\mu_{\beta,n}^{\otimes 2}(A)] \xrightarrow[n \rightarrow \infty]{} \mathbb{P}(\forall t \leq \varepsilon, \mathbf{e}_t = \mathbf{e}'_t) = 0,$$

using (2.16) and the Portmanteau theorem. \square

2.1.5 Comments on the results

Theorem 2.1.1 fully describes the transition from the size $n^{-3\beta/2}$ when $\beta > 1$ to the size $e^{n\Psi(\beta)}$ when $\beta < 1$ and Corollary 2.1.3 shows the transition in the location of the mass of the Gibbs measure from $[\frac{3}{2} \log n - C, \frac{3}{2} \log n + C]$ when $\beta > 1$, to $[-\Psi'(\beta)n - C\sqrt{n}, -\Psi'(\beta)n + C\sqrt{n}]$ when $\beta < 1$ (this follows from (2.14)). Secondly, Theorem 2.1.2 describes the transition between the Brownian excursion in case (i) and the straight line with Brownian fluctuations in case (iv). Note that, since $\min_{z \in \mathbb{T}} X(z) > -\infty$ a.s., it is natural that the limiting trajectory stays nonnegative on $[0, 1]$ in cases (i) to (iii). In case (iv), this constraint disappears in the limit due to the drift. Indeed, staying above a constant for a random walk with drift approximately $\sigma\sqrt{n}/\alpha_n$ needs effort until times of order α_n^2 , so it disappears in the trajectory after scaling by n . However, this effort has a cost of order $1/\alpha_n$, which explains the presence of this factor in the size $e^{n\Psi(\beta_n)}/\alpha_n$ of the partition function.

In cases (ii) and (iii), when α_n is of order \sqrt{n} or larger, the perturbation is too small to change radically the behavior of the Gibbs measure in regards to the critical case $\beta = 1$: the size of the partition function is still $n^{-1/2}$, the typical energy is of order \sqrt{n} and the limiting trajectory has a density w.r.t. the Brownian meander. Therefore, cases (ii) and (iii) are called the *critical window* by Alberts and Ortgieste [AO13]. It brings to light a family of laws $(P^\gamma)_{\gamma \in \mathbb{R}}$ on $\mathcal{D}([0, 1])$ defined by $P^\gamma(F) := \mathbb{E}[e^{-\sigma\gamma\mathcal{M}(1)} F(\mathcal{M})] / \mathbb{E}[e^{-\sigma\gamma\mathcal{M}(1)}]$ for all $F \in \mathcal{C}_b(\mathcal{D}([0, 1]))$, including the law of the Brownian meander of length 1 for $\gamma = 0$ and such that $P^\gamma \Rightarrow \mathcal{L}(\mathbf{e})$ as $\gamma \rightarrow \infty$, where $\mathcal{L}(\mathbf{e})$ denotes the law of \mathbf{e} . But there is no convergence as $\gamma \rightarrow -\infty$, because the trajectory is sent to infinity. However, we can consider another

family $(Q^\gamma)_{\gamma \in \mathbb{R}}$ defined by $Q^\gamma(F) := \mathbb{E}[e^{\sigma\gamma\mathcal{M}(1)}F(\mathcal{M}_t - \sigma\gamma t, t \in [0, 1])]/\mathbb{E}[e^{\sigma\gamma\mathcal{M}(1)}]$, so that, in case (iii), we have

$$\frac{1}{\widetilde{W}_{\beta_n, n}} \sum_{|z|=n} e^{-\beta_n X(z)} F\left(\frac{X(z_{[tn]}) + tn\Psi'(\beta_n)}{\sigma\sqrt{n}}, t \in [0, 1]\right) \xrightarrow[n \rightarrow \infty]{} Q^\gamma(F) \quad \text{in } \mathbb{P}^*\text{-probability,}$$

This family includes also the Brownian meander's law and we have $Q^\gamma \Rightarrow \mathcal{L}(B)$ as $\gamma \rightarrow \infty$.

As opposed to this, cases (i) and (iv) are called the *near-critical window* and highlight some new behaviors. In case (i), the transition between the critical size $n^{-1/2}$ and the strong disorder size $n^{-3\beta/2}$ appears. The factor $n^{3\beta_n/2}$ starts to behave differently than $n^{3/2}$ when $\alpha_n = O(\log n)$ and this is also the region where the particles mainly contributing to $\widetilde{W}_{\beta_n, n}$ are not simply those in $[C^{-1}\alpha_n, C\alpha_n]$: the fact that the lowest particle at time n is around $\frac{3}{2} \log n$ plays a role only in this region (see Lemma 2.5.2). Nevertheless, in the near-critical regime, the lowest particle at time n never has a positive weight in $\mathcal{G}_{\beta_n, n}$ in the limit, unlike in the case $\beta > 1$. Since the particles mainly contributing to $\widetilde{W}_{\beta_n, n}$ are far below \sqrt{n} , the endpoint of the limiting trajectory has to be 0 and, therefore, the excursion appears.

In case (iv), since β_n tends to 1 slowly enough, we find the same asymptotic behavior for the partition function as in (2.11) when we first take $n \rightarrow \infty$ and then $\beta \uparrow 1$. For the limiting trajectory, the result is also similar to (2.14) in the case $\beta > 1$. Moreover, when α_n is not too small, the different results in case (iv) can be rewritten only in terms of σ^2 : if $\alpha_n \gg n^{1/3}$, the size of the partition function is $e^{\sigma^2 n/2\alpha_n^2}/\alpha_n$ and, if $n^{1/4} = O(\alpha_n)$, the location of the mass is in $[\sigma^2 n/\alpha_n - C\sqrt{n}, \sigma^2 n/\alpha_n + C\sqrt{n}]$. But, on the contrary, if α_n is too small, there is a break of universality.

Finally, we stress that there is no discontinuity between the different cases of the results. Indeed, using that $\mathbb{E}[e^{-\sigma\gamma\mathcal{M}(1)}] \sim 1/(\sigma\gamma)^2$ and $\mathbb{E}[e^{\sigma\gamma\mathcal{M}(1)}] \sim \sqrt{2\pi}\sigma\gamma e^{(\sigma\gamma)^2/2}$ as $\gamma \rightarrow \infty$, all cases of Theorem 2.1.1 (requiring $\alpha_n \gg n^{1/3}$ in case (iv)) can be written

$$n^{3(1-\beta_n)/2} \frac{\sqrt{n}}{\mathbb{E}[e^{(1-\beta_n)\sigma\mathcal{M}(1)\sqrt{n}}]} \widetilde{W}_{\beta_n, n} \xrightarrow[n \rightarrow \infty]{} \frac{1}{\sigma} \sqrt{\frac{2}{\pi}} Z_\infty, \quad \text{in } \mathbb{P}^*\text{-probability,} \quad (2.17)$$

noting that $n^{3(1-\beta_n)/2} \rightarrow 1$ as soon as $\alpha_n \gg \log n$. For Theorem 2.1.2, the continuity between the different cases follows from the convergences $P^\gamma \Rightarrow \mathcal{L}(\mathbf{e})$ and $Q^\gamma \Rightarrow \mathcal{L}(B)$ as $\gamma \rightarrow \infty$.

2.1.6 Organization of the chapter

Sections of this chapter correspond to the different cases in the results: case (i) is treated in Section 2.5, cases (ii) and (iii) in Section 2.3 and case (iv) in Section 2.4. The behavior in the critical window (cases (ii) and (iii)) is a direct consequence of the analogue results (2.10) and (2.12) in the critical case (apart from some technical details). The near-critical window in the weak disorder regime (case (iv)) needs slightly more work, but relies mainly on Madaule's [Mad16a] results and on L^p inequalities techniques (see [Big92]). Finally, the main part of this chapter is dedicated to the proof of case (ii), which follows some ideas of Aïdékon and Shi [AS14], with change of measure and spine decomposition techniques. One main difference with the previous literature on the branching random walk is that we need here to consider particles that are far below \sqrt{n} but also far above the lowest particle. Note that we prove in Section 2.5.6 a new version of the so-called peeling lemma (see Shi [Shi15]) with a more general setting than what is needed for the proof of our results and that could be of independent interest.

On the other hand, Section 2.2 regroups some well-known results on the branching random walk and on classical random walk. Some new results are stated in this section and proved

in the appendix. Note that none of the results of Section 2.2 are needed for the proof of cases (ii) and (iii) and only a few of them for case (iv). The appendix contains some other technical results.

Throughout the chapter, C and c denote positive constants that can change from line to line, we set $\mathbb{N} := \{0, 1, 2, \dots\}$ and, for $a, b \in \mathbb{N}$, $[[a, b]] := [a, b] \cap \mathbb{N}$. For two sequences $(u_n)_{n \in \mathbb{N}}$ and $(v_n)_{n \in \mathbb{N}}$ of positive real numbers, we say that $u_n \sim v_n$ as $n \rightarrow \infty$ if $\lim_{n \rightarrow \infty} u_n/v_n = 1$, that $u_n = O(v_n)$ as $n \rightarrow \infty$ if $\limsup_{n \rightarrow \infty} u_n/v_n < \infty$, and that $u_n = o(v_n)$ or $u_n \ll v_n$ if $\lim_{n \rightarrow \infty} u_n/v_n = 0$. For (S, d) a metric space, let $\mathcal{C}_b(S)$ be the set of bounded continuous functions from $S \rightarrow \mathbb{R}$ and $\mathcal{C}_b^u(S)$ be its subset of uniformly continuous functions. For $F \in \mathcal{C}_b(S)$, we set $\|F\| := \sup_{x \in S} |f(x)|$. For $F \in \mathcal{C}_b^u(S)$, we will denote by ω_F a modulus of continuity for function F : ω_F is a continuous bounded nondecreasing function from $\mathbb{R}_+ \rightarrow \mathbb{R}_+$ such that $\omega_F(0) = 0$ and $\forall x, y \in S$, $|F(x) - F(y)| \leq \omega_F(d(x, y))$.

2.2 Preliminary results

In this section, we state some preliminary results that are mostly needed in Section 2.5. In Section 2.2.1, we present some well-known tools to study the branching random walk and the next subsections contain results concerning one-dimensional random walk.

2.2.1 Many-to-one lemma and change of probabilities

For $a \in \mathbb{R}$, let \mathbb{P}_a denote a probability measure under which $(X(z), z \in \mathbb{T})$ is the branching random walk starting from a , and \mathbb{E}_a the associated expectation (for brevity we will write \mathbb{P} and \mathbb{E} instead of \mathbb{P}_0 and \mathbb{E}_0). We define a random walk $(S_n)_{n \geq 0}$ associated to the branching random walk: under \mathbb{P}_a , $S_0 = a$ a.s. and the law of the increments is given by

$$\mathbb{E}_a[h(S_1 - S_0)] = \mathbb{E} \left[\sum_{|z|=1} h(X(z)) e^{-X(z)} \right],$$

for any measurable $h: \mathbb{R} \rightarrow \mathbb{R}_+$. This random walk is well-defined and centred thanks to assumption (2.2). Moreover, by assumption (2.3), we have $\mathbb{E}[S_1^2] = \sigma^2 \in (0, \infty)$. Then, by induction, one can get the many-to-one lemma for the branching random walk (see Biggins and Kyprianou [BK97]). It is also a corollary of the forthcoming Proposition 2.2.2.

Lemma 2.2.1 (Many-to-one lemma). *For any $n \geq 1$, $a \in \mathbb{R}$ and measurable function $g: \mathbb{R}^{n+1} \rightarrow \mathbb{R}_+$, we have*

$$\mathbb{E}_a \left[\sum_{|z|=n} g(X(z_0), \dots, X(z_n)) \right] = \mathbb{E}_a \left[e^{S_n - a} g(S_0, \dots, S_n) \right].$$

We now state some well-known change of probabilities and spinal decomposition results, whose history has been briefly presented in Section 1.1.3. See Section 3.4.1 for the counterparts of these results for branching Brownian motion. Let \mathcal{F}_n denote the σ -algebra generated by $(X(z), |z| \leq n)$ and $\mathcal{F}_\infty := \sigma(\bigvee_{n \in \mathbb{N}} \mathcal{F}_n)$.

We first introduce Lyons' change of measure [Lyo97]: since $(W_n)_{n \in \mathbb{N}}$ is a nonnegative martingale of mean e^{-a} under \mathbb{P}_a , we can define a new probability measure \mathbb{Q}_a on \mathcal{F}_∞ , by letting for all $n \in \mathbb{N}$,

$$\mathbb{Q}_a|_{\mathcal{F}_n} := e^a W_n \bullet \mathbb{P}_a|_{\mathcal{F}_n}.$$

We will denote by $\mathbb{E}_{\mathbb{Q}_a}$ the associated expectation and we will write \mathbb{Q} and $\mathbb{E}_{\mathbb{Q}}$ instead of \mathbb{Q}_0 and $\mathbb{E}_{\mathbb{Q}_0}$. Let $\widehat{\mathcal{L}}$ be a point process on \mathbb{R} which has the law of $(X(z), |z| = 1)$ under \mathbb{Q} .

Lyons [Lyo97] proved the following description for the branching random walk under \mathbb{Q}_a , with a decomposition along a *spine* $(w_n)_{n \in \mathbb{N}}$ which is a marked ray in the the genealogical tree \mathbb{T} (in order to be mathematically rigorous, one should enlarge the probability space and work on a product space, see Lyons [Lyo97]):

- The system starts with one particle w_0 in the spine at position a , forming the 0th generation.
- This particle generates offspring around its position according to the law of $\widehat{\mathcal{L}}$.
- Amongst the children, one is chosen to be in the spine, with probability proportional to $e^{-X(z)}$ for each child z , and continues in the same way.
- Other children spawn usual independent branching random walks (according to the law \mathbb{P}_b for a particle at position b).

Moreover, Lyons [Lyo97] showed the following result concerning the spine $(w_n)_{n \in \mathbb{N}}$ under \mathbb{Q}_a . The first point is useful for translating first and second moment computations under \mathbb{P}_a into quantities involving the spine under \mathbb{Q}_a . The second one describes the law of the trajectory of the spine under \mathbb{Q}_a .

Proposition 2.2.2. *Let $a \in \mathbb{R}$.*

- (i) *For each $n \in \mathbb{N}$ and $|z| = n$, we have*

$$\mathbb{Q}_a(w_n = z \mid \mathcal{F}_n) = \frac{e^{-X(z)}}{W_n}.$$

- (ii) *The process $(X(w_n))_{n \in \mathbb{N}}$ under \mathbb{Q}_a has the same law as $(S_n)_{n \in \mathbb{N}}$ under \mathbb{P}_a .*

Now, we present a second change of measure, that was firstly introduced by Biggins and Kyprianou [BK04a]. For this, we need to define R the renewal function in the first strict descending ladder height process of the random walk $(S_n)_{n \in \mathbb{N}}$. For $u \geq 0$,

$$R(u) := \sum_{k=0}^{\infty} \mathbb{P}(H_k \leq u),$$

where $(H_k)_{k \in \mathbb{N}}$ is the first strict descending ladder height process: we set $\tau_0 := 0$, $H_0 := 0$ and, for $k \geq 1$, $\tau_k := \inf\{n > \tau_{k-1} : S_n < S_{\tau_{k-1}}\}$ and $H_k := -S_{\tau_k}$. Then, we introduce the truncated derivative martingale: for $L \geq 0$ and $n \in \mathbb{N}$,

$$Z_n^{(L)} := \sum_{|z|=n} R_L(X(z)) e^{-X(z)} \mathbb{1}_{\underline{X}(z) \geq -L},$$

where, for $u \geq -L$, $R_L(u) := R(L + u)$ and, for $|z| = n$, $\underline{X}(z) := \min_{0 \leq i \leq n} X(z_i)$. Fix now some $L \geq 0$. For $a \geq -L$, under \mathbb{P}_a , $(Z_n^{(L)})_{n \in \mathbb{N}}$ is a nonnegative martingale of mean $R_L(a)$ and therefore we can define another probability measure $\mathbb{Q}_a^{(L)}$ by

$$\mathbb{Q}_a^{(L)}|_{\mathcal{F}_n} := \frac{Z_n^{(L)}}{R_L(a)} \bullet \mathbb{P}_a|_{\mathcal{F}_n}.$$

We will denote by $\mathbb{E}_{\mathbb{Q}_a^{(L)}}$ the associated expectation and write $\mathbb{Q}^{(L)}$ and $\mathbb{E}_{\mathbb{Q}}^{(L)}$ instead of $\mathbb{Q}_0^{(L)}$ and $\mathbb{E}_{\mathbb{Q}_0^{(L)}}$. For $a \geq -L$, let $\widehat{\mathcal{L}}_a^{(L)}$ be a point process on \mathbb{R} with the law of $(X(z), |z| = 1)$ under $\mathbb{Q}_a^{(L)}$.

Biggins and Kyprianou [BK04a] proved the following spinal decomposition description for the branching random walk under $\mathbb{Q}_a^{(L)}$, where the spine is denoted by $(w_n^{(L)})_{n \in \mathbb{N}}$:

- The system starts with one particle $w_0^{(L)}$ in the spine at position a .
- This particle generates offspring around its position according to the law of $\widehat{\mathcal{L}}_a^{(L)}$.
- Amongst the children, one is chosen to be in the spine, with probability proportional to $R_L(X(z))e^{-X(z)}\mathbb{1}_{X(z) \geq -L}$ for each child z , and continues in the same way (it has offspring according to $\widehat{\mathcal{L}}_b^{(L)}$ when at position b).
- Others spawn usual independent branching random walks.

Moreover, they showed the following analogue of Proposition 2.2.2.

Proposition 2.2.3. *Let $L \geq 0$ and $a \geq -L$.*

(i) *For each $n \in \mathbb{N}$ and $|z| = n$, we have*

$$\mathbb{Q}^{(L)}\left(w_n^{(L)} = z \mid \mathcal{F}_n\right) = \frac{R_L(X(z))e^{-X(z)}\mathbb{1}_{X(z) \geq -L}}{Z_n^{(L)}}.$$

(ii) *The process $(X(w_n^{(L)}))_{n \in \mathbb{N}}$ under $\mathbb{Q}_a^{(L)}$ has the same law as $(S_n)_{n \in \mathbb{N}}$ under \mathbb{P}_a conditioned to stay in $[-L, \infty)$: for all $n \in \mathbb{N}$ and all measurable function $g: \mathbb{R}^{n+1} \rightarrow \mathbb{R}_+$,*

$$\mathbb{E}_{\mathbb{Q}_a^{(L)}}\left[g\left(X(w_0^{(L)}), \dots, X(w_n^{(L)})\right)\right] = \frac{1}{R_L(a)}\mathbb{E}_a\left[g(S_0, \dots, S_n)R_L(S_n)\mathbb{1}_{S_n \geq -L}\right].$$

2.2.2 One-dimensional random walks

Up to the end of this section, we consider a centred random walk $(S_n)_{n \in \mathbb{N}}$ with finite variance $\mathbb{E}[S_1^2] = \sigma^2 \in (0, \infty)$. In this subsection, we state various results concerning this one-dimensional random walk and the associated renewal function R . For $n \in \mathbb{N}$, we set $\underline{S}_n := \min_{0 \leq i \leq n} S_i$.

Recall that R is the renewal function associated to the first strict descending ladder height process $(H_k)_{k \in \mathbb{N}}$. Since $\mathbb{E}[S_1] = 0$ and $\mathbb{E}[S_1^2] < \infty$, by Feller [Fel71, Theorem XVIII.5.1 (5.2)], we have $\mathbb{E}[H_1] < \infty$. Thus, it follows from Feller's [Fel71, p. 360] renewal theorem that there exists a constant $c_R > 0$ such that

$$\frac{R(u)}{u} \xrightarrow{u \rightarrow \infty} c_R \tag{2.18}$$

and therefore there exist also $C > c > 0$ such that, for all $u \geq 0$,

$$c(1+u) \leq R(u) \leq C(1+u). \tag{2.19}$$

We are interested in the behavior of random walks staying above a barrier. First, we recall the following estimate for the probability of a random walk to stay above $-a$: by Kozlov [Koz76, Theorem A], there exists a constant $\theta > 0$ such that for all $u \geq 0$,

$$\mathbb{P}(\underline{S}_n \geq -u) \underset{n \rightarrow \infty}{\sim} \frac{\theta R(u)}{\sqrt{n}}, \tag{2.20}$$

and there exists $C > 0$ such that, for all $n \in \mathbb{N}$ and $u \geq 0$, we have the uniform bound

$$\mathbb{P}(\underline{S}_n \geq -u) \leq \frac{C(1+u)}{\sqrt{n}}. \quad (2.21)$$

Constants c_R and θ will appear all along the chapter and they are related by the following equation, from Aïdékon and Shi [AS14, Lemma 2.1],

$$\theta c_R = \left(\frac{2}{\pi \sigma^2} \right)^{1/2}. \quad (2.22)$$

The following result states the convergence in law of $S_n/\sigma\sqrt{n}$ conditioned to stay above $-u$ towards a Rayleigh distribution, with uniformity in the position of the barrier $-u$: by Aïdékon and Jaffuel [AJ11, Lemma 2.2], if $(\gamma_n)_{n \in \mathbb{N}}$ is a sequence of positive numbers such that $\gamma_n \ll \sqrt{n}$ as $n \rightarrow \infty$, then we have, for all continuous bounded function $g: \mathbb{R}_+ \rightarrow \mathbb{R}$,

$$\mathbb{E} \left[g \left(\frac{S_n + u}{\sigma\sqrt{n}} \right) \mathbb{1}_{\underline{S}_n \geq -u} \right] = \frac{\theta R(u)}{\sqrt{n}} \left(\int_0^\infty g(t) t e^{-t^2/2} dt + o(1) \right), \quad (2.23)$$

uniformly in $u \in [0, \gamma_n]$.

From Lemmas 2.2 and 2.4 of Aïdékon and Shi [AS14], we have the following inequalities, sometimes called ballot theorems: there exists $C > 0$ such that, for all $b > a \geq 0$, $u \geq 0$ and $n \geq 1$,

$$\mathbb{P}(S_n \in [a - u, b - u], \underline{S}_n \geq -u) \leq C \frac{(u+1)(b+1)(b-a+1)}{n^{3/2}}, \quad (2.24)$$

and, for $\lambda \in (0, 1)$, there exists $C > 0$ depending on λ such that for all $b > a \geq 0$, $u \geq 0$, $v \in \mathbb{R}$ and $n \geq 1$, we have

$$\mathbb{P} \left(S_n \in [a + v, b + v], \underline{S}_{\lfloor \lambda n \rfloor} \geq -u, \min_{\lfloor \lambda n \rfloor \leq j \leq n} S_j \geq v \right) \leq C \frac{(u+1)(b+1)(b-a+1)}{n^{3/2}}, \quad (2.25)$$

where we added a second barrier between times $\lfloor \lambda n \rfloor$ and n . From the previous results, it follows (see Aïdékon [Aïd13, Lemma B.2]) that there exists $C > 0$ such that, for all $a, u \geq 0$,

$$\sum_{i \geq 0} \mathbb{P}(\underline{S}_i \geq -u, S_i \leq a - u) \leq C(1+a)(1 + \min(a, u)). \quad (2.26)$$

Finally, we state a slight extension of Lemma A.6 of Shi [Shi15]. It will be used for the proof of the peeling lemma in Section 2.5.6.

Lemma 2.2.4. *We set, for $0 \leq i \leq n$, $u, v, \mu \geq 0$,*

$$m_i^{(n)} := \begin{cases} -u + 2i^{1/7} - \mu & \text{if } 0 \leq i < \lfloor n/2 \rfloor, \\ v + 2(n-i)^{1/7} - \mu & \text{if } \lfloor n/2 \rfloor \leq i \leq n. \end{cases}$$

For each $\varepsilon > 0$, there exists $\mu > 0$ such that for any $b, u, v \geq 0$ and $n \in \mathbb{N}^$,*

$$\begin{aligned} & \mathbb{P} \left(\underline{S}_{\lfloor n/2 \rfloor} \geq -u, \min_{\lfloor n/2 \rfloor \leq j \leq n} S_j \geq v, S_n \in [b + v, b + v + 1], \exists i \in \llbracket 0, n \rrbracket : S_i \leq m_i^{(n)} \right) \\ & \leq (1+u)(1+b) \left(\frac{\varepsilon}{n^{3/2}} + C \frac{(n^{1/7} + v)^2}{n^{2-(1/7)}} \right), \end{aligned}$$

where $C > 0$ is a constant depending only on the law of the random walk.

Proof. Lemma A.6 of Shi [Shi15] deals with the event $\{S_n \in [v, b + v]\}$ instead of $\{S_n \in [b + v, b + v + 1]\}$ and, therefore, yields a factor $(1 + b)^2$ instead of our factor $(1 + b)$. However, the proof is exactly the same, except at two points, that we specify thereafter with Shi's notation (where his $(1 + u)$ corresponds to our $(1 + b)$). Firstly, at the equation before (A.11), the use of his Lemma A.4 gives a factor $(1 + u)$ instead of $(1 + u)^2$. Secondly, at the equation after (A.11), by using (2.24) instead of his Lemma A.1, we also get a factor $(1 + u)$ instead of $(1 + u)^2$. \square

Remark 2.2.5. This kind of result is usually proved with an envelope of order $i^\alpha \wedge (n - i)^\alpha$, where $\alpha \in (0, 1/6)$ (see also Aïdékon [Aïd13, Lemma B.3] and Madaule [Mad15, Lemma 6.1]). Indeed, with their arguments, a term $(n^\alpha + v)^2/n^{2-\alpha}$ appears and it is a $o(n^{-3/2})$ iff $\alpha < 1/6$ and $v = o(n^{(1-2\alpha)/4})$. But a similar result can be proved for any $\alpha \in (0, 1/2)$ and with a bound independent of $v \in \mathbb{R}$, see the arXiv version of this chapter for more details. However, the lemma as stated here is sufficient for the sequel.

2.2.3 Convergence towards the Brownian meander

We define the rescaled trajectory of the random walk until time n : for each $n \in \mathbb{N}^*$,

$$\mathbf{S}^{(n)} := \left(\frac{S_{[nt]}}{\sigma\sqrt{n}}, t \in [0, 1] \right).$$

We state the following convergence result for the trajectory $\mathbf{S}^{(n)}$ conditioned to stay nonnegative, with uniformity in the starting point of the random walk.

Proposition 2.2.6. *Let $(\gamma_n)_{n \in \mathbb{N}}$ be a sequence of positive numbers such that $\gamma_n \ll \sqrt{n}$ as $n \rightarrow \infty$. Then, for all $F \in \mathcal{C}_b(\mathcal{D}([0, 1]))$, we have*

$$\mathbb{E}_u \left[F(\mathbf{S}^{(n)}) \mathbb{1}_{\underline{S}_n \geq 0} \right] = \frac{\theta R(u)}{\sqrt{n}} (\mathbb{E}[F(\mathcal{M})] + o(1)),$$

as $n \rightarrow \infty$, uniformly in $u \in [0, \gamma_n]$, where \mathcal{M} denotes the Brownian meander of length 1.

This invariance principle has been proved in the case $u = 0$ by Iglehart [Igl74], Bolthausen [Bol76] and Doney [Don85]. The case where F is a function of the terminal value of the trajectory is already showed in (2.23). We give a short proof of this generalization in Section 2.B.1, that relies on the invariance principle by Caravenna and Chaumont [CC08], for random walk conditioned to stay nonnegative for all time.

We present also a corollary of Proposition 2.2.6, which holds under an additional assumption on the random walk S that is equivalent to assumption (2.5) by the many-to-one lemma. It will be used in Section 2.4 and its proof is postponed to Section 2.B.1.

Corollary 2.2.7. *Assume that there exists $\delta_0 > 0$ such that $\mathbb{E}[e^{\delta_0 S_1}] < \infty$. Then, for all $L, D > 0$ and $F \in \mathcal{C}_b(\mathcal{D}([0, 1]))$, we have*

$$\mathbb{E} \left[e^{DS_n/\sqrt{n}} F(\mathbf{S}^{(n)}) \mathbb{1}_{\underline{S}_n \geq -L} \right] = \frac{\theta R(L)}{\sqrt{n}} \left(\mathbb{E} \left[e^{D\sigma\mathcal{M}(1)} F(\mathcal{M}) \right] + o(1) \right),$$

as $n \rightarrow \infty$, where \mathcal{M} denotes the Brownian meander of length 1.

2.2.4 Convergence towards the Brownian excursion

In this subsection, our interest is the convergence of $\mathbf{S}^{(n)}$, conditioned to stay above two successive barriers and to end up in a small interval, towards the normalized Brownian excursion, with uniformity with respect to the barriers' positions and to the endpoint as long as they are much smaller than \sqrt{n} . This result will be used repetitively in Section 2.5 for the proof of part (ii) of Theorems 2.1.1 and 2.1.2.

At this scale for the endpoint S_n , the random walk behaves differently in the lattice and nonlattice cases, so they have to be distinguished. Moreover, we need some new notation: let $(S_n^-)_{n \in \mathbb{N}}$ be a random walk such that, under \mathbb{P}_a , $S_0^- = a$ a.s. and $S_1^- - S_0^-$ has the same law as $S_0 - S_1$. All objects referring to S (R , c_R , θ , ...) have their analogue for S^- denoted with a $-$ superscript (R^- , c_R^- , θ^- , ...).

We can now state our result, which generalizes Lemma 2.6 of Chen, Madaule and Mallein [CMM19] and is proved in Section 2.B.4.

Proposition 2.2.8. *Let $(\gamma_n)_{n \in \mathbb{N}}$ be a sequence of positive numbers such that $\gamma_n \ll \sqrt{n}$ as $n \rightarrow \infty$ and \mathfrak{e} be the normalized Brownian excursion.*

(i) *If the law of S_1 is nonlattice, then for all $h > 0$, $\lambda \in (0, 1)$ and $F \in \mathcal{C}_b(\mathcal{D}([0, 1]))$,*

$$\begin{aligned} & \mathbb{E} \left[F(\mathbf{S}^{(n)}) \mathbb{1}_{\underline{S}_{\lfloor \lambda n \rfloor} \geq -u, \min_{\lfloor \lambda n \rfloor \leq i \leq n} S_i \geq v, S_n \in [v+b, v+b+h]} \right] \\ &= \sqrt{\frac{\pi \theta \theta^-}{2}} \frac{R(u)}{\sigma} \frac{R(u)}{n^{3/2}} (\mathbb{E}[F(\mathfrak{e})] + o(1)) \int_b^{b+h} R^-(t) dt, \end{aligned}$$

as $n \rightarrow \infty$, uniformly in $b, u \in [0, \gamma_n]$ and $v \in [-\gamma_n, \gamma_n]$.

(ii) *If the law of S_1 is (h, a) -lattice, then for all $\lambda \in (0, 1)$ and $F \in \mathcal{C}_b^u(\mathcal{D}([0, 1]))$,*

$$\mathbb{E} \left[F(\mathbf{S}^{(n)}) \mathbb{1}_{\underline{S}_{\lfloor \lambda n \rfloor} \geq -u, \min_{\lfloor \lambda n \rfloor \leq i \leq n} S_i \geq v, S_n = v+b} \right] = \sqrt{\frac{\pi \theta \theta^-}{2}} \frac{R(u)}{\sigma} \frac{R(u)}{n^{3/2}} (\mathbb{E}[F(\mathfrak{e})] + o(1)) h R^-(b),$$

as $n \rightarrow \infty$, uniformly in $u \in [0, \gamma_n]$, $v \in [-\gamma_n, \gamma_n]$ and $b \in [0, \gamma_n] \cap (-v + an + h\mathbb{Z})$.

2.3 The critical window

We prove here cases (ii) and (iii) of Theorems 2.1.1 and 2.1.2, where $\beta_n = 1 \pm 1/\alpha_n$ with $\sqrt{n}/\alpha_n \rightarrow \gamma \in [0, \infty)$. This proof is based on Theorem 1.2 of Madaule [Mad16a], recalled in (2.12).

Proof of part (ii) of Theorems 2.1.1 and 2.1.2. Our aim is to show that, for any function $F \in \mathcal{C}_b(\mathcal{D}([0, 1]))$, we have

$$\frac{1}{W_n} \sum_{|z|=n} e^{-\beta_n X(z)} F(\mathbf{X}(z)) \xrightarrow[n \rightarrow \infty]{} \mathbb{E} \left[e^{-\sigma \gamma \mathcal{M}(1)} F(\mathcal{M}) \right], \quad \text{in } \mathbb{P}^* \text{-probability.} \quad (2.27)$$

Then, using (2.10) and the case $F \equiv 1$, part (ii) of Theorems 2.1.1 and 2.1.2 follows. Note also that it is sufficient to show (2.27) for F nonnegative.

We first deal with the case $\gamma \in (0, \infty)$. We consider some nonnegative function $F \in \mathcal{C}_b(\mathcal{D}([0, 1]))$ and $\varepsilon > 0$. By dominated convergence, we have that $\mathbb{E}[e^{-\sigma \gamma' \mathcal{M}(1)} F(\mathcal{M})]$ tends towards $\mathbb{E}[e^{-\sigma \gamma \mathcal{M}(1)} F(\mathcal{M})]$ as $\gamma' \rightarrow \gamma$, so we can choose $0 < \gamma^- < \gamma < \gamma^+$ such that

$$\mathbb{E} \left[e^{-\sigma \gamma \mathcal{M}(1)} F(\mathcal{M}) \right] - \frac{\varepsilon}{2} \leq \mathbb{E} \left[e^{-\sigma \gamma^\pm \mathcal{M}(1)} F(\mathcal{M}) \right] \leq \mathbb{E} \left[e^{-\sigma \gamma \mathcal{M}(1)} F(\mathcal{M}) \right] + \frac{\varepsilon}{2}. \quad (2.28)$$

Since $\sqrt{n}/\alpha_n \rightarrow \gamma$ and, under \mathbb{P}^* , $\min_{|z|=n} X(z) \rightarrow \infty$ a.s., there exists $n_0 \in \mathbb{N}$ such that, for all $n \geq n_0$, we have $\sqrt{n}/\alpha_n \in [\gamma^-, \gamma^+]$ and also $\mathbb{P}^*(\min_{|z|=n} X(z) < 0) \leq \varepsilon$. Moreover, we set, for $x \in \mathcal{D}([0, 1])$, $G^+(x) := F(x)(e^{-\sigma\gamma^+x_1} \wedge 1)$ and $G^-(x) := F(x)(e^{-\sigma\gamma^-x_1} \wedge 1)$: if $x_1 \geq 0$, then we have $G^+(x) \leq e^{(1-\beta_n)x_1} F(x) \leq G^-(x)$. Thus, we get, for all $n \geq n_0$,

$$\mathbb{P}^* \left(\frac{1}{W_n} \sum_{|z|=n} e^{-\beta_n X(z)} F(\mathbf{X}(z)) \notin [\mu_{1,n}(G^+), \mu_{1,n}(G^-)] \right) \leq \mathbb{P}^* \left(\min_{|z|=n} X(z) < 0 \right) \leq \varepsilon.$$

Therefore, we have

$$\begin{aligned} & \mathbb{P}^* \left(\left| \frac{1}{W_n} \sum_{|z|=n} e^{-\beta_n X(z)} F(\mathbf{X}(z)) - \mathbb{E} \left[e^{-\sigma\gamma \mathcal{M}(1)} F(\mathcal{M}) \right] \right| \leq \varepsilon \right) \\ & \leq \varepsilon + \mathbb{P}^* \left(\mu_{1,n}(G^-) \geq \mathbb{E} \left[e^{-\sigma\gamma \mathcal{M}(1)} F(\mathcal{M}) \right] + \varepsilon \right) + \mathbb{P}^* \left(\mu_{1,n}(G^+) \leq \mathbb{E} \left[e^{-\sigma\gamma \mathcal{M}(1)} F(\mathcal{M}) \right] - \varepsilon \right) \\ & \leq \varepsilon + \mathbb{P}^* \left(\mu_{1,n}(G^-) \geq \mathbb{E} \left[G^+(\mathcal{M}) \right] + \frac{\varepsilon}{2} \right) + \mathbb{P}^* \left(\mu_{1,n}(G^+) \leq \mathbb{E} \left[G^-(\mathcal{M}) \right] - \frac{\varepsilon}{2} \right), \end{aligned} \quad (2.29)$$

using (2.28). Then, applying (2.12), we get that both probabilities in (2.29) tends to 0, because $G^-, G^+ \in \mathcal{C}_b(\mathcal{D}([0, 1]))$ and it concludes the proof of (2.27) in the case $\gamma \in (0, \infty)$.

Finally, for the case $\gamma = 0$, we proceed in the same way as for $\gamma \in (0, \infty)$, taking here $\gamma^+ > 0$ such that $\mathbb{E}[F(\mathcal{M})] - \frac{\varepsilon}{2} \leq \mathbb{E}[e^{-\sigma\gamma^+ \mathcal{M}(1)} F(\mathcal{M})]$, G^+ defined as before and $G^- := F$. Then, the same inequalities hold. \square

Remark 2.3.1. In case (iii), we work under assumption (2.5) and we will use Proposition 3.8 of Madaule [Mad16a], whereas Madaule works in [Mad16a] under the stronger assumption (2.6). But, for the proof of his Proposition 3.8, he only uses Assumption (2.6) in the proof of his Lemma A.2, in order to have that Ψ is finite on a left-neighbourhood of 1 and $\Psi(\beta) = \frac{\sigma^2}{2}(\beta - 1)^2 + o((\beta - 1)^2)$ as $\beta \uparrow 1$, and this holds also under our assumption (2.5).

Proof of part (iii) of Theorems 2.1.1 and 2.1.2. Applying [Mad16a, Proposition 3.8] (see Remark 2.3.1 above), we get that $\mu_{1,n}(G) \rightarrow \mathbb{E}[G(\mathcal{M})]$ in \mathbb{P}^* -probability with $G: x \in \mathcal{D}([0, 1]) \mapsto e^{Cx_1}$ for any $C > 0$, although G is not bounded. Combining this with (2.12), it is straightforward to extend this convergence to functions of the type $G: x \in \mathcal{D}([0, 1]) \mapsto e^{Cx_1} F(x)$ with $C > 0$ and $F \in \mathcal{C}_b(\mathcal{D}([0, 1]))$.

Then, we prove that, for all $F \in \mathcal{C}_b(\mathcal{D}([0, 1]))$ nonnegative,

$$\frac{1}{W_n} \sum_{|z|=n} e^{-\beta_n X(z)} F(\mathbf{X}(z)) \xrightarrow{n \rightarrow \infty} \mathbb{E} \left[e^{-\sigma\gamma \mathcal{M}(1)} F(\mathcal{M}) \right], \quad \text{in } \mathbb{P}^*\text{-probability,} \quad (2.30)$$

using the same method as for the proof of case (ii): we approach function $x \mapsto e^{\sigma x_1 \sqrt{n}/\alpha_n} F(x)$ from above and from below, by taking here $G^+(x) := e^{\sigma\gamma^+ x_1} F(x)$ and $G^-(x) := e^{\sigma\gamma^- x_1} F(x)$ when $\gamma \in (0, \infty)$ and the same function G^+ but with $G^- := F$ when $\gamma = 0$. Finally, part (iii) of Theorems 2.1.1 and 2.1.2 follows from (2.30). \square

2.4 The near-critical window in the weak disorder regime

In this section, we deal with the case where $\beta_n = 1 - 1/\alpha_n$ and $\alpha_n \ll \sqrt{n}$ and prove successively convergence of the rescaled partition function and then convergence of the trajectories. We work here under assumption (2.6) so Ψ is analytic on an open interval I containing 1. Moreover, by Lemma 4.3 of Madaule [Mad16a], assumption (2.6) implies that there exist

$C > 0$ and $\eta_0 < 1$ such that $\mathbb{E}[(W_\infty(\beta))^{1+\frac{\eta}{2}}] \leq C$ for any $0 < \eta < \eta_0$ and $\beta = 1 - \eta$. Thus, for any $n \in \mathbb{N}$ and $0 < \eta < \eta_0$, we have, with $\beta = 1 - \eta$,

$$\mathbb{E}\left[(W_n(\beta))^{1+\frac{\eta}{2}}\right] = \mathbb{E}\left[\mathbb{E}[W_\infty(\beta)|\mathcal{F}_n]^{1+\frac{\eta}{2}}\right] \leq \mathbb{E}\left[(W_\infty(\beta))^{1+\frac{\eta}{2}}\right] \leq C, \quad (2.31)$$

by using Jensen's inequality.

We need to introduce a more general statement of the many-to-one lemma. For $\beta \in I$, we define another random walk $(S_{\beta,n})_{n \in \mathbb{N}}$ starting at 0 under \mathbb{P} and such that

$$\mathbb{E}[h(S_{\beta,1})] = e^{-\Psi(\beta)} \mathbb{E}\left[\sum_{|z|=1} h(X(z) + \Psi'(\beta))e^{-\beta X(z)}\right].$$

Then, $S_{\beta,1}$ is centred and has variance $\sigma_\beta^2 := \mathbb{E}[S_{\beta,1}^2] = \Psi''(\beta) \in (0, \infty)$. Moreover, we have the following analogue of the many-to-one lemma (see Shi [Shi15]): for all $n \geq 1$ and all measurable function $g: \mathbb{R}^{n+1} \rightarrow \mathbb{R}_+$, we have

$$\mathbb{E}\left[\sum_{|z|=n} g(X(z_i), i \in \llbracket 0, n \rrbracket)\right] = e^{n\Psi(\beta)} \mathbb{E}\left[e^{\beta(S_{\beta,n} - n\Psi'(\beta))} g(S_{\beta,i} - i\Psi'(\beta), i \in \llbracket 0, n \rrbracket)\right]. \quad (2.32)$$

One can see $(S_{\beta,n})_{n \in \mathbb{N}}$ as a discrete Girsanov transform of $(S_n)_{n \in \mathbb{N}}$.

We first establish a preliminary lemma.

Lemma 2.4.1. *Let $(\beta'_n)_{n \in \mathbb{N}} \in (0, 1)^\mathbb{N}$ and $(k_n)_{n \in \mathbb{N}} \in \mathbb{N}^\mathbb{N}$ be sequences such that $\beta'_n \rightarrow 1$ and $k_n \geq 1/(1 - \beta'_n)^2$ for any $n \in \mathbb{N}$. Then, for any $L > 0$,*

$$\limsup_{n \rightarrow \infty} \frac{1}{1 - \beta'_n} \mathbb{E}\left[W_{k_n}(\beta'_n) \mathbb{1}_{\inf_{x \in \mathbb{T}} X(x) \geq -L}\right] \leq \theta R(L) \mathbb{E}\left[e^{\sigma \mathcal{M}(1)}\right].$$

Proof. We first apply the many-to-one lemma to get that

$$\frac{1}{1 - \beta'_n} \mathbb{E}\left[W_{k_n}(\beta'_n) \mathbb{1}_{\inf_{x \in \mathbb{T}} X(x) \geq -L}\right] \leq \frac{1}{1 - \beta'_n} e^{-k_n \Psi(\beta'_n)} \mathbb{E}\left[e^{(1 - \beta'_n) S_{k_n}} \mathbb{1}_{S_{k_n} \geq -L}\right].$$

Then, we set $m_n := \lfloor (1 - \beta'_n)^{-2} \rfloor \leq k_n$ and, applying the Markov property at time m_n , we have

$$\begin{aligned} \mathbb{E}\left[e^{(1 - \beta'_n) S_{k_n}} \mathbb{1}_{S_{k_n} \geq -L}\right] &\leq \mathbb{E}\left[e^{(1 - \beta'_n) S_{m_n}} \mathbb{1}_{S_{m_n} \geq -L}\right] \mathbb{E}\left[e^{(1 - \beta'_n) S_{k_n - m_n}}\right] \\ &= \frac{\theta R(L)}{\sqrt{m_n}} \left(\mathbb{E}\left[e^{\sigma \mathcal{M}(1)}\right] + o(1)\right) e^{(k_n - m_n) \Psi(\beta'_n)}, \end{aligned} \quad (2.33)$$

using Corollary 2.2.7 to bound the first expectation in the middle part of (2.33) and the many-to-one lemma for the second expectation. Using that $e^{-m_n \Psi(\beta'_n)} \leq 1$, it proves the lemma. \square

Proof of part (iv) of Theorem 2.1.1. We set $\xi_n := \alpha_n |W_\infty(\beta_n) - W_n(\beta_n)|$ and want to show that $\xi_n \rightarrow 0$ in \mathbb{P}^* -probability. It will prove part (iv) of Theorem 2.1.1, since $\alpha_n W_\infty(\beta_n) \rightarrow 2Z_\infty$ in \mathbb{P}^* -probability by (2.11).

We first follow the proof of Lemma 4.2 of Madaule [Mad16a]. We set $p_n := 1 + 1/2\alpha_n$ and $\xi'_n := \mathbb{E}[\xi_n^{p_n} | \mathcal{F}_n]$. For $\varepsilon > 0$, we have

$$\mathbb{P}^*(\xi_n \geq \varepsilon) \leq \frac{1}{\mathbb{P}(S)} \mathbb{E}\left[\mathbb{1}_{\xi_n^{p_n} \geq \varepsilon^{p_n}} \mathbb{1}_{\xi'_n < \varepsilon^{1+p_n}}\right] + \mathbb{P}^*(\xi'_n \geq \varepsilon^{1+p_n}) \leq \frac{\varepsilon}{\mathbb{P}(S)} + \mathbb{P}^*(\xi'_n \geq \varepsilon^{1+p_n}), \quad (2.34)$$

using that $\mathbb{P}(\xi_n^{p_n} \geq \varepsilon^{p_n} | \mathcal{F}_n) \leq \varepsilon^{-p_n} \mathbb{E}[\xi_n^{p_n} | \mathcal{F}_n] = \varepsilon^{-p_n} \xi_n'$. By the branching property at time n , we have

$$\xi_n = \alpha_n \sum_{|x|=n} e^{-\beta_n X(x) - n\Psi(\beta_n)} (W_\infty^{(x)}(\beta_n) - 1),$$

where, conditionally on \mathcal{F}_n , the $W_\infty^{(x)}(\beta_n)$ for $|x| = n$ are independent variables with the same law as $W_\infty(\beta_n)$. Then, using that for any sequence $(Y_i)_{i \in \mathbb{N}}$ of independent centred variables and any $\gamma \in [1, 2]$ we have $\mathbb{E}[|\sum Y_i|^\gamma] \leq 2 \sum \mathbb{E}[|Y_i|^\gamma]$ (see [vE65]), we get

$$\begin{aligned} \xi_n' &= \mathbb{E}[\xi_n^{p_n} | \mathcal{F}_n] \leq 2\alpha_n^{p_n} \sum_{|x|=n} e^{-p_n \beta_n X(x) - np_n \Psi(\beta_n)} \mathbb{E}[|W_\infty(\beta_n) - 1|^{p_n}] \\ &\leq C(2\alpha_n)^{p_n} W_n(p_n \beta_n) e^{n[\Psi(p_n \beta_n) - p_n \Psi(\beta_n)]}, \end{aligned} \quad (2.35)$$

by using (2.31) for n large enough such that $1 - \eta_0 < 1 - \beta_n < 1$. Now, we choose $L > 0$ such that $\mathbb{P}^*(\inf_{x \in \mathbb{T}} X(x) < -L) \leq \varepsilon$ and, by (2.35) and Markov's inequality, we get

$$\mathbb{P}^*(\xi_n' \geq \varepsilon^{1+p_n}) \leq \varepsilon + \varepsilon^{-(1+p_n)} \frac{C}{\mathbb{P}(S)} (2\alpha_n)^{p_n} e^{n[\Psi(p_n \beta_n) - p_n \Psi(\beta_n)]} \mathbb{E}[W_n(p_n \beta_n) \mathbb{1}_{\inf_{x \in \mathbb{T}} X(x) \geq -L}].$$

As $n \rightarrow \infty$, we have $(2\alpha_n)^{p_n} \sim 2\alpha_n$, $1 - p_n \beta_n \sim 1/2\alpha_n$ and, by a Taylor expansion, $n[\Psi(p_n \beta_n) - p_n \Psi(\beta_n)] \sim -3\sigma^2 n/8\alpha_n^2 \rightarrow -\infty$. Thus, applying Lemma 2.4.1 with $k_n = n$ and $\beta_n' = p_n \beta_n$, we showed that $\limsup_{n \rightarrow \infty} \mathbb{P}^*(\xi_n' \geq \varepsilon^{1+p_n}) \leq \varepsilon$. Coming back to (2.34), it concludes the proof. \square

Proof of part (iv) of Theorem 2.1.2. By Lemma 2.A.1, we can reduce the proof to the case $F \in \mathcal{C}_b^u(\mathcal{D}([0, 1]))$. Moreover, by considering $F - \mathbb{E}[F(B)]$ instead of F , we can assume that $\mathbb{E}[F(B)] = 0$. By Theorem 2.1.1, we have $\alpha_n e^{-n\Psi(\beta_n)} \widetilde{W}_{\beta_n, n} \rightarrow 2Z_\infty$ in \mathbb{P}^* -probability with $Z_\infty > 0$ \mathbb{P}^* -a.s., so it is sufficient to prove that

$$U_n(F) := \alpha_n e^{-n\Psi(\beta_n)} \sum_{|z|=n} e^{-\beta_n X(z)} F(\widetilde{\mathbf{X}}^{(n)}(z)) \xrightarrow{n \rightarrow \infty} 2Z_\infty \mathbb{E}[F(B)] = 0, \quad (2.36)$$

in \mathbb{P}^* -probability, where $\widetilde{\mathbf{X}}_t^{(n)}(z) := [X(z_{[tn]}) + tn\Psi'(\beta_n)]/\sigma\sqrt{n}$ for $t \in [0, 1]$. For some $D > 0$, we set $k_n := \lfloor D\alpha_n \rfloor^2$ and, for each $x \in \mathcal{D}([0, 1])$, $F_n(x) := F(x_{((n-k_n)t+k_n)/n} - x_{k_n/n}, t \in [0, 1])$. Let $\varepsilon > 0$. In order to prove (2.36), it is sufficient to prove that we can choose D such that

$$\limsup_{n \rightarrow \infty} \mathbb{P}^*(|U_n(F) - U_n(F_n)| \geq \varepsilon) \leq 2\varepsilon, \quad (2.37)$$

$$\limsup_{n \rightarrow \infty} \mathbb{P}^*(|U_n(F_n) - \mathbb{E}[U_n(F_n) | \mathcal{F}_{k_n}]| \geq \varepsilon) \leq (2 + \mathbb{P}(S)^{-1})\varepsilon, \quad (2.38)$$

$$\limsup_{n \rightarrow \infty} \mathbb{P}^*(|\mathbb{E}[U_n(F_n) | \mathcal{F}_{k_n}]| \geq \varepsilon) \leq \varepsilon. \quad (2.39)$$

The assumption that $\mathbb{E}[F(B)] = 0$ is only needed for (2.39). For the sequel, we fix some $L > 0$ such that $\mathbb{P}^*(\inf_{x \in \mathbb{T}} X(x) < -L) \leq \varepsilon$.

We first prove (2.38). We set $\zeta_n := U_n(F_n) - \mathbb{E}[U_n(F_n) | \mathcal{F}_{k_n}]$ and proceed in a similar way as for the proof of part (iv) of Theorem 2.1.1, by setting $p_n := 1 + 1/2\alpha_n$ and $\zeta_n' := \mathbb{E}[|\zeta_n|^{p_n} | \mathcal{F}_n]$. By (2.34), we have $\mathbb{P}^*(|\zeta_n| \geq \varepsilon) \leq \varepsilon \mathbb{P}(S)^{-1} + \mathbb{P}^*(\zeta_n' \geq \varepsilon^{1+p_n})$. By the branching property at time k_n , we have

$$\zeta_n = \alpha_n \sum_{|x|=k_n} e^{-\beta_n X(x) - k_n \Psi(\beta_n)} (\Upsilon_n^{(x)} - \mathbb{E}[\Upsilon_n]), \quad (2.40)$$

where, conditionally on \mathcal{F}_{k_n} , the $\Upsilon_n^{(x)}$ for $|x| = k_n$ are independent variables with the same law as Υ_n defined by

$$\Upsilon_n := \sum_{|z|=n-k_n} e^{-\beta_n X(z) - (n-k_n)\Psi(\beta_n)} F\left(\frac{X(z_{\lfloor t(n-k_n) \rfloor}) + t(n-k_n)\Psi'(\beta_n)}{\sigma\sqrt{n}}, t \in [0, 1]\right). \quad (2.41)$$

Since the $\Upsilon_n^{(x)} - \mathbb{E}[\Upsilon_n]$ are also centred, we get, in the same way as for (2.35),

$$\begin{aligned} \zeta'_n &= \mathbb{E}[|\zeta_n|^{p_n} | \mathcal{F}_{k_n}] \leq 2\alpha_n^{p_n} \sum_{|x|=k_n} e^{-p_n\beta_n X(x) - k_n p_n \Psi(\beta_n)} \mathbb{E}[|\Upsilon_n - \mathbb{E}[\Upsilon_n]|^{p_n}] \\ &\leq C(2\|F\|\alpha_n)^{p_n} W_{k_n}(p_n\beta_n) e^{k_n(\Psi(p_n\beta_n) - p_n\Psi(\beta_n))}, \end{aligned} \quad (2.42)$$

by using the following bound

$$\mathbb{E}[|\Upsilon_n - \mathbb{E}[\Upsilon_n]|^{p_n}] \leq 2^{p_n+1} \mathbb{E}[|\Upsilon_n|^{p_n}] \leq 2^{p_n+1} \|F\|^{p_n} \mathbb{E}[|W_{n-k_n}(\beta_n)|^{p_n}] \leq 2^{p_n+1} \|F\|^{p_n} C,$$

where we used (2.31) for n large enough such that $1 - \eta_0 < 1 - \beta_n < 1$. Now, using that $\mathbb{P}^*(\inf_{x \in \mathbb{T}} X(x) < -L) \leq \varepsilon$ and Markov's inequality, we get

$$\begin{aligned} &\mathbb{P}^*(\zeta'_n \geq \varepsilon^{1+p_n}) \\ &\leq \varepsilon + \varepsilon^{-(1+p_n)} \frac{C}{\mathbb{P}(S)} (2\|F\|\alpha_n)^{p_n} e^{k_n[\Psi(p_n\beta_n) - p_n\Psi(\beta_n)]} \mathbb{E}[W_{k_n}(p_n\beta_n) \mathbb{1}_{\inf_{x \in \mathbb{T}} X(x) \geq -L}], \end{aligned}$$

hence, using that, as $n \rightarrow \infty$, we have $(2\|F\|\alpha_n/\varepsilon)^{p_n} \sim 2\|F\|\alpha_n/\varepsilon$, $1 - p_n\beta_n \sim 1/2\alpha_n$ and $k_n[\Psi(p_n\beta_n) - p_n\Psi(\beta_n)] \sim -3\sigma^2 k_n/8\alpha_n^2 \rightarrow -3\sigma^2 D^2/8$, and applying Lemma 2.4.1 with $\beta'_n = p_n\beta_n$, we get

$$\limsup_{n \rightarrow \infty} \mathbb{P}^*(\zeta'_n \geq \varepsilon^{1+p_n}) \leq \varepsilon + C \frac{R(L)}{\varepsilon^2} e^{-3\sigma^2 D^2/8} \leq 2\varepsilon,$$

by choosing D large enough. This proves (2.38). The constant D is now fixed.

We now prove (2.37). Using that $\mathbb{P}^*(\inf_{x \in \mathbb{T}} X(x) < -L) \leq \varepsilon$ and the Markov inequality, we get, with $C = 1/\mathbb{P}(S)$,

$$\mathbb{P}^*(|U_n(F) - U_n(F_n)| \geq \varepsilon) \leq \varepsilon + \frac{C\alpha_n}{\varepsilon e^{n\Psi(\beta_n)}} \mathbb{E}\left[\sum_{|z|=n} e^{-\beta_n X(z)} \mathbb{1}_{\underline{X}(z) \geq -L} |F - F_n|(\tilde{\mathbf{X}}^{(n)}(z))\right]. \quad (2.43)$$

For $t \in [0, 1]$, we define $\tilde{\mathbf{S}}_t^{(n)} := [S_{\lfloor tn \rfloor} + tn\Psi'(\beta_n)]/\sigma\sqrt{n}$. Then, using the many-to-one lemma and the triangle inequality, we get that, for any $M > 0$, the expectation in (2.43) is smaller than

$$\begin{aligned} &\mathbb{E}\left[e^{S_n/\alpha_n} \mathbb{1}_{\underline{S}_n \geq -L, \max_{0 \leq k \leq k_n} S_k \leq M\alpha_n} |F - F_n|(\tilde{\mathbf{S}}^{(n)})\right] \\ &+ 2\|F\| \mathbb{E}\left[e^{S_n/\alpha_n} \mathbb{1}_{\underline{S}_n \geq -L, \max_{0 \leq k \leq k_n} S_k > M\alpha_n}\right]. \end{aligned} \quad (2.44)$$

Note that, using (2.101) with here $\kappa_n = k_n/n$, we have, for any $x \in \mathcal{D}([0, 1])$,

$$|F - F_n|(x) \leq \omega_F \left(\frac{k_n}{n} \vee 3 \max_{[0, k_n/n]} |x| \right)$$

and, thus, the first term in (2.44) is smaller than

$$\omega_F \left(\frac{\lfloor D\alpha_n \rfloor^2}{n} \vee \frac{3M\alpha_n}{\sigma\sqrt{n}} \right) \mathbb{E} \left[e^{S_n/\alpha_n} \mathbb{1}_{S_n \geq -L} \right] = o \left(\frac{e^{n\Psi(\beta_n)}}{\alpha_n} \right),$$

using (2.33) to bound the expectation and recalling that $\alpha_n \ll \sqrt{n}$. On the other hand, using Markov property at time k_n , the second term in (2.44) is smaller than

$$\begin{aligned} & 2\|F\| \mathbb{E} \left[e^{S_{k_n}/\alpha_n} \mathbb{1}_{S_{k_n} \geq -L, \max_{0 \leq k \leq k_n} S_k > M\alpha_n} \right] \mathbb{E} \left[e^{S_{n-k_n}/\alpha_n} \right] \\ &= 2\|F\| \frac{\theta R(L)}{\sqrt{k_n}} \left(\mathbb{E} \left[e^{D\sigma\mathcal{M}(1)} \mathbb{1}_{\max \mathcal{M} > M/(D\sigma)} \right] + o(1) \right) e^{(n-k_n)\Psi(\beta_n)} \end{aligned}$$

applying Corollary 2.2.7 and recalling that $\sqrt{k_n} = \lfloor D\alpha_n \rfloor$. Coming back to (2.43), we finally get

$$\limsup_{n \rightarrow \infty} \mathbb{P}^* (|U_n(F) - U_n(F_n)| \geq \varepsilon) \leq \varepsilon + C \frac{R(L)}{\varepsilon D} \mathbb{E} \left[e^{D\sigma\mathcal{M}(1)} \mathbb{1}_{\max \mathcal{M} > M/(D\sigma)} \right] \leq 2\varepsilon, \quad (2.45)$$

by choosing M large enough (L and D being fixed). It proves (2.37).

Finally, we prove (2.39). Using the branching property in the same way as for (2.40), we have $\mathbb{E}[U_n(F_n) | \mathcal{F}_{k_n}] = \alpha_n W_{k_n}(\beta_n) \mathbb{E}[\Upsilon_n]$, where Υ_n is defined in (2.41). By (2.32), we get

$$\begin{aligned} \mathbb{E}[\Upsilon_n] &= \mathbb{E} \left[F \left(\frac{S_{\beta_n, \lfloor t(n-k_n) \rfloor} + (t(n-k_n) - \lfloor t(n-k_n) \rfloor) \Psi'(\beta_n)}{\sigma\sqrt{n}}, t \in [0, 1] \right) \right] \\ &= \mathbb{E} \left[F(u_n \mathbf{S}^{(\beta_n, n-k_n)} + v_n) \right], \end{aligned}$$

where we introduced $\mathbf{S}^{(\beta, n)} := (S_{\beta, \lfloor tn \rfloor} / \sigma\sqrt{n})_{t \in [0, 1]}$ and where the sequences $(u_n)_{n \in \mathbb{N}} \in (\mathbb{R}_+^*)^{\mathbb{N}}$ and $(v_n)_{n \in \mathbb{N}} \in \mathcal{D}([0, 1])^{\mathbb{N}}$ satisfy $u_n \rightarrow 1$ and $\|v_n\|_{\infty} \rightarrow 0$, using that $k_n \ll n$, $\Psi'(\beta_n) \rightarrow 0$ and $\sigma_{\beta_n} \rightarrow \sigma$. Now, note that $\mathbf{S}^{(\beta_n, n-k_n)} \rightarrow B$ in law. This is not a direct consequence of Donsker's theorem because here the law of the random walk changes for each n . However, we can apply a strong invariance principle like Equation (11) of Sakhanenko [Sak06]: there exists $c > 0$ such that, for any $n \geq 1$ and $\beta \in I$, there exists a Brownian motion $B^{(n, \beta)}$ such that

$$\mathbb{P} \left(\sup_{t \in [0, 1]} \left| \mathbf{S}_t^{(\beta, n)} - B_t^{(n, \beta)} \right| \geq c \frac{n^{2/5}}{\sigma\sqrt{n}} \right) \leq \frac{n \mathbb{E} [|S_{\beta, 1}|^3]}{(n^{2/5})^3}.$$

Since $\sigma_{\beta_n} \rightarrow \sigma$ and $\mathbb{E}[|S_{\beta_n, 1}|^3] \rightarrow \mathbb{E}[|S_1|^3] < \infty$ as $n \rightarrow \infty$, this proves that $\mathbf{S}^{(\beta_n, n-k_n)} \rightarrow B$ in law. Then, applying Lemma 2.A.3, we get that $\mathbb{E}[\Upsilon_n] \rightarrow \mathbb{E}[F(B)] = 0$ as $n \rightarrow \infty$. On the other hand, using that $\mathbb{P}^*(\inf_{x \in \mathbb{T}} X(x) < -L) \leq \varepsilon$ and the Markov inequality, we get

$$\mathbb{P}^* (|\mathbb{E}[U_n(F_n) | \mathcal{F}_{k_n}]| \geq \varepsilon) \leq \varepsilon + \frac{1}{\varepsilon} \alpha_n \mathbb{E} \left[W_{k_n}(\beta_n) \mathbb{1}_{\inf_{x \in \mathbb{T}} X(x) \geq -L} \right] |\mathbb{E}[\Upsilon_n]|,$$

and it proves (2.39) by using Lemma 2.4.1 and that $\mathbb{E}[\Upsilon_n] \rightarrow 0$ as $n \rightarrow \infty$. \square

2.5 The near-critical window in the strong disorder regime

In this section, we prove case (i) of Theorems 2.1.1 and 2.1.2 and of Corollary 2.1.3, where $\beta_n = 1 + 1/\alpha_n$ with $\alpha_n \ll \sqrt{n}$. This case constitutes the main part of this chapter.

2.5.1 Change of probabilities

We introduce a first barrier by setting, for $L > 0$ and $F \in \mathcal{C}_b(\mathcal{D}([0, 1]))$,

$$\begin{aligned}\widetilde{W}_{\beta_n, n}(F) &:= \sum_{|z|=n} e^{-\beta_n X(z)} F(\mathbf{X}(z)), \\ \widetilde{W}_{\beta_n, n}^{(L)}(F) &:= \sum_{|z|=n} e^{-\beta_n X(z)} F(\mathbf{X}(z)) \mathbb{1}_{\underline{X}(z) \geq -L},\end{aligned}$$

so that for L large this two variables are equal with high probability. Moreover, recall that, for $u \geq 0$, $R_L(u) = R(L + u)$ and

$$Z_n^{(L)} = \sum_{|z|=n} e^{-X(z)} R_L(X(z)) \mathbb{1}_{\underline{X}(z) \geq -L}$$

and that, using the martingale $(Z_n^{(L)})_{n \in \mathbb{N}}$, we defined the modified probability measure $\mathbb{Q}^{(L)}$. We will work under this measure to study the asymptotic behaviour of $\widetilde{W}_{\beta_n, n}(F)$.

Proposition 2.5.1. *For all $L > 0$ and $F \in \mathcal{C}_b^u(\mathcal{D}([0, 1]))$, we have the convergence*

$$\frac{n^{3\beta_n/2} \widetilde{W}_{\beta_n, n}^{(L)}(F)}{\alpha_n^2 Z_n^{(L)}} \xrightarrow{n \rightarrow \infty} \frac{\theta}{\sigma^2} \mathbb{E}[F(\mathbf{e})], \quad \text{in } \mathbb{Q}^{(L)\text{-probability.}}$$

This proposition will be proved in the following subsections, using a second moment argument similar to the one used by Aïdekon and Shi [AS14].

Proof of part (i) of Theorems 2.1.1 and 2.1.2. We consider $F \in \mathcal{C}_b^u(\mathcal{D}([0, 1]))$ and we are going to show here that

$$\frac{n^{3\beta_n/2} \widetilde{W}_{\beta_n, n}(F)}{\alpha_n^2} \xrightarrow{n \rightarrow \infty} \frac{c_R \theta}{\sigma^2} \mathbb{E}[F(\mathbf{e})] Z_\infty, \quad \text{in } \mathbb{P}^*\text{-probability.} \quad (2.46)$$

Using (2.22), it proves part (i) of Theorem 2.1.1 by taking $F \equiv 1$. Moreover, noting that $\mu_{\beta_n, n}(F) = \widetilde{W}_{\beta_n, n}(F) / \widetilde{W}_{\beta_n, n}(1)$ and $Z_\infty > 0$ \mathbb{P}^* -a.s., it proves part (i) of Theorem 2.1.2 in the case $F \in \mathcal{C}_b^u(\mathcal{D}([0, 1]))$. The general case follows by Lemma 2.A.1. Thus, it is now sufficient to prove (2.46) and we can for this purpose assume that F is nonnegative.

Let $\varepsilon, \eta > 0$. We first fix $L > 0$ such that $\mathbb{P}^*(\inf_{x \in \mathbb{T}} X(x) < -L) \leq \eta$. Combining that $\min_{|x|=n} X(x) \rightarrow \infty$ \mathbb{P}^* -a.s. as $n \rightarrow \infty$ and that $R_L(u) \sim c_R u$ as $u \rightarrow \infty$, we get that, on the event $\{\inf_{x \in \mathbb{T}} X(x) \geq -L\}$, $\lim_{n \rightarrow \infty} Z_n^{(L)} = c_R Z_\infty > 0$ \mathbb{P}^* -a.s. Thus, considering the event

$$\Omega_0 := S \cap \left\{ \inf_{x \in \mathbb{T}} X(x) \geq -L \right\} \cap \left\{ \forall n \geq n_0, 0 < c_R(1 - \varepsilon) Z_\infty \leq Z_n^{(L)} \leq c_R(1 + \varepsilon) Z_\infty \right\},$$

we can fix $n_0 \in \mathbb{N}$ such that $\mathbb{P}^*(\Omega_0) \geq 1 - 2\eta$. We now introduce the event

$$E_n := \left\{ \frac{n^{3\beta_n/2} \widetilde{W}_{\beta_n, n}(F)}{\alpha_n^2} \notin \left[\frac{c_R \theta}{\sigma^2} Z_\infty (\mathbb{E}[F(\mathbf{e})] - \varepsilon)(1 - \varepsilon), \frac{c_R \theta}{\sigma^2} Z_\infty (\mathbb{E}[F(\mathbf{e})] + \varepsilon)(1 + \varepsilon) \right] \right\}.$$

Then, using that on Ω_0 we have $\widetilde{W}_{\beta_n, n}^{(L)}(F) = \widetilde{W}_{\beta_n, n}(F)$, we get, for $n \geq n_0$,

$$\mathbb{E} \left[Z_n^{(L)} \mathbb{1}_{E_n \cap \Omega_0} \right] = \mathbb{Q}^{(L)}(E_n \cap \Omega_0) \leq \mathbb{Q}^{(L)} \left(\left| \frac{n^{3\beta_n/2} \widetilde{W}_{\beta_n, n}^{(L)}(F)}{\alpha_n^2 Z_n^{(L)}} - \frac{\theta}{\sigma^2} \mathbb{E}[F(\mathbf{e})] \right| > \frac{\theta \varepsilon}{\sigma^2} \right) \xrightarrow{n \rightarrow \infty} 0,$$

applying Proposition 2.5.1. Since $Z_n^{(L)} \mathbb{1}_{E_n \cap \Omega_0} \geq 0$, it follows that $Z_n^{(L)} \mathbb{1}_{E_n \cap \Omega_0} \rightarrow 0$ in \mathbb{P} -probability. Using again that, on Ω_0 , $\lim_{n \rightarrow \infty} Z_n^{(L)} = c_R Z_\infty > 0$ \mathbb{P}^* -a.s., we get that $\mathbb{P}^*(E_n \cap \Omega_0) \rightarrow 0$. Recalling that $\mathbb{P}^*(\Omega_0) \geq 1 - 2\eta$, we showed that $\limsup_{n \rightarrow \infty} \mathbb{P}^*(E_n) \leq 2\eta$ and, therefore, it proves (2.46). \square

2.5.2 Proof of Proposition 2.5.1 and of part (i) of Corollary 2.1.3

The aim of this section is to break down the proof of Proposition 2.5.1 into the proof of several lemmas. Our goal is to use a second moment argument, but the first moment of $\widetilde{W}_{\beta_n, n}^{(L)}(F)/Z_n^{(L)}$ under $\mathbb{Q}^{(L)}$ does not have the right order and the second moment is not even necessarily finite. Thus, we first need to come down to another random variable $Y_n'(F)$ that is close to $\widetilde{W}_{\beta_n, n}^{(L)}(F)$ with high probability and that has first and second moments of the right order, by eliminating some rare particles with a too strong weight in the expectations. The lemmas stated in this subsection will also allow us to prove part (i) of Corollary 2.1.3.

Until the end of the Section 2.5, L is a fixed positive constant. We first add a second barrier between times $\lfloor n/2 \rfloor$ and n at position $(3/2) \log n - K$, by setting, for $K > 0$,

$$\widetilde{W}_{\beta_n, n}^{(L, K)}(F) := \sum_{|z|=n} e^{-\beta_n X(z)} F(\mathbf{X}(z)) \mathbb{1}_{\underline{X}(z) \geq -L, \min_{\lfloor n/2 \rfloor \leq j \leq n} X(z_j) \geq \frac{3}{2} \log n - K}.$$

This first lemma shows that $\widetilde{W}_{\beta_n, n}^{(L)}(F)$ and $\widetilde{W}_{\beta_n, n}^{(L, K)}(F)$ are close with high probability and will be proved in Section 2.5.4. Note that this step is superfluous when $\log n \ll \alpha_n \ll \sqrt{n}$: since the particles contributing to $\widetilde{W}_{\beta_n, n}^{(L)}$ are of order α_n , it is approximately the same difficulty for them to stay above the two barriers than only above the first one (see Proposition 2.2.8) and, thus, $\widetilde{W}_{\beta_n, n}^{(L)}(F)$ and $\widetilde{W}_{\beta_n, n}^{(L, K)}(F)$ are asymptotically close in L^1 in that case.

Lemma 2.5.2. *For all $L > 0$ and $\varepsilon, \eta > 0$, there exists $K > 0$ such that, for each $F \in \mathcal{C}_b(\mathcal{D}([0, 1]))$,*

$$\limsup_{n \rightarrow \infty} \mathbb{Q}^{(L)} \left(\frac{n^{3\beta_n/2} \left| \widetilde{W}_{\beta_n, n}^{(L)}(F) - \widetilde{W}_{\beta_n, n}^{(L, K)}(F) \right|}{\alpha_n^2 Z_n^{(L)}} > \varepsilon \|F\| \right) \leq \eta.$$

We now consider a fixed $K > 0$. We will see in Lemma 2.5.4 that $\widetilde{W}_{\beta_n, n}^{(L, K)}(F)$ has the right first moment, but we still need to remove other particles for the second moment. Let $(\alpha_n^+)_{n \in \mathbb{N}}$ and $(\alpha_n^-)_{n \in \mathbb{N}}$ be sequences of positive real numbers and $(k_n)_{n \in \mathbb{N}}$ be a sequence of integers such that

$$\begin{aligned} 1 &\ll \alpha_n^- \ll \alpha_n \ll \alpha_n^+ \ll \sqrt{n}, \\ (\log n)^6 &\ll k_n \ll \sqrt{n}, \end{aligned}$$

when $n \rightarrow \infty$. We add some controls on the trajectory of the particle's lineage, by considering

$$Y_n(F) := \sum_{|z|=n} e^{-\beta_n X(z)} F(\mathbf{X}(z)) \mathbb{1}_{z \in A_n},$$

where we set $A_n := \{|z| = n : \forall j \in \llbracket 0, n \rrbracket, X(z_j) \in I_{n, j}\}$ (see Figure 2.1), with

$$I_{n, j} := \begin{cases} [-L, \infty) & \text{if } 0 \leq j < \lfloor n/2 \rfloor \text{ and } j \neq k_n, \\ [k_n^{1/3}, k_n] & \text{if } j = k_n, \\ [(3/2) \log n, \infty) & \text{if } \lfloor n/2 \rfloor \leq j \leq n, \\ [(3/2) \log n + \alpha_n^-, (3/2) \log n + \alpha_n^+] & \text{if } j = n. \end{cases}$$

Note that the second barrier is here simply at $(3/2) \log n$: indeed, Lemma 2.5.4 shows that it does not change the first moment (and we could even have taken $(3/2) \log n + C$ with any $C > 0$).

But, in order to compute the first moment of $Y_n(F)$, we will first need to take the conditional expectation given \mathcal{F}_{k_n} , hence we want to show that $F(\mathbf{X}(z))$ does not asymptotically

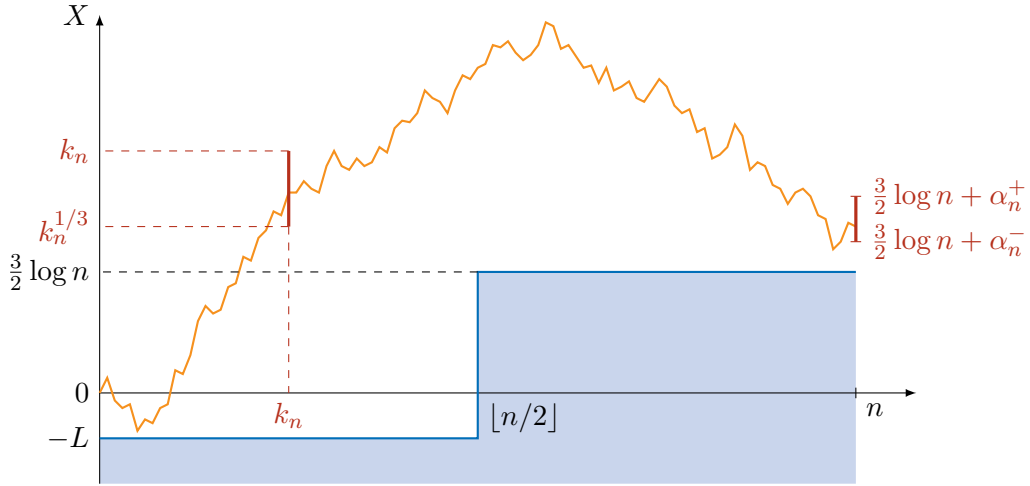

Figure 2.1 – Representation of the trajectory of a particle in A_n . It has to stay above the blue area and to pass through both thick red segments.

depend on what happen before time k_n . For this, we consider for each $n \in \mathbb{N}^*$ a slight modification F_n of function F such that

$$F_n(\mathbf{X}(z)) := F\left(\frac{X(z_{\lfloor(n-k_n)t\rfloor+k_n}) - X(z_{k_n})}{\sigma\sqrt{n-k_n}}, t \in [0, 1]\right).$$

More formally, we set, for each $x \in \mathcal{D}([0, 1])$, $F_n(x) := F([\sqrt{n}/\sqrt{n-k_n}] \cdot [x_{((n-k_n)t+k_n)/n} - x_{k_n/n}], t \in [0, 1])$. The following lemma, proved in Section 2.5.5, shows that we can replace F with F_n . It does not play a crucial role, but makes the calculations easier for the next lemmas.

Lemma 2.5.3. *For all $L, K > 0$ and $F \in \mathcal{C}_b^u(\mathcal{D}([0, 1]))$, we have*

$$\mathbb{E}_{\mathbb{Q}^{(L)}} \left[\frac{\widetilde{W}_{\beta_n, n}^{(L, K)}(|F - F_n|)}{Z_n^{(L)}} \right] = o\left(\frac{\alpha_n^2}{n^{3\beta_n/2}}\right),$$

as $n \rightarrow \infty$.

Noting that, for F nonnegative, $Y_n(F) \leq \widetilde{W}_{\beta_n, n}^{(L, K)}(F)$, Lemma 2.5.3 combined with the following lemma shows that the first moments under $\mathbb{Q}^{(L)}$ of $\widetilde{W}_{\beta_n, n}^{(L, K)}(F)$, $\widetilde{W}_{\beta_n, n}^{(L, K)}(F_n)$, $Y_n(F)$ and $Y_n(F_n)$ (divided by $Z_n^{(L)}$) are asymptotically equivalent as $n \rightarrow \infty$. This will be proved in Section 2.5.3.

Lemma 2.5.4. *For all $L, K > 0$ and $F \in \mathcal{C}_b(\mathcal{D}([0, 1]))$ nonnegative, we have*

$$\limsup_{n \rightarrow \infty} \frac{n^{3\beta_n/2}}{\alpha_n^2} \mathbb{E}_{\mathbb{Q}^{(L)}} \left[\frac{\widetilde{W}_{\beta_n, n}^{(L, K)}(F)}{Z_n^{(L)}} \right] \leq \frac{\theta}{\sigma^2} \mathbb{E}[F(\epsilon)] \leq \liminf_{n \rightarrow \infty} \frac{n^{3\beta_n/2}}{\alpha_n^2} \mathbb{E}_{\mathbb{Q}^{(L)}} \left[\frac{Y_n(F_n)}{Z_n^{(L)}} \right].$$

However, this is still not sufficient for controlling the second moment of $Y_n(F)$ and we need to introduce a new random variable $Y_n'(F)$. We consider the sequences

$$a_j^{(n)} := \begin{cases} -L & \text{if } 0 \leq j < \lfloor n/2 \rfloor, \\ \frac{3}{2} \log n & \text{if } \lfloor n/2 \rfloor \leq j \leq n, \end{cases} \quad \text{and} \quad \ell_j^{(n)} := \begin{cases} j^{1/7} & \text{if } 0 \leq j < \lfloor n/2 \rfloor, \\ (n-j)^{1/7} & \text{if } \lfloor n/2 \rfloor \leq j \leq n. \end{cases}$$

Then, for some fixed sequence $(\varrho_n)_{n \in \mathbb{N}}$ that tends to infinity such that $\varrho_n \ll \alpha_n^2$, we define the following set, that will allow us to control the offspring of the spine in the second moment calculation (see Aïdékon [Aïd13] for the first use of this method),

$$B_n := \left\{ |z| = n : \forall j \in \llbracket 0, n-1 \rrbracket, \sum_{y \in \Omega(z_{j+1})} e^{-[X(y) - a_j^{(n)}]} \leq \varrho_n e^{-\ell_j^{(n)}} \right\},$$

where $\Omega(x)$ is the set of brothers of x , and we set

$$Y'_n(F) := \sum_{|z|=n} e^{-\beta_n X(z)} F_n(\mathbf{X}(z)) \mathbb{1}_{z \in A_n \cap B_n}.$$

The following lemma shows that this new random variable $Y'_n(F)$ is close to $Y_n(F)$. Its proof relies on the peeling lemma stated in Section 2.5.6 in a more general feature.

Lemma 2.5.5. *For all $L, K > 0$ and $F \in \mathcal{C}_b(\mathcal{D}([0, 1]))$, we have*

$$\mathbb{E}_{\mathbb{Q}^{(L)}} \left[\frac{|Y_n(F_n) - Y'_n(F_n)|}{Z_n^{(L)}} \right] = o\left(\frac{\alpha_n^2}{n^{3\beta_n/2}}\right),$$

as $n \rightarrow \infty$.

By considering $Y'_n(F_n)$, we can now control the second moment properly, as stated in this last lemma, proved in Section 2.5.7. This second moment is exactly the square of the first moment in Lemma 2.5.4.

Lemma 2.5.6. *For all $L, K > 0$ and $F \in \mathcal{C}_b(\mathcal{D}([0, 1]))$ nonnegative, we have*

$$\limsup_{n \rightarrow \infty} \left(\frac{n^{3\beta_n/2}}{\alpha_n^2} \right)^2 \mathbb{E}_{\mathbb{Q}^{(L)}} \left[\left(\frac{Y'_n(F_n)}{Z_n^{(L)}} \right)^2 \right] \leq \left(\frac{\theta}{\sigma^2} \mathbb{E}[F(\mathfrak{e})] \right)^2.$$

Using these lemmas, we can now prove Proposition 2.5.1.

Proof of Proposition 2.5.1. We consider here the case $F \geq 0$ and the general case follows by taking the positive and negative parts of F . We first fix $K > 0$. Using Lemmas 2.5.4 et 2.5.5, we have

$$\liminf_{n \rightarrow \infty} \frac{n^{3\beta_n/2}}{\alpha_n^2} \mathbb{E}_{\mathbb{Q}^{(L)}} \left[\frac{Y'_n(F_n)}{Z_n^{(L)}} \right] \geq \frac{\theta}{\sigma^2} \mathbb{E}[F(\mathfrak{e})], \quad (2.47)$$

and so, by applying Bienaymé-Chebyshev inequality and Lemma 2.5.6, we get that

$$\frac{n^{3\beta_n/2}}{\alpha_n^2} \frac{Y'_n(F_n)}{Z_n^{(L)}} \xrightarrow[n \rightarrow \infty]{} \frac{\theta}{\sigma^2} \mathbb{E}[F(\mathfrak{e})], \quad \text{in } \mathbb{Q}^{(L)\text{-probability.}} \quad (2.48)$$

Combining (2.48) with Lemmas 2.5.4, 2.5.3 and 2.5.5, we deduce that for all $K > 0$,

$$\frac{n^{3\beta_n/2}}{\alpha_n^2} \frac{\widetilde{W}_{\beta_n, n}^{(L, K)}(F)}{Z_n^{(L)}} \xrightarrow[n \rightarrow \infty]{} \frac{\theta}{\sigma^2} \mathbb{E}[F(\mathfrak{e})], \quad \text{in } \mathbb{Q}^{(L)\text{-probability.}} \quad (2.49)$$

Now, for $\varepsilon, \eta > 0$, by Lemma 2.5.2, we can choose $K > 0$ such that

$$\limsup_{n \rightarrow \infty} \mathbb{Q}^{(L)} \left(\frac{n^{3\beta_n/2}}{\alpha_n^2} \frac{|\widetilde{W}_{\beta_n, n}^{(L)}(F) - \widetilde{W}_{\beta_n, n}^{(L, K)}(F)|}{Z_n^{(L)}} > \frac{\varepsilon}{2} \right) \leq \eta \quad (2.50)$$

and, thus, we get, using the triangle inequality, (2.49) and (2.50),

$$\limsup_{n \rightarrow \infty} \mathbb{Q}^{(L)} \left(\left| \frac{n^{3\beta_n/2} \widetilde{W}_{\beta_n, n}^{(L)}(F)}{\alpha_n^2 Z_n^{(L)}} - \frac{\theta}{\sigma^2} \mathbb{E}[F(\mathbf{e})] \right| > \varepsilon \right) \leq \eta.$$

This concludes the proof of Proposition 2.5.1. \square

We conclude this subsection by proving part (i) of Corollary 2.1.3, which is a consequence of the fact that considering only particles in A_n does not change the first moment asymptotic.

Proof of part (i) of Corollary 2.1.3. First note that it is sufficient to prove that, for all sequences $(\alpha_n^-)_{n \in \mathbb{N}}$ and $(\alpha_n^+)_{n \in \mathbb{N}}$ such that $1 \ll \alpha_n^- \ll \alpha_n \ll \alpha_n^+ \ll \sqrt{n}$, we have

$$\mathcal{G}_{\beta_n, n} \left(\left[(3/2) \log n + \alpha_n^-, (3/2) \log n + \alpha_n^+ \right] \right) \xrightarrow[n \rightarrow \infty]{} 1, \quad \text{in } \mathbb{P}^* \text{-probability.} \quad (2.51)$$

Indeed, if we assume that part (i) of Corollary 2.1.3 is false, then there exists $\varepsilon > 0$ such that for any $k \geq 1$, there exists $n_k > n_{k-1}$ (with $n_0 := 0$) such that

$$\mathbb{P}^* \left(\mathcal{G}_{\beta_{n_k}, n_k} \left(\left[(3/2) \log n_k + k^{-1} \alpha_{n_k}, (3/2) \log n_k + k \alpha_{n_k} \right] \right) \leq 1 - \varepsilon \right) \geq 1 - \varepsilon. \quad (2.52)$$

Setting $e_n := \inf\{k \in \mathbb{N} : n_k \geq n\}$, we have $e_n \rightarrow \infty$ and $e_{n_k} = k$. Thus, with $\alpha_n^+ := e_n \alpha_n$ and $\alpha_n^- := e_n^{-1} \alpha_n$, (2.52) implies the negation of (2.51). Therefore, we now want to prove (2.51).

The left-hand side of (2.51) is larger than $Y_n(1)/\widetilde{W}_{\beta_n, n}$, therefore, it is sufficient to show that $Y_n(1)/\widetilde{W}_{\beta_n, n} \rightarrow 1$ in \mathbb{P}^* -probability. Combining (2.48) with Lemma 2.5.5, we first have

$$\frac{n^{3\beta_n/2} Y_n(1)}{\alpha_n^2 Z_n^{(L)}} \xrightarrow[n \rightarrow \infty]{} \frac{\theta}{\sigma^2}, \quad \text{in } \mathbb{Q}^{(L)} \text{-probability,} \quad (2.53)$$

and, in the same way as in the proof of part (i) of Theorems 2.1.1 and 2.1.2, where we showed (2.46) from Proposition 2.5.1, it follows from (2.53) that

$$\frac{n^{3\beta_n/2} Y_n(1)}{\alpha_n^2 Z_n} \xrightarrow[n \rightarrow \infty]{} \frac{c_R \theta}{\sigma^2}, \quad \text{in } \mathbb{P}^* \text{-probability.} \quad (2.54)$$

Using (2.54) and (2.46) with $F \equiv 1$, we get that $Y_n(1)/\widetilde{W}_{\beta_n, n} \rightarrow 1$ in \mathbb{P}^* -probability and so (2.51) is proved. \square

2.5.3 First moments of $\widetilde{W}_{\beta_n, n}^{(L, K)}(F)$ and $Y_n(F_n)$

We start with the proof of Lemma 2.5.4 in this subsection, because this first moment calculation will be a kind of routine at which we will refer for the proof of other lemmas. In this calculations, sums of general term $(i + C)e^{-i/\gamma_n}$ appear regularly, with $C \in \mathbb{R}$ a constant and $\gamma_n \rightarrow \infty$ as $n \rightarrow \infty$. Therefore, we state the following result, proved by straightforward computations: if $(\gamma_n^+)_{n \in \mathbb{N}}$ and $(\gamma_n^-)_{n \in \mathbb{N}}$ are sequences with values in $\mathbb{R}_+ \cup \{\infty\}$ such that $\gamma_n^- \ll \gamma_n \ll \gamma_n^+$ as $n \rightarrow \infty$, then we have, for any constant $C \in \mathbb{R}$,

$$\sum_{i \in [\gamma_n^-, \gamma_n^+] \cap \mathbb{N}} (i + C)e^{-i/\gamma_n} \underset{n \rightarrow \infty}{\sim} \gamma_n^2 \quad \text{and} \quad \sum_{i \notin [\gamma_n^-, \gamma_n^+] \cap \mathbb{N}} (i + C)e^{-i/\gamma_n} = o(\gamma_n^2). \quad (2.55)$$

Proof of Lemma 2.5.4. Recall that we consider $F \in \mathcal{C}_b(\mathcal{D}([0, 1]))$ nonnegative. We begin with the control of $\mathbb{E}_{\mathbb{Q}(L)}[\widetilde{W}_{\beta_n, n}^{(L, K)}(F)/Z_n^{(L)}] = \mathbb{E}[\widetilde{W}_{\beta_n, n}^{(L, K)}(F)]/R(L)$. Using the many-to-one lemma, we get

$$\mathbb{E}[\widetilde{W}_{\beta_n, n}^{(L, K)}(F)] = \mathbb{E}\left[e^{-S_n/\alpha_n} F(\mathbf{S}^{(n)}) \mathbb{1}_{\underline{S}_n \geq -L, \min_{\lfloor n/2 \rfloor \leq j \leq n} X(z_j) \geq \frac{3}{2} \log n - K}\right].$$

We cut this expectation in two pieces depending on whether $S_n \leq \frac{3}{2} \log n + \alpha_n^+$ or $S_n > \frac{3}{2} \log n + \alpha_n^+$. Let start with the case $S_n > \frac{3}{2} \log n + \alpha_n^+$: we have, by cutting the interval $[\alpha_n^+ + K, \infty)$ in pieces of length 1,

$$\begin{aligned} & \mathbb{E}\left[e^{-S_n/\alpha_n} F(\mathbf{S}^{(n)}) \mathbb{1}_{\underline{S}_n \geq -L, \min_{\lfloor n/2 \rfloor \leq j \leq n} S_j \geq \frac{3}{2} \log n - K, S_n > \frac{3}{2} \log n + \alpha_n^+}\right] \\ & \leq \sum_{i \geq \lfloor \alpha_n^+ + K \rfloor} \mathbb{E}\left[e^{-(\frac{3}{2} \log n - K + i)/\alpha_n} \|F\| \mathbb{1}_{\underline{S}_n \geq -L, \min_{\lfloor n/2 \rfloor \leq j \leq n} S_j \geq \frac{3}{2} \log n - K, S_n - (\frac{3}{2} \log n - K) \in [i, i+1)}\right] \\ & \leq \|F\| \frac{e^{K/\alpha_n}}{n^{3/2\alpha_n}} \sum_{i \geq \lfloor \alpha_n^+ + K \rfloor} e^{-i/\alpha_n} C \frac{(L+1)2(i+2)}{n^{3/2}}, \end{aligned} \quad (2.56)$$

by using (2.25). Since $\lfloor \alpha_n^+ + K \rfloor \gg \alpha_n$, it follows from (2.55) that the right-hand side of (2.56) is a $o(\alpha_n^2/n^{3\beta_n/2})$. We now control the term corresponding to the case $S_n \leq \frac{3}{2} \log n + \alpha_n^+$, which is the dominant term in $\mathbb{E}[\widetilde{W}_{\beta_n, n}^{(L, K)}(F)]$. This time, we cut the segment $[0, \alpha_n^+ + K]$ in pieces of length $h > 0$, where h is any real number if S_1 is nonlattice and is the span of the lattice if S_1 is lattice, and thus we get

$$\begin{aligned} & \mathbb{E}\left[e^{-S_n/\alpha_n} F(\mathbf{S}^{(n)}) \mathbb{1}_{\underline{S}_n \geq -L, \min_{\lfloor n/2 \rfloor \leq j \leq n} S_j \geq \frac{3}{2} \log n - K, S_n \leq \frac{3}{2} \log n + \alpha_n^+}\right] \\ & \leq \sum_{i=0}^{\lceil (\alpha_n^+ + K)/h \rceil - 1} \frac{e^{(K-ih)/\alpha_n}}{n^{3/2\alpha_n}} \mathbb{E}\left[F(\mathbf{S}^{(n)}) \mathbb{1}_{\underline{S}_n \geq -L, \min_{\lfloor n/2 \rfloor \leq j \leq n} S_j \geq \frac{3}{2} \log n - K, S_n - (\frac{3}{2} \log n - K) \in [ih, (i+1)h)}\right] \\ & \leq \sum_{i=0}^{\lceil (\alpha_n^+ + K)/h \rceil - 1} \frac{e^{-ih/\alpha_n}}{n^{3/2\alpha_n}} \sqrt{\frac{\pi}{2}} \frac{\theta \theta^-}{\sigma} \frac{R(L)}{n^{3/2}} (\mathbb{E}[F(\mathbf{e})] + o(1)) h R^-((i+1)h), \end{aligned} \quad (2.57)$$

by using Proposition 2.2.8 in both lattice and nonlattice cases, with uniformity in i because $h(\lceil (\alpha_n^+ + K)/h \rceil - 1) \ll \sqrt{n}$. Then, by applying (2.18) to R^- , for $\varepsilon > 0$, there exists $M > 0$ such that, for all $u \geq 0$, $R^-(u) \leq c_R^-(1 + \varepsilon)(M + u)$ and thus we get

$$\begin{aligned} & \sum_{i=0}^{\lceil (\alpha_n^+ + K)/h \rceil - 1} R^-((i+1)h) e^{-ih/\alpha_n} \leq \sum_{i=0}^{\infty} c_R^-(1 + \varepsilon) \left(i + 1 + \frac{M}{h}\right) h e^{-ih/\alpha_n} \\ & = (1 + o(1)) c_R^-(1 + \varepsilon) h \left(\frac{\alpha_n}{h}\right)^2, \end{aligned} \quad (2.58)$$

by applying (2.55). Coming back to (2.57), we get

$$\begin{aligned} & \limsup_{n \rightarrow \infty} \frac{n^{3\beta_n/2}}{\alpha_n^2} \mathbb{E}\left[e^{-S_n/\alpha_n} F(\mathbf{S}^{(n)}) \mathbb{1}_{\underline{S}_n \geq -L, \min_{\lfloor n/2 \rfloor \leq j \leq n} S_j \geq \frac{3}{2} \log n - K, S_n \leq \frac{3}{2} \log n + \alpha_n^+}\right] \\ & \leq \sqrt{\frac{\pi}{2}} \frac{\theta \theta^-}{\sigma} R(L) \mathbb{E}[F(\mathbf{e})] h \frac{c_R^-(1 + \varepsilon)}{h} \xrightarrow{\varepsilon \rightarrow 0} \frac{\theta}{\sigma^2} R(L) \mathbb{E}[F(\mathbf{e})], \end{aligned} \quad (2.59)$$

by applying (2.22) to constants c_R^- and θ^- . Combining (2.56) and (2.59), we conclude that

$$\mathbb{E}_{\mathbb{Q}(L)} \left[\frac{\widetilde{W}_{\beta_n, n}^{(L, K)}}{Z_n^{(L)}} \right] = \frac{1}{R(L)} \mathbb{E}[\widetilde{W}_{\beta_n, n}^{(L, K)}] \leq \frac{\theta}{\sigma^2} \frac{\alpha_n^2}{n^{3\beta_n/2}} (\mathbb{E}[F(\mathbf{e})] + o(1)),$$

and it shows the first part of Lemma 2.5.4.

We now want to prove the lower bound for $\mathbb{E}_{\mathbb{Q}(L)}[Y_n(F_n)/Z_n^{(L)}] = \mathbb{E}[Y_n(F_n)]/R(L)$. We use the branching property at time k_n to get

$$\mathbb{E}[Y_n(F_n)] = \mathbb{E}\left[\sum_{|x|=k_n} \mathbb{1}_{\underline{X}(x) \geq -L, X(x) \in [k_n^{1/3}, k_n]} \psi(X(x))\right], \quad (2.60)$$

where we set, for all $b \in [k_n^{1/3}, k_n]$,

$$\psi(b) := \mathbb{E}_b\left[\sum_{|z|=n-k_n} e^{-\beta_n X(z)} F\left(\mathbf{X}(z) - \frac{b}{\sigma\sqrt{n-k_n}}\right) \mathbb{1}_{\forall 0 \leq i \leq n-k_n, X(z_i) \in I_{n, i+k_n}}\right].$$

We note $m := n - k_n$ and fix $\lambda \in (0, 1/2)$, then we have $\lfloor \lambda m \rfloor \leq \lfloor n/2 \rfloor - k_n$ for n large enough because $k_n \ll n$. Using the many-to-one lemma, we get, for $b \in [k_n^{1/3}, k_n]$,

$$\begin{aligned} \psi(b) &\geq e^{-b} \mathbb{E}_b\left[e^{-S_m/\alpha_n} F\left(\mathbf{S}^{(m)} - \frac{b}{\sigma\sqrt{m}}\right) \mathbb{1}_{S_m - \frac{3}{2} \log n \in [\alpha_n^-, \alpha_n^+], \underline{S}_m \geq -L, \min_{\lfloor \lambda m \rfloor \leq j \leq m} S_j \geq \frac{3}{2} \log n}\right] \\ &= e^{-b} \mathbb{E}\left[e^{-(S_m+b)/\alpha_n} F(\mathbf{S}^{(m)}) \mathbb{1}_{S_m - (\frac{3}{2} \log n - b) \in [\alpha_n^-, \alpha_n^+], \underline{S}_m \geq -(L+b), \min_{\lfloor \lambda m \rfloor \leq j \leq m} S_j \geq \frac{3}{2} \log n - b}\right]. \end{aligned}$$

Then, we cut the segment $[\alpha_n^-, \alpha_n^+]$ in pieces of length $h > 0$, where h is any real number if S_1 is nonlattice and is the span of the lattice if S_1 is lattice, and we get that $\psi(b)$ is larger than

$$\begin{aligned} &e^{-b} \sum_{i=\lceil \alpha_n^-/h \rceil}^{\lfloor \alpha_n^+/h \rfloor - 1} \frac{e^{-(i+1)h/\alpha_n}}{n^{3/2}\alpha_n} \mathbb{E}\left[F(\mathbf{S}^{(m)}) \mathbb{1}_{S_m - (\frac{3}{2} \log n - b) \in [ih, (i+1)h], \underline{S}_m \geq -(L+b), \min_{\lfloor \lambda m \rfloor \leq j \leq m} S_j \geq \frac{3}{2} \log n - b}\right] \\ &\geq \frac{e^{-b}}{n^{3/2}\alpha_n} \sum_{i=\lceil \alpha_n^-/h \rceil}^{\lfloor \alpha_n^+/h \rfloor - 1} e^{-(i+1)h/\alpha_n} \sqrt{\frac{\pi}{2}} \frac{\theta\theta^-}{\sigma} \frac{R(L+b)}{m^{3/2}} (\mathbb{E}[F(\mathbf{e})] + o(1)) h R^-(ih), \end{aligned}$$

where the $o(1)$ is uniform in $b \in [k_n^{1/3}, k_n]$ and $i \in \llbracket \lceil \alpha_n^-/h \rceil, \lfloor \alpha_n^+/h \rfloor - 1 \rrbracket$, by using Proposition 2.2.8, because we have $L + k_n \ll \sqrt{n}$ and $h(\lfloor \alpha_n^+/h \rfloor - 1) \ll \sqrt{n}$. Thus, we get, using that $R(L+b) \sim c_R(L+b)$ and $R^-(ih) \sim c_R^- ih$ uniformly in b and i ,

$$\begin{aligned} \psi(b) &\geq \frac{e^{-b}}{n^{3/2}\alpha_n} \sqrt{\frac{\pi}{2}} \frac{\theta\theta^-}{\sigma} \frac{c_R(L+b)}{n^{3/2}} h (\mathbb{E}[F(\mathbf{e})] + o(1)) \sum_{i=\lceil \alpha_n^-/h \rceil}^{\lfloor \alpha_n^+/h \rfloor - 1} e^{-(i+1)h/\alpha_n} c_R^- ih \\ &= (L+b) e^{-b} \sqrt{\frac{2}{\pi}} \frac{1}{\sigma^3} \frac{\alpha_n^2}{n^{3\beta_n/2}} (\mathbb{E}[F(\mathbf{e})] + o(1)), \end{aligned}$$

uniformly in $b \in [k_n^{1/3}, k_n]$, where we used (2.22) twice and also (2.55). Coming back to (2.60), we get that $\mathbb{E}[Y_n(F_n)]$ is larger than

$$\sqrt{\frac{2}{\pi}} \frac{1}{\sigma^3} \frac{\alpha_n^2}{n^{3\beta_n/2}} (\mathbb{E}[F(\mathbf{e})] + o(1)) \mathbb{E}\left[\sum_{|x|=k_n} \mathbb{1}_{\underline{X}(x) \geq -L, X(x) \in [k_n^{1/3}, k_n]} (L + X(x)) e^{-X(x)}\right]. \quad (2.61)$$

Using the many-to-one lemma, the expectation in (2.61) is equal to

$$\mathbb{E}\left[(S_{k_n} + L) \mathbb{1}_{\underline{S}_{k_n} \geq -L, S_{k_n} \in [k_n^{1/3}, k_n]}\right] \geq \mathbb{E}\left[(S_{k_n} + L) \mathbb{1}_{\underline{S}_{k_n} \geq -L, (S_{k_n} + L)/\sigma k_n^{1/2} \in [D^{-1}, D]}\right], \quad (2.62)$$

for all $D > 0$. We then choose a function $\chi: \mathbb{R}_+ \rightarrow \mathbb{R}$ continuous and bounded such that, for all $t \in \mathbb{R}_+$,

$$t \mathbb{1}_{t \in [2D-1, D/2]} \leq \chi(t) \leq t \mathbb{1}_{t \in [D-1, D]},$$

and (2.62) is larger than

$$\begin{aligned} \sigma k_n^{1/2} \mathbb{E} \left[\chi \left(\frac{S_{k_n} + L}{\sigma k_n^{1/2}} \right) \mathbb{1}_{S_{k_n} \geq -L} \right] &= \sigma k_n^{1/2} (1 + o(1)) \frac{\theta R(L)}{k_n^{1/2}} \int_0^\infty \chi(t) t e^{-t^2/2} dt \\ &\geq \sigma \theta R(L) (1 + o(1)) \int_{2D-1}^{D/2} t^2 e^{-t^2/2} dt, \end{aligned}$$

by applying (2.23). Coming back to (2.61), we get

$$\liminf_{n \rightarrow \infty} \frac{n^{3\beta_n/2}}{\alpha_n^2} \mathbb{E}[Y_n(F_n)] \geq \sqrt{\frac{2}{\pi}} \frac{1}{\sigma^3} \mathbb{E}[F(\epsilon)] \sigma \theta R(L) \int_{2D-1}^{D/2} t^2 e^{-t^2/2} dt \xrightarrow{D \rightarrow \infty} \frac{\theta}{\sigma^2} R(L) \mathbb{E}[F(\epsilon)],$$

using that $\int_0^\infty t^2 e^{-t^2/2} dt = \sqrt{\frac{\pi}{2}}$. Since $\mathbb{E}_{\mathbb{Q}^{(L)}}[Y_n(F_n)/Z_n^{(L)}] = \mathbb{E}[Y_n(F_n)]/R(L)$, it concludes the proof of Lemma 2.5.4. \square

2.5.4 Addition of the second barrier

In this section, we prove Lemma 2.5.2 with a method similar to the one used by Madaule [Mad15] for his Lemma 4.9 (or Lemma 3.3 of Aïdékon [Aïd13]). The main difference is that we do not only consider particles that are at a distance of order 1 from $(3/2) \log n$, but we can nevertheless apply some of Madaule's results.

Proof of Lemma 2.5.2. We fix $L > 0$ and $\varepsilon, \eta > 0$. For all $F \in \mathcal{C}_b(\mathcal{D}([0, 1]))$ and $K > 0$, we have $|\widetilde{W}_{\beta_n, n}^{(L)}(F) - \widetilde{W}_{\beta_n, n}^{(L, K)}(F)| \leq 2\|F\| |\widetilde{W}_{\beta_n, n}^{(L)} - \widetilde{W}_{\beta_n, n}^{(L, K)}|$, where $\widetilde{W}_{\beta_n, n}^{(L)} := \widetilde{W}_{\beta_n, n}^{(L)}(1)$ and $\widetilde{W}_{\beta_n, n}^{(L, K)} := \widetilde{W}_{\beta_n, n}^{(L, K)}(1)$. Therefore, it is sufficient to show that we have

$$\limsup_{n \rightarrow \infty} \mathbb{Q}^{(L)} \left(\frac{n^{3\beta_n/2}}{\alpha_n^2} \frac{|\widetilde{W}_{\beta_n, n}^{(L)} - \widetilde{W}_{\beta_n, n}^{(L, K)}|}{Z_n^{(L)}} > \varepsilon \right) \leq \eta, \quad (2.63)$$

for $K > 0$ large enough.

Using Proposition A.3 of Aïdékon [Aïd13], we know that $Z_n^{(L)}$ converges in L^1 to $Z_\infty^{(L)}$ under \mathbb{P} , so we can choose $M > 0$ large enough such that, for all $n \in \mathbb{N}$, $\mathbb{Q}^{(L)}(Z_n^{(L)} > M) = \mathbb{E}[Z_n^{(L)} \mathbb{1}_{Z_n^{(L)} > M}] / R(L) \leq \eta/4$. Therefore, the probability in (2.63) is smaller than

$$\begin{aligned} &\mathbb{Q}^{(L)} \left(n^{3\beta_n/2} |\widetilde{W}_{\beta_n, n}^{(L)} - \widetilde{W}_{\beta_n, n}^{(L, K)}| > \varepsilon \alpha_n^2 Z_n^{(L)}, \frac{\eta}{4} \leq Z_n^{(L)} \leq M \right) + \frac{\eta}{4} + \mathbb{Q}^{(L)} \left(Z_n^{(L)} < \frac{\eta}{4} \right) \\ &= \mathbb{E} \left[Z_n^{(L)} \mathbb{1}_{n^{3\beta_n/2} |\widetilde{W}_{\beta_n, n}^{(L)} - \widetilde{W}_{\beta_n, n}^{(L, K)}| > \varepsilon \alpha_n^2 Z_n^{(L)}, \frac{\eta}{4} \leq Z_n^{(L)} \leq M} \right] + \frac{\eta}{4} + \frac{1}{R(L)} \mathbb{E} \left[Z_n^{(L)} \mathbb{1}_{Z_n^{(L)} < \frac{\eta}{4}} \right] \\ &\leq M \mathbb{P} \left(n^{3\beta_n/2} |\widetilde{W}_{\beta_n, n}^{(L)} - \widetilde{W}_{\beta_n, n}^{(L, K)}| > \varepsilon \alpha_n^2 \frac{\eta}{4} \right) + \frac{\eta}{4} + \frac{\eta}{4}, \end{aligned}$$

because $R(L) \geq 1$. Thus, we now want to prove that, for some $K > 0$ large enough, we have

$$\limsup_{n \rightarrow \infty} \mathbb{P} \left(n^{3\beta_n/2} |\widetilde{W}_{\beta_n, n}^{(L)} - \widetilde{W}_{\beta_n, n}^{(L, K)}| > \varepsilon' \alpha_n^2 \right) \leq 2\eta',$$

with $\eta' := \eta/4M$ and $\varepsilon' := \varepsilon\eta/4$. Moreover, using (2.8), we can fix $K' \geq 0$ such that $\mathbb{P}(\min_{|z|=n} X(z) < \frac{3}{2} \log n - K') \leq \eta'$. Thus, our aim is now to show that we have

$$\limsup_{n \rightarrow \infty} \mathbb{P} \left(\left| \widetilde{W}_{\beta_n, n}^{(L)} - \widetilde{W}_{\beta_n, n}^{(L, K)} \right| \mathbb{1}_{\min_{|z|=n} X(z) \geq \frac{3}{2} \log n - K'} > \varepsilon' \frac{\alpha_n^2}{n^{3\beta_n/2}} \right) \leq \eta', \quad (2.64)$$

for some $K \geq K'$ large enough.

Now, following Madaule's [Mad15] proof of his Lemma 4.9, we introduce the intervals $J_n(x) := [\frac{3}{2} \log n - x - 1, \frac{3}{2} \log n - x)$, for $x \in \mathbb{R}$, and the events, for $i, \ell \in \mathbb{N}$ and $\lfloor n/2 \rfloor \leq k \leq n$,

$$E_{i, k, \ell}(z) := \left\{ \underline{X}(z) \geq -L, X(z_k) = \min_{\lfloor n/2 \rfloor \leq j \leq n} X(z_j) \in J_n(K) - \ell, X(z) \in J_n(K') + i \right\},$$

and, denoting $a_\ell := \lfloor e^{\nu(\ell+K)} \rfloor$ for some fixed $\nu \in (0, 1)$,

$$F_\ell^1(z) := \bigcup_{i \geq 1, \lfloor n/2 \rfloor \leq k < n - a_\ell} E_{i, k, \ell}(z) \quad \text{and} \quad F_\ell^2(z) := \bigcup_{i \geq 1, n - a_\ell \leq k \leq n} E_{i, k, \ell}(z).$$

Then, we have

$$\left| \widetilde{W}_{\beta_n, n}^{(L)} - \widetilde{W}_{\beta_n, n}^{(L, K)} \right| \mathbb{1}_{\min_{|z|=n} X(z) \geq \frac{3}{2} \log n - K'} \leq \sum_{\ell \geq 0} \sum_{|z|=n} e^{-\beta_n X(z)} \left(\mathbb{1}_{F_\ell^1(z)} + \mathbb{1}_{F_\ell^2(z)} \right). \quad (2.65)$$

On the one hand, by Madaule's [Mad15] proof of his Lemma 4.9, we have the inequality

$$\mathbb{P} \left(\sum_{|z|=n} \mathbb{1}_{F_\ell^2(z)} \geq 1 \right) \leq C(1 + a_\ell)(1 + L)e^{-K - \ell}$$

and, therefore,

$$\mathbb{P} \left(\sum_{\ell \geq 0} \sum_{|z|=n} e^{-\beta_n X(z)} \mathbb{1}_{F_\ell^2(z)} > 0 \right) \leq \sum_{\ell \geq 0} \mathbb{P} \left(\sum_{|z|=n} \mathbb{1}_{F_\ell^2(z)} \geq 1 \right) \leq C(1 + L)e^{-(1-\nu)K}. \quad (2.66)$$

On the other hand, by using the many-to-one lemma, we get, for $i \geq 1$, $\lfloor n/2 \rfloor \leq k < n - a_\ell$ and $\ell \geq 0$,

$$\mathbb{E} \left[\sum_{|z|=n} e^{-\beta_n X(z)} \mathbb{1}_{E_{i, k, \ell}(z)} \right] = \mathbb{E} \left[e^{-S_n/\alpha_n} \mathbb{1}_{E_{i, k, \ell}} \right] \leq \frac{e^{-(i-1-K')/\alpha_n}}{n^{3/2\alpha_n}} \mathbb{P}(E_{i, k, \ell}), \quad (2.67)$$

where we set

$$E_{i, k, \ell} := \left\{ \underline{S}_n \geq -L, S_k = \min_{\lfloor n/2 \rfloor \leq j \leq n} S_j \in J_n(K) - \ell, S_n \in J_n(K') + i \right\}.$$

We recall Equation (4.27) of Madaule [Mad15]:

$$\mathbb{P}(E_{i, k, \ell}) \leq \begin{cases} C \frac{(1+L) \log n}{n^{3/2} (n-k+1)^{3/2}} (1 + \ell + i) & \text{if } \lfloor n/2 \rfloor \leq k < \lfloor 3n/4 \rfloor, \\ C \frac{(1+L)}{n^{3/2} (n-k+1)^{3/2}} (1 + \ell + i) & \text{if } \lfloor 3n/4 \rfloor \leq k \leq n. \end{cases} \quad (2.68)$$

Applying (2.68), we get

$$\sum_{k=\lfloor n/2 \rfloor}^{n-a_\ell-1} \mathbb{P}(E_{i, k, \ell}) \leq C \frac{(1+L)}{n^{3/2}} (1 + \ell + i) \left(\frac{\log n}{\sqrt{n}} + a_\ell^{-1/2} \right). \quad (2.69)$$

Using (2.67), (2.69) and that $\mathbb{P}(E_{i,k,\ell}) = 0$ for $\ell \geq \frac{3}{2} \log n - K + L$, we have

$$\begin{aligned} & \mathbb{E} \left[\sum_{\ell \geq 0} \sum_{|z|=n} e^{-\beta_n X(z)} \mathbb{1}_{F_\ell^1(z)} \right] \\ & \leq \sum_{\ell \geq 0} \sum_{i \geq 1} \sum_{k=\lfloor n/2 \rfloor}^{n-a_\ell-1} \mathbb{E} \left[\sum_{|z|=n} e^{-\beta_n X(z)} \mathbb{1}_{E_{i,k,\ell}(z)} \right] \\ & \leq C e^{(K'+1)/\alpha_n} \frac{(1+L)}{n^{3\beta_n/2}} \sum_{\ell=0}^{\lceil \frac{3}{2} \log n - K + L \rceil} \left(\frac{\log n}{\sqrt{n}} + a_\ell^{-1/2} \right) \sum_{i \geq 1} e^{-i/\alpha_n} (1 + \ell + i). \end{aligned} \quad (2.70)$$

We can bound the sum on i in (2.70) by $(1 + \ell)\alpha_n^2(1 + o(1))$ uniformly in ℓ . Moreover, taking K large enough such that $e^{-\nu K} < 1/2$, we have $a_\ell \geq e^{\nu(\ell+K)}/2$ for all $\ell \geq 0$. Thus, we get that (2.70) is smaller than

$$C(1 + o(1)) \frac{(1+L)}{n^{3\beta_n/2}} \alpha_n^2 \left(\frac{(\log n)^3}{n^{1/2}} + e^{-\nu K/2} \right) = C e^{-\nu K/2} (1+L)(1 + o(1)) \frac{\alpha_n^2}{n^{3\beta_n/2}},$$

and, thus, with the Markov inequality, we have

$$\mathbb{P} \left(\sum_{\ell \geq 0} \sum_{|z|=n} e^{-\beta_n X(z)} \mathbb{1}_{F_\ell^1(z)} > \varepsilon' \frac{\alpha_n^2}{n^{3\beta_n/2}} \right) \leq \frac{C}{\varepsilon'} e^{-\nu K/2} (1+L)(1 + o(1)). \quad (2.71)$$

Finally, (2.64) follows from (2.65), (2.66) and (2.71) by taking K large enough and it concludes the proof of Lemma 2.5.2. \square

2.5.5 From F to F_n

We prove here that considering F_n instead of F does not change significantly the first moment.

Proof of Lemma 2.5.3. In order to control the first moment of $\widetilde{W}_{\beta_n, n}^{(L, K)}(|F - F_n|)/Z_n^{(L)}$ under $\mathbb{E}_{\mathbb{Q}^{(L)}}$, we follow the proof of Lemma 2.5.4 for the upper bound of the first moment of $\widetilde{W}_{\beta_n, n}^{(L, K)}(F)/Z_n^{(L)}$, but, instead of applying directly Proposition 2.2.8 as in (2.57), we use that

$$\begin{aligned} & \mathbb{E} \left[|F - F_n|(\mathbf{S}^{(n)}) \mathbb{1}_{\underline{S}_n \geq -L, \min_{\lfloor n/2 \rfloor \leq j \leq n} S_j \geq \frac{3}{2} \log n - K, S_n - (\frac{3}{2} \log n - K) \in [ih, (i+1)h]} \right] \\ & = o \left(\sqrt{\frac{\pi}{2}} \frac{\theta \theta^-}{\sigma} \frac{R(L)}{n^{3/2}} h R^-((i+1)h) \right), \end{aligned}$$

uniformly in $i \in [0, h(\lceil (\alpha_n^+ + K)/h \rceil - 1)]$, by using Proposition 2.2.8 combined with Lemmas 2.A.3 and 2.A.5, because $F \in \mathcal{C}_b^u(\mathcal{D}([0, 1]))$. The result follows with the same calculations as in the proof of Lemma 2.5.4. \square

2.5.6 The peeling lemma

The aim of this subsection is to prove Lemma 2.5.5, which shows that introducing the event $\{z \in B_n\}$ does not change the first moment. This proof is based on the so-called peeling lemma (see Shi [Shi15]), which controls that the spine, conditioned to have a specific trajectory, does not have too many and too low children. Such lemmas have been proved in the case where the spine ends up at a distance of constant order from $\frac{3}{2} \log n$ (see [Aid13, Lemma C.1], [Mad15, Lemma 7.1] and [Shi15, Theorem 5.14]) and also when it ends up at a position

of order \sqrt{n} (see [AS14, Lemma 4.7]). Here we have to deal with the intermediate case where the spine end up far above $\frac{3}{2} \log n$ and far below \sqrt{n} .

In order to state the peeling lemma in a general setting, we introduce some notation. For $b, u, v \in \mathbb{R}$ and $n \in \mathbb{N}$, we set

$$A_n^{b,u,v} := \left\{ |z| = n : X(z) \in [v+b, v+b+1), \underline{X}(z) \geq -u, \min_{\lfloor n/2 \rfloor \leq j \leq n} X(z_j) \geq v \right\}.$$

We consider

$$a_i^{(n)} := \begin{cases} -u & \text{if } 0 \leq i < \lfloor n/2 \rfloor, \\ v & \text{if } \lfloor n/2 \rfloor \leq i \leq n, \end{cases} \quad \text{and} \quad \ell_i^{(n)} := \begin{cases} i^{1/7} & \text{if } 0 \leq i < \lfloor n/2 \rfloor, \\ (n-i)^{1/7} & \text{if } \lfloor n/2 \rfloor \leq i \leq n, \end{cases}$$

and the following set

$$B_n^\varrho := \left\{ |z| = n : \forall j \in \llbracket 0, n-1 \rrbracket, \sum_{y \in \Omega(z_{j+1})} \left(1 + [X(y) - a_j^{(n)}]_+\right) e^{-[X(y) - a_j^{(n)}]} \leq \varrho e^{-\ell_j^{(n)}} \right\}.$$

We can now state our version of the peeling lemma, which covers the case where the spine ends up far below \sqrt{n} and is therefore more general than the peeling lemmas in [Aïd13, Mad15, Shi15].

Lemma 2.5.7 (Peeling lemma). *For all $\varepsilon > 0$, there exist $\varrho > 0$ and $n_0 \in \mathbb{N}$ such that, for all $n \geq n_0$, $b \in \mathbb{R}_+$ and $u, v \in [0, n^{1/8}]$,*

$$\mathbb{Q} \left(w_n \in A_n^{b,u,v} \cap (B_n^\varrho)^c \right) \leq \varepsilon \frac{R(u)R^-(b)}{n^{3/2}}.$$

Peeling lemmas for the branching random walk require generally technical proofs, as it is the case below. However, the main idea is rather simple. If for some j the inequality in the definition of B_n^ϱ does not hold for the spine, we see this event as an upper bound for its position $X(w_j)$ in terms of the size of the offspring of w_j . Then, conditionally on the offspring of w_j , we bound the probability of this event by integrating with respect to the rest of the trajectory of the spine. This leads to a moment depending only on the offspring of w_j , where we have kept that this offspring has to be large when ϱ is large (see (2.77) and (2.82)). Finally, letting $\varrho \rightarrow \infty$ and using dominated convergence theorem combined with assumption (2.3), this moment becomes smaller than ε . For a clearer illustration of this idea, see proofs of Lemmas 3.4.3, 3.4.7 and 3.4.10 in the next chapter, which are peeling lemmas in the case of branching Brownian motion, where the proof can be reduced to a few lines.

Remark 2.5.8. We present here the peeling lemma in terms of probability measure \mathbb{Q} , because it simplifies somehow the proof (for example, under \mathbb{Q} , the reproduction law along the spine does not depend on the position), but it is a direct consequence that, for all $\varepsilon > 0$, there exist $\varrho > 0$ and $n_0 \in \mathbb{N}$ such that, for all $n \geq n_0$, $b \in \mathbb{R}_+$ and $u, v \in [0, n^{1/8}]$,

$$\mathbb{Q}^{(u)} \left(w_n^{(u)} \in A_n^{b,u,v} \cap (B_n^\varrho)^c \right) \leq \varepsilon \frac{R(u+v+b)R^-(b)}{n^{3/2}}.$$

Before proving the peeling lemma, we first use it to show Lemma 2.5.5.

Proof of Lemma 2.5.5. We set $Y_n := Y_n(1)$ and $Y'_n := Y'_n(1)$ and, since F is bounded, it is sufficient to show that

$$\mathbb{E}_{\mathbb{Q}^{(L)}} \left[\frac{Y_n - Y'_n}{Z_n^{(L)}} \right] = o \left(\frac{\alpha_n^2}{n^{3\beta_n/2}} \right).$$

We first change probabilities from $\mathbb{Q}^{(L)}$ to \mathbb{Q} : we have

$$\mathbb{E}_{\mathbb{Q}^{(L)}} \left[\frac{Y_n - Y'_n}{Z_n^{(L)}} \right] = \frac{1}{R(L)} \mathbb{E}_{\mathbb{Q}} \left[\frac{Y_n - Y'_n}{W_n} \right] = \frac{1}{R(L)} \mathbb{E}_{\mathbb{Q}} \left[e^{-X(w_n)/\alpha_n} \mathbb{1}_{w_n \in A_n \cap B_n^c} \right]. \quad (2.72)$$

Then, setting $u = L$ and $v = \frac{3}{2} \log n$ and cutting the segment $[\alpha_n^-, \alpha_n^+]$ in pieces of length 1, we get that (2.72) is smaller than

$$\frac{1}{R(L)} \sum_{i=\lfloor \alpha_n^- \rfloor}^{\lceil \alpha_n^+ \rceil - 1} e^{-i/\alpha_n} \mathbb{Q}(w_n \in A_n^{i,u,v} \cap B_n^c) \leq o\left(\frac{1}{n^{3/2}}\right) \sum_{i=\lfloor \alpha_n^- \rfloor}^{\lceil \alpha_n^+ \rceil - 1} e^{-i/\alpha_n} R^-(i), \quad (2.73)$$

using Lemma 2.5.7 uniformly in i , noting that $B_n \subset B_n^{\rho_n}$ and $\rho_n \rightarrow \infty$. Using then (2.19) and (2.55), we get that (2.73) is a $o(\alpha_n^2/n^{3/2})$ and it concludes the proof of Lemma 2.5.5. \square

Proof of Lemma 2.5.7. By Lemma 2.2.4 and (2.19), there exists $\mu > 0$ such that, for all $b \in \mathbb{R}_+$, $n \in \mathbb{N}^*$ and $u, v \in [0, n^{1/7}]$, we have

$$\begin{aligned} \mathbb{Q}(w_n \in A_n^{b,u,v}, \exists i \in \llbracket 0, n \rrbracket : X(w_i) < a_i^{(n)} + 2\ell_i^{(n)} - \mu) &\leq R(u)R^-(b) \left(\frac{\varepsilon}{3n^{3/2}} + \frac{C}{n^{2-3/7}} \right) \\ &\leq \frac{\varepsilon}{2} \frac{R(u)R^-(b)}{n^{3/2}}, \end{aligned}$$

for n large enough (independent of u, v and b). Thus, it is sufficient to show that

$$\mathbb{Q}(w_n \in A_n^{b,u,v} \cap B_n^c, \forall j \in \llbracket 0, n \rrbracket, X(w_j) \geq a_j^{(n)} + 2\ell_j^{(n)} - \mu) \leq \frac{\varepsilon}{2} \frac{R(u)R^-(b)}{n^{3/2}}, \quad (2.74)$$

for n large enough, $b \in \mathbb{R}_+$ and $u, v \in [0, n^{1/8}]$. Therefore, we now prove (2.74). We first set, for $0 \leq i \leq n-1$,

$$B_{n,i}^{\rho} := \left\{ |z| = n : \sum_{y \in \Omega(z_{i+1})} \left(1 + [X(y) - a_i^{(n)}]_+ \right) e^{-[X(y) - a_i^{(n)}]} \leq \rho e^{-\ell_i^{(n)}} \right\}.$$

Since for all $u, v \in \mathbb{R}$, $1 + (u+v)_+ \leq (1+u_+)(1+v_+)$, we have

$$\sum_{y \in \Omega(z_{i+1})} \left(1 + [X(y) - a_i^{(n)}]_+ \right) e^{-[X(y) - a_i^{(n)}]} \leq \left(1 + [X(w_i) - a_i^{(n)}]_+ \right) e^{-[X(w_i) - a_i^{(n)}]} \Theta(w_{i+1}),$$

where we set, for $x \in \mathbb{T}$, by noting \overleftarrow{x} the parent of x and $\Delta(x) := X(x) - X(\overleftarrow{x})$,

$$\Theta(x) := \sum_{y \in \Omega(x)} (1 + \Delta(y)_+) e^{-\Delta(y)}.$$

Thus, we have, on event $\{w_n \notin B_{n,i}^{\rho}\} \cap \{X(w_i) \geq a_i^{(n)} + 2\ell_i^{(n)} - \mu\}$,

$$\left(1 + [X(w_i) - a_i^{(n)}]_+ \right) e^{-[X(w_i) - a_i^{(n)}]} \Theta(w_{i+1}) \geq \rho e^{-\ell_i^{(n)}} \geq \rho e^{-[X(w_i) - a_i^{(n)} + \mu]/2}$$

and, if we are moreover on event $\{w_n \in A_n^{b,u,v}\}$ so that $X(w_i) \geq a_i^{(n)}$, it implies that

$$\Theta(w_{i+1}) \geq \rho e^{-\mu/2} \frac{e^{[X(w_i) - a_i^{(n)}]/2}}{1 + [X(w_i) - a_i^{(n)}]_+} \geq c \rho e^{-\mu/2} e^{[X(w_i) - a_i^{(n)}]/3},$$

where $c = \inf_{u \geq 0} e^{u/6}/(1+u) > 0$. Therefore, we get

$$\mathbb{Q}\left(w_n \in A_n^{b,u,v} \cap (B_n^\varrho)^c, \forall j \in \llbracket 0, n \rrbracket, X(w_j) \geq a_j^{(n)} + 2\ell_j^{(n)} - \mu\right) \leq \sum_{i=0}^{n-1} q_i, \quad (2.75)$$

where we set, for $0 \leq i \leq n-1$,

$$q_i := \mathbb{Q}\left(w_n \in A_n^{b,u,v}, \forall j \in \llbracket 0, n \rrbracket, X(w_j) \geq a_j^{(n)} + 2\ell_j^{(n)} - \mu, \Theta(w_{i+1}) > \tilde{\varrho} e^{[X(w_i) - a_i^{(n)}]/3}\right)$$

and $\tilde{\varrho} := c\varrho e^{-\mu/2}$. From now, we choose ϱ such that $\tilde{\varrho} \geq e$.

We first consider the case $0 \leq i < \lfloor n/2 \rfloor$. Since $a_i^{(n)} = -u$, we have

$$q_i \leq \mathbb{E}_{\mathbb{Q}}\left[\mathbb{1}_{\underline{X}(w_i) \geq -u, \Theta(w_{i+1}) > \tilde{\varrho} e^{[X(w_i) + u]/3}} G_i(X(w_{i+1}))\right],$$

where we set, for $x \in \mathbb{R}$,

$$\begin{aligned} G_i(x) &:= \mathbb{Q}_x\left(\underline{X}(w_{n-i-1}) \geq -u, X(w_{n-i-1}) - v \in [b, b+1), \min_{\lfloor n/2 \rfloor - i - 1 \leq j \leq n-i-1} X(w_j) \geq v\right) \\ &\leq \mathbb{P}\left(\underline{S}_{n-i-1} \geq -u - x, S_{n-i-1} - (v - x) \in [b, b+1), \min_{\lfloor (n-i-1)/2 \rfloor \leq j \leq n-i-1} S_j \geq v - x\right) \\ &\leq C \frac{(1+x+u)2(b+2)}{(n-i)^{3/2}} \\ &\leq C \frac{(1+x+u)R^-(b)}{n^{3/2}}, \end{aligned}$$

using successively Proposition 2.2.2 (ii), (2.25) and (2.19). We thus get

$$\begin{aligned} q_i &\leq C \frac{R^-(b)}{n^{3/2}} \mathbb{E}_{\mathbb{Q}}\left[\mathbb{1}_{\underline{X}(w_i) \geq -u, \Theta(w_{i+1}) > \tilde{\varrho} e^{[X(w_i) + u]/3}} (1 + X(w_{i+1}) + u)\right] \\ &\leq C \frac{R^-(b)}{n^{3/2}} \mathbb{E}_{\mathbb{Q}}\left[\mathbb{1}_{\underline{X}(w_i) \geq -u, X(w_i) + u < 3 \log \frac{\Theta(w_{i+1})}{\tilde{\varrho}}} (1 + X(w_i) + u + \Delta(w_{i+1}))\right] \\ &\leq C \frac{R^-(b)}{n^{3/2}} \mathbb{E}_{\mathbb{Q}}\left[\mathbb{1}_{\underline{X}(w_i) \geq -u, X(w_i) + u < 3 \log \frac{\Theta(w_{i+1})}{\tilde{\varrho}}} \left[1 + 3 \log_+ \frac{\Theta(w_{i+1})}{\tilde{\varrho}} + (\Delta(w_{i+1}))_+\right]\right]. \end{aligned}$$

But, under \mathbb{Q} , $(\Theta(w_{i+1}), \Delta(w_{i+1}))$ is independent of $(X(w_j))_{0 \leq j \leq i}$ and has moreover the same law as $(W_1 + Z_1^+, X(w_1))$, where W_1 and Z_1^+ are defined in (2.4). Therefore, we get, by integrating first on $(X(w_j))_{0 \leq j \leq i}$,

$$q_i \leq C \frac{R^-(b)}{n^{3/2}} \mathbb{E}_{\mathbb{Q}}\left[F_i(W_1 + Z_1^+) \left(1 + 3 \log_+ \frac{W_1 + Z_1^+}{\tilde{\varrho}} + X(w_1)_+\right)\right], \quad (2.76)$$

where we set, for $x > 0$,

$$F_i(x) := \mathbb{Q}\left(\underline{X}(w_i) \geq -u, X(w_i) + u < 3 \log \frac{x}{\tilde{\varrho}}\right) = \mathbb{1}_{0 < \log \frac{x}{\tilde{\varrho}}} \mathbb{P}(\underline{S}_i \geq -u, S_i < -u + 3 \log_+ x),$$

by using Proposition 2.2.2 (ii) and that $\tilde{\varrho} \geq 1$. Then, applying (2.26), we have

$$\sum_{i=k_n}^{\lfloor n/2 \rfloor - 1} F_i(x) \leq \mathbb{1}_{x > \tilde{\varrho}} C(1 + 3 \log_+ x)(1 + u) \leq CR(u)(1 + \log_+ x) \mathbb{1}_{x > \tilde{\varrho}}$$

using also (2.19). Coming back to (2.76) and noting that, since $W_1 + Z_1^+ > \tilde{\varrho} \geq e$, we have $\log_+(W_1 + Z_1^+) \geq 1$, this gives

$$\sum_{i=k_n}^{\lfloor n/2 \rfloor - 1} q_i \leq C \frac{R(u)R^-(b)}{n^{3/2}} \mathbb{E}_{\mathbb{Q}} \left[\mathbb{1}_{W_1 + Z_1^+ > \tilde{\varrho}} \log_+(W_1 + Z_1^+) \left(\log_+(W_1 + Z_1^+) + X(w_1)_+ \right) \right] \quad (2.77)$$

and concludes the case $0 \leq i < \lfloor n/2 \rfloor$.

We now consider the case $\lfloor n/2 \rfloor \leq i < n$, so $a_i^{(n)} = v$. On event $\{w_n \in A_n^{b,u,v}, \Theta(w_{i+1}) > \tilde{\varrho} e^{[X(w_i) - v]/3}\}$, we have $X(w_i) = X(w_n) - (X(w_n) - X(w_i)) \in [v + b - (X(w_n) - X(w_i)), v + b + 1 - (X(w_n) - X(w_i))]$, $\Theta(w_{i+1}) > \tilde{\varrho} \vee \tilde{\varrho} e^{[X(w_i) - X(w_n) + b]/3}$ and, for all $i + 1 \leq j \leq n$, $X(w_n) - X(w_j) \leq b + 1$. Moreover, we set

$$\tilde{a}_j^{(n)} := \begin{cases} -u & \text{if } 0 \leq j < \lfloor n/4 \rfloor, \\ v & \text{if } \lfloor n/4 \rfloor \leq j \leq n, \end{cases}$$

and note that, on event $\{w_n \in A_n^{b,u,v}, \forall j \in \llbracket 0, n \rrbracket, X(w_j) \geq a_j^{(n)} + 2\ell_j^{(n)} - \mu\}$, for n large enough, we have $\forall j \in \llbracket \lfloor n/4 \rfloor, \lfloor n/2 \rfloor - 1 \rrbracket, X(w_j) \geq v = \tilde{a}_j^{(n)}$, because $\ell_j^{(n)} \geq \lfloor n/4 \rfloor^{1/7}$ and $u + v \leq 2n^{1/8}$. Thus, we get

$$\begin{aligned} q_i &\leq \mathbb{Q} \left(\forall j \in \llbracket 1, i \rrbracket, X(w_j) \geq \tilde{a}_j^{(n)}, X(w_i) - (v - (X(w_n) - X(w_i))) \in [b, b + 1] \right. \\ &\quad \left. \Theta(w_{i+1}) > \tilde{\varrho} \vee \tilde{\varrho} e^{[X(w_i) - X(w_n) + b]/3}, \forall j \in \llbracket i + 1, n \rrbracket, X(w_n) - X(w_j) \leq b + 1 \right). \end{aligned} \quad (2.78)$$

Under \mathbb{Q} , $(\Theta(w_{i+1}), (X(w_n) - X(w_j))_{i \leq j \leq n})$ is independent of $(X(w_j))_{0 \leq j \leq i}$, so the right-hand side of (2.78) is equal to

$$\mathbb{E}_{\mathbb{Q}} \left[H_i(X(w_n) - X(w_i)) \mathbb{1}_{\Theta(w_{i+1}) > \tilde{\varrho} \vee \tilde{\varrho} e^{[X(w_i) - X(w_n) + b]/3}, \forall j \in \llbracket i + 1, n \rrbracket, X(w_n) - X(w_j) \leq b + 1} \right], \quad (2.79)$$

where we set, for $x \in \mathbb{R}$,

$$\begin{aligned} H_i(x) &:= \mathbb{Q} \left(\underline{X}(w_i) \geq -u, \min_{\lfloor n/4 \rfloor \leq j \leq i} X(w_j) \geq v, X(w_i) - (v - x) \in [b, b + 1] \right) \\ &\leq \mathbb{P} \left(\underline{S}_i \geq -u, \min_{\lfloor i/2 \rfloor \leq j \leq i} S_j \geq v, S_i - v \in [b - x, b - x + 1] \right) \\ &\leq C \frac{R(u)}{n^{3/2}} (1 + b - x), \end{aligned}$$

using successively Proposition 2.2.2 (ii), (2.25) and (2.19) as before. On the event $\{\Theta(w_{i+1}) > \tilde{\varrho} e^{[X(w_i) - X(w_n) + b]/3}\}$, using that $\tilde{\varrho} \geq 1$, we have $b - (X(w_n) - X(w_i)) \leq 3 \log_+ \Theta(w_{i+1})$ and also $X(w_n) - X(w_{i+1}) \geq b - 3 \log_+ \Theta(w_{i+1}) - \Delta(w_{i+1})_+$, therefore, (2.79) is smaller than

$$\begin{aligned} C \frac{R(u)}{n^{3/2}} \mathbb{E}_{\mathbb{Q}} \left[(1 + 3 \log_+ \Theta(w_{i+1})) \mathbb{1}_{\Theta(w_{i+1}) > \tilde{\varrho}} \right. \\ \left. \times \mathbb{1}_{X(w_n) - X(w_{i+1}) \geq b - 3 \log_+ \Theta(w_{i+1}) - \Delta(w_{i+1})_+, \forall j \in \llbracket i + 1, n \rrbracket, X(w_n) - X(w_j) \leq b + 1} \right]. \end{aligned} \quad (2.80)$$

Note then that, under \mathbb{Q} , $(\Theta(w_{i+1}), \Delta(w_{i+1}))$ is independent of $(X(w_n) - X(w_j))_{i+1 \leq j \leq n}$ and has the same law as $(W_1 + Z_1^+, X(w_1))$, so (2.80) is equal to

$$C \frac{R(u)}{n^{3/2}} \mathbb{E}_{\mathbb{Q}} \left[\left(1 + 3 \log_+(W_1 + Z_1^+) \right) \mathbb{1}_{W_1 + Z_1^+ > \tilde{\varrho}} \Gamma_i \left(3 \log_+(W_1 + Z_1^+) + X(w_1)_+ \right) \right], \quad (2.81)$$

where we set, for $x \geq 0$,

$$\begin{aligned} \Gamma_i(x) &:= \mathbb{Q}(X(w_n) - X(w_{i+1}) \geq b - x, \forall j \in [i+1, n], X(w_n) - X(w_j) \leq b + 1) \\ &= \mathbb{P}\left(S_{n-i-1}^- \leq (x+1) - (b+1), \underline{S}_{n-i-1}^- \geq -(b+1)\right), \end{aligned}$$

by applying Proposition 2.2.2 (ii) and then reversing time. Thus, using (2.26) and (2.19), we get

$$\sum_{i=\lfloor n/2 \rfloor}^{n-1} \Gamma_i(x) \leq C(1+x+1)(1+b+1) \leq C(1+x)R^-(b).$$

On event $\{W_1 + Z_1^+ > \tilde{\varrho}\}$, we have $\log_+(W_1 + Z_1^+) \geq 1$ so, coming back to (2.81), we get

$$\sum_{i=\lfloor n/2 \rfloor}^{n-1} q_i \leq C \frac{R(u)R^-(b)}{n^{3/2}} \mathbb{E}_{\mathbb{Q}} \left[\log_+(W_1 + Z_1^+) \mathbb{1}_{W_1 + Z_1^+ > \tilde{\varrho}} \left(\log_+(W_1 + Z_1^+) + X(w_1)_+ \right) \right]. \quad (2.82)$$

Finally, using (2.77), (2.82) and that $\mathbb{E}_{\mathbb{Q}}[X(w_1)_+ | \mathcal{F}_1] = Z_1^+/W_1$ by Proposition 2.2.2 (i), we get

$$\sum_{i=0}^{n-1} q_i \leq C \frac{R(u)R^-(b)}{n^{3/2}} \mathbb{E} \left[\left(W_1 \log_+^2(W_1 + Z_1^+) + Z_1^+ \log_+(W_1 + Z_1^+) \right) \mathbb{1}_{W_1 + Z_1^+ > \tilde{\varrho}} \right]. \quad (2.83)$$

Using (2.3), we can choose ϱ large enough such that the expectation in (2.83) is smaller than $\varepsilon/2C$ and, recalling (2.75), it proves (2.74) and concludes the proof of Lemma 2.5.7. \square

2.5.7 Second moment of $Y'_n(F_n)$

For $F \in \mathcal{C}(\mathcal{D}([0, 1]))$, by decomposing along the spine, $Y'_n(F)$ is equal to

$$\sum_{i=0}^{n-1} \sum_{y \in \Omega(w_{i+1}^{(L)})} \sum_{|z|=n, z \geq y} e^{-\beta_n X(z)} F(\mathbf{X}(z)) \mathbb{1}_{z \in A_n \cap B_n} + e^{-\beta_n X(w_n^{(L)})} F(\mathbf{X}(w_n^{(L)})) \mathbb{1}_{w_n^{(L)} \in A_n \cap B_n}.$$

We cut this sum in two pieces, depending on whether the lineage of the considered particle z splits off from the spine's lineage before or after time k_n :

$$\begin{aligned} Y_n'^{(0, k_n)}(F) &:= \sum_{i=0}^{k_n-1} \sum_{y \in \Omega(w_{i+1}^{(L)})} \sum_{|z|=n, z \geq y} e^{-\beta_n X(z)} F(\mathbf{X}(z)) \mathbb{1}_{z \in A_n \cap B_n} \\ Y_n'^{[k_n, n]}(F) &:= Y'_n(F) - Y_n'^{(0, k_n)}(F). \end{aligned}$$

We define in the same way $Z_n^{(L), [0, k_n]}$ and $Z_n^{(L), [k_n, n]}$. Then, by Aïdékon and Shi [AS14, Lemma 4.7], since $(\log n)^6 \ll k_n \ll \sqrt{n}$, we have

$$\inf_{u \in [k_n^{1/3}, k_n]} \mathbb{Q}^{(L)} \left(Z_n^{(L), [k_n, n]} \leq n^{-2} \mid X(w_{k_n}^{(L)}) = u \right) \xrightarrow{n \rightarrow \infty} 1. \quad (2.84)$$

Proof of Lemma 2.5.6. First note that, using Proposition 2.2.3 (i),

$$\begin{aligned} \frac{Y'_n(F_n)}{Z_n^{(L)}} &= \sum_{|z|=n} \mathbb{Q}^{(L)} \left(w_n^{(L)} = z \mid \mathcal{F}_n \right) \frac{e^{-X(z)/\alpha_n}}{R_L(X(z))} F_n(\mathbf{X}(z)) \mathbb{1}_{z \in A_n \cap B_n} \\ &= \mathbb{E}_{\mathbb{Q}^{(L)}} \left[\frac{e^{-X(w_n^{(L)})/\alpha_n}}{R_L(X(w_n^{(L)}))} F_n(\mathbf{X}(w_n^{(L)})) \mathbb{1}_{w_n^{(L)} \in A_n \cap B_n} \mid \mathcal{F}_n \right] \end{aligned}$$

and, thus, we have

$$\begin{aligned} \mathbb{E}_{\mathbb{Q}^{(L)}} \left[\left(\frac{Y'_n(F_n)}{Z_n^{(L)}} \right)^2 \right] &= \mathbb{E}_{\mathbb{Q}^{(L)}} \left[\frac{Y'_n(F_n)}{Z_n^{(L)}} \frac{e^{-X(w_n^{(L)})/\alpha_n}}{R_L(X(w_n^{(L)}))} F_n(\mathbf{X}(w_n^{(L)})) \mathbb{1}_{w_n^{(L)} \in A_n \cap B_n} \right] \\ &=: \mathbb{E}_{\mathbb{Q}^{(L)}}^{[0, k_n]} + \mathbb{E}_{\mathbb{Q}^{(L)}}^{[k_n, n]}, \end{aligned}$$

by splitting $Y'_n(F_n) = Y_n'^{[0, k_n]}(F_n) + Y_n'^{[k_n, n]}(F_n)$. The first part will give the right order and constant and the second part will be negligible. Recall that F is assumed to be nonnegative.

We begin by bounding $\mathbb{E}_{\mathbb{Q}^{(L)}}^{[0, k_n]}$. Using $Z_n^{(L)} \geq Z_n^{(L), [0, k_n]}$ and $\mathbb{1}_{w_n^{(L)} \in B_n} \leq 1$, we get

$$\begin{aligned} \mathbb{E}_{\mathbb{Q}^{(L)}}^{[0, k_n]} &\leq \mathbb{E}_{\mathbb{Q}^{(L)}} \left[\frac{Y_n'^{[0, k_n]}(F_n)}{Z_n^{(L), [0, k_n]}} \frac{e^{-X(w_n^{(L)})/\alpha_n}}{R_L(X(w_n^{(L)}))} F_n(\mathbf{X}(w_n^{(L)})) \mathbb{1}_{w_n^{(L)} \in A_n} \right] \\ &= \mathbb{E}_{\mathbb{Q}^{(L)}} \left[\frac{Y_n'^{[0, k_n]}(F_n)}{Z_n^{(L), [0, k_n]}} \varphi(X(w_{k_n}^{(L)})) \mathbb{1}_{X(w_{k_n}^{(L)}) \in [k_n^{1/3}, k_n]} \right], \end{aligned} \quad (2.85)$$

where we set, for $b \in [k_n^{1/3}, k_n]$ and with $m := n - k_n$,

$$\begin{aligned} \varphi(b) &:= \mathbb{E}_{\mathbb{Q}_b^{(L)}} \left[\frac{e^{-X(w_m^{(L)})/\alpha_n}}{R_L(X(w_m^{(L)}))} F\left(\mathbf{X}(w_m^{(L)}) - \frac{b}{\sigma\sqrt{m}}\right) \mathbb{1}_{\forall 0 \leq i \leq n-k_n, X(w_i^{(L)}) \in I_{n, i+k_n}} \right] \\ &\leq \frac{1}{R_L(b)} \mathbb{E} \left[e^{-(S_m+b)/\alpha_n} F(\mathbf{S}^{(m)}) \mathbb{1}_{S_m \geq -L-b, \min_{\lfloor \lambda m \rfloor \leq j \leq m} S_j \geq \frac{3}{2} \log n - b, S_m - (\frac{3}{2} \log n - b) \in [\alpha_n^-, \alpha_n^+]} \right], \end{aligned}$$

for some fixed $\lambda \in (1/2, 1)$ and n large enough, by applying Proposition 2.2.3 (ii). Then, proceeding in the same way as for the lower bound of $\psi(b)$ in the proof of Lemma 2.5.4 (but with a sum on i from $\lfloor \alpha_n^-/h \rfloor$ to $\lceil \alpha_n^+/h \rceil - 1$), we get the upper bound

$$\varphi(b) \leq \frac{1}{R_L(b)} (L+b) \sqrt{\frac{2}{\pi}} \frac{1}{\sigma^3} \frac{\alpha_n^2}{n^{3\beta_n/2}} (\mathbb{E}[F(\boldsymbol{\epsilon})] + o(1)) = \frac{\theta}{\sigma^2} \frac{\alpha_n^2}{n^{3\beta_n/2}} (\mathbb{E}[F(\boldsymbol{\epsilon})] + o(1)), \quad (2.86)$$

uniformly in $b \in [k_n^{1/3}, k_n]$, using (2.18) and (2.22) for the last equality. Coming back to (2.85), we showed that

$$\mathbb{E}_{\mathbb{Q}^{(L)}}^{[0, k_n]} \leq \frac{\theta}{\sigma^2} \frac{\alpha_n^2}{n^{3\beta_n/2}} (\mathbb{E}[F(\boldsymbol{\epsilon})] + o(1)) \mathbb{E}_{\mathbb{Q}^{(L)}} \left[\frac{Y_n'^{[0, k_n]}(F_n)}{Z_n^{(L), [0, k_n]}} \mathbb{1}_{X(w_{k_n}^{(L)}) \in [k_n^{1/3}, k_n]} \right], \quad (2.87)$$

and thus we now want to bound the expectation in (2.87). We proceed in a way similar to the proof of Lemma 4.5 of Aïdekon et Shi [AS14], by introducing the event $\{Z_n^{(L), [k_n, n]} \leq n^{-2}\}$:

$$\begin{aligned} &\mathbb{E}_{\mathbb{Q}^{(L)}} \left[\frac{Y_n'^{[0, k_n]}(F_n)}{Z_n^{(L), [0, k_n]}} \mathbb{1}_{Z_n^{(L), [k_n, n]} \leq n^{-2}} \right] \\ &= \mathbb{E}_{\mathbb{Q}^{(L)}} \left[\frac{Y_n'^{[0, k_n]}(F_n)}{Z_n^{(L), [0, k_n]}} \mathbb{Q}^{(L)} \left(Z_n^{(L), [k_n, n]} \leq n^{-2} \mid X(w_{k_n}^{(L)}) = u \right) \right] \\ &\geq \mathbb{E}_{\mathbb{Q}^{(L)}} \left[\frac{Y_n'^{[0, k_n]}(F_n)}{Z_n^{(L), [0, k_n]}} \mathbb{1}_{X(w_{k_n}^{(L)}) \in [k_n^{1/3}, k_n]} \right] \inf_{u \in [k_n^{1/3}, k_n]} \mathbb{Q}^{(L)} \left(Z_n^{(L), [k_n, n]} \leq n^{-2} \mid X(w_{k_n}^{(L)}) = u \right). \end{aligned}$$

Thus, applying (2.84), we get that the expectation in (2.87) is smaller than

$$\begin{aligned}
& (1 + o(1)) \mathbb{E}_{\mathbb{Q}^{(L)}} \left[\frac{Y_n'^{[0,k_n]}(F_n)}{Z_n^{(L),[0,k_n]}} \mathbb{1}_{Z_n^{(L),[k_n,n]} \leq n^{-2}} \right] \\
& \leq (1 + o(1)) \left(\mathbb{E}_{\mathbb{Q}^{(L)}} \left[\frac{Y_n'^{[0,k_n]}(F_n)}{Z_n^{(L),[0,k_n]}} \mathbb{1}_{Z_n^{(L)} \geq n^{-7/4}, Z_n^{(L),[k_n,n]} \leq n^{-2}} \right] + \|F\| \mathbb{Q}^{(L)}(Z_n^{(L)} < n^{-7/4}) \right) \\
& \leq (1 + o(1)) \left(\mathbb{E}_{\mathbb{Q}^{(L)}} \left[\frac{Y_n'^{[0,k_n]}(F_n)}{(1 - n^{-1/4}) Z_n^{(L)}} \right] + \|F\| n^{-7/4} \mathbb{E}_{\mathbb{Q}^{(L)}} \left[\frac{1}{Z_n^{(L)}} \right] \right), \tag{2.88}
\end{aligned}$$

using that $Y_n'^{[0,k_n]}(F_n)/Z_n^{(L),[0,k_n]} \leq \|F\|$ and applying the Markov inequality for the second term. Using that $Y_n'^{[0,k_n]} \leq Y_n' \leq \widetilde{W}_{\beta_n, n}^{(L,K)}$, and then Lemmas 2.5.4 and 2.5.3, we get that (2.88) is smaller than

$$(1 + o(1)) \left((\mathbb{E}[F(\mathfrak{e})] + o(1)) \frac{\theta}{\sigma^2} \frac{\alpha_n^2}{n^{3\beta_n/2}} + \|F\| \frac{n^{-7/4}}{R(L)} \right) = (\mathbb{E}[F(\mathfrak{e})] + o(1)) \frac{\theta}{\sigma^2} \frac{\alpha_n^2}{n^{3\beta_n/2}},$$

because $3\beta_n/2 \leq 7/4$ for n large enough. Thus, coming back to (2.87), we proved that

$$\mathbb{E}_{\mathbb{Q}^{(L)}}^{[0,k_n]} \leq \left((\mathbb{E}[F(\mathfrak{e})] + o(1)) \frac{\theta}{\sigma^2} \frac{\alpha_n^2}{n^{3\beta_n/2}} \right)^2. \tag{2.89}$$

We now want to show that $\mathbb{E}_{\mathbb{Q}^{(L)}}^{[k_n,n]} = o((\alpha_n^2/n^{3\beta_n/2})^2)$ and, by bounding $F \leq \|F\|$, it is sufficient to deal with the case $F \equiv 1$. Using that $Z_n^{(L),[0,k_n]} \leq Z_n^{(L)}$, $\mathbb{1}_{z \in B_n} \leq 1$ and breaking down $Y_n'^{[k_n,n]}(1)$ along the spine, we first have that $\mathbb{E}_{\mathbb{Q}^{(L)}}^{[k_n,n]}$ is smaller than

$$\begin{aligned}
& \sum_{i=k_n}^{n-1} \mathbb{E}_{\mathbb{Q}^{(L)}} \left[\frac{1}{Z_n^{(L),[0,k_n]}} \frac{e^{-X(w_n^{(L)})/\alpha_n}}{R_L(X(w_n^{(L)}))} \mathbb{1}_{w_n^{(L)} \in A_n \cap B_n} \sum_{y \in \Omega(w_{i+1}^{(L)})} \sum_{|z|=n, z \geq y} e^{-\beta_n X(z)} \mathbb{1}_{z \in A_n} \right] \\
& + \mathbb{E}_{\mathbb{Q}^{(L)}} \left[\frac{1}{Z_n^{(L),[0,k_n]}} \frac{e^{-X(w_n^{(L)})/\alpha_n}}{R_L(X(w_n^{(L)}))} \mathbb{1}_{w_n^{(L)} \in A_n \cap B_n} e^{-\beta_n X(w_n^{(L)})} \right]. \tag{2.90}
\end{aligned}$$

Noting that, on the event $\{z \in A_n\}$, we have $e^{-\beta_n X(z)} \leq e^{-X(z)} n^{-3/2\alpha_n}$, the first term in (2.90) is smaller than

$$\begin{aligned}
& \sum_{i=k_n}^{n-1} \mathbb{E}_{\mathbb{Q}^{(L)}} \left[\frac{1}{Z_n^{(L),[0,k_n]}} \frac{e^{-X(w_n^{(L)})/\alpha_n}}{R_L(X(w_n^{(L)}))} \mathbb{1}_{w_n^{(L)} \in A_n \cap B_n} \sum_{y \in \Omega(w_{i+1}^{(L)})} \sum_{|z|=n, z \geq y} e^{-X(z)} n^{-3/2\alpha_n} \right] \\
& = n^{-3/2\alpha_n} \sum_{i=k_n}^{n-1} \mathbb{E}_{\mathbb{Q}^{(L)}} \left[\frac{1}{Z_n^{(L),[0,k_n]}} \frac{e^{-X(w_n^{(L)})/\alpha_n}}{R_L(X(w_n^{(L)}))} \mathbb{1}_{w_n^{(L)} \in A_n \cap B_n} \sum_{y \in \Omega(w_{i+1}^{(L)})} e^{-X(y)} \right], \tag{2.91}
\end{aligned}$$

by conditioning with respect to $\mathcal{G}_\infty := \sigma(X(w_i^{(L)}), X(y), y \in \Omega(w_{i+1}^{(L)}), i \in \mathbb{N})$ and noting that, given \mathcal{G}_∞ , $Z_n^{(L),[0,k_n]}$ is independent of $(X(z), |z| = n, z \geq y, y \in \Omega(w_{i+1}^{(L)}))$. Noting that we

are on the event $\{w_n^{(L)} \in B_n\}$, (2.91) is smaller than

$$\begin{aligned}
& n^{-3/2\alpha_n} \sum_{i=k_n}^{n-1} \mathbb{E}_{\mathbb{Q}^{(L)}} \left[\frac{1}{Z_n^{(L),[0,k_n]}} \frac{e^{-X(w_n^{(L)})/\alpha_n}}{R_L(X(w_n^{(L)}))} \mathbb{1}_{w_n^{(L)} \in A_n \cap B_n} \varrho_n e^{-a_i^{(n)} - \ell_i^{(n)}} \right] \\
& \leq \frac{\varrho_n}{n^{3/2\alpha_n}} \left(\sum_{i=k_n}^{\lfloor n/2 \rfloor - 1} e^{L-i^{1/7}} + \sum_{i=\lfloor n/2 \rfloor}^{n-1} \frac{e^{-(n-i)^{1/7}}}{n^{3/2}} \right) \mathbb{E}_{\mathbb{Q}^{(L)}} \left[\frac{1}{Z_n^{(L),[0,k_n]}} \frac{e^{-X(w_n^{(L)})/\alpha_n}}{R_L(X(w_n^{(L)}))} \mathbb{1}_{w_n^{(L)} \in A_n} \right] \\
& \leq C e^L \frac{\varrho_n}{n^{3\beta_n/2}} (1 + o(1)) \mathbb{E}_{\mathbb{Q}^{(L)}} \left[\frac{1}{Z_n^{(L),[0,k_n]}} \frac{e^{-X(w_n^{(L)})/\alpha_n}}{R_L(X(w_n^{(L)}))} \mathbb{1}_{w_n^{(L)} \in A_n} \right], \tag{2.92}
\end{aligned}$$

because $k_n^{1/7} \gg \log n$ and therefore the sum for $i \in \llbracket k_n, \lfloor n/2 \rfloor - 1 \rrbracket$ is a $o(n^{-3/2})$. For the second term in (2.90), we use that, on the event $\{w_n^{(L)} \in A_n\}$, $e^{-\beta_n X(w_n^{(L)})} \leq n^{-3\beta_n/2}$, and, thus, combining with (2.92), we get

$$\begin{aligned}
\mathbb{E}_{\mathbb{Q}^{(L)}}^{[k_n, n]} & \leq C e^L \frac{\varrho_n}{n^{3\beta_n/2}} (1 + o(1)) \mathbb{E}_{\mathbb{Q}^{(L)}} \left[\frac{1}{Z_n^{(L),[0,k_n]}} \frac{e^{-X(w_n^{(L)})/\alpha_n}}{R_L(X(w_n^{(L)}))} \mathbb{1}_{w_n^{(L)} \in A_n} \right] \\
& = C e^L \frac{\varrho_n}{n^{3\beta_n/2}} (1 + o(1)) \mathbb{E}_{\mathbb{Q}^{(L)}} \left[\frac{1}{Z_n^{(L),[0,k_n]}} \varphi \left(X(w_{k_n}^{(L)}) \right) \mathbb{1}_{X(w_{k_n}^{(L)}) \in [k_n^{1/3}, k_n]} \right],
\end{aligned}$$

where the function φ has been defined previously in the proof. Using (2.86) again, we get

$$\mathbb{E}_{\mathbb{Q}^{(L)}}^{[k_n, n]} \leq C e^L \frac{\varrho_n}{n^{3\beta_n/2}} \frac{\alpha_n^2}{n^{3\beta_n/2}} (1 + o(1)) \mathbb{E}_{\mathbb{Q}^{(L)}} \left[\frac{1}{Z_n^{(L),[0,k_n]}} \mathbb{1}_{X(w_{k_n}^{(L)}) \in [k_n^{1/3}, k_n]} \right]. \tag{2.93}$$

Proceeding in the same way as before by using (2.84) to introduce the event $\{Z_n^{(L),[k_n, n]} \leq n^{-2}\}$, the expectation in (2.93) is smaller than

$$\begin{aligned}
& (1 + o(1)) \mathbb{E}_{\mathbb{Q}^{(L)}} \left[\frac{1}{Z_n^{(L),[0,k_n]}} \mathbb{1}_{Z_n^{(L),[k_n, n]} \leq n^{-2}} \right] \\
& \leq (1 + o(1)) \left(\mathbb{E}_{\mathbb{Q}^{(L)}} \left[\frac{1}{Z_n^{(L),[0,k_n]}} \mathbb{1}_{Z_n^{(L)} \geq n^{-7/4}, Z_n^{(L),[k_n, n]} \leq n^{-2}} \right] + \mathbb{Q}^{(L)} \left(Z_n^{(L)} < n^{-7/4} \right) \right). \tag{2.94}
\end{aligned}$$

As for (2.88), (2.94) is equal to $(1 + o(1))/R(L)$ and, coming back to (2.93), we get

$$\mathbb{E}_{\mathbb{Q}^{(L)}}^{[k_n, n]} \leq C \frac{e^L}{R(L)} \frac{\varrho_n}{n^{3\beta_n/2}} \frac{\alpha_n^2}{n^{3\beta_n/2}} (1 + o(1)) = o \left(\left(\frac{\alpha_n^2}{n^{3\beta_n/2}} \right)^2 \right),$$

because $\varrho_n \ll \alpha_n^2$. This concludes the proof of Lemma 2.5.6. \square

2.A Convergence of random measures

In this section, we present some results concerning convergence of random or deterministic probability measures on a polish space S or more specifically on $\mathcal{D}([0, 1])$. Some of these results are classical, but we state them here with uniformity in some parameter $\theta \in \Theta$.

2.A.1 General space

Let (S, d) , (S_1, d_1) and (S_2, d_2) be Polish spaces. We consider some set Θ . In the sequel, for each $\theta \in \Theta$, $(\mu_n^\theta)_{n \in \mathbb{N}}$ will denote a sequence of random probability measures on S and $(\xi_n^\theta)_{n \in \mathbb{N}}$ a sequence of deterministic probability measures on S . Moreover, μ and ξ will be probability measures on S , that are deterministic and do not depend on θ .

Lemma 2.A.1. *Assume that for all Lipschitz $F \in \mathcal{C}_b(S)$ and $\varepsilon > 0$, $\mathbb{P}(|\mu_n^\theta(F) - \mu(F)| \geq \varepsilon) \rightarrow 0$ as $n \rightarrow \infty$ uniformly in $\theta \in \Theta$. Then, the same convergence holds for all $F \in \mathcal{C}_b(S)$.*

Note that in the case where we consider a deterministic sequence $(\xi_n^\theta)_{n \in \mathbb{N}}$, it simply means that $\xi_n^\theta(F) \rightarrow \xi(F)$ uniformly in $\theta \in \Theta$. It is necessary that the limit does not depend on θ .

Proof. We follow the proof of Portmanteau Theorem in Billingsley [Bil99, Theorem 2.1]. Thus, we first consider a closed set A and $\varepsilon > 0$ and we want to show that

$$\lim_{n \rightarrow \infty} \sup_{\theta \in \Theta} \mathbb{P}\left(\mu_n^\theta(A) \geq \mu(A) + \varepsilon\right) = 0. \quad (2.95)$$

We consider, for each $\eta > 0$, the function $F^\eta: x \mapsto 1 - (1 \wedge \eta^{-1}d(x, A)) \in [0, 1]$ that is Lipschitz and such that $F^\eta \downarrow \mathbb{1}_A$. Thus, by dominated convergence, we have $\mu(F^\eta) \rightarrow \mu(A)$ as $\eta \rightarrow 0$. We fix η such that $\mu(F^\eta) \leq \mu(A) + (\varepsilon/2)$. Since $\mu_n^\theta(F^\eta) \geq \mu_n^\theta(A)$, we get

$$\sup_{\theta \in \Theta} \mathbb{P}\left(\mu_n^\theta(A) \geq \mu(A) + \varepsilon\right) \leq \sup_{\theta \in \Theta} \mathbb{P}\left(\mu_n^\theta(F^\eta) \geq \mu(F^\eta) + \frac{\varepsilon}{2}\right) \xrightarrow{n \rightarrow \infty} 0,$$

by using the assumption of the lemma. From (2.95), we get that, for all set A such that $\mu(\partial A) = 0$ \mathbb{P} -a.s. and all $\varepsilon > 0$,

$$\lim_{n \rightarrow \infty} \sup_{\theta \in \Theta} \mathbb{P}\left(\left|\mu_n^\theta(A) - \mu(A)\right| \geq \varepsilon\right) = 0. \quad (2.96)$$

We now consider $F \in \mathcal{C}_b(S)$ and we can assume that F is nonnegative. We fix $\varepsilon > 0$ and set $M := \|F\|$. Firstly, we have

$$\int_0^M \mathbb{E}[\mu(\partial\{F > t\})] dt \leq \int_0^M \mathbb{E}[\mu(\{F = t\})] dt = \mathbb{E}\left[\int_S \int_0^M \mathbb{1}_{F(x)=t} dt d\mu(x)\right] = 0,$$

and, therefore, for almost every $t \in [0, M]$ (in the sense of the Lebesgue measure), \mathbb{P} -a.s., $\mu(\partial\{F > t\}) = 0$. Thus, for all $N \in \mathbb{N}$, we can fix a subdivision $0 = t_0 < t_1 < \dots < t_N = M$ such that for all $0 \leq k \leq N-1$, $t_{k+1} - t_k \leq 2M/N$ and for all $1 \leq k \leq N-1$, $\mu(\partial\{F > t_k\}) = 0$ \mathbb{P} -a.s. Since $\mu(F) = \int_0^M \mu(F > t) dt$ and $t \mapsto \mu(F > t)$ is nonincreasing, we have

$$\sum_{k=1}^N (t_k - t_{k-1})\mu(F > t_k) \leq \mu(F) \leq \sum_{k=0}^{N-1} (t_{k+1} - t_k)\mu(F > t_k) \quad (2.97)$$

and the same holds for μ_n^θ instead of μ , for all $n \in \mathbb{N}$ and $\theta \in \Theta$. Since, in (2.97), the left-hand side and right-hand side of (2.97) tend to $\mu(F)$ as $N \rightarrow \infty$, we can choose N large enough such that they are at most at distance $\varepsilon/2$ from $\mu(F)$. Then, using (2.97) for μ_n^θ , it follows that

$$\begin{aligned} \sup_{\theta \in \Theta} \mathbb{P}\left(\left|\mu_n^\theta(F) - \mu(F)\right| \geq \varepsilon\right) &\leq \sup_{\theta \in \Theta} \left(\mathbb{P}\left(\sum_{k=1}^{N-1} (t_{k+1} - t_k) \left(\mu_n^\theta(F > t_k) - \mu(F > t_k)\right) \geq \frac{\varepsilon}{4}\right) \right. \\ &\quad \left. + \mathbb{P}\left(\sum_{k=1}^{N-1} (t_{k+1} - t_k) \left(\mu_n^\theta(F > t_k) - \mu(F > t_k)\right) \leq -\frac{\varepsilon}{4}\right) \right), \end{aligned}$$

by noting that, in the sums, the term for $k = N$ is zero, since $t_N = M = \|F\|$, and the term for $k = 0$ is smaller than $2t_1 \leq 4M/N \leq \varepsilon/4$, if we choose N large enough. Then, we have

$$\sup_{\theta \in \Theta} \mathbb{P} \left(\left| \mu_n^\theta(F) - \mu(F) \right| \geq \varepsilon \right) \leq \sup_{\theta \in \Theta} \sum_{k=1}^{N-1} \mathbb{P} \left(\left| \mu_n^\theta(F > t_k) - \mu(F > t_k) \right| \geq \frac{\varepsilon N}{8M(N-1)} \right) \xrightarrow{n \rightarrow \infty} 0,$$

by using (2.96), because for all $1 \leq k \leq N-1$, $\mu(\partial\{F > t_k\}) = 0$ \mathbb{P} -a.s. \square

Lemma 2.A.2. *We consider the product space $S := S_1 \times S_2$. Assume that, for all $G_1 \in \mathcal{C}_b^u(S_1)$ and $G_2 \in \mathcal{C}_b^u(S_2)$, $\xi_n^\theta(G_1 \star G_2) \rightarrow \xi(G_1 \star G_2)$ as $n \rightarrow \infty$ uniformly in $\theta \in \Theta$, where $G_1 \star G_2: (x, y) \in S \mapsto G_1(x)G_2(y)$. Then, for all $F \in \mathcal{C}_b(S)$, $\xi_n^\theta(F) \rightarrow \xi(F)$ uniformly in $\theta \in \Theta$.*

Proof. Using Lemma 2.A.1, it is sufficient to consider $F \in \mathcal{C}_b^u(S)$. Let $\varepsilon > 0$. Since F is uniformly continuous, there exists $\eta > 0$ such that for any $x, y \in S$ that verify $d(x, y) \leq \eta$, we have $|F(x) - F(y)| \leq \varepsilon$. Since S_2 is separable for the metric d , there exists $(y_i)_{i \in \mathbb{N}} \in S_2^{\mathbb{N}}$ such that $\bigcup_{i \in \mathbb{N}} B_2(y_i, \eta/2) = S_2$, where $B_2(y, r)$ denotes the open ball of radius r centred at y in S_2 . Now we consider a compact set $K \subset S$ such that $\xi(K) \geq 1 - \varepsilon$ and K' the image of K under the canonical projection $S \rightarrow S_2$. Since K' is a compact set of S_2 , we can extract a finite cover $K' \subset \bigcup_{i=0}^N B(y_i, \eta/2)$. Using again the compactness of K' , there exist nonnegative Lipschitz functions $\chi_0, \dots, \chi_N \in \mathcal{C}_b(S_2)$ such that, for all $0 \leq i \leq N$, $\text{supp} \chi_i \subset B(y_i, \eta/2)$, $\chi_0 + \dots + \chi_N \leq 1$ and $\chi_0 + \dots + \chi_N = 1$ on K' . Finally, we set $\chi := 1 \star (\chi_0 + \dots + \chi_N)$, so that χ is a Lipschitz continuous function from $S \rightarrow [0, 1]$ and $\chi = 1$ on K .

We can now construct some functions of the form $G_1 \star G_2$ to approach F . For $0 \leq i \leq N$, we set $G_1^i: x \in S_1 \mapsto F(x, y_i)$ and $G_2^i: y \in S_2 \mapsto \chi_i(y)$. By the triangle inequality, we have that $|\xi_n^\theta(F) - \xi(F)|$ is smaller than

$$\left| \xi_n^\theta \left(F - \sum_{i=0}^N G_1^i \star G_2^i \right) \right| + \sum_{i=0}^N \left| \xi_n^\theta(G_1^i \star G_2^i) - \xi(G_1^i \star G_2^i) \right| + \left| \xi \left(F - \sum_{i=0}^N G_1^i \star G_2^i \right) \right|. \quad (2.98)$$

The second term in (2.98) tends to 0 as $n \rightarrow \infty$ uniformly in $\theta \in \Theta$ by the assumption of the lemma. On the other hand, we have

$$\left| F - \sum_{i=0}^N G_1^i \star G_2^i \right| \leq \|F\|(1 - \chi) + \left| \chi F - \sum_{i=0}^N G_1^i \star G_2^i \right| \leq \|F\|(1 - \chi) + \varepsilon \chi,$$

because of the choice of η . Thus, we get that the first and third terms of (2.98) are smaller than $2\varepsilon + \|F\|(\xi_n^\theta(1 - \chi) + \xi(1 - \chi))$. Since $1 - \chi = 1 \star (1 - \chi_0 - \dots - \chi_N)$, we can use again the assumption of the lemma to get that $\xi_n^\theta(1 - \chi) \rightarrow \xi(1 - \chi)$ as $n \rightarrow \infty$ uniformly in $\theta \in \Theta$. Noting that $1 - \chi \leq \mathbb{1}_{K^c}$ and $\xi(K^c) \leq \varepsilon$, it proves Lemma 2.A.2. \square

2.A.2 Weak convergence in $\mathcal{D}([0, 1])$

We keep here the notation of the previous subsection, but we take $S = \mathcal{D}([0, 1])$. Recall the definition of the Skorokhod distance d on $\mathcal{D}([0, 1])$: for $x, y \in \mathcal{D}([0, 1])$,

$$d(x, y) := \inf_{\lambda \in \Lambda} (\|\lambda - \text{id}\|_\infty \vee \|x - y \circ \lambda\|_\infty),$$

where we set $\Lambda := \{\lambda: [0, 1] \rightarrow [0, 1] \mid \lambda(0) = 0, \lambda(1) = 1, \lambda \text{ continuous and increasing}\}$, and that, equipped with this distance, $\mathcal{D}([0, 1])$ is a polish space (see Billingsley [Bil99]).

Lemma 2.A.3. *Assume that, for all $F \in C_b^u(\mathcal{D}([0, 1]))$, we have $\xi_n^\theta(F) \rightarrow \xi(F)$ as $n \rightarrow \infty$ uniformly in $\theta \in \Theta$. We consider $F \in C_b^u(\mathcal{D}([0, 1]))$, $(u_n)_{n \in \mathbb{N}} \in (\mathbb{R}_+^*)^{\mathbb{N}}$, $(v_n)_{n \in \mathbb{N}} \in \mathcal{D}([0, 1])^{\mathbb{N}}$ and $(\lambda_n)_{n \in \mathbb{N}} \in \Lambda^{\mathbb{N}}$ such that $u_n \rightarrow 1$, $\|v_n\|_\infty \rightarrow 0$ and $\|\lambda_n - \text{id}\|_\infty \rightarrow 0$. We set $F_n: x \in \mathcal{D}([0, 1]) \mapsto F(v_n + u_n(x \circ \lambda_n))$. Then, we have $\xi_n^\theta(|F_n - F|) \rightarrow 0$ uniformly in $\theta \in \Theta$.*

Proof. For $x \in \mathcal{D}([0, 1])$, we first have

$$\begin{aligned} d(x, v_n + u_n(x \circ \lambda_n)) &\leq \|v_n\|_\infty + d(x, x \circ \lambda_n) + d(x \circ \lambda_n, u_n(x \circ \lambda_n)) \\ &\leq \|v_n\|_\infty + \|\lambda_n - \text{id}\|_\infty + |u_n - 1|\|x\|_\infty. \end{aligned} \quad (2.99)$$

Now, we consider $\varepsilon > 0$ and we fix $K > 0$ such that $\xi(\{\|x\|_\infty \geq K\}) \leq \varepsilon$ and some Lipschitz function $\chi: \mathcal{D}([0, 1]) \rightarrow [0, 1]$ such that $\mathbb{1}_{\|x\|_\infty < K} \leq \chi(x) \leq \mathbb{1}_{\|x\|_\infty < K+1}$ for all $x \in \mathcal{D}([0, 1])$ (this is possible since $\|\cdot\|_\infty$ is Lipschitz on $\mathcal{D}([0, 1])$). Thus, we have

$$\xi_n^\theta(|F_n - F|) \leq \|F_n\| \xi_n^\theta(1 - \chi) + \xi_n^\theta(\chi|F_n - F|) + \|F\| \xi_n^\theta(1 - \chi). \quad (2.100)$$

On the one hand, for $x \in \mathcal{D}([0, 1])$, we have, using $\chi(x) \leq \mathbb{1}_{\|x\|_\infty < K+1}$ and (2.99),

$$\chi(x)|F_n(x) - F(x)| \leq \omega_F(\|v_n\|_\infty + \|\lambda_n - \text{id}\|_\infty + |u_n - 1|(K + 1)),$$

so we get $|\xi_n^\theta(\chi(F_n - F))| \leq \|\chi(F_n - F)\| \rightarrow 0$ as $n \rightarrow \infty$ uniformly in $\theta \in \Theta$. On the other hand, by using the assumption of the lemma with the function $1 - \chi$, the first and third terms in the right-hand side of (2.100) tend towards $2\|F\|\xi(1 - \chi)$ uniformly in $\theta \in \Theta$. Since $\xi(1 - \chi) \leq \varepsilon$, it concludes the proof of Lemma 2.A.3. \square

Remark 2.A.4. In Lemma 2.A.3, if the limit measure ξ^θ depends on $\theta \in \Theta$, then the result is still true under the additional assumption that $\sup_{\theta \in \Theta} \xi(\{\|x\|_\infty \geq K\}) \rightarrow 0$ as $K \rightarrow \infty$, so that in the proof K and χ could be chosen independently of θ .

Lemma 2.A.5. *Assume that $\xi(\{x(0) = 0\}) = 1$ and that, for all $F \in C_b^u(\mathcal{D}([0, 1]))$, we have $\xi_n^\theta(F) \rightarrow \xi(F)$ as $n \rightarrow \infty$ uniformly in $\theta \in \Theta$. We consider $F \in C_b^u(\mathcal{D}([0, 1]))$ and $(\kappa_n)_{n \in \mathbb{N}}$ such that $\kappa_n \rightarrow 0$. We set $F_n: x \in \mathcal{D}([0, 1]) \mapsto F(x_{\kappa_n + (1 - \kappa_n)t} - x_{\kappa_n}, t \in [0, 1])$. Then, we have $\xi_n^\theta(|F_n - F|) \rightarrow 0$ uniformly in $\theta \in \Theta$.*

Proof. The function $\varphi_n: t \in [0, 1] \mapsto \kappa_n + (1 - \kappa_n)t$ is not bijective from $[0, 1]$ to $[0, 1]$, so we consider a function $\lambda_n \in \Lambda$ such that $\lambda_n(t) = \kappa_n + (1 - \kappa_n)t$ for $t \geq \kappa_n$ and that is linear on $[0, \kappa_n]$. Then, for $x \in \mathcal{D}([0, 1])$, we have

$$d(x, x \circ \varphi_n - x_{\kappa_n}) \leq \|\lambda_n - \text{id}\|_\infty \vee \|x \circ \lambda_n - x \circ \varphi_n - x_{\kappa_n}\|_\infty \leq \kappa_n \vee 3 \max_{[0, \kappa_n]} |x|. \quad (2.101)$$

Let $\varepsilon > 0$. Since $\xi(\{x(0) = 0\}) = 1$, there exists $\delta > 0$ such that $\xi(\{\max_{[0, \delta]} |x| > \varepsilon\}) \leq \varepsilon$. Let $\chi: \mathcal{D}([0, 1]) \rightarrow [0, 1]$ be a Lipschitz function such that $\mathbb{1}_{\max_{[0, \delta]} |x| < \varepsilon} \leq \chi(x) \leq \mathbb{1}_{\max_{[0, \delta]} |x| < 2\varepsilon}$ for all $x \in \mathcal{D}([0, 1])$. Thus, we have, using the triangle inequality and then (2.101),

$$\begin{aligned} \xi_n^\theta(|F_n - F|) &\leq \|F_n\| \xi_n^\theta(1 - \chi) + \xi_n^\theta(\chi|F_n - F|) + \|F\| \xi_n^\theta(1 - \chi) \\ &\leq 2\|F\| \xi_n^\theta(1 - \chi) + \omega_F(\kappa_n \vee 6\varepsilon), \end{aligned}$$

for n large enough such that $\kappa_n \leq \delta$ (so independent of θ). Finally, using the assumption of the lemma with the function $1 - \chi$ and recalling that $\xi(1 - \chi) \leq \varepsilon$, it concludes the proof. \square

2.B Proofs of preliminary results concerning random walk

In this section, we prove the results stated in Section 2.2. Section 2.B.1 is devoted to the proof of Proposition 2.2.6 and Corollary 2.2.7. Sections 2.B.2 and 2.B.3 contain preliminary results for the proof of Proposition 2.2.8 in Section 2.B.4.

2.B.1 Convergence towards the Bessel process and the Brownian meander

We first recall a known invariance principle for the random walk conditioned to stay nonnegative for all time. For all $n \in \mathbb{N}$, $u \in \mathbb{R}_+$ and $B \in \mathcal{F}_n$, we set

$$\mathbb{P}_u^+(B) := \frac{1}{R(u)} \mathbb{E}_u \left[R(S_n) \mathbb{1}_B \mathbb{1}_{\underline{S}_n \geq 0} \right]. \quad (2.102)$$

It defines a probability measure \mathbb{P}_u^+ , that is called the law of the random walk started at $u \in \mathbb{R}_+$ and conditioned to stay nonnegative for all time. Then we have the following invariance principle, by Theorem 1.1 of Caravenna and Chaumont [CC08]: for any $b \in \mathbb{R}_+$ and $(b_n)_{n \in \mathbb{N}}$ such that $b_n/\sigma\sqrt{n} \rightarrow b$ as $n \rightarrow \infty$ and for any $F \in \mathcal{C}_b(\mathcal{D}([0, 1]))$,

$$\mathbb{E}_{b_n}^+ \left[F(\mathbf{S}^{(n)}) \right] \xrightarrow{n \rightarrow \infty} \mathbb{E}_b[F(\mathcal{R})], \quad (2.103)$$

where \mathcal{R} denotes the 3-dimensional Bessel process on $[0, 1]$.

Proposition 2.2.6 follows from (2.103) and the following link between the 3-dimensional Bessel process and the Brownian meander (see Imhof [Imh84]): for all $F \in \mathcal{C}_b(\mathcal{D}([0, 1]))$, we have

$$\mathbb{E}[F(\mathcal{M})] = \sqrt{\frac{\pi}{2}} \mathbb{E} \left[\frac{1}{\mathcal{R}(1)} F(\mathcal{R}) \right]. \quad (2.104)$$

Proof of Proposition 2.2.6. We can assume that F is nonnegative. For $K > 0$, we consider $\chi: \mathbb{R}_+ \rightarrow [0, 1]$ continuous such that $\mathbb{1}_{[K^{-1}, K]} \leq \chi \leq \mathbb{1}_{[(2K)^{-1}, 2K]}$. On the one hand, we have

$$\mathbb{E}_u \left[F(\mathbf{S}^{(n)}) \left(1 - \chi \left(\frac{S_n}{\sigma\sqrt{n}} \right) \right) \mathbb{1}_{\underline{S}_n \geq 0} \right] \leq \|F\| \frac{\theta R(u)}{\sqrt{n}} \left(\int_0^\infty (1 - \chi(t)) t e^{-t^2/2} dt + o(1) \right), \quad (2.105)$$

uniformly in $u \in [0, \gamma_n]$, using (2.23). On the other hand, we have

$$\mathbb{E}_u \left[F(\mathbf{S}^{(n)}) \chi \left(\frac{S_n}{\sigma\sqrt{n}} \right) \mathbb{1}_{\underline{S}_n \geq 0} \right] = \frac{R(u)}{\sqrt{n}} \mathbb{E}_u^+ \left[h_n \left(\frac{S_n}{\sigma\sqrt{n}} \right) F(\mathbf{S}^{(n)}) \right], \quad (2.106)$$

where we set, for $z \in \mathbb{R}_+$, $h_n(z) := \sqrt{n} \chi(z) / R(z\sigma\sqrt{n})$. Using (2.18) and $\chi \leq \mathbb{1}_{[(2K)^{-1}, 2K]}$, we have $\limsup_{n \rightarrow \infty} \sup_{z \in \mathbb{R}_+} |h_n(z) - h(z)| = 0$, with $h(z) := \chi(z) / c_R \sigma z$. Thus, we get, uniformly in u because h_n and h do not depend on u ,

$$\limsup_{n \rightarrow \infty} \left| \mathbb{E}_u^+ \left[h_n \left(\frac{S_n}{\sigma\sqrt{n}} \right) F(\mathbf{S}^{(n)}) \right] - \mathbb{E}_u^+ \left[h \left(\frac{S_n}{\sigma\sqrt{n}} \right) F(\mathbf{S}^{(n)}) \right] \right| = 0.$$

Moreover, using (2.103), (2.104) and (2.22), we have

$$\mathbb{E}_u^+ \left[h \left(\frac{S_n}{\sigma\sqrt{n}} \right) F(\mathbf{S}^{(n)}) \right] \xrightarrow{n \rightarrow \infty} \mathbb{E} \left[\frac{\chi(\mathcal{R}(1))}{c_R \sigma \mathcal{R}(1)} F(\mathcal{R}(t), t \in [0, 1]) \right] = \theta \mathbb{E}[\chi(\mathcal{M}(1)) F(\mathcal{M})],$$

uniformly in $u \in [0, \gamma_n]$. Coming back to (2.105) and (2.106) and using that the density of $\mathcal{M}(1)$ is $t \mapsto t e^{-t^2/2} \mathbb{1}_{t > 0}$, we showed that

$$\limsup_{n \rightarrow \infty} \sup_{u \in [0, \gamma_n]} \left| \frac{\sqrt{n}}{\theta R(u)} \mathbb{E}_u \left[F(\mathbf{S}^{(n)}) \mathbb{1}_{\underline{S}_n \geq 0} \right] - \mathbb{E}[F(\mathcal{M})] \right| \leq 2 \|F\| \int_0^\infty (1 - \chi(t)) t e^{-t^2/2} dt,$$

which tends to 0 as $K \rightarrow \infty$, so it concludes the proof. \square

Proof of Corollary 2.2.7. By Lemma A.2 of Madaule [Mad16a] (that holds under the assumption of this corollary, see Remark 2.3.1), there exists $C > 0$ depending on L and D such that for all n large enough and $K \geq 0$,

$$\mathbb{E}\left[e^{DS_n/\sqrt{n}} \mathbb{1}_{\underline{S}_n \geq -L, S_n \geq K\sqrt{n}}\right] \leq \frac{C}{\sqrt{n}} e^{-DK/2}. \quad (2.107)$$

We consider some $\varepsilon > 0$ and fix K large enough such that $Ce^{-DK/2} \leq \varepsilon\theta R(L)/\|F\|$ and also $\mathbb{E}[e^{D\sigma\mathcal{M}(1)} \mathbb{1}_{\mathcal{M}(1) \geq K}] \leq \varepsilon/\|F\|$. Considering a continuous function $\chi: \mathbb{R} \rightarrow [0, 1]$ such that $\mathbb{1}_{x \leq K} \leq \chi(x) \leq \mathbb{1}_{x \leq K+1}$ and using the triangle inequality, we get

$$\begin{aligned} & \left| \frac{\sqrt{n}}{\theta R(L)} \mathbb{E}\left[e^{DS_n/\sqrt{n}} F(\mathbf{S}^{(n)}) \mathbb{1}_{\underline{S}_n \geq -L}\right] - \mathbb{E}\left[e^{D\sigma\mathcal{M}(1)} F(\mathcal{M})\right] \right| \\ & \leq 2\varepsilon + \left| \frac{\sqrt{n}}{\theta R(L)} \mathbb{E}\left[e^{DS_n/\sqrt{n}} F(\mathbf{S}^{(n)}) \chi\left(\frac{S_n}{\sqrt{n}}\right) \mathbb{1}_{\underline{S}_n \geq -L}\right] - \mathbb{E}\left[e^{D\sigma\mathcal{M}(1)} F(\mathcal{M}) \chi(\sigma\mathcal{M}(1))\right] \right|. \end{aligned} \quad (2.108)$$

Then, note that in Proposition 2.2.6, we can replace $\mathbb{E}_u[F(\mathbf{S}^{(n)}) \mathbb{1}_{\underline{S}_n \geq 0}]$ by $\mathbb{E}[F(\mathbf{S}^{(n)}) \mathbb{1}_{\underline{S}_n \geq -u}]$: indeed, it works when $F \in \mathcal{C}_b^u(\mathcal{D}([0, 1]))$ and we extend to $F \in \mathcal{C}_b(\mathcal{D}([0, 1]))$ by Lemma 2.A.1. Thus, applying Proposition 2.2.6 with the function $x \in \mathcal{D}([0, 1]) \mapsto e^{D\sigma x_1} F(x) \chi(\sigma x_1)$ which belongs to $\mathcal{C}_b(\mathcal{D}([0, 1]))$ we get that the right-hand of (2.108) tends to 2ε as $n \rightarrow \infty$ and it concludes the proof of Corollary 2.2.7. \square

2.B.2 Local limit theorems

We first recall the classical Stone's [Sto65] local limit theorem: letting $h > 0$ be any real number if S_1 is nonlattice and be the span of the lattice if S_1 is lattice, we have

$$\mathbb{P}(S_n \in [b, b+h]) = \frac{h}{\sigma\sqrt{2\pi n}} e^{-b^2/2\sigma^2 n} + o\left(\frac{1}{\sqrt{n}}\right), \quad (2.109)$$

as $n \rightarrow \infty$, uniformly in $b \in \mathbb{R}$. Thus we have the following uniform bound: there exists $C > 0$ such that, for all $n \geq 1$ and $b \in \mathbb{R}$,

$$\mathbb{P}(S_n \in [b, b+1]) \leq \frac{C}{\sqrt{n}}. \quad (2.110)$$

Now, we state a local limit theorem for the random walk staying above a barrier, in the case where the starting point is at distance of order \sqrt{n} from the barrier and the endpoint at distance $o(\sqrt{n})$.

Lemma 2.B.1. *Let $(\gamma_n)_{n \in \mathbb{N}}$ be a sequence of positive numbers such that $\gamma_n \ll \sqrt{n}$ as $n \rightarrow \infty$. We set $f: t \in \mathbb{R} \mapsto te^{-t^2/2} \mathbb{1}_{t \geq 0}$.*

(i) *If the law of S_1 is nonlattice, then, for all $h > 0$,*

$$\mathbb{P}(S_n \in [u-b, u-b+h], \underline{S}_n \geq -b) = \frac{\theta^-}{\sigma n} f\left(\frac{b}{\sigma\sqrt{n}}\right) \int_u^{u+h} R^-(t) dt + o\left(\frac{R^-(u)}{n}\right),$$

as $n \rightarrow \infty$, uniformly in $b \in \mathbb{R}$ and in $u \in [0, \gamma_n]$.

(ii) *If the law of S_1 is (h, a) -lattice, then,*

$$\mathbb{P}(S_n = u-b, \underline{S}_n \geq -b) = \frac{\theta^-}{\sigma n} f\left(\frac{b}{\sigma\sqrt{n}}\right) h R^-(u) + o\left(\frac{R^-(u)}{n}\right),$$

as $n \rightarrow \infty$, uniformly in $b \in \mathbb{R}$ and $u \in [0, \gamma_n] \cap (b + an + h\mathbb{Z})$.

Proof. First note that, for each $D > 0$, by Propositions 11, 18 and 24 of Doney [Don12], both estimates of Lemma 2.B.1 holds uniformly in $b \in [D^{-1}\sqrt{n}, D\sqrt{n}]$ and $u \in [0, \gamma_n]^4$. Noting also that f tends to 0 at 0 and at infinity, it is sufficient to prove that, for each $h > 0$ and $\varepsilon > 0$, there exist D and n large enough such that $\mathbb{P}(S_n \in [u - b, u - b + h], \underline{S}_n \geq -b) \leq \varepsilon R^-(u)/n$ for all $b \notin [D^{-1}\sqrt{n}, D\sqrt{n}]$ and $u \in \mathbb{R}_+$. Reversing time, we can equivalently prove that $\mathbb{P}(S_n \in [b - u, b - u + h], \underline{S}_n \geq -u) \leq \varepsilon R(u)/n$.

For $b \in [0, D^{-1}\sqrt{n}]$, using (2.24) and (2.19), we get $\mathbb{P}(S_n \in [b - u, b - u + h], \underline{S}_n \geq -u) \leq CR(u)(1 + D^{-1}\sqrt{n})/n^{3/2}$. For D and n large enough and independent of u , this is smaller than $\varepsilon R(u)/n$.

For $b > D\sqrt{n}$, we cancel the lower barrier between times $\lfloor n/2 \rfloor + 1$ and n so that we get

$$\mathbb{P}(S_n \in [b - u, b - u + h], \underline{S}_n \geq -u) \leq \mathbb{E} \left[\mathbb{1}_{\underline{S}_{\lfloor n/2 \rfloor} \geq -u} h \left(\frac{S_{\lfloor n/2 \rfloor} + u}{\sigma_{\lfloor n/2 \rfloor}^{1/2}} \right) \right], \quad (2.111)$$

where we set for $x \geq 0$, $h(x) := \mathbb{P}(S_{n - \lfloor n/2 \rfloor} + x\sigma_{\lfloor n/2 \rfloor}^{1/2} \in [b, b + h])$. Using (2.109), we have, uniformly in $b > D\sqrt{n}$ and $x \in \mathbb{R}_+$,

$$h(x) \leq \frac{C}{\sqrt{n}} \exp \left(-\frac{(x\sigma_{\lfloor n/2 \rfloor}^{1/2} - b)^2}{2\sigma^2(n - \lfloor n/2 \rfloor)} \right) + o \left(\frac{1}{\sqrt{n}} \right) \leq \frac{C}{\sqrt{n}} g_D(x) + o \left(\frac{1}{\sqrt{n}} \right),$$

where $g_D: \mathbb{R}_+ \rightarrow [0, 1]$, obtained by taking the supremum on $b > D\sqrt{n}$, is continuous and converges simply to 0 as $D \rightarrow \infty$. Thus, using (2.23) and (2.21), we get that (2.111) is smaller than

$$\frac{C}{\sqrt{n}} \frac{\theta R(u)}{\sqrt{n}} \left(\int_0^\infty g_D(t) t e^{-t^2/2} dt + o(1) \right) + \frac{CR(u)}{\sqrt{n}} o \left(\frac{1}{\sqrt{n}} \right), \quad (2.112)$$

uniformly in $b \geq D\sqrt{n}$ and $u \in [0, \gamma_n]$. By the dominated convergence theorem, the integral in (2.112) tends to 0 as $D \rightarrow \infty$ and, thus, (2.111) is smaller than $\varepsilon R(u)/n$ for D and n large enough and independent of u . \square

2.B.3 Convergence towards the Bessel bridge

In this subsection, we are going to prove the following generalization of Lemma 2.4 of Chen, Madaule and Mallein [CMM19]. It proves that conditioned by the event of Lemma 2.B.1 the trajectory $\mathbf{S}^{(n)}$ converges to the Bessel bridge. This is a first step in the proof of Proposition 2.2.8.

Lemma 2.B.2. *Let $(\gamma_n)_{n \in \mathbb{N}}$ be a sequence of positive numbers such that $\gamma_n \ll \sqrt{n}$ as $n \rightarrow \infty$. We set $f: t \in \mathbb{R} \mapsto t e^{-t^2/2} \mathbb{1}_{t \geq 0}$ and we denote by $\varrho_{b,0}^1$ the 3-dimensional Bessel bridge of length 1 from $b \in \mathbb{R}_+$ to 0.*

(i) *If the law of S_1 is nonlattice, then, for all $h > 0$ and $F \in \mathcal{C}_b^u(\mathcal{D}([0, 1]))$,*

$$\mathbb{E}_{b\sigma\sqrt{n}} \left[F(\mathbf{S}^{(n)}) \mathbb{1}_{S_n \in [u, u+h], \underline{S}_n \geq 0} \right] = \frac{\theta^-}{\sigma n} \int_u^{u+h} R^-(t) dt f(b) \mathbb{E} \left[F(\varrho_{b,0}^1) \right] + o \left(\frac{R^-(u)}{n} \right),$$

as $n \rightarrow \infty$, uniformly in $b \in \mathbb{R}$ and in $u \in [0, \gamma_n]$.

4. Doney states his results in terms of the renewal function for the first *weak* increasing ladder height process of S and of $\mathbb{P}(\min_{1 \leq k \leq n} S_n > 0)$. Our formulation follows from Remark 4.6 of Caravenna and Chaumont [CC13] (although they work only in the lattice and absolutely continuous cases, this remark does not rely on these assumptions).

(ii) If the law of S_1 is (h, a) -lattice, then, for all $F \in \mathcal{C}_b^u(\mathcal{D}([0, 1]))$,

$$\mathbb{E}_{b\sigma\sqrt{n}}[F(\mathbf{S}^{(n)})\mathbb{1}_{S_n=u, \underline{S}_n \geq 0}] = \frac{\theta^-}{\sigma n} h R^-(u) f(b) \mathbb{E}[F(\varrho_{b,0}^1)] + o\left(\frac{R^-(u)}{n}\right),$$

as $n \rightarrow \infty$, uniformly in $b \in \mathbb{R}$ and $u \in [0, \gamma_n] \cap (b\sigma\sqrt{n} + an + h\mathbb{Z})$.

Proof. We will treat only the nonlattice case, because the proof in the lattice case is exactly the same, with $hR^-(u)$ instead of $\int_u^{u+h} R^-(t) dt$. Moreover, since F is bounded, $f(b) \rightarrow 0$ as $b \rightarrow \infty$ and Lemma 2.B.1 deals with the case $F \equiv 1$, it is sufficient to show that, for each $K > 0$, the estimate holds uniformly in $b \in [0, K]$ instead of $b \in \mathbb{R}_+$.

We first assume that $\forall x \in \mathcal{D}([0, 1])$, $F(x) = F'(x_t, t \in [0, 1-\varepsilon])$ for some $F' \in \mathcal{C}_b^u(\mathcal{D}([0, 1-\varepsilon]))$. Thus, $F(\mathbf{S}^{(n)})$ is \mathcal{F}_m -measurable with $m := \lceil (1-\varepsilon)n \rceil$ and we have

$$\mathbb{E}_{b\sigma\sqrt{n}}[F(\mathbf{S}^{(n)})\mathbb{1}_{S_n \in [u, u+h], \underline{S}_n \geq 0}] = \mathbb{E}_{b\sigma\sqrt{n}}\left[F(\mathbf{S}^{(n)})g\left(\frac{S_m}{\sigma\sqrt{n}}\right)\mathbb{1}_{\underline{S}_m \geq 0}\right], \quad (2.113)$$

where we set, for $z \in \mathbb{R}_+$,

$$g(z) := \mathbb{P}_{z\sigma\sqrt{n}}(\underline{S}_{n-m} \geq 0, S_{n-m} \in [u, u+h]) = \frac{\theta^-}{\sigma\varepsilon n} f\left(\frac{z}{\sqrt{\varepsilon}}\right) \int_u^{u+h} R^-(t) dt + o\left(\frac{R^-(u)}{n}\right),$$

uniformly in $u \in [0, \gamma_n]$ and $z \in \mathbb{R}_+$, using Lemma 2.B.1. Therefore, (2.113) is equal to

$$\frac{\theta^-}{\sigma\varepsilon n} \int_u^{u+h} R^-(t) dt \mathbb{E}_{b\sigma\sqrt{n}}\left[F(\mathbf{S}^{(n)})f\left(\frac{S_m}{\sigma\sqrt{\varepsilon n}}\right)\mathbb{1}_{\underline{S}_m \geq 0}\right] + \mathbb{E}_{b\sigma\sqrt{n}}[F(\mathbf{S}^{(n)})\mathbb{1}_{\underline{S}_m \geq 0}] o\left(\frac{R^-(u)}{n}\right),$$

uniformly in $u \in [0, \gamma_n]$ and $b \in [0, K]$. Thus, it is now sufficient to prove that

$$\mathbb{E}_{b\sigma\sqrt{n}}\left[F(\mathbf{S}^{(n)})f\left(\frac{S_m}{\sigma\sqrt{\varepsilon n}}\right)\mathbb{1}_{\underline{S}_m \geq 0}\right] \xrightarrow{n \rightarrow \infty} \varepsilon f(b) \mathbb{E}[F(\varrho_{b,0}^1)], \quad (2.114)$$

uniformly in $b \in [0, K]$. On the one hand, by Equation (2.30) of Chen, Madaule and Mallein [CMM19], we have

$$\varepsilon f(b) \mathbb{E}[F(\varrho_{b,0}^1)] = \frac{b}{\sqrt{\varepsilon}} \mathbb{E}_b[F'(\mathcal{R}(s), s \in [0, 1-\varepsilon])e^{-\mathcal{R}(1-\varepsilon)^2/2\varepsilon}]. \quad (2.115)$$

On the other hand, recalling (2.102), we get

$$\mathbb{E}_{b\sigma\sqrt{n}}\left[F(\mathbf{S}^{(n)})f\left(\frac{S_m}{\sigma\sqrt{\varepsilon n}}\right)\mathbb{1}_{\underline{S}_m \geq 0}\right] = \mathbb{E}_{b\sigma\sqrt{n}}^+\left[F(\mathbf{S}^{(n)})h_{\varepsilon,b}^n\left(\frac{S_m}{\sigma\sqrt{n}}\right)\right], \quad (2.116)$$

where we set, for $z \in \mathbb{R}_+$,

$$h_{\varepsilon,b}^n(z) := f\left(\frac{z}{\sqrt{\varepsilon}}\right) \frac{R(b\sigma\sqrt{n})}{R(z\sigma\sqrt{n})} = \frac{z}{\sqrt{\varepsilon}} e^{-z^2/2\varepsilon} \frac{R(b\sigma\sqrt{n})}{R(z\sigma\sqrt{n})}.$$

Since $e^{-z^2/2\varepsilon} \rightarrow 0$ as $z \rightarrow \infty$ and using (2.18), it is clear that

$$\sup_{b \in [0, K], z \in \mathbb{R}_+} \left| h_{\varepsilon,b}^n(z) - \frac{b}{\sqrt{\varepsilon}} e^{-z^2/2\varepsilon} \right| \xrightarrow{n \rightarrow \infty} 0, \quad (2.117)$$

so we get, combining (2.115), (2.116) and (2.117),

$$\begin{aligned} & \limsup_{n \rightarrow \infty} \sup_{b \in [0, K]} \left| \mathbb{E}_{b\sigma\sqrt{n}} \left[F(\mathbf{S}^{(n)}) f\left(\frac{S_m}{\sigma\sqrt{\varepsilon n}}\right) \mathbb{1}_{S_m \geq 0} \right] - \varepsilon f(b) \mathbb{E} \left[F(\varrho_{b,0}^1) \right] \right| \\ & \leq \limsup_{n \rightarrow \infty} \sup_{b \in [0, K]} \frac{b}{\sqrt{\varepsilon}} \left| \mathbb{E}_{b\sigma\sqrt{n}}^+ \left[F(\mathbf{S}^{(n)}) e^{-S_m^2/2\sigma^2\varepsilon n} \right] - \mathbb{E}_b \left[F'(\mathcal{R}(s), s \in [0, 1 - \varepsilon]) e^{-\mathcal{R}(1-\varepsilon)^2/2\varepsilon} \right] \right|, \end{aligned}$$

which is equal to 0 by applying (2.103). It proves (2.114) and so it concludes the case where $F(x) = F'(x_t, t \in [0, 1 - \varepsilon])$ for some $F' \in \mathcal{C}_b^u(\mathcal{D}([0, 1 - \varepsilon]))$.

We now want to extend the result to the case $F \in \mathcal{C}_b^u(\mathcal{D}([0, 1]))$. For $\varepsilon > 0$ and $x \in \mathcal{D}([0, 1])$, we define $\varphi_\varepsilon(x) \in \mathcal{D}([0, 1])$ by $\varphi_\varepsilon(x)|_{[0, 1-\varepsilon]} = x|_{[0, 1-\varepsilon]}$ and $\varphi_\varepsilon(x)|_{[1-\varepsilon, 1]} \equiv 0$, so that $F \circ \varphi_\varepsilon$ satisfies the assumption of the particular case that is already proved. Thus, it is now sufficient to show that, for each $\eta > 0$, there exists $\varepsilon > 0$ such that

$$\limsup_{n \rightarrow \infty} \sup_{u \in [0, \gamma_n], b \in [0, K]} \mathbb{E}_{b\sigma\sqrt{n}} \left[\left| F(\mathbf{S}^{(n)}) - F \circ \varphi_\varepsilon(\mathbf{S}^{(n)}) \right| \mathbb{1}_{S_n \in [u, u+h], S_n \geq 0} \right] \leq \eta \frac{R^-(u)}{n}, \quad (2.118)$$

$$\sup_{b \in [0, K]} f(b) \mathbb{E} \left[\left| F(\varrho_{b,0}^1) - F \circ \varphi_\varepsilon(\varrho_{b,0}^1) \right| \right] \leq \eta. \quad (2.119)$$

We first prove (2.119): we have

$$\mathbb{E} \left[\left| F(\varrho_{b,0}^1) - F \circ \varphi_\varepsilon(\varrho_{b,0}^1) \right| \right] \leq \mathbb{E} \left[\omega_F(\|\varrho_{b,0}^1 - \varphi_\varepsilon(\varrho_{b,0}^1)\|_\infty) \right] \leq \mathbb{E} \left[\omega_F \left(\sup_{t \in [1-\varepsilon, 1]} \varrho_{b,0}^1(t) \right) \right] =: \mathbb{E}_{b,\varepsilon}.$$

Since the function $b \mapsto \mathbb{E}_{b,\varepsilon}$ is nondecreasing and $f \leq 1$, the left-hand side of (2.119) is smaller than $\mathbb{E}_{K,\varepsilon}$ and, thus, it tends to 0 as $\varepsilon \rightarrow 0$ by dominated convergence, because ω_F is bounded. Now, we prove (2.118): using that $d(\mathbf{S}^{(n)}, \varphi_\varepsilon(\mathbf{S}^{(n)})) \leq \max_{0 \leq k \leq \varepsilon n} S_{n-k}/\sigma\sqrt{n}$ and reversing time, we get that the expectation in (2.118) is smaller than

$$\mathbb{E} \left[\omega_F \left(\sup_{0 \leq k \leq \varepsilon n} \frac{S_k^- + u + h}{\sigma\sqrt{n}} \right) \mathbb{1}_{S_n^- - b\sigma\sqrt{n} \in (-u-h, -u], S_n^- \geq -u-h} \right]. \quad (2.120)$$

Conditioning with respect to $\mathcal{F}_{\lfloor n/2 \rfloor}$ and applying (2.110), we get that (2.120) is smaller than

$$\begin{aligned} & \frac{C(1+h)}{(n - \lfloor n/2 \rfloor)^{1/2}} \mathbb{E} \left[\omega_F \left(\sup_{0 \leq k \leq \varepsilon n} \frac{S_k^- + u + h}{\sigma\sqrt{n}} \right) \mathbb{1}_{S_{\lfloor n/2 \rfloor}^- \geq -u-h} \right] \\ & = \frac{C(1+h)}{\sqrt{n/2}} \frac{\theta^- R^-(u+h)}{\sqrt{n/2}} \left(\mathbb{E} \left[\omega_F \left(\frac{1}{\sqrt{2}} \sup_{t \in [0, 2\varepsilon]} \mathcal{M}_t \right) \right] + o(1) \right), \end{aligned} \quad (2.121)$$

uniformly in $u \in [0, \gamma_n]$ et $b \in [0, K]$, by using Lemma 2.2.6 to get the last equality. The expectation in the right-hand side of (2.121) does not depend on n , b and u and tends to 0 as $\varepsilon \rightarrow 0$ by dominated convergence, so it shows (2.118) and concludes the proof. \square

2.B.4 Convergence towards the Brownian excursion

We prove here Proposition 2.2.8, in a similar way as Lemma 2.5 of Chen, Madaule and Mallein [CMM19], but directly with a first barrier that can be different of 0. Following [CMM19], we fix some $\lambda \in (0, 1)$ and, for $G_1: \mathcal{D}([0, \lambda]) \rightarrow \mathbb{R}$, $G_2: \mathcal{D}([0, 1 - \lambda]) \rightarrow \mathbb{R}$ and $x \in \mathcal{D}([0, 1])$, we set

$$G_1 \star G_2(x) := G_1(x_s, s \in [0, \lambda]) G_2(x_{\lambda+s}, s \in [0, 1 - \lambda]).$$

Then, by [CMM19, Lemma 2.3], we have, for each $G_1 \in \mathcal{C}_b(\mathcal{D}([0, \lambda]))$ and $G_2 \in \mathcal{C}_b(\mathcal{D}([0, 1 - \lambda]))$,

$$\mathbb{E}[G_1 \star G_2(\mathbf{e})] = \sqrt{\frac{2}{\pi}} \frac{1}{\lambda^{1/2}(1-\lambda)^{3/2}} \mathbb{E}\left[\mathcal{M}(\lambda) e^{-\mathcal{M}(\lambda)^2/2(1-\lambda)} G_1(\mathcal{M}) G_2(\varrho_{\mathcal{M}(\lambda), 0}^{1-\lambda})\right], \quad (2.122)$$

where \mathbf{e} is the normalized Brownian excursion, \mathcal{M} is the Brownian meander of length λ and $(\varrho_{z, 0}^{1-\lambda})_{z \in \mathbb{R}_+}$ is a family of Bessel bridges of length $1 - \lambda$ from z to 0 , independent of \mathcal{M} .

Proof of Proposition 2.2.8. Using Lemma 2.A.2, it is sufficient to consider the case where $F = G_1 \star G_2$ for some $G_1 \in \mathcal{C}_b^u(\mathcal{D}([0, \lambda]))$ and $G_2 \in \mathcal{C}_b^u(\mathcal{D}([0, 1 - \lambda]))$. The proof will be only treated in the lattice case: in the nonlattice case, the reasoning is exactly the same with $\int_b^{b+h} R^-(t) dt$ instead of $hR^-(b)$. We set $m := \lfloor \lambda n \rfloor$ and take the conditional expectation according to \mathcal{F}_m to get that

$$\mathbb{E}\left[F(\mathbf{S}^{(n)}) \mathbb{1}_{\underline{S}_{\lfloor \lambda n \rfloor} \geq -u, \min_{\lfloor \lambda n \rfloor \leq i \leq n} S_i \geq v, S_n = v+b}\right] = \mathbb{E}\left[G_1\left(\frac{S_{\lfloor sn \rfloor}}{\sigma\sqrt{n}}, s \leq \lambda\right) \varphi\left(\frac{S_m}{\sigma\sqrt{n}}\right) \mathbb{1}_{\underline{S}_m \geq -u}\right], \quad (2.123)$$

where we set $\varphi(z) := \mathbb{E}_{z, \sigma\sqrt{n}}[G_2(S_{\lfloor (s+\lambda)n \rfloor - m}/\sigma\sqrt{n}, s \leq 1 - \lambda) \mathbb{1}_{\underline{S}_{n-m} \geq v, S_n = v+b}]$, for each $z \in \mathbb{R}$ such that $v + b + z\sigma\sqrt{n} \in a(n - m) + h\mathbb{Z}$. Then, since G_2 is uniformly continuous, using Lemma 2.B.2 combined with Lemma 2.A.3⁵, we get that $\varphi(z)$ is equal to

$$\frac{\theta^-}{\sigma(1-\lambda)n} hR^-(b) f\left(\frac{z}{\sqrt{1-\lambda}}\right) \mathbb{E}\left[G_2\left(\sqrt{1-\lambda} \varrho_{z/\sqrt{1-\lambda}, 0}^1(s/(1-\lambda)), s \leq 1-\lambda\right)\right] + o\left(\frac{R^-(b)}{n}\right),$$

uniformly in $v \in [-\gamma n, \gamma n]$, $b \in [0, \gamma n] \cap (-v + an + h\mathbb{Z})$ and $z \in \mathbb{R}$ such that $v + b + z\sigma\sqrt{n} \in a(n - m) + h\mathbb{Z}$ (note that if $z < 0$, the fact that the Bessel bridge is not well-defined is not a problem, because $f(z/\sqrt{1-\lambda}) = 0$ so the first term is zero). Since the last expectation is equal to $\mathbb{E}[G_2(\varrho_{z, 0}^{1-\lambda})]$ by scaling properties of the Bessel bridge, (2.123) is equal to

$$\begin{aligned} & \frac{\theta^-}{\sigma(1-\lambda)n} hR^-(b) \mathbb{E}\left[G_1\left(\frac{S_{\lfloor sn \rfloor}}{\sigma\sqrt{n}}, s \leq \lambda\right) f\left(\frac{S_m}{\sqrt{1-\lambda}\sigma\sqrt{n}}\right) G_2\left(\varrho_{S_m/\sigma\sqrt{n}, 0}^{1-\lambda}\right) \mathbb{1}_{\underline{S}_m \geq -u}\right] \\ & + \mathbb{E}\left[G_1\left(\frac{S_{\lfloor sn \rfloor}}{\sigma\sqrt{n}}, s \leq \lambda\right) \mathbb{1}_{\underline{S}_m \geq -u}\right] o\left(\frac{R^-(b)}{n}\right), \end{aligned} \quad (2.124)$$

where $(\varrho_{z, 0}^{1-\lambda})_{z \in \mathbb{R}_+}$ is independent of $(S_n)_{n \in \mathbb{N}}$. Then, since the function $z \in \mathbb{R} \mapsto \mathbb{E}[G_2(\varrho_{z, 0}^{1-\lambda})]$ is continuous, using Lemma 2.2.6 combined with Lemma 2.A.3, we get that (2.124) is equal to

$$\frac{\theta^-}{\sigma(1-\lambda)n} hR^-(b) \frac{\theta R(u)}{\sqrt{m}} \left(\mathbb{E}\left[G_1(\mathcal{M}) f\left(\frac{\mathcal{M}(\lambda)}{\sqrt{1-\lambda}}\right) G_2\left(\varrho_{\mathcal{M}(\lambda), 0}^{1-\lambda}\right)\right] + o(1) \right) + o\left(\frac{R^-(b)R(u)}{n^{3/2}}\right),$$

where \mathcal{M} is the Brownian meander of length λ , independent of $(\varrho_{z, 0}^{1-\lambda})_{z \in \mathbb{R}_+}$. Finally, recalling the definition of f and using (2.122), it concludes the proof of Proposition 2.2.8. \square

5. Here the limit measure is the law of $\varrho_{z, 0}^{1-\lambda}$ that depends on the parameter (b, v, z) . Thus, using Remark 2.A.4, we should prove that $\mathbb{P}(\|\varrho_{z, 0}^{1-\lambda}\|_\infty > K) \rightarrow 0$ as $K \rightarrow \infty$ uniformly in $z \in \mathbb{R}_+$, but it is obviously false. However, since $f(z/\sqrt{1-\lambda}) \rightarrow 0$ as $z \rightarrow \infty$, it is sufficient to have, for each $M > 0$, $\mathbb{P}(\|\varrho_{z, 0}^{1-\lambda}\|_\infty > K) \rightarrow 0$ as $K \rightarrow \infty$ uniformly in $z \in [0, M]$ and this is clearly true.

2.C Trajectories in the weak disorder regime

We prove here (2.14). We consider some $\beta < 1$ and $p > 1$ such that $\mathbb{E}[\widetilde{W}_1(\beta)^p] < \infty$. Using also (2.2), (2.3) and the convexity of Ψ , we get that Ψ is finite and nonincreasing on $[\beta, 1]$ and positive on $[\beta, 1)$. Moreover, we can assume that $p \leq 2$ and that $p\beta < 1$. Then, we have $\Psi(p\beta) \leq \Psi(\beta) < p\Psi(\beta)$ and, by Theorem 1 of Biggins [Big92], we get that $W_n(\beta) \rightarrow W_\infty(\beta)$ in L^p . The proof follows the lines of the proof of part (iv) of Theorem 2.1.2, without having to introduce the barrier at $-L$.

By Lemma 2.A.1, we can reduce the proof to the case $F \in \mathcal{C}_b^u(\mathcal{D}([0, 1]))$. Since $W_\infty(\beta)$ is positive \mathbb{P}^* -a.s., it is sufficient to prove that

$$U_n(F) := e^{-n\Psi(\beta)} \sum_{|z|=n} e^{-\beta X(z)} F(\widetilde{\mathbf{X}}^{(n)}(z)) \xrightarrow{n \rightarrow \infty} W_\infty(\beta) \mathbb{E}[F(B)], \quad (2.125)$$

in \mathbb{P}^* -probability, where $\widetilde{\mathbf{X}}_t^{(n)}(z) := [X(z_{[tn]}) + tn\Psi'(\beta)]/\sigma_\beta\sqrt{n}$ for $t \in [0, 1]$. We consider a sequence of integers $(k_n)_{n \in \mathbb{N}}$ such that $1 \ll k_n \ll n$ and, for each $x \in \mathcal{D}([0, 1])$, $F_n(x) := F(x_{((n-k_n)t+k_n)/n} - x_{k_n/n}, t \in [0, 1])$. Then, using (2.32) and setting $\mathbf{S}^{(\beta, n)} := (S_{\beta, [tn]}/\sigma_\beta\sqrt{n})_{t \in [0, 1]}$, we get

$$\mathbb{E}^*[|U_n(F) - U_n(F_n)|] \leq \mathbb{E}^*[U_n(|F - F_n|)] = \mathbb{E}[|F - F_n|(\mathbf{S}^{(\beta, n)})] \xrightarrow{n \rightarrow \infty} 0,$$

by Lemma 2.A.5. Thus, in order to prove (2.125), it is now sufficient to prove that $U_n(F_n) \rightarrow W_\infty(\beta)\mathbb{E}[F(B)]$ in \mathbb{P}^* -probability.

First, we prove that $\zeta_n := U_n(F_n) - \mathbb{E}[U_n(F_n)|\mathcal{F}_{k_n}] \rightarrow 0$ in \mathbb{P}^* -probability. We set $\zeta'_n := \mathbb{E}[|\zeta_n|^p|\mathcal{F}_n]$ and, by (2.34), we have $\mathbb{P}^*(|\zeta_n| \geq \varepsilon) \leq \varepsilon\mathbb{P}(S)^{-1} + \mathbb{P}^*(\zeta'_n \geq \varepsilon^{1+p_n})$. By the branching property at time k_n , we have

$$\zeta_n = \sum_{|x|=k_n} e^{-\beta X(x) - k_n\Psi(\beta)} (\Upsilon_n^{(x)} - \mathbb{E}[\Upsilon_n]), \quad (2.126)$$

where, conditionally on \mathcal{F}_{k_n} , the $\Upsilon_n^{(x)}$ for $|x| = k_n$ are independent variables with the same law as Υ_n defined by

$$\Upsilon_n := \sum_{|z|=n-k_n} e^{-\beta X(z) - (n-k_n)\Psi(\beta)} F\left(\frac{X(z_{[t(n-k_n)])} + t(n-k_n)\Psi'(\beta)}{\sigma_\beta\sqrt{n}}, t \in [0, 1]\right). \quad (2.127)$$

Since $p \in [1, 2]$ and $C = \sup_{n \in \mathbb{N}} \mathbb{E}[W_n(\beta)^p] < \infty$, we get, in the same way as for (2.42),

$$\zeta'_n \leq 2C(4\|F\|)^p W_{k_n}(p\beta) e^{k_n(\Psi(p\beta) - p\Psi(\beta))}.$$

Using that $\Psi(p\beta) - p\Psi(\beta) < 0$ and $W_{k_n}(p\beta) \rightarrow W_\infty(p\beta) < \infty$ \mathbb{P}^* -a.s., we get $\zeta'_n \rightarrow 0$ \mathbb{P}^* -a.s. and, therefore, $\zeta_n \rightarrow 0$ in \mathbb{P}^* -probability.

Finally, we prove that $\mathbb{E}[U_n(F_n)|\mathcal{F}_{k_n}] \rightarrow W_\infty(\beta)\mathbb{E}[F(B)]$ \mathbb{P}^* -a.s. Using the branching property in the same way as for (2.126), we have $\mathbb{E}[U_n(F_n)|\mathcal{F}_{k_n}] = W_{k_n}(\beta)\mathbb{E}[\Upsilon_n]$, where Υ_n is defined in (2.127). By (2.32) and recalling that $\mathbf{S}^{(\beta, n)} := (S_{\beta, [tn]}/\sigma_\beta\sqrt{n})_{t \in [0, 1]}$, we have

$$\begin{aligned} \mathbb{E}[\Upsilon_n] &= \mathbb{E}\left[F\left(\frac{S_{\beta, [t(n-k_n)]} + (t(n-k_n) - [t(n-k_n)])\Psi'(\beta)}{\sigma_\beta\sqrt{n}}, t \in [0, 1]\right)\right] \\ &= \mathbb{E}\left[F(u_n \mathbf{S}^{(\beta, n-k_n)} + v_n)\right], \end{aligned}$$

where $(u_n)_{n \in \mathbb{N}} \in (\mathbb{R}_+^*)^{\mathbb{N}}$ and $(v_n)_{n \in \mathbb{N}} \in \mathcal{D}([0, 1])^{\mathbb{N}}$ satisfy $u_n \rightarrow 1$ and $\|v_n\|_\infty \rightarrow 0$. Using that $\mathbf{S}^{(\beta, n-k_n)}$ converges in law towards the Brownian motion and applying Lemma 2.A.3, we get that $\mathbb{E}[\Upsilon_n] \rightarrow \mathbb{E}[F(B)]$ as $n \rightarrow \infty$. On the other hand, we have $W_{k_n}(\beta) \rightarrow W_\infty(\beta)$ \mathbb{P}^* -a.s. Therefore, $\mathbb{E}[U_n(F_n)|\mathcal{F}_{k_n}] \rightarrow W_\infty(\beta)\mathbb{E}[F(B)]$ \mathbb{P}^* -a.s. and it concludes the proof.

Chapter 3

1-stable fluctuations in branching Brownian motion at critical temperature I: the derivative martingale

Abstract

This chapter is a joint work with Pascal Maillard [MP18], which has been accepted for publication in the *Annals of Probability*. We are interested in the derivative martingale $(Z_t)_{t \geq 0}$ of branching Brownian motion, which is the derivative with respect to the inverse temperature of the normalized partition function at critical temperature. A well-known result by Lalley and Sellke [LS87] says that this martingale converges almost surely to a limit Z_∞ , positive on the event of survival. In this chapter, our concern is the fluctuations of the derivative martingale around its limit. A corollary of our results is the following convergence, confirming and strengthening a conjecture by Mueller and Munier [MM14]:

$$\sqrt{t} \left(Z_\infty - Z_t + \frac{\log t}{\sqrt{2\pi t}} Z_\infty \right) \xrightarrow[t \rightarrow \infty]{} S_{Z_\infty}, \quad \text{in law,}$$

where $(S_r)_{r \geq 0}$ is a spectrally positive 1-stable Lévy process independent of Z_∞ . In a first part of the chapter, a relatively short proof of (a slightly stronger form of) this convergence is given based on the functional equation satisfied by the characteristic function of Z_∞ together with tail asymptotics of this random variable. We then set up more elaborate arguments which yield a more thorough understanding of the trajectories of the particles contributing to the fluctuations. In this way, we can upgrade our convergence result to functional convergence. This approach also sets the ground for Chapter 4, where fluctuations of more general functionals are studied, including the renormalized critical additive martingale.

3.1 Introduction

Branching Brownian motion (BBM) is a branching Markov process defined as follows. Initially, there is a single particle at the origin. Each particle moves according to a Brownian motion with variance $\sigma^2 > 0$ and drift $\varrho \in \mathbb{R}$, during an exponentially distributed time of parameter $\lambda > 0$ and then splits into a random number of new particles, chosen according to the law of L , a random variable on $\mathbb{N} := \{0, 1, \dots\}$. These new particles start the same process from their place of birth, behaving independently of the others. See Section 1.2 of this thesis for various motivations behind the study of branching Brownian motion, in particular the link with F-KPP equation and the role of the derivative martingale for the study of extremes of logarithmically correlated fields.

In this chapter, we address the *fluctuations* of the derivative martingale around its limit. We establish a functional convergence in law with speed of convergence $1/\sqrt{t}$ towards a randomly time-changed spectrally positive 1-stable Lévy process. Unlike the derivative martingale, whose law depends on the model, we believe that these fluctuations are *universal* and, to our knowledge, are proven here for the first time for such a model. In Chapter 4, based on the results from this chapter, we study the fluctuations of more general functionals including the renormalized critical additive martingale.

3.1.1 Definitions and assumptions

Our assumptions in this chapter concerning the reproduction law are

$$\mathbb{E}[L] > 1 \quad \text{and} \quad \mathbb{E}\left[L \log_+^3 L\right] < \infty, \quad (3.1)$$

(throughout the chapter we write $\log_+ x = (\log x) \vee 0$ and $\log_+^n x = (\log_+ x)^n$). The first inequality implies that the underlying Galton-Watson tree is supercritical and the event S of survival of the population has positive probability.

Let $\mathcal{N}(t)$ be the set of particles alive at time t and $X_u(t)$ the position of particle u at time t or of its ancestor alive at time t (if it exists). We denote by $(\mathcal{F}_t)_{t \geq 0}$ the canonical filtration associated with the BBM. As in introduction of this thesis, we choose $\sigma^2 = \varrho = 1$ and $\lambda = 1/(2\mathbb{E}[L - 1])$ as parameters, in order to have, for any $t \geq 0$,

$$\mathbb{E}\left[\sum_{u \in \mathcal{N}(t)} e^{-X_u(t)}\right] = 1 \quad \text{and} \quad \mathbb{E}\left[\sum_{u \in \mathcal{N}(t)} X_u(t) e^{-X_u(t)}\right] = 0, \quad (3.2)$$

similarly to usual assumptions in the branching random walk literature [Aid13, AS14], and also

$$\mathbb{E}\left[\sum_{u \in \mathcal{N}(t)} X_u(t)^2 e^{-X_u(t)}\right] = t. \quad (3.3)$$

One can always reduce to these parameters by a combination of translation in space and scaling in space and time. Under these assumptions, it is well-known (and an easy consequence of the convergence of W_t defined below, see Remark 1.1.1) that

$$\min_{u \in \mathcal{N}(t)} X_u(t) \rightarrow +\infty, \quad \text{almost surely as } t \rightarrow \infty. \quad (3.4)$$

One of the main objects of study for the BBM has been the *additive martingales*, or normalized partition functions of the system, which display a phase transition, see Section 1.1.2 for more details and related literature. In this chapter, we work at criticality and the additive martingale is defined by

$$W_t := \sum_{u \in \mathcal{N}(t)} e^{-X_u(t)}, \quad t \geq 0.$$

However, it converges a.s. to zero and one is rather interested in the so-called *derivative martingale*

$$Z_t := \sum_{u \in \mathcal{N}(t)} X_u(t) e^{-X_u(t)}, \quad t \geq 0.$$

Indeed, it has been proved by Lalley and Sellke [LS87] for binary branching and then by Yang and Ren [YR11] under the optimal assumption $\mathbb{E}[L \log_+^2 L] < \infty$ that

$$Z_t \xrightarrow[t \rightarrow \infty]{} Z_\infty, \quad \text{a.s.}, \quad (3.5)$$

and $Z_\infty > 0$ a.s. on the event S of survival. The limit Z_∞ appears in many limit theorems on branching Brownian motion. For example, Lalley and Sellke [LS87], relying on deep results by Bramson [Bra83], proved that the distributional limit of the minimum of the BBM at time t is a Gumbel law randomly shifted by $\log Z_\infty$:

$$\mathbb{P}\left(\min_{u \in \mathcal{N}(t)} X_u(t) \geq \frac{3}{2} \log t + x\right) \xrightarrow[t \rightarrow \infty]{} \mathbb{E}\left[e^{-c^* e^x Z_\infty}\right], \quad (3.6)$$

for some positive constant c^* (see also Aïdékon [Aïd13] for a proof under the optimal assumption $\mathbb{E}[L \log_+^2 L] < \infty$, but for the branching random walk). The critical additive martingale $W = (W_t)_{t \geq 0}$ is also related to the derivative martingale by the following convergence

$$\sqrt{t}W_t \xrightarrow[t \rightarrow \infty]{} \sqrt{\frac{2}{\pi}}Z_\infty, \quad \text{in probability,} \quad (3.7)$$

proved for the branching random walk by Aïdékon and Shi [AS14]. Their result applies to the BBM under the assumption $\mathbb{E}[L \log_+^2 L] < \infty$.

Some precise estimates have been proved recently for the tail of Z_∞ . Berestycki, Berestycki and Schweinsberg [BBS13] proved in the case of binary branching that

$$\mathbb{P}(Z_\infty > x) \underset{x \rightarrow \infty}{\sim} \frac{1}{x} \quad (3.8)$$

and also that, for some constant $c_Z \in \mathbb{R}$, depending on the reproduction law given by L ,

$$\mathbb{E}[Z_\infty \mathbb{1}_{Z_\infty \leq x}] - \log x \xrightarrow[x \rightarrow \infty]{} c_Z. \quad (3.9)$$

Moreover, Maillard [Mai12, Chap. 2 Proposition 4.1] proved that (3.8) holds as soon as $\mathbb{E}[L \log_+^2 L] < \infty$ and (3.9) holds if $\mathbb{E}[L \log_+^3 L] < \infty$. See also Buraczewski [Bur09] and Madaule [Mad16b] for (3.8) in the case of the branching random walk.

As can be seen from (3.8), 1-stable laws will play an important role and we recall now some definitions and facts. The totally asymmetric to the right 1-stable distribution $\mathcal{S}_1(\sigma, \mu)$, with parameters $\sigma > 0$ and $\mu \in \mathbb{R}$, has characteristic function

$$\Psi_{\sigma, \mu}(\lambda) = \exp(-\psi_{\sigma, \mu}(\lambda)),$$

where (see e.g. Samorodnitsky and Taqqu [ST94]):

$$\psi_{\sigma, \mu}(\lambda) = \sigma |\lambda| \left[1 + i \frac{2}{\pi} \text{sign}(\lambda) \log |\lambda| \right] - i \mu \lambda, \quad \lambda \in \mathbb{R}. \quad (3.10)$$

Since it is an infinitely divisible distribution, there is an associated Lévy process $(S_r)_{r \geq 0}$ called spectrally positive 1-stable process with parameters (σ, μ) , starting at $S_0 = 0$. The characteristic functions of its one-dimensional marginals are given by

$$\Psi_{S_t}(\lambda) = \exp(-t \psi_{\sigma, \mu}(\lambda)) = \Psi_{t\sigma, t\mu}(\lambda), \quad t \geq 0, \lambda \in \mathbb{R}. \quad (3.11)$$

In other words, S_t follows the distribution $\mathcal{S}_1(t\sigma, t\mu)$.

Denote by Ψ_{Z_∞} the characteristic function of Z_∞ , i.e. $\Psi_{Z_\infty}(\lambda) = \mathbb{E}[e^{i\lambda Z_\infty}]$, $\lambda \in \mathbb{R}$. Equations (3.8) and (3.9) together with Lemma 3.C.1 yield the following asymptotic for Ψ_{Z_∞} : there exists a continuous function $g: \mathbb{R} \rightarrow \mathbb{C}$, with $g(0) = 0$, such that for every sufficiently small λ ,

$$\Psi_{Z_\infty}(\lambda) = \Psi_{\pi/2, \mu_Z}(\lambda) e^{\lambda g(\lambda)}, \quad (3.12)$$

where $\mu_Z = c_Z - \gamma + 1$ with c_Z the constant in (3.9) and γ the Euler-Mascheroni constant. In particular, the distribution of Z_∞ belongs to the domain of attraction of a totally asymmetric (to the right) 1-stable law.

3.1.2 Results

Recall that our assumptions are (3.1), (3.2) and (3.3). Our main result is the functional convergence in law of the fluctuations of the derivative martingale, conditionally on the past. The notion of weak convergence in probability is recalled in Section 3.A.

Theorem 3.1.1. *Let $(S_r)_{r \geq 0}$ denote a spectrally positive 1-stable Lévy process with parameters $(\sqrt{\pi}/2, \mu_Z \sqrt{2/\pi})$, independent of Z_∞ . Then the conditional law of $(\sqrt{t}(Z_\infty - Z_{at} + \frac{\log t}{\sqrt{2\pi at}} Z_\infty))_{a \geq 1}$ given \mathcal{F}_t converges weakly in probability (in the sense of finite-dimensional distributions) to the conditional law of $(S_{Z_\infty/\sqrt{a}})_{a \geq 1}$ given Z_∞ . In other words, for every $n \geq 1$, $a_1, \dots, a_n \in [1, \infty)$ and $f: \mathbb{R}^n \rightarrow \mathbb{R}$ bounded and continuous, we have the following convergence in probability*

$$\mathbb{E} \left[f \left(\sqrt{t} \left(Z_\infty - Z_{a_k t} + \frac{\log t}{\sqrt{2\pi a_k t}} Z_\infty \right), 1 \leq k \leq n \right) \middle| \mathcal{F}_t \right] \xrightarrow{t \rightarrow \infty} \mathbb{E} \left[f \left(S_{Z_\infty/\sqrt{a_k}}, 1 \leq k \leq n \right) \middle| Z_\infty \right].$$

In particular (take $n = 1$ and $a_1 = 1$), the conditional law of $\sqrt{t}(Z_\infty - Z_t + \frac{\log t}{\sqrt{2\pi t}} Z_\infty)$ given \mathcal{F}_t converges weakly in probability to the conditional law $\mathcal{S}_1(Z_\infty \sqrt{\pi}/2, Z_\infty \mu_Z \sqrt{2/\pi})$ given Z_∞ .

Remark 3.1.2. One may wonder whether one actually has almost sure weak convergence in Theorem 3.1.1 instead of mere weak convergence in probability. This is not the case and due to the fact that the convergence in (3.7) does not hold almost surely [AS14].

Removing the conditioning, we get the following corollary:

Corollary 3.1.3. *Let $(S_r)_{r \geq 0}$ denote a spectrally positive 1-stable Lévy process with parameters $(\sqrt{\pi}/2, \mu_Z \sqrt{2/\pi})$, independent of Z_∞ . Then, we have the following convergence in law with respect to finite-dimensional distributions:*

$$\left(\sqrt{t} \left(Z_\infty - Z_{at} + \frac{\log t}{\sqrt{2\pi at}} Z_\infty \right) \right)_{a \geq 1} \xrightarrow[t \rightarrow \infty]{(law)} \left(S_{Z_\infty/\sqrt{a}} \right)_{a \geq 1}.$$

In particular, we have the following convergence in law:

$$\sqrt{t} \left(Z_\infty - Z_t + \frac{\log t}{\sqrt{2\pi t}} Z_\infty \right) \xrightarrow[t \rightarrow \infty]{(law)} \mathcal{S}_1 \left(Z_\infty \sqrt{\pi}/2, Z_\infty \mu_Z \sqrt{2/\pi} \right).$$

Remark 3.1.4. We believe the assumption $\mathbb{E}[L \log_+^3 L] < \infty$ to be optimal for our result. It should be compared to the assumption $\mathbb{E}[L \log_+^2 L] < \infty$ in previous results concerning the derivative martingale and the extremal particles. Our assumption is used to get the precise tail of Z_∞ in (3.9) and also at three different places in Section 3.4. It can apparently not be relaxed in any one of these places.

Finally, we state a second result, giving an explicit control on the rate of convergence of Z_t to Z_∞ . It can be proved with the same tools and will be useful in Chapter 4.

Proposition 3.1.5. *There exists $C > 0$ such that, for any $0 < \delta \leq 1$ and $t \geq 2$, we have*

$$\mathbb{P}(|Z_\infty - Z_t| \geq \delta) \leq C \frac{(\log t)^2}{\delta \sqrt{t}}.$$

3.1.3 Comments and heuristics

Our motivation for studying the fluctuations of the derivative martingale Z_t came from an article by Mueller and Munier [MM14] in the physics literature. In this article, the authors mainly work with the additive martingale W_t . Their findings can be interpreted as the following conjecture:

$$\sqrt{t} \left(\sqrt{\frac{2}{\pi}} Z_\infty - \sqrt{t} W_t \right) \text{ converges in law, as } t \rightarrow \infty. \quad (3.13)$$

In their appendix, they note that, for the derivative martingale Z_t , a corrective term of order $(\log t)/\sqrt{t}$ has to be added to get the convergence, a conjecture which they derived from numerical simulations.

Mueller and Munier give a phenomenological description of BBM in order to support their conjectures concerning the fluctuations of the front of BBM¹. This picture is as follows: at early times of order $O(1)$, there are fluctuations due to the small number of particles, to whom the randomness of Z_∞ is due. This random variable Z_∞ determines the position of the minimum of the BBM at later times, as seen in (3.6). Then, after a large time of order $O(1)$, Mueller and Munier introduce the curved barrier $s \mapsto \frac{3}{2} \log s - \log Z_\infty$. Following previous works by Ebert and van Saarloos [Ev00] on the rate of convergence of the F-KPP equation to a traveling wave, they go on to say that the density of the particles staying above this barrier can be approximated to sufficient precision by a deterministic function (with a random shift $\log Z_\infty$), whose expression is fairly intricate, involving hypergeometric functions. Mueller and Munier then argue that this density is randomly perturbed by the descendants of the particles that go below the barrier, in the spirit of previous works by Brunet, Derrida, Mueller and Munier [BDMM06b]. Using the explicit form of the particle density and the stipulated law of the perturbations, Mueller and Munier are then able to derive (3.13). We stress that their approach, although ingenious, relies on several unjustified assumptions and approximations and uses quite intricate algebra.

Our approach is loosely inspired by Mueller and Munier [MM14] but has several important differences. First, we found that instead of working with the martingale W_t , it is easier to work with the derivative martingale Z_t , which is the object of this chapter. Second, as in Mueller and Munier [MM14] we introduce a killing barrier but which is very different from theirs. Our barrier, instead of ending at time t , *starts at time t* and stays at a *fixed position* $\gamma_t = \frac{1}{2} \log t + \beta_t$, for some slowly increasing function β_t (one might think of it as a large constant K and first let t , then K go to infinity). The advantage of working with Z_t is that the translated derivative martingale

$$\sum_{u \in \mathcal{N}(s)} (X_u(s) - \gamma_t) e^{-X_u(t)} = Z_s - \gamma_t W_s, \quad s \geq t,$$

is also a martingale when particles are killed when going below γ_t . With this killing, we show that the fluctuations of this martingale are of order $o(1/\sqrt{t})$ and therefore negligible. Roughly speaking, this allows us to write Z_∞ as the sum

$$Z_\infty = Z_t - \gamma_t W_t + F_t + o(1/\sqrt{t}),$$

where F_t is the contribution to Z_∞ from the particles going below the barrier. Estimating the number of particles hitting the barrier and using the tail asymptotics of Z_∞ provided by

1. We call here the *front* of BBM the particles that mainly contribute to Z_t (and to W_t): these are the particles at a position of order \sqrt{t} at time t . The extremal particles at time at for some $a > 1$ (those which are around $\frac{3}{2} \log(at) + O(1)$) mostly descend from particles in the front at time t .

(3.8) and (3.9) allows us to obtain precise asymptotics on the characteristic function of F_t , from which one can derive the one-dimensional ($n = 1$, $a_1 = 1$) case of Theorem 3.1.1. The functional limit requires slightly more work but follows along the same lines. More details of the proof are exposed in Section 3.3.

We remark that our proof shows that the fluctuations of the derivative martingale are due to the particles that come down exceptionally low: around $\frac{1}{2} \log t + O(1)$. In fact, it is well-known [HS09, Hu16] that, although the minimum of the BBM is most of the time around $\frac{3}{2} \log t$, one has

$$\liminf_{t \rightarrow \infty} \frac{1}{\log t} \min_{u \in \mathcal{N}(t)} X_u(t) = \frac{1}{2}, \quad \mathbb{P}\text{-a.s. on } S.$$

These rare particles are exactly the ones leading to the limit in Theorem 3.1.1 and the contribution to Z_∞ of the descendants of a particle coming down to $\frac{1}{2} \log t + O(1)$ around time at correspond to a jump of the limiting 1-stable Lévy process S at time Z_∞/\sqrt{a} .

We also remark that the one-dimensional case of Theorem 3.1.1 can be obtained by simpler means, namely by exploiting the decomposition

$$Z_\infty = \sum_{u \in \mathcal{N}(t)} e^{-X_u(t)} Z_\infty^u,$$

where, given $\mathcal{N}(t)$, $(Z_\infty^u)_{u \in \mathcal{N}(t)}$ are independent copies of Z_∞ , independent of $(X_u(t))_{u \in \mathcal{N}(t)}$. This is done in Section 3.2. However, this method does not allow to obtain a functional convergence and also does not explain which particles contribute to the fluctuations.

Further outlook. In Chapter 4, we will consider random variables of the form

$$Z_t(f) = \sum_{u \in \mathcal{N}(t)} X_u(t) e^{-X_u(t)} f\left(\frac{X_u(t)}{\sqrt{t}}\right),$$

for a large class of functions f . Special cases are the derivative martingale Z_t and the renormalized additive martingale $\sqrt{t}W_t$, which correspond to $f \equiv 1$ and $f(x) = \frac{1}{x}$, respectively. We will prove a limit theorem in law analogous to Theorem 3.1.1 for these random variables, relying on the results of the present chapter. The limiting random variables are again of the form S_{Z_∞} for $(S_r)_{r \geq 0}$ a 1-stable Lévy process, but the asymmetry parameter of the process can be anything and depends on the function f . For example, in the case of the renormalized additive martingale, the process $(S_r)_{r \geq 0}$ is a Cauchy process and the logarithmic correction term vanishes. In other words, we prove Mueller and Munier's conjecture (3.13) and identify the limit.

In future work, we plan to study the fluctuations of the minimal position at time t in BBM, $M_t := \min_{u \in \mathcal{N}(t)} X_u(t)$. This should be related to the fluctuations of the martingale W_t . Specifically, we conjecture the following:

Conjecture 3.1.6. *As $t \rightarrow \infty$, for some constant $C > 0$,*

$$M_t \stackrel{\text{law}}{=} \frac{3}{2} \log t - \log(CZ_\infty) - G + \frac{1}{\sqrt{t}} S_{Z_\infty} + o\left(\frac{1}{\sqrt{t}}\right),$$

where G is a standard Gumbel distributed random variable, $(S_r)_{r \geq 0}$ is a Cauchy process and Z_∞ , G , $(S_r)_{r \geq 0}$ are independent².

2. The way to make this statement formal is in the language of *mod-φ-convergence* from [DKN15].

We note that a rich literature exists on $1/\sqrt{t}$ corrections for solutions to the F-KPP equation and related equations, see e.g. [Ev00, BBHR17, BBD18, NRR16, Gra17] and the references therein. Conjecture 3.1.6 can be seen as a probabilistic version of these results. Analogous to the deterministic equation, we believe that the term $\frac{1}{\sqrt{t}}S_{Z_\infty}$ appearing in Conjecture 3.1.6 is *universal*, in that it is (up to scaling, translation and the term Z_∞) the same for all models in the so-called *F-KPP universality class* [BDMM06b]. We also believe that there is a direct relation between the deterministic and probabilistic versions and plan to make this relation explicit in future work.

Finally, the methods used in this chapter seem to be applicable to the case of the *branching random walk*, with probably a few additional technical difficulties for the proof of the functional convergence. However, we emphasize that both the main method as well as the one from Section 3.2 rely on the precise tail asymptotics of Z_∞ in (3.9), which so far has only been proved for BBM.

3.1.4 Related literature

Fluctuations of martingales have been studied for the Galton-Watson process by Heyde [Hey70, Hey71], when the reproduction law belongs to the domain of attraction of a α -stable law with $1 < \alpha \leq 2$. In that case, one needs an exponential scaling to get the convergence of the fluctuations towards a mixture of α -stable laws. See also Heyde and Brown [HB71] for a functional convergence and Kesten-Stigum [KS66a], Athreya [Ath68] and Asmussen and Keiding [AK78] for multitype branching processes (but only in the case $\alpha = 2$).

More recently, similar results have been proved for the additive martingale $W_n(\beta)$ of a *branching random walk* in the subcritical regime $\beta < 1$. Rösler, Topchii and Vatutin [RTV02] show, in the more general setting of stable weighted branching processes, the convergence of the fluctuations of $W_n(\beta)$ when $W_1(\beta)$ belongs to the domain of attraction of a α -stable law with $1 < \alpha \leq 2$, with also an exponential scaling and a mixture of α -stable laws as limit. More related to our results is the work [IKM18a] by Iksanov, Kolesko and Meiners where $W_1(\beta)$ is light-tailed (and β may be complex). In particular, if $\beta \in (1/2, 1)$, they show that the fluctuations of $W_t(\beta)$ are exponentially small in t and converge in law after rescaling to a random variable expressed in terms of the limiting extremal process of the branching random walk and of the law of $W_\infty(\beta)$.

Note that the appearance of stable processes subordinated by Z_∞ in branching random walks has been observed previously in the study of the martingales $W_t(\beta)$ in the *supercritical* regime $\beta > 1$, see e.g. [DL83, Gui90, BJR13].

Functional convergence results have been obtained in the branching random walk setting by Iksanov and Kabluchko [IK16], when $\text{Var}(W_1(\beta)) < \infty$ and $\beta < 1/2$ (in our setting), and by Iksanov, Kolesko and Meiners [IKM18b], when $\mathbb{P}(W_1(\beta) \geq x) \sim cx^{-\alpha}$ and $(\beta\alpha - 1)^2 < \alpha(\beta - 1)^2$ for some $\beta < 1 < \alpha < 2$. See also, Hartung and Klimovsky [HK18] for the case of complex BBM. To our knowledge, 1-stable fluctuations have not been studied yet. Note also that all aforementioned results exhibit an exponential scaling, while it is polynomial here.

Fluctuations of the partition function have also been studied for other models related to BBM. For directed polymers in random environment in the L^2 -phase, there is also a Gaussian limit but with a polynomial scaling [CL17, CN19]. Other results have been obtained for many different spin glasses models: for example, the Sherrington-Kirkpatrick model [ALR87], the REM and the p -spin model [BKL02], the GREM [BK08], the complex REM [KK14] and the spherical Sherrington-Kirkpatrick model [BL16a, BL17]. In comparing to our setting, one might argue that the situation is a bit different in these models in that the fluctuation is the *first* random term appearing in the large- N expansion of the partition function, whereas in

our setting it is the *second* or even *third* random term (the first ones being Z_∞ and $\frac{\log t}{\sqrt{2\pi t}}Z_\infty$). However, the conditioning in Theorem 3.1.1 effectively shows that one can consider Z_∞ as a constant, making the term S_{Z_∞} the first “truly” random term in the large- t expansion of Z_t . Another argument is that the term S_{Z_∞} is (as we believe) the first *universal* term in the expansion, the term Z_∞ depending on the offspring distribution and, in general, on the model. It is thus fair to say that the results from this chapter are of the same nature as the results for the statistical mechanics models cited above.

3.1.5 Organization of the chapter

In Section 3.3, we state another Theorem 3.3.1 which is easier to prove than Theorem 3.1.1. The fact that one can get Theorem 3.1.1 from Theorem 3.3.1 (in the case $n = 1$ or in the multi-dimensional case) follows from Proposition 3.2.2, which is stated in Section 3.2 and proved in Section 3.7. In Section 3.2, we give a short proof of the case $n = 1$ of Theorem 3.3.1, which corresponds to Proposition 3.2.1.

The rest of the chapter is dedicated to the proof of Theorem 3.3.1 in the multi-dimensional case. In Section 3.3, its proof is divided into three propositions, which are proved in Sections 3.5 and 3.6, using preliminary results stated and proved in Section 3.4.

In Appendix 3.A, some theoretical definitions and results concerning weak convergence in probability for random measures are given. Appendix 3.B contains some calculations concerning Brownian motion and the 3-dimensional Bessel process used in the chapter. The lemma in Appendix 3.C provides an asymptotic for the characteristic function of a random variable satisfying (3.8) and (3.9). Appendix 3.D contains the proof of Proposition 3.1.5.

Throughout the chapter, C denotes a positive constant that does not depend on the parameters and can change from line to line. For $f: \mathbb{R}_+ \rightarrow \mathbb{R}$ and $g: \mathbb{R}_+ \rightarrow \mathbb{R}_+^*$, we say that $f(t) = o(g(t))$ as $t \rightarrow \infty$ if $\lim_{t \rightarrow \infty} f(t)/g(t) = 0$ and that $f(t) = O(g(t))$ as $t \rightarrow \infty$ if $\limsup_{t \rightarrow \infty} |f(t)|/g(t) < \infty$. Moreover, $(B_t)_{t \geq 0}$ denotes a standard Brownian motion and $(R_t)_{t \geq 0}$ a 3-dimensional Bessel process.

3.2 One-dimensional marginals: a (fairly) short proof

In this section, we give a relatively short proof of Theorem 3.1.1 in the case $n = 1$, $a_1 = 1$. It will follow from the following two results:

Proposition 3.2.1. *The conditional law of $\sqrt{t}(Z_\infty - Z_t + \frac{\log t}{2}W_t)$ given \mathcal{F}_t converges weakly in probability to the law $\mathcal{S}_1(Z_\infty\sqrt{\pi/2}, Z_\infty\mu_Z\sqrt{2/\pi})$ given Z_∞ .*

Proposition 3.2.2. *For any $\theta < 1/5$, we have*

$$\limsup_{t \rightarrow \infty} \mathbb{P} \left(\left| \sqrt{t}W_t - \sqrt{\frac{2}{\pi}}Z_\infty \right| \geq t^{-\theta} \right) = 0.$$

The main point in Proposition 3.2.1 is the replacement of the term $\frac{\log t}{\sqrt{2\pi t}}Z_\infty$ by $\frac{\log t}{2}W_t$, making its proof a lot easier. Below, we give a one-page proof of Proposition 3.2.1, relying on a direct calculation of the characteristic function based on the branching property and the asymptotic (3.12) on Ψ_{Z_∞} , the characteristic function of Z_∞ . These arguments are similar to those used for the Galton-Watson process [Hey70, Hey71] or for the subcritical additive martingales of the branching random walk [RTV02]. Proposition 3.2.2 on the other hand is quite technical and its proof is delegated to Section 3.7, which also relies on results from Section 3.4. Proposition 3.2.2 actually also uses Proposition 3.2.1 as an ingredient in order

to get a certain a priori control of the speed of convergence of Z_t to Z_∞ , but this could be replaced by more technical calculations.

Proof of the case $n = 1$, $a_1 = 1$ of Theorem 3.1.1. This follows immediately from the combination of Proposition 3.2.1, Proposition 3.2.2 and Remark 3.A.3. \square

The following lemma will be convenient for the proof of Proposition 3.2.1 and later. For $\sigma > 0$ and $\mu \in \mathbb{R}$, recall that $\Psi_{\sigma,\mu}$ denotes the characteristic function of the law $\mathcal{S}_1(\sigma, \mu)$ defined in (3.10).

Lemma 3.2.3. *Let $\sigma > 0$, $\mu \in \mathbb{R}$ and $\lambda \in \mathbb{R}$. Then, for every $x > 0$,*

$$\Psi_{\sigma,\mu}(\lambda x) = \Psi_{x\sigma, x(\mu - \sigma(2/\pi) \log x)}(\lambda) = \exp\left(-x\psi_{\sigma,\mu}(\lambda) - i\lambda \frac{2}{\pi} \sigma x \log x\right).$$

Proof. Direct calculation. \square

Proof of Proposition 3.2.1. By Proposition 3.A.1, it is enough to show that, for any $\lambda \in \mathbb{R}$,

$$\varphi_t(\lambda) := \mathbb{E}\left[\exp\left(i\lambda\sqrt{t}\left(Z_\infty - Z_t + \frac{\log t}{2}W_t\right)\right)\middle|\mathcal{F}_t\right] \xrightarrow[t \rightarrow \infty]{\mathbb{P}} \Psi_{Z_\infty\sqrt{\pi/2}, Z_\infty\mu_Z\sqrt{2/\pi}}(\lambda). \quad (3.14)$$

We now fix some $\lambda \in \mathbb{R}$. The crucial fact that we use is the following well-known decomposition:

$$Z_\infty = \sum_{u \in \mathcal{N}(t)} e^{-X_u(t)} Z_\infty^{(u)}, \quad (3.15)$$

where given \mathcal{F}_t , the random variables $Z_\infty^{(u)}$ for $u \in \mathcal{N}(t)$ are i.i.d. copies of Z_∞ . Recalling that Ψ_{Z_∞} denotes the characteristic function of Z_∞ , the decomposition (3.15) yields,

$$\mathbb{E}[\exp(i\lambda Z_\infty) | \mathcal{F}_t] = \prod_{u \in \mathcal{N}(t)} \Psi_{Z_\infty}(\lambda e^{-X_u(t)}). \quad (3.16)$$

Furthermore, by the definitions of Z_t and W_t , we have

$$\exp\left(i\lambda\left(-Z_t + \frac{\log t}{2}W_t\right)\right) = \prod_{u \in \mathcal{N}(t)} \exp\left(i\lambda e^{-X_u(t)}\left(\frac{\log t}{2} - X_u(t)\right)\right), \quad (3.17)$$

and obviously this quantity is \mathcal{F}_t -measurable. Applying (3.16) and (3.17) with $\lambda\sqrt{t}$ instead of λ and writing $\xi_{u,t} = \sqrt{t}e^{-X_u(t)}$, we get

$$\varphi_t(\lambda) = \prod_{u \in \mathcal{N}(t)} \Psi_{Z_\infty}(\lambda \xi_{u,t}) \exp(i\lambda \xi_{u,t} \log \xi_{u,t}).$$

Now recall that for sufficiently small λ' , say $|\lambda'| \leq \varepsilon$ for some $\varepsilon > 0$, by (3.12), $\Psi_{Z_\infty}(\lambda') = \Psi_{\pi/2, \mu_Z}(\lambda') e^{\lambda' g(\lambda')}$, with g a continuous function vanishing at 0. In order to apply this to the previous equation, define the event $\mathcal{E}_t = \{\max_{u \in \mathcal{N}(t)} |\lambda \xi_{u,t}| \leq \varepsilon\}$. On \mathcal{E}_t , we get

$$\varphi_t(\lambda) = \prod_{u \in \mathcal{N}(t)} \Psi_{\pi/2, \mu_Z}(\lambda \xi_{u,t}) \exp(\lambda \xi_{u,t} g(\lambda \xi_{u,t}) + i\lambda \xi_{u,t} \log \xi_{u,t}).$$

Applying Lemma 3.2.3, together with the equality $\sqrt{t}W_t = \sum_{u \in \mathcal{N}(t)} \xi_{u,t}$, we get on \mathcal{E}_t ,

$$\begin{aligned} \varphi_t(\lambda) &= \prod_{u \in \mathcal{N}(t)} \exp\left(-\xi_{u,t}\psi_{\pi/2, \mu_Z}(\lambda) + \lambda \xi_{u,t} g(\lambda \xi_{u,t})\right) \\ &= \exp\left(-\sqrt{t}W_t\psi_{\pi/2, \mu_Z}(\lambda) + Y_t^\lambda\right), \quad \text{with } Y_t^\lambda := \sum_{u \in \mathcal{N}(t)} \lambda \xi_{u,t} g(\lambda \xi_{u,t}). \end{aligned}$$

Now note that by (3.6), we have $\max_{u \in \mathcal{N}(t)} \xi_{u,t} \rightarrow 0$ in probability and by (3.7), we have $\sqrt{t}W_t \rightarrow \sqrt{2/\pi}Z_\infty$ in probability, as $t \rightarrow \infty$. As a consequence, $\mathbb{P}(\mathcal{E}_t) \rightarrow 1$ as $t \rightarrow \infty$ and $Y_t^\lambda \rightarrow 0$ in probability, as $t \rightarrow \infty$. All of the above now shows that $\varphi_t(\lambda) \rightarrow \Psi_{Z_\infty \sqrt{\pi/2}, Z_\infty \mu_Z \sqrt{2/\pi}}(\lambda)$ in probability, as $t \rightarrow \infty$, which concludes the proof. \square

Remark 3.2.4. What would go wrong if one were to try to extend this proof to the case $n = 2$, say? What made the above proof possible was the marvelous decomposition (3.15) of Z_∞ . One can write a similar decomposition of Z_s conditioned on \mathcal{F}_t , for $s > t$, but it is much more complicated, with the presence of additional terms interplaying in a subtle way with the time-inhomogeneity of the equation (we encourage the reader to try it out!) This road therefore seems like a dead end.

3.3 Strategy of the proof of Theorem 3.1.1

In this section, we present the strategy for the proof of Theorem 3.1.1. As in the one-dimensional case, we will first prove a slightly different version of the result, namely Theorem 3.3.1 below, and will deduce Theorem 3.1.1 from it and Proposition 3.2.2.

Theorem 3.3.1. *Let $(S_r)_{r \geq 0}$ denote a spectrally positive 1-stable Lévy process with parameters $(\sqrt{\pi/2}, \mu_Z \sqrt{2/\pi})$, independent of Z_∞ . Then the conditional law of $(\sqrt{t}(Z_\infty - Z_{at} + \frac{\log t}{2}W_{at}))_{a \geq 1}$ given \mathcal{F}_t converges weakly in probability (in the sense of finite-dimensional distributions) to the conditional law of $(S_{Z_\infty/\sqrt{a}})_{a \geq 1}$ given Z_∞ .*

The proof of Theorem 3.3.1 is split into three propositions stated below. The method of proof also leads to Proposition 3.1.5, proved in Appendix 3.D.

For $t > 0$, we set

$$\gamma_t := \frac{1}{2} \log t + \beta_t,$$

where $(\beta_t)_{t > 0}$ is a family of positive numbers such that

$$\beta_t \xrightarrow[t \rightarrow \infty]{} \infty \quad \text{and} \quad \frac{\beta_t}{t^{1/4}} \xrightarrow[t \rightarrow \infty]{} 0. \quad (3.18)$$

Loosely speaking, β_t could be seen as a large constant K that does not depend on t and that tends to infinity after $t \rightarrow \infty$, but it is worthwhile to point out that the general choice of β_t in (3.18) is sufficient.

In order to study Z_{at} for some $a \geq 1$, we kill particles that come below γ_t after time at . For this, we use the framework of *stopping lines*, which have been defined in Chauvin [Cha91]. Let $\mathcal{L}^{at, \gamma_t}$ denote the stopping line of the killed particles and, for $u \in \mathcal{L}^{at, \gamma_t}$, Δ_u^{at, γ_t} the time of the death of u , formally³,

$$\begin{aligned} \mathcal{L}^{at, \gamma_t} &:= \{u \in \mathbb{T} : \exists s \geq at \text{ such that } u \in \mathcal{N}(s), X_u(s) \leq \gamma_t \text{ and } \forall r \in [at, s), X_u(r) > \gamma_t\}, \\ \Delta_u^{at, \gamma_t} &:= \inf\{s \geq at : u \in \mathcal{N}(s) \text{ and } X_u(s) \leq \gamma_t\}. \end{aligned}$$

We denote by $\mathcal{F}_{\mathcal{L}^{at, \gamma_t}}$ the σ -algebra associated with the stopping line $\mathcal{L}^{at, \gamma_t}$, see [Cha91].

3. To be precise, in the definition of the stopping line $\mathcal{L}^{at, \gamma_t}$, in order to be consistent with Chauvin [Cha91], one also has to add the information of the killing times. However, for notational convenience we omit throughout the chapter the killing times from the definition of stopping lines. It will always be the case that the killing times can be inferred from the context without ambiguity.

For the remaining particles, we consider the following random variables: for $s \geq at$, we set

$$\tilde{Z}_s^{at, \gamma t} := \sum_{u \in \mathcal{N}(s)} (X_u(s) - \gamma t) e^{-X_u(s)} \mathbb{1}_{\forall r \in [at, s], X_u(r) > \gamma t}.$$

Then $(\tilde{Z}_s^{at, \gamma t})_{s \geq at}$ is a non-negative martingale (see [Kyp04]) and, therefore, it has an almost sure limit $\tilde{Z}_\infty^{at, \gamma t}$. Furthermore, we have, using that $W_s \rightarrow 0$ \mathbb{P} -a.s. as $s \rightarrow \infty$,

$$Z_\infty = \lim_{s \rightarrow \infty} \sum_{v \in \mathcal{N}(s)} (X_v(s) - \gamma t) e^{-X_v(s)} = \tilde{Z}_\infty^{at, \gamma t} + \sum_{u \in \mathcal{L}^{at, \gamma t}} e^{-X_u(\Delta_u^{at, \gamma t})} Z_\infty^{(u, at, \gamma t)}, \quad (3.19)$$

where we set, for $u \in \mathcal{L}^{at, \gamma t}$,

$$\begin{aligned} Z_\infty^{(u, at, \gamma t)} &:= \lim_{s \rightarrow \infty} \sum_{v \in \mathcal{N}(s): u \leq v} (X_v(s) - \gamma t) e^{-(X_v(s) - X_u(\Delta_u^{at, \gamma t}))} \\ &= \lim_{s \rightarrow \infty} \sum_{v \in \mathcal{N}(s): u \leq v} (X_v(s) - X_u(\Delta_u^{at, \gamma t})) e^{-(X_v(s) - X_u(\Delta_u^{at, \gamma t}))}, \end{aligned}$$

saying that $u \leq v$ if u is an ancestor of particle v and using again that $W_s \rightarrow 0$ \mathbb{P} -a.s. Thus, by the branching property, conditionally on $\mathcal{F}_{\mathcal{L}^{at, \gamma t}}$, the $Z_\infty^{(u, at, \gamma t)}$ for $u \in \mathcal{L}^{at, \gamma t}$ are independent and have the same law as Z_∞ .

Looking at (3.19), our first step will be to study the limit $\tilde{Z}_\infty^{at, \gamma t}$, which is well concentrated around its conditional expectation given \mathcal{F}_{at} thanks to the killing barrier. Moreover, this conditional expectation is $\tilde{Z}_{at}^{at, \gamma t}$, which is very close to $Z_{at} - \gamma t W_{at}$, since the particles below γt at time at have a negligible weight under the assumption (3.18). Therefore, it leads to the following result that will be shown in Section 3.5.

Proposition 3.3.2. *For any $a \geq 1$, we have the following convergence in probability*

$$\sqrt{t} \left| \tilde{Z}_\infty^{at, \gamma t} - (Z_{at} - \gamma t W_{at}) \right| \xrightarrow[t \rightarrow \infty]{} 0.$$

Now, we want to deal with the second term on the right-hand side of (3.19). It leads to the limiting process of Theorem 3.1.1, so we need to catch the dependence in a . Heuristically, we want to see $\mathcal{L}^{at, \gamma t}$ as a decreasing set in a , with $\mathcal{L}^{at, \gamma t} \simeq \{u \in \mathcal{L}^{t, \gamma t} : \Delta_u^{t, \gamma t} > at\}$. This is not exactly the case and, therefore, we need to split $\mathcal{L}^{at, \gamma t}$ into two disjoint parts by setting

$$\begin{aligned} \mathcal{L}_{\text{good}}^{at, \gamma t} &:= \{u \in \mathcal{L}^{at, \gamma t} : u \in \mathcal{L}^{t, \gamma t} \text{ and } \Delta_u^{t, \gamma t} = \Delta_u^{at, \gamma t} > at\}, \\ \mathcal{L}_{\text{bad}}^{at, \gamma t} &:= \mathcal{L}^{at, \gamma t} \setminus \mathcal{L}_{\text{good}}^{at, \gamma t}. \end{aligned}$$

The ‘‘good’’ particles are those which contribute to the limiting process. They satisfy $\mathcal{L}_{\text{good}}^{at, \gamma t} = \{u \in \mathcal{L}_{\text{good}}^{t, \gamma t} : \Delta_u^{t, \gamma t} > at\}$. Note that we have the equivalent definitions

$$\begin{aligned} \mathcal{L}_{\text{good}}^{at, \gamma t} &= \{u \in \mathcal{L}^{at, \gamma t} : \min_{r \in [t, at]} X_u(r) > \gamma t\}, \\ \mathcal{L}_{\text{bad}}^{at, \gamma t} &= \{u \in \mathcal{L}^{at, \gamma t} : \min_{r \in [t, at]} X_u(r) \leq \gamma t\}. \end{aligned}$$

See Figure 3.1 for some examples.

Now, we can rewrite (3.19) as

$$Z_\infty = \tilde{Z}_\infty^{at, \gamma t} + F_{\text{good}}^{at, \gamma t} + F_{\text{bad}}^{at, \gamma t}, \quad (3.20)$$

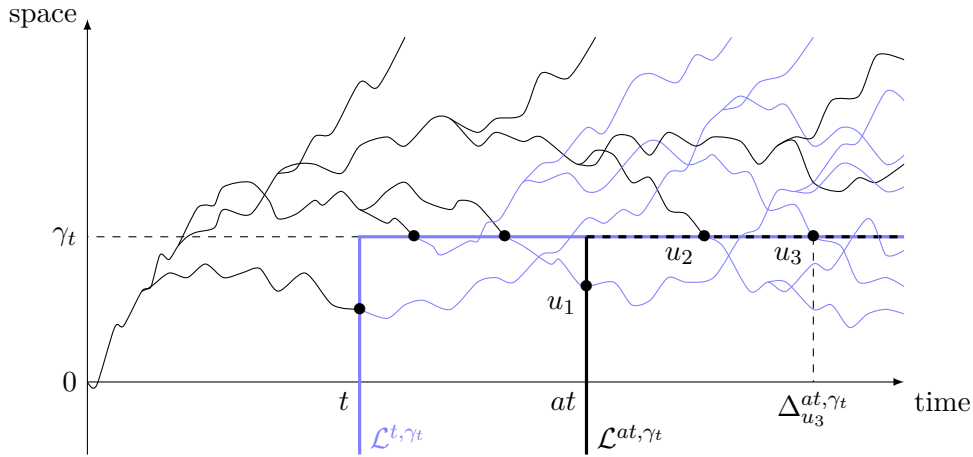

Figure 3.1 – Representation of a BBM with binary branching. The killing barrier that defines $\mathcal{L}^{t, \gamma t}$ is the thick blue line. The one for $\mathcal{L}^{at, \gamma t}$ is the thick black line. At each time $s \geq t$, the blue particles do not contribute to $\tilde{Z}_s^{t, \gamma t}$. We have $u_1, u_3 \in \mathcal{L}_{\text{bad}}^{at, \gamma t}$ and $u_2 \in \mathcal{L}_{\text{good}}^{at, \gamma t}$.

where we set

$$F_{\text{good/bad}}^{at, \gamma t} := \sum_{u \in \mathcal{L}_{\text{good/bad}}^{at, \gamma t}} e^{-X_u(\Delta_u^{at, \gamma t})} Z_{\infty}^{(u, at, \gamma t)}.$$

Note that $X_u(\Delta_u^{at, \gamma t}) = \gamma t$ for $u \in \mathcal{L}_{\text{good}}^{at, \gamma t}$.

We can now state two propositions, which will be proved later in the chapter. They basically state that the “good” particles lead to the limiting process (after an appropriate compensation) and the “bad” particles have a negligible contribution.

Proposition 3.3.3. *Let $(S_r)_{r \geq 0}$ be the 1-stable Lévy process defined in Theorem 3.1.1. For any $n \geq 1$, $a \in [1, \infty)^n$ and $\lambda \in \mathbb{R}^n$, we have the following convergence in probability*

$$\mathbb{E} \left[\exp \left(i \sum_{k=1}^n \lambda_k \sqrt{t} \left(F_{\text{good}}^{akt, \gamma t} - \beta_t W_{akt} \right) \right) \middle| \mathcal{F}_t \right] \xrightarrow{t \rightarrow \infty} \mathbb{E} \left[\exp \left(i \sum_{k=1}^n \lambda_k S_{Z_{\infty} / \sqrt{a_k}} \right) \middle| Z_{\infty} \right].$$

Proposition 3.3.4. *For any $a \geq 1$, we have the following convergence in probability*

$$\sqrt{t} F_{\text{bad}}^{at, \gamma t} \xrightarrow{t \rightarrow \infty} 0.$$

Proof of Theorems 3.1.1 and 3.3.1. Using decomposition (3.20) and recalling that we chose $\gamma t = \frac{1}{2} \log t + \beta_t$, we have for every $a \geq 1$,

$$Z_{\infty} - Z_{at} + \frac{\log t}{2} W_{at} = \tilde{Z}_{\infty}^{at, \gamma t} - (Z_{at} - \gamma_t W_{at}) + F_{\text{good}}^{at, \gamma t} - \beta_t W_{at} + F_{\text{bad}}^{at, \gamma t}.$$

Propositions 3.3.2 and 3.3.4 now give for every $a \geq 1$,

$$\sqrt{t} \left(Z_{\infty} - Z_{at} + \frac{\log t}{2} W_{at} \right) - \sqrt{t} \left(F_{\text{good}}^{at, \gamma t} - \beta_t W_{at} \right) \xrightarrow{t \rightarrow \infty} 0.$$

Then, combining Propositions 3.3.3 and 3.A.1 with Remark 3.A.3, this proves Theorem 3.3.1. We recall that Theorem 3.1.1 follows then from Proposition 3.2.2. \square

3.4 Preliminary results on BBM with a barrier

3.4.1 Many-to-one formula and change of probabilities

It will be handy in the sequel to allow the BBM to start at an arbitrary point $x \in \mathbb{R}$, in which case we write \mathbb{P}_x and \mathbb{E}_x instead of \mathbb{P} and \mathbb{E} . The martingale property of the processes $(W_t)_{t \geq 0}$ and $(Z_t)_{t \geq 0}$ defined in the introduction then implies that for every $x \in \mathbb{R}$ and $t \geq 0$,

$$\mathbb{E}_x[W_t] = e^{-x}, \quad \mathbb{E}_x[Z_t] = xe^{-x}. \quad (3.21)$$

A generalization of this fact is provided by the following *many-to-one formula*, which is an essential tool in the study of BBM. Let $\mathcal{C}([0, t])$ denote the space of continuous functions from $[0, t]$ to \mathbb{R} . For any $x \in \mathbb{R}$, $t \geq 0$ and any measurable function $F: \mathcal{C}([0, t]) \rightarrow \mathbb{R}_+$, one can compute the following expectation:

$$\mathbb{E}_x \left[\sum_{u \in \mathcal{N}(t)} e^{-X_u(t)} F(X_u(s), s \in [0, t]) \right] = e^{-x} \mathbb{E}_x[F(B_s, s \in [0, t])], \quad (3.22)$$

with $(B_s)_{s \geq 0}$ a standard Brownian motion, starting from x under \mathbb{P}_x . Note that this formula follows from forthcoming Proposition 3.4.1.

Throughout the chapter, we will use three changes of probabilities and their associated spinal decompositions. Two of them are presented below. See Section 1.1.3 for an historical background of these techniques and Section 2.5.1 for similar results in the case of branching random walks. Let \mathcal{F}_t denote the σ -algebra containing all the information until time t ,

$$\mathcal{F}_t := \sigma(\mathcal{N}(s), 0 \leq s \leq t) \vee \sigma(X_u(s), 0 \leq s \leq t, u \in \mathcal{N}(s)),$$

and $\mathcal{F}_\infty := \sigma(\bigvee_{t \geq 0} \mathcal{F}_t)$.

The first change of probability is done with respect to the critical additive martingale $(W_s)_{s \geq 0}$ and has been introduced by Chauvin and Rouault [CR88]. Since it is a non-negative martingale, we can define, for $x > 0$, a new probability measure \mathbb{Q}_x on \mathcal{F}_∞ by

$$\mathbb{Q}_x|_{\mathcal{F}_s} := e^x W_s \bullet \mathbb{P}_x|_{\mathcal{F}_s}, \quad \forall s \geq 0.$$

Following Hardy and Harris [HH09], we rather view \mathbb{Q}_x as the projection to \mathcal{F}_∞ of a probability measure (denoted by \mathbb{Q}_x as well for simplicity) on an enlarged probability space, carrying a so-called *spine*, i.e. a marked ray in the genealogical tree. The particle on the spine by time s will be denoted by w_s . Recall that λ denotes the branching rate and L a random variable distributed according to the offspring distribution in the original BBM. We then have the following description for the BBM with spine under \mathbb{Q}_x .

- The system starts with one particle w_0 at position x .
- This particle moves like a standard Brownian motion (without drift!) during a time distributed according to the exponential law of parameter $\mu_1 \lambda$, where $\mu_1 := \mathbb{E}[L]$.
- Then, it gives birth to a random number \widehat{L} of particles distributed according to the *size-biased* reproduction law, i.e. $\forall k \in \mathbb{N}, \mathbb{P}(\widehat{L} = k) = k\mathbb{P}(L = k)/\mu_1$.
- Amongst the children, one is uniformly chosen to be on the spine and continues in the same way.
- Others spawn usual BBMs (according to the law \mathbb{P} , but started from the position of their parent).

The following proposition generalizes the many-to-one formula stated above and follows from the results in [HH09]. Recall that a “particle” is formally a word on the alphabet of natural numbers, i.e. an element of the countable set $\mathbb{T} = \bigcup_{n=0}^{\infty} \mathbb{N}^n$.

Proposition 3.4.1. *Let $x \in \mathbb{R}$. Let $s \geq 0$ and let $(H_s(u))_{u \in \mathbb{T}}$ be a family of uniformly bounded \mathcal{F}_s -measurable random variables. Then, we have*

$$\mathbb{E}_x \left[\sum_{u \in \mathcal{N}(s)} e^{-X_u(s)} H_s(u) \right] = e^{-x} \mathbb{E}_{\mathbb{Q}_x} [H_s(w_s)].$$

The second change of probability we will use has been introduced by Kyprianou [Kyp04] and is done with respect to a modification of the derivative martingale, obtained by killing particles coming below 0: it is called the *truncated derivative martingale* and is defined by

$$\tilde{Z}_s := \sum_{u \in \mathcal{N}(s)} X_u(s) e^{-X_u(s)} \mathbb{1}_{\forall r \in [0, s], X_u(r) > 0}, \quad s \geq 0.$$

Then, for $x \geq 0$, $(\tilde{Z}_s)_{s \geq 0}$ is a non-negative martingale under \mathbb{P}_x and, therefore, we define a new probability measure $\tilde{\mathbb{Q}}_x$ on \mathcal{F}_∞ by

$$\tilde{\mathbb{Q}}_x|_{\mathcal{F}_s} := \frac{e^x}{x} \tilde{Z}_s \bullet \mathbb{P}_x|_{\mathcal{F}_s}, \quad \forall s \geq 0.$$

We have an analogous description for the BBM with spine $(w_s)_{s \geq 0}$ under $\tilde{\mathbb{Q}}_x$:

- The system starts with one particle w_0 at position x .
- This particle moves like a 3-dimensional Bessel process during a time distributed according to the exponential law of parameter $\mu_1 \lambda$, where $\mu_1 := \mathbb{E}[L]$.
- Then, it gives birth to a random number of particles distributed as \hat{L} defined above.
- Amongst the children, one is uniformly chosen to be on the spine and continues in the same way.
- Others spawn usual BBMs (according to the law \mathbb{P} , but started from the position of their parent).

Moreover, one has the following generalization of the many-to-one lemma:

Proposition 3.4.2. *Let $x \geq 0$. Let $s \geq 0$ and let $(H_s(u))_{u \in \mathbb{T}}$ be a family of uniformly bounded \mathcal{F}_s -measurable random variables. Then, we have*

$$\mathbb{E}_x \left[\sum_{u \in \mathcal{N}(s)} X_u(s) e^{-X_u(s)} \mathbb{1}_{\forall r \in [0, s], X_u(r) > 0} H_s(u) \right] = x e^{-x} \mathbb{E}_{\tilde{\mathbb{Q}}_x} [H_s(w_s)].$$

3.4.2 Truncated derivative martingale: moments

The second moment of the truncated derivative martingale $(\tilde{Z}_s)_{s \geq 0}$ is infinite if $\mathbb{E}[L^2] = \infty$. We therefore introduce a variant of $(\tilde{Z}_s)_{s \geq 0}$, which is close to it in L^1 -distance and whose second moment can be controlled. This method, which uses the probability $\tilde{\mathbb{Q}}_x$ defined in the previous section, is due to Aïdékon [Aïd13] and sometimes called the *peeling lemma*, see Shi [Shi15] for more applications. We also incorporate simplifications of this method from Pain [Pai18].

Throughout, let $x \geq 0$. For $u \in \mathbb{T}$, such that $u \in \mathcal{N}(s)$ for some $s \geq 0$, let O_u denote the number of children of particle u and d_u the death time of u (and leave undefined otherwise). Write $v < u$ if v is a strict ancestor of u and $v \leq u$ if $v < u$ or $v = u$. We set, for $s, \kappa \geq 0$,

$$\begin{aligned} B_{s,\kappa} &:= \left\{ u \in \mathcal{N}(s) : \forall v < u, O_v \leq \kappa e^{X_v(d_v)/2} \right\}, \\ \tilde{Z}_{s,\kappa} &:= \sum_{u \in \mathcal{N}(s)} X_u(s) e^{-X_u(s)} \mathbb{1}_{\forall r \in [0,s], X_u(r) > 0} \mathbb{1}_{u \in B_{s,\kappa}}. \end{aligned}$$

Note that formally, $\tilde{Z}_{s,\infty} = \tilde{Z}_s$. The next lemma bounds the L^1 -distance between $\tilde{Z}_{s,\kappa}$ and \tilde{Z}_s for large κ .

Lemma 3.4.3. *There exists a decreasing function $h: \mathbb{R}_+ \rightarrow \mathbb{R}_+$ such that $\lim_{a \rightarrow \infty} h(a) = 0$ and for every $x, \kappa > 0$ and $s \geq 0$,*

$$\mathbb{E}_x \left[\left| \tilde{Z}_s - \tilde{Z}_{s,\kappa} \right| \right] \leq h(\kappa) e^{-x}.$$

Proof. First note that $\tilde{Z}_s \geq \tilde{Z}_{s,\kappa}$, so we can ignore the absolute value in the expectation. Using Proposition 3.4.2, we get

$$\mathbb{E}_x \left[\tilde{Z}_s - \tilde{Z}_{s,\kappa} \right] = \mathbb{E}_x \left[\sum_{u \in \mathcal{N}(s)} X_u(s) e^{-X_u(s)} \mathbb{1}_{\forall r \in [0,s], X_u(r) > 0} \mathbb{1}_{u \notin B_{s,\kappa}} \right] = x e^{-x} \tilde{\mathbb{Q}}_x(w_s \notin B_{s,\kappa}).$$

Under \mathbb{P}_x , let $(R_r)_{r \geq 0}$ denote a 3-dimensional Bessel process and let \hat{L} be a random variable independent of $(R_r)_{r \geq 0}$ following the size-biased reproduction law. Then, using the spinal decomposition description and the formula for expectations of additive functionals of Poisson point processes (applied to the branching times r of the spine where the number of children exceeds $e^{X_{w_r}(r)/2}$), we have

$$\begin{aligned} \tilde{\mathbb{Q}}_x(w_s \notin B_{s,\kappa}) &\leq \mathbb{E}_x \left[\int_0^s \mathbb{P}_x \left(\hat{L} > \kappa e^{R_r/2} \mid (R_r)_{r \geq 0} \right) \mu_1 \lambda \, dr \right] \\ &= \mu_1 \lambda \mathbb{E}_x \left[\mathbb{E}_x \left[\int_0^s \mathbb{1}_{R_r < 2 \log_+(\hat{L}/\kappa)} \, dr \mid \hat{L} \right] \right] \\ &\leq \mu_1 \lambda \mathbb{E} \left[\frac{1}{x} \left(2 \log_+(\hat{L}/\kappa) \right)^3 \right], \quad \text{by (3.52)}. \end{aligned}$$

The previous inequalities and the definition of \hat{L} yield,

$$\mathbb{E}_x \left[\tilde{Z}_s - \tilde{Z}_{s,\kappa} \right] \leq h(\kappa) e^{-x}, \quad h(\kappa) := 8\lambda \mathbb{E}[L(\log_+(L/\kappa))^3].$$

The function $h(\kappa)$ is decreasing in κ and vanishes as $\kappa \rightarrow \infty$, by dominated convergence and Assumption (3.1). This proves the result. \square

Lemma 3.4.4. *There exists $C > 0$ such that for every $x \geq 0$, $\kappa \geq 1$ and $s \geq 0$,*

$$\mathbb{E}_x \left[\tilde{Z}_{s,\kappa}^2 \right] \leq C \kappa e^{-x}.$$

Proof. Using Proposition 3.4.2, we have

$$\begin{aligned} \mathbb{E}_x \left[\tilde{Z}_{s,\kappa}^2 \right] &= \mathbb{E}_x \left[\sum_{u \in \mathcal{N}(s)} X_u(s) e^{-X_u(s)} \mathbb{1}_{\forall r \in [0,s], X_u(r) > 0} \mathbb{1}_{u \notin B_{s,\kappa}} \tilde{Z}_{s,\kappa} \right] \\ &= x e^{-x} \mathbb{E}_{\tilde{\mathbb{Q}}_x} \left[\tilde{Z}_{s,\kappa} \mathbb{1}_{w_s \in B_{s,\kappa}} \right] \leq x e^{-x} \mathbb{E}_{\tilde{\mathbb{Q}}_x} \left[\tilde{Z}_s \mathbb{1}_{w_s \in B_{s,\kappa}} \right]. \end{aligned}$$

The \tilde{Z}_s appearing in this last expectation can be decomposed as a sum indexed by the (non-spine) children of the spine particles, each term in the sum corresponding to the contribution of the descendants of this child, plus the contribution from the spine particle at time s . With Π_s denoting the set of branching times of the spine before s , we then get

$$\begin{aligned} \mathbb{E}_{\tilde{\mathbb{Q}}_x} \left[\tilde{Z}_s \mathbb{1}_{w_s \in B_{s,\kappa}} \right] &= \mathbb{E}_{\tilde{\mathbb{Q}}_x} \left[\mathbb{1}_{w_s \in B_{s,\kappa}} \sum_{r \in \Pi_s} (O_{w_r} - 1) \mathbb{E}_{X_{w_r}(r)} \left[\tilde{Z}_{s-r} \right] + X_{w_s}(s) e^{-X_{w_s}(s)} \right] \\ &\leq \mathbb{E}_x \left[\int_0^s \kappa e^{R_r/2} \mathbb{E}_{R_r} \left[\tilde{Z}_{s-r} \right] \mu_1 \lambda \, dr + R_s e^{-R_s} \right] \\ &= \mu_1 \lambda \kappa \mathbb{E}_x \left[\int_0^s R_r e^{-R_r/2} \, dr \right] + \mathbb{E}_x \left[R_s e^{-R_s} \right], \end{aligned}$$

using that $\mathbb{E}_{R_r}[\tilde{Z}_{s-r}] = R_r e^{-R_r}$. The first expectation is bounded by $\frac{192}{x}$ by (3.53). The second expectation is bounded by $\frac{C'}{x}$, with $C' = \max_{y \geq 0} y^2 e^{-y}$, since the density of R_s under \mathbb{P}_x is bounded by $\frac{y}{x} g_s(x, y)$, with $g_s(x, y)$ the Gaussian kernel of variance s , see (3.51). This concludes the proof. \square

3.4.3 Number of particles killed by the barrier

We still consider here a BBM starting with a single particle at $x \geq 0$ and where particles are killed when hitting 0. Let \mathcal{L} denote the stopping line of the killed particles and, for $u \in \mathcal{L}$, let Δ_u be the killing time of u . Our interest in this section is the number

$$N_{[a,b]} := \#\{u \in \mathcal{L} : \Delta_u \in [a, b]\}$$

of particles that are killed at 0 between times a and b . More generally, we introduce as before a new random variable, where we remove the particles with too many children: for $\kappa \geq 0$ and $0 \leq a \leq b$, we set

$$\begin{aligned} C_\kappa &:= \left\{ u \in \mathcal{L} : \forall v < u, O_v \leq \kappa e^{X_v(d_v)/2} \right\}, \\ N_{[a,b],\kappa} &:= \#\{u \in C_\kappa : \Delta_u \in [a, b]\}. \end{aligned}$$

It will be most convenient to consider a different branching Markov process (in the sense of Hardy and Harris [HH09]), namely, BBM where particles are *stopped* at the origin. Formally, this is a branching Markov process where the motion of the particles is standard Brownian motion on $[0, \infty)$, stopped when it hits the origin, and the branching rate is equal to λ on $(0, \infty)$ and zero at the origin (the offspring distribution is the same as before). We will denote the law and expectation w.r.t. this process by \mathbb{P}_x^0 and \mathbb{E}_x^0 , respectively. It is clear that $(W_t)_{t \geq 0}$ is still a martingale under \mathbb{P}_x^0 . As in Section 3.4.1, we can therefore define a new measure \mathbb{Q}_x^0 by changing the measure \mathbb{P}_x^0 w.r.t. the normalized martingale $(e^{-x} W_t)_{t \geq 0}$. This measure has an analogous description as the measure \mathbb{Q}_x , except that all particles (including the spine), are stopped at the origin and do not branch once stopped. Furthermore, we have the following many-to-one lemma:

Proposition 3.4.5. *Let $x \geq 0$. Let $s \geq 0$ and let $(H_s(u))_{u \in \mathbb{T}}$ be a family of uniformly bounded \mathcal{F}_s -measurable random variables. Then, we have*

$$\mathbb{E}_x^0 \left[\sum_{u \in \mathcal{N}(s)} e^{-X_u(s)} H_s(u) \right] = e^{-x} \mathbb{E}_{\mathbb{Q}_x^0} [H_s(w_s)].$$

As a first application of Proposition 3.4.5, we calculate the first moment of $N_{[a,b]}$ (this calculation is standard but we include it for convenience).

Lemma 3.4.6. *For $x \geq 0$ and $0 \leq a \leq b$, we have*

$$\mathbb{E}_x[N_{[a,b]}] = e^{-x} \int_a^b \frac{x}{\sqrt{2\pi}s^{3/2}} e^{-x^2/2s} ds.$$

Moreover, it follows that $\mathbb{E}_x[N_{[0,\infty)}] = e^{-x}$.

Proof. We first rewrite the expectation using BBM stopped at the origin:

$$\mathbb{E}_x[N_{[a,b]}] = \mathbb{E}_x^0 \left[\sum_{u \in \mathcal{N}(b)} \mathbb{1}_{X_u(b)=0, \forall r < a, X_u(r) > 0} \right].$$

Note that if $X_u(b) = 0$, then $1 = e^{-X_u(b)}$. We can therefore apply the many-to-one formula (Proposition 3.4.5) and get,

$$\mathbb{E}_x[N_{[a,b]}] = e^{-x} \mathbb{Q}_x^0(X_{w_b}(b) = 0, \forall r < a, X_{w_b}(r) > 0) = e^{-x} \mathbb{P}_x(\inf\{r \geq 0 : B_r = 0\} \in [a, b]),$$

where $(B_r)_{r \geq 0}$ is a standard Brownian motion started at x under \mathbb{P}_x . The law of the hitting time of the origin of Brownian motion started at x is known (see e.g. Equation 1.2.0.2 of Borodin and Salminen [BS02]) and implies the first statement of the lemma. The second statement follows by setting $a = 0$, letting $b \rightarrow \infty$ and observing that the hitting time is finite almost surely (or by direct calculation, using for example the change of variables $v = x/\sqrt{s}$). \square

Lemma 3.4.7. *There exists a decreasing function $h: \mathbb{R}_+ \rightarrow \mathbb{R}_+$ such that $\lim_{a \rightarrow \infty} h(a) = 0$ and, for any $x \geq 0$, $\kappa > 1$,*

$$\mathbb{E}_x[N_{[0,\infty)} - N_{[0,\infty),\kappa}] \leq \frac{h(\kappa)}{\log \kappa} e^{-x}.$$

Proof. As in the beginning of the proof of Lemma 3.4.6, for any $s \geq 0$, we have

$$\mathbb{E}_x[N_{[0,s]} - N_{[0,s],\kappa}] = e^{-x} \mathbb{Q}_x^0(X_{w_s}(s) = 0, w_s \notin C_\kappa).$$

Under \mathbb{P}_x , let $(B_r)_{r \geq 0}$ denote a Brownian motion and let \widehat{L} be a random variable independent of $(B_r)_{r \geq 0}$ following the size-biased reproduction law. Furthermore, set $\tau := \inf\{r \geq 0 : B_r = 0\}$. Then, using the spinal decomposition description under \mathbb{Q}_x^0 , we obtain as in Lemma 3.4.3,

$$\begin{aligned} \mathbb{Q}_x^0(X_{w_s}(s) = 0, w_s \notin C_\kappa) &\leq \mathbb{E}_x \left[\mathbb{1}_{\tau \leq s} \int_0^\tau \mathbb{P}_x(\widehat{L} > \kappa e^{B_t/2} \mid (B_t)_{t \geq 0}) \mu_1 \lambda dt \right] \\ &\leq \mu_1 \lambda \mathbb{E}_x \left[\mathbb{E}_x \left[\int_0^\tau \mathbb{1}_{B_t < 2 \log_+(\widehat{L}/\kappa)} dt \mid \widehat{L} \right] \right] \\ &\leq \mu_1 \lambda \mathbb{E} \left[\left(2 \log_+(\widehat{L}/\kappa) \right)^2 \right] \quad \text{by (3.47)} \\ &\leq 4\mu_1 \lambda \mathbb{E} \left[\left(\log_+(\widehat{L}/\kappa) \right)^2 \mathbb{1}_{\widehat{L} \geq \kappa} \frac{\log_+ \widehat{L}}{\log_+ \kappa} \right]. \end{aligned}$$

Setting $h(\kappa) := 4\lambda \mathbb{E}[L(\log_+(L/\kappa))^2 \log_+ L]$, we have $\lim_{\kappa \rightarrow \infty} h(\kappa) = 0$ by dominated convergence (and using Assumption (3.1)). Letting $s \rightarrow \infty$, this proves the result. \square

Lemma 3.4.8. *There exists $C > 0$ such that we have, for any $x \geq 0$ and $\kappa \geq 1$,*

$$\mathbb{E}_x \left[N_{[0,\infty),\kappa}^2 \right] \leq C \kappa e^{-x}.$$

Proof. First note that

$$\mathbb{E}_x \left[N_{[0,\infty),\kappa}^2 \right] = \mathbb{E}_x \left[N_{[0,\infty),\kappa} (N_{[0,\infty),\kappa} - 1) \right] + \mathbb{E}_x \left[N_{[0,\infty),\kappa} \right],$$

and the second summand is bounded by e^{-x} using the inequality $N_{[0,\infty),\kappa} \leq N_{[0,\infty)}$ and applying Lemma 3.4.6. It thus remains to show that the first summand is bounded by $C \kappa e^{-x}$ for some $C > 0$.

The proof is similar to the proof of Lemma 3.4.4. We first have for $s \geq 0$, by Proposition 3.4.5,

$$\begin{aligned} \mathbb{E}_x \left[N_{[0,s],\kappa} (N_{[0,s],\kappa} - 1) \right] &= \mathbb{E}_x^0 \left[\sum_{u \in \mathcal{N}(s)} \mathbb{1}_{X_u(s)=0, u \in C_\kappa} (N_{[0,s],\kappa} - 1) \right] \\ &= e^{-x} \mathbb{E}_{\mathbb{Q}_x^0} \left[(N_{[0,s],\kappa} - 1) \mathbb{1}_{X_{w_s}(s)=0, w_s \in C_\kappa} \right]. \end{aligned}$$

Denoting again Π_s the set of branching times of the spine before s and using the spinal decomposition description, we get

$$\begin{aligned} \mathbb{E}_{\mathbb{Q}_x^0} \left[(N_{[0,s],\kappa} - 1) \mathbb{1}_{X_{w_s}(s)=0, w_s \in C_\kappa} \right] &= \mathbb{E}_{\mathbb{Q}_x^0} \left[\mathbb{1}_{X_{w_s}(s)=0, w_s \in C_\kappa} \sum_{t \in \Pi_s} (O_{w_t} - 1) \mathbb{E}_{X_{w_t}(t)} \left[N_{[0,s-t],\kappa} \right] \right] \\ &\leq \kappa \mathbb{E}_{\mathbb{Q}_x^0} \left[\mathbb{1}_{X_{w_s}(s)=0} \sum_{t \in \Pi_s} e^{X_{w_t}(t)/2} \mathbb{E}_{X_{w_t}(t)} \left[N_{[0,\infty)} \right] \right]. \end{aligned}$$

We denote again by $(B_r)_{r \geq 0}$ a Brownian motion started at x under \mathbb{P}_x and set $\tau := \inf\{r \geq 0 : B_r = 0\}$. Using Lemma 3.4.6 and the formula for expectations of additive functionals of Poisson point processes, the last estimates gives

$$\mathbb{E}_x \left[N_{[0,s],\kappa} (N_{[0,s],\kappa} - 1) \right] \leq \kappa \mu_1 \lambda e^{-x} \mathbb{E}_x \left[\mathbb{1}_{\tau \leq s} \int_0^\tau e^{-B_t/2} dt \right],$$

and, letting $s \rightarrow \infty$, we get

$$\mathbb{E}_x \left[N_{[0,\infty),\kappa} (N_{[0,\infty),\kappa} - 1) \right] \leq \kappa \mu_1 \lambda e^{-x} \mathbb{E}_x \left[\int_0^\tau e^{-B_t/2} dt \right].$$

This last integral is bounded by a constant by (3.48), which finishes the proof of the theorem. \square

3.4.4 Truncation of the critical additive martingale

In this section, using again the new probability measure $\tilde{\mathbb{Q}}_x$, we study the truncation of the critical additive martingale, when particles are killed below 0, defined by

$$\tilde{W}_s := \sum_{u \in \mathcal{N}(s)} e^{-X_u(s)} \mathbb{1}_{\forall r \in [0,s], X_u(r) > 0}, \quad s \geq 0.$$

Note that $(\tilde{W}_s)_{s \geq 0}$ is not a martingale. Moreover, we introduce, for $\kappa \geq 0$ and $s \geq 0$,

$$\tilde{W}_{s,\kappa} := \sum_{u \in \mathcal{N}(s)} e^{-X_u(s)} \mathbb{1}_{\forall r \in [0,s], X_u(r) > 0} \mathbb{1}_{u \in B_{s,\kappa}},$$

where $B_{s,\kappa}$ has been introduced in Subsection 3.4.2.

Lemma 3.4.9. For $x \geq 0$, set $F(x) := \sqrt{2/\pi} \int_0^x e^{-z^2/2} dz$. For any $x, s \geq 0$ we have

$$\mathbb{E}_x[\widetilde{W}_s] = e^{-x} F\left(\frac{x}{\sqrt{s}}\right) \leq e^{-x} \left(1 \wedge \sqrt{\frac{2}{\pi}} \frac{x}{\sqrt{s}}\right).$$

Proof. Using the many-to-one formula (Proposition 3.4.1) and the reflection principle, we have

$$\mathbb{E}_x[\widetilde{W}_s] = e^{-x} \mathbb{P}_x(\forall r \in [0, s], B_r \geq 0) = e^{-x} \mathbb{P}(|B_s| \leq x) = e^{-x} F\left(\frac{x}{\sqrt{s}}\right),$$

because $F(y) = \mathbb{P}(|B_1| \leq y)$. Then, note that, for any $y > 0$, we have $F(y) \leq \sqrt{2/\pi}y$ and also $F(y) \leq 1$. \square

Lemma 3.4.10. There exists a decreasing function $h: \mathbb{R}_+ \rightarrow \mathbb{R}_+$ such that $\lim_{a \rightarrow \infty} h(a) = 0$ and, for any $x, \kappa, s \geq 0$,

$$\mathbb{E}_x[\widetilde{W}_s - \widetilde{W}_{s,\kappa}] \leq h(\kappa) e^{-x} \left(\frac{1}{\sqrt{s}} + \frac{x}{s}\right).$$

Proof. Using Proposition 3.4.2, we get

$$\mathbb{E}_x[\widetilde{W}_s - \widetilde{W}_{s,\kappa}] = \mathbb{E}_x \left[\sum_{u \in \mathcal{N}(s)} X_u(s) e^{-X_u(s)} \mathbb{1}_{\forall r \in [0, s], X_u(r) > 0} \frac{\mathbb{1}_{u \notin B_{s,\kappa}}}{X_u(s)} \right] = x e^{-x} \mathbb{E}_{\widetilde{Q}_x} \left[\frac{\mathbb{1}_{w_s \notin B_{s,\kappa}}}{X_{w_s}(s)} \right].$$

Then, using the spinal decomposition description, we obtain

$$\begin{aligned} \mathbb{E}_{\widetilde{Q}_x} \left[\frac{\mathbb{1}_{w_s \notin B_{s,\kappa}}}{X_{w_s}(s)} \right] &\leq \mathbb{E}_x \left[\frac{1}{R_s} \int_0^s \mathbb{P}(\widehat{L} > \kappa e^{R_r/2} | (R_r)_{r \geq 0}) \mu_1 \lambda dr \right] \\ &= \mu_1 \lambda \mathbb{E}_x \left[\mathbb{E}_x \left[\frac{1}{R_s} \int_0^s \mathbb{1}_{R_r < 2 \log_+(\widehat{L}/\kappa)} dr \mid \widehat{L} \right] \right], \end{aligned}$$

and applying Lemma 3.B.1, we get

$$\mathbb{E}_{\widetilde{Q}_x} \left[\frac{\mathbb{1}_{w_s \notin B_{s,\kappa}}}{X_{w_s}(s)} \right] \leq \mu_1 \lambda \mathbb{E} \left[C \left(2 \log_+(\widehat{L}/\kappa)\right)^3 \left(\frac{1}{x\sqrt{s}} + \frac{1}{s}\right) \right].$$

Setting $h(\kappa) := C \lambda \mathbb{E}[L(\log_+(L/\kappa))^3]$, it proves the result. \square

Lemma 3.4.11. There exists $C > 0$ such that, for any $x \geq 0$, $\kappa \geq 1$ and $s \geq 2$, we have

$$\mathbb{E}_x[\widetilde{W}_{s,\kappa}^2] \leq C \kappa e^{-x} \left(\frac{1}{s} + \frac{x \ln s}{s^{3/2}}\right).$$

Proof. Using Proposition 3.4.2, we have

$$\mathbb{E}_x[\widetilde{W}_{s,\kappa}^2] = x e^{-x} \mathbb{E}_{\widetilde{Q}_x} \left[\widetilde{W}_{s,\kappa} \frac{\mathbb{1}_{w_s \in B_{s,\kappa}}}{X_{w_s}(s)} \right] \leq x e^{-x} \mathbb{E}_{\widetilde{Q}_x} \left[\widetilde{W}_s \frac{\mathbb{1}_{w_s \in B_{s,\kappa}}}{X_{w_s}(s)} \right].$$

As in the proof of Lemma 3.4.4, we get (using Lemma 3.4.9 in the last step)

$$\begin{aligned} \mathbb{E}_{\widetilde{Q}_x} \left[\widetilde{W}_s \frac{\mathbb{1}_{w_s \in B_{s,\kappa}}}{X_{w_s}(s)} \right] &= \mathbb{E}_{\widetilde{Q}_x} \left[\frac{\mathbb{1}_{w_s \in B_{s,\kappa}}}{X_{w_s}(s)} \left(\sum_{r \in \Pi_s} (O_{w_r} - 1) \mathbb{E}_{X_{w_r}(r)}[\widetilde{W}_{s-r}] + e^{-X_{w_s}(s)} \right) \right] \\ &\leq \mathbb{E}_x \left[\frac{1}{R_s} \left(\int_0^s \kappa e^{R_r/2} \mathbb{E}_{R_r}[\widetilde{W}_{s-r}] \mu_1 \lambda dr + e^{-R_s} \right) \right] \\ &\leq \mu_1 \lambda \kappa \mathbb{E}_x \left[\frac{1}{R_s} \int_0^s e^{-R_r/2} \left(1 \wedge \sqrt{\frac{2}{\pi}} \frac{R_r}{\sqrt{s-r}} \right) dr \right] + \mathbb{E}_x \left[\frac{1}{R_s} e^{-R_s} \right]. \end{aligned}$$

The first expectation is bounded by $C\left(\frac{1}{xs} + \frac{\ln s}{s^{3/2}}\right)$ for some constant C , by Lemma 3.B.2, for $x > 0$ (and the statement of the lemma is trivial if $x = 0$). The second expectation is bounded by $C/s^{3/2}$, because the density of R_s under \mathbb{P}_x is bounded by $Cy^2/s^{3/2}$ for all $x \geq 0$, by (3.51) and the inequality $1 - e^{-x} \leq x$ for all $x \geq 0$. Together with the previous inequalities, this yields the result. \square

3.5 Particles staying above γ_t : proof of Proposition 3.3.2

In this section, we prove Proposition 3.3.2 using the results from Section 3.4.2. As explained below, it will be enough to consider $a = 1$. We recall the notation from Section 3.3: for $t \geq 0$,

$$\begin{aligned} \gamma_t &= \frac{1}{2} \log t + \beta_t, \quad \text{with } \beta_t \rightarrow \infty \text{ and } \frac{\beta_t}{t^{1/4}} \rightarrow 0 \text{ as } t \rightarrow \infty, \\ \tilde{Z}_s^{t,\gamma_t} &= \sum_{u \in \mathcal{N}(s)} (X_u(s) - \gamma_t) e^{-X_u(s)} \mathbb{1}_{\forall r \in [t,s], X_u(r) > \gamma_t}, \quad s \geq t. \end{aligned}$$

We start with a preliminary lemma.

Lemma 3.5.1. *We have the following convergence in probability*

$$\sqrt{t} \left| \tilde{Z}_\infty^{t,\gamma_t} - \tilde{Z}_t^{t,\gamma_t} \right| \xrightarrow[t \rightarrow \infty]{} 0.$$

Proof of Lemma 3.5.1. The proof basically follows a first- and second moment argument, with a truncation as in Section 3.4.2 in order to handle offspring distributions of infinite variance. By analogy with Section 3.4.2, we set, for $\kappa \geq 1$ and $s \geq t$,

$$\begin{aligned} B_{s,\kappa}^{t,\gamma_t} &:= \left\{ u \in \mathcal{N}(s) : \forall v < u, d_v \geq t \Rightarrow O_v \leq \kappa e^{(X_v(d_v) - \gamma_t)/2} \right\} \\ \tilde{Z}_{s,\kappa}^{t,\gamma_t} &:= \sum_{u \in \mathcal{N}(s)} (X_u(s) - \gamma_t) e^{-X_u(s)} \mathbb{1}_{\forall r \in [t,s], X_u(r) > \gamma_t} \mathbb{1}_{u \in B_{s,\kappa}^{t,\gamma_t}}. \end{aligned}$$

It is enough to show the following: for every $\varepsilon > 0$,

$$\mathbb{P} \left(\left| \tilde{Z}_s^{t,\gamma_t} - \tilde{Z}_t^{t,\gamma_t} \right| \geq \frac{\varepsilon}{\sqrt{t}} \middle| \mathcal{F}_t \right) \xrightarrow[t \rightarrow \infty]{} 0, \quad \text{in probability.} \quad (3.23)$$

Noting that $\tilde{Z}_s^{t,\gamma_t} - \tilde{Z}_{s,\kappa}^{t,\gamma_t} \geq 0$ and $\mathbb{E}[\tilde{Z}_s^{t,\gamma_t} | \mathcal{F}_t] = \tilde{Z}_t^{t,\gamma_t}$, we decompose

$$\begin{aligned} &\mathbb{P} \left(\left| \tilde{Z}_s^{t,\gamma_t} - \tilde{Z}_t^{t,\gamma_t} \right| \geq \frac{3\varepsilon}{\sqrt{t}} \middle| \mathcal{F}_t \right) \\ &\leq \mathbb{P} \left(\tilde{Z}_s^{t,\gamma_t} - \tilde{Z}_{s,\kappa}^{t,\gamma_t} \geq \frac{\varepsilon}{\sqrt{t}} \middle| \mathcal{F}_t \right) + \mathbb{P} \left(\left| \tilde{Z}_{s,\kappa}^{t,\gamma_t} - \mathbb{E}[\tilde{Z}_{s,\kappa}^{t,\gamma_t} | \mathcal{F}_t] \right| \geq \frac{\varepsilon}{\sqrt{t}} \middle| \mathcal{F}_t \right) + \mathbb{1}_{\mathbb{E}[\tilde{Z}_s^{t,\gamma_t} - \tilde{Z}_{s,\kappa}^{t,\gamma_t} | \mathcal{F}_t] \geq \varepsilon/\sqrt{t}} \\ &\leq 2 \cdot \frac{\sqrt{t}}{\varepsilon} \mathbb{E}[\tilde{Z}_s^{t,\gamma_t} - \tilde{Z}_{s,\kappa}^{t,\gamma_t} | \mathcal{F}_t] + \left(\frac{\sqrt{t}}{\varepsilon} \right)^2 \text{Var}(\tilde{Z}_{s,\kappa}^{t,\gamma_t} | \mathcal{F}_t), \end{aligned} \quad (3.24)$$

using Markov's inequality, Chebyshev's inequality and the inequality $\mathbb{1}_{x \geq \varepsilon} \leq x/\varepsilon$ for $x \geq 0$.

For the first term in (3.24), using the branching property at time t and Lemma 3.4.3, we have with the notation used there,

$$\begin{aligned} \mathbb{E}[\tilde{Z}_s^{t,\gamma_t} - \tilde{Z}_{s,\kappa}^{t,\gamma_t} | \mathcal{F}_t] &= \sum_{u \in \mathcal{N}(t)} e^{-\gamma_t} \mathbb{E}_{X_u(t) - \gamma_t} [\tilde{Z}_{s-t} - \tilde{Z}_{s-t,\kappa}] \mathbb{1}_{X_u(t) > \gamma_t} \\ &\leq \sum_{u \in \mathcal{N}(t)} e^{-\gamma_t} e^{-(X_u(t) - \gamma_t)} h(\kappa) = CW_t h(\kappa). \end{aligned} \quad (3.25)$$

For the second term in (3.24), using again the branching property at time t and Lemma 3.4.4, we get

$$\begin{aligned} \text{Var}\left(\tilde{Z}_{s,\kappa}^{t,\gamma_t} \mid \mathcal{F}_t\right) &\leq \sum_{u \in \mathcal{N}(t)} \mathbb{E}_{X_u(t)-\gamma_t} \left[\left(e^{-\gamma_t} \tilde{Z}_{s-t,\kappa} \right)^2 \right] \mathbb{1}_{X_u(t) > \gamma_t} \\ &\leq \sum_{u \in \mathcal{N}(t)} e^{-2\gamma_t} C \kappa e^{-(X_u(t)-\gamma_t)} = C \kappa e^{-\gamma_t} W_t. \end{aligned} \quad (3.26)$$

Combining (3.24), (3.25), (3.26) and taking $s \rightarrow \infty$, we get for every $\kappa \geq 1$ and $t \geq 0$,

$$\mathbb{P}\left(\left| \tilde{Z}_{\infty}^{t,\gamma_t} - \tilde{Z}_t^{t,\gamma_t} \right| \geq \frac{\varepsilon}{\sqrt{t}} \mid \mathcal{F}_t\right) \leq C \sqrt{t} W_t \left(\frac{h(\kappa)}{\varepsilon} + \frac{\kappa e^{-\beta t}}{\varepsilon^2} \right). \quad (3.27)$$

Now recall from (3.7) that $\sqrt{t}W_t$ converges in probability, as $t \rightarrow \infty$. Taking $\kappa = e^{\beta t/2}$ and using that $h(\kappa) \rightarrow 0$ as $\kappa \rightarrow \infty$, the right-hand side of (3.27) then goes to 0 in probability as $t \rightarrow \infty$, which shows (3.23). The result follows. \square

The next lemma shows that the contribution of the particles below γ_t at time t is negligible. It is stated in greater generality since it will be used in Section 3.6 as well. It is here that we use the assumption $\gamma_t = o(t^{1/4})$. Define for $s \geq t \geq 0$,

$$\tilde{W}_s^{t,\gamma_t} := \sum_{u \in \mathcal{N}(s)} e^{-X_u(s)} \mathbb{1}_{\forall r \in [t,s], X_u(r) > \gamma_t}. \quad (3.28)$$

Lemma 3.5.2. *For all $a \geq 1$, we have $\gamma_t \sqrt{t} (W_{at} - \tilde{W}_{at}^{t,\gamma_t}) \rightarrow 0$ in probability as $t \rightarrow \infty$.*

Proof. Fix $\varepsilon > 0$. By (3.4), there exists $L > 0$ such that

$$\mathbb{P}\left(\min_{s \geq 0} \min_{u \in \mathcal{N}(s)} X_u(s) \leq -L\right) \leq \varepsilon.$$

By Markov's inequality,

$$\begin{aligned} &\mathbb{P}\left(W_{at} - \tilde{W}_{at}^{t,\gamma_t} \geq \frac{\varepsilon}{\gamma_t \sqrt{t}}\right) \\ &\leq \varepsilon + \varepsilon^{-1} \gamma_t \sqrt{t} \mathbb{E}\left[(W_{at} - \tilde{W}_{at}^{t,\gamma_t}) \mathbb{1}_{\min_{s \geq 0} \min_{u \in \mathcal{N}(s)} X_u(s) > -L}\right] \\ &\leq \varepsilon + \varepsilon^{-1} \gamma_t \sqrt{t} \mathbb{E}\left[\sum_{u \in \mathcal{N}(at)} e^{-X_u(at)} \mathbb{1}_{\min_{r \in [t,at]} X_u(r) \leq \gamma_t} \mathbb{1}_{\forall s \in [0,at], X_u(s) > -L}\right]. \end{aligned} \quad (3.29)$$

It follows from the many-to-one formula and the relation (3.49) between Brownian motion and the three-dimensional Bessel process that the expectation on the right-hand side of (3.29) is equal to

$$\mathbb{E}_L \left[\mathbb{1}_{\min_{r \in [t,at]} B_r \leq \gamma_t + L} \mathbb{1}_{\min_{s \in [0,at]} B_s > 0} \right] = L \mathbb{E}_L \left[\frac{1}{R_{at}} \mathbb{1}_{\min_{r \in [t,at]} R_r \leq \gamma_t + L} \right],$$

By Lemma 3.B.3,

$$\mathbb{E}_L \left[\frac{1}{R_{at}} \mathbb{1}_{\min_{r \in [t,at]} R_r \leq \gamma_t + L} \right] \leq C \left(\frac{(\gamma_t + L)^2}{t^{3/2}} + \frac{\gamma_t + L}{\sqrt{a-1} t} \mathbb{1}_{a > 1} \right).$$

Coming back to (3.29), we proved that

$$\mathbb{P}\left(W_{at} - \tilde{W}_{at}^{t,\gamma_t} \geq \frac{\varepsilon}{\gamma_t \sqrt{t}}\right) \leq \varepsilon + C \varepsilon^{-1} L \left(\frac{\gamma_t(\gamma_t + L)^2}{t} + \frac{\gamma_t(\gamma_t + L)}{\sqrt{(a-1)t}} \mathbb{1}_{a > 1} \right) \xrightarrow{t \rightarrow \infty} \varepsilon,$$

because $\gamma_t = o(t^{1/4})$. This proves the lemma. \square

Proof of Proposition 3.3.2. First note that it is sufficient to prove the case $a = 1$: for $a > 1$, $\beta'_{at} := \gamma_t - \frac{1}{2} \log(at)$ satisfies (3.18) with at instead of t , so one can directly apply the case $a = 1$. We therefore have to show:

$$\sqrt{t} \left| \tilde{Z}_\infty^{t, \gamma_t} - (Z_t - \gamma_t W_t) \right| \xrightarrow[t \rightarrow \infty]{\mathbb{P}} 0. \quad (3.30)$$

We decompose:

$$\sqrt{t} \left| \tilde{Z}_\infty^{t, \gamma_t} - (Z_t - \gamma_t W_t) \right| \leq \sqrt{t} \left| \tilde{Z}_\infty^{t, \gamma_t} - \tilde{Z}_t^{t, \gamma_t} \right| + \sqrt{t} \left| \tilde{Z}_t^{t, \gamma_t} - (Z_t - \gamma_t W_t) \right|.$$

The first term goes to 0 in probability by Lemma 3.5.1. The second term can be written as

$$\sqrt{t} \left| \tilde{Z}_t^{t, \gamma_t} - (Z_t - \gamma_t W_t) \right| = \sqrt{t} \sum_{u \in \mathcal{N}(t)} (\gamma_t - X_u(t)) e^{-X_u(t)} \mathbb{1}_{X_u(t) \leq \gamma_t}.$$

Since $\min_{u \in \mathcal{N}(t)} X_u(t) \rightarrow \infty$ a.s. as $t \rightarrow \infty$ by (3.4), the right-hand side is bounded by $\gamma_t \sqrt{t} (W_t - \tilde{W}_t^{t, \gamma_t})$ with high probability for large t , and this goes to 0 by Lemma 3.5.2 as $t \rightarrow \infty$. Equation (3.30) follows. \square

3.6 Contribution of killed particles

In this section we prove Propositions 3.3.3 and 3.3.4. We use throughout the notation from Section 3.3, in particular the stopping line $\mathcal{L}^{at, \gamma_t}$ and its decomposition into

$$\mathcal{L}^{at, \gamma_t} = \mathcal{L}_{\text{good}}^{at, \gamma_t} \cup \mathcal{L}_{\text{bad}}^{at, \gamma_t}.$$

Section 3.6.1 handles the “bad” particles: Proposition 3.3.4 is proven there. Section 3.6.2 contains bounds on the number of good particles hitting γ_t at a certain time. Section 3.6.3 wraps up the proof of Proposition 3.3.3.

3.6.1 The “bad” particles

In this section, we prove that the “bad” particles have a negligible contribution to Z_∞ , i.e., we prove Proposition 3.3.4. We will need the following estimate: there exists a constant $C > 0$, such that for all $x \geq 0$,

$$\mathbb{E}[Z_\infty \wedge x] \leq C(1 + \log_+ x). \quad (3.31)$$

This estimate is a direct consequence of (3.8) and the equality $\mathbb{E}[X \wedge x] = \int_0^x \mathbb{P}(X > x) dx$ for a non-negative random variable X .

Proof of Proposition 3.3.4. We perform a truncated first moment computation. For simplicity, write Δ_u for Δ_u^{at, γ_t} . Then note that

$$F_{\text{bad}}^{at, \gamma_t} \wedge 1 \leq \sum_{u \in \mathcal{L}_{\text{bad}}^{at, \gamma_t}} e^{-X_u(\Delta_u)} \left(Z_\infty^{(u, at, \gamma_t)} \wedge e^{X_u(\Delta_u)} \right) \leq \sum_{u \in \mathcal{L}_{\text{bad}}^{at, \gamma_t}} e^{-X_u(\Delta_u)} \left(Z_\infty^{(u, at, \gamma_t)} \wedge e^{\gamma_t} \right),$$

because the particles $u \in \mathcal{L}_{\text{bad}}^{at, \gamma_t}$ satisfy $X_u(\Delta_u) \leq \gamma_t$. This gives

$$\begin{aligned} \mathbb{E} \left[F_{\text{bad}}^{at, \gamma_t} \wedge 1 \mid \mathcal{F}_{\mathcal{L}^{at, \gamma_t}} \right] &\leq \sum_{u \in \mathcal{L}_{\text{bad}}^{at, \gamma_t}} e^{-X_u(\Delta_u)} \mathbb{E} \left[Z_\infty^{(u, at, \gamma_t)} \wedge e^{\gamma_t} \mid \mathcal{F}_{\mathcal{L}^{at, \gamma_t}} \right] \\ &\leq C(1 + \gamma_t) \sum_{u \in \mathcal{L}_{\text{bad}}^{at, \gamma_t}} e^{-X_u(\Delta_u)}, \end{aligned}$$

by (3.31). Now define $\mathcal{N}_{\text{bad}}(at)$ as the set of particles $u \in \mathcal{N}(at)$ such that $\min_{r \in [t, at]} X_u(r) \leq \gamma_t$. Then, $\mathcal{L}_{\text{bad}}^{at, \gamma_t}$ forms exactly the descendants of the particles in $\mathcal{N}_{\text{bad}}(at)$ at the time when they go below γ_t . By the branching property at time at and Lemma 3.4.6 (for particles above γ_t at time at),

$$\mathbb{E} \left[\sum_{u \in \mathcal{L}_{\text{bad}}^{at, \gamma_t}} e^{-X_u(\Delta_u)} \middle| \mathcal{F}_{at} \right] = \sum_{v \in \mathcal{N}_{\text{bad}}(at)} e^{-X_v(at)} = W_{at} - \widetilde{W}_{at}^{t, \gamma_t},$$

where $\widetilde{W}_{at}^{t, \gamma_t}$ is defined in Section 3.5. Altogether, we get

$$\mathbb{E} \left[\sqrt{t} (F_{\text{bad}}^{at, \gamma_t} \wedge 1) \middle| \mathcal{F}_{at} \right] \leq C(1 + \gamma_t) \sqrt{t} (W_{at} - \widetilde{W}_{at}^{t, \gamma_t}).$$

The proposition now readily follows from Lemma 3.5.2 and Markov's inequality. \square

3.6.2 The number of “good” particles

We recall that $\mathcal{L}_{\text{good}}^{at, \gamma_t}$ is a decreasing set in a , with $\mathcal{L}_{\text{good}}^{at, \gamma_t} = \{u \in \mathcal{L}_{\text{good}}^{t, \gamma_t} : \Delta_u^{t, \gamma_t} > at\}$. For each $a \geq 1$, we set

$$N_{\text{good}}^{at, \gamma_t} := \#\mathcal{L}_{\text{good}}^{at, \gamma_t}.$$

In this section, we study the convergence of $N_{\text{good}}^{at, \gamma_t}$ after a proper renormalization.

Lemma 3.6.1. *For any $a \geq 1$, we have the following convergence in probability*

$$\beta_t e^{-\beta_t} \left| N_{\text{good}}^{at, \gamma_t} - \mathbb{E} \left[N_{\text{good}}^{at, \gamma_t} \middle| \mathcal{F}_{at} \right] \right| \xrightarrow[t \rightarrow \infty]{} 0.$$

Proof. The proof goes by a truncated second moment computation as in Section 3.4.3. Fix $a \geq 1$ and $\varepsilon > 0$. We set, for $\kappa > 1$,

$$C_{\kappa}^{at, \gamma_t} := \left\{ u \in \mathcal{L}_{\text{good}}^{at, \gamma_t} : \forall v < u, d_v \geq at \Rightarrow O_v \leq \kappa e^{(X_v(d_v) - \gamma_t)/2} \right\}$$

$$N_{\text{good}, \kappa}^{at, \gamma_t} := \#C_{\kappa}^{at, \gamma_t}.$$

Noting that $N_{\text{good}}^{at, \gamma_t} - N_{\text{good}, \kappa}^{at, \gamma_t} \geq 0$ and working conditionally on \mathcal{F}_{at} , we have

$$\begin{aligned} & \mathbb{P} \left(\left| N_{\text{good}}^{at, \gamma_t} - \mathbb{E} \left[N_{\text{good}}^{at, \gamma_t} \middle| \mathcal{F}_{at} \right] \right| \geq \frac{3\varepsilon e^{\beta_t}}{\beta_t} \middle| \mathcal{F}_{at} \right) \\ & \leq \mathbb{P} \left(N_{\text{good}}^{at, \gamma_t} - N_{\text{good}, \kappa}^{at, \gamma_t} \geq \frac{\varepsilon e^{\beta_t}}{\beta_t} \middle| \mathcal{F}_{at} \right) + \mathbb{P} \left(\left| N_{\text{good}, \kappa}^{at, \gamma_t} - \mathbb{E} \left[N_{\text{good}, \kappa}^{at, \gamma_t} \middle| \mathcal{F}_{at} \right] \right| \geq \frac{\varepsilon e^{\beta_t}}{\beta_t} \middle| \mathcal{F}_{at} \right) \\ & \quad + \mathbb{1}_{\mathbb{E} \left[N_{\text{good}}^{at, \gamma_t} - N_{\text{good}, \kappa}^{at, \gamma_t} \middle| \mathcal{F}_{at} \right] \geq \varepsilon e^{\beta_t} / \beta_t} \\ & \leq \frac{2\beta_t}{\varepsilon e^{\beta_t}} \mathbb{E} \left[N_{\text{good}}^{at, \gamma_t} - N_{\text{good}, \kappa}^{at, \gamma_t} \middle| \mathcal{F}_{at} \right] + \left(\frac{\beta_t}{\varepsilon e^{\beta_t}} \right)^2 \text{Var} \left(N_{\text{good}, \kappa}^{at, \gamma_t} \middle| \mathcal{F}_{at} \right), \end{aligned} \quad (3.32)$$

using Markov's inequality, Chebyshev's inequality and the inequality $\mathbb{1}_{x \geq \varepsilon} \leq x/\varepsilon$ for $x \geq 0$.

For the first term in (3.32), using the branching property at time at and Lemma 3.4.7, we have with the notation used there,

$$\begin{aligned} \mathbb{E} \left[N_{\text{good}}^{at, \gamma_t} - N_{\text{good}, \kappa}^{at, \gamma_t} \middle| \mathcal{F}_{at} \right] &= \sum_{u \in \mathcal{N}(at)} \mathbb{E}_{X_u(at) - \gamma_t} \left[N_{(0, \infty)} - N_{(0, \infty), \kappa} \right] \mathbb{1}_{X_u(at) > \gamma_t} \\ &\leq \sum_{u \in \mathcal{N}(at)} e^{-(X_u(at) - \gamma_t)} \frac{h(\kappa)}{\log \kappa} = \sqrt{t} e^{\beta_t} W_{at} \frac{h(\kappa)}{\log \kappa}. \end{aligned} \quad (3.33)$$

For the second term in (3.24), using again the branching property at time at and Lemma 3.4.8, we get

$$\begin{aligned} \text{Var}\left(N_{\text{good},\kappa}^{at,\gamma_t} \middle| \mathcal{F}_{at}\right) &\leq \sum_{u \in \mathcal{N}(at)} \mathbb{E}_{X_u(at)-\gamma_t} \left[\left(N_{(0,\infty),\kappa} \right)^2 \right] \mathbb{1}_{X_u(at) > \gamma_t} \\ &\leq \sum_{u \in \mathcal{N}(at)} C\kappa e^{-(X_u(at)-\gamma_t)} = C\kappa\sqrt{t}e^{\beta t}W_{at}. \end{aligned} \quad (3.34)$$

Combining (3.32), (3.33) and (3.34) with $\kappa = e^{\beta t/2}$, it follows that

$$\mathbb{P}\left(e^{-\beta t} \left| N_{\text{good}}^{at,\gamma_t} - \mathbb{E}\left[N_{\text{good}}^{at,\gamma_t} \middle| \mathcal{F}_{at}\right] \right| \geq \frac{\varepsilon}{\beta_t} \middle| \mathcal{F}_{at}\right) \leq C\sqrt{t}W_{at} \left(\frac{h(e^{\beta t/2})}{\varepsilon} + \frac{\beta_t^2 e^{-\beta t/2}}{\varepsilon^2} \right) \xrightarrow{t \rightarrow \infty} 0,$$

in probability, using the convergence in probability of $\sqrt{t}W_t$ from (3.7) and that $h(e^{\beta t/2}) \rightarrow 0$. The result follows. \square

Proposition 3.6.2. *For every $a \geq 1$, we have the following convergence in probability*

$$\beta_t \left| e^{-\beta t} N_{\text{good}}^{at,\gamma_t} - \sqrt{t}W_{at} \right| \xrightarrow{t \rightarrow \infty} 0.$$

Proof. Using the branching property at time at and then applying Lemma 3.4.6, we have

$$e^{-\beta t} \mathbb{E}\left[N_{\text{good}}^{at,\gamma_t} \middle| \mathcal{F}_{at}\right] = e^{-\beta t} \sum_{u \in \mathcal{N}(at)} \mathbb{1}_{\forall r \in [t, at]: X_u(r) > \gamma_t} \mathbb{E}_{X_u(at)-\gamma_t} \left[N_{(0,\infty)} \right] = \sqrt{t} \widetilde{W}_{at}^{t,\gamma_t}. \quad (3.35)$$

Using the triangle inequality, it follows that

$$\beta_t \left| e^{-\beta t} N_{\text{good}}^{at,\gamma_t} - \sqrt{t}W_{at} \right| \leq \beta_t e^{-\beta t} \left| N_{\text{good}}^{at,\gamma_t} - \mathbb{E}\left[N_{\text{good}}^{at,\gamma_t} \middle| \mathcal{F}_{at}\right] \right| + \beta_t \sqrt{t} \left| \widetilde{W}_{at}^{t,\gamma_t} - W_{at} \right|.$$

Both terms vanish in probability as $t \rightarrow \infty$ by Lemmas 3.6.1 and 3.5.2. This concludes the proof. \square

Corollary 3.6.3. *Let $n \geq 1$, $1 \leq a_1 < \dots < a_n < a_{n+1} = \infty$ and $(z^t)_{t \geq 0} \in (\mathbb{C}^n)^{\mathbb{R}_+}$. Assume that, for any $1 \leq k \leq n$ and $t \geq 0$, $\text{Re}(z_k^t) \leq 0$ and that z^t converges to some $z \in \mathbb{C}^n$. Then, we have the following convergence in probability*

$$\mathbb{E}\left[\exp\left(\sum_{k=1}^n z_k^t e^{-\beta t} \left(N_{\text{good}}^{a_k t, \gamma_t} - N_{\text{good}}^{a_{k+1} t, \gamma_t} \right)\right) \middle| \mathcal{F}_t\right] \xrightarrow{t \rightarrow \infty} \exp\left(\sqrt{\frac{2}{\pi}} Z_\infty \sum_{k=1}^n z_k \left(\frac{1}{\sqrt{a_k}} - \frac{1}{\sqrt{a_{k+1}}} \right)\right).$$

Proof. Recalling that $\sqrt{t}W_{at} \rightarrow \sqrt{2/\pi}aZ_\infty$ in probability by (3.7) and $Z_t \rightarrow Z_\infty$ a.s., it follows from Proposition 3.6.2 that, for every $1 \leq a < b \leq \infty$, we have

$$\left| e^{-\beta t} \left(N_{\text{good}}^{at,\gamma_t} - N_{\text{good}}^{bt,\gamma_t} \right) - \sqrt{\frac{2}{\pi}} Z_t \left(\frac{1}{\sqrt{a}} - \frac{1}{\sqrt{b}} \right) \right| \xrightarrow{t \rightarrow \infty} 0.$$

Noting that everything is bounded by 1 because $\text{Re}(z_k^t) \leq 0$ and using Remark 3.A.3, it is sufficient to prove that

$$\mathbb{E}\left[\exp\left(\sum_{k=1}^n z_k^t \sqrt{\frac{2}{\pi}} Z_t \left(\frac{1}{\sqrt{a_k}} - \frac{1}{\sqrt{a_{k+1}}} \right)\right) \middle| \mathcal{F}_t\right] \xrightarrow{t \rightarrow \infty} \exp\left(\sqrt{\frac{2}{\pi}} Z_\infty \sum_{k=1}^n z_k \left(\frac{1}{\sqrt{a_k}} - \frac{1}{\sqrt{a_{k+1}}} \right)\right).$$

But this holds because Z_t is \mathcal{F}_t -measurable and $Z_t \rightarrow Z_\infty$ a.s. \square

3.6.3 Contribution of the “good” particles

In this section, we use the results of the last section for proving Proposition 3.3.3.

Proof of Proposition 3.3.3. Note that we can assume w.l.o.g. that $a_1 < a_2 < \dots < a_n$. Using Proposition 3.6.2 and Remark 3.A.3, it is sufficient to prove that

$$\begin{aligned} & \mathbb{E} \left[\exp \left(i \sum_{k=1}^n \lambda_k \left(\sqrt{t} F_{\text{good}}^{a_k t, \gamma t} - \beta t e^{-\beta t} N_{\text{good}}^{a_k t, \gamma t} \right) \right) \middle| \mathcal{F}_t \right] \\ & \xrightarrow[t \rightarrow \infty]{\mathbb{P}} \mathbb{E} \left[\exp \left(i \sum_{k=1}^n \lambda_k S_{Z_\infty / \sqrt{a_k}} \right) \middle| Z_\infty \right], \end{aligned} \quad (3.36)$$

where $(S_t)_{t \geq 0}$ is the Lévy process from the statement of Theorem 3.1.1. Recall that $\mathcal{L}_{\text{good}}^{at, \gamma t} = \{u \in \mathcal{L}_{\text{good}}^{t, \gamma t} : \Delta_u^{t, \gamma t} > at\}$ and that, for $u \in \mathcal{L}_{\text{good}}^{at, \gamma t}$, we have $\Delta_u^{at, \gamma t} = \Delta_u^{t, \gamma t}$ and, therefore $Z_\infty^{(u, at, \gamma t)} = Z_\infty^{(u, t, \gamma t)}$. Thus, we have

$$F_{\text{good}}^{at, \gamma t} = \sum_{u \in \mathcal{L}_{\text{good}}^{t, \gamma t} \text{ s.t. } \Delta_u^{t, \gamma t} > at} e^{-\gamma t} Z_\infty^{(u, t, \gamma t)},$$

where, given $\mathcal{F}_{\mathcal{L}^{t, \gamma t}}$, the $Z_\infty^{(u, t, \gamma t)}$ for $u \in \mathcal{L}_{\text{good}}^{t, \gamma t}$ are i.i.d. copies of Z_∞ . Recalling that Ψ_{Z_∞} denotes the characteristic function of Z_∞ , setting $\lambda'_k := \lambda_1 + \dots + \lambda_k$ and $a_{n+1} = \infty$, it gives

$$\begin{aligned} & \mathbb{E} \left[\exp \left(i \sum_{k=1}^n \lambda_k \left(\sqrt{t} F_{\text{good}}^{a_k t, \gamma t} - \beta t e^{-\beta t} N_{\text{good}}^{a_k t, \gamma t} \right) \right) \middle| \mathcal{F}_{\mathcal{L}^{t, \gamma t}} \right] \\ & = \mathbb{E} \left[\exp \left(i \sum_{k=1}^n \lambda'_k \sum_{u \in \mathcal{L}_{\text{good}}^{t, \gamma t} \text{ s.t. } \Delta_u^{t, \gamma t} \in (a_k t, a_{k+1} t]} e^{-\beta t} \left(Z_\infty^{(u, t, \gamma t)} - \beta t \right) \right) \middle| \mathcal{F}_{\mathcal{L}^{t, \gamma t}} \right] \\ & = \prod_{k=1}^n \left[\Psi_{Z_\infty} \left(\lambda'_k e^{-\beta t} \right) \exp \left(-i \lambda'_k \beta t e^{-\beta t} \right) \right]^{N_{\text{good}}^{a_k t, \gamma t} - N_{\text{good}}^{a_{k+1} t, \gamma t}}. \end{aligned} \quad (3.37)$$

But, using (3.12) and Lemma 3.2.3, we have for every $\lambda \in \mathbb{R}$ and large enough t ,

$$\begin{aligned} \Psi_{Z_\infty} \left(\lambda e^{-\beta t} \right) \exp \left(-i \lambda \beta t e^{-\beta t} \right) & = \Psi_{\pi/2, \mu_Z} \left(\lambda e^{-\beta t} \right) \exp \left(-i \lambda \beta t e^{-\beta t} + \lambda e^{-\beta t} g(\lambda e^{-\beta t}) \right) \\ & = \exp \left(e^{-\beta t} \left[-\psi_{\pi/2, \mu_Z}(\lambda) + \lambda g(\lambda e^{-\beta t}) \right] \right), \end{aligned}$$

with $g(\lambda) \rightarrow 0$ as $\lambda \rightarrow 0$. Therefore (3.37) is equal to

$$\exp \left(\sum_{k=1}^n e^{-\beta t} \left(N_{\text{good}}^{a_k t, \gamma t} - N_{\text{good}}^{a_{k+1} t, \gamma t} \right) \left[-\psi_{\pi/2, \mu_Z}(\lambda'_k) + \lambda'_k g(\lambda'_k e^{-\beta t}) \right] \right). \quad (3.38)$$

Taking the conditional expectation given \mathcal{F}_t in (3.38) and applying Corollary 3.6.3, we get that the left-hand side of (3.36) converges in probability to

$$\exp \left(-\sqrt{\frac{2}{\pi}} Z_\infty \sum_{k=1}^n \left(\frac{1}{\sqrt{a_k}} - \frac{1}{\sqrt{a_{k+1}}} \right) \psi_{\pi/2, \mu_Z}(\lambda'_k) \right).$$

Note that $\sqrt{\frac{2}{\pi}} \psi_{\pi/2, \mu_Z} = \psi_{\sqrt{\pi/2}, \mu_Z} \sqrt{2/\pi}$ by (3.11). Hence, the quantity in the last display is exactly the right-hand side of (3.36), since $(S_t)_{t \geq 0}$ is a Lévy process and so has independent increments. This concludes the proof. \square

3.7 Proof of Proposition 3.2.2

In this section, we prove Proposition 3.2.2, controlling the speed of convergence of $\sqrt{t}W_t$ towards $\sqrt{2/\pi}Z_\infty$. We use in the proof the following fact, which is a consequence of Proposition 3.2.1 combined with (3.7):

$$\forall \varepsilon > 0, \quad \limsup_{t \rightarrow \infty} \mathbb{P}\left(|Z_t - Z_\infty| \geq t^{-1/2+\varepsilon}\right) = 0. \quad (3.39)$$

The arguments used here are a very rough version of the arguments used in the forthcoming Chapter 4 for the fluctuations of the critical additive martingale.

Proof of Proposition 3.2.2. Fix some $\alpha \in (0, 1)$; its value will later be chosen appropriately. Let $t \geq 2$. We introduce a killing barrier at 0 between times t^α and t : we set, for $s \in [t^\alpha, t]$,

$$\begin{aligned} \overline{W}_s &:= \sum_{u \in \mathcal{N}(s)} e^{-X_u(s)} \mathbb{1}_{\forall r \in [t^\alpha, t], X_u(r) > 0} \\ \overline{Z}_s &:= \sum_{u \in \mathcal{N}(s)} X_u(s) e^{-X_u(s)} \mathbb{1}_{\forall r \in [t^\alpha, s], X_u(r) > 0}. \end{aligned}$$

The steps of the proof are the following. First note that, with high probability, none of the particles is killed, since $\min_{u \in \mathcal{N}(s)} X_u(s) \rightarrow \infty$ a.s. as $s \rightarrow \infty$ by (3.4). Therefore, we have

$$\mathbb{P}\left(W_t \neq \overline{W}_t\right) \xrightarrow[t \rightarrow \infty]{} 0 \quad (3.40)$$

and we can consider \overline{W}_t instead of W_t . We will show that the conditional first moment $\mathbb{E}[\overline{W}_t | \mathcal{F}_{t^\alpha}]$ is very close to $\sqrt{2/\pi}Z_{t^\alpha}$ and so to $\sqrt{2/\pi}Z_\infty$, by (3.39). Then, we prove that \overline{W}_t is close to $\mathbb{E}[\overline{W}_t | \mathcal{F}_{t^\alpha}]$ by a second moment argument, using results proved with the change of probability in Section 3.4.4. We will use parameters α and β , that will be fixed at the end, and the constants C can depend on them.

We first deal with the first moment. Recall from Lemma 3.4.9 the definition of the function $F(y) = \sqrt{2/\pi} \int_0^y e^{-z^2/2} dz$, $y \geq 0$. Applying the branching property at time t^α and Lemma 3.4.9, we get

$$\mathbb{E}[\overline{W}_t | \mathcal{F}_{t^\alpha}] = \sum_{v \in \mathcal{N}(t^\alpha)} e^{-X_v(t^\alpha)} F\left(\frac{X_v(t^\alpha)}{\sqrt{t-t^\alpha}}\right) \mathbb{1}_{X_v(t^\alpha) > 0}.$$

Since $|F(y) - \sqrt{2/\pi}y| \leq Cy^3$, for $y \geq 0$, and $t - t^\alpha \geq Ct$ for $t \geq 2$, we get

$$\begin{aligned} \left| \mathbb{E}[\overline{W}_t | \mathcal{F}_{t^\alpha}] - \sqrt{\frac{2}{\pi(t-t^\alpha)}} \overline{Z}_{t^\alpha} \right| &\leq C \sum_{v \in \mathcal{N}(t^\alpha)} e^{-X_v(t^\alpha)} \left(\frac{X_v(t^\alpha)}{\sqrt{t-t^\alpha}}\right)^3 \mathbb{1}_{X_v(t^\alpha) > 0} \\ &\leq Ct^{\alpha-(3/2)} \sum_{v \in \mathcal{N}(t^\alpha)} e^{-X_v(t^\alpha)} X_v(t^\alpha) \left(\frac{X_v(t^\alpha)}{\sqrt{t^\alpha}}\right)^2 \mathbb{1}_{X_v(t^\alpha) > 0}. \end{aligned}$$

Using furthermore that $|(t-t^\alpha)^{-1/2} - t^{-1/2}| \leq Ct^{\alpha-(3/2)}$, we have

$$\left| \sqrt{t} \mathbb{E}[\overline{W}_t | \mathcal{F}_{t^\alpha}] - \sqrt{\frac{2}{\pi}} \overline{Z}_{t^\alpha} \right| \leq Ct^{\alpha-1} \sum_{v \in \mathcal{N}(t^\alpha)} e^{-X_v(t^\alpha)} X_v(t^\alpha) \left(1 + \left(\frac{X_v(t^\alpha)}{\sqrt{t^\alpha}}\right)^2\right) \mathbb{1}_{X_v(t^\alpha) > 0}.$$

We want to use Markov's inequality to bound the left-hand side of this inequality in probability, but have to truncate the paths for this. For any $\varepsilon > 0$, there exists $K > 0$ such that

$\mathbb{P}(\min_{s \geq 0} \min_{u \in \mathcal{N}(s)} X_u(s) < -K) \leq \varepsilon$, by (3.4). Decomposing with respect to this event, then applying Markov's inequality, the many-to-one formula and the relation (3.49) between the Brownian motion killed at 0 and the 3-dimensional Bessel process, we successively get,

$$\begin{aligned} & \mathbb{P}\left(\left|\sqrt{t}\mathbb{E}[\overline{W}_t | \mathcal{F}_{t^\alpha}] - \sqrt{\frac{2}{\pi}}\overline{Z}_{t^\alpha}\right| \geq \frac{A}{t^{1-\alpha}}\right) \\ & \leq \varepsilon + \frac{C}{A}\mathbb{E}\left[\sum_{v \in \mathcal{N}(t^\alpha)} e^{-X_v(t^\alpha)} X_v(t^\alpha) \left(1 + \left(\frac{X_v(t^\alpha)}{\sqrt{t^\alpha}}\right)^2\right) \mathbb{1}_{X_v(t^\alpha) > 0} \mathbb{1}_{\forall s \leq t^\alpha, X_u(s) \geq -K}\right] \\ & = \varepsilon + \frac{C}{A}\mathbb{E}\left[B_{t^\alpha} \left(1 + \left(\frac{B_{t^\alpha}}{\sqrt{t^\alpha}}\right)^2\right) \mathbb{1}_{B_{t^\alpha} > 0} \mathbb{1}_{\forall s \leq t^\alpha, B_s \geq -K}\right] \\ & \leq \varepsilon + \frac{C}{A}\mathbb{E}_K\left[B_{t^\alpha} \left(1 + \left(\frac{B_{t^\alpha}}{\sqrt{t^\alpha}}\right)^2\right) \mathbb{1}_{\forall s \leq t^\alpha, B_s \geq 0}\right] \\ & = \varepsilon + \frac{CK}{A}\mathbb{E}_{K/\sqrt{t^\alpha}}[1 + R_1^2] \xrightarrow{t \rightarrow \infty} \varepsilon + \frac{CK}{A}\mathbb{E}[1 + R_1^2]. \end{aligned}$$

Combining this with the fact that $\mathbb{P}(Z_{t^\alpha} \neq \overline{Z}_{t^\alpha}) \rightarrow 0$ as $t \rightarrow \infty$, we finally get, by taking $\varepsilon \rightarrow 0$,

$$\limsup_{A \rightarrow \infty} \limsup_{t \rightarrow \infty} \mathbb{P}\left(\left|\sqrt{t}\mathbb{E}[\overline{W}_t | \mathcal{F}_{t^\alpha}] - \sqrt{\frac{2}{\pi}}Z_{t^\alpha}\right| \geq \frac{A}{t^{1-\alpha}}\right) = 0. \quad (3.41)$$

We now want to prove that $\mathbb{E}[\overline{W}_t | \mathcal{F}_{t^\alpha}]$ is close to \overline{W}_t . By analogy with Section 3.4.4, we introduce, for $\kappa \geq 1$,

$$\begin{aligned} \overline{B}_{t,\kappa} & := \left\{u \in \mathcal{N}(t) : \forall v < u, d_v \geq t^\alpha \Rightarrow O_v \leq \kappa e^{X_v(d_v)/2}\right\} \\ \overline{W}_{t,\kappa} & := \sum_{u \in \mathcal{N}(t)} e^{-X_u(t)} \mathbb{1}_{\forall s \in [t^\alpha, t], X_u(s) > 0} \mathbb{1}_{u \in \overline{B}_{t,\kappa}}. \end{aligned}$$

Then, by the triangle inequality and noting that $\overline{W}_t - \overline{W}_{t,\kappa} \geq 0$, we have, for any $\varepsilon > 0$,

$$\begin{aligned} & \mathbb{P}\left(\left|\overline{W}_t - \mathbb{E}[\overline{W}_t | \mathcal{F}_{t^\alpha}]\right| \geq 3\varepsilon \mid \mathcal{F}_{t^\alpha}\right) \\ & \leq \mathbb{P}\left(\overline{W}_t - \overline{W}_{t,\kappa} \geq \varepsilon \mid \mathcal{F}_{t^\alpha}\right) + \mathbb{P}\left(\left|\overline{W}_{t,\kappa} - \mathbb{E}[\overline{W}_{t,\kappa} | \mathcal{F}_{t^\alpha}]\right| \geq \varepsilon \mid \mathcal{F}_{t^\alpha}\right) + \mathbb{1}_{\mathbb{E}[\overline{W}_t - \overline{W}_{t,\kappa} | \mathcal{F}_{t^\alpha}] \geq \varepsilon}. \end{aligned}$$

Applying Markov's inequality, Chebyshev's inequality and the inequality $\mathbb{1}_{x \geq \varepsilon} \leq x/\varepsilon$ for $x \geq 0$, we get

$$\mathbb{P}\left(\left|\overline{W}_t - \mathbb{E}[\overline{W}_t | \mathcal{F}_{t^\alpha}]\right| \geq 3\varepsilon \mid \mathcal{F}_{t^\alpha}\right) \leq 2 \cdot \frac{1}{\varepsilon} \mathbb{E}[\overline{W}_t - \overline{W}_{t,\kappa} | \mathcal{F}_{t^\alpha}] + \frac{1}{\varepsilon^2} \text{Var}(\overline{W}_{t,\kappa} | \mathcal{F}_{t^\alpha}). \quad (3.42)$$

In order to bound these two terms, we use the branching property at time t^α and then Lemma 3.4.10 for the first term and Lemma 3.4.11 for the second. This gives

$$\begin{aligned} \mathbb{E}[\overline{W}_t - \overline{W}_{t,\kappa} | \mathcal{F}_{t^\alpha}] & \leq \sum_{v \in \mathcal{N}(t^\alpha)} Ch(\kappa) e^{-X_v(t^\alpha)} \left(\frac{1}{\sqrt{t-t^\alpha}} + \frac{X_v(t^\alpha)}{t-t^\alpha}\right) \mathbb{1}_{X_v(t^\alpha) > 0} \\ & = Ch(\kappa) \left(\frac{\overline{W}_{t^\alpha}}{\sqrt{t-t^\alpha}} + \frac{\overline{Z}_{t^\alpha}}{t-t^\alpha}\right), \\ \text{Var}(\overline{W}_{t,\kappa} | \mathcal{F}_{t^\alpha}) & \leq \sum_{v \in \mathcal{N}(t^\alpha)} \mathbb{E}_{X_v(t^\alpha)}[(\widetilde{W}_{t-t^\alpha, \kappa})^2] \leq C\kappa \left(\frac{\overline{W}_{t^\alpha}}{t-t^\alpha} + \frac{\overline{Z}_{t^\alpha} \ln(t-t^\alpha)}{(t-t^\alpha)^{3/2}}\right). \end{aligned}$$

We plug these bounds into (3.42) with $\kappa := 1$ and $\varepsilon := t^{-\beta-\frac{1}{2}}$ for some $\beta \in (0, \alpha/4)$. Using again the inequality $t - t^\alpha \geq Ct$ for $t \geq 2$, this gives

$$\begin{aligned} \mathbb{P}\left(\sqrt{t}|\overline{W}_t - \mathbb{E}[\overline{W}_t | \mathcal{F}_{t^\alpha}]| \geq 3t^{-\beta} | \mathcal{F}_{t^\alpha}\right) &\leq C\left(\overline{W}_{t^\alpha}(t^\beta + t^{2\beta}) + \overline{Z}_{t^\alpha}(t^{\beta-\frac{1}{2}} + t^{2\beta-\frac{1}{2}} \ln t)\right) \\ &\leq Ct^{2\beta-\frac{\alpha}{2}}(t^{\alpha/2}W_{t^\alpha} + Z_{t^\alpha}) \xrightarrow[t \rightarrow \infty]{\mathbb{P}} 0, \end{aligned}$$

using (3.5) and (3.7). It follows that

$$\mathbb{P}\left(\sqrt{t}|\overline{W}_t - \mathbb{E}[\overline{W}_t | \mathcal{F}_{t^\alpha}]| \geq 3t^{-\beta}\right) \xrightarrow[t \rightarrow \infty]{} 0. \quad (3.43)$$

Finally, we consider some $\theta \in (0, 1/5)$ and choose $\alpha \in (4\theta, 1 - \theta)$ and $\beta \in (\theta, \alpha/4)$. Then, for t large enough, we have $t^{-\theta} \geq 3t^{-\beta} + t^{1-\theta-\alpha}/(3t^{1-\alpha}) + t^{\frac{\alpha}{2}-\theta}/(3\sqrt{t^\alpha})$ and, therefore,

$$\begin{aligned} &\limsup_{t \rightarrow \infty} \mathbb{P}\left(\left|\sqrt{t}W_t - \sqrt{\frac{2}{\pi}}Z_\infty\right| \geq t^{-\theta}\right) \\ &\leq \limsup_{t \rightarrow \infty} \left\{ \mathbb{P}(W_t \neq \overline{W}_t) + \mathbb{P}\left(\sqrt{t}|\overline{W}_t - \mathbb{E}[\overline{W}_t | \mathcal{F}_{t^\alpha}]| \geq 3t^{-\beta}\right) \right. \\ &\quad \left. + \mathbb{P}\left(\left|\sqrt{t}\mathbb{E}[\overline{W}_t | \mathcal{F}_{t^\alpha}] - \sqrt{\frac{2}{\pi}}Z_{t^\alpha}\right| \geq \frac{t^{1-\theta-\alpha}}{3t^{1-\alpha}}\right) + \mathbb{P}\left(\sqrt{\frac{2}{\pi}}|Z_\infty - Z_{t^\alpha}| \geq \frac{t^{\frac{\alpha}{2}-\theta}}{3\sqrt{t^\alpha}}\right) \right\} \end{aligned}$$

and all terms vanish in the limit by (3.40), (3.43), (3.41) (because $t^{1-\theta-\alpha} \rightarrow \infty$) and (3.39) (because $\alpha/2 - \theta > 0$). \square

3.A Weak convergence in probability

We work here on a Polish space E with its Borel algebra \mathcal{E} . We denote by $\mathcal{C}_b(E)$ the set of bounded continuous functions from $E \rightarrow \mathbb{R}$. For a finite measure ξ on (E, \mathcal{E}) and a function $f \in \mathcal{C}_b(E)$, we set $\xi(f) := \int_E f d\xi$.

Let $(\mu_n)_{n \in \mathbb{N}}$ be a sequence of random probability measures on (E, \mathcal{E}) . We say that μ_n converges weakly almost surely to a random probability measure μ_∞ as $n \rightarrow \infty$ if

$$\text{a.s., } \forall f \in \mathcal{C}_b(E), \quad \mu_n(f) \xrightarrow[n \rightarrow \infty]{} \mu_\infty(f).$$

Berti, Pratelli and Rigo [BPR06] proved that the two following statements are equivalent:

- (i) for any $f \in \mathcal{C}_b(E)$, $\mu_n(f)$ converges a.s. as $n \rightarrow \infty$;
- (ii) there exists a random probability measure μ_∞ such that $\mu_n \rightarrow \mu_\infty$ weakly almost surely.

The point here is the interchange of ‘‘a.s.’’ and the quantifier ‘‘ $\forall f$ ’’.

We say that μ_n converges weakly in probability to μ_∞ as $n \rightarrow \infty$ if, for any subsequence $(n_k)_{k \in \mathbb{N}}$, there exists a subsequence $(n_{k_i})_{i \in \mathbb{N}}$ such that $\mu_{n_{k_i}}$ converges to μ_∞ weakly almost surely as $i \rightarrow \infty$. Then, Berti, Pratelli and Rigo [BPR06] also showed the equivalence between the following statements:

- (i)’ for any $f \in \mathcal{C}_b(E)$, $\mu_n(f)$ converges in probability as $n \rightarrow \infty$;
- (ii)’ there exists a random probability measure μ_∞ such that $\mu_n \rightarrow \mu_\infty$ weakly in probability.

For $n \in [0, \infty)$, we will denote by $\mathbb{P}\mu_n$ the *annealed* probability measure defined by

$$\forall A \in \mathcal{E}, \quad \mathbb{P}\mu_n(A) := \mathbb{E}[\mu_n(A)].$$

Note that, if μ_n converges weakly in probability to μ_∞ , then $\mathbb{P}\mu_n$ converges weakly to $\mathbb{P}\mu_\infty$.

We now work on the space $E = \mathbb{R}^d$ and establish the following proposition. An analogous result for the weak convergence almost surely has been proved by Berti, Pratelli and Rigo [BPR06].

Proposition 3.A.1. *Let μ_n for $n \in \mathbb{N} \cup \{\infty\}$ be random probability measures on \mathbb{R}^d . Then, μ_n converges weakly in probability to μ_∞ iff, for any $\lambda \in \mathbb{R}^d$, we have*

$$\int_{\mathbb{R}^d} e^{i(\lambda, x)} d\mu_n(x) \xrightarrow{n \rightarrow \infty} \int_{\mathbb{R}^d} e^{i(\lambda, x)} d\mu_\infty(x), \quad \text{in probability.}$$

Proof. For $\lambda \in \mathbb{R}^d$, we set $f_\lambda: x \in \mathbb{R}^d \mapsto e^{i(\lambda, x)}$. The direct implication is obvious, so we prove the reciprocal: we assume that, for any $\lambda \in \mathbb{R}^d$, $\mu_n(f_\lambda) \rightarrow \mu_\infty(f_\lambda)$ in probability. Let $(n_k)_{k \in \mathbb{N}}$ be a subsequence. We want to prove that there exists a subsequence $(n_{k_m})_{m \in \mathbb{N}}$ of $(n_k)_{k \in \mathbb{N}}$ such that, a.s., $\forall \lambda \in \mathbb{R}^d$, $\mu_{n_{k_m}}(f_\lambda) \rightarrow \mu_\infty(f_\lambda)$ as $m \rightarrow \infty$. Indeed, by Lévy's theorem, this implies that $\mu_{n_{k_m}}$ weakly converges to μ_∞ , almost surely. Note that the point is to be able to change the order of “almost surely” and “for all λ ”.

For $n \in \mathbb{N} \cup \{\infty\}$ and $\delta > 0$, we set

$$Y_n(\delta) := \int_{\mathbb{R}^d} (2 \wedge \delta|x|) d\mu_n(x),$$

so that, if $|\lambda - \lambda'| \leq \delta$, then

$$|\mu_n(f_\lambda) - \mu_\infty(f_\lambda)| \leq |\mu_n(f_{\lambda'}) - \mu_\infty(f_{\lambda'})| + Y_n(\delta) + Y_\infty(\delta). \quad (3.44)$$

The assumption implies that, for any $\lambda \in \mathbb{R}^d$, $\mathbb{P}\mu_n(f_\lambda) \rightarrow \mathbb{P}\mu_\infty(f_\lambda)$ and therefore that $\mathbb{P}\mu_n$ converges weakly to $\mathbb{P}\mu_\infty$. Thus, it follows that $\mathbb{E}[Y_n(\delta)] \rightarrow \mathbb{E}[Y_\infty(\delta)]$ as $n \rightarrow \infty$. Moreover, by dominated convergence, for any $n \in \mathbb{N} \cup \{\infty\}$, we have $\mathbb{E}[Y_n(\delta)] \downarrow 0$ as $\delta \downarrow 0$. Combining this and the fact that $Y_n(\delta)$ is increasing in δ for every n , one can easily get that

$$\sup_{n \in \mathbb{N} \cup \{\infty\}} \mathbb{E}[Y_n(\delta)] \xrightarrow{\delta \downarrow 0} 0.$$

Therefore, for any $m \in \mathbb{N}^*$, there exists $\delta_m > 0$ such that

$$\sup_{n \in \mathbb{N} \cup \{\infty\}} \mathbb{E}[Y_n(\delta_m)] \leq 2^{-m}.$$

Now, we set $\Lambda_i := [-m, m]^d \cap \delta_m \mathbb{Z}^d$. By the assumption, we can construct the subsequence $(n_{k_m})_{m \in \mathbb{N}}$ of $(n_k)_{k \in \mathbb{N}}$ as follows: let $n_{k_0} := n_0$ and, for $m \geq 1$, choose $n_{k_m} > n_{k_{m-1}}$ such that

$$\mathbb{P}\left(\exists \lambda \in \Lambda_m : \left| \mu_{n_{k_m}}(f_\lambda) - \mu_\infty(f_\lambda) \right| \geq \frac{1}{3m}\right) \leq \frac{1}{2^m}. \quad (3.45)$$

Using (3.44) and (3.45), we get, for any $m \geq 1$,

$$\begin{aligned} & \mathbb{P}\left(\exists \lambda \in [-m, m]^d : \left| \mu_{n_{k_m}}(f_\lambda) - \mu_\infty(f_\lambda) \right| \geq \frac{1}{m}\right) \\ & \leq \frac{1}{2^m} + \mathbb{P}\left(Y_{n_{k_m}}(\delta_m) \geq \frac{1}{3m}\right) + \mathbb{P}\left(Y_\infty(\delta_m) \geq \frac{1}{3m}\right). \end{aligned} \quad (3.46)$$

Using Markov's inequality and the definitions of n_{k_m} and of δ_m , both probabilities on the right-hand side of (3.46) are bounded by $\frac{3m}{2m}$. The right-hand side of (3.46) is therefore summable in $m \in \mathbb{N}^*$ and it follows by Borel-Cantelli lemma that a.s. there exists $m_0 \geq 1$ such that, for any $m \geq m_0$ and $\lambda \in [-m, m]^d$, $|\mu_{n_{k_m}}(f_\lambda) - \mu_\infty(f_\lambda)| < 1/m$. This implies that, a.s., for any $\lambda \in \mathbb{R}^d$, $\mu_{n_{k_m}}(f_\lambda) \rightarrow \mu_\infty(f_\lambda)$ as $m \rightarrow \infty$. \square

As a corollary of this result, we state the following generalization of Slutsky's theorem.

Corollary 3.A.2. *Let μ_n for $n \in \mathbb{N}$ be random probability measures on $\mathbb{R}^{d+d'}$. We denote by μ_n^1 the marginal distribution of μ_n associated with the d first coordinates and μ_n^2 associated with the d' last coordinates. Assume that μ_n^1 converges weakly in probability to a random probability measure μ_∞^1 on \mathbb{R}^d and that μ_n^2 converges weakly in probability to δ_x , for some $x \in \mathbb{R}^{d'}$. Then, μ_n converges weakly in probability to $\mu_\infty^1 \otimes \delta_x$.*

Remark 3.A.3. One consequence of this corollary that we use repetitively in the chapter is the following. Let X_n and Y_n for $n \in \mathbb{N}$ be random variables taking values in \mathbb{R}^d and \mathcal{F}_n for $n \in \mathbb{N}$ be σ -fields. If the conditional law of X_n given \mathcal{F}_n converges weakly in probability to some random probability μ_∞ and Y_n converges in probability to 0, then the conditional law of $X_n + Y_n$ given \mathcal{F}_n converges weakly in probability to μ_∞ .

3.B Some formulae for the three-dimensional Bessel process

Let $(B_s)_{s \geq 0}$ denote a standard Brownian motion starting from x under \mathbb{P}_x and $\tau := \inf\{r \geq 0 : B_r = 0\}$. Using that the Green function of the Brownian motion killed at 0 is $G(x, y) = 2(x \wedge y) \leq 2y$ for $x, y > 0$, one can get the two following bounds, for any $x, a > 0$,

$$\mathbb{E}_x \left[\int_0^\tau \mathbb{1}_{B_r < a} dr \right] \leq a^2, \quad (3.47)$$

$$\mathbb{E}_x \left[\int_0^\tau e^{-B_t/2} dt \right] \leq 8, \quad (3.48)$$

obtained by a direct computation.

Let $(R_s)_{s \geq 0}$ denote a 3-dimensional Bessel process starting from x under \mathbb{P}_x . Recall that, for $x > 0$, one has the following link between the 3-dimensional Bessel process and the Brownian motion (see Imhof [Imh84]): for any $t \geq 0$ and any measurable function $F: \mathcal{C}([0, t]) \rightarrow \mathbb{R}_+$,

$$\mathbb{E}_x \left[F(B_s, s \in [0, t]) \mathbb{1}_{\forall s \in [0, t], B_s > 0} \right] = \mathbb{E}_x \left[\frac{x}{R_t} F(R_s, s \in [0, t]) \right]. \quad (3.49)$$

Note that the law of the process $(R_s)_{s \geq 0}$ is stochastically increasing in x , as can be seen by a coupling argument. Hence, every functional F which is non-increasing in the sense that $F((y_s)_{s \geq 0}) \leq F((z_s)_{s \geq 0})$ as long as $y_s \geq z_s$ for every $s \geq 0$, we have

$$\forall x \geq 0 : \mathbb{E}_x [F(R_s, s \geq 0)] \leq \mathbb{E}_0 [F(R_s, s \geq 0)]. \quad (3.50)$$

The density of R_s under \mathbb{P}_x is

$$z \mapsto \frac{e^{-(z-x)^2/2s}}{\sqrt{2\pi}} \mathbb{1}_{z > 0} \times \begin{cases} \frac{z}{x\sqrt{s}} (1 - e^{-2xz/s}) & \text{if } x > 0 \\ \frac{2z^2}{s^{3/2}} & \text{if } x = 0. \end{cases} \quad (3.51)$$

The Green function of the 3-dimensional Bessel process (w.r.t. Lebesgue measure) is $G(x, y) = 2y^2(x^{-1} \wedge y^{-1})$ for $x, y > 0$, and the two following bounds follow: for any $a, x > 0$

$$\mathbb{E}_x \left[\int_0^\infty \mathbb{1}_{R_r < a} dr \right] \leq \frac{a^3}{x}, \quad (3.52)$$

$$\mathbb{E}_x \left[\int_0^\infty R_r e^{-R_r/2} dr \right] \leq \frac{192}{x}. \quad (3.53)$$

We now establish three lemmas that are slightly more technical.

Lemma 3.B.1. *There exists $C > 0$ such that, for any $s, x, a > 0$, we have*

$$\mathbb{E}_x \left[\frac{1}{R_s} \int_0^s \mathbb{1}_{R_r < a} dr \right] \leq Ca^3 \left(\frac{1}{x\sqrt{s}} + \frac{1}{s} \right).$$

Proof. First note that we have for any $y, t \geq 0$, by (3.50), $\mathbb{E}_y[1/R_t] \leq \mathbb{E}_0[1/R_t] = \sqrt{2/\pi t}$. We cut the integral into two pieces and first deal with the part $r \in [0, s/2]$: we have, by Markov's property at time $s/2$,

$$\mathbb{E}_x \left[\frac{1}{R_s} \int_0^{s/2} \mathbb{1}_{R_r < a} dr \right] = \mathbb{E}_x \left[\mathbb{E}_{R_{s/2}} \left[\frac{1}{R_{s/2}} \right] \int_0^{s/2} \mathbb{1}_{R_r < a} dr \right] \leq \sqrt{\frac{4}{\pi s}} \mathbb{E}_x \left[\int_0^{s/2} \mathbb{1}_{R_r < a} dr \right],$$

and applying (3.52), we get

$$\mathbb{E}_x \left[\frac{1}{R_s} \int_0^{s/2} \mathbb{1}_{R_r < a} dr \right] \leq \frac{2}{\sqrt{\pi s}} \frac{a^3}{x}. \quad (3.54)$$

Now, we deal with the second part of the integral:

$$\begin{aligned} \mathbb{E}_x \left[\frac{1}{R_s} \int_{s/2}^s \mathbb{1}_{R_r < a} dr \right] &= \int_{s/2}^s \mathbb{E}_x \left[\frac{1}{R_s} \mathbb{1}_{R_r < a} \right] dr = \int_{s/2}^s \mathbb{E}_x \left[\mathbb{E}_{R_r} \left[\frac{1}{R_{s-r}} \right] \mathbb{1}_{R_r < a} \right] dr \\ &\leq \int_{s/2}^s \sqrt{\frac{2}{\pi(s-r)}} \mathbb{P}_x(R_r < a) dr. \end{aligned} \quad (3.55)$$

Moreover, by (3.50) we have

$$\mathbb{P}_x(R_r < a) \leq \mathbb{P}_0(R_r < a) = \int_0^a \sqrt{\frac{2}{\pi}} \frac{z^2}{r^{3/2}} e^{-z^2/2r} dz,$$

and using that $r \geq s/2$, we get

$$\mathbb{P}_x(R_r < a) \leq \sqrt{\frac{2}{\pi}} \left(\frac{2}{s} \right)^{3/2} \int_0^a z^2 dz = \frac{4a^3}{3\sqrt{\pi s^{3/2}}}. \quad (3.56)$$

Thus, we get

$$\mathbb{E}_x \left[\frac{1}{R_s} \int_{s/2}^s \mathbb{1}_{R_r < a} dr \right] \leq \frac{4\sqrt{2}a^3}{3\pi s^{3/2}} \int_{s/2}^s \frac{dr}{\sqrt{s-r}} = \frac{8a^3}{3\pi s},$$

and it concludes the proof. \square

Lemma 3.B.2. *There exists $C > 0$ such that, for any $x, a > 0$ and $s \geq 2$, we have*

$$\mathbb{E}_x \left[\frac{1}{R_s} \int_0^s \left(\frac{R_r}{\sqrt{s-r}} \wedge 1 \right) e^{-R_r/2} dr \right] \leq C \left(\frac{1}{xs} + \frac{\ln s}{s^{3/2}} \right).$$

Proof. We have

$$\begin{aligned} \mathbb{E}_x \left[\frac{1}{R_s} \int_0^s \left(\frac{R_r}{\sqrt{s-r}} \wedge 1 \right) e^{-R_r/2} dr \right] &\leq \mathbb{E}_x \left[\frac{1}{R_s} \int_0^s \sum_{k \geq 0} \left(\frac{k+1}{\sqrt{s-r}} \wedge 1 \right) e^{-k/2} \mathbb{1}_{R_r \in [k, k+1)} dr \right] \\ &\leq \sum_{k \geq 0} (k+1) e^{-k/2} \mathbb{E}_x \left[\frac{1}{R_s} \int_0^s \left(\frac{1}{\sqrt{s-r}} \wedge 1 \right) \mathbb{1}_{R_r < k+1} dr \right]. \end{aligned}$$

We split the integral into two pieces as in the proof of Lemma 3.B.1 and then use (3.54) for the first term and (3.55) with (3.56) for the second term to obtain,

$$\begin{aligned} &\mathbb{E}_x \left[\frac{1}{R_s} \int_0^s \left(\frac{1}{\sqrt{s-r}} \wedge 1 \right) \mathbb{1}_{R_r < k+1} dr \right] \\ &\leq \mathbb{E}_x \left[\frac{1}{R_s} \int_0^{\frac{s}{2}} \sqrt{\frac{2}{s}} \mathbb{1}_{R_r < k+1} dr \right] + \int_{\frac{s}{2}}^s \left(\frac{1}{\sqrt{s-r}} \wedge 1 \right) \mathbb{E}_x \left[\frac{1}{R_s} \mathbb{1}_{R_r < k+1} \right] dr \\ &\leq \sqrt{\frac{2}{s}} \frac{2}{\sqrt{\pi s}} \frac{(k+1)^3}{x} + \int_{\frac{s}{2}}^s \left(\frac{1}{\sqrt{s-r}} \wedge 1 \right) \frac{4\sqrt{2}(k+1)^3}{3\pi s^{3/2} \sqrt{s-r}} dr. \end{aligned}$$

Noting that, for $s \geq 2$,

$$\int_{\frac{s}{2}}^s \left(\frac{1}{\sqrt{s-r}} \wedge 1 \right) \frac{1}{\sqrt{s-r}} dr = \int_0^1 \frac{dr}{\sqrt{r}} + \int_1^{\frac{s}{2}} \frac{dr}{r} \leq C \ln s,$$

we finally get

$$\mathbb{E}_x \left[\frac{1}{R_s} \int_0^s \left(\frac{R_r}{\sqrt{s-r}} \wedge 1 \right) R_r e^{-R_r/2} dr \right] \leq C \sum_{k \geq 0} (k+1)^4 e^{-k/2} \left(\frac{1}{xs} + \frac{\ln s}{s^{3/2}} \right),$$

and it concludes the proof. \square

Lemma 3.B.3. *There exists $C > 0$ such that, for any $x, y > 0$, $t > 0$ and $s \geq 0$, we have*

$$\mathbb{E}_x \left[\frac{1}{R_{t+s}} \mathbb{1}_{\min_{r \in [t, t+s]} R_r \leq y} \right] \leq C \left(\frac{y^2}{t^{3/2}} + \frac{1}{\sqrt{t}} \left(\frac{y}{\sqrt{s}} \wedge 1 \right) \mathbb{1}_{s > 0} \right).$$

Proof. By (3.50), it suffices to consider $x = 0$. We furthermore drop the subscript and write \mathbb{E} and \mathbb{P} instead of \mathbb{E}_0 and \mathbb{P}_0 . Using Markov's property at time t , we get

$$\begin{aligned} \mathbb{E} \left[\frac{1}{R_{t+s}} \mathbb{1}_{\min_{r \in [t, t+s]} R_r \leq y} \right] &= \mathbb{E} \left[\mathbb{E}_{R_t} \left[\frac{1}{R_s} \mathbb{1}_{\min_{r \in [0, s]} R_r \leq y} \right] \right] \\ &= \mathbb{E} \left[\mathbb{E}_{R_t} \left[\frac{1}{R_s} \right] \mathbb{1}_{R_t \leq y} \right] + \mathbb{E} \left[\mathbb{E}_{R_t} \left[\frac{1}{R_s} \mathbb{1}_{\min_{r \in [0, s]} R_r \leq y} \right] \mathbb{1}_{R_t > y} \right] \\ &=: T_1 + T_2. \end{aligned} \tag{3.57}$$

Since $x \mapsto 1/x$ is a superharmonic function for the Bessel process, the first term is bounded by

$$T_1 \leq \mathbb{E} \left[\frac{1}{R_t} \mathbb{1}_{R_t \leq y} \right] = \frac{1}{\sqrt{t}} \mathbb{E} \left[\frac{1}{R_1} \mathbb{1}_{R_1 \leq y/\sqrt{t}} \right] = \frac{1}{\sqrt{t}} \int_0^{y/\sqrt{t}} \frac{1}{z} \sqrt{\frac{2}{\pi}} z^2 e^{-z^2/2} dz \leq C \frac{y^2}{t^{3/2}}. \tag{3.58}$$

As for the term T_2 in (3.57), first note that it vanishes if $s = 0$. If $s > 0$, we use that for $z \geq y > 0$, by Equation 5.1.2.8 of Borodin and Salminen [BS02],

$$\begin{aligned} \mathbb{E}_z \left[\frac{1}{R_s} \mathbb{1}_{\min_{r \in [0, s]} R_r \leq y} \right] &= \frac{1}{\sqrt{2\pi s z}} \int_0^\infty \left(e^{-(u+z-2y)^2/2s} - e^{-(u+z)^2/2s} \right) du \\ &= \frac{1}{\sqrt{2\pi s z}} \int_{z-y}^\infty \left(e^{-(u-y)^2/2s} - e^{-(u+y)^2/2s} \right) du \\ &\leq \frac{1}{z} \times \frac{1}{\sqrt{2\pi s}} \int_0^\infty \left(e^{-(u-y)^2/2s} - e^{-(u+y)^2/2s} \right) du, \end{aligned}$$

using that $z \geq y$ in the last inequality. The second term in the product on the right-hand side equals the probability that a Brownian motion starting from y does not hit 0 by time s (see e.g. Appendix 1.3 in Borodin and Salminen [BS02]) and is easily bounded by $C(y/\sqrt{s} \wedge 1)$. Therefore, if $s > 0$,

$$T_2 \leq C \mathbb{E} \left[\frac{1}{R_t} \right] \left(\frac{y}{\sqrt{s}} \wedge 1 \right) \leq \frac{C}{\sqrt{t}} \left(\frac{y}{\sqrt{s}} \wedge 1 \right),$$

by the scaling invariance of the Bessel process. Together with (3.57) and (3.58), this proves the lemma. \square

3.C Asymptotic of Ψ_{Z_∞}

The following lemma can be deduced from classical results about the domain of attraction of (1-)stable laws, but it is difficult to find good references where all constants are explicit. We therefore prove it here for convenience.

Lemma 3.C.1. *Let $Z \geq 0$ be a random variable satisfying*

- (i) $\mathbb{P}(Z > x) \sim 1/x$ as $x \rightarrow \infty$,
- (ii) $\int_0^x \mathbb{P}(Z > y) dy - \log x \rightarrow c_Z$ as $x \rightarrow \infty$, for some $c_Z \in \mathbb{R}$.

Let γ denote the Euler–Mascheroni constant. Then, as $\lambda \rightarrow 0$ in \mathbb{R} ,

$$\mathbb{E} \left[e^{i\lambda Z} \right] = \exp \left(-\frac{\pi}{2} |\lambda| + i\lambda (-\log |\lambda| + c_Z - \gamma) + o(|\lambda|) \right), \quad (3.59)$$

where $o(|\lambda|)$ is a (complex-valued) term that satisfies $|o(|\lambda|)|/|\lambda| \rightarrow 0$ as $\lambda \rightarrow 0$.

Proof. Since $\mathbb{E}[e^{-i\lambda Z}] = \overline{\mathbb{E}[e^{i\lambda Z}]}$, it suffices to consider $\lambda > 0$. We will separate the regions where $Z \ll \lambda^{-1}$, $Z \asymp \lambda^{-1}$ and $Z \gg \lambda^{-1}$. For this, fix $\varepsilon > 0$. Throughout the proof, we use the Landau symbols o and O which have their usual meaning, with the slight twist that the o symbol may depend on ε . We first recall the following formula easily obtained by integration by parts (formally, using Fubini's theorem):

$$\forall y \geq 0, \quad \mathbb{E} \left[e^{i\lambda(Z \wedge y)} \right] = 1 + i\lambda \int_0^y e^{i\lambda x} \mathbb{P}(Z > x) dx.$$

This allows us to split up $\mathbb{E}[e^{i\lambda Z}]$ as follows: using hypothesis 1,

$$\mathbb{E} \left[e^{i\lambda Z} \right] = \mathbb{E} \left[e^{i\lambda(Z \wedge (\varepsilon\lambda)^{-1})} \right] + O \left(\mathbb{P} \left(Z > (\varepsilon\lambda)^{-1} \right) \right) = 1 + i\lambda(I_1 + I_2) + O(\varepsilon\lambda), \quad (3.60)$$

where we set

$$I_1 := \int_0^{\varepsilon\lambda^{-1}} e^{i\lambda x} \mathbb{P}(Z > x) dx \quad \text{and} \quad I_2 := \int_{\varepsilon\lambda^{-1}}^{(\varepsilon\lambda)^{-1}} e^{i\lambda x} \mathbb{P}(Z > x) dx.$$

It remains to estimate the integrals I_1 and I_2 . For the first integral, we have by hypotheses 1 and 2, as $\lambda \rightarrow 0$,

$$I_1 = \int_0^{\varepsilon\lambda^{-1}} (1 + O(\lambda x)) \mathbb{P}(Z > x) dx = \log(\varepsilon\lambda^{-1}) + c_Z + o(1) + O(\varepsilon). \quad (3.61)$$

For the second integral, we have by a change of variables,

$$I_2 = \int_{\varepsilon}^{\varepsilon^{-1}} e^{ix} \mathbb{P}(Z > \lambda^{-1}x) \frac{dx}{\lambda}.$$

Together with hypothesis 1 and dominated convergence, this gives as $\lambda \rightarrow 0$,

$$I_2 = \int_{\varepsilon}^{\varepsilon^{-1}} e^{ix} \frac{dx}{x} + o(1). \quad (3.62)$$

Recall ([AS64, pp. 228ff]) that the *exponential integral* E_1 is defined for $|\arg(z)| < \pi$ by $E_1(z) = \int_z^{\infty} e^{-t} \frac{dt}{t}$, and that it satisfies

$$E_1(z) = -\gamma - \log z + O(z) \quad (|z| \rightarrow 0), \quad E_1(z) \sim \frac{e^{-z}}{z} \quad (|z| \rightarrow \infty).$$

In particular, this gives

$$\int_{\varepsilon}^{\varepsilon^{-1}} e^{ix} \frac{dx}{x} = E_1(-i\varepsilon) - E_1(-i\varepsilon^{-1}) = -\gamma - \log \varepsilon + \frac{\pi}{2}i + O(\varepsilon),$$

and plugging this into (3.62) gives

$$I_2 = -\gamma - \log \varepsilon + \frac{\pi}{2}i + O(\varepsilon) + o(1). \quad (3.63)$$

Equations (3.60), (3.61) and (3.63) now give as $\lambda \rightarrow 0$,

$$\mathbb{E}[e^{i\lambda Z}] = 1 + i\lambda \left(-\log(\lambda) + c_Z - \gamma + \frac{\pi}{2}i + O(\varepsilon) + o(1) \right).$$

Letting first $\lambda \rightarrow 0$ then $\varepsilon \rightarrow 0$ gives the desired result. \square

3.D Rate of convergence of the derivative martingale

In this last section, we prove Proposition 3.1.5. For this, we need to recall two explicit bounds. The first one concerns the global minimum of the BBM: for any $L > 0$,

$$\mathbb{P}\left(\exists s \geq 0 : \min_{u \in \mathcal{N}(s)} X_u(s) \leq -L\right) \leq e^{-L}. \quad (3.64)$$

This follows easily from Doob's inequality applied to the martingale $(W_t)_{t \geq 0}$. We remark that more precise estimates have been proved recently under additional assumptions by Madaule [Mad16b] (for the branching random walk) and Berestycki et al. [BBHM17] (for the binary

branching Brownian motion). The second bound deals with the minimum at a given time : there exists $C > 0$ such that, for any $s \geq 2$ and $x \in (-\infty, \sqrt{s}]$,

$$\mathbb{P}\left(\min_{u \in \mathcal{N}(s)} X_u(s) \leq \frac{3}{2} \log s - x\right) \leq C(1 + x^2)e^{-x}. \quad (3.65)$$

This has been proved by Bramson [Bra78, Proposition 3] in the case $\mathbb{E}[L^2] < \infty$, but since the proof relies only on first moments arguments, it holds also under (3.1).

Proof of Proposition 3.1.5. First note that we can assume that $\delta \geq t^{-1/2}$, because otherwise it is enough to bound the probability by 1. We keep the notation of Section 3.3, but take here $\beta_t = \frac{1}{2} \log t$, so that $\gamma_t = \log t$. Using (3.20), it is sufficient to prove the following inequalities

$$\mathbb{P}\left(|Z_t - \tilde{Z}_t^{t, \gamma_t}| \geq \delta\right) \leq C \frac{(\log t)^2}{\delta \sqrt{t}}, \quad (3.66)$$

$$\mathbb{P}\left(|\tilde{Z}_t^{t, \gamma_t} - \tilde{Z}_\infty^{t, \gamma_t}| \geq \delta\right) \leq C \frac{\log t}{\delta \sqrt{t}}, \quad (3.67)$$

$$\mathbb{P}\left(F_{\text{good}}^{t, \gamma_t} \geq \delta\right) \leq C \frac{(\log t)^2}{\delta \sqrt{t}}, \quad (3.68)$$

$$\mathbb{P}\left(\mathcal{L}_{\text{bad}}^{t, \gamma_t} \neq \emptyset\right) \leq C \frac{(\log t)^2}{\sqrt{t}}, \quad (3.69)$$

noting that (3.69) is sufficient because $\delta \leq 1$.

We start with (3.69). Using (3.65), we get

$$\mathbb{P}\left(\mathcal{L}_{\text{bad}}^{t, \gamma_t} \neq \emptyset\right) = \mathbb{P}\left(\min_{u \in \mathcal{N}(t)} X_u(t) \leq \log t\right) \leq C \left(1 + \frac{1}{2} \log t\right)^2 \frac{1}{\sqrt{t}},$$

and it proves (3.69).

Now, we prove (3.66). On the event $\{\mathcal{L}_{\text{bad}}^{t, \gamma_t} = \emptyset\}$, we have $\tilde{Z}_t^{t, \gamma_t} = Z_t - (\log t)W_t$. Therefore, using (3.64) with $L = \log t > 0$ and using (3.69), we get

$$\mathbb{P}\left(|Z_t - \tilde{Z}_t^{t, \gamma_t}| \geq \delta\right) \leq C \frac{(\log t)^2}{\sqrt{t}} + \frac{1}{t} + \mathbb{P}\left((\log t)W_t \geq \delta, \min_{s \geq 0} \min_{u \in \mathcal{N}(s)} X_u(s) \geq -\log t\right).$$

But, using the many-to-one formula, we have, for any $L > 0$,

$$\mathbb{E}\left[W_t \mathbb{1}_{\min_{s \geq 0} \min_{u \in \mathcal{N}(s)} X_u(s) \geq -L}\right] \leq \mathbb{P}\left(\min_{s \in [0, t]} B_s \geq -L\right) = \mathbb{P}(|B_t| \leq L) \leq C \frac{L}{\sqrt{t}} \quad (3.70)$$

and this shows (3.66) using Markov's inequality.

We now deal with (3.67). For this, applying first (3.27) with $\kappa = 1$ and $\varepsilon = \delta \sqrt{t}$ and then using that $\delta \geq t^{-1/2}$ and $t \geq 2$, we get

$$\mathbb{P}\left(|\tilde{Z}_\infty^{t, \gamma_t} - \tilde{Z}_t^{t, \gamma_t}| \geq \delta \mid \mathcal{F}_t\right) \leq C \sqrt{t} W_t \left(\frac{h(1)}{\delta \sqrt{t}} + \frac{e^{-\beta_t}}{\delta^2 t}\right) \leq \frac{C}{\delta} W_t.$$

Applying again (3.64) with $L = \log t$ and (3.70), we get

$$\mathbb{P}\left(|\tilde{Z}_s^{t, \gamma_t} - \tilde{Z}_t^{t, \gamma_t}| \geq \delta\right) \leq \frac{1}{t} + \frac{C}{\delta} \mathbb{E}\left[W_t \mathbb{1}_{\min_{s \geq 0} \min_{u \in \mathcal{N}(s)} X_u(s) \geq -\log t}\right] \leq \frac{1}{t} + C \frac{\log t}{\delta \sqrt{t}}.$$

This proves (3.67).

Finally, we deal with (3.68). By Markov's inequality and the bound (3.31) on the truncated moment of Z_∞ ,

$$\begin{aligned} \mathbb{P}\left(F_{\text{good}}^{t,\gamma_t} \geq \delta \mid \mathcal{F}_{\mathcal{L}^{t,\gamma_t}}\right) &\leq \frac{1}{\delta} \mathbb{E} \left[\left(\sum_{u \in \mathcal{L}_{\text{good}}^{t,\gamma_t}} \frac{1}{t} Z_\infty^{(u,t,\gamma_t)} \right) \wedge 1 \mid \mathcal{F}_{\mathcal{L}^{t,\gamma_t}} \right] \\ &\leq \frac{\#\mathcal{L}_{\text{good}}^{t,\gamma_t}}{\delta t} \mathbb{E}[Z_\infty \wedge t] \leq C N_{\text{good}}^{t,\gamma_t} \frac{\log t}{\delta t}. \end{aligned}$$

Applying again (3.64) with $L = \log t$, we get

$$\mathbb{P}\left(F_{\text{good}}^{t,\gamma_t} \geq \delta\right) \leq \frac{1}{t} + C \frac{\log t}{\delta t} \mathbb{E} \left[N_{\text{good}}^{t,\gamma_t} \mathbb{1}_{\min_{s \in [0,t]} \min_{u \in \mathcal{N}(s)} X_u(s) \geq -\log t} \right].$$

But, using (3.35) with here $\beta_t = (\log t)/2$, we have $\mathbb{E}[N_{\text{good}}^{t,\gamma_t} \mid \mathcal{F}_t] = t \widetilde{W}_t^{t,\gamma_t} \leq t W_t$. Therefore, using (3.70), it follows that

$$\mathbb{P}\left(F_{\text{good}}^{t,\gamma_t} \geq \delta\right) \leq \frac{1}{t} + C \frac{\log t}{\delta t} t \frac{\log t}{\sqrt{t}}$$

and this proves (3.68). □

Chapter 4

1-stable fluctuations in branching Brownian motion at critical temperature II: the derivative Gibbs measure

Abstract

This chapter contains a preliminary version of a joint work with Pascal Maillard [MP19], which is the sequel of the previous chapter where fluctuations of the derivative martingale have been studied. Here, our concern is fluctuations for more general quantities describing the front of branching Brownian motion:

$$Z_t(f) := \sum_{u \in \mathcal{N}(t)} X_u(t) e^{-X_u(t)} f\left(\frac{X_u(t)}{\sqrt{t}}\right),$$

for some function $f: \mathbb{R} \rightarrow \mathbb{R}$. It has been proved by Madaule [Mad16a] and Maillard and Zeitouni [MZ16] that $Z_t(f)$ converges in probability to $Z_\infty \int_0^\infty \sqrt{2/\pi} x^2 e^{-x^2/2} f(x) dx$, where Z_∞ is the limit of the derivative martingale. In this chapter, we are interested in the fluctuations occurring in this convergence and prove for a large class of functions f that

$$\sqrt{t} \left(\int_{\mathbb{R}} f d\mu'_t - Z_\infty \int_0^\infty f(x) \sqrt{\frac{2}{\pi}} x^2 e^{-x^2/2} dx - \frac{c(f) \log t}{\sqrt{t}} Z_\infty \right) \xrightarrow[t \rightarrow \infty]{} S_{Z_\infty}^f, \quad \text{in law,}$$

where $c(f)$ is a constant and $(S_r^f)_{r \geq 0}$ is a 1-stable Lévy process independent of Z_∞ . In particular, this proves the following result for the critical additive martingale $(W_t)_{t \geq 0}$:

$$\sqrt{t} \left(\sqrt{t} W_t - \sqrt{\frac{2}{\pi}} Z_\infty \right) \xrightarrow[t \rightarrow \infty]{} S_{Z_\infty}, \quad \text{in law,}$$

where here $(S_r)_{r \geq 0}$ is a Cauchy Lévy process, confirming in particular a conjecture by Mueller and Munier [MM14] in the physics literature.

4.1 Introduction

4.1.1 Definitions and result

As in Chapter 3, we consider here a branching Brownian motion with variance $\sigma^2 = 1$, drift $\varrho = 1$, branching rate $\lambda > 0$ and reproduction law L such that $\mathbb{E}[L] = 1 + (2\lambda)^{-1} > 1$. Moreover, unlike in the previous chapter, we assume additionally here that

$$\mathbb{E}[L^2] < \infty.$$

Recall that $\mathcal{N}(t)$ denote the set of particles alive at time t , $X_u(t)$ the position of particle u at time t or of its ancestor alive at time t and $(\mathcal{F}_t)_{t \geq 0}$ the canonical filtration associated with the BBM.

The main concern of Chapter 3 was fluctuations of the derivative martingale, defined by

$$Z_t := \sum_{u \in \mathcal{N}(t)} X_u(t) e^{-X_u(t)}, \quad t \geq 0,$$

around its almost sure limit Z_∞ . This martingale is the partition function of the *derivative Gibbs measure* $\sum_{u \in \mathcal{N}(t)} X_u(t) e^{-X_u(t)} \delta_u$, obtained by differentiating the Gibbs measure at criticality with respect to the inverse temperature. This measure is mainly supported by particles at a position of order \sqrt{t} and we call this set of particles the *front* of BBM. Recall from Section 1.1.4 that the front of BBM is related with the behavior of its extremal particles: for any $s \leq t$ such that s and $t - s$ are large, an extremal particles at time t descend with high probability of a particle in the front at time s .

A way to describe the spatial distribution of the front is to consider the following measure

$$\sum_{u \in \mathcal{N}(t)} X_u(t) e^{-X_u(t)} \delta_{X_u(t)/\sqrt{t}},$$

which is the image measure of the derivative Gibbs measure by the map $u \mapsto X_u(t)/\sqrt{t}$. This measure converges weakly as $t \rightarrow \infty$: more precisely, Madaule [Mad16a] (for the branching random walk) and Maillard and Zeitouni [MZ16] proved that, for any $f: \mathbb{R} \rightarrow \mathbb{R}$ continuous and bounded, we have

$$Z_t(f) := \sum_{u \in \mathcal{N}(t)} X_u(t) e^{-X_u(t)} f\left(\frac{X_u(t)}{\sqrt{t}}\right) \xrightarrow[t \rightarrow \infty]{} \mathbb{E}[f(R_1)] Z_\infty, \quad \text{in probability,} \quad (4.1)$$

where $(R_s)_{s \geq 0}$ denotes a 3-dimensional Bessel process. This shows that the derivative martingale is the key quantity to describe the front of BBM and generalizes the Seneta–Heyde norming for the critical additive martingale,

$$\sqrt{t} W_t \xrightarrow[t \rightarrow \infty]{} \sqrt{\frac{2}{\pi}} Z_\infty, \quad \text{in probability,} \quad (4.2)$$

proved by Aïdékon and Shi [AS14], where we recall that $W_t := \sum_{u \in \mathcal{N}(t)} e^{-X_u(t)}$.

In this chapter, we want to generalize Theorem 3.1.1 by studying fluctuations occurring in the convergence (4.1). Before stating the main result, we need to make some assumptions on the function f . Note that we allow $f(x)$ to diverge like $1/x$ as $x \rightarrow 0$ in order to apply our result to the additive martingale, which corresponds to the case $f: x \mapsto 1/x$. It is more convenient to set these assumptions using the auxiliary function $g: x \mapsto x f(x) \mathbb{1}_{x > 0}$:

- (i) There exists $C > 0$ such that, for any $x > 0$, $|g(x)| \leq C e^{C x}$.
- (ii) There exists $C > 0$ such that, for any $x > 0$ and $\delta \in [0, 1)$, $|g(x) - g((1 - \delta)x)| \leq C \delta e^{C x}$.
- (iii) The function g is differentiable at any point $x > 0$ and Assumptions (i) and (ii) hold with g' instead of g .

Note that these assumptions only concern the behaviour of f on \mathbb{R}_+^* . For example, if g is twice differentiable on \mathbb{R}_+^* and, for any $x > 0$, $g''(x) \leq C e^{C x}$, then Assumptions (i)-(iii) hold. In the main part of the chapter, only Assumptions (i) and (ii) are required.

the following theorem is the main result of the chapter. It is stated in terms of convergence of the conditional characteristic functions, but it could have been equivalently stated as a weak convergence in probability of the conditionnal laws, see Proposition 3.A.1.

Theorem 4.1.1. *For any function $f: \mathbb{R} \rightarrow \mathbb{R}$ satisfying Assumptions (i)-(iii), any $a \in (0, 1/2)$ and any $\lambda \in \mathbb{R}$, we have the following convergence in probability*

$$\mathbb{E} \left[\exp \left(i\lambda \sqrt{t} \left(Z_t(f) - \mathbb{E}[f(R_1)]Z_\infty - c_1(f) \frac{\log t}{2\sqrt{t}} Z_\infty \right) \right) \middle| \mathcal{F}_{t^a} \right] \xrightarrow{t \rightarrow \infty} \mathbb{E} \left[e^{i\lambda S_{Z_\infty}^f} \middle| Z_\infty \right],$$

where $(S_r^f)_{r \geq 0}$ is a 1-stable Lévy process with $\mathbb{E}[e^{i\lambda S_1^f}] = \exp(-[c_2(f)|\lambda| + i\lambda(c_3(f) \log|\lambda| + c_4(f))])$ and independent of Z_∞ . The constants are defined by

$$\begin{aligned} c_1(f) &:= \mathbb{E} \left[f'(R_1) + \frac{f(R_1)}{R_1} \right], \\ c_2(f) &:= \frac{1}{2} \sqrt{\frac{\pi}{2}} \int_0^\infty \left| \mathbb{E} \left[f(\sqrt{1-u}R_1) \mathbb{1}_{u < 1} - f(R_1) \right] \right| \frac{du}{u^{3/2}}, \\ c_3(f) &:= \frac{1}{\sqrt{2\pi}} \int_0^\infty \mathbb{E} \left[f(\sqrt{1-u}R_1) \mathbb{1}_{u < 1} - f(R_1) \right] \frac{du}{u^{3/2}} = -c_1(f), \\ c_4(f) &:= \frac{1}{\sqrt{2\pi}} \int_0^\infty \mathbb{E} \left[f(\sqrt{1-u}R_1) - f(R_1) \right] \left(\log \left| \mathbb{E} \left[f(\sqrt{1-u}R_1) \mathbb{1}_{u < 1} - f(R_1) \right] \right| - \mu_Z \right) \frac{du}{u^{3/2}}, \end{aligned}$$

where μ_Z is a constant appearing in the characteristic function of Z_∞ , see (3.12).

Remark 4.1.2. In Chapter 3, fluctuations of the derivative martingale have been obtained under the assumption $\mathbb{E}[L(\log_+ L)^3] < \infty$, instead of $\mathbb{E}[L^2] < \infty$. We believe that Theorem 4.1.1 holds also under this weaker assumption and that it is optimal. Nevertheless, the proof of fluctuations of the derivative Gibbs measure in this chapter involves several additional technicalities and, therefore, we chose to avoid the truncation arguments needed to work under the assumption $\mathbb{E}[L(\log_+ L)^3] < \infty$.

Remark 4.1.3. Using the method developed in this chapter, the convergence in Theorem 4.1.1 could be extended to a functional convergence similar to Theorem 3.1.1 for the derivative martingale, but we stay here in the one-dimensional case, again for the sake of simplicity.

Applying Theorem 4.1.1 to the function $f: x \mapsto 1/x$, we obtain the fluctuations in the convergence of $\sqrt{t}W_t$ towards $\sqrt{2/\pi}Z_\infty$ in (4.2). This confirms a conjecture by Mueller and Munier [MM14] in the physics literature, who also noticed that, in this case, the $\log(t)/\sqrt{t}$ term cancels. Furthermore, the limit distribution is in this special case a mixture of Cauchy distributions.

Corollary 4.1.4. *For any $a \in (0, \frac{1}{2})$ and any $\lambda \in \mathbb{R}$, we have the following convergence in probability*

$$\mathbb{E} \left[\exp \left(i\lambda \sqrt{t} \left(\sqrt{t}W_t - \sqrt{\frac{2}{\pi}} Z_\infty \right) \right) \middle| \mathcal{F}_{t^a} \right] \xrightarrow{t \rightarrow \infty} \mathbb{E} \left[e^{i\lambda S_{Z_\infty}} \middle| Z_\infty \right],$$

where $(S_r)_{r \geq 0}$ is a Cauchy Lévy process with $\mathbb{E}[e^{i\lambda S_1} | Z_\infty] = \exp(-[2|\lambda| - \frac{2 \log 2}{\pi} i\lambda])$ and independent of Z_∞ .

4.1.2 Comments

The main motivation of this chapter has been the conjecture of Mueller and Munier [MM14] concerning the fluctuations of the critical additive martingale $(W_t)_{t \geq 0}$. See the introduction of Chapter 3 for other related literature and perspectives.

Mueller and Munier [MM14] deal both with W_t and Z_t , but it turned out that, from a mathematical point of view, the fluctuations are much more easier to get for the derivative

martingale (see the short proof in Section 3.2). For W_t , it appeared that the martingale property does not play any role, the main advantage of Z_t being that it is still a martingale when particles are killed at 0. Therefore, dealing with W_t does not differ much from dealing with any of the $Z_t(f)$ and we decided to study the fluctuations for the whole density of the front.

Let's briefly describe the main ideas of the proof, before to dive into the many technicalities. For the proof of the functional convergence of the fluctuations of Z_t in Chapter 3, the idea is the following. When particles are killed from time t at a barrier at $\frac{1}{2} \log t + \beta_t$ with $\beta_t \rightarrow \infty$ slowly enough, then the translated derivative martingale is still a martingale and its limit is very close to its conditional expectation given \mathcal{F}_t . Then, the contributions of the killed particles are i.i.d. copies of $e^{\beta_t} Z_\infty / \sqrt{t}$ and lead to the 1-stable fluctuations.

Here, in order to get the fluctuations of $Z_t(f)$, we have instead to introduce the barrier *before* time t , also at level $\frac{1}{2} \log t + \beta_t$ with $\beta_t \rightarrow \infty$ slowly enough. When particles are killed between times t^a and t , one can prove that, after a translation, $Z_t(f)$ is very close to $\mathbb{E}[f(R_1)]Z_t$. Then, fluctuations come from the contributions of killed particles to the translated version of $Z_t(f) - \mathbb{E}[f(R_1)]Z_t$. This helps to read the definition of the constants $c_i(f)$: for $u \in (0, 1)$, the number of particles hitting the barrier between times ut and $(u+du)t$ is approximately $(2\pi)^{-1} Z_\infty e^{\beta_t} u^{-3/2} du$ and each of them contributes by (4.1) approximately as an independent copy of $e^{-\beta_t} \mathbb{E}[f(\sqrt{1-u}R_1) - f(R_1)]Z_\infty$. Note that the fluctuations are again due to the particles that come extremely low, around $\frac{1}{2} \log t$, which is far below the usual minimum of BBM at a time of order t .

We emphasize that this work is not a more general rewriting of Chapter 3. In the whole chapter, our goal will be to show forthcoming Theorem 4.2.1 describing fluctuations of $Z_t(f) - \mathbb{E}[f(R_1)]Z_t$ (and not $Z_t(f) - \mathbb{E}[f(R_1)]Z_\infty$ as in Theorem 4.1.1) and, as explained above, the proof relies on the study of BBM between times t^a and t . On the contrary, Chapter 3 focus on the study of BBM between times t and $+\infty$ in order to show fluctuations of the derivative martingale in Theorem 3.1.1. Combining Theorems 3.1.1 and 4.2.1 will prove Theorem 4.1.1.

4.1.3 Organization of the chapter and notation

The chapter is organized as follows. In Section 4.2, we state in Theorem 4.2.1 a slightly different version of Theorem 4.1.1 and, then, we split its proof into several propositions, explaining the main lines of the proof. However, the method presented in Section 4.2 does not enable to prove these propositions on the first try. Therefore, we firstly use this method in Section 4.4 in order to prove in Proposition 4.4.1 an explicit control on the rate of convergence of $Z_t(f)$ towards $\mathbb{E}[f(R_1)]Z_\infty$. Then, using this first result, we can then refine the same method in Sections 4.5 and 4.6 in order to prove the propositions stated in Section 4.2. See the graph of results in Figure 4.1.

Section 4.3 is devoted to preliminary results concerning branching Brownian motion, in particular when particles are killed at 0. Other technical results concerning the 3-dimensional Bessel process are shown in Section 4.C. Finally, we give in Section 4.A an alternative proof of Proposition 4.2.4, in order to emphasize that the particles contributing to the fluctuations are indeed those coming around $\frac{1}{2} \log t$ as claimed above.

In the sequel, we denote by C a positive constant that can depend on f and on the other parameters a and c and that can change from line to line. Moreover, for $x \in \mathbb{R}$, we set $x_+ = \max(x, 0)$. For $\varphi_1: \mathbb{R}_+ \rightarrow \mathbb{R}$ and $\varphi_2: \mathbb{R}_+ \rightarrow \mathbb{R}_+^*$, we say that $\varphi_1(t) = o(\varphi_2(t))$ as $t \rightarrow \infty$ if $\lim_{t \rightarrow \infty} \varphi_1(t)/\varphi_2(t) = 0$ and that $\varphi_1(t) = O(\varphi_2(t))$ as $t \rightarrow \infty$ if $\limsup_{t \rightarrow \infty} |\varphi_1(t)|/\varphi_2(t) < \infty$. Let $(B_t)_{t \geq 0}$ denote a standard Brownian motion and $(R_t)_{t \geq 0}$ a 3-dimensional Bessel process. For $u, v \in \mathbb{T}$, we say that $u \leq v$ if v is a descendant of u . If $n \geq 1$ is an integer, we set $\llbracket 1, n \rrbracket := \{1, 2, \dots, n\}$.

where $(\tilde{S}_r^f)_{r \geq 0}$ is a 1-stable Lévy process with $\mathbb{E}[e^{i\lambda \tilde{S}_1^f}] = \exp(-[\tilde{c}_2(f)|\lambda| + i\lambda(\tilde{c}_3(f) \log|\lambda| + \tilde{c}_4(f))])$ and independent of Z_∞ . The constants are defined by

$$\begin{aligned}\tilde{c}_1(f) &:= \mathbb{E}\left[f'(R_1) + \frac{f(R_1)}{R_1}\right] - \sqrt{\frac{2}{\pi}}\mathbb{E}[f(R_1)], \\ \tilde{c}_2(f) &:= \frac{1}{2}\sqrt{\frac{\pi}{2}}\int_0^1 \left|\mathbb{E}\left[f(\sqrt{1-u}R_1) - f(R_1)\right]\right| \frac{du}{u^{3/2}}, \\ \tilde{c}_3(f) &:= \frac{1}{\sqrt{2\pi}}\int_0^1 \mathbb{E}\left[f(\sqrt{1-u}R_1) - f(R_1)\right] \frac{du}{u^{3/2}} = -\tilde{c}_1(f), \\ \tilde{c}_4(f) &:= \frac{1}{\sqrt{2\pi}}\int_0^1 \mathbb{E}\left[f(\sqrt{1-u}R_1) - f(R_1)\right] \left(\log\left|\mathbb{E}\left[f(\sqrt{1-u}R_1) - f(R_1)\right]\right| - \mu_Z\right) \frac{du}{u^{3/2}}.\end{aligned}$$

We now split the proof of Theorem 4.2.1 into different pieces. First note, that it is sufficient and much more convenient to deal with a function f such that $\mathbb{E}[f(R_1)] = 0$, in order to have simply $Z_t(f) - \mathbb{E}[f(R_1)]Z_t = Z_t(f)$ (note that it simplifies also the expressions of the constants $c_i(f)$ and $\tilde{c}_i(f)$). As in Chapter 3 for the derivative martingale, the right quantity to look at is a translated version of $Z_t(f)$, which is defined by

$$Z_t(f, \gamma_t) := \sum_{u \in \mathcal{N}(t)} (X_u(t) - \gamma_t)_+ e^{-X_u(t)} f\left(\frac{X_u(t) - \gamma_t}{\sqrt{t}}\right),$$

where we take $\gamma_t := \frac{1}{2} \log t + \beta_t$ with $(\beta_t)_{t \geq 0}$ a family of positive real numbers such that

$$\beta_t \xrightarrow[t \rightarrow \infty]{} \infty \quad \text{and} \quad \frac{\beta_t}{\log t} \xrightarrow[t \rightarrow \infty]{} 0. \quad (4.3)$$

Note that, in $Z_t(f, \gamma_t)$, only particles above γ_t at time t are taken into account. Then, the proof of Theorem 4.1.1 is firstly split into the two following propositions.

Proposition 4.2.2. *For any function $f: \mathbb{R} \rightarrow \mathbb{R}$ satisfying Assumptions (i)-(iii) and such that $\mathbb{E}[f(R_1)] = 0$, we have the following convergence in probability*

$$\sqrt{t} \left[Z_t(f) - Z_t(f, \gamma_t) - \tilde{c}_1(f) Z_\infty \frac{\gamma_t}{\sqrt{t}} \right] \xrightarrow[t \rightarrow \infty]{} 0.$$

Proposition 4.2.3. *If $a = \frac{1}{2} - \eta$ for some $\eta \in (0, \frac{1}{24})$, then, for any function $f: \mathbb{R} \rightarrow \mathbb{R}$ satisfying Assumptions (i)-(ii) and such that $\mathbb{E}[f(R_1)] = 0$, we have the following convergence in probability*

$$\mathbb{E} \left[\exp \left(i\lambda \sqrt{t} \left(Z_t(f, \gamma_t) - \tilde{c}_3(f) \frac{\beta_t}{\sqrt{t}} Z_\infty \right) \right) \middle| \mathcal{F}^{t^a} \right] \xrightarrow[t \rightarrow \infty]{} \mathbb{E} \left[e^{i\lambda \tilde{S}^f} \middle| Z_\infty \right].$$

Theorem 4.2.1 will follow from the combination of Propositions 4.2.2 and 4.2.3, if both terms of order β_t/\sqrt{t} simplify each other, which means

$$\tilde{c}_1(f) = -\tilde{c}_3(f). \quad (4.4)$$

It is necessarily true because β_t should not appear in Theorem 4.2.1 since it has been arbitrarily chosen according to (4.3). However, Equation (4.4) can also be proved by an easy calculation, see Section 4.B of the appendix.

Proposition 4.2.2 is the easy part and is proved in Section 4.6. The main part of this chapter is dedicated to the proof of Proposition 4.2.3. Therefore, we indicate here the major steps of its proof. We consider some $a \in (0, 1)$ and set

$$\tilde{Z}_t^{t^a, \gamma_t}(f, \gamma_t) := \sum_{u \in \mathcal{N}(t)} (X_u(t) - \gamma_t)_+ e^{-X_u(t)} \mathbb{1}_{\forall r \in [t^a, t], X_u(r) > \gamma_t} f\left(\frac{X_u(t) - \gamma_t}{\sqrt{t}}\right),$$

where particles are killed by coming below γ_t during $[t^a, t]$. Let $\mathcal{L}^{t^a, \gamma_t}$ denote the stopping line of the killed particles and, for $u \in \mathcal{L}^{t^a, \gamma_t}$, T_u the time of the death of u :

$$\begin{aligned} \mathcal{L}^{t^a, \gamma_t} &:= \{u \in \mathbb{T} : \exists s \in [t^a, t] \text{ such that } u \in \mathcal{N}(s), X_u(s) \leq \gamma_t \text{ and } \forall r \in [t^a, s), X_u(r) > \gamma_t\}, \\ T_u &:= \inf\{s \geq t^a : u \in \mathcal{N}(s) \text{ and } X_u(s) \leq \gamma_t\}, \end{aligned}$$

see Figure 4.2 for an illustration. Let $\mathcal{F}_{\mathcal{L}^{t^a, \gamma_t}}$ be the σ -algebra associated with the stopping line $\mathcal{L}^{t^a, \gamma_t}$ (see Chauvin [Cha91] for formal definitions). Then, we have the following decomposition

$$Z_t(f, \gamma_t) = \tilde{Z}_t^{t^a, \gamma_t}(f, \gamma_t) + \sum_{u \in \mathcal{L}^{t^a, \gamma_t}} \Omega_t^{(u)}, \quad (4.5)$$

where $\Omega_t^{(u)}$ is the contribution of the progeny of the killed particle u in $Z_t(f, \gamma_t)$ and is defined by

$$\Omega_t^{(u)} := \sum_{v \in \mathcal{N}(t) \text{ s.t. } u \leq v} (X_v(t) - \gamma_t)_+ e^{-X_v(t)} f\left(\frac{X_v(t) - \gamma_t}{\sqrt{t}}\right).$$

Then, Proposition 4.2.3 is a consequence of the two following propositions, that show that

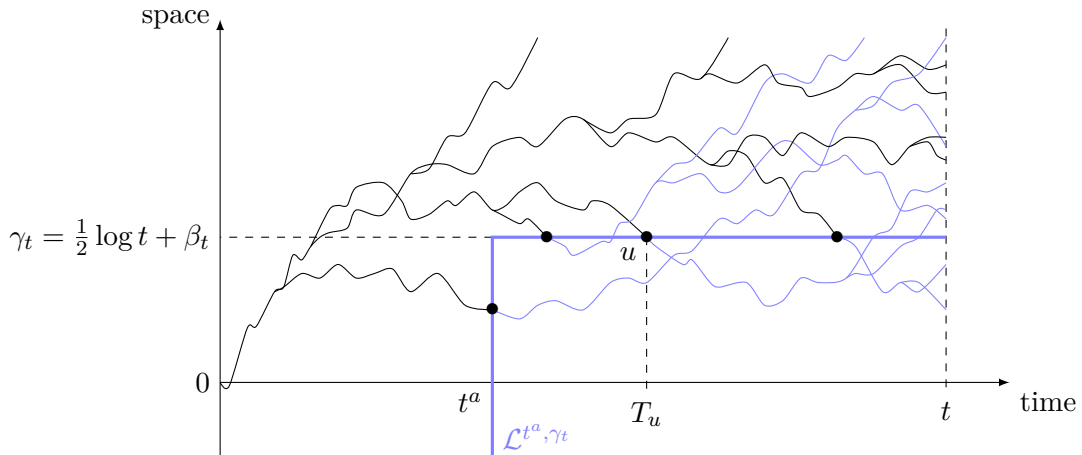

Figure 4.2 – Representation of a BBM with binary branching. The killing barrier that defines $\mathcal{L}^{t^a, \gamma_t}$ is the thick blue line. At time t , only the black particles contribute to $\tilde{Z}_t^{t^a, \gamma_t}(f, \gamma_t)$. For each u in the stopping line, the blue particles descending from u at time t contribute to $\Omega_t^{(u)}$.

the fluctuations of $Z_t(f)$ come from the particles hitting γ_t between times t^a and t .

Proposition 4.2.4. *If $a < 1/2$, then, for any function $f: \mathbb{R} \rightarrow \mathbb{R}$ satisfying Assumptions (i)-(ii) and such that $\mathbb{E}[f(R_1)] = 0$, we have the following convergence in probability*

$$\sqrt{t} \tilde{Z}_t^{t^a, \gamma_t}(f, \gamma_t) \xrightarrow[t \rightarrow \infty]{} 0.$$

Proposition 4.2.5. *If $a = \frac{1}{2} - \eta$ for some $\eta \in (0, \frac{1}{24})$, then, for any function $f: \mathbb{R} \rightarrow \mathbb{R}$ satisfying Assumptions (i)-(ii) and such that $\mathbb{E}[f(R_1)] = 0$, we have the following convergence in probability*

$$\mathbb{E} \left[\exp \left(i\lambda \sqrt{t} \left(\sum_{u \in \mathcal{L}^{t^a, \gamma_t}} \Omega_t^{(u)} - \tilde{c}_3(f) \frac{\beta_t}{\sqrt{t}} Z_\infty \right) \right) \middle| \mathcal{F}_{t^a} \right] \xrightarrow[t \rightarrow \infty]{} \mathbb{E} \left[e^{i\lambda \tilde{S}(f)} \middle| Z_\infty \right].$$

Proposition 4.2.4 follows from first and second moment calculations done in Sections 4.3.2 and 4.4.1 and is finally proved in Section 4.5.1 in the case where $\log t = o(e^{\beta t})$. It is possible to choose $(\beta_t)_{t \geq 0}$ satisfying simultaneously (4.3) and $\log t = o(e^{\beta t})$, so this is sufficient to prove Theorems 4.1.1 and 4.2.1. However, we prove in Section 4.A that Proposition 4.2.4 holds without the additional assumption $\log t = o(e^{\beta t})$, because this shows that one can choose β_t that grows to infinity as slowly as we want and, thus, that the fluctuations of the front originate from the particles coming around $\frac{1}{2} \log t$ between times t^a and t .

For Proposition 4.2.5, note that, conditionally on $\mathcal{F}_{\mathcal{L}^{t^a, \gamma t}}$, the $\Omega_t^{(u)}$ for $u \in \mathcal{L}^{t^a, \gamma t}$ are independent random variables with the same law as $e^{-\gamma t} Z_{t-T_u}(f)$ (but still with a \sqrt{t} scaling in the function f). As there is a large number of killed particles, we need an explicit control for the rate of convergence of $Z_{t-T_u}(f)$ to $\mathbb{E}[f(\sqrt{(t-T_u)/t}R_1)]Z_\infty$: this is done in Proposition 4.4.1. The proof uses exactly the same kind of arguments: killing at some barrier γ and reintroducing the contribution of killed particles. Therefore, some of the lemmas in Section 4.4, can be reused afterwards. Finally, Proposition 4.2.5 is proved in Section 4.5.3.

We can now conclude this section by proving the main results of the chapter, by means of the previous propositions.

Proof of Theorems 4.1.1 and 4.2.1. First assume that $\mathbb{E}[f(R_1)] = 0$. If $a \in (\frac{1}{2} - \frac{1}{24}, \frac{1}{2})$, Theorem 4.2.1 follows from Propositions 4.2.2 and 4.2.3. Since $Z_{t^b} \rightarrow Z_\infty$ a.s., it follows that, for any $b \in (0, a)$, we have the following convergence in probability

$$\mathbb{E} \left[\exp \left(i\lambda \sqrt{t} \left(Z_t(f) - \tilde{c}_1(f) Z_\infty \frac{\log t}{2\sqrt{t}} \right) \right) \middle| \mathcal{F}_{t^a} \right] - \exp(-Z_{t^b}[\tilde{c}_2(f)|\lambda| + i\lambda(\tilde{c}_3(f) \log|\lambda| + \tilde{c}_4(f))]) \xrightarrow[t \rightarrow \infty]{} 0.$$

Taking the conditional expectation given \mathcal{F}_{t^b} , it proves Theorem 4.2.1 for any $a \in (0, \frac{1}{2})$. Then, it extends directly to the case $\mathbb{E}[f(R_1)] \neq 0$.

Theorem 4.1.1 follows from Theorems 4.2.1 and 3.1.1. More precisely, using Proposition 3.1.5, we can replace $\sqrt{t}(Z_t(f) - \mathbb{E}[f(R_1)]Z_\infty - c_1(f) \frac{\log t}{2\sqrt{t}} Z_\infty)$ in the statement of Theorem 4.1.1 by

$$\sqrt{t} \left(Z_t(f) - \mathbb{E}[f(R_1)]Z_t - \tilde{c}_1(f) \frac{\log t}{2\sqrt{t}} Z_t \right) + \sqrt{t} \mathbb{E}[f(R_1)] \left(Z_t - Z_\infty - \frac{\log t}{\sqrt{2\pi t}} Z_\infty \right). \quad (4.6)$$

Taking the conditional expectation given \mathcal{F}_t , we apply Theorem 3.1.1 to the second term in (4.6) and we approximate Z_∞ in the limit by Z_{t^a} . Using again Proposition 3.1.5, we can now replace $\tilde{c}_1(f) \frac{\log t}{2\sqrt{t}} Z_t$ by $\tilde{c}_1(f) \frac{\log t}{2\sqrt{t}} Z_\infty$. Finally, taking the conditional expectation given \mathcal{F}_{t^a} , we can apply Theorem 4.2.1 to the first term in (4.6) and it concludes the proof. \square

4.3 Preliminary results on branching Brownian motion

4.3.1 Many-to-few formulas

In the sequel, we allow the BBM to start at an arbitrary point $x \in \mathbb{R}$, in which case we write \mathbb{P}_x and \mathbb{E}_x instead of \mathbb{P} and \mathbb{E} . Recall from (3.22) the many-to-one formula, which will use repetitively in the following form, using the link (4.75) between the Brownian motion staying positive and the 3-dimensional Bessel process: for any $x > 0$, $t \geq 0$ and any measurable function $\varphi: \mathbb{R} \rightarrow \mathbb{R}_+$, we have

$$\mathbb{E}_x \left[\sum_{u \in \mathcal{N}(t)} e^{-X_u(t)} \varphi(X_u(t)) \mathbb{1}_{\forall s \in [0, t], X_u(s) > 0} \right] = x e^{-x} \mathbb{E}_x \left[\frac{\varphi(R_t)}{R_t} \right], \quad (4.7)$$

where $(R_s)_{s \geq 0}$ denotes a 3-dimensional Bessel process, starting from x under \mathbb{P}_x .

Since we assumed that $\mathbb{E}[L^2] < \infty$, the *many-to-two formula* holds, see (1.10). We state it here in a special case: for any $x > 0$, $t \geq 0$ and any measurable function $\varphi: \mathbb{R} \rightarrow \mathbb{R}_+$, we have

$$\begin{aligned} & \mathbb{E}_x \left[\left(\sum_{u \in \mathcal{N}(t)} e^{-X_u(t)} \varphi(X_u(t)) \mathbb{1}_{\forall s \in [0, t], X_u(s) > 0} \right)^2 \right] \\ &= K e^{-x} \int_0^t dr \int_0^\infty \mathbb{E}_y \left[\sum_{u \in \mathcal{N}(t-r)} e^{-X_u(t-r)} \varphi(X_u(t-r)) \mathbb{1}_{\forall s \in [0, t-r], X_u(s) > 0} \right]^2 e^y q_r(x, y) dy \\ & \quad + e^{-x} \int_0^\infty e^{-y} \varphi(y)^2 q_t(x, y) dy, \end{aligned} \tag{4.8}$$

where $q_r(x, y) := (2\pi r)^{-1/2} (e^{-(x-y)^2/2r} - e^{-(x+y)^2/2r})$ for any $x, y > 0$ and K is a positive constant. Note that $q_r(x, \cdot)$ is the density on \mathbb{R}_+^* of a Brownian motion at time r starting from x and killed at 0.

4.3.2 Branching Brownian motion killed at 0

In this subsection, we prove preliminary results controlling first and second moments for the following quantity of BBM killed at 0, defined for $\Delta \in \mathbb{R}$ and $t \geq r \geq 0$ by

$$\tilde{Z}_r(f, \Delta) = \tilde{Z}_r(f, \Delta, t) := \sum_{u \in \mathcal{N}(r)} (X_u(r) - \Delta)_+ e^{-X_u(r)} \mathbb{1}_{\forall q \in [0, r], X_u(q) > 0} f\left(\frac{X_u(r) - \Delta}{\sqrt{t}}\right). \tag{4.9}$$

Note that the \sqrt{t} scaling in the function f is not necessarily corresponding to the time r where particles are considered. Moreover, since the scaling in the function f is very frequently \sqrt{t} in this chapter, we usually skip the dependence in t in the notation $\tilde{Z}_r(f, \Delta)$ and use the whole notation only when the scaling is not \sqrt{t} .

Lemma 4.3.1. *For any $x > 0$, $\Delta \in \mathbb{R}$ and $t \geq r \geq 0$, we have the two following bounds*

$$\begin{aligned} \left| \mathbb{E}_x \left[\tilde{Z}_r(1, \Delta) \right] - x e^{-x} \right| &\leq C e^{-x} |\Delta| \left(1 \wedge \frac{x}{\sqrt{r}} \right) \\ \mathbb{E}_x \left[\tilde{Z}_r(1, \Delta) \right] &\leq C e^{-x} \left(x + |\Delta| \left(1 \wedge \frac{x}{\sqrt{r}} \right) \right). \end{aligned}$$

Proof. Using the many-to-one formula (4.7), we have

$$\mathbb{E}_x \left[\tilde{Z}_r(f, \Delta) \right] = x e^{-x} \mathbb{E}_x \left[\frac{(R_r - \Delta)_+}{R_r} \right]$$

and, therefore, we get

$$\begin{aligned} \left| \mathbb{E}_x \left[\tilde{Z}_r(1, \Delta) \right] - x e^{-x} \right| &\leq x e^{-x} \mathbb{E}_x \left[\frac{|(R_r - \Delta)_+ - R_r|}{R_r} \right] \leq x e^{-x} \mathbb{E}_x \left[\frac{|\Delta|}{R_r} \right] = x e^{-x} \frac{|\Delta|}{\sqrt{r}} \mathbb{E}_{x/\sqrt{r}} \left[\frac{1}{R_1} \right] \\ &\leq C x e^{-x} \frac{|\Delta|}{\sqrt{r}} \left(1 \wedge \frac{\sqrt{r}}{x} \right), \end{aligned}$$

using Lemma 4.C.1, and the first inequality is proved. The second one follows. \square

Before stating the next lemma, we introduce for brevity an auxiliary function h_t defined by

$$h_t(r) := \mathbb{E} \left[f \left(\sqrt{\frac{r}{t}} R_1 \right) \right], \quad r > 0. \quad (4.10)$$

For the two following lemmas, we need to work with many parameters in order to make them fit to all the cases where we want to apply them.

Lemma 4.3.2. *For any function $f: \mathbb{R} \rightarrow \mathbb{R}$ satisfying Assumptions (i)-(ii) and $\mathbb{E}[f(R_1)] = 0$, there exists a constant $C > 0$ such that, for any $x > 0$, $t \geq s \geq r > 0$ and $\Delta \in [-\sqrt{s}, \sqrt{s}]$, we have the two following bounds*

$$\begin{aligned} \left| \mathbb{E}_x \left[\tilde{Z}_r(f - h_t(s), \Delta) \right] \right| &\leq C x e^{-x} \sqrt{\frac{t}{r}} \left(\frac{x^2}{r} \left(1 + \frac{x^3}{r^{3/2}} \right) e^{Cx/\sqrt{t}} + \frac{|\Delta|}{\sqrt{r}} + \frac{s-r}{s} \right), \\ \mathbb{E}_x \left[\left| \tilde{Z}_r(f - h_t(s_0), \Delta) \right| \right] &\leq C x e^{-x} \sqrt{\frac{t}{r}} \left(1 \wedge \frac{\sqrt{r}}{x} \right) e^{Cx/\sqrt{t}}. \end{aligned}$$

Proof. For the first bound, using the many-to-one formula (4.7), we have

$$\begin{aligned} \mathbb{E}_x \left[\tilde{Z}_r(f, \Delta) \right] &= x e^{-x} \mathbb{E}_x \left[\frac{1}{R_r} (R_r - \Delta)_+ f \left(\frac{R_r - \Delta}{\sqrt{t}} \right) \right] \\ &= x e^{-x} \mathbb{E}_{x/\sqrt{r}} \left[\frac{(R_1 - \frac{\Delta}{\sqrt{r}})_+}{R_1} f \left(\sqrt{\frac{r}{t}} \left(R_1 - \frac{\Delta}{\sqrt{r}} \right) \right) \right], \end{aligned} \quad (4.11)$$

using the scaling property of the Bessel process. Then, we use the following decomposition: $\tilde{Z}_r(f - h_t(s), \Delta) = (\tilde{Z}_r(f, \Delta) - h_t(r)x e^{-x}) - (h_t(s)\tilde{Z}_r(1, \Delta) - h_t(r)x e^{-x})$. On the one hand, applying (4.11), we have

$$\begin{aligned} \left| \mathbb{E}_x \left[\tilde{Z}_r(f, \Delta) \right] - h_t(r)x e^{-x} \right| &= x e^{-x} \left| \mathbb{E}_{x/\sqrt{r}} \left[\frac{(R_1 - \frac{\Delta}{\sqrt{r}})_+}{R_1} f \left(\sqrt{\frac{r}{t}} \left(R_1 - \frac{\Delta}{\sqrt{r}} \right) \right) \right] - h_t(r) \right| \\ &\leq C x e^{-x} \sqrt{\frac{t}{r}} e^{C|\Delta|/\sqrt{t}} \left(\frac{x^2}{r} \left(1 + \frac{x^3}{r^{3/2}} \right) e^{Cx/\sqrt{t}} + \frac{|\Delta|}{\sqrt{r}} \right), \end{aligned} \quad (4.12)$$

recalling that $h_t(r) = \mathbb{E}[f(\sqrt{r/t}R_1)]$ and using Lemma 4.C.4 with $\delta = 1 - \sqrt{r/t}$, $y = x/\sqrt{r}$, $\eta = \Delta/\sqrt{r}$. On the other hand, using Lemma 4.3.1 and Lemma 4.C.5, we get

$$\begin{aligned} \left| h_t(s)\mathbb{E}_x \left[\tilde{Z}_r(1, \Delta) \right] - h_t(r)x e^{-x} \right| &\leq |h_t(s)| \cdot \left| \mathbb{E}_x \left[\tilde{Z}_r(1, \Delta) \right] - x e^{-x} \right| + x e^{-x} |h_t(s) - h_t(r)| \\ &\leq C \sqrt{\frac{t}{s}} x e^{-x} \frac{|\Delta|}{\sqrt{r}} + C \sqrt{\frac{t}{r}} \frac{s-r}{s} x e^{-x}. \end{aligned} \quad (4.13)$$

Combining (4.12) and (4.13) and noting that $e^{C|\delta|/\sqrt{t}} \leq e^C$, it proves the first bound.

We now deal with the second bound. Proceeding as in (4.11), we get

$$\begin{aligned} \mathbb{E}_x \left[\left| \tilde{Z}_r(f, \Delta) \right| \right] &\leq \mathbb{E}_x \left[\tilde{Z}_r(|f|, \Delta) \right] = x e^{-x} \mathbb{E}_{x/\sqrt{r}} \left[\frac{(R_1 - \frac{\Delta}{\sqrt{r}})_+}{R_1} \left| f \left(\sqrt{\frac{r}{t}} \left(R_1 - \frac{\Delta}{\sqrt{r}} \right) \right) \right| \right] \\ &\leq x e^{-x} C \sqrt{\frac{t}{r}} \exp \left(C \sqrt{\frac{r}{t}} \frac{x - \Delta}{\sqrt{r}} \right) \left(1 \wedge \frac{\sqrt{r}}{x} \right), \end{aligned} \quad (4.14)$$

using Lemma 4.C.6. Furthermore, using Lemma 4.3.1 and Lemma 4.C.5, we have

$$\mathbb{E}_x \left[\left| h_t(s) \tilde{Z}_r(1, \Delta) \right| \right] \leq C \sqrt{\frac{t}{s}} e^{-x} |\Delta| \left(1 \wedge \frac{x}{\sqrt{r}} \right) = C \sqrt{\frac{t}{r}} x e^{-x} \frac{|\Delta|}{\sqrt{s}} \left(1 \wedge \frac{\sqrt{r}}{x} \right),$$

and the second bound follows, because $|\Delta|/\sqrt{s} \leq 1$. \square

Remark 4.3.3. Let $f: \mathbb{R} \rightarrow \mathbb{R}_+$ be a function satisfying Assumption (i) (but with possibly $\mathbb{E}[f(R_1)] \neq 0$). Then, Equation (4.14) still holds (because we can also apply Lemma 4.C.6 in this case). It follows that there exists $C > 0$ such that, for r large enough, $M \geq 1$ and $\gamma \in \mathbb{R}$ satisfying $|M| + |\gamma| \leq \sqrt{r}$, we have

$$\mathbb{E} \left[\left| Z_r(f, \gamma, r) \mathbb{1}_{\forall q \in [0, r], \min_{u \in \mathcal{N}(q)} X_u(q) > -M} \right| \right] = e^M \mathbb{E}_M \left[\left| \tilde{Z}_r(f, \gamma + M, r) \right| \right] \leq CM. \quad (4.15)$$

Note that here the scaling in function f is \sqrt{r} , because this equation will typically be applied in the sequel with a scaling different from \sqrt{t} .

Remark 4.3.4. Let $f: \mathbb{R} \rightarrow \mathbb{R}_+$ be a function satisfying Assumption (i) (but with possibly $\mathbb{E}[f(R_1)] \neq 0$) and $A := \{\forall q \in [0, t^a], \min_{u \in \mathcal{N}(q)} X_u(q) > -M\}$ for some $M > 0$. Recalling from (3.64) that $\mathbb{P}(A^c) \leq e^{-M}$, we get, for any $L > 0$,

$$\mathbb{P}(|Z_{t^a}(f, \gamma_t, t^a)| \geq L) \leq e^{-M} + \frac{1}{L} \mathbb{E}[|Z_{t^a}(f, \gamma_t, t^a)| \mathbb{1}_A] \leq e^{-M} + \frac{CM}{L},$$

using (4.15) as soon as $|M| + |\gamma| \leq t^{a/2}$. It follows that the process $(|Z_{t^a}(f, \gamma_t, t^a)|)_{t \geq 1}$ is tight.

Lemma 4.3.5. *For any function $f: \mathbb{R} \rightarrow \mathbb{R}$ satisfying Assumptions (i)-(ii) and $\mathbb{E}[f(R_1)] = 0$, there exists $C > 0$ such that, for any $x > 0$, any t large enough, any $2 \leq r \leq s \leq t$ and $\Delta \in [-\sqrt{s}, \sqrt{s}]$, we have*

$$\mathbb{E}_x \left[\left(\tilde{Z}_r(f - h_t(s), \Delta) \right)^2 \right] \leq C e^{-x} \left[\left(\frac{1}{r^2} + \frac{\Delta^2}{r} + \left(\frac{s-r}{s} \right)^2 \right) + x \left(\frac{t \log r}{r^{3/2}} + \frac{r^{3/2}}{s^2} \right) \right].$$

Proof. It follows from (4.8) that, with $q_v(x, y) := (2\pi v)^{-1/2} (e^{-(x-y)^2/2v} - e^{-(x+y)^2/2v})$,

$$\begin{aligned} \mathbb{E}_x \left[\left(\tilde{Z}_r(f - h_t(s), \Delta) \right)^2 \right] &= K e^{-x} \int_0^r dv \int_0^\infty \mathbb{E}_y \left[\tilde{Z}_{r-v}(f - h_t(s), \Delta) \right]^2 e^y q_v(x, y) dy \\ &\quad + e^{-x} \int_0^\infty e^{-y} \left((y - \Delta)_+ f \left(\frac{y - \Delta}{\sqrt{t}} \right) \right)^2 q_r(x, y) dy. \end{aligned} \quad (4.16)$$

We first deal with the second term in the right-hand side of (4.16). Using Assumption (i) and that $q_r(x, y) \leq Cxy/r^{3/2}$, we get

$$\int_0^\infty e^{-y} \left((y - \Delta)_+ f \left(\frac{y - \Delta}{\sqrt{t}} \right) \right)^2 q_r(x, y) dy \leq \int_0^\infty e^{-yt} C e^{C(y-\Delta)/\sqrt{t}} \frac{xy}{r^{3/2}} dy \leq \frac{Cxt}{r^{3/2}},$$

using that $|\Delta| \leq \sqrt{t}$ and choosing t large enough such that $C/\sqrt{t} \leq 1/2$.

Now, we deal with the first term in the right-hand side of (4.16): for this, we split the integral on $[0, r]$ in two pieces. Let start with the part $v \in [0, r/2]$. Using the first bound of Lemma 4.3.2 and that $r - v \geq r/2$, we have

$$\begin{aligned} \left| \mathbb{E}_y \left[\tilde{Z}_{r-v}(f - h_t(s), \Delta) \right] \right| &\leq C y e^{-y} \sqrt{\frac{t}{r}} \left(\frac{y^2}{r} \left(1 + \frac{y^3}{r^{3/2}} \right) e^{Cy/\sqrt{t}} + \frac{|\Delta|}{\sqrt{r}} + \frac{s-r+v}{s} \right) \\ &\leq C y e^{-y} \sqrt{\frac{t}{r}} \left(\frac{y^2}{r} (1 + y^3) e^{y/5} + \frac{|\Delta|}{\sqrt{r}} + \frac{s-r+v}{s} \right), \end{aligned}$$

using that $r \geq 1$ and choosing t large enough such that $C/\sqrt{t} \leq 1/5$. Therefore, noting that $y^2(1+y^3)e^{y/5} \leq Ce^{y/4}$, we get

$$\begin{aligned} & \int_0^{r/2} dv \int_0^\infty \mathbb{E}_y \left[\tilde{Z}_{r-v}(f - h_t(s), \Delta) \right]^2 e^y q_v(x, y) dy \\ & \leq C \int_0^{r/2} dv \int_0^\infty y^2 e^{-y} \frac{t}{r} \left(\frac{e^{y/2}}{r^2} + \frac{\Delta^2}{r} + \left(\frac{s-r}{s} \right)^2 + \left(\frac{v}{s} \right)^2 \right) q_v(x, y) dy \\ & \leq C \frac{t}{r} \int_0^\infty y^2 e^{-y} \left(\left(\frac{e^{y/2}}{r^2} + \frac{\Delta^2}{r} + \left(\frac{s-r}{s} \right)^2 \right) \int_0^{r/2} q_v(x, y) dv + \frac{1}{s^2} \int_0^{r/2} v^2 q_v(x, y) dv \right) dy. \end{aligned}$$

Then, on the one hand, we have, using that $q_v(x, y) \leq \sqrt{2/\pi} v^{-3/2} xy$,

$$\int_0^{r/2} v^2 q_v(x, y) dv \leq \int_0^{r/2} v^2 \sqrt{\frac{2}{\pi}} \frac{xy}{v^{3/2}} dv \leq Cxyr^{3/2},$$

and, on the other hand, $\int_0^\infty q_v(x, y) dy = 2(x \wedge y) \leq 2y$. Thus, it follows that

$$\begin{aligned} & \int_0^{r/2} dv \int_0^\infty \mathbb{E}_y \left[\tilde{Z}_{r-v}(f - h_t(s), \Delta) \right]^2 e^y q_v(x, y) dy \\ & \leq C \int_0^\infty y^3 e^{-y} \left(\frac{e^{y/2}}{r^2} + \frac{\Delta^2}{r} + \left(\frac{s-r}{s} \right)^2 + \frac{xr^{3/2}}{s^2} \right) dy \\ & \leq C \left(\frac{1}{r^2} + \frac{\Delta^2}{r} + \left(\frac{s-r}{s} \right)^2 + \frac{xr^{3/2}}{s^2} \right), \end{aligned} \tag{4.17}$$

and it concludes our work with the part $v \in [0, r/2]$.

Now, we deal with the part $v \in [r/2, r]$ and have, using the second bound of Lemma 4.3.2,

$$\begin{aligned} \left| \mathbb{E}_y \left[\tilde{Z}_{r-v}(f - h_t(s), \Delta) \right] \right| & \leq Cy e^{-y} \sqrt{\frac{t}{r-v}} \left(1 \wedge \frac{\sqrt{r-v}}{y} \right) e^{Cy/\sqrt{t}} \\ & \leq Cy e^{-3y/4} \sqrt{t} \left(\frac{1}{\sqrt{r-v}} \wedge \frac{1}{y} \right), \end{aligned}$$

using that $C/\sqrt{t} \leq 1/4$. Noting also that $q_v(x, y) \leq Cxy/r^{3/2}$ because $v \geq r/2$, we get

$$\begin{aligned} & \int_{r/2}^r dv \int_0^\infty \mathbb{E}_y \left[\tilde{Z}_{r-v}(f - h_t(s), \Delta) \right]^2 e^y q_v(x, y) dy \\ & \leq C \int_0^\infty y^2 e^{-y/2} \int_{r/2}^r t \left(\frac{1}{r-v} \wedge \frac{1}{y^2} \right) \frac{xy}{r^{3/2}} dv dy \\ & \leq C \frac{xt}{r^{3/2}} \int_0^\infty y^3 e^{-y/2} \left(\log r + \frac{1}{y^2} \right) dy \\ & \leq Cx \frac{t \log r}{r^{3/2}}. \end{aligned}$$

This concludes the proof. \square

4.3.3 Number of killed particles

In this subsection, we study BBM starting with a single particle at $x > 0$ and where particles are killed by hitting 0, and focus on the stopping line \mathcal{L} of the killed particles defined by

$$\mathcal{L} := \{u \in \mathbb{T} : \text{there exists } s \geq 0 \text{ s.t. } u \in \mathcal{N}(s), X_u(s) \leq 0 \text{ and } \forall r \in [t^a, s), X_u(r) > 0\}.$$

Moreover, for $u \in \mathcal{L}$, let $T_u := \inf\{s \geq 0 : u \in \mathcal{N}(s) \text{ and } X_u(s) \leq 0\}$ be the killing time of u . Lastly, for $I \subset \mathbb{R}_+$ an interval, let $\mathcal{L}_I := \{u \in \mathcal{L} : T_u \in I\}$ denote the subset of particles that are killed at 0 during the time interval I .

Firstly, the following first moment formula follows from Lemma 3.4.5 (in the same way as Lemma 3.4.6): for any measurable function $\varphi: \mathbb{R} \rightarrow \mathbb{R}_+$ and any $x > 0$, we have

$$\mathbb{E}_x \left[\sum_{u \in \mathcal{L}} \varphi(T_u) \right] = xe^{-x} \int_0^\infty \varphi(r) \frac{e^{-x^2/2r}}{\sqrt{2\pi r^{3/2}}} dr. \quad (4.18)$$

Now, we prove two lemmas bounding the first and second moment of the number of particles killed during the time interval $[s, \infty)$.

Lemma 4.3.6. *There exists $C > 0$ such that, for any $s, x > 0$, we have*

$$\mathbb{E}_x [\#\mathcal{L}_{[s, \infty)}] \leq Ce^{-x} \left(1 \wedge \frac{x}{\sqrt{s}} \right).$$

Proof. It has already been shown in Lemma 3.4.6 that $\mathbb{E}_x[\#\mathcal{L}] = e^{-x}$. Moreover,

$$\mathbb{E}_x [\#\mathcal{L}_{[s, \infty)}] = xe^{-x} \int_s^\infty \frac{e^{-x^2/2r}}{\sqrt{2\pi r^{3/2}}} dr \leq Cxe^{-x} \int_s^\infty \frac{1}{r^{3/2}} dr \leq C \frac{x}{\sqrt{s}} e^{-x}.$$

Combining both results, it proves the result. \square

Lemma 4.3.7. *There exists $C > 0$ such that, for any $s, x > 0$, we have*

$$\mathbb{E}_x [(\#\mathcal{L}_{[s, \infty)})^2] \leq C \frac{xe^{-x}}{\sqrt{s}}.$$

Proof. For this proof, we use the change of measure introduced in Section 3.4.3. We follow the proof of Lemma 3.4.8, but note that here, since we assumed that $\mathbb{E}[L^2] < \infty$, we do not need to use a truncation of the number of offspring of the spine. Firstly, note that

$$\mathbb{E}_x [(\#\mathcal{L}_{[s, \infty)})^2] = \mathbb{E}_x [\#\mathcal{L}_{[s, \infty)}(\#\mathcal{L}_{[s, \infty)} - 1)] + \mathbb{E}_x [\#\mathcal{L}_{[s, \infty)}]$$

and $\mathbb{E}_x[\#\mathcal{L}_{[s, \infty)}] \leq Cxe^{-x}/\sqrt{s}$ by Lemma 4.3.6, so we only have to deal with the first summand.

Following the proof of Lemma 3.4.8, we introduce $\tau_u := \inf\{r \geq 0 : X_u(r) = 0\}$ with $\inf \emptyset = \infty$ and have, for any $t \geq s$,

$$\begin{aligned} \mathbb{E}_x [\#\mathcal{L}_{[s, t)}(\#\mathcal{L}_{[s, t)} - 1)] &= \mathbb{E}_x \left[\sum_{u \in \mathcal{N}(t)} \mathbb{1}_{\tau_u \in [s, t)} (\#\mathcal{L}_{[s, t)} - 1) \right] \\ &= e^{-x} \mathbb{E}_{\mathbb{Q}_x} [\mathbb{1}_{\tau_{w_t} \in [s, t)} (\#\mathcal{L}_{[s, t)} - 1)]. \end{aligned}$$

Then, denoting O_{w_r} the number of offspring of w_r and Π_t the set of branching times of the spine before t and using the spinal decomposition description, we get

$$\begin{aligned} \mathbb{E}_x [\#\mathcal{L}_{[s, t)}(\#\mathcal{L}_{[s, t)} - 1)] &= e^{-x} \mathbb{E}_{\mathbb{Q}_x} \left[\mathbb{1}_{\tau_{w_t} \in [s, t)} \sum_{r \in \Pi_t} (O_{w_r} - 1) \mathbb{E}_{X_{w_r}(r)} [\#\mathcal{L}_{[(s-r) \vee 0, t-r]}] \right] \\ &\leq Ce^{-x} \mathbb{E}_{\mathbb{Q}_x} \left[\mathbb{1}_{\tau_{w_t} \in [s, t)} \sum_{r \in \Pi_t} e^{-X_{w_r}(r)} \left(1 \wedge \frac{X_{w_r}(r)}{\sqrt{(s-r) \vee 0}} \right) \right], \end{aligned}$$

using Lemma 4.3.6 and that $\mathbb{E}[\widehat{L}] < \infty$, where \widehat{L} has the size-biased distribution of L . Denoting by $(B_r)_{r \geq 0}$ a Brownian motion started at x under \mathbb{P}_x and setting $\tau := \inf\{r \geq 0 : B_r = 0\}$, it follows from the spinal decomposition description and from the formula for expectations of additive functionals of Poisson point processes that

$$\begin{aligned} \mathbb{E}_x \left[\#\mathcal{L}_{[s,t]}(\#\mathcal{L}_{[s,t]} - 1) \right] &\leq C e^{-x} \mathbb{E}_x \left[\mathbb{1}_{\tau \in [s,t]} \int_0^\tau e^{-B_r} \left(1 \wedge \frac{B_r}{\sqrt{(s-r) \vee 0}} \right) dr \right] \\ &\leq C e^{-x} \mathbb{E}_x \left[\mathbb{1}_{\tau \geq s} \int_0^{s/2} e^{-B_r} \frac{B_r}{\sqrt{s}} dr \right] + C e^{-x} \mathbb{E}_x \left[\mathbb{1}_{\tau \geq s} \int_{s/2}^\tau e^{-B_r} dr \right] \\ &\leq \frac{C e^{-x}}{\sqrt{s}} \mathbb{E}_x \left[\int_0^\tau B_r e^{-B_r} dr \right] + C e^{-x} \int_{s/2}^\infty \mathbb{E}_x \left[e^{-B_r} \mathbb{1}_{\tau \geq r} \right] dr \quad (4.19) \end{aligned}$$

On the one hand, the first expectation in the right-hand side of (4.19) is smaller than Cx using (4.73). On the other hand, it follows from (4.74) that, for any $r, x > 0$, $\mathbb{E}_x[e^{-B_r} \mathbb{1}_{\tau \geq r}] \leq Cxr^{-3/2}$, and therefore the second term in the right-hand side of (4.19) is smaller than Cxe^{-x}/\sqrt{s} and it concludes the proof. \square

4.4 A first control on the rate of convergence

We fix $a \in (0, 1)$ and kill particles between times s^a and s at some level $\gamma \in \mathbb{R}$. We set, for any $r, s, t \geq 0$ and $\gamma, \Delta \in \mathbb{R}$,

$$\begin{aligned} Z_r(f, \Delta, t) &= Z_r(f, \Delta) := \sum_{u \in \mathcal{N}(r)} (X_u(r) - \Delta)_+ e^{-X_u(r)} f\left(\frac{X_u(r) - \Delta}{\sqrt{t}}\right), \\ \widetilde{Z}_r^{s^a, \gamma}(f, \Delta, t) &= \widetilde{Z}_r^{s^a, \gamma}(f, \Delta) := \sum_{u \in \mathcal{N}(r)} (X_u(r) - \Delta)_+ e^{-X_u(r)} \mathbb{1}_{\forall q \in [s^a, r], X_u(q) > \gamma} f\left(\frac{X_u(r) - \Delta}{\sqrt{t}}\right). \end{aligned}$$

As before, we skip the dependence in t in the notation $Z_r(f, \Delta)$ or $\widetilde{Z}_r^{s^a, \gamma}(f, \Delta)$ except when the scaling in the function f is not \sqrt{t} . We will work with γ and Δ that can depend on s , but that will not be larger than $c \log s$ for some constant $c > 0$. In this section, the main goal is to prove the following proposition, which is finally proved in Section 4.4.5, but some of the established lemmas will be reused afterwards.

Proposition 4.4.1. *Let $f: \mathbb{R} \rightarrow \mathbb{R}_+$ be a function satisfying Assumptions (i)-(ii) and such that $\mathbb{E}[f(R_1)] = 0$. For any $c > 0$, there exists $C > 0$ such that for any s large enough, any $|\Delta| \leq c \log s$, any $t \geq s$ and any $\delta \in (0, 1]$, we have*

$$\mathbb{P} \left(\left| Z_s(f, \Delta) - \mathbb{E} \left[f \left(\sqrt{\frac{s}{t}} R_1 \right) \right] Z_s(1, \Delta) \right| \geq \delta \right) \leq C \frac{t}{s} (\log s)^3 (s^{-1/4} + \delta^{-1} s^{-1/3}).$$

In order to prove this, we use a similar strategy as the one for Theorem 4.2.1 presented in Section 4.2, by introducing a barrier at γ from time s^a to time s . Let $\mathcal{L}^{s^a, \gamma}$ denote the stopping line of the killed particles, T_u the time of the death of a killed particle u and $\mathcal{F}_{\mathcal{L}^{s^a, \gamma}}$ be the σ -algebra associated with the stopping line. Then, recalling that $h_t(s) = \mathbb{E}[f(\sqrt{s/t} R_1)]$ we have the following decomposition

$$Z_s(f, \Delta) - \mathbb{E} \left[f \left(\sqrt{\frac{s}{t}} R_1 \right) \right] Z_s(1, \Delta) = \widetilde{Z}_s^{s^a, \gamma}(f - h_t(s), \Delta) + \sum_{u \in \mathcal{L}^{s^a, \gamma}} \Omega_s^{(u)}, \quad (4.20)$$

where $\Omega_s^{(u)}$ is the contribution of the progeny of the killed particle u in $Z_s(f - h_t(s), \gamma)$ and is defined by

$$\Omega_s^{(u)} := \sum_{v \in \mathcal{N}(s) \text{ s.t. } u \leq v} (X_v(s) - \Delta)_+ e^{-X_v(s)} \left(f \left(\frac{X_v(s) - \Delta}{\sqrt{t}} \right) - h_t(s) \right).$$

Note that conditionally on $\mathcal{F}_{\mathcal{L}^{s^a, \gamma}}$, the $\Omega_s^{(u)}$ for $u \in \mathcal{L}^{s^a, \gamma}$ are independent with respectively the same law as $Z_{s-T_u}(f - h_t(s), \Delta)$ under $\mathbb{P}_{X_u(T_u)}$.

4.4.1 Branching Brownian motion with barrier between times s^a and s

In this subsection, our aim is to deal with the first part in the decomposition (4.20): we prove that $\tilde{Z}_s^{s^a, \gamma}(f - h_t(s), \Delta)$ is small, by controlling its first moment and its variance conditionally on \mathcal{F}_{s^a} . These results will be reused for the proof of Proposition 4.2.4 in Section 4.5.1.

Lemma 4.4.2. *Let $f: \mathbb{R} \rightarrow \mathbb{R}_+$ be a function satisfying Assumptions (i)-(ii) and such that $\mathbb{E}[f(R_1)] = 0$. For any $a \in (0, 1)$ and $c > 0$, there exists $C > 0$ such that for any s large enough, any $|\Delta - \gamma| \leq c \log s$, any $t \geq s$, we have*

$$\begin{aligned} \left| \mathbb{E} \left[\tilde{Z}_s^{s^a, \gamma}(f - h_t(s), \Delta) \middle| \mathcal{F}_{s^a} \right] \right| &\leq C \sqrt{\frac{t}{s}} \left(\frac{1}{s^{1-a}} + \frac{|\Delta - \gamma|}{\sqrt{s}} \right) Z_{s^a}(x \mapsto e^{Cx}, \gamma, s^a), \\ \text{Var} \left(\tilde{Z}_s^{s^a, \gamma}(f - h_t(s), \Delta) \middle| \mathcal{F}_{s^a} \right) &\leq C e^{-\gamma} \frac{t \log s}{s^{3/2}} Z_{s^a}(x \mapsto 1 + x^{-1}, \gamma, s^a). \end{aligned}$$

Proof. Let start with the first moment. Using the branching property at time s^a , we get

$$\left| \mathbb{E} \left[\tilde{Z}_s^{s^a, \gamma}(f - h_t(s), \Delta) \middle| \mathcal{F}_{s^a} \right] \right| \leq \sum_{v \in \mathcal{N}(s^a)} e^{-\gamma} \mathbb{1}_{X_v(s^a) > \gamma} \left| \mathbb{E}_{X_v(s^a) - \gamma} \left[\tilde{Z}_{s-s^a}(f - h_t(s), \Delta - \gamma) \right] \right|.$$

Then, applying the first bound of Lemma 4.3.2 (because $|\Delta - \gamma| \in [-\sqrt{s}, \sqrt{s}]$ for s large enough) and noting that $s - s^a \geq s/2$ for s large enough, we have, for any $y > 0$,

$$\begin{aligned} \left| \mathbb{E}_y \left[\tilde{Z}_{s-s^a}(f - h_t(s), \Delta - \gamma) \right] \right| &\leq C y e^{-y} \sqrt{\frac{t}{s}} \left(\frac{y^2}{s} \left(1 + \frac{y^3}{s^{3/2}} \right) e^{Cy/\sqrt{t}} + \frac{|\Delta - \gamma|}{\sqrt{s}} + \frac{s^a}{s} \right) \\ &\leq C y e^{-y} \sqrt{\frac{t}{s}} \left(\frac{s^a}{s} + \frac{|\Delta - \gamma|}{\sqrt{s}} \right) \left(\frac{y^2}{s^a} \left(1 + \frac{y^3}{s^{3a/2}} \right) e^{Cy/\sqrt{s^a}} + 1 \right). \end{aligned}$$

Finally, using that there exists $C' > 0$ such that $x^2(1 + x^3)e^{Cx} + 1 \leq e^{C'x}$ for any $x \geq 0$, the result follows.

We can now deal with the second moment. Using the branching property at time s^a , we get

$$\text{Var} \left(\tilde{Z}_s^{s^a, \gamma}(f - h_t(s), \Delta) \middle| \mathcal{F}_{s^a} \right) \leq \sum_{v \in \mathcal{N}(s^a)} e^{-2\gamma} \mathbb{1}_{X_v(s^a) > \gamma} \mathbb{E}_{X_v(s^a) - \gamma} \left[\tilde{Z}_{s-s^a}(f - h_t(s), \Delta - \gamma)^2 \right].$$

Then, applying Lemma 4.3.5 and noting that $s - s^a \geq s/2$ for s large enough, we have, for any $y > 0$,

$$\begin{aligned} \mathbb{E}_y \left[\left(\tilde{Z}_{s-s^a}(f - h_t(s), \Delta - \gamma) \right)^2 \right] &\leq C e^{-y} \left[\left(\frac{1}{s^2} + \frac{(\Delta - \gamma)^2}{s} + \left(\frac{s^a}{s} \right)^2 \right) + y \left(\frac{t \log s}{s^{3/2}} + \frac{s^{3/2}}{s^2} \right) \right] \\ &\leq C y e^{-y} \left(1 + \frac{\sqrt{s^a}}{y} \right) \left(\frac{(\log s)^2}{s \sqrt{s^a}} + \frac{s^{3a/2}}{s^2} + \frac{t \log s}{s^{3/2}} \right), \end{aligned}$$

and the result follows, using that $t \geq s$ hence the last term dominates. \square

In the following lemma, we combine the first and second moments calculation to get a concentration result on $\tilde{Z}_s^{s^a, \gamma}(f - h_t(s), \Delta)$ around 0. Note that the bound depend on an additional parameter M , that will be chosen afterwards either as $\log s$ or as a fixed large constant.

Lemma 4.4.3. *Let $f: \mathbb{R} \rightarrow \mathbb{R}_+$ be a function satisfying Assumptions (i)-(ii) and such that $\mathbb{E}[f(R_1)] = 0$. For any $a \in (0, 1)$ and $c > 0$, there exists $C > 0$ such that for any s large enough, any $|\Delta - \gamma| \leq c \log s$, any $M \in [1, c \log s]$, any $t \geq s$, we have*

$$\mathbb{P}\left(\left|\tilde{Z}_s^{s^a, \gamma}(f - h_t(s), \Delta)\right| \geq \delta\right) \leq Ce^{-M} + C \frac{M}{\delta} \sqrt{\frac{t}{s}} \left(\frac{1}{s^{1-a}} + \frac{|\Delta - \gamma|}{\sqrt{s}} + \frac{1}{\delta} \sqrt{\frac{t}{s}} e^{-\gamma} \frac{\log s}{\sqrt{s}} \right).$$

Proof. We introduce a barrier at $-M$ between times 0 and s^a by considering the event $A := \{\forall r \in [0, s^a], \min_{u \in \mathcal{N}(r)} X_u(r) > -M\}$. Using (3.64), we have $\mathbb{P}(A^c) \leq e^{-M}$ and, therefore,

$$\begin{aligned} & \mathbb{P}\left(\left|\tilde{Z}_s^{s^a, \gamma}(f - h_t(s), \Delta)\right| \geq \delta\right) \\ & \leq e^{-M} + \mathbb{P}\left(A, \left|\mathbb{E}\left[\tilde{Z}_s^{s^a, \gamma}(f - h_t(s), \Delta) \middle| \mathcal{F}_{s^a}\right]\right| \geq \frac{\delta}{2}\right) \\ & \quad + \mathbb{P}\left(A, \left|\tilde{Z}_s^{s^a, \gamma}(f - h_t(s), \Delta) - \mathbb{E}\left[\tilde{Z}_s^{s^a, \gamma}(f - h_t(s), \Delta) \middle| \mathcal{F}_{s^a}\right]\right| \geq \frac{\delta}{2}\right). \end{aligned} \tag{4.21}$$

Then, using Markov's inequality and the first part of Lemma 4.4.2, the second term in the right-hand side of (4.21) is smaller than

$$\frac{2}{\delta} \mathbb{E}\left[\mathbb{1}_A \left|\mathbb{E}\left[\tilde{Z}_s^{s^a, \gamma}(f - h_t(s), \Delta) \middle| \mathcal{F}_{s^a}\right]\right|\right] \leq C \frac{1}{\delta} \sqrt{\frac{t}{s}} \left(\frac{1}{s^{1-a}} + \frac{|\Delta - \gamma|}{\sqrt{s}} \right) \mathbb{E}\left[\mathbb{1}_A Z_{s^a}(x \mapsto e^{Cx}, \gamma, s^a)\right]$$

and it follows from (4.15) that $\mathbb{E}[\mathbb{1}_A Z_{s^a}(x \mapsto e^{Cx}, \gamma, s^a)] \leq CM$ for s large enough. On the other hand, using Chebyshev's inequality and the second part of Lemma 4.4.2, the third term in the right-hand side of (4.21) is smaller than

$$\begin{aligned} \frac{4}{\delta^2} \mathbb{E}\left[\mathbb{1}_A \text{Var}\left(\tilde{Z}_s^{s^a, \gamma}(f - h_t(s), \Delta) \middle| \mathcal{F}_{s^a}\right)\right] & \leq \frac{C}{\delta^2} e^{-\gamma} \frac{t \log s}{s^{3/2}} \mathbb{E}\left[\mathbb{1}_A Z_{s^a}(x \mapsto 1 + x^{-1}, \gamma, s^a)\right] \\ & \leq \frac{C}{\delta^2} e^{-\gamma} \frac{t \log s}{s^{3/2}} M, \end{aligned}$$

using again (4.15). It concludes the proof. \square

4.4.2 Number of killed particles at level γ

In this subsection, we state some straightforward consequences of the results in Section 4.3.3, concerning the number of particles killed by the barrier at γ . This results will be used repetitively throughout the chapter. Before stating them, we define, for any interval $I \subset [s^a, s]$,

$$\mathcal{L}_I^{s^a, \gamma} := \{u \in \mathcal{L}^{s^a, \gamma} : T_u \in I\}$$

the subset of $\mathcal{L}^{s^a, \gamma}$ consisting of particles killed during the time interval I . Note that $\mathcal{L}_{\{s^a\}}^{s^a, \gamma}$ plays a special role, because particles killed at time s^a can be strictly below γ . We are not considering these particles in this subsection.

Firstly, it follows from (4.18) that, for any measurable function $\varphi: (s^a, s] \rightarrow \mathbb{R}_+$ and any $x > 0$,

$$\begin{aligned} \mathbb{E} \left[\sum_{u \in \mathcal{L}_{(s^a, s]}^{s^a, \gamma}} \varphi(T_u) \middle| \mathcal{F}_{s^a} \right] &= \sum_{v \in \mathcal{N}(s^a)} (X_v(s^a) - \gamma)_+ e^{-(X_v(s^a) - \gamma)} \int_{s^a}^s \varphi(r) \frac{e^{-(X_v(s^a) - \gamma)^2 / 2(r - s^a)}}{\sqrt{2\pi}(r - s^a)^{3/2}} dr \\ &\leq C e^\gamma Z_{s^a}(1, \gamma) \int_{s^a}^s \frac{\varphi(r)}{(r - s^a)^{3/2}} dr. \end{aligned} \quad (4.22)$$

Now, we consider some $s_1 \in [s^a, s)$ and state some different controls on $\#\mathcal{L}_{(s_1, s]}$.

Lemma 4.4.4. *For any $s > 0$, $\gamma \in \mathbb{R}$ and $s_1 \in [s^a, s)$, we have*

$$\mathbb{E} \left[\#\mathcal{L}_{(s_1, s]}^{s^a, \gamma} \middle| \mathcal{F}_{s^a} \right] \leq C e^\gamma \left(W_{s^a} \wedge \frac{Z_{s^a}(1, \gamma)}{\sqrt{s_1 - s^a}} \right).$$

Proof. This inequality follows from branching property at time s^a and Lemma 4.3.6. \square

Lemma 4.4.5. *If γ and s_1 are depending on s such that $|\gamma| = O(\log s)$ and $s_1 \in [s^a, s)$, then, for any function $\varepsilon: \mathbb{R}_+ \rightarrow \mathbb{R}$ such that $\varepsilon(s) \rightarrow 0$ as $s \rightarrow \infty$, we have the following convergence in probability*

$$\varepsilon(s) \sqrt{s_1} e^{-\gamma} \#\mathcal{L}_{(s_1, s]}^{s^a, \gamma} \xrightarrow{s \rightarrow \infty} 0.$$

Proof. Using Lemma 4.4.4, we get

$$\begin{aligned} \mathbb{E} \left[\varepsilon(s) \sqrt{s_1} e^{-\gamma} \#\mathcal{L}_{(s_1, s]}^{s^a, \gamma} \middle| \mathcal{F}_{s^a} \right] &\leq C \varepsilon(s) \sqrt{s_1} \left(W_{s^a} \wedge \frac{Z_{s^a}(1, \gamma)}{\sqrt{s_1 - s^a}} \right) \\ &\leq C \varepsilon(s) \left(\sqrt{2s^a} W_{s^a} + \sqrt{2} Z_{s^a}(1, \gamma) \right), \end{aligned}$$

by distinguishing cases $s_1 \leq 2s^a$ and $s_1 > 2s^a$. Using that $Z_{s^a}(1, \gamma) \rightarrow Z_\infty$ and $\sqrt{s^a} W_{s^a} \rightarrow \sqrt{2/\pi} Z_\infty$ in probability, we get that $\mathbb{E}[\varepsilon(s) \sqrt{s_1} e^{-\gamma} \#\mathcal{L}_{(s_1, s]}^{s^a, \gamma} | \mathcal{F}_{s^a}] \rightarrow 0$ in probability and the result follows. \square

4.4.3 The early killed particles

In this subsection, we want to deal with the contributions of the particles killed between times s^a and s_1 with some $s_1 \leq s/2$. For this, we define, for any interval $I \subset [s^a, s]$,

$$\mathcal{L}_I^{s^a, \gamma} := \{u \in \mathcal{L}^{s^a, \gamma} : T_u \in I\}$$

the subset of $\mathcal{L}^{s^a, \gamma}$ consisting of particles killed during the time interval I . In this subsection, we deal with the particles such that $T_u \in (s^a, s_1]$.

For this, we consider another level $\xi < \gamma$ and, for $u \in \mathcal{L}^{s^a, \gamma}$, denote by $\tilde{\Omega}_s^{(u, \xi)}$ the part of $\Omega_s^{(u)}$ when particles are killed when hitting ξ :

$$\tilde{\Omega}_s^{(u, \xi)} := \sum_{v \in \mathcal{N}(s) \text{ s.t. } u \leq v} (X_v(s) - \Delta)_+ e^{-X_v(s)} \mathbb{1}_{\forall q \in [T_u, s], X_v(q) > \xi} \left(f \left(\frac{X_v(s) - \Delta}{\sqrt{t}} \right) - h_t(s) \right),$$

see Figure 4.3 for an illustration. In the following lemma, we prove estimates for the first and second moment of the sum of the $\tilde{\Omega}_s^{(u, \xi)}$ for particles u killed at γ_t before time s_1 .

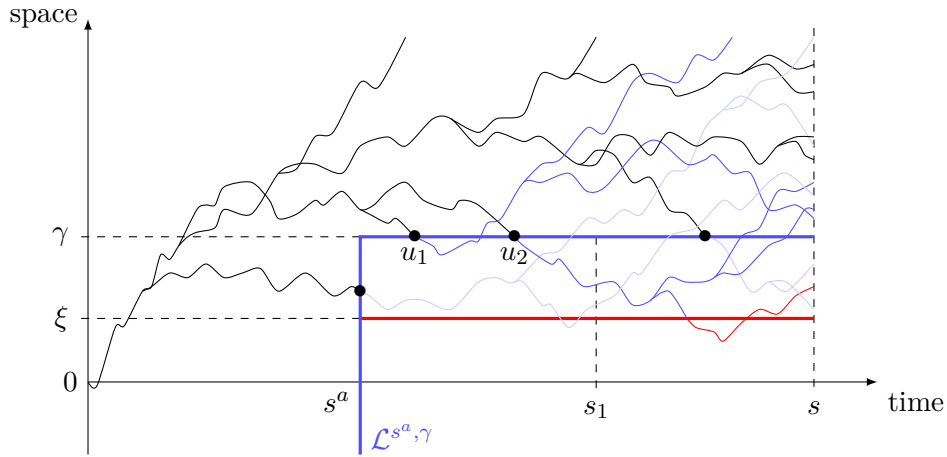

Figure 4.3 – Representation of a BBM with binary branching. Here, there are 4 particles in the stopping line $\mathcal{L}^{s^a, \gamma}$ (in blue), but only particles u_1 and u_2 are in $\mathcal{L}_{(s^a, s_1]}^{s^a, \gamma}$. For these particles, we introduce another barrier at level ξ (in red). For each u in $\mathcal{L}_{(s^a, s_1]}^{s^a, \gamma}$, only the blue particles descending from u at time t contribute to $\tilde{\Omega}_s^{(u, \xi)}$, and not the red one.

Lemma 4.4.6. *Let $f: \mathbb{R} \rightarrow \mathbb{R}_+$ be a function satisfying Assumptions (i)-(ii) and such that $\mathbb{E}[f(R_1)] = 0$. For any $a \in (0, 1)$ and $c > 0$, there exists $C > 0$ such that for any s large enough, any $|\Delta - \xi| + |\gamma - \xi| \leq c \log s$, any $s^a < s_1 \leq s/2$ and $t \geq s$, we have*

$$\left| \mathbb{E} \left[\sum_{u \in \mathcal{L}_{(s^a, s_1]}^{s^a, \gamma}} \tilde{\Omega}_s^{(u, \xi)} \middle| \mathcal{F}_{\mathcal{L}^{s^a, \gamma}} \right] \right| \leq C(\log s) e^{-\gamma} \sqrt{\frac{t}{s}} \sum_{u \in \mathcal{L}_{(s^a, s_1]}^{s^a, \gamma}} \left(\frac{T_u}{s} + \frac{\log s}{\sqrt{s}} \right),$$

$$\text{Var} \left(\sum_{u \in \mathcal{L}_{(s^a, s_1]}^{s^a, \gamma}} \tilde{\Omega}_s^{(u, \xi)} \middle| \mathcal{F}_{\mathcal{L}^{s^a, \gamma}} \right) \leq C e^{-\xi - \gamma} \sum_{u \in \mathcal{L}_{(s^a, s_1]}^{s^a, \gamma}} \left(\frac{T_u^2}{s^2} + \frac{t(\log s)^2}{s^{3/2}} \right).$$

Proof. First note that, conditionally on $\mathcal{F}_{\mathcal{L}^{s^a, \gamma}}$, the $\tilde{\Omega}_s^{(u, \xi)}$ for $u \in \mathcal{L}_{(s^a, s_1]}^{s^a, \gamma}$ are independent with respectively the same law as $e^{-\xi} \tilde{Z}_{s-T_u}(f - h_t(s), \Delta - \xi)$ under $\mathbb{P}_{\gamma - \xi}$. Thus, using the branching property along the stopping line $\mathcal{L}^{s^a, \gamma}$, we get

$$\mathbb{E} \left[\sum_{u \in \mathcal{L}_{(s^a, s_1]}^{s^a, \gamma}} \tilde{\Omega}_s^{(u, \xi)} \middle| \mathcal{F}_{\mathcal{L}^{s^a, \gamma}} \right] = \sum_{u \in \mathcal{L}_{(s^a, s_1]}^{s^a, \gamma}} e^{-\xi} \chi_1(T_u),$$

where we set, for any $r \in (s^a, s_1]$, $\chi_1(r) := \mathbb{E}_{\gamma - \xi}[\tilde{Z}_{s-r}(f - h_t(s), \Delta - \xi)]$. Then, for $r \in (s^a, s_1]$, using the first bound of Lemma 4.3.2, we get

$$|\chi_1(r)| \leq C(\gamma - \xi) e^{-(\gamma - \xi)} \sqrt{\frac{t}{s-r}} \left(\frac{(\gamma - \xi)^2}{s-r} \left(1 + \frac{(\gamma - \xi)^3}{s^{3/2}} \right) e^{C(\gamma - \xi)/\sqrt{t}} + \frac{|\Delta - \xi|}{\sqrt{s-r}} + \frac{r}{s-r} \right)$$

$$\leq C(\log s) e^{\xi - \gamma} \sqrt{\frac{t}{s}} \left(\frac{r}{s} + \frac{\log s}{\sqrt{s}} \right),$$

using that $s - r \geq s/2$ and $r \geq s^a$. It proves the first moment control.

Secondly, using again the branching property, we have

$$\text{Var} \left(\sum_{u \in \mathcal{L}_{(s^a, s_1]}^{s^a, \gamma}} \tilde{\Omega}_s^{(u, \xi)} \middle| \mathcal{F}_{\mathcal{L}^{s^a, \gamma}} \right) \leq \sum_{u \in \mathcal{L}_{(s^a, s_1]}^{s^a, \gamma}} \mathbb{E} \left[\left(\tilde{\Omega}_s^{(u, \xi)} \right)^2 \middle| \mathcal{F}_{\mathcal{L}^{s^a, \gamma}} \right] \leq \sum_{u \in \mathcal{L}_{(s^a, s_1]}^{s^a, \gamma}} e^{-2\xi} \chi_2(r).$$

where we set, for any $r \in (s^a, s_1]$, $\chi_2(r) := \mathbb{E}_{\gamma-\xi}[(\tilde{Z}_{s-r}(f - h_t(s), \Delta - \xi))^2]$. Then, for $r \in (s^a, s_1]$, using Lemma 4.3.5, we have

$$\begin{aligned} \chi_2(r) &\leq C e^{-(\gamma-\xi)} \left[\left(\frac{1}{(s-r)^2} + \frac{(\Delta - \xi)^2}{s-r} + \left(\frac{r}{s} \right)^2 \right) + (\gamma - \xi) \left(\frac{t \log(s-r)}{(s-r)^{3/2}} + \frac{(s-r)^{3/2}}{s^2} \right) \right] \\ &\leq C e^{\xi-\gamma} \left(\frac{r^2}{s^2} + \frac{t(\log s)^2}{s^{3/2}} \right), \end{aligned}$$

and it concludes the proof. \square

Lemma 4.4.7. *Let $f: \mathbb{R} \rightarrow \mathbb{R}_+$ be a function satisfying Assumptions (i)-(ii) and such that $\mathbb{E}[f(R_1)] = 0$. For any $a \in (0, 1)$ and $c > 0$, there exists $C > 0$ such that for any s large enough, any $|\Delta - \xi| + |\gamma - \xi| \leq c \log s$, any $s^a < s_1 \leq s/2$, any $t \geq s$ and any $\delta \in (0, 1]$, we have*

$$\begin{aligned} &\mathbb{P} \left(\left| \sum_{u \in \mathcal{L}_{(s^a, s_1]}^{s^a, \gamma}} \tilde{\Omega}_s^{(u, \xi)} \right| \geq \delta \right) \\ &\leq \frac{C}{s} + C(\log s)^3 \left(\frac{1}{\delta} \sqrt{\frac{t}{s}} \left(\frac{\sqrt{s_1}}{s} + \frac{1}{s^{(1+a)/2}} \right) + \frac{e^{-\xi}}{\delta^2} \left(\frac{s_1^{3/2}}{s^2} + \frac{t}{s^{(3+a)/2}} \right) \right). \end{aligned}$$

Proof. We first introduce, for brevity, $\Gamma_s := \sum_{u \in \mathcal{L}_{(s^a, s_1]}^{s^a, \gamma}} \tilde{\Omega}_s^{(u, \xi)}$. Then, we have

$$\begin{aligned} \mathbb{P}(|\Gamma_s| \geq \delta | \mathcal{F}_{\mathcal{L}^{s^a, \gamma}}) &\leq \mathbb{1}_{|\mathbb{E}[\Gamma_s | \mathcal{F}_{\mathcal{L}^{s^a, \gamma}}]| \geq \delta/2} + \mathbb{P}(|\Gamma_s - \mathbb{E}[\Gamma_s | \mathcal{F}_{\mathcal{L}^{s^a, \gamma}}]| \geq \delta/2 | \mathcal{F}_{\mathcal{L}^{s^a, \gamma}}) \\ &\leq \frac{2}{\delta} |\mathbb{E}[\Gamma_s | \mathcal{F}_{\mathcal{L}^{s^a, \gamma}}]| + \frac{4}{\delta^2} \text{Var}(\Gamma_s | \mathcal{F}_{\mathcal{L}^{s^a, \gamma}}) \\ &\leq C \sum_{u \in \mathcal{L}_{(s^a, s_1]}^{s^a, \gamma}} e^{-\gamma} (\log s)^2 \left(\frac{1}{\delta} \sqrt{\frac{t}{s}} \left(\frac{T_u}{s} + \frac{1}{\sqrt{s}} \right) + \frac{1}{\delta^2} e^{-\xi} \left(\frac{T_u^2}{s^2} + \frac{t}{s^{3/2}} \right) \right), \end{aligned}$$

by applying Lemma 4.4.6. Then, using the branching property at time s^a and then Equation (4.22), we have

$$\begin{aligned} &\mathbb{P}(|\Gamma_s| \geq \delta | \mathcal{F}_{s^a}) \\ &\leq C e^{-\gamma} (\log s)^2 \sum_{v \in \mathcal{N}(s^a)} (X_v(s^a) - \gamma)_+ e^{-(X_v(s^a) - \gamma)} \\ &\quad \times \int_0^{s_1 - s^a} \frac{e^{-(X_v(s^a) - \gamma)^2/2r}}{\sqrt{2\pi r^{3/2}}} \left(\frac{1}{\delta} \sqrt{\frac{t}{s}} \left(\frac{r + s^a}{s} + \frac{1}{\sqrt{s}} \right) + \frac{e^{-\xi}}{\delta^2} \left(\frac{r^2 + s^{2a}}{s^2} + \frac{t}{s^{3/2}} \right) \right) dr \\ &\leq C (\log s)^2 \left(\left[\frac{1}{\delta} \sqrt{\frac{t}{s}} \left(\frac{s^a}{s} + \frac{1}{\sqrt{s}} \right) + \frac{e^{-\xi}}{\delta^2} \left(\frac{s^{2a}}{s^2} + \frac{t}{s^{3/2}} \right) \right] W_{s^a} \right. \\ &\quad \left. + \left[\frac{1}{\delta} \sqrt{\frac{t}{s}} \frac{\sqrt{s_1}}{s} + \frac{1}{\delta^2} e^{-\xi} \frac{s_1^{3/2}}{s^2} \right] Z_{s^a}(1, \gamma) \right) \end{aligned} \tag{4.23}$$

using that, for any $y > 0$, $\int_0^{s_1 - s^a} e^{-y^2/2r} r^{-3/2} dr \leq C/y$, $\int_0^{s_1 - s^a} e^{-y^2/2r} r^{-1/2} dr \leq C\sqrt{s_1}$ and $\int_0^{s_1 - s^a} e^{-y^2/2r} r^{1/2} dr \leq C s_1^{3/2}$.

Before taking the final expectation, we introduce another barrier at $-\log s$ between times 0 and s^a : we set $A := \{\forall r \in [0, s^a], \min_{u \in \mathcal{N}(r)} X_u(r) > -\log s\}$. Then, it follows from (3.64)

that $\mathbb{P}(A^c) \leq 1/s$ and, therefore,

$$\mathbb{P}(|\Gamma_s| \geq \delta) \leq \frac{1}{s} + \mathbb{P}(A, |\Gamma_s| \geq \delta) \leq \frac{1}{s} + \mathbb{E}[\mathbb{1}_A \mathbb{P}(|\Gamma_s| \geq \delta | \mathcal{F}_{s^a})]. \quad (4.24)$$

Applying (4.15), we have $\mathbb{E}[\mathbb{1}_A W_{s^a}] \leq C(\log s)/\sqrt{s^a}$ and $\mathbb{E}[\mathbb{1}_A Z_{s^a}(1, \gamma)] \leq C \log s$. Combining this with (4.23) and (4.24), we get

$$\mathbb{P}(|\Gamma_s| \geq \delta) \leq \frac{1}{s} + C(\log s)^3 \left(\frac{1}{\delta} \sqrt{\frac{t}{s}} \left(\frac{\sqrt{s_1}}{s} + \frac{1}{s^{a/2} \sqrt{s}} \right) + \frac{e^{-\xi}}{\delta^2} \left(\frac{s_1^{3/2}}{s^2} + \frac{t}{s^{a/2} s^{3/2}} \right) \right)$$

and it concludes the proof. \square

4.4.4 Dealing with all killed particles

Lemma 4.4.8. *Let $f: \mathbb{R} \rightarrow \mathbb{R}_+$ be a function satisfying Assumptions (i)-(ii) and such that $\mathbb{E}[f(R_1)] = 0$. For any $a \in (0, 1)$ and $c > 0$, there exists $C > 0$ such that for any s large enough, any $|\Delta| + |\gamma| \leq c \log s$, any $s^a \leq s_1 \leq s/2$, any $t \geq s$ and any $\delta \in (0, 1]$, we have*

$$\mathbb{P} \left(\left| \sum_{u \in \mathcal{L}_{s^a, \gamma}} \Omega_s^{(u)} \right| \geq \delta \right) \leq C(\log s)^3 \left[\frac{e^\gamma}{s^{3a/2}} + \frac{1}{s^{a/2}} + \sqrt{\frac{t}{s}} \frac{\delta^{-1}}{\sqrt{s_1 - s^a}} + \frac{\delta^{-2}}{\sqrt{s}} \left(\left(\frac{s_1}{s} \right)^{3/2} + \frac{t}{s} \frac{1}{s^{a/2}} \right) \right].$$

Proof. We first deal with the particles killed immediately at time s^a when the barrier is added: using (3.65), we get

$$\mathbb{P}(\mathcal{L}_{\{s^a\}}^{s^a, \gamma} \neq \emptyset) \leq C \left(\frac{3}{2} \log(s^a) - \gamma \right) e^{-\frac{3}{2} \log(s^a) + \gamma} \leq C(\log s) \frac{e^\gamma}{s^{3a/2}}. \quad (4.25)$$

Now, we deal with $\mathcal{L}_{(s^a, s]}^{s^a, \gamma}$. We first introduce the barrier at $-\log s$: we set, as before, $A := \{\forall r \in [0, s^a], \min_{u \in \mathcal{N}(r)} X_u(r) > -\log s\}$ and have, using (3.64), $\mathbb{P}(A^c) \leq 1/s$ and, therefore,

$$\mathbb{P} \left(\left| \sum_{u \in \mathcal{L}_{(s^a, s]}^{s^a, \gamma}} \Omega_s^{(u)} \right| \geq \delta \right) \leq \frac{1}{s} + \mathbb{P} \left(A, \left| \sum_{u \in \mathcal{L}_{(s^a, s]}^{s^a, \gamma}} \Omega_s^{(u)} \right| \geq \delta \right).$$

Then, we introduce another barrier at 0 between times s^a and s . For this, we control the probability that some particle hits this new barrier: using the branching property at time s^a , we have

$$\begin{aligned} \mathbb{P} \left(A, \exists r \in [s^a, s], \min_{u \in \mathcal{N}(r)} X_u(r) \leq 0 \right) &\leq \mathbb{E} \left[\mathbb{1}_A \sum_{v \in \mathcal{N}(s^a)} \mathbb{P}_{X_v(s^a)} \left(\exists r \geq 0, \min_{u \in \mathcal{N}(r)} X_u(r) \leq 0 \right) \right] \\ &\leq C \mathbb{E}[\mathbb{1}_A W_{s^a}] \leq C \frac{\log s}{s^{a/2}}, \end{aligned} \quad (4.26)$$

using successively (3.64) and (4.15). Now, we bound

$$\begin{aligned} &\mathbb{P} \left(A, \forall r \in [s^a, s], \min_{u \in \mathcal{N}(r)} X_u(r) > 0, \left| \sum_{u \in \mathcal{L}_{(s^a, s]}^{s^a, \gamma}} \Omega_s^{(u)} \right| \geq \delta \right) \\ &\leq \mathbb{P} \left(\left| \sum_{u \in \mathcal{L}_{(s^a, s_1]}^{s^a, \gamma}} \tilde{\Omega}_s^{(u, 0)} \right| \geq \frac{\delta}{2} \right) + \mathbb{P} \left(A, \left| \sum_{u \in \mathcal{L}_{(s_1, s]}^{s^a, \gamma}} \tilde{\Omega}_s^{(u, 0)} \right| \geq \frac{\delta}{2} \right), \end{aligned} \quad (4.27)$$

recalling the notation $\tilde{\Omega}_s^{(u,\xi)}$ in Section 4.4.3, with here $\xi = 0$. Applying Lemma 4.4.7, we get

$$\begin{aligned} \mathbb{P}\left(\left|\sum_{u \in \mathcal{L}_{(s^a, s_1]}^{s^a, \gamma}} \tilde{\Omega}_s^{(u,0)}\right| \geq \frac{\delta}{2}\right) &\leq C(\log s)^3 \left(\frac{\delta^{-1}}{\sqrt{s}} \sqrt{t} \left(\sqrt{\frac{s_1}{s}} + \frac{1}{s^{a/2}} \right) + \frac{\delta^{-2}}{\sqrt{s}} \left(\left(\frac{s_1}{s} \right)^{3/2} + \frac{t}{s} \frac{1}{s^{a/2}} \right) \right) \\ &\leq C(\log s)^3 \left(\sqrt{\frac{t}{s}} \frac{\delta^{-1}}{\sqrt{s_1 - s^a}} + \frac{\delta^{-2}}{\sqrt{s}} \left(\left(\frac{s_1}{s} \right)^{3/2} + \frac{t}{s} \frac{1}{s^{a/2}} \right) \right). \end{aligned} \quad (4.28)$$

We can now deal with the second term in the right-hand side of (4.27). Recalling that, conditionally on $\mathcal{F}_{\mathcal{L}^{s^a, \gamma}}$, the $\tilde{\Omega}_s^{(u,0)}$ for $u \in \mathcal{L}_{(s^a, s]}^{s^a, \gamma}$ are independent with respectively the same law as $\tilde{Z}_{s-T_u}(f - h_t(s), \Delta, t)$ under \mathbb{P}_γ , we have

$$\begin{aligned} &\mathbb{P}\left(A, \left|\sum_{u \in \mathcal{L}_{(s_1, s]}^{s^a, \gamma}} \tilde{\Omega}_s^{(u,0)}\right| \geq \delta \middle| \mathcal{F}_{\mathcal{L}^{s^a, \gamma}}\right) \\ &\leq \mathbb{1}_A \frac{1}{\delta} \sum_{u \in \mathcal{L}_{(s_1, s]}^{s^a, \gamma}} \mathbb{E}_\gamma \left[\left| \tilde{Z}_{s-T_u}(f - h_t(s), \Delta, t) \right| \right] \\ &\leq \mathbb{1}_A \frac{1}{\delta} \sum_{u \in \mathcal{L}_{(s_1, s]}^{s^a, \gamma}} C \gamma e^{-\gamma} \sqrt{\frac{t}{s - T_u}} \left(1 \wedge \frac{\sqrt{s - T_u}}{\gamma} \right) \left(1 + \frac{|\Delta|}{\sqrt{s}} \right) e^{C(\gamma - \Delta)/\sqrt{t}} \\ &\leq \mathbb{1}_A \frac{C}{\delta} (\log s) e^{-\gamma} \sqrt{t} \sum_{u \in \mathcal{L}_{(s_1, s]}^{s^a, \gamma}} \frac{1}{\sqrt{s - T_u}}, \end{aligned}$$

using the second bound of Lemma 4.3.2. Then, applying (4.22), we get

$$\begin{aligned} \mathbb{P}\left(A, \left|\sum_{u \in \mathcal{L}_{(s_1, s]}^{s^a, \gamma}} \tilde{\Omega}_s^{(u,0)}\right| \geq \delta \middle| \mathcal{F}_{s^a}\right) &\leq \mathbb{1}_A \frac{C}{\delta} (\log s) \sqrt{t} Z_{s^a}(1, \gamma) \int_{s_1}^s \frac{dr}{\sqrt{s-r}(r-s^a)^{3/2}} \\ &\leq \mathbb{1}_A \frac{C}{\delta} (\log s) \frac{\sqrt{t} Z_{s^a}(1, \gamma)}{\sqrt{s} \sqrt{s_1 - s^a}}. \end{aligned}$$

But, it follows from (4.15) that $\mathbb{E}[\mathbb{1}_A Z_{s^a}(1, \gamma)] \leq C \log s$ and therefore

$$\mathbb{P}\left(A, \left|\sum_{u \in \mathcal{L}_{(s_1, s]}^{s^a, \gamma}} \tilde{\Omega}_s^{(u,0)}\right| \geq \delta\right) \leq \frac{C}{\delta} \sqrt{\frac{t}{s}} \frac{(\log s)^2}{\sqrt{s_1 - s^a}}.$$

Combining this with (4.25), (4.26) and (4.28), it concludes the proof. \square

4.4.5 Rate of convergence of $Z_s(f, \Delta)$

Proof of Proposition 4.4.1. We take $s_1 := s^b$ and $\gamma := d \log s$ with $b \in (a, 1)$ and $d \in (0, 3a/2)$ and we will choose a , d and b afterwards. Using (4.20), Lemma 4.4.3 (with $M = \log s$) and Lemma 4.4.8, we get

$$\begin{aligned} &\mathbb{P}\left(\left|Z_s(f, \Delta, t) - \mathbb{E}\left[f\left(\sqrt{\frac{s}{t}} R_1\right)\right] Z_s(1, \Delta, t)\right| \geq \delta\right) \\ &\leq C \frac{t}{s} (\log s)^3 \left[s^{d - \frac{3a}{2}} + s^{-\frac{a}{2}} + \delta^{-1} \left(s^{a-1} + s^{-\frac{1}{2}} + s^{-\frac{b}{2}} \right) + \delta^{-2} \left(s^{-\frac{1}{2}-d} + s^{-2+\frac{3}{2}b} + s^{-\frac{1}{2}-\frac{a}{2}} \right) \right]. \end{aligned}$$

Many values of a , d and b can be chosen in order to get different kinds of inequalities. Here, we take $a = 1/2$, $d = 1/2$ and $b = 2/3$, and it gives

$$\mathbb{P}\left(\left|Z_s(f, \Delta, t) - \mathbb{E}\left[f\left(\sqrt{\frac{s}{t}}R_1\right)\right]Z_s(1, \Delta, t)\right| \geq \delta\right) \leq C\frac{t}{s}(\log s)^3\left(s^{-1/4} + \delta^{-1}s^{-\frac{1}{3}} + \delta^{-2}s^{-\frac{3}{4}}\right),$$

and it proves the result, noting that the last term is either smaller than the second one or greater than 1. \square

4.5 Precise behavior of $Z_t(f, \gamma_t)$

In this section, our aim is to prove Propositions 4.2.4 and 4.2.5 (that imply together Proposition 4.2.3). For Proposition 4.2.4, that shows that $\tilde{Z}_t^{t^a, \gamma_t}(f, \gamma_t)$ is negligible, almost everything has already been done and the proof is shortly concluded in Section 4.5.1. Proposition 4.2.5 still needs some more work. In this section, we use repetitively results of Section 4.4, with $s = t$ and $\gamma = \gamma_t = \frac{1}{2} \log t + \beta_t$. Note that in that case $h_t(s) = \mathbb{E}[f(R_1)] = 0$.

4.5.1 Proof of Proposition 4.2.4

From the work done in Section 4.4.1, the control of $\tilde{Z}_t^{t^a, \gamma_t}(f, \gamma_t)$, where particles are killed when hitting γ_t , follows easily if we assume that $\log t = o(e^{\beta_t})$. See Section 4.A for a proof without this additional assumption.

Proof of Proposition 4.2.4 in the case $\log t = o(e^{\beta_t})$. Let $\varepsilon \in (0, 1)$. Applying Lemma 4.4.3 with $s = t$, $\Delta = \gamma_t$, $\delta = \varepsilon/\sqrt{t}$ and $M \geq 1$ that does not depend of t , we get that, for t large enough,

$$\mathbb{P}\left(\left|\tilde{Z}_t^{t^a, \gamma_t}(f, \gamma_t)\right| \geq \frac{\varepsilon}{\sqrt{t}}\right) \leq e^{-M} + C\frac{\sqrt{t}}{\varepsilon}M\left(\frac{1}{t^{1-a}} + \frac{\sqrt{t}}{\varepsilon}e^{-\gamma_t}\frac{\log t}{\sqrt{t}}\right) \xrightarrow{t \rightarrow \infty} e^{-M},$$

using that $a < 1/2$ and that $\sqrt{t}e^{-\gamma_t} = e^{-\beta_t} = o(1/\log t)$ by the assumption of the proof. Letting $M \rightarrow \infty$, it proves the result. \square

4.5.2 Simplifying the contribution of killed particles

This subsection contains some preliminary work for the proof of Proposition 4.2.5. We recall some notation introduced in Section 4.4.3. For any interval $I \subset [t^a, t]$, let $\mathcal{L}_I^{t^a, \gamma_t} := \{u \in \mathcal{L}^{t^a, \gamma_t} : T_u \in I\}$ be the subset of $\mathcal{L}^{t^a, \gamma_t}$ consisting of particles killed during the time interval I . Recall that for $u \in \mathcal{L}^{t^a, \gamma_t}$, the contribution of the killed particle u in $Z_t(f, \gamma_t)$ is

$$\Omega_t^{(u)} := \sum_{v \in \mathcal{N}(t) \text{ s.t. } u \leq v} (X_v(t) - \gamma_t)_+ e^{-X_v(t)} f\left(\frac{X_v(t) - \gamma_t}{\sqrt{t}}\right).$$

Conditionnally on $\mathcal{F}_{\mathcal{L}^{t^a, \gamma_t}}$, the $\Omega_t^{(u)}$ for $u \in \mathcal{L}_{(t^a, t]}^{t^a, \gamma_t}$ are independent and have the same law as $e^{-\gamma_t} Z_{t-T_u}(f, 0)$. Therefore, by Proposition 4.4.1, they are close to $e^{-\gamma_t} h_t(t - T_u) Z_\infty^{(u)}$, where $Z_\infty^{(u)}$ is the limit of the derivative martingale of the BBM rooted at u , defined as

$$Z_\infty^{(u)} := \lim_{s \rightarrow \infty} \sum_{v \in \mathcal{N}(s) \text{ s.t. } u \leq v} (X_v(s) - X_u(T_u)) e^{-(X_v(s) - X_u(T_u))}.$$

Note that, conditionnally on $\mathcal{F}_{\mathcal{L}^{t^a, \gamma_t}}$, the $Z_\infty^{(u)}$ for $u \in \mathcal{L}_{(t^a, t]}^{t^a, \gamma_t}$ are independent and have the same law as Z_∞ .

The purpose of this subsection is to prove the following lemma, that shows that the contributions $\Omega_t^{(u)}$ can be replaced by $e^{-\gamma t} h_t(t - T_u) Z_\infty^{(u)}$. Moreover, it shows that the contributions of particles killed outside a smaller interval $(t_1, t_2] \subset [t^a, t]$ are negligible.

Lemma 4.5.1. *Let $f: \mathbb{R} \rightarrow \mathbb{R}_+$ be a function satisfying Assumptions (i)-(ii) and such that $\mathbb{E}[f(R_1)] = 0$. If $a = \frac{1}{2} - \eta$ for some $\eta \in (0, \frac{1}{24})$, then with $t_1 = t^{\frac{2}{3} + \eta}$ and $t_2 = t - te^{-3\beta t/2}$, we have, for any $\varepsilon \in (0, 1)$,*

$$\mathbb{P}\left(\left|\sum_{u \in \mathcal{L}^{t^a, \gamma t}} \Omega_t^{(u)} - \sum_{u \in \mathcal{L}_{(t_1, t_2]}^{t^a, \gamma t}} h_t(t - T_u) e^{-\gamma t} Z_\infty^{(u)}\right| \geq \frac{\varepsilon}{\sqrt{t}}\right) \xrightarrow{t \rightarrow \infty} 0.$$

In order to improve the readability of the proof, we prove separately that the contributions of particles killed during $[t^a, t_1]$ and $(t_2, t]$ are negligible. This is done in the two following lemmas.

Lemma 4.5.2. *Let $f: \mathbb{R} \rightarrow \mathbb{R}_+$ be a function satisfying Assumptions (i)-(ii) and such that $\mathbb{E}[f(R_1)] = 0$. If $a = \frac{1}{2} - \eta$ for some $\eta \in (0, \frac{1}{24})$, then with $t_1 = t^{\frac{2}{3} + \eta}$, we have, for any $\varepsilon \in (0, 1)$,*

$$\mathbb{P}\left(\left|\sum_{u \in \mathcal{L}_{[t^a, t_1]}^{t^a, \gamma t}} \Omega_t^{(u)}\right| \geq \frac{\varepsilon}{\sqrt{t}}\right) \xrightarrow{t \rightarrow \infty} 0.$$

Lemma 4.5.3. *With $t_2 = t - te^{-3\beta t/2}$, we have $\mathbb{P}(\mathcal{L}_{(t_2, t]}^{t^a, \gamma t} \neq \emptyset) \rightarrow 0$ as $t \rightarrow \infty$.*

Proof of Lemma 4.5.2. Note that, as in (4.25), we have

$$\mathbb{P}(\mathcal{L}_{\{t^a\}}^{t^a, \gamma t} \neq \emptyset) \leq C(\log t) e^{\gamma t} t^{-3a/2} \xrightarrow{t \rightarrow \infty} 0,$$

using that $a > 1/3$, so we only have to deal with the $\Omega_t^{(u)}$ for $u \in \mathcal{L}_{(t^a, t_1]}^{t^a, \gamma t}$. For this, our goal is to apply Lemma 4.4.7. Therefore, as in Section 4.4.3, we introduce another level $\xi_t = (\frac{1}{4} + \eta) \log t$ and, for $u \in \mathcal{L}^{t^a, \gamma}$, denote by $\tilde{\Omega}_t^{(u, \xi_t)}$ the part of $\Omega_t^{(u)}$ when particles are killed when hitting ξ_t :

$$\tilde{\Omega}_t^{(u, \xi_t)} := \sum_{v \in \mathcal{N}(t) \text{ s.t. } u \leq v} (X_v(t) - \gamma t)_+ e^{-X_v(t)} \mathbb{1}_{\forall q \in [T_u, t], X_v(q) > \xi_t} f\left(\frac{X_v(s) - \gamma t}{\sqrt{t}}\right).$$

Moreover, let \mathcal{L}^{t^a, ξ_t} denote as before the stopping line of the particles killed at ξ_t and $\mathcal{L}_I^{t^a, \xi_t}$ the subset of particles killed during the time interval I . Then, we have

$$\left|\sum_{u \in \mathcal{L}_{(t^a, t_1]}^{t^a, \gamma t}} \Omega_t^{(u)}\right| \leq \left|\sum_{u \in \mathcal{L}_{(t^a, t_1]}^{t^a, \gamma t}} \tilde{\Omega}_t^{(u, \xi_t)}\right| + \left|\sum_{v \in \mathcal{L}_{(t^a, t]}^{t^a, \xi_t}} \Omega_t^{(v)}\right|,$$

where $\Omega_t^{(v)}$ is still defined as the contribution of the progeny of the particle v in $Z_t(f, \gamma_t)$. It is now sufficient to prove that, for any $\varepsilon \in (0, 1)$,

$$\mathbb{P}\left(\left|\sum_{u \in \mathcal{L}_{(t^a, t_1]}^{t^a, \gamma t}} \tilde{\Omega}_t^{(u, \xi_t)}\right| \geq \frac{\varepsilon}{\sqrt{t}}\right) + \mathbb{P}\left(\left|\sum_{v \in \mathcal{L}_{(t^a, t]}^{t^a, \xi_t}} \Omega_t^{(v)}\right| \geq \frac{\varepsilon}{\sqrt{t}}\right) \xrightarrow{t \rightarrow \infty} 0. \tag{4.29}$$

We start with the first term in the left-hand side of (4.29). Using Lemma 4.4.7 with $s = t$, we get that, for t large enough,

$$\begin{aligned} \mathbb{P}\left(\left|\sum_{u \in \mathcal{L}_{(t^a, t_1]}^{t^a, \gamma_t}} \tilde{\Omega}_t^{(u, \xi_t)}\right| \geq \frac{\varepsilon}{\sqrt{t}}\right) &\leq C(\log t)^3 \left(\frac{1}{\varepsilon} \left(\sqrt{\frac{t_1}{t}} + \frac{1}{t^{a/2}}\right) + \frac{\sqrt{t}}{\varepsilon^2} e^{-\xi_t} \left(\left(\frac{t_1}{t}\right)^{3/2} + \frac{1}{t^{a/2}}\right)\right) \\ &\leq \frac{C}{\varepsilon^2} (\log t)^3 \left(t^{\frac{\eta}{2} - \frac{1}{6}} + t^{-\frac{a}{2}} + t^{\frac{\eta}{2} - \frac{1}{4}} + t^{-\frac{\eta}{2}}\right) \\ &\xrightarrow{t \rightarrow \infty} 0, \end{aligned}$$

recalling that $a = \frac{1}{2} - \eta$, $t_1 = t^{\frac{2}{3} + \eta}$, $\xi_t = (\frac{1}{4} + \eta) \log t$ and $\eta < \frac{1}{24}$.

Now, we show that the second term in the left-hand side of (4.29) tends to 0 as $t \rightarrow \infty$. We split the time interval $(t^a, t]$ at time $t^{2/3}$. It is sufficient to prove that, for any $\varepsilon > 0$,

$$\mathbb{P}\left(\sum_{v \in \mathcal{L}_{(t^a, t^{2/3}]}^{t^a, \xi_t}} |\Omega^{(v)}| \geq \frac{\varepsilon}{\sqrt{t}}\right) + \mathbb{P}\left(\mathcal{L}_{(t^{2/3}, t]}^{t^a, \xi_t} \neq \emptyset\right) \xrightarrow{t \rightarrow \infty} 0. \quad (4.30)$$

Note that $\sqrt{t^{2/3}} e^{-\xi_t} = t^{\frac{1}{12} - \eta} \rightarrow \infty$ as $t \rightarrow \infty$ and, therefore, it follows from Lemma 4.4.5 that $\#\mathcal{L}_{(t^{2/3}, t]}^{t^a, \xi_t} \rightarrow 0$ in probability, which proves that $\mathbb{P}(\mathcal{L}_{(t^{2/3}, t]}^{t^a, \xi_t} \neq \emptyset) \rightarrow 0$ as $t \rightarrow \infty$. Thus, we now have to deal with the first term of the left-hand side of (4.30). For brevity, we set $N := \#\mathcal{L}_{(t^a, t^{2/3}]}^{t^a, \xi_t}$. Recall that, given $\mathcal{F}_{\mathcal{L}^{t^a, \xi_t}}$, the $\Omega^{(v)}$ for $v \in \mathcal{L}_{(t^a, t^{2/3}]}^{t^a, \xi_t}$ are independent with the same law as $Z_{t-T_u}(f, \gamma_t - \xi_t)$ under \mathbb{P} . Therefore, we have

$$\mathbb{P}\left(\sum_{v \in \mathcal{L}_{(t^a, t^{2/3}]}^{t^a, \xi_t}} |\Omega^{(v)}| \geq \frac{\varepsilon}{\sqrt{t}} \middle| \mathcal{F}_{\mathcal{L}^{t^a, \xi_t}}\right) \leq \sum_{v \in \mathcal{L}_{(t^a, t^{2/3}]}^{t^a, \xi_t}} \chi_3\left(T_u, \frac{\varepsilon e^{\xi_t}}{N\sqrt{t}}\right), \quad (4.31)$$

where we set $\chi_3(s, \delta) := \mathbb{P}(|Z_{t-s}(f, \gamma_t - \xi_t)| \geq \delta)$. We know by Proposition 4.4.1 that $Z_{t-s}(f - h_t(t-s), \gamma_t - \xi_t)$ is small and, moreover, since $t - s \simeq t$, $h_t(t-s)$ is closed to $h_t(t) = 0$. Therefore, we use the following decomposition

$$\chi_3(s, \delta) \leq \mathbb{P}\left(|Z_{t-s}(f - h_t(t-s), \gamma_t - \xi_t)| \geq \frac{\delta}{2}\right) + \mathbb{P}\left(|h_t(t-s)| |Z_{t-s}(1, \gamma_t - \xi_t)| \geq \frac{\delta}{2}\right).$$

On the one hand, introducing $A' := \{\forall r \in [0, t-s], \min_{u \in \mathcal{N}(r)} X_u(r) > -\log t\}$ and using (3.64), we have, for any $K > 0$,

$$\mathbb{P}(Z_{t-s}(1, \gamma_t - \xi_t) \geq K) \leq \frac{C}{t} + \frac{1}{K} \mathbb{E}[\mathbb{1}_{A'} Z_{t-s}(1, \gamma_t - \xi_t)] \leq \frac{C}{t} + \frac{C \log t}{K},$$

applying (4.15). On the other hand, using Lemma 4.C.5, we have $|h_t(t-s)| \leq Cs/(t-s)$. Therefore, combining this with Proposition 4.4.1, we get that, for any $\delta \in (0, 1]$ and $s \in [t^a, t^{2/3}]$,

$$\begin{aligned} \chi_3(s, \delta) &\leq C(\log(t-s))^3 \frac{t}{t-s} \left((t-s)^{-1/4} + \frac{1}{\delta} (t-s)^{-1/3}\right) + \frac{C}{t} + C \frac{1}{\delta} \frac{s}{t-s} \log t \\ &\leq C \frac{(\log t)^3}{t^{1/4}} + \frac{C}{\delta} (\log t)^3 t^{-1/3}. \end{aligned}$$

Since this bounds $\chi_3(s, \delta)$ uniformly in $s \in [t^a, t^{2/3}]$, it follows that (4.31) is smaller than

$$\begin{aligned} CN \frac{(\log t)^3}{t^{1/4}} + CN^2 \frac{\sqrt{t}}{\varepsilon e^{\xi_t}} (\log t)^3 t^{-1/3} &= C \left(t^{a/2} e^{-\xi_t} N\right) \frac{(\log t)^3}{t^{\frac{1}{4} - \frac{3\eta}{2}}} + \frac{C}{\varepsilon} \left(t^{a/2} e^{-\xi_t} N\right)^2 \frac{(\log t)^3}{t^{\frac{1}{12} - 2\eta}} \\ &\xrightarrow{t \rightarrow \infty} 0, \end{aligned}$$

in probability by Lemma 4.4.5 and using that $\eta < 1/24$. Therefore, the first term of the left-hand side of (4.30) tends to 0 and it concludes the proof. \square

Proof of Lemma 4.5.3. It follows from (4.22) that

$$\mathbb{E}\left[\#\mathcal{L}_{(t_2, t]}^{t, \gamma_t} \middle| \mathcal{F}_{t^a}\right] \leq C e^{\gamma t} Z_{t^a}(1, \xi_t) \int_{t_2 - t^a}^{t - t^a} \frac{dr}{r^{3/2}} \leq C e^{\gamma t} Z_{t^a}(1, \xi_t) \frac{t - t_2}{t^{3/2}} = C Z_{t^a}(1, \xi_t) e^{-\beta t/2} \\ \xrightarrow[t \rightarrow \infty]{} 0,$$

in probability, recalling that $e^{\gamma t} = \sqrt{t} e^{\beta t}$ and $t - t_2 = t e^{3\beta t/2}$. The result follows. \square

Proof of Lemma 4.5.1. Combining Lemmas 4.5.2 and 4.5.3, it is now sufficient to prove that

$$\mathbb{P}\left(\sum_{u \in \mathcal{L}_{(t_1, t_2]}^{t^a, \gamma_t}} \left| \Omega_t^{(u)} - h_t(t - T_u) e^{-\gamma t} Z_\infty^{(u)} \right| \geq \frac{\varepsilon}{\sqrt{t}}\right) \xrightarrow[t \rightarrow \infty]{} 0. \quad (4.32)$$

For this, we proceed similarly as in (4.31). For brevity, we set $N := \#\mathcal{L}_{(t_1, t_2]}^{t^a, \gamma_t}$. Using that, conditionally on $\mathcal{F}_{\mathcal{L}_{t^a, \gamma_t}}$, the $\Omega_t^{(u)} - h_t(t - T_u) e^{-\gamma t} Z_\infty^{(u)}$ for $u \in \mathcal{L}_{(t_1, t_2]}^{t^a, \gamma_t}$ are independent with the same law as $e^{-\gamma t} (Z_{t - T_u}(f, 0) - h_t(t - T_u) Z_\infty)$ under \mathbb{P} , we get

$$\mathbb{P}\left(\sum_{u \in \mathcal{L}_{(t_1, t_2]}^{t^a, \gamma_t}} \left| \Omega_t^{(u)} - h_t(t - T_u) e^{-\gamma t} Z_\infty^{(u)} \right| \geq \frac{\varepsilon}{\sqrt{t}} \middle| \mathcal{F}_{\mathcal{L}_{t^a, \gamma_t}}\right) \leq \sum_{u \in \mathcal{L}_{(t_1, t_2]}^{t^a, \gamma_t}} \chi_4\left(T_u, \frac{\varepsilon e^{\gamma t}}{N \sqrt{t}}\right), \quad (4.33)$$

where we set $\chi_4(s, \delta) := \mathbb{P}(|Z_{t-s}(f, 0) - h_t(t-s) Z_\infty| \geq \delta)$. Then, we use the following decomposition

$$\chi_4(s, \delta) \leq \mathbb{P}\left(|Z_{t-s}(f - h_t(t-s), 0)| \geq \frac{\delta}{2}\right) + \mathbb{P}\left(|h_t(t-s)(Z_{t-s} - Z_\infty)| \geq \frac{\delta}{2}\right).$$

Using Lemma 4.C.5, we have $|h_t(t-s)| \leq C \sqrt{t/(t-s)}$. Therefore, using Propositions 4.4.1 and 3.1.5, we get

$$\chi_4(s, \delta) \leq C \frac{t}{t-s} (\log(t-s))^3 \left((t-s)^{-1/4} + \frac{1}{\delta} (t-s)^{-1/3} \right) + \frac{C}{\delta} \sqrt{\frac{t}{t-s}} \frac{(\log(t-s))^2}{\sqrt{t-s}} \\ = C e^{3\beta t/2} (\log t)^3 \left(t^{-1/4} e^{3\beta t/8} + \frac{1}{\delta} t^{-1/3} e^{\beta t/2} \right) + \frac{C}{\delta} (\log t)^2 t^{-1/2} e^{3\beta t/2} \\ \leq C \frac{(\log t)^3}{t^{1/4}} e^{2\beta t} + \frac{C}{\delta} \frac{(\log t)^3}{t^{1/3}} e^{2\beta t},$$

using that $t \geq t-s \geq t-t_2 = t e^{-3\beta t/2}$. Therefore, (4.33) is smaller than

$$N \left(C \frac{(\log t)^3}{t^{1/4}} e^{2\beta t} + C \frac{N \sqrt{t} (\log t)^3}{\varepsilon e^{\gamma t} t^{1/3}} e^{2\beta t} \right) \\ \leq C \frac{(\log t)^3}{t^{\frac{1}{12} + \frac{\eta}{2}}} e^{3\beta t} \left(\sqrt{t_1} e^{-\gamma t} N \right) + C \frac{(\log t)^3}{\varepsilon t^\eta} e^{3\beta t} \left(\sqrt{t_1} e^{-\gamma t} N \right)^2 \xrightarrow[t \rightarrow \infty]{} 0,$$

in probability, using Lemma 4.4.5 and that $\beta_t = o(\log t)$ by (4.3). It proves (4.32). \square

4.5.3 Proof of Proposition 4.2.5

In this section, we prove the convergence in law for the contributions of the killed particles. Using Lemma 4.5.1 and recalling that $t_1 = t^{\frac{2}{3}+\eta}$ and $t_2 = t - te^{-3\beta t/2}$, the convergence in Proposition 4.2.5 is equivalent to the following convergence in probability,

$$\mathbb{E} \left[\exp \left(i\lambda \left(\sum_{u \in \mathcal{L}_{[t_1, t_2]}^{t_a, \gamma_t}} e^{-\beta t} h_t(t - T_u) Z_\infty^{(u)} - \tilde{c}_3(f) \beta_t Z_\infty \right) \right) \middle| \mathcal{F}_{t_a} \right] \xrightarrow{t \rightarrow \infty} \mathbb{E} \left[e^{i\lambda \tilde{S}_{Z_\infty}^f} \middle| Z_\infty \right]. \quad (4.34)$$

using that $e^{\gamma t} = \sqrt{t} e^{\beta t}$. We recall that $H(v) = \mathbb{E}[f(\sqrt{v}R_1)]$, $h_t(s) = H(s/t)$ and

$$\tilde{c}_3(f) := \frac{1}{\sqrt{2\pi}} \int_0^1 H(1-u) \frac{du}{u^{3/2}},$$

because we work in the case $\mathbb{E}[f(R_1)] = 0$. We split the proof of the convergence (4.34) into the two following lemmas.

Lemma 4.5.4. *Let $f: \mathbb{R} \rightarrow \mathbb{R}_+$ be a function satisfying Assumptions (i)-(ii) and such that $\mathbb{E}[f(R_1)] = 0$. If $a = \frac{1}{2} - \eta$ for some $\eta \in (0, \frac{1}{24})$, $t_1 = t^{\frac{2}{3}+\eta}$ and $t_2 = t - te^{-3\beta t/2}$, then we have the following convergence in probability*

$$\mathbb{E} \left[\exp \left(i\lambda \sum_{u \in \mathcal{L}_{[t_1, t_2]}^{t_a, \gamma_t}} e^{-\beta t} h_t(t - T_u) (Z_\infty^{(u)} - \beta_t) \right) \middle| \mathcal{F}_{t_a} \right] \xrightarrow{t \rightarrow \infty} \mathbb{E} \left[e^{i\lambda \tilde{S}_{Z_\infty}^f} \middle| Z_\infty \right].$$

Lemma 4.5.5. *Let $f: \mathbb{R} \rightarrow \mathbb{R}_+$ be a function satisfying Assumptions (i)-(ii) and such that $\mathbb{E}[f(R_1)] = 0$. If $a = \frac{1}{2} - \eta$ for some $\eta \in (0, \frac{1}{24})$, $t_1 = t^{\frac{2}{3}+\eta}$ and $t_2 = t - te^{-3\beta t/2}$, then we have the following convergence in probability*

$$\beta_t \left(\sum_{u \in \mathcal{L}_{[t_1, t_2]}^{t_a, \gamma_t}} e^{-\beta t} h_t(t - T_u) - \tilde{c}_3(f) Z_\infty \right) \xrightarrow{t \rightarrow \infty} 0.$$

Instead of proving Lemma 4.5.5, we prove the following slightly more general result that will also be useful in the proof of Lemma 4.5.4.

Lemma 4.5.6. *Let $f: \mathbb{R} \rightarrow \mathbb{R}_+$ be a function satisfying Assumptions (i)-(ii) and such that $\mathbb{E}[f(R_1)] = 0$. Let $\Upsilon: \mathbb{R} \rightarrow \mathbb{C}$ be a continuous function such that there exists $C > 0$ such that, for any $x \in \mathbb{R}$, $|\Upsilon(x)| \leq C|x|(1 + |\log|x||)$. If $a = \frac{1}{2} - \eta$ for some $\eta \in (0, \frac{1}{24})$, $t_1 = t^{\frac{2}{3}+\eta}$ and $t_2 = t - te^{-3\beta t/2}$, then we have the following convergence in probability*

$$\beta_t \left(\sum_{u \in \mathcal{L}_{[t_1, t_2]}^{t_a, \gamma_t}} e^{-\beta t} \Upsilon(h_t(t - T_u)) - \frac{Z_\infty}{\sqrt{2\pi}} \int_0^1 \Upsilon(H(1-u)) \frac{du}{u^{3/2}} \right) \xrightarrow{t \rightarrow \infty} 0.$$

Proof of Lemma 4.5.6. For any $u \in [0, 1]$, it follows from Lemma 4.C.5 that $|H(1-u)| \leq Cu/\sqrt{1-u}$. We have also, for any $x \in \mathbb{R}$, $|\Upsilon(x)| \leq C|x|(1 + |\log|x||)$, and since $x \in \mathbb{R}_+ \mapsto x(1 + |\log|x||)$ is non decreasing, we get

$$|\Upsilon(h_t(t - ut))| = |\Upsilon(H(1-u))| \leq C \frac{u}{\sqrt{1-u}} \left(1 + \left| \log \frac{u}{\sqrt{1-u}} \right| \right). \quad (4.35)$$

Thus, we get

$$\int_0^1 |\Upsilon(H(1-u))| \frac{du}{u^{3/2}} < \infty, \quad (4.36)$$

so the integral in the result is well defined.

The idea of the proof is to use a first and second moment calculation given \mathcal{F}_{t^a} to prove that the sum converges to the integral faster than $1/\beta_t$. For technical reasons, we have first to reduce again the time interval where we are working, by choosing $[t_3, t_4] \subset [t_1, t_2]$. We set $t_3 := t\beta_t^{-4}$, $t_4 := t - t\beta_t^{-4}$ and

$$\Xi_t := \sum_{u \in \mathcal{L}_{[t_3, t_4]}^{t^a, \gamma_t}} e^{-\beta_t} \Upsilon(h_t(t - T_u)) - \frac{Z_{t^a}(1, \gamma_t)}{\sqrt{2\pi}} \int_{t_3/t}^{t_4/t} \Upsilon(H(1-u)) \frac{du}{u^{3/2}}.$$

The first step consists of showing that $\beta_t \Xi_t \rightarrow 0$ in probability, by the means of a first and second moment calculation. Let start with the first moment. Using (4.22), we have

$$\begin{aligned} & \mathbb{E} \left[\sum_{u \in \mathcal{L}_{[t_3, t_4]}^{t^a, \gamma_t}} \Upsilon(h_t(t - T_u)) \middle| \mathcal{F}_{t^a} \right] \\ &= \sum_{v \in \mathcal{N}(t^a)} (X_v(t^a) - \gamma_t)_+ e^{-(X_v(t^a) - \gamma_t)} \int_{t_3}^{t_4} \frac{e^{-(X_v(t^a) - \gamma_t)^2/2(r-t^a)}}{\sqrt{2\pi}(r-t^a)^{3/2}} \Upsilon(h_t(t-r)) dr \\ &= e^{\beta_t} \sum_{v \in \mathcal{N}(t^a)} (X_v(t^a) - \gamma_t)_+ e^{-X_v(t^a)} \int_{t_3/t}^{t_4/t} \frac{e^{-(X_v(t^a) - \gamma_t)^2/2(ut-t^a)}}{\sqrt{2\pi}(u-t^{a-1})^{3/2}} \Upsilon(H(1-u)) du, \end{aligned}$$

with $u = r/t$. Therefore, we have

$$\begin{aligned} & |\mathbb{E}[\Xi_t | \mathcal{F}_{t^a}]| \\ & \leq \sum_{v \in \mathcal{N}(t^a)} (X_v(t^a) - \gamma_t)_+ e^{-X_v(t^a)} \int_{t_3/t}^{t_4/t} \left| \frac{e^{-(X_v(t^a) - \gamma_t)^2/2(ut-t^a)}}{(1-t^{a-1}/u)^{3/2}} - 1 \right| \frac{|\Upsilon(H(1-u))|}{\sqrt{2\pi}u^{3/2}} du. \end{aligned}$$

Now, for $y > 0$ and $u \in [t_3/t, 1]$, we have

$$\begin{aligned} & \left| \frac{e^{-y^2/2(ut-t^a)}}{(1-t^{a-1}/u)^{3/2}} - 1 \right| \leq e^{-y^2/2(ut-t^a)} \left| \frac{1}{(1-t^{a-1}/u)^{3/2}} - 1 \right| + \left| e^{-y^2/2(ut-t^a)} - 1 \right| \\ & \leq \left| \frac{1}{(1-t^a/t_3)^{3/2}} - 1 \right| + \frac{y^2}{2(ut-t^a)} \\ & \leq C \left(\frac{t^a}{t_3} + \frac{y^2}{t_3} \right) = C \beta_t^4 \frac{t^a}{t} \left(1 + \frac{y^2}{t^a} \right), \end{aligned}$$

for t large enough, recalling that $t_3 = t\beta_t^{-4}$, and it leads to

$$\begin{aligned} & |\mathbb{E}[\Xi_t | \mathcal{F}_{t^a}]| \\ & \leq \sum_{v \in \mathcal{N}(t^a)} (X_v(t^a) - \gamma_t)_+ e^{-X_v(t^a)} C \beta_t^4 \frac{t^a}{t} \left(1 + \frac{(X_v(t^a) - \gamma_t)^2}{t^a} \right) \int_0^1 \frac{|\Upsilon(H(1-u))|}{u^{3/2}} du \\ & \leq C \beta_t^4 \frac{t^a}{t} Z_{t^a}(x \mapsto 1+x^2, \gamma_t, t^a), \end{aligned} \quad (4.37)$$

because the integral is finite. Now, we deal with the second moment. First note that, using again (4.35) and that $x \in \mathbb{R}_+ \mapsto x(1 + |\log x|)$ is increasing, we have, for $u \in [t_3/t, t_4/t]$,

$$|\Upsilon(h_t(t - ut))| \leq C \frac{t_4/t}{\sqrt{1 - t_4/t}} \left(1 + \left| \log \frac{t_4/t}{\sqrt{1 - t_4/t}} \right| \right) \leq C \beta_t^2 (1 + \log \beta_t^2) \leq C \beta_t^3, \quad (4.38)$$

for t large enough. Then, it follows from the branching property at time t^a that

$$\begin{aligned} \text{Var}(\Xi_t | \mathcal{F}_{t^a}) &= \text{Var} \left(\sum_{u \in \mathcal{L}_{[t_3, t_4]}^{t^a, \gamma_t}} e^{-\beta_t} \Upsilon(h_t(t - T_u)) \middle| \mathcal{F}_{t^a} \right) \\ &\leq C e^{-2\beta_t} \beta_t^6 \sum_{v \in \mathcal{N}(t^a)} \mathbb{1}_{X_v(t^a) > \gamma_t} \mathbb{E}_{X_v(t^a) - \gamma_t} \left[(\#\mathcal{L}_{[t_3 - t^a, t_4 - t^a]})^2 \right], \end{aligned}$$

applying (4.38) and using notation of Section 4.3.3. Applying Lemma 4.3.7, it proves

$$\text{Var}(\Xi_t | \mathcal{F}_{t^a}) \leq C e^{-2\beta_t} \beta_t^6 e^{\gamma_t} \frac{Z_{t^a}(1, \gamma_t)}{\sqrt{t_3}} = C e^{-\beta_t} \beta_t^8 Z_{t^a}(1, \gamma_t). \quad (4.39)$$

For $\varepsilon > 0$, we can now apply Markov's and Chebyshev's inequalities given \mathcal{F}_{t^a} to get

$$\begin{aligned} \mathbb{P} \left(|\Xi_t| \geq \frac{\varepsilon}{\beta_t} \middle| \mathcal{F}_{t^a} \right) &\leq \mathbb{1}_{|\mathbb{E}[\Xi_t | \mathcal{F}_{t^a}]| \geq \varepsilon / (2\beta_t)} + \mathbb{P} \left(|\Xi_t - \mathbb{E}[\Xi_t | \mathcal{F}_{t^a}]| \geq \frac{\varepsilon}{2\beta_t} \middle| \mathcal{F}_{t^a} \right) \\ &\leq \frac{2\beta_t}{\varepsilon} |\mathbb{E}[\Xi_t | \mathcal{F}_{t^a}]| + \left(\frac{2\beta_t}{\varepsilon} \right)^2 \text{Var}(\Xi_t | \mathcal{F}_{t^a}) \\ &\leq \left(\frac{C}{\varepsilon} \beta_t^5 \frac{t^a}{t} + \frac{C}{\varepsilon^2} \beta_t^{10} e^{-\beta_t} \right) Z_{t^a}(x \mapsto 1 + x^2, \gamma_t, t^a), \end{aligned}$$

applying (4.37) and (4.39). But, it follows from Remark 4.3.4 that $(Z_{t^a}(x \mapsto 1 + x^2, \gamma_t, t^a))_{t \geq 1}$ is tight and, therefore, it proves that

$$\mathbb{P} \left(|\Xi_t| \geq \frac{\varepsilon}{\beta_t} \right) \xrightarrow[t \rightarrow \infty]{} 0 \quad (4.40)$$

and concludes the first step.

The second step consists of dealing with the remaining terms, that are

$$\begin{aligned} \Xi_t^{(1)} &:= \sum_{u \in \mathcal{L}_{[t_1, t_3] \cup [t_4, t_2]}^{t^a, \gamma_t}} e^{-\beta_t} \Upsilon(h_t(t - T_u)), \\ \Xi_t^{(2)} &:= \frac{Z_{t^a}(1, \gamma_t)}{\sqrt{2\pi}} \left(\int_0^1 \Upsilon(H(1 - u)) \frac{du}{u^{3/2}} - \int_{t_3/t}^{t_4/t} \Upsilon(H(1 - u)) \frac{du}{u^{3/2}} \right), \\ \Xi_t^{(3)} &:= \frac{Z_\infty - Z_{t^a}(1, \gamma_t)}{\sqrt{2\pi}} \int_0^1 \Upsilon(H(1 - u)) \frac{du}{u^{3/2}}, \end{aligned}$$

so that the convergence of Lemma 4.5.6 can be written $\beta_t(\Xi_t + \Xi_t^{(1)} - \Xi_t^{(2)} - \Xi_t^{(3)}) \rightarrow 0$ in probability. For $\Xi_t^{(3)}$, recalling that the integral is finite, we have to prove that $\beta_t(Z_{t^a}(1, \gamma_t) - Z_\infty) \rightarrow 0$ in probability. But, we have $Z_{t^a}(1, \gamma_t) = Z_{t^a} - \gamma_t W_{t^a}$ and it follows from Proposition 3.1.5 that $\beta_t(Z_{t^a} - Z_\infty) \rightarrow 0$ in probability, and from (4.2) that $\beta_t \gamma_t W_{t^a} \rightarrow 0$. Thus, it proves that $\beta_t \Xi_t^{(3)} \rightarrow 0$ in probability. We now deal with $\Xi_t^{(2)}$. For this, we bound the following integrals, by applying (4.35),

$$\begin{aligned} \int_0^{t_3/t} |\Upsilon(H(1 - u))| \frac{du}{u^{3/2}} &\leq \int_0^{t_3/t} C \frac{u}{\sqrt{1 - u}} \left(1 + \left| \log \frac{u}{\sqrt{1 - u}} \right| \right) \frac{du}{u^{3/2}} \leq C \int_0^{t_3/t} |\log u| \frac{du}{\sqrt{u}} \\ &\leq C \sqrt{\frac{t_3}{t}} \log \left(\frac{t}{t_3} \right) = C \beta_t^{-2} \log \beta_t, \end{aligned} \quad (4.41)$$

and, with the same method,

$$\begin{aligned} \int_{t_4/t}^t |\Upsilon(H(1-u))| \frac{du}{u^{3/2}} &\leq \int_{t_4/t}^t C \frac{u}{\sqrt{1-u}} \left(1 + \left| \log \frac{u}{\sqrt{1-u}} \right| \right) \frac{du}{u^{3/2}} \\ &\leq C \int_{t_4/t}^t \left| \log \sqrt{1-u} \right| \frac{du}{\sqrt{1-u}} \\ &\leq C \beta_t^{-2} \log \beta_t. \end{aligned} \quad (4.42)$$

Combining (4.41) and (4.42), we get that $\beta_t |\Xi_t^{(2)}| \leq C \beta_t^{-1} (\log \beta_t) Z_{t^a}(1, \gamma_t) \rightarrow 0$, since $Z_{t^a}(1, \gamma_t) \rightarrow Z_\infty$. Finally, we deal with $\Xi_t^{(1)}$, by bounding its first moment given \mathcal{F}_{t^a} : using (4.22) and noting that, for $r \geq t_1$, $r - t^a \geq r/2$ for t large enough because $t_1 = t^{\frac{2}{3}+\eta} \gg t^{\frac{1}{2}-\eta} = t^a$, we have

$$\begin{aligned} \mathbb{E} \left[\beta_t |\Xi_t^{(1)}| \middle| \mathcal{F}_{t^a} \right] &\leq C \beta_t e^{\gamma t} Z_{t^a}(1, \gamma_t) \int_{[t_1, t_3] \cup [t_4, t_2]} e^{-\beta_t \frac{|\Upsilon(h_t(t-r))|}{(r-t^a)^{3/2}}} dr \\ &\leq C \beta_t Z_{t^a}(1, \gamma_t) \int_{[0, t_3/t] \cup [t_4/t, 1]} \frac{|\Upsilon(H(1-u))|}{u^{3/2}} du \\ &\leq C Z_{t^a}(1, \gamma_t) \beta_t^{-1} \log \beta_t \xrightarrow{t \rightarrow \infty} 0, \quad \text{in probability,} \end{aligned}$$

applying again (4.41) and (4.42), and it follows that $\beta_t \Xi_t^{(1)} \rightarrow 0$ in probability. Therefore, we showed that $\beta_t \Xi_t^{(i)} \rightarrow 0$ in probability for each $i \in \{1, 2, 3\}$ and, combining this with (4.40), it concludes the proof. \square

Proof of Lemma 4.5.4. For brevity, we introduce

$$\Gamma_t := \sum_{u \in \mathcal{L}_{[t_1, t_2]}^{t^a, \gamma_t}} e^{-\beta_t} h_t(t - T_u) \left(Z_\infty^{(u)} - \beta_t \right).$$

Recalling the definition of $\mathbb{E}[e^{i\lambda \tilde{S}(f)} | Z_\infty]$ in Theorem 4.2.1, first note that it is sufficient to prove that, for any $\lambda \in \mathbb{R}$, the following convergence holds in probability

$$\mathbb{E} \left[e^{i\lambda \Gamma_t} \middle| \mathcal{F}_{\mathcal{L}^{t^a, \gamma_t}} \right] \xrightarrow{t \rightarrow \infty} \exp \left(-Z_\infty [\tilde{c}_2(f) |\lambda| + i\lambda (\tilde{c}_3(f) \log |\lambda| + \tilde{c}_4(f))] \right). \quad (4.43)$$

Indeed, the limit can be approximated by replacing Z_∞ by Z_{t^a} and then one can take the conditional expectation given \mathcal{F}_{t^a} . We now compute the conditional expectation of Γ_t given $\mathcal{F}_{\mathcal{L}^{t^a, \gamma_t}}$: for $\lambda \in \mathbb{R}$, we have

$$\mathbb{E} \left[e^{i\lambda \Gamma_t} \middle| \mathcal{F}_{\mathcal{L}^{t^a, \gamma_t}} \right] = \prod_{u \in \mathcal{L}_{[t_1, t_2]}^{t^a, \gamma_t}} \Psi_{Z_\infty} \left(\lambda e^{-\beta_t} h_t(t - T_u) \right) \exp \left(-i\lambda \beta_t e^{-\beta_t} h_t(t - T_u) \right), \quad (4.44)$$

where Ψ_{Z_∞} denotes the characteristic function of Z_∞ . Recall that we proved in Lemma 3.C.1 that there exists a continuous function $\psi: \mathbb{R} \rightarrow \mathbb{C}$, with $\psi(0) = 0$, such that for any $\lambda \in \mathbb{R}$,

$$\Psi_{Z_\infty}(\lambda) = \exp \left(-\frac{\pi}{2} |\lambda| + i\lambda (-\log |\lambda| + \mu_Z) + \lambda \psi(\lambda) \right), \quad (4.45)$$

where $\mu_Z \in \mathbb{R}$ is a constant. Using this development of Ψ_{Z_∞} around 0, we get

$$\begin{aligned} &\Psi_{Z_\infty} \left(\lambda e^{-\beta_t} h_t(t - T_u) \right) \exp \left(-i\lambda \beta_t e^{-\beta_t} h_t(t - T_u) \right) \\ &= \exp \left(-\frac{\pi}{2} \left| \lambda e^{-\beta_t} h_t(t - T_u) \right| + i\lambda e^{-\beta_t} h_t(t - T_u) (-\log |\lambda h_t(t - T_u)| + \mu_Z) \right. \\ &\quad \left. + \lambda e^{-\beta_t} h_t(t - T_u) \psi \left(\lambda e^{-\beta_t} h_t(t - T_u) \right) \right) \\ &= \exp \left(e^{-\beta_t} \Upsilon_\lambda(h_t(t - T_u)) + \lambda e^{-\beta_t} h_t(t - T_u) \psi \left(\lambda e^{-\beta_t} h_t(t - T_u) \right) \right), \end{aligned}$$

with $\Upsilon_\lambda(x) := -\frac{\pi}{2}|\lambda x| + i\lambda x(-\log|\lambda x| + \mu_Z)$. Therefore, (4.44) is equal to

$$\exp\left(e^{-\beta t} \sum_{u \in \mathcal{L}_{[t_1, t_2]}^{t^a, \gamma_t}} \left[\Upsilon_\lambda(h_t(t - T_u)) + \lambda h_t(t - T_u) \psi(\lambda e^{-\beta t} h_t(t - T_u)) \right]\right).$$

Then, using that, for any $z_1, z_2 \in \{z \in \mathbb{C} : \operatorname{Re}(z) \leq 0\}$, $|e^{z_1} - e^{z_2}| \leq 2 \wedge |z_2 - z_1|$.

$$\begin{aligned} & \left| \mathbb{E}\left[e^{i\lambda \Gamma_t} \middle| \mathcal{F}_{\mathcal{L}^{t^a, \gamma_t}}\right] - \exp\left(e^{-\beta t} \sum_{u \in \mathcal{L}_{[t_1, t_2]}^{t^a, \gamma_t}} \Upsilon_\lambda(h_t(t - T_u))\right) \right| \\ & \leq e^{-\beta t} \sum_{u \in \mathcal{L}_{[t_1, t_2]}^{t^a, \gamma_t}} \left| \lambda h_t(t - T_u) \psi(\lambda e^{-\beta t} h_t(t - T_u)) \right|. \end{aligned} \quad (4.46)$$

Now, we prove that the right-hand side of (4.46) tends to 0 in probability. Let $\bar{\psi}$ be a continuous nondecreasing function on \mathbb{R}_+ with $\bar{\psi}(0) = 0$ and such that, for any $\lambda \in \mathbb{R}$, $\psi(\lambda) \leq \bar{\psi}(|\lambda|)$. Then, using (4.22), we have

$$\begin{aligned} & e^{-\beta t} \mathbb{E} \left[\sum_{u \in \mathcal{L}_{[t_1, t_2]}^{t^a, \gamma_t}} \left| \lambda h_t(t - T_u) \psi(\lambda e^{-\beta t} h_t(t - T_u)) \right| \middle| \mathcal{F}_{t^a} \right] \\ & \leq C\sqrt{t} Z_{t^a}(1, \gamma_t) \int_{t_1}^{t_2} |\lambda h_t(t - r)| \bar{\psi}\left(|\lambda e^{-\beta t} h_t(t - r)|\right) \frac{dr}{(r - t^a)^{3/2}}. \end{aligned} \quad (4.47)$$

Note that, for $r \geq t_1$, $r - t^a \geq r/2$ for t large enough because $t_1 = t^{\frac{2}{3} + \eta} \gg t^{\frac{1}{2} - \eta} = t^a$. Moreover, applying Lemma 4.C.5, we have $|h_t(t - r)| \leq Cr/\sqrt{t(t - r)}$. Therefore, using that $\bar{\psi}$ is nondecreasing and recalling that $t - t_2 = te^{-3\beta t/2}$, we get that (4.47) is smaller than

$$\begin{aligned} & C\sqrt{t} Z_{t^a}(1, \gamma_t) \int_{t_1}^{t_2} \frac{r}{\sqrt{t(t - r)}} \bar{\psi}\left(|\lambda| e^{-\beta t} C \frac{t}{\sqrt{t \cdot te^{-3\beta t/2}}}\right) \frac{dr}{r^{3/2}} \\ & \leq CZ_{t^a}(1, \gamma_t) \bar{\psi}\left(C|\lambda| e^{-\beta t/4}\right) \int_0^t \frac{dr}{\sqrt{r(t - r)}} \\ & = CZ_{t^a}(1, \gamma_t) \bar{\psi}\left(C|\lambda| e^{-\beta t/4}\right) \xrightarrow[t \rightarrow \infty]{} 0, \quad \text{in probability,} \end{aligned}$$

because $Z_{t^a}(1, \gamma_t) \rightarrow Z_\infty < \infty$ in probability and $\bar{\psi}(x) \rightarrow 0$ as $x \rightarrow 0$. Therefore, the right-hand side of (4.46) tends to 0 in probability. On the other hand, using Lemma 4.5.6, we have, in probability

$$\exp\left(e^{-\beta t} \sum_{u \in \mathcal{L}_{[t_1, t_2]}^{t^a, \gamma_t}} \Upsilon_\lambda(h_t(t - T_u))\right) \xrightarrow[t \rightarrow \infty]{} \exp\left(\frac{Z_\infty}{\sqrt{2\pi}} \int_0^1 \Upsilon_\lambda(H(1 - u)) \frac{du}{u^{3/2}}\right). \quad (4.48)$$

The right-hand side of (4.48) coincides with the right-hand side of (4.43), recalling the definition of the $\tilde{c}_i(f)$'s in Theorem 4.2.1 with here $\mathbb{E}[f(R_1)] = 0$ and that we set $\Upsilon_\lambda(x) = -\frac{\pi}{2}|\lambda x| + i\lambda x(-\log|\lambda x| + \mu_Z)$ for any $x \in \mathbb{R}$. This concludes the proof. \square

4.6 From centring around γ_t to centring around 0

Proof of Proposition 4.2.2. We introduce the event $E_t := \{\min_{u \in \mathcal{N}(t)} X_u(t) > \gamma_t\}$. Using (3.65), we have $\mathbb{P}((E_t)^c) \leq C(\log t)^2 e^{\gamma_t} t^{-3/2} \rightarrow 0$ as $t \rightarrow \infty$ and, therefore it is sufficient to

prove that

$$\mathbb{1}_{E_t} \sqrt{t} \left(Z_t(f) - Z_t(f, \gamma_t) - \tilde{c}_1(f) Z_\infty \frac{\gamma_t}{\sqrt{t}} \right) \xrightarrow[t \rightarrow \infty]{} 0. \quad (4.49)$$

Firstly, on event E_t , we have

$$\begin{aligned} Z_t(f) - Z_t(f, \gamma_t) &= \sum_{u \in \mathcal{N}(t)} e^{-X_u(t)} \left[X_u(t) f \left(\frac{X_u(t)}{\sqrt{t}} \right) - (X_u(t) - \gamma_t) f \left(\frac{X_u(t) - \gamma_t}{\sqrt{t}} \right) \right] \mathbb{1}_{X_u(t) > \gamma_t} \\ &= Z_t(\Phi_t), \end{aligned}$$

where we set $\delta_t := \gamma_t/\sqrt{t}$ and, for $x \in \mathbb{R}$, $\Phi_t(x) := [f(x) - (x - \delta_t)f(x - \delta_t)] \mathbb{1}_{x > \delta_t}$. Recall that $g(x) = xf(x)$ for any $x > 0$ and that we work here under Assumption (iii), so g is differentiable on \mathbb{R}_+^* and g' satisfies Assumptions (i) and (ii). Then, (4.49) follows from the two convergences in probability:

$$\mathbb{1}_{E_t} \sqrt{t} \left(Z_t(\Phi_t) - \delta_t Z_t \left(x \mapsto \frac{g'(x)}{x} \right) \right) \xrightarrow[t \rightarrow \infty]{} 0, \quad (4.50)$$

$$\gamma_t \left(Z_t \left(x \mapsto \frac{g'(x)}{x} \right) - \mathbb{E} \left[\frac{g'(R_1)}{R_1} \right] Z_\infty \right) \xrightarrow[t \rightarrow \infty]{} 0, \quad (4.51)$$

recalling that $\tilde{c}_1(f) = \mathbb{E}[f'(R_1) + f(R_1)/R_1] = \mathbb{E}[g'(R_1)/R_1]$. Convergence (4.51) follows from Proposition 4.4.1 applied to the function $x \mapsto g'(x)/x$ instead of f (using here that g' satisfies Assumptions (i) and (ii)) and combined with Proposition 3.1.5. Therefore, we now prove (4.50). For $x > \delta_t$, we have

$$\Phi_t(x) = \frac{1}{x} (g(x) - g(x - \delta_t)) = \frac{1}{x} \int_0^{\delta_t} g'(x - u) du.$$

Then, using Assumption (ii) for g' with $\delta = u/x$, we get, for any $x > \delta_t$,

$$\left| \Phi_t(x) - \delta_t \frac{g'(x)}{x} \right| \leq \frac{1}{x} \int_0^{\delta_t} |g'(x - u) - g'(x)| du \leq \frac{1}{x} \int_0^{\delta_t} \frac{Cu}{x} e^{Cx} du \leq C \delta_t^2 \frac{e^{Cx}}{x^2}.$$

Thus, it follows that

$$\mathbb{1}_{E_t} \sqrt{t} \left| Z_t(\Phi_t) - \delta_t Z_t \left(x \mapsto \frac{g'(x)}{x} \right) \right| \leq C \frac{\gamma_t^2}{\sqrt{t}} \mathbb{1}_{E_t} Z_t \left(x \mapsto \frac{e^{Cx}}{x^2} \right). \quad (4.52)$$

Since $\gamma_t^2/\sqrt{t} \rightarrow 0$, it suffices now to show that $(\mathbb{1}_{E_t} Z_t(x \mapsto x^{-2}e^{Cx}))_{t>0}$ is tight in order to get that the right-hand side of (4.52) tends to 0 in probability.

We can not apply directly Remark 4.3.4, because the function $x \mapsto x^{-2}e^{Cx}$ does not satisfy Assumption (i). However, we proceed in a similar way. For some $M > 0$, we introduce the event $A := \{\forall r \in [0, t], \min_{u \in \mathcal{N}(r)} X_u(r) > -M\}$ and bound the following first moment, using that, on event E_t , $X_u(t) > \gamma_t \geq M$ for any $u \in \mathcal{N}(t)$,

$$\begin{aligned} &\mathbb{E} \left[\left| Z_t \left(x \mapsto \frac{e^{Cx}}{x^2} \right) \right| \mathbb{1}_{A \cap E_t} \right] \\ &\leq \mathbb{E}_M \left[\sum_{u \in \mathcal{N}(t)} e^{-(X_u(t) - M)} \frac{t e^{C(X_u(t) - M)/\sqrt{t}}}{X_u(t) - M} \mathbb{1}_{\forall r \in [0, t], X_u(r) > 0} \mathbb{1}_{X_u(t) > 2M} \right] \\ &= \mathbb{E}_M \left[\frac{M t e^{C(R_t - M)/\sqrt{t}}}{R_t} \frac{1}{R_t - M} \mathbb{1}_{R_t > 2M} \right], \end{aligned} \quad (4.53)$$

applying the many-to-one formula (4.7). If $R_t > 2M$, we have $R_t - M \geq R_t/2$ and, therefore, using the scaling property of the Bessel process, (4.53) is smaller than $M\mathbb{E}_M[(R_1)^{-2}e^{CR_1}]$, which is finite and depends only on M . Therefore, the tightness of $(\mathbb{1}_{E_t}Z_t(x \mapsto x^{-2}e^{Cx}))_{t>0}$ follows as in Remark 4.3.4 and it concludes the proof. \square

4.A Weakening the condition on β_t

In Section 4.5.1, Proposition 4.2.4 has been proved with the additional assumption $\log t = o(e^{\beta t})$. This is sufficient in order to prove the main results of this chapter, but nonetheless it is also interesting to see that we can assume only that $\beta_t \rightarrow \infty$: it shows that the fluctuations of the critical Gibbs measure of BBM are due to the particles that come down to $\frac{1}{2} \log t + O(1)$ between times t^a and t .

4.A.1 Introducing the multi-level barrier

The issue in the proof of Proposition 4.2.4, that makes necessary the assumption $\log t = o(e^{\beta t})$, comes from the $\log t/\sqrt{t}$ term that appears in the bound of the second moment of $\tilde{Z}_{t-t^a}(f, 0)$ when applying Lemma 4.3.5. We do not believe that the calculations in the proof of Lemma 4.3.5 can be improved: this $\log t$ factor come from the fact that we allow $f(x)$ to grow as x^{-1} as $x \rightarrow 0$, see also Lemma 3.4.11 where this term appears for the second moment of $\sqrt{t}W_t$ when particles are killed at 0.

Therefore, we have to kill more particles before computing the second moment: for this, we introduce a multi-level barrier. Let $\log^{\circ k} = \log \circ \dots \circ \log$ denote the log function composed k times and n_t be the single nonnegative integer such that $e^{\beta t/2} < \log^{\circ n_t}(t) \leq e^{\beta t/2}$, which is well-defined for t large enough (recall from (4.3) that $e^{\beta t/2} = o(t)$). For any $k \in \llbracket 1, n_t \rrbracket$, we set

$$\varrho_k := 5 \log^{\circ(k+1)}(t), \quad \varepsilon_k := \left(\log^{\circ k}(t) \right)^{-4} \quad \text{and} \quad t_k := t - \varepsilon_k t. \quad (4.54)$$

Note that $\varrho_1 \geq \varrho_2 \geq \dots \geq \varrho_{n_t} \geq 0$ and $t =: t_0 \geq t_1 \geq t_2 \geq \dots \geq t_{n_t} \geq t^a$. We choose to kill particles at level $\gamma_t + \varrho_k$ between times t_k and t_{k-1} , by defining the new barrier as

$$\forall r \in [t^a, t], \quad \bar{\gamma}_t(r) := \begin{cases} \gamma_t & \text{if } t \in [t^a, t_{n_t}), \\ \gamma_t + \varrho_k & \text{if } t \in [t_k, t_{k-1}) \text{ for some } k \in \llbracket 1, n_t \rrbracket. \end{cases} \quad (4.55)$$

see Figure 4.4 for an illustration. Note that, by definition of n_t , we have $\varepsilon_{n_t} \leq e^{-2\beta t}$ and therefore, $t_{n_t} > t/2$ for t large enough.

Then, instead of computing the second moment of $\tilde{Z}_t^{t^a, \gamma_t}(f, \gamma_t)$, we are going to work with

$$\tilde{Z}_t^{t^a, \bar{\gamma}_t}(f, \gamma_t) := \sum_{u \in \mathcal{N}(t)} (X_u(t) - \gamma_t)_+ e^{-X_u(t)} \mathbb{1}_{\forall r \in [t^a, t], X_u(r) > \bar{\gamma}_t(r)} f\left(\frac{X_u(t) - \gamma_t}{\sqrt{t}}\right).$$

The choice of the ϱ_k 's and the ε_k 's could be different. In order to make clear what motivated this particular choice, let introduce the two following sums:

$$S_1(t) := \sum_{k=1}^{n_t} \varrho_k \sqrt{\varepsilon_k} \quad \text{and} \quad S_2(t) := (\varrho_1 + 1)^3 e^{-\varrho_1} \log t + \sum_{k=2}^{n_t} (\varrho_k + 1)^3 e^{-\varrho_k} |\log \varepsilon_{k-1}|. \quad (4.56)$$

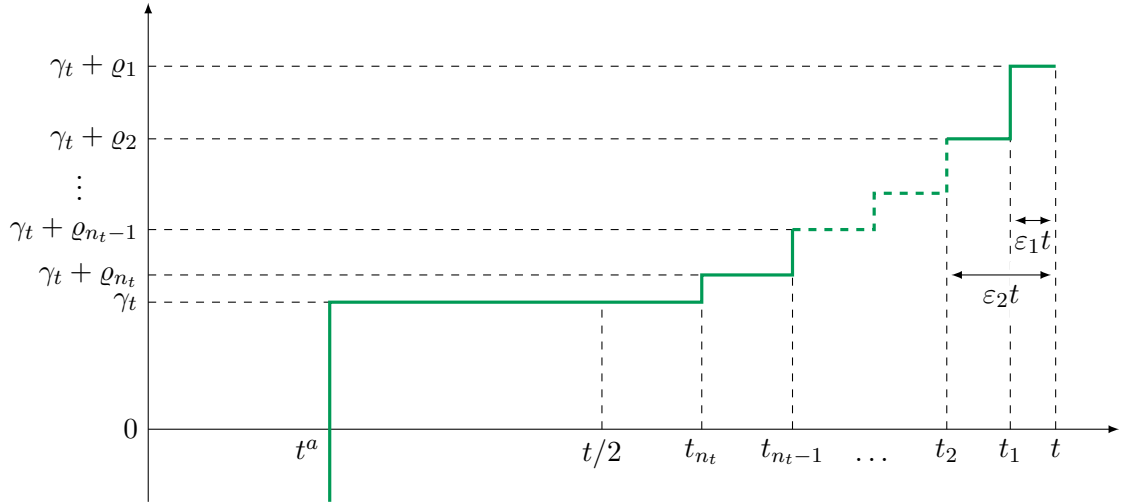

Figure 4.4 – Representation in green of the multi-level barrier, associated with the function $\bar{\gamma}_t$.

Then, our choice of ε_k and ϱ_k in (4.54) was aimed at ensuring that $S_1(t) \rightarrow 0$ and $S_2(t) \rightarrow 0$ as $t \rightarrow \infty$. Indeed, we note that

$$S_1(t) = \sum_{k=1}^{n_t} \frac{5 \log^{\circ(k+1)}(t)}{(\log^{\circ k}(t))^2} \leq \sum_{k=1}^{n_t} \frac{5}{\log^{\circ k}(t)} = \sum_{k=1}^{n_t} \frac{5}{\exp^{\circ(n_t-k)}(\log^{\circ n_t}(t))} \leq \sum_{j=0}^{\infty} \frac{5}{\exp^{\circ j}(e^{\beta_t/2})} \xrightarrow{t \rightarrow \infty} 0,$$

where $\exp^{\circ j}$ denotes the exp function composed j times and we used that $\beta_t \rightarrow \infty$, and, on the other hand,

$$S_2(t) \leq \sum_{k=1}^{n_t} \frac{4(5 \log^{\circ(k+1)}(t) + 1)^3}{(\log^{\circ k}(t))^4} \leq \sum_{k=1}^{n_t} \frac{C}{\log^{\circ k}(t)} \xrightarrow{t \rightarrow \infty} 0,$$

proceeding in the same way.

4.A.2 First moment with the multi-level barrier

We define, for any $s \in [t/2, t - t^a]$ and any $r \in [0, s]$,

$$\bar{\gamma}_t^s(r) := \bar{\gamma}_t(r + t - s) - \gamma_t,$$

which is the barrier $\bar{\gamma}_t - \gamma_t$ seen as if one was starting at time $t - s$. Let $\bar{\mathcal{L}}^s$ denote the associated stopping line and, for any $I \subset [0, s]$, $\bar{\mathcal{L}}_I^s$ denote the subset of particles killed during time interval I . As in Section 4.3.3, let \mathcal{L} denote the stopping line of particles killed at 0. Then, we introduce

$$\begin{aligned} \bar{Z}_s(f) &:= \sum_{u \in \mathcal{N}(s)} X_u(s) e^{-X_u(s)} \mathbb{1}_{\forall r \in [0, s], X_u(r) > \bar{\gamma}_t^s(r)} f\left(\frac{X_u(s)}{\sqrt{t}}\right) \\ \tilde{Z}_s(f) &:= \sum_{u \in \mathcal{N}(s)} X_u(s) e^{-X_u(s)} \mathbb{1}_{\forall r \in [0, s], X_u(r) > 0} f\left(\frac{X_u(s)}{\sqrt{t}}\right). \end{aligned}$$

where we forget the dependance in t (and $\tilde{Z}_s(f)$ is only a shorter way to denote $\tilde{Z}_s(f, 0)$). Note that the contribution to $\tilde{Z}_t^{t^a, \bar{\gamma}_t}(f, \gamma_t)$ of the progeny of a particle at position x at time

$t - s$ has the same distribution as $\bar{Z}_s(f)$ under $\mathbb{P}_{x-\gamma_t}$. In the same way, the contribution to $\tilde{Z}_t^{t^a, \gamma_t}(f, \gamma_t)$ of this particle has the same distribution as $\tilde{Z}_s(f)$ under $\mathbb{P}_{x-\gamma_t}$.

The following lemma controls the difference between $\tilde{Z}_s(f)$ and $\bar{Z}_s(f)$. Among other things, it will lead in Section 4.A.4 to a bound on the first moment of $|\tilde{Z}_t^{t^a, \gamma_t}(f, \gamma_t) - \bar{Z}_t^{t^a, \gamma_t}(f, \gamma_t)|$.

Lemma 4.A.1. *Let $f: \mathbb{R} \rightarrow \mathbb{R}_+$ be a function satisfying Assumptions (i)-(ii) and such that $\mathbb{E}[f(R_1)] = 0$. For any $a \in (0, 1)$, there exists $C > 0$ such that for any t large enough, for any $s \in [t/2, t - t^a]$ and $x > 0$, we have*

$$\mathbb{E}_x \left[\left| \tilde{Z}_s(f) - \bar{Z}_s(f) \right| \right] \leq \frac{C}{\sqrt{t}} x e^{-x} \left(1 + \frac{x^2}{t} \right) S_1(t),$$

where $S_1(t)$ is defined in (4.56).

Proof. For $0 \leq k \leq n_t$, let $s_k := t_k - (t - s) = s - \varepsilon_k t$ denote the times between which the barrier $\bar{\gamma}_t^s$ is constant. Note that until time s_{n_t} both barrier are at 0 and afterwards $\bar{\gamma}_t^s$ is strictly above 0. Using branching property along the stopping line $\bar{\mathcal{L}}^s$, we have

$$\begin{aligned} \mathbb{E}_x \left[\left| \tilde{Z}_s(f) - \bar{Z}_s(f) \right| \mid \mathcal{F}_{\bar{\mathcal{L}}^s} \right] &= \sum_{u \in \bar{\mathcal{L}}_{[s_{n_t}, s]}^s} \mathbb{E}_{X_u(\bar{T}_u)} \left[\left| \tilde{Z}_{s-\bar{T}_u}(f) \right| \right] \\ &\leq \sum_{u \in \bar{\mathcal{L}}_{[s_{n_t}, s]}^s} C X_u(\bar{T}_u) e^{-X_u(\bar{T}_u)} \sqrt{\frac{t}{s - \bar{T}_u}} e^{C X_u(\bar{T}_u)/\sqrt{t}}, \end{aligned} \quad (4.57)$$

applying the second bound of Lemma 4.3.2. Then, we cut the stopping line $\bar{\mathcal{L}}_{[s_{n_t}, s]}^s$ into the horizontal pieces $\bar{\mathcal{L}}_{(s_k, s_{k-1})}^s$ and the vertical pieces $\bar{\mathcal{L}}_{\{s_k\}}^s$ for $1 \leq k \leq n_t$. It gives that (4.57) is smaller than

$$\sum_{k=1}^{n_t} C \varrho_k e^{-\varrho_k} \sum_{u \in \bar{\mathcal{L}}_{(s_k, s_{k-1})}^s} \sqrt{\frac{t}{s - \bar{T}_u}} + \sum_{k=1}^{n_t} C \sqrt{\frac{t}{s - s_k}} \sum_{u \in \bar{\mathcal{L}}_{\{s_k\}}^s} X_u(\bar{T}_u) e^{-X_u(\bar{T}_u)}, \quad (4.58)$$

where we used that $e^{C X_u(\bar{T}_u)/\sqrt{t}} \leq e^{C \varrho_1/\sqrt{t}} \leq C'$ for t large enough. We first deal with the second sum in (4.58), which is the easiest part. Using that $\bar{\gamma}_t^s \geq 0$ and then the many-to-one formula (4.7), we get

$$\begin{aligned} \mathbb{E}_x \left[\sum_{u \in \bar{\mathcal{L}}_{\{s_k\}}^s} X_u(\bar{T}_u) e^{-X_u(\bar{T}_u)} \right] &\leq \mathbb{E}_x \left[\sum_{u \in \mathcal{N}(s_k)} X_u(s_k) e^{-X_u(s_k)} \mathbb{1}_{X_u(s_k) \leq \varrho_k} \mathbb{1}_{\forall r \in [0, s_k], X_u(r) > 0} \right] \\ &= x e^{-x} \mathbb{P}_x(R_{s_k} \leq \varrho_k), \end{aligned}$$

Then, on the one hand, note that $\mathbb{P}_x(R_{s_k} \leq \varrho_k) \leq \mathbb{P}(R_1 \leq \varrho_k/\sqrt{s_k}) \leq C \varrho_k^3/s_k^{3/2}$, using the explicit density of R_1 in (4.76), and, on the other hand, recall that $s_k = s - \varepsilon_k t \geq t/2 - e^{-2\beta} t \geq t/3$ for t large enough (independent of $k \in \llbracket 1, n_t \rrbracket$). Therefore, it follows that

$$\mathbb{E}_x \left[\sum_{k=1}^{n_t} C \sqrt{\frac{t}{s - s_k}} \sum_{u \in \bar{\mathcal{L}}_{\{s_k\}}^s} X_u(\bar{T}_u) e^{-X_u(\bar{T}_u)} \right] \leq \sum_{k=1}^{n_t} \frac{C}{\sqrt{\varepsilon_k}} x e^{-x} \frac{\varrho_k^3}{t^{3/2}}, \quad (4.59)$$

for t large enough, recalling the definition of ε_k , ϱ_k and n_t . Note that the right-hand side of (4.59) is (much) smaller than $C t^{-1/2} x e^{-x} S_1(t)$, so we are done with the second sum in (4.58).

Now we deal with the first sum in (4.58). Using the branching property at time s_k and notation of Section 4.3.3, we have

$$\begin{aligned} & \mathbb{E}_x \left[\sum_{u \in \bar{\mathcal{L}}^s_{(s_k, s_{k-1})}} \sqrt{\frac{t}{s - \bar{T}_u}} \middle| \mathcal{F}_{s_k} \right] \\ &= \sum_{u \in \mathcal{N}(s_k)} \mathbb{E}_{X_u(s_k) - \varrho_k} \left[\sum_{u \in \mathcal{L}_{(0, s_{k-1} - s_k)}} \sqrt{\frac{t}{s - s_k - T_u}} \mathbb{1}_{\forall r \leq s_k, X_u(r) > \bar{\gamma}_t^s(r)} \right]. \end{aligned} \quad (4.60)$$

Then, using that $s_{k-1} - s_k \leq s - s_k = \varepsilon_k t$, we get, for any $y > 0$,

$$\begin{aligned} \mathbb{E}_y \left[\sum_{u \in \mathcal{L}_{(0, s_{k-1} - s_k)}} \sqrt{\frac{t}{s - s_k - T_u}} \right] &\leq \mathbb{E}_y \left[\sum_{u \in \mathcal{L}_{(0, \varepsilon_k t)}} \sqrt{\frac{t}{\varepsilon_k t - T_u}} \right] \\ &= y e^{-y} \int_0^{\varepsilon_k t} \sqrt{\frac{t}{\varepsilon_k t - r}} \frac{e^{-y^2/2r}}{\sqrt{2\pi r^{3/2}}} dr, \quad \text{by (4.18)} \\ &= \sqrt{\frac{2}{\pi \varepsilon_k}} e^{-y} \int_{y/\sqrt{\varepsilon_k t}}^{\infty} \left(v^2 - \frac{y^2}{\varepsilon_k t} \right)^{-1/2} v e^{-v^2/2} dv, \end{aligned} \quad (4.61)$$

setting $v = y/\sqrt{r}$. Cutting the integral at $v = 2y/\sqrt{\varepsilon_k t}$, (4.61) is smaller than

$$\begin{aligned} & \frac{C}{\sqrt{\varepsilon_k}} e^{-y} e^{-y^2/2\varepsilon_k t} \int_{y/\sqrt{\varepsilon_k t}}^{2y/\sqrt{\varepsilon_k t}} \left(v^2 - \frac{y^2}{\varepsilon_k t} \right)^{-1/2} v dv + \frac{C}{\sqrt{\varepsilon_k}} e^{-y} \int_{2y/\sqrt{\varepsilon_k t}}^{\infty} e^{-v^2/2} dv \\ &\leq \frac{C}{\sqrt{\varepsilon_k}} e^{-y} e^{-y^2/2\varepsilon_k t} \int_{y^2/\varepsilon_k t}^{4y^2/\varepsilon_k t} \left(u - \frac{y^2}{\varepsilon_k t} \right)^{-1/2} du + \frac{C}{\sqrt{\varepsilon_k}} e^{-y} e^{-2y^2/\varepsilon_k t} \\ &\leq \frac{C}{\sqrt{\varepsilon_k}} e^{-y} e^{-y^2/2\varepsilon_k t} \left(\frac{y}{\sqrt{\varepsilon_k t}} + 1 \right), \end{aligned}$$

where we used the classical Gaussian tail bound $\int_x^{\infty} e^{-v^2/2} dv \leq C e^{-x^2/2}$ for $x \geq 0$. Hence, using also that $\bar{\gamma}_t^s \geq 0$ and $\bar{\gamma}_t^s(s_k) = \varrho_k$, we proved that (4.60) is smaller than

$$\frac{C e^{\varrho_k}}{\sqrt{\varepsilon_k}} \sum_{u \in \mathcal{N}(s_k)} e^{-X_u(s_k) - (X_u(s_k) - \varrho_k)^2/2\varepsilon_k t} \left(1 + \frac{(X_u(s_k) - \varrho_k)_+}{\sqrt{\varepsilon_k t}} \right) \mathbb{1}_{\forall r \leq s_k, X_u(r) > 0}.$$

Therefore, using the many-to-one formula (4.7), we get

$$\mathbb{E}_x \left[\sum_{u \in \bar{\mathcal{L}}^s_{(s_k, s_{k-1})}} \sqrt{\frac{t}{s - \bar{T}_u}} \right] \leq \frac{C e^{\varrho_k}}{\sqrt{\varepsilon_k}} x e^{-x} \mathbb{E}_x \left[e^{-(R_{s_k} - \varrho_k)^2/2\varepsilon_k t} \left(\frac{1}{R_{s_k}} + \frac{1}{\sqrt{\varepsilon_k t}} \right) \right]. \quad (4.62)$$

Applying Lemma 4.C.3 with $(s_k, \varepsilon_k t)$ instead of (s, r) , (4.62) is smaller than

$$\begin{aligned} & \frac{C e^{\varrho_k}}{\sqrt{\varepsilon_k}} x e^{-x} \left(\frac{1}{\sqrt{s_k}} \frac{\varepsilon_k t}{s} \left(1 + \frac{1}{\sqrt{s_k}} \left(\frac{\varrho_k s}{\varepsilon_k t} + x \right) \right) + \frac{\varepsilon_k t}{s^{3/2}} \left(1 + \frac{1}{s_k} \left(\frac{\varrho_k s}{\varepsilon_k t} + x \right)^2 \right) \right) \\ &\leq \frac{C}{\sqrt{t}} e^{\varrho_k} \sqrt{\varepsilon_k} x e^{-x} \left(1 + \frac{x^2}{t} \right), \end{aligned}$$

using that $t \geq s \geq s_k \geq t/3$ and $\varrho_k s / \varepsilon_k t \leq \sqrt{s}$ for t large enough (independent of k). Finally, we proved that

$$\mathbb{E}_x \left[\sum_{k=1}^{nt} C \varrho_k e^{-\varrho_k} \sum_{u \in \bar{\mathcal{L}}_{(s_k, s_{k-1})}^s} \sqrt{\frac{t}{s - T_u}} \right] \leq \frac{C}{\sqrt{t}} x e^{-x} \left(1 + \frac{x^2}{t} \right) \sum_{k=1}^{nt} \varrho_k \sqrt{\varepsilon_k}.$$

Combining this with (4.59), we proved the result. \square

4.A.3 Second moment with the new barrier

Keeping notation of the previous subsection, we prove here the following bound on the second moment of $\bar{Z}_{t-t^a}(f)$, that will be used to control the variance of $\tilde{Z}_t^{t^a, \bar{\gamma}_t}(f, \gamma_t)$ given \mathcal{F}_{t^a} in the next subsection. It replaces Lemma 4.3.5 in the proof of Proposition 4.2.4: note that here there is a $e^{\beta t/2}/\sqrt{t}$ term instead of $\log(t)/\sqrt{t}$.

Lemma 4.A.2. *Let $f: \mathbb{R} \rightarrow \mathbb{R}_+$ be a function satisfying Assumptions (i)-(ii) and such that $\mathbb{E}[f(R_1)] = 0$. For any $a \in (0, \frac{1}{2})$, there exists $C > 0$ such that, for any $x > 0$ and for any t large enough, we have*

$$\mathbb{E}_x \left[\left(\bar{Z}_{t-t^a}(f) \right)^2 \right] \leq \frac{C}{\sqrt{t}} e^{-x} \left(x e^{\beta t/2} + \frac{1}{\sqrt{t}} \right).$$

Proof. For brevity, we introduce $s := t - t^a$. We first need to use a many-to-two formula, in order to compute this second moment. However, we are not here in the case of (4.8) and need a slightly more general many-to-two formula: it follows from (1.10) that

$$\begin{aligned} \mathbb{E}_x \left[\left(\bar{Z}_s(f) \right)^2 \right] &= K e^{-x} \int_0^t \mathbb{E}_x \left[e^{B_r} \mathbb{E}_{B_r} \left[\bar{Z}_{s-r}(f) \right]^2 \mathbb{1}_{\forall q \in [0, r], B_q > \bar{\gamma}_t^s(q)} \right] dr \\ &\quad + e^{-x} \mathbb{E}_x \left[e^{-B_s} \left(B_s f \left(\frac{B_s}{\sqrt{t}} \right) \right)^2 \mathbb{1}_{\forall q \in [0, s], B_q > \bar{\gamma}_t^s(q)} \right]. \end{aligned} \quad (4.63)$$

Recall that we set $q_r(x, y) := (2\pi r)^{-1/2} (e^{-(x-y)^2/2r} - e^{-(x+y)^2/2r})$ for any $x, y > 0$. Then, using that $\mathbb{1}_{\forall q \in [0, r], B_q > \bar{\gamma}_t^s(q)} \leq \mathbb{1}_{\forall q \in [0, r], B_q > 0} \mathbb{1}_{B_r > \bar{\gamma}_t^s(r)}$ and that $q_r(x, \cdot)$ is the density at time r of a Brownian motion starting at x and killed at 0, we get that (4.63) is smaller than

$$K e^{-x} \int_0^s \int_{\bar{\gamma}_t^s(r)}^\infty e^y \mathbb{E}_y \left[\bar{Z}_{s-r}(f) \right]^2 q_r(x, y) dy dr + e^{-x} \int_0^\infty e^{-y} \left(y f \left(\frac{y}{\sqrt{t}} \right) \right)^2 q_s(x, y) dy. \quad (4.64)$$

As we have seen in the proof of Lemma 4.3.5, the second term in (4.64) is smaller than $C x e^{-x} t/s^{3/2}$ for t large enough, and so is smaller than $C x e^{-x} e^{\beta t/2}/\sqrt{t}$ for t large enough. Therefore, we only have to deal with the first term in (4.64).

For this, we proceed also as in the proof of Lemma 4.3.5: we cut the integral against r at time $t/2$. For $r \in [0, t/2]$ and $y > 0$, we have

$$\begin{aligned} \left| \mathbb{E}_y \left[\bar{Z}_{s-r}(f) \right] \right| &\leq \left| \mathbb{E}_y \left[\tilde{Z}_{s-r}(f) \right] \right| + \mathbb{E}_y \left[\left| \tilde{Z}_{s-r}(f) - \bar{Z}_{s-r}(f) \right| \right] \\ &\leq C y e^{-y} \left(\frac{y^2}{t} \left(1 + \frac{y^3}{t^{3/2}} \right) e^{C y/\sqrt{t}} + \frac{t^a + r}{t} \right) + \frac{C}{\sqrt{t}} y e^{-y} \left(1 + \frac{y^2}{t} \right), \end{aligned}$$

applying the first bound of Lemma 4.3.2 and Lemma 4.A.1 (noting that $S_1(t) \leq 1$ for t large enough) and using that $s - r \geq t/2 - t^a \geq t/3$ for t large enough. Then, using that $\bar{\gamma}_t^s(r) \geq 0$

and proceeding as in the proof of Lemma 4.3.5, we get

$$\begin{aligned} Ke^{-x} \int_0^{t/2} \int_{\bar{\gamma}_t^s(r)}^\infty e^y \mathbb{E}_y \left[\bar{Z}_{s-r}(f) \right]^2 q_r(x, y) dy dr &\leq Ce^{-x} \left(\frac{1}{t^2} + \frac{t^{2a}}{t^2} + \frac{x}{\sqrt{t}} + \frac{1}{t} \right) \\ &\leq Ce^{-x} \left(\frac{x}{\sqrt{t}} + \frac{1}{t} \right), \end{aligned}$$

using that $a < 1/2$.

Now, we deal with the part $r \in [t/2, s]$: here we use the new barrier in order to get rid of the $\log t$ that appears in Lemma 4.3.5. For $y > 0$, using that $\bar{\gamma}_t^s(r) \geq 0$ and proceeding as in (4.14), we have

$$\begin{aligned} \left| \mathbb{E}_y \left[\bar{Z}_{s-r}(f) \right] \right| &\leq \mathbb{E}_y \left[\tilde{Z}_{s-r}(|f|) \right] = ye^{-y} \mathbb{E}_{y/\sqrt{s-r}} \left[\left| f \left(\sqrt{\frac{s-r}{t}} R_1 \right) \right| \right] \\ &\leq Cy e^{-y} \sqrt{\frac{t}{s-r}} e^{Cy/\sqrt{t}} \left(1 \wedge \frac{\sqrt{s-r}}{y} \right) \leq C\sqrt{t}(y+1) e^{-y(1-\frac{C}{\sqrt{t}})} \left(\frac{1}{\sqrt{s-r}} \wedge 1 \right), \end{aligned}$$

using Lemma 4.C.6. Then, using that $q_r(x, y) \leq Cxy/t^{3/2}$ because $r \geq t/2$, we get

$$\begin{aligned} Ke^{-x} \int_{t/2}^s \int_{\bar{\gamma}_t^s(r)}^\infty e^y \mathbb{E}_y \left[\bar{Z}_{s-r}(f) \right]^2 q_r(x, y) dy dr &\leq \frac{C}{\sqrt{t}} x e^{-x} \int_{t/2}^s \left(\frac{1}{s-r} \wedge 1 \right) \int_{\bar{\gamma}_t^s(r)}^\infty y(y+1)^2 e^{-y(1-\frac{C}{\sqrt{t}})} dy dr \\ &\leq \frac{C}{\sqrt{t}} x e^{-x} \int_{t/2}^s \left(\frac{1}{s-r} \wedge 1 \right) (\bar{\gamma}_t^s(r) + 1)^3 e^{-\bar{\gamma}_t^s(r)(1-\frac{C}{\sqrt{t}})} dr, \end{aligned} \quad (4.65)$$

using that there exists $C > 0$ such that for any $a, \mu > 0$, $\int_a^\infty (1+y)^3 e^{-\mu y} dy \leq Ce^{-\mu a} (\mu^{-4} + (1+a)^3 \mu^{-1})$. Recall that $\bar{\gamma}_t^s(r) = \bar{\gamma}_t(r+t^a) - \gamma_t$ is equal to 0 for $r \in [0, t_{n_t} - t^a]$ and equal to ϱ_k for $r \in [t_k - t^a, t_{k-1} - t^a]$. Therefore, using the change of variable $w = r + t^a$, (4.65) is smaller than

$$\begin{aligned} &\frac{C}{\sqrt{t}} x e^{-x} \left(\int_{\frac{t}{2}+t^a}^{t_{n_t}} \frac{dw}{t-w} + \sum_{k=1}^{n_t} (\varrho_k + 1)^3 e^{-\varrho_k(1-\frac{C}{\sqrt{t}})} \int_{t_k}^{t_{k-1}} \left(\frac{1}{t-w} \wedge 1 \right) dw \right) \\ &\leq \frac{C}{\sqrt{t}} x e^{-x} \left(\left(\log \left(\frac{t}{2} + t^a \right) - \log(\varepsilon_{n_t} t) \right) + (\varrho_1 + 1)^3 e^{-\varrho_1(1-\frac{C}{\sqrt{t}})} (\log(\varepsilon_1 t) + 1) \right. \\ &\quad \left. + \sum_{k=2}^{n_t} (\varrho_k + 1)^3 e^{-\varrho_k(1-\frac{C}{\sqrt{t}})} (\log(\varepsilon_k t) - \log(\varepsilon_{k-1} t)) \right) \\ &\leq \frac{C}{\sqrt{t}} x e^{-x} \left(\log^{\circ(n_t+1)}(t) + (\varrho_1 + 1)^3 e^{-\varrho_1} \log t + \sum_{k=2}^{n_t} (\varrho_k + 1)^3 e^{-\varrho_k} |\log \varepsilon_{k-1}| \right), \end{aligned} \quad (4.66)$$

recalling that $t_k = t - \varepsilon_k t$ and that $\varrho_k/\sqrt{t} \leq 1$ for t large enough. Then, by definition of n_t , we have $\log^{\circ(n_t+1)}(t) \leq e^{\beta_t/2}$, and, recalling the definition of $S_2(t)$ in (4.56), we get that (4.66) is smaller than $(C/\sqrt{t})x e^{-x} (e^{\beta_t/2} + S_2(t))$. Recalling that $S_2(t) \rightarrow 0$ and $\beta_t \rightarrow \infty$ and combining previous results, it proves the lemma. \square

4.A.4 General proof of Proposition 4.2.4

Proof of Proposition 4.2.4. For any $\varepsilon > 0$, we use the following decomposition

$$\begin{aligned}
& \mathbb{P}\left(\left|\tilde{Z}_t^{t^a, \gamma_t}(f, \gamma_t)\right| \geq \frac{3\varepsilon}{\sqrt{t}} \middle| \mathcal{F}_{t^a}\right) \\
& \leq \mathbb{P}\left(\left|\tilde{Z}_t^{t^a, \gamma_t}(f, \gamma_t) - \tilde{Z}_t^{t^a, \bar{\gamma}_t}(f, \gamma_t)\right| \geq \frac{\varepsilon}{\sqrt{t}} \middle| \mathcal{F}_{t^a}\right) \\
& \quad + \mathbb{P}\left(\left|\tilde{Z}_t^{t^a, \bar{\gamma}_t}(f, \gamma_t) - \mathbb{E}\left[\tilde{Z}_t^{t^a, \bar{\gamma}_t}(f, \gamma_t) \middle| \mathcal{F}_{t^a}\right]\right| \geq \frac{\varepsilon}{\sqrt{t}} \middle| \mathcal{F}_{t^a}\right) + \mathbb{1}_{\left|\mathbb{E}\left[\tilde{Z}_t^{t^a, \bar{\gamma}_t}(f, \gamma_t) \middle| \mathcal{F}_{t^a}\right]\right| \geq \varepsilon/\sqrt{t}} \\
& \leq \frac{\sqrt{t}}{\varepsilon} \mathbb{E}\left[\left|\tilde{Z}_t^{t^a, \gamma_t}(f, \gamma_t) - \tilde{Z}_t^{t^a, \bar{\gamma}_t}(f, \gamma_t)\right| \middle| \mathcal{F}_{t^a}\right] \\
& \quad + \frac{t}{\varepsilon^2} \text{Var}\left(\tilde{Z}_t^{t^a, \bar{\gamma}_t}(f, \gamma_t) \middle| \mathcal{F}_{t^a}\right) + \frac{\sqrt{t}}{\varepsilon} \left|\mathbb{E}\left[\tilde{Z}_t^{t^a, \bar{\gamma}_t}(f, \gamma_t) \middle| \mathcal{F}_{t^a}\right]\right|, \tag{4.67}
\end{aligned}$$

using Markov's and Chebyshev's inequalities and that $\mathbb{1}_{a \geq b} \leq a/b$ for any $a, b > 0$.

Let start with the first term in the right-hand side of (4.67). Using branching property at time t^a and then Lemma 4.A.1, it is smaller than

$$\begin{aligned}
& \frac{\sqrt{t}}{\varepsilon} \sum_{v \in \mathcal{N}(t^a)} e^{-\gamma_t} \mathbb{1}_{X_v(t^a) > \gamma_t} \mathbb{E}_{X_v(t^a) - \gamma_t} \left[\left| \tilde{Z}_{t-t^a}(f) - \bar{Z}_{t-t^a}(f) \right| \right] \\
& \leq \frac{\sqrt{t} C}{\varepsilon \sqrt{t}} \sum_{v \in \mathcal{N}(t^a)} (X_v(t^a) - \gamma_t)_+ e^{-X_v(t^a)} \left(1 + \frac{(X_v(t^a) - \gamma_t)^2}{t} \right) S_1(t) \\
& \leq \frac{C}{\varepsilon} S_1(t) Z_{t^a}(x \mapsto 1 + x^2, \gamma_t, t^a) \xrightarrow{t \rightarrow \infty} 0, \quad \text{in probability,} \tag{4.68}
\end{aligned}$$

because $S_1(t) \rightarrow 0$ and $(Z_{t^a}(x \mapsto 1 + x^2, \gamma_t, t^a))_{t \geq 1}$ is tight by Remark 4.3.4.

Now, we deal with the second term in the right-hand side of (4.67). Using the branching property at time t^a and then Lemma 4.A.2, it is smaller than

$$\begin{aligned}
& \frac{t}{\varepsilon^2} \sum_{v \in \mathcal{N}(t^a)} e^{-2\gamma_t} \mathbb{1}_{X_v(t^a) > \gamma_t} \mathbb{E}_{X_v(t^a) - \gamma_t} \left[\left(\bar{Z}_{t-t^a}(f) \right)^2 \right] \\
& \leq \frac{C\sqrt{t}}{\varepsilon^2} e^{-\gamma_t} \sum_{v \in \mathcal{N}(t^a)} \mathbb{1}_{X_v(t^a) > \gamma_t} e^{-X_v(t^a)} \left((X_v(t^a) - \gamma_t) e^{\beta t/2} + \frac{1}{\sqrt{t}} \right) \\
& \leq \frac{C}{\varepsilon^2} e^{-\beta t} \left(Z_{t^a}(1, \gamma_t) e^{\beta t/2} + \frac{W_{t^a}}{\sqrt{t}} \right) \xrightarrow{t \rightarrow \infty} 0, \quad \text{in probability,} \tag{4.69}
\end{aligned}$$

because $Z_{t^a}(1, \gamma_t) \rightarrow Z_\infty$ and $W_{t^a} \rightarrow 0$ in probability.

Finally, the third term in the right-hand side of (4.67) is smaller than

$$\frac{\sqrt{t}}{\varepsilon} \left| \mathbb{E}\left[\tilde{Z}_t^{t^a, \gamma_t}(f, \gamma_t) \middle| \mathcal{F}_{t^a}\right] \right| + \frac{\sqrt{t}}{\varepsilon} \left| \mathbb{E}\left[\tilde{Z}_t^{t^a, \gamma_t}(f, \gamma_t) - \tilde{Z}_t^{t^a, \bar{\gamma}_t}(f, \gamma_t) \middle| \mathcal{F}_{t^a}\right] \right|. \tag{4.70}$$

The second term in (4.70) is smaller than the first term in the right-hand side of (4.67) and therefore tends to 0 in probability. Then, using the branching property at time t^a and then Lemma 4.4.2 with $s = t$ and $\gamma = \Delta = \gamma_t$, the first term in (4.70) is smaller than

$$\frac{\sqrt{t} C}{\varepsilon t^{1-a}} Z_{t^a}(x \mapsto e^{Cx}, \gamma_t, t^a) \xrightarrow{t \rightarrow \infty} 0, \quad \text{in probability,} \tag{4.71}$$

using that $a < 1/2$ and $(Z_{t^a}(x \mapsto e^{Cx}, \gamma_t, t^a))_{t \geq 1}$ is tight by Remark 4.3.4. Combining (4.68), (4.69) and (4.71), we proved that (4.67) tends to 0 in probability and the result follows. \square

4.B Two constants depending of f are identical

Proof of Equation (4.4). We first introduce artificially a factor $\sqrt{1-u}$:

$$\sqrt{2\pi}\tilde{c}_3(f) = \int_0^1 \mathbb{E}\left[f(\sqrt{1-u}R_1)\right] \frac{du}{u^{3/2}} = \int_0^1 \sqrt{1-u} \mathbb{E}\left[f(\sqrt{1-u}R_1)\right] \frac{du}{u^{3/2}\sqrt{1-u}} \quad (4.72)$$

and, using an integration by part, (4.72) is equal to

$$\begin{aligned} & \left[\sqrt{1-u} \mathbb{E}\left[f(\sqrt{1-u}R_1)\right] \left(\frac{-2\sqrt{1-u}}{\sqrt{u}} \right) \right]_0^1 \\ & + \int_0^1 \left(\frac{-1}{2\sqrt{1-u}} \mathbb{E}\left[f(\sqrt{1-u}R_1)\right] + \sqrt{1-u} \mathbb{E}\left[\frac{-R_1}{2\sqrt{1-u}} f'(\sqrt{1-u}R_1) \right] \right) \frac{2\sqrt{1-u}}{\sqrt{u}} du. \end{aligned}$$

We have $(1-u)\mathbb{E}[f(\sqrt{1-u}R_1)] \rightarrow 0$ as $u \rightarrow 1$ and $\mathbb{E}[f(\sqrt{1-u}R_1)]/\sqrt{u} \rightarrow 0$ as $u \rightarrow 0$ by Lemma 4.C.5, so the first term in the last equation is zero and (4.72) is equal to

$$\begin{aligned} & - \int_0^1 \mathbb{E}\left[f(\sqrt{1-u}R_1) + \sqrt{1-u}R_1 f'(\sqrt{1-u}R_1)\right] \frac{du}{\sqrt{u}} \\ & = - \int_0^1 \int_0^\infty \left(f(\sqrt{1-uz}) + \sqrt{1-uz} f'(\sqrt{1-uz})\right) \sqrt{\frac{2}{\pi}} z^2 e^{-z^2/2} dz \frac{du}{\sqrt{u}} \\ & = - \int_0^\infty \sqrt{\frac{2}{\pi}} y^2 e^{-y^2/2} (f(y) + y f'(y)) \left(\int_0^1 e^{-uy^2/2(1-u)} \frac{du}{(1-u)^{3/2}\sqrt{u}} \right) dy, \end{aligned}$$

with the change of variables $y = \sqrt{1-uz}$. Then, with $v = y\sqrt{u/1-u} \Leftrightarrow u = v^2/(y^2 + v^2)$, we have

$$\begin{aligned} \int_0^1 e^{-uy^2/2(1-u)} \frac{du}{(1-u)^{3/2}\sqrt{u}} & = \int_0^1 e^{-v^2/2} \left(\frac{y^2 + v^2}{y^2} \right)^{3/2} \left(\frac{y^2 + v^2}{v^2} \right)^{1/2} \frac{2v(y^2 + v^2) - v^2 2v}{(y^2 + v^2)^2} dv \\ & = \int_0^1 e^{-v^2/2} \frac{2}{y} dv = \frac{\sqrt{2\pi}}{y}. \end{aligned}$$

Thus, (4.72) is finally equal to

$$- \int_0^\infty \sqrt{\frac{2}{\pi}} y^2 e^{-y^2/2} (f(y) + y f'(y)) \frac{\sqrt{2\pi}}{y} dy = -\sqrt{2\pi} \mathbb{E}\left[f'(R_1) + \frac{f(R_1)}{R_1}\right] = -\sqrt{2\pi}\tilde{c}_1(f)$$

and the result is proved. \square

4.C Technical results on the 3-dimensional Bessel process

4.C.1 Brownian motion killed at 0

Let $(B_s)_{s \geq 0}$ denotes a standard Brownian motion starting from x under \mathbb{P}_x and $\tau := \inf\{r \geq 0 : B_r = 0\}$. Using that the Green function of the Brownian motion killed at 0 is $G(x, y) = 2(x \wedge y) \leq 2x$ for $x, y > 0$, one can get the following bound, for any $x > 0$,

$$\mathbb{E}_x \left[\int_0^\tau B_r e^{-Br} dr \right] \leq Cx, \quad (4.73)$$

obtained by a direct computation. Furthermore, we set $q_r(x, y) := (2\pi r)^{-1/2} (e^{-(x-y)^2/2r} - e^{-(x+y)^2/2r})$ for any $x, y, r > 0$. Then, $q_r(x, \cdot)$ is the density of a Brownian motion at time r

starting from x and killed at 0. Using that $q_r(x, y) \leq \sqrt{2/\pi} r^{-3/2} xy$, it follows that, for any $x, t > 0$,

$$\mathbb{E}_x \left[e^{-Bt} \mathbb{1}_{\tau \geq t} \right] \leq C \frac{x}{t^{3/2}}, \quad (4.74)$$

where $\tau := \inf\{r \geq 0 : B_r = 0\}$.

4.C.2 Some calculus on the law of R_1

Let $(R_s)_{s \geq 0}$ denotes a 3-dimensional Bessel process starting from x under \mathbb{P}_x . Recall that, for $x > 0$, one has the following link between the 3-dimensional Bessel process and the Brownian motion (see Imhof [Imh84]): for any $t \geq 0$ and any measurable function $\Theta: \mathcal{C}([0, t]) \rightarrow \mathbb{R}_+$,

$$\mathbb{E}_x \left[\Theta(B_s, s \in [0, t]) \mathbb{1}_{\forall s \in [0, t], B_s > 0} \right] = \mathbb{E}_x \left[\frac{x}{R_s} \Theta(R_s, s \in [0, t]) \right]. \quad (4.75)$$

Moreover, under $\mathbb{P} = \mathbb{P}_0$, the density of R_t is $z \mapsto \sqrt{2/\pi} z^2 r^{-3/2} e^{-z^2/2r} \mathbb{1}_{z > 0}$.

In this subsection, we estimate the expectations of some functions of R_1 . First recall that the density of R_1 under $\mathbb{P} = \mathbb{P}_0$ is

$$z \mapsto \sqrt{\frac{2}{\pi}} z^2 e^{-z^2/2} \mathbb{1}_{z > 0}, \quad (4.76)$$

and the density of R_1 under \mathbb{P}_y , for $y > 0$, is

$$z \mapsto \frac{z e^{-(z-y)^2/2}}{y \sqrt{2\pi}} (1 - e^{-2zy}) \mathbb{1}_{z > 0} = \sqrt{\frac{2}{\pi}} \frac{z}{y} e^{-z^2/2} e^{-y^2/2} \sinh(zy) \mathbb{1}_{z > 0}. \quad (4.77)$$

Note that, for any $\lambda > 0$ and $a \in [0, 3)$, $\mathbb{E}[(R_1)^{-a} e^{\lambda R_1}]$ is finite. We establish now several lemmas, that will be used in the next subsection.

Lemma 4.C.1. *For any $y > 0$ and $a \in [0, 3)$, we have*

$$\mathbb{E}_y \left[(R_1)^{-1} \right] \leq C \left(1 \wedge \frac{1}{y} \right).$$

Proof. Using (4.77) and that, for any $y, z > 0$, $1 - e^{-2zy} \leq 1$, we have

$$\mathbb{E}_y \left[(R_1)^{-1} \right] \leq \int_0^\infty \frac{1}{y} \frac{e^{-(z-y)^2/2}}{\sqrt{2\pi}} dz \leq \frac{1}{y}.$$

Moreover, we have $\mathbb{E}_y[(R_1)^{-1}] \leq \mathbb{E}[(R_1)^{-1}] < \infty$, and therefore it proves the result. \square

Lemma 4.C.2. *For any $y > 0$ and $\lambda > 0$, we have*

$$\mathbb{E}_y \left[\frac{1}{R_1} e^{\lambda R_1} \right] \leq C e^{\lambda^2} e^{\lambda y} \left(1 \wedge \frac{1}{y} \right).$$

Proof. Using that, for any $z > 0$, $1 - e^{-2zy} \leq 1$, we have,

$$\mathbb{E}_y \left[\frac{e^{\lambda R_1}}{R_1} \right] \leq \frac{1}{y} \int_0^\infty e^{\lambda z} \frac{e^{-(z-y)^2/2}}{\sqrt{2\pi}} dz = \frac{1}{y} e^{\lambda y} e^{\lambda^2/2} \int_{-y-\lambda}^\infty \frac{e^{-z^2/2}}{\sqrt{2\pi}} dz \leq e^{\lambda^2/2} \frac{e^{\lambda y}}{y},$$

and, on the other hand, using here that, for any $y, z > 0$, $1 - e^{-2zy} \leq 2zy$,

$$\begin{aligned} \mathbb{E}_y \left[\frac{e^{\lambda R_1}}{R_1} \right] &\leq 2 \int_0^\infty e^{\lambda z} z \frac{e^{-(z-y)^2/2}}{\sqrt{2\pi}} dz = 2e^{\lambda y} e^{\lambda^2/2} \int_0^\infty z \frac{e^{-(z-y-\lambda)^2/2}}{\sqrt{2\pi}} dz \\ &= 2e^{\lambda y} e^{\lambda^2/2} \int_{-y-\lambda}^\infty (z+y+\lambda) \frac{e^{-z^2/2}}{\sqrt{2\pi}} dz \leq C e^{\lambda^2/2} e^{\lambda y} (1+y+\lambda). \end{aligned}$$

The result follows. \square

Lemma 4.C.3. *There exists $C > 0$ such that, for any $x, r, s, \varrho > 0$, we have*

$$\begin{aligned} \mathbb{E}_x \left[\frac{1}{R_s} e^{-(R_s - \varrho)^2/2r} \right] &\leq \frac{C}{\sqrt{s}} \frac{r}{s+r} \left(1 + \frac{1}{\sqrt{s}} \left(\frac{\varrho s}{r} + x \right) \right), \\ \mathbb{E}_x \left[e^{-(R_s - \varrho)^2/2r} \right] &\leq C \left(\frac{r}{s+r} \right)^{3/2} \left(1 + \frac{1}{s} \left(\frac{\varrho s}{r} + x \right)^2 \right). \end{aligned}$$

Proof. Let start with the first inequality. Applying the scaling property of the Bessel process, we have

$$\mathbb{E}_x \left[\frac{1}{R_s} e^{-(R_s - \varrho)^2/2r} \right] = \frac{1}{\sqrt{s}} \mathbb{E}_y \left[\frac{1}{R_1} e^{-(R_1 - \eta)^2 s/2r} \right], \quad (4.78)$$

setting $\eta := \varrho/\sqrt{s}$ and $y := x/\sqrt{s}$. Then, using (4.77) and that, for any $y, z > 0$, $1 - e^{-2zy} \leq 2zy$, (4.78) is smaller than

$$\begin{aligned} &\sqrt{\frac{2}{\pi s}} \int_0^\infty z e^{-(z-\eta)^2 s/2r} e^{-(z-y)^2/2} dz \\ &= \sqrt{\frac{2}{\pi s}} \int_0^\infty z \exp \left(-\frac{1}{2} \left[\left(z \sqrt{\frac{s+r}{r}} - \left(\frac{\eta s}{r} + y \right) \sqrt{\frac{r}{s+r}} \right)^2 + \frac{s(\eta-y)^2}{s+r} \right] \right) dz \\ &\leq \sqrt{\frac{2}{\pi s}} \int_{-\infty}^\infty \left(|w| \sqrt{\frac{r}{s+r}} + \left(\frac{\eta s}{r} + y \right) \frac{r}{s+r} \right) \exp \left(-\frac{w^2}{2} \right) \sqrt{\frac{r}{s+r}} dw \\ &\leq \frac{C}{\sqrt{s}} \frac{r}{s+r} \left(1 + \left(\frac{\eta s}{r} + y \right) \right), \end{aligned}$$

and the first inequality follows.

Proceeding in the same way, we get

$$\begin{aligned} &\mathbb{E}_x \left[e^{-(R_s - \varrho)^2/2r} \right] \\ &= \sqrt{\frac{2}{\pi}} \int_0^\infty z^2 \exp \left(-\frac{1}{2} \left[\left(z \sqrt{\frac{s+r}{r}} - \left(\frac{\eta s}{r} + y \right) \sqrt{\frac{r}{s+r}} \right)^2 + \frac{s(\eta-y)^2}{s+r} \right] \right) dz \\ &\leq \sqrt{\frac{2}{\pi}} \int_{-\infty}^\infty 2 \left(w^2 \frac{r}{s+r} + \left(\frac{\eta s}{r} + y \right)^2 \left(\frac{r}{s+r} \right)^2 \right) \exp \left(-\frac{w^2}{2} \right) \sqrt{\frac{r}{s+r}} dw \\ &\leq C \left(\frac{r}{s+r} \right)^{3/2} \left(1 + \left(\frac{\eta s}{r} + y \right)^2 \right), \end{aligned}$$

and it proves the second inequality. \square

4.C.3 Some consequences of Assumptions (i) and (ii)

We establish here some technical lemmas concerning the function f , relying on Assumptions (i) and (ii). The first one is useful when δ is small.

Lemma 4.C.4. *Let $f: \mathbb{R} \rightarrow \mathbb{R}_+$ be a function satisfying Assumptions (i)-(ii) and such that $\mathbb{E}[f(R_1)] = 0$. For any, $y \geq 0$, $\eta \in \mathbb{R}$, $\varepsilon > 0$ and $\delta \in [0, 1)$, we have*

$$\begin{aligned} & \left| \mathbb{E}_y \left[\frac{(R_1 - \eta)_+}{R_1} f((1 - \delta)(R_1 - \eta)) \right] - \mathbb{E}[f((1 - \delta)R_1)] \right| \\ & \leq \frac{C}{1 - \delta} e^{C(1 - \delta)|\eta|} \left(y^2(1 + y^3)e^{C(1 - \delta)y} + |\eta| \right). \end{aligned}$$

Proof. We prove the inequality in three steps. The first step is to prove that

$$\begin{aligned} & \left| \mathbb{E}_y \left[\frac{(R_1 - \eta)_+}{R_1} f((1 - \delta)(R_1 - \eta)) \right] - \mathbb{E} \left[\frac{(R_1 - \eta)_+}{R_1} f((1 - \delta)(R_1 - \eta)) \right] \right| \\ & \leq \frac{C}{1 - \delta} e^{-C(1 - \delta)\eta} y^2(1 + y^3)e^{C(1 - \delta)y}. \end{aligned} \quad (4.79)$$

The right-hand side of (4.79) is equal to

$$\begin{aligned} & \frac{1}{1 - \delta} \left| \mathbb{E}_y \left[\frac{1}{R_1} g((1 - \delta)(R_1 - \eta)) \mathbb{1}_{R_1 > \eta_+} \right] - \mathbb{E} \left[\frac{1}{R_1} g((1 - \delta)(R_1 - \eta)) \mathbb{1}_{R_1 > \eta_+} \right] \right| \\ & \leq \frac{1}{1 - \delta} \int_{\varepsilon + \eta_+}^{\infty} \frac{1}{z} |g((1 - \delta)(z - \eta))| \sqrt{\frac{2}{\pi}} \frac{z}{y} e^{-z^2/2} \left(e^{-y^2/2} \sinh(zy) - zy \right) dz. \end{aligned} \quad (4.80)$$

But, for $y, z > 0$, we have

$$\begin{aligned} \left| e^{-y^2/2} \sinh(zy) - zy \right| & \leq e^{-y^2/2} |\sinh(zy) - zy| + \left| e^{-y^2/2} - 1 \right| zy \leq e^{-y^2/2} \sum_{k \geq 1} \frac{(zy)^{2k+1}}{(2k+1)!} + \frac{zy^3}{2} \\ & \leq e^{-y^2/2} (zy)^3 \sum_{k \geq 0} \frac{(zy)^{2k}}{(2k+3)!} + zy^3 \leq e^{-y^2/2} (zy)^3 e^{zy} + zy^3. \end{aligned}$$

Then, using Assumption (i) (thanks to the indicator function, g is only evaluated at positive points), the right-hand side of (4.80) is smaller than

$$\begin{aligned} & \frac{1}{1 - \delta} \int_0^{\infty} C e^{C(1 - \delta)(z - \eta)} \sqrt{\frac{2}{\pi}} e^{-z^2/2} y^2 \left(e^{-y^2/2} z^3 e^{zy} + z \right) dz \\ & \leq \frac{C}{1 - \delta} y^2 e^{-C(1 - \delta)\eta} \int_0^{\infty} e^{C(1 - \delta)z} z e^{-z^2/2} \left(1 + z^2 e^{zy} e^{-y^2/2} \right) dz \\ & \leq \frac{C}{1 - \delta} y^2 e^{-C(1 - \delta)\eta} \left(1 + \int_0^{\infty} e^{C(1 - \delta)z} z^3 e^{-(z - y)^2/2} dz \right) \\ & \leq \frac{C}{1 - \delta} y^2 e^{-C(1 - \delta)\eta} \left(1 + \int_{-y}^{\infty} e^{C(1 - \delta)(z + y)} (z + y)^3 e^{-z^2/2} dz \right) \\ & \leq \frac{C}{1 - \delta} y^2 e^{-C(1 - \delta)\eta} \left(1 + e^{C(1 - \delta)y} (1 + y^3) \right), \end{aligned}$$

and we get (4.79), by noting that $1 + e^{C(1 - \delta)y}(1 + y^3) \leq 2(1 + y^3)e^{C(1 - \delta)y}$. The second step consists in proving that

$$\mathbb{E} \left[\left| \frac{(R_1 - \eta)_+}{R_1} f((1 - \delta)(R_1 - \eta)) - f((1 - \delta)R_1) \mathbb{1}_{R_1 > \eta_+} \right| \right] \leq \frac{C|\eta|}{1 - \delta} e^{C(1 - \delta)|\eta|}. \quad (4.81)$$

The left-hand side of (4.81) is equal to

$$\mathbb{E}\left[\frac{1}{(1-\delta)R_1}|g((1-\delta)(R_1-\eta)) - g((1-\delta)R_1)|\mathbb{1}_{R_1>\eta_+}\right]. \quad (4.82)$$

In order to bound (4.82), we distinguish the cases $\eta > 0$ and $\eta \leq 0$. When $\eta > 0$, for any $x > \eta$, we have, using Assumption (ii) with $\delta' = \eta/x \in [0, 1]$,

$$|g((1-\delta)(x-\eta)) - g((1-\delta)x)| = |g((1-\delta)(1-\delta')x) - g((1-\delta)x)| \leq C\delta'e^{C(1-\delta)x},$$

and, therefore, (4.82) is smaller than

$$\mathbb{E}\left[\frac{1}{(1-\delta)R_1}C\frac{\eta}{R_1}e^{C(1-\delta)R_1}\right] = \frac{C\eta}{1-\delta}\mathbb{E}\left[\frac{1}{R_1^2}e^{CR_1}\right] \leq C\frac{\eta}{1-\delta}. \quad (4.83)$$

When $\eta \leq 0$, we have, for any $x \geq 0$, using Assumption (ii) with $\delta' = -\eta/(x-\eta)$,

$$\begin{aligned} |g((1-\delta)(x-\eta)) - g((1-\delta)x)| &= |g((1-\delta)(x-\eta)) - g((1-\delta)(x-\eta)(1-\delta'))| \\ &\leq C\delta'e^{C(1-\delta)(x-\eta)}, \end{aligned}$$

and (4.82) is smaller than

$$\mathbb{E}\left[\frac{1}{(1-\delta)R_1}C\frac{|\eta|}{R_1+|\eta|}e^{C(1-\delta)(R_1-\eta)}\right] \leq \frac{C|\eta|}{1-\delta}e^{-C(1-\delta)\eta}\mathbb{E}\left[\frac{1}{R_1^2}e^{CR_1}\right] \leq \frac{C|\eta|}{1-\delta}e^{-C(1-\delta)\eta}. \quad (4.84)$$

Combining (4.83) and (4.84), it proves (4.81). The third and final step in the proof of the lemma is to bound

$$\begin{aligned} \mathbb{E}[|f((1-\delta)R_1)\mathbb{1}_{R_1>\eta_+} - f((1-\delta)R_1)|] &= \mathbb{E}[|f((1-\delta)R_1)|\mathbb{1}_{R_1\leq\eta_+}] \\ &\leq \mathbb{E}\left[C\frac{e^{C(1-\delta)R_1}}{(1-\delta)R_1}\mathbb{1}_{R_1\leq\eta_+}\right] \\ &\leq \frac{C}{1-\delta}\eta_+e^{C(1-\delta)\eta_+}, \end{aligned}$$

using Assumption (i) and then that $\mathbb{E}[(R_1)^{-1}\mathbb{1}_{R_1\leq\eta_+}] \leq C\eta_+$ (this follows from explicit computation with the density of R_1). Combining this with (4.79) and (4.81), it concludes the proof. \square

Lemma 4.C.5. *Let $f: \mathbb{R} \rightarrow \mathbb{R}_+$ be a function satisfying Assumptions (i)-(ii) and such that $\mathbb{E}[f(R_1)] = 0$. We define the function $H: a \in (0, 1] \mapsto \mathbb{E}[f(\sqrt{a}R_1)]$. For any $0 < a \leq b \leq 1$, we have*

$$|H(a)| \leq \frac{C}{\sqrt{a}}(1-a) \quad \text{and} \quad |H(a) - H(b)| \leq \frac{C}{\sqrt{a}}\frac{b-a}{b}.$$

Proof. We have, with $\delta := 1 - \sqrt{a/b}$ and using Assumptions (i) and (ii),

$$\begin{aligned} |H(a) - H(b)| &\leq \mathbb{E}[|f(\sqrt{a}R_1) - f(\sqrt{b}R_1)|] = \mathbb{E}[|f((1-\delta)\sqrt{b}R_1) - f(\sqrt{b}R_1)|] \\ &\leq \mathbb{E}[\delta|f((1-\delta)\sqrt{b}R_1)|] + \mathbb{E}\left[\frac{1}{\sqrt{b}R_1}|g((1-\delta)\sqrt{b}R_1) - g(\sqrt{b}R_1)|\right] \\ &\leq C\left(1 - \sqrt{\frac{a}{b}}\right)\left(\mathbb{E}\left[\frac{e^{C\sqrt{a}R_1}}{\sqrt{a}R_1}\right] + \mathbb{E}\left[\frac{e^{C\sqrt{b}R_1}}{\sqrt{b}R_1}\right]\right) \leq C\left(1 - \sqrt{\frac{a}{b}}\right)\left(\frac{1}{\sqrt{a}} + \frac{1}{\sqrt{b}}\right). \end{aligned}$$

Noting that $a^{-1/2} + b^{-1/2} \leq 2a^{-1/2}$ and that $1 - \sqrt{a/b} \leq 1 - a/b$, it proves the second inequality and, taking $b = 1$, the first one. \square

Lemma 4.C.6. *Let $f: \mathbb{R} \rightarrow \mathbb{R}_+$ be a function satisfying Assumption (i). For any, $y \geq 0$, $\eta \in \mathbb{R}$, $\varepsilon > 0$ and $\delta \in [0, 1)$, we have*

$$\mathbb{E}_y \left[\frac{(R_1 - \eta)_+}{R_1} |f((1 - \delta)(R_1 - \eta))| \right] \leq \frac{C}{1 - \delta} e^{C(1 - \delta)(y - \eta)} \left(1 \wedge \frac{1}{y} \right).$$

Proof. Using Assumption (i), we get

$$\begin{aligned} \mathbb{E}_y \left[\frac{(R_1 - \eta)_+}{R_1} |f((1 - \delta)(R_1 - \eta))| \right] &\leq \frac{C}{1 - \delta} \mathbb{E}_y \left[\frac{1}{R_1} e^{C(1 - \delta)(R_1 - \eta)} \right] \\ &\leq \frac{C}{1 - \delta} e^{-C(1 - \delta)\eta} e^{C(1 - \delta)y} \left(1 \wedge \frac{1}{y} \right), \end{aligned}$$

using Lemma 4.C.2. □

Chapter 5

Two temperatures overlap for the two-dimensional discrete Gaussian free field

Abstract

In this chapter, which is a joint work with Olivier Zindy [PZ18a], we prove absence of temperature chaos for the two-dimensional discrete Gaussian free field using the convergence of the full extremal process, which has been obtained recently by Biskup and Louidor. This means that the overlap of two points chosen under Gibbs measures at different temperatures has a nontrivial distribution. Whereas this distribution is the same as for the random energy model when the two points are sampled at the same temperature, we point out here that they are different when temperatures are distinct: more precisely, we prove that the mean overlap of two points chosen under Gibbs measures at different temperatures for the DGFF is strictly smaller than the REM's one. Therefore, although neither of these models exhibits temperature chaos, one could say that the DGFF is more chaotic in temperature than the REM.

5.1 Introduction

5.1.1 Spin glasses and chaos phenomenon

The phenomenon of chaos in temperature or disorder is a classical problem in spin glasses, which was discovered by Fisher and Huse [FH86] for the Edwards-Anderson model, and Bray and Moore [BM87] for the Sherrington-Kirkpatrick model. It arose from the discovery that, for some models, a small change in the external parameters (such as temperature or disorder) can induce a dramatic change of the overall energy landscape or may modify the location of the ground state and the organization of the pure states for the Gibbs measure. In the last decades, this phenomenon has been studied extensively by physicists for various models, see Rizzo [Riz09] for a recent survey. Several mathematical results have also been obtained by Chen and Panchenko [CP13], Chen [Che14], Auffinger and Chen [AC16], Panchenko [Pan16], Subag [Sub17], Chen and Panchenko [CP17] and Ben Arous, Subag and Zeitouni [BASZ18] in recent years.

This chapter concerns the problem of chaos in temperature, which can be described more precisely as follows. The *overlap* between two configurations is defined as the normalized covariance between energies of these configurations. *Temperature chaos* means that, if one samples independently two spin configurations from Gibbs measures at different temperatures

but with fixed disorder, then their overlap will be almost deterministic. This phenomenon happens when the set of most likely configurations under the Gibbs measure changes radically when the temperature varies only slightly: in spin glass models, the Gibbs measure at a given temperature is concentrated near some fixed level of energy and on some pure states and both of them can change with temperature.

Some spin glass models display temperature chaos and some others do not. For example, Subag [Sub17] proved recently the absence of chaos in temperature for spherical *pure* p -spin models with $p \geq 3$, while Ben Arous, Subag and Zeitouni [BASZ18] proved chaos in temperature for some spherical *mixed* p -spin models. Both results rely on a precise geometrical description of the Gibbs measure and hold at low temperature (β large enough), in part of the one-step replica symmetry breaking (1-RSB) regime. For the spherical pure p -spin models, the supports of the Gibbs measures are close to each other for different (low enough) temperatures, while, for spherical mixed p -spin models, the Gibbs measure concentrates on thin spherical bands which depend on the temperature. This difference explains partially why chaos in temperature occurs for the second class of models but not for the first one.

In order to shed some light on the mysteries of the Parisi theory for mean field spin glasses, Derrida introduced in the 80's the random energy model (REM) [Der80, Der81], where the Gaussian energy levels are assumed to be independent, and its generalization, the generalized random energy model (GREM) [Der85], whose correlations are given by a tree structure of finite depth. These tractable models have been extensively studied and allowed, in particular, to investigate the phenomenon of replica symmetry breaking, see Section 1.2 for more details. Let us mention here that Kurkova [Kur03] proved the absence of chaos in temperature for the REM; this will be made more precise later.

Natural hierarchical models with an infinite number of levels are the branching Brownian motion (BBM) and the branching random walk (BRW), see e.g. the seminal paper by Derrida and Spohn [DS88], who introduced directed polymers on trees (a BRW with i.i.d. displacements) as an infinite hierarchical extension of the GREM for spin glasses. As we have seen in Section 1.2, these models belong to the universality class of log-correlated Gaussian fields, such as the two-dimensional discrete Gaussian free field that we study in this chapter. This Gaussian field can be seen as a spin glass model where the dimension is fixed, unlike the mean fields model mentioned above where the dimension tends to infinity. We refer to the works by Carpentier et Le Doussal [CLD01], Fyodorov and Bouchaud [FB08a, FB08b] and Fyodorov, Le Doussal and Rosso [FLDR09] for connection between log-correlated Gaussian fields and spin glass theory. The lecture notes of Biskup [Bis17] give an excellent account of recent results about two-dimensional DGFF. Note also that this model has an implicit hierarchical structure, see the lecture notes of Zeitouni [Zei17] for connections with BRW.

In this chapter, we prove absence of temperature chaos for the two-dimensional discrete Gaussian free field using the convergence of the full extremal process recently proved by Biskup and Louidor [BL18b]. We also show that the mean overlap between two points sampled independently according to Gibbs measures at different temperatures is strictly smaller than the REM's one, which might be surprising since the overlap distribution is the same for both models if the two points are sampled at the same temperature, see (5.3) and (5.11). Note that we focus here on the behavior near the maximum of the DGFF and of the REM, whereas in Chapter 1 we presented our results near the minimum. In particular, Gibbs measures have weights $e^{\beta h_x}$ here, instead of $e^{-\beta h_x}$ in previous chapters.

5.1.2 The two-dimensional discrete Gaussian free field

We consider in this chapter the two-dimensional discrete Gaussian free field (DGFF) on an *admissible* lattice approximation of a bounded open set $D \subset \mathbb{C}$. More precisely, let D be

a bounded open set of \mathbb{C} such that its boundary ∂D has only a finite number of connected components, each of which has a positive diameter and is a \mathcal{C}^1 path (i.e. the range of a \mathcal{C}^1 function from $[0, 1]$ to \mathbb{C}). We denote by dist_∞ the ℓ^∞ -distance on \mathbb{Z}^2 . Let $(D_N)_{N \geq 1}$ be the sequence of subsets of \mathbb{Z}^2 defined by

$$D_N := \left\{ x \in \mathbb{Z}^2 : \text{dist}_\infty \left(\frac{x}{N}, D^c \right) > \frac{1}{N} \right\}.$$

These assumptions are slightly more restrictive than those in the recent papers of Biskup and Louidor [BL14, BL16c, BL18b], but only to avoid some technical issues due to boundary effects.

The *discrete Gaussian free field* on D_N is the Gaussian process $(h_x^N)_{x \in D_N}$ with covariance given by the Green function G_N of the simple random walk on \mathbb{Z}^2 killed upon exiting D_N . See (5.38) for a detailed definition of G_N . In the sequel, we will skip the dependence in N for the field h^N , denoting simply $(h_x)_{x \in D_N}$. In comparison with spin glass theory, D_N plays the role of the configurations set and $-h_x$ is the energy of configuration x . Moreover, the *overlap* between $x, y \in D_N$ can be defined by

$$q_N(x, y) := \frac{\mathbb{E}[h_x h_y]}{\sup_{x \in D_N} \mathbb{E}[h_x^2]} = \frac{G_N(x, y)}{\sup_{x \in D_N} G_N(x, x)}.$$

Note that $q_N(x, y) \in [0, 1]$ and behaves roughly like $1 - \frac{\log \|x-y\|}{\log N}$ at least for points x and y far enough from the boundary ∂D_N , using the asymptotic behavior of G_N (see Lemma 5.A.2).

It was shown by Bolthausen, Deuschel and Giacomin [BDG01] that the maximum of the DGFF, or *ground state* in spin glass terminology, satisfies

$$\frac{\max_{x \in V_N} h_x}{\log N^2} \xrightarrow{N \rightarrow \infty} \sqrt{g}, \quad \text{in probability,}$$

with $g := 2/\pi$ and in the special case of the square lattice $V_N := (0, N)^2 \cap \mathbb{Z}^2$. Their technique was later refined by Daviaud [Dav06] who computed the *log-number of high points* in V_N : for any $0 < \lambda < 1$,

$$\lim_{N \rightarrow \infty} \frac{1}{\log N^2} \log \#\{x \in V_N : h_x \geq \lambda \sqrt{g} \log N^2\} = 1 - \lambda^2, \quad \text{in probability.} \quad (5.1)$$

This result holds also with a general admissible lattice approximation $(D_N)_{N \geq 1}$, as a consequence of [BL16c, Theorem 2.1].

The *Gibbs measure* at inverse temperature $\beta > 0$ associated with the DGFF is defined by

$$\mathcal{G}_{\beta, N} := \frac{1}{Z_{\beta, N}} \sum_{x \in D_N} e^{\beta h_x} \delta_x,$$

where $Z_{\beta, N} := \sum_{x \in D_N} e^{\beta h_x}$ is the partition function. This model exhibits a phase transition in the asymptotic behavior of the *free energy* defined by

$$f_N(\beta) := \frac{\log Z_{\beta, N}}{\log N^2}.$$

Indeed, it follows easily from (5.1) (see [AZ15]) that the free energy converges as $N \rightarrow \infty$ and

$$\lim_{N \rightarrow \infty} f_N(\beta) = f(\beta) := \begin{cases} 1 + (\beta/\beta_c)^2, & \text{if } \beta \leq \beta_c, \\ 2\beta/\beta_c, & \text{if } \beta \geq \beta_c, \end{cases} \quad \text{in probability and in } L^1, \quad (5.2)$$

where the critical inverse temperature is given by

$$\beta_c := \sqrt{2\pi} = \frac{2}{\sqrt{g}}.$$

Arguin and Zindy [AZ15] used the previous results to prove that the model displays a one-step replica symmetry breaking in spin glass terminology. More precisely, they showed that, on the square lattice V_N ,

$$\mathbb{E}\left[\mathcal{G}_{\beta,N}^{\otimes 2}(q_N(u,v) \in \cdot)\right] \xrightarrow{n \rightarrow \infty} \frac{\beta_c}{\beta} \delta_0 + \left(1 - \frac{\beta_c}{\beta}\right) \delta_1, \quad \forall \beta > \beta_c, \quad (5.3)$$

where, in the left-hand side, u and v are chosen independently according to $\mathcal{G}_{\beta,N}$ given the Gaussian free field h , before taking the expectation w.r.t. h . In other words, the left-hand side is the pushforward of the measure $\mathbb{E}[\mathcal{G}_{\beta,N}^{\otimes 2}]$ on D_N^2 by the function q_N . To prove this, they adopted a spin glass approach, introducing a perturbed DGFF and adapting the so-called Bovier-Kurkova technique, which relates the free energy of the perturbed DGFF with the overlap distribution of the initial DGFF.

Let us notice that all the aforementioned results hold also for the REM defined, for each $N \geq 1$, as $(h_x^{\text{REM}})_{x \in D_N}$, which are i.i.d. centered Gaussian random variables with variance $\max_{x \in D_N} G_N(x,x)$, in order to be comparable to the DGFF. The first difference between the REM and the DGFF that has been observed mathematically is the second order of the maximum: it has been proved by Bolthausen, Deuschel and Zeitouni [BDZ11], Bramson and Zeitouni [BZ12] and Bramson, Ding and Zeitouni [BDZ16], also in the special case of the square lattice V_N , that the centered maximum of the DGFF $\max_{x \in V_N} h_x - m_N$, where

$$m_N := 2\sqrt{g} \log N - \frac{3}{4}\sqrt{g} \log \log N, \quad (5.4)$$

converges in distribution towards a nontrivial limit, whereas the right centering term for the REM is $m_N^{\text{REM}} := 2\sqrt{g} \log N - \frac{1}{4}\sqrt{g} \log \log N$. Biskup and Louidor described the limit in [BL16b] and extended the result to a class of *admissible* lattice approximations for D in [BL14].

The next step in the description of extremes of the DGFF has been the study of the extremal process, which describes the field seen from position m_N . More precisely, the *full extremal process* is defined as the following random measure on $D \times \mathbb{R} \times \mathbb{R}^{\mathbb{Z}^2}$:

$$\eta_{N,r} := \sum_{x \in D_N} \mathbb{1}_{\{h_x = \max_{y \in \Lambda_r(x)} h_y\}} \delta_{x/N} \otimes \delta_{h_x - m_N} \otimes \delta_{(h_x - h_{x+z})_{z \in \mathbb{Z}^2}}, \quad (5.5)$$

where $\Lambda_r(x) := \{y \in D_N : \|x - y\| \leq r\}$. It encodes the rescaled position of the local maxima, their centered value and the field seen from this local maximum. The convergence of the full extremal process has been proved by Biskup and Louidor [BL18b] and can be stated as follows. There exist a random finite Borel measure Z^D on \bar{D} and a probability measure ν on $(\mathbb{R}_+)^{\mathbb{Z}^2}$ such that, for any sequence $(r_N)_{N \geq 1}$ of positive real numbers with $r_N \rightarrow \infty$ and $N/r_N \rightarrow \infty$,

$$\eta_{N,r_N} \xrightarrow[N \rightarrow \infty]{\text{law}} \eta := \text{PPP}\left(Z^D(dz) \otimes e^{-\beta_c h} dh \otimes \nu(d\phi)\right), \quad (5.6)$$

in the sense that, for any continuous function $f: \bar{D} \times \mathbb{R} \times \mathbb{R}^{\mathbb{Z}^2} \rightarrow \mathbb{R}$ depending only on a finite subset of coordinates $A \subset \mathbb{Z}^2$ and with compact support in $\bar{D} \times \mathbb{R} \times \mathbb{R}^A$, $\eta_{N,r_N}(f) = \int f d\eta_{N,r_N}$ converges in distribution towards $\eta(f)^1$. It means that, given Z^D , rescaled positions of local

1. This is not the vague convergence for random Radon measures on $\bar{D} \times \mathbb{R} \times \mathbb{R}^{\mathbb{Z}^2}$ as stated in [BL18b, Theorem 2.1], but this is what is shown in their proof.

maxima are asymptotically i.i.d. variables with law $Z^D/Z^D(\bar{D})$, their centered values are given by an independent Poisson point process with intensity $Z^D(\bar{D})e^{-\beta_c h} dh$ and to each of these local maxima is attached an independent cluster with law ν . The random measure Z^D has been studied and characterized in [BL14]: in particular, Z^D has full support in \bar{D} and $Z^D(\partial D) = 0$ almost surely. Moreover, Biskup and Louidor [BL18b] give an explicit description of the cluster law ν , see Section 5.3.4 for more details.

The convergence of the full extremal process leads to a precise description of the supercritical Gibbs measure $\mathcal{G}_{\beta,N}$ for $\beta > \beta_c$. For large N , this measure is concentrated on points $x \in D_N$ such that $h_x = m_N + O(1)$. Therefore, in spin glass terminology, the pure states are balls of diameter $O(1)$ centered at each local maximum of height $m_N + O(1)$: if two points are in the same pure state, then they have an overlap close to 1 and, if they are in two different pure states, their overlap is close to 0. This explains the one-step replica symmetry breaking of the model. Moreover, the ordered weights of the pure states under $\mathcal{G}_{\beta,N}$ follows asymptotically a *Poisson–Dirichlet distribution* of parameter β_c/β denoted $\text{PD}(\beta_c/\beta)$, which is the law of $(a_i/\sum_j a_j, i \geq 1)_\downarrow$ where \downarrow stands for the decreasing rearrangement and $(a_i)_{i \geq 1}$ are the atoms of a Poisson point process on $(0, \infty)$ with intensity $s^{-(\beta_c/\beta)-1} ds$. More precisely, Biskup and Louidor [BL18b, Corollary 2.7] proved that, for $\beta > \beta_c$, on the space of Radon measures on \bar{D} endowed with the vague convergence, we have

$$\sum_{x \in D_N} \mathcal{G}_{\beta,N}(\{x\}) \delta_{x/N} \xrightarrow{N \rightarrow \infty} \sum_{i \geq 1} p_i \delta_{\chi_i}, \quad \text{in distribution,} \quad (5.7)$$

where, conditionally on Z^D , $(\chi_i)_{i \geq 1}$ is an i.i.d. sequence of random variables with distribution $Z^D/Z^D(D)$ and $(p_i)_{i \geq 1}$ is independent of $(\chi_i)_{i \geq 1}$ with law $\text{PD}(\beta_c/\beta)$. We also mention that a weaker version of this Poisson–Dirichlet convergence (for the overlap distribution) has been obtained by Arguin and Zindy [AZ14, AZ15].

For the REM, the supercritical Gibbs measure $\mathcal{G}_{\beta,N}^{\text{REM}}$ for $\beta > \beta_c$ is also carried by extremal points, which are the $x \in D_N$ such that $h_x^{\text{REM}} = m_N^{\text{REM}} + O(1)$. Moreover, these points are uniformly chosen in D_N and, in the limit, their heights are given by an independent Poisson point process with intensity $c e^{-\beta_c h} dh$, with $c > 0$. Hence, the pure states are here the singletons formed by extremal points and are at distance of order N of each other. However, these pure states have also Gibbs weights following asymptotically the Poisson–Dirichlet distribution of parameter β_c/β and therefore the overlap under $(\mathcal{G}_{\beta,N}^{\text{REM}})^{\otimes 2}$ has asymptotically the same law as for the DGFF. See Figure 5.1.

5.1.3 Overlap distribution at two different temperatures

In the previous subsection, we saw that the pure states of the supercritical Gibbs measure of the DGFF are points with height $m_N + O(1)$. In particular, they do not depend on the temperature and, for $\beta, \beta' > \beta_c$, two points chosen independently according to $\mathcal{G}_{\beta,N}$ and $\mathcal{G}_{\beta',N}$ have a positive probability to be in the same pure state, but also to be in different pure states: therefore, their overlap can be either 0 or 1 and there is clearly no temperature chaos for the DGFF. This is made more precise in our first result, stating the convergence of the overlap under $\mathcal{G}_{\beta,N} \otimes \mathcal{G}_{\beta',N}$.

Theorem 5.1.1. *Let $\beta, \beta' > 0$.*

- (i) *If $\beta \leq \beta_c$ or $\beta' \leq \beta_c$, then, for all $a \in (0, 1)$,*

$$\mathcal{G}_{\beta,N} \otimes \mathcal{G}_{\beta',N}(q_N(u, v) \geq a) \xrightarrow{N \rightarrow \infty} 0, \quad \text{in } L^1.$$

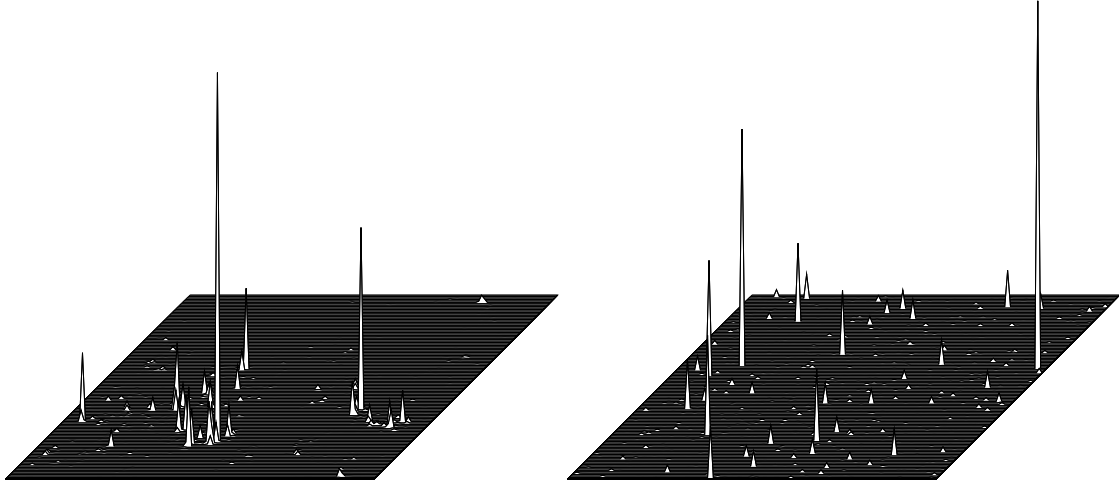

Figure 5.1 – Realization of $e^{\beta h}$, where h is a DGFF on the left and a REM on the right. The domain is the square $V_N = (0, N) \cap \mathbb{Z}^2$ with $N = 127$ and β is slightly supercritical ($\beta = 1.1 \cdot \beta_c$). Note that points carrying the mass of the Gibbs measure at inverse temperature β are gathered in clusters for the DGFF and are uniformly distributed on the square for the REM.

(ii) If $\beta > \beta_c$ and $\beta' > \beta_c$, then, for all $a \in (0, 1)$,

$$\mathcal{G}_{\beta, N} \otimes \mathcal{G}_{\beta', N}(q_N(u, v) \geq a) \xrightarrow{N \rightarrow \infty} Q(\beta, \beta'), \quad \text{in distribution,}$$

where

$$Q(\beta, \beta') := \frac{\sum_{k \geq 1} \left(\sum_{x \in \mathbb{Z}^2} e^{\beta(\xi_k - \phi_x^k)} \right) \left(\sum_{x \in \mathbb{Z}^2} e^{\beta'(\xi_k - \phi_x^k)} \right)}{\left(\sum_{k \geq 1} \sum_{x \in \mathbb{Z}^2} e^{\beta(\xi_k - \phi_x^k)} \right) \left(\sum_{k \geq 1} \sum_{x \in \mathbb{Z}^2} e^{\beta'(\xi_k - \phi_x^k)} \right)},$$

with $(\xi_k)_{k \geq 1}$ the atoms of a Poisson point process with intensity $e^{-\beta_c h} dh$ and $(\phi_x^k)_{k \geq 1}$ independent samples from the measure ν , independent of $(\xi_k)_{k \geq 1}$.

In other words, this result proves the convergence of the pushforward of the measure $\mathcal{G}_{\beta, N} \otimes \mathcal{G}_{\beta', N}$ on D_N^2 by the function q_N , which is a random measure on $[0, 1]$. The limit is either δ_0 if $\beta \wedge \beta' \leq \beta_c$, or $(1 - Q(\beta, \beta'))\delta_0 + Q(\beta, \beta')\delta_1$ otherwise. In case (ii), given the limit of the full extremal process, $Q(\beta, \beta')$ is simply the probability of choosing two points in the same cluster, when they are chosen proportionally to their Gibbs weights with inverse temperature β and β' respectively.

For the REM, the overlap between $x, y \in D_N$ is defined by

$$q_N^{\text{REM}}(x, y) := \frac{\mathbb{E}[h_x^{\text{REM}} h_y^{\text{REM}}]}{\sup_{x \in D_N} G_N(x, x)} = \mathbb{1}_{\{x=y\}}.$$

Kurkova [Kur03] proved the following result: if $\beta, \beta' > \beta_c$, then, for any $a \in (0, 1)$, we have

$$\mathcal{G}_{\beta, N}^{\text{REM}} \otimes \mathcal{G}_{\beta', N}^{\text{REM}}(q_N^{\text{REM}}(u, v) \geq a) \xrightarrow{N \rightarrow \infty} Q^{\text{REM}}(\beta, \beta') := \frac{\sum_{k \geq 1} e^{\beta \xi_k} e^{\beta' \xi_k}}{(\sum_{k \geq 1} e^{\beta \xi_k}) (\sum_{k \geq 1} e^{\beta' \xi_k})}, \quad (5.8)$$

where the $(\xi_k)_{k \geq 1}$ are also the atoms of a Poisson point process with intensity $e^{-\beta_c x} dx$. Our aim is now to compare $Q(\beta, \beta')$ and $Q^{\text{REM}}(\beta, \beta')$.

In the case $\beta = \beta'$, it is known that $Q(\beta, \beta)$ and $Q^{\text{REM}}(\beta, \beta)$ have the same distribution. Indeed, for $\beta > \beta_c$ and $k \geq 1$, we introduce the random variable

$$X_{\beta, k} := \frac{1}{\beta} \log \sum_{x \in \mathbb{Z}^2} e^{-\beta \phi_x^k},$$

so that the limit of the overlap can be rewritten as

$$Q(\beta, \beta') = \frac{\sum_{k \geq 1} e^{\beta(\xi_k + X_{\beta,k})} e^{\beta'(\xi_k + X_{\beta',k})}}{\left(\sum_{k \geq 1} e^{\beta(\xi_k + X_{\beta,k})}\right) \left(\sum_{k \geq 1} e^{\beta'(\xi_k + X_{\beta',k})}\right)}. \quad (5.9)$$

Then, noting that $(X_{\beta,k})_{k \geq 1}$ is a sequence of i.i.d. random variables, which is independent of $(\xi_k)_{k \geq 1}$, we have

$$(\xi_k + X_{\beta,k})_{k \geq 1} \stackrel{(d)}{=} \left(\xi_k + \beta_c^{-1} \log \mathbb{E}\left[e^{\beta_c X_{\beta,1}}\right]\right)_{k \geq 1}, \quad (5.10)$$

where the equality in distribution holds with both sides seen as point processes (this observation for point processes with exponential intensity dates back at least to [RA05]). It shows that

$$Q(\beta, \beta) \stackrel{(d)}{=} \frac{\sum_{k \geq 1} e^{2\beta\xi_k}}{\left(\sum_{k \geq 1} e^{\beta\xi_k}\right)^2} = Q^{\text{REM}}(\beta, \beta). \quad (5.11)$$

Moreover, it follows from a simple change of variable that $(e^{\beta\xi_i} / \sum_{k \geq 1} e^{\beta\xi_k}, i \geq 1)_\downarrow$ has the same law as $(p_i)_{i \geq 1}$ a Poisson–Dirichlet random variable of parameter β_c/β , hence $Q(\beta, \beta)$ and $Q^{\text{REM}}(\beta, \beta)$ have the same law as $\sum_{i \geq 1} p_i^2$, which corresponds to the fact that the pure states have Poisson–Dirichlet weights.

One may ask whether $Q(\beta, \beta')$ and $Q^{\text{REM}}(\beta, \beta')$ have the same distribution when $\beta \neq \beta'$. The answer is negative and the second result shows that, in mean, the overlap is less likely to be close to 1 under $\mathcal{G}_{\beta,N} \otimes \mathcal{G}_{\beta',N}$ than under $\mathcal{G}_{\beta,N}^{\text{REM}} \otimes \mathcal{G}_{\beta',N}^{\text{REM}}$.

Theorem 5.1.2. *For any $\beta, \beta' > \beta_c$ such that $\beta \neq \beta'$, we have*

$$\mathbb{E}[Q(\beta, \beta')] < \mathbb{E}[Q^{\text{REM}}(\beta, \beta')].$$

The reason behind this inequality is the following. For the REM, the weight of a pure state depends only on its height: a likely pure state under $\mathcal{G}_{\beta,N}^{\text{REM}}$ will also be likely under $\mathcal{G}_{\beta',N}^{\text{REM}}$. Rather, the weight of a pure state for the DGFF depends both on the height of the local maximum and on the size of the cluster around it, hence some pure states are likely for β close to β_c and unlikely for large β , or vice-versa. Therefore, it is more difficult to choose twice the same pure state under the Gibbs measures at two different temperatures for the DGFF than for the REM and one could say that the DGFF is more chaotic in temperature than the REM. This result leads to the picture displayed in Figure 5.2 for the mean overlap in both models.

Remark 5.1.3. Theorem 5.1.2 could be approached as follows. Both $Q(\beta, \beta')$ and $Q^{\text{REM}}(\beta, \beta')$ have the same law as $\sum_{i \geq 1} p_i q_i$, where p and q have law $\text{PD}(\beta_c/\beta)$ and $\text{PD}(\beta_c/\beta')$ respectively and can be correlated in a certain way. Finding such p and q maximizing $\mathbb{E}[\sum_{i \geq 1} p_i q_i] = \mathbb{E}[\langle p, q \rangle]$ is equivalent to find (p, q) reaching the minimum in the Wasserstein distance between the measures $\text{PD}(\beta_c/\beta)$ and $\text{PD}(\beta_c/\beta')$ on the Hilbert space ℓ^2 of square-summable sequences. In the case of the REM, we have

$$q_i = \frac{p_i^{\beta'/\beta}}{\sum_{k \geq 1} p_k^{\beta'/\beta}},$$

and one could ask if this choice is optimal (as suggested by the statement of Theorem 5.1.2). But, this is not the case because one can check that

$$\mathbb{P} \otimes \mathbb{P}(\{(\omega, \omega') : \langle p(\omega) - p(\omega'), q(\omega) - q(\omega') \rangle < 0\}) > 0,$$

and it shows that this pair (p, q) is not reaching the Wasserstein distance by [CM89, Theorem 2.3].

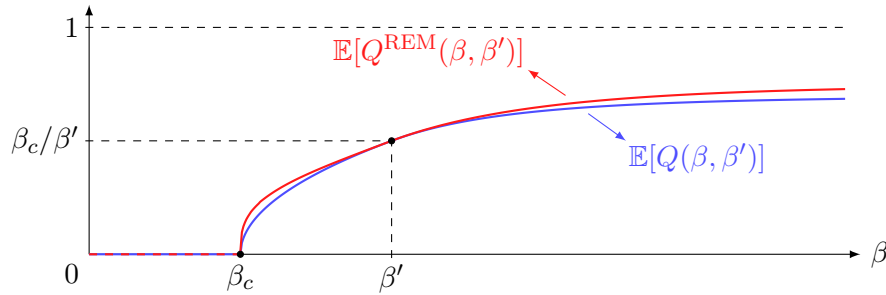

Figure 5.2 – Schematic representation of the mean overlap at two different inverse temperatures β and β' , as β' is fixed and β varies, for the DGFF (in blue) and the REM (in red). The difference between the curves is actually exaggerated on the figure: computer calculations suggest that they should be indistinguishable at this scale.

Remark 5.1.4. In the case where $\beta < \infty$ and $\beta' = \infty$, it is easier to see that the overlap distribution for the DGFF should be different from the REM's one. We can define $\mathcal{G}_{\infty, N}$ as the measure which gives mass 1 to the point where $\max_{x \in D_N} h_x$ is reached. Then, assuming that $(\xi_k)_{k \geq 1}$ is ranked in the decreasing order, one can prove in this case that the limiting overlap distribution is given by

$$Q(\beta, \infty) = \frac{\sum_{x \in \mathbb{Z}^2} e^{\beta(\xi_1 - \phi_x^1)}}{\sum_{k \geq 1} \sum_{x \in \mathbb{Z}^2} e^{\beta(\xi_k - \phi_x^k)}} = \frac{e^{\beta(\xi_1 + X_{\beta, 1})}}{\sum_{k \geq 1} e^{\beta(\xi_k + X_{\beta, k})}},$$

which is asymptotically the probability that the point chosen according to $\mathcal{G}_{\beta, N}$ is in the same cluster as the highest particle. On the other hand, we have $Q^{\text{REM}}(\beta, \infty) = e^{\beta \xi_1} / (\sum_{k \geq 1} e^{\beta \xi_k})$. Then, it follows from (5.10) that $Q(\beta, \infty)$ is stochastically strictly dominated by $Q^{\text{REM}}(\beta, \infty)$, because with positive probability $\max_{k \geq 1} (\xi_k + X_{\beta, k})$ is not reached at $k = 1$ (this is true as soon as $X_{\beta, k}$ is not a.s. constant, which holds by the proof of Lemma 5.3.5).

Remark 5.1.5. Similar results could be proved for the branching Brownian motion or the branching random walk (see Section 1.4.2). Indeed, using the convergence of the extremal process of the BBM [ABBS13, ABK13, BH17] or of the BRW [Mad17, Mal18b], one can deduce Theorem 5.1.1 (see in particular the proof of Theorem 4.3 in [Mal18b]). For Theorem 5.1.2, the method used here is quite general and works also for BBM and BRW, aside from Lemma 5.3.5 that should be adapted.

5.1.4 Organization of the chapter

The chapter is organized as follows. Theorem 5.1.1 is proved in Section 5.2 and Theorem 5.1.2 in Section 5.3. Appendix 5.A contains well-known results concerning the two-dimensional Gaussian free field.

5.2 Convergence of the overlap distribution

5.2.1 Proof of Part (i) of Theorem 5.1.1

The proof of Part (i) of Theorem 5.1.1 will be a direct consequence of the following result, which relies on the fact that the free energy contains all information about the mean overlap under the measure $\mathbb{E}[\mathcal{G}_{\beta, N}^{\otimes 2}]$.

Proposition 5.2.1. *If $\beta \leq \beta_c$, then for any $a \in (0, 1]$,*

$$\mathcal{G}_{\beta, N}^{\otimes 2}(q_N(u, v) \geq a) \xrightarrow{n \rightarrow \infty} 0, \quad \text{in } L^1.$$

Proof. Recall that $f_N(\beta)$ denotes the free energy of the DGFF on D_N at inverse temperature β . Observe that $\mathbb{E}[f_N(\beta)]$ is a convex function of the parameter β . Moreover, it was already mentioned that $\mathbb{E}[f_N(\beta)]$ converges towards $f(\beta)$, which is also convex in β . In particular, by a standard result of convexity (see e.g. Proposition I.3.2 in [Sim93]), at each point of differentiability of f , the limit of the derivatives equals the derivative of the limit. It follows from (5.2) that f is differentiable at any $\beta > 0$, hence we get

$$f'(\beta) = \lim_{N \rightarrow \infty} \frac{d}{d\beta} \mathbb{E}[f_N(\beta)] = \lim_{N \rightarrow \infty} \frac{1}{\log N^2} \sum_{x \in D_N} \mathbb{E} \left[\frac{h_x e^{\beta h_x}}{\sum_{z \in D_N} e^{\beta h_z}} \right].$$

Applying Gaussian integration by part (see Lemma 5.A.1) with respect to the factor h_x , it follows that

$$f'(\beta) = \lim_{N \rightarrow \infty} \frac{\beta}{\log N^2} \left(\sum_{x \in D_N} \mathbb{E}[h_x^2] \mathbb{E} \left[\frac{e^{\beta h_x}}{\sum_{z \in D_N} e^{\beta h_z}} \right] - \sum_{x, y \in D_N} \mathbb{E}[h_x h_y] \mathbb{E} \left[\frac{e^{\beta h_x} e^{\beta h_y}}{(\sum_{z \in D_N} e^{\beta h_z})^2} \right] \right).$$

In order to deal with the first sum, we introduce $D_{N,\delta} := \{x \in D_N : d(x, D_N^c) > N^{1-\delta}\}$ for some small $\delta \in (0, 1)$. It follows from (5.39) and (5.40), that $\sup_{x \in D_N} G_N(x, x) = \frac{2}{\pi} \log N + O_N(1)$ and $G_N(x, x) \geq \frac{2(1-\delta)}{\pi} \log N + O_N(1)$ uniformly in $x \in D_{N,\delta}$ as $N \rightarrow \infty$. On the other hand, we have $\mathbb{E}[\mathcal{G}_{\beta,N}(D_{N,\delta}^c)] \rightarrow 0$ by Lemma 5.A.3. Combining this, we get

$$f'(\beta) = \lim_{N \rightarrow \infty} \frac{\beta}{\pi} \left(1 - \mathbb{E} \left[\mathcal{G}_{\beta,N}^{\otimes 2}[q_N(u, v)] \right] \right).$$

Moreover, it follows from (5.2) that $f'(\beta) = \beta/\pi$ for any $\beta \leq \beta_c$, and therefore

$$\lim_{N \rightarrow \infty} \mathbb{E} \left[\mathcal{G}_{\beta,N}^{\otimes 2}[q_N(u, v)] \right] = 0,$$

which concludes the proof. \square

Proof of Part (i) of Theorem 5.1.1. By symmetry, we can assume that $\beta \leq \beta_c$. Fix some $0 < a < 1$. We want to prove that $\mathcal{G}_{\beta,N} \otimes \mathcal{G}_{\beta',N}(q_N(u, v) \geq a)$ converges to 0 in L^1 when N tends to infinity. Since it is bounded by 1, it is sufficient to prove the convergence in \mathbb{P} -probability. In order to avoid problems near the boundary of D_N , we first restrict ourselves to the set $D_{N,\delta} := \{x \in D_N : d(x, D_N^c) > N^{1-\delta}\}$ for some fixed $\delta \in (0, a)$: we have

$$\begin{aligned} \mathcal{G}_{\beta,N} \otimes \mathcal{G}_{\beta',N}(q_N(u, v) \geq a) &= \sum_{x, y \in D_N} \mathcal{G}_{\beta,N}(x) \mathcal{G}_{\beta',N}(y) \mathbb{1}_{\{q_N(x, y) \geq a\}} \\ &\leq \sum_{x, y \in D_{N,\delta}} \mathcal{G}_{\beta,N}(x) \mathcal{G}_{\beta',N}(y) \mathbb{1}_{\{q_N(x, y) \geq a\}} + \mathcal{G}_{\beta,N}(D_{N,\delta}^c) + \mathcal{G}_{\beta',N}(D_{N,\delta}^c). \end{aligned}$$

Since $\mathcal{G}_{\beta,N}(D_{N,\delta}^c)$ and $\mathcal{G}_{\beta',N}(D_{N,\delta}^c)$ tend to 0 in \mathbb{P} -probability by Lemma 5.A.3, it is sufficient to prove that the sum in the last line converges to 0 in \mathbb{P} -probability. Observe that Part (i) of Lemma 5.A.2 implies

$$\sum_{x, y \in D_{N,\delta}} \mathcal{G}_{\beta,N}(x) \mathcal{G}_{\beta',N}(y) \mathbb{1}_{\{q_N(x, y) \geq a\}} \leq \sum_{x, y \in D_{N,\delta}} \mathcal{G}_{\beta,N}(x) \mathcal{G}_{\beta',N}(y) \mathbb{1}_{\{\|x-y\| \leq c_1 N^{1-a}\}}. \quad (5.12)$$

Now we introduce a partition of $D_{N,\delta}$ by considering the intersection of $D_{N,\delta}$ with a partition of \mathbb{R}^2 with boxes of side-length $c_1 N^{1-a}$: let $\mathcal{B}_{N,a,\delta}$ denote this partition of $D_{N,\delta}$. Then, (5.12)

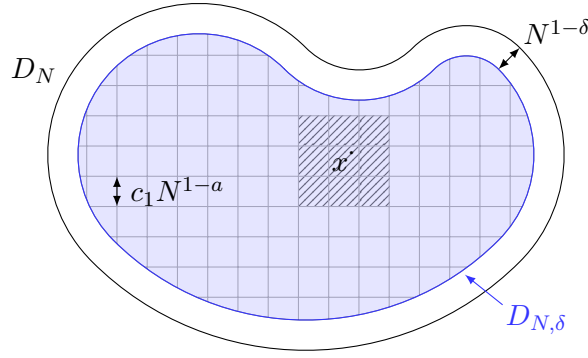

Figure 5.3 – The set $D_{N,\delta}$ (in blue) is partitioned using a square grid of span $c_1 N^{1-a}$ (in gray). If x is in a given box and $\|x - y\| \leq c_1 N^{1-a}$, then y belongs to one of the hatched boxes.

is smaller than

$$\begin{aligned} & \sum_{B \in \mathcal{B}_{N,a,\delta}} \mathcal{G}_{\beta,N}(B) \mathcal{G}_{\beta',N}(\{y \in D_{N,\delta} : \exists x \in B : \|x - y\| \leq c_1 N^{1-a}\}) \\ & \leq \left(\max_{B \in \mathcal{B}_{N,a,\delta}} \mathcal{G}_{\beta,N}(B) \right) \sum_{B \in \mathcal{B}_{N,a,\delta}} \mathcal{G}_{\beta',N}(\{y \in D_{N,\delta} : \exists x \in B : \|x - y\| \leq c_1 N^{1-a}\}) \\ & \leq 9 \left(\max_{B \in \mathcal{B}_{N,a,\delta}} \mathcal{G}_{\beta,N}(B) \right) \sum_{B \in \mathcal{B}_{N,a,\delta}} \mathcal{G}_{\beta',N}(B) \leq 9 \max_{B \in \mathcal{B}_{N,a,\delta}} \mathcal{G}_{\beta,N}(B), \end{aligned}$$

noting that the factor 9, which appears in the second inequality, comes from the fact that if $x \in B$ and $\|x - y\| \leq c_1 N^{1-a}$, then either y belongs to B or to a box neighbor to B , and the number of such neighbors is bounded by 8 (see Figure 5.3). Therefore, proving that

$$\max_{B \in \mathcal{B}_{N,a,\delta}} \mathcal{G}_{\beta,N}(B) \xrightarrow[n \rightarrow \infty]{} 0, \quad \text{in } \mathbb{P}\text{-probability,}$$

will conclude the proof. To this aim, we fix some $b \in (\delta, a)$ and, applying Part (ii) of Lemma 5.A.2, we get

$$\mathcal{G}_{\beta,N}^{\otimes 2}(q_N(u, v) \geq b - \delta) \geq \mathcal{G}_{\beta,N}^{\otimes 2}(\{(x, y) \in D_{N,\delta}^2 : \|x - y\| \leq c_2 N^{1-b}\}). \quad (5.13)$$

Then, note that, for N large enough, $\sqrt{2}c_1 N^{1-a} \leq c_2 N^{1-b}$ and hence the set in the right-hand side of (5.13) contains each $B \times B$ for $B \in \mathcal{B}_{N,a,\delta}$. Therefore, we get

$$\mathcal{G}_{\beta,N}^{\otimes 2}(q_N(u, v) \geq b - \delta) \geq \sum_{B \in \mathcal{B}_{N,a,\delta}} (\mathcal{G}_{\beta,N}(B))^2 \geq \max_{B \in \mathcal{B}_{N,a,\delta}} (\mathcal{G}_{\beta,N}(B))^2.$$

Recalling that $\mathcal{G}_{\beta,N}^{\otimes 2}(q_N(u, v) \geq b - \delta) \rightarrow 0$ in \mathbb{P} -probability by Proposition 5.2.1, it follows that $\max_{B \in \mathcal{B}_{N,a,\delta}} (\mathcal{G}_{\beta,N}(B))^2$ tends to 0 in \mathbb{P} -probability and concludes the proof. \square

5.2.2 Proof of Part (ii) of Theorem 5.1.1

For proving Part (ii) of Theorem 5.1.1, we use the convergence of the full extremal process (5.6). We first prove finite-dimensional convergence of the following family of random measures on D :

$$\varrho_{\beta,N} := \sum_{x \in D_N} e^{\beta(h_x - m_N)} \delta_{x/N}, \quad \forall \beta > \beta_c.$$

The one-dimensional convergence has been proven by Biskup and Louidor [BL18b, Theorem 2.6]: on the space of Radon measures on \bar{D} endowed with the vague convergence, we have

$$\varrho_{\beta,N} \xrightarrow{N \rightarrow \infty} c(\beta)Z^D(D)^{\beta/\beta_c}\Sigma_\beta, \quad \text{in distribution,} \quad (5.14)$$

where Σ_β is a random measure on \bar{D} such that, conditionally on Z^D , $\Sigma_\beta = \sum_{k \geq 1} e^{\beta \xi_k} \delta_{\chi_k}$, with $(\chi_k)_{k \geq 1}$ an i.i.d. sequence of random variables with distribution $Z^D/Z^D(D)$, $(\xi_k)_{k \geq 1}$ a Poisson point process with intensity $e^{-\beta_c h} dh$ independent of $(\chi_k)_{k \geq 1}$ and $c(\beta)$ a positive constant defined by $c(\beta) := \beta^{-\beta/\beta_c} (\mathbb{E}[(\sum_{x \in \mathbb{Z}^2} e^{-\beta \phi_x})^{\beta_c/\beta}])^{\beta/\beta_c}$ where ϕ has distribution ν .

We introduce another family of random measures $(\varrho_\beta)_{\beta > \beta_c}$ defined as follows. Conditionally on Z^D , let $(\chi_k)_{k \geq 1}$ be an i.i.d. sequence of random variables with distribution $Z^D/Z^D(D)$, $(\xi_k)_{k \geq 1}$ a Poisson point process with intensity $e^{-\beta_c h} dh$ and $(\phi^k)_{k \geq 1}$ be an i.i.d. sequence of random variables with distribution ν such that $(\chi_k)_{k \geq 1}$, $(\xi_k)_{k \geq 1}$ and $(\phi^k)_{k \geq 1}$ are independent. Then, we set

$$\varrho_\beta := Z^D(D)^{\beta/\beta_c} \sum_{k \geq 1} e^{\beta \xi_k} \left(\sum_{x \in \mathbb{Z}^2} e^{-\beta \phi_x^k} \right) \delta_{\chi_k}, \quad \forall \beta > \beta_c.$$

By (5.10), $(c(\beta)Z^D(D)^{\beta/\beta_c}\Sigma_\beta)_{\beta > \beta_c}$ and $(\varrho_\beta)_{\beta > \beta_c}$ have the same one-dimensional marginal distributions, but not the same multi-dimensional ones. Our first aim is to prove the following extension of convergence (5.14) to the case of several temperatures.

Proposition 5.2.2. *For any $p \geq 1$ and $\beta_1, \dots, \beta_p > \beta_c$, we have*

$$\varrho_{\beta_1,N} \otimes \dots \otimes \varrho_{\beta_p,N} \xrightarrow{N \rightarrow \infty} \varrho_{\beta_1} \otimes \dots \otimes \varrho_{\beta_p}, \quad \text{in distribution,}$$

on the space of Radon measures on \bar{D}^p endowed with the vague convergence.

Before proving this proposition and then Part (ii) of Theorem 5.1.1, we first recall some results on supercritical Gibbs measures. Let $\beta > \beta_c$. Firstly, it follows from (5.14) that the renormalized partition function converges in distribution towards a positive limit:

$$e^{-\beta m_N} Z_{\beta,N} = \sum_{x \in D_N} e^{\beta(h_x - m_N)} \xrightarrow{N \rightarrow \infty} c(\beta)Z^D(D)^{\beta/\beta_c}\Sigma_\beta(\bar{D}), \quad \text{in distribution.} \quad (5.15)$$

By [BL18b, Equation (6.58)], for any $\eta > 0$,

$$\lim_{\ell \rightarrow \infty} \limsup_{N \rightarrow \infty} \mathbb{P} \left(\sum_{x \in D_N} e^{\beta(h_x - m_N)} \mathbb{1}_{\{h_x - m_N \notin [-\ell, \ell]\}} > \eta \right) = 0 \quad (5.16)$$

and, combined with the convergence of the renormalized partition function towards a positive limit, it shows that the supercritical Gibbs measure is mainly supported by extremal points: more precisely, for any $\eta > 0$,

$$\lim_{\ell \rightarrow \infty} \limsup_{N \rightarrow \infty} \mathbb{P}(\mathcal{G}_{\beta,N}(h_u - m_N \notin [-\ell, \ell]) > \eta) = 0. \quad (5.17)$$

On the other hand, by [BL18b, Lemma B.11], for any $K > 0$,

$$\lim_{r \rightarrow \infty} \limsup_{N \rightarrow \infty} \mathbb{P}(\exists x, y \in D_N : h_x, h_y > m_N - K, r < \|x - y\| < N/r) = 0. \quad (5.18)$$

Combining (5.17) and (5.18), it follows that, for any $\beta, \beta' > \beta_c$,

$$\lim_{r \rightarrow \infty} \limsup_{N \rightarrow \infty} \mathbb{P}(\mathcal{G}_{\beta,N} \otimes \mathcal{G}_{\beta',N}(r < \|u - v\| < N/r) > \eta) = 0, \quad (5.19)$$

which means that two points sampled accordingly to two supercritical Gibbs measures are typically either very close to each other or very far.

Proof of Proposition 5.2.2. The goal is to apply properly the convergence of the full extremal process (5.6) and, for this, we use arguments close to those in the proof of Theorem 2.6 of [BL18b]. In order to prove the result, it is sufficient to show that, for any $f_1, \dots, f_p: \overline{D} \rightarrow \mathbb{R}_+$ continuous functions with compact support (which is always the case since \overline{D} is compact),

$$\left(\varrho_{\beta_1, N}(f_1), \dots, \varrho_{\beta_p, N}(f_p) \right) \xrightarrow{N \rightarrow \infty} \left(\varrho_{\beta_1}(f_1), \dots, \varrho_{\beta_p}(f_p) \right), \quad \text{in distribution,}$$

see Kallenberg [Kal17, Lemma 4.1]. For this, it is sufficient to prove that

$$\mathbb{E} \left[\exp \left(- \sum_{i=1}^p \varrho_{\beta_i, N}(f_i) \right) \right] \xrightarrow{N \rightarrow \infty} \mathbb{E} \left[\exp \left(- \sum_{i=1}^p \varrho_{\beta_i}(f_i) \right) \right]. \quad (5.20)$$

Proceeding as in [BL18b], in order to apply (5.6), we need to keep in $\varrho_{\beta, N}$ only the $x \in D_N$ such that $|h_x - m_N|$ is bounded. Therefore, we introduce an increasing sequence of continuous functions $(g_\ell)_{\ell \geq 1}$ from \mathbb{R} to \mathbb{R} such that, for each $\ell \geq 1$, $\mathbb{1}_{[-\ell, \ell]} \leq g_\ell \leq \mathbb{1}_{[-\ell-1, \ell+1]}$. It follows from (5.16) that, for any $\varepsilon > 0$, $\beta > \beta_c$ and $f: \overline{D} \rightarrow \mathbb{R}_+$ continuous function, we have

$$\lim_{\ell \rightarrow \infty} \limsup_{N \rightarrow \infty} \mathbb{P} \left(\left| \varrho_{\beta, N}(f) - \sum_{x \in D_N} e^{\beta(h_x - m_N)} f(x/N) g_{\ell-1}(h_x - m_N) \right| > \varepsilon \right) = 0. \quad (5.21)$$

Then, we introduce the event

$$A_{N, \ell, r} := \{ \forall x, y \in D_N, (h_x, h_y > m_N - \ell) \Rightarrow \|x - y\| \notin (r, N/r) \}.$$

We are going to transform repeatedly the sum in (5.21), with changes that are well-controlled on the event $A_{N, \ell, r}$. By (5.18), $A_{N, \ell, r}$ is very likely as $N \rightarrow \infty$ and then $r \rightarrow \infty$, so this will be sufficient.

Let $(r_N)_{N \geq 1}$ be a sequence of positive real numbers with $r_N \rightarrow \infty$ and $N/r_N \rightarrow \infty$, that will be used to apply (5.6). On the event $A_{N, \ell, r}$, for N large enough such that $r \leq r_N < \frac{N}{2r}$, we have

$$\begin{aligned} & \sum_{x \in D_N} e^{\beta(h_x - m_N)} f(x/N) g_{\ell-1}(h_x - m_N) \\ &= \sum_{x \in D_N} \mathbb{1}_{\{h_x = \max_{y \in \Lambda_{r_N}(x)} h_y\}} e^{\beta(h_x - m_N)} \sum_{y \in \Lambda_r(x)} e^{\beta(h_y - h_x)} f(y/N) g_{\ell-1}(h_y - m_N), \end{aligned} \quad (5.22)$$

where we emphasize that $\Lambda_{r_N}(x)$ and $\Lambda_r(x)$ do not have the same index. Then, we replace $f(y/N)$ with $f(x/N)$ in the right-hand side of (5.22): the error committed on $A_{N, \ell, r}$ is smaller than $\omega_f(r/N) \sum_{x \in D_N} e^{\beta(h_x - m_N)}$, where ω_f is a modulus of continuity for f (which is uniformly continuous), and hence tends to 0 in probability as $N \rightarrow \infty$ and then $r \rightarrow \infty$ by (5.15). Besides this change, note that we can substitute $g_{\ell-1}(h_y - m_N)$ for $g_\ell(h_x - m_N) g_{2\ell}(h_y - h_x)$ so that (5.22) is replaced with

$$\sum_{x \in D_N} \mathbb{1}_{\{h_x = \max_{y \in \Lambda_{r_N}(x)} h_y\}} e^{\beta(h_x - m_N)} \sum_{y \in \Lambda_r(x)} e^{\beta(h_y - h_x)} f(x/N) g_\ell(h_x - m_N) g_{2\ell}(h_y - h_x).$$

Indeed, on the event $A_{N, \ell, r} \cap \{ \max_{x \in D_N} h_x - m_N \leq \ell \}$, we have, using that $h_y \leq h_x$,

$$\begin{aligned} g_{\ell-1}(h_y - m_N) &\leq \mathbb{1}_{\{h_y - m_N \in [-\ell, \ell]\}} \leq \mathbb{1}_{\{h_x - m_N \in [-\ell, \ell]\}} \mathbb{1}_{\{h_x - h_y \in [-2\ell, 2\ell]\}} \\ &\leq g_\ell(h_x - m_N) g_{2\ell}(h_y - h_x), \end{aligned}$$

and, therefore, on this likely event (by (5.4) and (5.18)), the error term can be bounded by $\|f\|_\infty \sum_{x \in D_N} e^{\beta(h_x - m_N)} \mathbb{1}_{\{h_y - m_N \notin [-\ell+1, \ell-1]\}}$ which tends to 0 in probability as $N \rightarrow \infty$ and $\ell \rightarrow \infty$ by (5.16). Finally, we proved the following analogue of [BL18b, Equation (6.59)]:

$$\lim_{\ell \rightarrow \infty} \limsup_{r \rightarrow \infty} \limsup_{N \rightarrow \infty} \mathbb{P}(|\varrho_{\beta,N}(f) - \langle \eta_{N,r_N}, F_{\beta,r,\ell} \rangle| > \varepsilon) = 0, \quad (5.23)$$

where we set $F_{\beta,r,\ell}(x, h, \phi) := e^{\beta h} f(x) g_\ell(h) Y_{r,\ell}^\beta(\phi)$ and $Y_{r,\ell}^\beta(\phi) := \sum_{y \in \Lambda_r(0)} e^{-\beta \phi_y} g_{2\ell}(\phi_y)$ in order to get

$$\langle \eta_{N,r_N}, F_{\beta,r,\ell} \rangle = \sum_{x \in D_N} \mathbb{1}_{\{h_x = \max_{y \in \Lambda_{r_N}(x)} h_y\}} e^{\beta(h_x - m_N)} f(x/N) g_\ell(h_x - m_N) Y_{r,\ell}^\beta(h_x - h_{x+}),$$

recalling that η_{N,r_N} is the extremal point process defined in (5.5).

Now, we apply what precedes and the full extremal process convergence in order to prove (5.20). Let $F_{r,\ell}^i(x, h, \phi) := e^{\beta_i h} f_i(x) g_\ell(h) Y_{r,\ell}^{\beta_i}(\phi)$ for each $i \in \{1, \dots, p\}$. It follows from (5.23) that

$$\lim_{\ell \rightarrow \infty} \limsup_{r \rightarrow \infty} \limsup_{N \rightarrow \infty} \left| \mathbb{E} \left[\exp \left(- \sum_{i=1}^p \varrho_{\beta_i,N}(f_i) \right) \right] - \mathbb{E} \left[\exp \left(- \sum_{i=1}^p \langle \eta_{N,r_N}, F_{r,\ell}^i \rangle \right) \right] \right| = 0.$$

But, applying the full extremal process convergence (5.6) to the function $\sum_{i=1}^p F_{r,\ell}^i$ which is continuous with compact support from $\overline{D} \times \mathbb{R} \times \mathbb{R}^{\Lambda_r(0)} \rightarrow \mathbb{R}_+$, we have

$$\begin{aligned} & \mathbb{E} \left[\exp \left(- \sum_{i=1}^p \langle \eta_{N,r_N}, F_{r,\ell}^i \rangle \right) \right] \\ & \xrightarrow{N \rightarrow \infty} \mathbb{E} \left[\exp \left(- \int_{\overline{D} \times \mathbb{R} \times \mathbb{R}^{\mathbb{Z}^2}} Z^D(dx) \otimes e^{-\beta_c h} dh \otimes \nu(d\phi) \left(1 - e^{-\sum_{i=1}^p F_{r,\ell}^i(x,h,\phi)} \right) \right) \right]. \end{aligned} \quad (5.24)$$

Note that $F_{r,\ell}^i(x, h, \phi) \uparrow F^i(x, h, \phi) := e^{\beta_i h} f_i(x) Y^{\beta_i}(\phi)$ as $r \rightarrow \infty$ and then $\ell \rightarrow \infty$, where $Y^\beta(\phi) := \sum_{y \in \mathbb{Z}^2} e^{-\beta \phi_y}$. Therefore, taking the limit inside the expectation (by dominated convergence theorem) and then inside the integral (by monotone convergence theorem), yields that the right-hand side of (5.24) tends to

$$\mathbb{E} \left[\exp \left(- \int_{\overline{D} \times \mathbb{R} \times \mathbb{R}^{\mathbb{Z}^2}} Z^D(dx) \otimes e^{-\beta_c h} dh \otimes \nu(d\phi) \left(1 - e^{-\sum_{i=1}^p F^i(x,h,\phi)} \right) \right) \right], \quad (5.25)$$

as $r \rightarrow \infty$ and then $\ell \rightarrow \infty$. Finally, note that (5.25) is equal to the right-hand side of (5.20) and, therefore, the result is proved. \square

Proof of Part (ii) of Theorem 5.1.1. Our first aim is to prove that, for any $a \in (0, 1)$ and $\eta > 0$,

$$\limsup_{\varepsilon \rightarrow 0} \limsup_{N \rightarrow \infty} \mathbb{P}(|\mathcal{G}_{\beta,N} \otimes \mathcal{G}_{\beta',N}(q_N(u,v) \geq a) - \mathcal{G}_{\beta,N} \otimes \mathcal{G}_{\beta',N}(\|u - v\| \leq \varepsilon N)| > \eta) = 0. \quad (5.26)$$

Fix some $\delta \in (0, 1 - a)$ and recall that $D_{N,\delta} = \{x \in D_N : d(x, D_N^c) > N^{1-\delta}\}$. It follows from Lemma 5.A.2 that, for any $\varepsilon > 0$, we have, for N large enough,

$$\{\|x - y\| \leq \varepsilon^{-1}\} \cap D_{N,\delta}^2 \subset \{q_N(x, y) \geq a\} \cap D_{N,\delta}^2 \subset \{\|x - y\| \leq \varepsilon N\} \cap D_{N,\delta}^2$$

and it follows that

$$\begin{aligned} & |\mathcal{G}_{\beta,N} \otimes \mathcal{G}_{\beta',N}(q_N(u,v) \geq a) - \mathcal{G}_{\beta,N} \otimes \mathcal{G}_{\beta',N}(\|u-v\| \leq \varepsilon N)| \\ & \leq \mathcal{G}_{\beta,N} \otimes \mathcal{G}_{\beta',N}(D_N^2 \setminus D_{N,\delta}^2) + \mathcal{G}_{\beta,N} \otimes \mathcal{G}_{\beta',N}(\varepsilon^{-1} < \|u-v\| \leq \varepsilon N). \end{aligned} \quad (5.27)$$

The first term in the right-hand side of (5.27) is smaller than $\mathcal{G}_{\beta,N}(D_{N,\delta}^c) + \mathcal{G}_{\beta',N}(D_{N,\delta}^c)$, which tends to 0 in \mathbb{P} -probability as $N \rightarrow \infty$ by Lemma 5.A.3. On the other hand, the second term in the right-hand side of (5.27) tends to zero in probability as $N \rightarrow \infty$ and then $\varepsilon \rightarrow 0$, by (5.19). Therefore, (5.26) is proved.

For any $\varepsilon > 0$, let $f_\varepsilon: D^2 \rightarrow \mathbb{R}_+$ be a continuous function such that $\mathbb{1}_{\{|z-z'| \leq \varepsilon\}} \leq f_\varepsilon(z, z') \leq \mathbb{1}_{\{|z-z'| \leq 2\varepsilon\}}$. Then, we have

$$\frac{\varrho_{\beta,N} \otimes \varrho_{\beta',N}(f_{\varepsilon/2})}{\varrho_{\beta,N} \otimes \varrho_{\beta',N}(D^2)} \leq \mathcal{G}_{\beta,N} \otimes \mathcal{G}_{\beta',N}(\|u-v\| \leq \varepsilon N) \leq \frac{\varrho_{\beta,N} \otimes \varrho_{\beta',N}(f_\varepsilon)}{\varrho_{\beta,N} \otimes \varrho_{\beta',N}(D^2)}.$$

Moreover, by Proposition 5.2.2, we get

$$\frac{\varrho_{\beta,N} \otimes \varrho_{\beta',N}(f_\varepsilon)}{\varrho_{\beta,N} \otimes \varrho_{\beta',N}(D^2)} \xrightarrow[N \rightarrow \infty]{(d)} \frac{\varrho_\beta \otimes \varrho_{\beta'}(f_\varepsilon)}{\varrho_\beta \otimes \varrho_{\beta'}(D^2)} \xrightarrow[\varepsilon \rightarrow 0]{\text{a.s.}} \frac{\varrho_\beta \otimes \varrho_{\beta'}(\{(z,z) : z \in D\})}{\varrho_\beta \otimes \varrho_{\beta'}(D^2)}.$$

Coming back to (5.26), this implies that

$$\mathcal{G}_{\beta,N} \otimes \mathcal{G}_{\beta',N}(q_N(u,v) \geq a) \xrightarrow[N \rightarrow \infty]{(d)} \frac{\varrho_\beta \otimes \varrho_{\beta'}(\{(z,z) : z \in D\})}{\varrho_\beta \otimes \varrho_{\beta'}(D^2)},$$

which is equal to $Q(\beta, \beta')$, concluding the proof of Part (ii) of Theorem 5.1.1. \square

5.3 Comparison with the overlap for the REM

5.3.1 Structure of the proof of Theorem 5.1.2

In this subsection, we split the proof of Theorem 5.1.2 into three lemmas that will be proved in the next subsections. Therefore, we consider some $\beta, \beta' > \beta_c$ such that $\beta \neq \beta'$. Let ϕ be a random field with distribution ν and, for any $\beta > \beta_c$, $X_\beta := \frac{1}{\beta} \log \sum_{x \in \mathbb{Z}^2} e^{-\beta \phi_x}$. Recall from (5.9) that

$$Q(\beta, \beta') = \frac{\sum_{k \geq 1} e^{\beta(\xi_k + X_{\beta,k})} e^{\beta'(\xi_k + X_{\beta',k})}}{\left(\sum_{k \geq 1} e^{\beta(\xi_k + X_{\beta,k})} \right) \left(\sum_{k \geq 1} e^{\beta'(\xi_k + X_{\beta',k})} \right)},$$

with $(\xi_k)_{k \geq 1}$ the atoms of a Poisson point process with intensity $e^{-\beta c h} dh$ and $(X_{\beta,k}, X_{\beta',k})_{k \geq 1}$ i.i.d. copies of $(X_\beta, X_{\beta'})$, independent of $(\xi_k)_{k \geq 1}$.

In the case $\beta = \beta'$, we saw in the introduction that the classical argument to get rid of the $X_{\beta,k}$'s in the description of the overlap distribution is the fact that $(\xi_k + X_{\beta,k})_{k \geq 1}$ has the same distribution as $(\xi_k + c_\beta)_{k \geq 1}$ where c_β is a constant (see (5.10)). Here, we have instead to work with the joint distribution $(\xi_k + X_{\beta,k}, \xi_k + X_{\beta',k})_{k \geq 1}$ for $\beta \neq \beta'$. The following lemma shows that, if we apply the previous change of point process to the first coordinate, the random shift in the second coordinate is still independent of $(\xi_k)_{k \geq 1}$, although this can seem counter-intuitive at first sight. This result appeared previously in a paper by Panchenko and Talagrand [PT07, Lemma 2.1]. It will be proved for the sake of completeness in Section 5.3.2.

Lemma 5.3.1. *Let $c_\beta := \beta_c^{-1} \log \mathbb{E}[e^{\beta_c X_\beta}]$ and Y be a random variable such that, for any measurable function $f: \mathbb{R} \rightarrow \mathbb{R}_+$,*

$$\mathbb{E}[f(Y)] = \frac{\mathbb{E}[e^{\beta_c X_\beta} f(X_{\beta'} - X_\beta)]}{\mathbb{E}[e^{\beta_c X_\beta}]}.$$
 (5.28)

Then, the point process $(\xi_k + X_{\beta,k}, \xi_k + X_{\beta',k})_{k \geq 1}$ with values in \mathbb{R}^2 has the same distribution as $(\xi_k + c_\beta, \xi_k + c_\beta + Y_k)_{k \geq 1}$, where $(Y_k)_{k \geq 1}$ are i.i.d. copies of Y independent of $(\xi_k)_{k \geq 1}$.

Now, our aim is to prove that the random perturbations Y_k on the second coordinate of $(\xi_k + c_\beta, \xi_k + c_\beta + Y_k)_{k \geq 1}$ play a negative role in maximizing $Q(\beta, \beta')$. This is done in the following lemma, stated in a more general setting and shown in Section 5.3.3.

Lemma 5.3.2. *Let $(p_n)_{n \geq 1}$ and $(q_n)_{n \geq 1}$ be nonincreasing sequences of nonnegative real numbers such that $\sum_{n \geq 1} p_n = 1$. Let $(A_n)_{n \geq 1}$ be a sequence of i.i.d. positive random variables. We set*

$$\tilde{p}_n := \frac{A_n p_n}{\sum_{k \geq 1} A_k p_k}, \quad \forall n \geq 1.$$

Then, we have

$$\mathbb{E} \left[\sum_{n \geq 1} \tilde{p}_n q_n \right] \leq \sum_{n \geq 1} p_n q_n.$$
 (5.29)

Moreover, if A_1 is not almost surely constant, $(q_n)_{n \geq 1}$ is not constant and, for any $n \geq 1$, $p_n > 0$, then the inequality in (5.29) is strict.

Remark 5.3.3. In order to maximize the inner product $\sum_{n \geq 1} p_n q_n$, sequences $(p_n)_{n \geq 1}$ and $(q_n)_{n \geq 1}$ have to be ordered in the same way, as in particular in the assumption of the lemma. The random perturbation on $(\tilde{p}_n)_{n \geq 1}$ may disturb this shared ordering and, hence, tends to reduce the inner product. However, note that, without the expectation, the inequality in (5.29) can be wrong with positive probability. Therefore, apart from the case where β or β' is infinite (see Remark 5.1.4), it is not clear whether the inequality in Theorem 5.1.2 can hold without the expectations or not.

Remark 5.3.4. One could also assume that $\sum_{n \geq 1} q_n = 1$ and perturb the sequence $(q_n)_{n \geq 1}$, by defining $\tilde{q}_n := B_n q_n / \sum_{k \geq 1} B_k q_k$ with $(A_n, B_n)_{n \geq 1}$ a sequence of i.i.d. random variables with values in $(0, \infty)^2$. But then, we *do not* necessarily have $\mathbb{E}[\sum_{n \geq 1} \tilde{p}_n \tilde{q}_n] \leq \sum_{n \geq 1} p_n q_n$. For this reason, in order to prove Theorem 5.1.2, we first have to use Lemma 5.3.1, so that only one of the two sequences is perturbed (in comparison with the REM).

Looking at Lemma 5.3.2, one can observe that, in order to get a strict inequality in Theorem 5.1.2, we still need the following lemma, which is proved in Section 5.3.4.

Lemma 5.3.5. *The random variable Y defined by (5.28) is not almost surely constant.*

This result is the only step in the proof of Theorem 5.1.2 which is specific to the DGFF, because it depends on the law ν of the decorations in the limit of the full extremal process. Now, with these three lemmas, we can proceed to the proof of Theorem 5.1.2.

Proof of Theorem 5.1.2. Applying Lemma 5.3.1, we get

$$\mathbb{E}[Q(\beta, \beta')] = \mathbb{E} \left[\frac{\sum_{n \geq 1} e^{\beta \xi_n} e^{\beta'(\xi_n + Y_n)}}{(\sum_{k \geq 1} e^{\beta \xi_k}) (\sum_{k \geq 1} e^{\beta'(\xi_k + Y_k)})} \right].$$

We can assume that the atoms $(\xi_k)_{k \geq 1}$ are ranked in decreasing order. Then, Lemma 5.3.2 with

$$p_n := \frac{e^{\beta' \xi_n}}{\sum_{k \geq 1} e^{\beta' \xi_k}}, \quad q_n := \frac{e^{\beta \xi_n}}{\sum_{k \geq 1} e^{\beta \xi_k}}, \quad \text{and} \quad A_n := e^{\beta' Y_n},$$

where A_n is not almost surely constant by Lemma 5.3.5, implies that, almost surely,

$$\mathbb{E} \left[\frac{\sum_{n \geq 1} e^{\beta \xi_n} e^{\beta' (\xi_n + Y_n)}}{(\sum_{k \geq 1} e^{\beta \xi_k}) (\sum_{k \geq 1} e^{\beta' (\xi_k + Y_k)})} \middle| (\xi_k)_{k \geq 1} \right] < \frac{\sum_{n \geq 1} e^{\beta \xi_n} e^{\beta' \xi_n}}{(\sum_{k \geq 1} e^{\beta \xi_k}) (\sum_{k \geq 1} e^{\beta' \xi_k})} = Q^{\text{REM}}(\beta, \beta'),$$

recalling the definition of $Q^{\text{REM}}(\beta, \beta')$ from (5.8). Taking the expectation proves the result. \square

5.3.2 Change of point process

Proof of Lemma 5.3.1. By [Kal17, Corollary 2.3], it is sufficient to prove that, for any function $f: \mathbb{R}^2 \rightarrow \mathbb{R}_+$ continuous with compact support,

$$\mathbb{E} \left[\exp \left(- \sum_{k \geq 1} f(\xi_k + X_{\beta, k}, \xi_k + X_{\beta', k}) \right) \right] = \mathbb{E} \left[\exp \left(- \sum_{k \geq 1} f(\xi_k + c_\beta, \xi_k + c_\beta + Y_k) \right) \right].$$

Starting from the left-hand side and integrating with respect to $(X_{\beta, k}, X_{\beta', k})_{k \geq 1}$, we get

$$\mathbb{E} \left[\exp \left(- \sum_{k \geq 1} f(\xi_k + X_{\beta, k}, \xi_k + X_{\beta', k}) \right) \right] = \mathbb{E} \left[\exp \left(- \sum_{k \geq 1} \varphi(\xi_k) \right) \right], \quad (5.30)$$

where we set $\varphi(x) := -\log \mathbb{E}[e^{-f(x+X_\beta, x+X_{\beta'})}]$ for any $x \in \mathbb{R}$. Then, using the exponential formula for Poisson point processes, (5.30) is equal to

$$\exp \left(- \int_{\mathbb{R}} dx e^{-\beta c x} (1 - e^{-\varphi(x)}) \right) = \exp \left(- \mathbb{E} \left[\int_{\mathbb{R}} dy e^{-\beta c (y - X_\beta)} (1 - e^{-f(y, y + X_{\beta'} - X_\beta)}) \right] \right),$$

using Fubini's theorem and changing x into $y - X_\beta$. Then, applying again Fubini's theorem and recalling the definition of the random variable Y in (5.28), we get that (5.30) is equal to

$$\exp \left(- \int_{\mathbb{R}} dy \mathbb{E}[e^{\beta c X_\beta}] e^{-\beta c y} (1 - \mathbb{E}[e^{-f(y, y + Y)}]) \right). \quad (5.31)$$

We proceed then in the same way, but backwards: setting $\psi(x) := -\log \mathbb{E}[e^{-f(x, x + Y)}]$ for any $x \in \mathbb{R}$ and changing y into $z + c_\beta$, (5.31) is equal to

$$\begin{aligned} \exp \left(- \int_{\mathbb{R}} dz e^{-\beta c z} (1 - e^{-\psi(z + c_\beta)}) \right) &= \mathbb{E} \left[\exp \left(- \sum_{k \geq 1} \psi(\xi_k + c_\beta) \right) \right] \\ &= \mathbb{E} \left[\exp \left(- \sum_{k \geq 1} f(\xi_k + c_\beta, \xi_k + c_\beta + Y_k) \right) \right], \end{aligned}$$

which concludes the proof. \square

5.3.3 Random perturbation of a nonincreasing sequence

Proof of Lemma 5.3.2. If $\sum_{n \geq 1} A_n p_n = \infty$ a.s., then $\tilde{p}_n = 0$ a.s. for any $n \geq 1$ and therefore (5.29) holds clearly and the inequality is strict as soon as $(q_n)_{n \geq 1}$ is not constant equal to zero. Otherwise, we have $\sum_{n \geq 1} A_n p_n < \infty$ a.s. by Kolmogorov's zero-one law and we work under this assumption until the end of the proof. Using also that $\sum_{n \geq 1} p_n = 1$ and $(q_n)_{n \geq 1}$ is bounded, it follows that all forthcoming sums converge absolutely almost surely. Note also that if $(q_n)_{n \geq 1}$ is constant, then (5.29) is clear, hence we assume that it is not.

We introduce

$$S := \sum_{n \geq 1} (p_n - \tilde{p}_n) q_n$$

and our aim is to prove that $\mathbb{E}[S] \geq 0$. Using that $\sum_{k \geq 1} p_k = 1$, we have

$$S = \sum_{n \geq 1} \frac{(\sum_{k \geq 1} A_k p_k) p_n - (\sum_{k \geq 1} p_k) A_n p_n}{\sum_{j \geq 1} A_j p_j} q_n = \frac{1}{\sum_{j \geq 1} A_j p_j} \sum_{n, k \geq 1} (A_k - A_n) p_k p_n q_n.$$

Then, switching the role of k and n in one of the sums, we get

$$\sum_{n, k \geq 1} (A_k - A_n) p_k p_n q_n = \sum_{n, k \geq 1} A_k p_k p_n q_n - \sum_{n, k \geq 1} A_n p_k p_n q_n = \sum_{n, k \geq 1} A_n p_n p_k (q_k - q_n).$$

Therefore, applying dominated convergence theorem, we have

$$\mathbb{E}[S] = \sum_{n, k \geq 1} \mathbb{E} \left[\frac{A_n}{\sum_{j \geq 1} A_j p_j} \right] p_n p_k (q_k - q_n) = \sum_{n \geq 1} y_n p_n x_n,$$

where we set, for any $n \geq 1$,

$$x_n := \sum_{k \geq 1} p_k (q_k - q_n) \quad \text{and} \quad y_n := \mathbb{E} \left[\frac{A_n}{\sum_{j \geq 1} A_j p_j} \right].$$

Note that $x_n = (\sum_{k \geq 1} q_k p_k) - q_n$ is nondecreasing in n , with $x_1 \leq 0$ and $\lim_{n \rightarrow \infty} x_n > 0$ (because $\sum_{k \geq 1} p_k = 1$ and $(q_n)_{n \geq 1}$ is nonincreasing and not constant), and therefore there exists $n_0 \geq 1$ such that $x_n \leq 0$ for $n \leq n_0$ and $x_n > 0$ for $n > n_0$. Moreover, we have $\sum_{n \geq 1} p_n x_n = 0$, where the n_0 first terms are nonpositive and the other ones are nonnegative. Therefore, in order to prove that $\mathbb{E}[S] = \sum_{n \geq 1} y_n p_n x_n$ is nonnegative, it is sufficient to prove that $(y_n)_{n \geq 1}$ is a nondecreasing sequence. Indeed, it follows then that

$$\sum_{n \geq 1} y_n p_n x_n \geq \sum_{n \geq 1} y_{n_0} p_n x_n = 0,$$

by distinguishing the case $n \leq n_0$ and the case $n > n_0$.

For any $n > m \geq 1$, our aim is now to prove that $y_n \geq y_m$. Setting $B := \sum_{j \notin \{m, n\}} A_j p_j$, we have

$$y_n - y_m = \mathbb{E} \left[\frac{A_n - A_m}{A_n p_n + A_m p_m + B} \right].$$

We distinguish two cases. On the event $\{A_n \geq A_m\}$, since $p_n \leq p_m$, we have $A_n p_n + A_m p_m \leq (A_n + A_m)(p_n + p_m)/2$ and so

$$\frac{A_n - A_m}{A_n p_n + A_m p_m + B} \geq \frac{A_n - A_m}{\frac{(A_n + A_m)(p_n + p_m)}{2} + B}. \quad (5.32)$$

On the other hand, on the event $\{A_n < A_m\}$, we have $A_n p_n + A_m p_m \geq (A_n + A_m)(p_n + p_m)/2$ and (5.32) holds too. Therefore, we get

$$y_n - y_m \geq \mathbb{E} \left[\frac{2(A_n - A_m)}{(A_n + A_m)(p_n + p_m) + 2B} \right] = 0, \quad (5.33)$$

because A_n and A_m have the same distribution and play a symmetric role in the last expectation (and B is independent of (A_n, A_m)). It proves that $(y_n)_{n \geq 1}$ is a nondecreasing sequence and therefore that $\mathbb{E}[S] \geq 0$.

Now, we assume in addition that A_1 is not almost surely constant and, for each $n \geq 1$, $p_n > 0$. Our aim is to prove that

$$\mathbb{E}[S] = \sum_{n \geq 1} y_n p_n x_n > 0. \quad (5.34)$$

First note that, for any $n > m \geq 1$, if $p_n < p_m$ then $y_n > y_m$. Indeed, on the event $\{A_n < A_m\}$, we have in this case $A_n p_n + A_m p_m > (A_n + A_m)(p_n + p_m)/2$ and, therefore,

$$\frac{A_n - A_m}{A_n p_n + A_m p_m + B} > \frac{A_n - A_m}{\frac{(A_n + A_m)(p_n + p_m)}{2} + B}.$$

But the event $\{A_n < A_m\}$ has positive probability (because A_n and A_m are independent with the same non-constant distribution) and, thus, we get a strict inequality in (5.33). We can now prove (5.34). Recall that $\sum_{n \geq 1} p_n x_n = 0$, where the n_0 first terms are nonpositive and the other ones are positive (because now $p_n > 0$). Since $p_n \downarrow 0$ and $p_{n_0} > 0$, there exists $n_1 > n_0$ such that $p_{n_1} < p_{n_0}$ and therefore $y_{n_1} > y_{n_0}$. Then, using that $p_{n_1} x_{n_1} > 0$, we get the following *strict* inequality

$$\sum_{n \geq 1} y_n p_n x_n > y_{n_0} \sum_{n \geq 1} p_n x_n = 0,$$

which concludes the proof. \square

5.3.4 Decorations are nontrivial

In this subsection we prove Lemma 5.3.5, which states that the random variable Y , whose distribution depends on the decoration law ν , is not almost surely constant. The contrary would have been surprising, but, in order to prove it properly, we first need to show a basic property of the law ν in Lemma 5.3.6 below.

Let us start by recalling some results from [BL18b] concerning the decoration law ν for the DGFF. Let ν^0 denote the law of the DGFF in $\mathbb{Z}^2 \setminus \{0\}$. Its covariance is given by $\text{Cov}_{\nu^0}(\phi_x, \phi_y) = \mathbf{a}(x) + \mathbf{a}(y) - \mathbf{a}(x - y)$, where $\mathbf{a}: \mathbb{Z}^2 \rightarrow \mathbb{R}$ is the potential kernel of the simple symmetric random walk started from zero (see Appendix 5.A for more details). In this subsection, we denote by \mathbb{E}_ν and \mathbb{E}_{ν^0} the expectations under which $\phi = (\phi_x)_{x \in \mathbb{Z}^2}$ has respectively law ν and ν^0 . Let $\mathcal{C}_b^{\text{loc}}(\mathbb{R}^{\mathbb{Z}^2})$ denote the set of continuous bounded functions on $\mathbb{R}^{\mathbb{Z}^2}$ that depend only on a finite number of coordinates in \mathbb{Z}^2 . Then, Biskup and Louidor [BL18b, Theorem 2.3 and Proposition 5.8] proved the following description for the decoration law: for any $f \in \mathcal{C}_b^{\text{loc}}(\mathbb{R}^{\mathbb{Z}^2})$,

$$\mathbb{E}_\nu[f(\phi)] = \lim_{r \rightarrow \infty} \mathbb{E}_{\nu^0} \left[f \left(\phi + \frac{2}{\sqrt{g}} \mathbf{a} \right) \middle| \forall x \in \Lambda_r(0), \phi_x + \frac{2}{\sqrt{g}} \mathbf{a}(x) \geq 0 \right], \quad (5.35)$$

where we recall that $\Lambda_r(0) = \{x \in \mathbb{Z}^2 : |x| \leq r\}$. The main tool for the proof of Lemma 5.3.5 is the following lemma, that describes the conditional law of one coordinate of the decoration given the other coordinates.

Lemma 5.3.6. *For any $y \in \mathbb{Z}^2 \setminus \{0\}$, under ν , the conditional law of ϕ_y given $(\phi_x)_{x \neq y}$ is a normal law with mean $\frac{1}{4} \sum_{x \sim y} \phi_x$ and variance 1 conditioned to be nonnegative.*

Proof. Let $f \in \mathcal{C}_b^{\text{loc}}(\mathbb{R}^{\mathbb{Z}^2})$ that does not depend on the y -coordinate. Let $h \in \mathcal{C}_b(\mathbb{R})$. Applying the domain Markov property to the DGFF ϕ with law ν^0 , conditionnally on the ϕ_x for $x \neq y$, ϕ_y has the same law as $Z + \frac{1}{4} \sum_{x \sim y} \phi_x$, where Z is independent of $(\phi_x)_{x \neq y}$ with law $\mathcal{N}(0, 1)$. On the other hand, by [LL10, Proposition 4.4.2], the potential kernel \mathbf{a} is discrete harmonic on $\mathbb{Z}^2 \setminus \{0\}$, so we have $\mathbf{a}(y) = \frac{1}{4} \sum_{x \sim y} \mathbf{a}(x)$. Therefore, we get

$$\begin{aligned} & \mathbb{E}_{\nu^0} \left[f \left(\phi + \frac{2}{\sqrt{g}} \mathbf{a} \right) h \left(\phi_y + \frac{2}{\sqrt{g}} \mathbf{a}(y) \right) \prod_{x \in \Lambda_r(0)} \mathbb{1}_{\{\phi_x + \frac{2}{\sqrt{g}} \mathbf{a}(x) \geq 0\}} \right] \\ &= \mathbb{E}_{\nu^0} \left[f \left(\phi + \frac{2}{\sqrt{g}} \mathbf{a} \right) \prod_{x \in \Lambda_r(0) \setminus \{y\}} \mathbb{1}_{\{\phi_x + \frac{2}{\sqrt{g}} \mathbf{a}(x) \geq 0\}} \right. \\ & \quad \left. \times \int_{\mathbb{R}} h \left(z + \frac{1}{4} \sum_{x \sim y} \left(\phi_x + \frac{2}{\sqrt{g}} \mathbf{a}(x) \right) \right) \mathbb{1}_{\{z + \frac{1}{4} \sum_{x \sim y} \left(\phi_x + \frac{2}{\sqrt{g}} \mathbf{a}(x) \right) \geq 0\}} \frac{e^{-z^2/2}}{\sqrt{2\pi}} dz \right]. \end{aligned} \tag{5.36}$$

Now, we define a function $H: \mathbb{R} \rightarrow \mathbb{R}$ by

$$H(t) := \frac{\int_{\mathbb{R}} h(z+t) \mathbb{1}_{\{z+t \geq 0\}} \frac{e^{-z^2/2}}{\sqrt{2\pi}} dz}{\int_{\mathbb{R}} \mathbb{1}_{\{z+t \geq 0\}} \frac{e^{-z^2/2}}{\sqrt{2\pi}} dz},$$

which is a continuous bounded function. Then, (5.36) is equal to

$$\begin{aligned} & \mathbb{E}_{\nu^0} \left[f \left(\phi + \frac{2}{\sqrt{g}} \mathbf{a} \right) \prod_{x \in \Lambda_r(0) \setminus \{y\}} \mathbb{1}_{\{\phi_x + \frac{2}{\sqrt{g}} \mathbf{a}(x) \geq 0\}} \right. \\ & \quad \left. \times H \left(\frac{1}{4} \sum_{x \sim y} \left(\phi_x + \frac{2}{\sqrt{g}} \mathbf{a}(x) \right) \right) \int_{\mathbb{R}} \mathbb{1}_{\{z + \frac{1}{4} \sum_{x \sim y} \left(\phi_x + \frac{2}{\sqrt{g}} \mathbf{a}(x) \right) \geq 0\}} \frac{e^{-z^2/2}}{\sqrt{2\pi}} dz \right] \\ &= \mathbb{E}_{\nu^0} \left[f \left(\phi + \frac{2}{\sqrt{g}} \mathbf{a} \right) H \left(\frac{1}{4} \sum_{x \sim y} \left(\phi_x + \frac{2}{\sqrt{g}} \mathbf{a}(x) \right) \right) \prod_{x \in \Lambda_r(0)} \mathbb{1}_{\{\phi_x + \frac{2}{\sqrt{g}} \mathbf{a}(x) \geq 0\}} \right], \end{aligned} \tag{5.37}$$

using the Markov domain property as before. Applying (5.35) to the left-hand side of (5.36) and to the right-hand side of (5.37), we get

$$\mathbb{E}_{\nu} [f(\phi)h(\phi_y)] = \mathbb{E}_{\nu} \left[f(\phi)H \left(\frac{1}{4} \sum_{x \sim y} \phi_x \right) \right]$$

Recalling the definition of function H and since this equality holds for any $f \in \mathcal{C}_b^{\text{loc}}(\mathbb{R}^{\mathbb{Z}^2})$ not depending on the y -coordinate and any $h \in \mathcal{C}_b(\mathbb{R})$, it proves the claimed result. \square

Proof of Lemma 5.3.5. By contradiction, assume that Y is almost surely constant. Then, $X_{\beta'} - X_{\beta}$ is a.s. constant and, taking the exponential, there exists some constant $c > 0$ such that

$$\sum_{x \in \mathbb{Z}^2} e^{-\beta \phi_x} = c \left(\sum_{x \in \mathbb{Z}^2} e^{-\beta' \phi_x} \right)^{\beta/\beta'}, \quad \nu\text{-a.s.}$$

Fix some $y \in \mathbb{Z}^2 \setminus \{0\}$. We have, ν -a.s.,

$$\mathbb{E}_\nu \left[\left| e^{-\beta\phi_y} + \sum_{x \neq y} e^{-\beta\phi_x} - c \left(e^{-\beta\phi_y} + \sum_{x \neq y} e^{-\beta'\phi_x} \right)^{\beta/\beta'} \right| \middle| (\phi_x)_{x \neq y} \right] = 0, \quad \nu\text{-a.s.}$$

But, given $(\phi_x)_{x \neq y}$, ϕ_y has a distribution with positive density on $(0, \infty)$ by Lemma 5.3.6. Recalling that $\sum_{x \neq y} e^{-\beta\phi_x} \geq 1$, it shows that there exist some $s, s' \geq 1$ such that,

$$e^{-\beta z} + s - c(e^{-\beta z} + s')^{\beta/\beta'} = 0, \quad \text{for almost every } z \in (0, \infty).$$

This cannot be true for $\beta \neq \beta'$ and, therefore, one gets a contradiction. \square

5.A Some useful results

In this appendix, we state some known results used throughout the chapter. The first result is the well-known *Gaussian integration by part*, whose proof can be found in [Tal11a, Equation (A.17)].

Lemma 5.A.1. *Let (X, Z_1, \dots, Z_d) be a centered Gaussian random vector. Then, for any \mathcal{C}^1 function $F: \mathbb{R}^d \rightarrow \mathbb{R}$ of moderate growth at infinity, we have*

$$\mathbb{E}[XF(Z_1, \dots, Z_d)] = \sum_{i=1}^d \mathbb{E}[XZ_i] \mathbb{E} \left[\frac{\partial F}{\partial z_i}(Z_1, \dots, Z_d) \right].$$

Now we define formally the Green function G_N and state some of its properties. Let $(S_n)_{n \geq 0}$ be a simple symmetric random walk on \mathbb{Z}^2 starting from x under \mathbb{P}_x and $\tau_N := \inf\{n \geq 0 : S_n \notin D_N\}$ be the first exit time of the walk from the set D_N . Then, the Green function is defined, for $x, y \in \mathbb{Z}^2$, by

$$G_N(x, y) = \mathbb{E}_x \left[\sum_{k=0}^{\tau_N-1} \mathbb{1}_{\{S_k=y\}} \right]. \quad (5.38)$$

The Green function is related to the potential kernel of the simple symmetric random walk started from zero, which is a function $\mathfrak{a}: \mathbb{Z}^2 \rightarrow \mathbb{R}$ defined by

$$\mathfrak{a}(x) := \sum_{n \geq 0} (\mathbb{P}(S_n = 0) - \mathbb{P}(S_n = x))$$

and can also be written explicitly as a double integral, see [LL10, Proposition 4.4.3]. Indeed, by [LL10, Proposition 4.6.2] and since D_N is finite, the following relation between these functions holds for any $x, y \in \mathbb{Z}^2$,

$$G_N(x, y) = \mathbb{E}_x[\mathfrak{a}(S_{\tau_N} - y)] - \mathfrak{a}(x - y). \quad (5.39)$$

Furthermore, Theorem 4.4.4 of [LL10] gives the asymptotic behavior of function \mathfrak{a} : as $\|x\| \rightarrow \infty$, we have

$$\mathfrak{a}(x) = \frac{2}{\pi} \log \|x\| + \frac{2\gamma + \log 8}{\pi} + O(\|x\|^{-2}), \quad (5.40)$$

where γ is Euler's constant. From these tools, we can easily deduce the following result, relating the overlap between two points to their euclidean distance.

Lemma 5.A.2. (i) *There exists a constant $c_1 > 0$ such that, for any $N \geq 1$, $0 < \alpha < 1$ and any $x, y \in D_N$,*

$$q_N(x, y) \geq \alpha \quad \Rightarrow \quad \|x - y\| \leq c_1 N^{1-\alpha}.$$

(ii) *There exists a constant $c_1 > 0$ such that, for any $N \geq 1$, $0 < \delta < \alpha < 1$ and any $x, y \in D_{N,\delta} := \{x \in D_N : d(x, D_N^c) > N^{1-\delta}\}$,*

$$\|x - y\| \leq c_2 N^{1-\alpha} \quad \Rightarrow \quad q_N(x, y) \geq \alpha - \delta.$$

Proof. Recall that $q_N(x, y) = G_N(x, y) / \sup_{x \in D_N} G_N(x, x)$. Combining (5.39) and (5.40), first note that $\sup_{x \in D_N} G_N(x, x) = \frac{2}{\pi} \log N + O_N(1)$ as $N \rightarrow \infty$. Using again (5.39) and (5.40), we get the following upper bound, uniformly in $x, y \in D_N$,

$$q_N(x, y) \leq 1 - \frac{\log \|x - y\|}{\log N} + O_N((\log N)^{-1}), \tag{5.41}$$

and the following lower bound, uniformly in $x, y \in D_{N,\delta}$,

$$q_N(x, y) \geq 1 - \delta - \frac{\log \|x - y\|}{\log N} + O_N((\log N)^{-1}). \tag{5.42}$$

Part (i) of the lemma follows from (5.41) and Part (ii) from (5.42). □

In the previous lemma, we saw that the overlap is properly related to the distance if the points of interest are not too close from the boundary of D_N . The following result shows that, for any inverse temperature $\beta > 0$, the Gibbs measure of $D_{N,\delta}^c := D_N \setminus D_{N,\delta}$ is negligible.

Lemma 5.A.3. *Let $\delta > 0$ and $D_{N,\delta} := \{x \in D_N : d(x, D_N^c) > N^{1-\delta}\}$. For any $\beta > 0$,*

$$\mathcal{G}_{\beta,N}(D_{N,\delta}^c) \xrightarrow{N \rightarrow \infty} 0, \quad \text{in } L^1.$$

Proof. This result is shown in [AZ15, Lemma 3.1] in the case of the square lattice $V_N = (0, N)^2 \cap \mathbb{Z}^2$, but the proof works also in our more general framework because we also have $\#D_{N,\delta}^c = O(N^{2-\delta})$ under our assumptions. Indeed, we assumed that ∂D has a finite number of connected components, each of which is a \mathcal{C}^1 path: therefore, there exists $C > 0$ such that, for any $\varepsilon > 0$, ∂D can be covered by at most $C\varepsilon^{-1}$ balls of radius ε . Fix some $N \geq 1$, there exist $M \leq CN^\delta/2$ and z_1, \dots, z_M such that $\partial D \subset \bigcup_{i=1}^M B(z_i, 2N^{-\delta})$. Then, recalling the definition of D_N and $D_{N,\delta}$, note that

$$\frac{D_{N,\delta}}{N} \subset \left\{ z \in D : d(z, \partial D) \leq 2N^{-\delta} \right\} \cap \frac{\mathbb{Z}^2}{N} \subset \bigcup_{i=1}^M \left(B(z_i, 4N^{-\delta}) \cap \frac{\mathbb{Z}^2}{N} \right).$$

It follows that $\#D_{N,\delta} \leq M4(4N^{1-\delta})^2 \leq C'N^{2-\delta}$, which is the announced result. □

Chapter 6

Velocity of the L -branching Brownian motion

Abstract

This chapter is a slight modification of the paper [Pai16], that have been published in the *Electronic Journal of Probability*. We consider a branching-selection system of particles on the real line that evolves according to the following rules: each particle moves according to a Brownian motion during an exponential lifetime and then splits into two new particles and, when a particle is at a distance L of the highest particle, it dies without splitting. This model has been introduced by Brunet, Derrida, Mueller and Munier [BDMM06b] in the physics literature and is called the L -branching Brownian motion. We show that the position of the system grows linearly at a velocity v_L almost surely and we compute the asymptotic behavior of v_L as L tends to infinity:

$$v_L = \sqrt{2} - \frac{\pi^2}{2\sqrt{2}L^2} + o\left(\frac{1}{L^2}\right),$$

as conjectured in [BDMM06b]. The proof makes use of results by Berestycki, Berestycki and Schweinsberg [BBS13] concerning branching Brownian motion in a strip.

6.1 Introduction

In this chapter, we consider a branching Brownian motion with the following parameters: particles move according to Brownian motions with variance 1 during an exponentially distributed time with parameter 1 and then split into 2 new particles. Our aim is to introduce some natural selection into this process. For this, we say that a particle's position describes its survival capacity and reproductive success (biologists call it *fitness*): it changes during the particle's life because of mutations and is then transmitted to the particle's children. The selection tends to eliminate the lowest particles, that have a too small fitness value by comparison with the best ones. Thus, we study here a system of particles evolving as a branching Brownian motion, but where in addition a particle dies as soon as it is at a distance L of the highest particle alive at the same time. This system is called the *L -branching Brownian motion* or *L -BBM*.

6.1.1 Statement of the results

First of all, we need to introduce some notation. We denote by $\mathcal{N}(t)$ the set of particles alive in the BBM at time t and by $X_u(t)$ the position of particle u at time t . We will say that

$X = (X_u(t), u \in \mathcal{N}(t))_{t \geq 0}$ is a branching Brownian motion. Let $\mathcal{C} := \bigcup_{n \in \mathbb{N}^*} \mathbb{R}^n$ be the set of particles configurations: we see $X(t) = (X_u(t), u \in \mathcal{N}(t))$ as an element of \mathcal{C} . For each $\xi \in \mathcal{C}$, let \mathbb{P}_ξ denote a probability measure such that, under \mathbb{P}_ξ , the branching Brownian motion X starts from the configuration $X(0) = \xi$ almost surely. When $\xi = (x)$ is the configuration with a single particle located at $x \in \mathbb{R}$, we write simply \mathbb{P}_x instead of $\mathbb{P}_{(x)}$. For $\xi = (\xi_1, \dots, \xi_n)$ and $\xi' = (\xi'_1, \dots, \xi'_m)$ configurations, we say that $\xi' \subset \xi$ if $\sum_{i=1}^m \delta_{\xi'_i} \leq \sum_{i=1}^n \delta_{\xi_i}$ as measures and we define $\max \xi := \max_{1 \leq i \leq n} \xi_i$. Thus, $\max X(t)$ is the position of the highest particle of the BBM living at time t .

Then, we define the L -branching Brownian motion on the same space, by coupling it canonically with the standard branching Brownian motion: for each realization of the BBM, we can define a realization of the L -BBM by killing every particle that is at a distance greater than L from the highest particle of the L -BBM. We denote by $\mathcal{N}^L(t)$ the set of particles alive in the L -BBM at time t and by $X^L(t) := (X_u^L(t), u \in \mathcal{N}^L(t))$ the configuration of particles of the L -BBM. By definition, we have the inclusion $X^L(t) \subset X(t)$ for all $t \geq 0$. See Figure 6.1. We have not yet specified the drift of particles: actually, it will be more convenient to choose it differently depending on the section. In the introduction, we assume that particles do not have any drift.

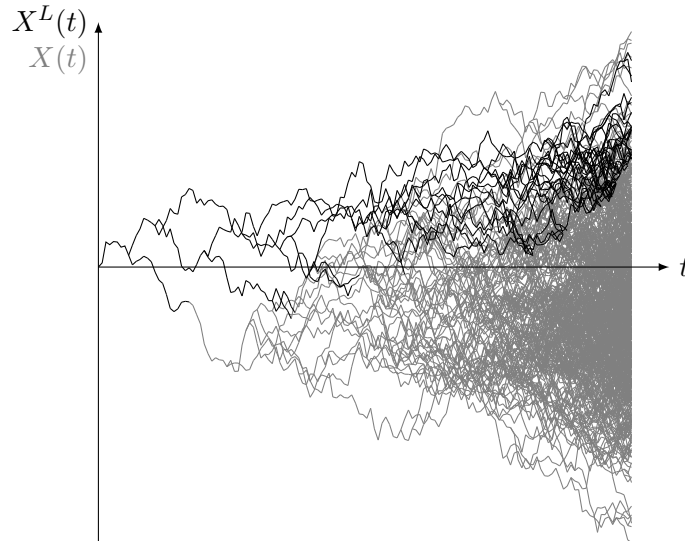

Figure 6.1 – Simulation of a BBM starting with a single particle at 0 and of the coupled L -BBM with $L = 3$ between times 0 and 7. Particles in black belong to the L -BBM and particles in gray belong only to the BBM without selection and not to the L -BBM. Note that quickly some particles killed by selection have descendants with a better fitness value than the particles of the L -BBM.

Our aim here is to study the asymptotic behavior of the position of the highest particle of the L -branching Brownian motion at time t , that is $\max X^L(t)$. For the standard branching Brownian motion, it is known [CHT⁺95] that

$$\frac{1}{t} \max X(t) \xrightarrow[t \rightarrow \infty]{} \sqrt{2}$$

almost surely. Hence, the speed of the highest particle of the L -BBM, whenever there exists, has to be no more than $\sqrt{2}$, because there are less particles in the L -BBM than in the BBM owing to selection. Moreover, it is clear that if this velocity exists, then all particles of the L -BBM moves at the same speed. Our first result ensures that the velocity of the L -branching Brownian motion is well-defined and does not depend on the initial configuration. The same result is proved in a similar way by Derrida and Shi in their article [DS16] in preparation

at the time of writing of this paper, but, nonetheless, we present it here in order to work legitimately on v_L in what follows.

Proposition 6.1.1. *For each $L > 0$, there exists $v_L \in \mathbb{R}$ such that for each $\xi \in \mathcal{C}$ we have the following convergence*

$$\frac{1}{t} \max X^L(t) \xrightarrow[t \rightarrow \infty]{} v_L$$

\mathbb{P}_ξ -almost surely.

We focus in this chapter on the behavior of v_L as L tends to infinity. It means that the selection effect vanishes, so we can expect that v_L tends to $\sqrt{2}$, which is the asymptotic velocity of the highest particle of the BBM without selection. Furthermore, we are interested in the asymptotic order of $\sqrt{2} - v_L$, which permits to estimate the slowdown due to selection. The main result of this work shows this second term in the asymptotic expansion of v_L , validating a conjecture of Brunet, Derrida, Mueller and Munier [BDMM06b] (see Section 6.1.2 for more details).

Theorem 6.1.2. *We have the following asymptotic behavior:*

$$v_L = \sqrt{2} - \frac{\pi^2}{2\sqrt{2}L^2} + o\left(\frac{1}{L^2}\right),$$

as L tends to infinity.

This is analogous to the result of Bérard and Gouéré [BG10] for the N -branching random walk, where the selection imposes a constant population size N . One can expect that the population of the L -BBM is of order e^{cL} with c some positive constant and, then, the result of Bérard and Gouéré suggests by taking $N = e^{cL}$ that the first correction term for v_L must be of order $1/L^2$. Actually, we will see in the next subsection that Brunet, Derrida, Mueller and Munier [BDMM06b] conjecture that $c = \sqrt{2}$ and it leads exactly to the term $-\pi^2/2\sqrt{2}L^2$. However, the strategy to prove Theorem 6.1.2 will neither be to use comparisons with the N -BBM nor to control precisely the population size of the L -BBM.

6.1.2 Motivations

The L -branching Brownian motion has been introduced by Brunet, Derrida, Mueller and Munier [BDMM06b] in order to describe the effect of a white noise on the F-KPP equation. The F-KPP equation (for Fisher [Fis37] and Kolmogorov, Petrovsky, Piscounov [KPP37])

$$\partial_t h = \frac{1}{2} \partial_x^2 h + h(1 - h) \tag{6.1}$$

is a traveling wave equation that describes how a stable phase ($h = 1$) invades an unstable phase ($h = 0$). Depending on the initial condition, the front between the two phases can travel at any velocity v larger than a minimal velocity $v_{\min} = \sqrt{2}$ (which is as well the asymptotic velocity of the highest particle of standard BBM). This equation often represents a large-scale limit or a mean-field description of some microscopic discrete stochastic processes. In order to understand the fluctuations that appear at the microscopic scale with a finite number of particles, one might consider instead the F-KPP equation with noise [BD01, BDMM06b, BDMM06a]

$$\partial_t h = \frac{1}{2} \partial_x^2 h + h(1 - h) + \sqrt{\frac{h(1 - h)}{N}} \dot{W}, \tag{6.2}$$

where N is the number of particles involved and \dot{W} is a normalized Gaussian white noise. Contrary to Equation (6.1), this equation with noise selects a single velocity v_N for the front propagation. A first approximation for Equation (6.2) consists in replacing the noise term by a deterministic cut-off, leading to the equation [BD97, BD99]

$$\partial_t h = \frac{1}{2} \partial_x^2 h + h(1-h) \mathbb{1}_{h \geq 1/N}, \quad (6.3)$$

which selects also a single velocity v_N^{cutoff} . It has been conjectured in [BD97, BD99] for the velocity v_N^{cutoff} and in [BD01] for the velocity v_N that, as N tends to infinity,

$$v_{\min} - v_N \sim v_{\min} - v_N^{\text{cutoff}} \sim \frac{\pi^2}{\sqrt{2}(\log N)^2},$$

which is an extremely slow convergence. These results have been given a rigorous mathematical proof in [DPK07] for the F-KPP equation with cut-off and more recently in [MMQ11] for the F-KPP equation with white noise.

Brunet and Derrida in [BD97, BD99, BD01] support their conjecture by studying directly a particular microscopic stochastic processes involving N particles. In the same way, Brunet, Derrida, Mueller and Munier [BDMM06b] introduce three different branching-selection particle systems, in order to describe more precisely the velocity and the diffusion constant of the front for Equation (6.2). Among these processes, they consider the L -BBM and the N -BBM. The latter is defined with a different selection rule: particles move according to Brownian motion, split after an exponential lifetime and, whenever the population size exceeds N , the lowest particle is killed. They conjecture, among other things, that the asymptotic velocity of the N -BBM is v_N and satisfies the more precise asymptotic expansion as $N \rightarrow \infty$:

$$v_N = \sqrt{2} - \frac{\pi^2}{\sqrt{2}(\log N)^2} \left(1 - \frac{6 \log \log N}{\log N} (1 + o(1)) \right).$$

This conjecture has not yet been mathematically proved, but some rigorous results have been obtained concerning the N -BBM or the N -branching random walk (its discrete time analog), in particular by Bérard and Gouéré [BG10], who showed the asymptotic behavior in $\pi^2/\sqrt{2}(\log N)^2(1 + o(1))$ for $\sqrt{2} - v_N$, but also by Durrett and Remenik [DR11], Bérard and Maillard [BM14], Mallein [Mal18a] and Maillard [Mai16]. For its part, the L -BBM has not yet been studied in the mathematical literature, but Brunet, Derrida, Mueller and Munier [BDMM06b] conjectured that it behaves as the N -BBM by taking

$$L = \frac{\log N}{\sqrt{2}}, \quad (6.4)$$

which means that, with (6.4), the population size of the L -BBM is around N and the N -BBM has approximately a width L . It follows that the L -BBM must have an asymptotic velocity v_L that satisfies, as $L \rightarrow \infty$,

$$\sqrt{2} - v_L \sim \frac{\pi^2}{2\sqrt{2}L^2}, \quad (6.5)$$

which is the result proved in this chapter.

Furthermore, some recent results of Berestycki, Berestycki and Schweinsberg [BBS13, BBS11], concerning BBM with absorption on a linear barrier and BBM in a strip, suggested also that the asymptotic behavior (6.5) must hold. Indeed, they show that for a BBM in the strip $(0, K)$ with drift $-\mu$ (it means that particles move according to Brownian motions with

drift $-\mu$ and are killed by hitting 0 or K), the size of the population stays of the same order on a time scale of K^3 when

$$\mu := \sqrt{2 - \frac{\pi^2}{K^2}},$$

see Proposition 6.2.3 further. Thus, if the fluctuations of the L -BBM around the deterministic speed v_L are not too large (less than εL on a time scale of L^3), one can expect that

$$\sqrt{2 - \frac{\pi^2}{(L - \varepsilon L)^2}} - \frac{\varepsilon L}{L^3} \leq v_L \leq \sqrt{2 - \frac{\pi^2}{(L + \varepsilon L)^2}} + \frac{\varepsilon L}{L^3}, \quad (6.6)$$

for $\varepsilon > 0$ and L large enough, with comparison with BBM in strips $(0, L - \varepsilon L)$ and $(0, L + \varepsilon L)$, and (6.5) follows from (6.6) by letting $\varepsilon \rightarrow 0$. Actually, fluctuations of the L -BBM are believed to be of order $\log L$ on a time scale of L^3 and a precise understanding of them will probably lead to the next order in the asymptotic behavior of v_L .

6.1.3 Proof overview and organization of the chapter

One of the major difficulty in working with the L -BBM or the N -BBM is that they do not satisfy the branching property and, therefore, any form of many-to-one lemma (see Lemma 6.2.1): the offspring of a particle at a time t depends on the offspring of other particles alive at time t . For this reason, Bérard and Gouéré [BG10] compare the N -BRW with a branching random walk with absorption on a linear barrier in order to apply the precise results of Gantert, Hu and Shi [GHS11]. In the same way, we come down here to results of Berestycki, Berestycki and Schweinsberg [BBS13] concerning branching Brownian motion in a strip (see Section 6.2.2). In both cases, the study is reduced to another process that satisfies the branching property and, thus, on which the work is easier.

However, the arguments used here are quite different from those of Bérard and Gouéré [BG10]. The main reason is the absence of a monotonicity property for the L -BBM, like the one used by Bérard and Gouéré (see Lemma 1 of [BG10]): it does not seem to exist a coupling such that, when one of the initial particles of the L -BBM is removed, its maximum becomes stochastically smaller.

The proof of Proposition 6.1.1 is based on the study of the return times to 1 for the population size. These times delimit i.i.d. pieces of the L -BBM, so, showing that they are sub-exponential, we can use the law of large numbers to prove the convergence of $\max X^L(t)/t$.

Although return times to 1 for the population size are sub-exponential, they are too large and, therefore, irrelevant for a more precise result. Thus, to prove Theorem 6.1.2, we work instead with stopping times $(\tau_i)_{i \in \mathbb{N}}$ such that $\tau_{i+1} - \tau_i$ is shorter than L^3 and use on such a time interval a comparison with the BBM in a strip.

For the lower bound, we come down to a BBM in a strip that starts at time τ_i with exactly the same particles than the L -BBM and is then included in the L -BBM until time τ_{i+1} . Therefore, it is sufficient to show that this BBM in a strip goes up high enough between times τ_i and τ_{i+1} . It is done by using the monotonicity property of the BBM in a strip to consider the worst case with only a single initial particle at time τ_i and, then, applying results of Berestycki, Berestycki and Schweinsberg [BBS13].

In the same way, for the upper bound, we come down between times τ_i and τ_{i+1} to a BBM in a strip with more particles than the L -BBM and we show that it cannot rise too fast. But here, we need to control the population size at time τ_i : the bad cases happen when there are too many particles. To this end, we use the following fact: a large population involves a quick increase of $\max X^L$ but, when the maximum of the L -BBM rises fast, many particle

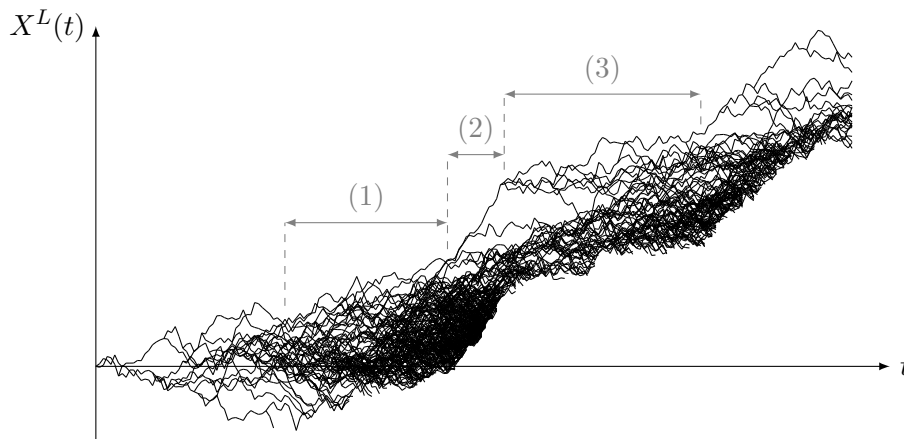

Figure 6.2 – Simulation between times 0 and 10 of an L -BBM with $L = 5$ starting with a single particle at 0. During the period (1), $\max X^L$ grows slowly so the number of particles becomes very large. Among all these particles, there is one that goes up very fast during the period (2) and it reduces drastically the population. Therefore, after that, during period (3), $\max X^L$ grows once again slowly, involving an increase of the population size.

are killed by selection (see Figure 6.2). This leads to the conclusion that $\max X^L$ cannot grow quickly during a too long period.

The chapter is organized as follows. Section 6.2 introduces some useful results concerning the standard BBM and the BBM in a strip. Then, Section 6.3 contains the proof of Proposition 6.1.1. Finally, the lower bound in Theorem 6.1.2 is proved in Section 6.4 and the upper bound in Section 6.5.

Throughout the chapter, C denotes a positive constant that does not depend on the parameters and can change from line to line. For x and y real numbers, we set $x \wedge y := \min(x, y)$ and $x \vee y := \max(x, y)$. For $f: \mathbb{R} \rightarrow \mathbb{R}$ and $g: \mathbb{R} \rightarrow \mathbb{R}_+^*$, we say that $f(x) \sim g(x)$ as $x \rightarrow \infty$ if $\lim_{x \rightarrow \infty} f(x)/g(x) = 1$ and that $f(x) = o(g(x))$ as $x \rightarrow \infty$ if $\lim_{x \rightarrow \infty} f(x)/g(x) = 0$. Lastly, we set $\mathbb{N} := \{0, 1, 2, \dots\}$ and denote by $\mathcal{C}([0, t], \mathbb{R})$ the set of continuous functions from $[0, t]$ to \mathbb{R} .

6.2 Some useful results

6.2.1 Standard branching Brownian motion

In this section, we present some classical results concerning branching Brownian motion without selection. We assume here that there is initially one particle at 0, therefore we work under the probability \mathbb{P}_0 and the associated expectation \mathbb{E}_0 .

First of all, $(\#\mathcal{N}(t))_{t \geq 0}$ under \mathbb{P}_0 is a Yule process (or pure birth process) with parameter 1, which means that it is a Markov process on \mathbb{N} with transitions $i \rightarrow i + 1$ at rate i for all $i \in \mathbb{N}$. Thus, $\#\mathcal{N}(t)$ follows under \mathbb{P}_0 a geometric distribution with parameter e^{-t} : for each $k \geq 1$, $\mathbb{P}_0(\#\mathcal{N}(t) = k) = (1 - e^{-t})^{k-1} e^{-t}$. With our settings, the many-to-one lemma can be stated as follows.

Lemma 6.2.1 (Many-to-one lemma). *Let $F: \mathcal{C}([0, t], \mathbb{R}) \rightarrow \mathbb{R}_+$ be a measurable function and $(B_s)_{s \geq 0}$ denote a Brownian motion starting at 0. Then, we have*

$$\mathbb{E}_0 \left[\sum_{u \in \mathcal{N}(t)} F(X_u(s), s \in [0, t]) \right] = e^t \mathbb{E}[F(B_s, s \in [0, t])],$$

where we denote by $X_u(s)$ the position of the unique ancestor at time s of u .

This lemma will be useful to compute the expectation of some functionals of the branching Brownian motion without selection. There is no similar result for the L -BBM because the number of particles of the L -BBM living at time t is not independent of their trajectories on $[0, t]$.

We saw before that the first order for the asymptotic behavior of the position of the highest particle of the BBM is $\sqrt{2}t$, but we will need more accurate information on the extremal particle of the BBM. The extremal particle has been a main topic in the study of the BBM, with in particular the seminal works of Bramson [Bra78, Bra83] who shows the existence of a real random variable W such that

$$\max X(t) - m(t) \xrightarrow[t \rightarrow \infty]{(\text{law})} W, \quad (6.7)$$

where

$$m(t) := \sqrt{2}t - \frac{3}{2\sqrt{2}} \log t, \quad (6.8)$$

and of Lalley and Sellke [LS87] who describe the limit W as a random mixture of Gumbel distributions.

We will need some further information on the trajectory leading to the extremal particle at time t . The following proposition is an immediate consequence of convergence (6.7) and of Theorem 2.5 of Arguin, Bovier and Kistler [ABK11]. It shows that there exists a high particle at time t (above $m(t) - d$) whose trajectory does not go too far under the line $s \mapsto \frac{s}{t}m(t)$. Actually, Arguin, Bovier and Kistler [ABK11] show that every high particle at time t is likely to satisfy this property.

Proposition 6.2.2. *For all $\gamma > 0$ and $\delta > 0$, there exist $d > 0$, $r > 0$ and $t_0 > 0$ large enough such that for all $t \geq t_0$,*

$$\begin{aligned} & \mathbb{P}_0 \left(\exists u \in \mathcal{N}(t) : X_u(t) \geq m(t) - d \right. \\ & \left. \text{and } \forall s \in [0, t], X_u(s) \geq \frac{s}{t}m(t) - r \vee \left(s^{\frac{1}{2}+\gamma} \wedge (t-s)^{\frac{1}{2}+\gamma} \right) \right) \geq 1 - \delta, \end{aligned}$$

where $X_u(s)$ denotes the position of the unique ancestor at time s of u .

6.2.2 Branching Brownian motion in a strip

The branching Brownian motion with absorption on a linear barrier has been introduced by Kesten [Kes78]. In this process, each particle moves according to a Brownian motion with drift $-\mu$, splits into two new particles after an exponentially distributed time and is killed when it reaches a non-positive position. Kesten [Kes78] showed that the process survives with positive probability if and only if $\mu < \sqrt{2}$. More recently, the branching Brownian motion with absorption has been studied by Harris, Harris and Kyprianou [HHK06], by Harris and Harris [HH07] and, in the near-critical case, that is when $\mu \rightarrow \sqrt{2}$ while keeping $\mu < \sqrt{2}$, by Berestycki, Berestycki and Schweinsberg [BBS13, BBS11]. For recent results concerning the branching Brownian motion in a strip, see Harris, Hesse and Kyprianou [HHK16].

We focus here on results of Berestycki, Berestycki and Schweinsberg [BBS13] concerning the branching Brownian motion in a strip, where particles move according to a Brownian motion with drift $-\mu$, split into two new particles after an exponentially distributed time and are killed when they come out of a fixed interval, that we will specify hereafter. We fix a positive real K , we set

$$\mu := \sqrt{2 - \frac{\pi^2}{K^2}} \quad (6.9)$$

and we choose the interval $(0, K_A)$, where we set

$$K_A := K - \frac{A}{\sqrt{2}},$$

in order to keep notation similar to those of Berestycki, Berestycki and Schweinsberg [BBS13] (but with K and K_A instead of L and L_A). We denote by $(\tilde{X}_u^{K, K_A}(t), u \in \tilde{\mathcal{N}}^{K, K_A}(t))_{t \geq 0}$ the BBM in the strip $(0, K_A)$ with drift $-\mu$, where μ is given by (6.9). Note that for this process, we keep track of the drift in the notation through the K index. When $A = 0$ (that is $K = K_A$), we write \tilde{X}^K instead of \tilde{X}^{K, K_A} , in order to simplify notation.

Berestycki, Berestycki and Schweinsberg [BBS13] introduce the following functional of the BBM in a strip, defined by

$$\tilde{Z}^{K, K_A}(t) := \sum_{u \in \tilde{\mathcal{N}}^{K, K_A}(t)} e^{\mu \tilde{X}_u^{K, K_A}(t)} \sin\left(\frac{\pi \tilde{X}_u^{K, K_A}(t)}{K_A}\right), \tag{6.10}$$

for each $t \geq 0$. The random variable $\tilde{Z}^{K, K_A}(t)$ estimates the size of the process and the process $(\tilde{Z}^{K, K_A}(t))_{t \geq 0}$ has the advantage of being a martingale in the particular case where $K_A = K$, as stated in the following proposition (see Lemma 7 of [BBS13]). The sin function comes into play when one computes the density of a Brownian motion without drift started at $x \in (0, K)$ and killed when it hits 0 or K , by solving the heat equation on $(0, K)$ with zero as boundary conditions. It brings also an exponential part that is then modified when one adds the drift and the branching events.

Proposition 6.2.3. *The process $(e^{(1-\mu^2/2-\pi^2/2K_A^2)t} \tilde{Z}^{K, K_A}(t))_{t \geq 0}$ is a martingale. In particular, when $A = 0$, $(\tilde{Z}^K(t))_{t \geq 0}$ is a martingale.*

So the drift $-\mu$ given by (6.9) is exactly the right choice such that the size of the BBM in the strip $(0, K)$ does not degenerate. When $A > 0$ (that is $K_A < K$), the population decreases exponentially and when $A < 0$ (that is $K_A > K$), the population explodes exponentially.

The following results concern the number of particles that are killed by hitting K_A between times 0 and θK^3 . This corresponds to Section 3.2 of Berestycki, Berestycki and Schweinsberg [BBS13] but with some modifications: here θ is not assumed small (rather, θ will be close to 1), we consider only the particular case $A = 0$ and we do not make the same assumptions about the initial configuration.

This first proposition is a rewrite of Proposition 16 of Berestycki, Berestycki and Schweinsberg [BBS13] in the case $A = 0$ and estimates the mean number of particles that are killed by hitting K_A between times 0 and θK^3 for any initial configuration.

Proposition 6.2.4. *Assume $A = 0$. For some fixed $\theta > 0$, let R be the number of particles that hit K between times 0 and θK^3 and R' the number of particles that hit K between times $K^{5/2}$ and θK^3 . Then, for all $\xi \in \mathcal{C}$, \mathbb{P}_ξ -a.s. we have the following inequalities as $K \rightarrow \infty$:*

$$\begin{aligned} \mathbb{E}_\xi[R] &\leq C \frac{e^{-\mu K}}{K} \tilde{V}^K(0) + 2\sqrt{2}\pi\theta K e^{-\mu K} \tilde{Z}^K(0)(1 + o(1)), \\ \mathbb{E}_\xi[R'] &\geq 2\sqrt{2}\pi\theta K e^{-\mu K} \tilde{Z}^K(0)(1 + o(1)), \end{aligned}$$

where C is a positive constant and $\tilde{V}^K(0) := \sum_{u \in \tilde{\mathcal{N}}^K(0)} \tilde{X}_u^K(0) e^{\mu \tilde{X}_u^K(0)}$.

Proof. This result follows directly from the proof of Proposition 16 of Berestycki, Berestycki and Schweinsberg [BBS13], by noting that $K = (\log N + 3 \log \log N)/\sqrt{2}$ and that the only place where they need θ to be small enough is their inequality (69), whose left-hand side is simply zero in the case $A = 0$. □

The second proposition gives an upper bound for the second moment of R and follows from the proof of Proposition 18 of [BBS13]. We still work under the assumption $A = 0$ but moreover with a single initial particle, therefore the initial configuration is denoted by (x) , where $x \in (0, K)$. Here x can be close to K , so the initial configuration does not necessarily satisfy the assumption of Proposition 18 of [BBS13].

Proposition 6.2.5. *Assume $A = 0$ and suppose there is a single particle x at time 0, where $x \in (0, K)$. Let R be the number of particles that hit K between times 0 and K^3 . Then, as $K \rightarrow \infty$,*

$$\mathbb{E}_x[R^2] \leq C e^{-\mu K} e^{\mu x} \left(1 + K \sin\left(\frac{\pi x}{K}\right)\right) (1 + o(1)),$$

where C is a positive constant.

Proof. In the same way as Berestycki, Berestycki and Schweinsberg [BBS13] in the proof of their Proposition 18, we write $R^2 = R + Y$, where Y is the number of distinct pairs of particles that hit K between times 0 and K^3 . Here, as there is only a single initial particle, we have $Y = Y_2 = Y_2^x$ with notation of [BBS13], which means that all particles that hit K have the same ancestor at time 0. From their bounds (76) and (77), it follows that

$$\mathbb{E}_x[Y] \leq C e^{-\mu K} e^{\mu x} (1 + o(1)) + C e^{-\mu K} K e^{\mu x} \sin\left(\frac{\pi x}{K}\right) (1 + o(1)),$$

because they only use the assumption that $\theta \leq 1$ and we chose here $\theta = 1$. Moreover, using Proposition 6.2.4, we get

$$\begin{aligned} \mathbb{E}_x[R] &\leq C \frac{e^{-\mu K}}{K} x e^{\mu x} + 2\sqrt{2}\pi K e^{-\mu K} e^{\mu x} \sin\left(\frac{\pi x}{K}\right) (1 + o(1)) \\ &\leq C e^{-\mu K} e^{\mu x} \left(1 + K \sin\left(\frac{\pi x}{K}\right)\right) (1 + o(1)) \end{aligned}$$

and the result follows. □

6.3 Existence of the asymptotic velocity

In this section, we prove Proposition 6.1.1. We recall that the following proof is similar to the one presented by Derrida and Shi [DS16]. However, the methods carried out here are very rough and cannot be used to get more elaborate results as Theorem 6.1.2, but we want to be ensured that the velocity v_L of the L -branching Brownian motion is well defined.

We work here with a fixed $L > 0$ and particles have no drift. The strategy will be to show that the return time to 1 for the population size of the L -BBM is sub-exponential and then to apply the law of large numbers to the renewal structure obtained from the sequence of successive return times to 1 for the population size. Foremost, we need the following coupling result that will be useful to show that there cannot be too many particles in the L -BBM.

Lemma 6.3.1. *Let M be a positive integer and $\xi = (\xi_1, \dots, \xi_N)$ be a configuration, with $N \geq M$ and $\xi_1 \geq \dots \geq \xi_N$. Then, there exist Brownian motions B^1, \dots, B^M starting at ξ_1, \dots, ξ_M respectively, that are mutually independent but not independent of the L -BBM, such that, for all $t \geq 0$, on the event $\{\forall s \in [0, t], \#N^L(s) \geq M\}$, we have*

$$\max X^L(t) \geq \max_{1 \leq i \leq M} B_t^i, \quad \mathbb{P}_\xi\text{-a.s.}$$

Proof. We choose for B^i the trajectory of the particle of the L -BBM that is at ξ_i at time 0. When this particle splits, we choose uniformly one of its children and B^i continues by following the trajectory of this child. We proceed like this until a particle followed by one of the Brownian motions B^1, \dots, B^M , say B^i , is killed by selection in the L -BBM. Then, we distinguish two cases:

- (i) If there are at least M particles in the L -BBM at this time denoted by t , then there is at least 1 particle that is not followed by one of the Brownian motions B^1, \dots, B^M , so we choose uniformly one of those particles and B^i continues by following, from the position B_t^i , the trajectory of the chosen particle. We proceed then as before.
- (ii) Otherwise, we lay the L -BBM aside and work only on the BBM without selection: each Brownian motion continues following its particle until it splits and then follows one of its child, and so on.

Thus, B^1, \dots, B^M are defined for all time and are independent Brownian motions. On the event $\{\forall s \in [0, t], \#\mathcal{N}^L(s) \geq M\}$, we do not meet the case (ii) until time t and so we have for all $s \in [0, t]$

$$\max X^L(s) \geq \max_{1 \leq i \leq M} B_s^i,$$

because B^i at time s is always lower than the particle it follows: when, in the case (i), B^i changes the particle it follows, the new particle is necessarily above B^i , because the new particle is in the L -BBM and B^i is at the low extremity of the L -BBM. \square

We can now prove that the return time to 1 for the population size of the L -BBM is sub-exponential. For this purpose, we show with Lemma 6.3.1 that, if there is a very large number of particles in the population, then the maximum of the L -BBM can with high probability increase by $2L$ in a short time and, thus, a large proportion of particles is killed by selection.

Proposition 6.3.2. *Let $T := \inf\{t \geq 1 : \#\mathcal{N}^L(t) = 1\}$. There exists a positive constant c that depends on L such that for all $\xi \in \mathcal{C}$, $\mathbb{P}_\xi(T \leq 2) \geq c$.*

Proof. The strategy will be to show firstly the same result for $S_{M_0} := \inf\{t \geq 0 : \#\mathcal{N}^L(t) \leq M_0\}$, which is the return time under a fixed size M_0 for the population of the L -BBM, where M_0 will be chosen very large.

Let M be a positive integer and $\xi = (\xi_1, \dots, \xi_N)$ a configuration, with $N \geq M$ and $\xi_1 \geq \dots \geq \xi_N$. We can suppose with no loss of generality that $\xi_1 = 0$, because the law of $(\#\mathcal{N}^L(t))_{t \geq 0}$ is invariant under shift of the initial configuration, and that $\xi_N > -L$, otherwise the low particles will die instantly. Let a be a positive real number and $t := aL^2/\log N$. We have

$$\begin{aligned} \mathbb{P}_\xi(\forall s \in [0, t], \#\mathcal{N}^L(s) \geq M) &\leq \mathbb{P}_\xi(\forall s \in [0, t], \#\mathcal{N}^L(s) \geq M, \max X^L(t) < 2L) \\ &\quad + \mathbb{P}_\xi(\#\mathcal{N}^L(t) \geq M, \max X^L(t) \geq 2L). \end{aligned} \tag{6.11}$$

The second term on the right-hand side of (6.11) can be bounded by noting that, on the event $\{\#\mathcal{N}^L(t) \geq M, \max X^L(t) \geq 2L\}$, there are at least M particles of the BBM without

selection that are above L . Thus,

$$\begin{aligned} \mathbb{P}_\xi\left(\#\mathcal{N}^L(t) \geq M, \max X^L(t) \geq 2L\right) &\leq \mathbb{P}_\xi\left(\sum_{u \in \mathcal{N}(t)} \mathbb{1}_{X_u(t) \geq L} \geq M\right) \\ &\leq \frac{1}{M} \mathbb{E}_\xi \left[\sum_{u \in \mathcal{N}(t)} \mathbb{1}_{X_u(t) \geq L} \right] \\ &= \frac{1}{M} \sum_{i=1}^N e^t \mathbb{P}(B_t + \xi_i \geq L), \end{aligned} \quad (6.12)$$

where we used successively the Markov inequality and the many-to-one lemma (Lemma 6.2.1) applied to the BBM starting at each ξ_i , with $(B_t)_{t \geq 0}$ denoting a Brownian motion starting at 0. With our choice for t and recalling that $\xi_i \leq 0$, (6.12) is bounded from above by

$$\frac{N}{M} e^{aL^2/\log N} \mathbb{P}\left(\sqrt{t}\mathcal{N}(0,1) \geq L\right) \leq e^{aL^2/\log N} \frac{N}{M} \frac{e^{-\log N/2a}}{2} = e^{aL^2/\log N} \frac{N^{1-1/2a}}{2M},$$

where $\mathcal{N}(0,1)$ denotes the standard normal distribution and we use that $\mathbb{P}(\mathcal{N}(0,1) \geq x) \leq e^{-x^2/2}/2$ for all $x \geq 0$. From now on, we set $M := \lfloor N^{\lambda+1-1/2a} \rfloor$, where $0 < \lambda < 1/2a$. Thus, since $e^{aL^2/\log N} \rightarrow 1$ as $N \rightarrow \infty$, we proved that the second term on the right-hand side of (6.11) is smaller than $N^{-\lambda}$ for N large enough.

We now deal with the first term on the right-hand side of (6.11). It can be bounded using Lemma 6.3.1: we have, with B^1, \dots, B^M independent Brownian motions starting at ξ_1, \dots, ξ_M under \mathbb{P}_ξ ,

$$\begin{aligned} \mathbb{P}_\xi\left(\forall s \in [0, t], \#\mathcal{N}^L(s) \geq M, \max X^L(t) < 2L\right) &\leq \mathbb{P}_\xi\left(\max_{1 \leq i \leq M} B^i(t) < 2L\right) \\ &\leq \mathbb{P}\left(\sqrt{t}\mathcal{N}(0,1) - L < 2L\right)^M, \end{aligned}$$

since $\xi_i > -L$ for all i . Using that $\mathbb{P}(\mathcal{N}(0,1) \geq x) \geq e^{-x^2/2}/2x$ for x large enough and that $\ln(1-u) \leq -u$ for $u < 1$, with our choice for t and M , we get

$$\begin{aligned} \mathbb{P}\left(\sqrt{t}\mathcal{N}(0,1) - L < 2L\right)^M &= \left(1 - \mathbb{P}\left(\mathcal{N}(0,1) \geq \frac{3(\log N)^{1/2}}{a^{1/2}}\right)\right)^{\lfloor N^{\lambda+1-1/2a} \rfloor} \\ &\leq \exp\left(-\lfloor N^{\lambda+1-1/2a} \rfloor \frac{N^{-9/2a} a^{1/2}}{6(\log N)^{1/2}}\right), \end{aligned} \quad (6.13)$$

for N large enough. Thus, we want that $\lambda + 1 - 10/2a > 0$, but we need $\lambda < 1/2a$ to have $M < N$. So that such a $\lambda > 0$ exists, it is sufficient that $10/2a - 1 < 1/2a$, which means $a > 9/2$. Then, we get (6.13) $\leq N^{-\lambda}$ for N large enough.

Going back to (6.11), we showed that there exist M_0 large enough, $a > 0$, $\lambda > 0$ and $0 < \mu < 1$ such that, for all $\xi = (\xi_1, \dots, \xi_N)$ with $N \geq M_0$,

$$\mathbb{P}_\xi\left(\exists s \in [0, aL^2/\log N] : \#\mathcal{N}^L(s) \leq N^\mu\right) \geq 1 - N^{-\lambda}. \quad (6.14)$$

We fix $N \geq M_0$ and we set $k := \lceil \frac{\log \log N - \log \log M_0}{\log(1/\mu)} \rceil$, so that k is the single integer that satisfies $N^{\mu^k} \leq M_0 < N^{\mu^{k-1}}$. Then, by applying k times the strong Markov property and

the inequality (6.14) with successively $N^{\mu^{k-1}}, N^{\mu^{k-2}}, \dots, N$ in place of N , we get

$$\mathbb{P}_\xi \left(\exists s \in \left[0, \sum_{i=1}^k \frac{aL^2}{\log(N^{\mu^{i-1}})} \right] : \#\mathcal{N}^L(s) \leq N^{\mu^k} \right) \geq \prod_{i=0}^{k-1} (1 - N^{-\lambda\mu^i}) \geq \prod_{j=0}^{k-1} (1 - M_0^{-\lambda\mu^{-j}}), \tag{6.15}$$

by using that $N > M_0^{\mu^{-k+1}}$ and setting $j = k - i - 1$. It is easy to see that the product on the right-hand side of (6.15) converges to a positive limit as k tends to infinity, if $M_0 > 1$. Moreover, we have

$$\sum_{i=1}^k \frac{aL^2}{\log(N^{\mu^{i-1}})} = \frac{aL^2}{\log N} \sum_{i=1}^k \mu^{-(i-1)} \leq \frac{aL^2}{\log N} \frac{\mu^{1-k}}{1-\mu} \leq \frac{aL^2}{(1-\mu)\log M_0} \leq 1,$$

for M_0 large enough, where we used the definition of k . Thus, we have proved that there exist $c_1 > 0$ and M_0 such that, for all $\xi = (\xi_1, \dots, \xi_N)$ with $N \geq M_0$,

$$\mathbb{P}_\xi \left(\exists s \in [0, 1] : \#\mathcal{N}^L(s) \leq M_0 \right) \geq c_1, \tag{6.16}$$

that is $\mathbb{P}_\xi(S_{M_0} \leq 1) \geq c_1$ with $S_{M_0} := \inf\{t \geq 0 : \#\mathcal{N}^L(t) \leq M_0\}$.

Now, we consider an initial configuration $\xi = (\xi_1, \dots, \xi_N)$ but with $N \leq M_0$. We suppose $\xi_1 \geq \dots \geq \xi_N$. If no particle splits on the time interval $[0, 1]$, if the particle starting at ξ_1 stays above $\xi_1 - L/2$ on $[0, 1]$ and reaches $\xi_1 + 2L$ at time 1 and if all other particles stay strictly under $\xi_1 + L/2$ on $[0, 1]$, then at time 1 only the particle starting at ξ_1 is alive so $T = 1$. Therefore, if B denotes a Brownian motion starting at 0, we have

$$\mathbb{P}_\xi(T = 1) \geq (e^{-1})^N \mathbb{P} \left(\min_{s \in [0, 1]} B_s \geq -\frac{L}{2}, B_t \geq 2L \right) \mathbb{P} \left(\max_{s \in [0, 1]} B_s < \frac{L}{2} \right)^{N-1} \geq c_2,$$

where $c_2 > 0$ is reached in the case $N = M_0$. So we can conclude that $\forall \xi \in \mathcal{C}, \mathbb{P}_\xi(T \leq 2) \geq c_1 c_2$, by using (6.16) and the strong Markov property at time S_{M_0} in the case where there are more than M_0 particles in the initial configuration. \square

The controls performed in the previous proof are very loose: with slightly more computation, one can see that M_0 needs to be larger than e^{bL^2} with some $b > 0$, whereas most of the time $M^L(t)$ is of the order of $e^{\sqrt{2}L}$. Indeed, the return to 1 for the population size is a too infrequent event for a more accurate study of the L -BBM as in Sections 6.4 and 6.5. But it is sufficient here to prove the existence of the asymptotic velocity v_L for the L -BBM.

Proof of Proposition 6.1.1. Let $\xi \in \mathcal{C}$ be a fixed configuration. We set $T_0 := 0$ and $T_{i+1} := \inf\{t \geq T_i + 1 : \#\mathcal{N}^L(t) = 1\}$ for each $i \in \mathbb{N}$. Since for $i \geq 1$ there is a single particle in the L -BBM at time T_i , by the strong Markov property, $(T_{i+1} - T_i)_{i \geq 1}$ and $(\max X^L(T_{i+1}) - \max X^L(T_i))_{i \geq 1}$ are sequences of i.i.d. random variables with the same distributions as T and $\max X^L(T)$ under \mathbb{P}_0 respectively.

Using Proposition 6.3.2 and the strong Markov property, we have for all $\xi \in \mathcal{C}$ and $n \in \mathbb{N}$,

$$\mathbb{P}_\xi(T \geq 2n) \leq (1 - c)^n,$$

which means that T has a sub-exponential distribution under \mathbb{P}_ξ , so T has finite moments and, in particular, \mathbb{P}_ξ -almost surely we have $T_1 < \infty$. Therefore, by the law of large numbers, we get that \mathbb{P}_ξ -a.s. $T_n/n \rightarrow \mathbb{E}_0[T]$ as $n \rightarrow \infty$.

It is clear that \mathbb{P}_ξ -a.s. $\max X^L(T_1) < \infty$ but in order to apply the law of large numbers to the sequence $(\max X^L(T_{i+1}) - \max X^L(T_i))_{i \geq 1}$, we need to check that $\mathbb{E}_0[|\max X^L(T)|]$ is finite. We are going to prove something stronger that will be useful afterwards in the proof, which is $\mathbb{E}_0[\zeta] < \infty$ where

$$\zeta := \max_{t \in [0, T]} |\max X^L(t)|.$$

For this, it is sufficient to prove that the function $a \mapsto \mathbb{P}_0(\zeta \geq a)$ is integrable on \mathbb{R}_+ . For all $a > 0$, we have

$$\mathbb{P}_0(\zeta \geq a) \leq \mathbb{P}_0(T > \sqrt{a}) + \mathbb{P}_0(\exists t \in [0, \sqrt{a}] : |\max X^L(t)| \geq a). \quad (6.17)$$

Since $\mathbb{E}_0[T^2]$ is finite, $a \mapsto \mathbb{P}_0(T > \sqrt{a})$ is integrable on \mathbb{R}_+ . So we now have to deal with the second term on the right-hand side of (6.17). By the coupling with the BBM without selection, it is bounded by

$$\begin{aligned} \mathbb{P}_0(\exists t \in [0, \sqrt{a}] : |\max X(t)| \geq a) &\leq 2\mathbb{P}_0(\exists t \in [0, \sqrt{a}] : \max X(t) \geq a) \\ &\leq 2\mathbb{E}_0 \left[\sum_{u \in \mathcal{N}(\sqrt{a})} \mathbb{1}_{\exists t \in [0, \sqrt{a}] : X_u(t) \geq a} \right], \end{aligned} \quad (6.18)$$

where we denote by $X_u(t)$ the position of the unique ancestor at time t of $X_u(\sqrt{a})$. Using the many-to-one lemma (Lemma 6.2.1), (6.18) is equal to

$$2e^{\sqrt{a}} \mathbb{P}(\exists t \in [0, \sqrt{a}] : B_t \geq a) = 4e^{\sqrt{a}} \mathbb{P}(a^{1/4} \mathcal{N}(0, 1) \geq a) \leq 2e^{\sqrt{a}} e^{-a^{3/2}/2},$$

which is an integrable function of a . This concludes the proof of the fact that $\mathbb{E}_0[\zeta]$ is finite. In particular, we can apply the law of large numbers to the sequence $(\max X^L(T_{i+1}) - \max X^L(T_i))_{i \geq 1}$ and get that \mathbb{P}_ξ -a.s. $\max X^L(T_n)/n \rightarrow \mathbb{E}_0[\max X^L(T)]$ as $n \rightarrow \infty$. Thus, we have the convergence

$$\frac{\max X^L(T_n)}{T_n} \xrightarrow{n \rightarrow \infty} \frac{\mathbb{E}_0[\max X^L(T)]}{\mathbb{E}_0[T]} =: v_L \quad (6.19)$$

\mathbb{P}_ξ -almost surely.

For each $t \geq 0$, let n_t be the integer such that $T_{n_t} \leq t < T_{n_t+1}$. It suffices now to show that \mathbb{P}_ξ -a.s. $\max X^L(t)/t - \max X^L(T_{n_t})/T_{n_t} \rightarrow 0$ as $t \rightarrow \infty$. We have

$$\begin{aligned} \left| \frac{\max X^L(t)}{t} - \frac{\max X^L(T_{n_t})}{T_{n_t}} \right| &\leq \left| \frac{\max X^L(t) - \max X^L(T_{n_t})}{t} \right| + \left| \frac{\max X^L(T_{n_t})}{T_{n_t}} \right| \left(\frac{t - T_{n_t}}{t} \right) \\ &\leq \frac{\zeta_{n_t}}{t} + \left| \frac{\max X^L(T_{n_t})}{T_{n_t}} \right| \left(1 - \frac{T_{n_t}}{t} \right), \end{aligned} \quad (6.20)$$

where, for $n \in \mathbb{N}$, we set

$$\zeta_n := \max_{t \in [T_n, T_{n+1}]} |\max X^L(t) - \max X^L(T_n)|.$$

Since $T_{n_t}/n_t \leq t/n_t < T_{n_t+1}/n_t$, we get that \mathbb{P}_ξ -a.s. $t/n_t \rightarrow \mathbb{E}_0[T]$ as $n \rightarrow \infty$, so $T_{n_t}/t \rightarrow 1$ and combining with (6.19), we deduce that \mathbb{P}_ξ -a.s. the second term on the right-hand side of (6.20) tends to 0. We now have to deal with the first term. Since $(\zeta_n)_{n \geq 1}$ is a sequence of i.i.d. random variables with the same law as ζ under \mathbb{P}_0 and $\mathbb{E}_0[\zeta]$ is finite, we have by the law of large numbers \mathbb{P}_ξ -a.s. $\zeta_n/n \rightarrow 0$ as $n \rightarrow \infty$ and so \mathbb{P}_ξ -a.s. $\zeta_{n_t}/t \rightarrow 0$ as $t \rightarrow \infty$. It concludes the proof of Proposition 6.1.1. \square

6.4 Lower bound for v_L

In this section, we fix $0 < \varepsilon < 1$ and consider all processes with drift $-\mu$, where

$$\mu := \sqrt{2 - \frac{\pi^2}{(1 - \varepsilon)^2 L^2}},$$

which means that, for each $\xi \in \mathcal{C}$, under \mathbb{P}_ξ , $(X_u(t), u \in \mathcal{N}(t))_{t \geq 0}$ is a BBM without selection, with drift $-\mu$ and starting from the configuration ξ and $(X_u^L(t), u \in \mathcal{N}^L(t))_{t \geq 0}$ is the associated L -BBM with drift $-\mu$. However, v_L still denotes the asymptotic velocity of L -BBM without drift, so Proposition 6.1.1 shows that, for all $L > 0$ and all $\xi \in \mathcal{C}$,

$$\frac{\max X^L(t)}{t} \xrightarrow[t \rightarrow \infty]{} v_L - \mu \tag{6.21}$$

\mathbb{P}_ξ -almost surely. Actually, the aim is to show that for L large enough $\lim \max X^L(t)/t \geq 0$ \mathbb{P}_0 -a.s. so that we can conclude that $v_L \geq \mu$ and the lower bound follows by letting $\varepsilon \rightarrow 0$.

6.4.1 Proof of the lower bound

In this subsection, we prove the lower bound in Theorem 6.1.2, by postponing to the next subsection the proof of a proposition. The strategy is to study the L -BBM on time intervals of length at most L^3 associated to a sequence of stopping times $(\tau_i)_{i \in \mathbb{N}}$ defined by $\tau_0 := 0$ and for each $i \in \mathbb{N}$,

$$\tau_{i+1} := (\tau_i + L^3) \wedge \inf \left\{ t \geq \tau_i \mid \max X^L(t) - \max X^L(\tau_i) \notin (-(L - 1), 1) \right\}.$$

We also define the event $A_i := \{ \max X^L(\tau_{i+1}) < \max X^L(\tau_i) + 1 \}$ (see Figure 6.3 for an illustration of these definitions).

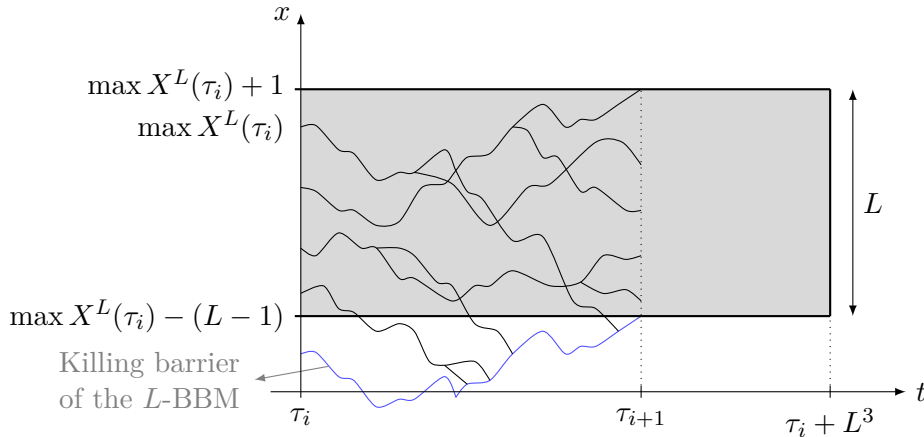

Figure 6.3 – Representation of a L -BBM between times τ_i and τ_{i+1} . By definition, τ_{i+1} is the time where $t \mapsto \max X^L(t)$ leaves the gray area. We are here on the event A_i^c because $t \mapsto \max X^L(t)$ leaves the area from above. Note that the killing barrier of X^L (drawn in blue) stays below $\max X^L(\tau_i) - (L - 1)$.

The event A_i is a “bad” event, because on the event A_i^c the position of the highest particle of the L -BBM goes up between times τ_i and τ_{i+1} . The following proposition shows that the event A_i is very unlikely, regardless of the configuration of the L -BBM at time τ_i . Its proof is postponed to Section 6.4.2.

Proposition 6.4.1. *Let $h(L) := \sup_{\xi \in \mathcal{C}} \mathbb{P}_\xi(A_0)$. Then, as $L \rightarrow \infty$, we have $h(L) = o(1/L)$.*

Using Proposition 6.4.1, we can now conclude the proof of the lower bound. Let $K_n := \sum_{i=0}^{n-1} \mathbb{1}_{A_i}$ be the number of “bad” events A_i that happen before time τ_n . On the event A_i^c , we have $\max X^L(\tau_{i+1}) - \max X^L(\tau_i) = 1$ and, on the event A_i , we only have $\max X^L(\tau_{i+1}) - \max X^L(\tau_i) \geq -(L - 1)$ and, therefore, we get

$$\max X^L(\tau_n) - \max X^L(0) \geq (n - K_n) - (L - 1)K_n = n - LK_n$$

and, thus,

$$\frac{\max X^L(\tau_n) - \max X^L(0)}{\tau_n} \geq \frac{n}{\tau_n} \left(1 - L \frac{K_n}{n}\right). \tag{6.22}$$

We now want to prove that the right-hand side of (6.22) is non-negative as n tends to infinity. For this, we need to control K_n . Using Proposition 6.4.1 and the strong Markov property, we get that, for each $0 \leq k \leq n$, $\mathbb{P}_0(K_n \geq k) \leq \binom{n}{k} h(L)^k$ and so

$$\mathbb{E}_0[e^{K_n}] \leq \sum_{k=0}^n \binom{n}{k} h(L)^k e^k = (1 + h(L)e)^n \leq e^{nh(L)e}.$$

Then, applying the Markov inequality, we get

$$\mathbb{P}_0(K_n \geq 3nh(L)) \leq e^{-3nh(L)} \mathbb{E}_0[e^{K_n}] \leq e^{-nh(L)(3-e)}$$

which is summable, so the Borel-Cantelli lemma implies that \mathbb{P}_0 -a.s. $\limsup_{n \rightarrow \infty} \frac{K_n}{n} \leq 3h(L)$. Moreover, using Proposition 6.4.1, we get that for L large enough $1 - 3h(L)L \geq 1/2$, so we conclude that for L large enough,

$$\liminf_{n \rightarrow \infty} \frac{n}{\tau_n} \left(1 - L \frac{K_n}{n}\right) \geq 0. \tag{6.23}$$

Assume for now that τ_n tends to infinity \mathbb{P}_0 -almost surely as $n \rightarrow \infty$. Then, the left-hand side of (6.22) converges \mathbb{P}_0 -almost surely to $v_L - \mu$ as $n \rightarrow \infty$, so with (6.23) we get $v_L - \mu \geq 0$ for L large enough, that is

$$v_L \geq \sqrt{2} - \frac{\pi^2}{2\sqrt{2}(1 - \varepsilon)^2 L^2} + o\left(\frac{1}{L^2}\right)$$

and the lower bound in Theorem 6.1.2 follows by letting $\varepsilon \rightarrow 0$. It remains to show that τ_n tends to infinity \mathbb{P}_0 -almost surely. On the event $\{(\tau_n)_{n \geq 0} \text{ is bounded}\}$, τ_n tends to a finite limit τ_∞ as $n \rightarrow \infty$, so it follows from (6.22) that \mathbb{P}_0 -almost surely

$$\frac{\max X^L(\tau_\infty)}{\tau_\infty} = \infty,$$

for L large enough such that $1 - 3h(L)L \geq 1/2$. But \mathbb{P}_0 -almost surely, for all $t \geq 0$, $\max X^L(t)/t < \infty$, so $\mathbb{P}_0((\tau_n)_{n \geq 0} \text{ is bounded}) = 0$. It concludes the proof of the lower bound in Theorem 6.1.2.

6.4.2 Proof of Proposition 6.4.1

In this subsection, we prove Proposition 6.4.1, that is we show that the event A_0^c is very likely. For this, we compare the L -BBM with a BBM in a strip that has less particles than the L -BBM between times 0 and τ_1 . Thus, if a particle of the BBM in a strip reaches $\max X^L(0) + 1$, then it is also the case for the L -BBM. To prove that there is a particle of the BBM in a strip reaching $\max X^L(0) + 1$ with high probability, we will use Proposition 6.2.4, Proposition 6.2.5 and the following lemma that allows to have many independent BBM in a strip trying to reach $\max X^L(0) + 1$ instead of only one.

Lemma 6.4.2. *Assume that X is a BBM with drift $-\mu$ where $\mu \leq \sqrt{2}$. Then, for each $\alpha > 0$, for L large enough, we have*

$$\mathbb{P}_0(\#\mathcal{N}(L^\alpha) < L \text{ or } \exists t \in [0, L^\alpha] : \min X(t) \leq -4L^\alpha) \leq 2Le^{-L^\alpha}.$$

Note that this lemma concerns branching Brownian motion without selection and is stated for a large choice of drift $-\mu$ so that it can be applied here and also in Section 6.5.

Proof. Since $\#\mathcal{N}(L^\alpha)$ follows a geometric distribution with parameter e^{-L^α} , we get

$$\mathbb{P}(\#\mathcal{N}(L^\alpha) < L) = \sum_{k=1}^{L-1} e^{-L^\alpha} (1 - e^{-L^\alpha})^{k-1} = 1 - (1 - e^{-L^\alpha})^{L-1} \underset{L \rightarrow \infty}{\sim} Le^{-L^\alpha}. \quad (6.24)$$

Moreover, applying the many-to-one lemma (Lemma 6.2.1) without forgetting the drift $-\mu$, we have, with $(B_t)_{t \geq 0}$ a Brownian motion,

$$\begin{aligned} \mathbb{P}(\exists t \in [0, L^\alpha] : \min X(t) \leq -4L^\alpha) &\leq e^{L^\alpha} \mathbb{P}(\exists t \in [0, L^\alpha] : B_t - \mu t \leq -4L^\alpha) \\ &\leq e^{L^\alpha} \mathbb{P}(\exists t \in [0, L^\alpha] : B_t \leq -(4 - \mu)L^\alpha) \\ &= e^{L^\alpha} 2\mathbb{P}(L^{\alpha/2} \mathcal{N}(0, 1) > (4 - \mu)L^\alpha) \\ &\leq e^{L^\alpha - (4 - \mu)^2 L^\alpha / 2}. \end{aligned} \quad (6.25)$$

The result follows from (6.24) and (6.25) with $\mu \leq \sqrt{2}$. \square

We now have enough tools to prove Proposition 6.4.1. Actually, the control will be much more accurate than needed.

Proof of Proposition 6.4.1. Let $\xi \in \mathcal{C}$ be a configuration. Note first that $\mathbb{P}_\xi(A_0)$ is invariant under shift of ξ , so we can assume without loss of generality that $\max \xi = L - 1$. Then, \mathbb{P}_ξ -a.s. $\tau_1 = L^3 \wedge \inf\{t \geq 0 : \max X^L(t) \notin (0, L)\}$ and A_0 is \mathbb{P}_ξ -a.s. equal to the event “no particle of the L -BBM reaches L before reaching 0 on the time interval $[0, L^3]$ ”. Moreover, \mathbb{P}_ξ -a.s. on the time interval $[0, \tau_1]$ the killing barrier of the L -BBM stays under 0 (see Figure 6.3), so we have the inclusion

$$\forall t \in [0, \tau_1], \tilde{X}^{K,L}(t) \subset X^L(t), \quad (6.26)$$

where we set $K := (1 - \varepsilon)L$ so that (6.9) is satisfied and $A := -\varepsilon L$ so that $K_A = L$: thus, under \mathbb{P}_ξ , $(\tilde{X}_u^{K,L}(t), u \in \tilde{\mathcal{N}}^{K,L}(t))_{t \geq 0}$ is a BBM in the strip $(0, L)$ with drift $-\mu$ starting from the configuration ξ . Let C_0 denote the event “no particle of $\tilde{X}^{K,L}$ reaches L on the time interval $[0, L^3]$ ”, then it follows from (6.26) that \mathbb{P}_ξ -a.s. $A_0 \subset C_0$. Moreover, the BBM in a strip satisfies the branching property: the offspring of a single particle at x at time 0 is independent of the offspring of other initial particles and follows the law of a BBM in a strip under \mathbb{P}_x . So we have $\mathbb{P}_\xi(C_0) \leq \mathbb{P}_{L-1}(C_0)$, by keeping only the offspring of the highest initial particle. Thus, we get $h(L) \leq \mathbb{P}_{L-1}(C_0)$ because it does not depend any more on the initial configuration.

Now, our aim is to give an upper bound for $\mathbb{P}_{L-1}(C_0)$. For this purpose, we will first use Lemma 6.4.2 to have at least L particles above $L - 1 - 4L^\alpha$ after a short time L^α and then apply Propositions 6.2.4 and 6.2.5 to show that each particle at time L^α has a descendant that reaches L before time L^3 with a positive probability that does not depend on L . We fix $0 < \alpha < 1/2$. Using Lemma 6.4.2, we get, for L large enough such that $L - 1 - 4L^\alpha > 0$,

$$\begin{aligned} \mathbb{P}_{L-1}(C_0) &\leq 2Le^{-L^\alpha} + \mathbb{P}_{L-1}(\{\#\mathcal{N}(L^\alpha) \geq L\} \cap \{\forall t \in [0, L^\alpha], \min X(t) > L - 1 - 4L^\alpha\} \cap C_0) \\ &\leq 2Le^{-L^\alpha} + \mathbb{P}_{L-1}(\{\#\tilde{\mathcal{N}}^{K,L}(L^\alpha) \geq L\} \cap \{\min \tilde{X}^{K,L}(L^\alpha) > L - 1 - 4L^\alpha\} \cap C_0), \end{aligned} \quad (6.27)$$

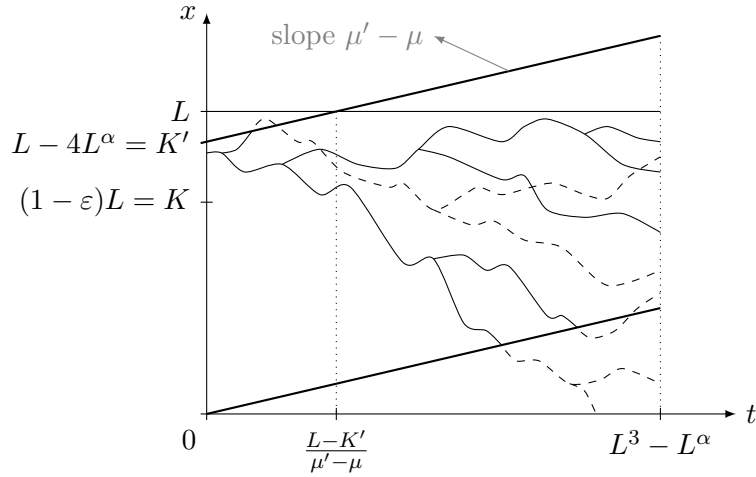

Figure 6.4 – Representation of the coupled systems \bar{X} (full line) and $\tilde{X}^{K,L}$ (dashed line) starting with a single initial particle at $K' - 1$, on the event C'_0 . The two thick straight lines of slope $\mu' - \mu$ are the killing barriers that define \bar{X} .

because on the event $\{\forall t \in [0, L^\alpha], \min X(t) > -4L^\alpha\} \cap C_0$, no particle of the BBM in a strip is killed between times 0 and L^α , so $\tilde{\mathcal{N}}(L^\alpha) = \mathcal{N}(L^\alpha)$. Applying the branching property at time L^α , we bound from above the second term of the right-hand side of (6.27) by

$$\mathbb{E}_{L-1} \left[\mathbb{1}_{\#\tilde{\mathcal{N}}^{K,L}(L^\alpha) \geq L} \mathbb{1}_{\min \tilde{X}^{K,L}(L^\alpha) > L-1-4L^\alpha} \prod_{u \in \tilde{\mathcal{N}}^{K,L}(L^\alpha)} \mathbb{P}_{\tilde{X}_u^{K,L}(L^\alpha)}(C'_0) \right], \quad (6.28)$$

where C'_0 denotes the event “no particle of $\tilde{X}^{K,L}$ reaches L on the time interval $[0, L^3 - L^\alpha]$ ”. Note that the function $x \in (0, L) \mapsto \mathbb{P}_x(C'_0)$ is nonincreasing¹. So it follows from (6.28) that

$$h(L) \leq 2Le^{-L^\alpha} + \mathbb{P}_{L-1-4L^\alpha}(C'_0)^L, \quad (6.29)$$

for L large enough.

Our aim is now to control $\mathbb{P}_{L-1-4L^\alpha}(C'_0)$. We set $K' := L - 4L^\alpha$ and

$$\mu' := \sqrt{2 - \frac{\pi^2}{(L - 4L^\alpha)^2}},$$

the drift associated to K' (see equation (6.9)). Moreover, we define a new process \bar{X} from the standard BBM X with drift $-\mu$ by killing particles that go below $t \mapsto (\mu' - \mu)t$ or above $t \mapsto K' + (\mu' - \mu)t$ (see Figure 6.4). With this coupling, on the event C'_0 , we have the inclusion $\forall t \in [0, L^3 - L^\alpha], \bar{X}(t) \subset \tilde{X}^{K,L}(t)$ and it follows that

$$\begin{aligned} C'_0 &\subset \left\{ \text{no particle of } \bar{X} \text{ reaches } L \text{ on time interval } \left[\frac{L - K'}{\mu' - \mu}, L^3 - L^\alpha \right] \right\} \\ &\subset \left\{ \text{no particle of } \bar{X} \text{ reaches } t \mapsto K' + (\mu' - \mu)t \text{ on } \left[\frac{L - K'}{\mu' - \mu}, L^3 - L^\alpha \right] \right\}, \end{aligned}$$

1. This follows from the fact that $\mathbb{P}_x(C'_0) = \mathbb{P}_x(\text{no particle of } \hat{X} \text{ reaches } L \text{ on } [0, L^3 - L^\alpha])$, where \hat{X} denotes the BBM with drift $-\mu$, with absorption at 0 and with a single initial particle at x under \mathbb{P}_x .

where the last event means that $\forall t \in [(L - K')/(\mu' - \mu), L^3 - L^\alpha]$, $\max \bar{X}(t) < K' + (\mu' - \mu)t$. Then, recalling that $\tilde{X}^{K'}$ denotes the BBM in the strip $(0, K')$ with drift $-\mu'$, note that

$$\begin{aligned} & \mathbb{P}_{L-1-4L^\alpha} \left(\text{no particle of } \bar{X} \text{ reaches } t \mapsto K' + (\mu' - \mu)t \text{ on } \left[\frac{L - K'}{\mu' - \mu}, L^3 - L^\alpha \right] \right) \\ & \leq \mathbb{P}_{L-1-4L^\alpha} \left(\text{no particle of } \tilde{X}^{K'} \text{ reaches } K' \text{ on } \left[\frac{L - K'}{\mu' - \mu}, L^3 - L^\alpha \right] \right) \\ & \leq \mathbb{P}_{L-1-4L^\alpha} \left(\text{no particle of } \tilde{X}^{K'} \text{ reaches } K' \text{ on } \left[K'^{5/2}, K'^3 \right] \right), \end{aligned}$$

using that $L^3 - L^\alpha \geq K'^3$ and $(L - K')/(\mu' - \mu) = C_\varepsilon L^{2+\alpha}(1 + o(1)) \leq K'^{5/2}$ for L large enough, with C_ε a positive constant depending only on ε . Thus, we get

$$\mathbb{P}_{L-1-4L^\alpha}(C'_0) \leq \mathbb{P}_{L-1-4L^\alpha}(R' = 0) = 1 - \mathbb{P}_{K'-1}(R' \geq 1) \leq 1 - \frac{\mathbb{E}_{K'-1}[R']^2}{\mathbb{E}_{K'-1}[R'^2]},$$

where R' is the number of particles of $\tilde{X}^{K'}$ that hit K' between times $K'^{5/2}$ and K'^3 . We now want to give a lower bound for $\mathbb{E}_{K'-1}[R']^2/\mathbb{E}_{K'-1}[R'^2]$. Using first Proposition 6.2.4 with $\theta = 1$, we get

$$\mathbb{E}_{K'-1}[R'] \geq 2\sqrt{2}\pi K' e^{-\mu K'} e^{\mu(K'-1)} \sin\left(\frac{\pi(K'-1)}{K'}\right) (1 + o(1)) \xrightarrow{L \rightarrow \infty} 2\sqrt{2}\pi^2 e^{-\mu}.$$

Then, using Proposition 6.2.5 with R denoting the number of particles of $\tilde{X}^{K'}$ that hit K' between times 0 and K'^3 , we get

$$\begin{aligned} \mathbb{E}_{K'-1}[R'^2] & \leq \mathbb{E}_{K'-1}[R^2] \\ & \leq C e^{-\mu K'} e^{\mu(K'-1)} \left(1 + K' \sin\left(\frac{\pi(K'-1)}{K'}\right) \right) (1 + o(1)) \\ & \xrightarrow{L \rightarrow \infty} C e^{-\mu} (1 + \pi). \end{aligned}$$

So, for L large enough, we have $\mathbb{E}_{K'-1}[R']^2/\mathbb{E}_{K'-1}[R'^2] \geq c > 0$. Coming back to (6.29), we get that, for L large enough,

$$h(L) \leq 2L e^{-L^\alpha} + (1 - c)L,$$

and the result follows. \square

6.5 Upper bound for v_L

As in Section 6.4, we fix $0 < \varepsilon < 1/3$ and we consider all processes with drift $-\mu$, but we set here

$$\mu := \sqrt{2 - \frac{\pi^2}{(1 + 4\varepsilon)^2 L^2}}.$$

We want to show that for L large enough, \mathbb{P}_0 -a.s. $\lim_{t \rightarrow \infty} \max X^L(t)/t \leq C\varepsilon/L^2$, which gives $v_L \leq \mu + C\varepsilon/L^2$, and then the upper bound follows by letting $\varepsilon \rightarrow 0$. Moreover, we set for $j \geq 1$, $L_j := (1 + j\varepsilon)L$. Thus, μ is the drift corresponding to L_4 according to the results of Section 6.2.2.

6.5.1 Proof of the upper bound

In this subsection, we prove the upper bound in Theorem 6.1.2, by postponing to the next subsections the proof of two propositions. As in Section 6.4, the L -BBM will be studied on time intervals of length at most L^3 associated to a sequence of stopping times $(\tau_i)_{i \in \mathbb{N}}$ defined by $\tau_0 := 0$ and for each $i \in \mathbb{N}$,

$$\tau_{i+1} := \inf \left\{ t \geq \tau_i : \max X^L(t) - \max X^L(\tau_i) \notin \left(-\varepsilon L + \frac{2\varepsilon}{L^2}(t - \tau_i), \varepsilon L \right) \right\}.$$

Hence we have $\tau_{i+1} - \tau_i \leq L^3$ (see Figure 6.5). We also define the event $A_i := \{\max X^L(\tau_{i+1}) = \max X^L(\tau_i) + \varepsilon L\}$, as a “bad” event: on A_i , $\max X^L$ can increase quickly between times τ_i and τ_{i+1} .

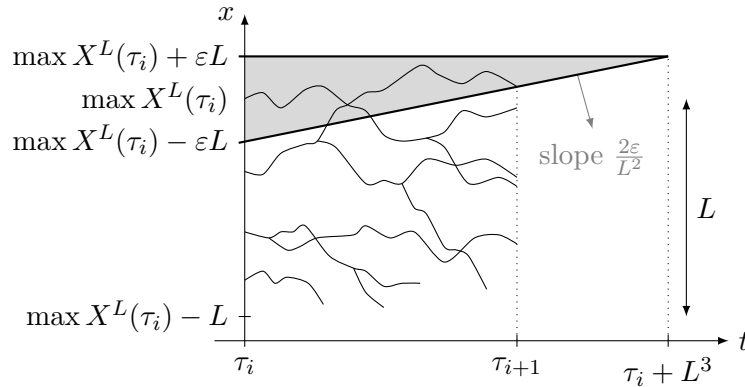

Figure 6.5 – Representation of a L -BBM between times τ_i and τ_{i+1} . By definition, τ_{i+1} is the time where $t \mapsto \max X^L(t)$ leaves the gray area. The two thick straight lines that delimit the gray area intersect at time $\tau_i + L^3$. We are here on the event A_i^c because $t \mapsto \max X^L(t)$ leaves the area from below.

Let $K_n := \sum_{i=0}^{n-1} \mathbb{1}_{A_i}$ be the number of “bad” events A_i that happen before time τ_n . On the event A_i^c , we have $\max X^L(\tau_{i+1}) - \max X^L(\tau_i) = -\varepsilon L + 2\varepsilon(\tau_{i+1} - \tau_i)/L^2$ and, on the event A_i , we have $\max X^L(\tau_{i+1}) - \max X^L(\tau_i) = \varepsilon L$. Therefore, we get

$$\begin{aligned} \max X^L(\tau_n) - \max X^L(0) &= \sum_{i=0}^{n-1} \mathbb{1}_{A_i} \varepsilon L + \sum_{i=0}^{n-1} \mathbb{1}_{A_i^c} \left(-\varepsilon L + \frac{2\varepsilon}{L^2}(\tau_{i+1} - \tau_i) \right) \\ &\leq K_n \varepsilon L - (n - K_n) \varepsilon L + \frac{2\varepsilon}{L^2} \tau_n \end{aligned}$$

and so

$$\frac{\max X^L(\tau_n) - \max X^L(0)}{\tau_n} \leq \frac{2\varepsilon}{L^2} + \frac{n}{\tau_n} \left(-\varepsilon L + 2 \frac{K_n}{n} \varepsilon L \right). \quad (6.30)$$

We now need two propositions to conclude. The first one shows that there cannot be much more than $(1/2 + 1/\varepsilon L)n$ events A_i happening before time τ_n . Its proof is postponed to Sections 6.5.2 and 6.5.3.

Proposition 6.5.1. *For L large enough, \mathbb{P}_0 -a.s. we have*

$$\limsup_{n \rightarrow \infty} \frac{K_n}{n} \leq \frac{1}{2} + \frac{1}{\varepsilon L}.$$

Remark 6.5.2. The constant $1/2$ appears here because we work in the proof as if the lower barrier that defines τ_{i+1} was horizontal too, so that the population size increase between

times τ_i and τ_{i+1} on event A_i^c is more or less the inverse of the decrease on event A_i . But, if the lower barrier was horizontal and if there was a vertical barrier at time L^3 , then we would probably have $\tau_{i+1} = \tau_i + L^3$ most of the time, because fluctuations of the L -BBM are believed to be of order $\log L$ (and not εL) on a time scale of L^3 . Thus, with the actual lower barrier, event A_i^c should happen most of the time and $\limsup_{n \rightarrow \infty} K_n/n$ should be close to zero. Moreover, we took μ greater than the presumed value of v_L and this is also favorable to event A_i^c .

The second proposition gives a lower bound for τ_n/n as $n \rightarrow \infty$ and shows that it is much larger than L^2 . Its proof is postponed to Section 6.5.4. Note that by using some results of Berestycki, Berestycki and Schweinsberg [BBS14] concerning critical BBM with absorption instead of Corollary 6.5.7, we could have $\liminf_{n \rightarrow \infty} \tau_n/n \geq c(\varepsilon L)^3$ for some constant $c > 0$ (see Remark 6.5.8).

Proposition 6.5.3. *There exists $\gamma > 0$ such that, for L large enough, \mathbb{P}_0 -a.s. we have*

$$\liminf_{n \rightarrow \infty} \frac{\tau_n}{n} \geq \frac{L^{2+\gamma}}{6}.$$

We can now conclude the proof of the upper bound. Using Proposition 6.5.1, we get that \mathbb{P}_0 -a.s. $\limsup_{n \rightarrow \infty} (-\varepsilon L + 2\frac{K_n}{n}\varepsilon L) \leq 2$. Therefore, it follows from (6.30) that \mathbb{P}_0 -a.s.

$$\lim_{n \rightarrow \infty} \frac{\max X^L(\tau_n)}{\tau_n} \leq \frac{2\varepsilon}{L^2} + 2 \limsup_{n \rightarrow \infty} \frac{n}{\tau_n} \leq \frac{2\varepsilon}{L^2} + \frac{12}{L^{2+\gamma}}, \quad (6.31)$$

for L large enough, applying Proposition 6.5.3. From Proposition 6.5.3, we get that \mathbb{P}_0 -a.s. $\tau_n \rightarrow \infty$ as $n \rightarrow \infty$, so the left-hand side of (6.31) is equal to $v_L - \mu$. Thus, we have

$$v_L \leq \sqrt{2} - \frac{\pi^2}{2\sqrt{2}(1+4\varepsilon)^2 L^2} + \frac{2\varepsilon}{L^2} + o\left(\frac{1}{L^2}\right)$$

and, letting $\varepsilon \rightarrow 0$, we get the upper bound in Theorem 6.1.2.

6.5.2 Comparison with the BBM in a strip

We use here results of Section 6.2.2 concerning BBM in a strip to show two lemmas that will be useful for the proof of Proposition 6.5.1 in the next subsection. To bound the probability of events A_i , we will need to control the size of the L -BBM at times τ_i . For this, we introduce a functional of the L -BBM, analogous to the functional \tilde{Z}^{K,K_A} of the BBM in a strip (see equation (6.10)): recalling that $L_j = (1+j\varepsilon)L$, we set, for $i \in \mathbb{N}$,

$$U_i := \max X^L(\tau_i) - L_2$$

$$S_i^L := \sum_{u \in \mathcal{N}^L(\tau_i)} e^{\mu(X_u^L(\tau_i) - U_i)} \sin\left(\frac{\pi(X_u^L(\tau_i) - U_i)}{L_4}\right).$$

It amounts to shift the population at time τ_i such that the highest particle is at L_2 and then to take the value of the functional \tilde{Z}^{L_4} associated with the shifted population. We can now state the two lemmas of this subsection, used later for the proof of Proposition 6.5.1. The first one gives an upper bound for the conditional probability of event A_i given \mathcal{F}_{τ_i} , in terms of S_i^L : if the size of the L -BBM at time τ_i is small enough, then A_i is unlikely.

Lemma 6.5.4. *There exists $C_\varepsilon > 0$ depending only on ε such that, for L large enough, for all $i \in \mathbb{N}$,*

$$\mathbb{P}_0(A_i \mid \mathcal{F}_{\tau_i}) \leq C_\varepsilon L e^{-\mu L_3} S_i^L.$$

Therefore, according to Lemma 6.5.4, we need to control S_i^L in order to bound the probability of A_i . The second lemma controls the conditional expectation of S_{i+1}^L given \mathcal{F}_{τ_i} in terms of S_i^L , with a poor bound in the general case but with a much more accurate one on the event A_i . Indeed, even if A_i is a “bad” event because it involves a growth of $\max X^L$, it causes at the same time a large decrease of the population size: when $\max X^L$ grows quickly, more particles are killed by selection. So each event A_i that happens makes the following events A_j less likely.

Lemma 6.5.5. *We have the following inequalities for L large enough and for all $i \in \mathbb{N}$:*

$$\mathbb{E}_0 \left[S_{i+1}^L \mid \mathcal{F}_{\tau_i} \right] \leq 2e^{\mu\varepsilon L} S_i^L, \quad (6.32)$$

$$\mathbb{E}_0 \left[S_{i+1}^L \mathbb{1}_{A_i} \mid \mathcal{F}_{\tau_i} \right] \leq 2e^{-\mu\varepsilon L} S_i^L. \quad (6.33)$$

Proof of Lemma 6.5.4. The strategy is as follows: we first come down to the study of $\mathbb{P}_\xi(A_0)$, where $\max \xi = L_2$ and $\min \xi \geq 2\varepsilon L$, and then use Proposition 6.2.4 concerning BBM in a strip to bound from above the mean number of particles that hit L_3 and thus the probability of event A_0 . Applying the strong Markov property at the stopping time τ_i , we get

$$\mathbb{P}_0(A_i \mid \mathcal{F}_{\tau_i}) = \mathbb{P}_{X^L(\tau_i)}(A_0) = \mathbb{P}_{X^L(\tau_i) - U_i}(A_0), \quad (6.34)$$

using for the second equality the fact that $\mathbb{P}_\xi(A_0)$ is invariant under shift of the initial configuration ξ . We have $\max X^L(\tau_i) - U_i = L_2$ by definition of U_i and therefore $\min X^L(\tau_i) - U_i \geq 2\varepsilon L$, so we have to bound $\mathbb{P}_\xi(A_0)$ with an initial configuration ξ that satisfies $\max \xi = L_2$ and $\min \xi \geq 2\varepsilon L$.

We fix such a configuration ξ . Then, \mathbb{P}_ξ -a.s., for all $t \in [0, \tau_1)$, we have the inclusion $X^L(t) \subset \tilde{X}^{L_4, L_3}(t)$, because until time τ_1 the killing barrier of X^L stays above 0 (see Figure 6.6) and particles of X^L stay below L_3 so no particle of \tilde{X}^{L_4, L_3} is killed by hitting L_3 . Therefore, we get that \mathbb{P}_ξ -a.s.

$$A_0 \subset \left\{ \text{at least one particle of } \tilde{X}^{L_4, L_3} \text{ hits } L_3 \text{ on time interval } [0, L^3] \right\}. \quad (6.35)$$

Then, our aim is to come down to \tilde{X}^{L_3} instead of \tilde{X}^{L_4, L_3} , in order to apply Proposition 6.2.4. For this, let

$$\mu' := \sqrt{2 - \frac{\pi^2}{L_3^2}}$$

be the drift associated to L_3 (see Equation (6.9)). We have $\mu' < \mu$, so the right-hand side of (6.35) is obviously included in the event

$$\left\{ \text{at least one particle of } \tilde{X}^{L_4, L_3} \text{ hits } t \mapsto L_3 + (\mu' - \mu)t \text{ on time interval } [0, L^3] \right\}. \quad (6.36)$$

As in the proof of Proposition 6.4.1, we define now a new process \bar{X} from the standard BBM X with drift $-\mu$ by killing particles that go below $t \mapsto (\mu' - \mu)t$ or above $t \mapsto L_3 + (\mu' - \mu)t$. Thus, the event in (6.36) is included in the event

$$\left\{ \text{at least one particle of } \bar{X} \text{ hits } t \mapsto L_3 + (\mu' - \mu)t \text{ on time interval } [0, L^3] \right\},$$

because as long as no particle of \bar{X} reaches $t \mapsto L_3 + (\mu' - \mu)t$, the population of \tilde{X}^{L_4, L_3} is included in the population of \bar{X} . The probability of this last event under \mathbb{P}_ξ is equal to

$$\mathbb{P}_\xi \left(\text{at least one particle of } \tilde{X}^{L_3} \text{ hits } L_3 \text{ on time interval } [0, L^3] \right).$$

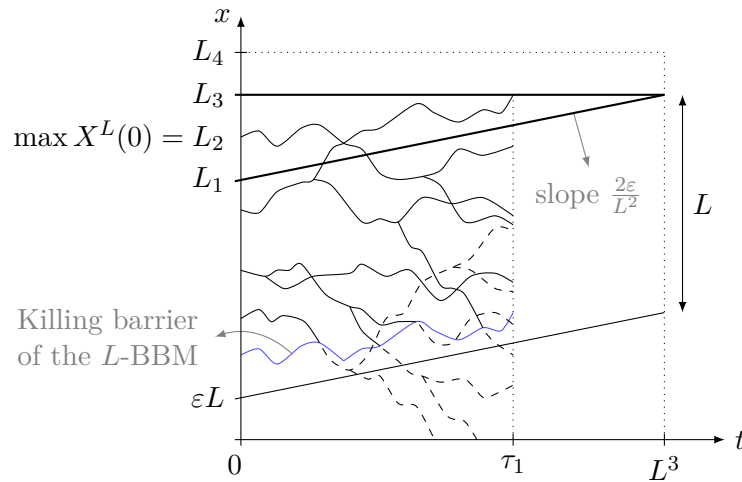

Figure 6.6 – Representation of the coupled systems X^L (full line) and \tilde{X}^{L_4, L_3} (dashed line) between times 0 and τ_1 , starting with the highest particle at L_2 , on the event A_0 . Until time τ_1 , the killing barrier of X^L (drawn in blue) stays above the straight line $t \mapsto \varepsilon L + \frac{2\varepsilon}{L^2}t$ so above 0.

Therefore, coming back to (6.35), we showed that $\mathbb{P}_\xi(A_0) \leq \mathbb{E}_\xi[R]$, where R is the number of particles of \tilde{X}^{L_3} that hit L_3 between times 0 and L^3 , and applying Proposition 6.2.4 with $\theta = 1/(1 + 3\varepsilon)^3$, we get that, as $L \rightarrow \infty$,

$$\mathbb{E}_\xi[R] \leq C \frac{e^{-\mu L_3}}{L_3} \sum_{k=1}^n \xi_k e^{\mu \xi_k} + 2\sqrt{2}\pi\theta L_3 e^{-\mu L_3} \left(\sum_{k=1}^n e^{\mu \xi_k} \sin\left(\frac{\pi \xi_k}{L_3}\right) \right) (1 + o(1)) \quad (6.37)$$

where we wrote $\xi = (\xi_1, \dots, \xi_n)$. In order to make S_i^L appear, our upper bound has to depend on $\sum_{k=1}^n e^{\mu \xi_k} \sin(\pi \xi_k / L_4)$. Recalling that $\xi_k \in [2\varepsilon L, L_2]$ for each $1 \leq k \leq n$, we get

$$\frac{\xi_k}{L_2} \leq \frac{\sin\left(\frac{\pi \xi_k}{L_3}\right)}{\sin\left(\frac{\pi L_2}{L_3}\right)} = \frac{\sin\left(\frac{\pi \xi_k}{L_3}\right)}{\sin\left(\frac{\pi \varepsilon}{1+3\varepsilon}\right)}$$

and it follows that

$$\sum_{k=1}^n \xi_k e^{\mu \xi_k} \leq \frac{L_2}{\sin\left(\frac{\pi \varepsilon}{1+3\varepsilon}\right)} \sum_{k=1}^n e^{\mu \xi_k} \sin\left(\frac{\pi \xi_k}{L_3}\right). \quad (6.38)$$

Moreover, using the inequality $\sin(\pi \xi_k / L_3) / \sin(\pi \xi_k / L_4) \leq L_4 / L_3$, we have

$$\sum_{k=1}^n e^{\mu \xi_k} \sin\left(\frac{\pi \xi_k}{L_3}\right) \leq \frac{1 + 4\varepsilon}{1 + 3\varepsilon} \sum_{k=1}^n e^{\mu \xi_k} \sin\left(\frac{\pi \xi_k}{L_4}\right). \quad (6.39)$$

Thus, bringing together (6.37), (6.38) and (6.39), we get that, for L large enough,

$$\mathbb{P}_\xi(A_0) \leq C_\varepsilon L e^{-\mu L_3} \sum_{k=1}^n e^{\mu \xi_k} \sin\left(\frac{\pi \xi_k}{L_4}\right)$$

and coming back to (6.34), the result follows with $\xi = X^L(\tau_i) - U_i$. □

Proof of Lemma 6.5.5. The reasoning is similar to the proof of Lemma 6.5.4: we first come down to the study of S_1^L under \mathbb{P}_ξ where $\max \xi = L_2$, then we compare S_1^L with $\tilde{Z}^{L_4}(\tau_1)$ under \mathbb{P}_ξ in the general case and on the event A_0 and finally we use Proposition 6.2.3 and the optional stopping theorem to get an upper bound for $\mathbb{E}_\xi[\tilde{Z}^{L_4}(\tau_1)]$.

Applying the strong Markov property at the stopping time τ_i and using that the laws of S_1^L and $S_1^L \mathbb{1}_{A_0}$ are invariant under shift of the initial configuration, we get

$$\mathbb{E}_0 \left[S_i^L \mid \mathcal{F}_{\tau_i} \right] = \mathbb{E}_{X^L(\tau_i)} \left[S_1^L \right] = \mathbb{E}_{X^L(\tau_i) - U_i} \left[S_1^L \right] \quad (6.40)$$

and, in the same way, $\mathbb{E}_0[S_i^L \mathbb{1}_{A_0} \mid \mathcal{F}_{\tau_i}] = \mathbb{E}_{X^L(\tau_i) - U_i}[S_1^L \mathbb{1}_{A_0}]$. Thus, we now have to bound $\mathbb{E}_\xi[S_1^L]$ and $\mathbb{E}_\xi[S_1^L \mathbb{1}_{A_0}]$, for an initial configuration ξ that satisfies $\max \xi = L_2$.

We fix such a configuration ξ . As in the proof of Lemma 6.5.4, we note that \mathbb{P}_ξ -a.s., for all $t \in [0, \tau_1]^2$, we have the inclusion $X^L(t) \subset \tilde{X}^{L_4}(t)$ (see Figure 6.6). Thus, we have \mathbb{P}_ξ -a.s.

$$\sum_{u \in \mathcal{N}^L(\tau_1)} e^{\mu X_u^L(\tau_1)} \sin\left(\frac{\pi X_u^L(\tau_1)}{L_4}\right) \leq \tilde{Z}^{L_4}(\tau_1). \quad (6.41)$$

Therefore, we want to compare S_1^L with the left-hand side of (6.41), first in the general case and then on the event A_0 . Note that $U_1 \in [-\varepsilon L, \varepsilon L]$ and for $u \in \mathcal{N}^L(\tau_1)$, $X_u^L(\tau_1) \in [\max X^L(\tau_1) - L, \max X^L(\tau_1)] = [U_1 + 2\varepsilon L, U_1 + L_2]$. On the one hand, if $v \leq 0$, then the function $x \in (0, \pi + v] \mapsto \sin(x - v)/\sin(x)$ is nonincreasing, so if $U_1 \leq 0$, we get the upper bound

$$\frac{\sin\left(\frac{\pi(X_k^L(\tau_1) - U_1)}{L_4}\right)}{\sin\left(\frac{\pi X_k^L(\tau_1)}{L_4}\right)} \leq \frac{\sin\left(\frac{\pi 2\varepsilon L}{L_4}\right)}{\sin\left(\frac{\pi(U_1 + 2\varepsilon L)}{L_4}\right)} \leq \frac{\sin\left(\frac{\pi 2\varepsilon}{1 + 4\varepsilon}\right)}{\sin\left(\frac{\pi \varepsilon}{1 + 4\varepsilon}\right)} \leq 2.$$

On the other hand, if $v \geq 0$, then the function $x \in (v, \pi] \mapsto \sin(x - v)/\sin(x)$ is nondecreasing, so if $U_1 \geq 0$, we get the upper bound

$$\frac{\sin\left(\frac{\pi(X_k^L(\tau_1) - U_1)}{L_4}\right)}{\sin\left(\frac{\pi X_k^L(\tau_1)}{L_4}\right)} \leq \frac{\sin\left(\frac{\pi L_2}{L_4}\right)}{\sin\left(\frac{\pi(U_1 + L_2)}{L_4}\right)} \leq \frac{\sin\left(\frac{\pi 2\varepsilon}{1 + 4\varepsilon}\right)}{\sin\left(\frac{\pi \varepsilon}{1 + 4\varepsilon}\right)} \leq 2.$$

It follows that

$$S_1^L \leq 2e^{-\mu U_1} \sum_{u \in \mathcal{N}^L(\tau_1)} e^{\mu X_u^L(\tau_1)} \sin\left(\frac{\pi X_u^L(\tau_1)}{L_4}\right).$$

Coming back to (6.41) and using that $U_1 \geq -\varepsilon L$ and, on the event A_0 , $U_1 = \varepsilon L$, we get

$$\begin{aligned} \mathbb{E}_\xi \left[S_1^L \right] &\leq 2e^{\mu \varepsilon L} \mathbb{E}_\xi \left[\tilde{Z}^{L_4}(\tau_1) \right], \\ \mathbb{E}_\xi \left[S_1^L \mathbb{1}_{A_0} \right] &\leq 2e^{-\mu \varepsilon L} \mathbb{E}_\xi \left[\tilde{Z}^{L_4}(\tau_1) \right]. \end{aligned} \quad (6.42)$$

Note that the bound for $S_1^L \mathbb{1}_{A_0}$ is better not because the event A_0 is unlikely, but because it involves a large increase of $\max X^L$ while most of the particles stay at the same height (because μ is chosen such that \tilde{Z}^{L_4} is a martingale) and so all these particles have a much smaller weight in S_1^L .

Finally, applying the optional stopping theorem to $(\tilde{Z}^{L_4}(t))_{t \geq 0}$, which is a martingale by Proposition 6.2.3, and to τ_1 , which is a bounded stopping time, we get

$$\mathbb{E}_\xi \left[\tilde{Z}^{L_4}(\tau_1) \right] \leq \sum_{k=1}^n e^{\mu \xi_k} \sin\left(\frac{\pi \xi_k}{L_4}\right). \quad (6.43)$$

The result follows from (6.40), (6.42) and (6.43) with $\xi = X^L(\tau_i) - U_i$. \square

2. Note that here the inclusion is still true at time τ_1 , because a particle of \tilde{X}^{L_4} that hits L_3 is not killed, unlike a particle of \tilde{X}^{L_4, L_3} .

6.5.3 Proof of Proposition 6.5.1

We prove here Proposition 6.5.1 that states that K_n , the number of events A_i that happen before time τ_n , cannot be much larger than $n/2$.

Proof of Proposition 6.5.1. For $1 \leq k \leq n$, we first give an upper bound for $\mathbb{P}_0(K_n \geq k)$. We have

$$\mathbb{P}_0(K_n \geq k) \leq \sum_{1 \leq i_1 < \dots < i_k \leq n} \mathbb{P}_0(A_{i_1} \cap \dots \cap A_{i_k}).$$

So we fix $1 \leq i_1 < \dots < i_k \leq n$ and deal with $\mathbb{P}_0(A_{i_1} \cap \dots \cap A_{i_k})$. The strategy is to control S_i^L for $1 \leq i \leq i_k$ using Lemma 6.5.5 and then to bound $\mathbb{P}_0(A_{i_k} | \mathcal{F}_{\tau_{i_k}})$ with Lemma 6.5.4 and our control of $S_{i_k}^L$: if k is large, then $S_{i_k}^L$ is small and A_{i_k} is unlikely. First conditioning on $\mathcal{F}_{\tau_{i_k}}$, using that for all $i \geq 0$, $A_i \in \mathcal{F}_{\tau_{i+1}}$ and then applying Lemma 6.5.4, we get

$$\begin{aligned} \mathbb{P}_0(A_{i_1} \cap \dots \cap A_{i_k}) &= \mathbb{E}_0 \left[\mathbb{1}_{A_{i_1}} \dots \mathbb{1}_{A_{i_{k-1}}} \mathbb{P}_0 \left(A_{i_k} \mid \mathcal{F}_{\tau_{i_k}} \right) \right] \\ &\leq C_\varepsilon L e^{-\mu L^3} \mathbb{E}_0 \left[\mathbb{1}_{A_{i_1}} \dots \mathbb{1}_{A_{i_{k-1}}} S_{i_k}^L \right]. \end{aligned} \quad (6.44)$$

Then, conditioning successively on all \mathcal{F}_i for i from $i_k - 1$ to 0 and applying Lemma 6.5.5 (we use (6.32) if $i \notin \{i_1, \dots, i_{k-1}\}$ and (6.33) otherwise), we bound (6.44) by

$$C_\varepsilon L e^{-\mu L^3} \left(2e^{\mu \varepsilon L} \right)^{i_k - (k-1)} \left(2e^{-\mu \varepsilon L} \right)^{k-1} \mathbb{E}_0 \left[S_0^L \right]$$

and it follows that

$$\mathbb{P}_0(K_n \geq k) \leq \binom{n}{k} C_\varepsilon L \left(2e^{\mu \varepsilon L} \right)^{n - (k-1)} \left(2e^{-\mu \varepsilon L} \right)^{k-1}, \quad (6.45)$$

using that $\mathbb{E}_0[S_0^L] = e^{\mu L^2} \sin(\pi L^2/L_4) \leq e^{\mu L^3}$.

We take now

$$k := \left\lceil n \left(\frac{1}{2} + \frac{1}{\varepsilon L} \right) \right\rceil.$$

Using $\binom{n}{k} \leq 2^n$, (6.45) becomes

$$\mathbb{P}_0(K_n \geq k) \leq C_\varepsilon L 2^{2n} \exp(\mu \varepsilon L(n - 2(k-1))) \leq CL 2^{2n} \exp(-2\mu n),$$

which is summable because $2 < e^\mu$ for L large enough, so the Borel-Cantelli lemma implies that \mathbb{P}_0 -almost surely for n large enough we have $K_n \leq k - 1$ and the result follows. \square

6.5.4 Proof of Proposition 6.5.3

In this section, we fix $0 < \gamma < 1/7$ and we will show that, on the event A_i^c , with high probability we have $\tau_{i+1} - \tau_i \geq L^{2+\gamma}$: the standard BBM starting at $\max X^L(\tau_i)$ at time τ_i has with high probability a particle that stays above $t \mapsto \max X^L(\tau_i) - \varepsilon L + 2\varepsilon(t - \tau_i)/L^2$ between times τ_i and $\tau_i + L^{2+\gamma}$. Then, by Proposition 6.5.1, we know that $\liminf_{n \rightarrow \infty} n^{-1} \sum_{i=0}^{n-1} \mathbb{1}_{A_i^c} \geq 1/2 - 1/\varepsilon L > 1/3$: thus, more than $n/3$ events A_i^c happen until time τ_n , so we have often enough $\tau_{i+1} - \tau_i \geq L^{2+\gamma}$ and Proposition 6.5.3 will follow. Therefore, we first show a lemma concerning the standard BBM starting with a single particle (we still work with drift $-\mu$).

Lemma 6.5.6. *We define $T := L^\gamma + L^{2-5\gamma}$ and the event*

$$C := \left\{ \exists u \in \mathcal{N}(T) : X_u(T) \geq -5L^\gamma \text{ and } \forall t \in [0, T], X_u(t) \geq -\frac{\varepsilon L}{2} \right\},$$

where $X_u(t)$ denotes the position of the unique ancestor of u at time t . Then, for L large enough, we have $\mathbb{P}_0(C) \geq 1 - 3Le^{-L^\gamma}$.

Proof. The strategy is to use first Lemma 6.4.2 in order to get more than L particles after a short time L^γ and then Proposition 6.2.2 to see that each of these particles is likely to stay high between times L^γ and T . Applying Lemma 6.4.2 (we still have $\mu \leq \sqrt{2}$), we get

$$\mathbb{P}_0(C^c) \leq 2Le^{-L^\gamma} + \mathbb{P}(\{\#\mathcal{N}(L^\gamma) \geq L\} \cap \{\forall t \in [0, L^\gamma], \min X(t) > -4L^\gamma\} \cap C^c). \quad (6.46)$$

Then, using the branching property at time L^γ , the probability on the right-hand side of (6.46) is equal to

$$\mathbb{E}_0 \left[\mathbb{1}_{\#\mathcal{N}(L^\gamma) \geq L} \mathbb{1}_{\forall t \in [0, L^\gamma], \min X(t) > -4L^\gamma} \prod_{u \in \mathcal{N}(L^\gamma)} \mathbb{P}_{X_u(L^\gamma)}(C_1^c) \right], \quad (6.47)$$

for L large enough, where we set

$$C_1 := \left\{ \exists u \in \mathcal{N}(L^{2-5\gamma}) : X_u(L^{2-5\gamma}) \geq -5L^\gamma \text{ and } \forall t \in [0, L^{2-5\gamma}], X_u(t) \geq -\frac{\varepsilon L}{2} \right\}.$$

We now want to bound $\mathbb{P}_x(C_1^c)$ for $x \geq -4L^\gamma$. First, as $x \mapsto \mathbb{P}_x(C_1^c)$ is nonincreasing, it is clear that $\mathbb{P}_x(C_1^c) \leq \mathbb{P}_{-4L^\gamma}(C_1^c) = \mathbb{P}_0(C_2^c)$, where we set

$$C_2 := \left\{ \exists u \in \mathcal{N}(L^{2-5\gamma}) : X_u(L^{2-5\gamma}) \geq -L^\gamma \text{ and } \forall t \in [0, L^{2-5\gamma}], X_u(t) \geq -\frac{\varepsilon L}{2} + 4L^\gamma \right\}.$$

Then, we apply Proposition 6.2.2 to $\delta = 1/2$: there exist $d > 0$, $r > 0$ and $t_0 > 0$ large enough such that for all $t \geq t_0$, $\mathbb{P}_0(D_t) \geq 1/2$, where we set for all $t \geq 0$

$$D_t := \left\{ \exists u \in \mathcal{N}(t) : X_u(t) \geq m(t) - \mu t - d \right. \\ \left. \text{and } \forall s \in [0, t], X_u(s) \geq \frac{s}{t}m(t) - \mu s - r \vee \left(s^{\frac{1}{2}+\gamma} \wedge (t-s)^{\frac{1}{2}+\gamma} \right) \right\}.$$

Note that $D_{L^{2-5\gamma}} \subset C_2$ for L large enough³, so we have showed that for $x \geq -4L^\gamma$, $\mathbb{P}_x(C_1^c) \leq \mathbb{P}_0(D_{L^{2-5\gamma}}^c) \leq 1/2$ for L large enough such that $L^{2-5\gamma} \geq t_0$ (because $2 - 5\gamma > 0$). Thus, we get (6.47) $\leq 1/2^L$ and, combining with (6.46), the result follows. \square

We now state a corollary that will be used in the proof of Proposition 6.5.3: it says that a standard BBM with drift $-\mu$ starting with a single particle at 0 has with high probability a particle that stays above $t \mapsto -\varepsilon L + 2\varepsilon t/L^2$ between times 0 and $L^{2+\gamma}$.

Corollary 6.5.7. *We define the event*

$$E := \left\{ \exists u \in \mathcal{N}(L^{2+\gamma}) : \forall t \in [0, L^{2+\gamma}], X_u(t) > -\varepsilon L + \frac{2\varepsilon}{L^2}t \right\},$$

where $X_u(t)$ denotes the position of the unique ancestor of u at time t . Then, $\mathbb{P}_0(E)$ tends to 1 as $L \rightarrow \infty$.

Proof. First note that the slope $2\varepsilon/L^2$ plays only a negligible role on a time period of length $L^{2+\gamma}$ and that we can replace $L^{2+\gamma}$ by NT where $N := \lceil L^{6\gamma} \rceil$: we have $\bar{E} \subset E$ with

$$\bar{E} := \{ \exists u \in \mathcal{N}(NT) : \forall t \in [0, NT], X_u(t) \geq -\varepsilon L + L^\gamma \}.$$

3. On the one hand, with $t := L^{2-5\gamma}$ and $0 \leq s \leq t$, we have $t^{\frac{1}{2}+\gamma} = L^{1-\frac{\gamma}{2}-5\gamma^2} = o(L)$ and $\frac{s}{t}m(t) - \mu s \geq (\sqrt{2} - \mu)s \geq 0$ so $\frac{s}{t}m(t) - \mu s - r \vee (s^{\frac{1}{2}+\gamma} \wedge (t-s)^{\frac{1}{2}+\gamma}) \geq -\frac{\varepsilon L}{2} + 4L^\gamma$ for L large enough. On the other hand, $m(t) - \mu t - d \geq -\frac{3(2-5\gamma)}{2\sqrt{2}} \log L - d \geq -L^\gamma$ for L large enough.

We now want to apply Lemma 6.5.6 to N consecutive time intervals of length T . Formally, we introduce for $0 \leq j \leq N$ the event

$$\bar{E}_j := \{\exists u \in \mathcal{N}(jT) : \forall t \in [0, jT], X_u(t) \geq -\varepsilon L + (5(N-j) + 1)L^\gamma\}$$

and we have then, for all $0 \leq j \leq N-1$ and for L large enough such that $(5N+1)L^\gamma \leq \varepsilon L/2$ (which is possible since $\gamma < 1/7$),

$$\begin{aligned} \bar{E}_{j+1} \supset & \left\{ \exists u \in \mathcal{N}(T) : X_u(T) \geq -5L^\gamma \text{ and } \forall t \in [0, T], X_u(t) \geq -\varepsilon L/2 \text{ and} \right. \\ & \left. \exists v \in \mathcal{N}^{(u)}(jT) : \forall s \in [0, jT], X_u(T) + X_v^{(u)}(s) \geq -\varepsilon L + (5(N-j-1) + 1)L^\gamma \right\}, \end{aligned} \quad (6.48)$$

where $X^{(u)}$ denotes the BBM emanating from the particle u at time T , that is then shifted so that it starts from 0 at time 0. According to the branching property, $(X^{(u)}, u \in \mathcal{N}(T))$ is a family of independent BBMs, which is moreover independent of \mathcal{F}_T , hence it follows from (6.48) that $\mathbb{P}_0(\bar{E}_{j+1}) \geq \mathbb{P}_0(C)\mathbb{P}_0(\bar{E}_j)$, where C is defined in Lemma 6.5.6. As $E_0 = \Omega$ and $\bar{E}_N = \bar{E}$, we get

$$\mathbb{P}_0(E) \geq \mathbb{P}_0(C)^N \geq (1 - 2Le^{-L^\gamma})^{\lfloor L^{4\gamma} \rfloor} = \exp(-2Le^{-L^\gamma} L^{4\gamma}(1 + o(1))) \xrightarrow{L \rightarrow \infty} 1,$$

for L large enough, using Lemma 6.5.6. \square

Remark 6.5.8. Instead of showing Lemma 6.5.6 and Corollary 6.5.7, we could have used Theorem 2 of Berestycki, Berestycki and Schweinsberg [BBS14], showing that a BBM with drift $-\sqrt{2}$ starting with a single particle at x has an extinction time close to $(2\sqrt{2}/3\pi^2)x^3$ when x is large enough. Thus, Corollary 6.5.7 is still true with $c(\varepsilon L)^3$ instead of $L^{2+\gamma}$, for any $c \in (0, 2\sqrt{2}/3\pi^2)$. But the proof given here is much more elementary and is sufficient for our purpose, so we kept it.

Proof of Proposition 6.5.3. We introduce for $i \geq 0$ the event E_i defined by “in the BBM X , the particle at $\max X^L(\tau_i)$ at time τ_i has a descendant at time $\tau_i + L^{2+\gamma}$ whose trajectory between times τ_i and $\tau_i + L^{2+\gamma}$ stays above $t \mapsto \max X^L(\tau_i) - \varepsilon L + \frac{2\varepsilon}{L^2}(t - \tau_i)$ ”. It is clear that $\mathbb{P}_0(E_i | \mathcal{F}_{\tau_i}) = \mathbb{P}_0(E)$, where E is defined in Corollary 6.5.7. Moreover, we have $A_i^c \cap E_i \subset \{\tau_{i+1} - \tau_i \geq L^{2+\gamma}\}$: on the event A_i^c , τ_{i+1} is the first time after τ_i when $\max X^L$ goes below $t \mapsto \max X^L(\tau_i) - \varepsilon L + \frac{2\varepsilon}{L^2}(t - \tau_i)$, so on the event $A_i^c \cap E_i$ the descendant at time $\tau_i + L^{2+\gamma}$ in the definition of E_i cannot be killed by selection⁴ and so belongs to the L -BBM and guarantees that $\tau_{i+1} \geq L^{2+\gamma} + \tau_i$. Thus, we have

$$\mathbb{P}_0\left(A_i^c \cap \{\tau_{i+1} - \tau_i < L^{2+\gamma}\} \mid \mathcal{F}_{\tau_i}\right) \leq \mathbb{P}_0(E_i^c \mid \mathcal{F}_{\tau_i}) = 1 - \mathbb{P}_0(E) \quad (6.49)$$

for all $i \geq 0$.

Now the reasoning is as follows: by (6.49) and Corollary 6.5.7, on each event A_i^c we have $\tau_{i+1} - \tau_i \geq L^{2+\gamma}$ with high probability and, by Proposition 6.5.1, we know that more than $n/3$ events A_i^c happen until time τ_n , thus τ_n/n must be larger than $L^{2+\gamma}/6$ for n large enough. For $n \in \mathbb{N}^*$, we have

$$\mathbb{P}_0\left(\frac{\tau_n}{n} < \frac{L^{2+\gamma}}{6}\right) \leq \mathbb{P}_0\left(\frac{\tau_n}{n} < \frac{L^{2+\gamma}}{6} \text{ and } \frac{K_n}{n} \leq \frac{2}{3}\right) + \mathbb{P}_0\left(\frac{K_n}{n} > \frac{2}{3}\right). \quad (6.50)$$

4. The killing barrier of the L -BBM stays below $\max X^L(\tau_i) + \varepsilon L - L$ and, thus, below $t \mapsto \max X^L(\tau_i) - \varepsilon L + \frac{2\varepsilon}{L^2}(t - \tau_i)$.

By the proof of Proposition 6.5.1, we know that $\mathbb{P}_0(K_n/n > 2/3)$ is summable in n for L large enough. Moreover, denoting by $\mathcal{P}_k(S)$ the set of the subsets with k elements of a set S , the first term on the right-hand side of (6.50) is equal to

$$\begin{aligned} & \sum_{k=0}^{\lfloor 2n/3 \rfloor} \mathbb{P}_0 \left(\frac{\tau_n}{n} < \frac{L^{2+\gamma}}{6} \text{ and } K_n = k \right) \\ &= \sum_{k=0}^{\lfloor 2n/3 \rfloor} \sum_{I \in \mathcal{P}_{n-k}(\llbracket 1, n \rrbracket)} \mathbb{P}_0 \left(\left\{ \frac{\tau_n}{n} < \frac{L^{2+\gamma}}{6} \right\} \cap \bigcap_{i \in I} A_i^c \cap \bigcap_{i \notin I} A_i \right). \end{aligned} \quad (6.51)$$

But, on the event $\{\tau_n/n < L^{2+\gamma}/6\}$, the events $\{\tau_{i+1} - \tau_i \geq L^{2+\gamma}\}$ happen for at most $\lfloor n/6 \rfloor$ indices i . Therefore, (6.51) is bounded by

$$\begin{aligned} & \sum_{k=0}^{\lfloor 2n/3 \rfloor} \sum_{I \in \mathcal{P}_{n-k}(\llbracket 1, n \rrbracket)} \sum_{J \in \mathcal{P}_{n-k-\lfloor n/6 \rfloor}(I)} \mathbb{P}_0 \left(\bigcap_{i \in J} (A_i^c \cap \{\tau_{i+1} - \tau_i < L^{2+\gamma}\}) \right) \\ & \leq \sum_{k=0}^{\lfloor 2n/3 \rfloor} \binom{n}{n-k} \binom{n-k}{n-k-\lfloor n/6 \rfloor} (1 - \mathbb{P}_0(E))^{n-k-\lfloor n/6 \rfloor}, \end{aligned} \quad (6.52)$$

by conditioning successively on \mathcal{F}_{τ_i} for all $i \in J$ (in descending order) and using repeatedly (6.49). Then, we bound (6.52) from above by

$$\left(\left\lfloor \frac{2n}{3} \right\rfloor + 1 \right) 2^n 2^n (1 - \mathbb{P}_0(E))^{n-\lfloor 2n/3 \rfloor - \lfloor n/6 \rfloor} \leq n \left(4(1 - \mathbb{P}_0(E))^{1/6} \right)^n,$$

which is summable for L large enough according to Corollary 6.5.7. Coming back to (6.50), $\mathbb{P}_0(\tau_n/n < L^{2+\gamma}/6)$ is summable and the result follows by the Borel-Cantelli lemma. \square

Chapter 7

An exactly solvable continuous-time Derrida–Retaux model

Abstract

This chapter contains a joint work with Yueyun Hu and Bastien Mallein [HMP19], which has been accepted for publication in *Communications in Mathematical Physics*. We present here a continuous-time version of a discrete-time max-type recursive model introduced by Derrida and Retaux [DR14] for the study of the depinning transition for polymers. This transition is believed to be of infinite order and to hold for a large class of statistical physics models. Our continuous-time model, built on a Yule tree, yields an exactly solvable model belonging to this universality class. The integrability of this model allows us to study in details the phase transition near criticality and can be used to confirm the infinite order phase transition predicted by physicists. We also study the scaling limit of this model at criticality, which we believe to be universal.

7.1 Introduction

In order to shed some light on the depinning transition for polymer models, Derrida and Retaux introduced in [DR14] a max-type recursive model, that can be defined, up to a simple change of variables, as follows:

$$X_{n+1} \stackrel{(d)}{=} \left(X_n + \tilde{X}_n - 1 \right)_+, \quad \forall n \geq 0, \quad (7.1)$$

where, for any $x \in \mathbb{R}$, $x_+ := \max(x, 0)$, \tilde{X}_n denotes an independent copy of X_n , and $\stackrel{(d)}{=}$ stands for the identity in distribution. See Section 1.6.1 for some details concerning the link with pinning models.

Despite its simplicity in the definition, the Derrida–Retaux model turns out to exhibit complex behaviours at criticality, which are difficult to prove rigorously, and many fundamental questions remain open. It is believed that for a large class of recursive models, including (7.1) and pinning models with disorder, there is an infinite order phase transition from the pinned to the unpinned regime. In this chapter, we present an exactly solvable version of a continuous-time generalization of the Derrida–Retaux model. The integrability of the model allows us to study in details the phase transition of our model near criticality and can be used to clarify some of the conjectures made for the discrete Derrida–Retaux models.

Before the introduction of the continuous-time version model, we (re)-present the discrete-time model (7.1) from three different though equivalent viewpoints. In particular, we give a

process description of this model, which is best suited for comparison with the continuous-time version model that we are going to introduce.

Notation. By $f(t) \sim g(t)$ as $t \rightarrow a$, we mean that $\lim_{t \rightarrow a} f(t)/g(t) = 1$. The constant C is a generic positive constant, which might change from line to line. Moreover, we set $\mathbb{N} := \{0, 1, 2, \dots\}$ and $\mathbb{R}_+ := [0, \infty)$.

7.1.1 The discrete-time Derrida–Retaux model

At first, one might observe that (7.1) does not describe a stochastic process $(X_n)_{n \geq 0}$, but rather a measure-valued sequence $(\mu_n)_{n \geq 0}$ where μ_n is the law of X_n . This leads us to the following definition.

Definition 7.1.1 ((Discrete-time) Derrida–Retaux model). A sequence $(\mu_n)_{n \geq 0}$ of probability distributions on \mathbb{R}_+ is called a *Derrida–Retaux model* if for all continuous bounded function f , we have

$$\forall n \geq 0, \quad \int_{\mathbb{R}_+} f(x) \mu_{n+1}(dx) = \int_{\mathbb{R}_+} f((x+y-1)_+) \mu_n(dx) \mu_n(dy).$$

The fundamental quantity in a Derrida–Retaux model is its associated *free energy*, defined as follows:

$$F_\infty := \lim_{n \rightarrow \infty} 2^{-n} \int_0^\infty x \mu_n(dx). \quad (7.2)$$

It allows the distinction between the pinned and the unpinned regimes in this model. We refer to the model as *unpinned* if $F_\infty = 0$, and as *pinned* if $F_\infty > 0$. Note that as for $x, y \in \mathbb{R}_+$, $(x+y-1)_+ \leq x+y$, the sequence $(2^{-n} \int_0^\infty x \mu_n(dx))_{n \geq 0}$ is non-increasing, therefore the limit in (7.2) is always well-defined. One of the main questions for this model is to determine for which starting measure μ_0 the model ends up being pinned or unpinned.

When the support of μ_0 is included in \mathbb{N} , this question was previously answered by Collet et al. [CEGM84]. By a careful study of the recursion equation for the generating functions of μ_n , they proved that

$$F_\infty = 0 \iff \int_0^\infty x 2^x \mu_0(dx) \leq \int_0^\infty 2^x \mu_0(dx) < \infty. \quad (7.3)$$

However, this characterization of the unpinned phase, which is valid for integer-valued random variables does not extend to more general initial conditions, even to the half-integers valued random variables. We refer to Chen et al. [CDH⁺17] for further discussions and a list of open questions on this topic.

To discuss the phase transition from the pinned to the unpinned regime, it will be more convenient to specify the mass at 0 of μ_0 . Consider an initial distribution μ_0 of form:

$$\mu_0 = p\delta_0 + (1-p)\vartheta,$$

where $p \in [0, 1]$ and ϑ denotes a probability measure on $\mathbb{R}_+ \setminus \{0\}$. Denote by $F_\infty(p)$ the associated free energy. Clearly, $p \rightarrow F_\infty(p)$ is non-increasing. Write p_c for the critical parameter distinguishing between the pinned and the unpinned regimes

$$p_c := \sup\{p \in [0, 1] : F_\infty(p) > 0\},$$

with the convention that $\sup \emptyset = 0$.

Assuming that $p_c \in (0, 1)$, are of particular interest to characterize the rate of convergence of $F_\infty(p) \rightarrow 0$ as $p \uparrow p_c$, and to study the critical regime when $p = p_c$. For the rate of convergence, assuming $p_c > 0$ and some integrability conditions on ϑ , Derrida and Retaux [DR14] conjectured that there exists some constant $C > 0$ such that

$$F_\infty(p) = \exp\left(-\frac{C + o(1)}{\sqrt{p_c - p}}\right), \quad p \uparrow p_c. \tag{7.4}$$

When the support of ϑ is included in $\mathbb{N} \setminus \{0\}$, a weaker form of the above conjecture has been obtained in a recent work by Chen et al. [CDD⁺19].

It is necessary to assume some integrability assumptions on ϑ in Derrida and Retaux' conjecture. Indeed, Collet et al. [CEGM84]'s result yields the following characterization:

$$p_c < 1 \iff \int_0^\infty x 2^x \vartheta(dx) < \infty,$$

see Hu and Shi [HS18]. Furthermore, the latter paper shows some non-universal behaviors of $F_\infty(p)$ as $p \uparrow 1$ for a class of distributions ϑ satisfying $p_c = 1$, in contrast with (7.4).

Now we turn our attention to a second viewpoint of the Derrida and Retaux model. If the support of μ_0 is included in \mathbb{N} , the law μ_n can be constructed as a so-called *parking scheme* on the binary tree, which can be described as follows. For $n \in \mathbb{N}$, we denote by \mathbb{T}_n the binary tree of height n , rooted at \emptyset . To each leaf of the tree at depth n is attached an i.i.d. random variable with law μ_0 , representing the number of cars starting from that position. Each internal node has a single parking spot, initially empty. All cars drive from the leaves toward the root of the tree, parking as soon as possible. For each $u \in \mathbb{T}_n$, we write $X^n(u)$ the number of cars passing by the parking spot at position u without being allowed to park (because another car is already parked). We call the random map $X^n: \mathbb{T}_n \rightarrow \mathbb{R}_+$ the Derrida–Retaux tree. See Figure 7.1.

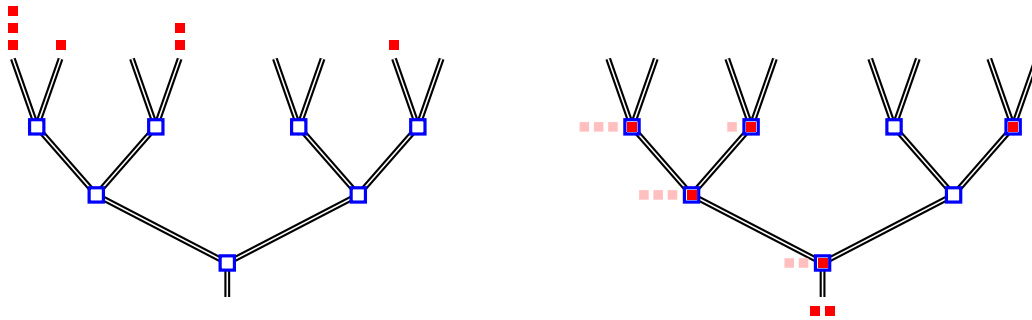

Figure 7.1 – Illustration of the parking scheme on a binary tree. On the left, cars (red squares) are starting from the leaves and each internal node has an empty parking spot. On the right, cars drove down to the root, parking as soon as they could. At each node u , the number $X^n(u)$ of cars that passed by u without being able to park is indicated by pink squares.

Observe that the following equation holds for each internal node $u \in \mathbb{T}_n$:

$$X^n(u) = (X^n(u1) + X^n(u2) - 1)_+, \tag{7.5}$$

where $u1$ and $u2$ are the left and right children of u respectively. As a result, one can observe that for any $0 \leq k \leq n$, the family $X^n(v)$ for all nodes v at the k th generation of \mathbb{T}_n forms a collection of i.i.d. random variables with common law μ_{n-k} . In particular $X^n(\emptyset)$ has law μ_n .

We generalize this definition to any initial law μ_0 on \mathbb{R}_+ . For any $u \in \mathbb{T}_n$, denote by $|u|$ its generation. As such, $\{u : |u| = n\}$ is exactly the set of leaves of \mathbb{T}_n .

Definition 7.1.2 ((Discrete time) Derrida–Retaux tree). Let μ_0 be a probability distribution on \mathbb{R}_+ . A *Derrida–Retaux tree* of height n and initial law μ_0 is a random map $X^n: \mathbb{T}_n \rightarrow \mathbb{R}_+$, with \mathbb{T}_n being the binary tree of height n , which can be constructed as follows:

- The values of the leaves ($X^n(u), |u| = n$) are i.i.d. random variables with law μ_0 .
- Each internal node value is constructed as $X^n(u) = (X^n(u1) + X^n(u2) - 1)_+$, for any $u \in \mathbb{T}_n$ with $|u| < n$.

Equation (7.5) is a max-type recursive equation on trees, that belongs to the class of recursive models analysed in the survey of Aldous and Bandyopadhyay [AB05]. The parking scheme we describe here has been studied by Goldschmidt and Przykucki [GP19] on critical Poisson Galton–Watson trees conditioned to be large. Curien and Hénard [CH19] are also studying parking scheme on uniform trees with n nodes. In these different cases, the key observation is that the models can be analysed through the study of some generating function. However, parking on critical and supercritical Galton–Watson trees appear to belong to different *universality class*, as their behavior, in particular near criticality is very different. Namely, the phase transition of the parking scheme on a critical Galton–Watson tree is of the second order in all known examples ([GP19, CH19]), while it is of infinite order on supercritical Galton–Watson trees (see (7.4)).

The Derrida–Retaux tree gives a natural method to generate a random variable X_n with law μ_n . However, this construction does not make easy the consideration of the family $(X_n, n \geq 0)$ as a process. Indeed, making the cars start from generation n and flow back to the root only allows to construct the first n generations of that process. We introduce here a self-contained construction of $(X_n, n \geq 0)$ as a time-inhomogeneous discrete-time Markov chain.

Definition 7.1.3 (Derrida–Retaux process). Let μ_0 be a probability distribution on \mathbb{R}_+ . A *Derrida–Retaux process* with initial law μ_0 is the process constructed from the following recursion equation

$$\forall n \geq 0, \quad \begin{cases} X_{n+1} = (X_n + F_n^{-1}(U_{n+1}) - 1)_+, \\ F_n(x) = \mathbb{P}(X_n \leq x) \text{ for all } x \geq 0. \end{cases} \quad (7.6)$$

where $(U_n, n \geq 1)$ is an i.i.d. family of uniform random variables, and X_0 is an independent random variable with law μ_0 .

Note that the Derrida–Retaux process can be seen as a discrete-time version of a solution of a McKean–Vlasov type SDE, see McKean [McK66], i.e. a Markov process interacting with its distribution. It follows from an easy recursion that for all $n \in \mathbb{N}$, X_n has law μ_n .

The aim of this chapter is to define continuous-time versions of the Derrida–Retaux model, tree and process. In particular, we are looking for a process with a density $r_t(x)$ with respect to the Lebesgue measure which could solve [DR14, Equation (33)], that we recall here

$$\partial_t r = \partial_x r + r * r - r. \quad (7.7)$$

This differential equation (7.7) plays a key role in the prediction (7.4), and was obtained by Derrida and Retaux as an informal scaling limit of the sequence of measures $(\mu_{\lfloor nt \rfloor}(n dx))$.

7.1.2 A continuous-time version of the model, tree and process

By analogy with the Derrida–Retaux process, we introduce a continuous-time version as the following Markov process. Starting from an initial distribution X_0 , the process drifts

downward at speed 1 until reaching 0, where it stays put. Additionally, at each atom t of a Poisson point process with intensity 1, an independent copy of X_t is added to X_t . More formally, the process is defined in the following way.

Definition 7.1.4 ((Continuous-time) Derrida–Retaux process). A *Derrida–Retaux process* $(X_t)_{t \geq 0}$ is a solution of the McKean–Vlasov type differential equation

$$\begin{cases} X_t = X_0 - \int_0^t \mathbb{1}_{X_s > 0} ds + \int_0^t \int_{[0,1]} F_s^{-1}(u) N(ds, du) \\ F_t(x) = \mathbb{P}(X_t \leq x), \text{ for all } x \geq 0, t \geq 0, \end{cases} \tag{7.8}$$

where N is a Poisson point process on $\mathbb{R}_+ \times [0, 1]$ with intensity $ds du$ and F_s^{-1} is the right-continuous inverse of F_s defined by $F_s^{-1}(u) := \inf\{x \geq 0 : F_s(x) > u\}$.

Observe that this continuous-time process has the same features as the discrete-time Derrida–Retaux process. It exhibits the similar pattern of losing mass up to hitting zero and being added independent copies of itself. Note that, in order to study a continuous-time Derrida–Retaux process Y losing mass at speed a and being added independent copies of x at rate b , one only needs to make the space-time change $Y_t = \frac{a}{b} X_{bt}$.

We prove that for any initial random variable X_0 on \mathbb{R}_+ , there is a unique strong solution of (7.8). Moreover, setting μ_t for the law of X_t , the family $(\mu_t)_{t \geq 0}$ is continuous with respect to the usual topology of the weak convergence. It turns out that the family $(\mu_t)_{t \geq 0}$ will be the solution of a partial differential equation similar to (7.7). In that sense, it will be called a Derrida–Retaux model, enticing the following definition.

Definition 7.1.5. [(Continuous-time) Derrida–Retaux model] A *Derrida–Retaux model* is a family $(\mu_t)_{t \geq 0}$ of weakly continuous probability distributions that are weak solution to the partial differential equation

$$\partial_t \mu_t = \partial_x (\mathbb{1}_{x > 0} \mu_t) + \mu_t * \mu_t - \mu_t, \tag{7.9}$$

where by “weak solution” we mean that for any \mathcal{C}^1 bounded functions f with bounded derivative and any $t > 0$, we have

$$\begin{aligned} & \int_{\mathbb{R}} f(x) \mu_t(dx) - \int_{\mathbb{R}} f(x) \mu_0(dx) \\ &= \int_0^t \left(- \int_{\mathbb{R}} (f'(x) \mathbb{1}_{x > 0} + f(x)) \mu_s(dx) + \int_{\mathbb{R}^2} f(x+y) \mu_s(dx) \mu_s(dy) \right) ds. \end{aligned} \tag{7.10}$$

Remark 7.1.6. Note that (7.9) is very similar to Equation (7.7) predicted by physicists. In particular, the behaviors of the PDEs are the same for all $x > 0$. The effect of adding the $\mathbb{1}_{x > 0}$ term in (7.9) is to specify the evolution of the Dirac mass at 0 separately. Contrarily to what happens in (7.7), this ensures that the total mass of the measures is preserved.

The partial differential equation (7.9) might be related to a Smoluchowski-type coagulation equation [Smo16] with constant kernel. However, we were not able to find references in the PDE literature to partial differential equations exhibiting a behavior similar to (7.9). Nevertheless, it has recently gained focus in the probability literature, for example in the recent article of Lambert and Schertzer [LS18], where a PDE of the form

$$\partial_t \varrho = \partial_x (\psi \varrho) + a(t) (\varrho * \varrho - \varrho),$$

with ψ the branching mechanism of a continuous-state branching process, was introduced and studied in detail.

The family of law $(\mu_t)_{t \geq 0}$ associated to the Derrida–Retaux process can also be constructed on a Yule tree with a method similar to the parking scheme. We recall that a Yule tree is a continuous tree in which each branch has i.i.d. exponential length of parameter 1, and the branching is always binary. For $s \geq 0$, we denote by \mathcal{N}_s the set of individuals alive in the tree at time s .

For some fixed $t > 0$, we define a process $X^t = (X_s^t(u), s \in [0, t], u \in \mathcal{N}_s)$ on a Yule tree truncated at height t by the following *painting scheme*. On each leaf $u \in \mathcal{N}_t$ of the truncated tree, there is a painter with an i.i.d. random amount of paint $X_t^t(u)$, distributed according to the law μ_0 . Then, the procedure is completely deterministic. Each painter climbs down the tree, painting the branches of the tree, using a quantity 1 of paint per unit of branch length. When two painters meet, they put their remaining paint in common. For each $s \in [0, t]$ and $u \in \mathcal{N}_s$, the quantity $X_s^t(u)$ is the amount of paint left when the painters reach level s in the branch u . See Figure 7.2 for an illustration. This leads to the following definition.

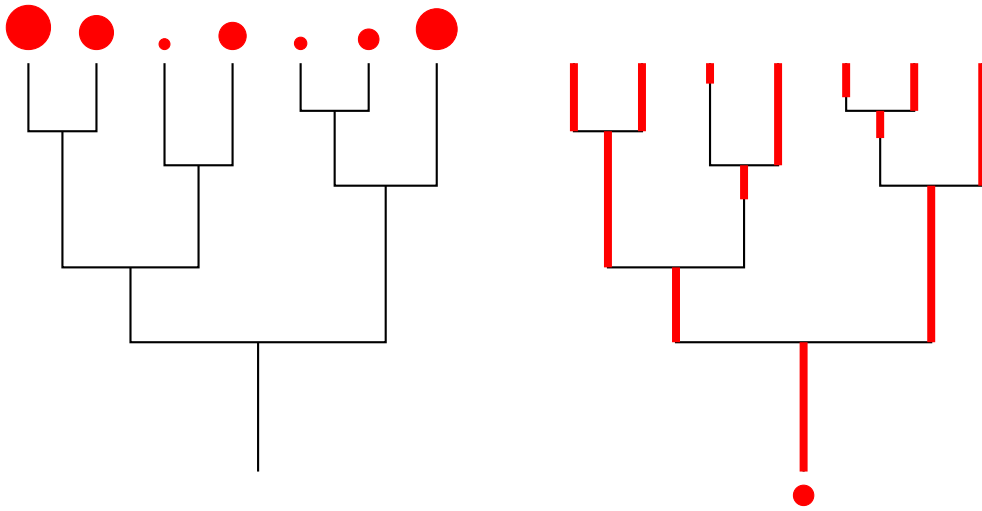

Figure 7.2 – Illustration of the painting scheme on a Yule tree. On the left, painters are starting on the leaves with a random amount of red paint. On the right, painters climbed down to the root, painting the tree as long as they could. The remaining paint at the root is $X_0^t(\emptyset)$.

Definition 7.1.7 ((Continuous-time) Derrida–Retaux tree). Let μ_0 be a probability distribution on \mathbb{R}_+ . For $t > 0$, a *Derrida–Retaux tree* of height t and initial law μ_0 is a random process $X^t = (X_s^t(u), s \in [0, t], u \in \mathcal{N}_s)$, where $X_s^t(v)$ represents the amount of paint remaining at level s on the branch v in the painting scheme starting with $(X_t^t(u), u \in \mathcal{N}_t)$ that are i.i.d. with law μ_0 conditionally on the Yule tree.

Denoting by $\bar{\mu}_t$ the law of $X_0^t(\emptyset)$, we call $(\bar{\mu}_t)_{t \geq 0}$ the *family of laws obtained from the tree-painting scheme* (in particular, $\bar{\mu}_0 = \mu_0$). We observe that by the branching property of the Yule tree, the subtree starting from individual u at time s is a Yule tree of height $t - s$. Therefore for all $s \leq t$, the family $(X_s^t(u), u \in \mathcal{N}_s)$ are i.i.d. random variables with law $\bar{\mu}_{t-s}$. Contrarily to the two previous definitions, the question of existence and uniqueness of $(\bar{\mu}_t)_{t \geq 0}$ is straightforward in Definition 7.1.7. We prove later that $(\bar{\mu}_t)_{t \geq 0}$ is a Derrida–Retaux model, see Theorem 7.1.8 below.

We refer to Section 7.2.1 for a detailed definition of the continuous-time Derrida–Retaux tree. However, it is worth noticing that the painting scheme can be obtained straightforwardly as a scaling limit, when $K \rightarrow \infty$, of the parking scheme on a Galton–Watson tree of height Kt , in which particles give birth to two children with probability $1/K$ and to one child with

probability $1 - 1/K$, and the starting number of cars in a given leaf has law $\lfloor KX_0 \rfloor$, with X_0 of law μ_0 .

The first main result of the chapter justifies and unifies the three definitions of the continuous-time model given above.

Theorem 7.1.8. *Let μ_0 be a probability distribution on \mathbb{R}_+ , and $(\bar{\mu}_t)_{t \geq 0}$ the family of laws obtained from the tree-painting scheme.*

- (i) *There exists a unique strong solution $(X_t)_{t \geq 0}$ to Equation (7.8) with X_0 of law μ_0 . Moreover, for all $t \geq 0$, X_t has law $\bar{\mu}_t$.*
- (ii) *The family $(\bar{\mu}_t)_{t \geq 0}$ is the unique weak solution of the PDE (7.9) with initial condition μ_0 , therefore a Derrida–Retaux model with initial law μ_0 .*

Additionally, we obtain some results on the asymptotic behavior of general continuous-time Derrida–Retaux models, see Section 7.6. However, many fundamental questions remain open for this complex dynamics in the general case. In the next subsection, we shall present a simple two-parameter family of measures which turns out to be stable by the dynamics (7.9). Therefore, by restricting ourselves to this family, we are able to introduce an exactly solvable model, which exhibits the researched phase transition at criticality.

7.1.3 An exactly solvable model

Let $(\mu_t)_{t \geq 0}$ be a continuous-time Derrida–Retaux model. We are particularly interested in an exactly solvable case where the initial law μ_0 is a mixture of an exponential distribution and a Dirac mass at 0:

$$\mu_0 = p\delta_0 + (1 - p)\lambda e^{-\lambda x} \mathbb{1}_{\{x > 0\}} dx, \quad p \in [0, 1], \lambda > 0. \tag{7.11}$$

Denote by $F_\infty(p, \lambda)$ the associated *free energy*:

$$F_\infty(p, \lambda) := \lim_{t \rightarrow \infty} e^{-t} \int_0^\infty x \mu_t(dx). \tag{7.12}$$

To describe the asymptotic behavior of μ_t with respect to the parameters (p, λ) of the initial distribution μ_0 , we introduce three sets:

$$\begin{aligned} \mathcal{P} &:= \{(p, \lambda) \in [0, 1] \times [0, \infty) : \lambda < 1 \text{ or } (\lambda > 1 \text{ and } p < \lambda - \lambda \log \lambda)\}, \\ \mathcal{C} &:= \{(p, \lambda) \in [0, 1] \times [1, \infty) : p = \lambda - \lambda \log \lambda\}, \\ \mathcal{U} &:= \{(p, \lambda) \in [0, 1] \times [1, \infty) : p > \lambda - \lambda \log \lambda\}, \end{aligned}$$

which are represented in Figure 7.3. The case $p = 1$ is degenerate therefore excluded from the set of parameters.

The following result gives a classification of this Derrida–Retaux model in pinned, unpinned and critical behaviors for any starting distribution.

Theorem 7.1.9. *Let $(\mu_t)_{t \geq 0}$ be the continuous-time Derrida–Retaux model with initial distribution μ_0 given by (7.11).*

- (i) *If $(p, \lambda) \in \mathcal{P}$, then $F_\infty(p, \lambda) > 0$.*
- (ii) *If $(p, \lambda) \in \mathcal{U}$, then there exists some positive constant C such that*

$$\int_0^\infty y \mu_t(dy) \sim C e^{-(x-1)t}, \quad \text{as } t \rightarrow \infty,$$

where x is the unique solution larger than 1 of the equation $px = \lambda + \lambda x \log \frac{x}{\lambda}$.

(iii) If $(p, \lambda) \in \mathcal{C}$, then

$$\int_0^\infty y \mu_t(dy) \sim \frac{2}{t^2}, \quad \text{as } t \rightarrow \infty.$$

Furthermore, conditionally on $(0, \infty)$, μ_t converges weakly to a standard exponential distribution.

For the discrete-time Derrida–Retaux model, the counterpart of (iii) was conjectured in Chen et al. [CDH⁺17].

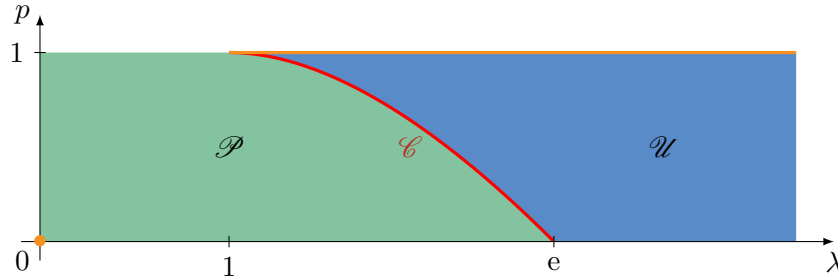

Figure 7.3 – The pinned and unpinned regions of the solvable Derrida–Retaux model

Let us call \mathcal{P} , \mathcal{U} and \mathcal{C} respectively the *supercritical*, *subcritical* and *critical* zones of the dynamics. Note that the critical zone \mathcal{C} is the graph of the function $\lambda \mapsto \lambda - \lambda \log \lambda$ on $(1, \infty)$, which splits the domain $[0, 1] \times \mathbb{R}_+$ into the supercritical and subcritical zones. In the supercritical zone, the dynamics is such that the measure μ_t is attracted by the stable equilibrium $(0, 0)$ (in orange in Figure 7.3). In the critical zone, μ_t is attracted by the critical point $(1, 1)$ (in red in Figure 7.3). Finally, in the subcritical zone, μ_t converges toward a point on the orange lane, with $p = 1$ and $\lambda > 1$. In other words, μ_t converges toward δ_0 in probability if $(p, \lambda) \in \mathcal{U} \cup \mathcal{C}$.

It is of interest to give the precise behavior of $p \mapsto F_\infty(p, \lambda)$ as the function hits 0, whenever that point exists (note that for $\lambda \geq e$, there is no phase transition since $F_\infty(p, \lambda) = 0$ for any $p \in [0, 1]$).

Theorem 7.1.10. *Fix some $\lambda \in (0, e)$ and let $p \in (0, 1)$ vary.*

(i) *If $\lambda \in (1, e)$, setting $p_c = \lambda - \lambda \log \lambda$, there exists $C > 0$ such that*

$$F_\infty(p, \lambda) \sim \mathbb{1}_{p < p_c} C \exp\left(-\pi\sqrt{2\lambda}(p_c - p)^{-1/2}\right) \quad \text{as } p \uparrow p_c.$$

(ii) *If $\lambda = 1$, we have $F_\infty(1, 1) = 0$ and there exists $C > 0$ such that*

$$F_\infty(p, \lambda) \sim C(1 - p)^{2/3} \exp\left(-\frac{\pi}{\sqrt{2}}(1 - p)^{-1/2}\right) \quad \text{as } p \uparrow 1.$$

(iii) *If $\lambda \in (0, 1)$, we have $F_\infty(1, \lambda) = 0$ and there exists $C > 0$ such that*

$$F_\infty(p, \lambda) \sim C(1 - p)^{1/(1-\lambda)} \quad \text{as } p \uparrow 1.$$

We may observe the difference of a factor 2 in the exponents of the right-hand sides in cases (i) and (ii). Moreover, (i) and (ii) prove the Derrida–Retaux conjecture for our model, with enough precision to see the polynomial factor that appears in case (ii). On the other hand, part (iii) gives a continuous version of the polynomial decay obtained in by Hu and Shi [HS18].

We shall take a particular interest in the Derrida–Retaux tree in the critical regime, conditioned on survival. It is believed that the conditioned tree limit is an universal characteristic, and would appear in numerous models related to Derrida–Retaux at criticality. For $t > 0$, let X^t denote the continuous-time Derrida–Retaux tree with initial distribution μ_0 given by (7.11) (see Definition 7.1.7). Conditionally on the event $\{X_0^t(\emptyset) > 0\}$, let \mathfrak{X}^t be the restriction of the process X^t to the painted connected component of the root \emptyset . Assuming that the paint is red, the tree \mathfrak{X}^t is called the *red tree*, see Section 7.4 for a more precise definition and properties.

Theorem 7.1.11. *Assume $(p, \lambda) \in \mathcal{C}$.*

- (i) *The rescaled process $(\frac{1}{t}\mathfrak{X}_{st}^t)_{0 \leq s < 1}$ converges locally in law as $t \rightarrow \infty$ toward a time-inhomogeneous branching Markov process $(\mathfrak{X}_s)_{0 \leq s < 1}$.*
- (ii) *For each $t \geq 0$, let N_t denote the number of leaves in \mathfrak{X}^t . There exists a positive constant C such that N_t/t^2 converges in law to $C \int_0^1 r^2(s) ds$ as $t \rightarrow \infty$, where $(r(s))_{0 \leq s < 1}$ denotes a 4-dimensional Bessel bridge.*

The limiting process \mathfrak{X} is a continuous-time system of particles with masses, that grow continuously and split at random times. As such, it can be called a time-inhomogeneous Markovian growth-fragmentation process. It can be described as satisfying the following properties:

- (i) It starts at time 0 with a unique particle of mass 0.
- (ii) The mass associated to each particle grows linearly at speed 1.
- (iii) A particle of mass m at time s splits at rate $2m/(1-s)^2$ into two children, the mass m being split uniformly between the two children.
- (iv) Particles behave independently after their splitting time.

The local convergence in the statement (i) can be seen equivalently as the convergence of the particle system on the interval $[0, 1 - \varepsilon]$ for all fixed $\varepsilon > 0$ as $t \rightarrow \infty$, or the joint convergence in law of the splitting time of the individuals in the n first generations of the process for all $n \geq 1$. Indeed, at height $(1 - \varepsilon)t$ the number of particles in \mathfrak{X}^t is tight, whereas the number of particles at height t explodes as $t \rightarrow \infty$ as shown in statement (ii); see Figure 7.4. We refer to Theorems 7.4.5 and 7.5.1 respectively for a more refined statement of (i) and (ii), respectively.

Remark 7.1.12. The counterpart of Theorem 7.1.11(ii) for the discrete Derrida–Retaux model is predicted to hold by B. Derrida (personal communication).

7.1.4 Organization of the chapter

The rest of the chapter is organised as follows. In Section 7.2, we define properly the three constructions of the continuous version of the Derrida–Retaux model. These constructions turn out to be equivalent, as shown by Propositions 7.2.2 and 7.2.3. In particular, Theorem 7.1.8 follows.

In Section 7.3 we study the exactly solvable model in which the evolution is restricted to the class of mixtures of exponential distributions and Dirac masses at 0. We give at first the phase diagram of the model (Proposition 7.3.5), then analyze the asymptotic of a system of differential equations (Proposition 7.3.7), and prove Theorems 7.1.9 and 7.1.10 in Sections 7.3.2 and 7.3.3 respectively.

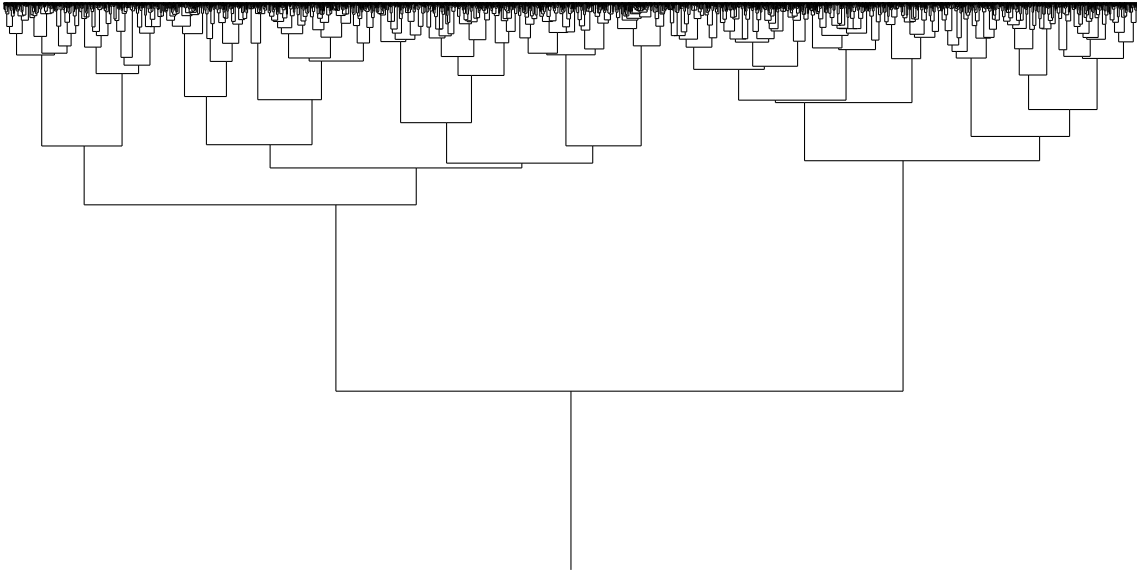

Figure 7.4 – Realization of the red tree \mathfrak{X}^t with $t = 200$ and initial condition $(p, \lambda) = (0, e)$.

Sections 7.4 and 7.5 are devoted to the study of the critical regime of our model. Conditioned on survival, the Derrida–Retaux tree at any fixed height is a time-inhomogeneous branching Markov process (Proposition 7.4.1). By letting the height go to infinity, the scaling limit of the conditioned tree exists (Theorem 7.4.5) which gives the part (i) in Theorem 7.1.11. In Section 7.5, we are interested in some quantitative characteristics of the conditioned (red) tree, the number N_t and mass M_t of leaves of the red tree of height t . We prove in Lemma 7.5.3 that the joint Laplace transform of (N_t, M_t) is given by the unique solution of a differential equation whose asymptotics are given in Section 7.5.3. This allows us to obtain the convergence in law of $(N_t/t^2, M_t/t^2)$ (Theorem 7.5.1) as $t \rightarrow \infty$. The part (ii) in Theorem 7.1.11 is a particular case of Theorem 7.5.1.

In Section 7.6, we give some results on the continuous-time Derrida–Retaux model with a general initial distribution on \mathbb{R}_+ . In particular, we prove that $e^{-t}X_t$ converges in law to an exponential distribution in the pinned case (Proposition 7.6.3) and give some necessary conditions for the model to being unpinned (Proposition 7.6.6). We end Section 7.6 by presenting some open questions.

7.2 Different constructions of the continuous-time Derrida–Retaux model

In this section, we first give a precise definition of the Derrida–Retaux tree and a characterization of the family of laws obtained from the tree-painting scheme. Then, we show that the Derrida–Retaux process is well-defined as a solution of the “McKean–Vlasov type” stochastic differential equation (7.8) and that its one-dimensional marginal distributions can be obtained from the tree-painting scheme. Finally, we prove that the Derrida–Retaux model is well-defined as the solution of the partial differential equation (7.9): existence follows from Itô formula applied to the Derrida–Retaux process and uniqueness from the characterization of the family of laws obtained from the tree-painting scheme. This shows that these constructions are equivalent, as stated in Theorem 7.1.8.

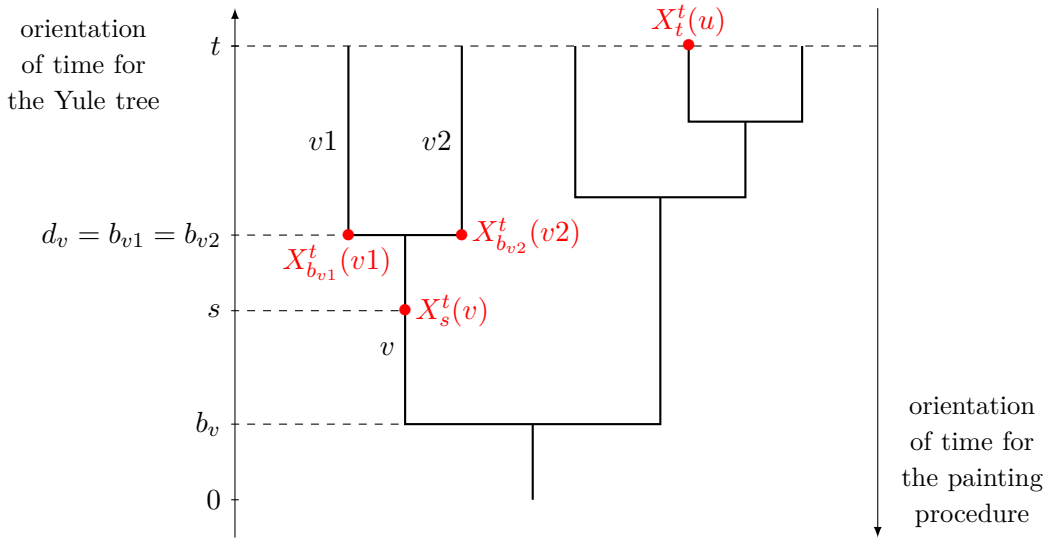

Figure 7.5 – Illustration of the definition of the $X_s^t(u)$'s on the Yule tree.

7.2.1 Construction from a Yule tree: the Derrida–Retaux tree

We recall that a *Yule tree* is the genealogical tree of a simple population, in which every individual splits after an independent exponential time of parameter one into two children. Recall from Section (1.1.1) that the binary tree can be defined as the set of all finite words on $\{1, 2\}$: $\mathbb{T} := \bigcup_{n \in \mathbb{Z}_+} \{1, 2\}^n$. This way, for any $u \in \mathbb{T}$, $u1$ and $u2$ denote the labels of the two children of u , obtained by adding 1 or 2 to the end of the word u .

The Yule tree is constructed as follows. We denote by $\{e_u, u \in \mathbb{T}\}$ a family of i.i.d. exponential random variables, that represent the time that individual u waits until splitting into its two children $u1$ and $u2$. We then define recursively the birth time b_u of each individual $u \in \mathbb{T}$ by

$$b_u := \sum_{k < |u|} e_{u_k}, \quad \text{with } b_\emptyset := 0.$$

We also set $d_u := b_u + e_u$ the time at which the individual u splits into its children, and $\mathcal{N}_t := \{u \in \mathbb{T} : b_u \leq t < d_u\}$ the set of particles alive at time t .

We now give the detailed definition of the continuous-time Derrida–Retaux tree, by analogy with its definition for Galton–Watson trees. Let μ_0 be a probability distribution on \mathbb{R}_+ and $t > 0$. Given the Yule tree, we denote by $(X_t^t(u), u \in \mathcal{N}_t)$ i.i.d. random variables with law μ_0 . For $u \in \mathcal{N}_t$, we define $X_s^t(u) := (X_t^t(u) - (t - s))_+$ for each $s \in [b_u, t]$. Then, we proceed recursively from the leaves to the root by setting, for any $v \in \mathbb{T}$ such that $d_v \leq t$ and any $s \in [b_v, d_v)$,

$$X_s^t(v) := (X_{b_{v1}}^t(v1) + X_{b_{v2}}^t(v2) - (d_v - s))_+, \tag{7.13}$$

noting that $b_{v1} = b_{v2} = d_v$ (see Figure 7.5). The process $X^t = (X_s^t(u), s \in [0, t], u \in \mathcal{N}_s)$ is a *continuous-time Derrida–Retaux tree* of height t and initial law μ_0 , introduced in Definition 7.1.7. Denoting by μ_t the law of $X_0^t(\emptyset)$, the family $(\mu_t)_{t \geq 0}$ is called *the family of laws obtained from the tree-painting scheme*.

We now give a characterization of family of laws obtained from the tree-painting scheme. For any probability distribution ν on \mathbb{R}_+ and $t > 0$, we introduce the shifted distribution $\tau_t \nu$ satisfying

$$\forall f \in \mathcal{C}_b(\mathbb{R}_+), \quad \int_{\mathbb{R}_+} f(x)(\tau_t \nu)(dx) = f(0)\nu([0, t]) + \int_{\mathbb{R}_+} f(x - t)\nu(dx), \tag{7.14}$$

that represents the law of $(Z - t)_+$ if Z has law ν . We can now describe the law of μ_t by decomposing it with respect to the first branching time in the Yule tree.

Lemma 7.2.1. *The family $(\mu_t)_{t \geq 0}$ of laws on \mathbb{R}_+ is a family obtained from the tree-painting scheme if and only if*

$$\forall t \geq 0, \quad \mu_t = \int_0^t e^{-s} \tau_s(\mu_{t-s} * \mu_{t-s}) ds + e^{-t} \tau_t(\mu_0). \tag{7.15}$$

Proof. Let \mathbb{T} be a Yule tree, we recall that the first branching time d_\emptyset is distributed according to an exponential random variable with parameter 1. Moreover, the subtrees starting from each child are i.i.d. Yule trees. As a result, conditionally on $\{d_\emptyset = s\}$ with $s \leq t$, $X_s^t(1)$ and $X_s^t(2)$ are two independent random variables with law μ_{t-s} , where as before, 1 and 2 are the two children of the root \emptyset . Note that by construction, for every measurable bounded function f , we have

$$\mathbb{E}\left[f(X_0^t(\emptyset))\right] = \mathbb{E}\left[f((X_{d_\emptyset}^t(1) + X_{d_\emptyset}^t(2) - d_\emptyset)_+) \mathbb{1}_{d_\emptyset \leq t}\right] + \mathbb{E}\left[f((X_0 - t)_+) \mathbb{1}_{d_\emptyset > t}\right],$$

where X_0 is a random variable independent of d_\emptyset with law μ_0 . Integrating w.r.t. d_\emptyset , this proves that (μ_t) satisfies (7.15).

Reciprocally, let $(\mu_t)_{t \geq 0}$ be a family of probability measures satisfying (7.15). Fix $t > 0$, we shall construct a continuous-time Derrida–Retaux tree X^t of height t and initial law μ_0 such that $X_0^t(\emptyset)$ has law μ_t . To this end, we consider on the same probability space three independent random variables T, U, \tilde{U} such that T has the standard exponential distribution, U and \tilde{U} are uniformly distributed on $[0, 1]$. For any $s \geq 0$, let $F_s(x) := \mu_s([0, x])$, $x \geq 0$ and F_s^{-1} be the right-continuous inverse of F_s . Let \emptyset be the root of the Derrida–Retaux tree that we are constructing. Define $d_\emptyset := T$ and denote by 1 and 2 the two children of \emptyset . Let

$$X_0^t(\emptyset) := (X_0 - t)_+ \mathbb{1}_{T > t} + (X_T^t(1) + X_T^t(2) - T)_+ \mathbb{1}_{T \leq t},$$

where $X_T^t(1) := F_{t-T}^{-1}(U)$, $X_T^t(2) := F_{t-T}^{-1}(\tilde{U})$ and $X_0 = F_0^{-1}(U)$. By (7.15), we observe immediately that $X_0^t(\emptyset)$ has law μ_t .

Now, on the event $\{T \leq t\}$, we consider 1 and 2 as two new roots, and we replace $X_T^t(1)$ and $X_T^t(2)$ by new random variables constructed using new independent exponential and uniform variables on an eventually enlarged probability space, constructed in the same way as $X_0^t(\emptyset)$. The procedure can be iterated until one obtains a Yule tree of height t , with i.i.d. random variables of law μ_0 attached to each leaf of \mathbb{T}_t , in such a way that $X_0^t(\emptyset)$ is the result of the painting scheme applied to that tree, which concludes the proof. \square

7.2.2 Associated McKean-Vlasov type SDE

In the previous section, we introduced a family $(\mu_t)_{t \geq 0}$ of probability distributions on \mathbb{R}_+ , obtained from the tree-painting scheme on a Yule tree. This procedure allows also to introduce a Markov process $(X_s)_{s \in [0, t]}$ such that for each $s \in [0, t]$, X_s has law μ_s : for this, consider a Yule tree of height t and let $X_s := X_{t-s}^t(u)$ where u is the leftmost particle alive at time $t - s$. Note that time is running in the opposite direction as for the Yule tree.

This process X can be described as follows: X decreases linearly at speed 1 until reaching 0. At each branching time s of the leftmost particle, X_s is replaced by $X_s + \tilde{X}_s$, where \tilde{X}_s is independent of X_s with law μ_s . This description leads to Definition 7.1.4 which says that a *Derrida–Retaux process* is a non-negative Markov process $(X_t)_{t \geq 0}$ solution to the McKean–Vlasov type stochastic differential equation:

$$\begin{cases} X_t = X_0 - \int_0^t \mathbb{1}_{X_s > 0} ds + \int_0^t \int_0^1 F_s^{-1}(u) N(ds, du) \\ F_t^{-1}(u) = \inf\{y \in [0, \infty) : \mathbb{P}(X_t \leq y) > u\}, \end{cases} \tag{7.16}$$

where N is a Poisson point process on $\mathbb{R}_+ \times [0, 1]$ with intensity $ds du$. The drift term $-\mathbb{1}_{X_s > 0} ds$ indicates the amount of paint lost per unit of length, and each atom (s, u) of N corresponds to a time s at which the subtree gains a new branching time, in which case $F_s^{-1}(u)$ is an independent copy of X_s . The following result shows that the one-dimensional marginals of X constitutes a family obtained from the tree-painting scheme.

Proposition 7.2.2. *Let μ_0 be a probability distribution on \mathbb{R}_+ . There exists a unique strong solution to Equation (7.16) such that X_0 has law μ_0 . Moreover, writing μ_t the law of X_t for each $t \geq 0$, the family $(\mu_t)_{t \geq 0}$ is a family of laws obtained from the tree-painting scheme.*

Proof. We first prove there exists a solution to (7.16). To do so, let $(\mu_t)_{t \geq 0}$ be a family obtained from the tree-painting scheme. For all $t \geq 0$ and $u \in [0, 1]$, we denote by $G_t(u) = \inf\{y \in [0, \infty) : \mu_t([0, y]) > u\}$. We observe easily that there exists a unique strong solution to the SDE

$$X_t = X_0 - \int_0^t \mathbb{1}_{X_s > 0} ds + \int_0^t \int_0^1 G_s(u) N(ds, du),$$

by decomposing on the atoms of the point measure N . We are going to show that, if X_0 has law μ_0 , then X_t has law μ_t for each $t > 0$. This will prove that X is a strong solution of (7.16), as in that case we will have $G_s = F_s^{-1}$ for all $s \geq 0$.

Let $t > 0$, we denote by $(s_j, u_j)_{1 \leq j \leq n}$ the atoms of N in $[0, t] \times [0, 1]$, ranked in the increasing order of their first coordinate. For each $j \leq n$, we write $\tilde{X}_j = G_{s_j}(u_j)$. We note that conditionally on $(s_j)_{1 \leq j \leq n}$, (\tilde{X}_j) are independent random variables, and X_j has law μ_{s_j} . As $(\mu_s)_{s \geq 0}$ is a Derrida–Retaux model, one can construct a Yule tree τ_j and a decoration of the leaves with i.i.d. random variables with law μ_0 , such that the amount of paint remaining at the root of τ_j is \tilde{X}_j .

We then define a tree of height t with a decoration on its leaves as follows: we start with a line of height t , and for each $j \leq n$, we attach the decorated tree τ_j to the line at height $t - s_j$. To the top of the line we attach the random variable X_0 . This procedure constructs a Yule tree of height t , such that each leaf is decorated with an i.i.d. variable with law μ_0 (see Figure 7.6(b)). Therefore, X_t is obtained as the result of a tree-painting procedure, hence has law μ_t . We conclude that $(X_t, t \geq 0)$ is a strong solution to (7.16).

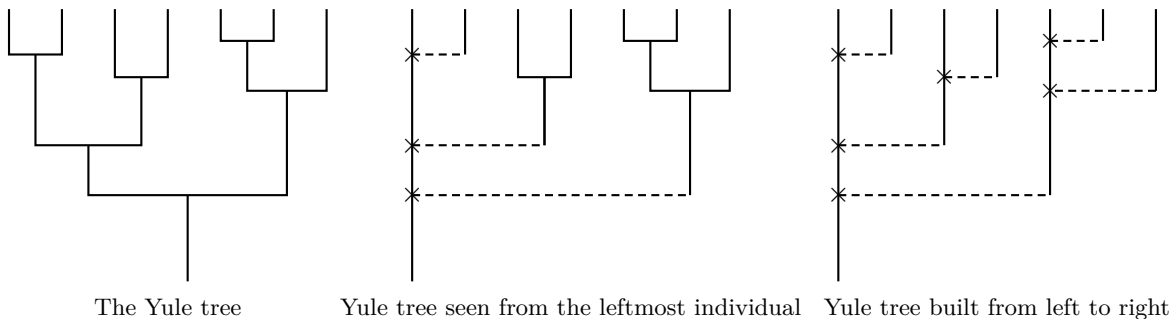

Figure 7.6 – Two alternative constructions of a Yule tree.

We now prove strong uniqueness of the solution to (7.16). We first show uniqueness in law, from which we will immediately deduce pathwise uniqueness. Let $(X_t, t \geq 0)$ be a solution to (7.16), for all $t \geq 0$, we denote by ν_t the law of X_t , and we define $H_t(u) = \inf\{y \geq 0 :$

$\nu_t([0, y]) > u\}$. We first remark that there is strong existence and uniqueness of the solution of

$$X_t = X_0 - \int_0^t \mathbb{1}_{X_s > 0} ds + \int_0^t \int_0^1 H_s(u) N(ds, du), \quad (7.17)$$

and that X is this solution.

Let $t > 0$, our aim is to prove that $\nu_t = \mu_t$. For this, we show that, using the same procedure as above, we can represent X_t as the result of a tree-painting procedure on a Yule tree of height t , with leaves decorated with law μ_0 . Indeed, we denote once again $(s_j, u_j)_{1 \leq j \leq n}$ the atoms of the point process N on $[0, t] \times [0, 1]$ and $\tilde{X}_j := H_{s_j}(u_j)$. Observe that, conditionally on $(s_j)_{1 \leq j \leq n}$, each \tilde{X}_j is a copy of X_{s_j} , independent of $(\tilde{X}_i)_{i \neq j}$ and of X_0 . We construct the tree of height t as follows. We start with a line of height t , and for each $j \leq n$, we add a mark on this line at height $t - s_j$. At each of these marks is added the random variable \tilde{X}_j . As \tilde{X}_j is an independent copy of X_{s_j} , it can be itself constructed as the unique strong solution of Equation (7.17), where the point process N and the initial value X_0 are replaced by i.i.d. copies $N^{(j)}$ and $X_0^{(j)}$.

Hence, we can construct new lines and marks starting from each of the marks in the original line and proceed so on recursively. This constructs a Yule tree, defined in a slightly different way: indeed, in this tree, each line lives until time t , giving independently birth to children at rate 1 (this is the construction pictured in Figure 7.6(c)). Moreover, on each of the leaves at level t are placed i.i.d. random variables with law μ_0 , corresponding to the starting position for each of the stochastic differential equation. Therefore, X_t is once again constructed as a tree-painting procedure on a Yule tree of height t and we can conclude that $\nu_t = \mu_t$.

In particular, this proves that $H = G$ and, thus, that X is a solution to the SDE

$$X_t = X_0 - \int_0^t \mathbb{1}_{X_s > 0} ds + \int_0^t \int_0^1 G_s(u) N(ds, du),$$

for which there is pathwise uniqueness of the solution associated to a given X_0 and N . Hence, given X_0 and N , there exists a unique strong solution to (7.16), and its unidimensional marginals form a family of laws obtained from the tree-painting scheme. \square

This result proves there is equivalence between the family of laws defined via the tree-painting scheme, or by the McKean–Vlasov type equation. To complete the proof of Theorem 7.1.8, it is therefore enough to show that this family of law is the unique solution of the partial differential equation (7.16), which is done in the next section.

7.2.3 The partial differential equation representation

We observe here that a family of laws obtained from the tree-painting scheme can be rewritten as the weak solution of a partial differential equation, the key being the application of Itô's formula to the solution of the stochastic differential equation (7.16). We then study the existence and uniqueness of the solutions of this partial differential equation using the tree-painting scheme, and in particular Lemma 7.2.1.

As in Definition 7.1.5, we say that a family $(\nu_t)_{t \geq 0}$ of finite measures on \mathbb{R} is a weak solution to the partial differential equation

$$\partial_t \nu_t(dx) = \partial_x (\mathbb{1}_{x > 0} \nu_t(dx)) + (\nu_t * \nu_t)(dx) - \nu_t(dx), \quad (7.18)$$

if $t \mapsto \nu_t$ is measurable and, for all \mathcal{C}^1 bounded functions f with bounded derivative, we have

$$\begin{aligned} & \int_{\mathbb{R}} f(x) \nu_t(dx) - \int_{\mathbb{R}} f(x) \nu_0(dx) \\ &= \int_0^t \left(- \int_{\mathbb{R}} (f'(x) \mathbb{1}_{x>0} + f(x)) \nu_s(dx) + \int_{\mathbb{R}^2} f(x+y) \nu_s(dx) \nu_s(dy) \right) ds. \end{aligned} \quad (7.19)$$

In particular, if $(\nu_t, t \geq 0)$ is a family of probability measures, this equation can be rewritten

$$\begin{aligned} & \int_{\mathbb{R}} f(x) \nu_t(dx) - \int_{\mathbb{R}} f(x) \nu_0(dx) \\ &= \int_0^t \left(- \int_{\mathbb{R}} f'(x) \mathbb{1}_{x>0} \nu_s(dx) + \int_{\mathbb{R}^2} (f(x+y) - f(x)) \nu_s(dx) \nu_s(dy) \right) ds. \end{aligned} \quad (7.20)$$

The following result proves existence and uniqueness of weak solutions of (7.18) in the case where the initial condition is a probability measure on \mathbb{R}_+ . In other words, there exists a unique (continuous-time) Derrida–Retaux model with initial distribution μ_0 , for all probability measure μ_0 on \mathbb{R}_+ .

Proposition 7.2.3. *Let $(\mu_t)_{t \geq 0}$ be a family of laws obtained from the tree-painting scheme, then $(\mu_t)_{t \geq 0}$ is a weak solution to (7.18).*

Reciprocally, if $(\nu_t)_{t \geq 0}$ is a family of non-negative finite measures on \mathbb{R} which is a weak solution to (7.18) and ν_0 is a probability distribution on \mathbb{R}_+ , then $(\nu_t)_{t \geq 0}$ is a family of laws obtained from the tree-painting scheme.

Proof. From Proposition 7.2.2, we observe that if $(\mu_t)_{t \geq 0}$ is a family of laws obtained from the tree-painting scheme, we can construct a Markov process $(X_t)_{t \geq 0}$ solution of (7.16) such that the law of X_t is μ_t for all $t \geq 0$. Therefore, for all \mathcal{C}^1 bounded function f , we have

$$\begin{aligned} \mathbb{E}[f(X_t)] &= \mathbb{E} \left[f(X_0) - \int_0^t f'(X_s) \mathbb{1}_{X_s>0} ds \right] \\ &\quad + \mathbb{E} \left[\int_0^t \int_0^1 (f(X_{s-} + F_s^{-1}(u)) - f(X_{s-})) N(ds, du) \right], \end{aligned}$$

by the Itô formula. Therefore, using the linearity of the expectation and Campbell's formula, we obtain

$$\mathbb{E}[f(X_t)] - \mathbb{E}[f(X_0)] = \int_0^t (-\mathbb{E}[f'(X_s) \mathbb{1}_{X_s>0}] + \mathbb{E}[f(X_s + Y_s) - f(X_s)]) ds,$$

with Y_s an independent copy of X_s , proving that $(\mu_t)_{t \geq 0}$ is a weak solution of (7.18).

Reciprocally, let ν_0 be a probability distribution on \mathbb{R} and $(\nu_t)_{t \geq 0}$ be a weak solution of (7.18) (in particular, ν_t is finite). We first observe that for each $t > 0$, the total mass of ν_t remains equal to 1. Indeed, using $f = 1$, we have

$$\nu_t(\mathbb{R}) - \nu_0(\mathbb{R}) = \int_0^t (\nu_s(\mathbb{R})^2 - \nu_s(\mathbb{R})) ds.$$

Hence, the total mass is the solution of the differential equation $y' = -y(1 - y)$ with initial condition $y(0) = 1$, which is $y(t) = 1$ for all $t \geq 0$, proving the total mass is preserved in (7.18). We conclude that $(\nu_t, t \geq 0)$ is a family of probability distributions.

We now prove that if ν_0 put no mass on $(-\infty, 0)$ then so does ν_t for all $t > 0$. To do so, we observe that for all \mathcal{C}^1 non-negative bounded function f with support in $(-\infty, 0)$, we have

$$\int f(x) \nu_t(dx) = \int_0^t \int_{\mathbb{R}^2} (f(x+y) - f(x)) \nu_s(dx) \nu_s(dy) ds,$$

Standard arguments say that the above equality may be extended to $f = \mathbb{1}_{(-\infty, 0)}$. It follows that $\nu_t((-\infty, 0)) = \int_0^t \int_{\mathbb{R}^2} (\mathbb{1}_{x+y < 0} - \mathbb{1}_{x < 0}) \nu_s(dx) \nu_s(dy) ds \leq \int_0^t \nu_s((-\infty, 0)) ds$. We conclude by Grönwall's lemma that $\nu_t((-\infty, 0)) = 0$ for all $t > 0$.

Finally, we prove that $(\nu_t)_{t \geq 0}$ satisfies Equation (7.15). To do so, let g be a \mathcal{C}^1 function with compact support in $(0, \infty)$. We define the function

$$G_g(a, b) := \int g((x - a)_+) \nu_b(dx).$$

By dominated convergence and (7.19), we observe that G_g is a \mathcal{C}^1 function, and that

$$\begin{aligned} \partial_a G_g(a, b) &= - \int g'(x - a) \mathbb{1}_{x > a} \nu_b(dx) \\ \partial_b G_g(a, b) &= - \int (g'(x - a) \mathbb{1}_{x > a} + g((x - a)_+)) \nu_b(dx) \\ &\quad + \int g((x + y - a)_+) \nu_b(dx) \nu_b(dy). \end{aligned}$$

Combining both equations, it follows that

$$\int g(z) \tau_a(\nu_b * \nu_b)(dz) = \partial_b G_g(a, b) - \partial_a(G_g(a, b)) + \int g((x - a)_+) \nu_b(dx).$$

and, therefore, we get

$$\begin{aligned} G_g(0, t) - e^{-t} G_g(t, 0) &= \int_0^t \partial_s(e^{-(t-s)} G_g(t - s, s)) ds \\ &= \int_0^t \int_0^t e^{-(t-s)} (G_g(t - s, s) - \partial_a G_g(t - s, s) + \partial_b G_g(t - s, s)) ds \\ &= \int_0^t e^{-s} g(z) \tau_s(\nu_{t-s} * \nu_{t-s})(dz) ds, \end{aligned}$$

using the change of variables $s \rightarrow t - s$ in the last line. This proves that $(\nu_t)_{t \geq 0}$ satisfies (7.15), hence by Lemma 7.2.1, this is a family of laws obtained from the tree-painting scheme, concluding the proof. \square

Remark 7.2.4. Note that by definition, there exists a unique family $(\mu_t)_{t \geq 0}$ of laws obtained from the tree-painting scheme and associated to a given initial probability measure μ_0 . As a result, Proposition 7.2.3 shows there exists a unique family of probability measures which are weak solutions of (7.18).

Proof of Theorem 7.1.8. The proof follows directly from Propositions 7.2.2 and 7.2.3. \square

Thanks to Proposition 7.2.3, we observe that if we can find a solution to (7.18), then this family of probability measures is a Derrida–Retaux model. Despite obtaining few information from (7.18) (for example, we were not able to prove the uniqueness of the solution in the space of distributions, or that a weak solution starting from a smooth initial condition remains smooth at all times), we were able to exhibit a set of measures, which is stable with respect to the continuous-time Derrida–Retaux transformation.

We note that strong solutions to (7.18) can be described in the following way. Let p, ϕ be two \mathcal{C}^1 functions, the family defined by

$$\mu_t(dx) = p(t) \delta_0(dx) + (1 - p(t)) \phi(t, x) dx$$

is a Derrida–Retaux model if and only if $p(0) \in [0, 1]$, $\phi(0, x) \geq 0$ and $\int \phi(0, x) dx = 1$, and

$$\begin{cases} p'(t) = (1 - p(t))(\phi(t, 0) - p(t)) \\ \partial_t \phi(t, \cdot) = \partial_x \phi(t, \cdot) + (1 - p(t))\phi(t, \cdot) * \phi(t, \cdot) + (p(t) + \phi(t, 0) - 1)\phi(t, \cdot). \end{cases} \quad (7.21)$$

Finding solutions to this differential equation, or proving existence, uniqueness and regularity for the solutions appears to be an interesting open problem.

7.3 Exactly solvable Derrida–Retaux model

In this section, we study a continuous-time Derrida–Retaux model starting from an initial measure

$$\mu_0(dx) = p(0)\delta_0(dx) + (1 - p(0))\lambda(0)e^{-\lambda(0)x} dx, \quad p(0) \in [0, 1], \lambda(0) > 0, \quad (7.22)$$

which is a mixture of a Dirac mass at 0 and an exponential random variable (on \mathbb{R}_+). It turns out that the evolution of the Derrida–Retaux model preserves the class of mixtures of exponential random variables and Dirac masses at 0. In other words, for all $t > 0$, there exists $p(t) \in [0, 1]$ and $\lambda(t) > 0$ such that

$$\mu_t(dx) = p(t)\delta_0(dx) + (1 - p(t))\lambda(t)e^{-\lambda(t)x} dx, \quad (7.23)$$

and the functions (p, λ) solve a system of ordinary differential equations. More precisely, the following result holds.

Lemma 7.3.1. *The family $(\mu_t)_{t \geq 0}$ is a Derrida–Retaux model if and only if (p, λ) is solution of the system of ordinary differential equations*

$$\begin{cases} p' = (1 - p)(\lambda - p) \\ \lambda' = -\lambda(1 - p). \end{cases} \quad (7.24)$$

Proof. By Proposition 7.2.3, there exists a unique Derrida–Retaux model with initial distribution μ_0 given by (7.22). Therefore, letting (p, λ) denote the maximal solution of the system of ordinary differential equations (7.24) with initial condition $(p(0), \lambda(0))$ (unique by Cauchy–Lipschitz theorem), it is enough to prove that this solution is well-defined for all $t \geq 0$ and that $(\mu_t)_{t \geq 0}$ is a Derrida–Retaux model.

We first observe that if (p, λ) solve (7.24), then λ is non-increasing, and if $\lambda(0) > 0$ then $\lambda(t) > 0$ as long as the solution is well-defined. Similarly, if $p(0) \leq 1$ then $p(t) \leq 1$, and as $p'(t) \geq -(1 - p(t))p(t)$, $p(t) \geq 0$ for all t such that the solution is well-defined. As a result, we deduce that $(p(t), \lambda(t)) \in [0, 1] \times [0, \lambda_0]$. The solution remaining in a compact set, it cannot explode in finite time, therefore (p, λ) is well-defined for all $t \geq 0$.

We now prove that $(\mu_t)_{t \geq 0}$ is a Derrida–Retaux model. By Proposition 7.2.3, it is enough to prove that the function is a weak solution to (7.18). Let f be a C^1 bounded function with a bounded derivative. We define

$$g(t) = \int_{\mathbb{R}_+} f(x)\mu_t(dx) = p(t)f(0) + (1 - p(t))\lambda(t) \int_0^\infty f(x)e^{-\lambda(t)x} dx.$$

We write $E_0(t) := \lambda(t) \int_0^\infty f(x)e^{-\lambda(t)x} dx$ and $E_1(t) := \lambda(t) \int_0^\infty xf(x)e^{-\lambda(t)x} dx$. By dominated convergence, we observe that, on the one hand, the derivative of g is given by

$$\begin{aligned} g' &= p'f(0) + \left(-p' + (1 - p)\frac{\lambda'}{\lambda}\right)E_0 - (1 - p)\lambda'E_1 \\ &= (1 - p)(\lambda - p)f(0) - (1 - p)(1 + \lambda - 2p)E_0 + (1 - p)^2\lambda E_1. \end{aligned}$$

On the other hand, simple computations yield

$$\begin{aligned} \int_{\mathbb{R}_+} (f'(x)\mathbb{1}_{x>0} + f(x))\mu_t(dx) &= p(t)f(0) + \lambda(t)(1-p(t)) \int_0^\infty (f'(x) + f(x))e^{-\lambda(t)x} dx \\ &= (p(t) - \lambda(t)(1-p(t)))f(0) + (1-p(t))(1+\lambda(t))E_0(t), \end{aligned}$$

by integration by part, and

$$\begin{aligned} &\int_{(\mathbb{R}_+)^2} f(x+y)\mu_t(dx)\mu_t(dy) \\ &= p(t)^2 f(0) + 2(1-p(t))E_0(t) + (1-p(t))^2 \lambda(t)^2 \int_{(\mathbb{R}_+)^2} f(x+y)e^{-\lambda(t)(x+y)} dx dy \\ &= p(t)^2 f(0) + 2p(t)(1-p(t))E_0(t) + (1-p(t))^2 \lambda(t)E_1(t). \end{aligned}$$

As a result, we obtain that

$$-\int_{\mathbb{R}_+} (f'(x)\mathbb{1}_{x>0} + f(x))\mu_t(dx) + \int_{(\mathbb{R}_+)^2} f(x+y)\mu_t(dx)\mu_t(dy) = g'(t)$$

showing that $(\mu_t)_{t \geq 0}$ is a Derrida–Retaux model, which concludes the proof. \square

As a result of Lemma 7.3.1, to study the Derrida–Retaux model with initial law μ_0 given in (7.22), it is enough to study the system of ordinary differential equations (7.24). This is what is done in the rest of the section, allowing us in particular to prove the Derrida–Retaux conjecture in this particular setting.

Remark 7.3.2. Observe that, similarly, the evolution of a Derrida–Retaux model starting by any mixture of Dirac mass at 0 and exponential random variables at time 0 can be represented by a system of differential equations. More precisely, for any $n \in \mathbb{N}$ the measure

$$\nu_t(dx) = p(t)\delta_0 + (1-p(t)) \sum_{j=1}^n q_j(t)\lambda_j(t)e^{-\lambda_j(t)x} dx$$

is a Derrida–Retaux model if and only if the functions p, q_j, λ_j satisfy

$$\begin{cases} p' = (1-p)(\sum_{k=1}^n q_k \lambda_k - p) \\ q'_j = -q_j \left((1-p)(1-q_j + 2 \sum_{k \neq j} \frac{q_k \lambda_k}{\lambda_j - \lambda_k}) + \lambda_j - \sum_{k=1}^n q_k \lambda_k \right) \\ \lambda'_j = -(1-p)q_j \lambda_j, \end{cases} \quad (7.25)$$

and if $p(0), q_j(0) \in [0, 1]$, $\lambda_j(0) \geq 0$ and $\sum_{j=1}^n q_j(0) = 1$. However, we concentrate on the simple mixture of a Dirac mass at 0 and one exponential random variable in this chapter, as this simple model exhibits the main features believed to hold for any Derrida–Retaux model.

In the next section, we give the phase diagram of the differential system (7.24), with a description of all stable and unstable equilibrium points, as well as their zone of attraction. In Section 7.3.2, we refine the study by giving asymptotic equivalents for the solutions of (7.24). Finally, we use these results to prove in Section 7.3.3 the Derrida–Retaux conjecture for continuous models with exponential initial condition.

7.3.1 Phase diagram of the model

We first observe that some quantities are preserved under the dynamics (7.24).

Lemma 7.3.3. *The function $t \mapsto \frac{p(t)}{\lambda(t)} + \log \lambda(t)$ is a constant.*

Proof. We compute the derivative of the function $H : t \mapsto \frac{p(t)}{\lambda(t)} + \log \lambda(t)$, we have

$$\begin{aligned} H'(t) &= \frac{p'(t)}{\lambda(t)} - \frac{p(t)\lambda'(t)}{\lambda(t)^2} + \frac{\lambda'(t)}{\lambda(t)} \\ &= \frac{(1-p(t))(\lambda(t)-p(t))}{\lambda(t)} + \frac{p(t)\lambda(t)(1-p(t))}{\lambda(t)^2} - \frac{\lambda(t)(1-p(t))}{\lambda(t)} = 0, \end{aligned}$$

which concludes the proof. \square

As a straightforward consequence of this remark, we deduce that p can be written as an explicit function of λ , for all initial condition.

Corollary 7.3.4. *Let $H := \frac{p(0)}{\lambda(0)} + \log \lambda(0)$, for all $t \geq 0$, we have*

$$p(t) = H\lambda(t) - \lambda(t) \log \lambda(t). \tag{7.26}$$

In particular, λ is the solution of the ordinary differential equation

$$\lambda' = -\lambda(1 - H\lambda + \lambda \log \lambda). \tag{7.27}$$

Using Lemma 7.3.3, we can draw the phase diagram of the differential system (7.24), obtain the asymptotic behavior of (p, λ) as $t \rightarrow \infty$ and describe all the equilibrium points of (7.24), with their stability properties.

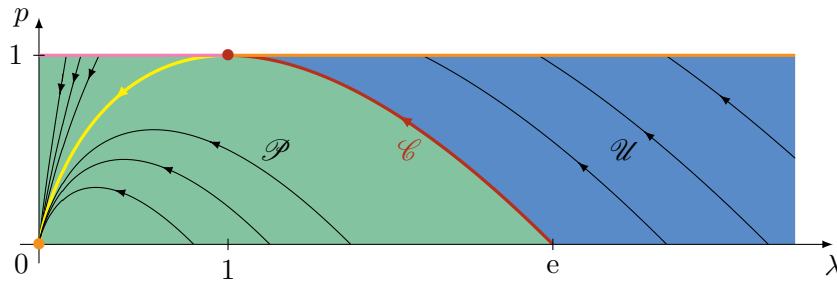

Figure 7.7 – The phase diagram of the differential system (7.24).

Recall the three sets \mathcal{P} , \mathcal{C} and \mathcal{U} defined in the introduction, respectively the supercritical, critical and subcritical zones, which we recall on Figure 7.7. We added on Figure 7.3, the trajectories of some solutions of the equation (in black). Some interesting additional sets are represented on that figure, such as the supercritical branch (in yellow) of the critical curve

$$\widehat{\mathcal{C}} = \{(p, \lambda) \in [0, 1] \times [0, 1] : p = \lambda - \lambda \log \lambda\},$$

as well as the attractive, critical and repulsive points of the dynamics (in orange, red and pink respectively):

$$\mathcal{A}_p = \{(0, 0)\} \cup (\{1\} \times (1, \infty)), \quad \mathcal{C}_p = \{(1, 1)\} \quad \text{and} \quad \mathcal{R}_p = \{1\} \times [0, 1).$$

We now describe the asymptotic behavior of this Derrida–Retaux model as $t \rightarrow \infty$.

Proposition 7.3.5. *Let (p, λ) be a solution of (7.24) on \mathbb{R}_+ . If $(p(0), \lambda(0)) \in [0, 1] \times [0, \infty)$, then the domain of definition of (p, λ) includes $[0, \infty)$, and moreover,*

- (i) *if $(p(0), \lambda(0)) \in \mathcal{P}$, then $\lim_{t \rightarrow \infty} (p(t), \lambda(t)) = (0, 0)$.*

- (ii) if $(p(0), \lambda(0)) \in \mathcal{U}$, then $\lim_{t \rightarrow \infty} (p(t), \lambda(t)) = (1, x)$, where x is the unique solution larger than 1 of the equation $Hx - x \log x = 1$.
- (iii) if $(p(0), \lambda(0)) \in \mathcal{C}$, then $\lim_{t \rightarrow \infty} (p(t), \lambda(t)) = (1, 1)$.

Proof. We first remark from (7.24) that the function λ is non-increasing. Moreover, we observe the following behavior for the solutions of (7.24) starting from the boundary of the domain:

- if $p(0) = 1$, then $(p(t), \lambda(t)) = (1, \lambda(0))$ for all $t \in \mathbb{R}$,
- if $\lambda(0) = 0$ and $p(0) \in (0, 1)$, then $(p(t), \lambda(t)) = (\frac{1}{(p(0)^{-1}-1)e^t+1}, 0)$ for all $t \in \mathbb{R}$,
- if $\lambda(0) = p(0) = 0$ then $(p(t), \lambda(t)) = (0, 0)$ for all $t \in \mathbb{R}$,
- if $\lambda(0) > 0$ and $p(0) = 0$, then for all $h > 0$ small enough, we have $(p(h), \lambda(h)) \in (0, 1) \times (0, \infty)$.

The possible values of $\lim_{t \rightarrow \infty} (p(t), \lambda(t))$ then belong to the set of equilibrium points of the dynamics, defined by the system of equation

$$\begin{cases} 0 = (1-p)(\lambda-p) \\ 0 = -\lambda(1-p), \end{cases}$$

which is exactly $\mathcal{A}_p \cup \mathcal{C}_p \cup \mathcal{R}_p$. Moreover, recall that $(p(t), \lambda(t))$ move along the trajectory of $x \mapsto Hx - x \log x$, as $\lambda(t)$ decreases.

Hence, if $(p(0), \lambda(0)) \in \mathcal{P}$, then either $H < 1$, and the only equilibrium point belonging to $x \mapsto Hx - x \log x$ is $(0, 0)$, or $H > 1$ and this is the only equilibrium point left of the starting point. If $(p(0), \lambda(0)) \in \mathcal{U}$, the first equilibrium point met by the trajectory is the one described in the second point. Finally, if $(p(0), \lambda(0)) \in \mathcal{C}$, then the trajectory of (p, λ) would go through the critical point $(1, 1)$ which is impossible, proving the third case. \square

Remark 7.3.6. Note that $(p(0), \lambda(0)) \in [0, 1] \times [0, 1]$ and $H \geq 1$ is a necessary and sufficient condition for the existence of a meaningful solution of (7.27) defined on \mathbb{R} . From any other starting position, there exists a finite $t \in (-\infty, 0)$ such that $p(t) < 0$, therefore the Derrida–Retaux model cannot be extended as a process on \mathbb{R} in general.

7.3.2 Asymptotic behavior of the solutions

In this section, we study the asymptotic behavior of the solution $(p(t), \lambda(t))$ as $t \rightarrow \infty$, in the three different phases. In the critical case, this corresponds to Conjectures 1.3 and 1.4 of Chen et al. [CDH⁺17] in the discrete setting. Using the properties of the differential system, we were able to study the asymptotic behavior in the critical case beyond the computation of an equivalent.

Proposition 7.3.7. *Let (p, λ) be a solution of (7.24).*

- (i) *If $(p(0), \lambda(0)) \in \mathcal{P}$ with $\lambda(0) > 0$, then there exists $K > 0$ such that, as $t \rightarrow \infty$,*

$$\lambda(t) \sim Ke^{-t} \quad \text{and} \quad p(t) \sim Kte^{-t}.$$

- (ii) *If $(p(0), \lambda(0)) \in \mathcal{U}$, then there exists $K > 0$ such that, as $t \rightarrow \infty$,*

$$\lambda(t) - x \sim Ke^{-(x-1)t} \quad \text{and} \quad 1 - p(t) \sim \left(1 - \frac{1}{x}\right)Ke^{-(x-1)t},$$

where x is the unique solution larger than 1 of the equation $Hx - x \log x = 1$.

(iii) If $(p(0), \lambda(0)) \in \mathcal{C}$, then we have, as $t \rightarrow \infty$,

$$\lambda(t) = 1 + \frac{2}{t} - \frac{8 \log t}{3t^2} + o\left(\frac{\log t}{t^2}\right) \quad \text{and} \quad p(t) = 1 - \frac{2}{t^2} + \frac{16 \log t}{3t^3} + o\left(\frac{\log t}{t^3}\right).$$

Proof. Let start with the supercritical case $(p(0), \lambda(0)) \in \mathcal{P}$. Recall from Theorem 7.1.9 that $\lambda(t) \rightarrow 0$. Using (7.27), we get that $\lambda'(t)/\lambda(t) \rightarrow -1$ and therefore

$$\log \lambda(t) - \log \lambda(0) = \int_0^t \frac{\lambda'(s)}{\lambda(s)} ds \sim -t,$$

hence $\lambda(t) = e^{-t+o(t)}$. Using again (7.27), we get that

$$\frac{\lambda'(t)}{\lambda(t)} + 1 = -\lambda(t) \log \lambda(t) (1 + o(1)) = -e^{-t+o(t)},$$

which is integrable at infinity. Therefore, it follows that

$$\log \lambda(t) - \log \lambda(0) + t = \int_0^t \left(\frac{\lambda'(s)}{\lambda(s)} + 1 \right) ds \xrightarrow{t \rightarrow \infty} \int_0^\infty \left(\frac{\lambda'(s)}{\lambda(s)} + 1 \right) ds,$$

where the last integral is finite. This proves that $\lambda(t) \sim Ke^{-t}$ for some constant $K > 0$. Then, the behavior of $p(t)$ follows directly from (7.26).

We now deal with the subcritical case $(p(0), \lambda(0)) \in \mathcal{U}$. Recall from Theorem 7.1.9 that $\lambda(t) \rightarrow x$, where $x > 1$ satisfies $Hx - x \log x = 1$. We introduce the auxiliary function $u(t) := \lambda(t) - x$, which is positive for all $t \in \mathbb{R}_+$. Using (7.27), we get

$$\begin{aligned} u' &= -(x + u)(1 - H(x + u) + (x + u) \log(x + u)) \\ &= -(x + u) \left(-Hu + x \log\left(\frac{x + u}{x}\right) + u \log(x + u) \right), \end{aligned}$$

using that $Hx - x \log x = 1$. Since $u(t) \rightarrow 0$, we get the following asymptotic development

$$u'(t) = -x(-H + 1 + \log x)u(t) + O(u(t)^2) = -(x - 1)u(t) + O(u(t)^2). \tag{7.28}$$

Proceeding as in the supercritical case, we first deduce from (7.28) that $u(t) = e^{-(x-1)t+o(t)}$ and, then, that $u(t) \sim Ke^{-(x-1)t}$. Plugging this in (7.26), the behavior of $p(t)$ follows.

Finally, we deal with the critical case $(p(0), \lambda(0)) \in \mathcal{C}$. Recall from Theorem 7.1.9 that $\lambda(t) \rightarrow 1$, so we introduce the auxiliary function $v(t) := \lambda(t) - 1$, which is positive for all $t \in \mathbb{R}_+$. Using (7.27) with here $H = 1$, we get

$$v' = -(1 + v)(1 - (1 + v) + (1 + v) \log(1 + v)),$$

and, using that $v(t) \rightarrow 0$, we get

$$v'(t) = -\frac{v(t)^2}{2} - \frac{v(t)^3}{3} + O(v(t)^4). \tag{7.29}$$

First, we deduce from (7.29) that $(1/v)'(t) \rightarrow 1/2$ as $t \rightarrow \infty$ and therefore,

$$\left(\frac{1}{v(t)} - \frac{1}{v(0)} \right) = \int_0^t \left(\frac{1}{v} \right)'(s) ds \sim \frac{t}{2}.$$

It proves that $v(t) \sim 2/t$ as $t \rightarrow \infty$. Then, using again (7.29), we have

$$\left(\frac{1}{v} \right)'(t) - \frac{1}{2} = \frac{v(t)}{3} + o(v(t)) \sim \frac{2}{3t},$$

as $t \rightarrow \infty$, and it follows that

$$\int_1^t \left(\left(\frac{1}{v} \right)'(s) - \frac{1}{2} \right) ds \sim \int_1^t \frac{2}{3s} ds = \frac{2}{3} \log t,$$

and, finally,

$$v(t) = \left(\frac{t}{2} + \frac{2}{3} \log t + o(\log t) \right)^{-1} = \frac{2}{t} - \frac{8 \log t}{3t^2} + o\left(\frac{\log t}{t^2}\right). \quad (7.30)$$

Then, it follows from (7.26) that

$$p(t) = (1 + v(t)) - (1 + v(t)) \log(1 + v(t)) = 1 - \frac{v(t)^2}{2} + O(v(t)^3),$$

and plugging (7.30) in this equation gives the desired result. \square

Proof of Theorem 7.1.9. Recalling from (7.23) that

$$\mu_t(dx) = p(t)\delta_0(dx) + (1 - p(t))\lambda(t)e^{-\lambda(t)x} dx.$$

Note that $\int_{\mathbb{R}_+} x \mu_t(dx) = \frac{1-p(t)}{\lambda(t)}$. Theorem 7.1.9 is now an immediate consequence of the asymptotic behavior of $(p(t), \lambda(t))$ stated in Proposition 7.3.7. \square

7.3.3 Proof of the Derrida–Retaux conjectures

Using the fact that the Derrida–Retaux model we are considering consists in a mixture of exponential random variables and Dirac masses at 0 and is integrable, we obtain a straightforward proof of the Derrida–Retaux conjecture for this model, which states that the free energy has an infinite order phase transition between the supercritical and the subcritical phases. We begin by observing that if we write

$$\mu_0(dx) = p(0)\delta_0(dx) + (1 - p(0))\lambda(0)e^{-\lambda(0)x} dx,$$

then the free energy can be rewritten

$$F_\infty(\mu_0) = F_\infty(p(0), \lambda(0)) = \lim_{t \rightarrow \infty} e^{-t} \frac{1 - p(t)}{\lambda(t)}. \quad (7.31)$$

Remark 7.3.8. The proof of Theorem 7.1.10 is crucially based on Corollary 7.3.4, which states that λ satisfies an ordinary differential equation. In the case $\lambda \in [1, e)$, note that as $p(0)$ approaches p_c , the trajectory followed by (p, λ) approaches closer and closer to the critical point $(1, 1)$ (see Figure 7.7). Moreover, trajectories typically stay a long time around this critical point, as both p' and λ' become small (of order $(1-p)$). The main asymptotic behavior of the free energy turns out to be driven by the amount of time “lost” by the trajectory (p, λ) in the neighborhood of $(1, 1)$ before eventually converging toward $(0, 0)$.

Proof of Theorem 7.1.10. We fix some $\lambda \in (0, e)$ and set $p_c := \lambda - \lambda \log \lambda$ if $\lambda > 1$ and, by extension, $p_c := 1$ if $\lambda \leq 1$. We work with p such that $(p, \lambda) \in \mathcal{P}$, which means exactly $p < p_c$. Let (p, λ) be a solution to (7.24) with initial conditions $\lambda(0) = \lambda$ and $p(0) = p$. Recall that setting $H := \frac{p}{\lambda} + \log \lambda$, the function λ is solution to the differential equation

$$\forall t \geq 0, \quad \lambda'(t) = -\lambda(t)(1 - H\lambda(t) + \lambda(t) \log \lambda(t)),$$

which can be rewritten as: for all $t \geq 0$, we have

$$\int_{\lambda(t)}^{\lambda(0)} \frac{dy}{y(1 - Hy + y \log y)} = t.$$

We take interest in the asymptotic behavior, as $x \rightarrow 0$ of the function

$$G_H: x \mapsto \int_x^\lambda \frac{dy}{y(1 - Hy + y \log y)}.$$

Indeed, since $(p, \lambda) \in \mathcal{P}$, we have $p(t) \rightarrow 0$ and $\lambda(t) \rightarrow 0$ by Theorem 7.1.9 and it follows from (7.31) that

$$F_\infty(p, \lambda) = \lim_{t \rightarrow \infty} \frac{e^{-t}}{\lambda(t)} = \exp\left(-\lim_{x \rightarrow 0} (G_H(x) + \log x)\right), \tag{7.32}$$

by composition of limits. Thus, in order to prove the result, it is enough to compute the asymptotic behavior, as $p \rightarrow p_c$ or equivalently $H \rightarrow H_c := \frac{p_c}{\lambda} + \log \lambda$, of

$$\begin{aligned} \lim_{x \rightarrow 0} (G_H(x) + \log x) &= \log \lambda + \int_0^\lambda \left(\frac{1}{y(1 - Hy + y \log y)} - \frac{1}{y} \right) dy \\ &= \log \lambda + \int_0^\lambda \frac{H - \log y}{1 - Hy + y \log y} dy, \end{aligned} \tag{7.33}$$

in the three different cases $\lambda \in (1, e)$, $\lambda = 1$ and $\lambda \in (0, 1)$.

We start with the case $\lambda \in [1, e)$ (we will distinguish later between $\lambda = 1$ and $\lambda \neq 1$), in which case $H_c = 1$. We first observe that

$$C_1 := \lim_{H \rightarrow 1} \int_0^\lambda \left(\frac{H - \log y}{1 - Hy + y \log y} - \frac{H + 1 - y}{(1 - H)y + \frac{(y-1)^2}{2} - \frac{(y-1)^3}{6}} \right) dy$$

exists and is finite, by dominated convergence¹. Setting $\delta := 1 - H$, it follows that

$$\lim_{x \rightarrow 0} (G_H(x) + \log x) = \log \lambda + C_1 + \int_0^\lambda \frac{2 - \delta - y}{\delta y + \frac{(y-1)^2}{2} - \frac{(y-1)^3}{6}} dy + o(1), \tag{7.34}$$

where the $o(1)$ holds as $\delta \rightarrow 0$, or equivalently as $p \rightarrow p_c$. In order to compute the integral, we need to compute the partial fraction decomposition of the rational function in the integral. The polynomial $\delta y + \frac{(y-1)^2}{2} + \frac{(y-1)^3}{6}$ has a real root x_0 and two complex conjugate roots $x_1 + iy_1$ and $x_1 - iy_1$. These roots are explicit and one can check that $x_0 = 4 + O(\delta)$, $x_1 = 1 - O(\delta)$ and $y_1 = \sqrt{2\delta} + O(\delta)$. Then, we have the following decomposition

$$\frac{2 - \delta - y}{\delta y + \frac{(y-1)^2}{2} - \frac{(y-1)^3}{6}} = \frac{a}{y - x_0} + \frac{b - ay}{(y - x_1)^2 + y_1^2},$$

with $a = \frac{4}{3} + O(\delta)$ and $b = \frac{10}{3} + O(\delta)$. Therefore, we can finally compute

$$\begin{aligned} &\int_0^\lambda \frac{2 - \delta - y}{\delta y + \frac{(y-1)^2}{2} - \frac{(y-1)^3}{6}} dy \\ &= a(\ln(x_0 - \lambda) - \ln(x_0)) + \frac{b - ax_1}{y_1} \left(\arctan\left(\frac{\lambda - x_1}{y_1}\right) - \arctan\left(\frac{-x_1}{y_1}\right) \right) \\ &\quad - \frac{a}{2} \left(\ln\left((\lambda - x_1)^2 + y_1^2\right) - \ln\left(x_1^2 + y_1^2\right) \right). \end{aligned}$$

1. Note that the main issue to be addressed is the divergence at 1 as $(y - 1)^{-2}$ in the limit. For this, we replaced the $\log y$ in the numerator by $y - 1$ and the $1 + y \log y$ in the denominator by its Taylor expansion $1 + (y - 1) + \frac{(y-1)^2}{2} - \frac{(y-1)^3}{6}$. For the domination, one can use the triangle inequality, in order to make one replacement after the other, and then deal with them separately, using Taylor–Lagrange inequality.

From now on, we distinguish $\lambda > 1$ and $\lambda = 1$. We start with $\lambda > 1$: using the development of the different constants and that $\arctan(t) = \frac{\pi}{2} + O(\frac{1}{t})$ as $t \rightarrow \infty$, we get

$$\int_0^\lambda \frac{2 - \delta - y}{\delta y + \frac{(y-1)^2}{2} - \frac{(y-1)^3}{6}} dy = \pi \sqrt{\frac{2}{\delta}} + C_2 + o(1),$$

where C_2 is a constant depending on λ . Recalling that $\delta = 1 - \frac{p}{\lambda} - \log \lambda = \frac{p_c - p}{\lambda}$, coming back to (7.32), (7.33) and (7.34), we get

$$F_\infty(p, \lambda) = \exp\left(-\pi \sqrt{\frac{2\lambda}{p_c - p}} - \log \lambda - C_1 - C_2 + o(1)\right)$$

and it concludes the proof of the first point.

We now consider the case $\lambda = 1$. In that case $\lambda - x_1 = O(\delta)$, so the development of the integral is slightly different:

$$\int_0^\lambda \frac{2 - \delta - y}{\delta y + \frac{(y-1)^2}{2} - \frac{(y-1)^3}{6}} dy = \frac{\pi}{\sqrt{2\delta}} - \frac{2}{3} \ln \delta + C_3 + o(1),$$

and, in the same way,

$$F_\infty(p, \lambda) = \exp\left(-\frac{\pi}{\sqrt{2(p_c - p)}} + \frac{2}{3} \ln(p_c - p) - \log \lambda - C_1 - C_3 + o(1)\right),$$

which proves the second point.

Finally, we deal with $\lambda \in (0, 1)$ and, therefore, $p_c = 1$. Recall from (7.32) and (7.33), that our aim is to compute the asymptotic behavior, as $p \rightarrow 1$, of

$$\int_0^\lambda \frac{H - \log y}{1 - Hy + y \log y} dy = \int_0^\lambda \frac{p - \lambda \log \frac{y}{\lambda}}{\lambda - py + \lambda y \log \frac{y}{\lambda}} dy,$$

where we used that $H = \frac{p}{\lambda} + \log \lambda$. Note that

$$C_4 := \lim_{p \rightarrow 1} \int_0^\lambda \left(\frac{p - \lambda \log \frac{y}{\lambda}}{\lambda - py + \lambda y \log \frac{y}{\lambda}} - \frac{p}{\lambda(1 - \lambda) - y(p - \lambda)} \right) dy$$

exists and is finite, by dominated convergence². Then, we compute

$$\int_0^\lambda \frac{p}{\lambda(1 - \lambda) - y(p - \lambda)} dy = -\frac{p}{p - \lambda} \log\left(\frac{1 - p}{1 - \lambda}\right),$$

and conclude that

$$F_\infty(p, \lambda) = \exp\left(\frac{1}{1 - \lambda} \log\left(\frac{1 - p}{1 - \lambda}\right) - \log \lambda - C_4 + o(1)\right),$$

which proves the third point. □

². Here, the issue is the divergence at λ as $(y - \lambda)^{-1}$ in the limit and, therefore, we replaced the $\log \frac{y}{\lambda}$ in the numerator by 0 and the $y \log \frac{y}{\lambda}$ in the denominator by $\lambda(\frac{y}{\lambda} - 1)$.

7.4.1 The red tree as a Markovian branching process

The purpose of this subsection is the description of the law of $(\mathfrak{X}_s^t(v), v \in \mathfrak{N}_s^t, s \leq t)$ conditioned by $X_0^t(\emptyset) = x$ for some $x > 0$. However, the event $\{X_0^t(\emptyset) = x\}$ has zero probability, so the question is not well-posed. But, we give a particular description, as a Markovian branching process, of the law of \mathfrak{X}^t given $X_0^t(\emptyset)$, such that, for this description, it makes sense to consider the process “starting from x ”.

Let $(p(t), \lambda(t), t \geq 0)$ be the solution of (7.24) starting from initial condition $p(0) = p$, $\lambda(0) = \lambda$ for some $(p, \lambda) \in [0, 1) \times (0, \infty)$. Note that in this section, we *do not* restrict ourselves to the critical case. We introduce the auxiliary function

$$\varrho(s) := (1 - p(s))\lambda(s), \quad s \geq 0,$$

which will appear regularly in the sequel.

Proposition 7.4.1. *Assume that the initial law μ_0 is given by (7.22) with $(p(0), \lambda(0)) \in (0, 1) \times (0, \infty)$. Given $X_0^t(\emptyset)$, on the event $\{X_0^t(\emptyset) > 0\}$, \mathfrak{X}^t has the law of a time-inhomogeneous branching Markov process, which can be described as follows:*

- (i) *The process starts at time 0 with a unique particle of mass $\mathfrak{X}_0^t(\emptyset) = X_0^t(\emptyset)$.*
- (ii) *The mass associated to each particle grows linearly at speed 1.*
- (iii) *A particle of mass m at time s splits at rate $\varrho(t - s)m$ into two children, the mass m being split uniformly between the two children.*
- (iv) *Particles behave independently after their splitting time.*

This proposition allows us to define the distribution of \mathfrak{X}^t “starting from x ”. Indeed, for any $x > 0$, let \mathbb{P}_x denote a probability measure such that, under \mathbb{P}_x , the process \mathfrak{X}^t is the time-inhomogeneous branching Markov process starting with $\mathfrak{X}_0^t(\emptyset) = x$ and satisfying Points 2, 3 and 4 of Proposition 7.4.1. Then, informally, the law of \mathfrak{X}^t under \mathbb{P} conditioned by $X_0^t(\emptyset) = x$ is the law of \mathfrak{X}^t under \mathbb{P}_x . Before proving Proposition 7.4.1, the following lemma shows that the whole process X^t satisfies also a branching property.

Lemma 7.4.2. *Let $s \in (0, t)$. Given the Yule tree and the process X^t until time s , the $(X_{s+r}^t(v), r \in [0, t - s], v \in \mathcal{N}_{s+r} \text{ s.t. } v \geq u)$ for $u \in \mathcal{N}_s$ are independent with respectively the same law as X^{t-s} starting from $X_s^t(u)$.*

Proof. Let $\mathbb{T}_s := (\mathcal{N}_r, r \in [0, s])$ denote the Yule tree until time s . Our aim is to prove that, for any family of nonnegative measurable functions $(F_u)_{u \in \mathbb{T}}$ and any r.v. Υ_s measurable w.r.t. the σ -field generated by \mathbb{T}_s and the process X^t until time s ,

$$\begin{aligned} & \mathbb{E} \left[\Upsilon_s \prod_{u \in \mathcal{N}_s} F_u \left(X_{s+r}^t(v), r \in [0, t - s], v \in \mathcal{N}_{s+r} \text{ s.t. } v \geq u \right) \right] \\ &= \mathbb{E} \left[\Upsilon_s \prod_{u \in \mathcal{N}_s} \tilde{F}_u \left(X_s^t(u) \right) \right]. \end{aligned} \tag{7.35}$$

where, for $u \in \mathbb{T}$, $\tilde{F}_u: \mathbb{R}_+ \rightarrow \mathbb{R}_+$ is the measurable function (unique up to a Lebesgue-negligible set) such that

$$\tilde{G}_u(X_0^{t-s}(\emptyset)) := \mathbb{E} \left[F_u \left(X_r^{t-s}(v), r \in [0, t - s], v \in \mathcal{N}_r \right) \middle| X_0^{t-s}(\emptyset) \right].$$

The process X^t until time s is a deterministic function of \mathbb{T}_s and of the $X_u(s)$ for $u \in \mathcal{N}_s$. Therefore, it suffices to prove (7.35) for Υ_s of the form $\Upsilon_s = g(\mathbb{T}_s) \prod_{u \in \mathcal{N}_s} h_u(X_u(s))$, with g and $(h_u)_{u \in \mathbb{T}}$ measurable functions. But, each factor $h_u(X_u(s))$ can be incorporated in $F_u(\cdots)$, with an appropriate change of the function F_u . Hence, it is finally enough to consider $\Upsilon_s = g(\mathbb{T}_s)$.

Given \mathbb{T}_s , the subtrees rooted in the u 's for $u \in \mathcal{N}_s$ are independent Yule trees of height $t - s$ and the labels on their leaves are independent of each other. Therefore, given \mathbb{T}_s , the $(X_{s+r}^t(v), r \in [0, t - s], v \in \mathcal{N}_{s+r}$ s.t. $v \geq u$) for $u \in \mathcal{N}_s$ are independent copies of X^{t-s} and it proves (7.35) in the case $\Upsilon_s = g(\mathbb{T}_s)$. This concludes the proof. \square

Remark 7.4.3. Note that this proof does not use the fact that we are working with the exponential model. Therefore, for any initial law μ_0 , X^t is a time-inhomogeneous branching Markov process.

Proof of Proposition 7.4.1. Points (i) and (ii) are clearly true. Point (iv) follows directly from the branching property for X^t established in Lemma 7.4.2. We focus now on Point (iii). By the branching property, it is sufficient to prove it for the root of the tree: hence, our aim is to prove that, for any $0 \leq s < t$ and any measurable functions $f, g_1, g_2: \mathbb{R} \rightarrow \mathbb{R}_+$,

$$\begin{aligned} & \mathbb{E} \left[f(X_0^t(\emptyset)) \mathbb{1}_{X_0^t(\emptyset) > 0} \mathbb{1}_{\epsilon_{\emptyset}^t \leq s} g_1(\mathfrak{X}_{\epsilon_{\emptyset}^t}^t(1)) g_2(\mathfrak{X}_{\epsilon_{\emptyset}^t}^t(2)) \right] \\ &= \int_0^\infty f(x) \varrho(t) e^{-\lambda(t)x} \int_0^s \varrho(t-r)(x+r) \exp\left(-\int_0^r \varrho(t-v)(x+v) dv\right) \\ & \quad \times \int_0^{x+r} g_1(y) g_2(x+r-y) \frac{dy}{x+r} dr dx, \end{aligned} \tag{7.36}$$

recalling that ϵ_{\emptyset}^t denotes the lifetime of \emptyset in the red tree. First note that $X_0^t(\emptyset) + \epsilon_{\emptyset}^t = \mathfrak{X}_{\epsilon_{\emptyset}^t}^t(1) + \mathfrak{X}_{\epsilon_{\emptyset}^t}^t(2)$ and, therefore, the left-hand side of (7.36) is equal to

$$\mathbb{E} \left[f(\mathfrak{X}_{\epsilon_{\emptyset}^t}^t(1) + \mathfrak{X}_{\epsilon_{\emptyset}^t}^t(2) - \epsilon_{\emptyset}^t) \mathbb{1}_{\mathfrak{X}_{\epsilon_{\emptyset}^t}^t(1) + \mathfrak{X}_{\epsilon_{\emptyset}^t}^t(2) > \epsilon_{\emptyset}^t} \mathbb{1}_{\epsilon_{\emptyset}^t \leq s} g_1(\mathfrak{X}_{\epsilon_{\emptyset}^t}^t(1)) g_2(\mathfrak{X}_{\epsilon_{\emptyset}^t}^t(2)) \right]. \tag{7.37}$$

Then, we distinguish on the first particle u starting from the root, that splits its mass into two *positive* masses between its children. Denoting $\emptyset = u_0 < u_1 < \cdots < u_k = u$ the lineage of u and, for $v \in \mathbb{T} \setminus \{\emptyset\}$, \bar{v} the single brother of v , we get that (7.37) is equal to

$$\begin{aligned} & \sum_{k \geq 0} \sum_{|u|=k} \mathbb{E} \left[\mathbb{1}_{\forall i \in [1, k], X_{b_{u_i}}^t(\bar{u}_i) = 0} \mathbb{1}_{X_{d_u}^t(u_1), X_{d_u}^t(u_2) > 0} f(X_{d_u}^t(u_1) + X_{d_u}^t(u_2) - d_u) \right. \\ & \quad \left. \times \mathbb{1}_{X_{d_u}^t(u_1) + X_{d_u}^t(u_2) > d_u} \mathbb{1}_{d_u \leq s} g_1(X_{d_u}^t(u_1)) g_2(X_{d_u}^t(u_2)) \right]. \end{aligned} \tag{7.38}$$

Using the branching property, on the event $d_u \leq s$ and given $b_{u_1}, \dots, b_{u_k}, d_u$, the Yule trees rooted in $\bar{u}_1, \dots, \bar{u}_k, u_1, u_2$ and the labels on their leaves are independent and, therefore, the r.v. $X_{b_{u_1}}^t(\bar{u}_1), \dots, X_{b_{u_k}}^t(\bar{u}_k), X_{d_u}^t(u_1), X_{d_u}^t(u_2)$ are independent with distributions $\mu_{b_{u_1}}, \dots, \mu_{b_{u_k}}, \mu_{d_u}, \mu_{d_u}$ respectively. Hence, taking first the expectation given $b_{u_1}, \dots, b_{u_k}, d_u$, we get that (7.38) is equal to

$$\begin{aligned} & \sum_{k \geq 0} \sum_{|u|=k} \mathbb{E} \left[\left(\prod_{i=1}^k p(t - b_{u_i}) \right) \mathbb{1}_{d_u \leq s} (1 - p(t - d_u))^2 \lambda(t - d_u)^2 \right. \\ & \quad \left. \times \int_0^\infty \int_0^\infty e^{-\lambda(t-d_u)(y+z)} f(y+z-d_u) \mathbb{1}_{y+z > d_u} g_1(y) g_2(z) dz dy \right]. \end{aligned} \tag{7.39}$$

On the other hand, given d_u , the vector $(b_{u_i})_{1 \leq i \leq k}$ has the same law as the ordered vector $(U_i)_{1 \leq i \leq k}$, where the U_i 's are i.i.d. uniform r.v. on $[0, d_u]$, so, for any measurable positive function h and any $|u| = k$, we have

$$\begin{aligned} \mathbb{E} \left[\left(\prod_{i=1}^k p(t - b_{u_i}) \right) \mathbb{1}_{d_u \leq s} h(d_u) \right] &= \mathbb{E} \left[\left(\int_0^{d_u} p(t - v) \frac{dv}{d_u} \right)^k \mathbb{1}_{d_u \leq s} h(d_u) \right] \\ &= \int_0^s \left(\int_0^r p(t - v) \frac{dv}{r} \right)^k h(r) \frac{r^k e^{-r}}{k!} dr, \end{aligned}$$

using that d_u follows the $\Gamma(k+1, 1)$ distribution. Noting that $\#\{|u| = k\} = 2^k$ and summing over k , we get that (7.39) is equal to

$$\begin{aligned} &\int_{r=0}^s \exp\left(\int_0^r 2p(t-v) dv\right) (1-p(t-r))^2 \lambda(t-r)^2 \\ &\quad \times \int_{y=0}^{\infty} \int_{z=0}^{\infty} e^{-\lambda(t-r)(y+z)} f(y+z-r) \mathbb{1}_{y+z > r} g_1(y) g_2(z) dz dy e^{-r} dr. \end{aligned} \quad (7.40)$$

Changing z into $x = y + z - r$, using Fubini's theorem and recalling that $\varrho(t) = (1-p(t))\lambda(t)$, (7.40) is equal to

$$\begin{aligned} &\int_{x=0}^{\infty} f(x) \int_{r=0}^s \exp\left(\int_0^r (2p(t-v) - 1) dv\right) \varrho(t-r)^2 e^{-\lambda(t-r)(x+r)} \\ &\quad \times \int_{y=0}^{x+r} g_1(y) g_2(x+r-y) dy dr dx. \end{aligned}$$

Now, in order to prove (7.36), it is sufficient to prove that

$$\begin{aligned} &\varrho(t-r) e^{-\lambda(t-r)(x+r)} \exp\left(-\int_0^r (1-2p(t-v)) dv\right) \\ &= \varrho(t) e^{-\lambda(t)x} \exp\left(-\int_0^r \varrho(t-v)(x+v) dv\right). \end{aligned} \quad (7.41)$$

For this, note that $(\log \varrho)' = 2p - 1 - \lambda$ by (7.24) and therefore

$$\frac{\varrho(t-r)}{\varrho(t)} = \exp(\log \varrho(t-r) - \log \varrho(t)) = \exp\left(-\int_0^r (2p(t-v) - 1 - \lambda(t-v)) dv\right).$$

On the other hand, using that $\frac{d}{dv}(\lambda(t-v)(x+v)) = \varrho(t-v)(x+v) + \lambda(t-v)$, we get

$$\frac{e^{-\lambda(t-r)(x+r)}}{e^{-\lambda(t)x}} = \exp\left(-\int_0^r (\varrho(t-v)(x+v) + \lambda(t-v)) dv\right).$$

Combining the two previous equations, it proves (7.41) and concludes the proof. \square

Remark 7.4.4. Using [HR14], one can prove a many-to-one lemma for the red tree. More precisely, the following result holds: For all measurable bounded function f , we have

$$\mathbb{E} \left[\sum_{u \in \mathcal{N}_t} f(Y_s^{t,x}(u), s \leq t) \right] = \mathbb{E} \left[e^{\int_0^t \varrho(t-s) Z_s^{t,x} ds} f(Z_s^{t,x}, s \leq t) \right],$$

where $Z^{t,x}$ is a time-inhomogeneous Markov process with $Z_0^{t,x} = x$, with a positive drift 1, that jumps at rate $2\varrho(t-s)Z_s$ to position $UZ^{t,x}$ with U an independent uniform random variable.

7.4.2 Scaling limit of the red tree

In this subsection, we consider the critical case by taking as initial law μ_0 given by (7.22) with $(p(0), \lambda(0)) \in \mathcal{C}$. In that case, it follows from Proposition 7.3.7 that $\varrho(s) = \lambda(s)(1 - p(s)) \sim 2/s^2$ as $s \rightarrow \infty$. Using this asymptotic result, one can take the limit $t \rightarrow \infty$ in the description of the red tree of Proposition 7.4.1, as shown in the next result.

Before stating and proving this result, we need some additional formalism. The set of binary continuous trees is $(\mathbb{R}_+)^{\mathbb{T}}$, where a tree is represented by the lengths of its branches, and the set of masses is $\mathcal{C}(\mathbb{R}_+)^{\mathbb{T}}$, where to each particle of the tree is associated the continuous function of its mass during its lifetime. Then, the process $(\mathfrak{X}_s^t(v), v \in \mathfrak{N}_s^t, s \leq t)$ is encoded as the following random variable in $(\mathbb{R}_+)^{\mathbb{T}} \times \mathcal{C}(\mathbb{R}_+)^{\mathbb{T}}$:

$$\left((\mathfrak{e}_u^t)_{u \in \mathbb{T}}, (\mathfrak{X}_{(\mathfrak{b}_u^t + s) \wedge \mathfrak{d}_u^t}^t(u), s \geq 0)_{u \in \mathbb{T}} \right),$$

where we recall that for any $u \in \mathbb{T}$, \mathfrak{e}_u^t , \mathfrak{b}_u^t and \mathfrak{d}_u^t denotes respectively the lifetime, birth time and death time of u . The set $\mathcal{C}(\mathbb{R}_+)^{\mathbb{T}}$ is endowed with the topology of uniform convergence on every compact set and $(\mathbb{R}_+)^{\mathbb{T}} \times \mathcal{C}(\mathbb{R}_+)^{\mathbb{T}}$ with the product topology.

Now, for $T \geq 0$, we define the restriction of the tree to the time interval $[0, T]$ by

$$\left(((\mathfrak{d}_u^t \wedge T) - (\mathfrak{b}_u^t \wedge T))_{u \in \mathbb{T}}, (\mathfrak{X}_{(\mathfrak{b}_u^t + s) \wedge \mathfrak{d}_u^t \wedge T}^t(u) \mathbb{1}_{\mathfrak{b}_u^t \leq T}, s \geq 0)_{u \in \mathbb{T}} \right),$$

which is still an element of $(\mathbb{R}_+)^{\mathbb{T}} \times \mathcal{C}(\mathbb{R}_+)^{\mathbb{T}}$.

Theorem 7.4.5. *Let $\mathfrak{X} = (\mathfrak{X}_s(u), u \in \mathfrak{N}(s), s \in [0, 1])$ be a time-inhomogeneous branching Markov process such that under \mathbb{P}_x :*

- (i) *The process starts at time 0 with a unique particle of mass x : $\mathfrak{X}_0(\emptyset) = x$.*
- (ii) *The mass associated to each particle grows linearly at speed 1.*
- (iii) *A particle of mass m at time s splits at rate $2m/(1 - s)^2$ into two children, the mass m being split uniformly between the two children.*
- (iv) *Particles behave independently after their splitting time.*

Assume that the initial law μ_0 is given by (7.22) with $(p(0), \lambda(0)) \in \mathcal{C}$. Let $(x_t)_{t \geq 0}$ be a family of positive real numbers such that $x_t/t \rightarrow x \in \mathbb{R}_+$ as $t \rightarrow \infty$. Then, for any $\varepsilon \in (0, 1)$, the restriction of $(\mathfrak{X}_{st}^t(v)/t, v \in \mathfrak{N}_{st}^t, s \in [0, 1])$ to $[0, 1 - \varepsilon]$ under \mathbb{P}_{x_t} converges in law toward the restriction of \mathfrak{X} to $[0, 1 - \varepsilon]$ under \mathbb{P}_x .

Proof. The first step is to prove that we can deal only with a finite number of particles. Let $m_t := \max_{u \in \mathfrak{N}_{(1-\varepsilon)t}} |u|$ be the maximal generation among the red particles alive at time $(1 - \varepsilon)t$, we are going to show that $(M_t)_{t \geq 0}$ is tight in \mathbb{R}_+ . By Proposition 7.3.7, for any t large enough and $s \in [0, (1 - \varepsilon)t]$, we have $\varrho(t - s) \leq 4/(t - s)^2 \leq 4/(\varepsilon t)^2$. On the other hand, note that under \mathbb{P}_{x_t} , the mass of any particle at any time is bounded by $x_t + t$, and therefore by $(x + 2)t$ for t large enough. Therefore, by Proposition 7.4.1, the branching rate of any particle on the time interval $[0, (1 - \varepsilon)t]$ can be upper bounded by $4(x + 2)/(\varepsilon^2 t)$. We conclude that m_t is stochastically dominated by the maximal generation among the particles alive at time $(1 - \varepsilon)t$ in a Yule tree with parameter $4(x + 2)/\varepsilon^2$ and, thus, $(m_t)_{t \geq 0}$ is tight.

Hence, it is now sufficient to prove, for any $m \in \mathbb{N}$, the following convergence in law

$$\begin{aligned} & \left((\mathfrak{e}_u^t/t)_{u \in \mathbb{T}, |u| \leq m}, (\mathfrak{X}_{(\mathfrak{b}_u^t + st) \wedge \mathfrak{d}_u^t}^t(u)/t, s \geq 0)_{u \in \mathbb{T}, |u| \leq m} \right) \text{ under } \mathbb{P}_{x_t} \\ & \xrightarrow[t \rightarrow \infty]{(d)} \left((\mathfrak{e}_u)_{u \in \mathbb{T}, |u| \leq m}, (\mathfrak{X}_{(\mathfrak{b}_u + s) \wedge \mathfrak{d}_u}^t(u), s \geq 0)_{u \in \mathbb{T}, |u| \leq m} \right) \text{ under } \mathbb{P}_x. \end{aligned}$$

By recurrence on m and using the Markov property of \mathfrak{X}^t (Point (iv) of Proposition 7.4.1), it is sufficient to prove that,

$$\left(\mathbf{e}_{\emptyset}^t/t, (\mathfrak{X}_{(st)\wedge\partial_{\emptyset}^t}(\emptyset)/t, s \geq 0)\right) \text{ under } \mathbb{P}_{x_t} \xrightarrow[t \rightarrow \infty]{(d)} \left(\mathbf{e}_{\emptyset}, (\mathfrak{X}_{s\wedge\partial_{\emptyset}}(\emptyset), s \geq 0)\right) \text{ under } \mathbb{P}_x \quad (7.42)$$

But, $\mathfrak{X}_{(st)\wedge\partial_{\emptyset}^t}(\emptyset) = x_t + ((st) \wedge \mathbf{e}_{\emptyset}^t)$ and $\mathfrak{X}_{s\wedge\partial_{\emptyset}}(\emptyset) = x + (s \wedge \mathbf{e}_{\emptyset})$, so (7.42) reduces to the proof of the convergence in distribution of $\mathbf{e}_{\emptyset}^t/t$ under \mathbb{P}_{x_t} toward \mathbf{e}_{\emptyset} under \mathbb{P}_x . By Point (iii) of Proposition 7.4.1, for any $r \in (0, 1)$, as $t \rightarrow \infty$,

$$\mathbb{P}_{x_t}(\mathbf{e}_{\emptyset}^t/t > r) = \exp\left(-\int_0^{rt} \varrho(t-u)(x_t+u) du\right) \xrightarrow[t \rightarrow \infty]{} \exp\left(-\int_0^r \frac{2(x+v) dv}{(1-v)^2}\right), \quad (7.43)$$

using that $\varrho(s) \sim 2/s^2$ as $s \rightarrow \infty$ by Proposition 7.3.7 and $x_t/t \rightarrow x$ as $t \rightarrow \infty$. Finally, note that, by definition of the limit \mathfrak{X} , the right-hand side of (7.43) is equal to $\mathbb{P}_x(\mathbf{e}_{\emptyset} > r)$, which completes the proof. \square

Remark 7.4.6. We believe that the limit \mathfrak{X} should be universal. Defining similarly the red tree for the discrete Derrida–Retaux model, we expect the same scaling limit to hold in the critical case. This is supported by computer calculations of the distribution of first branching time in the discrete red tree, which can be compared with the distribution of \mathbf{e}_{\emptyset} under \mathbb{P}_0 given by

$$\forall r \in [0, 1], \quad \mathbb{P}_0(\mathbf{e}_{\emptyset} \leq r) = 1 - \exp\left(-\int_0^r \frac{2v dv}{(1-v)^2}\right) = 1 - \frac{1}{(1-r)^2} \exp\left(-\frac{2r}{1-r}\right),$$

see Figure 7.9. Similarly, computer calculations show that the mass in the red tree of height n is split uniformly among children as $n \rightarrow \infty$.

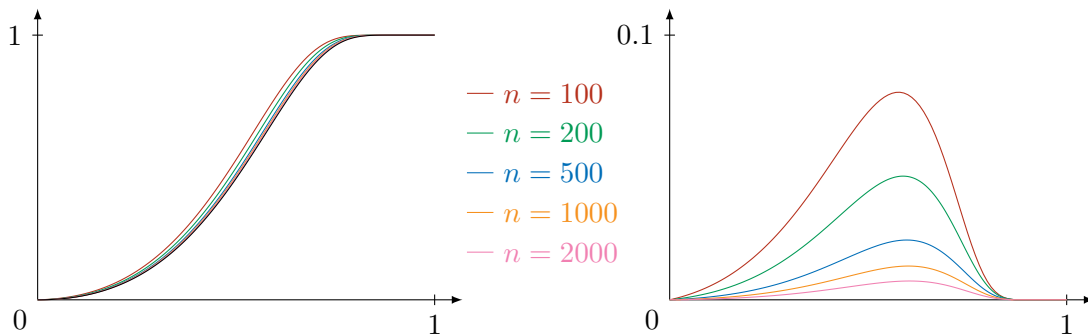

Figure 7.9 – For each $n \in \{100, 200, 500, 1000\}$, the repartition function F_n of the first branching time of the discrete red tree of height n with critical initial law $\frac{4}{5}\delta_0 + \frac{1}{5}\delta_2$ has been computed. On the left, the F_n ’s are drawn in color and the repartition function F of \mathbf{e}_{\emptyset} under \mathbb{P}_0 is drawn in black. On the right, the $F_n - F$ ’s are drawn.

7.5 Asymptotic behavior of the number and mass of red leaves

The red tree, studied in the previous section, is a tool for understanding how mass can be brought from the leaves to the root. We focus here on the critical case, with initial law μ_0 given by (7.22) with $(p(0), \lambda(0)) \in \mathcal{C}$, and answer the following questions: typically, when mass is brought to the root, how many leaves have contributed to this amount of mass? How much mass do these leaves carry?

In order to answer these questions, let N_t be the number of red leaves and M_t the total mass of the red leaves:

$$N_t := \#\mathfrak{N}_t^t \quad \text{and} \quad M_t := \sum_{u \in \mathfrak{N}_t^t} \mathfrak{x}_t^t(u).$$

The joint asymptotic behavior of N_t and M_t is given by the following result.

Theorem 7.5.1. *Let $(p(0), \lambda(0)) \in \mathcal{C}$. There exist $\gamma_1, \gamma_2 > 0$ such that, for any family $(x_t)_{t \geq 0}$ of positive real numbers such that $x_t/t \rightarrow x \in \mathbb{R}_+$ as $t \rightarrow \infty$, $(t^{-2}N_t, t^{-2}M_t)$ under \mathbb{P}_{x_t} converges in distribution to $(\gamma_1\eta, \gamma_2\eta)$, where $\eta := \frac{3}{2} \int_0^1 r^2(s) ds$, with $r(\cdot)$ denoting a 4-dimensional Bessel bridge from 0 to $2\sqrt{x}$.*

Constants γ_1 and γ_2 are defined implicitly in Lemma 7.5.4 and depend on the initial condition $(p(0), \lambda(0))$. This section is devoted to the proof of Theorem 7.5.1, via the analytic study of the Laplace transform of (N_t, M_t) . In the sequel, $(p(0), \lambda(0)) \in \mathcal{C}$ is fixed and thus also the auxiliary function $\varrho(s) = (1 - p(s))\lambda(s)$.

A further question that we do not answer here is the following: what is the typical mass of a red leaf? Thereupon, we state the following conjecture.

Conjecture 7.5.2. *For any family $(x_t)_{t \geq 0}$ of positive real numbers such that $x_t/t \rightarrow x \in \mathbb{R}_+$ as $t \rightarrow \infty$, the random measure*

$$\frac{1}{N_t} \sum_{u \in \mathfrak{N}_t^t} \delta_{\mathfrak{x}_t^t(u)} \quad \text{under } \mathbb{P}_{x_t}$$

converges in law for the topology of vague convergence and the limit does not depend on x .

7.5.1 The Laplace transform of the mass and number of red leaves

For $\varepsilon_1, \varepsilon_2 > 0$, we introduce the following function

$$\phi(t, x) = \phi_{\varepsilon_1, \varepsilon_2}(t, x) := \mathbb{E}_x \left[e^{-\varepsilon_1 N_t - \varepsilon_2 M_t} \right], \quad t, x \geq 0. \tag{7.44}$$

As a function of $(\varepsilon_1, \varepsilon_2)$, $\phi_{\varepsilon_1, \varepsilon_2}(t, x)$ is the Laplace transform of (N_t, M_t) under \mathbb{P}_x . However, in this subsection, we fix $(\varepsilon_1, \varepsilon_2)$ and study analytically $\phi_{\varepsilon_1, \varepsilon_2}$ as a function of (t, x) : therefore, we forget the dependence in $\varepsilon_1, \varepsilon_2$ and write simply ϕ . The aim of this subsection is to prove the following result.

Lemma 7.5.3. *Let $\varepsilon_1, \varepsilon_2 > 0$. Then, for any $t, x \geq 0$, we have*

$$\phi(t, x) = e^{-(\Theta(t) + x\Theta'(t))}, \tag{7.45}$$

where Θ is the unique solution on \mathbb{R}_+ to the following differential equation

$$\begin{cases} \Theta'' = \varrho(1 - e^{-\Theta}), \\ \Theta(0) = \varepsilon_1, \\ \Theta'(0) = \varepsilon_2. \end{cases} \tag{7.46}$$

Moreover, for any $t \geq 0$, we have $\Theta(t) > 0$ and $\Theta'(t) > 0$.

Proof. Recall that $\mathfrak{e}_{\emptyset}^t$ is the first branching time in the red tree. Distinguishing on the cases $\mathfrak{e}_{\emptyset}^t = t$ and $\mathfrak{e}_{\emptyset}^t < t$ and using Proposition 7.4.1, we have

$$\phi(t, x) = \mathbb{P}(\mathfrak{e}_{\emptyset}^t = t) \phi(0, x + t) + \int_0^t \mathbb{P}(\mathfrak{e}_{\emptyset}^t \in ds) \int_0^{x+s} \phi(t - s, y) \phi(t - s, x + s - y) \frac{dy}{x + s}$$

and, moreover, the law of $\mathbf{e}_{\varnothing}^t$ is given by

$$\mathbb{P}\left(\mathbf{e}_{\varnothing}^t \geq s\right) = \exp\left(-\int_0^s \varrho(t-r)(x+r) dr\right) = \exp\left(-\int_{t-s}^t \varrho(r)(x+t-r) dr\right),$$

for any $s \in [0, t]$. Therefore, replacing s by $t-s$ in the first integral, we get the following integral equation for ϕ :

$$\begin{aligned} \phi(t, x) &= \exp\left(-\int_0^t \varrho(r)(x+t-r) dr\right) \phi(0, x+t) \\ &\quad + \int_0^t \varrho(s) \exp\left(-\int_s^t \varrho(r)(x+t-r) dr\right) \int_0^{x+t-s} \phi(s, y) \phi(s, x+t-s-y) dy ds. \end{aligned} \tag{7.47}$$

Let first check that the function ϕ suggested in the lemma is a solution of Equation (7.47). By Cauchy-Lipschitz theorem, there exists a unique maximal \mathcal{C}^2 solution Θ to Equation (7.46) and (Θ, Θ') has to stay in $(0, \infty) \times (0, \infty)$ at positive times. Therefore, $\varrho(1 - e^{-\Theta})$ remains bounded and it follows that Θ is well-defined on \mathbb{R}_+ . Hence, for $t, x \geq 0$, we can define $\phi(t, x) = e^{-(\Theta(t)+x\Theta'(t))}$ and the second term in the right-hand side of (7.47) is equal to

$$\begin{aligned} &\int_0^t \varrho(s) \exp\left(-\int_s^t \varrho(r)(x+t-r) dr\right) (x+t-s) e^{-(2\Theta(s)+(x+t-s)\Theta'(s))} ds \\ &= \int_0^t \frac{d}{ds} \left[\exp\left(-\int_s^t \varrho(r)(x+t-r) dr\right) e^{-(\Theta(s)+(x+t-s)\Theta'(s))} \right] ds \\ &= \phi(t, x) - \exp\left(-\int_0^t \varrho(r)(x+t-r) dr\right) \phi(0, x+t), \end{aligned}$$

using (7.46) in order to compute the derivative. This proves that $(x, t) \mapsto e^{-(\Theta(t)+x\Theta'(t))}$ is solution of (7.47).

We now prove uniqueness for Equation (7.47) among the set of measurable locally bounded functions from $(\mathbb{R}_+)^2 \rightarrow \mathbb{R}$. Let $\phi_1, \phi_2: (\mathbb{R}_+)^2 \rightarrow \mathbb{R}$ be measurable locally bounded functions satisfying (7.47). We fix some $x_0 \geq 0$ and prove that $\phi_1 = \phi_2$ on the triangle $T := \{(t, x) \in (\mathbb{R}_+)^2 : x+t \leq x_0\}$. It follows from (7.47) that

$$|\phi_1(t, x) - \phi_2(t, x)| \leq C \int_0^t \int_0^{x+t-s} |\phi_1(s, y) - \phi_2(s, y)| dy ds, \tag{7.48}$$

with $C := (\sup_{\mathbb{R}_+} \varrho)(\sup_T |\phi_1| + \sup_T |\phi_2|)$, using that ϱ is bounded and ϕ_1, ϕ_2 are locally bounded. Now, we introduce $T_t := T \cap ([0, t] \times \mathbb{R}_+)$: note that, for any $(x, t) \in T$, the variable (y, s) in the right-hand side of (7.48) remains in T_t . Let $t_0 := 1/(2Cx_0)$, we prove by induction on $k \in \mathbb{N}$ that $\phi_1 - \phi_2 = 0$ on T_{kt_0} . For $k = 0$, it's clearly true. Now, assume that it holds for some $k \in \mathbb{N}$. Then, for any $(t, x) \in T_{(k+1)t_0}$, it follows from (7.48) that

$$|\phi_1(t, x) - \phi_2(t, x)| \leq C(t - kt_0)x_0 \sup_{T_{(k+1)t_0}} |\phi_1 - \phi_2|,$$

and, taking the supremum over $(t, x) \in T_{(k+1)t_0}$, we get

$$\sup_{T_{(k+1)t_0}} |\phi_1 - \phi_2| \leq Ct_0x_0 \sup_{T_{(k+1)t_0}} |\phi_1 - \phi_2| \leq \frac{1}{2} \sup_{T_{(k+1)t_0}} |\phi_1 - \phi_2|,$$

which proves that $\phi_1 - \phi_2 = 0$ on $T_{(k+1)t_0}$. Therefore, we proved that $\phi_1 = \phi_2$ on T and, since it holds for any $x_0 \geq 0$, we get the uniqueness. The function ϕ defined by (7.44) takes value in $[0, 1]$ and the function $(t, x) \mapsto e^{-(\Theta(t)+x\Theta'(t))}$ is continuous on $(\mathbb{R}_+)^2$ and therefore locally bounded. Moreover, they both satisfy Equation (7.47) so they coincide. \square

7.5.2 An auxiliary differential equation

Recall that our aim is to prove the convergence in law of $(N_t/t^2, M_t/t^2)$ and, for this, the convergence of the Laplace transform $\phi_{\theta_1/t^2, \theta_2/t^2}(t, x_t)$. Therefore, we will need to study the function Θ solution of (7.46) for small initial conditions $\varepsilon_1, \varepsilon_2$ and, when Θ is small, it behaves like the function a , solution to the following linearized equation:

$$a'' = \varrho a. \quad (7.49)$$

In this subsection, we prove a preliminary result concerning the asymptotic behavior of the function a solution of (7.49).

Lemma 7.5.4. *There exists positive constants $\gamma_1, \gamma_2 > 0$ such that, for any $\theta_1, \theta_2 \in \mathbb{R}$, if a is the unique solution on \mathbb{R}_+ to the differential equation $a'' = \varrho a$ with initial conditions $a(0) = \theta_1$ and $a'(0) = \theta_2$, then we have $a(t) \sim (\gamma_1\theta_1 + \gamma_2\theta_2)t^2$ and $a'(t) \sim 2(\gamma_1\theta_1 + \gamma_2\theta_2)t$ as $t \rightarrow \infty$.*

Proof. First note that, by linearity, it is sufficient to deal with the cases $(\theta_1, \theta_2) = (1, 0)$ and $(\theta_1, \theta_2) = (0, 1)$. From now on, assume that we are in one of this cases. In particular, this implies that $a(t) > 0$ and $a'(t) > 0$ for any $t > 0$. The main idea of the proof is to show that, for large t , we can replace $\varrho(t)$ by $2/t^2$ in the equation: indeed, it follows from Proposition 7.3.7 that

$$\varrho(t) = \frac{2}{t^2} - \frac{16 \log t}{3t^3} + o\left(\frac{\log t}{t^3}\right),$$

so we can choose some t_0 large enough such that

$$\forall t \geq t_0, \quad 0 < \frac{2}{t^2} - \frac{1}{t^{5/2}} \leq \varrho(t) \leq \frac{2}{t^2}.$$

We first prove a upper bound on $a(t)$. Let a_0 be the solution on $[t_0, \infty)$ of the following ODE:

$$a_0''(t) = \frac{2}{t^2} a_0(t), \quad a_0(t_0) = a(t_0), \quad a_0'(t_0) = a'(t_0).$$

Then, $a_0(t) = c_1 t^2 + c_2 t^{-1}$ for any $t \geq t_0$, for some $c_1, c_2 \in \mathbb{R}$ and, using the initial conditions, we get

$$a_0(t) = \frac{a(t_0) + t_0 a'(t_0)}{3t_0^2} t^2 + \frac{2t_0 a(t_0) - t_0^2 a'(t_0)}{3t}. \quad (7.50)$$

Then, setting

$$C = C(t_0) := \frac{a(t_0) + t_0 a'(t_0)}{t_0^2} > 0,$$

we get that $a_0(t) \leq Ct^2$ for any $t \geq t_0$. On the other hand, for any $t \geq t_0$, we have $a(t) \leq a_0(t)$ and, therefore, we proved that

$$\forall t \geq t_0, \quad a(t) \leq Ct^2, \quad (7.51)$$

which is a upper bound with a rough constant.

Now, we prove that $a(t)$ is of order t^2 and $a'(t)$ of order t as $t \rightarrow \infty$. For this, we consider some $t_1 > t_0$ and let a_1 be the solution on $[t_1, \infty)$ of the following ODE:

$$a_1''(t) = \frac{2}{t^2} a_1(t), \quad a_1(t_1) = a(t_1), \quad a_1'(t_1) = a'(t_1).$$

Similarly to a_0 , a_1 has an exact expression of the form (7.50) with t_0 replaced by t_1 . As before, for any $t \geq t_1$, we have $a(t) \leq a_1(t)$ and

$$\begin{aligned} (a_1 - a)''(t) &= \frac{2}{t^2}a_1(t) - \varrho(t)a(t) = \frac{2}{t^2}(a_1(t) - a(t)) + \left(\frac{2}{t^2} - \varrho(t)\right)a(t) \\ &\leq \frac{2}{t^2}(a_1(t) - a(t)) + \frac{1}{t^{5/2}}Ct^2, \end{aligned} \quad (7.52)$$

using that $a(t) \leq Ct^2$ for any $t \geq t_0$. Then, we introduce the auxiliary function $y(t) := a_1(t) - a(t) + \frac{4C}{5}t^{3/2}$ and it follows from (7.52) that, for any $t \geq t_1$,

$$y''(t) \leq \frac{2}{t^2}y(t).$$

Therefore, we get $y \leq \bar{y}$, where \bar{y} is the solution on $[t_1, \infty)$ of the following ODE:

$$\bar{y}''(t) \leq \frac{2}{t^2}\bar{y}(t), \quad \bar{y}(t_1) = y(t_1) = \frac{4C}{5}t_1^{3/2}, \quad \bar{y}'(t_1) = y'(t_1) = \frac{6C}{5}t_1^{1/2}.$$

One compute as before that, for any $t \geq t_1$,

$$\bar{y}(t) = \frac{2C}{\sqrt{t_1}}t^2 + \frac{2Ct_1^{5/2}}{15t}.$$

Therefore, it follows that

$$a_1(t) - a(t) = y(t) - \frac{4C}{5}t^{3/2} \leq \frac{2C}{\sqrt{t_1}}t^2 + \frac{2Ct_1^{5/2}}{15t}. \quad (7.53)$$

and, using the explicit value of a_1 , we finally proved that, for any $t_1 \geq t_0$, as $t \rightarrow \infty$,

$$\left(\frac{a(t_1) + t_1 a'(t_1)}{3t_1^2} - \frac{2C}{\sqrt{t_1}}\right)t^2 + o(t^2) \leq a(t) \leq \frac{a(t_1) + t_1 a'(t_1)}{3t_1^2}t^2 + o(t^2). \quad (7.54)$$

We apply this result with $t_1 = t_0$ and it gives, as $t \rightarrow \infty$,

$$\left(\frac{C}{3} - \frac{2C}{\sqrt{t_0}}\right)t^2 + o(t^2) \leq a(t) \leq \frac{C}{3} + o(t^2), \quad (7.55)$$

where $\frac{C}{3} - \frac{2C}{\sqrt{t_0}} > 0$ by choosing $t_0 > 36$ at the beginning. Thus, we proved that $a(t)$ is of order t^2 . Combining this with $a'(t) = \int_0^t \varrho(s)a(s) ds$ and $\varrho(t) \sim 2/t^2$, we get

$$2\left(\frac{C}{3} - \frac{2C}{\sqrt{t_0}}\right)t + o(t) \leq a'(t) \leq \frac{2C}{3}t + o(t), \quad (7.56)$$

so $a'(t)$ is of order t .

Finally, we prove the result. Using (7.55) and (7.56), there exist an increasing sequence $(s_n)_{n \in \mathbb{N}}$ with $s_n \rightarrow \infty$ and two constants $c, c' > 0$ such that

$$\frac{a(s_n)}{s_n^2} \xrightarrow{n \rightarrow \infty} c \quad \text{and} \quad \frac{a'(s_n)}{s_n} \xrightarrow{n \rightarrow \infty} c'. \quad (7.57)$$

Then, for any $n \in \mathbb{N}$, applying (7.54) with $t_1 = s_n$, we get

$$\left(\frac{a(s_n) + s_n a'(s_n)}{3s_n^2} - \frac{2C}{\sqrt{s_n}}\right)t^2 + o(t^2) \leq a(t) \leq \frac{a(s_n) + s_n a'(s_n)}{3s_n^2}t^2 + o(t^2)$$

and, using (7.57), it follows that $a(t)/t^2 \rightarrow (c + c')/3$. In particular, we have $c = (c + c')/3$. Using again that $a'(t) = \int_0^t \varrho(s)a(s) ds$ and $\varrho(t) \sim 2/t^2$, it follows that $a'(t)/t \rightarrow 2c$. Therefore, we proved the result for $(\theta_1, \theta_2) = (1, 0)$ and $(\theta_1, \theta_2) = (0, 1)$ and the result follows. \square

Remark 7.5.5. Let $\psi(t, x) := \mathbb{E}_x[N_t]$ (or similarly $\mathbb{E}_x[M_t]$), then one can check in the same way as in Lemma 7.5.3 that $\psi(t, x) = a(t) + a'(t)x$ with a solution of Equation (7.49). Therefore, Lemma 7.5.4 implies that $\mathbb{E}_{xt}[N_t] \sim \gamma_1(1 + 2x)t^2$ and $\mathbb{E}_{xt}[M_t] \sim \gamma_2(1 + 2x)t^2$ as $t \rightarrow \infty$.

7.5.3 Asymptotics of the Laplace transform

In this subsection, we prove Theorem 7.5.1, using results of the two previous subsections. Recall that $\phi_{\varepsilon_1, \varepsilon_2}(t, x) = \mathbb{E}_x[e^{-\varepsilon_1 N_t - \varepsilon_2 M_t}] = e^{-(\Theta(t) + x\Theta'(t))}$, where Θ is the solution of (7.46). Our aim is to prove the convergence of $\mathbb{E}_{x_t}[e^{-\theta_1 t^{-2} N_t - \theta_2 t^{-2} M_t}]$ as $t \rightarrow \infty$. Hence, we consider Θ_ε solution of

$$\begin{cases} \Theta''_\varepsilon = \varrho(1 - e^{-\Theta_\varepsilon}), \\ \Theta_\varepsilon(0) = \theta_1 \varepsilon, \\ \Theta'_\varepsilon(0) = \theta_2 \varepsilon, \end{cases} \tag{7.58}$$

for any fixed $\theta_1, \theta_2 > 0$, and study the asymptotics of $\Theta_\varepsilon(1/\sqrt{\varepsilon})$ and $\Theta'_\varepsilon(1/\sqrt{\varepsilon})$ as $\varepsilon \rightarrow 0$. The first step is to control the behavior of Θ_ε and Θ'_ε at large but fixed time, as $\varepsilon \rightarrow 0$. This is done in the following result.

Lemma 7.5.6. *Let $\theta_1, \theta_2 \in \mathbb{R}$ and $\delta > 0$. For large enough t , there exists $\varepsilon_0 = \varepsilon_0(t, \delta) > 0$ such that for any $0 < \varepsilon < \varepsilon_0$,*

$$\left| \Theta_\varepsilon(t) - \varepsilon c t^2 \right| \leq \delta \varepsilon t^2 \quad \text{and} \quad \left| \Theta'_\varepsilon(t) - 2\varepsilon c t \right| \leq \delta \varepsilon t,$$

where $c = \gamma_1 \theta_1 + \gamma_2 \theta_2$ and γ_1, γ_2 are defined in Lemma 7.5.4.

Proof. Let a be solution of $a'' = \varrho a$ with initial conditions $a(0) = \theta_1$ and $a'(0) = \theta_2$. The strategy of the proof is to show that $\Theta_\varepsilon(t)$ and $\Theta'_\varepsilon(t)$ are close to $\varepsilon a(t)$ and $\varepsilon a'(t)$ for small ε and then to apply Lemma 7.5.4. From now on, we fix some $t \geq 0$ and the constants C_i can depend on t , as well as on $\theta_1, \theta_2, \delta$. First note that $\Theta''_\varepsilon = \varrho(1 - e^{-\Theta_\varepsilon}) \leq \varrho \Theta_\varepsilon$ and, therefore, $\Theta_\varepsilon \leq \varepsilon a$. Then, it follows from Lemma 7.5.4 that there exists $C > 0$ such that, for any $s \geq 0$,

$$\Theta_\varepsilon(s) \leq \varepsilon a(s) \leq C\varepsilon(s + 1)^2. \tag{7.59}$$

In order to prove that $\Theta_\varepsilon(t)$ is close to $\varepsilon a(t)$, we introduce $y := \varepsilon a - \Theta_\varepsilon$, which satisfies $y(0) = 0$, $y'(0) = 0$ and, for any $s \geq 0$,

$$\begin{aligned} y''(s) &= \varrho(s) \left(\varepsilon a(s) - 1 + e^{-\Theta_\varepsilon(s)} \right) = \varrho(s) \left(y(s) + \Theta_\varepsilon(s) - 1 + e^{-\Theta_\varepsilon(s)} \right) \\ &\leq \varrho(s) \left(y(s) + \frac{\Theta_\varepsilon(s)^2}{2} \right) \leq \varrho(s) \left(y(s) + \frac{C}{2}(s + 1)^4 \varepsilon^2 \right), \end{aligned}$$

using (7.59). Since the function ϱ is bounded, we deduce that, for any $s \in [0, t]$, $y''(s) \leq C_1 y(s) + C_2 \varepsilon^2$, where C_2 depends on t . Thus, we get, for any $s \in [0, t]$,

$$y(s) \leq C_2 \varepsilon^2 \left(\cosh\left(\sqrt{C_1} s\right) - 1 \right) \leq C_3 \varepsilon^2.$$

It follows that, for any $s \in [0, t]$,

$$\left| \Theta_\varepsilon(s) - \varepsilon a(s) \right| \leq C_3 \varepsilon^2. \tag{7.60}$$

Moreover, since $\Theta'_\varepsilon(t) = \int_0^t \varrho(s)(1 - e^{-\Theta_\varepsilon(s)}) ds$ and $a'(t) = \int_0^t \varrho(s)a(s) ds$, we get

$$\begin{aligned} |\Theta'_\varepsilon(t) - \varepsilon a'(t)| &\leq \int_0^t \varrho(s) |1 - e^{-\Theta_\varepsilon(s)} - \varepsilon a(s)| ds \\ &\leq \int_0^t \varrho(s) \left(\frac{\Theta_\varepsilon(s)^2}{2} + |\Theta_\varepsilon(s) - \varepsilon a(s)| \right) ds \\ &\leq \varepsilon^2 \int_0^t \varrho(s) \left(\frac{C}{2}(s+1)^4 + C_3 \right) ds = C_4 \varepsilon^2, \end{aligned}$$

using (7.59) and (7.60). Therefore, we proved that, for any $\varepsilon < \delta t^2 / (2(C_3 \vee C_4))$, we have

$$|\Theta_\varepsilon(t) - \varepsilon a(t)| \leq \frac{\delta \varepsilon t^2}{2} \quad \text{and} \quad |\Theta'_\varepsilon(t) - \varepsilon a'(t)| \leq \frac{\delta \varepsilon t^2}{2}$$

But, on the other hand, it follows from Lemma 7.5.4 that there exists $t_0 > 0$ such that, for all $t \geq t_0$,

$$|a(t) - ct^2| \leq \frac{\delta}{2} t^2 \quad \text{and} \quad |a'(t) - 2ct^2| \leq \frac{\delta}{2} t^2,$$

so the result holds for $t \geq t_0$ and $\varepsilon < \delta t^2 / (2(C_3 \vee C_4))$. \square

Using the previous lemma, we now can control Θ_ε at some large fixed time t . Then, in order to get the asymptotics of $\Theta_\varepsilon(1/\sqrt{\varepsilon})$ as $\varepsilon \rightarrow 0$, we can replace $\varrho(s)$ by $2/s^2$ for $s \in [t, 1/\sqrt{\varepsilon}]$ in Equation (7.58) and this will prove the following result.

Lemma 7.5.7. *Let $\theta_1, \theta_2 \in \mathbb{R}$. Then, we have*

$$\Theta_\varepsilon(1/\sqrt{\varepsilon}) \xrightarrow{\varepsilon \rightarrow 0} \log \frac{\sinh^2(\sqrt{3c})}{3c} \quad \text{and} \quad \frac{\Theta'_\varepsilon(1/\sqrt{\varepsilon})}{\sqrt{\varepsilon}} \xrightarrow{\varepsilon \rightarrow 0} 2(\sqrt{3c} \coth(\sqrt{3c}) - 1),$$

where $c = \gamma_1 \theta_1 + \gamma_2 \theta_2$ and γ_1, γ_2 are defined in Lemma 7.5.4.

Proof. By Proposition 7.3.7, we can choose $t_1 \geq 1$ large enough such that

$$\forall s \geq t_1, \quad 0 < \frac{2}{s^2} - \frac{1}{s^{5/2}} \leq \varrho(s) \leq \frac{2}{s^2}. \quad (7.61)$$

We fix some $t \geq t_1$, and consider z the solution (depending on t and ε) of the following equation:

$$\forall s \geq t, \quad z''(s) = \frac{2}{s^2}(1 - e^{-z(s)}),$$

with initial conditions $z(t) = \Theta_\varepsilon(t)$ and $z'(t) = \Theta'_\varepsilon(t)$. Then, z is explicitly given by

$$\forall s \geq t, \quad z(s) = \log \frac{\sinh^2(\sqrt{\xi}(s-t) + \zeta)}{\xi s^2},$$

where

$$\xi := \frac{1}{t^2} \left(\left(1 + \frac{t}{2} \Theta'_\varepsilon(t) \right)^2 - e^{-\Theta_\varepsilon(t)} \right) \quad \text{and} \quad \zeta := \operatorname{arccosh} \left(e^{\Theta_\varepsilon(t)/2} \left(1 + \frac{t}{2} \Theta'_\varepsilon(t) \right) \right).$$

Using Lemma 7.5.6, we get that

$$\lim_{t \rightarrow \infty} \limsup_{\varepsilon \rightarrow 0} \left| \frac{\xi}{\varepsilon} - 3c \right| = 0 \quad \text{and} \quad \lim_{t \rightarrow \infty} \limsup_{\varepsilon \rightarrow 0} \left| \frac{\zeta}{\sqrt{\varepsilon}} - \sqrt{3ct} \right| = 0,$$

and it follows that

$$\lim_{t \rightarrow \infty} \limsup_{\varepsilon \rightarrow 0} \left| z(1/\sqrt{\varepsilon}) - \log \frac{\sinh^2(\sqrt{3c})}{3c} \right| = 0, \tag{7.62}$$

$$\lim_{t \rightarrow \infty} \limsup_{\varepsilon \rightarrow 0} \left| \frac{z'(1/\sqrt{\varepsilon})}{\sqrt{\varepsilon}} - 2(\sqrt{3c} \coth(\sqrt{3c}) - 1) \right| = 0. \tag{7.63}$$

Now, we have to prove that $\Theta_\varepsilon(1/\sqrt{\varepsilon})$ and $\Theta'_\varepsilon(1/\sqrt{\varepsilon})$ are close to $z(1/\sqrt{\varepsilon})$ and $z'(1/\sqrt{\varepsilon})$ when $\varepsilon \rightarrow 0$ and then $t \rightarrow \infty$. Firstly, it follows from (7.61) that $\Theta_\varepsilon(s) \leq z(s)$ for any $s \geq t$. Then, recalling from (7.59) that there exists $C > 0$ such that $\Theta_\varepsilon(s) \leq C\varepsilon s^2$ for any $s \geq 1$, we get that, for any $s \geq t$,

$$\begin{aligned} (z - \Theta_\varepsilon)''(s) &= \frac{2}{s^2} (e^{-\Theta_\varepsilon(s)} - e^{-z(s)}) + \left(\frac{2}{s^2} - \varrho(s) \right) (1 - e^{-\Theta_\varepsilon(s)}) \\ &\leq \frac{2}{s^2} (z - \Theta_\varepsilon)(s) + \frac{C\varepsilon}{\sqrt{s}}, \end{aligned} \tag{7.64}$$

using that $\Theta_\varepsilon(s), z(s) \geq 0$ and (7.61). This is the same differential inequality as in (7.52), so we get the same result as in (7.53): for any $s \geq t$,

$$z(s) - \Theta_\varepsilon(s) \leq \frac{2C\varepsilon}{\sqrt{t}} s^2 + \frac{2C\varepsilon t^{5/2}}{15s}. \tag{7.65}$$

Recalling that $z(s) - \Theta_\varepsilon(s) \geq 0$, we get

$$\lim_{t \rightarrow \infty} \limsup_{\varepsilon \rightarrow 0} |z(1/\sqrt{\varepsilon}) - \Theta_\varepsilon(1/\sqrt{\varepsilon})| = 0.$$

Coming back to (7.62), the first convergence of the lemma follows. For the second one, note that we have $\Theta'_\varepsilon(1/\varepsilon) \leq z'(1/\varepsilon)$ and, integrating (7.64) and using (7.65),

$$\begin{aligned} (z - \Theta_\varepsilon)'(1/\varepsilon) &\leq \int_t^{1/\sqrt{\varepsilon}} \left(\frac{2}{s^2} \left(\frac{2C\varepsilon}{\sqrt{t}} s^2 + \frac{2C\varepsilon t^{5/2}}{15s} \right) + \frac{C\varepsilon}{\sqrt{s}} \right) ds \\ &\leq \frac{4C\sqrt{\varepsilon}}{\sqrt{t}} + \frac{2C\varepsilon\sqrt{t}}{15} + 2C\varepsilon^{3/4}. \end{aligned}$$

Combining this with (7.63), it proves the second convergence. □

We can now conclude this subsection by proving Theorem 7.5.1.

Proof of Theorem 7.5.1. Let $\theta_1, \theta_2 > 0$. Then, with $\varepsilon = 1/t^2$ and Θ_ε the solution of (7.58), we have by Lemma 7.5.7

$$\begin{aligned} \mathbb{E}_{x_t} \left[e^{-\theta_1 t^{-2} N_t - \theta_2 t^{-2} M_t} \right] &= \phi_{\theta_1/t^2, \theta_2/t^2}(t, x_t) = \exp \left(-\Theta_\varepsilon(1/\sqrt{\varepsilon}) - \frac{x_t}{t} \frac{\Theta'_\varepsilon(1/\sqrt{\varepsilon})}{\sqrt{\varepsilon}} \right) \\ &\xrightarrow{t \rightarrow \infty} \frac{3c}{\sinh^2(\sqrt{3c})} \exp \left(-2x \left(\sqrt{3c} \coth(\sqrt{3c}) - 1 \right) \right), \end{aligned} \tag{7.66}$$

where $c = \gamma_1 \theta_1 + \gamma_2 \theta_2$. The right-hand side of (7.66), seen as a function of (θ_1, θ_2) , is the Laplace transform of $(\gamma_1 \eta, \gamma_2 \eta)$ by [Yor92, Equation (2.5)], hence it proves the result. □

Proof of Theorem 7.1.11. It follows immediately from Theorems 7.4.5 and 7.5.1. □

7.6 Some properties of Derrida–Retaux models

In this section, we prove some elementary results on general continuous-time Derrida–Retaux models, in other words, we do not assume the initial law to be a mixture of exponential laws. We end the chapter by some open questions.

In the continuous Derrida–Retaux model, the analogous to the free energy in the discrete case is the quantity

$$F_\infty(\mu_0) := \lim_{t \rightarrow \infty} e^{-t} \mathbb{E}[X_t] \in [0, \infty). \quad (7.67)$$

In this section, we prove that the above quantity always exists, and that $e^{-t}X_t$ converges in law, as $t \rightarrow \infty$, toward an exponential random variable with parameter $F_\infty(\mu_0)^{-1}$. We also give some necessary conditions for $F_\infty(\mu_0) = 0$, giving a partial characterization of the supercritical and subcritical laws. The proofs are based on simple coupling arguments, as well as the computation of $\mathbb{E}[f(X_t)]$ for various \mathcal{C}^1 function f , using the SDE representation of the process and the Itô formula.

Lemma 7.6.1. *The limit in (7.67) exists for any initial distribution μ_0 on \mathbb{R}_+ . More precisely, if $\mathbb{E}[X_0] = \infty$, then $\lim_{t \rightarrow \infty} e^{-t}X_t = \infty$ in law and, if $\mathbb{E}[X_0] < \infty$, then*

$$\forall t \geq 0, \quad F_\infty(\mu_0) = e^{-t} \mathbb{E}[X_t] - \int_t^\infty e^{-s} \mathbb{P}(X_s > 0) ds.$$

Proof. We first observe that for all $t \geq 0$, the random variable X_t stochastically dominates

$$S_t = \sum_{j=1}^{\#\mathcal{N}_t} X_0^j - L_t,$$

where $(X_0^j, j \geq 1)$ are i.i.d. copies of X_0 , and L_t is the total length at time t of the Yule tree. By classical results on continuous time branching processes (see Athreya and Ney [AN72, Section III.7]), there exists a random variable N_∞ such that $e^{-t} \#\mathcal{N}_t \rightarrow N_\infty > 0$ a.s. and it follows easily that

$$e^{-t}L_t = e^{-t} \int_0^t \#\mathcal{N}_s ds \xrightarrow[t \rightarrow \infty]{\text{a.s.}} N_\infty. \quad (7.68)$$

If $\mathbb{E}[X_0] = \infty$, then, by the law of large numbers, we get $\lim_{t \rightarrow \infty} e^{-t}S_t = \infty$ a.s. and therefore $F_\infty(\mu_0) = \infty$.

Reciprocally, we now assume that $\mathbb{E}[X_0] < \infty$, and we prove that $F_\infty(\mu_0)$ exists and is finite. Using the SDE representation of X_t , we have immediately that

$$\mathbb{E}[X_t] = \mathbb{E}[X_0] - \int_0^t \mathbb{P}(X_s > 0) ds + \int_0^t \mathbb{E}[X_s] ds.$$

Solving this differential equation, we obtain that

$$\mathbb{E}[X_t] = \mathbb{E}[X_0]e^t - e^t \int_0^t e^{-s} \mathbb{P}(X_s > 0) ds.$$

As $\mathbb{P}(X_s > 0) \in [0, 1]$, we deduce that $\mathbb{E}[e^{-t}X_t]$ converges as $t \rightarrow \infty$, and that

$$F_\infty(\mu_0) = \mathbb{E}[X_0] - \int_0^\infty e^{-s} \mathbb{P}(X_s > 0) ds.$$

Applying this formula with the starting law X_t , this concludes the proof of the lemma. \square

This lemma proves the existence of the free energy of the continuous-time Derrida–Retaux model, and that as soon as $\mathbb{E}[X_t] < \infty$, the free energy can be seen as a preserved quantity of the evolution. In the next lemma, we observe that if X_0 has moments of order n , then the n th moment of X_t converges toward the n th moment of an exponential random variable of parameter $F_\infty(\mu_0)^{-1}$.

Lemma 7.6.2. *If $\mathbb{E}[X_0^n] < \infty$ for some $n \in \mathbb{N}$, then $\mathbb{E}[X_t^n]e^{-nt}$ converges to $n!F_\infty(\mu_0)^n$ as $t \rightarrow \infty$.*

Proof. We prove this result by recurrence on n . By Lemma 7.6.1, we know that $\mathbb{E}[X_t]e^{-t} \rightarrow F_\infty(\mu_0)$ as long as $\mathbb{E}[X_0] < \infty$, hence the property is true for $n = 1$.

Let $n \geq 2$ and assume the lemma to be true for initial random variables in L^k for $k < n$. Let X_0 be a random variable in L^n , we note that $X_0 \in L^k$ for all $k < n$, hence by recurrence assumption, we have

$$\lim_{t \rightarrow \infty} \mathbb{E}[(e^{-t}X_t)^k] = k!F_\infty(\mu_0)^k. \tag{7.69}$$

Using the SDE representation of X , we now observe that we can write

$$\mathbb{E}[X_t^n] = \mathbb{E}[X_0^n] - n \int_0^t \mathbb{E}[X_s^{n-1}] ds + \int_0^t \mathbb{E}[(X_s + \tilde{X}_s)^n - X_s^n] ds,$$

with \tilde{X}_s an independent copy of X_s . We rewrite this equality as follows:

$$\mathbb{E}[X_t^n] = \mathbb{E}[X_0^n] + \int_0^t \mathbb{E}[X_s^n] ds + \int_0^t \left(-n\mathbb{E}[X_s^{n-1}] + \sum_{k=1}^{n-1} \binom{n}{k} \mathbb{E}[X_s^k] \mathbb{E}[X_s^{n-k}] \right) ds.$$

This first order differential equation can be solved as

$$\mathbb{E}[X_t^n] = \mathbb{E}[X_0^n]e^t + e^t \int_0^t e^{-s} \left(-n\mathbb{E}[X_s]^{n-1} + \sum_{k=1}^{n-1} \binom{n}{k} \mathbb{E}[X_s^k] \mathbb{E}[X_s^{n-k}] \right) ds, \tag{7.70}$$

which can be rewritten

$$\begin{aligned} \mathbb{E}[(X_t e^{-t})^n] &= \mathbb{E}[X_0^n]e^{-(n-1)t} - e^{-(n-1)t} \int_0^t e^{(n-2)s} n\mathbb{E}[(X_s e^{-s})^{n-1}] ds \\ &\quad + e^{-(n-1)t} \int_0^t e^{(n-1)s} \sum_{k=1}^{n-1} \binom{n}{k} \mathbb{E}[(X_s e^{-s})^k] \mathbb{E}[(X_s e^{-s})^{n-k}] ds. \end{aligned}$$

Therefore, using (7.69) and the L’Hospital rule, we obtain that $\mathbb{E}[(X_t e^{-t})^n]$ converges toward

$$\begin{aligned} \frac{1}{n-1} \sum_{k=1}^{n-1} \binom{n}{k} \lim_{t \rightarrow \infty} \mathbb{E}[(X_s e^{-s})^k] \mathbb{E}[(X_s e^{-s})^{n-k}] &= \frac{1}{n-1} \sum_{k=1}^{n-1} \binom{n}{k} F_\infty(\mu_0)^n k!(n-k)! \\ &= n!F_\infty(\mu_0)^n \end{aligned}$$

completing the proof. □

A direct consequence of this proof is the convergence, as $t \rightarrow \infty$, of the law of $e^{-t}X_t$, as soon as X_0 has some finite exponential moments. In fact, this convergence holds as soon as $F_\infty(\mu_0)$ is well-defined, which is equivalent to $\mathbb{E}[X_0] < \infty$ by Lemma 7.6.1.

Proposition 7.6.3. *Let $(X_t, t \geq 0)$ be a Derrida–Retaux model with $\mathbb{E}[X_0] < \infty$. Then $e^{-t}X_t$ converges in law toward an exponential random variable with parameter $F_\infty(\mu_0)^{-1}$.*

Proof. We first observe that by Lemma 7.6.1, $\sup_{t \geq 0} \mathbb{E}(e^{-t} X_t) < \infty$. Therefore the family $(e^{-t} X_t, t \geq 0)$ is tight. The only thing left to do is thus to identify the limit in distribution.

Remark that for all $t, T \geq 0$, the random variable X_{t+T} can be written as

$$e^{-(t+T)} X_{t+T} = e^{-T} \sum_{u \in \mathcal{N}_T} e^{-t} X_t^{(u)} - e^{-(t+T)} R_T,$$

where, conditionally on \mathcal{N}_T , $(X_t^{(u)}, u \in \mathcal{N}_T)$ are i.i.d. random variables with the same law as X_t , and R_T is a random variable which takes values between 0 and L_T the length of the Yule tree of height T . Recall from (7.68) that $\lim_{T \rightarrow \infty} e^{-T} L_T$ exists a.s., hence if t and T both tend to ∞ , then $e^{-(t+T)} R_T$ converges to 0 in probability.

We now write $(t_n, n \geq 1)$ a sequence along which (X_{t_n}) converges in law toward a random variable Y . Up to extraction, we can assume that $r_n := t_{n+1} - t_n \rightarrow \infty$. Therefore, we have that

$$Y = \lim_{n \rightarrow \infty} e^{-t_{n+1}} X_{t_{n+1}} = \lim_{n \rightarrow \infty} e^{-r_n} \sum_{u \in \mathcal{N}_{r_n}} e^{-t_n} X_{t_n}^{(u)}.$$

Thus, computing the characteristic function of Y for some $\xi \in \mathbb{R}$ and using that $\#\mathcal{N}_t$ is a geometric random variable with parameter e^{-t} , we have

$$\begin{aligned} \mathbb{E}[e^{i\xi Y}] &= \lim_{n \rightarrow \infty} \mathbb{E} \left[\prod_{u \in \mathcal{N}_{r_n}} e^{i\xi e^{-r_n - t_n} X_{t_n}^{(u)}} \right] \\ &= \lim_{n \rightarrow \infty} \frac{e^{-r_n} \mathbb{E}[e^{i\xi e^{-r_n - t_n} X_{t_n}}]}{1 - (1 - e^{-r_n}) \mathbb{E}[e^{i\xi e^{-r_n - t_n} X_{t_n}}]} \\ &= \lim_{n \rightarrow \infty} \frac{\mathbb{E}[e^{i\xi e^{-r_n - t_n} X_{t_n}}]}{\mathbb{E}(e^{i\xi e^{-r_n - t_n} X_{t_n}}) + e^{r_n} \mathbb{E}[1 - e^{i\xi e^{-r_n - t_n} X_{t_n}}]}. \end{aligned}$$

Using the fact that $\mathbb{E}(X_{t_n} e^{-t_n}) \rightarrow F_\infty(\mu_0)$ by Lemma 7.6.1, we have that

$$\mathbb{E}[e^{i\xi e^{-r_n - t_n} X_{t_n}}] = 1 + i\xi e^{-r_n} F_\infty(\mu_0) + o(e^{-r_n}) \quad \text{as } n \rightarrow \infty.$$

Therefore, this yields

$$\mathbb{E}[e^{i\xi Y}] = \frac{1}{1 - i\xi F_\infty(\mu_0)},$$

which is the characteristic function of the exponential distribution of parameter $F_\infty(\mu_0)^{-1}$, concluding the proof. \square

In the rest of the section, we now focus on the (sub)critical case $F_\infty(\mu_0) = 0$. Previous lemma shows that $\lim_{t \rightarrow \infty} X_t e^{-t} = 0$ in probability. However, an interesting problem is to obtain the precise asymptotic behavior of X_t in this (sub)critical case. It is known that for discrete Derrida–Retaux models with integer-valued measures, we have $\lim_{n \rightarrow \infty} X_n = 0$ in probability when the free energy $F_\infty = 0$. Therefore, this yields the following conjecture.

Conjecture 7.6.4. *If $F_\infty(\mu_0) = 0$, then $X_t \rightarrow 0$ in probability as $t \rightarrow \infty$.*

Assuming the above conjecture, one might be interested in the limiting law of X_t conditioned to be positive. In light of (7.21), if such a limit exists, its density should satisfy $\phi'(x) = -\phi(0)\phi(x), x > 0$. This implies the following conjecture:

Conjecture 7.6.5. *If $F_\infty(\mu_0) = 0$, then $\mathcal{L}(X_t | X_t > 0)$ converges to an exponential distribution of parameter larger than or equal to 1.*

We were not able to prove these conjectures, and more generally to obtain characterizations, in terms of the law of X_0 , of measures satisfying $F_\infty(\mu_0) = 0$ (as (7.3) in the discrete case with integer-valued measures). However, we obtained the following partial answer, which is notably similar to what is known in the general discrete Derrida–Retaux model.

Proposition 7.6.6. *Let $(X_t, t \geq 0)$ be a Derrida–Retaux process, with μ_0 the law of X_0 satisfying $F_\infty(\mu_0) = 0$. The following results hold:*

- (i) For any $t, x \geq 0$, $\mathbb{P}(X_t \geq x) \leq e^{1-x}$.
- (ii) For any $t \geq 0$, $\mathbb{E}[X_t^2] < \frac{1}{2}$ and, in particular, $\mathbb{E}[X_t] \leq \frac{1}{\sqrt{2}}$.
- (iii) For any $\theta \in (0, 1)$ and $t \geq 0$,

$$\mathbb{E}\left[\left(1 - \theta X_t - 2(1 - \theta)X_t^2\right)e^{\theta X_t}\right] \geq 0.$$

- (iv) We have $\sup_{t \geq 0} \mathbb{E}[X_t e^{X_t}] < \infty$ and, for any $t \geq 0$, $\mathbb{E}[X_t e^{X_t}] \leq \mathbb{E}[e^{X_t}]$.

Note that Point (iv) gives a characterization of the subcritical case similar to (7.3) for the discrete model, but here it does not depend only on moments of X_0 . The main reason for this is that the sign of $\mathbb{E}[X_n 2^{X_n}] - \mathbb{E}[2^{X_n}]$ is an invariant of the dynamics for the discrete model with integer valued measures, whereas it is not the case for $\mathbb{E}[X_t e^{X_t}] - \mathbb{E}[e^{X_t}]$ here.

Proof. We first observe that, if $F_\infty(\mu_0) = 0$, then $\mathbb{E}[X_t] \leq 1$ for any $t \geq 0$. Indeed, by Lemma 7.6.1, we have

$$\mathbb{E}[X_t] = \int_t^\infty e^{-(s-t)} \mathbb{P}(X_s > 0) ds \tag{7.71}$$

and it follows that $\mathbb{E}[X_t] \leq 1$.

Let $s, t \geq 0$, we consider the Yule tree representation of X_{t+s} . One has immediately that

$$X_{t+s} \geq \sum_{u \in \mathcal{N}_s} (X_t^{(u)} - s)_+ \geq \sum_{u \in \mathcal{N}_s} \mathbb{1}_{\{X_t^{(u)} > s+1\}},$$

where, conditionally on \mathcal{N}_s , $(X_t^{(u)}, u \in \mathcal{N}_s)$ are i.i.d. random variables with the same law as X_t . Hence, we have that $\mathbb{E}(X_{t+s}) \geq e^s \mathbb{P}(X_t > s + 1)$ and, since $\mathbb{E}(X_{t+s}) \leq 1$, this proves Point (i).

It follows from Point (i) that $\sup_{t \geq 0} \mathbb{E}[X_t^2] < \infty$. Then, using (7.70) with $n = 2$, we have

$$\mathbb{E}[X_t^2] = e^t \mathbb{E}[X_0^2] + e^t \int_0^t 2e^{-s} \mathbb{E}[X_s] (\mathbb{E}[X_s] - 1) ds,$$

and, letting $t \rightarrow \infty$,

$$\mathbb{E}[X_0^2] = 2 \int_0^\infty e^{-s} \mathbb{E}[X_s] (1 - \mathbb{E}[X_s]) ds \leq \frac{1}{2},$$

using that $\mathbb{E}[X_s] \in [0, 1]$ for any $s \geq 0$. Finally, $\mathbb{E}[X_t^2] \leq \frac{1}{2}$ holds for any $t \geq 0$, because $F_\infty(\mu_t) = e^t F_\infty(\mu_0) = 0$. This proves Point (ii).

Let $b \in \mathbb{R}$ be a constant whose value will be fixed later on. Consider the function

$$\phi(t) := \mathbb{E}\left[\left(1 - \theta X_t - bX_t^2\right)e^{\theta X_t}\right].$$

By Itô’s formula, we have that

$$\begin{aligned} \phi'(t) &= \mathbb{E}\left[\left((\theta^2 + 2b)X_t + \theta bX_t^2\right)e^{\theta X_t}\right] \\ &\quad + \mathbb{E}\left[\left(1 - \theta(X_t + Y_t) - b(X_t + Y_t)^2\right)e^{\theta(X_t + Y_t)}\right] - \mathbb{E}\left[\left(1 - \theta X_t - bX_t^2\right)e^{\theta X_t}\right], \end{aligned}$$

where Y_t is an independent copy of X_t . We introduce the functions

$$g(t) := \mathbb{E}[e^{\theta X_t}] \quad \text{and} \quad h(t) := \mathbb{E}[X_t e^{\theta X_t}],$$

we can rewrite

$$\phi' = (2g - \theta - 1)\phi + 2b(h - h^2) - (g^2 - \theta g).$$

Let $\eta := 2b(h - h^2) - (g^2 - \theta g)$, then, for any $0 \leq r \leq t$, the differential equation can be solved as

$$\phi(t) = e^{\int_r^t (2g(s) - \theta - 1) ds} \left(\phi(r) + \int_r^t \eta(s) e^{\int_r^s (2g(u) - \theta - 1) du} ds \right).$$

On the one hand, we have $g \geq 1$ and therefore $g^2 - \theta g \geq 1 - \theta$ and, on the other hand, $h - h^2 \leq 1/4$. Thus, choosing $b := 2(1 - \theta)$, we have $\eta \leq b/2 - 1 + \theta = 0$. If $\phi(r) < 0$ for some $r \geq 0$, then

$$\phi(t) \leq e^{\int_r^t (2g(s) - \theta - 1) ds} \phi(r) \xrightarrow[t \rightarrow \infty]{} -\infty,$$

which contradicts the fact that, by Point (i), $\sup_{t \geq 0} \mathbb{E}[e^{\lambda X_t}] < \infty$ for any $\lambda \in (\theta, 1)$. Therefore, $\phi(r) \geq 0$ for any $r \geq 0$ and this proves Point (iii).

Now we prove that necessarily $\mathbb{E}[X_0 e^{X_0}] < \infty$. Indeed, if $\mathbb{E}[X_0 e^{X_0}] = \infty$, then we have $\lim_{n \rightarrow \infty} \mathbb{E}[X_0 e^{X_0} \mathbb{1}_{\{2 \leq X_0 < n\}}] \rightarrow \infty$. Choose and fix an integer n such that

$$\mathbb{E}[X_0 e^{X_0} \mathbb{1}_{\{2 \leq X_0 < n\}}] > 2.$$

Write $Y_0 := X_0 \mathbb{1}_{\{2 \leq X_0 < n\}}$ and $(Y_t)_{t \geq 0}$ the solution of the SDE (7.16) starting from Y_0 . By coupling, a.s. $X_t \geq Y_t$ for all $t \geq 0$. Observe that

$$\mathbb{E}[(1 - Y_0)e^{Y_0}] = \mathbb{P}(Y_0 = 0) + \mathbb{E}[(1 - Y_0)e^{Y_0} \mathbb{1}_{\{Y_0 > 0\}}] \leq 1 - \frac{1}{2} \mathbb{E}[Y_0 e^{Y_0} \mathbb{1}_{\{Y_0 > 0\}}] < 0.$$

By continuity, for $\theta < 1$ sufficiently close to 1, we have $\mathbb{E}[(1 - \theta Y_0)e^{\theta Y_0}] < 0$, which, by Point (iii), proves that $\lim_{t \rightarrow \infty} e^{-t} \mathbb{E}[Y_t] > 0$. But we have $F_\infty(\mu_0) \geq \lim_{t \rightarrow \infty} e^{-t} \mathbb{E}[Y_t] > 0$, so it contradicts the assumption $F_\infty(\mu_0) = 0$. This proves that $\mathbb{E}[X_0 e^{X_0}] < \infty$.

The same argument shows that, for any $t > 0$, $\mathbb{E}[X_t e^{X_t}] < \infty$. Therefore, noting that $(1 - \theta)X_t^2 e^{\theta X_t} \leq X_t e^{X_t} \sup_{x \geq 0} x e^{-x}$, we can apply dominated convergence theorem as $\theta \rightarrow 1$ in Point (iii) and get $\mathbb{E}[(1 - X_t)e^{X_t}] \geq 0$ for any $t \geq 0$. This proves the second part of Point (iv) and can also be re-written as

$$\mathbb{E}[(1 - X_t)e^{X_t} \mathbb{1}_{\{X_t < 2\}}] \geq \mathbb{E}[(X_t - 1)e^{X_t} \mathbb{1}_{\{X_t \geq 2\}}].$$

Then, note that, on the one hand, $\mathbb{E}[(1 - X_t)e^{X_t} \mathbb{1}_{\{X_t < 2\}}] \leq e^2$ and, on the other hand, $\mathbb{E}[(X_t - 1)e^{X_t} \mathbb{1}_{\{X_t \geq 2\}}] \geq \frac{1}{2} \mathbb{E}[X_t e^{X_t} \mathbb{1}_{\{X_t \geq 2\}}]$. Hence $\mathbb{E}[X_t e^{X_t} \mathbb{1}_{\{X_t \geq 2\}}] \leq 2e^2$, which yields that $\mathbb{E}[X_t e^{X_t}] \leq 4e^2$ and proves the first part of Point (iv). \square

In addition to Conjectures 7.5.2 and 7.6.4, we list some open questions below. At first, Proposition 7.6.6 gives some necessary conditions on μ_0 so that the free energy vanishes. Naturally we may ask

Question 7.6.7. *What are necessary and sufficient condition on μ_0 so that $F_\infty(\mu_0) = 0$?*

It is predicted by physicists that the infinite order phase transition holds for a large classe of recursive model. This motivates our next question:

Question 7.6.8. *Replace the indicator function $\mathbb{1}_{x>0}$ in (7.8) by a monotone increasing bounded function f with $f(0) = 0$, such as $\tanh(x)$, $1 - e^{-x}$ or $x \wedge 1$. For regular f , there exists a unique strong solution of the McKean–Vlasov type SDE, see [Gra92]. Are the phase transitions for these models of same nature as for the Derrida–Retaux process?*

Concerning our exactly solvable model, a crucial point is the preservation of the mixture of exponential distributions and Dirac masses at 0. This was proved by using the explicit solution of (7.9). However, there is no direct probabilistic proof of this result, yielding the following question.

Question 7.6.9. *Is there any probabilistic proof that the family of mixtures of exponentials and Dirac masses at 0 is stable under the dynamics of the continuous-time Derrida–Retaux model?*

Bibliography

- [AB05] David J. Aldous and Antar Bandyopadhyay. A survey of max-type recursive distributional equations. *Ann. Appl. Probab.*, 15(2):1047–1110, 2005.
- [ABB17] Louis-Pierre Arguin, David Belius, and Paul Bourgade. Maximum of the characteristic polynomial of random unitary matrices. *Comm. Math. Phys.*, 349(2):703–751, 2017.
- [ABB⁺19] Louis-Pierre Arguin, David Belius, Paul Bourgade, Maksym Radziwiłł, and Kannan Soundararajan. Maximum of the Riemann Zeta Function on a Short Interval of the Critical Line. *Comm. Pure Appl. Math.*, 72(3):500–535, 2019.
- [ABBS13] E. Aïdékon, J. Berestycki, É. Brunet, and Z. Shi. Branching Brownian motion seen from its tip. *Probab. Theory Related Fields*, 157(1):405–451, 2013.
- [Abe17] Yoshihiro Abe. Second order term of cover time for planar simple random walk. *arXiv:1709.08151*, 2017.
- [ABH17] Louis-Pierre Arguin, David Belius, and Adam J. Harper. Maxima of a randomized Riemann zeta function, and branching random walks. *Ann. Appl. Probab.*, 27(1):178–215, 2017.
- [ABK11] L.-P. Arguin, A. Bovier, and N. Kistler. Genealogy of extremal particles of branching Brownian motion. *Comm. Pure Appl. Math.*, 64(12):1647–1676, 2011.
- [ABK13] Louis-Pierre Arguin, Anton Bovier, and Nicola Kistler. The extremal process of branching Brownian motion. *Probab. Theory Related Fields*, 157(3-4):535–574, 2013.
- [AC16] Antonio Auffinger and Wei-Kuo Chen. Universality of chaos and ultrametricity in mixed p -spin models. *Comm. Pure Appl. Math.*, 69(11):2107–2130, 2016.
- [Aco14] Javier Acosta. Tightness of the recentered maximum of log-correlated Gaussian fields. *Electron. J. Probab.*, 19:no. 90, 25, 2014.
- [Aïd13] Elie Aïdékon. Convergence in law of the minimum of a branching random walk. *Ann. Probab.*, 41(3A):1362–1426, 2013.
- [AJ11] Elie Aïdékon and Bruno Jaffuel. Survival of branching random walks with absorption. *Stochastic Process. Appl.*, 121(9):1901–1937, 2011.
- [AK78] Søren Asmussen and Niels Keiding. Martingale central limit theorems and asymptotic estimation theory for multitype branching processes. *Advances in Appl. Probability*, 10(1):109–129, 1978.

- [AKQ14] Tom Alberts, Konstantin Khanin, and Jeremy Quastel. The intermediate disorder regime for directed polymers in dimension $1 + 1$. *Ann. Probab.*, 42(3):1212–1256, 2014.
- [Ale08] Kenneth S. Alexander. The effect of disorder on polymer depinning transitions. *Comm. Math. Phys.*, 279(1):117–146, 2008.
- [ALR87] M. Aizenman, J. L. Lebowitz, and D. Ruelle. Some rigorous results on the Sherrington-Kirkpatrick spin glass model. *Comm. Math. Phys.*, 112(1):3–20, 1987.
- [AN72] Krishna B. Athreya and Peter E. Ney. *Branching Processes*. Springer-Verlag, New York-Heidelberg, 1972.
- [AO13] Tom Alberts and Marcel Ortgiese. The near-critical scaling window for directed polymers on disordered trees. *Electron. J. Probab.*, 18:no. 19, 24, 2013.
- [APS17] Juhan Aru, Ellen Powell, and Avelio Sepúlveda. Liouville measure as a multiplicative cascade via level sets of the Gaussian free field. *arXiv:1701.05872*, 2017.
- [APS18] Juhan Aru, Ellen Powell, and Avelio Sepúlveda. Critical Liouville measure as a limit of subcritical measures. *arXiv:1802.08433*, 2018.
- [AR09] Louigi Addario-Berry and Bruce Reed. Minima in branching random walks. *Ann. Probab.*, 37(3):1044–1079, 2009.
- [ARV13] Romain Allez, Rémi Rhodes, and Vincent Vargas. Lognormal \star -scale invariant random measures. *Probab. Theory Related Fields*, 155(3-4):751–788, 2013.
- [AS64] Milton Abramowitz and Irene A. Stegun. *Handbook of Mathematical Functions with Formulas, Graphs, and Mathematical Tables*, volume 55 of *National Bureau of Standards Applied Mathematics Series*. For sale by the Superintendent of Documents, U.S. Government Printing Office, Washington, D.C., 1964.
- [AS14] Elie Aïdékon and Zhan Shi. The Seneta-Heyde scaling for the branching random walk. *Ann. Probab.*, 42(3):959–993, 2014.
- [AT17] Louis-Pierre Arguin and Warren Tai. Is the Riemann zeta function in a short interval a 1-RSB spin glass? *arXiv:1706.08462*, 2017.
- [Ath68] Krishna Balasundaram Athreya. Some results on multitype continuous time Markov branching processes. *Ann. Math. Statist.*, 39:347–357, 1968.
- [AZ14] Louis-Pierre Arguin and Olivier Zindy. Poisson-Dirichlet statistics for the extremes of a log-correlated Gaussian field. *Ann. Appl. Probab.*, 24(4):1446–1481, 2014.
- [AZ15] Louis-Pierre Arguin and Olivier Zindy. Poisson-Dirichlet statistics for the extremes of the two-dimensional discrete Gaussian free field. *Electron. J. Probab.*, 20:no. 59, 19, 2015.
- [Bac00] Markus Bachmann. Limit theorems for the minimal position in a branching random walk with independent logconcave displacements. *Adv. in Appl. Probab.*, 32(1):159–176, 2000.
- [BASZ18] Gérard Ben Arous, Eliran Subag, and Ofer Zeitouni. Geometry and temperature chaos in mixed spherical spin glasses at low temperature - the perturbative regime. *arXiv:1804.10573*, 2018.
- [BBD18] Julien Berestycki, Éric Brunet, and Bernard Derrida. A new approach to computing the asymptotics of the position of Fisher-KPP fronts. *Europhys. Lett. EPL*, 122(1):10001, 2018.

- [BBHM17] Julien Berestycki, Éric Brunet, Simon C. Harris, and Piotr Miłoś. Branching Brownian motion with absorption and the all-time minimum of branching Brownian motion with drift. *J. Funct. Anal.*, 273(6):2107–2143, 2017.
- [BBHR17] Julien Berestycki, Éric Brunet, Simon C. Harris, and Matt Roberts. Vanishing corrections for the position in a linear model of FKPP fronts. *Comm. Math. Phys.*, 349(3):857–893, 2017.
- [BBS11] Julien Berestycki, Nathanaël Berestycki, and Jason Schweinsberg. Survival of near-critical branching Brownian motion. *J. Stat. Phys.*, 143(5):833–854, 2011.
- [BBS13] Julien Berestycki, Nathanaël Berestycki, and Jason Schweinsberg. The genealogy of branching Brownian motion with absorption. *Ann. Probab.*, 41(2):527–618, 2013.
- [BBS14] Julien Berestycki, Nathanaël Berestycki, and Jason Schweinsberg. Critical branching Brownian motion with absorption: Survival probability. *Probab. Theory Related Fields*, 160(3-4):489–520, 2014.
- [BD97] Eric Brunet and Bernard Derrida. Shift in the velocity of a front due to a cutoff. *Phys. Rev. E (3)*, 56(3, part A):2597–2604, 1997.
- [BD99] Eric Brunet and Bernard Derrida. Microscopic models of traveling wave equations. *Comput. Phys. Commun.*, 121–122:376–381, 1999.
- [BD01] Éric Brunet and Bernard Derrida. Effect of microscopic noise on front propagation. *J. Statist. Phys.*, 103(1-2):269–282, 2001.
- [BDG01] Erwin Bolthausen, Jean-Dominique Deuschel, and Giambattista Giacomin. Entropic repulsion and the maximum of the two-dimensional harmonic crystal. *Ann. Probab.*, 29(4):1670–1692, 2001.
- [BDMM06a] E. Brunet, B. Derrida, A. H. Mueller, and S. Munier. Noisy traveling waves: Effect of selection on genealogies. *Europhys. Lett.*, 76(1):1–7, 2006.
- [BDMM06b] E. Brunet, B. Derrida, A. H. Mueller, and S. Munier. Phenomenological theory giving the full statistics of the position of fluctuating pulled fronts. *Phys. Rev. E*, 73(5):056126, 2006.
- [BDMM07] É. Brunet, B. Derrida, A. H. Mueller, and S. Munier. Effect of selection on ancestry: An exactly soluble case and its phenomenological generalization. *Phys. Rev. E (3)*, 76(4):041104, 20, 2007.
- [BDZ11] Erwin Bolthausen, Jean Dominique Deuschel, and Ofer Zeitouni. Recursions and tightness for the maximum of the discrete, two dimensional Gaussian free field. *Electron. Commun. Probab.*, 16:114–119, 2011.
- [BDZ16] Maury Bramson, Jian Ding, and Ofer Zeitouni. Convergence in law of the maximum of the two-dimensional discrete Gaussian free field. *Comm. Pure Appl. Math.*, 69(1):62–123, 2016.
- [Ber17a] Nathanaël Berestycki. An elementary approach to Gaussian multiplicative chaos. *Electron. Commun. Probab.*, 22:Paper No. 27, 12, 2017.
- [Ber17b] Jean Bertoin. Markovian growth-fragmentation processes. *Bernoulli*, 23(2):1082–1101, 2017.
- [BEV10] N. H. Barton, A. M. Etheridge, and A. Véber. A new model for evolution in a spatial continuum. *Electron. J. Probab.*, 15:no. 7, 162–216, 2010.
- [BG10] Jean Bérard and Jean-Baptiste Gouéré. Brunet-Derrida behavior of branching-selection particle systems on the line. *Comm. Math. Phys.*, 298(2):323–342, 2010.

- [BH48] Richard Bellman and Theodore E. Harris. On the theory of age-dependent stochastic branching processes. *Proc. Nat. Acad. Sci. U. S. A.*, 34:601–604, 1948.
- [BH17] Anton Bovier and Lisa Hartung. Extended convergence of the extremal process of branching Brownian motion. *Ann. Appl. Probab.*, 27(3):1756–1777, 2017.
- [Bie45] Irénée-Jules Bienaymé. De la loi de multiplication et de la durée des familles. *Soc. Philomat. Paris Extraits*, 5:37–39, 1845.
- [Big76] J. D. Biggins. The first- and last-birth problems for a multitype age-dependent branching process. *Advances in Appl. Probability*, 8(3):446–459, 1976.
- [Big77] J. D. Biggins. Martingale convergence in the branching random walk. *J. Appl. Probability*, 14(1):25–37, 1977.
- [Big79] J. D. Biggins. Growth rates in the branching random walk. *Z. Wahrsch. Verw. Gebiete*, 48(1):17–34, 1979.
- [Big91] J. D. Biggins. Uniform convergence of martingales in the one-dimensional branching random walk. In *Selected Proceedings of the Sheffield Symposium on Applied Probability (Sheffield, 1989)*, volume 18 of *IMS Lecture Notes Monogr. Ser.*, pages 159–173. Inst. Math. Statist., Hayward, CA, 1991.
- [Big92] J. D. Biggins. Uniform Convergence of Martingales in the Branching Random Walk. *Ann. Probab.*, 20(1):137–151, 1992.
- [Bil99] Patrick Billingsley. *Convergence of Probability Measures*. Wiley Series in Probability and Statistics: Probability and Statistics. John Wiley & Sons, Inc., New York, second edition, 1999.
- [Bis17] Marek Biskup. Extrema of the two-dimensional Discrete Gaussian Free Field. *arXiv:1712.09972*, 2017.
- [BJM10] Julien Barral, Xiong Jin, and Benoît Mandelbrot. Convergence of complex multiplicative cascades. *Ann. Appl. Probab.*, 20(4):1219–1252, 2010.
- [BJRV13] Julien Barral, Xiong Jin, Rémi Rhodes, and Vincent Vargas. Gaussian multiplicative chaos and KPZ duality. *Comm. Math. Phys.*, 323(2):451–485, 2013.
- [BK97] J. D. Biggins and A. E. Kyprianou. Seneta-Heyde norming in the branching random walk. *Ann. Probab.*, 25(1):337–360, 1997.
- [BK04a] J. D. Biggins and A. E. Kyprianou. Measure change in multitype branching. *Adv. in Appl. Probab.*, 36(2):544–581, 2004.
- [BK04b] Anton Bovier and Irina Kurkova. Derrida’s generalized random energy models. II. Models with continuous hierarchies. *Ann. Inst. H. Poincaré Probab. Statist.*, 40(4):481–495, 2004.
- [BK05] J. D. Biggins and A. E. Kyprianou. Fixed points of the smoothing transform: The boundary case. *Electron. J. Probab.*, 10:no. 17, 609–631, 2005.
- [BK08] Anton Bovier and Anton Klimovsky. Fluctuations of the partition function in the generalized random energy model with external field. *J. Math. Phys.*, 49(12):125202, 27, 2008.
- [BK17] David Belius and Nicola Kistler. The subleading order of two dimensional cover times. *Probab. Theory Related Fields*, 167(1-2):461–552, 2017.
- [BKL02] Anton Bovier, Irina Kurkova, and Matthias Löwe. Fluctuations of the free energy in the REM and the p -spin SK models. *Ann. Probab.*, 30(2):605–651, 2002.

- [BL14] Marek Biskup and Oren Louidor. Conformal symmetries in the extremal process of two-dimensional discrete Gaussian Free Field. *arXiv:1410.4676*, 2014.
- [BL16a] Jinho Baik and Ji Oon Lee. Fluctuations of the free energy of the spherical Sherrington-Kirkpatrick model. *J. Stat. Phys.*, 165(2):185–224, 2016.
- [BL16b] Marek Biskup and Oren Louidor. Extreme local extrema of two-dimensional discrete Gaussian free field. *Comm. Math. Phys.*, 345(1):271–304, 2016.
- [BL16c] Marek Biskup and Oren Louidor. On intermediate level sets of two-dimensional discrete Gaussian Free Field. *to appear in Ann. Inst. Henri Poincaré Probab. Stat.*, 2016.
- [BL17] Jinho Baik and Ji Oon Lee. Fluctuations of the free energy of the spherical Sherrington-Kirkpatrick model with ferromagnetic interaction. *Ann. Henri Poincaré*, 18(6):1867–1917, 2017.
- [BL18a] Quentin Berger and Hubert Lacoin. Pinning on a defect line: Characterization of marginal disorder relevance and sharp asymptotics for the critical point shift. *J. Inst. Math. Jussieu*, 17(2):305–346, 2018.
- [BL18b] Marek Biskup and Oren Louidor. Full extremal process, cluster law and freezing for the two-dimensional discrete Gaussian free field. *Adv. Math.*, 330:589–687, 2018.
- [BM87] A. J. Bray and M. A. Moore. Chaotic Nature of the Spin-Glass Phase. *Phys. Rev. Lett.*, 58(1):57–60, 1987.
- [BM04] Julien Barral and Benoît B. Mandelbrot. Introduction to infinite products of independent random functions (Random multiplicative multifractal measures. I). In *Fractal Geometry and Applications: A Jubilee of Benoît Mandelbrot, Part 2*, volume 72 of *Proc. Sympos. Pure Math.*, pages 3–16. Amer. Math. Soc., Providence, RI, 2004.
- [BM14] Jean Bérard and Pascal Maillard. The limiting process of N -particle branching random walk with polynomial tails. *Electron. J. Probab.*, 19:no. 22, 17, 2014.
- [BM19] Pierre Boutaud and Pascal Maillard. A simple proof of the Seneta-Heyde norming for branching random walks under optimal assumptions. *arXiv:1902.05330*, 2019.
- [Bol76] Erwin Bolthausen. On a functional central limit theorem for random walks conditioned to stay positive. *Ann. Probability*, 4(3):480–485, 1976.
- [Bol89] Erwin Bolthausen. A note on the diffusion of directed polymers in a random environment. *Comm. Math. Phys.*, 123(4):529–534, 1989.
- [Bou10] P. Bourgade. Mesoscopic fluctuations of the zeta zeros. *Probab. Theory Related Fields*, 148(3-4):479–500, 2010.
- [Bov17] Anton Bovier. *Gaussian Processes on Trees*, volume 163 of *Cambridge Studies in Advanced Mathematics*. Cambridge University Press, Cambridge, 2017.
- [BPPV84] Roberto Benzi, Giovanni Paladin, Giorgio Parisi, and Angelo Vulpiani. On the multifractal nature of fully developed turbulence and chaotic systems. *J. Phys. A: Math. Gen.*, 17:3521–3531, 1984.
- [BPR06] Patrizia Berti, Luca Pratelli, and Pietro Rigo. Almost sure weak convergence of random probability measures. *Stochastics*, 78(2):91–97, 2006.
- [Bra78] Maury D. Bramson. Maximal displacement of branching Brownian motion. *Comm. Pure Appl. Math.*, 31(5):531–581, 1978.
- [Bra83] Maury Bramson. Convergence of solutions of the Kolmogorov equation to travelling waves. *Mem. Amer. Math. Soc.*, 44(285):iv+190, 1983.

- [BRV12] Julien Barral, Rémi Rhodes, and Vincent Vargas. Limiting laws of supercritical branching random walks. *C. R. Math. Acad. Sci. Paris*, 350(9-10):535–538, 2012.
- [BRZ17] David Belius, Jay Rosen, and Ofer Zeitouni. Tightness for the Cover Time of the two dimensional sphere. *arXiv:1711.02845*, 2017.
- [BS98] E. Bolthausen and A.-S. Sznitman. On Ruelle’s probability cascades and an abstract cavity method. *Comm. Math. Phys.*, 197(2):247–276, 1998.
- [BS02] Andrei N. Borodin and Paavo Salminen. *Handbook of Brownian Motion—Facts and Formulae*. Probability and Its Applications. Birkhäuser Verlag, Basel, second edition, 2002.
- [Bur09] Dariusz Buraczewski. On tails of fixed points of the smoothing transform in the boundary case. *Stochastic Process. Appl.*, 119(11):3955–3961, 2009.
- [BW18] Jean Bertoin and Alexander R. Watson. A probabilistic approach to spectral analysis of growth-fragmentation equations. *J. Funct. Anal.*, 274(8):2163–2204, 2018.
- [BWW18] Nathanaël Berestycki, Christian Webb, and Mo Dick Wong. Random Hermitian matrices and Gaussian multiplicative chaos. *Probab. Theory Related Fields*, 172(1-2):103–189, 2018.
- [BZ12] Maury Bramson and Ofer Zeitouni. Tightness of the recentered maximum of the two-dimensional discrete Gaussian free field. *Comm. Pure Appl. Math.*, 65(1):1–20, 2012.
- [CC08] Francesco Caravenna and Loïc Chaumont. Invariance principles for random walks conditioned to stay positive. *Ann. Inst. Henri Poincaré Probab. Stat.*, 44(1):170–190, 2008.
- [CC13] Francesco Caravenna and Loïc Chaumont. An invariance principle for random walk bridges conditioned to stay positive. *Electron. J. Probab.*, 18:no. 60, 32, 2013.
- [CCM17] Linxiao Chen, Nicolas Curien, and Pascal Maillard. The perimeter cascade in critical Boltzmann quadrangulations decorated by an $O(n)$ loop model. *arXiv:1702.06916*, 2017.
- [CD90] J. Cook and B. Derrida. Directed polymers in a random medium: $1/d$ expansion and the n -tree approximation. *J. Phys. A*, 23(9):1523–1554, 1990.
- [CDD⁺19] Xinxing Chen, Victor Dagar, Bernard Derrida, Yueyun Hu, Mikhail Lifshits, and Zhan Shi. The Derrida–Retaux conjecture for recursive models. *in preparation*, 2019.
- [CDH⁺17] Xinxing Chen, Bernard Derrida, Yueyun Hu, Mikhail Lifshits, and Zhan Shi. A hierarchical renormalization model: Some properties and open questions. *arXiv:1705.04787*, 2017.
- [CEGM84] P. Collet, J.-P. Eckmann, V. Glaser, and A. Martin. Study of the iterations of a mapping associated to a spin glass model. *Comm. Math. Phys.*, 94(3):353–370, 1984.
- [CGRV17] Laurent Chevillard, Christophe Garban, Rémi Rhodes, and Vincent Vargas. On a skewed and multifractal uni-dimensional random field, as a probabilistic representation of Kolmogorov’s views on turbulence. *arXiv:1712.00332*, 2017.
- [CH19] Nicolas Curien and Olivier Hénard. Critical parking on a random tree. *in preparation*, 2019.

- [Cha91] Brigitte Chauvin. Product martingales and stopping lines for branching Brownian motion. *Ann. Probab.*, 19(3):1195–1205, 1991.
- [Che14] Wei-Kuo Chen. Chaos in the mixed even-spin models. *Comm. Math. Phys.*, 328(3):867–901, 2014.
- [Che15a] X. Chen. Scaling limit of the path leading to the leftmost particle in a branching random walk. *Theory Probab. Appl.*, 59(4):567–589, 2015.
- [Che15b] Xinxin Chen. A necessary and sufficient condition for the nontrivial limit of the derivative martingale in a branching random walk. *Adv. in Appl. Probab.*, 47(3):741–760, 2015.
- [CHT⁺95] Alan Champneys, Simon Harris, John Toland, Jonathan Warren, and David Williams. Algebra, analysis and probability for a coupled system of reaction-diffusion equations. *Philos. Trans. Roy. Soc. London Ser. A*, 350(1692):69–112, 1995.
- [CKMR05] B. Chauvin, T. Klein, J.-F. Marckert, and A. Rouault. Martingales and profile of binary search trees. *Electron. J. Probab.*, 10:no. 12, 420–435, 2005.
- [CL17] Francis Comets and Quansheng Liu. Rate of convergence for polymers in a weak disorder. *J. Math. Anal. Appl.*, 455(1):312–335, 2017.
- [CLD01] David Carpentier and Pierre Le Doussal. Glass transition of a particle in a random potential, front selection in nonlinear renormalization group, and entropic phenomena in Liouville and sinh-Gordon models. *Phys. Rev. E*, 63(2):026110, 2001.
- [CM68] Kenny S. Crump and Charles J. Mode. A general age-dependent branching process. I. *J. Math. Anal. Appl.*, 24:494–508, 1968.
- [CM89] Juan Antonio Cuesta and Carlos Matrán. Notes on the Wasserstein metric in Hilbert spaces. *Ann. Probab.*, 17(3):1264–1276, 1989.
- [CM17] Aser Cortines and Bastien Mallein. A N -branching random walk with random selection. *ALEA Lat. Am. J. Probab. Math. Stat.*, 14(1):117–137, 2017.
- [CM18] Aser Cortines and Bastien Mallein. The genealogy of an exactly solvable Ornstein-Uhlenbeck type branching process with selection. *Electron. Commun. Probab.*, 23:Paper No. 98, 13, 2018.
- [CMM19] Xinxin Chen, Thomas Madaule, and Bastien Mallein. On the trajectory of an individual chosen according to supercritical Gibbs measure in the branching random walk. *to appear in Stochastic Process. Appl.*, 2019.
- [CMN18] Reda Chhaibi, Thomas Madaule, and Joseph Najnudel. On the maximum of the $c\beta e$ field. *Duke Math. J.*, 167(12):2243–2345, 2018.
- [CN19] Clément Cosco and Shuta Nakajima. Gaussian fluctuations for the directed polymer partition function for $d \geq 3$ and in the whole L^2 -region. *arXiv:1903.00997*, 2019.
- [Com17] Francis Comets. *Directed Polymers in Random Environments*, volume 2175 of *Lecture Notes in Mathematics*. Springer, Cham, 2017.
- [Cor16] Aser Cortines. The genealogy of a solvable population model under selection with dynamics related to directed polymers. *Bernoulli*, 22(4):2209–2236, 2016.
- [CP13] Wei-Kuo Chen and Dmitry Panchenko. An approach to chaos in some mixed p -spin models. *Probab. Theory Related Fields*, 157(1-2):389–404, 2013.
- [CP17] Wei-Kuo Chen and Dmitry Panchenko. Temperature chaos in some spherical mixed p -spin models. *J. Stat. Phys.*, 166(5):1151–1162, 2017.

- [CR88] Brigitte Chauvin and Alain Rouault. KPP equation and supercritical branching Brownian motion in the subcritical speed area. Application to spatial trees. *Probab. Theory Related Fields*, 80(2):299–314, 1988.
- [CRV10] L. Chevillard, R. Robert, and V. Vargas. A stochastic representation of the local structure of turbulence. *Europhys. Lett. EPL*, 89(5):54002, 2010.
- [CSZ17a] Francesco Caravenna, Rongfeng Sun, and Nikos Zygouras. Polynomial chaos and scaling limits of disordered systems. *J. Eur. Math. Soc. (JEMS)*, 19(1):1–65, 2017.
- [CSZ17b] Francesco Caravenna, Rongfeng Sun, and Nikos Zygouras. Universality in marginally relevant disordered systems. *Ann. Appl. Probab.*, 27(5):3050–3112, 2017.
- [CY06] Francis Comets and Nobuo Yoshida. Directed polymers in random environment are diffusive at weak disorder. *Ann. Probab.*, 34(5):1746–1770, 2006.
- [Dav06] Olivier Daviaud. Extremes of the discrete two-dimensional Gaussian free field. *Ann. Probab.*, 34(3):962–986, 2006.
- [Daw75] D. A. Dawson. Stochastic evolution equations and related measure processes. *J. Multivariate Anal.*, 5:1–52, 1975.
- [Der80] B. Derrida. Random-energy model: Limit of a family of disordered models. *Phys. Rev. Lett.*, 45(2):79–82, 1980.
- [Der81] Bernard Derrida. Random-energy model: An exactly solvable model of disordered systems. *Phys. Rev. B*, 24(5):2613–2626, 1981.
- [Der85] B. Derrida. A generalization of the Random Energy Model which includes correlations between energies. *J. Physique Lett.*, 46(9):401–407, 1985.
- [DES93] B. Derrida, M. R. Evans, and E. R. Speer. Mean field theory of directed polymers with random complex weights. *Comm. Math. Phys.*, 156(2):221–244, 1993.
- [Dev86] Luc Devroye. A note on the height of binary search trees. *J. Assoc. Comput. Mach.*, 33(3):489–498, 1986.
- [DG86a] B. Derrida and E. Gardner. Magnetic properties and the function $q(x)$ of the generalised random-energy model. *J. Phys. C: Solid State Phys.*, 19(29):5783–5798, 1986.
- [DG86b] B. Derrida and E. Gardner. Solution of the generalised random energy model. *J. Phys. C: Solid State Phys.*, 19(13):2253–2274, 1986.
- [DGLT09] Bernard Derrida, Giambattista Giacomin, Hubert Lacoïn, and Fabio Lucio Toninelli. Fractional moment bounds and disorder relevance for pinning models. *Comm. Math. Phys.*, 287(3):867–887, 2009.
- [DHV92] B. Derrida, V. Hakim, and J. Vannimenus. Effect of disorder on two-dimensional wetting. *J. Statist. Phys.*, 66(5-6):1189–1213, 1992.
- [DKN15] Freddy Delbaen, Emmanuel Kowalski, and Ashkan Nikeghbali. Mod- φ convergence. *Int. Math. Res. Not. IMRN*, (11):3445–3485, 2015.
- [DKRV16] François David, Antti Kupiainen, Rémi Rhodes, and Vincent Vargas. Liouville quantum gravity on the Riemann sphere. *Comm. Math. Phys.*, 342(3):869–907, 2016.
- [DL83] Richard Durrett and Thomas M. Liggett. Fixed points of the smoothing transformation. *Z. Wahrsch. Verw. Gebiete*, 64(3):275–301, 1983.
- [DMFPS17] Anna De Masi, Pablo A. Ferrari, Errico Presutti, and Nahuel Soprano-Loto. Hydrodynamics of the N -BBM process. *arXiv:1707.00799*, 2017.

- [Don85] R. A. Doney. Conditional limit theorems for asymptotically stable random walks. *Z. Wahrsch. Verw. Gebiete*, 70(3):351–360, 1985.
- [Don12] R. A. Doney. Local behaviour of first passage probabilities. *Probab. Theory Related Fields*, 152(3-4):559–588, 2012.
- [DPK07] Freddy Dumortier, Nikola Popović, and Tasso J. Kaper. The critical wave speed for the Fisher-Kolmogorov-Petrovskii-Piscounov equation with cut-off. *Nonlinearity*, 20(4):855–877, 2007.
- [DPRZ04] Amir Dembo, Yuval Peres, Jay Rosen, and Ofer Zeitouni. Cover times for Brownian motion and random walks in two dimensions. *Ann. of Math. (2)*, 160(2):433–464, 2004.
- [DR11] Rick Durrett and Daniel Remenik. Brunet–Derrida particle systems, free boundary problems and Wiener–Hopf equations. *Ann. Probab.*, 39(6):2043–2078, 2011.
- [DR14] Bernard Derrida and Martin Retaux. The Depinning Transition in Presence of Disorder: A Toy Model. *J. Stat. Phys.*, 156(2):268–290, 2014.
- [DRSV14a] Bertrand Duplantier, Rémi Rhodes, Scott Sheffield, and Vincent Vargas. Critical Gaussian multiplicative chaos: Convergence of the derivative martingale. *Ann. Probab.*, 42(5):1769–1808, 2014.
- [DRSV14b] Bertrand Duplantier, Rémi Rhodes, Scott Sheffield, and Vincent Vargas. Renormalization of Critical Gaussian Multiplicative Chaos and KPZ Relation. *Comm. Math. Phys.*, 330(1):283–330, 2014.
- [DRV16] François David, Rémi Rhodes, and Vincent Vargas. Liouville quantum gravity on complex tori. *J. Math. Phys.*, 57(2):022302, 25, 2016.
- [DRZ17] Jian Ding, Rishideep Roy, and Ofer Zeitouni. Convergence of the centered maximum of log-correlated Gaussian fields. *Ann. Probab.*, 45(6A):3886–3928, 2017.
- [DS88] B. Derrida and H. Spohn. Polymers on disordered trees, spin glasses, and traveling waves. *J. Statist. Phys.*, 51(5):817–840, 1988.
- [DS16] Bernard Derrida and Zhan Shi. Large deviations for the branching Brownian motion in presence of selection or coalescence. *J. Stat. Phys.*, 163(6):1285–1311, 2016.
- [DZ14] Jian Ding and Ofer Zeitouni. Extreme values for two-dimensional discrete Gaussian free field. *Ann. Probab.*, 42(4):1480–1515, 2014.
- [EFPS17] Alison Etheridge, Nic Freeman, Sarah Penington, and Daniel Straulino. Branching Brownian motion and selection in the spatial Λ -Fleming-Viot process. *Ann. Appl. Probab.*, 27(5):2605–2645, 2017.
- [EM14] Maren Eckhoff and Peter Mörters. Vulnerability of robust preferential attachment networks. *Electron. J. Probab.*, 19:no. 57, 47, 2014.
- [EMO18] Maren Eckhoff, Peter Mörters, and Marcel Ortgiese. Near critical preferential attachment networks have small giant components. *J. Stat. Phys.*, 173(3-4):663–703, 2018.
- [Ev00] Ute Ebert and Wim van Saarloos. Front propagation into unstable states: Universal algebraic convergence towards uniformly translating pulled fronts. *Phys. D*, 146(1-4):1–99, 2000.
- [FB08a] Yan V. Fyodorov and Jean-Philippe Bouchaud. Freezing and extreme-value statistics in a random energy model with logarithmically correlated potential. *J. Phys. A: Math. Gen.*, 41(37):372001, 12, 2008.

- [FB08b] Yan V. Fyodorov and Jean-Philippe Bouchaud. Statistical mechanics of a single particle in a multiscale random potential: Parisi landscapes in finite-dimensional Euclidean spaces. *J. Phys. A: Math. Gen.*, 41(32):324009, 25, 2008.
- [Fel71] William Feller. *An Introduction to Probability Theory and Its Applications. Vol. II*. Second Edition. John Wiley & Sons, Inc., New York-London-Sydney, 1971.
- [FH86] Daniel S. Fisher and David A. Huse. Ordered Phase of Short-Range Ising Spin-Glasses. *Phys. Rev. Lett.*, 56(15):1601–1604, 1986.
- [FHK12] Yan V. Fyodorov, Ghaith A. Hiary, and Jonathan P. Keating. Freezing Transition, Characteristic Polynomials of Random Matrices, and the Riemann Zeta Function. *Phys. Rev. Lett.*, 108(17):170601, 2012.
- [Fis37] R. A. Fisher. The wave of advance of advantageous genes. *Ann. Eugenics*, 7(4):355–369, 1937.
- [Fis84] Michael E. Fisher. Walks, walls, wetting, and melting. *J. Statist. Phys.*, 34(5-6):667–729, 1984.
- [FK14] Yan V. Fyodorov and Jonathan P. Keating. Freezing transitions and extreme values: Random matrix theory, $\zeta(\frac{1}{2} + it)$ and disordered landscapes. *Philos. Trans. R. Soc. Lond. Ser. A Math. Phys. Eng. Sci.*, 372(2007):20120503, 32, 2014.
- [FKS16] Y. V. Fyodorov, B. A. Khoruzhenko, and N. J. Simm. Fractional Brownian motion with Hurst index $H = 0$ and the Gaussian unitary ensemble. *Ann. Probab.*, 44(4):2980–3031, 2016.
- [FLDR09] Yan V. Fyodorov, Pierre Le Doussal, and Alberto Rosso. Statistical mechanics of logarithmic REM: Duality, freezing and extreme value statistics of $1/f$ noises generated by Gaussian free fields. *J. Stat. Mech. Theory Exp.*, (10):P10005, 32, 2009.
- [FP85] Uriel Frisch and Giorgio Parisi. *Turbulence and Predictability of Geophysical Fluid Dynamics and Climate Dynamics*. Number LXXXVIII in Proceedings of Enrico Fermi Varenna Physics School. M. Ghil, North Holland, 1985.
- [FS16] Y. V. Fyodorov and N. J. Simm. On the distribution of the maximum value of the characteristic polynomial of GUE random matrices. *Nonlinearity*, 29(9):2837–2855, 2016.
- [GHS11] Nina Gantert, Yueyun Hu, and Zhan Shi. Asymptotics for the survival probability in a killed branching random walk. *Ann. Inst. Henri Poincaré Probab. Stat.*, 47(1):111–129, 2011.
- [Gia07] Giambattista Giacomin. *Random Polymer Models*. Imperial College Press, London, 2007.
- [Gia11] Giambattista Giacomin. *Disorder and Critical Phenomena through Basic Probability Models*, volume 2025 of *Lecture Notes in Mathematics*. Springer, Heidelberg, 2011.
- [GLT10a] Giambattista Giacomin, Hubert Lacoin, and Fabio Toninelli. Marginal relevance of disorder for pinning models. *Comm. Pure Appl. Math.*, 63(2):233–265, 2010.
- [GLT10b] Giambattista Giacomin, Hubert Lacoin, and Fabio Lucio Toninelli. Hierarchical pinning models, quadratic maps and quenched disorder. *Probab. Theory Related Fields*, 147(1-2):185–216, 2010.
- [GP19] Christina Goldschmidt and Michał Przykucki. Parking on a Random Tree. *Combin. Probab. Comput.*, 28(1):23–45, 2019.

- [Gra92] Carl Graham. McKean-Vlasov Itô-Skorohod equations, and nonlinear diffusions with discrete jump sets. *Stochastic Process. Appl.*, 40(1):69–82, 1992.
- [Gra17] Cole Graham. Precise asymptotics for Fisher-KPP fronts. *arXiv:1712.02472*, 2017.
- [Gui90] Yves Guivarc’h. Sur une extension de la notion de loi semi-stable. *Ann. Inst. H. Poincaré Probab. Statist.*, 26(2):261–285, 1990.
- [GW74] Francis Galton and Henry William Watson. On the probability of the extinction of families. *J. Roy. Anthropol. Inst.*, 4:138–144, 1874.
- [Ham74] J. M. Hammersley. Postulates for subadditive processes. *Ann. Probability*, 2(4):652–680, 1974.
- [Har99] Simon C. Harris. Travelling-waves for the FKPP equation via probabilistic arguments. *Proc. Roy. Soc. Edinburgh Sect. A*, 129(3):503–517, 1999.
- [HB71] C. C. Heyde and B. M. Brown. An invariance principle and some convergence rate results for branching processes. *Z. Wahrscheinlichkeitstheorie und Verw. Gebiete*, 20:271–278, 1971.
- [Hey70] C. C. Heyde. A rate of convergence result for the super-critical Galton-Watson process. *J. Appl. Probability*, 7:451–454, 1970.
- [Hey71] C. C. Heyde. Some central limit analogues for supercritical Galton-Watson processes. *J. Appl. Probability*, 8:52–59, 1971.
- [HH85] David A. Huse and Christopher L. Henley. Pinning and Roughening of Domain Walls in Ising Systems Due to Random Impurities. *Phys. Rev. Lett.*, 54(25):2708–2711, 1985.
- [HH07] J. W. Harris and S. C. Harris. Survival probabilities for branching Brownian motion with absorption. *Electron. Comm. Probab.*, 12:81–92, 2007.
- [HH09] Robert Hardy and Simon C. Harris. A spine approach to branching diffusions with applications to \mathcal{L}^p -convergence of martingales. In *Séminaire de Probabilités XLII*, volume 1979 of *Lecture Notes in Math.*, pages 281–330. Springer, Berlin, 2009.
- [HHK06] J. W. Harris, S. C. Harris, and A. E. Kyprianou. Further probabilistic analysis of the Fisher-Kolmogorov-Petrovskii-Piscounov equation: One sided travelling-waves. *Ann. Inst. H. Poincaré Probab. Statist.*, 42(1):125–145, 2006.
- [HHK16] S. C. Harris, M. Hesse, and A. E. Kyprianou. Branching Brownian motion in a strip: Survival near criticality. *Ann. Probab.*, 44(1):235–275, 2016.
- [HK15] Lisa Hartung and Anton Klimovsky. The glassy phase of the complex branching Brownian motion energy model. *Electron. Commun. Probab.*, 20:Paper No. 78, 15, 2015.
- [HK18] Lisa Hartung and Anton Klimovsky. The phase diagram of the complex branching Brownian motion energy model. *Electron. J. Probab.*, 23:no. 127, 27, 2018.
- [HKO01] C. P. Hughes, J. P. Keating, and Neil O’Connell. On the characteristic polynomial of a random unitary matrix. *Comm. Math. Phys.*, 220(2):429–451, 2001.
- [HMP19] Yueyun Hu, Bastien Mallein, and Michel Pain. An exactly solvable continuous-time Derrida–Retaux model. *to appear in Comm. Math. Phys.*, 2019.
- [HNRR13] François Hamel, James Nolen, Jean-Michel Roquejoffre, and Lenya Ryzhik. A short proof of the logarithmic Bramson correction in Fisher-KPP equations. *Netw. Heterog. Media*, 8(1):275–289, 2013.

- [HOT⁺19] Pierre Henry-Labordère, Nadia Oudjane, Xiaolu Tan, Nizar Touzi, and Xavier Warin. Branching diffusion representation of semilinear PDEs and Monte Carlo approximation. *Ann. Inst. Henri Poincaré Probab. Stat.*, 55(1):184–210, 2019.
- [HR14] Simon C. Harris and Matthew I. Roberts. A strong law of large numbers for branching processes: Almost sure spine events. *Electron. Commun. Probab.*, 19:no. 28, 6, 2014.
- [HR17] Simon C. Harris and Matthew I. Roberts. The many-to-few lemma and multiple spines. *Ann. Inst. Henri Poincaré Probab. Stat.*, 53(1):226–242, 2017.
- [HRV18] Yichao Huang, Rémi Rhodes, and Vincent Vargas. Liouville quantum gravity on the unit disk. *Ann. Inst. Henri Poincaré Probab. Stat.*, 54(3):1694–1730, 2018.
- [HS09] Yueyun Hu and Zhan Shi. Minimal position and critical martingale convergence in branching random walks, and directed polymers on disordered trees. *Ann. Probab.*, 37(2):742–789, 2009.
- [HS16] Yueyun Hu and Zhan Shi. The slow regime of randomly biased walks on trees. *Ann. Probab.*, 44(6):3893–3933, 2016.
- [HS18] Yueyun Hu and Zhan Shi. The free energy in the Derrida-Retaux recursive model. *J. Stat. Phys.*, 172(3):718–741, 2018.
- [HTT14] Pierre Henry-Labordère, Xiaolu Tan, and Nizar Touzi. A numerical algorithm for a class of BSDEs via the branching process. *Stochastic Process. Appl.*, 124(2):1112–1140, 2014.
- [Hu16] Yueyun Hu. How big is the minimum of a branching random walk? *Ann. Inst. Henri Poincaré Probab. Stat.*, 52(1):233–260, 2016.
- [Igl74] Donald L. Iglehart. Functional central limit theorems for random walks conditioned to stay positive. *Ann. Probability*, 2(4):608–619, 1974.
- [IK16] Alexander Iksanov and Zakhar Kabluchko. A central limit theorem and a law of the iterated logarithm for the Biggins martingale of the supercritical branching random walk. *J. Appl. Probab.*, 53(4):1178–1192, 2016.
- [IKM18a] Alexander Iksanov, Konrad Kolesko, and Matthias Meiners. Fluctuations of Biggins’ martingales at complex parameters. *arXiv:1806.09943*, 2018.
- [IKM18b] Alexander Iksanov, Konrad Kolesko, and Matthias Meiners. Stable-like fluctuations of Biggins’ martingales. *Stochastic Process. Appl.*, 2018.
- [Imh84] J.-P. Imhof. Density factorizations for Brownian motion, meander and the three-dimensional Bessel process, and applications. *J. Appl. Probab.*, 21(3):500–510, 1984.
- [INW65] Nobuyuki Ikeda, Masao Nagasawa, and Shinzo Watanabe. On branching Markov processes. *Proc. Japan Acad.*, 41:816–821, 1965.
- [IS88] J. Z. Imbrie and T. Spencer. Diffusion of directed polymers in a random environment. *J. Statist. Phys.*, 52(3-4):609–626, 1988.
- [Jaf12] Bruno Jaffuel. The critical barrier for the survival of branching random walk with absorption. *Ann. Inst. Henri Poincaré Probab. Stat.*, 48(4):989–1009, 2012.
- [Jag69] Peter Jagers. A general stochastic model for population development. *Skand. Aktuarietidskr.*, 1-2:84–103, 1969.
- [JS17] Janne Junnila and Eero Saksman. Uniqueness of critical Gaussian chaos. *Electron. J. Probab.*, 22:Paper No. 11, 31, 2017.

- [Kah85] Jean-Pierre Kahane. Sur le chaos multiplicatif. *Ann. Sci. Math. Québec*, 9(2):105–150, 1985.
- [Kal17] Olav Kallenberg. *Random Measures, Theory and Applications*, volume 77 of *Probability Theory and Stochastic Modelling*. Springer, Cham, 2017.
- [KD47] A. N. Kolmogoroff and N. A. Dmitriev. Branching stochastic processes. *C. R. (Doklady) Acad. Sci. URSS (N.S.)*, 56:5–8, 1947.
- [Ken66] David G. Kendall. Branching processes since 1873. *J. London Math. Soc.*, 41:385–406. (1 plate), 1966.
- [Ken75] David G. Kendall. The genealogy of genealogy: Branching processes before (and after) 1873. *Bull. London Math. Soc.*, 7(3):225–253, 1975.
- [Kes78] Harry Kesten. Branching Brownian motion with absorption. *Stochastic Processes Appl.*, 7(1):9–47, 1978.
- [Kin75] J. F. C. Kingman. The first birth problem for an age-dependent branching process. *Ann. Probability*, 3(5):790–801, 1975.
- [KK14] Zakhar Kabluchko and Anton Klimovsky. Complex random energy model: Zeros and fluctuations. *Probab. Theory Related Fields*, 158(1-2):159–196, 2014.
- [KM17] Konrad Kolesko and Matthias Meiners. Convergence of complex martingales in the branching random walk: The boundary. *Electron. Commun. Probab.*, 22:Paper No. 18, 14, 2017.
- [KMS17] Zakhar Kabluchko, Alexander Marynych, and Henning Sulzbach. General Edgeworth expansions with applications to profiles of random trees. *Ann. Appl. Probab.*, 27(6):3478–3524, 2017.
- [Koz76] M. V. Kozlov. The asymptotic behavior of the probability of non-extinction of critical branching processes in a random environment. *Teor. Veroyatnost. i Primenen.*, 21(4):813–825, 1976.
- [KP76] J.-P. Kahane and J. Peyrière. Sur certaines martingales de Benoit Mandelbrot. *Advances in Math.*, 22(2):131–145, 1976.
- [KPP37] A.N. Kolmogorov, I.G. Petrovsky, and N.S. Piskunov. Etude de l'équation de la diffusion avec croissance de la quantité de matière et son application à un problème biologique. *Bull. Univ. État Moscou*, 1:1–26, 1937.
- [KQ18] Arjun Krishnan and Jeremy Quastel. Tracy-Widom fluctuations for perturbations of the log-gamma polymer in intermediate disorder. *Ann. Appl. Probab.*, 28(6):3736–3764, 2018.
- [KS66a] H. Kesten and B. P. Stigum. Additional limit theorems for indecomposable multidimensional Galton-Watson processes. *Ann. Math. Statist.*, 37:1463–1481, 1966.
- [KS66b] H. Kesten and B. P. Stigum. A limit theorem for multidimensional Galton-Watson processes. *Ann. Math. Statist.*, 37:1211–1223, 1966.
- [KS00] J. P. Keating and N. C. Snaith. Random matrix theory and $\zeta(1/2 + it)$. *Comm. Math. Phys.*, 214(1):57–89, 2000.
- [KT73] J. M. Kosterlitz and D. J. Thouless. Ordering, metastability and phase transitions in two-dimensional systems. *J. Phys. C: Solid State Phys.*, 6(7):1181–1203, 1973.
- [KT13] J. Michael Kosterlitz and David J. Thouless. Early work on defect driven phase transitions. In *40 Years of Berezinskii–Kosterlitz–Thouless Theory*, pages 1–67. Jose Jorge, V., Singapore, world scientific publishing co. pte. ltd. edition, 2013.

- [Kur03] I. Kurkova. Temperature dependence of the Gibbs state in the random energy model. *J. Statist. Phys.*, 111(1-2):35–56, 2003.
- [Kyp04] A. E. Kyprianou. Travelling wave solutions to the K-P-P equation: Alternatives to Simon Harris’ probabilistic analysis. *Ann. Inst. H. Poincaré Probab. Statist.*, 40(1):53–72, 2004.
- [Lam19a] Gaultier Lambert. The law of large numbers for the maximum of the characteristic polynomial of the Ginibre ensemble. *arXiv:1902.01983*, 2019.
- [Lam19b] Gaultier Lambert. Mesoscopic central limit theorem for the circular beta-ensembles and applications. *arXiv:1902.06611*, 2019.
- [Lau85] Ka-Sing Lau. On the nonlinear diffusion equation of Kolmogorov, Petrovsky, and Piscounov. *J. Differential Equations*, 59(1):44–70, 1985.
- [Liu98] Quansheng Liu. Fixed points of a generalized smoothing transformation and applications to the branching random walk. *Adv. in Appl. Probab.*, 30(1):85–112, 1998.
- [LL10] Gregory F. Lawler and Vlada Limic. *Random Walk: A Modern Introduction*, volume 123 of *Cambridge Studies in Advanced Mathematics*. Cambridge University Press, Cambridge, 2010.
- [LLR83] M. R. Leadbetter, Georg Lindgren, and Holger Rootzén. *Extremes and Related Properties of Random Sequences and Processes*. Springer Series in Statistics. Springer-Verlag, New York-Berlin, 1983.
- [LOS18] Gaultier Lambert, Dmitry Ostrovsky, and Nick Simm. Subcritical multiplicative chaos for regularized counting statistics from random matrix theory. *Comm. Math. Phys.*, 360(1):1–54, 2018.
- [LP92] Russell Lyons and Robin Pemantle. Random walk in a random environment and first-passage percolation on trees. *Ann. Probab.*, 20(1):125–136, 1992.
- [LP19] Gaultier Lambert and Elliot Paquette. The law of large numbers for the maximum of almost Gaussian log-correlated fields coming from random matrices. *Probab. Theory Related Fields*, 173(1-2):157–209, 2019.
- [LPP95] Russell Lyons, Robin Pemantle, and Yuval Peres. Conceptual proofs of $L \log L$ criteria for mean behavior of branching processes. *Ann. Probab.*, 23(3):1125–1138, 1995.
- [LRS11] Rong-Li Liu, Yan-Xia Ren, and Renming Song. $L \log L$ condition for supercritical branching Hunt processes. *J. Theoret. Probab.*, 24(1):170–193, 2011.
- [LS87] S. P. Lalley and T. Sellke. A conditional limit theorem for the frontier of a branching Brownian motion. *Ann. Probab.*, 15(3):1052–1061, 1987.
- [LS18] Amaury Lambert and Emmanuel Schertzer. Coagulation-transport equations and the nested coalescents. *arXiv:1807.09153*, 2018.
- [LT09] Hubert Lacoïn and Fabio Lucio Toninelli. A smoothing inequality for hierarchical pinning models. In *Spin Glasses: Statics and Dynamics*, volume 62 of *Progr. Probab.*, pages 271–278. Birkhäuser Verlag, Basel, 2009.
- [Lyo97] Russell Lyons. A simple path to Biggins’ martingale convergence for branching random walk. In *Classical and Modern Branching Processes (Minneapolis, MN, 1994)*, volume 84 of *IMA Vol. Math. Appl.*, pages 217–221. Springer, New York, 1997.
- [Mad15] Thomas Madaule. Maximum of a log-correlated Gaussian field. *Ann. Inst. Henri Poincaré Probab. Stat.*, 51(4):1369–1431, 2015.

- [Mad16a] Thomas Madaule. First order transition for the branching random walk at the critical parameter. *Stochastic Process. Appl.*, 126(2):470–502, 2016.
- [Mad16b] Thomas Madaule. The tail distribution of the Derivative martingale and the global minimum of the branching random walk. *arXiv:1606.03211*, 2016.
- [Mad17] Thomas Madaule. Convergence in law for the branching random walk seen from its tip. *J. Theoret. Probab.*, 30(1):27–63, 2017.
- [Mai12] Pascal Maillard. Branching Brownian motion with selection. *PhD thesis, arXiv:1210.3500*, 2012.
- [Mai13] Pascal Maillard. A note on stable point processes occurring in branching Brownian motion. *Electron. Commun. Probab.*, 18:Paper No. 5, 9, 2013.
- [Mai16] Pascal Maillard. Speed and fluctuations of N -particle branching Brownian motion with spatial selection. *Probab. Theory Related Fields*, 166(3-4):1061–1173, 2016.
- [Mal16] Bastien Mallein. Asymptotic of the maximal displacement in a branching random walk. *Grad. J. Math.*, 1(2):92–104, 2016.
- [Mal18a] B. Mallein. N -branching random walk with α -stable spine. *Theory Probab. Appl.*, 62(2):295–318, 2018.
- [Mal18b] Bastien Mallein. Genealogy of the extremal process of the branching random walk. *ALEA Lat. Am. J. Probab. Math. Stat.*, 15(2):1065–1087, 2018.
- [Man74a] Benoit Mandelbrot. Multiplications aléatoires itérées et distributions invariantes par moyenne pondérée aléatoire. *C. R. Acad. Sci. Paris Sér. A*, 278:289–292, 1974.
- [Man74b] Benoit Mandelbrot. Multiplications aléatoires itérées et distributions invariantes par moyenne pondérée aléatoire: Quelques extensions. *C. R. Acad. Sci. Paris Sér. A*, 278:355–358, 1974.
- [Man74c] Benoit B. Mandelbrot. Intermittent turbulence in self-similar cascades: Divergence of high moments and dimension of the carrier. *J. Fluid Mech.*, 62(2):331–358, 1974.
- [McK66] H. P. McKean, Jr. A class of Markov processes associated with nonlinear parabolic equations. *Proc. Nat. Acad. Sci. U.S.A.*, 56:1907–1911, 1966.
- [McK75] H. P. McKean. Application of Brownian motion to the equation of Kolmogorov-Petrovskii-Piskunov. *Comm. Pure Appl. Math.*, 28(3):323–331, 1975.
- [McK76] H. P. McKean. A correction to: Application of Brownian motion to the equation of Kolmogorov-Petrovskii-Piskunov. *Comm. Pure Appl. Math.*, 29(5):553–554, 1976.
- [MM09] Marc Mézard and Andrea Montanari. *Information, Physics, and Computation*. Oxford Graduate Texts. Oxford University Press, Oxford, 2009.
- [MM14] A. H. Mueller and S. Munier. Phenomenological picture of fluctuations in branching random walks. *Phys. Rev. E*, 90(4):042143, 2014.
- [MMQ11] Carl Mueller, Leonid Mytnik, and Jeremy Quastel. Effect of noise on front propagation in reaction-diffusion equations of KPP type. *Invent. Math.*, 184(2):405–453, 2011.
- [Mon73] H. L. Montgomery. The pair correlation of zeros of the zeta function. *Proc. Symp. Pure Math.*, 24:181–193, 1973.
- [Moy62] J. E. Moyal. Multiplicative population chains. *Proc. Roy. Soc. Ser. A*, 266:518–526, 1962.

- [MP18] Pascal Maillard and Michel Pain. 1-stable fluctuations in branching Brownian motion at critical temperature I: The derivative martingale. *to appear in Ann. Probab.*, 2018.
- [MP19] Pascal Maillard and Michel Pain. 1-stable fluctuations in branching Brownian motion at critical temperature II: The derivative Gibbs measure. *in preparation*, 2019.
- [MPS+84a] M. Mézard, G. Parisi, N. Surlas, G. Toulouse, and M. Virasoro. Nature of the Spin-Glass Phase. *Phys. Rev. Lett.*, 52(13):1156–1159, 1984.
- [MPS+84b] M. Mézard, G. Parisi, N. Surlas, G. Toulouse, and M. Virasoro. Replica symmetry breaking and the nature of the spin glass phase. *J. Physique*, 45(5):843–854, 1984.
- [MR16] Bastien Mallein and Sanjay Ramassamy. Barak-Erdős graphs and the infinite-bin model. *arXiv:1610.04043*, 2016.
- [MRV15] Thomas Madaule, Rémi Rhodes, and Vincent Vargas. Continuity estimates for the complex cascade model on the phase boundary. *arXiv:1502.05655*, 2015.
- [MZ16] Pascal Maillard and Ofer Zeitouni. Slowdown in branching Brownian motion with inhomogeneous variance. *Ann. Inst. Henri Poincaré Probab. Stat.*, 52(3):1144–1160, 2016.
- [Naj18] Joseph Najnudel. On the extreme values of the Riemann zeta function on random intervals of the critical line. *Probab. Theory Related Fields*, 172(1-2):387–452, 2018.
- [Nev86] J. Neveu. Arbres et processus de Galton-Watson. *Ann. Inst. H. Poincaré Probab. Statist.*, 22(2):199–207, 1986.
- [Nev88] J. Neveu. Multiplicative martingales for spatial branching processes. In *Seminar on Stochastic Processes, 1987 (Princeton, NJ, 1987)*, volume 15 of *Progr. Probab. Statist.*, pages 223–242. Birkhäuser Boston, Boston, MA, 1988.
- [NRR16] James Nolen, Jean-Michel Roquejoffre, and Lenya Ryzhik. Refined long time asymptotics for Fisher-KPP fronts. *arXiv:1607.08802*, 2016.
- [NRR17] James Nolen, Jean-Michel Roquejoffre, and Lenya Ryzhik. Convergence to a single wave in the Fisher-KPP equation. *Chin. Ann. Math. Ser. B*, 38(2):629–646, 2017.
- [NSW18] Miika Nikula, Eero Saksman, and Christian Webb. Multiplicative chaos and the characteristic polynomial of the CUE: The L^1 -phase. *arXiv:1806.01831*, 2018.
- [Oui18] Frédéric Ouimet. Poisson-Dirichlet statistics for the extremes of a randomized Riemann zeta function. *Electron. Commun. Probab.*, 23:Paper No. 46, 15, 2018.
- [Pai16] Michel Pain. Velocity of the L -branching Brownian motion. *Electron. J. Probab.*, 21:Paper No. 28, 28, 2016.
- [Pai18] Michel Pain. The near-critical Gibbs measure of the branching random walk. *Ann. Inst. Henri Poincaré Probab. Stat.*, 54(3):1622–1666, 2018.
- [Pan13a] Dmitry Panchenko. The Parisi ultrametricity conjecture. *Ann. of Math. (2)*, 177(1):383–393, 2013.
- [Pan13b] Dmitry Panchenko. *The Sherrington-Kirkpatrick Model*. Springer Monographs in Mathematics. Springer, New York, 2013.
- [Pan16] Dmitry Panchenko. Chaos in Temperature in Generic $2p$ -Spin Models. *Comm. Math. Phys.*, 346(2):703–739, 2016.

- [Par79] G. Parisi. Infinite Number of Order Parameters for Spin-Glasses. *Phys. Rev. Lett.*, 43(23):1754–1756, 1979.
- [Par80] G. Parisi. A sequence of approximated solutions to the S-K model for spin glasses. *J. Phys. A: Math. Gen.*, 13(4):L115–L121, 1980.
- [Par83] Giorgio Parisi. Order parameter for spin-glasses. *Phys. Rev. Lett.*, 50(24):1946–1948, 1983.
- [Pol81] A. M. Polyakov. Quantum geometry of bosonic strings. *Phys. Lett. B*, 103(3):207–210, 1981.
- [Pow18] Ellen Powell. Critical Gaussian chaos: Convergence and uniqueness in the derivative normalisation. *Electron. J. Probab.*, 23, 2018.
- [PS66a] Douglas Poland and Harold A. Scheraga. Occurrence of a Phase Transition in Nucleic Acid Models. *J. Chem. Phys.*, 45(5):1464–1469, 1966.
- [PS66b] Douglas Poland and Harold A. Scheraga. Phase Transitions in One Dimension and the Helix—Coil Transition in Polyamino Acids. *J. Chem. Phys.*, 45(5):1456–1463, 1966.
- [PT07] Dmitry Panchenko and Michel Talagrand. On one property of Derrida-Ruelle cascades. *C. R. Math. Acad. Sci. Paris*, 345(11):653–656, 2007.
- [PZ18a] Michel Pain and Olivier Zindy. Absence of temperature chaos for the 2D discrete Gaussian free field: An overlap distribution different from the random energy model. *arXiv:1811.08313*, 2018.
- [PZ18b] Elliot Paquette and Ofer Zeitouni. The maximum of the CUE field. *Int. Math. Res. Not. IMRN*, (16):5028–5119, 2018.
- [RA05] Anastasia Ruzmaikina and Michael Aizenman. Characterization of invariant measures at the leading edge for competing particle systems. *Ann. Probab.*, 33(1):82–113, 2005.
- [Rem17] Guillaume Remy. The Fyodorov-Bouchaud formula and Liouville conformal field theory. *arXiv:1710.06897*, 2017.
- [Rem18] Guillaume Remy. Liouville quantum gravity on the annulus. *J. Math. Phys.*, 59(8):082303, 26, 2018.
- [Riz09] Tommaso Rizzo. Chaos in mean-field spin-glass models. In *Spin Glasses: Statics and Dynamics*, volume 62 of *Progr. Probab.*, pages 143–157. Birkhäuser Verlag, Basel, 2009.
- [RTV02] U. Röslér, V. A. Topchii, and V. A. Vatutin. The rate of convergence for weighted branching processes. *Siberian Adv. Math.*, 12(4):57–82 (2003), 2002.
- [Rue87] David Ruelle. A mathematical reformulation of Derrida’s REM and GREM. *Comm. Math. Phys.*, 108(2):225–239, 1987.
- [RV07] Brian Rider and Bálint Virág. The noise in the circular law and the Gaussian free field. *Int. Math. Res. Not. IMRN*, (2):Art. ID rnm006, 33, 2007.
- [RV10] Raoul Robert and Vincent Vargas. Gaussian multiplicative chaos revisited. *Ann. Probab.*, 38(2):605–631, 2010.
- [RV14] Rémi Rhodes and Vincent Vargas. Gaussian multiplicative chaos and applications: A review. *Probab. Surv.*, 11:315–392, 2014.
- [RZ18] Guillaume Remy and Tunan Zhu. The distribution of Gaussian multiplicative chaos on the unit interval. *arXiv:1804.02942*, 2018.
- [Sak06] A. I. Sakhanenko. Estimates in the invariance principle in terms of truncated power moments. *Sibirsk. Mat. Zh.*, 47(6):1355–1371, 2006.

- [Sch18] Marius A. Schmidt. A Simple Proof of the DPRZ-Theorem for 2D Cover Times. *arXiv:1805.09744*, 2018.
- [Sch19] Florian Schweiger. The maximum of the four-dimensional membrane model. *arXiv:1903.02522*, 2019.
- [Sel46] Atle Selberg. Contributions to the theory of the Riemann zeta-function. *Arch. Math. Naturvid.*, 48(5):89–155, 1946.
- [Sha16] Alexander Shamov. On Gaussian multiplicative chaos. *J. Funct. Anal.*, 270(9):3224–3261, 2016.
- [She07] Scott Sheffield. Gaussian free fields for mathematicians. *Probab. Theory Related Fields*, 139(3-4):521–541, 2007.
- [Shi15] Zhan Shi. *Branching Random Walks*, volume 2151 of *Lecture Notes in Mathematics*. Springer, Cham, 2015.
- [Sim93] Barry Simon. *The Statistical Mechanics of Lattice Gases. Vol. I*. Princeton Series in Physics. Princeton University Press, Princeton, NJ, 1993.
- [SK75] David Sherrington and Scott Kirkpatrick. Solvable Model of a Spin-Glass. *Phys. Rev. Lett.*, 35(26):1792–1796, 1975.
- [Smo16] M. V. Smoluchowski. Drei Vorträge über Diffusion, Brownsche Bewegung und Koagulation von Kolloidteilchen. *Z. Phys.*, 17:557–585, 1916.
- [ST94] Gennady Samorodnitsky and Murad S. Taqqu. *Stable Non-Gaussian Random Processes*. Stochastic Modeling. Chapman & Hall, New York, 1994.
- [Sto65] Charles Stone. A local limit theorem for nonlattice multi-dimensional distribution functions. *Ann. Math. Statist.*, 36:546–551, 1965.
- [Sub17] Eliran Subag. The geometry of the Gibbs measure of pure spherical spin glasses. *Invent. Math.*, 210(1):135–209, 2017.
- [SW16] Eero Saksman and Christian Webb. The Riemann zeta function and Gaussian multiplicative chaos: Statistics on the critical line. *arXiv:1609.00027*, 2016.
- [Tal06] Michel Talagrand. The Parisi formula. *Ann. of Math. (2)*, 163(1):221–263, 2006.
- [Tal11a] Michel Talagrand. *Mean Field Models for Spin Glasses. Volume I*, volume 54 of *Ergebnisse Der Mathematik Und Ihrer Grenzgebiete. 3. Folge. A Series of Modern Surveys in Mathematics*. Springer-Verlag, Berlin, 2011.
- [Tal11b] Michel Talagrand. *Mean Field Models for Spin Glasses. Volume II*, volume 55 of *Ergebnisse Der Mathematik Und Ihrer Grenzgebiete. 3. Folge. A Series of Modern Surveys in Mathematics*. Springer, Heidelberg, 2011.
- [TC01] Lei-Han Tang and Hugues Chaté. Rare-Event Induced Binding Transition of Heteropolymers. *Phys. Rev. Lett.*, 86(5):830–833, 2001.
- [Uch82] Kohei Uchiyama. Spatial growth of a branching process of particles living in \mathbb{R}^d . *Ann. Probab.*, 10(4):896–918, 1982.
- [vE65] Bengt von Bahr and Carl-Gustav Esseen. Inequalities for the r th absolute moment of a sum of random variables, $1 \leq r \leq 2$. *Ann. Math. Statist.*, 36:299–303, 1965.
- [Wat68] Shinzo Watanabe. A limit theorem of branching processes and continuous state branching processes. *J. Math. Kyoto Univ.*, 8:141–167, 1968.
- [Web11] Christian Webb. Exact asymptotics of the freezing transition of a logarithmically correlated random energy model. *J. Stat. Phys.*, 145(6):1595–1619, 2011.

-
- [Web15] Christian Webb. The characteristic polynomial of a random unitary matrix and Gaussian multiplicative chaos—the L^2 -phase. *Electron. J. Probab.*, 20:no. 104, 21, 2015.
- [Yor92] Marc Yor. *Some Aspects of Brownian Motion. Part I*. Lectures in Mathematics ETH Zürich. Birkhäuser Verlag, Basel, 1992.
- [YR11] Ting Yang and Yan-Xia Ren. Limit theorem for derivative martingale at criticality w.r.t. branching Brownian motion. *Statist. Probab. Lett.*, 81(2):195–200, 2011.
- [Zei17] Ofer Zeitouni. Gaussian fields. Available at <http://www.wisdom.weizmann.ac.il/~zeitouni/notesGauss.pdf>, 2017.